

73 Magazine

for Radio Amateurs

- 38 New Rig for 10 FM**
—a review of the Comtronix FM80. K4TWJ
- 40 The Black Art of Antenna Design**
—shedding some light on the workings of vertical whips. Reynolds
- 48 Introducing the 2m/220 Connection**
—give crossband operation a try with this interconnection scheme. WB4HXE
- 52 A Fresh Start for your Old Tx**
—modernize it with grid-block keying. KE4Y
- 54 An Inflation Fighter for 220**
—join the fun . . . inexpensively. WA3HWG
- 56 Building Long Yagis for UHF**
—some pitfalls to avoid. W8DMR
- 60 Working with FETs**
—part I. WA2SUT/NNN0VB
- 64 The MARC Success Story**
—your club can do it, too! K9EID
- 66 Want to Upgrade? Take a Tip from a Ham Who Did!**
—previewing the new code test. KB6FC
- 68 A Microwave Primer**
—waveguides, X-band, and other fun stuff W1SNN
- 72 CB to 10**
—part XX: converting the Royce I-655. N8AMR
- 74 Something New: the MVM**
—“most versatile meter” measures capacitance and frequency. Ogushwitz
- 80 Amplify Your 6-Meter Fun**
—a cheap but effective linear. N4QH
- 82 CB to 10**
—part XXI: the Johnson Viking 352. WA6OYS
- 84 Exploring Uncle Sam's Bookstore**
—what's for you at the GPO. WB3DRF
- 90  Computerized Slow Scan . . . Revisited**
—further enhancements for the K6AEP system. K6AEP
- 106 Son of Keycoder**
—an even simpler CW typewriter. W4RNL
- 116 Sloppiness Will Get You Nowhere**
—organize your coax. WASTDT
- 120 The Satellite TV Primer**
—thousands watch satellite TV every day . . . here's how they do it and what they see. W5KHT
- 136 A Three-Digit Timer for TTL Illiterates**
—c'mon, tube fans, give it a try. K3VTQ
- 138 Sound for the CMOS Logic Probe**
—keeps your eyes on your work. WB9PHM
- 140 External Relay Control for Converted CBs**
—switch anything with this setup. W5JJ
- 144 Preserve Your Sanity with this Midland 509 Mod**
—why put up with rotten noises? WA6MPG
- 146 Touchtoning Your Memorizer**
—Yaesu's made it easy. AD1B
- 148 The Small But Mighty Arboreal Aerial**
—tree-hanging triband vertical. K5JRN
- 149 What Do You Do When Your Rotator Dies?**
—you fix it . . . like this. W5JJ
- 156 Beams vs. Linears: Which Should You Buy First?**
—get the most bang for your buck. N4OE
- 158 The Chicken Delight Beam**
—a tasty morsel for 10. K8SD
- 160 The TR-7500 Goes Inverted**
—see you on the flip-flop WA2JKN
- 162 Ready for the New Repeater Subband?**
—your FT-221R can be. WA6FWQ
- 170 "Hey! That Sounds Like .01 uF!"**
—intended for the blind, this audible multimeter is great for everyone. W4KIX, W4RYV
- 178 The W4HCY Antenna System**
—give this new design a try. W4HCY
- 182 A 3-Band Mast-Mountable Miniquad**
—a quad need not be monstrous. WA6UHU
- 185 Bargains in Remote Antenna Switches**
—watch for these surplus gems. W5JJ
- 186 A No-Nonsense Operating Table**
—basically, it's a flat surface on legs. Anderson



Never Say Die—4, Ham Help—6, 187, 190, 192, 193, 197, 202, Letters—16, Looking West—18, RTTY Loop—20, Awards—22, Leaky Lines—24, Microcomputer Interfacing—28, Contests—30, New Products—32, Dealer Directory—98, Social Events—187, OSCAR Orbits—192, Review—192, Corrections—198, Faces, Places—204, Propagation—241

the praise is pouring in



*Shown with accessory touch tone pad

Top view

We have never enjoyed such an overwhelming response to a new product. Letters of praise for Tempo's S-1 are coming in daily. Words such as great, fabulous, and fantastic are common. In a few short months the S-1 has taken the Amateur world by storm. In addition to its unique features and its versatility, it has now proven itself to be an extremely rugged and dependable unit...qualities unmatched at any price, but unheard of at the S-1's low price.

This amazing pocket sized radio represents a major breakthrough in 2-meter communications. Other units that are larger, heavier and are similarly priced can offer only 6 channels. The S-1's price includes the battery pack, charger, and a telescoping antenna. But, far more important is its *proven* performance record as a fully synthesized 800 channel hand held transceiver.

The optional touch tone pad adds greatly to its convenience and the addition of a Tempo solid state amplifier adds tremendously to its power.

The Tempo line also features a fine line of extremely compact UHF and VHF pocket receivers. They're low priced, dependable, and available with CTCSS and 2-tone decoders. The Tempo FMT-2 & FMT-42 (UHF) provides excellent mobile communications and features a remote control head for hide-away mounting.

The Tempo FMH-42 (UHF) and the *NEW* FMH-12 and FMH-15 (VHF) micro hand held transceivers provide 6 channel capability, dependability plus many worthwhile features at a low price. FCC type accepted models also available. Please call or write for complete information. Also available from Tempo dealers throughout the U.S. and abroad.

The proven
TEMPO S-1
does it all...
portable...mobile
...base station
and gives you
800 channels
in one of the
smallest hand helds

SPECIFICATIONS

Frequency Coverage: 144 to 148 MHz
Channel Spacing: Receive every 5 kHz, transmit Simplex or ± 600 kHz
Power Requirements: 9.6 VDC
Current Drain: 17 ma-standby
500 ma-transmit
Batteries: 8 cell ni-cad pack included
Antenna Impedance: 50 ohms
Dimensions: 40 mm x 62 mm x 165 mm (1.6" x 2.5" x 6.5")
RF Output: Better than 1.5 watts
Sensitivity: Better than .5 microvolts

Price... \$349.00 With touch tone pad... \$399.00

SUPPLIED ACCESSORIES

Telescoping whip antenna, ni-cad battery pack, charger.

OPTIONAL ACCESSORIES

Touch tone pad: \$55 • Tone burst generator: \$29.95 • CTCSS sub-audible tone control: \$29.95 • Rubber flex antenna: \$8 • Leather holster: \$16 • Cigarette lighter plug mobile charging unit: \$6 • Matching 30 watt output 13.8 VDC power amplifier (S30): \$89 • Matching 80 watt output power amplifier (S80): \$169

TEMPO VHF & UHF SOLID STATE POWER AMPLIFIERS

Boost your signal... give it the range and clarity of a high powered base station. VHF (135 to 175 MHz)

Drive Power	Output	Model No.	Price
2W	130W	130A02	\$209
10W	130W	130A10	\$189
30W	130W	130A30	\$199
2W	80W	80A02	\$169
10W	80W	80A10	\$149
30W	80W	80A30	\$159
2W	50W	50A02	\$129
2W	30W	30A02	\$ 89

UHF (400 to 512 MHz) models, lower power and FCC type accepted models also available.

NEW TOLL FREE ORDER NUMBER: (800) 421-6631

For all states except California
Calif. residents please call collect on our regular numbers.

11240 W. Olympic Blvd., Los Angeles, Calif. 90064 213/477-6701
931 N. Euclid, Anaheim, Calif. 92801 714/772-9200
Butler, Missouri 64730 816/679-3127



Henry Radio

Prices subject to change without notice

Wilson...

has your needs well in hand.

Today's Amateur demands rugged, rapid and accurate communications between Hams in the know. That's why they choose the Wilson Mark Series of hand-held radios. With exceptional qualities like these . . . why not choose the most popular radio available for yourself?

**ACTUAL
SIZE!!!**

FEATURES

Advantages such as solid state circuitry, rugged Lexan® case, removable rear panel (enabling easy access to battery compartment) and compact mini-size enhance the Mark Series portable radio's versatility. In addition, Wilson carries a full line of accessories to satisfy almost any of your requirements.

SPECIFICATIONS

The Mark radios offer: • 144-148 MHz range • 6 Channel operation • Individual trimmers on TX and RX xtals • Rugged Lexan® outer case • Current drain: RX; 15 mA, TX; Mark II: 500 mA, Mark IV: 900 mA • A power saving Hi/Lo Switch • 12 KHz ceramic filter and 10.7 monolithic filter included • 10.7 MHz and 455 KHz IF • Spurious and harmonics, more than 50 dB below quieting • Uses special rechargeable Ni-Cad battery pack • LED battery condition indicator • Rubber duck and one pair Xtals 52/52 included • Weight: 19 oz. including batteries • Size: 6" x 1.770" x 2.440".

OPTIONS

Options available, include Touch Tone Pad, CTCSS, Leather Case, Chargers for Desk Top, Travel or Automobile, Speaker Mike and large capacity, small size batteries.

For more details and/or the name of your nearest dealer, contact: Consumer Products Division, Wilson Electronics Incorporated, 4288 So. Polaris Ave., P. O. Box 19000, Las Vegas, Nevada 89119. Phone 702/739-1931.

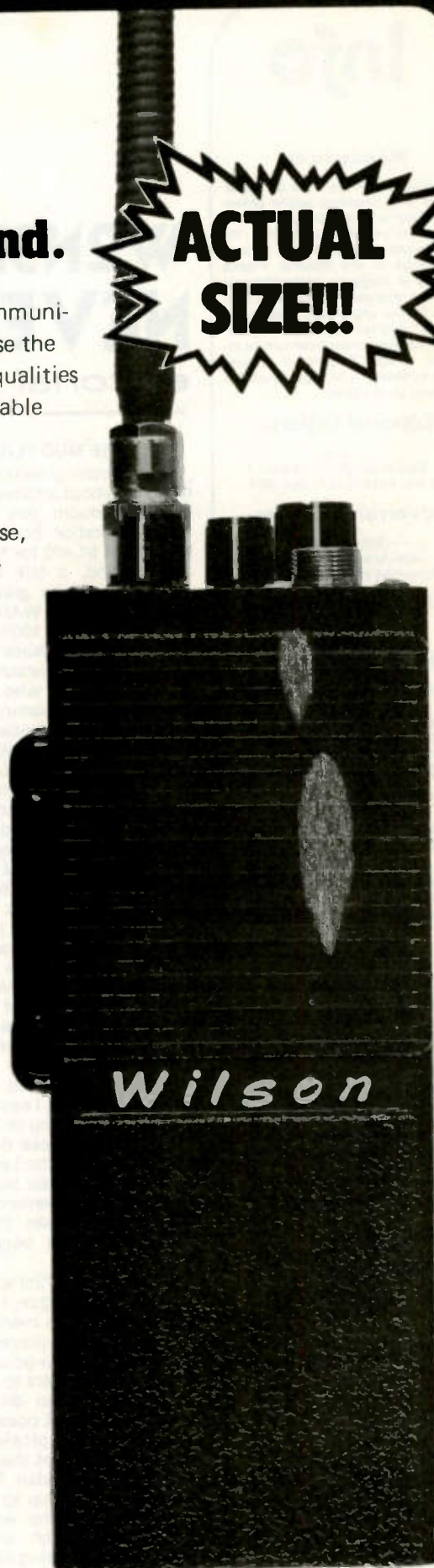

**Wilson Electronics
Incorporated**

W33

A Subsidiary of REGENCY ELECTRONICS, INC.

Prices and specifications subject to change without notice.

Info

Manuscripts

Contributions in the form of manuscripts with drawings and/or photographs are welcome and will be considered for possible publication. We can assume no responsibility for loss or damage to any material. Please enclose a stamped, self-addressed envelope with each submission. Payment for the use of any unsolicited material will be made upon acceptance. All contributions should be directed to the 73 editorial offices. "How to Write for 73" guidelines are available upon request.

Editorial Offices:

Pine Street
Peterborough NH 03458
Phone: 603-924-3873, 924-3874

Advertising Offices:

Elm Street
Peterborough NH 03458
Phone: 603-924-7138, 924-7139

Circulation Offices:

Phone: 603-924-7296

Subscription Rates

In the United States and Possessions:

One Year (12 Issues) \$18.00
Two Years (24 Issues) \$30.00
Three Years (36 Issues) \$45.00
Lifetime subscription \$240.00

Elsewhere:

Canadian subscriptions—add \$2.00 per year unless paid with U.S. currency.

All other foreign—one year only—\$26.00 payable in U.S. currency through a U.S. bank. (Surface mail).

To subscribe, renew or change an address:

Write to 73 Magazine, Subscription Department, PO Box 931, Farmingdale NY 11737. For renewals and changes of address, include the address label from your most recent issue of 73. For gift subscriptions, include your name and address as well as those of gift recipients. Postmaster: Send form #3579 to 73 Magazine, Subscription Services, P.O. Box 931, Farmingdale NY 11737.

Subscription problem or question:

Write to 73 Magazine, Subscription Department, PO Box 931, Farmingdale NY 11737. Please include an address label.

73 Magazine (ISSN 0098-9010) is published monthly by 73, Inc., Pine Street, Peterborough NH 03458. Second class postage is paid at Peterborough NH 03458 and at additional mailing offices. Copyright (c) 1979 by 73, Inc. All rights reserved. No part of this publication may be reprinted or otherwise reproduced without written permission from the publisher. Microfilm Edition—University Microfilm, Ann Arbor MI 48106.

W2NSD/1 NEVER SAY DIE

editorial by Wayne Green



THE MUD FLIES

The recent premiere of the ham film about amateur radio in Jordan brought two things—first, a donation from those attending of \$1,400 for the ARRL, and second, a talk by Bruce Johnson on how great things are looking for WARC. I fervently hope he is 100% right.

In one spot in Bruce's talk, he refers to a "gentleman in northern Connecticut" who has been glooming and dooming WARC, saying that this gentleman had been invited by him (Bruce) on several occasions to go to Africa and see for himself what the situation was, but had on every occasion turned it down. For some reason, many of those hearing the talk got the immediate impression that Bruce was talking about me.

For those who are just a bit fuzzy on geography east of the Rockies, I would like to point out that New Hampshire is not, and has never been, in northern Connecticut. I would also like to say that no one has even vaguely offered me any trip to Africa... if they had, I would probably be there. I assume that Bruce was referring to Baldwin.

I sure hope these donations will help to keep the League going... despite their lack of experienced management. What a comedown to see the once proud ARRL out begging for handouts.

Since the new film was sponsored by the League, I assume that there was no mention in it of the part that I played in getting amateur radio going in Jordan. For newcomers to amateur radio, there is no doubt that most of the credit goes to King Hussein for the project, but I might remind hams that it was I who went to Jordan first and brought the idea up to His Majesty... and I who wrote the regulations which were the basis of the licensing in Jordan. The League is very much aware of this... so let's see if it has gotten into the film, even

fleetingly.

My trip to Jordan in 1970 was written up in detail in 73... as was my return visit in 1973 to see the ham clubs from one end of the country to the other. I first wrote of this idea in 73 back in 1967 after a trip around the world, talking with government officials in many countries. The first opportunity I had to do anything about it was when I visited King Hussein and operated his station for two weeks in 1970. His Majesty agreed that my plan for generating technicians was a good one and he arranged for me to address his government and explain the plan to them. Then, despite the country being in the throes of a civil war, the plan was implemented.

NBVM NEEDS MORE WORK

Those of you who have been reading my publications for any length of time recognize that I do not fight change. To the contrary, I try to keep alert to any technological changes which seem to hold out benefits for amateur radio and then do my damndest to get them accepted.

This all started back in 1949, thirty years ago, when I discovered RTTY and had a ball with it. I'd already been one of the early NBFM pioneers on the HF bands and was one of the earliest users of six meters. The need for spreading RTTY information and organizing an effort to get it permitted on the low bands got me into publishing. That was the first time I ran up against the ARRL. They were dedicated to preventing RTTY on the low bands at any cost, apparently on the basis that it would interfere with their most beloved mode: CW. There was also the element of NIH (not invented here) involved. They felt that in order to maintain total control over amateur radio, they had to fight any rule changes not proposed by them. If you have any serious doubts about that, if you think I am maybe stretching the truth a bit to put

down the League, please check it out with any RTTY pioneer.

When SSB came along in the mid-50s, I quickly built a rig and found the mode to have so many benefits that I felt it would eventually replace AM. My editorials along this line were not well received. I persisted and published hundreds of articles on SSB, set up an SSB contest, and watched my predictions come true. League true believers would do well to go back and take a good close look at QST during this period. While the ARRL was quick to publish the early articles on SSB in the early 50s, they then dropped the ball almost completely and did little to encourage its growth.

We saw the same pattern with SSTV later on. The first material by Copthorne Macdonald was published in QST and then virtually nothing. The bulk of the support for SSTV was in 73 Magazine!

In the early 60s, I saw the potential of solid state for amateurs and I encouraged amateur experimentation with transistors by publishing everything I could on the subject. QST stuck to tubes. As late as 1968, the technical editor of QST explained that amateurs were tube people, that transistors would never really replace tubes, and that that was why QST avoided solid-state material.

In the late 60s, I got interested in repeaters for two-meter work and discovered a fantastic new type of operation that I felt should be made known. I backed my conviction with hundreds of FM and repeater articles, several books, a repeater bulletin, several repeater symposiums to encourage repeater groups to change to standardized pairs, put out a repeater atlas, and watched the activity grow from a couple hundred repeaters and a couple thousand users to the present 5,000 repeaters and nearly 100,000 users. What did QST do? Hardly

anything until way late in the game... and even that might not have happened if Lew McCoy hadn't bucked the system and forced it to happen. Now Lew is gone from the League.

At any rate, when I heard about the new NBVM (narrow band voice modulation) system, I was interested in learning more. I wanted to know if this might have some good possibilities for amateur radio... in which case I would do my best to get information out on it. I found little real information available. I was not surprised to see *QST* out there in front with the first material on NBVM, and I was impressed when the Baldwin editorial said that the ARRL would be pushing this system and that we could expect to hear it via W1AW, etc.

The *QST* editorials were followed up by two feature articles in *QST* on NBVM plus coverage in the *Handbook*. Unfortunately, the articles did not offer much for the average amateur, despite their up-front placement in *QST*. The parts needed to make an NBVM unit had to come from one supplier... the outfit with the patents on the new mode. It looked like all of us would have to wait for this firm, VBC, to bring out a working unit.

It was at about this time that I got some notes (anon) from insiders at the ARRL suggesting that NBVM had little to offer amateurs and that those at HQ suspected a payoff of some sort was involved with the support given this totally untried system. Normally, I would dismiss such information as perhaps trying to get me into trouble. But some of the other inside information in the notes checked out with recent departees of the League (and there are a lot of them). Considering the amount of money involved should this new mode catch on... a matter of billions of dollars... a payoff to get things going was not unreasonable to consider.

I pushed to get a test unit for my ham shack so we could check it out and see if it was as good as the material in *QST* made it sound. In the meanwhile, I got occasional reports on tests of the system which did not look encouraging. It had been checked out for the FCC and the report there must have been most discouraging to VBC.

When a test unit finally arrived, we started trying to use it, but could get no encouraging results. I decided to wait until our new station had been set up, complete with a nice new tower and beam, kilowatt, etc. This finally was in good working shape by summer and the further NBVM tests were set up. Tim N8RK, an Extra class

amateur, ran the tests as objectively as possible. I listened in on the best of the tests and was disappointed. Tim's report on NBVM appears elsewhere in this issue.

CW enthusiasts using very narrow band audio filters have a good idea of what NBVM sounds like. The narrow band being received has a tendency to ring and the voice quality is changed substantially. Yes, you can learn to adapt to the new sound... but I found it far more of a change than the one from AM to SSB as far as voice quality is concerned. And the attention to detailed tuning required to get the voice into that small channel and keep it there, with the levels not going too low or too high, keeps you busy.

If NBVM had as much to offer over SSB as SSB did over AM, I might sigh and figure that, heck, we are just starting with a new system... we'll get better equipment as we go along. But the advantages are not manifest.

Should amateur radio ever get back to the growth it had before the League tried to put through what they called "incentive licensing," which was an 11% per year growth, the time would soon arrive when band conditions on our more popular bands would force us to seriously consider almost anything in the way of narrowing our voice bands. At present, though we do have some crowded parts of our bands, during most of the hours of the day there is more than enough room for operators to make contacts without serious interference.

It is my understanding that the League is now aware of the drawbacks of the NBVM system and has, as a result, cancelled all plans for using this with W1AW or for publishing anything further on the system. I believe they will be taking it out of the *Handbook* and stonewalling any questions about their involvement with it in the first place. The units sent to the League for tests seem to have disappeared, with ARRL lab people saying that they have nothing on hand any further.

It now appears that *QST* published the material on this sys-

tem on the basis of some tape recordings and not with any tests of the equipment. Since this is absolutely opposite to their posture of testing everything before accepting ads, one wonders at the possibility of the inside leaks about a conflict of interest having some foundation. This certainly puts the lie to the bragged protection of the membership on new products.

Though the pages of *QST* may be closed to more information on the NBVM system, I would like to emphasize that I do not approach this with a closed mind. I did hear some improvement in communications as a result of this system and I think it is important that pioneers and inventors within the amateur ranks have a place to promote their ideas... so, if anyone is having success with the NBVM system, I ask that you document your work and pass the results along to the rest of us.

I think a particular word of encouragement should be said for Ted Henry and Henry Radio for making the first NBVM units available. It is a costly experiment to get involved with something new such as this and to set up the distribution and advertising to support it. Many of the early VBC-3000 units have apparently been bought by firms and government agencies interested in evaluating the system for their own uses, but even so there has been a substantial investment by individual amateurs interested in pioneering... and that is the amateur spirit which has put across FM, SSB, NFM, SSTV, and many other communications developments in the past.

I'm sorry that our report on NBVM isn't more enthusiastic, but it wouldn't be fair to call 'em any different than we see 'em. If more positive data comes in, you can be sure that we'll reflect it with our own support.

WHAT ABOUT THE XYL?

I have a message for your wife.

Look here, you married this guy because you loved him. Remember that you didn't just marry a piece of meat... he is a living person and a part of the

life that you bought when you got married was his business and another was his hobbies and interests.

A recent movie, *The Seduction of Joe Tynan*, featured a wife who hated her husband's business (politics). Well, I've run into wives who hated ham radio. It is a jealous and frustrated hate because often he seems to love amateur radio more than you or the family. You'll get a lot more from this man if you encourage his loves than if you fight them.

I've seen so many ham wives who hate hams because they are so boring. That's funny... I don't find ham talk boring. Hams run the gamut from Idiots to geniuses, from bums and dropouts to corporation presidents and even kings. I'm not suggesting that the way to marital happiness is for you to get a ham ticket and operate... just that you encourage your man to do what he wants to and enjoy life.

If those DX pileups are keeping him from the bedroom, then tackle that problem. When he picks up his copy of *73* to read, you casually pick up a copy of *Penthouse* and start reading. I think you'll find that he will somehow manage to get that rare country tomorrow night instead of tonight. There are ways to win the war without ever having a battle. It's a question of who is smarter.

If he wants to go to the ham club... fine... it's better than a bar. Why not make some muffins for him to serve later when he brings a few of the fellows over for coffee?

I'll never forget the poor ham who honked me over to the side of the road one day to show me his mobile setup. He opened the trunk of his car, pulled out an antenna, and plugged it into the mount on the bumper... then pulled out the rig and slid it into a tiny bracket under the dash and said with pride, "How about that! And my wife doesn't even know I have it!"

People do the things that are of the most interest as much as possible. If work is of interest, they'll be at work much of the time. If home is of interest, they'll be home. If nothing is of interest, they'll watch the ball games. I know a chap who went to his grave knowing the batting averages of every major leaguer... and another who spent an equal amount of time on amateur radio and pioneered moonbounce, invented the parametric amplifier, inspired thousands of hams, and helped move our sluggish world along just a bit.

If you make it fun for your husband to do the things you want him to, he'll have time. If you use surliness, arguing,

CAREERS WITH 73

With continued growth in both amateur radio and micro-computing, we have many career positions open in Peterborough for non-smokers. We need writers to test and report on new ham gear and computer products... editors to help prepare articles and books... ad salespersons... maintenance (towers, antennas, electrical work, plumbing, carpentry) people... editorial assistants... proofreaders... micro-computer techs and programmers... draftsmen... graphic artists... Send a resume outlining your work, responsibilities, and pay history plus a letter saying what you think you can do for us. Send it to Wayne Green, 73 Inc., Peterborough NH 03458.

Staff

EDITOR/PUBLISHER
Wayne Green W2NSD/1

EXECUTIVE VICE PRESIDENT
Sherry Smythe

CORPORATE CONTROLLER
O. Alan Thulander

ASSISTANT PUBLISHER
Jeffrey D. DeTray WB8BTH

ADMINISTRATIVE ASSISTANT
Dotty Gibson

MANAGING EDITOR
John C. Burnett

ASSISTANT MANAGING EDITOR
Susan G. Philbrick

NEWS EDITOR
Gene Smarte WB6TOV/1

EDITORIAL ASSISTANTS
Ellsabeth Blackmore
John Mitchell
Richard Phenix

PRODUCTION MANAGER
Noel R. Self WB1ARP

ASSISTANT PRODUCTION MANAGER
Robin M. Sloan

ART DEPARTMENT
Steve Baldwin
Bob Drew
James H. Gray II
Bruce Hedin
Chlp Jackson
Ken Jackson
Dion Owens
Nancy Salmon
Patrice Scribner
John W. White

BOOK PUBLICATIONS
Jim Perry

BOOK PRODUCTION
Peter Perrin
Emily A. Gibbs
Chris Brown

PRINTING
Gary Steinbach, Mgr.
Vinoy Laughner
Dean Zanga

PHOTOGRAPHY
Bill Heydolph
Tedd Cluff
Terrie Anderson

TYPESETTING
Barbara J. Latti
Sara Bedell
Sandie Gunseth
Rita Rivard

BOOKKEEPER
Knud E. M. Keller KV4GG/1

CIRCULATION
Pauline Johnstone

DATA ENTRY
Cathy DeSilva

CIRCULATION MANAGER
Harold L. Stephens

ASSISTANT CIRCULATION MANAGER
Donna Taylor

BULK SALES MANAGER
Judy Waterman

SHIPPING
Mark Denny
Bill Barry

RECEPTIONIST
Rhonda Clapper

ASSOCIATES
Robert Baker WB2GFE
W. Sanger Green
Dave Ingram K4TJW
Larry Kahaner WB2NEL
Joe Kasser G3ZCZ
Bill Pasternak WA6ITF
John Schultz W4FA
Peter Stark K2OAW

COMPUTER PROGRAMMING
Richard J. Dykema

ADVERTISING
Aline Goutu, Mgr.
Bill York
Kevin Rushalko
Nancy Clampa
Patricia Record
Marcia Stone
Cheryl McDaniel
Jerry Merrifield
Lori Mugford

nagging, and other negative means to try to force him to do what you want, you'll be as successful as the FCC was in trying to force hams to get the Extra class license. They flatly refused to do it until the FCC came up with some rewards instead of punishment.

There is one feature of many ARRL conventions that irritates the hell out of me. This is the SWOOP ridiculousness. I think that stands for the Suffering Wives of Operating Personnel or some such foolishness. One high point of these SWOOP meetings is the destruction of a piece of ham equipment by the wives... taking out their frustrations and resentments on equipment. Disgusting.

Won't you be happier if your husband is happy? So all you have to do is look at the good points and work out ways to have him enjoy some of the things you want to do, too.

Now, OMs... it is really important for you to come to terms with your wife. Explain to her that your love of your job or your love of amateur radio are not taking away from your love of her. Your progress in your job is a reflection of her help... and your fun and relaxation with amateur radio are an important part of your life. It is important that you be considerate and fair. You can't really expect her to enjoy being dragged to a hamfest and made to look at a hundred booths full of ham gear and parts any more than you'd probably want to go to a knitting show. You'll be happier in the long run if you go to a hamfest and give her the car and a credit card... and tell her how to find the big shopping mall. She might get you a present. She also might put you in hock.

Despite the fun you have with amateur radio, you still have responsibilities to the world... to do a good job of work... and to keep your wife and family happy. It's tough to have dinner with another ham and not sit talking ham talk all night, so keep this in mind and maybe get your wives together at the next table for their dinner so they can talk, too. In the long run, you'll get a lot more out of ham radio if you have a good working relationship with your wife about it.

MICRO COUNTRIES

A chap who specializes in getting information on very small and often virtually unknown countries called the other day. I think I convinced him to write an article which should be of intense interest to DXers... and even more to potential DXpeditioners.

We discussed the Hut River Province, which I've written about before in 73... still no

hamming activity from there, more's the pity. And Sealand is still virgin territory. Do I have to start working on these things myself? I have plenty to do without leading another DXpedition somewhere.

He mentioned that as far as he knows, Miller's St. Brandon's Island is completely mythical. He also suggested a new one which has never been done by a DXpedition... an easy-to-reach island in the Mediterranean. Anyone interested in putting a new one on the air? If I tell you the name, I know damned well that a bunch will pop off to there and I'll get left behind. I've had that happen a couple of times. I'll be cagier this time.

FIFTH ANNUAL HAM WORKSHOP JANUARY 12-19

Members of the ham industry get together each January in Aspen, Colorado, for a week of skiing and workshops on ham topics. With the growth of amateur radio stagnating and the sales of ham gear along with it, both manufacturers and dealers will be discussing plans for getting the hobby going again.

Some of the problem is obviously the drop in interest in CB radio, which had gotten thousands of newcomers interested in radio communications each year. Another has been the worry over what might happen at WARC. Still another has been inflation and the recession. One of the workshops will be devoted to discussing ideas for re-creating interest in hamming.

Those firms in the consumer electronics business may want to go first to Las Vegas for the Winter Consumer Electronic Show, January 5-9. Then, for those with a strong stomach, there is SAROC, January 10-12. One day of that is more than enough, if they have the same number of exhibitors as two years ago and the same exciting program. If enough people want to fly from Las Vegas to Aspen, we could charter a special plane.

Ham Help

I have acquired a Model 34 oscilloscope manufactured by Bell & Howell Schools - De Vry Institute and need manuals and/or information on it. I would like to purchase the manuals, if possible, or borrow them for copying. I will pay for all expenses. Any assistance will be greatly appreciated. Thank you.

Ernest C. Wankowski KA5EGD
622 Bishop Rd., F-6
Lawton OK 73501

There are workshops planned on dealer financing, mail-order success, how to get over \$50,000 in free advertising, what the ham gear of 1983 will be like, how the ARRL turned the American ham industry over to Japan, how to design and write ads which will sell like crazy, where to run the ads, what to do about the WARC results, etc. It should be understood that the workshops will not interfere with skiing.

The host hotel this time will be the Limelight, which is one block from downtown Aspen. You won't need a car. The organizing committee for the Ham Workshop checked out Vail last winter, just to make sure that it was not as good as Aspen. It wasn't, despite its having a McDonald's and a Burger King. Aspen has more good restaurants per square mile than any other town in the world... and some of them are incredible. I've got to start dieting, to be ready for that.

You are on your own as far as getting to and from Aspen is concerned... and also hotel reservations. Please let Sherry know (c/o 73 Magazine, Peterborough NH 03458) so she will include you in the meeting room plans and dinner reservations. There is no charge for the event again this year... except for the costs of Aspen, which are formidable. Any manufacturer, dealer, or even a ham seriously interested in both skiing and the progress of amateur radio is invited. We have about a dozen signed up so far... including Chuck Martin WA1KPS of Tufts Electronics.

It will be fun and might be money well spent if you get one good idea which bears fruit in business.

JULY WINNER

July's most popular article, as voted by our readers with their Reader Service card ballots, was James Wyma WA7DPX's "So You Want to Raise a Tower." A check for \$100 is on its way to him.

I would like to exchange ideas on Atlas 210 mods.

Chris Kilgus N7ABI/0
PO Box 3000
Boulder CO 80307

I'm interested in contacting anyone who has experimented in the VLF (FCC Part 15, approximately 160-kHz) band.

Carl A. Mitchell K1JDJ
PO Box 1003
Fairfield CT 06430

Welcome to the World of Kenwood.



7 Full pages
of Products
& Accessories

 **KENWOOD**
...pacesetter in amateur radio



TS-180S with DFC

The TS-180S with DFC (Digital Frequency Control) is Kenwood's top-of-the-line all solid-state HF SSB/CW/FSK transceiver covering 160 through 10 meters, with outstanding performance and many advanced functions, including four tunable memories to provide more operating flexibility than any other rig!

TS-180S FEATURES:

- Digital Frequency Control (DFC), including four memories and digital up/down paddle-switch tuning. Memories are usable in transceiver or split modes, and can be tuned in 20-Hz steps up or down, slow or fast, with recall of the original stored frequency. (Also available without DFC.)
- All solid-state; 200 W PEP/160 W DC input on 160-15 meters, and 160 W PEP/140 W DC on 10 meters.
- Improved dynamic range, with improved circuit design and RF AGC ("RGC"), which activates as an automatic RF attenuator to prevent receiver overload.
- Adaptable to three new bands, and VFO covers more than 50 MHz and DFC 100 kHz above and below each band.
- Built-in microprocessor-controlled digital display. Shows actual frequency and switches to show the difference between the VFO and "M1" memory frequencies. Blinking decimal points indicate "out of band." (An analog monoscale dial is also included.)
- IF shift (passband dialing to eliminate QRM).
- Dual SSB filter system (second filter is optional) to provide very sharp receiver selectivity, improved S/N, and 30 dB compression with RF speech processor on transmit.
- Tunable noise blanker, to eliminate cross modulation from strong signals when noise blencer is on.
- Selectable wide and narrow CW bandwidth on receive (500-Hz CW filter is optional).
- SSB normal/reverse switch (proper sideband is automatically selected with band switch).
- Dual RIT (VFO and memory) fix.
- Available without DFC. Digital frequency display still included, with differential function showing difference between VFO and "digital hold" frequencies.

OPTIONAL ACCESSORIES:

- DF-180 digital frequency control (for TS-180S without DFC).
- YK-88CW 500-Hz CW filter.
- YK-88SSB second filter for dual-filter system.



MC-50

PS-30

SP-180

TS-180S

VFO-180

AT-180

TS-120S

**IMC-35S
MIKE
OPTIONAL**



Truly a "big little rig" the TS-120S has created a new excitement in HF communications for highly versatile Amateur operation. The compact, all solid-state 80-10 meter transceiver, with up to 200 watts PEP in put, requires no tuning and includes a large digital readout, making it ideal for mobile operation. IF shift and other important features make it a high-quality rig for the ham shack as well.

TS-120S FEATURES:

- All solid-state with wideband amplifier stages. No final dipping or loading, no transmit drive peaking, and no receive preselector tuning.
- Transceives on 80 through all of 10 meters, and receives WWV on 15 MHz.
- 200 W PEP/160 W DC input on 160-15 meters, and 160 W PEP/100 W DC on 10 meters. LSB, USB, and CW.
- Digital frequency display (standard) shows actual frequency. Backup analog subdial also included.
- IF shift (passband tuning) to eliminate QRM.
- Advanced PLL circuit, with improved stability and spurious characteristics on transmit and receive.
- Effective noise blanker.
- Built-in cooling fan, which activates automatically when final amplifier heatsink temperature rises to 90° C.
- Protection circuit for final transistors.
- VOX.

OPTIONAL ACCESSORIES:

- YK-8ECW 500-Hz filter.
- MB-100 mobile mount.



PS-30 SP-120 TS-120S VFO-120 MC-50



AT-120

AT-120 antenna tuner with mobile mounting bracket included. Features SWR meter and matches 50-ohm input to 20-300 ohms unbalanced output. Handles 150 watts (120 watts on 80 meters).



SP-520 TS-520SE W/DG-5 VFO-520S

TS-520SE

The TS-520SE is an economical version of the TS-520S...the world's most popular 80-10 meter Amateur transceiver. Now, any Amateur can afford a high-quality HF transceiver for his ham shack.

TS-520SE FEATURES:

- Covers 160-10 meters and receives WWV on 15 MHz.
- 200 W PEP input on USB and 160 W DC on CW.
- CW WIDE/NARROW bandwidth switch for use with the optional CW-520 500-Hz CW filter.
- Digital display with optional DG-5 showing actual frequency.
- Speech processor, effective in QRP pileups.
- VOX and semi-break for CW with sidetone.
- Built-in 25-kHz calibrator.

The TS-520S is still available with DC (mobile) operating capability (with the optional DS-10 DC-DC converter) and transverter terminals, which were eliminated from the TS-520SE.

OPTIONAL ACCESSORIES:

- CW-520 500-Hz CW filter.
- AT-200 antenna tuner.

R-820/TS-820S



SP-820

R-820

TS-820S

TS-820S

The TS-820S is a very popular 160-10 meter SSB/CW/RTTY transceiver, preferred by DX operators and other particular Amateurs. It employs a single-conversion PLL circuit.

TS-820S FEATURES:

- 200 W PEP SSB/160 W DC CW/100 W DC FSK input on 160-10 meters.
- Digital frequency display, with backup monoscale analog dial.
- IF shift (receiver passband tuning) to eliminate interference.

- RF speech processor.
- Effective noise blanker.

OPTIONAL ACCESSORIES:

- CW-820 (YG-88C) 500-Hz CW filter.
- OS-1A DC-DC converter.
- AT-200 antenna tuner.



SP-820

TS-820S

VFO-820

R-820

The R-820 is a highly sophisticated HF receiver for the Amateur who wants the highest quality with the most operating features. A combination of the R-820 and TS-820S provides the ultimate HF operating system.

R-820 FEATURES:

- Full transceive operation with TS-820S, providing full frequency control with either unit.
- Covers 160-10 meters, as well as WWV (15.0-15.5 MHz), and four shortwave broadcast bands (49, 31, 25, and 16 meters).
- Receives SSB, CW, AM, and RTTY modes.
- Double-tuned RF stages and improved dynamic range.
- IF shift (passband tuning).
- Variable bandwidth tuning (VBT).
- Very sharp, deep notch circuit... in 50-kHz IF.
- Provisions for extra-sharp 455-kHz IF filters.
- Noise-blanker with variable threshold level.
- Digital frequency display, with backup analog dial.

OPTIONAL ACCESSORIES:

- YG-88C 500-Hz CW filter, for first IF.
- YG-88A 6-kHz AM filter, for first IF.
- YG-455C 500-Hz filter, for second IF.
- YG-455CN 250-Hz filter, for second IF.



TV-502S TV-506
(not for TS-520SE)

AT-200

ACCESSORIES FOR TS-820 AND TS-520 SERIES

AT-200 antenna tuner handles 200 W, 160-10 meters.
TV-502S 2-meter transverter covers 144-146 MHz. (Not intended for TS-520SE.)
TV-506 6-meter transverter covers 50-54-MHz. (Not intended for TS-520SE.)



TL-922A

The TL-922A linear amplifier for all Kenwood HF equipment provides maximum legal power on the 160-15 meter Amateur bands, employing a pair of EIMAC 3-500Z high-performance transmitting tubes.

TL-922A FEATURES:

- 2000 W PEP (SSB)/1000 W DC (CW, RTTY) input power on 160-15 meters, with 80 W drive.
- Excellent IMD characteristics.
- Safety protection.
- Blower with automatic delay circuit.
- Variable threshold level type ALC.



SM-220

The SM-220 Station Monitor is capable of various monitoring functions, and performs as a wideband oscilloscope, and is expandable for pan-display operation.

SM-220 FEATURES:

- Monitors transmitted SSB and CW waveforms from 1.8 to 150 MHz.
- High-sensitivity, wide-frequency-range (up to 10 MHz) oscilloscope.
- Monitors received signals in IF stage.
- Tests linearity of linear amplifiers (provides trapezoid pattern).
- Allows observation of RTTY tuning points (cross pattern).
- Built-in two-tone (1000-Hz and 1575-Hz) generator.
- Expandable to pan-display capability for observing the number and amplitude of stations within a switchable ± 20 kHz/ ± 100 kHz bandwidth.

OPTIONAL ACCESSORIES:

- BS-8 pan-display module for TS-180S and TS-820 series.
- BS-5 pan-display module for TS-520 series.

R-1000



SP-100

R-1000

The R-1000 is a highly advanced communications receiver. Up-conversion, PLL circuitry and other new technology provide optimum sensitivity, selectivity, and stability from 200 kHz to 30 MHz. Featuring easy-to-operate single-knob tuning and digital frequency display, it's perfect for listening to shortwave, medium-wave, and long-wave bands. Even SSB signals are received perfectly. Included is a quartz digital clock and timer.

R-1000 FEATURES:

- Continuous frequency coverage from 200 kHz to 30 MHz.
- 30 bands, each 1 MHz wide.
- Five-digit frequency display and illuminated analog dial.
- Quartz digital clock and ON/OFF timer.
- Multi-modes... AM (wide and narrow), SSB (USB and LSB), and CW.
- Three IF filters... 2.7 kHz for SSB and CW, 6.0 kHz for AM narrow, and 12 kHz for AM wide.
- Effective noise blanker.
- Built-in speaker.
- Three antenna terminals.
- RF step attenuator.
- Tone control.
- Recording terminal.
- Remote terminal, for access to timer relay ON/OFF circuit and muting circuit.
- SSB sensitivity of 0.5 μ V from 2 to 30 MHz.
- More than 60 dB IF image ratio.
- More than 70 dB IF rejection.



R-300

R-300 FEATURES:

- Continuous frequency coverage from 170 kHz to 30 MHz, in six bands.
- Multi-modes... AM, SSB, and CW.
- High sensitivity, selectivity, and image ratio.
- 500-kHz marker.
- Three-way power supply (AC/batteries/external DC), with automatic switching from AC to DC in the event of AC power failure.

The R-300 all-band communications receiver covers 170 kHz to 30 MHz in six bands. It's ideal for listening to foreign broadcasts and other exciting transmissions throughout a wide range of the radio spectrum.



TR-7600

TR-7625

The TR-7600 and TR-7625 are Kenwood's popular synthesized 2-meter FM mobile transceivers. Combined with the RM-76 Microprocessor Control Unit, several memory and scanning capabilities are provided.



KPS-7

The KPS-7 is a matching AC power supply for the TR-7600 and TR-7625. Output is 13.8 VDC at 7 A ICS (50% duty cycle).



RM-76

TR-7600/TR-7625 FEATURES:

- One memory channel.
- Mode switch for simplex or repeater operation. Repeater mode shifts the transmit frequency + 600 kHz or - 600 kHz or to the memory frequency.
- Full 5-kHz coverage from 144.000 to 147.995 MHz.
- Adaptable to any one MARS simplex or repeater channel between 143.7 and 148.3 (with modification kit).

ADDED FEATURES WITH RM-76:

- Six memories.
- Automatic memory scan.
- Automatic scan up the band in 5-kHz steps, with selectable upper and lower frequency limits.
- Manual scan up or down the band in single or

fast continuous 5-kHz steps.

- ± 1 MHz transmitter offset as well as ± 600 kHz and memory offset for repeater operation.
- MARS operation on 143.95 MHz simplex.
- Versatile digital display of transmit and receive frequencies, and operating functions.

TR-2400

The TR-2400 synthesized 2-meter hand-held transceiver features a large LCD frequency readout, 10 memories, scanning, and much more.

TR-2400 FEATURES:

- Large, illuminated LCD digital frequency readout. Readable in direct sunlight, and a lamp switch makes it readable in the dark. Shows receive and transmit frequencies and memory channels, and indicates "ON AIR", memory recall, battery status, and lamp switch on.
- 10 memories, with battery backup.
 - Automatic memory scan, for "busy" or "open" channels.
 - Mode switch for simplex, ± 600 kHz transmit repeater offset, and memory-frequency ("M O") transmit repeater offset.
 - REVERSE momentary switch.
 - Built-in 16-button Touch-Tone generator.
 - Keyboard selection of 5-kHz channels from 144.00 to 147.995 MHz.



ST-1

- Up/down manual scan and repeater or simplex operation from 143.900 to 148.495 MHz in single or fast continuous 5-kHz steps.
- Two lock switches to prevent accidental frequency change and accidental transmission.
- Subtone switch (subtone module not Kenwood supplied).
- More than 1.5 W RF output.
- High-impact plastic case and zinc die-cast frame.
- BNC antenna connector.
- Standard accessories included with the TR-2400 are a flexible rubberized antenna with BNC connector, ni-cad battery pack, and AC charger.

OPTIONAL ACCESSORIES:

- Attractive leather case.
- Model ST-1 base stand, which provides 1.5-hour quick charge, trickle charge, and base-station operation with microphone connector and impedance-conversion circuit for using MC-30S microphone.
- Model BC-5 DC quick charger.



TOP CONTROLS



KENWOOD
...pioneer in amateur radio

...for the discerning Amateur
who demands quality.

TS-700SP



SP-70

TS-700SP

VFO-700S

The TS-700SP is an all-mode (SSB, FM, CW, and AM) solid-state transceiver covering the entire 2-meter band, including repeater operation on all sub-bands. It's the perfect rig for the serious 2-meter Amateur.

TS-700SP FEATURES:

- All modes...SSB (USB and LSB), FM, CW, and AM.
- VFO tuning from 144 to 148 MHz in four bands.
- Seven-digit readout of receive frequency, with 100-Hz resolution. (Last digit can be eliminated automatically in the FM mode.)
- Simplex and repeater operation, including all repeater subbands. Switchable to REVERSE mode.
- Built-in receiver preamplifier.
- AC/DC capability, for fixed or mobile operation.
- 44 fixed channels with T crystals.
- Multifunction meter...S-meter on all receive modes, zero-center meter on FM receive and RF transmit.
- High-low power switch (IC W/1 W)
- RIT for both VFO and fixed channels.
- Effective noise blanker.

TS-600



SP-70

TS-600 W/VOX-3

The TS-600 is an all-mode (SSB, FM, CW, and AM) solid-state transceiver covering the entire 6-meter band. It's the ideal transceiver to enjoy the many exciting propagation conditions on 6 meters.

TS-600 FEATURES:

- All modes...SSB (USB and LSB), FM, CW and AM.
- VFO tuning from 50 to 54 MHz in four bands. Main dial graduated at 1-kHz intervals.
- AC/DC capability, for fixed or mobile operation.
- 20 fixed channels with five crystals.
- Effective noise blanker.
- 100-Hz marker.
- Multifunction meter...S-meter on all receive modes, zero-center meter on FM receive, and RF or transmit.
- RIT for both VFO and fixed channels.
- 20 W PEP input on SSB, 10 W output on CW and FM, 5 W output on AM.

OPTIONAL ACCESSORY:

- VOX-3, to provide VOX and semi-break-in CW operation.



The TR-8300 mobile FM transceiver operates in the 70-cm band, on 23 crystal-controlled channels (three supplied). Transmitter output is 10 watts, and a very sensitive and selective receiver is provided.

TR-8300

TR-8300 FEATURES:

- Covers 445.0-450.0 MHz (transmit) and 442.0-447.0 MHz (receive).
- 23 channels, three supplied (446.0 MHz simplex, 446.5 MHz simplex, and 449.10 MHz transmit/447.0 MHz receive).
- Five-section helical resonator and two-pole crystal filter in receiver IF, for improved intermodulation characteristics.
- Call channel switch, for user-desired function (such as subtone).
- High low power switch (IC W/1 W).
- Monitor circuit, to allow listening to modulation while making frequency adjustments.

OPTIONAL ACCESSORIES



PC-1 phone patch.



MC-50 dynamic dual-impedance (50 k Ω /500 Ω) desk microphone.



MC-30S (500 Ω) dynamic noise-cancelling hard microphone. Also available, MC-35S (50 k Ω).



MC-45 Touch-Tone (with automatic transmit) microphone.



HS-5 deluxe 8 Ω headphone set.



HS-4 8 Ω headphone set.



MB-100 mobile mount for TS-120S.

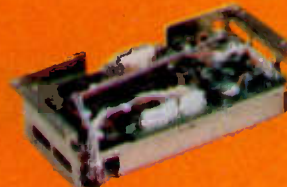

DF-180 digital frequency control for TS-180S without DFC.



DG-1A digital counter/display for TS-820.



DS-1A DC-DC (mobile) converter for TS-E20S/TS-520S (not for TS-520SE).



BS-8 (for TS-180S and TS-820S) and BS-5 (for TS-520 series) S-M-22 speaker display



FK-88CW 500-Hz CW filter for TS-180S/TS-120S and FK-88SSB IF SSB filter for TS-180S dual-filter system.



YG-820 (YG-88C* 500-Hz CW filter for TS-320S/R-320. YG-520 500-Hz CW filter for TS-520 series.



YG-88A 6-dB AM filter, YG-455C 500-Hz CW filter and YG-455CN 250-Hz CW filter for R-820.

KLM MAKES 40 EASY!

GOT A HOLE IN YOUR COVERAGE?
MISSING THE CONSISTENTLY GOOD
LOCAL COMMUNICATIONS AND DX
CAPABILITIES OF 40 METERS?

KLM's 7.2-1 Dipole Module is the Answer!

- **LIGHTWEIGHT** — for easy one man installation on your boom or mast (horizontal or vertical)
- **ROTATABLE** — right along with your other antennas
- **BROADBAND** — VSWR 2:1 and better across the whole amateur band — or OPTIMIZE, 6.95 to 10 MHz
- **VERSATILE** — divide for 2 el. vertical or add modules later and upgrade to 2 or 3 el. beam!
- **COMPACT** — KLM's unique linear loading system reduces size to a practical and efficient 46 ft.

You get the same quality materials as KLM's world famous HF "Big Stickers"; virtually indestructible Lexan insulator, stainless steel electrical hardware, seamless 6063-T832 alloy elements. Assembly is simple and speedy. No special tools or skills are needed.

Why wait any longer? 40 METERS IS EASY WITH KLM'S 7.2-1 DIPOLE MODULE. IT'S AVAILABLE NOW. SEE YOUR LOCAL KLM DEALER

KLM ALSO BUILDS THE FULL SIZE 7.2-4 ELEMENT "BIG STICKER" AND A VARIETY OF MONOBANDERS, LOGS, DIPOLES, VERTICALS, AND OTHER ANTENNAS FOR HF, VHF, OSCAR, AND UHF. POWER AMPS, PREAMPS, AND CONVERTERS, TOO. WRITE FOR A COMPLETE CATALOG.

KLM — HELPING YOU MAKE THE MOST OF AMATEUR RADIO ✓K4

17025 LAUREL ROAD, MORGAN HILL, CALIFORNIA 95037

MORE FEATURES FROM ALLIANCE!



HD-73 HEAVY-DUTY ROTATOR

with exclusive Dual-Speed Control!

For antennas up to 10.7 sq. ft. of wind load area. Mast support bracket design permits easy centering and offers a positive drive no-slip option. Automatic brake action cushions stops to reduce inertia stresses. Unique control unit features DUAL-SPEED rotation with one five-position switch. SPECIFICATIONS: Max. wind load bending moment—10,000 in.-lbs. (side-thrust overturning); Starting torque — 400 in.-lbs.; Hardened steel drive gears; Bearings — 100- $\frac{3}{8}$ " diameter (hardened); Meter — D'Arsonval, taut band (back-lighted). There's much, much more — so get the whole story!

Mail this coupon for complete details! ✓A57

YES! Send me complete details on the HD-73!
 Give me the name of my nearest dealer!

NAME _____

ADDRESS _____

CITY _____

STATE _____ ZIP _____



The **ALLIANCE** Manufacturing Co., Inc., Alliance, Ohio 44601
A NORTH AMERICAN PHILIPS COMPANY

Maker of the famous Antenna Rotator . . . Alliance Tenna-Rotor® . . . "TV's Better Color Getter!"

© 1978 The Alliance Mfg. Co., Inc.

ou goons don't ever profic
lously manuscripts from bat
burth in the k...
you li...
I insist that you print ev
tell Ma Bell that she shou

LETTERS

INTRUDER WATCH

Wells R. Chapin W8GI
Byron H. Kretzman W2JTP
Steve Baumrucker WD4MKQ

I refer to W2JTP's comment to W8GI in the August, 1979, Letters section regarding the ARRL and the Intruder Watch.

I do not think that you are correct about the ARRL coining the word "intruder" and establishing the first intruder watch—well, not exactly. I believe from the RSGB's *Radio Communications* publication and other sources that the "Intruder Watch" was first formed in Britain and was followed, somewhere around 1965 in the USA, as one of many such watches organized under the IARU around the world. However, the thousands of reports monthly via the ARRL and massive help from the FCC Monitoring Branch and Treaty Branch have brought about many improvements, but not in every country. It was my estimate some time ago that about 80% of the intruders (disregarding assigned sharing of the 40- and 80-meter bands by normal broadcasting) were Russian, 10% Chinese, with the remaining 10% being miscellaneous intentional or accidental occupants.

My records were searched over the past several years, but none of you was listed in the "roster" of USA and Canadian "Intruder Watchers." The ARRL could not begin to handle the massive problem of intruders using paid help in Newington, but they do make an effort (particularly before the present "bind" in Newington regarding manpower) to keep up with the IARU monitoring system.

Within that system, and sometimes a little outside of it, we have eliminated numbers of intruders—but few Russians or Chinese. Personal contact also has been helpful, including designing antenna traps for distant broadcasting stations, getting some moved to proper allocations, and so on. BBC Johore (Far-East Relay) had a strong harmonic on 14240 kHz; with the help of the British watch, BBC designed a new antenna trap for the second harmonic of 7120 kHz, then wrote to me saying that they had reduced the har-

monic to -76.9 dB, asking me to check it (it had completely disappeared) and to inform them informally if it ever returns. Many such improvements have been brought about.

But the manpower to listen to cassettes of Russian fishing boats on 3550/3650 kHz and the like just wasn't available at Newington, which already had received many, many identifications, calls, times, frequencies, dates, and records of alerting FCC Monitoring to confirm this intrusion of 80 meters.

If you look into the *ARRL License Manual*, you will find a "Geneva Amateur Allocations Summary" taken from their big allband "Allocations" chart. This shows that mobile services share the 3500-3800-kHz segment of the 80-meter band in Region 1 (Europe-Africa-Siberia-Middle East), 3500-4000 in Region 2 (North and South America), and 3500-3900 in Region 3 (rest of the world). So, the Russian fishing fleet was legal, at least when it was in Region 1 waters. If the FCC was able to find some point on which to base a complaint, my guess is that they *did* take such action, usually by an ITU-standardized cable or radiogram. So, what more could we do, especially with the frequency being legally shared with the mobile service in each region?

Until recently, I averaged 95 long-distance calls to FCC Monitoring a month to alert them to intruders on the air at the time subject to "treaty" action—with the phone expense paid by the ARRL. Subsequently, I found that I was overloading the monitoring system of the country and cut it down largely to those transmissions with a particularly good reason to complain and get action, such as spurious families in the bands, whether the cause is inside or outside. Remember that the USSR has the special right to use 14250/14350 for "fixed" (point-to-point) service, and also the ITU allocations have a footnote exempting "military" everywhere. I lay off of legal broadcasting like VOA and others, though recently I did try to point out to VOA that by the USA giving up Okinawa and VOA moving to the Philippines, their Chinese service antennas now practically point at the USA

east coast, which ought to be protected from receiving "harmful levels" of interference. I informed VOA of the specific cases in Europe and Africa where sites are used which involve antennas which, in addition to covering the service area, are incidentally aimed at Region 2 and cause harmful interference in North and South America. Also, we have complained about Deutsche Welle broadcasting on 3995 kHz afternoons and evenings in German to Latin America, which is contrary to ITU regulations.

But there are hundreds upon hundreds of individual cases of intruders on amateur frequencies. I have been preparing reports on some 400 to 450 different frequencies (mainly 14 MHz, lately) a month, with many reports listing as many as 25 additional date/time groups of "sightings" of the same signal. The ARRL has had to sort and ship by air up to about 4000 report forms a month to G3PSM, who produces a 20-22 page *Intruder Monthly Summary*. This goes to the ITU in multiple copies, to VOA and others, and to many Intruder Watchers around the world requesting action on *their* country's responsibilities in the summary, and so on. We especially need more Intruder Watchers from the Caribbean and Central and South America, now coordinated by K6DL, who has taken over the Region 2 work so that I can write letters such as this!

Let's give more of the facts about what is going on, what is legal and what is not, who is doing what, and what can be done. But let us not repeat WD4MKQ's boo-boo of doing illegal things ourselves and becoming intruders, too, by following that suggestion of trying to jam the intruders. Often that harms other amateurs as much as, or more than, the intruder. We have had little apparent success over the years on the part of those, especially in other countries, who are willing to jam the radar pulse, but it is very unlikely to be more than a happenstance, if it seems to work.

Remember that if A and B are intruders, and we may know the direction to A, which we hear, we still do not do any harm unless we jam the receiver at B, who is in an unknown direction usually. Not only that, but because of the geographical problem, it is highly likely that the band is not even open to the receiving point, B, from the USA. Two amateurs on CW did, however, get on an Arabic phone net in the 14-MHz CW band, call "CQ Intruder Watch," and raise other stations, who proceeded to discuss the interference; when the phone net moved, more "CQ IW" calls appeared

on the new frequency, and finally the intruders got out of the amateur band and stayed out. But intentional jamming of communications draws very severe penalties under FCC Regulations, Sec. 97.125: "Interference—No licensed radio operator shall willfully or maliciously interfere with or cause interference to any radiocommunication or signal."

Let us divert our efforts to legal things that we can do to assist in this work, worldwide, and hope that our efforts, at least in part, may minimize the increase of such interference from intruders. I personally hope that my last 14 years of nearly full-time IW and OO work, to the exclusion of most other activities, has not been in vain.

E. H. Conklin K6KA
La Canada CA

RIGHT ON!

I read your August, 1979, editorial with great interest. I agree that Mr. Booth's attitude towards the FCC's commissioners was indeed wrong. As a sales representative, I know your method is the most successful.

I would add, in closing, that this was the first issue of 73 that I have read in one year as a ham. I read your editorial with fervor, and I can honestly say that that never happens when I read *QST*. Right on!

John Cerniglia N9AGB
Madison WI

2M RTTY

In reference to Wayne's editorial concerning crossband repeaters (August, 1979, p. 6), I might pass on a unique situation that occurred not long ago.

On January 16, 1979, quite a few local 2-meter RTTY buffs were astounded to see in print, from autostart, that a KH6 had been on the repeater (146.10/.70) calling CQ RTTY! A little further down the paper, they also saw that two stations actually worked him. After a previous QSO on 20-meter RTTY and a short lesson in how to access, Tony KH6JEO from Makakilo, Hawaii, transmitted at 14.083 MHz. My station, acting as a manual repeater, retransmitted his signal onto the input of the 2-meter repeater via my ST-6 terminal system and a few routing switches (the same way we retransmit W1AW RTTY bulletins onto the RTTY repeater).

The replying signals, originating on two meters, were reversed, outputting onto twenty meters, and, therefore, became perhaps the first "crossband,

Continued on page 190

"THE INFLATION FIGHTER"

Top Performance For The Budget-Minded Amateur

Analog Model FT-101Z



If economy is an important consideration, and you don't need the frequency counter and digital display, then choose the FT-101Z. The precision VFO gear mechanism is coupled to an easy-to-read analog display, providing resolution to greater than 1 kHz. All other features—the variable IF

bandwidth, RF speech processor, superb noise blanker, VOX—are identical to the FT-101ZD. Yaesu gives you greater choice, so that you don't have to pay for what you don't need! The counter and digital display can be added to your FT-101Z at a later date, if you wish.

Specifications : FT-101Z

GENERAL

Frequency coverage: Amateur bands from 1.8–29.9 MHz + WWV/JJY (receive)

Emission types: LSB, USB, CW

Power requirements: AC 100/110/117/200/220/234 volts, 50/60 Hz, DC 13.5 volts, negative ground (with optional DC-DC converter installed)

Power consumption: AC 85 VA receive (73 VA HEATER OFF) 330 VA transmit, DC 5.5 amps receive (1.1 amps HEATER OFF) 21 amps transmit

Case size: 345(W) x 157(H) x 326(D) mm

Weight: Approx. 15 kg.

RECEIVER

Sensitivity: 0.25 μ V for S/N 10 dB

Selectivity: SSB 2.4 kHz at -6 dB, 4.0 kHz at -60 dB. CW (with optional CW filter: 600 Hz at -6 dB, 1.2 kHz at -60 dB)

Image rejection: Better than 60 dB (160–15 m), better than

50 dB (40 m)

IF Bandwidth: Continuously variable from 2.4 kHz to 300 Hz, using two 8-pole IF filters

Audio output: 3 watts at 10% THD into 4 ohms.

TRANSMITTER

Power input: 180 watts DC

Carrier suppression: Better than 40 dB

Unwanted sideband suppression: Better than 40 dB (14 MHz, 1 kHz modulation)

Other spurious radiation: Better than 40 dB down

Third order distortion products: Better than 31 dB down

Transmitter frequency response: 300 – 2700 Hz (-6 dB)

Antenna output impedance: 50–75 ohms, unbalanced.

Microphone input impedance: 500–600 ohms (low impedance)

Note: FT-101Z (analog) cannot be used with the FV-901DM, as there is no frequency display.

Price And Specifications Subject To
Change Without Notice Or Obligation



Y1

YAESU

The radio.

YAESU ELECTRONICS CORP., 15954 Downey Ave., Paramount, CA 90723 • (213) 633-4007
YAESU ELECTRONICS Eastern Service Ctr., 9812 Princeton-Glendale Rd., Cincinnati OH 45246

Looking West

Bill Pasternak WA6ITF
24854-C Newhall Ave.
Newhall CA 91321

CONGRESSMAN TO HELP THE AMATEUR COMMUNITY CONQUER MALICIOUS INTERFERENCE

"Amateur radio is a service, not just a hobby, and must be protected." These were the words of Congressman James Corman, a democrat from Van Nuys, California, spoken in an exclusive interview with this reporter on Monday, August 29, 1979, at the congressman's San Fernando Valley office.

I met with Congressman Corman after it had been reported that he had shown an interest in helping the amateur community to clean house. I wanted to know exactly where he stood on certain issues and thought you might also be interested. In early August, Congressman Corman met with ARRL Southwestern Division Director Jay Holliday W6EJJ and Special Assistant Director Joe Merdler N6AHU to discuss the growing malicious interference and regulatory violation problems. At that time, he voiced strong support for the cleanup task that Jay and Joe had started; many felt that his was the type of help most needed now. It was through Joe Merdler (who also serves as our legal correspondent for the Westlink Amateur Radio News) that the interview with Congressman Corman was arranged.

From the start, Congressman Corman made it clear that this would be a coordinated effort on his part. He stated, "Four hundred thirty-five congressmen going in different directions will accomplish nothing." He intends to meet in Washington with ARRL General Council Bob Booth, along with Joe Merdler. There they will begin attacking the whole problem, with the support of the ARRL. He also stated that he intends to find out the reason why the FCC has failed to act in the case of Scott Lookholder WB6LHB, who was convicted of malicious interference earlier this year. The congressman concluded by stating that the 1st Amendment does not give any person the right to use obscene language or in any other way maliciously interfere with the legitimate use of the airwaves.

THE CREATION OF "NATIONTIE '80" DEPARTMENT

In last month's column we began discussing what might be accomplished were a fair

number of already existing two-meter open repeaters linked together to provide coast-to-coast, border-to-border amateur relay communication. We suggested that you might want to try some interlinking experiments with other repeaters in your general area that are outside your normal system coverage. In essence, we hope that we have whetted your appetite for even bigger and better things. If we have, then I suggest you pay special attention to this column for the next couple of months because the creation of an open national intertie will be the center of attraction for some time to come.

If you have never operated through a repeater intertie, you are really missing something. When you spend a lot of your operating time on local repeaters, it is easy to forget that there are many people out there who, while still living in your general area, may have dramatically different lifestyles than yours. Most HF operators, especially those who enjoy chewing the rag, can easily relate to this. Through long-winded QSOing, amateurs in different areas learn about each other through the interaction that is the classic QSO. It's sad, but true, that this is rarely the case for VHF repeater operation. Most amateurs, even those with the most sophisticated equipment, seem to wind up as habitual users on one or two local repeaters where they become part of that system's "in" crowd.

There is another aspect of repeater operation that tends to be a limiting factor in this area. On many repeaters, holding anything more than a quick "hello, how are you, good-bye" QSO is a taboo, enforced by a device known as a "blab-off timer." I never could see the strict rules barring normal QSOs on repeaters, because "someday an emergency might arise and the repeater will be busy." Believe me, if I ever have an emergency and a repeater is busy, I will find a way to be heard! It is, however, such regulations that tend to discourage true interaction by amateurs. True, two people living six blocks away from each other should not hold their QSOs through a repeater sixty miles away just to have an audience for their rhetoric. Such regulations do tend to discourage this type of activity; however, the same rules also tend to stifle meaningful communication. If necessary, a telephone call to an offender can usually solve

any problem quite quickly.

While we cannot and will not attempt to change the operating rules on a repeater belonging to someone else, we will suggest that one of the objectives of Nationtie '80 must be to develop true lines of intercommunication and interaction among those amateurs who desire it.

Another objective must be the "advancement of the state of the art," or, more simply, "scientific achievement." There are two aspects of science, research and the application of what has been learned. Research is pointless if never applied. I say this because in many ways we will be doing nothing really new. Interlinks of varying sizes have existed for years, but their accessibility has been limited to a select few. These limited operations can be the cornerstone of something bigger and better, available to any amateur who may wish to utilize it. The technology already exists and is waiting for us to develop and utilize it.

Last month, we described a simple linking experiment that might best be termed "hazardous local linking." If we are to build a national intertie, we must have a definite objective. The obvious objective is to find a way for point A (Los Angeles, perhaps) to converse with point G (New York, perhaps) even though they are well outside what is considered normal VHF communications range. They must have their signals relayed several times. Now, if at each of the relay points you place input/output ports (local relay devices that can talk with any other relay point as well as with both terminal points), you will have an interactive radio intertie. There are various ways in which such linking can be accomplished, and we will now touch upon each.

For occasional links over long distances, the most common form of linking is accomplished via the long-distance telephone call—along with its long-distance toll rates. If the two systems involved in such a link have autopatch facilities or telephone accessibility for command purposes, the task of completing such a link is simple. If I, as repeater A, want to link with repeater G, I simply dial their dial-in number. This has been the basis of many long-distance links reported in this column over the years. The major drawback of this method is its cost, and for that reason it has never really become popular.

A second method involves the use of crossband, remote-base operation from spectrum considered local to one of our HF bands, which provides for

longer-distance propagation. Many links have already been accomplished by cross-linking from VHF/UHF to ten-meter FM. However, ten meters is far from the ideal band in which to develop an interlink system that will function with reliability on a day-to-day basis. This is due to the somewhat erratic nature of long-haul ten-meter propagation. Actually, our most crowded HF band, twenty meters, probably offers the best potential for such an operation by crossband/cross-mode (FM to SSB) remoting. Again, this is far from an ideal situation, even though 14.285 MHz has become the de facto HF remote downlink DX frequency, much to the chagrin of many other spectrum users who do not appreciate hearing SSB signals with built-in squelch crashes! Though far more predictable and reliable in its propagation characteristics, the crowding one finds across the twenty-meter spectrum precludes its use on a regular basis for the establishment of an ongoing intertie operation.

This brings us to our third and probably most cost-effective method of interlinking, that of total radio relay. If we were to start from scratch to build a coast-to-coast intertie using multi-hop radio relay techniques, there would be very few able to foot the bill. However, with over 3,000 operational open two-meter repeaters throughout the country already, the cost factor looks a little more positive. Most of what is needed is already in place. The equipment sits atop tall buildings, towers, and mountaintops, and is already in day-to-day operation. The cost of interlinking is thereby minimal, since only one receiver and one transmitter need to be added to any existing system in order to interlink with any other system, and only two receivers and two transmitters are needed for it to become an interactive radio-relay device as part of a large intertie. (This is assuming that the existing two-meter facilities will take on a second job as the local access port to such a national system.) If the 220 band were used for the actual linking, then, at today's current market prices for new equipment, you are talking under \$500 for the basic hardware (including your yagi-type antennas). You can get very elaborate and "go for broke," but that is neither necessary nor encouraged. If we keep sight of the old computer-industry adage of KISS (Keep It Simple, Stupid), we are far better off. The less complex we make it, the fewer headaches we will have in days to come.

Continued on page 194

The following are excerpts from unsolicited letters and registration cards received from owners of the new TEN-TEC OMNI transceiver.

- "I sold a Yaesu to buy this and am very impressed" —WB5ULA
 "My first QSO with OMNI-A was LA1SV on CW and second was EA8SK on SSB." —N2CC
 "Excellent rig, just as advertised." —WB5TMD
 "Very pleased with performance. QSK feature very slick." —WB0ELM
 "This is my 5th TEN-TEC transceiver in less than 2 years. I loved them all and still have 3." —WB0VCA
 "Through the years I have had complete Drake and Collins stations. I tried a 544 Digital and liked it the best so decided to purchase the 546 OMNI-D Digital." —WA4NFM
 "Your OMNI is the best rig I have had in 20 years of haming." —K4IHI
 "As a owner of Collins rig, your OMNI-D is the best." —K9JLL
 "I already have an OMNI-A, 544 and a TRITON IV. You may ask why I own so many TEN-TEC rigs. In case there is a great RF famine, I want to be ready!" —WD4HCS
 "You guys really know how to turn on an old timer!" —K8ELS
 "Best operating & most conveniences of any transceiver I've ever used." —W6LZI
 "I like CW. Compared OMNI against IC701 (rcvr) and OMNI won hands down. XYL WD6GSB really enjoys rig on SSB. Finds rig is very stable and digital readout accurate." —AC6B
 "Have checked it out on both modes from "top band" (160) all the way to 29 MHz. Terrific!!!!" —W4DN
 "Works well, parts layout and design much better for any possible servicing than other ham gear. The Japanese hybrid sets can't compare to TEN-TEC for audio. Audio reports excellent without special speech processors, etc., to distort the signal." —AG8K
 "I have been using the S-Line over 15 yrs and never thought anything could outperform it. I got the biggest surprise and THRILLED with this OMNI-D even though I have been a ham since 1936." —KV4GD

- "This must be the greatest. I've spent enough money on final tubes to almost pay for this." —KA4BIH
 "This transceiver was recommended to me by old time hams (Xtras) whom I have known for 40 yrs. Has excellent break-in." —N6AVQ
 "Best package job I've ever seen! First licensed 6AAV in 1926. Now in operation—a sweetheart!" —W7LUP
 "From a 32V2/SX115 to an OMNI is a big step!" —K6YD
 "Receiver prominent—transmitter likewise—working comfortable—pleasing design." —OE1FAA
 "First new rig for me in 10 years but seems to be very good." —W5GBY
 "The best transceiver I ever used or owned." —W3TS
 "I wouldn't swap my OMNI for anything on the market, regardless of price." —WD0HTE

OMNI/SERIES B FEATURES

All solid-state; 160-10 meters; Broadband design; Standard 8-Pole 2.4 kHz Crystal Ladder I-F Filter + Optional 1.8 kHz SSB Filter & 0.5 kHz 8-Pole CW Filter; 3-Bandwidth Active Audio Filter; Choice of readout — OMNI-A (analog dial), OMNI-D (digital); Built-in VOX and PTT, Selectable Break-In, Dual-Range Receiver Offset Tuning, Wide Overload Capabilities, Phone Patch Interface Jacks; Adjustable ALC; Adjustable Sidetone; Exceptional Sensitivity; 200 Watts INPUT; 100% Duty Cycle, Front Panel Microphone and Key Jacks; Zero-Beat Switch; "S"/SWR Meter; Dual Speakers; Plug-In Circuit Boards; Complete Shielding; Easier-to-use size: 5¼" h x 14¼" w x 14" d; Full Options: Model 645 Keyer \$85; Model 243 Remote VFO \$139; Model 252MO matching AC power supply \$139; Model 248 Noise Blanker \$49; Model 217 500 Hz 8-Pole Crystal Ladder CW Filter \$55; Model 218 1.8 kHz 8-Pole Crystal Ladder SSB Filter \$55.

Model 545 Series B OMNI-A . . . \$949
 Model 546 Series B OMNI-D . . . \$1119

To add your name to the fast-growing list of OMNI owners, see your TEN-TEC dealer, or write for full details.

TEN-TEC, INC.
 SEVIERVILLE, TENNESSEE 37862
 EXPORT: 5715 LINCOLN AVE., CHICAGO, ILL. 60646

OMNI OWNERS SAY:



RTTY Loop

Marc I. Leavey, M.D. WA3AJR
4006 Winlee Road
Randallstown MD 21133

Not all keyboards are created equal. Depending upon what you are copying, ham RTTY, weather, or press, some are definitely more equal than others. With the interest shown in copying these other-than-ham RTTY signals, I thought it might be a good idea to review the keytops and symbols found on Teletype™ machines.

My Model 15 manual lists over a dozen sets of keytops used on various models of teleprinters. Most of the variation is in the uppercase, or FIGS, character set. The diversity can be simplified to three main groups, and I will call them, for the sake of simplicity, communications, weather, and press. These names derive from the principal function of each character set. A diagram of their relation is presented in Fig. 1. This shows the binary code, lowercase character, and uppercase character of each set.

The communications character set, also known as the American Communications keyboard, Teletype keyboard BS, 78932, or a few others, is what we commonly use on ham

RTTY. It contains all the commonly-used uppercase characters with no unusual representations. Several variations of this keyboard are possible without too much conflict. Uppercase H has at least three assignments commonly found: #, STOP, and £ (British pound sign). For this reason, it is usually best to avoid sending very many uppercase Hs unless you know what the fellow has to whom you are sending. That STOP code, if hooked up, will disable his machine!

There is one other variation of the communications keyboard that bears mentioning: the so-called "Western Union" keyboard. This is identical except for one minor variation: The BELL is an uppercase J rather than an uppercase S. The S, in this case, is an apostrophe ('). These keyboards are common enough so that, frequently, when one wants to send a series of bells, JSJSJSJS is sent in uppercase. The printer prints "" with a bell between each apostrophe, no matter which code is used.

The press code, also known as a Bell System, TWX, or fractions code (again, there are many other names and numbers), is notable for re-

placement of certain uppercase symbols with fractions. Now, you and I might not be too thrilled with having uppercase B a fraction instead of a question mark — imagine sending "HOW ARE YOU COPYING OVER THERE 5/8"—but if you are trying to send stock quotations and such, there is great value in being able to send each fraction in one byte rather than three. If this is what you have or is the only kind of machine you can get, don't despair; I'll touch on what you can do later.

Another interesting code is the weather code, with aliases of Weather Map Service, 89410, or 82750. Here, specialized symbols are used to give weather information that might otherwise take several characters or words. The utility of this for pilots and meteorologists is self-evident; for the rest of us, it means one more code to crack if we anticipate copying some

of those interesting commercial stations. In Fig. 2, we look into just what those symbols mean and how to interpret them. These aviation weather reports provide a wealth of information, and Fig. 3 is derived from a US Department of Commerce example of how to decode them.

Now, if you don't have a particular set of symbols and you want to change, all is not lost. For Model 15s and 19s, it is rather simple. If you have, for example, a communications keyboard and you want to be able to copy weather code, the easiest way to change is to obtain an extra typing basket set up for the new codes. When you desire to shift codes, simply slide the old basket off and the new one on. Voilà!—a transformed machine. Return things to normal by shifting back. Extra typing baskets are available

Continued on page 194

5-Level Code	Lower-case	Communications	Weather	Press
11000	A	-	↑	-
10011	B	?	⊙	5/8
01110	C	:	⊙	1/8
10010	D	\$?	\$
10000	E	3	3	3
10110	F	!	→	¼
01011	G	&	\	&
00101	H	#	↓	#
01100	I	8	8	8
11010	J	'	↑	'
11110	K	(←	½
01001	L)	\	¾
00111	M	.	.	.
00110	N	.	⊙	7/8
00011	O	9	9	9
01101	P	0	0	0
11101	Q	1	1	1
01010	R	4	4	4
10100	S	BELL	BELL	BELL
00001	T	5	5	5
11100	U	7	7	7
01111	V	:	⊙	3/8
11001	W	2	2	2
10111	X	/	/	/
10101	Y	6	6	6
10001	Z	"	+	"

Fig. 1.

Sky cover symbols are in ascending order. Figures preceding symbols are heights in hundreds of feet above station.

Sky cover symbols are:

- Clear: Less than 0.1 sky cover
- ⊙ Scattered: 0.1 to less than 0.6 sky cover
- ⊖ Broken: 0.6 to 0.9 sky cover
- ⊕ Overcast: More than 0.9 cover
- Thin (when prefixed to the above symbols)
- X Partly obscured: 0.1 to less than 1.0 sky hidden by precipitation or obstruction to vision
- X Obscured: 1.0 sky hidden by precipitation or obstruction to vision

Fig. 2. Sky symbols on aviation weather reports.

CEILING:

Letter preceding height of layer identifies ceiling layer and indicates how ceiling height was obtained.

A = Aircraft B = Balloon E = Estimated M = Measured
R = Radar W = Indefinite V (suffix) = Variable Height

VISIBILITY:

Reported in statute miles and fractions (V = Variable)

WEATHER AND OBSTRUCTION TO VISION SYMBOLS:

A Hall	IC Ice Crystals	RW Rain Showers
BD Blowing Dust	IF Ice Fog	S Snow
BN Blowing Sand	IP Ice Pellets	SG Snow Grains
BS Blowing Snow	IPW Ice Pellet Shwr	SW Snow Showers
D Dust	K Smoke	T Thunderstorms
F Fog	L Drizzle	T+ Severe T'storm
GF Ground Fog	R Rain	ZL Freezing Drizzle
H Haze		ZR Freezing Rain

Precipitation: - very light, - light, (no sign) moderate, + heavy

WIND

Direction in tens of degrees from north, speed in knots.
Example: 3627 = 360 degrees, 27 knots

RUNWAY VISUAL RANGE (RVR):

RVR is reported from some stations. Extreme values for ten minutes prior to observation are given in hundreds of feet. Runway identification precedes RVR report.

ALTIMETER SETTING:

The first figure of the actual altimeter setting is always omitted from the report.

CODED PILOT REPORTS:

Pilot reports (PIREPS) of clouds not visible from ground are coded with MSL height data preceding and/or following sky cover symbol to indicate cloud bases and/or tops, respectively.

Fig. 3. Aviation weather reports, other features.

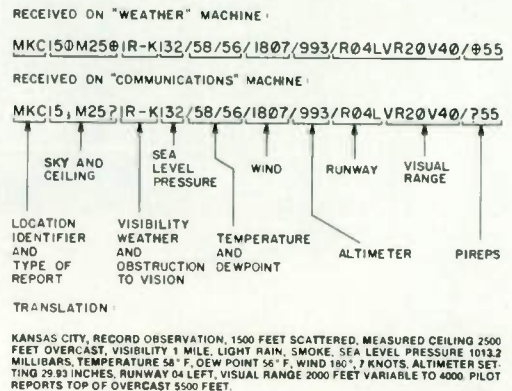

Fig. 4. Sample aviation weather report.

WHEN OUR CUSTOMERS TALK...WE LISTEN.

DS3100 ASR



We've Been Taking Notes.

Combining your ideas with some of our own, we've come up with what has to be the most advanced and convenient terminal available. These are some of the conveniences you can now enjoy by putting the DS3100 ASR in your RTTY and CW station:

ASR Operation (Compose your transmission *WHILE* receiving)

- 150-line Receiver Buffer
- 50-line Transmit Buffer
- Split Screen to Show Buffers
- Internal Real-Time Clock
- 10 Programmable Messages
- Automatic Answer-Back (WRU)
- Morse, Baudot, or ASCII Operation
- RTTY and CW Identification
- Full 128-Character ASCII
- 110-9600 baud ASCII
- 60-130 WPM Baudot
- 1-175 WPM Morse

Write or call for the DS3100 ASR specifications and see how **YOU** have helped design the new standard in amateur radio terminals.



HAL COMMUNICATIONS CORP.

Box 365
Urbana, Illinois 61801
217-367-7373

For our European Customers Contact:
Richter & Co., Hannover
I.E.C. Interelco, Bissone

Awards

Bill Gosney WB7BFK
2665 North 1250 East
Whidbey Island
Oak Harbor WA 98277

The response to the new 73 Awards Program announced in the September and October issues has been beyond all expectations. Award applications are being received from all over. Countless letters and telephone calls of support have been received, each claiming 73 now has one of the best award columns in existence. Let it be known that the readers are the ones to thank if this is true. All I can say is that we'll continue to strive for improvement.

Speaking of improvements, those of you who have your September copy of 73 might turn to pages 28 and 155, respectively, and make the following additions and changes. Completely overlooked was Jamaica (6Y5), which should have been included on the North American list. Looking at the list for Africa, transfer Yemen (4W) and People's Democratic Republic of Yemen (7O) over to the Asian listing. Also, it should be noted that the prefixes for each country shown do not represent the entire list of prefixes assigned to that country. Prefixes were shown merely for convenience.

By telephone, amateurs have asked why the Central American countries were identified as a South American claim. One such caller assumed our reasons were political. I assure you that this editor and this publication are not in the business of politics. The identity of Central America's countries was given to the South American listing merely to add balance to the overall program, nothing more. As for the con-

tacts which are made to Antarctica, it was decided long ago that there would be 6 continental awards and contacts with Antarctica would count toward that country from which the call sign was issued. In other words, should I confirm contact with KC4AAA, I would be able to count that as USA toward my North American award. Likewise, should I work FB8YF on the polar cap, I would be able to count that as France in my bid for the European award.

And speaking of the WTW (Work the World) Award Program, there has been some confusion as to the award fee schedule. Let me try to explain it. In the WTW Award Program, there is a series of six continental awards which are in themselves quite an accomplishment. Each of these continental awards has a \$3.00 award fee. Once the applicant has collected all six continental awards (European, African, Asian, South American, North American, and Oceanic), I (as custodian of the Awards Program) will request the New Hampshire offices to issue the seventh and ultimate WTW (Work the World) Award at no extra charge.

A week ago, I received a very impressive letter from one of our readers and I can't resist sharing parts of it with you. Hal Dennin AC3Q, who is the Chief of Police in Watsontown, Pennsylvania, wrote to inform me that he had accomplished in a little over one week something which takes most of us months and even years to achieve. To add insult to injury, Hal went on to claim that his feat was mastered operating QRP with his new Yaesu FT-7 into an ATB-34 triband beam. Claimed

power... a mere 9 Watts output!

Well, have you guessed Hal's achievement? Not to keep you in further suspense, it appears that over 73 DX countries have been worked by Hal in only 10 days. Once confirmation is received, Hal will have qualified for the new 73 DX Country Club which was announced for the first time only a couple months ago. Hal's first contact was with LU3EEC on 28.750, and QSO number seventy-three came only 9 days later when he exchanged signal reports with 6W8FZ on 14.220 MHz.

Not one to give up, Hal proceeded past the 100 mark, having reached that goal on the thirteenth day, and is well on his way to 200 countries as you read this. As a matter of fact, Hal is so insistent on breaking records that he didn't even take the time to put his letter to me in the mailbox for fear he might miss a "new one" while away from the radio. Instead, his XYL was delegated the duty of putting the letter in the hands of the postman for delivery. Talk about dedication!

Neither Hal nor I know if this feat is a world record or not! I would think not too many (if

any) could claim such an accomplishment, which, I might add, was completely independent of contest operation. Whether a world record or not, Hal deserves a hearty congratulations from us all... although at the same time I wonder if perhaps there shouldn't be a law against a crime like this.

Should any readers have a similar success story, why not drop us a line? Keep the details brief and straight to the point. Can you top Hal's new record?

The other day I received a letter from Vic Misek W1WCR, who represents the Top Band SSB Net. For those not familiar with the term, "top band" refers to those frequencies assigned the 160-meter segment of the radio spectrum. This band also has been referred to as the "gentleman's band" on occasion, largely due to the carefree, easygoing pace that appears so predominant on the band.

The Top Band SSB Net was formed in February, 1972, by a small group of operators composed of W2FWU, K2ANR, W2UBL, W2IMB, and W4NVN (formerly W1GJE). Over the

Continued on page 196

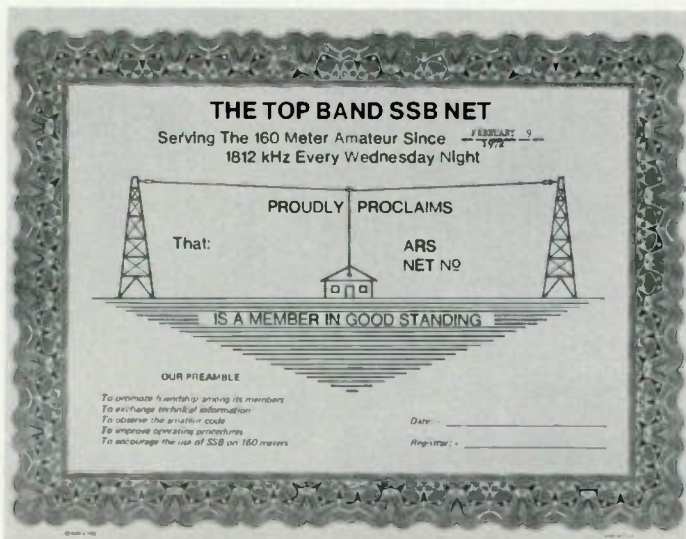

A Knob with a new twist "VRS™"

Swan Astro 150 Exclusive Microprocessor Control w/memory gives you over 100,000 fully synthesized frequencies, and more!

- VRS — Variable Rate Scanning, a dramatic new technique for unprecedented tuning ease and accuracy
- POWER — 235 watts PEP and CW on all bands for that DX punch
- Advanced microcomputer technology developed and manufactured in the U.S.A.
- Price? See your authorized SWAN dealer for a pleasant surprise!



Dual Meter
Reads PEP output in watts and receive "S" units.

Full Break-in CW
(or semi, switch selected)

Wide Frequency Coverage

- 10M — 28.0-30.0 MHz
 - 15M — 20.8-23.0 MHz
 - 20M — 13.8-16.0 MHz
 - 40M — 6.0-8.3 MHz
 - 80M — 3.0-4.5 MHz
 - 160M — 1.8-2.4 MHz*
- *in lieu of 10M band on Model Astro 151

Mike Tuning
For accurate 100 Hz steps or fixed rate scan.

PSU-5
Power Supply
with Speaker



THE MOST ADVANCED HF SSB TRANSCEIVER AVAILABLE.

FULLY SOLID-STATE **SWAN ASTRO 150**



SWAN
ELECTRONICS

A member of the Cubic Corporation family of companies.

305 Airport Road / OceanSide, CA 92054 / 714-757-7525

Leaky Lines

Dave Mann K2AGZ
3 Daniel Lane
Kinnelon NJ 07405

Lest any of you out there in Ham Radioland have somehow gotten the idea that old Dave has curled up his toes and given up his perennial nit-picking and hump-bustin', let me hasten to assure you that such is far from the case. I have been lying doggo, as our VK and ZL friends are apt to put it, but this has not been due to a change of heart or mind on my part. It's just that I've been kept rather busy with other matters. But I can no more change my sour disposition than the proverbial leopard can change his spots—once a crank, always a crank.

The fact is that for every rotten situation that gets cleared up, there are many more that spring up in its place. If it isn't one thing, it's another. When Pandora opened up that legendary box, she released troubles enough to plague amateur radio, too, as well as all other human institutions. Why should we be exempt? After all, does anyone know of any other field in which the well-known Mr. Murphy (of Murphy's Law) is as ubiquitous as he is right here amid the kilohertz and megahertz?

So, while I haven't been transcribing my various chronic displeasures and gripes in deathless prose, I must report that, to paraphrase a popular song of a few seasons ago, "the beef goes on!"

Listening to a W4 discussing a potential operation in one of the rare countries I still need, I decided to wait until his QSO with a VE ended, then break him to query him about it. While I stood by, listening, a loud twenty-over-nine carrier was thrown on the frequency. The tester took his good old time; he spent about a minute and a half tuning up his exciter and another minute firing up his final. After that, he QSYed about three kilohertz up the band, where I could hear his splatter while he called CQ DX. His signal was plenty strong, and I couldn't miss the little metallic ping when he worked the mike switch on the VOX-less transmitter.

At length, the W4 and his VE contact signed, so I broke in and called the former, announcing my call. I had scarcely completed the shout when the VE lit into me like an avenging angel of retribution. To tell the truth, I was stunned at this. As old Chester Riley used to say on TV,

"What a revoltin' development." The VE blasted me: "What's the idea of putting a loud carrier on an occupied frequency. Where did you get your license, at Sears?"

I stuttered and stammered: "But-but-but I didn't . . ."

"When will lids like you learn to check the frequency before you start barreling right in with carriers?" he continued.

I was shocked . . . for a couple of seconds, I could come up with zilch in the way of a comeback. I wanted to say something to put him in his place, but under the circumstances, I concluded that it would probably be useless. After all, anyone who assumes that you're guilty of some infraction against him, even if he has no proof of it, is not likely to accept a reasonable explanation. He is bound and determined to continue to be convinced that he is justified in his allegation.

Resigned to this unpleasant reality, I spun my vfo to another frequency and fought against the impulse to go back to him, chew him up, and spit him out!

So I did not find out about the DX operation they were discussing. But the way my luck has been running lately, it probably would have been a pirate anyway. At any rate, that's what I keep telling myself.

And speaking of DX, I simply cannot understand why the DX Advisory Committee consistently rejects the suggestion that the present game be terminated and a brand new one inaugurated. You have an Honor Roll which, for all practical purposes, will remain exactly as it has been for years, with virtually no chance for anyone to displace the occupants. They are like squatters who barricade themselves behind the battlements. Should anyone have the temerity to suggest that this is not a healthy situation, the Committee invariably rejects any idea of a change. Yet it is perfectly clear that unless changes are brought about, the best that any relatively new DXer can achieve is one of the lower rungs on the Honor Roll ladder. I will not go through the rather tedious explanation of its mechanics, but a bit of surface examination will easily disclose the reasons.

What it boils down to, in essence, is that there has never really been any real logic used in determining what should and should not be counted as a country. I cannot understand how anyone can include any

location which is incapable of sustaining life—all those reefs and atolls that are under water all or part of the time . . . the only life they sustain are seagulls and crabs! By the same token, there are still so-called legitimate countries on the DXCC list which have remained off the air for decades and even entire generations! From all indications, they are no closer to permitting ham operations now than they were on the very day amateur radio was shut down. The only signs of activity are those constant unfounded rumors about some unidentified DXpeditioner "who has a license to operate." But whenever you check with such persons, if you do manage to locate them, they invariably say that they do not have such official sanction. A friend recently ran such a rumor down to earth and received a letter from the chap in question. He stated that there was absolutely no foundation for a single word of it!

Consider the question of Burma, XZ2, for example. The foreign *Callbook* still lists a number of licensed amateurs in Burma, but that country's amateur operations have been prohibited for years. The government adamantly refuses permission for its own nationals to operate, and it is said that equipment has been confiscated and constant surveillance over amateurs makes it impossible for outsiders to contact them, even by mail. There is no indication that Burma intends to relent . . . it looks like a permanent situation. Why, therefore, still include Burma on the DXCC list?

But while it is still on the list, those few Honor Roll members who worked it when it was available (very few indeed, for our numbers have grown enormously since that remote time) are still credited with it. If it were deleted, of course, this would tend to equalize the chance for newer DXers to make the Honor Roll and to ascend the rungs of the ladder. As long as it remains on the list, those who have it credited enjoy an advantage impossible to overcome; their position on the Honor Roll remains unassailable.

But Burma is not the only example. Kamanan Island, VS9K, is another. And there are several in which the same condition prevails.

I firmly believe that any country which does not produce any activity for a reasonable period of time, say ten consecutive years, should be automatically deleted from the countries list. For as long as they are allowed to remain, the top dogs on the Honor Roll will continue to enjoy this advantage. The rest of the DX fraternity cannot pos-

sibly compete fairly under such a circumstance.

Incidentally, a new racket has developed. Some foreign stations, aware that since the increase in the price of International Reply Coupons has impelled many to enclose "green stamps" instead, have taken to deliberately ignoring first mailings and even subsequent ones. They simply pocket the dollar bill and just sit back and wait for a second buck to come in the daily mail. In this way, an active operator can practically guarantee a tidy little flow of dollar bills for himself. Unfortunately, some of these birds are really a bit too gluttonous. After they milk the pigeon who's seeking their QSL, they fail to send it to him at all. I think that an active file of such operators should be maintained by DXCC, and if it appears that this sort of chiseling is a regular thing, the guilty party should be disqualified from DXCC participation and his name and call should be publicized so that the DX fraternity can be made aware of the racket.

As things now stand, this crooked scam can go on and on for years and nothing is done to terminate it.

Present costs of new equipment, high though they may be, do not seem to be much of a deterrent. I've never heard so many new rigs on the air . . . evidently price is no object. One noticeable result of the proliferation of the new state-of-the-art gear is a general improvement in the quality of signals. Some of these rigs sound truly magnificent. It's pretty easy nowadays to spot the old clunkers when you hear them. And there are still plenty of them in use. Just tune back and forth across the phone bands and you can hear the unsuppressed carriers and all the slop generated on the unwanted sideband. Some of the old birds who use them have very raunchy signals, yet you will often hear their contacts telling them that their audio quality is fine. Some of them drift all over the place. But that makes no never mind . . . the guy they're working is drifting right along with them, and besides, his hearing acuity has fallen off so badly that he can't tell the difference anyway.

To get back to the subject of prices, have you seen the present selling price on the S-Line? I've been running mine for a long time, and as I recall, I bought it back in about 1963 for less than \$1500, including transmitter, power supply, receiver, and station console. At today's

Continued on page 194



For some, only the best is good enough.

In every discipline there is one definitive statement of quality. In driving it's Rolls Royce, and in amateur radio it's Vibroplex. Vibroplex introduces the definitive statement for 2m FM Transceivers: The Vibroplex 225 SL. From now on, all others will be compared with its quality, performance, and sense of pride it will give its owners. Since 1890 Vibroplex has set the standard in its field, and Vibroplex owners have been perceived by their fraternity as the highest achievers and most skillful practitioners of their art. Frankly, the Vibroplex 225 SL is not for everyone. It is for those who wish to defy mediocrity; who wish to state that they appreciate owning only the best. We know you'll agree.

Like our world famous "bugs", our design concept was simple. First we built a unique transceiver with unmatched performance characteristics; then we added advanced digital circuitry to allow you to operate it to suit your own style. We think that amateurs who want to operate in style, with the best equipment, will have only one choice: the Vibroplex 225 SL.

In designing the ultimate 2m radio, we asked you, the customer what you wanted. Here is what you said: "... front end selectivity," "... a good receiver," "... eliminate intermodulation." And we listened. Never before has such a superior receiver been built. By using an advanced dual-gate MOSFET and a five-pole, high-Q torodial filter in an ad-

vanced circuit design intermodulation is a thing of the past. Our specs say we're the best and your field test will prove it. Add state-of-the-art 10 pole filters and you have IF adjacent channel selectivity of remarkable quality. We say we have the best transceiver on the market. When you test it, we know you'll agree. Next you said: "... make it flexible," "... easy to operate," "... good looking." Again we listened.

Designed for mobile or fixed use, this radio is microcomputer based to provide unequalled operating flexibility; sixteen completely flexible, programmable memory channels (no diodes); memory channel monitoring (lets you operate on one channel while monitoring another for a friend); any transmitter off-set (programmable from the front panel); two scanners—one to tune the band, the other to scan the memory channels; selectable pause/latch, pause defeat feature with programmable pause from .5 sec. to 10 sec. This feature takes all the effort out of making the next contact. Full 1 year Vibroplex warranty against defects. And good looking? Well, you tell us!

For a brochure on the most exciting radio this year, write us, or better yet, give us a call. But, if you are really serious, ACT NOW to be sure of receiving yours soon. The Vibroplex Company Inc., P.O. Box 7320, 476 Fore Street, Portland, Maine 04112, (207) 775-7710.

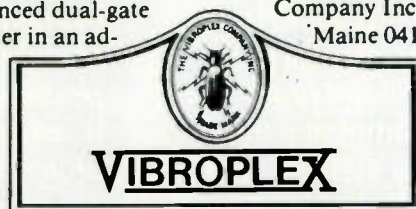

*"the oldest name in amateur radio"
Since 1890*

✓ V24

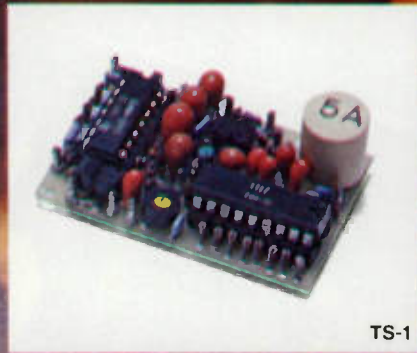

TS-1

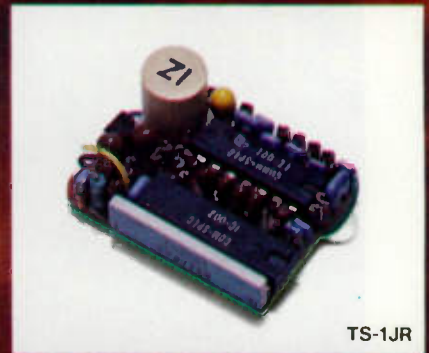

TS-1JR



PE-2

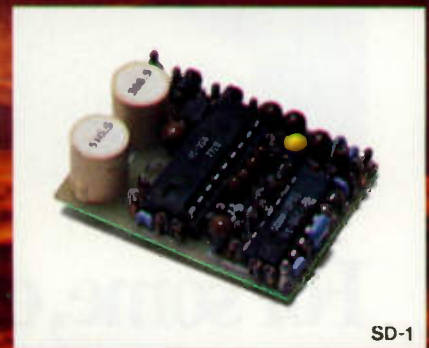

SD-1

THE DAWNING

The age of tone control has come to Amateur Radio. What better way to utilize our ever diminishing resource of frequency spectrum? Sub-audible tone control allows several repeaters to share the same channel with minimal geographic separation. It allows protection from intermod and interference for repeaters, remote base stations, and autopatches. It even allows silent monitoring of our crowded simplex channels.

We make the most reliable and complete line of tone products available. All are totally immune to RF, use plug-in, field replaceable, frequency determining elements for low cost and the most accurate and stable frequency control possible. Our impeccable 1 day delivery is unmatched in the industry and you are protected by a full 1 year warranty when our products are returned to the factory for repair. Isn't it time for you to get into the New Age of tone control?

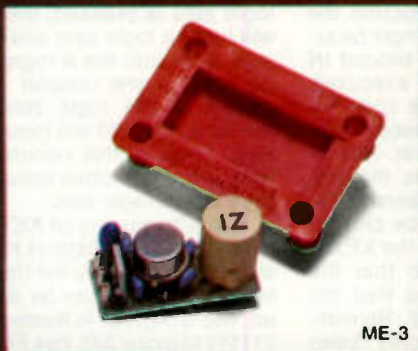

ME-3

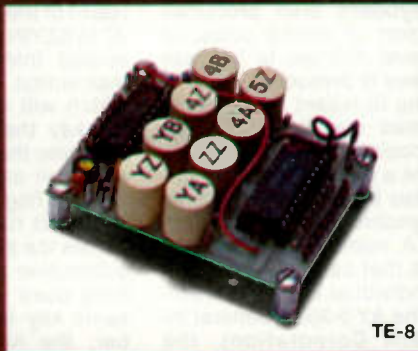

TE-8



TE-12

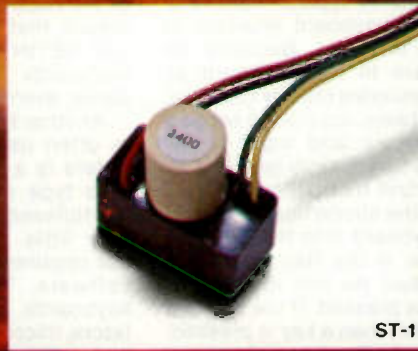

SD-1

OF A NEW AGE.

TS-1 Sub-Audible Encoder-Decoder • Microminiature in size, 1.25" x 2.0" x .65" • Encodes and decodes simultaneously • \$59.95 complete with K-1 element.

TS-1JR Sub-Audible Encoder-Decoder • Microminiature version of the TS-1 measuring just 1.0" x 1.25" x .65", for hand-held units • \$79.95 complete with K-1 element.

ME-3 Sub-Audible Encoder • Microminiature in size, measures .45" x 1.1" x .6" • Instant start-up • \$29.95 complete with K-1 element.

TE-8 Eight-Tone Sub-Audible Encoder • Measures 2.6" x 2.0" x .7" • Frequency selection made by either a pull to ground or to supply • \$69.95 with 8 K-1 elements.

PE-2 Two-Tone-Sequential Encoder for paging • Two call unit • Measures 1.25" x 2.0" x .65" • \$49.95 with 2K-2 elements.

SD-1 Two-Tone Sequential Decoder • Frequency range is 268.5 - 2109.4 Hz • Measures 1.2" x 1.67" x .65" • Momentary output for horn relay, latched output for call light and receiver muting built-in • \$59.95 with 2 K-2 elements.

TE-12 Twelve-Tone Sub-Audible or Burst-Tone Encoder • Frequency range is 67.0 - 263.0 Hz sub-audible or 1650 - 4200 Hz burst-tone • Measures 4.25" x 2.5" x 1.5" • \$79.95 with 12 K-1 elements.

ST-1 Burst-Tone Encoder • Measures .95" x .5" x .5" plus K-1 measurements • Frequency range is 1650 - 4200 Hz • \$29.95 with K-1 element.



COMMUNICATIONS SPECIALISTS

426 West Taft Avenue, Orange, CA 92667
(800) 854-0547, California residents use: (714) 998-3021



Microcomputer Interfacing

Christopher A. Titus
David G. Larsen
Peter R. Rony
Jonathan A. Titus

In the September column, we described several different seven-segment display interfaces as well as programs that can be used to display information on these displays. Here we shall describe the hardware and software required so that information can be entered into a microcomputer using a keyboard. There are a number of other general-purpose devices that can also be used to enter information into a microcomputer, including thumbwheel switches, analog-to-digital converters, thermostatic switches, and pressure switches. Of all the different input devices, keyboards are probably the most popular, simply because they are the most general-purpose input devices.

There are basically two types of keyboards that are used with microcomputers: *hardware-encoded* and *scanned*. A hardware-encoded keyboard, regardless of the type of keys used (metallic contact, Hall effect, capacitive), produces a unique code for each key. The code produced by each key may be ASCII, EBCDIC, binary, or

BCD. The encoder section of the keyboard also produces some sort of *strobe pulse*, or logic level change, to indicate that a key is pressed.

Owing to recent advances in integrated circuit technology, the encoding logic may not only produce a unique key code, but may also transmit the code as an asynchronous serial character. A number of integrated circuits that can be used to encode individual key closures include the AY-5-3600 (General Instrument Corporation), the MM74C922 and MM74C923 (National Semiconductor Corporation), and the 8279 (Intel Corporation). A typical hardware-encoded keyboard interface is shown in Fig. 1. Because the hardware in the keyboard already encodes the key closures, the software required to sense a key closure and input a key code is very simple (see Fig. 2).

The first instruction in Fig. 2 inputs the strobe line, or flag, of the keyboard into the 8080's A register. If the flag is a logic zero, then no key in the keyboard is pressed. If the flag is a logic one, then a key is pressed. The ANI instruction sets all the bits in the A register to a logic zero with the exception of bit D0, which represents the state of the keyboard's flag. If the flag

is a logic zero (no key is pressed), the A register will contain zero as a result of the ANI instruction and the JZ (jump on zero) instruction to KEYIN will be executed. When a key is pressed, bit D0 of the A register will be a logic one after the first IN instruction is executed. As a result of the ANI instruction, the JZ to KEYIN will no longer be executed. Instead, the second IN instruction will be executed, which will cause the code for the key that is pressed to be read into the A register. *This instruction also causes the keyboard's flag to be cleared.* The keyboard flag must be cleared before the 8080 calls the KEYIN subroutine again, so that the 8080 does not sense that the same key is pressed. Remember, the key has only been pressed once. After the key code is input, the second ANI instruction sets the parity bit (D7) of the code to a logic zero. This means that the programs that call KEYIN can be used with keyboards that generate odd parity, even parity, or no parity.

Another type of keyboard that is often used with microcomputers is a *scanned* keyboard. This type of keyboard, like a multiplexed display, requires very little interface hardware but requires a large amount of software. Typically, scanned keyboards are used in calculators, microwave ovens, single-board microcomputers, and low-cost microcomputer-based games. The interface for a 16-key keyboard, arranged as four columns of four keys, is shown in Fig. 3. The software that causes the 8080 to scan the keyboard and generate a unique code for each key is listed in Fig. 4. This software has to perform many of the functions that were previously performed by the hardware-encoding logic. For instance, the software must (1) sense a key closure, (2) debounce the key closure, (3) determine which key is pressed, (4) generate a unique key code for the key that is pressed, (5) wait for the key to be released,

and (6) debounce the key opening.

To detect if a key in the keyboard is pressed, the 8080 outputs a logic zero to one of the columns of keys and a logic one to the remaining columns. If one of the keys in the column that is being "driven" by the logic zero is pressed, the 8080 will input a logic zero and three logic ones into the A register. If no keys in the column being driven by the logic zero are pressed, the 8080 will input four logic ones. If this occurs, the 8080 will test another column of keys with a logic zero.

At the beginning of KEYSYN in Fig. 4, the D register is loaded with three, the code for the first key closure that can be detected. The B register is loaded with 11111110 (octal 376, hex FE), the first test pattern that will be output to the scanned keyboard. The test pattern is then moved to the A register where it is output to the keyboard. The same test pattern is then rotated once to the left, and the result, 11111101, is saved in the B register. The 8080 then inputs the row data of the keyboard and sets bits D7-D4 of the A register to zero (ANI 017). If no key in column A is pressed (keys 3, 7, 11, or 15), the A register will contain 017. If one of the keys in column A is pressed, the A register will not contain 017. Therefore, the JNZ to NXTKEY will be executed if one of the keys in the A column is pressed. If no key in this column is pressed, the 8080 executes the DCRD instruction, causing the content of the D register to be decremented from three to two. Since this value is not equal to 377, the 8080 jumps back to NXTGRP, so that the B column of the keyboard can be tested. Remember, the B register already contains the test pattern required to test this column of keys.

If a key in the A column is pressed (3, 7, 11, or 15), the 8080 calls the DELAY subroutine at

Continued on page 193

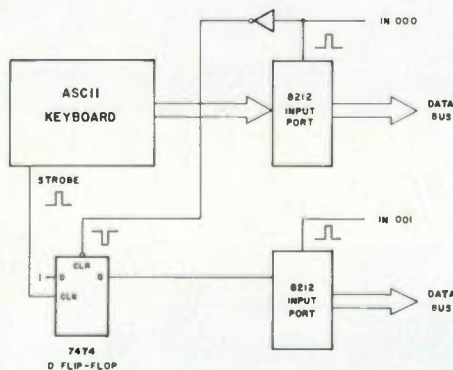

Fig. 1. A simple hardware-encoded (ASCII) keyboard interface.

```

/THIS SUBROUTINE SENSES A KEY CLOSURE ON AN
/ASCII KEYBOARD AND THEN INPUTS THE EIGHT-BIT
/PARALLEL ASCII KEY CODE.

KEYIN, IN      /INPUT THE DATA WORD THAT CONTAINS
001           /THE STATUS BIT FOR THE ASCII KEYBOARD
ANI          /SAVE ONLY THE STATUS BIT FOR
001           /THE KEYBOARD
JZ           /JUMP BACK TO KEYIN IF THE STATUS BIT
KEYIN       /IS ZERO, BECAUSE NO KEY IS PRESSED
0
IN          /A KEY IS PRESSED, SO INPUT THE
000         /ASCII CODE INTO A
ANI         /SET THE PARITY BIT TO
177        /A LOGIC ZERO
RET        /AND THEN RETURN TO THE CALLING PROGRAM
    
```

Fig. 2. A simple ASCII keyboard input subroutine.

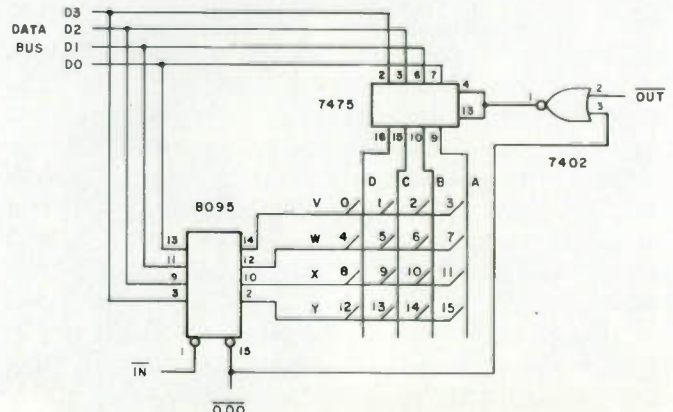

Fig. 3. The interface for a 4 x 4 matrix keyboard.

ATR-6800

A NEW DIMENSION IN DIGITAL COMMUNICATION
FEATURING THE FULLY AUTOMATIC ATR-6800 SPLIT SCREEN VIDEO
TERMINAL FOR CW & RTTY



ATR-6800 comes "FULLY LOADED" with all options
Direct hook-up to your Transceiver Nothing else to buy

- AFSK Generator with programmable MARK/SPACE
- Computer enhanced dual tone demodulator
- Audio-visual tuning aids plus scope output
- Automatic Response (WRU)
- 10 programmable message memories
- 4 programmable SELCAL memories
- Non-volatile (battery backup) memory
- 2000 character text buffer
- Split Screen - Type & Edit while receiving
- Black or white; Normal or Zoom display
- Real time clock
- Auto Ident for CW/RTTY
- Morse 1-199 WPM
- Baudot 60, 66, 75, 100, 130 WPM
- ASCII 110-4800 baud; Upper & lower case
- Printer-Speed Converter output
- Cassette "Brag Tape" record/play interface
- Computer mode (M6802) 4K byte RAM
- Full/half Duplex Computer Terminal Mode
- 16 I/O lines for external control



Plus much, much more . . .

ATR-6800 video terminal with built-in AFSK modem
and nine inch video monitor. Amateur net \$1895.

Ask your dealer or call for additional information.

Prices subject to change.



✓ M55

MICROLOG
CORPORATION

4 Professional Drive - Suite 119
Gaithersburg, Maryland 20760
Telephone (301) 948-5307

Contests

Robert Baker WB2GFE
15 Windsor Dr.
Atco NJ 08004

5 CONTINENT WORLD RTTY CHAMPIONSHIP 1979-1980

Sponsored by IATG-Radio-communications

IATG-Radiocommunications and CD Publications, in continuation of their more than 10 years of activity promoting the most advanced radio amateur techniques, have decided to sponsor a new series of contests for teletypers of all continents.

The purpose of the contests is not only to increase interest among radio amateurs for the radioteletype, but also to promote interest in long-range contacts, that is, to stress intercontinental contacts rather than domestic and intracontinental contacts as in previous contests.

For this purpose, IATG and CD have organized the following three contests: Australia-Oceania and Asia RTTY Flash Contest—3/4 November 1979; North and South American RTTY Flash Contest—19/20 January 1980; Europe and Africa RTTY Giant Flash Contest—9/10 March 1980.

For each of the three contests, there will be a general winner plus a winner from each of the two continents involved.

Separate standings for each continent plus a general standing for each contest will be published in *CQ Elettronica Magazine* and other magazines and points will be awarded as follows:

a) For contest winners: first place—50 points, second place—46 points, third place—43 points, fourth place—41 points, fifth place—40 points, etc., 44th place—1 point.

b) For continental winners (e.g., Australia-Oceania and Asia in the first contest): first place—25 points, second place—22 points, third place—20 points, fourth place—18 points, fifth place—17 points, etc., 21st place—1 point.

Standings are independent, that is, continental winners can also be general winners.

At the end of the three contests, continental and general standing points will be totaled and a *World Champion of the 5 Continents* will be declared according to the new final standing obtained.

Grand prizes, as usual, are reserved for the four first place winners. Consolation prizes along with medals and certificates will also be awarded.

AUSTRALIA-OCEANIA AND ASIA RTTY FLASH CONTEST

Contest periods:
0800 to 1800 GMT November 3
0800 to 1800 GMT November 4

This contest is sponsored by IATG-Radiocommunications to increase interest in intercontinental communications. Experience gained from this contest will be incorporated into the organization of future contests. All suggestions and constructive criticism are welcome. The DXCC list will be used except that the VE/VO, W/K, VK, PY, LU, JA, and UA0/9 call areas will be considered as separate

Results

RESULTS OF THE 9TH WORLDWIDE SSTV CONTEST 1979

Sponsor: IATG—Radio-communicazioni

1) SM5EEP	32,032
2) WB9OGS	31,360
3) IQVMV	30,688
4) IQPCB	26,418
5) W6WDL	25,974
6) HA6JI	21,216
7) G3WW	18,800
8) HA1ZH	16,224
9) HA5KBM	14,952
10) I4LRH	14,608

SWL

1) Tonzzer Luciano	1,722
2) Hans Schalk	378

countries. Use all amateur bands from 80 to 10 meters. Operating classes include single- or multi-operator, single transmitter, and SWLs.

EXCHANGE MESSAGE:

RST, number of the QSO, and continent.

SCORING:

Score 1 point per 80- or 40-meter QSO, 2 points per 20-meter QSO, 8 points per 15-meter QSO, and 12 points per 10-meter QSO. No points or multipliers for contacts with one's own country. Only 2x RTTY QSOs are valid. Each station may be contacted only once on any band; additional contacts may be made with the same station if a different band is used. Multipliers are given for countries and continents. A multiplier is given for each country worked on 20-10 meters. No multipliers for 80-40 meters. A separate multiplier may be claimed for the same country if a different band is used (max. of 3 times). Only countries which appear in at least 5 other logs will be valid as multipliers. One's own country is not valid as a multiplier. The continents are valid as multipliers; for contacts with Europe and/or Africa, the sender and the receiver will each be assigned 100 points as multiplier. 50 points will be assigned for each of the remaining continents contacted. An additional 100 points will be given for each contact with Australia-Oceania and/or Asia on 15 or 10 meters. Total points times total number of countries times total continent points plus total Australia-Oceania and Asia station points equals total score. Also, there are two promotional periods included in the contest: Saturday, November 3, between 1300 and 1400 GMT, and Sunday, November 4, between 1600 and 1700 GMT.

Stations operating from NA, SA, EU, and AF contacting Australia-Oceania and/or Asia during these hours will *double* their points for these periods.

RTTYers entering logs in the contest who have not participated in previous contests will receive an additional bonus of 5% of their final score. Winners of previous RTTY Championships will receive 10% of the total final score; there is an 8% handicap of the total final score for the winner of one or more previous RTTY contests. This contest is also open to RTTY SWLs with the same scoring.

ENTRIES:

Use one log for each band. Logs must contain date/time in GMT, callsign, RST, QSO number, continent sent and received, country, and continent multipliers, points, and final score. In order to qualify, all logs must be received not later than December 15th. Send all logs to: Prof. Franco Fantl, Via A. Dallolio n 19, 40139 Bologna, Italy. Grand prizes are reserved for the four first place winners. Consolation prizes along with medals and certificates will also be awarded. Logs with compiling errors which exceed 10% of the final score will be excluded from the final standing and will receive/serve only as check logs. Logs will not be returned.

REMEMBER: this contest is valid towards the final standing of the 5 Continent World Championship!!!

IPA CONTEST

Contest Periods:

Saturday, November 10

0800 to 1000 GMT

1400 to 1700 GMT

1800 to 2000 GMT

Sunday, November 11

0800 to 1000 GMT

1400 to 1700 GMT

1800 to 2000 GMT

The International Police Association Radio Club—Section Francaise (IPARC) has organized a contest which will enable participants to work the Sherlock Holmes Award. The contest is open to all radio amateurs and SWLs. General call is "CQ IPA." Non-members may contact only members.

EXCHANGE:

Non-members send RS(T) and serial number. Members send IPA, RS(T), and serial number.

SCORING:

Every completed QSO counts 2 points on 80 and 40 meters, 4 points on 20, 15, or 10 meters. Stations may be worked once per band. Cross-mode and cross-band contacts are not valid. Multiplier is the number of IPA countries worked per band. Final score then is the total

Calendar

Nov 3-4	ARRL Sweepstakes—CW RSGB 7 MHz CW Australia-Oceania and Asia RTTY Flash
Nov 10-11	CQ-WE Contest IPA Contest Delaware QSO Party
Nov 11	OK DX Contest
Nov 17-18	ARRL Sweepstakes—Phone Austrian 160 CW Contest
Nov 24	DAFG Short Contest—SW
Nov 24-25	CQ Worldwide DX Contest—CW
Nov 25	DAFG Short Contest—VHF
Dec 1-2	ARRL 160 Meter Contest TOPS CW Contest North Carolina QSO Party Connecticut QSO Party
Dec 8-9	ARRL 10 Meter Contest
Dec 22-23	Teenage Radio Sprint
Jan 5-6	QSL Exchange Contest
Jan 19-20	North and South America RTTY Flash
Feb 2-3	South Carolina QSO Party
Mar 9-10	Europe and Africa RTTY Giant Flash

Continued on page 196

MFJ SUPER CW/SSB FILTERS



\$59⁹⁵

MFJ-721 SUPER SELECTOR CW/SSB FILTER gives 80 Hz BW, steep SSB skirts, noise limiting.

CW Filter gives 80 Hz BW. No ringing. 8 poles give super steep skirts (60 dB down one octave from center freq. of 750 Hz). No tunable filter can match performance. BW: 80, 110, 150, 180 Hz. Reduces noise up to 15 dB.

SSB Filter improves readability. Reduces splatter, hiss, static, noise, hum. IC active filter has 375 Hz highpass cutoff; 2.5, 2.0, 1.5 KHz (36 dB/octave) lowpass cutoffs.

Works with any rig. AM, SSB, CW. Plugs into phone Jack. 2 watts for speaker. Inputs for 2 rigs. Speaker and phone jacks. Phones disable speaker. OFF bypasses filter. 9-18 VDC, 300 ma. 10x2x6 in. Optional AC adapter, \$7.95.

Switchable noise limiter for impulse noise; trough clipper removes background noise.

Simulated stereo for CW lets ears, brain reject ORM. Yet, hear off frequency calls.

\$44⁹⁵



THIS NEW MFJ-720 DELUXE SUPER CW FILTER gives you 80 Hz BW that is 60 dB down one octave from center frequency. 8 poles give super steep skirts with no ringing for razor sharp selectivity that no tunable filter can match.

Bandwidths: 80, 110, 180 Hz. Center freq.: 750 Hz. Up to 15 dB noise reduction.

Noise limiter. Plugs in phone jack. 2 watts for speaker. 2x4x6 inches. Requires 9-18 VDC, 300 ma. Optional AC adapter, \$7.95.



\$29⁹⁵
EACH

THE CWF-2BX SUPER CW FILTER AND SBF-2BX SSB FILTER are same as in the MFJ-721, less speaker amplifier, noise limiter. Plus in rig to drive phones or connect between audio stage for speaker operation. 9 V battery. 2x3x4 in.

Try it. If not delighted return within 30 days for refund (less shipping). One year unconditional guarantee. **Order today.** Call toll-free 800-647-1800, charge VISA, MC. Or mail check, money order. Add \$3.00 shipping. ✓M52

CALL TOLL FREE . . . 800-647-1800

For technical information, order/repair status, in Miss., outside continental USA, call 601-323-5869.

MFJ ENTERPRISES, INC.

BOX 494, MISSISSIPPI STATE, MS 39762

Govt. SURPLUS ELECTRONIC EQUIPMENT CATALOG

New ITEMS . . . New BARGAINS!

FREE UPON REQUEST!

✓F1 Send today for FREE copy of
New CATALOG WS-79 — and Supplement!

Address Dept. 73 • Phone: 419/227-6573

FAIR RADIO SALES

1016 E. EUREKA • Box 1105 • LIMA, OHIO • 45802

1-805-485-0942

VINEYARD AMATEUR RADIO

We sell Ten-Tec, Alda, SST, Wilson, Lunar, Mirage, and many others for less.

★ INTRODUCING ★

The RM-101 and TS-820 rcvr mod kit

If you own a YAESU FT-101 Series Transceiver or a Kenwood TS-820, the "RM" series mod kits will greatly improve AGC characteristics and signal-to-noise ratio, as well as reduce strong signal overload and internal noise.

Best of all, at \$14.95, the "RM" Series kit is an excellent investment in improved receiver performance.

Drop us a card or call for our low prices

VAR

Vineyard Amateur Radio

4407 Vineyard Rd.

✓V75 Oxnard, CA 93030



SCANNERS * SCANNERS * SCANNERS

YOU'VE SEEN THE REST, NOW BUY THE BEST

HAM SCAN-2

Kenwood 7400A, KDK 2015R, KDK 2016A, Pace Comm II, Midland 13-510, HW-2036, others

- Features one channel of memory, without need of resetting dials to zeros as required by others.
- Unit mounts totally inside of rig, no external boxes.
- Scanning rate 200 kHz nom, not 50 kHz, with a 3 second pause on all active channels before resuming scan.
- Mike-mounted switch provides 3 functions: scan start/stop, remote frequency incrementing, and transmit interlocking when in active scan mode.
- Totally assembled and tested \$59.95 \$1.50 shp.

Order HAM SCAN-2 and please specify type of rig

Technical Clinic

P.O. BOX 636

STERLING HTS. MI 48078

Phone Orders Call: (313) 286-4836

✓T64

✓ Reader Service—see page 243

All Bands Preamplifier



- Improved reception. For receivers and transceivers.
- Continuously tuneable 1.8-54 MHz. Covers all amateur bands 160 to 6 meters; all shortwave broadcast bands.
- Low noise figure. Up to 20 db gain. Reduces image and spurious response.

Here is an exciting new device to improve your reception on all bands 1.8 to 54 MHz. It gives up to 20 db extra gain and the low noise figure of a dual gate FET to pep up your noisy receiver or transceiver. And it adds a high Q tuned circuit to give improved overload capability and image reduction. Makes that tired old rig come to life again. Even helps new models dig into weak signal territory.

Works with all transceivers up to 350 watts input power. A unique and improved circuit automatically bypasses the preamplifier when the transceiver transmits.

A built-in 117 volt AC supply and a connecting coaxial cable for the transceiver are included.

Order yours now! Price \$89.50 plus \$3.00 shipping/handling U.S. & Canada. Calif. residents add sales tax.



Palomar Engineers

Box 455 | Escondido, CA. 92025

Phone: (714) 747-3343

New Products

REVIEW OF MAGGIORE COR IDENTIFIER

Everybody wants to build a repeater, it would seem. Many groups are stopped by the high cost of a "store-bought" machine and are unable to handle the task of designing the necessary logic for the identifier and COR circuits. If you fit this category, however, take heart. I was asked to do a review of the Maggiore COR Identifier, and since I have designed units for a competitor, it was felt that I would understand the unit and be able to appraise it in a knowledgeable manner. Before I get into the details of this unit, let me say this: If you are wanting to build a repeater, take a look at this unit.

When looking at the board, the first thing that you will notice is the diode matrix located at one end. The board given to me to test had 58 diodes installed. My first thought was, "Who wants to figure out and stuff all of those diodes?" My next thought was, "This unit comes wired and tested and diodes are a sure and safe way to program an ID." Upon closer examination, I found that the ID may be set for a short ID and the whole matrix does not have to be scanned, which is a nice feature.

Another nice thing about this unit is the provision for running a backup battery. If primary power fails and the repeater is running on battery, this unit produces a distinctive beep to signal the user that the repeater is on battery.

Interfacing this circuit to other circuitry should be a snap, because three inputs are provided

for squelch information. One looks for a high-to-low logic change, one looks for low-to-high logic change, and finally another looks for a small voltage change in the noise amplifier of the receiver. It would seem to me that this covers just about every possible need that might arise in building your repeater.

The COR also provides a choice between an adjustable time-delay drop or an instant drop with the drop of the received carrier. This COR/ID circuit also has a built-in timer for the ID circuit. Assuming the repeater has been sitting unused and somebody keys it, the ID will cycle once and the timer will trigger. Until the timer times out, the repeater will not ID again. This is a good way of doing the ID time as the repeater is in use. If the repeater has IDed and activity stops, the repeater will not ID at the end of the time cycle as the trigger that keys the ID after the timeout is the received carrier and that is not present since activity has stopped. The ID circuit produces an audio tone to go directly into the transmitter and has plenty of drive even to drive a small loudspeaker.

This circuit has another nice feature in that one of the option modes is a "beacon" mode. In this mode, the unit will produce a tone with regular IDs. This feature makes this unit good for the person who wants a beacon and might not even be interested in a repeater.

I did find a couple of things that I did not care for, but they are minor. One is the optional

beep. I like the idea of the beep, but on this unit it occurs the instant the COR goes, which says that it is right on the end of the squelch tail. In talking to the people at Maggiore, I am told there is an option on a separate PC board that can be added to allow an adjustable delay before the beep, but I am sure this is not a problem to lose any sleep over.

Another thing I noticed was the timeout function. It is adjustable and can be disabled, of course, but when it times out, the repeater drops. It can be in the middle of an ID or anything else. The repeater would drop off the air. If the offending carrier clears, there is no way for the other users to know, except to give a kerchunck to see if the repeater responds.

One very nice feature of this circuit is the output key. It is a relay so that there should be no problems with interfacing to anything.

In way of summation, let me state that I rate this Maggiore COR Identifier quite high. The design is straightforward; the PC board is double-sided and of the highest quality. The components are of high quality and are common parts. The circuit has a built-in connector so that it can be plugged in and out as necessary. And last but far from not least, *the unit comes wired, tested, and programmed.* I say that for the money, it's hard to go wrong on this deal.

Maggiore Electronics Laboratory, 845 Westtown Road, West Chester PA 19380; (215)-436-6051. Reader service number M36.

C. W. Andreasen N6WA
Van Nuys CA

KANTRONICS' GENERAL COMBO

Kantronics' General Combo is a complete, carefully-orga-

nized program with the upgrading amateur in mind.

The *General-Class Amateur License Study Guide*, SAMS #21617, by W0XI, explains radio circuits in an easy-to-understand style. The primary purpose of the text is to assist the prospective General in obtaining the General class license.

A second purpose of the text is to provide not only memorizable information for the exam, but also usable knowledge on electronics and practical radio circuits. The author's point of view is that an understanding of the material can then lead to a more detailed study of electronics later and to a greater enjoyment of our hobby, amateur radio.

Each chapter begins with introductory material and builds on this material to form more general concepts. The text explains the test, amateur regulations, radio-wave propagation, practical radio circuits, modulation characteristics, and transmission lines. Throughout each chapter, sample exam questions test your understanding of the material and prepare you for the FCC exam.

The General Cassette Tapes discuss rules, regulations, and radio theory in an interview format. The QSO Tape simulates exam-like "on-the-air" code transmissions. It progresses from 7½ to 15 wpm. Text key and practice exams are included. These test your proficiency in copying the content of the message and prepare you for the new FCC code test format. *Kantronics, Inc., 1202 E. 23rd Street, Lawrence KS 66044; (913)-842-7745.*

PERSONAL USE REPORT— THE BEARCAT BC-250 SCANNER

In the not-too-distant past, a great pastime was listening to

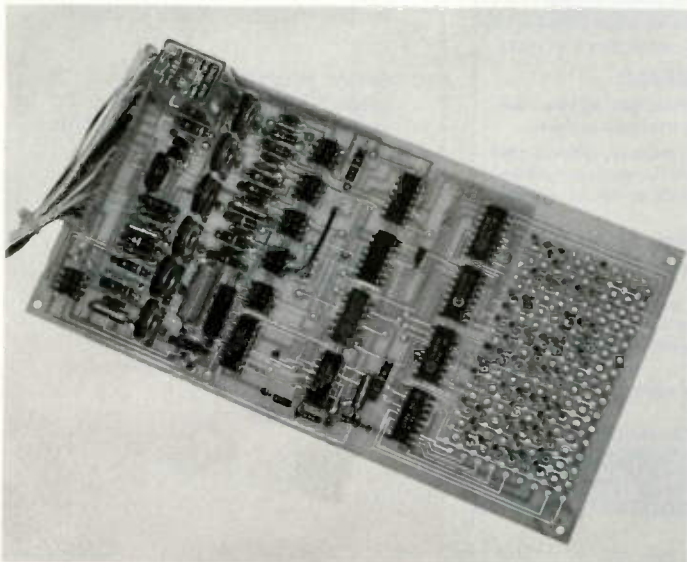

COR Identifier from Maggiore.

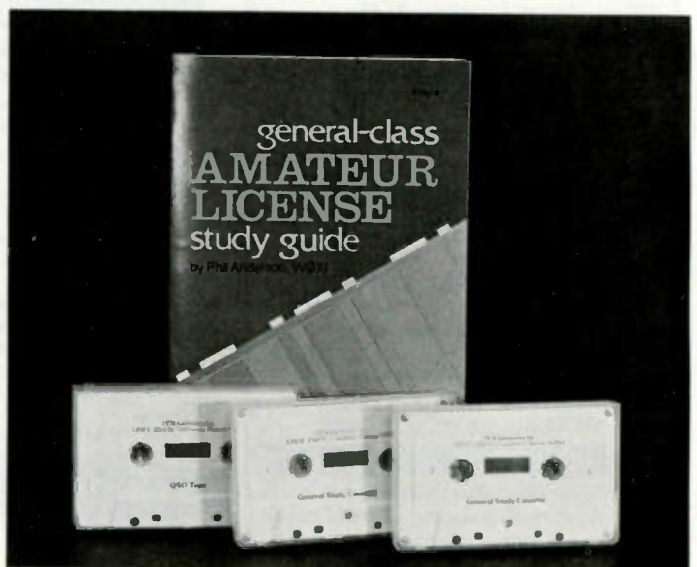

New study guide from Kantronics.

WHEN QUALITY COUNTS.....

COUNT ON OPTOELECTRONICS FOR STATE-OF-THE-ART,
TOP QUALITY FREQUENCY COUNTERS AT PACE SETTING PRICES.

NEW Model K-7000 [Kit]	7 Digits	550 MHz	\$ 79.95
NEW Model 7010	9 Digits	600 MHz	\$145.00
NEW Model 8010	9 Digits	1 GHz	\$325.00

Note: Model K-7000 is available "KIT FORM" only, other models factory assembled only. Model K-7000 requires #AC-70 Adapter (\$4.95) for 115VAC Operation, AC Adapters are included with the other models. See chart below for NI-CAD Battery Pack Option, etc.

ALL MODELS HAVE MANY STANDARD QUALITY FEATURES INCLUDING:

- ANODIZED ALUMINUM CASES - PROVIDING RF SHIELDING
 - 1 MEG AND 50 OHM INPUTS - WITH EXCELLENT SENSITIVITY
 - AUTO DECIMAL PLACEMENT AT Hz AND MHz
 - AC-DC or NI-CAD BATTERY PORTABLE OPERATION
 - FULL YEAR 100% GUARANTEE [PARTS ONLY ON K-7000 KIT]
 - NBS TRACEABLE CALIBRATION
- MADE IN U.S.A.
- COMPACT SIZES: 8010 = 3" H x 7 1/2" W x 6 1/2" D
K-7000/7010 = 1 3/4" H x 4 1/4" W x 5 1/4" D

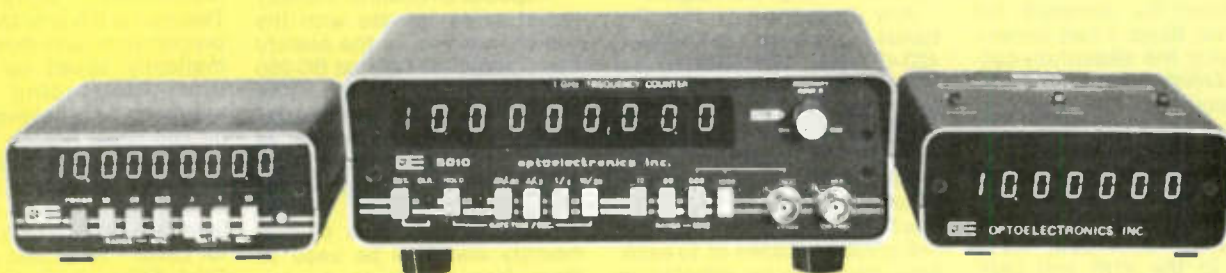

7010/7010.1
600 MHz
9 DIGITS

8010/8010.1
1 GHz
9 DIGITS

K-7000 KIT
550 MHz
\$79.95

MODEL	\$ PRICE	RANGE 10Hz to	LED DIGITS	SENSITIVITY			HI-Z INPUT 10Hz - 80 MHz	GATE TIMES	RESOLUTION			TCXO TIME BASE		EXT CLOCK INPUT	NI-CAD BATT PACK
				25-250 MHz	250-450 MHz	450 MHz-1GHz			12 MHz	60 MHz	MAX FREQ	20°-40°C	FREQ.		
K-7000 kit	79.95	550 MHz	7	5-20 mV	10-30 mV	20-50 mV to 550 MHz	1-10 mV	(2) 1.1 SEC	10 Hz	10 Hz	100 Hz 550 MHz	1.6 PPM	5.24288 MHz	NO	YES OPTION \$15
7010 7010.1	145.00 225.00	600 MHz	9	5-20 mV	10-30 mV	20-40 mV to 600 MHz	1-10 mV	(3) 1.1, 10 SEC	1Hz	1 Hz	10 Hz 600 MHz	1 PPM 0.1 PPM	10 MHz	YES OPTION \$25	YES OPTION \$15
8010 8010.1	325.00 405.00	1 GHz	9	1-10 mV	5-20mV	10-35 mV	1-10 mV	(8) 01-20 SEC	1 Hz	1 Hz	10 Hz 1 GHz	1 PPM 0.1 PPM	10 MHz	YES STD	YES OPTION \$39

*Has precision (0.1PPM) TCXO Time Base

Enjoy the great looks and ruggedness of the RF shielded metal case. Discover unsurpassed quality throughout for years of trouble free operation. Call or write for additional information or quick delivery of your order.

OPTOELECTRONICS, INC. ✓03
5821 N.E. 14th Avenue, Fort Lauderdale, Florida 33334

PHONE ORDERS
(305) 771-2050



TERMS: Orders to U.S. and Canada, add 5% for shipping, handling and insurance, to a maximum of \$10.00. All other orders, add 10%. C.O.D. collection fee \$1.00. Orders under \$15.00 add extra \$1.00 handling. Regular checks must clear before order is shipped. Florida residents add 4% sales tax.



The Bearcat BC-250 scanner.

police calls on about 1700 kHz, just above the standard AM broadcast band. I can remember tuning the beautifully-cabineted Zenith that stood in our living room and feeling the excitement as dispatchers sent cars to various incidents.

In the quest for more channels and better communications, the police (and other emergency services) have moved to the VHF and UHF spectrums. Public Safety Radio, as it is called, still has police and firefighters, news reporters, radiotelephone calls, air rescue, G-men, weather forecasts, and just about any other safety service that you might imagine. The frequencies may be different, but the excitement is still there, and scanning monitor receivers have become the hottest item in consumer electronics since calculators.

Several generations of product development have yielded the Bearcat BC-250 scanner by Electra. When I saw the specs of this programmable scanner, I had to have one. After using it for a few months, I feel that it is a complete listening post in one package.

This microprocessor-controlled scanner needs no crystals for any of its 50 synthesized channels; frequencies are entered directly by a simple numerical keyboard. An 11-digit LED readout displays frequency, channel number, and

function in large bold digits.

Any frequency in the five bands (32-50 MHz, 146-174 MHz, 420-450 MHz, 450-470 MHz, and 470-512 MHz) can be entered on any channel. Bearcat automatically retunes the front end for optimum sensitivity at any frequency, including the 2-meter and 450-MHz FM bands. The 50 channels are arranged in five groups or banks of 10 each. Each bank can be selected to scan or bypass. This allows you, for instance, to put the police on bank 1, fire on bank 2, and so on. My favorite local repeaters are on banks 3 and 4. If there are no QSOs that interest me, I just push a button and bypass those banks.

Momentary power outages or moving the radio to another room pose no problems for the BC-250. All frequencies are stored in a non-volatile memory that requires no battery. If power is lost, the scanner still retains all frequencies.

The Bearcat BC-250 has a unique search function to find those hidden or secret channels. Just enter an upper and a lower frequency limit and the BC-250 will check all channels between the limits. Active frequencies can then be read out on the display or entered into one of the 50 regular channels. It's great for finding those "secret" repeater inputs or special channels used by the local police.

A special 64-channel memory is set aside for use with the search function. In the search/store mode, the Bearcat BC-250 will search between the limits and automatically store the frequencies of up to 64 active channels. These can later be recalled on the display and/or entered into any of the 50 regular channels. The special memory also can be used to store frequencies to be bypassed during the regular search mode.

I hate to miss any action on the local "DX tip-off" frequency, so I program it on channel one. Priority listening is a selectable feature of the BC-250 that allows me to hear channel 1 whenever it becomes active, regardless of any other signals or functions. This is automatically done by momentarily sampling channel 1 and, if active, switching to that channel.

A two-second delay can be selected on any channel. This delays the start of scanning long enough to allow a reply to be heard on simplex channels. When things get boring on any channel, a lockout can be programmed. The BC-250 will then skip over that channel when scanning.

My favorite function available on the Bearcat BC-250 is the auxiliary control. This allows selective control of accessories connected to terminals on the rear of the scanner. I use the

auxiliary control to record the paramedic channels on a battery-operated tape recorder while I'm not at home. When I am at home and not in the shack, a Sonalert triggered by channel 1 lets me know that the DX net is active.

The Bearcat BC-250 is, of course, 100% solid state. Most of the functions are controlled by seven custom-designed ICs. It has a sensitivity (12 dB SINAD) of .4 microvolts VHF and .6 microvolts UHF. Dual power supplies allow operation on 117 V ac or 12 V dc. There are external antenna and speaker jacks on the rear, and the scanner comes with power cords and a mobile mounting bracket. Useful even when not scanning, the BC-250 also functions as a highly-accurate digital clock, displaying time to the second. The darn thing's so exciting, my CW is getting a little rusty.

Electra Company, PO Box 29243, Cumberland IN 46229. Reader service number E40.

James E. Arconati K0FBJ
Creve Coeur MO

MORSE CODE PROGRAM AVAILABLE FOR THE TRS-80

Cost Effective Computer Services announces the AMCT-80, a program for the TRS-80 to teach and build proficiency in receiving Morse code. AMCT-80 (Automatic Morse Code Teacher) is the only Morse code program available that will automatically speed up or slow down depending on the student's proficiency in receiving code. Among the many options is the ability to receive in single or group character mode. Written in machine language, AMCT-80 is available for Level 1 and Level 2 TRS-80. Cost Effective Computer Services, 728 S. 10th St., Suite #2, Grand Junction CO 81501. Reader service number C124.

NEW MULTI-PURPOSE TERMINATION WATTMETER

A new-concept series of 10/50/250-Watt to 100/500/2500-Watt Rf Absorption Wattmeters/Line Terminations with convenience features suggested by communications users has been designed by Bird Electronics Corporation. The eight new models are direct-reading termination instruments for servicing 50-Ohm communications systems and for maintaining them at peak operation.

The new TERMALINE® wattmeters feature three power ranges selected by switch. This flexibility, without the need to transfer the crystal diode, frees one hand for equipment fine-tuning or troubleshooting. The new series 6730 wattmeters can be checked and calibrated in the field to a known standard. Frequency coverage has been

AT LAST!!!

AN ALL NEW MICROCOMPUTER MAGAZINE FOR THE TRS-80*

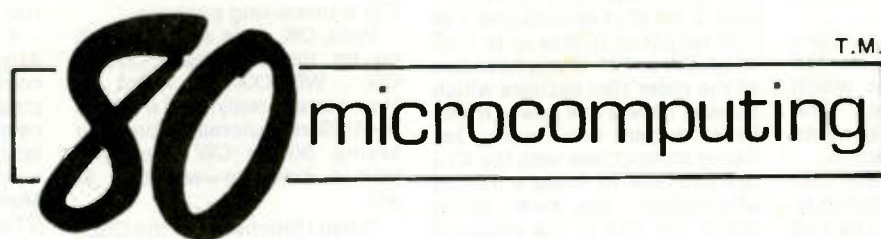

Subscribe today and take advantage of this super charter member offer . . . 12 months of **80 MICROCOMPUTING** for \$12 . . . (that's half the newsstand price) **PLUS**, if you subscribe now, we will send you **FREE OF CHARGE** a giant book of **80 PROGRAMS** for the TRS-80*.

80 MICROCOMPUTING is the only major publication that addresses your TRS-80* directly. This magazine contains a wealth of information designed to appeal to every owner of the TRS-80*, from business, personal, and educational software to upgrading your system . . . from reviews of new products to new languages . . . from text editing to music and more! You'll stay on top with this encyclopedia of information as the market—and the world—opens up to the TRS-80*.

Utilize your TRS-80* to its fullest potential . . . Subscribe today by sending in the coupon below or the attached postage-paid card and enjoy a Charter Subscription to this unique and informative magazine.

*(TRS-80 is a trademark of the Tandy Corporation.)

Yes! Sign me on as a Charter Subscriber to 80 Microcomputing for \$12 (half the newsstand price) and send me your giant book of 80 Microcomputing programs—FREE!

12 issues—\$12 36 issues—\$36
 Payment enclosed Please bill me
 Bill my: Master Charge Visa

Credit card# _____
Exp. date _____ Signature _____
Name _____
Address _____
City _____ State _____ Zip _____

Canada: \$12 per year U.S. funds only. Please add \$2 per year for Canadian currency. All foreign subscriptions \$26 one year only, payable in U.S. currency.



SNN2

Subscription Dept. • Box 981 • Farmingdale NY 11737

Yes! Sign me on as a Charter Subscriber to 80 Microcomputing for \$12 (half the newsstand price) and send me your giant book of 80 Microcomputing programs—FREE!

12 Issues—\$12 36 Issues—\$36
 Payment enclosed Please bill me
 Bill my: Master Charge Visa

Credit card# _____
Exp. date _____ Signature _____
Name _____
Address _____
City _____ State _____ Zip _____

Canada: \$12 per year U.S. funds only. Please add \$2 per year for Canadian currency. All foreign subscriptions \$26 one year only, payable in U.S. currency.



SNN2

Subscription Dept. • Box 981 • Farmingdale NY 11737



TERMALINE® Wattmeter, model 6736, 50/250/1000 Watts.

extended and the use of Schotky diodes increases long-term reliability.

Wattmeter and load sections are joined with the patented quick-change QC feature, which allows easy separation. The load resistor can then serve as an independent termination.

The eight models have full-scale power values of 250, 500, 1000, 1200, and 2500 Watts and frequency coverage of 25 to 1000 MHz or 1.5 to 35 MHz. Vswr of the terminating loads is less than 1.15 from dc to 1000 MHz. The new series joins established TERMALINE Wattmeters with scales from 2 Watts to 150 Watts. Available from Bird Electronics Corporation, 30303 Aurora Road, Cleveland (Solon) OH 44139; (216)-248-1200. Reader service number B10.

NEW UHF TRANSMITTING CONVERTER FROM HAMTRONICS

Hamtronics, Inc., has done it again! In the tradition of other fine products, they have a new UHF transmitting converter, and just in time to gear up for the new OSCAR Phase III. Designed to convert 28-30 MHz to

435-437 MHz or 432-434 MHz, the new model SV4 requires 1 mW to 1/2 W of drive to give 1 W PEP output on SSB or up to 1-1/2 W on CW or FM. If you have one of the older 10m exciters which doesn't have a low power transmitter output, don't worry, because instructions with the XV4 tell you how to make a simple attenuator. The best thing about the XV4 is the price—it costs much less than other types of equipment which have been available until now. Even adding an LPA 4-10 10-Watt linear power amplifier, a C432 UHF receiving converter, or a C144 VHF receiving converter to the system, you still save a bundle of money! The XV4 has an oscillator output to be used with a receiving converter if you like to transceive. It also has two oscillators, so it is easy to change frequency ranges without returning. For those who have a 2-meter multimode rig, an XV28 adapter is available to allow the XV4 transmitting converter to operate with a 2-meter input signal.

For more information, call or write for free catalog on these and other VHF and UHF kits, including preamps, converters,

FM transmitters, and receivers. Hamtronics, Inc., 65F Moul Rd., Hilton NY 14468; (716)-392-9430. Reader service number H16.

A REVIEW OF THE ATLAS TX-110

Cute little box! That was my first impression as I sat down before the dark grey and black cabinet. I had come into Georgetown Communications only to browse, with not a thought of spending a dime, even less of falling in love. A very impressive price, indeed, but was it a receiver or a transmitter?

"It's both," a voice behind me said. Carl N4AA, the owner, handed me a key and told me to take it for a spin.

You see, the Atlas RX-110S is Atlas's hot new allband receiver, and with the addition of the TX-110 transmitting module, it's an all-solid-state SSB and CW transceiving package.

Well, OK, let's see what it'll do on the oval track. Ah, a CQ...WB2XXX DE N4KJ... Hey, instant reply, and a 589 to boot! Semi-automatic break-in keying, 800-Hz CW filter, and built-in sidetone—not bad at all!

When I finished with the QSO, I asked Carl for a mike and quickly switched to 20 SSB. A W7 answered my CQ, but a bit high in frequency; no problem, the RX-110S is equipped with receiver incremental tuning. I'm impressed... I'll drive it home.

In the shack, I gave the little box a real operator's shake-down. The transmitter runs 20 Watts input or, with the high power module added, a full 250 Watts is possible. The output is broadbanded, which requires no tuning, and it's fed to the antenna via an SO-239 connector (not a cheap phono plug). In addition to the relative output meter on the front panel, there's provision to monitor current to the solid-state final amplifier. There's plenty of mike gain, and audio quality is excellent. The CW note is likewise "clickless" and chirp-free.

As I mentioned before, this is a transmitting module; certain stages of the RX-110S are required to make a complete transmitter. All connections for this are supplied through a 12-pin connector plug.

Jarring the receiver around, I found the mechanical stability excellent. Drift also is well within the 500-Hz figure as quoted in the manufacturer's specifications. The tuning dial reads to 5 kHz with 1-kHz marks on the tuning knob skirt. The handy RIT control I mentioned tunes up and down 5 kHz from the transmit frequency. When I switched the 800-Hz filter on a CW signal, a clean note with little ringing was realized. The re-

ceiver uses no rf stage, but behold the .25 microvolts for a 10-dB S + N/N sensitivity figure. Selectivity on SSB is 2.7 kHz at 6 dB down with a 2.2 shape factor, provided by a 6-pole crystal ladder filter. Image rejection is better than 60 dB. There's also plenty of audio—2 Watts into the internal 3-inch speaker. Dynamic range is rated at a terrific 80 dB above a noise floor of 130 dB. On-the-air tuning is smooth, and with no backlash you get the feeling of operating a much more expensive rig. Key down, the low-power transmitter draws about 2 Amps, or 16 Amps with the high-power module addition. I used my home-brew supply, but Atlas makes a nice matching supply along with many other accessories. A bracket and hardware are supplied to join the receiver to the transmitting module, making a great compact station.

I travel quite a bit, so the Atlas will be a nice traveling companion. Hours of operating pleasure are ahead from my new-found friend. So, congratulations, Atlas! A cute little rig!

Atlas Radio, Inc., 417 Via Del Monte, OceanSide CA 92054; (714)-433-1983. Reader service number A16.

Jerry Robinson III N4KJ
Asheville NC

M80 USER REPORT

The Macrotronics M80 ham interface for the Radio Shack TRS-80 computer includes an interface board and software for RTTY and CW operation. The hardware employs one board which provides access to the computer through the expansion port (an expansion interface is not required). On and off pulses generated by the computer can be coupled by a relay with normally-open or normally-closed contacts (or an accessory optoisolator for keying RTTY loops), a PNP transistor, or an NPN transistor. These options permit keying of virtually any transmitter for CW or FSK or the RS-232 Input of a TTY AFSK system. For receiving CW or TTY, the board transfers pulses to the expansion port of the computer. This can be accomplished by providing the board with receiver audio which is detected by a phase locked loop or by connecting the RS-232 leads of a demodulator to the board. With the optional optoisolator, the board can be keyed directly by the TTY loop supply.

The software includes machine-language routines for CW and TTY encoding and decoding and a BASIC program for running the system. The instruction manual supplied with

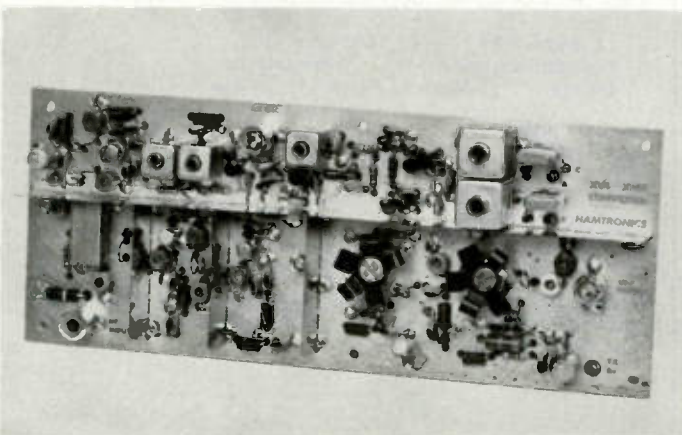

The XV4 transmitting converter from Hamtronics.

Continued on page 199

A Breakthrough In Technology!

THE YAESU FT-207R

MICROPROCESSOR CONTROLLED SYNTHESIZED HANDIE

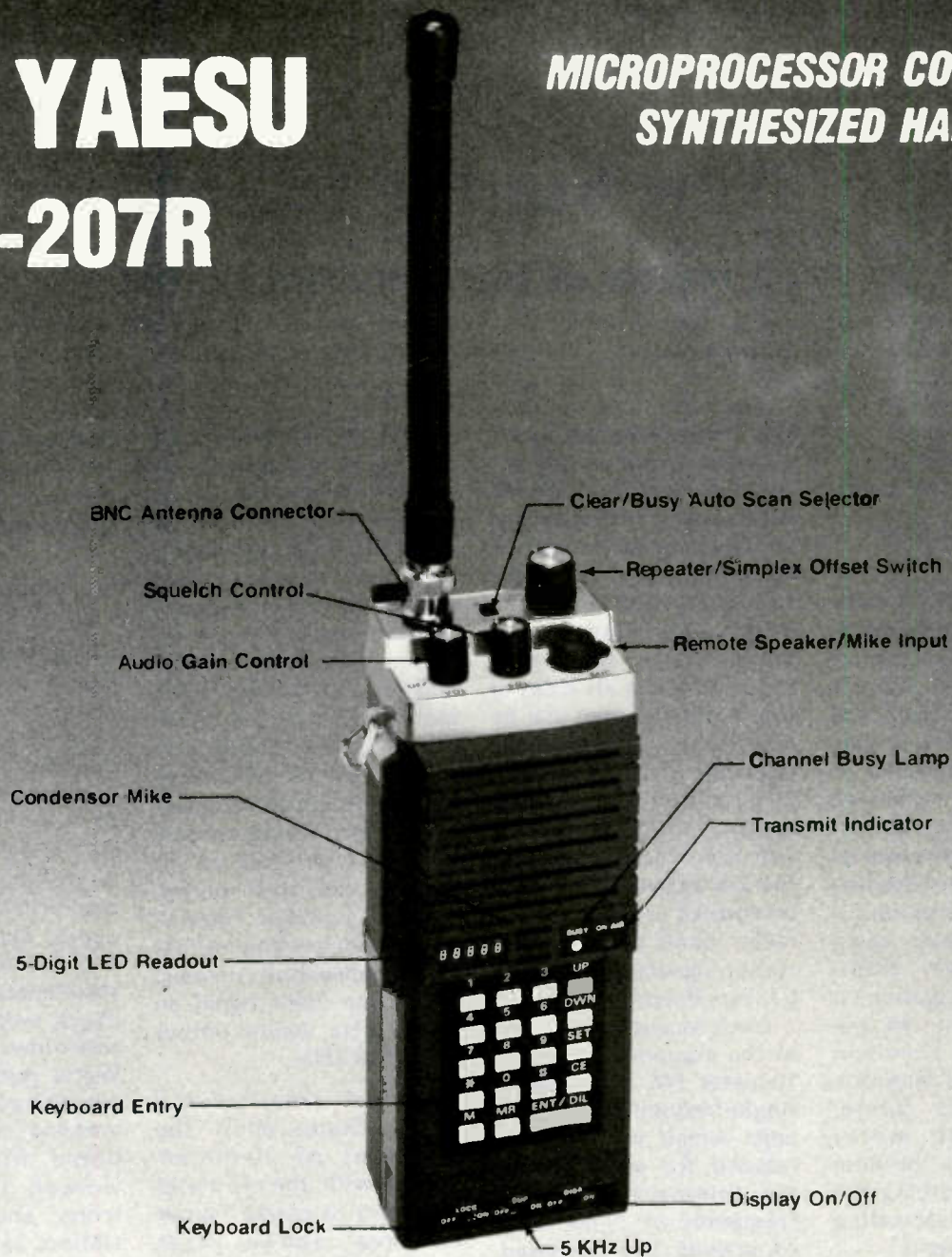

**The Yaesu FT-207R Synthesized Handie
has all the features you could want in a very compact package**

- 144-148 MHz Range
- 10 KHz Steps
- 3 Watts Output
- 4 Memories plus Programmable Offset
- Priority Channel
- Memory and Band Auto Scan
- Optional Equipment:
 - Keyboard Encoded Frequency Entry
 - 2 Tone (Touchtone®) Input from Keyboard
 - Keyboard Lock guards against accidental frequency change
 - Odd Splits Can Be Programmed from Keyboard
 - Automatic Battery Saver Feature for LED Display
 - Rubber Flex Antenna

Tone Squelch, Speaker/Mike, Nicads, Battery Charger



Price And Specifications Subject To
Change Without Notice Or Obligation

Y1
YAESU
The radio.



1179X

YAESU ELECTRONICS CORP., 15954 Downey Ave., Paramount, CA 90723 ● (213) 633-4007
YAESU ELECTRONICS Eastern Service Ctr., 9812 Princeton-Glendale Rd., Cincinnati, OH 45246

New Rig for 10 FM

— a review of the Comtronix FM80

*Dave Ingram K4TWJ
Eastwood Village 1201 South
Rte. 11, Box 499
Birmingham AL 35210*

An exciting new frontier in amateur communications is presently being pioneered on the high end of 10 meters, and this field promises to gain widespread acceptance in the near future. Channelized FM operations similar to those presently enjoyed on 2-meter FM are producing worldwide communications for amateurs using small, low-power transceivers. DX propagation on 10 meters is on the upswing, and this condition shows no sign of diminishing in the near future. Meanwhile, 10 meter FMers are having the time of their lives working the world on this fascinating high-frequency band.

Although 10 FM supports a substantial amount of activity each weekday,

this band becomes an absolute blowout of fun and pleasure every weekend. This super-excitement usually begins around mid-day Fridays and continues full blast until the band drops out Sunday evenings. During these periods, stations in all areas of the world frequent the internationally popular frequencies of 29,600 kHz or 29,620 kHz as activity booms and QSOs flourish. On numerous occasions, the DX activity on 10 FM resembles a gigantic 2-meter band opening with station signals stacking 5 or 6 layers deep.

Until recent times, most of the equipment used on 10-meter FM consisted of single-frequency business units which were usually retuned for operation on the International Direct Frequency of 29,600 kHz. As activity has increased, this "channel" has become quite busy, and secondary "channels" of 29,620,

29,640, and 29,680 kHz are also becoming popular. In order to assure the acceptance and future development of 10 FM, pioneering amateurs are now working toward the common goal of distributing on-the-air activities throughout the high end of 10 meters. Ultimately, this will divert mass pileups from 29,600 kHz during periods of intense activity. A substantial number of FM repeaters operate on the high end of 10 meters, and their performance is fantastic. Most of these repeaters employ 100 kHz input/output spacing, so that an input signal on 29,540 kHz would output on 29,640 kHz.

Several areas of the United States enjoy the pleasures of 10-meter-linking with their 2-meter repeaters to create "super machines". The Las Vegas machine, for example, permits HT-equipped amateurs to communicate with others thousands of miles away via a 2-to-10-meter link. An inestimable number of individually owned remote base units is active on 10 FM, and their operators truly have the world at their fingertips.

My first 10 FM rig was a single-frequency unit which ran 5 Watts on 29,600 kHz. I recently switched to the multi-frequency Comtronix FM-80, however, and the results have been a totally

new ball game. Obviously, the Comtronix FM transceiver will prove to be a super-innovation for 10 FM.

The Comtronix

When UPS delivered the Comtronix package, the carrier dropped it approximately 2 feet to the floor (what else is new)! I quickly unpacked the unit and carried it to my car to check damage. When I connected the FM80 and switched on power, stations in Montana and Washington state came booming through. The FM80 is definitely a stout-hearted rig! A quick check with my trusty W4 wattmeter indicated 10-Watts output, which was exactly as Comtronix advertised. While mobiling home that evening, I worked California, Arizona, and Alabama. All stations agreed the FM80's audio sounded very good and its signal strength was quite ample (low power is very popular on 10 FM).

During the first weekend I used the Comtronix, some serious medical problems limited my on-the-air operations to a total of 2 hours—and much of this time was interrupted for handling chores. I did, however, manage approximately 12 contacts with 9 countries in four of the world's 7 continents. The FM80 was used barefoot during these operations, and the antennas used



The Comtronix FM80 with matching microphone. This compact unit places the wide world of 10 FM directly at one's fingertips.

were either a Hy-Gain TH3 triband beam or Newtronics 4-BTV vertical. One DX contact was also made from my car while using a Hustler mobile whip. Need I say more?

The Comtronix FM80 is a compact unit which operates directly from an auto's 12-volt battery or an external 12-volt power supply. Current requirements are approximately 350 mA during receive and 2.2 Amps when the unit is transmitting at high power. Frequency coverage is 28,910 kHz to 29,700 kHz in eighty 10-kHz channelized steps. 40 channels are covered with a front-panel switch "in" (CHA), and the additional 40 channels are covered when this switch is "out" (CHB). FM operations are not legally permitted on the first 9 positions of CHA (28,910 through 29,000 kHz), so the operator must remember merely to listen in this range. 10 FM activity is far removed from this range on either CHA or CHB, however, so no problems should be encountered. Transmission on frequency positions 6 through 25 of CHB (29,360 through 29,550 kHz) should also be avoided, as this range is used by OSCAR amateur satellites. Considering that the FM80 is capable of covering part of the 73 10-meter band plan (provided the unit is modified for AM operation), plus receiving OSCAR satellite signals (provided a simple product detector and bfo are added), I suspect modification-oriented amateurs will make a mad dive for this rig. I'm already thinking of ways to use my FM80 on 29,150-kHz medium-scan TV, plus mating it with my similar-sized 2-meter rig for OSCAR mobile work. I have also used a 2-carrier operated relay interface between the FM80 and my TR-7600

for occasional remote base functions. A scanning adapter, priority channel, and memory function also are being considered, and a portable pack containing a motorcycle battery and short whip antenna are future considerations.

In addition to being an outstanding performer, the Comtronix FM80 is a beautifully engineered and packaged unit. A dark plastic sunscreen on the front panel's upper right corner covers the channel LED readout, illuminated S/output meter, and two function-monitoring LEDs. One LED is bipolar: green during receive and red during transmit. The other LED changes intensity according to audio input from the mike. This feature is particularly beneficial since FM signal amplitudes do not vary during modulation.

Since I also operate a Yaesu FT-901DM on 10 FM, I've received numerous requests for a personal comparison of the Yaesu and the Comtronix. Here is my opinion: The Comtronix is broadband—pretuned and all solid state, whereas the Yaesu uses 6146s and requires loading. I definitely prefer tube finals for low-band DXing and SSTV operations, but the FM80's "instant on" can't be beat for FM activity. Published specs rate the 901DM's receiver more sensitive than the FM80's, but I've found performance of both units identical. Yaesu suggests running the 901DM at 20-Watts output on 10 FM, and I think this is an excellent idea. Transmitted signal strength comparisons on the 901DM and the FM80 (10-Watt mode) are usually identical. Frequency/channel changes are easier with the FM80, but the 901DM's memory is great for repeater operations. Comtronix now has a split-frequency modifica-

10 FM Band Plan
29-MHz simplex operation on repeater output is OK if no intentional QRM is produced.

Repeater Inputs	Direct	Repeater Outputs
.520	.570	.620
.540	.600	.640
.560	.620	.660
.580	.640	.680
	.660	
	.680	

Table 1. 10 FM band plan.

tion for repeater operation and Cushcraft just introduced a 10m FM Ringo.

In conclusion, I feel 10 FM is a fantastic frontier and the Comtronix FM80 is a superb little rig. The unit is easy to carry, it's great for mobile operations, and it doesn't represent a life's savings when gleaming under the dash of an automobile. It will never replace my low-band all-mode transceiver (FT-901DM), but it isn't intended for that purpose. The FM80's receiver is double-conversion with a first i-f of 10.7 MHz and a second i-f of 455 kHz. Its

sensitivity is excellent (.5 microvolt for 20 dB quieting; squelch threshold also at .5 microvolt), and its selectivity is quite adequate (10 kHz at 15 dB and 20 kHz at 40 dB). Ultimate image rejection is better than -60 dB, and an rf output filter is included to eliminate spurious radiations.

If you would like to renew your interest in amateur radio and enjoy pioneering a great new frontier, grab one of these units and mobile to the nearest mountaintop. It's a grand experience. ■

START ENJOYING 10 METER FM...

in minutes!

80 chan.
10M transceiver
complete, ready-to-operate

(with addition of 12VDC and antenna).

- Freq. synthesized (28.9-29.7MHz) in 10KHz steps.
- Outstanding receiver w/MOSFET front-end and filter in I-F.
- 10W power output.
- Repeater off-set kit available.
- Broad band...no tuning required.

\$269 Suggested price.

Write for literature.

COMTRONIX, Inc.

116 Lark Center Drive, Santa Rosa, CA 95401 (707) 528-7670

✓C160

The Black Art of Antenna Design

— shedding some light on the workings
of vertical whips

The purpose of this article is to correct some widespread misconceptions about antennas. These misconceptions, as will be explained later, are not confined to certain users of an-

tennas, but evidently extend to some of the manufacturers as well. Unfortunately, there is a widely held belief that antenna design is a "black art." While I do not wish to undermine the livelihoods of those well-qualified antenna engineers who thrive on perpetuating the notion that the operation of an antenna is incomprehensible to the layman, I do feel that some of the secrets should be revealed in the interest of the betterment of ham radio!

The Problem

The problem to be treated in this article is related to the way in which antennas are connected to transmission lines. We will exclude from the discus-

sion microwave antennas such as horns or slots which are driven by waveguides. Practically all other antennas possess two terminals, the points at which one can say that the transmission line to the transmitter or receiver is connected, and the antenna begins.

The problem arises from what I shall call the "one-terminal impedance" misconception. As a starting point, let's take a look at an old and time-honored antenna, popular in the early days of ham radio, known as the "Zepp," and shown in Fig. 1(a). The Zepp consists of a half-wave wire, usually mounted horizontally, driven at one end by a two-wire transmission line. The feedline is normally one quarter-wavelength long, and is usually coupled inductively to a tuned circuit at the driving end. The antenna is said to be "voltage fed" because the extremity of a wire antenna is a point of high voltage and low current.

You must surely agree that terminals A and B in Fig. 1(a) are the input terminals of the antenna because this is where the two-wire transmission line is connected. If we concentrate on the antenna alone, we have the situation portrayed in Fig. 1(b), where point B is one end of the half-wave antenna, while point A is a disembodied point hanging in the air. What, then, is the impedance terminating the transmission line? It is evidently infinite, because an impedance is the ratio of an ac voltage to an ac current. An ac voltage, V_{ab} , applied across the two terminals of an antenna should certainly excite the antenna. If such a voltage generator is applied across terminals A and B, as shown in Fig. 1(c), no current can flow, because the same current which goes out of one terminal of the generator must come into the other, and in this case, terminal A is not connected to anything. But there *must* be a finite current entering the

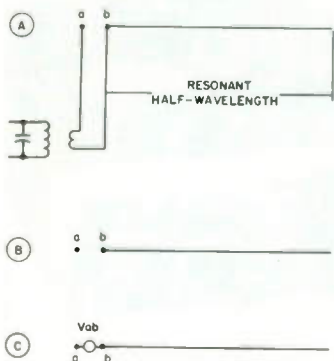

Fig. 1. (a) Zepp antenna with feedline. (b) Zepp with feedline removed. (c) The one-terminal impedance.

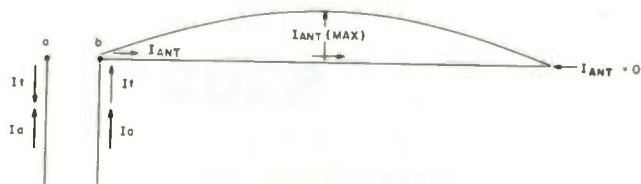

Fig. 2. Current distribution on the Zepp antenna.

antenna at the feed point, or there could be no power radiated by the antenna! Here lies the misconception which I have called "one-terminal impedance."

This dilemma was known to at least some of the early users of Zepp antennas, as can be verified by studying technical literature on the subject written 40 years ago. The truth of the matter is that the transmission line *must* also be a part of the antenna.

Since the horizontal part of the antenna is a half wave in length, there will be a standing wave of current along the wire with a magnitude of zero at the far extremity, maximum in the center, and small, *but finite*, at the driven end (see Fig. 2). The magnitude of this input current depends on the length-to-diameter ratio of the wire, and will be about 25 percent of the maximum current at the center for a length-to-diameter ratio of 100. The current on the transmission line wires will be composed of two components, the first of which is the ordinary transmission line component with equal and opposite currents on the two legs. This component is designated as I_t in Fig. 2.

The second component is the antenna current, with equal amplitudes and equal directions on both legs, shown as I_a in Fig. 2. At point A, the total current must be zero. Thus, I_t and I_a must be equal in amplitude but 180° out of phase to add up to zero at A, and equal in amplitude but in phase to add up to the current entering the antenna at point B, labeled I_{ant} .

The transmission line currents are produced by the transmitter, usually through inductive coupling at the input end of the two-wire line. The antenna current is in the form of a standing wave on the antenna wire, but its distribu-

tion along the feedline is in some doubt. The electromagnetic field due to the transmission line currents alone is localized in the near neighborhood of the feedline, but the field due to the antenna currents is not so confined—in fact, it produces substantial radiation from the feedline. There will be coupling by this field to nearby objects such as to the building in which the transmitter is located, and to any electrical conductors nearby. The input end of the feedline will have inevitable capacitive coupling to the transmitter chassis, and the entire transmitter will be hot with rf, along with the house wiring. At higher power levels, the operator may receive rf burns when his lip brushes up against a metallic microphone! Frankly, the old Zepp antenna is a mess!

All of this is easily corrected by moving the feedline to the center of the half-wave dipole, which is a point of symmetry. The radiating antenna currents are now confined entirely to the antenna and no antenna currents are superimposed on the transmission line currents. Note, however, that this situation prevails only as long as a balanced transmission line is used to feed the antenna. If coaxial cable is used, then an appropriate "balance-to-unbalance" transformer, or balun, must be employed between the coaxial line and the antenna to inhibit currents from flowing on the outside of the coaxial cable.

While the old Zepp antenna is rarely used today, there are many other antennas in common use which must be driven from one extremity. These are the class of vertical whips in which the feedpoint is elevated above earth ground, highly popular for base station use in the VHF

and UHF bands in amateur, commercial, and marine service. This class of antennas is used in an effort to obtain vertically-polarized radiation which is omnidirectional in azimuth. Unfortunately, the one-terminal impedance misconception, which should have been laid to rest 40 years ago, has reappeared with a vengeance!

Antennas are commercially available from a number of different manufacturers which consist of a vertical whip extending up from an impedance-matching network at the base, which is fed through a coaxial cable connector. The most popular lengths for the whip are $1/4$, $1/2$, and $5/8$ wavelength. If this type of antenna is used on the outside metal surface of an automobile, there is no problem. One has a kind of highly-unbalanced dipole, one leg of which is the whip, the other being the outside metal surface of the car. The outer conductor of the coaxial cable is electrically connected (either conductively or capacitively) to the car body, while the center conductor couples to the whip. The

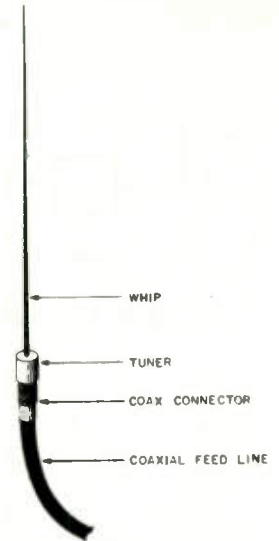

Fig. 3. Typical whip with base tuner connected to a coaxial line.

same magnitude of current which enters the base of the whip must also spill out over the car body. If the antenna is mounted at a point of symmetry, ideally at the center of the rooftop, current will flow radially out from the base of the whip, as in the case of a vertical broadcast antenna system. The car top is an elevated "ground plane" of finite size. The radiation pattern will show only minor variations in azimuth, but the maximum radiation inten-

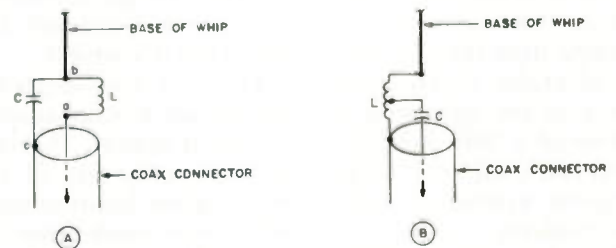

Fig. 4. Tuners for end-driven whips. (a) L-network. (b) Tapped-inductor.

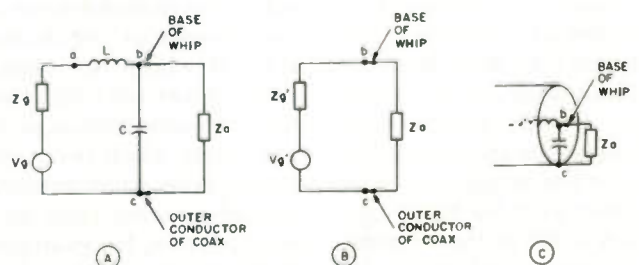

Fig. 5. Equivalent circuits of end-driven whip.

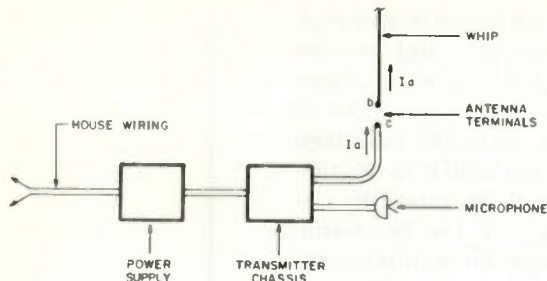

Fig. 6. The complete end-driven whip.

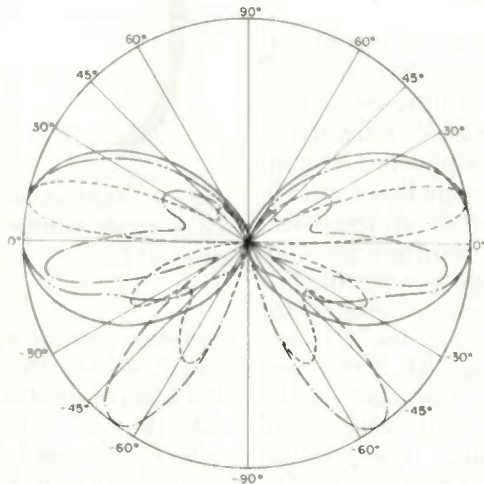

Fig. 7. Measured radiation patterns showing relative power vs. vertical angle: 1. --- half-wave whip, no decoupling. 2. - · - · - 5/8-wavelength whip, no decoupling. 3. — — — half-wave whip with quarter-wave decoupling sleeve. 4. — — — reference half-wave center-driven dipole.

sity will typically occur at some vertical angle above the horizon. This effect is usually tolerated as the price to pay for the simplicity and economy of the simple vertical whip extending from the car body. (Incidentally, severe asymmetry in the mounting location of a VHF vehicular whip can result in a highly-irregular azimuthal radiation pattern).

The great one-terminal impedance misconception rears its head again when an automotive-type whip antenna is connected to the end of a coaxial transmission line, with the automobile deleted. This situation is not uncommon. Many an amateur radio operator has bought an automotive whip for home use, stuck it out of the window, and connected it to his 2-meter base station

through a length of coaxial cable. If he could only see where the rf was going, he would be shocked! (At the end of this article I will reveal the design of a handy device which actually can make the rf visible!)

For ham use, degraded performance is not usually a critical matter. The user may be unaware of the degradation because he is still able to work other stations. The user may be quite happy. Unfortunately, users rarely receive any technical guidance from either the manufacturer of the antenna or the dealer, both of whom are principally concerned with sales. A much more serious problem arises when the automotive-type whip antenna is used in other than ham radio service, for example, in the marine band of 156-162 MHz. If you happen to

live in a coastal area where large marinas are located, look at the sailboats and see how many vertical whip antennas of the thin wire, automotive type are mounted on the mast-heads. As will be explained below, this type of antenna system can produce severe degradation of the radiation pattern, caused by unwanted currents excited on the outside of the coax line as well as on the stays, shrouds, and the mast itself—all functioning as long-wire antennas. The degradation in communications performance could result in tragedy because of the inability of the boater to summon help in an emergency situation. I cannot believe that the manufacturers and dealers of these antennas are aware of the problem; it is much more likely to be a matter of ignorance. It happens that there *do* exist well-designed vertically-polarized marine VHF antennas on the market, in which the radiating element is superbly decoupled from the coax line and mounting structure. It is unfortunate that in this consumer-oriented market, when the sailboater asks for a lightweight VHF antenna, the dealer happily sends him off to his (possible) doom with degraded communications capabilities!

Returning to the one-terminal impedance misconception, Fig. 3 portrays a typical coaxially-driven whip antenna with tuner in the base, connected to a coaxial cable. The antenna might be either a half-wave or 5/8-wavelength whip.

A popular network for impedance-matching the whip to the coax line is shown in Fig. 4(a). This is an L-network in a configuration useful for a load impedance whose resistive part is greater than 50 Ohms, as in the case of both the 1/2- and 5/8-wave-

length whips. Another possible tuning network, using a tapped inductor, is shown in Fig. 4(b). Capacitor C in Fig. 4(b) is sometimes deleted, and the length of the whip is made variable in order to gain another tuning parameter.

We now come to another point about which I suspect there are misconceptions among many amateur radio operators. This concerns the respective roles of the *inside* and the *outside* of the coaxial line. The transmitter normally resides within a rather well-shielded box. The signal generated by the transmitter is conveyed *within* the coax line to the feedpoint of the antenna before it (the signal) emerges and first "sees the light of day." I like to call the shielded interior of the transmitter and the inside of the coax cable out to the antenna terminals the "inside world." The "outside world" consists of the whip antenna *and the outside surface of the outer conductor of the coax line!* This is the point missed by many users of antennas. They perceive of the coax line purely as a transmission line connecting their transceiver to the antenna, and fail to understand that it can also be a part of the antenna. Please understand that this is not a new or revolutionary concept, but has been well understood by antenna engineers during at least the last 35 to 40 years.

Looking down into the coax line between points A and C—see Fig. 4(a)—we can replace the "inside world" by a voltage source, V_g , in series with an internal impedance, Z_g . This is an application of Thevenin's theorem—well known to all electrical engineers. The voltage source drives the antenna impedance, Z_a , through the LC network, as shown in Fig.

5(a). The circuit can be simplified by including the tuner as a part of the effective source impedance, looking back toward the source at terminals B and C, as shown in Fig. 5(b). The effect of the tuner is to modify the source voltage to a new value, $V_{g'}$, and the source impedance to $Z_{g'}$. The tuner can properly be considered to be a part of the "inside world." You could just as easily mount the L and C elements just inside the coax line as shown in Fig. 5(c).

Aha! We now note that the load impedance terminating the coax line is connected across terminals B and C. If we disconnect the coax line with its tuner from the antenna, we are left with only one terminal (B), the other terminal having been carried away with the coax line! The one-terminal impedance problem has struck again.

We are led to the correct conclusion that the coax line must provide the other "half" of the antenna. Antenna currents *must* be carried on the outside of the coax line. Unlike the open-wire feedline of the Zepp antenna, where transmission-line and antenna currents were superimposed, the coax line forces the antenna currents to be entirely on the outside of the outer conductor. This results from the fact that a coaxial line forces currents *within* the line to be equal and opposite on the center conductor and inside wall of the outer conductor, respectively. The antenna current is forced to flow on the outside surface of the outer conductor.

The antenna is really a horrendously unbalanced dipole, as shown in Fig. 6, the two sides being (1) the whip itself, and (2) the outside of the coax line all the way to the transmitter, the outer box housing the transmitter, and, very pos-

sibly, many other conductors associated with the system, such as the microphone cable, leads to a power supply, house wiring, etc.

The magnitude of the antenna current at all points along the outside of the coax line is not easily predictable. One can be sure that at the feed point the instantaneous current, I_a , entering the whip must be exactly equal to the antenna current at the extremity of the outer conductor of the coax line (see Fig. 6). Below the feed point, the current on the outside of the coax will probably be in the form of standing waves produced by reflection processes at the bottom end of the coax-transmitter system. At the antenna terminals, the standing-wave amplitude on the outside of the coax could produce a current maximum (resonance), current minimum (anti-resonance), or anywhere in between. If there are many wavelengths of coax between the transmitter and the antenna terminals, there will be only a small percentage difference in frequency between resonance and anti-resonance. The degradation of the radiation pattern is highest for antiresonance conditions on the cable, at which time the resulting radiation pattern in the vertical plane will be broken up into a mass of lobes. Additional degradation will result from power loss where the coax line is in close proximity to lossy materials, such as the wall of a house, the ground, etc. Also, horizontal runs of the coax between the antenna

and the transmitter will radiate a component which is cross-polarized with respect to the radiation from the whip.

If you are skeptical, make up an rf sniffer like the one described at the end of the article, and convince yourself! Connect a 2-meter band, automotive-type whip at the end of a length of coaxial cable of arbitrary length—3 feet, 6 feet, 10 feet—whatever is available. Connect the other end to your 2-meter rig. Ten Watts of output power is a satisfactory level for good rf sniffing, but higher power produces more spectacular results.

First, while transmitting (on some unused frequency!), bring the coupling loop of the sniffer up toward the whip. For maximum coupling, the plane of the loop should lie in the plane containing the whip. Tune the loop with an insulated tuning tool to obtain maximum brightness in the indicator lamp. You can search along the whip and see the standing wave of current, since the loop is magnetically coupled and a point of maximum brightness means of a point of maximum current. Now search with the sniffer along the coax line below the antenna. Provided that your rig really is putting out the better part of 10 Watts, or more, the sniffer will light up merrily along the coax all of the way back to the rig!

I have performed this demonstration (with good effect) before a number of different ham groups. At one meeting, I also demonstrated a 2-meter model of

a Zepp antenna, and showed how the feedline was strongly radiating. After the meeting was over, one of the old-timers present said to me, "That demonstration of the Zepp was like killing an old friend!" I prefer to think that I was helping kill an old bandit who had been

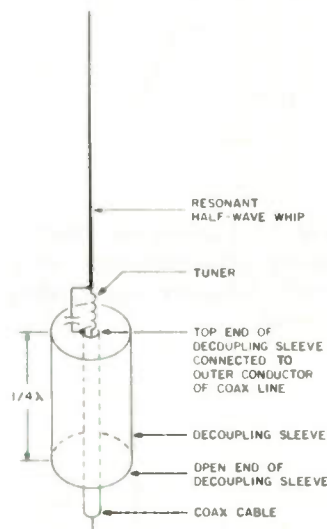

Fig. 8. Half-wave whip with quarter-wave decoupling sleeve.

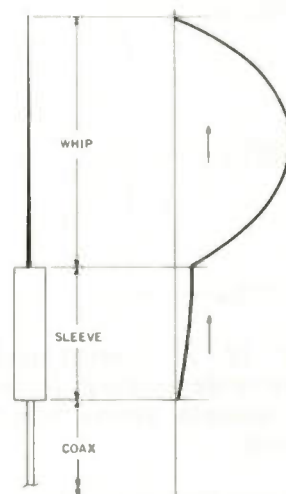

Fig. 9. Current distribution on a sleeve-decoupled half-wave whip.

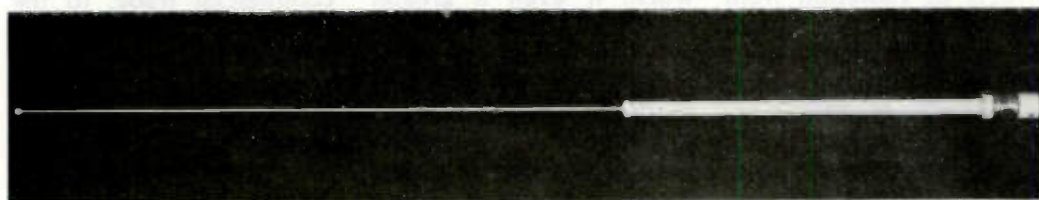

Fig. 10. Sleeve-decoupled half-wave whip designed for marine VHF use

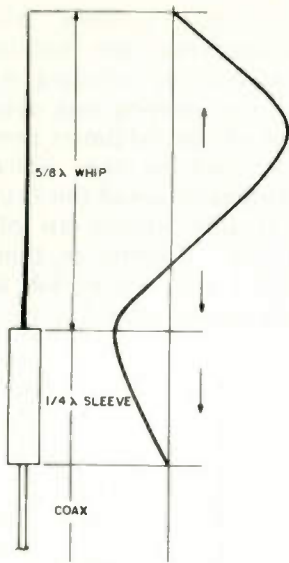

Fig. 11. Current distribution along $5/8$ -wavelength whip with $1/4$ -wavelength decoupling sleeve.

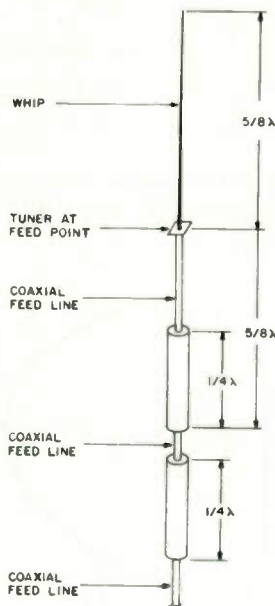

Fig. 12. A coaxially-fed, sleeve-decoupled $1\frac{1}{4}$ -wavelength center-driven dipole.

robbing the hams of rf power for years.!

Some representative measured radiation patterns of whips showing the effects of radiation from the coax line are shown in Fig. 7. The azimuthal pattern of a vertical whip is necessarily omnidirectional. The radiation pattern in the vertical plane is most easily measured by supporting the whip horizon-

tally above a turntable, and rotating it in the horizontal plane at a fixed height above the earth. A signal generator on the turntable drives the antenna, and the radiated signal is picked up at some distance away on a horizontally-polarized antenna, amplified, detected, and plotted on an automatic chart recorder, the paper drive of which is synchronized with the rotation of the turntable. The vertical polar diagrams of Fig. 7 were obtained in this way, using a commercial antenna pattern recorder and facilities of the University of Washington. The original recordings were made in terms of a decibel plot on an X-Y recorder, and were carefully replotted in a polar diagram to make the result more generally understandable.

Fig. 7 shows the relative radiated power versus vertical angle for 3 different end-fed whip antennas, all patterns normalized to a maximum value of unity. Each of these antennas was mounted horizontally, with the coaxial feedline extending out in line with the whip for a distance of $8\frac{1}{2}$ feet, and then coming vertically down to near ground level, and then back to the turntable.

Pattern 1 is that of a commercial half-wave whip with tuner in the base. Note how the pattern is of "butterfly" shape, with lobes above and below the horizon. This is a typical result of the radiation from the coax combining in and out of phase with the component from the whip. The pattern would be much worse if even a greater length of coax extended down from the base of the whip, the main effect being to break up the vertical pattern into a mass of lobes, with no assurance that there would be a maximum of radiation toward the

horizon.

Pattern 2 is that of a $5/8$ -wavelength whip with base tuner, and it exhibits considerably more severe degradation than the half-wave whip. This arises from the larger base current of a $5/8$ whip than in a half-wave whip, resulting in a correspondingly larger "spill-over" current on the outside of the coax.

Pattern 3 is that of a half-wave whip with a quarter-wavelength decoupling sleeve, to be described in the next section. Only slight pattern distortion is evident, this being due to the small current necessarily excited on the decoupling sleeve.

Finally, pattern 4 is that of a center-driven balanced dipole which is used as a test antenna to calibrate the antenna range.

The Cure

The conclusion to be drawn from the above discussions and test results is this: Use your mobile whip antenna where it belongs (on your car) and be skeptical of any commercially-available antennas which are claimed to be designed for base station use but which consist of an end-driven vertical radiator with no decoupling system evident.

How then can you radiate a clean, omnidirectional, vertically-polarized signal from an end-driven whip antenna, and know that it is performing correctly? Again, we turn to the old pros, the antenna engineers who have known how to design such antennas for the last 40 years, and have been furnishing them to the commercial trade, to the military services, the government agencies, the telephone company, etc. These are the sophisticated users, who are not fooled by advertising claims, and who insist on proof of performance, including mea-

sured radiation patterns under specified conditions and measured gain figures, before they buy.

The solution to the problem of end-driving the whip is to employ a suitable "decoupling system" to inhibit the antenna currents from flowing down the outside of the coax. For the VHF bands, one of the most widely used and (when properly designed) highly effective systems employs a $1/4$ -wavelength section of tubing, extending down from the base of the whip over the outside of the coax line, as shown in Fig. 8. This system is very effective for half-wave whips, very poor for $5/8$ whips, and only fair for $1/4$ -wave whips. (This last design has been called a "sleeve dipole" for many years.)

Note in Fig. 8, which shows a half-wave whip, that the outer conductor of the coax line at the base of the whip is folded down and over the coax in the form of a quarter-wave sleeve, which is open at the bottom. For good decoupling, the diameter of the sleeve must be considerably greater than the outer diameter of the coax line, at least in the order of 5 or 10 to one. Looking up into the open end of the sleeve, one sees a coaxial line with the sleeve as the outer conductor, and the outer surface of the feed coax as the inner conductor. This coaxial line is open at the bottom end, but terminated at its top end in a short circuit. At quarter-wave resonance, there is a high impedance between the lower lip of the sleeve and the inner coax line. This impedance is in the path of the "spill-over" current, and forces a current minimum to exist at this point. There is a portion of a standing wave of current on the outside of the sleeve, with maximum amplitude at the top of the sleeve. This max-

imum amplitude is small, since it must be equal to the base current entering the whip. The other end of the standing wave is at the open end of the sleeve, where the current amplitude is practically zero. The outside of the coax line below the sleeve is now very effectively decoupled from the antenna. The current distribution along the entire structure is shown in Fig. 9. The small section of a standing wave on the decoupling sleeve is in phase with the current on the whip, but has little effect on the radiation pattern, as was shown in Fig. 7. A commercially-available version of this antenna, designed for the 156-162-MHz marine VHF band, is shown in Fig. 10. This antenna is particularly attractive for masthead mounting on sailboats, because the decoupling sleeve prevents the stays, shrouds, mast, etc., from becoming inadvertent parts of the antenna.

A $5/8$ -wavelength whip cannot be decoupled effectively with a quarter-wave sleeve, as can be seen by the current distribution shown in Fig. 11. The standing wave of current along the whip has a phase reversal one half wavelength down from the top. The feedpoint current amplitude is 70 percent of the maximum current, and the current at the top of the decoupling sleeve must have the same amplitude and phase as the current at the base of the whip. The result is that even though the coax line below the sleeve may be fairly well decoupled, the radiation pattern of the antenna will be poor. Radiation toward the horizon from the upper and lower halves of the system tends to cancel, with maximum radiation occurring in lobes at high and low angles.

A more intelligent way to drive a $5/8$ -wavelength whip is to place the quarter-wave

decoupling sleeve down below the feedpoint so that the open end of the sleeve is $5/8$ wavelength below the feedpoint, as shown in Fig. 12. The antenna now becomes a center-driven $1-1/4$ -wavelength dipole, which happens to be the "magic" length needed to produce power gain toward the horizon of 3 dB

with respect to an ideal vertical half-wave dipole. This is the maximum gain attainable from a center-driven dipole, and is certainly worth getting.

Experimental measurements have shown that a single quarter-wave sleeve terminating the bottom end of the $5/8$ -wavelength antenna is insufficient to provide

good decoupling of the coax cable below. Unlike the case of the decoupling sleeve on the base-driven half-wave whip, there is now an antenna current maximum at the top end of the sleeve. The decoupling is found to be only partial, and the radiation pattern shows degradation from the currents on the



Fig. 13. Commercial VHF version of marine antenna shown in Fig. 12. Here, the author provides temporary (and decoupled) support.

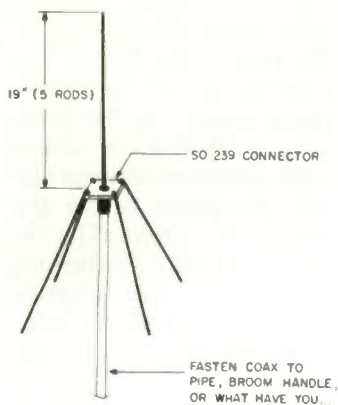

Fig. 14. The "famous" coat-hanger special.

outside of the coax below the sleeve. The cure is to place a second quarter-wave sleeve below the first, as shown in Fig. 12. A commercial marine VHF antenna utilizing this construction is shown in Fig. 13. The upper 5/8 whip, the tuner, and the two quarter-wave sleeves are enclosed within a tapered fiberglass tube. The ratio of the diameter of the lower decoupling sleeve to the braid diameter of the coaxial line (RG-58A/U, in this case) is about 6 to 1, ensuring good decoupling.

This antenna produces a vertical radiation pattern very close to that of an ideal, isolated, center-driven 1-1/4-wavelength dipole in free space, unaffected by the feed cable at the bottom end. Another antenna based on the same principles has recently been announced for amateur radio service in the 2-meter band. It is designed for base station use and features twin decoupling sleeves of conical shape in order to obtain an adequately large mouth diameter in a rigid structure.

This article would be incomplete without a mention of the ideal antenna for the amateur who wishes to rush a 2-meter base station on the air on an absolutely minimal budget. This is the famous "coat hanger special," which actually can be made with coat hanger

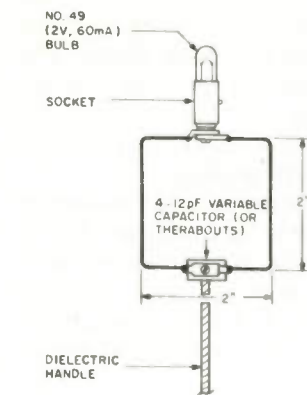

Fig. 15. An rf sniffer for the 2-meter band.

wire, and which performs spectacularly better than just about any automotive-type whip antenna when connected to the end of a length of coaxial cable. Fig. 14 shows the details.

This simple antenna, made on a UHF coaxial chassis connector, behaves like a vertical, center-driven half-wave dipole. Note that the 4 radial rods, referred to erroneously by many people as a "ground plane," are bent down at about a 45° angle from the horizontal. Don't mount these rods so that they extend out horizontally from the base of the whip. To do so will produce (1) a radiation pattern in which maximum radiation is lifted from the horizon, and (2) an input impedance of around 35 Ohms, resulting in a mismatch on a 50-Ohm cable. Bending the radial rods down at about a 45° angle (1) brings the maximum radiation intensity down to the horizon, and (2) brings the input impedance up to about 50 Ohms, giving an excellent impedance match. A low vswr over the entire 144-148-MHz band will be obtained.

Although a good antenna, the coat-hanger special is not the answer to all of the world's problems. It is driven at a point of current maximum, and there is no reason to believe that all of the spill-over current will be confined to the radial rods.

Some current is bound to flow down the outside of the coax, and will produce standing waves of current, interfering with the radiation pattern of the antenna. The hope is that the 4 radial rods, being of resonant length, will hog the current, keeping the spill-over current along the outside of the coax small. To check your coat-hanger special, use your rf sniffer. If you detect appreciable rf on the coax below the antenna, try adding (or subtracting) about a quarter wavelength of coax to (or from) the feed cable. The reasoning behind this move is to try to make the outside of the coax change from an anti-resonant to a resonant condition.

The Rf Sniffer

The rf sniffer alluded to in the previous discussions is easy to build from junk-box parts. Even if one buys all of the components at a radio store, the total cost is unlikely to exceed \$2.00.

The sniffer consists of a loop of wire, a pilot light, and a tuning capacitor all connected in series. The relative positions of the 3 components is immaterial. You can put the tuning capacitor right next to the lamp if you wish, or connect it in series with the loop on the side opposite to the lamp. I like to use a 2-volt, 60-mA bulb (No. 49) because this produces good sensitivity. The capacitor can be a compression mica-type, a ceramic variable, a tubular plastic variable, a miniature air variable, etc.

The dimensions of the loop shown in Fig. 15 are suitable for the 144-148-MHz band. The actual capacitance required to achieve resonance will be a function of the loop area and the wire size. By using No. 20 copper bus wire and the loop dimensions shown, resonance will be obtained somewhere within the range of 4 to 12 pF.

While the light bulb can be soldered into the loop, a socket is recommended. The bulb can easily burn out, especially when you are showing your friends how poorly their antennas are decoupled! It is also convenient to glue the sniffer to the end of a stick, plastic tube, or rod, to prevent your hand from detuning the loop.

Conclusion

This article can be summed up as follows: 1) There is no such thing as a one-terminal impedance; 2) A whip antenna cannot be end-driven successfully from a coaxial transmission line unless an appropriate decoupling system is incorporated in the design.

When the ham attaches an automotive-type whip to a length of coax line to serve as a base station antenna, he is doing so at his own risk. Ideally, the manufacturer or the dealer should call the attention of the buyer to the bad effects of this kind of misuse of the product. This is similar to the responsibility of a manufacturer of medicine to call the buyer's attention to the possibility of adverse side effects! A more serious situation exists in the case of some end-driven base station antennas, currently on the market, which totally lack any form of decoupling.

Armed with information gained from this article, and with your rf sniffer in hand, you should now be able to approach the marketplace with a more critical eye, asking the dealer embarrassing questions about spill-over and decoupling, and insisting on proof of performance! So much of the electronic equipment offered to the amateur radio buyer today is truly representative of the state of the art that it is high time that we elevate the antenna to this same status. ■



S-f Amateur Radio Services
 (213) 837-4870
 4384 KEYSTONE AVE.,
 CULVER CITY, CA. 90230

the W6TOG
 RECEIVER MODIFICATION KITS
 INCREASE SELECTIVITY
 IMPROVE SENSITIVITY
 LOWER INTERNAL NOISE
 COMBAT BLOCKING
 FROM LOCAL SIGNALS

TS-520 KIT	\$27.50
TS-520S KIT	32.50
TS-820 & 820S KIT	34.50
TS-820 MIXER KIT	27.50
TS-120S KIT	32.50
R-820 KIT	34.50
FRG-7000 KIT	32.50
FT-101 SERIES KIT	32.50
FT-101ZD KIT	34.50
FR-101 SERIES KIT	34.50
FT-301 SERIES KIT	34.50
FT-901 SERIES KIT	34.50
ATLAS 210 OR 215X KIT	34.50
ALDA-103 OR 105 KIT	32.50

MAGICOM
 PROCESSOR
 MODIFICATION KIT

INCREASES AUDIO PUNCH
 IMPROVES
 PROCESSED SPEECH QUALITY

TS-520/S	42.50
TS-820/S	27.50

NEW

TS-120/S	42.50
DRAKE T4XC	52.50
DRAKE TR7	42.50

The "MAGICOM" provides up to 6dB increase in output with smooth, clean, non-distorted audio and more penetration for those pile-ups. Easy installation. (No front panel alteration)

HI POWER
 KITS

INCREASE OUTPUT POWER BY 30%

Set of (2) 6146-W final tubes
 Plate rating 40W per tube

GET MORE DRIVE FOR
 THOSE HI POWER AMPLIFIERS!!!

TS-520 / 520S QRO KIT	\$39.50
TS-820 / 820S QRO KIT	39.50

10% OFF ON KIT ORDERS
 TOTALING \$75.00 OR MORE

SEND FOR PRICING
 AND INFORMATION ✓S33

ALL PRICES POSTPAID
 IN CALIF. ADD 6% SALES TAX
 MASTERCARD & VISA ACCEPTED
 SATISFACTION GUARANTEED
 OR MONEY REFUNDED

WHY ARE ANTENNA MAKERS ANGRY ABOUT THE NEW AEA ISOPOLE™?

Introductory Price:
 Isopole 144 - \$49.95
 Isopole 220 - \$44.95



For the first time, ham operators are finding out just how poorly designed most vertical, omnidirectional VHF antennas really are.

AEA university level research has proven that most antennas now being offered create unwanted coupling of RF currents onto the antenna support structure and coaxial feedline shield from the transceiver.

Proper design and decoupling on the new AEA ISOPOLE™ virtually eliminates the RF spillover problem and can help you achieve the maximum attainable gain for the size of the antenna—equivalent to doubling your power in all directions on the horizon relative to an ideal half-wave dipole, or 6 db gain over a typical one quarter wavelength groundplane antenna. The most popular 2 meter omnidirectional "gain" antennas are unable to achieve the gain figures for an ideal half-wave dipole, resulting from poor feedline decoupling.

Plus! The new AEA ISOPOLE™:

- requires no tuning.
- is easy to assemble.
- covers a bandwidth nearly double the two meter ham band.

- has less than 2:1 SWR over the entire 2 meter band.
- has a beam pattern independent of feedline length.
- requires no ground plane.
- features completely weather protected RF connections.
- is designed for maximum legal power.
- mounts easily on a standard TV mast. (TV mast NOT supplied by AEA)

Prove it to yourself.

Let us send you a design for a simple tester you can use to see just how much RF spillover is coming off your own equipment.

The design is included in a copy of our free booklet: **FACTS ABOUT PROPER VHF VERTICAL ANTENNA DESIGN**. To get your copy, or information about ordering an AEA ISOPOLE™, write or call Advanced Electronic Applications, Inc., P.O. Box 2160, Lynnwood, Washington 98036. Call 206/775-7373.



✓A94

AEA

Brings you the breakthrough!

Introducing the 2m/220 Connection

— give crossband operation a try with this interconnection scheme

Carey I. Fisher WB4HXE
5428A Langhorn Way
Norcross GA 30093

With the introduction of 220 FM to the Atlanta area, I decided it was time to do some serious experimenting. I hope that the project described here will encourage others to use this fine band.

It all started when Neil Stone WB4UPC installed a 220 repeater and turned it into a remote base for 2m. While operating 220 through this system, a user can dial up, with a tone pad, any legal combination

of 2m transmit and receive frequencies in 5-kHz increments. This capability, coupled with a good site, opens many possibilities!

After using this system a couple of times with a newly purchased Midland 13-509 from my home QTH, I wanted to be able to access it from my mobile. However, I also desired the capability of using a hand-held to achieve the excellent coverage afforded by the remote base.

Mounting the 13-509 in the mobile was no problem, but the question of using a hand-held required some thought since, own-

ing a 2m hand-held, I did not want to purchase another. The solution appeared as if in a vision: Why not a crossband repeater?

With an IC-22S for the 2 meter end and the 13-509 on 220, all that was needed was some control and audio interfacing and my 2m hand-held could be used to get into the 220 machine. A block diagram of the system is shown in Fig. 1. This system was originally designed to be used in the mobile; however, it has also been used at the home QTH.

A look at the schematic in Fig. 2 will show how simple the audio interface is. Connections to the rigs' speakers are most easily made using the external

speaker jacks. The mike connections can be made via either the front-panel connectors or the accessory jack on the back of each rig. The capacitor and pot values were chosen to fit the particular impedance and audio characteristics of the rigs involved. For interfacing to other rigs, general guidelines can be given. The pot should be approximately the same value as the mike impedance. The capacitor value can be experimentally determined for best audio quality.

Fig. 3 shows the schematic of the control section. While many variations of the transistor switches are possible, it seems that every time I designed one "by the book," it failed to operate properly. The circuits were finally debugged using a deterministic (read "cut-and-try") approach. One word about the use of relays instead of solid-state PTT is in order. While I am normally dead set against using relays in modern ham gear, two beautiful miniature relays were available in the junk box. Also,

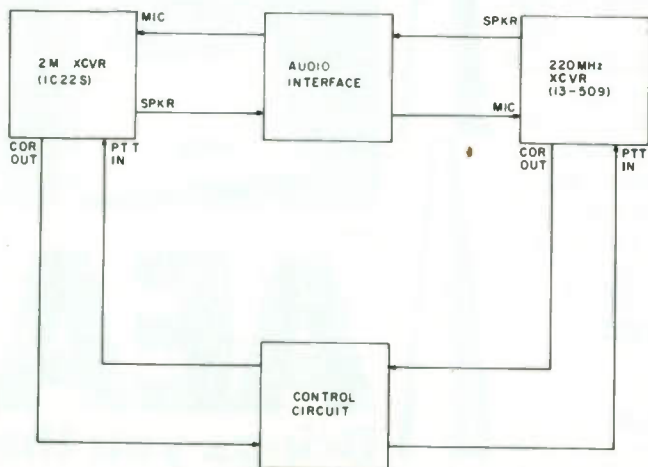

Fig. 1. Block diagram.

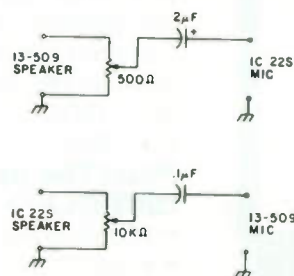

Fig. 2. Audio interface schematic.

NOW... YOU SAVE THREE WAYS AT HENRY RADIO

1. CALL FOR OUR LOW, LOW CASH OR CREDIT CARD PRICES ON ALL MAJOR EQUIPMENT.

2. TAKE ADVANTAGE OF OUR FANTASTIC MONTHLY SPECIALS ON SELECTED FINE EQUIPMENT.

3. ENJOY THE WORLD FAMOUS HENRY RADIO SERVICE. NO ONE ELSE CAN OFFER YOU THE BACKGROUND OF EXPERIENCE AND THE VALUE OF RESPONSIBLE MARKETING LIKE HENRY RADIO.

Henry Radio also offers a broad line of commercial and FCC type accepted amplifiers covering the range of 3 MHz to 500 MHz. Henry amplifiers are in use all around the world. Commercial and export inquiries are invited.

Tempo solid state amplifiers are available at Tempo dealers throughout the U.S.

NEW TOLL FREE ORDER NUMBER: (800) 421-6631
For all states except California
Calif. residents please call collect on our regular numbers.

11240 W. Olympic Blvd., Los Angeles, Calif. 90064 213/477-6701
931 N. Euclid, Anaheim, Calif. 92801 714/772-9200
Butler, Missouri 64730 816/679-3127



Henry Radio

"dry" relay contacts will switch any PTT system.

The connection for COR in the 22S was made at the low end of the signal light. When no signal is being received, this point is high, turning on Q1, which closes RY1, thus opening PTT to the 13-509. When a signal is being received, this point goes low, turning Q1 off, which opens RY1, closing PTT, thus repeating from 2m to 220. The "220 TRANSMIT" LED is also turned on by this relay.

COR from the 13-509 is taken from the collector of TR13. This is the noise amp switch and the collector is low when a signal is not present. This is the opposite of the operation of the 22S, so the relay, RY2, is wired oppositely, that is, the normally-open contacts are used on RY2 as opposed to the normally-closed contacts on RY1.

A bit of caution: Don't

forget to include an on/off switch that disables both PTT lines or you will have one or the other rig transmitting when you don't want it to.

All connections to the rigs were made to the accessory connectors. This allows normal use of the rigs without cable swapping.

This crossband repeater controller has really added versatility to my 2m hand-held. I can park my mobile, turn this device on, and leave. From anywhere within in simplex range of the mobile (I usually use 146.49), I can communicate through my hand-held, through this system onto 220, through the 220 to 2m remote base, and out on any combination of 2m frequencies. Using this system, I have worked over a hundred miles using a 5-Watt hand-held in North Georgia terrain that is almost im-

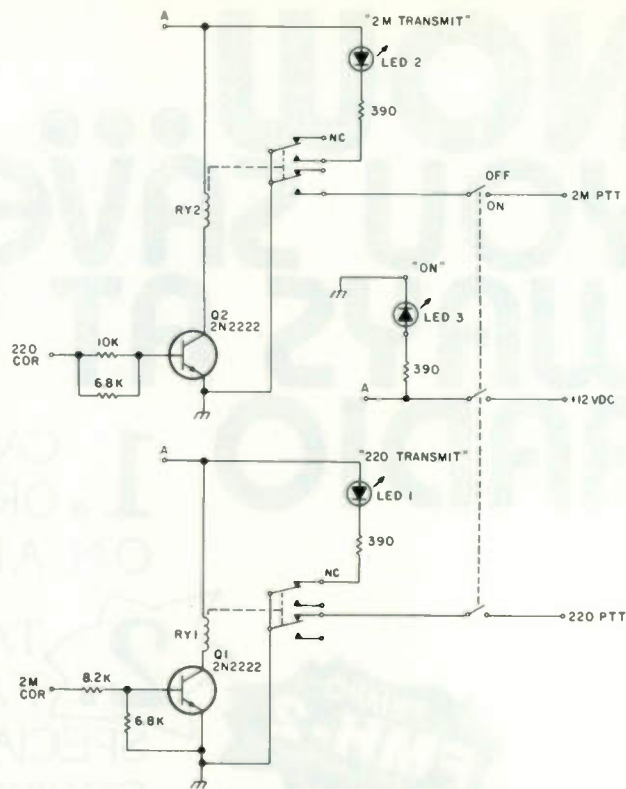

Fig. 3. Schematic of the control section.

possible to communicate 220 has finally come to Georgia! ■

ALL-MODE VHF amplifiers

FOR BASE STATION & REPEATER USE

MODEL: V350



- ☆ Built-in 115/230 VAC Supply
- ☆ AM-FM-CW-SSB-RTTY
- ☆ 60dB Harmonics
- ☆ 60dB Spurious
- ☆ Heavy Duty Design

MODEL: V180



- ☆ Illuminated Panel Meter
- ☆ Automatic T/R Switching
- ☆ VSWR Protected
- ☆ +13V/3A Accessory Socket
- ☆ U.S. Manufactured

All Solid-State!

MODEL	FREQUENCY	INPUT	OUTPUT	SIZE WxDxH	WEIGHT	FAN KIT REQUIRED	PRICE
V76	50-54MHz	8-15W	100-120W	216x330x178mm	11.7 kg (26 lbs)	No	\$339.00
V360	50-54MHz	2-10W	400-450W	432x330x178mm	23.4 kg (52 lbs)	Yes	\$895.00
V70	144-148MHz	10-15W	75-90W	216x330x178mm	11.7 kg (26 lbs)	No	\$315.00
V71	144-148MHz	1-3W	75-90W	216x330x178mm	11.7 kg (26 lbs)	No	\$349.00
V180	144-148MHz	5-15W	170-200W	216x330x178mm	13.5 kg (30 lbs)	CW & FM	\$539.00
V350	144-148MHz	10-20W	350-400W	432x330x178mm	23.4 kg (52 lbs)	Yes	\$895.00
V130B	220-225MHz	10-15W	70-85W	216x330x178mm	11.7 kg (26 lbs)	No	\$329.00
V135B	220-225MHz	25-35W	140-160W	216x330x178mm	11.7 kg (26 lbs)	CW & FM	\$469.00
F110		Fan Kit, 115VAC		135x135x50mm	1 kg (2.2 lbs)		\$ 33.00
F220		Fan Kit, 230VAC		135x135x50mm	1 kg (2.2 lbs)		\$ 33.00
*F135		Fan Kit, 115VAC		381x140x89mm	3.2 kg (7 lbs)		\$ 59.00
*F235		Fan Kit, 230VAC		381x140x89mm	3.2 kg (7 lbs)		\$ 59.00
RM-1		19 Inch Rack Adaptor		483x3x178mm	1 kg (2.2 lbs)		\$ 25.00
*RM-2		19 Inch Rack Adaptor		197x32x28mm	.5 kg (1.1 lbs)		\$ 12.00

* Used with the V360 & V350 Amplifiers

Other Frequencies Available on Request

Dealer Inquiries Invited

Meeting all applicable FCC Requirements.



RF POWER LABS, INC.

✓ R27



VISA

11013-118th Place N.E. • Kirkland, Washington 98033

Telephone: (206) 822-1251 • TELEX No. 32-1042



143.800 — 148.200 MHz Mobile Transceiver

Power to the mobile operators! This one is brand new, and it carries a powerhouse punch wherever you're going. ICOM unveils a full 25 watts of mobile power with the introduction of the new **IC-255A**. When you want increased mobile QSO range, ICOM delivers; and **nobody does it better.**

The microprocessor controlled **IC-255A** is a deceasingly compact unit which packs more big, multifeature flexibility than any other ICOM mobile to date. This one offers a 5 channel memory, complete with memory scan, adjustable scanning speed, and auto-stop. The 5 channels can easily be written from any Inband frequencies; and the scan function can be programmed to scan all 5 or only 2, stopping on any signal.

Like the other new ICOM transceivers, the IC-255A comes with 2 VFO's built-in at no extra cost. The radio is programmed to come up to power operating at 600Khz splits,

but it can be reprogrammed to any split of your choice. The dual VFO's and single tuning knob provide you with smooth, easy tuning in 15KHz or 5KHz steps.

The use of new low-noise, dynamic range junction FET's (for the RF amplifier and the first mixer) and helical cavity filters (for the antenna and RF circuits) provides excellent sensitivity and intermodulation distortion characteristics. A pair of high quality monolithic crystal filters and ceramic filters facilitates interference free reception reliability.

The new **IC-255A's** power is selectable 25W high or 1W low, yet it draws only 5.5 amps when transmitting in the high power mode. A directly amplified VCO output, without the use of multipliers or mixers, and a power module in the PA unit produce a very clean transmitted signal, with low spurious radiation. When you're in an RF trap, the **IC-255A** can get out the signal. To give your mobile FM operations big features with a power punch, give yourself the **IC-255A**.

Specifications subject to change without notice. All ICOM radios significantly exceed FCC regulations limiting spurious emissions. © 1979, ICOM East, Inc.

HF/VHF/UMF AMATEUR AND MARINE COMMUNICATION EQUIPMENT



ICOM WEST, INC.
Suite 3
13256 Northrup Way
Bellevue, Wash. 98005
(206) 747-9020

ICOM EAST, INC.
Suite 307
3331 Towerwood Drive
Dallas, Texas 75234
(214) 620-2780

ICOM CANADA
7087 Victoria Drive
Vancouver B.C. V5P 3Y9
Canada
(604) 321-1833

Phone numbers for parts orders: **ICOM West, Inc.**, (206) 747-9020; **ICOM East, Inc.**, (800) 527-7425 (orders only), Texas Residents call (214) 620-2780.

ICOM INFORMATION SERVICE
3331 Towerwood Dr., Suite 304 H Q S W Z
Dallas, Texas 75234

Please send me: IC-255A specifications sheet; full color ICOM Product Line Catalog; List of Authorized ICOM Dealers.

NAME _____ CALL _____
ADDRESS _____
CITY _____ STATE _____ ZIP _____

You may send a machine copy of this form.

A Fresh Start for your Old Tx

— modernize it with grid-block keying

As a result of the most recent boom in amateur radio, many older pieces of tube-type equipment have been pulled out of the closet and placed into active service. My old Heathkit DX-40 occupies a prominent place in my shack and has been the workhorse of many hours of DXing and rag chewing. However, when I moved into the fast-paced Extra subbands, I found my hand key inadequate and decided to move up to electronic keying. I homebrewed the keyer with few complications. A reed relay was used to perform the main switching function. I plugged the keyer in-

to the DX-40 and hunted my first victim on the receiver. Tragedy! The very first dit fused the relay contacts and the rig had to be turned off to terminate the transmission. I had obviously overestimated the power handling capability of the relay.

In cathode-keyed circuits, virtually the total input power of the transmitter is passed through the key (or keying relay). In the case of my DX-40, this amounts to about 150 mA at 600 V. The solution to the problem was obviously to use a relay with greater power handling capability (or was it?). A search for such a relay left me empty-

handed. I could find no relay that was fast, cheap, fitted the voltage and power requirements, and was available locally.

Finally, it dawned on me that there must be a way to key the transmitter without switching the full power of the transmitter directly. It did not take long to find a grid-block keying circuit in a old handbook. This type of keying requires the switching of only 150 V at a current of just a few milliamps. This was well within the limitations of my small reed relays and could even be handled by an inexpensive transistor. An important bonus in using grid-block keying is the reduction in potential shock hazards. Scrounging through the junk box, I found everything I needed for the project. In an additional hour and a half, I was on the air at 25 wpm.

The principle of grid-block keying is very simple. During key-up periods, the final amplifier is blocked by placing a strongly negative charge on the grid of the power amplifier tube. When the key is closed, this voltage drops across a resistor (R1 in Fig. 1). This removes the charge from the grid and the amplifier is free to run

normally. Basically, the keying circuit is composed of a voltage source and dropping resistors. An isolated negative 150-V dc source can be inexpensively obtained by using a 6.3-V filament transformer as the main component. The transformer's 6.3-V winding is connected to the 6.3-V ac filament line of the transmitter. The original primary of the transformer then becomes the high voltage secondary. The transformer can be conveniently tapped into the filament line of the transmitter at the filament terminals of one of the tube sockets. Note that the rectifier is connected in such a manner that the ground is positive with respect to the negative keying voltage. It is important that filter capacitor C1 be connected properly with respect to this polarity. Also keep this in mind when making any voltage measurements. R3 is included as a bleeder resistor.

We now have a negative voltage source and a mechanism for turning it on and off. Getting the charge to the grid requires some special consideration. In my first grid-block keying circuit, none of the components was shielded. As a

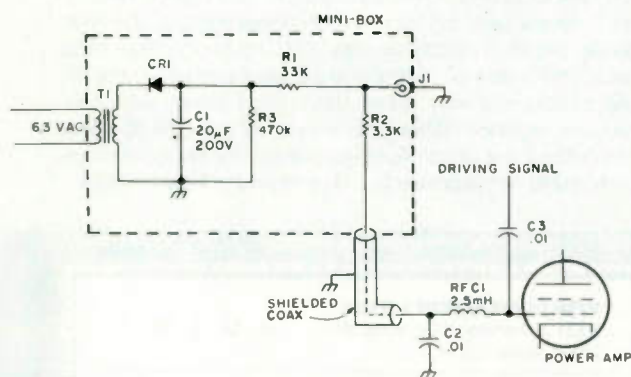

Fig. 1. Grid-block keying modification. C1—20- μ F, 200-V dc electrolytic. C2, C3—.01- μ F, 1-kV disc ceramic. CR1—200-V, 0.5-Amp silicon rectifier. R1, R2—1-Watt, 20%. R3— $\frac{1}{2}$ -Watt. RFC1—2.5 mH. T1—filament transformer, 115-V primary, 6.3 secondary at 300 mA.

1-800-228-4097

CALL TOLL FREE

Hy-Gain 3806

2-Meter Hand-Held Amateur Transceiver



**SPECIALLY
PRICED
ONLY
\$119.⁹⁵**

- Low cost, 6-channel hand-held provides superb voice transmission over short to medium distances
- Sharply tuned on-frequency selectivity in the RF amplifier stages plus FET's in the 1st and 2nd mixers for virtual immunity to out-of-band signals intermodulation distortion and cross-modulation
- Separate microphone and speaker elements for enhanced audio
- Internally adjustable mic preamp—a Hy-Gain exclusive
- Specially gasketed case seals out water, dirt and corrosive salt air
- Watertight, high-impact ABS plastic case—ribbed for non-slip grip
- Top-mounted controls for instant access

Accessories:

Model No.	Description	Price
3807	Nicad Battery Pack	\$31.95
1104	Touch Tone Pad	\$44.95
1106	AC Battery Charger	\$ 9.95
1107	Cigarette Lighter Adaptor Cord	\$ 9.95
1108	Antenna Adaptor Cord	\$ 9.95
1110	Carrying Case (Leather)	\$17.85
1111	Carrying Case (Vinyl)	\$ 9.95
269	Rubber Duck Antenna	\$ 9.95
	Crystal Certificates	\$ 3.95

PLEASE ENCLOSE \$2.50 FOR SHIPPING AND HANDLING PER UNIT

CALL TOLL FREE

1-800-228-4097

for Quality Ham Radio Products at Discount Prices

KENWOOD
YAESU
DRAKE
ICOM
STANDARD
PANASONIC
AEA

DENTRON
HY-GAIN
MOSLEY
CUSHCRAFT
WILSON
HUSTLER
LARSEN
BENCHER

TAYLOR
SWAN
TEMPO
TEN-TEC
MIDLAND
CDE
AUTEK
MIRAGE

E.T.O. ALPHA
VHF ENGINEERING
BERK-TEK CABLE
CONSOLIDATED TOWER
SAY
SHURE
TELEX
ROBOT-SSTV

Our Mail Order Hours (CST)

M-F 8 am to 12 Midnight
Saturday 8 am to 6 pm
Sunday Noon to 8 pm

Call and Talk to

Don	WBØYEZ	John	WBØMTS
Denny	WØQR	Blaine	WBØQLH
Bill	KA7CDF	Bob	WBØRQZ
Joe	WAØWRI	Jim	KAØCRK

✓ C58



Communications Center

443 N. 48th, Lincoln, Nebraska 68504

In Nebraska Call (402)466-8402



a result, the transmitter emitted a signal during key-up periods. The emitted signal would gradually creep up in intensity until it reached almost full power. Placing the voltage source in a minibox and using coax to get the voltage to the power amplifier eliminated the problem. The driving signal is kept from entering the keying circuit by RFC1 and C2. The dc keying voltage is prevent-

ed from entering the driving circuitry by the .01 blocking capacitor, C3. If the grid is already dc-isolated from the driver by a capacitor, C3 is not needed.

It should be noted that the grid-block keying modification in my DX-40 disabled the "grid" function of the meter. This is only a slight hindrance in actual operation. Too much grid drive with grid-block key-

ing will cause the transmission of a "backwave" or residual signal during key-up periods. Grid drive should be adjusted to the point where no plate current can be detected during key-up periods. The output could be checked with a sensitive rf power meter or an swr meter to detect any backwave that might be leaking through.

Most older cathode-keyed tube rigs are de-

signed so that the transmitter is activated when the plug is removed from the original jack. Some designs may require that the jack be shorted. A word of warning: If you leave the original cathode-keying jack in the transmitter, cover it so that your keyer won't be accidentally plugged into this high voltage gap. I learned this lesson the hard way. You guessed it—I fused another relay. ■

An Inflation Fighter for 220

—join the fun . . . inexpensively

\$18.50 and 90 minutes, and you're listening in.

*Michael J. Clarkson WA3HWG
RD 4
Export PA 15632*

How would you like to be on 223.5 MHz for a nominal investment of \$18.50 and an hour and a half of your time? Well, I think this article may help some people who are stymied right now about the whats and wherefores of how to get on, seeing that there is no surplus equipment available and "scanners," per se, don't cover that area of the frequency spectrum.

For some 6 months now, a few of us hams here in southwest Pennsylvania have been fooling around

with 223.5 MHz. Even with the availability of some Midlands, Cobras, and FM 76s, the activity is very sparse. As many of you are aware, VHF Engineering sells rf decks for 10 through ¼ meters. These modules are easy to build and tune up, and they are inexpensive. They also have, as a standard feature, an output of 10.7 MHz as an i-f frequency. Now, think about that for a minute! What else uses 10.7 MHz as an i-f? Well, almost all scanners except Bearcat and some Lafayettes. Also, almost all 2 meter rigs do. So, if you already own some sort of scanner (and a lot of hams do), \$18.50, and a little time, you are in the listening business on 220 or 440 or 50 or 144 MHz.

All you have to do is wire in the output of the VHF Engineering rf module to the 10.7 MHz i-f in your scanner or 2 meter rig and you are ready to go. This modification does not alter the performance of the scanner or 2 meter rig, but enhances it by adding, in this case, 220 MHz capabilities. You can even use an old portable AM-FM radio which has its i-f at 10.7 MHz. The gain in these sets is not very great, but they will work.

To be more specific, in my own practical application I bought a VHF Engineering 220 rf module, built it, and needed a 10.7 i-f—preferably another stage at 455 i-f—and an audio and squelch stage. So, considering what to do, I spied my much-experi-

mented-with, obsolete, Radio Shack Pro 4 scanner, which is a pocket monitor for VHF frequencies. With a little investigation, the first i-f 10.7 MHz ceramic filter was found, and I injected the output of the rf module in there. "Voilà, it worked!" So for a very modest investment, I now hear quite well on 220.

Another idea would be to inject the output of the module into any 2 meter FM rig having an i-f of 10.7 MHz. I tried the above-outlined procedure on my own Icom 22S, and it works great, with very good sensitivity and gain.

A VHF Engineering 220 transmitter goes well with my setup. In fact, I am contemplating building a 220 walkie-talkie utilizing these ideas. ■

**QUASAR VIDEO
TAPE RECORDER SALE!**



- ★ Records to two hours, color or black & white
 - ★ Records off the air—record one program while watching another
 - ★ Camera input to make your own tapes
 - ★ Can be used with optional timer while you are out
 - ★ Pause control for editing
 - ★ Limited supply—these \$1,000 VTRs were demonstrators & come with new warrantee . . . \$499
- \$100 worth of new blank tape will be included at no extra charge!

Send for our new catalog!
\$3 Shipping charge per order • NO C.O.D.s!

Bill: MC Visa

Credit card # _____

Exp. date _____

Signature _____

Name _____

Address _____

City _____ State _____ Zip _____



209 S. Mystic Ave
Medford MA 02155
(800) 225-4428
(617) 395-6280

✓T3

COMPACT RTW

TU-170

\$159.95 buys a terminal unit kit with capabilities beyond your expectations for the price. And

the Flesher Corp TU-170 won't devour your precious space. Wired units are available at \$234.95. Call or write today for our free 1980 catalog of affordable kits, wired units and accessories.



FLESHER CORP

P.O. Box 976 • Topeka, Kansas 66601 • 913 • 234 • 0198

The Only Automatic Dialing Touch Tone MIC

The CES Model 235A Automatic Micro-dialer has a 10 number memory that can store even 11 digit numbers. Just dial * and one digit to bring up auto-patch, pause and dial phone number automatically. Program Dialing speed for virtually any repeater auto-patch, then dial number at fastest speed. Automatic PTT with manual or automatic dialing. All dialing and programming done from Keyboard. LED indicator for programming or PTT and . . . ✓C115



69.95

ALL CONTAINED IN A SMALL MIC.

At your Ham Radio Dealer
or Call or Write



**COMMUNICATIONS
ELECTRONICS
SPECIALTIES, inc.**

399 W. Fairbanks Ave., Winter Park, Fla. 32789
305-645-0474

Terminating load resistors from Dielectric

Dielectric, the leader in supplying the communications industry with RF measuring instrumentation, has a wide selection of Terminating Load



Resistors. From a 5W dry load to a 50KW heat exchanger type load, Dielectric has a dummy load that meets your power and frequency requirements. Low power dry loads are available up to 150 Watts. Liquid/Air loads up to 10,000 watts and high power loads — either direct water-cooled or with heat

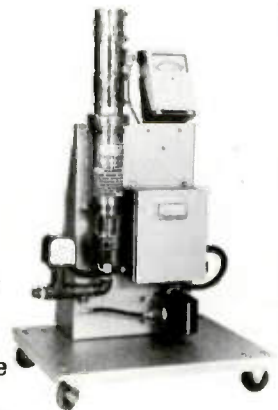

exchanger — up to 50,000 watts. All loads have a minimum VSWR specification of 1.1:1 (or better) over their rated frequency ranges.

RF Instruments for Professionals

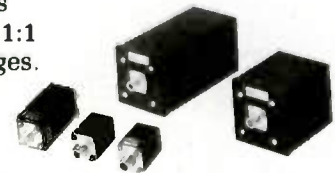

For the name of your local distributor, call Toll Free 800-341-9678.

A limited number of distributor locations are currently available; inquiries welcomed.



DIELECTRIC COMMUNICATIONS ✓D29

A UNIT OF GENERAL SIGNAL
RAYMOND, MAINE 04071 • TEL. 207-655-4555 • 800-341-9678

Building Long Yagis for UHF

— some pitfalls to avoid

Beware of the “something for nothing” offer! With this thought in mind, the long yagi antenna is being placed under suspicion. Would you believe a 48-element collinear array (24 driven elements and 24 reflectors), whose gain is approximately 16 dB, could be replaced with a single 13-element long yagi? In addition, the long yagi has:

1. Less wind resistance; 2. More directivity per pound of aluminum; 3. Greater ease of fabrication; and 4. Excellent mechanical stability. Certainly there is a temptation to believe that the long yagi antenna offers something for nothing when compared with other antenna arrays. What must be sacrificed to obtain the aforementioned advantages? Followers of the

“Collinear Clan,” read on! The cautious amateur constructing a beam antenna intended for application in the VHF and UHF range would exhibit a tendency to cut the elements longer than necessary. This stems from the old adage, “It is easier to cut ‘em long than to add a piece on.” This is the philosophy that has helped give the long yagi a questionable reputation.

In an attempt to restate the long yagi in its rightful position, antenna patterns of a 13-element yagi were made. Fig. 1 shows polar patterns of the long yagi in horizontal polarization. Fig. 2 shows patterns with the yagi vertically polarized. Fig. 3 shows the reference dipole in the horizontal plane. Curve A is plotted in the same relative gain scale as

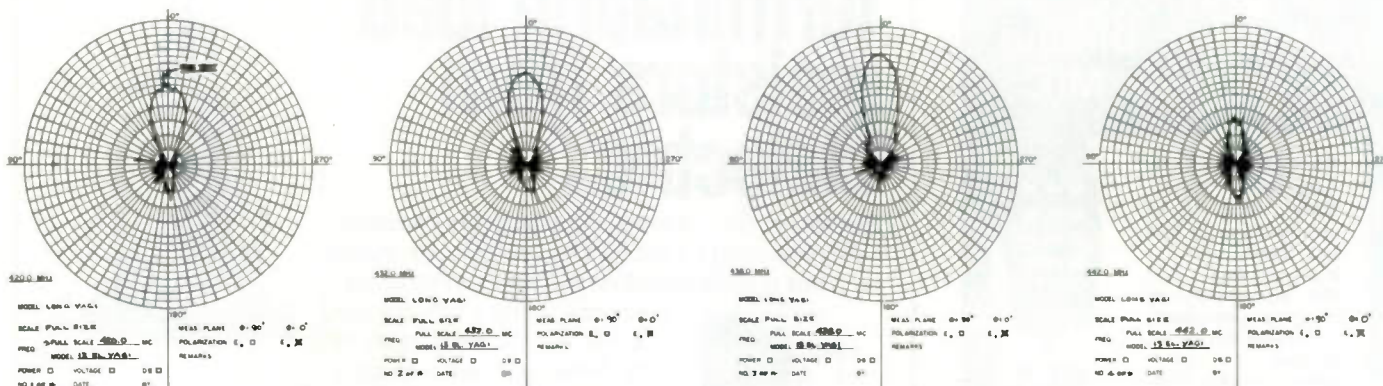

Fig. 1. Horizontal polarization radiation patterns for the 13-element yagi at 420, 432, 438, and 442 MHz.

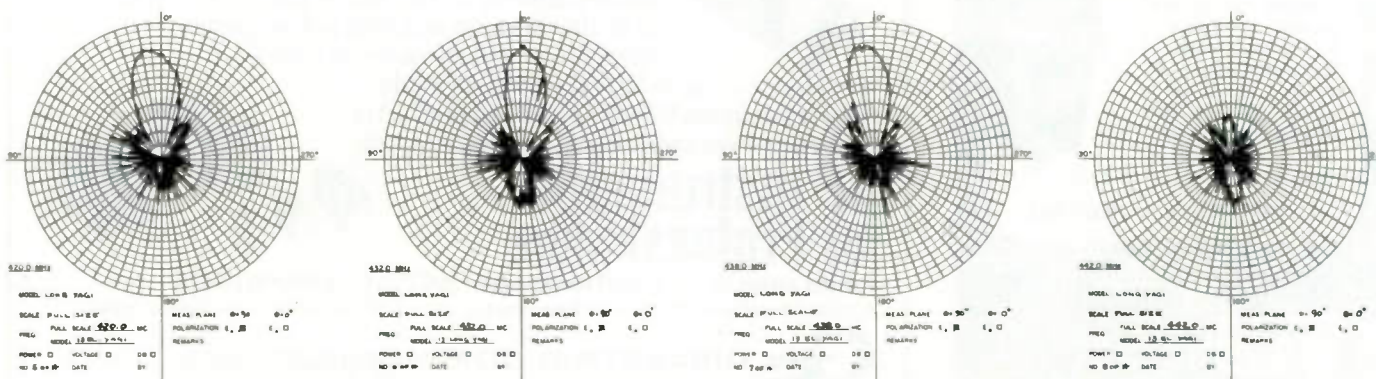

Fig. 2. Vertical polarization radiation patterns for the 13-element yagi at 420, 432, 438, and 442 MHz.

Figs. 1 and 2. Curve B is merely an expanded plot due to gain increase in plotting technique. The spike at the upper-left of Fig. 1 was produced by a search radar of an adjacent airport. A cool, windy fall day and the lack of more output from the signal generator kept the patterns from being of the picture-book variety. Fig. 4 shows the test setup.

Fig. 5 shows graphically the nonsymmetrical bandpass characteristics of the long yagi-type of antenna. The extremely rapid cutoff on the high side of the intended operating frequency has caused many an amateur to cast aside this type of antenna. This curve shows readily that it is unwise to cut the antenna to operate below the intended operating frequency.

The 438-MHz pattern in Fig. 1 indicates that the beam width at the half-power points is approximately 25 degrees. Gain measurements further revealed that 16 dB of gain can be realized without difficulty. This gain figure can be obtained over a frequency range of at least four megahertz. Four megahertz is approximately plus and minus 0.5% of 435 Hz, which is more than ample for ham frequencies. Just make sure that your beam design frequency is at or near the high end of the bandwidth desired.

Four long yagi antennas (Fig. 6) operating on 432 Hz, using 13 elements each, will yield a gain of 22 dB (assuming 16 dB per each 13-element yagi). To obtain this same gain with a collinear array, approximately 176 elements would be required (88 driven

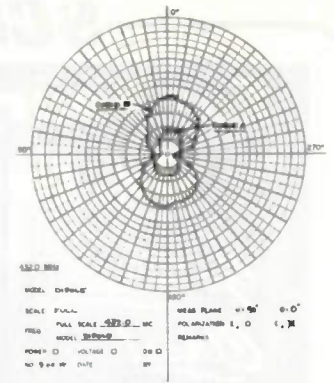

Fig. 3. Reference dipole radiation pattern in the horizontal plane.

elements and 88 reflectors). At this point in comparison, does the singular feature of unnecessary bandwidth seem worthwhile?

If reasonable care is exercised during construction (Fig. 7) and all dimensions are adhered to within one sixteenth of an inch, then you can boast, "Have yagi, will radiate." ■

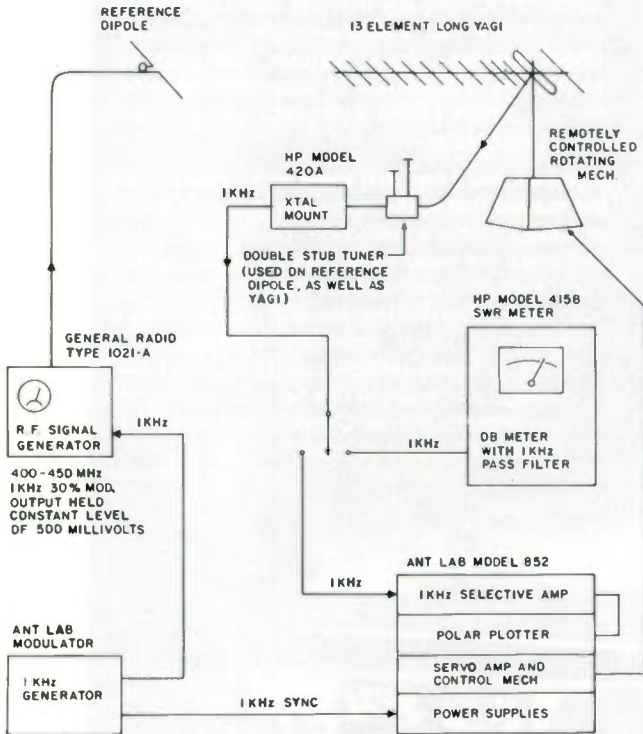

Fig. 4. Radiation pattern test setup.

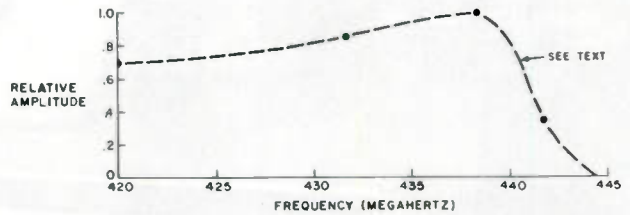

Fig. 5. Bandpass characteristics of 13-element yagi.

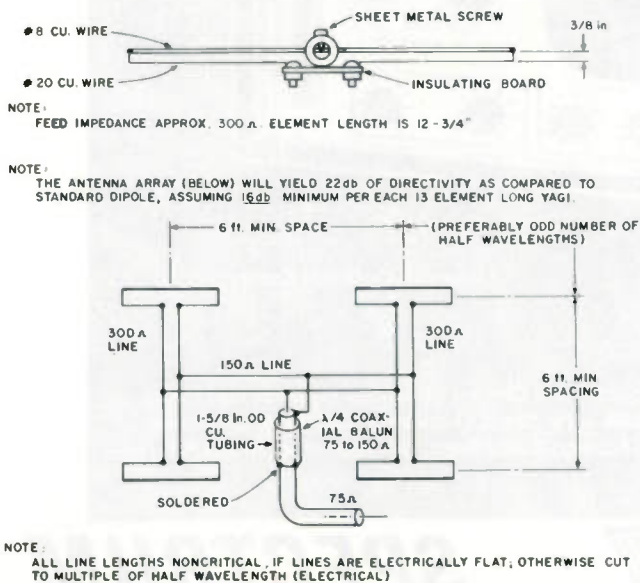

Fig. 6. Method of interconnecting four yagis.

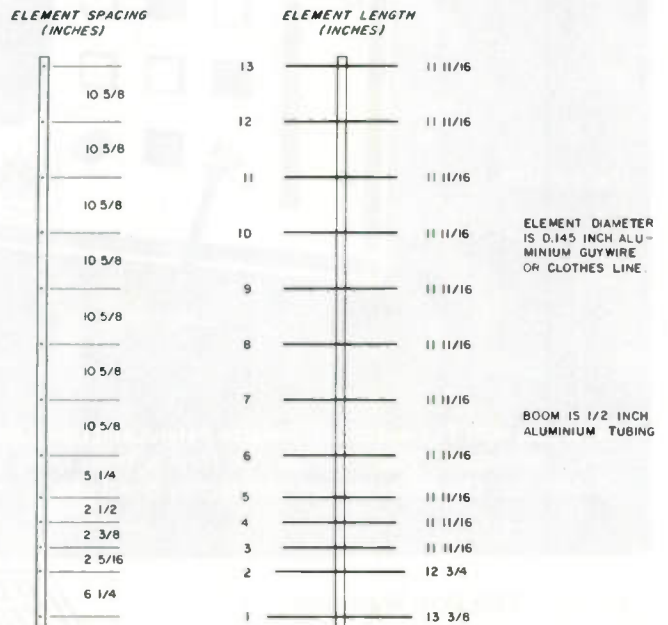

Fig. 7. Construction details for the 13-element yagi.

SCR1000 VHF — SCR4000 UHF

**For Your New Repeater System,
Or, to Replace Your Old "Klunker"**

*Go First
Class!*

2Mtr.

220 MHz

450 MHz

- 50W Output
- Low Noise Wide Dynamic Range Front End for Excellent Sensitivity & IM Rejection.
- Sensitivity: 0.35uV Typ.
- 6 Pole IF Crystal Filter.
- Full Metering, Lighted Status Indicators/Control Push-buttons, Btry. Power Input, AC Pwr. Supply, CW IDer, etc., etc.!

Go With Spec Comm!

Whether you want to instal a new repeater system or upgrade your old one, don't you want the *finest* repeater available... at a reasonable price? And don't you want to buy it from a reputable firm with years of experience in Repeater Systems? A company that will stand behind the unit 100% if you should encounter a problem? Check around—check features, performance availability of a full line of accessories and options... check prices, and *check into the company's reputation.*

If you do, you'll find that there isn't a repeater on the market that really compares to the SCR1000 or 4000! There are low-power 'barebones' units and there are super-expensive repeaters (which don't even offer many of our features)! All things considered, we *feel* that the SCR1000 & 4000 are *simply the finest repeaters available*—produced by a very reliable company which *speaks with specificity in this field.* So, make your next repeater a Spec Comm. Years from now you'll still be glad you did!



Made in USA

Shown in Optional Cabinet

Available with Full Autopatch, Reverse Patch, and Line Control; Touch Tone Control of various repeater functions; "PL"; "Emergency Pwr. I.D."; various Tone & Timer Urts, etc. **PLUS**—the finest Duplexers, Cabinets, Antennas, Cables, etc. Our Repeaters are sold factory direct only, through Foreign Sales Reps. Get your order in A.S.A.P.!

180 Day Warranty



SPECTRUM

Call or write today and get the details!

Export Orders — Contact our International Dept.

1055 W. Germantown Pk., Dept. S11

new

COMMERCIAL MOBILE & BASE TRANSCEIVERS

Spec Comm "Professional Communications Line"

Features

- 136-174 MHz & 220-240 MHz (450 soon).
- 6 channels.
- 0.35 uV Rcvr.
- 6 or 8 Pole Crystal Ftr.
- Beautiful Audio—RX & TX.
- Very Reasonable Price!

SC250 25 Wt. Mobile Unit



• "Super Rugged" Housing.



• Very attractive woodgrain housing.

SC300 25 Wt. Base Station

- Built-In AC Power Supply.
- Front Panel Status Indicator Lights.
- Optional Rcvr. Scanning Function Available.

SPEC COMM REPEATER BOARDS, SUB-ASSEMBLIES & ACCESSORIES

These are Professional "Commercial Grade" Units—Designed for Extreme Environments (−30 to +60° C).

All equipment assembled & tested. For 2M & 220 MHz.

SCR100 BOARD

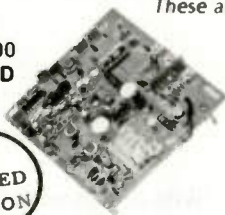

NEW REVISED VERSION

SCR100 Receiver Board

- Wide dynamic range! Reduces overload, 'desense', and IM.
- Sens. 0.3 uV/20 dB Qt. typ.
- Sel. -6dB @ ± 6.5 KHz, -110dB @ ± 30KHz, (8 Pole Crystal Ftr.)
- 'S Meter' Output.
- Exc. audio quality! Fast squelch! \$139.95 w/xtal.

SCR100 Receiver Assembly

- SCR100 mounted in shielded housing
- Same as used on SCR1000
- Completely asmbld. w/F.T. caps, SO239 conn., AF GAIN POT, etc. \$205.00



SCAP Autopatch Board

- Provides all basic autopatch functions
- 3 Digit Access; 1 Aux. On/Off function; Audio AGC; Built-in Timers; etc.
- See our Dec. 73 Ad or write/call for details. \$235.00

RPCM Board

- Used w/SCAP board to provide "Reverse Patch and Land-Line Control of Repeater.
- Includes land line "answering" circuitry \$79.95

WP641 Duplexer

- Superior Band Pass/Band Reject design
- Provides great rejection of "out-of-band" signals
- Extremely easy to adjust
- -93 dB typ. Isolation \$550.00 (fully ckd out w/SCR1000).

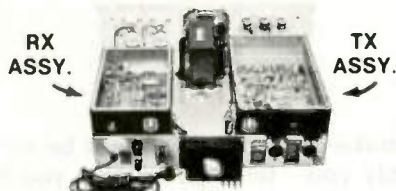

RX ASSY.

TX ASSY.

FL-6 Rcvr. Front-End Preselector

- 6 Hi Q Resonators with FET preamp.
- Provides tremendous rejection of "out-of-band" signals w/out the usual loss! Can often be used instead of large, expensive cavity filters.
- Extremely helpful at sites with many nearby VHF transmitters.
- Gain: apx. 10 dB.
- Selectivity: -20 dB @ ±2.0 MHz; -60 dB @ ±6 MHz (typ.). \$85.00.

TRA-1 Timer Reset Annunciator Board

- Puts out a tone "beep" on rptr. xmtr. apx. 1 sec. after rcvd. signal drops—thus allowing time for breakers.
- Resets rptr. time-out timer when tone is emitted.
- Adjustable time delay and tone duration.
- For use with CTC100 and ID100/250.
- \$20.95 (Add \$29.95 for inst. & ckd. out in SCR1000).

TMR-1 Timer Board

- Can be set up for 1 of 2 configurations.
- #1) Time Out Warning Tone.
- #2) "Kerchunker Killer"—Initial Rptr. Xmtr. key-up delay.
- For use w/SCR1000, or CTC100/ID250. \$20.95.

CTC100 COR/Timer/Control Board

- Complete COR circuitry.
- Carrier 'Hang' & T.O. Timers.
- Remote xmtr. Inhibit/Reset control.
- Provision for panel control switches & lamps.
- 100% Solid State CMOS logic.
- Many other features \$36.00.

ID250 CW ID & Audio Mixer Board

- Adjustable ID tone, speed, level, timing cycle.
- 4 Input AF Mixer & Local Mic amp.
- COR input & xmtr. hold circuits.
- CMOS logic; PROM memory—250 bits/channel.
- Up to 4 different ID channels!
- Many other features. Programmed \$75.00 (1 chan.) Add'l Chan. \$4.00 ea.

FL-6



SCT 110 BOARD

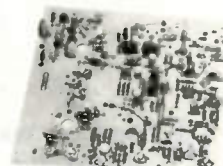

SCT110 Xmtr/Exciter Board

- 7 or 10 Wts. Output. 100% Duty Cycle!
- Infinite VSWR proof
- True FM for exc. audio quality
- New Design—specifically for continuous rptr. service
- Very low in "white noise"
- Spurious -70 dB
- With .0005% xtal. \$139.95
- BA-10 30 Wt. Amp board & Heat Sink, 3 sec. LPF & rel. pwr. sensor. \$55.95

SCT110 Transmitter Assembly

- SCT110 mounted in shielded housing
- Same as used on SCR1000
- Completely asmbld. w/F.T. caps, SO239 conn.
- 7 or 10 Wt. unit \$205.00. Add \$69.95 for 30 Wt. unit.

new

NEW!



TTC100 TOUCHTONE CONTROL BOARD

TTC100 Touchtone Control Board

- 3 digit ON, 3 digit OFF control of a single repeater function. Or, 2 functions (2 digits ON each) with 1 digit (each) OFF.
- Can be used to pull in a relay, trigger logic, etc.
- Typically used for Rptr. ON/OFF, HI/LO Pwr., P.L. ON/OFF, Patch Inhibit/Reset, etc.
- Stable, anti-falsing design. 5s Limit on access.
- \$85.00 (\$125.00 inst. & ckd. out in SCR1000).
- 2 Function or Custom Programming - + \$15.00.
- For Add'l Function(s)—Add a "Partial TTC" Board. \$42.00.

COMMUNICATIONS

(Ship./Handl.—\$3.75. PA residents add 6% tax)

Send for Data Sheets!

Norristown, PA 19401 • (215) 631-1710

Working with FETs

— part I

When it was introduced, the FET was billed as "the transistor that thinks it's a tube." There's been a lot of current through the gate since then, but there are a lot of similarities.

It is one of the few transistors that does give a hard-line tube man a fighting chance at making it work.

There are a few basic differences. The voltage, current, and power ratings are much less. You also lose one important tube advantage right off the bat. The trouble with thinking of the FET as just a teensy tube is that it really just thinks it is a tube; it really is a transistor.

As with almost all transistor situations, they are unforgiving of errors. With

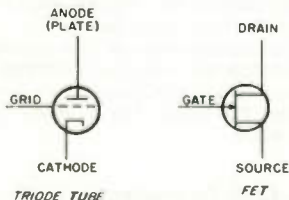

Fig. 1. Schematic symbols.

a tube, you can make a mistake and probably you won't hurt the tube if you were paying attention and correct it. Transistors either get treated right or they quit on you. That's it. There is rarely any middle ground.

In that one sense, the FET is a transistor, not a tube. While you probably can understand that the operating conditions are at a much lower level than a tube, it may be hard to get away from the tube thinking you are used to, which can harm the FET.

Circuit operation has a number of similarities between the FET and the tube. If you did much bench work with tubes, the

circuits will not be far different. The thing you have to catch on to is the trick of treating it like a transistor. A few simple precautions should be enough to get you going.

There must have been a time when you were told not to connect the plate supply to the filament, and what would happen if you did. Somewhere along the line you probably did it, too. That's how you learned not to for all time. FETs are much cheaper than the tubes were even then, so it's not too traumatic to lose a few learning. Let's just try and cut down on the number.

First, a few terms. Fig. 1 shows a triode tube schematic and an FET schematic, with a comparison of the terms for the elements.

While you probably did not have to think much about the safety of the tube while you worked, you did have to think of your own safety. Those high voltages could kill you if you didn't keep your

wits about you. One of the unfortunate things about working with transistors is the tendency to forget about safety. At those low voltages, a serious accident is rare. You can still get hurt, though. There is also plenty of kick in the line voltage of your power supply. Still, most people tend to get careless working with transistors; and they usually get away with it. All this talk of safety has a purpose.

Besides saving your own hide, a little common sense safety-thinking can save your transistors. With FETs, there are things to watch for. Here I am speaking of the normal run-of-the-mill three-element FET, not the MOSFETs or other exotic breeds. Just your average FET. They have a few weak spots. Some of them I learned about the hard way. Let's start with a few of those nasty parameters.

The FET has a maximum safe voltage that can be applied to the drain (plate). It also has a maximum safe current; this is just about

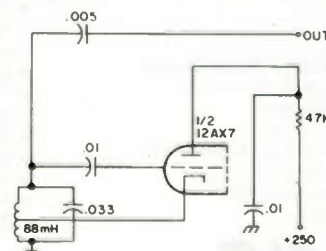

Fig. 2. Simplified tube AFSK oscillator circuit.

the same as with tubes. There just is less chance of recovery if you go wrong. There is one other basic maximum. This is the safe voltage that can be applied between the source and the gate. There is a comparable safe grid voltage with a tube, but it was not something that you ran into often. What this all gets to is that it is often fairly simple to adapt a tube-type circuit to an FET if you just watch out for the ratings.

The FET audio oscillator to be described is almost an exact duplicate of a tube circuit. However, there are certain key factors in its design that are a direct result of its being an FET rather than a tube.

Some of the guidelines for working with the circuit were learned the hard way. Once learned, they can be adapted to working with other FET circuits, as the safety factor is the same no matter what the circuit function is.

The basic tube circuit started life as a simple AFSK circuit. A double triode was used as an oscillator buffer circuit. Since the oscillator part was so simple, it was chosen for the FET circuit. The basic circuit is shown in Fig. 2.¹ This is much simplified. The AFSK part was left out, and only the oscillator part is shown. This can be transferred to the FET, but, in fact, it was not done that way.

I like to see how many parts can be left out and have it still work. (It usually works better that way, too.)

What was first tried was something similar to Fig. 3. At some point, fiddling with values, it did work. Now my education began.

The output at the drain was not much to write home about, and the waveform was no great bargain. There were, however, two

basic considerations working here. I was carefully monitoring the current the FET was drawing, the output waveform and voltage, and the dc voltage at the drain. The one thing I wanted to be sure of was that I was not exceeding the drain voltage or current. Since both were quite small, and well within limits, it was just a question of getting the waveform and output right.

Then the fun began. With a little more work, I managed to go through about ten bargain FETs. I kept my eyes glued to those meters and that scope; I never even got close to the ratings. What I did get was ten zapped trannies and a bad eye twitch. There had to be something I was missing.

Then the great light dawned. I was zapping the input. But how? With such a dinky current and output how could I zap the input?

There were two answers here. The el-cheapos did not have the same between-element ratings of the HEP801 I also was using, and the input circuit is where the action is.

This is going to sound strange, but when I got around the measuring it was startling. Even in the original tube circuit, the output was taken from the grid circuit. That's where all the signal is. That was where all the trouble was in my FET oscillator, too. A simple matter of peak-to-peak was killing me.

Now we have to go back a bit and see what is happening in the gate (grid) circuit. Let's start with my power supply. It is adjustable, and I was testing at 5 through 12 or more volts dc to the FET. That's a normal transistor range, and I even gave it a bit more for test purposes. It was about that time when I began to notice a distinct lack of functional FETs.

Since I obviously (?) was not exceeding the ratings, it was quite upsetting.

Having nothing left to do, and only one FET left, I went and took a look at the gate circuit with the scope. It nearly knocked me off the chair. The scope had been set for a small signal, and the gate signal nearly punched a hole in the top and bottom of the CRT. Where did all the signal come from all of a sudden ... and how do I get rid of some of it?

That was the problem, once I recognized it. Then a few facts filled in the rest. First off, I turned off the gear until my head cleared. While it was obvious that there was a walloping signal in the gate circuit, I had not fully pinned it all down. I could see that there was a probability that I was zapping the gate though, so I went back to the spec sheets. The specs for the 801 FET showed a maximum of 20 volts difference between the source and the gate. If this were exceeded, it would damage the FET. There went a handful of FETs.

That was what happened; but why, and how do I avoid it next time? It was obvious that more testing and measuring would have to be done, so there was going to be a risk.

The first obvious thing to do was lower the supply voltage. This was done and the scope watched while it was turned back on. At some lower voltage, the circuit started up again. A quick check of the scope

showed that the signal voltage was safe. Then a few measurements gave me the data. The signal voltage is a peak-to-peak sine wave. A peak-to-peak signal also will count as the maximum value, too. Thus, even though the specs imply a dc difference of potential not to exceed 20 volts, a sine wave more than that also will be a difference exceeding 20 volts.

There is another factor here, too. The signal voltage can approach twice the value of the dc voltage to the drain. In an oscillator circuit, the coil and capacitor can store a charge that will add to the charge of the opposite swing of the wave. That means a nine-volt supply voltage can deliver almost an eighteen-volt peak-to-peak signal. Go up to 12 and you get 24 volts p-p. Test it at 15 volts, and your 30 volt signal zaps the transistor.

The first thing you can do is keep your power supply voltage low. But what if you want to run the oscillator at a higher voltage, say 12, for mobile use or to go with other circuitry?

The obvious thing would be to dampen its enthusiasm. There's a simple way to do this. Just add a resistor across the circuit as in Fig. 4. The value isn't critical. Just watch the scope as you play with values (an ideal place for a resistance substitution box).

By loading the circuit, you cut down its output. I settled on a value of 2.2k

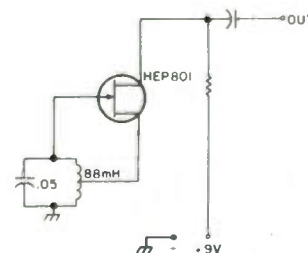

Fig. 3. Experimental FET oscillator.

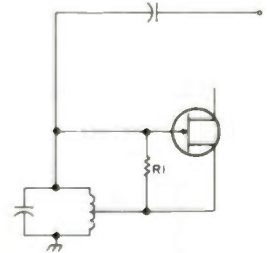

Fig. 4. Resistor added to cut signal.

for one circuit. That gave me an output of about 11 volts p-p with a drain current of 2.2 mA. My notes show a voltage of 9-12 volts, but that is just nominal. The circuit was tested and worked at both lower and higher voltages.

In the final circuit (Fig. 5), there was no load resistor. It seems to work well without one. There was one additional part that might be needed.

With some circuits there may be some TVI or RFI caused by the unshielded

circuit or long test leads.

When you get it going, try a few values of bypass capacitors at the drain. Too big a value will stop the oscillator from working. Too small will not filter, but there should be a range of values that will do the bypassing job. Start around 0.005 to 0.5 μ F.

That brings up an important point. There are several performance characteristics you want to have in your oscillator. These are simple things that tell you the design is sound. You will hear a good tone, even if there is distortion that would be unacceptable for many purposes. The scope will show you the actual waveform of the output. What you want is a good clean sine wave output. Noticeable clipping of one or more peaks usually will give you harmonic content that can cause trouble. So for openers, it should look right.

It is not shown here, but break the source lead and put in a key. Then key the oscillator as a code oscillator. If it does not key well, your circuit is not the best. That's one reason I did not follow many standard designs; they did not key well. This one keys cleanly and starts right up. At the least you can use it for code practice.

There are some simple stability tests. Leave it on for a while. Does it drift as you listen? A low frequency tone is best for this; a slight frequency shift will be more noticeable at low frequencies than at higher. An obvious short-term drift is a sign of poor design or of circuit trouble. A hot or warm FET is another trouble signal. If you have a counter or some other standard, you can check also for long-term stability. However, make sure your standard does not drift, too.

If your circuit shows good form, does not change characteristics over a long-term test, and keys cleanly, you probably have a usable circuit.

Another tip-off is your tolerance factor. This circuit will work over a wide range of parts values and voltages. Beware of any circuit where values are critical for operation. That does not mean don't use precision where you want it—for example, to get an exact frequency—but if the oscillator is critical in operation, it will be trouble no matter how precise it is.

Remember that your output is taken from the gate circuit. Almost any normal coupling capacitor value will work. 0.05 μ F to 10 μ F would be median, although I have coupled the output with a gimmick capacitor of a few turns of wire.

The pitch is easily adjusted over the audio range by the choice of C1. A ca-

pacitance substitution box can help here, though I have used just a handful of caps and done as well.

While this is a simple circuit, there were a number of very important guidelines for working with FETs. These will be restated as rules of thumb.

1. Do not exceed the maximum drain voltage or current.

2. Do not exceed the maximum voltage between elements, particularly the source-gate junction.

3. Monitor all key voltages and signals.

4. Start at the lowest practical drain voltage and work your way up.

5. Leave yourself the largest margin for safety you can.

6. A critical circuit should be a tip-off of poor design.

I found the final circuit I used to be reliable for most of my purposes. I think it can be adapted easily for many ham uses. A little time working with that circuit should make you much more comfortable when working with FETs. The circuit is not the only one in the world; however, a great deal can be learned by trying other tube-type circuits with your test set up. Some will work right off, some you may have to fiddle with values or change the circuit around some.

In any case, there is no substitute for the pragmatic experience of actually working with these circuits, and having first-hand knowledge of what happens as you vary values or circuit configuration.

I hope these circuits and test methods shown will encourage experimentation with this and other published circuits. ■

References

1. *The New RTTY Handbook*, Byron H. Kretzman W2JTP, Cowan Publishing Corp., February, 1967, ed1ton, p. 116.

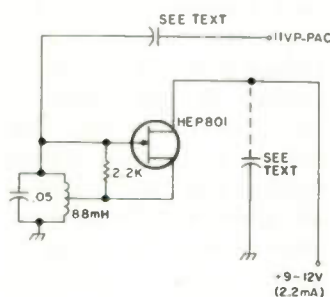

Fig. 5. Practical FET audio oscillator circuit.

Call or Write for Delivery or Quote

DRAKE TR7 Transceiver



LEAVE A MESSAGE & WE'LL CALL YOU BACK!



MADISON

Electronics Supply, Inc.

1508 McKinney • Houston, Texas 77002 • (713) 658-0268

✓ M35

**We're convinced...we've built the world's
finest amplifier in its class!**



HENRY RADIO'S

1KD-5

THE NEWEST MEMBER OF THE FAMOUS HENRY RADIO FAMILY OF FINE AMPLIFIERS

The 2KD-5 and 2K-4A linear amplifiers completely fulfill the needs of discriminating amateurs who want the very best and are willing to pay the price. But we have long felt that many amateurs would be satisfied with less power if they could still have the same high quality and dependability.

The 1KD-5 fulfills that need beautifully.

- Quality that is unmatched in any other linear in its class. The same high standards of engineering and construction as the 2KD-5 and 2K-4A. Heavy duty components guarantee years of trouble free, dependable performance.
- Smaller and lighter. Weighs about 27 pounds less... easier to take along on vacation trips and DXpeditions.
- Less expensive. If your budget is limited, but you still want a GOOD quality linear to kick your signal way up, with sharp, clear signals, the 1KD-5 will give you just about everything you want... and without sacrificing quality.

GENERAL INFORMATION

The 1KD-5 is a 1200 watt PEP input (700 watt PEP nominal output) RF linear amplifier, covering the 80, 40, 20 and 15 meter amateur bands. (10 meters on units shipped outside the U.S.)

Tube Complement: Eimac 3-500Z glass envelope triode operating in a grounded grid circuit.

ALC Circuit: ALC Circuit to prevent overdrive from high power exciters, also boosts average talk power

Type of Emission: SSB, CW, RTTY or AM

Antenna Relay: DC relay system for hum-free operation, requires shunting contact to ground during transmit to key amplifier into transmit.

Power Output Indicator: Self-contained relative RF power meter.

Tank Circuit: Pi-L place circuit with a rotary silver plated tank coil for greatest efficiency and maximum attenuation of unwanted harmonics.

Input Circuits: Cathode Pi input matching circuits for maximum drive and linearity.
Power Supply: Conservative power supply with solid state rectifiers for reliable, long term operation.

Dimensions: 8 75" high x 14" wide x 15" deep.

Weight: 48 pounds.

Price \$695.00

2K-4A floor console linear amplifier... still the "workhorse" of Amateur Radio. Engineering, construction and features second to none. Provides a long life of reliable service while its heavy duty components allow it to loaf along at full legal power. **\$1195.00**

2KD-5 desk model linear amplifier... lighter, more compact and less expensive, but still a heavy duty, high quality linear that will operate at full legal power month after month for years to come. **\$945.00**

Tempo 2002 amplifier for 2-meter operation. 2000 watts PEP input on SSB or 1000 watts input on FM or CW. **\$795.00**

Tempo VHF/UHF solid state power amplifiers for use in most land mobile applications. Call or write for list of models available.

Tempo 100AL10 VHF linear amplifier. Power output of 100 watts (nom.) with only 10 watts (nom.) in. **\$209.00**

3K-A linear amplifier (for export and military use only) Superior quality, extremely reliable. At least three kilowatt PEP input on SSB... 2000 watt PEP output. **\$1595.00**

4K-ULTRA linear amplifier (for export and military use only) For the most demanding operation... SSB, CW, FSK or AM. For general coverage operation from 3.0 to 30 MHz, but can be modified for operation on frequencies up to 100 MHz. 100 watts drive delivers 4000 watts PEP input. **\$3450.00**

All of the above except the 2002, 3K-A & 4K-ULTRA are available at Tempo dealers throughout the U.S.

11240 W. Olympic Blvd., Los Angeles, Calif. 90064 213/477-6701
931 N. Euclid, Anaheim, Calif. 92801 714/772-9200
Butler, Missouri 64730 816/679-3127

✓ H3

Henry Radio

Prices subject to change without notice.

The MARC Success Story

— your club can do it, too!

*Bob Heil K9EID
Box 68
#2 Heil Industrial Drive
Marissa IL 62257*

Radio clubs can be fun. Radio clubs promote and increase the awareness of this great hobby of ours. Radio clubs generate goodwill and fellowship among our ranks. Radio clubs become effective and successful only in major cities with large populations.

All but one of the above statements are very true. The last statement will get blown to the wind as you learn more about MARC, the Marissa Amateur Radio Club. This club celebrated its first anniversary last May. It has a roster of almost ninety members. Its monthly meetings average fifty in attendance, and each month its programs and special events keep drawing the members closer and increasing the activity. The club owns a massive repeater system with wide-area 150-mile coverage.

Every Monday night a highly successful "Swap Net" is activated by MARC on the 81/21 repeater. MARC has been active in two Field Days, has sponsored two March of Dimes Walk-A-Thons, and has graduated many through its license classes. A code practice session is run each evening on the repeater.

This scope of activities is remarkable for a club located in a small town like Marissa, Illinois, fifty miles southeast of St. Louis in the middle of the southern Illinois coal fields. The population of Marissa is 2400, when counting all men, women, children, and pets!

Humble Beginnings

In April of 1977, Dick Smith WB9VZE and I began discussing the idea of a club for the area. Steve K9SR had been holding classes in his home and had helped many in obtaining the knowledge necessary for them to get their

licenses. Dick and I called an organizational meeting to see what kind of interest and support for an area-wide club would be generated. That first meeting was attended by Bernice WD9CXQ, Floyd W9ZVT, Windell K9ZQK, Bud WD9WFX, Scot K9SF, Dick WB9VZE, and me. As it turned out, the seven of us chartered the club.

Making It Happen

It was agreed that the best way to really promote MARC and give the area amateurs a gathering place on the air was to build a repeater. I took on the project. Hundreds of hours went into building not "just a repeater," but a complex system that turned out to be one of the finest repeater systems in the Midwest. Jim WA9FDP (builder of the 22/82 in Gillespie) gave Dick and me a new Motran receiver, Lloyd W0LLC gave us a new Sinclair antenna, Floyd W9ZVT donated a small power amp, Gus

K9EBA supplied the rack, Paul WB9IGB aligned the transmitter, and Hank W0CZE donated a Midland link transceiver. The club continued to promote donations, gifts, and help. The Peabody Coal Company gave permission to use one of their 250-foot silos for a remote receiver site.

Dick and I got the biggest boost from the Village Board of Marissa. We attended a Board meeting to explain how this repeater would be effective in emergency communications, as well as in promotion of the city of Marissa. We left the meeting with a \$250.00 check and a terrific repeater location, rent-free, atop the First National Bank Building. One final donation came from Dow Com, the southern Illinois Wilson distributor: a brand new 60-foot crank-up tower!

All the pieces were assembled, and 81/21 was on the air! Bernice, Floyd, and Windell were spreading the word. MARC was happen-

ing! Club meetings, OSCAR slide shows, demonstrations on antenna phasing, birthday parties. If you don't show up, you really miss something! The meetings are happenings!

A great help was Ernie WB9TDC, who set up a raffle of a new Hy-Gain HT. Many tickets were sold by all club members, but Ernie really promoted those tickets. With each ticket came more support for MARC. Membership increased and the meeting room at the bank was outgrown, so meetings were moved to the new Community Center. Memberships continued to roll in; each and every ham was proud to be a MARC member.

This same warm, country atmosphere was projected onto the repeater. The members of the "Double M" (Marissa Machine) are, without a doubt, one of the most friendly, fun-loving, and helpful groups on any repeater system.

Newsletters

In December, seven months after charter, our club trustee, Tania WB9TKC, and Bernice WD9CXQ produced the first monthly newsletter, *Harmonics*. The newsletter has become one of the key factors in keeping the present members informed, as well as introducing the club to prospective members. Tania has the cover page offset-printed, so pictures of club members and events can be published, as well as small construction articles, reports, and useful information normally not found in the regular magazines. No one element or person can be credited with the great success of MARC, but the promotion and communication constantly provided by the newsletter certainly help.

Maintaining Interest

What all of this can

mean to your local club is that there is no need for a club to stay dormant. Amateur radio has so many facets to keep the members interested. It is up to each of your members to contribute something, even if it's a simple mention of the club on the air.

There are simple programs that can generate fantastic interest and enthusiasm. Here are a few ideas for your next club meeting.

Ask a local Motorola or GE sales office about a speaker to explain some new communications development or alignment technique.

Find a police department radio technician to come and explain its sophisticated radio system.

Your CD office, Civil Preparedness Office, armed services, or Weather Bureau will be pleased to explain disaster and evacuation techniques.

Railroads have fantastic slides and programs to explain hazardous materials handling, radio communications, or general routing.

Airline or FAA radio technicians can talk about their communications systems and control operations.

Look for a collector of antique radios to bring some of his collection for nostalgia night.

Local ham radio stores are always willing to demonstrate some SSTV, video RTTY, or video CW equipment.

AMSAT directors love to discuss OSCAR.

The list is endless! These are some of the things it takes, month after month, to promote those meetings. You must get the members into the habit of setting the second Tuesday (or whatever day) aside for that important radio club meeting. You must entertain or inform them. They must want to return. It's the activities director's job

to see that this is done.

Home-Grown Programs

Sometimes clubs are unable to contact outside speakers to present a program. To fill a void, here are some ideas that members themselves can use to put programs together.

Have a Home-Brew Night (no Kentucky moonshine, please!). Ask any and all to bring their best attempts at building equipment. Award a ribbon or small trophy for the best—or worst.

QSL Night—see who has the most DXCC, VHF, counties, longest distance, oldest, etc. Again, give awards.

Antenna Gain Measurement Night—bring your home-brew VHF antennas, and award trophies for the best.

Fix It Night—bug a few radios or keyers and see who can find the faults.

Grid-Dip Night—wind some coils, check their frequencies, show how to check antenna resonance, and so on.

Those of us who have been around for awhile sometimes forget that the newcomers have not seen or heard a lot of the "take it for granted" things. These simple things can be turned into fantastic programs. Talk about feedlines, show them how different types of coax work better, or worse; discuss design. Be original. Be innovative. Keep it simple and *fun*! Always acknowledge the oldest license, the guest or member from farthest away, the one who can operate the most bands or modes.

For a surefire barn-burner meeting, celebrate a member's birthday, but keep it a surprise. A surprise party can really be a great amount of fun. Keeping the secret is difficult, but can be done. Just think of the crazy gifts you can rid your junk boxes of!

Selling donations to the club in the form of chances on handie-talkies, keyers, antenna systems, etc., can be very successful as well as a heck of a lot of fun. It gets to be an "in" thing for all of the members to buy their tickets so they won't get left out. With enough promotion, the meeting you select for the drawing can really be turned into a mini-hamfest.

Public Activities

The club has to keep the public informed of its existence. Local newspapers love to have articles about your meetings or activities. Exposure to the outside world can be achieved by setting up portable stations in shopping malls, grocery centers, schools, and service clubs (Lions, Rotary). Many times you can solicit donations at these outings, also. Try to have the local TV mini-cam, radio station, newspapers, and magazine reporters on hand to report on your activities. Traffic handling, OSCAR, phone patches, and, best of all, SSTV, can be effective in attracting attention. Don't forget to hang *big* signs with the club logo (You don't have one? Shame!) or name predominant, as well as names and phone numbers of those members who can sign up prospects for Novice classes. Advertise your local repeater frequencies. You won't believe how many VHF scanners are out there just waiting for amateur radio to inhabit the speaker!

It is up to you and your club. Do you really want bigger and better membership? Do you want to have more fun? Do you want to expand each member's awareness and knowledge? The MARC has proven that all of this can be done in a village of 2000 people. The best part of this is that the entire effort can only benefit amateur radio everywhere. ■

Want to Upgrade? Take a Tip from a Ham Who Did!

— previewing the new code test

You should upgrade. It's easy. I'm writing this to encourage you. If I could pass and upgrade to the Advanced license, so can you. Let me explain.

In the Los Angeles area, one can attend Murphy's Radio Class. This class increases your knowledge and ability to pass the theory and regulation segments of the FCC tests. Also, Murphy's sells code tapes to help you pass the 13 wpm requirement. Other cities probably have similar classes and aids.

So now we are down to the crux of the problem: code, code, code, 13 wpm, 13 wpm, 13 wpm. That does not sound like much. But it takes study and time and effort and is well worth it.

I got up about one-half hour earlier each morning to study code. Also, a local repeater was broadcasting the Murphy tapes 3 or 4 nights a week. They were so helpful to me that I finally bought a set. Then I made progress to about 10 wpm. It took the 13+ wpm tape by *73 Magazine* to

push me over the magic 13 wpm. The tape from *73 Magazine* was mind-stretching and of great help.

I was cool, man. Psyched up and all that. No way will the FCC cause me to falter. The 13 wpm will be a breeze.

On a nice Wednesday, I studied in the morning, ate a late brunch, and drove to Long Beach, Calif. I parked my pickup and walked about 3 blocks. Nice day. Nice sun. I was cool, man.

I arrived at the FCC reception area on time, about noon, and that's about an hour before anyone wants to get serious at the FCC. So now I cooled my heels. Being cool, man, I read a *Reader's Digest* and acted nonchalant. No code test is going to get me down.

While waiting, one episode was interesting. A young man asked if I was going for my Extra, probably because of my grey sideburns. No, I was not, but I could help because I am an electronics engineer. His question concerned

microvolts at the half-power points from an antenna when given microvolts at the center of the lobe or beam. Be careful here to calculate in microvolts, not Watts. A factor of 0.707 enters. Such final reviews are common while waiting for the tests to start. Later I saw the young man taking the Extra written test, so he had passed the 20 wpm test. Good for him.

Finally, it was my time. The group for 13 wpm was called. We filed in, adjusted earphones, and waited. A young lady said we should copy down everything we could. Since the code test is one of comprehension, anything could help to select the correct multiple-choice answer. I found that to be very helpful and the FCC people friendly.

Then the palpitation commenced. My heartbeat went up. My breath came in short pants. My hand shook somewhat. And believe me, I'm serious. I had been psyched up. I had been cool. Yet the Funny Candy Company had re-

duced me to a driveling idiot and the test had not yet started.

During the one-minute warmup run, I copied about 50%. This indicated I was about to fail miserably. Naturally, this did not calm me. In fact, if anything, I was ready to quit then. But I was tangled up in the earphone wires, so I decided to stay.

The test began. W4— was talking to WA4— or close to that. Then there was something called RST. I figured that was CW short for RUST. The trouble was, some numbers followed RUST, so I dutifully copied them down. Lucky for me that I did. They had the nerve to ask me later how much RUST there was. So I picked 479's worth, and that was right.

Some guy named Fred was ... and about there I blanked out and lost a whole string of stuff. But I did pick out two Rs in the middle. Keep them. May be useful later.

As things progressed, old Fred turned out to be 43 years of age and lived in Some City, USA. He

worked as a cowboy in Alabama or somewhere. Also, the weather was wet and windy.

The test proceeded to consider technical things like antennas, heights, tubes, rigs, etc. The rig I copied was an HQ-101 followed by something, something, something. I shifted my brain to zero and picked only an 8 out of the whole mess.

Finally, the pain subsided. Some 73s and old W4—signed with WA4—, but my palpitating heart did not slow. The FCC lady passed out the questions. Questions have never bothered me, but the answers do.

The first question said the two stations were W6— and W8— or W5— and W1—, etc. Not a mention of a W4 call. So I moved on to the second question. Aha! Weather! Once again I had four choices, but none was wet and windy. The third question also was

from left field. It did not relate to my copy. Oh well, if I could answer all 8 of the remaining 7 questions, I could still pass.

I got up, not to leave in dejection, but to ask if I had received the correct questions. The kind FCC lady checked the cassette tape in use and told me #203 was correct and I should proceed.

Ready to quit, I stole a glance at the top of the question sheet at the next desk. The number at the top truly was #203 preceded by 12. My sheet had a preface of 20. So, back to the nice lady who finally gave me the correct 12-203. Aha! Now W4 and WA4 were involved, but by now my heart was more than palpitating.

The rest of the questions were straightforward. The other person's name was Randy, Rocky, Rory, or Rindy. I had copied only the name Fred plus two Rs in a

monstrous gap. So obviously the two Rs had some relationship to Rory. So I marked it.

Later, I had to identify the rig transmitting. That should be easy. I had clearly copied HQ-101. Eagerly I searched for an HQ-101 answer. By golly, there was one—in fact, there were two. One had 14 tubes, while the other answer had 17 tubes. I had copied no tubes in my panic. But I did have the random 8 in the middle of a second tremendous gap. Well, 8 is fairly close to 7, and certainly a long way from a 4. So I guessed the answer as an HQ-101 with 17 tubes, which was correct. See how easy it is to pass?

Completed the test. Turned in the papers. Knew I had failed. Takes 8 out of 10 to pass. Heart still pounding. Oh well, I can come back in 30 days and try again.

Time clanked by and I

was not thrown out on my ear. Maybe I had passed. Finally my name was called. I went into the next room to hear, "You passed."

The story above is true, but changes were made to disguise the FCC questions and answers. It had a happy ending. I qualified for the Advanced license. But the code test could have been a breeze if I had followed one simple rule: Concentrate on one character at a time. Worry about the words and the meaning after the test. Either of my lapses could have caused me to fail. Both occurred because I began to think about the words and lost my concentration. So concentrate and win your new license.

Remember, the people at the Funny Candy Company are okay and helpful throughout. So study and good luck. You, too, can upgrade. ■



MONITOR \$149, 12" B&W

COMPLETE KEYBOARD TERMINAL \$375
Full Kit \$325 (includes SCT-100)

Stand Alone Video Terminal

@B7G@0u.pv@Z4v@R@1@2@0@:~@J|@+@+@
!"#\$%&'()*+,-./012456789:;<=>?
@ABCDEFGHIJKLMN@P@R@S@T@U@V@W@X@Y@Z@[\]^_`
~@abcdefghijklmnopqrstuvwxyz@{|}~@

SCT-100 VIDEO BOARD FEATURES

- 64x16 line format with 128 displayable characters
- Serial ASCII or BAUDOT with multiple Baud rates
- \$197 Assembled or \$167 Kit (Partial Kit \$99)
- Full cursor control with scrolling and paging
- On board power supply
- Serial interface RS232 or current loop
- Purchase SCT-100 alone or complete terminal



9881 Chartwell Drive
Dallas, Texas 75243 (214) 349-2490

ORDER BY PHONE/Overseas orders & dealers welcome

MRS100 FEATURES:

- Connects directly with any ASCII or Baudot Teletype®/Terminal
- Operates from 1 to 150 WPM with Auto-Sync.
- Displays WPM rate of copied signal plus FIFO buffer status.
- Contains a built-in 80 Hz bandpass filter and sidetone oscillator.

\$295 Assembled & Tested • \$225 Complete Kit • \$95 Partial Kit



XITEX MORSE TRANSCIEVER

NEW FROM XITEX...ABM-100

Universal Converter ASCII • Baudot • Morse

The ABM-100 is a universal code converter for translating between ASCII and Baudot, or between Morse and ASCII (or Baudot). Also used as a TTY® speed converter. Assembled and tested the ABM will operate from a single +5V supply and sells for \$129. Write for complete details

A Microwave Primer

— waveguides, X-band, and other fun stuff

If one inspected the frequency assignments to amateur radio which lie in the spectrum above the ultra high frequency (UHF) region, one would find thousands of megacycles are available. Much of this spectrum is unused by radio amateurs; only small portions are occupied and then only sporadically. Some of these bands are shared by other services.

The thrill of communicating over very long distances on these frequencies is experienced by few amateurs and is reported and read by an equal few. What is it that makes this part of our hobby so compelling to those few that they will continue to experiment when there is lit-

tle company on these bands? Why aren't there more experimenters? Perhaps you think that the equipment is expensive, or that construction is difficult, or maybe you can't find information on how to implement a microwave project.

The expense in implementation of a microwave station is not as great as some of the equipment costs for an HF or VHF station. The components are a little more difficult to acquire, but are available via surplus or from microwave component manufacturers. As for information on construction and operation, an abundance of information has been published in amateur radio

journals for the last 40 years and much more is available from technical societies through the papers they present.

How does communication differ from that found on the lower bands, and why should you be inspired to try your hand at using these frequencies? These questions are easy to answer. A microwave QSO, depending on the mode used—and there are many modes available that can't be used on the lower bands—rarely if ever suffers from QRM, QSB and QRN, sure. (Anyhow, microwave QRM might even be a pleasure to hear sometimes!)

Most of the operations at W1SNN have been

either FM or pulsed CW, and in most cases the signals were dead full quieting at each end of the circuit. It is true that the QSOs require an expedition to a high point, and a great deal of work goes into the project, but go out in the field on a Field Day and work five states and numerous sections with other stations and then see who has the highest multipliers. Most of all, the work is forgotten when you realize that the power levels transmitted are in the tenth of a Watt to a Watt level, into a three foot dish, and the guy you were talking to using similar equipment was forty or fifty miles away on top of a mountain that you couldn't even see.

Well, now that I have extolled some of the great things about working microwaves, I suppose you might like to know what microwaves are.

The name, microwaves, has been given to those frequencies which fall into and above the UHF spectrum. Who named it microwaves? I suspect, but cannot authenticate this, that it was so named during the early part of World War II when radar was coming into its own. Perhaps the

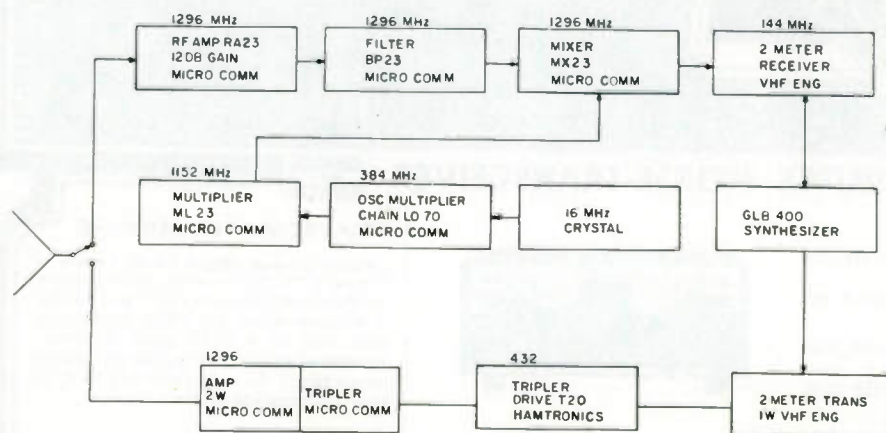

Fig. 1. 1296-MHz transceiver.

security measures which gave the various bands letter designations during this conflict brought the name into use. At any rate, it is a good name for the spectrum which, as we proceed to examine it, will be seen to include wavelengths of some frequencies we can use as amateurs which are hardly as long as the word microwave itself.

Let us examine how the Federal Communications Commission has assigned band nomenclatures to the radio spectrum and also how microwave equipment manufacturers have retained the WWII designations.

The FCC has assigned band numbers and lettered designations as nomenclature for all of the electromagnetic spectrum. The frequency allocations that are assigned to the ham bands are known to us by their designations, VHF, UHF, VLF and others. (See Table 1.)

The designations in Table 1 are found in the Rules and Regulations part of many of the commercial license examination question-and-answer books. Notice that the way they are grouped falls in line with the metric system, and that if the metric equation is worked out to become meters in wavelength, it falls in decades. Either way, it's easy to remember after a slight bit of study.

Further examination of the other tables may open your eyes to several facts about the bands that we occupy and rarely think about in terms of how they are located in the radio spectrum.

Table 2 shows how the HF spectrum adds up to the number of megacycles that we as amateurs occupy. When one examines

the dial of the station HF receiver, the number of bands and the spread of them over the dial make it look vast. The frequency ranges are in very small steps from 160 to 10 meters in most receivers, but when the total number of amateur frequencies is added up it's only 3.5 MHz total coverage out of thirty—a little more than ten percent.

Some of the small nations that will attend the World Administrative Radio Conference (WARC) are of the opinion that, although they have a very small population in the vast high frequency sea, they now will need more. When they band together with their 1 vote-per-nation, they are going to be a formidable group, looking at our 10% as something they want—and may get.

Why bring this up? Let's look further at the number of megahertz we have available in the high frequencies. The total up to the end of VHF assignments, that stop at 1 3/4 meters, is 20.5 MHz. If we go on up into the microwaves, the total number of gigahertz that we have is 23.290 (see Table 2). Out of this, very little is used by amateurs. The 3/4-meter band is used quite a bit for repeaters, and 1296 MHz is really catching on these days as are many of the frequencies up through 10 GHz, but not enough. It looks as if we could lose a lot of spectrum simply because we do not lay claim to it by enough use. These frequencies are very attractive to the 40 or more nations who will certainly exercise their combined single votes.

When you look at Table 2 again, you can see that the total number of gigahertz, not megacycles, is listed at 23.290, and the last assignment, which starts at 300 GHz, isn't listed in

Band 4	VLF Very Low Frequencies	Below 30 kHz
Band 5	LF Low Frequency	30 to 300 kHz
Band 6	MF Medium Frequency	300 to 3000 kHz
Band 7	HF High Frequency	3 to 30 MHz
Band 8	VHF Very High Frequency	30 to 300 MHz
Band 9	UHF Ultra High Frequency	300 to 3000 MHz
Band 10	SHF Super High Frequency	3 to 30 GHz
Band 11	EHF Extremely High Frequency	30 to 300 GHz

Table 1. Nomenclature of frequencies.

the table; that gives us all above that to play in.

Well, I can hear some of the groans and moans from those who will say, "So what? How in the heck can we get up that high?" I'll tell you: These frequencies are in use commonly by commercial users right up to and well beyond the highest assignment.

The microwave spectrum is made up of bands, referred to popularly by designations such as "S"-band or "X"-band. An examination of Table 3 shows how these bands are designated today. The table was taken from a manufacturer's list of waveguides and waveguide components such as flanges and covers, and, later on, the Electronic Industries Association (EIA) gave additional references. There are many others, but those listed are the most popularly used. Table 3 designations are useful to amateurs who are scrounging the surplus market for components for microwave construction. Many of the components are marked with waveguide designations that may confuse them, however. For example, a waveguide sec-

tion with an EIA WR designation of 90 will mate with other components that are marked RG-52 and (reading horizontally) can be cross-referenced so that pieces of copper guide or components made of aluminum can be mated.

Similar designations are found on flanges and covers of various dimensions. It is also a guide to square and round flanges which have holes arranged to preclude crossguide couplings.

Many of the older modes of communication are in use on the microwave bands, CW, MCW, and AM, and not too often, pulse-modulated signals are used. SSB has been used, but not without problems that embrace the fundamental stability of the equipment. These problems are being overcome however, and that mode is increasingly in use.

With the advent of the VHF repeater, microwave systems that have been used by amateurs are being pressed into service as control links for receivers and transmitters used to augment coverage of a particular repeater. X-band is being used for many of

160 . . . 10 meters	3.5 MHz	High Frequencies only
160 . . . 1 3/4 meters	20.5 MHz	
420-450 MHz	30 MHz	High Frequencies and VHF
1215-1300 MHz	85 MHz	
2300-2450 MHz	150 MHz	
3300-3500 MHz	200 MHz	
5650-5925 MHz	275 MHz	
10.0-10.5 GHz	500 MHz	
24.0-24.25 GHz	250 MHz	
48-50 GHz	2 GHz	
71-76 GHz	5 GHz	
165-170 GHz	5 GHz	
240-250 GHz	10 GHz	(20.5 MHz to 10 GHz totals up to 23.290 GHz)

Table 2.

these systems because of the availability of equipment and because the equipment can be made small. In the repeater system used by The Waltham Amateur Radio Astronomy Society, data is sent between three different sites via radioteletype on X-band, and reprocessed in a Southwest Technical Products 6800-2 computer system. Direct data also has been transmitted to control the WR1AJE repeater operated by the Society.

Present day amateur station equipment has reached a sophistication that makes even the modest frequency-controlling system incorporated in transceivers useful additions to the componentry needed to make up an amateur microwave station.

The frequency relation to the lower frequency equipment is easily mixed up with many of the MW frequencies, or in many

cases it simply can be the start of a multiplier chain. An example is operation on the L-band assignment at 1296 MHz. By building a multiplier chain, the output of a low-powered two-meter transmitter can be utilized at 1296 and have the stability of a crystal-controlled or synthesized frequency source. The stability of the overall system, of course, is within the constraints of the frequency error multiplied nine times. But it is stabilized well within the needs of a communication system employing a reasonable receiving bandwidth. Multiplying by 16 of the same two-meter system will put you into 3204 MHz with the same general constraints. Starting with a 432-MHz transmitter will make things easier to construct, but in either case it puts the beginnings of an excellent transmitting system within the realm of any amateur possessing the

driving source.

Receiving equipment for these bands can be constructed around lower frequency station equipment and provide excellent companion sections for the method of constructing a transmitter previously described. There are several manufacturers who produce multiplier chains, mixers, and other components made precisely for amateur use at a cost which is within the size of most pocketbooks.

To move up into the higher microwave frequencies one must improvise upon components which are available through the surplus markets, or construct one's own. In many cases the latter approach is easier. Most of the real great steps in microwave communication have been taken by amateurs, and they were using equipment of their own design. In many cases, this departed from classic methods only

because componentry was not available. Much has been written about this equipment, and many good DX records and firsts still remain in the realm of amateur radio because of ingenuity prompted by component unavailability.

This same approach must be applied to antennas for microwaves. There are many articles available on the construction of dish antennas if you choose to make one. Several are listed in the references. They can be constructed from plywood for the ribs and fine mesh for the reflecting surface, and will be as sturdy as your craftsmanship makes them. Some amateurs have made them of aluminum, and these units are certainly as good as the "commercial" make them. They also may be found as surplus or, for that matter, may be purchased as new goods. In any event, it will be important to know the focal

EIA WR No.	/Fxr Band Prefix	Former Microlab Code	Former Bogart Code	Frequency Range (GHz)	Waveguide			Waveguide Size (in.)	
					Brass	Aluminum	Silver	i.d.	o.d.
650	L	05	L	1.12-1.70	RG-69/U	RG-103/U		6.500 x 3.250	6.660 x 3.410
430	R	15	R	1.70-2.60	RG-104/U	RG-105/U		4.300 x 2.150	4.460 x 2.310
284	S	25	S	2.60-3.95	RG-48/U	RG-75/U		2.840 x 1.340	3.000 x 1.500
187	H	35	H	3.95-5.85	RG-49/U	RG-95/U		1.872 x 0.872	2.000 x 1.000
137	C	45	C	5.85-8.20	RG-50/U	RG-106/U		1.372 x 0.622	1.500 x 0.750
112	W	50	B	7.05-10.0	RG-51/U	RG-68/U		1.122 x 0.497	1.250 x 0.625
90	X	55	X	8.20-12.4	RG-52/U	RG-67/U		0.900 x 0.400	1.000 x 0.500
62	Y	65	KU	12.4-18.0	RG-91/U	RG-349/U		0.622 x 0.311	0.702 x 0.391
42	K	75	K	18.0-26.5	RG-53/U	RG-121/U		0.420 x 0.170	0.500 x 0.250
28	U	85	KA	26.5-40.0			RG-96/U	0.280 x 0.140	0.360 x 0.220
22	Q			33.0-50.0			RG-97/U	0.244 x 0.112	0.304 x 0.192
15	M			50.0-75.0			RG-98/U	0.148 x 0.074	0.228 x 0.154
12	E			60.0-90.0			RG-99/U	0.122 x 0.061	0.202 x 0.141
8	F			90.0-140			RG-138/U	0.080 x 0.040	0.156 diam.
5	G			140-220			RG-135/U	0.051 x 0.025	0.156 diam.

EIA WR No.	Brass Cover	Brass Contact	Brass Choke	Aluminum Cover	Aluminum Contact	Aluminum Choke	CPR Flat	CPR Grooved	CMR
650		UG-417A/U	R		UG-418A/U	R	650 R	650 R	
430		UG-435A/U	R		UG-437A/U	R	430 R	430 R	
284	UG-53/U	O	UG-54B/U	O	UG-584/U	O	UG-585A/U	O	284 R
187	UG-149A/U	O	UG-148C/U	O	UG-407/U	O	UG-406B/U	O	187 R
137	UG-344/U	O	UG-343B/U	O	UG-441/U	O	UG-440B/U	O	137 R
112	UG-51/U	S	UG-52B/U	S	UG-138/U	S	UG-137B/U	S	112 R
90	UG-39/U	S	UG-40B/U	S	UG-135/U	S	UG-136B/U	S	90 R
62	UG-419/U	S	UG-541A/U	S	UG-1665/U	S	UG-598/AU	S	90 R
42	UG-595/U	S	UG-425/U	O	UG-596A/U	S			
28	UG-599/U	S	UG-381/U	O	UG-600A/U	S			
22			UG-383/U	O					
15			UG-385/U	O					
12			UG-387/U	O					
8			FXR Special	O					
5			FXR Special	O					

Table 3. O = circular flange. R = rectangular flange. S = square flange.

length of these devices for reasons which will become apparent when you design or follow another's design for the "feed" antenna that illuminates the dish. This part of the project is one of the most interesting and will require that you bone up on the subject.

How much gain does the antenna have to have and does a dish have it? Well, I am assuming that you will use a dish, but there are other reflector-type antennas that will work, like the helical, and corner reflectors. They will have gains dependent on how elaborate you make them. These antennas also will work at the microwave frequencies, but with much less efficiency. So, back to the parabolic antenna. As you can see from the plot shown, the gain of a dish is proportional to its size: as the diameter goes up, the gain goes up.

Table 4 was taken from an antenna gain calculator and neglects many factors that this article does not have the space to treat. It does show that from a diameter of 12 inches to six feet, the gain goes up tremendously, and that the reason is that the beamwidth becomes very narrow. The beamwidth scale shows that at 1.3 GHz the angle is 7.5 degrees wide, and that as we move up to X-band, it is only .79 degrees wide at the half-power points for a 96-inch dish. Move the diameter down to 36 inches, and the 1.3-GHz beamwidth is quite wide (nearly 20 degrees) and the X-band beamwidth is 2.7 degrees. You can see that depending on what frequency range you are in, you may either have an antenna that works like a flashlight beam or one that is about like having a multi-element linear array. It also shows that if you choose to make an antenna like a parabolic

reflector to be used at the lower frequencies, a dish of 72 inches would be most practical, while at the S- to X-band assignments, a 36-inch reflector will have a power gain of 25.1 decibels at 2.4 GHz, and at X-band, 37 decibels. This is where you make a decision dependent upon the amount of work you must do.

Antenna feeds are another part of the problem and will require great care in construction. They are not very hard to make, however, and most of the work can be done in your shop with hand tools, which makes the rewards even more worth the trouble.

Several manufacturers make excellent equipment for use in amateur bands L and S, which require multipliers to these two assignments. These manufacturers are owned for the most part by radio amateurs who have designed the equipment so that it meets the rigid requirements for the job. The price of the gear is moderate.

Activity in the higher S-band and C-band assignments has been moderate. The S-band frequency is the most used of the two since the equipment available is mostly from wartime radar. The C-band frequency, which is a very interesting one, is quite inactive, probably because of the equipment availability problem. Several interesting reports by amateurs using each of these assignments have appeared in amateur magazines, and should be of interest to those who plan to use them.

Activity in the X-band range (10-10.5 GHz) at the present time is very high. This is because of the availability of much equipment that has been showing up in the surplus area in the past year. Radar-measuring equipment, STL link equip-

ment, and, yes, even police radar sets are showing up as surplus. Several microwave manufacturers make police radar oscillators which easily can be returned from the police band (10.525 GHz) to the amateur band.

The bands above X-band offer unlimited possibilities. The amount of spectrum available in these frequencies is so large that it becomes hard to compare except to say that considerably more space is available than within all of the other amateur bands combined. ■

Dish Diameter	E-H Plane Beamwidth at 65% Efficiency Frequency (GHz)			Power Gain, dB		
	1.296	2.4	10.2			
	120 inches	5.5	2.7	.7	31	35
96 inches	7.5	3.5	.79	28	33.5	45.5
72 inches	9	4.5	1.25	26	31	43
36 inches	18	10.2	2.7	20	25.1	37
24 inches	27	14	3.5	16.5	21	33
12 Inches	60	30	7	12.5	17	23

Table 4.

References

- Microcomm, 14908 Sandy Lane, San Jose CA 95124—microwave modules.
- Texas RF Distributors, 4800 West 34th St., Houston TX 77092—UHF equipment.
- RIW Products, Box 191, Babylon NY 11702—UHF and MW antennas.
- Microwave Associates, Inc., Burlington MA 01803—X-band amateur gear.
- "A Brass Horn For X-Band," S. M. Olberg, March, 1978, *73 Magazine*.
- "A Complete X-Band Transmitter," S. M. Olberg, August, 1978, *73 Magazine*.
- Microwave Bibliography*, Cliff Buttschardt, January, 1978, *Ham Radio*.

MADISON DOUBLE YOUR WARRANTY POLICY

Any large piece of gear we sell you (average \$300 or up) we will **double** your warranty period!

FOR EXAMPLE: A 3 month warranty = 6 months from date of purchase. 1 year = 2 years from date of purchase.

(OUR RELIABLE SERVICE DEPARTMENT REPAIRS NON-WARRANTY GEAR, TOO!)

Simply send your rig in a good shipping carton, postage prepaid, with a copy of your receipt showing date of purchase. We will repair promptly and return by best way.

NOTE: Manufacturers do not cover final in most cases, but we will try!

Try Our Competitive Prices, Too!

You, the customer, can only benefit from the **Madison Double Your Warranty Policy**.

Call **Don - K5AAD** or **Mike - W5VVM** for specific warranty claim questions.

POLICY SUBJECT TO CHANGE WITHOUT NOTICE
DOES NOT COVER SPECIALS OR CLOSEOUTS.



MADISON
Electronics Supply, Inc.

1508 McKinney, Houston, TX 77002, 713/658-0268

✓ M35

CB to 10

— part XX: converting the Royce I-655

Shortly before the deadline for the sale of 23-channel CB sets, a local department store ran a special sale to get rid of an overstock of the Royce 23-channel sets. Since the price was so low, I could not resist buying one of the Model I-655s. Although I didn't know exactly what I would do with the thing, I thought the PLL synthesizer was worth at least the purchase price of the unit.

The radio sat in the closet until I saw an ad in *73 Magazine* for conversion kits to put CB sets on 10 meters. Unfortunately, after checking the catalog of kits, I found that none was available for the I-655. The company offered to make a special kit for a \$15.00-an-hour engineering

fee, but, although this is a reasonable fee, it easily could have cost me more than for the rig itself.

Not easily discouraged, I sent a letter to Royce requesting information on the PLL unit. I received a brief, but polite letter informing me that the unit was sealed and no information was available. Being told this was enough to prompt me to tear into the unit and convert it myself. The project turned out to be extremely easy and straightforward. I will describe now the conversion procedure used on the rig.

It is worth mentioning that the Royce is not the only CB that uses this particular PLL unit. The I-655

is a 23-channel set, but the PLL unit itself is capable of generating 64 ten-kilohertz channels due to the 6-bit binary input that sets the divider chain. I imagine the unit is also used in the newer 40-channel sets as well. By adding only one SPST switch, the extra channels available on a converted 40-channel unit may be obtained on the cheaper 23-channel units.

The block diagram included with my I-655 indicated the rig has three oscillators: 37.38 MHz, 10.24 MHz, and 10.695 MHz. When I opened the unit I found a 36.190 MHz oscillator instead of the indicated 37.38 MHz one. I do not know why the diagram is wrong, but if your unit has the 36.190 MHz oscillator instead of the indicated 37.38 MHz one, the conversion will work. I cannot say what the results would be on a unit with the oscillator frequency indicated on the block diagram—so be careful.

In order to work on the PLL unit, you must first remove the box that encloses it (I guess this is what is meant by sealed unit). The box is removed by unsoldering the two

ends and then snapping it off. Once the cover is removed, you should see a 36.190 MHz crystal roughly in the center of the PC board. Directly below the crystal is an adjustable coil of the metal can type. The two 10-MHz crystals are off to either side. Each oscillator has a trimmer capacitor to touch up the crystal frequency. You will adjust only the coil and trimmer for the 36 MHz crystal, so do not touch the others.

The new crystal frequency is simply 36.190 MHz + the amount you wish to move the transmitter up by. Since I converted my set according to the 73 plan, I moved it exactly 2.0 MHz, giving a new crystal frequency of 38.190 MHz. I ordered my crystal from Jan Crystals, and they were quite helpful in providing the necessary correlation information for me. Table 1 gives the information needed to order a new crystal. Using the 2.0 MHz shift gives coverage from 28.965 MHz (channel 1) to 29.255 MHz (channel 23). If you in-

Crystal frequency: 38.190 MHz
Type: Third overtone
Holder type: HC-18/U
Equivalent series resistance: $< 30 \Omega$
Load capacitance: 25 pF
Tolerance: 0.0025% or better
Temperature: 25 °C (non-oven)

Table 1. Crystal correlation data for the Royce I-655 PLL unit. The indicated crystal frequency moves the output up by 2.0 MHz.

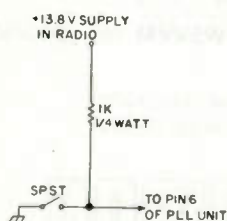

Fig. 1. The switch is closed for normal operation, open for extended frequency operation. (See text.)

stall the range-extending switch, you will have coverage to 29.575 MHz. The frequencies generated are listed in Table 2 for reference.

Once you obtain the new crystal, solder it in where the original crystal was and connect the rig to a dummy load. When you key the radio, you will have no output. This is because the drive is cut off if the PLL is not locked up. With the rig keyed, carefully adjust the coil directly below the new crystal. At some point the output meter will suddenly jump up, indicating the unit has locked. You will probably need to adjust the coil slightly more in order to get lock over the entire range of available frequencies. My unit would lock over the entire expanded frequency range with no problems.

There are two coils at the end of the PLL board nearest the front of the radio that should be touched up for the best output at midband. In order to set the operating frequency exactly, you will need to couple a counter to the output by an appropriate means, and adjust the trimmer for the 38-MHz oscillator to put you on the right transmit frequency. This also will take care of the receive frequency.

Tuning the transmitter and receiver strips are a bit tricky in the I-655, due to the mounting configuration of the PC boards. Since the individual boards are mounted at right angles to the main PC board, you probably will need to make a very short alignment tool to fit the coils. The transmitter board is located next to the PLL unit. There are only three coils to adjust when tuning the transmitter section.

These are T401, T402, and L403 on the schematic diagram supplied with the radio. I found that my unit would put about 5 Watts into a 50-Ohm load when properly tuned up. Do not try to adjust L404 since it is fixed (the slug is glued in).

The receiver has only two transformers to adjust in the rf stage. The if uses ceramic filters that require no alignment. Using whatever signal source you have, touch up the tuning on T101 and T102. T101 is located at the back of the PC board, above the keying relay. You may want to remove the speaker to adjust T102, since it is partially under the speaker frame. Once you have tuned up the front end, the rig is ready for use. My set checked out with less than 0.3-uV sensitivity for 10 dB (S + N)/N over the entire band.

You might want to add the simple modification to give you the extra channels of a 40-channel rig. As I mentioned before, the PLL unit itself can generate 64 channels. This will cover all the frequencies from 28.965 MHz to 29.605 MHz in 10-kHz steps. Although I did not install the necessary 6 switches to accomplish the full conversion, it is only a simple extension of the single-switch conversion that I will describe. If you install the single switch and use it in conjunction with the channel selector, you will have the 46 channels listed in Table 2. You might want to attach this table to the radio for easy reference.

Turn the radio over and you will see that there are 24 pins which come from the PLL unit and extend through the main PC board. I will refer to these pins as numbers 1 through 24, with number 1 starting at the rear of the radio. Pins 5

through 10 program the frequency of the PLL. On the 23-channel rigs, pin 6 is permanently grounded, disabling the input. To reactivate pin 6, cut the traces on either side of the pin and connect the pin to an SPST switch as shown in Fig. 1. Since you are only switching dc here, you can mount the switch wherever you feel is most convenient. When the switch is closed, the unit operates normally; when the switch is open, the higher 23 frequencies are produced starting with channel 1 on the selector.

If you want to have all 64 channels, simply install six switches in the same manner as given in Fig. 1, one switch for each of pins 5 through 10. With six switches, the channel selector will be nonfunctional and you must program the frequency with the individual switches. It should be an easy matter to make a table of the resultant channels.

I made one final modification that has proven quite useful while operating the rig. I installed a BNC jack on the back of

the radio just below the power jack. I coupled the BNC jack to the rf output jack with a gimmick capacitor so that I could monitor the output frequency of the rig.

Although the specific instructions given here are intended for the Royce I-655, they should be broadly applicable to many CB sets which use the same PLL unit. The fact that only a single crystal is needed for the conversion makes the PLL rig a much better value than the heterodyne-type sets requiring several crystals for the same or smaller number of channels. Since the 23-channel PLL sets often can be obtained quite cheaply, this also makes them attractive for conversion when the extra channels can be obtained easily, as I have described. If you opt for the extra channel switch or switches, I would suggest discretion in their use to avoid interference with OSCAR, etc. I will do my best to answer any questions if an SASE is included with your inquiry. ■

Channel Selector	Operating Frequency (MHz)	
	Switch Closed	Switch Open
1	28.965	29.285
2	28.975	29.285
3	28.985	29.295
4	29.005	29.305
5	29.015	29.325
6	29.025	29.345
7	29.035	29.355
8	29.055	29.375
9	29.065	29.385
10	29.075	29.395
11	29.085	29.405
12	29.105	29.425
13	29.115	29.435
14	29.125	29.445
15	29.135	29.455
16	29.155	29.475
17	29.165	29.485
18	29.175	29.495
19	29.185	29.505
20	29.205	29.525
21	29.215	29.535
22	29.225	29.545
23	29.255	29.575

Table 2. Operating frequencies available with normal operation (switch closed) and extended operation (switch open). See text for explanation.

Something New: the MVM

— “most versatile meter” measures capacitance and frequency

Building the Heathkit function generator was easy—and it worked when I turned it on. I soon realized, however, that if I wanted to know the output frequency more accurately, I would have to have a separate instrument that would give me a quick and easy-to-read value. I could, of course, have built a digital counter, a harmonic crystal oscillator, or any of a number of exotic frequency-measuring devices, but all I wanted was a simple device that would be easy to build, simple to calibrate, and easy to read. Little did I realize what I was about to find out!

Some years ago, when atomic physicists required a device that would measure pulse rates from

radioactive materials, they came up with the simple circuit shown in Fig. 1.

Before we get into the operation of this device, however, it is necessary to know that the pulse input to the circuit must be shaped. This is called “signal processing.” The pulse required must have a fast rise and fall time and also a specific duration time. What I’m describing is a pulse like the one in Fig. 2(a), where t_r is the rise time, t_f is the fall time, and t_d is the pulse duration. If t_r and t_f are very short, then the pulse will look rectangular, as in Fig. 2(b). This is the kind of input signal needed by the circuit in Fig. 1.

Keep in mind that the in-

put signal—the frequency of which we want to measure—can be a sine wave, triangular wave, square wave, or something in between these shapes. To turn these wave shapes into rectangular pulses, we need a trigger circuit, a squaring amplifier, or a zero-crossing comparator.

The RCA 3130S, a fairly new operational amplifier with differential input, was selected as a zero-crossing comparator. This device has an excellent frequency response which allows a rapid output voltage rise as the input voltage crosses the zero or reference point. This is true even if the input voltage is rising very slowly, because, as the input voltage crosses the reference point, the gain of

the amplifier snaps the output voltage toward saturation, which is approximately the dc supply voltage—in this case, 12 volts.

The RCA “Solid-State Devices Manual SC-16” states that small amounts of positive feedback and symmetrical supply voltages would allow the device to operate satisfactorily to over 1 MHz. The maximum frequency we are interested in, however, is only 100 kHz. To preserve circuit simplicity, I decided to stay with the single supply voltage and no frequency compensation or bias control. This can be seen in the complete circuit diagram of Fig. 3. Note that a low-impedance driver circuit was added to ensure that the pulse shape would not

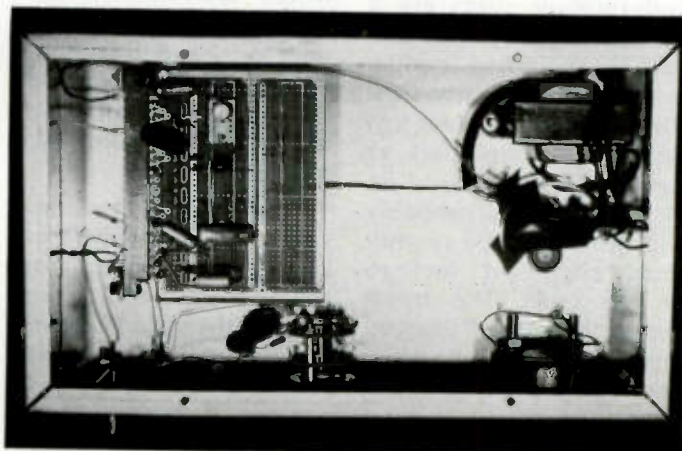
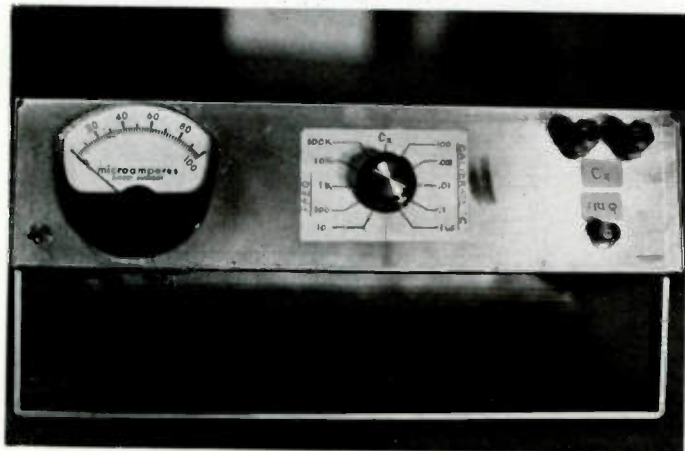

be degraded by the meter circuit.

Meter Circuit

Now refer to Fig. 4. Many people, when writing about this circuit, describe it as a rectifier and let it go at that. It is a rectifier, but without the input capacitor and the pulse-type waveform of input, we will learn that this circuit would not be so useful.

If you ask how much electric charge moves into the capacitor when a particular constant voltage is applied, you will find that the following relation holds: $Q = VC$, where Q is the amount of charge that has moved into the capacitor, C is the capacitance in farads, and V is the applied constant voltage. I keep using the words "constant voltage" because I want to be sure that the charge reaches a specific value and does not change.

Remember, too, that a capacitor does not charge instantly but takes an amount of time that depends on the resistance in series with it. The mathematical shorthand $t = RC$ is used to describe the phenomenon, with t the time in seconds, R the resistance in Ohms, and C again being in farads.

The graph in Fig. 5 shows the amount of time represented by RC . If we multiply the equation by ten, however, we come very close to the time it takes for the capacitor to reach full charge. So, let $t = 10RC$, where t is now the time it takes the total charge (Q) to move into the capacitor through the resistor (R).

Now we can get back to our measuring circuit. We have just learned that in order for the charge to reach a constant value, the time that the voltage is constant must be greater than $10RC$. To ensure this, all we have to do is make the dura-

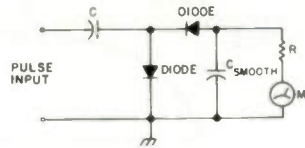

Fig. 1.

tion of the input pulse, t_d , greater than $10RC$. This is written: $t_d > 10RC$.

Look at Fig. 4. Assume that the pulse is at $+V$, $S1$ is closed, and $S2$ is open. C is, therefore, charging through R and the meter. Now assume that the pulse has passed and the input is at 0 volts. This is the same as saying that we have a wire connected from the capacitor to the ground wire. At this time, we also open $S1$ and close $S2$. This completes the discharge circuit, and C discharges very rapidly because the discharge resistance is usually very small. Now if we bring the next pulse along, close $S1$, and open $S2$, another charge cycle occurs—and so on.

Also, notice that more charge will move through the meter if the input pulse rate or frequency is increased. This charging current always moves through the meter in the same direction, so the meter

reads a pulsating dc value. This is why it is referred to as a rectifier, or, in the mathematical sense, an integrator.

Now that we know how the circuit works, we have to answer only two major questions. First, what can we use for the switches, and second, how can the circuit be used for measurement purposes?

The switching can be handled by mechanical relays or semiconductor FETs. Both of these devices require some kind of circuitry synchronized with the incoming pulses. The simplest switches, however, are diodes. The potentials (voltages) occurring in the circuit cause the diodes to switch automatically to the proper position. With no need for synchronizing circuitry, let's use diodes.

The second question, how to use the circuit for measurement purposes, is

best answered by some simple arithmetic. Remember that the capacitor is fully charged during each pulse if the voltage reaches a value, V , and remains constant for a time, t_d . If we multiply the charge by the frequency, (or by the number of pulses per second), we get: $FQ = FCV$, where F is the frequency.

If we realize that FQ is equal to the total charge that flows each second and we remember that "charge per second" is the way current is defined, it is easy to see that we can rewrite our equation as: $I = FCV$, where I is the current in Amperes—and there you have it!

What this equation says is that if V (the pulse height) and C (the input capacitor) are kept constant, we can use this circuit to measure frequency, F . If, on the other hand, F and V are held constant, we can

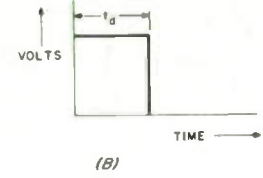
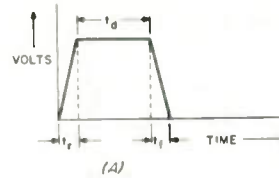

Fig. 2.

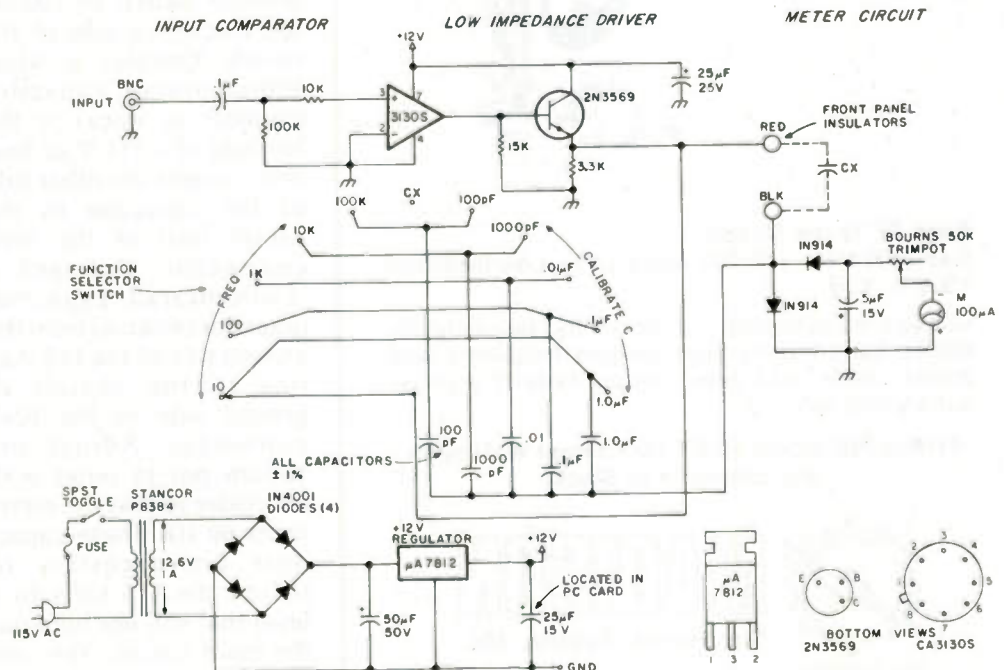

Fig. 3.

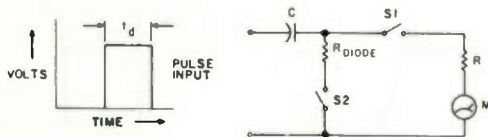

Fig. 4.

measure capacitance, C.

As an example, if we let the pulse height (V) = 10 volts, F = 100 kHz, and C = 100 pF, then $I = 100 \times 10^{-12} \times 10 \times 10^5 = 100 \times 10^{-6} = 100$ microamps. With a capacitor of 100 pF and a 100-microamp meter, we now can measure any frequency from 0 to 100 kHz.

One interesting twist to the circuit (see Fig. 6) is that if we multiply the average current (I) by the resistance (R), we get (from Ohm's Law) a voltage, e. Our equation now becomes: $IR = e = RFCV$.

If we measure the voltage across the resistor with a high input impedance voltmeter, we

now can measure not only F and C, but also R or V, the pulse height.

One last point: Since the metered values I and e are linearly related to the values we are measuring — R or C or F or V — calibration is very simple. It is necessary to calibrate at one point only.

The instrument I've finally ended up with can measure both capacity and frequency when used with the Heathkit function generator.

Construction

The photos give an indication of how this instrument was assembled. Most of the electronics were mounted on a 4½" by

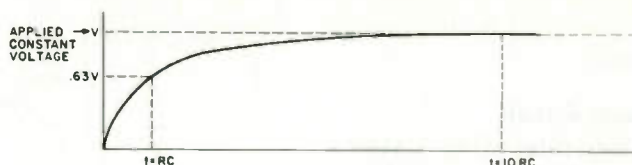

Fig. 5.

4½" printed circuit card. The power supply and regulator components are mounted on a "cut to fit the chassis" perfboard, seen just above the transformer. The power-on switch, meter, function-selector switch (frequency or capacity), input BNC connector, and "unknown capacitor" (C_x) terminals are all on the front panel. The PC card is plugged into a 22-pin edge connector that is mounted on two metal brackets. Everything is enclosed in an aluminum 3" × 12" × 7" chassis with a bottom plate. Incidentally, a PC card that I find very useful is the Vero DIP board no. 06-0147B. It handles integrated circuits as well as discrete components and can be clipped to fit tight quarters with a hacksaw or, better yet, a jeweler's saw.

Operation

Switch the instrument on and set the function selector switch to 100 on the frequency side of the switch. Connect the input BNC connector to an audio generator, or to your Heathkit function generator, and set the generator to 100 kHz (the frequency value on the frequency side of the switch). Increase or decrease this frequency so that the meter reads full scale. Now flip the function selector switch to the C_x position. The capacity meter is now ready to measure values of capacitance between 0 and 100 picofarads. The same procedure is used on the other ranges. ■

ment transformer.)

The instrument is now calibrated. You can use any frequency that you are sure is accurate on any of the ranges from 10 Hz to 100 kHz to do this calibration. Notice that the frequency side of the function-selector switch is connected to the "capacitor calibrate" side of this same switch. This puts the proper capacitor in series with the measuring circuit. In order to be sure that this accuracy is maintained in the frequency measurement, these capacitors should have a tolerance of not more than ±1.0%. Since these capacitors are available, we can use them to calibrate the instrument to measure capacity.

For example, suppose we want to measure capacity between 0 and 100 pF. Set the function selector switch to 100 pF on the capacitor-calibrate side of the switch. Connect the input BNC connector to an audio generator, or to your Heathkit function generator, and set the generator to 100 kHz (the frequency value on the frequency side of the switch). Increase or decrease this frequency so that the meter reads full scale. Now flip the function selector switch to the C_x position. The capacity meter is now ready to measure values of capacitance between 0 and 100 picofarads. The same procedure is used on the other ranges. ■

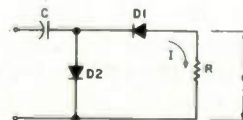

Fig. 6.

the indispensable
BIRD 43
 THRULINE® WATTMETER

Read RF Watts Directly.
 0.45-2300 MHz, 1-10,000 watts ± 5%, Low Insertion VSWR - 1.05.

Unequaled economy and flexibility: Buy only the element(s) covering your present frequency and power needs, add extra ranges later if your requirements expand.

THRULINE Model 43 RF Directional Wattmeter and Elements in Stock.

MADISON
 Electronics Supply, Inc.
 1508 McKinney • Houston, Texas 77002 • (713) 658-0268 ✓ M35

When you're not available, Phone-mate's Remote 930 is!

Our Telephone Products Division of Communications Electronics™ is pleased to introduce the new and improved Phone-mate Remote 930 telephone answering system. Unlike other telephone answerers, the Remote 930 has many useful and unique features not available on any other machine at any price. Features such as a LED digital message counter and Audio-Scan™ are standard on the Remote 930.

You can connect your Remote 930 to any phone system including the new "com-key" and private business systems. More importantly, the Remote 930 has built-in fail-safe features controlled by an internal computer to correct common user mistakes.

The incredible, new Phone-mate Remote 930 gives you complete control of all calls while you're away!

MANY IMPORTANT FEATURES

Only the Remote 930 gives you so many important features such as call monitor, ring adjust and remote control. You can retrieve your messages from anywhere in the world by calling in from any telephone, anywhere, anytime. Sound your coded pocket tone key and hear your messages played over the phone in complete privacy. The Remote 930 is your 24 hour message center for business contacts, family and friends.

SAVE TIME AND MONEY!

Save valuable time and money when retrieving messages by remote control. One phone call plays all messages as many times as you like without requiring you to hang up and call again. The remote backspace feature allows you to replay individual messages instantly without waiting for the entire tape to rewind and replay.

C-VOX™ AN EXCLUSIVE FEATURE

Controlled Voice Activation will allow your caller to leave a lengthy or involved message, but will also let you set a maximum time limit. With the Voice Controlled Announcement feature, you can tailor your personal outgoing message to any length, up to 30 seconds. A single control knob for operational simplicity can be set for: Record Calls, Playback Calls, Record Two-Way Conversations, Tape Record/Dictation, Record Announcement and Announce Only. A LED Digital Message Counter instantly indicates (up to 99) how many messages you have received. The counter also functions as a "timer" to let you know the precise length of your outgoing message.

The Remote 930 uses readily available, reliable cassettes that pop in and out instantly. Messages can then be stored for future reference.

FAIL-SAFE DESIGN

Advanced computer technology, unavailable until now, has been designed into the Remote 930. The specially engineered microprocessor has been programmed to recognize user mistakes and automatically correct them. For example, when the incoming message tape is full, some systems will not answer the phone. This means you would not be able to access your system to retrieve calls. However with the Remote 930, when an incoming message tape is completely filled, the machine will allow you to playback your messages and also respond to all remote commands. This is only one of several built-in self-correcting back-up measures to insure ultimate reliability and ease of operation.

TEST IT FREE FOR 31 DAYS!

Test a Phone-mate Remote 930 FREE for 31 days. Because the Remote 930 is such a new and improved answering system, we want you to put it to the test at your office or home for 31 days before you decide to keep it. Check out the unique features that put the Remote 930 in a class by itself. See how the handsome woodgrain styling and compact size compliment any home or office. Notice how effectively the Remote 930 will take your every call and give you your messages exactly as you received them. If for any reason you are not completely satisfied, we insist that you return it in new condition with all enclosed parts in 31 days, for a prompt refund.

phone·mate



COMPLETE NATIONAL SERVICE

With your Phone-mate Remote 930, we will send a complete set of simple operating instructions and a one-year limited warranty on parts and 90 days on labor. If service is ever required on any Phone-mate product purchased from Communications Electronics, simply send your system to one of our approved national service centers. When you purchase your telephone answering system from CE, you're buying from one of the world's leaders in high technology electronics.

MADE BY PHONE-MATE QUALITY CHECKED BY CE

Since all Remote 930 telephone answering systems sold by Communications Electronics are products of Phone-mate, the company that pioneered consumer answering devices, you can be assured of purchasing the finest and most reliable telephone answering machine in the world. In addition, our Quality Control Department further audits the quality of every Phone-mate model sold by us to ensure the high reliability found in all Phone-mate answering devices. CE has given the Remote 930 our quality control rating #1, which is our highest quality grade for technologically sophisticated equipment.

BUY WITH CONFIDENCE

The Remote 930 is an extraordinary telephone message center. It provides virtually any answering and message processing features that the most demanding businessperson could require. To order the world's only computer controlled and fail-safe engineered remote controlled answering system, send or phone your order directly to our Telephone Products Division. Mail orders to: Communications Electronics, Box 1002, Ann Arbor, Michigan 48106 U.S.A. Send \$299.95 plus \$5.00 for U.P.S. U.S. shipping for each Remote 930 system. If you have more than one person using your system, we suggest that you purchase an extra remote pocket tone key for every person authorized to receive messages at \$29.95 each. Prices and specifications are subject to change without notice. No COD's please. Cashier's checks and credit card order will be processed immediately. All sales are subject to availability, but because this is the most fantastic answering device that CE has ever offered, we have reserved enough units for immediate shipment. If you have a Master Charge or Visa card, you may call anytime and place a credit card order. Dial toll free 800-521-4414. International orders are invited at slightly higher cost. If you are outside the U.S. or in Michigan, dial anytime 313-994-4444. Michigan residents please add 4% tax. All order lines at CE are staffed 24 hours, seven days a week.

Due to the high demand for this most exciting and useful telephone answering system, please place your order today without obligation, to assure prompt delivery.

Copyright © 1979 Communications Electronics™



COMMUNICATIONS ELECTRONICS™

854 Phoenix □ Box 1002 □ Ann Arbor, Michigan 48106 U.S.A.
Call TOLL-FREE (800) 521-4414 or outside U.S.A. (313) 994-4444

We're first with the best.™

✓ Reader Service—see page 243

Other Phone-mate® Remote 930 Features:

- **Exclusive C-VOX**—Controlled Voice Activation means your caller has time to leave a long or involved message. As long as C-VOX™ recognizes the sound of a voice it will continue to record, making it ideal for detailed job orders or messages.
- **Remote Control Feature**—Hear your messages played back over the phone from any phone, anywhere by sounding your coded pocket tone key. Backspace to repeat message or backspace directly to the message desired. Erase/Store messages...you can reset back to the beginning, record new messages over old ones, or continue recording after old ones to save them.
- **Fail-Safe Design**—Advanced computer technology in the Remote 930 represents a major breakthrough in telephone answerers. The Remote 930's specially designed and engineered microprocessor is programmed to recognize user mistakes and automatically correct them. The built-in self-correcting back-up features insure ultimate reliability and ease of operation.
- **Dual Cassettes**—means versatility and convenience. By keeping your incoming messages and outgoing announcements on separate tapes, you can file important messages for future reference while also establishing an "Announcement Library" for recurring needs.
- **Useful for Dictating Ideas**—Use the Remote 930 as a tape recorder or for dictation, then file the cassette or have it ready for transcription.
- **Change Tape Without a Service Call**—Unlike reel-to-reel answerers, the Phone-mate's dual cassette system allows you to quickly change tapes without the inconvenience and expense of having a technician do it for you.
- **Voice Controlled Announcement**—Allows you to tailor your outgoing message. The voice controlled announcement feature, with automatic level control, lets you record outgoing announcements up to 30 seconds in length. This eliminates the inconvenience of having to rehearse and time messages to fit a fixed time limit.
- **Call Monitor**—screens your calls and eliminates unwanted interruptions by letting you hear who's calling without touching your phone or letting the caller know you're there. If you wish to talk, just pick up the phone. If not, let Phone-mate take the message and return the call at your convenience.
- **Record Two-Way Conversations**—Keep a record of important conversations. Phone-mate records both sides of important telephone conversations. This enables you to keep a record of negotiations, orders or appointments.
- **Audio-Scan™**—Designed to help you locate your messages fast. The specially engineered cassette system enables you to hear messages in rewind or fast-forward. This lets you locate specific messages rapidly for instant replay. Fast-forward moves the tape rapidly past unwanted messages.
- **Ring Adjust**—Phone-mate answers when you want it to. Adjust your Phone-mate to answer on any ring one through five, and leave it on at all times. When you're in, you have ample time to answer the phone yourself. If you're away, Phone-mate will take the call for you. Never worry about remembering to always turn your machine "on" when you leave. This protects you from the "telephone burglar." Your phone is never left to ring and ring unanswered...a sure signal that no one is home, and an open invitation to burglary.
- **Announce Only**—Broadcast important information. The announce only feature lets you give each caller an announcement message without recording an incoming message. Ideal to announce business hours, vacation schedules, movie times, etc. The message counter always operates, so you know how many people have called and heard your message. Great for tabulating calls in telephone surveys, etc.
- **Communications Electronics™**—quality control approval rating #1. Our highest quality grade for FCC certified technologically sophisticated telephone equipment.
- **LED Power On Light**—tells if your unit is on and functioning without examining power knobs.
- **LED Digital Message Counter**—indicates how many messages you have received. The counter also functions as a "timer" to let you know the precise length of your outgoing announcement.
- **Manual Erase**—allows you to erase previous messages when rewinding.
- **FCC Registered**—Conforms to all requirements for plug-in connection to a standard phone company modular jack.
- **Power**—Regular 110V AC; 60 Hz. house current.
- **Warranty**—1 year parts, 90 days labor.
- **Dimensions**—8 3/4" Wide, 11 1/4" Deep, 3 1/2" High
- **Shipping Weight**—3.18 Kilograms, 7 pounds

The World's biggest Bearcat® scanner sale!

Communications Electronics, the world's largest distributor of radio scanners, celebrates the introduction of four new Bearcat brand monitors with the world's largest scanner sale. From now, until January 31, 1980, you can save hundreds of dollars during our **two-million dollar Bearcat sale**. Even the new Bearcat models 300, 220 and Eight Track scanners are on sale. If you've previously purchased a Bearcat scanner from Communications Electronics, then you already know you're getting all the real, live excitement that a television program or newspaper can't provide. If you don't have at least one Bearcat scanner, the time to buy is now! Since we distribute more scanners worldwide than anyone else, we can sell the newest factory production models with the latest engineering updates, at rock bottom prices. Our warehouse facilities are equipped to process over 1,000 Bearcat orders per week and our order lines are always staffed 24 hours. We also export Bearcat scanners to more than 300 countries and military installations. Almost all items are in stock for immediate shipment, so save now and get a Bearcat scanner during the world's largest two-million dollar scanner sale!

NEW! Bearcat® 300

Available February - March, 1980

List price \$499.95/CE price \$329.00

7-Band, 50 Channel • Service Search • No-crystal scanner • AM Aircraft and Public Service bands. • Priority Channel • AC/DC Bands: 32-50, 118-136 AM, 144-174, 420-512 MHz. The new Bearcat 300 is the most advanced automatic scanning radio that Communications Electronics has ever offered to the public. Since the Bearcat 300 has over 2,100 active frequencies in memory, you can touch one button and search any of many preprogrammed services such as police, fire, marine and government. Of course, you still can program your own frequencies and monitor up to 50 channels at once. Since the Bearcat 300 uses a bright green fluorescent digital display, it's ideal for mobile applications. The Bearcat 300 now has these added features: Service Search, Display Intensity Control, Hold Search and Resume Search keys, Separate Band keys to permit lock-in/lock-out of any band for more efficient service search and a new vacuum fluorescent digital display. Reserve your Bearcat 300 now for February - March, 1980 delivery.

Bearcat® 250

List price \$399.95/CE price \$259.00

50 Channels • Crystalless • Searches Stores • Recalls • Self-Destruct • Priority channel • 50 Channel • 6-Band.

Frequency range 32-50, 146-174, 420-512 MHz. The Bearcat 250 performs any scanning function you could possibly want. With push button ease you can program up to 50 channels for automatic monitoring. Push another button and search for new frequencies. There are no crystals to limit what you want to hear. A special search feature of the Bearcat 250 actually stores 64 frequencies, and recalls them, one at a time, at your convenience. Automatic "count" remembers how often frequencies are activated by transmission—so you know where the action is. Decimal display shows the channel, frequency and other programmed features. The priority feature samples your programmed frequency every two seconds. Plus, a digital clock shows the time at the touch of a button. This is the only monitor radio that has received the Communications Electronics quality control approval rating #1. Our highest quality grade for technologically sophisticated equipment. The Bearcat 250. Scanning like you've never seen or heard before. Now in stock!



NEW! 50-Channel Bearcat 300

NEW! Aircraft Bearcat 220



Aircraft Bearcat® 220

List price \$399.95/CE price \$259.00

Aircraft and public service monitor. Frequency range 32-50, 118-136 AM, 144-174, 420-512 MHz. The Bearcat 220 is one scanner which can monitor all public service bands plus the exciting aircraft band channels. Up to twenty frequencies may be scanned at the same time.

Not only does this new scanner feature normal search operation, where frequency limits are set and the scanner searches between your programmed parameters, it also searches marine or aircraft frequencies by pressing a single button. These frequencies are already stored in memory so no reprogramming is required. The Bearcat 220 also features a Priority channel, Dual scanning speeds, Patented track tuning and Direct channel access and AC/DC operation.

New! Bearcat® 211

List price \$339.95/CE price \$229.00

Frequency range: 32-50, 146-174, 420-512 MHz. The Bearcat 211. It's an evolutionary explosion of features and function. 18-channel monitoring. With no-crystal six-band coverage. Dual scan speeds. Color-coded keyboard. Even a digital clock. All at a modest price. More scanning excitement than you bargained for.

Bearcat® 210

List price \$299.95/CE price \$199.00

10 Channels • 5 Bands • Crystalless Frequency range: 30-50, 146-174, 416-512 MHz. Use the simple keyboard to select the 10 channels to be scanned. Automatic search finds new frequencies. The 210 features patented selectable scan delay, push button lockout, single antenna, patented track tuning, AC/DC operation. With no crystals to buy. Ever!

NEW! Bearcat® 8 Track

List price \$99.95/CE price \$79.00

4 Channels • 2 Bands • Plays off any AC or DC Powered 8 Track Tape Player. Frequency range: 33-49, 151-165 MHz.

The Bearcat 8 Track Scanner. It converts any 8 track tape player into a live-action scanning radio instantly.

This incredibly compact 4-channel/2-band crystal scanner plugs into the tape player where an 8 track cartridge normally goes. Police, fire, emergency calls—as-it-happens scanning excitement—from an existing home entertainment center, in-car/in-boat system or portable 8 track tape player. The Bearcat 8 Track Scanner plugs live-action into any 8 track player. Anywhere. Crystal certificates # A-135 cc are \$4.00 each.

Bearcat® Four-Six

List price \$169.95/CE price \$109.00

The first 4 Band, 6 Channel, Hand-Held Scanner. Frequency range: 33-47, 152-164, 450-512 MHz.

The Bearcat Four-Six offers "hip pocket" access to police, fire, weather and special interest public service broadcasts. Lightweight. Extremely compact. The Bearcat Four-Six—with its popular "rubber ducky" antenna and belt clip—provides "go anywhere/hands-off" scanning.

NEW! Aircraft and UHF

Bearcat® ThinScan™

List price \$149.95/CE price \$99.00

World's smallest scanner! The Bearcat ThinScan™ High-performance scanning has never been this portable. There are now three models available. The BC 2-4 L/H receives 33-44 and 152-164 MHz. The BC 2-4 H/U receives 152-164 and 450-508 MHz. The new high-performance Aircraft ThinScan model BC 2-4 AC receives 118-136 and 450-470 MHz. Go ahead, size it up. Bearcat's ThinScan™ measures 2 1/2" across. Just 1" deep. And 5 1/2" high. Four crystal-controlled channels are scanned every 1/2 second providing immediate access to police, fire, weather and other special-interest broadcasts.



NEW! Bearcat 8 Track scanner

INCREASED PERFORMANCE ANTENNAS

If you want the utmost in performance from your Bearcat scanner, it is essential that you use an external antenna. We have four base and mobile antennas specifically designed for receiving all bands. Order #A60 is a magnet mount mobile antenna. Order #A61 is a gutter clip mobile antenna. Order #A62 is a trunk-clip mobile antenna and #A70 is an all band base station antenna. All antennas are \$25.00 and \$3.00 for UPS shipping in the continental United States.

OTHER BEARCAT ACCESSORIES

SP50 AC Adapter	\$12.00
SP51 Battery Charger	\$12.00
SP55 Carrying Case for Four-Six	\$15.00
SP57 Carrying Case for ThinScan	\$15.00
SM210 Service manual for Bearcat 210	\$15.00
SM220 Service manual for Bearcat 220	\$15.00
SM250 Service manual for Bearcat 250	\$15.00
B-31.2 V AA Ni-Cad's for Four-Six (Pack of 4)	\$15.00
B-41.2 V AAA Ni-Cad's for ThinScan (Pack of 4)	\$15.00
B-5 Replacement memory battery for Bearcat 210	\$5.00
A-135cc Crystal certificate	\$4.00
Add \$3.00 shipping for all accessories ordered at the same time.	

TEST A BEARCAT SCANNER FREE

Test any Bearcat brand scanner from Communications Electronics™ for 31 days before you decide to keep it. If you do, you'll own the most sophisticated and technologically advanced scanner available. If for any reason you are not completely satisfied, return it in new condition with all accessories in 31 days, for a courteous and prompt refund (less shipping charges).

NATIONAL SERVICE

With your Bearcat scanner, we will send all accessories, a complete set of simple operating instructions and a one-year limited warranty. If service is ever required on any Bearcat scanner purchased from Communications Electronics™, just send your receiver to a CE approved Bearcat national service center. Another Bearcat service is the frequency information hotline. After you get your scanner from CE, you may call 317-894-1230 and get up to the second information on active frequencies in your area. If you ever need engineering assistance, feel free to call the factory during the day at 317-894-1440.

BUY WITH CONFIDENCE

All Bearcat scanners are extraordinary scanning instruments. They provide virtually any scanning function that the most professional monitor could require. To get the fastest delivery of any Bearcat scanner, send or phone your order directly to our Scanner Distribution Center™. Be sure to calculate your price using the CE prices in this ad. Michigan residents please add 4% sales tax. Written purchase orders are accepted from approved government agencies and well rated firms at a 10% surcharge for net 30 billing. All sales are subject to availability. Prices and specifications are subject to change without notice. Out of stock items will be placed on backorder automatically unless CE is instructed differently. International orders are invited with a \$10.00 surcharge for special handling in addition to shipping charges. All shipments are F.O.B. Ann Arbor, Michigan. No COD's please. Cashier's checks will be processed immediately and receive an order priority number. Personal checks require three weeks bank clearance. Mail orders to: Communications Electronics™, Box 1002, Ann Arbor, Michigan 48106 U.S.A. Add \$5.00 per scanner for U.P.S. ground shipping, \$9.00 for faster U.P.S. air shipping or \$30.00 for overnight delivery to most major U.S. cities via Airborne Air Freight. If you have a Master Card or Visa card, you may call anytime and place a credit card order. Order toll free 800-521-4414. If you are outside the U.S. or in Michigan, dial 313-994-4444. Dealer Inquiries Invited. All order lines at Communications Electronics™ are staffed 24 hours.

Since this two-million dollar Bearcat sale is the world's largest, please order today at no obligation to assure a prompt order confirmation and delivery.

When you follow the leader to real excitement, your journey ends at Communications Electronics.

Autoprogramming™, Scanner Distribution Center™ and CE logos are trademarks of Communications Electronics™. Copyright ©1979 Communications Electronics™



COMMUNICATIONS
ELECTRONICS™

854 Phoenix □ Box 1002 □ Ann Arbor, Michigan 48106 U.S.A.
Call TOLL-FREE (800) 521-4414 or outside U.S.A. (313) 994-4444

We're first
with the best.™

The World's biggest Regency® scanner sale!

Communications Electronics, the world's largest distributor of radio scanners, is pleased to announce that all Regency brand scanners are on sale during our world's biggest scanner sale. Even the new Regency models K500, M100 and R-804 are on sale. If you don't own at least one scanner, your missing all the action of police, fire, marine and government transmissions. Since you can monitor most business or government broadcasts in your area, it's like listening to a party line full of vital information. Regency scanners bring home the action. From now until January 31, 1980, you can save hundreds of dollars during our **multi-million dollar scanner sale**. Since we distribute more scanners worldwide than anyone else, we can sell the newest factory production models with the latest engineering updates, at rock bottom prices. Our warehouse facilities are equipped to process over 1,000 Regency orders per week and our order lines are always staffed 24 hours. We also export Regency scanners to more than 300 countries and military installations. Almost all items are in stock for immediate shipment, so save now and get a new Regency scanner during the **world's largest scanner sale!**

NEW! Regency® K500

List price \$399.00/CE price \$259.00
40 Channels • Synthesized • Service Search Digital count • Weather with tone alert Search/Store • Priority Channel • AC/DC
Frequency range: 30-50, 144-174, 440-512 MHz.
The new Regency Touch K500 is an advanced synthesized scanner with many new features. In addition to the conventional no-crystal touch entry programming for 40 channels, there are over 500 preprogrammed channels for receiving selected services such as police, fire, marine and mobile phone. It's like having an accurate frequency directory built into your scanner. The K500 will also find new frequencies in your area and store them in memory so you may enjoy them later. Any frequency found in the search mode or manually entered, will be displayed in the LED digital readout. There is a built in digital clock that also functions as an alarm clock to wake you to a 60 second beep.

When you activate the priority feature, you can program calls coming in on your favorite frequency to override all others. If you have a National Weather Service transmitter in your area, the K500 can alert you to severe weather warnings. With the "count" feature, frequency "traffic analysis" may be easily recorded to keep track of potentially hostile forces. Automatically counts the number of transmissions on each channel to determine the most active frequencies. The Touch K500...for those who won't settle for anything less than everything.

Regency® K100

List price \$279.00/CE price \$179.00
10 Channels • Crystalline • Searches Wood Cabinet • AC/DC • Delay feature
Frequency range: 30-50, 144-174, 440-512 MHz.
The Regency Touch K100 brings the versatility of a totally synthesized scanner within anyone's reach. It's the lowest cost no-crystal scanner that we have ever offered. By merely touching the pressure pads, you can receive any one of 15,757 frequencies. The possibilities are endless. Imagine putting the whole world of police, fire, weather, emergency broadcasts and more at the tip of your finger. It's the kind of exciting listening you'd expect from Regency, the people who built the first transistor radio. The Regency Touch K100...where computer control brings new dimensions to scanning.



NEW! Improved Regency K500

NEW! Aircraft Regency 720-A



NEW! Aircraft radio Regency® Touch 720-A

List price \$349.00/CE price \$229.00
16 channels • Two separate priority channels AC/DC • Search or Scan • Synthesized
Frequency range: 108-136 MHz.
The new Regency Digital Flight Scan uses advanced computer circuitry to put any civil aircraft navigation or communications frequency at the tip of your finger. From Lear Jet to DC-10 you'll hear it all.

You can store your favorite frequencies in the sixteen channels then watch the LED's sequentially scan for a call. There's even a two channel priority scan function. So you can listen for bone chilling "maydays" on 121.5 MHz., plus any other frequency of your choice.

NEW! Regency® M100

Available February - March, 1980
List price \$279.00/CE price \$179.00
10 Channels • Backlighted Program Panel Synthesized • Priority • AC/DC • Searches
Frequency range: 30-50, 144-174, 440-512 MHz.
The Regency Touch M100 provides the ease of computer controlled, touch-entry programming in a compact sized scanner for use at home or on the road. Enter your favorite public service frequencies by simply touching the numbered pressure pads. You'll even hear a "beep" tone to ensure you've entered a command. The multi-function digital display shows channel numbers during the scan mode, channel and frequency when a call is received, loss of power, delay function status, channel lockout and search mode selection. In addition to scanning the programmed channels, the M100 has the ability to search through an entire band for an active frequency. When a call is received, the frequency will appear in the digital display. Special features of the M100 include: channel 1 priority, scan or search delay and a brightness switch for day or night operation. Reserve your Regency Touch M100 now for February - March, 1980 delivery.

Regency® E-106

List price \$149.00/CE price \$99.00
Performance and Priority in one Scanner
Frequency range: 30-50, 146-174, 450-512 MHz.
Easy. That's the word to describe the Regency E-106 scanner. First, easy crystal access is made possible through a special bottom panel. Second, listening to your favorite frequency is easy with the Priority feature on channel one. An all-new wood grain cabinet and smart control panel design make the Regency E-106 one of the best looking scanners around. Not to mention that you get ten crystal controlled channels to listen in on police, fire and emergency calls. Crystal certificates #A-135cc are \$4.00 each.

Regency® R-106

List price \$129.00/CE price \$85.00
Hear 10 channel action at home or on the go.
Frequency range: 30-50, 146-174, 450-512 MHz.
A versatile scanner the Regency R-106 is built to provide maximum reception at home or on the road. AC/DC power cords for versatility of operation from almost anywhere. External speaker jack, external antenna jack and mobile mounting bracket are standard.

New! Regency® R-804

List price \$119.00/CE price \$79.00
The first full feature budget priced scanner.
Frequency range 30-50, 146-174, 450-512 MHz.
Value. That's the word that best describes the R-804. Because this is the first full-feature scanner that we have ever offered at such a low price. You'll hear all the action of police, fire, weather, and emergency calls on a full eight channels. Crystals are easily inserted and programmed through a flip-top panel. Supplied with detachable, swivel mount antenna and AC power cord. AC only. Also order crystal certificates at \$4.00 each.

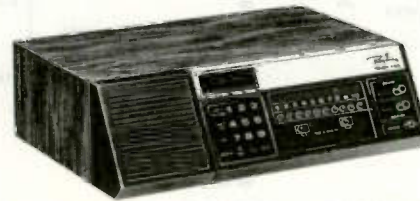

Lowest Cost! Regency K100

INCREASED PERFORMANCE ANTENNAS

If you want the utmost in performance from your Regency scanner, it is essential that you use an external antenna. We have six base and mobile antennas specifically designed for receiving all bands. Order #A60 is a magnet mount mobile antenna. Order #A61 is a gutter clip mobile antenna. Order #A62 is a trunk-clip mobile antenna. Order #A63 is a 3/4 inch hole mount, order #A64 is a 3/8 snap-in mount antenna and #A70 is an all band base station antenna. All antennas are \$25.00 and \$3.00 for UPS shipping in the continental United States.

TEST A REGENCY SCANNER FREE

Test any Regency brand scanner from Communications Electronics™ for 31 days before you decide to keep it. If for any reason you are not completely satisfied, return it in new condition with all accessories in 31 days, for a courteous and prompt refund (less shipping charges).

NATIONAL SERVICE BY MAIL

With your Regency scanner, we will send a complete set of simple operating instructions and a one-year limited warranty. If service is ever required on any Regency scanner purchased from Communications Electronics, just send your receiver to Regency at their headquarters in Indianapolis, Indiana for prompt repair. If you need engineering assistance or additional information on any Regency scanner, feel free to call the factory during the day at 317-545-4281. It is your responsibility to pay for return insured shipping if you want a refund, repair or replacement.

BUY IN QUANTITY - SAVE EVEN MORE

As incredible as our sale prices are on Regency scanners, you can save even more when you order in quantity or in our incentive program. Order one extra scanner with your order, save 1%. Order two extra scanners, save 2%. You can save up to 5% when you order five or more extra scanners at the same time.

BUY WITH CONFIDENCE

All Regency scanners are extraordinary scanning instruments. They provide virtually any scanning function that the most professional monitor could require. To get the fastest delivery of any Regency scanner, send or phone your order directly to our Scanner Distribution Center. Be sure to calculate your price using the CE prices in this ad. Michigan residents please add 4% sales tax. Written purchase orders are accepted from approved government agencies and well rated firms at a 10% surcharge for net 30 billing. All sales are subject to availability. All sales on accessories are final. Prices and specifications are subject to change without notice. Out of stock items will be placed on back-order automatically unless CE is instructed differently. International orders are invited with a \$10.00 surcharge for special handling in addition to shipping charges. All shipments are F.O.B. Ann Arbor, Michigan. No COD's please. Cashier's checks will be processed immediately and receive an order priority number. Personal checks require three weeks bank clearance. Mail orders to: Communications Electronics™, Box 1002, Ann Arbor, Michigan 48106 U.S.A. Add \$5.00 per scanner for U.P.S. ground shipping, \$9.00 for faster U.P.S. air shipping or \$30.00 for overnight delivery to most major U.S. cities via Airborne Air Freight or Federal Express. If you have a Master Charge or Visa card, you may call anytime and place a credit card order. Order toll free 800-521-4414. If you are outside the U.S. or in Michigan, dial 313-994-4444. You may also order via TWX 810-223-2400. Dealer inquiries invited. All order lines at Communications Electronics™ are staffed 24 hours. Since this multi-million dollar Regency sale is the world's largest, please order today at no obligation to assure a prompt order confirmation and delivery.

When you follow the leader to real excitement, your journey ends at Communications Electronics.

Autoprogramming™ Scanner Distribution Center™ and CE logos are trademarks of Communications Electronics™. Copyright © 1979 Communications Electronics™



**COMMUNICATIONS
ELECTRONICS™**

854 Phoenix □ Box 1002 □ Ann Arbor, Michigan 48106 U.S.A.
Call TOLL-FREE (800) 521-4414 or outside U.S.A. (313) 994-4444

**We're first
with the best.™**

Amplify Your 6-Meter Fun

— a cheap but effective linear

After I managed to scare up enough cash for a new FT-620B, I was amazed at the good results that I was obtaining with a puny 14 Watts output. After a few modifications (S-meter circuit, alc, etc.) and super-tweaking, I was able to cough up 17 Watts — not bad. Even then, the FT-620B was not able by itself to work the long-haul ground wave which I was accustomed to with my previous 6 meter SSB rig.

I decided that it was time to construct an afterburner for the 620. Next came the problem of what to use for parts and tubes. In northeast Georgia, electronic parts are as scarce as hen's teeth; so it must be simple. So, now I had 17 Watts of drive available — too much for a 4X250B tube and too little for a 3-500Z. Then I remembered our old friend the 811A (or 812A, even). According to the specs, it's

good for 170 Watts output to 60 MHz with 12 Watts drive and 1400 volts on the plate. People laughed when they heard me on the air discussing an old 811 on 6 meters. Now everyone in the local area is building one, especially when 811As can be obtained at our not-so-local parts store for 3 bucks a throw, including 4-pin socket!

Construction

I built the amplifier on a

chassis and cabinet which once used to be a WRL 6 & 2 MTR Hi-Bander transmitter. I was able to use the same power transformer, meter, switches, and the 2 coax SO-239 connectors for antenna and transceiver. However, after construction, I realized that the whole amplifier could have been built on a smaller 7" x 9" x 3" chassis with front plate, back plate, and top covers.

As the schematic shows (Fig. 1), T1 is a TV power transformer, with an 800-volt secondary at 200 mA, 6 volts at 6 A, and 5 volts at 2 A. A transformer with voltage higher than 800 volts can be used, maybe to 900 volts ac maximum. A rating lower than 800 volts ac will not give enough plate voltage. My transformer yielded 1165 volts with no load and 1080 volts under load, measured at the top of the filter capacitor bank. The ac line cord is a 3-prong unit, with the ground pin going to chassis ground. The rectifier bank, D1-D4, is made of 4007s with three diodes in each leg. Relay K1 is a 3PDT P & B relay with a 6-volt dc coil and 10-Amp contacts. One pole of the relay grounds the cathode circuit during transmit and the other two poles control

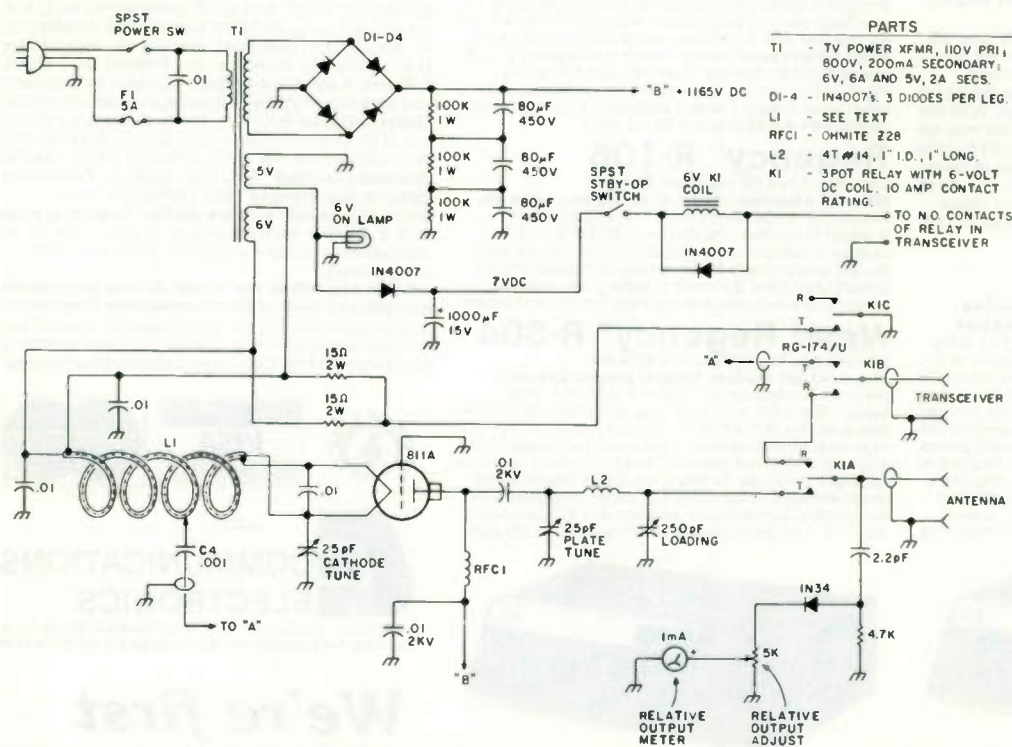

Fig. 1. 6 meter linear amplifier.

the antenna circuits. The standby/operate switch applies 7 volts dc to the relay coil in the operate position; the other side of the coil gets grounded by the normally-open relay accessory part of the transceiver during transmit. It should be noted that plate voltage appears on the 811A at all times, but it draws no plate current unless relay K1 is energized. I have found that smaller relays do not like 1165 volts on their contacts, so interrupting the cathode circuit between was a logical move since there is only a small amount of voltage in the cathode circuit.

The 25-pF cathode tuning capacitor can be any small air variable or ceramic trimmer. The 25-pF plate capacitor is a small double-spaced air variable and the 250-pF loading capacitor is a modified 365-pF variable sal-

vaged from an old bc-band table radio. The plate tank circuit was built with short leads as close as possible around the 811A. I had my 811A countersunk in the chassis to facilitate shorter leads in the tank circuit.

The relative-output meter circuit is simple and adjustable. I have it wired so that it can measure transceiver output or amplifier output, depending on whether the amplifier is on or off.

Coil L1 is the heart of the whole amplifier. It consists of 4 turns of 1/8" copper tubing wound to produce a coil 1 1/2" long and with a 3/4" i.d. However, before the tubing is bent into a coil, insert a piece of #18 teflon™-covered wire. Now we have a 2-conductor coil. Attach the coil to the 4-pin tube socket on one end. The other end should go to a terminal strip mounted on the

chassis. Mount the two .01-uF filament capacitors and two 15-Ohm resistors on the terminal strip.

Tack-solder the .001-uF cathode coupling capacitor (C4) approximately 1 turn from the filament end of the copper coil. The rest of the construction should be simple and straightforward.

Testing and Use

After construction, carefully check for shorts and cold solder joints. Check for a short in coil L1. If you used teflon™ inner conductor, you should have no problems. Rubber or vinyl wire used for L1 will melt when soldering the copper tubing. Fire up the amplifier and check for HV and filament power. Temporarily break the HV line and insert a milliamp meter. Energize relay K1 and check the idling plate current. It should be about 20 mA. Now apply a small

amount of drive and peak the cathode tuning for maximum plate current and tune the tank circuit for maximum output. Now, note the drive power and experiment with the location of the C4 capacitor tap on L1. Adjust the tap placement and cathode tuning capacitor for maximum efficiency. There will be a certain tap placement of C4 which couples the most drive power to the filament/cathode circuit.

With about 14 Watts of drive and the tank circuit fairly loaded, the plate current will be about 175 mA with 1100 volts on the plate. This produces 120 Watts dc output. Your amplifier should now be ready for service. I built my amplifier for a grand total of about \$25, including scrounged and begged parts. Besides using an 811, I also plugged in an 812A with similar good results. ■

Field Day is ready to go

The best code / radioteletype reader and speed-display package available!

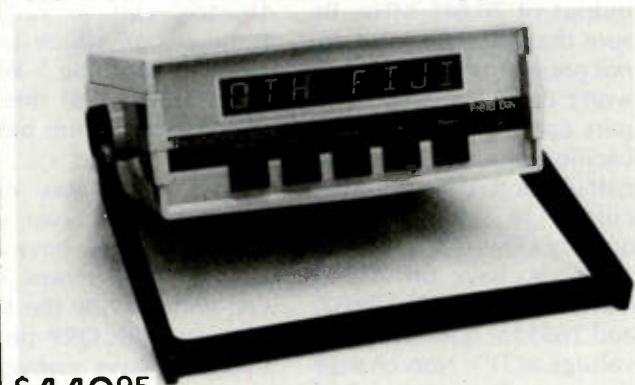

\$449⁹⁵
Plus shipping

We've designed a special **Field Day**, model "B," that is in stock and ready to ship. Right now. Some of the parts designed into the original **Field Day** just couldn't meet your ordering demand.

The **Field Day-B** has a special, high-reliability, 8 character display that costs us about \$40 more than the original displays! But we've still held the original price. We've added a "tuning eye" to make tuning easier and faster. Slow-arrival parts have been designed out, and an improved demodulator circuit has been designed in.

But the best part is they're ready to go now. Get 'um while they're hot.

Alabama - Long's; **California** - Electronics Emporium, Fontana; **Colorado** - H-E-P Enterprises; **Delaware** - Amateur & Advanced Communications; **Florida** - Amateur Electronic Supply, Amateur Radio Center, N & G Distributors, Ray's Amateur Radio; **Georgia** - ZZZ; **Idaho** - Ross Distributing; **Illinois** - Spectronics; **Indiana** - Ham Shack; **Kansas** - Associated Radio; **Kentucky** - Cohoon; **Massachusetts** - Tufts; **Michigan** - Omar; **Minneapolis** - PAL; **Missouri** - Burstein-Applebee, MidCom; **North Carolina** - Bob's Amateur Center; **Nebraska** - Heinrich's Communication; **New Hampshire** - Metz Communication; **New York** - Amerisil Overseas, Barry, Communications Technology, Ham Shack, Hirsch, Kelper, Radio World; **Ohio** - Queen City; **Oklahoma** - Brodie; **South Dakota** - Burghardt; **Texas** - Kennedy Associates, Madison, Tracy; **Virginia** - Tuned Circuit; **Washington** - Northwest Radio; **Wisconsin** - Amateur Electronic Supply; **Ontario** - Metro Ham Shack; **West Germany** - Richter & Company

Kantronics
A commitment to excellence.

1202 E. 23rd Street (913) 842-7745
Lawrence, Kansas 66044
Visa, Master Charge accepted

CB to 10

— part XXI: the Johnson Viking 352

Here it comes folks, another CB rig converted to ten meters—the Johnson Viking 352. This rig has a great deal of flexibility when properly modified. It can offer more features than the average CB-to-ten-meter conversion, and this means more QRP contacts for you.

The 352 is an SSB/AM eleven-meter 23-channel transceiver. The logical place to convert it seems to be 28.5 MHz to 28.8 MHz, so the SSB can be used at the lower end and the AM section will cover the upper end where there is activity in this mode.

At this point, it would be wise to pick up the Sams Photofact® no. CB-112 on the rig if you don't have the schematic for it already.

The rig has a standard four-by-six crystals synthesis scheme, so the bank of four crystals is changed in the interest of economy. The bank of crystals was changed from the 7 MHz range to 9.065 MHz, 9.045 MHz, 9.035 MHz, and 9.025 MHz for crystal positions Y610 to Y607 respectively. While awaiting delivery of your crystals, you can perform the following modifi-

cations to attain greater frequency coverage (fill in the "holes" between channels) and add one more channel.

First, we will activate the mysterious "blank" channel between channels 22 and 23. Locate the pink wire which runs from S1, deck C, pin 14 to R608 and disconnect it from the switch deck. Tape the end so that it will not short to anything else, and *voila*, 24 channels.

Next, we switch the fine tune from a receive-only function to a receive-and-transmit function. Cut the green wire at relay K1's swing arm and reconnect it to the fine-tune potentiometer (R625) wiper. This produces approximately 2 kHz of transmit-and-receive fine tune which is usually not enough for serious QRP work on ten meters. The fine tune can be expanded to 10 kHz and more by adding a variable inductor (Miller 4204) between the anode of CR606 and ground. Note that this is a variable inductor; a frequency counter should be used to adjust it to allow a maximum of 12½ kHz of fine tune. Any more than this will cause excessive

non-linearity and fast tuning in the fine-tune knob.

When these modifications are complete and operating well, your new crystals should be well along the way. When you get them replace Y607 through Y610 with 9.025, 9.035, 9.045, and 9.065 MHz, respectively. Connect a frequency counter to TP1; with the Johnson Viking 352 on channel 11 AM, adjust T601, T602, and T603 for an output of 20.845 MHz. Be sure that 17 or 24 MHz are not present, or the synthesis won't come out right. This part can be done with an oscilloscope, using a hand calculator to determine frequency to determine frequency. (This is how I do it.) After you have the 20.845 MHz, adjust T601, T602, and T603 for maximum rms voltage at TP1. Now change the controls to channel 13 and USB; with the VTVM rf probe or scope still connected to TP1, adjust T604, T605, T606, T501, and T502 for maximum.

The synthesis is now producing 28 MHz rf and the receiver needs to be aligned. Set up a low-level signal source at approximately 28.6 MHz. If you have obtained and installed

the previously-mentioned crystals, 28.6 MHz should be at channel 7 with the fine tune at 9 o'clock position. Couple the weak signal source to the antenna jack and adjust T401 through T409 for maximum signal indication on the S-meter. (Be sure to reduce signal strength as you align the receiver, to avoid overload and false tuning.) The transmitter alignment is done by using an output indicator and a 52-Ohm dummy load which is capable of handling 5 Watts or so. Adjust T701 through T705 for maximum output power.

Now, that was easy, wasn't it? Whatever your answer, you now have a rig which will perform very well and provide the flexibility to work QRP on ten meters. I have converted four of these rigs, and all of the operators (including myself) are doing very well with modest antenna systems. I am presently 8 states away from my WAS QRP 10m SSB, have worked all continents, and have 48 countries worked (including a JT1, a 5N2, and a VP2S). Not bad for an obsolete CB rig. See you on ten meters QRP. ■



Germantown Amateur Supply, Inc.



✓ G12

MEMPHIS, TENNESSEE

NO MONKEY BUSINESS!

- (A) Complete Service Facilities
- (B) Good Deals on most Brands
- (C) Shipping within 24 Hours
- (D) All inquiries handled by Active Hams with over 20 years experience in ham radio

CALL TOLL FREE
1-800-238-6168

IN TENNESSEE, CALL 901-452-4276
MONDAY - SATURDAY 8:30-5:30
FOR YOUR SPECIAL.

Write: 3202 Summer Ave., Memphis, Tennessee 38112

Exploring Uncle Sam's Bookstore

— what's for you at the GPO

"Oh yes," I kept telling myself. "One day I'll find the time to study so I might earn my amateur radio license." That was my total commitment for a period of at least twenty years, until about one year and a half ago. At that point, I decided to devote the necessary time to some honest

study toward that end.

My first task was to locate reference materials in order to accumulate the information that would aid in preparing for the written examinations. Although I am employed at what some consider to be the world's largest printing establishment, the US Government Printing Office

(GPO), I did not realize initially that the GPO bookstore would be a ready source and a prime repository for such specialized literature. This discovery was made one day when I walked in to purchase a current copy of the FCC Part 97, Amateur Radio Service Regulations.

There, to my amaze-

ment, on the bookshelf beside Part 97, were many publications relating to the general categories of communications and electronics. Some further investigating on my part revealed a number of relevant publications that are both informational and useful to the radio amateur. The wide range of topics and titles

GPO BOOKSTORES

Main Bookstore
710 North Capitol Street
Washington DC 20402
(202)-275-2091

Atlanta Bookstore
Rm. 100, Federal Bldg.
275 Peachtree Street, N.E.
Atlanta GA 30303
(402)-221-6947

Chicago Bookstore
Rm. 1463, 14th floor
Everett McKinley Dirksen Bldg.
219 S. Dearborn Street
Chicago IL 60604
(312)-353-5133

Dallas Bookstore
Room 1C50, Federal Bldg.
1100 Commerce Street
Dallas TX 75242
(214)-749-1541

Houston Bookstore
45 College Center
9319 Gulf Freeway
Houston TX 77017
(713)-527-5453

Los Angeles Bookstore
Rm. 2039, Federal Off. Bldg.
300 North Los Angeles St.
Los Angeles CA 90012
(213)-688-5841

Philadelphia Bookstore
Rm. 1214, Federal Office Bldg.
600 Arch Street
Philadelphia PA 19106
(215)-677-7879

Birmingham Bookstore
Roebuck Shopping City
9220 Parkway East-B
Birmingham AL 35206
(205)-254-1056

Cleveland Bookstore
First Floor, Fed. Off. Bldg.
1240 E. 9th Street
Cleveland OH 44199
(216)-522-4922

Denver Bookstore
Rm. 117, Federal Bldg.
1961 Stout Street
Denver CO 80294
(303)-837-3964

Jacksonville Bookstore
400 West Bay Street
Rm. 158, Federal Bldg.
Jacksonville FL 32202
(904)-791-3801

Milwaukee Bookstore
Rm. 190, Federal Bldg.
519 E. Wisconsin Avenue
Milwaukee WI 53202
(414)-224-1304

Pueblo Bookstore
720 North Main Street
Majestic Bldg.
Pueblo CO 81003
(303)-544-3142

Seattle Bookstore
Rm. 194, Federal Office Bldg.
915 Second Avenue
Seattle WA 98174
(206)-442-4270

Boston Bookstore
Rm. G-25, J.F.K. Fed. Bldg.
Sudbury Street
Boston MA 02203
(617)-223-6071

Columbus Bookstore
Rm. 207, Federal Bldg.
200 North High Street
Columbus OH 43215
(614)-469-6956

Detroit Bookstore
Patrick V. McNamara Fed. Bldg.
Suite 160
477 Michigan Avenue
Detroit MI 48226
(313)-226-7816

Kansas City Bookstore
Rm. 144, Federal Office Bldg.
601 East 12th Street
Kansas City, MO 64106
(816)-374-2160

New York Bookstore
Rm. 110, 26 Federal Plaza
New York NY 10007
(212)-264-3825

San Francisco Bookstore
Rm. 1023, Federal Office Bldg.
450 Golden Gate Avenue
San Francisco CA 94102
(415)-556-0643

CALL TOLL FREE

1-800-228-4097
Communications Center

443 N 48th Street
 Lincoln, Nebraska 68504
 In Nebraska Call (402)466-8402

✓CS8

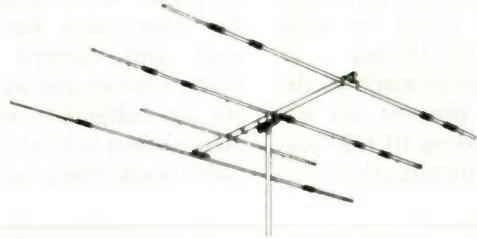

Antenna Sale!

HY-GAIN

		Regular	Special			Regular	Special
TH6DXX	Super Thunderbird	\$329.95	\$259.95	18HT	Hy-Tower 80-10M vertical	\$359.95	\$289.95
TH3MK3	3 el. 10-15-20M beam	222.95	179.95	18AVT/WB	80-10M Trap vertical	105.95	84.95
TH3JR	3 el. 10-15-20M beam	169.95	139.95	14AVQ/WB	40-10M Trap vertical	69.95	57.00
Hy-Quad	2 el. 10-15-20M Quad	274.95	219.95	12AVQ	20-10M Trap Vertical	42.95	34.95
205BA	5 el. "Long John" 20M beam	329.95	259.95	14RMQ	Roof Mounting kit (verticals)	33.95	29.95
155BA	5 el. "Long John" 15M beam	199.95	159.95	5BDQ	80-10M Trap doublet	109.95	89.95
105BA	5 el. "Long John" 10M beam	129.95	109.95	2BDQ	80-40M Trap doublet	59.95	49.95
204BA	4 el. 20M beam	249.95	199.95	66B	6 el. 6M beam	119.95	99.95
204MK5	5 el. conversion kit	99.95	79.95	203	3 el. 2M beam	15.95	
153BA	3 el. 15M beam	89.95	79.95	205	5 el. 2M beam	21.95	
103BA	3 el. 10M beam	74.95	59.95	208	8 el. 2M beam	29.95	
402BA	2 el. 40M beam	239.95	189.95	214	14 el. 2M beam	34.95	
BN-86	Balun for beam antennas	15.95	15.95	LA-1	Deluxe lightning arrestor	59.95	49.95
TH2MK3	2 el. 10-15-20M beam	149.95	119.95	TH5DX		269.95	209.95

MOSLEY

		Regular	Special
Classic 33	3 el. 10, 15, 20 Mtr. beam	304.75	209.95
Classic 36	6 el. 10, 15, 20 Mtr. beam	392.75	249.95
TA-33	3 el. 10, 15, 20 Mtr. beam	264.00	189.95
TA-36	6 el. 10, 15, 20 Mtr. beam	392.75	249.95
TA-33 Jr.	3 el. 10, 15, 20 Mtr. beam	197.00	149.95
TA-40KR	40 Mtr. Add On	119.95	89.95

CUSHCRAFT

ATB-34	4 ele. 10, 15, 20 Mtr. beam	289.95	219.95	A147-11	11 ele. 146-148 Mhz. beam	36.95	30.95
ATV-4	10, 15, 20, 40 Mtr. Vertical	89.95	69.95	A147-22	22 ele. Power Pack	109.95	89.95
ATV-5	10, 15, 20, 40, 80 Mtr. Vertical	109.95	89.95	A144-10T	2 Mtr. "Twist" 10 ele.	42.95	34.95
ARX-2	2 Mtr. Ringo Ranger	39.95	32.95	A144-20T	2 Mtr. "Twist" 20 ele.	62.95	52.95
AR-6	6 Mtr. Ringo	36.95	32.95	A147-20T	2 Mtr. beam	62.95	52.95
ARX-220	220 Mhz. Ringo Ranger	39.95	32.95	A430-11	432 Mhz. 11 ele. beam	34.95	29.95
ARX-450	435 Mhz. Ringo Ranger	39.95	32.95	A432-20T	430-436 Mhz. Beam	59.95	49.95
A144-11	11 ele. 144-146 Mhz. beam	36.95	30.95				

HUSTLER

3-TBA	3 ele; 10, 15, 20 Mtr. beam	259.95	189.95
4-BTV	10-40 Mtr. Vertical	99.95	79.95
5-BTV	10-80 Mtr. Vertical	134.95	99.95
RM-75	75 Meter Resonator	16.95	14.50
RM-75S	75 Meter Super Resonator	31.95	27.50
G6-144B	2 Mtr. Base Colinear	79.95	59.95
G7-144	2 Mtr. Base Colinear	119.95	89.95

ROTORS

HAM 4 \$149.95 T2X Tailtwister \$199.95 Alliance HD 73 \$109.95
 Call for prices on rotor cable, Coax, Towers, and Accessories. All prices do not include shipping.

**We carry all major brands of ham radios
 AT DISCOUNT PRICES**

18HT

VISA®

Kenwood — Yaesu — Drake — ICOM — Dentron —
 Ten-Tec — Swan — Tempo — Midland — E.T.O. — Wilson



available were extremely helpful to me, and can serve your needs also, if you are in search of additional study or reference books to place in your home or club library.

As a convenience to the reader, I present an abstracted listing of US Government publications of

general interest to radio amateurs. Shown in the listing are the document title, publication date, number of pages, GPO stock number (necessary for ordering), and current selling price. (Prices and availability are subject to change.) Also shown is a listing of 20 GPO bookstores located in

major US cities. You may wish to contact your local GPO bookstore for ordering or if you desire you may place your order with the Superintendent of Documents, Washington DC 20402. Prices shown are for domestic mailing. Add 25% for orders mailed outside the US and its posses-

sions. Any specific questions you may have should not be directed to me but to the Superintendent of Documents.

I'm sure that you will find, as I did, many helpful and interesting publications here for both beginners and experienced radio amateurs. ■

FCC Rules and Regulations

- Part 95, Sub-part A, May, 1977, General Mobile Radio Service. 19 pp. 004-000-00340-3 \$1.00
- Part 95, Sub-part C, May, 1977, Radio Control Radio Service. 13 pp. 004-000-00341-1 \$0.80
- Part 95, Sub-part D, August, 1978, Citizens Band Radio Service Rules. 56 pp. 004-000-00356-0 \$1.25
- Part 95, Sub-part E, May, 1977, Technical Regulations, Personal Radio Services. 13 pp. 004-000-00343-8 \$0.80
- Part 97, Amateur Radio Service, January, 1979. 28 pp. 004-000-00357-8 \$1.40
- Part 99, Disaster Communications Service, May, 1976. 10 pp. 004-000-00326-8 \$0.75

Broadcast Operator Handbook. 1976. 103 pp. 004-000-00329-2 \$3.00

Estimated Effective Ground Conductivity in the United States: Maps.

● Eastern United States. Reprinted 1976, 48 x 39 inches. 004-000-00279-2 \$2.75

● Western United States. Reprinted 1976, 48 x 39 inches. 004-000-00280-6 \$2.75

How To Identify and Resolve Radio-TV Interference Problems. 1977. 31 pp. 004-000-00345-4 \$1.50

Broadcasting Stations of the World (excluding US)

● Part 1, Amplitude Modulation Broadcasting Stations, According to Country and City. 1974. 261 pp. (out of print)

● Part 2, Amplitude Modulation Broadcasting Stations, According to Frequency. 1974. 261 pp. (out of print)

● Part 3, Frequency Modulation Broadcasting Stations. 1974. 216 pp. 041-005-00011-4 \$2.40

● Part 4, Television Stations. 1974. 444 pp. 041-005-00012-2 \$4.25

Basic Electronics

● Vol. 1. 1971. 566 pp. 008-047-00134-7 \$7.70

● Vol. 2. 1971 323 pp. 008-047-00142-8 \$3.85

Basic Electricity. Reprinted 1978. 490 pp. III. 008-047-00069-3 \$6.25

Electronics Technician 3 & 2, Vol. 1. 1973, reprinted 1975. 309 pp. III. 008-047-00156-8 \$7.60

Electrician's Mate 1 & C. 1970. 155 pp. 008-047-00066-9 \$2.70

Fundamentals of Electronics (All missing volumes are out of print.)

● Vol. 1a. Basic Electricity, Direct Current. 1966, reprinted 1976. 147 pp. III. 008-047-00097-9 \$2.15

● Vol. 1b. Basic Electricity, Alternating Current. 1967, reprinted 1977. 210 pp. III. 008-047-00098-7 \$2.80

● Vol 2. Power Supplies and Amplifiers. 1965, reprinted 1976. 144 pp. III. 008-047-00099-5 \$3.50

● Vol. 3. Transmitter Circuit Applications. 1965, reprinted 1978. 138 pp. III. 008-047-00100-2 \$4.25

● Vol. 4. Receiver Circuit Applications. Reprinted 1970. 200 pp. III. 008-047-00105-3 \$3.95

● Vol. 5. Oscilloscope Circuit Applications. 1964. 133 pp. III. 008-047-00101-1 \$2.00

● Vol. 6. Microwave Circuit Applications. 1965, reprinted 1976. 123 pp. III. 008-047-00102-9 \$1.90

● Vol. 7. Electromagnetic Circuits and Devices. 1964. 181 pp. III. 008-047-00103-7 \$1.45

● Vol. 8. Tables and Master Index. 1965. 162 pp. III. 008-047-00104-5 \$3.60

Engineering Design Handbook: Reliable Military Electronics. 1976. 452 pp. 008-020-00602-5 \$7.25

Basic Theory and Application of Electron Tubes (includes changes 1 and 2). 1952, reprinted 1976. 215 pp. 008-020-00048-5 \$3.05

Theory and Use of Electronic Test Equipment. 1952, reprinted 1975. 158 pp. III. 008-020-00050-7 \$2.45

● Change 1 to above. 1958. 2 pp. 008-020-00049-3 \$0.35

Higher Frequency Techniques (Excluding Microwaves). 1952, reprinted 1978. 129 pp. III. 008-020-00577-1 \$2.75

FM Transmitters and Receivers (change 1 inserted). 1952, reprinted 1976. 198 pp. 008-020-00052-3 \$3.65

Transients and Waveforms (includes change 1). 1951, reprinted 1975. 90 pp. III. 008-020-00053-1 \$1.65

Cathode Ray Tubes and Their Associated Circuits. 1951, reprinted 1971. 218 pp. 008-020-00379-4 \$3.55

Pulse Techniques. 1951, reprinted 1978. 102 pp. III. 008-020-00056-6 \$1.85

Electrical Fundamentals (Alternating Current) (changes 1 through 3 inserted). 1951, reprinted 1977. 231 pp. III. 008-020-00060-4 \$4.10

Principles and Applications of Mathematics for Communications-Electronics. 1961, reprinted 1975. 248 pp. 008-020-00061-2 \$3.30

Interior Wiring. 1968, reprinted 1977. 120 pp. III. 008-020-00401-4 \$2.40

Electric Motor and Generator Repair. 1972, reprinted 1975. 233 pp. III. 008-020-00456-1 \$3.10

Troubleshooting and Repair of Radio Equipment. 1958, reprinted 1973. 180 pp. 008-020-00040-0 \$4.40

Communications Electronics Fundamentals Basic Principles (Direct Current). 1974. 296 pp. III. 008-020-00581-9 \$3.75

Field Wire and Field Cable Techniques. 1970, reprinted 1975. 350 pp. III. 008-020-00558-4 \$3.15

Electrical Engineering Units and Constants. Revised 1976. 2½" x 3½" wallet-size plastic card 003-003-01665-9 \$0.35 (\$4.65 per 100)

Survey of Ground Fault Circuit Interrupter Usage For Protection Against Hazardous Shock. 1976. 13 pp. III. 003-003-01591-1 \$0.45

Electric Current Abroad, 1975 Edition. 1975. 81 pp. 003-025-0046-2 \$1.15

Air Frame and Powerplant Mechanics—General Handbook. Revised 1976. 549 pp. III. 050-007-00379-0 \$6.75

United States Frequency Allocations: Map. 1975. 32 x 55 inches. 003-000-00469-4 \$1.35

Amateur Radio Supply of Nashville, Inc.

615 South Gallatin Road - Madison, Tennessee 37115

CALL A.R.S.O.N. NOW!

615 868-4956

for the Best DEALS

Sure, we take trades on new equipment! Call or write.

We're Burning to Make "Hot" Deals!!

VISA 
Accepted at slightly higher prices!

YAESU

NOW IN STOCK!
FT101ZD
Digital 160M-10M Deluxe Features
Check the others then get our price!

YAESU FT 901 DM
Call for yours today!

NEW! YAESU FT207R
Synthesized Handi-Talkie. 2 Watts
CALL NOW FOR OUR PRICE!
We stock the complete YAESU line!

KENWOOD

NEW! TS 520 SE
A new version of the FAMOUS STANDARD!
Call or write for our price!

NEW! TS 180S
All Solid State with Digital Frequency Control. 200W P.E.P. Memory. Best Price Anywhere!

NEW! TS 120S
ALL SOLID STATE HF TRANSCEIVER PLUS A FULL LINE OF ACCESSORIES!

TEN-TEC **OMNI D&A**
Unbeatable Prices! 540-544 and Argonaut. Full Ten-Tec Line in stock!

SWAN ELECTRONICS **NEW!**
ASTRO 150 HF SSB
Transceiver featuring "VRS"
Fully Synthesized 235 Watts PEP & CW.
See the Swan ads and Call us or write for BEST PRICES ANYWHERE!

NEW! 1028X
Dual PTO's SYNTHESIZED 1.8-30 MHZ
235 Watts PEP
SWAN 100 MX P.S. and ANT. TUNER.
Call or write for quote, ideal for home QTH or mobile!

Dentron

Dentron GLA 1000
1 KW DC INPUT! 1200 W. PEP!
LOW PRICES!

CLIPPERTON L
1 KW DC INPUT! 2 KW P.E.P.
In Stock - Low Prices!

We have the New Dentron AF-1A Audio Processor, Dentron Antenna Tuners, Antennas and SWR Meters.
MLA 2500 B - DTR 2000L
CHECK OUR LOW PRICES!

TR 7600/7625 **TS 700SP**
HOLIDAY SALE! Special low prices!
TR 7600/7625 and RM 76 Micro Processor, and TS 700SP—Call or write for these special lowest prices yet!

NEW! Ask us about the **NEW TR 2400 2M HANDI TALKIE!**

NEW! KENWOOD OWNERS! We have the new Kenwood Phone Patch!
We stock the full **KENWOOD** line and provide warranty and after-warranty service. **BUY WITH CONFIDENCE!**

DATONG
We have in stock the amazing Datong FL-1 active audio filter. Also now have the ASP, Automatic speech processor... plus the Code tutor... Fantastic additions to your station. Call or write for information and prices.

ICOM
701, 211, 215, 280, 30A—All in stock!

MIRAGE **MP1 HF & MP2 VHF**
SWR MTR. - B108 2M AMP. & B1016
160 WATT, 2M AMP. In Stock, call or write!

DRAKE
TR/DR-7
Now in stock!
Full 7 line of accessories!

ROBOT
SSTV - ROBOT
PUT YOURSELF IN THE PICTURE!
Get in on the latest in Ham Radio!
CALL OR WRITE NOW FOR PRICES!

DSI Counter Semi-kit
Get on Frequency! Write or call for special price!

BW ANTENNA SWITCHES in stock!

DAIWA **J. W. Miller**

Call or write for SUPER LOW prices!

ALLIANCE SPECIAL OFFER!! **Rotor Special**
ALLIANCE HD-73
\$105.00 Including Shipping in U.S.A.
HD-73 with 100 feet rotor cable \$120.00
HD73 with 100 feet rotor cable and 100 feet R68U \$150.00
Cashiers check or M.O. please

ANTENNAS CUSHCRAFT - HYGAIN
LARSEN - HUSTLER - AVANTI
SPECIAL! Cushcraft ATB34—\$220.00
Delivered anywhere in the Cont. U.S.A.

MFJ ENTERPRISES, INC.
TUNERS - FILTERS - We've got 'em!
CHECK US FIRST!

SEND S.A.S.E. FOR OUR PINK SHEET SPECIALS!
USED AND CLEARANCE GEAR!

USED EQUIPMENT? OUR STOCK TURNS FAST. WRITE OR CALL YOUR SPECIFIC NEEDS.

CDE ROTOR SPECIALS
The NEW HAM IV Rotor
Shipping included

HAM IV Rotor \$147.00
HAM IV Rotor with 100 ft. rotor cable \$162.00
HAM IV Rotor plus 100 ft each rotor cable and first grade R68U \$185.00
Send cashiers check or M.O. please.

avanti antennas

The fantastic new Avanti 2 meter Mobile Antenna—mounts on your car window glass! 3 DB gain. Neat and compact installation!
SPECIAL PRICE! \$30.00
Please send Cashiers Check or Money Order. Delivered anywhere in the cont. U.S.A.

Fast UPS Delivery. Place your order then STAND BACK! We ship your order the same day we get it. Best prices and quick handling of your order.

STORE HOURS - Monday thru Friday, 9 AM to 5 PM

Amateur Radio Supply of Nashville, Inc.



JUST WRAP™ WIRE WRAPPING TOOL

WHY CUT? WHY STRIP? WHY SLIT?
WHY NOT JUST WRAP?

JW-1-B	BLUE WIRE	\$14.95
JW-1-W	WHITE WIRE	\$14.95
JW-1-Y	YELLOW WIRE	\$14.95
JW-1-R	RED WIRE	\$14.95

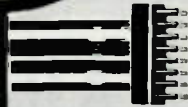

JUST WRAP REPLACEMENT ROLLS

R-JW-B	BLUE WIRE	50 ft. Roll	\$2.98
R-JW-W	WHITE WIRE	50 ft. Roll	\$2.98
R-JW-Y	YELLOW WIRE	50 ft. Roll	\$2.98
R-JW-R	RED WIRE	50 ft. Roll	\$2.98

UNWRAP TOOL FOR JUST WRAP

JUW-1	UNWRAPPING TOOL	\$3.49
-------	-----------------	--------

JUST WRAP KIT

JWK-6	JUST WRAP KIT	\$24.95
-------	---------------	---------

"HOBBY" WIRE WRAPPING TOOL BATTERY POWERED

BW-2630	FOR AWG 26-30	\$19.95
---------	---------------	---------

Use "C" size NICAD Batteries, not included. Bits not included.

BT-30	BIT FOR AWG 30	\$3.95
BT-2628	BIT FOR AWG 26-28	\$7.95

HOBBY WRAP TOOLS

WSU-30	REGULAR WRAP	\$6.95
WSU-30M	MODIFIED WRAP	\$7.95

30 B 50 010	30 AWG Blue Wire 1' Long	\$.99
30 Y 50 010	30 AWG Yellow Wire 1' Long	\$.99
30 W 50 010	30 AWG White Wire 1' Long	\$.99
30 R 50 010	30 AWG Red Wire 1' Long	\$.99
30 B 50 020	30 AWG Blue Wire 2' Long	\$ 1.07
30 Y 50 020	30 AWG Yellow Wire 2' Long	\$ 1.07
30 W 50 020	30 AWG White Wire 2' Long	\$ 1.07
30 R 50 020	30 AWG Red Wire 2' Long	\$ 1.07
30 B 50 030	30 AWG Blue Wire 3' Long	\$ 1.16
30 Y 50 030	30 AWG Yellow Wire 3' Long	\$ 1.16
30 W 50 030	30 AWG White Wire 3' Long	\$ 1.16
30 R 50 030	30 AWG Red Wire 3' Long	\$ 1.16
30 B 50 040	30 AWG Blue Wire 4' Long	\$ 1.23
30 Y 50 040	30 AWG Yellow Wire 4' Long	\$ 1.23
30 W 50 040	30 AWG White Wire 4' Long	\$ 1.23
30 R 50 040	30 AWG Red Wire 4' Long	\$ 1.23
30 B 50 050	30 AWG Blue Wire 5' Long	\$ 1.30
30 Y 50 050	30 AWG Yellow Wire 5' Long	\$ 1.30
30 W 50 050	30 AWG White Wire 5' Long	\$ 1.30
30 R 50 050	30 AWG Red Wire 5' Long	\$ 1.30
30 B 50 060	30 AWG Blue Wire 6' Long	\$ 1.38
30 Y 50 060	30 AWG Yellow Wire 6' Long	\$ 1.38
30 W 50 060	30 AWG White Wire 6' Long	\$ 1.38
30 R 50 060	30 AWG Red Wire 6' Long	\$ 1.38

PRE-STRIPPED WIRE WRAPPING WIRE

Wire for wire wrapping, AWG 30 (0.25mm) KYNAR™ wire, 50 wires per package stripped 1" both ends.

TRI-COLOR DISPENSER

WD-30-TRI	TRI-COLOR DISPENSER	\$5.95
-----------	---------------------	--------

R-30-TRI	REPLACEMENT ROLLS	\$3.95
----------	-------------------	--------

WIRE DISPENSER

WD-30-B	BLUE WIRE	\$3.95
WD-30-Y	YELLOW WIRE	\$3.95
WD-30-W	WHITE WIRE	\$3.95
WD-30-R	RED WIRE	\$3.95

DISPENSER REPLACEMENT ROLLS

R-30B-0050	30-AWG BLUE 50 FT. ROLL	\$1.98
R-30Y-0050	30-AWG YELLOW 50 FT. ROLL	\$1.98
R-30W-0050	30-AWG WHITE 50 FT. ROLL	\$1.98
R-30R-0050	30-AWG RED 50 FT. ROLL	\$1.98

HOOK-UP WIRE

HK-18	18 AWG 25 FT.	SOLID CONDUCTOR	\$1.20
HK-20	20 AWG 25 FT.	SOLID CONDUCTOR	\$.98
HK-22	22 AWG 50 FT.	SOLID CONDUCTOR	\$1.35
HK-24	24 AWG 50 FT.	SOLID CONDUCTOR	\$1.35
HK-26	26 AWG 50 FT.	SOLID CONDUCTOR	\$1.35
SHK-18	18 AWG 25 FT.	STRANDED CONDUCTOR	\$1.20
SHK-20	20 AWG 25 FT.	STRANDED CONDUCTOR	\$.98
SHK-22	22 AWG 50 FT.	STRANDED CONDUCTOR	\$1.35
SHK-24	24 AWG 50 FT.	STRANDED CONDUCTOR	\$1.35
SHK-26	26 AWG 50 FT.	STRANDED CONDUCTOR	\$1.35

RIBBON CABLE ASSEMBLY SINGLE END

26 AWG Rainbow Coded flat cable.

SE 14-24	WITH 14 PIN DIP PLUG 24" LONG (609MM)	\$3.55
SE 14-48	WITH 14 PIN DIP PLUG 48" LONG (1218MM)	\$4.25
SE 16-24	WITH 16 PIN LONG DIP PLUG 24" LONG (609MM)	\$3.75
SE 16-48	WITH 16 PIN LONG DIP PLUG 48" LONG (1218MM)	\$4.45

DIP PLUG WITH COVER FOR USE WITH RIBBON CABLE

14-PLG	14 PIN PLUG & COVER	\$1.45
16-PLG	16 PIN PLUG & COVER	\$1.59

QUANTITY: 2 PLUGS, 2 COVERS

RIBBON CABLE ASSEMBLY DOUBLE END

DE 14-2	WITH 14 PIN DIP PLUG - 2"	\$3.75
DE 14-4	WITH 14 PIN DIP PLUG - 4"	\$3.85
DE 14-8	WITH 14 PIN DIP PLUG - 8"	\$3.95
DE 14-12	WITH 14 PIN DIP PLUG - 12"	\$4.07
DE 14-16	WITH 14 PIN DIP PLUG - 16"	\$4.12
DE 14-24	WITH 14 PIN DIP PLUG - 24"	\$4.15
DE 16-2	WITH 16 PIN DIP PLUG - 2"	\$4.15
DE 16-4	WITH 16 PIN DIP PLUG - 4"	\$4.25
DE 16-8	WITH 16 PIN DIP PLUG - 8"	\$4.35
DE 16-12	WITH 16 PIN DIP PLUG - 12"	\$4.47
DE 16-16	WITH 16 PIN DIP PLUG - 16"	\$4.52
DE 16-24	WITH 16 PIN DIP PLUG - 24"	\$4.55
DE 24-6	WITH 24 PIN DIP PLUG - 6"	\$6.05
DE 24-8	WITH 24 PIN DIP PLUG - 8"	\$6.50
DE 24-12	WITH 24 PIN DIP PLUG - 12"	\$6.90
DE 24-16	WITH 24 PIN DIP PLUG - 16"	\$7.10
DE 24-24	WITH 24 PIN DIP PLUG - 24"	\$7.70

DIP SOCKETS

14 DIP	14 PIN DIP SOCKET	\$0.79
16 DIP	16 PIN DIP SOCKET	\$0.89
24 DIP	24 PIN DIP SOCKET	\$1.49
36 DIP	36 PIN DIP SOCKET	\$2.49
40 DIP	40 PIN DIP SOCKET	\$2.99

DIP IC INSERTION TOOLS WITH PIN STRAIGHTNER

Narrow profile. Pin straightener built into tool. Automatic ejector.

INS-1416	14-16 PIN DIP IC INSERTER	\$3.49
----------	---------------------------	--------

MOS, CMOS-SAFE

GROUND STRAP NOT INCLUDED

MOS-1416	14-16 PIN MOS CMOS SAFE INSERTER	\$7.95
MOS-2428	24-28 PIN MOS CMOS SAFE INSERTER	\$7.95

36-40 PIN CMOS-SAFE IC INSERTION TOOL

Aligns bent out pins. Includes terminal lug for attachment of ground strap.

MOS-40	36-40 PIN CMOS SAFE IC INSERTION TOOL	\$7.95
--------	---------------------------------------	--------

DIP IC EXTRACTOR TOOL

Extracts all LSI, MSI and SSI devices of from 8 to 24 pins.

EX-1	EXTRACTOR TOOL	\$1.49
------	----------------	--------

24-40 CMOS-SAFE EXTRACTOR TOOL

Removes 24-40 pin IC's, .600" centers. C-MOS safe. Includes terminal lug for attachment of ground strap.

EX-2	CMOS SAFE EXTRACTOR TOOL	\$7.95
------	--------------------------	--------

MINIMUM ORDER \$25.00. SHIPPING CHARGE \$2.00. N.Y. CITY AND STATE RESIDENTS ADD TAX

OK MACHINE & TOOL CORPORATION

3455 Conner St. Bronx N.Y. 10475 (212) 994-6600 Telex 125091



PRB-1 DIGITAL LOGIC PROBE

- DC to > 50 MHz
- 10 Nsec. pulse response
- 120 K Ω impedance
- Automatic pulse stretching to 50 Msec.
- Automatic resetting memory
- Open circuit detection
- Automatic threshold resetting
- Compatible with all logic families 4-15 VDC
- Range extended to 15-25 VDC with optional PA-1 adapter
- Supply O.V.P. to < 70 VDC
- No switches/no calibration

PRB-1 DIGITAL LOGIC PROBE \$36 95



PC BOARD

4 x 4.5 x 1/8 in. board, glass coated EPOXY laminate, solder coated 1 oz. copper pads. The board has provision for a 22/44 two sided edge connector. .156 in. spacing. Edge contacts are non-dedicated for maximum flexibility. The board contains a matrix of .040 in. diameter holes on .100 in. centers. Component side contains 76 two-hole pads. Two independent bus systems are provided for voltage and ground on both sides of the board.

H-PCB-1 HOBBY BOARD \$4 99



PROTOTYPE BOARD CM-100

TERMINALS: 1,020 TEST POINTS. 188 separate 5 point terminals, plus 2 horizontal bus lines of 40 common test points each. SIZE: 6 1/2" Wide, 5" Long.

CM-100 MODULAR PROTOTYPE BOARD \$25 95



PROTOTYPE BOARD CM-200

TERMINALS: 630 TEST POINTS. 94 separate 5 point terminals, plus 4 bus lines of 40 common test points each. SIZE: 6" Wide, 3 1/2" Long.

CM-200 MODULAR PROTOTYPE BOARD \$16 45



PROTOTYPE BOARD CM-300, CM-400

CM-300 and CM-400 have two separated rows of five interconnected contacts each. Each pin of a DIP inserted in the strip will have four additional tie-points per pin to insert connecting wires. They accept leads and components up to .032 in. diameter. Interconnections are readily made with RW-50 Jumper Wire. All contact sockets are on a .100 in. square grid (1 1/8 in. wide).

CM-300 MODULAR PROTOTYPE BOARD \$9 95
CM-400 MODULAR PROTOTYPE BOARD \$2 45

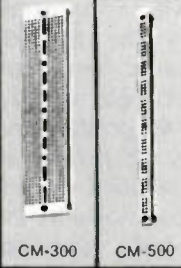

MODULAR BUS STRIP

CM-500 is a bus strip to be used in conjunction with CM-300 and CM-400 for distribution of power and common signed lines. Two separate rows of common terminals, grouped into clusters of five. All contact sockets are on a .100 in. square grid.

CM-500 MODULAR BUS STRIP \$1 95



JUMPER WIRES

50 Preformed wires, from 1 1/2 to 4 inches, 20 AWG solid wire, white insulation.

RW-50 JUMPER WIRES \$2 98



"CLIP AND STRIP" TOOL

For cutting and stripping 1 in. insulation from 30 AWG wire.

CAS-130 CLIP AND STRIP \$1 98

THE ABOVE CUT AND STRIP TOOL IS NOT APPLICABLE FOR NYLON OR TEFLON INSULATION

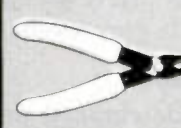

MINI SHEAR

MS-10 MINI-SHEAR \$4 95

MINI SHEAR WITH SAFETY CLIP

MS-20 MINI-SHEAR WITH CLIP \$5 95



VACUUM VISE

ABS construction, 1 1/2 in. wide jaws.

V V-1 VACUUM VISE \$3 49



WIRE WRAPPING KITS WK-2, WK-3, WK-4

WK-2-B WIRE-WRAPPING KIT (BLUE) \$12 95
WK-2-Y WIRE-WRAPPING KIT (YELLOW) \$12 95
WK-2-W WIRE-WRAPPING KIT (WHITE) \$12 95
WK-2-R WIRE-WRAPPING KIT (RED) \$12 95
WK-3B (BLUE) WIRE-WRAPPING KIT \$16 95
WK-4B (BLUE) WIRE-WRAPPING KIT \$25 99



WIRE WRAPPING KIT WK-5

BW-630, WSU-30M, CON-1, EX-1, INS-1416, TRS-2, MS-20, 14, 16, 24 and 40 DIP sockets, WWT-1, WD-30-TR1, H-PCB-1.

WK-5 WIRE-WRAPPING KIT \$74 95



TERMINAL BOARD

.062 thick glass coated epoxy laminate. Outside dimensions 6.3 in. x 3.94 in. Not plated.

A-PC-01 TERMINAL BOARD \$3 45

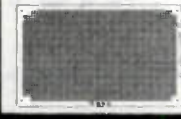

PC BOARD

Same specifications as A-PC-01 except matrix pattern is copper plated and solder coated on one side.

A-PC-02 PRINTED CIRCUIT BOARD \$5 95



PC BOARD

Same specifications as A-PC-01. Each line of holes is connected with copper plated and solder coated parallel strips on one side.

A-PC-03 PRINTED CIRCUIT BOARD \$5 95



PC BOARD

Same specifications as A-PC-01. One side has horizontal copper strips, solder coated. Second side has vertical parallel bars.

A-PC-04 PRINTED CIRCUIT BOARD \$7 95

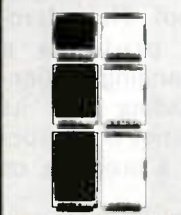

PC BOARD

The A-PC-05 features numbered contacts for easy reference along with a numbered matrix for easy hole locations. Made of .062 in. thick epoxy laminate. 4.5 in. x 5 in. Edge Connector Board.

A-PC-05 PRINTED CIRCUIT BOARD \$5 45

Same as A-PC-05 except outside dimensions are 4.5 in. x 6.5 in. Edge Connector Board.

A-PC-06 PRINTED CIRCUIT BOARD \$6 95

Same as A-PC-05 except outside dimensions are 4.5 in. x 7 in. Edge Connector Board.

A-PC-07 PRINTED CIRCUIT BOARD \$8 95

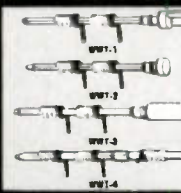

TERMINALS

WWT-1	SLOTTED TERMINAL	\$4 98
WWT-2	SINGLE SIDED TERMINAL	\$2 98
WWT-3	IC SOCKET TERMINAL	\$4 98
WWT-4	DOUBLE SIDED TERMINAL	\$1 98



TERMINAL INSERTING TOOL

For inserting WWT-1, -2, -3 and -4 terminals.

INS-1 INSERTING TOOL \$2 49



P.C.B. TERMINAL STRIPS

TS-4	4-POLE	\$1 39
TS-8	8-POLE	\$2 19
TS-12	12-POLE	\$2 99



MODULAR TERMINAL STRIPS

TS-6MD 2-POLE \$1 79
(3 per Package)



PC CARD GUIDES

TR-1 CARD GUIDES \$1 89

QUANTITY — ONE PAIR (2 PCS.)



PC CARD GUIDES & BRACKETS

TRS-2 GUIDES & BRACKETS \$3 79

QUANTITY — ONE SET (4 PCS.)



PC EDGE CONNECTOR

44 pin, dual read-out, .156 in. spacing, wire-wrapping.

CON-1 P.C. EDGE CONNECTOR \$3 49

MINIMUM ORDER \$25.00. SHIPPING CHARGE \$2.00. N.Y. CITY AND STATE RESIDENTS ADD TAX

OK MACHINE & TOOL CORPORATION

3455 Conner St. Bronx, N.Y. 10475 (212) 994-6600 Telex 125091

Computerized Slow Scan . . . Revisited

— further enhancements for the K6AEP system

SSTV is probably one of the most exciting means of amateur radio communications.

In what other mode of amateur communications can you see the person you are talking to even though the amateur may be thousands of miles away?

Interest in SSTV is growing daily, and one of the

easiest ways to experiment with it is by using a micro-processor. Never before have amateurs been provided with such a flexible, powerful tool. The micro-processor provides a means of changing its function by loading into its memory a series of instructions called a program, or software.

This article was written

to upgrade the software package described in my previous article.¹ It will explore the effect of digitizing SSTV pictures with more picture elements (pixels) and gray levels. It also will tell how to rotate pictures and title pictures in computer memory. For those of you who are not aware of my previous article, I think a short review might be appropriate.

The SSTV Enhancement Program

In my article, I provided an interface between an SSTV monitor, a ham transmitter, and an SWTPC 6800 computer system. Fig. 1 provides a block diagram of the interface card. The interface card accepts sync pulses and video which have been previously demodulated and scaled to a 0- to 5-volt swing from the SSTV monitor. The video input portion of the card consists of an analog-to-digital converter (ADC) and a sample-and-hold (S/H). The computer output consists of a digital-to-analog (D/A) converter, an amplifier, and a SSTV modulator. All of the analog devices are connected to a 6820 PIA which allows the computer control.

The software package in the article made it possible

to (1) receive and transmit SSTV from the SWTPC 6800; (2) print hard-copy SSTV pictures on an SWTPC PR-40 printer; and (3) enhance the picture in computer memory, since it would remove noise by averaging pictures received, add contrast to pictures, zoom in on 5 areas of the picture in memory by 2 times, reduce the gray level content of pictures on transmit from 16 to 2, and produce negative or inverted pictures. All of these pictures were digitized to 128 pixels on 128 lines with 16 gray levels.

Picture Quality

When I determined the picture density for my original article, the above seemed like a good idea at the time for two reasons. First, only 12K of memory was required for the SSTV picture and control program; second, the Robot 400² used this format with the same number of picture elements and gray levels as I planned.

During the initial stages of the project, I discussed my idea with knowledgeable people. They warned me that more picture elements would produce better results. Despite these warnings I proceeded, and, sure enough, they were right. My results were

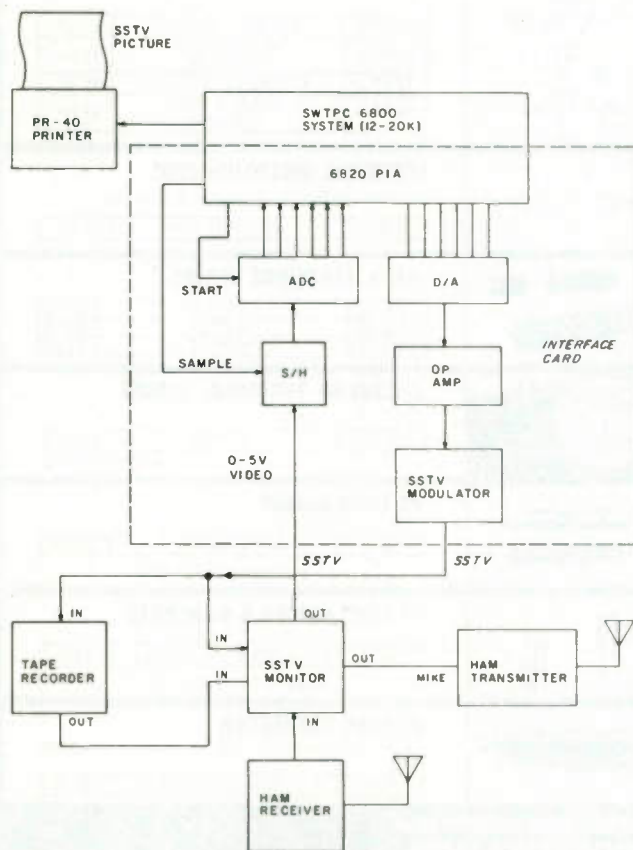

Fig. 1. Computer interface.



Photo 1. Analog SSTV picture.



Photo 2. SSTV picture digitized to 128 pixels with 16 gray levels.

marginal.

After a little prodding by others, I decided to perform a few experiments to determine the effect on picture quality of changing the picture elements per line and gray level.

Since the control of the SSTV picture reception is accomplished by constants in the software, the experiment was easy to conduct. I decided to increase the pixels per line in gradual steps to see the effect. I had a few concerns relative to computer overhead, since all of my routines were fine-tuned for 128 pixels per line. If I tried to digitize the picture with too many pixels, the memory requirements would be high. Additionally, I would reach a point where the software would not function due to execution speeds. I decided that the maximum memory requirements for the picture would be 16K. With this requirement in mind, I decided to experiment by (1)

varying the pixels/line from 128 to 176, 224, and 256, and (2) keeping the format at 128 pixels by 128 lines and increasing the gray level content of the picture to 64.

The pixel variation experiment took only a few hours to perform. It was quite easy, since only 7 memory locations had to be altered in the enhancement program. I found that the 256 pixel/line rate was the maximum rate which my systems would support. If I had had a faster clock, a higher picture density could have been achieved.

The gray level variation experiment took a little longer. It involved the writing of an entire routine, which ended up with about 256 bytes of object code. No hardware changes were required, since I planned ahead on my initial design of the interface card and placed six bits of the ADC and D/A on the PIA (6820). The results were interesting. Photos 1 through 4

show my results:

Photo 1. Normal SSTV Picture. This picture was produced by a TV camera and a scan converter. The SSTV picture was displayed on an MXV 100 (P7 CRT) monitor.³

Photo 2. Digitized Picture (128 pixels). This picture was digitized to 128 pixels/line on 128 lines with 16 gray levels. The picture has some 60-Hz ripple in the monitor/computer interface, due to a ground loop which I have not found. The picture also contains some software jitter which I will discuss later.

Photo 3. Digitized Picture (256 pixels). This picture was digitized with 256 pixels/line on 128 lines with 16 gray levels.

Photo 4. Digitized Picture (64 gray levels). This picture was digitized with 128 pixels/line on 128 lines with 64 gray levels.

After close scrutiny of the pictures and analyzing

the results on my monitor, these conclusions were drawn:

1. The picture density of 128 pixels on 128 lines, with 16 gray levels, produced marginal results. If the 60-Hz noise and jitter were removed, the results would be somewhat better.

2. A density of 128 pixels on 128 lines, with 64 gray levels, produced better results. However, the problem of contouring would appear if a zoom feature were added.

3. The best all-around digitized picture tested had 256 pixels on 128 lines, with 16 gray levels.

This selection was not based entirely on picture quality, but also on memory size and the amount of contouring experienced. The contouring could be reduced even further by averaging pixels together before they were transmitted. I did not try to program this feature, since my system overhead was so





Photo 3. SSTV picture digitized to 256 pixels with 16 gray levels.



Photo 4. SSTV picture digitized to 128 pixels with 64 gray levels.

high that it might not have been possible with the standard SWTPC cycle-time of approximately 1 MHz. A faster CPU card would have been desirable in this application.

The implementation of the 256 pixels/line feature required numerous changes in my enhancement program software package. I decided to use code, which modified the basic program for the selection of either 128 or 256 pixels/line. The effect of higher picture densities thus can be observed quickly by the selection of program options. The process of modifying all of the enhancement algorithms for the additional density was complex. I found that everything but the noise routine could be modified for the higher density. This routine has high overhead even at 128 pixels per line.

I decided to include the software in this article for the 128 pixels on 128 lines,

with 64 gray levels, as an optional program. The program was assembled on a boundary greater than 20K and allows for further experimentation.

Additional Features

For some time I have felt a need existed to add titles to SSTV pictures received. Since all the SSTV inputs are routed through the SSTV monitor, the software now allows titling of pictures received over the air, outputted from a tape recorder, or generated by a scan converter. The applications of this feature are endless.

I decided to make the letters small and allow a total of 9 lines to be displayed with 9 characters on each line. This size was found to be very adequate and visible under QRM conditions. I additionally decided to add the letters with and without background and to select the lettering with and without

gray level. I assembled into my program only the selection of white or black characters, but a gray level selection can be made by changing program constants.

The titling feature is available for only 256 pixels/line for two reasons. I felt that the character resolution would not be sufficient with 128 pixels/line, and I did not have enough memory available in the remaining lower 4K to support the luxury of switching between 128- and 256-pixels-per-line lettering. Photo 5 is an example of the various modes of titling.

Another feature added to the package was the ability to rotate pictures on transmit. The overall effect has been dramatic and demonstrates the power of microprocessors. Imagine receiving an SSTV picture over the air, adding titling to the picture, and then sending it back to the origi-

nator rotated at either 90° or 180°. With more memory available, it would be fun to code the routine to rotate the picture by any 45° angle between 45° and 315°. I'll leave this exercise for some future date.

Software Concepts

To understand the software, it is important to first know how an SSTV picture is formatted in computer memory. Fig. 2 depicts a typical SSTV picture in memory, formatted to 128 or 256 pixels on 128 lines, with 16 gray levels.

As you can see from Fig. 2, two pixels are packed into one byte. This allows the picture to be stored efficiently into memory, since all bits in each byte contain picture information. However, this software format was considerably more difficult to write, since bytes must be separated or packed into nibbles (4 bits) prior to each operation. Part of the

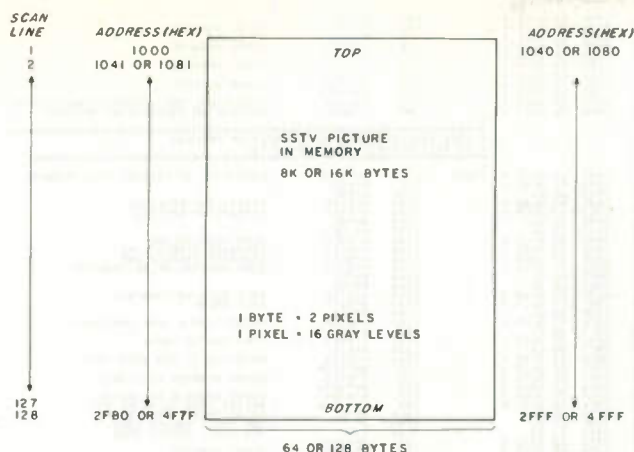

Fig. 2. Digitized SSTV picture memory map.

so-called 60-Hz noise shown in the preceding pictures is due to the unpacking of the nibbles on transmission to the SSTV modulator on the interface card. This noise, or jitter, is due to unequal cycle times in the software which was used to unpack each nibble. If I had been aware of this problem during my initial coding of the program, I would have eliminated this condition.

The 64 gray level pictures were formatted in a different manner. Since six bits were available on the ADC and the D/A, I decided to pack all bits into a single byte. This process made the coding of the software much easier. A side benefit was that I took more care in my software to eliminate jitter, and the results show an improvement in this regard. The 64 gray level picture requires 16K of memory and does not use 2 bits of each byte to store picture information. One bit is not used and the other is used for sync.

The Software

Fig. 3 contains a complete source listing of the program. Fig. 4 contains a listing of the dot and translate tables for the character dots. I'll discuss the software by function, and describe each routine used or called for by the main line program.

Pixel Selection

The pixel selection of 128 or 256 pixels was made by modifying the code of the SSTV enhancement program.¹ Five routines were modified in the enhancement program: receive SSTV, xmit SSTV, zoom, contrast enhancement, and print. The modifications consisted of two types: address changes and constant changes. The address changes were used to tell the software where parts of the picture are located in memory. The constants were used to tell the software how many pixels are contained in each line of the SSTV picture, and also for delay constants.

I will not go into detail on how these constants were selected, but two points are important. The noise routine of the enhancement program will not function at 256 pixels/line due to program overhead, and the 256 pixels per line is the maximum rate at which the software will function. This is due to a combination of software overhead and ADC conversion time.

Picture Rotation

The picture rotation was divided into two types—180° (upside down) and 90°. I'll discuss the simplest one first, the 180° rotation.



Photo 5. SSTV picture with computer titling.

Two routines are used to accomplish this, UD128 and UD256. The number in the label refers to the picture density. These routines modify two instructions in the transmit routine of the enhancement program for an INX (increment index register) to a DEX (decrement index). The transmit routine in normal operation is entered with the first byte of the picture start address. Each byte then is transmitted, and the index is incremented until the last byte is transmitted. To transmit a picture upside-down, all that has to be done is to load the index with the last byte of the picture and decrement the index register. This trick was easy and took only 50 bytes of code.

The 90-degree rotation took a little more code. The main line routine is ROT and ROT1. A flowchart was not provided for this routine, since all lines of code are well comment-

ed. I took care in this routine to remove all software jitter. This was accomplished by transmitting each nibble of the byte in the same number of CPU cycles. At address 0972-5, four NOP instructions were assembled. These instructions compensate for the four ASLA instructions at address 099A-D which are required to format the byte for the transmission of the 2nd pixel.

The operation of the routine is quite simple. All that has to be done is to load the index with the start address of the picture, transmit the high-order nibble, and then add 64 or 128 to the index register. The index is now pointing at the first byte on the next line. If you repeat this process for all bytes and nibbles, the SSTV picture will be transmitted at 90 degrees.

After writing this routine, I found that I scanned the picture backwards. Wow! What the software produced was a mirror-image



```

300 0A00 7E 02F5 A      JMP  M*02F5  IF 50 BRANCH TO TRANSPIT SSVY PICTURE
301          * CONSTANT MODIFICATION ROUTINES
302          *
303          *
304 0A00 4F 033 A      CHAR2  CLRA  DOTC  GRAY LEVEL OF PICTURE DOTS
305 0A00 4E 033 A      CHAR2  STAA  CHARS  GRAY LEVEL OF PICTURE DOTS
306 0A00 4E 033 A      CHAR2  LDAA  CHARS  GRAY LEVEL OF PICTURE DOTS
307 0A00 4E 033 A      CHAR2  STAA  CHARS  GRAY LEVEL OF PICTURE DOTS
308 0A00 4E 033 A      CHAR2  LDAA  CHARS  GRAY LEVEL OF PICTURE DOTS
309 0A00 4E 033 A      CHAR2  STAA  CHARS  GRAY LEVEL OF PICTURE DOTS
310 0A00 4E 033 A      CHAR2  LDAA  CHARS  GRAY LEVEL OF PICTURE DOTS
311 0A00 4E 033 A      CHAR2  STAA  CHARS  GRAY LEVEL OF PICTURE DOTS
312 0A00 4E 033 A      CHAR2  LDAA  CHARS  GRAY LEVEL OF PICTURE DOTS
313 0A00 4E 033 A      CHAR2  STAA  CHARS  GRAY LEVEL OF PICTURE DOTS
314 0A00 4E 033 A      CHAR2  LDAA  CHARS  GRAY LEVEL OF PICTURE DOTS
315 0A00 4E 033 A      CHAR2  STAA  CHARS  GRAY LEVEL OF PICTURE DOTS
316 0A00 4E 033 A      CHAR2  LDAA  CHARS  GRAY LEVEL OF PICTURE DOTS
317 0A00 4E 033 A      CHAR2  STAA  CHARS  GRAY LEVEL OF PICTURE DOTS
318 0A00 4E 033 A      CHAR2  LDAA  CHARS  GRAY LEVEL OF PICTURE DOTS
319 0A00 4E 033 A      CHAR2  STAA  CHARS  GRAY LEVEL OF PICTURE DOTS
320 0A00 4E 033 A      CHAR2  LDAA  CHARS  GRAY LEVEL OF PICTURE DOTS
321 0A00 4E 033 A      CHAR2  STAA  CHARS  GRAY LEVEL OF PICTURE DOTS
322 0A00 4E 033 A      CHAR2  LDAA  CHARS  GRAY LEVEL OF PICTURE DOTS
323 0A00 4E 033 A      CHAR2  STAA  CHARS  GRAY LEVEL OF PICTURE DOTS
324 0A00 4E 033 A      CHAR2  LDAA  CHARS  GRAY LEVEL OF PICTURE DOTS
325 0A00 4E 033 A      CHAR2  STAA  CHARS  GRAY LEVEL OF PICTURE DOTS
326 0A00 4E 033 A      CHAR2  LDAA  CHARS  GRAY LEVEL OF PICTURE DOTS
327 0A00 4E 033 A      CHAR2  STAA  CHARS  GRAY LEVEL OF PICTURE DOTS
328 0A00 4E 033 A      CHAR2  LDAA  CHARS  GRAY LEVEL OF PICTURE DOTS
329 0A00 4E 033 A      CHAR2  STAA  CHARS  GRAY LEVEL OF PICTURE DOTS
330 0A00 4E 033 A      CHAR2  LDAA  CHARS  GRAY LEVEL OF PICTURE DOTS
331 0A00 4E 033 A      CHAR2  STAA  CHARS  GRAY LEVEL OF PICTURE DOTS
332 0A00 4E 033 A      CHAR2  LDAA  CHARS  GRAY LEVEL OF PICTURE DOTS
333 0A00 4E 033 A      CHAR2  STAA  CHARS  GRAY LEVEL OF PICTURE DOTS
334 0A00 4E 033 A      CHAR2  LDAA  CHARS  GRAY LEVEL OF PICTURE DOTS
335 0A00 4E 033 A      CHAR2  STAA  CHARS  GRAY LEVEL OF PICTURE DOTS
336 0A00 4E 033 A      CHAR2  LDAA  CHARS  GRAY LEVEL OF PICTURE DOTS
337 0A00 4E 033 A      CHAR2  STAA  CHARS  GRAY LEVEL OF PICTURE DOTS
338 0A00 4E 033 A      CHAR2  LDAA  CHARS  GRAY LEVEL OF PICTURE DOTS
339 0A00 4E 033 A      CHAR2  STAA  CHARS  GRAY LEVEL OF PICTURE DOTS
340 0A00 4E 033 A      CHAR2  LDAA  CHARS  GRAY LEVEL OF PICTURE DOTS
341 0A00 4E 033 A      CHAR2  STAA  CHARS  GRAY LEVEL OF PICTURE DOTS
342 0A00 4E 033 A      CHAR2  LDAA  CHARS  GRAY LEVEL OF PICTURE DOTS
343 0A00 4E 033 A      CHAR2  STAA  CHARS  GRAY LEVEL OF PICTURE DOTS
344 0A00 4E 033 A      CHAR2  LDAA  CHARS  GRAY LEVEL OF PICTURE DOTS
345 0A00 4E 033 A      CHAR2  STAA  CHARS  GRAY LEVEL OF PICTURE DOTS
346 0A00 4E 033 A      CHAR2  LDAA  CHARS  GRAY LEVEL OF PICTURE DOTS
347 0A00 4E 033 A      CHAR2  STAA  CHARS  GRAY LEVEL OF PICTURE DOTS
348 0A00 4E 033 A      CHAR2  LDAA  CHARS  GRAY LEVEL OF PICTURE DOTS
349 0A00 4E 033 A      CHAR2  STAA  CHARS  GRAY LEVEL OF PICTURE DOTS
350 0A00 4E 033 A      CHAR2  LDAA  CHARS  GRAY LEVEL OF PICTURE DOTS
351 0A00 4E 033 A      CHAR2  STAA  CHARS  GRAY LEVEL OF PICTURE DOTS
352 0A00 4E 033 A      CHAR2  LDAA  CHARS  GRAY LEVEL OF PICTURE DOTS
353 0A00 4E 033 A      CHAR2  STAA  CHARS  GRAY LEVEL OF PICTURE DOTS
354 0A00 4E 033 A      CHAR2  LDAA  CHARS  GRAY LEVEL OF PICTURE DOTS
355 0A00 4E 033 A      CHAR2  STAA  CHARS  GRAY LEVEL OF PICTURE DOTS
356 0A00 4E 033 A      CHAR2  LDAA  CHARS  GRAY LEVEL OF PICTURE DOTS
357 0A00 4E 033 A      CHAR2  STAA  CHARS  GRAY LEVEL OF PICTURE DOTS
358 0A00 4E 033 A      CHAR2  LDAA  CHARS  GRAY LEVEL OF PICTURE DOTS
359 0A00 4E 033 A      CHAR2  STAA  CHARS  GRAY LEVEL OF PICTURE DOTS
360 0A00 4E 033 A      CHAR2  LDAA  CHARS  GRAY LEVEL OF PICTURE DOTS
361 0A00 4E 033 A      CHAR2  STAA  CHARS  GRAY LEVEL OF PICTURE DOTS
362 0A00 4E 033 A      CHAR2  LDAA  CHARS  GRAY LEVEL OF PICTURE DOTS
363 0A00 4E 033 A      CHAR2  STAA  CHARS  GRAY LEVEL OF PICTURE DOTS
364 0A00 4E 033 A      CHAR2  LDAA  CHARS  GRAY LEVEL OF PICTURE DOTS
365 0A00 4E 033 A      CHAR2  STAA  CHARS  GRAY LEVEL OF PICTURE DOTS
366 0A00 4E 033 A      CHAR2  LDAA  CHARS  GRAY LEVEL OF PICTURE DOTS
367 0A00 4E 033 A      CHAR2  STAA  CHARS  GRAY LEVEL OF PICTURE DOTS
368 0A00 4E 033 A      CHAR2  LDAA  CHARS  GRAY LEVEL OF PICTURE DOTS
369 0A00 4E 033 A      CHAR2  STAA  CHARS  GRAY LEVEL OF PICTURE DOTS
370 0A00 4E 033 A      CHAR2  LDAA  CHARS  GRAY LEVEL OF PICTURE DOTS
371 0A00 4E 033 A      CHAR2  STAA  CHARS  GRAY LEVEL OF PICTURE DOTS
372 0A00 4E 033 A      CHAR2  LDAA  CHARS  GRAY LEVEL OF PICTURE DOTS
373 0A00 4E 033 A      CHAR2  STAA  CHARS  GRAY LEVEL OF PICTURE DOTS
374 0A00 4E 033 A      CHAR2  LDAA  CHARS  GRAY LEVEL OF PICTURE DOTS
375 0A00 4E 033 A      CHAR2  STAA  CHARS  GRAY LEVEL OF PICTURE DOTS
376 0A00 4E 033 A      CHAR2  LDAA  CHARS  GRAY LEVEL OF PICTURE DOTS
377 0A00 4E 033 A      CHAR2  STAA  CHARS  GRAY LEVEL OF PICTURE DOTS
378 0A00 4E 033 A      CHAR2  LDAA  CHARS  GRAY LEVEL OF PICTURE DOTS
379 0A00 4E 033 A      CHAR2  STAA  CHARS  GRAY LEVEL OF PICTURE DOTS
380 0A00 4E 033 A      CHAR2  LDAA  CHARS  GRAY LEVEL OF PICTURE DOTS
381 0A00 4E 033 A      CHAR2  STAA  CHARS  GRAY LEVEL OF PICTURE DOTS
382 0A00 4E 033 A      CHAR2  LDAA  CHARS  GRAY LEVEL OF PICTURE DOTS
383 0A00 4E 033 A      CHAR2  STAA  CHARS  GRAY LEVEL OF PICTURE DOTS
384 0A00 4E 033 A      CHAR2  LDAA  CHARS  GRAY LEVEL OF PICTURE DOTS
385 0A00 4E 033 A      CHAR2  STAA  CHARS  GRAY LEVEL OF PICTURE DOTS
386 0A00 4E 033 A      CHAR2  LDAA  CHARS  GRAY LEVEL OF PICTURE DOTS
387 0A00 4E 033 A      CHAR2  STAA  CHARS  GRAY LEVEL OF PICTURE DOTS
388 0A00 4E 033 A      CHAR2  LDAA  CHARS  GRAY LEVEL OF PICTURE DOTS
389 0A00 4E 033 A      CHAR2  STAA  CHARS  GRAY LEVEL OF PICTURE DOTS
390 0A00 4E 033 A      CHAR2  LDAA  CHARS  GRAY LEVEL OF PICTURE DOTS
391 0A00 4E 033 A      CHAR2  STAA  CHARS  GRAY LEVEL OF PICTURE DOTS
392 0A00 4E 033 A      CHAR2  LDAA  CHARS  GRAY LEVEL OF PICTURE DOTS
393 0A00 4E 033 A      CHAR2  STAA  CHARS  GRAY LEVEL OF PICTURE DOTS
394 0A00 4E 033 A      CHAR2  LDAA  CHARS  GRAY LEVEL OF PICTURE DOTS
395 0A00 4E 033 A      CHAR2  STAA  CHARS  GRAY LEVEL OF PICTURE DOTS
396 0A00 4E 033 A      CHAR2  LDAA  CHARS  GRAY LEVEL OF PICTURE DOTS
397 0A00 4E 033 A      CHAR2  STAA  CHARS  GRAY LEVEL OF PICTURE DOTS
398 0A00 4E 033 A      CHAR2  LDAA  CHARS  GRAY LEVEL OF PICTURE DOTS
399 0A00 4E 033 A      CHAR2  STAA  CHARS  GRAY LEVEL OF PICTURE DOTS
400 0A00 4E 033 A      CHAR2  LDAA  CHARS  GRAY LEVEL OF PICTURE DOTS
401 0A00 4E 033 A      CHAR2  STAA  CHARS  GRAY LEVEL OF PICTURE DOTS
402 0A00 4E 033 A      CHAR2  LDAA  CHARS  GRAY LEVEL OF PICTURE DOTS
403 0A00 4E 033 A      CHAR2  STAA  CHARS  GRAY LEVEL OF PICTURE DOTS
404 0A00 4E 033 A      CHAR2  LDAA  CHARS  GRAY LEVEL OF PICTURE DOTS
405 0A00 4E 033 A      CHAR2  STAA  CHARS  GRAY LEVEL OF PICTURE DOTS
406 0A00 4E 033 A      CHAR2  LDAA  CHARS  GRAY LEVEL OF PICTURE DOTS
407 0A00 4E 033 A      CHAR2  STAA  CHARS  GRAY LEVEL OF PICTURE DOTS
408 0A00 4E 033 A      CHAR2  LDAA  CHARS  GRAY LEVEL OF PICTURE DOTS
409 0A00 4E 033 A      CHAR2  STAA  CHARS  GRAY LEVEL OF PICTURE DOTS
410 0A00 4E 033 A      CHAR2  LDAA  CHARS  GRAY LEVEL OF PICTURE DOTS
411 0A00 4E 033 A      CHAR2  STAA  CHARS  GRAY LEVEL OF PICTURE DOTS
412 0A00 4E 033 A      CHAR2  LDAA  CHARS  GRAY LEVEL OF PICTURE DOTS
413 0A00 4E 033 A      CHAR2  STAA  CHARS  GRAY LEVEL OF PICTURE DOTS
414 0A00 4E 033 A      CHAR2  LDAA  CHARS  GRAY LEVEL OF PICTURE DOTS
415 0A00 4E 033 A      CHAR2  STAA  CHARS  GRAY LEVEL OF PICTURE DOTS
416 0A00 4E 033 A      CHAR2  LDAA  CHARS  GRAY LEVEL OF PICTURE DOTS
417 0A00 4E 033 A      CHAR2  STAA  CHARS  GRAY LEVEL OF PICTURE DOTS
418 0A00 4E 033 A      CHAR2  LDAA  CHARS  GRAY LEVEL OF PICTURE DOTS
419 0A00 4E 033 A      CHAR2  STAA  CHARS  GRAY LEVEL OF PICTURE DOTS
420 0A00 4E 033 A      CHAR2  LDAA  CHARS  GRAY LEVEL OF PICTURE DOTS
421 0A00 4E 033 A      CHAR2  STAA  CHARS  GRAY LEVEL OF PICTURE DOTS
422 0A00 4E 033 A      CHAR2  LDAA  CHARS  GRAY LEVEL OF PICTURE DOTS
423 0A00 4E 033 A      CHAR2  STAA  CHARS  GRAY LEVEL OF PICTURE DOTS
424 0A00 4E 033 A      CHAR2  LDAA  CHARS  GRAY LEVEL OF PICTURE DOTS
425 0A00 4E 033 A      CHAR2  STAA  CHARS  GRAY LEVEL OF PICTURE DOTS
426 0A00 4E 033 A      CHAR2  LDAA  CHARS  GRAY LEVEL OF PICTURE DOTS
427 0A00 4E 033 A      CHAR2  STAA  CHARS  GRAY LEVEL OF PICTURE DOTS
428 0A00 4E 033 A      CHAR2  LDAA  CHARS  GRAY LEVEL OF PICTURE DOTS
429 0A00 4E 033 A      CHAR2  STAA  CHARS  GRAY LEVEL OF PICTURE DOTS
430 0A00 4E 033 A      CHAR2  LDAA  CHARS  GRAY LEVEL OF PICTURE DOTS
431 0A00 4E 033 A      CHAR2  STAA  CHARS  GRAY LEVEL OF PICTURE DOTS
432 0A00 4E 033 A      CHAR2  LDAA  CHARS  GRAY LEVEL OF PICTURE DOTS
433 0A00 4E 033 A      CHAR2  STAA  CHARS  GRAY LEVEL OF PICTURE DOTS
434 0A00 4E 033 A      CHAR2  LDAA  CHARS  GRAY LEVEL OF PICTURE DOTS
435 0A00 4E 033 A      CHAR2  STAA  CHARS  GRAY LEVEL OF PICTURE DOTS
436 0A00 4E 033 A      CHAR2  LDAA  CHARS  GRAY LEVEL OF PICTURE DOTS
437 0A00 4E 033 A      CHAR2  STAA  CHARS  GRAY LEVEL OF PICTURE DOTS
438 0A00 4E 033 A      CHAR2  LDAA  CHARS  GRAY LEVEL OF PICTURE DOTS
439 0A00 4E 033 A      CHAR2  STAA  CHARS  GRAY LEVEL OF PICTURE DOTS
440 0A00 4E 033 A      CHAR2  LDAA  CHARS  GRAY LEVEL OF PICTURE DOTS
441 0A00 4E 033 A      CHAR2  STAA  CHARS  GRAY LEVEL OF PICTURE DOTS
442 0A00 4E 033 A      CHAR2  LDAA  CHARS  GRAY LEVEL OF PICTURE DOTS
443 0A00 4E 033 A      CHAR2  STAA  CHARS  GRAY LEVEL OF PICTURE DOTS
444 0A00 4E 033 A      CHAR2  LDAA  CHARS  GRAY LEVEL OF PICTURE DOTS
445 0A00 4E 033 A      CHAR2  STAA  CHARS  GRAY LEVEL OF PICTURE DOTS
446 0A00 4E 033 A      CHAR2  LDAA  CHARS  GRAY LEVEL OF PICTURE DOTS
447 0A00 4E 033 A      CHAR2  STAA  CHARS  GRAY LEVEL OF PICTURE DOTS
448 0A00 4E 033 A      CHAR2  LDAA  CHARS  GRAY LEVEL OF PICTURE DOTS
449 0A00 4E 033 A      CHAR2  STAA  CHARS  GRAY LEVEL OF PICTURE DOTS
450 0A00 4E 033 A      CHAR2  LDAA  CHARS  GRAY LEVEL OF PICTURE DOTS
451 0A00 4E 033 A      CHAR2  STAA  CHARS  GRAY LEVEL OF PICTURE DOTS
452 0A00 4E 033 A      CHAR2  LDAA  CHARS  GRAY LEVEL OF PICTURE DOTS
453 0A00 4E 033 A      CHAR2  STAA  CHARS  GRAY LEVEL OF PICTURE DOTS
454 0A00 4E 033 A      CHAR2  LDAA  CHARS  GRAY LEVEL OF PICTURE DOTS
455 0A00 4E 033 A      CHAR2  STAA  CHARS  GRAY LEVEL OF PICTURE DOTS
456 0A00 4E 033 A      CHAR2  LDAA  CHARS  GRAY LEVEL OF PICTURE DOTS
457 0A00 4E 033 A      CHAR2  STAA  CHARS  GRAY LEVEL OF PICTURE DOTS
458 0A00 4E 033 A      CHAR2  LDAA  CHARS  GRAY LEVEL OF PICTURE DOTS
459 0A00 4E 033 A      CHAR2  STAA  CHARS  GRAY LEVEL OF PICTURE DOTS
460 0A00 4E 033 A      CHAR2  LDAA  CHARS  GRAY LEVEL OF PICTURE DOTS
461 0A00 4E 033 A      CHAR2  STAA  CHARS  GRAY LEVEL OF PICTURE DOTS
462 0A00 4E 033 A      CHAR2  LDAA  CHARS  GRAY LEVEL OF PICTURE DOTS
463 0A00 4E 033 A      CHAR2  STAA  CHARS  GRAY LEVEL OF PICTURE DOTS
464 0A00 4E 033 A      CHAR2  LDAA  CHARS  GRAY LEVEL OF PICTURE DOTS
465 0A00 4E 033 A      CHAR2  STAA  CHARS  GRAY LEVEL OF PICTURE DOTS
466 0A00 4E 033 A      CHAR2  LDAA  CHARS  GRAY LEVEL OF PICTURE DOTS
467 0A00 4E 033 A      CHAR2  STAA  CHARS  GRAY LEVEL OF PICTURE DOTS
468 0A00 4E 033 A      CHAR2  LDAA  CHARS  GRAY LEVEL OF PICTURE DOTS
469 0A00 4E 033 A      CHAR2  STAA  CHARS  GRAY LEVEL OF PICTURE DOTS
470 0A00 4E 033 A      CHAR2  LDAA  CHARS  GRAY LEVEL OF PICTURE DOTS
471 0A00 4E 033 A      CHAR2  STAA  CHARS  GRAY LEVEL OF PICTURE DOTS
472 0A00 4E 033 A      CHAR2  LDAA  CHARS  GRAY LEVEL OF PICTURE DOTS

```

```

0=PRINT,1=128 PIX-LINE
2=256 PIX-LINE
3=ROTATE 128 PIX-LINE
4=UPON 128,5=UPON 256
6=ROT 256 PIX-LINE
7=LETTERS 256

*****
ROUTINE TO SELECT MOD PROGRAM
OPTIONS WHICH SELECT PIXELS/
LINE,PRINTING OF PICTURES OR
TITLING<LETTERS> OPTION IS
SELECTED BY THE APPROPRIATE
NUMBER OPTION
*****

```

Photo 7. TV menu for program option selection.

for zero. If the results are zero, a return from subroutine is executed. If the results are not zero, the gray level byte DOTC is loaded in the A accumulator and stored indexed at 4 locations (X, X+1, X+128,

and X+129). This is the format of one picture dot. The mask is then placed over scan line dot byte 5 times for each horizontal dot position and DOTX is called. The whole process is repeated for all 7 bytes

of character dots.

7. BACK: The BACK routine is used to insert scan lines of background into the picture, onto which characters can be overlaid. This routine is selected by use of the CHART routine.

64 Gray Level Program

For those of you interested in duplicating my experiment with picture gray levels, the software is included in Fig. 3. The routine was assembled to run in more than 20K of memory. The routine includes a mini-monitor, and four program options can be selected to allow co-resident operation with the other software. The software is well commented and requires no additional

discussion. One patch must be included if you plan to use the routine. The jump-to-print option of the MOD routine must be changed to jump to this routine (see statement 766) of the source code.

The routine options can be selected by typing:

- R = Receive a picture into memory (64 gray levels).
- X = Xmit a picture from memory 4 times (64 gray levels).
- P = Print a picture from memory formatted by 128/128 or 256/128 with 16 gray levels.
- M = Jump to the monitor at location 0F01.

System Requirements

Fig. 5 is a memory map of the entire programming

NOTE to 73 Subscribers

From time to time 73 Magazine makes its subscriber lists available to carefully-screened companies and organizations whose products, services or information may be of interest to you. In every case, we must approve all organizations wishing to mail to our subscribers. In every case they receive a list of names and addresses only—no other information we may have is divulged. Each organization may use the list only once and agrees never to make any personal or telephone solicitations from it.

The overwhelming majority of our subscribers appreciate this controlled use of our mailing lists—it helps them shop conveniently by mail for products and services they need, often at substantial savings. A few people prefer their names not be used. It is to them we address this message.

If you do *not* wish to be a part of this service, please complete the form below... your name will not be used in this manner for any reason.

(If you asked us in the past to remove your name from our lists, there is no need to repeat the request.) Please allow about six weeks for your request to take effect.

I wish to have my name removed from the list of subscribers receiving mail other than the regular subscription to 73 Magazine.

Mr. _____
Mrs. _____
Ms. _____
Please Print

Address _____
City _____ State _____ Zip _____

Mail this form with your mailing label from the latest issue (or fill out the information as it appears on the label) to:

73 Magazine
Subscription Services Dept.
P.O. Box 931
Farmingdale NY 11737

Fig. 5. Program memory map.

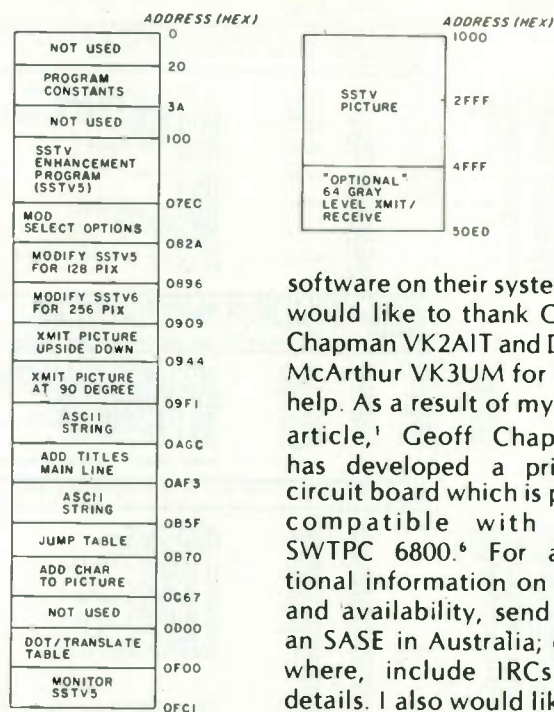

software on their systems. I would like to thank Geoff Chapman VK2AIT and Doug McArthur VK3UM for their help. As a result of my first article,¹ Geoff Chapman has developed a printed circuit board which is plug-compatible with the SWTPC 6800.⁶ For additional information on cost and availability, send him an SASE in Australia; elsewhere, include IRCs for details. I also would like to thank Walt Cole for his assistance on the photography. If you decide to write me a letter with additional questions, please enclose an SASE. ■

amount of work. Two amateurs assisted me in this project by reviewing my article and evaluating the

DEALER DIRECTORY

Fontana CA

We carry the following: ICOM, Midland, Amcom, DenTron, KLM, Swan, Drake, Ten-Tec, Wilson, SST, MFJ, Hy-Gain, Lunar, Nye-Viking, B&W, Redi-kilowatt, CushCraft, Mosley, Big Signal, Pipco, etc. Full Service Store **Fontana Electronics, 8628 Sierra Ave., Fontana CA 92335, 822-7710.**

San Jose CA

Bay area's newest Amateur Radio store. New & used Amateur Radio sales & service. We feature Kenwood, ICOM, Wilson, Yaesu, Atlas, Ten-Tec, VHF Engineering & many more. **Hobby-Tronics, 1378 So. Bascom Ave., San Jose CA 95128, 293-6268.**

Denver CO

Experimenter's paradise! Electronic and mechanical components for computer people, audio people, hams, robot builders, experimenters. Open six days a week. **Gateway Electronics Corp., 2839 W. 44th Ave., Denver CO 80211, 458-5444.**

New Castle DE

ICOM, Ten-Tec, Swan, KDK, NDI, Tempo, Wilson; Authorized dealer: 1 mile off I-95. No sales tax. **Delaware Amateur Supply, 71 Meadow Rd., New Castle DE 19720, 328-7728.**

Columbus GA

KENWOOD—YAESU—DRAKE
The world's most fantastic amateur show-room! You gotta see it to believe it! **Radio Wholesale, 2012 Auburn Avenue, Columbus GA 31906, 561-7000.**

Preston ID

Ross WB7BYZ, has the Largest Stock of Amateur Gear in the Intermountain West and the Best Prices. Call me for all your ham needs. **Ross Distributing, 78 So. State, Preston ID 83263, 852-0830.**

Terre Haute IN

Your ham headquarters located in the heart of the Midwest. **Hoosier Electronics, Inc., 43B Meadows Shopping Center, P.O. Box 2001, Terre Haute IN 47802, 238-1456.**

Littleton MA

The ham store of N.E. you can rely on. Kenwood, ICOM, Wilson, Yaesu, DenTron, KLM amps, B&W switches & wattmeters, Whistler radar detectors, Bearcat, Regency, antennas by Larsen; Wilson, Hustler, GAM. **TEL-COM Inc. Communications & Electronics, 675 Great Rd., Rt. 119, Littleton MA 01460, 486-3040.**

Laurel MD

We stock Drake, Icom, Ten-Tec, Swan, Tempo, Dentron, DSI, KDK, Wilson, Midland and others. Call toll free 800-638-4486. **The Comm Center, Inc., Laurel Plaza, Rte. 198, Laurel MD 20810.**

St. Louis MO

Experimenter's paradise! Electronic and mechanical components for computer people, audio people, hams, robot builders, experimenters. Open six days a week. **Gateway Electronics Corp., 8123-25 Page Blvd., St. Louis MO 63130, 427-6116.**

Camden NJ

X-Band (& other frequencies) Microwave Components & Equipment, Laboratory Grade Test Instruments, Power Supplies, 1000's in stock at all times. **BUY & SELL** all popular makes—HP, GR, FXR, ESI, Sorensen, Singer, etc. **Electronic Research Labs, 1423 Ferry Ave., Camden NJ 08104, 541-4200.**

North Arlington NJ

Collins, General Radio, Tektronix, Hewlett Packard. Radio sales/service. Cash or trade for tubes or gear. **Ted W2KUU, DCO, INC., 10 Schuyler Avenue, No. Arlington NJ 07032 998-4246.**

Syracuse—Central NY

We deal, we trade, we discount, we please! Yaesu, Ten-Tec, Cushcraft, Drake, Dentron, KLM, Midland, B&W, ICOM, Hygain, Swan, Amcom, Telco, Mirage, DSI etc. Complete 2-way service shop! **Ham-Bone Radio (Div. Stereo Repair Shop) 3206 Erie Blvd. East, Syracuse NY 13214, 446-2266.**

Syracuse-Rome-Utica NY

Featuring: Yaesu, ICOM, Drake, Atlas, DenTron, Ten-Tec, Swan, Tempo, KLM, Hy-Gain, Mosley, Wilson, Larsen, Midland Southwest Technical Products. You won't be disappointed with equipment/service. **Radio World, Oneida County Airport-Terminal Building, Oriskany NY 13424, 337-2622.**

Phila. PA/Camden NJ

Waveguide & coaxial microwave components & equipment. Laboratory grade test instruments, power supplies. Buy, sell & trade all popular makes. **HP, GR, FXR, ESI, Sorensen, Singer, etc. Lectronic Research Labs., 1423 Ferry Ave., Camden NJ 08104, 541-4200.**

Scranton PA

ICOM, Bird, CushCraft, VHF Engineering, Antenna Specialists, Barker & Williamson, CDE Rotators, Ham-Keys, Belden, W2AU/W2VS, Shure, Regency, CES Touch-Tone pads, Radio Amateur Callbooks, **LaRue Electronics, 1112 Grandview St., Scranton PA 18509, 343-2124.**

Houston TX

Experimenter's paradise! Electronic and mechanical components for computer people, audio people, hams, robot builders, experimenters. Open six days a week. **Gateway Electronics Inc., 8932 Clarkcrest, Houston TX 77063, 978-6575.**

San Antonio TX

Complete 2 way service shop. Call Dec, W5FSP. Selling Atlas, Avanti, Bird, Black Cat, Cush-Craft, Hustler, ICOM, KDK, Kenwood, MFJ, Nye, Palomar, Shure, Swan, Tempo, Yaesu and others. **Appliance & Equipment Co., Inc., 2317 Vance Jackson Road, San Antonio TX 78213, 734-7793.**

Port Angeles WA

Mobile RFI shielding for elimination of ignition and alternator noises. Bonding straps. Components for "do-it-yourself" projects. Plenty of free advice. **Fstes Engineering, 930 Marine Drive, Port Angeles WA 98362, 457-0904.**

DEALERS

Your company name and message can contain up to 25 words for as little as \$150 yearly (prepaid), or \$15 per month (prepaid quarterly). No mention of mail-order business or area code permitted. Directory text and payment must reach us 45 days in advance of publication. For example, advertising for the January issue must be in our hands by November 15th. Mail to 73 Magazine, Peterborough NH 03458. **ATTN: Aline Coulu.**

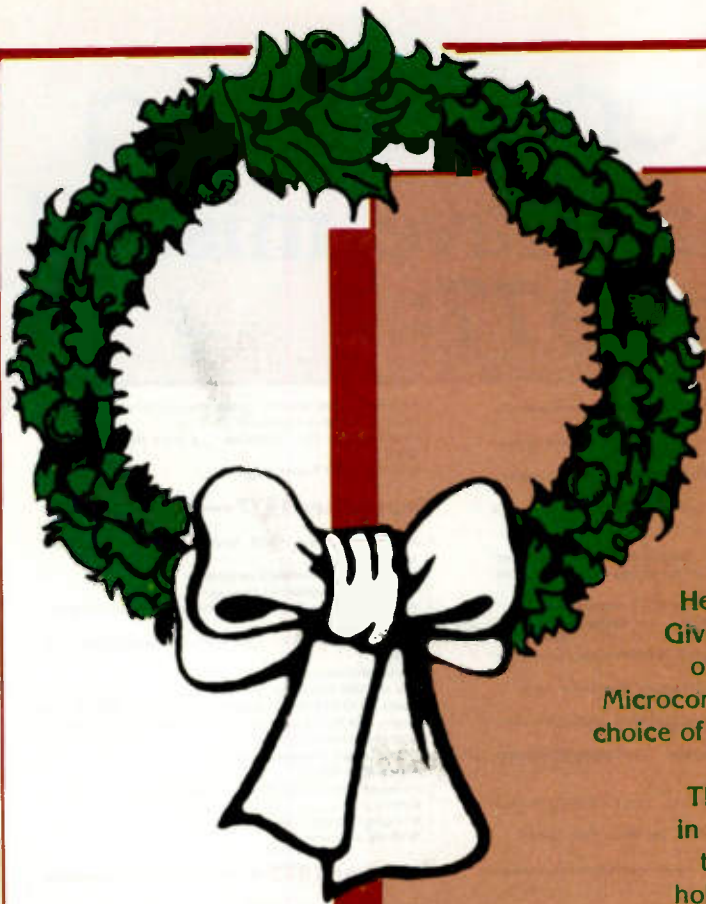

GIVE MICROCOMPUTING TO YOURSELF AND TO YOUR FRIENDS

Here's a smart way to brighten your holidays. Give yourself—as well as your friends, relatives, or business associates—the gift of Kilobaud Microcomputing at HALF the newsstand price, PLUS your choice of 3 of the back issues listed on the following pages.

Think over the wealth of information included in these issues. There is little or no information that goes stale. Give a gift subscription this holiday season and our gift to you will be 3 free back issues of your choice.

Build up your encyclopedia of Microcomputing now! Simply indicate on the coupon below or on the attached postage-paid card the issues you wish to receive. Please include alternate choices, as these issues are limited and are going fast.

I would like to give Kilobaud Microcomputing to myself and my friends!

1 year at \$15.00*

Check or m.o. enclosed Bill me

Bill my: Visa Master Charge American Express

Card # _____

Exp. date _____ Signature _____

The January 1980 issue of Kilobaud Microcomputing will arrive before Christmas with a gift card from:

Your name: _____

Address _____

City _____

State _____ Zip _____

*Canada: \$15 per year, US funds only. Please add \$2 per year for Canadian currency. Other foreign subscriptions \$26, one year only, payable in US funds.

Please enter a one-year gift subscription for:

Name _____

Address _____

City _____

State _____ Zip _____

I haven't forgotten to choose my 3 FREE Back Issues from the attached catalog. My choices are (specify month & year):

1) _____

2) _____

3) _____

My alternate choices are (specify month & year):

1) _____

2) _____

3) _____

Please allow 60 days to process your order. Mail early!

kilobaud microcomputing

articles you may have missed during 1977:

January 1977*

February 1977

- ZAP!
- Chasing Those Naughty Bits
- Why So Many Computer Languages?
- The Remarkable Apple Computer
- Beware the Wumpus
- Chase!
- Will the Z-80 Crush All Competitors?
- Practical Microcomputer Programming ... Part 2: Operating Systems
- The Trouble with Mass Storage Systems
- A Useful Loan Payment Program
- Submarine! ... a game for the SR-52
- The Hobbyist's Operating System ... Part 2: Interfacing with the Monitor
- Found: A Use for Your Computer! ... a clock program for the KIM
- Sophisticating a Surplus Keyboard
- At the Races
- RCA Tries Again ... with the 1802
- 8080 vs. 370
- Cut 6800 Programming Time with this Extraordinary Program
- $7 \times 9 = 56$
- Learning Computerease
- How to WIN the Surplus Game
- Making Money Is Nice
- The 8080 You May Have Missed
- The "Kill a Byte" Standard
- A 6800 Single Stepper
- Computerized Statements

March 1977

- Practical Microcomputer Programming ... Part 3: Software Tools
- The Motorola Way! ... review of the MEK6800D1
- Let's Hear It for the 6801!
- The Paper Tape Caper
- Computers for Free!
- A New Approach to the 6800 ... the Astral 2000
- Journey into the CPU
- Only Five Senses
- Floppy Disks
- The Jupiter II
- How to Win \$25,000 of Your Own Money ... Keno game program
- Using the "\$50" Terminal
- External Mass Storage ... Part 2: Digital and Audio Cassette Systems
- Make Your 680b Smarter ... a cheap memory expander
- Stop Bugs Now!
- Clocked Logic ... Part 1: The D Type and JK Flip-Flops
- The Gory Details of Cassette Storage
- The Fun of Learning BASIC
- Super-Tube ... jazzing up the Digital Group TVT

April 1977

- Interrupts Exposed ... using microprocessor interrupt capability effectively
- Clocked Logic ... Part 2: Some Basic Applications
- Build an Eight Channel Multiplexer for Your Scope
- Sorting Routines
- Number Rounding Program
- Meet the Tarbell/KC Interface
- Super-Tester ... a digital design aid
- The Hobbyist's Operating System ... Part 3: Command Language Processing
- The Slow-Stepping Debugger
- BASIC—The Easy Way
- Now You Can Use Software Timing Loops
- KIM-1 Memory Expansion
- Heavy Duty Power Supply
- Digital Audio
- HI-LO
- Interfacing the Analog World
- Everything about Semiconductor Memory
- Three-State Logic ... explanation of a key microprocessor element
- Automatic Memory Dumper ... utility dump program for 6800 users
- Hangmath! ... a new puzzle game
- Now—BASIC for the 8008—Even!
- Microprogramming ... an insight into microprocessor design
- Computerized Babysitter

May 1977

- Clocked Logic ... Part 3: Data Converters and Special Functions
- Cure Those End-of-Month Blues ... with a sales analysis program
- Make Your Investment Count ... the inside view of a custom MP-68
- Speed Up Your 6800
- Who's Afraid of RS-232 ... data communications explained!
- Is it High?—or Low? ... understanding logic design conventions
- Know Thyself! ... confessions of a kit-builder
- Prototyping Systems Exposed! ... a revealing look at the Intercept Jr.
- Interrupts Exposed ... Part 2: Implementing an Interrupt-driven System
- Digital Audio ... Part 2: Generating that Weird Music
- Now It's Insa! BASIC!
- Bridging the Gap ... tips on turning an application into a program
- Adding "Plop" to Your System ... a noisemaker for computer games
- Lunar Lander
- Silence Noisy Teletype Motors ... Part 1: Getting the Ball Rolling
- A Home Computer Pioneer ... profile of Don Tarbell

June 1977

- Build Your Own Interface
- Computer Club Promotional Techniques
- Artillery Practice
- Put a Micro in Your School
- Torpedoes Away!
- Build a Pulse Generator
- A TVT For Your KIM
- The BYTEDESTROYER ... review of an EPROM eraser
- BASIC Timing Comparisons
- Solving Keyboard Interface Problems
- A Clean Cassette
- Try a Design Console ... for practical hardware prototyping
- Try Solar Energy
- Simplified Billing System ... in BASIC for the small business
- Kilobaud Classroom ... No. 2: Gates and Flip-flops Explained
- Computerized Typesetting ... an introduction to word processing
- Introducing! The World's Cheapest Computer ... a \$60 SCMP
- My Friend is a Computer Junkie

July 1977

- Inside the Sphere Microcontroller
- The Great TV to CRT Monitor Conversion
- Computer Turns Director ... an interview with filmmaker John Whitney
- The Random Number Game
- Cassette Interface First Aid ... use your processor to set timing
- Understand Your Computer's Language
- Kilobaud Classroom ... No. 3: JK Flip-Flops and Clock Logic
- Digital Audio ... Part 3: Signal Expansion and Compression
- It Was Great! ... reviewing The First West Coast Computer Faire
- Pass the Buck ... computer decision-maker program
- Inside the Amazing ASR 33 ... checking out the most popular terminal
- Try Computer Composition

August 1977

- Cassette I/O Format
- Expand Your SWTP 6800 ... with a new 8K board
- Trigger Your Oscilloscope
- Sobriety Tester Program
- Random Integer Program
- Test ICs With Your Micro
- Heavy Duty Altair Power Supply
- Is the KIM-1 For Every-1?
- Electronic Design by Computer
- Understand Your Computer's Language ... Part 2: Instruction Sets
- Enter the Audible Computer!
- Time Bomb Game
- Try a Do-All Program!
- Sooo, You Want to be an Author!
- SWTP 4K BASIC Notes ... implementing it on the 680b

- Hexdec ... hexadecimal to decimal conversion
- Start a One-Man Computer Club
- Troubleshoot Your Software ... a trace program for the 6502
- Cure that Hot Power Supply

September 1977

- Build Your Own ASCII Keyboard ... with serial and parallel output
- The Ultimate Personal Computer
- Talk Your Computer's Language!
- A PET For Every Home ... a look at the Commodore PI 1200!
- Kilobaud Classroom ... No. 4: PC boards and power supplies
- Seals Electronics
- Try an 8080 Simulator
- Build a \$20 EPROM Programmer ... for the 5402 4K chip
- Faster MIKBUG Load Technique ... uses binary format
- Decoding Device Control Codes ... uses a UART, naturally
- Tarbell Asynchronous Format
- Baseball in BASIC
- Using an Invisible PROM ... how to relocate monitor programs
- Klingon Capture Game
- Starting a Business!

October 1977

- BASIC Timing Comparisons
- Learn and Earn ... BASIC and business programming
- Bargain Time!
- Hello! Today's Program Is ... understanding computer speech recognition
- Beware the Altair Bus
- Put Your Insa! on the Rack!
- 3D Computer Graphics
- Memory Troubleshooting Techniques
- Understand Your Interrupts! ... real time clock applications
- Kilobaud Classroom ... No. 5: hardware logical functions
- Digital Group MAXI-Basic
- Utilize ASCII Control Codes!
- Dedicated Controllers
- Try WORDMATH!
- Time for Timesharing!
- Build a Universal I/O Board ... for your Altair

November 1977

- Everything about Assemblers! ... sure beats hand coding
- Your Image Counts!
- Lifetime Program
- Consider a MITE Printer ... alternative to the ASR-33
- Tired of Substituting Chips?
- Stretch Those Characters ... mods for the SWTP PR 4U
- Magnetic Bubble Memory
- Reliable Conversion Techniques
- Salesmanship, Hardware and Coffee
- Hyper about Slow Load Times! ... KIM Hypertape is an alternative
- Interested in Commercial Programming?
- Kilobaud Classroom ... No. 6: voltage, current and power supplies
- Expand Your KIM! ... with Altair bus devices
- Enhance Your Memory ... with home information retrieval
- Build the \$35 Modem ... uses the MC14412 and a UART
- Another Look at Benchmark Program
- Son of Submarine Game
- Payroll Program ... for small businessmen
- SC/MP Goes Baudot ... add an inexpensive TTY

December 1977

- TVT Hardware Design ... Part 1: instruction decoder and scan
- Expand Your KIM! ... Part 2: getting to the nuts and bolts
- Payroll Program (Continued) ... cassette techniques
- The Business Market
- ALL CAPS
- The "Learning Machine" ... math tutor program
- Kilobaud Classroom ... No. 7: transistors, diodes and op amps
- Complete Guide to Logic Diagrams
- Tiny BASIC
- The Twelve Days of Christmas
- Paper Tape: It's Here to Stay ... a look at the OP-80A
- Tempus Fugit
- Who Needs a Broker?
- Here's HUEY! ... super calculator for the 6502
- Crash Landing! ... a real-time Lunar Lander game
- File Structures Simplified

* issues not available.

kilobaud microcomputing

articles you may have missed during '78 & '79

January 1978

- Business Applications
- Growing with KIM... expansion PC board
- Has Godbout Done It Again?... Econoram II: \$150 assembled
- The TRS-80: how does it stack up?
- A Tale of Four BASICS
- Hardware Program Relocation
- TVT Hardware Design
- Understanding Loaders
- Kilobaud Klassroom... No. 8: pulses—and more pulses
- Help for Beginning Programmers
- Your Insat and You
- Rocket Pilot... an interactive game for the Apple-II
- Micro Maestro
- Software Keyboard Interface
- Morrow's I/O Cassette Board
- It's Your Hobby!

February 1978*

March 1978

- Build the "Simple Computer"... a home-brew 8080
- Hardware Program Relocation, Part 2
- State Capitals
- Customized MIKBUG
- TV Typewriter Update
- Foolproof Cassette Operation
- Number-Crunching Time
- Super Terminal!... interfacing the Burroughs 9350-2
- Consumer Computer, Inc.
- Programmed Instruction Made Easy: Tiny PILOT, Part 1
- Protect Your Memory Against Power Failure
- Backup Techniques... how fail-safe is your system?
- Small Business Software, Part 2
- Expand Your KIM!... Part 4: a TTY substitute
- Faster Erase Times... build a quicker EPROM eraser
- I/O Programming for the Altair Disks
- The Astrom EX-800
- Tiger Trouble!... TI programmable-calculator safari
- Temperature Sensing
- A Different Approach to HI-LO

April 1978*

May 1978*

June 1978*

July 1978

- Two Hobbies: Model Railroad and Computing
- Revolving Charge Account Calculations
- A Tour of the Faire, Part 2
- Taming the I/O Selectric... Part 2: software
- Heath's Experimenter's Breadboard
- Draw Dazzling Color Graphics... routines for Cromemco's Dazzler
- Atwood Memory for Your KIM
- MIKBUG with Muscle!
- Little Bits... strings, statements, routines
- Cook's Memory Test... for the 8080
- An S-100 Front Panel Replacement
- Home-Brew Z-80 System... Part 2: CPU and memory board
- Battleship!
- Improvements Make the Difference... SWTP's new system
- Simple and Low-Cost PROM Programmer
- Compatibility and the Altair Bus
- Retail Pricing System

August 1978

- DOCUFORM: A Word-Processing System for Everyone!
- Kilobaud Klassroom... No. 11: Data and Address Buses
- Software Debugging for Beginners
- Mits vs North Star
- Kansas City Standard... at 1200 baud
- Swords and Sorcery!
- Two Hobbies: Model Railroad and Computing, Part 2
- Update: Lunar Lander
- The Do-It-Yourself System... Heath's H8 is a winner!
- KIM + Chess = Microchess
- Is There Intelligent Life in Your Computer Room?
- From Base to Base... with your HP 25
- FINANC: A Home/Small-Business Financial Package
- Computer-Generated Signs
- Copying Computer Cassettes
- Something Extra With Radio Shack's BASIC
- The Amazing 1802
- Who Needs a UART?
- Can't Find It?... an index for your SWTP BASIC manual

September 1978

- (Context) Editor
- At Last: A Client Timekeeping System
- Troubleshooters' Guide
- Metric-American Conversion Program
- The Heath/DEC Connection... Part 1: overview
- Home System Demo Program
- Do-It-All Expansion Board for KIM
- Tally Ho!... fox and hounds game
- Baudot Interface Cookbook
- Error-Correcting Techniques
- KIM Organ
- Kilobaud Klassroom... No. 12: ROM and RAM memories
- Motorola's Latest: The MC6802
- TRS-80 Update: Level II BASIC
- Super Cheap 2708 Programmer
- Something Extra In Mass Storage... Meca's Alpha-1
- From Blg BASIC to Tiny BASIC

October 1978

- Budget System... KIM, keyboard, TV, TVT-6L and AKIM
- The Heath/DEC Connection... Part 2: H11 system peripherals
- Depreciation Calculations
- Looping in Tiny BASIC
- Kilobaud Klassroom... No. 13: I/O Circuitry
- Let Your Computer Wear a Watch
- Randomness is Wonderful
- Dazzler and BASIC
- The Latest in Operating Systems for the 6800: FLEX
- Action on the Enterprise
- Will DEC and IBM Be the Final Winners?
- Little Bits
- View from the Far East
- Use That Parity Line!
- The Software Patchcord
- A Useful Address List Program
- Ready for the Nuthouse!
- Build a One-Chip Single Stepper for the 6502

November 1978*

December 1978

- Dura/Intel Selectric for Low-Cost Hard Copy
- A "Gift" That Keeps on Giving
- The Art of Generating Expense Reports
- Deep, Dark Secrets of the TRS-80 (Level I)
- Interfacing the EI II
- The Care and Feeding of Cassette Tapes, Part 1
- Kilobaud Klassroom... No. 15: computer I/O III
- Raster Scan Graphics for the 6800... Part 2: the software
- SWTP 4K RAM Write Protect Option
- TSC Text Editor
- Spelling Bee
- Two Interface Boards from Teletek
- Attention, Chess Buffs!
- The Ups and Downs of Business
- BASIC Control of Servomechanisms
- There Is a Better MIKBUG!
- How to Write Good Application Programs
- Sharing Scheme for RS-232 Channels
- Scratched Diskette!

January 1979

- An Editor for 6800 BASIC Programs
- u-Panel for KIM
- Rolling Dice
- Pseudo Graphics
- The BCS and Its President
- Address List Editor
- Display Your PET!
- TRS-80 Tape Controller
- SHHH—People Are Sleeping
- Say It with a Banner
- Open House
- Cassette Interfacing
- PET Techniques Explained
- A Service Bureau for Hobbyists
- Little Bits
- Keeping Ma Bell Happy

February 1979

- Block-Structured Language for Microcomputers
- Kilobaud Klassroom, No. 16: I/O IV
- Computerized Climate Control
- Music, Maestro!
- Madam Dupre's House of the Zodiac
- Disk Power!
- Inventory Control with the TRS-80
- Onward with the COSMAC EII!
- Build a \$50 TVT!
- Percom's LFD-400 Floppy Disk System
- DOTS

- The Apple Speaks—Softly
- Super Mastermind
- TRS-80 Level II Reference Manual Index
- Care and Feeding of Cassette Tapes (Part 2)
- Text/Document Preparation Made Easy
- Simpler Interest
- Learn BASIC—with BASIC
- Use Flowcharts to Communicate
- Joystick Interface for Your Altair
- Attack on the Pack!

March 1979

- Cheap Video for Your Heathkit H8
- Analog and Digital Interfaces
- The "EI Cheap" EPROM Programmer
- Is Your Video Monitor Dangerous?
- Thoughts on the SWTP Computer System
- PET User Port Cookbook
- Chess Pawn
- Home Computer Exterior Ballistics
- Heath H9 Page Erase
- The SKIP II Microcomputer
- Ultra Banner
- Teletype's KSR-43
- The One Percent Forecasting Method
- Too Many Variables!
- Kilobaud Klassroom No. 17: I/O V
- The Electric Pencil
- How to Talk to Your 8080
- Programming the 1802
- Keyboard Interrupt for the TRS-80
- The OSI Model 500
- Sleep Better with a Microcomputer
- Telpar Thermal Printer

April 1979

- A Look at TRS-80 Peripherals
- Heath H8 Disk System
- DOTS (Part 2)
- Truly Random Numbers
- SWTP CT-1024 Mod
- Who Sells Software?
- How Important Is Proper Termination?
- How to Talk to Your 8080 (Part 2)
- Parallel Port to RS-232—Inexpensively
- Free Speech Lessons for the TRS-80
- Let's Go Flying
- Floppy Disk System from Tarbell
- The Wait State Explained
- Depreciation Analysis
- Twin Cassettes for Your TRS-80
- Bar-Graph Generator
- Let's Have Some Order
- Quicksort!
- Put Something Super in Your Life
- Starship Attack
- Terminate Your Troubles
- Testing PET Search Algorithms
- Two Diamonds
- How about a Printer?
- A Look inside the TRS-80

May 1979

- A Text Formatter in BASIC
- KIMCTR
- High-Speed Cassette Interface
- How to Talk to Your 8080 (Part 3)
- Data Base Management
- Analog and Digital Interfaces (Part 2)
- COSMAC Double Play
- COSMAC Double Play (cont.)
- From Microcomputer to Micro-Piano
- A Game of Darts
- Prettyprinting with Microsoft BASIC
- Kilobaud Klassroom No. 18
- MDOS
- A TRS-80 Cross-Index
- Graphing with the TRS-80
- An All-in-One Interface

June 1979

- "Monitor"
- TRS-80/Selectric Word Processor
- Thoughts on the SWTP Computer System (2)
- New Life for Our Altair
- TVBUG
- Creative Tabulation
- A Handle on Programming
- Keepbook
- Vector Graphing Techniques
- Putting the 1802 on the S-100 Bus
- A Personal Finance System (Part 1)
- Building a New Horizon
- Microcomputers and TVI
- Translating Between TTL and RS-232 Levels

* issues not available.

... and more!

Get a Software Discount!

Now you can get the best for less! Just clip out the coupon at right, bring it to your local computer store, and you'll get \$1.00 off the list price of any program package from Instant Software!

TRS-80*

LEVEL I

- KNIGHT'S QUEST/ROBOT CHASE/HORSE RACE** 16K; Order No. 0003R.
- CAVE EXPLORING/YACHT/MEMORY** 16K; Order No. 0010R.
- CAR RACE/RAT TRAP/ANITAIRCRAFT** 4K; Order No. 0011R.
- STATUS OF HOMES/AUTO EXPENSES** 4K; Order No. 0012R.
- BUSINESS PACKAGE I** 4K; Order No. 0013R. \$29.95
- DEMO I** 4K; Order No. 0020R.
- DESTROY ALL SUBS/BOMBER/GUNBOATS** 4K; Order No. 0021R.
- PERSONAL FINANCE I** 4K; Order No. 0027R.
- DOODLES AND DISPLAYS I** 16K Order No. 0030R.
- SPACE TREK III** 4K; Order No. 0031R.
- FUN PACKAGE I** 16K; Order No. 0037R.
- HEX PAWN/SHUTTLE CRAFT DOCKING/SPACE CHASE/SEA BATTLE** 16K; Order No. 0041R.
- BUSINESS PACKAGE III** 4K; Order No. 0061R.

Level I and II

- BASIC AND INTERMEDIATE LUNAR LANDER** 4K; L.I, 16K L.II; Order No. 0001R.
- SPACE TREK II** 4K L.I, 16K L.II; Order No. 0002R.
- BEGINNER'S BACKGAMMON AND KENO** 4K L.I, 16K L.II; Order No. 0004R.
- HAM PACKAGE I** 4K L.I, 16K L.II; Order No. 0007R.
- ELECTRONICS I** 4K L.I, 16K L.II; Order No. 0008R.
- GOLF/CROSSOUT** 4K L.I, 16K L.II; Order No. 0009R.
- AIR FLIGHT SIMULATION** 4K L.I, 16K L.II; Order No. 0017R.
- OIL TYCOON** 4K L.I, and L.II; Order No. 0023R.
- BOWLING** 4K L.I, 16K L.II; Order No. 0033R.
- SANTA PARAVIA AND FIUMACCIO** 4K L.I, 16K L.II; Order No. 0043R.
- BUSINESS PACKAGE IV** This package can help any businessman get the right information for those critical decisions.
 - **Business Cycle Analysis**—This program can plot the expansion and contraction cycles of any aspect of your business. You'll see in black and white just what's happening.
 - **Financial Analysis**—Now you can get the figures for any type of annuity, sinking fund, or mortgage, and compute the yield and value for bonds.
 The package includes a blank data tape and requires a TRS-80 Level I 4K or Level II 16K. Order No. 0019R \$9.95.

LEVEL II

- MODEL ROCKET ANALYZER AND PREFLIGHT CHECK** 16K; Order No. 0024R.
- RAMROM PATROL/TIE FIGHTER/KLINGON CAPTURE** 16K; Order No. 0028R.
- PERSONAL BILL PAYING** This system goes beyond the mere function of a checkbook program. Now you can see your bill-paying records for an entire year—not only what you've paid, but what you owe as well. You can keep a computerized list of up to 22 accounts. Each account can be listed with its name, number, due date, and the amount owed. All you need is the TRS-80 Level II 16K. Order No. 0103R \$7.95.
- FINANCIAL ASSISTANT** 16K; Order No. 0072R.
- TRS-80 UTILITY II** 16K; Order No. 0076R.
- TRS-80 UTILITY I** 16K; Order No. 0081R.
- VIDEO SPEED-READING TRAINER** Increase your reading speed and comprehension. This three-part package will train your mind and eyes to quickly grasp numbers, letters, words, and phrases. You can start at your own level of competency and progress as fast as you want. The computer will monitor your progress and automatically advance you as your reading speed and comprehension increase. This package requires a TRS-80 Level II 16K. Order No. 0100R \$7.95.

All Packages \$7.95 except where otherwise indicated.

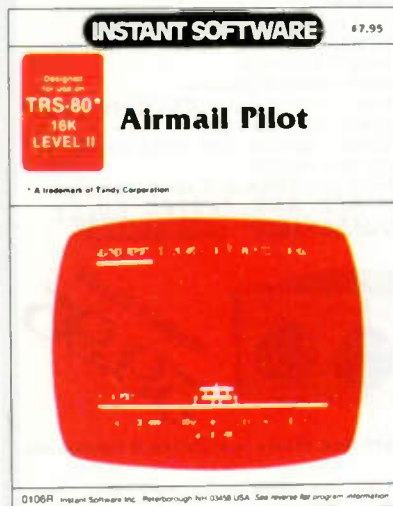

AIRMAIL PILOT Go back in time to the early days of aviation. You must fly the mail from Columbus to Chicago. Your Jenny, a cloth-covered biplane, must take you through unpredictable winds and electrical storms. The onboard clock will time your flight. You must get the mail through in the shortest time possible. All you'll need is a TRS-80 Level II 16K. Order No. 0106R \$7.95.

- DEMO II** Now get more fun for the bucks with this amazing package.
- **Tic-Tac-Toe**—Play an old-time favorite with three levels of difficulty.
 - **Time Trials**—Try to beat the clock as you race your car through curves, chutes, and chicanes.
 - **Maze**—One of two players can search through the maze for the secret square.
 - **Hangman**—One or two players can try to guess the secret word.
 - **Wheel of Fortune**—Choose your number, place your bet, and see if you can break the bank (for one to eight players).
 - **Hurricane**—Now you can track and monitor hurricanes anywhere in the world.
 - **Bugsy**—Can you build your Z-80 bug before the computer does?
 - **Horse Race**—Pick a sure winner and place your bet (for 1 to 100 players).
- All you'll need is a TRS-80 Level II 16K. Order No. 0049R \$7.95.

- DEMO III** This is the biggest package that Instant Software has ever released. Just look at what's Included:
- **Race 1**—Caren around the race course as you try to beat the clock.
 - **Target UFO**—Destroy all the invading UFOs to rack up a big score.
 - **Life**—Experiment with this simulation of the life cycle of a colony of bacteria.
 - **Phone Number Converter**—Change those hard-to-remember 7-digit phone numbers into easily remembered words.
 - **Biorhythm**—You or your friends can see your biorhythm curves whenever you want.
 - **Graphics Program**—This program will really show you what your TRS-80's graphics display can do.
 - **Race 2**—Our racing game simulation for the more experienced driver includes a choice of five different tracks.
 - **Horse Race**—Up to nine players can bet on and enjoy our most entertaining horse race program.
 - **Drawing Board**—Draw pictures or messages and store them in memory or on cassette tape with this easy-to-use program.
 - **24-Hour Clock**—Transform your computer into an accurate digital clock.
- To enjoy this tremendous value, you'll need a TRS-80 Level II 16K. Order No. 0055R \$7.95.
- CARDS** 16K; Order No. 0063R.
 - TEACHER** 16K; Order No. 0065R. \$9.95.
 - HOUSEHOLD ACCOUNTANT** 16K; Order No. 0069R.

- SPACE TREK IV** 16K; Order No. 0034R.
- DOODLES AND DISPLAYS II** 16K; Order No. 0042R.
- BOWLING LEAGUE STATISTICS SYSTEM** 16K; Order No. 0056R. \$24.95.

PET**

- PERSONAL WEIGHT CONTROL/BIORHYTHMS** 8K; Order No. 0005P.
- MORTGAGE WITH PREPAYMENT OPTION/FINANCIER** 8K; Order No. 0006P.
- CASINO I** 8K; Order No. 0014P.
- CASINO II** 8K; Order No. 0015P.
- CHECKERS/BACCARAT** 8K Order No. 0022P.
- DOW JONES** 8K; Order No. 0026P.
- TANGLE/SUPERTRAP** 8K; Order No. 0029P.
- QUBIC-4/GO-MOKU** 8K; Order No. 0038P.
- MIMIC** 8K; Order No. 0039P.
- PENNY ARCADE** 8K; Order No. 0044P.
- ARCADE II** 8K; Order No. 0045P.
- BASEBALL MANAGER** 8K; Order No. 0062P. \$14.95.
- DUNGEON OF DEATH** 8K; Order No. 0064P.
- ARCADE I** 8K; Order No. 0074P.
- DIGITAL CLOCK** 8K; Order No. 0083P.
- TURF AND TARGET** 8K; Order No. 0097P.



DECORATOR'S ASSISTANT This integrated set of five programs will compute the amount of materials needed to redecorate any room, and their cost. All you do is enter the room dimensions, the number of windows and doors, and the base cost of the materials. These programs can handle wallpaper, paint, panelling, and carpeting, letting you compare the cost of different finishing materials. All you'll need is a PET 8K. Order No. 0104P \$7.95.

TREK-X Command the Enterprise as you scour the quadrant for enemy warships. This package not only has superb graphics, but also includes programming for optional sound effects. A one-player game for the PET 8K. Order No. 0032P \$7.95.

Apple***

- GOLF** Applesoft II 20K Order No. 0018A.
- BOWLING/TRIOLOGY** 20K; Order No. 0040A.
- MATH TUTOR I** Applesoft II 24K Order No. 0073A.
- MATH TUTOR II** Applesoft II 20K Order No. 0098A.

*A trademark of Tandy Corporation
 **A trademark of Commodore Business Machines Inc.
 ***A trademark of Apple Computer Inc.

MESSAGE MEMORY KEYER



Model # TE201

\$69.95

Features:

- Advanced CMOS message memory
- Two (50 char. each) message storage
- Repeat function
- Records at any speed—plays back at any speed
- Longer message capacity
Example: send CQ CQ CQ DX de WB2YJM WB2YJM K—then play second message on contact—de WB2YJM QSL NY NY 579 579 Paul Paul K
- Use for dally QSOs or contests

PLUS:

- State-of-the-art-CMOS keyer
- Self completing dots and dashes
- Both dot and dash memory
- Iambic keying with any squeeze paddle
- 5-50 wpm
- Speed, volume, tone, tune and weight controls
- Sidetone and speaker
- Low current drain CMOS battery operation—portable
- Deluxe quarter-inch jacks for keying and output
- Keys grid block and solid state rigs
- **WIRED AND TESTED FULLY GUARANTEED—LESS BATTERY**

"BRAND NEW"



Model # TE144
\$59.95

Features: Deluxe CMOS Electronic Keyer

- State-of-the-art CMOS circuitry
- Self completing dots and dashes
- Both dot and dash memory
- IAMBIC keying with any squeeze paddle 5-50 wpm
- Speed, weight, tone, volume tune controls & sidetone and speaker
- Semi-automatic "bug" operation & straight keying—rear panel switch
- Low current drain CMOS battery operation—portable
- Deluxe quarter inch jacks for keying and output
- Keys grid block and solid state rigs
- Wired and tested—fully guaranteed—less battery



Model # TE133

\$49.95

Features CMOS ELECTRONIC KEYER

- State-of-the-art-CMOS circuitry
- Self completing dots and dashes
- Dot and dash memory
- Iambic keying with any squeeze paddle
- 5-50 WPM
- Speed, volume, tone, weight & tune controls, sidetone and speaker
- Low current drain CMOS battery operation
- Deluxe quarter Inch jacks for keying and output
- Handsome eggshell white base—woodgrain top
- Compact and portable 1-7/8 x 4-1/4 x 6-1/4
- Grid block & solid state keying
- Wired and rested—fully guaranteed—less battery

MODEL TE122—same as TE133 less wgt, tune, solid state keying \$36.50

FEATURES:

- Twin paddle squeeze key
- Extra heavy base—non-skid feet
- Adjustable contact spacing
- Touch tension—comfort keying
- Smooth friction free paddle movement
- Handsome crinkle finish base and rich red paddles
- Five way binding posts
- Use with Trac CMOS keyer or any keyer

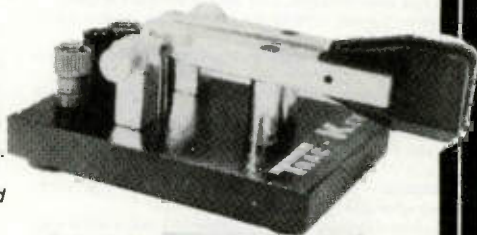

\$25.95 TRAC - KEY

AT YOUR DEALER OR SEND CHECK OR MONEY ORDER.

PLUS \$2.00 SH.
NY RES. ADD 10%

TRAC ELECTRONICS, INC
1106 RAND BLDG.
BUFFALO NY 14203

CLOSE OUT KIM BUS 8K RAM

The famous HDE 8K RAM now on sale at the incredible price of \$155.00—quantity one. Two or more—\$150.00. Hurry while supply lasts.



P.D. Box 1712, Auburn AL 36830
Call Toll Free 1-800-633-8724
regular phone number (205) 745-7735

✓ L25

AMCT-80

Automatic Morse Code Teacher for the TRS-80

This is the only morse code program available that will automatically speed up or slow down depending on your proficiency to receive code. Will send in single or group character mode. Written in machine language. Specify Level 1 or Level 2 and memory size.

AMCT-80 on cassette \$14.95

Send for TRS-80 catalog.

COST EFFECTIVE COMPUTER SERVICES

728 S. 10th St., Suite #2
Grand Junction, CO 81501
(303) 243-3629 ✓ C124

New SATELLITE For the TV home.



Supersharp Reception—Color Like Never Before

Get over 50 channels of television directly from the satellite! HBO, Showtime, the Superstations, and sports from around the world!



Works Anywhere!

Buy complete or build and save. Our book tells everything! Send \$7.95 today or call our 24 hr. C.O.D. Hotline!

(305) 869-4283

SPACECOAST RESEARCH ✓ S117
P.O. Box 442, Dept. G, Altamonte Springs, FL 32701

Key Electronics

AUTOMATIC DIALING TOUCH TONE MICROPHONE

CES Model 235

- Stores 5 eleven digit and 5 seven digit phone numbers
- Programs and operates entirely from keyboard
- Programmable dialing rate
- Stores last manually dialed number
- Built-in speaker for tone monitor
- Programmable 2 second pause
- Automatic PTY, 5 second before first tone



69⁹⁵

INTEGRATED CIRCUITS:

SN76477N	Complex sound generator	\$2.95
TL489C	Analog level detector	\$1.25
LM317T	Adj. volt. reg. 1.5 amp.	\$2.75
ICM7555	Low pwr. CMOS Timer	\$1.25
LF351N	High speed JFET Op Amp	75
NE565	PLL	\$1.10

FREE CA3140 with orders of \$5.00 or more

Please include \$1.00 for postage and handling

N.Y.S. Residents Add 4% Sales Tax

Send to: Key Electronics

P.O. Box 3506

Schenectady, NY 12303

✓K14



CONNECTOR ASSORTMENT

\$25.00 \$23.50 each

Postpaid lots of three

Includes: 5 - PL259, 5 - SO239, 5 - UG175, 5 - UG176,
2 - PL258, 1 - DM, 1 - M358, 2 - M359, 1 - UG255,
1 - UG273, 2 - PL259PO, 1 - 1021-20, 1 - Lightning
Arrestor.

Master Charge & Visa accepted / Send for Free Catalog

COAKIT ✓C21

P.O. Box 101-A Dumont, N. J. 07628

Circle C21 on Reader Service Card



Know instantly what you have worked, what bands, modes—what needs to be confirmed—right at your fingertips. All your QSL's in one neat place—no more lost cards. ✓I43

Unconditional money back guarantee—ONLY \$12.95
Mail to: INSTA-PAC, Box 22974, Honolulu, Hawaii 96822

NAME _____
STREET _____
CITY _____ STATE _____ ZIP _____

THE SMART CHOICE IN

MARK 3C REPEATER CONTROL

Now with three exciting new features:



- Long Distance Calling
- Autodialing
- Remotely selectable timeout limits

IMAGINE A CONTROLLER —

SO VERSATILE It provides four different classes of output functions in addition to autopatch and reverse autopatch.

SO RESPONSIVE It sends thirteen Morse coded messages to keep you fully informed. Messages like BZ if you try to access a busy autopatch line.

SO ADVANCED It uses microprocessor technology and non-falsing digital tone decoding.

SO PERSONALIZED that many features are custom programmed to accommodate your unique needs.

SO EASY It can be installed in minutes with only five essential connections.

NDW imagine automatic dialing of emergency telephone numbers, long distance autopatch calling under control or supervision, plus remotely commandable timeout limits to match various operating conditions and you've just imagined the MARK 3C.

The MARK 3C is a complete control system with all audio and logic circuitry, status display, and power supply in one handsome cabinet. Its third generation design can replace racks of hardwired equipment while giving vastly expanded capability.

Get the field-proven power that only a MARK 3C can give at \$995. (100% factory assembled and tested)

✓M69

Call or Write for specifications

MICRO CONTROL SPECIALITIES (617) 372-3442

23 Elm Park, Groveland, Ma. 01834

New! General Theory Tapes and simulated on-the-air QSOs



Cassette yourself! Upgrade!
only \$4.95 each

Start upgrading today with Kantronics Super 5 WPM, QSO, Super QSO, QXX or Q-signal code tapes or theory tapes:

New Super 5 WPM Morse Course, message at 5 wpm, characters at 13. Introduces characters in small groups and builds from there.

QSO series, simulated exam type "on-the-air" messages, including simulated exam questions too.

QSO or QSO-2, contain 7½, 10, 13 & 15 wpm QSOs.

QSO-13, contains all 13 wpm QSOs.

New Super QSO-13, contains all 13 wpm QSOs, characters sent at 20 wpm.

QXX or QXX-2, contain all 20 wpm QSOs.

Q-Signal Tape, contains common Q signals and short words at 22 and 40 wpm.

Novice Study Cassette, rules and regulations, basic theory too.

New General Theory Cassettes, a two tape set, including rules, regs., and general theory. Two tape set is \$8.95.

KANTRONICS

The Training Company

1202 East 23rd Street
Lawrence, Kansas 66044

We accept Visa, Master Charge, check and money orders.

Phone: 913-842-7745

Son of Keycoder

— an even simpler CW typewriter

There are many good designs for CW typewriters. They have been designed around various levels of IC technology from RTLs to PROMs. One of the best is W9UBS's TTL version, which makes use of the W9TO encoding system. This machine, dubbed Keycoder I, was described in the July, 1976, issue of *73 Magazine* by WA9VGS. It

represents a conversion of W4UX's RTL-based Touchcoder II, which was written up in the July, 1969, issue of *QST*. K6BS restocked the machine with CMOS chips (see *73 Magazine* for October, 1976), and perhaps his version should be called Keycoder II. It seems that one problem facing anyone developing a CW typewriter is coming up

with an original name for it.

If anything, my version of the TTL CW typewriter should be called Son of Keycoder I. In fact, the mill is less a new design than a wedding of two designs: the electronics of W9UBA/WA9VGS (with encoding a la W9TO), and the old-fashioned diode matrix. It provides a lesson in the

adaptability of designs, and may provide some useful ideas for those faced with modifying designs to suit local junk box conditions.

What Makes the Machine Work

Fig. 1 shows the schematic diagram of the typewriter used here. With the major exception of the method of setting the flip-flops, the circuit closely resembles the one specified by WA9VGS. Included is the transistor output suggested in the original article as an alternative to relay output. The suggested means of construction, using the Radio Shack Universal Display Board (P/N 277-108), proved so easy that this same board has been used for other projects. The busses on this board can be chopped into short subsections, thus increasing the number of available lines far beyond eight.

Let us briefly review circuit operation, just to get a feel for the machine. When any key (letter, number, or prosign) is depressed, two things happen. First, the SCR fires 5 volts through the diode matrix, through one or more of the inverters, and sets some of the flip-flops. For example, for the letter A, f-f 2 and f-f 3 are set. The presence of a



This is a view of the code typewriter amidst other CW-making equipment in the W4RNL shack. The photo also shows clearly how the use of wood end pieces will obtain the slope needed for the keyboard. To enjoy CW, everything on the operating table (including the coffee cup and ashtray) is needed except the mike. The 25-year-old J-38 and the Codax keyer are used often in an attempt to send CW as perfectly as does the typewriter.

set on any flip-flop—by virtue of the sequence of gates—changes pin 6 of the 7400 to a low, which closes down the SCR until the letter is complete. When all the flip-flops are clear, pin 6 of the 7400 goes high, readying the SCR for another letter. In the meantime, the anode of the SCR has charged up for the next letter.

Second, when pin 6 of the 7400 goes low, the NE555 clock turns on and produces a series of dots. These go to f-f 8 and to pin 5 of the 7402. F-f 8 is the dash generator whose output goes to pin 6 of the 7402. This section of the 7402 sums its inputs and sends them to pin 11, a different gate of the same DIP, where they are again summed with the output of the gates running from f-f 2 through f-f 7. If both pins 11 and 12 of the 7402 show a low—the case where we have a dot or dash—the output drives the two-transistor circuit to key the transmitter. The output circuit is set up for blocked-grid keying, i.e., negative voltage. Relay circuits are available for keying other voltages.

The sort of output that occurs is a function of which and how many flip-flops from f-f 1 through f-f 7 are set. If any one or more flip-flops from f-f 2 through f-f 7 are set, then a sequence of dots is generated as the set moves right, with the last one stemming from f-f 2. If f-f 1 and any other flip-flop (from f-f 2 through f-f 7) are set, then a dash is generated. This occurs because pin 10 of the 7402, having received a low on both its input pins 8 and 9, enables the dash generator. Once the dash is enabled by keying the dash generator, the set on f-f 1 drops out since it has no other flip-flop to its right to pick up the set. If only f-f 1 is set, as is the case at the

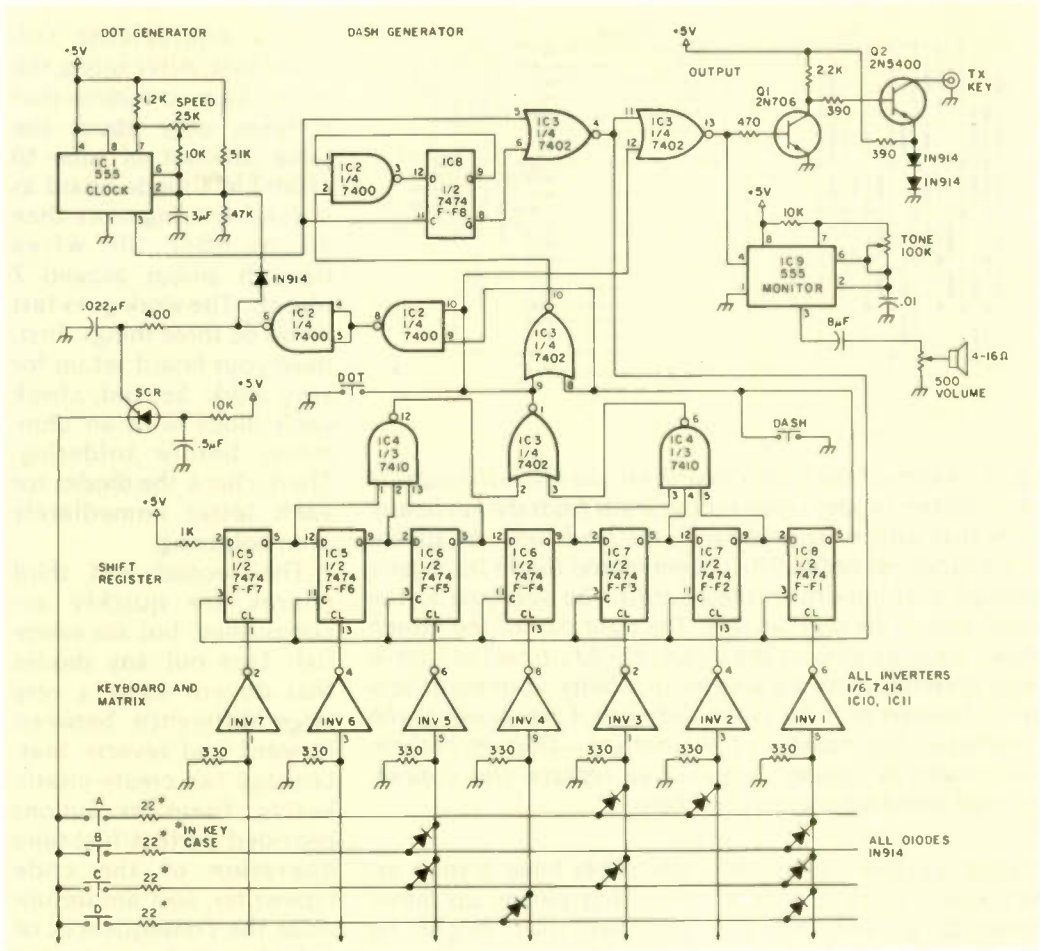

Fig. 1. Schematic diagram of the CW typewriter. Only part of the keyboard and matrix is shown. Not shown on the diagram is the pin 14 Vcc (+5 volts dc) and pin 7 ground connection to every IC. Every IC should have pin 14 bypassed with a .01 disc ceramic. Q1 can be almost any NPN transistor; Q2 should have a rating of—100 volts or better (see the article by WA9VGS for a list of suggestions). For this project, by all means, use IC sockets.

end of every letter, then a silent E is sent; that is, the dot generator goes through one more complete cycle, but the output summing gate (pins 11, 12, 13 of the 7402) is disabled due to a lack of a set on any of the other flip-flops, f-f 2 through f-f 7. This ensures the proper spacing between letters. Thus, we have dots, dashes, and letter spacing, with the negative half of each cycle of the clock providing self-completion of each.

The output, pin 13, of the 7402 also drives another NE555 set up as an audio oscillator for the purposes of monitoring and practice. Getting used to a code typer does take some practice, since the rhythm of Morse code is quite unlike the rhythm of touch typing.

In fact, having patience during letter formation, while still being ready for the letter after that surprisingly short E, is the hardest task. The results, however, bring rave notices on the air.

This circuit review has been kept brief, since full pulse-by-pulse details of circuit operation are contained in the Touchcoder and Keycoder articles mentioned above. Both discussions are complete and clear, and I heartily recommend them.

My unit differs from Keycoder I in three specifics: (1) setting the flip-flops (a major change); (2) the SCR circuit (a minor change, but a major problem in the minds of some builders), and (3), the

method of cabinet construction (a personal and economic matter). Discussion will be confined to these areas.

From Keyboard to Diode Matrix to Flip-Flop

The authors (or sires) of Keycoder specified a cost of about \$60 to \$70 for their unit. Much of this cost was for the keyboard and case. If you have a keyboard and can make a case, the cost can be halved. Just this thought prompted me to use an old keyboard given to me long ago.

My keyboard is made up of individual switches about an inch and a half long, each of which contains a series resistor of 22 Ohms. As is, this switching system will not drive the

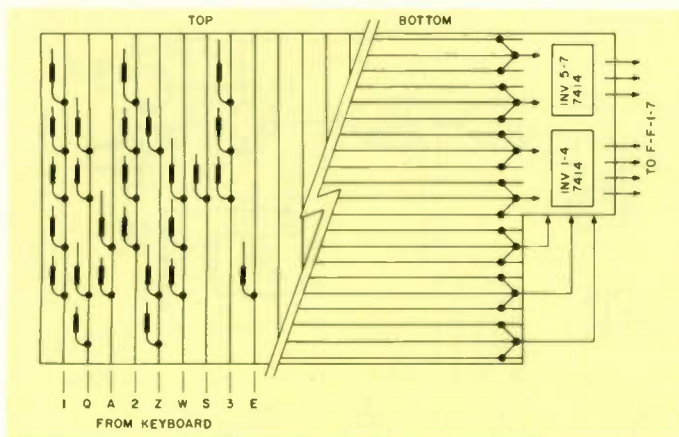

Fig. 2. Sketch of the Matrix Board. On the left is the topside showing the copper strips for the leads from the keyboard. Note that with most keyboards, the leads will not appear in alphabetical order. The unterminated diode leads pass through perforations in the board to be soldered to the transverse strips on that side. The right half of the sketch shows an X-ray view of the underside. Multiple lines serve each inverter, allowing greater flexibility in diode placement. Inverter pins for input and output are shown in the schematic. Any number of alternatives—from etched circuit board to copper wires—may replace the copper-bonded adhesive plastic used here.

toroid system used by Keycoder. Since the SCR pulse to ground through the toroids runs high current, the voltage drop across the resistor leaves too little for reliable setting of the flip-flops. The choice was clear: Either cut open 44 individual keys, short the resistor, and reclose with glue, or find an alternative method of triggering the flip-flops.

The surest method of getting a signal through the switches is to run a high through them, triggering some device that needs a high. The low current requirements for this state provide an insignificant voltage drop through the switch resistors. However, the flip-flops (7474s), typical of TTL technology, get set on a low. Therefore, on the diode matrix board there are shown seven Schmitt trigger inverters, packaged in two 7414s. This leaves several inverters unused, since they come six to a DIP. The Schmitt triggers may not be strictly necessary. Regular inverters (7404) might do just as well, but

the 7414s have a snap action that cleans up minor glitches that might be caused by line variations or soft keying in the 22-Ohm switches. They have worked beautifully.

When no key is pressed, the input to the 7414s shows an open circuit rather than a low. Therefore, 330-Ohm resistors were run from the inputs to ground to hold the inputs low until a letter is keyed. The value of the resistor is non-critical, but something in the 300-Ohm ballpark should be used. Since the path of the high is through the switch resistor and the input resistor to ground, the voltage drop across the switch resistor is held to well-under ten percent of the 5-volts V_{cc} . Even with the voltage drop across the matrix, the minimum voltage needed to set the inverter high is more than met. Thus, the inverter output shows definite lows and highs to keep the flip-flops set inversely at high and low as needed.

Between the switch and the inverters is a diode matrix with some 130

1N914 equivalents soldered to it. After wiring the board, I am convinced that it takes only about the same amount of time to assemble a diode board as it does to string more than 40 number 30 wires through and/or around 7 toroids. The work goes fast if you do three things. First, have your board set up for easy work. Second, check each diode with an ohmmeter before soldering. Third, check the diodes for each letter immediately after soldering.

The second and third chores are quickly accomplished, but are essential. Toss out any diodes that do not show a very large difference between forward and reverse bias. Leakage can create erratic keying. These precautions provided perfect first-time operation of the code typewriter, so I am unsure what the consequences of a leaky diode might be. However, in a commercially made keyer, one such diode provided dots that sometimes became dashes, much to the chagrin of those trying to copy me. Finding the problem cost me several hours of hunting.

Setting up the diode matrix board is not difficult. Those who like to etch circuit boards can set up 44 thin lines on one side and seven broad lines on the other. The inverter ends of the diodes can pass through holes between pairs of thin lines, and emerge in the middle of a broad line on the reverse side. Other methods are equally possible. I had access to clear plastic with copper lines permanently bonded to it. The reverse side was sticky, and adhered perfectly to per-board (.100 × .100 hole spacing). A four by seven inch board allowed all 44 letter lines to fit the length, while transverse lines were run across the back. To

keep diodes well separated, I used three lines per inverter, wired in parallel. For keys like zero, which need six diodes, the spacing made assembly and any future servicing a matter of ease. Diodes are mounted on the 44-line side with their inverter leads puncturing the plastic to pass through a perf to the other side. The 44 leads to the keyboard make a dandy hinge (if not flexed too often), and the matrix board folds back under the keyboard. Even with a sheet of insulation between boards, the matrix adds less than a half-inch depth to the keyboard.

Fig. 2 shows a diagram of the principles of the matrix board. Here a drawing is definitely clearer than a photo. Although much maligned in recent years, with the advent of PROMs and the like, diode-matrices still have much to recommend them. Should something go wrong, a replacement diode costs a few cents; a replacement PROM costs much more and creates a much longer downtime, unless one can afford to have a spare programmed memory. Also, the diode matrix allows me to change my mind and revise the keying setup in just a few minutes; PROMs are permanent. In comparison to toroids, there is not much to choose from, except that diode matrices are generally voltage-fed devices, whereas toroid transformers demand a fairly high current. Of course my typewriter matrix requires only low current; it may be of use to remember diodes for other similar applications, where current is not available or needed in large doses.

One ham friend has characterized my diode-driven TTL keyer as a marriage between the slightly advanced Cro-Magnon and the very regressive Neanderthal. I prefer to think of

it as crossbreeding for the best characteristics of both. Neanderthal man, after all, had some socially redeeming characteristics.

Programming the matrix is no problem. The toroid threading chart provided by WA9VGS is also a diode chart for this keyer. Wherever there is an X on the chart, run a diode between the letter line and the proper inverter line. For convenience, Fig. 3 reproduces the character generation table.

Something About SCRs

If you were to compare the SCR circuit of Keycoder I with the circuit used here, you would find only one small difference. Instead of a capacitor of 1.5 uF from the SCR anode to ground, the value given here is only .5 uF. Actually, the value is uncritical, and anything from .25 to 1 uF will work.

The SCR circuit has one function: to provide a quick shot of voltage through the key and diodes to the proper inverters, and then to shut down. When there is a letter being processed by the keyer, pin 6 of the 7400 holds the SCR gate low, inhibiting current flow through the diode. However, a low on the gate will not cut off current flow unless the voltage on the anode also drops below minimum. The resistor in the 5-volt line, and the capacitor to ground (10k and .5 uF respectively), allow the voltage on the anode to drop as a key switch is closed, thus cutting off the SCR when its gate goes low. As the capacitor recharges, the low gate prevents the SCR from conducting until the keyboard clears, at which time pin 6 on the 7400 and the gate go high; then the SCR has an open gate and full voltage, ready for another key to be struck. If the same key has been held closed, the SCR will con-

Character	INV/f-17	INV/f-16	INV/f-15	INV/f-14	INV/f-13	INV/f-12	INV/f-11
A					X	X	
B			X				X
C			X		X		X
D				X			X
E						X	
F			X		X		
G				X		X	X
H			X				
I					X		
J			X	X	X	X	
K				X	X		
L			X			X	
M					X	X	X
N					X		X
O				X	X	X	X
P			X		X	X	
Q			X	X		X	X
R				X		X	
S				X			
T						X	X
U				X	X		
V			X	X			
W				X	X	X	
X			X				X
Y			X	X	X		X
Z			X				X
1		X	X	X	X	X	
2		X	X	X	X		
3		X	X	X			
4		X	X				
5		X					
6		X					X
7		X				X	X
8		X			X	X	X
9		X		X	X	X	X
0		X	X	X	X	X	X
.	X	X		X		X	
,	X	X	X			X	X
?	X			X	X		
/		X		X			X
—		X	X				X
AR		X		X		X	
SK	X	X		X			
AS		X				X	
Silent E							X

Fig. 3. Diode matrixing table. An "X" indicates that a diode is wired from the character line to the inverter-flip-flop line (INV/FF). Thus the proper flip-flops are set to generate the indicated character.

duct through it for a repeated letter.

The reason for this explanation is that many hams view SCRs as strange devices. Where they will substitute tubes and transistors freely, they fear to try substitutions for unfamiliar devices. In the given circuit, almost any hobbyist-grade SCR will work. From a package of five from Radio Shack, each having a different current rating, not one failed to work properly—once I had sorted out the cathode and anode leads, and quit

installing them backwards! For the diode matrix system used here, a 15-volt rating was plenty, and the current demands are small. For the toroid application, as in the original Keycoder, somewhat higher ratings may be useful—say, 30 volts at half an Ampere. Since the diode matrix does not draw much current, a large capacitor across the anode of the SCR is unneeded; its value should be only large enough to hold the anode voltage down until the gate is cut off with a low, i.e.,

until the 7400 gate (pin 6) has registered that something is in the flip-flops. Some nanoseconds are all that is needed for this to happen. No new pulse can then interfere with the processing of the letter in progress.

SCRs have many other potential applications for voltage control in digital circuits. If the basic operating order of SCRs is remembered, they should become as useful and familiar to hams as transistors and FETs.

The only other circuit

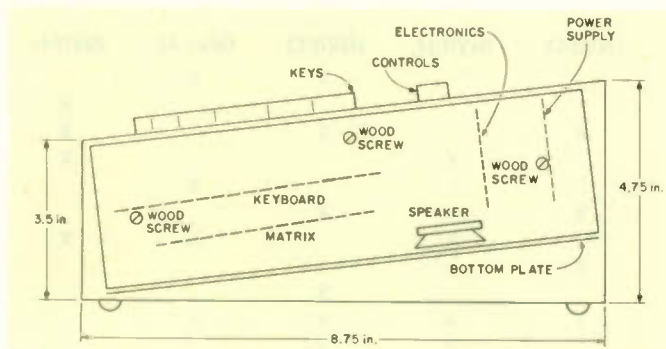

Fig. 4. X-ray view of end panel showing the alignment of the chassis to achieve the proper slope for the keyboard. The speaker mounts on the bottom plate. The dashed lines show the approximate placement of the power supply, main electronics, key switch, and matrix boards. Three half-inch wood screws hold the chassis to the wood end pieces cut from one-by-six. Rubber feet protect the operating desk.

notes are the following two. First, a DASH line is added to the DOT line of the original. It works by grounding pin 8 of the 7402 along with pin 9, i.e., by pressing both the DOT and DASH keys together. (Using a diode across the DOT and DASH lines did not work, since the low remains above the diode-voltage drop, and this causes erratic dashes when letter keys are pressed.) The only practical use of this is to test the dot and dash generators, and to demonstrate to prospective hams the distinction between dots and dashes. Holding the DOT key

closed, then keying and unkeying the DASH line, produces a string of alternating dashes and dots.

Second, a SPACE key has been provided. It keys the silent E, i.e., only the last flip-flop (f-f 1). For on-the-air use, this key has no function, but it is useful for keying serial input memories or Morse-to-ASCII converters which are tied to the typewriter clock. The space ensures proper word separation; paragraphing might be accomplished by some related means, such as a sequence of three successive spaces. In this unit, the space bar was removed and the space function

moved to the key in the lower left hand corner of the keyboard, which simplified construction.

Construction Notes

Since part of the project included cutting costs, the case is home brew. As the photograph shows, the case is made from a 12-by-8-by-3-inch aluminum chassis base. The depth was made necessary by the length of the key-switch bodies. The power supply is edge-mounted, in the upper right corner as you look at the photo. The main electronics board also is edge-mounted just above the row of switches and knobs. The SCR and output circuits are mounted on separate pieces of perf-board, since some bread-board experiments are occasionally tried with them. Leads between boards are long so that any board can be removed for checking without unwiring the circuit. No rf interference was noted when I used the unit with either the Drake transmitter or the Heath linear.

The switches on my keyboard are tilted to present the operator with a tiered effect. This resembles the old-fashioned manual typewriter keyboard. The chassis had to slope, therefore. After cutting the keyboard hole with a saber saw, I built two wood end-pieces to hold the chassis at the correct angle. They also serve to elevate the rear underside of the chassis, which is covered with a bottom plate of scrap perforated aluminum. The monitor speaker is held to this plate by four clips, and the angle of the case projects the sound into the crowd of future hams eagerly taking code practice. A little stain and varnish finished the end-pieces to a soft shine, while several light, spray coats of light blue finished the cabinet. Fig. 4 provides

a cutaway drawing to show how the end-pieces fit to the chassis to provide tilt in a simple but effective way.

The only item purchased for the cabinetry was the chassis base. Still, visitors to the shack seem to find the case striking, despite my poverty of skills in metal work. I think the reason is the use of a little wood. There is something about the use of natural materials in home brew projects which humanizes them a bit. They are not just plastic and metal products of technology and mass production (although some modern equipment deserves high grades for industrial design); they are the end result of personal craftsmanship. There is no need to copy commercially-built items to the last detail; indeed, one probably should avoid trying to do this. The manufacturer has manufacturing reasons for his choice of materials and appearance; likewise, the personal craftsman should have at least a few personal reasons for the materials and appearance of his projects. Money-saving is not a bad reason, for a starter.

While these notes may not add much to the span of modern technology, I hope they have accomplished a few things. First, they are a reminder that designs are adaptable, with a little effort, to what you have available. Second, they resurrect the diode matrix from threatened oblivion. Third, they may encourage hams to try SCRs a little more often. Fourth, they are a reminder that home brew products are not just second best to manufactured ones, but in some ways often are superior.

Finally, perhaps these notes may encourage a few others to try their hand at building what may become the "Grandson of Keycoder I!" ■



This is a close-up top view of the code typewriter. The controls above the keyboard are, from left to right, the ac pilot light, power switch, volume control, speed control, tone control, tune-up switch, and tune-up pilot light. Keys with white squares were labeled by using adhesive address labels with a transparent tape cover; all were typed and then cut to fit the keys. The DOT and DASH keys have had their internal resistors removed.

WILSON SYSTEMS, INC. presents the SYSTEM 36

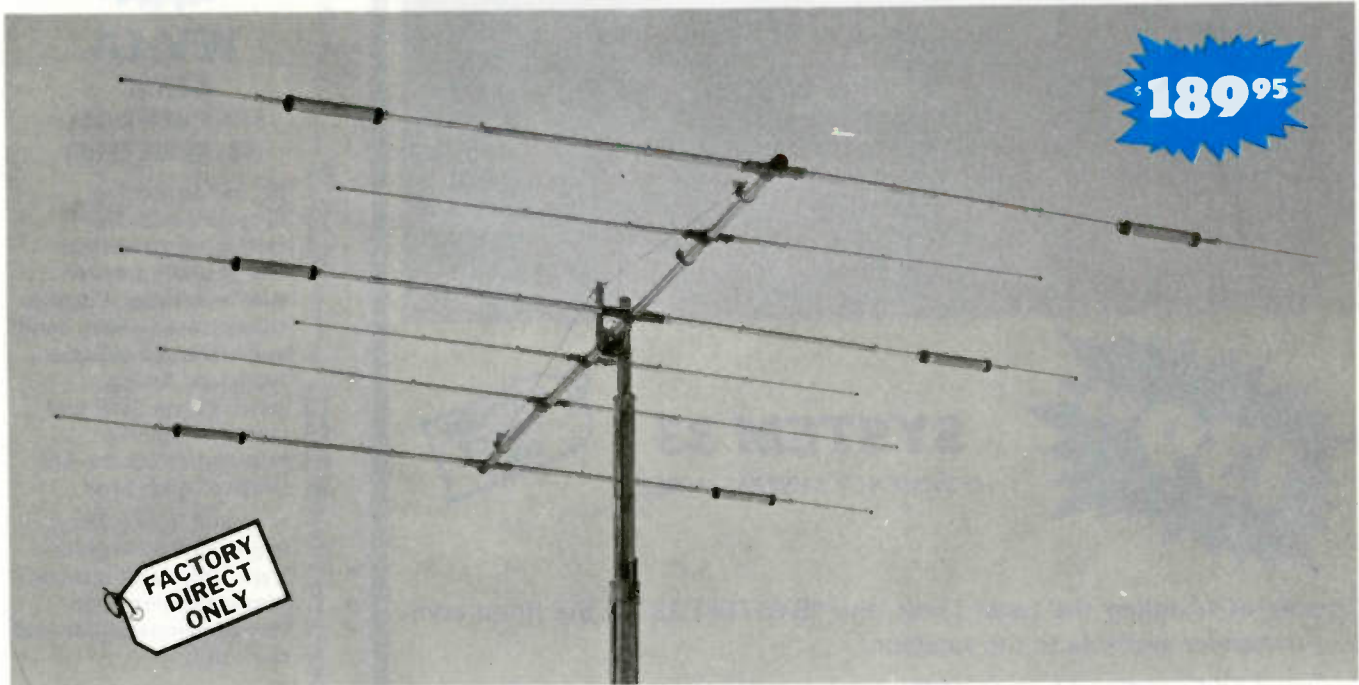

A trap loaded antenna that performs like a monobander! That's the characteristic of this six element three band beam. Through the use of wide spacing and interlacing of elements, the following is possible: three active elements on 20, three active elements on 15, and four active elements on 10 meters. No need to run separate coax feed lines for each band,

as the bandswitching is automatically made via the High-Q Wilson traps. Designed to handle the maximum legal power, the traps are capped at each end to provide a weather-proof seal against rain and dust. The special High-Q traps are the strongest available in the industry today.

SPECIFICATIONS

Band MHz 14-21-28
 Maximum power input . Legal limit
 Gain (dBd) Up to 9 dB
 VSWR @ resonance . . . 1.3:1
 Impedance 50 Ω
 F/B ratio 20 dB or better

Boom (O.D. x Length) . . 2" x 24'2 1/2"
 No. of elements 6
 Longest element 28'2 1/2"
 Turning radius 18'6"
 Maximum mast diameter. 2"
 Surface area 8.6 sq. ft.

Wind loading @ 80 mph . . 215 lbs.
 Maximum wind survival . . 100 mph
 Feed method Coaxial Balun
 Assembled weight (approx. 53 lbs.
 Shipping weight (approx.) . 62 lbs.

Compare the SY-36 with others . . .

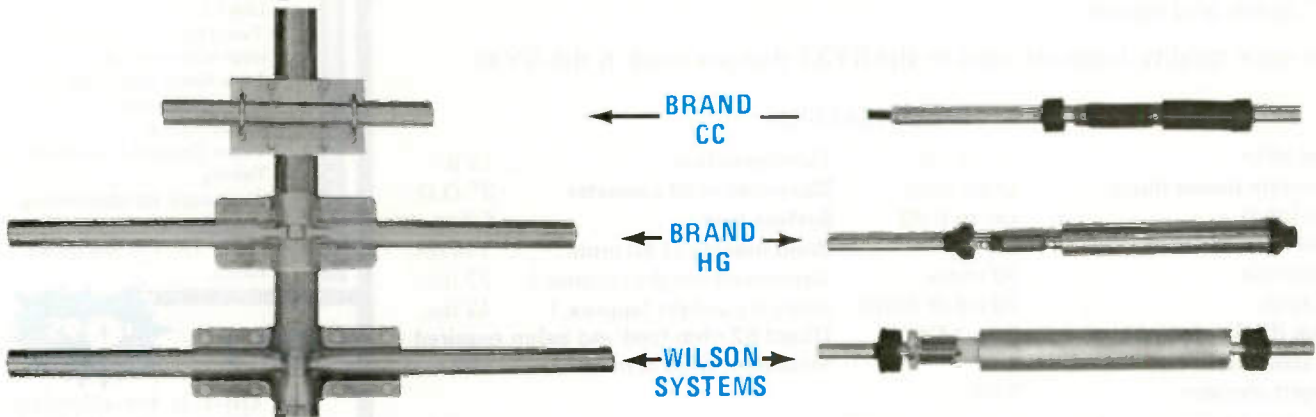

Compare the size and strength of the boom to element traps. See who offers the largest and heaviest duty. Which would you prefer?

Wilson Systems traps offer a larger diameter trap coil and a larger outside housing, giving excellent Q and power capabilities.

**CALL
 FACTORY DIRECT
 1-800-634-6898**

**W S I WILSON
 SYSTEMS, INC.**

4286 S. Polaris Ave., Las Vegas, Nevada 89103

W33

Prices and specifications subject to change without notice.

WILSON SYSTEMS INC. MULTI-BAND ANTENNAS

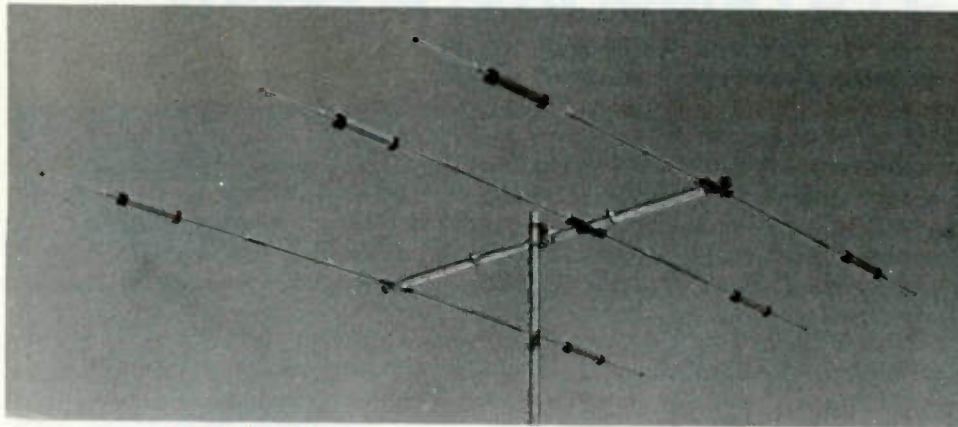

\$139⁹⁵

SYSTEM 33 (FORMERLY SYSTEM THREE)

**FACTORY
DIRECT
ONLY**

Capable of handling the Legal Limit, the "SYSTEM 33" is the finest compact tri-bander available to the amateur.

Designed and produced by one of the world's largest antenna manufacturers, the traditional quality of workmanship and materials excels with the "SYSTEM 33".

New boom-to-element mount consists of two 1/8" thick formed aluminum plates that will provide more clamping and holding strength to prevent element misalignment.

Superior clamping power is obtained with the use of a rugged 1/4" thick aluminum plate for boom to mast mounting.

The use of large diameter High-Q traps in the "SYSTEM 33" makes it a high performing tri-bander and at a very economical price.

A complete step-by-step illustrated instruction manual guides you to easy assembly and the lightweight antenna makes installation of the "SYSTEM 33" quick and simple.

The same quality traps are used in the SY33 that are used in the SY36.

SPECIFICATIONS

Band MHz	14-21-28	Turning radius	15'9"
Maximum power input	Legal limit	Maximum mast diameter	2" O.D.
Gain (dbd)	Up to 8 dB	Surface area	5.7 sq. ft.
VSWR at resonance	1.3:1	Wind loading at 80 mph	114 lbs.
Impedance	50 ohms	Assembled weight (approx.)	37 lbs.
F/B ratio	20 dB or better	Shipping weight (approx.)	42 lbs.
Boom (O.D. x length)	2" x 14'4"	Direct 52 ohm feed—no balun required	
No. elements	3	maximum wind survival	100 mph
Longest element	27'4"		

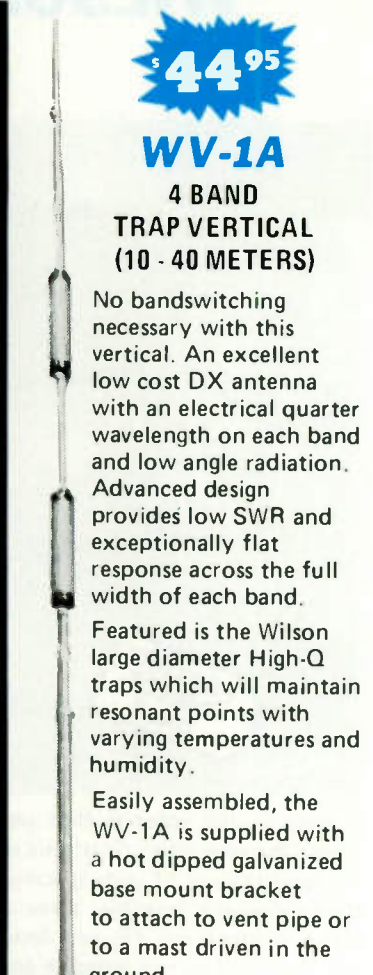

\$44⁹⁵

WV-1A

**4 BAND
TRAP VERTICAL
(10 - 40 METERS)**

No bandswitching necessary with this vertical. An excellent low cost DX antenna with an electrical quarter wavelength on each band and low angle radiation. Advanced design provides low SWR and exceptionally flat response across the full width of each band.

Featured is the Wilson large diameter High-Q traps which will maintain resonant points with varying temperatures and humidity.

Easily assembled, the WV-1A is supplied with a hot dipped galvanized base mount bracket to attach to vent pipe or to a mast driven in the ground.

Note:

Radials are required for peak operation. (See GR-1 below).

SPECIFICATIONS:

- Self supporting—no guys required.
- Input Impedance: 50 Ω
- Powerhandling capability: Legal Limit
- Two High-Q Traps with large diameter coils
- Low Angle Radiation
- Omnidirectional performance
- Taper Swaged Aluminum Tubing
- Automatic Bandswitching
- Mast Bracket furnished
- SWR: 1.1:1 or less on all Bands

GR-1

\$9⁹⁵

The GR-1 is the complete ground radial kit for the WV-1A. It consists of: 150' of 7/14 stranded copper wire and heavy duty egg insulators, instructions. The GR-1 will increase the efficiency of the WV-1A by providing the correct counterpoise.

**CALL
FACTORY DIRECT
1-800-634-6898**

**W S I WILSON
SYSTEMS, INC.**
4286 S. Polaris Ave., Las Vegas, Nevada 89103

Prices and specifications subject to change without notice.

WILSON MONO-BAND BEAMS

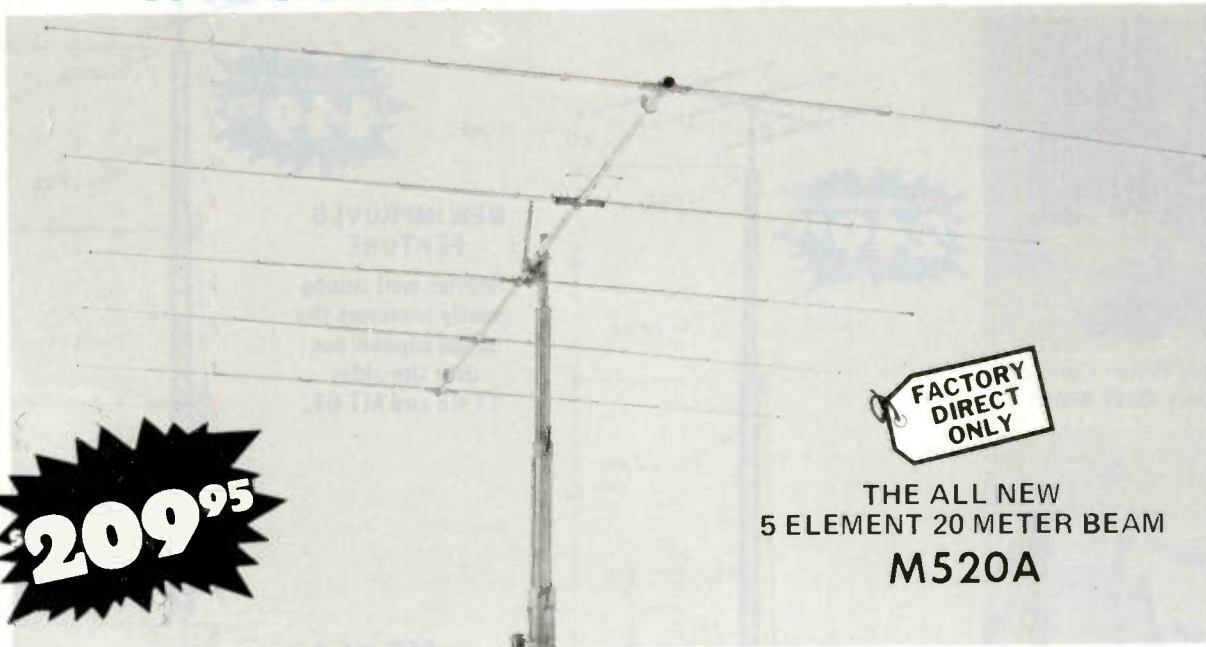

209.95

FACTORY DIRECT ONLY

THE ALL NEW
5 ELEMENT 20 METER BEAM
M520A

At last, the antennas that you have been waiting for are here! The top quality, optimum spaced, and newest designed mono-banders. The Wilson Systems' new Monoband beams are the latest in modern design and incorporate the latest in design principles utilizing some of the strongest materials available. Through the select use of the current production of aluminum and the new boom to element plates, the Wilson Systems' antennas will stay up when others are falling down due to heavy ice loading or strong winds. Note the following features:

1. **Taper Swaged Elements** — The taper swaged elements provide strength where it counts and lowers the wind loading more efficiently than the conventional method of telescoping elements of different sizes.
2. **Mounting Plates — Element to Boom** — The new formed aluminum plates provide the strongest method of mounting the elements to the boom that is available in the entire market today. No longer will the elements tilt out of line if a bird should land on one end of the element.
3. **Mounting Plates — Boom to Mast** — Rugged 1/4" thick aluminum plates are used in combination with sturdy U-bolts and saddles for superior clamping power.
4. **Holes** — There are no holes drilled in the elements of the Wilson HF Monobanders. The careful attention given to the design has made it possible to eliminate this requirement as the use of holes adds an unnecessary weak point to the antenna boom.

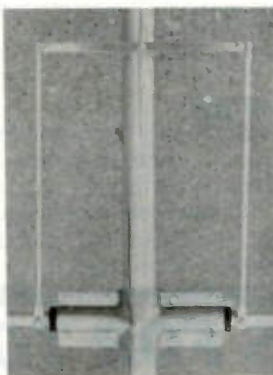

Wilson's Beta match offers maximum power transfer.

The Wilson Beta-match offers the ability to adjust the terminating impedance that is far superior to the other matching methods including the Gamma match and other Beta-matches. As this method of matching requires a balanced line it will be necessary to use a 1:1 balun, or RF choke, for the most efficient use of the HF Monobanders.

The Wilson Monobanders are the perfect answer to the Ham who wants to stack antennas for maximum utilization of space and gain. They offer the most economical method to have more antenna for less money with better gain and maximum strength. Order yours today and see why the serious DXers are running up that impressive score in contests and number of countries worked.

With the Wilson Beta-match method, it is a "set it and forget it" process. You can now assemble the antenna on the ground, and using the guidelines from the detailed instruction manual, adjust the tuning of the Beta-match so that it will remain set when raised to the top of the tower.

SPECIFICATIONS

Model	Band Mtrs	Gain dBd	F/B Ratio	Bandwidth @ Resonance 2:1 VSWR Limits	VSWR @ Resonance	Impedance	Matching	Elements	Longest Element	Boom O.D.	Boom Length	Turning Radius	Surface Area (Sq. Ft.)	Windload @ 80 mph (Lbs./Ft.)	Maximum Mast	Assembled Weight (Lbs.)
M520A	20	11.5	25 dB	500 KHz	1.1:1	50 Ω	Beta	5	36'6"	2"	34'2½"	25'1"	8.9	227	2"	68
M420A	20	10.0	25 dB	500 KHz	1.1:1	50 Ω	Beta	4	36'6"	2"	26'0"	22'6"	7.6	189	2"	50
M515A	15	12.0	25 dB	400 KHz	1.1:1	50 Ω	Beta	5	25'3"	2"	26'0"	17'6"	4.2	107	2"	41
M415A	15	10.0	25 dB	400 KHz	1.1:1	50 Ω	Beta	4	24'2½"	2"	17'0"	14'11"	3.1	54	2"	25
M510A	10	12.0	25 dB	1.5 MHz	1.1:1	50 Ω	Beta	5	18'6"	2"	26'0"	16'0"	2.8	72	2"	36
M410A	10	10.0	25 dB	1.5 MHz	1.1:1	50 Ω	Beta	4	18'3"	2"	12'11"	11'3"	1.4	36	2"	20

**CALL
FACTORY DIRECT
1-800-634-6898**

**W S I WILSON
SYSTEMS, INC.**

4286 S. Polaris Ave., Las Vegas, Nevada 89103

Prices and specifications subject to change without notice.

New, Improved Wilson Towers



Hinged Base Plate - Concrete Pad, Heavy Duty Winch



Mounting the House Bracket



The Hinged Base Plate allows tower to be tilted over for access to antenna and rotor from the ground.

FACTORY DIRECT
\$249⁹⁵

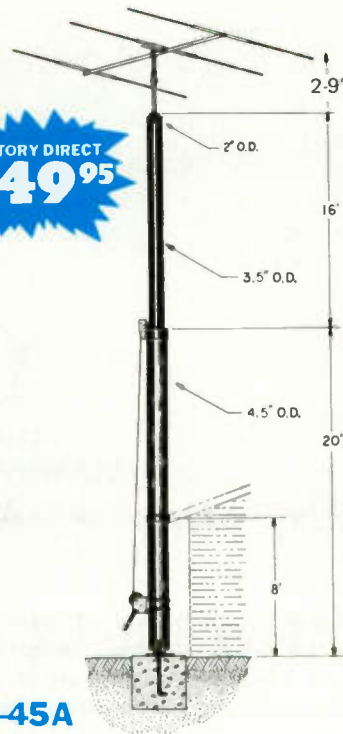

TT-45A

FEATURES:

- Maximum Height 45' (will handle 12 sq. ft. at 38') @ 50 mph
- 1200 lb. winch
- Totally freestanding with proper base
- Total Weight, 243 lbs.

The TT-45A is a freestanding tower, ideal for installations where guys cannot be used. If the tower is not being supported against the house, the proper base fixture accessory must be selected. (Requires 12"x12"x36" of concrete.)

GENERAL FEATURES

All towers use high strength heavy galvanized steel tubing that conforms to ASTM specifications for years of maintenance-free service. The large diameters provide unexcelled strength. All welding is performed with state-of-the-art equipment. Top sections are 2" O.D. for proper antenna/rotor mounting. A 10' push-up mast is included in the top section of each tower. Hinge-over base plates are standard with each tower. The high loads of today's antennas make Wilson crank-ups a logical choice.

FACTORY DIRECT
\$449⁹⁵

NEW IMPROVED FEATURE

Heavier wall tubing greatly increases the stress capabilities over the older TT-45 and MT-61.

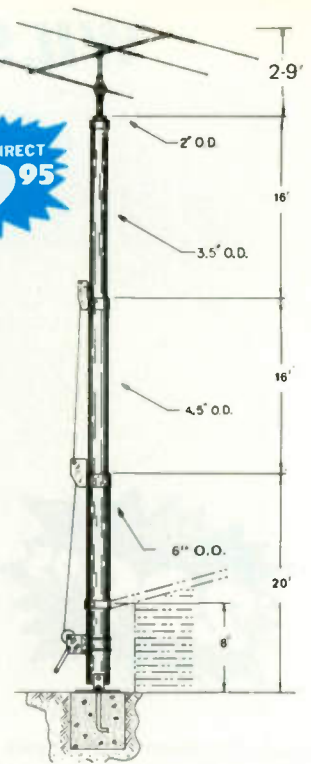

MT-61A

FEATURES:

- Is freestanding with use of proper base
 - Maximum Height is 61' (will handle 12 sq. ft. at 53') @ 50 mph
 - 1200 lb. brake winch
 - 4200 lb. raising cable
 - Total Weight, 400 lbs.
- Recommended base accessory: RB-61A, FB-61A.

The MT-61A is our largest and tallest freestanding tower. By using the RB-61A rotating base fixture the MT-61A is ideally suited for the SY33 or SY-36. If you plan to mount the tower to your house, caution should be taken to make certain the eave is properly reinforced to handle the tower. If not, one of the base accessory fixtures should be used. (Requires 18"x18"x48" concrete.)

TILT-OVER BASES FOR TOWERS

FIXED BASE

The FB Series was designed to provide an economical method of moving the tower away from the house. It will support the tower in a completely free-standing vertical position, while also having the capabilities of tilting the tower over to provide an easy access to the antenna. The rotor mounts at the top of the tower in the conventional manner, and will not rotate the complete tower. (Requires 3'x3'x5½' of concrete.)

FB-45A ... \$99.95
FB-61A ... 129.95



ROTATING BASE

The RB Series was designed for the Amateur who wants the added convenience of being able to work on the rotor from the ground position. This series of bases will give that ease plus rotate the complete tower and antenna system by the use of a heavy duty thrust bearing at the base of the tower mounting position, while still being able to tilt the tower over when desiring to make changes on the antenna system. (Requires 3'x3'x6' of concrete.)

RB-45A ... \$139.95
RB-61A ... 199.95

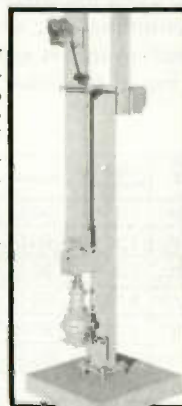

Tilting the tower over is a one-man task with the Wilson bases.

(Shown above is the RB-61A.)
(Rotor not included)

W S I WILSON SYSTEMS, INC.

4286 S. Polaris Avenue
Las Vegas, Nevada 89103
(702) 739-7401

Toll-Free Order Number 800-634-6898

Prices and specifications subject to change without notice.

6 METER BEAMS

Model M68

As low as
\$27⁹⁵

SPECIFICATIONS	MODEL M68	MODEL M66	MODEL M64
Band MHz	50	50	50
Maximum Power Input	4 Kw	4 Kw	4 Kw
Gain (dB)	13.5	13.0	10.0
VSWR (at resonance)	1.1:1	1.1:1	1.1:1
Impedance	50 ohms	50 ohms	50 ohms
F/B Ratio (dB)	26	26	25
Boom (O.D. x Length)	2" to 1 1/2" x 36"10"	2" x 25'8"	1 1/2" x 11'6"
No. Elements	8	6	4
Longest Element (Ft.)	9'8"	9'8"	9'8"
Turning Radius (Ft.)	19'0"	13'10"	7'6"
Mast Diameter	2" O.D.	2" O.D.	1 1/2" O.D.
Boom Diameter	2" to 1 1/2" O.D.	2" O.D.	1 1/2" O.D.
Surface Area (Sq. Ft.)	5.8	4.5	1.5
Wind Loading @ 80 mph	145	112	37
Assembled wght. Approx.	34 lbs.	26 lbs.	11 lbs.
Shipping wght. Approx.	39 lbs.	31 lbs.	13 lbs.
Matching Method	Gamma	Gamma	Gamma
PRICE	\$84.95	\$54.95	\$27.95

8 elements W - I - D - E spaced on a L - O - N - G 37' boom . . . for those long hauls to JA and VK land! Choose 4, 6 or 8 elements to put you in the action on six meters.

Starting at
\$19⁹⁵

2 METER BEAMS

Wilson's new 2 meter series combines the ultimate in design and quality materials. These top performing beams feature 7, 9 or 11 aluminum elements held to the heavy walled boom with the exclusive molded Lexan® boom to element mounting. The four driven elements use Log Periodic design for broad band characteristics providing full 144-148 MHz coverage with less than 1.2 to 1 VSWR across the band. Universal mounting is provided for vertical or horizontal polarization.

SPECIFICATIONS	M27	M29	M211
Band MHz	144-148 MHz	144-148 MHz	144-148 MHz
Gain (dB)	11 dB	13.7 dB	14.5 dB
VSWR	Less than 1.2:1 across band	Less than 1.2:1 across band	Less than 1.2:1 across band
Impedance	50 ohms balanced	50 ohms balanced	50 ohms balanced
Number of Elements	7	9	11
Boom (O.D. x Length)	1" O.D. x 5'4"L.	1" O.D. x 10'0"L.	1 1/2" O.D. x 12'6"
Longest Element	40"	40"	40"
Surface Area (Sq. Ft.)	.8	1.5	2.8
Assembled wght. Approx.	3.5 lbs.	5 lbs.	6 lbs.
Shipping wght. Approx.	6.5 lbs.	8 lbs.	9 lbs.
Turning Radius	38"	64"	78"
PRICE	\$19.95	\$24.95	\$28.95

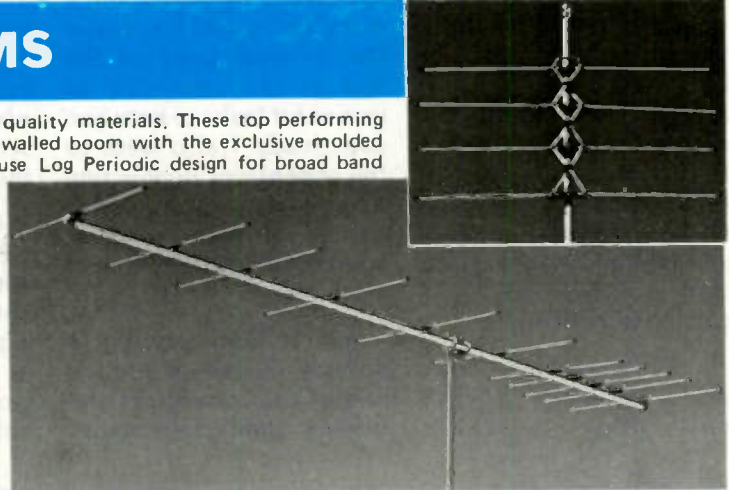

WILSON SYSTEMS, INC. — 4286 S. Polaris
Las Vegas, NV 89103 — (702) 739-7401

**FACTORY DIRECT
ORDER BLANK**

Toll-Free Order Number
1-800-634-6898

WILSON SYSTEMS ANTENNAS

WILSON SYSTEMS TOWERS

Qty	Model	Description	Shipping	Price
	SY33	3 Ele. Tribander for 10, 15, 20 Mtrs.	UPS	\$139.95
	SY36	6 Ele. Tribander for 10, 15, 20 Mtrs.	UPS	189.95
	WV-1A	Trap Vertical for 10, 15, 20, 40 Mtrs.	UPS	44.95
	GR-1	Ground Radials for WV-1A	UPS	9.95
	M-520A	5 Elements on 20 Mtrs.	TRUCK	209.95
	M-420A	4 Elements on 20 Mtrs.	UPS	139.95
	M-515A	5 Elements on 15 Mtrs.	UPS	119.95
	M-415A	4 Elements on 15 Mtrs.	UPS	79.95
	M-510A	5 Elements on 10 Mtrs.	UPS	84.95
	M-410A	4 Elements on 10 Mtrs.	UPS	64.95
	WM-62A	Mobile Antenna: 5/8 λ on 2, 1/4 λ on 6	UPS	19.95
	M-86	8 Elements on 6 Mtrs.	UPS	84.95
	M-66A	6 Elements on 6 Mtrs.	UPS	54.95
	M-46	4 Elements on 6 Mtrs.	UPS	27.95
	M-112	11 Elements on 2 Mtrs.	UPS	29.95
	M-92	9 Elements on 2 Mtrs.	UPS	24.95
	M-72	7 Elements on 2 Mtrs.	UPS	19.95
	ACCESSORIES			
	HD-73	Alliance Heavy Duty Rotor	UPS	109.95
	RC-8C	8/C Rotor Cable	UPS	.12/ft.
	RG-8U	RG-8U Foam-Ultra Flexible Coaxial Cable, 38 strand center conductor, 11 gauge	UPS	.21/ft.

Qty.	Model	Description	Shipping	Price
	TT-45A	Freestanding 45' Tubular Tower	TRUCK	\$249.95
	RB-45A	Rotating Base for TT-45A w/tilt over feature	TRUCK	139.95
	FB-45A	Fixed Base for TT-45A w/tilt over feature	TRUCK	99.95
	MT-61A	Freestanding 61' Tubular Tower	TRUCK	449.95
	RB-61A	Rotating Base for MT-61A w/tilt over feature	TRUCK	199.95
	FB-61A	Fixed Base for MT-61A w/tilt over feature	TRUCK	129.95

NOTE:
On Coaxial and Rotor Cable, minimum order is 100 ft. and in 50' multiples.
Prices and specifications subject to change without notice.
Ninety Day Limited Warranty, All Products FOB Las Vegas, Nevada
PRICES EFFECTIVE NOV. 1, 1979

Nevada Residents Add Sales Tax

Ship C.O.D. Check enclosed Charge to Visa M/C

Card # _____ Expires _____

Bank # _____ Signature _____

Please Print

Name _____ Phone _____

Street _____

City _____ State _____ Zip _____

Prices and specifications subject to change without notice.

Sloppiness Will Get You Nowhere

— organize your coax

If you are like me, all the suggestions given by friends on how to route coax into the QTH don't meet your standards—or those of your wife. Holes in window panes, walls, and window frames just don't look right and are hard to patch if one moves. The solution I found is relatively simple and very easy to disguise if the equipment must be removed later.

I terminated my coax under the eave of the house, using an SO-239

connector for each coax cable. The SO-239 connectors were mounted on a metal plate, and hood-type shields were used on the rear of the connector to prevent rf leakage between coax leads. I also went to the expense of connecting a lightning arrester in each line at the plate—and, of course, the plate was well grounded.

A hole large enough to provide clearance for the rear of the connectors and smaller than the exterior

dimensions of the plate was cut in the plywood under the eave of the house, and the plate was mounted in place so that it covered the hole completely. Several wood screws were used to secure the plate to the plywood.

Now, you ask, what is so easy to patch about a 2-inch x several-inch hole? Easy—just purchase an inexpensive attic vent plate at your nearby hardware store to properly cover the hole when it is time to

move. It might be a good idea to visit the hardware store ahead of time and measure common sizes of vents that are available in your area so that you do not make the hole the wrong size or shape to cover.

Now that you have accomplished the feat of gaining access to the interior of the attic for your coax, how do you feed it down through a wall without making a mess? Another easy solution: Visit your friendly hardware man or electrical parts warehouse and purchase an electrical wall box such as those in which wall outlets and light switches are mounted. If the salesman is competent, he can sell you the box for the type of wall you have in your house. Also, buy a blank cover for the box, if you want, and you will be ready to cover the box if and when you move.

Locate carefully the place where you want to mount the box. It should be mounted in the wall at the same height above the floor as all other wall boxes. In the attic, measure carefully from known reference points and drill a hole vertically down into the wall directly above the location for the box before



New OMNI/SERIES B Filters The Crowd

The new OMNI/SERIES B makes today's bands seem less crowded. By offering a new i-f selection that provides up to 16 poles of filtering for superior selectivity. And a new Notch Filter to remove QRM. No other amateur transceiver we know of out-performs it.

NEW I-F RESPONSE SELECTION. OMNI comes equipped with an excellent 8-pole 2.4 kHz crystal ladder i-f filter which is highly satisfactory in normal conditions. But when the going gets rough, the new OMNI/SERIES B, with optional filters installed, provides two additional special purpose i-f responses.

The 1.8 kHz crystal ladder filter transforms an unreadable SSB signal in heavy QRM into one that gets the message through. The 0.5 kHz 8-pole filter provides extremely steep and deep skirts to the CW passband window which effectively blocks out even the very strong adjacent signals.

Both of these filters can be front-panel switched in series with the standard filter to provide up to 16 poles of filtering for near-ultimate selectivity. In addition, the standard CW active audio filters have three bandwidths (450, 300, and 150 Hz) to give even further attenuation to adjacent signals. In effect, OMNI/SERIES B has six selectivity curves—three for SSB and three for CW. That's true state-of-the-art selectivity.

NEW NOTCH FILTER. A variable frequency notch filter in OMNI/SERIES B is placed inside the AGC loop to eliminate interfering carriers and CW signals without affecting received signals. Attenuation is more than 8 "S" units (over 50 db) for any frequency between 0.2 kHz and 3.5 kHz.

OMNI/SERIES B RETAINS ALL THE FEATURES THAT MADE IT FAMOUS.

All solid-state; 160-10 meters plus convertible 10 MHz and AUX band positions; Broadband design for band changing without tuneup, without danger;

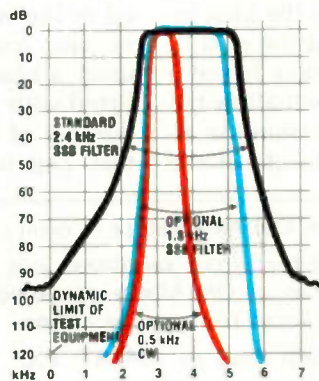

OMNI/SERIES B I-F RESPONSES WITH STANDARD AND OPTIONAL FILTERS.

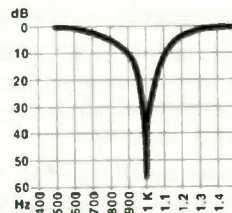

NOTCH FILTER PERFORMANCE ADJUSTED TO 1 kHz POINT.

TEN-TEC, INC.
SEVIERVILLE, TENNESSEE 37862
EXPORT: 5715 LINCOLN AVE., CHICAGO, ILL. 60646

Choice of readouts — OMNI-A for analog dial or OMNI-D for digital dial; Built-in VOX and PTT facilities; Selectable Break-in, instant or delayed receiver muting; Dual-Range Receiver Offset Tuning, ± 5 kHz or ± 0.5 kHz; Wide Overload Capabilities, dynamic range typically exceeds 90 dB and a PIN diode switched 18 dB attenuator is also included; Phone Patch Interface Jacks; Adjustable ALC; Adjustable Sidetone; Exceptional Sensitivity; 200 Watts input to final with full warranty on final transistors for first year, pro-rata for 5 years; 100% Duty Cycle for RTTY, SSTV or sustained hard usage; 12 VDC Circuitry for mobile use, external supplies for 117/220 VAC operation; Front Panel Microphone and Key Jacks; Built-in 25 kHz Calibrator in analog dial model; Zero-Beat Switch; "S"/SWR Meter; Dual Speakers; Plug-In Circuit Boards; Functional Styling, black textured vinyl over aluminum "clamshell" case, complementary non-reflective warm dark metal front panel; Complete Shielding; Easier-to-use size: 5 $\frac{1}{4}$ "h x 14 $\frac{1}{4}$ "w x 14"d; Full Options: Model 645 Keyer \$85; Model 243 Remote VFO \$139; Model 252MO matching AC power supply \$139; Model 248 Noise Blanker \$49; Model 217 500 Hz 8-pole Crystal Ladder CW Filter \$55; Model 218 1.8 kHz 8-pole Crystal Ladder SSB Filter \$55;

OMNI owners note: Your OMNI can be converted to a SERIES B model at the factory for just \$50 (plus \$5 for packing and shipping). The notch filter replaces your present squelch control and provision is made for the two additional optional filters; a partial panel with new nomenclature is provided. Contact us for details.

Model 545 Series B OMNI-A \$949
Model 546 Series B OMNI-D \$1119

Experience the uncrowded world of OMNI/SERIES B. See your TEN-TEC dealer or write for full details.



cutting the hole for the box in the wall. Drop a weight on the end of a string into the hole and play it out until the string goes slack. Mark the string at that point, remove it from the hole, and measure from the mark to the bottom of the weight. If the measurement is the same as the measurement from the floor to the top of the wall, plus or minus one or two inches, then you are in

business. If the measurement is shorter by two or three feet, it is obvious that there is an obstruction of some sort in the wall at the location you have chosen, and you must move left or right several inches and try again, drilling another vertical hole from the attic into the inside of the wall.

When you have found a location that will allow the coax to be fed from the attic down the inside of the

wall, cut the opening in the wall at the proper height for the electrical box. Feed the coax through the cut-out at the back or top of the electrical box as far as necessary and tighten the clamp to secure the coax. The box now can be mounted in the wall. If only one or two coax cables are used, a blank plate can be fitted with the appropriate number of SO-239 connectors and mounted to the

box to make a neat and XYL-approved installation.

My installation consists of a bundle of 8 cables, and I used a double-width wall box without a cover. A desk and radio rack are in front of the box where it is installed, so I did not bother with using a cover. When we move, I will cover the empty box with a double-width blank cover, and the hole in the wall will be neatly concealed. ■

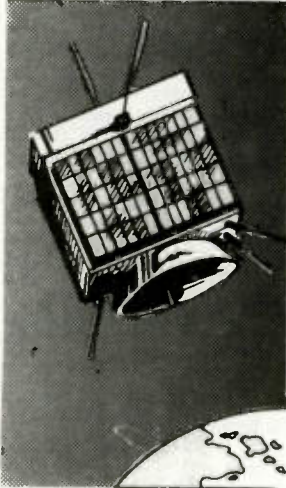

There's a new, eighth OSCAR satellite in orbit, and the AMSAT team helped put it there!

Your help is needed for future satellites. Join AMSAT and support the new, advanced Phase III series of OSCARs, engineered to provide communications over transcontinental distances for hours at a time.

Send \$10 membership dues to AMSAT, P.O. Box 27, Washington, D.C. 20044. Life membership is available for a tax-deductible donation of \$100 or more, payable in quarterly installments if you wish.

Phase III satellite solar cells may be sponsored for \$10 each, and we'll send you a certificate specifying the cells you are sponsoring.

For a tax-deductible contribution of \$1,000 or more, we'll even inscribe your name on a plaque to be placed in orbit aboard the Phase III spacecraft for posterity, and we'll send you a replica honoring your contribution.

Dues and contributions may be charged to VISA or Master Charge. Phone us at (202) 488-8649.

Radio Amateur Satellite Corporation
P.O. BOX 27, WASHINGTON, D.C. 20044
AMSAT
AMSAT MEMBER

HAM RADIO CENTER

for the famous **HAM-KEY*** and **KEYER!**

*TM trade-mark



Model **HK-3M**

With anti-tip bracket even a heavy-handed key pounder cannot tip. All the features of the HK-3.

- Deluxe straight key
- Heavy base — no need to attach to desk
- Navy type knob

CC-3 shielded cable w/plug for HK-3M \$3.95

\$19⁹⁵



Model **HK-1**

- Dual-lever squeeze paddle
- \$29⁹⁵**
- CC-1 shielded cable w/plug for HK-1 \$4.49



Model **HK-2**

- Same as HK-1, less base for incorporation in own keyer
- \$19⁹⁵**



Model **HK-5A** Electronic Keyer

- New Cabinet Colored-Keyed to match most modern radio equipment
 - Iambic Circuit for squeeze keying
 - Self-completing dots and dashes
 - Curtis 8044 I.C. Keyer Chip
- \$69⁹⁵**

NEW! Model **AT-B** Anti-Tip Bracket

Converts any HK-3 to HK-3M

\$2⁹⁹
Prepaid



Model **HK-4**

- Combination of HK-1 and HK-3M
- \$44⁹⁵**
- CC-1/3 shielded cable w/plugs for HK-4 \$7.95

Order today direct or from your favorite dealer • Add \$2.00 shipping & handling per unit (USA) Same day shipment...

HAM RADIO CENTER



JUST DIAL
8340 OLIVE BLVD.
PO. BOX 28271

1-800-325-3636

TOLL FREE
ST. LOUIS, MO.
63132

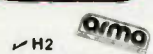

Heathkit® service is at the other end.



(616) 982-3296

WA8ZVO

Heathkit Service Techs know their stuff and you can count on them for answers on any Heathkit HAM gear. Most problems can be solved right over the phone. Those that require hands-on service can be brought to one of the 55 Heathkit Electronic Centers throughout the U.S. or sent in to the Heathkit factory. Either way, you'll find reliable, experienced people who know what they're doing. And that's a very good reason to con-

sider Heathkit when you're considering amateur radio gear.

free catalog

For all the newest in Heathkit Amateur Radio, send for the latest, free Heathkit Catalog. It's loaded with nearly 400 exciting kits for your home, work or pleasure. Send for yours today or pick one up at your Heathkit Electronic Center.

Heathkit®

Heath Company, Dept. 122-590, Benton Harbor, MI 49022

Heathkit Products are also sold at Heathkit Electronic Centers
(Units of Schlumberger Products Corp.) in major cities throughout the U.S.
See your white pages.

HEATH
Schlumberger

The Satellite TV Primer

— thousands watch satellite TV every day . . . here's how they do it and what they see

Robert B. Cooper, Jr. WSKHT
Rte. 5, Box 364
Guthrie OK 73044

Amateurs worldwide can be justifiably proud of amateur achievements with our noncom-

mercial design, construction, and operation of space repeater/relay stations. The amateur fraternity's OSCAR-series satellites, and, more recently, the Russian RS-series satellites, have shown the commercial space communications world that gold-plated multi-million dollar space programs are not essential to the establishment of routine, predictable, space communication programs.

limited budgets and large teams of technicians and engineers.

And history has a way of repeating itself. Geosynchronous satellites are a case in point.

To date, mankind has utilized four different types of satellites to achieve communications via "space stations." In the amateur world, the most familiar satellite is the low-orbit constantly-moving (with respect to a point on earth) active relay station symbolized by OSCAR.

OSCAR follows in the footsteps of TELSTAR I (a commercial satellite launched in July, 1962, by Bell Labs) and RELAY I (a NASA-launched low-orbit satellite put into space in December of the same year). Low-orbit satellites are placed into a launch sequence which takes the satellite around and around the earth at relatively low altitudes (typically, within a couple of hundred miles of the Earth's surface) at a forward speed which allows them to circle the Earth

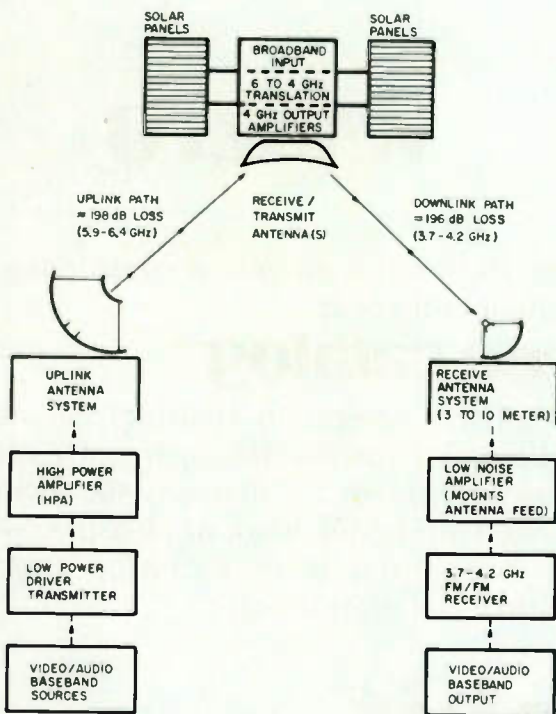

Fig. 1. How the geostationary satellite path works. Uplink transmitters send signals to appropriate bird in 5.9- to 6.4-GHz range. Within the satellite, the uplink signals are processed and downconverted to the 3.7-4.2-GHz range. The satellite is broadband processing until the final (single channel/transponder) output stage where individual transponders have their own 5-Watt peak power TWT amplifiers.

completely in several hours. Because the Earth is spinning on its own axis at the same time the satellite is circling the Earth, a low-orbit satellite crosses over different regions of Earth with each "pass"—a fact well known to OSCAR buffs.

Perhaps the next most-commonly utilized satellite is the Earth's moon, a "satellite" first used for communications in 1946 by a US Army communications team, with equipment originally conceived in the closing years of World War II. Amateur use of this particular satellite was pioneered in 1953 when moon echoes were first successfully received on the 144-MHz amateur band.

In our 1979 world of sophisticated rocket-launched active satellites, one may have some difficulty including the moon in our discussion of satellite communications, but it fits the mold nonetheless. In fact, the use of a passive relay device (the moon or similarly passive object) continued to spark interest in the scientific community up through 1963. In 1957, the moon was first utilized for passive relay of two-way voice communications. In August of 1960, a NASA-launched balloon satellite some 30 meters in diameter achieved a 1,600-km elevation orbit, producing the first satellite relay of both telephone and television communications (ECHO I). Even as late as May, 1963, MIT (in cooperation with NASA) launched another type of passive relay satellite: The West Ford Project put into space approximately 400,000,000 "dipoles" (thin strands of reflective material). ECHO I provided NASA, Bell Labs, and the California Jet Propulsion Labs with the opportunity to test 1- and 2.5-GHz FM transmissions

(telephone and television) by directing high-power transmitters and large parabolic antennas at the mid-range (height) of the elevated passive reflector. A measure of success was achieved, while the multi-million-dipole West Ford Project was far less successful.

Yet a third form of satellite had been launched in 1957 by the Russians. SPUTNIK I was a low-orbiting satellite with its own self-contained capsule message on board. As the satellite circled the globe it transmitted the Morse message "Hi" over and over. The fact that it had been programmed to transmit in International Morse code and in English was not lost on anxious American defense and security personnel.

The mold created by SPUTNIK actually continued for several years. The United States rushed a satellite into low orbit in December, 1958 (SCORE, a US Air Force experimental satellite), with a tape-recorded Presidential message on board—just in time for the holiday season.

The first use of active electronics on board a satellite came in October, 1960, when the US Army launched COURIER 1B, a satellite that achieved a maximum altitude of 1,000 km, and was outfitted with high-speed magnetic tape equipment. COURIER was capable of being ground-loaded with voice and other communications as it passed over one remote location, storing the data, and then releasing it on command from a second earthbound terminal. This was hardly real-time communications, but it did fill both scientific and political needs of that era.

Another type of low-orbit "first" also happened back in 1960. In April of

Uplink frequency range	5.9 to 6.4 GHz
Downlink frequency range	3.7 to 4.2 GHz
Modulation	FM video with FM subcarrier audio
Bandwidth per transponder	36 MHz*
Peak deviation	10.75 MHz*
Top of video baseband	4.2 MHz
Aural subcarrier frequency	6.8 MHz (6.2 MHz)**
Deviation of subcarrier	75 kHz
Top of audio baseband	15 kHz
Channelization	WESTAR, ANIK, vertical on SATCOM—40-MHz wide, each in even steps with transponder 1, 3700-3740; horizontal on SATCOM interleaved, with transponder 2 at 3720-3760.
Typical (free) space loss	196 dB
Typical EIRP	37 dBW WESTAR on boresight; 36 dBW SATCOM on boresight; 36 dBW ANIK on boresight. INTELSAT, 22 dBW global beam, 26 dBW hemispherical beam, and 29 dBW spot beam.
Polarization	WESTAR, ANIK—linear horizontal; SATCOM, COMSTAR—linear, horizontal, and vertical; INTELSAT—circular (either sense).

*Transponder 23 on SATCOM F2, utilized to relay television programming to Alaskan Bush Terminals, uses a split- (half-) transponder format; all INTELSAT transponders carrying video also utilize a split- (half transponder working) format.

**Aural subcarriers for INTELSAT and transponder 23 on SATCOM F2 may not be on the same transponder as the video.

Fig. 2. Geostationary Satellite System Parameters. With the exception of some Russian RADUGA-series geostationary satellites, this data pertains to all operating satellites in this service providing television relay.

that year, NASA launched the first meteorological observation satellite (TIROS I) at a 700-km elevation. This weather satellite operated long enough to transmit back to Earth more than 22,000 meteorological pictures in about a two-month period. While this satellite was generally capable of what would today be called low-resolution pictures, it nonetheless did attract the interest of the general public when an inventive journalist called it "the world's first spy in the sky." And that message was hardly lost on defense and security planners worldwide.

During most of the late 50s and early 60s, communication via satellites was done in the lower VHF range or even the HF range. SPUTNIK I beat against

WWV's 20-MHz assignment, SCORE sent a Presidential greeting via VHF, and TIROS transmitted cloud-cover and landmass black-and-white pictures via a frequency range just below our amateur two-meter band. All of this was destined to change when our fourth type of satellite was first launched in July, 1963. The magic word was "geostationary."

Our OSCAR and other low-orbit satellites provide a useful communications relay largely because they are predictable. Once the parameters of the launch are known (i.e., the intended altitude and inclination, or angle of trajectory), telemetering from the "bird" allows ground control stations associated with the launch to calculate with a high degree of precision

the period of rotation about the Earth and the precise overfly route of the satellite. Given this data, it is no big trick to have the proper ground station equipment in operation and the satellite-accessing antenna pointed at that spot on the horizon where the low-orbiting satellite will first appear as it travels around the Earth. However, all low-orbiting satellites do move, and the ground stations that access data from or transmit data to such low-orbiting satellites must be capable of tracking the satellite as it passes from the access horizon through the sky and then out of view once again over the opposite horizon. It is a little bit like having a totally-predictable ionosphere at work at HF—something we have never achieved, incidentally.

Way back in 1945, an "amateur" with both an inventive mind and an amazing understanding of geophysics prescribed a solution to this low-orbit problem—long before low-orbit satellites were even dreamed of! His name was Arthur C. Clarke, and in *Wireless World* in 1945 Clarke postulated that if man could launch a "microwave repeater station" into a precise orbit position some 22,300 miles above the equator, the forward speed of the satellite would exactly match the rotational speed of the Earth on its own axis. Clarke demonstrated, on paper, that such a satellite would "appear to stand still" to an observer on Earth. Clarke saw this stationary orbit position as a key to achieving instant worldwide communications on command, since

one satellite could "see" approximately 40% of the Earth's ground surface area; a trio of such satellites, properly spaced around the Earth, could be interconnected in such a way that a ground station could communicate with virtually any other ground station in the world.

Such a satellite was successfully placed into orbit in July of 1963. It was called SYNCOM 2, and it connected nations together across the Atlantic from an altitude of 35,900 km. It had a forward speed of 11,200 km per hour, matching the Earth's rotation. With a capacity of 50 telephone circuits or one television channel, SYNCOM was the first man-built machine capable of interconnecting two or more continents simultaneously for real-time television.

Geostationary satellites (or geosynchronous, as they also are known), are what this is all about. More precisely, the present generations of geostationary satellites, providing real-time television relay throughout the world today, are what this is all about.

International vs. Domestic

The present generation's geostationary birds generally fall into two operational categories, International and Domestic. Fig. 1 summarizes the operation of both types.

Satellites intended for international relay are known as INTELSAT birds, and they are operated by an international consortium formed initially in 1965, with the launch of EARLYBIRD. Although only three (properly-selected) satellites are required to provide Earth-circling communications, INTELSAT presently operates a total of 12 such satellites; they are identified on the map

in Fig. 3. There are three primary regions, or "parking areas," for the INTELSAT satellites: the Pacific Ocean area (generally around 180 degrees west or over the equator north of the Fiji Islands), the Atlantic Ocean area (generally between 0 degrees west and 35 degrees west, over the equator between Africa and the eastern tip of South America), and the Indian Ocean area (generally near 300 degrees west 60 degrees east, over the equator north of the Seychelles Islands). At least two separate satellites are positioned in each region, one as a primary or operational bird and the other as a reserve or secondary bird. In the Atlantic region and the Indian Ocean region, there are more than two INTELSAT birds parked, largely because of the high volume of commercial traffic in these regions of the world.

The present generation of satellites is of the IV (or 4) class—which simply means there were other generations ahead of them. These satellites are capable of handling 20 or so simultaneous television channels or some combination of television plus telephone (voice) or data channels. They all operate in the 3.7- to 4.2-GHz downlink (i.e., satellite-to-ground) frequency range, a range that is shared in North America and many other portions of the world by terrestrial point-to-point (telephone) or common-carrier microwave. They are fed input signal in the 5.9- to 6.4-GHz range (the so-called uplink path) from earthbound transmitters operating typically with 1 to 3 kW of transmitting power and very large parabolic antennas (40-100 feet in diameter) with gains in the 55-65-dB range. All of which make the 100-Watt ERP requirement for access

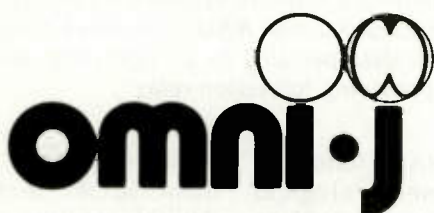

omni·j

ANTENNAS

Model OJA-146

TWO METER AMATEUR BAND 146-148MHz

- NO GROUND PLANE REQUIRED
- USE FIXED, MOBILE, OR PORTABLE
- 5dB GAIN OVER ISOTROPIC IN MOST MOBILE APPLICATIONS
- OVERALL LENGTH: LESS THAN 64 INCHES
- COLLAPSIBLE TO 22 INCHES. MAY BE PACKED IN SUIT CASE FOR THOSE OUT-OF-TOWN TRIPS
- STEEL WHIP AND ADAPTER INCLUDED FOR MOBILE AND FIXED APPLICATIONS
- VSWR: LESS THAN 1.2:1

PRICE \$39.95 UPS Prepaid

220 MHz — \$37.95 450 MHz — \$37.95



MADISON

Electronics Supply, Inc. M35

1508 McKinney • Houston, Texas 77002 • (713) 658-0268

to OSCAR seem tame.

In our second family we have "domestic satellites," those intended for and licensed for operation within the borders of a single nation. Under international agreements reached in 1970 and 1971, the equatorial satellite "belt" has been broken into an "assignment table" where certain locations above the equator are reserved for INTELSAT-cflass birds while other locations are set aside for operation of domestic or non-INTELSAT satellites. These locations are specified in terms of the prime meridian (0 degrees, or Greenwich), and the

equatorial region (from 70 degrees west—roughly due south of Boston—to 135 degrees west—roughly due south of Sitka, Alaska) are set aside for satellite parking of birds intended to serve North America. Within that arc there are presently 10 US and Canadian satellites in operation. The arc has been chosen to ensure that a satellite parked at either end of the arc can still see all or the majority of the North American landmass. Remember, just as with OSCAR, the reliable coverage of such satellites is limited to those portions of the Earth where line-of-sight contact

MARINE SATELLITES

28	29	30	31	32	33	34	35	36
15	183	287	140	261		15	230	225
MARISAT	ATS	EKRAN	SIRIC	ETS	CS			
1	2	3	6	1	2		2	
'76	'76	'76	'74	'76	'76	'77	'77	'77
COMSAT								
GENERAL	NASA	USSR	ITALY	JAPAN				
P P S	E	DOM	E	E E				
		(SIBERIA)						

INTELSAT SATELLITES

Key No.	Longitude (°W)	Name	Year Launched	Service Status
1	34.5	I-IV-F3	1971	Secondary
2	181	I-IV-F4	1972	Reserve
3	300	I-IV-F5	1972	Reserve
4	186	I-IV-F8	1974	Primary
5	298.6	I-IV-F1	1975	Primary
6	4	I-IV-F2	1971	Reserve
7	1	I-IV-F7	1973	Secondary
8	24.5	I-IV-F1	1975	Primary
9	29.5	I-IV-F2	1976	Reserve
10	19.5	I-IV-F4	1977	Reserve
	297	I-IV-F3	1978	Primary
	300	I-IV-F6	1978	Reserve

DOMESTIC SATELLITES

Key No.	11	12	13	14	15	16	17	18	19	20	21	22	23	24	25	26	27
Long. (°W)	114	109	104	99	123.5	135	119	128	95	116	277	283	280	325	275	311	11.5
Name	ANIK-A			WESTAR		SATCOM		COMSTAR		CTS	PALAPA		STATSIONAR			SYMPHONIE	
Year Launched																	
Org. or Country	TELESAT CANADA			WESTERN UNION		RCA		ATT/ GTE		CANADA —USA	INDONESIA		USSR DOMESTIC & FOREIGN			FRANCE/ W. GERM.	
Service Status	P	S	R	S	P	S	P	P	S	E	S	P				E	E

Note: P indicates primary operating satellite, S—secondary, R—rescue, and E—experimental.

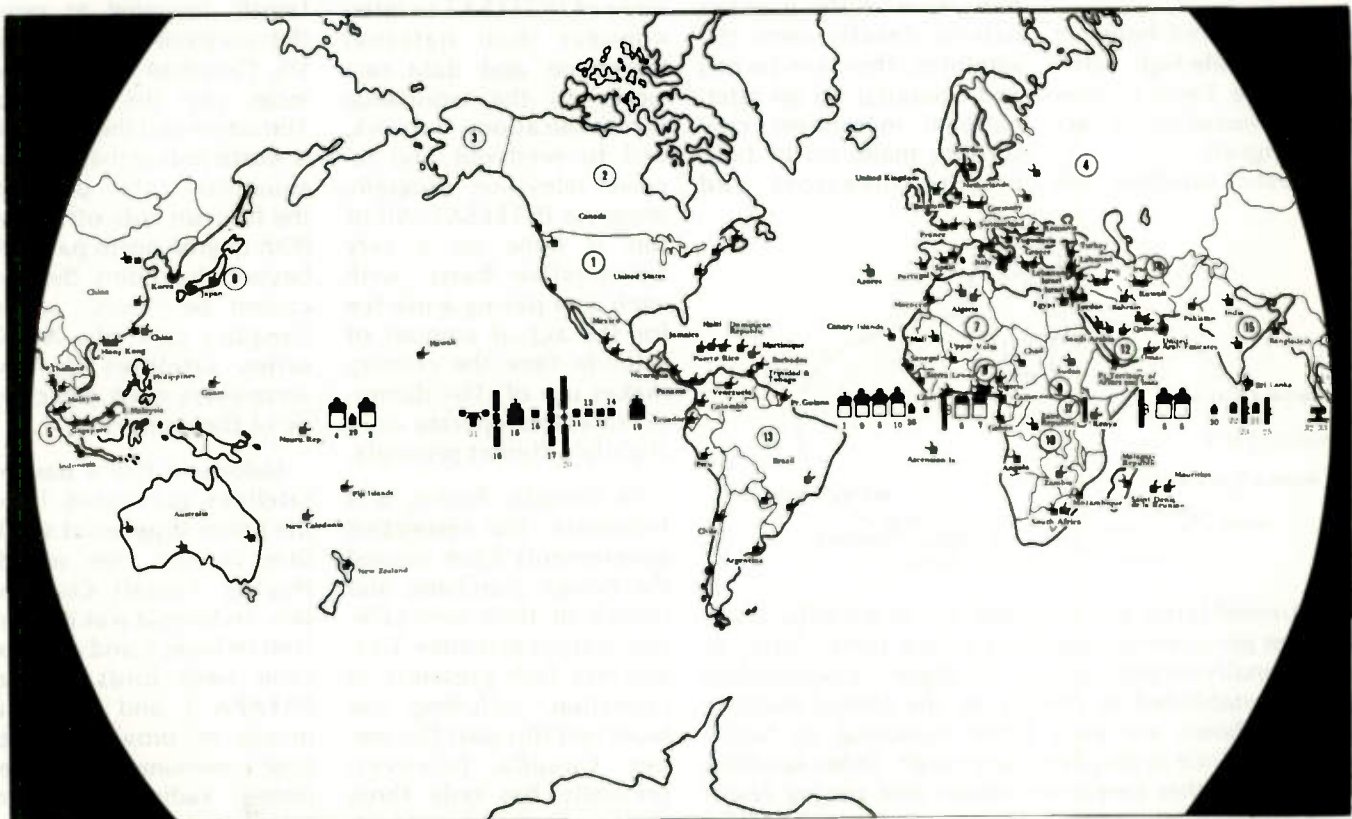

Fig. 3. Geostationary satellites and their locations. Equatorial parking locations of INTELSAT and domestic satellites providing television (plus voice and data) communications circuits are shown. Maritime satellites (which do not provide video services) are also shown because of high interest in their operation.

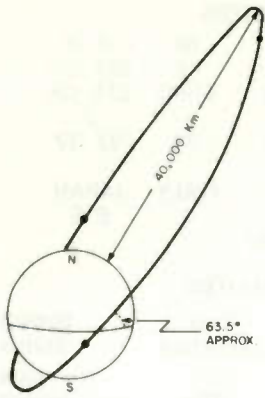

Fig. 4. Russian MOLNIYA satellites have been launched in an unusual inclined orbit resulting in elliptical orbits with a 12-hour period. By placing several satellites in the same ring, or train, virtually full-time service is maintained because of the length of the apogee period (8 hours) during which satellites appear (almost) to stand still to the ground receiving terminal. The system also provides coverage over the polar region, something not possible with equatorial-region geostationary satellites.

can be achieved between the 22,300-mile-high satellite and the Earth receive terminal installed to access its signals.

Domestic satellites are

fairly new in the satellite world. While more than 100 nations of the world now belong to INTELSAT and participate in its worldwide communications system, none of the member nations directly owns the satellites; they are owned and operated by an international investment consortium made up of both private investors and

government agencies established in countries such as Nigeria to buy into the operation. Having bought in, the member nations are entitled to utilize the services of INTELSAT to interconnect their national telephone and data networks to the worldwide communications network, and to send out and receive television programming via INTELSAT. All of this is done on a very businesslike basis, with each user paying a use fee for the actual amount of satellite time the country makes use of. The domestic satellites operate on a slightly different principle.

In Canada, Russia, and Indonesia, the respective governments have funded the design, purchase, and launch of their own communication satellites. Canada has four presently in operation, including one launched this past December. Canada, however, presently has only three "orbit spots" assigned to it, and one of the four will be retired shortly. The Canadian domestic satellites

are utilized to provide telephone, data, and television communications to and from the less densely settled portions of Canada. This means that they are largely intended to serve the northern areas of the US, Canadian border provinces, plus the Northwest Territories and the Yukon. It is worth noting that with an equatorial orbit position, the horizon cuts off at the 80th degree north parallel; beyond that point, the bird cannot be "seen," so, in Canada's case, the ANIK-series satellites do not serve every nook and cranny of the country.

Indonesia has a pair of satellites purchased from the prime supplier of satellites in the free world, Hughes Aircraft Corporation. Indonesia was authorized to launch and operate their twin birds named PALAPA I and II, as a means of providing first-time communications (telephone, radio, data, and television) to the thousands of islands which make up the nation. However, the Indonesians have been

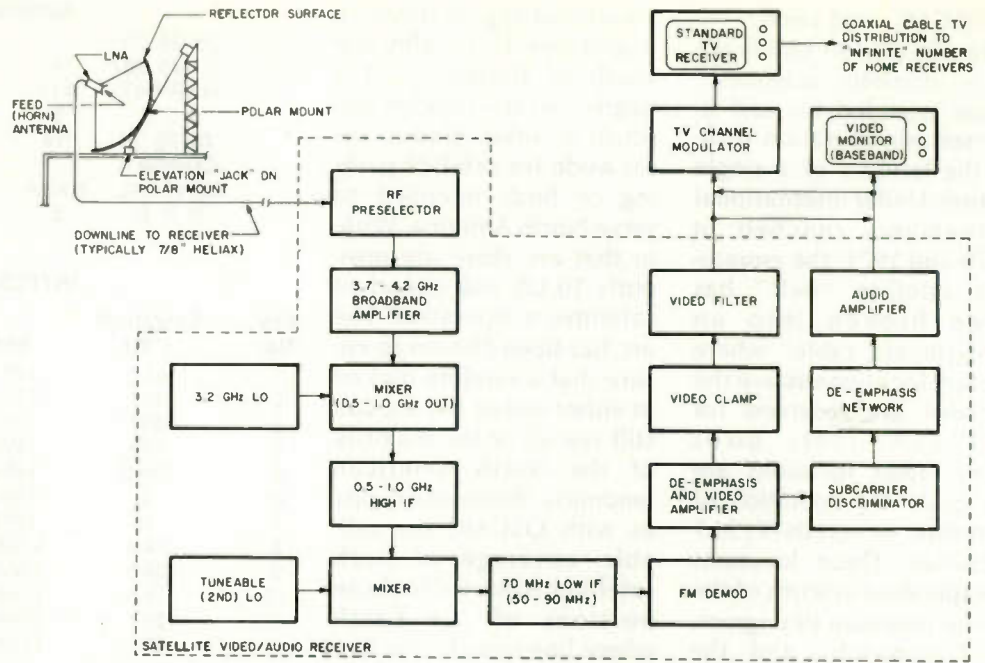

Fig. 6. Typical "small Earth receive-terminal" system (private or low-grade commercial) shows how the various component parts interrelate. The EIRP level present in a location determines the requirements for minimum size (i.e., gain) parabolic antenna, noise figure of LNA, and acceptable receiver i-f bandwidth.

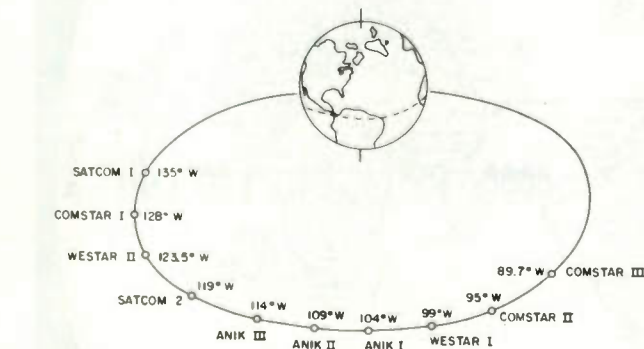

Fig. 5. United States and Canadian 3.7- to 4.2-GHz downlink-range geostationary satellites follow fairly closely to internationally-recommended 4-5-degree inter-satellite spacings established in 1970-71 by the United Nations. Satellites shown are only those operating in North-American service in this frequency range. Other satellites operating in other frequency ranges and serving North America are not shown. With the proposed launch of RCA SATCOM F3 this fall (scheduled to be spotted at 132 degrees), tests will be conducted to determine if closer (3-degree) spacing is feasible.



Photo A. "Novosti" or Russian news broadcast as received on an early model G8AKQ receive system with an 8-foot parabolic antenna. At the time this photo was taken, Birkill estimated his system receiver noise figure at about 3.8 dB (400 degrees Kelvin). He is within the 29-dBW contour from STATIONAR. The satellite broadcasts on 3.89 GHz, well within the worldwide 3.7- to 4.2-GHz downlink range.

experimenting with leasing satellite channel space to other nearby nations, and television for the Philippines, Brunei, and other neighboring countries is relayed via PALAPA birds on a regular basis.

Russia's domestic satellites don't quite fit the mold of the balance of the world. The Russians first launched a domestic satellite system in 1965. The first Russian satellite was launched prior to the time the Russians had the capability to launch a heavy payload (2,200 pounds) into a geostationary orbit. So MOLNIYA 1 ("Lightning") was launched into an inclined, highly-elliptical orbit (see Fig. 4). This is a 12-hour orbit period with an apogee such that for approximately 8 hours per day the MOLNIYA bird appears to stand almost still with reference to Earth. By placing three satellites in the ring the Russians thus achieved many of the benefits of geostationary orbit without the precise orbiting equipment or launch power required for such a launch. More than 40 such satellites have

been launched by the Russians, and one of the advantages of this approach is that there is coverage over the north polar regions, something not possible with equatorial geostationary satellites. In 1975 the Russians launched their first geostationary satellite (STATIONAR) in the now-classic INTELSAT format. In the STATIONAR series are two separate types of satellites: RADUGA, which is intended for both domestic and international telephone, data, and television relay, and EKTRAN, which is a direct-to-the-home UHF-region broadcasting satellite. EKTRAN operates at a much lower downlink frequency than other television-oriented satellites; a center frequency of 714 MHz (inside the US UHF television band, or, roughly, UHF channel 54). The onboard transmitter and antenna system create a very powerful ground level signal, such that simple yagi antennas provide first-class television to Siberia and other portions of far eastern Russia. Because of the location of

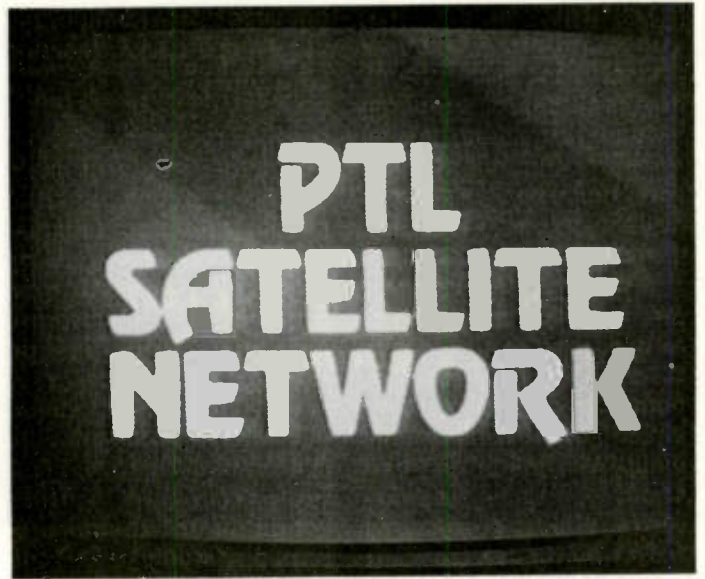

Photo B. PTL (transponder 2) is one of three full-time religious channels on the RCA SATCOM F1 satellite.

this satellite (99 degrees east), it has a line-of-sight situation to portions of western Alaska and the Pacific, including Guam. Although the antenna is supposed to be "bore-sighted" on the UA9/UA0 region, amateur experimenters as far east and south as Rhodesia report reception from this powerful UHF-region television satellite.

The US Domestic System

By now, you may be getting the general idea that reception of geostationary satellites by amateur-constructed terminals offers a certain fascination. This may be the understatement of the year!

For example, how would you like to have access (via satellite) to *all* of the following in your own home?

1) Four of the nation's top independent television stations, such as Chicago's WGN, San Francisco/Oakland's KTVU, Atlanta's WTCC, and NYC's WOR?

2) Five separate pay cable services, including HBO (Home Box Office), SHOWTIME, FANFARE, HTN (Home Theater Network), and Warner's STAR CHANNEL?

3) Three separate full-time family/religion channels including PTL, CBN, and Trinity Broadcasting's KTBN?

4) A 13-hour per day Children's Television Network called Nickelodeon, created by the corporate family at Warner Brothers?

5) Over 1,000 hours per year of live sporting events from Madison Square Garden in New York, plus Notre Dame basketball, Penn State college football, and more?

6) A twenty-four-hour-per-day (!) all-sports channel?

7) A twenty-four-hour per day still-frame video news channel with accompanying audio from United Press International?

Too much television you say? Well, that's but the service list (early in 1979, and it grows monthly) on but a *single domestic satellite* serving North America. There are a total of ten such satellites with more than 40 such channels now in operation if you sum the video programmed services on the satellites serving the US and Canada.

The United States has followed a unique policy

COMING UP NEXT!

BIG BAD MAMA
Pistol-packing Angie
Dickinson on a cross-
country crime spree

HERE ON HBO

Photo C. HBO (Home Box Office) is perhaps the best known of the pay-cable services on satellite, although it is only one of five presently in service. Movies run 8-13 hours per day, are unedited, and run without interruptions (i.e., no commercials!).



Photo D. Major market (i.e., big city), non-network stations, carried via satellite to cable firms across the country, provide a wide choice of movies, sporting events, and syndicated programs not seen on local televisions. Chicago's WGN, "the nation's highest-rated independent station" (or so they say), is presently on transponders on both SATCOM F1 and WESTAR II.

of allowing private corporations to invest from 20 to 25 million dollars per satellite (for the bird itself), plus allowing these private corporations to rent launching services from NASA, in the hope that the firms launching such satellites can recoup their investments by renting out satellite relay services to qualified takers. A bird in

orbit today represents between 40 and 50 million dollars invested. Compare that to OSCAR!

Following this opportunity, RCA has launched two such domestic satellites (a third is scheduled to be placed into orbit late in 1979), Western Union has launched three, and ATT/GT&E have launched three.

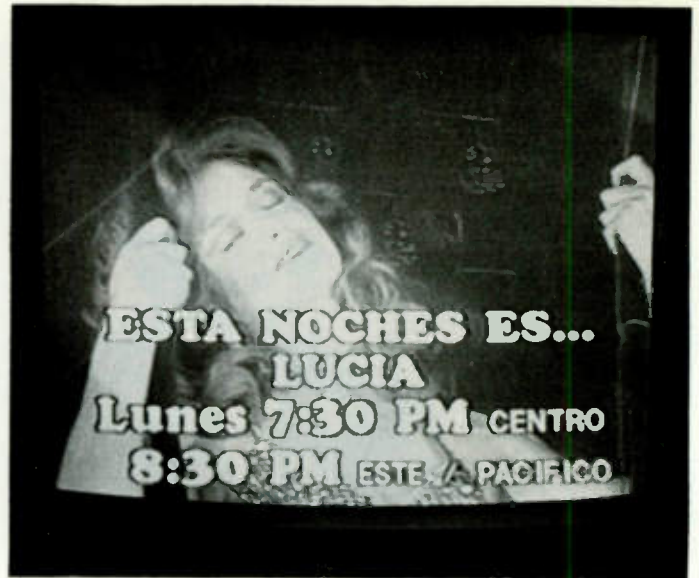

Photo E. SIN, or (the) Spanish Internation Network, is a consortium of US television stations in markets such as Miami, San Antonio, Los Angeles, etc., which have banded together to bring live Mexico City (Spanish language) programming into the US via WESTAR II. Bullfights, soccer matches, and a wide variety of Spanish soap operas, variety shows, and other entertainment fill the SIN channel approximately 12 hours per day.

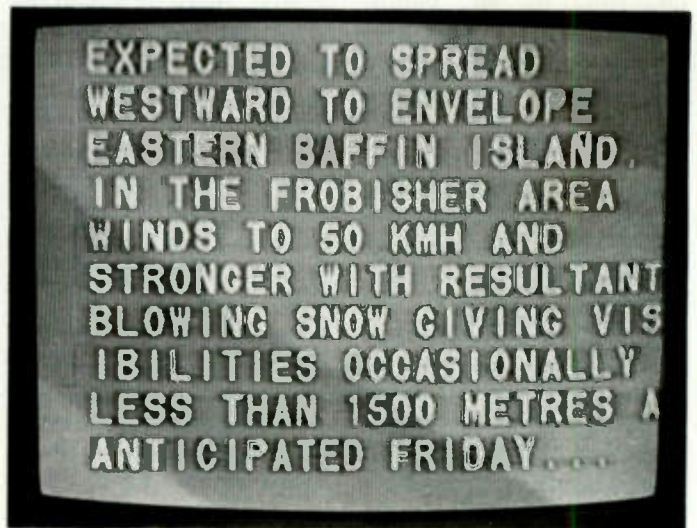

Photo F. Canada's three ANIK III television channels provide excellent diversion from US programming, since more than 50% of Canadian broadcasting now must be Canadian-produced. Weather reports for far northern Canada, Canadian coverage of US politics, and their own excellently produced documentary programs give one a broader slant on life than does US television.

Their orbital locations are shown in Fig. 5. Western Union satellites employ linear (horizontal) polarization, and they squeeze 12 separate video channels (known as transponders) of capacity into the 3,700- to 4,200-MHz downlink as-

ignment. RCA and the telephone company birds (known as COMSTAR) employ dual polarization; they run one set of transponders in vertical uplink and vertical downlink and a separate set of transponders in horizontal uplink

Table 1. US/Canadian Domestic Satellite Channel Usage. Transponder assignments are not governed or made by the FCC (or DOC); they are subject to the engineering requirements of the various satellite operators.

SATCOM F2 (US domestic, 119 degrees west)

Transponder	Type of Video
4	Contract video, sports, and news
8	NBC pre-network feeds
10	Contract video, sports, and news
16	Contract video, sports, and news
18	Contract video, sports, and news
20	Contract video, sports, and news
22	Contract video, sports, and news
23	Alaskan Bush Terminal Video, half-transponder format

WESTAR I (US domestic, 99 degrees west)

Transponder	Type of Video
1	Contract video, sports, and news (networks)
2	Contract video, sports, and news (networks)
6	Contract video, sports, and news (networks)
8	PBS video (primarily eastern time zone)
9	PBS video (primarily central/mountain zones)
11	PBS video (primarily pacific time zone)
12	Contract and PBS video

WESTAR II (US domestic, 123.5 degrees west)

Transponder	Type of Video
1	WOR-TV, New York City (independent)
4	WGN-TV, Chicago (independent)
7	Spanish International Network (SIN) video, Mexico City
12	KTTV, Los Angeles (independent)

and horizontal downlink. And they get away with this dual-polarization format inside the same 500-MHz bandwidth. By today's technology, this is just about the ultimate in frequency conservation since, in fact, two separate sets of signals manage to occupy the same spectrum at the same time, and they do so without interfering with one another!

Canada's domestic system (which was operational prior to the first US domestic satellites) fits the same operational format as the Western Union (WESTAR) birds. There are three of the Canadian ANIK birds with assigned orbital spots, although four have been launched. A recent (December, 1978) launch of ANIK-B is ultimately intended to be a re-

placement for one of the earlier ANIK-A-series birds. Although the Canadian system is run differently than the US system (the birds and their control stations are owned jointly by a government agency and by a consortium of Canadian telephone companies, operating under the trade name of TELESAT), it has the same technical operational characteristics as the US systems and will be described jointly with the US birds.

There are possibly three questions that might pop into your mind at this point. 1) Is it legal to set up a receiving terminal to access any or all of these satellites? 2) How much does it cost? 3) Where do I get the equipment or information necessary to build the equipment?

One question at a time.

SATCOM F1 (US domestic, 135 degrees west)

Transponder	Type of Video
1	KTVU, San Francisco (independent)
2	PTL—Praise The Lord (religion)
3	WGN, Chicago (independent)
5	Star channel (east-coast and early west-coast feed)
6	WTCG, Atlanta (independent)
7	ESP (New England regional sports)
8	CBN—Christian Broadcasting Network (religion)
9	Madison Square Garden Events (sports)
10	Showtime (west-coast feed)
11	Warner Nickelodeon Children's Network
12	Showtime (east-coast feed)
13	KTBN—Trinity Broadcasting (Corona religious channel)
16	Fanfare (and shared feed for Holiday Inns of America)
17	WOR, New York (independent)
18	Reuters New Service
20	Modern Motion Picture Services, Penn State Sports
21	SPN (movies, sports)
22	HBO (west-coast feed)
23	HBO Family Channel ("Take Two")
24	HBO (east-coast feed)

ANIK III (Canadian domestic, 109 degrees west)

Transponder	Type of Video
4	CBC pre-network feeds, occasional use
8	CBC French-language television, 18 hours per day
10	CBC English-language television, 18 hours per day
12	CBC English television, northern TV service, 18 hours per day

Is it legal? Yes, if you follow the proper guidelines established by the FCC or, in Canada, by the DOC. Basically, a geostationary satellite is nothing more than a common-carrier microwave relay station positioned in space. It is a broadband repeater not unlike the Bell or other microwave relay stations you see bundled atop nearby hilltops or tall buildings in your area. It is not a broadcasting station, like your local television station (although each is assigned call letters by the FCC), and the transmissions it relays are either privately owned or privately controlled. This means simply that under Section 605 of the Communications Act, you are not free to erect a station and receive the transmissions from a satellite unless you have ob-

tained the permission of the owners of the programming material to access that material. The distinction here is that a satellite is a common-carrier relay station and its transmissions are not intended for the general public. They may ultimately be seen by the general public, but only after your local broadcasting station(s) or cable TV company have contracted with the owner of the program material to broadcast that material. This says, quite correctly, that the programming material on the birds is, by and large, privately owned while it is going through the satellite, and until you "buy a ticket of admission" you are not supposed to be enjoying it in your home.

There are thousands of backyard terminals now in operation or under con-

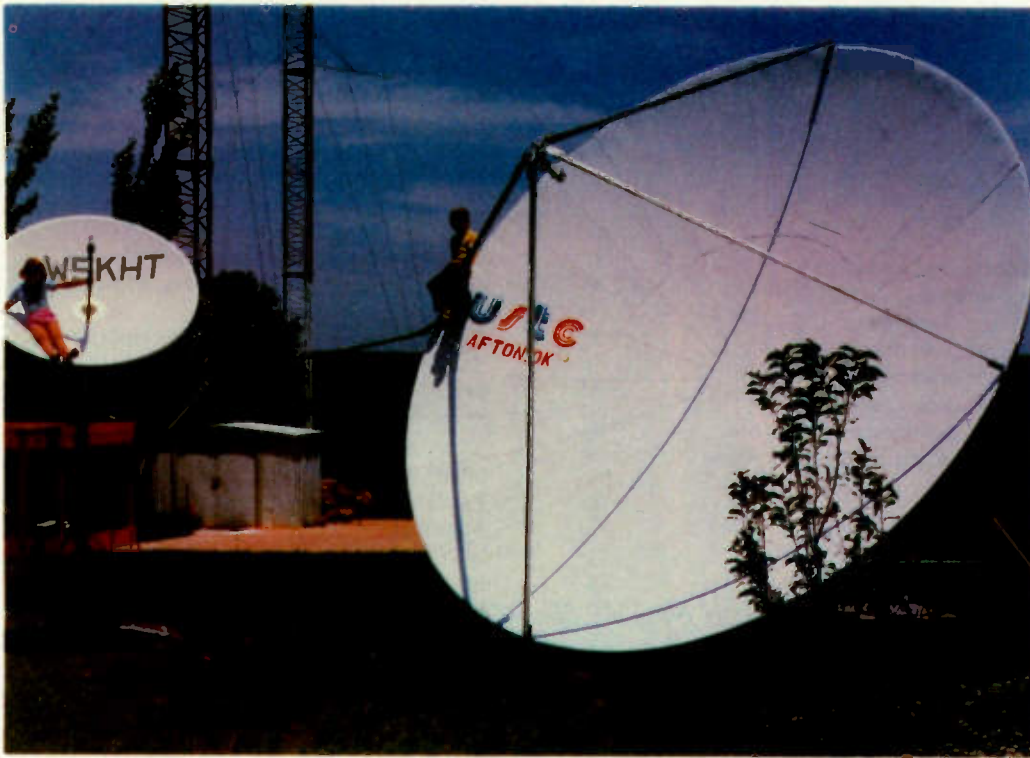

Photo G. Six-foot (left) and twenty-foot satellite antennas. The six-foot one is positioned on WESTAR 1 while the 20-foot one is on SATCOM F1. White reflective surface is essential to keep the sun's rays from "cooking" feed (and electronics there).

struction. Very few of these seem concerned about the legal requirement to obtain the permission of program owners before accessing the programs. Obtaining permission, at least from some of the program suppliers, is very simple, however. For example, the company that brings Atlanta WTCC and San Francisco KTVU up to the bird (Southern Satellite Systems) will grant a one-year use-right for an annual fee of \$60 (per station). The religious channels (PTL, CBN, and KTBN) make such written grants without a fee. (I prepare a weekly program entitled *Satellite Magazine* which is distributed to the cable television industry on one of the satellites, and we routinely grant permission to access our program for no fee.) Table 1 summarizes current transponder usage.

Once you have written permission from a single program supplier, you then are able to complete FCC

form 503, which is an application for an experimental radio receiving station license under Part 25. This one year, renewable license keeps you square with the FCC. The FCC is currently studying the possibility that satellite receiving terminals may not really need to be licensed after all, and perhaps before long, much of this paperwork will be a thing of the past.

How Much?

This is a tricky question because a great deal of the answer depends upon your own abilities, or the combined abilities of several people who agree to work together on the project. There are three essential elements to a TVRO (Television Receive-Only) terminal: the antenna, the antenna-mounted signal pre-amplifier (called an LNA, for low-noise amplifier), and the receiver itself. Fig. 6 shows the various parts of a typical satellite terminal. We'll look at each

of these shortly.

When the first satellite programs for use by the cable television industry appeared in September, 1975, the terminals cost in excess of \$100,000 each, installed. In those days, the FCC had a strange rule on the books which made it mandatory that a receive terminal utilize a receiving antenna with an aperture (diameter) of at least 9 meters. That translates to a parabolic dish antenna nearly 30 feet across—not something you would put in a normal backyard! Prior to the cable television industry's use of satellites for programming relay, the only intensive use of satellites was in the INTELSAT area. The big INTELSAT stations routinely cost several mega-bucks each, with receive antennas in the 50-100-foot class.

In December, 1976, acting on a petition that I drew up, the FCC removed the 9-meter restriction and began routinely to permit receive terminals as small

as 4.3 meters (roughly 15 feet in diameter).

As a result of this change in FCC policy, the primary domestic industry utilizing satellites, the cable firms, has grown at an extremely rapid rate and is attracting all sorts of other industrial users of satellites. Back in December, 1976, there were but three channels or transponders in use for cable programming relay. By late spring, 1979, that number had grown to 20 on just one satellite, with another 4 to 6 on other satellites. The number of receive terminals installed by cable companies in operation in late 1976 was 75; now it is pushing 1,200 terminals and growing at a rate of nearly 100 per month.

A major motel chain (Holiday Inns of America) is currently installing the first of what will ultimately be perhaps 750 terminals. These motel terminals will be plugged into a special 14-18-hour per day satellite channel programmed with movies and sporting events available only at the affiliated Holiday Inns. Other major motel and hotel chains are expected to follow in short order. At least one national religious group (Full Gospel Businessmen International) initially will install around 350 terminals, which will be connected to local-service 100-Watt UHF translators operating in the UHF television band. Programming will be a mixture of the existing three religious programmed channels on SATCOM F1. And the surface is barely dented.

With volume production of satellite equipment now starting, the prices, not unexpectedly, are coming down. Cable firms are installing single-receiver 4.5-meter terminals for "as little as" \$9,000 these days. And several hundred well-heeled individuals

have spent at least that much money to have their own backyard terminals.

Now, how cheaply can it be done? Taylor Howard W6HD of San Andreas, California, put his electrical engineering skills to work on the project at Stanford University where he is a professor. He ended up scrounging (in the best of amateur traditions) a 15-foot reflector surface and an azimuth-over-elevation mount from a surplus radar installation. Then he worked with some engineers at Hewlett-Packard, and, using the HP-6101-series bipolar transistors, he built a 2.8-to-3.0-dB LNA (low-noise amplifier) to mount at the feed of the antenna. Finally, for his receiver, he did some more scrounging and ended up with a surplus telephone company microwave communications receiver. Tay figures he may have \$1,500 invested in the project, and his only real complaint is that his neighbors (when shown the pictures from HBO and other satellite programming sources) usually comment, "Yes, that's nice, but it's not any better than my Sacramento reception." People just don't have much appreciation for the technology!

The quiet and steady development of backyard terminals by amateurs came into the full light of day this past October. In the October 21st edition of *TV Guide*, I had a short three-page article published which revealed just what a person could do in his own backyard. Thousands of telephone inquiries and letters later, a relatively clear pattern has evolved. There are apparently three types of enthusiasts out there.

1) Members of the "I don't care what it costs" group have socks filled with bucks and are willing to part with 12,000 or more



Photo H. The author checks the elevation angle on the six-foot satellite receive-terminal using a 29-cent protractor. The back of the dish presents a right angle to the feed, allowing use of a simple protractor with string and weight to check the elevation angle.

of them to have a terminal installed by professionals. One energetic salesman for a major satellite terminal supplier took a stack of the October 21st *TV Guides* with him to Palm Springs and spent a weekend plying the country clubs. When he returned to his office the following Monday morning, he had ten checks in his pocket for \$40,000 each, having sold that number of his firm's super-deluxe terminals simply on the strength of the *TV Guide* article!

2) Most people fall into the "I don't have any money but I'd sure like one of those terminals" crowd. Unfortunately, most of them also do not have any background which would equip them to sit down and assemble or construct the terminal on their own. Perhaps by 1983, or so, they will be able to walk into their neighborhood Radio Shack and buy such a terminal for around today's price of a TRS-80 computer. For now, they will

simply have to sit and drool.

3) And, finally, there is the group that you probably fall into: the "I don't have much money but I have a ham radio license and a background which should equip me to do most of this on my own" set.

Of the three major elements in a satellite receive terminal, the antenna presents the best opportunity for individual effort. Some people will be fortunate enough to locate surplus or used dish (parabolic) antennas. A few of these may even come equipped with feeds for the 4-GHz range. But parabolic dishes are not that common, and the first wave of satellite TV enthusiasts has succeeded in driving up the prices and increasing their scarcity tenfold. Here are some parameters to watch out for.

1) The minimum dish diameter for most areas of the United States is ten

feet. If you will look at Fig. 7, you will see an outline map of the United States and Canada with a set of "signal contours." For this particular satellite (RCA F1), if you are located within a 35-dBW or better contour, you can expect reasonably good reception with a ten-foot dish. In the 33- and 34-dBW contours, you will need a 12- to 15-footer. We'll come back to this.

2) The dish should have a design f/d (focal length to diameter ratio) in the .4 to .5 range. Most surplus parabolic surfaces will not have a feed attached and you will have to design your own (typically a simple horn antenna). Your feed should illuminate the total surface area and be 10-dB down at the edges of the dish surface. To simplify the design of the feed, the focal length should be in the range suggested.

3) The surface area need not be solid. The 4-GHz range is in the cross-over region where grid-wire or

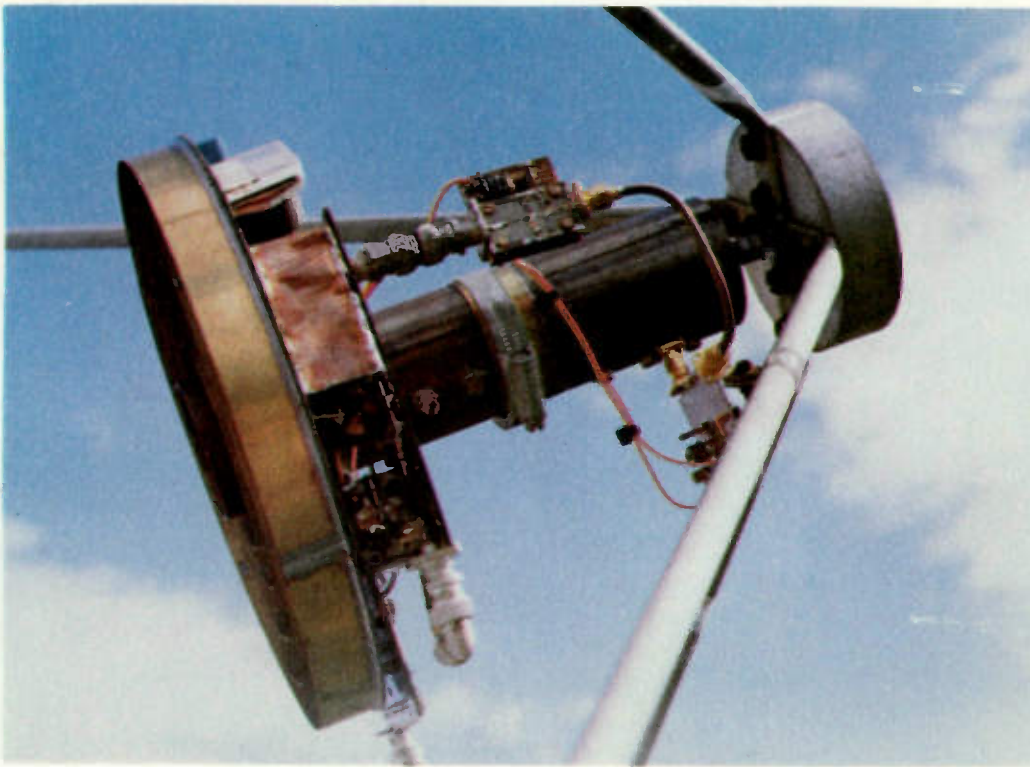

Photo I. G8AKQ's feed has two stages of low-noise amplification at the feed, with mixer, LO, and gain stages at his 450-950-MHz i-f also at the feed. The feed is a hybrid-mode scalar feed (corrugated horn) home-designed and built, allowing him to receive circular polarization from INTELSAT and Russian STATIONAR satellites as well as linear-feed format birds.

fine-mesh reflector surfaces will work, but at reduced efficiency. Ideally, you will hope to have 55-58% efficiency from the antenna surface and feed combination to make the system operate properly.

You probably won't find a mount for the antenna, but if you do, the ideal mount is a polar mount system. Because there are numerous satellites in the sky, it is very handy to be able to install the antenna on a north-south (corrected) line and leave the elevation adjustment (i.e., up an down movement of the dish) alone, moving from bird to bird by swinging the antenna left or right (azimuth). This is what a polar mount does. The alternative to this is either an az-el (azimuth-over-elevation) mount or a fixed mount. Photo H shows an experimental six-foot antenna on a 4.5" fold-over pipe mount. The antenna is

a terrestrial-style parabolic with a side-of-tower mounting kit which I have modified to allow manual elevation adjustment (a long support bolt that threads in and out to change the pitch, or elevation angle, of the dish). Azimuth adjustment is by the "armstrong" rotator method: You loosen some nuts and swing the antenna on the fixed pipe mount. A heavy prop-pitch motor could be rigged up to rotate the whole pipe just as well.

Another approach is simply to build the framework yourself and surface it with thin aluminum or galvanized steel sheet. One source¹ provides both plans and antenna kits for a 16-foot reflector surface, polar mount, and feed.

The antenna is the easiest place to make up system gain so that you can afford the luxury of less-sophisticated electronics. There is a very real trade-

off possible between the noise figure (or noise temperature, as it is specified in these circles) of the LNA and the antenna gain. The satellite-to-Earth path is a long one with space losses in the 196-dB region. However, the long-term path loss varies less than 1/2 of one dB, so a receive-system designer can spend most of his time worrying about things like achieving an additional 1 or 2 dB of antenna gain, or lowering the LNA noise temperature by another 0.5 dB, with the expectation that such efforts will produce noticeable differences in his system.

The parameters of the system are shown in Fig. 2. It is an FM/FM system with 36-MHz-wide channels. Because it is FM video (and not AM video, as regular TV is) the system designer has the ability to take advantage of things such as the FM improvement factor and the "threshold" of noise. Getting the receive

signal above the threshold is the key to high-quality reception, and slipping even half a dB below the threshold makes a big difference in the quality of the picture you see. For this reason, satellite terminal designers spend an inordinate amount of time looking for half-dB improvements, knowing that when they "make threshold" they are suddenly (and often dramatically, in terms of picture quality) "home free." The trade-off between LNA noise figure and antenna gain is summarized in Fig. 8.

All of this is another way of saying that, given an option, it is far better to build the antenna to achieve an extra couple of dB of raw signal gain than to assume that you can make up the difference (say between a 10-foot and a 16-foot antenna) with better quality electronics. This brings us to the electronics.

In the commercial area, virtually all LNAs are designed around mysterious little state-of-the-art devices called GaAs FET transistors. GaAs is short for gallium arsenide, a doping agent utilized in the manufacture of these very low noise, moderately high-gain transistors. Prior to GaAs FETs, if you wanted low-noise front ends at 4 GHz, you had to invest in parametric amplifiers priced upward from \$20,000 each. With the advent of GaAs FETs, the cost of low-noise amplifiers "came down" to around \$5,000 each for 2.5-dB-type noise figures at 4 GHz. More recently, 4-GHz preamplifiers have stabilized in the 1.5-dB noise-figure region at around \$1,200 each.

Because of the very high losses in even 7/8-inch Heliac-type cable at 4 GHz (in the 3-dB region per 100 feet) and the extremely small signal margins (above the magic FM

threshold), the LNA is mounted directly at the feed of the antenna. Some experimental terminal designers, notably H. Paul Shuch N6TX, recommend that the LNA and the first downconversion stage (to a high i-f in the 1.2-GHz region) be located at the antenna feed.² A similar approach has been in use for two years by Steve Birkill G8AKQ, the world's foremost amateur experimenter in the satellite field. Ultimately, it is likely that many home terminals will be constructed in this fashion, but that is not fodder for this discussion. If the LNAs in use by the commercial folks are out of your price league, there is an alternate approach which hundreds of home terminals utilize.

Hewlett-Packard has an Applications Note (#967) which describes a single-stage amplifier producing around 10.5 to 11 dB of gain in the 2.6- to 2.8-dB noise figure region. By using two of their HXTR-6101 bipolar transistors, the circuit in the Application Note, and the board layout there, it is possible to achieve sufficient low-noise signal gain to drive perhaps 50 feet of 7/8-inch Heliacx cable. To ensure that the noise figure of the HXTR-6101 LNA dominates the relatively high noise figure of the receiver (typically in the 11-14-dB region) it may be necessary to get into the 30-dB gain range with the LNA. Commercial units typically offer 50 dB of gain for this reason—as well as to allow for circuit aging.

This brings us to the receiver. Cable users first began buying receivers when they sold in the \$10,000 to \$12,000 range. More recently, a myriad of commercial receivers has appeared on the market including both tunable (i.e., covering all of the tran-

sponders) and single-channel (crystal-oscillator-controlled) models. Even with the stiffer competition and the market base broadening, satellite TV receivers remain expensive; the lowest-priced tunable units are in the \$3,000 region, while the single-channel units are around \$2,700. This is too high for most people.

The ultimate in low-cost receivers was assembled by a South Carolina amateur, Robert Coleman K4AWB. Robert has scrounged surplus equipment and assembled a fully operational home terminal for under \$500. He even designed his own GaAs-FET LNA!

Another approach is the latest receiver designed by California's Taylor Howard. Starting out from scratch, Tay has created a widely duplicated receiver that tunes all 24 transponders, includes a bipolar LNA system, receives all of the audio subcarriers, and, using brand new parts from commonly available parts sources, can be copied for under \$1,000 per "radio." Plans for both the Howard Terminal and Coleman (TD-2) Conversion terminal are available.³

Some home-brew terminal builders have taken advantage of one possibility by scrounging around for a Bell microwave TD-2 (video) receiver. Recall that (Bell) terrestrial microwave systems occupy the same 3.7- to 4.2-GHz range as the satellite downlink signals. With some work, these receivers can be made to function in

*Most US and Canadian domestic satellites transmit the accompanying audio on a 6.8-MHz FM aural subcarrier. However, certain of the WESTAR (Western Union) users prefer to utilize a 6.2-MHz FM aural subcarrier. Thus, a receiving system for "all possible" signals must be equipped for either subcarrier audio.

this service. Other than sitting down and designing your own 4-GHz-to-baseband receiver, there are two other possibilities. Microcomm (H. Paul Shuch N6TX) has a series of mod-

ules which, when combined, make up a 4-GHz to 70-MHz i-f system in two downconversion steps. This particular system, if you elect to use all Microcomm modules, includes a

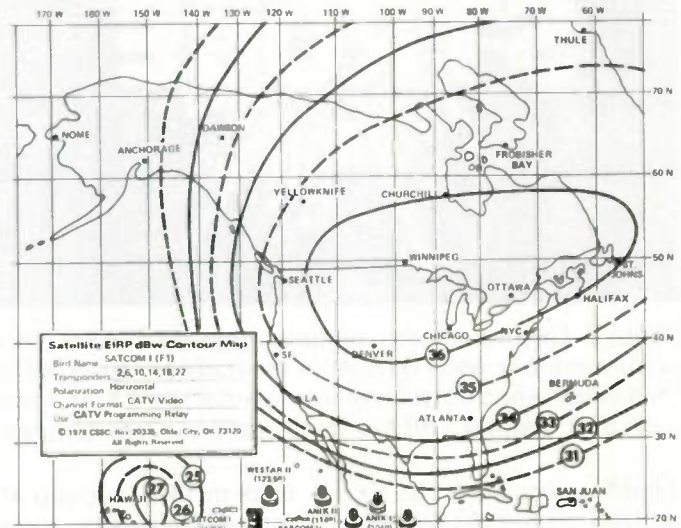

Fig. 7. This EIRP map illustrates the effect of carefully engineered "sculptured antenna radiation patterns" on the ground level signals from a satellite. WESTAR and ANIK-series satellites have a single pattern for all 12 channels, while SATCOM and COMSTAR satellites have four different patterns per satellite with six transponder channels grouped to a single transmit antenna (four such antennas per bird). Signal contours are in dBW (decibels above one Watt) nomenclature, with progressive circles in 1-dBW steps.

For An EIRP Area Of 36 dBW*

Antenna Diameter (60% efficiency)	Antenna gain	LNA noise figure	Video signal to noise ratio
6 foot (1.8 meters)	36 dB	1.0 dB	48 dB
8 foot (2.4 meters)	38 dB	1.7 dB	48 dB
10 foot (3.0 meters)	40 dB	2.6 dB	48 dB
12 foot (3.7 meters)	42 dB	3.8 dB	48 dB
15 foot (4.5 meters)	44 dB	5.1 dB	48 dB
20 foot (6.0 meters)	46 dB	6.6 dB	48 dB
30 foot (9.2 meters)	49 dB	9.2 dB	48 dB

*These numbers assume a 27-MHz i-f bandwidth, which creates an improvement over a full 36-MHz-wide bandwidth of approximately 1.3 dB without sacrificing baseband video picture quality.

Fig. 8. Private receive terminal parameters. To determine (with 95% or better accuracy) the type of results you can expect with various match-ups in antenna size, LNA noise figure, and receiver i-f bandwidths, these numbers are useful. Note that you must first determine the EIRP in your area using EIRP maps available for this purpose.



Photo J. Six-foot antenna pictures from WESTAR I. This picture exhibits noise (known in the trade as "sparklies"); LNA in use when the picture was taken was a 1.5-dB noise level unit, about 0.5 dB too "high" for noise-free pictures.

24-dB-gain LNA built around the HXTR-6101 bipolar transistors, and when this is considered, the \$1,700 price tag for the complete set of modules (wired and tested) may be cost-effective to some terminal builders. For individuals interested in the Microcomm approach, an applications note is available.²

The final approach at this time is to carefully study how the existing commercial receivers are designed and select the best of the various circuits to suit your own capabilities and pocketbook. A "Satellite Study Package" prepared to assist people in making a decision on the best way to go for your location is available.⁴

The Road Ahead

Having piqued your curiosity regarding satellite television terminals just a tad, some practical suggestions on what to do next might be in order.

There are only two things which usually create substantially lower equipment pricing. One is technological breakthrough and the other is very high volume production. Let's talk about both.

Back in 1971, a group at Stanford University studied the Earth terminal design vs. pricing conflict. They had a NASA contract which was part of a then-current proposal to launch a geostationary satellite to provide television reception to rural areas of Brazil. The group came to the conclusion (and developed the hardware to substantiate it) that with the 2.6-GHz satellite proposed, they could produce seven-foot parabolic antennas with feed, LNA, and receivers for well under a \$200 material and labor cost per terminal, in 100,000-terminals-per-annum quantities. Brazil never bought the NASA proposed package, so the proposal more or less died.

More recently, the Japanese launched an experimental satellite called BSE. This one operates in the 12-GHz range, and to support the program (which is providing a channel of color television to all of Japan and Okinawa), the Japanese electronics industry has produced a small quantity (around 200) of experimental terminals. The Japanese have calculated the cost of the terminals in annualized quan-

ties of 10,000, and they come to the conclusion that they could be built for a market cost of under \$300 each.

So why do our terminals cost so much?

Two reasons, and they interrelate. In the Stanford study for NASA, a relatively low frequency for the downlink was assumed: 2.6 GHz. If you are rock-bound on 80 meters, 2,600 MHz may seem very exotic to you, but it is sufficiently low in the microwave spectrum so that exotic and expensive components such as GaAs FETs are not required for system design. The ability to use a \$1.00 transistor in the front end versus having to use a \$125 (GaAs FET) transistor is very important indeed!

In both the Stanford NASA study for Brazil and the existing Japanese BSE experimental bird program, the designers purposefully built a considerable amount of transmitter power into the bird itself—a subject we've not discussed up to this point. With the exception of the new ANIK-B satellite, the signals that wing their way through around 196 dB of space loss start out at the 5-Watt peak-power level. This output level (+7 dBW) plus the gain of the downlink transmitting antennas (28-29 dB in the center of the pattern) result in the EIRP pattern shown in Fig. 7: +36 dBW in the center or boresight of the antenna pattern. The Japanese BSE manages to start out with 200 Watts of transmitter power, and when that is coupled with its transmit antenna gain, the boresight (center) of the EIRP pattern is +55.5 dBW. That makes it around 20-dB hotter on the ground than our domestic satellites (and as much as 33.5-dB hotter than G8AKQ's INTELSAT signals which he receives in

Sheffield, England!). On the surface, that translates to far simpler receivers, even when you add in the additional "free-space loss" that occurs at 12 GHz as compared to the 4-GHz downlink of the present domestic birds.

On top of that, you must remember that for a given size of parabolic reflector surface, each time the frequency is doubled the gain goes up 6 dB. On the receive end of the circuit, if you have 20 dB more signal at the antenna (because of the more powerful satellite signal) and antenna gain is 9 dB higher for a reflector surface of a comparable size than the same reflector would be at 4 GHz, some things can give. In the BSE experiment, two things "gave." First, they threw out the LNA and went directly into special diode mixers with noise figures in the 7-dB region. Then the BSE engineers reduced the size of the receive antenna (reflector surface) so that they had just enough antenna to provide a margin for system aging and some additional weather-effect losses that start to be troublesome in this frequency range. The net result is that 6-foot (1.83 meter) antennas, no LNA, and relatively simple single-channel receivers are practical with the BSE program. With these kinds of changes from our present domestic satellite system parameters, it is little wonder that the Japanese can bring the production costs down to the \$300 range. Perhaps it is a wonder that it is so high!

As noted, space loss (from the bird to you) increases with frequency. While antenna gain goes up, LNA technology becomes more difficult with an increase in frequency and that translates to more expense. Fortunately, per-

haps, there is no need for LNAs at that frequency range. The receiver design stays about the same in either case, being more dependent upon frequency agility than input frequency.

Direct broadcasting satellites are something of a political problem. Regardless of who owns and operates them (i.e., government or private industry), there are many opposing forces pulling and tugging at the prospect of their operating in the United States. This leaves us coming to some logical conclusions about the next five years or more in the world of North-American satellite communications.

What You Can See

Commercially-constructed satellite terminals for the present 4-GHz band (although also perhaps for services not yet dreamed of) will proliferate. Battle lines already are forming to tighten satellite-to-satellite spacings in the orbit belt; present regulations require 4- to 5-degree spacing between birds operating on the same downlink band. RCA will have a shot at a 3-degree spacing late this year, and if that works, there will be room for perhaps six additional satellites serving North America. Experience has proven that with 4-degree spacing, when your 15-foot or larger antenna is pointed at one satellite, the interference from adjacent satellites cannot be detected on the television screen. It is there, but it is down so far in amplitude as not to be noticeable.

The American appetite for multiple channels of service will keep our future satellites multi-channelled. Having proven that 24 channels can be crowded into the spectrum space originally allocated to 12 channels through the use of

dual polarization, future satellites will follow this format. Spectrum use (or maximum use of the spectrum) is a very important ingredient in space communications.

However, as long as it takes approximately as much solar power and battery reserve to operate one 200-Watt single-channel satellite (i.e., BSE) as it takes to operate twenty-four 5-Watt satellite channels, and additional solar power comes only at the expense of larger solar panels which come at the expense of larger rocket or Space Shuttle payloads, it is unlikely that short-term future American domestic satellites will go up in transmitter power much beyond their present limits. The recently launched ANIK-B has twelve channels with 10-Watt peak power aboard per channel, which results in Earth terminal antenna sizes within the boresight decreasing by the same 3 dB (or LNA noise figures going up approximately 3 dB); but that is for 12, not 24, channels. For the Canadians, having 3 dB more signal on the ground is more important to their space communications program than having another 12 channels of transponders available. Unlike the Americans, the Canadians have space spectrum to spare.

All of which suggests that, at least through 1985, it is unlikely that very many of the domestic satellite communications channels will be coming downward with very much more ground level signal than we now have available. Clearly, if advances are to be made in reducing the cost of the Earth terminals, it will have to be as the result of creative ground-station engineering. Much higher satellite powers are not likely for us in the foreseeable



Photo K. Private terminal receiver designed initially for Canadian "backwoods terminals" features continuous tuning dial, tuning meter (with afc on and off switch), and selectable aural subcarriers. Unit (PT-1024) is manufactured by Satco, in Lewisville, Texas.

future. And that says, for all of the kitchen-table-building amateurs out there, that here is the type of frontier which fascinated the amateurs of the 20s and early 30s. The challenge of the 80s is in space communications.

The nitty-gritty of the challenge has been outlined for you here. Now, get out your tin snips, your micrometer, and your microwave diodes and go to work. Hundreds—no, thousands—are already at work on this project. A handful will make significant contributions to microwave state-of-the-art. A few will become wealthy beyond their wildest dreams. And everyone will become a part of the most fascinating television programming ever radiated from a transmitting antenna in or out of this planet we call Earth. ■

References

1. A 16-foot parabolic antenna designed specifically for the private experimental terminal user is available in either kit form or as a do-it-yourself project from a comprehensive set of plans from Paraframe, 611 Farmview Road, Park Forest South IL 60466.
2. An 8-page application note

(#3), describing satellite TV terminal receive-system design parameters utilizing pre-wired and tested modules, is available for \$1.00 plus an SASE from Microcomm, 14908 Sandy Lane, San Jose CA 95124.

3. The *Howard Terminal Manual*, describing complete construction of a state-of-the-art TVRO receiving system with LNA, and a 24-channel tunable receiver, is available; it includes complete schematics, board layouts where required, and part sourcing. The *Coleman TD-2 Conversion Manual* describes conversion of surplus equipment to TVRO reception service, plus details of the layout and construction of state-of-the-art GaAs-FET low-noise amplifiers for 3.7 to 4.2 GHz. Each manual is \$30 alone, or both together are \$50, from Satellite Television Technology, PO Box G, Arcadia OK 73007; (405) 396-2574.

4. A foundation in the world of geostationary (TV relaying) satellites can be acquired through the "Satellite Study Package." Included is a 72-page booklet describing the full satellite TV system, programming sources, typical system layout, and many references. Also included is a 22 x 35 four-color, two-sided "Satellite Wallchart" which details the operation of more than 30 geostationary satellites. The price is \$13 US (\$16 Canada) from Satellite Television Technology, PO Box G, Arcadia OK 73007.

COAXIAL SWITCHES AND ACCESSORIES
for antenna selection and RF switching



Model	PRICE	Outputs	Remarks
375	19.75	6	PROTAX switch. Grounds all except selected output circuit.
376	19.75	5	PROTAX switch. Grounds all except selected output circuit. Sixth switch position grounds all outputs.
550A	16.95	5	
550A-2	13.75	2	
551A	17.95	2	Special 2-pole, 2-position switch used to switch any RF device in or out of series connection in a coaxial line. See figure (over).
556	.95	-	Bracket only, for wall mounting of radial connector switches.
590	18.50	5	
590G	18.50	5	Grounds all except selected output circuit.
592	17.25	2	
595	19.75	6	Grounds all except selected output circuit.

COAXIAL SWITCHES AND ACCESSORIES for antenna selection and RF switching. These high-quality switches have set the standard for the industry for years. Ceramic switches with silver alloy contacts and silver-plated conductors give unmatched performance and reliability from audio frequencies to 150 MHz. B&W coaxial switches are de-

signed for use with 52- to 75-ohm non-reactive loads, and are power rated at 1000 watts AM, 2000 watts SSB. Connectors are UHF type. Insertion loss is negligible, and VSWR is less than 1.2:1 up to 150 MHz. Crosstalk (measured at 30 MHz) is 45 dB between adjacent outlets and -60 dB between alternate outlets.

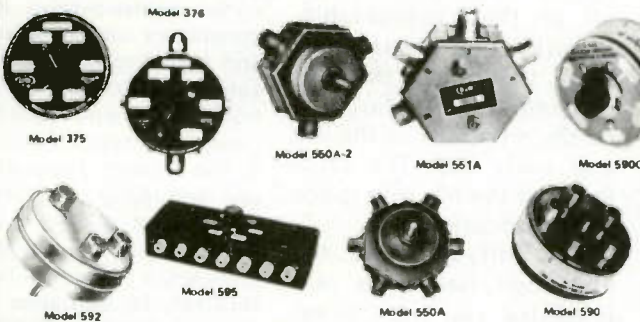

PRODUCTS OF SOUND RESEARCH
TELEX
COMMUNICATIONS, INC.

PROFESSIONAL HEADPHONES & HEADSETS

BOOM MIC HEADSETS
For the ultimate in communications convenience and efficiency, select a boom mic headset. Long-time favorites of professional communicators, boom mic headsets allow more personal mobility while always keeping the mic properly positioned for fast, precise voice transmission. Boom microphones are completely adjustable to allow perfect positioning. And, boom mic headsets have both hands free to perform other tasks. All models are supplied with "close talking" microphones to limit ambient noise pickup and provide superior intelligibility. Each model has a convenient, sliding push-to-talk switch, which can be wired for either push-to-talk or control of mic circuit interrupt for voice operated transmitters. The switch may be used as a momentary push button or it can be locked in the down position. All models have tough, flexible B floor cards which are stropped and terminated, unintermitted. Communication only with black rim.

MODEL	C 610	SWL 610	C 1210	C 1320	CM 610	CM 1210	CM 1320	CM 1328S
Headphone Sensitivity Ref: 0002 Dynes/cm ² at 1mW input, 1kHz	103dB SPL *5dB	103dB SPL *5dB	103dB SPL *3dB	105dB SPL *5dB	103dB SPL *5dB	103dB SPL *3dB	105dB SPL *5dB	105dB SPL *5dB
Headphone Impedance	32 20 ohms	2000 ohms	32 20 ohms	32 20 ohms	32 20 ohms	32 20 ohms	32 20 ohms	32 20 ohms
Microphone Frequency Response					50 8000 Hz	50 8000 Hz	50 8000 Hz	50 8000 Hz
Microphone Impedance					High	High	High	High
Microphone Sensitivity Below 1 volt/microbar at 1kHz					51dB *5dB	51dB *5dB	51dB *5dB	51dB *5dB
Price:	\$10.45	\$12.25	\$29.70	\$41.80	\$47.20	\$62.75	\$75.25	\$59.95

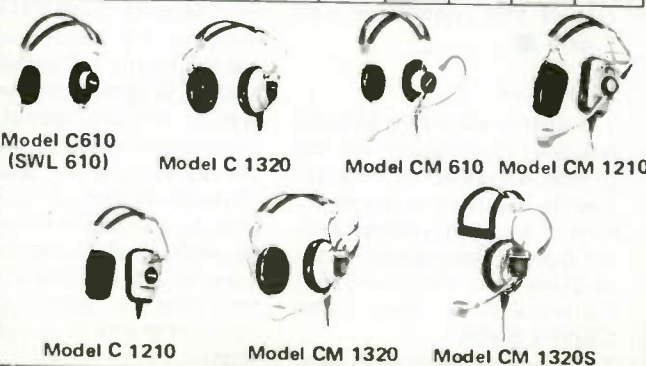

BE PREPARED FOR CYCLE 21 GET HY-GAIN'S NEW LONG-JOHN'S THE STACKABLES

Specifications:

Order Model Number	377 2058A	376 1058A	375 1058A
Price	\$289.95	\$169.95	\$119.95
SWR (at resonance)	Less than 1.5:1	Less than 1.5:1	Less than 1.5:1
Impedance	50 ohms	50 ohms	50 ohms
Power rating	21 VSWR Bandwidth	Maximum Legal	Maximum Legal
Longest Element	400 KHz	500 KHz	1.5 MHz
Boom length	36 1/2"	24"	18 1/2"
Boom Diameter	34"	26"	24"
Turning Radius	2"	2"	2"
Surface Area	25'	17 1/2'	15'
Wind Load at 80 mph	9.0 sq. ft.	5.2 sq. ft.	3.9 sq. ft.
Maximum Wind Survival	230 lbs	133 lbs	100 lbs
Mast DIA Accepted	80 mph	100 mph	100 mph *
	1 1/4" to 2 1/2"	1 1/4" to 2 1/2"	1 1/4" to 2 1/2"

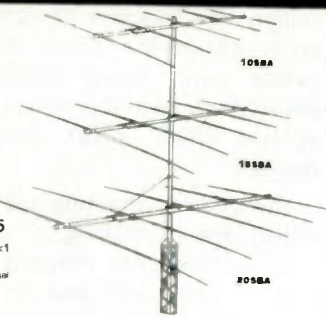

5 Element Maximum Performance Monoband Beams for 10, 15, and 20 meters

With sunspot cycle 21 now in the upswing, you should be prepared for the DX available on the 3 top HF bands. If not, our new "Long-Johns" are for you. The new 5 element "Long-John" monobanders are ideal for the serious DX'er. Each utilizes Hy-Gain's unique Beta-match for optimum power transfer. Also each antenna uses tapered tubing for minimum wind load and maximum strength. For maximum durability each "Long-John" uses Hy-Gain's rugged boom-to-mast clamp.

Larsen Küroed Antennas

- Handle full 200 watts • low-loss V.S.W.R.
 - Deliver 3 dB gain and more!
 - Pick the one that best fits your needs:
- MAGNETIC MOUNT stays put even at 100 mph!
- MM-JM-150 for 144 MHz use } Only \$38.50 complete
 - MM-JM-220 for 220 MHz use } \$38.50 complete
 - MM-JM-440 for 440 MHz use } \$38.50 complete

- TRUNK LID MOUNT No holes and low silhouette too!
- TLM-JM-150 for 144 MHz use } Only \$38.50 complete
 - TLM-JM-220 for 220 MHz use } \$38.50 complete
 - TLM-JM-440 for 440 MHz use } \$38.50 complete
- And 1/4 wave antenna for trunk and magnetic mount - \$18.50
- ROOF or FENDER MOUNT Goes on quick and easy in 3/8" or 3/4" with fewest parts.
- JM-150-K for 144 MHz use } Only \$31.50 complete
 - JM-220-K for 220 MHz use } \$31.50 complete
 - JM-440-K for 440 MHz use } \$31.50 complete
- And 1/4 wave antenna for roof and fender mounts \$11.50

Communications Essentials From DAIWA CORPORATION

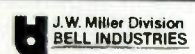

SWR & Power Meter / Model CN-720 \$166.95
Simultaneous direct reading SWR, Forward Power and Reflected Power.
Frequency Range: 1.8-150 MHz
SWR Detection Sensitivity: 5W Min
Power: 3 Ranges (FWD 20/200/1000 W)
Input/Output Impedance: 50 Ohm
Dimensions: 180 x 120 x 130 mm, 6 x 4 x 4.5 in.
Tolerance: ± 100% full scale



RF Speech Processor/Model RF-440 \$135.95
Increases talk power with splatter free operation. RF clipping assures low distortion. Simply install between microphone and transmitter.
Talk Power: Better than 6 dB
Clipping Threshold: Less than 2 mV at 1 KHz
Bandwidth: 2200 Hz at 6 dB down
Frequency Response: 300-3000 Hz at 12 dB down
Distortion: Less than 3% at 1 KHz, 20 dB clipping
Output Level: More than 50 mV at 1 KHz
Power Requirement: 115 VAC, 60 Hz, 1.4 W; or 13.5 VDC, 55 mA
Dimensions: 150 x 70 x 150 mm, 5 x 2.5 x 5 in.

Interference Filters From J.W. Miller

- LOW PASS FILTERS
Input/output impedance 50 ohms. Insertion loss .3 dB max. VWSR 1.2:1. Attenuation greater than 25 dB above 41 MHz.
C-511-T - \$19.90
25 W AM 50 W PEP SSB
C-514-T - \$25.00
100 W AM 200 W PEP SSB.
- HIGH PASS FILTERS
Filter attenuates signals below 40 MHz by a power factor greater than 1,000,000:1.
C-513-T1 - \$10.18; 75/300 ohm
C-513-T2 - \$10.18; 75/ 75 ohm
C-513-T3 - \$10.18
300/300 ohm
- AUDIO INTERFERENCE FILTERS
C-505-R - \$5.07
Installs in the Input lines of audio equipment. Consists of 1 pair.
C-506-R - \$6.07
Installs in speaker lines. Unit will take care of stereo speaker systems.
- AC POWER LINE FILTERS
An easy way to prevent radio signals from entering power line.
C-508-L - \$8.35
3-section LC filter, 3 A max.
C-509-L - \$18.35
5-section LC filter (for more severe interference), 5 A max.

Coaxial Switches

- 2 Position/Model CS-201
4 Position/Model CS-401
- \$20.95
- \$65.95
- Professional engineer of Coaxial Construction - high isolation
Power Rating: 2.5 kW PEP, 1 kW CW
Impedance: 50 Ohm
Insertion Loss: Less than 2 dB
VSWR: 1.1:1
Maximum Frequency: 500 MHz
Isolation: Better than 45 dB at 300 MHz, better than 40 dB at 450 MHz
Indicates normal Connectors: SO 238

Tempo, Ten-Tec, Texas RF, Tonna Antennas, TPL, Tri-EX, Van Gorden, Vibroplex, Vidair, Vista, VHF Engineering, VOMAX, Wilson, YAESU?

QUESTION: Who has Advanced Electronics, Alpha, AMECO, Amphenol, Antenna Specialists, Astatic,

☆☆☆☆☆☆ **PALOMAR ENGINEERS** ☆☆☆☆☆

R-X NOISE BRIDGE \$49.95



- Learn the truth about your antenna.
- Find its resonant frequency.
- Find R and X off-resonance.
- Broadband 1-100 MHz.
- Simple to use. — Self contained.

VLF CONVERTER \$55.00



- New device opens up the world of VLF radio.
- Converts VLF to 80 meters. For use with any shortwave receiver covering 3.5-4 MHz.
- Advanced design for simple operation, high performance.
- Gives reception of the 1750 meter band.
- Also covers navigation radiobeacons, WWVB, ship-to-shore, and LF broadcast band.

LOOP ANTENNA
Loop Amplifier \$67.50
Plug-in loops \$47.50 ea.

- Plug-in loops available for:
1600-5000 KHz (160/80 meter amateur bands)
550-1600 KHz (Broadcast Band)
150-550 KHz (VLF-1750 meter band)
40-150 KHz (WWVB, Loran)
10-40 KHz (Omega)
- Nulls out interference



ALL BANDS PREAMPLIFIER \$89.50



- Tunes 1.8 to 54 MHz. Covers ALL amateur bands 160 to 6 meters. ALL shortwave broadcast bands.
- For receivers AND transceivers.
- Up to 20 db gain.
- Peps up that tired receiver.
- Reduces image and spurious response.



Model MB II \$295
(with Balun) \$325

MB II provides:

- Constant SWR monitoring.
- Precision tuning of final amp.
- Harmonic suppression.
- Receiver input impedance-matching.
- Maximum power transfer to antenna.
- Continuous frequency coverage 1.6 to 30 MHz.
- Precision tuning of any wire 1/2 wavelength or longer, with SWR of 1:1.

MB II features:

- Finest quality, made-in-USA components.
- Large, precision, easy-to-read dials with 360° readout.
- Optional 3000 watt Balun for twin lead antennas.

BIRD
Electronic Corporation

\$94 VHF model 4362 (140-180 MHz)
\$94 HF model 4360 (18-30 MHz)

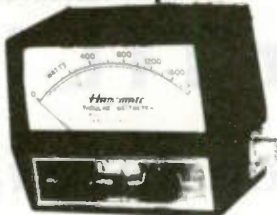

The 4360, 4362 HAM-MATE Directional Wattmeters are insertion type instruments for measuring forward or reflected power in 50-ohm coaxial transmission lines. They are direct descendants of the model 43 THRULINE® Wattmeter — the professional standard of the industry—and will accurately measure RF power flow under any load condition. Each wattmeter is made up of a precisely machined section of 50-ohm line, a rotatable sensing element and meter calibrated in watts, all mounted in a high-impact plastic housing. It is this type of solid construction and the directional THRULINE coupling circuit, without toroids, that account for the superiority of the HAM-MATE Wattmeters.

the indispensable
BIRD 43

THRULINE
WATTMETER



Power Range	Frequency Bands (MHz)							
	3-30	25-60	100-250	250-500	500-1000	1000-2500	2500-5000	5000-10000
5 watts	—	5A	5C	5D	5E	—	—	—
10 watts	—	10A	10C	10D	10E	—	—	—
25 watts	—	25A	25C	25D	25E	—	—	—
50 watts	—	50H	50A	50C	50D	50E	—	—
100 watts	—	100H	100A	100C	100D	100E	—	—
250 watts	—	250H	250A	250C	250D	250E	—	—
500 watts	—	500H	500A	500C	500D	500E	—	—
1000 watts	—	1000H	1000A	1000C	1000D	1000E	—	—
2500 watts	—	2500H	2500A	2500C	2500D	2500E	—	—
5000 watts	—	5000H	5000A	5000C	5000D	5000E	—	—

MODEL 43
Elements (Table 1) 2-30 MHz 45.00
Elements (Table 1) 25-1000 MHz 38.00
Carrying case for Model 43 & 6 elements 27.50
Carrying case for 12 elements 17.00

READ RF WATTS DIRECTLY! (Specify Type N or SO239 connectors) 0.45 - 2300 MHz, 1-10,000 Watts ±5%, low insertion VSWR - 1.05. Unequaled economy and flexibility. Buy only the element(s) covering your present frequency and power needs, add extra ranges later if your requirements expand.



TWO METER

CRYSTALS IN STOCK

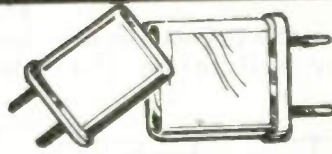

Standard • Icom • Heathkit • Ken • Clegg • Regency • Wilson • VHF Eng • Drake • And Others! Lifetime Guarantee! Now only \$9/pair.



5-BAND TRAP DIPOLE
(80 thru 10 Meters)

Barker & Williamson

Power rated 2k WPEP, approx. 110 ft. span

Complete with: wire, traps, end insulators, 50 ft. RG-8/U, PL-259 connector, heavy-duty cast aluminum and statite center connector. 4-Band (40 thru 10M) 55 ft.



Pre-assembled:
Model 370-11
— \$59.95

Kit (illustrated):
Model 370-12 — \$49.95

Hy-Gain REEL TAPE PORTABLE DIPOLE
for 10 thru 80 Meters Model 18TD

The most portable high performance dipole ever...

The Model 18TD is unquestionably the most foolproof high performance portable doublet antenna system ever developed. It has proven invaluable in providing reliable communications in vital military and commercial applications throughout the world. Two stainless steel tapes, calibrated in meters, extend from either side of the main housing up to a total distance of 132 feet for 3.5 mc operation. 25 ft. lengths of polypropylene rope attached to each tape permits installation to poles, trees, buildings... whatever is available for forming a doublet antenna system. Integrated in the high impact housing is a frequency to length conversion chart calibrated to meter measurements on the tapes... makes installation foolproof. Feeds with 52 ohm coax. Delivers outstanding performance as a portable or permanent installation. Measures 10x5x2 inches retracted. Wt., 4.1 lbs. Order No. 228 Price: \$94.95



hy-gain

BANDPASS-REJECT DUPLEXER
DPLA-144 FOR 144-174 MHz

Also available for
54, 220, 450 MHz.

THESE BAND PASS BAND REJECT CIRCUITS... PLEASE include the use of an enclosed circuit diagram for correct wiring which provides superior suppression of spurious signals... Band Pass Band Reject Circuit provides frequency response curves... quality characteristics of the frequency to be passed and rejected... Performance characteristics of the circuit are... stability of the Band Pass Band Reject Circuit... equipment... all important factors at 144 MHz operating... Each model will handle transmitter outputs up to 350 watts and all models are supplied with complete cable harness and mounting brackets.

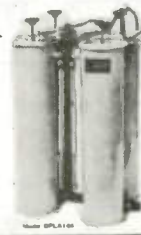

\$409.95

Name _____ Call _____
Address _____
City _____ State _____ Zip _____
Order: _____
 Check Enclosed Visa Master Charge Send for Free Catalog
PRICES SUBJECT TO CHANGE WITHOUT NOTICE
Card no. _____ Card exp. date _____
Signature _____

TUFTS

Radio Electronics
OPEN DAILY 9-9
SATURDAY 9-6

206 Mystic Avenue, Medford, Mass. 02155, 1-800-225-4428, (Mass. residents: 1-617-395-8280

JMR, KLM, Kenwood, Larsen, MFJ, Microwave Filter, Morgain, Mosley, Newtronics, NPC, Nye Viking,

Atlas, Benchner, Bird, Bomar, B&W, CDE, CES, CSC, Cushcraft, Daiwa, Datong, DGM, Drake, ETO, F9FT, Finco, Ham Key, Henry Hustler, Hygain,

the three-digit timer. I prototyped one, and another ham built a working model for his station console using larger readouts. I have not converted my timer, however. I am waiting for some ambitious cat to come up with a drilled PC board for the three-digit model.

I did not know how to reset that middle digit at the end of 60 seconds, so the following is an adventurous safari into the unknown. My first unfruitful attack was researching my old magazine issues for a cut-and-dried circuit to do the resetting job. This takes a lot of time because I found some neat projects and started to check the junk box. I could not find what I wanted, however; life isn't that long. Then the power of reasoning was tried. We know the counters are held low to count and made high to reset to zero. We needed a circuit that would reset the middle digit to zero at the end of six counts and we also wanted to manually reset the counters at any time.

An examination of the truth tables in Fig. 3 shows that the 7492 was the ideal choice, as the "D" output goes high at the end of six counts and could be used for the high we needed to reset the counter. The *TTL Cookbook*, page 83, describing the 7492, stated, "The counter may be reset to zero by bringing either or both "0" set inputs positive." (These reset pins are #6 and #7.) Boy! This is going to be easier than I had hoped. All I needed to do was wire one reset pin to the "D" output and the other reset pin to the manual reset line. This first failure left me rather numb for some time. It took a long time to convince myself that there was a misprint in Don Lancaster's famous *TTL Cookbook*. My next source was the *TTL*

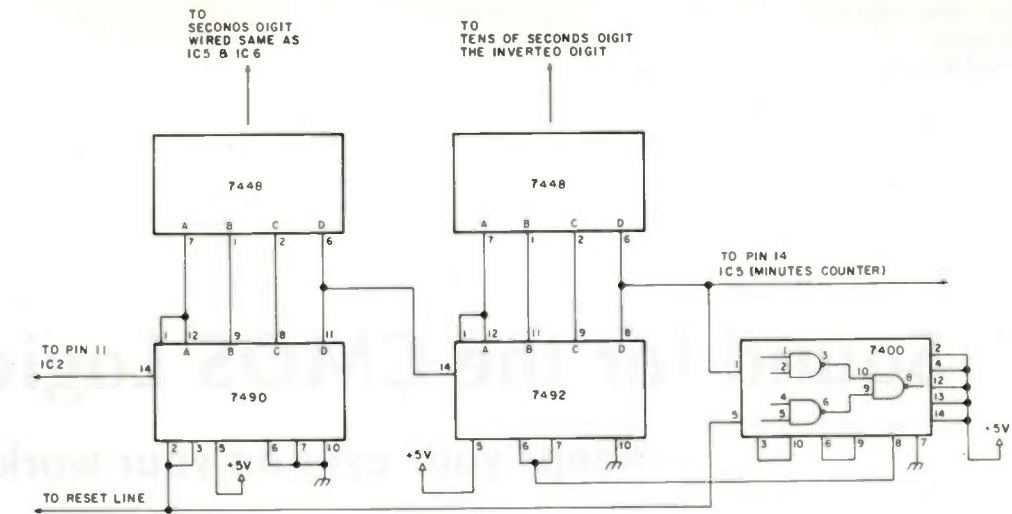

Fig. 2. Automatic reset of tens-of-seconds digit at end of 60-second count.

Data Book by Texas Instruments. Fig. 3(d) shows the 7492 reset/count function table. It plainly shows that both reset pins must be made high to reset to zero.

The average TTL illiterate would have given up by now, but not this one. What was needed was a little black box with two inputs and one output so designed that a high on either or both inputs would give a high output to reset the timer; also, when both inputs are low, the output must be low to hold the reset low in order to count. This sounded a bit familiar and is described on page 128 of *The TTL Cookbook* as the OR gate. The truth table of the OR gate is shown in Fig. 3(a) and is exactly what I had been looking for. I am getting picky now, but I found another mistake on the same page. A NOR gate symbol is shown instead of the OR gate. The OR gate is not stocked here, so I used 1/4 of the 7432 or 3/4 of the 7400 as shown on that same page, to custom-make the OR gate.

The purpose of this article is to illustrate to the novice and diehard tube addict who has never wired a transistor that they can have a ball playing with ICs. Almost all of my projects are one-shot deals, so I use

the direct wiring method on .1" vectorboard for the projects I intend to keep. This is confusing when you turn the board over to do the wiring. Some people have been known to wire the wrong IC backwards. Wiring from a schematic is always a hassle, as the designer puts the pins anywhere for ease of drawing. It is much easier if you place a piece of carbon paper with the carbon side up under a plain piece of paper. Draw in all the components on the side just as they will be placed in your vectorboard. There is a tendency to crowd things, but this should be avoided.

I use sockets for all the ICs, as it makes for easier troubleshooting. It is nice to be able to try other ICs if a project fails, just to prove to yourself that you made a wiring error. Draw in all the wiring and make an over-sized period at every solder connection. When the working diagram is completed, turn it over and you are all set to go (if you had the carbon paper turned the proper way). Stick the components in the board, bending pins here and there to hold them in place. Heat up the old soldering iron and you are on your way to becoming a TTL addict. ■

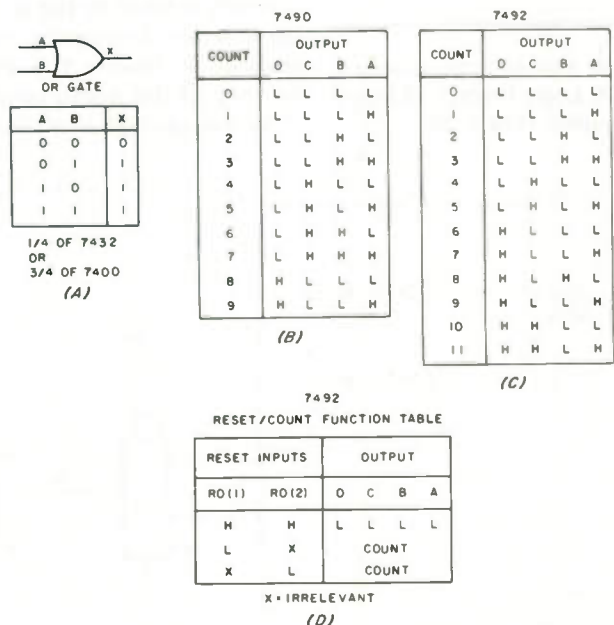

Fig. 3. Truth tables.

Sound for the CMOS Logic Probe

— keeps your eyes on your work

As mentioned in my previous article, "Ultra-Simple CMOS Logic Probe,"* sound can be added either in addition to the LED lamps or instead of any visual signal. This article describes a circuit which adds the sound option, and provides a design which meets the same criterion as the design for the logic probe: inexpensive implementation. A way devised to use a single 555 timer in its astable mode to produce three different tones. These tones are then amplified with a single op amp and fed to a speaker.

*Mark Forbes, "Ultra-Simple CMOS Logic Probe," 73 Magazine, June, 1979, p. 50.

Operation

The operation of the audio circuit is really quite simple, although perhaps unique. As shown in the schematic, the use of the 4049 buffers must be included in the logic probe. These provide the necessary drive for the 555. The 555 is shown in the familiar astable configuration with one modification: Instead of pulling pin 7 to Vcc through a single resistor, three resistors are used in series and are driven high by the 4049s. The 1N914 diodes provide isolation. Since the time constant is directly related to the pull-up resistor, increasing the resistance lowers the frequency of the audio tone.

When no signal is present

on the probe tip, the oscillator does not operate. When a low is present, the 6.8k resistor is effectively tied to Vcc, and a low frequency tone is heard. If a high is detected, an additional 3.3k is added and the diodes act in an OR gate fashion so that the path is from the HI inverter, through both resistors, to pin 7. A pulse signal acts similarly. It should be noted that a high overrides a low, and a pulse will override either. Therefore, if a pulse is detected, the corresponding tone will be heard even if a high or a low is already present.

From the 555, the signal is amplified by an LM386 audio amplifier. A high-low volume switch is provided

to allow the volume to suit the conditions. The circuit will work at a reduced volume if the 555 is fed directly through a 27-Ohm resistor to a speaker. However, the LM386 is recommended.

Construction

My version of the audible logic probe was built on a Vero DIP prototyping board. This allowed easy placement of parts, and made the board narrower by eliminating circuit board foils. A circuit board could be made fairly easily if the builder so desired. The 555 and LM386 seem to be relatively immune to extraneous oscillations, so parts placement is not too critical.

Conclusion

After building and using the audible logic probe, I found a marked preference for this type over the visual type. First, the probe can be made quite thin and small since all the control circuitry can be housed remotely. Secondly, the audible tones allow the operator to keep his vision fixed on the circuit under test; he will not have to look at the lights. The addition of this device requires only a handful of parts; it is quite worthwhile. ■

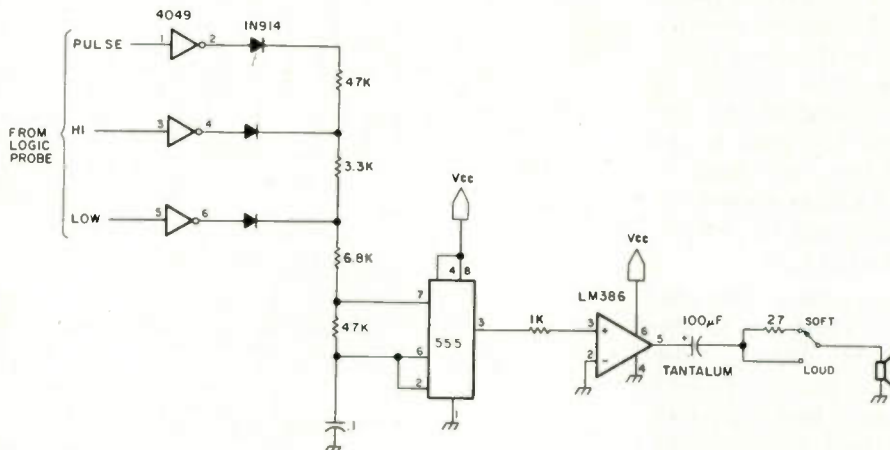

Fig. 1. Audible option for the logic probe.

The LEADER In the Northwest!



ATLAS • ICOM • KENWOOD • YAESU

Come to ABC Communications today for the best solution to your particular communication requirements, whether they be Amateur, Two-way Business Band, VHF Marine or Police Scanner.



Kenwood 7625
2m FM Transceiver



DENTRON MT-3000A
Deluxe Tuner

DENTRON 160-10 AT (not shown)
Super Tuner



TS 180S

TS 120S



Kenwood 7600
2m FM Transceiver

NATIONWIDE NUMBER

Call 206-364-8300 to place your order.

We will pay for call when order is shipped.



FT7B



FT-207R



YAESU 901 DM



Yaesu FT101ZD



ABC
COMMUNICATIONS

✓ A46

17550 15TH AVE. N.E. • SEATTLE, WASH. 98155 • (206) 364-8300

We also handle Wilson, Cushcraft, Hy-Gain, Antenna Specialists, KLM, etc.

Attention Washington residents: Come on in for excellent service in our complete Communications Repair Shop.

Write or call for SPECIAL tower, rotor, antenna package! Tri-Ex, Rohn, Wilson Towers. Shipping Info: F.O.B. Seattle via UPS, truck, or parcel post.

Washington residents add sales tax.



Other locations: (Walk-in customers only) • Bellevue — 12001 N. E. 12th • Everett — 4610 Evergreen Way • Open Mon. thru Sat.

External Relay Control for Converted CBs

— switch anything with this setup

A simple accessory with many uses.

You can pick up new CB transceivers for very little cash. It's really not a difficult job to put these on the amateur 10 meter band. There's just one little catch: Very few CB transceivers have means of controlling external circuits. We radio amateurs, however, are accustomed to having means in our excitors for the control of external devices. This article describes a simple, easily constructed accessory that provides the missing control function.

Really, the circuit is just a third of a larger project, one that will use a CB SSB transceiver for operation on one of the Air Force MARS frequencies that lie far removed from any amateur frequency band and therefore require something other than the com-

mon amateur transceiver for operation. That project will be treated later.

For now, let's consider just what's needed to provide that control function. First, we'll need some means of sensing the rf generated by the transceiver when it's activated to the transmit mode. An isolating resistor backed up by a capacitor for further isolation, an rf choke for a return dc circuit, a signal-type diode, and a bypass capacitor take ample care of that job. Now the rf signal has been transliterated into a dc form, a form suited for actuating a transistor amplifier.

Although it might be feasible to use a single transistor to control a suitable relay, a pair of transistors connected as a

two-stage dc amplifier can use readily-available components, ones you can pick up at Radio Shack or, better still, salvage off a surplus computer board. Such an amplifier can provide sufficient current to actuate a multi-pole, double-throw relay. Finding such a relay may not be an easy task. I was fortunate, as my junk box yielded several General Electric Company model CR2791 B100J3 relays. These are three-pole, double-throw relays that snap over firmly at a current flow well within the capability of run-of-the-mill transistors.

With the components identified, let's take a look at the circuit. You'll note that it's one well-adapted for laying out on a printed circuit board. For the proto-

type, I used a Radio Shack model 276-1392 perfboard and flea clips. This board also had the unexpected advantage of having suitable hole spacing for mounting the G.E. relay!

The values of the several components were arrived at by experimentation. In most cases, considerable latitude is permissible. For instance, R1 was varied from 500 Ohms to 5000 Ohms with no discernible effect upon circuit operation. The two .005-uF bypass capacitors may be replaced by any ones having low reactance at 27 MHz. Similarly, the rf choke was shifted from 45 microhenries to 2 millihenries with no undesirable effect.

A number of NPN transistors were tried. Most worked. A 2N335 was left

**When a DXer really wants to break through the pile-up...
He goes with G.I.S.M.O. & Dentron.**

The DTR-2000L



SPECIFICATIONS:

- Frequency Ranges:
 - 160 Meter Band 1.8 -2.5 MHz
 - 80 Meter Band 3.45-4.6 MHz
 - 40 Meter Band 6.00-9.0 MHz
 - 20 Meter Band 11.00-16.00 MHz
 - 15 Meter Band 20.95-23.50 MHz
- The DTR-2000L will cover most MARS frequencies just outside the Amateur Bands. (With proper coil tap changes and band switch modification, the unit will also cover the 10 meter amateur band.)
- Modes: USB, LSB, CW, RTTY, SSTV
- Power Requirements: 234/117 VAC 50/60 Hz
- RF Drive Power: 125 Watts maximum, and 65 Watts RMS minimum for 1 KW DC input.
- DC Plate Voltage: SSB (Idle + 2600V approximate), CW (Idle + 1800 V approximate)
- Duty Cycle: 100%
- Input Impedance: 50 Ohms nominal
- Input VSWR: 1.5 to 1 average
- Output Impedance: 50 Ohms nominal
- Antenna load VSWR: 3 to 1 maximum
- ALC: negative going, adjustable from rear panel.
- Spurious Emissions: IMD — greater than 30 db down, Harmonics — greater than 40 db down
- FCC Type Accepted
- Size: H 7 1/4" x W 14 1/2" x D 14 1/2"
- Weight: (Including 8877) 54 pounds

The CLIPPERTON L



SPECIFICATIONS

- NEW FEATURE: HI-LO power switching
- 160 thru 15 meters
- 2000 watts PEP input on SSB
- 1000 watts DC input on CW, RTTY, or SSTV
- Forced air cooling
- Self contained continuous duty power supply 2500 V idle SSB — 1800 V idle CW approx.
- 4-572 B Triodes operating in grounded grid.
- Covers most MARS frequencies just outside Ham bands.
- 50 ohm input impedance unbalanced at better than 1.5 to 1 VSWR
- 50 ohm output impedance
- Harmonic Suppression: meets or exceeds FCC requirements
- Built-in ALC (adjustable)
- Easily changed 117V or 234V AC 50-60 hz
- Meter (illuminated) for plate voltage or plate current
- Size: 6" H x 14 1/2" W x 14 1/2" D Weight: 42 lbs.

The GLA-1000



SPECIFICATIONS

- Size: H. 5 3/4" W. 11" D. 11"
- Weight: 24 lbs.
- Electrical Power Consumption:
 - 117 VAC 50/60 Hz 12.5 Amps.
 - Factory fused at 15 Amps.
 - 234 VAC 50/60 Hz 7 Amps.
 - Recommended fuse 10 Amps.
- Frequency Coverage
 - 80 Mtrs: 3.45 to 4.3 MHz
 - 40 Mtrs: 6.950 to 7.5 MHz
 - 20 Mtrs: 13.950 to 14.5 MHz
 - 15 Mtrs: 20.950 to 21.350 MHz
 - 10 Mtrs: With Modification by Licensed Amateur (Covers most MARS frequencies just outside the Amateur Bands.)
- RF Drive: Maximum 135 Watts
- DC Input: 1 KW CW and 1200 Watts PEP SSB
- Input Impedance: 50 ohms 1.5: 1 VSWR APX.
- Spurious Emissions:
 - Ind better than 30 dB
 - Harmonics down better than 40 dB
- Components:
 - 4 — D-50A tubes (6LQ6)
 - 6 — Diodes
- FCC Type Accepted

The MLA-2500B



SPECIFICATIONS

- NEW FEATURE Hi-Lo power switching
- 160 thru 15 meters
- 2000 watts PEP Input on SSB
- 1000 watts DC Input on CW, RTTY, or SSTV Continuous Duty
- Variable forced air cooling system
- Self contained continuous duty power supply 2250 V idle SSB - 1575 V idle CW approx.
- Two EIMAC 8875 external-anode ceramic/metal triodes operating in grounded grid.
- Covers most MARS frequencies just outside Ham bands.
- 50 ohm input impedance unbalanced at better than 1.5 to 1 VSWR
- Harmonic Suppression: meets or exceeds FCC requirements
- Built-in ALC (negative going)
- Built in RF wattmeter
- Easily changed 117V or 234V AC 50-60 hz
- Third order distortion down better than 30 db
- Frequency Range: 1.8 Mhz (1.8-2.5) 3.5 Mhz (3.5-4.2) 7 Mhz (6.8-8.0) 14 Mhz (13.5-15.0) 21 Mhz (20.0-22.0)
- 65 watts minimum drive for 1 KW DC input
- Rack mounting kit available (standard 19" rack)
- Size: 5 1/2" H x 14" W x 14" D
- Weight: 47 lbs.

✓ G22

G.I.S.M.O. 1-800-845-6183

In S. C. call 1-366-7157
2305 Cherry Road, Rock Hill, S.C.
29730 (Exit 66-B off I-77)

in the circuit solely because it was the last of a satisfactory series tested. The PNP is a bit more critical. It has to develop sufficient collector current to snap over a relay and hold it over for a considerable period. Therefore, it needs to be husky as well as being easily turned on. A number fell within this category. The 2N1381 does an excellent job, as do the Radio Shack HEP S5013 and HEP S0012. The one left in position was unmarked and was salvaged off a computer board.

Needless to say, the signal-type diode is highly un-critical. Just about any one will work and work well.

The 1000-microfarad capacitor across the relay coil may be omitted if you don't intend to use the unit with an SSB transceiver. Its function is to hold the relay actuated between spoken words. In the prototype, that particular value

provided the desired delay. You may have to experiment to get the delay you want.

Now, let's talk about how the thing works! A signal is piped in through the R1C1 isolating (and power-reducing) combination to CR1, where it is rectified. The resultant dc circulates through the CR1-Ch1-C2-emitter/base junction mesh to trigger off TR1. Current then flows from the negative terminal of the power supply through TR1 through R2 to the positive power supply terminal. That resistor serves to limit the collector current of TR1 and should not be reduced appreciably in magnitude. The IR drop across R2 is applied through R3 (another current-limiting resistor) to the base of TR2, with C3 serving to bypass any residual radio-frequency component of the signal. That transistor (TR2) is in-

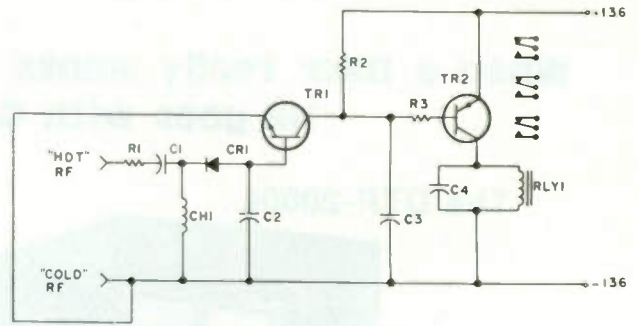

Fig. 1. Rf-actuated control unit. C1—47 pF. C2, C3—.005 uF. C4—1000 uF. R1—5000 Ohms. R2—2200 Ohms. R3—1000 Ohms. CH1—56 uH. CR1—signal diode. RLY1—General Electric CR2791 B100J3. TR1—2N335. TR2—2N1381. R1 is adequate for 4 Watts carried in a 52-Ohm cable; adjust for other powers or impedances. All resistors are 1/2-Watt. C1, C2, and C3 are mica. C4 is rated at 16 volts.

verted, having its emitter to the positive power supply lead. Its collector load consists solely of the dc resistance of the relay; therefore, a relay of at least 200-Ohms resistance should be used in order to limit the collector current to a tolerable figure. As mentioned earlier, capacitor C4 is used only to hold

the relay contacts closed during the short pauses in SSB speech.

With the use of a multipole relay, a variety of control functions can be had. You may want to bypass an amplifier, turn off a power supply, or... you name it!

Build this unit. It's fun to build, and it has many uses. ■

Hustler: The First Family of fixed station two meter gain antennas.

Whatever your requirement, Hustler provides outstanding performance. Precision engineered antennas manufactured with finest materials available.

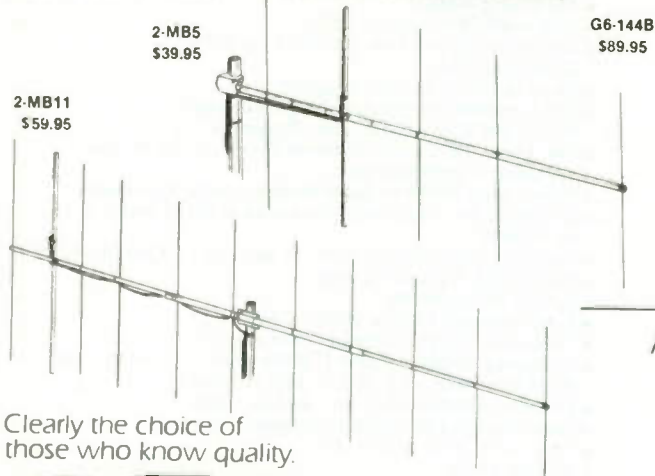

Clearly the choice of those who know quality.

HUSTLER INC

3275 North B. Ave. • Kissimmee, Florida 32741

✓ H36

G7-144*
\$139.95

*Also available in 1-1/4 meter

HUSTLER

DEALERS

Amateur Radio Equipment
1203 East Douglas
Wichita, KS 67211
316-264-9166

Communications Center, Inc.
9624 Fort Meade Rd.
Laurel, MD 20810
301-792-0600

Radio Wholesale
2012 Auburn Ave.
Columbus, GA 31906
404-561-7000

Sandro's Electronics
1559 Brentwood Rd.
Bay Shore, NY 11706
516-666-4434

Stephen's Electronics
5412 Everhart Rd.
Corpus Christi, TX 78411
512-591-6789

Tuft's Radio Electronics
209 Mystic Ave.
Medford, MA 02155
800-225-4428

The MICROLOG Video Display Terminal for Morse & RTTY . . .

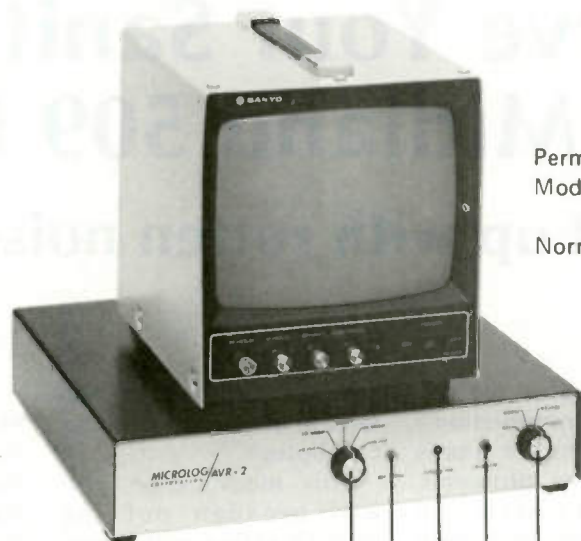

Permanent display of selected
Mode, Speed and clock

Normal or ZOOM* display

Computer Enhanced
dual tone RTTY demod

Audio tuning
aid-on/off

LED tuning indicator

On/off-Morse Baudot
& ASCII select

Morse calibrate & RTTY
speed select

. . . and the Story Behind It

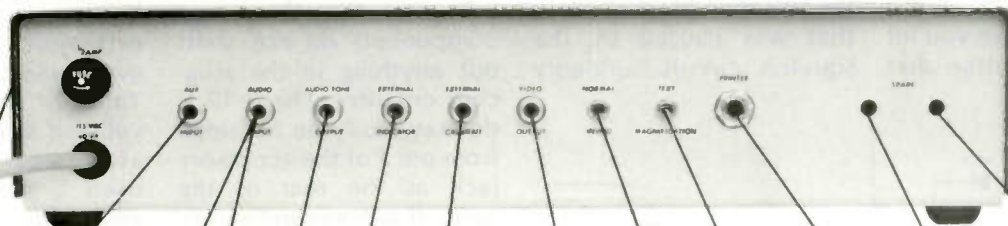

Heavy duty enclosure
Keyboard hand Key or TTL
Receiver speaker
To scope display
Remote LED
Remote pushbutton
Monitor or television
Black or White screen
Normal/ Zoom select*
Loop or RS-232*
Split-Screen cable to AKB-1*
Computer cassette interface*

AVR-2 Video Display Terminal	\$499
VM-4209 Video Monitor (9 inch)	\$189
VHF Video Modulator	\$ 30

Prices subject to change

*Optional Features

One year warranty on all products. Write for additional information.



✓ M55

MICROLOG
CORPORATION

4 Professional Drive – Suite 119
Gaithersburg, Maryland 20760
Telephone (301) 948-5307

Preserve Your Sanity with this Midland 509 Mod

— why put up with rotten noises?

Wayne Rankin WA6MPG
PO Box 41
Tujunga CA 91042

The Midland 13-509 is basically a nice radio. It does, however, have a few areas where there is room for improvement. One of the most obvious shortcomings of the 509 is the squelch circuit. It has been properly accused of a rather sharp attack, and a blast of noise when you let go of the mic button that

becomes loud after the second or third transmission.

There is a rather simple cure for these problems, and all it will cost you is a resistor, a diode, and about ten minutes of your time.

Fig. 1 shows the squelch circuit of the 509. The addition of a diode connected in series with a resistor from a keyed 12-V dc bus will keep the squelch switching transistor (TR-13) closed during the transmit period. This will eliminate the irritating blast of noise that was caused by the squelch circuit suddenly

being energized at the release of the mic push-to-talk button.

This modification also will broaden out the squelch action, which may or may not be desirable, depending on personal preference. If a harder squelch action is desired, cut C91 out of the base circuit of TR-13. This capacitor does nothing but delay the lockup of the transistor.

Placement of the parts is not very important, but take care that these new components do not short out anything in the adjacent circuitry. The +12 V dc may easily be obtained from pin 3 of the accessory jack at the rear of the radio. If a more sanitary approach is desired, I suggest point 27, near the speaker on the transmit board. I have used both points with equal results.

The slender lead of the 914 diode will probably slip right into the hole in the PC board, allowing installation from the top. If this method is not practical, attach the diode to the bottom of the board. Be sure that you have located the correct place for the connection, as all of that foil down there tends to look the same.

My experience has been that a small, slightly-obnoxious noise, frequently repeated, will become extremely irritating over even a short period of time. Think of this as you find yourself strangely enraged after what should have been a pleasant QSO in your mobile. Was it the weather, the traffic, or the "squelch tail" on your radio?

Modify your squelch and have a nicer day! ■

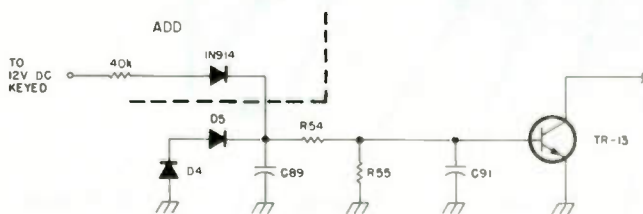

Fig. 1.

something new!

ALL WE DO IS AMATEUR SERVICE, SO... WE HAVE TO BE GOOD!

Why buy new gear when your old gear can be refurbished for a fraction of the cost? Just send your equipment with mic, manuals and a description of the problem. For faster service, call first. We try to anticipate needs and have parts on hand.



International Electronic Communications, Inc.

503 Avon St., Mocksville, NC 27028 PH (704) 634 5661

✓144





MOBILE 10

- 17-7 PH Stainless Steel Tapered 54" Whip—Deflects easily when struck—Minimum wind deflection—cut in field to match ground plane variables.
- 150 Watt capacity
- Unique dual-angle radiation pattern is ideal for groundwave communications as well as skip propagation.
- Minimum SWR at Band Edges
- Frequency Range 28-29.7mc

MOBILE 2

- 17-7 PH Stainless Steel Tapered 42" Whip—Deflects easily when struck—Minimum wind deflection.
- No ground plane required.
- 200 Watt capacity
- Low angle of radiation for repeater and Simplex operations.
- Low SWR across entire 2-Meter Band—Excellent for existing and new repeater channel operation
- Frequency Range 144-174mc

MOBILE 70CM

- 17-7 PH Stainless Steel 14" Whip
- 200 Watt capacity
- No ground plane required.
- Low Angle of radiation maximizes performance to hilltop remote base stations
- Designed for uplink and direct communications.
- Frequency Range 430-470mc



METZ COMMUNICATION CORP.

Corner Route 11 & 11C
Laconia, New Hampshire 03246
Tel.: 603-524-8806

✓ M100

PRICING (Any frequency)

- Coil with 90 lb. pull Mag Base _____ \$49.95
- Coil with Thru-Vehicle Mount _____ 39.95
- Coil with Right Angle Bracket _____ 34.95

Enclosed \$ _____ Check Money Order
 Master Charge VISA
 Credit card # _____ Exp. date _____
 Name _____
 Address _____
 City _____ State _____ Zip _____
 Signature _____

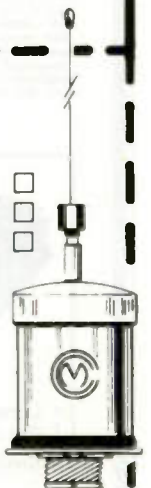

Touchtoning Your Memorizer

— Yaesu's made it easy

Tom Hart AD1B
730 Gay St.
Westwood MA 02090

I recently purchased a Yaesu Memorizer for my two meter operations. This



Fig. 1. Front view of Yaesu connector.

has been my first exposure to synthesized operations, and I've been very surprised at the amount of activity that I can hear while listening up and down the band. All in all, the Memorizer is an excellent buy and meets all of my expectations.

Since touchtone™ facilities come in very handy at times, I decided to look into using my Drake touchtone mike

(model 1525EM) with the rig. The Yaesu manual does not give any data on the microphone requirements, so I checked the schematic. It appeared that the rig is factory-wired to provide 12 V dc at the mike connector. A check with a VOM showed that pin #4 does provide the voltage necessary for the pad and that no internal modifications would be required. I rewired the Drake micro-

phone with a Yaesu connector as shown in Fig. 1.

The new arrangement works quite well and no adjustments were necessary to the tone levels. It worked on the first try. What's more, the new mike caused no loss to the audio qualities of my golden tones while in the windbag mode. So, if you want to use a touchtone pad with your Memorizer, this arrangement will work quite well. ■

DON'T ACCEPT SUBSTITUTES

LUNAR ELECTRONICS DEALERS: ALASKA: Jalco Imports, P.O. Box 1253, Anchorage, AK 99510 • ARIZONA: Communication Sales, 9727 North Central, Phoenix, AZ 85022 • CALIFORNIA: Buddy Sales, 18552 Sherman Way, Reseda, CA 91335 • C & A Electronics, 27010 S. Wilmington Ave., #105, Carson, CA 90745 • C. W. Electronics, 7528 Topoka, Reseda, CA 91335 • C. Iron, 48 South Chestnut Street, Ventura, CA 93001 • Fontana Electronics, 8628 Sierra Ave., Fontana, CA 92335 • Ham Radio Outlet, 2620 West La Palma Ave., Anaheim, CA 92801 • Ham Radio Outlet, 999 Howard Avenue, Burlingame, CA 94010 • Ham Radio Outlet, 2811 Telegraph Ave., Oakland, CA 94609 • Ham Radio Outlet, 5375 Keamy Villa Road, San Diego, CA 92123 • Ham Radio Outlet, 6265 Sepulveda Blvd., Van Nuys, CA 91401 • H.E.M.C., 217 West Gutierrez St., Santa Barbara, CA 93101 • Henry Radio, 931 North Euclid, Anaheim, CA 92803 • Henry Radio, 11240 W. Olympic Blvd., Los Angeles, CA 90064 • Hobbis-Tronics, 1378 S. Bascom Ave., San Jose, CA 95128 • Lion Electronics, 457 Broadway, Chula Vista, CA 92010 • M & M RF Distributors, 2785 Kurtz St., Suite 4, San Diego, CA 92110 • Vineyard Amateur Sales & Service, 8407 Vineyard Rd., Oxnard, CA 93030 • FLORIDA: Bob's Amateur Radio Center, 7322 N. W. 46th St., Miami, FL 33166 • GEORGIA: Radio Wholesale, 2921 Auburn Avenue, Columbus, GA 31906 • KANSAS: Revcom Electronics, 6247 N. Hydraulic, Wichita, KS 67219 • Wheel's Communications, 15001 Mullen Road, Olathe, KS 66061 • KENTUCKY: Wise Radio & TV Service, P.O. Box 152, Irving, KY 40336 • MARYLAND: Tycol Communications, Route 2, Box 499, Olde Oak Drive, Mt. Airy, MD 21771 • MASSACHUSETTS: Spectrum International, 17 Deacon Hunt Drive, West Acton, MA 01932 • MISSOURI: Henry Radio, 211 North Main, Butler, MO 64730 • MINNESOTA:

Authorized
LUNAR
electronics
Dealer

Pal Electronics Inc., 3452 Fremont Ave., No. Minneapolis, MN 55412 • NEW JERSEY: Radios Unlimited, P.O. Box 347, Somerset, NJ 08854 • NORTH CAROLINA: Bob's Amateur Radio Center, 318 North Main St., Salisbury, NC 28144 • OHIO: JRS Electronics, 6381 Muller Road, Cincinnati, OH 45239 • Universal Amateur Radio, 1280 Aida Drive, Reynoldsburg, OH 43068 • OKLAHOMA: Brodie Electronics, 2537 Edgewood Drive, Moore, OK 73160 • SOUTH CAROLINA: Maury's VHF-UHF, 253 Providence Square, Greenville, SC 29615 • TENNESSEE: Rush Electronics, 1315 Bluff City Hwy., Bristol, TN 37620 • TEXAS: Madison Electronics Supply, Inc., 1508 McKinney Ave., Houston, TX 77002 • WASHINGTON: C. Comm., 6115 15th Northwest, Seattle, WA 98107 • AUSTRALIA: Emona Electronics, Room 208, 661 George St., Sydney, New South Wales • CANADA: Communications Plus, 3650 Cole Valley St., Laurent, Quebec H4R 1P9 • CHILE: Manuel H. Urzua, Casilla 6059, Santiago, Chile • FINLAND: Erhoismediala, P.O. Box 677, SF-00101, Helsinki 10 • GERMANY: Ingenieurburo Ulrich Hansen, Wurselener Strasse 73, D-5190 Stolberg • JAPAN: Tama Electronics Company, Kumuraya Bldg., 2F, 515 Higashi-Ozumi, Nerima-Ku, Tokyo 177 • NEW ZEALAND: Southern Cross Electronics, 26 Southern Cross Rd., Rohnarama, Auckland • PORTUGAL: Germino Lopes & CIA, Lda, Av. Fernao de Magalhaes, 860, Porto • REPUBLIC OF SOUTH AFRICA: Wild & Mann Communications, P.O. Box 3553, Johannesburg 2000 • SPAIN: Distribuidora Sistemas Electronics, SA Villarrod 68 Bajos A, Barcelona • SWEDEN: Kungsinport, Box 10257, S-434 01, Kungälv • VENEZUELA: Panamericana De Comunicaciones CA Apdo 76093, Caracas •

Look for this Authorized Lunar Dealer Emblem.

Lunar offers a complete line of Linearized Amplifiers, Pre-Amps, Transverter modules, and portable antenna towers. See them today at your Authorized Dealer.

If you're looking for quality Lunar products, be sure you go to one of the authorized Lunar dealers listed above. He can give you complete information on our outstanding line of amateur products, and if he doesn't have exactly what you want in stock, he can get it for you almost immediately.

We choose our dealers because they are qualified, professional ham dealers. Why don't you do the same.

✓ L17
arma
Louis N. Anclaux
WB6NMT

LUNAR
electronics

2785 Kurtz Street
Suite 10
San Diego,
CA 92110
(714) 299-9740
Telex 181747

Call 1-203-667-0811

ORDER YOURS TODAY!



USED EQUIPMENT—We have a great selection of clean, used gear. We bring it up to normal specifications in our Service Shop before resale.



OUR 2 METER CORNER—Seems a lot of the local hams like this: spot the best... Must be the free coffee pot.



LOOK—at the clean used Collins gear! They just don't build 'em like that anymore. Now you can afford to own an "S" line!



We have a great selection of used gear ready to demonstrate. All new gear for sale is in factory sealed cartons in our warehouse.



SERVICE SHOP—Using Cushman CE-4B Signal Generators, CE-15 Spectrum Analyzers, H.P. Scopes—We fix it Right!



INVENTORY WAREHOUSE—Our large volume assures you the best prices and latest stock!

Call for New Retail Catalog & Monthly Used Equipment List!

AUTHORIZED DEALER . . .

. . . FOR OVER 50 MAJOR LINES

NEW AND USED EQUIPMENT "Get on our used equipment mailing list."

TRADES WELCOME "The best allowances anywhere"
"We buy good used SSB gear"

OUR EVERYDAY LOW PRICES "remain the same for cash or trade-ins!"

24 HOUR U.P.S. SHIPPING "Just a phone call away"

COMPLETE RADIO SERVICE SHOP "Mail Order Repair Service"

- Fast Efficient Service
- Most Repairs Done and Shipped Within 14 Days
- We Repair All Brands
- Amateur Extra/First Class Licenses
- All Work Guaranteed
- Include Manuals and Power Supply
- Send Us Your Defective Equipment Prepaid Shipping

OUR FINE REPUTATION SPEAKS FOR ITSELF . . . "YOU SHIP IT — WE FIX IT"
WE TAKE PHONE ORDERS OR SHIP C.O.D.

We Sell and Service the Following New and Used Equipment:

- | | | |
|------------|-----------|-------------------|
| Alda | DSI | Mirage |
| Alliance | ETO Alpha | Mosley |
| Ameco | Ham Key | Murch |
| ARRL | Hustler | PIPO |
| Atlas | Hy-Gain | Robot |
| Bencher | ICOM | Rohn |
| Bird | JW Miller | Saxton Wire |
| B & W | KDK | Shure |
| Callbook | KLM | SST Electronics |
| CDE | Larsen | Swan |
| CES | MFJ | Telex |
| Covercraft | Microlog | Ten Tec |
| Cushcraft | | TET Antennas |
| Dentron | | Trac |
| Drake | | Unadilla |
| | | VHF Engineering |
| | | Vibroplex |
| | | Wilson |
| | | Wilson Commercial |
| | | Yaesu |

**Call
or Write
for your
super quote
today!**



**WE EXPORT
(Sub-Dealers
wanted in
foreign countries)**

THOMAS COMMUNICATIONS

95 Kitts Lane, Newington, Conn. 06111
"Near ARRL Headquarters"

Connecticut Residents Call: 203-667-0811
OPEN MON. - FRI. 10-6 • THURS. 10-8 P.M. • SAT. 10-4
EASY DIRECTIONS: Rt. 15 South — 2 blocks past McDonald's (Berlin Turnpike)

SUB-DEALER INQUIRIES INVITED! (Send letterhead for complete package)

The Small But Mighty Arboreal Aerial

— tree-hanging triband vertical

Living in apartments these past five years, I've learned a lot about short antennas, bent antennas, and antennas with traps. I've had to. I simply haven't had the room to put up the kinds of antennas that I would really like to have. Fortunately, I've usually had a small patch of dirt and a sturdy tree outside the window. By

stringing up, over the years, an assortment of temporary wire antennas running to the nearest tree limb, I have been able to make many good contacts on all bands from 160 meters to 2 meters. And I've done my DXing with low power to minimize TVI and CQs coming out of the speakers of neighbors' stereos.

An efficient three-band vertical for power levels under 200 Watts can be made cheaply with wire, insulators, and homemade traps. The wire vertical that I've used for more than two years can be suspended from a tree limb or other support. It can be bent, sloped at angles up to 45 degrees or more, used indoors, rolled up and taken on camping trips, or tossed out an upstairs window to work as an "inverted vertical." Some sort of ground system is necessary, and a network of radial wires beneath the vertical could make it perform as well as a store-bought trap vertical.

Begin by cutting a piece of antenna wire to a length of 8 feet 6 inches. Connect one end of this wire to your coax and ground system. Suspend the other end vertically from an insulator and a support. Using your swr bridge as a guide and a few Watts of 28-MHz rf, trim the antenna from the top—a half inch at a time—for the lowest swr in your favorite section of the

10-meter band. Take down the wire temporarily and build the first trap. I used a 47-pF, 5-kV disc ceramic capacitor hooked across 8½ turns of no. 18 wire, ¼ of an inch in diameter and 1½ inches long, with the turns spaced by 1/8 of an inch. Do not solder the leads together until you have trimmed the coil to resonance at 28

You also can make two of these wire antennas for 20, 15, and 10, hook them to coaxial cable in the usual dipole fashion, and have a dandy three-band antenna for horizontal or vertical mounting.

A grid-dip oscillator is necessary to adjust the traps to the right frequency range. To protect the traps from rain and ice, I enclosed them inside plastic

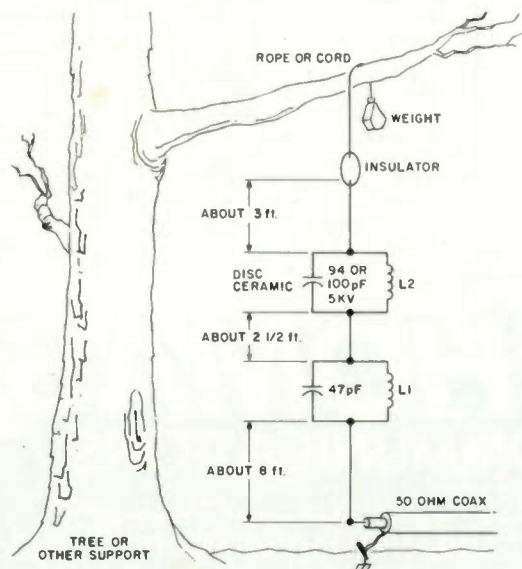

Fig. 1. The tree-limb antenna. L1 = 8½ turns of no. 18 wire, ¼" diameter and 1½" long, with 1/8" turn spacing. L2 = 9 turns of no. 18 wire, 5/8" diameter and 1½" long, with 1/8" turn spacing.

MHz using the grid-dip meter. Then install the trap in its case and solder one lead to the top of the wire previously trimmed for lowest swr on 10 meters. Solder a 3-foot piece of antenna wire to the top lead of the trap, suspend this combination from a support, and trim the top section for lowest swr on either 21 MHz or your favorite section of the 15-meter band. On my an-

tenna, this top section turned out to be 2½ feet long.

If you want only a 15- and 10-meter trap vertical, you can stop right here and put the antenna up in the air. But if you add just one more trap resonant to 21 MHz and another 3 feet of antenna wire, you can operate 20 meters as well. My second trap consists of two 47-pF, 5-kV disc ceramics in parallel (94 pF total

capacity—or use 100 pF) hooked across 9 turns of no. 18 wire, 5/8 of an inch in diameter, 1½ inches long, with the turns spaced by 1/8 of an inch.

Using the grid-dip meter, trim the coil and capacitor combination to resonate at 21 MHz. Then solder the trap to the top of the wire previously trimmed for lowest swr at 21 MHz. Solder 3 feet of antenna wire to the top of the trap and

trim the wire for lowest swr on 14 MHz.

Hang the wire securely from a tree limb or other support and put it on the air. The whole antenna is about 14 feet long.

I don't make any great DX claims for this antenna, but it has helped me reach all continents with 180 Watts or less. And I haven't had to give up ham radio just because I live in an apartment. ■

What Do You Do When Your Rotator Dies? —you fix it . . . like this

*Carl C. Drumeller WSJJ
5824 NW 58 St.
Warr Acres OK 73122*

The Problem: After several decades of faithful service, the control unit of my Ham-M rotator ceased functioning. A postmortem examination revealed a

dead 130-microfarad, 50-volt alternating-current motor-starting capacitor.

The Non-Solution: A quick survey of electronic supply stores showed that no such capacitors were available. A visit to electrical supply houses revealed numerous motor-starting capacitors, but none was physically small enough to fit into the space within the control unit housing.

The Solution: Two 150-microfarad, 50-volt electrolytic capacitors and two 100-volt, 3-Ampere silicon rectifiers were used in the

circuit shown. The control unit was resuscitated.

Another interesting situation came to light during the repair job. The meter had been intermittent, sometimes operating normally, sometimes quite dead. The cause was the 1/16-Ampere fuse used in series with it. This is indeed unusual. A fuse normally is fully conductive or unmistakably open. This one probably had a mechanical discontinuity instead of having been blown. The original one was soldered in place, an action fraught with peril to the delicate in-

terior conductor. A clip-type fuse holder was installed to minimize the probability of future trouble.

For those interested in the theory of the functioning of the circuit, the explanation is simple. During any half-cycle, one capacitor is shorted by its associated diode. It might be presumed that having two capacitors in series, the resultant capacitance would be halved. This, however, is not the case because the diode acts as a bypass for the capacitor during every half-cycle. ■

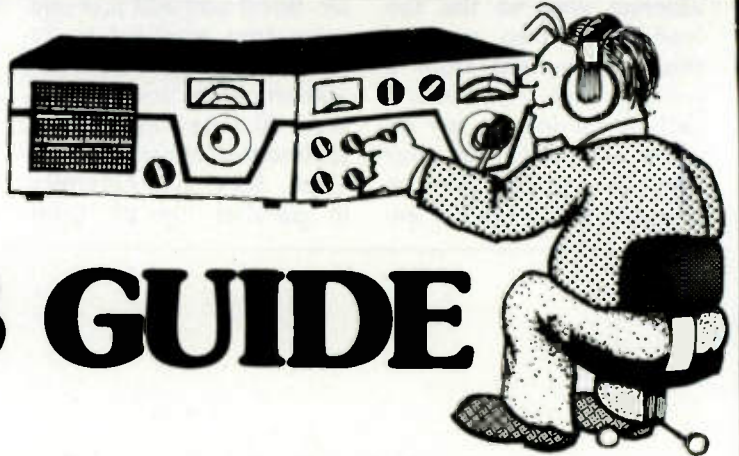

Fig. 1.

CALL LONG'S TOLL FREE

1-800-633-3410 TODAY!

LONG'S HAM BUYERS GUIDE



Prices in this catalog subject to change without notice. Prices good only while supply lasts.



YAESU FT-101Z high performance HF transceiver

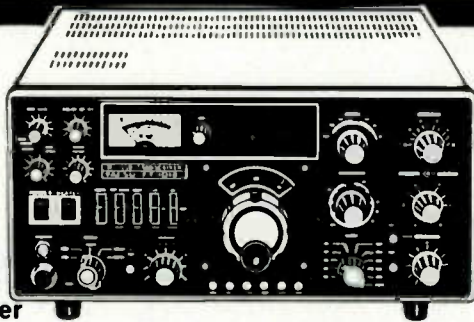

Covers 160 thru 10 meters plus WWV, modes are: LSB, USB, and CW, built-in power supply, built-in RF speech processor, built-in noise blanker, variable IF bandwidth, analog frequency readout, 6146 final tubes with RF negative feedback, heater switch, VOX, attenuator 10 dB or 20 dB selectable. Power requirements: 110/110/227/200/220/234 volts AC 50/60 Hz.

749.00 List. Call for quote.

Introducing the new KENWOOD TR-2400 synthesized 2m hand-held transceiver

Featuring: 143.900-148.495 MHz, operates on MARS, 10 memories, automatic memory scanning and up/down manual scanning for busy or open channel, mode switch for standard repeater \pm 600 KHz, offset, simplex and non-standard repeater splits, LCD digital readout, built-in touch tone generator with 16 button keyboard, and 1.5 watts RF output. Includes flex antenna with BNC connector, NiCad battery pack and charger.



349.00 Call today.

YAESU

YAESU FT-207R Synthesized Handie-Talkie

Covers 144-148 MHz, has 10 KHz steps, 3 watt output, 4 memories plus programmable offset, priority channel, memory band and auto scan, keyboard encoded frequency entry, 2 tone input from keyboard, keyboard lock, odd splits can be programmed from keyboard, automatic battery saver feature for LED display and a rubber flex antenna.

399.00 List. Call for quote.



**ORDER
NOW!**

NEW KENWOOD TS-520SE High Quality HF transceiver

200 watts PEP SSB, 160 watts DC CW, 160 thru 10 meters, noise blanker, 3 position amplified-type AGC, RIT, 8 pole crystal filter, built-in 25 KHz calibrator, VOX, PTT, MANUAL operation, speech processor, semi-break-in CW with sidetone, low power tune up, 20-dB RF attenuator and built-in speaker.

629.95 List. Call for quote.



Long's Electronics



CALL LONG'S TODAY!

CALL FOR SPECIAL DISCOUNT PRICE!



KENWOOD RM-76
microprocessor control unit

The remote control unit with a built-in microprocessor for use with the TR-7600 and the TR-7625. Has a digital display, 6 memory channels, scans 6 memory channels and empty & busy ones. Memory data stored even if power switch is off.

125.00 List. Call for quote.

CALL FOR SPECIAL DISCOUNT PRICE!

KENWOOD TR-7625
25W
transceiver

The unit has memory channel with simplex or repeater operation ± 600 KHz transmitter offset, mode switch for switching the transmit freq. up or down, full 4 MHz coverage on 2m (144.00-147.995), 800 channels, 5 KHz offset switch, MHz selector switch, digital freq. display, unlock indicator for transceiver protection.

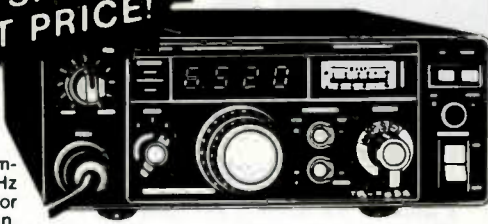

425.00 List. Call for quote.



KENWOOD MC-45
touchtone mic

Touchtone circuit provides PTT (push to talk) with 1/2 second hangtime after any button is pushed. Dynamic, omnidirectional, 500 ohm impedance mic with adjustable tone output level. Power requirement: 8 VDC, 20 mA. Complete with coiled cord and 5 pin mic connector. Compatible with the TR-7600 and TR-7625 with no modification.

49.95 Call today.

CALL FOR SPECIAL DISCOUNT PRICE!



KENWOOD TR-7600 2m 10 watt
FM transceiver

A high performance FM transceiver with memory, 800 channel operation, 4 digit frequency display, memory circuit to store any desired channel, memory circuit used to shift transmit frequency desired amount besides ± 600 KHz. Final stage protective circuit. Small RF power module for compact design.

375.00 Call for quote.

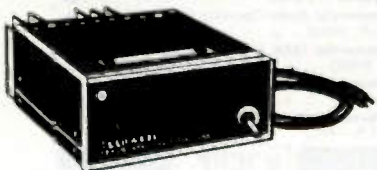

KENWOOD KPS7
power supply

This is power supply designed for use with the 7600/7625 transceivers. 6 A continuous, output voltage 13.8 VDC, current limiting protection circuit and voltage limiting protection circuit.

79.95 Call today.

CALL FOR SPECIAL DISCOUNT PRICE!

KENWOOD TS-700SP
all mode
2m transceiver

Covers the entire 2 meter band, SSB, CW, FM, AM, and semi-break in CW, side tone monitor, digital frequency readout, receiver preamp ± 600 KHz repeater offset operation within all 2m repeater subbands including the new 144.5-145.5 MHz. 10 watts RF output complete with AC/DC power supply.

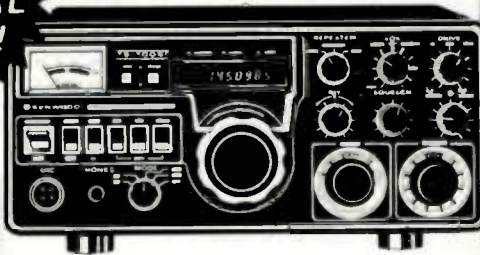

799.00 List. Call for quote.

CALL FOR SPECIAL DISCOUNT PRICE!



KENWOOD PS-6
power supply

Power consumption: less than, output voltage: DC 13.8V, 2A continuous. Speaker section: 1W input, 3 inch speaker, freq. res.: 200-3500 Hz.

79.00 Call today.

BIG BUY!

200 WATTS PEP!
KENWOOD TS-120S
All solid state
HF SSB transceiver

No tune up! Miniaturized circuits, solid state construction, built-in digital display, IF shift, final transistor protection, VOX, noise blanker, 25 KHz marker. Frequency range is 80 to 10 meters and WWV, modes: SSB and CW, power requirements: RX-0.7A 13.8 VDC, TX-18A 13.8 VDC. 3 1/2"Hx9 1/4"Wx13 1/2"L. Weight: 11.7 lbs.



699.95 List. Call for quote.

1-800-633-3410 TOLL FREE



Long's Electronics



& MAPS CALL TOLL

FOR YOUR BOOKS, TAPES



ARRL Publications

ARRL Radio Amateur's Handbook Newly revised & jam-packed with everything from basics to latest developments. I.N. 10081 9.75

ARRL Radio Amateur's License Manual The most up to date compilation of rules & regulations. Covers from Novice to Extra Class. I.N. 10012 4.00

ARRL Novice Q and A Book. A new pocket sized study guide with 223 sample question and answers and a sample novice exam. 96 pages. I.N. 10008 2.00



ARRL Antenna Handbook Complete instructions for building antennas of all types. I.N. 10026 5.00

ARRL World Map I.N. 10099 3.50

LCF Calculator Slide rule type calculator to compute resonant frequency, etc. A great aid! I.N. 10062 3.00

Electronic Data Book All you need to know about Filter design, RF circuit data, antennas and feedline info & more. I.N. 10027 4.00

Learning to Work With Integrated Circuits Build a digital voltmeter/freq. counter while learning about IC's. I.N. 10060 2.00

Single Sideband for the Radio Amateur Covers theory and practical how-to-built ideas. I.N. 10017 3.00

FM and Repeaters for the Radio Amateur Learn all about FM and repeaters from this handy book. I.N. 10014 5.00

Solid State Design for the Radio Amateur Packed with information for practical use of solid state devices. I.N. 10061 7.00

Solid State Basics Pure solid state information and practical basics for today's ham. I.N. 10037 5.00

ARRL Repeater Directory By Stan Horzepa, W1LOU. Handy sized booklet with room for your own notations. I.N. 10047 1.00

ARRL Radiogram Message Pads I.N. 10007 75 ea.

ARRL Special Operating Kit Consists of ARRL Ham Radio Guide, full color U.S. area call map, ARRL log book, 70 ARRL radiograms. I.N. 10063 6.50

ARRL Ham Radio Operating Guide Brush up on good operating practices with this ready reference source. I.N. 10025 4.00

ARRL Satellite Communications Includes Getting to Know OSCAR, info on the "RS" satellites, maps, locators and more! I.N. 10064 4.75

80 meter DXing Handbook. Contains 4 sections on propagation, antennas, station equipment, and operating practices. It's filled with solid practical experience. I.N. 26307 4.50

The Amateur Radio Vertical Antenna Handbook The first book for amateurs solely about vertical antennas. It is full of information. I.N. 26316 5.00

The Challenge of 160 The unique operating characteristics are explained and there are tips on building simple equipment. I.N. 26312 4.95

WIRE ANTENNAS

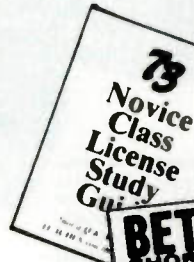

BETTER SHORTWAVE RECEPTION



Hints and Kinks New ideas written by hams themselves. This is full of practical ideas and tips that they have used successfully. I.N. 10029 4.00

Radio Frequency Interference A new book to help everyone understand RFI. It covers all from good neighbor relations to simple technical cures for RFI. Helps identify and solve problems. I.N. 10083 3.00



ARRL Code Kit Upgrade your Novice or Tech. License with these 2-60 min. cassettes with speeds of 5, 7 1/2, 10 & 13 wpm. Instruction book included. I.N. 10046 8.00

ARRL Log Books spiral bound books
Large I.N. 10015 1.75
Small I.N. 1002075

Tune In the World with Ham Radio Learn all about amateur radio with a text and a Morse code cassette. For the beginner studying for the Novice exam. I.N. 10031 7.00

Understanding Amateur Radio A must guide for the newcomer. It explains in simple language elementary principles of electronics & tells how to build low cost equipment. I.N. 10016 5.00

Radio Publications, Inc.

Beam Antennas Handbook by Wm. Orr, W6SAI. I.N. 26200 4.95

Wire Antennas by Wm. Orr, W6SAI. I.N. 10058 5.95

All About Cubical Quad by Wm. Orr, W6SAI. I.N. 26201 4.75

The Truth About CB Antennas by Wm. Orr, W6SAI. I.N. 26202 5.95

EIMAC's Care and Feeding of Power Grid Tubes I.N. 26205 6.95

The Antenna Handbook I.N. 26207 6.95

VHF Handbook by Wm. Orr, W6SAI. I.N. 26203 5.95

Better Short Wave Reception by Wm. Orr, W6SAI. I.N. 26204 4.95



Ameco Books

Communicate with the World with Ham Radio NP-1. I.N. 24825 6.95

Ameco 7-01 Question and Answer Guide for the Novice Exam I.N. 24828 1.00

Ameco 12-01 General Class Question and Answer Guide. I.N. 24829 1.50

Question & Answer for Advanced Class Exam 16-1 I.N. 24809 1.50

Question & Answer for Extra Class Exam 17-1 I.N. 24810 1.50

Radio Amateur Theory Course 102-01 I.N. 24812 5.95

Radio Electronics Made Simple I.N. 24800 2.50

Logbook I.N. 24807 1.50

Commercial Radio Operator Theory Course 15-01 I.N. 24808 6.95

Commercial Q&A License Guide Ele. 4 10-01 I.N. 24805 1.95

Commercial Q&A License Guide Ele. 3 9-01. I.N. 24804 2.95

Commercial Q&A License Guide Ele. 1, 2, & 8, 9, 01. I.N. 24803 1.50



Other Great Books

Practical Antennas for the Radio Amateur by Robert Myers, W1XT. A new basic antenna book to tell you every thing about making and using antennas. Ills. with pictures and line drawings. I.N. 32407 9.95

Collins Radio Co. SSB Amateur Single Sideband. I.N. 10092 4.95

73 Magazine VHF Antenna Handbook I.N. 26303 4.95

73 Magazine Novice Class Study Guide. I.N. 26300 4.95

73 Magazine General Class Study Guide. I.N. 26301 5.95

The Beverage Antenna Handbook. I.N. 26208 5.00

K3CHP DX OSL Guide I.N. 26313 3.95

Amateur TV in a Nutshell. I.N. 26322 5.00

How to Make Better OSL's. I.N. 26304 4.95

The Complete Handbook of Slow Scan TV. I.N. 30518 9.95

Remember, you can Call Toll Free: 1-800-633-3410 in the U.S.A. or call 1-800-292-8668 in Alabama for our low price quote. Store hours: 9:00 AM til 5:30 PM, Monday thru Friday.



Long's Electronics



FREE 1-800-633-3410 OR

ORDER BY MAIL TODAY

Tab Books

- Novice Class Study Guide I.N. 30517 5.95
- General Class Study Guide I.N. 30519 7.95
- Advanced Class Study Guide I.N. 30522 5.95
- Extra Class Study Guide I.N. 26302 5.95
- A Beginners Guide to Microprocessors I.N. 30502 5.95
- 57 Programs and Games in Basic I.N. 30501 7.95
- The "Compuator" Book I.N. 30506 7.95
- Ham Radio Incentive Licensing Guide I.N. 30503 4.95
- Programming Microprocessors I.N. 30508 6.95

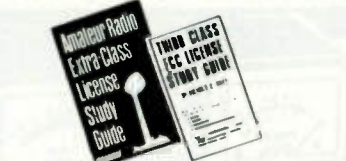

- Third Class FCC License Study Guide I.N. 30514 6.95
- First Class FCC License Study Guide I.N. 30542 7.95
- Electronics Data Handbook I.N. 30549 5.95
- Impedance I.N. 30520 5.95
- Basic Digital Electronics I.N. 30527 4.95
- Basic Electronic Problems Solved I.N. 30545 4.95
- Tower's International FET Selector I.N. 30500 6.95
- Second Class FCC Encyclopedia I.N. 30535 7.95
- How to Use AF and RF Signal Generators I.N. 30512 5.95
- Electronics Unraveled I.N. 30531 5.95
- Master Transistor/IC Substitutor Handbook I.N. 30510 7.95
- RF and Digital Test Equipment You Can Build I.N. 30521 5.95
- Commercial FCC License Handbook I.N. 30542 7.95
- IC Projects for the Amateur and Experimenter I.N. 30543 5.94
- How to Read Electronic Circuit Diagrams I.N. 30546 6.95

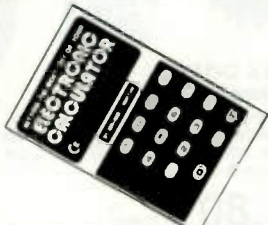

- Getting the Most Out of Your Electronic Calculator I.N. 30528 4.95
- How to Install Everything Electronic I.N. 30552 7.95
- The 2 Meter FM Repeater Circuit Handbook I.N. 30537 6.95
- Modern Applications of Linear IC's I.N. 30530 9.95
- Mobile Radio Handbook I.N. 30534 4.95
- Basic Electricity and Beginning Electronics I.N. 30536 5.95
- Practical Solid State DC Power Supplies I.N. 30515 6.95
- Electronic Conversions, Symbols, and Formulas I.N. 30524 5.95
- Tower's International Transistor Selector I.N. 30507 6.95
- Electronic Test Equipment and How to Use It I.N. 30526 4.95

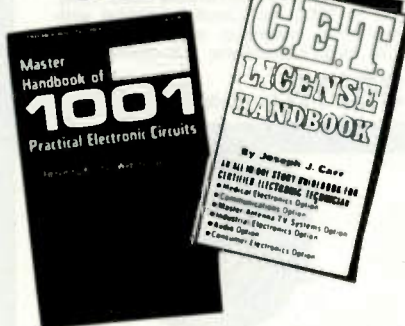

- Master Handbook of 1001 Practical Electronic Circuits I.N. 30523 9.95
- Master Handbook of Ham Radio Circuits I.N. 30506 8.95
- Complete Short Wave Listeners handbook I.N. 30532 6.95
- Master OP-AMP Applications Handbook I.N. 30505 9.95
- C.E.T. License Handbook I.N. 30513 8.95
- Effective Trouble Shooting with EVM and Scope I.N. 30525 5.95
- Handbook of Electronic Tables I.N. 30548 4.95
- Homebrew HF/VHF Antenna Handbook I.N. 30504 5.95
- How to Be a Ham I.N. 30533 3.95



Radio Amateur Callbook

- Map Library A complete set of maps, prefix world map, great circle chart, map of N. America, and world atlas. I.N. 10005 3.75
- Callbook binders
 - U.S. callbook red I.N. 10054 6.00
 - DX callbook blue I.N. 10055 6.00
 - DX Callbooks I.N. 10001 14.95
 - U.S. Callbooks I.N. 10000 15.95
 - Prefix map of North America I.N. 10004 1.25
 - Zone prefix map of the World I.N. 10022 1.25
 - Great circle chart of the World I.N. 10003 1.25
- ARRL US Call Area Map I.N. 10030 3.00
- ARRL World Prefix Map I.N. 10006 3.50

RSGB Books

- Oscar - Amateur Radio Satellites The comprehensive book on amateur satellites illustrated with pictures and charts. I.N. 10059 8.50
- VHF-UHF Manual If you have any interest above 30 MHz, then get this book. It covers everything in this field. I.N. 26208 13.95



TRAINING PACKAGES TAPES

Crack the code and ace your exam by studying the new way with our selection of cassettes. Just drop them into a cassette player and study anywhere easily and quickly. You'll have great results.

- 73 cassettes
- Novice Theory Tapes prepare you for the FCC novice exam. Clearly presented material can be reviewed many times. I.N. 26306 15.95

- Code Tapes
 - 5 word per min. Blitz Tape I.N. 26308 4.95
 - 6 word per min. Blitz Tape I.N. 26309 4.95
 - 13 word per min. Blitz Tape I.N. 26310 4.95
 - 20 word per min. Blitz Tape I.N. 26311 4.95



Te co Code Practice Tape are guaranteed for life.

- Novice tape I.N. 31461 3.95
- 5 wpm tape I.N. 31450 3.95
- 7 1/2 wpm tape I.N. 31451 3.95
- 10 wpm tape I.N. 31452 3.95
- 13 wpm tape I.N. 31460 3.95
- 15 wpm tape I.N. 31454 3.95
- 17 wpm tape I.N. 31455 3.95
- 20 wpm tape I.N. 31456 3.95
- 22 wpm tape I.N. 31457 3.95
- 25/30 wpm tape I.N. 31458 3.95
- 35/40 wpm tape I.N. 31459 3.95

Ameco Code Tapes

- Junior Code Course #100-T Covers start to 8 wpm I.N. 24819 4.95
- Advanced Code Course #103-T From 8 1/2 to 18 wpm. I.N. 24821 4.95
- Senior Code Course #101-T Double length covering the Junior and Advanced Courses start to 18 wpm. I.N. 24820 8.95
- Extra Class Code Course #104-T Covers from 13 wpm to 22 wpm Includes FCC type exam. I.N. 24822 4.95
- General Class QSO tapes #105-QT 12, 13, 14, & 15 wpm. I.N. 24827 4.95
- Extra Class QSO tape #106QT 19, 20, 21, & 22 wpm. I.N. 24826 4.95

Kantronics

- QSO Code Tapes Covers 7 1/2, 10, 13, & 15 wpm. Be ready for the new FCC exams! I.N. 28906 4.95
- Super QSO 13 A 13 wpm cassette tape. An excellent study guide. I.N. 28921 4.95
- Novice Combo A kit that includes a novice License Manual, Novice theory cassette, 5 wpm cassette, and 7 1/2, 10, 13, 15 wpm QSO tape. I.N. 28922 14.95
- General Class Theory Course A set of two cassettes. I.N. 28920 8.95
- Novice Theory Cassette Theory for the novice on 1 cassette. I.N. 28920 4.95

Remember, you can Call Toll Free: 1-800-633-3410 in the U.S.A. or call 1-800-292-8668 in Alabama for our low price quote. Store hours: 9:00 AM til 5:30 PM, Monday thru Friday.



Long's Electronics



MAIL ORDERS: P.O. BOX 11347 BIRMINGHAM, AL 35202 • STREET ADDRESS: 2808 7TH AVENUE SOUTH BIRMINGHAM, ALABAMA 35233

1-800-633-3410 TODAY!

CALL LONG'S TOLL FREE



KENWOOD MC-50 dynamic desk mic

This mic has dual impedance, 50 ohms or 50K ohms. Compatible with Kenwood equipment.

45.00 Call today.



SHURE 444 desk mic

Has PTT switch, adjustable head. Freq. 300 to 3000 Hz. Omnidirectional with controlled magnetic mic element for SSB. High impedance: 50K ohms.

39.18 Call today.

YAESU



YAESU YD-148 desk mic

The YD-148 desk-top microphone comes with a flexible neck to suit individual needs. Its smart styling matches the FT-101Z and FT-901 series of transceivers, and the impedance may be switched between 500 ohms and 50 K ohms for universal use.

30.00 Call today.

B&W 595 coax switch

Features: 6 outputs, a power rating of 2 KW PEP, VSWR of less than 1.2:1 up to 150 MHz, grounds all unused antennas.

21.50 Call today.



B&W 593 3 position coax switch

This switch features: 3 outputs, a power rating of 2 KW PEP, VSWR of less than 1.2:1 up to 150 MHz, & grounds all unused antennas.

17.50 Call today.

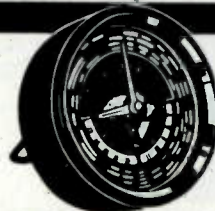
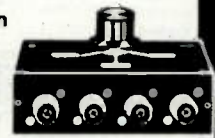

YAESU QTR-24 world clock

The QTR-24 World Clocks allows you to determine the time anywhere in the world at a glance. Using the included batteries, operation up to a year is possible without replacement of cells, making the QTR-24 perfect for home or portable operation.

35.00 Call today.

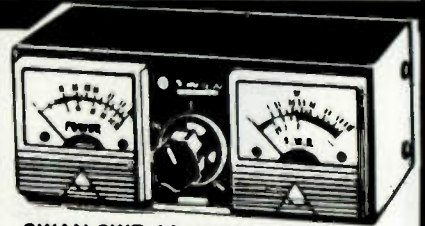

SWAN SWR-1A power meter and SWR bridge

Frequency range: 3.5 to 150 MHz. Compact and light weight for portable or mobile use. Capable of handling 1,000 watts RF and measures 1:1 to infinity VSWR.

29.95 Call today.



KENWOOD HS-4 headphones

You can wear these comfortable headphones for hours. Adjustable and light-weight.

19.50 Call today.



YAESU YH-55 headphones

The YH-55 headphones are light in weight, and an extra-soft cushion makes for many hours of comfort. The audio response is shaped to match that of your transceiver.

15.00 Call today.



TELEX C-1320 headphone

The headphone is fully cushioned, audiometric type drivers are ultra-sensitive DX'er's choice. 20-20,000 Hz. Low impedance 8-20 ohms.

41.80 Call today.

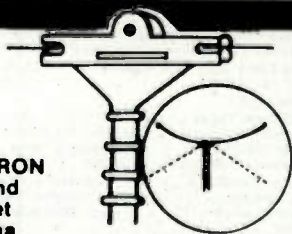

DENTRON All band doublet antenna

Covers 160 thru 10 meters and has a total length of 130' (14 ga. stranded copper). It may be made shorter. It is center fed through 100' of 470 PVC covered balanced transmission line. Assembly is complete. Antenna tuner required. Tunes 160 thru 10 with 1 antenna.

24.50 Call today.



BIRD Model 43 Thruline® watt meter

50 ohms nominal impedance, permits direct reading of full scale power from 100 Mw to 10,000 W. Shock mounted.

130.00 Call for yours today.

BIRD plug-in elements

Frequency Bands in MHz

Power range	2-30	25-60	100-250	200-500	400-1000
5W		5A	5C	5D	5E
10W		10A	10C	10D	10E
25W		25A	25C	25D	25E
50W	50H	50A	50C	50D	50E
100W	100H	100A	100C	100D	100E
250W	250H	250A	250C	250D	250E
500W	500H	500A	500C	500D	500E
1000W	1000H	1000A	1000C	1000D	1000E
2500W	2500H				
5000W	5000H				

H-Elements (2-30 MHz) 47.00 ea.
A-C-D-E Elements (25-1000 MHz) 39.00 ea.



Long's Electronics



CALL LONG'S TODAY!

1-800-633-3410 TOLL FREE



MFJ 949 Deluxe Versa Tuner II
A 300 watt antenna tuner with features like dummy load, SWR, forward and reflected power meters, antenna switch and balun. It matches every thing from 1.8 thru 30 MHz, coax random wires and balanced lines.

119.95 List. Call for quote.



MFJ-16010 random wire tuner
Operate on all bands with a simple random wire. Up to 200 W RF output. Ultra compact 2" x 3" x 4". Match high and low impedances by interchanging input and output. SO-239 connectors.

29.95 List. Call today.



MFJ-941B Versa tuner II
This accurate unit has SWR and dual range wattmeter, antenna switch, built-in balun, 300W RF output. Matches everything from 1.8 thru 30 MHz. You can use just one antenna and increase the useable bandwidth. Has SO-239 connectors. Mobile mounting bracket.

79.95 List. Call today.

**BENCHER BY-1
Iambic paddle**

The Ultimate Iambic paddle. Features solid silver contact points, full range adjustment, non-skid feet and heavy steel black textured base.

39.95 Call today.

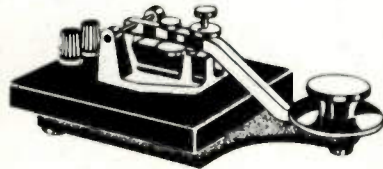

HAM-KEY HK3M

Improved straight key with a footed base so there's no reason to attach it to the desk. It has velvet smooth action.

19.95 Call today.



**NYE VIKING
'Master Key'**

The "master key" is the first major improvement in telegraph key design in 50 years! Contact assembly is isolated from base, greatly reducing shock hazard. Heavy diecast body eliminates "walking". Gold-plated silver contacts. Complete with Navy knob and two conductor cords with 1/4" key plug.

19.50 Call today.

**BENCHER BY-2
Iambic paddle**

The BY-2 has all the features of the By-1 but comes with chrome base.

49.95 Call today.



ORDER NOW!

KANTRONICS 2m trunk mount antenna

1/4 wave trunk mount antenna complete with coax cable and connectors. No drilling necessary.

7.95 Call today.



ORDER NOW!

AVANTI Thru the glass antenna

A 2 meter antenna that attaches thru glass without drilling holes. VHF Use for mobile, marine, & base station.

32.95 Call today.



**HY-GAIN HB-MAG 287
Hy-bander foldover antenna**

A magnetic mount antenna with foldover for hatchback cars. 5/8 wave provides low angle radiation for maximum gain. Ratchet foldover thru 180 degrees. Holds position up to 120 mph. Less than 1.4:1 VSWR, 144-148 MHz, 3 dB gain.

19.95 Call today.

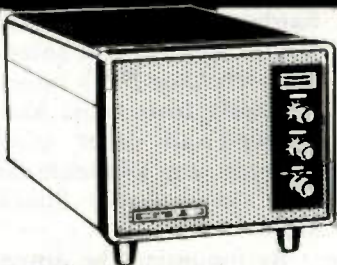
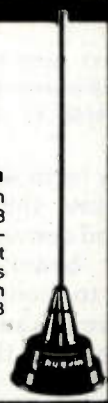

SP-301P speaker/patch

A speaker/phone patch to match the FT-901 series. The unit has full metering and level controls.

74.00 Call today.

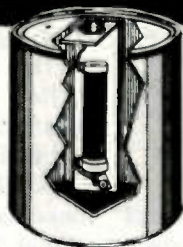

**DENTRON
Big Dummy load**

Now you can tune-up off the air with the Big Dummy! It has a flat SWR, full freq. coverage from 1.8 to 300 MHz and a high grade of industrial cooling oil furnished with the unit. Fully assembled. Cut out the QRM factor now!

29.50 Call today!

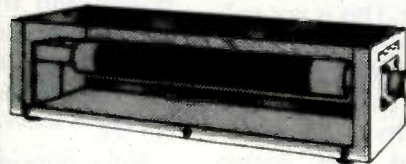

DRAKE Dummy loads

DL-1000 air cooled dummy load. Power rating 1000 watts. SWR: 1.5:1 max. 0-30 MHz. SO-239 connectors. Expanded rating limitation when used with the FA-7 cooling fan. Also available: DL-300 dummy load 19.95.

49.95 Call today.

VISA

Long's Electronics



Beams vs. Linears: Which Should You Buy First?

— get the most bang for your buck

John O. Battle N4OE
4612 Broadmeadow
Huntsville AL 35810

Many hams who would enjoy the performance and convenience of a rotary beam antenna hesitate to consider this alternative because of the cost. Instead, they purchase a linear amplifier with hopes of making up for the lost antenna gain with power. This is not only a less desirable solution from the standpoint of "spectrum pollution," but it also results in less performance and more dollars spent, making it a poor choice indeed. Why? Read on.

First, consider the average amateur installation prior to purchasing either a beam or a linear. The transmitter input power is about 180 Watts, and the antenna is a trap vertical. The effective

radiated power on twenty meters is given by: $P_{erp} = (P_t)(\eta_t)(\eta_a)(10^{-1}G_a)$, where G_a = antenna directive gain (dB); P_t = transmitter dc input power (Watts); η_t = efficiency of transmitter final (%); and η_a = antenna radiation efficiency (%).

For a trap vertical, therefore, the directive gain is approximately 0 dB, and the radiation efficiency is anywhere from 10 to 50% depending on the radial system and traps. Assuming the best, say 50%, and assuming a transmitter efficiency of 70%, the resulting erp is 63 Watts.

Now, consider the addition of a medium power amplifier—say a Heathkit SB-200 or Yaesu FL-2100A, with 1200-Watt PEP input power. The resulting erp is now 420 Watts! Sounds pretty good, huh? Well, maybe so. But first let's see what a moderate beam can do.

Consider the Hy-Gain

TH-3 Junior. This is an extremely lightweight (26 pounds) beam which is small enough (12-foot boom, and approximately 25-foot elements) to be turned by a TV rotor. The TH-3 Junior boasts a gain of 8 dB over a dipole, or 10.4 dB over isotropic. And the efficiency is essentially 100%. Let's see how this stacks up against the linear. The erp of a 180-Watt transmitter with a TH-3 Junior is a whopping 1382 Watts!

This is not to mention other advantages of a beam over a vertical. First, a beam will improve the strength of the signals you hear as well as your own signal. (Remember the old adage: "You can't work 'um if you can't hear 'um.") Also, the directivity of the beam may often be used to reduce QRM from state-side stations, etc., or even line noise. Finally, TVI is reduced whenever an antenna system is raised to a higher location.

Okay, you say. But what about cost? That's the best part. First, what is the best deal on a medium-power linear amplifier that you can hope for? The Heathkit® SB-201 is about the best buy for the money at \$449. A three-band rotary beam, on the other hand, can be yours for the bargain price of only \$243.70, including tax, rotor, and mounting hardware. Table 1 gives a cost breakdown for the antenna and associated hardware. Notice that, with the exception of the antenna (a Hy-Gain TH-3 Junior available from most ham dealers), all other components are available at your local Radio Shack store.

By mounting the antenna on the roof, one is able to get about 15 to 25 feet of height for free, thus making the overall height about 30 to 40 feet, depending on the house. While not optimum for long-haul DX on 20 meters, this antenna will perform

**MY COMPETITION KNOWS
ME, YOU SHOULD TOO.**



COMPLETE KITS: CONSISTING OF EVERY ESSENTIAL PART NEEDED TO MAKE YOUR COUNTER COMPLETE. HAL-600A 7-DIGIT COUNTER WITH FREQUENCY RANGE OF ZERO TO 600 MHz. FEATURES TWO INPUTS: ONE FOR LOW FREQUENCY AND ONE FOR HIGH FREQUENCY; AUTOMATIC ZERO SUPPRESSION. TIME BASE IS 1.0 SEC OR .1 SEC GATE WITH OPTIONAL 10 SEC GATE AVAILABLE. ACCURACY $\pm .001\%$. UTILIZES 10-MHz CRYSTAL 5 PPM.

COMPLETE KIT.....\$129

HAL-300A 7-DIGIT COUNTER WITH FREQUENCY RANGE OF ZERO TO 300 MHz. FEATURES TWO INPUTS: ONE FOR LOW FREQUENCY AND ONE FOR HIGH FREQUENCY; AUTOMATIC ZERO SUPPRESSION. TIME BASE IS 1.0 SEC OR .1 SEC GATE WITH OPTIONAL 10 SEC GATE AVAILABLE. ACCURACY $\pm .001\%$. UTILIZES 10-MHz CRYSTAL 5 PPM.

COMPLETE KIT.....\$109

HAL-50A 8-DIGIT COUNTER WITH FREQUENCY RANGE OF ZERO TO 50 MHz OR BETTER. AUTOMATIC DECIMAL POINT, ZERO SUPPRESSION UPON DEMAND. FEATURES TWO INPUTS: ONE FOR LOW FREQUENCY INPUT, AND ONE ON PANEL FOR USE WITH ANY INTERNALLY MOUNTED HALTRONIX PRE-SCALER FOR WHICH PROVISIONS HAVE ALREADY BEEN MADE. 1.0 SEC AND .1 SEC TIME GATES. ACCURACY $\pm .001\%$. UTILIZES 10-MHz CRYSTAL 5 PPM.

COMPLETE KIT.....\$109

PRE-SCALER KITS

HAL 300 PRE.....\$19.95

(Pre-drilled G10 board and all components)

HAL 300 A/PRE.....\$24.95

(Same as above with preamp)

HAL 600 PRE.....\$34.95

(Pre-drilled G10 board and all components)

HAL 600 A/PRE.....\$39.95

(Same as above but with preamp)

TOUCH TONE DECODER KIT

HIGHLY STABLE DECODER KIT. COMES WITH 2 SIDED, PLATED THRU AND SOLDER FLOWED G-10 PC BOARD, 7.567s, 2.7402, AND ALL ELECTRONIC COMPONENTS. BOARD MEASURES 3 1/2 x 5 1/2 INCHES. HAS 12 LINES OUT. ONLY \$39.95

DELUXE 12-BUTTON TOUCHTONE ENCODER KIT utilizing the new ICM 7206 chip. Provides both VISUAL AND AUDIO indications! Comes with its own two-tone anodized aluminum cabinet. Measures only 2 3/4 x 3 3/4". Complete with Touch-Tone pad, board, crystal, chip and all necessary components to finish the kit.

PRICED AT.....\$29.95

For those who wish to mount the encoder in a hand-held unit, the PC board measures only 9/16" x 1 3/4". This partial kit with PC board, crystal, chip and components.

PRICED AT.....\$14.95

ACCUKEYER—MEMORY OPTION KIT THIS ACCUKEYER MEMORY KIT PROVIDES A SIMPLE, LOW COST METHOD OF ADDING MEMORY CAPABILITY TO THE WB4VVF ACCUKEYER. WHILE DESIGNED FOR DIRECT ATTACHMENT TO THE ABOVE ACCUKEYER, IT CAN ALSO BE ATTACHED TO ANY STANDARD ACCUKEYER BOARD WITH LITTLE DIFFICULTY. \$16.95

ACCUKEYER (KIT) THIS ACCUKEYER IS A REVISED VERSION OF THE VERY POPULAR WB4VVF ACCUKEYER ORIGINALLY DESCRIBED BY JAMES GARRETT, IN QST MAGAZINE AND THE 1975 RADIO AMATEURS HANDBOOK. \$16.95

ACCUKEYER—MEMORY OPTION KIT—TOGETHER ONLY \$32.00

6-DIGIT CLOCK • 12/24 HOUR

COMPLETE KIT CONSISTING OF 2 PC G10 PRE-DRILLED PC BOARDS, 1 CLOCK CHIP, 6 FND 359 READOUTS, 13 TRANSISTORS, 3 CAPS, 9 RESISTORS, 5 DIODES, 3 PUSH-BUTTON SWITCHES, POWER TRANSFORMER AND INSTRUCTIONS. DON'T BE FOOLED BY PARTIAL KITS WHERE YOU HAVE TO BUY EVERYTHING EXTRA.

PRICED AT.....\$12.95

CLOCK CASE Available and will fit any one of the above clocks. Regular Price... \$6.50 But Only \$4.50 when bought with clock

SIX-DIGIT ALARM CLOCK KIT for home, camper, RV, or field-day use. Operates on 12-volt AC or DC, and has its own 60-Hz time base on the board. Complete with all electronic components and two-piece, pre-drilled PC boards. Board size 4" x 3". Complete with speaker and switches. If operated on DC, there is nothing more to buy.

PRICED AT.....\$16.95

Twelve-volt AC line cord for those who wish to operate the clock from 110-volt AC. \$2.95

SHIPPING INFORMATION

ORDERS OVER \$15.00 WILL BE SHIPPED POSTPAID EXCEPT ON ITEMS WHERE ADDITIONAL CHARGES ARE REQUESTED. ON ORDERS LESS THAN \$15.00 PLEASE INCLUDE ADDITIONAL \$1.00 FOR HANDLING AND MAILING CHARGES. SEND SASE FOR FREE FLYER.



HAL-TRONIX ✓H24
P. O. BOX 1101
SOUTHGATE, MICH. 48195
PHONE (313) 285-1782

"HAL" HAROLD C. NOWLAND
W8ZXH



FM-88S with SCANNER (optional)

**THE
FM-88 & 88S**
25 watts/143.0-149.0 MHz

In the tradition of the famous FM-DX and the FM-28 Clegg proudly announces the 2 Meter FM Transceiver of the next decade.

We've retained all the features and performance of the popular FM-28. And we've added CAP and MARS frequency coverage. And we've added an optional SCANNER. You'll have continuous control of output power from 1 to 25 watts right from the panel.

As with the FM-28 we give a full 1 YEAR limited warranty. And when you purchase an FM-88 or 88S we will refund your purchase price if for any reason you elect to return it within the first 10 days.

Because the FM-88 is available ONLY DIRECTLY from CLEGG and there is no "MIDDLEMAN" involved, we are able to deliver to you much more RADIO for your hard earned dollar. You are virtually buying WHOLESAL!

A LIMITED QUANTITY OF THE NEW FM-88 WILL BE AVAILABLE FOR OCTOBER DELIVERY. YOUR DEPOSIT NOW WILL ASSURE YOU OF EARLIEST DELIVERY. Whether you elect the FM-88S at \$439.00 or the FM-88 (without SCANNER) at only \$345.00, we are certain you'll be delighted with your selection. (These introductory prices won't last long).

Each unit is supplied complete with Mobile Mounting Bracket; Base Station Bale; Microphone; Mobile Power Cable; Base Station Power Cable and many many hours of OPERATING ENJOYMENT.

A detailed SPECIFICATION sheet describing the new transceivers and Clegg's coordinated accessories and antennas is yours for the asking. Phone 1 (800)-233-0250 today for your copy or to order either one of these super TRANSCEIVERS!

Clegg ✓C3
Communications Corp.

1911 Old Homestead Lane
Greenfield Industrial Park East
Lancaster, PA 17601
(717) 299-7221



quite respectably on 15 and 10 meters, and will be considerably better than a vertical even on twenty. My wife (WA4WQH) has, at last count, totaled up 101 countries on just such an antenna, driven with a KWM-1!

Although the TH-3 Junior is my personal choice, there are several other antennas which might fit the bill. Mosley, for example, has the TA-33

Junior for only \$130.00. Several companies offer lightweight quad kits, and even a CB antenna turned horizontal would be a good bet. If you just can't bear to mount the antenna on the roof of your house, a telescoping mast could be substituted for a slight increase in cost. Any way you do it, such an antenna system will be the best buy in a linear on the market. 73 and good DX. ■

15-1220	Archer servo-rotor	\$54.95
15-842	5 ft. mast, 1-1/4"	3.29
15-843	10 ft., 1-1/4" mast	5.99
15-517	Heavy-duty tripod	15.95
15-888	Universal mount mast anchor	1.19
15-1204	50 feet of rotor cable	3.99
278-971	50 feet of RG-58/U	9.95
15-825	Guy wire anchors (2 sets)	1.18
15-829	Turnbuckles (2 sets of 2)	1.58
15-031	100 feet of RoH galvanized steel guy wire (2 each)	1.89
	TH-3 Junior antenna	<u>\$29.95</u>
		\$229.91
	Alabama sales tax 6%	<u>+ 13.79</u>
		\$243.70

Table 1. Cost breakdown.

Dr. Barry S. Fromm K8SD
3107 Ridgecrest Rd.
Greenville TX 75401

The Chicken Delight Beam

— a tasty morsel for 10

Requires a Crossbow.

The Chicken Delight 10 meter beam is a quick, inexpensive, and effective monoband yagi. There's no need for truck or UPS shipments, just a trip to Radio Shack.

The main ingredient is a Radio Shack Archer® 3-element CB (known around these parts as chicken band) beam. This one is

stock number 21-933, known as the Crossbow™ III. This lightweight beam can be easily modified for 10 meter operation. The element spacing and lengths must be changed as well as the gamma match network.

The Dimensions

The distance between the reflector and the center of the boom mast bracket remains at 65", but the boom bracket center to the driven element dimension is shortened to 13". The driven element to director distance is increased to 60". These dimensions create a yagi with a .2-wavelength reflector spacing and a .15-wavelength director spacing. The reflector element length is 17' 1/2". The

driven element length is 16' 5 1/2" and the director length is 16' 1 1/2". These dimensions place resonance in the phone portion of the band. Transposing the above dimensions directly to the assembly instructions makes for rapid construction of the antenna.

The gamma match will need to be readjusted a small amount from the 11 meter setting. This adjustment will need to be made on an individual basis. An easy way to adjust the match is to place the beam on end, with the reflector against the ground and the antenna pointing straight in the air. Matching performed in this manner is usually close enough for practical purposes. The construction of the match

is good and it takes legal-limit rf easily.

I recommend using a small quantity of anti-corrosion compound where the elements slide together, a dab of RTV on each element end sheet metal screw head, and plenty of RTV on the gamma match coax connector.

Because of the beam's light weight, it is easy to erect and may be turned by a light-duty rotor.

The performance of the Chicken Delight is far superior to the 10 and 15 meter interlaced duobander I also have up, even though the duobander is 30' higher in the air.

There is no doubt the Chicken Delight is an inexpensive, effective beam. There now can be no excuse for not using a yagi on 10 meters. ■

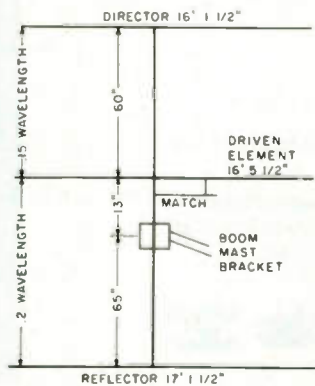

Fig. 1.

Call or Write for Delivery or Quote

RF POWER LABS V-350



Other Models in stock
2 Meter Base Amplifier
15W In — 400W Out

LEAVE A MESSAGE & WE'LL CALL YOU BACK!

MADISON ELECTRONICS SUPPLY, INC.

1508 McKINNEY • HOUSTON, TEXAS 77002

713/658-0268

✓ M35

AG5K, W5VVM, WD5EDE, K5ZD, WA5TGU, WB5AYF, K5RC, K5BGB,
W5GJ, W5MBB, K5AAD, N5JJ, W5USV.

MASTERCARD • VISA

The Ultimate QRM Killer

DATONG MODEL FL-1



FREQUENCY-AGILE
AUDIO FILTER

\$199.⁹⁵

Including Pre-Paid
Shipping & Full Insurance

- Made in England
- 90 Day Warranty
- Reviewed in QST Aug. 1979
- VISA MASTERCARD accepted

Model FL 1 is a versatile add-on audio filter for communications receivers. It gives great flexibility in helping to extract the desired signal (SSB, CW, RTTY, etc.) from background interference and yet simply connects between loudspeaker and receiver output.

- Fully automatic search/lock/track operation for notching out unwanted heterodynes.
- Selectable bandpass or band-reject modes.
- Bandwidth smoothly variable from 20 Hz to 1000 Hz.
- Center frequency smoothly variable from 280 to 3000 Hz.
- Built-in 2 watt power output stage.
- Uses internal 9-volt battery or external source of 6 to 12 volts DC.

Application to CW

Model FL 1 is superb for CW reception. As an extra refinement automatic frequency control can be switched, which enables the filter to tune itself onto a CW station over a 100 Hz range. This way the 20 Hz minimum bandwidth becomes as easy to tune in as if it were 100 Hz.

Application to SSB and RTTY

For SSB or RTTY reception Model FL 1 can be used to give either a fully adjustable audio "window" to pass the wanted signal and to reject others, or as a variable notch to remove unwanted narrow band signals. Tuning in the notch mode can be fully automatic or manual. Auto-notching allows routine "hands off" use of a notch only 20 Hz wide so that the wanted signal is completely unaffected.

Dedicated to Excellence (Exclusive importers of DATONG ASP's)

AR Technical
Products
Corp. ✓ A105

Box 62
Birmingham, Michigan 48010
Telephone 313/644-5698

A Breakthrough In Technology!

**MICROPROCESSOR CONTROLLED
SYNTHESIZED HANDLE**

FT-207R



144-148 MHz Range

3 Watts Output

Memory and
Band Auto Scan

Automatic Battery Saver
Feature for LED Display

4 Memories plus
Programmable Offset

Priority Channel

Rubber Flex Antenna

BNC Antenna
Connector

Clear/Busy Auto
Scan Selector

Repeater/Simplex
Offset Switch

Squelch Control

Remote
Speaker/Mike
Input

Audio Gain
Control

Channel
Busy Lamp

Transmit
Indicator

Condensor Mike

5-Digit LED
Readout

Keyboard Encoded
Frequency Entry

Keyboard Lock
guards against
accidental frequency
change

Display
On/Off

5 KHz Up

- Optional Equipment:

Tone Squelch, Speaker/Mike, Nicads, Battery Charger

*The Yaesu FT-207R Synthesized Handle
has all the features you could want in a very compact package*

✓ T48

TOWER ELECTRONICS

24001 Alicia Pky., Mission Viejo, CA 92691

(714) 768-8900

"The Southwest's full-line Yaesu Distributor"

The TR-7500 Goes Inverted

— see you on the flip-flop

Put it in reverse.

Louis E. Voeman WA2JKN
25 Tamarack Hill Drive
Poughkeepsie NY 12603

The Kenwood TR-7500 is a beautiful 2 meter FM rig. It is synthesized and has a 50-position channel switch, which, together with a +15 kHz switch, gives 100 channels. It also has selectable ± 600 kHz transmitter offset and simplex for each channel. The rig comes set up with $44 \times 2 = 88$ preprogrammed channels to cover all repeater and most simplex frequencies listed

in the ARRL 2 meter band plan. For what more could you ask?

Well, you could ask for the rest of the simplex channels (147.57, 60, 63, 66, and 69). And that's no problem: The TR-7500 has a diode program board which allows you to program six frequencies of your choice. The above-listed simplex frequencies take five of the six channels. Now you have all repeater frequencies and all simplex frequencies, and one channel left on the program board. What do you do with that one channel?

How about programming it for your favorite repeater's input frequency so you can go reverse if the repeater is down and you want to QSO with your rock-bound buddy? Or perhaps you want to be able to listen on the input to determine if you are in direct range of another amateur? Good! Just program the remaining channel for the favorite repeater's input frequency. Suppose, however, there are two or more favorite repeaters? Which simplex frequencies do you give up? Another problem with programming the repeater input frequencies (at least in my case) is that the programmable

channels are on the opposite side of the channel selector switch from the repeater output frequencies. In switching from output to input and back, I'd miss half the conversation.

After going through all of the above within the first couple of months of purchasing my 7500, I decided to look for a better way. The squelch knob has a pull-on push-off switch which is meant to control an optional subaudible tone encoder. I had no intention of installing that option on my rig, which meant that there was a free switch on the front panel. I decided it would be nice if I could go reverse by simply pulling out the squelch knob.

This modification will allow you to do just that. It is inexpensive (a resistor, an IC, and an IC socket) and very easy to install. No circuit board lands have to be cut. Just unsolder a couple of wires and add more. The modification has performed flawlessly for several months in my rig, and for about a month in a friend's rig.

The circuit works quite simply (see Fig. 1). The two exclusive OR gates are used as controllable inverters. The two lines inverted are labeled RS and TS

on the 7500's schematic. These lines control the selection of the correct offset crystal during transmit and receive. For normal operation (squelch knob pulled out), the simplex crystal is used for transmit and the receive crystal is selected by the transmit offset switch.

The circuit is constructed on the bottom of a 14-pin IC socket (see Fig. 2). All leads are brought out, the IC is plugged in, and the whole assembly is wrapped in electrical tape. (Be careful not to short anything when applying the tape.) The front panel, diode program board, and the transmit offset switch are removed. The red and yellow wires are unsoldered from the offset switch. The red wire is TS and the yellow wire is RS, coming from the phase locked loop circuit board. The red wire goes to TSIN in Figs. 1 and 2; the yellow wire goes to RSIN. TSOUT is soldered to the lug of the offset switch from which the red wire was removed. RSOUT is soldered to the lug from which the yellow wire was removed.

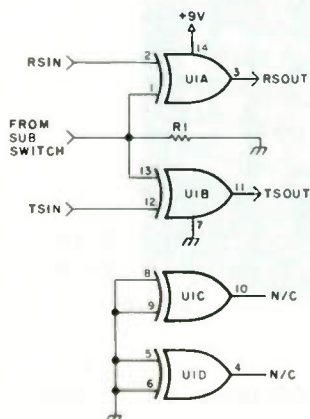

Fig. 1. The unused inputs (pins 5, 6, 8, and 9) of the IC are grounded. This is good practice for any CMOS project. U1 = 4070 CMOS "quad exclusive OR" IC. R1 = 47k Ohms, 1/4-Watt resistor.

NEW MFJ-624 Deluxe Hybrid Phone Patch

Feature Packed: VU meter for line level and null. Has receiver gain, transmitter gain, null controls, bypass switch. Beautiful hum-free audio. RF filtered. VOX or push-to-talk. Works with any rig. Simple patch-in-patch-out installation.

Crisp, clear hum-free audio is what phone patching is all about and MFJ has it.

✓ M52



\$59⁹⁵

This new MFJ-624 Telepatch II hybrid phone patch gives you a combination of performance, features, and quality that you won't find in other phone patches.

PERFORMANCE: Gives you crisp clear, hum-free audio which is what phone patching is all about. Use automatic VOX or push-to-talk. RF pi-filters and PC board construction eliminates RF feedback. Works with any rig.

FEATURES: VU meter monitors telephone line level to prevent crosstalk between telephone channels. Also lets you adjust null depth for maximum isolation between receiver and transmitter.

Separate transmitter and receiver gain controls eliminate readjusting rig's controls after patching. Null control for maximum isolation.

Function switch: OFF for normal operation. ON connects your rig to phone line for patching. NULL switches VU meter to let you adjust for maximum null.

Simple 2 cable installation (plus phone line) when rig has patch-in-patch-out jacks. Connects easily to any rig.

Phono jacks for patch-in-patch-out, speaker, microphone. Screw terminals for phone lines.

Eggshell white, walnut sides. 8x2x6 inches.

QUALITY: Every single unit is tested for performance and inspected for quality. Solid American construction, quality components.

MFJ-620 TELEPATCH HYBRID PHONE PATCH. Same as MFJ-624 but less VU meter. 6x2x6



inches. \$49.95 plus \$3.00 shipping and handling.

One year unconditional guarantee.

Order from MFJ and try it — no obligation. If not delighted, return it within 30 days for refund (less shipping).

Order today. Call toll free 800-647-1800. Charge VISA, MC or mail check, money order for \$59.95 plus \$3.00 shipping for MFJ-624 and \$49.95 plus \$3.00 shipping for MFJ-620.

CALL TOLL FREE ... 800-647-1800

For technical information, order/repair status, in Miss., outside continental USA, call 601-323-5869.

MFJ ENTERPRISES, INC.
BOX 494, MISSISSIPPI STATE, MS 39762

NEW!



30 day Free Trial GUARANTEE
Your money refunded if not completely satisfied.

File, preserve and display 240 QSL Cards

in the QSL ORGANIZER™

This handsome Album FREE with every 40 pages ordered.

Tired of cluttering up your walls, stuffing QSL's in drawers and boxes? The modern way to keep your QSL cards neatly organized and always on beautiful display, is in the all new QSL Organizer™. It consists of a handsome Album, and crystal clear vinyl pocketed pages. Each specially designed heavy duty page, has three top-loading pockets to hold 6 cards (back to back).

The roomy pockets even hold those extra large Japanese QSL's. With every 40 pages ordered (minimum), you'll receive the handsome QSL Organizer™ album, FREE. It's richly padded, in long lasting 'Brown-Hide' vinyl with gold imprint on cover and spine. The 3-ring binder allows you to arrange or re-arrange your pages quickly, easily.

You'll find the QSL Organizer™ is a great way to file contest cards, give as club prizes, gifts, and a great way to tidy up the radio shack.

Fill in the Handy Order Form below ... and mail today.

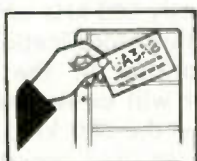

New top-loading pages for fast, easy arranging of QSL's.

✓ M109

MIL INDUSTRIES
P.O. Box 44457, Panorama City, CA 91402

HANDY ORDER FORM

Please send:	PRICE	Postage & Handling	TOTAL	Check or Money Order enclosed (No COD)
<input type="checkbox"/> 1 FREE Album and 40 pages (min) at .47 each.	18.80	1.95	\$20.75	(CA residents add 6% tax)
<input type="checkbox"/> 2 FREE Albums and 80 pages at .45 each.	36.00	3.45	\$39.45	
<input type="checkbox"/> 3 FREE Albums and 120 pages at .44 each.	52.80	4.75	\$57.55	
			(Pages available in packages of 40 only)	TOTAL \$
Ship to: _____	(Please Print)	Call _____	Mail to: MIL INDUSTRIES Dept 3	
Name _____	Address _____	City _____	P. O. Box #44457	
State _____	Zip _____	Panorama City, CA 91402		

soldered to the small PC board on the back of the power selection switch (see the 7500 owner's manual). Plus nine volts can be taken from the brown wire, which is plugged into the driver circuit board at the point labeled C9. Don't unplug this wire, just solder to it. A convenient ground can be found next to the microphone jack. The completed circuit is fitted into the clear spot on

the driver circuit board, where the subaudible tone assembly is meant to go. The rig can now be reassembled.

Operation is a joy; just dial your local repeater normally, including setting the normal transmitter offset, pull out the squelch knob, and you are operating reverse. Note that when the squelch knob is pulled out, the transmit frequency is displayed on

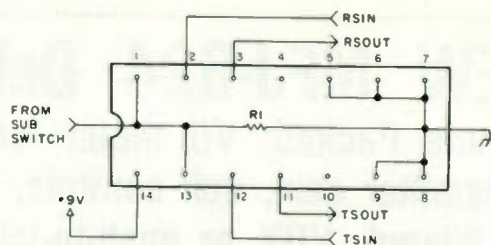

Fig. 2. Bottom view of the 14-pin IC socket.

the LED readouts; the receive frequency is set by the transmit offset switch. After using this mod a cou-

ple of times, you'll wonder why it wasn't included as original equipment in the rig. ■

Ready for the New Repeater Subband?

— your FT-221R can be

Simple mod does the trick.

Alex A. Webster WA6FWQ
11921 Sheldon Lake Drive
Elk Grove CA 95624

With the announcement by the FCC of the opening of 144.5 to 145.5 MHz of the 2 meter band for repeater operation, many of us were caught with rigs that would not operate in that portion of the 2 meter band. In my case, I have a Yaesu FT-221R.

Not wanting to spend a lot of money for a new rig, I

decided to find another solution to the problem. After looking over the schematic diagram, I decided that a simple modification should do the trick. So, after about thirty minutes of work, I was on the new subband. I'm sure there are other ways of modifying the FT-221R to operate on the new subband, but this way seems to be the fastest and the simplest. It requires only the addition of one crystal, one jumper wire, and the relocation of two wires. The crystal required is a

13.96666 MHz in an HC-25/U holder, shunt capacitance 34 pF, drive level 5 mW, resistance below 20 Ohms, tolerance 20 ppm, fundamental mode.

The modification steps are as follows:

1. Place the new crystal in crystal socket X09 on PB-1454 (local unit).
2. Place a jumper between terminals 3 and 6 on S2B (bandswitch).
3. Remove the wire on terminal 6 on S2C and place it on terminal 3.
4. Remove the wire from J18, pin 6 (PB-1459), that

runs to S8 and place it on pin 4 of J18. Be sure to select the correct wire on pin 6 because there are two of the same color.

After the modification is completed, TC09 on PB-1454 may be adjusted to trim the crystal frequency for exactly 600 kHz offset. When this modification is incorporated in the FT-221R, it will be necessary to place the 600 kHz-Aux switch in Aux position when operating 144.5-145.5 and in the 600 kHz position when operating 146-148 MHz. ■

GIVE 73 MAGAZINE TO YOURSELF AND TO YOUR FRIENDS



START YOUR OWN ENCYCLOPEDIA OF AMATEUR RADIO—AND SOMEONE ELSE'S—BY TAKING ADVANTAGE OF THIS SUPER OFFER.

Give yourself—as well as your friends, relatives, or business associates—the gift of **73 MAGAZINE** at **HALF** the newsstand price, **PLUS** your choice of 3 of the back issues listed on the following pages, **FREE!**

Each issue is full of information on building projects, antennas, traffic handling, radioteletype, computers, and more. Look over the wealth of material included in these issues. There is little or no information which goes stale. And by entering a gift subscription now, you can choose three free back issues and start your encyclopedia of amateur radio right away. Simply indicate on the coupon below or on the attached postage-paid card the issues you wish to receive. Please include alternate choices, as these issues are limited and are going fast.

- 1 year at \$15.00*
 Check or m.o. enclosed Bill me
 Bill my: Visa Master Charge
 American Express

Card # _____
 Exp. date _____
 Signature _____

A one-year gift subscription for:
 Name _____
 Address _____
 City _____
 State _____ Zip _____

Your name: _____
 Address _____
 City _____
 State _____ Zip _____

I haven't forgotten to choose my 3 FREE Back Issues from the attached catalog. My choices are (specify month & year):

- 1) _____
 2) _____
 3) _____

My alternate choices are (specify month & year):

- 1) _____
 2) _____

*Canada \$15 a year USA funds only. Please add \$2 per year for Canadian funds. All other foreign subscriptions \$26, one year only, payable in US funds.

What have you missed?

68

JUNE 68. Surplus Issue! transformer tricks; BC-1206 RX, APS-13 ATV TX; low voltage dc supply; surplus scopes; FM rig; commercial xtal types; Wilcox F-3 RX; re-storing old equipment; 75A-1 RX mode TRA 19 on 432; frequency counter uses transistor power supply; uses for cheap tape recorders; surplus conversion blibliography; RT-209 walkie on 2m; ARC-1 guard RX; RTTY TX TU.

JULY 68. Wooden tower construction; tilt-over towers; erecting a telephone pole; IC AF oscillator; "dB" explained; ham club tips (part 1).

SEPT 68. Mobile VHF; 432 FET preamps; converting TV tuners; xtal oscillation stability; parallel-tee design; moonbounce rhombic; 6m exciter (corrections Jan. 69); 6m transceiver (corrections Jan. 69); 2m DSB amp; ham club tips (part 3).

NOV 68. SSB xtal filters; solid-state troubleshooting; IC frequency counter (many errors & omissions); "CV" transformers; space communications odyssey; pulsar info; thin-wire antennas; 40m transistor CW TX/RX; BC 348M double conversion; multifunction tester; copper wire specs; thermistor applications; hi-voltage transistor list; ham club tips (part 5).

Available Issues published from 1968 are listed at the end of this catalogue.

69

JAN 69. Suppressor compressor; HW 12 on 160; beam tuning; ac voltage control 2m transistor TX; LC power reducer; spectrum analysis info; 6m transistor RX; operating console; RTTY autostart; calculating oscillation stability; low-power 40 CW TX; sequential relay switching; sightless operator's bridge; ham club tips (part 7).

FEB 69. SSTV camera mod for fast scan; tri-band linear; selective AF filter; unijunction transistor info; Nikola Tesla biography; mobile installation hints; Extra class license study (part 1).

MAR 69. Surplus Issue: TCS TX mods; cheap compressor/amp; RXZ calculations; transistor keyer; better balanced modulator; transistor oscillators; using blowers; half-wave feedline info; surplus conversion bibliography; Extra class license study (part 2).

APR 69. 2-channel scope amp; RX preamp; Two-er PTT; variable dc load; swr bridge; 100 kHz marker gen.; some transistor specs; SB-610 monitorscope mods; portable 6m AM TX; 2m converter; Extra class license study (part 3).

MAY 69. 2m turnstile; 2m slot; RX attenuator; generator filter; short vee; quad tuning; using antennoscope; measuring antenna gain; phone patch regs; swr indicator; 160m short verticals; 15m antenna; HF propagation angles; FSK exciter; kW dummy load; hi-power linear; Extra class license study (part 4); all-band curtain array.

JUNE 69. Microwave power generation; 5m SSB TX; 432-er TX/RX; 6m converter; 2m 5/8 wave whip; UHF TV tuners ATV video modulator; UHF FET preamps; RTTY monitorscope; Extra class license study (part 5); building UHF cavities; mini-vee for 10-20m; VHF vfo.

JULY 69. AM modulator; SSTV signal generator; 6m kW linear; 432 kW amp; 432-34 TX/RX; 6m IC converter; radio-controlled models; RTTY IC TU; audio notch filter; /RC-19 conversion; tube substitution; 2m transistor exciter; Extra class license study (part 6); HF FET vfo.

AUG 69. FET regen for 3.5 MHz up; FM crystal switching; 5/8-wave vertical; introduction to ICs; RTTY tone generator; good/bad transistor checker; 2m AM TX; measure transistor Ft; 160m propagation; triac applications; simple I-f sweep generator; transistor keyer; SB-100 on 6m; xtal frequency measurement; Extra class license study (part 7); FM deviation meter; QRP AM 6m TX; circular quads; FM noise figure; transistor parameter tracer.

SEPT 69. Tunnel diode theory; magic tee; soldering techniques; wave-travel theory;

cable shielding; transistor theory; AM noise limiter; AFSK generator transistor amp debugging; measure meter resistance; diode-stack power supply; transistor testing; 2 1/2 W 6m TX; HX-10 neutralizing; capacitor usage; radio propagation AM mod percentage; Extra class license study (part 8); 3-400Z linear; ATV vidicon camera; 2 transistor testers; FET compressor; rf plate choke.

OCT 69. Super-gain 40m antenna; FET chirper; telephone info; scope calibrator; thyrector surge protector; slower tuning rates; identify calibrator harmonics. FM adapter for AM TX; CB sets on 6m; proportional control xtal oven; xtal filter installation; Q-multiplier; transceiver power supply; Extra class study (part 9).

NOV 69. NCX-3 on 6m; i-f notch filters; dial calibration; HW-32A external vfo; 6m converter; feedline info; rf Z-bridge; FM mobile hints; umbrella antenna 432-34 TX (part 1); power supply tricks with diodes; transistor keyer; transistor bias design; xtal VHF signal generation; electronic variac; SB-33 mods; Extra class study (part 10); SB-34 linear improvements.

DEC 69. Transistor-diode checker; dummy load/attenuator; tuned filter chokes; band-switching Swan 250 & TV-2; 88 mH selectivity; math exercises; RTL xtal calibrator; transistor PA design; HV mobile p.s.; 1-10 GHz freqmeter; CB rig on 6m; Extra class license study (part 11); 1970 buyer's guide.

70

JAN 70. Transceiver accessory unit; bench power supply; SSTV color method; base-tuned center-loaded antenna; 6m bandpass filter; Extra class license study (part 12); rectifier diode usage; facsimile info.

FEB 70. 18-inch 15m dipole; 6m converter; high-density PC board; camper-mobile hints; 2m frequency synthesizer; encoding/decoding for repeaters; DX-35 mods; panoramic VHF RX; variable Z HF mobile mount; Extra class license study (part 13); linear IC info; QRP 40m TX; IC Q-multiplier.

MAR 70. Gdo applications; charger for dry cells; FM frequency meter; PC board construction; ham FM standards; cheap rf wattmeter; multifreq FM oscillation; "I-F" system modules (part 1); Six-er mods; gdo dip lite; Motorola 41 V conversion; CW monitor; buying surplus logic; SSG-23A sobobuoy conversion; GRC-9 RX/TX conversion; Extra class study (part 14); intro to VHF FM.

APR 70. Noise blanker; 2m hot carrier diode converter; repeater controller; under-standing COR repeater; 7/8-wave 2m antenna; Extra class study (part 15); inexpensive semiconductors; renovating surplus meters; linear amp bias regulator; hi-performance I-f amp & agc system; SSB bfo for shortwave radio; vacuum-tube load box; general FM dope & repeater guide; meggering your antenna.

MAY 70. comments on "FM docket" #18803; future of CW; FM-AM RX aligner; 5/8-wave verticals; using 2m intelligently; auto burglar alarms; power supplies from surplus components; "I-F" system modules (part 2); VHF FET preamps; educated "idiot" lights; postage-stamp 6m TX; Extra class study (part 16); Bishop IFNL; low-band police monitor; mobile CW TX; Wichita autopatch.

JUNE 70. DRRR antenna; vfo circuit; remote swr indicator; indoor HF vertical; two RX on one antenna; environment & coax loss; 2-el trap verticals; buying surplus; two 40m QRP TX; 21 dB 2m beam; Extra class study (part 17).

JULY 70. Improved Color Slow-Scan Television; How to Build a Keyer; 450-MHz Mighty Mile—one-transistor superregenerative receiver; Cheapie 6-Meter Half-Gallon—use 811-As and be heard; A High-Performance Power Supply—using an IC voltage regulator; Latham Island Expedition; Db to Power; Protection for Grid-Dipper Coils; Mobile CW Receiver; QSLing... Ham Radio's Own Con Game.

SEPT 70. Integrated Circuit CW ID Generator; The Indication Oscillator—another dipper circuit; 1-400 MHz; Tuning VHF Receivers—clever infinite attenuator and oscillator unit; Repeater Antenna Separation;

Diode Stacks; Deluxe Receiver Gain Control—using one transistor and a zener; Reed Relays for Coaxial Switching; Beer-Can Two Meter Coaxial Antenna; Converting 24 V Relays to 115 V ac; Versatile 2m MOSFET Converter—low noise, high gain, ultra stable.

NOV 70. Differential J-FET preamplifier; Remote Quad Tuning; Two-Watt Six Meter Transmitter—using the crystal-heterodyne vfo; Semiautomatic FM channel Scanning; Low-cost Automatic Keyer—an excellent "first project"; Ac Switching with Self-Powered ICs—clever zero voltage switch; Pioneer Radio on the Prairies—what it was like 45 years ago; SST-1 Solid-State Transceiver for 40 Meters; A Low-Cost RF Wattmeter; Calibrate That Calibrator.

DEC 70. Solid-state VHF exciter; delta frequency control for SSB; 2m transistor FM TX; HW-100 offset tuning; "little gate" dipper; 3-500Z HF linear; General class study (part 5); "first-test" (no good error); transistor p.s. current limiter.

Available Issues published from 1970 are listed at the end of this catalogue.

71

JAN 71. Split phones for DXing; Heath Ten-er mods; CW duty cycle; repeater zero beater; HEP IC projects; 10-15-20m parabolic ideas; lightning protection; IC RX accessory; attic antennas; double-balanced mixers; permanent marker tool; ham license study questions.

FEB 71. metal locator; varactor theory; AFSK unit; SSTV patch box; ATV hints; RTTY tuning indicator; tone encoder/decoder; 220-MHz converter; SSTV magnetic deflection; IC code oscillator; 6m TX beeper; General class study (part 6); RTTY intro; perboard terminal; low ohmmeter.

MAR 71. IC audio filter; IC 6m converter; trap vertical ideas; digital counter info; surplus equipment identification; HF linear; simple phone patch; repeater audio mixer; digital RTTY accessories; coat-hanger ground plane; General class study (part 7).

MAY 71. 75m mobile whip; 2m preamp; transistor amp design; 10m DSB TX; portable FM transceiver directory; audio compressor-clipper; transistor LM freqmeter; 450-MHz link TX; simple AF filter; 1-tube 2m transceiver; surplus 2m power amp; General class study (part 8).

JUNE 71. 2m beam experiments; 3-el 2m quad; multi-band dipole patterns; weather balloon vertical; pocket-pager squelch; Two-er vfo; tuning mobile whips; transistor power supply; capacity decade box; 40m gain antennas; General class study (part 9).

JULY 71. IC audio processor; audio signal generator; CW filter; 2m FM oscillator; 2m collinear vertical; FM supplier directory; Motorola G-strip conversion; transistor beta tester; General class study (part 10).

AUG 71. Ham facsimile (part 1); 500-Watt linear; dimensions for July collinear; 4-tube 80/40 station; vfo digital readout; Jupiter on 15m; General class study (part 11); pink ticket wave-meter.

SEPT 71. Transformerless power supplies; solid-state TV camera; IC substitution; two rf wattmeters; IC compressor-agc; multichannel HT-200; ham facsimile (part 2); causes of man-made noise; vfo with tracking mixer; General class study (part 12); transistor heatsinking; IC pulse generator; phone patch isolation; hcd wattmeters.

OCT 71. Emergency repeater COR; transceiver power supply; predicting meteor showers; digital switching; reverse-current battery charger; passive repeaters; earth grounds; audio "tailoring" filters; Swan 350 mods.

NOV 71. 3-el 75m beam; motor-tuned ground plane; 2m gain vertical; transistor biasing; split-site repeater; fox-hunting; audio filter; transistor/diode tester; xtal tester; 6m kW amp; 10-15-20m quad; transistor pi-net final; antenna feedline; communications dBs; 2300-MHz exciter.

DEC 71. Convert Your 7-MHz Cubical Quad to All Bands; The Indoor Quad; Get-

63

JUNE 63. Surplus Issue! DMQ-2 Beacon TX on 220; Increasing ARC-2 transceiver selectivity; PE-97A power supply conversion; BC-348 band-spread; inductance tester; converting BC-230 TX; beginner's RX using BC-453; receiver motor-tuning transistor CW monitor; BC-442 antenna relay conversion; mobile loading coils; increasing Two-er selectivity; TV with the ART-26 TX; TRC-8 RX on 220; ARC-5 HF RX & TX; ARC-3 TX on 2m.

AUG 63. Battery-op 6m station; diode noise generator; video modulation; magic T-F switch; antenna gain; halo mods; CW break-in; VEE beam design; coax losses; rf wattmeter; TX tube guide; diode power supply; "Lunchbox" squelch; swr calibration; vertical antenna info; info on Windom antenna.

OCT 63. WBFM transceiver ideas HF propagation; cheap phone patch; remote-tuned yagi; construction hints; antenna coupler; \$5 vertical; filament transformer construction; 2m nuvistor converter; Lafayette HE-35 mods; buyer's guide to TX & TX; product detector; novel converter; compact mike amplifier.

Available Issues published from 1960-1963 are listed at the end of this catalogue.

64

FEB 64. 2m multichannel exciter; RZ design ideas; magic T/F switch; loudspeaker enclosures; 40m 2 W TX; look at test equipment; radio grounds; 40m ZL special antenna; neutralization.

Available Issues published from 1964 are listed at the end of this catalogue.

65

Available Issues published from 1965 are listed at the end of this catalogue.

66

Available Issues published from 1966 are listed at the end of this catalogue.

67

MAY 67. Quad Issue! 432 quad-quad-quad; expanded HF quad; two el quad mini-quad; 40m quad; quad experiments; half-quad; three-el quad; quad bibliography; VFO vfo; tube troubleshooting; HF dummy load; understanding "dB"; HF SSB-CW RX; geometric circuit design; GSB 201 transceiver; FET converter for 10-20m hi-pass RX filters.

JULY 67. VE ham radio; VE0 hams; DSB adaptor; home-brew tower; transistor design; '39 World's Fair; ground plane antenna; G4ZU beam; SSTV monitor; UHF FET preamps; IC "I-F" strip; vertical antenna; VHF/UHF dipper; tower hints; scope monitoring; operating desk S-line cross-band; hi-school ham club; Heath HR-10 mods.

OCT 67. HF solid-state coils; rugged rotator; designing slug-tuned coils; FET converter; SSTV pix generator; VHF log-periodic; rotatable dipole; gamma-match cap; odd-time DXing; modern DXing.

Available Issues published from 1967 are listed at the end of this catalogue.

ting to Know Tee Squared EI; More Power From 6146s; Radio Direction/Range Finder; Morse Memory—30-letter memory for ident, contests, etc.; SCR Mobile Theft Alarm; DX QSOs or contacts; Code Short-hand; VHF Double Sideband.

72

FEB 72. A Solid-State High Frequency Regenerative Receiver—el cheapo using one IC; Tips for Raising Your Code Speed to 20 WPM; Why Not Try QRP? VHF Dummy Load Wattmeter; CW DX On 1/2 Watt—enjoy QRP with this 1-Watt rig; 20-60 W 1.4 Band TX—two-tube CW transmitter; Quick and Easy PNP/NPN Transistor Sorter; Self-Contained Reflected Power and CW Monitor; Circuits, Circuits, Circuits; The Automatic Transmission Line Tuner.

MAY 72. Quick Band Change Mobile Antenna—with output indicator; How to Get the Stuff Into the House; Anti-CV/ RTTY Autostart; A Modern VHF Frequency Counter—can be built for under \$100; TV Sync Generator—using ICs; Radio Astronomy; Noise and Receiving Antennas; The Sewerpipe Antenna—2m FM, of course; Circuits, Circuits, Circuits; Simple Car Ammeter—all solid state.

JUNE 72. Six Elements on Twenty Meters—eliminate QRM; Slow Scan Television—basics; Active Filter Design and Use—all kinds of filters... Part I; Radio Astronomy for Amateurs (Part II); 20 dB Beams—design and construction of VHF antennas; Phasing Multiband Verticals—ten thru eighty meters; 300-MHz Frequency Scaler—extends frequency counters to VHF; Circuits Circuits, Circuits; RTTY Filters—elliptic function filters; Trouble-shooting for the Novice.

JULY 72. Solid-State VHF Amplifier; The Phase-Locked Loop; VHF Converters; Add \$15 T-Power; 1296-MHz Mixer; The VHF Specialists FM Amplifier; Meteor Shower DXing; Tone Decoder and Carrier Relay Circuits—using the 741 op amp; Flying Spot Scanner for SSTV—solid-state unit, simple, relatively; Active Filter Design, Part II.

AUG 72. SSTV Intro; speech processor; FM repeater info; test probe construction; GE Progline ac supply; 432 rf testing; preamp compressor; Six-er mods; phone patch; Two-er info; solar info; SCR regulator for HVPS; "ideal" xtal oscillator; FM RX adapter; auto theft alarm.

SEPT 72. Plumbeon TV camera: WWVB 60-kHz RX; cigar tube signal generator; CW active filter; rf testing at 1296-3500 GHz; balun antenna feed; transistor power supply; IC 6m RX; IC FM/AM detector (part 2); active filter design (part 3); K2OAW frequency counter (part 3); 2m frequency synthesizer (part 1).

OCT 72. Corrections for Aug. FM RX adapter; 2m frequency synthesizer (part 2); 6m transistor vfo; nano-ampere meter; time-frequency measurement (part 1); active filter design (part 4); repeater timer; Extra class Q&A (part 3); balloon vertical; 1D generator; time-delay relay; 432 filter ideas; dc-ac inverter; hc-diode converter; RTL decade and nixie driver; plus-minus supply for ICs.

NOV 72. HF transistor power amps; RTTY Selcal; IC trf RX transistor keyer; emergency power; 220-MHz preamp; double delta antenna; simple converter using modules; HF rf tester; "lumped line" oscillator; 2m frequency synthesizer (part 3); K2OAW counter errata; 2m preamp; Extra class Q&A (part 4); hi-Z voltmeter Nikola Tesla story; VHF swr meter; transistor regen RX; 432 SSB transverter; ac arc welder; Intro to computers; hybrid AM modulator; HR-10 RX mods; 10m transistor AM TX; 40m ground plane; IC logic demonstrator; overload protection; i-trf sweep generator; digital frequency counter; aural TX tuning.

DEC 72. SSTV scope analyzer; 2m FM RX; tone burst encoder and decoder; universal i-f amp; autopatch hookup; LM380N infc voltage variable cap info; 2m 18-Watt amp; SSB modulation monitor; xtal freq activity meter; 10 A v. dc supply; transmission line uses; radio astronomy; inductance meter; 75 to 20m transverter; LED info; 40m preamp; transistor vfo; 1972 Index; 2m preamp.

73

JAN 73. HT-220 touchtone; 3-el 20m yagi; 50-MHz frequency counter; speech processor; 1-tone generator; FM test set; tilt-over tower; 2m converter using modules; tunable AF filter; six-band linear; 10m i-f tuner; diode noise limiter; CW/SSB agc; HW-22A transceiver 40m mod; HAL ID-1 mod.

MAR 73. A Fast-Scan Facsimile System—use it with SSTV; Six and Two Meter High Power—using a \$25 surplus amplifier; A Digital Tape Distributor for RTTY; The Amplic Amplifier—all band, 1200 Watts; Popular SSTV Circuits (Part II); Improving the Indoor Antenna System—using copper foil; FM Deviation Meters; Time Frequency Measuring System (Part III); Another Use for 400-Cycle Transformers; Bandpass Filter Design.

APR 73. FM deviation meter; 2m FET preamp; two 2m power amps; repeater control (part 1); repeater licensing; European 2m FM; FM scanner adapter RCA CMU15 mods; lightning detector; CB alignment gadget; transistor rf power amps (part 2); repeater economics.

JUNE 73. 220-MHz signal generator, UHF power meter; repeater licensing info; RTTY autoswitch; 40m hybrid vfo TX; antenna polar mount; 10-15-20m quad; K2OAW counter mods; double coax antenna; ham summer job; tone decoder; field strength meter; nicad battery pack; ohmmeter; FCC regs (part 1).

JULY 73. Tuneable Oscillators for 2m FM Receivers; Basic ATV System—a T-44 transmitter strip does most of the work; Multiple Output Frequency Standard—lets you calibrate your receiver in .0625-Hz increments; Digital Identification Unit; 450-MHz Power Divider—easily-constructed matching system for stacked arrays; CW Filters, Bared and Compared—complete with scope traces and bandwidth specs; 85 dB Gain 2m Antenna; Compromise Multiband Antennas; Grid-Dip Tuning the Quad Antenna.

AUG 73. Log-periodics (part 1); tone burst generator; rf power amp design; transistor radio intercom; 160m antenna; SSTV monitor; low-cost frequency counter; VOM design; QRP 40m TX; 432-MHz exciter; FM audio processing; FCC regs (part 3).

SEPT 73. Repeater control system; log periodics (part 2); 2m RX calibrator; PLL IC applications; TT pad hookup; Heath HW-7 "S" meter; OSCAR-6 Doppler; 2m coaxial antenna; 2m converter; IC keyer; measure antenna Z; FCC regs (part 4).

NOV 73. 450-MHz exciter; intro to ATV circuits; nicad voltage monitor; autopatch connections; IC meter amplifier; TR-22 ac supply; indoor vertical; IC AF filter; momentary power failure protection; 160m antenna coupler; Motorola HT info; SSTV-15B, Class B AF amp; FCC regs (part 6).

74

FEB 74. SSTV monitor info! IC audio amps; scope sweep generator; 15/20m vertical; telephone line control system; PC board construction; var-Q AF filter; blown-fuse indicator; 40m CW station with Ten-Tec modules; simple preamp compressor; single-IC RX; "432-34" final assembly; transistor keying circuit; 7-segment readout with nixie driver.

APR 74. VOX for repeaters; tone-operated relay; HF transverter; 10 to 2m TX converter; remote control panel for scanner; RCA FM TX tuning; subaudible tone generator; FCC regs (part 9); repeater atlas.

MAY 74. CD car ignition; audio compressor info; interference suppression for boats; auto burglar alarms; 2m IC preamp; 10m FET converter.

JUNE 74. Poor Man's Quad; Reconciling the Long Squared Quad—developing a new type antenna; Antenna Load Indicator; Matching: Remotely tunable Antenna Coupler; A Practical Ground System for 160; Wide-Range Antenna Tuner; Old Antennas and New Baluns—build a double zepp; A Multiband Ground Plane—10-40 meters; Mod Quad for Frustrated Cliff Dwellers.

JULY 74. 4-1000A linear; universal frequency generator; universal AFSK generator; 555 IC timer; 80m phasing array; 135-kHz-432-MHz preamps; 10m QRP AM TX; 3000 V dc supply; how to read diagrams.

AUG 74. Toroidal directional wattmeters; 450-Hz FET preamp; use gdo to find "C"; Trimline TT pad hookup; R390 & R392 RX mods; tracking CW filter; aural voltmeter; universal regulated supply; SSTV scan converter; TTL logic problems; ID timer.

SEPT 74. MOSKEY electronic keyer (part 1); WX warning system; Heath IO-103 scope mods; QRP 6m AM TX; rf speech clipper; audio noise limiter; WX satellite on SSTV monitor; universal IC tester; miniature rig construction; tower construction; infinite rf attenuator; electronic photo flash ideas; IC "select-o-ject."

OCT 74. Microtransistor circuits; synthesized HT-220 (part 1); repeater government; regulated 5 V dc supply; FM Selcal; removable mobile antennas; Motorola metering; 2m vertical collinear; Motorola model code; 2m coaxial dipole; 1.6-MHz i-f strip; MOSKEY electronic keyer (part 2); carbon mike circuit; hi-power lo-pass filter; 6m preamp; 3-wire dipole; ATV sync generator; NCX-5 mods; mobile whip for apartment dwellers; SSTV automatic vertical trigger.

NOV 74. K2OAW counter update; regulated 5 V dc supply; wind direction indicator; synthesized HT-220 (part 2); 20m 3-el beam; autopatch pad hookups; double-stub antenna match; Novice class instruction; digital swr meter (part 1); 6m converter (1.6-MHz i-f); "C-bridge"; MOSKEY electronic keyer (part 3); Aug. SSTV scan converter errata; repeater off-frequency indicator.

DEC 74. Care of nicads; wind speed/direction indicator; WX satellite video converter; electronic keyer; hints for Novices; unknown meter scales; SSTV tape ideas; TTL logic probe; public service band converter; tuned-diode test receivers; digital swr meter (part 2); telephone pole beam support; rhombic antennas; 1974 Index.

75

FEB 75. Heath HO-10 scope mod for SSTV; electronic keyer; digital satellite orbital timer; OSCAR-7 operation; satellite orbital prediction; Heath SB-102 mods; comparing FM & AM; repeater engineering; Robot 80-A SSTV camera mod; neutralizing Heath SB-110A; "Bounceless" IC switch; tape keyer for CW TX.

MAY 75. IC Callsign Generator; Playing with Power on 432; Does Ether Cause Gravity?; OSCARing Your FM Rig; In Pursuit of the Perfect SSTV Picture; Ac Power for the HW-202; You Can Work 75m DX; The Postage Stamp Squelcher; disaster in Honduras.

JUNE 75. Home Brew this SSTV Monitor; El Cheapo Superbeam; The Smart Alarm; RF Power at 432; Dirt Cheap Tunable I-F for Converters; All Band Frequency Marker; Front Burner for Six; Three on Fifteen; Presto! Transistor Checker from VOM; How to Put on a Professional Slide Show.

JULY 75. OSCAR Special! Antennas for OSCAR—What Really Works?; How You Can Take OSCAR's Temperature; FM Alignment Oscillator; The Audio Synthesizer for RTTY, SSTV and Whatever; Ham Radio in the Arctic—1925; Gee, What's a Zepp?; Vertical Antennas for the Novice Preventing Regulator Carnage; The Ultimate in Variable Selectivity; Phone Patching—A Public Service.

AUG 75. 146/432-MHz helical antennas (part 2); 20 minute ID timer; digital swr computer (part 1); debugging rf feedback DVM buyer's guide; WX satellite monitor CMOS "accu-keyer"; PC board methods sweep-tube final precautions; compact multiband dipoles; small digital clock; accessory vfo for HF transceiver; modern non-Morse codes; multi-function generator; 2m scanning synthesizer errata; KP-202 walky charger; 10m multi-element beam.

SEPT 75. Calculating frequency counter; WX satellite FAX system (part 1); IC millivoltmeter; three-button TT decoder; troubleshooting SSTV pix; 40m DX antennas; 146/432-MHz helical antennas (con-

clusion); digital swr computer (conclusion); reed relay for CW bk-in; NE555 preset timer; power-failure alarm; portable QRP rig power unit; precision 10 V dc reference standard; 135-kHz i-f strip; telephone handsets with FM transceivers; Motorola T-44 TX mod for ATV; 0.60-MHz synthesizer (part 1); ham radio PR.

OCT 75. A deluxe TTY keyboard (part 1); op amps; a basic primer; an Introduction to microprocessors; 2m synthesizer (conclusion); satellite FAX system (conclusion); regulated supplies (dispelling the mystery); digital logic made simple; FCC interview; a contest up system; digital clock timebases; the operating desk; QRP 432; ram PR.

NOV-DEC 75. Blockbuster double issue! Flip-flops exposed; breakthrough in fast scan ATV; strobing displays is cool; the tuned lunch box (antenna tuner for HF transceivers); a deluxe TTY keyboard (part 2); the 127 rotating mast; less than \$100 multi-purpose scope for your shack (part 1); predicting third-order intermod; feed-line primer; QRMing the Third Reich; why tubes haven't died; instant circuits—build your own IC test rig; the K2OAW synthesizer PROM-oted; a ham's intro to micro-processing; ground fault interrupter (a keep-alive circuit for yourself); a \$1 strip chart recorder; an even simpler clock oscillator; the Fun City surplus scene; updating the Heath IB-1101 counter; 256 pages!

76

FEB 76. Build a Starfleet Communicator—Trekles special; Synthesized IC Frequency Standard! You Can Make Photo PC Boards; How's Your Speech Quality?; ASCII-to-Baudot converter; RTTY Autocall—the Digital Way; Improving the FT-101; Night DXing on 10 and 15m; Really Soup Up Your 2m Receiver; Put Your SB-10 on 160m.

MAY 76. Special Antenna Issue! The Magnificent Stevens Microhelix; An Allband Inverted Vee; Closed Loop Antenna Tuning; The 75-80m Broadbander; The Magic of a Matchmaker; How to Coax Your Antenna; 40m DXing—City Style; The Secret 2m Mobile Antenna; An Inverted Vee for 160/80m; The Dipole Dangler; Amateur Weather Satellite Reception; Scan Your HR-212; A Very Cheap I/O—the Model 15; Code Converter Using PROMs; A Nifty Cassette-Computer Systems; The Ins and Outs of TTL; Build a CW Memory; 5/8-Wave Power for Your HT; 555 Timer Sweep Circuit for SSTV; AM Is Not Dead—It Never Existed at All; Computer Languages—Simplified.

JUNE 76. VHF Special! Super COR—Digital; of course; Touchtone Decoder—using a calculator readout; Simple Amateur TV Transmitter, Amateur TV Receiving System; Mobile Autodialer; Autocall '76—using a touchtone decoder; Build This Lab Type Bridge—and measure transformer impedances; How Those Triangle Things Work—a sort of op amp handbook; Those Exciting Memory Chips—RAMS, ROMs, PROMs, etc.; ASCII/Baudot with a PROM—for ribbonless RTTY on computers; Aim Your Beam Right—with a programmable calculator.

JULY 76. Perfect CW—drive 'em crazy with the keycoder I; The Mini-Mite Allband QRP Rig—a mighty 7 Watts; A Fun Counter Project—under \$50; Build a FAX from Scratch—then get satellite pictures and other things; Der Repeatermeister—repeater control with ID; The Giant Nixie clock; Creative SSTV Programming; CW Regenerator/Process; What's Up on 156 MHz?; TT Pad for the Wilson HT; Power Supply Testing—to save your digital circuits; A RTTY/Computer Display Unit; Your Computer Can Talk Morse; Gain for Your HT—a half-wave whip; The Super Transmatch; Simple VHF Monitor.

SEPT 76. The Surprising DRRR Low Noise Antenna (part II); Ultrasimple Regulation with New IC—power supply design greatly simplified; Can an Indoor Antenna Work?—making the best out of a bad bargain; Inexpensive 12 Volts for Your Base Station; A Test Lab Bonanza—using a transistor radio; Protect Your VHF Converter—novel antenna relay; ridiculously simple RTTY System; How to Catch a CBER; A 450-MHz Transceiver for Under \$130; Space Age Junque II; PROM Memory Revisited; Eight Trace Scope Adapter;

The PROM Zapper; Sneaky Baudot—with an ASCII keyboard; Simple Graphics Terminal—using surplus; Counters Are Not Magic—they're simple.

OCT 76. Build a Weird 2 Band Mobile Antenna; Build a Counter for Your Receiver; How Do You Use ICs? (part II); QRP Fun on 40 and 80—have a real ball with just 5 Watts; The Hybrid Quad—low windload, expense, hassle!; Frequency Detector for Your Counter; Programmable CW ID Unit—for RTTY, repeaters, mobile, etc.; New ICs for the Counter Culture—simpler counters with less used power; Is My Rig Working or Not?—build an effective radiated field meter and know! Quickie Coilnears for 15 and 10—satisfaction guaranteed; Build a Super Standard—goes right down to 1 Hz; The Incredible Lambda Diode; Mechanical RTTY Buffer; Have You Used a Triac Yet?; How To Interface a Clock Chip—Baudot, BCD, or ASCII conversion; A TTL Tester—great for unmarked bargain ICs; The New Ham Programmer—making those confounded uPs work; BASIC? What's That?—the basics of BASIC; The Soft Art of Programming (part I).

NOV 76. Blockbuster 288-pg. Issue! Cordless Iron Tips; Bicycle Mobile; Build a Simple Lab Scope—costs less than \$70!; Get on Six with Surplus—the el cheapo RT-70 is a natural; The Beam Saver—rotor memory system; Updated Universal Frequency Generator; The Shirt-Pocket Touchtone Liquid Crystal Display Guide; Self-Powered Mike Preamp; The Wind Counter; The S38 Is Not Dead! The Amazing Inverted L—antenna for 20, 40, and 80m; Battery Chargers Exposed; How Do You Use ICs (part III); Thirty Years of Ham RTTY; Big Noise Burglar Alarm; Dandy Digital Dial Decoder; Weather Satellite Display Control; Ham Time-Sharing Is Here for You!; The Soft Art of Programming (part III); OSCAR Smoke Tester—power supply tester; The Man Who Invented AC—Tesla, the greatest pioneer of them all; Baudot to ASCII—you want to learn programming?; Baudot and BASIC—an interpreter for a Baudot computer; Toward a More Perfect Touchtone Decoder; Using a Wireless Broadcaster; The Quiet Sp—amateur uncovers spy ring in the US!; The Benefits of Sidetone Monitoring—and how to do it.

DEC 76. Go Tone for Ten—simple sub-audible encoder; World's Simplest Five Band Receiver?; How Do You Use ICs? (part IV); A Super Cheap CW IDer; The ZF Special Antenna; CT7001 Cluckbuster; Saving a C&R; A Ham's Computer; What's All This LSI Bunk?—an ostrich's eye view of the microprocessor; The Soft Art of Programming (part III); Put Snip into Your SSTV Pictures—using a \$20 frequency standard; What's All This Wire-Wrap Stuff?—talk about cold solder joints! Exploding the Power Myth; Exploding the SWR Myth; The IC-22 Walkie—portabilization with nicads; Watch DX with a Spectrum Analyzer; DXing with a Weather Map.

HOLIDAY 76. 55-article Issue! An inexpensive 400-Watt HF Amplifier; How Do You Use ICs? (part V); Mobile Smokey Detector—10.5 GHz; use it or lose it!; Add RIT to Your Transceiver; DXpedition: Memories for a Lifetime—reflections of HK1TL; Design Your Own QRP Dummy Load; Fall-safe Super Charger—multi-rate, too!; The Amazing 18" Antenna for 160m; Replacing the Knife Switch—simple TR system for the Novice; Now You Can Synthesize—the VHF Engineering approach to 2m happiness; Hutchinson's Remedy—the chirpless CW machine; The Mod Squad Does the Pocket Scanner—Radio Shack Pro-4 update; TR-22 Mod Squad; What Computers Can and Can't Do; A Ham Shack File Handler—program in BASIC for QSLs, repeaters, etc.; Print Your Own Logbook—on your nearest computer; Shoeing Your HT; Cash in on the CB—Installation for fun and profit; Tuning Those Big Antenna Coils; The 2m Mod Squad Tackles the Weather Radio—and wins!; Hamming by laser; A 60-Foot Antenna on a 20-Foot Lot—solving a 40m Novice problem; Dual-Voltage Power Supply; An Autopatch Busy Signal; Inside the GLB—a gutsy look at a synthesizer! How to Bug an Automatic Keyer; A 450 Duplexer—that fits in your car; Will Silver-Zinc Replace the Nicad?

77

JAN 77. SSTV Test Generator—invaluable diagnostic tool; How Does Your Rig Perform?—an example using the HW-7;

What's The Best Antenna for 160?—the inverted vee compromise; 200 lb. Cookie—microwave repeater control; A Super Log—a program for the ham shack computer; Practical Solar Cell Power—great for remote repeaters; A Simple RC substitution Box—using a matrix; Double Sideband: Something New?—one for voice, one for SSTV; A Vest Pocket QRP Rig—if you have a big one; Antenna Magic—good advice on antenna fundamentals. Plus 40 more.

FEB 77. Give That Professional Look To Your Home-Brew Equipment—win prizes; Give the Burglar Heart Failure—car alarm system; Contest Special Keyer—has short but adequate memory; You Can sound better With Speech Pre-emphasis—a simple circuit which will work wonders; Getting a Patent—Is It Really Worth It?—how to do it, if you really want to SSB; The Third Method—bet you can't even name the first two; The TTL One Shot—another digital building block; Computerized Satellite Tracking—the needec software; Drive More Safely With A Mobile Dialer—hold 4 or 8 phone numbers in a PROM; Tune Up A Random Wire—world's simplest antenna for 80-15. Plus 10 more.

MAR 77. Pitcairn Island—an inside look at VRET; How Do You Use ICs?—part VI; PROM Message Generator For RTTY—keyboards are obsolete; Inexpensive Variable DC Supply—easy and quick; The History of Ham Radio—part I; Versatility Plus For the HW-202—external channel mod Making Your Own PC Boards—part I; Announcing the PCF—legal aid for ham problems; Build Your Own Car Regulator—solid state; The Happy Flyers—fun and public service. Plus 15 more.

APR 77. RTTY? What's That?—how to get started with teletype; Making Your Own PC Boards—part II; 80 CW for the 6800—it works; The Super Clock—what'll they think of next?; The Final Feeder—driving a high power amplifier; What About Surplus Nicads?—how to test and repair them; The History of Ham Radio—part II; Retire to a Ham Heaven—how to go on a permanent DXpedition; The Carbon Marvel—best mobile mike yet?; The Minicom Receiver—finally, a QRP albander. Plus 25 more.

MAY 77. Build The World's Simplest Keyer—uses 555 timers; Predict the Weather!—a complete satellite receiver; The History of Ham Radio—part III; Let BASIC Control Your Next Contest!—with Extended Tiny BASIC language; Understand Your Pet Rock—tips on crystal oscillators; TTL Techniques—bypass those glitches; Stop Timeouts!—build this 10-minute ID timer; Quick Vertical—for 20 and 40; Try Power Saver Logic—a guide to CMOS applications; All-Electronic Seical—uses a UART for versatility. Plus 24 more.

JUNE 77. Build This CW Filter—darned good; The W1BB Story—a visit with the king of 160; Ten Watts on 2—it's possible with this rock crusher!; At Last! A 10m Band Plan—requires a CB radio; Sheet Metal Brake—build microwave components; Practical P.S. Design—do it right this time; Regulated Nicad Charger—don't cook 'em! Current-Saver Counter Display—multiplex those LEDs; New PC Techniques Unveiled!—dig out your old chemicals; How Do You Use ICs—part VII. Plus 22 more.

JULY 77. A Battery Voltage Monitor—how simple can an IC project get?; Hunting Noise—with a grid dipper; Hams Profit From CB—how to set up a service center; Patch Up Your 101—simple mod for the HW-101; Dipole Designer Program—calculates coils and length; CB to 10—parts III, IV, and V; World's Smallest Continuity Tester—It's almost minute; Digital Synthesizer—revitalize old xmr strips; Phone Patch Tips—a lost art?; Digital Clock Fall-Safe—so you won't miss the train. Plus 18 more.

AUG 77. Antenna Special! Centered Specials—for the small city lot; Build a Double Bazooka—give your signal a blast; Dirt Cheap Directional Array—for the serious DX hound; Instant PS Regulation—a quickie; The Zeppy Vertical—a perfect 2m antenna; The 8JK Array Revisited—Inexpensive and effective; Build a Brute Power Supply—completely regulated and protected; Computer Logger—for those who keep logbooks; build a KW Linea—a 4-1000 provides the punch; PC Layout Tips—next time, do it right! Plus 44 more.

SEPT 77. RTTY Special! A FAAR-OUT DX pedition—airborne VHF and OSCAR!; So You Want to Get Into RTTY?—"Call For Papers" winner; Design an Active RTTY Filter—eliminate CW QRM and noise; Build a RTTY Message Generator—It's programmable!; FSK for the Drake—easy Baudot To ASCII Converter—use it for OSCAR RTTY; RTTY with the KIM—features built-in display!; FSK for the FT-10—simple mod for RTTY; Noise Rejector—great for CW or phone receivers; A Practical 2m Synthesizer—who said it can't be built? Plus 17 more.

OCT 77. W.A.S.—Easily!—catching the last few; Try Your KIM-1 on RTTY—CUL on your computer; Try a Trapped Dipole—save copper and coax!; Novice Antenna Specials—tips for that first antenna; Traffic Handling Explained—a lost art?; One-Cent Channels For the IC-22S—Inflation fighter!; Sensitive Meters Saved; Add Jazz to Your Tempo—with a few simple mods; Interested in Television?—how to get started; Digital To Audio Decoder—for the blind operator. Plus 26 more.

DEC 77. The History of Ham Radio—part V; How Do You Use ICs?—part VIII; A Kilowatt Alternative—try a gain antenna; The DA4FB Story—American repeater in Germany; Computerized Global Calculations—finding the best way to Pago Pago; Run, Sheila, Run!—real-life radio control; CB to 10—parts VI and VII; amplitude vs. frequency—poor man's spectrum analyzer; Regenerated CW—CW as you like it. Plus 41 more.

JAN 78. Build a Better Phone Patch—hybrid op amps—the works; Build a 3 1/2 Digit DVM—replaces old meters!; QRP Hints—for low-power freaks; Custom-Made Thermistors—for precise values; UHF Propagation—believe it; Put an ELF in Your Keyer—sneaky computer strikes again; CB to 10—part VIII; The Extreme Basics of Antennas—for pre-Novices; Versatile Transistor Tester—save expensive devices; How to dissipate 200,000 Megawatts—fool Mother Nature. Plus 36 more.

MAR 78. Old Rigs Can Live Again!—a guide to their resurrection; Novices, Paddle Your Way to Happiness—super deluxe Novice keyer; 1220 MHz—Use It or Lose It!—simple gear you can build and enjoy; New Protection For Your Car—simple force field system; The World of Tone Control—a virtual encyclopedia on the subject; Another Approach to the ASCII/Baudot Headache—a Model 15 and an SWTP system; Surprisingly Low-Cost Lab Supply—an IC regulator does it!; The Solar-Powered Ham Station—one hundred Watts, yet; Are You Afraid To Build?—how to get organized and started; How to Use a Varactor—And Why—semi-exhaustive article. Plus 33 more.

APR 78. How to Succeed on 1296—catfood can 50-Watt amplifier; How Do You Use ICs?—part IX; The Challenge of 10.5 GHz—use it or lose it to Smokey; Now Anyone Can Afford a Keyboard—surplus keyboard, KIM, and software; Is TTL Already Obsolete?—CMOS vs. TTL; Improve Your HW-202—more flexibility, etc.; Simple CW Interference "Filter"—diode code regeneration; How Sunspots Work—basics for the Novice; Use Noise to Tune Your Station—build this simple noise generator; Danger! Microwave Radiation!—just how much is dangerous? Plus 19 more.

MAY 78. Official FCC RFI Report—curing radio and TV; Fake 'Em Out With Remote Control—TT-operated control unit; Now—A Digital Capacity Meter!—simple construction project; DMM Survival Course—"all" about using digital multimeters; Build This Exciting Simple Receiver; Diary of a Survivor—cyberosis victim tells all; The Super Select-o-Ject—kill rotten QRM with this filter system; The Miser's Delight Repeater Controller—the very IDI; Make Antenna Tuning A Joy—Instant swr bridge; The COR Goes Solid State—turning two Midland rigs into a repeater. Plus 18 more.

JUNE 78. Antenna Special! Wait Till You Try 16 Elements!—15 dB gain on 2m is a real kick; Working 15m with a 20m Beam—by adding three more elements; Resurrecting the Beverage Antenna—try this

55-year old, low-noise, low-band antenna Better Than a Quad?—try a delta loop Towering Low-Band Antennas—berserk mathematical figures impedance; Modernize the Matchbox—increased capability for a classic coupler; The 75m DX Chaser Antenna—the 5/8λ works on 75m as well as 2m; Computerized Loop Antenna Design—in BASIC; Novice Guide To Phased Antennas—part I; The 21-Element Brown Bomber—2m beam with sadistical by strong signal. Plus 29 more.

JULY 78. Reincarnating Old Test Equipment—a 1942 capacitance meter is born again; Novice Guide to Phased Antennas—part II; Build Your Own Digital Dial—great update for your receiver; You Scope Can Be Improved—simple callibrator; The 55 Memory Keyer—for lazy cheapskates; RAMmed By Morrow—ECONRAM III lauded; VHF Notch Filter—rejection can be beautiful; Yes, You Can Build A Synthesizer!—220-MHz synthesizer for under \$50; A Darn Good Ider—repeaters get smarter every day; VHF Transverters and the FT-101—quickie FM conversion. Plus 34 more.

AUG 78. Radio Row Revisited—It's alive and well in Tokyo; A Complete X-Band Transmitter—easy to build; Power Line DX—(almost) wireless remote control; The End of RF Feedback—here's how the pros do it; CB to 10—part IX; A WWW Primer—become a calibration freak; Super Charger—keeps nicads up to snuff; HW-101 Owners, Check This!—RIT mod for the good old HW-101; Ham Radio Is NOT A Rich Man's Hobby—another myth exploded; New Life for Double Sideband?—awake, ye pioneers, and get cracking. Plus 34 more.

SEPT 78. Another IC-22S Scheme—for oddball repeaters; Tracking the Wild Turkey—DF tips; DVM Scrapbook—the basics; How Do You Use ICs?—part X; Computerized QSO Records—who needs a logbook?; CB to 10—parts X & XI; Build the Triple Threat Keyer—great Novice project; The Ten Meter AM Antenna Special—\$5 vertical also works on SSB or FM; Build the IC Experimenter—getting started with TTL and CMOS; Two Meters at the Summit—a backpackers delight. Plus 37 more.

OCT 78. DXpeditioning—a "how to" guide; The History of Ham Radio—part VI; Building From Magazine Articles—the breadboard/wire-wrap way; High Seas Adventure—Ham Style—part I; Use a Computer? Who, Me?—yes, you!; Bird Watching in BASIC Land—another use for your micro; World's Cheapest QSLs—BASIC program keeps your log, too; Happiness Is a Smart Scanner—mods for the PBM/AWE FMS-1; A Perfect Power Supply?—well... almost; Antenna Design: Something New!—controlled-current distribution. Plus 37 more.

NOV 78. Murphy's Masterpiece—the lost weekend; How About Some Ham Shack Safety?—don't be a statistic; The History of Ham Radio—part VII; CB to 10—part XIV; A Realistic PLL rig; High Seas Adventure—Ham Style—part II; Squelchifying Cheap Receivers—junk-box project; Build the Brute—unique heavy-duty power supply; The Circuit Board Aquarium—no fish story; Who Needs Transistors?—you do; Ham Help!—a telephone aid for the blind. Plus 47 more.

DEC 78. A DXer's Dream Vacation—try sunny Montserrat; Close Encounters—the eyes of Texans are upon them; Receiver Diseases—and how to cure them; Confessions of a Stripper—confirmed junker tells all; Whither Microcomputers?—a pro looks ahead; "This Is Your Computer Speaking"—how to dial up your micro; Big Max Attacks—It's W2DU vs. K4KL in the battle of the bazooka; WARC '79 Preview—showdown in Geneva; Build the Flexi-Filter—a very active device; Code-Practice Oscillators—an exhaustive report. Plus 29 more.

Also Available: December, 1960; June, July, August, September, October, December, 1961; January, February, November, 1962; January, April, May, July, September, November, 1963; January, March, April, July, September, October, November, December, 1964; May, June, July, August, December, 1965; August, September, December, 1966; January, February, March, April, June, August, September, December, 1967; January, March, April, May, August, October, December, 1968; October, 1970.

\$5.95

ARE YOU A BIG GUN CONTESTER?

The small number of elite operators at the top of the list when the results are published know what it takes to win a major contest . . . do you?

Now the winners reveal their secrets in **THE CONTEST COOKBOOK** by Bill Zachary N6OP. It contains detailed suggestions for the first-time contestant as well as tips for the advanced operator.

Domestic, DX and specialty contests are all discussed . . . complete with photographs and diagrams showing the equipment and operating aids used by the top scorers.

Can you make 150 contacts . . . in one hour? Find out how in 73's latest publication, **THE CONTEST COOKBOOK**. Whether you take contests seriously or just enjoy a few hours of skilled operating, this 170-page book is sure to make your participation more pleasurable . . . and increase your score.

Winning a contest means more than having a kilowatt and beam—it takes a good operator with lots of determination. Don't settle for being a little gun . . . **THE CONTEST COOKBOOK** (BK7308) is available from the Radio Bookshop.

**MAIL THE COUPON
BELOW OR FILL OUT THE
POSTAGE PAID CARD AT
THE BACK OF THIS ISSUE.
ORDER TODAY!**

THE CONTEST COOKBOOK

By Bill Zachary N6OP

Basic and Advanced Techniques
Domestic, DX and Specialty Contests
Station Engineering for Higher Scores
Winners Reveal Their Operating Secrets

A 73 PUBLICATION

Yes! Please rush me _____ copies of **THE CONTEST COOKBOOK** (BK7308) at \$5.95 each.

Bill me

Visa Mastercharge American Express

Card # _____ Exp. date _____ Signature _____

Name _____

Street _____

City _____

State _____ Zip _____

NEW FROM DSI!

50 Hz — 500 MHz 8 DIGITS
1 Meg INPUT — 1 Hz RESOLUTION — 1 PPM TCXO



- AC—DC Operation
- BNC Inputs 1 Meg Direct 50 Ohms Prescaled
- 8 Large .4" LED Readouts
- Auto Decimal Point & Zero Blanking
- 1 Year Limited Warranty Parts & Labor
- 100% Factory Assembled In U.S.A.

\$149⁹⁵

MODEL 500 HH
50 Hz — 500 MHz
Without Battery Capability

MODEL 100 HH
50 Hz — 100 MHz

\$99⁹⁵

Without Battery Capability

SAVE \$5⁰⁰

With Battery Capability

MODEL 500 HH . . \$169.95

MODEL 100 HH . . \$119.95

Includes AC-9 Battery Eliminator

The 100 HH and 500 HH hand held frequency counters represent a significant new advancement, utilizing the latest LSI design . . . and because it's a DSI innovation, you know it obsoletes any competitive makes, both in price and performance. No longer do you have to sacrifice accuracy, ultra small readouts and poor resolution to get a calculator size instrument. Both the 100 HH and 500 HH have eight .4 inch LED digits — 1 Hz resolution — direct in only 1 sec. or 10 Hz in .1 sec. — 1 PPM TCXO time base. These counters are perfect for all applications be it mobile, hilltop, marine or bench work. **CALL TODAY TOLL FREE: (800—854-2049) Cal. Res. CALL (800—542-6253) TO ORDER OR RECEIVE MORE INFORMATION ON DSI'S FULL PRODUCT LINE OF FREQUENCY COUNTERS RANGING FROM 10 Hz TO 1.3 GHz.**

FREQUENCY COUNTER CONSUMER DATA COMPARISON CHART

MANUFACTURER	MODEL	SUG'STD. LIST PRICE	FREQUENCY RANGE	TYPE OF TIME BASE	ACCURACY OVER TEMPERATURE		SENSITIVITY			DIGITS		PRE-SCALE INPUT RESOLUTION	
					17° - 40°C	0° - 40°C	100 Hz - 25 MHz	50 MHz - 250 MHz	250 MHz - 450 MHz	No.	SIZE IN INCHES	.1 SEC	1 SEC
DSI INSTRUMENTS	100 HH	\$ 99.95	50Hz-100MHz	TCXO	1 PPM	2 PPM	25 MV	NA	NA	8	.4	100 Hz	10 Hz
DSI INSTRUMENTS	500 HH	\$149.95	50Hz-550MHz	TCXO	1 PPM	2 PPM	25 MV	20 MV	30 MV	8	.4	100 Hz	10 Hz
CSC‡	MAX-550	\$149.95	1kHz-550MHz	Non-Compensated	3 PPM @ 25°C	8 PPM	500 MV*	250 MV	250 MV	6	.1	NA	1 kHz
OPTOELECTRONICS	OPT-7000	\$139.95	10Hz-600MHz	TCXO	1.8 PPM	3.2 PPM	NS	NS	NS	7	.4	1 kHz	100 Hz

* 1 KHz - 50 MHz ‡ Continental Specialties Corp.

The specifications and prices included in the above chart are as published in manufacturer's literature and advertisements appearing in early 1979. DSI INSTRUMENTS only assumes responsibility for their own specifications.

100 HH . . . \$ 99.95 W/Battery Pack . . . \$119.95
500 HH . . . \$149.95 W/Battery Pack . . . \$169.95

Prices and/or specifications subject to change without notice or obligation.

These prices include factory installed rechargeable NiCad battery packs

✓ D25



DSI INSTRUMENTS, INC.
7924 Ronson Road, Dept. G
San Diego, California 92111

T-500 Ant. \$ 7.95
AC-9 Battery Eliminator \$ 7.95

TERMS: MC - VISA - AE - Check - M.O. - COD in U.S. Funds. Please add 10% to a maximum of \$10.00 for shipping, handling and insurance. Orders outside of USA & Canada, please add \$20.00 addition to cover air shipment. California residents add 6% Sales Tax.

DSI HAS DONE IT AGAIN

QUIK-KIT II®

INCLUDES PROPORTIONAL OVEN TIME BASE

- DC-BATT-AC (W-AC9)
- 95% Factory Assembled
- 100% Factory Tested
- .2 PPM 10° to 40° C Accuracy
- 9 Digits .5 Inch LED's
- 0.1 HZ Resolution
- Auto Zero Blanking



\$149⁹⁵
MODEL 5600A KIT

WHY BUY A 5600A: Because 95% of the assembly is completed by DSI and you are only one hour away from solving all those difficult bench problems, from setting the frequency of an audio signal to within 1/10 of a HZ, to checking the frequency of a 486 MHz mobile radio. Whether you are servicing a VTR, trouble shooting a PLL circuit, the 5600A is the right counter with accuracy that will meet any FCC land mobile, broadcast, or telecommunications requirements. On the bench or in the field the 5600A will do the job you need. The 5600A includes a self contained battery holder providing instant portability or we offer a 10 hour rechargeable battery pack option. Other options include an audio multiplier which allows you to resolve a 1/1000 of a HZ signal and finally a 25db preamplifier with an adjustable attenuator making the 5600A perfect for communications, TV servicing, Industrial testing or meeting your QSO on the correct frequency every time.

FACTS ARE FACTS: With the introduction of the 5600A. The sun has set on the competition. This may sound like a bold statement on the part of DSI BUT FACTS ARE FACTS. No counter manufacturer except DSI offers a Full Range 50 HZ to 600 MHZ counter with — 9 Digits — 0.1 HZ resolution — .2 PPM 10° to 40° C proportional oven — RF pre-amp — 600 MHZ prescaler — three selectable gate times — oven ready, standby and gate time indicator lights as standard features — For only \$149.95 kit and \$179.95 factory wired. In fact the competition doesn't even come close unless you consider \$200.00 to \$800.00 close. With DSI having the best price to quality features ratio in the industry, no wonder we've become one of the world's largest manufacturers of high quality frequency counter instrumentation.

FOR INFORMATION — DEALER LOCATION — ORDERS — OEM
CALL 800-854-2049 CALIFORNIA RESIDENTS CALL 800-542-6253

Model	Price	Frequency Range	Accuracy Over Temperature	Sensitivity			Number of Readouts	Size of Readouts	Power Requirements	Size		
				@ 100Hz-25MHz	@ 50-250MHz	@ 250-450MHz				H	W	D
5600A-K	\$149.95	50Hz-600MHz	Proportional Oven	10MV	10MV	50MV	9	5 Inch	*115 VAC or 8.2-14.5 VDC	3 1/4"	9 1/2"	9"
5600A-W	\$179.95		.2 PPM 10° - 40° C									
3550	99.95	50Hz-550MHz	TCXO	25MV	25MV	75MV	8	5 Inch	*115 VAC or 8.2-14.5 VDC	2 1/2"	8"	5"
			1 PPM 17° - 40° C									
500HH	\$149.95	50Hz-550MHz	TCXO	25MV	20MV	75MV	8	4 Inch	*115 VAC or 8.2-14.5 VDC or NICAD PAK.	1"	3 1/2"	5 3/4"
			1 PPM 17° - 40° C									

5600A wired factory burned in 1 year limited warranty. 5600A kit 90 day limited warranty. Prices and/or specifications subject to change without notice or obligation.

*With AC-9 Adaptor.



- T101 Ant. \$3.95
- AC-9 AC Adaptor 7.95
- 35P.2 29.95
- Factory Installed 49.95

3550 OWNERS
 You can add the 35P.2 .22 PPM 10° to 40° C proportional oven to your existing 3550



DSI INSTRUMENTS, INC.
 7924 Ronson Road
 San Diego, California 92111

TERMS: MC - VISA - AE - Check - M.O. - COO in U.S. Funds. Please add 10% to a maximum of \$10.00 for shipping, handling and insurance. Orders outside of USA & Canada, please add \$20.00 addition to cover air shipment. California residents add 6% Sales Tax.

- 5600A Kit \$149.95
- 5600A Wired 179.95
- AC-9 AC Adaptor 7.95
- T600 BNC Ant. 7.95

BUILT-IN OPTIONS

- BA56 Rechargeable 10 Hr. Bat. Pack 24.95
- AM56 Audio Multiplier 34.95
- .001Hz Resolution 34.95
- PA56 25dB Preamplifier with Attenuator 59.95

L. B. Peirce W4KIX
210 Carolyn Avenue
Panama City FL 32407

Grady Clark W4RYY
213 Sandifer Road
Athens AL 35611

"Hey! That Sounds Like .01 μ F!"

— intended for the blind, this audible
multitester is great for everyone

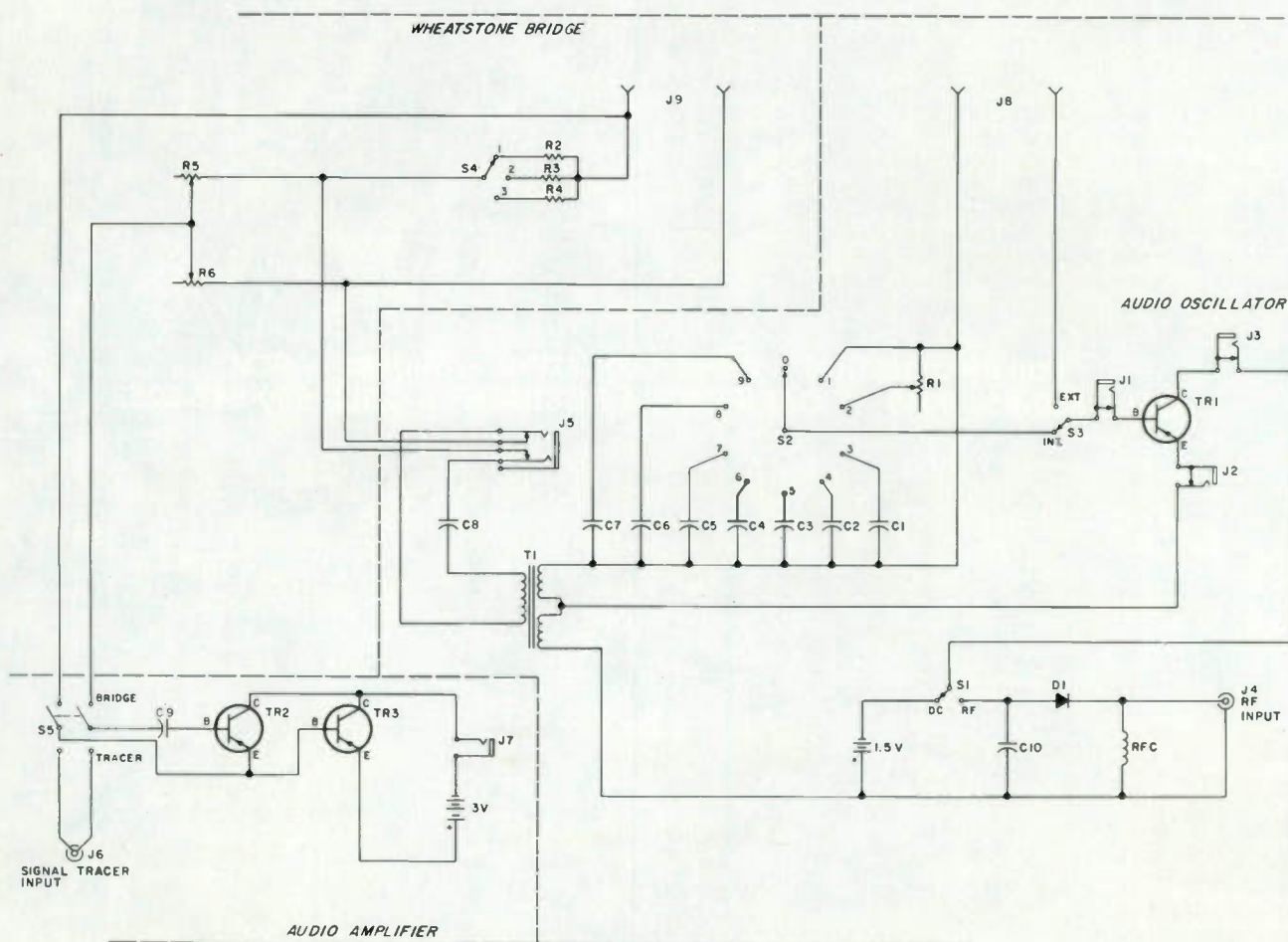

Fig. 1. Circuit diagram.

This article describes a simple but versatile test instrument designed especially for use by the sightless radio amateur or electronics experimenter. Although it may also prove useful to persons of normal vision, the instrument does not require the sense of sight for its use. All measurements of which the instrument is capable can be made using only the auditory and tactile senses. This is accomplished by 1) nulling or peaking an audio tone, 2) comparing and matching the pitch of audio tones, 3) counting the time-rate of audio pulses, or 4) reading by touch from dial plates especially suited to that purpose.

The two dials that must be read by touch are the controls for variable resistors. Dial reading is greatly facilitated by using variable resistors of the Helipot® or Spectrol® type. These are precision potentiometers requiring exactly ten turns of the control shaft to cover the full range of resistance with a high degree of linearity. When fitted with a pointer knob and a dial plate divided into ten equal divisions marked by raised dots, variable resistors of this type can easily be read by touch, in increments of one one-hundredth of the total resistance. For example, with the 10k-Ohm Spectrol, each revolution of the knob represents 1,000 Ohms and each dial division represents 100 Ohms; similarly, with the 200k-Ohm Helipot, each knob revolution represents 20,000 Ohms and each dial division, 2,000 Ohms.

Our dials were cut from thin sheet aluminum, and are about 2 inches in diameter. The raised dots marking the dial divisions were made with a center punch from the reverse side. Two dots were used at the

12-o'clock position to mark the fiducial point of zero and full resistance.

When used with appropriate test probes to be described later, this instrument has the following capabilities:

1. Checks continuity of circuits.
2. Provides an audio signal source of variable pitch for test purposes.
3. Measures capacitance from 0.0015 uF to 20 uF or higher.
4. Measures resistance from 10 to 200,000 Ohms.
5. Determines polarity of electrolytic capacitors.
6. Serves as an audio amplifier for weak signals.
7. Serves as a signal tracer for either audio or modulated rf/i-f signals.
8. Serves as an rf detector, transmitter tuning indicator, approximate frequency meter, or CW keying monitor for rf signals.

Circuitry and Applications

Fig. 1 shows the circuit diagram of the test instrument. As indicated in this figure by the dashed lines, the circuit is comprised of three basic elements: an audio oscillator, a Wheatstone bridge, and an audio amplifier.

The heart of the instrument is the audio oscillator, which can be powered by either an internal battery or an external source of rf energy. The oscillator uses a 2N107 PNP transistor in the familiar Hartley circuit. Inductive feedback is provided by T₁, which is a vertical blocking oscillator transformer from a TV set. In our case, this transformer is a Merit A-3001, with one primary and two secondary windings. The ratio of primary to secondary #1 is 1:48, and the ratio of the primary to secondary #2 is 1:1. These ratios are not critical, and any transformer of approximately similar characteristics should

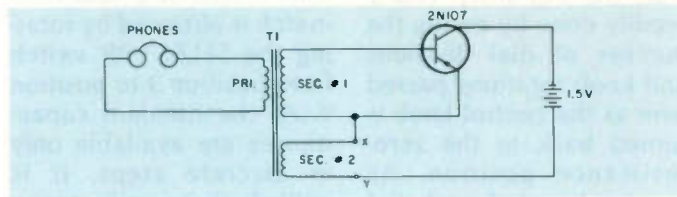

Fig. 2. Basic oscillator circuit.

serve. It is important, however, that the two secondary windings be connected so as to provide positive feedback for oscillation. The simplest way to determine the proper connections to the transformer is to temporarily hook up the basic oscillator circuit with clip leads as shown in Fig. 2. If oscillation is not obtained, as indicated by a low-pitched buzz in the phones, reverse the connections of secondary #2 at points X and Y.

A characteristic of this oscillator is that the frequency of oscillation can be varied over a wide range by inserting different values of resistance, capacitance, or inductance in series with the base lead of the transistor. Low values of series resistance produce low-pitched tones, and high values, high-pitched tones; whereas low values of series capacitance produce high-pitched tones, and high values produce low-pitched tones. The frequency of oscillation is highly sensitive to small variations of this kind, so that even quite small variations in series resistance or capacitance can be detected by a keen sense of pitch, which most sightless persons possess.

The important point, however, is that two resistors of equal resistance, or two capacitors of equal capacitance, when alternately inserted in the base lead, will produce tones of the same pitch. This characteristic provides a means for determining the value of an unknown resistance

or capacitance by comparing the pitch of the tone it produces with the pitch produced by a standard resistor or capacitor of known value contained in the test instrument.

The standard resistor incorporated in the instrument for measuring resistance by the tone-comparison method is the 200,000-Ohm Helipot, R₁. It is inserted in series with the transistor base circuit when the selector switch, S₂, is placed in position 2.

Referring to Fig. 1, the procedure for measuring an unknown resistance by the tone-comparison method is as follows:

1. Connect the unknown resistance across the test leads plugged into the jacks at J₈.
2. Plug the headphones into J₅ (or J₃).
3. Set the SELECTOR switch, S₂, at position 2.
4. Apply battery power to the oscillator by throwing the power supply transfer switch, S₁, to the DC position.
5. Throw the tone comparison switch, S₃, to the up or EXTERNAL position and note the pitch of the tone heard. This is the tone produced by the unknown resistance.
6. Now throw S₃ to the down or INTERNAL position, thereby substituting the standard resistor, R₁, for the unknown resistance. Adjust R₁ until no difference in pitch is heard when S₃ is thrown from one position to the other.
7. R₁ now has the same resistance as the resistor under test. Read this value

from the dial of R₁. This is readily done by noting the number of dial divisions and knob rotations passed over as the control knob is turned back to the zero-resistance position. As previously noted, each dial division represents 2,000 Ohms and each knob rotation, 20,000 Ohms.

On our instrument, this method of resistance measurement was found to be more useful for resistances greater than about 1,000 Ohms. For smaller values of resistance, the pitch becomes so low that all tonal character is lost and an accurate matching of pulse rates is more difficult. However, resistances under 1,000 Ohms can be accurately measured by the Wheatstone bridge.

Seven capacitors, C₁ through C₇, are incorporated in the instrument as standards for estimating capacitance. They are inserted individually into the base circuit by setting the SELECTOR switch, S₂, in positions 3 through 9. These capacitors range in value from 0.0015 uF to 0.1 uF in increments such that the capacitance is doubled each time the selector switch is advanced one position. In our case, we were fortunate enough to find in the junk box a multi-section capacitor containing all of these seven capacitances in one shielded can. Individual capacitors will serve just as well, of course, though perhaps not as neatly.

The procedure for estimating capacitance is the same as that for measuring resistance, except that a

tone match or a near tone match is obtained by rotating the SELECTOR switch from position 3 to position 9. As the standard capacitances are available only in discrete steps, it is unlikely that a perfect tone match with the unknown capacitance can be obtained. More commonly, the pitch produced by the unknown capacitance will be bracketed by two SELECTOR switch positions, one giving a higher pitch and the other a lower pitch than the capacitor under test. The unknown capacitance is then approximated as somewhere within the range of capacitance represented by these switch positions, giving consideration to the relative differences in pitch of the three tones.

Although the highest standard capacitance provided is 0.1 uF, much higher values can be measured by using a different technique. As the unknown capacitance across the test leads is increased, the audio tone becomes lower in pitch; for capacitances greater than 0.5 uF, the pitch becomes so low that individual pulses can be counted. On our instrument, pulse rates were counted for high-quality oil-filled capacitors of different values as shown in Table 1.

These pulse rates were counted by ear with the phones plugged into J₅. A stopwatch was used for timing purposes, but the one-minute intervals from WWV could also be used and probably would be more convenient for the

blind. These same pulse rates would probably not be duplicated in replicas of the tester, but they are indicative of what is to be expected. Each instrument would need to be calibrated individually, which is a simple process if a variety of marked capacitors is at hand.

The capability of operating from an external rf source as well as from the internal battery greatly increases the utility of the audio oscillator. With the power transfer switch, S₁, in the RF position, the oscillator may be powered by rf injected at J₄. The components RFC, D₁, and C₁₀, comprise a half-wave rectifier and filter for converting the rf current to dc. More will be said about this feature of the instrument in connection with the rf pickup to be described later.

Note that the power transfer switch, S₁, also serves as the off/on switch for the battery and should be left in the rf position when the instrument is not in use.

One final comment on the oscillator may be worthwhile. The closed-circuit jacks, J₁₋₃, were installed in case it might be desired to insert other test components into the oscillator circuit. The audio tone can be heard with the phones plugged into either the base jack, J₁, or the collector jack, J₃, as well as the regular phone jack, J₅. A useful application of the emitter jack, J₂, was discovered quite by accident. An electrolytic capacitor inserted into the circuit at J₂ will have a dc voltage impressed across it. If the polarity of the capacitor is correctly observed, the capacitor will slowly charge, and the pitch of the tone heard with the phones plugged in at J₅ will gradually rise until it pinches off when the capacitor reaches full charge. If the

polarity of the capacitor is incorrect, the tone may continue indefinitely or it may pinch out as before, but at a much slower rate. This characteristic can be used to determine the polarity of electrolytic capacitors or to detect leaky electrolytics.

Wheatstone Bridge

The Wheatstone bridge is energized by a tone from the audio oscillator. The audio tone is automatically transferred to the bridge input by the switching function of J₅ when the headphone plug is removed from that jack. The bridge circuit is composed of four resistors: any one of the three standard resistors, R₂, R₃, or R₄ selected by S₄; the variable balancing resistor, R₅; the Spectrol variable resistor, R₆, and the unknown resistance, R_x, connected across the test leads at J₉. The theory of the Wheatstone bridge is explained in any high school physics book. Suffice it to say here that the bridge is in balance when the ratio of a standard resistor (R₂, R₃, or R₄) to the balancing resistor, R₅, is equal to the ratio of the resistor under test, R_x, to the Spectrol nulling resistor, R₆. The instrument provides three bridge ratios: 1:10, 1:1, and 10:1. The upper limit of resistance that can be measured by the bridge is the maximum resistance of R₆, 10,000 Ohms, multiplied by the bridge ratio. Thus, if the bridge ratio is set up as 1:10, the bridge will measure up to 1,000 Ohms in calibrated dial divisions of 10 Ohms each. If the bridge ratio is set up as 1:1, resistance values up to 10,000 Ohms can be measured with dial divisions of 100 Ohms each. If the bridge ratio is set up as 10:1, resistance values up to 100,000 Ohms can be measured with dial divisions of 1,000 Ohms each.

Capacitance (uF)	Pulses Per Minute
0.5	360
1	180
2	90
3	54
4	45
8	24
10	20
20	10

Table 1.

73 MAGAZINE CHRISTMAS SPECIAL

15 Issues for only \$15

That's right . . . you can receive 15 issues of 73 Magazine for only \$15, by simply filling out this coupon today.

1 year at \$15.00*

Check or m.o. enclosed Bill me

Bill my: Visa Master Charge American Express

Card # _____

Exp. date _____ Signature _____



The January 1980 issue of 73 Magazine will arrive with a personalized gift card from:

Your name _____

Address _____

City _____

State _____ Zip _____

Please enter a one-year subscription for:

Name _____

Address _____

City _____

State _____ Zip _____

I haven't forgotten to choose my 3 FREE Back Issues from the catalog on pages 164-166. My choices are: (specify month & year):

1) _____

2) _____

3) _____

My alternate choices are: (specify month & year):

1) _____

2) _____

*Canada \$15 a year USA funds only. Please add \$2 per year for Canadian funds. All other foreign subscriptions \$26, one year only, payable in US funds.



NO POSTAGE
NECESSARY
IF MAILED
IN THE
UNITED STATES

BUSINESS REPLY CARD
FIRST CLASS PERMIT NO. 17 PETERBOROUGH NH 03458

POSTAGE WILL BE PAID BY ADDRESSEE

73 magazine

Subscription Department • Box 931
Farmingdale NY 11737



It may be noted that the standard resistors, R2-4, need not be precision resistors. In fact, they need not even have the nominal values indicated. The only criterion for selecting these resistors is that they must have some value that will allow the desired bridge ratio to be obtained by adjusting R5. The values indicated were chosen merely because they make the proper setting of R5 fall at about midscale.

Three precision resistors will be required, however, for initially setting up the bridge to measure unknown resistances. Ideally, these precision resistors would be 500, 5,000, and 50,000 Ohms, but, again, this is not necessary. The closest we could come from our junk box was 500, 1,000, and 79,000 Ohms, and these values will be used in the explanation to follow.

To set up the bridge for a 1:10 ratio, proceed as follows:

1. Connect the 500-Ohm precision resistor across the test leads plugged in at J9.

2. Connect the output of the bridge to the input of the audio amplifier by throwing the transfer switch, S2, to position 8.

3. Throw S3 to INTERNAL (down) position.

4. Plug the headphones into J7. This automatically turns on the audio amplifier.

5. Set the bridge RATIO switch, S4, to position 1.

6. Set the nulling Spectrol, R6, to 5,000 Ohms by turning its pointer knob 5 revolutions counterclockwise from the zero resistance setting. If your precision resistor in step 1 is some value other than 500 Ohms (any value in the range 100-900 Ohms would be satisfactory), set R6 to read ten times the value of your precision resistor.

7. Set the SELECTOR

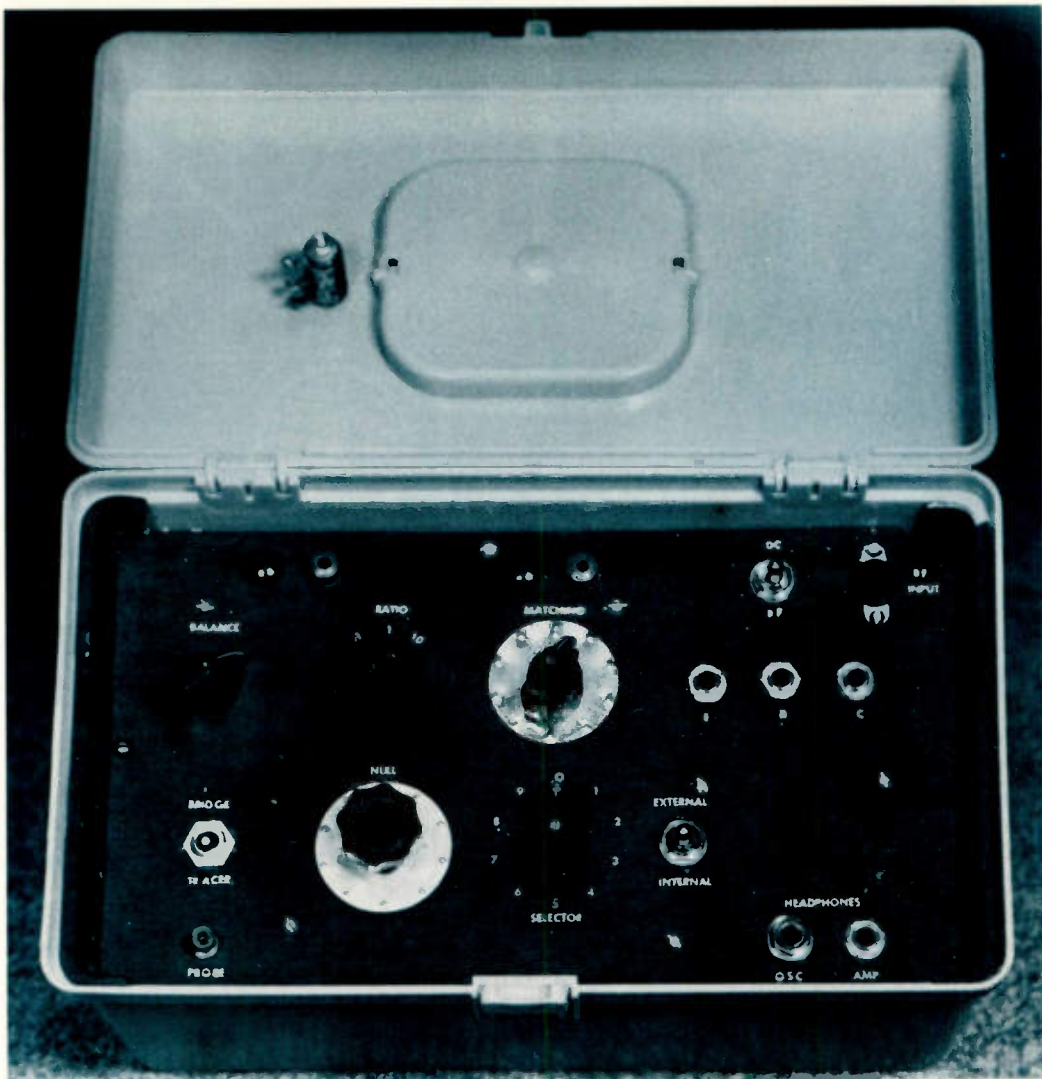

Photo A. Related controls are shown here, grouped to facilitate memorizing the panel layout. A precision resistor used for setting up the bridge is bolted to the lid for safekeeping.

8. Turn on the audio oscillator by throwing the power transfer switch, S1, to the DC position. A tone will now be heard.

9. Null this tone by adjusting the balancing resistor, R5, until the tone disappears or is weakest. Once the null position is found, do not move this control again.

10. The bridge is now in balance for a 1:10 ratio. Remove the test leads from the precision resistor and clip on the unknown resis-

tance. Find a new null by adjusting the Spectrol potentiometer, R6. The unknown resistance will be one-tenth of the resistance read from the Spectrol dial at the new null setting.

To set up the bridge for a 1:1 ratio, the same procedure is followed except that the 1,000-Ohm precision resistor is clipped to the test leads, and R6 is initially set to read 1,000 Ohms. If your precision resistor is of some other value in the range 1,000 to 9,000 Ohms, set R6 to that same value. The bridge RATIO switch, S4, is set to position 2. With the 1:1 ratio, the null-point reading of R6 for an unknown resistance will directly indicate that resistance.

To set up the bridge for a 10:1 ratio, again proceed as before, but clip the 79k-Ohm precision resistor across the test leads and set R6 to 7,900 Ohms. If your precision resistor is of some other value in the range 10k-90k Ohms, set R6 to read one-tenth the value of your precision resistor. The bridge RATIO switch, S4, is set to position 3. With the 10:1 ratio, the null point reading on R6 for an unknown resistance must be multiplied by 10 to equal the unknown resistance.

Audio Amplifier

The circuit of the audio amplifier is about as barebones as it can be made, consisting only of the two

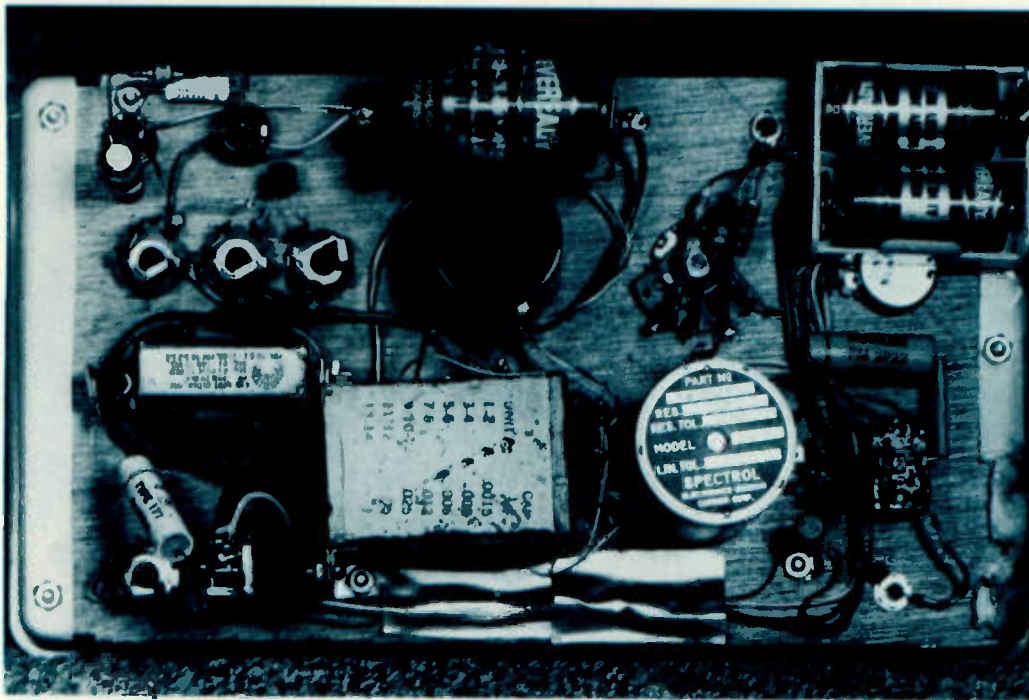

Photo B. All components are mounted on the panel, as shown here.

directly-coupled transistors, TR_{2,3}, and the coupling capacitor, C₉. The DPDT switch, S₅, serves to transfer the amplifier input either to the bridge output or to the jack, J₆, for the signal-tracing probes. The amplifier is powered by a separate 3-volt battery supply. There is no on/off switch, as this function is served by plugging or unplugging the phones at the open-circuit jack, J₇. Initially, we tried to operate the audio amplifier and the oscillator from a common 1.5-volt battery, but this did not work out because of audio leakage around the Wheatstone bridge that made it impossible to obtain a distinct null. The separate power supply for the amplifier cured this trouble, and raising the supply voltage to 3 volts gave the amplifier a little more clout.

Construction and Arrangement of Parts

Construction of the test instrument is easy and simple. No PC boards are needed, and the only material to be drilled is the 1/8-inch plywood panel. Our tester was built in a

plastic cosmetic box purchased at the local drugstore for about \$3. The box is approximately 12 inches long, 7 inches wide, 6 inches deep, and has a hinged lid with a latch and a recessed carrying handle. Originally, the box had a removable tray which, unfortunately, was divided into compartments with rounded bottoms so that it could not be used as a mounting panel. The supporting ends of the tray were sawed off, therefore, and attached to the ends of a plywood panel. All components are mounted on this panel, which can be lifted out for battery replacement or servicing.

Electrically, the placement of parts is not at all critical, but a little thought should be given to grouping associated controls in some coherent fashion that will be easier for a sightless user to memorize. The external appearance and panel arrangement of our version of the instrument are shown in Photo A. Photo B shows the "works" underneath the panel. Referring to Photo A, the controls related to the oscillator occupy the right half

of the panel; those for the bridge and audio amplifier, the left half. At top center are the test-lead jacks, J₈. In line below these jacks, are the pointer knob with embossed dial plate for the Helipot, R₁, and the pointer knob for the SELECTOR switch, S₂. In the right corner are the power supply transfer switch, S₁, and the jack, J₄, for the rf pickup. The two phone jacks, J₅ and J₇, are in the lower right corner. The tone comparison switch, S₃, is to the right of the selector switch, and the three jacks, J₁₋₃, are in line to the right of the Helipot dial.

In the lower left corner is the jack, J₆, for the signal-tracing probes; above this is the transfer switch, S₅, for the audio amplifier input. To the right of this switch is the other embossed dial for the Spectrol bridge-nulling resistor, R₆. Above this dial is the bridge RATIO selector switch, S₄, and to the left of this switch is the control for the bridge-balancing resistor, R₅. Finally, at top left are the jacks at J₉ for the bridge test leads.

The reader may wonder

why all of the controls are so elegantly labeled on an instrument intended for use by the blind. The truth of the matter is that the builder wanted to try out those rub-on letters, and could not resist the urge to add this utterly useless embellishment.

Accessories

Accessories for the test instrument include, in addition to the three precision resistors for setting up the Wheatstone bridge, a pair of test leads, an audio signal-tracing probe, an rf signal-tracing probe, and an rf pickup (Photo C).

The test leads are unshielded, with a clip at one end and a plug at the other, to match the panel jacks at both J₈ and J₉.

The audio signal-tracing probe uses shielded wire with a phone plug at one end to match jack J₆ and an ordinary test prod at the other. A short grounding lead with a clip is provided to complete the ground circuit at the prod end.

The circuit for the rf signal-tracing probe is shown in Fig. 3. The components are mounted on a narrow strip of perfboard and inserted into a cylindrical aluminum shield can about 1 inch in diameter and 5 inches long. The shield can we used was obtained at the drugstore as a small butane cylinder intended for refilling cigarette lighters. After releasing all of the butane outside in the open air (butane and air form an explosive mixture—don't do this in the shack), the valve end of the cylinder was sawed off and replaced with a wooden disk to hold and insulate the probe tip. The wire lead for the probe is shielded phono cable with a phono plug to match J₆. A short grounding lead with a clip is provided to complete the ground circuit at the probe end.

With a short antenna

(Cut on dotted line and keep next to your radio equipment)

Buy One Of These Transceivers From Ham Radio Center & Be Guaranteed That You Will Get The Best Price!

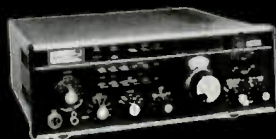

DRAKE®



KENWOOD®



TEN-TEC®

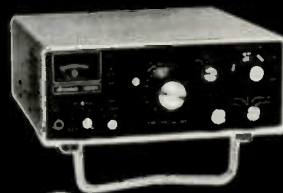

SWAN®
ELECTRONICS



YAESU®

Ham Radio Center's Best Price Guarantee

1. Shop any or all the ham dealers with a TOLL-FREE (WATS) Line.
2. Then call HAM RADIO CENTER.
3. HAM RADIO CENTER guarantees to meet or beat any legitimate price* quoted by a factory authorized ham dealer with a TOLL-FREE (WATS) Line on the following equipment:

DRAKE	KENWOOD	TEN-TEC	SWAN	YAESU
TR-7/DR-7	TS-120S	509 (Argonaut)	100-MX	FT-101Z
R-7/DR-7	TS-180S/DFC	570 (Century/21)	Astro-150	FT-101ZD
	TS-520SE	545B (Omni-A)		FT-901DM
	TR-7600	546B (Omni-D)		FT-227RB
	TR-7625			CPU-2500RK

4. This guarantee on the above transceivers expires November 30, 1979.

*NOTE: HAM RADIO CENTER limits legitimate price to current dealer cost plus mark-up!

CALL TOLL-FREE

1-800-325-3636

FOR BEST PRICE GUARANTEE

HAM RADIO CENTER

8340-42 Olive Blvd • P.O. Box 28271 • St. Louis, MO 63132



(Cut on dotted line and keep next to your radio equipment)

connected to the probe tip, and the probe feeding the audio amplifier, local broadcast stations can be heard with good volume (although with considerable QRM if there are several stations). With a good antenna and a tuned circuit ahead of the probe, we might also claim that the test instrument will serve as an emergency BC receiver.

With the power transfer switch, S_1 , in the RF position, and a short random-length wire plugged into J_4 for an antenna, the oscillator can be powered by any strong rf field in the high-frequency range. Sensitivity is much increased, however, by using a tuned pickup. This pickup consists of a simple parallel-tuned circuit, enclosed for convenience in handling in a cylindrical cardboard container about 2 inches in diameter and 6 inches long (see Photo C and Fig. 4). The container we used was originally full of ready-mixed biscuit dough. We cut off one of the metal ends, disposed of the dough, and removed the tinfoil inner lining, since no shielding is desired for the pickup. The components

of the tuned circuit are then wired and inserted, using the metal end left in place as a mounting plate for the variable capacitor. A wooden disk restores the strength of the open end.

The frequency range covered by the pickup is left to individual preferences. We selected a small variable capacitor of perhaps 150-pF maximum and a coil from a defunct surplus item that looked as though it might tune the 80- and 40-meter amateur bands. Actually, the combination tunes the range 3.2 to 11.4 MHz, which suited our particular needs quite well. The range covered by the pickup could be extended if desired by arranging to tap the coil, or by using plug-in coils of different sizes.

With this pickup plugged into J_4 , the oscillator will work with the pickup about 3 inches away from the coil of our grid-dip meter, which would seem to indicate fairly good sensitivity. It also works well as a transmitter peaking indicator or CW keying monitor, with the pickup on the operating table about 6 feet from the transmitting antenna tuner.

The resonance point of

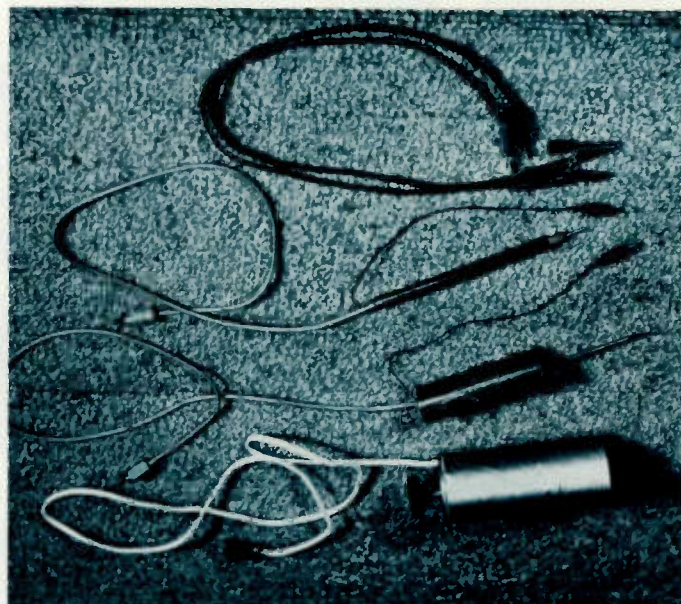

Photo C. The tester is completed with the test leads, signal-tracing probes, and rf pickup shown here.

the tuned pickup is fairly sharp, so that the pickup also could be made to serve as a wavemeter by fitting the variable capacitor with a calibrated dial readable by touch. Although our efforts did not extend that far, this possibility is pointed out to those who might wish to increase the versatility of the instrument in that direc-

tion.

Credit for the concept and general design of the test instrument is due W4RYV, who had previously used the basic circuits individually but had never combined them as an integrated unit. Except for a few minor refinements, all I did was to build the instrument and prepare this description of it. ■

Parts List for Fig. 1

- C1—0.0015 μ F
- C2— .003 μ F
- C3— .006 μ F
- C4— .012 μ F
- C5— .025 μ F
- C6— .05 μ F
- C7— .1 μ F
- C8— .1 μ F
- C9— .22 μ F
- C10—.002 μ F
- D1—1N34A germanium diode
- J1,2,3—Closed-circuit jacks
- J4,6—Phono jacks
- J5—Double closed-circuit jack
- J7—Open-circuit jack
- J8,9—Paired test-lead jacks
- R1—200k-Ohm precision potentiometer (Helipot)
- R2—500 Ohm, 1/2-Watt
- R3—5,000 Ohm, 1/2-Watt
- R4—50k Ohm, 1/2-Watt
- R5—10k-Ohm potentiometer
- R6—10k-Ohm precision potentiometer (Spectrol)
- RFC—2.5-millihenry rf choke
- S1,3—SPDT toggle switch
- S2—10-position rotary switch
- S4—3-position rotary switch
- S5—DPDT toggle switch
- T1—Oscillation transformer (see text)
- TR1,2,3—Type 2N107 PNP transistors

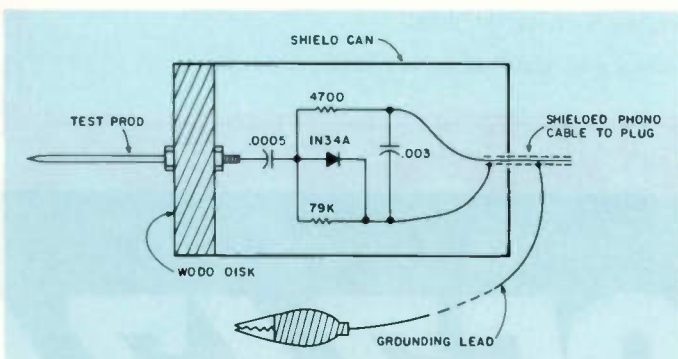

Fig. 3. Circuit and construction of the rf signal-tracing probe.

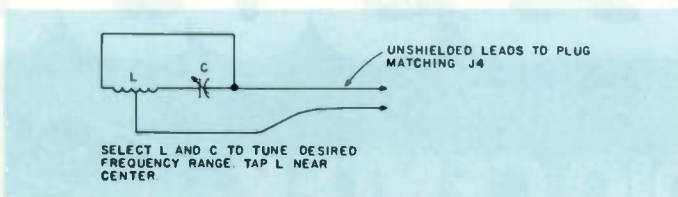
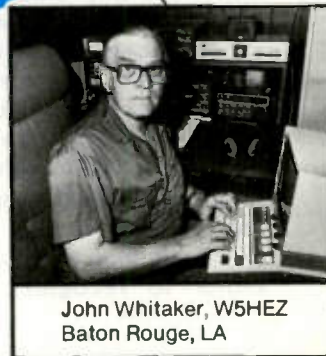
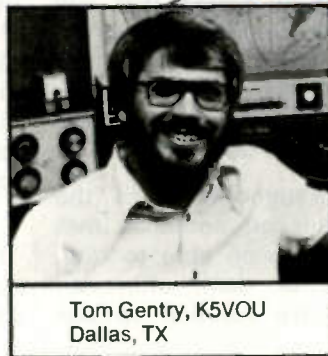
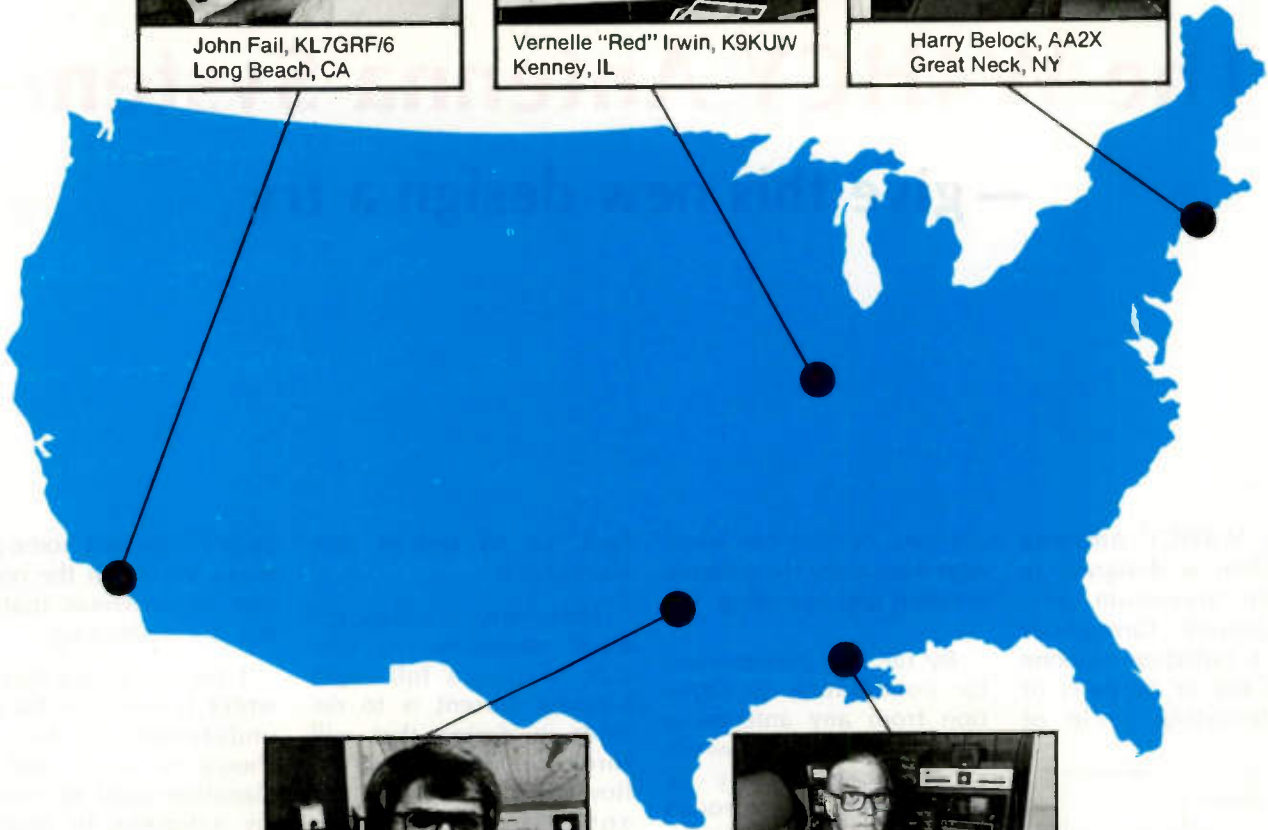
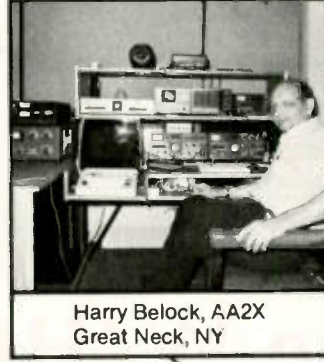

Fig. 4. Circuit for rf pickup.

WHEN OUR CUSTOMERS TALK... WE LISTEN.



And we respond with unexcelled RTTY equipment.

One reason RTTY equipment designed by HAL is always state-of-the-art quality is our open channel of communications with customers.

We *want* to hear the "What if's..." and "How about's..." that come from active and dedicated RTTY operators. Our engineers have combined

customer ideas with their own to create the most advanced equipment features and capabilities in the industry.

It adds up to greater enjoyment of RTTY operation and a dependability factor backed with a full one-year warranty.

Write or give us a call. We'll be glad to send you our new RTTY catalog.



HAL COMMUNICATIONS CORP.
Box 365
Urbana, Illinois 61801
217-367-7373

For our European Customers Contact:
Richter & Co., D3000 Hannover 1
I.E.C. Interelco, 6816 Bissone/Lugano

The W4HCY Antenna System

— give this new design a try

The W4HCY antenna system is designed to provide maximum possible current throughout all of a radiating antenna during any or all parts of an alternating cycle of

antenna current for whatever frequency the antenna is tuned and operating.

By far, the greatest factor contributing to radiation from any antenna is its magnetic field, which is produced directly by the current flow through the antenna. In my opinion, failure to provide for maximum full-length antenna current in amateur antennas up to this time has been due to a failure either to recognize this

fact, or to design provision for it.

Therefore, the requirement necessary to provide maximum full-length antenna current is to develop a design that will force maximum current flow throughout the full antenna length. The W4HCY design is engineered to do this job.

Throughout all of the articles on antennas that I have been able to find, none of them offers an effective solution to this

problem. In fact, some give explanations on the operation of antennas that, to me, are misleading.

I am not saying that the writer is wrong in his own understanding, but the choice of words and explanation used do not, in my judgment, fit properly into the fundamental factors which determine operation of ac circuits.

Here is an example: "When a charge reaches the end of the antenna and is reflected, the

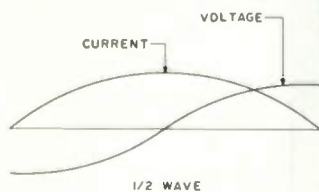

Fig. 1. From The ARRL Antenna Book (page 25).

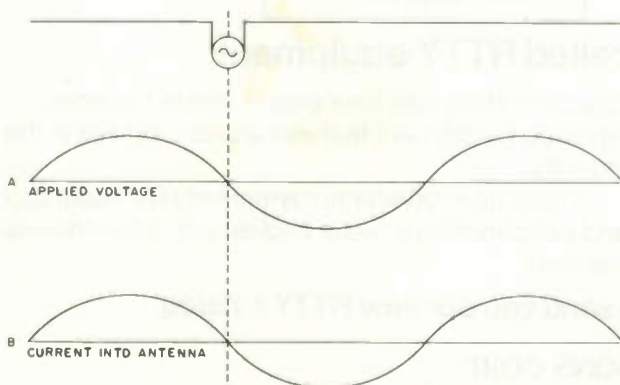

Fig. 2. From The ARRL Antenna Book (page 28).

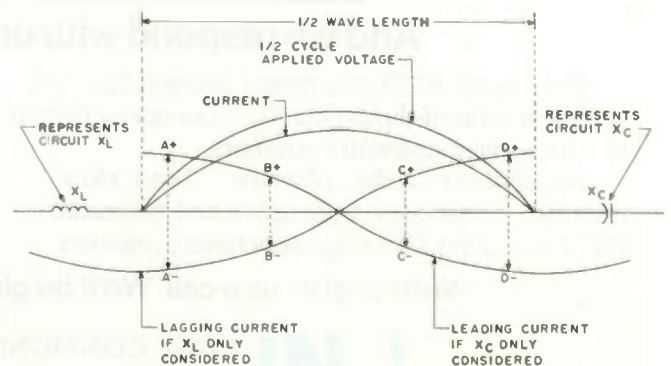

Fig. 3.

direction of current flow reverses, since the charge is now traveling in the opposite direction."¹

The word "reflected" is misleading in that it implies that there is some kind of barrier at the end of the antenna that a charge strikes and bounces back from. This is similar to an earlier example in the same article wherein it is said that a ball traveling along a trough bounces back whenever it strikes the far end.

"Bouncing back" and "being reflected from" are poor descriptions of what really happens. The following is a more accurate description of what actually happens:

At the end of each half cycle, the voltage from end to end of a resonant antenna reverses polarity and the current is driven back in the opposite direction, not reflected.

The same article further states that the current and voltage are out of phase by 90° , and Fig. 1 shows the phase difference between voltage and current along a half-wave antenna. I fail to understand such an explanation for current and voltage relationship in a resonant antenna.

If current flowing in an antenna circuit were this far out of phase with the voltage, I doubt that it would be possible to keep the overload relay closed.

Further on in the same antenna article, the following correct statement is made in describing operation of antennas: "Exactly at resonance, the current at the input terminals will be in phase with the applied voltage."²

Yes! And who wants an antenna that is not tuned to resonance at the operating frequency? Fig. 2 illustrates the above quote wherein

voltage and current are in phase. Yes, Fig. 2 shows the way it really is.

Now let's take a good look at what actually happens in an antenna circuit when we make use of accepted fundamentals which govern the operation of alternating-current circuits. These would be resistance (R), inductive reactance (X_L), capacitive reactance (X_C), alternating voltage (alternating polarity), and alternating current.

It will not be necessary to describe here in detail all these functions, but it is essential to state that current in a capacitor leads the voltage by 90° , and that current in an inductance lags the voltage by 90° . It is necessary for proper balance in a series resonant circuit that the X_L and X_C be adjusted to balance against each other sufficiently to bring the current in phase with the applied alternating voltage.

Fig 3 shows how it works in a half-wave antenna. At radio frequencies, a straight wire or conductor presents inductance (X_L) to rf current. The spacing between antenna conductors and between antenna conductors and ground presents capacitance (X_C) to rf current. When these reactances are combined (made equal) to resonate an antenna to a

given frequency, the antenna current flows in phase with the antenna voltage. Reactances X_L and X_C cancel, and only resistance remains; voltage and current are in phase. Note that the A+ and A- currents cancel each other, leaving only pure resistance in the half-wave length of antenna wire. Other examples are shown at B+ and B-, C+ and C-, and D+ and D- for all the length of the antenna. The inductor and capacitor shown at the ends of the antenna represent the total X_L and X_C of the whole circuit. They are not intended in this case to represent a physical presence

as shown in the drawing.

Now let's take a look at a typical antenna installation along with the circuitry inside a transmitter which is the source that supplies energy to the antenna. To illustrate the theory of operation, I have chosen to use the typical pi-network-type final transmitter circuit. However, the basic fundamentals of transferring radio energy to antennas are the same for other types of antenna coupling. Fig. 4 is a typical example. The transmission line is omitted for simplicity.

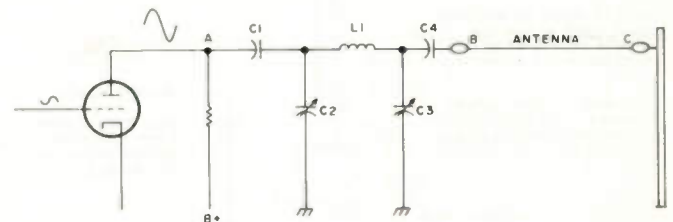

Fig. 4.

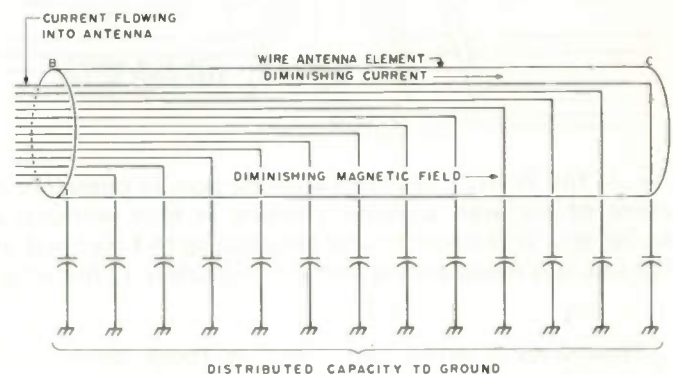

Fig. 5.

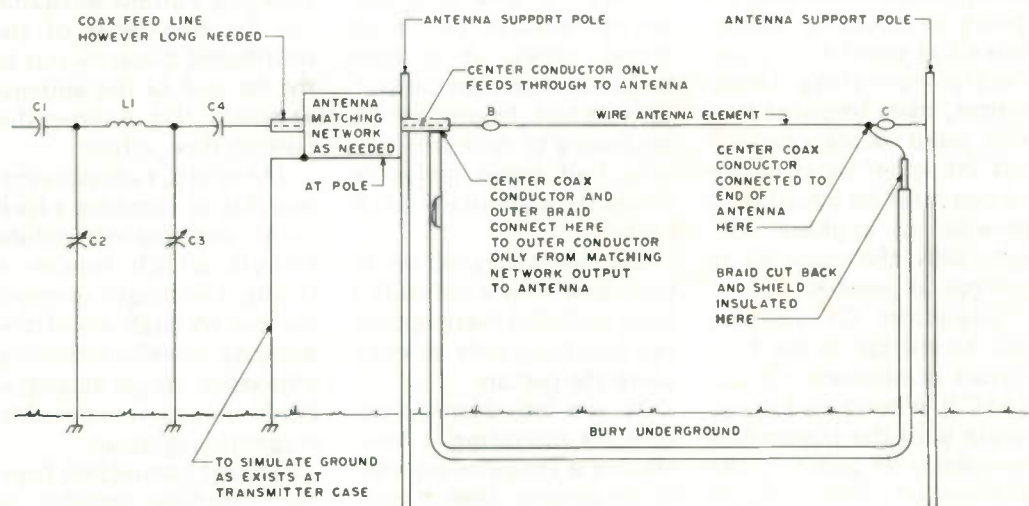

Fig. 6.

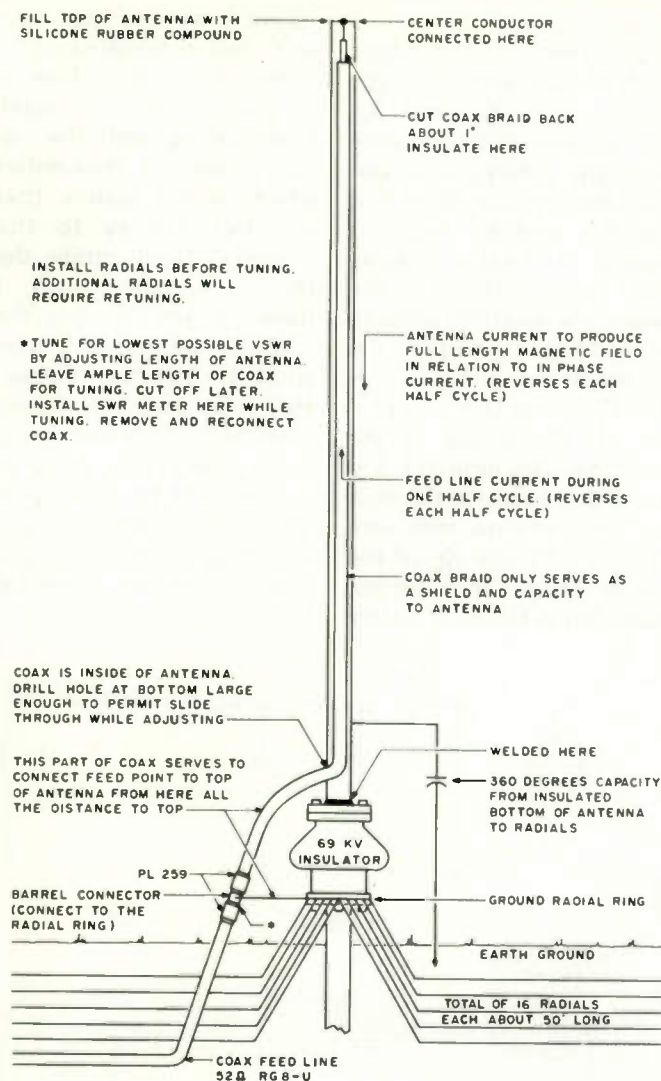

Fig. 7. The W4HCY 40-meter antenna now in operation is made of 1/8"-wall aluminum tubing in four sections: 2 inches o.d. at the bottom and telescoping to 1 inch o.d. at the top. It is free-standing and approximately 33 feet long.

How does it work? The desired frequency appears at tube grid where it is amplified, inverted and appears at coupling capacitor C1 at point A. In a correctly operating transmitter, the frequency at this point never changes. All the other parts of the circuit *must* be adjusted to provide an in-phase voltage with the tube plate voltage at point A.

Capacitor C1 couples this ac voltage to the tank circuit pi network (C2, L1, and C3). When tuned to resonate with the transmitter frequency at point A, the action of inductor L1 and capacitors C1 and C2 set up an oscillating cur-

rent in these three components that is free-running at the transmitter frequency. It will, however decay because of circuit losses unless it is reinforced by the tube output. This action begins at the beginning of each free-running half cycle and continues throughout each half cycle.

Ok, we all agree up to this point. This is old stuff. I have included these operating functions only to complete the picture.

So now let's examine the antenna operation. I have chosen a longwire parallel to the ground. Does it radiate because of something mythical, or some type of

tangible reflecting substance at the end of the antenna at point C? Absolutely not.

No current can ever flow anywhere except where there is a voltage (potential) difference between two points wherein it is desired that a current should flow. But, the antenna shown in our example, Fig. 4, will work. How?

Whenever the loading capacitor, C3, is adjusted to load the antenna, the resonant tank circuit does not go out of resonance as one might expect. Why? Because the capacity in C3 is transferred in part to the distributed capacity that exists between the antenna wire and ground. Resonance is maintained, however, because more intensive use of the antenna capacity to ground is now made and current is now flowing in the antenna.

Right here is where the real important thing about this article begins. Let's watch it carefully.

As the voltage increases on the end of the antenna wire nearest the coupling capacitor at point B, the current flowing first sees the portion of the distributed capacity that is nearest to this end of the antenna from point B to ground. Therefore, this capacity becomes charged most and there is a *diminishing* charging current available for the remainder of the distributed capacity out to the far end of the antenna at point C. Fig. 5 shows this current flow action.

The W4HCY antenna system (Fig. 6) provides a feed point and current return circuit which forces a strong, full-length antenna current through all of the antenna, thereby providing a stronger, longer magnetic field for maximum possible magnetic radiation.

Ground connection from the matching network is made to the far end of the antenna through the shield-

ed coax. The shield must be left ungrounded at the outer end of antenna point C. Outer braid is only used to serve as a shield. It is not a part of the antenna. It does not carry antenna current. Only the antenna radiates.

I have a home-brew 1/4-wave vertical antenna for 40 meters that is made of heavy-wall aluminum tubing and is free-standing, supported by a 69-kV insulator. There are 16 underground radials, each about 50 feet long.

I have changed the feed line on this antenna as shown in Fig. 7. No other changes were necessary except lengthening the antenna by 8-1/2 inches to offset the increased X_C due to its higher efficiency to the same capacity radials and added X_C of the coax shield braid inside the vertical radiator.

The use of coax, by which the braid serves as a shield between the center conductor and radiating element, introduces extra X_C into the antenna tuning network. This added X_C must be considered in the design. Compensation can be made by making the antenna element longer, using a larger diameter antenna, spacing the coax to the exact center of the antenna, and using smaller diameter coax such as RG-58/U.

Although this antenna is only a 1/4-wave radiator, the results have been very rewarding. I have never operated it yet when I did not get back reports such as, "strongest signal on the band," etc. My monitor scope shows a 25 to 30 percent increase in talk power.

Another operating feature is that the antenna appears to operate at a much higher Q. This is evidenced by much sharper receive and transmit action. I find that I must tune very sharply to a received signal

to prevent distortion. At only 100 cycles each side of a received signal, distortion becomes annoying. Before changing to the antenna feed as described herein, the same off-frequency tuning would only change the voice quality of the received signal.

I have checked the transmitting improvements by asking other amateurs to tune slightly off my frequency, and the reports have been the same (very narrow and very strong) and without even asking about audio quality, I almost always hear reports of excellent audio.

The W4HCY antenna feed system is applicable to a large variety of antennas, except those that already use full-current feed, such as a terminated rhombic, quad, delta loop, etc.

I am presently in the process of applying it to my five-element monoband

yagi for 20 meters. This will require a matching network which I do not have. However, I have put it on the air a couple of times using a James Millen Co. antenna tuner. The same improved operation is evident both on receive and transmit. The feed method for the driven element on this beam is shown in Fig. 8. The coax inside the antenna serves only as a shield to prevent cancellation of the antenna element current. Be sure to connect as shown. Always insulate the outside end of the braids.

This system can be used on multiband antennas by using a separate shielded feedline inside the driven element and correctly connecting to each band outer end section of the antenna. Only one feedline up to the antenna will be necessary.

I am very confident that this antenna system will outperform most other con-

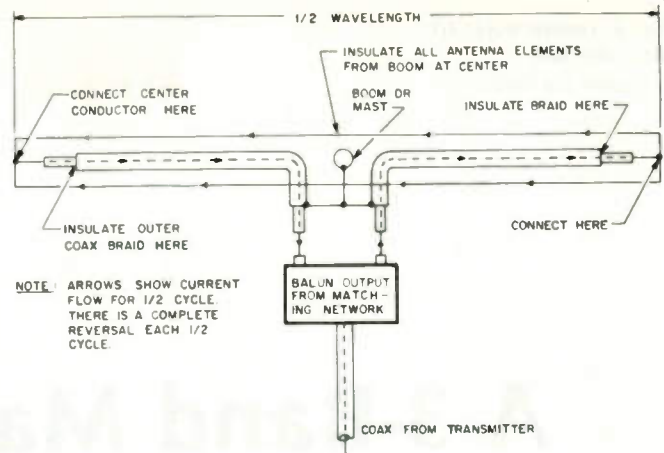

Fig. 8.

ventional antennas. Radiation will be greatly improved and signals transmitted from the antenna will require less space on the band.

Please feel free to use the system for your own pleasure. I will be delighted to hear from you about your results—pro or con. But, I will not be able to answer a multitude of letters.

I reserve the right to require permission from me or my heirs for the use of this system by anyone who may desire to use or apply it in any way to antennas manufactured and sold for profit. ■

References

1. *The ARRL Antenna Book*, The American Radio Relay League, Inc., 1976, page 25.
2. *Ibid.*, page 28.

NEW MFJ Deluxe Keyer has Speed Readout

Socket for external Curtis memory, random code generator, keyboard. Uses Curtis 8044 IC. Gives you dot-dash memories, weight, speed, volume, tone controls, speaker. Sends iambic, automatic, semi-automatic, manual. Reliable solid state keying, RF proof.



Speed Readout Meter
lets you read to 50 WPM.
Socket for Curtis memory,
random code generator, keyboard.

\$79⁹⁵

The new MFJ-408 Deluxe Electronic Keyer II is based on the proven Curtis 8044 IC keyer chip. **Speed readout meter** lets you read sending speed to 50 WPM. **Socket** (optional cable with plug, \$3.00) lets you use external Curtis memory, random code generator, keyboard (available from Curtis Electro Devices).

Sends iambic, automatic, semi-automatic, manual. Use squeeze, single lever or straight key. **Iambic operation** with squeeze key. Dot-dash insertion. **Semi-automatic "bug" operation** provides automatic dots and manual dashes.

Dot-dash memory, self-completing dots and dashes, jam-proof spacing, instant start. **RF proof.** **Ultra-reliable solid-state keying:** grid block, cathode, solid state transmitters (-300 V, 10 ma. max, +300 V, 100 ma. max).

All controls are on front panel: speed, weight, tone volume, function switch. Smooth linear speed control. 8 to 50 WPM.

Weight control adjusts dot-dash space ratio; makes your signal distinctive to penetrate QRM.

Tone control. Room filling volume. Built-in speaker. Ideal for classroom teaching.

Function switch selects off, on, semi-automatic/manual, tune. Tune keys transmitter for tuning.

Completely portable. Operates up to a year on 4 C-cells. 2.5 mm phone jack for external power (6 to 9 VDC). Optional AC adapter \$7.95.

Eggshell white, walnut slides. 8x2x6 inches.

Stereo phone jack for key, phone jack outputs. **OPTIONAL BENCHER IAMBIC PADDLE.** Dot and dash pad-

dles have fully adjustable tension and spacing. Heavy base with non-slip rubber feet eliminates "walking." \$39.95.

Order from MFJ and try it — no obligation. If not delighted, return it within 30 days for refund (less shipping). **One year unconditional guarantee.**

Order today. Call toll free 800-647-1800. Charge VISA, MC or mail check, money order for \$79.95 plus \$3.00 shipping for MFJ-408 keyer and/or \$39.95 plus \$3.00 shipping for Bencher paddle.

CALL TOLL FREE ... 800-647-1800

For technical information, order/repair status, in Miss., outside continental USA, call 601-323-5869.

MFJ ENTERPRISES, INC.
BOX 494, MISSISSIPPI STATE, MS 39762

A 3-Band Mast-Mountable Miniquad

— a quad need not be monstrous

Small in size, high in performance.

Combining two compact quad designs into one results in a miniquad with lots of appeal. It's small in size and cost and high in performance. So, after numerous requests during QSOs for a detailed description of this somewhat unorthodox quad, I decided to write it up for

73 Magazine.

What Is Different About It

A full-size 20-meter quad measures approximately 19' x 19'. This miniquad for 10, 15, and 20 meters measures 6½' x 14'. The unorthodox part of this design is that the 20-meter loops (using load-

ing coils) are mounted between the 10- and 15-meter loops. It wasn't planned that way, but the physical dimensions required to resonate each band resulted in that configuration. Also, all three bands use vertical wire stubs both for tuning and to reduce the vertical dimensions.

weigh the slight loss. The miniquad performance is really impressive when compared with the inverted vee antenna, especially when the band appears to be dead on the inverted vee. I have made some excellent DX contacts since switching to the miniquad.

Why You'll Like It

You will find that, unlike the full-size quad, this one is a breeze for one man to handle and mount on a tower. What's more, because of its small wind load, it can be mounted on an ordinary TV rotor and a low-cost telescoping TV mast. Also, this antenna requires only about half the copper wire of a full-size quad. Overall, that represents quite a savings for the typical low-budget ham like me!

While the miniquad may have slightly less gain than a full-size quad, for most of us, the advantages far out-

How It Evolved

Being dissatisfied with the performance of an inverted vee on 10, 15, and 20 meters, I made a search of ham magazines and antenna books for various types of beams and quads. I decided that the quad, which requires less height than a yagi-type beam, was best for this QTH, as the degree of acceptance by the XYL of another antenna on top of the house was calculated to be inversely proportional to the square of antenna height!

Two interesting quad designs were found. Neither was small enough to fit on

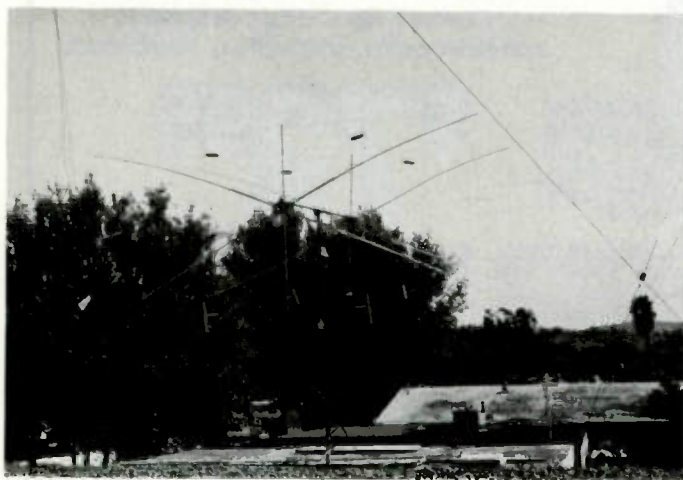

This is the miniquad after two years of operation (lowered for refinishing spreaders). Optional materials for spreaders are fiberglass (expensive, but non-deteriorating) or PVC tubing, if properly braced. (See Reference 3.)

them, you can't work them!

The next day, using the miniquad, I answered a "CQ". Running barefoot (150 Watts), a fine 20-minute QSO was made with OK1TA in Czechoslovakia. (Later I received a fine QSL card and letter.) At the conclusion of the QSO, there was a big pile-up, mostly east coast stations trying to work him! I was impressed, as this was

my first European contact as a ham! After adding the 10- and 15-meter elements, results were equally satisfying. Many contacts have since been made around the world, on all three bands.

The antenna has been in service for two years now, and is still performing as well as it did originally. The two coats of varnish are starting to show some deterioration from exposure

to the intense radiation of the southern California sun, however, and while I don't have the problem of ice as do my eastern counterparts, we do have Santa Ana (devil) winds. These winds can reach 70 miles per hour and higher. At times, they have really made the antenna dance a jig, but it has stood up well.

I think that for a cheap, compact, directional, gain antenna, this one is hard to

beat, since much of it can be built with bits of material you may have lying around your QTH! ■

References

1. "The Low Profile Quad," J. P. Tyskewicz, *CQ Magazine*, February, 1974.
2. "Unusual Cubical-Quad Antennas," J. R. Fisk W1DTY, *Ham Radio Magazine*, May, 1970.
3. "Meet the Plastic Wonder—Quad Antenna," D. Starr, *73 Magazine*, March, 1978.

Bargains in Remote Antenna Switches

— watch for these surplus gems

Carl C. Drumeller W5JJ
5824 NW 58 St.
Warr Acres OK 73122

Remote antenna switching can be a highly desired feature in one's station. The high cost, up to \$125.00 or over, deters many amateurs from giving it serious consideration. The answer? Keep an eye on military surplus outlets and on swapfests.

The choicest item to look for is the Thompson Products, Inc., type 10281 coaxial switch. It'll mount outdoors, antenna level or wherever you elect to put it; it operates on direct current at a low voltage. Although rated at 24 volts, it'll function at as low as 10 volts. Its control requires a 5-wire cable, as it involves positive selection of the desired switching function... no stopping at a

wrong position. It provides for selection of three antennas from one incoming cable. The cable connectors are of the type N variety, which means they can be weatherproof, quite unlike the UHF type often used for outdoor applications. The control function connector involves a standard type of Amphenol, one readily available.

Why is this "choice"? Well, for one thing, there are 12 steps in its transfer action. These provide for such operations as grounding the unused antennas, opening all incoming circuits, grounding all incoming circuits, and then connecting through the selected antenna. One purpose of these operations is to ensure that all accumulated electrostatic charges are drained off an antenna before it is shifted into service. Thoughtful, huh? Note that when one anten-

na is in use, the other two are not grounded. Some may find this preferable, some may not. But with 12 steps in the operation, only one action is needed. You just close a switch placing the direct current voltage between the common and the wire controlling the antenna outlet you want. The interior stepping motor does the rest! No continuing current is required to hold the desired selection. The circuit is broken when the stepping motor reaches the selected segment. The switch you used can be left closed to provide an indication of the antenna in use.

There's another surplus relay worth looking for, too. Like the first mentioned, it's suited to outdoor mounting, has type N rf connectors and an Amphenol control connector, and operates on low voltage direct current. It,

however, is only a single-pole double-throw coaxial switch. Although rated at 24 volts, my advice is to supply it with no less than 28 volts. I've had one stick between antennas when the controlling voltage was less... a highly undesirable condition, as the controlling circuit is broken and the relay must be disassembled in order to move it on to a position that permits the controlling circuit to function!

This second item is made by General Communications Co., and is the model 2N18ORC-5 rf coax switch. It appears to be a bit more readily available than the Thompson Products relay.

Either of these two devices can be an asset to an amateur station. Neither should cost the "arm and a leg" asked for commercial relays that are no better and probably not as good. If you see one, grab it. ■

A No-Nonsense Operating Table

— basically, it's a flat surface on legs

Ken Anderson
Age 11
3005 W. 19th
Lawrence KS 66044

To build this table, you will need 8 or 9 two-by-fours. Check to see if some are crooked. If some are, do not use them; this is important to your table. Us-

ing the two-by-fours, cut four pieces 27 inches long; these will be the legs. For the sides, cut out two 72-inch pieces. For the leg supports, cut four pieces 24.5 inches long. For the footrest support, cut out a 72-inch piece.

Now you are ready to begin the main part of the table. Take two of the legs

and two of the supports and bolt them together as shown in Fig. 1. Do the same to the other legs and leg supports. Now get a piece of particle board 72 inches by 28 inches, but don't put it on until the end. Have someone holding one of

the leg pieces while you are bolting the footrest support to the middle of the bottom leg support. Then do the same to the other side. Now nail the sides on and screw the top on as shown in Figs. 2 and 3. If you want your table to be very flat on top, countersink some flathead screws. To cover up the screws, use wood putty.

Tools and materials needed include: drill, hammer, right angle, power saw, wrench, 14 bolts, 8 nails, 8 or 9 two-by-fours, 1 piece of particle board 72 inches by 28 inches. ■

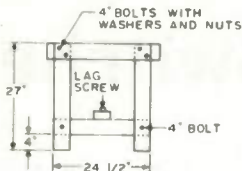

Fig. 1.



Fig. 2.

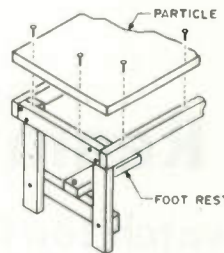

Fig. 3.

Code Made Easy.

To really master code, get Pickering Code Master instruction tapes. They're easy to use, easy to learn, complete and reliable. But don't just take our word for it, ask any ham. Or order a set and see for yourself.

CM-1 Novice. A complete course with 5, 7 and 9 WPM code group practice.

CM-1½ General. No instruction, just practice. ½ hr. at 11 WPM, 1 hr. at 14 WPM and ½ hr. at 17 WPM. Tape includes coded groups and straight text.

CM-2 Extra Class. Mostly straight text, some groups. 1 hr. at 20 WPM, ½ hr. at 25 and 30 WPM.

All courses are two hours long and come with key sheets for checking problem areas.

To order, send your check, money order, Master Charge or Visa number (along with card expiration date) to Codemaster. Specify number and quantity of tapes desired. Tapes are \$7.95 each, two for \$14, and three for \$19. Also specify 7" reel or cassette. We'll send your tapes post paid by fourth class mail. First class, Canada and Mexico orders, add \$1 per reel, 50¢ per cassette. To order by phone, call (401) 683-0575.

R.I. residents, add 6% sales tax.

Pickering
Codemaster Co.,
P.O. Box 396 D,
Portsmouth, R.I.
02871

✓ P44



Pickering Codemaster. Your key to code.

New 3 dB Gain Mobile Antenna

Mounts directly on glass in minutes. No tools needed. No holes to drill (or patch later). No ground plane required.

AH 151.3G

This sleek new low contour concept provides improved VHF communications. It features a new higher radiating 1/2 wavelength design that is guaranteed to deliver superior obstruction free performance over a 3 dB deck mounted 5/8" wavelength antenna and transmit a more uniform omni pattern than a "ground plane."

The unique AH 151.3G eliminates the need for external electrical connections — thus preventing coax cable deterioration caused by corrosion and water seepage. Its patented "High-Q" impedance coupling unit with built-in Ritter noise reduction systems, mounts inside the vehicle to assure maximum performance throughout the 2 meter band. Since there are no holes to drill at installation time, there are no holes to patch at resale time.

New aerospace adhesive discovery securely "locks" antenna mount to glass with the tenacity of a 1/4" bolt. (Guaranteed fail safe.) Contour mount and 180° tilt-angle adjustable whip holder are both triple chrome plated. 17.7 pH stainless steel whip.

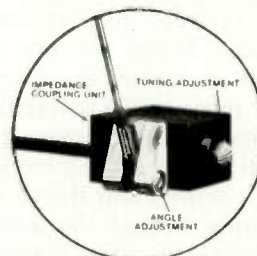

Electrical	
Gain	3 dB
Maximum Power	100 Watts Continuous
	150 Watts Intermittent
Frequency Range	144-174 MHz —
	External tuning adjustment
VSWR	1:1:1
Nominal Impedance	50 Ohms
Radiation Pattern	Omni Directional
Electrical Characteristics	End Fed
Matching Coil	1/2 Wave Radiator
	1/2 Wave Resonant, DC Grounded, Shunt Fed

LIST 33.95
SALE 29.95
ORDER FROM

PHONE 614-866-4267

avanti® antennas

AVANTI RESEARCH AND DEVELOPMENT, INC.
340 Stewart Avenue, Addison, IL 60101

UNIVERSAL AMATEUR RADIO INC
1280 AIDA DRIVE COLUMBUS, OHIO (Reynoldsburg) 43068

✓ U6

Social Events

Listings in this column are provided free of charge on a space-available basis. The following information should be included in every announcement: sponsor, event, date, time, place, city, state, admission charge (if any), features, talk-in frequencies, and the name of whom to contact for further information. Announcements must be received two months prior to the month in which the event takes place.

FORT MYERS FL NOV 3-4

The Fort Myers Amateur Radio Club and the ARRL will host Hamarama '79 on November 3-4, 1979, at the Ramada Inn, Fort Myers Florida. Featured will be dealer displays, educational forums, and an outdoor flea market. Registration is \$3.00 per person. For information contact K4VGN at (813)-334-6190, or WD4ERA (813)-332-1825.

HICKSVILLE OH NOV 4

The Defiance County Amateur Radio Club is sponsoring its 2nd annual hamfest on Sunday, November 4, 1979, from 8:00 am until 4:00 pm at the

Defiance County Fair Grounds, Hicksville, Ohio. Tickets are \$1.50 in advance and \$2.00 at the door. Talk-in on 146.52 and the club repeater, 147.69/09.

WEST MONROE LA NOV 11

The Twin City Ham Club will sponsor North Louisiana's annual "Hamfest" on Sunday, November 11, 1979, from 8:00 am until 3:00 pm at the West Monroe Civic Center, North 7th Street and Ridge Avenue, West Monroe, Louisiana. Tickets may be purchased at the door or in advance for admission and for the prize drawings. Featured will be swap tables for buying, selling, or trading amateur and related equipment, displays of new radio and electronic equipment, information on becoming an amateur operator, and prizes. Everyone is invited. The building is heated and cooled for your comfort. Talk-in on .25/.85, .52/.52, and 3910.

FRAMINGHAM MA NOV 11

The Framingham Amateur Radio Association will hold its annual fall flea market on Sunday, November 11, 1979, from 10:00 am to 3:00 pm at the Framingham Police Station Drill Shed, Framingham, Massachusetts. Admission is \$1.00 for the general public and \$5.00 per table for sellers. Sellers are advised to pre-register as tables are limited! Talk-in on .75/.15 and .52. For information, contact Ron Egalka K1YHM, FARA, PO Box 3005, Saxonville MA 01701, or phone (617)-877-4520.

CLEARWATER FL NOV 17-18

The Florida State ARRL convention will take place on November 17-18 at the Sheraton Sand Key Hotel on Clearwater Beach, Clearwater, Florida. An

Icom 701 HF station is the main door prize. The latest update on WARC proceedings is just one of the interesting forums we have scheduled. FCC exams will be given on Saturday at 9:00 am. Please send 610s to the Tampa office by November 9. There will be ladies' events both days, with a luncheon and style show on Sunday. Tickets are \$5, which includes a Tappan microwave oven as first prize. The QCWA Gator Chapter will host the Saturday luncheon, with all hams and guests welcome, too; tickets are \$6. Saturday evening banquet tickets are \$9. Swap tables are \$10 for both days—no one-day tables, all advance sold. There should be plenty of parking with courtesy buses running on demand for the duration of the hamfest. We have arranged for special room rates at \$30 double, per day, with each extra person \$4 and kids under 18 free. Hamfest donation is \$3; each advance ticket includes two free prize tickets. Talk-in on .37/.97 and 223.34/224.94. Please make all reservations through and checks payable to: FGCARC (Florida Gulf Coast Amateur Radio Council, Inc.), PO Box 157, Clearwater FL 33517. For ham convention and hotel reservations, phone (813)-461-HAMS.

MASSILLON OH NOV 18

The 22nd annual auction, Auctionfest '79, sponsored by the Massillon ARC, will be held on November 18, 1979, from 8:00 am until 5:00 pm at the Massillon Knights of Columbus Hall, Massillon, Ohio. The flea market opens at 8:00 am, with auction action at 11:00 am. There will be prizes and displays. Talk-in on 146.52 simplex. Tickets are \$2.00 in advance; table reservations are \$1.00 per table. For further info, write to Joe Turkal K8EKG, 1234 Concord NW, Massillon OH 44646.

FORT WAYNE IN NOV 18

The Allen County Amateur Radio Technical Society will hold its 7th annual hamfest on Sunday, November 18, 1979, at the Allen County Memorial Coliseum on US 30, Fort Wayne, Indiana. This will be an all-indoor exhibition and giant flea market. There will be many prizes, including a TS-120/PS and an FT-207R. Admission is \$3.00 at the door and \$2.50 in advance. Children under 12 are free. A 3' x 8' table rental will cost \$4.00. Talk-in on 146.28/.88, 147.255/.855 and 146.52. Hamfest fun starts Saturday night at the Fort Wayne Radio

RIPPED OFF?

If you have a serious problem with a ham firm, send them a letter with all the facts in detail, plainly and simply... and send a copy to Wayne Green W2NSD/1, c/o 73 MAGAZINE. 73 protects its readers more than any other magazine.

Ham Help

I am a 54-year-old Novice and have purchased an old Harvey Wells Bandmaster Senior, model TBS 50-C. I would appreciate hearing from anyone who may have the operating instructions for it. I would be most happy to pay for them or have them copied and returned to you.

Al Santi
PO Box 946
Bend OR 97701

I need a schematic and infor-

mation on an INOUE model FDFM-2 2-meter 6-channel rig. I will copy and return or pay a reasonable price for a copy.

Harold S. Roth W0LFH
602 W. Nebraska
Algona IA 50511

I'm looking for someone competent to repair a Hallicrafters HT-37 that has a poor CW note.

Roy A. Holman WD9GXZ
2124 East Kansas Street
Springfield IL 62703

AUTHORIZED DEALER

Vhf engineering

Makers of the World's Most Complete Line of
VHF-FM Equipment



*If you ever worked a repeater . . .
Chances are, it was one of these!*



MADISON

Electronics Supply, Inc.

1508 McKinney • Houston, Texas 77002 • (713) 658-0268

Club's Saturday Night Funfest. There will be prizes, hot and cold snacks, a cash bar, information, displays, and mini-forums from 7:00 pm to 11:00 pm, Saturday, November 17, at the Holiday Inn, 3330 West California Road. There will be displays by 10-X, ARES, ACARTS, FWDXA, and others, as well as mini-forums on NBVM, DX, Field Day, and more.

Funfest tickets (Include food and raffle) are \$2.00 in advance, \$2.50 at the door. For reservations, write to ACARTS, PO Box 342, Fort Wayne IN 46801. For confirmation, include an SASE. Tables are available for setup at 7:00 am.

COLUMBIA MD
NOV 25
The Columbia Amateur

Radio Association will hold its 3rd annual Hamfest on Sunday, November 25, 1979, at the Ellicott City National Guard Armory, just east of Rte. 29 on Rte. 103, Columbia, Maryland. Doors will open at 6:00 am for exhibitors and 8:00 am for the general public. Admission is \$2.00; tables are \$5.00. There will be no tallgating. Food will be available and prizes will be

awarded. Talk-in on 147.735/.135, 146.16/.76, and 146.52/.52. For table reservations and information, write Sue Crawford N3SC, 6880 Mink Hollow Road, Highland MD 20777.

OAK PARK MI
NOV 25

The Oak Park High School Electronics Club will present a Swap 'n Shop on Sunday, November 25, 1979, at Oak Park High School, 13701 Oak Park Blvd., Oak Park, Michigan. Donation is \$1.50 and tables are \$2.50. There will be refreshments and door prizes available.

LANCASTER PA
FEB 24

The Lancaster Hamfest will be held on February 24, 1980, at the Guernsey Pavilion, located at the intersection of Rtes. 30 and 896, east of Lancaster, Pennsylvania. General admission is \$3.00, except children and XYLs. Doors will open at 8:00 am. All inside spaces are available by advance registration only and are \$3.00 each for an 8-foot space, which includes a table. There will be free tailgating in a specified area outside, if the weather permits. There will be a two-hour Dutch Country tour by an advance registration of \$4.00. Food will be served at the hamfest. Also, there are excellent restaurants and accommodations in the area. Talk-in on .01/.61. For information, write Sercom, Box 6082, Rohrerstown PA 17603.

STERLING ILL
MAR 9

The Sterling-Rock Falls Amateur Radio Society will hold its 20th annual hamfest on Sunday, March 9, 1980, at Sterling High School field house, 1608 4th Ave., Sterling, Illinois.

SCANNERS:

KDK 2015R, KDK 2016A

MIDLAND 13-510, 13-513, CLEGG FM-28

YAESU FT227R, ICOM IC22S, KENWOOD TR7400A

- AED continues to expand its line of quality scanners. All of the above scanners are custom designed for their respective rigs.
- All scanners install completely inside the rig. No obtrusive external connections.
- All are easy to assemble and come complete with a detailed instruction manual.
- Scanned frequency displayed on digital readout (except IC22S).
- In the scanner OFF mode the rig operates normally. In the scanner ON mode the scanner locks on an occupied frequency, pauses for a preset time (about 5 secs.) and then resumes scanning.
- This gives you the ability to eavesdrop all over the band without lifting a finger. When you hear something interesting, you flip the switch to the LOCK mode and the rig is ready to transmit.

AED SCANNER SPECIFICATIONS

	KDK 2015R	KDK 2016A	KENWOOD TR7400A	YAESU FT227R	MIDLAND 13-510 13-513	CLEGG FM-28	ICOM IC22S
SCAN RATE	Adjustable 100kHz/sec-1mHz/sec		50kHz/sec	200kHz/sec	100kHz/sec	100kHz/sec	100kHz/sec
SCAN WIDTH	144-148 or only the mHz segment you select on mHz switch	142-149.995	complete band or mHz you want	adjustable eg. 146-148 144-146 146-147	scans the mHz seg. selected by the mHz switch	same as Midland	145.35-147.99
SCAN CONTROLS	2 mini toggle switches mounted on rig—LOCK switch may be mounted on mic.		2 mini toggle switches mounted on rig.	1 mini toggle switch mounted on mic or rig.	2 mini toggle switches mounted on rig.	same as Midland	1 mini toggle switch mounted on mic or rig.
PRICE FOR KIT	\$39.95		\$39.95	\$34.95	\$39.95	\$39.95	\$34.95
PRICE PRE ASSEMBLED	\$59.95		\$59.95	\$54.95	\$59.95	\$59.95	\$54.95

DEALER INQUIRIES INVITED

AED
ELECTRONICS

750 LUCERNE RD., SUITE 120
MONTREAL, QUEBEC, CANADA H3R 2H6
TEL. 514-737-7293

Add \$1.50 for postage & handling

✓ A60

CUSTOM "AMATEUR RADIO" T-SHIRTS & CAPS! NEW — Stylish Flock Lettering & MARS

CAPS — Full color MARS OR your call in ¾ inch high, soft black letters on an attractive solid front, mesh back adjustable cap for only \$6.00 plus \$1.00 shipping. Add your name up to 7 letters, now only 50¢ extra! Choice of solid colors in Light Blue, Red, White, Gold, or Orange; also white fronts with colored mesh and bills in Royal Blue, Red, Black, Gold, or Orange. Specify mailing address, color, and lettering or MARS.

T-SHIRTS — Your call and name printed in 1½ inch high, soft black letters on 50/50 polyester-cotton T-shirts with "Amateur Radio" design featuring the basis and purpose of the Service. All for only \$6.95 plus \$1.00 shipping. Full color MARS shirt — \$6.50 plus shipping; add \$1.00 per line for call letters. Specify mailing address, size (Men's S,M,L,XL), color (Sky Blue, Yellow, Light Green, or Orange), and lettering or MARS.

Michigan residents add 4% tax. ✓ F22

Send check or money order with your order to:
FREESTYLE, P.O. Box 606, Walled Lake, Michigan 48088



Radio Shack DEALER

COMPUTER CENTER

MICRO MANAGEMENT SYSTEMS



✓ M95

Up To 15% Discount on TRS-80's

WE HAVE THE HIGHLY RELIABLE LOBO DISK DRIVE IN STOCK!

MINI MALL—DOWNTOWN SHOPPING CENTER
CAIRO, GEORGIA 31728
912-377-7120

CUSTOM TRANSFORMERS

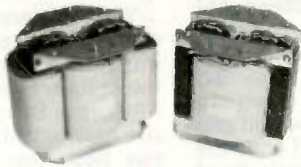

HEAVY-DUTY

REPLACEMENT TRANSFORMERS

BTILK-2000 Plate.....	\$135	HEATH HA-10 Plate.....	\$115
COLLINS 305-1 Power.....	\$215	HEATH HX-10 Power.....	\$95
COLLINS KWS-1 Plate.....	\$135	HEATH SB-220 Plate.....	\$125
COLLINS 516F-2 Power.....	\$ 95	HENRY 2K Plate.....	\$150
DENTRON 160-10L Power.....	\$125	HENRY 2K-2 Power.....	\$155
DRAKE L4B Plate.....	\$165	HENRY 2K-4 Power.....	\$165
GONSET GSB-100 Power.....	\$ 95	HENRY 3K-A Plate.....	\$165
GONSET GSB-201 Power.....	\$135	HENRY 3K-A DC Choke.....	\$ 85
H-CRAFTERS HT-32 Power.....	\$ 95	EFJ T-BOLT Plate.....	\$125
H-CRAFTERS HT-37 Power.....	\$ 95	EFJ 500 Modulation.....	\$ 95
HEATH DX-100 LV Power.....	\$ 95	EFJ 500 DC Choke.....	\$ 75
HEATH DX-100 Modl.....	\$ 95	NATL NCL-2000 Plate.....	\$125

OFF-THE-SHELF SPECIALS

PLATE XFMR:	3000 VAC @ 3.0A CCS 230 PRI-120LB.	\$450
PLATE XFMR:	2400 VAC @ 1.5A ICAS 220/240 PRI-41LB.	\$150
PLATE XFMR:	3000 VAC @ 1.5A CCS 230 PRI-60LB.	\$195
PLATE XFMR:	3000 VAC @ 0.7A ICAS 115/230 PRI-27LB.	\$115
PLATE XFMR:	3500 VAC @ 1.0A ICAS 115/230 PRI-41LB.	\$150
PLATE XFMR:	4000/4600 VAC @ 1.5A ICAS 230 PRI-60LB.	\$195
PLATE XFMR:	6000 VCT @ 0.8A CCS 115/230 PRI-41LB.	\$150
FILMT XFMR:	5.0 VCT @ 30A 117 PRI-9.5LB.	\$ 30
FILMT XFMR:	7.5 VCT @ 21A 117 PRI-9.5LB.	\$ 30
FILMT XFMR:	7.5 VCT @ 55A 115/230 PRI-14.6LB.	\$ 65
FILMT XFMR:	7.5 VCT @ 75A 115/230 PRI-20.2LB.	\$ 95
FIL CHOKE:	30 AMP Bifilar Wound on 1/2" x 7" rod.	\$ 9
DC CHOKE:	8.0 Henries @ 1.5 AMP DC 41LB.	\$150
SWG CHOKE:	5-30 Henries @ 1.0 AMP DC 23LB.	\$100

ALL TRANSFORMERS & CHOKES GUARANTEED FOR 24 MONTHS

Many others also available. Write for free list or quote on any custom transformer, choke, or saturable reactor.

Peter W. Dahl Co.

4007 Fort Blvd. • El Paso, Texas 79930
Telephone (915) 566-5365



NEW DIGITAL READOUT



UPDATE YOUR
HEATHKIT.
PUT IT IN
YOURSELF FOR

\$89.95

Low-cost digital frequency readout for Heath models listed below. Retains 1KHZ analog frequency readout and replaces top 100KHZ analog dial with digital frequency readout. Digital resolution to 100HZ, covers all ham bands.

Easy step by step installation instructions: two wires one small coax and band switch wafer. Unit installs with same two screws used for 100KHZ analog dial. To modify Heath models:

HW-101 use DMK-101 (available in Dec. 1979)
SB-102 use DMK-102 SB-400 use DMK-400
SB-303 use DMK-303 SB-401 use DMK-401

The DMK-101 for HW-101 is self-contained and digital frequency readout has same coverage as DMK for SB units.

Labor for DMK-5B units installed in your rig:

DMK-303...\$19.95 DMK-all others...\$29.95

Includes installation, return shipping and insurance. Write for schedule form. Order by stock number. Send check or money order. We accept MasterCard and visa. USA and Canada add \$3.50 shipping and handling. Washington residents add 5.1% tax. Open 24 hours - call code 206-829-0056 or 206-588-5804

Allow 6 weeks for delivery.

PROTRONICS, INC. P.O. BOX 778 BUCKLEY, WN. 98321

AUXILIARY POWER for Emergency or Portable Operation

Model 6869

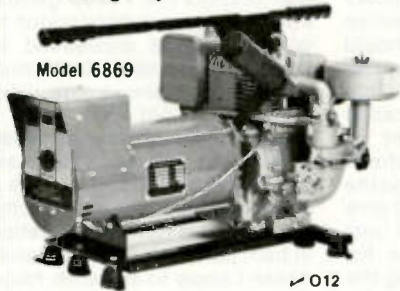

✓O12

Light wt. Portable Alternator. Stand-by power for Ham Equipment, household needs during power outages or operation in remote areas. Operates lighting, refrigerators, heating systems or other appliances including freq. sensitive loads such as TV sets, induction motors and fluorescent lights. Solid-State voltage regulation. 3750W rating; 25% surge capacity. 120/240V at 31.3/15.6A. 8 HP/3600 RPM B&S engine. Alternator draws just enough engine output to meet load resulting in up to 25% fuel savings. Low interference. Advanced design. Drip-proof construction protects windings from rain and dirt assuring long life. One year warranty by manufacturer. 30"L x 18"W x 19"H. 128 lbs. Shipped via Truck

PREPAID (No extra charges). \$725.00
Electric Start..... 121.00
Battery Charging..... 12.00
Spark Arrest Muffler..... 23.00

Models available with 1350 to 7900 watt ratings. Write for our quote and additional information.

Mastercharge or VISA accepted

OUTDOOR OUTFITTERS

705 Elm Ct. Waukesha, WI 53186
Ph. 1-414-542-7772 • Ken, N9KS - Mgr.



THE FIRST CHOICE IN REPEATER CONTROL

The Power and Flexibility of Microprocessor Technology

AUTOPATCH, REVERSE PATCH, SMART ID, ACCESS CODE MUTING, MORSE CODE ANNOUNCEMENTS, FLEXIBLE FUNCTION TIMEOUT, COURTESY TONE, LINKING, CONTROL OP. FUNCTIONS, TWELVE USER FUNCTIONS, ... AND MUCH MORE.

Call or write for specifications:

MICRO CONTROL SPECIALTIES (617) 372-3442

✓M69

23 ELM PARK GROVELAND, MA. 01834



Radio World



CENTRAL NEW YORK'S FASTEST GROWING HAM DEALER



DRAKE TR7-DR7



YAESU FT225RD



YAESU CPU-2500RK



ICOM IC701



YAESU FT-301DM

Featuring Yaesu, Icom, Drake, Atlas, Ten-Tec, Swan, Dentron, Pace, Palomar, Alda, Midland, Wilson, KDK, MFJ, Microwave Module, Standard, Tempo, Astron, KLM, Hy-Gain, Mosley, Larsen, Cushcraft, Hustler, Mini Products, Universal and Tristao Towers. We service everything we sell! Write or call for quote. You Won't be Disappointed. We are just a few minutes off the NYS Thruway (I-90) Exit 32

CALL TOLL-FREE ONEIDA COUNTY AIRPORT TERMINAL BUILDING
1-800-448-7914 ORISKANY, NEW YORK 13424

Bob Warren
WA2MSH K2IXN

NY STATE RESIDENTS CALL 315-337-2622 or 315-337-0203

ou goons don't ever proof
lousy manuscripts from bat
burh...
you li...
I insist that you print ev
tell Ma Bell that she shou

LETTERS

from page 16

crossmode, regenerated-teletype" contact ever. Not only were K0JUY and WB0SAX glad to get a confirming QSL from Tony, but Tony is still bragging about his accomplishment of working Iowa RTTY on "two meters"!

For a brief while, our unique teletype repeater system actually had begun experimenting with a secondary 6-meter FM input at 52.700 into the two-meter system for the purpose of auxiliary input, extension of range, and full-duplex teletype. Unfortunately, the idea did not get much further due to conflicting club problems.

Crossbanding, if handled intelligently and not just to add another feature-type thing, can be a unique, rewarding, and usable addition to the VHF ham's communication system.

Keep up the good work. We need more RTTY articles and more SSTV articles, too!

Michael W. Stone WB0QCD
Lowden IA

WANE

Congratulations to Wayne on bagging all the New England states on 10 GHz. I guess that makes him the first 3-cm WANE.

John A. Carroll
Bedford MA

CLUB DISCOUNT

It has come to our attention that numerous amateur radio clubs and organizations are conducting CW training programs and are always seeking new and better teaching aids. In order to assist them, Xitex Corporation, Dallas, Texas, is offering a new Morse code "transceiver" at a substantially-reduced club price. The unit connects to any TTY or video terminal (Xitex SKT-100) and can be an extremely useful tool for improving both sending and copying skills.

For further details on how to apply for this limited club discount price, write or call me.

Steve Kriss
Xitex Corporation
9861 Chartwell Dr.
Dallas TX 75243
(214)-349-2490

DEPLORABLE

During the recent passing of hurricane David along the east coast, I was tuned to 14.325 where the Hurricane Watch Net was operating. I have never heard such deplorable conduct by amateurs. There was deliberate jamming, foul language, and amateurs operating so close to the frequency (some I know were running excessive power) that it made copy almost impossible.

At one time, there were two ships in trouble. The Coast Guard was attempting to get a fix on their positions through the amateur frequencies, but, due to the deliberate jamming by these individuals, it was impossible. This alone is enough to turn one that is interested in amateur radio against it.

To think that some amateurs would stoop this low, knowing human lives are involved, is disgusting. I hope that the FCC was able to apprehend some of these individuals and that their licenses are revoked permanently.

Henry Ponder KA4DCQ
Lawndale NC

THE END

I have been monitoring the Hurricane Watch Net on 14.325 for the past 24 hours. At the present time, hurricane David is off the Florida coast and hurricane Frederic is over Barbuda. The net has been operating for the past 7 days. What I heard sounded more like CB (an insult to the Citizens Radio Service). Given the incredible number of lds, SOSers, tuners, etc., on the net frequency (sounded like the majority of US stations), Lynne WA1KKP did a very commendable job. If I were net control, I would have asked for a loaded shotgun. US amateurs make communications almost impossible.

If any of the delegates who will be at the upcoming WARC were listening to this mess, we can kiss each and every amateur band good-bye now! I have been licensed for four years and I have never heard such inconsiderate operators. I refuse to operate under these

conditions, so all of my activity was on the Army MARS bands.

This hurricane was not only a disaster for the Caribbean, but also a disaster for amateur radio. I think that this may be the end. I will miss hamming very much. To all the operators in other countries, I would like to apologize on behalf of all the American hams, the majority of whom are very fine people. It's a shame that a minority can ruin it for us all. Oh well, I guess there's still microcomputing.

Keep up the good work, Wayne, and if you can get us out of this mess, you should be elected President. 73.

Christopher R. Wiener
N2CR/AND1DY
Tenafly NJ

BAD TASTE

I read with deep concern the article on receiving MDS channels in the August, '79, issue of 73 Magazine. Just where do we draw the line as responsible American citizens, let alone those who have been granted the privilege of operating amateur radio stations in this country?

Why is it that your magazine chose to use an article detailing how to, in effect, steal a television signal? The reason these frequencies are not included in home TV receivers is because they are not intended to be received by home receivers.

Instead of printing articles such as this, why not exercise some discretion? You should have printed a fiery reprimand concerning the irresponsible use of technology by so-called "amateurs" who amount to nothing more than "justified" petty thieves. 73 Magazine should set an example and give us leadership. Amateurs all over the world are crying out for newsworthy PR concerning the reality of service amateur radio affords to the community and to the world. Printing an article such as this is just plain bad taste and shows the deep spiritual need for a reawakening of the American spirit on which this country was founded.

Dale Alan Richman W4NHM
Sevierville TN

Ham Help

I'm looking for a schematic for an ARC-27. Can anyone out there help? I'll be glad to pay a reasonable price for one. Thanks.

Ron Johnson WA5RON
3524 Greystone, #194
Austin TX 78731

I am in need of a schematic

SOUR GRAPES

Your response to Vic Clark K4KFC (Letters, August, 1979) was pure sour grapes. Some of the criticisms you have for the ARRL may be well-founded, but you must admit that the League has been the only long-term, stable representative of the radio amateur. Your efforts on behalf of hams can at best be described as mercurial. It's probably more accurate to call them erratic. On the other hand, your criticism of the ARRL has been unflinching.

You are right in saying that the League has led too little, but you have not led either. Too many of us, like you, only react to situations, rather than create them. I, for one, am glad to see the ARRL considering the long-range problems and opportunities of amateur radio, and I'm glad that they are considering the views of all hams.

David Swierenga K4FNE
Fairfax VA

DEAR OM/YL

First, I would like to say that I enjoy reading 73. My husband and I are both Novices and are working toward our Generals. Our antenna is a five-band dipole worked out from an article in one of your magazines.

However, I do have one thing that bothers me. I keep getting information on subscriptions to your magazine addressed to Dear OM. This particular form of salutation annoys me very much. It is not that I am a woman's libber in the full sense of the word, but I am proud that I am a woman and like to have it acknowledged. I know that this is a standard form of salutation in ham parlance, but it certainly doesn't apply to all hams. Hope that something can be done about this.

Clare N. White WB6WSP
Sonora CA

OK! You win! All reference by 73 in the future will include Young Ladies. How about "Dear OM/YL"?—Robert R. LaPointe, Marketing Director.

INVENTORY CLEARANCE SALE

**MANY MAJOR PRODUCTS
OFFERED
@ CLOSE-OUT PRICES
GIVE US A CALL FOR PRICES
203-667-0811**

Call or write for
your super quote today!

T34
**THOMAS
COMMUNICATIONS**

95 Kitts Lane
Newington, Conn. 06111
"Near ARRL Headquarters"

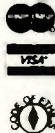

OPEN MON.-FRI. 10-6 • THURS. 10-8 P.M. • SAT. 10-4
EASY DIRECTIONS: Rt. 15 South - 2 blocks past Mr. Donald's (Berlin Turnpike)

"CALL FOR QUOTE"

KENWOOD TS-520SE



**MADISON ELECTRONICS
SUPPLY, INC.** ✓M35

1508 McKinney • Houston, TX 77002
(713) 658-0268
MASTERCHARGE • VISA



IT'S HERE!!

THE AMCODER

4" x 2 3/8" x 6"

A NEW ERA IN CW REGENERATION

- Select any CW signal that's 40 hz away from any other (Tune—400 to 1500 hz)
- Lock and switch to "auto" and you have tape quality audio. One and one only signal reception.
- Only 20 mv of audio above receiver noise required for acquisition.
- A 40 db over S9 signal, 50 hz away cannot come through.
- Reduce operator fatigue by not listening to any other band and/or signal noise except the one you want to work.
- Variable acquisition frequency—400 to 1500 hz.
- Variable output tone frequency—100 to 2000 hz.
- Variable output audio level (drives ear-phones or station speaker).

Kit includes all parts including cabinet, power supply and complete instructions. Epoxy glass boards, plated and pre-drilled.

Available—Factory wired and tested with 1 year warranty on parts and workmanship.

Kit—\$69.95 FWT—\$89.95

VISA and Master Charge Accepted.

AMC ENGINEERING ✓A106
P. O. Box 427, Jessup, MD 20794

ALL BAND TRAP ANTENNAS!



PRETUNED - COMPLETELY ASSEMBLED - ONLY ONE NEAT SMALL ANTENNA FOR UP TO 6 BANDS! EXCELLENT FOR CONGESTED HOUSING AREAS - APARTMENTS LIGHT - STRONG - ALMOST INVISIBLE!

FOR ALL MAKES & MODELS OF AMATEUR TRANSCEIVERS - TRANSMITTERS - GUARANTEED FOR 2000 WATTS SSB 1000 WATTS CW INPUT FOR NOVICE AND ALL CLASS AMATEURS!

COMPLETE AS SHOWN with 90 ft. RG58U-52 ohm feedline, and PL259 connector, insulators, 30 ft. 300 lb. test dacron end supports, center connector with built in lightning arrester and static discharge - molded, sealed, weatherproof, resonant traps 1"X6"- you just switch to band desired for excellent worldwide operation - transmitting and receiving! WT. LESS THAN 5 LBS.

160-80-40-20-15-10 bands 2 trap--209 ft. with 90 ft. RG58U - connector - Model 777BU ... \$64.95
80-40-20-15-10 bands 2 trap -- 102 ft. with 90 ft. RG58U - connector - Model 998BU ... \$59.95
40-20-15-10 bands 2 trap --- 54 ft. with 90 ft. RG58U coax - connector - Model 1001BU ... \$58.95
20-15-10 bands 2 trap --- 26 ft. with 90 ft. RG58U coax - connector - Model 1007BU ... \$57.95

SEND FULL PRICE FOR POST PAID INSURED DEL. IN USA. (Canada is \$5.00 extra for postage - clerical - customs - etc.) or order using VISA Bank Americard - MASTER CHARGE - AMER. EXPRESS. Give number and ex. date. Ph 1-308-236-5333 9AM - 6PM week days. We ship in 2-3 days. ALL PRICES WILL INCREASE MAR 1-SAVE - ORDER NOW! All antennas guaranteed for 1 year. 10 day Money back trial! Made in USA. FREE INFO. AVAILABLE ONLY FROM.

WESTERN ELECTRONICS ✓W18 Dept. A7-11

Kearney, Nebraska, 68847

HAMTRONICS, INC.

WHERE THE HAM IS KING

FOR OVER 30 YEARS ✓H8

Let Us Fill Your



Specific Needs From

OUR \$2,000,000.00 AMATEUR GEAR INVENTORY

ALL THE FAMOUS NAMES—TRANSCEIVERS—AMPLIFIERS—ANTENNAS—TOWERS

Give us a try before you buy • Call Jim Titus

a Division of TREVOSÉ ELECTRONICS, INC./ 4033 Brownsville Road, Trevose, PA 19047

FREE UPS SHIPPING
ON PREPAID ORDERS



215-357-1400

OSCAR Orbits

Courtesy of AMSAT

The listed data tells you the time and place that OSCAR 7 and OSCAR 8 cross the equator in an ascending orbit for the first time each day. To calculate successive OSCAR 7 orbits, make a list of the first orbit number and the next twelve orbits for that day. List the time of the first orbit. Each successive orbit is 115 minutes later (two hours less five minutes). The chart gives the longitude of the day's first ascending (northbound) equatorial crossing. Add 29° for each succeeding orbit. When OSCAR is ascending on the other side of the world from you, it will descend over you. To find the equatorial descending longitude, subtract 166° from the ascending longitude. To find the time OSCAR 7 passes the North Pole, add 29 minutes to the time it passes the equator. You should be able to hear OSCAR 7 when it is within 45 degrees of you. The easiest way to determine if OSCAR is above the horizon (and thus within range) at your location is to take a globe and draw a circle with a radius of 2450 miles (4000 kilometers) from your QTH. If OSCAR passes above that circle, you should be able to hear it. If it passes right overhead, you should hear it for about 24 minutes

total. OSCAR 7 will pass an imaginary line drawn from San Francisco to Norfolk about 12 minutes after passing the equator. Add about a minute for each 200 miles that you live north of this line. If OSCAR passes 15° east or west of you, add another minute; at 30°, three minutes; at 45°, ten minutes. Mode A: 145.85-.95 MHz uplink, 29.4-29.5 MHz downlink, beacon at 29.502 MHz. Mode B: 432.125-.175 MHz uplink, 145.975-.925 MHz downlink, beacon at 145.972 MHz.

OSCAR 8 calculations are similar to those for OSCAR 7, with some important exceptions. Instead of making 13 orbits each day, OSCAR 8 makes 14 orbits during each 24-hour period. The orbital period of OSCAR 8 is therefore somewhat shorter: 103 minutes.

To calculate successive OSCAR 8 orbits, make a list of the first orbit number (from the OSCAR 8 chart) and the next thirteen orbits for that day. List the time of the first orbit. Each successive orbit is then 103 minutes later. The chart gives the longitude of the day's first ascending equatorial crossing. Add 26° for each succeeding orbit. To find the time OSCAR 8 passes the North Pole, add 26 minutes to the time it crosses the equator. OSCAR 8 will cross the imaginary San Francisco-to-Norfolk line about 11 minutes after crossing the equator. Mode A: 145.85-.95 MHz uplink, 29.4-29.50 MHz downlink, beacon at 29.400 MHz. Mode J: 145.90-146.00 MHz uplink, 435.20-435.10 MHz downlink, beacon on 435.090 MHz.

OSCAR 7 Orbital Information				OSCAR 8 Orbital Information				OSCAR 7 Orbital Information				OSCAR 8 Orbital Information			
Orbit	Date (Nov)	Time (GMT)	Longitude of Eq. Crossing °W	Orbit	Date (Nov)	Time (GMT)	Longitude of Eq. Crossing °W	Orbit	Date (Dec)	Time (GMT)	Longitude of Eq. Crossing °W	Orbit	Date (Dec)	Time (GMT)	Longitude of Eq. Crossing °W
22692	1	0031:35	74.1	8444Abn	1	0100:50	62.2	23068	1	0050:49	79.5	8862Jbn	1	0008:41	49.7
22705	2	0125:52	87.7	8458Abn	2	0105:59	63.5	23081	2	0145:06	93.1	8876Jbn	2	0013:49	51.0
22717	3	0025:12	72.6	8472Jbn	3	0111:08	64.8	23093qrp	3	0044:26	78.0	8890Abn	3	0018:58	52.3
22730	4	0119:29	86.1	8486Jbn	4	0116:17	66.1	23106	4	0138:43	91.5	8904Abn	4	0024:06	53.6
22742qrp	5	0018:49	71.0	8500Abn	5	0121:25	67.4	23118X	5	0038:04	76.4	8918X	5	0029:14	54.9
22755	6	0113:06	84.6	8514Abn	6	0126:34	68.7	23131	6	0132:20	90.0	8932Abn	6	0034:23	56.2
22767X	7	0012:27	69.4	8528X	7	0131:43	70.0	23143	7	0031:41	74.8	8946Abn	7	0039:31	57.5
22780	8	0106:44	83.0	8542Abn	8	0136:52	71.3	23156	8	0125:58	88.4	8960Jbn	8	0044:39	58.8
22792	9	0006:04	67.9	8556Abn	9	0142:00	72.6	23168	9	0025:18	73.3	8974Jbn	9	0049:48	60.1
22805	10	0100:21	81.5	8569Jbn	10	0003:55	48.1	23181qrp	10	0119:35	86.9	8988Abn	10	0054:56	61.4
22818	11	0154:38	95.1	8583Jbn	11	0009:04	49.4	23193	11	0018:55	71.7	9002Abn	11	0100:04	62.7
22830qrp	12	0053:58	79.9	8597Abn	12	0014:13	50.7	23206X	12	0113:12	85.3	9016X	12	0105:12	64.0
22843	13	0148:15	93.5	8611Abn	13	0019:21	52.0	23218	13	0012:32	70.2	9030Abn	13	0110:21	65.3
22855X	14	0047:35	78.4	8625X	14	0024:30	53.3	23231	14	0106:49	83.8	9044Abn	14	0115:29	66.6
22868	15	0141:52	92.0	8639Abn	15	0029:39	54.6	23243	15	0006:09	68.6	9058Jbn	15	0120:37	67.9
22880	16	0041:12	76.8	8653Abn	16	0034:47	55.9	23256	16	0100:26	82.2	9072Jbn	16	0125:45	69.2
22893	17	0135:29	90.4	8667Jbn	17	0039:56	57.2	23269qrp	17	0154:43	95.8	9086Abn	17	0130:53	70.5
22905	18	0034:49	75.3	8681Jbn	18	0045:04	58.5	23281	18	0054:03	80.7	9100Abn	18	0136:02	71.8
22918qrp	19	0129:06	88.8	8695Abn	19	0050:13	59.8	23294X	19	0148:20	94.2	9114X	19	0141:10	73.1
22930	20	0028:27	73.7	8709Abn	20	0055:21	61.1	23306	20	0047:40	79.1	9127Abn	20	0003:04	48.6
22943X	21	0122:43	87.3	8723X	21	0100:30	62.5	23319	21	0141:57	92.7	9141Abn	21	0008:13	49.9
22955	22	0022:04	72.1	8737Abn	22	0105:38	63.8	23331	22	0041:18	77.5	9155Jbn	22	0013:21	51.2
22968	23	0116:21	85.7	8751Abn	23	0110:47	65.1	23344	23	0135:35	91.1	9169Jbn	23	0018:29	52.5
22980	24	0015:41	70.6	8765Jbn	24	0115:55	66.4	23356qrp	24	0034:55	76.0	9183Abn	24	0023:37	53.8
22993	25	0109:58	84.2	8779Jbn	25	0121:04	67.7	23369	25	0129:12	89.6	9197Abn	25	0028:45	55.1
23005qrp	26	0009:18	69.0	8793Abn	26	0126:12	69.0	23381X	26	0028:32	74.4	9211X	26	0033:53	56.4
23018	27	0103:35	82.6	8807Abn	27	0131:21	70.3	23394	27	0122:49	88.0	9225Abn	27	0039:01	57.7
23030X	28	0002:55	67.5	8821X	28	0136:29	71.6	23406	28	0022:09	72.9	9239Abn	28	0044:09	59.0
23043	29	0057:12	81.1	8835Abn	29	0141:38	72.9	23419	29	0116:26	86.5	9253Jbn	29	0049:17	60.3
23056	30	0151:29	94.7	8848Abn	30	0003:32	48.4	23431	30	0015:46	71.3	9267Jbn	30	0054:25	61.6
								23444qrp	31	0110:03	84.9	9281Abn	31	0059:33	62.9

Review

CONFIDENTIAL FREQUENCY LIST

by Oliver P. Ferrell,
4th Edition, 1979, 104 pages,
6-1/8" x 9", paper, \$6.95,
distributed by
Gilfer Associates, Inc.,
PO Box 239, 52 Park Ave.,
Park Ridge NJ 07656

Have you ever wanted to listen to NASA, INTERPOL, the Russian Navy, the US Coast Guard, or the Rumanian Embassy in Washington? Or have you heard stations with strange call signs like XSV and KKN50 and wondered just who they were? Perhaps you're just curious about "what's out there" other than hams, broadcast, and CB. If any of these descriptions fit you, then you'll probably be interested in this book.

The *Confidential Frequency List (CFL)*, now in its fourth edition, lists hundreds of stations

in ascending order of frequency from 4001 to 25590 kHz. Included, in most cases, are the frequency, mode, call sign, location, type of service, and power. Many entries also have remarks which tell the listener more specifically what to expect on a frequency—aircraft in Southeast Asia and western Australia, weather reports, telephone conversations, etc.

Previous editions of the *CFL* were arranged by type of service—a section for INTERPOL, one for broadcast feeders, one for VOLMET (aviation weather), etc. That was convenient for eavesdropping on a particular service or station. This new edition, listed by frequency, is very good for identifying "weird" stations heard. It's a bit difficult, though, to find (for example) all the frequencies for NOJ (Coast Guard Radio, Kodiak, Alaska) or NASA. Perhaps the future edi-

tions of *CFL* will have some type of cross index to eliminate this problem. One further suggestion for future editions would be to include a wider range of frequencies. (There are interesting stations all the way down to about 10 kHz. Nationwide VHF frequencies would be of interest to the many owners of scanning VHF receivers.)

These few criticisms are minor. A book can't be all things to all people. As it is, the *CFL* is a most valuable resource for

anyone with access to a general-coverage radio who wonders, "What's going on?"

Readers should note the author's admonition that the "confidential" part of the title is no joke. It refers to the secrecy provision of the Communications Act which prohibits the disclosure of the content of any non-ham and non-broadcast radio transmission.

Dennis G. Brewer
APO New York

Ham Help

I need information on converting a Collins R-390A to product detection or installing a product detector. Thanks.

George Shira WD4BUM
RT. #7, Box 101-I
Anderson SC 29624

I have been trying to find some parts for an AN/ARR-52 Radio Receiver. I have been able to find everything I need ex-

cept for the channel selector control box (model C-3109/ARR-52) and the signal level meter box (model SB-1084/ARR-52).

It's a little slow changing channels with a screwdriver. Does anyone know where I might find these two items? Thanks.

Craig Winters
Box 79, Federal St.
Wiscasset ME 04578

Microcomputer Interfacing

from page 28

NXTKEY. In ten milliseconds, the 8080 returns from DELAY, which is a sufficient period of time to debounce the switch closure. The 8080 now has to determine which key in column A is pressed. It does this by rotating to the right into the carry the word that was pre-

viously input. If a logic one is rotated into the carry, the JNC to RELESE is not executed. Instead, the content of the D register is increased by four. By jumping back to AGAIN, the 8080 can rotate another bit of the A register into the carry. When a logic zero is rotated into the carry, the unique code for the key that is pressed is in the

```

/THIS SUBROUTINE SCANS A MATRIX KEYBOARD
/THAT IS ARRANGED AS FOUR ROWS OF FOUR KEYS,
/A 4X4 KEY MATRIX. IN ADDITION, INSTRUCTIONS
/HAVE BEEN ADDED TO THE SUBROUTINE TO DEBOUNCE
/THE KEYS.

KEYSCN, MVID    /LOAD D WITH THE CODE FOR THE
003            /FIRST KEY THAT CAN BE SENSED
MVI B         /LOAD B WITH THE WORD THAT IS USED TO
376           /ACTIVATE ONE ROW OF KEYS AT A TIME
NXTGRP, MOVAB  /GET THE TEST WORD
OUT           /AND OUTPUT IT TO THE KEYBOARD
003
RLC           /ROTATE THE TEST WORD LEFT ONE BIT
MOVBA        /AND THEN SAVE IT IN B
IN           /INPUT THE DATA FROM THE FOUR
000           /ROWS OF KEYS
ANI          /SAVE ONLY THE FOUR LSBs, WHICH CON-
017           /TAIN THE ROW DATA
CPI          /SEE IF ANY KEYS ARE PRESSED BY COM-
017           /PARING 017 (0F) TO THE INPUT WORD
JNZ          /A KEY IS PRESSED IN THIS ROW, SO
NXTKEY       /DETERMINE WHICH KEY IT IS
0
DCRD         /NO KEYS ARE PRESSED IN THE TESTED ROW
MOVAD        /SO DECREMENT THE KEY CODE BY ONE AND
CPI          /SEE IF ALL FOUR ROWS HAVE BEEN TESTED
377          /377 - HEX FF
JNZ         /NOT ALL FOUR ROWS HAVE BEEN TESTED,
NXTGRP       /SO TEST ANOTHER ROW
0
JMP         /ALL THE ROWS HAVE BEEN TESTED AND
KEYSCN       /NO KEYS ARE PRESSED, SO KEEP LOOKING
0
NXTKEY, CALL  /A KEY IS PRESSED, SO EXECUTE THE
DELAY        /DELAY SUBROUTINE FOR 10 MSEC.
0
AGAIN, RRC   /ROTATE THE ROW DATA INTO THE CARRY
JNC         /FOUND THE KEY, SO WAIT FOR IT TO
RELESE     /BE RELEASED BEFORE RETURNING FROM
0          /THE SUBROUTINE
PUSHPSW    /OTHERWISE, SAVE THE PSW ON THE STACK
MOVAD      /AND INCREASE THE KEY CODE IN D BY 4
ADI        /
004
MOVDA      /SAVE THE NEW KEY CODE IN D
POPMSW     /POP THE PSW OFF OF THE STACK
JMP        /AND THEN TRY FOR A ZERO CARRY
AGAIN      /
0
RELESE, IN  /INPUT THE DATA WORD AGAIN
000
ANI        /SAVE ONLY THE FOUR DATA BITS THAT
017        /REPRESENT ROWS OF KEYS
CPI        /COMPARE THIS VALUE TO THE VALUE OBTAINED
017        /WHEN NO KEYS ARE PRESSED (017, HEX 0F)
JNZ        /JUMP IF A KEY IS STILL PRESSED
RELESE     /AND WAIT FOR IT TO BE RELEASED
0
DELAY, PUSHPSW /SAVE THE PSW ON THE STACK
PUSHD     /THEN SAVE REGISTER PAIR D ON THE STACK
LXID      /LOAD REGISTER PAIR D WITH A COUNT
101       /OF 003 101 (HEX 0341)
003
WAIT, DCXD  /DECREMENT THE COUNT
MOVAD     /MOVE THE MSBY TO A
ORAE      /OR IT WITH THE LSBY
JNZ       /IF THE RESULT IS NON-ZERO, JUMP
WAIT      /TO THE DCXD INSTRUCTION
0
POPD      /WHEN IT IS ZERO, POP D&E OFF OF THE STACK
POPMSW    /AND THEN POP THE PSW OFF OF THE STACK
RET       /AND RETURN WITH THE KEY CODE IN D

```

Fig. 4. A subroutine that scans the 16-key keyboard.

D register, so the jump to RELESE is executed by the 8080.

The 8080 now waits for the key to be released, at which time the DELAY subroutine is called again. This causes the key opening to be debounced. The RET instruction at the end of the DELAY causes the 8080 to return to the program that called KEYSCN. When it does, the key code is in the D register.

As an example, let us assume that the nine key is pressed. The 8080 loads the D register with three and the B register with 11111110. The content of the B register is output to the keyboard and is then rotated to 11111101. The row data from the keyboard is then input, but since no key in column A is pressed, the A register contains 017 after the ANI instruction is executed. Therefore, the content of the D register is decremented from three to two and the 8080 jumps back to NXTGRP so that the B column can be tested. When the 8080 executes the instruction at NXTGRP this time, a 11111101 is output to the keyboard, but since no keys in the B column are pressed, the 8080 inputs a 017. Because of this, the content of the D register is decremented from two to one, and since this value is not equal to 377, the 8080 jumps back to NXTGRP.

The 8080 now tests the C column by latching out a 11111011 to the keyboard interface. Since a key in the C column is pressed (the 9 key), the A register will contain 11111011 when the IN 000 instruction is executed. The ANI 017 instruction sets bits D7 through D4 to zero, so the A register contains 00001011. Since this value is not equal to 017, the 8080 executes the jump to NXTKEY. The DELAY subroutine is then called, so that the key closure is debounced. The A register still contains 00001011, so a logic one is rotated into the carry when the RRC instruction is executed the first time. This means that the JNC to RELESE is not executed. Instead, four is added to the content of the D register (one) and the result (five) is saved in the D register. By jumping back to AGAIN, the 8080 rotates the 00000101 once to the right, and again, a logic one is rotated into the carry. As before, the JNC to RELESE is not executed, so four is added to the content of the D register

(five) and the result (octal 011, decimal 9) is saved in the D register. When the 8080 jumps to AGAIN this time, the 00000010 in the A register is rotated to 00000001, and a logic zero is rotated into the carry. This means that the JNC to RELESE is executed. Once the 9 key is released, the DELAY instructions are executed, and the 8080 returns from the subroutine with the code for the nine key (octal 011, decimal 9) in the D register.

Surprisingly enough, no additional software instructions have to be added to the subroutine in Fig. 4 for the 8080 to scan and encode a 64-key keyboard! In fact, only four immediate data bytes have to be changed. However, the interface would have to consist of an eight-bit output port (so that a test pattern for eight columns of keys could be output) and an eight-bit input port (because there are eight keys in each column). This means that the keyboard consists of eight columns, each containing eight keys. Note that the software in Fig. 4 does not produce ASCII values for the key closures. However, this could be done very easily, simply by using a look-up table that contains 64 entries.

As you have seen, key closures can be encoded by means of hardware or software. A number of integrated circuit manufacturers have keyboard-encoder integrated circuits available which can be used very easily and with a minimum of software. However, they may be too expensive or not flexible enough for your needs. By using a scanned keyboard, the interface electronics are kept to a minimum. However, a long and complex subroutine must now be used to debounce and encode the key closures. This subroutine consists of 38 instructions and requires 67 memory locations for storage. If a look-up table is used to convert the key codes to ASCII values, an additional 72 memory locations will be required to store the look-up table and some additional assembly language instructions.



Ham Help

I would like to get in touch with hams around the world who are under the age of 20 and who are interested in joining the Young Amateurs World Net

(YAWN). Please send an SASE for info.

Stephen V. Genusa WD5EAE
2106 Park Ave.
Monroe LA 71201

RTTY Loop

from page 20

for nominal amounts from several of the teletype suppliers mentioned in the column a few months back or from many 73 advertisers.

If only a few symbols are to be changed (say you want to change from press to communications), replacement type pallets also are available. These are simply soldered onto the end of the type bar after the old pallet is removed by desolder-

ing. It takes only a few minutes, and the procedure is painless unless you try to hold the type bar while soldering.

Turning to other matters, Bill Taylor K8TBW writes describing a nice RTTY setup including the Microlog equipment and Drake line. Bill is trying to use the Heath SB-610 monitor scope with the station, but has a problem. The scope requires the mark and space detector outputs, and the Microlog unit does not provide them. He wonders if

there is any way to use the 610 with audio input and still get an X or + pattern.

I don't know, Bill. It seems to me that you would have to build the front end of a demodulator to feed the thing. Basically, the limiter and mark/space filters would be needed to get differential outputs. That is really not all that much, but it seems like a waste. If any readers have information on such a wedding, I would be interested in passing it along to Bill and others.

Have received a snazzy publication from the Stark County RTTY Group called *Watts Happening*. Passed along by

Joseph Ebner WB8RVM, it points to an active group out there in Massillon, Ohio, and I am sure that they would appreciate hearing from hams in the area who are interested in RTTY.

As of this writing, no word has been received on Teleprinter Art, Ltd., as reported in last month's "RTTY Loop." A communication to the firm has been without response, and several more individuals have reported to me that they have received less than satisfactory service from the company. I urge all readers to be cautious in their dealings with all mail-order firms.

Leaky Lines

from page 24

prices, I don't think that this amount would even cover the cost of the receiver alone! The strange thing about this is that this particular design has not been altered in any significant way since I bought mine. Even

more important, it's practically impossible to find reliable sources for quality vacuum tubes. A friend told me that he put forty 12AT7s on his tube checker in an attempt to find a matched pair and no two even came close in transconductance figures. Is it any

wonder that hams are switching to more modern equipment?

As far as I know, there are only two major American companies producing gear that is competitive with the imported equipment. All others seem to have fallen by the wayside. Kenwood, Yaesu, Icom, Trio, Tempo... these are the names that show up nowadays, and I must confess that they sound at least as good as the best old stuff, and usually a good deal cleaner.

This makes me laugh, really. A fellow I know only slightly gave me a bad going over for driving a foreign car. He said that buying an export is practically treasonous in these times. But about six weeks later, he showed up on 20 meters with a brand new Icom 701 with all the goodies to match!

There's nothing like a little consistency... right?

Looking West

from page 18

Now, then, New York and Los Angeles, in our example, are terminal cities or terminal ports. Since in the southwest repeating devices sit atop high mountains, fewer hops are necessary than in areas where such elevation and line-of-sight characteristics are not attainable. Out here, the average repeater has saturated coverage for about 150 miles from a good mountaintop and peripheral coverage for another 50 to 70 miles. A similar repeater atop a building in an eastern or midwestern city might cover 50 to 70 miles saturated and another 15 or so in peripheral. Remember, we are discussing ideal average systems and not the occasional super system that, through some odd circumstance, is able to do what others cannot. Let's go ahead with these figures as our reference. Then, in like manner, we can apply a similar program to the interlinking portion of our intertie.

Again, using 220 MHz as our intertie band and considering normal band conditions most of the time, it should be possible to accomplish between 150- to 275-mile minimum hops, using nominal power and directional antennas at any given linking

site. If all things were equal (and due to the variations in terrain they are not), we would come up with an approximate figure of 20 linking sites, giving us coast-to-coast communication between two major American cities with a large two-meter FM population. If we worked with a 275-mile link figure, the number of linking sites would be down to about a dozen. This might be further enhanced if we were to borrow some weak-signal technology from experts in this field and utilize SSB rather than FM for the modulation system on our interlink channels. This would be the ideal situation. However, in real life I suspect that it would probably necessitate more on the order of 30 links to accomplish such a goal. If that sounds like a lot, it is, in reality, less than 1% of the total number of two-meter open systems operational at this time. I think that I am safe in assuming that there are at least 30 repeater owners out there who might find a project such as this an exciting challenge. Making it happen requires only a bit of "bread," some well-thought-out technology, and believing in the motto, "Yes, I can!"

As I write this, I can imagine some of you asking, "How will it be policed? What if it gets jammed—what then?" Or,

"Nobody will be able to use it; it will be a madhouse." Things like this can happen and, at least at the outset, I would expect them to. However, if we spend our lives worrying about the "might" and the "maybe," we will live to see nothing of consequence accomplished. Everything in life has an element of risk. There comes a time in any person's life when he must look in the mirror and decide if he is a man of a mouse. Is he willing to look forward to and participate in the future, or does he take the ostrich approach? Sure, we have problems, both technological and sociological, but to run and hide our heads in the sand will accomplish nothing. We amateurs have faced problems before and have whipped them before. Why should this situation be different?

CROSSBAND REPEATER DEPARTMENT

Earlier this month, I spent about a half hour on the telephone with Wayne, and one of the subjects we discussed was crossband repeaters. This idea is not new. In fact, crossband repeaters were in vogue prior to the "18803" dark ages. Lately they are coming back, along with crossband/cross-mode repeaters, to allband HF SSB. I can see only one drawback to such crossband devices: the necessity of carrying two radios wherever one goes. Usually this is not a problem at one's base

station. In fact, some of the newest of the five-band HF transceivers feature an FM-mode position. Yaesu and others have pioneered this knowing full well that FM capability, with its intended use on ten meters, makes for a more useful all-around transceiver package. This is fine for home, but a mobile installation is a different story, especially as today's "mobiles" are a lot more cramped for space than were their cousins of a few years back. I drive a compact car myself these days, and trying to fit two adults, radios for both two meters and 220 MHz, and associated tone-pads into the front seat is a bit of a chore. Even if I were to trunk-mount something like a Motrac, there would be little if any room for a control head.

If you are like most amateurs I know, you will want to have both bands with you. For example, most of my operating out here is on 220 MHz. Most of my two-meter operating is done through a remote base accessed from 220 MHz. However, once out of range of the 220 remote, I rely heavily on my Icom 22A and/or Clegg FM-27B, depending on which one happens to be in the car at the moment. A solution to this dilemma may be in using a highly modified mini-CB radio as the ten-meter mobile station. Such radios can usually be had for a song at local swapmeets and CB breaks. With a bit of

time and correct technology, such radios might be excellent ten-meter FM performers. Also, who says that the ten-meter portion of such systems must be FM? Judging by the number of CB-to-ten-meter conversions appearing in 73 and elsewhere, it might be wise to standardize on good old "ancient modulation" for ten-meter crossband operations. This would open things up to many more people. Not everyone is prepared to pay a lot of money to try something new, but they might spend a few bucks to get their feet wet. QRP AM on ten meters blends nicely with two-to-ten crossband operation and, while it cannot match the fade margin afforded by FM operation, it's a nice, inexpensive way to begin. Also, it will fit in the tiniest of vehicles along with the two-meter rig.

If you deal with a crossband repeater in the purest sense (in a classic repeater configuration), then you will require two radios in order to both talk and listen. A true crossband repeater is one that listens on a given band and re-transmits on another. However, there is a better way of doing things, and this is known out west as "remote-base configuration."

We have discussed remote-base operation, but a quick review might be in order. First, the accepted full designator for a remote base is (get ready for this) "the individually owned and operated, advanced format, remotely-controlled amateur base station radio." I prefer the simple term "remote." A classic remote is one in which the base station is at some good site and is controlled by some form of auxiliary intertie. This can be a phone line, direct hard-wire, or a radio link above 220 MHz. In most cases, a remote serves the dual function of repeater (or autopatch repeater) and interlink to other bands. Until recently, most remotes restricted operation to such simplex channels as the national remote-base intertie channel of 146.46 on two meters, along with such others as 146.94, 52.525, and 29.6, all of the latter being nationally accepted simplex allocations.

Frequency synthesis revolutionized not only 2m FM operation, but 2m remote downlink use as well. Many older remotes opted for synthesis over crystal control, and virtually every new remote I run into is fully synthesized on its two-meter downlinks.

It's not uncommon around here to work someone on a two-meter repeater which, in turn, is operating from an area removed from that repeater's normal coverage through a remote-base system that can talk to the repeater. Sound confusing? It

really isn't. For example, Newhall, California, is an rf pit. Though only a few miles north of Los Angeles, we are surrounded by several kilofeet of mountains, which makes working most Los Angeles repeaters impossible. However, by operating two meters through a remote base (which sees both my QTH and LA's, as it is located atop a 4800-foot hill that overlooks both), I can operate easily through most area systems using only ten Watts and a Ringo on 220 MHz. Without the remote, my access to Los Angeles would be very limited.

There is much to be said for the remote-base concept of crossband operation. First, since all the crossbanding is accomplished at the repeater site itself, the user of this system need carry only one radio. Second, on a remote (or on a private or closed repeater), every system user is automatically a control operator. He has total control over all aspects of a QSO, including the right to "dump it off" should a problem arise with regard to content of communication. The only problem is that there still exist certain prohibitions with regard to controlling a transmitter on another band from frequencies below 220 MHz. However, this might really encourage 220-MHz repeater expansion. Though by tradition remotes have restricted themselves to small private groups, there is no law that says this must be the case. The recent establishment of 145.60 as a general intertie channel for any 220 repeater wishing to converse with any other 220 repeater is an obvious step in that direction. (145.6 is the correct frequency, rather than the 145.56 which was printed in the August column.) The repeater that initiated it, WA6VNV on Oat Mountain, is a heavily used 220-MHz open-access repeater. They could just as easily have selected a ten-meter frequency, a twenty-meter frequency, and a crossband open remote-base system. It is not a traditional remote base by any means, but nowhere in part 97 does it state that, to be a remote base, a system must be private or restricted access. Most are, for traditional reasons, but as more and more systems join WA6VNV on 145.6 MHz, that tradition, like many others, begins to slip away.

It was suggested several months ago by a "Looking West" reader in Chicago that we should establish a national remote-base intertie channel on ten meters as a common meeting ground for such operations nationwide. At that time, it drew very little response and we let it

go. However, the infusion of new crossband VHF relay activity to ten meters brings this concept into the limelight once again. I'd appreciate your input on this subject. A spot lying between the top of the OSCAR downlink and 29.6 has been suggested by some. Maybe you have a better idea. If so, pass it along to the rest of us.

In the meantime, give some serious consideration to the remote-base concept of downlink operation. The user need not buy any extra radio, and only a linking radio is needed at the repeater site. The rewards are great and the cost is minimal.

MORE CHANGES AT WESTLINK DEPARTMENT

I really was not planning to write the following for reasons that will soon become obvious. To some it may sound as though I am tooting my own horn, and that's not true. I am furnishing the following information after having been urged to do so by Wayne, as he convinced me that it is quite newsworthy.

In mid-July, Westlink's network director, Jim Hendershot WA6VQP, asked me if I would consider producing the weekly Westlink Amateur Radio News "QSTs." I told him that I would if I could get both the space to set up a production facility and some assistance. Jim was away on vacation earlier this year, and I filled in for him. During that time, I managed to put together a good news team. It consisted of myself as writer/producer, Bill Orenstein KH6IAF as engineer/production coordinator, and Al Kaul W6RCL and Burt Hicks WB6MQV as anchorpersons. I felt that Bill would be gung-ho. I was right. He was not only elated at the prospect, but even donated office space and much of the production equipment. We then contacted Burt and Al, who were also interested. I spoke with Jim and arranged to take over on the first Sunday of August.

During the transition period, Bill introduced me to a very talented man named Zeke Manners. Zeke is not a ham (not yet), but I think we are getting to him. Zeke is, however, a professional broadcaster who has emceed many radio programs and, thanks to Bill, he agreed to become part of the Westlink news team as well. With this many people involved in Westlink, no one person is totally responsible for the burden of weekly production except for Bill Orenstein, who edits the programs for time and continuity. He does so in the time-honored tradition of hand-cutting the newscast and then transferring it from

reel to cart for dissemination. We hope to enlist the aid of at least one other editor to minimize Bill's workload in the future. Keep in mind that this is a voluntary effort on our part, and that each of us has another "real" job. Having produced a fair number of newscasts, I find it hard to believe that any one individual could have done this alone for over two and a half years. Jim did, and he is to be commended for his work.

We are disseminating the newscast in only one way at present. There is no cassette exchange program any longer. Jim discontinued it about six months ago and, after much consideration, we decided not to revive it, though not for the same reasons. For Jim the problem was the time it took for duplication. This would not be a problem for us since we could have utilized high-speed duplication processes and paid for it ourselves. However, there is another reason for not reviving it, and that is the quality of duplication. Bill happens to be an audio engineer by profession, and if there is one thing he knows like the back of his hand, it's tape recording techniques. Bill feels that the main problem with cassette exchange is one of quality control. It seems that no two people ever send the same type or quality of cassettes, and this gives rise to complaints about recording quality. We have therefore elected to utilize an automated telephone system fed from a Collins broadcast cartridge machine. The newscast is first recorded on reel-to-reel tape, then edited by Bill, and finally transferred to cart. It is available from 9:00 pm Sunday to 10:00 pm Wednesday, local Pacific time. The rest of the week, the equipment is tied up in production. Also, the first half hour (9:00 to 9:30 pm Sunday) is reserved for local Los Angeles/San Diego feeds, after which the facilities are available to any repeater or hand-capped amateur on a first-come, first-served basis. We will continue this way for the foreseeable future.

Finally, along with those already mentioned, we have added a number of other volunteer correspondents, including Joe Merdler N6AHU (law) and Pat Corrigan KH6DD (Pacific Islands). We also found someone to cover major national conventions and are trying to add a European correspondent from Germany. This is where we currently stand. We admit to being a shoestring operation, trying to do out-of-pocket what other stations do by spending hundreds of thousands of dollars. The amazing thing is that it all seems to be coming together

for us, and this makes me very happy. By the way, if anyone out there happens to have some usable "Fedlipak" cartridges (large or small) that they are willing to give away, we would

be happy to receive them. In fact, it would be much appreciated.

If you would like to get more information on Westlink, have a story you feel is air-worthy, or

want to arrange to get the weekly service (which is still free), then drop a note to us at Westlink, 7046 Hollywood Boulevard, Suite 718, Hollywood CA 90028. Also, if you are among those

who sent cassette tapes to Jim prior to the discontinuation of the cassette exchange program, they will be returned to you in the near future. We ask that you be patient a bit longer.

Contests

from page 30

QSO points times the IPA countries multiplier.

FREQUENCIES:

SB—3650, 7075, 14295, 21295, 28560 kHz ± 25 kHz.

CW—3575, 7025, 14075, 21075, 28075.

ENTRIES AND AWARDS:

US stations wanting a copy of Sherlock Holmes Award rules, IPARC membership list, contest logs, and results of the 1978 contest should send an SASE with 2 stamps (others send 2 IRCs) to: Vince Gambino WB4QJO, 7606 Kingsbury Rd., Alexandria VA 22310. Any station fulfilling the conditions of the SHA may apply with an application sheet. The approval of 2 licensed amateurs is not necessary when the SHA application is submitted with the contest logs. See SHA rules for more information. The contest winners, the 3 operators with the highest score, receive a certificate and are honored in the Award Chronicle of the International Police Association RC. Logs must be postmarked no later than December 31st and sent to: Bureau National IPA, Section Francaise, CNAS, Mr. Gerard Dupuis, 15 Rue Cambaceres, 75008 Paris, France.

DELAWARE QSO PARTY

Starts: 1700 GMT Saturday,
November 10
Ends: 2300 GMT Sunday,
November 11

Sponsored by the Delaware Amateur Radio Club (DARC), the contest is open to all amateurs. Non-DE stations work only DE stations.

EXCHANGE:

DE stations send QSO number, RS(T), and DE county. Non-DE stations send QSO number, RS(T), and ARRL section or country.

SCORING:

DE stations score 1 point per QSO and multiply by the total of ARRL sections and countries. Non-DE stations score 5 points per QSO and multiply by the total sum of counties worked per band per mode (max. possible 36, assuming 160 through 10 meters). DE counties = New Castle, Kent, and Sussex.

FREQUENCIES:

CW—60 kHz from low end of each band and 1805.

Phone—1815, 3900, 7275, 14325, 21425, 28560.

Novice—3710, 7120, 21120, 28120.

Check 160 at 0500 GMT and 0600 GMT or make skeds.

ENTRIES:

Send logs by December 15th to: Stephen J. Momot, K2HBP, 14 Balsam Rd., Wilmington DE 19804. If you work all three counties and wish the WDEL Award, include two 15c stamps and an address label. Include an SASE for results only.

INTERNATIONAL OK DX CONTEST

Starts: 0000 GMT November 11

Ends: 2400 GMT Sunday,
November 11

Participating stations work stations of other countries according to the official DXCC Countries List. Contacts between stations of the same country count as a multiplier but 0 points. Use all amateur bands from 160 through 10 meters on both CW and phone. Cross-band and cross-mode contacts are not valid.

EXCHANGE:

RS(T) and two-digit ITU zone number. Note: ITU zones are different from the ARRL zones. A list and map of the ITU zones are available from the contest sponsors for 2 IRCs.

SCORING:

A station may be worked once per band. A complete exchange of codes counts one point, but three points are earned for a complete contact with a Czechoslovak station. The multiplier is the sum of the ITU zones from all bands. The final score is then the total QSO points times the total multiplier.

ENTRIES:

Categories of participating stations: A) single-operator, all bands; B) single-operator, one band; C) multi-operator, all bands.

Any station operated by a single person obtaining assistance, such as in keeping the log, monitoring other bands, tuning the transmitter, etc., is considered as a multi-operator station. Club stations may work in category C only. A separate log must be kept for each band and must contain the following data: date and time in GMT, sta-

tions worked, exchange sent and received, QSO points, and ITU zone multipliers (with first QSO in each zone only). The log must contain in its heading the category of the station (A, B, or C), name, call sign, address, band(s), etc. There is also a sum of contacts, QSO points, and multipliers and the total score for the participating station. Each log must be accompanied by a declaration that all rules and operating procedures were observed. A performance list of participants will be created for each country by the contest committee. A certificate will be awarded to the top-scoring operators in each country and each category. The "100 OK" award may be issued to the stations working 100 OK stations, and the "S6S" award may be issued to a station for contacts with all continents. Both awards will be issued upon written application in the log and no QSL cards are required. Logs must be sent to: the Central Radio Club, Prague 1, Czechoslovakia, postmarked no later than December 31st.

27TH ANNUAL BREEZE SHOOTER TEN-METER GROUND WAVE CONTEST

Starts: 2100 EST November 24

Ends: 0100 EST November 25

Sponsored by the Breeze Shooters, Inc., of Pittsburgh PA, this contest will feature separate categories for Novice/Technician, QRP, mobile entries, and fixed stations. For log sheets and rules, send an SASE to: George Proudfoot K3GP, 3472 Ivy Hill Lane, Finleyville PA 15332.

Awards

from page 22

years, the net has become a popular meeting place for 160-meter hams. The golden frequency was and still is 1818 kHz, and you'll find the net originating from the eastern shores of the United States each and every Wednesday evening at 2100 Eastern Time.

Keep in mind, should you wish to join the net, good conditions are more prevalent in the winter than in the summer months. This is important to mention due to the fact that many have listened on the frequency before and have copied nothing more than a high noise

level in their respective areas. As will be noted by all of us at one time or another on 160, some nights are better than others.

Naturally, the net recognized the popularity of an awards program and now offers a very handsome certificate to those applicants meeting the requirements outlined below.

THE TOP BAND SSB NET AWARD

The Top Band SSB Net Award program was started in February, 1977, and is dedicated to those operators who check into the net either on three consecutive nights in

which the net meets or on five non-consecutive nights in which the net meets. You should mail a copy of your log entries showing check-ins to the net registrar, Vic Misek W1WCR, 142 Wason Road, Hudson NH 03051, and be sure to enclose the award fee of \$1.00 to cover the cost of printing, postage, and handling. Do not send an SASE since the award fee covers this cost.

Should any of our readers have 160-meter capabilities, why not join the fun? Should antennas be your obstacle, why not contact Vic and the group as there are several surprising antenna designs which are compact and cost under \$5.00 to put you on the air with a respectable signal! And, of course, don't forget that in January, for the first time ever,

73 Magazine will be sponsoring the 160-meter Phone Contest. More on this next month.

Traveling abroad, I wish to share with you information about a very respectable award being sponsored by the International Telecommunications Union (ITU) and the International Amateur Radio Club.

DIPLOME DES 100

This award is given by the ITU to radio amateurs and short-wave listeners everywhere in recognition of their achievement in communicating with, or logging the reception of, amateur radio stations in the territory of 100 or more member administrations of the ITU. Any licensed radio amateur or short-wave listener is eligible for this award. It is given to the individual, and the qualifying con-

tacts may be made over any period of time subsequent to the dates shown in the ITU official countries list available from the awards manager.

Applications shall be made by letter and shall include a list of stations claimed in alphabetical order, showing claimed dates. No special form is required for this purpose. Only frequencies, modes, and prefixes approved by the Radio Regulations of the ITU may be used. To qualify, 100 or more contacts must be made.

QSL cards or proper log entries will be considered proof of contact to back up an award application. Attached to the application should be a statement from two licensed amateurs or an ITU administration representative to the effect that all claimed contacts have been verified. No other proof is required. Do not send QSL cards! Do not send logs!

There will be no endorsements for special conditions. Stickers will be given for each ten (10) additional contacts.

The administration of this award has been delegated to the International Amateur Radio Club, 4U1ITU, PO Box 6, 1211 Geneva 20, Switzerland. The IARC has named Mr. L.M. Rundlett K4ZA as awards manager. All applications should be accompanied by 10 IRCs or US \$2.00 for the award, and one IRC or a US self-addressed, stamped envelope for each sticker. Mail all applications to L.M. Rundlett K4ZA, Route 3, Box 447, Lake Placid FL 33852.

I received a very complete package of information from the Central Radio Club in Moscow and take pleasure in featuring their award program in more detail. It is unfortunate they did not send samples of their certificates, as I'm sure they are unique diplomas to possess.

R-100-O AWARD

This award (as is the case for all awards listed below) is issued to all licensed radio amateurs and shortwave listeners throughout the world who can meet the requirements. For the R-100-O, radio amateur applicants must carry out two-way contacts with, and shortwave listeners must log reception reports of, radio stations in 100 oblasts (provinces) of the Soviet Union.

There are three categories of R-100-O awards. The First Class is for two-way contacts on the 3.5-MHz band only, the Second Class is for two-way contacts on the 7-MHz band only, and the Third Class is for two-way contacts on any amateur band. All contacts must be made on phone or CW only. Endorsements will be given for each

mode of operation, but cross-mode or mixed-mode contacts are not allowed. All reports exchanged between stations must be RST 337 or RS 33 as a minimum. All contacts or observations must be made on or after January 1, 1957, to be valid.

Applications must include a list of contacts or observations with date, calls, mode, and frequency shown in order of callsign prefix. QSL cards must be submitted along with the award fee of one ruble or 14 IRCs to cover the cost of the award and safe handling of your QSL cards back to you. One should allow three to six months for the processing of any of the awards I am describing. Send all applications and inquiries related to this or any of the following awards to The Central Radio Club USSR, Postbox 88, Moscow, USSR.

W-100-U AWARD

The W-100-U Award (worked 100 radio stations in the USSR) was established in 1959 on the occasion of the 100th anniversary of the birth of A.S. Popov, the great Russian scientist claimed to be the inventor of radio. For this award, amateurs must carry out two-way contacts on one or more amateur bands with 100 different amateur stations of the Soviet Union, including 5 radio stations of the 9th region (Minsk-aya). All contacts must be on either phone or CW, and applications must state which mode is to be credited for the award. Cross-mode or mixed-mode contacts do not count. All contacts must have been made January 1, 1959, or after and all signal reports exchanged must be at least RS 33 or RST 337 to be claimed. As with the R-100-O award, the applicant must prepare a list of contacts claimed and give the calls, date, frequencies, and type of emissions used to achieve the contacts. The cost of the award is 1 ruble or 14 IRCs, to be sent with your application, and QSL cards are required. The award fee is used to provide for the safe return of your confirmation cards.

R-6-K AWARD

The worked-all-six-continents award is offered by the Central Radio Club to amateurs and to shortwave listeners who can carry out 12 two-way contacts or observations on SSB, CW, and phone with radio amateurs as follows: one contact each in Europe, South America, Africa, Asia, North America, and Oceania, plus 3 contacts each in the European USSR (UA1, UN1, UW1, UA2, UC2, UP2, UQ2, UR2, UA3, UW3, UV3, UA4, UW4, UB5, UO5, UT5, UY5, UA6, or UW6) and the Asiatic USSR

(UD6, UG6, UF6, UL7, UI8, UJ8, UH8, UM8, UA9, UW9, UV9, UA0, or UW0). The award has three categories: First Class is for two-way contacts on 3.5 MHz only, Second Class is for two-way contacts on 7 MHz only, and Third Class is for two-way contacts on any amateur band. As with all awards of the Central Radio Club, confirmation cards must be sent with your application. To qualify, all contacts must have been made May 7, 1962, or after. The award fee is 1 ruble or 14 IRCs—the same as it is for each of the awards of the Central Radio Club.

R-10-R AWARD

The R-10-R Award (worked 10 radio amateur regions in the USSR) is available to those who carry out, on one or more amateur bands, two-way contacts with 10 radio amateur regions in the USSR. These regions may also be termed call districts; in any case, numbers one (1) throughout zero (0) must be worked. All contacts must be made on either phone or CW. Mixed-mode or cross-mode contacts will not count. All contacts must be made after July 1, 1958, and signal reports must be a minimum of RST 337 or RS 33. The submission of applications and the cost of the award is the same as noted with the other awards in the Central Radio Club portfolio.

R-15-R AWARD

The R-15-R Award (worked with radio stations in 15 USSR Republics) is offered to those who work at least 15 of the 18 USSR Republics within a period of 24 hours. They are: European Russian SFSR, Franz Josef Land, Kaliningradsk, Asiatic Russian SFSR, Ukraine, White Russian SFSR, Azerbaijan,

Georgia, Armenia, Turkoman, Uzbek, Tadzhik, Kazakh, Kirghiz, Moldavia, Lithuania, Latvia, and Estonia.

All contacts for the R-15-R Award must be made on CW or phone on or after July 1, 1958. Applicant must submit a list of claimed contacts giving date, emission, and frequency for each contact and must provide a QSL card for each contact claimed. Cost and mailing directions are the same as for the other Central Radio Club awards.

R-150-S AWARD

Probably the most sought-after award in the program offered by the Central Radio Club is the R-150-S Award. Amateurs and shortwave listeners throughout the world are eligible to compete for this award and must complete the following operating requirements to qualify.

The R-150-S Award requires the applicant to work at least 150 countries of the world and 15 Republics of the USSR from a special USSR DX Countries Listing.

There are no band restrictions, but contacts must be made on either phone or CW. All contacts must be made on or after June 1, 1956. Signal reports exchanged must be a minimum of RST 337 or RS 33.

Submission of applications and cost of the award is the same as noted for the other Central Radio Club awards.

Be sure to tell your friends to obtain a copy of *73 Magazine* next month, as we will surprise you with two more awards to add to our already famous *73 Magazine* Awards Program. Until then, continue to climb the ladder of recognition.

Ham Help

I am attempting, as part of full-time retirement, to combine family hobbies, the main ones being amateur radio and camping. I would like to hear from all amateurs who combine any form of RVing with amateur radio (QSLs, please).

Also, I am interested in obtaining information that could be used as a basis for future magazine articles and a possible book on the subject. I'm interested in pictures of stations inside RVs, information on antennas, etc. Do not worry about details, just the basics. If I need to, I will get back to you for more details. Credit for original ideas will be recorded and published when used.

Ward B. Baker K7YUC
PO Box 553
Prescott AZ 86302

I would appreciate hearing from anyone who has converted a Realistic TRC-52 23-channel CB rig to 10 meters.

John P. McCormick WB3IQW
110 Hilltop Drive
Severna Park MD 21146

Many thanks to all of you who mailed complete instructions on the Mosley TA-33 Jr. beam (Ham Help, July, '79, p. 180). I was amazed at the response.

Now I would like a circuit diagram of a Harvey Wells Bandmaster transmitter. I'm trying to rebuild an old unit, as it was the first commercial unit I used many years ago. Will pay for copy or I'll reproduce and return diagram.

Hubert J. Harlow KA5COS/4
1600 Raven's Place
Charlottesville VA 22901

Corrections

There has been considerable feedback on my article ("Hit The Panic Button!") in the August, 1979, issue. Most of the comments took issue with the statement that the reset switch "needn't be especially reliable" and pointed out further that the reset switch would carry the entire shack load, if any, until the contactor had time to close. These are excellent points.

Many of the comments suggested using a multi-pole contactor, with one set carrying the entire shack load, the other only the coil current; in this case the reset switch need handle only the coil current and can be light-duty. While multi-pole contactors with high current ratings are prohibitive in cost, heavy-duty relays can be had with a set of light-duty "auxiliary contacts," which would do the job just fine. The revised circuit is enclosed.

One suggestion proposed an enhancement including a number of reset switches in parallel with each other. This probably is not a good idea from the standpoint of safety. While the switches may be 99.99% reliable, paralleling a number of them increases the chance of one failing in the closed position defeating the system.

By the way, the contactor should be rated to *break* a current of at least three times the current limit of the shack circuit breaker. If you have a 30-Amp breaker feeding the shack, the contactor should be able to break a 90-Amp load. This is independent of the current *carrying* rating which, in this case, could safely be specified as 30 Amps. The reason for this is that the peak current differs from the rms current (just as peak voltage differs from rms voltage) and you have to design for worst case—and then add a

safety margin.

One comment raised an excellent question: How do you know when the reset switch is open so the kill switch will work when you need it? In my case, I use a key-lock switch for the reset function. When I reset the system, I know the shack is alive because the clock starts running again. When I turn the switch back to remove the key, I can *feel* the switch operation. If the contacts were welded shut or somehow broke loose from the actuator, the switch wouldn't have the same "snappy" feel.

Another comment proposed using the kill switch as a "main power" switch, to make sure everything was shut off at the end of operation. This is probably not a good idea, for a number of reasons. First, you probably don't want to kill *everything* (the clocks, for instance) routinely. Second, shutting down a lot of equipment drawing a heavy load can, over a period of time, damage the contactor contacts and they may get sticky and not open when you really need them to open. A better solution, I think, is to use a separate "main power" switch, as I do, and as is shown in the circuit.

Interestingly, if you use a separate main power switch, you don't need the auxiliary contacts on the relay. Before resetting, turn the main power switch off. Then the only load on the reset line is the contactor coil (and perhaps a clock or pilot light). Once reset, turn the main switch on.

All of the comments are greatly appreciated. I would especially like to thank K8KK, WB2OVQ, and WD6FGX, along with others who omitted calls or

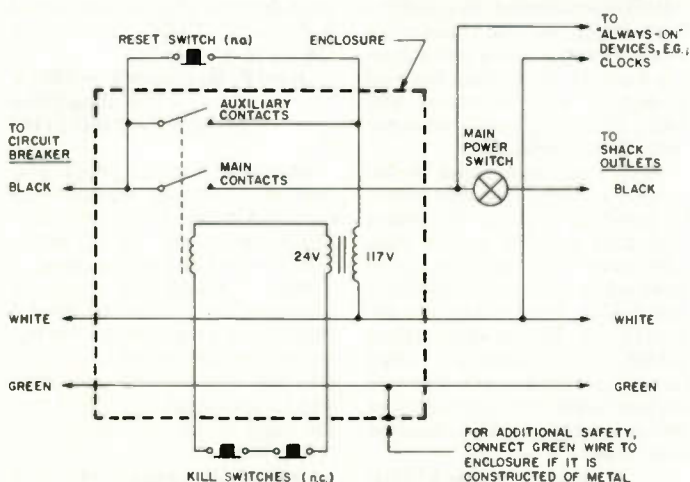

Revised Fig. 1, "Hit the Panic Button!"

Channel	Frequency*	Channel	Frequency*
4A	4,125.0 kHz	22A	22,124.0 kHz
4B	4,143.6 kHz	22B	22,127.1 kHz
4C	4,419.4 kHz	22C	22,130.2 kHz
6A	6,218.6 kHz	22D	22,133.3 kHz
6B	6,221.6 kHz	22E	22,136.4 kHz
6C	6,521.9 kHz		
		2-MHz frequencies	
8A	8,291.1 kHz		2,182 kHz
8B	8,294.2 kHz		2,638 kHz
12A	12,429.2 kHz		2,670 kHz
12B	12,432.3 kHz		(U.S.C.G.)
12C	12,435.4 kHz		2,738 kHz
16A	16,587.1 kHz		
16B	16,590.2 kHz		
16C	16,593.3 kHz		

Revised Table 3, "Marine-Band Activity." HF ship-ship (plus limited coast) simplex channels. *Carrier frequencies are listed; listen on USB. The above 2-MHz frequencies are not, strictly speaking, in the same category, but are often used for similar purposes.

from whom I haven't heard as of this writing.

Frank Bates AA6C
San Jose CA

I am enclosing a corrected Table 3 for my article "Marine-Band Activity," which appeared in the July issue on page 155. It lists new frequencies for ship-to-ship simplex operation. A change in assignments by the FCC occurred shortly after the article was written, and I missed this table in my proofreading. The remainder of the info is correct. Also, QKM in Hawaii has closed down, and station UIS is actually VIS.

Karl Schulte WA2KBZ
Hoffman Estates IL

Please note the following correction to my article "Add-On Keyboard for Your Keyer," which appeared in the August, 1979, issue. Fig. 2 contains a wiring error. As shown in the accompanying schematic, the following changes should make the Letter-Space oscillator work:

1. Pins 3, 9, and 13 of U3 should be connected together. Pin 3 should not be connected to the cathode of CR2.
2. Pins 6 and 1 of U3 should be connected to the cathode of CR2.

Edward J. Faber K4BZD
Columbia SC

This letter is in reference to my article "A Poor Man's CW Memory" in the June, 1979,

issue of 73. A number of people have written asking for ways to expand the memory. We now have a schematic available for a 4K version (twice the memory capacity) for 50c.

Eric Unruh WB0RYN
Rt. 2, Box 56A
Newton KS 67114

In my article "70-Watt Shoes for the IC-502," which appears on page 128 of the September issue, there is a minor mistake in the schematic diagram. The connection of the bias pot to relay RLY 1 should be reversed so that during standby periods the bottom of the bias pot is lifted above ground as described in the text. I hope this problem has not caused any inconvenience for readers constructing this project.

George Hovorka WA1PDY
Milton MA

There is an error in our article on constructing the E-Z Loader for the TRS-80 in the September, 1979, issue of 73 (pages 96 to 99). The circuit will work as shown as long as the optional LED driver is *not* used. If you wish to incorporate the LED minimum level indicator, the pick-off point for R12 should be the emitter of Q2, *not* the base of Q2 as shown in the article.

Additionally, a transformer for use as T1 is available from Radio Shack (part no. 273-1380), but only 1/2 of the 1k winding should be used. A note of caution: Several reports of reverse-

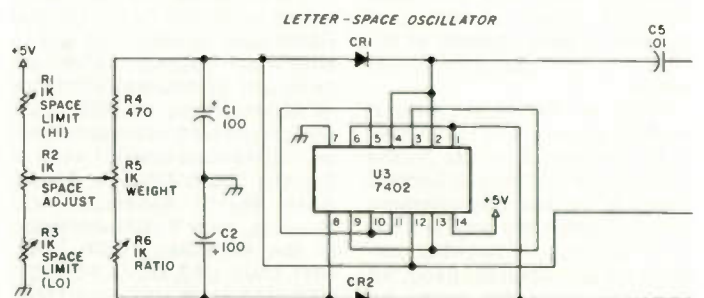

Revised Fig. 2, "Add-On Keyboard for Your Keyer."

biased Radio Shack 2N2222 transistors have been received. In these devices, the emitter and collector leads are opposite of normal, and even opposite of what is shown on the back of the bubble package!

If you are having problems with the circuit, drop us a note describing the symptoms along with an SASE and we will be glad to offer any help that we can.

Paul Goelz WA9PUL
2228 Madison Place
Evanston IL 60202
Dave Miller K9POX
7462 Lawler Avenue
Niles IL 60648

In the September issue of 73, on page 116, my article "The Amazing Audio Elixir" was published. Unfortunately, the TL081 called out does not seem to be available anymore. Builders should use the RCA CA3140E in its place. If one end of resistor R4 is lifted and a 1-uF capacitor is placed in series with it (with the positive end of the capacitor pointing away from pin 2 of the IC), a common 741-type op amp may be used.

A reader has correctly pointed out that there is an error in the article. The wire running from the gate of FET Q1 to the

junction of C4 and CR2 does not tie to the junction of R2, R1, R4, and R5. If it were connected as shown, the circuit would not work, since the gate of the FET would be shorted to the source.

The article stated that the unit would drive even a small speaker. This was misleading, as the loaded down amplifier would work poorly, but you would hear something and it would not hurt the circuit. If a person wants to drive a speaker, he should use the Audio Elixir in front of another amplifier which can drive a speaker properly.

The demand for the PC

boards was beyond expectation and my entire supply was used up within the first few days of the magazine mailing. I have ordered more PC boards from my supplier and hope I will have them before this letter is printed. If anyone is trying to deal with me and wonders why I am so slow, hang in there—I am buried in a mountain of mail.

One final note: If anyone is having trouble getting the CA3140E and the MPF111, I will supply them with the PC board if an extra \$1.50 is enclosed.

C. W. Andreasen N6WA
PO Box 8306
Van Nuys CA 91409

New Products

from page 36

my version 1.1 of the M80 includes sections on operation and theory so that the great versatility of the system can be exploited. Ron Lodewyck N6EE, the president of Macrotronics and the system copyright holder, deserves much credit for the product. Directions for setup are clear, and the system has functioned well in the few months I've had it on the air. (I understand that version 1.2 will be available soon. This has some improvements in the machine-language timing routines.)

When the system is in operation, the user loads the machine and BASIC programs and can then select either Morse or RTTY operation. Several special functions can be selected in each mode so that the user has control of what will be keyed in transmit, speeds, etc. The unit transmits flawless CW and RTTY. Reception of strong TTY signals is possible with the on-board loop, but anyone really interested in RTTY will want to use an external demodulator. Reception of CW is perfect if one is copying W1AW or a station sending with a keyboard. Someone with a good fist will produce readable though not perfect copy, and many fists cannot be copied well. (Version 1.2 is supposed to help with this problem.)

I am going to describe a number of operating hints which may improve the enjoyment or versatility of the system. If you study the BASIC program, you can see how the program initializes various things such as keying polarity and speed. You can then modify a few statements to change the initialization. For example, the machine is set to key the "negative" transistor. The program permits the operator to

change this to "positive" transistor and relay keying, but since I use the relay most of the time, I wanted it to initialize that way. The following statement changes the initialization routine to "positive" and relay keying: POKE 31346,4:POKE 31353,4:POKE 31364,3.

I use the system with the MLK-1 optoisolator instead of the relay and I have found that the loop is often latched up open at start-up. This presents no problem if a character is sent, since the first character will leave the loop closed, but if you don't notice the latch up and switch to RTTY receive, you can never get back to send. To help this I included the following: 6 X=INP(4).

Now when the program is run, the loop circuit is closed automatically. Furthermore, since my TRS-80 has a ROM error in the RESTORE routine, I include POKE 16553,255 in statement 6. That POKE fixes up the RESTORE routine and lets the M80 program run with no problems.

The program includes a routine which permits sending a CW ID while in the RTTY mode. The routine then forces the program to RTTY receive. That is fine at the end of a transmission, but when you send the ID at the beginning of a transmission, the system goes to receive and you then have to put it back to transmit to send in RTTY. To get around this, I added a routine that sends the CW ID but then keeps the system in transmit mode. I use the * key to enter this routine. The program steps are as follows: 13851 If B\$="" then 17050.

Statements 17050-17053 are then copies of program statements 17000 through 17010 except that instead of ending with GOTO20000, I end with GOTO10000 and the system stays in transmit. If you find that

the loop latches open during this transition, just add X=INP(4) after X=USR(X) and the loop will get closed again.

I have found that these few modifications custom-tailor the system to my operation, but probably you will find some other minor changes that you would prefer. I also am using the system to drive my old Model 15 as a hard-copy output from the computer. The manual provides the necessary steps for doing that. Since a number of POKES are required, I wrote these POKES as a short program which is on tape just to save myself the typing each time I use the system. The following short program will let you use the system to get a hard copy of anything which is on the screen:

```
2 CLEAR 800
10 C$="" : FOR I = 15360 TO 15614 : C$ = C$ + CHR$(PEEK(I)) : NEXT
20 POKE 30208,1 : POKE 30209,LEN(C$) : POKE 30211,PEEK(VARPTR(C$) + 2) : POKE 30214,PEEK(VARPTR(C$) + 1)
30 MS = INT(30214/256) : POKE 16527,MS : POKE 16526,30214 - MS * 256 : X = USR(X) : LPRINT : GOTO 10
```

To use this little program, you do the following. Enter the M80 machine-language program according to the instructions. Do the POKES required for line-printing according to instructions. CLOAD this program. The statement numbers in this program must all be smaller than those in the program you are actually planning to use. Follow the method outlined by Roger Pape (*Kilobaud Microcomputing*, July, 1979, page 39) to permit saving this program while CLOADING another. When you get some material you want to save on the screen, you break out of the program which is running and type RUN 2. This program will run and will line-print the first three lines of the screen. It will pause at that point. If you want further line output, just hit CLEAR and

three more lines will be printed. You then can break out of this program and begin your original program again.

Obviously, this little program could be incorporated as a routine in any other program to avoid the problem of loading two BASIC programs at the same time. These few lines create a string variable called C\$ which consists of the characters on the first 3 lines of the screen (locations 15360 through 15614). This variable is then treated by the machine-language program as a "message" to be sent by TTY. The CLEAR command returns to the BASIC program.

These are just a few of the ideas I've had for the M80 system. As the originator says, the possibilities are virtually limitless since the board permits easy access to the computer. As you use the system, you will certainly come up with many other ideas.

Macrotronics, Inc., PO Box 518(S), Keyes CA 95328; (209) 634-8888. Reader service number M48.

Buzz Gorsky K8BG
Cleveland Heights OH

THE RADIO SHACK® QUICK PRINTER II

Last year around Christmas, I convinced my wife that I should get a TRS-80 microcomputer. I justified it on the basis of my part-time business, which is statistical consulting. In reality, I use a much larger university computer system and didn't think a microcomputer would be of much help. Well, sure enough, the kids loved the games (even the wife enjoyed blackjack) and I learned a little about BASIC language, but not much statistical work was done. It wasn't long, however, before I expanded the system to 16K RAM and Level II BASIC and slowly but surely began doing more and more of my consulting work on the TRS-80.

One of the more frustrating aspects of getting into micro-computing is the growing desire

```

!#$%&'()*+,-./0123456789:;<=>?
@ABCDEFGHIJKLMNPQRSTUVWXYZ↑↓←→_
'abcde fghijklmnoPqrs tuvwxyz(!)~■
! " # $ % & ' ( ) * + , - . /
0 1 2 3 4 5 6 7 8 9 : ; < = > ?
@ A B C D E F G H I J K L M N O
P Q R S T U V W X Y Z ↑ ↓ ← → _
' a b c d e f g h i j k l m n o
P q r s t u v w x y z { ! } ~ ■

```

Fig. 1. Quick Printer II character set.

for more and more hardware. I could just visualize an expansion interface with 32K additional RAM and maybe a couple of disks. More important, I was really drooling over the possibility of some sort of hard copy. At the time, Radio Shack's cheapest printer was "only" \$500, but that required the expansion interface (another 300 bucks). Now, for that kind of money my wife would probably divorce me, so my longings remained longings.

When troubleshooting (I guess the proper word is debugging) programs on the TRS-80, you use paper and pencil a lot if you get beyond 16 lines (the display capacity of the CRT). Since I was developing statistical programs of 100 or more lines with several hundred data entries, I was going nuts. Then Radio Shack came out with their Quick Printer II, a small and inexpensive (\$219) hard-copy device measuring 3-5/16" x 6-3/4" x 9-1/4" (8.4 cm x 17.2 cm x 23.5 cm). I quickly ordered one and then waited close to a month for delivery.

The Quick Printer II uses aluminum paper 2-3/8" wide, similar to (but narrower than) the paper used in the larger Quick Printer. Some people say they don't like the black letters (5 by 7 dot matrix) on silver paper, but either they have a lot more money than I do or they enjoy looking at the CRT scroll through their lovely long programs. No expansion interface is required and the unit can be plugged directly into the TRS-80 bus on the back. If you happen to own the expansion interface, you also can plug into it using an optional ribbon cable. A third option is a serial (RS-232C) input at 600 baud. I suspect that this last option would enable owners of other systems to use the Quick Printer II.

Printing speed is 120 lines per minute at 64 characters per second. Pretty fast stuff, this printer. It isn't as quiet as the CRT, but it sure beats the old Model 15. (I use it a lot at night.) The characters available are a modified subset of ASCII-96 with uppercase and lowercase. (See Fig. 1.) Yep, lowercase! Lowercase is supported by the TRS-80 although, unmodified, it does not display lowercase on

```

HERE IS AN EXAMPLE OF TEXT OUT-
PUT IN REGULAR WIDTH
AND HERE IT IS
IN DOUBLE WIDTH

```

Fig. 2. Sample output showing double-width option.

the CRT—just on the printer.

Now for the bad part—at least some of you might think so—the characters per line: only 32 (or 16, software selectable; see Fig. 2). Now, admittedly, that doesn't seem like very many characters, but for my purposes I find it totally adequate. I'm not into word processing and I'm sure that 32 characters per line would be grossly short for that use. But for listing programs and data and providing hard copy of program results (such as statistical analyses), 32 characters per line is great. By the way, don't worry about exceeding 32 characters, as there is automatic wraparound (up to 263 characters). That is, if the output exceeds 32 characters, the unit automatically carriage-returns and line-feeds and prints out the rest on subsequent lines, but it certainly splits words in funny places!

The unit is well built, using an ABS plastic housing which matches the TRS-80. Besides the friction paper feed, there is only one moving part (the seven-dot print head). Expected print-head life is 30 million characters. Now that's a lot of output! Each roll of aluminum paper costs about two bucks and lasts and lasts and lasts. For one very large run, I bought four extra rolls and I'm still using paper that came with the printer.

If you carefully look at Fig. 2, you will see an example of variable vertical spacing. This is not a planned feature, nor is it desirable. However, it happens very rarely and only after you

```

Las Cruces, New Mexico USA 88001
W 5 S X L
CONFIRMING QSO WITH K C 6 J D F
Date: 6 / 13 / 79 Time: 0856 Z
Freq: 14.3 MHz Mode: SSB
UR RST: 59 RIG: TEN TEC 509
with 405 Linear @ 50 Watts
Ant: 2 el. Quad wP 27'
Tnx fer QSO, 73's, & PSE QSL
OP: Tim Pettibone
Adr: 2625 Huntingdon Drive
This QSL Printed by TRS-80 Micro
computer from data in memory

```

Fig. 3. Paste-on QSL.

have aggressively torn off the previous printout. The paper is a bit sensitive to oil and dirt, but once printed on seems to be very resistant to handling. Sometimes I do get a fingerprint smudge or two on it, but then I just wash my hands and run it off again. The printout reproduces very well and readily takes pencil or ink.

Now, how about ham radio use (this is a ham publication, isn't it)? Well, so far, I do two things: I keep my log in memory (sometimes) and print paste-on mini QSLs to attach to picture post cards of New Mexico for those special contacts. (See Fig. 3.) I also modified an excellent program for both the logging and QSL functions written by Charles Zappala WA7VZR for the October, 1978, issue of 73.

All in all, I'm quite satisfied with my new printer. So if you need hard copy and operate on a slender budget, consider the Quick Printer II. I don't think you'd be going wrong.

Radio Shack, 1300 One Tandy Center, Fort Worth TX 76102; (817)-390-3272.

Tim Pettibone W5SXL
Las Cruces NM

IC-551 50-MHZ FIXED STATION TRANSCEIVER

This microcomputer-con-

trolled 50-54-MHz (SSB-AM-CW) fixed station transceiver uses a built-in microprocessor for frequency control and scanning. The 551 also uses the new style digital readout in green phosphorescent digits similar to the IC-RM2 controller. The no-backlash, no-delay dual vfo, light chopper system similar to the IC-701 and IC-211 is included as a standard feature. The handsome styling and small size of the unit provide function with flair to please the eye while matching the other Icom fixed station units.

Three memories are available for programming and beacon watching. Using the SSB squelch and scan mode, three beacon frequencies may be scanned and the 551 set to stop on the first one heard, thus alerting the user to the presence of conditions producing DX excitement. When not scanning, the three memories and two vfo provide five different frequencies for use by the 551.

The dual vfo system provided by the microprocessor allows split-frequency operation for contest and DX work as well as completely variable offset operation for six-meter FM (optional unit EX106 required for FM operation). The 551 uses the now-famous 100-Hz-per-step digital tuning system. Many thousands of satisfied users on SSB-CW and FM have proven the suitability of this system. For faster QSY, a touch of the button next to the main tuning results in 1 kHz steps. (In FM, tuning rates are 10 kHz per step normal, and 1 kHz per step with tuning speed button depressed.)

The 551 is an all-mode six-meter unit in a compact easy-to-use instrument. The large tuning knob (50 mm) provides the comfort and feel of a big unit while the small size provides the room you need at the console.

Icom, Suite 307, 3331 Towerwood Drive, Dallas TX 75234; (214)-620-2780.

FCC GENERAL CLASS AMATEUR RADIO LICENSE SELF-INSTRUCTION PROGRAM NOW AVAILABLE FROM HEATH

A self-instruction program for passing the FCC Technician and General class amateur radio license exams has been introduced by Heath Company, world's largest manufacturer of electronics kits.

The program, divided into 15 units, covers the materials that FCC exams are based on. Unit exams check the student's progress while giving practice at exam-taking. Also included are cassette practice tapes said to prepare the individual to send and receive Morse code up to 15



Icom's IC-551 transceiver.

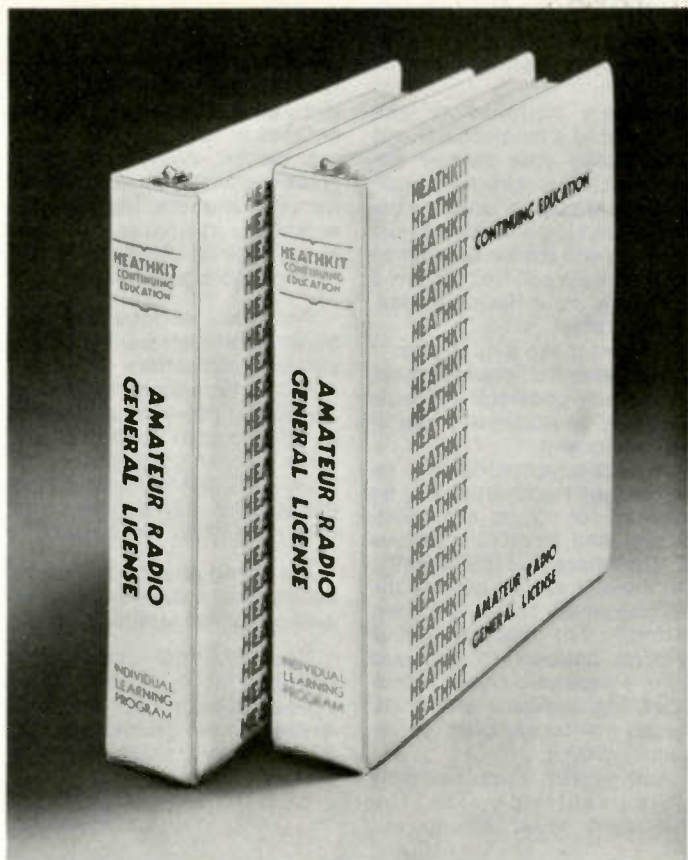

Instruction program now available from Heath.

words per minute, two words per minute above the FCC General class requirement.

The program also includes a code-practice workbook, a world map of call areas, a booklet on solving radio and TV interference problems, a logbook, a copy of FCC amateur radio rules and regulations, FCC Form 610 required to apply for the exam, and a schedule of exam dates and locations.

The program carries a money-back guarantee should the purchaser fail the Technician or General class FCC exam. The program is described in the latest free Heathkit catalog. For a copy, write *Heath Company, Dept. 350-890, Benton Harbor MI 49022; (616)-982-3417*. Reader service number H5.

3½-DIGIT PORTABLE 0.1% DMM OFFERS LCD READOUT AND RF INTERFERENCE SHIELDING

A unique new portable DMM has just been announced by the B&K-Precision product group of Dynascan Corporation. The Model 2815 is a compact instrument that is protected and shielded against rf interference so that it retains its accuracy in rf fields. As a result, the 2815 can be used near two-way radios or broadcast transmitters up to 450 MHz. This new design features high resolution, excellent overload protection, and 0.1% dc accuracy.

The resolution of the 2815 permits its use in exacting R and D applications. For example, the 10-Ohm range offers 0.01-Ohm resolution for accurate resistance measurement of switch and point contacts, motor and coil winding, wire lengths, or any low-resistance circuit. Current resolution is 100 nA and the 100-mV scale permits voltage resolution to 100 μ V.

A major feature of the 2815 is its protection against accidental overloads on all ranges. In the Ohms range, where this protection is needed most, the 2815 excels. Its design will resist damage from momentary overloads up to 1000 volts dc or ac peak. Continuous Ohms protection is +1000 V dc and -450 V dc or 350 V ac. The 10-Ohm range will momentarily sink currents of 3 Amps without damage. Current ranges are double-protected by both diodes and a fuse.

The large LCD readout of the 2815 is designed to be used in bright sunlight, making the unit ideal for field-service applications. An inexpensive 9-volt alkaline battery powers the 2815. Low-battery warning indication is automatic. Auto-zero and auto-polarity are also featured.

According to Gus Rose, Director of Engineering, "the B&K-Precision 2815 employs new LSI technology for ac-



The B&K Precision Model 2815.

curacy and reliability. Our LSI integrated circuit is highly immune to stray rf fields, but for still more protection, we provide internal case shielding. We strongly believe that for dependability, a DMM should be able to perform accurately in rf fields."

The new B&K-Precision 2815 portable DMM is now available at local distributors. It includes test leads, built-in tilt stand, detailed operating manual, and spare fuses. A wide range of optional accessories is available. For additional information, contact your local distributor or *B&K-Precision, Dynascan Corporation, 6460 West Cortland Street, Chicago IL 60635; (312)-889-9087*. Reader service number B45.

OPTOELECTRONICS K-7000 FREQUENCY COUNTER KIT

It doesn't seem too many years ago that hams were clamoring for surplus BC-221s and LM frequency meters for frequency calibration in their shacks. To be sure, these venerable vfos did provide good stability and fair readout accuracy for the user—by consulting look-up charts. But the scene has changed dramatically. Digital technology has opened up no-nonsense

measurement techniques. Visual displays feature bright readouts of frequencies directly—no interpolation required.

The term "frequency counter" refers to the fact that the actual periodic pulses of the source being measured are summed for a period of time (called the gate time), and the total number of pulses per time unit is displayed. Assuming the reference frequency of the time-base or "clock" is accurate, the frequency counter can't miss. It's about as absolute a measuring device as you can find.

The new K-7000 550-MHz frequency counter from Optoelectronics is an excellent example of this new technology. Featuring seven bright, large (.4") LED characters, actual frequency performance will typically reach 600-700 MHz! At this writing, the K-7000 is advertised as the cheapest 550-MHz counter kit ever available—less than fifteen cents per megahertz!

This neat little package costs less than \$80 in kit form. The K-7000 is compactly contained in a rugged metal cabinet, not in a flimsy plastic shell as are many competitive units. It measures down to 10 Hz, making audio applications a natural. With a top end in ex-

cess of 550 MHz, measurements of rf through UHF are a snap.

Input impedance is 1 megohm, shunted by 20 pF (up to 55 MHz) or 50 Ohms (up to 550 MHz). Gating times are switch-selectable between .1 and 1 second. An automatic decimal point is included. Resolution of the display is 10 Hz at 55 MHz or 100 Hz at 550 MHz. Sensitivity is better than 10 millivolts up to 55 MHz, increasing to 50 millivolts (nominal) at UHF. It is typically 20 mV at 2 meters.

A temperature-compensated quartz crystal timebase (TCXO) features first-order linear compensation, providing stability of better than ± 1 part per million at room temperature. Aging of the oscillator is less than 2 ppm per year, making calibration unnecessary for long periods of time.

While many pieces of test equipment require sophisticated power supplies, the little K-7000 will accept anything between 7.5 and 15 volts ac or dc that can supply 250 milliamps! Internal rectification and regulation will take care of the rest. An optional ac power sup-

ply is available (#AC-70 for \$4.95), as is a nicad battery pack/charger circuit (#Ni-CAD-70K for \$15.00). A telescoping whip antenna with a right-angle BNC connector is available for \$9.95. A wide variety of additional accessories is available to extend the flexibilities of this versatile counter even further. The K-7000 measures only 1-3/4" H x 4-1/4" W x 5-1/4" D and weighs less than a pound.

Kit assembly involves 40 short steps, including checkout procedures. Directions are concise and clear.

The manual which accompanies the K-7000 is well-written and liberally illustrated. It contains an excellent theory section to acquaint the newcomer with operational theory as well as practical applications of the instrument.

An endless variety of applications for the frequency counter appears around the ham shack. Sitting adjacent to the rig, whip extended, the counter will display your actual transmitted carrier frequency (assuming some stray rf leakage during transmit). Whether or not you have digital readout already or

think you know your band edges, the counter provides backup protection against pink tickets!

Loosely coupled to the oscillator of a receiver, the unit will display your receive frequency (plus or minus the intermediate frequency used in conversion). A simple outboard mixer circuit will enable the user to read received frequencies directly without having to consider i-f offset.

Hooked to the output of an rf signal generator, even the most inexpensive generator suddenly becomes an accurate piece of test equipment.

Various mixer products in receivers and transmitters can be checked for proper alignment, as well. And, by probing various points throughout the circuitry, the counter can be used to determine which stages are operational. For example, if a receiver appears to be dead from a received signal standpoint, the oscillator and mixer stages can be sampled for frequency output.

And finally (and certainly more esoteric), for the frustrated spies among our

readers who always wanted to know the output frequency of a transmitter at a government office: Watch the display for a few minutes in the vicinity of the antenna in question. The closer the better. With reasonably short distance between the little unit and the transmitting antenna, a sudden stable readout is a direct giveaway of the transmitted signal frequency!

For more serious applications of this nature, Optoelectronics also offers a model AP-8015 broadband amplifier capable of providing a nominal 25 dB gain from 10-1000 MHz or more. Used in conjunction with the K-7000, discrete transmitted frequencies may be measured from considerable distances.

We would rate the K-7000 an outstanding value for hams as well as service technicians.

The K-7000 frequency counter kit is \$79.95 from *Optoelectronics*, 5821 N.E. 14th Avenue, Fort Lauderdale FL 33334. Reader service number 03.

Robert B. Grove
Brasstown NC

Ham Help

How long can amateur radio survive in Arizona or anywhere else if a "closed-shop" atmosphere prevails? How can a newcomer enter this select group unless a friendly hand is extended? Where are the new hams going to come from if there is no Novice program functioning?

Since moving to Tucson 5 months ago, I have been unable to make contact with any radio club, and I have seen no evidence of any effort to teach or introduce would-be hams to our hobby. This comes as a real shock to me, and I can only hope that my initial impressions are wrong.

As a federal employee, I have spent 20 of my 32 years overseas, where the spirit of helpfulness and friendship was dominant among my fellow MARS members and the Canadian and British hams whom I came to know. We worked together in maintaining and repairing our rigs, held antenna-raising parties, operated various emergency nets, and studied and later taught code and theory classes that were free and open to all interested parties. I am proud of the friends I have known, and I count these years as the most enjoyable years of my life.

If my admittedly bleak impressions of Arizona are cor-

rect, and if they are generally applicable to the rest of our country, then amateur radio is unquestionably doomed! If the amateur spirit dies, then the question of survival in the face of possible losses in spectrum becomes academic. Hopefully, this situation is reversible.

I am now retired, but I am not dead yet. I am available to teach code or theory or to help in any way that I can to ensure that amateur radio is alive and well in the state of Arizona.

Thomas J. Gillam W4NHX/7
4426 E. 22 St., Lot 93
Tucson AZ 85711

I have picked up a transmitter/receiver system and don't have any manuals for it. I have asked many people, but nobody has ever seen it before! The system consists of four units, and the only numbers on them are RR-6, RP-6, RT-6, and RA-6.

The receiver, RR-6, covers two bands: 3-6.5 and 6.5-15 MHz. It is a superhet with an rf amp. It is all tubes, has a bfo, crystal calibrator, and can use crystal control. Size is 6 1/2" x 5" x 2 1/2".

The transmitter, RT-6, covers two bands: 3-7 and 7-16.5 MHz. It is crystal controlled only with output for a longwire antenna. Tubes are a 2E26 final and a 6AG5 osc.-driver. It is CW only, with built-in key. Size is 6 1/2" x 5" x 2".

The power supply, RP-6, provides all voltage required for both receiver and transmitter with any one of the following inputs: 70-270 V ac, 40-400 Hz, a GN 58 hand generator (I don't have this), or a 6-volt storage battery. The RP-6 will also charge a 6-volt storage battery with an ac input. Size is 4" x 8" x 2". The RA-6 unit is a function box. Size is 4" x 8" x 2".

I would appreciate any help in identifying this gear.

John Oppenheimer WD5GNY
165 Woodruff St.
San Angelo TX 76903

I have been unable to locate a source for manuals for the following pieces of test equipment from the original manufacturers and hope someone out there can help. I will pay for a photo copy, or I'll copy and return. Write first to prevent duplication.

Technology Instruments Co., Inc., model 311-A rf Z bridge; Eico signal generator, model 324, and ac VTVM and Audio Load, model 260; Midland CB xcvr tester; Bell & Howell Schools electro-lab design console.

Any help would be appreciated.

Robert Monaghan W5VC
PO Box 2182, SMU
Dallas TX 75275

I am in great need of a service manual, user's manual, schematic, or any other information for the Hammarlund HQ-129X receiver. Hammarlund is, un-

fortunately, out of business and this manual seems to be very hard to find. I will pay postage and duplicate promptly, or reimburse your copying cost. Thanks.

Fred Goldberg WA2BJZ
29 Clearview Road
East Brunswick NJ 08816

I would like to obtain a ham-band receiver (not necessarily working) for up to \$25. Type and vintage are immaterial. I will pay by bank draft before shipping.

Daniel Bell ZL1AKV
Box 5676
Auckland NZ

We would like to swap QSL cards with anyone. We would also like to make contact and exchange information on radio communications.

George Szekely AK4458
PO Box 348
Auckland NZ

I need a schematic and operating instructions for a Data Engineering Co. Memory Matic 500B keyer. I will gladly pay copying costs and postage.

M. H. Hansen
Route 1
Windom TX 75492

I'm interested in locating amateurs who have operated from US possessions in the Pacific, including the Marshall and Caroline Islands.

Gary Mitchell WA1GXE
PO Box 1003
Fairfield CT 06430

FAST SCAN ATV

WHY GET ON FAST SCAN ATV?

- You can send broadcast quality video of home movies, video tapes, computer games, etc., at a cost that is less than slowscan.
- Really improves public service communications for parades, RACES, CAP searches, weather watch, etc.
- DX is about the same as 2 meter simplex — 15 to 100 miles.



ALL IN ONE BOX
TC-1 Transmitter/Conv
 Plug in camera, ant, mic and you are on the air \$399 ppd



HITACHI HV-62 TV CAMERA
 High performance closed circuit camera just right for atv. with lens \$239 ppd

PUT YOUR OWN SYSTEM TOGETHER



TVC-1B CONVERTER tunes 420 mhz down to ch 2 or 3 . . \$49.50 ppd
TXA5 EXCITER \$69 ppd
PA5 10 WATT LINEAR . . \$79 ppd
FMA5 Audio Subcarrier . \$24.50 ppd

SEND FOR OUR CATALOG, WE HAVE IT ALL
 Modules for the builder, complete units for the operator, antennas, color cameras, repeaters, preamps, linears, video ider and clock, and more. 19 years in ATV.

Call 213-447-4565 5-6 pm ✓P41



P.C. ELECTRONICS

Maryann WB6YSS 2522 PAXSON ARCADIA, CA 91006 Tom W6ORG



Call or Write for Delivery or Quote

KENWOOD TS180S



LEAVE A MESSAGE & WE'LL CALL YOU BACK!

MADISON ELECTRONICS SUPPLY, INC.

1508 MCKINNEY • HOUSTON, TEXAS 77002

713/658-0268 ✓M35

MASTERCHARGE • VISA

All prices fob Houston, except where indicated. Prices subject to change without notice, all items guaranteed. Some items subject prior sale. Send letterhead for Dealer price list . . . Texas residents add 6% tax . . . please add postage estimate, \$1.00 minimum. W5GJ, W5MBB, K5AAD, N5JJ, AG5K, W5VVM, WD5EDE, K5ZD, WA5TGU, WB5AYF, K5RC, K5GB, WB5USV.

2-METER MOBILE



AT-200 Antenna Matcher

Use your car's AM/FM antenna for your 2-meter mobile rig.—Eliminate the two-antenna tip-off to thieves, without the nuisance of hideaways.

Save the cost of a 2-meter mobile antenna.

AT-200 tunes from the front panel for maximum output, minimum VSWR (1.2:1 or less for most car antennas).

at your B&W dealer. ✓B23

Made in the U.S.A. by **BW**

Barker & Williamson, Inc.
 10 Canal Street, Bristol, PA 19007

THE BIG SIGNAL UNADILLA "W2AU" Baluns

DEMANDED BY PROFESSIONALS WORLD-WIDE OVER 12 YEARS

- The Original Lightning Arrest
- 650# Strength
- Stainless Hardware
- Sealed
- GUARANTEED ASSISTANCE?

Call: HUGH GUNNISON, WA2EOT
 Toll-Free 800-448-1666
 [NYS Collect 315-437-3953]

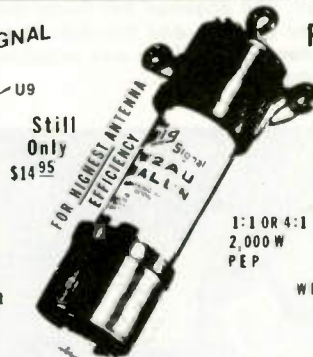

FULL-POWER, QUALITY HAM ANTENNA PARTS

AT YOUR DEALER

- BALUNS - TRAPS - INSULATORS
- QUAD PARTS - ANTENNA RITS
- BOOM/MAST MOUNTS - WIRE
- CABLE CONNECTORS

1:1 OR 4:1
 2,000 W
 PEP

WRITE FOR FULL CATALOG
 [Enclose 30c Stamps]

MFC UNADILLA/REYCO DIVISION [Dept. 73]
 MICROWAVE FILTER COMPANY INC.
 6743 KINNE STREET, EAST SYRACUSE NEW YORK 13007

DEALERS WANTED - OVER 300 WORLD-WIDE



PERSONALIZED LICENSE PLATE FRAMES

YOUR NAME, QTH, 73 ETC. IN RAISED, WHITE LETTERS ON A BLACK BACKGROUND.

- DURABLE, DIE CAST METAL FRAME
- TRIPLE CHROME PLATED
- LETTERS CHEMICALLY FUSED
- FITS ALL AUTOMOBILES
- ACCOMMODATES ALL LICENSE PLATES
- EXCITING NEW GIFT ITEM!

\$ 8.95
 PER FRAME
 POSTPAID

✓A107



AJT ENTERPRISES

4442 VINTON AVENUE CULVER CITY, CA. 90230 (213) 836-2223

SATISFACTION GUARANTEED OR MONEY REFUNDED
 CHECKS AND MONEY ORDERS ACCEPTED. CALIF. RESIDENTS ADD 6% SALES TAX

Faces, Places



Jonelle Lewis KB4RS of Franklin, Georgia, was the first female ever to graduate from the electronics study program at Troup County Area Vocational Technical School in LaGrange, Georgia. She was at the top of her class academically throughout the program and accomplished some remarkable things. She acquired her Radar Endorsed First Class Radio Telephone License and her Advanced amateur license within a period of two weeks. Each was acquired on the first attempt and in one sitting.



On June 7, 1979, Captain Thomas C. Watson, Jr., Commanding Officer of the aircraft carrier USS Independence (CV-62), presented awards to Norfolk area ham operators in recognition of their handling of phone patch traffic between the Indy's crew and their relatives and/or friends while the ship had been at sea. Ham operators aboard the Independence were also cited for their efforts. The awardees have been handling Indy's phone patches since she left the Portsmouth Naval Shipyard last September and will also handle the phone traffic while the ship is underway during its upcoming deployment. Pictured left to right: Marty Roberg N4BKL, Wayne Walker WD4MNP, Kevin Newberry WB2NGL, Gib Patterson WB6VIE, Jeff Parker WA1WXL, George "Ike" Ikonen WB4NEE, Bill Keller WA4FCK, Bill Ames WB4CUY, Ralph Chamberlain N4AXM, Jerry Oxenburgh WA4RQU, Bob Edward WB4ZSE, and Wes Woessnen WB4ZSQ. (Official U.S. Navy photograph by Phan Webb)



Contrary to what our October, 1978, article stated, Dick Torrey WB1EEM (age 13) of Rockland, Massachusetts, was KM1CC's youngest operator.

FIELD DAY, 1979, FOR THE SOUTH EAST AMATEUR RADIO CLUB (K8EMY) OF CLEVELAND, OHIO

Photos by Al Willinger WB8PMB



The Novice/Tech station of K8EMY. This station was run totally on dc using an auto battery charged by a small gas generator. At left is Ron Headley WD8QAZ and at right is Ron Wexler KA8CBQ. Also pictured is a minicomputer lent to the club by "Computerland." This Apple was used to log contacts and keep track of points. The antenna for the station was a mobile one located on WD8QAZ's Honda.



K8EMY's phone station. Left to right: Kevin Ritchey WB8YXU, Dave Hubbert WD8KIS, and Jon Taylor WB8TTP. This station ran off a gas-powered generator donated by Ohio Bell Telephone. The antenna for this station was a TA-33 Jr. on a monopole mounted alongside the pavilion at the city park in Shaker Heights that was the club location.



Goolam Karim ZS6VQ was the first Indian ham in South Africa to obtain an operating license. He is a doctor practicing in Bethal, an Eastern Transvaal town. To encourage improvement of their Morse code speed, new South African hams for the first 12 months are restricted to CW on the HF bands.



Billy Hassler KA7DOV (age 7) recently became the youngest member of the Cheyenne, Wyoming, ham family which also includes Dad, Jim WB7TRQ, Mat KA7CPD (age 14), and Jean KA7CWO (age 12). The Hasslers give much credit to Instructor Bob Madden WA7YHK.

SOLAR-POWERED AMATEUR RADIO STATION AT THE CALGARY STAMPEDE

Photos by T. MountJoy VE6MX



The Calgary Amateur Radio Association station VE6UN with some of its volunteers manning the booth. Approximately 75,000 people visited the booth and got a first-hand, first-class glimpse of an operating ham station. The station operated 13 hours a day and while in operation was the subject of two well-produced television documentaries.



Promoting amateur radio on a 30-minute television program on KRIS-TV in Corpus Christi, Texas, were (from left) David Horton K5GT, Bob Douglas W5GEL, and Joe Cowen WA5TUM, with show host Judy Wenger of the Texas Coastal Bend Council of Governments. The program, "State of the Region," was aired at noon July 14 and again July 18 and traced the history of amateur radio, gave insight into the public service benefits of the hobby, and stressed the versatility of the hobby and its technical contributions to communicative art. A radio version of the program with Cowen and Wenger was broadcast over 10 commercial AM and FM South Texas radio stations. Horton is a board member of the Texas VHF-FM Society, Douglas is widely known in amateur radio circles due to his affiliation with Douglas Electronics, a Corpus Christi ham store and wholesale electronics parts network, and Cowen, secretary of the Beeville, Texas, Amateur Radio Club, is public information director of a college in the Texas Coastal Bend. (Photo by W5PIL)



The power supply and tribander up on the roof of the exhibition building housing the station. The solar panels shown provided enough power to keep the six 105-Amp batteries stored at the base of the panels always close to full charge.

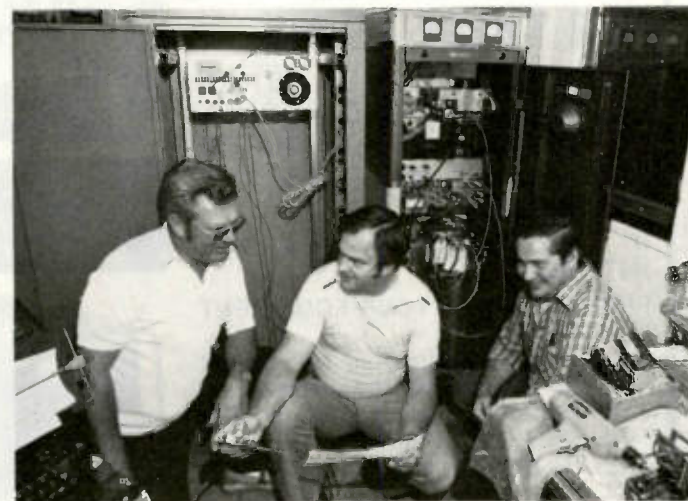

Pictured in front of the Chicago Area Radioteletype Repeater System are (left to right) Ben Delaney WB9RTX, Neil Petlock K9WRL, and Howie Olson WA9KEK. The CARRS repeater went into service on July 9, 1979, and is the first teletype-only repeater in the Chicagoland area. This repeater is located in the new two-meter subband at 144.71 in/145.31 out.

TRS-80 OWNERS!

M800 Deluxe RTTY for the TRS-80

Adds these additional RTTY features to the M80.

- Split-screen display. Full ASR.
- Save all text on cassette.
- Instant Replay - RCV and XMT text.
- Instant break operation - preserves buffers.
- WRU - save on cassette - automatically.
- Execute external programs - Interactive graphics.
- One-time callsign insertion.
- Auto line numbers, margin labels, CR / LF, CR suppress, XMTR control.
- 4 small messages (255 char. ea.) plus big message (up to max. RAM).
- Additional RY, FOX, CO messages.
- UT4 output speed control.
- Baudot (4speeds) plus ASCII (110 baud).

Requires the
M80 Ham
Interface.

\$99

- PET, APPLE, SORCERER versions available.

Write or Call for Complete Catalog.

M80 Ham Interface Send-Receive RTTY & CW

- Auto send. & receive: RTTY & CW
- Complete hardware & software.
- Connects to TRS-80 User Port & Key / headphone jacks.
- 10 message memories - 255 char. ea.
- Keyboard buffer - allows typing ahead.
- Uses built-in PLL or external TU.
- Includes hardware, cassette & manual.
- Morse trainer - random 5 letter words.
- Requires Level II Basic & 16K RAM.

NEW FEATURES★

- MORSE tutorial-10 lessons-corrects mistakes-Simplest, fastest way to learn the code!
- Auto-numbering contest keyer.
- Interactive Graphics-Custom PIX.
- Auto transmitter control-PTT.

Assembled
& Tested **\$149**



MACROTRONICS, inc.

P.O. Box 518 (S) Keyes, CA 95328
(209) 634-8888 / 667-2888

We are experiencing telephone difficulties, please keep trying.

✓ M48

California residents
add 6% tax

AMATEUR TELEVISION

FAST SCAN 420-450 MHz

APTRON OFFERS THE ATV
ENTHUSIAST THE MOST
COMPLETE LINE OF EQUIPMENT
AVAILABLE

- *Model 1570B ATV REPEATER
a complete unit-transmitter,
receiver-demodulator, control,
identifier, power supply
- *TXR15A ATV TRANSCEIVER
a complete unit-15w transmitter
with subcarrier sound, dual
frequency xtal converter-ch2 or
3 out, power supply
- *TX15A ATV TRANSMITTER
a complete unit-15w, subcarrier
sound, power supply
- *XR 70B XTAL CONVERTER
dual frequency, ch2 or 3 out,
high performance, power supply
- *XD25 B IN-LINE DETECTOR
samples-detects video modulation
at xmtr output, video output
drives any standard tv monitor
- *TD100A VIDEO-AUDIO DEMOD
demodulates converter output,
video drives monitor, audio
drives speaker, power supply
- *TV HANDBOOK for the AMATEUR

Call 812-336-4775, or write for
our detailed catalog.

APTRON LABORATORIES ✓ A6
PO Box 323, Bloomington, IN
47402

RECOGNIZE
THESE?

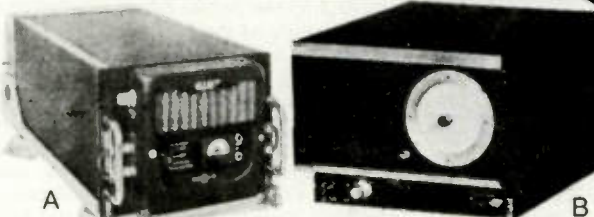

TOP CASH PAID FOR THESE ITEMS

ALSO WANT ANY OTHER
COLLINS AVOINIC EQUIP-
MENT, MODULES, OR PARTS.
ALSO NAVY AND GROUND
EQUIPMENT.

IF IT'S MILITARY, WE ARE
INTERESTED.

FIND OUT WHAT YOUR EQUIPMENT
IS WORTH.

Absolutely no obligation, call collect
NOW for information and prices.
WHO KNOWS? YOU MIGHT BE SIT-
TING ON A "GOLD MINE".
CALL COLLECT TODAY AND FIND
OUT.

SPACE ELECTRONIC CO.

DIV. OF MILITARY ELECTRONIC CORP.
35 Ruta Court, S. Hackensack
N.J. 07606, (201) 440-8787

✓ 87

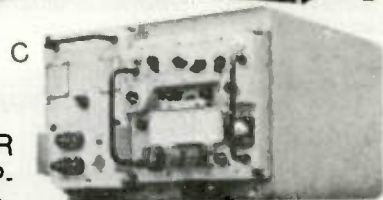

URGENTLY NEEDED
AN/SRC-21 or AN/SRC-20
or parts from same.

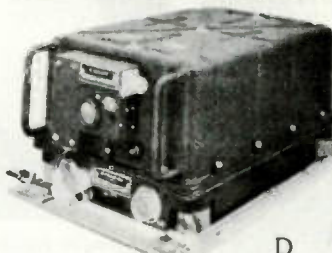

A-618T or ARC-94 or ARC-102.
B-490T or CU-1658 or CU-1669.
C-URC-9A or RT-581 and PP-2702.
D-ARC-51

**JAN
CRYSTALS**

HOLD THE FREQUENCY

- CB
- CB standard
- 2 meter
- Scanners
- Amateur Bands
- General Communication
- Industry
- Marine VHF
- Micro processor crystals

Send 10¢ for our latest catalog. Write or
phone for more details.

**JAN
CRYSTALS**

easy
to
charge

2400 Crystal Drive
Ft. Myers, Florida 33907
all phones (813) 936-2397

✓ J2

Call or Write for Delivery or Quote

ICOM IC701 with AC/MIC



LEAVE A MESSAGE & WE'LL CALL YOU BACK!

All prices fob Houston, except where indicated. Prices subject to change without notice, all items guaranteed. Some items subject prior sale. Send letterhead for Dealer price list. Texas residents add 6% tax. please add postage estimate. \$1.00 minimum. W5GJ, W5MBB, K5AAD, N5JJ, AG5K, W5VVM, WD5EDE, K5ZD, WA5TGU, WB5AYF, K5RC, K5BGB, WB5USV.

MASTERCARD • VISA

MADISON ELECTRONICS SUPPLY, INC.

1508 MCKINNEY • HOUSTON, TEXAS 77002
713/658-0268 ✓M35

State of the art TECHNICAL EXCELLENCE in RTTY



The FSK-1000 Demodulator

If you demand the finest, no compromise technology, you need the FSK-1000 demodulator. Can't be outcompeted because its design, computer grade parts, and modern technology offer landline copy over radio circuits.

Stops QRM with selectable 55 or 100 Hz. filters and two tone limiterless operation

Decision level correction improves selective fading

Uses either 170 volt, 60 Ma. or RS-232 loops

Video operation available. Interfaces microcomputers. We can install your Xitex SCT-100 board inside, too

Continuously adjustable shift from 100 to 1000 Hz.

Write for details. Visa and Master Charge accepted.

\$449.00

FOB Columbus, Ohio

Dealer Inquiries Welcome

IRL ✓127

700 Taylor Road
Columbus, Ohio 43230
(614) 864-2464

TIMETRAC

By Comus

the microcomputer-controlled
appointment clock

NEW
First Time Offer

— NOT A KIT —
Regular Price \$79.95
Introductory Offer by
HAL-TRONIX
only \$69.95



FEATURES:

- Sleek modern styling to complement any home or office decor.
- Tells the time.
- Tells the date and year.
- Up-timer to 60 minutes, 59 seconds with pause.
- Alarm to ring at the same time everyday.
- Daily appointment sets appointments for the next 23 hours, 59 minutes.
- Future appointments up to one year.
- Dimmer switch for display.
- Memory will hold up to 30 appointments.
- Lithium power cell to retain memory during power outage.
- Appointments entered out of chronological order will be stored in chronological order.
- Colon flashes once each second.
- A.M./P.M. indicator.
- Plugs into any wall outlet.
- Easy to read vacuum fluorescent display.
- Extremely accurate quartz crystal clock.

EFFICIENT. REMARKABLE.

TimeTrac sold and distributed by HAL-TRONIX. Dealers welcome.

Send 15¢ stamp or S.A.S.E. for information and flyer on other HAL-TRONIX products. To order by phone: 1-313-285-1782.



"HAL" HAROLD C. NOWLAND
WBZXH

HAL-TRONIX ✓H24
P.O. Box 1101
Southgate, MI 48195

SHIPPING
INFORMATION:

ORDERS OVER \$15.00 WILL BE SHIPPED POSTPAID EXCEPT ON ITEMS WHERE ADDITIONAL CHARGES ARE REQUESTED. ON ORDERS LESS THAN \$15.00 PLEASE INCLUDE ADDITIONAL \$1.00 FOR HANDLING AND MAILING CHARGES.

50 144 REPEATERS 220 450 Mhz

BASIC AUTO PATCH

*Access, #Disable and adjustable Timer.
COMPLETELY ASSEMBLED—\$75.00.

EXTENSION BOARD

Antialiasing, 3 digit sequential Touch Tone™ decoder with automatic reset, Antialiasing Ring detector, reverse auto patch capability for basic auto patch and two, two-watt audio amplifiers.

COMPLETELY ASSEMBLED—\$140.00

New and Improved Receiver and Transmitter

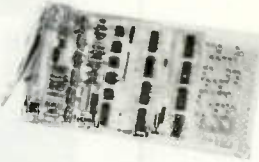

Available Separately:

COR Identifier: All on one board, programmable, Fully adjustable, time out (.5-7 min.), hang time (0-1 min.), identifier (1-10 min.), tone, speed, volume, L.E.D. outputs, low current drain CMOS logic, plugs for easy installation and removal plus much more. \$79.95 COMPLETELY ASSEMBLED

Basic Repeater **599.95** COMPLETELY ASSEMBLED
2M 130-175 MHz Basic Repeater for 2 meters with all the features of the Hi Pro Mkl less the power supply and front panel controls and accessories.

PA Res. add 6% tax
PLUS SHIPPING

Maggtore Electronic Laboratory

845 WESTTOWN RD.
WEST CHESTER, PA. 19380 PHONE 215 436-6051

Hi Pro Mk I
REPEATERS

50 MHz \$889.95 450 MHz 899.95
144 or 220 MHz 799.95

✓ M36

ALL NEW

Real-State-of-the-Art

TWO NEW AC•DC•BATTERY PORTABLE COUNTERS

OPTO-8000.1A 10Hz to 600 MHz — FREQUENCY COUNTER

- Precision TCXO time base 0.1 PPM Stability 17-40°C
- Super Sensitivity with preamps in both HI-Z & 50 Ohm inputs <10mV to 50MHz, 25 mV @ 150 MHz <50mV to 600MHz
- Auto Decimal Point • Aluminum Case • Socketed IC's
- Three position attenuator: X1, X10, X100 (avoids false counting)

#OPTO-8000.1A Factory Assembled \$329.95
#OPTO-8000.1AK Kit Form \$279.95
#NI-CAD-80 NI-CAD Battery Pack \$ 19.95

OPTO-7000 10 Hz to 600 MHz MINIATURE COUNTER

- XTAL (TCXO) Time Base ±.08PPM/°C
- Aluminum Case • HI-Z & 50 Ohm inputs
- 1 Sec. & 1/10 Sec. Gate times • Auto Dec. Pt.
- Built-in Prescaler and Preamps Standard

#OPTO-7000 Factory Assembled - 1 Year-Guar .. \$139.95
#OPTO-7000K Kit Form 99.95
#AC-70 AC Power Pack 4.95
#NI-CAD-70 NI-CAD Battery Pack 19.95
#TCXO-70 Precision TCXO Time Base <0.1PPM, 17-40°C 79.95

ACCESSORIES

PROBES:

#P-100 50 Ohm, 1X \$13.95
#P-101 Lo-Pass 16.95
#P-102 HI-Z, 2X 16.95
#AP-8015 UHF Counter Preamp 20 MHz to 600 MHz 15-50 DB Gain (Not Shown) .. \$49.95/Kit \$39.95

#D-450 Antenna Rubber Duck RF Pick-up 450 MHz ... \$12.50
#D-146 Same as above 146.5MHz \$12.50
#RA-BNC Right-Angle BNC Adapter for above Antenna 2.95

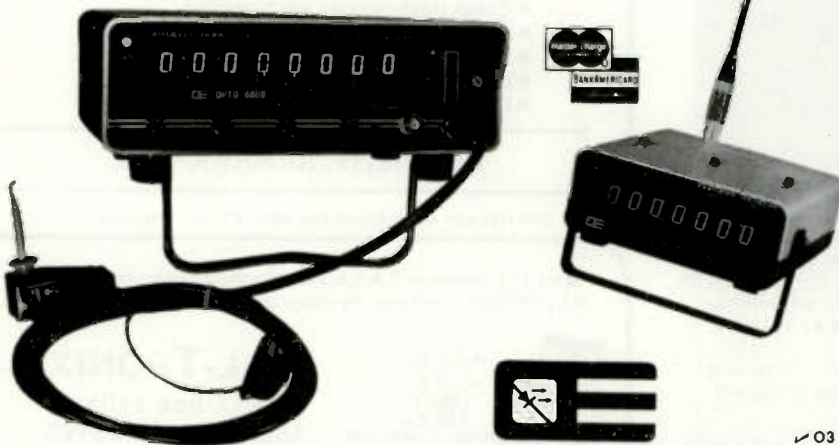

ORDER FACTORY DIRECT — PHONE OR MAIL

TERMS: Orders to U.S. and Canada, add 5% to maximum of \$10.00 per order for shipping, handling and insurance. To all other countries, add 10% of total order. Florida residents add 4% state tax. C.O.D. fee: \$1.00. Personal checks must clear before merchandise is shipped.



OPTOELECTRONICS, INC.

5821 NE 14 Avenue
Ft. Lauderdale, FL 33334
Phones: (305) 771-2050 771-2051

Phone orders accepted

ALL BAND TRAP VERTICAL ANTENNAS!

FULL 1/4th WAVE - All Bands! Automatic Selection with proven HI-Q Traps. 3 Models-ALL self supporting - Ground or roof mount. HEAVY Double wall seamless Aluminum lower section - HI IMPACT POLY Low Loss Plastic Cover OVER-ALL. NO WOBBLY, LUMPY TRAPS - NO UNSIGHTLY CLAMPS needed - Same size all the way up - 1 1/4" - Traps hidden inside. You can use it in a 1 ft. sq. Backyard! Neighbors will never know this is a HI-Power, ALL Direction DX Antenna. FOR APARTMENTS, ROW HOUSES, MOBILE HOMES - CONDOS etc. where minimum space and neat appearance is MANDATORY! Instant "Drive In" ground mount (included). Use with or without radials (included) (All angle roof mount - Extra) COMPLETELY PRETUNED - NO ADJUSTMENTS NEEDED EVER! NO TUNER NEEDED Over All Bands (except 80 meter - 400 KC) SWR 1-1 to 2-1 at Band edges, Std, SO239 connector - 50 ohm for any length RG58U - RGPU feedline. MATCHES ALL MAKES TRANSCEIVERS. 2000 Watt PEP. Shipped in 5 ft. Box - PREPAID IN USA. Assembles in 3 min. using only screwdriver. WEATHERPROOF!

No.-AVT80-10 5 Band 24'9" \$79.95
No.- AVT40-10 4 Band 18'9" \$69.95
No.- AVT20-10 3 Band 12'6" \$59.95

SEND FULL PRICE FOR PP DEL IN USA (Canada is \$5.00 extra for postage, clerical, Customs etc.) or order using VISA (BankAmericard) or MASTER CHARGE or AMER EXP. Give Number and Ex. date. Ph 1-308-236-5333 9AM-6PM weekdays. We ship in 2-3 days. Prices will increase Sept 1, so order NOW AND SAVE. All Antennas Guaranteed for 1 year - 10 day money back trial. Made in USA. Free Inf. Available from WESTERN ELECTRONICS, Dept. A7-11 Kearney Ne, 68847



✓ W18

✓ T48



FT-207R

in stock at

TOWER ELECTRONICS

24001 Alicia Pky.
Mission Viejo, CA 92691
(714) 768-8900

✓ O3

The **ONLY** thing you need to know about

Quartz Crystals

is: **1-405-224-6780**

• Best delivery plus Emergency Service with Guaranteed Delivery

• Highest Quality with gold MIL-C-3098 Process

• Ask for Sentry Technology Manual

And, order Toll Free 1-800-654-8850

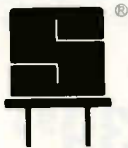

SENTRY

✓S3 Crystal Park
Chickasha, Oklahoma
73018

GREAT CHRISTMAS GIFTS BY WA1KDG!

QUALITY U.S. T-SHIRTS WITH YOUR CALLSIGN AND NAME, OR YOUR XYL'S NAME AND YOUR CALL. SHIRTS ARE AVAILABLE IN YELLOW, RED, LIGHT BLUE, OR WHITE WITH BLUE TRIM. LETTERING EITHER RED OR BLACK. SIZES S, M, L, XL. JUST \$6.50-POSTPAID!

"LITTLE HAM" CHILDREN'S SHIRTS ARE WHITE WITH BLUE TRIM. CHOICE OF RED OR BLACK LETTERS. SIZES 2-4, 6-8, 10-12, 14-16. JUST \$5—POSTPAID!



✓T72

T-SHIRTS & WONDERS

P.O. BOX 2304 B
DARIEN CT 06820

Prompt, attentive service!

TOP QUALITY: WILL NOT SHRINK OR FADE.

Now from J. W. Miller

DAWA DAIWA CORPORATION Communications Essentials



CN-720

SWR & Power Meters Models CN-720 and CN-620

Simultaneous direct reading SWR, Forward Power and Reflected Power.

Frequency Range: 1.8—150 MHz
SWR Detection Sensitivity: 5 Watts min.
Power: 3 Ranges (Forward, 20/200/1000 Watts)
(Reflected, 4/40/200 Watts)

Tolerance: ± 10% full scale
Input/output Impedance: 50 Ohms
Connectors: SO-239
Dimensions: 180 x 120 x 130 mm;
7 x 4.75 x 5 in.
165 x 75 x 97 mm;
6.5 x 3 x 4 in.

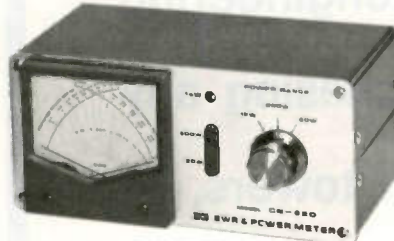

CN-620

SWR & Power Meter Model CN-630

Simultaneous direct reading SWR, Forward Power and Reflected Power.

Frequency Range: 140—450 MHz
SWR Detection Sensitivity: 5 Watts min.
Power: 2 Ranges (Forward, 20/200 Watts)
(Reflected, 4/40 Watts)

Tolerance: ± 10% full scale
Input/output Impedance: 50 Ohms
Connectors: SO-239
Dimensions: 180 x 85 x 120 mm;
7.12 x 3.37 x 4.75 in.



CN-630

Exclusive USA agent for these units;
inquiries invited.

Write for literature.



J. W. Miller Division
BELL INDUSTRIES ✓M92

19070 REYES AVE. ■ P.O. BOX 5825
COMPTON, CALIFORNIA 90224

CTU Dozen

Buy 12—get 2 free (mix or match)

**EXACT Replacements for
SYLVANIA**

ECG Transistor-Diodes-ICs

ECG#	ECG#	ECG#	ECG#	ECG#	ECG#
100	94	183	5.95	220	1.72
101	98	184	5.75	221	1.90
102	96	165	6.95	222	1.99
102A	98	171	1.37	223	2.79
103	1.05	172A	.72	224	5.06
103A	1.11	175	1.62	225	4.24
104	1.06	176	2.06	226	1.87
105	2.27	177	.49	228	1.38
106	.80	179	5.69	229	1.06
107	.79	180	5.88	230	3.60
108	.89	181	4.85	231	3.96
121	2.15	182	3.35	232	.70
123	.69	183	3.63	233	.74
123A	.79	184	1.37	234	.72
124	1.53	185	1.70	235	2.45
126	1.16	186A	1.46	236	5.75
127	4.60	187A	1.46	237	5.07
128	1.37	188	1.59	238	7.95
129	1.56	189	1.59	239	3.02
130	1.95	190	1.85	241	1.71
131	1.98	191	2.07	242	1.90
132	1.01	192	.98	276	8.72
133	1.14	193	1.04	278	2.36
152	1.43	194	.82	279	5.85
153	1.85	195A	2.87	280	5.06
154	1.85	196	1.98	281	6.35
155	2.02	197	1.89	282	4.24
157	1.43	198	1.89	283	6.32
158	1.08	199	.59	284	7.35
159	.86	210	1.37	285	7.99
160	1.43	211	1.56	286	5.75
161	.98	218	3.08	287	.69
162	5.75	219	4.36	288	.74

- Above only partial listing—please inquire
- R-U-S-H, All Orders Shipped Same Day Received
- FREE Freight on \$20.00 & up prepaid orders
All others—\$150 freight charge
- 1979 Accessory Catalogues In stock—send \$3.00
- Longer Hours Mon-Sat 9a-10p, Sun 1-7p
- Call or write today—to place your order (518)465-3367

Communications & T.V. Unlimited
Dept 73, 17 Washington St., Rensselaer, N.Y. 12144

DISTRIBUTOR INQUIRIES INVITED
T.V.-C.B.-AMATEUR RADIO-STEREO-MONITORS-
ELECTRONIC PARTS ✓C105

JUST GETTING ON THE AIR?
See Adirondack for

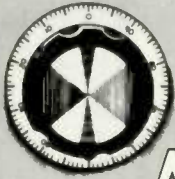

- New Equipment
- Used Gear
- Friendly Advice

ADIRONDACK Radio Supply

185-191 West Main Street • P.O. Box 88
 Amsterdam, N.Y. 12010 Tel. (518) 842-8350
 Just 5 minutes from N.Y. Thruway — Exit 27

✓ A1

BEWARE!!

Aluminum towers are not usually as strong as steel towers — ask for engineering facts before purchasing any tower. Aluminum towers, in most cases, are one-half as strong as steel towers within the same price range.

Notice Paid For By Unarco-Rohn U2

(Advertisement)

MFJ ✓ MS2

ANTENNA TUNERS



\$69⁹⁵

NEW MFJ-940 VERSA TUNER II matches coax and random wire 1.8 to 30 MHz.

Up to **300 watts RF OUTPUT**. SWR, dual range **wattmeter** (300 and 30 watts full scale).

Six position antenna switch on rear. Select 2 coax lines direct or thru tuner, random wire, and tuner bypass for dummy load.

New efficient airwound inductor (12 positions) gives you less losses than tapped toroid for more watts out. 8x2x6 inches. S0-239 coax connectors. 208 pf, 1000 volt capacitors.

Optional mobile mounting bracket, add \$3.00.

Beware of imitators. When you buy MFJ you buy proven MFJ quality . . . and a one year unconditional guarantee.



\$39⁹⁵

MFJ-900 ECONO TUNER matches coax, random wires. Full band coverage 1.8 to 30 MHz.

Up to **200 watts RF OUTPUT**. Efficient airwound inductor gives more watts out than tapped toroid.

S0-239 coax connectors, 5x2x6 inches. One year unconditional guarantee.

MFJ-901 Versa Tuner available. Same as MFJ-900 but has 4:1 balun for balanced lines. \$49.95.

Beware of imitators. Some are still copying our earlier models. MFJ has made improvements.

For example, a new efficient airwound inductor gives you less losses than a tapped toroid for more watts out and plenty of inductance for full band coverage 1.8 to 30 MHz.

\$29⁹⁵



MFJ-16010 RANDOM WIRE TUNER lets you operate 1.8 to 30 MHz with random wire. Up to **200 watts RF OUTPUT**. Small enough to carry in your hip pocket. Ultra compact 2x3x4 inches.

Match low and high impedances by Interchanging input and output. S0-239 coax connectors.

One year unconditional guarantee.

Order from MFJ and try it. If not delighted, return within 30 days for refund (less shipping).

Order yours today. Call toll free 800-647-1800. Charge VISA, MC. Or mail check, money order. Add \$3.00 each for shipping.

CALL TOLL FREE . . . 800-647-1800

For technical information, order/repair status, in Miss., outside continental USA, call 601-323-5869.

MFJ ENTERPRISES, INC.

BOX 494, MISSISSIPPI STATE, MS 39762

Completely Free Standing Towers

TELE TOW'R

PAT. NO. 4,151,534

40' MODEL

Model 40 (extends from 21' to 40')
List \$259.10

55' MODEL

Model 55 (extends from 21' to 55')
List \$473.97

Breakover Model 40 (extends from 23' to 40' with breakover at ground level)
List \$440.62

Breakover Model 55 (extends from 23' to 55' with breakover at ground level)
List \$661.75

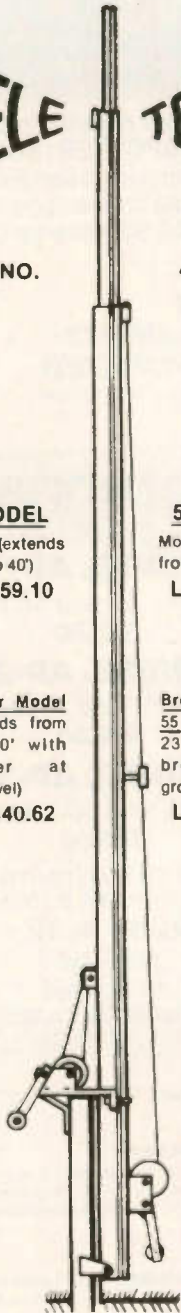

All steel constructed.

Concrete sleeve available for all models.

TELE-TOW'R MFG. CO., INC.
P.O. Box 3412 • Enid, OK 73701
405-233-4412 ✓ T52



Available for Kenwood TR 7400, Midland 13-510, Yaesu 227R, or KDK FM-144

At your Ham Radio Dealer or Call or Write ✓ C115

CES COMMUNICATIONS ELECTRONICS SPECIALTIES, inc.
399 W. Fairbanks Ave., Winter Park, Fla. 32789
305/645-0474

TODAY'S MOST VERSATILE SCANNER

Scan a few channels or all 800 - for example - you can program CES Model 800 to scan Repeater and Simplex Channels or all 2 Meter Bands - Other Features include: Instantaneous Addition or Deletion of Channels • Scan Resume delay assures hearing return calls • Resume and Hold provides complete control of scanning action • Hold Control activated by mic's P.T.T. switch • Scan entire band in 5 KHz steps and retain programmed memory • Selectable automatic scan resume after 10 secs. on channel. Slow Scan of memory to locate specific channels.

DOVETRON



MPC-1000C

Multipath Correction
In-Band Diversity &
AFSK Tone Keyer

Amateur Net: \$545.00

Standard features include CONTINUOUSLY tuneable Mark and Space channels (1000 Hz to 3200 Hz), Dual Mode (MARK or FSK) Autostart and internal high level neutral loop keyer (20 to 60 ml). Both EIA and MIL FSK outputs are provided for direct interface to microprocessor and video terminal peripherals.



MPC-1000CR

Signal Regeneration &
Speed Conversion

Amateur Net: \$645.00

A front panel switch permits internal TSR-200 Signal Regenerator-Speed converter assembly to electronically "gear-shift" between 60, 67, 75 and 100 WPM. All incoming and outgoing signals are regenerated to less than 0.5% bias distortion. Also available with DIGITAL Autostart (TSR-200D): Amateur Net: \$695.00



MPC-1000R/- TSR-500

Dual UART Regeneration,
Speed Conversion, 200
Char. Memory, Word Cor-
rection & DIGITAL
Autostart

Amateur Net: \$895.00*

The MPC-1000R/TSR-500 provides Preloading and Recirculation of the 200 character FIFO Memory, a keyboard-controlled Word Correction circuit, Variable Character Rate, Tee Dee Inhibit, Blank/LTRS Diddle, a Triple Tone-Pair AFSK Tone Keyer and a Character Recognition/Speed Determination DIGITAL (DAS-100) Autostart mode.

*The MPC-1000R is also available without a TSR assembly and functions as a MPC-1000C with a Triple Tone-Pair AFSK Tone Keyer. This "Basic-R" permits future expansion with a TSR-100, TSR-200, TSR-200D or TSR-500 by simply lifting the lid and plugging in the appropriate TSR assembly: Amateur Net (Basic-R): \$595.00

Your QSL will bring complete specifications, or call: 213-682-3705.

✓ D23



DOVETRON

627 FREMONT AVENUE
(P. O. BOX 267)
SOUTH PASADENA, CA. 91030

★ For Sale ★

\$10,000,000
INVENTORY

The ultimate source for electronic components and equipment.

PRODUCTION OVERRUNS
SURPLUS MATERIALS

Send us your inquiries. Get on our exclusive mailing list. Inquire in writing or by Telex

TWX: 510-224-6539

Serving domestic and overseas markets.

Ultima
Electronics, Ltd.
(516) 423-3770

✓ U13

73 Sherwood Ct., Huntington, N.Y. 11743 U.S.A.

NOW! NOW! NOW! NOW! NOW!

The ultimate answer for eliminating the damaging effects of antenna weight on your rotor . . . it's the

"UDM THRUSTOR"



- Fits any taper tower or can be used with flat top.
- Accepts 1 1/4" mast pipe
- All steel construction.
- Utilizing precision ground & hardened ball-type thrust bearing.
- Comes ready to install.
- Eliminates the damaging effect on your rotor.
- Shipped prepaid UPS (U.S.A.)
- Check, cash, money order, Visa, MasterCard. \$49.95 complete.
- Also available for 2" mast pipe for \$59.95

UDM ENTERPRISES ✓ U10
P.O. Box 2037, Sandusky, Ohio 44870

You can't tell the players without a scorecard!

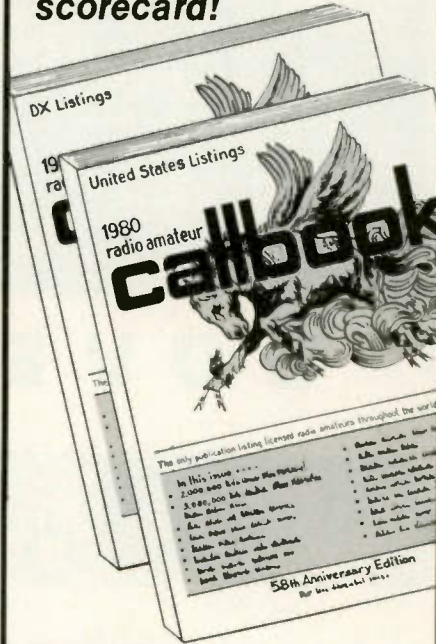

Order today!
NEW 1980 RADIO AMATEUR CALLBOOKS READY DECEMBER 1ST!

The latest editions will be published soon! World-famous Radio Amateur Callbooks, the most respected and complete listing of radio amateurs. Lists calls, license classes, address information. Loaded with special features such as call changes, prefixes of the world, standard time charts, world-wide QSL bureaus and more. The new 1980 Callbooks will be available on December 1, 1979. The U.S. Edition features over 400,000 listings, over 120,000 changes from last year. The Foreign Edition, over 315,000 listings, over 90,000 changes. Place your order now.

	Each	Shipping	Total
<input type="checkbox"/> US Callbook	\$16.95	\$1.75	\$18.70
<input type="checkbox"/> Foreign Callbook	\$15.95	\$1.75	\$17.70

Order both books at the same time for \$34.65, includes shipping.

Order from your favorite electronics dealer or direct from the publisher. All direct orders add \$1.75 for shipping. Illinois residents add 5% Sales Tax.



SPECIAL LIMITED OFFER!
Amateur Radio Emblem Patch
only \$2.50 postpaid

Pegasus on blue field, red lettering. 3" wide x 3" high. Great on jackets and caps. Sorry, no call letters.

ORDER TODAY!

✓ R1

RADIO AMATEUR callbook INC.
Dept. B1
925 Sherwood Drive
Lake Bluff, IL 60044

URFI

(UNIVERSAL RECEIVED
FREQUENCY INDICATOR)



Digitize your receiver's dial with the DIAL SPOTTER. Adapts to most Communication Receivers with simple connection to VFO. From \$149.95 Write for Data Sheet.

GEMINI INSTRUMENTS INCORPORATED

Box 205, Larchmont, NY 10538 ✓ G27

antennas

MODEL AP-1

80, 40, 20, 15 and 10 meters
\$35.00

MODEL AP-2

40, 20, 15 and 10 meters
\$30.00

MODEL AP-3

20, 15 and 10 meters
\$25.00

SHIPPED POSTPAID USA
SEND FOR FREE BROCHURE

RUDY PLAK W6TIK ✓ P64

PO BOX 966
SAN MARCOS CA 92069

SELELECTRONICS

REGULATED POWER SUPPLY

± 12V. 6 amp. or can be connected in parallel for 12V 12 amp. Voltage adjustable 10-14V. Regulation .01%. 5" x 8" x 16". SHPT. WT. 23#. PRICE: \$30.00 ea.

12V. 8 amp. ADJUSTABLE. 10-14V current limited. SHORT PROTECTED. O.V. PROTECTION. 5" x 5" x 9". SHPT. WT. 15#. PRICE: \$30.00 ea.

SELELECTRONICS ✓ S16

TELEPHONES:
Area Code 215
HOward 8-4645
HOward 8-7891

WAREHOUSE
1206 18 S. Napa St.
1201-49 S. Patton St.
1207-25 S. Napa St.

1206 S. Napa Street • Philadelphia PA 19146

PENNA. RESIDENT PLEASE ADD 6% SALES TAX. ALL PRICES ARE F.O.B. OUR WAREHOUSE, PHILA., PA. ALL MERCHANDISE ACCURATE AS TO DESCRIPTION TO THE BEST OF OUR KNOWLEDGE. YOUR PURCHASE MONEY REFUNDED IF NOT SATISFIED. MIN. ORDER \$10.00.

GND INPUT

MINI MODULES & PLUG IN ASSEMBLIES TO FIT YOUR PROJECT & POCKET

BROADBAND AMPLIFIERS Q1 RF & IF AMPLIFIERS Q2 FET MIXERS & CONVERTER

COMPRESSIVE AUDIO PREAMPLIFIER

This ad is a scale outline of an Audio Power Amplifier 1101-2



DESIGN MANUAL & CATALOG ✓ H44

HFT INC

158 WEST 9TH ST.
DEER PARK NY
11729

TO SPEAKER 8 OHM

1101-2

SEMICONDUCTORS SURPLUS

✓S63

2822 North 32nd Street/Unit -1 Phoenix, Arizona 85008 (602) 956-9423

We accept checks, MasterCard, and Visa

Prices subject to change without notice

R.F. CONNECTORS

UG-1095A/U	\$3.99
UG-58/U	3.29
UG-30C/U	3.00
UG-27C/U	3.50
PL-259	.50
SO-239	.43
UG-175	.36
PL-258	2.99
UG-106	.69
UG-177	.69
UG-274/U	3.27
UG-447/U	1.50
UG-492	3.69
UG-306/U	3.00
UG-646/U	3.29
UG-260B/U	1.59
UG-1094/U	.90
UG-701/U	3.00
UG-212C/U	3.00

TUBES

3-500Z	\$90.00
572B/T160L	34.00
6146	5.09
6146A	5.99
6-46W	7.95
811A	12.95
811	9.95
4CX250B	36.95
4CX250R	39.95
6KD6	4.99
6LF6	4.99
6LQ6/6JE6	6.25
8950	6.65
2E26	6.00
3B28	5.00
4X150A	15.00
6360/A	7.95
6939	5.95
7289/2C39	4.95
8072	45.00
4-400A	90.00
8877	300.00
PL172	250.00
4-1000A	160.00
4-250A	35.00

FERRITE BEADS

12/\$.89 or
100/\$4.00

1N914/1N4148

30/\$1.00 or
120/\$3.00

R.F. TRANSISTORS

2N2857	\$1.80
2N2857JAN	2.45
2N2947	17.00
2N3375	7.00
2N3553	1.80
2N3818	6.00
2N3866	1.09
2N3866JAN	2.70
2N2866JANTX	4.43
2N3925	6.00
2N3948	2.00
2N3950	26.25
2N3960	4.70
2N4072	1.70
2N4427	1.09
2N4877	2.57
2N4957	3.50
2N5108	3.90
2N5109	1.55
2N5179	.59
2N5589	4.60
2N5583	5.00
2N5590	6.30
2N5591	10.35
2N6080	5.45
2N6081	8.80
2N6082	10.75
2N6083	12.00
2N6084	13.20
2N6095	10.35
2N6097	19.35
MRF502	.69
MRF8004	.75
SS2548	.75
40280	3.50
40281	10.90
40282	11.90

TRIMMERS 5-80pf

45¢ each or 10/3.50
or 100/25.00

CHOKE (U252) 2.5mh

150ma 30MHZ
2/\$1.00

TRIMMER CAPS

small enough to
fit in your watch
3.5-11pf 75¢ each
or 10/\$6.00

PISTON CAPS 1.2-10pf

75¢ each or 10/\$5.50

F.E.T.'s

MPF4391	\$.75 or 10/ 6.50
MPF112	.69 or 10/ 5.50
MPF102	.43 or 10/ 3.50
40673	1.39 or 10/10.00
3N128	1.35 or 10/10.00
2N5248	.60 or 10/ 4.50
MPF131	.60 or 10/ 5.00
2N4303	.45 or 10/ 3.50
2N3958	2.95 each
MFE2000	.90 or 10/ 8.00
MFE2001	.99 or 10/ 8.00
MFE2008	4.20 or 10/36.00
MFE2009	4.80 or 10/39.00
MFE3002	3.35 each
MMF-5	5.00 each
MFE120	1.00 or 10/ 8.50
2N3436	2.25 each
2N4416	1.00 each
MFE131	1.05 each

MICROWAVE DIODES

1N21D	\$ 1.40
1N21C	1.05
1N21WE	2.00
1N23B	1.05
1N23C	1.05
1N23CR	2.00
1N23E	2.00
1N23F	4.10
1N23WE	2.10
1N25	3.03
1N121WE	4.00
1N286	5.00
1N416E	5.00
1N446	8.00
1N3655A	4.00
1N5153	15.00
1N5711	1.20

ADDITIONAL R.F. TRANSISTORS

40894 \$ 2.50
MRF454/568BLYCF 17.10

BRIDGES 24 AMPS

500PIV \$2.99 each

LM566V VCO/FUNCTION GENERATOR

\$.99 each

LM340T-5 & LM340T-12

\$1.49 each

VACUUM CAPACITORS

Amperex Model CVC
10/1k-5KV405A 10 pf to 1000
pf @5000 volts \$59.95

MC4024P &

MC4044P \$3.25 each

HEP 170 2.5 Amps

1000PIV 10/\$2.00 or 100/\$14.50

POTTER & BRUMFIELD 12VDC RELAYS

SPDT 25 Amps \$5.95
2PDT 3 Amps \$1.99

KILOVAC H-8/54 VACUUM RELAY

26 volt coil \$29.95 each

E. F. JOHNSON TUBE SOCKETS for 3-400Z and 3-5000Z tubes \$29.95 per pair

TOROIDAL CORES

T-37-6 6/1.00
25/4.00, 50/6.00
100/10.00

4CX250B/R SOCKETS AND CHIMNEYS NEW

\$14.95 per set (1 socket, 1 chimney)

B&W COILS

1206T \$3.99
2006T \$7.99

FAIRCHILD REGULATOR 78H05KC \$6.99 each

TUBES

6146B \$6.50

MINIMUM ORDER \$5.00

Minimum Shipping \$1. Insurance 35¢ per \$100. COD charges 85¢ to street address only! We prefer street address as we ship UPS and P.O. Box #'s take up to 50% longer to deliver. We accept VISA or MasterCard. Please list complete card number and expiration date. Allow 10% extra for shipping of heavy items. We reserve the right to change prices without notice. All items listed are subject to prior sale. Some items listed are in small quantities.

Does Your Shiny New Rig Really Have: "STATE-OF-THE-ART" SELECTIVITY

**EXCITING
NEW RADIO
ACCESSORIES**



Add an Autek.
QF-1A Active Filter

For SSB & CW
PATENT PENDING

Only \$65 ppd. U.S.A.

115 VAC supply built-in. Filter by-passed when off.

SUPER-RANGE
Auxiliary Notch rejects 80 to 11,000 Hz! Covers signals other notches can't touch.

Four main filter modes for any QRM situation.

Continuously variable main selectivity (to an incredible 20 Hz!)

Continuously variable main frequency. (250 to 2500 Hz, all modes.)

AUTEK pioneered the **ACTIVE AUDIO FILTER** way back in 1972. Today, we're still maintaining that engineering leadership. Our QF-1A evolved from suggestions from thousands of owners, and years of dedication to making the "ultimate" filter. No gimmicks — just something that really "works" like the ad says. You're in for a treat!

Autek filters gained their reputation by using a costly **INFINITELY VARIABLE** design. Yet, mass-production (we sell only **ONE MODEL** — the best) makes it a tremendous bargain. You're not limited by a few fixed positions. You vary selectivity 100:1, and vary frequency over the entire usable audio range. **PEAK CW** (or voice) with an incredible 20 HZ

BANDWIDTH, but also variable all the way to "flat." Imagine what the **NARROWEST CW FILTER MADE** will do to QRM! Reject whistles with the most flexible **NOTCH** you've heard. Wide or narrow. Depth to 70 dB. **LOWPASS** helps you cope with SSB hiss and splatter. Skirts exceed 80 dB. Most above features were in the popular QF-1 (See excellent review in March, 1977 QST.) The new "A" model is more selective, adds a **HIGHPASS** mode for SSB, and a great **AUXILIARY NOTCH** (35 to 60 dB) to give **TWO NOTCHES**, **NOTCH/PEAK**, **NOTCH/LOWPASS**, or **NOTCH/HIGHPASS**! If this doesn't convince you, please **ASK ON THE AIR**. Owners are our best salesmen!

Due to cost and panel-space limitations, even the latest rigs only include a fraction of the QF-1A features. We recommend you buy the best rig you can afford, spend \$3,000 or more, then add a QF-1A and listen to the improvement! **WORKS WITH** Yaesu, Kenwood, Drake, Swan, Atlas, Tempco, Collins, Heath, S/1, etc., **ANY RIG!**

Hooks up in minutes. Plug into your rig's phone jack, or attach to speaker wires. Plug speaker or phones into QF-1A rear-panel jack. That's it! Filter supplies 1 watt to fill a room. No batteries reqd. (+12 VDC hookup possible.) 6 1/2x5x2 1/2". Handsome light/dark grey styling. Get yours today.!

CMOS PROGRAMMABLE KEYSER MAKES CW FUN!



Calls CQ while you relax.
Also remembers name, QTH, contest exchanges.
Record anything you want in seconds!

Model MK-1 \$99.50 ppd. U.S.A.

Our classic MK-1 should make you wonder why anyone would buy an ordinary keyer, when memory costs so little! Records 4 messages. Just select "record," tap the A, B, C, or D message, and start sending at any speed! Record over old messages as easily. Playback by tapping the same button. Each message holds about 25 characters (letters, numbers). Total 100 characters. Handy repeat switch repeats message forever until reset. Very useful for CQ's. **YOU SIT BACK AND WAIT FOR A CALL!** Another switch combines two messages for 50

characters. "Memory-saver" feature standard.

This "state-of-the-art" keyer pleases beginners and CW "pros" alike. **DOT AND DASH MEMORIES. TRIGGERED CLOCK. IAMBIC. SELF COMPLETING. JAM PROOF.** 5 to 50+ WPM. **LATEST CMOS FOR LOW CURRENT.** Built-in monitor, speaker. Widely adjustable tone, volume. Perfect weighting at all times. No fiddling with an adjustment that varies with speed. **NEW: DUAL TRANSMITTER OUTPUTS** key ANY modern (post

1963) ham rig directly without a battery or relay, including difficult-to-key solid-state rigs. 115VAC supply built in, or connect 9-14 VDC to rear panel. Use with ANY paddle. 6x3 1/2x5". Burned-in and tested. Sockets for IC's. Full instructions.

NOW AVAILABLE. 40% BIT MEMORY EXPANDER (ME-1) allows 16 messages, 400 chars. & "combine" for longer messages. Plugs into memory socket of ANY MK-1 ever made. Installs in 10 to 30 mins. Full instructions. Buy your MK-1 now and easily add memory later if you wish!

FLASH! MK-1 used to set new world's CW record. A single operator worked 3992 DXQSO's & 275 band-countries in only 48 hours! Get the choice of champions — AUTEK.

ORDER WITH CONFIDENCE. NO LONG DELAYS HERE. We ship 95% of orders from stock. 1 year limited parts & labor warranty. Try our great service! **VISA & MC Welcome.**

Order by mail or call our **TOLL FREE** order operator:

**NATIONWIDE
CALIF.**

1-800-854-2003 ext. 842

1-800-522-1500 ext. 842

CALL 24 HOURS, 7 DAYS A WEEK.

Important: Operator can only take your order. For other information, you must write.

Autek Research

Box 5127F
Sherman Oaks, Ca.
91403

✓ A100

ORDER BLANK (Or Use Separate Sheet of Paper)

Please Rush QF-1A Filter at \$65.00
ppd. via MK-1 Keyer at \$99.50
Speedy UPS. ME-1 Expander for MK-1 at \$40 (factory installed)
 ME-1 Owner installed at \$30 (save \$10)

Add 6% tax in Calif. Add \$3 each to Canada, Hawaii and Alaska. \$2 for UPS air. Add \$15 each elsewhere (shipped air).

Enclosed is \$ _____

VISA or MC# _____ Exp. date _____

NAME _____

ADDRESS _____

CITY _____ STATE _____ ZIP _____

Send to Autek Research, Box 5127F, Sherman Oaks, Ca. 91403.

AZDEN. ★ NEW! ★ AZDEN. ★ NEW! ★ AZDEN. ★ NEW! ★ AZDEN.

AZDEN®

REVOLUTIONIZES THE STATE OF THE ART AWE AND AZDEN. INTRODUCE THE BRILLIANT NEW PCS-2000 MICROCOMPUTER CONTROLLED

NEW!

2 METER FM TRANSCEIVER

NOT \$550.00
**INTRODUCTORY
 PRICE**

\$369⁰⁰

ALSO PCS 2800 10 METER
 VERSION WITH THE SAME
 BASIC FEATURES COMING IN
 NOVEMBER. PRICE TBA.



COMPARE THESE FEATURES WITH ANY UNIT AT ANY PRICE

- **FREQUENCY RANGE:** Receive and transmit: 144.00 to 147.995 MHz, 5Khz steps + MARS-CAP* and MULTIPLE OFFSET BUILT IN.
- **ALL SOLID STATE-CMOS PL DIGITAL SYNTHESIZED.**
- **SIZE:** UNBELIEVABLE! ONLY 6 1/4" x 2 3/4" x 9 3/4". COMPARE!
- **MICROCOMPUTER CONTROLLED:** All scanning and frequency-control functions are performed by microcomputer.
- **DETACHABLE HEAD:** The control head may be separated from the radio for use in limited spaces and for security purposes.
- **SIX-CHANNEL MEMORY:** Each memory is re-programmable. Memory is retained even when the unit is turned off.
- **MEMORY SCAN:** The six channels may be scanned in either the "busy" or "vacant" modes for quick, easy location of an occupied or unoccupied frequency.
- **FULL-BAND SCAN:** All channels may be scanned in either "busy" or "vacant" mode. This is especially useful for locating repeater frequencies in an unfamiliar area.
- **INSTANT MEMORY-1 RECALL:** By pressing a button on the microphone or front panel, memory channel 1 may be recalled for immediate use.
- **MIC-CONTROLLED VOLUME AND SQUELCH:** Volume and squelch can be adjusted from the microphone for convenience in mobile operation.
- **ACCESSORY OFFSET:** Provides three additional offset values: +0.4 MHz, +1 MHz and +1.6 MHz. Other offsets may also be obtained.
- **25 WATTS OUTPUT:** Also 5 watts low power for short-distance communication.
- **DIGITAL S/R/F METER:** LEDs indicate signal strength and power output. No more mechanical meter movements to fall apart!
- **LARGE 1/2-INCH LED DISPLAY:** Easy-to-read frequency display minimizes "eyes-off-the-road" time.
- **PUSHBUTTON FREQUENCY CONTROL FROM MIC OR FRONT PANEL:** Any frequency may be selected by pressing a microphone or front-panel switch.
- **SUPERIOR RECEIVER SENSITIVITY:** 0.28 uV for 20-dB quieting. The squelch sensitivity is superb, requiring less than 0.1 uV to open. The receiver audio circuits are designed and built to exacting specifications, resulting in unsurpassed received-signal intelligibility.
- **TRUE FM, NOT PHASE MODULATION:** Transmitted audio quality is optimized by the same high standard of design and construction as is found in the receiver. The microphone amplifier and compression circuits offer intelligibility second to none.
- **OTHER FEATURES:** Dynamic Microphone, built in speaker, mobile mounting bracket, external remote speaker jack (head and radio) and much, much more. All cords, plugs, fuses, microphone hanger, etc. included. Weight: 6 lbs.
- **ACCESSORIES:** 15' REMOTE CABLE... \$29.95. *MARS-CAP KIT... TBA. PCS-6R A/C POWER SUPPLY... \$49.95. TOUCHTONE MIC. KIT... \$39.95.



AMATEUR-WHOLESALE ELECTRONICS

8817 S.W. 129th Terrace, Miami, Florida 33176
 Telephone (305) 233-3631 • Telex: 80-3356
 U.S. DISTRIBUTOR DEALER INQUIRIES INVITED

ORDER NOW TOLL-FREE

Credit card holders may use

our toll-free ordering number

Ask for operator 701

(800) 824-7888

In California (800) 852-7777

Alaska and Hawaii (800) 824-7919

800 800





FM2016A

All Solid State-CMOS PL digital synthesized - No Crystals to Buy! 5KHz steps - 144-149 MHz-HUGE 3/4" LED digital readout PLUS MARS-CAP and MULTIPLE OFFSET BUILT IN.
 ● 5 MHz Band Coverage - 1000 Channels (instead of the usual 2 MHz to 4 MHz-400 to 800 Channels) ● 4 CHANNEL RAM IC MEMORY WITH SCANNING AND AUTO TRANSMIT ● MULTIPLE FREQUENCY OFFSETS ● ELECTRONIC AUTO TUNING - TRANSMIT AND RECEIVE ● INTERNAL MULTIPURPOSE TONE OSCILLATOR ● RIT ● RF ATT ● DISCRIMINATOR METER - 16 Watts Output-Superior Receiver Sensitivity and Selectivity - 15 POLE FILTER, MONOLITHIC CRYSTAL FILTER AND AUTOMATIC TUNED RECEIVER FRONT END, COMPARE!
 ● Superb Engineering and Superior Commercial Avionics Grade Quality and Construction Second to None at ANY PRICE.

SPECIAL SALE
\$299.00
 REG. \$369.00



FM2016 - Microphone with built-in Touch Tone Pad
 WHY BUY THIS? THE FM2016 HAS IT ALL!
 • New! Auto key up
 • Snap Action Receiver!
 • Adj. level, and tone balance
 • Use with any transceiver
 • Only 3 1/2" x 2" x 3 1/2"

Regulated AC/PS Model FMP5-4R ... \$39.95

SHOWN WITH OPTIONAL µP-800 MICRO-PROGRAMMER* \$99.00

NEW CDE HAM IV ROTATORS

Reg. \$189.95 **Our Price \$149.00**

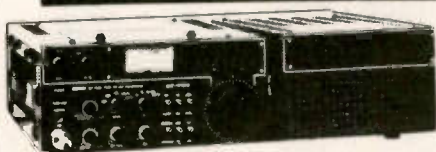

SUPERB!
NEW ICOM IC-701S
H.F. XCEIVER

Please Call or Write for Special Package Price

TWO ANTENNAS! FOR THE PRICE OF ONE!

NEW!

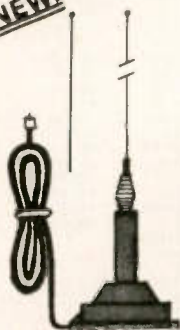

KDK MAX II

TWIN ANTENNA

- SUPER 80 LB. 100 M.P.H. BLACK MAGNETIC MOUNT
- 1/4 WAVE FOR MAX II SIGNAL AND
- 1/4 WAVE FOR CLOSE-IN AND RESTRICTED HEIGHT AREAS
- INSTANT CHANGE-OVER
- SUPERIOR PERFORMANCE
- STAINLESS STEEL SPRING AND WHIP, CHROME ON BRASS BASE - COMPARE!
- COMPLETE WITH 17' COAX AND CONNECTOR

REG. \$29.95

SALE \$25.00

COMPARE!! Nothing Else Does!

NEW!
TOWER MASTER
 40 foot Self-Supporting
 Crank-up
 Mast



Regular
\$399

COMPLETE With Hinged Mounting Plate And House Bracket

Our Price \$359

\$29 Shipping Anywhere USA

ORDER NOW TOLL-FREE

Credit Card Holders May Use Our Toll Free Ordering Number

ASK FOR OPERATOR 701

(800) 824-7888

IN CALIFORNIA (800) 852-7777

ALASKA and HAWAII (800) 824-7919

AMATEUR-WHOLESALE ELECTRONICS

8817 S.W. 129 Terr.
 Miami, Fla. 33176
 Tel: (305) 233-3631

✓ A21

MFJ KEYERS

Uses Curtis 8044 IC. All have dot-dash memories, weight control, solid state keying. RF proof. ✓ M52



\$69.95

The MFJ-8044C Deluxe Electronic Keyer sends iambic, automatic, semi-automatic, manual. Use squeeze, single lever or straight key. Iambic operation with squeeze key. Dot-dash insertion. Semi-automatic "bug" operation provides automatic dots and manual dashes.

Dot-dash memory, self-completing dots and dashes, jam-proof spacing, instant start. **RF proof.** Solid-state keying: grid block, solid state xmtrs (± 300V, -10 ma, +100 ma. max.)

Front panel controls: linear speed, weight, tone, volume, function switch. 8 to 50 WPM.

Weight control adjusts dot-dash space ratio; makes your signal distinctive to penetrate ORM.

Tone control. Speaker. Ideal for classroom.

Function switch selects off, on, semi-automatic/manual, tune. Tune keys transmitter for tuning.

Uses 4 C-cells. 2.5 mm phone jacks for external power (6-9 VDC). Optional AC adapter \$7.95.

Eggshell white, walnut sides. 6x2x6 inches. Stereo phone jacks for key, phone jack outputs. Optional Bencher Iambic Paddle, \$39.95.

\$39.95



The MFJ-400 8044 IC Econo Keyer is a reliable, full feature economy keyer for squeeze, single lever or straight key.

Sidetone, speaker, volume, speed, internal weight and tone controls. Pull-to-tune switch. On-off, iambic operation. Dot-dash memories. 8 to 50 WPM. Uses 9 V battery. 2x3x4 inches.

Reliable solid state keying: grid block, cathode solid state transmitters.



\$54.95



\$39.95

MFJ-404 8044 IC ECONO KEYS at \$54.95 has adjustable single paddle, sidetone, speaker, weight, tone, volume, speed controls. Dot-dash memories. 8 to 50 WPM. Solid state keying. 2x3x4 inches. Uses 9 V battery. Switch for TUNE, OFF, ON, SIDETONE OFF. Jacks for external key. Iambic with squeeze key.

MFJ-402 ECONO KEYS. \$39.95. Paddle, weight, speed controls. Dot-dash memories. 8 to 50 WPM. 2x3x4 inches. Uses 9 V battery. No sidetone and jacks for external key.

Order from MFJ and try it. If not delighted, return within 30 days for refund (less shipping). One year unconditional guarantee.

Order yours today. Call toll free 800-647-1800. Charge VISA, MC. Or mail check, money order. Add \$3.00 each for shipping and handling.

CALL TOLL FREE ... 800-647-1800

For technical information, order/repair status, in Miss., outside continental USA, call 601-323-5869.

MFJ ENTERPRISES, INC.
 BOX 494, MISSISSIPPI STATE, MS 39762

EIMAC 3-500 Z

Special price — limited quantity
\$150.00/pair

ALL CRYSTALS \$4.95

TEKTRONIX
 585A Oscilloscope
 with 82 dual trace plug-in
 DC-100 MHz \$800.00

TEKTRONIX
 IL30 Spectrum Analyzer plug-in
 925MHz-10.25GHz \$899.00

MURATA CERAMIC FILTERS
 Model SFD-455D
 455 kHz \$3.00
 Model SFB-455D
 455 kHz \$2.00
 Type: CFM-455E 455 kHz \$7.95
 Type: SFE-10.7 10.7 MHz \$5.95

HEWLETT PACKARD UHF, VHF, AND MICROWAVE SIGNAL GENERATORS AND SWEEPERS, AND OTHER EQUIPMENT

MODEL 434A
 Calorimetric power meter
 \$450.00

MODEL 416A
 Ratio meter
 \$125.00

MODEL 413AR
 DC null voltmeter
 \$112.50

MODEL 400DR
 Vacuum tube voltmeter
 \$79.95

MODEL 616B/A
 1.8 to 4.2 GHz
 only \$399.00

MODEL 618B
 3.8 to 7.6 GHz
 only \$499.99
 A Model \$299.00

MODEL 606A
 50 kHz to 65 MHz
 .1mV to 3V into 50 ohms
 \$1,000.00

MODEL 683C
 2 to 4 GHz
 ONLY \$299.00

MODEL 612A
 450 to 1230 MHz
 .1uv to .5uv into 50 ohms
 ONLY \$499.99

MODEL TS510/U HP608D
 10 MHz to 420 MHz
 .1V to .5V
 \$399.95

MODEL 620A
 7 to 11 GHz
 .223V to 1uv.
 \$699.99

302A with a 297A
 Wave Analyzer and Sweep Drive
 20 HZ to 50 kHz
 \$799.00

WISPER FANS

This fan is super quiet, efficient cooling where low acoustical disturbance is a must.
 Size 4.68" x 4.68" x 1.50", Impedance protected, 50/60 Hz 120 volts AC
 ONLY \$9.95 or 2/\$18.00

TRW BROADBAND AMPLIFIER MODEL CA615B

Frequency response 40 to 300 MHz

Gain 300 MHz 16dB MIN.
 17.5dB MAX.
 50 MHz 0 to -1dB from 300 MHz
 24 volts DC at 220ma MAX
 ONLY \$14.95

CARBIDE CIRCUIT BOARD DRILL BITS

Size	Price	Size	Price
35	\$2.15	58	\$1.85
42	\$2.15	59	\$1.85
47	\$2.15	60	\$1.85
49	\$2.15	61	\$1.85
50	\$2.15	62	\$1.85
51	\$2.15	63	\$1.85
52	\$2.15	64	\$1.85
53	\$1.85	65	\$1.85
54	\$1.85	66	\$1.90
55	\$1.85	1.25 mm	\$1.85
56	\$1.85	1.45 mm	\$1.85
57	\$1.85	3.20 mm	\$3.58

MICROWAVE DIODES

H.P. 2835	2.20
MA4882	5.00
MBD101	1.89
MBD102	1.98
1N831	8.00
1N5711	2.20
1N5712	3.45

INTEGRATED CIRCUITS

MC1303L	\$2.00	MC1463R	\$5.15
MC1461R	6.90	MC1469R	3.55
MC1469G	2.05	MC1560G	10.20
MC1550G	1.50	MC1563R	10.00
MC1560R	12.40	MC1568L	5.00
MC1568G	5.31	MC1590G	6.50
MC1569R	8.15	MC1648L	4.70
MC4024P	3.82	MC1648P	3.75
MC6820P	6.95	MC68B21P	12.00
2513	6.95	TMS4060	6.95
8080A	3.95	TMS4024	13.90
2716TI	29.95		
MC1460R	5.40		

19.2 kHz	2.4 MHz	3.1545MHz	5.733333MHz	11.228MHz	38.77777MHz
31.5	2.42	3.158	5.8968	11.2375	38.77778
37.35	2.4375	3.1585	6.00	11.27	38.88888
49.710	2.44275	3.1615	6.155	11.2995	38.88889
70	2.4495	3.1625	6.210	11.3565	39.00000
81.9	2.45	3.166	6.321458	11.705	39.160
96	2.4585	3.16975	6.380416	11.750	39.51851
225	2.46125	3.177	6.380833	11.755	39.55555
250	2.482	3.181	6.381041	11.805	39.592593
285.714	2.486	3.1825	6.381666	11.855	39.629630
576	2.5	3.18475	6.382291	11.905	39.666667
720	2.51375	3.1885	6.382916	11.955	39.703704
1.0000 MHz	2.56	3.2035	6.384166	11.96125	39.70371
1.2288	2.581	3.20725	6.384791	11.965	39.77778
1.3047	2.604	3.2105	6.383541	12.70666	39.81481
1.4	2.6245	3.2165	6.385416	12.8666	39.851852
1.455	2.618	3.2175	6.427083	12.925	39.88888
1.689600	2.62825	3.2315	6.45	12.93	39.92592
1.7	2.633125	3.23275	6.47	12.99	39.962963
1.76375	2.639	3.2365	6.4711	13.09	40.00000
1.77125	2.63575	3.23775	6.510	13.102	40.037037
1.773125	2.64325	3.2385	6.537	13.2155	40.074074
1.76675	2.646	3.238875	6.567	13.2455	40.111111
1.80224	2.647	3.23925	6.582	13.2745	40.14814
1.81875	2.650750	3.24	6.612	13.2845	40.18518
1.845125	2.6545	3.24025	6.6645	13.2945	40.222222
1.84375	2.65825	3.2405	6.673	13.3045	40.25925
1.845625	2.660	3.241	6.693	13.3145	40.29629
1.84575	2.662	3.2425	6.7	13.3245	40.33333
1.846	2.66575	3.244	6.705	13.3345	40.37037
1.84825	2.6695	3.248875	6.723	13.3445	40.407407
1.84975	2.677	3.24925	6.7305	13.3545	40.444444
1.8575	2.68075	3.24975	6.738	13.395	40.48148
1.908125	2.681	3.2515	6.75125	14.315	40.51851
1.925	2.6845	3.253625	6.753	15.016	40.555556
1.925125	2.68825	3.255	6.7562	15.020	40.59259
1.927	2.69575	3.256125	6.7605	15.036	40.62963
1.932	2.702	3.258625	6.7712	16.39074	40.66666
1.982	2.704	3.261	6.77625	16.39166	40.703704
1.985	2.71075	3.261125	6.880000	16.51111	40.740741
1.9942	2.715	3.266125	6.910	16.75185	40.77777
1.995975	2.716	3.268625	6.940	16.965	40.814815
1.964750	2.723	3.271125	7.0057	17.00925	40.85185
2.0000	2.730	3.273625	7.15	17.01018	40.88888
2.0285	2.7315	3.3	7.17333	17.015	40.925926
2.05975	2.73225	3.3345	7.186666	17.065	40.96296
2.125	2.732625	3.4045	7.193333	17.115	41.00000
2.126175	2.733	3.4115	7.34350	17.165	41.037037
2.12795	2.737	3.4325	7.35	17.215	41.11111
2.1315	2.73975	3.4535	7.390	17.280	43.33333
2.133275	2.742125	3.4675	7.443	17.8710	45.0000
2.13505	2.7425	3.4815	7.45850	17.9065	47.48
2.136825	2.744	3.5	7.4615	17.9165	48.50000
2.1425	2.7445	3.579545	7.4685	17.9265	49.84166
2.144625	2.74475	3.64	7.4715	17.9365	49.95
2.14675	2.746875	3.656	7.473	17.9465	50.0000
2.148875	2.751	3.80	7.47850	17.9665	53.45
2.151	2.754	3.803	7.4815	17.975	57.45
2.153125	2.75525	3.805	7.49850	17.9735	59.45
2.15375	2.762375	3.860	7.5	17.9935	60.45
2.155	2.7735	3.901	7.5015	18.290	61.95
2.15525	2.776625	3.908	7.79850	18.330	66.66667
2.157375	2.78	3.9168	7.80150	19.100	70.00000
2.1595	2.790	4.0000	7.81	20.1	72.855
2.16375	2.814	4.011	7.926667	23.25	75.185
2.165875	2.817	4.126666	8.00769	23.575	76.66667
2.170125	2.8225	4.194	8.075	25.9	82.75
2.17225	2.835	4.26	8.15571	25.99961	83.0000
2.174375	2.85	4.3	8.364	26.66667	84.0000
2.1765	2.854	4.57	8.820	26.965	90.833
2.17925	2.854285	4.6895	8.8285	26.9	93.1346
2.18475	2.865	4.6965	8.837	26.958	93.535
2.18575	2.868	4.7	8.8455	27.70	93.9353
2.194125	2.8725	4.7175	8.854	27.77778	94.3
2.207063	2.876875	4.7275	8.8625	27.845	95.35
2.208313	2.887	4.7315	8.871	27.9	106.850
2.209563	2.889	4.765	8.879500	28.728	146.64
2.210812	2.894	4.89	8.888	28.88889	147.09
2.210813	2.910	5.000	8.905	28.9	165.5
2.212063	2.920	5.13125	8.9135	28.93888	
2.214562	2.925450	5.139585	8.9305	29.896	
2.214563	2.92545	5.147917	8.939	29.9	
2.215625	2.931	5.164583	8.956	30.0000	
2.217938	2.94375	5.348400	9.0265	30.9	
2.21975	2.945	5.426636	9.203906	31.0000	
2.222125	2.94675	5.436636	9.37491	31.11111	
2.22325	2.952	5.456	9.545	31.66667	
2.22675	2.966	5.4675	9.555	31.9	
2.22875	2.973	5.4990	9.565	32.0000	
2.23725	2.980	5.5065	9.585	32.22222	
2.2395	2.981	5.515	9.65	32.6	
2.24075	2.98325	5.5215	9.7	32.9	
2.241	2.987 MHz	5.544	9.75	33.0000	
2.246	2.9989	5.5515	9.8	33.33333	
2.2475	3.001	5.559	9.85	33.9	
2.2925	3.0235	5.5665	9.9	34.0000	
2.2975	3.045	5.574	9.934375	34.4444	
2.30000	3.049	5.5815	9.95	34.44444	
2.320	3.053	5.589	9.999	35.0000	
2.326	3.062	5.604	10.0000	35.55555	
2.32625	3.067	5.619	10.010	36.0000	
2.32825	3.074	5.6115	10.020	36.21750	
2.3525	3.1125	5.6265	10.021	36.66667	
2.35256	3.126	5.6415	10.040	37.00000	
2.368	3.137	5.6715	10.20833	37.2175	
2.374	3.13975	5.675	10.80375	37.385	
2.375	3.1435	5.680	11.0000	37.460	
2.38725	3.144	5.695	11.13	37.77777	
2.395	3.145	5.7	11.1805	38.00000	
2.396875	3.151	5.7105		38.33333	

Prices are subject to change. Some items are in limited quantity.

Polarad Model 1206
1.95 to 4.20 GHz
signal source
\$400.00

Model 1107 3.8 to 8.20
GHz signal generator
\$550.00

Alfred Model 632D
Sweep signal generator
2-4 GHz \$339.00

FETS

3N128	\$1.00
40673	1.39
MPF102	.45
MPF121	1.00
MPF131	1.00

AA NICADS
Used/pull out of calculators
79¢ each or \$59.00/100

E.F. Johnson tube socket #122-0275-001
for 3-400Z, 3-500Z, 4-125A, 4-250A, 4-400A
\$29.95/pair

TUNNEL DIODES

TYPE	PRICE
TD261A	\$10.00
TD266A	10.00
1N2930	7.65
1N2939	7.65
1N4395	5.40

2300 MHz CONVERTER KIT

PC board and assembly instructions
\$29.95

PC board with 13 chip caps - assembled
\$39.95

PC board assembled and tested
\$119.95

RF TRANSISTORS

TYPE	PRICE
2N1561	\$15.00
2N1562	15.00
2N1892	15.00
2N1693	15.00
2N2857JAN	2.45
2N2876	12.35
2N2880	25.00
2N2927	7.00
2N2947	17.25
2N2948	15.50
2N2949	3.90
2N2950	5.00
2N3287	4.30
2N3294	1.15
2N3301	.75
2N3302	1.05
2N3304	1.48
2N3307	10.50
2N3309	3.90
2N3553	1.45
2N3818	6.00
2N3866	1.09
2N3866JAN	2.70
2N3866JANTX	4.43
2N3924	3.20
2N3925	6.00
2N3927	11.50
2N3950	26.25
2N4072	1.70
2N4135	2.00
2N4261	14.60
2N4427	1.09
2N4429	7.50
2N4430	20.00
2N4957	3.50
2N4958	2.80
2N4959	2.12
2N4976	19.00
2N5090	6.90
2N5108	3.90
2N5109	1.55
2N5160	3.34
2N5179	.49

MM1552	50.00
MM1553	56.50
MM1601	5.50
MM1602/2N5842	7.50
MM1607	8.65
MM1661	15.00
MM1669	17.50
MM1943	3.00
MM2605	3.00
MM2608	5.00
MM8006	2.15
MMCM918	1.00
MMT72	.61
MMT74	.94
MMT2857	2.68
MMT3960A	6.25
MRF245	31.05
MRF304	43.45
MRF420	20.00
MRF450A	10.35
MRF472	1.15
MRF475	2.90
MRF476	1.38
MRF502	.49
MRF504	6.95
MRF509	4.90
MRF511	8.60
MRF901	3.00
MRF5177	20.70
MRF8004	1.44
PT3539B	3.00
PT4186B	3.00
PT4571A	1.50
PT4612	5.00
PT4628	5.00
PT4640	5.00
PT8659	10.72
PT9784	24.30
PT9790	41.70
PT9847	26.40
SD1043	5.00
SD1116	3.00
SD1118	5.00
SD1119	3.00
TA7993	75.00
TA7994	100.00
40281	10.90
40282	11.90
40290	2.48

MHZ ELECTRONIC KITS:

Kit #1
Motorola MC14410CP CMOS Tone Generator
CMOS Tone Generator uses 1MHZ crystal to produce standard dual frequency dialing signal. Directly compatible with 12 key Chomeric Touch Tone Pads. KIT includes the following:
1 Motorola MC14410CP Chip.
1 PC Board
And all other parts for assembly
with 1 MHz crystal

NOW ONLY \$15.70
\$20.65

Kit #2
Fairchild 95H90DC Prescaler 350MHZ.
95H90DC Prescaler divides by 10 to 350 MHZ. This kit will take any 35MHZ Counter to 350 MHZ. KIT includes the following:
1 Fairchild 95H90DC Chip
1 2N5179 Transistor
2 UG-88/U BNC Connectors
1 PC Board
And all other parts for assembly.
Less 95H90 chip

NOW ONLY \$19.95
\$10.95

FAIRCHILD VHF AND UHF PRESCALER CHIPS

95H90DC	350MHZ Prescaler Divide by 10/11	\$ 9.50
95H91DC	350MHZ Prescaler Divide by 5/6	8.95
11C90DC	650MHZ Prescaler Divide by 10/11	16.50
11C91DC	650MHZ Prescaler Divide by 5/6	15.95
11C83DC	1GHZ Divide by 248/256 Prescaler	29.90
11C70DC	600MHZ Flip/Flop with reset	12.30
11C58DC	ECL VCM	4.53
11C44DC	Phase Frequency Detector (MC4044P/L)	3.82
11C24DC	Dual TTL VCM (MC4024P/L)	3.82
11C06DC	UHF Prescaler 750MHZ D Type Flip/Flop	12.30
11C05DC	1GHZ Counter Divide by 4	74.35
11C01FC	High Speed Dual 5-4 Input NO/NOR Gate	15.40

CRYSTAL FILTERS: Tycos 001-19880 same as 2194F
10.7MHZ Narrow Band Crystal Filter
3 db bandwidth 15khz minimum 20 db bandwidth 60khz minimum 40 db bandwidth 150khz minimum. Ultimate 50 db: Insertion loss 1.0db Max. Ripple 1.0db Max. Ct. 0+
- 5pf. Rt. 3600 Ohms.

NOW ONLY \$5.95

TUBES

2E26	\$5.00	4X150G	70.00
3-500Z	90.00	100TH	144.00
3-1000Z	225.00	572B	39.00
3B28	5.00	811A	12.95
3X2500A3	150.00	813	29.00
4 65A	54.50	589A	39.00
4-125A	68.75	6146A	5.25
4-250A	80.00	6146B	6.25
4-400A	81.50	6159	10.60
4-1000A	255.00	6293	18.50
5-500A	145.00	6360	7.95
4CX250B	38.50	6907	35.00
4CX250F	53.50	6939	9.95
4CX250G	53.50	7360	10.60
4CX250K	72.00	7984	10.40
4CX250R	48.00	8072	45.00
4CX350A	60.00	8156	7.85
4CX350FJ	70.00	8226	127.70
4CX1000A	289.00	8295A/PL172	328.00
4CX1500B	285.00	8458	25.75
4CX15000A	400.00	8560AS	50.00
4X150A	37.00	8950	5.95

TERMS:
ALL CHECKS AND MONEY ORDERS ARE IN US FUNDS!
ALL ORDERS SENT FIRST CLASS OR UPS
Please include \$1.50 Minimum for postage
ALL PRICES ARE IN US DOLLARS
ALL PARTS PRIME/GUARANTEED

5% service charge on all bank cards.

BANK AMERICARD/VISA/MASTERCARD

Your Number:
(or equivalent)

Exp. Date

Your Signature:



✓ M8

(602) 242-3037

2111 W. Camelback
Phoenix, Arizona 85015

Low Cost... High Performance

DIGITAL MULTIMETER



\$99.95 WIRED

Low cost, high performance, that's the DM-700. Unlike some of the hobby grade DMMs available, the DM-700 offers professional quality performance and appearance at a hobbyist price. It features 26 different ranges and 5 functions, all arranged in a convenient, easy to use format. Measurements are displayed on a large 3 1/2 digit, 1/2 inch high LED display, with automatic decimal placement, automatic polarity, and overrange indication. You can depend upon the DM-700, state-of-the-art components such as a precision laser trimmed resistor array, semiconductor band gap reference, and reliable LSI circuitry insure lab quality performance for years to come. Basic DC volts and ohms accuracy is 0.1%, and you can measure voltage all the way from 100 μ V to 1000 volts, current from 0.1 μ A to 2.0 amps and resistance from 0.1 ohms to 20 megohms. Overload protection is inherent in the design of the DM-700, 1250 volts, AC or DC on all ranges, making it virtually goof proof. Power is supplied by four 'C' size cells, making the DM-700 portable, and, as options, a nicad battery pack and AC adapter are available. The DM-700 features a handsome, jet black, rugged ABS case with convenient retractable tilt ball. All factory wired units are covered by a one year limited warranty and kits have a 90 day parts warranty.

Order a DM-700, examine it for 10 days, and if you're not satisfied in every way, return it in original form for a prompt refund.

Specifications

DC and AC volts: 100 μ V to 1000 Volts, 5 ranges
 DC and AC current: 0.1 μ A to 2.0 Amps, 5 ranges
 Resistance: 0.1 Ω to 20 megohms, 6 ranges
 Input protection: 1250 volts AC/DC all ranges fuse protected for overcurrent
 Input impedance: 10 megohms, DC/AC volts
 Display: 3 1/2 digits, 0.5 inch LED
 Accuracy: 0.1% basic DC volts
 Power: 4 'C' cells, optional nicad pack, or AC adapter
 Size: 6" W x 3" H x 6" D
 Weight: 2 lbs with batteries

Prices

DM-700 wired + tested.	\$99.95
DM-700 kit form.	79.95
AC adapter/charger.	4.95
Nicad pack with AC adapter/charger.	19.95
Probe kit.	3.95

TERMS: Satisfaction guaranteed or money refunded, COD, add \$1.50. Minimum order \$6.00. Orders under \$10.00, add \$.75. Add 5% for postage insurance, handling. Overseas, add 15%. NY residents, add 7% tax.



600 mHz COUNTER



\$99.95 WIRED

The CT-70 breaks the price barrier on lab quality frequency counters. No longer do you have to settle for a kit, half-kit or poor performance, the CT-70 is completely wired and tested, features professional quality construction and specifications, plus is covered by a one year warranty. Power for the CT-70 is provided by four 'AA' size batteries or 12 volts, AC or DC, available as options are a nicad battery pack, and AC adapter. Three selectable frequency ranges, each with its own pre-amp, enable you to make accurate measurements from less than 10 Hz to greater than 600 mHz. All switches are conveniently located on the front panel for ease of operation, and a single input jack eliminates the need to change cables as different ranges are selected. Accurate readings are insured by the use of a large 0.4 inch seven digit LED display, a 1.0 ppm TCXO time base and a handy LED gate light indicator.

The CT-70 is the answer to all your measurement needs, in the field, in the lab, or in the ham shack. Order yours today, examine it for 10 days, if you're not completely satisfied, return the unit for a prompt and courteous refund.

Specifications

Frequency range: 10 Hz to over 600 mHz
 Sensitivity: less than 25 mv to 150 mHz
 less than 150 mv to 600 mHz
 Stability: 1.0 ppm, 20-40°C; 0.05 ppm/°C TCXO crystal time base
 Display: 7 digits, LED, 0.4 inch height
 Input protection: 50 VAC to 60 mHz, 10 VAC to 600 mHz
 Input impedance: 1 megohm, 6 and 60 mHz ranges 50 ohms, 600 mHz range
 Power: 4 'AA' cells, 12 V AC/DC
 Gate: 0.1 sec and 1.0 sec LED gate light
 Decimal point: Automatic, all ranges
 Size: 5" W x 1 1/2" H x 5 1/2" D
 Weight: 1 lb with batteries

Prices

CT-70 wired + tested.	\$99.95
CT-70 kit form.	75.95
AC adapter.	4.95
Nicad pack with AC adapter/charger.	14.95
Telescopic whip antenna. BNC plug.	7.95
Tilt ball assembly.	3.95

ramsey electronics

✓R8 BOX 4072, ROCHESTER, N.Y. 14610
 PHONE ORDERS CALL
 (716) 271-6487

GET ON PHASE THREE FOR MUCH LESS THAN YOU THINK!

These Low Cost SSB TRANSMITTING CONVERTERS

Let you use inexpensive recycled 10M or 2M SSB exciters on UHF & VHF!

- Linear Converters for SSB, CW, FM, etc.
- A fraction of the price of other units; no need to spend \$300 - \$400!
- Use with any exciter; works with input levels as low as 1 mW.
- Use low power tap on exciter or simple resistor attenuator pad (Instructions Included).
- Link osc with RX converter for transceiver.

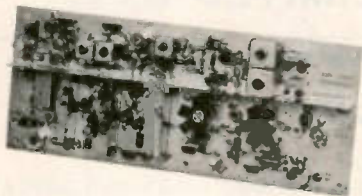

HAMTRONICS DOES IT AGAIN!

NEW XV4 UHF KIT - ONLY \$99.95

28-30 MHz In, 435-437 MHz out; 1W p.e.p. on ssb, up to 1½W on CW or FM. Has second oscillator for other ranges. Atten. supplied for 1 to 500 mW input, use external attenuator for higher levels.

Extra crystal for 432-434 MHz range \$5.95



XV2 VHF KIT - ONLY \$69.95

2W p.e.p. output with as little as 1mW input. Use simple external attenuator. Many freq. ranges available.

MODEL	INPUT (MHz)	OUTPUT (MHz)
XV2-1	28-30	50-52
XV2-2	28-30	220-222
XV2-4	28-30	144-146
XV2-5	28-29 (27-27.4 CB)	145-146 (144-144.4)
XV2-7	144-146	50-52

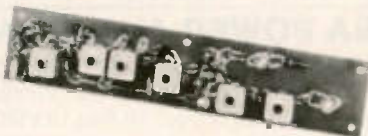

XV28 2M ADAPTER KIT - \$24.95

Converts any 2M exciter to provide the 10M signal required to drive above 220 or 435 MHz units.

Easy to Build FET RECEIVING CONVERTERS

Let you receive OSCAR and other exciting VHF and UHF signals on your present HF or 2M receiver

VHF KIT STILL ONLY \$34.95



MODEL	RF RANGE	OUTPUT RANGE
C28	28-32 MHz	144-148 MHz
C50	50-52	28-30
C50-2	50-54	144-148
C144	144-146	28-30
C145	145-147	28-30
or	144-144.4	27-27.4 (CB)
C146	146-148	28-30
C220	220-222	28-30
C220-2	220-224	144-148
C110 (less xtal)	Any 2MHz of Aircraft Band	26-28 or 28-30

UHF KIT ONLY \$34.95

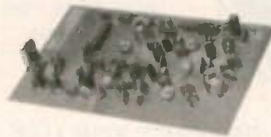

MODEL	RF RANGE	OUTPUT RANGE
C432-2	432-434	28-30
C432-5	435-437	28-30
C432-4	432-436	144-148
C432-9	439.25	61.25

Professional Quality VHF/UHF FM/CW EXCITERS

- Fully shielded designs
- Double tuned circuits for spurious suppression
- Easy to align with built-in test aids



T50-50	6-chan, 6M, 2W Kit	\$49.95
T50-150	6-chan, 2M, 2W Kit	\$49.95
T50-220	6-chan, 220 MHz, 1½W Kit	\$49.95
T450	1-chan, 450 MHz, 1W Kit	\$49.95

See our Complete Line of VHF & UHF Linear PA's

- Use as linear or class C PA
- For use with SSB Xmtg Converters, FM Exciters, etc.

LPA 2-15 VHF PA, 2W in/15-20W out. Solid-state 1/r switching. Kit	\$59.95
LPA 2-45 VHF PA, 2W in/40-45W out. Can also be used with 8-10W drive. Kit	\$109.95
LPA 4-10 UHF PA, ½W-1W in/8-10W out. Kit	\$79.95

FAMOUS HAMTRONICS PREAMPS

Let you hear the weak ones too! Great for OSCAR, SSB, FM, ATV. Over 14,000 in use throughout the world on all types of receivers.



P9 Kit \$12.95
P14 Wired \$24.95
Specify band when ordering

- Deluxe vhf model for applications where space permits ● 1½" x 3" ● Models available to cover any 4MHz band in the 26 to 230 MHz range ● 12 Vdc ● 2 stages ● Ideal for OSCAR ● 20 dB gain

P8 Kit \$10.95
Specify band when ordering



- Miniature vhf model for tight spaces—size only ½ x 2 ½
- Models available to cover any 4MHz band in the range 20 to 230 MHz ● 20 dB gain ● 12 Vdc

P15 Kit \$18.95
P35 Wired \$34.95

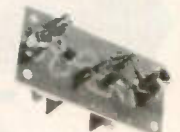

- Covers any 6 MHz band in UHF range of 380 to 520 MHz ● 20 dB gain ● 2 stages ● 12 Vdc

NEW VHF/UHF FM RCVR'S

Offer Unprecedented Range of Selectivity Options

- New generation
- More sensitive
- More selective
- Low cross mod
- Uses crystal filters.
- Smaller
- Easy to align



R75A* VHF Kit for monitor or weather satellite service. Uses wide L-C filter. -60dB at ± 30 kHz. \$69.95

R75B* VHF Kit for normal nbm service. Equivalent to most transceivers. -60dB at ± 17 kHz. -80dB at ± 25 kHz. \$74.95

R75C* VHF Kit for repeater service or high rf density area. -60dB at ± 14kHz. -80dB ± 22kHz. -100dB ± 30kHz. \$84.95

R75D* VHF Kit for split channel operation or repeater in high density area. Uses 8-pole crystal filter. -60dB at ± 9kHz. -100dB at ± 15 kHz. The ultimate receiver! ... \$99.95

* Specify band: 10M, 6M, 2M, or 220 MHz. May also be used for adjacent commercial bands. Use 2M version for 137 MHz WX satellites.

R85 () UHF FM Receiver Kits, triple conversion, include C432 UHF Front End Module. Add \$20 to above prices. (Add selectivity letter to model number.)

A13-45A 6-Channel Adapter for receivers \$13.95

IT'S EASY TO ORDER!

- Write or phone 716-392-9430 (Electronic answering service evenings & weekends)
- Use Credit Card, UPS COD, Check, Money Order
- Add \$2.00 shipping & handling per order

Call or Write to get FREE CATALOG With Complete Details

(Send 4 IRC's for overseas mailing)

hamtronics, inc.

65C MOUL RD · HILTON, NY 14468

NATIONAL SEMICONDUCTOR

NEW!

CAR CLOCK MODULE - #MA6008

\$6⁹⁹ each

Originally used by HYGAIN to indicate time and channel on an expensive C.B. Mini size, self contained module. Not a Kit. Four digits plus flashing indicator for seconds. Includes MM5369 and 3.58 MHZ crystal for super accurate time base. With hookup data.

**INCLUDES CRYSTAL TIMEBASE!
WORKS ON 12 VDC!**

**MFGR'S CLOSEOUT
LIMITED QTY.**

NATIONAL SEMICONDUCTOR

MILITARY TIME FORMAT!

JUMBO CLOCK MODULE

**MA1008D
BRAND NEW!**

ASSEMBLED,
NOT A KIT!

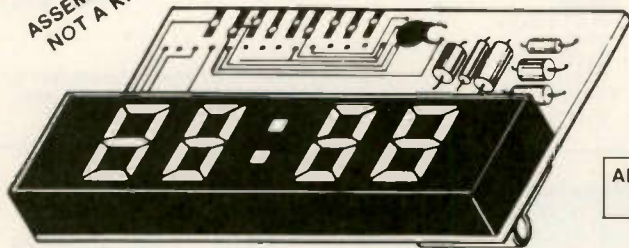

\$4⁹⁵
REG. \$9.95

ADD \$1.95 FOR
AC XFMR

FEATURES:

- * FOUR JUMBO 1/2 INCH LED DISPLAYS
- * 24 HR REAL TIME FORMAT
- * 24 HR ALARM SIGNAL OUTPUT
- * 50 OR 60 Hz OPERATION
- * LED BRIGHTNESS CONTROL
- * POWER FAILURE INDICATOR
- * SLEEP & SNOOZE TIMERS
- * DIRECT LED DRIVE (LOW RFI)
- * COMES WITH FULL DATA

ZULU

50% OFF SALE!

PERFECT FOR USE
WITH A TIMEBASE.

**COMPARE AT UP TO TWICE
OUR PRICE!**

MANUFACTURER'S CLOSEOUT!

FAIRCHILD RED LED LAMPS

#FLV5057 Medium Size. Clear Case. RED EMITTING. These are not retested off-spec units as sold by some of our competition. These are factory prime, first quality, new units.



**10 FOR \$1¹⁹
50 FOR \$4⁹⁵**

"WE BOUGHT 250,000 PCS."

LAB-BENCH VARIABLE POWER SUPPLY KIT

5 to 20 VDC at 1 AMP. Short circuit protected by current limit. Uses IC regulator and 10 AMP Power Darlington. Very good regulation and low ripple. Kit includes PC Board, all parts, large heatsink and shielded transformer. 50 MV. TYP. Regulation. **\$15.99 KIT**

LED BAR GRAPH AND ANALOG METER DRIVER

New from National Semi. #LM3914. Drives 10 LED directly for making bar graphs, audio power meters, analog meters, LED oscilloscopes, etc. Units can be stacked for more LED's. A super versatile and truly remarkable IC. Just out!

SPECIAL PRICE: \$3.99 INCLUDES 12 Page Spec. Sheet

CLOCK MODULE OPTIONS MA1008 A and D MA1013

Switches and pot for all options.

Includes:

- 5 push buttons
 - 1 toggle
 - 1 10K pot
 - Alarm Parts (Including high impedance transducer). Much more efficient than a speaker.
- \$2.50**
\$1.50
\$1.10

16K DYNAMIC RAM CHIP WORKS IN TRS-80 OR APPLE II

16K X 1 Bits. 16 Pin Package. Same as Mostek 4116-4. 250 NS access. 410 NS cycle time. Our best price yet for this state of the art RAM. 32K and 64K RAM boards using this chip are readily available. These are new fully guaranteed devices by a major mfg.

VERY LIMITED STOCK!

"MAGAZINE SPECIAL" - 8/\$79.50

SONY 23 WATT AUDIO AMP MODULE

#STK-054. 23 WATTS SUPER CLEAN AUDIO. 20HZ to 100 KHZ ± 2 DB. HYBRID, SILICON, SELF-CONTAINED MODULE. ONLY 1 1/4 x 2 1/2 IN. WITH DATA.

COMPARE AT UP TO TWICE OUR PRICE! \$8⁹⁹ each

60 Hz CRYSTAL TIME BASE

\$4.95 (Complete Kit)

Uses MM5369 CMOS divider IC with high accuracy 3.579545 MHZ Crystal. Use with all MOS Clock Chips or Modules. Draws only 1.5 MA. All parts, data and PC Board included. 100 Hz, same as above, except \$5.95.

SILICON POWER SOLAR CELLS

2 Inch Dia. Approx. .5 VDC at 500 MA. In sunlight. Factory new units, not rejects as sold by others. Series for higher voltage, parallel for higher current. Converts solar energy directly to electricity.

LIMITED QUANTITY. \$5⁹⁹ ea

FAIRCHILD PNP

"SUPER TRANSISTOR"

2N4402. TO-92 Plastic. Silicon PNP Driver. High Current. VCEO-40 HFE-50 to 150 at 150 MA. FT-150 MHZ. A super "BEEFED-UP" Version of the 2N3906.

8 FOR \$1.19

JUMBO IC ASSORTMENT

All new not rejects. BIG computer mfg. Surplus. Some standard marked, many house numbered. TTL, DTL, LINEAR. All prime. 1st line.

50 for \$1.59 500 for \$12.95

NATIONAL SEMICONDUCTOR

"COLOSSUS JR." JUMBO CLOCK MODULE



\$8.50

2 FOR
\$15

(AC XFMR \$1.95)

ASSEMBLED! NOT A KIT!

MANUFACTURER'S CLOSEOUT!

PERFECT FOR USE
WITH A TIMEBASE

**MA1013
BRAND NEW!**

- Bright 4 digit 0.7" LED Display
- Complete-Add only Transformer and Switches
- 24 Hour Alarm Signal Output
- 12 Hour Real Time Format
- 50 or 60 Hz Operation
- Power Failure Indication
- LED Brightness Control
- Sleep and Snooze Timers
- Alarm "on" and PM Indicators
- Direct Drive - No RFI
- Direct Replacement for MA1012
- Comes with Full Data

TOSHIBA POWER AUDIO AMP

5.8 WATTS RMS Typical Output. 50 to 30,000 HZ ± 3 DB. For CB's, tape decks, PA's, etc. Works off of a single supply voltage from 10.5 to 18 VDC. 10 Pin plastic DIP with special built in heat sink tab. Perfect for use on 12VDC.

\$3⁹⁹ each

Digital Research: Parts

(OF TEXAS)

P.O. BOX 401247 • GARLAND, TEXAS 75041 • (214) 271-2461

TERMS: Add 50¢ postage, we pay balance. Orders under \$15 add 75¢ handling. No C.O.D. We accept Visa, MasterCard and American Express cards. Tex. Res. add 5% Tax. Foreign orders (except Canada) add 20% P&H. 90 Day Money Back Guarantee on all items.

16K EPROM CARD-S 100 BUSS

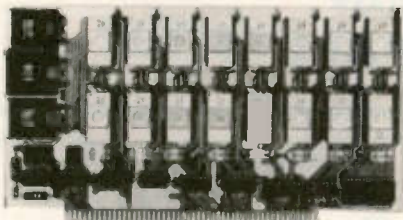

\$59.95

KIT

OUR
BEST
SELLING
KIT!

USES 2708's!

Thousands of personal and business systems around the world use this board with complete satisfaction. Puts 16K of software on line at **ALL TIMES!** Kit features a top quality soldermasked and silk-screened PC board and first run parts and sockets. All parts (except 2708's) are included. Any number of EPROM locations may be disabled to avoid any memory conflicts. Fully buffered and has WAIT STATE capabilities.

OUR 450NS 2708'S
ARE \$8.95 EA. WITH
PURCHASE OF KIT

ASSEMBLED
AND FULLY TESTED
ADD \$25

8K LOW POWER RAM KIT-S 100 BUSS SALE

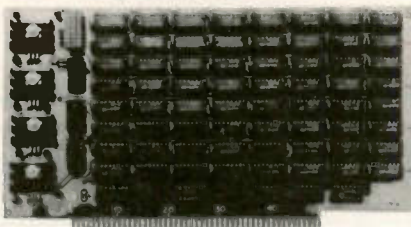

PRICE
CUT!

\$119.50
KIT

(450 NS RAMS!)

Thousands of computer systems rely on this rugged, work horse, RAM board. Designed for error-free, NO HASSLE, systems use.

KIT FEATURES:

1. Doubled sided PC Board with solder mask and silk screen layout. Gold plated contact fingers.
2. All sockets included.
3. Fully buffered on all address and data lines.
4. Phantom is jumper selectable to pin 67.
5. FOUR 7805 regulators are provided on card.

Blank PC Board w/Documentation \$29.95
Low Profile Socket Set...13.50
Support IC's (TTL & Regulators) \$9.75
Bypass CAP's (Disc & Tantalums) \$4.50

ASSEMBLED AND FULLY
BURNED IN ADD \$30

16K STATIC RAM KIT-S 100 BUSS

PRICE CUT!

\$279 KIT

FOR 250NS
ADD \$10

FULLY
STATIC, AT
DYNAMIC PRICES

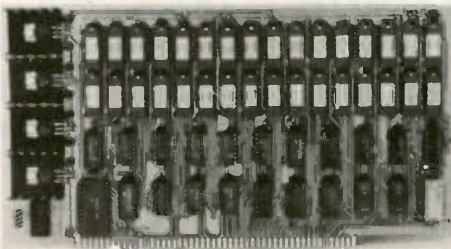

WHY THE 2114 RAM CHIP?
We feel the 2114 will be the next industry standard RAM chip (like the 2102 was). This means price, availability, and quality will all be good! Next, the 2114 is FULLY STATIC! We feel this is the ONLY way to go on the S-100 Buss! We've all heard the HORROR stories about some Dynamic Ram Boards having trouble with DMA and FLOPPY DISC DRIVES. Who needs these kinds of problems? And finally, even among other 4K Static RAM's the 2114 stands out! Not all 4K static Rams are created equal! Some of the other 4K's have clocked chip enable lines and various timing windows just as critical as Dynamic RAM's. Some of our competitor's 16K boards use these "tricky" devices. But not us! The 2114 is the ONLY logical choice for a trouble-free, straightforward design.

KIT FEATURES:

1. Addressable as four separate 4K Blocks.
2. ON BOARD BANK SELECT circuitry. (Cromemco Standard!). Allows up to 512K on line!
3. Uses 2114 (450NS) 4K Static Rams.
4. ON BOARD SELECTABLE WAIT STATES.
5. Double sided PC Board, with solder mask and silk screened layout. Gold plated contact fingers.
6. All address and data lines fully buffered.
7. Kit includes ALL parts and sockets.
8. PHANTOM is jumpered to PIN 67.
9. LOW POWER: under 2 amps TYPICAL from the +8 Volt Buss.
10. Blank PC Board can be populated as any multiple of 4K.

BLANK PC BOARD W/DATA—\$33

LOW PROFILE SOCKET SET—\$12 ASSEMBLED & TESTED—ADD \$30
SUPPORT IC'S & CAPS—\$19.95

16K STATIC RAM SS-50 BUSS

PRICE CUT!

\$275 KIT

FULLY STATIC
AT DYNAMIC PRICES

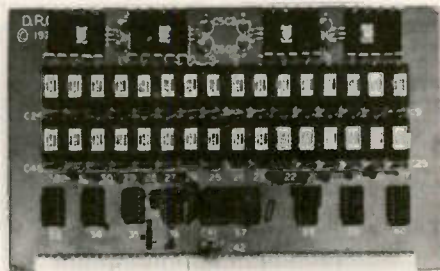

KIT FEATURES:

1. Addressable on 16K Boundaries
2. Uses 2114 Static Ram
3. Runs at Full Speed
4. Double sided PC Board. Solder mask and silk screened layout. Gold fingers.
5. All Parts and Sockets included
6. Low Power: Under 2 Amps Typical

FOR SWTPC
6800 BUSS!

ASSEMBLED AND
TESTED - \$30

BLANK PC BOARD—\$33

COMPLETE SOCKET SET—\$12
SUPPORT IC'S AND CAPS—\$19.95

S-100 Z80 CPU CARD

ASSEMBLED AND TESTED! READY TO USE! Over 3 years of design efforts were required to produce a TRUE S-100 Z80 CPU at a genuinely bargain price! **4 MHZ! \$159.95**

FEATURES:

- * 2 or 4 MHZ Operation.
- * Generates MWRITE, so no front panel required.
- * Jump on reset capability
- * 8080 Signals emulated for S-100 compatibility.
- * Top Quality PCB. Silk Screened, Solder Masked, Gold Plated Contact Fingers.

Perfect For
OEM's

LOW POWER - 250NS 2114 RAM SALE!

4K STATIC RAM'S. MAJOR BRAND, NEW PARTS. These are the most sought after 2114's, LOW POWER and 250NS FAST. **\$7.50 ea. or 8 For \$55**
SPECIAL SALE: (We reserve the right to limit quantities.)

NOT ASSOCIATED WITH DIGITAL RESEARCH OF CALIFORNIA, THE SUPPLIERS OF CPM SOFTWARE.

PROC. TECH. QUILTS THE MICROPROCESSOR BUSINESS!

FACTORY CLOSE OUT - SPECIAL PURCHASE!

#16KRA

16K S-100 Dynamic Ram Board - \$149.95

ORIGINALLY PRICED AT \$429 each!

We purchased the remaining inventory of PT's popular 16K Ram Board when they recently closed their plant. Don't miss the boat! These are brand new, fully tested, ASSEMBLED and ready to go. All are sold with our standard 90 day limited warranty!!

72 Page Full Manual, Included Free!

Digital Research: Computers
(OF TEXAS)

P.O. Box 401565 • GARLAND, TEXAS 75040 • (214) 494-1505

TERMS: Add 50¢ postage, we pay balance. Orders under \$15 add 75¢ handling. No C.O.D. We accept Visa, MasterCard, and American Express cards. Tex. Res. add 5% Tax. Foreign orders (except Canada add 20% P & H. 90 Day Money Back Guarantee on all items.



SPECTRONICS, INC.

1009 Garfield St., Oak Park, Illinois • 60304

(312) 848-6777 ✓S81

BARGAIN FAVORITES!

OUR BEST-SELLING MULTI-BAND!



AS LOW AS
\$73⁷⁵

- One half the length of conventional half-wave dipoles
- Multi-band, Multi-frequency.
- Maximum efficiency — no traps, loading coils, or stubs.
- Fully assembled and pre-tuned — no measuring, no cutting.
- All weather rated — 1 KW AM, 2.5 KW CW or PEP SSB.
- Proven performance — more than 10,000 have been delivered.
- Permit use of the full capabilities of today's 5-band xcvrs.
- One feedline for operation on all bands.

40-10HD/A 40/20/15/10 Mtrs (36)	\$73.75 c
80-40HD/A 80/40 Mtr bands (69)	77.25 c
75/40HD/A 75/40 Mtr bands (66)	73.75 c
75-10HD/A 75/40/20/15/10 Mtr (66)	89.95 c
80-10HD/A 80/40/20/15/10 Mtr (69)	94.95 c

Famous "W2AU" Balun

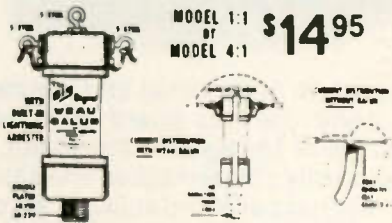

MODEL 1-1
OR
MODEL 4-1 **\$14⁹⁵**

- HANDLES FULL 2 KW PEP AND THEN SOME. Broad Banded 3 to 40 Mc.
- HELPS THE PROBLEMS BY Reducing Coax Line Radiation
- NOW ALL STAINLESS STEEL HARDWARE. SO239 Double Silver Plated
- IMPROVES F/R RATIO BY Reducing Coax Line Pick-Up
- REPLACES CENTER INSULATOR Withstands Antenna Pull of Over 600 Lbs.
- BUILT-IN LIGHTNING ARRESTER. Helps Protect Balun—Could Also Save Your Valuable Gear
- BUILT-IN HANG-UP HOOK. Ideal For Inverted Vees, Multi-Band Antennas, Dipoles, Beam and Quads.

NOW BEING USED BY ALL BRANCHES OF THE U.S. ARMED FORCES, FAA, RCA, CIA, CANADIAN DEFENSE DEPT. PLUS THOUSANDS OF HAM'S THE WORLD OVER

Comes in 2 Models: 1-1 matches 50 or 75 ohm unbalanced (coax line) to 50 or 75 ohm balanced load. 4-1 model matches 50 or 75 ohm unbalanced (coax line) to 700 or 300 ohm balanced load.

Model 1-1 \$14.95 Model 4-1 \$14.95

2 METER ANTENNAS at BARGAIN PRICES!!

hy-gain 3 db GAIN
NEW! MAGNETIC MOUNT
ONLY

Model 287
Wt. 2.5 lbs.

\$19.⁹⁵

An economical alternative to drilling a hole. A magnetic antenna by a name you can trust at a low, low price.

Model 286 Same but trunk lid. \$15.95 b

NEW! **FINCO**
2.8 dbd GAIN
BASE ANTENNA

ONLY **\$9.⁹⁵**

Model A2.GP
Wt. 2 lbs.

At last! An inexpensive, omni directional, 144-148 MHz, 1/2 wave antenna. Fits 1 1/4" mast, 50 ohm imp. A good antenna at a very affordable price.

NEW! FROM **avanti antennas**

ON GLASS MOBILE ANTENNAS

Modern technology lets you mount a mobile antenna right on the window. Ideal for tough installations. 3 models available

AH151.3G 144-174 MHz, 3 db gn.	\$33.95 b
AH220.3G 220 MHz, 3 db gn.	33.95 b
AH450.5G 406-512 MHz, 5 db gn.	36.95 b

IMPROVE YOUR RECEPTION!

AN AMECO ALL-BAND PREAMPI
• 6-160 Meters
• 20+ dB Gain
• Low Price

ONLY **\$49⁹⁵**



MODEL PLF-2 . . . Improves weak signals as well as image and spurious rejection of most receivers. Direct switching to rec. or preamp. Includes pwr. supp. T17 VAC wired & tested **\$49.95**

DIPOLE HEADQUARTERS

CABLE

8U FOAM, hi dens braid 50 ft.	\$12.95 c
8U FOAM, hi dens braid 100 ft.	24.00 e
RG58A/U stranded center 50 ft.	6.95 c
RG58A/U stranded center 100 ft.	9.95 d
RG58 3 ft w/PL259 each end.	3.35 b
RG58 5 ft w/PL259 each end.	4.39 b
RG58 50 ft w/PL259 each end.	9.95 c

COPPER WIRE

#14 stranded, 100 ft spool.	5.95 c
#14 solidcopper enameled 100'.	5.95 c

INSULATORS

Egg Ins, porcelain per pair99 a
DOG BONE, porcelain set of 3	1.50 a
HY GAIN #155 center insulator	5.95 b
HY GAIN Cycolac end ins per pair	3.95 b
MOSLEY dipole center insulator	5.75 a

CONNECTORS

PL259 UHF male, 2 per pkg	1.59 a
SO239 UHF female chassis mt69 a
UG175 Adapts RG58 to PL259, pkg 259 a
UG176 Adapts RG59 to PL259, pkg 259 a
PL258 UHF double female99 a
DM-SP UHF double male	1.69 a
M359 90 deg UHF elbow conn	2.10 a
UG88U BNC male for RG58	1.49 a
1094 BNC female	1.49 a
M358 UHF "T" connector	3.95 a
UG255 UHF female to BNC male	3.49 a
UG273 BNC female to UHF male	2.45 a

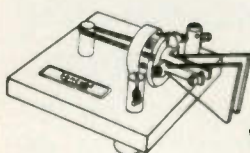

BENCHER

If it's the ultimate in paddles your looking for may we recommend the Bencher. It's simply the nicest one we've seen yet.

BY1 paddle w/black base.	\$39.95 c
BY1 Deluxe model w/chrome base.	49.95 c

DSI

A 550 MHz
COUNTER
FOR UNDER
\$100.00!
\$99⁹⁵

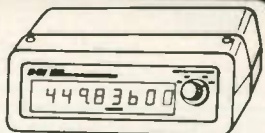

- ONE HOUR easy assembly. • 1 YEAR warranty
- 8 DIGIT readout • 1 Hz resolution • 12 VDC operation • 1/2 INCH LED's • 95% assembled

Whether it's adjusting a 60 Hz. time base, or netting a UHF radio, here's one low cost counter to do it all! Ideal for all types of radios, TV and PLL repair, computer maintenance & construction, and audio amplifier & Receiver repair.

3550 Kit	\$99.95	AC-9 AC Adapter.	\$7.95
T-101 Antenna.	3.95	Shipping & Handling.	2.50

CATALOG SPECIAL —
T101 antenna free!
A \$3.95 value!

NEW from HY-GAIN!

A \$269.95 Value! **TH50XX 5 El.**
ONLY **\$221⁵⁰** 10-15-20 Meter
Beam — Rated Full Legal Power
TRUCK SHIP ONLY Output

HF & VHF BEAMS and VERTICALS



SPECTRONICS, INC.
1009 Garfield St., Oak Park, Illinois • 60304
(312) 848-6777

the antenna
specialists



2 MTR DUCKIES

- Model HM-4. Has 5/16"-32 thread. Fits Motorola HT's. ICOM IC215 and Standard 146A \$7.00
- Model HM-5. Same as above, but with PL-259 connector \$7.00
- Model HM-226. Same, with TNC connector for Wilson 1405 \$18.50
- Model HM-227. Same, but with BNC connector termination \$12.00
- Model HM-228. With F connector for Wilson 1402 & Tempo \$11.50

- HM180 2mtr, 3db trunk lip ant. \$33.50 b
- HM179 2mtr, 3db hole mount ant. 29.00 b
- HM20 2mtr, 3db for marine use. 39.00 b
- HM176 440MHz 5db trunk lip ant. 33.00 b
- HM175 440MHz 5db hole mount ant. 29.00 b
- HM224 220MHz 4db trunk lip ant. 33.50 b



- AR2 2meter Ringo base ant. \$24.95 b
- ARX2 2mtr Ringo Ranger base ant. 39.95 c
- AR220 220MHz Ringo base ant. 24.95 b
- ARX220 220MHz Ringo Ranger. 39.95 c
- AR450 UHF Ringo base ant. 24.95 b
- ARX450 UHF Ringo Ranger bse ant. 39.95 c
- AR6 6 meter Ringo base ant. 36.95 c
- ARX2K Adapts 2M Ringo to Ranger. 16.95 b
- A147-4 4 ele 2M FM beam ant. 24.95 b
- A147-11 11 ele 2M FM beam. 36.95 c
- A147-20T 10 ele 2M vert/horz twist. 62.95 d
- A144-7 7 ele 2M CW/SSB beam. 26.95 c
- A144-11 11 ele 2M CW/SSB beam. 36.95 d
- A144-10T 10 ele Twist OSCAR ant. 42.95 c
- A144-20T 20 ele Twist OSCAR ant. 62.95 d
- A220-7 7 ele 220MHz beam. 26.95 c
- A220-11 11 ele 220MHz beam. 34.95 c
- A449-6 6 ele UHF FM beam. 24.95 c
- A449-11 11 ele UHF beam. 34.95 c
- A432-11 11ele 432MHz SSB/CW beam. 34.95 c
- AFM4D 144-148MHz Four Pole. 69.95 c
- AFM24D 220MHz Four Pole. 64.95 c
- AFM44D 435-450MHz Four Pole. 64.95 c
- ASQ-2 2M Squalo horiz ant. 19.95 b
- LAC-1 Coax lightning arrester. 4.95 a
- LAC2- Coax lightning arrester. 4.95 a
- ATB34 ★ 4 ele 20-10mtr beam. 219.95 ★
- ATV3 20-10mtr trap vertical. 49.95 e
- ATV4 40-10mtr trap vertical. 69.95 e
- ATV5 80-10mtr trap vertical. 89.95 e
- A50-3 3 element 6 meter beam. 39.95 d
- A50-5 5 element 6 meter beam. 59.95 e
- A28-3 ★ 3 element 10 meter beam. 69.95 ★
- A432-20T 432MHz 20 ele twist. 59.95 d

AVERAGE SHIPPING COST GUIDE (Continental U.S.) Items sent UPS whenever possible.

Please estimate the shipping charge for your order. Any excess payment over 25c will be refunded or credited. Underpayment will be billed or sent collect. For insurance add 25c for each \$100.00 value over the first \$100.00.

WT	CALL AREA	ESTIMATED WEIGHT CODING
1 lb.	1, 2, 3, 4, 5, 6, 7, 8, 0, 9	1, 2, 3, 4, 5, 6, 7, 8, 0, 9
5 lbs.	1, 50, 1, 00, 1, 35, 1, 20	1, 50, 1, 00, 1, 35, 1, 20
10 lbs.	2, 25, 3, 20, 1, 35, 1, 20	2, 25, 3, 20, 1, 35, 1, 20
20 lbs.	3, 60, 5, 00, 3, 20, 2, 90	3, 60, 5, 00, 3, 20, 2, 90
30 lbs.	5, 30, 8, 05, 4, 40, 3, 90	5, 30, 8, 05, 4, 40, 3, 90
50 lbs.	8, 40, 12, 90, 6, 80, 5, 35	8, 40, 12, 90, 6, 80, 5, 35

NOTE: INTERNATIONAL ORDERS write for Proforma Invoice. ITEMS MARKED ★ will be sent truck collect.

2M BASE ANT. PACKAGE

Here's what you get:

- Cushcraft AR2 Ringo South River.
- PFM71 Roof mount.
- A125-5P 5' alum mast.
- Lag bolts.
- 50' 8U foam coax.
- PL259 coax conn.

\$59⁹⁵

Wt. 16 lbs.



FINCO

The most rugged 6 & 2 meter beams we've seen yet!!

- A 2-10 10 ele, 2M beam \$44.95 d
- A 2-5 5 ele, 2M beam, 9.5db gain 27.95 c
- A 2-2 10 ele, 2M dual polarization. 46.50 e
- A62 6&2M antenna on one boom 74.95 e
- A6-5 5 element 6M beam, 11db 46.50 d
- A6-3 3 ele 6M beam, 7db gain 30.00 d
- A 1 1/4 220MHz 10 ele, 13.8db 32.95 d



\$9⁹⁵ "BUCK-BUSTER" SF-2 ANTENNA

Fits all Hustler deluxe mobile mounts. 3/8"x24 base. 5/8" wave two meters, 3.4 db gain. SWR at resonance: adj to 1.5:1 or better. Bandwidth: 6 MHz, 2:1 or better SWR. 100 watts max.

\$7995 NEW 4-BTV VERTICAL

One setting covers 10, 15, 20, 40M. Space restricted or unlimited, you get top signal reports, consistent contacts and complete coverage. Add 5th band with a 75M resonator. Use one feedline, any length. Requires no switching or matching devices. 15 lbs.

SF-2

4-BTV

- MO1 Mobile mast \$22.95 c
- MO2 Mobile mast 22.95 c
- RM10 10 Meter resonator 6.95 b
- RM15 15 meter resonator 7.95 b
- RM20 20 Meter resonator 8.95 b
- RM40 40 Meter resonator 14.95 b
- RM75 75 Meter resonator 16.95 b
- RM80 80 Meter resonator 17.95 b
- RM10S 10M resonator 2KW PEP 11.95 b
- RM15S 15M resonator 2KW PEP 12.95 b
- RM20S 20M resonator 2KW PEP 13.95 b
- RM40S 40M resonator 2KW PEP 16.95 b
- RM75S 75M resonator 2KW PEP 31.95 b
- RM80S 80M resonator 2KW PEP 31.95 b
- CG144 5.2db 2mtr ant 1/2" x 24 stud 26.95 b
- CGT144 Same but trunk lip mount 42.95 c
- SF2 3db 2mtr ant 1/2" x 24 stud 9.95 b
- SF220 3db 220MHz ant 1/2" x 24 stud 11.95 b
- 4BTV 40-10mtr vertical 79.95 e
- G6-144 2mtr base ant 6db 79.95 d
- BM1 Bumper mount 1/2" x 24 thread. 15.95 d
- RSS2 Mobile resonator spring 5.95 a
- QD1 Quick disconnect 1/2" x 24 16.95 a



VERTICAL ANTENNAS

- Model 14AVQ/WB **SAVE \$10.00!**
- 40 thru 10 meters List
- Wide band performance \$69.95
- New Hy-Q traps

Self-supporting, automatic band switching vertical antenna. Omni-directional performance. Favorable L/C ratio. High Q True 1/4 wave resonance on all bands. Low angle radiation pattern. Taper swagged seamless aluminum construction. 12" double-grip mast bracket. Full circumference compression clamps at tubing joints. Weight: 8.2 lbs.
Model 14AVQ/WB 59.95

Model 18AVT/WB **SAVE \$18.00**

- Automatic band switching List
- Completely Self-Supporting \$105.00
- Omni-Directional Performance

Three beefed-up Hy-Q traps permit automatic switching 5 band capability. Favorable L/C ratio. Top loading coil. Across the band performance with one furnished setting for each band (10 thru 40). True 1/4 wave resonance on all bands. SWR of 2:1 or less at band edges. Low angle radiation pattern. Extra heavy duty tapered swaged seamless aluminum tubing with full circumference, corrosion resistant compression clamps at tubing joints. Antenna can be mounted without guide wires. 25 high. Weight: 10.7 lbs.
Model 18 AVT/WB 87.00

- BN86 Ferrite balun for 80-10mtrs. \$15.95 a
- 155 Center Insulator for doublet 5.95 a
- 156 End insul. for doublet (pair) 3.95 a
- 18HT ★ HyTower 80-10M vertical 289.95 ★
- 18V Economy 80 tru 10M vertical. 29.95 c
- 12AVQ 20-10mtr trap vertical. 39.95 c
- 14AVQ 40-10mtr trap vertical. 59.95 c
- 18AVT/WB 80-10mtr trap vertical. 87.00 d
- 2BDQ Trap doublet for 80 & 40mtr. 49.95 d
- 5BDQ Trap doublet for 80-10mtrs. 89.95 e
- TH3 MkIII ★ 3 ele 20-10 tribander. 189.95 ★
- TH6DXX ★ 6 ele 20-10M tribander. 264.95 ★
- TH3 Jr 3 ele tribander (750W PEP). 149.95 e
- HY QUAD ★ 2 ele quad 20-10 mtrs. 229.95 ★
- 103BA 3 element 10Mtr beam 64.95 e
- 153BA ★ 3 element 15mtr beam. 79.95 e
- 204BA ★ 4 element 20mtr beam. 214.95 ★
- 402BA ★ 2 element 40 mtr beam. 204.95 ★
- 64B ★ 4 element 6 meter beam 49.95 b
- 270 6db fiberglass 2M antenna. 49.95 b
- 203 3 element 2 meter yagi. 21.95 b
- 205 5 element 2 meter yagi. 17.95 c
- 208 8 element 2 meter yagi. 29.95 c
- 214 14 element 2 meter yagi. 34.95 d

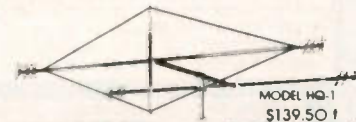

CRAMPED FOR SPACE?

Mini-Products, Inc.

When you want the antenna that's known around the world for its small size and superior performance... The Multiband HYBRID QUAD for 6-10-15 & 20 meters

- WING SPAN-11 FT.
- BOOM-54 INCHES LONG
- WIND AREA-1.5 SQ FT
- 1200 WAITS PEP INPUT TO FINAL
- FEED LINE-50 OHMS

MFJ

GIVE US A TRY ON YOUR MFJ NEEDS. MANY TIMES WE CAN GIVE QUICKER DELIVERY THAN WHEN YOU ORDER DIRECT.

prime products at popular prices

✓G46

MA1003 CLOCK MODULE \$16.50



MATCHING CASE \$5.95 SPECIAL! CLOCK & CASE COMBINATION \$19.95

Here is a clock module designed specifically for mobile applications. No external timebase necessary; a built-in timebase, accurate to .01%, provides the timing accuracy you need. We don't use wash-out prone LED displays, either; instead, you get blue/green fluorescent readouts that are as beautiful as they are readable. No time consuming, tedious assembly; just add two time setting switches, attach 12V DC, and you're ready to go (order our matching case mentioned below for a truly professional look). Additionally, our applications sheet tells you how to take maximum advantage of this module in mobile situations, including how to hook up the display so that it dims at night, and blanks to conserve power when the ignition is off.

Also available: Matching case with mounting hardware, and an optical filter that brings out the best in the clock readouts, for \$5.95.

This clock is not only an excellent addition to your car, van, boat or home, but also makes a great gift. Order now — you'll have it ready to go in plenty of time for holiday giving.

12 VOLT, 8 AMP POWER SUPPLY KIT \$44.50

The original hefty 12V supply, and still going strong... one look at the specs will tell you why this has been our longest-running kit. Handles 8A continuous, and 12A (I) with a 50% duty cycle. Features foldback current limiting, crowbar overvoltage protection, RF suppression, adjustable output 11-14V, heavy-duty custom wound transformer, and much more.

Applications? This supply powers mobile transceivers (ham or CB) in the home, as well as other automotive/home accessories (tape players, radios, TVs, etc.). It also makes an excellent bench supply, or can power bunches of floppy disc drives.

Assembly is about as simple as we can make it: All parts, except for transformer/power diodes/filter capacitors mount directly on the circuit board — including power transistors and heat sinks.

This supply is available from stock. Please include extra postage for this kit, as the transformer adds quite a bit of shipping weight.

NEW! The Godbout Box is here!

At last — a high quality, industrial grade home for your computer. Includes power supply. Use for either desk or rack mount. Check your local computer store for details, or write us direct... this is a product that has been needed for a long time, and we're filling that need in style.

TERMS: Cal res add tax. Allow 5% for shipping, excess refunded. VISA®/Mastercharge® call our 24 hour order desk at (415) 562-0636. COD OK with street address for UPS. Prices good through cover month of magazine. Thanks for your business!

GODBOUT

GODBOUT ELECTRONICS
Bldg. 725, Oakland Airport, CA 94614

FREE CATALOG: This ad is way too small to tell you all the things you need to know about our products, and why we feel they're second to none in the business. Send for our free catalog today.

NEW S-100 COMPUTER PRODUCTS!

S-100 machines are flexible, professional level systems that are easy to upgrade, modify, and adapt to specific applications. Over the years the S-100 buss has proven to be the ideal choice for commercial, industrial, and scientific applications.

We're expanding the options for S-100 systems by using the experience we've acquired in the past, mixing in the best technology offered by the present, and building products for the future... products that meet, and often exceed, the demands of the new wave of S-100 professional users. For example...

NEW! HIGH-PERFORMANCE S-100 MOTHERBOARDS

19 slot: \$174 unkit*, \$214 assm
12 slot: \$129 unkit*, \$169 assm
6 slot: \$89 unkit*, \$129 assm

*"Unkits" have edge connectors and termination resistors pre-soldered in place for easy assembly.

These 3rd generation motherboards are shielded, terminated, and designed to work with the latest 5 and 10 MHz CPUs coming on line. Fits in Godbout, vector, IMSAI, TEI, and similar enclosures. These high quality products are a welcome addition to any system — or the start of a great one.

2S "Interfacer" S-100 I/O Board \$189 unkit, \$249 assm, \$324 CSC**

Dual serial port with 2 full duplex parallel ports for RS-232 handshake. Crystal timebase, Baud rates up to 19.2 Kbaud selectable for each port, much more.

NEW! 3P + S "Interfacer II" S-100 I/O Board \$189 unkit, \$249 assm, \$324 CSC**

Incorporates 1 channel of serial I/O (with all the features of a port from the 2S "Interfacer"), along with 3 full duplex parallel ports with attention/enable/strobe bits for each parallel port and individual interrupts. The versatility of each port contributes to a very versatile, and extremely flexible, I/O board.

NEW! S-100 "Memory Manager" Board \$59 kit, \$85 assm, \$100 CSC**

Add bank select and extended addressing to older S-100 machines — boost memory capacity beyond 64K, up to 1/2 megabyte! Use our new extended addressing memory boards, or retrofit existing memories that have phantom or extra qualifier lines.

... AND DON'T FORGET OUR MEMORIES!

All our memory boards are fully static, zip along with 4 or 5 MHz systems, include a 1 year limited warranty, and are available in 3 different configurations (unkit for lower costs, assembled and tested, or CSC**). Here are just some selections from our roster of 14 Econoram™...

Name	Buss & Notes	Unkit	Assm	CSC**
8K Econoram IIA	5-100	\$149	\$179	\$239
32K Econoram X	5-100	\$529	\$649	\$789
24K Econoram XII	5-100 (1)	\$329	\$419	\$519
16K Econoram XIV	5-100 (2)	\$289	\$349	\$448
16K Memory Expansion	(3)	\$87.20	n/a	n/a

Notes

- (1) Bank select board - 2 independent banks addressable on 8K boundaries.
- (2) Extended addressing (24 address lines)
- (3) Chip set expands memory in Radio Shack-80, Apple, and Exidy Sorcerer computers.

**CSC boards are qualified under our high-reliability Certified System component program (200 hour burn-in, replacement in event of failure within 1 year of invoice date).

ASSOCIATED RADIO

913-381-5900

8012 CONSER BOX 4327

OVERLAND PARK, KANSAS 66204



CALL US WITH YOUR REQUIREMENTS
AMERICA'S NO. 1 Real Amateur Radio Store



**(Associated Wants to TRADE - BUY - SELL)
GOT YOUR BEST DEAL? THEN CALL US AT
913-381-5900 - NO TRADE? ASK FOR EXT. 12)**

**NOTE: SEND \$1.00 FOR OUR CURRENT CATALOG
OF NEW AND RECONDITIONED EQUIPMENT.**

*** ALSO WE PERIODICALLY PUBLISH A LIST OF
UNSERVICED EQUIPMENT AT GREAT SAVINGS.
A BONANZA FOR THE EXPERIENCED OPERATOR.
TO OBTAIN THE NEXT UNSERVICED BARGAIN LIST,
SEND A SELF ADDRESSED STAMPED ENVELOPE.**

POLY PAKS "PRE HOLIDAY" SPECIALS



BURROUGHS CONSTANT VOLTAGE 5-12-24V TRANSFORMER

• With Resonant 2.5mf @ 60VAC Oil Input Constant Voltage Capacitor

The best overall power supply transformer we've ever carried! Input: 86 to 284 VRMS 60Hz. Output: 5 VDC @ 24A Cont. (28A max.), ± 12 VDC @ 11A (14A max.), and 24 VDC @ 11A, (14A max.) Ideal for multiple voltage computer systems! Size: 4" x 3 1/2" x 3 1/4" Stack: 1.7/8" thick x 4" x 3-1/8". Mtg. centers: 4" x 2 1/4". Wt: 6 lbs. With diagram & data sheets. Cat. No. 92CU5861

Only \$24.95

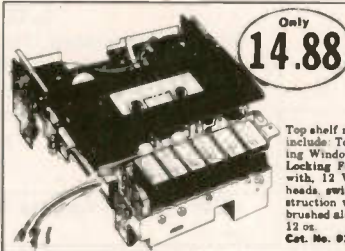

Only 14.88 AUDIO/COMPUTER STEREO CASSETTE DECK

Top shelf mechanisms at this bargain basement price! Features include: Top Load Design, Pushbutton Operation, Tape Monitoring Window, and individual keys for: Stop/Eject, Play, Record, Locking Fast Forward, Locking Rewind, and Pause. Complete with 12 VDC belt-drive motor, stereo play/record and erase heads, switches and solenoid. Device boasts rugged metal construction with black plastic tape compartment and keys with brushed aluminum pads. Size: 7-1/8" x 5-1/4" x 3-5/8". Wt: 2 lbs, 12 oz. Cat. No. 92CU5861

only \$2.95 3 ELEMENT 120 VAC HOTPLATE

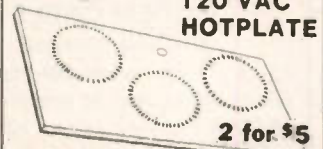

This Top Quality, Multi-Purpose Hotplate features Built-in Thermostat, Neon "Red" AC Indicator Lamp, and 1/8" Textured Glass Surface for even heat distribution. Generates up to 150° C. 120 watt! Use for photographic applications, laboratory work, aquarium heater, plants, etc. Size: 10 3/8" x 5-3/8" x 1/8". Wt. 1 lb. 2 oz. Cat. No. 92CU5723

2 for \$5

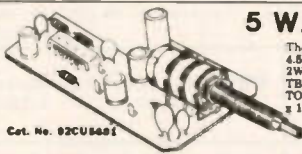

5 WATT MONO AMPLIFIER

These popular, multi-purpose units require 12 VDC to produce 4.5W RMS, (5W max.) into 4 ohms from 20-40 KHz. THD: 0.8% @ 2W @ 1 KHz. Other features include: heat-sinked SGS/ATES TBA-641B amp chip, concentrically mounted ON/OFF-VOL and TONE controls, and dual source input capability. Size: 2 1/8" x 4 1/4" x 1 1/4". Wt: 8 oz w/hookup sheet.

\$4.88 each 2 for \$8.00

FRAME FILM STRIP PROJECTOR WITH CASE

High quality ELBA "VIP" 35mm projector sets feature: 115 VAC 60 Hz. AC motor, remote pushbutton control, (to advance the film strip and wind it on lower spindle) and Sylvania type CAR 150W lamp. Unit comes in an attractive granular finish Samsonite carrying case. Case has 10 x 12 1/2" rear projection screen built into the cover, along with AC socket & extension cord, and polyfoam insulation which is cut out to fit the projector in transit. Size: 18 1/2" x 18 1/4" x 4 1/2". Wt: 13 lbs. 4 oz. With instructions. Cat. No. 92CU5864



• 35mm • Worth Over \$100

\$49.95

STEREO AM-FM-MPX TUNER/AMPLIFIER

Slide volume, bass, treble, balance controls! 2 & 4 speaker systems.

\$39.95

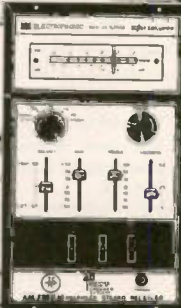

"CRIMP-ON" PL-259 COAX PLUG 4 for \$1.29

Quick, Easy plier crimping. No Soldering! Strip insulation-ease. Mats to SO-339, For R355/U-58/U.



"TIE-PIN" CONDENSER MIKE

It's a little giant in sound quality. Metal encased, and omnidirectional. Frequency response 20-20,000 Hz. Less tie pin or lapel clip. 600 ohm impedance. 1.5 VDC. Cat. No. 92CU5730

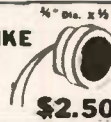

\$2.50

NEW 12 VOLT ROTARY SOLENOID

Similar to Ledes model 1E, combines SPST, SPST, & DPST in a single device. Interior shaft rotates 360° in 12 "steps". Unit switches 1 "step" when 12V surge is applied. Rated: 12 VDC @ 125A, only 1-3/8" (dia.) x 2-3/8". Metal encased. Color-coded wires extend from front. Uses standard rotary contact wafer system. Wt: 7 oz. With specs. Cat. No. 92CU5852

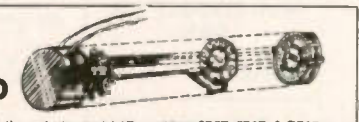

\$3.95 EACH 3 for \$11.00

LEDS! LEDS! LEDS! Your Choice under \$2.49

Cat. No. 92CU5857

1782	MICRO TOPHAT RED
1802	MICRO SINGLE PIN RED
1948	MICRO YELLOW
2135	JUMBO RED
2136	JUMBO TAPER RED
2137	MICRO RED
1944	Jumbo Yellow
2138	Jumbo Green

1N4000 Epoxy Rectifiers

Cat. No.	Type	Volts	Size	Price
2377	1N4001	50	10 Ter.	\$.75
2378	1N4002	100	10 Ter.	\$.85
2379	1N4003	200	10 Ter.	\$.95
2380	1N4004	400	10 Ter.	1.19
2381	1N4005	600	10 Ter.	1.39
2382	1N4006	800	10 Ter.	1.49
2383	1N4007	1000	10 Ter.	1.59

MINI LECTROS

MFD.	VOLTS	LEADS	SALE
26	15	Asiel	14
26	25	Asiel	17
50	15	Asiel	17
50	25	Asiel	19
50	100	Asiel	21
100	10	Asiel	23
100	50	Asiel	25
220	25	P.C.	32
300	25	P.C.	33
500	15	P.C.	33
500	25	P.C.	34
1000	15	P.C.	35
1000	25	Asiel	39

Order by Cat. No. 92CU8718 and Value



HY-GAIN BANDIT MIKES

Take one hand command of your mobile or base, rig with Hy-Gain's One Arm Bandit Mike. ON/OFF, VOLUME, SQUELCH, CHANNEL SELECTOR, SPEAKER, and DIGITAL DISPLAY are all conveniently located where your fingers do the talking. Comes with 6 ft. multi-conductor, color-coded, coiled cable. (separate) for easy integration into any type of rig. Size: 4 1/4" x 2 1/4" x 1 1/4". Wt. 9 oz. No. 92CU8686



Only \$9.95

HY GAIN LED CLOCK KIT*

*Kit consists of a 3 pc set, transformer, function switches on a board, and a National MA1012A digital clock module with all parts and IC chip mounted on a 3" x 1 3/8" (2-10 pc board). The RED filtered module measures 3" x 3/4" x 3/16". The PC board module is mounted in a bakelite frame 3 7/8" x 1 3/4" x 1/8" with 2 holes for easy panel mounting. (3/4" on centers).



\$9.95

2000 DEGREE SOLAR FURNACE Only \$895

Giant Fresnel Flat Magnifying Lenses

Very different! It's unusual! Magnifies like a series of small concave mirrors around the edge of the lens, acting like a giant prism. Light waves that hit it, acting like a magnifying glass, intensify and extremely heat the target. Harvests the sun's energy with the Fresnel lens (panel) Focus the sun on any target. It burns into flames within seconds! Size 24" x 24" x 1 1/2". Wt. 15 lbs. \$895.00

ULTRASONIC TRANSDUCER \$298

Perfect for dozens of projects, including remote control devices, alarms, etc. Bends and Receives 1" diameter, 1/2" deep, with standard RCA type phono jack. Wt. 2 oz. Cat. No. 92CU8375

When ordering always use catalog number, type no. the name of the magazine you're ordering from and the month

HOW TO ORDER FOREIGN AND CANADIAN POSTAGE

CANADIANS ADD \$5.00 (U. S. Funds) FOREIGN ADD \$10.00 EXCESS WILL BE RETURNED

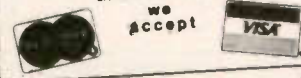

40 CHANNEL CB ON A BOARD \$9.99

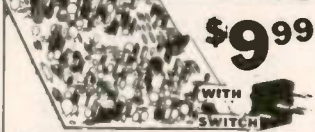

Poly Pak buys up factory close-out from Hy-Gain... so you gain! Boards have: Heat-sinked 9 Watt Amp Chip, RF and Mod. Transformers and Motorola MC-series PLL. May be used for 10 meter conversion, (see continuing series "CB to 10" in 73 magazine). The parts alone make it an offer you can't refuse. Wt. 9 oz. Cat. No. 92CU884

PARALLEL ENTRY DIGITAL PRINTER \$9.95

These unique printers feature precision Swiss construction. 18 key columns are divided into 16 for numerals and 2 for alphabetical and trig figures, and mathematical functions. Each wheel is 18 position. Utilizes 2 7/8" wide adding machine tape, and dual color ribbon. Printing technique: parallel pressure printing, multiple copies. Print Rate: 3 lines per second. Operating voltage: 22 to 28 VDC. Comes in original packing w/roll of tape. Size: 6-1/2" x 3-1/8" x 5-3/8". Wt. 7 lbs

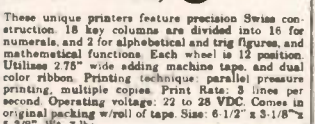

"SKINNY-TRIMS" POTENTIOMETERS

3/8" square Single-turn style Screw-driver adjust. 20% tolerance, 0.5 Watt ratings, ceramic construction. PC leads. ORDER BY CAT. NO. AND VALUE

Type-03	SINGLE TURN FLAT
10	100 1K 5K 25K 200K
20	200 2K 10K 50K 500K
50	500 2.5K 20K 100K 1Meg

Cat. No. 92CU8864

LED WATCH GUTS \$1.49

Cat. No. 92CU8115C

POLY PAKS®

P.O. BOX 942-A11 SO. LYNNFIELD, MA 01940

Terms: Add Postage Rated: Net 30

Phone: (617) 245-3828

Retail: 16-18 Del Carmine St.

MINIMUM ORDER: \$8 Wakefield, MA

7294 N.W. 54 STREET
MIAMI, FLORIDA 33166

SURPLUS ELECTRONICS CORP. ✓S43

PHONE: (305) 887-8228
TWX: 810-848-6085
WHOLESALE · RETAIL

<p>PL259's/SO 239's Quality American Made 10/\$5.00 100/\$35.00 50/\$20.00 1000/\$300.00</p>	<p>CB SPECIAL Brand new printed circuit board assembly. Used in all HyGain 40 channel CB transceivers. Fits many other manufacturers' units also. Squelch pot/volume control/channel selector switch not included. 1- 9—7.50 ea. 50-99—6.00 ea. Board Dimensions 6" x 6 1/2" 10-49—6.50 ea. 100-up—5.50 ea.</p>		<p>IC SOCKETS Cambion Gold Plated Wire Wrap 14 pin .35 ea 10/\$3.00 16 pin .38 ea 10/\$3.30</p>
<p>E. F. Johnson NICAD 12.0 V. 1.2 AH @ 10 hr rate 4 1/2" x 1 7/8" x 1 3/4" \$1495ea.</p>	<p>NEW Hy-Gain Remote 40ch CB Less Case, Speaker & Control Mic (as is) \$14.95 ea</p>		<p>SIGNAL DIODE IN 4148 \$5.00 PER 100 25.00 PER 1000 OR 15 FOR \$1.00</p>
<p>E F Johnson External Battery Charger Model 239-0206-001, Output 14.5 V dc @ 50 mA. \$3.50 ea.</p>	<p>Serviceman Special New Hy-Gain 40ch CB Less Case, Speaker & Knobs (as is) \$14.95 ea</p>		<p>MODEM CABLE 50' cable contains 13 # 22 ga. wire DB-25p with DB-51226-1 cover on one end \$6.50 ea 10/\$50.00</p>
<p>E. F. Johnson S Meter Edge Meter 250 UA. Fits in 5/8" x 1-3/8" hole. MTG holes on each end 1-1/4" behind panel. Black scale 0-5 bottom 1-20 top \$1.25ea. 5/\$5.00</p>	<p>ASTATIC T-UG8-D104 PREAMP Desktop microphone w/crystal element 3 Pin Plug \$35ea.</p>	<p>NEW E.F. Johnson Power Mic/Less Cord. Desktop Style \$19.95 ea</p>	<p>EFJ CRYSTAL OVENS 6V/12V 75° \$5.00 ea.</p>
<p>Edge meter same as above with silver scale and reads SWR 1-10 \$1.25ea 5/\$5.00</p>	<p>New 40 CH CB Boards 1-9 \$10.50 ea 10-49 \$9.50 ea w/40 ch SW 50-99 \$9.00 ea 100-up \$8.50 ea</p>		<p>Double Row/Solder Eyelet .156 6 pins \$1.10 ea 10/\$ 9.00 15 pins \$1.55 ea 10/\$12.50 22 pins \$2.08 ea 10/\$17.00 43 pins \$3.66 ea 10/\$30.00</p>
<p>E. F. Johnson Signal Strength Meter 200 UA 2 1/2" x 2 1/2" Sq. mounts in 1 1/4" hole 1" behind panel. Scale: 1-30 db top 0-5 bottom. \$4.95ea 5/\$20.00</p>	<p>22 pins/Double Row/Dipped Solder .156 \$2.08 ea 10/\$17.00</p>	<p>22 pins/Double Row/Wire Wrap .156 \$2.44 ea 10/\$19.00</p>	<p>100 ASSORTED DISC CAPS (FULL LEADS) 20 EA OF 5 DIFFERENT VALUES \$2.00 PER PACK</p> <p>RECEIVER FRONT ENDS Made by EFJ 132-174 MHz \$12.00 ea.</p>
<p>PANEL METERS \$4.00 ea 2 for \$7.00</p> <p>25-0-25 dc Volts } 2 1/4" x 3" 0-25 dc Volts } 0-50 ac Volts } 2 1/4" x 2 1/4" -Shunt Required-</p>	<p>MINI TOGGLE SW C&H SPDT \$1.00 ea 6/\$5.00</p>	<p>2 SIDED .062 Copper Clad Board 9 1/4" x 10 1/4" \$2.00ea 3/\$5.00</p> <p>Sony RK64A 2 conductor mini phono plug w/patch cord 3' long \$2.00ea</p>	
<p>Double Row/Wire Wrap .100 25 pins \$3.49 ea 10/\$30.00 30 pins \$3.96 ea 10/\$32.00 50 pins \$5.43 ea 10/\$45.00</p>	<p>E. F. Johnson 40ch Selector Switch \$3.50ea</p>	<p>POLYFOAM COAX—50 OHM Equal to RG174 \$4.95/100' Low Loss Polyfoam Coax Cable</p>	<p>TRIMMER CAPS Small enough to fit in your watch— 3.5 to 20 pF 5 to 30 pF \$.75 ea., 2 for \$1.25 5 for \$3.00</p>
<p>C & K SWITCHES PART # MOVEMENT 7101 ON/NONE/ON SPST 7103 ON/OFF/ON SPST 7107 ON/NONE/ON SPST 7108 ON/NONE/ON SPST 7201 ON/NONE/ON DPDT \$1.00 EA 6 FOR \$5.00</p>	<p>12 Vdc RELAY SPST Open Frame 5 Amp Contacts Mfg-Magnecraft \$1.50 ea 4/\$5.00</p>	<p>STANCOR TRANSFORMERS STEP-DOWN AUTO (3) COND LINE CORD W/RECPT GSD 200 (230V In/115V Out @ 200 Va) \$12.00 ea GSD 400 (230 In/115 V Out @ 400 Va) \$14.50 ea</p>	<p>CAPS 2200 UF @ 16V Radial Leads .25 ea. 10/\$2.00</p>
<p>6 TV GAMES ON (1) CHIP Gen Instr AY-3-8500-1 28 Pin Plastic Case EVERYDAY LOW PRICE \$7.50 ea</p>	<p>12 Vdc RELAY SPST 35 Amp Contacts Open Frame Rugged, great for mobile use \$4.50 ea 5/\$20.00</p>	<p>CRYSTAL FILTERS 10.7 3/Lead Can Type \$3.00 ea.</p>	<p>White Porcelain Egg Insulator 1 1/2" x 1" 50c ea. 3 for \$1.25</p>
	<p>Coax Connectors UG-273/U BNC-F/UHF-M 2.50 UG-255/U BNC-M/UHF-F 3.00 UG-146A/U N-M/UHF-F 4.50 UG-83B/U N-F/UHF-M 4.50 UG-175 RG-58 Adapt. .20 UG-176 RG-59 Adapt. .20</p>	<p>CERAMIC IF FILTERS EFC L455K \$3.50 ea.</p>	

ASSORTED ELECTROLYTICS

VALUE/MFD	VOLTS	DIA	LENGTH	PRICE										
250,000	@ 5V	3"	53/4"	\$4.00 ea	21,000	@ 25V	2 1/2"	x	3"	3.00 ea				
30,000	@ 15V	3"	4 1/2"	4.00 ea	39,000	@ 45V	3"	x	53/4"	3.00 ea				
63,000	@ 15V	3"	5 1/2"	4.00 ea	1,000	@ 50V	1 1/2"	x	3 1/4"	2.50 ea				
10,000	@ 20V	1 1/2"	53/4"	3.00 ea	34,800	@ 50V	3"	x	5 1/2"	3.00 ea				
2,700	@ 25V	1 1/4"	2 1/4"	2.00 ea	450	@ 75V	1 1/4"	x	2 1/4"	2.00 ea				
2,900	@ 25V	1 1/4"	2"	2.00 ea	500	@ 100V	1 1/2"	x	3 1/2"	2.00 ea				
3,000	@ 25V	1 1/2"	4 1/2"	2.00 ea	240	@ 300V	1 1/4"	x	3 1/4"	2.00 ea				
18,000	@ 25V	2"	4"	3.00 ea	50	@ 450V	1 1/4"	x	2"	2.00 ea				
					140	@ 450V	1 1/4"	x	3"	2.00 ea				

TERMS: All material guaranteed • If for any reason you are not satisfied, our products may be returned within 10 days for a full refund (less shipping). Please add \$3 for shipping and handling on all orders. Additional 5% charge for shipping any item over 5 lbs. COD's accepted for orders totaling \$50.00 or more. All orders shipped UPS unless otherwise specified. Florida residents please add 4% sales tax. Minimum order \$15.00.

EQUIPMENT / COMPONENTS / WIRE & CABLE / ACCESSORIES

SEMICONDUCTORS SURPLUS

✓S63

2822 North 32nd Street/Unit -1 Phoenix, Arizona 85008 (602) 956-9423

We accept checks, MasterCharge, and Visa

Prices subject to change without notice

TEKTRONIX IL30 SPECTRUM ANALYZER Plug-In 925 MHz-10.25 GHz \$899.00	ANTENNA ROTOR CABLE Columbia #04083 8 Cond. 2-#18, 6-#22 100 FT Spools \$10.99	ITT/JENNINGS VACUUM RELAYS SPST NORMALLY CLOSED MODEL RF-2B-26S 26.5 VDC \$19.99
MICROWAVE PARTS HP-5082-2835/IN5712 MDB 101 \$1.50 MRF 901/911 \$3.00 .001 chip cap \$1.00	<div style="text-align: center;"> <p>MONSANTO</p> <p>FREQUENCY</p> <p>COUNTER</p> <p>10-512 MHz</p> <p>\$299.00</p> </div>	CARBIDE DRILL BITS 5 for \$5.99 (MIX) #61 for \$1.99 each
TEKTRONIX model 575 transistor curve tracer \$300.00		SOLID STATE TUBES 1N2637/866/866A/3B28 \$9.99 each
HP851B/8551B MICROWAVE SPECTRUM ANALYZER: 10 MHz-40 GHz = 1 GHz gate. \$3599.00		SOLID STATE RELAYS CRYDOM CONTROLS MODEL D2425-GP 3-32 VDC INPUT 240 VAC @ 25 Amps \$9.99 each
POLARAD SPECTRUM ANALYZER DU2/TSA-W with STU-2W plug-in 910-4560 MHz \$399.00		SPRAGUE CAP. CAN TYPE 150 MFD @ 450 VDC MODEL 68D10688 \$2.99
TEKTRONIX 3T77 SAMPLING plug-In 10ps to 0.2us 10X Magnifier Single Sweep will work in tek. 560 series scopes \$199.00	<div style="background-color: black; color: white; padding: 10px; font-size: 2em; font-weight: bold; transform: rotate(-2deg);"> SURPLUS </div>	UNELCO RF CAPS.# 350 VDC 6.8 pf, 10 pf, 12 pf, 13 pf 43 pf, 100 pf, 200 pf, 820 pf & 1000 pf ALL \$1.00 each
TRW CA602/CA2601BU Microelectronics Broadband Amplifier. 15 to 270 MHz 30 db Gain Maximum Supply, Voltage 30 Vdc \$9.99 each		TEKTRONIX 5" CrtS. 545 Type Part # 154-0409-00 NEW... \$99.99 each
BURROUGHS 100-Element Dual Linear Bar Graph Display Model BG-16101-2 \$9.99 each DATA 50¢ each	ALPHA METALS SOLDER 1 LB 60/40 .032 \$9.99 per pound	MABUCHI 375S-2265 Heavy Duty, High Torque Permanent Magnet 1½ to 9 VDC W/O Lead .25 Amp. Generates tach .75 V @ 1000 RPM. 1½ VDC 1000RPM 3 VDC 2400RPM 4.5 VDC 5500RPM 6 VDC 7700RPM MOTORS \$1.99 each
TEKTRONIX-190A constant amplitude signal generator .35 through 50 MHz, 50 KC. Priced at \$150.00	SST A-1 VHF AMPLIFIER Kit \$29.95 each	<p>ALL EQUIPMENT IS FOB</p> <p>PHOENIX</p>
STANDARD POWER SUPPLY MODEL SPS-120-5 5 VDC @ 12 AMPS (NEW) \$59.95 each	POWERTEC POWER SUPPLY MODEL 2B5-3 5 VDC @ 3AMPS REMOVED FROM NEW EQUIPMENT \$19.99 each	
KILOVAC VACUUM RELAYS SPDT 26.5 VDC H-8/S4 \$32.95 HC-1/S75 \$29.99		

BULLET ELECTRONICS

B8 P.O. Box 401244-E Garland, Texas 75040 (214) 278-3553

AY3-8910 PROGRAMMABLE SOUND GENERATOR

The AY3-8910 is a 40 pin LSI chip with three oscillators, three amplitude controls, programmable noise generator, three mixers, an envelope generator, and three D/A converters that are controlled by 8 BIT WORDS. No external pots or caps required. This chip hooked to an 8 bit microprocessor chip or Bus (8080, Z80, 6800 etc.) can be software controlled to produce almost any sound. It will play three note chords, make bangs, whistles, sirens, gunshots, explosions, bleets, whines, or grunts. In addition, it has provisions to control its own memory chips with two IO ports. The chip requires +5V @ 75ma and a standard TTL clock oscillator. A truly incredible circuit.

\$14.95 W/Basic Spec Sheet (4 pages)
60 page manual with S-100 interface Instructions and several programming examples, \$3.00 extra

SE-01 SOUND EFFECTS KIT

• 76477 CHIP IS INCLUDED. EXTRA CHIPS \$2.95 EACH

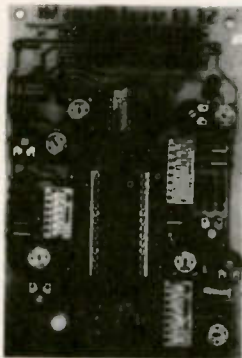

The SE-01 is a complete kit that contains all the parts to build a programmable sound effects generator. Designed around the new Texas Instruments SN76477 Sound Chip, the board provides banks of MINI DIP switches and pots to program the various combinations of the SLF Oscillator, VCO, Noise, One Shot, and Envelope Controls. A Quad Op Amp IC is used to implement an Adjustable Pulse Generator, Level Comparator and Multiplex Oscillator for even more versatility. The 3 1/4" x 5" PC Board features a prototype area to allow for user added circuitry. Easily programmed to duplicate Explosions, Phasor Guns, Steam Trains, or almost an infinite number of other sounds. The unit has a multiple of applications. The low price includes all parts,

assembly manual, programming charts, and detailed 76477 chip specifications. It runs on a 9V battery (not included). On board 100MW amp will drive a small speaker directly, or the unit can be connected to your stereo with incredible results! (Speaker not included).

• \$16.95
LESS SPEAKER & BATTERY

ALLOW 3 WKS. FOR DELIVERY

A RARE FIND! LAMBDA HIGH POWER REGULATOR 3205 MODULE

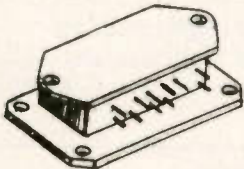

\$12.95
W/SPECS
LIMITED QTY.

- 5V @ 10A with 8-30VDC Input.
- Current limiting, thermal shutdown and short protection.
- 2% Load regulation.
- Only 2 external components needed.

All you need to add is a transformer, rectifier, heatsink and filter cap to have a super regulated supply for 5volts at 10 amps!

SPECIAL BONUS! Order the 3205 Module and get FREE a LAMBDA L-20-5 overvoltage protector that triggers at 6.6 volts up to 20 amps.

LAS15U - 1.5A Four Terminal Adjustable Regulator. 3-30V W/current limiting, short protection and thermal shutdown. TO-3 style. All units are prime. Spec sheets included. **\$2.50**

- * NO C.O.D.'s
- * SEND CHECK M.O. OR CHARGE CARD NO.
- * PHONE ORDERS ACCEPTED ON VISA AND MASTERCARD ONLY.
- (214) 278-3553 9:00 AM - 6:00 PM CST
- * ORDERS OVER 1 LB. SHIPPED VIA UPS

P
O
L
I
C
I
E
S

4 DIGIT 1/2 INCH CHARACTER LED DISPLAY
Bowmar readout stick with colons. COMMON CATHODE ONLY. 100% Prime. All segments and colons brought out to edge pads. With pinout. LIMIT 5 PER CUSTOMER



SPECIAL
\$1.90

From T.I.: TL490 BAR/DOT DRIVER IC. Drives 10 LED's with adjustable analog steps. Units are cascadable up to 10 (100 steps). Drives LED's directly. Great for voltage, current, or audio displays. Similar in features to LM3914 with specs and circuit notes.

2.95

NEW!



XAN SUPER DIGITS

.6" JUMBO LED
7 SEGMENT
RED

99¢

6640 COMMON ANODE
6920 COMMON CATHODE



NOW A SUPER READOUT AT A SUPER BUY! These are factory fresh prime LED readouts, not seconds or rejects as sold by others. Compare our price and send for yours today, but hurry, the supply is limited! SPECIFY: COMMON ANODE OR COMMON CATHODE

NEW ITEMS

LM3046	(CA3046) Transistor Array	.75
LM3909	Led Flasher	.50
CA3086	RCA Transistor Array	.80
MC1438R	Power Op Amp/Driver	.50
1N4148	Prime, Full Lead	100/2.50
LM3302	Quad Comparator	.89
2SC1849	High Freq NPN TO-92	6/1.00

POTENTIOMETER ASSORTMENT

A mix of new, panel mount 3/8" bushing pots in various values. Some dual, some with switches.

10/2.00

1/2W RESISTOR ASSORTMENT

A good mix of 5% and 10% values in both full lead and PC lead devices. All new, first quality.

(Asst.) 200 pieces/ 2.00

SLIDE SWITCH ASSORTMENT

An outstanding bargain. Includes miniature and standard sizes and multiposition units. All new first quality, name brand switches. Try one pack and you'll reorder more: SPECIAL — 12 for \$1.20 (Assortment)

- * ADD 5% FOR SHIPPING
 - * TX. RES. ADD 5% STATE SALES TAX
 - * FOREIGN ORDERS ADD 10% (EXCEPT CANADA) (20% AIRMAIL) U.S. FUNDS ONLY.
 - * SORRY WE CANNOT SHIP INSURED TO MEXICO
- PRICES SUBJECT TO CHANGE WITHOUT NOTICE.

9500@75V Filter Cap
Computer Computer 2"x5 1/2"
Grade 2.95

ZENER GRAB BAG

A very nice assortment of 1/4, 1/2 & 1W zeners. Voltage ranges are from 2.7 to 30 VDC. Most have house # but we provide a cross over list to standard numbers. A great buy for any shop. 12 different types.

.50 ea.

MC1469R POSITIVE VOLTAGE REGULATOR

1/2 AMP COMPLETE SPECS AND APPLICATIONS SHOW HOW TO BUILD FIXED OR VARIABLE POWER SUPPLIES FROM 3 TO 30VDC DRIVE EXTERNAL SERIES PASS FOR CURRENT TO 20 AMPS!

1.25 EA.
10/10.00
HOUSE #



QUAD MATCHED DIODES

4 1N914 type diodes that have been closely matched for use in bridge and balanced modulator circuits.

50¢ ONE SET (4)

PARTS

301 OP AMP 8 LEAD CAN	3/1.00
723 VOLT REG 10 LEAD CAN	.50
*13741 FET INPUT 741 MINI DIP	3/1.10
30.000 @ 15V COMPUTER GRADE	2.10
2N4400 NPN GEN PURPOSE	8/1.00
2N4402 PNP COMPLIMENT	8/1.00
2N6028 P.U.T. W/SPECS	.50
LM380 2W AUDIO IC W/SPECS	1.00
LM377 DUAL LM380 W/SPECS	2.50
*7815 VOLT REG 1A 15V	.69
*725 LOW NOISE OP AMP	.99
IL-1 OPTO ISOLATOR MINI DIP	.60
*MEM 631 DUAL GATE MOSFET. DIODE PROTECTED SIMILAR TO 40673	.50
MV1624 VARICAP DIODE 10 PFD	.49
1N4003 1A 200V DIODE	15/1.00
TIP30 TAB PWR FET	3/1.00
*MC1351P FM IF. DISC IC	.50

*INDICATES ITEM IS "HOUSE NUMBERED"

LED'S

JUMBO GREEN	4/.89
JUMBO RED	5/.89
MEDIUM RED (1/4")	.15
MEDIUM GRN OR YELLOW	.16

7 WATT AUDIO AMP KIT

SMALL SINGLE HYBRID IC AND COMPONENTS FIT ON A 2" x 3" PC BOARD (INCLUDED). RUNS ON 12 VDC. GREAT FOR ANY PROJECT THAT NEEDS AN INEXPENSIVE AMP. LESS THAN 3% THD @ 5 WATTS. COMPATIBLE WITH SE-01 SOUND KIT. **\$5.95**

6 DIGIT AUTO/VAN CLOCK

- LARGE 1/2" CHARACTERS (LED)
- QUARTZ XTAL TIMEBASE
- ALARM & SNOOZE OPTIONS
- NOISE FILTERING
- EASY TO ASSEMBLE
- 4 1/2" x 3" x 1 1/2"
- DRILLED & PLATED PC BOARDS

NEW!

COMPLETE KIT
12 VDC **\$16.95**

ULTRASONIC RELAY KIT

INVISIBLE BEAM WORKS LIKE A PHOTO ELECTRIC EYE. USE UP TO 25 FT. APART. COMPLETE KIT. ALL PARTS & PC BOARDS

\$21.50

DIODES/ZENERS			
QTY.			
1N914	100v	10mA	.05
1N4005	600v	1A	.08
1N4007	1000v	1A	.15
1N4148	75v	10mA	.05
1N4733	5.1v	1 W Zener	.25
1N4749	24v	1W	.25
1N753A	6.2v	500 mW Zener	.25
1N758A	10v	"	.25
1N759A	12v	"	.25
1N5243	13v	"	.25
1N5244B	14v	"	.25
1N5245B	15v	"	.25
1N5349	12v	3W	.25

SOCKETS/BRIDGES			
QTY.			
8-pin	pcb	.16 ww	.35
14-pin	pcb	.20 ww	.40
16-pin	pcb	.25 ww	.45
18-pin	pcb	.30 ww	.95
20-pin	pcb	.35 ww	1.05
22-pin	pcb	.40 ww	1.15
24-pin	pcb	.45 ww	1.25
28-pin	pcb	.50 ww	1.35
40-pin	pcb	.55 ww	1.45
Molex pins	.01	To-3 Sockets	.35
2 Amp Bridge		100-prv	.95
25 Amp Bridge		200-prv	1.50

TRANSISTORS, LEDS, etc.			
QTY.			
2N2222M	(2N2222 Plastic .10)		.15
2N2222A			.19
2N2907A	PNP		.19
2N3906	PNP (Plastic)		.19
2N3904	NPN (Plastic)		.19
2N3054	NPN		.55
2N3055	NPN 15A 60v		.60
T1P125	PNP Darlington		1.95
LED Green,	Red, Clear, Yellow		.19
D.L.747	7 seg 5/8" High com-anode		1.95
MAN72	7 seg com-anode (Red)		1.25
MAN3610	7 seg com-anode (Orange)		1.25
MAN82A	7 seg com-anode (Yellow)		1.25
MAN74	7 seg com-cathode (Red)		1.50
FND359	7 seg com-cathode (Red)		1.25

9000 SERIES			
QTY.		QTY.	
9301	.85	9322	.65
9309	.50	9601	.30
9316	1.25	9602	.45

MICRO's, RAMS, CPU's, E-PROMS	
QTY.	
8T13	2.50
8T23	2.50
8T24	3.00
8T97	1.75
74S188	3.00
1488	1.25
1489	1.25
1702A	6.50
AM 9050	5.00
ICM 7207	6.95
ICM 7208	13.95
MPS 6520	10.00
MM 5314	4.00
MM 5316	4.50
MM 5387	3.50
MM 5369	2.95
TR 16028	3.95
UPD 414	4.95
Z 80 A	19.50
Z 80	14.50
Z 80 P10	10.50
2102	1.45
2102L	1.75
2107B-4	4.95
2114	9.50
2513 Upper or Lower	7.25
2708	12.50
2716 D.S.	29.00
2716 (5v)	69.00
2758 (5v)	32.95
3242	10.50
4116	13.50
6800	13.95
6850	7.95
8080	9.50
8085	22.50
8212	3.75
8214	4.95
8216	4.50
8224	5.25
8228	6.00
8251	8.50
8253	18.50
8255	9.50
TMS 4044	10.95

- T T L -							
QTY.		QTY.		QTY.		QTY.	
7400	.20	7492	.45	74H10	.35	74LS51	.75
7401	.20	7493	.35	74H11	.25	74LS74	1.50
7402	.20	7494	.75	74H15	.45	74LS75	1.20
7403	.20	7495	.60	74H20	.25	74LS76	.70
7404	.45	7496	.80	74H21	.25	74LS86	.95
7405	.35	74100	1.15	74H22	.40	74LS90	.85
7406	.35	74107	.35	74H30	.30	74LS93	.85
7407	.55	74121	.45	74H40	.35	74LS96	2.00
7408	.40	74122	.55	74H50	.30	74LS107	.90
7409	.25	74123	.55	74H51	.30	74LS109	1.50
7410	.20	74125	.45	74H52	.20	74LS123	1.95
7411	.25	74126	.45	74H53	.25	74LS138	2.00
7412	.25	74132	.75	74H55	.25	74LS151	.95
7413	.45	74141	.90	74H72	.35	74LS153	1.15
7414	.95	74145	1.35	74H74	.35	74LS157	1.15
7416	.25	74150	.85	74H101	.95	74LS160	1.15
7417	.40	74151	1.15	74H103	.55	74LS164	2.90
7420	.25	74153	1.15	74H106	1.15	74LS193	2.00
7426	.25	74154	1.15	74L00	.30	74LS195	1.15
7427	.25	74156	.70	74L02	.30	74LS244	2.90
7430	.20	74157	.65	74L03	.35	74LS259	1.50
7432	.50	74161	.95	74L04	.40	74LS298	1.50
7437	.20	74163	.85	74L10	.30	74LS367	2.50
7438	.30	74164	.75	74L20	.45	74LS368	1.25
7440	.20	74165	1.10	74L30	.55	74LS373	2.50
7441	1.15	74166	2.25	74L47	1.95	74S00	.60
7442	.55	74175	.90	74L51	.65	74S02	.45
7443	.45	74176	.95	74L55	.85	74S03	.35
7444	.45	74177	1.10	74L72	.65	74S04	.65
7445	.75	74180	.95	74L73	.70	74S05	.45
7446	.70	74181	2.25	74L74	.75	74S08	.65
7447	.70	74182	.75	74L75	1.05	74S10	.45
7448	.50	74190	1.25	74L85	2.00	74S11	.45
7450	.25	74191	1.25	74L93	.75	74S20	.35
7451	.25	74192	.75	74L123	1.95	74S22	.55
7453	.20	74193	.85	74LS00	.60	74S40	.30
7454	.25	74194	.95	74LS01	.40	74S50	.30
7460	.40	74195	.95	74LS02	.55	74S51	.35
7470	.45	74196	.95	74LS03	.45	74S64	.15
7472	.40	74197	.95	74LS04	.65	74S74	1.50
7473	.25	74198	1.45	74LS05	.45	74S112	.60
7474	.50	74221	2.25	74LS08	.65	74S114	.85
7475	.35	74298	1.50	74LS09	.45	74S133	.85
7476	.40	74367	1.35	74LS10	.45	74S140	.75
7480	.75	75451	.65	74LS11	.45	74S151	.95
7481	.85	75452	.85	74LS20	.45	74S153	.95
7482	.95	75491	.65	74LS21	.45	74S157	.98
7483	.95	75492	.65	74LS22	.45	74S158	.80
7485	.75	74H00	.20	74LS32	.60	74S194	2.25
7486	.55	74H01	.30	74LS37	.45	74S196	2.00
7489	1.05	74H04	.30	74LS38	.65	74S257 (8123)	2.95
7490	.55	74H05	.25	74LS40	.70	8131	2.75
7491	.70	74H08	.35	74LS42	1.25		

C MOS			
QTY.		QTY.	
4000	.20	4018	.75
4001	.30	4019	.35
4002	.25	4020	.85
4004	3.95	4021	.75
4006	1.50	4022	.75
4007	.25	4023	.25
4008	.75	4024	.75
4009	.35	4025	.25
4010	.35	4026	1.95
4011	.35	4027	.35
4012	.25	4028	.75
4013	.40	4029	1.15
4014	.75	4030	.30
4015	.75	4033	1.50
4016	.35	4034	2.45
4017	.75	4035	.75
4037	1.80	4040	.75
4041	.69	4042	.65
4043	.50	4044	.65
4046	1.25	4046	1.25
4047	2.50	4048	1.75
4049	.65	4049	.65
4050	.45	4050	.45
4052	.75	4052	.75
4053	.95	4053	.95
4066	.75	4066	.75
4069/74C04	.45	4069/74C04	.45
4070	1.00	4070	1.00
4071	.25	4071	.25
4072	.60	4072	.60
4081	.30	4081	.30
4082	.30	4082	.30
4507	.95	4507	.95
4511	.95	4511	.95
4512	1.25	4512	1.25
4515	2.95	4515	2.95
4519	.85	4519	.85
4522	1.10	4522	1.10
4526	.95	4526	.95
4528	1.10	4528	1.10
4529	.95	4529	.95
MC14409	14.50	MC14409	14.50
MC14419	4.85	MC14419	4.85
74C151	2.50	74C151	2.50

I ² L, LINEARS, REGULATORS, ETC.			
QTY.		QTY.	
MCT2	.95	LM320K24	1.65
8038	3.95	LM320T5(7905)	1.65
LM201	.75	LM320T12	1.65
LM301	.45	LM320T15	1.65
LM308	.65	LM323K	5.95
LM309H	.85	LM324	1.25
LM309 (340K-5)	1.50	LM339	.75
LM310	.85	7805 (340T5)	1.15
LM311 (8-14 Pin)	.75	LM340T12	.95
LM318	1.50	LM340T15	.95
LM320H6	.79	LM340T18	.95
LM320H15	.79	LM340T24	.95
LM320H24	.79	LM340K12	1.25
LM320K5	1.65	LM340K15	1.25
LM320K12	1.65	LM340K18	1.25
LM320K15	1.65	LM340K24	1.25
LM373	3.95	LM377	3.95
78L05	.75	78L12	.75
78L15	.75	78L15	.75
78M05	.75	LM380 (8-14 Pin)	1.19
LM709 (8-14 Pin)	.45	LM709 (8-14 Pin)	.45
LM711	.45	LM711	.45
LM723	.40	LM723	.40
LM725	3.50	LM725	3.50
LM739	1.50	LM739	1.50
LM741 (8-14)	.45	LM741 (8-14)	.45
LM747	1.10	LM747	1.10
LM1307	1.75	LM1307	1.75
LM1458	.65	LM1458	.65

INTEGRATED CIRCUITS UNLIMITED
 7889 Clairemont Mesa Blvd., San Diego, California 92111
 Out of State 1-800-854-2211 TWX 910-335-1577 Telex: 697-827
 (714) 278-4394 California Residents 1-800-542-6239

NAME _____
 STREET ADDRESS _____
 CITY _____ STATE _____ ZIP _____
 PHONE _____ CHARGE CARD # AE Visa BA MC _____ EXP. DATE _____

C.O.D. _____ WILL CALL _____ UPS _____ POST _____ NET 10th OF THE MONTH _____ PO # _____

ALL ORDERS SHIPPED PREPAID - NO MINIMUM - COD ORDERS ACCEPTED - ALL ORDERS SHIPPED SAME DAY
 OPEN ACCOUNTS INVITED - California Residents add 6% Sales Tax. PRICES SUBJECT TO CHANGE WITHOUT NOTICE.
 24 Hour Phone Service - We accept American Express / Visa / BankAmericard / Master Charge

LM3900	1.50
NE555	.45
NE556	.85
NE565	1.15
NE566	1.25
NE567	.95
TA7206	4.95
76477	2.95
95H90	9.95

SPECIAL DISCOUNTS

Total Order	Deduct
\$35-\$99	10%
\$100-\$300	15%
\$301-\$1000	20%

VARIABLE POWER SUPPLY KIT \$11⁹⁵

- Continuously Variable from 2V to over 15V
- Short-Circuit Proof
- Typical Regulation of 0.1%
- Electronic Current Limiting at 300mA
- Very Low Output Ripple
- Fiberglass PC Board Mounts All Components
- Assemble in about One Hour
- Makes a Great Bench or Lab Power Supply
- Includes All Components except Case and Meters

ADD \$1.25 FOR POSTAGE/HANDLING

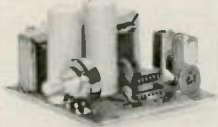

FREE

IC or FET'S WITH
\$5 & \$10 ORDERS.¹
DATA SHEETS
WITH MANY ITEMS.

SPECIALS—THIS MONTH ONLY

1N34A	Germanium Diode 50V 10mA	10/81	LM308H	Low Bias Current Op Amp Super 709	\$0.86
1N470	Germanium Diode 80V 200mA	4/21	LM309K	5 Volt Regulator TO-3	54
1N414	Silicon Diode 100V 10mA	25/51	LM317K	Adjustable Voltage Regulator 2-37V	3.50
1N6263	Hot Carrier Diode (HP2800, etc.)	\$1.00	LM320A	2 Watt Audio Power Amplifier DIP	94
F7	Power Varactor 1-2W Dcut @ 432MHz		NE555A	Phase Locked Loop DIP	94
	(Specs & Circuits included with F7)	\$2.00	LM723CN	Precision Voltage Regulator DIP	3/51
DIODE GRAB BAG	Mixed diodes, rectifiers, etc.	5/751	LM747	Dual 741 Compensated Op Amp DIP	2/51
2N705	NPN High Speed Switch 75m	4/21	2102	1024 Bit Static RAM (1024 x 1) DIP	\$1.75
2N918	UMF Transistor—Dec/Amp up to 1 GHz	4/21	27400E	FET Input Op Amp—like NE 536/μA740	95
2N2809	P-Channel FET Amplifier 2500,uhms	\$1.00	CA3018A	4-Transistor Array/Darlington	95
2N2920	NPN Dual Transistor 3mV Match 228	2/95	CA3028A	RF/IF Amplifier OC to 120MHz	1,45
2N3904	NPN Amp/Switch β100 40V 200mA	8/51	CA3075E	FM IF Amp/Limiter/Detector DIP	1,45
2N4122	PnP RF Amplifier & Switch	3/51	RC4558	Dual High Gain Op Amp mDIP	3/51
2N4859E	N-Channel Audio FET Super Low Noise	2/51	N5558V	Precision Fast Op Amp mDIP	2/51
2N4858	150 Volt PNP Transistor for Relay	2/51	N5558V	Dual Hi Gain Op Amp Comp. mDIP	3/51
E112	N-Channel FET VHF RF Amp	3/51	8038	Function Generator/VCO with circuits	\$3.75
15174	N-Channel FET High Speed Switch 40ct	3/51			

LP-10 LOGIC PROBE w/ TTL CMOS, etc.
Machine case included—kit, assembly \$7.85

SEND FOR ADVA'S NEW 1979 CATALOG
NEARLY 1000 SEMICONDUCTORS, KITS, CAPACITORS, ETC.—SEND 25¢ STAMP.

OTHER ADVA KITS:

LOGIC PROBE KIT—Use with CMOS, TTL, DTL, RTL, HTL, HML and most MOS IC's. Built-in protection against polarity reversal and overvoltage. Draws only a few mA from circuit under test. Dual LED readout. Complete kit includes case and clip leads. ONLY \$7.85
FIXED REGULATED POWER SUPPLY KITS—Short-circuit proof with thermal current limiting. Compact size and typical regulation of 0.05% make these ideal for most electronic projects. Available for 5V @ 500mA, 5V @ 500mA, 5V @ 500mA, 12V @ 400mA, 15V @ 300mA. Specify voltage when ordering. \$9.95 ea.
These easy-to-assemble kits include all components, complete detailed instructions and plated fiberglass PC boards. Power supply kits do not include case or meters. Add \$1.25 per kit for postage and handling.

1MAIL NOW! FREE DATA SHEETS supplied with many items from this ad. FREE ON REQUEST—741 Op Amp with every order of \$5 or more—749 Dual Op Amp or two E100 FET's with every order of \$10 or more, postmarked prior to 12/31/78. One free item per order. ORDER TODAY—All items subject to prior sale and prices subject to change without notice. All items are new surplus parts—100% functionally tested.
WRITE FOR FREE CATALOG #999 offering over 700 semiconductors carried in stock. Send 25¢ stamp.
TERMS: Send check or money order (U.S. funds) with order. Add 5% postage for U.S., Canada and Mexico. \$1.00 handling charge on orders under \$10. Calif. residents add 8% sales tax. Foreign orders add 10% postage. COD orders—add \$1.00 service charge.

MORE SPECIALS:

RC4195DN ±15V @ 50mA VOLTAGE REGULATOR IC. Very easy to use. Makes a neat Highly Regulated ±15V Supply for OP AMP's, etc. Requires only unregulated DC (18-30V) and 2 bypass capacitors. With Data Sheet and Schematics. 8-pin mDIP \$1.25
RC4136 Quad 741 Low-Noise Op Amp mDIP \$0.95
LM1304 FM Multiplex Stereo Demodulator DIP 0.99
LM2111 FM IF Subsystem (IF Amp, Det., Limiter) DIP 0.99
1N6263 Hot Carrier Diode 0.4V @ 1mA Q1m DO-35 1.00
ZENERS—Specify Voltage 3.3, 3.9, 4.3, 5.1, 6.8, 8.2 400mW 4/51.00
9.1, 10, 12, 15, 16, 18, 20, 22, 24, 27, or 33V (±10%) 1 Watt 3/51.00

- MONEY-BACK GUARANTEE
- ALL TESTED AND GUARANTEED

ADVA

ELECTRONICS
BOX 4181 GB, WOODSIDE, CA 94062
Tel. (415) 328-1500

DIODES & RECTIFIERS	TRANSISTORS	TRANSISTORS	TRANSISTORS	LINEAR IC's
1N4551a	2N706	2N4091	2N4091	LM3400-6
1N4551b	2N707	2N4091	2N4091	LM3400-6
1N4551c	2N708	2N4091	2N4091	LM3400-6
1N4551d	2N709	2N4091	2N4091	LM3400-6
1N4551e	2N710	2N4091	2N4091	LM3400-6
1N4551f	2N711	2N4091	2N4091	LM3400-6
1N4551g	2N712	2N4091	2N4091	LM3400-6
1N4551h	2N713	2N4091	2N4091	LM3400-6
1N4551i	2N714	2N4091	2N4091	LM3400-6
1N4551j	2N715	2N4091	2N4091	LM3400-6
1N4551k	2N716	2N4091	2N4091	LM3400-6
1N4551l	2N717	2N4091	2N4091	LM3400-6
1N4551m	2N718	2N4091	2N4091	LM3400-6
1N4551n	2N719	2N4091	2N4091	LM3400-6
1N4551o	2N720	2N4091	2N4091	LM3400-6
1N4551p	2N721	2N4091	2N4091	LM3400-6
1N4551q	2N722	2N4091	2N4091	LM3400-6
1N4551r	2N723	2N4091	2N4091	LM3400-6
1N4551s	2N724	2N4091	2N4091	LM3400-6
1N4551t	2N725	2N4091	2N4091	LM3400-6
1N4551u	2N726	2N4091	2N4091	LM3400-6
1N4551v	2N727	2N4091	2N4091	LM3400-6
1N4551w	2N728	2N4091	2N4091	LM3400-6
1N4551x	2N729	2N4091	2N4091	LM3400-6
1N4551y	2N730	2N4091	2N4091	LM3400-6
1N4551z	2N731	2N4091	2N4091	LM3400-6
1N4551aa	2N732	2N4091	2N4091	LM3400-6
1N4551ab	2N733	2N4091	2N4091	LM3400-6
1N4551ac	2N734	2N4091	2N4091	LM3400-6
1N4551ad	2N735	2N4091	2N4091	LM3400-6
1N4551ae	2N736	2N4091	2N4091	LM3400-6
1N4551af	2N737	2N4091	2N4091	LM3400-6
1N4551ag	2N738	2N4091	2N4091	LM3400-6
1N4551ah	2N739	2N4091	2N4091	LM3400-6
1N4551ai	2N740	2N4091	2N4091	LM3400-6
1N4551aj	2N741	2N4091	2N4091	LM3400-6
1N4551ak	2N742	2N4091	2N4091	LM3400-6
1N4551al	2N743	2N4091	2N4091	LM3400-6
1N4551am	2N744	2N4091	2N4091	LM3400-6
1N4551an	2N745	2N4091	2N4091	LM3400-6
1N4551ao	2N746	2N4091	2N4091	LM3400-6
1N4551ap	2N747	2N4091	2N4091	LM3400-6
1N4551aq	2N748	2N4091	2N4091	LM3400-6
1N4551ar	2N749	2N4091	2N4091	LM3400-6
1N4551as	2N750	2N4091	2N4091	LM3400-6
1N4551at	2N751	2N4091	2N4091	LM3400-6
1N4551au	2N752	2N4091	2N4091	LM3400-6
1N4551av	2N753	2N4091	2N4091	LM3400-6
1N4551aw	2N754	2N4091	2N4091	LM3400-6
1N4551ax	2N755	2N4091	2N4091	LM3400-6
1N4551ay	2N756	2N4091	2N4091	LM3400-6
1N4551az	2N757	2N4091	2N4091	LM3400-6
1N4551ba	2N758	2N4091	2N4091	LM3400-6
1N4551bb	2N759	2N4091	2N4091	LM3400-6
1N4551bc	2N760	2N4091	2N4091	LM3400-6
1N4551bd	2N761	2N4091	2N4091	LM3400-6
1N4551be	2N762	2N4091	2N4091	LM3400-6
1N4551bf	2N763	2N4091	2N4091	LM3400-6
1N4551bg	2N764	2N4091	2N4091	LM3400-6
1N4551bh	2N765	2N4091	2N4091	LM3400-6
1N4551bi	2N766	2N4091	2N4091	LM3400-6
1N4551bj	2N767	2N4091	2N4091	LM3400-6
1N4551bk	2N768	2N4091	2N4091	LM3400-6
1N4551bl	2N769	2N4091	2N4091	LM3400-6
1N4551bm	2N770	2N4091	2N4091	LM3400-6
1N4551bn	2N771	2N4091	2N4091	LM3400-6
1N4551bo	2N772	2N4091	2N4091	LM3400-6
1N4551bp	2N773	2N4091	2N4091	LM3400-6
1N4551bq	2N774	2N4091	2N4091	LM3400-6
1N4551br	2N775	2N4091	2N4091	LM3400-6
1N4551bs	2N776	2N4091	2N4091	LM3400-6
1N4551bt	2N777	2N4091	2N4091	LM3400-6
1N4551bu	2N778	2N4091	2N4091	LM3400-6
1N4551bv	2N779	2N4091	2N4091	LM3400-6
1N4551bw	2N780	2N4091	2N4091	LM3400-6
1N4551bx	2N781	2N4091	2N4091	LM3400-6
1N4551by	2N782	2N4091	2N4091	LM3400-6
1N4551bz	2N783	2N4091	2N4091	LM3400-6
1N4551ca	2N784	2N4091	2N4091	LM3400-6
1N4551cb	2N785	2N4091	2N4091	LM3400-6
1N4551cc	2N786	2N4091	2N4091	LM3400-6
1N4551cd	2N787	2N4091	2N4091	LM3400-6
1N4551ce	2N788	2N4091	2N4091	LM3400-6
1N4551cd	2N789	2N4091	2N4091	LM3400-6
1N4551ce	2N790	2N4091	2N4091	LM3400-6
1N4551cd	2N791	2N4091	2N4091	LM3400-6
1N4551ce	2N792	2N4091	2N4091	LM3400-6
1N4551cd	2N793	2N4091	2N4091	LM3400-6
1N4551ce	2N794	2N4091	2N4091	LM3400-6
1N4551cd	2N795	2N4091	2N4091	LM3400-6
1N4551ce	2N796	2N4091	2N4091	LM3400-6
1N4551cd	2N797	2N4091	2N4091	LM3400-6
1N4551ce	2N798	2N4091	2N4091	LM3400-6
1N4551cd	2N799	2N4091	2N4091	LM3400-6
1N4551ce	2N800	2N4091	2N4091	LM3400-6

*SUPER SPECIALS:

1N34	Germanium Diode	10/81	FS24501M Diode Array	2/51
1N914	100V/10mA Diode	20/51	MPF102 200MHz RF Amp	3/51
1N4001	50V/1A Rectifier	15/51	40673 MOSFET RF Amp	\$1.75
1N4154	30V 1N914	25/51	LM326 Quad 741 Op Amp	94
BR1	50V V/A Bridge Rec	4/51	NE555 Pos Volt Reg mDIP	56
2N2222	NPN Transistor	6/51	NE555 Timer mDIP	38
2N2907	PNP Transistor	6/51	LM723 2-37V Reg DIP	3/51
2N3055	Power Xistor 10A	\$0.75	LM741 Comp Op Amp mDIP	6/51
2N3904	NPN Amp/Sw β100	6/51	LM1458 Dual 741 mDIP	3/51
2N3906	PNP Amp/Sw β100	6/51	CA3086 5 Trans Array DIP	62
CP650	Power FET V/Amp	55	RC429 Pwr Xistor 1A 30W	70
RF 391	RF Power Amp Transistor 10-25W @ 3-30MHz TO-3	\$5.00		
555X	Timer 1us-tri Different pinout from 555 (w/datas)	3/51		
RC4195K	Tracking Regulator +0.2 to 30V @ 200mA TO-66	\$2.50		
RC4195T	Track Tracking Regulator ±15V @ 100mA (TO-66)	\$2.25		
8038	Waveform Generator 1/2 Wave With Circuits & Data	\$3.75		

NEW SPECIALS

LM318CN	High Speed Op Amp 50V/μs mDIP	\$0.94
LM318D	High Speed Op Amp 50V/μs DIP	.90
LM339N	Quad Comparator Single or Dual Supply	.79
LM380N-8	1/2W Audio Power Amplifier 8-22V	.90
NE567V	Tone Decoder (PLL) 0.01Hz to 500kHz	.99
XR567CP	Tone Decoder (PLL) 0.01Hz to 500 kHz	.99
LM723CN	Precision Voltage Regulator 2-37V DIP	3/51
LM747CN	Dual 741 Compensated Op Amp	2/51
SAD1024	Dual 512 Stage (1024) Audio Delay Line "Bucket Brigade" Appl. Data included	\$18.95
XR2206CP	Function Generator with applic. data	4.40
XR2242CP	Long-Range Precision Timer μs to days	1.50
1 YEAR TIMER Kit-2 XR2242's and Applic. Note		3.00
LM2901N	Quad Comparator +5V or 2 to 36VDC	\$1.20
CA3018A	4-Transistor Array/Darlington	.99
CA3028A	RF/IF Amplifier OC to 120MHz	1.25
RC4558	Quad High Gain Op Amp mDIP	3/51
SPACER Kit - 4 ea of 5 assorted size spacers		\$1.00
±15 VOLT Regulated Power Supply Kit-Easy assembly, 5mV regulation, 100mA, fully protected. Includes all components and hardware, no PCB or case—Add \$1.50 for shipping		\$13.95

1N270	Germanium Diode 80V 200mA	4/51
1N823	Temp Comp Reference 6.2V ± 5% ± .005%/°C	\$0.60
1N914	Silicon Diode 100V 10mA	25/51
1N3044	100V Zener 1W—Better than an OB3	.75
1N3045	110V Zener 1W—Better than an OB2/DC3	.75
1N3071	200V 100mA Switching Diode 40ns	.30
2N2915	NPN Dual Transistor 3mV Match β100	\$1.95
2N3819M	N-Channel RF FET 100MHz Amp	.35
2N4020	PNP Dual Transistor 5mV Match β250	5.00
2N4445	N-Channel FET 5Ω Switch	3.50
2N5394E	Ultra-Low Noise J-FET Audio Amp	\$1.25
2N5912	Dual J-FET RF Oif Amp to 800MHz	2.9

M-M Electronic Sales

A division of **united products** Corporation

Corp. Hqts., 2300 1st Ave. — Seattle, WA 98121 • (206) 682-5025

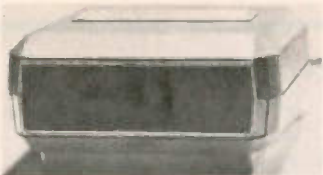

INSTRUMENT CLOCK CASE KIT

A real jewel for those small projects. Hinged top door allows you to hide your control area. O.D. 4 1/2" x 4" x 1 3/4". **\$1.99 each.**



ANTENNA SELECTING SWITCH D.P.D.T.

Long through slide switch providing correct isolation for 300 OHM Twin Lead. 35¢ ea. 4 for ONLY \$1.00

DIODES

TYPE	VOLTS	WATTS	PRICE
1N4001	50	1A	15/\$1.00
1N4002	100	1A	15/\$1.00
1N4003	200	1A	12/\$1.00
1N4004	400	1A	12/\$1.00
1N4005	600	1A	10/\$1.00
1N4006	800	1A	10/\$1.00
1N4007	1000	1A	6/\$1.00
1N5400	50	3A	5/\$1.00
1N5401	100	3A	5/\$1.00
1N5402	200	3A	5/\$1.25
1N5403	300	3A	4/\$1.25
1N5404	400	3A	4/\$1.25
1N5405	500	3A	4/\$1.49
1N5406	600	3A	4/\$1.49
1N5407	800	3A	3/\$1.49
1N5408	1000	3A	2/\$.99
1N4148	75	10M	20/\$1.00

DIODE SALE 1N4148

1000/\$1.95
1000/\$14.95

TAPE/REEL



FERROX CUBE TORROID CORE

9/16" I.D. **95¢**

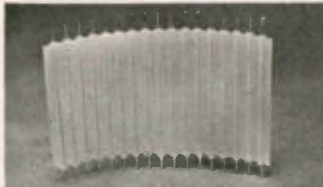

DIP SPACED FLEX JUMPER Pre-cut 1 1/2" L. and pre-stripped. Pkg. 20 **\$1.99**

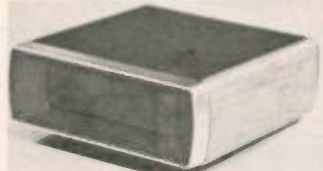

INSTRUMENT/CLOCK CASE KIT

Perfect for your opto projects. Solid aluminum construction with real walnut sides. O.D. 5-3/8" by 5-3/8" by 2". **\$6.95 ea.**



DEFECTIVE CALCULATORS

Well, some are and some are not. We can't afford the time to test them. **\$2.50 ea.** Batteries not included. 2/\$4.00.

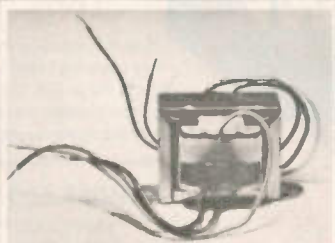

TRANSFORMER Pri. 110 VAC Sec. 11.2 and 5VCT @ .1 amp **\$95 ea.**



ROTRON WHISPER FAN #WR2H1

75CFM, 115VAC. Net \$17.00 Meas. 4" diam. NOTE: These are not pull outs, these are new. **YOUR PRICE \$9.95**



CRYSTAL 3.579545 MHZ

This is the one you need for your time base. Reg. Price \$4.95 **YOUR PRICE \$2.50** (while they last)

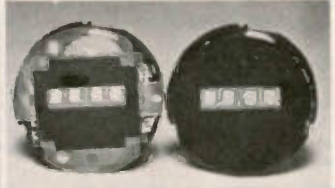

L.E.D. WATCH GUTS (untested)

All take 2, 1.5V Bat. Mens size 75¢ ea. 2 for \$1.00

REPEAT OF A SELL-OUT A complete 12 hour digital clock. Some are manufacture line rejects, some are returns, and some are just scratched. Features: hours, minutes, alarm, snooze alarm. Parts value alone would equal \$20.00, you pay only **\$6.00 ea.**

EDGE METER 100-0-100 ua 1/2" by 1 1/16". Compare with other meters costing \$6.00. Only **\$2.00 ea.** Why pay more?

1/4 WATT 5% DEPOSITED CARBON FILM RESISTOR ASSORTMENTS

ASST. A	10 ea 1 OHM 1.5 OHM 2 OHM 2.7 OHM 3 OHM 3.6 OHM 4.7 OHM 5.6 OHM 6.8 OHM 8.2 OHM	100 pcs \$2.40
ASST. B	10 ea 10 OHM 12 OHM 15 OHM 18 OHM 22 OHM 27 OHM 33 OHM 39 OHM 47 OHM 56 OHM	100 pcs \$2.40
ASST. C	10 ea 68 OHM 82 OHM 100 OHM 120 OHM 150 OHM 180 OHM 220 OHM 270 OHM 330 OHM 390 OHM	100 pcs \$2.40
ASST. D	10 ea 470 OHM 560 OHM 680 OHM 820 OHM 1K 1.2K 1.5K 1.8K 2.2K 2.7K	100 pcs \$2.40
ASST. E	10 ea 3.3K 3.9K 4.7K 5.6K 6.8K 8.2K 10K 12K 15K 18K	100 pcs \$2.40
ASST. F	10 ea 22K 27K 33K 39K 47K 56K 68K 82K 100K 120K	100 pcs \$2.40
ASST. G	10 ea 150K 180K 220K 270K 330K 390K 470K 560K 680K 820K	100 pcs \$2.40
ASST. H	10 ea 1M 1.2M 1.5M 1.8M 2.2M 2.7M 3.3M 3.9M 4.7M 5.6M	100 pcs \$2.40
ASST. A-H	INCLUDES ALL RESISTOR ASSORTMENTS (600 pcs)	\$14.95 ea

THE GOODIE BOX

1000 uf 25VDC P-C \$.25
2000 uf 25VDC AXIAL50
18 ga. LINE CORD 6'25
Trimmer Cap. 3-30pf VERT. P-C50
RCA Jack, Right Angle P-C25
TINI-JAX 50¢ ea. 3/1.00
TO-220 Clip on Heat Sink20
#30 Kynar (any color) 100' Spool 1.00
Speaker Terms 15¢ ea. 10/1.00
10K Lin. 2 watt Pot50
AAA Rechargeable NI-CAD95
Mini-Plug50
S.P.D.T. min. Slide Switch .. 25¢ ea. 5/1.00



A.P. PRODUCTS

A.C.E. 212 \$34.95
We stock the full line of A.P. Breadboard Products.



22VDC @ 140 MA Adapter \$1.95
4.5 VDC @ 265 MA Adapter \$1.95



MINIATURE D.P.O.T. 12VDC RELAY
500 OHM Coil 1-1/8" X 3/4 X 3/8"
ARROW-M #NF2-12V **ONLY \$2.99 ea.**
P-C Mount

CLOCK DISPLAY

National Semi. 6 Digit Multiplexed Display; .33" Characters (Common Cathode). A REAL BUY AT JUST \$1.00.

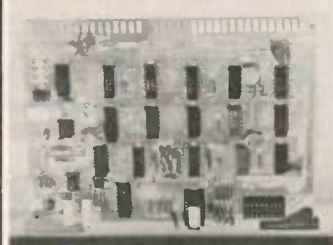

PARTS BOARDS A great way to buy parts on a budget. We guarantee your money's worth. **ONLY \$1.00 ea.**



MINIATURE VARIABLE CHOKE 7-14UH
TRW#102233 **75¢**



NAUGAHYDE ZIPPER POUCH

O.D. Approx. 4"X7" Brand new and of the finest quality. It even has a convenient belt loop. **95¢**



IN LINE 3AG FUSE HOLDER **75¢**

L.C.D. DISPLAYS

SMALL SIZE
45¢ EA. 3 FOR \$1.00
(UNTESTED)



FREE 5 FUNCTION L.C.D. MENS WATCH

SECONDS-MINUTES-HOURS-DAY-MONTH
If your order totals \$50.00 or more we will send you this national semiconductor L.C.D. Watch, valued at \$29.95

FREE!

For Master Charge/Visa Orders Use Our TOLL FREE HOT LINE: 1-800-426-0634

for areas outside Washington (incl. Alaska & Hawaii)

O.E.M.'s WELCOME



Terms: All orders shipped promptly. Minimum order \$5.00. Telephone orders accepted. All orders shipped UPS or PP. Add 5% extra for shipping & handling. Washington state residents add additional 5.4% sales tax. Master Charge & Visa cards accepted. Money orders & your personal or company check are welcome. Funds made payable in U.S. currency only. No C.O.D. orders. Your satisfaction is guaranteed on all merchandise purchased. All merchandise subject to prior sale. Open account to govt. agencies & publicly funded schools.

Store Hours **M-F 9-6 • SAT 9-5**

NEW!



Tunable 420 MHz Fast Scan TV Converter

Receive Fast Scan Amateur TV in the 420 to 450 MHz Band with any TV set. Low noise, high gain rf Amp with Varactor Tuned input and outputs. Built in AC supply. Comes in two tone walnut & beige cabinet measuring 1-7/8" x 4-1/4" x 4-1/8". Factory wired with 2-year guarantee. ATVC-10 \$59.95

Basic Varactor Tuner & PS Kit w/instructions
ATVC-10K \$39.95

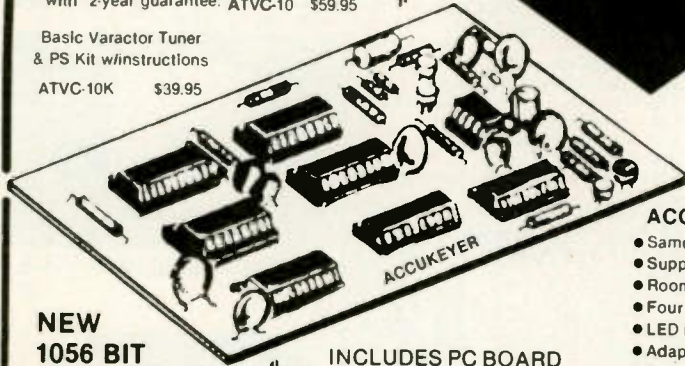

NEW 1056 BIT EXPANDABLE MEMORY KIT

INCLUDES PC BOARD AND PARTS STILL ONLY
\$19.95

ALDELCO ELECTRONIC COMPANY

THE VERY POPULAR

TOPE ACCUKEYER KIT

- Self Completing Dots & Dashes
- Iambic Operation
- Single Dot & Dash Memories
- Provision for Attachment of Memory for DX or Contest Work

Revised version of the Accukeyer featured in the ARRL Handbook. Has more logical IC Layout and ON Board sidetone Oscillator. Includes PC Board, TTL ICs, 555 Timer, IC Sockets, Switch, Speaker, Transistors, capacitors and resistors. Requires 5VDC. **\$19.95**
Use our PS-5 Power supply kit to power keyer & Memory only \$7.95

MEMORY ADD ON KIT

3 each: 2102, Push Button Switch, Led, 16 Pin Socket \$6.00

OV-12 Crow Bar Overvoltage Protection Circuit. Triggers App. 16 to 18 volts \$8.95
5 to 8 volts 9.95

ACCUKEYER MEMORY KIT

- Same size PC Board as Accukeyer
- Supplied with one 2102 Memory Chip
- Room on the board for three more
- Four chips will total 4224 BITS
- LED indicator for Programming
- Adaptable to other keyers
- Requires 5 volts DC

BUILD A 6 DIGIT 500 MHz FREQUENCY COUNTER



COMPLETE LUNCH COUNTER KIT \$79.95
Includes a reprint of a six-page construction article from Dec. 1978, 73 Magazine.

Aidelco can supply 3 PC boards. Silk screened front panel and complete instructions for only \$12.50 & shipping.

SOME PARTS USED IN COUNTER

11C90 Prescaler	\$19.95
74C925 Multiplex	12.95
F9368 Driver (2)	12.90
1 MHz XTAL	7.95
10.60 pF trim cap	.60
Resistor kit	1.75
Capacitor kit	5.50

See six page construction article in Dec. 1978 73 Magazine

RF TRANSISTORS									
SD1018-4	40W	4.5db	450MHz	380-4FL	15.25	2N3375	3.0W	400 MHz TO60	5.60
SD1074	50W	11db	30MHz	500-6LFL	21.15	2N3553	2.5W	175 MHz TO39	1.40
SD1076	75W	13	50	500-6LFL	24.00	2N3866	1.0W	400 MHz TO39	1.25
SD1088	25W	6	450	500-6LFL	23.25	2N4427	1.0W	175 MHz TO39	1.35
SD1089	40W	5	450	500-6LFL	27.15	2N5589	3.0W	175 MHz MT71	4.75
SD1143	10W	10	200	MT72	10.95	2N5590	10W	175 MHz MT72	7.80
SD1158	12W	5.3	200	TO117	12.30	2N5591	25W	175 MHz MT72	10.25
SD1272	30W	6	220	MT72	9.60	2N5913	1.75W	175 MHz TO39	1.70
SD1278	50W	10	50	MT72	16.30	2N6080	4.0W	175 MHz MT72	5.40
SD1416	70W	6.7	175	500-6LFL	26.80	2N6081	15W	175 MHz MT72	8.45
SD1428	45W	6.5	175	500-6LFL	22.65	2N6082	25W	175 MHz MT72	11.70
SD1433	8W	7.5	450	MT90	9.50	2N6083	30W	175 MHz MT72	11.70
SD1434	50W	5	450	500-6LFL	34.00	2N6084	40W	175 MHz MT72	13.50
SD1451	50	14	50	500-6LFL	18.10	2N6094	4.0W	175 MHz X106	6.60
SD1477	100W	6	175	500-6LFL	52.85	2N6095	15W	175 MHz X106	8.50
2N5945	4W	8	450	MT90	10.75	2N6096	30W	175 MHz X106	10.35
2N5946	10W	6	450	MT90	13.00	2N6097	40W	175 MHz X106	20.00

TELCO COMMANDER SERIES RF POWER AMPLIFIERS

Model	Watts input	Watts output	144-148 MHz
125	1	25	\$99.00
180	10	80	\$149.00
250	25	100	\$199.00
256	25	160	\$249.00
258	1-25	25-180	\$299.00
ULTRA 430 MHz III	3-5	up to 50	\$379.00

other UHF models in production



FMMC 1



Dynamic
Touch
Tone Mic
\$39.95



FM2016A New Yorkers must pay sales tax
144 to 149 MHz 1000 CHANNELS

SHOWN WITH OPTIONAL μP-800 MICRO PROGRAMMER

Buy your KDK from Aidelco and we'll pay UPS shipping and insurance in the 48 states. Sorry no charge cards accepted



All the features of the 2015R and now with adjustable sine wave PL 60 Hz to 203 Hz. Adjustable low power position 1 Watt to 16 Watts.

Low, Low Price

\$299

Regulated AC/PS Model FMPS-4R... \$39.95

ALARM CLOCK KIT

6 Big 0.5 LED Displays • On Board AC Transformer • 12 Hour Format with 24 Hour Alarm • Snooze Feature • Elapsed Timer. Timer feature makes this Popular in Broadcast Stations. It's a natural for cars, boats and campers when used with optional crystal time base. Fits our standard cabinet. \$21.95
Crystal time base when purchased with clock. \$3.95

12 or 24 HOUR DIGITAL CLOCK KIT

Uses 0.5 Display LED. 5314 Clock Chip. Freeze feature for accurate set. Fits our standard cabinet. ONLY \$19.95

CLOCK CABINETS

Woodgrain or black leather ea. \$4.95

CRYSTAL TIME BASE KIT

Includes PC Board, Crystal, all parts and Instructions. \$4.95

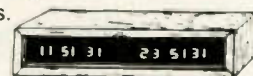

MODEL ALD 5-W 0.5 LEDS

Features:
12 or 24 Hour Operation on either clock
Each Clock separately controlled
Freeze feature for time set
Easy assembly for clock and cabinet

ADJUSTABLE POWER SUPPLY KITS

5-15 Volts 500 MA Model PS5	\$7.95
12-20 Volts 500 MA Model PS12	7.95

ALDELCO

2789A MILBURN AVE, BALDWIN, N.Y. 11510
516-378-4555

Radio Bookshop

LICENSE STUDY GUIDES & TAPES

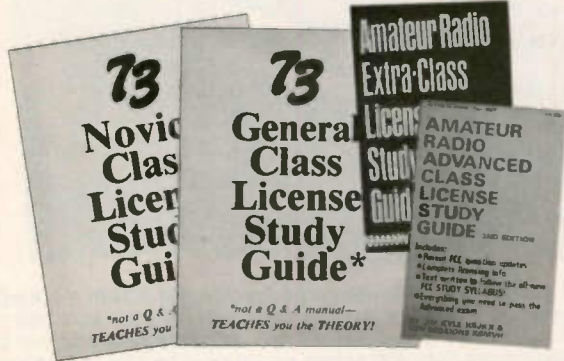

● **NOVICE STUDY GUIDE—SG7357**—Here is a completely new study guide and reference book for the potential ham. This is not a question/answer memorization course. Electronic and radio fundamentals are presented and explained in an easy-to-understand fashion, preparing the beginner for the Novice exam. Includes the latest FCC amateur regulations, as well as application forms. Easily the best path into the exciting world of ham radio! \$4.95.*

● **GENERAL CLASS STUDY GUIDE—SG7358**—A complete theory course for the prospective General or Technician. This reference explains transistor, amplifier, and general radio theory, while preparing the Novice for the "big" ticket. After getting your ticket, you'll use this guide again and again as an electronic reference source. Not a question/answer guide that becomes dated when the FCC updates the amateur exams. \$5.95.*

● **ADVANCED CLASS STUDY GUIDE—SG1081**—Ready to upgrade your license? To prevent re-taking the FCC theory exam, you need the 73 Advanced theory guide. SSB, antenna theory, transmitters, and electronics measuring techniques are covered in detail in this easy-to-follow study guide. Special modes and techniques, such as RTTY, are also treated. An engineering degree is not necessary to master Advanced theory—try this book before visiting the examiner's office! \$5.95.*

● **EXTRA CLASS LICENSE STUDY GUIDE—SG1080**—Before going for your 1 x 2 call, it pays to be a master of the Extra class electronic theory. This study guide is the logical extension of the 73 theory course. All the theory necessary to pass the exam is presented. Antennas, transmission lines, SWR are discussed, as well as noise, propagation, and specialized communication techniques. This book is not a classroom lecture or memorization guide, but rather a logical presentation of the material that must be understood before attempting the Extra exam. Save yourself a return trip to the FCC and try the 73 method first! \$5.95.*



NOVICE THEORY TAPES Startling Learning Breakthrough

● **NOVICE THEORY TAPES—CT7300**—Startling Learning Breakthrough. You'll be astounded at how really simple the theory is when you hear it explained on these tapes. Three tapes of theory and one of questions and answers from the latest Novice exams give you the edge you need to breeze through your exam. 73 is interested in helping get more amateurs, so we're giving you the complete set of our tapes for the incredibly low price of **ONLY \$15.95.***

Scientists have proven that you learn faster by listening than by reading because you can play a cassette tape over and over in your spare time—even while you're driving! You get more and more info each time you hear it.

You can't progress without solid fundamentals. These four hour-long tapes give you all the basics you'll need to pass the Novice exam easily. You'll have an understanding of the basics which will be invaluable to you for the rest of your life! Can you afford to take your Novice exam without first listening to these tapes? Set of 4—\$15.95.*



SSTV

● **SLOW SCAN TELEVISION TAPE—CT7350**—Prize-winning programs from the 73 SSTV contest. Excellent for Demo! \$5.95.*

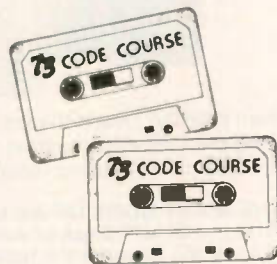

73 CODE SYSTEM TAPES

code, sent at the official FCC standard (no other tape we've heard uses these standards, so many people flunk the code when they are suddenly—under pressure—faced with characters sent at 13 wpm and spaced for 5 wpm). This tape is not memorizable, unlike the zany 5 wpm tape, since the code groups are entirely random characters sent in groups of five.

"COURAGEOUS"

20+ WPM—CT7320—Code is what gets you when you go for the Extra class license. It is so embarrassing to panic out just because you didn't prepare yourself with this tape. Though this is only one word faster, the code groups are so difficult that you'll almost fall asleep copying the FCC stuff by comparison. Users report that they can't believe how easy 20 per really is with this fantastic one hour tape.

Any Four Tapes For \$15.95!
\$4.95 Each!*

"GENESIS"

5 WPM—CT7305—This is the beginning tape for people who do not know the code at all. It takes them through the 26 letters, 10 numbers and necessary punctuation, complete with practice every step of the way using the newest blitz teaching techniques. It is almost miraculous! In one hour many people—including kids of ten—are able to master the code. The ease of learning gives confidence to beginners who might otherwise drop out.

"THE CANADIAN"

10+ WPM—CT7310—73 hasn't forgotten the Canadian hams—our 10 WPM tape prepares you to breeze through your country's licensing exams. Like the other code groups, the tape is not memorizable and, once mastered, provides a margin of safety in the actual text situation.

"OUTRAGEOUS"

25+ WPM—CT7325—This is the tape for that small group of overachieving hams who wouldn't be content to simply satisfy the code requirements of the Extra Class license. It's the toughest tape we've got and we keep a permanent file of hams who have mastered it. Let us know when you're up to speed and we'll inscribe your name in 73's CW "Hall of Fame."

"BACK BREAKER"

13+ WPM—CT7313—Code groups again, at a brisk 13 per so you will be at ease when you sit down in front of the steely-eyed government inspector and he starts sending you plain language at only 13 per. You need this extra margin to overcome the panic which is universal in the test situations. When you've spent your money and time to take the test, you'll thank heavens you had this back-breaking tape.

"THE STICKLER"

6+ WPM—CT7306—This is the practice tape for the Novice and Technician licenses. It is made up of one solid hour of

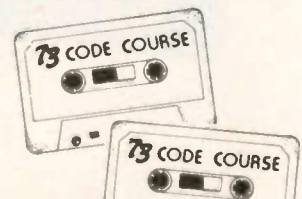

Use the order card in the back of this magazine or itemize your order on a separate piece of paper and mail to: 73 Radio Bookshop • Peterborough NH 03458. Be sure to include check or detailed credit card information. *Add \$1.00 handling charge. Note: Prices subject to change on books not published by 73 Magazine.

FOR CUSTOMER SERVICE CALL (603) 924-7298

Radio Bookshop

73 TECHNICAL LIBRARY

● **BEHIND THE DIAL**—BK7307—By Bob Grove. Get more fun out of shortwave listening with this interesting guide to receivers, antennas, frequencies and Interference. \$4.95.*

● **THE CHALLENGE OF 160**—BK7309—is the newest book in the 73 technical library, dedicated to 160 meter operating. Si Dunn provides all necessary information to get started on this unique band. The all-important antenna and ground systems are described in detail. The introduction contains interesting photos of Stew Perry's (the King of 160) shack. This reference is a must for new and experienced "Top Band" operators. Price: \$4.95.*

● **IC OP-AMP COOKBOOK**—BK1028—by Walter G. Jung. Covers not only the basic theory of the IC op amp in great detail, but also includes over 250 practical circuit applications, liberally illustrated. 592 pages, 5½ x 8½, softbound. \$12.95.*

● **THE POWER SUPPLY HANDBOOK**—BK7305—Need a power supply for a gadget you're building? In the **POWER SUPPLY HANDBOOK** there are dozens ready-to-build, plus detailed steps for designing your own. There are circuits and parts lists for all kinds of supplies, ranging from simple DC types to highly stable regulated versions. If you need a circuit to convert a DC voltage to a higher or lower voltage, turn DC into AC, or AC to DC—then this is the book you need. With more than 400 pages, you should be able to find just the circuit you need. Without a doubt one of the best power supply source books available, compiled by the editors of 73. \$7.95.*



● **INTRODUCTION TO RTTY**—BK7380—A beginner's guide to radioteletype including teletypewriter fundamentals, signals, distortion and RTTY art. You can be a RTTY artist! A 73 publication. \$2.00.*

● **THE NEW RTTY HANDBOOK**—BK7347—is a new edition and the only up-to-date RTTY book available. The state of the art has been changing radically and has made all previous RTTY books obsolete. It has the latest circuits, great for the newcomer and expert alike. \$5.95.*

● **PROPAGATION WIZARD'S HANDBOOK**—BK7302—by J. H. Nelson. When sunspots riddled the worldwide communications networks of the 1940's, John Henry Nelson looked to the planets for an answer. The result was a theory of propagation forecasting based upon interplanetary alignment that made the author the most reliable forecaster in America today. The book provides an enlightened look at communications past, present, and future, as well as teaching the art of propagation forecasting. \$6.95.*



● **SSB . . . THE MISUNDERSTOOD MODE**—BK7351—by James B. Wilson. Single Sideband Transmission . . . thousands of us use it every day, yet it remains one of the least understood facets of amateur radio. J. B. Wilson presents several methods of sideband generation, amply illustrated with charts and schematics, which will enable the ambitious reader to construct his own sideband generator. A must for the technically-serious ham. \$5.50.*

● **SSTV HANDBOOK**—BK7354(hardcover), BK7355(softcover)—This excellent book tells all about it, from its history and basics to the present state-of-the-art techniques. Contains chapters on circuits, monitors, cameras, color SSTV, test equipment and much more. Hardbound \$7.00, softbound \$5.00.*

● **WEATHER SATELLITE HANDBOOK**—BK7370—Simple equipment and methods for getting good pictures from the weather satellite. Antennas, receivers, monitors, facsimile you can build, tracking, automatic control (you don't even have to be home). Dr. Taggart WB8DQT. \$4.95.*

● **73 DIPOLE AND LONG-WIRE ANTENNAS**—BK1016—by Edward M. Noll W3FQJ. This is the first collection of virtually every type of wire antenna used by amateurs. Includes dimensions, configurations, and detailed construction data for 73 different antenna types. Appendices describe the construction of noise bridges, line tuners, and data on measuring resonant frequency, velocity factor, and swr. \$5.50.*



● **THE GIANT BOOK OF AMATEUR RADIO ANTENNAS**—BK7304—With the **Giant Book of Amateur Radio Antennas** by your side, antennas will become the least of your worries. Over 450 pages of design ideas, theory and reference data make this book live up to its title. The 7 chapters cover everything from basic antenna theory through designs for DIY accessories, as well as dozens of antenna designs. Whether planning to build or buy, design or admire, test or enjoy a ham antenna—this is the book for you. From the editors of 73; published by Tab Books. \$12.95 Hardback.*

● **73 VERTICAL, BEAM AND TRIANGLE ANTENNAS**—BK1069—by Edward M. Noll W3FQJ. Describes 73 different antennas for amateurs. Each design is the result of the author's own experiments covering the construction of noise bridges and antenna line tuners, as well as methods for measuring resonant frequency, velocity factor, and standing-wave ratios. 160 pages. \$5.50.*

● **VHF ANTENNA HANDBOOK**—BK7368—The **NEW VHF Antenna Handbook** details the theory, design and construction of hundreds of different VHF and UHF antennas . . . A practical book written for the average amateur who takes joy in building, not full of complex formulas for the design engineer. Packed with fabulous antenna projects you can build. \$4.95.*



Use the order card in the back of this magazine or itemize your order on a separate piece of paper and mail to:
73 Radio Bookshop • Peterborough NH 03458. Be sure to include check or detailed credit card information.
* Add \$1.00 handling charge. Note: Prices subject to change on books not published by 73 Magazine.

FOR TOLL FREE ORDERING CALL 1-800-258-5473

Radio Bookshop

TEST EQUIPMENT

● **RF AND DIGITAL TEST EQUIPMENT YOU CAN BUILD**—BK1044—Rf burst, function, square wave generators, variable length pulse generators—100 kHz marker, i-f and rf sweep generators, audio osc, af/rf signal injector, 146 MHz synthesizer, digital readouts for counters, several counters, prescaler, microwave meter, etc. 252 pages. \$5.95.*

● **VOL. I COMPONENT TESTERS**—LB7359—... how to build transistor testers (8), diode testers (3), IC testers (3), voltmeters and VTVMs (9), ohmmeters (8 different kinds), inductance (3), capacity (9), Q measurement, crystal checking (6), temperature (2), aural meters for the blind (3) and all sorts of miscellaneous data on meters... using them, making them more versatile, making standards. Invaluable book. \$4.95.*

● **VOL. II AUDIO FREQUENCY TESTERS**—LB7360—... jam packed with all kinds of audio frequency test equipment. If you're into SSB, RTTY, SSTV, etc., this book is a must for you... a good book for hi-fi addicts and experimenters, too! \$4.95.*

● **VOL. III RADIO FREQUENCY TESTERS**—LB7361—Radio frequency waves, the common denominator of Amateur Radio. Such items as SWR, antenna impedance, line impedance, rf output and field strength; detailed instructions on testing these items includes sections on signal generators, crystal calibrators, grid dip oscillators, noise generators, dummy loads and much more. \$4.95.*

● **VOL. IV IC TEST EQUIPMENT**—LB7362—Become a troubleshooting wizard! In this fourth volume of the 73 TEST EQUIPMENT LIBRARY are 42 home construction projects for building test equipment to work with your ham station and in servicing digital equipment. Plus a cumulative index for all four volumes of the 73 TEST EQUIPMENT LIBRARY. \$4.95.*



The well-equipped ham shack

● **73 MAGAZINE BINDERS**—Preserve and protect your collection for your lifetime! There's no excuse for lost issues when you have these handsome red binders with gold lettering. Order 1—BN1001—for \$6.50*; 2 or more—BN1002—for \$6.00 each.* (specify 1978 or 1979 binders)

● **QSL CARDS**—73 turns out a fantastic series of QSL cards at about half the cost of having them done elsewhere because they are run as a fill-in between printing books and other items in the 73 Print Shop. 250 Style W—QW0250—for \$8.95*; 500 Style W—QW0500—for \$13.95*; 250 Style X—QX0250—for \$8.95*; 500 Style X—QX0500—for \$13.95*; 250 Style Y—QY0250—for \$8.95*; 500 Style Y—QY0500—for \$13.95.*

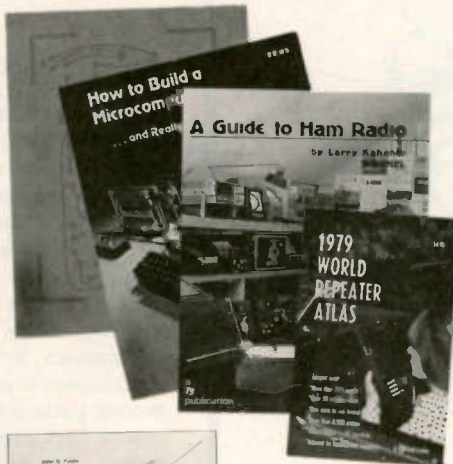
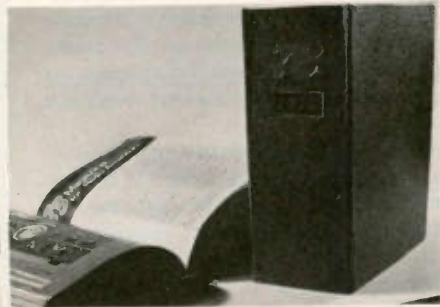

● **HOW TO BUILD A MICROCOMPUTER—AND REALLY UNDERSTAND IT**—BK7325—by Sam Creason. The electronics hobbyist who wants to build his own microcomputer system now has a practical "How-To" guidebook. Sam Creason's book is a combination technical manual and programming guide that takes the hobbyist step-by-step through the design, construction, testing and debugging of a complete microcomputer system. \$9.95.*

● **1979 WORLD REPEATER ATLAS**—BK7346—With a new easy-to-use format, the 1979 World Repeater Atlas is the largest ever published by 73. More than 230 pages of repeaters, listed by both location and frequency, together with over 50 location maps—make this the best repeater atlas ever! Nearly 2000 separate repeater locations are shown on the maps, with greater accuracy than ever before. \$4.95.*

● **BACK ISSUES**—Complete your collection; many are prime collectables now, classics in the field! A full collection is an invaluable compendium of radio and electronics knowledge!



Style X

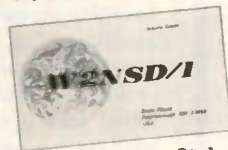

Style W

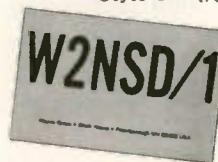

Style Y

Single back issue—ST0000—\$3.00*;
25 your choice—ST2500—\$12.00*;
25 your choice—ST2501—\$25.00*;
5 your choice—ST0500—\$8.50*;
10 your choice—ST1000—\$14.00.*

● **OWNER REPAIR OF AMATEUR RADIO EQUIPMENT**—BK7310—Frank Glass shares over 40 years of operating, servicing, and design experience in this book. There are several books and numerous articles available on the subject of repairs to electronic equipment. The information within these books ranges from the elementary to the highly technical written for the top engineers in the field. But this book stands out from the rest in that it is written in narrative style aimed at conveying the concept of electronic servicing. A written discussion of how components work and how they are combined to provide communication equipment is used to help the reader understand the concepts required to service station equipment. \$7.95.*

● **A GUIDE TO HAM RADIO**—BK7321—by Larry Kahaner WB2NEL. What's Amateur Radio all about? You can learn the basics of this fascinating hobby with this excellent beginner's guide. It answers the most frequently asked questions in an easy-going manner, and it shows the best way to go about getting an FCC license. A Guide to Ham Radio is an ideal introduction to a hobby enjoyed by people around the world. \$4.95.*

● **LIBRARY SHELF BOXES**—These sturdy white, corrugated, dirt-resistant boxes each hold a full year of 73 or Kilobaud Microcomputing. With your order, request self-sticking labels for any of the following: 73, Kilobaud Microcomputing, CQ, QST, Ham Radio, Personal Computing, Radio Electronics, Interface Age, and Byte. Order 1—BX1000—for \$2.00*; order 2-7—BX2002—for \$1.50 each*; order 8 or more—BX1002—for \$1.25 each*.

Use the order card in the back of this magazine or itemize your order on a separate piece of paper and mail to: 73 Radio Bookshop • Peterborough NH 03458. Be sure to include check or detailed credit card information.
*Add \$1.00 handling charge. Note: Prices subject to change on books not published by 73 Magazine.

FOR CUSTOMER SERVICE CALL (603) 924-7298

19 years of 73 magazine

**The world's most
comprehensive
guide to the subject
of ham radio.**



The back issues of 73 are a gold mine of interesting articles. Unlike the other magazines, which fill their pages with activity reports, there's little to go stale in 73. You'll find pioneering articles on SSTV, FM, repeaters, ICs, and computers. Even the editorials are fun as Wayne Green's dire predictions, like the debacle of incentive licensing, have come to pass.

Clip the coupon below and send for 73's new back issue catalogue. Treat yourself (or a friendly ham) to some fun, and a fantastic bargain to boot.

YES! Rush me 73's FREE Back Issue Catalogue!

Name _____

Address _____

City _____

State _____ Zip _____

73 Magazine • Peterborough NH 03458 • USA

NEW FROM 73



Tools and Techniques for Electronics (BK7348) is a comprehensive guide to the tools and construction practices used by today's electronics hobbyist. This new 73 Magazine publication should be a part of the library of anyone who has ever built or fixed any electronic gear. The text and numerous pictures and illustrations provide an easy-to-understand description of the safe and correct way to use the basic and specialized tools needed for electronics work.

The first part of Tools and Techniques for Electronics covers the basic tools that will assist the amateur Novice, CB operator, or beginning computer kit builder. It is also an excellent review for more experienced hobbyists. The second portion of the text will be of interest to the advanced tool user. It explains specialized metal working tools as well as the chemical aids that are used in repair shops. The final chapters of Tools and Techniques for Electronics discuss the construction skills that result in a professional-looking project.

Handy reference data on English/metric conversions, machine screw data, and the like will be found in the appendices. The contents of basic and advanced tool kits are outlined, and the book includes a list of suppliers.

Whether you are interested in working with tubes or the latest wire-wrap techniques, a great deal of pride and satisfaction can be gained by building or repairing your own equipment. 73's Tools and Techniques for Electronics shows you the way.

Order your copy today! Only \$4.95 from the Radio Bookshop. Use the handy order form on the Reader Service Card at the back of the magazine or phone toll free 1-800-258-5473.

ALL NEW 1979 REPEATER ATLAS OF THE WORLD

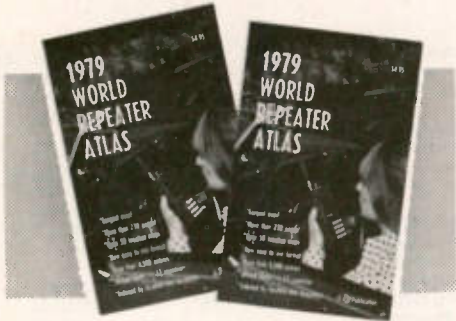

The all new 1979 Repeater Atlas is now available as a result of the cooperation of hundreds of individuals, repeater groups, and coordinators. This is the largest atlas available anywhere. It includes 234 pages, 50 location maps, over 4,500 stations, and 9,000 entries, in a new, easy-to-use format indexed by location and frequency. Call Toll Free (800) 258-5473; have your credit card handy and order your 1979 Repeater Atlas (BK 7346) today. \$4.95

73 magazine

Peterborough NH 03458

MOVING?

Let us know 8 weeks in advance so that you won't miss a single issue of 73 Magazine. Attach old label where indicated and print new address in space provided. Also include your mailing label whenever you write concerning your subscription. It helps us serve you promptly. Write to:

73 magazine

Subscription Department
P.O. Box 931
Farmingdale NY 11737

- | | |
|---|---|
| <input type="checkbox"/> Address change only | <input type="checkbox"/> Payment enclosed |
| <input type="checkbox"/> Extend subscription | (1 extra BONUS issue) |
| <input type="checkbox"/> Enter new subscription | <input type="checkbox"/> Bill me later |
| <input type="checkbox"/> 1 year \$18.00 | |

If you have no label handy, print OLD address here.

Name _____ Call _____

Address _____

City _____ State _____ Zip _____

print NEW address here:

Name _____ Call _____

Address _____

City _____ State _____ Zip _____

AFFIX LABEL

S71-79

propagation

by
J. H. Nelson

EASTERN UNITED STATES TO:

	GMT:	00	02	04	06	08	10	12	14	16	18	20	22
ALASKA	14	7A	7	7	7	7	7	7	14	21	21A	21	
ARGENTINA	21	14	7A	7B	7	7	14	21A	21A	21A	21A	21	
AUSTRALIA	21	14	14	7B	7B	7B	7B	14	21	21	21A	21A	
CANAL ZONE	14A	14	7	7	7	7	14	21A	21A	21A	21A	21	
ENGLAND	7	7	7	7	7	7	7	14	21A	21A	14	7A	
HAWAII	21	14	7A	7	7	7	7	7B	14	21A	21A	21A	
INDIA	7	7	7B	7B	7B	7B	14	21	14	14B	14B	14B	
JAPAN	14	14B	7B	7B	7	7	7	7B	7B	7B	14B	14A	
MEXICO	14	14	7	7	7	7	7A	14A	21A	21A	21A	21A	
PHILIPPINES	14A	14B	7B	7B	7B	7B	7B	14	14	14	14B	14	
PUERTO RICO	14	7	7	7	7	7	14	21A	21A	21A	21	21	
SOUTH AFRICA	14	7	7	7B	7B	14	21	21A	21A	21A	21	21	
U. S. S. R.	7	7	7	7	7	7	7B	14	21A	21	14B	7B	
WEST COAST	21	14	7A	7	7	7	7	14	21	21A	21A	21	

CENTRAL UNITED STATES TO:

ALASKA	21	14	7	7	7	7	7	7	14	21	21	21A
ARGENTINA	21	14	14	7B	7	7	14	21A	21A	21A	21A	21A
AUSTRALIA	21A	21	14	7B	7B	7B	7B	14	21	21	21A	21A
CANAL ZONE	21A	14	14	7	7	7	14	21A	21A	21A	21A	21A
ENGLAND	7	7	7	7	7	7B	7B	14A	21A	21A	14	7B
HAWAII	21A	21	14	7	7	7	7	7	14	21A	21A	21A
INDIA	14	14	7B	7B	7B	7B	14	14	14B	14B	14B	14B
JAPAN	21	14	14B	7B	7	7	7	7	7	7B	14B	21A
MEXICO	14A	14	7	7	7	7	7	14	21A	21A	21A	21A
PHILIPPINES	21A	14	14B	7B	7B	7B	7B	7	14	14	14B	14A
PUERTO RICO	21	7A	7	7	7	7	14	21A	21A	21A	21A	21
SOUTH AFRICA	14	7A	7	7B	7B	14	21A	21A	21A	21A	21	21
U. S. S. R.	7	7	7	7	7	7	7B	7B	14	14A	14B	7B

WESTERN UNITED STATES TO:

ALASKA	21	14A	7	7	7	7	7	7	14	21	21	21A
ARGENTINA	21	14A	14	7B	7	7	7B	14	21A	21A	21A	21A
AUSTRALIA	21A	21A	21	14	7B	7B	7B	7	14	21	21A	21A
CANAL ZONE	21A	14	7	7	7	7	14	21A	21A	21A	21A	21A
ENGLAND	7B	7	7	7	7	7B	7B	14	21A	21A	14	7B
HAWAII	2B	21A	14A	14	7	7	7	7	14	21A	21A	21A
INDIA	14A	14A	7B	7B	7B	7B	7B	14	14	14B	14B	14B
JAPAN	21A	21	14	7B	7	7	7	7	7	7B	14	21A
MEXICO	21	14	7A	7	7	7	7	14	21A	21A	21A	21A
PHILIPPINES	21A	21	14	7B	7B	7B	7B	7B	14	14	14B	21
PUERTO RICO	21	14	7A	7	7	7	7	14	21A	21A	21A	21
SOUTH AFRICA	14A	14	7	7B	7B	7B	7B	14	21A	21A	21A	21
U. S. S. R.	7B	7	7	7	7	7	7B	7B	14B	14	14B	7B
EAST COAST	21	14	7A	7	7	7	7	14	21	21A	21A	21

- A = Next higher frequency may also be useful
- B = Difficult circuit this period
- F = Fair
- G = Good
- P = Poor
- SF = Chance of solar flares

november

sun	mon	tue	wed	thu	fri	sat
				1	2	3
				P	G	G
4	5	6	7	8	9	10
G	G	G	G	G	G	G
11	12	13	14	15	16	17
G	F/SF	P/SF	F	F	G	G
18	19	20	21	22	23	24
G	F/SF	P/SF	F	G	G	G
25	26	27	28	29	30	
G	G	G	F	F	F	

READER SERVICE

A46	ABC Communications.....	139	D29	Dielectric Communications.55	L17	Lunar Electronics.....	146	S33	S-F Amateur Radio Services.47
A1	Adirondack Radio Supply..	210	*	Digital Research	M48	Macrotronics, Inc.....	36, 206	S117	Spacecoast Research.....
A24	Adva Electronics.....	234	*	Computers.....	M35	Madison Electronics Supply...		S7	Space Electronics.....
A94	Advanced Electronics			Digital Research Parts.....		62, 71,		S81	Spectronics, Inc.....
	Applications.....	47	D23	Dovetron.....		76, 122, 159, 187, 191, 203, 207		S8	Spectrum
A60	AED Electronics.....	188	D25	DSI Instruments.....					Communications.....
A107	AJT Enterprises.....	203	E40	Electra.....					Surplus Electronics.....
A2	Aldelco.....	236	F1	Fair Radio Sales.....					Swan Electronics.....
A57	Alliance Manufacturing Co..	15	F5	Flesher Corporation.....	M100	Metz.....	32, 208	S43	Technical Clinic.....
A40	Amateur Radio Supply Of		F22	Freestyle.....	M52	MFJ		T64	Tele-Tow'r Mfg. Co.....
	Nashville, Inc.....	87	G27	Gemini Instruments Co.....		Enterprises31, 161, 181, 210, 217		T52	Ten-Tec, Inc.....
A21	Amateur-Wholesale		G12	Germantown Amateur	M8	MHZ Electronics.....	218, 219		19, 117
	Electronics.....	216, 217		Supply.....	M69	Micro Control		T34	Thomas
A106	AMC Engineering.....	191	G22	G.I.S.M.O.....		Specialists.....	105, 189		Communications.....
*	Amsat.....	118	G4	Godbout Electronics.....	M55	Microlog Corp.....	29, 143	T48	Tower Electronics
A6	Apron Laboratories.....	206	H24	Hal-Tronix.....	M95	Micro Management			Corp.....
A105	A R Technical Products.....	159	H2	Ham Radio Center.....		Systems.....	188	T18	Trac Electronics Corp.....
	Associated Radio.....	228	H16	Hamtronics, NY.....	M92	Mil Industries.....	161	T72	T-Shirts & Wonders.....
A16	Atlas.....	36	H8	Hamtronics, PA.....		J W Miller Div Bell		T3	Tufts Radio
A100	Autek.....	215	H5	Heath.....		Industries.....	209		Electronics.....
B23	Barker-Williamson.....	203	H3	Henry Radio.....		Inc.....	33, 201, 208	U10	UDM Enterprises.....
B10	Bird.....	34	H44	HFT, Inc.....		Outdoor Outfitters.....	189	U9	Ultima Electronics, Ltd.....
B45	B & K Precision.....	201	H36	Hustler.....		Palomar Engineers.....	31	U2	Unadilla/Reyco Division.....
B8	Bullet Electronics.....	232	I32	ICOM.....		P.C. Electronics.....	203	U8	Unarco-Rohn.....
C3	Clegg.....	157	I43	Instant Software.....		Pickering Codemaster		U6	Unlited Products.....
C21	CoakIt.....	105	I9	Insta-Pac.....		Company.....	186	V24	Unlversal Amateur Radio,
C58	Communications Center,		I27	Integrated Circuits, Unltd..		Rudy Plak.....	212	V75	Inc.....
	NE.....	53, 85	I44	IRL.....		Poly Paks.....	229	W18	Vibroplex.....
C5	Communications		J1	International Electronic Corp.,		Protronics, Inc.....	189	W2	Vineyard Amateur Radio.....
	Electronics.....	77-79	J2	Inc.....		Quest Electronics.....	213	W33	Western Electronics.....
C115	Communications Electronics		K14	Jameco Electronics.....		Radio Amateur Callbook.....	212	X3	Wilson Electronics.....
	Specialties.....	55, 211	*	Jan Crystals.....		Radio Shack.....	199	Y1	Wilson Systems, Inc.....
C6	Communications		K14	Kantronics.....		Radio World.....	189		Xitex Corp.....
	Specialists.....	26, 27	*	Kenwood.....		Ramsey Electronics.....	220		Yaesu Electronics
C105	Communications & TV		K4	Key Electronics.....		RF Power Labs, Inc.....	50		Corp.....
	Unltd.....	209	L25	Kilobaud.....		Selectronics.....	212		CIII, 17, 37
C160	Comtronix, Inc.....	39	L9	KLM Electronics.....		Semiconductor			
C124	Cost Effective Computer			The Logic Store.....		Surplus.....	214, 231		
	Services.....	34, 104		Long's Electronics.....		Sentry Manufacturing.....	209		
D6	Peter W Dahl Company.....	189							

From 73-98, 163-167, 237-242
From 80 Microcomputing-35
*Reader Service inquiries not honored.
Please contact advertiser directly.

BOOKS, ETC.

BK1016	73 DIPOLE & LONG WIRE ANTENNAS.....	\$ 5.50	BK7305	POWER SUPPLY HANDBOOK.....	\$ 7.95
ST0000	73 BACK ISSUE.....	\$ 3.00	BK1015	PRACTICAL ANTENNAS FOR THE RADIO	
ST2500	73 BACK ISSUES - 25 OUR CHOICE.....	\$12.00		AMATEUR.....	\$ 9.95
ST0500	73 BACK ISSUES - 5 YOUR CHOICE.....	\$ 8.50	BK7302	PROPAGATION WIZARD'S HANDBOOK.....	\$ 6.95
ST1000	73 BACK ISSUES - 10 YOUR CHOICE.....	\$14.00	QW0250	QSL CARDS - STYLE W - 250.....	\$ 8.95
ST2501	73 BACK ISSUES - 25 YOUR CHOICE.....	\$25.00	QW0500	QSL CARDS - STYLE W - 500.....	\$13.95
BK7307	BEHIND THE DIAL.....	\$ 4.95	QX0250	QSL CARDS - STYLE X - 250.....	\$ 8.95
BN1001	BINDER - 73 - 1.....	\$ 6.50	QX0500	QSL CARDS - STYLE X - 500.....	\$13.95
BN1002	BINDER - 73 - 2 AND UP.....	\$ 6.00	QY0250	QSL CARDS - STYLE Y - 250.....	\$ 8.95
BK7309	CHALLENGE OF 160.....	\$ 4.95	QY0500	QSL CARDS - STYLE Y - 500.....	\$13.95
CT7305	CODE TAPE - 5 WPM.....	\$ 4.95	BK7346	1979 WORLD REPEATER ATLAS.....	\$ 4.95
CT7306	CODE TAPE - 6 + WPM.....	\$ 4.95	BK1044	RF DIGITAL TEST EQUIPMENT.....	\$ 5.95
CT7310	CODE TAPE - 10 + WPM.....	\$ 4.95	BK7347	RTTY HANDBOOK.....	\$ 5.95
CT7313	CODE TAPE - 13 + WPM.....	\$ 4.95	BX1000	SHELF BOX - 1.....	\$ 2.00
CT7320	CODE TAPE - 20 + WPM.....	\$ 4.95	BX1001	SHELF BOXES - 2.....	\$1.50 each
CT7325	CODE TAPE - 25 + WPM.....	\$ 4.95	BX1002	SHELF BOXES - 8 AND UP.....	\$1.25 each
CT7394	CODE TAPES (ANY FOUR ABOVE).....	\$15.95	BK7351	SSB THE MISUNDERSTOOD MODE.....	\$ 5.50
BK7308	THE CONTEST COOKBOOK.....	\$ 5.95	BK7354	SSTV HANDBOOK (HARDCOVER).....	\$ 7.00
BK7321	GUIDE TO HAM RADIO.....	\$ 4.95	BK7355	SSTV HANDBOOK (SOFTCOVER).....	\$ 5.00
BK7304	GIANT BOOK OF AMATEUR RADIO		CT7350	SSTV TAPE.....	\$ 5.95
	ANTENNAS.....	\$12.95	SG1081	STUDY GUIDE - ADVANCED CLASS.....	\$ 5.95
BK7325	HOW TO BUILD A MICROCOMPUTER & REALLY		SG1080	STUDY GUIDE - EXTRA CLASS.....	\$ 5.95
	UNDERSTAND IT.....	\$ 9.95	SG7358	STUDY GUIDE - GENERAL CLASS.....	\$ 5.95
BK1028	IC OP AMP COOKBOOK.....	\$12.95	SG7357	STUDY GUIDE - NOVICE CLASS.....	\$ 4.95
BK7380	INTRO TO RTTY.....	\$ 2.00	LB7359	TEST EQUIP LIB V1 - COMP TESTERS.....	\$ 4.95
CT7300	NOVICE THEORY TAPES.....	\$15.95	LB7360	TEST EQUIP LIB V2 - AUDIO TESTERS.....	\$ 4.95
BK7310	OWNER REPAIR OF AMATEUR RADIO		LB7361	TEST EQUIP LIB V3 - RADIO EQUIP.....	\$ 4.95
	EQUIPMENT.....	\$ 7.95	LB7362	TEST EQUIP LIB V4 - IC TEST EQUIP.....	\$ 4.95
			BK7348	TOOLS & TECHNIQUES.....	\$ 4.95
			BK1069	VERTICAL BEAM & TRIANGLE ANTNS.....	\$ 5.50
			BK7368	VHF ANTENNA HANDBOOK.....	\$ 4.95
			BK7370	WEATHER SATELLITE HANDBOOK.....	\$ 4.95

SOMETHING DIFFERENT

The FT-107 Series with "DMS"*

"It's A Cut Above The Rest"

* **OPTIONAL DIGITAL MEMORY SHIFT ("DMS")**

12 discrete memories. Stores individual frequencies or use as 12 full coverage VFOs (500 kHz each)

- Solid State
- 240 watts DC SSB/CW
- 160-10 meters, WWV (2 auxiliary band positions are available for future expansion)
- RF Speech Processor
- SSB, CW, AM, FSK
- Built-in SWR Meter
- Excellent Dynamic Range
- Audio Peak/Notch Filter
- Variable Bandwidth
- Full Line of Accessories



The FT-107 has been created as a result of a blending of technologies — computer, solid state and RF design. By careful utilization of these disciplines and the experience gained from our FT-301 series, YAESU has achieved an HF transceiver which offers unique features (e. g. "Digital Memory Shift"), efficient operation and a level of performance that has been previously unattainable.

RECEIVER:

Sensitivity: 0.25 uV for 10dB S/N, CW/SSB, FSK
1.0 uV for 10dB S/N, AM

Image Rejection: 60dB except 10 meters (50dB)

IF Rejection: 70dB

Selectivity: SSB 2.4 kHz at -6dB, 4.0 kHz at -60dB.
CW 0.6 kHz at -6dB, 1.2 kHz at -60dB.
AM 6 kHz at -6dB, 12 kHz at -60dB
Variable IF Bandwidth

20dB RF Attenuator

Peak/Notch Audio Filter

Audio Output: 3 watts (4-16 ohms)

Accessories: FV-107 VFO (standard not synthesized)
FTV-107 VHF (UHF Transverter)
FC-107 Antenna Tuner
SP-107 Matching Speaker
FP-107 AC Power Supply

TRANSMITTER

Power Input: 240 watts DC SSB/CW
80 watts DC AM/FSK

Opposite Sideband Suppression: Better than 50dB

Spurious Radiation: -50dB.

Transmitter Bandwidth 350-2700 hz (-6dB)

Transmitter: 3rd IMD -31dB neg feedback 6dB

Transmitter Stability: 30 hz after 10 min. warmup
less than 100 hz after 30 min.

Antenna Input Impedance: 50 ohms

Microphone Impedance: 500 ohms

Power Required: 13.5V DC at 20 amps
100/110/117/200/220/234V AC at 650 VA

Price And Specifications Subject To
Change Without Notice Or Obligation

1179

YAESU
The radio.

YAESU ELECTRONICS CORP., 15954 Downey Ave., Paramount, CA 90723 • (213) 633-4007
YAESU ELECTRONICS Eastern Service Ctr., 9812 Princeton-Glendale Rd., Cincinnati, OH 45246



TS-700SP

TR-7600 TR-7625



Looks the same as the TR-7625, but offers 10 watts RF output (switchable to 1 watt low power). Also uses RM-76 Microprocessor Control Unit. Offers one built-in memory.

Featuring 25 watts RF output (switchable to 5 watts low power), the TR-7625 is a high-performance 2-meter FM transceiver with built-in memory, and is designed to permit multi-channel (800-channel) operation. Compact and perfect for mobile or ham shack use. When used with optional RM-76 Microprocessor Control Unit, the TR-7625 offers a whole new dimension in channel memory and scanning capability.



Here's an outstanding 2-meter ALL-MODE TRANSCIVER that provides an extra dimension of versatility over the entire 2-meter band. Feature-packed and equipped for SSB, FM, CW and AM. Complete with built-in digital frequency readout, receiver preamplifier, VOX, sidetone, and microphone.



RM-76

Optional Microprocessor Control Unit. Combines with either the TR-7600 or TR-7625. Stores frequencies in six memories (simplex/repeater), and it scans.

See your Authorized Kenwood Dealer for more details.



...pioneer in amateur radio
TRIO-KENWOOD COMMUNICATIONS INC.
1111 WEST WALNUT/COMPTON, CA 90220