



At All Lafayette
Company-Owned
Stores and
Mail Order

Lafayette

RADIO ELECTRONICS

Sale Prices
End
May 1, 1974

"Listen To Us, You Can't Go Wrong"



Mail Order and Sales Center: 111 Jericho Turnpike, Syosset, L.I., New York 11791

• Index—P. 48A • Store Addresses—p. 48B • Easy Pay Plan—p. 19 • Associate Stores Coast-to-Coast

Fantastic Sale on a Compact 4-Channel SQ AM/FM Modular System



NOW ONLY
99⁹⁵

SAVE 40.00! Lafayette SQR-20 4-Channel SQ AM/FM Modular System

**EVEN MORE
VALUE!**

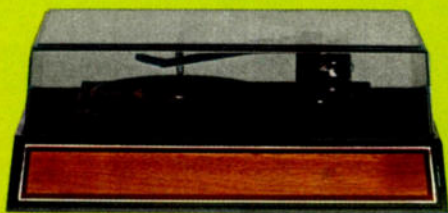

Add a Record Player

For Only **29⁹⁵** More

Fine performing system consists of the SQR-20 plus the Lafayette MC-22B 4-Speed Automatic Record Changer mounted on a black leatherette-vinyl base with dust cover. Imported.

99 K 92686WM Shpg. wt., 47½ lbs.Net 129.90

- 4 Separate Solid-State Amplifiers
- Built-in SQ 4-Channel Matrix Decoder
- "Composer" Circuit for Deriving 4-Channel Sound from 2-Channel Sources
- Sensitive AM/FM Stereo Tuner
- 4 Wide-Range Speaker Systems
- Inputs for Magnetic and Ceramic Phono
- FM Stereo Indicator Light
- Four 4-Channel Aux Inputs

The SQR-20 Modular System features a 4-channel stereo receiver consisting of an AM/FM Stereo Tuner, an SQ 4-channel Matrix Decoder, and 4 separate amplifiers in one unit, plus 4 separate 6½" wide-range speakers in walnut wood enclosures. The SQR-20 reproduces 3 basic types of sound: Discrete, SQ and Derived. Just connect a 4-channel track tape cartridge or reel-to-reel player and listen to discrete 4-channel tapes. The built-in SQ-Matrix decoder permits you to listen to 4-channel SQ broadcasts on FM or to play the new SQ 4-channel records developed by Columbia, thru the Lafayette MC-22B or any conventional record changer or cartridge. No special changer or cartridge is required to play SQ records. You can also use the SQR-20's exclusive "Composer" circuit to derive 4-dimensional sound from 2-channel records, tapes and broadcasts. Four separate slide-lever volume controls are provided for adjusting sound for front left, front right, rear left, rear right. Output jacks are provided for headphone or tape recorder. Blackout Tuning Dial. Built-in AM and FM antennas. The two front speakers include 8 ft. of cable; the two rear speakers include 25 ft. of cable. Size: Each Speaker System, 8½W x 14½H x 5½"D; 4-Channel Receiver, 16½W x 10½D x 4½H". For 117 VAC, 60 Hz. Imported. Shpg. wt., 37½ lbs.
99 K 02887W No Money Down*Net 99.95

Get A Stereo Component Table

For Only **\$1.00** With The Purchase Of The Lafayette LSC-75 AM/FM Stereo Phono System

LSC-75 WITH COMPONENT TABLE

80⁹⁵
No Money Down*

79.95 less table

- Bold New Futuristic Styling with Cylindrical Speaker
- BSR 4-Speed Automatic Record Changer with Diamond Needle
- Front Panel Stereo Headphone Jack
- FM Stereo Indicator Light



With Plastic Dust Cover

BONUS OFFER EXPIRES 5/1/74

The LSC-75 4-piece compact phono system features 2 separate wide-range 4" high compliance cylindrical speaker systems, a calibrated slide rule tuning dial, separate volume controls for each channel, dual bass/treble control, and built-in AM and FM antennas. Plays 12", 10", and 7" records at 16 $\frac{1}{2}$, 33 $\frac{1}{3}$, 45, and 78 RPM. Diamond LP stylus ceramic cartridge. Size: Control Unit, 18" x 10 $\frac{3}{4}$ " x 5 $\frac{1}{4}$ "; Each Speaker, 7 $\frac{1}{2}$ " x 11". For 117 VAC, 60 Hz. Shpg. wt., 15 lbs.

24 K 03657HW LSC-75 onlyNet 79.95
LSC-75 SYSTEM PLUS STEREO COMPONENT TABLE.
24 K 90167HWM Shpg. wt., 28 lbs.Net 80.95
STEREO COMPONENT TABLE ONLY
Holds up to 80 records. Size: Top Shelf 19Hx21Wx12 $\frac{1}{2}$ "D;
Speaker Supports 12" x 12". Comes knocked down. Shpg.
wt., 13 lbs.
20 K 54005WNet 14.95

A Great Combination

Modular LAFAYETTE Stereo Hi-Fi Phono System
with a Headphone for Only **1c** More

LSC-35 WITH HEADPHONE

49⁹⁶
No Money Down*

49.95 less headphone



REG.
6.95



LSC-35

With Dust Cover

- BSR 4-Speed Automatic Record Changer
- Two 4" Wide-Range Matched Speaker Systems

The LSC-35's futuristic-styled, slim-lined control unit contains a reliable solid-state stereo amplifier, and a BSR 4-speed automatic record changer with a separate Bubble-Top dust cover. Each matching 4" high-compliance speaker is mounted in an attractive ebony-molded cylindrical enclosure. The LSC-35 features 3 controls—volume left, volume right, and tone. Automatic shut-off after last record has been played. Plays all size records at 16 $\frac{1}{2}$, 33 $\frac{1}{3}$, 45 and 78 RPM. Stereo turnover cartridge with diamond needle. Size: Control Unit—18W x 10 $\frac{3}{4}$ D x 5 $\frac{3}{4}$ H. Each Speaker—7 $\frac{1}{2}$ W x 11"H. For 110 VAC, 60 Hz. Wt., 14 lbs.
24 K 03673HW Model LSC-35 OnlyNet 49.95.

Model LSC-35 and SP-22 Stereo Headphone
24 K 90175HWM Shpg. wt., 15 $\frac{1}{2}$ lbs.Net 49.96
99 K 02123 SP-22 Stereo Headphone OnlyNet 6.95
45 RPM Spindle for LSC-35 and LSC-75.
24 K 02568 Shpg. wt., 4 oz.Net 1.49

*See Page 19 for Full Details on Easy Pay Plan

Lafayette Cat. No. 743 **3**

Our Best 4-Channel Receiver... It's Also Our Most Powerful With an FM Tuning Section Designed For Optimum Separation and Minimum Distortion

LR-4000



AAA 2 YEAR GUARANTEE

See Page 30 for details.

4
LAFAYETTE
4-CHANNEL

*Highly Sophisticated 4-Channel Wavematching Full Logic SQ Decoder Circuitry

*Also Plays All Stereo Records and FM Stereo Broadcasts With Outstanding Audio Quality

Lafayette's LR-4000 produces a more spectacularly true-to-life sound than any receiver we have ever designed! The reason is simple. We took the best features from our best receivers, then improved upon each. To our finest SQ decoder we added wavematching full logic circuits, giving SQ encoded music far wider front-to-rear and left-to-right separation and a much more dramatically beautiful sound than almost anyone had believed possible. To our best 4-channel amplifiers we added a lot more power so that even in the largest room in your home you'll be totally immersed in the sound. And, to our most sensitive FM tuner, we added Phase Locking FM Multiplex decoding circuitry to optimize FM stereo separation and minimize distortion. The FM tuner also includes dual-gate MOSFET RF transistors for superior AGC action and cross modulation rejection.

POWER RATINGS: 228 Watts RMS (4 x 57 Watts) at 4 ohms, THD 1% at 1 kHz; 290 Watts IHF at 4 ohms.

tion. The AM/FM signal strength and FM center scale tuning meters make precision fine tuning a breeze. Pushbuttons put you in control of Speakers (main and remote), Inputs (five choices), and Modes (including two tape monitor, loudness, high filter, and FM mute). Rotary switches let you choose the Function and Tuner Mode. Tape and stereo mike inputs and stereo tape and two headphone outputs allow use with any and all components. And, dual concentric Volume and Tone controls permit you to tailor the superb sound to your personal taste. Meticulously designed with a brushed aluminum front panel, in a handsome walnut-finished wood cabinet. Size: 21W x 5 1/4" H x 13" D. For 117 VAC, 60 Hz. Imported.

99 K 02941W Shpg. wt., 41 lbs.Net 569.95

SPECIFICATIONS

Amplifier: Frequency Response: 20-20,000 Hz \pm 1 db; THD: 1% or less at rated output, .07% at 1 watt; Power Bandwidth: 15-70,000 Hz; Hum and Noise: Aux -70 db, Phono Mag -60 db; Tuner FM: Usable Sensitivity (IHF): 1.65 μ V; Stereo Separation: 40 db at 400 Hz; HD: 0.15% at 100% Mod; Capture Ratio: 1.5 db; Antenna: Built-in plus 300-ohm balanced for external antenna.

RECEIVER PRICE

569⁹⁵

No Money Down*

Add These Matched Components To Lafayette's Best Receiver and SAVE 121.61 to 138.62 from Individual Catalog Prices. That's Sound Value!



Criterion 666

Garrard 62

Pickering V15
Micro IV/ACE

Pickering UV15/2000Q

CD-4

THE LR-4000 PLAYS ALL 4-CHANNEL MODES

MATRIX 4-CHANNEL

The LR-4000 decodes and plays all matrix 4-channel records and FM broadcasts—SQ and all others (such as RM).

DISCRETE 4-CHANNEL

The LR-4000, through its four amplifiers, plays all discrete tapes—reel-to-reel and 8-track cartridges. Plays discrete 4-channel CD-4 records with the addition of accessory CD-4 demodulator. The LR-4000 even has an FM detector output, making it ready for discrete 4-channel FM MPX systems when they're available.

DERIVED 4-CHANNEL

The LR-4000 also has Lafayette's exclusive "Composer" circuitry that derives 4-channel sound from your present stereo records and tapes, and from FM stereo broadcasts.

LR-4000 AM/FM 4-CHANNEL MATRIX SYSTEM

Lafayette LR-4000 4-Channel AM/FM receiver

Garrard 62 3-speed automatic turntable

Garrard turntable base

Pickering V15 Micro IV/ACE stereo cartridge with elliptical diamond stylus

4 Lafayette Criterion 666 3-way acoustic suspension speaker systems each with 10" woofer, 6" mid-range, 2" tweeter, and mid-range and brilliance controls in ¾" oiled-walnut finish wood cabinet with foam grille
Plus speaker cable. Wt., 198¾ lbs.
22 K 92134WMNet 877.66

SAVE 121.61

From individual catalog prices!

877⁶⁶

No Money Down*

LR-4000 AM/FM 4-CHANNEL MATRIX and CD-4 DISCRETE SYSTEM

Same deluxe system, plus Lafayette CD-4 4-channel demodulator and Pickering UV15/2000Q 4-channel/stereo cartridge with quadrilateral diamond stylus instead of V15 Micro IV/ACE cartridge. The demodulator and this cartridge let you enjoy CD-4 discrete 4-channel records in addition to all matrix 4-channel records and FM broadcasts. Shpg. wt., 204¾ lbs.
22 K 92142WMNet 990.60
See page 29 for full description of CD-4 demodulator.

SAVE 138.62

From individual catalog prices!

990⁶⁰

No Money Down*

All mail orders accepted with Mastercharge and BankAmericard.

Lafayette Cat. No. 743

5

**The LR-441 Has Exactly The Same SQ Decoder Circuitry
As That In Lafayette's Best 4-Channel Receiver...
That's Why The Sound It Produces Is So Startlingly Vibrant!**



LR-441

AAA 2 YEAR GUARANTEE

See Page 30 for details



- ★ The SQ Channel Decoding Circuitry Incorporates Highly Sophisticated Wavematching Full Logic
- ★ Phase Locking Multiplex Decoder For Exceptional FM Stereo Separation and Minimum Distortion
- ★ Also Plays All Your Stereo Records and FM Stereo Broadcasts With Outstanding Audio Quality

In your home, Lafayette's LR-441 4-channel receiver will deliver a more remarkably realistic sound than you've probably ever heard anywhere—other than in the concert hall itself! Its wavematching full logic decoding circuits give SQ encoded 4-channel material such exceptionally wide front-to-rear and left-to-right separation that you'll almost believe the music is coming out of the four walls. The FM tuning section, containing Phase Locking Multiplex decoder circuitry, is so sensitive that, with the aid of the front panel signal strength and center scale tuning meters, you will be picking out clear, sharp signals from FM stations that you didn't even know existed. And this receiver's four excellent amplifiers produce more than enough power to completely envelop you in the life-like sound. With stereo and 4-channel tape and headphone outputs and a stereo microphone input all on the front panel,

and phono and tape inputs and tape and speaker outputs in the rear, the LR-441 is ready for virtually any 4 channel and stereo audio situation you might encounter. And whatever the situation, with this unit you're in command—with all the controls: clutch operated Master Volume; concentric Balance-Volume, Bass, and Treble; rotary Function, Tuner Mode, and Speakers/Headphones; five pushbutton Inputs; and six pushbutton Mode selectors (including Loudness, High Filter and FM Mute). All are carefully designed to facilitate simple, accurate operation. And they're all within easy reach, on the handsomely styled, brushed aluminum front panel. The LR-441 is housed in a walnut-finish wood cabinet that is sure to enhance the decor of any room in your home. Size: 19½" W x 5H x 12¼" D. Operates on 117 VAC, 60 Hz. Imported. Shpg. wt., 37 lbs. **99 K 02735W**Net **479.95**

POWER RATINGS: 160 Watts RMS (4 x 40 Watts) at 4 ohms, THD 1% at 1 kHz; 192 Watts IHF at 4 ohms.

SPECIFICATIONS

Amplifier: Frequency Response: 20-20,000 Hz at 1 watt; THD: 1% or less at rated output; **Power Bandwidth:** 15-25,000 Hz; **Channel Separation:** 65 db; **Tuner:** FM: Usable Sensitivity (IHF): 1.65 µV; **Stereo Separation:** 40 db at 400 Hz; S/N Ratio: 70 db. **Capacity Ratio:** 1.5 lb; **4 Gang Tuning Condenser;** Antenna: Built-in plus 300 ohm balanced for external antenna; **AM:** 3 Gang Tuning Condenser.

RECEIVER PRICE **479⁹⁵**
No Money Down*

Add These Specially Selected 4-Channel Components and Create A Sound System That Saves You \$98.61 To \$115.62 From Individual Catalog Prices! That's Sound Savings!



Criterion 444

Pickering

V15 Micro IV/ACE

Pickering UV15/2000Q

Garrard 62

CD-4

THE LR-441 PLAYS ALL 4-CHANNEL MODES

MATRIX 4-CHANNEL

The LR-441 decodes and plays all matrix 4-channel records and FM broadcasts—SQ and all others (such as QS/RM).

DISCRETE 4-CHANNEL

The LR-441, through its four amplifiers, plays all discrete tapes—reel-to-reel and 8-track cartridges. Plays discrete 4-channel CD-4 records with the addition of accessory CD-4 demodulator. The LR-441 even has an FM detector output, making it ready for discrete 4-channel FM MPX systems when they're available.

DERIVED 4-CHANNEL

The LR-441 also has Lafayette's exclusive "Composer" circuitry that derives 4-channel sound from your present stereo records and tapes, and from FM stereo broadcasts.

LR-441 AM/FM 4-CHANNEL MATRIX SYSTEM

- Lafayette LR-441 4-channel AM/FM receiver
 - Garrard 62 3-speed automatic turntable
 - Garrard turntable base
 - Pickering V15 Micro IV/ACE stereo cartridge with elliptical diamond stylus
 - 4 Lafayette Criterion 444 3-way acoustic suspension speaker systems, each with 8" woofer, 3½" mid-range, 1½" direct-radiator tweeter, 2 cross-over networks, and brilliance control in handsome walnut-vinyl finish enclosure
 - Plus speaker cable. Wt., 130¼ lbs.
- 22 K 92019WMNet 670.66

SAVE 98.61

From individual catalog prices!

670⁶⁶
No Money Down*

LR-441 AM/FM 4-CHANNEL MATRIX and CD-4 DISCRETE SYSTEM

- Same excellent system, plus Lafayette CD-4 4-channel demodulator and Pickering UV/2000Q 4-channel/stereo cartridge with quadrahedral diamond stylus instead of V15 Micro IV/ACE cartridge. The demodulator and this cartridge let you enjoy CD-4 discrete 4-channel records in addition to all matrix 4-channel records and FM broadcasts. Wt., 136¾ lbs.
- 22 K 92027WMNet 783.60

See page 29 for full description of CD-4 demodulator.

SAVE 115.62

From individual catalog prices!

783⁶⁰
No Money Down*

Charge it with BankAmericard or Mastercharge!

Here's Your Chance To Own A Fine Quality, Feature Laden Lafayette 4-Channel Receiver and Save \$90!

LR-220



AAA 2 YEAR GUARANTEE
See Page 30 for details

4
LAFAYETTE
4-CHANNEL

- ★ Four Amplifiers for All Matrix, Discrete, and Derived 4-Channel Program Sources
- ★ Also Plays All Your Stereo Records, Stereo Tapes, and FM Stereo Broadcasts

Lafayette's LR-220 is now at the lowest price ever! You can now save over 30% and still get a 4-channel receiver that does it all! Combining an AM/FM tuner, four amplifiers, and two separate matrix 4-channel decoding circuits in one excellently engineered unit, the LR-220 gives you quality high fidelity reproduction from all sources (records, tapes, and FM broadcasts), and in all modes (mono, stereo, and 4-channel). It also plays every kind of 4-channel program material—matrix, discrete, and derived. And the LR-220 has the inputs and outputs to handle it all. 4-channel headphone jacks are on the front panel, and tape and speaker outputs are on the rear. The rear panel also contains inputs for tape, Aux 1, Aux 2, and phono (with a Magnetic/Ceramic slide switch). And with this receiver's ingeniously designed front panel you're in complete control. Rotary selectors let you choose the Input Source,

Speakers (Main, Main plus Remote, and Remote) Headphones, and Function. Pushbutton switches are provided for Tape Monitor, Stereo/Mono, Loudness, and High Filter. You can even change the character of the sound by adjusting the front and rear channel Balance, Volume, Bass, and Treble controls. The handsome brushed aluminum front panel also features a blackout tuning dial, an illuminated signal strength tuning meter, and an FM stereo indicator light. The LR-220 is encased in walnut-finished wood that will add a touch of elegance to any spot in your home. And there will be many spots from which to choose, as this remarkable receiver is exceptionally compact—15 $\frac{1}{2}$ "W x 4 $\frac{3}{4}$ " x 11 $\frac{1}{4}$ "D. Operates on 117 VAC, 60 Hz. Imported. Shpg. wt. 21 lbs.

POWER RATINGS: 44 Watts RMS (4 x 11 Watts) at 4 ohms, THD 1% at 1 kHz; 68 Watts IHF at 4 ohms.

99 K 02933WNet 199.95

SPECIFICATIONS

Amplifier: Frequency Response (at 1 watt): 20-20,000 Hz \pm 1.5 db; THD (8 ohms, 1 kHz): 1% or less at rated output, 0.125% at 1 watt; **Power Bandwidth:** 35-30,000 Hz; **Tuner FM:** Usable Sensitivity (IHF): 2.5 μ V; **Stereo Separation:** 35 db at 400 Hz; S/N Ratio: 60 db at 400 Hz, 100% Mod; **Selectivity (Alternate Channel):** 40 db; **Capture Ratio:** 3 db; **Antenna:** Built-in plus 300 ohm balanced for external antenna.

SALE 199⁹⁵
No Money Down*

Now Get An Extra Savings With A 4-Channel Matrix System Or Matrix and CD-4 System! That's Value!

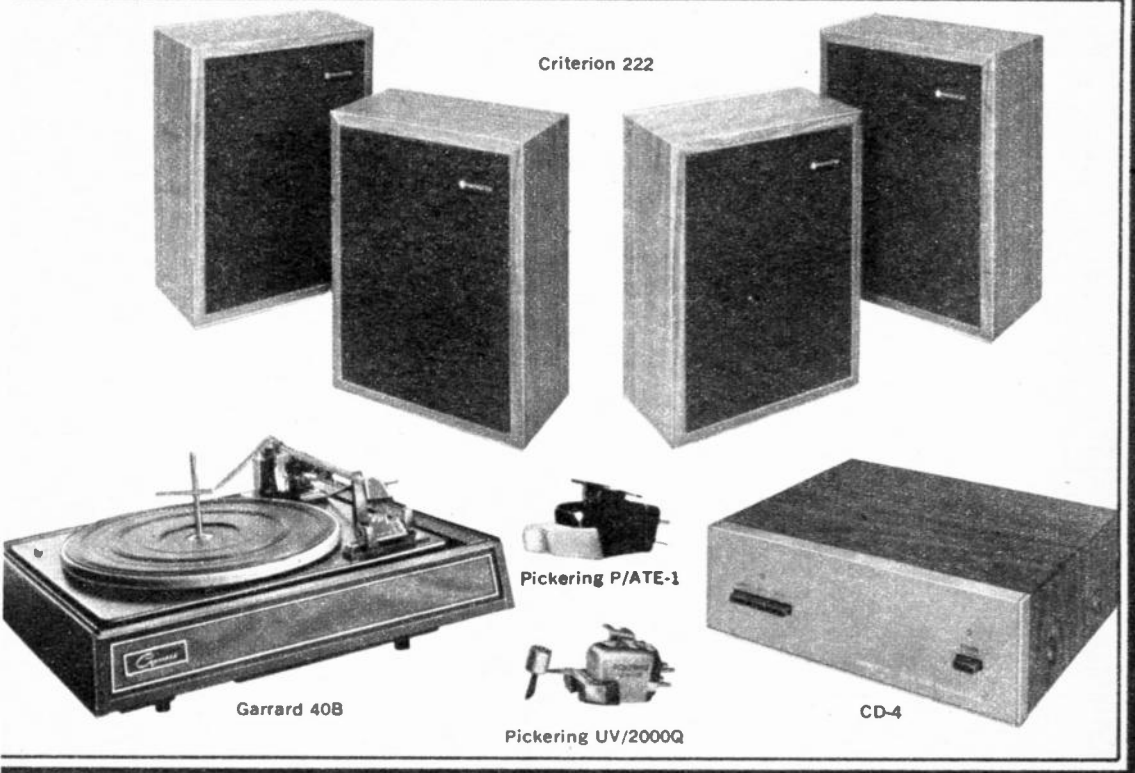

Criterion 222

Garrard 40B

Pickering P/ATE-1

Pickering UV/2000Q

CD-4

THE LR-220 PLAYS ALL 4-CHANNEL MODES

MATRIX 4-CHANNEL

The LR-220 decodes and plays all matrix 4-channel records and FM broadcasts—SQ and all others (such as QS/RM).

DISCRETE 4-CHANNEL

The LR-220, through its four amplifiers, plays all discrete tapes—reel-to-reel and 8-track cartridge. Plays discrete 4-channel CD-4 records with the addition of accessory CD-4 demodulator. The LR-220 even has an FM detector output, making it ready for discrete 4-channel FM MPX broadcast reception when available.

DERIVED 4-CHANNEL

The LR-220 also has Lafayette's exclusive "Composer" circuitry that derives 4-channel sound from your present stereo records and tapes, and from FM stereo broadcasts.

LR-220 AM/FM 4-CHANNEL MATRIX SYSTEM

Lafayette LR-220 4-channel AM/FM receiver

Garrard 40B 3-speed automatic turntable

Garrard Turntable Base

Pickering P/ATE-1 stereo cartridge with elliptical diamond stylus

4 Lafayette Criterion 222 efficient 2-way speaker systems, each with an 8" woofer and a 2½" tweeter in an attractive walnut-vinyl finish enclosure

Plus speaker cable. Wt., 75¼ lbs.

22 K 92092WMNet 326.66

SAVE 57.61 More

From individual catalog prices!

326⁶⁶

No Money Down*

LR-220 AM/FM 4-CHANNEL MATRIX and CD-4 DISCRETE SYSTEM

Same fine system, plus Lafayette CD-4 4-channel demodulator, Pickering UV15/2000Q 4-channel/stereo cartridge with quadrilateral diamond stylus instead of the P/ATE-1 cartridge, and Garrard 62 3-speed automatic turntable instead of the 40B. The demodulator, this cartridge, and this turntable let you enjoy CD-4 discrete 4-channel records in addition to all matrix 4-channel records and FM broadcasts. Shpg. wt., 120¼ lbs. 22 K 92381WMNet 459.60

See page 29 for full description of CD-4 demodulator.

SAVE 79.62 More

From individual catalog prices!

459⁶⁰

No Money Down*

Lafayette Cat. No. 743 9

Treat yourself with a BankAmericard or Mastercharge order.

Lafayette's Best Stereo Receiver Combines Sensitive FM Tuning And A Powerful Stereo Amplifier To Deliver "Live-Like" FM Stereo Reception and Audio Reproduction!

LR-2500



AAA 2 YEAR GUARANTEE
See page 30 for details

2
LAFAYETTE
STEREO

- Plays All Stereo Records, Stereo Tapes, and FM Stereo Broadcasts With Exceptional Audio Quality
- Has Large Illuminated AM/FM Signal Strength and FM Center Scale Tuning Meters For Precision Tuning
- Incorporates Two Monitor Circuits For Dual Recording or Tape Duplicating

Combining our best fully automatic FM stereo multiplex tuning section, our most sensitive AM tuning section, an excellent stereo control preamplifier, and our highest power stereo amplifier, the precision-engineered LR-2500 delivers a more "live-like" sound than any other stereo receiver we have ever designed! And consistently superior performance is insured by the IC's, FET's, and dual-gate MOSFET's in its dependable all solid-state circuitry. In addition to playing superbly in the stereo mode, if you connect two more speakers and turn a front panel switch, the LR-2500 will also derive exciting 4-dimensional sound from stereo records, tapes and FM broadcasts. And should you decide later to convert your stereo system to 4-channel, its two tape monitor circuits will accept all the necessary 4-channel add-on components. Other inputs include: Aux,

phono (with a low/high level switch), external FM and AM antenna (if you wish to bypass the internal antennas), and microphone (on the front panel). There are tape outputs on the rear, and tape and two headphone outputs on the front. The front panel also has all the controls you'll need, including: Master Volume, concentric left and right channel Balance, Bass and Treble, and pushbuttons for—Loudness Compensation, Flat Tone, 20 db Audio Mute, High Filter, Tuning Dial Lamp Dimmer, the two tape monitor circuits, and even FM Interstation Mute for quiet FM tuning. And the LR-2500 looks great, with its illuminated input and function indicators, extruded aluminum front panel, and decorative walnut-finished wood cabinet. Size: 19½"W x 13¾"D x 5¾"H. For 117 VAC, 60 Hz. Imported. 99 K 03352W Shpg. wt., 34½ lbs.Net 379.95

POWER RATINGS: 140 Watts RMS (2 x 70 Watts) at 4 ohms, THD 1% at 1 kHz; 190 Watts IHF at 4 ohms.

RECEIVER PRICE

379⁹⁵

No Money Down*

SPECIFICATIONS

Amplifier: Frequency Response: 20-20,000 Hz \pm 0.75 db; THD: 0.8% at rated output, 0.07% at 1 watt; Power Bandwidth: 18-55,000 Hz; Output Impedance: 4 and 8 ohms; Tuner FM: Usable Sensitivity (IHF): 1.65 μ V; Capture Ratio: 1.5 db; Selectivity: 60 db; S/N Ratio: 70 db; Image Rejection: 75 db; Spurious Response Rejection: 90 db; Cross Modulation Index: 90 db; AM: Antenna Terminal Sensitivity: 16 μ V; Image Rejection: 68 db.

Add these Outstanding Stereo Components To Our Best Stereo Receiver and Save \$80.92 to \$90.92 From Individual Catalog Prices! That's Sound Value!

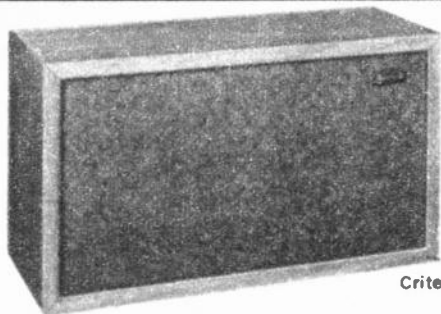

Criterion 555

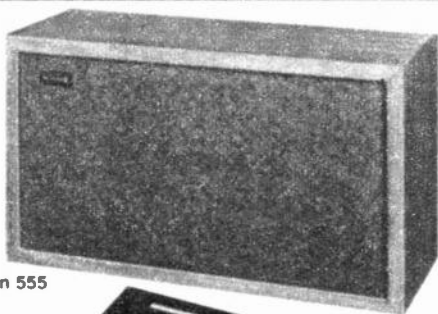

Garrard 62



Pickering V15 Micro IV/ACE



RK-725

LR-2500 AM/FM DELUXE STEREO SYSTEM

Lafayette LR-2500 AM/FM Stereo Receiver
 Garrard 62 3-Speed Automatic Turntable
 Garrard Turntable Base
 Pickering V15 Micro IV/ACE Stereo Cartridge with high-compliance elliptical diamond stylus
 2 Lafayette Criterion 555 3-Way Acoustic Suspension Speaker Systems, each with 10" woofer, 5" sealed-back mid-range speaker, 3" tweeter, and high frequency brilliance control in walnut-vinyl finish enclosure plus speaker cables.
 22 K 91938WM Shpg. wt., 105¾ lbs.Net 526.76

SAVE 80.92

From individual catalog prices!

526⁷⁶

No Money Down*

ADD A CASSETTE DECK AND SAVE EVEN MORE!

Same deluxe system, plus the Lafayette RK-725 stereo cassette record/playback tape deck. The RK-725 features an STD/CrO₂ (chromium dioxide) switchable bias equalization control for optimum performance when using either standard, CrO₂, or the new high-energy, low noise tapes. Its brushed aluminum front panel also features two illuminated VU record level meters and a 3-digit tape counter with reset button. This exceptional system lets you listen to your favorite stereo records and FM stereo broadcasts, and record them superbly, too. Shpg. wt., 113¾ lbs.
 22 K 91979WMNet 616.71

SAVE 90.92

From individual catalog prices!

616⁷¹

No Money Down*

Walnut-Finished Wood Cabinet and Softly Illuminated Tuning Dial Make This Lafayette Stereo Receiver a Knock-Out... and It Sounds Even Better Than It Looks!



- Plays Stereo Records, Tapes and FM Broadcasts with Exceptional Quality
- IC's, FET's and Dual Gate MOSFETS for Reliability, Quality FM Performance, and Extended Audio Tonal Range
- With Rich Wood Case

This superbly-designed receiver combines power, performance, versatility and appearance at an impressively low price. It delivers beautiful stereo sound from stereo records, tapes and FM broadcasts. It also derives highly enjoyable 4-Dimensional sound from these stereo sources, when two rear speakers are added. And the Tape Monitor circuitry makes this receiver compatible with decoder/amplifiers should you decide to convert your stereo system to play 4-channel sources. The FM tuner features a Muting circuit for silencing undesirable FM interstation noise, ceramic AM and FM IF filters for superior selectivity, and dual-gate MOSFET's for extra clear signal reception and

superior sensitivity. Precision tuning is aided by a large illuminated tuning meter and an automatic FM stereo indicator. The front panel includes controls for Speaker and Input selection, Bass, Treble, Volume and Balance, as well as pushbutton switches for Loudness, Tape Monitor, Hi Filter and Mute functions. Jacks are provided for Tape Output and a stereo Headphone. Inputs for Phono, Aux. and Tape, plus outputs for tape recording and 4 speakers are found on the rear panel. For 117 VAC, 50/60 Hz. Size: 4 $\frac{7}{8}$ "H x 17 $\frac{3}{4}$ "W x 12 $\frac{1}{4}$ "D. Imported. Shpg. wt., 18 $\frac{1}{2}$ lbs.

99 K 03360WNet 279.95

POWER RATINGS: 70 Watts (2 x 35 Watts) at 4 ohms, THD 1% at 1 kHz; 95 Watts IHF at 4 ohms.

RECEIVER PRICE

279⁹⁵

No Money Down*

SPECIFICATIONS

Amplifier: Frequency Response: 20-20,000 Hz ± 1 db at 1 watt. Power Bandwidth: 15-30 kHz. Total Harmonic Distortion at rated power: Less than 1%, at 1 watt .07%; Output Impedance 4 and 8 ohms, Headphones 8 ohms; FM Tuner: IHF Sensitivity: 1.75 μ V; Alternate Channel Selectivity: 60 db; Signal-to-Noise Ratio: 70 db; MD: 0.5%; Capture Ratio: 1.5 db; Stereo MPX Separation: 40 db (400 Hz); Spurious Response Rejection: 90 db; AM: External Antenna Sensitivity: 20 μ V; Image Rejection; 60 db at 1 MHz.

Add These Specially Selected Stereo Components To Lafayette's Stereo Receiver and Save \$62.92 to \$72.92 From Individual Catalog Prices! That's Sound Value!

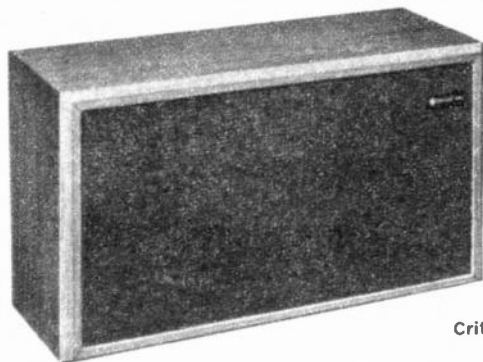

Criterion 444

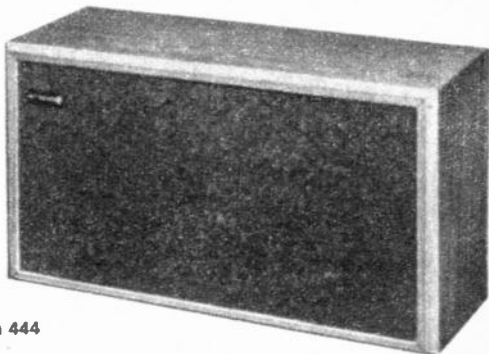

Garrard 40B



Pickering P/ATE-1



RK-725

LR-910 AM/FM DELUXE STEREO SYSTEM

Lafayette LR-910 AM/FM stereo receiver
 Garrard 40B 3-speed automatic turntable
 Garrard turntable base
 Pickering P/ATE-1 stereo cartridge with elliptical diamond stylus
 2 Lafayette Criterion 444 3-way acoustic suspension speaker systems, each with 8" woofer, 3½" midrange, 1½" tweeter, crossover networks and brilliance control in walnut-vinyl finish enclosure
 As above, plus speaker cables. Shpg. wt., 71¼ lbs.
 22 K 91797WM Net 389.76

SAVE 62.92

From Individual Catalog Prices!

389⁷⁶

No Money Down*

ADD A CASSETTE DECK AND SAVE EVEN MORE!

Same deluxe system, plus the Lafayette RK-725 stereo cassette record/playback tape deck. The RK-725 features a Standard/CrO₂ (chromium dioxide) switchable bias equalization control for optimum performance when using either standard cassettes, CrO₂, or the new high-energy, low-noise tapes. Its brushed aluminum front panel also features two illuminated VU record level meters and a 3-digit tape counter with reset button. This exceptional system lets you listen to great sounding stereo records and FM stereo broadcasts, and record them superbly too. Wt., 83¼ lbs.

22 K 91839WM Net 479.71

SAVE 72.92

From Individual Catalog Prices!

479⁷¹

No Money Down*

Charge it with BankAmericard or Mastercharge!

Lafayette's Widely Acclaimed LR-810 Stereo Receiver Delivers Superb Sound From Stereo Records, Tapes And FM Broadcasts With Matchless Clarity. What a Buy!

LR-810



AAA 2 YEAR GUARANTEE
See Page 30 for Details

2
LAFAYETTE
STEREO

- Plays Stereo Records, Tapes, and FM Broadcasts with Exceptional Quality
- Includes IC's and FET's for Reliability, Superior FM Performance and Extended Audio Tonal Quality

One of our most popular stereo receivers, the superbly engineered LR-810 delivers outstanding stereo sound. A special, built-in circuit also derives amazing 4-Dimension-all sound from stereo records, tapes, and FM broadcasts when 2 rear speakers are added. The built-in Tape Monitor circuitry is designed to permit future addition of a Decoder/Amplifier to reproduce all 4-channel sources. The FM tuner features a Muting circuit that minimizes interstation noise, AM and FM filters for superior station selectivity, and dual-gate MOSFETs for superior Automatic Gain Control, RF selectivity and protection against signal overload. A signal strength meter and automatic FM indicator

accentuate the handsome front panel, which also includes: Stereo Headphone and Tape Output Jacks, and controls for Speaker and Program Source selection, Bass, Treble, and Volume/Balance. Pushbutton Switches control Loudness, Stereo/Mono, Tape Monitor, Hi Filter and Mute functions. The rear panel includes Tape and Speaker outputs, as well as Tape Play, Aux, and switchable Magnetic or Ceramic Phono inputs. Both a switched and unswitched AC receptacle are also provided. With simulated walnut finish metal case, it measures 14½W x 4½H x 10½D. Operates on 117 VAC, 60 Hz. Imported. Shpg. wt., 18½ lbs. **99 K 02818WNet 229.95**

POWER RATINGS: 53 Watts (2 x 26.5) at 4 ohms, THD 1% at 1 kHz; 84 Watts IHF at 4 ohms

RECEIVER PRICE

229⁹⁵
No Money Down*

SPECIFICATIONS

Amplifier Freq. Response: 20-20 kHz ± 1 db at 1 watt; THD at rated power: 1% or less, at 1 watt, 1 kHz; .07%; Output Impedance: 4 and 8 ohms, Headphone 8 ohms. Tuner: IHF Sensitivity: 1.75 μ V at 98 MHz; Alternate Channel Selectivity: 60 db; Signal-to-Noise Ratio: 70 db; HD: 0.5%; Capture Ratio: 1.5 db; Stereo MPX Separation: 40 db (400 Hz) Spurious Response Rejection: 100 db. AM: External Antenna Sensitivity: 20 μ V; Image Rejection: 70 db at 1 MHz.

*See Page 19 for Full Details on Easy Pay Plan

Add a Complete Stereo Component System Power Matched To the LR-810 and Save! Then Add an 8-Track Stereo Cartridge Playback Tape Deck and Save Even More!

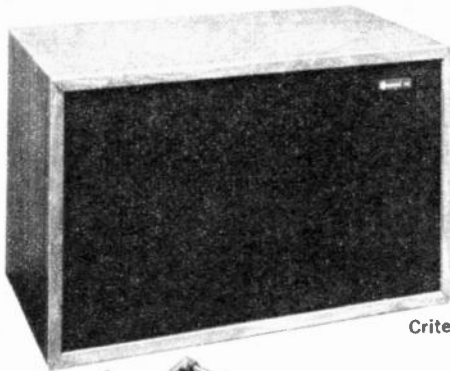

Criterion 333



Garrard 40B

Pickering P/ATE-1



RK-82

LR-810 AM/FM DELUXE STEREO SYSTEM

ADD AN 8-TRACK CARTRIDGE PLAYBACK DECK AND SAVE EVEN MORE!

Lafayette LR-810 AM/FM stereo receiver
 Garrard 40B 3-speed automatic turntable
 Garrard turntable base
 Pickering P/ATE-1 cartridge with elliptical diamond stylus
 2 Lafayette Criterion 333 acoustic suspension 2-way speaker systems, each with 8" woofer, 3" sealed-back tweeter, and crossover network in walnut-vinyl finish enclosure.
 As above, plus speaker cables.
 22 K 91755WM Shpg. wt., 69¼ lbs.Net 326.76

In addition to stereo records and FM broadcasts, listen to pre-recorded stereo 8-track tape cartridges. This system consists of the deluxe system components shown above, plus the RK-82 8-track stereo tape cartridge playback deck, with pushbutton track selector and individual illuminated track indicators. This deck also features a built-in stereo preamplifier, and an attractive black and silver brushed aluminum front panel. Shpg. wt., 78¼ lbs.
 22 K 91771WMNet 362.71

SAVE 55.92
 From Individual Catalog Prices

326⁷⁶

No Money Down*

SAVE 59.92
 From Individual Catalog Prices

362⁷¹

No Money Down*

You Get Consistently Fine High-Fidelity Stereo Performance You Can Depend On Year After Year From Lafayette's Best Selling LR-200A AM/FM Stereo Receiver

LR-200A



AAA 2-YEAR GUARANTEE

See Page 30 for Details

2
LAFAYETTE
STEREO

- Plays Stereo Records, Stereo Tapes, and FM Stereo Broadcasts with Outstanding Quality
- Tape Monitor Circuit Permits Addition of a Decoder/Amplifier for Playing SQ Records, Other Matrixed, and Discrete 4-Channel Sources
- IC and FET Semiconductors Plus Ceramic Filters Provide Superior Sensitivity, Selectivity, Noise Limiting, and Tonal Range

This deluxe receiver combines a superb fully-automatic FM stereo tuner, sensitive AM tuner, stereo control pre-amplifier and a quality stereo amplifier in a single, handsomely styled unit to produce delightful stereo sound. The LR-200A also derives rich 4-Dimensional sound from stereo records, tapes and FM broadcasts. The front panel features a Signal Strength Tuning Meter and FM Stereo Indicator for easy tuning, a full range of controls that include: Program Selection, Bass, Treble, Volume/Balance, Speaker Selection and Tuning, switches for Loudness, Mono/Stereo,

reo, Tape Monitor, High Filter and FM Muting (for silencing undesirable FM interstation noise), as well as Tape Output and stereo Headphone jacks. The rear panel features a switchable Magnetic or Ceramic Phono input, Aux., Tape Play and Record jacks, as well as 4 speaker outputs. Separate AM and FM antennas are also included. Styled with contrasting black and aluminum front panel and rich simulated walnut finish enclosure. For 117 VAC, 50/60 Hz. Size: 14½W x 10½D x 14½"H. Imported.
99 K 03105W Shpg. wt., 18½ lbs. Net 199.95

POWER RATINGS: 32 Watts RMS (2 x 16 Watts) at 4 ohms, THD 1% at 1 kHz; 60 Watts IHF at 4 ohms.

RECEIVER PRICE

199⁹⁵

No Money Down*

SPECIFICATIONS

Amplifier: Frequency Response: 20-20,000 Hz \pm 1.5 db (at 1 watt); Total Harmonic Distortion: 1% or less at rated output; **FM Tuner:** Sensitivity: 2.5 μ V; Selectivity (Alternate Channel): 60 db; Capture Ratio: 3 db; Stereo Separation: 35 db (at 400 Hz) at 1 mV input; Signal-to-Noise Ratio: 70 db (100% mod.); **AM Tuner:** Sensitivity: 20 μ V (antenna terminal); Semiconductors: 3 IC's, 2 FET's, 28 Transistors, 10 Diodes, and 2 Thermistors.

Add 2 Lafayette Speakers, A Garrard Turntable and Base, and A Pickering Cartridge and SAVE \$52.92 From Individual Catalog Prices.

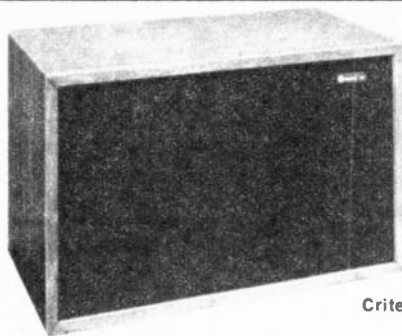

Criterion 333



Garrard 40B



Pickering
P/ATE-1



RK-82

LR-200A AM/FM DELUXE STEREO SYSTEM

Lafayette LR-200A AM/FM stereo receiver
Garrard Model 40B 3-speed automatic turntable
Garrard turntable base
Pickering P/ATE-1 stereo cartridge with high compliance
elliptical diamond stylus.

2 Lafayette Criterion 333 30-watt acoustic suspension 2-
way speaker systems, each with 8" woofer, 3" sealed-
back tweeter and crossover in walnut vinyl finish en-
closure

As above, plus speaker cables. Shpg. wt., 69¼ lbs.
22 K 91854WMNet 299.76

ADD AN 8-TRACK CARTRIDGE PLAYBACK DECK TO YOUR SYSTEM AND SAVE EVEN MORE

This system consists of the same deluxe components, plus
the Lafayette RK-82 8-track stereo cartridge playback deck.
This deck has individual illuminated track indicators to
let you see which track is playing at a glance, a pushbut-
ton selector to change tracks instantly, and a built-in solid-
state stereo playback preamplifier. It looks as good as it
sounds, with an attractive black and silver brushed alumi-
num front panel to complement its quality stereo repro-
duction. Just connect the RK-82 to the other matched
deluxe components, and this system will let you listen to
pre recorded stereo 8-track tape cartridges, in addition to
stereo records and FM broadcasts. Shpg. wt., 78¼ lbs.
22 K 91870WMNet 335.71

SAVE 52.92

From Individual Catalog Prices

299⁷⁶

No Money Down*

SAVE 56.92

From Individual Catalog Prices

335⁷¹

No Money Down*

Make your shopping easier with BankAmericard and Mastercharge.

Lafayette Cat. No. 743

17

Dependable Performance and Functional Design

The LAFAYETTE LR-75B AM/FM Stereo Receiver



ONLY
159⁹⁵

No Money Down*

AAA 2 YEAR GUARANTEE

See page 30 for details

POWER RATINGS
10 Watts RMS
(2 x 5 Watts) at 4 ohms
THD 1% at 1 KHz
20 Watts IHF at 4 ohms



- ★ Accepts Magnetic and Ceramic Phono Cartridges
- ★ Provides High Quality Playback of Stereo Records, Stereo Tapes, and FM Stereo Broadcasts

A boon to the budget-minded music lover, the LR-75B is the solution for big AM/FM stereo sound at an amazingly low price. Not only is the LR-75B a highly efficient stereo receiver, but it also derives exciting 4-dimensional sound from all 2-channel sources. Among its many outstanding conveniences are Automatic Stereo/Mono Switching with a Stereo Indicator Light and precision ACRITUNE visual FM tuning. A full complement of versatile controls permits outstanding performance, as well as precise accommodation to personal taste and room acoustics. Front panel conveniences include Front and Rear Speaker selector switches, headphone jack and a tape output jack. The rear panel includes front and rear speaker outputs, tape, aux. and magnetic or ceramic cartridge inputs, and Protective speaker fuses. Housed in beautiful wood-sided case. Operates on 117 VAC, 50/60 Hz. Size: 13W x 9½D x 4½"H. Imported. Shpg. wt., 15 lbs.

99 K 03014W Net 159.95

SPECIFICATIONS

Amplifier Frequency Response: 20-20,000 Hz ± 1 db. **Total Harmonic Distortion:** 0.8% at rated output. **Channel Separation:** 55 db (at 1 kHz). **Impedance:** 4 and 8 ohms. **TUNER SECTION:** Sensitivity (IHF): 3.5 μV. **Selectivity:** 35 db. **Capture Ratio:** 5 db. **Stereo Separation:** 30 db (at 400 Hz). **AM:** 3-Gang Tuning Capacitor; 20 μV sensitivity (ant. terminal).

Save on LR-75B Systems! System 1—SAVE 48.13†; System 2—SAVE 52.13†



Garrard 40B 3-speed automatic turntable with Garrard Base



Pickering P/ATE-1 stereo cartridge with high compliance elliptical diamond stylus

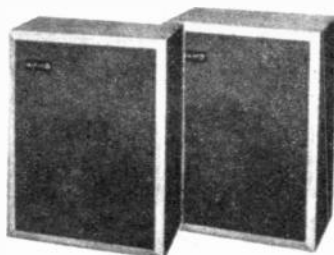

2 Lafayette Criterion 222 2-way speaker systems, each with 8" woofer, 2½" tweeter in walnut vinyl finish enclosure



Lafayette RK-82 8-track stereo cartridge playback tape deck featuring pushbutton track selector, solid-state playback preamplifier, and individual track indicator lights.

SYSTEM 1 PRICE 245⁷⁶

In System 1 you get the Lafayette LR-75B AM/FM stereo receiver, the Garrard 40B turntable with Garrard Base, the Pickering P/ATE-1 cartridge with diamond stylus, and the 2 Lafayette Criterion 222 speaker systems.
22 K 91896WM Shpg. wt., 48¼ lbs.Net 245.76

SYSTEM 2 PRICE 281⁷¹

In System 2 you get the Lafayette LR-75B AM/FM stereo receiver, Garrard 40B turntable and base, Pickering P/ATE-1 cartridge and stylus, 2 Lafayette Criterion 222 speaker systems, plus the Lafayette RK-82 tape deck.
22 K 91912WM Shpg. wt., 57¼ lbsNet 281.71

†From individual catalog prices

Lafayette has an "Easy Pay Plan" that's right for you!

NO MONEY DOWN

- It's easy to open a credit account. Simply fill in application on back of order blank when you send your order.
- Add-on any time you like. No money down and usually no increase in monthly payments.
- Pay your balance in 30 days and save the entire FINANCE CHARGE.

EXTENDED PLAN

**TAKE UP TO
2 Years To Pay**

STANDARD PLAN

**TAKE UP TO
16 Months To Pay**

EASY PAY PAYMENT SCHEDULE

\$250.01 to \$500.00		STANDARD PLAN		EXTENDED PLAN	
If Unpaid Balance (Amount Financed) Is From	To	Add for FINANCE CHARGE	Monthly Payment Is	Add for FINANCE CHARGE	Monthly Payment Is
\$490.01	\$500.00	\$64.75	\$35.00	\$98.00	\$25.00
480.01	490.00	63.50	34.50	96.00	24.50
470.01	480.00	62.25	33.50	94.00	24.00
460.01	470.00	61.00	33.00	92.00	23.50
450.01	460.00	59.50	32.50	90.00	23.00
440.01	450.00	58.25	31.50	88.00	22.50
430.01	440.00	57.00	31.00	86.00	22.00
420.01	430.00	55.75	30.00	84.00	21.50
410.01	420.00	54.25	29.50	82.00	21.00
400.01	410.00	53.00	29.00	80.00	20.50
390.01	400.00	51.75	28.00	78.00	20.00
380.01	390.00	50.50	27.50	76.00	19.50
370.01	380.00	49.00	26.50	74.00	19.00
360.01	370.00	47.75	26.00	72.00	18.50
350.01	360.00	46.50	25.00	70.00	18.00
340.01	350.00	45.25	24.50	68.00	17.50
330.01	340.00	43.75	24.00	66.00	17.00
320.01	330.00	42.50	23.00	64.00	16.50
310.01	320.00	41.25	22.50	62.00	16.00
300.01	310.00	40.00	22.00	60.00	15.50
290.01	300.00	38.50	21.00	58.00	14.50
280.01	290.00	37.25	20.00	56.00	14.00
270.01	280.00	36.00	19.50	54.00	13.50
260.01	270.00	34.50	19.00	52.00	13.00
250.01	260.00	33.25	18.00	50.00	12.50

\$100.01 to \$250.00		STANDARD PLAN		EXTENDED PLAN	
If Unpaid Balance (Amount Financed) Is From	To	Add for FINANCE CHARGE	Monthly Payment Is	Add for FINANCE CHARGE	Monthly Payment Is
\$240.01	\$250.00	\$32.00	\$17.50	\$48.00	\$12.00
230.01	240.00	30.50	17.00	46.00	11.50
220.01	230.00	29.25	16.00	44.00	11.00
210.01	220.00	28.00	15.50	42.00	10.50
200.01	210.00	26.50	15.00	40.00	10.00
195.01	200.00	25.75	14.50	39.00	9.75
190.01	195.00	25.25	14.00	38.00	9.50
185.01	190.00	24.50	13.75	37.00	9.25
180.01	185.00	23.75	13.50	36.00	9.00
175.01	180.00	23.25	13.00	35.00	8.75
170.01	175.00	22.50	12.50	34.00	8.50
165.01	170.00	22.00	12.00	33.00	8.25
160.01	165.00	21.25	11.50	32.00	8.00
155.01	160.00	20.50	11.00	31.00	7.75
150.01	155.00	20.00	10.75	30.00	7.50
145.01	150.00	19.25	10.50	29.00	7.25
140.01	145.00	18.50	10.50	28.00	7.00
135.01	140.00	16.75	10.50	27.00	6.75
130.01	135.00	16.25	10.25	26.00	6.50
125.01	130.00	14.50	10.25	24.00	6.50
120.01	125.00	14.00	10.00	23.00	6.25
115.01	120.00	12.50	10.00	21.00	6.25
110.01	115.00	12.00	10.00	20.00	6.00
105.01	110.00	10.50	10.00	18.35	6.00
100.01	105.00	9.25	10.00	17.50	5.75

The ANNUAL PERCENTAGE RATE of each FINANCE CHARGE set forth in the above tables is 17.75%. The number of payments will be the Total of Payments (Amount Financed plus the FINANCE CHARGES) divided by the amount of one monthly payment.

\$50.01 to \$100.00		STANDARD PLAN			EXTENDED PLAN		
If Unpaid Balance (Amount Financed) Is From	To	Add for FINANCE CHARGE	Monthly Payment Is	ANNUAL PERCENTAGE RATE	Add for FINANCE CHARGE	Monthly Payment Is	ANNUAL PERCENTAGE RATE
\$95.01	\$100.00	\$9.25	\$10.00	18.50%	\$15.65	\$5.50	17.50%
90.01	95.00	9.25	9.75	19.50	14.85	5.50	17.50
85.01	90.00	9.25	9.50	22.50	13.45	5.25	17.75
80.01	85.00	9.25	9.25	23.75	12.00	5.25	17.75
75.01	80.00	9.00	9.00	24.50	10.70	5.00	17.75
70.01	75.00	8.40	8.00	24.50	10.00	5.00	18.75
65.01	70.00	7.80	7.50	24.50	10.00	5.00	21.25
60.01	65.00	7.20	7.00	24.50	10.00	5.00	24.50
55.01	60.00	6.65	6.50	24.50	8.55	5.00	24.50
50.01	55.00	6.10	6.00	24.50	7.25	5.00	24.50

\$20.00 to \$50.00		STANDARD PLAN			ANNUAL PERCENTAGE RATE
If Unpaid Balance (Amount Financed) Is From	To	Add for FINANCE CHARGE	Monthly Payment Is	ANNUAL PERCENTAGE RATE	
\$45.01	\$50.00	\$6.00	\$5.00	24.50%	
40.01	45.00	5.25	4.75	28.00	
35.01	40.00	4.75	4.25	26.75	
30.01	35.00	4.50	3.70	29.25	
25.01	30.00	3.50	3.35	30.00	
20.00	25.00	3.00	2.70	32.00	

OVER \$500.00. Please write for terms for amounts to be financed over \$500.00.

minimum ORDER—\$30
minimum "ADD-ON"—\$20

Number of payments will be Total of Payments (Amount Financed plus the FINANCE CHARGE) divided by the amount of one monthly payment.

Make your shopping easier with BankAmericard and Mastercharge.

Our Finest 4-Channel Amplifier, LA-74, Has All the Outstanding 4-Channel Features Plus a Money Saving Choice of Systems

279⁹⁵

AAA 2-YEAR GUARANTEE

See Page 30 for Details

POWER RATING
168 Watts RMS (4 x 42 Watts)
at 4 ohms
THD 1% at 1 KHz
200 Watts IHF at 4 ohms



★ Built-in Full Logic Wavematching SQ Decoding Circuitry with Vari-Blend for Superb 4-Channel Sound

★ Excellent Playback of Stereo Records, Tapes and FM Broadcasts

★ 4 Powerful Amplifiers in One Compact Unit

The SQ decoding circuitry in our most powerful amplifier gives you the widest front-to-rear and left-to-right SQ separation available, for the most exciting SQ 4-channel reproduction you've ever heard. It's full complement of controls include rotary front and rear volume, balance, bass, treble, speaker mode and function, as well as push-button input and mode selectors (including tape monitor, loudness and high filter). Outputs for 2- and 4-channel tape deck, front and rear headphone, and for 8 speakers are also provided. Inputs include microphone, 2- and 4-channel tape, tuner, phono, and 2 aux. The matte ebony finish front panel and walnut finish wood case will enhance any room. For 117 VAC, 60 Hz. Size: 15½" W x 12¾" D x 4½" H. Imported. Shpg. wt., 22 lbs.

99 K 02990W No Money Down*Net 279.95



Garrard 62

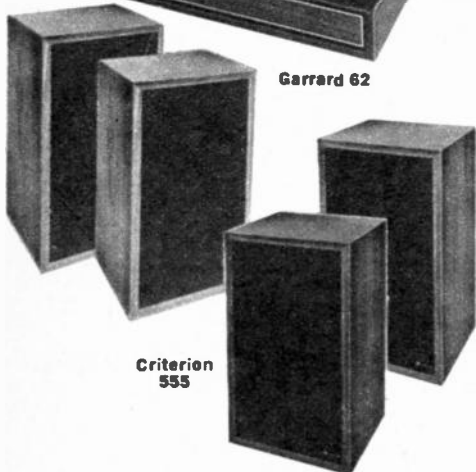

Criterion 555

SAVE 84.61
From individual catalog prices

SYSTEM PRICE
As Low As **544⁶⁶**
As No Money Down*

PLAYS ALL 4-CHANNEL MODES

MATRIX — decodes and plays all matrix 4-channel records and FM broadcasts—SQ and all others (such as QS/RM).

DISCRETE — through its four amplifiers, plays all discrete tapes—reel-to-reel and 8-track cartridge. Plays discrete 4-channel CD-4 records with the addition of accessory CD-4 demodulator. FM detector output will accept adapter when discrete 4-channel FM reception is available.

DERIVED — exclusive "Composer" circuitry derives 4-channel sound from your present stereo records and tapes, and from FM stereo broadcasts.



Picking V15 Micro IV/ACE

LA-74 4-CHANNEL MATRIX SYSTEM

- Lafayette Model LA-74 4-channel amplifier
- Garrard Model 62 3-speed automatic turntable
- Picking V15 Micro IV/ACE stereo cartridge with elliptical diamond stylus
- Garrard turntable base
- 4 Lafayette Criterion 555 3-way acoustic suspension speaker systems, each with 10" woofer, 5" sealed-back mid-range, 3" tweeter, and brilliance control in walnut-vinyl finish enclosure

Above, plus speaker cables. Shpg. wt., 151¾ lbs.
22 K 92217WMNet 544.66

2D Lafayette Cat. No. 743

4-CHANNEL MATRIX PLUS CD-4 DISCRETE SYSTEM

Same system plus Lafayette CD-4 4-channel demodulator required to play CD-4 4-channel records, and Picking UV15/2000Q 4-channel/stereo cartridge with quadrilateral diamond stylus instead of V15 Micro IV/ACE cartridge. Shpg. wt., 158 lbs.
22 K 92225WM No Money Down*Net 657.60

You SAVE \$101.62 from individual catalog prices!
See page 29 for full description of CD-4 demodulator

*See Page 19 for Full Details on Easy Pay Plan

Save Money With LAFAYETTE'S LA-2525 4-Channel Amplifier— and Save Even More When You Buy the Entire System!



AAA 2-YEAR GUARANTEE

See Page 30 for Details

CATALOG 742
LOW SALE PRICE
CONTINUED

69⁹⁵

with case

No Money Down*

POWER RATING
24 Watts RMS (4 x 6 Watts)
at 8 ohms
THD 1% at 1 KHz
32 Watts IHF at 8 ohms

This low priced amplifier consists of four separate solid-state amplifiers that will deliver exciting 4-channel sound from all discrete 4-channel tape sources, and rich derived 4-dimensional sound from 2-channel stereo records, tapes and FM broadcasts. With optional decoders, this versatile amplifier also reproduces 4-channel sound from SQ and CD-4 program sources. Dual concentric Volume, Bass and Treble controls allow individual adjustment of all four channels. Loudness and Hi Filter controls, stereo headphone jack, Tape, Tuner, Aux. and Phono inputs, and Speaker and Tape outputs are also included. For 117 VAC, 60 Hz. With metal case. Size: 4 $\frac{3}{4}$ "H x 13 $\frac{1}{2}$ "W x 8 $\frac{3}{4}$ "D. Imported. Shpg. wt., 14 lbs.

99 K 02626WNet 69.95
Lafayette SQ-M 4-Channel Decoder. For SQ records, tapes, FM broadcasts 99 K 02768 Imported. Shpg. wt., 4 $\frac{1}{4}$ lbs. No Money Down*Net 39.95

PLAYS ALL 4-CHANNEL SOURCES

- Discrete 4-Channel Tapes
- 4-Channel CD-4 Records with Optional CD-4 Demodulator
- 4-Channel SQ Records and FM Broadcasts with Optional SQ Decoder
- QS/RM Records and FM Broadcasts
- Derived 4-Dimensional Sound From Stereo Records, Tapes and FM

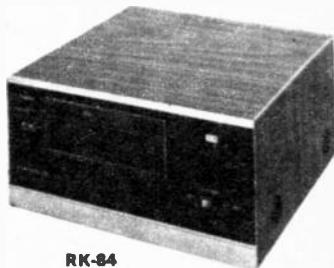

RK-84

SAVE 22.67

From individual catalog prices

SYSTEM PRICE

179⁷⁰

No Money Down*

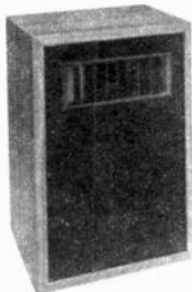

XL-44

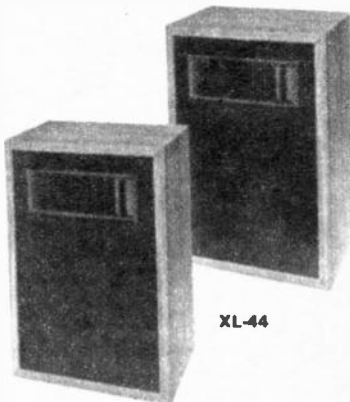
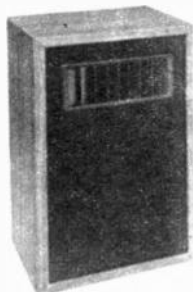

XL-44

This System includes the LA-2525 plus:
Lafayette RK-84 2- and 4-channel 8-track playback tape deck.

4 Lafayette XL-44 efficient bookshelf speaker systems,

Charge it with BankAmericard or Mastercharge!

each containing a 6 $\frac{1}{2}$ " wide-range speaker in a walnut-vinyl finish enclosure.

Above, plus speaker cables.

22 K 92472WM Shpg. wt., 48 lbs.Net 179.70

Save 20.00 on the LA-150, Lafayette's Most Powerful and Flexible Stereo Amplifier. Add the Matched Components and Save Even More!



SALE!
149⁹⁵

AAA 2 YEAR GUARANTEE

See Page 30 for Details

- ★ Plays 2-Channel Stereo Records, Stereo Tapes, and FM Stereo Broadcasts with Exceptional Clarity
- ★ Derives 4-Dimensional Sound from 2-Channel Stereo Records, Stereo Tapes, and FM Stereo Broadcasts
- Tape Monitor Circuit Permits Addition of SQ Decoder/Amplifier To Play Discrete 4-Channel Tapes and 4-Channel SQ Programs

An exceptional stereo amplifier with sufficient power to drive even low efficiency speakers. Flexible operation is facilitated by a full range of controls, including Operating Mode, Program Source, concentric Bass and Treble, dual Balance/Volume and Main/Remote speaker controls, as well as pushbutton switches for Low and High Filters to reduce program source noise, 2 levels of loudness compensation for realistic reproduction at low listening levels, and Power On/Off. A stereo Headphone jack, stereo Output and 2 Microphone/Musical Instrument jacks complete the LA-150's front panel conveniences. The rear panel provides inputs for 2-channel and derived 4-dimensional speakers and stereo tape record, outputs for tape play, Aux. high-gain and low-gain tuners, and magnetic or ceramic phonos, a high and low phono sensitivity slide switch, and both a switched and unswitched AC receptacle. Operates on 117 VAC. Size: 13 x 3 3/4 x 9 1/2". Imported. Wt., 19 1/2 lbs. **99 K 02834W No Money Down*Net 149.95**

POWER RATING

84 Watts RMS

(2 x 42 Watts) at 4 ohms

THD 1% at 1 kHz

125 Watts IHF at 4 ohms

SPECIFICATIONS

Frequency Response: 22-20,000 Hz ± 1.5 db. Total Harmonic Distortion: 1% or less at rated output, 0.05% at 1 watt (1 kHz). Power Bandwidth: 13-35,000 Hz. Channel Separation: 65 db at 1 kHz. Output Impedance: 4-8 ohms.



Garrard 40B



RK-82

SAVE 49.92

From Individual
Catalog Prices

SYSTEM PRICE

272⁷⁶



Pickering
P/ATE-1

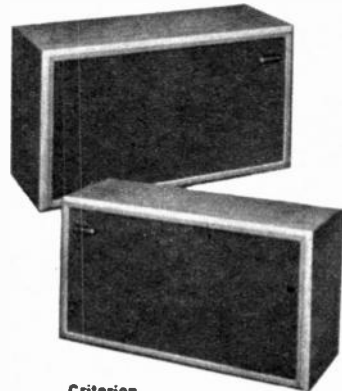

Criterion
444

In addition to Lafayette's LA-150, you get:

Garrard Model 40B 3-speed automatic turntable

Garrard Turntable Base

Pickering P/ATE-1 elliptical cartridge with diamond stylus

2 Lafayette Criterion 444 3-speaker acoustic suspension speaker systems, each with 8" woofer, 3 1/2" midrange, 1 1/2" direct-radiator tweeter, and brilliance control in a walnut-venyl finish enclosure.

Complete stereo system plus speaker cable. Wt., 72 1/2 lbs.

22 K 91631WMNet 272.76

Add an 8-Track Deck and Save More!

Same 2-channel stereo system as 22 - 91631WM plus the Lafayette RK-82 2-channel 8-track stereo cartridge playback deck. Shpg. wt., 81 1/2 lbs.

22 K 91656WM No Money Down*Net 308.71

You SAVE \$53.92 from Individual Catalog Prices!

*See Page 19 for Full Details on Easy Pay Plan

Get Quality Sound Reproduction with Lafayette's LA-950 Stereo Amplifier and Save 20.00! Save Even More with a Matched System!

SALE!
109⁹⁵

AAA 2 YEAR GUARANTEE

See Page 30 for Details



- ★ Excellent Playback of All 2-Channel Stereo Records, Stereo Tapes, and FM Stereo Broadcasts
- ★ Derives Exciting 4-Dimensional Sound from Your 2-Channel Stereo Records, Tapes and FM Broadcasts
- Tape Monitor Switchable Circuitry for Future Addition of SQ Decoder/Amplifier for Playing 4-Channel SQ Records and Discrete 4-Channel Tapes
- 4 Dimensional and 2-Channel Stereo Sound Speaker Selection
- Front Panel Stereo Headphone Jack

POWER RATING
52 Watts RMS
(2 x 26 Watts) at 4 ohms
THD 1% at 1 kHz

SPECIFICATIONS

Total Harmonic Distortion at rated power (1 kHz): 1% or less; at 1 watt output: .07%. Power Bandwidth: 15-30,000 Hz. Frequency Response at 1 watt: 20-20,000 Hz ± 1 db. Channel Separation: 65 db at 1 kHz. Output Impedance: 4-8 ohms.

The LA-950, a high quality, solid-state amplifier, will give you beautiful stereo reproduction. In addition, a built-in 4-dimensional decoder circuit provides impressive 4-dimensional sound when two rear speakers are added. It also features convenient front panel switches to adjust rear and front speakers; dual concentric Bass, Treble and Balance/Volume controls; front and rear panel Tape Recording Outputs; pushbutton switches for Main Power, Loudness, Stereo/Mono, Tape Monitor and High Filter; and Rear Panel jacks for Phono (magnetic or ceramic), tuner and Aux. With brushed gold anodized front panel and simulated walnut wood finish metal cabinet. 117 VAC, 50/60 Hz Size: 12W x 3¾H x 9½"D. Imported. Shpg. wt.: 12½ lbs.

99 K 02792W No Money Down*Net 109.95

SAVE 43.92

From individual
catalog prices

SYSTEM PRICE

218⁷⁶



Garrard 408



RK-82

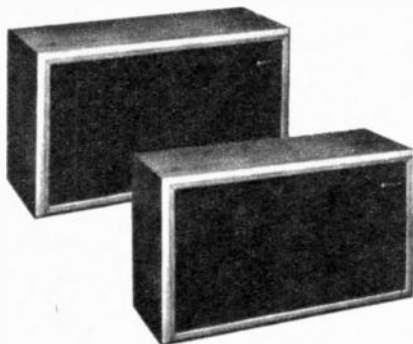

Criterion 333



Pickering
P/ATE-1

In addition to the LA-950, you get:

Garrard Model 40B 3-speed automatic turntable
Garrard Turntable Base

Pickering P/ATE-1 elliptical cartridge with diamond stylus
2 Lafayette Criterion 333 2-way acoustic suspension speaker
systems, each with 8" woofer and 3" sealed-back tweeter
in walnut-vinyl finished enclosure

Complete stereo system plus speaker cable. wt., 63½ lbs.
22 H 91672WM No Money Down*Net 218.76

Add an 8-Track Deck and Save More!

Same 2-channel stereo system as 22 - 91672WM above plus
Lafayette RK-82 8-track stereo cartridge playback tape deck.
22 K 91698WM Shpg. wt., 72½ lbs.,Net 254.71
You SAVE \$47.92 from Individual Catalog Prices!

Treat yourself with a BankAmericard or MasterCard order.

Lafayette Cat. No. 743 23

Lafayette's LA-375 Stereo Amplifier Has Built-In Extras and the Matched System Has Built-In Savings!



89⁹⁵
with case

LA-375 STEREO AMPLIFIER

AAA 2 YEAR GUARANTEE

See page 30 for details

- ★ Plays conventional 2-channel stereo records, tapes and FM broadcasts with superior reproductive quality
- ★ Provides 4-dimensional stereo sound from any conventional stereo record, tape or FM stereo broadcast

- Built-in Derived 4-Dimensional Stereo Adapter
- Rear Speaker 4-Dimensional Volume Level Switch
- Main-Remote Speaker Switch
- Front Stereo Headphone Jack

This popular 2-channel stereo amplifier will drive most speaker systems to maximum volume while maintaining very good frequency response and low distortion. It features fused output transistors for protection against overloads, and front panel controls which include concentric Volume/Balance, Treble and Bass, Input Selector for Aux, Tuner, Mag Phono, and Ceramic Phono. Also included are rocker switches for Mono/Stereo Mode, and Loudness. Rear panel features stereo inputs for Aux, Tuner, and Phono; 2 AC convenience outlets (1 switched); Tape Output jack; Main, Remote, and Rear Speaker Terminals for 4- and 8-ohm speakers; and Low and High Level Rear Speaker switch that varies the volume level of the rear speakers in the 4-dimensional mode of operation. Styled for "today" with a brushed gold anodized extruded aluminum front panel, matching knobs, and a rugged vinyl-clad metal cabinet with the simulated look of rich walnut wood grain. Size: 10³/₄"W x 3¹/₂"H x 8³/₄"D. For 117 VAC, 50/60 Hz with AC power fuse. Imported. Shpg. wt., 9³/₄ lbs.

99 K 02602W No Money Down*Net 89.95

POWER RATING

28 Watts RMS
(2 x 14 Watts) at 4 ohms

THD 1% at 1 kHz

55 Watts IHF at 4 ohms

SPECIFICATIONS

Amplifier Power Bandwidth: 35-30,000 Hz. Frequency Response: 20-20,000 Hz ± 1.5 db, Total Harmonic Distortion at 1 watt 0.07%. Stereo Separation: 60 db.



Garrard 40B

Pickering
P/ATE-1



SAVE 39.92

From Individual Catalog Prices

SYSTEM PRICE

182⁷⁶

No Money Down*



Criterion 222

Buy the Matched LA-375 System:

In addition to the LA-375, you get:

1 Garrard Model 40B 3-speed automatic turntable with matching turntable base

1 Pickering P/ATE-1 Elliptical Stereo Cartridge with high compliance diamond stylus

2 Lafayette Criterion 222 efficient 2-way speaker systems, each with 8" woofer and 2¹/₂" tweeter in walnut-vinyl enclosure, and speaker cable.

22 K 91714WM Shpg. wt., 43³/₄ lbs.Net 182.76

Sound Quality, Modest Price—Lafayette's LA-25 Solid-State Stereo Amplifier With Its System Components Are Outstanding Values!

LA-25 STEREO AMPLIFIER

59⁹⁵
with case



- Inputs for Magnetic and Ceramic Cartridges
- Main/Remote Speaker Switch
- Front Panel Stereo Headphone Jack
- Speaker Protection Fuses

POWER RATING

20 Watts RMS
(2 x 10 Watts) at 8 ohms
THD 1% at 1 kHz
24 Watts IHF at 8 ohms

SPECIFICATIONS

Frequency Response: 75-20,000 Hz at 1 watt ± 1 db. Power Bandwidth at rated power: 55-25,000 Hz., THD: 0.25% (1 kHz at 1 watt). Channel Separation: 55 db.

Designed for exceptional reliability and performance at an unbelievably modest price! The LA-25 faithfully reproduces the full spectrum of audio sound with more than adequate volume and very low distortion. Its solid-state design, incorporating 18 quality transistors and 4 diodes assures top notch performance. A full complement of controls is supplied for best stereo effects and acoustic variations. Its neatly designed front panel features rotary selector switches for Input Source (Aux, Tuner, Phono Ceramic, Phono Magnetic), Bass, Treble, and dual-concentric Volume/Balance. Also included on the front panel are rocker switches for Mode (Mono/Stereo), Speakers (Remote/Main), and Power (On/Off). The rear panel features stereo outputs for main and remote speakers; input jacks for Aux, Tuner, Phono, and Tape Recorder; AC convenience outlet; and AC line fuse. Styled to blend with any home decor. Size: 10 $\frac{1}{2}$ "W x 3 $\frac{1}{2}$ "H x 8 $\frac{3}{8}$ "D. For 105-120 VAC, 50/60 Hz. Imported. Shpg. wt., 9 lbs.

99 K 02842W No Money Down*Net 59.95

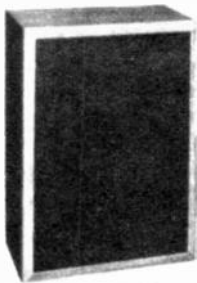

Criterion 222

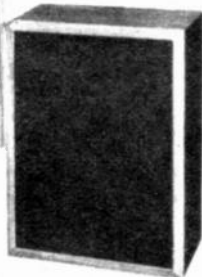

SAVE 36.92

From individual catalog prices

SYSTEM PRICE

155⁷⁶

No Money Down*



Garrard 405



Pickering
P/ATE-1

Buy the Matched LA-25 System:

Here's the deal—you get the LA-25, plus:

Garrard Model 405 3-speed automatic turntable with matching turntable base

Pickering P/ATE-1 Elliptical Stereo Cartridge with high compliance diamond stylus

2 Lafayette Criterion 222 efficient 2-way bookshelf speaker systems, each consisting of an 8" woofer and a 2 $\frac{1}{2}$ " tweeter in a neat walnut-vinyl finish enclosure, and speaker cable.

22 K 91573WM Shpg. wt., 42 $\frac{1}{4}$ lbs.Net 155.76

Make your shopping easier with BankAmericard and Mastercharge.

Lafayette Cat. No. 743 25

Our Highest Quality Stereo Tuners

LAFAYETTE LT-D10 Deluxe AM/FM Stereo Tuner Phase Locking MPX Decoder Circuitry for Optimum FM Stereo Separation and Minimum Distortion



A premium-quality AM/FM tuner with Dolby B noise reduction circuitry to take advantage of the growing number of FM stations that are now broadcasting Dolbyized signals. FM hiss and noise are virtually eliminated, even on the most distant FM stations. This, combined with such state-of-the-art circuitry as a phase locking loop in the multiplex section, dual-gate MOSFET's in the RF section, and IC's, makes for a truly superlative tuner. In addition to the outstanding front panel features, the LT-D10 also includes a rear panel that has both variable and fixed level outputs, FM detector output for the addition of a discrete 4-channel FM adapter (when available), internal AM and FM antennas, external AM and FM antenna binding posts, an AC convenience outlet, and a switch to select 75 μ s or 25 μ s Dolby de-emphasis. Size: 15 $\frac{3}{4}$ x 11 $\frac{1}{2}$ x 4 $\frac{1}{2}$ ". Imported. Shpg. wt., 12 $\frac{1}{2}$ lbs.

99 K 03139W No Money Down*Net 229.95

229⁹⁵

AAA 2-YEAR GUARANTEE

See Page 30 for Details



- Obsolescence-Proof
- 1.65 μ V IHF Sensitivity
- Front and Rear Panel Tape Output Jacks
- Dolby De-emphasis Switch
- Signal Strength and Center Scale Tuning Meters
- Dial Light Dimmer
- Function Mode Indicator Lights for Dolby, FM, Stereo, MPX Filter, FM Mute
- Handsome Front Panel in Rich Walnut Finish Wood Cabinet with Blackout Dial

LAFAYETTE LT-725A AM/FM Stereo Tuner

SAVE 20⁰⁰

SALE 129⁹⁵



AAA 2-YEAR GUARANTEE

See Page 30 for Details

- 1.7 μ V IHF FM Sensitivity
- 4 IC's, 2 FET's, 14 Transistors, 19 Diodes
- 4-Gang FM Tuning Condenser
- Front and Rear Panel Tape Output Jacks
- Illuminated Signal-Strength Tuning Meter for Normal and Center Scale Tuning
- Automatic FM Stereo Switching and Stereo Indicator Light
- Pushbutton FM Mute Switch
- Beautifully-styled Dial that Illuminates with "Power-On"
- 1.5 db Capture Ratio
- 40 db Stereo Separation

The Lafayette LT-725A establishes standards for performance, flexibility of controls, ease of operation and convenience, and yet is priced within the budget of the music lover who seeks superior performance and design at a moderate cost. In addition to high performance and unique circuit design, the LT-725A boasts an ultra-modern exterior with space-age styling, highlighted by an elegant ebony face-plate with gold embossed lettering. The front panel also features a row of pushbuttons for the functions of Stereo/Mono mode, MPX Filter, and FM/AM reception. There are rear inputs for external FM and AM antennas. Complete with built-in FM and AM antennas, AC fuse holder and grounding post. Output suitable for any quality stereo amplifier. Size: 12W x 3 $\frac{3}{4}$ H x 9 $\frac{1}{2}$ "D. For 117 VAC, 50/60 Hz. Imported. Shpg. wt., 13 lbs.

99 K 02297W No Money Down*Net 129.95

High Performance at a Low Price

LAFAYETTE'S LT-670B AM/FM Stereo Tuner



ONLY
107⁵⁰

AAA 2 YEAR GUARANTEE

See Page 30 for Details

- 1 IC, 18 Transistors, 23 Diodes
- ACRITUNE for Visual FM Tuning Accuracy
- Automatic FM Stereo Switching and Stereo Indicator Light
- Muting for Minimum Interstation Tuning Noise
- Multiplex Filter
- Internal FM Antenna plus Flexible-Mount AM Antenna
- Front and Rear Tape Output Jacks
- Neatly Styled to Blend with All Decors

Enjoy the full measure of high-priced AM/FM stereo reception at an amazingly low price. Solid-state circuitry combines advanced design and features that provide an outstanding level of performance. Every control feature for outstanding performance has been included: switchable (On/Off) MPX Filter for reduction of external interference on FM Stereo; a MODE selector (Mono or Stereo); and a SELECTOR for AM or FM reception. FM detector output jack will accept discrete 4-channel FM broadcast decoders when available. Terminals for adding an FM external antenna. Simulated walnut grain vinyl-covered metal enclosure, anodized brushed aluminum front panel and knobs. For 117 VAC, 50/60 Hz. Size: 10 $\frac{1}{2}$ "W x 3 $\frac{1}{2}$ "H x 8 $\frac{3}{8}$ "D. Imported.

99 K 03048W Shpg. wt., 12 $\frac{1}{4}$ lbs. Net 107.50

SPECIFICATIONS

FM SECTION: Range: 88-108 MHz. Sensitivity: 3.5 μ V. Harmonic Distortion: @ 400 Hz, 100% modulation: 0.7%. Selectivity (Alternate Channel): 35 db. Capture Ratio: 5 db. Stereo Separation: 30 db @ 400 Hz. Signal-to-Noise Ratio: 50 db (100% mod.). Image Rejection: 50 db. Tape Output Level: Average 350 mV, 1 Volt max. External Antenna Impedance: 300 ohms balanced. **AM SECTION:** 3-Gang Tuning Condenser. Range: 535-1605 kHz. Sensitivity (Antenna Terminals): 20 μ V. S/N: 40 db @ 1 mV input.

LAFAYETTE'S ST-22 AM/FM Stereo Tuner

ONLY
39⁹⁵

With Wood Case

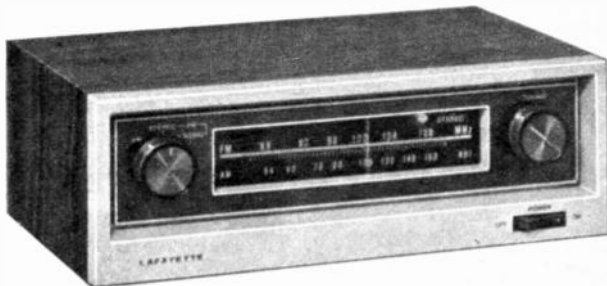

- Automatic Frequency Control
- 11 Transistors, 13 Diodes, and 1 Varicap Diode
- Automatic FM Stereo Switching and Stereo Indicator Light
- 7.5 μ V Sensitivity
- Attractive Wood Cabinet

Enjoy AM/FM stereo reception at an unbelievably low price! Mode selector switch selects AM, FM STEREO and FM MONO for reception with minimum of noise and static. Some of the ST-22's outstanding FM Section specifications include: Total Harmonic Distortion: 1% or less; MPX Separation at 1 kHz: 25 db; S/N Ratio: 55 db. The ST-22 also features an attractive front panel with large, easy-to-

read AM and FM station dial and FM stereo indicator. The rear apron includes left and right output jacks as well as antenna terminals for internal AM ferrite bar antenna, external AM antenna lead, and for internal and external FM antennas. For 120 VAC, 60 Hz operation. Imported. Size: 9 $\frac{1}{16}$ "W x 3 $\frac{1}{16}$ "H x 6"D. Wt., 4 $\frac{1}{4}$ lbs.

99 K 03337W No Money Down*. Net 39.95

Add Lafayette's LA-975 SQ Decoder/Amplifier To Your Higher Power Stereo Receiver and Amplifier To Enjoy 4-Channel Sound

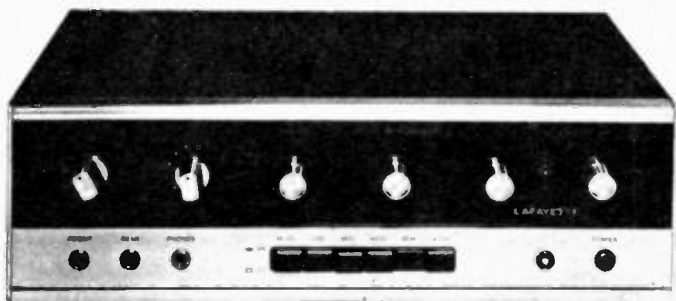

POWER RATINGS
 66 Watts RMS
 (33 Watts x 2) at 4 ohms
 THD 1% at 1 kHz
 104 Watts IHF at 4 ohms

**OUR LOWEST
 SALE PRICE EVER**

129⁹⁵
 With Case

No Money Down*
SAVE 20.00

AAA 2-YEAR GUARANTEE

See page 30 for details

- Converts Your Stereo System to Play SQ and Discrete 4-Channel
- Sophisticated SQ LOGIC DECODER
- Master Volume Control for All 4 Channels

- Also a High Quality Independent 2-Channel Stereo Amplifier

This high quality, high power SQ Decoder/Amplifier makes it easy to add exciting 4-channel sound to your present stereo system. The LA-975 adds 2 additional amplifier sections and decoder circuitry just by plugging it into your present stereo receiver or amplifier's tape monitor. Add 2 rear speakers, and you're ready to play 4-channel SQ records and discrete 4-channel reel-to-reel and 8-track tapes. The "Composer" circuit will decode all other matrix systems (such as QS/RM) and derive rich 4-Dimensional sound from your stereo records, tapes and FM broadcasts. The LA-975 can also be operated independently as a high quality stereo ampli-

fier. Input and 4-channel/stereo mode selection, as well as Volume/Balance, Bass and Treble are controlled by front panel rotary switches. The front panel also includes push-buttons to control Hi Filter, Loudness, and Front/Rear Speaker functions, in addition to stereo Headphone and 2 Tape Output jacks. The rear panel includes a full range of 2 and 4-channel program source inputs, outputs for 2 and 4-channel recording and for 4 speakers, line and speaker fuses, plus one switched and one unswitched AC outlet. For 117 VAC, 50/60 Hz. Size: 13W x 4 $\frac{1}{4}$ "H x 10 $\frac{1}{4}$ "D. Imported. 99 K 02859W Shpg. wt., 20 lbs.Net 129.95

Lafayette's LA-524 SQ Decoder/Auxiliary Amplifier Gives Your Present Stereo System 4-Channel Capability!



POWER RATINGS
 RMS: 25 Watts
 (12 $\frac{1}{2}$ Watts x 2) at 4 ohms
 THD 1% 1 kHz
 IHF: 44 Watts at 4 ohms

LOW SALE PRICE

69⁹⁵

No Money Down*

CONTINUED UNTIL 5/1/74

AAA 2-YEAR GUARANTEE

See page 30 for details

- Converts Your Stereo System to Play SQ and Discrete 4-Channel
- Built-in 4-Channel SQ-M Decoder

- 2-Channel 25-Watt RMS Auxiliary Amplifier
- Exclusive Master Gain Control for All 4 Channels of Amplification

If your stereo system receiver or amplifier has a tape monitor, you can have a 4-channel system just by adding the LA-524 SQ Decoder/Auxiliary Amplifier and 2 more speakers. You'll hear dramatic 4-channel sound when you play discrete 4-channel reel-to-reel and 8-track tapes, and 4-channel SQ records. Or, derive rich 4-dimensional sound from standard stereo records, tapes and FM broadcasts with the LA-524's "Composer" circuit. The LA-524 can not be used as an independent stereo amplifier. 4-channel Volume, Bass,

Treble and 4-Channel Mode are controlled by front panel rotary switches. Rocker switches control Hi Filter, Loudness and Front/Rear Speaker functions. 2- and 4-channel tape inputs and outputs, 2 speaker outputs, a stereo headphone jack, and protective line and speaker fuses are also provided. Operates on 117 VAC 50/60 Hz. Size: 10 $\frac{1}{4}$ "W x 8 $\frac{3}{4}$ " x 3 $\frac{1}{2}$ "H. Imported. Shpg. wt., 10 $\frac{1}{4}$ lbs.

99 K 02750WNet 69.95

LAFAYETTE SQ-W Full Logic SQ Matrix Decoder

Gives Unsurpassed SQ 4-Channel Separation

- Features Ultra Sophisticated Wavematching Full Logic SQ Decoder Circuitry with Variblend
- Convert Your Present Hi-Fi System to Play 4-Channel SQ Records and Decode 4-Channel SQ FM Broadcasts
- Selector Switch for SQ Full Logic, Discrete, 2-Channel, Composer A, Composer B

Incorporates the most advanced decoding circuitry available today for converting your present high fidelity system to play 4-channel program sources: (1) SQ discs, and (2) enjoy listening to 4-channel SQ FM broadcasts. The only system (with many records available) presently approved for 4-channel FM broadcasts is the SQ system. Requirements for converting to 4-channel SQ: (1) 2-Channel System—add the SQ-W decoder, additional stereo amplifier, and 2 more speakers. (2) 4-Channel System not incorporating SQ—just add the SQ-W decoder (the SQ-W must be used with amplifiers or receivers incorporating a Tape Monitor Feature). For added convenience, the SQ-W also includes Composer A and B circuitry for deriving 4-channel sound from conventional 2-channel program sources. Two input sensitivity controls, Master Volume Control for adjusting volume on all four channels simultaneously. 14¼W x 11¼D x 2¾H. For 117 VAC, 50/60 Hz. Imported. Wt., 7½ lbs. **99 K 03311W No Money Down*.....Net 99.95**



99⁹⁵ with connecting cables

LAFAYETTE CD-4 Discrete 4-Channel Demodulator



89⁹⁵ with CD-4 Test Record and Connecting Cables

- Designed For 4-Channel Systems That Do Not Have A Built-In CD-4 Demodulator Circuit
- Enables You To Listen To CD-4 4-Channel Discs
- Requires The Use Of A Special CD-4 Cartridge (See Listing Below)
- 3-Position Function Switch; CD-4, Direct, and Stereo

The Lafayette CD-4 Demodulator easily connects between your stereo turntable and existing 4-channel receiver or amplifier. The demodulator is the essential component required for playing the special CD-4 4-channel discs that are available. Utilizes the latest solid-state circuitry. Features a 4-channel "Radar" indicator that glows to indicate the playing of a CD-4 record. In the direct position, the signals to your receiver or amplifier bypass the demodulator. Includes CD-4 level adjustment control. Specifications: Separation: Left-to-Right 45 db at 1 kHz. Front-to-Rear 30 db at 1 kHz. Frequency Response: 20-16,000 Hz. Signal-to-Noise Ratio: more than 60 db. Size: 8¼W x 8¼D x 2¾H. For 117 VAC, 50/60 Hz. Imported. Shpg. wt., 5½ lbs.

99 K 03345W No Money Down*Net 89.95

CARTRIDGES FOR CD-4 4-CHANNEL PLAYBACK SYSTEMS

- Pickering UV-15/2000Q Quadrahedral Cartridge
- 21 K 55331L Wt., 1 lb. No Money Down*Net 69.95**
- Audio Technica AT14S Cartridge with Shibata Diamond Stylus
- 21 K 39509L Wt., 1 lb. No Money Down*Net 49.95**

Charge it with BankAmericard or Mastercharge!

Convert Your Stereo to 4-Channel Now and Save!

LAFAYETTE SQ-M 4-Channel SQ Matrix Decoder



SAVE
10.00

Cut 22%

Now 34⁹⁵

• Convert Your Stereo System to Play SQ 4-Channel

Play all the new exciting 4-channel SQ records. Incorporates a magnetic phono input for use with amplifiers or receivers that do not have a magnetic phono input feature. A stereo system requires adding an additional stereo amplifier, 2 more speakers, and the SQ-M. Present 4-channel systems not incorporating SQ circuitry only require an SQ-M. FM 4-channel broadcasts in SQ can be decoded by the SQ-M. Also features a circuit for deriving 4-channel sound from stereo tapes, records and FM broadcasts. Size: 6W x 2⁷/₈H x 7¹/₄"D. For 105-120 VAC, 50/60 Hz. Imported. Shpg. wt., 4¹/₄ lbs.
99 K 02768 No Money Down*Net 34.95

LAFAYETTE QD-4 Derived 4-Channel Adapter



SAVE
10.00

Cut 40%

Now 14⁹⁵

Add the QD-4 and two additional speakers to any existing stereo amplifier or receiver and enjoy derived 4-channel sound from regular stereo records, tapes, and FM broadcasts. Does not require an additional stereo amplifier. This will add a dramatic new dimension to almost all of your existing stereo programs. Three pairs of cables are supplied: One 6-ft. pair; one 15-ft. pair; and one 25-ft. pair. Size: 5³/₄W x 4⁵/₈D x 2⁷/₈"H. Imported.
99 K 02594 Shpg. wt., 4³/₈ lbs.Net 14.95

Lafayette's 4-WAY GUARANTEE

**... gives you
real protection**

When you buy from Lafayette, you buy with confidence. Lafayette's "4-Way Guarantee" is your assurance that we mean what we say. For 53 years we have given you real protection . . . and shall continue to do so in the future.

LAFAYETTE AAA GUARANTY

1	LAFAYETTE HI-FI SPEAKERS	= 5 YEARS
	LAFAYETTE HI-FI RECEIVERS	= 2 YEARS
	LAFAYETTE HI-FI TUNERS	= 2 YEARS
	LAFAYETTE HI-FI AMPLIFIERS	= 2 YEARS

All Lafayette high fidelity components identified as covered by Lafayette's AAA guaranty are guaranteed to be free of defects in material or workmanship from the date of sale for the time period shown above. During that period we will repair (or at our option replace) them without charge for either material or labor. Material must be returned prepaid to us for our inspection. This guaranty does not apply to items which have been subjected to misuse, abuse, alteration, repair without our authorization or used in violation of operating instructions, nor to normal wear and tear. The speaker guaranty does not cover external parts such as cabinets, grille cloth etc. Serial number must not be defaced. Guaranty is not transferrable.

LAFAYETTE AAM GUARANTY

2 This guaranty covers Lafayette items so indicated in our catalog which contain several integrated sections in a single unit such as compacts and integrated entertainment centers. The time period for each section is as follows:

SPEAKERS	5 YRS.
RECEIVER OR TUNER SECTION	2 YRS.
AMPLIFIER SECTION	2 YRS.
RECORDER SECTION	3 MOS.
CHANGER SECTION	3 MOS.

The terms and conditions of this guaranty are otherwise identical to the AAA Guaranty.

OTHER GUARANTEES

3 All merchandise not covered either by the special guarantees on this page or by other specific guarantees in the catalog are covered by a 90 day repair or replacement guarantee (at our option) against defects in material or workmanship.

SATISFACTION GUARANTEED

4 If for any reason you are not satisfied with your purchase return it to us within 30 days in the original factory carton and we will exchange it or return your money (less transportation charges). Merchandise returned must be in good condition and not soldered or abused—no holes drilled or changes made in any other way. This policy does not apply to kits, nor to pre-recorded tapes, records, books or merchandise not regularly stocked that has been ordered especially for you.

Claims must be accompanied with original sales slip, shipping documents, or our invoice as proof of date of purchase.

SAVE 10.00 On Each Of These LAFAYETTE Headphones

DELUXE F-4400 4-CHANNEL STEREO HEADPHONE

NOW ONLY

34⁹⁵

with 6 ft. cable
and connectors

WAS
44⁹⁵

- 4 Separate 2¼" Speakers
- Frequency Response: 20-20,000 Hz

Four separate speakers each in its own acoustically isolated chamber delivers magnificent 4-channel sound from 4-channel amplifiers or receivers. A switch on the headphone allows use of the F-4400 with conventional 2-channel stereo amplifiers. Special built-in circuitry will derive 4 dimensional sound from 2-channel program sources. Comfortable foam filled vinyl leatherette earpieces and adjustable headband. 4-Channel/2-Channel switch. Impedance: 4-16 ohms. Imported. Shpg. wt., 3 lbs

99 K 02925 No Money Down* Net 34.95



Each Speaker is Acoustically Isolated In its own air tight sealed chamber.

DELUXE F1000 TWO-WAY STEREO HEADPHONE

NOW ONLY

29⁹⁵

with 6 ft.
coiled cord

WAS
39⁹⁵

- Individual Left and Right Channel Volume Controls
- Response: 20-20,000 Hz
- Two 2½" 2-Way Woofer/Tweeter Transducers

Enjoy the realism of virtually distortion free wide-range stereo headphone listening. Each earcup contains a specifically designed 2-way woofer/tweeter transducer and a volume control for critical, controlled sound monitoring. Comfortable, lightweight, form fitting design permits you to enjoy extended listening without tiring—hour after hour—stereo or mono. Impedance, 8 ohms. With coiled cord that extends up to 6 feet. Imported. Shpg. wt., 2½ lbs.

99 K 02552 Net 29.95



Left and Right Channel Volume Controls

F990 STEREO HEADPHONE

NOW ONLY

24⁹⁵

with 6½ ft. cable

WAS
34⁹⁵

- Two Large 3½" Wide-Range Transducers
- Frequency Response: 20-20,000 Hz

Now the listener in his home can own a pair of stereo headphones similar to the ones used in laboratories, recording studios and broadcast stations. Superbly engineered to provide brilliant, full-dimensional stereo sound. A comfortably soft, but airtight seal to the ear is provided by foam-filled earphone cushions. Fully adjustable, cushioned vinyl headband. Comes with 6½ ft. of cable and standard stereo phone plug. Impedance: 8 ohms. Shpg. wt., 2½ lbs.

99 K 02099 Net 24.95



25 Ft. Universal Stereo Headphone Extension Cord

Plugs directly into receiver or amplifier front panel stereo headphone jacks. Flexible 3-conductor coiled cable. With a ¼" 3-circuit plug on one end, a 3-circuit jack on the other end. Imported. Shpg. wt., ¼ lb.

99 K 01166 Net 2.95



2.95 With
Coiled Cord

Lafayette SP22 Stereo Headphones

6.95

With 6-Ft. Cable

Designed for use with low-priced stereo receivers, amplifiers and phonographs. Adjustable headband, comfortable foam-filled, vinyl ear pads. Wide-range 2¼" transducers. Impedance: 8 ohms. With 6 ft. of cable and stereo phone plug. Imported.

99 K 02123 Shpg. wt., 1 lb. Net 6.95



LISTENING TO LAFAYETTE CRITERION®

LAFAYETTE XL 44 HI-FI SPEAKER SYSTEM FEATURING A MULTICELLULAR DIFFUSER

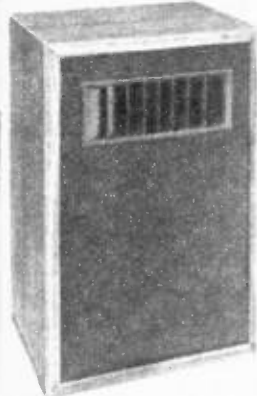

14⁹⁵

Ideal Replacement System for Upgrading Sound Quality in Modular and Compact Phono and Tape Systems

- Wide Range 6½" Speaker
- Power Handling Capacity 10 Watts
- Only 5½"D x 9⅞"W x 14⅜"H.

Quality Hi-Fi speaker system designed for virtually any application—use to improve the sound of your compact phono music system. Use as remote speakers for your Hi-Fi system, or use as extension speakers in your home or office. Features a multicellular diffuser to radiate high frequency sound throughout the listening area. Frequency response, 70 Hz to 15,000 Hz. The powerful 6½" wide-range speaker is housed in a handsomely styled wood cabinet with walnut vinyl covering and a decorative black grille cloth. Impedance, 8 ohms. Size: 14⅜"H x 9⅞"W x 5½"D. Imported. Shpg. wt., 6 lbs.

89 K 03204WNet 14.95

CRITERION 222 2-SPEAKER 2-WAY 8" AIR SUSPENSION SYSTEM

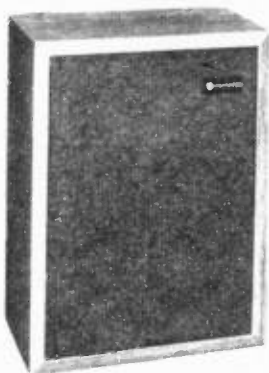

24⁹⁵

5 YEAR AAA GUARANTEE
SEE PAGE 30

- Power Handling Capacity 25 Watts
- Frequency Response 55 to 18,000 Hz
- 8" Woofer with 30 oz. Magnet Structure

Big size performance from this ultra-compact 2-speaker 2-way system. It achieves a purity of sound and music quality that is astounding for a speaker system measuring only 10H x 13½W x 5⅝"D. The 222 consists of a powerful 8" woofer which provides smooth bass sound reproduction down to 55 Hz, and a 2½" cone tweeter that gives you sparkling clean high frequency response. Built-in 7,000 Hz electrical crossover network. Power handling capacity of 25-watts makes it compatible for use with most amplifiers and receivers. Interior of cabinet is designed to damp out standing waves and other spurious vibrations. Walnut-vinyl finish, charcoal brown grille cloth. Impedance 8 ohms. Imported.

99 K 03220W Sngp. wt., 10½ lbs.Net 24.95

CRITERION 333 8" 2-WAY ACOUSTIC SUSPENSION BOOKSHELF SYSTEM



34⁹⁵

5 YEAR AAA GUARANTEE
SEE PAGE 30

- Power Handling Capacity 30 Watts
- Overall Response 40 to 18,000 Hz
- 8" Woofer with 2 lb. Magnet Structure
- 3" Sealed-Back Tweeter

Modest in price, without any sacrifice in quality and performance. Delivers such smooth sonic reproduction over such a broad range, that its "family resemblance" to the more expensive Criterion speaker systems is unmistakable. An 8" high-compliance woofer with polyurethane foam surround, 2 lb. magnet structure and a 1" 4-layer voice coil produces deep, rich bass down to 40 Hz. A 3" sealed-back tweeter widely disperses clean, clear music up to frequencies higher than audibility. 2,000 Hz electrical crossover. The ½" thick wood enclosure is covered on all four sides with protective walnut-finished vinyl. Handsomely accented by charcoal brown grille cloth. 18W x 11H x 10"D. Shpg. wt., 19 lbs.

21 K 05005HW No Money Down*Net 34.95

CRITERION 444 3-SPEAKER 8" 3-WAY ACOUSTIC SUSPENSION SYSTEM

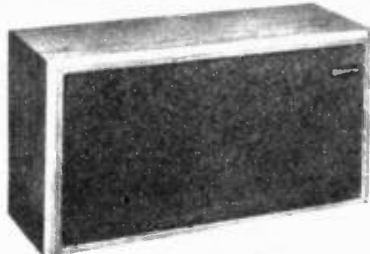

44⁹⁵

5 YEAR AAA GUARANTEE
SEE PAGE 30

- 30 Watts Power Handling Capability
- 8" Woofer with 1¾ lb. Magnet Structure
- 3½" Mid-Range Speaker with ½" Voice Coil
- 1½" Dome Type Tweeter

Expert combining of components for outstanding performance at an unbelievable low price! Heavy-duty 8" woofer in a sealed fiberglass-filled enclosure uses the well-known acoustic suspension principle, assuring deep, natural bass with outstanding clarity and impact. Reliable 3½" cone-type mid-range speaker reproduces clean, full-bodied sound throughout the important middle frequency range. Sharply detailed high frequency reproduction is accomplished with a 1½" dome-type tweeter. Electrical crossover network at 3,000 and 10,000 Hz. High frequency level control (on rear) permits you to tailor the sound to your specific room acoustics. Handsome walnut finish on four sides. Overall response: 40 Hz to 19,000 Hz. Impedance: 8 ohms. Imported. Size: 20H x 11¼W x 8⅝"D. Wt., 20 lbs.

99 K 03279W No Money Down*Net 44.95

SPEAKER SYSTEMS MAKES SOUND SENSE

CRITERION 555 3-SPEAKER 3-WAY 10" ACOUSTIC SUSPENSION SYSTEM

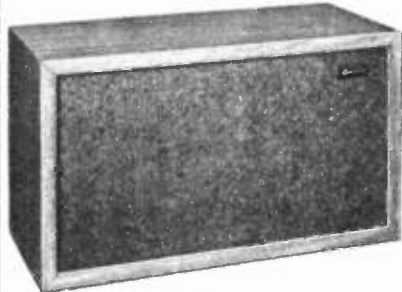

59⁹⁵

5 YEAR AAA
GUARANTEE
SEE PAGE 30

- 50 Watts Power Handling Capacity
- 10" Woofer with 4 lb. Magnet Structure and 1½" Voice Coil
- 5" Sealed-Back Mid-Range
- 3" High Frequency Tweeter

Provides powerful bass, sparkling mid-range, and crystal clear high frequencies. Overall Response 32 to 19,500 Hz. The powerful bass is produced by a 10" high-compliance woofer that is astonishingly large for a speaker system of this size and price. It has a huge 4 lb. magnet structure and a 1½" diameter, 4-layer voice coil. The 5" sealed-back mid-range speaker, with a ¾" diameter, 4-layer-voice coil reproduces middle frequencies with excellent fidelity. The 3" air-sealed, center-domed cone tweeter cleanly extends this system through the upper frequencies. High frequency brilliance control. The ¾" thick wood enclosure is covered on all sides with the finest walnut-finished vinyl available. Impedance: 8 ohms. Size: 21H x 12W x 10"D. Shpg. wt., 29 lbs.
21 K 05013HW No Money Down*Net 59.95

CRITERION 666 60-WATT 3-SPEAKER 3- WAY ACOUSTIC SUSPENSION SYSTEM

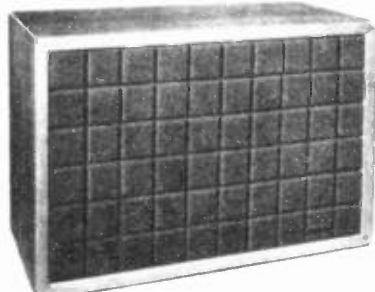

79⁹⁵

5 YEAR AAA
GUARANTEE
SEE PAGE 30

- ¾" Oiled-Walnut Wood Cabinet with Richly Accented 3 Dimensional Foam Grille
- 10" Woofer with 6 lb. Magnet Structure
- 6" Sealed-Back Mid-Range
- 2" High Frequency Tweeter

By employing an exclusive Lafayette system design, the 666 provides an extended frequency response and a degree of smoothness that are truly exceptional in a system of such modest size and price. Featuring a 10" high-compliance woofer with a sturdy 2" diameter, 4-layer voice coil and polyurethane foam surround, the Criterion 666 delivers deep, resonant bass. A 6" sealed-back mid-range speaker reproduces clean, peak-free sound throughout the important middle frequency range. Its 2" tweeter provides widely dispersed high frequencies extending beyond humanly audible levels. High frequency and mid-range controls. Crossover frequencies 800 and 5,000 Hz. Overall response 28-20,000 Hz. Impedance: 8 ohms. Size: 22H x 14½W x 11"D. Shpg. wt., 34 lbs.
21 K 05021HW No Money Down*Net 79.95

CRITERION 777 80-WATT 3-SPEAKER 3- WAY ACOUSTIC SUSPENSION SYSTEM

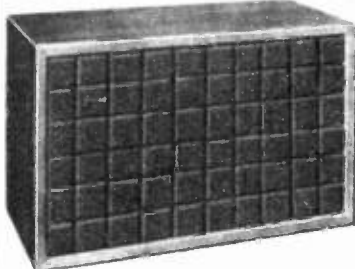

99⁹⁵

5 YEAR AAA
GUARANTEE
SEE PAGE 30

- 3 Dimensional Foam Grille and Rich ¾" Oiled-Walnut Finish Enclosure
- 10" Woofer with 8 lb. Magnet Structure
- 6" Sealed-Back Mid-Range Speaker
- 2" Direct-Radiator Super Tweeter

Distinctive in appearance, uncompromising in performance, suitable for use with the finest Hi-Fi components. Due to a unique Lafayette system design, the over-all smoothness and level of transparency of the Criterion 777 far exceeds many larger, floor standing systems. Its 10" high-compliance woofer, with polyurethane foam surround and a large, sturdy, 2" diameter, 4-layer voice coil, provides powerful bass and exceptional power handling capabilities. High-frequency and mid-range controls on the rear of the enclosure allow optimization of this system in any location. Crossover frequencies 800 and 4,000 Hz. Overall Response 20-20,000 Hz. Impedance 8 ohms. 23H x 15W x 12"D. Shpg. wt., 40 lbs.
21 K 05039HW No Money Down*Net 99.95

CRITERION 888 100-WATT 12" 4-WAY ACOUSTIC SUSPENSION SYSTEM

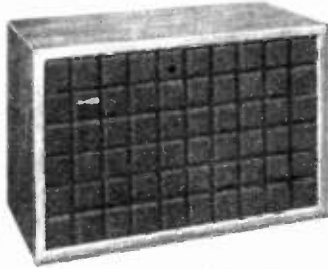

159⁹⁵

5-YEAR AAA
GUARANTEE
SEE PAGE 30

- Powerful 12" Woofer with 12 lb. Magnet Structure

- 6" Air Sealed Lower Mid-Range
- 5" Sealed-Back Upper Mid-Range
- 2" Direct-Radiator Super Tweeter

Performance of our best bookshelf speaker system is characterized by extended frequency response and extremely wide dynamic range, achieved through employing the acoustic suspension principle. Its powerful 12" high-compliance woofer features a massive 4-layer, 2½" diameter voice coil, allowing it to handle exceptionally high transient power, substantially beyond its rated 100-watt power handling capacity. Carefully selected crossover points assure a linear output. Crossover Frequencies: 400; 900; and 7000 Hz. Impedance: 8 ohms. Controls: HF Range, Upper Mid-range; and Lower Mid-range. Minimum Power Requirement: 15 W (RMS). Overall Response: 19-20,000 Hz. ¾" Oiled-Walnut finish cabinet with dramatic 3-dimensional acoustically transparent foam grille. Size: 24H x 15½W x 12"D. Shpg. wt., 55 lbs.

21 K 05047HWX No Money Down*Net 159.95

UTAH \$1.00 SPEAKER SALE

Buy 1 MK-30
Speaker System
At Our Regular Price

BUY A SECOND
FOR ONLY **\$1.00** MORE



Utah MK-30 Deluxe 12"
3-Way Acoustic
Suspension System

ONE SYSTEM / TWO SYSTEMS
129.95 / 130.95

- 12" High Compliance Woofer
- 3½ x 8" Compression Midrange Driver
- Dome Radiator Tweeter with Wide Angle Diffraction Horn
- Power Handling Capacity - 60 Watts Peak
- Hand-Rubbed Walnut Veneer Wood Enclosure

These deluxe systems sell for 129.95 each in our 1974 Catalog 740. However, thru May 1, 1974 Lafayette is offering a fantastic sale. Get 2 of these Utah MK30's for only \$1.00 more than the price of one. You pay only 130.95 for both systems. For particularly discriminating listeners, a variable high frequency control is provided to fine-tune the MK30 to individual room acoustics. Frequency Response 30 to 20,000 Hz. Crossover frequencies 2,500 and 5,000 Hz. Impedance 8 ohms. Size 15¼H x 24W x 12"D. Wt., 40 lbs. 21 K 47569W.. No Money Down*.....Net 129.95
2 for 130.95

Utah HL 12PC-HX
12" Coaxial Speaker

ONE SPEAKER / TWO SPEAKERS
39.95 / 40.95

- Power Handling Capacity 45 Watts
- 4 lb. Magnet Assembly
- 1½" Copper Voice Coil
- Horn Load Compression Tweeter
- Viscous-Damped Cone Suspension

A pair of deluxe 12 inch 3-way coaxial speakers for just \$1.00 more than the regular price of one. The HL12PC-HX sells for 39.95 in our 1974 Catalog 740, now you pay only 40.95 for 2 until May 1, 1974. The HL12PC-HX provides powerful bass reproduction with sparkling highs widely dispersed by the efficient horn loaded compression tweeter. Frequency response 23 to 20,000 Hz. Resonance 25 Hz. Includes high frequency control. Impedance 8 ohms. Shpg. wt., 13 lbs.

21 K 47601W No Money Down*.....Net 39.95
2 for 40.95

GET SECOND
SPEAKER

FOR ONLY
\$1.00
MORE

Save
38.95

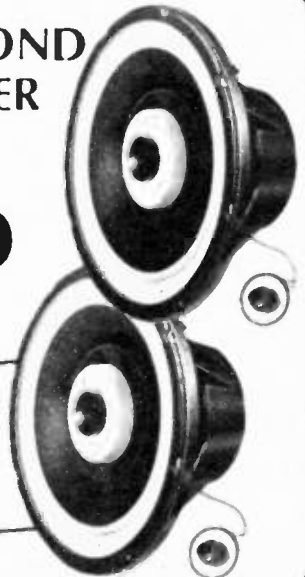

* See Page 19 for Full Details on Easy Pay Plan

SAVE UP TO 47⁸⁹

FROM
INDIVIDUAL
CATALOG PRICES

On Garrard or Dual Automatic Turntable, Elliptical Cartridge, and Base Packages...

GARRARD ZERO 100C Automatic Turntable Package



GARRARD ZERO 100C AUTO. TURNTABLE	209.95
PICKERING V15 MICRO IV/ATE CART.	39.95
GARRARD B2 PLASTIC BASE	7.95
	<u>257.85</u>

SPECIAL PACKAGE PRICE 209.96
SAVE 47.89

Heart of the Zero 100C is a tone arm engineered to provide zero tracking error. Plays 2 speeds: 33½, 45 RPM. Synchro-Lab Motor, Stylus Timer, Built-in Anti-Skating Control. Illuminated Stroboscope. Variable speed ±3%. Cueing/Pause with damped motion in both directions. Size: 15¼ x 14½"D, above motor board 4¾", below 2½". For 100-130 VAC, 60 Hz. Imported. Includes Pickering V15 Micro IV/ATE Elliptical Cartridge and Garrard B2 Ebony Pin-Seal Plastic Base.

22 K 92357WM Wt., 18½ lbs. No Money Down*Net 209.96

209⁹⁶

with Pickering
V15 Micro IV/ATE
Elliptical Cartridge and Base

NEW! DUAL 1216 Automatic Turntable Package



DUAL 1216 AUTOMATIC TURNTABLE	154.95
PICKERING V15 MICRO IV/ATE CART.	29.95
DUAL MB-10 PLASTIC BASE	9.95
	<u>194.85</u>

SPECIAL PACKAGE PRICE 154.96
SAVE 39.89

The Dual 1216 plays three speeds (33½, 45 and 78 rpm) and features a high-torque motor, 0- to 5.5-gram tracking, anti-skating calibrations for both conical and elliptical styli, and damped cueing control. Includes Pickering V15 Micro IV/ATE Elliptical Cartridge and Dual MB-10 simulated Walnut Base. Size: 13W x 10¾D with 5" clearance above the motor board and 2½" below. Imported.

22 K 92506WM Shpg. wt., 15 lbs. No Money Down* ...Net 154.96

154⁹⁶

with Pickering
V15 Micro IV/ATE
Elliptical Cartridge and Base

GARRARD MODEL 62 Automatic Turntable Package



GARRARD Model 62 AUTO. TURNTABLE	69.95
PICKERING P/ATE-1 ELLIPTICAL CART.	24.95
GARRARD B1 PLASTIC BASE	6.95
	<u>101.85</u>

SPECIAL PACKAGE PRICE 69.96
SAVE 31.89

The Model 62 plays 33½, 45, 78 RPM records. Features low mass aluminum tone arm. Heavy-duty, 4-pole induction motor. Adjustable anti-skating control. Damped cueing and pause control. Size: 14¾W x 12½"D. 4¾"H above motor board, 2½" below. For 110-130 VAC, 60 Hz. Imported. Includes Pickering P/ATE-1 Elliptical Cartridge and Garrard B1 Ebony Pin Seal Plastic Base. Shpg. wt., 12½ lbs.

22 K 92332WM No Money Down*Net 69.96

69⁹⁶

with Pickering
P/ATE-1 Elliptical
Cartridge and Base

All mail orders accepted with Mastercharge and BankAmericard.

Lafayette Cat. No. 743 35

Garrard & LAFAYETTE Automatic Stereo Turntables

**GARRARD Model 40B 3-Speed Automatic Stereo Turntable
Plus Money-Saving Pickering Cartridge Combinations**

Only 1¢ More

Pickering P/ATE-1
Elliptical
Cartridge
reg. 24.95

Only \$5 More

Pickering V15 Micro IV/ACE
Elliptical
Cartridge
reg. 29.95

49⁹⁵
Less
Cartridge
and Base

49⁹⁶
Less Base,
with Elliptical
Cartridge

54⁹⁵
Less Base,
with Deluxe
Elliptical
Cartridge

No
Money
Down*



Plays 33½, 45 and 78 rpm records. Full viscous damped, single lever cueing. Low mass, tubular, aluminum tone arm with fixed, isolated counterweight. Easy-to-adjust stylus pressure control with visible scale. Two interchangeable spindles. Oversize turntable with handsome safety mat. Size: 14½" W x 12½" L. Requires 4¾" above and 3" below motor board. With all connecting cables. Less base. For 110-130

VAC, 60 Hz Imported. Shpg. wt., 10 lbs.
21 K 40499W Model 40B onlyNet 49.95

Model 40B and Pickering P/ATE-1 Elliptical Cartridge
21 K 40556WNet 49.96

Model 40B and Pickering V15 Micro IV/ACE
22 K 90310WNet 54.95

Deluxe Lafayette AC-60 4-Speed Automatic Record Changer



CUT 5.00

SALE
24⁹⁵

- Cue and Pause Control
- 4 Speeds—16, 33½, 45, 78 RPM

With Tetra Stereo Turnover
Ceramic Cartridge, Less Base

Handsomely styled to provide a high standard of performance and reliability. Plays both stereo monaural 12", 10" and 7" records. Automatic shut-off after last record. Plays up to 6 records automatically. Full-size 10" turntable with rubber mat. Anti-skate control. Heavy-duty, constant-speed motor. Diamond LP needle. With all connecting cables. For 117 VAC, 60 Hz. Size: 13W x 11" D. Requires 3" below motor board, 3¼" above. Imported from England. Wt., 7 lbs.

21 K 01814HWNet 24.95

ACCESSORIES FOR MODEL AC-60

Ebony Base with simulated oiled-walnut and silver trim.
21K 01822HW Shpg. wt., 2 lbs.Net 5.95
Smoke Tint Polystyrene Dust Cover. Shpg. wt., 2 lbs.
21 K 01830HWNet 5.95
45 RPM Spindle. Shpg. wt., 6 oz.
21 K 01848Net 1.95

Accessories for Garrard Turntables

Stock No.	Description	For	Shpg. wt.	Net ea.
21 K 40226W	Plastic Base	40B, 30, 70, 62	2 lbs.	\$ 6.95
21 K 40234W	Plastic Base	Zero 100C, 92, 82	2 lbs.	7.95
21 K 40820W	Walnut Base	40B, 30, 70, 62	4 lbs.	19.95
21 K 40838W	Walnut Base	Zero 100C, 92, 82	4 lbs.	19.95
21 K 40267W	Dust Cover	See † Below	3 lbs.	6.95
21 K 40275W	Dust Cover	See † Below	3 lbs.	7.95
21 K 40531	45 Spindle	40B, 30, 70, 62	6 oz.	2.25
21 K 28007	45 Spindle	Zero 100C, 92, 82	6 oz.	3.80

†Can only be used with 21-40226W Base.

‡Can only be used with 21-40234W, 21-40838W and 21-40820W Bases.

LAFAYETTE "Mini" 4-Speed Automatic Stereo Record Changer Ensemble

Model MC22B
34⁹⁵



Pre-Mounted
on a Simulated
Black Leather Base
With Walnut Vinyl Trim,
Heavy-Gauge Tinted Plastic
Dust Cover, and Diamond Needle Cartridge

Completely ready to plug into your audio equipment. Four speeds: 16, 33½, 45 and 78 RPM. Features low-mass dynamic tone arm, high quality ceramic turnover stereo cartridge with diamond LP needle, detachable spindle, vibration-free, dynamically-balanced, 2-pole motor. Handles stack of 6 records automatically. Intermixes 10" or 12" records of the same speed. UL listed. Size (includes Base): 14½ x 5 x 10". For 117 VAC, 60 Hz. Made in England.
21 K 01772W Shpg. wt., 10 lbs. No Money Down*Net 34.95
24 K 02568 45 RPM Spindle. Shpg. wt., 3 oz.Net 1.49

LOW, LOW PRICES on FAMOUS NAME Stereo Cartridges

Deluxe Pickering V15/AME-3 Dustamatic Elliptical Stereo Cartridge



SPECIAL PURCHASE 16⁸⁸

One of Pickering's finest! Integrated with the stylus assembly is Pickering's exclusive Dustamatic Brush which automatically cleans the grooves in advance of the stylus without interfering with the tracking force. Freq. response 10 to 25,000 Hz, output 5.5 μ V, separation 32 db, tracking force $\frac{3}{4}$ to 1 $\frac{1}{2}$ grams. Shpg. wt., 6 oz.Net 16.88
21 K 53708L



ADC 220XE

9⁹⁵



Shure M3D

6⁹⁵



Empire 999E/X

17⁹⁵



Pickering V-15/ATE-2

11⁹⁵



Pickering V-15/ACE-3

13⁹⁵



SALE REG. 49.95
Shure M91E

24⁹⁵

ADC 220XE Elliptical Stereo Cartridge — Separation: 20 db. Response: 10-18 Hz \pm 3 db. Tracking force: 1 $\frac{1}{2}$ to 4 grams. Output: 5 μ V. 21 K 13306L Shpg. wt., 6 oz.Net 9.95

Pickering V-15/ATE-2 Elliptical Cartridge — With bi-radial .009 x .004 elliptical stylus. Tracking force: 2 to 5 grams; Response: 20 to 20,000 Hz; Channel Separation: 35 db. Shpg. wt., 4 oz. 21 K 53625LNet 11.95

Shure M3D — Shure's all-time best seller. Tracks at forces from 3 to 6 grams. Spherical diamond stylus. Response: 20-20,000 Hz. 21 K 62014L Shpg. wt., 4 oz.Net 6.95

Pickering V-15/ACE-3 — Elliptical diamond stylus. Dustamatic cleaning brush. Response: 10-20,000 Hz. Tracking force: 2 to 5 grams. Shpg. wt., 5 oz. 21 K 53773LNet 13.95

Empire 999E/X — Tracks at $\frac{3}{4}$ to 2 grams. Frequency Response: 10-30,000 Hz; Channel separation: 35 db. Bi-radial diamond stylus. 21 K 34930L Shpg. wt., 8 oz.Net 17.95

Shure M91E — .0007 x .0002" elliptical cartridge. Tracking force: $\frac{3}{4}$ to 1 $\frac{1}{2}$ grams. Channel separation: Nominally 25 db at 1,000 Hz. Output voltage: 5.0 μ V. Shpg. wt., 3 oz. 21 K 62444LNet 24.95

Shure Stylus Gauge

4⁹⁵



Model SFG-2 Stylus Force Gauge. The ideal way to have your tone arm set to exactly the correct tracking force. Detects both excessive or insufficient tracking forces. Accuracy to within 1/10 of a gram in the $\frac{1}{2}$ to 1 $\frac{1}{2}$ gram primary operating range; extended range to 3 grams. Shpg. wt., 4 oz. 21 K 62584Net 4.95

Pickering PST-1 Stylus Timer

ONLY 13⁹⁵



• Scientifically Measures Actual Stylus Wear-Time from 0-1,000 Hours

Save your records from stylus abuse. Fits any standard record changer or turntable. Scientifically measures actual stylus wear-time from 0-1000 hours in accurate increments of 100 hours. Compact and easy to mount without electrical connections. Includes mercury battery. Shpg. wt., 1 lb. 21 K 55323LNet 13.95

Lafayette Solid-State Stereo Phono Preamp

This self-powered phono preamplifier features a 4-silicon transistor circuit especially designed for use with Hi-Fi stereo amplifiers not having magnetic cartridge inputs. Its compact size permits easy mounting on a record changer/player base. Frequency response: 30-20 kHz. Input impedance: 50,000 ohms. S/N ratio over 60 db. 117 VAC, 50/60 Hz. Size: 4 x 2 $\frac{1}{2}$ x 1 $\frac{1}{2}$ ". Imported. 99 K 02198 Shpg. wt., 1 $\frac{1}{2}$ lbs. Net 9.95



9⁹⁵

Pioneer PL-12D Manual Turntable Package

SAVE 29.94

99⁹⁶



PIONEER PL-12D TURNTABLE\$ 99.95

PICKERING P/ATE-1 ELLIPTICAL CARTRIDGE 29.95

~~129.90~~

SPECIAL PACKAGE PRICE 99.96

SAVE 29.94

Professionally-styled manual turntable with a 4-pole synchronous motor and belt drive to insure constant speed that is free from line voltage fluctuation. The tonearm is a static-balanced, S-shaped type utilizing a super-hard alloy material at the pivot point for stable tracking at all times. Also features direct reading pressure gauge, anti-skating, and cueing control. Plays 33 $\frac{1}{3}$ and 45 RPM records. Includes Pickering P/ATE-1 elliptical cartridge. Size: 16 $\frac{1}{4}$ "W x 6 $\frac{1}{2}$ "H x 14 $\frac{1}{4}$ "D. For 117 VAC, 60 Hz. Imported. Shpg. wt., 18 $\frac{1}{2}$ lbs. 22 K 92514WM No Money Down*Net 99.96

Save 10.00 on Lafayette's Best AM/FM 8-Track Stereo Phono System

SALE 239⁹⁵ With Plastic Dust Cover



Model LSC9000

- Deluxe Garrard 4-Speed Automatic Record Changer with Cueing • Tape Inputs and Outputs
- Stereo Headphone and Remote Speaker Outputs
- FM Stereo Indicator Light

- 2 Acoustic Suspension Speaker Systems. Each Containing an 8" Woofer, 3½" Tweeter, and Cellular Horn Dispersion Duct.

The ultimate in a 3-piece modular stereo phono system. Consists of a handsome Control Center containing a powerful solid-state AM/FM stereo Tuner/Amplifier, a famous Garrard 4-speed Automatic stereo record changer, a deluxe 8-Track Stereo Cartridge Player, and two separate, perfectly balanced, full-range 2-speaker Acoustic Suspension systems. Specifications: Garrard Changer: 4 speeds—16%, 33½, 45, 78 rpm. Intermixes records of the same speed. Tone arm has turnover stereo ceramic cartridge with Diamond LP needle. 8-Track Stereo Tape Cartridge Player: Individual Illuminated Track Indicators, Pushbutton Track Selector. Stereo Tuner/

Amplifier: Blackout calibrated tuning dial—Separate slide controls for Balance, Bass, Treble and Volume. Front panel monitor jack. Tape input and output jacks. Beautiful walnut vinyl wood cabinetry. Includes Plastic Dust Cover and 45 rpm spindle. Control Center—23½W x 9¾H x 15"D. Each Speaker System—14¾H x 11¼W x 6¾"D. For 110-120 VAC. 60 Hz. Shpg. wt., 63 lbs. 24 K D3475HWX No Money Down*Net 239.95

Replacement Needle for LSC-9000
24 K 03202 Shpg. wt., 4 oz.Net 2.79

Sanyo GXT 4510 AM/FM Stereo Cassette Phono System Has Everything—You Can Even Make Stereo Recordings While Listening



229⁹⁵

No Money Down*

A versatile Stereo Music System consisting of an AM/FM Stereo Receiver, Garrard 4-Speed Automatic Record Changer, a Stereo Record/Playback Cassette Deck, and 2 separate acoustic suspension Speaker Systems, each containing a 6" wide-range speaker. The Garrard Record Changer plays 4 speeds: 16, 33½, 45 and 78 RPM, and features a cueing and pause control. The built-in Stereo Cassette Deck is pushbutton-operated with automatic stop at the

end of the tape. Other features include: tape output and input jacks, adjustable recording level monitor, front panel stereo headphone jack, and a separate tone control. Comes with dust cover, microphone, and a 30-minute blank cassette tape. 117 VAC, 60 Hz. Speaker size: 9¾W x 7D x 15¾"H. Unit: 19¼ x 14¾ x 8¼".

24 K 67017WX Imported. Shpg. wt., 26 lbs.Net 229.95

Now You Can Have Our Best AM/FM Stereo Modular System at a 10.00 Savings

SALE! 139⁹⁵

Reg. 149⁹⁵

With Plastic Dust Cover



Diamond Needle

Model LSC-100B

- Garrard 4-Speed Automatic Record Changer with Cueing
- Powerful Solid State Stereo Amplifier
- FM Stereo Indicator Light
- Stereo Headphone Jack for Private Listening

- Each Speaker Contains an 8" Woofer and 4" Tweeter
- Guitar Microphone Input Jack
- Tape Input and Output Jacks
- Main and Remote Speaker Jacks

Our finest stereo phonograph with built-in stereo FM/AM radio is fully solid-state and features magnificent ultra-modern styling. The control center's Powerful stereo amplifier has provisions for tape input and output, guitar mike input, and stereo headphone. Also includes AC convenience outlet on rear panel, and remote speaker output jacks for hooking up an additional pair of speakers for another room. Built-in AM/FM antennas. Provision for attaching external FM antenna. AFC switch for drift-free FM reception. Garrard 2025 4-speed automatic stereo record changer with cueing lever plays 7, 10 and 12" records at 16 $\frac{1}{2}$, 33 $\frac{1}{2}$, 45 and 78 rpm automatically or manually. Shuts off both changer and amplifier

automatically after last record. Features tubular tone arm with Vaco TN-4 stereo turnover cartridge with diamond LP needle. Each 2-way speaker system contains an 8" woofer and 4" tweeter. You also get a handsome tinted plastic dust cover for the complete control unit, speaker hook-up cable and a 45 rpm spindle. The components are mounted in beautiful walnut vinyl veneer-covered wood cabinets. Size: Control unit 23 $\frac{1}{2}$ "W x 14" x 10 $\frac{3}{8}$ "H (with dust cover). Includes tinted plastic dust cover and 45 RPM spindle. Speaker Encl.: 15 $\frac{1}{2}$ "H x 10 $\frac{1}{2}$ "W x 4 $\frac{5}{8}$ "D. For 110-120 VAC, 60 Hz. 24 K 03251HWX No Money Down*. Wt., 45 lbs.Net 139.95
24 K 03202 Replacement Needle for LSC-100BNet 2.79

LAFAYETTE LSC-15 4-Speed Stereo Manual Phono System

29⁹⁵

With Bubble Top Dust Cover



- Low Price—Quality Performance—Bold New Styling
- Two Acoustically Matched 4" Speakers in Handsome Ebony Molded Cabinets
- Front Panel Stereo Headphone Jack

Magnificently styled and sculptured, ebony molded high-impact polystyrene cabinetry. Solid-state amplifier has separate left and right channel volume controls. Famous BSR stereo record player manually plays at 4 speeds: 16 $\frac{1}{2}$, 33 $\frac{1}{2}$, 45 and 78 RPM. Stereo ceramic turnover cartridge with diamond needle. Includes speaker

hook-up cable. Size: Control Unit—18 x 10 $\frac{3}{4}$ x 5 $\frac{3}{8}$ "; Each speaker—7 x 4 $\frac{1}{4}$ x 12". For 117 VAC, 60 Hz. Shpg. wt., 10 lbs. 24 K 03681HWNet 29.95

24 K 02568 45 RPM Spindle for LSC-15Net 1.49

Treat yourself with a BankAmericard or Mastercharge order.

Lafayette Cat. No. 743 39

Just Plug Them In and Listen . . .

LAFAYETTE Modular Stereo Tape Centers

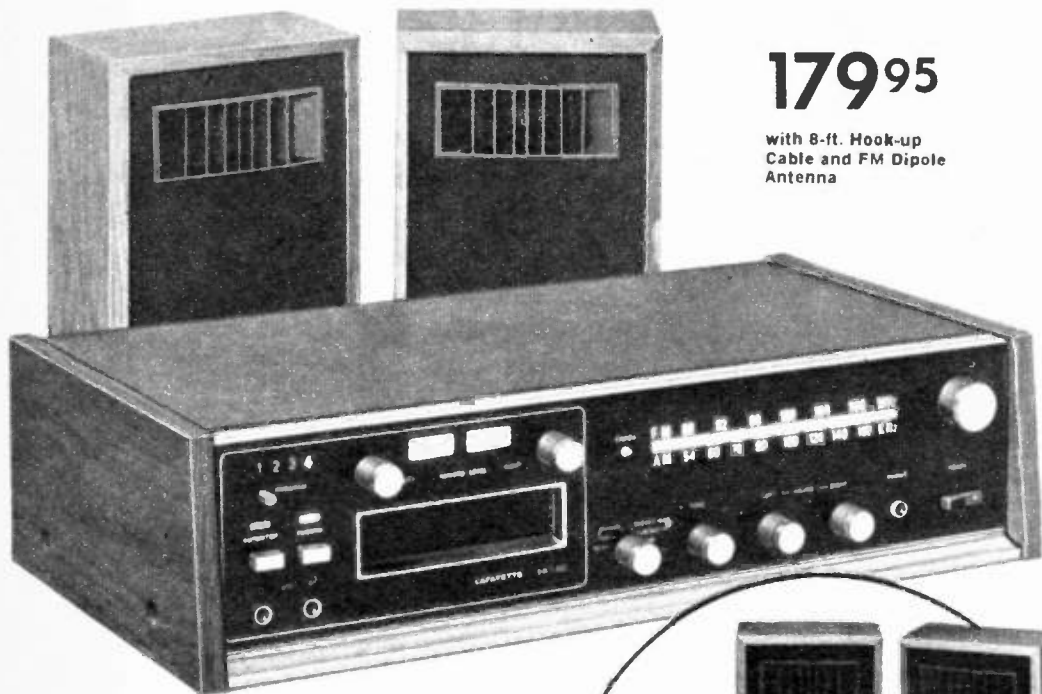

179⁹⁵

with 8-ft. Hook-up
Cable and FM Dipole
Antenna

MODEL SR-80 AM/FM STEREO 8-TRACK RECORD AND PLAYBACK 3-PIECE SYSTEM

The highly sophisticated Lafayette SR-80 consists of a fine performing AM/FM Stereo Receiver and 8-Track Stereo Tape Deck in one unit, with two separate wide-range speaker systems each containing a 6½" speaker with a multicellular diffuser. Record any program on the built-in 8-track recorder—from FM stereo or mono, from AM, or from any external program source connected to the unit, including microphones. The 8-track stereo recorder has separate dual record level meters; front panel microphone input jacks; separate left and right channel recording level controls; automatic stop pushbutton; record indicator light; pushbutton channel selector, and separate channel indicator lights. AM/FM stereo receiver features an FM stereo indicator light, front panel stereo headphone jack, AC convenience outlet, input for attaching a record changer (ceramic or crystal cartridge) or another tape recorder.

Solid-state circuitry. Handsome wood cabinet with walnut vinyl finish. Size: Receiver/Recorder Section: 18W x 10D x 4½"H; Each Speaker System: 14½ x 9¾ x 5½"D. For 117 VAC, 60 Hz. Imported. Shpg. wt., 27 lbs.
99 K 99707WM No Money Down*Net 179.95

Deluxe Microphone for SR-80
99 K 45882 Shpg. wt., 1 lb.Net 19.50

40 Lafayette Cat. No. 743



179⁹⁵

with 8-ft. Hook up
Cable and FM
Dipole Antenna

MODEL SR-50 AM/FM STEREO CASSETTE RECORD AND PLAYBACK 3-PIECE SYSTEM

Same deluxe features and speakers as the SR-80, but with a stereo cassette recorder in place of the 8-track recorder. The cassette stereo record and playback section features Record, Rewind, Fast Forward, Playback, Eject and Pause pushbutton tape function controls, as well as a digital tape counter with reset button. Imported. Wt., 27 lbs.
99 K 99699WM No Money Down*Net 179.95

Deluxe Microphone for SR-50.
99 K 45882 Shpg. wt., 1 lb.Net 19.50

*See Page 19 for Full Details on Easy Pay Plan

SPECIAL HI-FI SYSTEM QUOTATION

Select Your
Own System
and
SAVE

MAIL THE
CARD

TODAY

Or Bring Into
Your Local Store

No Charge

No Obligation



Name
Please Print

Address

City State Zip

Select Your Own Hi-Fi System and Get Lafayette's Special Low Price

A component hi-fi music system must consist of,
at least, all of the following:

RECEIVER OR AMPLIFIER PLUS MUSIC SOURCE (Changer,
Turntable, Tuner or Tape Deck) AND HI-FI SPEAKERS.

HOW MANY	COMPONENT	MFR's NAME AND MODEL
	RECEIVER or AMPLIFIER	
	TUNER	
	CHANGER or TURNTABLE	
	Cartridge	
	Base for Above	<input type="checkbox"/> Yes <input type="checkbox"/> No
	Dust Cover for Above	<input type="checkbox"/> Yes <input type="checkbox"/> No
	45-rpm Spindle for Above	<input type="checkbox"/> Yes <input type="checkbox"/> No
	SPEAKER	
	Wood finish, if in enclosures _____	

OTHER
ITEMS _____

**SPECIAL HI-FI
SYSTEM
QUOTATION**

**Select Your
Own System
and**

SAVE

**MAIL THE
CARD
TODAY**

**Or Bring Into
Your Local Store
No Charge
No Obligation**

**PLACE
STAMP
HERE**

LAFAYETTE RADIO ELECTRONICS
111 JERICHO TURNPIKE
SYOSSET, L. I., NEW YORK 11791



RUSH —Special Hi-Fi System Price Requested

Please Fill Out Other Side Before Mailing

Only at Lafayette! Solid-State AM/FM Stereo Modular System at this Low Price Plus a Stereo Headphone for Only 1c MORE!



SR-10A

- Two 5" Wide-Range High-Compliance Speakers in Handsome Walnut Wood Enclosures
- FM Stereo Indicator
- Stereo Headphone Jack
- Inputs for Connecting Record Changer or Tape Player

Advanced solid-state circuitry provides high quality performance. The AM/FM stereo radio receiver features precision blackout and illuminated sliderule tuning dial. A special FM stereo sensing circuit in the radio provides automatic switching to mono or stereo reception, depending on the broadcast. Individual slide-lever control for Bass, Treble and Balance. Provisions on the rear panel for connecting a record changer or tape player. Tape Output

jacks are also provided for connecting a tape recorder. Each speaker system is equipped with an 8-foot audio cable and connector. Size of AM FM radio: 13 $\frac{3}{4}$ "W x 9 $\frac{1}{4}$ "D x 4 $\frac{3}{4}$ " H. Size of each Speaker System: 9 $\frac{3}{4}$ "H x 7 $\frac{5}{8}$ "W x 4 $\frac{1}{4}$ "D. For 117 VAC, 60 Hz. Imported. Shpg. wt., 17 $\frac{1}{2}$ lbs.
99 K 03162W Model SR-10A onlyNet 79.95
Model SR-10A plus SP-22 Stereo Headphone
99 K 98022WM Shpg. wt., 19 lbs.Net 79.96

**LAFAYETTE
SP-22
Stereo
Headphones**



Reg. 6.95

79⁹⁵

No Money Down*

**LESS
HEADPHONE**

79⁹⁶

No Money Down*

**WITH
HEADPHONE**

DELUXE LAFAYETTE 3-BAND SOLID-STATE AM/FM/WEATHER TABLE RADIO

49⁹⁵

No Money Down*

Tunable FM/VHF Circuit for 24-Hour Monitoring of the U.S. Weather Bureau Radio Network System on 162.55 or 162.40 MHz.

A deluxe AM/FM table radio that also tunes the U.S. Weather Bureau Radio Network System. Receive the latest official U.S. Weather Bureau forecasts and weather observations for your area. Check your local Weather Bureau for exact operating frequency. Tuned RF FM amplifier and 3 IF stages. AFC for outstanding sensitivity and drift-free FM reception. IC audio section and a big 5" speaker provide full, rich tone. Handsome wood cabinet with walnut vinyl



finish. Illuminated vertical sliderule AM/FM tuning dial. Rear panel has terminals for external FM antenna, external speaker, tape recorder output jack, and fine tuning control for precise tuning of the Weather Bureau station in your listening area. Built-in AM and FM antennas. With whip antenna for Weather Band. Size: 15W x 8H x 5 $\frac{1}{2}$ "D. For 117 VAC, 60 Hz. Imported.
99 K 35651W Shpg. wt., 10 $\frac{1}{2}$ lbs.Net 49.95

WAKE UP WITH LAFAYETTE

Deluxe AM/FM Digital Clock Radio
With Pushbutton
"Doze" Control

Sale
44⁹⁵

With Earphone
& Pillow Speakers

SAVE 5.00



Unusually beautiful, 24-hour, full-feature digital clock radio. Luxuriously-styled red and ebony plastic cabinet. Softly illuminated tuning dial and clock lets you see time and station at a glance. Has superb sound. Features: 2-hour sleep timer, 24-hour alarm set, 9-minute "Doze" control, digi-bright clock, tone control, AFC to prevent FM drift, earphone and pillow speaker. FM line cord antenna. Size: 4 1/8 x 10 3/4 x 7 1/4. For 117 VAC, 60 Hz. Imported. Shpg. wt., 4 1/2 lbs. **17 K 02612W No Money Down* Net 44.95**

Handsome AM/FM Digital Clock Radio

Sale 34⁹⁵

Excellent performing AM/FM clock radio in a handsome, hi-impact, polystyrene, walnut-grained and ebony cabinet. Features 24-hour lighted digital clock, large 3 1/2" speaker, lighted sliderule tuning, big, easy-to-read leaf digital numerals, fingertip pushbutton controls, 1-hour sleep switch with automatic shut-off, and built-in AM and FM antennas. Includes provisions for connecting an external earphone or pillow speaker. Size: 4 x 11 3/4 x 6". For 117 VAC, 60 Hz. Imported. Shpg. wt., 5 lbs.

17 K 02372W No Money Down* Net 34.95



SAVE 5.00



ONLY
29⁹⁵

Low-Cost AM/FM
Digital Clock Radio

Sleek and attractive styling. Solid-state engineering for accurate and dependable performance. Features: large, leaf-type digital clock, 24-hour wake-up alarm, 180-minute sleep timer, soft-glow illuminated clock and tuning dial, built-in AFC for drift-free FM performance, slide-lever volume control, built-in antennas, and provisions for attaching an external FM antenna. Hi-impact plastic cabinet with walnut finish. Size: 9 1/2 W x 6 D x 3 1/4 H. For 117 VAC, 60 Hz. Imported. Wt., 4 lbs. **99 K 35735W Net 29.95**

Lafayette Pocket and Specialty Radios

Low-Priced Solid-State AM Pocket Radio



3⁹⁵ • Includes Carrying Strap and Battery

Low-priced pocket AM radio provides fine tone from a 2 1/4" dynamic speaker. Earphone for private listening. Instant-on solid-state circuitry. Built-in AM antenna. Operates on one inexpensive 9-volt battery. Comes in attractive case. Color may vary. Size 4 1/2" x 2 1/2" x 1 1/4" D. Imported. Wt., 1 1/2 lbs.

17 K 67029LNet **3.95**
99 K 60212Net **.35**

Lafayette Solid-State AM/FM Pocket Radio



11⁹⁵ With Earphone, Carrying Strap, and Battery

Easy-to-view sliderule tuning dial. Earphone/external speaker jack, 2 1/2" dynamic speaker. Built-in ferrite AM and telescopic FM whip antennas. Powered by a single inexpensive 9-volt battery. Black with wood grain trim. Size: 3 x 4 7/8 x 1 1/2". Imported. Wt., 1 1/2 lbs.

17 K 02562LNet **11.95**
99 K 60212Net **.35**

Lafayette "Guardian Micro 2" High-Band FM/VHF Police and AM Pocket Radio

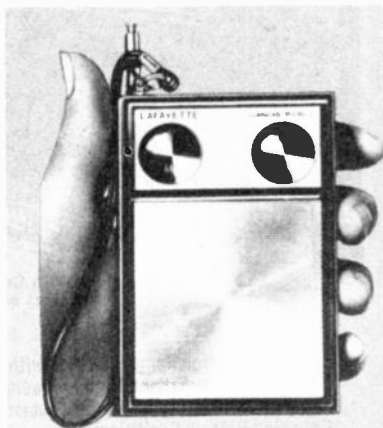

14⁹⁵ With Battery and Earphone

• Tunes 147-176 MHz FM/VHF Police, Fire, and Weather Frequencies

Provides continuous coverage of high-band (147-176 MHz) FM-VHF state and local police, fire, emergency services, defense and U.S. Weather Bureau forecasts on 162.55 MHz. Tunes standard AM broadcast band. Powerful solid-state circuitry. Built-in ferrite AM and telescopic VHF antennas. Size: 4 1/2 x 2 7/8 x 1 3/8". Imported. Shpg. wt., 1 lb.

99 K 35354LNet **14.95**
99 K 60212 Extra 9V BatteryNet **.35**

Bike Radio With Flashlight and Horn

16⁹⁵

- With Lock and Key, and All Mounting Hardware

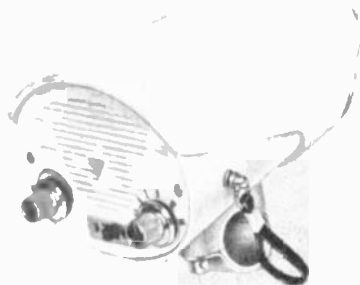

Weather-proof white plastic case. Fine performing AM radio has all-solid-state circuitry. Features a clamp bracket with lock and key to prevent theft. Size: 3 3/4" W x 4" H (including clamp) x 5 1/2" D. Imported. Shpg. wt., 3 1/2 lbs.

17 K 86011Net **16.95**
Batteries for Bike Radio
99 K 62572Net ea. **.19**
Extra 9V Battery (1 req.)
99 K 60212Net **.35**

Authentically-Styled Reproduction of the Most Popular Radio of the 1930's

39⁹⁵

No Money Down*

- Plays Both Standard AM and FM Broadcasts



All the charm of the 30's plus modern solid-state circuitry. Tunes FM as well as AM broadcasts. Vernier-styled tuning dial. AFC circuitry on FM to prevent drift. Dynamic wide-range speaker for fine tonal quality. Size 11 x 12 1/2 x 7 3/4". For 117 VAC, 60 Hz. Shpg. wt., 4 lbs.

17 K 81087WNet **39.95**

Charge it with BankAmericard or Mastercard!

Carry a Lafayette Portable Radio

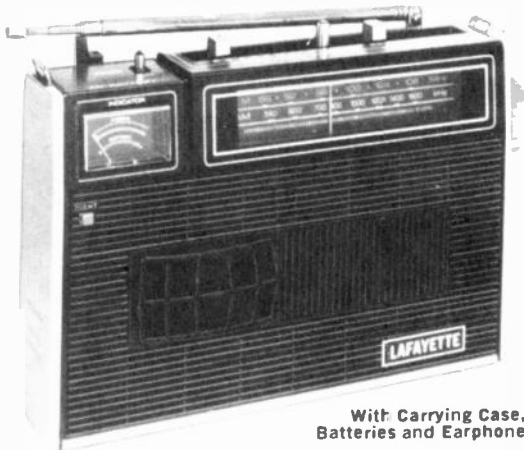

With Carrying Case,
Batteries and Earphone

- 4" Dual Cone Wide-Range Speaker with Multicellular Horn Diffuser to Expand High Frequency Tones
- Large Tuning/Battery Meter for Precise Tuning and Checking Battery Condition
- Tuned RF Stage for Highest Sensitivity

Our Finest AM/FM Solid-State Portable Radio

SAVE 3⁰⁰

SALE 44⁹⁵

Net Money Down*

More dynamic portable sound than ever before from Lafayette, with this portable radio featuring a dial check light, slide lever tone control, built-in AFC circuit and portable operation on 3 "C" batteries or 117 VAC house current with its built-in AC adapter. Telescoping FM antenna. Luxurious black and silver cabinet. Size: 5 $\frac{1}{8}$ " H x 8 $\frac{3}{8}$ " W x 2 $\frac{3}{4}$ " H. Imported. Shpg. wt., 4 lbs.

17 K 02620LNet 44.95



With Batteries
and Earphone

**Deluxe LAFAYETTE Battery/
Electric AM/FM Portable Radio**

SAVE 3⁰⁰

SALE 22⁹⁵

- Continuous Tone Control
- Precision Slide Rule Tuning
- Large 3 $\frac{1}{2}$ " Speaker for Outstanding Tonal Quality

Top quality performance. Powerful solid-state circuitry offers remarkably clear reception. Operates on 4 "C" batteries (included) or on 117 VAC with self-storing AC line cord. Automatic Frequency Control (AFC) on FM prevents station drift. Telescoping swivel rod antenna for FM plus built-in AM antenna. Black vinyl padded cabinet with silver trim. Size: 6 $\frac{1}{4}$ " x 10 $\frac{1}{4}$ " x 3 $\frac{1}{4}$ ". Imported.

17 K 02349L Shpg. wt., 5 lbs.Net 22.95

Extra "C" Batteries (4 required)

99 K 62572Net .19

*See Page 19 for Full Details on Easy Pay Plan

**Smartly
Styled
Lafayette
Battery/AC
AM/FM
Portable
Radio**

STILL ONLY

19⁹⁵

**OUR SALE
CONTINUES**

From Cat. 742

- Instant-On Solid-State Circuitry
- Slide Lever Volume Control
- Built-In AFC
- Slide Rule Tuning

Dramatic, upright styling. Operates on standard AC house current (117 VAC, 60 Hz) or with 4 "C" batteries (included). Built-in FM telescopic and AM ferrite core antennas. Handsome black padded simulated leather case. 3 $\frac{1}{2}$ " speaker provides full frequency sound. Size 5 $\frac{3}{4}$ " x 9" x 2 $\frac{3}{4}$ ". Imported.

17 K 02554L Shpg. wt., 4 lbs.Net 19.95

SONY STEREO PORTABLE RADIO Has 3 Self-Contained Speakers

3 Front-Mounted Speakers

69⁹⁵
with
batteries

The MR-9100W has a specially designed Stereo Sound system, which consists of three self-contained 4" x 2 3/4" speakers that deliver wide and well separated stereo sound. Also features an FM stereo indicator light, ceramic filters for high selectivity, switchable AFC, continuous tone control, battery or AC operation (4 "D" cells and built-in AC line cord included). Lightweight, modern cabinet with swingaway handle. In ivory white, with black and chrome trim. Size: 6 1/8" H x 10W x 4 3/8" D. Imported. Shpg. wt., 5 1/2 lbs.

17 K 33120W No Money Down*Net **69.95**
99 K 62572 Extra "D" BatteriesNet .19



SANYO STEREO PORTABLE AM/FM RADIO Even Has A TV Band For Listening Without Looking



59⁹⁵
With
Earphone

• Automatic Shut-off Timer

Listen to TV sportscasts, musical shows and other TV audio transmissions anywhere with this AM/FM radio that operates on batteries or 117 VAC. Plug in the optional Stereocast adapter and a pair of stereo headphones, and you can listen to superb FM Stereo. Also features Memoriode electronic shut-off timer, tuning/battery meter, slide controls, AFC, lighted dial and 4" unicone speaker for outstanding sound. Size: 7 1/4" W x 2 1/4" D x 4 3/4" H. Imported. Shpg. wt., 11 lbs.

17 K 59182L No Money Down*Net **59.95**
17 K 59075L Stereocast Adapter. Wt., 1 lb.Net **11.95**
99 K 62572 "D" Batteries (4 required)Net ea. .19

Instant FM/VHF Solid-State Weather Radio



ONLY **11⁹⁵**

At the instant touch of a button listen to 24 hour continuous Weather Reports on 162.55 MHz or 162.40 MHz U.S. Government broadcasts with this fine performing solid-state radio. Operates on one inexpensive 9 volt battery, (included). Separate volume and fine tuning control. Telescoping FM/VHF antenna. Attractive walnut plastic cabinet. Size 4 1/4" D x 3 3/4" H x 3 1/2" W. Imported. Shpg. wt., 2 lbs.
17 K 81020Net **11.95**

4-Band AM/FM/VHF Police Radio

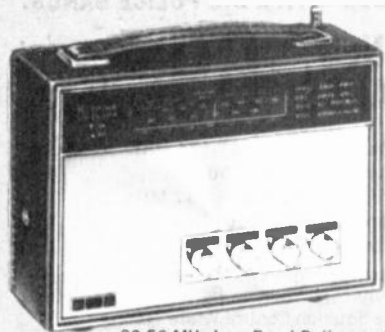

44⁹⁵

Comes With
Batteries,
Earphone and
VHF Guide

- 30-50 MHz Low-Band Police and Fire
- 147-174 MHz Hi-Band Police and Fire

This fine performing 4-band portable tunes Hi and Low police bands, fire, forestry, and continuous U.S. Weather Reports, in addition to receiving regular AM and FM broadcasts. Features continuous rotary squelch control for FM and Police, built-in AFC to prevent drift on FM, telescopic antenna for FM and Police bands, slide rule tuning dial. Big front-mounted 3 1/2" speaker for fine tone. Simulated, high-impact leather cabinet. Size 6 3/4" x 9 1/4" x 3 1/2". Imported.
17 K 69520W Wt., 4 lbs. No Money Down*Net **44.95**
99 K 62572 Extra "C" Batteries (6 req.)Net .19

LAFAYETTE "Guardian 6600" 6-Band Battery/AC AM/FM Police-Aircraft-Marine Portable Radio

TUNES
6 BANDS **89⁹⁵**
With Batteries,
AC Line Cord
and Earphone



- 1 LW: 180-380 kHz Beacon Band
- 2 AM: 540-1600 kHz Standard Broadcast
- 3 MB: 1.6-4.0 MHz Marine Band
- 4 FM: 88-108 MHz Standard Broadcast
- 5 AIR: 108-136 MHz AM/VHF Aircraft
- 6 POLICE: 147-174 MHz/VHF High Band Public Service, U.S. Weather Bureau Forecasts and New VHF/FM Marine Band

- Adjustable Squelch Control
- Signal Strength Tuning Meter
- Built-in Radio Direction Finder

Listen to: Ships at Sea, Aircraft, Local Police, Fire, and U.S. Weather Forecasts, and Standard AM and FM broadcasts. 6-band solid-state portable radio has individually tuned circuits to provide extra sharp reception on each band. Can be operated on 4 "C" batteries for portable use, or from 117 volts, 60 Hz AC with built-in AC line cord for home use. The Guardian "6600" also has Radio Direction Finding Facilities. This will permit the boat owner to obtain bearings from marine beacon stations on the Long Wave Beacon Band, from broadcast stations on the AM Band, and small craft stations on the Marine Band. Also includes a calibrated optical sighting arrangement for visual bearings. Other features include an adjustable telescoping whip antenna plus an external antenna jack for reception on FM, AM/VHF (Police Band) output jacks for use with headphone or external speaker; Automatic Gain Control to vary the sensitivity of the radio and a combination tuning/battery condition meter. Sliderule dial has a logging scale and pushbutton dial light. Large 4" speaker for exceptional tonal quality. Steel carrying handle. Size: 11½H x 10½W x 3¾"D. Imported. Shpg. wt., 4½ lbs.

99 K 35566W No Money Down*Net **89.95**
Extra "C" batteries (4 req.) Shpg. wt., 4 oz.
99 K 62572Net ea. **.19**

GUARDIAN 5500 5-BAND AM/FM/SW/FM-VHF PORTABLE WITH 2-BIG POLICE BANDS

TUNES
5 BANDS **69⁹⁵**
With Batteries,
AC Line Cord
and Earphone

- 1 High Band FM/VHF: 147-174 MHz
 - 2 Low Band FM/VHF: 30-50 MHz
 - 3 International Shortwave: 4-12 MHz
 - 4 Standard AM: 540-1600 kHz
 - 5 Standard FM: 88-108 MHz
- Two Separate Front-End RF Tuning Sections for Both High and Low Police FM-VHF Bands
 - Variable Squelch Control While Tuning FM-VHF Bands—Also serves as Interstation Muting on Standard FM Band

Monitor the airways of the world! Listen to Police, Fire, Civil Defense, 2-Way Business, and U.S. Weather forecasts (162.55 MHz) on BOTH THE HIGH (147-174 MHz) and LOW (30-50 MHz) FM-VHF bands. Tune international Shortwave Bands. Hear music on the standard FM and AM Bands. Operates on 4 "C" batteries or 117 VAC. Excellent tonal quality from large 3½" speaker. Signal Strength Tuning, Battery Condition Meter and Dial Light. Telescoping antenna for FM, FM-VHF and SW bands. Sliderule logging scale for precise tuning. AFC circuitry prevents drift on FM. Includes 4 "C" batteries, earphones, and AC adapter. Size: 10½H x 10¾W x 3¾"D. (Metal handle 2¾"H). Imported.

99 K 35453W No Money Down*. Shpg. wt., 5½ lbs.Net **69.95**



LAFAYETTE "Guardian 7700" 6-Band Battery/AC AM/FM/SW/FM-UHF Portable

3 BIG POLICE BANDS

- FM/VHF High 147-174 MHz
- FM/VHF Low 30-50 MHz
- FM/UHF Ultra-High 450-470 MHz

ALSO TUNES

- International Shortwave: 4-12 MHz
- FM Broadcast: 88-108 MHz
- AM Broadcast: 540-1600 KHz

99⁹⁵

with batteries,
AC line cord
& earphone

- Individual Tuned Circuits
- Signal Strength Tuning and Battery Condition Meter
- Covers All 3 Public Service Bands
- Adjustable Squelch Control

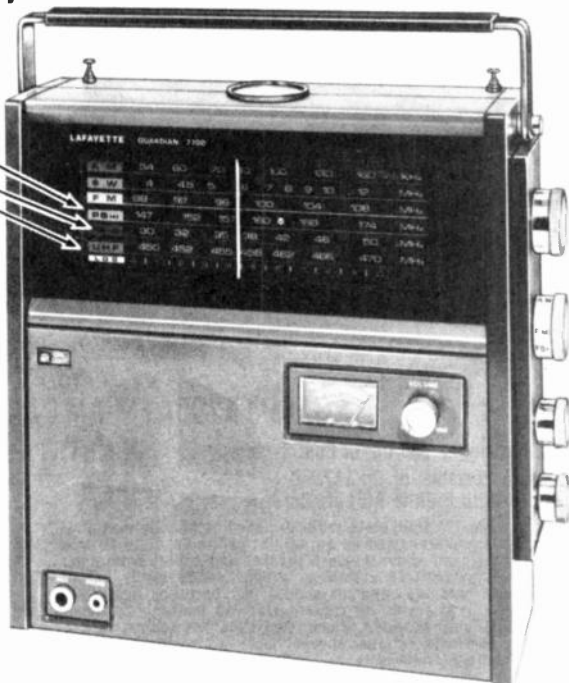

Our best solid-state multiband portable radio. Monitor the exciting UHF and VHF signals of police, fire, U.S. Weather (162.55 MHz), Civil Defense, Highway Maintenance, Forestry and Conservation, The Guardian 7700 can tune 3 POLICE BANDS—ULTRA-HIGH FM/UHF 450 to 470 MHz, HIGH FM/VHF 147 to 174 MHz, and LOW FM/VHF 30 to 50 MHz. You can also listen to International Shortwave Broadcasts on the 4-12 MHz band, as well as Standard AM and FM broadcasts. Operates on 4 "C" batteries, or 117 Volts, 60 Hz. AC with built-in

line cord. Features individual tuned circuits for each police band, dial light, adjustable telescoping whip antennas—one for UHF, the other for VHF, SW and FM Bands (plus an external antenna jack), output jacks for use with headphone or external speaker, logging scale, and continuous tone control. Size: 10½"H x 3¾"D x 10½"W. Imported. Shpg. wt., 5½ lbs.

99 K 35719W No Money Down* Net 99.95
99 K 62572 Extra "C" Batteries (4 req.) Net ea. .19

LAFAYETTE SOLID-STATE 4-BAND AM/FM/AIR/FM-VHF POLICE PORTABLE



ONLY **29⁹⁵** including earphone,
and batteries
— TUNES —

- Aircraft Band: 108 to 136 MHz
- Standard FM: Broadcasts 88 to 108 MHz
- Hi-Band Police: 145 to 174 MHz
- AM Broadcast: 54-1600 kHz

Listen to High-Band police and fire calls, official U.S. Weather Bureau forecasts on 162.55 MHz, aircraft in flight, and your favorite AM and FM broadcasts. Features include: slide lever controls, sliderule tuning dial with logging scale, AFC on FM to prevent station drift, and a big, 3½" wide-range speaker. Operates on 4 "C" batteries (included) or 117 VAC, 60 Hz. Brown, padded, simulated-leather cabinet. Telescopic antenna. Size: 9½ x 6½ x 3¾". Imported. Shpg. wt., 4½ lbs.

17 K 02638W Net 29.95
99 K 62572 Extra "C" Batteries (4 required) Net ea. .19

QUALITY CAR FM CONVERTERS AND CAR RADIOS

LAFAYETTE MODEL FMC SOLID-STATE FM CONVERTER FOR AM CAR RADIOS



ONLY **29⁹⁵** With All Mounting Hardware and Antenna Cable

So Compact—It Can Be Mounted in the Glove Compartment to Prevent Theft

- 3 IF Stages for Extremely High Sensitivity
- For 12-Volt Negative Ground Systems • Local/DX Switch
- Instant-on Solid-State Circuitry • FM Sensitivity .4 μ V

One of the most compact and reliable FM converters available. Converts any 12-volt negative ground AM car radio to an FM radio. Measures only 4 $\frac{1}{2}$ "W x 4 $\frac{3}{4}$ "D x 1 $\frac{1}{2}$ "H—can be mounted under the dash, or out of sight in the glove compartment to avoid theft. Solid-state IC circuitry—4 Transistors, 1 IC, and 5 Diodes. Ultra-Sensitive FM Tuner has 3 IF stages. Local/DX switch improves reception. Sliderule Tuning Dial. With antenna connector and all mounting hardware. Imported. Shpg. wt., 2 $\frac{1}{2}$ lbs.

99 K 16214LNet 29.95

SHARP FX200A FM-AM CAR/PORTABLE RADIO

- Install In Any 12 Volt Car or Boat System
- Use As A Portable, or On 117VAC 60 Hz. With Built-in AC Line Cord

49⁹⁵

Multi-purpose AM/FM solid-state radio designed to provide outstanding reception anywhere. Used as an AM/FM car radio, it locks into its specially designed under-the-dash bracket and operates thru the car's electrical system (12 volts/neg. ground). Slips easily out of bracket for use outdoors—and plays on 4 "C" batteries (included). For indoor use, it operates on regular 117 VAC household current with the AC line cord provided. Illuminated slide rule tuning, variable tone control, earphone/external speaker jack. AFC for drift free FM reception. Ferrite bar AM antenna, telescoping FM antenna. Wide-range 4 x 2 $\frac{3}{4}$ " oval speaker. Imported. UL listed. Dimensions: 9 $\frac{1}{2}$ "W x 5 $\frac{1}{2}$ "H x 2 $\frac{3}{4}$ "D. Shpg. wt., 6 lbs.

17 K 53185 No Money Down*Net 49.95

99 K 62572 Extra "C" Cells (4 required)Net ea. .19

Complete with Car Bracket, Lock and Key, Batteries, AC Line Cord, Earphone



CUSTOM SOLID-STATE RADIOS FOR POPULAR FOREIGN CARS

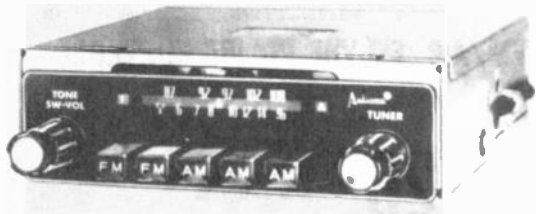

- as low as
- For Toyotas and Datsuns
- For Volkswagens

38⁵⁰

No Money Down*

Designed for custom in-dash mounting. Comes supplied with all mounting hardware. Features Instant-On solid-state circuitry, Pushbutton operation. All models include external speaker except FM stereo radios. For 12 volt negative ground systems. Imported.

Stock No.	Type	Speaker	For Model and Year	Shpg. wt.	Net
17 K 80196	AM Pushbutton	5 Round	VW Beetle '68-'73, '72 Super Beetle	7 lbs.	38.50
17 K 80204	AM Pushbutton	5 Round	VW Super Beetle '73	8 lbs.	44.95
17 K 80212	AM Pushbutton	5x7" Oval	VW Bus '68-'73	8 lbs.	44.95
17 K 80220	AM Pushbutton	4x6" Oval	VW Fastback/Square Type 3 '69-'73	7 lbs.	44.95
17 K 80238	AM-FM Pushbutton	5" Round	VW Beetle '68-'73, '72 Super Beetle	7 lbs.	72.50
17 K 80246	AM-FM Pushbutton	5 Round	VW Super Beetle '73	8 lbs.	74.95
17 K 80253	AM-FM Pushbutton	5x7" Oval	VW Bus '68-'73	9 lbs.	74.95
17 K 80261	AM-FM Pushbutton	4x6" Oval	VW Fastback/Square Type 3 '69-'73	8 lbs.	74.95
17 K 80279	AM-FM Stereo Pushbutton	No Spkr.	VW Super Beetle '73	6 lbs.	110.95
17 K 80287	AM-FM Stereo Pushbutton	No Spkr.	VW Beetle '68-'73, '72 Super Beetle	6 lbs.	110.95
17 K 80030	AM Pushbutton	5x7" Oval	Toyota Corona, Corina, Celicia, Corolla '68-'73, MK II '73	6 lbs.	38.50
17 K 80006	AM-FM Pushbutton	5x7" Oval	Toyota Corona, Corina, Celicia, Corolla '68-'73, MK II '73	6 lbs.	72.90
17 K 80022	AM-FM Pushbutton	5x7" Oval	Toyota MK II '71-'72	6 lbs.	72.90
17 K 80147	AM-FM Stereo Pushbutton	No Spkr.	Toyota Corona, Corina, Celicia, Corolla '68-'73, MK II '73	7 lbs.	110.95
17 K 80154	AM Pushbutton	4x6" Oval	Datsun 610 '71-'73	6 lbs.	42.90
17 K 80162	AM Pushbutton	5x7" Oval	Datsun 620, 1200 '71-'73	6 lbs.	42.90
17 K 80170	AM-FM Pushbutton	5x7" Oval	Datsun 610 '71-'73	7 lbs.	74.95
17 K 80188	AM-FM Pushbutton	5x7" Oval	Datsun 620, 1200 '71-'73	7 lbs.	74.95

Quality Solid-State Radios for the Car

Under-Dash Solid-State FM/FM Stereo Car Radio

OUR SALE

from cat. 742 continues

69⁹⁵
Less Speakers

With Antenna "Y" Connector

- FM Stereo Indicator Light
- Slide-Lever Balance and Tone Controls

Compact FM/FM Stereo car radio that measures only 1 1/2" x 5" x 6" W! Can be operated independently or can optionally be hooked up to your AM car radio. For 12 volt negative ground systems. Engineered with dependable solid-state IC circuitry. Features an illuminated slide-rule tuning dial, and a Stereo Indicator Light that shows when you're tuned to an FM Stereo station. Slide lever con-

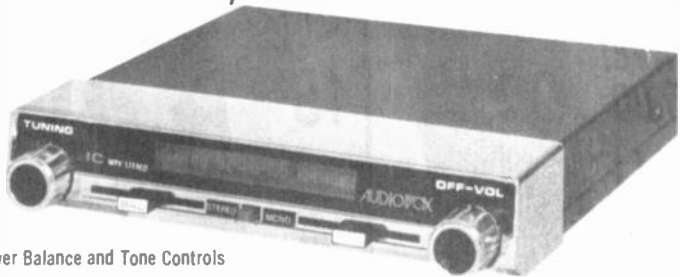

trols for Balance and Tone, and pushbutton Stereo/Mono selector. No holes or drilling required—installs easily with "Grip Tight" mounting strip. Supplied with antenna "Y" connector, all mounting hardware and accessories. Imported. Shpg. wt., 2 lbs.

17 K 80097L No Money Down*Net 69.95

New Sanyo AM/FM Weathermatic Pushbutton Car Radio



79⁹⁵
Less Speaker

- Receives U.S. Weather Network on 162.55 MHz
- Adjustable Shaft

High performance AM/FM car radio with built-in U.S. Weather Network Band. Adjustable shafts for in-dash mounting. Also mounts easily under dash. Powerful solid-state circuitry delivers 10 watts output power. Pushbutton operation. Tone control. For 12 volt negative ground systems. Size: 7 1/2" W x 4 3/4" D x 2" H. Imported. Wt., 6 lbs. 17 K 59190 No Money Down*Net 79.95

5 x 7" Car Speaker for above Car Radio.Net 4.53

Deluxe Universal AM/FM/FM Stereo Pushbutton Car Radio

99⁹⁵
Less Speakers



- 8 Tuned FM Circuits
- 6-Watt Output Per Channel
- 4 IC's and 1 FET

Powerful Solid-State AM/FM/FM Stereo Radio features: Integrated circuitry, 4 I.C.'s and 13 silicon transistors and 1 FET to produce more than 6 watts per channel of stable, drift-free output. Five tuned AM circuits, 8 tuned FM circuits, automatic frequency control, AFC On-Off switch, local/distance switch, Stereo-Mono switch, Stereo indicator light. Reversible insert panel resulting in 3-way die-cast face plate. Flexible antenna lead connector. 12-volt negative ground operation. Size: 6 1/2" W x 5 1/4" D x 1 5/8" H. Shpg. wt., 4 1/2 lbs. Imported. 17 K 80121W No Money Down*Net 99.95

Set of 2 Rear Deck 3" x 5" Speaker Systems. Imported. 99 K 62994 Shpg. wt., 2 1/2 lbs.Net 7.95

Manual AM Car Radio



22⁹⁵

- Built-in Speaker
- Removable Face Plate
- Tone Control Switch
- For 12-Volt Negative Ground Systems

Universal Solid-State AM radio that is easy to install under the dash. Offers fine sound reproduction. Features built-in speaker and tone control slide switch, 7 transistors, 2 diodes, RF stage, AVC, Removable face plate. For 12 volt negative ground system. Size: 2x4 3/4x6 1/2". Imported. Shpg. wt., 2 3/4 lbs. 17 K 74256Net 22.95

Deluxe Pushbutton AM Car Radio



34⁹⁵

- 6-Watt Push/Pull Output
- Large 5" x 7" External Speaker
- For 12-Volt Neg./Pos. Ground Systems

Attractively styled under-dash solid state AM push-button car radio with reversible face plate—black on one side, walnut on the other. 6-watt push-pull output with AGC; External 5 x 7" speaker. Size: 6 1/4" W x 4 3/4" D x 2" H. Imported. Shpg. wt., 5 lbs. 17 K 80048 No Money Down* Net 34.95

Pushbutton AM/FM Car Radio



59⁹⁵
With Speaker

- 5" x 7" Internal Speaker
- Solid-State IC Circuitry
- For 12-Volt Negative Ground Systems

For under-dash installation. Features 5 quick-set pushbuttons (three AM, two FM), and a local/distance switch. Comes with deluxe black, wood grain, and chrome face plate, and a separate 5" x 7" speaker. Size: 6 1/4" W x 4 1/2" D x 1 3/4" H. Imported. Shpg. wt., 4 lbs. 17 K 80139W No Money Down* ...Net 59.95

7-PIECE
BEGINNERS
OUTFIT

SAVE!
5.00

SALE
19⁹⁵



- Everything You Need Including Beginners Record Course and Book

Nicely finished with open headpiece and pinless bridge. Can be used either as nylon string classic or steel string Folk guitar. Steel reinforced neck. Guitar has hardwood body with blonde top. Highly polished finish with design around soundhole. Comes complete with nylon and extra set of steel strings, Vinyl zippered carrying bag, neck cord, pick, instruction book and record course. Size: 36 1/4 x 13 W x 3 1/2" D. Imported. 13 K 52921WUX Wt., 6 lbs. Net 19.95

DELUXE
JUMBO
ACOUSTIC
GUITAR

49⁹⁵

With Plush-
Lined
Carrying
Case



- 3-Color Shaded Sunburst Finish on Front
- Double Pick-Guard

You won't believe what your fingers can do when you play this large concert size guitar (41 1/2 x 16 x 4 1/8"). A steel reinforced neck assures you fine action while a rosewood fingerboard with inlaid position markers make for easy fingering. Spruce wood top and inlaid celluloid strips around the soundhole and an adjustable pin bridge give this guitar the sound as well as the looks to satisfy any guitarist. Front of guitar is finished in a highly polished 3-color shaded sunburst tone. Comes with sturdy plush-lined case and six steel strings. Imported. WL 16 lbs. 13 K 24771W No Money Down[®] Net 49.95

2 PICK-UP
CUTAWAY
ELECTRIC
GUITAR

SAVE
5.00

SALE
49⁹⁵



- Steel Reinforced Adjustable Neck
- Volume and Tone Controls

Electric solid body, double-cutaway guitar. Steel reinforced neck features fast fingering over rosewood fingerboard. 23 frets with 9 white inlaid position markers. Adjustable steel bridge guides strings over dual pick-ups, each with on/off switch and volume control; master tone control provided. Compression tremolo mounted to slimline body. Has large flat bar for convenient use. Black pickguard is beautifully inlaid with gold floral patterns. Lacquered highly polished body is finished in radiant yellow sunburst effect. Size: 40 1/2 x 13 1/2 W x 2" D. Imported. Shpg. wt., 8 1/2 lbs. 13 K 24656W No Money Down[®] Net 49.95 Sturdy Lined Case for above. Wt., 4 3/4 lbs. 13 K 13261WNet 9.95

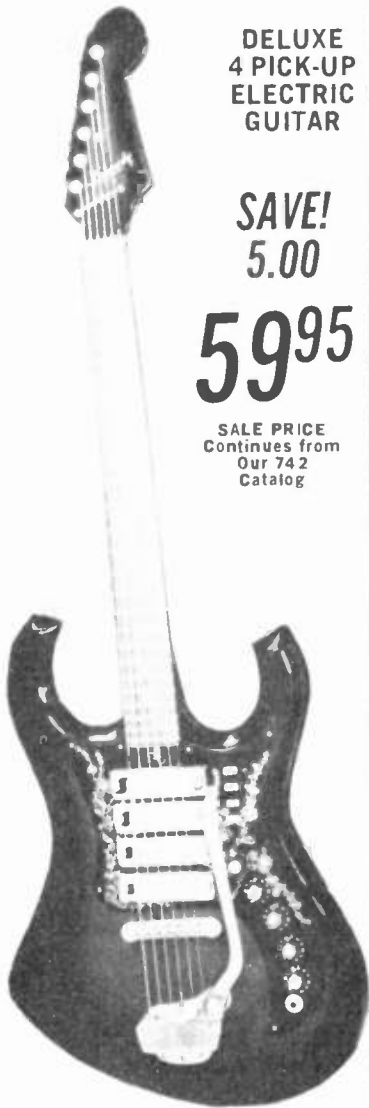

**DELUXE
4 PICK-UP
ELECTRIC
GUITAR**

**SAVE!
5.00**

59⁹⁵

**SALE PRICE
Continues from
Our 742
Catalog**

• Modern, Double Cutaway Design

Features a steel reinforced adjustable neck with variable string guides and an adjustable metal bridge. Includes tremolo with a large, flat bar for convenient use. Attractive oval rosewood fingerboard and 20 new flat-type frets provide faster action. Separate on/off switch and volume control for each pick-up plus a master tone control. Richly designed, ebony pick guard with gold floral inlay. 9 mother-of-pearl inlaid position markers. Highly polished green sunburst finish. Size: 40½" H x 13½" W x 2" D. Imported. Shpg. wt., 9 lbs. No Money Down*.

13 K 24599W Net 59.95
Sturdy Lined Case for above. Wt., 4¾ lbs.
13 K 13261W Net 9.95

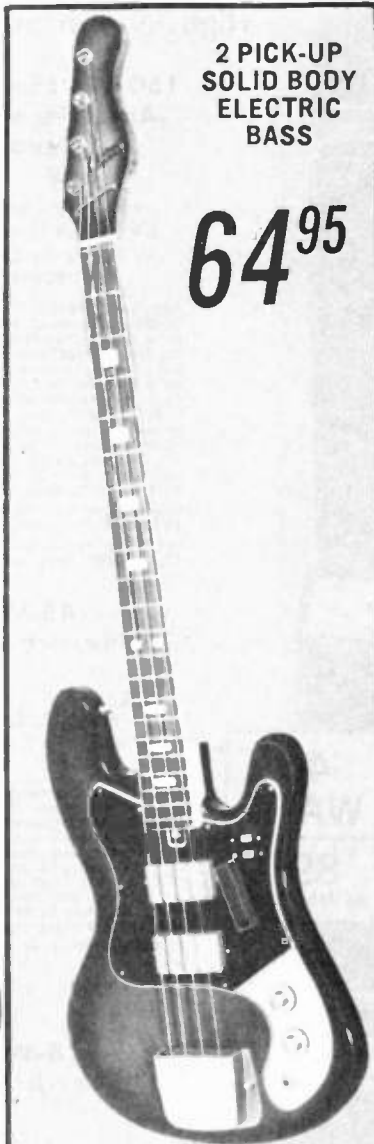

**2 PICK-UP
SOLID BODY
ELECTRIC
BASS**

64⁹⁵

Long neck, slimline electric bass guitar of selected woods for excellent speed and easy fingering. Hand rubbed, shaded sunburst body finished in durable acrylic lacquer. 46" steel reinforced adjustable neck has celluloid-bound oval rosewood fingerboard, 20 frets, 8 pearl inlaid position markers, and large machines for precise balancing of individual strings. Two, feathertouch rocker standby switches for instant control of each pick-up. Includes separate volume and tone controls and compensation adjustable bridge. With cord. 46L x 13½" W x 1" D. Imported. Shpg. wt., 9¾ lbs.

13 K 24615W No Money Down* Net 64.95
Sturdy Case for above.
13 K 24623W Shpg. wt., 4 lbs. Net 9.95



**PROFESSIONAL
2 PICK-UP
SOLID BODY
ELECTRIC GUITAR**

89⁹⁵

- Custom Designed Tremolo Tailpiece
- Contoured Body—Shaped for Super Fast Playing

A super fast-action guitar with features desired by today's top professionals. Ultra-slim double cutaway contoured body with adjustable reinforced hardwood neck, rosewood fingerboard, nickel silver frets and mother of pearl position markers make it perfect for string bending. Two balanced hum-free pick-ups with individual string adjusters and an adjustable bridge deliver a wide tonal response. Volume and tone controls, and toggle switch for selecting pick-ups for solo or rhythm performance—or both! Chrome plated machines. Tailpiece. Lustrous yellow sunburst finished body. Size: 39L x 13½" W x 1¼" D. Imported. Shpg. wt., 10 lbs.

13 K 66681W No Money Down* Net 89.95
Sturdy Lined Case for Above. Wt., 4 lbs.
13 K 66699W Net 9.95

Charge it with BankAmericard or Mastercharge!

Lafayette Cat. No. 743 51

High Performance Musical Instrument

150-Watt Solid-State "Piggy Back" Amplifier with Reverb-Tremolo, 3-Speakers, 2-Channels

- For Guitar, Organ and Vocal Use
- Hammond Reverberation Unit • Variable Tremolo
- 2-12" Special Design Heavy Duty Speakers plus High-Frequency Horn

**150
WATT**

234⁹⁵

No Money Down*

Piggy back amplifier incorporates a solid-state preamp, driving a powerful tube circuit output stage to produce 150 watts of peak music power—(50W RMS @ 5% THD). Utilizing "FET" transistors in the preamp stage, this amplifier develops and produces higher gain and better performance needed for the high powered guitar sound of today. Features two channels with Hi and Lo level inputs, superb flexibility with volume, bass and treble controls for each channel and tremolo intensity, plus dual foot switch jack for remote control of reverb and tremolo. Pilot light, fuse, and on-off switch. Sturdy wood cabinets covered in black textured scuff resistant vinyl with black and silver grille cloth. Amplifier size: 9H x 22W x 13½ D. Speaker cabinet size: 30H x 22½W x 13½ D. For 117 VAC 50 60 Hz.

13 K 01852WX Shpg. wt., 80 lbs.Net **234.95**

Dual Foot Switch for Remote Control of Tremolo and Reverb.

13 K 01506 Shpg. wt., 1½ lbs.Net **6.30**

Dolly for above amplifier.

13 K 01498W Shpg. wt., 6½ lbs.Net **12.50**

45-Watt Solid-State "Reverb-Tremolo" Amplifier

- "Reverb" For Echo-like Effect
- Tremolo For Pulsating Sound

**45
WATT**

89⁹⁵

No Money Down*

Features a built-in heavy duty 12" speaker for clean reproduction of every musical note. Excellent for guitar, microphone, and accordion use. Three instrument inputs. Five controls: two for volume and tone; two for speed and intensity of tremolo, and one for "reverb" depth control. Foot switch jacks for remote control of tremolo and reverb. 45-watt peak music power—(15W RMS @ 5% THD). Also has pilot light, on off switch and fuse. Sturdy wood cabinet covered in black vinyl. Size: 22H x 17W x 8½ D. For 117 VAC, 50-60 Hz. Imported. Dual Foot Switch for Remote Control of Tremolo and Reverb. 13 K 01662W Shpg. wt., 29¼ lbs.Net **89.95**

13 K 01506 Shpg. wt., 1½ lbs.Net **6.30**

18-Watt Solid-State "Reverb-Tremolo" Amplifier

- "Reverb" for Echo-like Effect
- Tremolo for Pulsating Sound
- Tremolo Speed/Reverb Depth Controls
- Heavy-Duty 8" Speaker

**18
WATT**

54⁹⁵

No Money Down*

Impressive 18-watt solid-state peak music power—(6W RMS @ 5% THD) reverb and tremolo amplifier with self-contained 8" heavy-duty speaker. Slanted, front-mounted control panel features "easy-to-reach" controls for Volume, Tone, Reverb, Tremolo: 3 instrument inputs. Bright-glow pilot light. Housed in an attractive, sturdy, vinyl-covered wood cabinet with carry handle and grille cloth. Size: 18½H x 13W x 6½"D. For 117V, 60 Hz AC. Imported. Shpg. wt., 14 lbs.

13 K 66616WNet **54.95**



Amplifiers and Accessories!

60-Watt Solid-State "Piggy Back" Bass Amplifier

- Heavy Duty 15" Special Design Speaker
- For Use With Electric Bass, Regular Guitar, Accordion and Combo-Organ
- 2-Instrument Inputs

Gives full bass and vibrant sound with a minimum of distortion. Powerful 60-watt peak music power amplifier—20 W. RMS @ 5% THD is ideal for use with electric bass or standard guitars, and combo organs. All solid-state circuitry (5-transistors and 4-silicon rectifiers) provides excellent sound. Features a specially designed 15" speaker with a wide range response. High/low gain inputs, separate volume and tone controls allow complete operating flexibility. Has On-Off switch plus pilot light and fuse. Two units; speaker and amplifier in matching black vinyl covered wood enclosures with handles. Size: Amp. 4 3/4" H x 14" W x 18" D; Speaker, 22 7/8" H x 18" W x 11" D. For. 117V 50/60 Hz AC. 13 K 01548W Shpg. wt., 46 lbs.Net 109.95

"Super" Automatic Rhythmer

- Produces background rhythms electronically
- Fox Trot/Swing Section with 36 Variations
- Nineteen Automatic Rhythms

Become a one-man combo with this fully-transistorized instrument—you'll never miss a beat! Provides nineteen computer programmed rhythms plus a special Fox Trot/Swing section with thirty-six variations. By mixing two or more rhythms, additional sounds can be added to create a myriad of accompaniments. The "Super" Automatic Rhythmer gives you "true-to-life" sound, tonal variations and accurate tempo. Actual musical instrument sounds created include: Bass Drum, Large and Small Conga, Claves, Cowbell, Maracas, Snare Drum and Cymbal. Computer-programmed rhythms include: Rock 1-2-3-4, Ballad, Western, Bossa Nova 1-2, Tango, Rhumba, Mambo, Cha-Cha, Samba, Beguine, Meringue, Waltz/Viennese Waltz, and thirty-six variations of Fox Trot/Swing. Controls: Tempo, Volume On/Off Switch, Pilot Light, Tone Downbeat Start Switch, Fuse, High-Low Impedance Outputs, and Foot Control. Vinyl carrying bag. For 117 VAC, 50/60 Hz. Size: 4 1/2" H x 9 1/2" W x 14" L. Imported.

13 K 66509W Shpg. wt., 10 3/4 lbs.Net 179.95

Quadra-Sound-Blender™ Special Effects Device

- Black Vinyl-Covered Case with Handle and Rubber Feet

The Quadra-Sound-Blender is an exciting device that plugs in between your guitar and amplifier to create four dramatic special effects, including: (1) Wide-range percussive tremolo, with a variable rate control; (2) Repeating echo, with adjustable delay between successive echoes; (3) Frequency-dependent vibrato with variable speed; and (4) Reverberation with control of depth. Many other sounds may be created by blending one effect with another. The front panel has controls for effect selection, rate controls for the effects, reverb/echo control, as well as input jacks for two instruments, jack for a footswitch to remotely control the device, output jack to the amplifier, power switch, and pilot light. Dimensions: 4 x 14 1/4 x 6". For 117 VAC. Shpg. wt., 7 lbs.

13 K 52012 No Money Down*Net 44.95

Echo Chamber

- Create exciting echo effects

An efficient echo chamber that lets you add a little extra "presence" to your group, or up to 6 echo repeats for the widest echo effect you've ever heard! No need to worry about tapes slipping or breaking, this unit runs on a replaceable endless-loop cartridge tape magazine. A full complement of controls enables you to create your desired effect: Volume, Echo Balance, Echo Repeat Time and Intensity. And there's an input for an external footswitch for instant on/off capability. Pre-amp frequency response 30-12,000 Hz ± 3 db. Input impedances: Low (600 ohms), High (47k ohms). Out impedances: Low (1500 ohms), High (3300 ohms). Size: 5 1/2" H x 10 1/4" W x 14" D. Imported.

13 K 66640W Shpg. wt., 7 lbs.Net 103.95

REPLACEMENT CARTRIDGE TAPE MAGAZINE. Shpg. wt., 4 oz. 13 K 66657WNet 4.95

Footswitch for above. Shpg. wt., 1/2 lb. 13 K 01514Net 3.75

Big
Bass
Sound

60
WATT

109⁹⁵
No Money Down*



179⁹⁵

No Money
Down*

- For teachers,
students, performers



44⁹⁵



103⁹⁵
No Money Down*

We Dig The Sound Effects You Want!

ROTO-VIBE



84⁹⁵



PRODUCE THE ROTATING SPEAKER EFFECT AND VIBRATO WITH YOUR OWN AMPLIFIER—ELECTRONICALLY

Finally an electronic instrument that can truly simulate the rotating speaker effect through any musical instrument amplifier! Not only produces the Fast or Slow rotating effect but, by the use of the remote speed control pedal, can vary the speed at any rate you desire. Enables the player to produce the various modern effects which are being used on the stage, in the studio, and with theater organs. Can be used with any of the following instruments: organ, bass guitar, rhythm and lead guitar, electric piano, accordion, & other electronic band instruments. Plus: Voice for vocal effects now being used by the top recording groups around the country. Easily connects between instrument and amplifier. Foot pedal has cancel switch to instantly cancel effect being produced. Also features a rocker switch for selecting either the rotating speaker effect or a true vibrato effect. Other controls include Volume, Chorus/Vibrato, Intensity, On/Off power switch, fuse, pilot light, inputs for 2 instruments, and an output for the amplifier. Unit is AC operated, fully transistorized, and has a rugged metal construction. Compact, only 10Wx6 1/2 Dx3 3/4" H. Can be placed in any conveniently reached location. Imported. Shpg. wt., 9 1/2 lbs.

13 K 66400 No Money Down*Net 84.95

LAFAYETTE "FUZZ SOUND"

14⁹⁵



- Make your guitar or bass produce the harmony of several wind instruments!

Add more instruments to your small combo with the "Fuzz" Sound! Create a wide variety of synthesized tones such as those produced by a baritone, or bass saxophone. Battery powered. It easily connects between your guitar, or bass and the amplifier and is operated by an On/Off foot switch. Has two variable control knobs; one for regulating the "fuzz" effect and one for volume and intensity. A supplementary On/Off switch is combined with the volume control to conserve battery life. Fully transistorized, the unit is built for heavy duty use and operates on a single penlight battery. A rugged metal case protects inside circuitry. Overall size: 5 1/2 L x 3 1/2 W x 2 1/4" H. Imported. Shpg. wt., 1 3/4 lbs.

99 K 91993Net 14.95

99 K 62580 Battery for aboveNet .14

WAH-WAH SOUND and VOLUME CONTROL

- Produce a Wide Variety of Special Sound Effects
- Use with Any Electric Guitar or Bass

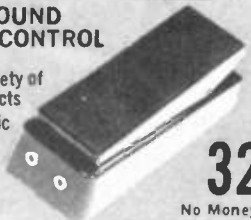

32⁹⁵

No Money Down*

Produce the Wah-Wah effect of a trumpet or trombone with your guitar or bass, electronically. Add extra instruments to your combo by creating the effect of synthesized tones identical to those of a trombone or trumpet when muted by hand or derby. No reaching down for controls. Large, 8 1/2" footpedal gives you the full range of Wah-Wah sounds plus operates as a volume control by depressing a built-in switch under the heel of the footpedal. Input jack contains an on/off switch. Operates on 3 "C" cells (included). Fully transistorized, rugged construction. Size: 10 x 3 3/4 x 3". Imported.

13 K 66301 Shpg. wt., 3 1/4 lbs.Net 32.95

99 K 62572 Extra Battery for above (3 req.)Net ea. .19

SUPER FUZZ

- Super Fuzz Can Produce an Expanded Dimension in Sound
- Full Control of Fuzz Sustain Effects
- Heavy Metal Casting For Long Life and Appearance

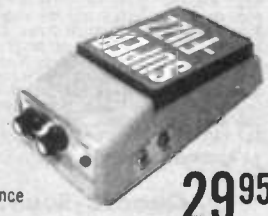

29⁹⁵

Solid state Super Fuzz provides a complete range of controlled new sustained harmonic effects. Produces the wild new in-Sound widely used by the top recording groups. Balance control enables perfect blend of fuzz and normal tones. Expander control provides unlimited range of sustained fuzz effects. Tone switch permits choice of conventional fuzz or new harmonic sustained effects. Master foot control switches instantly to normal guitar operation. Rugged die-cast metal construction. Size: 6 1/2 x 3 x 1 1/2". With cord and battery. Imported. Shpg. wt., 3 lbs.

13 K 66525Net 29.95

99 K 60212 Extra 9-Volt Battery for aboveNet .35

ELECTRO-HARMONIX LPB-1 POWER BOOSTER

8⁹⁵



Makes your amp up to 10 times louder! This solid-state preamp plugs into the input jack of your amplifier to boost the output of any electric guitar, bass, organ, or microphone. Increases guitar sustain as well as the performance of fuzz boxes, wah-wah pedals, and other accessories. Built-in Volume Level control and "Boost/Off" switch enable you to instantly change from regular instrument output to pre-set boosted output. Completely compatible and modular—use 2 for even more power and sustain! With battery. Size: 3 x 2 x 1 1/4". Shpg. wt., 1 lb.

13 K 14749Net 8.95

Extra 9-Volt Battery for above

99 K 60212Net .35

AMPLIFIED HEADPHONES

29⁹⁵



Practice your electric instrument anytime, without using your amplifier, and without disturbing anyone else! These headphones have a built-in 4-transistor amplifier, enabling you to plug directly into your electric guitar, bass, or any other electrified instrument. The cushioned vinyl headband lets you practice in comfort, even for long sessions. Frequency response of 50-20,000 Hz and 3" twin-cone speakers let you hear the true sound of an instrument. Supplied with 10-foot coiled cord with standard plug, power switch, 9-volt battery, and jacks for an AC adapter and monitor. Imported.

13 K 66723 Shpg. wt., 1 3/4 lbs.Net 29.95

Extra 9-Volt Battery for above

99 K 60212Net .35

"VU-PITCH" 6-STRING GUITAR TUNER

5²⁵

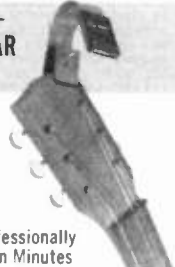

- Lets Anyone Professionally Tune a Guitar in Minutes

Tune your guitar visually! The easy-to-use "Vu-Pitch" tuner with 6 precision-tuned reeds works on the principle of sympathetic vibration. When the guitar string is exactly tuned, the vibration from the string will be transmitted to the associated reed and cause it to visibly vibrate, thereby indicating proper pitch. Great for the beginner, the VU-Pitch tuner will tune your guitar rapidly and precisely in a professional manner.

13 K 48507 Shpg. wt., 6 oz.Net 5.25

Best-Selling Intercom Systems From LAFAYETTE

2-STATION SOLID-STATE INTERCOM SYSTEM

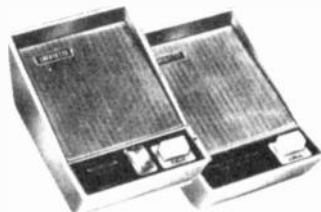

COMPLETE

11⁵⁰
With Battery

- Battery-Operated
- Inter-Unit Tone Calling
- Simple Plug-In Connecting Cord

Battery-operated. Especially useful where AC outlets are not readily available. Complete system includes 1 Master unit, 1 Remote unit, and 70 feet of interconnecting cable with molded plugs for easy installation. Master unit features On/Off/Volume control plus a Listen/Talk switch. "Beep" tone signaling from either Master or Remote operates even when Master is "Off." Has simple provision for stationary wall mounting or can be conveniently placed on desk top. 9-volt battery included. Size: 2H x 3½W x 5"D. Imported. Shpg. wt., 1½ lbs.
99 K 46245 2-Station System Net 11.50
99 K 60212 Extra 9-V Battery Net .35

2-STATION SOLIO-STATE WIRELESS INTERCOM SYSTEM

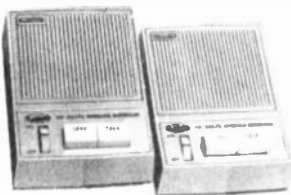

2 STATIONS FOR ONLY

25⁵⁰

- No wires to connect
- Operates from any 117 VAC Outlet

- No Installation Required—Just Plug In and Talk

A highly efficient wireless intercom system that simply plugs into standard 117V, 60 Hz AC outlets. Your voice is transmitted thru the electric power line. Talk-Lock button for monitoring baby's room or long time talking. Solid-state circuitry for instant-on communication. Highly efficient speaker-microphone. Operates on very low voltage for pennies a week. Each unit is a master so you can use as many intercoms as you need. High impact styrene cabinet. On/off switch—volume control. Pilot light. Size: 3¾W x 5¼D x 1¾H. For 117 VAC, 60 Hz. Imported.
99 K 46278 Shpg. wt., 3 lbs. ..Net 25.50

DELUXE 2-STATION WIRELESS INTERCOM SYSTEM



2 STATIONS FOR ONLY

36⁵⁰

- Operates from Any 117 VAC Outlet
- Powerful 4-Transistor Circuitry
- Instant-on Operation—No Warm-up

- No Installation Required, Just Plug In and Talk

Deluxe performing. Connects to outlets on the same 117 VAC electric line. No wiring required. Simply plug each unit into the AC outlet and start talking. 4-transistor circuit. Each unit is a "Master" — use as many as you need. Features a Volume/On-Off control. Push-to-Talk Bar with a "lock-bar" for continuous talking, and a pilot light. Case has rubber-tipped base that will not scratch furniture. Overall size: 6½" x 5" x 2½"H. For 117 VAC, 60 Hz. Imported.
99 K 45734M Wt., 4½ lbs.Net 36.50
 Additional Intercom Station. Wt., 2 lbs.
99 K 45726Net ea. 19.50

Call On Us For Telephones, Telephone Amplifiers and Accessories

DIAL PHONE



10⁹⁵

Popular, modern dial phone. Can be used to make complete private systems or add to your present system. Equipment taken from service, reconditioned and ready to work. Simple 3-wire hook-up. Complete with handset, dial bell, induction coil and connecting cable. General appearance may vary slightly from catalog illustration. Shpg. wt., 6 lbs.

44 K 18018Net 10.95

TELEPHONE SILENCER



3⁹⁸

- Automatically Cuts Off Telephone Transmitter

Actually, a telephone mouthpiece silencing button. Installs in seconds. Use at home or in the office. Allows you to talk privately to another person in the same room without covering the phone mouthpiece so the caller can't hear what is said. Shpg. wt., 2 oz.
44 K 72007Net 3.98

DELUXE TELEPHONE AMPLIFIER WITH EXTERNAL 3" SPEAKER

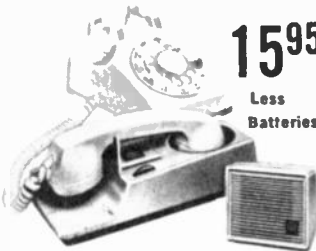

15⁹⁵

Less Batteries

- Amplifies Telephone to Room Volume
- Hands-Free Conversation
- Solid-State Circuitry
- No Warm-up, Instant Operation
- No Pick-ups to Connect

This deluxe amplifier is ideal for group conversations and conference calls with one telephone in the room. Easy to operate. Simply place the telephone on the amplifier, adjust the volume and everyone can listen through the separate matching speaker system, leaving both hands free for writing or typing. The solid-state amplifier is battery-powered and features an inductive pick-up and volume control. Separate 2" speaker. Size: Amplifier Section—9½ x 2½". Speaker section—3½W x 2H x 2¾"D. Imported. Shpg. wt., 4 lbs.

44 K 30388Net 15.95

9V Battery for above.Net .35

99 K 60212Net .35

ROARING TWENTIES TYPE PHONE



44⁹⁵ BRAND NEW!

with 4½ ft. Cord and Plug

- Handsome Styling in Black with Gold Trim
- Equipped with Electronic Components Compatible to Telephone Co. Systems

Magnificent reproduction of the phones used in the twenties and thirties. Complete with dial, ringer, induction coil, 4½ ft. cord and plug. Size: 12"H. Dia. of base 6".

44 K 24008 Shpg. wt., 6 lbs. ..Net 44.95

30-FT. TELEPHONE EXTENSION CORD

3²⁹



Add flexibility to your telephone intercom. Now be able to move your telephone intercom from room to room. 30 feet of telephone extension cord with standard 4-pin plug and jack. Color-coded cord to match screw terminals on plug and socket. Imported. Shpg. wt., 1½ lbs.

99 K 45395Net 3.29

Never Miss a Call with Phone-Mate Telephone Answering and Recording Machines

MODEL 300 99⁹⁵

ANSWERS UP TO 20 THIRTY SECOND INCOMING MESSAGES

Model 300. The Phone-Mate 300 will answer your phone in your voice and record the messages of your caller. Works with any type telephone. Multiline phones require an optional adapter (see listing below). Standard phones plug into an ordinary 4-prong telephone jack. Operates on 4 "D"-size alkaline flashlight batteries included. Comes housed in plastic cabinet. If necessary, contact your local telephone company for installation. Size: 9½ x 12 x 3½". Shpg. wt., 14 lbs.

27 K 58043WX*Net 99.95



MODEL 400S 129⁹⁵

ANSWERS UP TO 30 THIRTY SECOND INCOMING MESSAGES

Model 400S. Same specifications and size as Phone-Mate 300, and also includes Answer-Only Selector, Monitor Switch, and a fine-grain walnut veneer cabinet. Shpg. wt., 14 lbs.

27 K 58019WX*Net 129.95

MODEL 800S 149⁹⁵

ANSWERS UP TO 30 THIRTY SECOND INCOMING MESSAGES AND DELIVERS TWO DIFFERENT OUTGOING MESSAGES

Deluxe Model 800S. Same specifications and size as Model 400S, but also includes speaker on-off switch, erase button that removes old messages when recording, fast forward, two-track outgoing message tape, ear-phone jack, tape output jack, and a Ring Adjust to set your phone to answer on any ring you wish. Shpg. wt., 16 lbs.

27 K 58035WX*Net 149.95

KTA Adapter—For attaching Phone-Mates to multiline phone system. **27 K 58027 Shpg. wt., 6 oz.Net 29.95**

"Remote-Mate" Dial-In Phone-Mate Module

129⁹⁵

- Attaches to Models 300, 400S and 800S. Enables You to Dial-In from Anywhere in the World and Receive Your Messages
- Includes Specially-Coded Pocket Phone Activator

Enables you to call your phone from anywhere in the world—activate your phone with the specially-coded remote controller (included) and hear your messages. Each time you dial in, the Remote-Mate is reset at the beginning and plays any received messages you have. Operates on 6 "D"-size alkaline flashlight batteries (included). Size: 9½ x 12 x 2¾". Shpg. wt., 10 lbs.

27 K 58001WX*Net 129.95

- All Models Give a Thirty-Second Outgoing Message
- All Models Are Completely Self-Contained—No Additional Tape Recorder Required
- All Models Attach to Remote Dial-In Module



29⁹⁵

TELE-SECRETARY

- Keep A Record Of All Of Your Telephone Conversations

Automatically maintain a daily record of all conversations and transactions made on your telephone. The Tele-Secretary attaches to your phone line or any standard cassette tape recorder with a remote control microphone input jack. Completely self-contained. Size: 1¾W x 1¾L x 5/8"D. Wt., 1 lb.

44 K 67007Net 29.95



"SNAP-ON" LAFAYETTE TELEPHONE AMPLIFIER AND HEARING AID

8⁹⁵

- Portable—
Carry It in Your Pocket



Designed to fit any modern telephone. Attach amplifier to the receiver of the phone you are using. IDEAL FOR HARD-OF-HEARING. Specifications: 4 transistors, 2" dynamic speaker. Size: 2½" round, 1" in depth. With battery and snaparound band. Imported. Shpg. wt., ½ lb.

99 K 92082Net 8.95

Any
12
records
or
tapes
for only \$1.97
plus processing
and postage

If you join now and agree
to buy just nine selections
(at regular Club prices)
during the coming two years

- 234765 (SOUNDTRACK) NEIL DIAMOND
Jonathan Livingston Seagull
- 236133 ELTON JOHN
236134 Goodbye Yellow Brick Road
[MCA] COUNTS AS TWO
- 236885 CARPENTERS
The Singles 1969-1973
- 234922 * HAROLD MELVIN
& THE BLUE NOTES
BLACK & BLUE
- 237206 * ROY CLARK'S
[DPT] FAMILY ALBUM
- 236604 SONNY & CHER
236605 Live In Las Vegas, VOL. 2
[MCA] COUNTS AS TWO
- 237081 VIKKI CARR
[COLUMBIA] Live At The Greek Theatre
- 234369 * LORETTA LYNN
[MCA] Love Is The Foundation
- 237172 PETER NERO
[COLUMBIA] SAY, HAS ANYBODY SEEN
MY SWEET GYPSY ROSE?
- 235606 * THE STATLER BROS.
[RCA] CARRY ME BACK
- 232796 RICHARD STRAUSS
[COLUMBIA] Also Sprach Zarathustra
By mpuban, New York Philharmonic
- 237800 * SHA NA NA
[RAMA SUTRA] ROCK AND ROLL
IS HERE TO STAY
- 236075 LOGGINS & MESSINA
[COLUMBIA] FULL SAIL My Music
- 231530 THE BODY AND SOUL
[FAIRBOT] OF TOM JONES
Letter to Lucille
- 233452 GARFUNKEL
[COLUMBIA] ANGEL CLARE

- 235739 * MARIE OSMOND
[MGM] PAPER ROSES
- 235978 THREE DOG NIGHT
[ABC-DUNBELL] CYAN Shambala
- 236448 E. POWER BIGGS
[COLUMBIA] PLAYS SCOTT JOPLIN
Maple Leaf Rag
- 234377 * CONWAY TWITTY
[MCA] YOU'VE NEVER BEEN
THIS FAR BEFORE
- 234401 ANDY WILLIAMS
[COLUMBIA] SOLITAIRE
- 235853 GILBERT O'SULLIVAN
[RAM] I'M A WRITER,
NOT A FIGHTER
- 236117 * BILLY PRESTON
[RCA] EVERYBODY LIKES
SOME KIND OF MUSIC
- 236141 Gladys Knight & The Pips
[BUDDAH] IMAGINATION
- 235093 SHIRLEY BASSEY
235094 Live At Carnegie Hall
[RCA] COUNTS AS TWO
- 225367 ARTHUR FIEDLER
[POLYDOR] and THE BOSTON POPS
Gotta Travel On
- 236844 * BURT BACHARACH
[RCA] LIVING TOGETHER
- 229401 * RAY PRICE
[COLUMBIA] She's Got To Be A Saint
- 199158 LOVE STORY
[FALLMOUNT] Original Sound Track
- 231613 SLY AND THE FAMILY
[BEPIC] STONE FRESH
- 231308 AN EVENING
[London Phonos & Gramaphones] WITH MANTOVANI

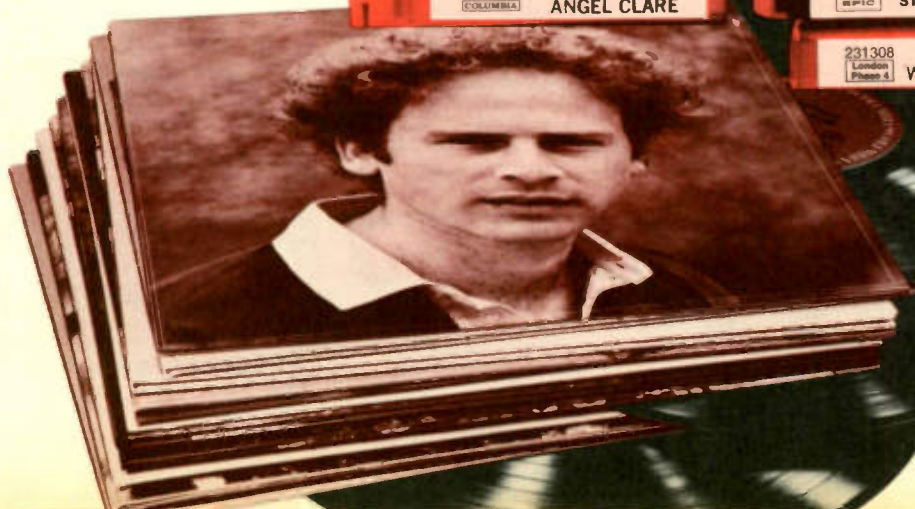

Any 12 records

If you join

Take yo



12" stereo records



8-track cartridges

* Selections marked with a star

- | | | |
|--|---|---|
| 237156
COLUMBIA
BARBRA STREISAND
AND OTHER
MUSICAL INSTRUMENTS | 237040
COLUMBIA
SANTANA
WELCOME
LOVE
DEVOTION &
SURRENDER | 235580*
KRISS KRISTOFFERSON
&
RITA COOLIDGE
FULL MOON |
| 234864
CHRYSALIS
PROCOL HARUM
GRAND HOTEL | 233320
BLUE THUMB
THE POINTER SISTERS
YES WE CAN CAN | 237198*
SURE
FOCUS
Live At The Rainbow |
| 237875*
80TH CENTURY
BARRY WHITE
STONE GON' | 237909*
MGM
DONNY OSMOND
A TIME FOR US | 235564
MCA
CHER
HALF-BREED |
| 234914*
FARON YOUNG
Just What I Had In Mind | 234831
LA
FERRANTE & TEICHER
KILLING ME SOFTLY | 207662
COLUMBIA
Everything You Always Wanted
To Hear On The Moog |
| 230714
CARPENTERS
NOW & THEN | 234344*
COLUMBIA
BLOOD, SWEAT & TEARS
NO SWEAT | 235846*
JERRY LEE LEWIS
SOMETIMES A MEMORY
AIN'T ENOUGH |
| 234419
COLUMBIA
JOHNNY MATHIS
I'M COMING HOME | 231647
COLUMBIA
LYNN ANDERSON
TOP OF THE WORLD | 233643*
RANWOOD
THE BIG BAND SOUND
OF LAWRENCE WELK |
| 235614*
80TH CENTURY
MAUREEN MCGOVERN
THE MORNING AFTER | 235572*
MCA
JERRY WALLACE
PRIMROSE LANE
DON'T GIVE UP ON ME | 234302
CHRYSALIS
JETHRO TULL
A Passion Play |
| 233346
PARROT
ENGELBERT HUMPERDINCK
KING OF HEARTS | 235598*
JOHNNY RODRIGUEZ
ALL I EVER MEANT
TO DO WAS SING | 232553*
COLUMBIA
SONNY JAMES
IF SHE JUST HELPS ME
GET OVER YOU |
| 234112*
PROJECT 3
TONY MOTTOLA
AND THE
QUAD GUITARS | 229781*
COLUMBIA
CONNIE SMITH
A LADY NAMED SMITH | 230607*
EASTWING
TANYA TUCKER
WHAT'S YOUR MAMA'S NAME |
| 234336*
COLUMBIA
THE MORMON TABERNACLE CHOIR
SINGS
STARS & STRIPES FOREVER | 236083*
80TH CENTURY
THE DE FRANCO FAMILY
Featuring TONY DE FRANCO
Heartbeat... It's a Lovebeat | 224485
EPIC
The Edgar Winter Group
THEY ONLY COME OUT
AT NIGHT |
| 230672*
COLUMBIA
Miles Davis
In Concert | 233437
The Best Of Procol Harum
Whiter Shade Of Pale | 230581*
SPOOKY TOOTH
YOU BROKE MY HEART,
SO I BUSTED YOUR JAW |
| 230912
COLUMBIA
PAUL SIMON
There Goes Rhym'n' Simon | 233411*
T-ARCE
THE ISLEY BROTHERS
3 + 3
That Lady | 232900*
CTI
EUMIR DEODATO
DEODATO 2 |
| 232926*
ABC
STEELY DAN
Countdown To Ecstasy | 223420
COLUMBIA
BARBRA STREISAND
Live Concert At The Forum | 228957*
DOT
JOE STAMPLEY
SOUL SONG |
| 218750*
COLUMBIA
FRANK SINATRA
IN THE BEGINNING
1943 To 1951 | 228791*
MGM
EDDY ARNOLD
So Many Ways/If The Whole
World Stopped Lovin' | 208868
COLUMBIA
Johnny Cash Portrait
Greatest Hits II |
| 236893†
MCA
THE BEST OF THE
ANDREWS SISTERS | 225862
THRESHOLD
THE MOODY BLUES
SEVENTH SOJOURN
Isn't Life Strange | 236091*
COLUMBIA
ROGER MILLER
DEAR FOLKS - SORRY I
HAVEN'T WRITTEN LATELY |
| 233007†
PARADISE
THE BEST OF THE
MILLS BROTHERS | 230367
BALL
VICKI LAWRENCE
THE NIGHT THE LIGHTS
WENT OUT IN GEORGIA | 224584*
MONUMENT
BOOTS RANDOLPH
PLAYS THE GREAT HITS
OF TODAY |
| 237073†
COLUMBIA
SENATOR SAM AT HOME
Bridge Over Troubled Water | 228759*
DOT
DONNA FARGO
My Second Album
SUPERMAN | |
| 232660†
EPIC
JOHNNY PAYCHECK
MR. LOVEMAKER | 220095
LA
BOBBY GOLDSBORO
Greatest Hits | |
| | 225938*
EPIC
MARTY ROBBINS
THIS MUCH A MAN | |

† Available on records and cartridges only

it's easy to shop at LAFAYETTE

by mail

in person

and by phone

Shop in the comfort of your home at any time no matter where you live. Simply fill in order blank and mail. See parcel post and express charts below to figure shipping charges.

Visit any of our Stores listed below, or any of the over 300 Associate Stores from Coast to Coast. Consult your telephone Directory for the Store nearest you.

Enjoy the extra convenience of shopping by phone. Simply dial 516-921-7500. Just give your C.O.D. or Master Charge order to our personal service shopper.

Take Advantage of Lafayette's EASY-PAY PLAN NO MONEY DOWN — UP TO 2 YEARS TO PAY

*See Page 19 for Full Details on Easy Pay Plan



At all LAFAYETTE
Company-Owned Stores
and Mail Order

SHIPPING AND DELIVERY INFORMATION

Use our Order Blank . . . To assure fast delivery fill in all information requested (Please Print). Always give your Zip Code! We'll send you new order blanks each time you order.

Cash Orders . . . Please remit full amount, including amount you calculate for shipping charges, tax, handling charge or insurance. Do NOT send Currency or Stamps. We refund any excess.

COD Orders . . . Ordering by COD is more expensive for you. You pay an extra fee (see COD Chart). For COD orders you must send a 20% deposit and pay the balance when your package arrives. No COD's under \$10.00.

Easy Pay Orders . . . Indicate on the order blank whether a "new" or "add-on" Easy Pay order and fill in all information requested on back of the order blank.

Fill in your credit charge card number, bank number and credit card expiration date in spaces provided on order blank. Amount for merchandise plus shipping charges, and tax (if any) will be billed to your credit charge account. (Less any deposit.)

PARCEL POST SHIPMENT

Parcel Post Rate Chart. Items Keyed "WX" are not shippable Parcel Post (Example = 18-0182WX). Figure Parcel Post Charges only for items not keyed WX. (See REA Express Information.)

WEIGHT 1 Lb. & Not Exceeding	Local	Zone up to 150 mi.							
		1st & 2nd Zone up to 150 mi.	3rd Zone 300 mi.	4th Zone 300 to 600 mi.	5th Zone 600 to 1000 mi.	6th Zone 1000 to 1400 mi.	7th Zone 1400 to 1800 mi.	8th Zone Over 1800 mi.	
2	\$0.60	\$0.65	\$0.70	\$0.75	\$0.80	\$0.90	\$1.00	\$1.05	
3	.60	.75	.80	.85	.95	1.10	1.20	1.35	
4	.65	.80	.85	.95	1.10	1.30	1.40	1.60	
5	.70	.85	.90	1.05	1.20	1.45	1.65	1.90	
6	.70	.95	1.00	1.15	1.35	1.60	1.85	2.10	
7	.75	1.05	1.10	1.25	1.50	1.75	2.10	2.35	
8	.75	1.10	1.15	1.35	1.60	1.90	2.30	2.60	
9	.80	1.15	1.20	1.45	1.75	2.05	2.45	2.85	
10	.80	1.20	1.30	1.55	1.90	2.20	2.65	3.10	
11	.80	1.25	1.35	1.60	2.00	2.30	2.85	3.35	
12	.85	1.30	1.45	1.70	2.10	2.45	3.05	3.55	
13	.85	1.35	1.55	1.80	2.20	2.60	3.25	3.80	
14	.90	1.40	1.60	1.90	2.35	2.75	3.45	4.00	
15	.90	1.45	1.65	2.00	2.45	2.85	3.60	4.20	
16	.95	1.55	1.75	2.05	2.55	2.95	3.80	4.40	
17	1.00	1.60	1.80	2.15	2.65	3.10	3.95	4.60	
18	1.00	1.65	1.90	2.20	2.75	3.20	4.15	4.80	
19	1.05	1.70	2.00	2.30	2.85	3.35	4.30	5.00	
20	1.05	1.75	2.05	2.40	2.95	3.50	4.50	5.20	
For Each Extra Lb.	Add 5c	Add 5c	Add 5c	Add 10c	Add 10c	Add 15c	Add 15c	Add 20c	

PARCEL POST C.O.O. FEES:

\$10.01 to \$25.00	.80	\$50.01 to \$100.00	1.00
\$25.01 to \$50.00	.90	\$100.01 to \$200.00	1.10

AIR PARCEL POST SHIPMENTS

We will ship your order via Air Parcel Post upon your request. Rates are given in the table below. Size and weight limits: 70 lbs. and 100 in. (length plus girth).

	1c per ounce, up to 8 ounces							
	ZONES 1, 2 & 3	4	5	6	7	8	1st LB.	2nd LB.
For Each	Add	Add	Add	Add	Add	Add	.48	.50
Extra Lb.	.56	.64	.72	.80				

U.S. Territories, Possessions and APO & FPO Addresses, 80c per lb.

ORDERS UNDER \$5.00 **.50**

PARCEL POST	\$ 5.00 to 15.00	20c
HANDLING	15.01 to 50.00	30c
CHARGE	50.01 to 100.00	40c
	100.01 to 150.00	50c
	151.01 to 200.00	60c

UNITED PARCEL DELIVERY

If your area is serviced by UPS and the service or rates are to your benefit, we will route your order via United Parcel Service. (you must give us a complete street address, we can not ship UPS to P.O. Box numbers only). This fast, economical service is available from New York to most states for parcels up to 50 lbs. and 108 inches in length and girth.

TERMS:

The prices listed in our catalog are net. All trade and cash discounts have already been deducted.

All Prices are net, F.O.B. shipping point. PRICES, SPECIFICATIONS & CONDITIONS OF SALE ARE SUBJECT TO CHANGE WITHOUT NOTICE.

Parcel Post and UPS charges should be included with fully paid orders. We refund any not used.

Please do not send currency or stamps.

REA EXPRESS INFORMATION

Items not shippable Parcel Post or UPS are sent Railway Express. The Letters WX identify these items. **DO NOT SEND MONEY** for express charges with your order. Express charges are collected upon delivery at no extra cost to you. Insurance is included in your express rates. Be sure to specify your nearest Express Office if there is no agent in your town.

APPROXIMATE REA EXPRESS CHARGES

Zone	1 & 2	3	4	5	6	7	8
0-150 Miles	151-300 Miles	301-600 Miles	601-1000 Miles	1001-1400 Miles	1401-1800 Miles	1801 & Over Miles	
1-125 Pounds	\$10.15	\$12.23	\$13.09	\$14.20	\$15.82	\$16.27	\$17.10
Over 125 lbs. add per lb.	12c	15c	18c	21c	24c	28c	35c

Make Lafayette Your One Dependable Source for Everything in Electronics

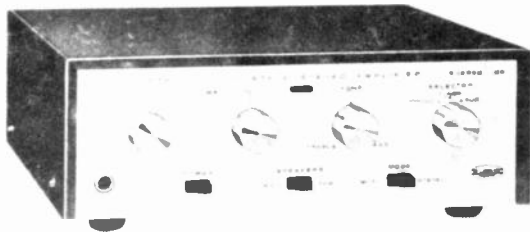

Attractive styling, plus compact size and big performance, characterize this inexpensively priced stereo system just great for the kids' room or dorm. The heart of this system is the "Stereo 10B," a powerful, 10-transistor, 6-diode, solid-state amplifier with a power output of 2.2 watts RMS per channel at 8 ohms. It features inputs for connecting a record changer with a crystal or ceramic cartridge, tuner or tape recorder, and a stereo headphone jack. The 10B's brushed aluminum front panel houses controls for Left and Right Volume, Bass, Treble, as well as slide switches for Main or Remote speakers, and Mono or Stereo listening mode. This system also includes the LAFAYETTE AC-60 4-speed automatic record changer with a diamond turn-over ceramic cartridge. It handles up to six 12", 10" or 7" records automatically, shutting off after the last record has played. Cue and Pause control, 10" turntable, heavy duty motor, and matching base are among this deluxe record changer's other features. And you'll hear it all through 2 LAFAYETTE XL-44 speaker systems. Each includes a 6½" wide-range speaker, and a multicellular diffuser to radiate high frequency sound. Frequency response: 70-15,000 Hz. Housed in a handsomely styled wood cabinet with walnut vinyl covering. All cables are included. For 117 VAC, 50/60 Hz. Imported. Shpg. wt., 5½ lbs

NOW!
Buy Lafayette's 10B
Stereo Amplifier
and
Matched
Components
for Only

89⁹⁵

No Money Down*

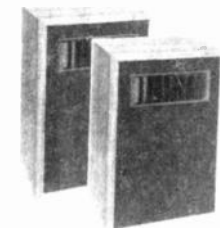

22 K 91995WM Net 89.95

Model "Stereo 10B" Stereo Amplifier, only. Size: 9W x 3½H x 6½D. Imported. Wt., 5½ lbs. No Money Down*.

99 K 02974 Net 34.95

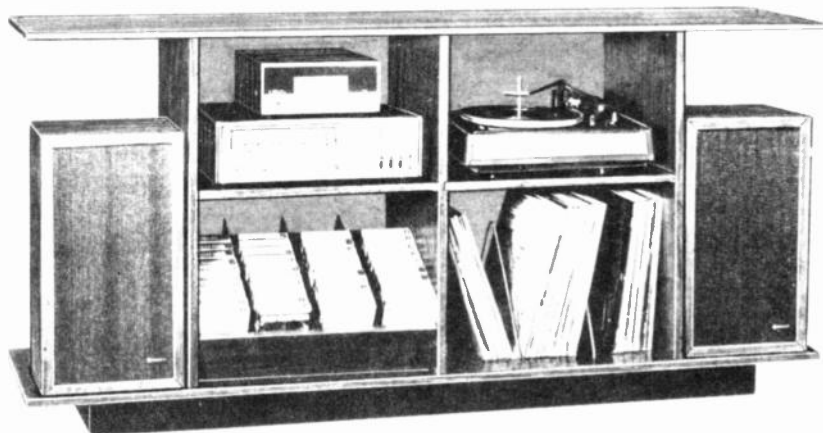

SAVE \$10! Contemporary All-Purpose Component Unit

SALE
39⁹⁵

- compartments for**
- Receiver
 - Amplifier and Tuner
 - Records • Tape • TV
 - Pull-out Shelf for Record Changer

This striking shelf unit provides impressive display and easy accessibility, plus ample storage space for records and tapes. The pressed-wood shelves have a remarkable surfacing material of rigid walnut-colored vinyl called PERMANEER. Permaneer is stain- and heat-resistant. Needs no special polishing, just wipe clean with a damp cloth. Assembled size: 65½W x 15½D x 30½ H. Comes knocked down. Shpg. wt., 91 lbs.

20 K 16004WX No Money Down* Net 39.95

RELIVE THE GOLDEN ERA OF RADIO WITH THESE 8-TRACK TAPE CARTRIDGES

\$2⁹⁵
ea.



Listen to These Famous Programs
As They Actually Were Presented
Radio as We All Knew and Loved
Jack Benny, Fred Allen, Burns & Allen
The Shadow, Green Hornet, and More!

Shgp. wt. ea., 6 oz.

Stock No.	Description	Net Ea.
28 K 49008	THE SHADOW, starring Orson Welles in "The White Guard." 1937	2.95
28 K 49016	DICK TRACY, "The Case of the Empty Safe," and WALTER WINCHELL	2.95
28 K 49024	THE GREEN HORNET	2.95
28 K 49032	INNER SANCTUM, "Death by Scripture." Oct. 9, 1945	2.95
28 K 49040	EDGAR BERGEN & CHARLIE McCARTHY. Nov. 2, 1947	2.95
28 K 49057	BURNS AND ALLEN. Dec. 4, 1947	2.95
28 K 49065	FRED ALLEN SHOW, with Frank Sinatra. Oct. 21, 1945	2.95
28 K 49073	JACK BENNY SHOW. Jan. 24, 1943	2.95
28 K 49081	EDDIE CANTOR SHOW, with Dinah Shore. Nov. 12, 1948	2.95
28 K 49099	BING CROSBY SHOW, with Fred Allen and Peggy Lee. Feb. 8, 1950	2.95

"GUARDIAN 300" 3-BAND BATTERY/ELECTRIC SOLID-STATE FM-VHF/FM/AM POLICE RADIOS

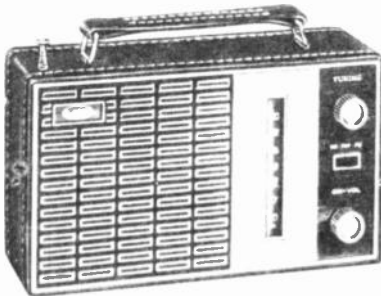

YOUR CHOICE
SALE! 24⁹⁵

HIGH-BAND FM-VHF POLICE AND AM/FM RADIO

Listen to Police and Fire calls anywhere—anyplace. Deluxe 3-band radio tunes FM-VHF 147-174 MHz, including 162.55 MHz U.S. Weather Bureau Forecasts, as well as standard AM and FM bands. Variable 6-gang tuning for extremely high sensitivity and selectivity enables you to pull in even the weakest stations. Slide-rule dial for precise tuning, ferrite rod antenna for AM, telescoping antenna for FM-VHF and FM, plus an external antenna jack. Padded black leatherette case with silver trim. Includes earphone and self-storing AC line cord. Operates on 4 "C" batteries (included) or 117 VAC, 60 Hz. Size: 8³/₈W x 4⁵/₈H x 2⁷/₈ D. Imported. Shgp. wt., 3¹/₄ lbs.

99 K 35461LNet 24.95

LOW-BAND FM-VHF POLICE AND AM/FM RADIO. Same deluxe features as High-Band Radio, but tunes low-band FM-VHF 30-50 MHz., in addition to standard AM and FM, Imported. Wt., 3¹/₄ lbs.

99 K 35479LNet 24.95

CUT \$20

LAFAYETTE HA-800B SSB/AM/CW
AMATEUR RECEIVER NOW ONLY

109⁹⁵

VARVARIANT

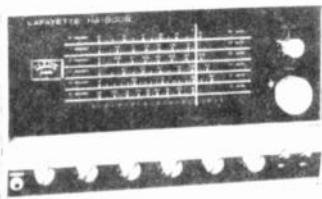

- 6 Thru 80 Meters Reception
- Built-in 12 VDC and 117 VAC Power Supplies

Big \$20 Amateur Savings! The HA-800B features tuned RF, mixer and oscillator stages with 4 FET's for outstanding front-end selectivity and sensitivity, built-in 100 kHz crystal calibrator (less crystal), variable fine tuning and calibrator, dual conversion on all bands, and an illuminated "S" meter. Sensitivity: better than 1 μ V on all bands. Selectivity: 60 db down at \pm 6 kHz, 8¹/₄H x 15W x 9³/₄"D. Imp. Wt., 24³/₄ lbs.

99 K 26155WX No Money Down*Net 109.95

Model HE-48C Matching 8-Ohm Speaker. Impdtd.

99 K 25397 Shgp. wt., 3 lbs.Net 10.50

100 kHz Calibrator Crystal for HA-800A

40 K 09015L Shgp. wt., 3 oz.Net 6.95

INDIANA

INDIANAPOLIS 6242 E. 82nd St.
NEW 82nd Street and Johnson Road
 (Adj. Castleton Square Shopping Center)

INDIANAPOLIS 4000 Georgetown Road
 (Opp. Lafayette Square Shopping Center)

INDIANAPOLIS Greenwood
NEW 870 N. US 315
 (Opp. Greenwood Center)

MINNESOTA

BROOKLYN CENTER
 5515 Xerxes Ave. N.
NEW (Opp. Brookdale Shopping Center)

EDINA
 3240 Southdale Circle at York Ave.
NEW (Opp. Southdale Shopping Center)

ROSEVILLE 2383 No. Fairview Ave.
NEW (Opp. Rosedale Shopping Center)

MARYLAND

BALTIMORE/CATONSVILLE (N. of Rt. 40)
 1122 N. Rolling Rd.
 Rolling Rd. Plaza Shopping Center

GLEN BURNIE 316 S. Ritchie H'way.
 Glen Burnie Shopping Center

MARLOW HGTS. 4620 St. Barnabas Rd.
 (¼ Mile South of Marlow Hgts. Shopping Ctr.)

MT. RAINIER/HYATTSVILLE
 3191 Queens Chapel Rd. (Rt. 500)

ROCKVILLE 824 Rockville Pike
 (So. of Viersmill Rd.)

TOWSON 815 Taylor Avenue
 (Loch Raven Plaza)

MASSACHUSETTS

BOSTON 899 Boylston St.
 (Opp. Prudential Center)

BROOKLINE 1048 Commonwealth Ave.
 (Cor. Winslow, opp. Eastern Mtn. Sports)

NEW

BURLINGTON Vinebrook Plaza
 Middlesex Tpke. & Lexington St.
 (Opp. Burlington Mall)

NEW

SAUGUS Rt. 1 & Walnut St.
 Saugus Plaza Shopping Center

NATICK 1400 Worcester St.
 (Rt. 9 opp. Shopper's World)

WEST ROXBURY 1530 V.F.W. Parkway
 (1 mile north of Dedham Mall)

MISSOURI

ST. LOUIS/JENNINGS
 8976 Jennings Station Rd.
 (Adj. Zayre's—Opp. River Rd. Shopping Ctr.)

ST. LOUIS/CRESTWOOD (Rte. 66)
 9222 Watson Rd.
 (Crestview Shopping Center)

ST. LOUIS/BRIDGETON (St. Ann)
 10939 St. Charles Rock Rd.
 Cypress Village Shopping Center
NEW (Opp. NW Plaza Shopping Center)

NEW JERSEY

E. BRUNSWICK 595 Rt. 18
 (Grand Plaza Shopping Center)
 (Bet. Milltown & Race Track Rd.)

NEWARK 24 Central Ave.
 (west of Broad St.)

PARAMUS 182 Route 17
 (1 mile north of Garden State Plaza)

NEW JERSEY

WATCHUNG (Plainfield) Rt. 22 West
 (¾ Mile W. of Blue Star Shopping Center)

TOTOWA 410 Route 46
 (½ Mile E. of Willow Brook Shopping Center)

WOODBIDGE Rt. 1 at Gill Lane
NEW (Opp. Woodbridge Center)
 (Opening Winter 1974)

OHIO

COLUMBUS 4676 West Broad St.
 (Lincoln Plaza Shopping Center—Adj. Zayre's)

COLUMBUS
 Great Eastern Shopping Center
 (Hamilton Rd. & Main St.)

COLUMBUS 3395 Cleveland Avenue
 (Northern Lights Shopping Center)

CINN./SPRINGDALE 11711 Princeton Pike
 (Princeton Plaza—Adj. Zayre's)

MENTOR 7531 Mentor Ave.
 (¼ Mile W. of Great Lakes Shopping Center)

NORTH OLMSTED Great Northern Blvd.
 (Olmsted Plaza—Adj. to Topps)

PARMA-HEIGHTS 6425 Pearl Road
 (3 Blocks W. of Stumph Rd.)

WARRENSVILLE HTS.
 Emery Rd. at Northfield Rd.
 (Across from Uncle Bills)

TOLEDO Miracle Mile Shopping Center
 (Jackman and Lasky Roads)

TOLEDO (Woodville) 4619 Woodville Rd.
NEW (in front of Woodville Mall)
 (Opening Winter 1974)

PENNSYLVANIA

BRIDGEVILLE (Collier) Washington Pike
 (Adjoining Zayre's)
 (Great Southern Shopping Center)

KING OF PRUSSIA Routes 202 and 23
 King of Prussia Shopping Center

LANCASTER 2153 Lincoln Plaza
 (Adjoining Two Guys)

MONROEVILLE
 4045 William Penn Highway
 Monroe Plaza Shopping Center

OXFORD VALLEY Oxford Valley Mall
NEW (Lower Level—Opp. Penney's)

PLEASANT HILLS Route 51
 525 Clairton Blvd.
 Southland Shopping Center

PHILADELPHIA 8156 Ogontz Ave.
 Wyncote (Cheltenham Township)
 (Opp. Cheltenham Shopping Center)

PITTSBURGH 4801 McKnight Road
 North Hills Village Shopping Center

RHODE ISLAND

PROVIDENCE
 1224 N. Main St. at Smithfield Ave.
NEW (Opp. Adam Drug)

WARWICK Bald Hill Road
 (½ mile S. of Midland Mall adj. Lincoln/Merc.)
NEW (Opening Spring 1974)

VIRGINIA

FALLS CHURCH Plaza 7 Shopping Center
 (Cor. Wilson & Roosevelt Blvd.)
 (across from 7 corners)

WISCONSIN

MILWAUKEE-GREENFIELD
NEW 4830 So. 76th Street
 (¼ Mile No. of Southridge Shopping Center)

OVER 350 ASSOCIATE STORES—COAST TO COAST

or tapes for only \$1.97

plus processing and postage

now and agree to buy just nine selections (at regular Club prices) during the coming two years

our pick



tape cassettes



7" reel-to-reel tapes

are not available in reel tapes

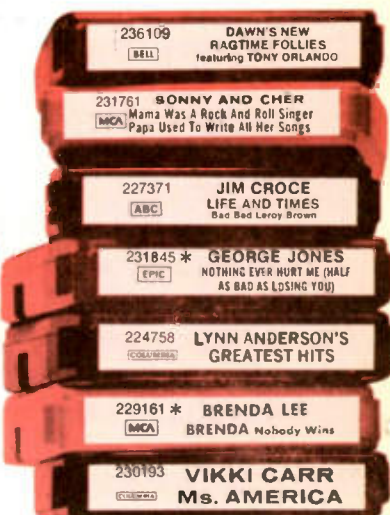

Yes, it's true!—if you join now, you may have any 12 of these records or tapes for only \$1.97. And just look at the wide range of recorded entertainment you have to choose from—not only the best and latest from Columbia's catalog... but also new releases and old favorites from A&M, Bell, Dunhill, Epic, MCA, Mercury, MGM, Parrot, United Artists and many, many other labels!

To order your 12 records or tapes for only \$1.97 just mail the handy postpaid application card (be sure to indicate whether you want cartridges, cassettes, reel tapes or records). In exchange...

You agree to buy just 9 more selections (at regular Club prices) in the coming two years—you may cancel membership any time after doing so.

Your own charge account will be opened upon enrollment... and the selections you order as a member will be mailed and billed at regular Club prices: cartridges and cassettes, \$6.98; reel-to-reel tapes, \$7.98; records, \$4.98 or \$5.98... plus a processing and postage charge. (Occasional special selections may be somewhat higher.)

You may accept or reject selections as follows: every four weeks (13 times a year) you will receive a new copy of the Club's music magazine, which describes the Selection of the Month for each musical interest... plus hundreds of alternate selections from every field of music. In addition, about six times a year we will offer some special selections (usually at a discount off regular Club prices). A response card will be enclosed with each magazine.

...if you do not want any selection offered, just mail the response card by the date specified

...if you want only the Selection of the Month for your musical interest, do nothing—it will be shipped to you automatically

...if you want any of the other selections offered, just order them on the response card and mail it by the date specified.

You will always have at least 10 days in which to make a decision. If for any reason you do not have 10 days in which to decide, you may return the regular selection at our expense and you will receive full credit for it.

You'll be eligible for our bonus plan upon completing your enrollment agreement—a plan which enables you to save at least 33% on all future purchases. Act now!

NOTE: All applications are subject to approval and Columbia House reserves the right to reject any application.

Columbia Record & Tape Club, Terre Haute, Indiana 47808

Please accept my membership application in the Club under the terms outlined in this advertisement. Send me the 12 selections listed below for only \$1.97, plus processing and postage. I agree to buy 9 selections (at regular Club prices) during the coming two years — and may cancel membership any time after doing so. I am interested in the following type of recordings:

Be sure to check one box only

- 8-Track Cartridges (1H-W) 9BZ
- Tape Cassettes (1J-X)
- Reel-to-Reel Tapes (1X-Y)
- 12" Stereo Records (K1-Z)

MY MAIN MUSICAL INTEREST IS (check one):

(But I am always free to choose from any category)

- Easy Listening 2
- Teen Hits 7
- Classical 1
- Country 5

Mr.
 Mrs.
 Miss

(Please Print) First Name Initial Last Name

Address.....

City.....

State..... Zip Code.....

Do You Have A Telephone? (Check one) YES..... NO
 APO, FPO addressees: write for special offer 042/874



Any 12 records or tapes

for only \$1.97
plus processing
and postage

- 237214 * DONNA FARGO
All About A Feeling
(DOT)
- 235960 DANNY THOMAS
TOMORROW
BELONGS TO YOU
(MYRR)
- 232918 * CONWAY WITTY
— LORETTA LYNN
Louisiana Woman / Mississippi Man
(MCA)
- 234757 ENOCH LIGHT & THE
LIGHT BRIGADE THE BIG BAND
HITS OF THE THIRTIES
(PROJECT 3)
- 234955 RAY CONNIFF
HARMONY
(COLUMBIA)
- 225318 * KRIS KRISTOFFERSON
JESUS WAS A CAPRICORN
(WARNER BROS)
- 229997 * MAC DAVIS
The Way You Look Today
(COLUMBIA)
- 230870 AL GREEN
CALL ME
(M)

- 236588 JOE WALSH
BARNSTORM
(ABC/DUNHILL)
- 237792 * ROGER WILLIAMS
LIVE Autumn Leaves
(MCA)
- 234724 JETHRO TULL
AQUALUNG
(CHRYSALIS)
- 230938 * DONALD BYRD
BLACK BYRD
(BLUE NOTE)
- 222018 THE 5th DIMENSION
Greatest Hits On Earth
(BELL)
- 234872 * TRAFFIC
ON THE ROAD
(ISLAND)
- 230904 RAY CONNIFF AND THE
SINGERS YOU ARE THE SUNSHINE
OF MY LIFE
(COLUMBIA)
- 227207 * EUMIR DEODATO
PRELUDE
(CTI)

- 236869 THE WHO
QUADROPHENIA
(TRACK) COUNTS AS TWO
- 237099 * CHARLIE McCOY
THE FASTEST HARP
IN THE SOUTH
(MONUMENT)
- 223123 * LIZA MINNELLI
Liza with a "Z"
(COLUMBIA)
- 232561 ANDY WILLIAMS
Greatest Hits, Vol. 2
(COLUMBIA)
- 229336 * INTRODUCING
JOHNNY RODRIGUEZ
(S)
- 232298 * JOE WALSH
THE SMOKER YOU DRINK,
THE PLAYER YOU GET.
(ABC/DUNHILL)
- 231084 CHARLIE RICH
Behind Closed Doors
(EPIC)
- 227439 * TAMMY WYNETTE
KIDS SAY THE
DARNEST THINGS
(EPIC)
- 185843 HERB ALPERT & THE
TIJUANA BRASS
GREATEST HITS
(M)
- 230839 * Sergio Mendes And
Brazil '77 LOVE MUSIC
(BELL)
- 230896 JOHNNY MATTHIS
KILLING ME SOFTLY
WITH HER SONG
(COLUMBIA)
- 228247 * TAMMY WYNETTE
THE FIRST SONGS
OF THE FIRST LADY
(EPIC)
- 230771 230772 URIAH HEEP
LIVE Easy Livin'
(Dunhill) COUNTS AS TWO
- 223131 * TONY BENNETT
All-Time Greatest Hits
(COLUMBIA)
- 229526 THE BEST OF BREAD
If/Make It With You
(ELEKTRA)
- 228692 * DAWN (featuring
TONY ORLANDO)
TUNEWAVING
(BELL)
- 227900 PERCY FAITH - CLAIR
Also Sprach Zarathustra (2001)
Duelling Banjos - 9 MORE
(SUNBELT)
- 223164 * TOM T. HALL
GREATEST HITS
(WARNER BROS)

BUSINESS REPLY MAIL
No Postage Stamp Necessary If Mailed in the United States

Postage will be paid by
COLUMBIA HOUSE
1 Music Lane
Terre Haute, Indiana
47808

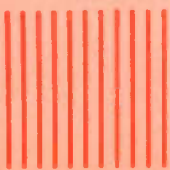

FIRST CLASS
Permit No. 1050
Terre Haute, Ind.

Lafayette Takes The Sound Outside

LAFAYETTE OUTDOOR 8" PATIO SPEAKERS



As Low As **12⁹⁵**

- Weatherproof—Waterproof
- Freq. Response: 40-15,000 Hz
- 5.5 oz. Ceramic Magnet
- Peak Power 20 Watts

Relax with music outdoors at patio, porch or poolside. Prewired with 25' cable for easy connection to radio, phono or hi-fi system. Unaffected by dampness or rain. Durable steel enclosure with baked-on finish. Convenient, step-saving volume control. 8 ohms; 20 watts peak; 40-15,000 Hz; 10 $\frac{1}{2}$ " x 10 $\frac{1}{8}$ " x 5 $\frac{3}{8}$ " D. Shpg. wt., 7 lbs.

44 K 33058WNet 12.95

DELUXE VERSION of above with heavy-duty speaker featuring 10 oz. ceramic magnet and coaxially mounted high-frequency cone for 35-19,000 Hz response, 15 watts normal, 30 watts peak.

44 K 33066W Shpg. wt., 7 $\frac{1}{4}$ lbs.Net 15.95

LAFAYETTE HORN PAGING SPEAKER



10⁹⁵

- Mounts Easily
- 90° Dispersion
- Weatherproof
- Only 5 $\frac{1}{2}$ " x 4 $\frac{3}{4}$ "

An excellent general purpose paging speaker of amazingly compact size. Ideal for portable PA systems, patios, etc. Long-throw projection of 90° dispersion offers maximum speech intelligibility in high noise areas. Compact size enables it to be mounted practically anywhere in almost any position. Frequency response 400-12,000 Hz. Impedance 8 ohms. Power handling capacity 5 watts, 8 watts maximum. With mounting bracket. Horn diameter 5 $\frac{1}{2}$ ", depth 4 $\frac{3}{4}$ ". Imported. Shpg. wt., 1 $\frac{1}{2}$ lbs.

99 K 45080Net 10.95

MISCO WEATHERPROOF SPEAKERS



As Low As **8⁸⁸**

- Gimbal-Type Mounting Bracket
- 3 $\frac{1}{2}$ " and 8" Models
- For Patio, Paging or Mobile Applications

Model MS-3-3BB. Compact, weatherproof, dustproof. Ideal for use in mobile communications, for intercom paging, and as an extension speaker. Can be immersed in water. Power rating 3 watts. Resp.: 100 to 10,000 Hz; 8 ohms impedance. 4 $\frac{1}{2}$ " x 4 $\frac{1}{4}$ " x 2 $\frac{1}{2}$ " with bracket.

44 K 52017 Shpg. wt., 1 $\frac{1}{4}$ lbs.Net 8.88

Model MMS-8F. Similar to above, but with 8" speaker. Power rating 8 watts. Resp.: 70-13,000 Hz. 9 x 9 x 4 $\frac{1}{4}$ ". Shpg. wt., 5 lbs.

44 K 52025Net 15.10

12" POLY-PLANAR OUTDOOR HI-FI SPEAKER

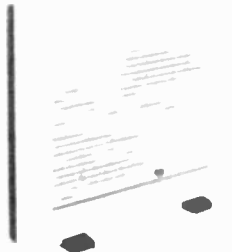

17⁹⁵

- Fully Weatherproof
- Can Be Mounted, Can Be Hung or Can Stand

For hi-fi or bidirectional PA paging. Handsome, high-impact white styrene enclosure with accessory walnut wood stand contains 12" Poly-Planar hi-fi speaker. Includes 8 feet of hook-up wire, and all necessary hardware to simply let you stand, hang or mount the system. Power: 25 watts peak. Response: 40-20,000 Hz handling capacity. Input Impedance: 8 ohms. Size: 2 x 13 $\frac{1}{4}$ " x 16 $\frac{1}{4}$ ". Wt., 4 lbs.

21 K 56032WNet 17.95

DELUXE UNIVERSITY MLC WEATHERPROOF 2-SPEAKER HI-FIDELITY SYSTEM

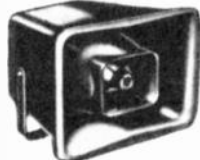

54⁹⁶
No Money Down*

- For Superb Outdoor Hi-Fi Reproduction

Ideal for coverage of moderate-sized areas or crowds—or for sound reinforcement where smooth, clean, wide-range musical reproduction and even distribution are important. Fiberglass-reinforced polyester housing with movable mounting bracket. Excellent reproduction from 150-15,000 Hz with a power rating of 15 watts. System has a 2000 Hz crossover, 120° dispersion, 8 ohms impedance. Dimensions 12 $\frac{3}{4}$ " x 9 $\frac{1}{4}$ " x 15 $\frac{1}{2}$ " D. Shpg. wt., 10 lbs.

44 K 80018WNet 54.96

NEW!

4J PORTABLE MUSIC HORN



29⁶⁵

- Weatherproof Indoor/Outdoor Speaker System

MODEL S-PM 8 MS lets you enjoy high fidelity music indoors or out, without making permanent installations. Strong, molded stand and carrying handles makes this lightweight system (6 lbs.) easy to carry and allows angling the speaker for the best reproduction. The 8" dual-cone speaker handles up to 10 watts of music and features 120° sound dispersion. Frequency response is 50 to 12,000 Hz, and impedance is 8 ohms. Connects to your hi-fi system through convenient miniature jack. Case and stand molded of high impact Cyclocac, in attractive, two-tone Neutral Mocha and blending Desert Sand design. Size: 14W x 10 $\frac{1}{4}$ D x 15 $\frac{1}{2}$ "H. Shpg. wt., 7 lbs.

44 K 28058WNet 29.65

Charge it with BankAmericard or Mastercharge!

Lafayette Cat. No. 743 **57**

Lafayette's Longlife 100 Watt PA Amplifier . . .

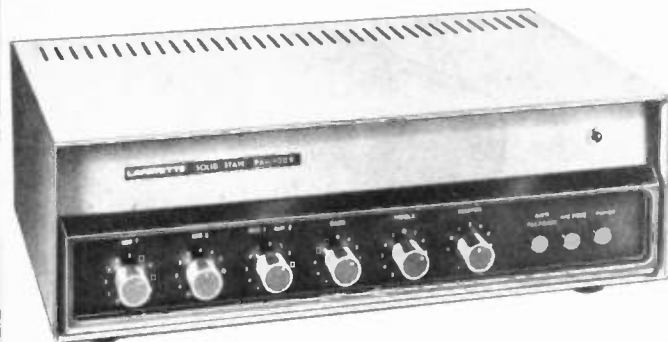

Model PA-100B

Only **144⁹⁵** No Money Down*

- 100-Watts (RMS)
- Switchable High & Low Level Mike Inputs
- Microphone Precedence Switch
- 25 and 70 Volt Constant Voltage Outputs
- Aux Inputs for Phono, Tuner, Tape Recorders and Tape Decks

SPECIFICATIONS

Power Output: 100 Watts at less than 5% Distortion (Peak Power 200 Watts). **Sensitivity:** High Impedance Microphone =4mV. Low Impedance Microphone =0.3mV. Aux 1/Phono =400mV, Aux 2 =200mV. **Inputs:** Mic-1 and Mic-2 High =100K ohms, Mic-1 and Mic-2 Low =200 ohms; Aux-1 =400K ohms; Aux-2 =100K ohms. **Outputs:** 4, 8, 16 ohm Speaker; 25V; 70V; Tape/Booster =5V; Tape Record =0.5V.

Lafayette's 100-watt solid-state P.A. amplifier features outstanding solid-state circuitry design for truly dependable public address long-life performance. Its high power and special features make it ideal for use in large meeting areas, where maximum coverage is essential. Some of its salient features are separate bass and treble controls, efficient master gain control, separate microphone volume controls for microphone 1 and microphone 2, mixer control for both auxiliary inputs (phono, tuner, etc.), 2 switchable high and low level microphone inputs, a switchable anti-feedback network to minimize feedback and to protect speakers against burnout. In addition the PA-100B incorporates a microphone precedence switch that permits direct and remote muting of auxiliary inputs when only microphone input is desired; one tape record output jack plus a common tape recorder and booster amplifier output jack; 2 speaker output sockets for 4, 8 and 16 ohm speakers; Aux-1 Input jack for phono, Aux-2 for tuner and for tape recorder and tape deck with minimum output of 1/2 volt; and 25-volt and 70-volt constant voltage speaker outputs for a constant level sound system. The PA-100B also includes power-on indicator light, AC convenience outlet and AC and DC fuses accessible at rear. Complete with microphone connector and 2 plug-in speaker connectors. For 105-125 volts, 60 Hz, 190 VA. Size: 15 1/8" x 5 1/4" x 10 1/2" D. Imported. Shpg. wt., 29 lbs.

99 K 46567W

Net 144.95

Lafayette's Dependable 50 Watt PA Amplifier . . .

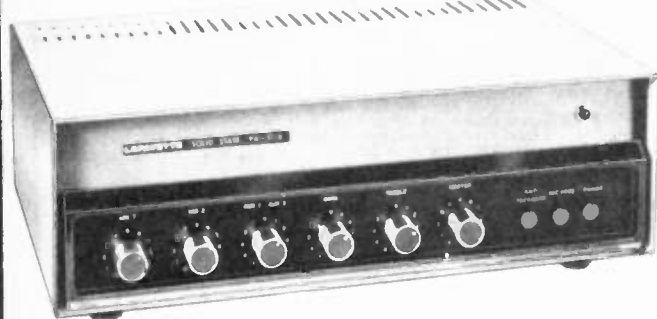

Model PA-50B

Only **119⁹⁵** No Money Down*

- 50 Watts Continuous Power (RMS)
- Microphone Precedence Switch
- Switchable High and Low Level Mike Inputs
- 25 and 70 Volt Constant Voltage Outputs
- Aux Inputs For Phono and Tape Recorder

SPECIFICATIONS

Power Output: 50 Watts at less than 5% Distortion (Peak Power 100 Watts). **Sensitivity:** High Impedance Microphone -4 mV; Low Impedance Microphone -0.3 mV; Aux 1/phono =400 mV. Aux 2 =200 mV. **Inputs:** Mic-1 High =100 K ohms, Low =200 ohms, Mic-2 High =100 K ohms; Aux-1 =400 K ohms; Aux-2 =400 K ohms. **Outputs:** 4, 8, 16-ohm Speaker; 25V; 70V; Tape/Booster =5V; Tape Record =0.5V.

Lafayette's 50-watt solid-state P.A. amplifier combines power with versatility for superb performance in indoor and outdoor applications. Features separate bass and treble controls, master gain control, 2 separate microphone volume controls, mixer control for both auxiliary inputs, and switchable anti-feedback network for minimizing feedback and for protection of speakers. The PA-50B also incorporates a microphone precedence switch and terminals for direct or remote muting of auxiliary inputs when only microphone input is desired; one tape record output jack plus a common tape record and booster amplifier output jack; 2 speaker output sockets for 4, 8 and 16-ohm speakers, and 25 volt and 70 volt constant voltage speaker outputs for a multiple-speaker constant level sound system. The PA-50B also includes Aux-1 Input jack for phono; Aux-2 Input jack for tuner, and for tape recorders and decks with minimum output of 1/2 volt, AC convenience outlet, and AC and DC fuses accessible at rear. Complete with microphone connector and 2 plug-in speaker connectors. For 105-125 volts, 60 Hz, 90 VA. Size: 15 1/8" x 5 1/4" x 10 1/2" D. Imported.

99 K 46559W Shpg. wt., 26 lbs.

Net 119.95

Powers Indoor PA Systems . . . Outdoor PA Systems

100-WATT INDOOR PA SYSTEMS



Wall Mount Speaker-Baffle Combinations with
25V/70.7V Matching Transformers



Lafayette
99-45981



PA-100B

276²⁵

- Lafayette PA-100B 100-Watt Solid-State PA Amplifier
- 6 Lafayette Pre-wired Speaker Baffle Combination with 8" Speakers, Volume Controls, and Universal 25 Volt/70.7 Volt Constant Voltage Matching Transformers
- Deluxe Dynamic Microphone
- Six 35 ft. Speaker Cables

Complete 100-watt indoor PA system as above with Lafayette 99-45981 deluxe dual impedance dynamic "pop-proof" microphone with on-off switch, desk stand and 6 ft. detachable cable. Shpg. wt., 73¼ lbs.

44 K 92625WM No Money Down*Net 276.25

100-WATT OUTDOOR PA SYSTEMS

203⁷⁵

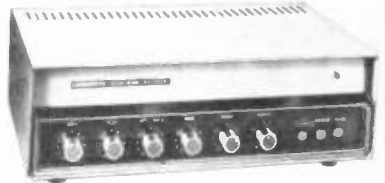

PA-100B



E-V PA30A
Projectors



Lafayette
99-45981

- Lafayette PA-100B 100-Watt Solid-State PA Amplifier
- 2 Electro-Voice PA30A 30-Watt Outdoor Speakers
- Choice of Deluxe Dynamic Microphones

An outstanding outdoor PA system with Lafayette 99-45981 deluxe dual-impedance dynamic "pop-proof" microphone with on-off switch, desk stand and 6-ft. detachable cable. Microphone can also be hand held or mounts on any standard floor stand. Shpg. wt., 46 lbs.

44 K 92641WM No Money Down*Net 203.75

Same system as above plus 2 additional E-V PA30A projector speakers. Shpg. wt., 58¼ lbs.

44 K 92633WM No Money Down*Net 252.25

Powers Indoor PA Systems . . . Portable PA Systems

50-WATT INDOOR PA SYSTEMS

12" Heavy
Duty
Speakers



PA-50B

169⁵⁰



Lafayette
99-46039
Dynamic
Mike with
99-45999
Desk Stand

Wall
Baffles

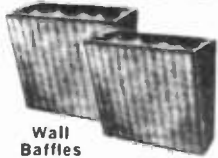

- Lafayette PA-50B 50-Watt P.A. Amplifier
- 2 12" 30-Watt (60 watts peak) Heavy-Duty Speakers. Each with Tough Industrial Type 1½" Voice Coil and 1¼ lb. Ceramic Magnet for Excellent Efficiency
- 2 Sturdy, Attractive Walnut Wall Baffles for Speakers
- Deluxe Dynamic Mike
- 2 35' Lengths of Speaker Cable

Above system with Lafayette 99-46039 dual impedance dynamic microphone and 99-45999 desk stand. Can also be hand held or used with standard floor stand, 110-130 VAC, 50/60 Hz. Shpg. wt., 49 lbs.

44 K 92385WM No Money Down*Net 169.50

50-WATT PORTABLE PA SYSTEMS with Dual Speakers

180⁹⁵

For the Majority
of Sound Sys-
tem Applica-
tions . . . School
Auditoriums,
Churches,
Theatres,
Dance Halls,
Studios, Lec-
ture Halls, etc.



- Lafayette PA-50B 50-Watt P.A. Amplifier
- Two 30-Watt Heavy Duty 12" P.A. Speakers
- Lafayette 99-46039 Dual Impedance Dynamic Microphone & Desk Stand
- Attractive, Sturdy Carrying Case for Amplifiers, Speakers & Accessories. Serves As Efficient Baffle
- Two 35' Speaker Cables



Lafayette
99-46039
Dynamic
Mike with
99-45999
Desk Stand

Complete System as above. Shpg. wt., 6 lbs.

44 K 92492WM No Money Down*Net 180.95

Charge it with BankAmericard or Mastercharge!

Lafayette Cat. No. 743 **59**

When It Comes To Sound Performance and Value LAFAYETTE Walkie-Talkies Come Over Loud and Clear

No FCC License Required

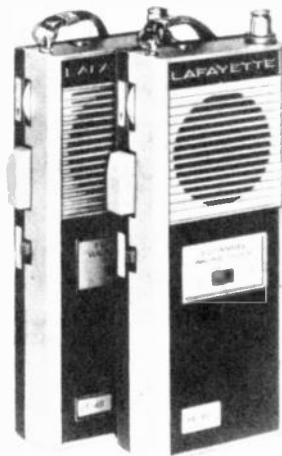

**3-Channel,
10-Transistor
Superhet CB
Walkie-Talkie**



Model HE-411

ONLY 32⁹⁵ EACH

- Built-in Call Alert
- "Range Boost" for More Talk Power

Complete hand-held portable 2-way communications for everyone, everywhere: Hunting, fishing, boating, construction, warehouse, office and on the farm. Features a powerful Range Boost modulated transmitter and efficient superheterodyne receiver in a lightweight, versatile 3-channel package. Call alert system sends or receives an alerting tone to initiate a call. Styled in a professionally designed black and brushed aluminum metal case. Supplied with antenna, 6 penlight batteries, and a pair of plug-in crystals for channel 10. Size: 6 $\frac{7}{8}$ x 2 $\frac{3}{4}$ x 1 $\frac{5}{8}$ ". Imported. Shpg. wt., 2 $\frac{1}{4}$ lbs.

99 K 32708L No Money Down*Net ea. 32.95

Extra Crystal (Specify Channel).....

46 K 15 TransmitNet 2.25

46 K 10 ReceiveNet 2.25

Replacement Dry Cell Batteries (6 req.).....

99 K 62580Net ea. .14

Alternate Alkaline Batteries (6 req.).....

99 K 63828Net ea. .45

99 K 31429 Battery Eliminator. Shpg. wt., 7 oz.Net 3.69

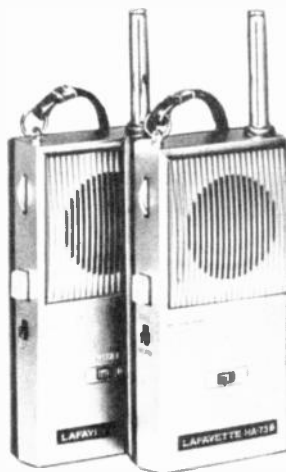

**2-Channel,
7 Transistor
Superhet CB
Walkie-Talkie**



Model HA-73B

ONLY 19⁹⁵ EACH

- Powerful Push-Pull Audio
- Built-in Call Alert
- Pi-Net Output

Power boost reflex circuit utilizes 7 silicon transistors to achieve higher sensitivity plus Pi-network antenna matching for extended range. 2-channel operation permits greater flexibility. Call alert system sends or receives a pleasant alerting tone for convenient calling. Case features beautiful die-cast chrome highlighted front panel. Supplied with carrying strap, telescoping antenna, battery and plug-in crystals for channel 15. Size 5 $\frac{7}{8}$ x 1 $\frac{1}{4}$ x 2 $\frac{3}{4}$ ". Imported. Shpg. wt., 1 $\frac{3}{4}$ lbs.

99 K 32542LNet ea. 19.95

46 K 15 Extra Transmit Crystal (Specify Channel).....Net 2.25

46 K 10 Extra Receive Crystal (Specify Channel).....Net 2.25

99 K 60212 Replacement BatteryNet .35

Optional 9V Lead-Acid Battery plus Charger. Imported.

99 K 90169 Shpg. wt., 5 oz.Net 3.75

Battery Eliminator.

99 K 31429 Shpg. wt., 7 oz.Net 3.69

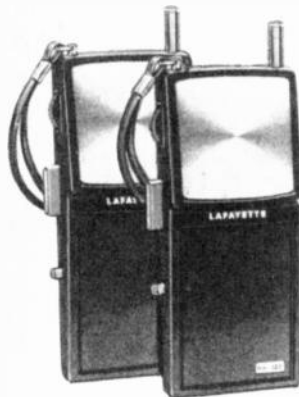

**6-Transistor
Walkie-Talkie**



Model HA-120

ONLY 14⁹⁵ EACH

- Built-in Call Alert
- Superheterodyne Circuit

Dependable 6-transistor 100 mW walkie-talkie. Features a superhet circuit for superior sensitivity and selectivity, and a call alert system. Includes volume control, wrist carrying strap, telescoping antenna, battery and plug-in crystals for channel 12. Size: 6 $\frac{1}{4}$ H x 2 $\frac{3}{4}$ W x 1 $\frac{1}{2}$ D. Imported.

99 K 32831L Shpg. wt., 1 $\frac{1}{2}$ lbs.Net ea. 14.95

99 K 60212 9-V Replacement Battery Wt., 4 oz.Net .35

46 K 15; Transmit CrystalNet 2.25

46 K 10; Receive CrystalNet 2.25



**3-IN-1
Walkie-Talkie
With
Morse Code Key**

Model HA-100

ONLY 7⁹⁵ EACH

- A 100 MW Walkie-Talkie
- A Code Message Transmitter
- A Morse Code Practice Oscillator

A 100-mw walkie-talkie that transmits and receives voice and coded messages! You can also listen to your own signal while practicing the Morse Code. Crystal-controlled transmitter, sensitive super-regenerative receiver, volume control, speaker/mike combination, special code key with international Morse Code on front panel. With Channel 14 crystal, battery, telescoping antenna and handcarry strap. Size: 6H (less antenna) x 1 $\frac{3}{4}$ D x 2 $\frac{3}{4}$ W. Imported. Shpg. wt., 1 $\frac{1}{4}$ lbs.

99 K 32815LNet 7.95

*How to Order Crystals. Use stock number indicated followed by channel number, i.e., Channel 1 transmit crystal is 46 K 1501; Channel 23 is 46 K 1523.

LAFAYETTE Walkie-Talkies Are Great For Industry, Public, Safety, Farm, Boats, Sports, Etc. !

1.5 Watt 3 Channel WALKIE TALKIE

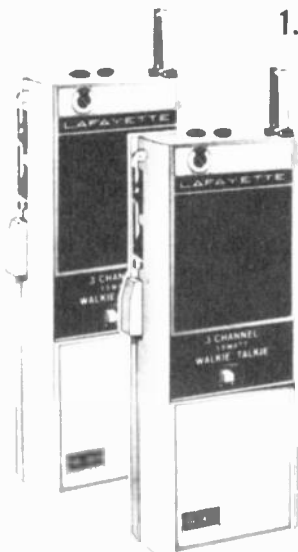

- 3 Switchable Crystal Channels
- Jack for Internal Charging
- Superhet Receiver with Less than 1 μ V Sensitivity
- Battery Condition Indicator
- Push-Pull Modulator with "Range-Boost"
- Jacks for External Battery Eliminator, Earphone and Antenna

A lightweight powerful walkie-talkie that features 3-channel operation and 1.5-watt transmitter input for flexible and dependable communications. The efficient superhet receiver incorporates an RF amplifier for extra sensitivity. Its 13-transistor, 4-diode circuit features a built-in battery indicator, a high level push-pull modulator with RANGE-BOOST for greater range, variable squelch and automatic noise limiting for quiet communications, and 117 VAC operation with optional battery eliminator/charger. With telescoping antenna, battery holder (less batteries), set of crystals for channel 10, FCC license

Form 505. Size: 8 $\frac{1}{2}$ " (less antenna) x 3W x 1 $\frac{1}{2}$ " D. Imported.

- 99 K 32674LNet ea. 42.95
- Alkaline Batteries (8 required)
- 99 K 63828 Wt., ea. 2 oz. Net ea. .45
- 117 Volt AC Battery Eliminator and Battery Charger. Shpg. wt., 3 $\frac{1}{2}$ lbs.
- 99 K 35081Net 19.95
- 99 K 25488 EarphoneNet .79
- 46 K 15 $\frac{1}{2}$ Transmit CrystalNet 2.25
- 46 K 10 $\frac{1}{2}$ Receive CrystalNet 2.25

†See Page 60 for "How To Order Crystals"

SUPER POWER LONG RANGE WALKIE-TALKIE

3 Watts Lafayette Dynacom 3b 3 Channels

- 3 Switchable Crystal Controlled Channel Positions
- 7 Stage Transmitter with "Range Boost" for Greater Range
- Superheterodyne Receiver plus RF Stage with 1 μ V Sensitivity
- External Microphone/Speaker Jack
- Ceramic IF Filter for Superior Selectivity
- Variable Squelch and Automatic Noise Limiting
- Battery Condition/Relative R.F. Power Output Indicator and Signal Strength "S" Meter
- Jacks for External Earphone/Speaker, External Antenna, External Battery Eliminator, and for Charger

69⁹⁵ Each

No Money Down*

FCC Type Accepted (26-28 MHz). Parts 95 (CB), 91 (Industrial), 93 (Transportation), D.O.C. Approved.

Lafayette's popular Dyna-Com 3b walkie-talkie is a veritable powerhouse featuring 3 full watts of power with the flexibility of 3 crystal controlled switchable transmit and receive channels. Its 12 transistor 7 diode circuitry incorporates a sensitive superhet receiver with RF amplification stage, lightning surge protection, and a highly selective ceramic filter for effective adjacent channel rejection. Its automatic gain control, automatic noise limiter, and variable squelch combine to achieve quiet operation. The 7 stage transmitter uses Range Boost modulation for higher average talk power and greater effective range, and incorporates a TVI trap for minimum TV interference. The Dyna-Com 3b includes a combined battery condition, relative RF power output indicator and received signal strength "S" meter. The external microphone/speaker jack permits the use of an optional plug-in microphone/speaker while it is either shoulder carried or belt carried with the optional leather carrying case. Activation of the walkie-talkie Push-to-Talk switch is required for transmission when the external mike is used. Jacks are also provided for external earphone or speaker, external antenna, battery

eliminator or external DC power and battery charger. Complete with battery holder with batteries, carrying strap, set of crystals for channel 10, and FCC license application Form 505. Size: 8 $\frac{1}{2}$ x3 $\frac{3}{4}$ x1 $\frac{1}{4}$ " D. Imported.

- 99 K 32450L Shpg. wt., 4 $\frac{1}{4}$ lbs. Net 69.95
- Extra Transmit Crystal:
- 46 K 15Net 2.25
- Extra Receive Crystal:
- 46 K 10Net 2.25
- 99 K 25488 EarphoneNet .79
- Dyna-Com 3b Special Frequency Modifications
- 26.620 MHz (C.A.P.)
- 99 K 32583YL No Money Down* .Net 79.95
- 27.575 MHz (U.S. Gov't)
- 99 K 32591YL No Money Down* .Net 79.95
- 27.585 MHz (U.S. Gov't)
- 99 K 32609YL No Money Down* .Net 79.95
- FOR INDUSTRIAL AND TRANSPORTATION (FCC Parts 91 and 93). No Money Down*.
- 99 K 32617YL 27.235 MHzNet 79.95
- 99 K 32625YL 27.245 MHzNet 79.95
- 99 K 32633YL 27.255 MHzNet 79.95
- 99 K 32641YL 27.265 MHzNet 79.95
- 99 K 32658YL 27.275 MHzNet 79.95

†See Page 60 for "How to Order Crystals"



See Page 62 for Dyna-Com Accessories.

Maximum Permitted FCC Power In The Palm Of Your Hands!

LAFAYETTE DYNA-COM 12A

FCC Type Accepted D.O.C. Approved

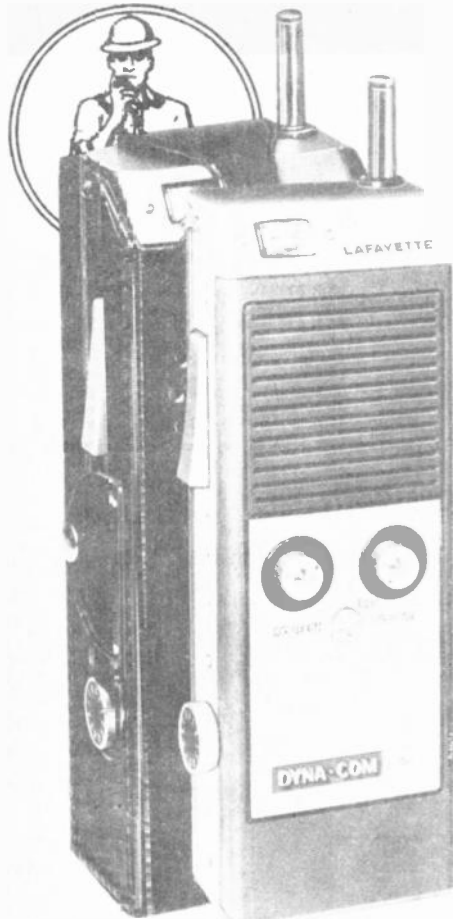

Leather Case Optional

5-Watt, 12-Channel CB Walkie-Talkie

ONLY **99⁹⁵**
Each

**IDEAL FOR INDUSTRY,
PUBLIC SAFETY, FARM,
MARINE, SPORTS, ETC.!**

- ★ Public Address External Speaker Jack with PA Switch
- ★ Superheterodyne Receiver plus RF Stage with 0.7 μ V. Sensitivity for 10db S/N
- ★ Automatic Compressor Range Boost for Consistently High Talk Power and Greater Range
- ★ Use It In Your Car with Optional Cigarette Lighter Adapter
- ★ External Microphone/Speaker Jack

- Mechanical Filter for Superior Selectivity
- Variable Squelch plus Automatic Noise Limiter for Minimum Noise
- Battery Condition and Automatic Relative RF Power Output Indicator/"S" Meter
- External Antenna Jack for Base Station and Mobile Antennas
- Provision for External Battery Source, Mobile Battery and Battery Charger Eliminator
- Push-Pull Audio/Modulator Circuit for More Powerful Speech Transmission and High Quality Reception

A veritable hand-held and portable powerhouse, the Dyna-Com 12A features 5 watts FCC maximum allowable input power, 12 switchable crystal controlled transmit and receiver channel positions, and a professionally designed sturdy lightweight housing for outstanding versatility and performance. Its 13 transistor, 7 diode, 1 thermistor and 1 posistor circuitry is ingeniously designed to give excellent sensitivity, selectivity, adjacent channel rejection and R.F. overload protection. This high power walkie-talkie operates on 12 Nickel Cadmium rechargeable batteries or 10 alkaline or dry cell batteries. It may also be connected to your auto, boat, or tractor 12 volt battery and to an external antenna for efficient mobile communications. The Dyna-Com 12A can also be used on 110 volt 60 Hz, A.C. with the optional battery eliminator/charger and with a base station antenna for reliable base station communications. Among its many outstanding features is the external microphone/speaker jack which permits the use of an optional plug-in microphone/speaker while the Dyna-Com 12A is conveniently shoulder carried or belt carried with the optional leather carrying case. Includes shoulder carrying strap, crystals for channel 10, and FCC license application Form 505. Size: 9 $\frac{1}{2}$ "H x 2 $\frac{3}{4}$ "D x 3 $\frac{1}{4}$ "W. Imported. Shpg. wt. 3 $\frac{3}{4}$ lbs.

99 K 32484L Less Batteries. No Money Down*	Net	99.95
46 K 15 Extra Transmit Crystal	Net	2.25
46 K 1D Extra Receive Crystal	Net	2.25
99 K 25488 Earphone for Dyna-Com 12A	Net	.79

†See Page 60 for "How to Order Crystals."

DYNA-COM OPTIONAL ACCESSORIES†

Battery Eliminator/Charger. For Dyna-Com 3B, 12A, and 23. Plugs into 117 VAC outlet to permit base station operation. Charges up to 12 nickel cadmium batteries internally and externally in Dyna-Com 3B, 12A, and 23. Negative ground only. Has fused AC line. Size 7 $\frac{1}{2}$ "H x 5 $\frac{1}{2}$ "D (at bottom) x 3 $\frac{1}{4}$ "W. Imported Shpg. wt., 5 $\frac{3}{4}$ lbs.
99 K 32443 Model HB-50BANet 28.95

Dyna-Charge. Charges from 8 to 15 nicad "AA" size cells. Plugs directly into Dyna-Com 3b, 5, 5a, 6, 12, 2a, 23 charge jacks and into jack of Extra Back Battery Pack Charges batteries of Dyna-Com 2, 2a, 3 and 3a externally in holder with use of adapter (Suoplied). Size: 3 $\frac{1}{4}$ " x 2 $\frac{1}{4}$ " x 2". Imported. Shpg. wt., 1 $\frac{1}{4}$ lbs.
99 K 31007Net 13.95

Mobile Cigarette Lighter Cable Assembly. Permits operation of Dyna-Com from car 12 volt DC cigarette lighter. Imported.
99 K 46054 Shpg. wt., 7 oz.Net 9.95

Dyna-Pack External Field Battery Pack less 10 "D" batteries. Plugs into Dynacom's for reserve power. Imported. 3 x 3 $\frac{1}{4}$ x 7 $\frac{1}{2}$ ".
99 K 32005 S'p'g. wt., 3 $\frac{1}{4}$ lbs. ..Net 4.25

Remote Microphone Speaker for Dyna-Com 3B, 12A and Dyna-Com 23. Plugs into microphone speaker jack. Activation of walkie talkie Push-to-Talk switch required for transmission. Imported.
99 K 32500 S'p'g. wt., 1 lb.Net 6.95

Miniature Top Loaded Antenna. Highly efficient coil loaded 18" antenna which mounts on top of collapsed telescopic antenna. Imported. Shpg. wt., $\frac{1}{2}$ lb.
99 K 31437Net 7.95

Antenna Adapter Cable. Adapts PL-259 plug of external antennas for connection to antenna jack. Shpg. wt., 8 oz. Imported.
99 K 32476Net 2.95

Nicad Rechargeable Batteries. 12 required for Dyna-Com 5, 5a, 6, 12, 12a, 23; 10 for Dyna-Com 2, 2a, 3, 3a, 3b. Shpg. wt., 3 oz.
32 K 47400Net ea. 1.85

Alternate Heavy-Duty Alkaline Batteries. 12 required for Dyna-Com 5, 5a, 6 and 12; 10 for Dyna-Com 2, 2a, 3, 3a, 3b, 12a and 23. Imported. Shpg. wt., 2 oz.
99 K 63B28Net ea. .45

Cases: Genuine Top Grain Leather. 12 oz.

42 K 28110 For Dyna-Com 12a Net 6.50
42 K 28136 For Dyna-Com 23 ..Net 6.50
42 K 28128 For Dyna-Com 3b ..Net 6.50

†Applicable to Dyna-Com 2, 2a, 3, 3a, 3b, 5, 5a, 6, 12, 12A, and 23 unless otherwise Specified.

Full FCC Power... With All 23 CB Channels!

5-WATT 23-CHANNEL CB WALKIE-TALKIE

For Public and Personal Safety, Industry, Farm, Marine, Sports, etc.

- ★ Dual Conversion Superheterodyne Receiver with RF Stage for 0.7 μ v Sensitivity
- ★ External Microphone/Speaker Jack
- ★ Automatic Range Boost for Greater Range
- ★ Operate Mobile with Optional Adapter Cable
- Public Address External Speaker Jack with PA Switch
- 455 kHz Mechanical Filter for Razor-Sharp Selectivity and Adjacent Channel Rejection
- Variable Squelch plus Automatic Noise Limiter
- Battery Condition and Automatic Relative RF Power Indicator/"S" Meter
- External Antenna Jack for Base and Mobile Antennas
- Input Jacks for External Battery Source, Mobile Battery and Battery Charger/Eliminator
- Push-Pull Audio Modulator Circuit • TV Interference Trap

The Dyna-Com 23 features ingenious dependable synthesis circuitry resulting in 23 crystal controlled transmit and receive channels with all crystals supplied; 5 watts FCC maximum allowable input power; and an attractive professionally designed sturdy lightweight housing for unexcelled versatility. Its dual conversion receiver features excellent sensitivity, RF overload protection, automatic noise limiting, variable squelch and push-pull audio amplification. The transmitter provides full 5-watt legal limit input and "Range Boost" circuitry for greater average talk power and transmitting range. The Dyna-Com 23 operates on 12 Nickel Cadmium rechargeable batteries or 10 alkaline or dry cell batteries and may also be connected to your auto, boat, truck, or tractor 12-volt battery and to an external antenna for efficient 23 channel mobile communications. It can also be used on 110 volt 60 Hz AC with the optional battery eliminator, charger, and with a base station antenna for reliable 23 channel base station communications. The external microphone/speaker jack permits use of the optional plug-in microphone/speaker while the Dyna-Com 23 is either shoulder carried or belt carried with the optional leather carrying case. Includes shoulder carrying strap and FCC license application Form 505. Size: 9 1/2"H x 3 1/4"W x 2 1/4"D. Imported. Shpg. wt. 3 3/4 lbs.

99 K 32567L Less Batteries Net 149.95
99 K 25488 Earphone Net 79

LAFAYETTE DYNA-COM 23

All Crystals Supplied!

149⁹⁵
Each

No Money Down*

Leather
Case Optional

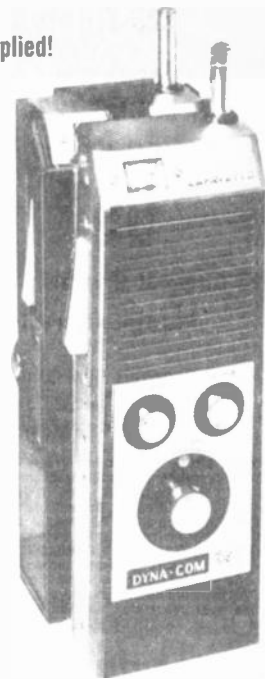

FCC Type Accepted

See Page 62 for Accessories

The Micro-Size Power House... A Natural For Mobile CB!

5-Watt, 6-Channel Mobile 2-Way Radio

- "Range-Boost" Circuitry
- Burglar Alarm Switch
- Built-in Speaker and External Dynamic Microphone-Speaker
- For 12 VDC Neg. or Pos. Ground
- 5-Watt Max. FCC Legal Power
- Ceramic IF Filter
- Slide-Lever Volume and Squelch Controls

Only

74⁹⁵

No Money Down*



LAFAYETTE MICRO 66

Great For Cars, Trucks,
Boats, Tractors, etc.

FCC Type Accepted

A superb value in 5-watt mobile communications, the Micro 66 is designed and built for exceptional versatility. Flexibility and extra reliable mobile performance. It includes a 3-stage transmitter with "Range Boost" circuitry for high average modulation and greater effective range, an antenna tuning adjustment for maximum radiated power, and a TVI filter for minimum TV interference. Its receiver incorporates a highly sensitive superheterodyne circuit with tuned RF stage, Automatic Noise Limiting, Automatic Gain Control for extra efficient reception, and mechanical IF filter for excellent selectivity and adjacent channel rejection. Additional outstanding features are pushbutton channel selection, pushbutton selection of internal speaker or of dynamic speaker-microphone, front panel modulation indicator lamp, separate pushbutton Power On-Off switch, external

8-16 ohm speaker or earphone jack, PA speaker jack and CB/PA slide switch. Complete with plug-in push-to-talk dynamic microphone-speaker with coiled cord, mobile mounting bracket, channel 10 crystals, DC power lead and FCC Form 505. Size: 1 1/2"H x 5 3/8"W x 6 3/8"D. Imported.

99 K 32716W Shpg. wt., 6 lbs. Net 74.95
46 K 15 Extra Transmit Crystal Net ea. 2.25
46 K 10 Extra Receive Crystal Net ea. 2.25

PS-54 AC Power Supply. Permits 117 μ AC base station operation of Micro 66. Imported Shpg. wt., 5 lbs.
99 K 32922 Net 22.95

!See page 60 on "How to Order Crystals."

For Your Personal, Business and Emergency Communications

23-Channel Miniature 5-Watt Mobile 2-Way Radio

**LAFAYETTE
MICRO 723**

Sensational Low Price!

99⁹⁵

All 23 Channel Crystals Supplied!

FCC Type Accepted

- ★ Sensitive Dual Conversion Receiver
- ★ Powerful 5-Watt Range Boost Transmitter
- ★ With "S"/PRF Meter

Lafayette brings you another great winner in the Micro 723 23 channel crystal controlled CB transceiver with all crystals supplied at a truly sensational low price. It is carefully designed with all the features required for dependable mobile and base station performance. This compact 23 channel synthesis CB transceiver has excellent sensitivity, superior automatic gain control and battery saving low current drain. The Micro 723 features a transmitter that provides full 5-watt FCC maximum power input, "Range Boost" circuitry for greater average modulation and transmitting range, a TVI network for minimum TV interference, and transmit indicator light. Its fine dual conversion superheterodyne receiver with RF stage features 1 μ V sensitivity at 10 db S/N, variable squelch and au-

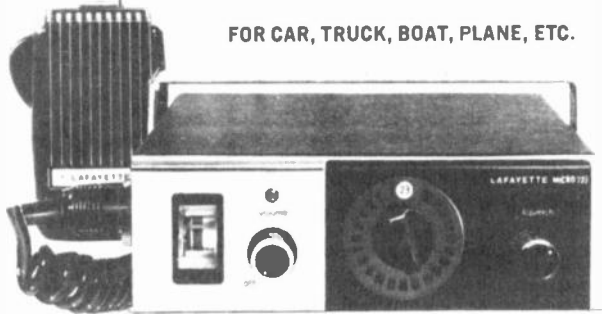

FOR CAR, TRUCK, BOAT, PLANE, ETC.

- Variable Squelch
- For 12 VDC Negative or Positive Ground
- 117 VAC with Optional Power Supply

tomatic noise limiting, efficient push-pull audio amplifier, and mechanical 455 kHz filter for excellent selectivity and adjacent channel rejection. Also features an "S"/PRF meter that measures signal strength of received signal as well as relative power output, and external speaker jack. Complete with dynamic electronic switching push-to-talk microphone, mobile mounting bracket, DC power cable, all crystals and FCC license application form 505. Size: 1 $\frac{3}{4}$ "H x 6 $\frac{1}{4}$ "W x 7 $\frac{3}{4}$ "D. Imported. Shpg. wt., 6 $\frac{1}{4}$ lbs.

99 K 32807W No Money Down* Net 99.95

PS-52 AC Power Supply/Charger. For 117 VAC operation of Micro 723.
99 K 32864W Shpg. wt., 5 lbs. Imported.....Net 34.95

Economy Plus Reliability... A Lafayette Exclusive!

2 More Channels With Each Added Plug-In Crystal!



**FCC Type Accepted
D.O.C. Approved**

23-Channel Mobile CB 2-Way Radio

LAFAYETTE HB-23A

119⁹⁵ with Crystals For Operation on Channels 9, 13, 19



- ★ Dual Conversion Superheterodyne Receiver
- ★ Full 23-Channel Crystal Control Capability
- ★ "Range Boost" for Greater Range
- ★ Burglar Alarm Switch
- Large 5x3" Speaker for Superior Audio
- Operates on 12 Volts DC Negative or Positive Ground and 117 VAC with Optional AC Supply

Solid-state ultra compact synthesis CB transceiver features excellent automatic gain control, sensitivity, dependability, and low current drain. Synthesis type frequency control section permits economical addition of 2 channels with each additional plug-in crystal. Carefully tuned 455 kHz mechanical filter assures razor sharp selectivity with excellent adjacent channel rejection. Dual conversion receiver with RF stage, features 0.7 μ V sensitivity, automatic noise limiting, variable squelch, and push-pull audio amplifier. Transmitter provides full 5-watt legal limit input and "Range Boost" circuitry for greater average modulation and transmitting range. Illuminated front panel meter monitors "S" units on receive and "PRF" output during transmit. PA Speaker/Earphone jack for silent listening or public address operation. Complete with dynamic push-to-talk microphone, mobile mounting bracket, fixed crystals for channels 9, 13, and 19, and FCC application Form 505. Size: 6W x 8D x 2"H. Imported.

99 K 32351W No Money Down* Wt. 6 $\frac{1}{4}$ lbs.Net 119.95

Package of 10 Plug-In Crystals. Converts HB-23A to full 23-channel operation. Imported.

99 K 31742 Shpg. wt., 1 lb., 2 oz.Net 19.95

PS-52 For 117 VAC base station operation also charges nickel cadmium batteries used in the HB-507. Imported.

99 K 32864W Shpg. wt., 5 lbs.Net 34.95

Model HB-507 Portable Battery Pack. Adapts HB-23A for convenient, portable operation, with shoulder strap. Less "C" batteries.

99 K 31551 Imported. Shpg. wt., 3 $\frac{1}{4}$ lbs.Net 21.95

"C" Alkaline Battery for HB-507 (8 req.). Imported.

99 K 63802 Shpg. wt., ea. 4 pz.Net ea. .52

Alternate Nickel Cadmium Battery. Shpg. wt., 5 oz. (10 req.).

32 K 48887Net ea. 4.46

See page 462 of Catalog 740 for optional Individual Plug-in Crystals. Each crystal adds 2 operating channels.

The CB Mobile Favorite . . .

LAFAYETTE HB-525F MOBILE 2-WAY RADIO

179⁹⁵
No Money
Down*

**23 CRYSTAL CONTROLLED
CB CHANNELS
All CB Crystals Supplied!**

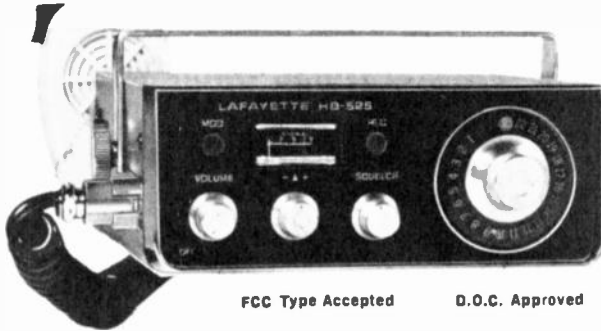

FCC Type Accepted D.O.C. Approved

Lafayette's most advanced model of the famous HB-525 series of CB transceivers. Crystal controlled synthesizer provides 23 channel transmit and receive operation . . . all crystals supplied. Dual conversion receiver incorporates 455 kHz mechanical filter plus IF stage for high selectivity, superior adjacent channel rejection, and exceptional Automatic Gain Control and audio characteristics. Variable squelch quiets receiver when no signal is being received. 3-position crystal delta tune permits easy copy of off-frequency stations. Powerful 5-watt transmitter features range boost modulation circuit for greater effective range. Large illuminated automatic S/Prf meter indicates signal strength on receive and RF output on transmit. Full public address provisions included audio input jack for tape recorder, tuner, etc. Also features indicator lights for transmit and receive modes. Supplied with PTT dynamic mike, mobile mounting bracket, and DC cable.
Size: 2³/₈ x 6¹/₄ x 8" D. Imported

99 K 32492W Shpg. wt., 7 lbs.	Net 179.95
MODEL PS-52 POWER SUPPLY/CHARGER	
For 117 VAC base station operation; charges HB-506A Nicad batteries.	
99 K 32864W Shpg. wt., 5 lbs.	Net 34.95
MODEL HB-506A PORTABLE DC POWER PACK	
99 K 32336W Less Batteries. Shpg. wt., 3 ¹ / ₂ lbs.	Net 26.95
"C" Alkaline Battery (8 req.) for HB-506A. Imported.	
99 K 63802 Shpg. wt., 4 oz.	Net ea. .52
Rechargeable "C" Nicad Alternate HB-506A Battery (10 rec.)	
32 K 48887 Shpg. wt., 5 oz.	Net ea. 4.46

- Dual Conversion for High Selectivity
- Variable Squelch Plus Series Gate ANL
- Mechanical 455 kHz Filter
- Large Automatic S/Prf Illuminated Meter
- Burglar Alarm Switch
- 3-Position Crystal Delta Tune
- Transmit and Receive Indicator Lights
- Range Boost™ Circuitry for Added Talk Power
- P.A. Amplifier When Used with Optional External Speaker
- 12 VDC Operation (Neg. or Pos. Ground)
- 117 VAC Operation with Optional AC Supply

Don't Hit the Road Without It . . . Lives May Depend on It!

**A 5-Watt 23 Channel CB Mobile 2-Way Radio plus
A Separate Emergency Channel 9 Monitor Receiver**

**LAFAYETTE
MICRO 923**

129⁹⁵
No Money
Down*

ALL CRYSTALS SUPPLIED

**Help Yourself . . .
Help Others Get Emergency
Mobile Assistance!**



FCC Type Accepted

- Dual Conversion 23-Channel Receiver
- Separate Channel 9 Emergency Monitor Receiver
- Individual Variable Squelch
- 455 kHz Ceramic Filter
- "Range Boost" for Greater Range
- Emergency Flashing Light
- Burglar Alarm Switch
- Operates on 12 Volts DC
- Operates on 117 Volts AC with Optional AC Power Supply

Now you can be warned of serious mobile emergencies while in your car and send help to those desperately in need of it without interfering with your CB communications. In addition, the Micro 923 is outstanding for mobile business or personal communications, as well as for base station operation with the addition of the optional AC power supply. It incorporates a truly dependable transmitter that includes "Range Boost" circuitry for greater effective range, adjustable antenna loading for maximum RF output, a T.V.I. trap for minimum TV interference, and AGC circuit to prevent overmodulation and distortion. The main 23 channel receiver features a highly sensitive dual conversion superheterodyne circuit plus tuned RF with individual variable squelch plus automatic noise limiting, automatic gain control and a 455 kHz ceramic filter for extra sharp selectivity and adjacent channel rejection. The channel 9 emergency monitor receiver is superheterodyne with tuned RF, automatic noise limiting, automatic gain control, individual variable squelch and visual receive flashing indicator light. In addition the Micro 923 also includes a burglar alarm switch and wiring, extensor speaker jack, and jack for external PA speaker or earphone. Supplied complete with dynamic plug-in microphone, mobile mounting bracket, and FCC license application form 505. For 12 volts DC negative or positive ground. Overall size: 8³/₈D x 6¹/₄W x 2"H. Imported.

99 K 32781W Shpg. wt., 6 ¹ / ₂ lbs.	Net 129.95
PS-52 AC Power Supply/Charger. For 117 VAC base station operation. Imported.	
99 K 32864W Shpg. wt., 5 lbs.	Net 34.95

Make your shopping easier with BankAmericard and Mastercharge.

Lafayette Cat. No. 743 65

Get The Message Loud & Clear With LAFAYETTE's HB-625A Mobile 2-Way Radio Because We Built In A Multi-Stage RF Ignition Noise Silencer

FCC Type Accepted D.O.C. Approved

214⁹⁵

23 Crystal-Controlled CB Channels . . . All Crystals Supplied!

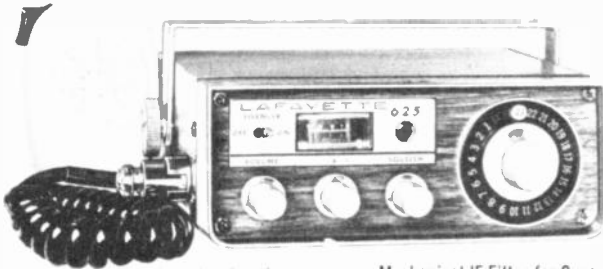

- 12-Volt Mobile Neg. or Pos. DC Operation; Portable and 117 VAC with Optional Power Supplies
- Built-in PA Amp Facilities

- Dual Conversion Superhet Receiver
- 3-Position Delta Fine Tune for Accurate Tuning

- Mechanical IF Filter for Superior Selectivity
- Front Panel Transmit Mode Light
- Range Boost™ Circuitry

The HB-625A incorporates a highly selective 455 kHz mechanical filter to virtually eliminate adjacent channel splatter. It utilizes a multistage RF noise silencer to keep ignition noise interference from getting into the receiver's audio without cutting the incoming signal strength. Range Boost audio system uses IC microcircuits for increased effective talk power. Variable squelch and standard ANL combine with noise silencer to provide quiet, highly sensitive reception. Other quality features include built-in public address amplifier facilities with rear panel jack for hi-fi tuner or tape recorder input. Supplied with mounting bracket, power cord, and PTT dynamic microphone with coiled cord. Size: 2 $\frac{3}{8}$ " x

5 $\frac{1}{4}$ "W x 8"D. Imported. Shpg. wt., 7 lbs., 8 oz.
 99 K 32468W No Money Down* Net 214.95
 PS-52 AC Power Supply for base station operation and Nicad Battery Charger. Imported.
 99 K 32864W Shpg. wt., 5 lbs. No Money Down* ..Net 34.95
 Model HB-506A Portable DC Power Pack. Attaches to HB-625A to permit portable DC operation. Includes battery pack (less batteries), telescoping antenna, and shoulder strap. Imported.
 99 K 32336W Shpg. wt., 3 $\frac{1}{2}$ lbs.Net 26.95
 Batteries for HB-506A Portable Pack. "C" Alkaline (8 req'd.)
 99 K 63802 Shpg. wt., 4 oz. ea.Net ea. .52

Lafayette's HB-700 is a 23-Channel CB Mobile 2-Way Radio and a VHF FM Weather and Marine/Police Monitor Receiver



FCC Type Accepted

179⁹⁵

No Money Down*



A natural for Boats, Cars, Trucks, etc.
All CB + Weather Crystals Supplied!

23 CB+1 Weather+1 Marine or Police Channels

- 2 Dual Conversion Receivers
- ± 1.5 KHz Delta Fine Tuning
- Large S/PRF Meter
- Corrosion Resistant Construction
- Ceramic IF Filter
- Range-Boost Circuitry
- Rear Waterproof Splash Cover
- Operates Mobile on 12 VDC

The HB-700 combines the finest in CB circuitry with a professional 2-channel, crystal-controlled VHF FM receiver in a specially-designed, corrosion-resistant construction with rear waterproof splash cover for years of extra dependable performance. Its CB section features a highly efficient 23-channel crystal-controlled 5-watt transmitter with "Range-Boost" circuitry for high average modulation and greater effective range. Its excellent dual conversion superheterodyne receiver includes a tuned RF stage, ± 1.5 kHz delta fine tuning facilitating reception of off-frequency stations, and a ceramic IF filter for outstanding selectivity and adjacent channel rejection. The VHF FM Monitor Receiver features dual conversion, and includes two crystal positions, one for 162.55 MHz weather (crystal supplied) and one for any marine, police, fire, etc., optional crystal for any frequency within the

range of 156 MHz to 163 MHz. The HB-700 also includes individual squelch controls for both CB and VHF, a jack for optional PA speaker, a jack for external speaker or earphone, antenna tuning for maximum power output, and an antenna switch that permits use of separate antennas for each band or one antenna for both bands. Includes push-to-talk dynamic microphone, mobile mounting bracket, all CB crystals plus 162.55 MHz weather crystal. Size: 8 $\frac{1}{4}$ " x 2 $\frac{3}{4}$ " x 10"D. Imported. Shpg. wt., 7 $\frac{1}{4}$ lbs.

99 K 32773W Net 179.95

Crystal Certificate for second VHF crystal position (marine, police, etc.) 156-163 MHz.

40 K 82145Y Net 4.95

Deluxe 23-Channel Solid-State CB 2-Way Radio Has Separate Emergency Channel 9 Monitor Receiver

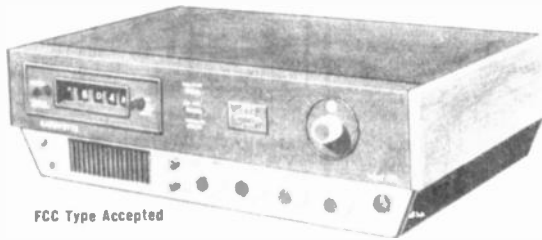

FCC Type Accepted

LAFAYETTE
TELSAT 925

229⁹⁵

ALL CRYSTALS SUPPLIED!

- ★ With Digital Alarm Clock
- ★ Handsome Cabinet with Walnut Finish Wood Sides

Designed for powerful base station performance—smartly styled for home or office

- Dual Conversion 23-Channel Receiver
- 3-Position Crystal Delta Fine Tuning
- Individual Variable Squelch for Each Receiver
- "Range Boost" for Greater Transmit Range
- Large Illuminated S/PRF Meter
- Flashing Emergency Channel 9 Indicator Light
- Lights for Transmit "ON-AIR" and Receive Mode
- Built-in 117 Volt AC Base Station Power Supply

Lafayette's Telsat-925 features an excellently designed 23-channel crystal-controlled transmit and receive CB two-way radio and a reliable separate receiver for monitoring Emergency Channel 9 combined into one smartly-styled, handsome unit. When an emergency affecting life or property is transmitted within receiving range the monitor flashes without interfering with any communication that you may be engaged in. You can listen to the emergency and immediately summon help or speak directly to the person requiring help. The unit includes a reliable digital clock that can be set to automatically turn the transmitter on or sound an alarm at preset time. The transmitter has FCC maximum allowable input power, "Range-Boost" circuitry for greater effective range, adjustable antenna loading for maximum RF output,

and a transmit "ON-AIR" indicator light. It also includes a main dual conversion 23-channel receiver with 0.7 μ V sensitivity, ± 1.5 kHz crystal delta fine tuning for receiving "off-channel" stations, variable squelch plus switchable ANL, a 455-kHz mechanical filter for superior selectivity and adjacent channel rejection, and receive mode indicator light. The Channel 9 Emergency monitor receiver features its own variable squelch and flashing monitor light. The Telsat-925 also includes output jacks for external PA speaker, tape recorder and headphone for private listening. Complete with dynamic push-to-talk plug-in microphone, and all crystals for CB and for Channel 9 monitor. For 117 VAC, 60 Hz. Size: 15 1/4" W x 4 7/8" H x 9 1/4" D Imported Shpg. wt., 18 lbs. 99 K 32856W No Money Down* Net 229.95

Increase Your Communications Range with the LAFAYETTE Telsat SSB-50A Single Sideband AM Mobile CB 2-Way Radio

23 AM PLUS 46 CRYSTAL-CONTROLLED SSB CHANNELS

319⁹⁵

FCC Type Accepted

Variable Fine Tuning on Transmit and Receive

- ★ Maximum FCC SSB Output Power!

- Suppressed Carrier on Sideband for Greater Talk Power
- "Range-Boost" and Automatic Modulation Control
- Dual Conversion Superheterodyne Receiver with Sensitivity of 0.5 μ V on AM and 0.15 μ V on SSB

In addition to the 23 crystal-controlled AM channels, the Telsat SSB-50A's dual conversion superheterodyne receiver receives 46 frequency modes on single sideband (23 on upper and 23 on lower sidebands) and features a crystal lattice filter that provides excellent signal-to-noise ratio and selectivity resulting in far greater usable sensitivity while rejecting adjacent channel interference. The receiver also features a built-in product detector for superior reception, as well as unique multi-stage RF noise silencing circuitry to minimize ignition-type noise interference. It's powerful "true" single-sideband transmitter gives 100% talk power with far greater effective output and range! The transmitter also includes internal RANGE-BOOST circuitry and adjustable antenna loading for maximum RF output as well as



- ★ Crystal Lattice Filter

- ★ 100% Talk Power

- Continuously Variable Fine Tuning for Clarifying SSB
- RF Noise Silencer Circuitry Plus Variable Squelch
- Large Illuminated Front-Panel "S"/PRF Meter

variable fine tuning to "slide" transmitter within FCC tolerance. The Telsat SSB-50A also includes output jacks for external speaker or headphone, tape recorder, and PA remote speaker, and input jack for tuner, record player, tape player, etc. Supplied complete with Push-to-talk Microphone, DC power cable and Mobile Mounting Bracket. Operates mobile on 12.6 VDC. Negative or Positive ground. Size: 7 1/4" W x 2 7/8" H x 9 1/4" D Imported Shpg. wt., 12 1/4 lbs.

99 K 32849W No Money Down* Net 319.95

Model PS-50 117 VAC Base Station Power Supply for Telsat SSB-50A, Imported.

99 K 32682 Shpg. wt., 7 1/2 lbs. Net 29.95

Charge it with BankAmericard or Mastercharge!

Lafayette CB Antennas and Accessories...

LAFAYETTE Range-Boost II Base Station CB Antenna



SALE
1795

Reg. 19.95

Made in U.S.A.

- Heavy Duty Mounting Bracket
- Static Clover Leaf Ball Design Reduces Receiver Noise
- 3.75 db True Omni-Directional Gain
- VSWR-1.17-1
- Signal to Noise Improvement of 6-20 db

Best selling 1/2 wave Base Station Antenna. Specially designed anti-static cloverleaf ball drastically reduces receiver noise by continuous dissipation of static discharge. Weatherproof phasing transformer, three 54" radials provide proper transmission line decoupling. Heavy duty mounting bracket. Direct ground lightning protection. 50 ohm match. 17'-6" over-all length. Accepts up to 1 1/2" masts, and PL-259 cable connector. (Less mast and coax). Wt., 6 lbs. 42 K 01448W Net 17.95

Deluxe Lafayette 4-Element Base Station Ground Plane Antenna

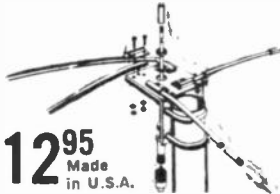

1295
Made in U.S.A.

Four heavy-duty, solid aluminum 108" heat-treated radials and radiator. Elements supplied in two 54" lengths joined by threaded coupling nuts. Radial droop for 50-ohm match. Accepts 1 1/4" tubing. RG-58/U cable and PL-259 connector. Less mast and coax. Wt. 4 lbs. 42 K 01562W Net 12.95

LAFAYETTE Stainless Steel Mobile CB Antenna

- 102" Stainless Steel Whip For Optimum 11-Meter Performance
- Heavy-Duty Cadmium Plated Steel Spring
- Aluminum Swivel Ball Jointed Mount Base

895

Aluminum swivel mount base designed to be mounted on any surface. Plated steel spring holds rod in properly adjusted position and prevents rod damage from shocks and blows. Stainless steel whip for resiliency and strength. Less cable. Shpg. wt., 4 lbs. 42 K 01554WX Net 8.95



LAFAYETTE "Rapid Grip" Mobile CB Antenna



1295
Made in U.S.A.

- No Holes to Drill

Especially suitable for trunk mounts. No holes to drill. Slips over trunk lip. Cable is completely hidden. Offers ideal omnidirectional signal pattern. Water resistant body seal. 39" stainless steel whip. Base loaded phasing transformer completely weather proof. Less cable. Has lug terminals for 42-70021 cable assembly. Shpg. wt., 11 oz. 42 K 01521 Net 12.95



LAFAYETTE "Range Master II" Deluxe Base-Loaded Mobile Roof Mount Antenna

Made in U.S.A.

- Oversize Base Loading Coil Provides Fantastic Built-in Reserve Power Handling Capability

2395
with 17 ft. of RG-58/U Cable

Handles the heaviest loads with ease and comfort. Meets the most exacting demands from commercial or serious CB users. Includes extra heavy plated whip for continuous use without detuning due to excessive heat. 46" overall height. Includes mount and 17 ft. RG-58/U cable with PL-259 connector. Shpg. wt., 3 lbs. 42 K 01679 Net 23.95



LAFAYETTE Super Range-Boost/II™ Base Station CB Antenna



2995

Made in U.S.A.



- 4 db Gain Delivers 13 Watts E.R.P. (Effective Radiated Power)
- Hi-Q Phasing Coil
- VSWR 1.4 to 1 or less
- Loaded Ground Radials

Deluxe base station antenna. 1/2-wave end-fed 4 db omnidirectional type. Huge loading coil will safely handle 50 to 75 times normal CB power. Three ground radials (54") are base loaded. Constructed of seamless aircraft tubing and corrosion-proof steel. Four element static ball reduces receiver noise. Direct ground lightning protection. Overall height: 18 ft. Accepts up to 1 1/2" mounting mast. Less mast and coax. Shpg. wt., 8 1/2 lbs. 42 K 01604W Net 29.95

LAFAYETTE "Marine-Mate" 1/2 Wave CB Antenna

2495

Made in U.S.A.

with 20 ft. of RG-58/U Cable, Two Connectors and All Mounting Hardware

- Gleaming White Marine Style Base with White Fiberglass Radial



Deluxe white fiber glass CB marine antenna. 1/2 wave length electrical construction. Gleaming white marine style base with white fiberglass radial. Triple chrome plated hardware. 48" overall length. Unique tuning tip allows exact matching of VSWR. No ground plate needed. Weatherproof and waterproof. Loading coils embedded in fiber glass for long-lasting performance. SO-239 connection for ease of installation. Includes mounting hardware and 20 ft. of RG-58/U cable and two connectors (one installed and one loose solderless). Shpg. wt., 3 lbs. 42 K 01661W Net 24.95

Universal Lafayette Mobile Antenna Accessories

Only
349



CHROME PLATED SWIVEL BALL MOUNT BASE. Can be mounted vertically or horizontally. With lug terminals. Imported. Shpg. wt., 1 lb. 99 K 30306 Net 3.49

Only
389



HEAVY DUTY STAINLESS STEEL SPRING. Provide maximum support for long whips and heavy centerloaded whips. Imported. Shpg. wt., 1 1/2 lbs. 99 K 30363 Net 3.99

Only
645



CHROME PLATED BUMPER MOUNT WITH STAINLESS STEEL STRAP. Completely adjustable for vertical mounting on most types of automobile bumpers. Highly reliable and durable. Eliminates need of cumbersome link type chain mounts. Imported. Wt., 1 1/4 lbs. 99 K 30355 Net 6.45

Give Top Base Station and Mobile Performance

Newtronics "Hustler" HTM Twin Mobile CB Truck Antenna

NEW!

29⁹⁵

- Mounts on Side-View Mirrors
- Oversize Power Resonator

Hustler Twin Huskies are designed specifically for the CB trucker. Provides superior signal radiation. Slotted mirror mounts permit instant and easy attachment to all side view mirror brackets. Plug-in cable assembly affords easy installation and rapid transfer from truck to truck. The Model HMT features 2 twin white 55" fiberglass antennas, heavy duty mirror mounting, oversize resonators, and stainless steel adjustable tip rods. Comes complete with 17" dual coax phasing harness. Wt., 4 lbs. 42 K 37053WNet 29.95



Deluxe Lafayette "Range-Master I" Omni-Direction Base Station CB Antenna

- 5.0 db Gain • VSWR 1.5:1 • No Coils or Matching Stubs
- 1/2 Wave Dipole, Full Aperturic Design
- Power Handling Capability Provides 500 to 1 Safety Factor

34⁹⁵

No Money Down*



Made in U.S.A.

Our finest CB base station antenna 5 db gain (6.85 db over an isotropic reference). VSWR 1.5:1 over entire Citizens Band. 100 mph wind survival. Weatherproof feed point eliminates RF leak and moisture migration through coax connection. Die cast machined parts. 8 ft. 10 in. radials constructed of seamless aircraft tubing. Mounts on 1 1/4" mast, SO-239 connector. Low angle of radiation. Major signal lobe at horizon assuring no wasted power and more useable signal gain. 6 ft. total span at widest point gives ease of mounting almost anywhere. No coils or matching stubs to burn out or detune. Overall height, 17 ft. Comes less cable. Shpg. wt., 4 lbs. 42 K 01653WNet 34.95

Antenna Coaxial Switch

5⁹⁵



- 2-Position
 - Rated At 1 KW AM, 2 KW PEP SSB
- CBer's and Hams can stop reaching behind their rigs, wasting time and missing calls switching antenna leads. With this quality coaxial switch—just turn the knob and instantly change from one antenna to another. Size: 2 1/2 x 1 3/4". Shpg. wt., 6 oz.

42 K 21024Net 5.95

CB Antenna Match

9⁹⁵

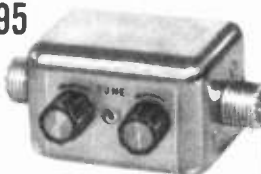

Gives a perfect antenna/transmission line match of 1.1:1 VSWR for full power. Requires no special tools for installation. Simply insert the CB MATCHER between the transmitter and antenna lead-in. Adjustable tuning knobs permit precise matching under various operating conditions.

42 K 21032 Shpg. wt., 6 oz.Net 9.95

Low Pass Filter

6⁴⁹



Avoid TV interference. Reduce TVI coming from your rig and interfering with TV sets by inserting an LP filter in your line. Rated at 100 watts input. Attenuation starts at 39 MHz, is 20 db down at 40 MHz, 26 db at 45 MHz and above. Impedance: 50 ohms. Insertion loss: 1/2 db at 27 MHz. Shpg. wt., 3/4 lb.

42 K 21123Net 6.49

6/12V Power Inverter

14⁹⁵



- Converts 6VDC to 12VDC
- 3 Amp Continuous, 10 Amp Surge

Converts foreign cars, trucks, and tractors with 6 volt negative or 12 volt positive ground electrical systems to 12 volt negative ground. Solid state circuitry—two power transistors. Toroid transformer. Fused line cord. Extruded aluminum construction. 2 3/4 x 3 x 5"D. Shpg. wt., 2 1/2 lbs.

42 K 50502Net 14.95

CB Phone Patch



- Ideal for Emergency Phone Calls Using Your CB Transceiver

15⁹⁵

Talk anywhere in the world from your car or truck. Simple installation allows your telephone to be connected to your CB communications system. For use with 3-16 ohm speakers and high impedance microphone inputs. Modulation gain control to compensate for varying line levels. On-off switch disconnects patch when not in use. Dimensions: 2 3/4 x 1 3/4 x 2"D. Shpg. wt., 1 lb.

42 K 21180Net 15.95

Cornell Dubilier AR-22R Automatic Rotor

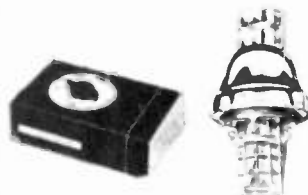

- Fingertip Control
- Control Unit Shows Direction of Rotation

Heavy-duty rotor unit will handle antennas up to 150 lbs. Simply set the control unit pointer to the desired direction, and the antenna will automatically rotate to this position and stop. Perfect for TV, Ham or Citizen Band applications. Rotor unit employs 12 heavy duty ball bearings in two 6 1/2" races. Reversible clamps on rotor will take masts from 3/8" to 2" O.D. Control unit is marked in compass points. N.S.E.W. Housed in attractive black vinyl steel cabinet. For 110-120 volts, 50-60 Hz AC. Uses 4-conductor rotor cable. Wt., 14 lbs. No Money Down*

42 K 86076 WNet 36.95
100-ft. Coil of 4-Conductor Rotor Cable
32 K 89105 Shpg. wt., 2 1/2 lbs. Net 3.65

ANTENNA CABLE ASSEMBLIES

FOR BASE STATIONS

Polyfoam dielectric insures low line loss important in getting the most from your base station. Ready to use. PL-259 connectors on both ends.

Stock No.	Type	Lgth. Wt. ft. lbs. Met.
42 K 09102	R8/U—50 ohms	50 7 9.65
42 K 09110	R8/U—50 ohms	100 11 16.95

FOR MOBILE APPLICATIONS

20 ft. RG-58/U cable with PL-259 plus UG-175/U on both ends. Shpg. wt., 8 oz.
42 K 70013Net 3.25

20 ft. RG-58/U cable with PL-259 plus UG-175/U on one end and with universal ring type terminal lugs on other end. Wt., 8 oz.
42 K 70021Net 2.95

HEAR THE EXCITING NEWS AS IT HAPPENS

Police, Fire, Civil Defense, Marine, Weather, Business, etc.!

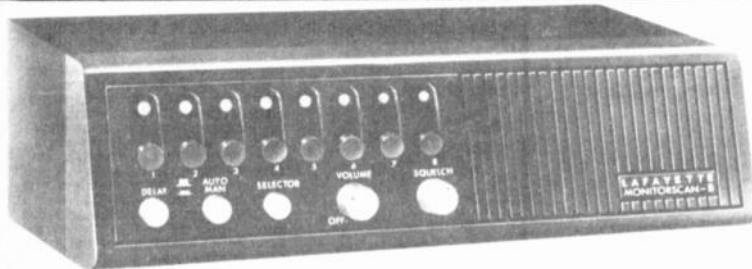

AMAZING
LOW PRICE!
99⁹⁵
No Money
Down*

For Base And Mobile

LAFAYETTE MONITORSCAN-8™ Eight-Channel VHF Monitor Scanner

- ★ 8 Front Panel Flashing Long-Life Light Emitting Diodes (LED's) Indicate Channel Receiving a Signal
- ★ 8 Individual Front Panel Pushbutton Lockout Controls for Selective Programming
- ★ Built-in Telescoping Antenna
- Automatic Scanning Stops when a Signal is Received and Continues Scanning After Transmission is Over
- Manual Channel Selection
- Variable Squelch Control
- For 150-170 MHz Reception
- For 117 VAC Base and 12 VDC Mobile Operation

Lafayette's MONITORSCAN-8 is meticulously designed for outstanding performance as an 8-channel, crystal controlled FM Monitor Scanner. The MONITORSCAN-8's brighter and much longer lasting front panel flashing L.E.D. (Light Emitting Diode) lights offer bold, positive scanning and automatically seek a voice signal on any of the eight programmed channels. Scanning stops on any channel receiving a signal and after transmission is over the scanning is resumed. The front panel also features individual "lock-out" controls, located directly beneath the channel light, for instant programming of wanted or unwanted channels. Additional deluxe features include double conversion superheterodyne circuit with better than 0.5 μ V sensitivity for 20 db quieting, variable squelch control, pushbutton switches for selecting automatic or manual scanning mode, individual

channel sequential selector, and front mounted speaker for maximum audio clarity. All solid-state circuit permits low current continuous monitoring. The MONITORSCAN-8 comes complete with telescoping antenna for shorter distance reception and professional PL-259 antenna connection for 50-ohm external antenna, all mounting hardware for quick installation in any vehicle or for AC tabletop use, and AC and DC line cords. For 117 VAC and 12 VDC operation. Size: 8 1/4" x 8 1/2" x 2 3/4" H. Imported Shpg. wt., 9 lbs.

99 K 26213W For 150-160 MHz Net **99.95**
 99 K 26221W For 160-170 MHz Net **99.95**
 Crystal Certificate for MONITORSCAN-8 Monitors. Fill one out for each crystal and send directly to manufacturer.
 40 K 82145Y Net **4.95**

EXCITING NEWS WHEREVER YOU ARE!

LAFAYETTE 4-CHANNEL FM VHF POLICE and FIRE POCKET SCANNING MONITOR

★ Small Enough to Fit into Your Hand . . .

Sensational
LOW
PRICE! **99⁹⁵**
No Money Down*

- Automatic Sequential Scanning on 4 VHF (Hi-Band) Frequencies
- Manual Selector Switch
- Pushbutton "BYPASS" Priority Switch
- Dual Conversion Superheterodyne Receiver for Maximum Selectivity and Adjacent Channel Rejection
- Sensitivity: 1 μ V for 20 db Noise Quieting
- 4 L.E.D. Long-Life Flashing Lights
- Built-in Antenna

Lafayette's PORTASCAN-4 enables auxiliary police, firemen and average citizens to monitor the throbbing pulse of everyday community life wherever they may be. It features four long-life L.E.D. (light emitting diode) flashing lights in automatic sequential scanning of 4 VHF (150-170 MHz) frequencies. AFC circuitry for extra frequency stability, a pushbutton "BYPASS" switch that automatically selects your priority (most important) channel, and a manual selector switch for manual sequential channel selection. In addition it incorporates variable squelch control, volume level switch, built-in antenna, jacks for external antenna and earphone, and a battery charge terminal for internal charging of optional nicad batteries. With clip for carrying monitor on belt. Requires 4 "AA" penlight batteries and up to four VHF crystals for frequencies you wish to monitor. Less batteries and crystals. Size: 6 3/8" x 2 7/8" x 1 1/2". Imported. Shpg. wt., 3 1/2 lbs.

99 K 26247L 150-160 MHz Net **99.95**
 99 K 26254L 160-170 MHz Net **99.95**
 99 K 63828 Alkaline Batteries (4 req.) Net ea. **.45**
 Alternate Rechargeable Nicad Batteries (4 required) Net ea. **1.85**
 32 K 47400 Net **.79**
 99 K 25488 Earphone Imported. Shpg. wt., 4 oz. Net **13.95**
 99 K 31007 Nicad Battery Charger Imported. Shpg wt, 1 1/4 lbs. Net **4.95**
 40 K 82145Y Crystal Certificate for Each VHF Crystal Net **4.95**

LAFAYETTE PORTASCAN-4

Save On These Lafayette Police and Fire Monitor Receivers

**Base and Mobile
117 VAC, 12 VDC**

**MICRO P-100A
(148-174MHz)**

**MICRO P-50A
(30-50MHz)**

Mobile 12 VDC

**MICRO P-450
(450-470MHz)**

**CUT
20.00
SALE
59⁹⁵**

No Money Down*



Tuneable Plus 2 Crystal Positions

Listen and thrill to the excitement of urgent police broadcasts, fire squads in action, to ambulances and to other public service communications. Compact size (13³/₄"H x 4⁷/₈"W x 7³/₈"D) permits convenient mobile and base operation. Micro P-450 uses optional base station AC supply. Includes tuneable plus 2 crystal receive positions, sensitivity of 0.7 μ V for Micro P-50A and 1 μ V or less for 20 db S+N N for Micro P-100A and Micro P-450. 3 ceramic IF filters for excellent selectivity, variable squelch, 2-watt audio output, and professional styling with an attractive illuminated dial. Ad-

vanced design circuitry for superior limiting and noise reduction includes built-in fused 12 VDC (neg. ground) power supply, power cables and mounting bracket. Micro P-50A and Micro P-100A also include 117 VAC 60 Hz power supplies. Easy portable operation with optional power pack. Imported Shpg wt., 5 lbs.

99 K 26197W Micro P-100A (148-174MHz) Net \$9.95

99 K 26189W Micro P-50A (30-50MHz) Net \$9.95

99 K 25843W Micro P-450 (450-470MHz) Net \$9.95

ACCESSORIES FOR MICRO P-50A, MICRO P-100A, and MICRO P-450

HB-509A Portable Battery Pack with shoulder strap, battery strength meter and antenna. Less batteries Imported Shpg Wt., 3¹/₂ lbs.

99 K 32260 For Micro P-50A, P-100A, and P-450 Net 23.50

Alkaline Batteries for HB-509A (8 req.). Imported.

99 K 63802 Shpg. wt., 4 oz. Net ea. .52

Alternate Nicad Rechargeable Batteries for HB-509A (10 req.)

32 K 48887 Shpg. wt., 5 oz. ea. Net ea. 4.46

HB-512 AC Supply permits operation of Micro P-450 on 117 volt AC 60 Hz and charges nicad batteries used in HB-509A. 99 K 32278 Imported. Shpg. wt., 5 lbs. Net 19.95

CRYSTAL CERTIFICATE FOR MICRO P-50A, P-100A and P-450. Send filled-out certificate, one for each crystal, to the manufacturer. Mfr. will ship crystal directly to you, postpaid, within 30 days. Specify Exact Monitoring Frequency.

40 K 82145Y No C.O.D.'s Net ea. 4.95

LAFAYETTE POLICE AND FIRE 3-BAND FM MONITOR RECEIVER



3 BANDS: 30-50 MHz.
144-174 MHz.
450-470 MHz.

4 Crystal Positions

**CUT 30.00
SALE 119⁹⁵**

No Money Down*

- For 117 VAC Base Station and 12 VDC (Negative ground only) Mobile Operation
- Sensitivity: 1 μ V. for 20 db Quieting
- Adjustable Broad and Sharp Selectivity On All 3 Bands



Model PF-300 CRYSTAL CONTROL PLUS TUNEABLE RECEPTION

An outstanding universal FM monitor receiver for the 450-470 MHz UHF band, 144-174 MHz VHF band and 30-50 MHz low band. The PF-300 is fully tuneable and can be crystal controlled on two frequencies on VHF, and/or low band or UHF; or on two VHF, one UHF and one low band frequencies. Receives U.S. Weather Bureau reports on 162.40 and 162.55 MHz in parts of the country where they are broadcast. Front panel features large tuning dials; switches for crystal or tuneable reception for each band; and variable squelch control that silences the receiver during no-signal conditions.

The PF-300 also features a large built-in speaker, phone jack for private listening, tape recorder output jack, and UHF, VHF and Low Band antenna jacks. A built-in universal power supply permits operation on 117 VAC and 12 VDC (negative ground only). Size: 13³/₄"W x 7¹/₂"D x 4¹/₂"H. Imported.

99 K 26163W Less Crystals Shpg. wt., 11¹/₂ lbs. Net 119.95

CRYSTAL CERTIFICATE. One required for each crystal. Specify exact monitoring frequency. Mfr. will ship direct

40 K 82145Y No C.O.D.'s Net 4.95

Charge it with BankAmericard or Master Charge!

Put Our Power Tools To Work For You!

COMPLETE 48-PIECE POWER WORKSHOP

WITH 2-SPEED HEAVY-DUTY
3/8" DRILL

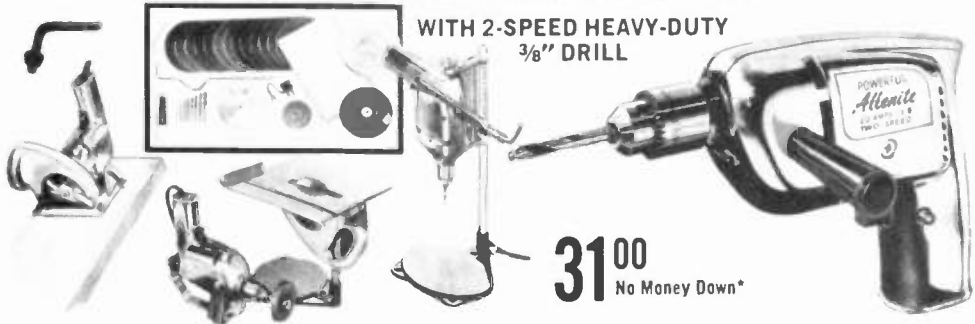

31⁰⁰
No Money Down*

Everything you need for most any job! All attachments powered by the premium-rated, heavy-duty 3 amp. 3/8" drill with self-locking trigger switch. Two speeds: Low (1600 RPM) for drilling tough metals, buffing, polishing; High (2000 RPM) for drilling soft metals, wood, sanding and sawing. Set includes: 0-45° tilting portable saw attachment, table saw attachment (angle cuts to 45°), lever-action drill press stand with mounting post and base, bench stand, 9 drill bits,

gear chuck and key, 4 1/2" cross cut and rip saw blade, lambswool polishing bonnet, rubber backing pad, paint mixer, 3 grinding wheel, 12 assorted sanding discs, side mount drill handle, 3-wire cord adapter set, 6-foot heavy-duty extension cord, and instruction booklet. Drill UL listed. For 117 VAC, 60 Hz.

13 K 47509W Shpg. wt. 12 lbs.Net 31.00

Black & Decker 3/8" POWER DRILL



9⁹⁹

- Double Insulation Gives Safety Without Grounding

Great general-purpose drill for most homeowner workshop use. Double reduction gear system delivers high power drilling action. Well balanced, comfortable to use. Equipped with ball-thrust bearing system. Double insulation. Exclusive recessed center locker button prevents accidental "lock-on". Drives the most popular accessories and attachments. Capacity: Steel 3/8", hardwood 3/4"; 1200 RPM; 22 HP (Max. Motor Output); 2 amps; For 117 VAC. UL listed.

12 K 68887 Shpg. wt., 3 1/4 lbs.Net 9.99

HEAVY DUTY PNEUMATIC AIR HAMMER KIT



29⁹⁵

- Punches, Cuts, Rivets, Hammers

This large, 7 1/2" long, all-purpose pneumatic hammer is powerful enough to easily drive 1/4" steel rivets, sturdy enough for foundry chipping and scaling, versatile enough for auto repair work. It operates at 100 to 150 PSI to deliver four pounds of multiplied power over a 2 1/16" stroke at 2500 blows per minute. It connects to compressor thru standard 1/4" threaded inlet. Kit includes four bits: a 3/8" cold chisel; a spot weld buster, curved to go around obstructions; a tapered punch for drifting out pins, punching holes and driving out frozen bits; and a T-type panel cutter, with V-cut blade for stability and endurance. Quick-change universal spring holds bits in place. Shpg. wt., 5 lbs.

12 K 11507Net 29.95

Black & Decker AUTOMATIC DRILL BIT SHARPENER



15⁹⁹

- Operates Like a Pencil Sharpener

Model 7980. Automatically precision sharpens dull or broken high speed steel twist drill bits (not carbide tipped). Bits need no oil or lubricants. Accepts 11 sizes: 3/8", 7/8", 1 1/2", 1 3/4", 1 7/8", 2", 2 1/8", 2 1/4", 2 3/8", 2 1/2", 2 7/8", and 3 1/8". Double-insulated for maximum user safety. 1/7 HP, 1.9 amps. 117 VAC, 50/60 Hz. Shpg. wt., 5 1/2 lbs.

12 K 68747Net 15.99

"JIFFY" VARIABLE MOTOR SPEED CONTROL



9⁹⁵

- Varies Speed on AC-DC Motors from 0 RPM to Full Speed
- Ideal for Electric Drills, Saws, Polishers

Dependable motor speed control ideal for workshop power tools using universal AC-DC and series DC motors. Assures constant speed variation from zero to maximum speed. Has built-in circuit breaker, 5 amps load rating. Input: 120 volts, 50-60 Hz AC. 3-wire receptacle and detachable line cord. 3 x 2 1/2 x 1 1/8" D. Shpg. wt., 1 lb.

13 K 27006Net 9.95

13-PC. HIGH-SPEED DRILL SET WITH CENTER PUNCH

Century



5⁹⁵

Made in U.S.A.

- 12 Sizes: 1/16"-1/4"

Precision-ground, high-speed drills and center punch placed in unbreakable, flexible plastic case which opens and closes like a book! Drill sizes: 1/16"-1/4". Handy center punch assures exact position of drill bit. Shpg. wt., 9 oz.

13 K 18500Net 5.95

Mail This Card Today For Your

FREE!

1974 Lafayette Catalog 740



97034

Name _____

Address _____

City _____ State _____ Zip Code _____

Please Give Your Zip Code Number

Do A Friend a Favor . . .

If you have a friend who would be interested in getting a copy of the big new 1974 Lafayette catalog 740 and future mailings, just give him this card . . . or fill his name in and complete address, and mail this card to us. He will receive a catalog absolutely FREE, without charge or obligation.

97034

Name _____

Address _____

City _____ State _____ Zip Code _____

Please Give Your Zip Code Number

PLACE
STAMP
HERE

**LAFAYETTE
RADIO ELECTRONICS**

111 JERICHO TURNPIKE
SYOSSET, L.I., N.Y. 11791

DEPT. 743

PLACE
STAMP
HERE

**LAFAYETTE
RADIO ELECTRONICS**

111 JERICHO TURNPIKE
SYOSSET, L.I., N.Y. 11791

DEPT. 743

DELUXE 7¼" CIRCULAR POWER SAW

- 1¾ HP Burnout Protected Motor
- 5700 RPM No Load Speed 10 Amp Motor
- Safety Switch Button

SKIL



29⁹⁹

Model 574. Tackle the "big" jobs with this dependable 7¼" builders' saw. Reinforced die-cast housing that really stands up. Cuts 2x 4's with ease, at 45° angle. Easy set bevel and depth adjustments. Safe non-binding blade guard with vari-torque safety clutch. Features safety switch—button must be depressed before saw can be started. Sawdust ejector keeps your work clean. Lets you see what you are doing. 7¼" combination blade and blade wrench. Powerful 1¾ HP motor is designed to be trouble free. Cutting depth: 90° 2¾, 45° 1¾". 10 amps. UL listed. 117 VAC. 3-wire cord and plug. Shpg. wt., 11½ lbs. See rip fence below.

13 K 69263Net 29.99

13 K 69123 Rip Fence. Shpg. wt., 4 oz.Net 2.25

Carrying Case for above Saw
13 K 69370 Shpg. wt., 5¼ lbs.Net 11.95

HEAVY-DUTY 4" BELT SANDER

44⁹⁵

No Money Down*



- Powerful 8 Amp Motor

Model 2530. A powerful belt sander for every sanding job. Rugged gear drive moves 1500 surface feet per minute. Unique snap-lock on front roller for easy belt changing, vacuum cleaner hook-up provided for dust pick-up. Die-cast aluminum housing, locking trigger switch. Uses standard 4x21¾" belt. AC motor with life-time lubricated bearings. 3-cond. cord. For 117 VAC, 60 Hz. UL listed.

13 K 85517 Wt., 12½ lbs.Net 44.95

Sanding Belts for above. Shpg. wt., 4 oz.

13 K 85525 40 Grit, Coarse.....Net 1.09

13 K 85533 60 Grit, Medium Net. 1.09

13 K 85541 80 Grit, FineNet 1.09

½ HP 2-WAY SANDER

WEN

19⁹⁵



- Orbital or Straight Line
- Positive Slide Switch

Versatile ½ HP sander is both an orbital and straight-line sander. Push-pull switch instantly switches from orbital to straight-line motion. Draws only 2.6 amps but delivers 4,000 orbits or 4,000 straight-line strokes per minute. Double-insulated for safety. Enclosed handle with a built-in front guide. For 117 VAC. Shpg., wt., 3¼ lbs.

13 K 65402Net 19.95

HEAVY-DUTY VARIABLE SPEED SABRE-JIG SAW



- Any Speed From 0-5200 S.P.M.

29⁹⁵

Electronic "TOTAL TORQUE" dial variable speed control lets you use this one tool for any cutting job. Cuts through 6" logs, 6 x 6" lumber, metal pipe, masonry—practically any material. Makes its own starting hole. Low speed for steel and plastics, medium for non-ferrous metals, high for rip or cross-cut. Bevel cuts to 45°. Features a 5 amp, ½ HP motor. With 6' 3-cond. cord, 5 assorted blades and rip guide with circle cutter. For 120VAC. 25-60 Hz. UL listed. Wt., 6¼ lbs.

14 K 48059Net 29.95

12" GASOLINE CHAIN SAW



119⁹⁵

No Money Down*

- Lightweight—Only 6½ Lbs.
- Automatic and Manual Chain Oiling

The ideal saw for the homeowner, farmer, sportsman and anyone who desires a rugged, lightweight saw. Weighs only 6½ lbs. without bar and chain, can tackle any job around the home, farm or camp site. Small enough to handle easily, even in close quarters. Its 2.2 cu. inch displacement, direct-drive engine supplies enough power to cut heavy logs in seconds. Felts trees up to 24" in diameter. Other features include: instant "feather touch" starter, retardant muffler, hard-tipped cutter bar, and automatic oiling.

14 K 67554W Shpg. wt., 10 lbs.Net 119.95

HEAVY DUTY TYPE SPRAYER



39⁹⁵

- Sprays Oils, Paints, Insecticides, Liquid Wax
- Quiet-running diaphragm type compressor
- 1-qt. aluminum canister

Economy priced portable sprayer designed for the homeowner and hobbyist. Precision engineered throughout to give professional results. Compact, lightweight, versatile... perfect for those dozens of small jobs around the house, wherever and whenever spraying is needed. The spray gun easily handles paint and other types of sprayable material. Sprayer unit features an internal mix spray gun, adjustable spray pattern, quart aluminum canister with a delrin thread insert to prevent fouling and 8' air hose. Easy to operate, just plug in any 115 V. outlet. Develops maximum pressure of 40 psi. 7 ft. power cord. Shpg. wt., 13¼ lbs.

14 K 67539 No Money Down*Net 39.95



SOLIDOX SOLID OXYGEN PORTABLE WELDING TORCH KIT

Braze—Weld—Silver Solder

- Generates 5000° Flame
- Cuts 3/8" Bolts
- Lightweight—Completely Portable

SALE 29⁹⁵

CUT 5.00

This safe welding torch enables you to Braze, Weld and Silver Solder with professional results. Uses oxygen pellets combined with propane, to create temperatures exceeding 5000°. Its compact, lightweight (7 lbs) design is ideal for home, farm, business, hobby work or boats. Kit includes torch with propane cylinder, 2 tips, SOLIDOX pellets (approximately 100 minutes of burning time.), safety glasses, igniter, assorted brazing rods, operating instructions and welding techniques booklet. Shpg. wt., 12 lbs.

14 K 50501W Net 29.95

100/140-Watt "EXPERT" SOLDERING KIT



Weller® 930

MODEL 8200-PK. Just the thing for the novice or professional. Compact design and built-in pre-focused spotlight eliminates maneuvering difficulties. Break-proof plastic utility case can be used to hold other parts or tools. Weller Expert Soldering Kit features the 8200 gun with exclusive tip Grip which assures constant heat. Dual heat feature gives choice of 100 or 140 watts with the pull of the trigger. Accessories include 3 durable soldering tips, tip changing wrench, nylon flux brush, soldering aid to facilitate difficult connections and all purpose solder. All the items you need for first-class solder connections are packed in a high impact plastic case. UL listed.

13 K 39159 Shpg. wt., 3 lbs. Net ea. 9.30
 Model 8200. Gun only. Shpg. wt., 2 3/4 lbs.
 13 K 39142 Net 7.65

MICROFLAME® GAS WELDING TORCH

WELDS, BRAZES, CUTS MOST METALS

17⁹⁵

Completely Self-Contained
 Torch Produces 5000°F
 Pin-Point Flame

Miniature gas welding torch for precision welding, brazing and cutting jobs. Pin-point flame produces high heat in a very selective area. Many uses in printed circuit repair, jewelry repair, shop, dental lab, tool and model making. Hand-held, lightweight torch has self-contained Micronox and LP cylinders which are easily replaced. Up to 20 minutes of continuous heat. Cylinders last indefinitely when not in use. Complete torch with 2 tip sizes, 1 cylinder butane, 1 cylinder oxygen, gaskets and instructions. Overall size: 5 1/4 x 2 1/4 x 1 1/4" thick.

14 K 42508 Shpg. wt., 1 1/4 lbs. Net 17.95
 14 K 42516 Butane Cylinder (Pk. of 2) Wt., 4 oz. Net .98
 14 K 42524 Micronox Cylinder (Pk. of 2) Wt., 4 oz. Net 1.29

BRAZING RODS

Silver Solder Brazing Rods (Pkg. of 12—6" long)
 14 K 42557 Shpg. wt., 4 oz. Net per Pkg. 2.59
 Aluminum Brazing Rods (Pkg. of 6—6" long)
 14 K 42565 Shpg. wt., 3 oz. Net per Pkg. .99

HEAVY-DUTY 18" BENDING AND FORMING BRAKE



21⁹⁵

- Clean, Smooth Bends
- Handles up to 18" Width in up to 16-Gauge Thickness
- Forms up to 90°
- For Experimenters—Servicemen—Shops

Rugged, heavy-duty, all-steel construction and unique design permits forming chassis, boxes, covers, trays, etc., by means of 1" deep slots in brake-bar which allows corners to fold in. Provides flange edges up to 1" high. Easy to adjust for thickness, accuracy, angle of bend. Features built-in clamps. Imported. Shpg. wt., 16 1/2 lbs.
 99 K 80640W Net 21.95

19 PIECE 3/8" DRIVE SOCKET SET



19⁹⁵

- Chrome Plated
- Drop Forged Steel

Mechanics quality socket set. Contains 3/8", 1/2", 5/8", 3/4", 7/8", 1 1/8", and 1 1/4" standard sockets; 3/8", 1/2", 5/8", 3/4", 7/8", and 1 1/4" deep sockets; 3/8" and 1/2" spark plug sockets with Neoprene inserts. Also includes 3" extension, universal joint and 8" reversible ratchet. Comes in enameled metal tool box. Imported. Shpg. wt., 6 lbs.
 13 K 56302 Net 19.95

FOUR TRAY CANTILEVER TOOL BOX



12⁹⁵

Professional quality tool box. Ideal for machinists, electronics and automotive repairmen. Double cover swings out for easy access to each compartment. Bottom compartment large enough to store bulky tools. Extra-heavy gauge steel. Heavy-duty round handles and padlock eyes for locking. Handsome baked blue enamel finish. Overall size: 17L x 8W x 8 1/4"H. Shpg. wt., 16 lbs.
 13 K 56104W Net 12.95

AQUA VAC DELUXE 8 GALLON WET/DRY VAC

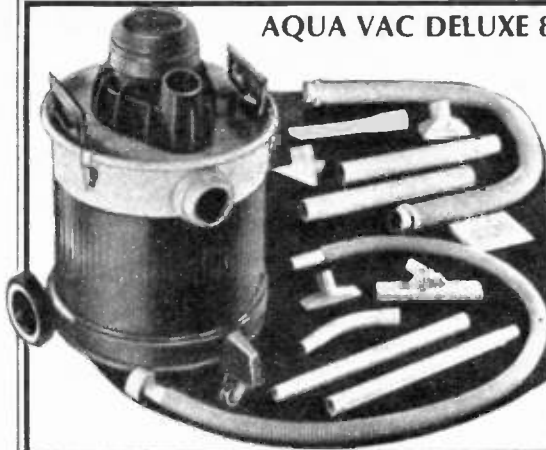

49⁹⁵

COMPLETE WITH
ACCESSORIES
SHOWN

- Picks up **HEAVY** Debris . . . **WET** and **DRY** . . . Easily and Quickly
- High-powered Performance-1 peak HP Motor . . . Air-Cooled & Fully Moisture Protected
- 8 Gallon Capacity . . . with Automatic Shutoff at 6 Gallons

Aqua Vac is the answer for those **TOUGH** cleaning jobs! Picks up **HEAVY** dirt; both **WET** & **DRY**. Its high performance & portability make it ideal for use around the shop, home, pool, patio, garage, etc. Features an 8 gallon rust resistant drum with an automatic shutoff at 6 gallons; an easy glide 3-wheel dolly; an 8" 3-wire power cord; TWO flexible 6-foot hoses, 1 1/4" dia. & 2 1/2" dia., for both light and heavy cleaning; and two easy-lift lid handles. Complete accessories include: 5 filter bags; 2-1 1/4" 20" extension wands; 1 1/4" 10" squeegee insert; 1 1/4" curved wand; 1 1/4" upholstery nozzle; 2-2 1/2" 20" extension wands; 2 1/2" utility nozzle; 2 1/2" triangular nozzle; 2 1/2" crevice tool. 120V AC/DC; Size: 18 3/4x14"W.

13 K 35710W Shpg. wt., 20 lbs. No Money Down* Net 49.95

PUDDLE GULPER Complete Pumping System 29⁹⁵

A pumping system with an electric motor pump, 7-foot inlet hose and a unique rust-proof "Puddle Gulper" attachment with a built-in strainer for motor protection. Attach ordinary 3/4" threaded garden hose to the outlet to pump oil, ball boats, pump water from pool covers, empty tanks, etc. To quickly drain puddles connect the "Gulper," place it on the flooded area. Motor has Thermal Over-load protection, a 3-prong grounded plug and a stainless steel shaft. Spec.: 115 VAC; 360 gal./hr.; Self-priming: 8-10' vertically, 25' horizontally; Pulls water once pumping 20' vert. and 50' horiz.

13 K 33764 Shpg. wt., 8 lbs.Net 29.95

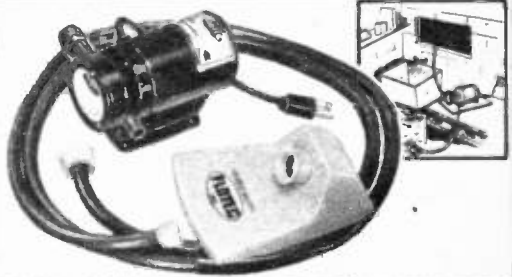

Black & Decker® SHRUB and GRASS EDGER/TRIMMERS

(A) DOUBLE-EDGED BLADE SHRUB AND HEDGE TRIMMER

- Large 13" Double-Edge Blade

17⁹⁹ (A)

Model 8114. Reciprocal blade action produces 3000 cutting strokes per min. Virtually vibration-free, with a sturdy up-front grip handle and comfortable rear handle that give steady, balanced control at any angle. 3-position safety switch lets you lock it "on" when operating and turn it "off" by releasing the trigger. Double-insulated, no ground wire needed. 117 VAC, 60 Hz. 2.2 amps

12 K 68721 Shpg. wt., 6 1/2 lbs.Net 17.99

(B) CORDLESS ELECTRIC GRASS SHEAR

14⁹⁹ (B)

Model 8280 cordless electric grass shear combines long blade life and extended cutting capacity to trim grass around trees and flower beds, under fences, and even for light trimming of shrubs. Features a ball-and-channel blade mechanism which improves operating efficiency and maintains proper tension on cutting edges for a "scissor like" cut. Locking switch on handle and paddle-type trigger switch combine to protect against accidental starting. 6000 cuts per minute from the six blade edges. Includes nickel cadmium batteries and charger. Durable high impact plastic housing. Shpg. wt., 2 3/4 lbs.

12 K 68796Net 14.99

12 K 68788 Blade Sharpener for above. Wt., 6 oz.Net 1.89

(C) DELUXE LAWN EDGER AND TRIMMER

(C) 39⁹⁹

Model 8220. Let this deluxe electric lawn edger and trimmer do all the hard work of edging and trimming for you! Sturdily made, it features two comfortable handles for sure control and large wheels for easy pushing. Pistol-grip On/Off trigger switch. Trenches an edge up to 3/4" wide on the first pass with its 1/2-HP burnout-protected motor. Has an 8" special winged blade that cuts with ease and keeps itself from clogging, and has a deflector for safer, cleaner operation. Easy-pull release knob allows you to convert from edging to trimming operation in a jiffy! Trim around flower beds, trees, fences, etc., without bending down—fast and easy. Motor speed: 8500 RPM. For 120 VAC, 6 amps. Shpg. wt., 18 1/4 lbs.

12 K 68770W No Money Down*Net 39.99

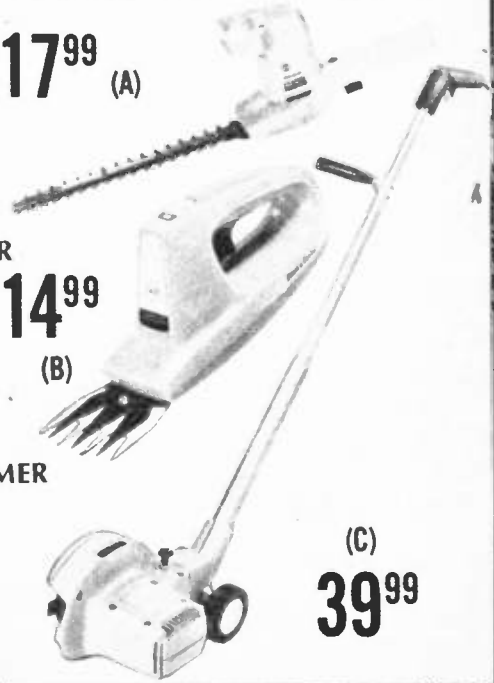

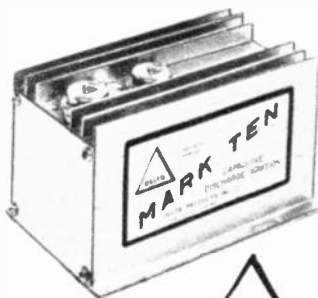

SAVE 5.00
SALE 34⁹⁵

DELTA MARK 10
CAPACITIVE DISCHARGE
IGNITION SYSTEM
With Silicon-Controlled Rectifier

- Constant Spark to 10,000 RPM
- Extremely Low Input Power
- Less Load on the Engine

MARK 10 WIRED. Combines all the advantages of capacitive discharge with those of solid-state circuitry. Eliminates point bounce problems and positively fires plugs regardless of point condition. Fast rise time prevents fouling; plugs last from three to ten times longer. Point contacts last indefinitely. Eliminates misfiring, reduces oil contaminants, prolongs engine life. Provides smoother and more efficient operation at all speeds; constant spark up to 10,000 RPM; with dramatically improved acceleration and economy. Provides faster, easier starting in all weather. Unit operates with all commercial and original tachometers. Installs immediately with two simple connections to the existing coil, leaving the standard system intact. No temperature limitations—mounts anywhere. Requires only a very small amount of input power—reduces load on engine and electrical load. For 12-volt negative ground systems only. Wt., 2½ lbs. **11 K 84506 No Money Down***Net 34.95



SAVE 3.00
SALE 16⁹⁵

JUDSON
ELECTRONIC IGNITION
SYSTEM

- Quick, Easy Installation
- Improves Performance and Gas Mileage

Install a Judson SEE/DEE Electronic Ignition System in your car. It provides the dependability and performance required for the modern high-speed engine. The current for the See/Dee system is completely controlled by a zener diode. It provides for a better and smoother running engine plus faster starting. In addition, point and plug life is extended and there is a reduction of ignition failure and tune-up requirements. Good for a 6- or 12-volt battery and single or dual point negative ground systems. Shpg. wt., 1 lb. **11 K 35516**Net 16.95

SAVE 3.00
SALE 16⁹⁵

3½"
HIGH PERFORMANCE
SOLID-STATE
TACHOMETER



Attractively-styled, easy-to-read, solid-state, 0-8000 RPM tachometer features a precision-jeweled D'Arsonval meter that assures steady and accurate readings. Includes adjustable shift indicator pointer. Self-contained, solid-state unit has Zener-stabilized circuitry, making the meter accurate to ±2%. Individually factory calibrated. Handsomely finished in chrome case with black trim; white RPM meter markings contrast on black satin illuminated dial. Easy-mount bracket. For all 4-, 6- or 8-cylinder engines; 12-volt positive or negative ground electrical systems. **11 K 36098 Shpg. wt., 1½ lbs.**Net 16.95



ELECTRIC
SPEED
CONTROL

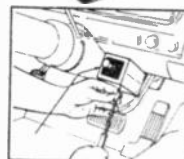

EASY TO
INSTALL
22⁵⁰

- Does Not Affect Braking or Instant Pick-up
- Sets Fast Idle for Quick Cold-Weather Warm-up
- Helps Adhere to Posted Speed Limits

An Electric Speed Control which enables you to drive at a constant speed over level surface by automatically holding the throttle steady. Eliminates the need to keep a foot glued on accelerator on long trips. Once you reach desired speed, simply pull out knob and the Speed Control will automatically hold that speed. Allows instant acceleration for passing but takes over again when the foot is taken off the gas pedal. Ceases to function the moment the brake pedal is depressed and completely disengages in the event of any malfunction. Designed to fit all cars and trucks.

11 K 59011 Shpg. wt., 2 lbs.Net 22.50

UNIVERSAL 6- AND 9-VOLT ADAPTER
FOR 12-VOLT CAR OR BOAT BATTERY

- Plugs into Cigarette Lighter
- Switch for 6 or 9 Volts

Provides 6 or 9 volts DC (to 300 mA) for operation of transistorized tape recorders, radios, etc. Five popular-size plugs and polarity change connector enable use with practically any set. Solid-state circuit provides constant, regulated supply of power. Shpg. wt., 6 oz. **11 K 41076**Net 6.50



GAS
SAVER
VACUUM
GAUGE

15⁹⁵



- Automatically Shows Miles Per Gallon
- Chrome Die Cast Case

DELUXE 3¼" TWIN VACUUM GAUGE. Automatically shows miles per gallon. Saves up to 40% of your gasoline dollars by showing you how to drive for the best economy or power. Checks your engine constantly by measuring its manifold pressure on a clear, four-color, illuminated dial. With universal mounting. Chrome-plated metal bezel with baked, black, wrinkle-case finish. One connector. 6 ft. vacuum tubing and instructions. Fits any car. Wt., 1¾ lbs. **11 K 42603**Net 15.95



6 1/2" DWELL TACHOMETER

- Tunes Up Electronically Any Car Ever Made
- Three Dwell Ranges
- Low & High Range Tach Scales

28⁹⁵

Made in U.S.A.

A complete, ready-to-use Dwell Meter and Tachometer which will operate on any car ever made. Tests cam Dwell angle and engine RPM on 4-, 6- or 8-cylinder cars, 6- or 12-volt, right on the engine. Giant 6 1/2" easy-to-read meter makes it simple for anyone to adjust points and carburetors to insure maximum gas economy and quiet engine-running. RPM readings are also essential to properly service automatic transmissions. Three dwell angle scales are provided: 0 to 45 degrees, 0 to 60 degrees, and 0 to 90 degrees. This instrument is suitable for dwell angle adjustment on all foreign and domestic cars. Dual range tachometer 0 to 1000 rpm for precise carburetor adjustments. 0 to 5000 rpm, suitable for making all other tests at high engine speeds. Complete with instruction manual. Wt., 3 1/2 lbs.

11 K 01013WNet 28.95

3 1/2" DWELL TACHOMETER

**SAVE
2.00
SALE
14⁹⁵**

Made in U.S.A.

- 3 1/2" Double Jeweled D'Arsonval Meter



Electronically tune your car! This Dwell Tachometer permits setting the carburetor for maximum efficiency, gas economy and greater power; indicates the correct point gap setting electrically (even if the points are pitted or corroded); permits setting points with the distributor cap off and engine cranking, and permits setting points on "Window" distributors with engine running. It also locates defective spark plugs; permits correct engine RPM setting for automatic transmission adjustments, throttle linkage and idle adjustment. RPM scale: 0-3000; 8-cylinder dwell: 5-45"; 6-cylinder dwell: 20-60". 4-cylinder reading obtained by doubling 8-cylinder scale reading. Two-color scale. Small and compact—measures only 6 1/4 x 3 3/4 x 2". For 6- or 12-Volt Systems. Complete with instruction manual.

11 K 01054 Shpg. wt., 1 1/2 lbs. Net 14.95

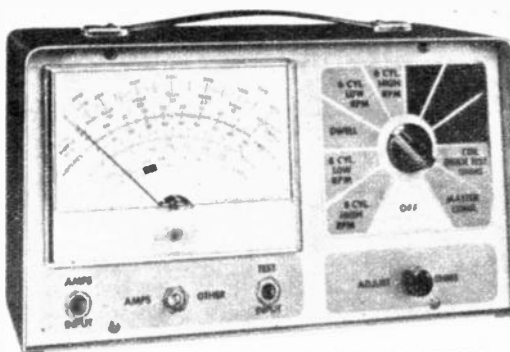

DELUXE SOLID-STATE ENGINE ANALYZER

For All Electrical Systems 6, 12, 24 or 32 Volt — Regular Transistorized or Magneto Ignition, 8, 6 or 4 Cylinder, 4 or 2 Cycle Engines.

- Large 6" D'Arsonval Double Jeweled Meter
- Tunes Up, Electronically, Any Car Made

Solid-State Engine Analyzer Will Test:

- Dwell or Cam Angle
- Measure Engine Speed
- Adjust Carburetors
- Adjust Points
- Check Condensers
- Check Coil Resistance
- Measure Carbon Suppressor Spark Plug Cable
- Check Batteries
- Test Alternators, Generators & Regulators
- Check Shorts & Opens in Wiring
- Checks All Lamps, Fuses, Relays & Switches
- Check Alternator Diodes

49⁹⁵

No Money Down*

Performs "FIFTEEN" authoritative tests under actual operating conditions; Tests output voltages in three separate ranges: 0-3.2, 0-16, 0-32 VDC. Determines the condition of batteries, battery cables, spark plug wires, coil wire, solenoids and starter motors. Permits precise setting of distributor points (cam-dwell angle) and tests centrifugal advance mechanism on three scales: 0-45" for 8-cylinder, 0-60" for 6-cylinder, and 0-90" for 4-cylinder. RPM scales allow precise setting of carburetor air/fuel mixture and engine RPM in four separate scales: 8- or 6-cylinder (low) 0-1,200, (high) 0-6000; 4-cylinder (low) 0-2400, (high) 0-12,000. Measures amps from -5 to +90. Resistance scale from 0-100,000 ohms. Operates on single "D" cell battery. Complete, simple operating instructions. Detailed information supplied by make and model. Rugged steel case finished in baked enamel. Rear storage compartment holds 5 1/2-ft. leads, clamps, plug jacks, probes and connectors. Size: 12 x 6 1/2 x 6". Wt., 7 3/4 lbs.

11 K 24502Net 49.95
99 K 63661 Battery for aboveNet 28

DELUXE AC OR DC POWER TIMING LIGHTS—KIT OR WIRED

- Ultra Brite Xenon Strobe Tube
- Heavy-Duty Wire and Grips

Ultra-bright Xenon timing lights, the ultimate in a mechanic's light. Special solid reflector design increases the useable light output for easy use, day or night. Plus—the light is shock-protected in a heat-resistant case that is not affected by oils or grease. The circuitry is fully transistorized, and is diode-protected against improper polarity. Heavy duty, extra long leads and contoured, balanced pistol grip case allow you to reach the most inaccessible timing marks with ease. Power is controlled by a professional trigger switch. The Xenon flashtube is easily replaceable. Shpg. wt., 2 lbs.

DC POWER TIMING LIGHTS

For 6- or 12-volt, positive or negative ground.
11 K 42611 WiredNet 22.95
11 K 42561 KitNet 16.95

AC POWER TIMING LIGHTS

For 110 VAC, 60 Hz.
11 K 42579 WiredNet 12.95
11 K 42587 KitNet 10.95

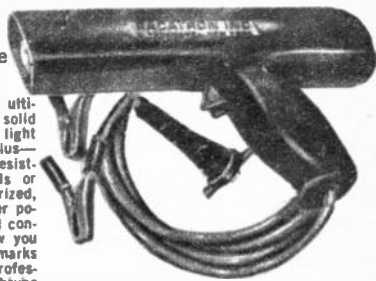

Take advantage of sales with Mastercharge and BankAmericard.

Lafayette Cat. No. 743 77

Automotive Accessories & Specialties



RADAR SENTRY

Warns of Traffic Zones

KIT **23⁹⁵** WIRED **31⁹⁵**

• Complete with Long-Life Mercury Batteries

• Rugged Printed Circuit
• Clips Easily on Sunvisor

RADAR ALERT WIRED. Miniature electronic detector gives an audible warning whenever it intercepts a radar beam. Dual-band circuit detects all commonly used police radar speed meters and traffic control devices, both vertically and horizontally polarized. Miniaturized and completely transistorized. Top-quality components; printed wiring; 8 transistors; two 1,000-hour mercury cell, self-testing batteries (equivalent to 35,000 miles of driving at 35 M.P.H.). Magnesium case eliminates radio, TV and other interference. Weighs only 13 oz., measures 3 3/8" x 2 1/4" x 3 1/4"; clips to sunvisor. Complete with batteries, sunvisor clip. Instructions included. Shpg. wt., 1 1/2 lbs.

11 K 42017 No Money Down. (See page 19 for full details)Net 31.95

RADAR ALERT KIT. Same as above in kit form.Net 23.95

11 K 42462

This item is not intended for resale in states where its use is forbidden in motor vehicles by public regulation.

PORTABLE HAND SPOTLIGHT

- 12-Volt, 35,000 Candle power Sealed Beam
- 9-Foot Cord with Plug
- All-chrome Die-cast Metal Housing



Plug-in portable spotlight is real "life-saver" in emergencies—provides dependable, instant, powerful light for safety in every night-driving need. Finger-grip handle with on/off switch permits easy direction of light beam. Flexible 9-foot cord; sealed beam; convenient hang-up hook; rich chrome plate on die-cast metal. Fits most cigarette lighter sockets. Wt., 2 lbs.

11 K 16250Net 5.50

5.50

ON-GUARD ELECTRONIC SIREN

VEHICLE BURGLAR ALARM SIREN

Featuring the Latest Sound Used by the Police, Fire, and Emergency Vehicles

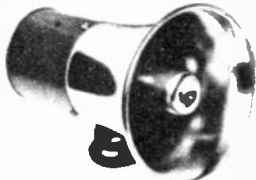

CUT 3.00
SALE
24⁸⁸

- Easy Installation, Installs in Less Than 15 Minutes
 - 100% Solid-State: Assures Maximum Reliability and Durability
- Use one of the most recent scientific techniques to protect your car, boat, camper or van. This vehicle burglar alarm uses advanced current sensing solid-state system. Installs easily. No need to wire switch to individual car doors; unit automatically senses any current drain caused by opening door, hood or trunk. Complete system includes: hood and trunk switches and brackets (for car without hood and trunk lights); electrical switch lock (factory wired); built-in dust cover; 2 keys; wire; mounting hardware; instructions; 2 warning decals. Shpg. wt., 3 lbs.

11 K 62536Net 24.88

Cut-off Timer With Automatic Reset

11 K 62520 Shpg. wt., 1/4 lb.Net 8.95

This item not intended for resale in States where its use is forbidden in motor vehicles by public regulation.

QUARTZ-IODINE FOG AND DRIVING LAMPS

11⁹⁵

- 200,000 Candle Power
- All Stainless Steel Slim-Line Case



High-power, long-life lamp gives life-saving illumination in poor weather, makes night driving safer and less tiring. Wide-angle, sharp cut-off fog lamp beam penetrates heavy fog. Driving lamp concentrates narrow beam for reaching far ahead of normal high beams. Stainless steel body. Sealed lens and reflector keeps out dirt and moisture. Fully adjustable mounting bracket. For 12V use. 5 7/8" diameter, 2 1/2" deep. Shpg. wt., 2 1/4 lbs.

Fog Lamp, amber fluted 11 K 82542Net 11.95

Driving Lamp, clear 11 K 82559Net 11.95

11 K 82567 Replacement BulbNet 3.95

11 K 82575 Switch & 10-ft. CableNet .99

"FIAMM" ELECTRO COMPRESSOR AIR HORN

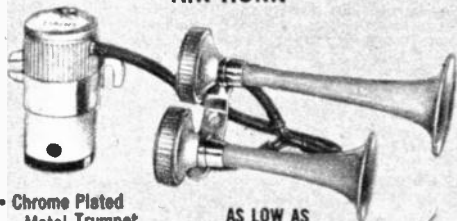

- Chrome Plated Metal Trumpet
- Range of 1/2 Mile
- Loud—Clear—Continental Tone

AS LOW AS
20⁹⁵

Model 32. Custom quality chromed trumpets with loud, clear, piercing, continental tone. Range up to 1/2 mile. Ideal for use on trucks, sports cars, emergency vehicles, buses, boats, etc. Compressor pumps air to trumpets instantly when horn is pressed—there's no waiting for pressure to build up. Supplied with Town and Country Selector Switch which enables use of original horns for city driving. Complete with: 2 horns (7" and 9"), compressor, fittings, horn relay, and all necessary hardware. For 12 volts only. From Italy.

11 K 82500 Shpg. wt., 4 1/2 lbs.*Net 23.95

Model 22. Same as above but trumpets are enameled die-cast metal

11 K 82518*Net 20.95

DELUXE AUTO AIR CONDITIONER FREON 12 RECHARGE KIT



4⁹⁵

- Special Safety Check Valve In Hose
- All Metal Parts

Your auto air conditioner may not be cooling properly due to lost refrigerant. Complete do-it-yourself kit will replace this loss. Designed for safety and easy use, it will service all auto air conditioners. Includes: a 15 ounce can of "Freon 12" Refrigerant; positive locking metal valve clamps, high pressure charging line with safety check valve. Simple to use, with instructions. Shpg. wt., 1 1/4 lbs.

11 K 85588Net 4.95

INVERTERS TO CONVERT POWER FOR SPECIAL NEEDS

TRIPP LITE 500-WATT SOLID-STATE INVERTER-CHARGER

129⁹⁵

No Money Down*

• Combination Power Inverter and Battery Charger

Model PV-500B. 500 watt inverter, 10 amp battery charger. Rugged, heavy-duty inverter with 500 watt continuous output, 550 watt intermittent. Battery charger rated at 10 amps. 10 power transistors. Will operate large color TV, 1/2" drills, or combinations of smaller tools and appliances. Fused, polarity reversal protected, with pilot light. 5 x 9 1/2 x 9". Shpg. wt., 19 3/4 lbs.

11 K 89562 Net 129.95

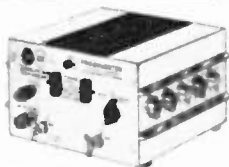

TRIPP LITE 150-WATT TRANSISTORIZED INVERTER

39⁹⁵

- Delivers 150 Watts Continuously
- Fused to Protect Battery
- Provides Household Current Anywhere

Model PV-150

A low-cost transistorized inverter which changes 12-volt DC to 115-volt 60 Hz AC. Delivers 150-watts continuously; 175-watts Intermittently for shavers, recorders, radios, TV and many other appliances. Has on-off switch and replaceable fuse. Rugged construction. Size: 5 x 5 x 3 1/2". Shpg. wt., 3 3/4 lbs.

11 K 89505 No Money Down* Net 39.95



TERA00 1000 WATTS CONVERTER

26⁹⁵

- Change 220 Volt AC To 110 Volt AC
- Ideal For Traveler

The TERA00 TRANS-VERTER is a heavy-duty power converter, designed for the traveler or permanent resident. This device changes foreign power to USA power. 220 Volts AC is converted to 110 Volts AC. The output is a true sine wave, single phase, and therefore can power any electrical device of up to 1000 watts, including refrigerators and television sets. Comes complete with 3 plugs for all European outlets. Size: 3 1/2 x 3 1/2 x 6". Shpg. wt., 8 1/2 lbs.

11 K 63302 Net 26.95

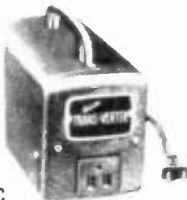

TRIPP LITE 350 WATT TRANSISTORIZED INVERTER

89⁹⁵

- Use It In Your Car, Boat, Trailer, Plane

Model PV-350. Converts 12-Volt D.C. current into 115-Volt A.C. Enables you to operate your house appliances and tools in your car, trailer, boat, plane, etc. Delivers 350 watts continuously, 385 intermittently. 8 power transistor circuitry for power boost. Advanced design has no moving parts to wear out. Inverter puts less strain on your battery, allowing your tool or appliance to do a quicker, better job. Mounts easily on any flat surface. Size: 3 1/2" H x 6 1/2" W x 9" D. Shpg. wt., 13 lbs.

11 K 89570W No Money Down* Net 89.95



SAVE \$2 to \$4 on DELUXE LAFAYETTE MULTITESTERS

LAFAYETTE "LAB TYPE" 20,000 OHMS PER VOLT MULTITESTER

SALE

14⁹⁵

WAS

16.95

Quantities Limited



CUT 2.00

- Self-Supporting • Burnout Protected
- Mirror Scale • 1% Precision Resistors
- 40 Microampere Meter Movement

Especially designed for ease of handling. Has every needed range and mirror scale for precise readings. 40 μ A meter movement permits a high input resistance on all ranges. Has a single range/function control plus zero ohms adjust. With batteries and test leads. SPECIFICATIONS: Sensitivity: 20,000 ohms/volt DC; 10,000 ohms/volt AC. Ranges: DC Volts: 0.6, 6, 30, 120, 600, 1200; AC Volts: 0.6, 30, 120, 600, 1200. Resistance: 0-10K, 100K, 1M, 10 Megohms. Current: 0-60 μ A, 0.6, 60, 600 ma. DB: -20 to +63. Capacity: 200 mmf to 0.2 mfd. Size: 7W x 4H x 2 1/2"D. Imported. Shpg. wt., 1 1/2 lbs.

99 K 50825 Net 14.95

LAFAYETTE "LAB TYPE" 30,000 OHMS PER VOLT MULTITESTER

SALE

18⁹⁵

WAS

22.95

Quantities Limited

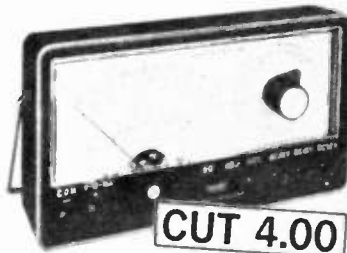

CUT 4.00

- Self-Supporting • Burnout Protected
- Mirror Scale • Buzzer for Short Tests
- Low Voltage Scale for Transistors

Deluxe VOM with easy-to-read 2-color calibrations and mirror scale. Built-in overload protective circuitry. Sensitivity is 30,000 ohms-per-volt DC and 15,000 ohms-per-volt AC. 1% precision resistors. Sensitive 33 μ A meter. Self-contained buzzer for fast in-circuit checks on opens and shorts. Audio output jack. AC Volts: 0-2.5, 10, 25, 100, 250, 500, 1000. DC Volts: 0-25, 1, 2.5, 10, 25, 100, 250, 500, 1000. DC Current: 0-0.5, 5, 50, 500 ma; 0-12 Amps. Ohms: 0.6k, 0-60k, 6M, 60 Meg. DB: -20 to +56. Dustproof plastic case. With leads and batteries. Size: 7W x 4H x 2 1/2"D. Imported. Shpg. wt., 1 1/2 lbs.

99 K 50817 Net 18.95

Charge it with BankAmericard or Mastercharge!

Lafayette Cat. No. 743 79

Be Secure—Protect Yourself With Our Burglar/Fire Alarms



FC-100 CONTROL CENTER



8-INCH BELL



EMERGENCY BUTTONS

Only

129⁹⁵

No Money Down*



SYSTEM INCLUDES

- Eico FC-100 Control Center
- Automatic Battery/AC Supply
- 8-inch Indoor/Outdoor Bell
- Key Switch with Indicator
- Remote Switch with Lamp
- 2 Emergency "Panic" Buttons
- Three 135° Fire/Heat Sensors
- Four Mag. Intrusion Switches
- Door Cords & Tamper Switches
- Decals, 250' Wire, Handbook



3 - FIRE/HEAT SENSORS



4 - MAGNETIC SWITCHES



HOOK-UP WIRE



KEY SWITCH



2 DOOR CORDS

Model SS-500 Security System has been expressly designed for the do-it-yourself installer. No soldering, special tools or skills are required. Supplied with one key and one remote station control, the FC-100 master accepts up to nine remote "on-off" stations. Master incorporates two indicator lights; a white circuit test light and a red alarm "on" light. 4 door/window magnetic switches, 2 door cords and tamper switches provide basic protection for the average home, apartment, or small business. Fire/heat sensors will sound optional separate fire klaxon horn. Panic buttons over-ride all other sensors. System automatically changes from 117 volts AC to battery power when AC current fails. 34 page handbook provides complete easy-to-follow installation procedures. Supplied less battery. Shpg. wt., 16 lbs.†

14 K 33507WNet 129.95

EICO MODEL FC-100 SECURITY CENTER ONLY

Start Your Custom Burglar/Fire Alarm System†

14 K 33580 Shpg. wt., 6 lbs.Net 69.95

ACCESSORIES FOR MODEL FC-100 AND SS-500

Entrance Key Switch with Signal Light. Shpg. wt., 1 lb.

14 K 33572Net 9.95

Additional Remote Station Control with Indicator Lamps

14 K 33549Net 3.25

100 Feet of 2-Conductor 20-Gauge Wire

14 K 13624Net 3.95

Stand-by 6-Volt Battery (1 req.)

32 K 48705 Shpg. wt., 3¼ lbs.Net 2.47

On-Guard COMPLETE SOLID-STATE BURGLAR ALARM SYSTEM

49⁹⁵

- Heavy-Duty Tamper-Proof Steel Weatherproof Box
- For Homes, Offices, Plants, etc.



Guards windows, doors or other entry points by sounding an extra loud 8" bell, upon intrusion. Self contained battery, bell, and master circuit are housed in a durable weatherproof grey hammetone box that has a built-in tampering protection circuit. Clipping wires or opening the outer box, as well as entering the protected windows or doors will sound the alarm. Sound continues until you turn it off by way of a dust proof key lock switch. Includes four sets of magnetic switches. Features key switch to permit exit and re-entry without sounding alarm. Panic button, which also operates as a test button, may be used to manually indicate an emergency. Operates on a standard 12-volt lantern battery, not supplied. Includes instructions, decal, 2 keys, 100 feet of wire. Shpg. wt., 13½ lbs.†

14 K 13558W No Money DownNet 49.95
14 K 13624 100 Feet of Additional Wire. Wt., 3 lbs. Net 3.95
32 K 47772 12-Volt Battery for above. Wt., ¾ lb.Net 2.84

DELUXE ULTRASONIC INTRUSION ALARM

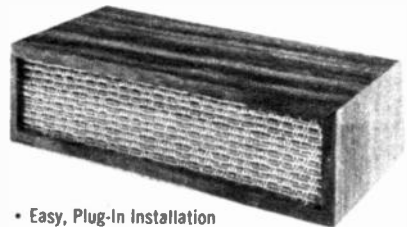

SAVE
10.00
SALE
69⁹⁵

- Easy, Plug-In Installation
- Can Be Used With Smoke And Fire Detectors
- Activates Lamps, Bells, Sirens

Invisible ultrasonic waves from this unit blanket any area of up to 300 sq. ft. Movement within this area will trigger any device plugged into the alarm, up to 5 amps. Accessory terminals permit the connection of sensors for smoke, fire, etc., to make this unit a complete warning system. After turning on the unit, a 30 sec. delay permits you to leave without setting off the alarm. Upon entering the protected area, alarm may be set to go off either immediately, or after a 20 second delay to give you time to shut off the system. After sounding the alerting device, the alarm recycles to the sensing mode to detect further motion. For 117VAC. 60 Hz. Size: 10½ x 3 x 5½". Shpg. wt., 4 lbs. †

14 K 11503 No Money DownNet 69.95
99 K 90235 3½" Bell for above. Shpg. wt., 1 lb.Net 3.98
12 K 39011 6-Foot Line CordNet .39

110-VOLT POLICE-TYPE SIREN

Features spun aluminum trumpet with heavy-duty motor and mounting bracket. For 110 VAC, 50/60 Hz. Size: 5¼ x 8" L. Wt., 4¼ lbs.†

14 K 13574Net 16.95

SECURITY SWITCHES FOR CLOSED CIRCUIT ALARM SYSTEMS

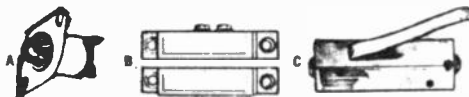

A) DOOR/WINDOW SECURITY SWITCH. For flush mounting in door and double-hung wooden window frames. Need not be mortised, fits ¾" hole. For closed circuit systems. Shpg. wt., 4 oz.

14 K 13665Net 1.70

B) MAGNETIC DOOR/WINDOW SECURITY SWITCH. 2-sets of switches and magnets. For use where surface mounting is necessary. For closed circuit systems. Shpg. wt., 4 oz.

14 K 13657Net 3.99

C) GENERAL PURPOSE WINDOW SECURITY SWITCH. Surface mount fits all windows. Ideal for sliding windows and screens. For closed circuit systems. Shpg. wt., 4 oz.

14 K 13673Net 1.60

†Check Your Local Ordinances Regulating Use of Alarms.

DELUXE 7x35 WIDE-ANGLE BINOCULARS

SALE! 34⁹⁵

CUT 5.00

- 578 Ft. Field of View at 1000 Yards
- Exceptional Quality
- Oversize Oculars

A multi-purpose, precise 7x35mm binocular that is particularly adept for field studies. Wide-angle hard coated prisms permit brilliant and close-up details of sporting events, without sacrificing the image, as is the case with regular narrow angle binoculars. Field of view at 1000 yards is 578 feet! Center focus and right eye adjustment insure perfect focus. All optics are sealed against moisture and are properly collimated and aligned. Hard lined case for protective storage when not in use. Complete with neck strap. Imported. Shpg. wt., 3 lbs.

99 K 70195 No Money Down*Net 34.95

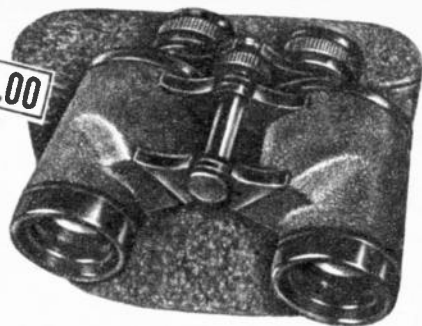

VERSATILE BINOCULARS

As Low As **26⁵⁰**

All lenses are hard coated. All are center focus with adjustable right eyepiece. Hard-lined case and neckstraps.

7x35 POPULAR, VERSATILE, ALL-PURPOSE BINOCULARS. For the sportsman—hunter—bird watcher—vacationer. High luminosity. Compact design. Field of view 367' at 1000 yards. Imported.

99 K 70167 Shpg. wt., 2 3/4 lbs.Net 26.50

7x50 NAVY STYLE NIGHT GLASSES. Favored for marine use. The choice of professionals because of exceptionally high light gathering power. Superior image brightness. Field of view 372' at 1000 yards. Imported.

99 K 70161 Shpg. wt., 3 3/4 lbs. No Money Down*Net 38.25

20x50 KING OF THE LONG RANGE. Hunters, mountain climbers, plane spotters, forest rangers—any long-distance viewing and observation requirement. Field of view 157' at 1000 yards. Imported.

99 K 70203 Shpg. wt., 3 3/4 lbs. No Money Down*Net 43.25



MAGNA SIGHT-MASTER 3-D BINOCULAR MAGNIFIER

As Low As **4⁹⁵**

- Leaves Hands Free
- 3-Dimensional
- Reduces Eyestrain
- Can be Worn With or Without Glasses

A precision optical instrument enabling anyone to do very close work and see it clearly in 3 dimensions. Adjusts to any head size comfortably. No moving parts to replace. Ideal for hobbyists, repairmen, inspectors and technicians. Available in 4 sizes. Imported. Shpg. wt., 9 oz.

15 K 20055 1.75X, 14" Working DistanceNet 4.95

15 K 20063 2.25X, 10" Working DistanceNet 4.95

15 K 20071 2.75X, 8" Working DistanceNet 5.75

15 K 20089 3.5X, 4" Working DistanceNet 6.50

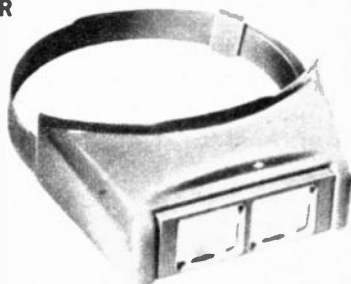

LAFAYETTE 8 x 24 MINI-SCOPE

17⁹⁵



- Includes 6X Super Wide Angle (11°) Objective

Versatile, precision pocket telescope provides powerful 8-power optics. Ideal for travel, hiking, nature study or sports. 24mm coated lens provides 435 ft. viewing area. 18mm lens 575 ft. at 1000 yds. With zippered case, wrist strap. Imported. Wt., 10 oz.

99 K 72159Net 17.95

600X MICROSCOPE SET

SALE! 749

Quantities Limited

- With Sub-Stage Light
- 75X - 300X - 600X
- Triple Revolving Turret

For the student—hobbyist—or budding scientist! Features built-in sub-stage light and three achromatic objective lenses giving magnification of 75X, 300X and 600X. Complete with 3 glass slides, 5-piece dissecting set and hardwood cabinet. All metal. Less batteries. Imported. Shpg wt., 2 1/2 lbs.

15 K 64020Net 7.49

99 K 62580 "AA" Batteries (2 req.)Net ea. .14





You Save When You Buy This Power Zoom Movie Outfit



FEATURING DUAL 8 ZOOM PROJECTOR

Only **174⁹⁵**

- ZOOM CAMERA FEATURES**
- 3-1 Power Zoom & Reflex Viewing
 - Thru-the-Lens CdS Electric Eye
 - Drop-in Film Cartridge Loading • ASA 25-160

Outfit includes everything you need for movie making and showing fun. Deluxe super 8 power zoom reflex camera features thru-the-lens CdS automatic exposure control, fast f/1.8 3-to-1 manual or power zoom, insufficient light indicator, electric film drive, built-in type A filter, focusing eyepiece, and drop-in loading. Fully automatic 500 watt brilliance dual 8 projector has f/1.5 zoom lens, automatic reel-to-reel thru gate threading, single knob control for forward, reverse, still, fast forward and automatic rapid rewind. 400 foot capacity

- ZOOM PROJECTOR FEATURES**
- Dual—For Both Super and Regular 8
 - Automatic Reel-to-Reel Threading
 - 400 Foot Film Reel Capacity

projector includes self-contained case, film trimmer and room light outlet. Outfit also includes camera case, roll of GAF color movie film with processing, 650 watt sealed beam movie light, batteries, and "Guide To Better Home Movie" book. Shpg. wt., 20 lbs.

15 K 78228W No Money Down*Net 174.95

15 K 78236L Camera Only. Shpg. wt., 2½ lbs.Net 88.00
15 K 78244W Projector Only. Shpg. wt., 11 lbs.Net 84.00

DeJUR Deluxe Dual 8mm Zoom Projector for Both Super and Standard 8

109⁹⁵

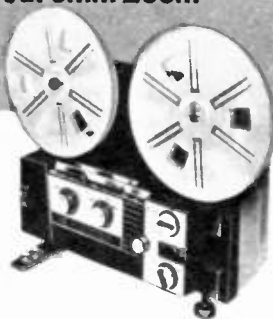

- A Movie Projector That Thinks It's A Slide Projector
- Slow Motion Plus Variable Speed

Eldorado 888AZ movie projector with the advanced features of variable speed control, true slow motion and forward or reverse projection, 100% illumination for extended "still" projection and cool, quiet operation. With sturdy diecast aluminum case, 400 ft. reel capacity, built-in automatic room light receptacle, automatic reel-to-reel threading, fast rewind, built-in film trimmer lifetime lubrication and self enclosed carrying case with handle. Sharp f/1.5 zoom lens for excellent sharpness. For 117 VAC, 60 Hz. Shpg. wt., 10 lbs.

15 K 52140W No Money Down*Net 109.95
CITATION 850AZ. Similar to above less slow motion and room light receptacle. Shpg. wt., 10½ lbs.

15 K 52165WNet 89.95

650 Watt Movie Light

- Head Tilts for Bounce Lighting
- For All Super-8 Cameras

Shoot brilliant movies indoors. Long life, 650 watt quartz-halogen movie light for maximum output. Small, all metal unbreakable housing with built-in on/off switch. UL listed. With 6¼ ft. cord. Shpg. wt., 1 lb.

15 K 68005Net 13.50



argus/cosina Power Zoom Super 8 Movie Cameras

4-1 ZOOM

138⁰⁰

8-1 ZOOM

199⁹⁵

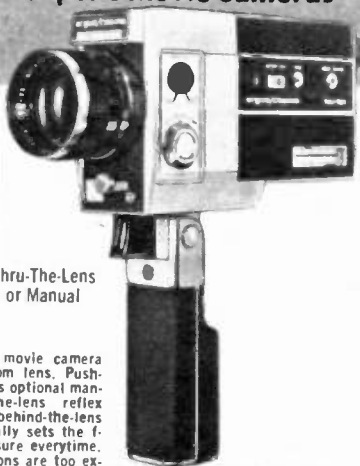

- Fully Automatic Thru-The-Lens CdS Electric Eye or Manual Override
- Three Speeds

Model 704. Super 8 movie camera with f/1.8 power zoom lens. Push-button power zoom has optional manual control. Thru-the-lens reflex viewing. Automatic behind-the-lens CdS meter automatically sets the f-stop for perfect exposure everytime. When lighting conditions are too extreme, an exposure warning signal appears in the viewfinder. The metering system has a manual override for use in unusual situations, and is powered by a mercury battery, included. The metering system can handle film speeds (ASA) of between 25 and 160. Eyepiece has adjustable diopter control. Three filming speeds—12, 18, and 24 frames per second, plus single frame advance. Lock-run switch. Built-in battery tester. Automatic film footage counter. Built-in type A filter. Foldaway pistol grip. Shpg. wt., 2¼ lbs.

15 K 34577L No Money Down*Net 138.00
99 K 63703 Batteries for above (4 req.)Net ea. .18

Model 708. Similar to above, except f/1.7 8-1 power zoom lens, and microprism rangefinder focusing. Shpg. wt., 2¼ lbs.

15 K 34585L No Money Down*Net 199.95
99 K 63703 Batteries for above (4 req.)Net ea. .18

MIRANDA AUTO

"SENSOREX EE"
35MM SLR

259⁹⁵

With Case

- Automatic Through-the-Lens CdS Meter
- Spot and Averaging Meter



Designed to provide the creative flexibility demanded by professional photographers yet have the operational simplicity needed by the novice. Fully automatic or manual Miranda Sensorex EE offers a host of refined useful features including a built-in CdS exposure circuit which automatically selects the correct lens opening for either average or spot lighting conditions. Sharp 50mm f/1.8 4 group, 6 element lens delivers superb resolving power. Features include an interchangeable pentaprism viewfinder, universal bayonet lens mount, variable delay self-timer, depth of field preview, focusing down to 17", and FP + X synchronized hot shoe. Focal Plane shutter speeds: B, 1-1/1,000 sec. EE coupling range: EV3-18, ASA 25-1600. Imported.

15 K 37588L No Money Down*. Shpg. wt., 4 lbs. ...Net 259.95

YASHICA TL-ELECTRO 35MM SLR

199⁹⁵

with case

- Electronic Exposure Readout
- Shutter Speeds Continuously Variable from 1 to 1/1000 sec.



Versatile, automatic SLR camera assures correct exposure setting at all times. Utilizes a positive signal lamp, visible through the viewfinder, and operated by an electronic integrated circuit coupled to precision CdS sensors. Features shutter speeds from 1-1/1000 sec.; ASA 12-1600; microprism focusing; through-the-lens viewfinder for depth-of-field analysis; Automatic FP-X sync. and built-in self timer 50MM F/2 AUTO YASHINON-DS lens with interchangeable screw-thread mounting. Exposure control switch for manual operation. With batteries, semi-hard case and shoulder strap. Imported. Wt., 3 lbs. 15 K 36861L No Money Down*Net 199.95

Extra Mercury Batteries (Mallory-RM640)Net 1.26
32 K 46675 Package of TwoNet 1.26

YASHICA ELECTRO-35 GS 35MM

109⁹⁵

With Case

- Sensitive CdS Sensor
- Electronic Exposure Control: 30 Sec. to 1/500 Sec.



MODEL ELECTRO-35GS. Advanced 35mm rangefinder camera with the "electronic brain". Sensitive solid-state circuit reads the existing lighting conditions and automatically sets the proper shutter speed at a preselected aperture. Continuously variable range of shutter speeds from 30 sec. to 1/500 sec. For maximum reliability when shooting flash, contacts are finished in gold providing very low resistance and long life. Also features coupled range/viewfinder focusing with automatic parallax correction, built-in self timer shutter release lock, accessory shoe for flash or other accessories, battery checker. ASA: 12-500, X sync. Sharp f/1.7, 45mm color corrected lens. Imported. Shpg. wt., 3 lbs.

15 K 36754L No Money Down*Net 109.95

LAFAYETTE ELECTRONIC STROBE FLASH

cut
3⁰⁰
Sale
10⁹⁵

- Fully Transistorized
- Use Horizontally Or Vertically

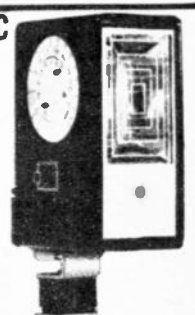

Lightweight strobe weighs under 7 oz. Small size: 3¼ x 2¼ x 1¾". Hot shoe adapter allows vertical or horizontal use. Recycles in 7-10 seconds on 2 easily replaceable penlight batteries. Kodachrome II (ASA 25) guide number 28. Flash duration 1/2000 sec. Color temperature 6000°K. On/Off switch to prolong battery life. Neon lamp. Built-in PC cord. Imported. Shpg. wt., ¼ lb. 99 K 71120Net 10.95

"A" Alkaline Batteries for above (2 req.)Net ea. .45
99 K 63820Net ea. .45
Strobe Adapter for Kodak Pocket Instamatic Cameras. Models 20, 30, and 40. Shpg. wt., 8 oz. 15 K 37770Net 4.95

AIREQUIPT REMOTE CONTROL SLIDE PROJECTOR

- With Circular Magazine For 100 Slides
- Remote Control Forward/Reverse and Micro Focus

Model 135. Fully remote controlled, jam-proof projector with a sharp 4" color-corrected lens and a 500-watt lamp for brilliant screen viewing. Features a highly efficient blower for cool, quiet operation, slide preheat to insure immediate focus, elevation control, 3-way on/off switch, panel focus control, remote control for forward/reverse and micro-focus. Smartly designed, self-contained, unbreakable case. Complete with circular slide magazine. Shpg. wt., 12 lbs. 15 K 36473WNet 49.95

100-Slide Circular Magazine
15 K 36481 Shpg. wt., 1½ lbs.Net 2.95
36-Slide Metal Magazine
15 K 36499 Shpg. wt., ½ lbs.Net 2.49

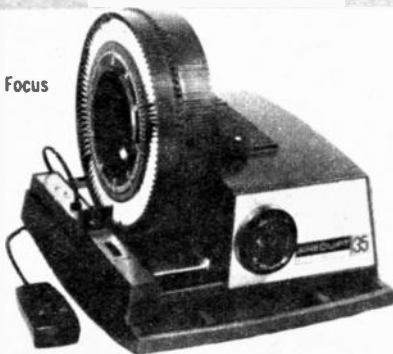

Save

10⁰⁰

Sale

49⁹⁵

No Money Down*

Make your shopping easier with BunkAmericard and Mastercharge.



POCKET INSTAMATIC CAMERA OUTFITS



As Low As **32⁹⁵**

- Includes Camera with Wriststrap, C-110-12 Color Film, 1 Magicube and Extender

Model 20 Outfit—Easy to use pocket size camera. Features drop-in loading with new 110 size cartridge, 25mm 3-element f/9.5 color corrected LUMENIZED lens with shutter speeds of (1/100-1/40) sec. for sharp, clear B & W, color prints, and slides. Fast, easy two stroke film advance, double exposure safety, built-in sliding lens cover, and tripod socket. Uses self-powered Magicube flashcubes with automatic cube rotation and "Used lamp" warning signal. Outfit: camera strap, C-110 Color Film, and 1 Magicube extender. Size: 2½x5x1".
15 K 26391L Shpg. wt., 1 lb. Net 32.95

Model 30 Outfit—Same as above except Electronic eye and shutter speeds of (1/160-5) sec. Size: 2½ x 5 x 1" Shpg. wt., 1 lb.
15 K 26409L No Money Down* Net 52.50

EVERFLASH INSTANT-LOAD CAMERAS

As Low As **35⁹⁵**

- With Built-in Electronic Strobe Light
- The Flash Camera That Never Needs Flashcubes



Model 10

Model 10. Features a built-in electronic flash in an easy-to-operate compact instant-load cartridge camera. No need to carry flashcubes. Up to 100 flash shots per set of batteries. "Ready Light" indicator tells you that the next flash shot is ready, 1/1000th second flash speed for "stop action" photography. Bright optical viewfinder and color-corrected 3-element Triplet glass lens. Uses 126 cartridge film. Wrist strap included. Shpg. wt., 2 lbs.

15 K 84176L No Money Down* Net 35.95
89 K 63703 Batteries for above (2 required) Net .18

DELUXE EVERFLASH MODEL 30

Model 30. Exposure setting is automatically controlled by an electric eye, permitting rapid shooting under varying light conditions. Built-in electronic strobe light and rechargeable nicad batteries. Flash-test button tells you when flash is ready and checks batteries. Color corrected f/5.6 Triplet glass lens. Uses 126 cartridge film.

15 K 84184L Shpg. wt., 2½ lbs. No Money Down* Net 56.50

INSTA-LOAD CAMERA OUTFIT



SALE 5⁸⁸

- Just Drop in Film and Snap Away

Instant loading lightweight cartridge camera that's perfect for recording your family fun. Simple to use... just drop in a Kodak 126 cartridge, close the back and snap excellent color or black and white pictures. Choose from slides or prints. No focusing, no settings. Flashcube automatically rotated and synchronized with each shot. Precision lens. Outfit includes Kodak color film cartridge, batteries and flashcube. Shpg. wt., 1½ lbs.
16 K 15501 Net 5.88

ELECTRICAL DIGITAL ALARM CLOCK

As Low As **14⁹⁵**



- 24 Hour Alarm Setting

Electric digital time in a clean, functionally styled alarm clock. The exact time is easily read at a glance on the large graphic numerals. Precision engineered 24-hour alarm system distinguishes between AM and PM to determine alarm setting. Alarm shutoff is conveniently located on top of cabinet. Soft, glare-free illumination makes it ideal for bedside, or atop TV. Self-starting synchronous motor for high accuracy and silent, dependable service. Rosewood finish cabinet. Size: 2¾Hx3¾Dx6"W. For 117 VAC, 60 Hz. Imported. Wt., 1½ lbs.
13 K 16538 Net 15.95
13 K 16520 Charcoal Grey Cabinet Net 14.95
13 K 16512 White Cabinet Net 14.95

LAFAYETTE TECHNI-TIMER II



ONLY 7⁹⁵

- Handles Up To 1875 Watts
- Turn Lights & Appliances On & Off Automatically
- Discourage prowlers with lights

Techni-Timer II makes practically everything electrical automatic. Turns radios on and off. Does not have to be reset each night. Defrosts refrigerator, controls roaster, electric blankets, fans, coffee makers, phonographs, etc. Turns your home lights on and off automatically while you're away. Repeats cycle every 24 hours—no need to reset. Minimum ON time ½ hour. Maximum ON time 22¾ hours. Easy-to-read 24-hour dial. Can be set to skip days and can be controlled manually without automatic reset. Attractive beige cabinet with walnut trim. Includes cord, plug and receptacle for equipment to be controlled. 2¾ x 3¾ x 1¼". Capacity 15 amps, 1875 watts, 125V, 60 Hz. UL listed. Shpg. wt., 1¾ lbs.

13 K 01803 Net ea. 7.95

LAFAYETTE PLUG-IN 24 HOUR TIMER



Automatically Turns Lights On and Off When You Are Away

ONLY 5⁹⁵

- Handles Up To 1500 Watts
- Gives Your Home A "Lived-in" Look...
- Discourages Prowlers

A compact cordless convenience... plugs directly into wall socket. Finger-tip control allows you to set and forget it. Once desired "on and off" times are set, plug in lamp, radio, or fan, etc.—up to 1500 Watts and the automatic timer takes over. Resets automatically. Maximum "on" time—21½ hours; minimum "on" times—2½ hours. Capacity: 12 amps, 1500 watts, 125 VAC. UL listed. Size: 2¾ x 3¾". Shpg. wt., 1 lb.

13 K 01738 Net 5.95

Specialty Swiss Watches Under \$20.00

DIGITAL WRIST WATCH



SAVE
2.00

SALE
14⁹⁵

Man's digital watch shows hours and minutes in large, easy-to-read numerals. Great for anyone who must account for time at a glance! Precision, shock-resistant anti-magnetic Swiss movement has unbreakable mainspring. Brushed gold-tone finish case with genuine lizard strap. Imported. Shpg. wt., 14 oz.

13 K 31520LNet 14.95

SPORTSMAN'S CALENDAR WATCH With World Timer



SAVE
2.00
SALE
11⁵⁰

An Underwater
Watch That Indicates
Elapsed Diving Time

The completely waterproof watch and strap are perfect for the fisherman, diver, etc. The hermetically sealed, pressurized case provides maximum protection to 5 atmospheres. The moveable outer bezel lets you know the time in 12 major world cities. Also features an automatic daily calendar and sweep second hand. Hour markers and hands are luminous. With anti-magnetic movement and unbreakable mainspring. Polished chrome case, stainless steel back. Imported.

13 K 31487L Shpg. wt., 7 oz.Net 11.50

DOUBLE BUTTON CHRONOGRAPH WATCH



19⁹⁵

Swiss-made chronograph performs 5 functions in addition to telling time: tachometer for measuring speed, telemeter for measuring distance of sound, elapsed timer, parking meter timer, and a stop-watch with a 30-minute register. Shock and water-resistant anti-magnetic movement has unbreakable mainspring. Imported. Shpg. wt., 13 oz.

13 K 31511LNet 19.95

WRIST ALARM WATCH



17⁹⁵

Swiss-made alarm watch won't let you forget appointments, parking meters, cooking, etc. Dial features sweep second hand on attractive face with gilt numerals and markings. Shock-resistant, anti-magnetic movement has unbreakable mainspring. Gold-tone case with stainless steel back and genuine lizard strap. Imported. Shpg. wt., 8 oz.

13 K 31545LNet 17.95

PRECISION SWISS STOP WATCHES



AS
Low
As
15⁹⁵

1/10 SECOND TIMER

Designed for close timing. Large hand registers 1/10 of a second, up to 30 seconds; small hand reads minutes, up to 15. Start, stop, and continue from crown; instant zero. 7 jewel movement. Chromium plated case. Imported. Shpg. wt., 6 oz.

13 K 31032LNet 16.95

Same as above, except 1 jewel.
13 K 31024L Wt., 6 oz.Net 15.95

- Accurate Jeweled Movements
- Unbreakable Main Spring
- Anti-Magnetic Hair Spring

1/5 SECOND TIMER

Second hand registers 1/5 of a second and completes turn in 60 seconds. Small hand indicates up to 30 minutes. Side slide starts and stops hands. Fast resetting, dependable 7-jewel movement. Imported. Shpg. wt., 6 oz.

13 K 31040LNet 16.95

Same as above, except 1 jewel.
13 K 31057L Wt., 6 oz.Net 15.95



HIGH INTENSITY DESK LAMP FOR EVERYONE, FOR EVERY ROOM



SALE
4⁹⁵

- Hi-Lo-Off Selector Switch
- Adjustable Arm and Shade

This beautiful modern lamp with adjustable arm and shade can be used as a desk lamp, T.V. light, night light or wall lamp. 12" height. Hi-intensity bulb is included. 117 VAC, 60 Hz. Imported. Shpg. wt., 1½ lbs.
12 K 52527Net 4.95
32 K 66846 Replacement BulbNet .43

FLOURESCENT MAGNIFYING LAMP FOR PRECISION WORK



KIT
23⁹⁵
ASSEMBLED
32⁹⁵
No Money Down*

A 5" diameter magnifying glass with a powerful 13" focus, surrounded by a 22-watt, shadow-free fluorescent tube, makes this lamp ideal for assembly, laboratory, quality control and other detail work. The 45" reach arm permits complete directional mobility—special adjustment knobs insure the proper tension and steadiness for any desired position. In kit or assembled form. Shpg. wt., 7 lbs.

12 K 69521W Kit, less bulbNet 23.95
12 K 69539W Assembled, less bulbNet 32.95
Model T9, 22-watt, cool, white bulb. Shpg. wt, 11 oz
12 K 75015Net ea. 4.20

TURN APPLIANCES ON AND OFF BY REMOTE CONTROL



Only **14⁹⁵**

- The Amazing Electro-Sonic Switch That Turns Anything Electrical On or Off

Let "Ultrasonic Control" do the work. Turns radios, televisions, Hi-Fi Lamps, outdoor light, On or Off while you relax in your chair or bed. No need to walk in darkness... Turn on lights in a different room before you get there. Just blow the whistle and appliance immediately goes On or Off. The Ultrasonic Control is plugged into any standard household outlet, then electrical appliance is plugged into the Ultrasonic Control. Nothing further is required. Complete with bulb whistle. 300-watt capacity. For 117 VAC, 60 Hz. Shpg. wt., 1 lb.
12 K 78522Net 14.95
Extra Bulb Whistle for above. Shpg. wt., 3 oz.
12 K 78530Net 1.18

THE BURGESS CITATION GIVES BRIGHT FLOURESCENT LIGHT ANYWHERE!

14⁹⁵

WITH BATTERY

- Ideal for Car—Home—Camping—Boating



Bright, wide-angle, shadow-free, fluorescent light. Rugged, lightweight, modern design—easy to carry anywhere. Powered by a safe, heavy-duty, 12-volt battery (included).

13 K 80583 Shpg. wt., 5½ lbs.Net 14.95
Replacement battery for above. Shpg. wt., 3½ lbs.
32 K 39076Net 3.12

CONTROL OUTDOOR LIGHTS AUTOMATICALLY



4⁵⁰

- Turns Lights On At Dusk/Off At Dawn Automatically
- Easily Screws Into Fixture Socket

Helps prevent burglary... vandalism... accident by turning on all your outdoor lights at home, store, office, factory, signs, etc. Screws into any standard or floodlight socket. Compact, requires little additional clearance in fixture. Weather resistant. 300 watts. U.L. listed. Imported.
12 K 46503 Shpg. wt., ½ lb.Net 4.50

600-WATT LIGHT DIMMER CONTROL

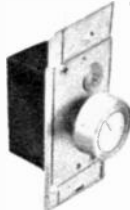

3⁹⁵

- Continuous Light Control from Dim to Full Brightness
- Rotary On/Off Switch

Convenient on/off dimmer control for use in living room, dining room, bedroom, family room, etc. Soft lighting for TV viewing and relaxing. Bright light for reading and working. Easy to install in any standard wall box without complicated rewiring. Operates incandescent lamps to 600-watt capacity. Ivory plastic knob with brass finish insert. For 117 VAC, 60 Hz. Shpg. wt., ½ lb.
12 K 26513Net 3.95

ADD 6 CONVENIENCE OUTLETS ANYWHERE

5²⁵

- 6 Fused Outlets Anywhere

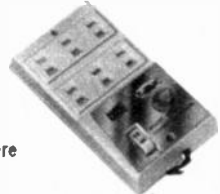

Designed to mount on walls, floor, benches, counter tops or for portable use. On/Off rocker switch and indicator light. Built-in fused holder with replaceable 15 amp fuse protects home circuits from an overload. Heavy-duty 8-foot line cord. For 117 VAC, 1500 watts, 15 amps. With fuse. Imported.
99 K 92090 Shpg. wt., 1 lb.Net 5.25
Pkg. of 5 fuses for above.
13 K 11679Net .93

Assemble Interesting Electronic Projects

80-IN-1 ELECTRONIC PROJECT KIT



20⁹⁵



- 100% Reusable Components
- No High Voltage or Soldering
- Sturdy Compact Wooden Case
- Detailed Instruction Manual

150-IN-1 I.C. ELECTRONIC EXPERIMENTERS KIT



29⁹⁵

Build over 80 safe, useful solid-state projects with this one kit. Detailed instruction manual provides easy-to-follow instructions for each project. Point-to-point wiring between spring-type connectors completely eliminates soldering. Each project can be assembled and disassembled in minutes. This "breadboard" type kit is ideally suited to the design of as many additional circuits as your ingenuity and creativity can produce. Nothing else is needed—kit contains all needed parts, including galvanometer, solar cell, semiconductors, relay, speaker, earphone, microphone, telegraph key, batteries, and connecting wires—all packed in a fitted hardwood case. Size: 15 x 8 3/4 x 4". Imported. Shpg. wt., 3 lbs.

99 K 35018 Complete 80-in-1 KitNet 20.95
 99 K 62580 1 1/2V Replacement Battery (2 req.)Net .14
 99 K 60212 9V Replacement Battery (1 req.).....Net .35

Lafayette's 150-in-1 IC Electronic Experimenters Kit supplies a variety of exciting projects dealing with measurement, radio broadcasting and receiving, sound and musical instruments, physics, chemistry, amusement, and convenient living. Its components are displayed in a sturdy wooden storage case, and include an enlarged visualized integrated circuit, which clearly shows the various devices that form a typical IC. Each experiment is wired using spring tension terminals, for complete reuse of components and to eliminate soldering. Power is supplied from low voltage batteries, eliminating any shock hazard. Simplified manual portrays each experiment in both visual and written forms. Supplied with all needed components, including batteries. Size: 3 1/2 x 15 1/2 x 8". Imported. Shpg. wt., 3 3/4 lbs.

99 K 35107 Complete 150-in-1 KitNet 29.95
 99 K 62572 1 1/2V Replacement Battery (2 req.) ..Net ea. .19
 99 K 60212 9V Replacement Battery (1 req.).....Net .35

EICO SOLID-STATE TREASURE/ METAL LOCATOR KIT

- Gives Positive Variable Audible Signal Indicating the Presence of Buried Coins and Metal Objects
- Locates Both Ferrous Metals (Iron, Steel, Tin) and Non-Ferrous Metals (Gold, Silver, Copper).

Opens up a new world of excitement and adventure. Electronically detects metal objects as small as a half-dollar up to 6 inches beneath the ground: gold, silver, coins, anything metallic. No meters or dials to check; solid-state integrated circuit gives positive audible low frequency beat heard through a built-in 2 1/4" speaker whenever a metal object is approached. Audible signal intensity increases when the treasure/metal locator draws nearer the object. Practical for home and public utilities (gas and telephone servicemen) too. Helps locate plumbing inside walls, or find pipes in yard or garden before digging. Epoxied super-sensitive 8 1/2" coil is shock, heat and water resistant. Special shield increases sensitivity, prevents false indications. Lightweight and easy to use. 36" handle collapses to 20" for easy storage. Easily assembled with instructions supplied. Uses single 9V transistor battery (not supplied). Overall length: 40"; housing 4 x 5 x 2 3/4". Shpg. wt., 3 lbs.

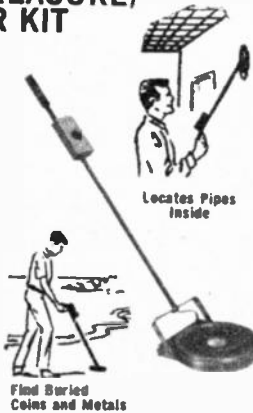

Special Purchase
MFR's Closeout

19⁹⁵

Treasure/Metal Locator Kit, Less Battery
 19 K 66175Net 19.95
 Treasure/Metal Locator Wired
 19 K 67017Net 29.95
 9V Battery, Shpg. wt., 3 oz.
 99 K 60212Net .35

17⁹⁵

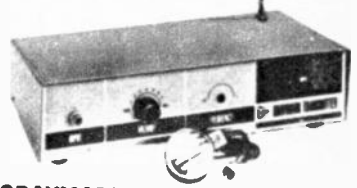

GRAYMARK AM BROADCAST BAND TRANSMITTER KIT

- Broadcast Through Any AM Radio
- No FCC License or Permit Required

This transmitter "broadcasts" voice, music, code, etc., through any AM radio receiver (540-1620 KHz). Simply plug in a microphone, record changer, code oscillator, tuner, telephone pick-up coil and you are on the air. The 100 Mw maximum power requires no license. Utilizes a printed circuit board. Complete kit includes crystal lapel microphone, telescoping antenna, 3 tubes, rectifier, low-profile metal cabinet and all necessary parts and fittings. A detailed step-by-step instruction manual simplifies construction. For 115 VAC. Cabinet size: 2 1/4 x 5 3/4 x 10 1/4". Imported. Shpg. wt., 4 lbs.

19 K 11015 Transmitter KitNet 17.95

All mail orders accepted with Mastercharge and BankAmericard.

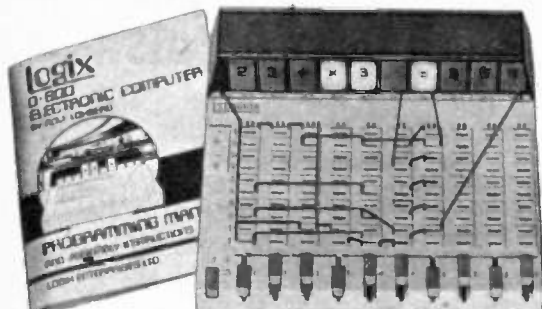

Logix ELECTRONIC COMPUTER KIT

Provides an insight to the
Complex World of the Computer

27⁹⁵

- Absolutely Safe—No High Voltage • No Soldering
- 50 Different Programs • Over 425 Parts
- 112 Page Detailed Illustrated Instruction Manual

The Logix electronic computer kit provides an introduction to computer technology by means of numerous experiments and programs. Its fundamental principles correspond to those of infinitely larger computers. Its manual details 50 different programs, progressing from very simple to more and more complex ones. Setting up a program simply involves connecting wires on the top side of the console exactly as shown in a wiring scheme. You can play computerized games with an opponent, or match wits with the computer. Computerized weather forecasting is obtained by use of weather input. You can program airline bookings, routing of long distance telephone calls, mixing of complex colors, translation of languages, detection of criminals and investigation of cybernetic problems. Programs also deal with Venn diagrams and the law of sets—as well as playing a game of simulated chess. In addition, provisions are made for individual's own creative programming. Imported. Shpg. wt., 4 3/4 lbs.

19 K 23036 Complete Kit (Less Batteries)Net 27.95
99 K 62572 C Cell for above (3 Req.)Net ea. .19

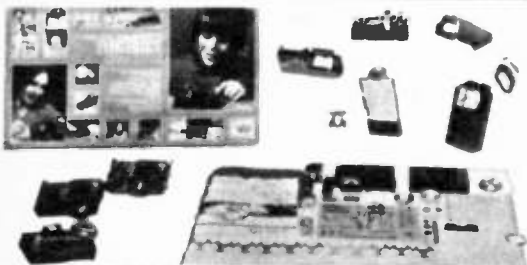

ELECTRICS ELECTRICITY EXPERIMENTERS KIT

16⁹⁵

Over 140 electrical experiments and construction projects can be performed using this quality laboratory kit! You assemble and learn about electrical circuits from a fully-illustrated, 112-page manual. Build an electroscopes, electromagnet, telegraph system, electric motor, burglar alarm and much more. Learn about voice transmission by building a complete working telephone system; you build the microphone, amplifier and speaker! Two functional consoles with special connectors. This kit offers a wealth of scientific knowledge and enjoyment. Requires 4 inexpensive "C" cells, not included. Imported. Shpg. wt., 3 1/2 lbs.

19 K 23028 Complete Kit (less batteries)Net 16.95
99 K 62572 "C" Cell (4 required)Net ea. .19



OPTICS OPTICAL AND PHOTOGRAPHY KIT

- Performs Over 135 Projects and Experiments
- A Complete Optical and Photographic Laboratory
- Build Microscope, Telescopes 35mm Reflex Camera
- 112-Page Detailed Illustrated Instruction Manual

19⁹⁵

This complete laboratory kit contains a set of 11 optically correct lenses, a prism, 144 precision-engineered components made of modern plastics, colored filters, mirrors and chemicals; all the components required to perform over 135 scientific projects. Learn about mirrors, lenses, prisms, color, the human eye and corrective eyeglasses, optical illusions and more. Build a periscope, microscope, kaleidoscope or several telescopes! You can actually construct a working 35 mm reflex camera with an interchangeable lens system, take pictures and develop them yourself. Easy-to-follow, step-by-step instructions. Everything you need is included. An ideal kit for the inquiring mind, for ages 11-60. Imported. Wt., 3 3/4 lbs. 19 K 23010 Complete KitNet 19.95

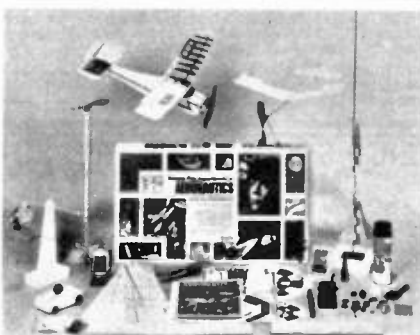

AERONAUTICS EXPERIMENTERS KIT

- Build a Helicopter, Helium Balloon, Rockets and Gliders
- 27" Wing Span Plane with working Ailerons, Elevators, and Rudder
- Concise Explanation of Flight Theory
- 112 Page Detailed Illustrated Instruction Manual

13⁷⁵

Turn your back yard into Kitty Hawk with this exciting and educational complete Aeronautics Lab. Learn the principles behind aerodynamics—from the Helium Balloon to the rockets used for space travel. Everything you learn is contained in the fully illustrated comprehensive manual. But there's more! By doing the more than 100 experiments contained in the kit you actually put the theory obtained to practical use by constructing real working models of over 15 different types of aeronautic devices. You will build out of parts entirely contained in the kit: 3 Air Planes, a Helium Balloon, 3 Rockets with automatic parachute recovery, a Land Helicopter, gliders, kites, and more. Imported. Shpg. wt., 3 lbs.

19 K 23044 Complete Aeronautics KitNet 13.75

Build an Engine—See How It Works



VISIBLE WANKEL ROTARY ENGINE KIT

- The Ecological Engine of the Future
- 1/5 Scale, See-Thru Operating Model

5⁷⁰

A revolutionary antipollution automotive power plant utilizing rotating discs for combustion, replacing the piston and cylinder in conventional engines. It features fewer parts, greater compactness and higher efficiency. This see-thru Mazda engine shows flashing plugs, rubber fan belt and has pre-colored parts, all visible in operation. Powered by two inexpensive penlite batteries (not supplied). Easily assembled from instructions. On 3 1/2" display stand. Assembled motor is 10" long x 8 1/2" high x 5" wide. Imported. Wt., 2 1/4 lbs. Complete Kit, less batteries.

19 K 41004Net 5.70
99 K 62580 AA Cells (2 req.) Net ea. .14



RENWAL VISIBLE V-8 ENGINE KIT

- Looks and Performs Like The Real Thing

11⁷⁵

The Visible V-8 is a superb guide to the study of the internal combustion engine. Precise 1/4-scale, "see-thru" model engine that simulates the power plant of V-8 autos. Parts molded in 4 colors, including "clear," so that functioning pistons, connecting rods, rocker arms and properly-timed spark plugs can be observed. Powerful permag motor activates over 100 moving parts. Powered by two "C" batteries (not supplied). Complete with polystyrene cement, hardware, screwdriver, and illustrated instruction manual which details how an auto engine works. Shpg. wt., 5 lbs.

19 K 69005 KitNet 11.75
99 K 62572 C Bat. (2 req.) Net ea. .19

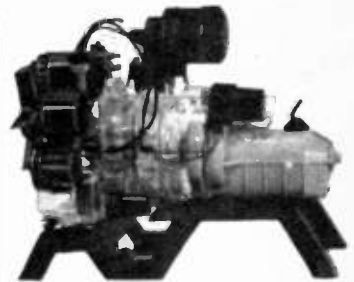

RENWAL VISIBLE WANKEL ENGINE KIT

- Transparent Operating Rotary Engine
- One-third Actual Size

11⁷⁵

A one-third scale, see-thru, operating model of a revolutionary power plant like the Mazda and which many car manufacturers plan to use in the near future. Made of high-impact styrene, the completed kit is hinged to divide directly in front of the rotating piston to reveal the combustion chamber. Spark plugs fire in the chamber at precise point of crankshaft and rotary piston movement during each perfectly-timed cycle—just like a real Wankel engine. A multi-colored chamber background helps you understand the underlying principle of rotary engine systems. Powered by two "C" batteries (not supplied). Contains more than 220 parts. Easily assembles to 13L x 10H x 8"W from detailed instructions with history of the Wankel engine. Shpg. wt., 5 lbs.

19 K 69013 KitNet 11.75
99 K 62572 C Batts. (2 req.) Net .19

Start a Hobby With a LAFAYETTE Kit



PHOTOGRAPHY DARKROOM LAB WITH ENLARGER

- Complete Darkroom Outfit
- Photo Enlarger, Contact Printer, 35mm Projector—All in One Kit

16⁷⁵

Print and develop your own photos, enlarge 35mm shots up to 8x10", and project your 35mm negatives. Kit includes developing chemicals, printing and enlarging paper, 3 trays, thermometer, neon safelight, print frame taking slides up to 3 1/2 x 4 1/4", twin condensing lenses and G.E. projection lamp. A complete photo lab in one kit. Wt., 4 1/4 lbs. 19 K 30031Net 16.75



WEATHER STATION KIT

- Operate Your Own Weather Station
- All Connection Safe to Touch

Fun to erect and fascinating to use, this weather station kit operates with flashing neon lights to show wind speed and direction on indoor indicator board. Includes a sensitive air tank barometer with 4-foot indicator column, a sling psychrometer to measure relative humidity, rain gauge with scale calibrated to measure 1/100th of an inch rainfall, cloud chart, weather map and forecasting manual. 150 feet of wire supplied, enough for a two-story house. Safety power cord. Shpg. wt., 3 3/4 lbs. 19 K 30023Net 12.35

Only
12³⁵

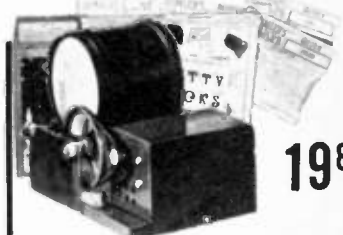

THUMLER'S GEM STONE TUMBLING AND JEWELRY MAKING KIT

- Complete Outfit—Nothing Else to Buy

This complete kit permits you to enjoy the fascinating craft of polishing stones and making them useful for decorative items, collections and jewelry making. This complete kit includes a 3-lb. capacity rubber barrel for quiet operation, 4 grades of grits and polishing abrasives, a 1-lb. assortment of exotic-quality gem rocks, assorted jewelry mountings (tie clasp, cuff links, charm bracelet, etc.), jewelry glue, rock identification book in color and full instructions. Simple to operate, no skill required. This ideal beginner's kit has everything needed to go from "rocks" to "jewelry." Motor operates on 117 VAC.

15 K 44543 Shpg. wt., 9 lbs. Net 19.85

Charge it with BankAmericard or Mastercharge!

PILOT THE BIG SKYHAWK BY REMOTE CONTROL

TESTOR'S R/C SKYHAWK



Only **79⁹⁵**
No Money Down*

Simply snap in wings and it's ready to fly! Radio controlled plane which incorporates true (pulse) proportional control for smoother, more realistic flight control. Even youngsters can fly it because no electronic or mechanical skill is required. Aircraft fuselage constructed of virtually indestructible super-impact styrene. Wings and horizontal stabilizer are of super light styrofoam. Tricycle landing gear assures simple landings. High torque .049 cubic inch internal combustion engine has gas tank attached for 4 minutes of powered flight. Super sensitive 9 transistor superhet receiver combines with a powerful dual coil, twin magnet actuator for superior reliability.

COMPLETE OUTFIT:
Plane, Receiver, Transmitter,
Batteries and Charger for Plane



- Easy to Fly—Ideal for Beginners
- One Mile Range of Control
- Rechargeable Batteries with Charger
- Big 44" Wingspan—Length 27"
- Internal Combustion .049 Engine

8-transistor 250-milliwatt transmitter provides up to one mile range control. Simple guidance controls include finger tip trim for basic in-flight stabilization. Transmitter powered by eight 1½V penlite cells (not supplied). Complete with R/C plane, transmitter, battery charger, and illustrated flying instruction book. Shpg. wt., 7 lbs.

42 K 73074W for 27.095 MHz Net 79.95
42 K 73058W for 26.995 MHz Net 79.95
42 K 73090W for 27.195 MHz Net 79.95
99 K 62580 1½V Penlite cells—8 required Net ea. .14

SKYHAWK SPECIFICATIONS

Length: Fuselage 27", Wing 44". Flying Weight: 23 ounces (approximately). Speed: 30 MPH True. Fuel Capacity: 4 Minutes powered

flight. Transmitter: Single Tone AM Modulated Relayless Pulse. Receiver: Superheterodyne. With Pulse Width Rate Decoders.

VALKYRIE-2 ROCKET KIT

12⁹⁵

- Altitude Capability Over 1000 Feet
- Reusable With Parachute Recovery
- Launched Mechanically or Electrically
- Safe, Non-Flammable Non-Toxic Propellant



Authentic, educational and safe rocket kit. Propellant releases no heat, is non-flammable, non-toxic and non-explosive. Rocket can be safely held in hand. Blasts off to 1000 ft.! Polished aluminum rocket, engine and parts, with real working valves, separator and parachute. Timer deploys rocket return parachute. May be launched either mechanically or electrically with battery (not supplied). Complete with rocket, engine, timer, separator, parachute, balsa nose cone, fins, loading valves and hose, electric firing assembly, launch stand, one can of propellant, accessories and instructions. Size: 18½" x 1" dia.

19 K 75010 Shpg. wt., 2¾ lbs. Net 12.95
15 oz. can of propellant for 3 launchings.
19 K 75028 Shpg. wt., 1½ lbs. Net 1.95
6V battery for electrical launchings.
32 K 48184 Shpg. wt., 1¾ lbs. Net 1.20
Replacement ignitor wire (electrical launchings).
19 K 75038 Shpg. wt., 3 oz. Net .35

RECHARGE YOUR BATTERIES WITH AUTOMATIC DRY CELL BATTERY CHARGER



- Charge Up to 14 Batteries At A Time
- Will Not Overcharge
- Built-in Battery Tester

8⁵⁰

Recharges all "D", "C", and 9-volt transistor carbon-zinc, alkaline, mercury, and nickel cadmium batteries. Charging receptacles for 4 "D" cells, 4 "C" cells, 6 "AA" cells and one 9V battery permits recharging up to 14 batteries at one time. Transformer circuitry operates on a demand principle and automatically prevents overcharging. Has built-in battery tester-indicator light. Shock-proof since low voltage charging occurs only when lid is closed. Attractive, decorator styled hi-impact pliable plastic case. For 110-120 volt AC 60 Hz. Size: 7½ x 4¾ x 2¾". Shpg. wt., 1½ lbs.

34 K 25006 Net 8.50

Jerobee DRIVE THE JEROBEE RADIO-CONTROLLED RACING CAR

94⁵⁰

No Money Down*

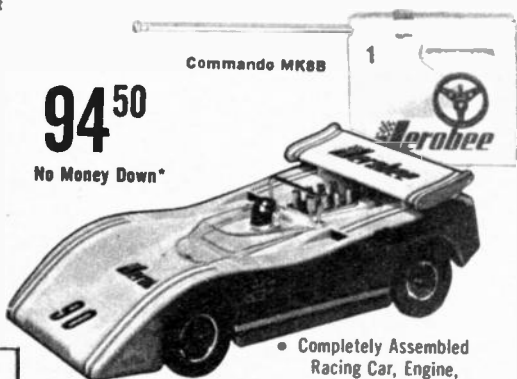

- Completely Assembled Racing Car, Engine, and Radio-Control System
- Races at Over 240 Scale Miles per Hour
- Fully Proportional Steering and Throttle

Drive this 1/12 scale gas powered racing car with all the sound, action, speed, and thrills of the track... on any concrete or asphalt surface. The 'Commando' features independent front suspension, Ackerman steering, centrifugal clutch, heavy-duty rear axle and 'mag' type wheels. Rugged high-strength cycloc® body and molded frame. 100 milliwatt radio control system (No FCC license required) has fully proportional simultaneous dual-servos for separate steering and throttle control for a range of over 300 feet. Car automatically slows and turns right when control range limit is reached. .049 Cox engine with recoil pull starter provides speed of 240 scale mph. Receiver powered by 9V battery (not supplied). Overall length: 13¼"; turning radius: 4". Complete package supplied ready to race, less only fuel and batteries, including operating manual. Shpg. wt., 3¼ lbs.

42 K 14003 For 26.995 MHz Net 94.50
99 K 62580 Receiver AA batteries (4 required) Net .14
32 K 47053 Transmitter 9V battery (1 required) Net 1.67
32 K 48871 Engine starting battery, 1½V Net 1.13



LAFAYETTE INTRODUCTORY FIBER OPTICS KIT

5⁹⁵

INCLUDES DC LIGHT SOURCE

- Bend Light Around Corners
- Make Decorative Light Sprays and a Flexible Trouble-Shooting Light

Let Lafayette introduce you to the magical world of plastic and glass fibers that transmit light energy from one end to the other—safely—even underwater. You can cut and bend these flexible strands to obtain a myriad of decorative effects. This is the ideal kit with which to get started. Kit includes a 2-cell penlite light source (batteries not supplied); two light hood adapters, a 12" vinyl covered flexible light pipe with polished ends (containing 225 glass microfibers), a rigid image pipe with attached ball magnifier, 12 20 mil diameter 1 foot long plastic fibers, a fiber optics image stone and a set of instructions. Shpg. wt., 7 oz.

19 K 32003 Complete kit, less batteriesNet 5.95
99 K 62580 1½V Penlite Cell (2 required)Net ea. .14

ACCESSORIES

COLORLED FLAME TIP KIT. Consists of 25 assorted colored plastic flame tips, and 25 1-ft. 20 mil. fibers. Mounting instructions. Shpg. wt., 4 oz.

19 K 32045Net 1.95

COLORLED MINI-SPRAYS. Set of 5 colored fan-shaped 2½" factory assembly sprays. Shpg. wt., 6 oz.

19 K 32144Net 1.95

50-FT. COLORED PLASTIC FIBERS. 25 2-ft. lengths of five assorted plastic optic fibers. Shpg. wt., 4 oz.

19 K 32029Net 2.49

100 FT. COIL 20 MIL PLASTIC FIBER



Here is the additional plastic fiber needed to expand your displays. A 100 ft. coil of 20 mil diameter light transmitting plastic fiber. Shpg. wt., 7 oz.

19 K 32128Net 1.99

FIBER OPTICS LAMP KIT

- Easy To Assemble
- Provides Sparkling Decorative Lighting

9⁹⁵

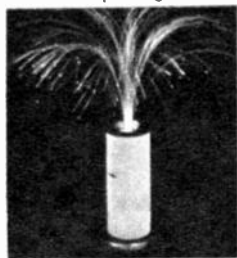

Assemble your own handsomely designed "conversation piece" fiber optics lamp and enjoy the dazzling beauty of its sprouting fibers. Light is transmitted to the ends of the fibers and glows in sparkling beauty. Has 250 fibers and translucent illuminated stand and switch. Adjustable height 15-18" with 5" dia. base. Easily assembled from instructions supplied. Operates on 115 V AC. Shpg. wt., 1½ lbs.

19 K 32060Net 9.95

PROJECT-A-SCOPE

- Projects Giant Pictures in Color or Black and White
- Films or Negatives Not Needed

Handsome projector molded of heat and abuse resistant, hi-impact plastic for long life. Casts sharp, giant-size enlargements on any white wall or screen in brilliant color or black and white. Simple to operate. Can be used by students, artists, lecturers and demonstrators. Children can project comic or story books to amuse themselves and their friends. Uses ordinary household bulbs. U/L listed. 110 volts, AC-DC. Shpg. wt., 2 lbs.

6⁵⁰



15 K 50011Net 6.50

LAFAYETTE HOBBYIST FIBER OPTICS KIT



9⁹⁵

INCLUDES DC LIGHT SOURCE

- Includes Colored Plastic Fibers For Colorful Arrays
- Make A Fiber Optics Tree And Lamp

The perfect kit for the hobbyist and experimenter. Gives complete simplified information on handling, bundling, cutting, and terminating optic fibers as well as additional suggestions for projects and decorative illumination. Kit contains a 2-cell penlite light source (batteries not included), light hood adapter, 12" vinyl covered glass light pipe (containing 225 glass microfibers), 20 1-ft. lengths of five assorted colored plastic fibers, 12" bundle of unjacketed 1.8 mil glass fibers (over 2,000 strands), 5 ft. vinyl jacketed glass light pipe, 1½" rigid image pipe, ½" square fiber optic image plate, ¼" square glass plate, lens, rigid image pipe with attached ball magnifier, rigid and flexible heat shrink, "Introduction to Fiber Optics Manual" and an instruction manual. Shpg. wt., ½ lb.

19 K 32011 Complete Kit, less batteriesNet 9.95
99 K 62580 1½V Penlite Cell (2 required)Net ea. .14

ELECTRO ROULETTE



SALE
7⁴⁵

CUT 2.50

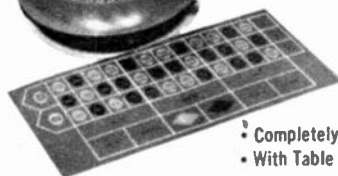

- Completely Automatic
- With Table Layout And Chips

An authentic roulette game. Simply press a lever and round and round a rotating light spot goes and where it stops nobody knows! Exciting with a wide variety of single and combination bets. Each player uses different color chips which are provided. Uses 3 "C" cells, not provided. With on/off switch. Size: 10½" dia. x 3½" h. Imported. Shpg. wt., 3 lbs.

19 K 26005 Less BatteriesNet 7.45

C batteries for above—3 requiredNet ea. .19
99 K 62572

ELECTRO MULTI-POKER

Repeat of **SALE 5⁴⁵**

- Play All Forms of Poker
- Cards Face Up or Face Down



Plays stud poker, draw poker and black jack (21). Main switch rotates cards, 5 lever switches stops cards with either face up or face down. Fully automatic and fascinating for everyone. A joker is included in the deck. Requires 2 inexpensive "C" cells (not supplied). Size: 6 x 4¾ x 3½". Imported. Shpg. wt., 1¼ lbs.

19 K 26039 Less batteriesNet 5.45

"C" Cells for above—2 requiredNet ea. .19
99 K 62572

ADP Electronic 8-Digit Four Function Calculator Shows Time and Date, too!

- Displays Time in Hours, Minutes & Seconds
- Will Alternately Display Date and Time

The Mark VII is a calculator, clock and calendar all in one! Using algebraic logic, this calculator adds, subtracts, multiplies, divides, and performs mixed calculations. "Constant" function allows multiplication or division of a series of figures by a preselected locked-in number—for calculating interest, etc. Full floating decimal accurately carries computations to completion. Overflow and Minus indicators for easy checkbook balancing. Automatic leading and trailing zero suppression. Clear and clear-entry keys. And if you keep it plugged in, this remarkable unit will remember the date and tell time accurately—within .01%! Black plastic cabinet with detachable AC line cord. Size: $9\frac{1}{2} \times 5\frac{7}{8} \times 3\frac{1}{4}$ ". Display size: $\frac{5}{8}$ ". For 117 VAC, 60 Hz. Imported. Shpg. wt., 3½ lbs.

15 K 54047LNet 59.95

NEW!
59⁹⁵

No Money Down*

SAVE \$10

ADP Electronic Calculator has Constant, Fixed and Floating Decimal

- Operates on 4 "C" Batteries or AC Adapter for Portable, Office Use
- Adds, Subtracts, Multiplies, Divides

Mark V. Novel, solid-state calculator designed for both portable and desk use. For traveling, it has a convenient carrying handle, a protective display cover, and a vinyl case. When in use, the handle folds under to elevate the uncovered display. Operates on 4 "C" cells or AC adapter, both included. Uses algebraic logic. Does mixed calculations. Constant function for repeated multiplication or division with a preselected number. Floating or fixed 2- or 3-place decimal. Leading and trailing zero suppression. Overflow and negative result indicators. Clear entry key. Battery meter. Size: $7\frac{1}{2} \times 4\frac{1}{2} \times 1\frac{1}{4}$ "H. Fluorescent display size: approx. $\frac{1}{4}$ ".

15 K 54021L Shpg. wt., 2 lbs.Net 59.95

Mark VIII. Similar to above, plus full feature memory. Shpg. wt., 2 lbs. 15 K 54039L No Money Down*Net 79.95

NOW ONLY
59⁹⁵

No Money Down*

ADP Palm Size Electronic 8-Digit Calculator has Memory and Floating Decimal

- Operates on 4 "AA" Batteries or AC Adapter, Carrying Case Also Included
- Separate M+, M-, MC, MR Keys, +/- Sign Change Key, % Key

An excellent value in a portable general purpose electronic calculator. Palm sized, only $4\text{W} \times 6\text{H} \times 1\frac{1}{2}\text{D}$. Clear, bright 8-digit fluorescent $\frac{1}{4}$ " display with full floating decimal, overflow indicator, and minus indicator for true credit balance. Algebraic logic on all functions. Displays zeros to the right of the decimal point for aid in checkbook balancing. Plus % key for automatic markups and discounts, change sign key (+/-), and four memory keys. Fully automatic constant. A single button for the clear and clear entry functions. Full sized keyboard with color-coded keys for the separate functions. Slide switch for on/off. AC adapter, 4 "AA" batteries, and carrying case are included. Display size: $\frac{1}{4}$ ". Imported. Shpg. wt., 2 lbs.

15 K 54013LNet 69.95

69⁹⁵

No Money Down*

SAVE \$20

Electronic 12-Digit Calculator with Memory and Constant by UNITREX

- M+, M-, RM, and CM Keys
- Adds, Subtracts, Multiplies, and Divides

Memory allows you to work with the results of previous calculations at any time. Constant permits repeated multiplication and division by a preselected number. Separate clear and clear entry keys. Floating decimal in, fixed selectable (0, 2, 4, 6) decimal out. Zero suppression. Dividend and divisor may be reserved for special applications. Performs chain and mixed calculations. Red lights indicate memory, overflow, and negative results (for true credit balance). $\frac{5}{4}$ round off and on/off switches. Two-tone grey cabinet with detachable AC line cord. Size: $7\frac{1}{2}\text{W} \times 2\frac{1}{2}\text{H} \times 9\frac{3}{4}\text{D}$. Display size: $\frac{3}{16}$ ". For 117 VAC. Shpg. wt., 5 lbs.

15 K 10526L No Money Down*Net 79.95

NOW ONLY
79⁹⁵

*See Page 19 for Full Details on Easy Pay Plan

RAPIDMAN 804 Pocket-Sized 8-Digit Calculator with Automatic Constant

- All Four Arithmetic Functions
- Floating or Fixed Decimal
- Chain and Mixed Calculations

A completely portable electronic calculator that fits in a briefcase, desk drawer, handbag, even a pocket! Using algebraic logic, it adds, subtracts, multiplies, divides, and performs chain and mixed calculations. Also does squares and reciprocals. Features automatic constant, and full floating or fixed decimal to 7 places. "C" key that clears calculator or a single entry. With a negative indicator for true credit balance. Also has overflow and low battery indicators, and an On/Off switch. Break-resistant polypropylene plastic case. Operates on battery (included) or 117 VAC with optional adapter. Display size: $\frac{3}{16}$ ". Shpg wt., $1\frac{1}{2}$ lbs.

18 K 27548L No Money Down*Net 39.95
 AC ADAPTER FOR ABOVE. Shpg wt., 8 oz.
 15 K 27522LNet 3.95
 99 K 63720 Extra 9-Volt BatteryNet .49

39⁹⁵

SIZE
 9/10H x 5³/₄L
 x 3³/₄"W

WEIGHS
 8 OUNCES



SAVE \$30

Bowmar Five Function, 8-Digit Pocket Electronic Calculator

- Operates on Built-in NiCad Rechargeable Batteries or 117 VAC Adapter/Charger (Incl.)
- % Key—Omni-Constant—Full Floating Decimal

Fits in your hand, yet outperforms many desk calculators. Adds (+), subtracts (-), multiplies (x), divides (\div), totals (=), and automatically gives the correct percentage answer, with the decimal point in proper position, when you engage the "%" key. Also features "Omni-Constant", which not only knows when you want it to operate and when you do not, but is also operable in all five functions. Plus... the "C" Key will clear either all preceding computations or an individual entry. Eight-digit input, 8-digit (plus full floating decimal), fully-lighted display output—and a checkbook feature: zeroes to the right of decimal are retained. With minus sign, overflow, and low battery indicators. Weighs only 9 oz.! Instruction book and vinyl pouch included. Display Size: $\frac{3}{16}$ ".

15 K 48502L No Money Down*. Shpg. wt., 2 lbs.Net 69.95

NOW ONLY

69⁹⁵

SIZE
 5¹/₂ x 3 x 1¹/₄"



Unisonic. Pocket 8-Digit Electronic Sliderule Calculator has Memory

- Keys to Figure Squares, Square Roots, Reciprocals, and Percentages
- Operates on Batteries or 117 VAC with Adapter (Both Included)

Compact sliderule calculator, with memory, that computes reciprocals, square roots, and squares. True algebraic logic, permitting direct negative entries without locking up keyboard. Features automatic constant and full floating decimal. Also allows single percentage figuring, and additions and subtractions from the original figures without re-entry. With a +/- charge sign key, and an exchange key to retrieve the first entry. Newly designed display with automatic zero suppression. 8-digit entry and readout, with 16-digit calculating capacity. Automatic overflow protection. Operates on batteries or 117 VAC house current with AC adapter. Batteries, AC adapter, and carrying case are included. Size 6 x 3¹/₂ x 1¹/₂". Display size: $\frac{3}{4}$ ". 15 K 11518L No Money Down*. Shpg. wt., ? lbs.Net 69.95

89⁹⁵

SIZE
 6L x 3¹/₂"W



20-Function "Scientific" Electronic Calculator—MX100 by Bowmar

- 13 Scientific Functions, Omni-Constant
- Full Slide Rule Capability, Full Memory
- Full Algebraic Operation, Radians and Degrees
- Full Floating Decimal

The wizard of the scientific calculators, the Bowmar MX100 "Scientific" Brain performs complex scientific calculations accurately and fast. This 20-function, hand-held calculator features full sliderule, Algebraic, and Memory Operation, as well as Omni-Constant with Register, Exchangers and Radians and Degrees notations. Functions are: (+) plus, (-) subtract, (=) equal, clear/clear entry, Sine, Cosine, Tangent, Arc Sine, Arc Cosine, Arc Tangent, e, Natural Log, Log, $1/x$, \sqrt{x} , π , y , change sign, M+, Memory Recall, Memory Clear, X/Memory Register Exchange, X/Y Register Exchange, Function Key, and Degrees/Radians Switch. Indicators include: Minus Sign, display for easy readouts. Operates on rechargeable NiCad battery or with AC/Adapter/Charger. Size: 5 x 3 x 1¹/₂". 15 K 48528L No Money Down*. Shpg wt., 1 lb. 6 oz.Net 179.95

179⁹⁵

NI-CAO Battery,
 AC Adapter, and
 Case



*See Page 19 for Full Details on Easy Pay Plan

**Illustrated
41 ELEMENTS**

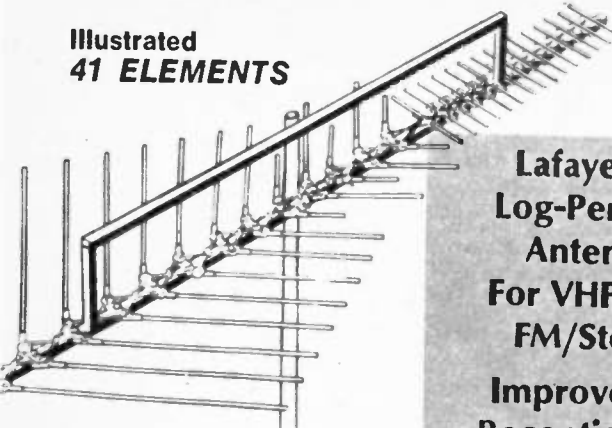

**LVL-UV Single Boom
Antenna Series**

As Low As **1295**

- For Color or Black-White Pictures Plus FM
- One Down Lead for All 3 Signals
- Powerful Log Periodic Design
- High Front-to-Back Ratio—High Gain
- Goldenized Finish For Long Lasting Protection
- More Picture Power On Channels 2 To 83

Super color-engineered antennas of famous log periodic design for color TV and stereo FM. Now you can easily install one antenna instead of three to obtain super reception on VHF channels 2-13, UHF channels 14-83 and the FM band with one downlead. Ends unsightly roof clutter while providing strong, clear signals to improve the performance of any TV or FM set. All antennas are preassembled. VHF elements are reinforced with triple-strength sleeves at pivot points. The goldenized finish provides weather protection. Larger model features boom brace supports for greater rigidity. Supplied with a 3-way splitter for VHF, UHF and FM operation. Less Mast.

41-ELEMENT "EXTREME FRINGE" ANTENNA

Range in miles up to: VHF to 175; UHF to 90, FM to 95. 41 individual elements, 26 for VHF/FM, 15 for UHF. Has 1" square 15-ft. boom with brace boom supports. Shipped express only. Shpg. wt., 13 lbs.
18 K 01802WX No Money Down*Net 37.75

25-ELEMENT "FRINGE" ANTENNA

Range in miles up to: VHF to 125, UHF to 65, FM to 70. 25 individual elements, 14 for VHF/FM, 11 for UHF. Has 1" square 10 1/2" boom.
18 K 01828W Shpg. wt., 9 lbs.Net 23.95

17-ELEMENT "SUBURBAN" ANTENNA

Range in miles up to: VHF to 85, UHF to 50, FM to 55. 17 individual elements, 10 VHF/FM, 7 for UHF. Has 1" square 7-ft. boom. Shpg. wt., 6 1/2 lbs.
18 K 01836WNet 17.50

13-ELEMENT "METROPOLITAN" ANTENNA

Range in miles up to: VHF to 60, UHF to 30, FM to 35. 13 individual elements, 6 for VHF/FM, 7 for UHF. Has 1" square 30" boom. Shpg. wt., 4 1/2 lbs.
18 K 01844WNet 12.95

94 Lafayette Cat. No. 743

**Lafayette's
Log-Periodic
Antennas
For VHF-UHF
FM/Stereo**

**Improve Your
Reception with**

3 Antennas in 1
UHF-VHF-FM
CHANNELS 2-83

Complete with VHF-
UHF-FM Signal Splitter

NO EXTRA CHARGE!

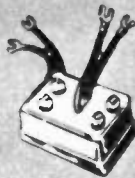

**Illustrated
63 ELEMENTS**

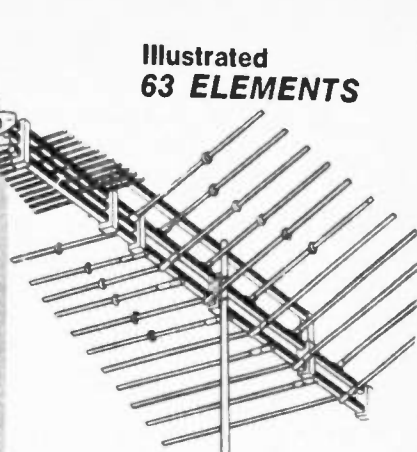

**Deluxe Twin Boom
Antenna Series**

As Low As **2150**

- One Down Lead Required
- Extra Long Super Sensitive Capacitor-Coupled VHF Elements
- Multiple Directors and UHF-Driven Elements for Maximum Picture Power
- Twin-Boom Construction for Extra Strength
- Goldenized Finish for Long Lasting Protection

Lafayette deluxe all purpose twin boom three-in-one antenna for VHF, UHF, FM/STEREO. Frequency independent design permits all elements to work together on both low and high bands for maximum front-to-back ratio and high db gain. Extra long up to 55" reinforced aluminum VHF elements with wide band "cap-electronic" elements operate on both fundamental and harmonic modes. The result is an increased number of working elements producing maximum gain and directivity to bring sharpness and color brilliance to your screen. Disc-on-Rod UHF director system reinforces performance of surface wave UHF driver on low end of UHF band. Improved impedance match obtained by unique twin boom construction which combines mechanical rigidity with superior electrical performance. This superior construction virtually does away with interference caused by wind and vibrations. Features heavy duty insulators, rust resistant hardware and lasting goldenized finish. Complete with splitter to separate VHF, UHF, and FM signals. Less mast.

63 ELEMENT "ULTRA-FRINGE" ANTENNA

Range in miles up to: VHF to 200, UHF to 100, FM to 110. 63 individual elements, 22 for VHF/FM, 41 for UHF. Has heavy-duty 3/4" square "Twin-Boom" and boom brace support. Boom Length 15 1/2". Shipped express only.
18 K 02172WX No Money Down* Wt., 16 lbs. Net 48.50

45 ELEMENT "DEEP-FRINGE" ANTENNA

Range in miles up to: VHF to 150, UHF to 80, FM to 85. 45 individual elements, 16 for VHF/FM, 29 for UHF. Has a heavy-duty 3/4" square "Twin-Boom" and boom brace support. Boom Length 11 1/2". Shipped express only. Shpg. wt., 12 1/4 lbs.
18 K 02180WX No Money Down*Net 32.50

27 ELEMENT "NEAR-FRINGE" ANTENNA

Range in miles up to: VHF to 100, UHF to 60, FM to 65. 27 individual elements. 12 for VHF/FM, 15 for UHF. Has heavy-duty 3/4" square "Twin-Boom". Boom Length 7'10". Shpg. wt., 9 lbs. Shipped express only.
18 K 02198WXNet 21.50

** See Page 19 for Full Details on Easy Pay Plan*

**LAFAYETTE
5-FT. PARABOLIC
UHF ANTENNA**

24⁹⁵

Ultimate In Directivity—
Rugged Construction
Sharp Pictures Even
In Fringe Areas

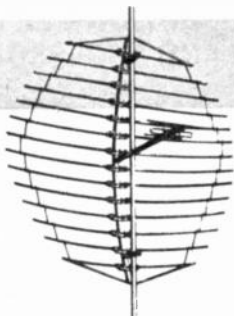

A 5 foot parabolic antenna which utilizes a signal drive broadband driver unit. The high front-to-back ratio eliminates the necessity of reflectors which shadow the center of the field. Signals reaching any part of the parabola are concentrated on the driver mounted at the exact focal point. This selective design provides up to 18.6 db gain. Back of reflector acts as a shield to reduce unwanted and reflected signals. Preamsembled for easy installation. Small diameter, rugged elements with vibration dampers limit ice loading. All aluminum with protective Gold Corqdzied finish. Shpg. wt., 7¾ lbs.

18 K 01901W Net **24.95**

LAFAYETTE UHF CORNER REFLECTOR

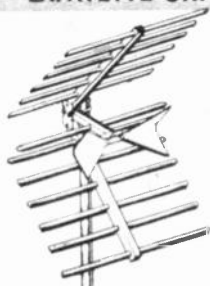

5⁵⁰

• Range Up to
50 Miles

For quality UHF reception even in fringe areas. High gain, sharp horizontal and vertical directivity eliminates "ghosts" and "snow." Rugged construction, large reflector screen made of highest grade aluminum tubing. "Fold open" assembly. "Gold-enized" finish for protection against weather and salt-air deterioration. Shpg. wt., 3 lbs.

18 K 01448W Net **5.50**

**"DOUBLE-DRIVEN"
10 ELEMENT FM ANTENNA**

GOLDENIZED

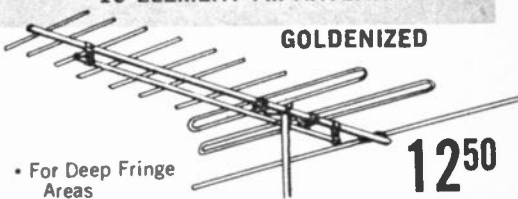

• For Deep Fringe
Areas

12⁵⁰

Ideally suited for FM-stereo reception. This 10-element double-driven, yagi array has the necessary added gain, sensitivity and directivity to compensate for the lack of signal strength. All-aluminum goldenized construction. Fiberglass insulators. Torsion lock hardware sure-lock mast clamp. Boom length: 128". Shpg. wt., 8 lbs.

18 K 01281W Net **12.50**



TV GHOST ELIMINATOR

6⁹⁵

- Improves Color Reception
- Receives from All Directions

Electrically rotates the polar-receiving pattern of your existing antenna and phases the ground wave picked up by the electrical wiring system with the sky wave picked up by the antenna. Improves any existing antenna; indoor, outdoor, master or built-in. Just a flick of the selector control tunes out ghosts—filters out interference—tunes in those "hard-to-get" problem channels. Works on every channel—in any location—with any antenna—for any TV set. No installation problem—simply attach to antenna terminals in back of TV set—and plug into 117V AC/DC socket. UL Listed. Shpg. wt., 1¾ lbs.

18 K 12064 Net **6.95**



ANTENNA INSTALLATION KITS

FOR ROTOR INSTALLATIONS
Choice of Chimney or Tripod Roof Tower

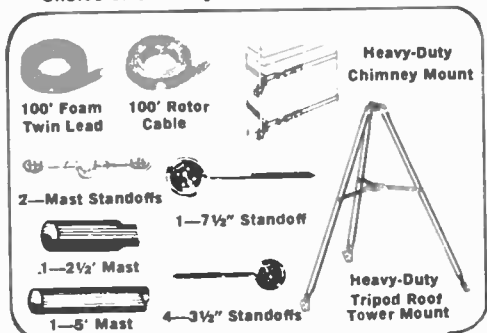

Installation accessory kits to be used with the antenna and rotator of your choice. Each kit includes either a tripod roof mount or chimney mount. All outfits include: 100 feet of heavy-duty rotor cable; 100 feet of 20 gauge VHF/UHF foam twin lead; 1 5-ft. and 1 2½-ft. Gold-Kote 16 gauge steel masts; 4 3½" wood screw eye standoffs; 1 7½" wood screw eye stand-off, and 2 dual mast snap-on insulators.

CHIMNEY MOUNT KIT

Above antenna accessories plus heavy-duty "Y" type snap-in chimney mount with 2 12-ft. ¾" stainless steel straps. Less rotor. Wt., 25 lbs.

18 K 56392W Net **18.95**

TRIPOD ROOF TOWER MOUNT KIT

Above antenna accessories plus heavy-duty 3-ft. tripod roof tower with pitch-patches and lag screws. Less rotor. Shpg. wt., 29 lbs.

18 K 58364W Net **21.95**

FOR NON-ROTOR ANTENNA INSTALLATIONS
Choice of Chimney or Wall Mounts

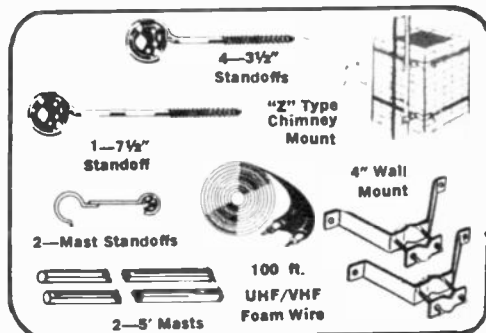

Customized Antenna Accessory kits to be used with the antenna of your choice. Each kit includes either chimney mount or wall mount 2-5-ft. 16 gauge gold-kote steel masts, 4 3½" wood screw insulators, 1 7½" wood screw insulator, 2 snap-on mast insulators, 100 ft. 20 gauge VHF/UHF foam twin lead.

CHIMNEY MOUNT KIT

Above antenna accessories plus heavy-duty "Z"-type brackets with rust resistant finish, 2 12-ft. ¾" stainless steel straps. Wt., 10 lbs.

18 K 58434W Net **12.95**

WALL MOUNT KIT

Above antenna accessories plus set of 2 4" wall brackets with rust resistant finish. Shpg. wt., 8 lbs.

18 K 58442W Net **10.95**

Charge it with BankAmericard or Mastercharge!

TO IMPROVE YOUR RECEPTION USE OUR TV BOOSTERS-ROTOR AND ACCESSORIES

LAFAYETTE SOLID-STATE 4-SET VHF-UHF-FM ANTENNA BOOSTER FOR CHANNEL 2-83 & FM/STEREO

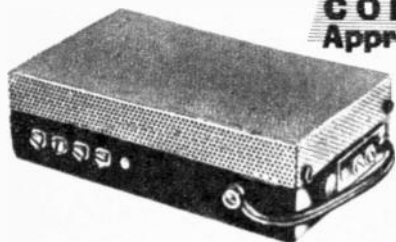

COLOR Approved

31⁹⁵

- 300 ohm Input — 4 - 300 ohm Outputs
- Ideal For Home TV/FM-Entertainment Systems
- Perfect For Color And Black and White

Highly efficient 3 transistor indoor amplifier boosts and distributes VHF/UHF/FM signals to as many as four TV and/or FM receivers. Three Moverload® silicon overlay transistor circuitry provides 6 db VHF gain and 6.5 db UHF gain at each of four 300-ohm outputs. Flat response across each channel for excellent color. 15 db gain isolation between outputs. High input signal capability boosts weak signals but will not overload from other strong signals in area. Pilot light. Amplifier and power supply are combined into one perforated steel cabinet. Size: 2Hx4Dx6¼"W. For 117 VAC, 60 Hz. Imported. Shpg. wt. 1½ lbs.

18 K 02214 No Money Down*Net 31.95

LAFAYETTE COLOR-AMP. SOLID-STATE VHF-UHF-FM ANTENNA BOOSTER FOR CHANNEL 2-83 & FM/STEREO

Made in U.S.A.

COLOR Approved



Indoor Power Supply

23⁵⁰



Mast Mounted Unit

- Gain 20 db VHF-FM—10 db UHF—Uses Low Noise 2-Transistor Solid-State Circuit
- Use With Any Outdoor TV or FM Antenna—AC Isolation Transformer—No Shock Hazard

Enjoy vivid color and crisp black and white pictures; instantly improve your FM reception. 2-transistor solid-state mast-mounted pre-amplifier overcomes download losses and rejects interference, matching your roof antenna to your TV or FM set under all atmospheric and weather conditions. Gives 20 db boost to VHF and FM; 10 db to UHF. Designed for moderate to fringe area signals. Weatherproof outdoor housing mounts easily on an antenna boom or mast. Complete with 117 VAC indoor power-supply and hardware. Has single 300-ohm input and output thru "no-strip" screw terminals. Shoe. wt. 1½ lbs.

18 K 02149Net 23.50

ALLIANCE AUTOMATIC ROTOR-SYSTEM



28⁷⁸

- Full 360° Rotation
- Will Handle the Largest Color TV Antenna In Winds In Excess of 90 M.P.H. Rotation Speed 1 R.P.M.
- Magnetic Brake for Instant Stops with No Drift

Model U-100 Automatic Rotor System. Accepts masts to 1¾" O.D. Guy wire access provides secure installation. Control Box fully automatic, just set control knob and antenna rotates to desired position and stops automatically. Indicator shows position of antenna. Has positive mechanical stop at the end of rotation. Sizes: Rotator 7¾x4½x8". Control Case 7x4½x4", 115 V, 60 Hz AC at 65 Watts. Uses 4 Cond. Cable. Shpg. wt., 9½ lbs.

18 K 14037WNet 28.78

4-Conductor Flat Cable. Shpg. wt., 2½ lbs. per 100 ft.

32 K 89105 Per 100 Ft.Net 3.85

COLOR CHAMPION UHF/VHF ANTENNA



19⁹⁵

- Features Color Tuning Loops and Power Boosters
- VHF-UHF Isolation Network Switch

Get clearer, sharper pictures on all VHF/UHF channels 2 thru 83, in color and black and white, plus FM stereo. Combined action of color tuning loops, power boosters, and 5 section 46" solid brass elements give superb reception. 12 position picture correction control clears up ghosts, snow and color fading in most difficult areas. Separate VHF/UHF isolation network switch allows consistent true color levels and sharper color register. Attractive styling with walnut finish. Shpg. wt., 4¼ lbs.

18 K 12411Net 19.85

7" COLOR TV PURIFIER FOR SHARP COLOR PIX



2⁹⁵

- For Sharp and Clear Color Reception

Sharpens color reception through demagnetization of the picture tube. Simply turn on the set, plug in the purifier, and with switch depressed rotate unit in front of the TV screen. Use regularly to keep your color reception sharp and clear. Imported. Shpg. wt., 1 lb.

99 K 48248Net 2.95

2-Set VHF-UHF-FM COUPLER



1⁷⁵

- Low Signal Loss

- Up to 2 TV or FM Sets From One Antenna

Couples 2 TV or FM sets from a single TV/FM antenna. Low insertion loss and high isolation between sets. Ideal for color or black and white installations. Imported. Shpg. wt., 5 oz.

99 K 40313Net 1.75

4-SET VHF-UHF-FM COUPLER
Similar to above except couples up to 4 TV or FM sets from one antenna. Imported.

99 K 40321 Shpg. wt., 5 oz.Net 2.39

LAFAYETTE RECORDING TAPE FOR SUPERIOR PERFORMANCE

LAFAYETTE'S GUARANTEE ... You be the Judge

Lafayette's open reel, cassette and 8-track blank tape is made by outstanding, nationally-known manufacturers. It is first quality, splice free, red oxide-coated, with full frequency response, uniform output and no "dropouts." Resistant to

moisture, heat, cold, abrasion. We guarantee absolute satisfaction or your money back. If for any reason you are dissatisfied, return the tape within 30 days and we will refund your money less only transportation charges. You are the sole judge.

LAFAYETTE STANDARD BLANK TAPE CASSETTES



As Low As

69¢

High quality tape assures full fidelity recordings at budget prices. Precision manufacturing standards provide excellent sound reproduction and mechanical reliability. Lubricated and calendared for longer tape life. Imported. Shpg. wt., 4 oz.

Stock No.	Model No.	Playing Time	NET EACH	
			1-9	10 Up
28 K 01538	C-40	40 Minutes	.79	.89
28 K 01223	C-60	60 Minutes	.99	.89
28 K 01207	C-90	90 Minutes	1.49	1.39
28 K 01215	C-120	120 Minutes	2.19	1.99

CRITERION® DELUXE BLANK TAPE CASSETTES



As Low As

99¢

- Head Cleaning Tape on Each Cassette
- Super-Calendered Tape to Minimize Wear and Improve Frequency Response
- With Plastic Album Storage Box

Lafayette's deluxe low noise, high output recording tape cassettes manufactured to our specifications, with extra deluxe features. Deep lubricated, super-calendered tape. Head cleaning tape at one end removes accumulated material from recorder heads. High quality oxide coating provides performance standards superior to conventional tape cassettes. Imported. Shpg. wt., 5 oz.

CRITERION® UD HI-FI CASSETTES



C-60 UD 2.40
C-90 UD 3.60
C-120 UD 4.75

- Wide Dynamic Range—30-20,000 Hz Response
- Low Noise—High Output
- Super-Calendering Minimizes Wear and Improves Frequency Response
- Head Cleaning Tape on Each Cassette

These Lafayette ultra-dynamic hi-fi cassettes are the only ones having all of these deluxe features and represent the peak of cassette excellence. Advanced oxide formulation provides a wide dynamic range with a frequency response of 30-20,000 Hz. The low noise, distortion-free high output results in the highest performance that can be expected of a cassette tape. Each tape has a section of head cleaner at one end. In hard, clear plastic hinged album storage box. Imported. Shpg. wt., 5 oz.

C-60 UD 60-MINUTE HI-FI CASSETTE		Net ea. 2.40
99 K 15851		
C-90 UD 90-MINUTE HI-FI CASSETTE		Net ea. 3.60
99 K 15901		
C-120 UD 120-MINUTE HI-FI CASSETTE		Net ea. 4.75
99 K 16032		

Stock No.	Model No.	Playing Time	NET EACH	
			1-9	10 Up
28 K 01553	C-40	40 Minutes	1.09	.99
28 K 01306	C-60	60 Minutes	1.29	1.18
28 K 01314	C-90	90 Minutes	1.99	1.79
28 K 01322	C-120	120 Minutes	2.99	2.69



LAFAYETTE MYLAR AND TENSILIZED MYLAR RECORDING TAPES

Studio-quality tape made to Lafayette's rigid specifications. Its mylar base is especially strong, durable, and virtually impervious to heat, cold or humidity, and is therefore ideal for your most treasured recordings. Tensilized mylar is pre-stretched to offset sudden starts and stops of fast wind and rewind, prevent wow, and maintain true sound reproduction. All in clear plastic reels, individually boxed. Shpg. wts., 3" reel ¼ lb.; 5" reel ¾ lb.; 7" reel 1¼ lb.

Stock No.	Feet	Reel	Mils	Base	Net per reel		
					1-4	5-24	25 up
28 K 01090	300	3"	0.5	Tens Mylar	.69	.63	.59
28 K 01108	600	3¼"	0.5	Tens Mylar	.99	.90	.81
28 K 01058	1200	5"	0.5	Mylar	1.75	1.58	1.42
28 K 01066	1800	7"	1.0	Mylar	2.14	1.93	1.75
28 K 01074	2400	7"	0.5	Mylar	3.10	2.79	2.51
28 K 01231	3600	7"	0.5	Tens Mylar	4.98	4.49	3.99

TDK 8-TRACK SD HI-FI CARTRIDGES



These TDK 8-track cartridges combine the high-fidelity reproduction of super-dynamic blank recording tape with high reliability cartridge construction. Features very broad dynamic range and high signal-to-noise ratio. Imported. Shpg. wt., 6 oz.

Stock No.	Type	Record Time	Net ea.
28 K 24530	8TR-40SD	40 min.	2.99
28 K 24548	8TR-80SD	80 min.	3.99

LAFAYETTE 8-TRACK CARTRIDGE MYLAR RECORDING TAPE

As Low As **1.29**



Continuous loop 8-track cartridges well lubricated to preserve tape life and reduce head wear. Calendared low-noise high output coating on mylar base. High reliability construction assures unexcelled sound reproduction performance. Shpg. wt., 6 oz.

Stock No.	Record Time	Net Each		
		1-5	6-11	12 up
28 K 01546	40 Min.	1.69	1.49	1.29
28 K 01439	70 Min.	1.95	1.79	1.49
28 K 01355	80 Min.	2.25	2.05	1.85



TDK ENDLESS CASSETTES

As Low As **4.00**

Provides repeat messages for point-of-purchase advertising, sales displays, telephone answering, background music, etc. Can be used in all conventional recorder players. Special feature prevents damage if reverse function is accidentally actuated. Available in 1, 3 and 6 minute playing times. Imported. Shpg. wt., 5 oz.

Stock No.	TDK No.	Playing Time	Net each
28 K 24555	EC-1	1 Minute	4.00
28 K 24563	EC-3	3 Minutes	4.20
28 K 24571	EC-6	6 Minutes	4.60

Take advantage of sales with Mastercharge and BankAmericard.

Lafayette Cat. No. 743 97

Keep Your Tapes in Shape with

Hand Held Bulk Erasers

- Utmost Versatility—Demagnetizes Cassettes, Cartridges, Capstans, Tape Guides Etc.

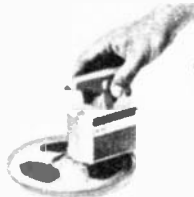

11⁵⁰

Easily erases tapes or sound films regardless of reel size. Convenient, comfortable hand-held design. Safe, durable plastic case and control switch. High intensity field with low power consumption. Shpg. wt., 2 3/4 lbs.
28 K 30016Net 11.50

Ampex 8-Track Cartridge Demagnetizer Cleaner



5⁹⁵

This completely cordless Ampex automatic combination demagnetizer-cleaner for 8-track cartridge equipment does its job simply in seconds. Removes both built-up oxide residues and eliminates residual magnetism from tape heads and guides. Non-abrasive fabric cleaning tape does no damage to tape heads.
28 K 54016 Shpg. wt., 8 oz.Net 5.95

Ampex Demagnetizing/Cleaning Cassette



4⁹⁵

Cleans and demagnetizes cassette recorder heads and guides in one brief pass through the recorder. Since it requires no power, fits all cassette recorders including slot-loaded ones. Non-abrasive cleaning tape will not damage tape heads.
28 K 54008 Shpg. wt., 4 oz.Net 4.95

Hum-Bucking Telephone Pickup Coil



7⁸⁰

Designed with symmetrical hum cancelling pick-up coils to eliminate high stray hum pickup usually encountered with conventional coils. For use with high impedance tape recorders, amplifiers and dictating machines. Double suction cup for easy mounting. 5' cable with stripped leads. Shpg. wt., 4 oz.
28 K 32012Net 7.80

Lafayette Foot Switch

4⁵⁰



Ideal for Stenographic Transcribing

Gives your cassette recorder the versatility of a dictating machine. Plays when the foot switch is depressed, stops when released. Simply plugs into "remote" jack. 5 ft. cable with micro-miniature plug. Imported.
99 K 15810 Shpg. wt., 3/4 lb.Net 4.50

Lafayette Tape Splicer



3⁴⁹

- Two Operations—Cuts & Trims
- Clean Splices in Seconds
- For Reel-To-Reel and 8-Track Recording Tape
- Splicing Tape Supplied

A sturdy precision instrument for professional use in all splicing and editing applications. Gives clean, quick cuts on all tapes without losing a significant portion of the sound track. Splicing tape fed from below will not foul and waste tape. Sharp, long-lasting blades provide trouble-free operation. A must for professionals and demanding audio hobbyists. Imported. Shpg. wt., 9 oz.
28 K 09051Net 3.49

Replacement splicing tape for above.
28 K 09069 Shpg. wt., 3 oz.Net .39

"Pin Ball" Total Service 8-Track Cartridge



2⁹⁵

- Head Cleaner
- Capstan Cleaner
- Demagnetizer
- Track Switch Test

The most complete service device for 8-track equipment. Tape head is cleaned and demagnetized in all track positions. Capstan is thoroughly cleaned to eliminate wow and flutter. A track switching mechanism moves the player head through all track positions while being serviced. Tape player cleaning solution supplied. Shpg. wt., 8 oz.
28 K 16023Net 2.95

Cassette Tape Splicer

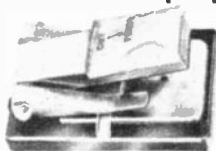

2⁸⁹

Sturdy precision instrument for use in all splicing and editing of cassette tapes. Imported. Shpg. wt., 7 oz.

99 K 15992Net 2.89

Lafayette Head Cleaner Spray



1²⁹ 6 oz. Spray Can

Sprays away accumulation of oxides, dirt and grease on all tape recorders and restores original sound quality. 5" extension tube pinpoints application to hard-to-reach locations.
28 K 01488 Shpg. wt., 10 oz.Net 1.29

Cassette Test Strobe



5¹⁹

Checks your cassette recorder/player for proper speed. Too fast causes flutter; too slow creates tape drag or wow. Strobe tape and light built into standard cassette. For 110 VAC 50/60 Hz. Shpg. wt., 5 oz.
28 K 72414Net 5.19

Telephone Pickup Coil



2⁹⁸

Extremely sensitive loop type telephone pick-up coil for use with recorders, amplifiers and dictating machines. Loop easily slips on ear piece of phone. 3 ft. shielded cable with miniature 1/8" plug. Imported.
28 K 65129 Shpg. wt., 6 oz.Net 2.98

Lafayette Tape Recorder Cleaner



With Applicator **60¢**

Removes oxide accumulations, dirt and grit from tape heads, capstan, and guides which come in contact with tape, and eliminates resulting distortions. Will not affect plastic parts. 2 oz. bottle with felt applicator. Shpg. wt., 7 oz.

28 K 01482Net .60

Lafayette Cleaning Swabs



59¢ Pkg. of 100

Cotton tipped 6-inch applicators for cleaning and oiling hard to reach parts of recorders, phonos and other equipment. Pkg. of 100. Shpg. wt., 4 oz.

28 K 01470Net .59

Cassette and 8-Track Accessories

Super-Deluxe Tape Cartridge Storage Cabinet

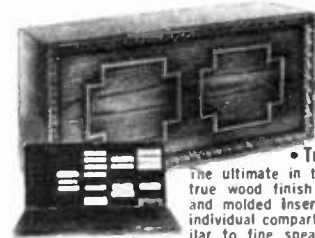

19⁹⁵

• Holds 45 Cartridges

• True Wood Finished Door

the ultimate in tape storage featuring a true wood finish hinged drop-down door and molded insert which stores tapes in individual compartments. Construction similar to fine speakers. Size: 24 3/4 x 6 3/4

x 11 1/4". Shpg. wt., 8 1/2 lbs.
28 K 78148W

Net 19.95

Home Storage Cabinets



7⁹⁵

• For Either Cassette or 8-Track Cartridges

• Store in Bookcase, on Wall or on Top of Desk or Stereo Cabinet

Economy and styling are combined in this new cabinet. The one piece molded insert stores tapes in individual compartments and assures neat stocking and easy cataloging of titles.

8-TRACK CARTRIDGE STORAGE CABINET. Holds up to 30 cartridges. Size: 24x3 3/4x7 3/4". Shpg. wt., 5 lbs.

28 K 78130W Net 7.95

CASSETTE STORAGE CABINET. Holds up to 36 cassettes. Size 21 x 2 3/4 x 8 1/4". Shpg. wt., 4 lbs.

28 K 78155W Net 7.95

Lafayette Tape Head Demagnetizers

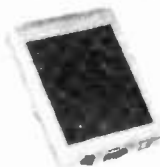

As Low As

4²⁵

• For Cassette or 8-Track

Removes excessive magnetic build-up on tape heads and improves sound performance. Use after every 15 hours of player-recorder use. Imported.

FOR 117 VAC 8-TRACK HOME PLAYERS

99 K 15091 Shpg. wt., 12 oz. Net 4.25

FOR 12 VDC 8-TRACK CAR PLAYERS

99 K 15422 Shpg. wt., 12 oz. Net 5.25

FOR CASSETTE RECORDER PLAYERS. Uses 117 VAC

99 K 16057 Shpg. wt., 6 oz. Net 4.39

Head Cleaner and Test Tapes



1⁴⁹



• For Either Cassette or 8-Track Equipment

- 1) Tests For Proper Head Alignment
- 2) Tests For Stereo Balance
- 3) Cleans Tape Head

Keep your recorder/player equipment sounding like new with professionally calibrated test tapes which also clean tape heads and restore full richness of tone.

8-TRACK HEAD CLEANER AND TEST TAPE

28 K 92016 Shpg. wt., 6 oz. Net 1.49

CASSETTE HEAD CLEANER AND TEST TAPE

28 K 92024 Shpg. wt., 3 oz. Net 1.49



Lazy Susan Type Storage Racks

Only

8⁹⁵

ASSEMBLED

Only

6⁹⁵

KIT FORM

• Holds Up to 48 Tapes

• For Either Cassette or 8-Track Cartridges

• Available Assembled or in Kit Form

Easy access to your recorded cassettes or 8-track cartridges with no more misplaced tapes. Attractively styled storage racks with simulated walnut vinyl finish. Rotating "Lazy Susan" type base. Each model holds up to 48 tapes.

ASSEMBLED STORAGE RACK

8-TRACK CARTRIDGE STORAGE RACK. Holds 48 cartridges. Size: 9 1/2" W x 9 1/2" D x 12 1/2" H. Shpg. wt., 5 lbs.

28 K 78049W Net 8.95

CASSETTE STORAGE RACK. Holds 48 cassettes. Size: 8 x 8 x 10" H.

28 K 78056W Shpg. wt., 3 1/4 lbs. Net 8.95

STORAGE RACKS IN KIT FORM

Kits contain only 11 simple parts easily assembled in minutes with only one screw.

8-TRACK CARTRIDGE STORAGE RACK. Holds 48 cartridges

28 K 78171 Shpg. wt., 3 1/4 lbs. Net 6.95

CASSETTE STORAGE RACK. Holds 48 cassettes

28 K 78189 Shpg. wt., 3 1/4 lbs. Net 6.95

Deluxe Tape Carrying Cases

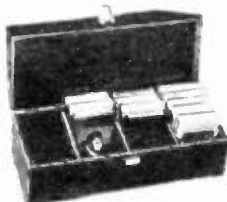

7⁹⁵

• For Either Cassette or 8-Track Cartridges

Solid wood construction. Durable alligator-vinyl covering with attractive red plush interior. Titles immediately visible. Equipped with sturdy handle, lock and key.

8-TRACK CARRYING CASE. Holds up to 24 8-track cartridges. Size: 17 1/2" W x 6 1/2" H x 7 1/2" D. Shpg. wt., 4 1/4 lbs.

28 K 78064W Net 7.95

CASSETTE CARRYING CASE. Holds up to 30 cassettes. Size: 14 1/2" W x 3 3/8" H x 9 1/2" D. Shpg. wt., 3 1/4 lbs.

28 K 78072 Net 7.95

Cassette Carrying Case



2⁴⁹

• Holds 12 Cassettes

Black vinyl with chrome trim shoulder strap, and spring snap lock. Size: 6 1/2" L x 5 1/2" H x 3" D. Shpg. wt., 3/4 lb.

28 K 27012 Net 2.49

Tape Head Cleaners



As Low As

85¢

• Available for Either Cassette or 8-Track Equipment

Removes coating deposits from tape heads and restores both volume and high frequency response. Simply insert and run equipment. Can be reused.

8-TRACK HEAD CLEANER. Shpg. wt., 6 oz.

28 K 12923 Net .99

CASSETTE HEAD CLEANER. Shpg. wt., 4 oz.

28 K 16015 Net .85

Make your shopping easier with BankAmericard and Mastercharge.

Lafayette Cat. No. 743 99

Buy Either Quality Stereo 8-Track Car Tape Player And Get A Pair Of Matching Speakers For Only 1c More!

LAFAYETTE "MICRO 8B"



44⁹⁵
No Money Down*
With Mounting
Bracket,
Less Speakers

44⁹⁶
No Money Down*
With Mounting
Bracket,
With Speakers

- Individual Illuminated Channel Lights
- Pushbutton Channel Selector Button
- Fine Tuning Control
- Self-Cleaning Head

Low-priced 8-track stereo car features: Fine tuning control to adjust playback head for worn or defective cartridges—tunes out crosstalk. Built-in head cleaner cleans the head each time a cartridge is inserted. Compact design permits installation—even where space is at a premium. Player is only 7 $\frac{3}{4}$ "D x 5 $\frac{1}{2}$ "W x 2 $\frac{3}{4}$ "H in size. Fully automatic operation—turns on when a tape is inserted, changes tracks automatically at the end of each program. Balance control to adjust for proper stereo channel separation. Freq. Response 30-10,000 Hz. For 12-volt neg. ground systems. Adjustable mounting bracket. Imported. Shpg. wt., 5 $\frac{3}{4}$ lbs.

17 K 02570W Micro 8B SeparatelyNet 44.95
Micro 8B plus pair of Matched Speakers
17 K 90187WM Shpg. wt., 8 $\frac{1}{4}$ lbs.Net 44.96
Pair of 3 x 5" matching speaker systems, separately.
99 K 62994 Imported. Shpg. wt., 2 $\frac{1}{2}$ lbs.Net 7.95

DELUXE LAFAYETTE "PRO 8"

WITH BUILT-IN LOCK
TO PREVENT THEFT



59⁹⁵ With Mounting
Bracket,
Less Speakers
No Money Down*

59⁹⁶ With
Mounting
Bracket,
With
Speakers
No Money Down*

- Fine Tuning Control Adjusts Playback Head
- Separate Slide Lever Controls for Volume, Balance and Tone
- Individual Channel Indicators
- Pushbutton Track Selector

Superbly engineered for convenience and quality. Measures only 6W x 3 $\frac{1}{4}$ "H x 7"D and mounts easily under the dash of your car with adjustable bracket. The Pro-8 is also easily removable when not in use. This bracket features a safety lock to prevent theft. Among its many professional features are individual slide controls for Stereo Balance, Volume and Tone. A Fine Tuning control tunes out crosstalk when using old, worn or defective cartridges. Pushbutton channel selector. Individual channel indicators. Powerful 12-watt, solid-state circuitry. For 12 VDC Neg. Ground systems. Imported. 17 K 02364W Separately. Shpg. wt., 7 lbs.Net 59.95

Pro 8 plus Pair of Matching Speakers
17 K 90161WM Shpg. wt., 9 $\frac{1}{2}$ lbs.Net 59.96
Pair of 3 x 5" matching speaker systems, separately.
99 K 62994 Imported. Shpg. wt., 2 $\frac{1}{2}$ lbs.Net 7.95

"Custom In-Dash" 8-Track Car Stereo Tape Player with AM/FM Stereo Radio

114⁹⁵

With Wood Grain Face Plate,
Less Speakers

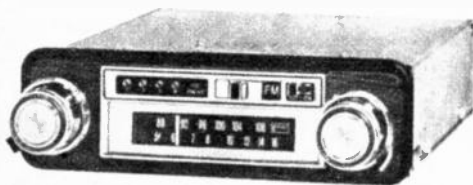

- For Custom In-Dash Installation in Foreign and Domestic Cars—Requires Optional Kit Listed Below

One of the most complete universal car sound-systems ever designed. Includes an AM/FM stereo radio and 8-track stereo tape player in one compact cabinet with adjustable shafts. Optional custom kits are available. (See listing below). These kits assure perfect in-dash placement for foreign or domestic car and trucks. Extra powerful tuner/amplifier delivers 7 watts per channel. Solid-state IC circuitry. Slide bar AM/FM tuning. Has channel indicator light, FM stereo indicator light. For 12-volt negative ground systems. Size: 7W x 2 $\frac{1}{2}$ "H x 6 $\frac{1}{4}$ "D. Imported. Shpg. wt., 8 $\frac{1}{2}$ lbs.

17 K 80105W No Money Down*Net 114.95
Set of 2 Deluxe Lafayette Quick Mount Speakers.
32 K 01977 Shpg. wt., 3 $\frac{3}{4}$ lbs.Net 14.95

CUSTOM INSTALLATION KITS

Custom Installed Kits for Most Cars. Specify make, model, and Year of Car. Three weeks for delivery. No COD's. Shpg. wt., 2 lbs.
17 K 80089ZNet 7.95

SAVE \$10! Lafayette's 2- and 4-Channel 8-Track Stereo Car Tape Player Even Plays New Q8 4-Channel Tapes

SALE!
79⁹⁵

WAS 89.95
1974 Cat. 741



**Completely Compatible—Plays Both
the New Q8 4-Channel and 2-Channel Stereo 8-Track Tapes**

• **FEATURES** •

- Front and Rear Balance Control
- Left and Right Balance Control
- Separate Tone and Volume Controls
- Pushbutton Channel Selector
- Mounting Bracket Included

Four-channel sound provides a magnificent new listening experience. Now with this deluxe tape player you can enjoy 4-channel sound in the comfort of your car. Plays both the new discrete Q8 4-channel tapes, and the conventional 2-channel 8-track stereo cartridges. Features solid-state circuitry, 4- or 2-channel selector button, automatic or manual program selection, tone control, volume control, front-rear balance control, left-right balance control, channel indicator, and channel selector button. Power output 4 watts x 4; Response 50-8,000 Hz. Signal-to-Noise Ratio 40 db or better. Speaker impedance 4 to 8 ohms, 20 transistors, 1 diode, and 8 Thermistors. For 12-volt negative ground car systems. Size: 2H x 8W x 8 1/4"D. Imported. Shpg. wt., 6 lbs.

99 K 16065W No Money Down* Net 79.95
Custom Set of 4 Lafayette Speakers Plus Grilles. Imported.
99 K 62861 Shpg. wt., 3 1/2 lbs. Net 10.95

Low Cost, Full Feature 8-Track Car Stereo Tape Player

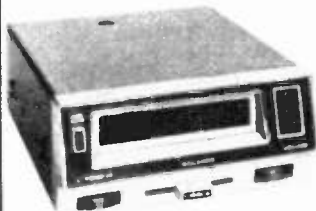

29⁹⁵

With All
Mounting Hardware

Low cost, fine performing 8-track car stereo player. Among its many features are individual controls for balance, volume, and tone; and a pushbutton track selector. For 12-volt negative ground systems. Size: 6 1/4" x 2 3/8" x 7"D. Imported. Shpg. wt., 6 lbs.
17 K 67011W Net 29.95
Pair of Two 3x5" Matching Speaker Systems. Imported.
99 K 62994 Shpg. wt., 2 1/2 lbs. Net 7.95

Tenna TC-82T 8-Track Car Stereo Tape Player Has Built-in Burglar Alarm!

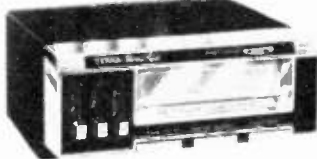

79⁹⁵

With All Mounting
Hardware,
Less Speakers

- Self-Cleaning Tape Head
- Fine Tuning
- Fast Forward Button

Highly styled, with exciting features: Built-In Head Cleaner. Fast Forward Button. Eject Button. Built-in Tape Light. Theft-Proof Built-In Burglar Alarm. Fine Tuning adjusts for worn or defective cartridges, tunes out crosstalk. Slide Controls for Tone, Volume, and Balance. Reversible polarity, for 12 volt negative/positive ground cars. Also includes automatic or pushbutton track selection. Peak audio output: 14 watts. Measures only 7 1/2" x 3H x 7 1/2"D. Impedance: 4 ohms. With universal mounting bracket. Imported. Shpg. wt., 7 1/2 lbs.
17 K 74686W No Money Down* ..Net 79.95
Set of 2 Matched Lafayette Rear Deck Speakers. Imported.
99 K 62994 Shpg. wt., 2 1/2 lbs. Net 7.95

Solid-State 8-Track Car Stereo Tape Player Has AM/FM Stereo Radio



99⁹⁵

With All Mounting
Hardware,
Less Speakers

- Balance & Volume Slide Controls
- Channel Selector Button
- Channel Repeat Button
- FM Stereo Indicator Light

Attractively styled 8-track car stereo cartridge player with built-in FM/FM stereo radio. Power output per channel is 6 watts. Features tone control, FM stereo indicator light, sliderule tuning, pushbutton track selector, and channel repeat button. For 12-Volt negative ground systems. Size: 8W x 8 1/4" x 3 1/4"H. Imported. Shpg. wt., 8 lbs.
17 K 80063W No Money Down* ..Net 99.95
Set of two Lafayette Matched Car Speaker Systems. Imported.
99 K 62994 Shpg. wt., 2 1/2 lbs. ..Net 7.95

1¢ SPEAKER BONUS



REGULARLY 7.95

Get A Pair of Matching Speaker Systems for Only 1¢
With The Purchase of Either A Lafayette RK-300
or "Auto-Mate" Car Cassette Stereo Tape Player



**Lafayette RK-300 Car
Stereo Cassette Player
with Continuous
Automatic Reverse**

79⁹⁵

Includes Mounting
Bracket and
Connecting Cable

Less Speakers

79⁹⁶

Includes Mounting
Bracket and
Connecting Cable

With Speakers

- Fast Forward and Rewind
- Stop/Eject Button
- For 12 Volt Negative Ground System

- Separate Slide Lever Controls For Volume, Balance and Tone
- All Solid-State Circuitry

Designed for the ultimate in stereo cassette car listening pleasure. Automatically reverses tape direction at the end of the tape. 10 watt solid-state stereo power amplifier for distortion free music. Mode selector button, fast forward, fast rewind, stop/eject button, slide lever volume, tone and balance controls. For 12 VDC negative

ground systems. Size: 7W x 2½H x 7"0. Imported. Wt., 7½ lbs.
99 K 16248L RK-300 Only. No Money Down*Net 79.95
RK-300 Plus Pair of 3x5" Matching Speakers.
99 K 92728LM Wt., 10 lbs. No Money Down*Net 79.96

Lafayette Stereo "Auto-Mate" Car Cassette Tape Player



41⁹⁵

Includes Mounting
Bracket and
Connecting Cable

Less Speakers

41⁹⁶

Includes Mounting
Bracket and
Connecting Cable

With Speakers

- Only 6W x 1½D x 6½"H—Can Easily Be Mounted In Your Car's Glove Compartment

- Fast Forward and Eject Buttons
- Separate Balance, Tone and Volume Controls
- For 12-volt Negative Ground Systems

The Lafayette "Auto-Mate" is so compact it can be installed in the glove compartment of most cars. Listen to the beautiful music of pre-recorded stereo cassette tapes. Powerful space-age solid-state circuitry. Fast forward and eject buttons. Separate tone and volume controls, plus slide lever balance control for adjusting proper sound

level in each speaker. For 12-volt negative ground systems. Speaker impedance 4-8 ohms. Size: 6W x 1½ x 6½". Imported. Wt., 4 lbs.
99 K 16180L "Auto-Mate" Only. No Money Down*Net 41.95
"Auto-Mate" Plus Pair of 3x5" Matching Speakers.
99 K 92736LM Shpg. wt., 6½ lbs. No Money Down* Net 41.96

Pioneer and Sanyo Car Stereo Cassette Players

PIONEER KP-300 AUTO REVERSE CAR CASSETTE TAPE PLAYER WITH FM/STEREO RADIO



- Continuous Play of Cassette Tapes in Both Directions
- FM Stereo Indicator Light
- Separate Volume, Tone and Balance Controls
- Illuminated Directional Indicator

129⁹⁵
less speakers

Compact enough to fit in most glove compartments. Automatic reverse for continuous play of cassette tapes in both directions. Illuminated directional indicator. Stereo/mono switch. Solid-state I.C. audio amplified circuitry. FET FM front end. FM stereo indicator light. Eject button. Power Output (RMS) 7.6 watts, 3.8 watts per channel. For 12 volt negative ground systems. Handsomely styled—will fit the decor of all cars. Includes all mounting hardware. Size: 5 $\frac{1}{2}$ "W x 2H x 7 $\frac{1}{4}$ "D. Imported. Shpg. wt., 7 lbs.

17 K 85047W No Money Down*Net 129.95
Deluxe set of Lafayette "Quick Mount" Car Speaker Systems.
32 K 01977 Shpg. wt., 3 $\frac{3}{4}$ lbs. Imported.Net 14.95

SANYO FT-433M AM/FM STEREO CAR CASSETTE PLAYER/RECORDER



Includes Microphone
With Remote Start/Stop Switch

179⁹⁵
less speakers

- Automatic Stop at End of Tape
- Separate Balance, Volume, and Tone Controls
- FM Stereo Indicator Light

The ultimate in a car stereo unit. Built-in AM/FM/FM Stereo radio with a high fidelity stereo recording and playback tape deck. Cassette Recorder features a unique cueing system with a pause push-button which starts and stops the tape instantaneously. Fast forward and rewind lever. Sensitive AM/FM Stereo Radio has cylindrical tuning. Power output 25 watts. Speaker impedance 4 & 8 ohms. For 12-volt negative ground systems. Includes mounting bracket and hardware. Size 9 x 8 $\frac{1}{2}$ x 3". Imported. Shpg. wt., 9 lbs.

17 K 59133W No Money*Net 179.95
Deluxe set of Lafayette "Quick Mount" Car Speaker Systems.
32 K 01977 Shpg. wt., 3 $\frac{3}{4}$ lbs. Imported.Net 14.95

Accessories for Car Stereo Tape Players

UNIVERSAL LOCK MOUNT FOR CAR TAPE PLAYERS



SALE 4⁹⁵

Made in U.S.A.

- For Under Dash Installation
- Remove Your Tape Player When Your Car is Unprotected

Prevents the theft of your car stereo tape player. Makes your player removable. Takes minutes to install. Adjustable mount adapts to car stereo tape players or CB transceivers. Once installed, no screws or wires are needed to disconnect player from mount. Plugs-in and locks. For 6 or 12 V. neg. or positive ground. Size: 6 $\frac{1}{2}$ "W x 7 $\frac{1}{4}$ "D x 1"H. Shpg. wt., 2 $\frac{3}{4}$ lbs.

17 K 63010Net 4.95

LAFAYETTE 4 DIMENSIONAL CAR ADAPTER

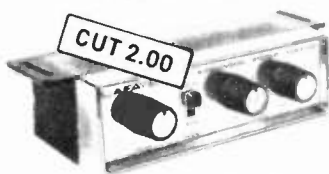

SALE 5⁹⁵

- Derives 4 Dimensional Sound From 2-Channel Stereo Tape Cartridges or Cassettes and FM Stereo Broadcasts.

Derives magnificent 4 dimensional sound from your present 2-channel car stereo tape player (8-track or cassette) or FM stereo radio. If your present car stereo system has 4 speakers — all you require is the Lafayette 4 Dimensional Adapter. If you have only 2 speakers, you must add the adapter and 2 additional speakers. Includes two 3 ft., two 6 ft., and two 15 ft. connecting cables. Size: 15 $\frac{1}{2}$ "W x 1 $\frac{3}{4}$ "H x 2 $\frac{1}{2}$ "D. For 12 Volt Negative Ground Systems. Imported.

99 K 85128 Shpg wt., 2 lbs.Net 5.95

LAFAYETTE 115 VAC TO 12 VDC HOME POWER SUPPLY



15⁹⁵

- Handles Up to 4 Amps
- Heavy-Duty Binding Posts
- Neon Indicator Light
- Overload Circuit Breaker

Double the use of a car stereo tape player by using it in your home or office. Converts 115 volts AC to 12 volts DC. Handles a maximum load of 4 amps. Incorporates a circuit breaker component that automatically shuts off 12-volt output in case of an accidental overload. Heavy-duty binding posts and neon light. For 117 VAC, 60 Hz. Size: 4 $\frac{3}{4}$ "W x 3H x 5 $\frac{3}{4}$ "D. Shpg. wt., 6 lbs.

17 K 02398Net 15.95

Speakers and Accessories for Car Stereo Tape Players

LAFAYETTE "QUICK MOUNT" STEREO HI-FI CAR SPEAKERS



Only
14⁹⁵ Pair

- Handles 10 Watts Per Speaker
- Easily Fastens to the Fire Wall, Kick Panel or Under Seat

Quality pair of 5½" speakers with 5.5 oz. ceramic magnets, and cloth roll suspension for true hi-fi sound in the car. Impedance, 8 ohms. Will mount in minutes. No holes to cut or saw. Just drive screws through the convenient flanges on the outer plastic grill. Includes wire, hardware, and illustrated mounting instructions. Wt., 3¾ lbs.

32 K 01977Net Per Pair 14.95

PAIR OF TRUSONIC 5" DIE-CAST STEREO HI-FI SPEAKERS FOR THE CAR



29⁹⁵ Pair
With Grills and
Mounting Hardware

- Power Handling: 12 Watts
- For Door or Rear Deck Mounting
- Frequency Response: 50-18,000 Hz

Reproduces magnificent hi-fi sound in the car. Powerful 5" full-range speaker delivers brilliant clean highs to 18,000 Hz and deep solid bass down to 50 Hz. Features rigid die-cast frame, free cone suspension, 2 lb. magnet structure and 1" edge-wound wire ribbon voice coil. Handles 12 full watts of power. Custom mounts in door panels or on rear deck. Impedance 8 ohms. Shpg. wt., 6¼ lbs.

32 K 49489 2-Speaker KitNet 29.95

PAIR OF DELUXE TRUSONIC 5" 2-WAY HI-FI SPEAKERS FOR THE CAR

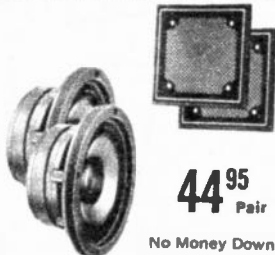

44⁹⁵ Pair

No Money Down*

- 2 lb. Magnet Structure
- 25 Watts Power Handling
- Frequency Response 45-18,000 Hz

The ultimate in an automobile speaker. Remarkably smooth response. Massive 2 lb. magnet structure, 1" voice coil. Pressure die-cast frame. Free edge cone suspension, separate high frequency cone. Free air resonance—40 Hz. Impedance: 8 ohms. Hand-some black square grille with silver trim. Custom mounts in door panels or on rear deck. Includes hook-up wire, instructions, and templates. Shpg. wt., 8 lbs.

32 K 49604Net Per Pair 44.95

LAFAYETTE PAIR OF 3 x 5 UNDER-DASH MATCHING SPEAKER SYSTEMS



7⁹⁵ Pair

Handsome pair of two 3 x 5" wide-range ceramic speakers mounted in plastic housing. Will mount under dash, under seats, on kick panels, doors, or rear package shelf. Includes all necessary cables and mounting hardware. Impedance, 8 ohms. Imported. Shpg. wt., 2½ lbs.

99 K 62994Net 7.95

LAFAYETTE CUSTOM INDOOR SET OF FOUR SPEAKERS & MATCHING GRILLS



10⁹⁵ Set

Ready for quick installation. Improves the sound of any car tape player. Kit includes: Four 4¾" extended range 8-ohm PM speakers; four round custom mount plastic speaker grilles; hookup wire with solderless connectors; mounting hardware and easy instructions. Imported. Shpg. wt., 3½ lbs.

99 K 62861Net 10.95

DELUXE PAIR OF PHILIPS REAR DECK SPEAKERS

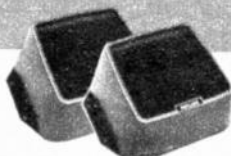

16⁹⁵ Pair
With All
Mounting
Hardware

- 2 Powerful Philips 5 Inch Wide Range Speakers

Quality 5" system installs easily on the Rear Deck or under the seat. Attractive black finish trimmed with chrome complements the decor of any auto. Frequency Response 100-9000 Hz. Impedance 4-8 ohms. Handles 10 watts power. Wt., 3 lbs.

32 K 44001Net 16.95

PAIR OF TACHOMETER STYLE CAR SPEAKER SYSTEMS



Sale
17⁹⁵ Pair

WAS 21.95

- Big 8-Oz. Magnet
- Mount on Dash, Under Dash or on Rear Deck

For auto, camper, van, truck, trailer or boat. Unbelievably true sound from two 4" air suspension speakers. Handles up to 15 watts. Adjustable, hi-impact, black plastic case. 4 and 8 ohm impedance. Shpg. wt., 4 lbs.

32 K 5008WNet \$17.95

UNIVERSAL 8-TRACK FM STEREO TUNER CARTRIDGE



34⁹⁵

with Auto-Y
antenna

- Converts Stereo 8-Track Car Tape Players into an FM Stereo Radio
- FM Stereo Indicator Light
- Built-in AFC

Listen to full-dimensional FM stereo radio broadcasts in your car. Inserts into your car tape player just like a regular tape cartridge. Features instant-on solid-state circuitry, FM stereo indicator light, built-in AFC to prevent station drift, roll-bar FM tuning, and an auto-Y antenna. Size: 7½ x 3¾ x ¾" D. Imported. Shpg. wt., 1 lb.

17 K 43061LNet 34.95

CASSETTE ADAPTER FOR 8-TRACK CARTRIDGE PLAYERS

Fits Into Existing
8 Track Players

- Fast Forward Button
- Tape Pops-Up Automatically



No
Money
Down*

34⁹⁵

Play your stereo cassettes in an 8-Track Tape Cartridge Player. Requires no installation or modification to the 8-Track Player. Cassettes easily fit into adapter. Pop out automatically. No battery is required, adapter draws its power directly from the 8-Track Tape Player. Cassettes can be changed without removing the adapter from the tape player. Imported. Shpg. wt., 1½ lbs.

17 K 80113Net 34.95

Musically-Activated Color Lights & Strobes

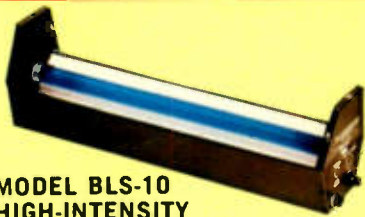

MODEL BLS-10 HIGH-INTENSITY BLACKLIGHT/STROBE

Kit **24⁹⁵** Wired **34⁹⁵**

Instant-starting, high-intensity, 15-watt UV bulb in a polished chrome reflector almost equals 75 watts of ordinary light. Mounts over paintings, in windows, etc., with multi-positional mounting slots. Illuminates up to 25 feet or more. Solid-state "strobe" (pulse) circuit for adjustable on-off rate. Jet black cabinet. Size: 4½ x 18¼ x 4". Shpg. wt., 9 lbs.

21 K 25458W BLS-10 KitNet 24.95
21 K 25466W BLS-10 wiredNet 34.95

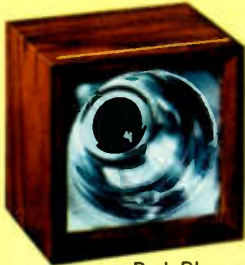

ELECTRONIC STROBE LIGHT

19⁹⁵

- Red, Blue, and Yellow Filters
- Fully Transistorized
- Variable Rate Control

For special lighting effects in photography, combo groups or discotheques, etc. Speed control can be varied to the beat of music from 1 to 10 flashes per second. A 4-inch chrome reflector, clear plastic lens cover and Xenon flash tube deliver a powerful light flash over a 60° arc. Walnut finish cabinet. For 117 VAC, 60 Hz. Size: 5½H x 5½W x 4¾"D. Shpg. wt., 2½ lbs.

21 K 26092Net 19.95



3-CHANNEL COLOR LIGHT CONTROL CENTER

- True Frequency Division
 - 500 Watts Per Channel (1500 Watts Total)
- 42⁵⁰**

Translates musical patterns into dynamic patterns of throbbing, flashing lights precisely synchronized to the music. Provides 500 watts per channel (1500 watts total). Audio spectrum is divided by 3 separate, transistorized frequency-selective amplifiers. Accepts 9 150-watt or 18 75-watt lights at once; on/off switch; 3 intensity adjustments; on/off pilot light and 3 channel indicator lights. For 110-120 VAC, 15 amps. max. Shpg. wt., 3 lbs.

13 K 48002 No Money Down*Net 42.50



DELUXE 4-CHANNEL FREQUENCY SYNCHRONIZED, SOUND ACTUATED COLOR LIGHTS

59⁹⁵

- Giant 28½" by 13½" Screen
- 4 Adjustable Color Controls
- Continuously Flowing Color Images

A sophisticated electronics system that provides true synchronization of color and sound. See every tone, each note, and every combination of instruments create its own vivid color pattern. The system includes 4 color channels: red, blue, green and yellow that are ever-changing, inter-weaving and blending to produce spontaneous, frequency-synchronized multicolor patterns to the music reproduced by your speakers. Connects in seconds to your Hi-Fi system or guitar amplifier. All-solid-state integrated circuitry. Handsome walnut vinyl-covered wood cabinet. Size: 30 x 15 x 11". For 117 VAC, 60 Hz. Shpg. wt., 23 lbs. No Money Down*.

21 K 03000WXNet 59.95

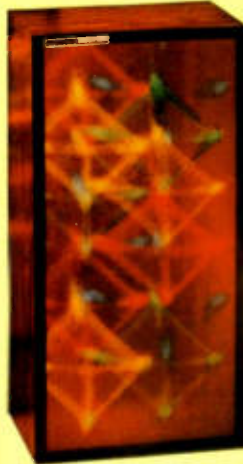

4-COLOR, SOUND- ACTUATED COLOR LIGHTS

SAVE **5.00** **29⁹⁵**

- Easily Connects to Speaker Leads

Top-quality, 4-color, solid-state, sound-actuated color organ. You can actually see every note and tone converted to a brilliantly moving panorama of colored, dancing images with each note and tone produced by the music. Flashing red, blue, green and yellow colors create an entertaining display of multi-color, 3-dimensional spontaneity which varies to the amplitude of the sound source. Hi/low inputs allow you to adjust for music power levels; exclusive 4-in-1 color control. Housed in walnut wood-grained cabinet. For 110 VAC, 60 Hz. Size: 24 x 12 x 10". No Money Down*.

21 K 25904WNet 29.95



3-SIDED, PRISMATIC COLOR AUDIO LIGHTS

24⁹⁵

- Easily Connects to Speaker Leads

One-piece, 3-sided prismatic lens produces a panorama of colors that have a 3-dimensional effect. Solid-state electronic control transposes music sound impulses into multi-color flashing light patterns. Hooks up to speaker leads of any sound source. For 117 VAC, 60 Hz. Size: 18 x 11 x 7". Walnut vinyl-grained wood cabinet. Shpg. wt., 8½ lbs.

13 K 75526WNet 24.95

OUR BEST 8-TRACK DECKS



Deluxe LAFAYETTE RK-890A Solid-State Stereo 8-Track Cartridge Recorder/Player Tape Deck

- Front Panel Mike Input Jacks
- Dual Recording VU Level Meter
- Pushbutton Fast-Forward

159.95 Less Mikes

- Stop after each Channel and Automatic Eject, or Stop after Channel 1 thru 4 and Eject
- Sound with Sound Mixing

Offers unsurpassed 8-track cartridge record and playback facilities. Connects to any stereo receiver or amplifier with tape input and output jacks. Exclusive Automatic Cartridge Ejector prevents damaging the recorder's heads by leaving a tape inserted after you have turned off the power. Also features separate dual concentric Microphone and Aux. Volume Controls, a repeat program selector, and meter overload protection circuitry. Specifications: 2 Mike inputs (Sensitivity ea., 1 mV and 100 mV). Bias Freq., 85 kHz. AC erasing system. Freq. Response: 30-12,000 Hz.

Wow and Flutter: less than 0.25%. Channel Separation: 30 db. Output Level: 1 volt max., 300 mV average. 17 transistors, 13 Diodes. Walnut metal wrap-around case. Brushed gold anodized aluminum trim. AC power line. For 117 VAC, 50/60 Hz. Size: 12 x 3 3/4 x 9 1/8". Includes connecting cables. Imported. Shpg. wt., 16 lbs.

99 K 15968W No Money Down*Net 159.95

Deluxe Recording Microphone for RK-890A. Imported.

99 K 45882 Shpg. wt., 8 oz.Net 19.50

LAFAYETTE RK-885 8-Track Stereo Recorder/Player Tape Deck

99.95

- Auto-Stop Switch
- Fast Forward Button

High quality 8-track stereo tape recorder and playback deck designed for use with any stereo receiver or amplifier with tape input and output jacks. Features front panel mike input jacks, dual VU recording level meters, recording volume controls, mode switch for continuous operation or for automatically stopping the unit, illuminated channel indicator lights, headphone jack on the front panel for 4-, 8-, or 16-ohm stereo phones, and stop indicator light. Input jacks for MIC(2), Aux(2). Output Level 0.7 V at 0 VU record -1 kHz. Bias Frequency 60 kHz. Channel Separation 30 db. Size: 13W x 5 1/2 H x 8 3/4 D. Includes cables. For 105-120 VAC, 50/60 Hz. Imported.

99 K 16198W No Money Down* Shpg. wt., 11 lbs.Net 99.95

99 K 46161 Microphone for RK-885. Wt., 6 oz.Net 8.60



LAFAYETTE RK-84 4- and 2-Channel 8-Track Stereo Playback Deck

69.95

- 4 Solid-State Stereo Playback Preamplifiers
- Individual Illuminated Channel Indicator Lights
- Pushbutton Track Selector

Plays all pre-recorded 4- and 2-channel 8-track stereo tape cartridges. Plugs into tape or auxiliary inputs of your 4-channel amplifier or receiver. Features 2- or 4-channel mode selector and indicator lights. Max output: 0.5 V, Distortion: 1.7%, Frequency response: 50 to 8 kHz. With connecting cables. For 117 VAC, 60 Hz. Size: 8 3/4 W x 8 1/2 D x 4 3/4 H. Imported. Shpg. wt., 9 lbs.

99 K 16115W No Money Down*Net 69.95



GET A STEREO HEADPHONE FOR ONLY 1c WITH PURCHASE OF Lafayette SR-30A AM/FM 8-Track Stereo System

119.95
LESS
HEADPHONE

119.96
WITH
HEADPHONE



**LAFAYETTE
8X**
REG. 9.95



Our "Low Price Luxury" Modular System features the same famous Lafayette quality and craftsmanship as found in our more expensive, widely-acclaimed high-fidelity units. The SR30A features an advanced Solid-State AM/FM Stereo Receiver and a 2-Channel, 8-Track Stereo Tape Cartridge Player in one deluxe unit, plus two acoustically-matched, wide-range HI-FI Speaker Systems. With the SR30A you can enjoy the ease and pleasure of listening to prerecorded 8-Track Stereo Tape Cartridges. Listen to magnificent FM stereo broadcasts as well as mono and AM programs. Input jacks are provided on the rear panel for connecting a record changer (ceramic cartridge) and a reel-to-reel or cassette tape player. You can also hook up a tape recorder to the tape output jacks. The rear panel

also contains an AC convenience jack, and provisions for attaching an external FM antenna. The 8-track cartridge player has a pushbutton channel selector and individual illuminated channel indicator lights. Size: 8-Track/Receiver Unit, 18 $\frac{3}{4}$ "W x 9 $\frac{1}{4}$ "D x 4 $\frac{7}{8}$ "H. Each Speaker System measures 14 $\frac{1}{16}$ "H x 9 $\frac{7}{16}$ "W x 5 $\frac{1}{2}$ "D and includes speaker hook-up cables. Built-in AM and FM antennas. For 117 VAC, 60 Hz. Imported. Shpg. wt., 32 lbs.

99 K 99681WM Model SR-30A OnlyNet 119.95
99 K 01802 Model 8X Headphone Only. 1 $\frac{1}{4}$ lbs. Net 9.95
Model SR-30A and Stereo Headphone
99 K 92710WM Wt., 33 $\frac{1}{4}$ lbs. No Money Down* Net 119.96

LAFAYETTE RK-44 8-Track Tape Music System

- Separate Slide Lever Controls for Volume, Tone and Balance
- Pushbutton Channel Selector
- Individual Channel Indicator Lights
- Front Panel Stereo Headphone Jack
- Handsome Walnut Side Panels

69.95
with Speaker
Hook-up Cable



A beautifully-styled and perfectly-priced music system that plays 8-track stereo tape cartridges. Advanced solid-state circuitry plus the 2 matching 5" high-compliance speakers will provide the high-quality performance normally found only in expensive hi-fi systems. Features record output

jack. Size of each speaker system: 9 $\frac{3}{4}$ "H x 7 $\frac{1}{2}$ "W x 4 $\frac{1}{4}$ "D. Size of 8-track playback amplifier: 10 $\frac{3}{4}$ "W x 4 $\frac{3}{4}$ "H x 8"D. For 117 VAC, 60 Hz. Imported. Shpg. wt., 16 lbs.

99 K 16172 W No Money Down*Net 69.95

Charge it with BankAmericard or Mastercharge!

Dolby Stereo Cassette Deck and Noise Reduction Systems

Lafayette RK-D50 Dolby[†] System High Fidelity Stereo Cassette Deck

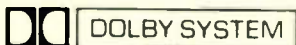

[†]Dolby is a trademark of Dolby Laboratories, Inc.

A stereo tape deck for the finest in cassette recording and playback. Memory rewind lets you immediately listen to a section of a program you have just recorded, without the need to jockey back and forth to find exactly where you started. SPECIFICATIONS: Records and plays back 4-Track stereo and 2-Track mono. 4 pole hysteresis synchronous motor. AC Bias and Erase Frequency: 100 kHz. Playback Outputs: Fixed 1 v at 0 VU, Variable 0-1 v at 0 VU. Frequency Response: 30-12,000 Hz \pm 3 db. S/N Ratio: with Dolby 59 db, without Dolby 49 db. Channel Separation:

- Dolby Noise Reduction System for Noise free Tape Recording and Playback
- Std/CrO₂/UD Pushbutton Tape Selectors
- Memory Rewind
- Sound With Sound Facilities
- Lockable Pause Control
- 2 Illuminated VU Record Level Meters
- 2 Peak Record Level Indicator Lights
- 3 Digit Tape Counter w/Reset Button
- Automatic Shut-Off, Electrical and Mechanical
- Individual Left and Right Channel Controls for Mike Input, Aux Input, and Output
- 4-Pole Hysteresis Synchronous Motor

ONLY **239⁹⁵** Less Microphones

tion: more than 30 db at kHz. Input Sensitivity: Mic-1 mv for 0 VU (10K ohm) Aux-100 μ v for 0 VU (47K ohm). Wow and Flutter: 0.12%. Other features include slide-type volume controls, mono-stereo pushbutton, and AC convenience outlets. For 105-120 VAC, 60 Hz Size: 14 $\frac{3}{8}$ " x 10 $\frac{1}{2}$ " x 3 $\frac{3}{8}$ "H. Imported. Shpg. wt., 16 lbs.
99 K 16156W No Money Down*Net 239.95
99 K 16156W Professional Lafayette Dynamic Microphone for RK-D50. Shpg. wt., 1 lb. Imported.
99 K 45882Net 19.50

Lafayette DNR-50 Dolby Noise Reduction Unit



79⁹⁵

No Money Down*

- Dolby Reference Meter with 3 Position Function Switch (Left, Right, L + R)
- Increased S/N Ratio of 10 db at 10,000 Hz

Reduce high frequency noise by 90% on cassette recordings. Also greatly improve open reel and 8 track recordings. The DNR-50 can be added to any tape deck or self-contained recorder with audio inputs and outputs. Separate slide lever record level controls for each channel. Frequency Response: 20-15,000 Hz \pm 2 db. Input Sensitivity: 100 mV. Input Impedance: 35k ohms. Harmonic Distortion: Below 0.5%. Requires a separate Dolby Calibration Tape, listed below. For 117 VAC 50/60 Hz. Size: 9 x 7 $\frac{3}{8}$ x 3 $\frac{3}{8}$ ". Imported. Shpg. wt., 5 lbs.

99 K 16206Net 79.95
Dolby Cassette Calibration Tape. Shpg. wt., 2 oz.
28 K 72885Net 4.89
Dolby Reel-to-Reel Calibration Tape.
28 K 80003 Shpg. wt., 2 lbs.Net 4.95
Dolby 8-Track Cartridge Calibration Tape.
28 K 80011 Shpg. wt, 2 lbs.Net 4.95

*See Page 19 for Full Details on Easy Pay Plan

Lafayette and Teac Stereo Cassette Tape Decks for Sound Performance

Lafayette RK-725 Stereo Cassette Record/Playback Tape Deck

- 3-Digit Tape Counter with Reset Button
- Front Panel Left and Right Channel Microphone Input Jacks
- 6 Pushbutton Tape Functions Including Pause
- Solid-State Record and Playback Preamplifier
- Standard/CrO₂ Level Control
- Illuminated VU Record Level Meters
- Handsome Walnut Wood Case
- Front Panel Stereo Headphone Jack



99⁹⁵

less microphones

The perfect addition to any fine home stereo music system. Connects to your stereo amplifier or receiver. Features STD/CrO₂ switchable bias equalization control. This provides optimum performance using either standard cassettes or the new high-energy, low noise tapes. Also features: 3-digit tape counter, record indicator light, and pushbutton controls for record, rewind, fast forward, play stop/stop, and pause. The RK-725 also incorporates a low impedance stereo amplifier to permit stereo headphone listening during recording or playback. Specifications: Playback Output Level: 0.7 volts; Freq. Response: 50-

13,000 Hz. S/N Ratio: 45 db. Channel Separation: 30 db. Input Sensitivity: Mic. 1mV; Aux. 100mV; Wow and Flutter: less than .25% (RMS), DC motor, AC bias and erase freq. 100 kHz. Cabinet is walnut finished wood side panels with brushed aluminum front panel, textured ebony finish plastic top panel with angled meters. Size: 12 $\frac{7}{8}$ " x 9 $\frac{1}{4}$ " x 3 $\frac{1}{8}$ ". Shpg. wt., 8 lbs. Imported.

99 K 16149W No Money Down*Net 99.95
Dynamic Mike for RK-725. Imported.
99 K 46161 Shpg. wt., 15 oz.Net 8.60

PROFESSIONAL SONY TAPE RECORDER ACCESSORIES



(A) SB-200 Sound-On-Sound and Echo Adapter

39⁹⁵ No Money Down*

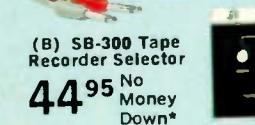

(B) SB-300 Tape Recorder Selector

44⁹⁵ No Money Down*



(A) SONY SB-200 SOUND-ON-SOUND AND ECHO ADAPTER

Add special effects to your tape recordings. To be used with any stereo tape recorder with separate facilities for recording each channel. Sound-on-sound may be used with two or three head recorders; use echo on three head recorders only. Features: separate buttons for sound-on-sound, echo, volume control for regulating intensity of echo. Size: 4 x 8 x 2 $\frac{1}{2}$ ". Imported.

27 K 60734 Shpg. wt., 2 $\frac{1}{2}$ lbs.Net 39.95

(B) SONY SB-300 TAPE RECORDER SELECTOR

Sophisticated switching control selector that adds professional versatility to any home recording system. When connected to a receiver or amplifier, the SB-300 expands the tape monitoring capabilities to enable recording and monitoring from up to three separate tape sources. Dubbing and transferring of tape from one machine to another can be done with professional quality without picking up switching clicks or pops on the recorded tape. Size: 4 x 8 x 2 $\frac{1}{2}$ ". Imported.

27 K 60742 Shpg. wt., 2 $\frac{1}{2}$ lbs.Net 44.95

NEW! Deluxe Teac 360S Stereo Cassette Tape Deck with Dolby Noise Reduction System

359⁹⁵

Including Dolby Test Tape, Head Cleaner and All Connecting Cables



- Dolby Tone Generator
- MPX Filter Switch
- Memory Rewind Counter
- Automatic Shut-Off

The Teac 360S with Dolby Noise Reduction System, features: High Density Permaflux Heads; 3 separate Bias and EQ positions to optimize the use of CrO₂, low noise/high output and standard cassette tapes; Hysteresis Synchronous motor, Automatic Output Stabilizing Network; and Dual VU Meters. Wow & Flutter: less than 0.7%. Freq. Response (low noise/high output tape): 30-13kHz. S/N Ratio: 60 db (Dolby Process). For Mike input impedance: 600 ohms, 117 VAC, 60 Hz. Size: 17 $\frac{3}{4}$ " x 4 $\frac{1}{4}$ " x 10 $\frac{1}{4}$ ". Imported. Less microphones. Shpg. wt., 18 lbs.

27 K 15142WX No Money Down*Net 359.95

Take advantage of sales with Mastercharge and BankAmericard.

Lafayette Has a Cassette Recorder for Everyone

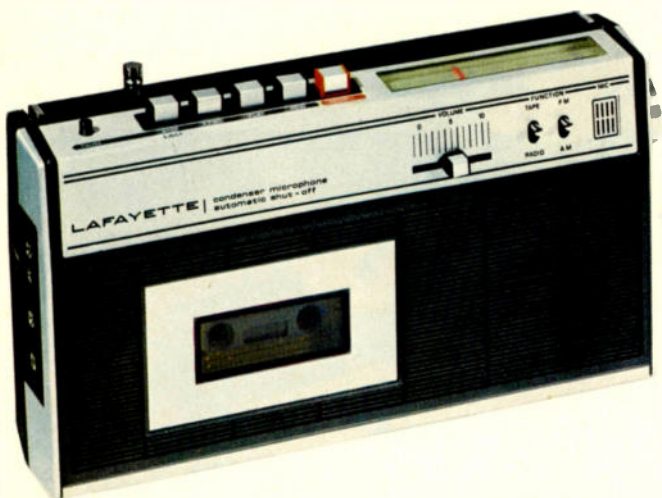

Lafayette RK-87 Battery/AC AM/FM Cassette Recorder

FEATURES:

- Built-In Condenser Microphone
- Automatic Shut-Off at End of Tape
- Automatic Record Level Control
- Tape Monitor Switch

SAVE 10.00
SALE 59⁹⁵

with 15-minute cassette tape, AC line cord and batteries. No Money Down*

Highly sophisticated solid-state Cassette Tape Recorder with built-in AM/FM Radio. Operates on 4 "C" batteries or 117 VAC 60 Hz. Direct recording from the radio to the recorder. Optional remote-control mike available (see listing below). Five pushbutton tape functions: Stop/Eject, Fast Forward, Playback, Rewind, and Record. Pause control for editing or cueing. Slide control for adjusting volume. Aux. input jacks. Semi-Slot Tape Loading. Powerful AM/FM radio features a precision slide rule tuning dial, telescopic

FM Antenna. 3½" high-compliance speaker provides superb wide-range tone. Handsome, high-impact plastic cabinet with chrome trim and integrated carrying handle. Size: 11½W x 6½H x 2¼"D. Imported. Shpg. wt., 7 lbs.
99 K 16131L RK-87. No Money Down*Net 59.95
Remote Control Mike for RK-87. Shpg. wt., 1 lb.
99 K 46526Net 4.95
99 K 62572 Extra "C" Batteries (4 required) Net ea. .19
28 K 01223 60-Min Tape Cassette. Shpg. wt., 4 oz. Net .99



SAVE 2.00

SALE
19⁹⁵
With Remote Control Mike

Lafayette RK-65 Solid-State Portable Cassette Recorder

- Record Safety Interlock Button

So easy to use! Just snap in a cassette and you are ready to record or play. No tape to thread. Operates on 4 "C" batteries (not included) or 117 VAC house current with optional AC adapter. Includes dynamic start-stop microphone for remote control operation. Big 2¾" speaker for excellent sound reproduction. Output jack for earphone or extension speaker. Built-in carrying handle. Size: 9L x 5¾W x 2½"H. Imported.

99 K 15828L Shpg. wt., 4 lbs.Net 19.95
99 K 35115 AC Adapter. Shpg. wt., 6 oz.Net 3.95
28 K 01223 Lafayette 60-Min. Cassette. Wt., 4 oz. Net .99
99 K 62572 Extra "C" Batteries (4 required) Net ea. .19
Lafayette Mono Headphones. Shpg. wt., 1 lb.Net 5.95
99 K 03378



SAVE 2.00

SALE
27⁹⁵
With Built-In Condenser Mike

Lafayette RK-72 Battery/AC Cassette Recorder With Built-In Condenser Microphone

Microphone will pick up sound from any direction with excellent sensitivity. Attractive charcoal black cabinet. Dynamic speaker provides fine voice and music reproduction. Record safety interlock button prevents accidental erasures. Input jacks for connecting a remote control microphone and for earphone or extension speaker. Size: 11L x 5½W x 2½"H. Imported.

99 K 16222L Shpg. wt., 3½ lbs.Net 27.95
99 K 62572 Extra "C" Batteries (4 required) Net ea. .19
28 K 01223 Lafayette 60-Min. Cassette. Wt., 4 oz. Net .99
Remote Control Dynamic Microphone. Imported.
99 K 46503 Shpg. wt., 6 oz.Net 4.95
Lafayette Mono Headphones. Shpg. wt., 1 lb.Net 5.95
99 K 03378

At Savings That Make Sound Sense

Lafayette RK-86A Battery/AC Pushbutton Cassette Recorder

- Professional Recording System AC Bias, AC Erase
- Dual Battery/Record Level Indicator
- Separate Tone and Volume Controls

SAVE 7.00
SALE 37⁹⁵

Includes Dynamic Microphone With Remote Control Switch, 60 Minute Tape, AC Line Cord, 4 "C" Batteries and Earphone.

No Money Down*



Beautifully designed portable cassette recorder of exceptional quality. One of the easiest recorders to operate. Features semi-slot tape loading. No reels to thread. Separate pushbuttons for record, play, rewind, fast forward, and stop/Cassette-up. Safety interlock on record button prevents accidental erasures. Aux. input jack is provided

for recording from external sources such as phono, TV set, or radio tuner directly onto tape. Integrated carrying handle. Size: 9 $\frac{3}{4}$ x 7 $\frac{3}{8}$ x 2 $\frac{5}{8}$ ". Imported. Shpg. wt., 5 lbs.
99 K 16073L RK-86A Net 37.95
28 K 01223 Lafayette 60-Min. Cassette. Wt., 4 oz. Net .99
99 K 62572 Extra "C" Batteries (4 required) Net ea. .19

special purchase!



- Automatic Level Control

32⁹⁵ With AC Line Cord, 4 "C" Batteries and Earphone

Battery/AC Pushbutton Cassette Recorder With Built-In Condenser Microphone

Easy-to-carry, portable, solid-state cassette recorder features built-in condenser microphone. This "live" "mike" has the ability to pick up sound with remarkable reproduction. Auto level (ALC) eliminates need to adjust volume manually—automatically adjusts to the proper level. Record, Play, Erase, Stop, Rewind, Fast Forward, and Stop/Cassette-up.

SAVE 5.00



SALE 44⁹⁵ With Remote Mike and Batteries

Lafayette RK-225 Battery/AC AM/FM Radio Cassette Recorder

...tes directly "off the air" anytime, "live" with the remote control indicator light permits you to adjust recording level. 3" dynamic speaker (gle function knob for rewind, stop, r fast forward and record safety in- antenna, telescoping FM antenna,

Lafayette Saves You More!

Full-Size Lafayette Personal AM/FM Portable

33 1/3% Price Slash!

WAS 14.95 **SALE 9⁹⁵** With Batteries and Earphone

• Magnificent Sound and Styling at This Low, Low Price

Full size features—top quality sound from a big 3 1/2" speaker. Powerful solid-state circuitry. Operates on 3 "C" batteries (included), or 117 VAC, 60 Hz with optional AC adapter. Large precision sliderule tuning dial. Built-in AM ferrite antenna. Telescopic FM antenna. Includes earphone for private listening. 7 1/4"W x 8"H x 2 3/4"D. Imported. Shpg. wt., 4 lbs.

99 K 35594LNet 9.95
99 K 35727 AC Adapter for above. Shpg. wt., 6 oz.Net 3.95
99 K 62572 Extra "C" batteries (3 required)Net ea. .19



LAFAYETTE RK-82 2-Channel 8-Track Stereo Playback Deck

Save 10.00

• Built-In Solid-State Stereo Playback Preampfier

A quality addition to your home music system. Just plug in to the tape or auxiliary input jack of your system, and you are ready to play back all pre-recorded 2-channel 8-track stereo tape cartridges. Illuminated track indicator light tells you which track is playing. Pushbutton selector changes tracks instantly. Frequency response 50 to 8 kHz. S/N ratio better than 44 db. Attractive black and silver brushed aluminum front panel. On/off power switch. Size: 8 7/8"W x 4 3/4"H x 8 1/2"D. For 117 VAC, 60 Hz. Imported. Shpg. wt., 9 lbs.

99 K 16107WNet 39.95

SALE 39⁹⁵ With Connecting Cables

LAFAYETTE RADIO ELECTRONICS

111 JERICHO TURNPIKE, SYOSSET, L.I., N.Y. 11791

BULK RATE

U.S. Postage

PAID

LAFAYETTE
Radio Electronics