



Winter Values

CATALOG 672

Sale Prices Effective
Until March 15, 1967

Index-See Center Flap



5 Watt LM 2-Way
Radio

NOW ONLY
89⁹⁵

Cut \$10.00

Sold on Page 62



LAFAYETTE HI-FI
Speakers

Cuts up to

27⁰⁰

Sold on Page 20



Deluxe FM Stereo Tuner

NOW ONLY

Cut \$10.00 **64⁹⁵**

Sold on Page 6



LAFAYETTE
30 Watt
Music System

Cut \$15

NOW ONLY

174⁹⁵

Sold on
Page 18



15 Transistor
Pocket Radio

Cut 1.00

NOW ONLY **7⁹⁵**

Sold on Page 43

LAFAYETTE RADIO ELECTRONICS

111 Jericho Turnpike, Syosset, L. I., New York 11791

STORES

BOSTON • BRONX • BROOKLYN • FALLS CHURCH • HAMDEN • JAMAICA • MANHATTAN
MT. RAINIER • NATICK • NEWARK • PHILADELPHIA • PITTSBURGH
PLAINFIELD • SAUGUS • SCARSDALE • SYOSSET • W. HARTFORD "Associate Stores" from Coast-to-Coast

SATISFACTION GUARANTEED OR YOUR MONEY BACK — See Center Insert

Model LR-1200T Super Deluxe 120 Watt Solid State FM/AM Stereo Receiver



44 Transistors,
31 Diodes

259⁹⁵
with case

No Money Down

Cool, Instantaneous
Operation—Long Life

- 120-Watt Stereo Amplifier at 8 Ohms
- 4 Gang Tuning Condenser and Tuned RF Stage with 1.5 μ V FM Sensitivity
- Interstation Muting

- Plug-in Transistors For Easy Servicing
- Automatic Stereo Indicator
- Center Channel Output
- Fused Output Transistors

Total solid-state circuitry creates new standards of performance. Solid state FM/AM tuner also features 4-IF/limiter stages for exceptional stability and selectivity. Multiplex circuitry automatically switches to stereo when an FM stereo program comes "on". Front panel stereo indicator light positively identifies stereo broadcasts. Easily accessible variable controls adjust the degree of AFC and muting required in your location for silence while tuning between stations. Wideband AM section has separate 3-gang tuning condenser and rf stage to open up the full sound potential of standard AM broadcasting. AM antenna is built-in plus local-distance connection for FM and external AM antenna. Softly illuminated slide rule dial features balanced flywheel tuning, logging scale and sensitive signal strength tuning meter for accurate station tuning on both AM and FM. The versatile preamplifier features simple to operate, logically-grouped controls: 7 position Mode Selector for

choice of stereo or mono reception; 6-position Input Selector, Auxiliary, Tape Head, Phono, FM, FM Noise Filter, AM; 4-position Tape Monitor, Off, Stereo, Left and Right tape channels—enable you to listen to tape stereophonically or each individual channel as it is being recorded; dual concentric Bass and Treble controls for each channel; concentric Volume/Balance controls; positive acting seesaw switches for Loudness contour, High and Low Frequency filters; Main-Remote speaker selector and Power "On-Off." Other deluxe features include front panel Stereo Headphone jack, derived Center Channel Preamp Output (on rear) and 3-position Phono Sensitivity switch. Size: 16W x 5H x 14 $\frac{1}{4}$ "D. Handsome brushed gold anodized extruded aluminum front panel with simulated walnut wood grain metal enclosure. Imported. For 117V, 50/60 cycles AC. Shpg. wt., 32 lbs. 99 E 0150WX \$12.50 Monthly Net 259.95

SPECIFICATIONS—Amplifier—Power Output: 120 watts at 8 ohms. IHF: 60 watts per channel. Frequency Response: \pm 1db. 20-50,000 cps at 1 watt. Harmonic Distortion: less than 1% at full output; 0.125% at 1 watt. Intermodulation Distortion: 0.3% at 1 watt. Power Bandwidth: 11 cps to 38kc. Input Sensitivity: Phono (3 positions), 2 mv. low, 5 mv. med., 12 mv. high; Tape Head, 2.5 mv., Aux., 275 mv., Tape Monitor, 370 mv. Hum and Noise: —58db on

Phono, Tape Head. —78db Auxiliary. Equalization: Phono, RIAA; Tape Head, NAB. Output Impedance: 4-16 ohms; low impedance stereo headphone jack. Tuner Section—IHF FM Sensitivity: 1.5 μ V. Image Rejection: —70db. FM Signal-to-Noise Ratio: —65db FM. Distortion: 0.5% at 100% modulation. Capture Ratio: 4db. AM Suppression: 53db on FM. Stereo MPX Separation: 40db at 400 cps. FM Antenna Imped.: 300 ohms balanced. AM Sens.: 15 μ v at 1000kc.

120 WATT MATCHED STEREO SYSTEM WITH MODEL LR-1200T DELUXE AM/FM STEREO RECEIVER

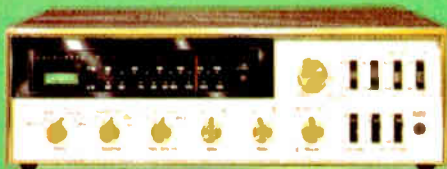

System Price Only **399⁹⁵**
No Money Down



from Individual Catalog Prices!

Lafayette Model LR-1200 Deluxe 120-Watt Solid State AM-FM Stereo Receiver	259.95
Garrard Model 60 MKII 4-Speed Automatic Turntable ..	74.50
Pickering V-15/ATE-2 High Compliance Stereo Elliptical Cartridge With Diamond Stylus*	34.95
Garrard Base For Automatic Turntable (Walnut and Ebony Color With Silver Trim)	4.50
Garrard Molded Plastic Dust Cover For Turntable	4.50
2 Lafayette Deluxe "Criterion 200A" High Power 3-Speaker 3-Way Speaker Systems (Oiled Walnut)	139.90
Total 118.30	

Deluxe Stereo System above with choice of Pickering V-15/ATE-2, Shure M44E, or Empire 888E Stereo cartridge with elliptical diamond stylus, cables and instructions. Shpg. wt., 121 lbs. 21 E 956DWX \$19 monthly Net 399.95

Same system as above except with 2-Lafayette deluxe "Criterion 3X" acoustic suspension speaker systems (Oiled Walnut) instead of 2-"Criterion 200A". Shpg. wt., 125 lbs. 21 E 9561WX \$22.00 monthly Net 435.95

Open a

Lafayette

Credit
Account
TODAY

NO MONEY DOWN

Up To 2 Years To Pay
LOW MONTHLY PAYMENTS

2 EASY PAY CREDIT PLANS

To suit your individual needs

EXTENDED PLAN*

**TAKE UP TO
2 Years To Pay**

BUDGET PLAN*

**LOW
Credit Service Charge**

*Pay balance in 30 days, save entire service charge.

**Start Now To Take FULL ADVANTAGE
LAFAYETTE'S Easy Pay Plans**

- No down payment.
- Take up to 2 years to pay.
- One low Monthly Payment buys all your electronic and hi-fi requirements.
- No hidden charges. Small service charge included in fixed monthly payment.
- Add-On any time you like. No money down and usually no change in monthly payment.
- Choose the plan that suits you best—Budget or Extended.

**No need to wait to enjoy anything
you need from LAFAYETTE**

HERE IS HOW YOU MULTIPLY YOUR SHOPPING DOLLAR UP TO 20 TIMES

Monthly Payments FOR ONLY	\$5	6	7	8	9	10	11	15	17	19	22	23	24
YOU CAN BUY UP TO	\$100	110	130	160	180	200	220	300	340	400	440	460	500

See Easy Pay Schedule on back of Order Blank

Model LR-450T 30 Watt Solid State FM Stereo Receiver



32-Transistors 17-Diodes

- 30-Watt Stereo Amplifier at 8 Ohms
- Tone Type Stereo Search
- 4-Gang RF, 5-IF Stages for 2uv Sensitivity and Excellent Selectivity
- Patented Protective Overload Circuit

Only
159⁹⁵

No Money Down

Enjoy the sound sensation of cool, instantaneous, crystal clear FM or FM stereo. The tuner section features the dependable "Stereo Search" circuit to audibly signal the presence of FM Stereo Broadcasts. 5 FM IF stages, excellent selectivity, stereo separation and rejection of signal interference. The LR-450T has 49 high grade semi-conductors for virtual elimination of heat and thermal noise; instant operation with no warm-up needed; patented protected overload circuit protects transistors. High frequency-type power transistors assure extended range response at full rated output. The beauty of the gold anodized extruded aluminum front panel is enhanced by a large easy-to-read slide rule dial, and precision

signal-strength "tuning" meter for accurate station tuning. Colored lights on dial face show at a glance your external program source (Phono, Tape HD, Aux). Front panel features a full set of easy-to-operate controls. Power (Off On), Speakers (Main-Remote), Headphones: Tuning; Volume Balance; Dual Concentric Bass and Treble and 5-position Selector switch. Sturdy seesaw type switches are used for: Loudness, Mode (Stereo, Mono), MPX Noise Filter and Monitor (Headphone listening). Remote speaker jacks in rear. Size: 15 1/2"W x 4 1/2"H x 11 1/2"D. Impuried. Shpg. wt., 18 lbs. For 117V. 50 60 cycles AC.

99 E 0158WX \$8.00 monthly ... **Net 159.95**

SPECIFICATIONS - Tuner Section. Tuning Range: 88-108mc. 1HF Sensitivity: 2 v. Signal-to-noise ratio: 60 db at 100% modulation. Harmonic Distortion: 1% at 100% modulation. MPX Channel Sep: 35 db at 400cps.

Amplifier Section. Power Output: 30-watts, 15-watts per channel 1HF at 8 ohms. Harmonic Distortion: 3% at 1 watt. Frequency Response: ±2db 30-20,000 cps. Signal-to-noise -65db. Output Impedance: 4-16 ohms.

30 WATT MATCHED STEREO SYSTEMS WITH MODEL LR-450T SOLID STATE STEREO RECEIVER



SAVE 58³⁵
from Individual Catalog Prices!



System Price **239⁹⁵** **No Money Down**

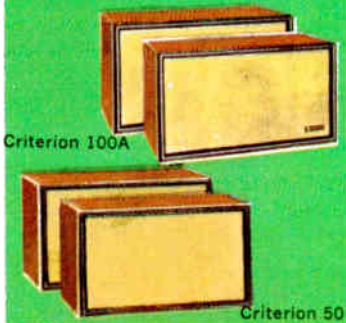

Lafayette Model LR-450T 30-Watt Solid State Stereo Receiver	169.95
Garrard Model 40 MKII 4-Speed Automatic Record Changer	44.50
Pickering V-15 AT-2 Diamond Needle Stereo Cartridge*	24.95
Garrard Base For Automatic Record Changer (Walnut and Ebony Color With Silver Trim)	4.50
Garrard Molded Plastic Dust Cover For Record Changer	4.50
2-Lafayette "Criterion 50" Wide Range 2-Way Bookshelf and or Floor Speaker Systems (Oiled Walnut)	59.90
TOTAL 298.30	

30-watt solid state stereo system above with *choice of Pickering V-15/AT-2, Shure M44-7, or Empire 888 diamond needle stereo cartridge, complete with speaker cable. Shpg. wt., 92 lbs.
21 E 9554WXM \$11.50 monthly Net 239.95

Same stereo system as above except with 2 Lafayette "Criterion 100A" deluxe 2-way tuned ducted-port shelf or floor speaker systems instead of 2 "Criterion 50" systems. Shpg. wt., 96 lbs.

21 E 9555WXM \$13.50 monthly Net 266.95

SAVE 61.35 from individual catalog prices

ARE YOU INTERESTED IN OWNING A LAFAYETTE ASSOCIATE STORE



ALL YOU NEED IS

1. Basic knowledge of Retailing or Radio, Television or Electronics
2. Financial Investment of \$10,000 to \$30,000

WE WILL PROVIDE YOU WITH

1. Initial Inventory Selection and Stimulating Sales Displays
2. Store Layout Designs and Administrative Supplies
3. Scheduled Delivery Service and Complete Parts Availability
4. Advertising and Publicity Aids Including Catalogs and Flyers
5. Price and Merchandise Return Protection

And The Famous LAFAYETTE Name

To learn how easy it is to join hands with Lafayette Radio Electronics and have your own electronics department store, fill in and mail the coupon below for full information FREE. There is no obligation.

Tear along this line

Mr. Robert Laub—Vice President, Lafayette Radio Electronics Corporation
111 Jericho Turnpike, Syosset, L. I., New York 11791

672

— I am interested in owning a Lafayette Associate Store. Without obligation on my part, please send me full information, FREE and postpaid.

Name

Address

City State Zip

it's easy to shop at LAFAYETTE

By Mail

Fill in any Lafayette order blank, enclose check and mail. Your order will be shipped direct to your home. See parcel post and express charts below to figure shipping charges.

By Phone

Dial 516 WA 1-7500 and a trained personal service shopper will help you. Your order will soon be on its way to your home.

In Person

Visit any of our conveniently located stores, specially trained sales personnel will assist you.

SATISFACTION GUARANTEED OR MONEY BACK

If for any reason you are not satisfied with your purchase return it to us at once and we will exchange it or return your money (less transportation charges). Merchandise returned must not have been altered or abused. This policy does not apply to pre-recorded tape, records or books.

See page 451 in our catalog No. 670 for special kit guarantee.

No matter how you shop LAFAYETTE'S EASY-PAY PLAN IS AVAILABLE FOR YOUR CONVENIENCE

REA EXPRESS INFORMATION

Large, bulky or delicate articles are shipped by Railway Express, the fastest and most economical way to ship merchandise which is unmailable. (If you desire other shipping methods, please specify). The letter "X" after our stock number (i.e. 21 T 44-17WX) identifies the item exceeding parcel post limits.

DO NOT SEND MONEY for express charges with your order. Express charges are collected upon delivery at no extra cost to you. Insurance is included in your express rates. Be sure to specify your nearest Express Office in there is no agent in your town.

APPROXIMATE EXPRESS CHARGES

	100	150	300	500	1000	2000	2400
Weight	Miles	Miles	Miles	Miles	Miles	Miles	Miles
20 lbs.	3.85	4.00	4.45	4.75	4.85	5.95	7.15
30 lbs.	4.20	4.40	5.15	5.55	5.85	7.50	9.30
40 lbs.	4.55	4.85	5.80	6.35	6.85	9.10	11.50
50 lbs.	4.95	5.25	6.50	7.15	7.85	10.65	13.65
60 lbs.	5.30	5.70	7.15	8.00	8.90	12.25	15.80
70 lbs.	5.70	6.10	7.85	8.80	9.90	13.80	17.95
80 lbs.	6.05	6.50	8.50	9.60	10.90	15.35	20.15
90 lbs.	6.40	6.95	9.15	10.40	11.95	16.95	22.30
100 lbs.	6.75	7.35	9.75	11.15	12.85	18.35	24.25

C.O.D. FEES

If you order C.O.D., the post office collects a handling charge, plus a money order fee, in addition to the regular parcel post charge. (We cannot accept C.O.D.'s for APO's, FPO's or for special-order merchandise). Here are the extra C.O.D. fees:

Amount of Order	Money Order Fee	COD Fee
Minimum order \$5.00	20c	40c
\$5.01 to 10.00	20c	50c
10.01 to 25.00	30c	70c
25.01 to 50.00	30c	80c
50.01 to 100.00	35c	90c

Subject to post office rate changes

PARCEL POST RATES FOR ALL ZONES

Hawaii and Alaska are in the 8th zone. Puerto Rico and the Virgin Islands in the 7th zone. All other U.S. possessions and territories in the 8th zone.

AIR SHIPMENTS

For fast delivery, you may specify Air Parcel Post, Air Express or Air Freight. For Air Express Rates see your local REA Agent. For Air Freight see your nearest commercial airport office. Air Parcel Post limits are 70 lbs. in weight, 100" in length and girth combined, except APO and FPO which are 2 lbs. and 20"

AIR PARCEL POST RATES

ZONES 1,2,3, 4 5 6 7 8
1st lb. .68 .73 .78 .83 .83 .88
For each add add add add add
extra lb. .48 .50 .56 .64 .72 .80
U.S. Possessions, Territories, APO's, FPO's—.80 per lb.

UNITED PARCEL DELIVERY

If your area is serviced by UPS and the service or rates are to your benefit, we will route your order via United Parcel Service. This fast, economical service is available from New York to most of the eastern states for parcels up to 50 lbs. and 108 inches in length and girth.

SHIPMENTS OUTSIDE OF THE UNITED STATES

We ship all over the free world. Allow up to 60 days for delivery. Write to our International Sales Division for details.

SHIPPING WEIGHT	Local	ZONES							
		1-2 up to 150 Miles	3 151 to 300 Miles	4 301 to 600 Miles	5 601 to 1,000 Miles	6 1,001 to 1,400 Miles	7 1,401 to 1,800 Miles	8 Over 1,800 Miles	
4c for the first 2 ounces and 2c for each additional ounce									
to 2 lbs.	\$0.40	\$0.50	\$0.50	\$0.55	\$0.60	\$0.70	\$0.75	\$0.80	\$0.80
3	.40	.55	.60	.65	.75	.85	.95	1.05	1.05
4	.45	.60	.65	.75	.85	1.00	1.10	1.25	1.25
5	.45	.65	.70	.80	.95	1.10	1.30	1.45	1.45
6	.45	.70	.80	.90	1.05	1.25	1.45	1.65	1.65
7	.50	.80	.85	1.00	1.15	1.40	1.60	1.85	1.85
8	.50	.85	.90	1.05	1.30	1.50	1.75	2.00	2.00
9	.55	.90	.95	1.15	1.40	1.65	1.90	2.20	2.20
10	.55	.95	1.05	1.20	1.50	1.75	2.10	2.40	2.40
11	.55	1.00	1.10	1.30	1.60	1.90	2.25	2.60	2.60
12	.60	1.05	1.15	1.35	1.70	2.00	2.40	2.75	2.75
13	.60	1.10	1.20	1.45	1.80	2.10	2.55	2.95	2.95
14	.65	1.15	1.30	1.50	1.90	2.25	2.70	3.10	3.10
15	.65	1.20	1.35	1.60	2.00	2.35	2.85	3.30	3.30
16	.65	1.25	1.40	1.65	2.10	2.45	3.00	3.45	3.45
17	.70	1.30	1.45	1.75	2.20	2.60	3.15	3.65	3.65
18	.70	1.35	1.50	1.80	2.30	2.70	3.30	3.80	3.80
19	.75	1.40	1.60	1.90	2.40	2.85	3.45	4.00	4.00
20	.75	1.40	1.65	1.95	2.50	2.95	3.60	4.15	4.15
For each added lb. add	3c	4c	5c	7c	8c	12c	16c	17c	

PARCEL POST HANDLING CHARGES

up to 5.00	.05	10.01 to 25.00	.15
5.01 to 10.00	.10	25.01 to 50.00	.20

ALL PRICES AND SPECIFICATIONS IN THIS CATALOG SUBJECT TO CHANGE WITHOUT NOTICE

Model LR-900T 65-Watt Solid State AM-FM Stereo Receiver



33-Transistors
22-Diodes

199⁹⁵

With Case
No Money Down



New Patented Output Transistor Protection

- 65-Watts Total IHF at 8-Ohms
- All Solid State for Cool, Instantaneous Operation
- Tone Type Stereo Search Indicates Presence of Stereo Broadcasts

- 4-gang RF, 5-IF Stages
- Front Panel Stereo Headphone Jack
- With Attractive Metal Walnut Simulated Wood Grain Case

Capture the sound of concert hall stereo, in your living room! Full compliment of controls puts you in complete command of every program source. Features: Sensitive Nuvistor front end; "Stereo Search" function offers a simple and fast means of locating FM stations which are broadcasting a stereo program. Ingenious new patented electronic circuit-breaker protects the output transistors from burning out during shorts and no-load conditions. Illuminated signal strength meter and easy-to-read slide rule dial for precision tuning; Smooth flywheel action; Illuminated selector indicator jewels on front panel show external program sources. Mode Selector switch allows choice of outputs, Left Channel, Right Channel, Stereo, Multi-track and Reverse. Input Selector controls access to; AM, FM, FM Stereo Tuner, Phono, Tape and Auxiliary program sources. The Audio

Control Center features separate friction-lock Bass and Treble controls for each channel, Balance control; Rumble and FM Noise filter; Loudness switch and front panel Stereo Headphone jack-Speaker "OFF" switch for private listening. Tape Monitor lets you listen to recorded material as you tape it. Inputs are provided for Tape head, Magnetic, Crystal or Ceramic phono cartridges and Auxiliary (high level) sources. Has built-in ferrite bar AM antenna, terminals for 300-ohm FM twin-line. Fused AC power cord. Gold anodized extruded aluminum front panel, with matching metal walnut simulated wood grain case. Size: 16½"Wx12¼"Dx4½"H. Imported. Shpg. wt., 21 lbs. For 117V, 50/60 cycles AC.

99 E 0157WX \$10.00 monthly Net 199.95

SPECIFICATIONS—Tuner Section. Tuning Range: FM: 88-108mc; AM: 550-1600kc. Antenna: Balanced input for external 300 ohm FM antenna; Built-in Ferrite bar AM antenna. Signal-to-noise ratio: 60db at 100% modulation. Image rejection: —56db. IF rejection: —100db. Capture ratio: 2.5db. Harmonic distortion: 6%. MPX Channel Separation: 35db at 400cps. Cross Modulation: —86db. MPX Noise Filter: 10 db or better at 10,000cps. Amplifier Section. Power Output: 65

watts, 32½ per channel IHF at 8 ohms. Total HD: at 1 watt 0.25%. Frequency Response: ±2db 20-20,000cps at 1 watt. Channel Separation: 53db at 1,000cps. Hum & Noise: Phone —55db; Auxiliary: —73db. Power Bandwidth: 30-20,000cps. Sensitivity: Phone: Magnetic 1.5mv; Ceramic 90mv; Tapehead 2.3mv; Auxiliary 120mv. Equalization: RIAA (phono) ±2 db; NAB (tape) ±2db. Output Impedance: for 4-16 ohms.

65 WATT MATCHED STEREO SYSTEMS WITH MODEL LR-900T SOLID STATE STEREO RECEIVERS



from Individual Catalog Prices

Lafayette Model LR-900T 65-Watt Solid State Stereo Receiver	199.95
Garrard Model 40 MKII 4-Speed Automatic Record Changer	44.50
Pickering V-15/AT-2 Diamond Needle Stereo Cartridge*	24.95
Garrard Base For Automatic Record Changer (Walnut and Ebony Color With Silver Trim)	4.50
Garrard Molded Plastic Dust Cover For Record Changer	4.50
2-Lafayette "Criterion 50" Wide Range 2-Way Bookshelf and/or Floor Speaker Systems (Oiled Walnut)	59.90
Total	338.30

Complete 65 Watt stereo system above with *choice of Pickering V-15/AT-2, Shure M44-7 or Empire 888 diamond reedie stereo cartridge. Includes speaker cable. Shpg. wt., 94 lbs.
21 E 9562WXM \$13.50 monthly Net 272.95
Same stereo system as above except with 2 Lafayette "Criterion 100A" deluxe 2-way tuned ducted port shelf or floor speaker systems instead of 2 "Criterion 50" systems. Shpg. wt., 98 lbs.
21 E 9563WXM \$15 monthly Net 299.95
SAVE 68.35 FROM INDIVIDUAL CATALOG PRICES



SYSTEM PRICE 272⁹⁵

No Money Down

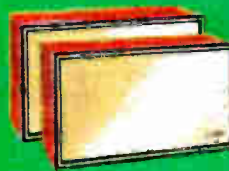

Criterion 50



Criterion 100A

Hi-Fi Components Are Available on Easy Pay Plan—No Money Down

Lafayette Cat. No. 672 3



30 Watt Stereo Systems With Model LA-224T Solid State Stereo Amplifier

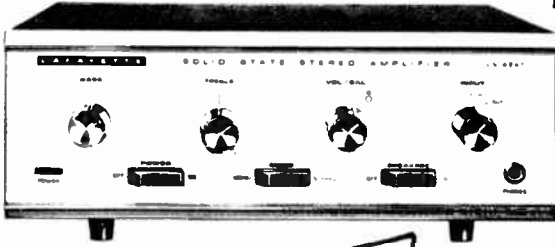

Lafayette Model LA-224T 30-Watt Solid State Stereo Amplifier 59.95
 Lafayette Model AC-66 Automatic Record Changer with
 Pickering PA-C1 Magnetic Cartridge and Diamond Stylus 37.95
 Wood Base for Record Changer (Oiled Walnut) 3.95
 2 Lafayette "Criterion 20A" 2-Way Ducted Port Shelf Speaker
 Systems (Oiled Walnut) 44.50
TOTAL 146.35



Lafayette Model AC-66

SAVE 26⁴⁰
 From Individual Catalog Prices

SYSTEM PRICE

ONLY 119⁹⁵

No Money Down

Complete 30 Watt stereo system as above with speaker cable. Shpg. wt., 42 lbs.
 21 E 9143WXM \$6.50 Monthly Net 119.95
 Same system as above except with 2 Lafayette "Criterion 50" wide range 2-way bookshelf or floor speaker systems (oiled walnut) instead of 2 "Criterion 20A" systems. Shpg. wt., 82 lbs.
 21 E 9123WXM \$7.50 Monthly Net 132.50
 You Save 30.05 from Individual Catalog Prices.

Model LA-224T 30-Watt Solid State Stereo Amplifier

All the characteristics of a quality solid state Hi Fi amplifier have been incorporated into the LA-224T. Attractive slim styling permits unrestricted placement of this unit in the home. 30-watts power supplied through the use of 19-transistors, 8-diode circuitry for instant cool operation; low current drain; minimum distortion (1% or less at 1 watt at 1 kc); excellent frequency response (30-20,000 cps ± 2 db at 1-watt). A full complement of front panel controls have been provided for maximum stereo capability. Dual Concentric Volume, Bass and Treble controls allow independent level control over each channel. Mode switch controls Mono, or Stereo operation. Selector switch determines external music source: Phono; Tuner; or Auxiliary positions. An additional switch has been provided for speaker or headphone listening. Rear panel features an AC convenience outlet; tape recorder output jacks; input jacks for Magnetic, Crystal or Ceramic cartridges; Outputs for 4, 8 and 16 ohm speakers. Attractive, brushed aluminum, gold anodized extruded front panel with complementary metal case. Size: 10 $\frac{1}{4}$ Wx3 $\frac{1}{2}$ Hx7 $\frac{1}{4}$ D. Shpg. wt., 9 lbs. Imported. For 110 to 125V., 50/60 cycles AC. 99 E 0167WX \$5.00 monthly Net 59.95

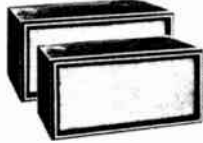

2-Lafayette "Criterion 20A"

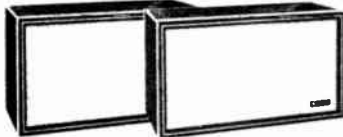

2-Lafayette "Criterion 50"

60 Watt Stereo Systems With Model LA-60T Solid State Stereo Amplifier

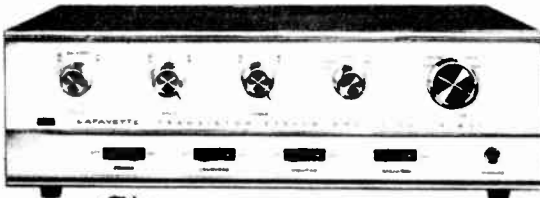

Lafayette Model LA-60T 60-Watt Solid State Stereo Amplifier 99.95
 Garrard Model 40 MKII 4-Speed Automatic Record Changer 44.50
 Pickering V-15/AT-2 Diamond Needle Stereo Cartridge* 24.95
 Garrard Matching Changer Base (Walnut and Ebony Color with Silver Trim) 4.50
 Garrard Molded Plastic Dust Cover for Record Changer 4.50
 2-Lafayette "Criterion 50" Wide Range 2-Way Bookshelf and/or Floor Speaker Systems (Oiled Walnut) 59.90
TOTAL 238.30



Garrard 40 MKII

SAVE 48³⁵
 From Individual Catalog Prices!

SYSTEM PRICE

ONLY 189⁹⁵

no money down

Above Stereo system with "choice of Pickering V-15/AT-2, Shure M44-7 or Empire 888 diamond needle stereo cartridge, complete with speaker cables. Shpg. wt., 88 lbs.
 21 E 9694WXM \$10.00 monthly Net 189.95
 Same 60-watt system above except with 2-Lafayette "Criterion 100A" deluxe ducted port 2-way bookshelf or floor speaker systems (oiled walnut) instead of 2 "Criterion 50" speakers. Shpg. wt., 92 lbs.
 21 E 9695WXM \$11.00 monthly Net 216.95
 You Save 51.35 from individual catalog prices.

Model LA-60T 60-Watt Solid State Stereo Amplifier

Quality solid state stereo pre-amplifier and dual channel 60-watt amplifier on one integrated chassis. Compact size and minimal heat permits easy installation. Controls are designed for maximum flexibility. Selector switch permits selection of tape head, phono, tuner or auxiliary inputs; mode switch permits selection of Right or Left channel only. Stereo or Mono operation or reversing of channel outputs; heavy duty rocker switches for Power Off/On, Loudness compensator, Monitor (tape) and Speakers Off/On for headphone listening; concentric Balance/Volume, Bass and Treble controls for precise aural balance. Rear panel features: Inputs for Magnetic or Ceramic cartridge, tape head for direct connection to a tape deck, and tuner; outputs for tape playback and Left-Right channel speaker connections for 4, 8 and 16 ohm speakers. Electronic short circuit protection against accidental shorting at speaker terminals. IHF Music Power: 60 watts at 8 ohms; 30 watts per channel; Frequency response: 30-40,000 cps at 1-watt ± 2 db; Harmonic Distortion: .3% at 1-watt at 1KC. Complete with walnut grained metal case and gold anodized extruded aluminum front panel. Size: 13Wx3 $\frac{1}{2}$ Hx9 $\frac{3}{8}$ D. Shpg. wt., 15 lbs. Imported. For 110 to 125V., 50/60 cycles AC. 99 E 0165WX \$5.00 monthly Net 99.95

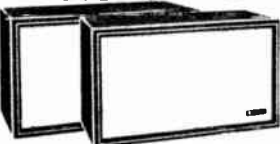

2-"Criterion 50"

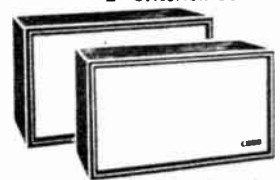

2-"Criterion 100A"

Choice of Stereo Cartridge

Pickering V-15/AT-2

Shure M44-7

Empire 888

50 Watt Stereo Systems With Model LA-248A Solid State Stereo Amplifier



Lafayette Model LA-248A 50-Watt Solid State Stereo Amplifier 84.95
 Garrard Model 40 MKII 4-Speed Automatic Record Changer 44.50
 Pickering V-15/AT-2 Diamond Needle Stereo Cartridge* 24.95
 Garrard Matching Changer Base (Walnut and Ebony) 4.50
 Color with Silver Trim) 4.50
 Garrard Molded Plastic Dust Cover for Record Changer 4.50
 2 Lafayette "Criterion 50" 2-Speaker, 2-Way Ducted
 Port Bookshelf and/or Floor Speaker Systems (Oiled Walnut) 59.90
TOTAL 223.30

Complete 50 watt solid state system above with choice* of Pickering V-15/AT-2, Shure M44-7, or Empire 888 diamond needle stereo cartridge, with necessary speaker cable. Shpg. wt., 85 lbs.
 21 E 9581WXM \$9.00 Monthly Net 174.95
 Same as above except with 2 Lafayette "Criterion 100A" deluxe 2-way speaker systems (oiled walnut) featuring 10" woofer with 1 lb. magnet, 4" closed-back tweeter, tuned tube-type ducted port, and brilliance control on rear of cabinet, instead of 2 "Criterion 50" systems. Shpg. wt., 89 lbs.
 21 E 9582WXM \$11.00 Monthly Net 201.95
 You Save 51.35 from Individual Catalog Prices

SYSTEM PRICE
ONLY 174⁹⁵
 No Money Down

SAVE 48³⁵
 From Individual Catalog Prices!



Garrard 40 MK II

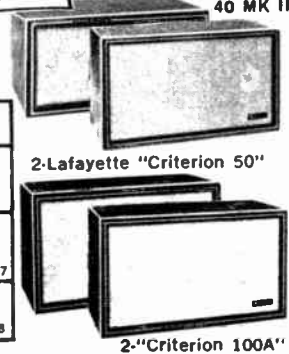

2-Lafayette "Criterion 50"

2-"Criterion 100A"

- Choice of Stereo Cartridge
- Pickering V-15/AT-2
- Shure M44-7
- Empire 888

NEW! Model LA-248A 50-Watt Solid State Stereo Amplifier

The LA-248A is an all transistor 50 watt integrated stereophonic preamplifier/amplifier in one compact and smartly designed unit. All transistor design offers instant warm-up, low current consumption, cool operation, low distortion and noise (-74db), excellent transient response, and wider frequency response (20-20,000 cps ±1 db at 1-watt). Inputs for all types of stereo/mono music sources: Magnetic and ceramic cartridges; tape head; tuner and auxiliary. Two pair of output terminals have been provided for 4, 8 and 16 ohms impedance speakers and tape recorder. A full range of controls allows complete flexibility of operation: 5-position selector switch; mode switch; volume, bass, treble controls. Five rocker switches for: Loudness, rumble filter, scratch filter, speakers Off/On (for headphone listening), power Off/Dn. Also features front panel headphone jack. Rear panel features a speaker phasing switch and two auxiliary AC outlets. Housed in brown textured metal case, gold anodized extruded aluminum panel and knobs. Size: 13 3/4" W x 4 7/8" H x 10 3/4" D. Shpg. wt., 18 lbs. Imported. For 110-125V., 50/60 cycles AC.
 99 E 0132WX \$5.00 Monthly Net 84.95

90 Watt Solid State Stereo Systems With LA-90T

Lafayette Model LA-90T 90-Watt Solid State Stereo Amplifier 129.85
 Garrard Model 40 MKII 4-Speed Automatic Record Changer 44.50
 Pickering V-15/AT-2 Diamond Needle Stereo Cartridge* 24.95
 Garrard Matching Changer Base (Walnut & Ebony) 4.50
 Color with Silver Trim) 4.50
 Garrard Molded Plastic Dust Cover for Record Changer 4.50
 2-Lafayette "Criterion 50" Wide Range 2-Way Bookshelf and/or Floor Speaker Systems (Oiled Walnut) 59.90
Total 268.30

Above system with choice* of Pickering V-15/AT-2, Shure M44-7 or Empire 888 diamond needle stereo cartridge, complete with speaker cable. Shpg. wt. 88 lbs.
 21 E 9568WXM \$11.00 Monthly Net 219.95
 Same system as above except with 2 Lafayette "Criterion 200A" speaker, 3-way systems (oiled walnut) featuring 12" woofer with 1 lb. magnet, 3" dome tweeter, 8" mid-range speaker, "tuned" tube type ducted port, brilliance controls and presence controls, instead of 2 "Criterion 50" systems. Shpg. wt., 102 lbs.
 21 E 9570WXM Net 291.95
 You save 56.35 from individual catalog prices

SYSTEM PRICE
ONLY 219⁹⁵
 no money down

SAVE 48³⁵
 From Individual Catalog Prices



Garrard 40 MK II

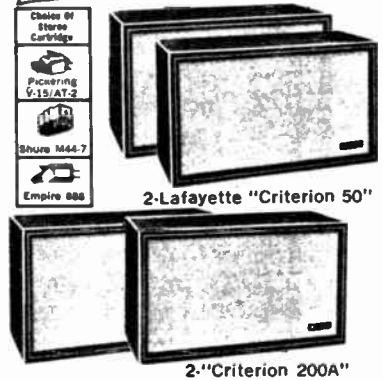

2-Lafayette "Criterion 50"

2-"Criterion 200A"

Model LA-90T 90-Watt Solid State Stereo Amplifier

Deluxe Lafayette solid state 90 watt single chassis pre-amplifier and amplifier. The LA-90T solid state circuits will give you many years of trouble free use. The LA-90T provides maximum flexibility; one large selector knob permits you to choose Tape Head, Phono 1, Phono 2, Tuner and Auxiliary positions. Mode control selects Balance, Left or Right Channels, Mono, Stereo Reverse and individual Left and Right Inputs. Five quality rocker switches for: Extension speakers, Low filter, High filter, loudness control for aural balance at low volume levels, and monitor that lets you listen to tape during recording. This switch is also used for playback.

Balance/Volume, Treble/Bass controls are concentric for easy operation on both channels. The rear panel provides you with 10 inputs and 4 outputs: Left and Right channels for Magnetic/Ceramic cartridge; Tape head for direct connection to a tape deck that does not have a pre-amplifier; Tuner; Tape Record; Tape Play output. Left and Right channel speaker connections permit the use of 4, 8 and 16 ohm speakers. IHF Music Power: 90 Watts total at 8 ohms, frequency response: 30-50,000 cps ±2db at 1-watt.

Special extension speaker terminals are provided for remote placement of speakers anywhere in your home. Built-in electronic short circuit device, prevents accidental shorting at speaker terminals. Smartly styled all metal cabinet finished in simulated walnut wood grain, plus non-terminating, gold anodized extruded aluminum front panel. Size 13Wx3 3/4Hx9 3/4D. Shpg. wt., 15 lbs. Imported for 117V 50-60 cycle AC.
 99 E D166WX \$7 Monthly Net 129.95

Hi-Fi Systems Are Available on Easy Pay Plan—No Money Down

Lafayette Cat. No. 672 5



Model LT-250A FM Stereo Tuner

SALE!

Save 10.00

Our Lowest
Price Ever!

64⁹⁵

NO MONEY
DOWN

Sale Prices Effective
Until March 15, 1967

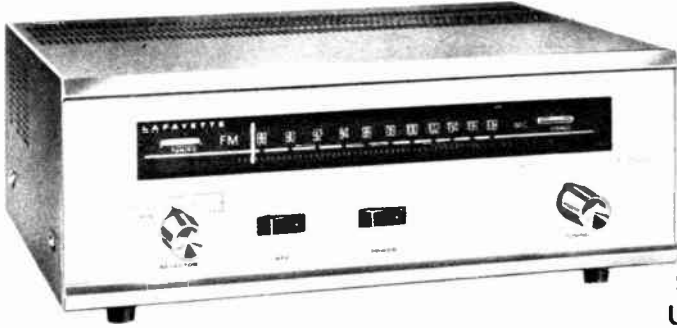

- New Audible Stereo Search System To Locate Stations Broadcasting In FM Multiplex Stereo
- 3-Gang Tuning Condenser Provides A Tuned RF Stage For Excellent Sensitivity and Selectivity

- Built-in FM Multiplex with 38 DB Stereo Separation
- Stereo Mode Indicator, Tuning Eye
- Frequency Response, 20-20,000 Cycles
- Low Silhouette Styling

TRULY remarkable, quality performance and styling that will delight both your eye and your ear. Features the new stereo search control. When this circuit is energized by a station broadcasting in FM multiplex stereo, it sends an audible signal through both the left and the right channels. Tuning eye facilitates accurate tuning of all signals with pin point sharpness. Automatic stereo indicator lights when control is set to the FM stereo position. Engineered to provide high-quality FM and FM stereo reception, the LT-250A has a grounded grid low noise front end. The multiplex circuit provides a stereo separation of 38 db at 400 cps. with less than 1% distortion. Front

panel controls consist of the Mode selector: (mono, stereo search, FM stereo, FM stereo noise filter); see-saw AFC and power switches; and main tuning. Stereo dimension control to custom blend stereo reception (in-rear). Flywheel tuning control gives velvet smooth tuning action. Two stereo output jacks on rear panel. Extruded aluminum front-panel with complementary case and metal knobs. Complete with cage and legs. Dimensions: 12³/₄Wx4⁷/₈Hx9¹/₂"D. For 117V 50/60 cps AC. Imported. Shpg. wt., 13 lbs.

99 E 0131WX \$5 Monthly

Net 64.95

MODEL LT-325T SOLID STATE AM/FM STEREO TUNER

- IHF FM Sensitivity of 2 μ V.
- IF Rejection of Better than -55db... More Signal, Less Noise
- Dependable Tone-Type Stereo Search
- Illuminated Tuning Meter

99⁹⁵

No Money Down

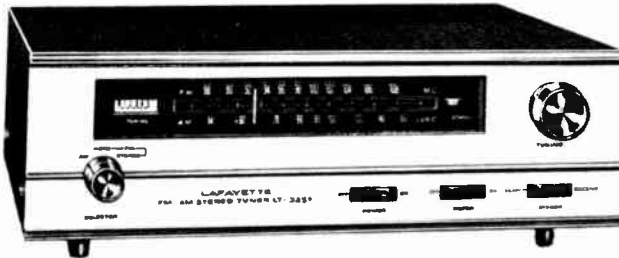

18 TRANSISTORS 17 DIODES

SPECIFICATIONS

FM Sensitivity, IHF: 2 μ V; FM Frequency Response: 20-15,000 cps \pm 2 db; Capture Ratio: 3 db; S/N: 60 db at 98 mc (100% modulation); Alt. Channel Selectivity: 42 db; Stereo FM Separation: 35 db at 400 cps; SCA Rejection: 40 db; Stereo Noise Filter: -10 db at 10 kc; Antenna Input: 300 Ω balanced; FM Frequency Drift: less than \pm 50kc. Tone-type stereo search. AM Sensitivity: 1 mv input = 0.6 volts \pm 2 db at 400 cps, 30% modulation output. 18 transistors. 17 diodes. 50/60 cps—117 VAC. Size: 13Wx3³/₄x9³/₈"D.

Offering extended versatility, the LT-325T features a positive Automatic Stereo Search that signals whenever you tune to a stereo station. The LT-325T may proudly grace an open shelf with its handsome brushed aluminum, gold anodized, extruded front panel and simulated walnut wood grain case. Or it may be built-in without fear of heat damage since there are no heat producing tubes. On the front panel there are large, easy-to-tune knobs for tuning, selection (AM, FM, MOND, FM STEREO), stereo search, MPX filter, and power. Tuning is simplified and made positive by a tuning meter. Built-in AM loopstick; balanced 300 Ω FM antenna input has distant-local connections. Imported. Shpg. wt., 11¹/₂ lbs.

99 E 0159WX \$5 Monthly

Net 99.95

MODEL LT-100B AM/FM TUNER

- AFC Defeat for Tuning Weaker Stations
- FM Multiplex Output Jack

- 10 Tube Performance — 7 Tubes (3 Dual Purpose)
- FM Ratio Detector Plus Limiter
- Grounded Grid RF Stage
- AFC for Tuning Simplicity — Locks in Stations

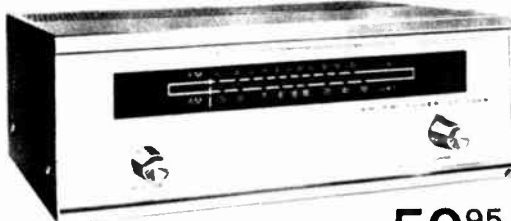

Transformer Power Supply

Only 59⁹⁵

NO MONEY DOWN

Features a powerful grounded grid RF stage, FM Multiplex output jack, flywheel tuning, large illuminated slide rule dial, built-in AM ferrite loop antenna and 4-position selector switch. FM SPECIFICATIONS Sensitivity: 3 μ V; Frequency Response: 20-20,000 cps \pm 1 db; Harmonic Distortion: less than 1% at 400 cps. Low silhouette metal enclosure with brown finish contrasts with the gold anodized extruded aluminum front panel. Size: 12³/₄Wx4⁷/₈Hx9¹/₂"D. For 110-125V 50/60 cps AC. Imported. Shpg. wt., 15 lbs.

99 E 0134WX \$5 Monthly

Net 59.95

MULTIPLEX ADAPTER KIT KT-220 plugs into multiplex jack of LT-100B and connects to any other wide-band FM or AM-FM tuner. Results in thrilling FM stereo with 30 db separation at 400 cycles. Self-powered, 8¹/₂Wx4³/₈Dx4³/₈"H. For 110-125V 50/60 cps AC. Shpg. wt., 4 lbs.

19 E 0907

Net 19.50

Deluxe Stereo Hi-Fi Music Systems

FEATURING **FISHER** *Garrard* AND LAFAYETTE COMPONENTS

SYSTEMS SAVE YOU MONEY AND ARE SIMPLE TO INSTALL

55-WATT AM-FM STEREO MUSIC SYSTEM

Complete System

362⁵⁰

YOU SAVE 5143

From Individual Catalogue Prices

No Money Down

A money saving system that lets you enjoy the thrill of beautiful stereo music reproduction. Consists of the new Fisher 220-T Solid State 55-watt AM-FM Stereo Receiver (less case), new Garrard Model 40 MK-II 4-speed automatic record changer with Garrard base, choice of Pickering V15AT-2, Empire 888, or Shure M44-7 Stereo Cartridge, and 2 Lafayette Criterion 50 True 2-way Bookshelf type speaker systems (oil walnut finish). Shpg. wt., 84 lbs.

21 E 3301WXM \$19 monthly Net 362.50

Fisher Model 220-T AM-FM Stereo Receiver Only. Net 280.08
21 E 3300WX Wt., 18 lbs.—\$15 monthly

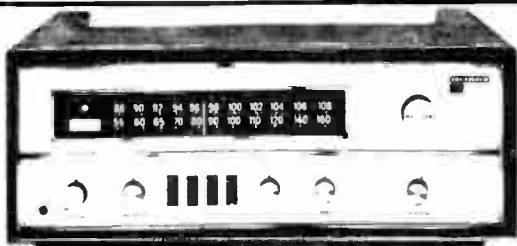

Fisher 220-T less enclosure

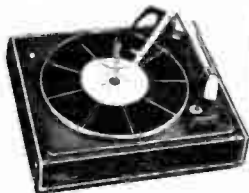
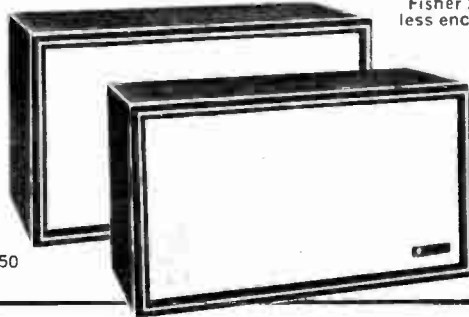

Garrard 40MK-II

2 Lafayette Criterion 50 Speaker Systems

90-WATT FM STEREO MUSIC SYSTEM

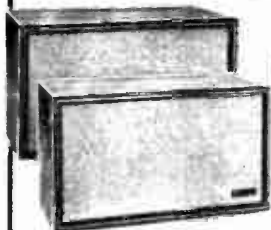

2 Lafayette Criterion 100 Speaker Systems



Garrard 50MK-II

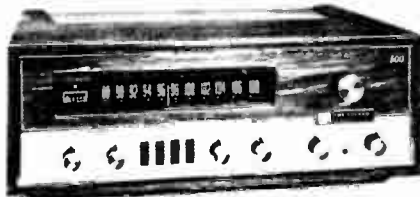

Fisher 500T less enclosure

Complete System

444⁵⁰

YOU SAVE 6893

From Individual Catalog Prices

No Money Down

Captivating stereo realism is yours with this deluxe stereo system. Consists of new Fisher 500T 90 watt FM stereo receiver (less enclosure), new Garrard Model 50 MK-II 4-speed stereo record changer with Garrard base; choice of either Pickering V15AT-2, Empire 888, or Shure M-44-7 diamond needle stereo cartridge; and 2 deluxe Lafayette Criterion 100A 10" 2 way bookshelf type speaker systems. (Oiled walnut finish) Shpg. wt., 98 lbs.

21 E 3305WXM \$23 monthly Net 444.50

Fisher Model 500T FM Stereo Receiver Only. Net 339.58
21 E 3303WX Wt., 26 lbs. \$17 monthly

120-WATT FM STEREO MUSIC SYSTEM

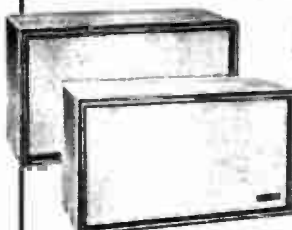

2 Lafayette Criterion 200 Speaker System



Garrard 60MK

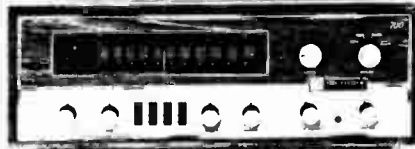

Fisher 700T less enclosure

Complete System

582⁵⁰

YOU SAVE 9593

From Individual Catalog Prices

No Money Down

Each component in this superb system is one of the manufacturers finest. Consists of Fisher's powerful new Model 700T 120-watt FM stereo Receiver (less enclosure); Garrard's superb new Model 60 MK-II 4-speed automatic stereo turntable with Garrard base; choice of either 1 of 3 elliptical diamond stereo cartridges—Pickering V15ATE-2, Empire 888E, or Shure M44E; and 2 superb Lafayette Criterion 200A 12" 2 way speaker systems (oil walnut finish). Shpg. wt., 110 lbs.

21 E 3306WXM Net 582.50

Fisher Model 700T FM Stereo Receiver Only. Net 424.58
21 E 3649WX Wt., 26 lbs., \$22 monthly

Solid State AM-FM Stereo Receivers

Offer These Outstanding Features

- Silver Plated FET Front End
- Silicon Output Transistors
- All Silicon I.F. Amplifier
- Automatic AM Wide-band Switching
- Stereo Indicator Light
- Automatic Stereo Switching
- Front Panel Phone Jack

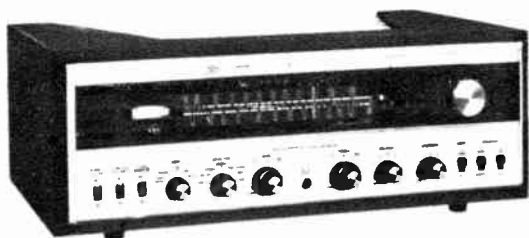

MODEL 388 120-WATT AM-FM STEREO RECEIVER

Music Power: 120 watts @ 4 ohms
100 watts @ 8 ohms

ONLY 449⁹⁵
No Money Down less enclosure

Expertly engineered unit provides the superb advantages of solid state reliability, plus magnificent sound. Top-performing AM/FM section has silver-plated front end featuring Scott's field-effect transistors (FET) for maximum sensitivity, freedom from drift and a high degree of cross modulation rejection. Features tape monitor switch; speaker Main/Remote switch; front panel stereo headphone output; stereo indicator light and automatic stereo switching. Specifications: Music power rating (IHF Standard @ 4 ohms) 120 watts. Harmonic Distortion: 0.8%. Frequency Response: ± 1 db, 15-30,000 cps. Hum and Noise: -55db. Stereo Separation: 40db. Tuner Usable Sensitivity: 1.7µV. Cross Modulation Rejection, 90 db. Capture ratio, 2.5db. Power requirements: 105-120V, 50/60 cycles AC. Size in case: 15½Wx6¼Hx11¼"D. Shpg. wt. 26lbs.

21 E 6064WX \$23 monthly Net 449.95
Custom oiled walnut wood cabinet for 388. Shpg. wt., 8 lbs.
21 E 6063W Net 26.95

MODEL 382 65-WATT AM-FM STEREO RECEIVER

Music Power: 65 watts @ 4 ohms
50 watts @ 8 ohms

ONLY 299⁹⁵
No Money Down less enclosure

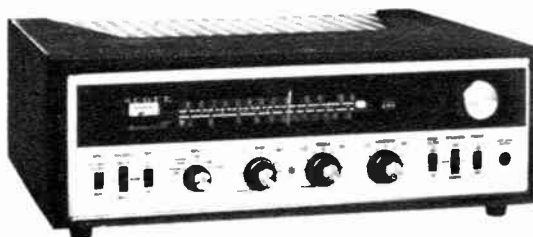

The Scott model 382 combines a superb solid state AM/FM tuner with a powerful 65 watt IHF solid state amplifier on one handsome chassis. Features Field Effect Transistor (FET) silver plated front end, and wide-range transformerless output. Controls: dual loudness, separate bass and treble controls, tuning, stereo/mono Mode switch; Tape Monitor; Noise filter, Speaker On/Off; front panel stereo headphone output; stereo indicator light gives positive indication of stereo and automatic stereo switching. Specifications: Music power rating (IHF Standard @ 4 ohms) 65 watts. Harmonic distortion: 0.8%. Frequency response: ±1 db, 18-25,000 cps. Hum and Noise: -55db. Stereo Separation: 35 db. Tuner usable sensitivity: 2.2µV. Cross modulation rejection, 80db. Capture ratio, 3.0db Power requirements: 105-120V, 50/60 cycles AC. Size in case: 15½Wx5¼Hx13¼"D. Shpg. wt., 19 lbs.

21 E 6082WX \$15 monthly Net 299.95
Custom oiled walnut wood cabinet for 382. Shpg. wt., 5 lbs.
21 E 6024W Net 22.50

SCOTT-GARRARD-LAFAYETTE AM-FM MUSIC SYSTEM

Featuring Scott 382 65-Watt AM-FM Stereo Receiver

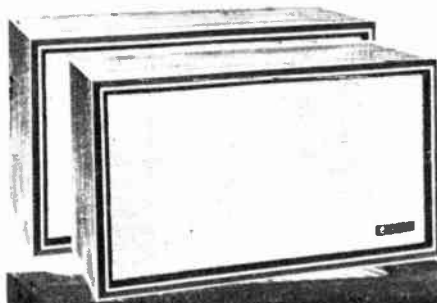

Complete System
369⁹⁵
No Money Down

YOU SAVE 63⁸⁵ from individual component prices

Spectacular stereo reproduction! Specially selected component Hi-Fi music system consists of new Scott 65-watt AM-FM Stereo Receiver (less enclosure), new Garrard Model 40 MK-11 4-speed automatic stereo record changer with Garrard base, choice of Pickering V15/AT-2, Empire 888, or Shure M44-7 diamond needle stereo cartridge, and 2 Lafayette "Criterion 50" true 2-way bookshelf type systems (oiled walnut finish). Shpg. wt., 88 lbs.
21 E 6089CWX \$19 monthly Net 369.95

NEW! Exciting LAFAYETTE "Criterion" 150" 10" Acoustic Suspension Speaker System

5 Year Guarantee

A Lafayette quality product that is guaranteed against defects in material and workmanship for 5 years. If this unit fails to operate due to such defects, simply return it prepaid with your original sales slip or order. Lafayette will repair it without charge including return transportation.

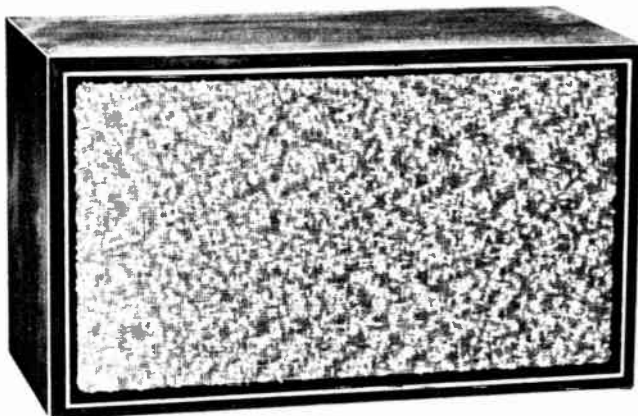

only **57⁹⁵**
No Money Down

Professional Quality 2-Way System Mounted in a Completely Sealed and Damped Enclosure for Superb Performance

- Average Program Material—40-Watts
- Overall Response—20 to 20,000 cps

A deluxe 2-way speaker system with high quality performance and handsome decorator styling. Uses the famous acoustic suspension design principle to develop in a cabinet of compact proportions, extended bass and smooth high frequency response. Heart of the system is a special 10" high compliance woofer. Free of the usual mechanical suspension, this woofer actually uses the air within the sealed enclosure as a spring suspension element. This arrangement, used with a speaker capable of extremely long cone excursions, gives bass reproduction that is outstanding in its depth and power. A 3½" tweeter extends high frequency response to beyond audibility for

- High Frequency Brilliance Control
- Fine Furniture Oiled Walnut Finish

thrilling clarity and wide angle sound dispersion. The system also features a high frequency "brilliance" control on the rear of the cabinet which enables the speaker to be adjusted to the best musical balance under all room conditions. An electrical LC crossover at 2000 cps assures peak-free highs. Overall Response: 20 to 20,000 cps. Average Program Material: 40 watts. Impedance: 8-Ohms. Solid ½" enclosure is finished on all four sides in luxurious hand-rubbed oiled walnut veneer with gold frame molding and contemporary beige color grille. Shelf size: 19Wx11Hx9"D. Shpg. wt., 17 lbs. 99 E 0181WX \$5 monthly Net \$7.95

NEW **LRE** 8X STEREO HEADPHONES



Only **795**

LAFAYETTE'S Lowest Price
Quality Stereo Hi-Fi Headphones

Lafayette has again achieved top performance at remarkably low cost. The moment you put this headset on you will be enveloped in glorious stereo sound with the best "seat" in the house. You needn't sit in one special place to achieve the best stereo effect. Wonderfully comfortable too. Soft rubber cushion earcups block out most external noise. Lightweight vinyl covered headband adjusts to fit easily . . . lets you listen comfortably to your favorite programs hour after hour without fatigue. The big 2" transducers in each earcup bring to your ears smooth, full fidelity sound and complete stereo separation. The headset weighs only 11 oz. Frequency response: 35 to 15,000 cps. Output: 100 mw. Matches 8 or 16-ohm impedance. Supplied complete with 5-ft. cord and standard ¼" phone plug. Imported. Shpg. wt., 1¼ lbs.

99 E 0180

Net 7.95

25 FT. UNIVERSAL STEREO HEADPHONE EXTENSION CORD

Listen to stereo through your favorite stereo headphone anywhere in the room. Ideal for use with Lafayette, Koss, Superex, Jensen, Sharpe and many other headsets. Flexible 3-conductor cable, grey vinyl jacket. 25 ft. in length. With a ¼" 3-circuit plug on one end a 3-circuit jack on the other end. Imported. Shpg. wt., 1 lb.

99 E 0116

Net 2.29

FAMOUS LAFAYETTE F-767 STEREO HEADPHONES

Widely Acclaimed
by Hi-Fi Critics

- Air Cushioned Headband
- Soft Foam Rubber Ear Cushions for Maximum Comfort and Bass Response
- High Sensitivity

Only

11⁸⁸

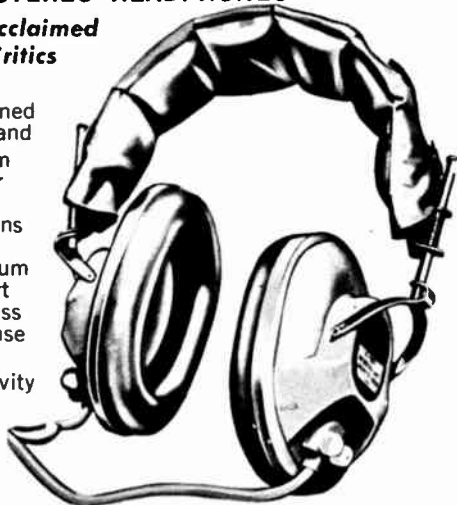

Our famous best selling quality stereo headphones, widely acclaimed by Hi-Fi critics, offer outstanding stereo sound reproduction to the listener. Extremely comfortable headband is covered with an air-filled vinyl bag which serves as a gentle cushion. Soft foam rubber ear pads keep out external noise and provide maximum bass response. Two specially designed full range 2½" speakers are precisely matched to each ear cup. Complete with attached stereo phone plug, overload junction box, 5 ft. cord, and instructions. Frequency Response: 30-15,000 cps. Impedance: 8 ohms per phone. Imported. Shpg. wt., 2¼ lbs.

99 E 0035

Net 11.88

Stereo headphone Control box for F-767 Permits switching from speakers to stereo phones. Imported. Shpg. wt., 2 lbs.

99 E 0036

Net 4.59

Hi-Fi Speakers Are Available on Easy Pay Plan—No Money Down

Lafayette Cat. No. 672 9



Professional Styling... Brilliant

5 Year Guarantee

A Lafayette quality product that is guaranteed against defects in material and workmanship for 5 years. If this unit fails to operate due to such defects, simply return it prepaid with your original sales slip or order. Lafayette will repair it without charge including return transportation.

LAFAYETTE "MINUETTE/II" 2 WAY HI-FIDELITY SPEAKER SYSTEM



Only **14⁹⁵** 2 For **28⁵⁰**

Buy 2 For Stereo SAVE 1.40

- 2 Speakers—5"x7" Woofer, 2½" Tweeter
- Shelf Size 6"Wx15½"x9½"D

Lafayette "Minuette/II" Hi-Fi Speaker System will bring music to any room in your home—and for a remarkably low cost. Designed for use where space is at a premium—ideal for the small apartment or listening area. Expand your stereo system to other areas of your home... easily used in the den, kitchen, patio or bedroom. Employs a specially designed 5x7" woofer, electrical crossover at 8,000 cps, plus a 2½" tweeter in a ducted-port brass reflex type enclosure. Provides an exceptionally fine musical quality yet measures only 6Wx15½Hx9½"D. Small enough to fit anywhere. Superb oiled walnut finish on 4 sides, allows placing speaker horizontally or vertically. Frequency response: 80 to 19,500 cps. Features adjustable level control for brilliance. Impedance 8 ohms. Rated at 10 watts. Imported. Shpg. wt., 8 lbs.

99 E 0171W Net 14.95

Set of Two For Stereo— Net 28.50
SAVE 1.40

LAFAYETTE Criterion® 20A THE "MINIATURIZED" SPEAKER SYSTEM!

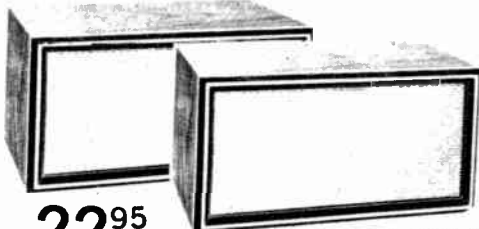

22⁹⁵

2 for 44.50

Only 5"x11"x7½"

- 20 Watt Power Handling Capacity

Hardly bigger than a table radio, yet offers astonishing high fidelity reproduction! The rich, deep-down bass must be heard to be believed—gives you excitingly real sound—fits anywhere... on a bookshelf... table... even on a wall! Comes finished on all four sides in a rich, hand-rubbed oiled walnut veneer, tastefully framed in an ebony and gold picture frame molding with white gold acoustic grille material. A powerful 5" woofer equipped with a large magnet and voice coil provides high efficiency and power capability. A 6 db per octave L-C crossover network transfers power to a newly developed 4" mid-range/high frequency unit which provides brilliant highs. Power Rating: 20 watts program material. Frequency Response: 45 to 20,000 cps. Crossover Frequency: 2800 cps. Nominal Impedance: 8 ohms. Imported. Shpg. wt., 8 lbs.

99 E 0168W \$5 Monthly Net 22.95

LAFAYETTE Criterion 50" TRUE 2-WAY BOOKSHELF SYSTEM

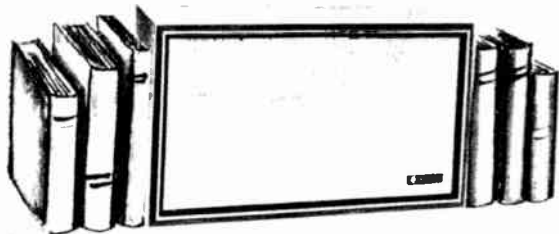

29⁹⁵

- Highly Efficient—Perfect for Low Power Amplifiers
- 8" Woofer Plus 4" Tweeter
- "Tuned" Enclosure with Tube-Type Ducted Port
- Overall Response 35-18,000 Cycles
- 3000 cps Electrical Crossover
- Handsome "Criterion" Styling
- 20-Watts Power Handling Capacity

A true 2-way bookshelf-type speaker system that offers impressive hi-fi sound, yet measures only 19Wx8½Dx10¾"H. Contains two separate speakers — you get an 8-inch woofer and a 4-inch tweeter to provide realistic wide-range reproduction. An acoustically "tuned" enclosure, fully lined, assures smooth, resonant-free sound output with extended bass response. The enclosure is finished on all four sides in a rich, hand-rubbed oiled walnut veneer and tastefully framed in the ebony and gold picture frame molding with white and gold acoustic grill material. Truly, an outstanding buy at this low price. For use with low-power stereo amplifiers — but rated at 20 watts program material for use with larger amplifiers. Designed for vertical or horizontal placement. Overall response: 35-18,000 cycles. 3000 cps electrical crossover. Nominal impedance: 8 ohms, imported. Shpg. wt., 28 lbs.

99 E 0128WX Criterion 50 Net 29.95

LAFAYETTE "Criterion® 30" COMPACT 2-WAY BOOKSHELF SYSTEM

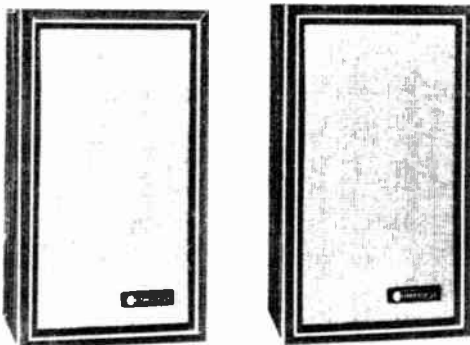

Only **34⁹⁵** 2 for 68.50

- 5" High Compliance Woofer Plus 3" Tweeter
- Overall Response 35-19,000 CPS.
- 25 Watt Power Capacity
- 1,200 CPS Crossover

A brilliantly sounding, moderately priced, compact speaker system featuring a specially engineered 5" woofer with a 1 lb. magnet perfectly matched to its compact enclosure. Its plasticized cone and high compliance suspension provides full, rich bass response down to 35 cycles. A 3" cone-type direct radio tweeter extends the frequency range to 19,000 cycles. A 6db/octave crossover network smoothly transfers the sound energy at 1,200 cycles. The deluxe bass reflex enclosure features a ducted tube-type port for smooth, peak-free frequency response. Has tweeter level control. Hand-rubbed oiled walnut finish on all 4 sides. Grille trimmed with ebony and gold frame molding. Size: 14Wx8Hx8"D. Impedance, 8-ohms. Imported. Shpg. wt., 13 lbs.

99 E 0164WX \$5 monthly Net 34.95

Wide Range Sound Reproduction

5 Year Guarantee



A Lafayette quality product that is guaranteed against defects in material and workmanship for 5 years. If this unit fails to operate due to such defects, simply return it prepaid with your original sales slip or order. Lafayette will repair it without charge including return transportation.

LAFAYETTE "decor-ette® V" SLIM 5-SPEAKER 3-WAY SYSTEM



Model SK-300

- Four Specially Engineered 6½-inch Low Resonance Speakers—One 2½-inch Cone Type Tweeter Designed to Achieve Optimum Performance in a Thin Type Audio-panel Enclosure Only 4¼ Inches Thick
- Frequency-Response 50-18,000 cps
- Power Handling Capacity: 25 Watts

39⁹⁵ 2 for 78.50

A dazzling 5-speaker system—magnificently styled and offered in an ultra-slim enclosure only 4¼" deep. Four 6½" low resonance woofers assure rich deep-down bass. A 2½" cone-type tweeter provides sparkling reproduction of the mid-range and highs. Overall response of this system is 50-18,000 cps. Enclosure is finished in a rich hand rubbed oiled walnut veneer with matching picture frame molding. System may be used for floor mounting, bookshelf, or even wall mounting. Supplied complete with matching legs. Dimensions: 21¾Hx17¾Wx4¼"D. Power handling capacity: 25 watts program material. Nominal impedance: 8 ohms. Imported. Shpg. wt., 17 lbs.

99 E 0008WX \$5 Monthly Net 39.95

LAFAYETTE "CRITERION 100A" DELUXE 2-SPEAKER 2-WAY SYSTEM

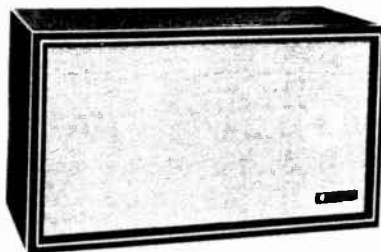

**44⁹⁵
2 for
88.88**

No money down

- Powerful Handling Capacity—30 Watts
- Powerful 10" Woofer with 1 lb. Magnet Plus 4" Tweeter
- Overall Response 30-19,000 Cycles

Top quality, moderately priced speaker system that delivers really "big" sound. A powerful 10-inch woofer provides smooth bass response down to 30 cycles. A 4-inch cone-type tweeter provides reproduction of the mid-range and high frequencies (to beyond audibility) and is of the closed back type to prevent interaction with the 10-inch woofer. Smooth transition is achieved by means of electrical crossover at 2800 cycles. Features high frequency brilliance control. Enclosure is a bass-reflex type using a ducted port to provide proper acoustic tuning and has a beautiful walnut finish on 4-sides. Dimensions are 21½Wx11¾Hx10½"D. Overall frequency response: 30-19,000 cycles; nominal impedance: 8 ohms; power handling capacity: 30 watts program material. Shpg. wt., 30 lbs. 99 E 0148WX \$5.00 monthly imported. Net 44.95

DELUXE LAFAYETTE "Criterion® 200A" 3-Speaker 3-WAY SYSTEM

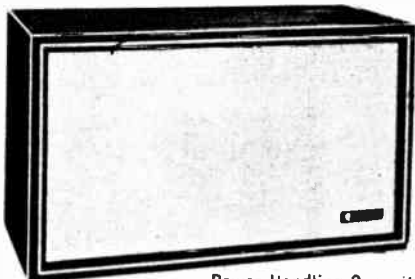

69⁹⁵

No Money Down

- Power Handling Capacity—40 Watts
- 12" Woofer With 1 LB Magnet
- 3" Dome-Type "Super" Tweeter
- 8" Closed Back Midrange Unit
- Response 25-25,000 cps
- "Tuned" Enclosure with Tube-Type Ducted Port
- 2 Controls—Brilliance Presence

One of our finest speaker systems—manufactured to rigid specifications and designed to provide full, wide-range response . . . from a low 25 cycles all the way up to 25,000 cycles! The Criterion 200 employs 3 separate speakers to provide performance that will satisfy even the more critical listener. 12" woofer with a 1 lb. magnet and 2½" diameter voice coil provides deep, solid bass . . . reproduces low-frequency instruments with thrilling realism! A superb 8" mid-range speaker and a back-loaded 3" metallic dome-type "Super" tweeter provide flawless reproduction of the mid-range and high frequencies. Features high frequency brilliance control range presence control at rear of cabinet. Enclosure is finished on all four sides in a rich, hand-rubbed oiled walnut veneer, attractively framed in an ebony and gold picture-frame molding with white and gold acoustic material. Dimensions 24Wx14Hx12"D. Overall Frequency Response: 25 to 25,000 cps. Crossover Frequencies: 700 and 5,000 cps. Impedance: 8 ohms. Power Handling: 40 watts program material. Imported. Shpg. wt., 35 lbs.

99 E 0149WX \$5 Monthly Net 69.95

SUPER LAFAYETTE Criterion® 3X 12" 3-WAY ACOUSTIC SUSPENSION SPEAKER

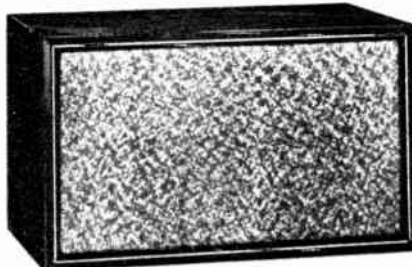

**ONLY
89⁹⁵**

No Money Down

- Power Handling Capacity 50 Watts
- Designed For Use with The Highest Quality Component Amplifiers and Receivers
- Overall Response 20-25,000 CPS
- Separate Midrange and High Frequency Controls

Superb 3-way speaker system for the critical listener seeking greater realism in reproduced sound. Uses the renowned acoustic suspension principle to extend low frequency response down to a low 20 cycles . . . gives you the deep, powerful bass that is so necessary to proper musical enjoyment. Heart of the system is a special 12" high compliance woofer with long-throw voice coil. Midrange frequencies are flawlessly reproduced by a 6½" cone driver which employs a sealed back to avoid interaction with the woofer and to prevent air leakage from the enclosure. 3" metallic, dome-type super tweeter provides brilliant, peak-free reproduction of the highs. Electrical 1200 and 6000 cps. L-C network ensures smooth crossover between all speaker units. Separate midrange and high frequency level controls. Fully air-tight enclosure is solid ¾" construction filled with fiber glass to prevent resonance. Rich, hand-rubbed oiled walnut veneer. Attractive frame of ebony and gold with new snap-off nubby grille cloth panel. Impedance: 8 ohms. Size: 23x13½x11¾" deep. Imported. Shpg. wt., 32 lbs. 99 E 0176WX \$5.00 Monthly Net 89.95

Hi-Fi Speaker Systems Are Available on Easy Pay Plan—No Money Down

Lafayette Cat. No. 672 11



Made in Great Britain by a Famous
Manufacturer Especially for LAFAYETTE

2 DELUXE 4-SPEED MODELS WITH
HEAVY-DUTY 4-POLE BALANCED MOTOR



MODEL AC-55	*	MODEL AC-66
29⁹⁵	*	37⁹⁵
less base	*	less base
With Ronette	*	With Famous
105 Stereo	*	Pickering PAC-1
Cartridge	*	Diamond
and Diamond	*	Needle
LP Needle	*	Magnetic
Installed	*	Stereo
	*	Cartridge
	*	Installed
	*	
	*	

OUR BEST PERFORMING 4-SPEED AUTOMATIC STEREO CHANGERS

- Plays 16 $\frac{3}{4}$, 33 $\frac{1}{3}$, 45, and 78 RPM Records
- Intermixes up to 10 Records of the Same Speed
- Heavy 11" Turntable Platter
- Automatic Locking Slim Low-Mass Tone Arm with Full Range of Stylus Pressures

- Built-In Record Stylus Brush
- Heavy-Duty 4-Pole Resiliently Mounted and Shaded Motor
- Automatic Shut-Off After Last Record Has Been Played

MODEL AC-55 4-SPEED AUTOMATIC STEREO RECORD CHANGER: Deluxe Precision Lafayette 4-speed automatic record changer made in England. Heavy duty 4-pole resiliently mounted and shaded motor and an 11" oversized turntable. Beautiful pearl gray and charcoal trim. Plays 16 $\frac{3}{4}$, 33 $\frac{1}{3}$, 45 and 78 RPM records—both stereo and monaural. Removable center spindle permits manual use of the changer. Intermixes up to ten records—7", 10", 12"—of the same speed. Built-in stylus brush cleans the needle each time the tone arm returns to the rest position. Muting suppressor mechanism eliminates noise during change cycle of records. Automatic shut-off after last record. Automatically locking, slim, low mass tone arm offers a full range of easy to adjust stylus pressures. Specifications. Wow: .1% to max. .18%, Flutter: .08%, Rumble, -32DB

reference 100 cps at 1.4 CM/SEC. For 110-120 VAC 60 cps. Size: 7 $\frac{1}{8}$ "H x 14 $\frac{1}{4}$ "W x 12 $\frac{1}{2}$ "D. 4 $\frac{7}{8}$ " above mounting surface, 3" below. Complete with 2 audio cables and line cord, and famous Ronette 105 stereo ceramic turnover cartridge with diamond LP stylus and 3 mil synthetic sapphire. Built-in 45 RPM centerpiece for manual play. Less Base. Made in England. Shpg. wt., 15 lbs. 21 E 0147W Net 29.95
MODEL AC-66 4-SPEED AUTOMATIC RECORD CHANGER. Same deluxe features, dimensions, color and specifications as above Model AC-55, but includes famous PICKERING PAC-1 diamond needle magnetic stereo cartridge installed instead of Ronette 105. Less base. Shpg. wt., 15 lbs. 21 E 0148W \$5 monthly Net 37.95

LOW PRICED 4-SPEED STEREO AUTOMATIC RECORD CHANGER



MODEL AC-44

ONLY
19⁹⁵
less base

- Made in Great Britain
- 4 Speeds—16 $\frac{3}{4}$, 33 $\frac{1}{3}$, 45, and 78 RPM
- Intermixes Records of Same Speed
- Built-In Stylus Brush

Lafayette Model AC-44 is a fine 4-speed automatic record changer made in England offering outstanding performance at a low, low, price. Plays 16 $\frac{3}{4}$, 33 $\frac{1}{3}$, 45, and 78 RPM records automatically or manually (when you remove the center spindle). Intermixes up to ten records—7", 10" and 12" of the same speed. Heavy, precision turntable delivers no noticeable hum, rumble, or wow. Features automatic locking tone arm, built-in 45 RPM centerpiece for manual play, stylus brush, Ronette ceramic stereo turnover cartridge, automatic shut-off after last record has been played. Color: pearl grey and charcoal trim. Dim.: 7 $\frac{1}{8}$ "H x 14 $\frac{1}{4}$ "W x 12 $\frac{1}{2}$ "D. 4 $\frac{7}{8}$ " above mounting board surface, 2 $\frac{1}{4}$ " below. For 110-120 VAC 60 cycles. Less base. Made in England. Shpg. wt., 12 lbs. 21 E 0146W Net 19.95

ACCESSORIES FOR LAFAYETTE MODELS AC-44, AC-55, AC-66 RECORD CHANGERS

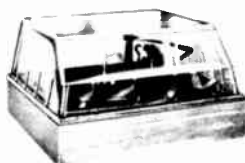

Deluxe Recessed Oil Walnut Wood Base. Shpg. wt., 2 lbs.
24 E 1213W Net 3.95

Attractive Plastic Dust Cover. Shpg. wt., 1 lb.
24 E 0247W Net 3.95

45 RPM Automatic Spindle. Shpg. wt., 1/2 lb.
21 E 0149 Net 1.95

united audio **Dual** and **AR** Professional Turntables

Only
1c
More

Your choice of 1 of 3 famous make elliptical stereo cartridges with the purchase of Dual 1019, Automatic Turntable or the Acoustic Research XA Turntable



Pickering V15ATE-2
34.95



EMPIRE 888E 34.95



SHURE M44E 34.50

SAVE UP TO 34⁹⁴

From Individual
Catalog Prices

DELUXE DUAL 1019 AUTOMATIC STEREO TURNTABLE with CHOICE OF ELLIPTICAL CARTRIDGE

Deluxe automatic stereo turntable combining unrestricted flexibility of operation with professional quality. Fully automatic and manual operation. Four speeds 16 $\frac{2}{3}$, 33 $\frac{1}{3}$, 45, 78 RPM. Elevator-action changer spindle holds up to 10 records. Dynamically balanced tonearm tracks and trips with as low as $\frac{1}{2}$ gram stylus force, permitting use of the finest high compliance cartridges at their lowest recommend tracking forces. Arm is completely free floating during play. Slip clutch prevents jamming. Direct reading stylus force adjustment and anti-skating compensation. Feather-Touch cueing control for both manual and automatic operation. Seven pound dynamically balanced non-ferrous cast turntable platter. Concave platter mat prevents slippage when playing warped records. Powerful constant speed continuous-pole motor with 6% vernier variable speed control. Magnesium tone arm head. Cartridge holder has adjustment for stylus overhang. Automatic shut-off after last record has been played. Trim is of cast metal. Size: 12 $\frac{3}{4}$ "x10 $\frac{1}{2}$ ", 6" clearance above and 3" below mounting board, $\frac{1}{2}$ " clearance at rear and right for cabinet installation, 110/220V, 60 cycle AC. Imported. Shpg. wt., 24 lbs.

21 E 6533WX 1019 Less Cartridge	Net 129.50
21 E 6538WXM 1019 Plus Pickering V15ATE-2 Ellip. Cart.	Net 129.51
21 E 6539WXM 1019 Plus Shure 888E Ellip. Cart.	Net 129.51
21 E 6540WXM 1019 Plus Shure M-44E Ellip. Cart.	Net 129.51

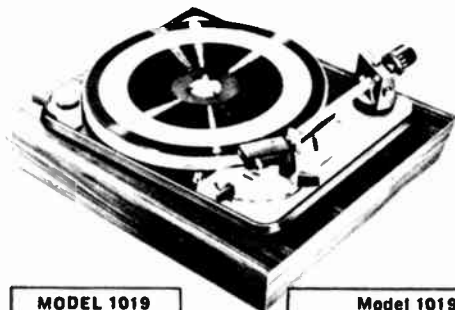

MODEL 1019
Less Cartridge
129⁵⁰
Less Base

Model 1019
With choice of cartridge
129⁵¹
Less Base

ACOUSTIC RESEARCH MODEL XA STEREO TURNTABLE with CHOICE OF ELLIPTICAL CARTRIDGE

SALE! SAVE ONLY Was
4.99 **78⁰¹** 83.00

(Special price in effect thru 3/ 15/67)

An outstanding turntable featuring a precision arm, oil walnut base and transparent dust cover in one compact unit. The rugged 3.3 lb. balanced aluminum platter is belt driven from synchronous motors operating at 33 $\frac{1}{3}$ and 45 RPM. Turntable and arm are shock-mounted from the top plate eliminating vibration. Meets NAB specifications for broadcast equipment on wow, flutter and speed accuracy. Also includes cables, overhang adjustment device and needle force gauge. Size with cover—12 $\frac{3}{4}$ "x16 $\frac{3}{4}$ "x5 $\frac{1}{4}$ ". Shpg. wt., 18 lbs.

21 E 7201WX XA less cartridge	Net 78.00
21 E 7254WXM XA with V15ATE-2	Net 78.01
21 E 7259WXM XA with 888E	Net 78.01
21 E 7256WXM XA with M-44-7	Net 78.01

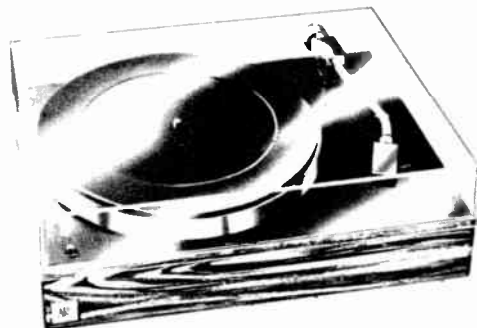

XA Turntable Comes Complete With Tone Arm, Walnut wood Base, Plastic Dust Cover and Choice of Elliptical Cartridge.

FAMOUS NAME STEREO CARTRIDGES with DIAMOND NEEDLES AT LOW LAFAYETTE PRICES

Grado BTR

Only **9⁹⁵**



Widely acclaimed ceramic stereo cartridge. Only 3 $\frac{1}{2}$ grams. Freq. response 10-50,000 cps; separation over 20db; recommended tracking force 1 $\frac{1}{2}$ to 5 grams. Shpg. wt., 6 oz.

21 E 4131L	Net 9.95
FAMOUS NAME STEREO ELLIPTICAL CARTRIDGES	
21 E 5362L Pickering V15/ATE-2	Net 34.95
21 E 3457 Empire 888E	Net 34.95
21 E 6236L Shure M-44E	Net 34.50

SPECIAL PURCHASE

FAMOUS EMPIRE 880P STEREO PHONIC CARTRIDGE

AMAZING ONLY
LOW PRICE **9⁹⁵**



Deluxe professional stereo cartridge for automatic turntables. Frequency response 8 to 30,000 cps. Output 8.0 mv per channel. Channel separation exceeds 30 db. Supplied with .6 MIL diamond stylus. Recommended tracking force $\frac{1}{2}$ to 4 grams. Shpg. wt., 7 oz.

21 E 3402L Net 9.95

World Famous *Garrard* Automatic Turntables

conical stereo cartridge

only **1^c** more with purchase of 40/MK-II or 50/MK-II



Pickering
V15/AT-2
24.95



Empire
888
24.95



Shure
M-44-7
19.95

Stereo Elliptical Cartridge

only **1^c** more with purchase of 60/MK-II or Lab 80/II
or \$5.00 more with purchase of 40/MK-II or 50/MK-II



Pickering
V15/ATE-2
34.95



Empire
888E
34.95



Shure
M-44E
34.50



Base Optional

Model 40/II
Alone
44⁵⁰

Model 40/II with
choice of
Conical
Cartridge
44⁵¹

Model 40/II with
choice of Elliptical
Cartridge
49⁵⁰



Base Optional

Model 50/II
Alone
54⁵⁰

Model 50/II with
choice of
Conical
Cartridge
54⁵¹

Model 50/II with
choice of Elliptical
Cartridge
59⁵⁰



Base Optional

Model 60/MK-II
Alone
74⁵⁰

Model 60/MK-II
with choice of
Elliptical
Cartridge
74⁵¹



Base Optional

Model LAB 80/II
Alone
99⁵⁰

Model LAB 80/II
with Choice of
Elliptical
Cartridge
99⁵¹

40/MK-II with Choice of Cartridge

Exciting low cost 4 speed automatic intermix turntable. 4 speeds: 16 $\frac{2}{3}$, 33 $\frac{1}{3}$, 45, and 78 RPM. Counterweighted cast aluminum tone arm. Automatic intermix operation. Handsomely styled unitized control panel with separate positions for manual and automatic play. Simple, convenient stylus pressure adjustment. Oversized turntable with decorative mat Garrard 4-pole shaded "Induction Surge" motor, with dynamically balanced rotor, shielded from hum. Size: 14 $\frac{1}{4}$ "L x 12 $\frac{1}{2}$ "D. Requires 4 $\frac{3}{8}$ " above and 2 $\frac{7}{8}$ " below motor board. Stereo wired. Complete with line cord, 2 plug-in cables and plug-in shell. Less base and 45 rpm spindle. For 110-130 volts. 60 cycles AC. Shpg. wt., 11 lbs. Imported from England.

21 E 3756W	Model 40/MK-II only	\$5 Monthly	Net 44.50
21 E 3766WM	Model 40/MK-II plus Pickering V15/AT-2		Net 44.51
21 E 3767WM	Model 40/MK-II plus Empire 888		Net 44.51
21 E 3768WM	Model 40/MK-II plus Shure M-44-7		Net 44.51
21 E 3769WM	Model 40/MK-II plus Pickering V15/ATE-2		Net 49.50
21 E 3770WM	Model 40/MK-II plus Empire 888-E		Net 49.50
21 E 3771WM	Model 40/MK-II plus Shure M44E		Net 49.50

50/MK-II with Choice of Cartridge

Model 50/MK-II completely restyled with a new turntable mat and trim, a new overarm, newly designed plug in shell and control housing. Features a lightweight tubular arm with a resiliently mounted non-adjustable counterweight, new stylus-pressure adjuster with gram markings, and a new manual cueing and pause device! Plays 16 $\frac{2}{3}$, 33 $\frac{1}{3}$, 45 and 78 RPM records. Automatic intermix operation when desired. Garrard 4-pole shaded "Induction Surge" motor, with dynamically balanced rotor, shielded from hum. Size: 14 $\frac{1}{4}$ "L x 12 $\frac{1}{2}$ "D. Requires 4 $\frac{3}{8}$ " above and 2 $\frac{7}{8}$ " below motor board. Stereo wired. Complete with line cord, 2 plug-in cables and plug-in shell. Less base and 45 rpm spindle. For 110-130 volts. 60 cycles AC. Shpg. wt., 11 lbs. Imported from England.

21 E 3757W	Model 50/MK-II only	\$5 Monthly	Net 54.50
21 E 3772WM	Model 50/MK-II plus Pickering V15/AT-2		Net 54.51
21 E 3773WM	Model 50/MK-II plus Empire 888		Net 54.51
21 E 3774WM	Model 50/MK-II plus Shure M-44-7		Net 54.51
21 E 3775WM	Model 50/MK-II plus Pickering V15/ATE-2		Net 59.50
21 E 3776WM	Model 50/MK-II plus Empire 888E		Net 59.50
21 E 3777WM	Model 50/MK-II plus Shure M44E		Net 59.50

60/MK-II with Choice of Elliptical Cartridge

Outstanding automatic turntable features: new manual cueing and pause device, Counterweight resiliently mounted to further reduce the already minimal rumble and resonance; a precision stylus pressure adjustment with knurled camera-type dial for highly accurate setting of tracking force. Includes Garrard's revolutionary new manual cueing; Tubular dynamically-balanced counterweight-adjusted tone arm. Heavy, cast oversized turntable. Double-shielded Laboratory Series* 4-pole shaded motor. 4-speeds: 16 $\frac{2}{3}$, 33 $\frac{1}{3}$, 45 and 78 RPM. Automatic intermix operation. Stereo wired. Size: 15 $\frac{3}{4}$ "L x 13 $\frac{1}{4}$ "D. Requires 4 $\frac{7}{8}$ " above and 2 $\frac{7}{8}$ " below mounting board. Complete with line cord, 2 audio cables, shell, standard and manual spindle. For 110-130V. 60 cycles AC. Base not included. Shpg. wt., 13 lbs. Imported from England.

21 E 3758WX	Model 60 MK-II only	\$5 monthly	Net 74.50
21 E 3778WXM	Model 60/MK-II plus Pickering V15 AT-2		Net 74.51
21 E 3779WXM	Model 60/MK-II plus Empire 888E		Net 74.51
21 E 3780WXM	Model 60/MK-II plus Shure M44E		Net 74.51

LAB 80/MK-II with Choice of Elliptical Cartridge

Deluxe automatic transcription turntable for professional reproduction of 33 $\frac{1}{3}$ and 45 rpm records. Dynamically balanced arm made of low resonant Aframosia wood. Tracking force adjustable with audible visual click settings. Adjustable, sliding weight anti-skating control. Integral hydraulic cueing device. Precision automatic spindle with famous pusher principle: heavy 12" balanced, cast non-magnetic turntable: stereo wired. Complete with line cord, 2 audio cables, shell, 45 rpm manual adapter, standard and manual spindles. Min. cabinet dimensions: 17 x 14 $\frac{1}{2}$ " x 5 $\frac{1}{2}$ " above and 3 $\frac{1}{2}$ " below mounting board. For 110-130V 60 cycles AC. Base not included. Shpg. wt., 22 lbs. Imported from England.

21 E 3760WX	Lab 80 MK-II only	\$5 monthly	Net 99.50
21 E 3784WXM	Lab 80 MK-II plus Pickering V15 ATE-2		Net 99.51
21 E 3785WXM	Lab 80 MK-II plus Empire 888E		Net 99.51
21 E 3786WXM	Lab 80 MK-II plus Shure M44E		Net 99.51

SPECTACULAR STEREO HI-FI OFFER

COMPLETE LAFAYETTE STEREOPHONIC HI-FI PHONO MUSIC SYSTEM

featuring

Lafayette Stereo/10 Solid State Amplifier
Lafayette AC 44 Automatic Stereo
Record Changer with
Oiled Walnut Base
Two Lafayette Minuette® II Speaker Systems

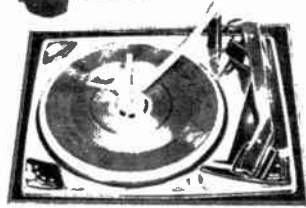

AT THE BARGAIN PRICE OF ONLY **59⁹⁵** No Money Down

YOU SAVE \$15.40 From Individual Catalog Prices

An ideal music system for the Hi-Fi beginner or as a second system in the den, bedroom, or office. You get the following fine components: A Lafayette Stereo/10 solid state amplifier designed to provide clean, smooth response. Features include separate volume controls for left/right channels and a tone control. The British made Lafayette AC-44 4-speed automatic record changer plays 16 $\frac{3}{4}$, 33 $\frac{1}{3}$, 45, and 78 RPM records. Includes a stylus brush, 45 RPM Centerpiece, automatic shut-off, Intermix of 7, 10, and 12" records, Ronettes stereo turnover cartridge, and deluxe oiled walnut base. Two rich sounding Lafayette Minuette / II 2-way speaker systems each containing a 5 x 7" Woofer and 2 $\frac{1}{2}$ " Tweeter mounted in a beautiful compact genuine oiled walnut wood bass reflex bookshelf enclosure. Size: 6"Wx15 $\frac{1}{2}$ "Hx9 $\frac{1}{4}$ "D. Shpg. wt., 35 lbs.

21 E 9583WXM \$5 monthly Net 59.95

LAFAYETTE PHONO PREAMPLIFIERS

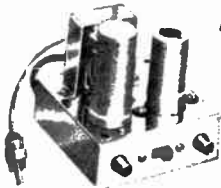

(A) Monaural

As Low As
5⁹⁵

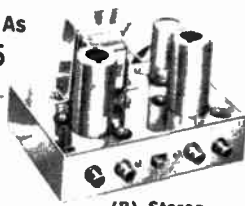

(B) Stereo

(A) Self Powered Monaural Preamp. For use with any Hi-Fi amplifier that does not have low level inputs for magnetic cartridges, tape heads, or microphones. Response: \pm 2 db at 30-20,000 cps. Gain (phono): 40 db, 5 mv. input for 1 volt output. Output impedance: 100,000 ohms. Features phono tape equalization switch, 2 input jacks, 16 inch output lead with plug. For 105-125 volts 50-60 cps 4 watts AC. Size: 3 $\frac{3}{4}$ x3 $\frac{3}{8}$ x3 $\frac{1}{4}$ ". Less 12AX7 Tube. Imported. Shpg. wt., 2 $\frac{1}{2}$ lbs.

99 E 0130 Net 5.95
12AX7 tube for above Net 1.20

(B) Self Powered Stereo Preamp. As above but for use with a stereo amplifier that does not have a low level input. Features 4 input jacks and 2 output leads. Size: 5 $\frac{3}{8}$ x3 $\frac{3}{8}$ x4 $\frac{1}{8}$ ". Less 2 12AX7 tubes. Imported. Wt., 3 $\frac{1}{2}$ lbs.

99 E 0139 Net 9.95
12AX7 Tubes for Above (2 Required) Net ea. 1.20

STEREO VU BALANCE METER

11⁹⁵

Ends the problem of balancing your stereo system. Two precisely damped loudness meters provide a continuous comparison of speaker levels. Scales calibrated in "Volume Units" and percent. 1.2 volts input sensitivity for 0 VU or 100 percent indication. The special calibrating switch and 20 db attenuation controls permit exact matching of channels. Greater than 8,000 ohm impedance permits connecting to output circuits without loading. 6Wx3 $\frac{1}{4}$ Hx2 $\frac{1}{8}$ "O. Imported. Shpg. wt., 3 lbs.

99 E 5038 Net 11.95

ROTRON WHISPER FAN

- Super Silent, Compact
- Reduces Service Costs

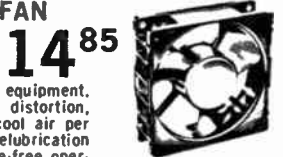

The ideal fan for cooling hi-fi equipment. Extremely quiet, introduces no distortion, yet it moves 60 cubic feet of cool air per minute. Airflow is reversible. Prelubrication will provide years of maintenance-free operation. For 115VAC, 60 cps, 7 watts. Size: 1 $\frac{1}{2}$ " deep and 4 $\frac{1}{16}$ " square. Shpg. wt., 1 lb.

24 E 7501 Net 14.85

ACCESSORIES FOR GARRARD AUTOMATIC TURNTABLES AND PLAYERS

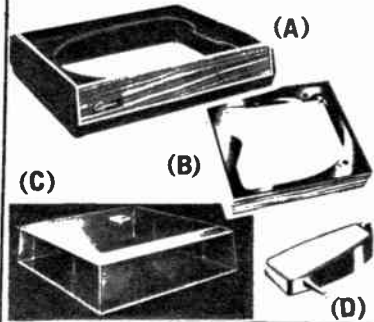

(A) Garrard Simulated Ebony and Walnut Base with Silver Trim. Shpg. wt., 2 lbs.
21 E 3763W For 70, Series Net 5.50
21 E 3762W For Lab 80 Series Net 5.50
For 60, 50, 40, 20, Series
21 E 3761W Net 4.50

(B) LAFAYETTE RECESSED WOOD BASES

OILED WALNUT — Shpg. wt., 6 lbs.
24 E 1203W For Lab 80 Series Net 5.50
24 E 1201W For A70 Series Net 4.50
24 E 1205W For 60, 50, 20 Series Net 4.50
MAHOGANY — Shpg. wt., 6 lbs.
24 E 1204W For Lab 80 Series Net 5.50
24 E 1202W For A70 Series Net 4.50
For 60, 50, 40, 20 Series
24 E 1206W Net 4.50

(C) GARRARD CRYSTAL CLEAR STYRENE DUST COVERS. Can be used in place while playing a stack of records. Shpg. wt., 1 $\frac{1}{2}$ lbs.
For Lab 80, 70, A Series
21 E 3765W Net 5.50
For 60, 50, 40, 20 Series, Autoslim & AT-6
21 E 3764W Net 4.50

(D) EXTRA-PLUG-IN SHELLS — complete with all mounting accessories. Shpg. wt., 6 oz.
For Lab 80 and 70 Series
21 E 3727 Net 2.50
For 60, 50, 40, 20 Series
21 E 3728 Net 2.50

(E) 45 RPM SPINDLES, Avg. Shpg. wt., 10 oz.
21 E 3710 For 70 Series Net 5.95
21 E 3709 For Lab 80 Series Net 5.95
For 60, 50, 40 Series
21 E 3787 Net 3.80

To Speed Your Mail Order — Please Give Your Zip Code Number

Lafayette Cat. No. 672 15

Combines Superb Quality,



INCLUDES
DIAMOND
STYLUS

89⁹⁵

Made In U.S.A.

No Money Down

DELUXE MODEL LS-33 SOLID-STATE STEREOHONIC HI-FI PORTABLE PHONOGRAPH

- 10 Watt Stereo Amplifier • Diamond Needle • 4 Speakers—Two 8" Woofers, Two 3½" Tweeters Offer Exquisite Tone
- GARRARD 4 Speed Automatic Intermix Changer • 4 Controls—Loudness, Balance, Bass, Treble

Luxurious styling with full dimensional high fidelity realism. Engineered with a fully solid-state circuit that offers "instant-on" and exquisite sound reproduction. Stereo amplifier gives 10 watts of power and has 4 controls—Loudness, Balance, Bass, Treble. Each detachable wing contains one 8" heavy-duty woofer and one 3½" tweeter plus a built-in 7' extension cord for wall-to-wall full-dimensional sound. Garrard 4-speed automatic intermix changer will handle all sizes and all speeds of both stereo and mono records. Intermixes different size records of the same speed. Automatic shut off. Wide range turnover stereo cartridge is equipped with a diamond stylus for

LP and stereo records, and a synthetic sapphire stylus for standard 78 RPM records. Housed in beautiful all-wood case with simulated walnut and black scuff-resistant Pyroxylin coated material. Speaker grill is brown and gold. For 110V 60C AC. Size: 2¼"L (with speaker wings open extends to 42") x 12½"D x 14¾"H. UL Approved. Shpg. wt., 40 lbs.

24 E 0227WX \$5 monthly Net 89.95

45 RPM Spindle for above
24 E 0217 Net 3.80

LAFAYETTE MODEL LS-25 SOLID STATE DECORATOR STYLED PORTABLE STEREO PHONO

MODEL L-10 SOLID STATE PORTABLE PHONOGRAPH



- Garrard 4-Speed Automatic Intermix Changer
- Two 6" Extended Range Detachable Speakers Offer Full Dimensional Stereo Sound
- Diamond Needle



SALE!
69⁹⁵

No Money Down
was 72.95



INCLUDES DIAMOND
STYLUS

Made In U.S.A.

Beautiful functional styling—each unit perfectly matched, assembling into one compact unit for ease of portability. The Garrard 4 speed automatic intermix record changer handles all size records and will intermix different size records of the same speed. Features automatic shut-off after the last record. Tone arm is equipped with a stereo turnover cartridge with diamond needle for LP and stereo records. Powerful Solid State Stereo amplifier offers exciting stereo realism—3 audio control functions. Separate

full range compensated loudness and balance controls plus a tone control. Each detachable speaker wing contains one 6" extended range speaker offering sparkling full dimensional sound—Wood case is covered with pyroxylin-coated silver and black scuff-resistant material. For 110-120 volt, 60 cycle AC. Dim: 22Lx13¾Hx8¾"D. Shpg. wt., 25 lbs. UL Approved.

24 E 0214WX \$5 monthly Net 69.95

45 RPM Spindle for above phono
24 E 0217 Net 3.80



MADE IN U.S.A. ONLY **19⁹⁵**

- Plays — 33½, 45, 16½, & 78 RPM
- Instantaneous ON
- Built-in 45 RPM Adapter Disc
- Front Mounted Speaker

Plays monaural records of all speeds . . . 33½, 45, 16½ and 78 RPM . . . all sizes 12", 7", 10". PM type speaker is set in front grille for full-tone sound dispersion. 2 controls—on/off Vol., tone. Manual turntable has foam rubber mat. Tone arm is equipped with Vaco dual turnover cartridge with 2 synthetic sapphire needles. Attractive two tone brown and white washable Pyroxylin coated fabric. Dim: 12¼"Lx10"Dx5" high. 110-120V. 60 cycles. AC UL Approved. Shpg. wt., 9 lbs.

24 E 0212 Net 19.95

Magnificent Sound...and Elegant Styling



INCLUDES
DIAMOND
STYLUS



149⁹⁵

No Money Down

Made in U.S.A.

DELUXE MODEL LS-44 SOLID STATE AM/FM/FM STEREOHONIC PHONOGRAPH

- 4-Speed Garrard Automatic Intermix Stereo Changer
- 12-Watt Stereo Amplifier • Diamond Needle
- Solid State AM/FM/FM Stereo Tuner
- Four Speakers—Two 6" Woofers, Two 3½" Tweeters

Handsome, designed, deluxe solid-state, stereo hi-fi Music Center featuring an all-transistor, dual 12-watt, stereo amplifier with instant-on performance, AM/FM/FM stereo tuner and a Garrard 4-speed intermix record changer. Plays 16, 33½, 45, and 78 RPM records. Intermixes all size records of the same speed. Automatic shut off after last record has been played. 5 controls: Continuous On-Off/Loudness, Base/Treble, Balance, Vernier Tuning, and 5-position Function Selector. Tunes in FM stereo broadcasts—for thrilling full-dimensional realism as well as static-free FM broadcasts and

standard AM broadcasts. Features AFC (Automatic Frequency Control) to prevent drift on FM. Each detachable speaker wing contains one 6" woofer and one 3½" tweeter for rich, clean sound reproduction. Space-age styled case with hideaway changer is in black with simulated walnut trim. Includes stereo turnover cartridge with diamond LP stylus. Size 23¾ x 15 H x 13" D. For 110-120 volt 60 cycle AC. UL approved. Shpg. wt., 37 lbs.

24 E 0220WX \$8.00 Monthly Net 149.95
24 E 0217 45 RPM Spindle for above phono Net 3.00

MODEL LS-22 SOLID STATE STEREO PHONO



INCLUDES DIAMOND
STYLUS



MADE IN U.S.A.

OUR
LOWEST PRICE
STEREO PHONO

54⁹⁵

No Money Down



- Famous BSR 4-Speed Automatic Intermix Record Changer
- Automatic Shut-Off After Last Record Has Been Played
- 2 Separate Full-Range Acoustically Balanced Speakers
- Solid-State Stereo Amplifier with 3 Controls

Handsome, low-priced, Lafayette, solid-state, portable, stereo phono—truly rich in looks as well as sound. Features famous BSR fully-automatic 4-speed changer. Stops after last record has played. Plays all sizes: 16, 33½, 45 and 78 records. Intermixes 12" and 10" records of the same speed in any sequence. Solid state stereo amplifier features powerful all-transistor circuit with "Instant-on." Three controls—Loudness Left, Loudness Right, and Bass/Treble. Two separate full-range speakers, one for each stereo chan-

nel, are acoustically balanced and spaced for true stereophonic full-dimensional sound. Includes Vaco stereo turnover cartridge with diamond LP stylus. Beautiful wood cabinet with washable, scuff-resistant Pyroxylin-coated ivory texture material and "rust home-spun" grill cloth. Size: 13¾x24¾x8½"D. UL Approved. For 110-120V 60 cycle AC. Shpg. wt., 25 lbs.
24 E 0226WX \$5 monthly Net 54.95
45 RPM Spindle for above Net 1.49
24 E 0220 Net 1.49

MODEL L-15 SOLID STATE AUTOMATIC PORTABLE PHONO



MADE IN
U.S.A.

37⁹⁵

No Money Down

- BSR Automatic Intermix Changer

Plays 16, 33½, 45 and 78 RPM records. Deluxe BSR automatic changer intermixes 12" and 10" records of the same speed. Automatic shut-off after last record has been played. Precision engineered solid state amplifier. Separate tone and volume controls, on-off reject switch. Front-mounted, acoustically-balanced, full-range speaker for clear tone with rich resonance. Dynamically balanced tone arm comes equipped with turnover cartridge with dual synthetic sapphire stylus. Two-tone platinum and white case, brown grille cloth. For 110-120V, 60 cycles AC. Size: 7¾x14Wx12¾"D. Shpg. wt., 15 lbs.
24 E 0225WX \$5 monthly Net 37.95
45 RPM Spindle for above Net 1.49
24 E 0220 Net 1.49

2 of Our Greatest Stereo Compact Values

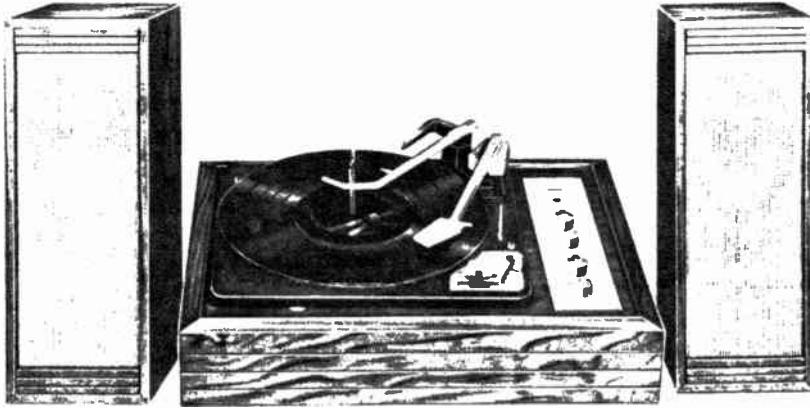

SALE
104⁹⁵
 WAS 114.95
SAVE 10.00
 No Money Down

LAFAYETTE LSC-20 SOLID STATE STEREO COMPACT HI-FI PHONO SYSTEM

- Famous Garrard Deluxe 4-Speed Intermix Changer With 11" Precision-Balanced Cushion Turntable

Outstanding performing stereo phonograph features solid-state circuitry combined with an exciting concept in high fidelity styling, the COMPACT—for enduring simplicity and unlimited flexibility. The components are mounted in luxurious oiled walnut cabinetry to enhance the decor of your home. The heart of this system is the powerful Lafayette Solid-State "Stereo 15" amplifier which features a front panel headphone jack for stereo headphone listening. 6 controls: Input Selector Switch (Phono-Tuner), Volume Left Channel, Volume Right Channel, Tone Left Channel, Tone Right Channel, AC Power On/Off Switch plus left and right inputs for stereo tuner. Garrard 4-speed automatic changer plays 7", 10", and 12" records. Intermixes different size records of the same speed. Features automatic shut-off, dynamically balanced tone arm, shock mounted motor. 11"

- 2 Rich Sounding 2-Way Lafayette Speaker Systems
- Diamond Needle

precision cushioned turntable and is equipped with a wide range turnover stereo cartridge with diamond stylus for LP records. The two Lafayette Minuette/II speaker systems each contain a 5 x 7" woofer and a 2½" tweeter. Both speakers feature a brilliance level control and have a full frequency range of 80 to 19,500 cps—offering outstanding rich sound reproduction. Size: Main Section 19½" L x 14¾" D x 3¾" H (8" overall height to top of spindle); Speaker System: 6" W x 15¾" H x 9¼" D. For 110V 60 cps AC. Imported. Shpg. wt., 48 lbs.

99 E 9144WXM \$6.00 Monthly	Net 104.95
24 E 2301W Plastic Dust Cover for Model LSC-20	Net 8.95
24 E 0217 45 RPM Spindle for Model LSC-20	Net 3.80

- Includes Garrard Model 50 4-speed Automatic Stereo Record Changer with Pickering V15 Diamond Needle Stereo Cartridge



SALE
164⁹⁵
 WAS 179.95
SAVE 15.00
 No Money Down

- With two DAZZLING Lafayette Criterion® 30 2-Way Full Range Speaker Systems

LAFAYETTE LSC-30 30-WATT SOLID STATE STEREO COMPACT MUSIC SYSTEM

Thrill to the magnificence of stereophonic sound while listening to this brilliant Hi-Fi music system. The main control section of the beautiful LSC-30 consists of a powerful Lafayette 30-watt stereo control amplifier, and the famous Garrard Model 50 series 4-speed automatic record changer with the Pickering V15 series diamond needle stereo cartridge—all mounted in an elegant oiled walnut wood base. The amplifier features a handsome brushed gold anodized aluminum panel with a Stereo headphone jack and six controls: 4 position Input Selector-Mode Switch (Phono Mono, Phono Stereo, Tuner Stereo, Tuner Mono) Loudness-on/off switch, Volume, Bass, Treble, AC Power-on/off switch. Includes 2 auxiliary input jacks for Left and Right channel enabling you to play an AM/FM stereo tuner or stereo tape deck thru the amplifier. AMPLIFIER SPECIFICATIONS: Power Output—30

watts (1HF)—15 watts per channel at 1% distortion; Frequency Response 40-25,000 cps ±2 db; Hum and Noise (s/n): Mag. 55 db, Tuner 65 db, Aux. 65 db; Input Sensitivity: Mag. 3 mv Tuner 250 mv, Aux. 250 mv, Transistors 17; Diodes 8. Each perfectly matched Criterion 30 Speaker System (see page 10 for complete specifications of the Criterion 30) features a 5" woofer with a 15 oz. magnet and a 3" tweeter. LSC-30 Dimensions: Main Section: 19½" L x 14¾" D x 3¾" H (8" overall height to top of spindle). Speaker System Dimensions: 14" H x 8" W x 8¼" D. Comes complete with two 10" speaker cables. Imported. Shpg. wt., 52 lbs.

99 E 9134WXM \$10.00 monthly	Net 164.95
24 E 2301W Plastic Dust Cover for above. Shpg. wt., 2 lbs. Net	8.95

Famous Name Stereo Hi-Fi Compacts

HARMON-KARDON SC-330 SOLID STATE FM STEREO MUSIC SYSTEM

SALE! 299⁹⁵

- Elegantly Styled Walnut Cabinetry
- 80-Watt FM Stereo Receiver

Save \$50 off of our 1967 catalog 670 price on this famous top quality solid state FM stereo music system. This fine performing unit features an 80-watt FM stereo receiver with up-front controls: Bass, treble, balance, volume (Off/On) function (tape, phono, FM); contour/speaker slide switches and stereo headphone jack. Tuning meter ensures fast, precise tuning of stations. Stereo indicator light flashes on when a stereocast is received. The Garrard Model 50 turntable features automatic shut-off and a high quality stereo magnetic cartridge with a diamond stylus. Each speaker cabinet contains 8" woofer and 3" tweeter in individual acoustic chambers, providing excellent frequency response. Specifications: EIA music power output: 80-watts. Frequency response: ± 1 db, 20 23,000 cps. Harmonic distortion: Less than 1%. FM sensitivity: 2.9 μ v. Dimensions: Receiver/Turntable, 22 $\frac{1}{2}$ "x13 $\frac{3}{8}$ "x10 $\frac{1}{2}$ "D. Speaker Systems each 16 $\frac{1}{2}$ "x11 $\frac{1}{8}$ "x8"D. For 110/120V 60 cycles AC. 21 E 4266WX \$15.00 Monthly. Shpg. wt., 80 lbs. Net 299.95
21 E 4257W Plastic Dust Cover. Wt., 2 lbs. Net 19.95

Was 349.50
1967 Cat. 670

**SAVE
\$50.00**



Exciting Solid State Hi-Fidelity Listening Pleasure



MODEL 11W STEREO COMPACT MUSIC SYSTEM

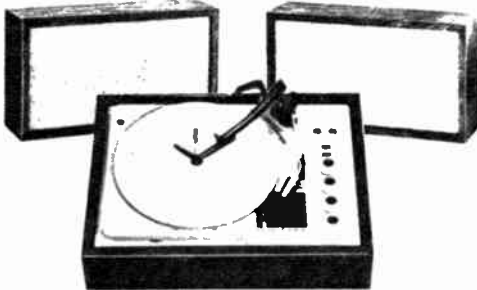

199⁹⁵

**No Money Down
24-4410WX**

- Oiled Walnut Finish
- Custom-built Turntable by Garrard
- Pickering V15 Magnetic Cartridge
- Diamond Stylus
- 2-Full Range KLH Speaker Systems

MODEL 24 FM STEREO MUSIC SYSTEM



299⁹⁵

**No Money Down
24-4409WX**

- 30-Watt Solid State Amplifier
- Custom-built Turntable by Garrard
- Pickering Cartridge/Diamond Stylus
- 2-Way Acoustic Suspension Speakers
- Built-in Drift-free FM tuner

MODEL 20 FM STEREO MUSIC SYSTEM

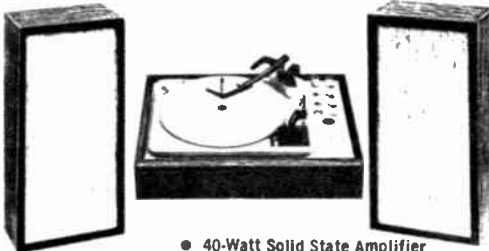

399⁹⁵

**No Money Down
24-4405WX**

- 40-Watt Solid State Amplifier
- Custom-built Turntable by Garrard
- Low-mass Tone Arm/Pickering V15 Magnetic Cartridge
- 2-Way Acoustic Suspension Speaker Systems
- Built-in Mono or Multiplex Stereo FM Tuner

MODEL 21 FM RADIO

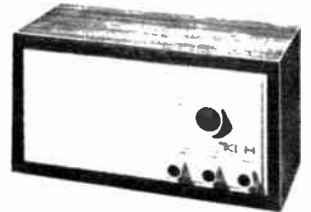

**Genuine Walnut
Veneer Cabinet**

79⁹⁵

**No Money Down
24-4407WX**

- Sealed Cabinet • Room Filling Sound
- Vernier Tuning/Planetary Dial
- Solid State FM Circuitry
- 2-Speaker Outputs, 1-Tape Output
- Two Year Warranty!

Sorry—No Mail orders on KLH products—Visit one of the 19 Lafayette Branch Stores and shop in person (Not available at Associate Stores)

SPEAKER SYSTEMS

CLEARANCE—QUANTITIES LIMITED

PLEASE SPECIFY ALTERNATE CHOICE

LAFAYETTE SK-58 ELIPTOFLEX® SPEAKER SYSTEM

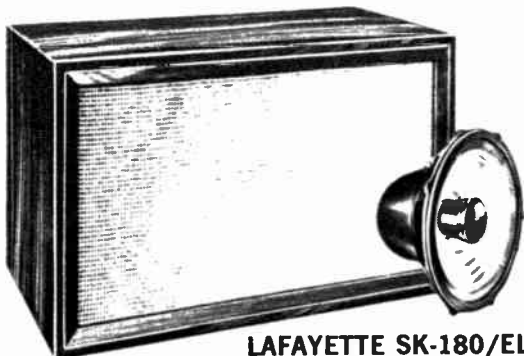

SALE! **SAVE UP TO \$20.00**
 AS LOW **36⁹⁵**
 AS

From 1966
Catalog 664

No Money Down

Popular 12" speaker system, featuring the famous Lafayette best selling SK-58 12" coaxial speaker, mounted in a Lafayette "Eliptoflex" enclosure. Response: 30-15,000 cps. Crossover: 3,000 cps. Power Handling Capacity: 20 watts; 35 watts peak. Impedance: 8 ohms. Shpg. wt., 36 lbs.

21 E 0115WX Mahogany	Net 39.95
21 E 0116WX Walnut	Net 39.95
21 E 0117WX Oiled Walnut	Net 39.95
21 E 0112WX Unfinished Birch	Net 36.95

LAFAYETTE SK-180/ELIPTOFLEX SPEAKER SYSTEM

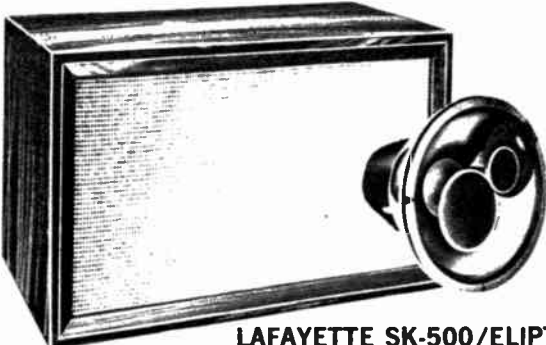

SALE! **SAVE UP TO \$25.00**
37⁹⁵

From 1966
Catalog 664

No Money Down

You get dazzling music reproduction from this fine performing speaker system. Features the exciting Lafayette SK-180 10" 3-way Trihelix® speaker mounted in the famous Lafayette Eliptoflex enclosure. Response: 30-18,000 cps. Crossover: 1500 and 5,000 cps. Power Rating: 20 watts. Shpg. wt., 32 lbs.

21 E 0118WX Mahogany	Net 37.95
21 E 0119WX Walnut	Net 37.95
21 E 0120WX Oiled Walnut	Net 37.95

LAFAYETTE SK-500/ELIPTOFLEX SPEAKER SYSTEM

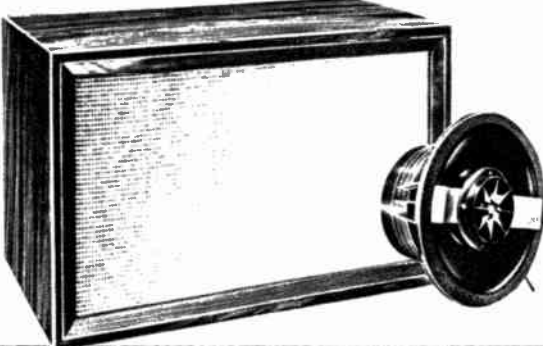

SALE! **SAVE UP TO \$27.00**
 AS LOW **44⁹⁵**
 AS

No Money Down

Professional quality speaker system at such a low price. Features deluxe Lafayette Model SK-500 12" 3-way Hi-Fi speaker mounted in the Lafayette Eliptoflex enclosure. Response: 25-20,000 cps. Crossover: 2,000 to 5,000 cps. Power Rating: 30 watts. Impedance: 8-16 ohms. Shpg. wt., 52 lbs.

21 E 0141WX Mahogany	Net 47.95
21 E 0143WX Oiled Walnut	Net 47.95
21 E 0144WX Walnut	Net 47.95
21 E 0142WX Unfinished Birch	Net 44.95

LAFAYETTE'S FAMOUS PATENTED ELIPTOFLEX ENCLOSURE

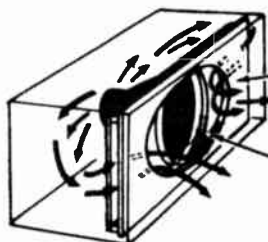

Specially Designed
Elliptical Port

Specially Engineered
Diffracting Ring

The patented "Eliptoflex" utilizes a unique elliptical port which broadens frequency response and provides better transient response. A specially engineered diffracting ring eliminates cancellation effects between front and rear radiation. "Eliptoflex" achieves a degree of natural smoothness, low distortion and robust bass hitherto found only in large quality, or expensive low efficiency speaker systems. Efficient design does not require high wattage amplification. Beautifully finished on 4 sides. Dimensions: 14x23³/₄x13³/₄"D.

C L O S E O U T S A L E

CLEARANCE—QUANTITIES LIMITED PLEASE SPECIFY ALTERNATE CHOICE

EXCITING LAFAYETTE "Criterion XL-360" MULTI-DIMENSIONAL 5-SPEAKER SYSTEM

- Full 360° Sound Dispersion of All Frequencies
- Four 6x3" Mid Range Speakers with Ultra-high Frequency Metallic Cone Tweeter
- One 8" High Compliance Woofer
- Power Handling Capacity—20 Watts



SALE!
39⁹⁵

No Money Down
SAVE 15.00 Was 54.95

Enjoy the thrilling experience of multi-dimensional, "all-around" sound with the Criterion XL-360. This remarkable system offers full 360-degree sound dispersion over its entire range—from 32 cycles all the way up to 20,000 cycles. The XL-360 delivers deep, powerful bass . . . clear, natural mid-range . . . smooth, unexaggerated highs. With two of these systems, stereo comes through with dramatic realism . . . virtually surrounds you with glorious, living sound-in-any-room and with almost any arrangement! SPECIFICATIONS Max. Freq. Range: 32-20,000 cycles; Power Handling Capacity: 20 watts; Nominal Impedance: 8 ohms; Crossover: Electrical at 3000-Mechanical at 8000. Genuine walnut veneer with rich oiled finish. Dimensions: 32½Hx11½Dx11½" W. Shpg. wt., 30 lbs. Imported.

99 E 0124WX \$5 Monthly

Net 39.95

LAFAYETTE SK-128/MINI-DUCT 8" ULTRA LINEAR SPEAKER SYSTEM

SALE! 25⁹⁵

SAVE 14.00
From 1966
Catalog 660 Price

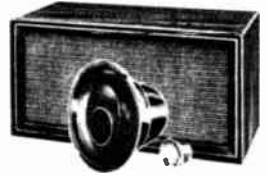

The perfect answer for those who demand realistic sound reproduction even where space is limited. Features Lafayette Model SK-128 8" Biaxial Full range speaker mounted in the Lafayette Mini-duct enclosure. Freq. response 40 to 16,000 cps ±3 db, Power rating 20 watts. Impedance 8 ohms. Dim.: 23W x 11½H x 11½"D. Shpg. wt., 28 lbs.

21 E 0108WX Speaker System in Walnut Net 25.95
21 E 0109WX Speaker System in Oiled Walnut Net 25.95
21 E 0110WX Speaker System in Mahogany Net 25.95

FAMOUS NAME 3-WAY SPEAKER SYSTEM

SALE! 29⁹⁵

SAVE 10.00
From 1966
Catalog 660 Price



- Jensen Speakers, Universal Woodcrafters Cabinet

Contains Jensen 12" woofer; 8" midrange driver and a 3½" tweeter mounted in a universal Woodcrafters heavy 7-ply furniture veneer cabinet. Crossover: 600 and 2000 cps. Imp.: 8 ohms. Response: 35-18,000 cps. Power Rating: 25 watts. Walnut finish. 24Wx14¼Hx13"D. Shpg. wt., 32 lbs.

21 E 8401WX

Net 29.95

LAFAYETTE ELECTRONIC LIGHT DIMMER CONTROL

750

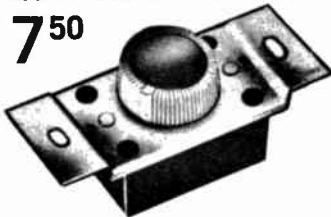

- Full Range—Total Darkness To Maximum Brightness
- Replaces Ordinary Wall Switch
- Full 360° Tapered Rheostat Provides 600 Watts Capacity
- No Complicated Wiring
- Sets the Light Mood in Any Room

Enjoy modern lighting in any room in your home or office. Soft light for TV viewing, bright light for reading or working. Easy to use, dimming is continuous from off to full illumination. Push on or off at any light level. Fits into standard single gang wall box without rewiring. Ivory plastic knob has brass finish insert. For 120 volts, 60 cycles AC. Operates incandescent lamps to 600 watt capacity. Shpg. wt., 1 lb.

12 E 0101 Net 7.50

LAFAYETTE WIRELESS REMOTE CONTROL

For Lamps, T.V., Hi-Fi, Household Appliances

Only **14⁹⁵**



- Turns Lights and Appliances On and Off From Anywhere In Your Home—By Remote Control
- Simply Plug In and Operate!
- A Lafayette Exclusive!

Now you may turn on or off any electrical device from anywhere in your home or shop. The Lafayette wireless remote control requires no additional wires. Simply plug in your transmitter wherever you choose in the house, and the appliance, TV, hi-fi system or lights that are plugged in to the receiver will be turned off or on by pressing the button on the transmitter. Perfect for viewing TV or listening to hi-fi in bed. When you get sleepy press the switch and turn everything off. Safe! Simple remote switch of lights, lamps, radios, TV and appliances. Transmitter and Receiver operate on ordinary house current, receiver accepts any 105 to 120 volt device up to 300 watts. Imported. Shpg. wt., 1/2 lb.

99 E 9118 Complete Transmitter & Receiving Unit Net 14.95
99 E 9122 Extra Receiver Net 9.95
99 E 9178 Extra Transmitter Net 5.95

Lamps For Office — Home — Lab — Industry

NEW! LAFAYETTE DESK LAMP

IDEAL FOR
STUDENT'S ROOM OR
HOME LIBRARY

Only
8⁹⁵

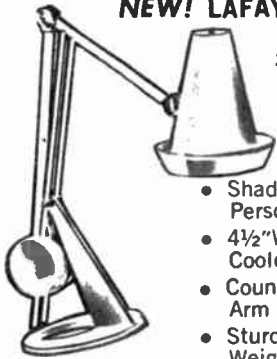

- Shade Swivels 360° For Personal Lighting
- 4½"Wx6"H Two Piece Air Cooled Shade
- Counterbalanced Extension Arm
- Sturdy 6" Diameter Weighted Base

Modern styled lamp that's ideally suited for use in any home where an area of bright, cool light is necessary. Lamp can be raised or lowered with a slight touch—yet arms are counterbalanced to stay in place. Lamp swivels 360°, has 15" reach. With felt bottom base to protect desk or table top, top ventilated lamp shade, 6 ft. white, U.L. listed line cord. Ivory finish with gold trim. For 110-120V., 50/60 cycles AC. Imported. Shpg. wt., 5½ lbs.

99 E 9183

Net 8.95

NEW! LAFAYETTE CLAMP-ON-LAMP

VERSATILE
ALL PURPOSE LAMP
FOR HOME OR OFFICE

Only
11⁹⁵

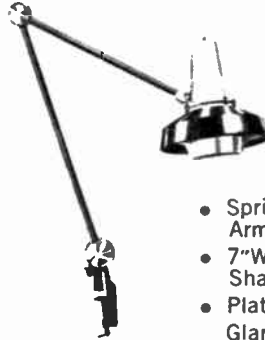

- Spring Controlled Extension Arms
- 7"Wx7"H Ventilated Lamp Shade
- Plated Inner Reflector For Glare-Free White Light

Ruggedly constructed, all-purpose clamp-on-lamp with "C" mounting clamp for easy installation. Adjusts with a touch; is spring controlled to stay put. Lamp swivels 360°; has 25" reach and air cooled ventilated lamp shade with light diffuser. Felt pad on "C" clamp protects finish on desk or table top. 6 ft. black U.L. listed line cord. Black enamel finish with brushed aluminum trim. For 110-120V., 50/60 cycles AC. Imported. Shpg. wt., 3 lbs.

99 E 9184

Net 11.95

LAFAYETTE HIGH INTENSITY LAMP

3⁹⁵



- Sleek Modern Styling!
- Rugged Construction

Ideal for desk or wall mounting. Lamp shade turns in any direction, giving an ample uniform, non-glare beam of light. Sturdy hinged arm extends to 14 inches, folds flat against a hi-impact base. On and off switch plus 6 ft. cord. Gold finish lamp shade and arms; ivory base. Uses #93 bulb. 117 volts, 50/60 cycles. Imported. Shpg. wt., 2 lbs.

99 E 9114

Net 3.95

32 E 6684 Replacement Bulb

Net .30

LAFAYETTE TRANSFORMERLESS HIGH INTENSITY LAMP

SALE!

2⁹⁵



- Features Magnetic or Clip-on Base

Powerful high intensity lamp featuring a handy magnetic or clip-on base for use on any surface. Inner reflecting shade for brighter non-glare illumination. 4-section telescoping arm with 360° rotating shade permits use in any position. Imported. For 117 Volts, 60 cycles. AC. Shpg. wt., 1 lb.

99 E 9126

Net 2.95

12 E 7504 Replacement bulb for above

Net .75

LAFAYETTE CLAMP-TYPE "DRAFTING LAMP"

7⁹⁹



- Spring Controlled Swivel Joints
- Extends To 30 Inches
- Perfect Illumination Anywhere

A deluxe lamp from Lafayette for perfect illumination wherever you require it. Ideal for benches, tables, and drafting boards. Clamps securely to any surface up to 3" thick. Spring controlled swivel joints and double arm action moves light in any direction. Arm extends to 30". Neutral color. For 110-125V, 60 cycles AC, less bulb. Imported. Shpg. wt., 9 lbs.

99 E 9077

Net 7.99

See our master catalog 670 for complete listing of fluorescent fixtures.

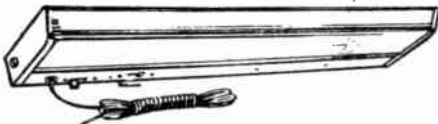

LAFAYETTE UNDER CABINET LAMP

As Low As

3⁹⁵

- Convenient AC Outlet
- Complete with Bulb

An extremely functional lamp, ideal for glare-free light over kitchen or shop work counters. Shallow design, only 1¼" deep. Complete with fluorescent lamp, built-in AC outlet, 7-foot line cord. White. Imported. Shpg. wt., 4 lbs.

99 E 9119 15-Watt Lamp:

Net 5.95

12 E 1002 15-Watt

Net .99

99 E 9120 8-Watt Lamp 12½" long

Net 3.95

12 E 1007 8-Watt Replacement Bulb

Net 1.39

2-LIGHT RAPID START CIRCLINE FIXTURE

- Complete with Lamps **11⁹⁵**
- All Chrome Plated

Cool, glare-free, easy on the eyes. Takes up little ceiling space; bulbs just snap in place. Chrome-plated, simple to clean. Produces comfortably soft light, intensity equal to 100-watt incandescent bulbs. Has 12" diameter 32-watt, and 8" diameter 22-watt lamps. For use with wall switch. Complete with lamps, hardware. For 110-125V., AC. Diameter 12". Shpg. wt., 11 lbs. UL approved.

12 E 4950

Net 11.95

LAFAYETTE AUTOMATIC 1000 WATT ILLUMINATOR

5⁹⁵



- Turns Lights On and Off Automatically
- For Permanent or Mobile Installation
- Never Needs Setting

A light-sensitive photo-electric switch that turns your lights on and off automatically at dusk and dawn. Has a capacity of 1000 watts so you can control several fixtures if you desire. Color-coded 6-foot 3-wire cord can be permanently connected to a fixture or wire it to the plug listed below for mobile or temporary installations. Waterproof construction makes it ideal for outdoor use. Housed in clear plastic case measuring 4x2x2". For 105-130V, 50-60 cps. Imported. Shpg. wt., 1 lb.

99 E 9115

Net 5.95

Plug for adapting Illuminator for Plug-in Use.

12 E 5050

Net .35

Timers — Watches — Clocks

PARAGON® TIMITE® MINIATURE 24-HOUR FOR HANDY MOUNTING

842

A compact time control ideal for window displays, night lights, yard lights, etc. Provides one on-off operation per day with minimum setting of two hours. Has manual trip lever. 24-hour dial is divided into 30 minute segments for easy, accurate setting. Fits over a U.S. standard single gang handy box. Size: 4½Hx2¾Wx3¼"D. Capacity: 15 amp. non-ind., 1800W. 1 HP. 12 amps., full load. For 120 v., 60 cycles. UL and CSA approved. 13 E 1751 Shpg. wt., 1½ lbs. Net 8.42



Intermatic® TYPE T101 TIME SWITCH

Turns equipment "on" and "off" once in 24 hours, or from 1-12 "on" and "off" operations a day can be obtained by use of extra trippers—can be added without removing dial. Min. on or off time 1 hr. max. 23 hours. Can be turned on or off manually with reset SPST switch rated at 40 amps. 4375 watt capacity. Mounting holes and knockouts. Gray steel case. UL approved. Operates on 110 volt 60 cycle AC. 7¾Lx5Wx3"D. Shpg. wt., 4 lbs. 13 E 2702 Net 8.95

895

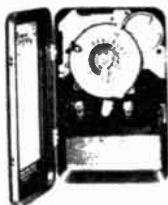

TIMED EXTENSION CORD

521



A 3-way combination for every home—an automatic time switch, extension cord, convenient outlet, 0-4 hour time cycle. Easy to operate—plug it into any wall outlet, connect one, two or three devices to be controlled, and turn the knob to the time period desired. At the end of this time period, the electricity is turned off automatically. 6-foot cord. Shpg. wt., 1 lb. 13 E 8501 Net 5.21



TELECHRON TIMER SWITCH

- Radio—TV—Appliance Timer
- 60 Minute Sleep Switch

- Simple Installation
- 1650 Watts

Automatically turns on radios—TV sets—etc.—at any preset time in a 12 hour period. "Sleep-Switch" allows up to 60 minutes of continuous run prior to "shut-off." Built in signal alarm. All controls on front. On-off-auto, 0 to 60 sleep switch, alarm set and time set. Gold finish dial—black lettering. 3½" square bezel, 1¾" deep. SPST rated 15 amps at 115 volts, 1650 watt load capacity. For 110-120V. 60 cy. AC only. Shpg. wt., 2 lbs. 13 E 4409 Net 5.40



APPLIANCE MINDER

10⁹⁹

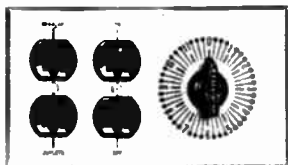

Add new space to the new or remodeled kitchen . . . more time for the harried housewife. Simply plug in the coffee-maker, rotisserie, electric frying pan, etc. . . set the timer up to 12 hours ahead . . . let the appliance minder do the rest. Easily installed in a 4-gang wall box—or surface mounted. Contains two timed outlets (one turns "on," the other turns "off") and two regular outlets. Allows advance planning of meals—go out and return home hours later to a cooked meal. Rated at 15 amps—125 volts AC. UL inspected. Shpg. wt., 1½ lbs. 13 E 8511 Net 10.99

LAFAYETTE® TECHNI-TIMER™.

795

- Makes Any Appliance Completely Automatic
- No Special Wiring—Just Plug In
- Handles Loads Up To 1875 Watts
- Turns Lights And Appliances On and Off
- 1 Year Guarantee



The Lafayette Techni-Timer makes practically everything electrical automatic. Turns radios on and off. Does not have to be reset each night. Defrosts refrigerator, controls roaster, electric blanket, fans, coffee-makers, phonographs, etc. Turns your home lights on and off automatically while you're away. Repeats cycle every 24 hours—no need to reset. Minimum ON time 15 minutes, maximum ON time, 23-hours. Minimum OFF time 1-hour, max. OFF time, 23-hours 45 minutes. Easy-to-read 24-hour dial. Can be controlled manually without automatic reset. Attractive design. For shelf, table or wall mounting. With 6 ft. cord, plug and receptacle for equipment to be controlled. Highest quality—we will repair any defect due to material or workmanship within 1 year without charge. Simply ship timer to Lafayette prepaid. 5Wx4Hx2½"D. For 110V 60 cycles AC. Shpg. wt., 2 lbs. UL/CSA approved. 13 E 0140 Net ea. 7.95

TV LAMP CLOCK

975



Ideal for use on a TV cabinet, in the kitchen or baby's room. Provides soft illumination and precise time. Attractive sturdy plastic case with gold trim. In walnut. Size: 4x7x3¾" Deep. Shpg. wt., 3½ lbs. U/L approved 110V. 14 E 6001 Net 9.75
14 E 6002 White Net 9.75

PRECISION - SWISS STOP WATCHES

As Low As

8⁵⁰



(A)



(B)

- Accurate Jeweled Movements
- Unbreakable Main Spring
- Anti-Magnetic Hair Spring

(A) 1/10 SECOND TIMER

Designed for close timing. Large hand registers 1/10 of a second, up to 30 seconds; small hand reads minutes, up to 15. Start, stop, and continue from crown; instant zero. 7 jewel movement. Chromium plated case. Imported. Shpg. wt., 8 oz. 13 E 3103L Net 9.95
Same as 13 E 3103 (above) except 1 jewel. 13 E 3102L Net 8.50

(B) 1/5 SECOND TIMER

- Ideal for Sports

Second hand registers 1/5 of a second and completes turn in 60 seconds. Small hand indicates up to 30 minutes. Side slide starts and stops hands. Fast resetting dependable 7-jewel movement. Imported Shpg. wt., 8 oz. 13 E 3104L Net 10.95
Same as 13 E 3104 (above) except 1 jewel. 13 E 3105L Net 9.50

Complete Super 8 ZOOM Movie Outfit

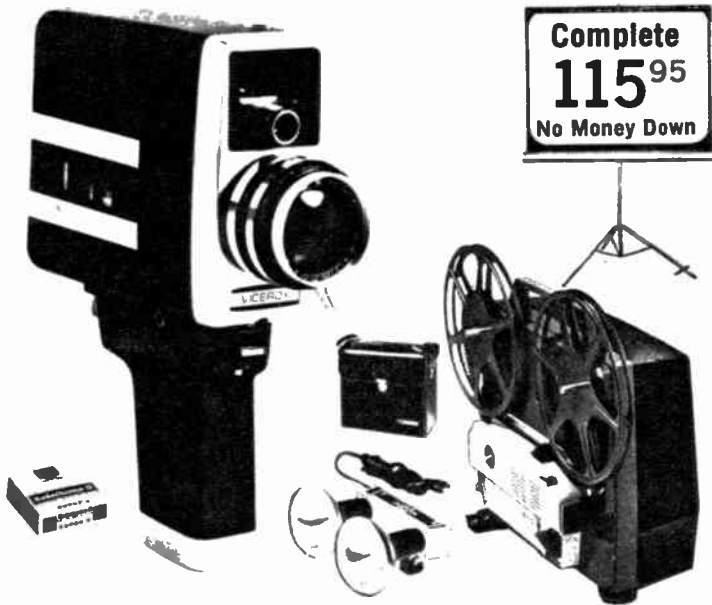

Complete
115⁹⁵
No Money Down

- Fully Automatic CDS Electric-eye
- Sharp f/1.8 Zoom Lens
- Automatic Reel-to-Reel Threading Projector
- Rapid Rewind Through Film Gate

Complete outfit for movie making! Camera features: single lens for sharp Zoom pictures from wide angle through normal to telephoto; snap-in cartridge, automatic electric eye with f/1.8 lens; type "A" filter that automatically disengages for indoor operation; over-or-under function that automatically warns you when light is not correct; battery-powered film drive; governor-controlled motor; automatic film footage indicator. Projector features: Super 8mm projection for larger, brighter picture; advanced easy to use focus; automatic reel-to-reel threading; rapid rewind; 400' reel capacity; f/1.4 lens; 500 watt brilliance. Single knob controls On, Cooling, Off, Rewind. Self contained elevation knob. Outfit also includes: camera case, light bar, 2-light bulbs, 50 ft. film cartridge, 30x40" folding tripod beaded screen, 4 alkaline batteries. Shpg. wt., 27 lbs.

15 E 9012WKM \$6.50 monthly Net 115.95
Vicroy Zoom Super 8 Automatic Movie Camera only.
15 E 7805L \$5 monthly Net 56.95
Automatic Super 8 Projector only. Wt. 15 lbs.
15 E 7806WX \$5 monthly Net 49.95

DELUXE ZOOM MOVIE CASE

- Adjustable Shoulder Strap
- Nickel Plated Hardware, Aluminum Valance Across Top For Added Strength



Holds virtually any super 8 camera with attached hand grip. Made of exquisite black vinyl material, firm core and fully lined, with French stitching. Ample space also provided for camera accessories: film, lens filters. Size: 11x10 1/4 x 3 3/4". Shpg. wt., 2 lbs.

15 E 1605 Net 6.95



Compact, powerful 650 watt tungsten sealed beam lamp will provide sparkling, bright indoor movies. Features top mounting and switch on power cord. Will fit all new super 8mm cameras plus all standard 8mm cameras with tripod socket on top, with 6 1/2 ft. cord and exposure guide. Shpg. wt., 3 1/2 lbs.

15 E 8406 Net 5.99

SUPER 8MM MOVIE LIGHT

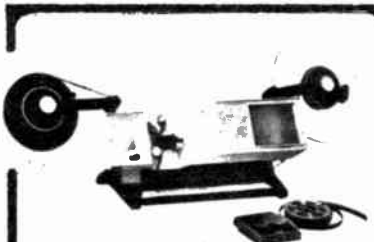

SUPER 8mm REVIEWER-EDITOR

- High Intensity
- 400-ft. Capacity
- Large Screen
- Includes Splicer

SALE!
11⁹⁵

Was 14.95

Handsome, functional action editor for easy viewing and editing super 8mm film. Features include: built-in film notcher, focusing and framing; large grainless screen; high intensity, 30-watt light source; Mylar-type Quick-Splicer for splicing without removal of film from gate; on-off switch; pilot light. UL and CSA approved. Size: 13 1/2 x 8 x 7". Shpg. wt., 4 1/2 lbs.

15 E 3441 Net 11.95

For standard 8mm film, as above.

15 E 3425 Net 11.95



11⁸⁸

DELUXE LENTICULAR SCREEN

Specially-designed, optically-correct lenticular screen is free of glare, sheen and hot spots. Amazing sharpness and color rendition. Durable vinyl fabric resists fire and fungus. Sturdy chrome tripod legs. Screen is 40x40" Shpg. wt., 12 lbs.

15 E 5005W Net 11.88

Same as above. Screen size 50"x50". Shpg. wt., 14 lbs.

15 E 5021W Net 18.95

GLASS BEADED SCREEN

Fine grain glass beading for extra brilliance, excellent viewing. Heavy-duty folding tripod adjustable to various heights. Large 30"x40" size. Shpg. wt., 10 lbs.

15 E 5003 Net 6.95

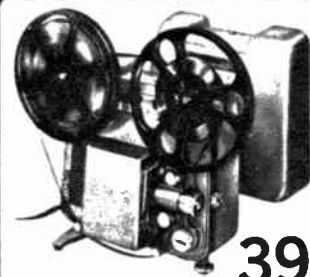

39⁹⁵

No Money Down

RICHMOND "600" STANDARD 8mm PROJECTOR

- f/1.5 3/4" Wide Angle Lens

Fan cooled tru-flector lamp gives more than 500 watts of sparkling brilliance. One knob control combines with easy threading, rapid rewinding, and 400-ft. film capacity to assure simple operation. Zinc die-cast construction features self-contained case. Supplied complete with reel. Shpg. wt., 15 lbs.

15 E 6702WX \$5 monthly Net 39.95

Deluxe Super 8 Movie Cameras - Projectors

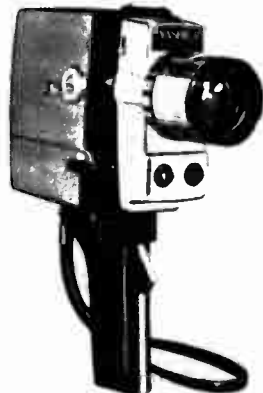

YASHICA
129⁹⁵
No Money Down

**YASHICA SUPER 8-50
REFLEX ZOOM**

- Behind The Lens CDS Exposure Control
- F/1.7 Lens Zooms From 8.5 to 42.5mm
- Push-Button Power Zoom With Pistol Grip

Brilliant new Super 8 movie camera features a Yashinon f/1.7 electric zoom lens, for automatic pushbutton zoom; 10 group, 12 elements, 5-1 zoom ratio; focuses to 5" with split-image rangefinder; stops down to f/22. Other features are: Through-the-lens exposure control with cadmium sulphide cell; reflex viewing with adjustable eyepiece, aperture scale, battery check, and over-under warning signal visible in finder; manual back-light control; 18 fps and single frame; built-in "A" filter; auto-reset footage counter; Three-way shutter control; remote input. Accessories: Remote control cable and switch, rubber eyecup, 4 "AA" cell Batteries, filter key. Imported. Shpg. wt., 3½ lbs.

15 E 3631L \$7 monthly Net 129.95
99 E 6258 Extra Batteries for above (4 req.) Net ea. .09



YASHICA
74⁹⁵
No Money Down

**YASHICA SUPER 8-25
REFLEX ZOOM**

- Fully Automatic Electric Eye f/1.8 Zoom lens

A completely automatic camera which has most of the features one could want in a single unit. This sleek, compact Yashica Super 8-25 features instant loading, fully automatic exposure, electric film drive and the brilliant Yashinon f/1.8 reflex zoom lens with a 2½ to 1 ratio—12 to 30mm. Incorporates an exposure warning system in the viewfinder, which indicates over- or under-exposure, as well as the lens opening. The selenium exposure system is automatically set by the cartridge for ASA 25 and 40. Other features include a battery check, diopter—adjustable eyepiece, footage counter, 18 fps speed and single frame cable release socket and molded pistol grip with attached wrist strap for comfortable shooting. With batteries. Imported. Shpg. wt., 3 lbs.

15 E 3622L Model Super 25 \$5 monthly Net 74.95
99 E 6258 Extra Batteries for above (4 req.) Net ea. .09

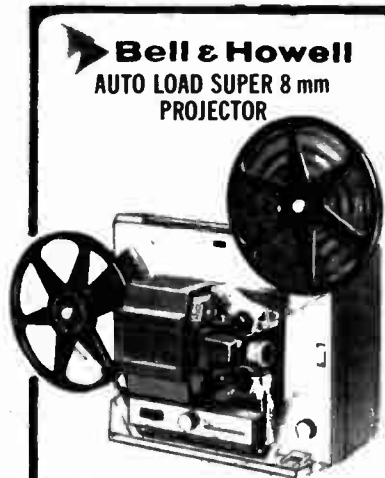

Bell & Howell
**AUTO LOAD SUPER 8 mm
PROJECTOR**

As Low As

81⁹⁵ No Money Down

Sharp 1" f/1.6 lens enhances all home movies. Brilliant illumination system allows enlarged viewing without light fall off. Design gives you finger-tip control of framing, tilt, and direction. Features automatic loop setter, still picture control, touch threading, and motor cooling switch. Rugged construction has built-in film cutter. Complete with 400-ft. reel. Wt. 20 lbs.

Model 356,
15 E 6501WX \$5 monthly Net 81.95
Same as above but with f/1.6 Filmovara Zoom Lens, automatic reel to reel threading, dial focusing, and cord storage door.
Model 357Z,
15 E 6502WX \$5 monthly Net 99.95

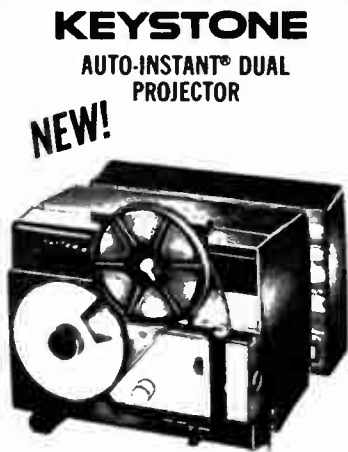

KEYSTONE
**AUTO-INSTANT® DUAL
PROJECTOR**

NEW!

- For Both Super and Standard 8mm.

99⁹⁵ No Money Down

Now you can show your standard-8 or super-8mm movies with the K-560M projector. Dual selector switch changes film-type instantly. Other features include: 15-mm Magnascope f/1.3 lens for brilliant pictures; fully automatic 6 second reel-to-reel threading; single lever projection control for forward, reverse, still and rewind; sprocketless transport for complete film safety; cool, economical DJA Tru-Flector projection lamp; 200-ft. reel. Compact walnut and black finish case only 11" long x 8" high x 7½" wide. For 110-120 v, 60 cps AC. Shpg. wt., 11¾ lbs.
15 E 2202WX \$5 monthly Net 99.95



DeJUR
VERSATILE® 1 DUAL PROJECTOR
For Both Super & Standard 8 mm

SALE! **129⁹⁵**
SAVE \$30.00

Model PT-90. At the flick of a switch lets you show standard 8 or super 8 mm Movies. Sprocketless film feed permits automatic reel to reel threading, 400 ft. capacity, 2 motors, one for reel drive, the other for cooling lamp and film. Transformer powered, low-voltage, high intensity dichroic lamp for 30% brighter, sharper pictures. 15 to 25 mm F/1.4 zoom lens for maximum brilliance; instant slow motion—both forward and reverse, multiple speed control, fast rewind, single frame still. (Less viewing screen). For 105-125 volt, 50/60 cycles AC. Shpg. wt., 20 lbs.
15 E 5205WX \$7.00 monthly Net 129.95

NEW! Mamiya/Sekor 35-mm SLR 500T Series

149⁹⁵

With Case

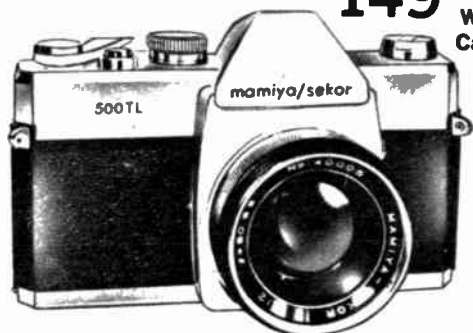

BEHIND THE LENS CdS SPOT METER

- Built-in Double Exposure Prevention
- Interchangeable Pentax Screw-in Lens Mount
- Automatic Instant Return Mirror
- With Leather Case

Offers professional quality features such as: behind-the-lens CdS spot meter internally coupled to both shutter speeds and lens aperture settings (ASA 25-800). Other features include pentaprism viewfinder with micro-diaphragm fresnel lens, full focusing screen, double exposure prevention, interchangeable lens mount, separate flash terminals for electronic flash units and FP flashbulbs. A thumb operated, single-stroke film advance lever cocks shutter mechanism and advances film counter simultaneously. Exposure needle is visible in viewfinder for selecting correct exposure. Film counter automatically returns to S (start). Specifications: 50-mm 1/2.0 lens, speed 1 sec. to 1/500 sec. and bulb. FP & X sync. Imported. Shpg. wt., 3 lbs. 15 E 2250L \$8.00 Monthly Net 149.95



LYNX 5000 35MM

- All-in-one Finder
- Sharp Super-fast f/1.8 lens
- Two-Stage CdS Meter

75⁹⁵

With Case
No Money Down

Set the needle in the finder and SHOOT! The LYNX-5000 combines an easy-to-operate match needle CdS exposure meter with a super-speed f/1.8 lens and a high speed (up to 1/1000 sec.) shutter. Features a split-image focus rangefinder, sensitive two-stage QdS meter with on-off switch and ASA range 10-800. Viewfinder lets you set perfect exposure without removing eyes from finder as you compose and focus. Imported Shpg. wt., 3 lbs. With case.

15 E 3613L \$5 monthly Net 75.95



MIRANDA "FV" 35MM SLR

No Money Down

139⁹⁵

With Case

- Internally Coupled f1.9 lens

Model FV features a sharp internally coupled f1.9 lens which is interchangeable with every other lens in the Miranda line. Brilliant viewfinder brings out details even in dimmest light. Multi-grid permits precise focusing. Accepts CdS clip-on meter which directly couples to camera speed dial. Fine features also include instant return mirror, depth of field preview button, and rapid advance lever. Specifications: 50 mm f1.9 lens. Focusing 17 inches to inf. Speeds 1 to 1/1000th sec. Imported Shpg. wt., 3 lbs. 15 E 3713L \$7.50 Monthly Net 139.95

15 E 3714L Cds Snap-on Meter Net 25.95



No Money Down

MIRANDA SENSOREX

- Behind-The-Lens CdS Exposure Meter
- Variable Delay Self Timer

209⁹⁵

With Case
No Money Down

Fully automatic SLR camera utilizes cross-coupled behind-the-lens CdS electric eye (ASA range 25-1600 and EV 3-18) and ultra sharp Auto Miranda lens. Multi-split-grid resolves into perfect clarity when pin point focus is achieved. Features interchangeable lens mount, built-in self timer, instant return mirror, open diaphragm focusing, interchangeable viewfinders, and rapid advance 150° cocking lever. Specifications: 50mm f1.9 lens. Speeds B, 1-1/1000th sec. FP & X sync. Imported. Shpg. wt., 3 lbs.

15 E 3711L \$11 Monthly Net 209.95

Minolta



ONLY

29⁹⁵

each



MINOLTA "16 II" SUBMINIATURE CAMERA

An extremely easy-to-operate, palm-size camera. Sliding camera in and out of built-in case advances film, cocks shutter, counts exposure and prevents double exposure—all automatically. 6 shutter speeds from 1/30 to 1/500 sec. plus B. Takes B & W pictures or color prints or color slides that fit any 35mm projector. Direct viewfinder shows picture exactly as it will appear on film. Lens opening from f/2.8 to f/16. 15 E 3416L With Case. Imported. Shpg. wt., 1 lb. Net 29.95

MINOLTA 16 II Accessories. Av. Shpg. wt., 6 oz.

15 E 3421 Baby BC Flash with Capacitor and Case	Net 4.95
15 E 3422 Bracket for Flash and Tripod Mtg.	Net 1.95
15 E 3423 Aux. Lens Set—2 closeup, 1 distance, 1 Y filter	Net 4.49
15 E 3424 Color Filter Set—1 ea. 1A, 80A, 81B	Net 4.49

FILM FOR "16 II"—All are 20-exposure magazines. Shpg. wt., 3 oz.

15 E 3417L Kodak Panatomic X	Net .98
15 E 3419L Kodachrome II	Net 1.25
15 E 3418L Kodak Tri-X	Net .98
15 E 3450L Ektacolor Negative (color prints)	Net 1.49

MINI-"16" COLOR SLIDE PROJECTOR

Compact, lightweight projector to match Minolta and other 16 mm sub-miniature cameras. Sharp 40 mm Rokker F/2.5 lens. Includes deluxe vinyl carrying case, standard slide carrier and 75 watt projector lamp. For 110-120 volts AC-DC. Imported. 15 E 3435 Shpg. wt., 3½ lbs. Net 29.95

500 WATT SLIDE PROJECTOR

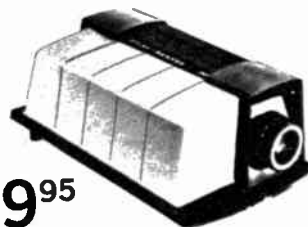

29⁹⁵

- Automatic Slide Changer
- Color Corrected 4 Inch f3.5 Lens
- Quiet Fan Cooled Operation

Designed for simplicity of operation and ease of maintenance, 500 watt lamp assures sharp brilliant pictures. Projects any 35 mm, Bantam, 127, or instamatic slides. Does not require slide trays. Loads up to 40 slides and allows intermix of different size slides. Uses standard projection lamp. Compact—5¾x4x14Lx8½"W. For 105/120 volts 50/60 cps. Shpg. wt., 7½ lbs. 15 E 8401 Net 29.95

LAFAYETTE Cds EXPOSURE METER

NOT A KIT!

Completely Wired

Only **15⁹⁵**

Shown Actual Size

- Professional Quality Ultra Sensitive — Measures Moonlight, Candlelight, Bouncelight

Now you can achieve correctly exposed photographs from the light of a single candle with this versatile, low cost Lafayette meter. Ultra-sensitive Cds photocell meter utilizes dual light ranges to accurately measure light intensity including extremely low light levels for night or available light photography. Operates comfortably with one hand. A single slide switch controls light range and automatically moves the proper scale into position for easier readings. Measures reflected and incident light with built-in hemispheric diffuser. The meter can be adjusted with a click stop switch to three angles of light acceptance; 15° telephoto, 45° standard and 75° wide angle matching your readings to the camera lens and scene being photographed. Reflex viewfinder with frame markers provide precise area readings for 15° and 45°. Has battery test and "off" position to prolong battery life. External zero adjustment and two mercury batteries (included) assure accuracy over long continuous use. Cushioned jewel mechanism and high impact case, 4 3/8 x 2 1/2 x 1 3/8" D. Imported. Shpg. wt., 13 oz.

99 E 7197L

Net 15.95

15 E 1609 Hard leather eveready case w/chain. Wt. 6 oz. Net 3.95

SPECIFICATIONS

Sensitivity: Low Range, 0.44 to 110 footcandles; High Range, 110 to 28,000 footcandles. ASA Film Speed Range: 6 to 12,000 (1° to 12°). Diaphragm Stops: 1/0.5 to f/64. Shutter Speeds: 1/4000 second to 30 minutes. Movie Scale: 4 to 128 frames per second. EL-VLS Scale: —12 to +22. Acceptance Angle: 15° Tele, 45° Std., 75° Wide Angle. Color Response: 5,600 Angstroms (peak). Photocell Type: Cadmium Sulphide. Batteries: 2 Mercury. (Mallory 625R or equiv.).

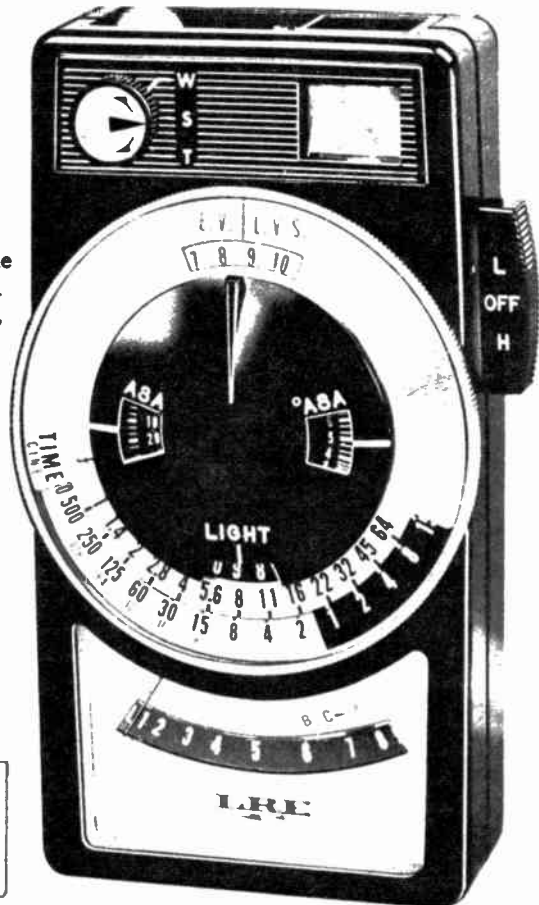

FRONT PHOTO FOCUS MONOCULAR

MAKES YOUR CAMERA TELEPHOTO
—Bring Distant Object from 6 to 8 Times Nearer

ENLARGES AS LOW AS

THIS **10⁹⁵**

TO THIS

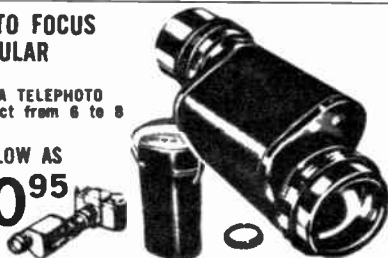

Take super-telephoto pictures with your single lens or twin-lens reflex camera. The front focus system is specially made for on-camera operation. There is no need to miss those once-in-a-lifetime shots. Increases focal length of your camera lens 6X, 7X or 8X depending on model selected (i.e. 50mm lens plus 8X monocular equals 400mm telephoto). Rugged, lightweight construction — weight only 7 1/2 ounces; is only 5 inches long. Converter supplied to fit any series VII adapter ring. Leather case. Shpg. wt., 1 lb. Imported.

99 E 7072 6x30 mm

Net 10.95

99 E 7073 7x35 mm

Net 12.95

99 E 7074 8x30 mm

Net 12.95

"35" CLIP-ON EXPOSURE METER

- ASA Scale 10 to 1000
- Measures Reflected and Incident Light

3⁹⁵



Exceptionally convenient exposure meter. Clips right on camera—quick easy reading. Gives better, more accurately exposed pictures with a minimum of effort. Speeds 1/1000 to 1 second. Lens aperture f:1.4 to f:22. Mounts on camera or may be hand held. Complete with leather case and instruction. Shpg. wt., 1/2 lb. Imported.

99 E 7034

Net 3.95

LAFAYETTE TRANSISTORIZED ELECTRONIC STROBE FLASH

- Lightweight & Compact
- Fully Transistorized
- Operates On 4 Economical "Z" Cell Batteries

Now you can have a high-powered transistorized electronic flash that operates from standard AC house current or 4 economical "Z" cell batteries. Compact and featherweight—no power pack is required. Flash duration of 1/2000 seconds for fast pictures. Recycling time: 6 to 8 seconds; color temperature: 5800° Kelvin. Guide number dial for f stop on back. Mounts either vertically or horizontally. Fits any camera shoe. Complete with AC cord, camera cord, and batteries. Imported. Shpg. wt., 2 lbs.

99 E 7184

Net 15.95

99 E 6258 Extra batteries

for above (4 req.) Net ea. .09

15⁹⁵

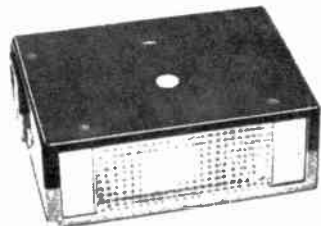

LAFAYETTE Cds EXPOSURE METER

Only

9⁹⁵

- Super Sensitive Cds Meter
- Push-Button Battery Test Circuit
- ASA 6 to 12,000

An extremely sensitive Cadmium Sulfide exposure meter. Perfect for all types of photography either indoors or outdoors. Perfect for all high or low level lighting. May be held in the hand, around the neck, or attached to camera. Film sensitivity scale: ASA 6 to 12,000. Exposure time scale 8 sec. to 1/1000 sec. Lens aperture f/1 to f/32. Light value scale (EV): LV4 to 17. Movie scale 8 to 64. Measures reflected or incident light. Complete with mercury battery, leather carrying case and carrying/neck cord. Imported.

99 E 7186 Shpg. wt., 1 lb. Net 9.95

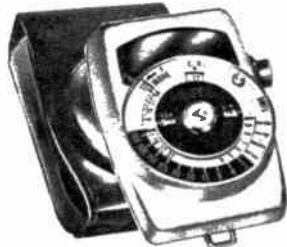

KODAK Instamatic Outfits — Accessories



104 outfit
15⁹⁵



154 outfit
23⁹⁵

KODAK

KODAK INSTAMATIC 104 OUTFIT. Automatically gives four brilliant flashes without bulb handling. Photoflash bulbs are enclosed in a revolutionary "flashcube." Pre-sets shutter speed for correct exposure. No dials to adjust. Film loads instantly. Take sharp color or black and white slides or snapshots. Outfit includes camera, wrist strap, flashcube, batteries, and color film cartridge. Shpg. wt., 5 lbs. **15 E 2630L Instamatic 104** Net 15.95

Package of 3 Four-shot Flashcubes
15 E 2632 Shpg. wt., 3 oz.

Net ea. 1.79

KODAK INSTAMATIC 154 OUTFIT. The complete photo outfit for the casual photographer who desires quality results. Features new "flashcube" for instant load photoflash shooting. Cube contains four bulbs with reflectors. Eliminates ejecting hot bulbs. Spring wound automatic advance, instant 10-thread loading, and automatic flash exposure setting are among the other features of this versatile camera. Complete with wrist strap, color film cartridge, flashcube batteries. Shpg. wt., 6 lbs.
15 E 2631L Instamatic 154 Net 23.95

Package of 3 Four-shot Flashcubes
15 E 2632 Shpg. wt., 3 oz.

Net ea. 1.79

ELEVATOR TRIPOD

As Low As

5⁹⁵ • Tri-Tilt Head
• Velvet Smooth Panning

For any small camera—35mm, reflex or movie. Compact and lightweight...folds to 16", extends to 47" plus 7" with geared center elevator. Single action tilt/pan and 180° swing over for vertical and horizontal format pictures. Positive lock, folding crank. Chrome plated brass legs. Weighs 31 Oz. Imported. Shpg. wt., 2½ lbs.

99 E 7029 Net 5.95

"PRO" ELEVATOR TRIPOD. Deluxe model for heavier cameras. Aluminum construction. Completely rigid to full height. Extends to 46½", gear drive elevator adds 10". Closes to 22". Pans 360°, tilts 160°. Positive leg stops, rubber tipped feet. Imported. Shpg. wt., 2½ lbs.

15 E 7202 Net 11.95



ADD WIDE ANGLE & TELEPHOTO TO YOUR KODAK INSTAMATIC MODEL 104 & 154



Add professional quality to your Instamatic 104 and 154 pictures with these easy-to-use custom made specialty lenses. No adjustments are necessary. Just slip on the lens and shoot! The telephoto lens increases the focal length and results in a magnification of about 2 times the image size, while the wide-angle lens boosts the subject coverage through an area increase of about 75% as compared with the normal lens. Each lens includes a built-in view-finder adapter to give you a true perspective of the shot you are taking. Shpg. wt., ½ lb.

15 E 3451 Wide-Angle Lens Net 5.95

15 E 3452 Telephoto Lens Net 5.95

3²⁹ COMBINATION GRIP AND BOUNCE FLASH BRACKET



Useful combination of grip and standard utility bracket. "Bounce Flash" bracket with lock allows easy multi-angle flash operation for electronic strobes or standard flash guns. Bracket is also useful for holding exposure meters and other camera accessories. Molded pistol handle affords solid grip. Permits ultra safe carry for your valuable camera. Imported. Shpg. wt., 1 lb.

99 E 7190 Net 3.29

LAFAYETTE BOUNCE BC FLASH

- For Straight or Bounce Flash
- Compact, with Vinyl Case

A versatile bounce BC flash gun with many outstanding features. Swivels for intermediate to full bounce light. Reflector completely folds for easy carrying. Positive shoe lock. Accepts AG-1, M2, M3, M5 and 25 bulbs. Used bulbs are disposed of by a spring action bulb ejector. Bright neon circuit testlight indicates that circuit is fully energized and ready to "shoot." Completely retractable PC cord. Useful exposure indicator dial. Complete with vinyl case. Less Battery. Shpg. wt., 1 lb. Imported.

99 E 7187 Net 3.99

99 E 6027 Battery for above Net .59



3⁹⁹

AG-1, M2, M3, M5 and 25 bulbs. Used bulbs are disposed of by a spring action bulb ejector. Bright neon circuit testlight indicates that circuit is fully energized and ready to "shoot." Completely retractable PC cord. Useful exposure indicator dial. Complete with vinyl case. Less Battery. Shpg. wt., 1 lb. Imported.

99 E 7187 Net 3.99

99 E 6027 Battery for above Net .59

LAFAYETTE FLASH CUBE GUN

2⁴⁹

Now any camera can use the new flashcubes! Simple trigger mechanism revolves the cubes with automated convenience. BC type unit for low battery drain. Compact unit takes one 15 volt battery. Push button battery tester light neon bulb, to indicate battery condition. Easy to read ASA exposure table. 7½" Sync-cord with PC Connector fits most cameras. Imported. Shpg. wt. 1/2 lb.

99 E 7199 Net 2.49

32 E 4835 15 Volt Battery (1 req.) Net .61

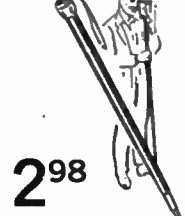

SPORTPOD

- Use It Anywhere

The Sportpod is a 3-section leg with tripod screw on top, protected with a removable cap. Offers rigid camera support with least possible weight and bulk. Supplied with suspension strap. Total extended length is 58"; telescopes to 21½". Sections measure 7/8", ¾" and ¾" in diameter. Shpg. wt., 1½ lbs.

15 E 3601 Net 2.98

KODAK FILM with PROCESSING INCLUDED

- Slides Returned Mounted, Ready for Viewing or Showing! • Convenient, direct-mail "mailers" in every roll • A full number of Prints guaranteed for Kodacolor and black and white.

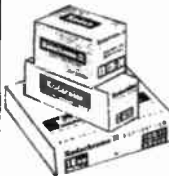

After the complete roll has been filmed, put it into the mailer, drop into a mailbox and in a few days your finished films are delivered postpaid to your door. You get 3½" square or 3½x5" giant prints with Kodacolor and Black and White (except CX-135 which is 2½x3½"). Should you get less than the full number of prints or printable negatives per roll, you will receive coupons for additional FREE prints. DO NOT MAIL FILM TO LAFAYETTE RADIO.

KODACHROME MOVIE FILM-TYPE II

ASA Index 25 Daylight—40 "A" Indoor

Stock No.	Film Size	Description	Net
15 E 4703L	KR459	8mm, 25 ft. Double roll, Daylight	3.25
15 E 4704L	KRA459	8mm, 25 ft. Double roll, "A" Indoor	3.25

KODAKAP MOVIE FILM FOR SUPER 8

15 E 4705L	KA-464 Super 8mm 50-ft. Cartridge	Indoor/Outdoor	Net 3.75
------------	-----------------------------------	----------------	----------

KODACHROME 35MM, TYPE II AND X

Type II ASA index 25 Type X ASA index 64

15 E 4706L	KR135-20	35mm, Type II, 20 Exp.	2.80
15 E 4707L	KR-135-3	35mm, Type II, 36 Exp.	4.25
15 E 4708L	KX135-20	35mm, Type X, 20 Exp.	2.80
15 E 4709L	KX135-36	35mm, Type X, 36 Exp.	4.25
15 E 4710L	KX126	Instamatic Cartridge, 20 Exp.	2.80

KODACOLOR-COLOR SNAPSHOTS

15 E 4714L	CX-126	Instamatic cartridge, 12 Exp.	3.29
15 E 4715L	CX-135	35mm Indoor/Outdoor, 20 Exp.	3.99

SMITH-CORONA Typewriter — Adding Machines

CORONET ELECTRIC



134⁹⁵

\$7.50 monthly
No Money Down.

Type Easier Electrically! Makes up to 10 clear carbons... repeats dots, dashes, spacing, the letter X, and underlines. Full sized 88 character keyboard features impression control dial and touch selector. Amazing accelerator action gives faster type bar action for a snappier, livelier touch. Packed with such effort saving features as the page gage and quick set margins. Equipped with exclusive forward-glide top deck. Strong steel frame construction. Perfect for every member of the family. Trimline luggage type carrying case. Shpg. wt., 26 lbs.

15 E 4008WX Pica-Tan Net 134.95
15 E 4004WX Pica-Star Mist Blue Net 134.95

"FIGUREMATIC" PORTABLE ELECTRIC ADDING MACHINE

- Totals up to \$999,999.99
- Compact—Lightweight

A fast-figuring electric portable that adds, subtracts and multiplies. Full-featured construction with 10 keys, Add-Subtotal, Subtract-Total, and Repeat. "Clear" and digital indicator are combined. Lists 7 columns of figures. Easy to carry—the cord tucks in, stylish dust cover snaps on, built-in retractable carrying handle comes out and away it goes. Overall 7x9x13". For 110-115 volts, 60 cycles AC. Shpg. wt., 10½ lbs.

15 E 4007WX \$5 Monthly Net 66.95
ADDING TAPE for Figurematic 2½" Wide.
15 E 4006 Net .29 each



Our Low
Price
66⁹⁵

No Money Down

DELUXE HEAVY-DUTY ELECTRIC ADDING MACHINE

- Totals Up To 9 Columns 9,999,999.99
- "Hand-Span" Keyboard

Model 890 is precision-engineered to handle adding, subtraction and multiplication problems at home or business. Easy to use key board with non-slip keys for accuracy. Large add bar and zero bar are contoured for natural finger movement. Correction key eliminates wrong numerals before you total. Clear perforated tear strip, for visible entries. Easy-feed paper chute for positive, quick loading of tape everytime. Functional design in charcoal gray, mar-proof finish. Shpg. wt. 12 lbs. Size: 8 x 12 x 5¾".
15 E 4005WX \$6.50 monthly Net 114.95



114⁹⁵ No Money Down

42⁹⁵

No Money Down



57⁹⁵

No Money Down

73⁹⁵

No Money Down



BROTHER PORTABLE TYPEWRITERS

PORTABLE TYPEWRITER

- All Steel/With Case

Model 885. Features an 88-character keyboard—4 more characters than most standard typewriters (I, +, -, 1): Red/Black ribbon, stencil position; 1-, 1½-, and 2-line spacing, and an erasure table. Also includes line-lock mechanism, easy margin setting, jam release key, synchronized measuring scale, card holder, and a touch selector. Popular pica type. All steel. With case. 6¾x14½x15". Shpg. wt., 15 lbs. Imported.
15 E 1701WX \$5 Monthly Net 42.95

DELUXE PORTABLE TYPEWRITER

- All Steel/With Case

Model 895. Deluxe features include an 88-character keyboard, convenient "touch" adjustment, automatic pushbutton tabulator, and a variable line spacer. 1, 1½ and 2 line spacing; Red/Black ribbon; stencil position. Hand-set margins, paper bale scale, jam release key, synchronized measuring scale and card holder provide additional typing comforts. Pica type. Dimensions: 16x18x8". With carrying case. Imported. Shpg. wt., 19 lbs.
15 E 1702WX \$5 Monthly Net 57.95

HOME/OFFICE TYPEWRITER

- With Molded Case

Model 900. Deluxe features include jam release key, synchronized measuring scale, card holder, convenient touch adjustment. Variable line spacer, and extra wide paper capacity. Also features an automatic and manual ribbon reverse, line finder, line drawing aperture, paper meter, segment shift and automatic pushbutton tabulator. With case. 88 characters pica type. Size: 16¾x18x7¾". Imported. Shpg. wt., 23 lbs.
15 E 1703WX \$5 Monthly Net 73.95

To Speed Your Mail Order — Please Give Your Zip Code Number

World Radio History

Lafayette Cat. No. 672 29

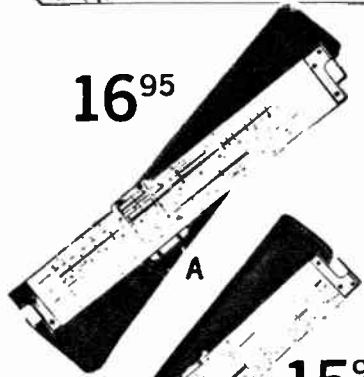

16⁹⁵

A

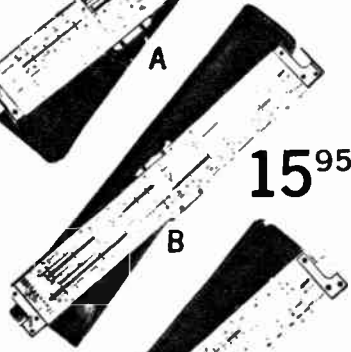

B

15⁹⁵

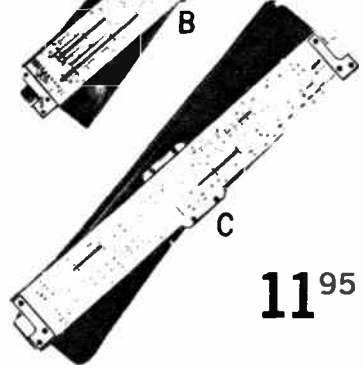

C

11⁹⁵

(A) LAFAYETTE VECTORLOG

- Laminated Bamboo Construction • P, P', and Q Scales. For Direct Vectnr Addition
- Hyperbolic Sine and Tangent Scales. Two Sine Scales — One Marked in Degrees. One Marked in Radians • 5 Log Log Scales Plus a Voltage DB Scale • Complete with Belt Carrying Loop and Leather Case

The Lafayette VECTORLOG Slide Rule provides a new concept in scientific calculation, incorporating scales and arrangement designed for quick-easy-manipulation. Twenty-seven (27) scales incorporate the many problems encountered in Electrical Engineering and Physics. The unique P, P', and Q scales allow direct right angle vector addition. No longer are several settings required to obtain right angle vector sums—these scales work in the same manner as the C and D for multiplication. The two Hyperbolic Sine and one Hyperbolic Tangent Scale, the voltage db scale, and the five Log Log scales, provide maximum coverage of these dynamic fields. VECTORLOG is the result of extensive tests for ease of manipulation. Several of these features are: C and D scales on both the front and back of the rule; Sine scales in both degrees and radians, removing the necessity of bothersome conversion of units; A problem-tested location of scales; and adjustment screws to allow variable tension on the slide. Scales include: (FRONT) Tr-1, TR-2, P', P, Q, ST, S-1, S-0, C, D, LL01, LL02, LL03, LL1'; (REAR) Sh-1, Sh-2, DF, A, B, Cl, CF, Th, C, D, LL3, LL2, db. With instruction book, leather carrying case, and belt carrying loop. Imported. Shpg. wt., 1 1/2 lbs. 99 E 7102

Net 16.95

(B) DELUXE LOG LOG DUPLI DECIMAL TRIG SLIDE RULE

- 25 Scales with 8 Log Log Scales • Two Color Scales • Extended Range Avoids "Going Off Scale" • Extra P Scale Simplifies Computations

10" log log dupli decimal trigonometric slide rule contains 25 scales including 8 Log Log Scales. Troublesome end-for-end resetting is eliminated by extensions of C and D scales. Twin set of Log Log scales run from 1.001 to 100,000 and .999 to .00001, enlarging the scale by one scale length each compared with ordinary log log slide rules. Extra features include P scale which enables direct "readout" of cosine value. Scales include LL01, LL02, LL03, DF, CF, Cl, C, D, LL3, LL2, LL1, LL00, L, K, A, B, S, ST, T, C, D, Di, P, and LLO. With instruction book, saddle leather case. Overall length is 14". Imported. 99 E 7055 Shpg. wt., 1 1/2 lbs. Net 15.95

Net 15.95

5" Pocket Version of Above Contains all the scales of above except "ST" scale. 99 E 7099 Shpg. wt., 8 oz. Net 6.95

(C) 10" LOG LOG TRIG SLIDE RULE

Specially selected, laminated, non-hygroscopic bamboo. Scales machine engraved on white plastic in permanently accurate calibrations. Adjusting screws permit varying tension on slide. 21 scales including C, D and Cl on both sides. LLO and LLO0 scales refer to B scale. All other scales coordinate and refer to D scale. Scales are L, LL1, DF, CF, Cl, C, D, LL3, LL2, LLO, LLO0, A, B, K, Cl, C, D, S, ST and T. Scale characteristics permit multiplication, division, proportion, inverse proportion, reciprocals, cotangents, squares, square roots, cubes, cube roots, logarithms, tangents, sines, PI factor multiplication and division, powers and roots of numbers less than 1, powers and roots of numbers greater than 1, logarithms to base "e." Shpg. wt., 1 1/2 lbs. Imported. 99 E 7031

Net 11.95

TECHNICAL DRAFTING SET

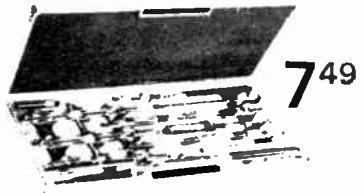

7.49

- Center Wheel Adjustment
- Professional Quality
- Made in W/Germany of Nickel Plated Brass

Contains 6 1/2" self-centering compass, one leg knuckle joint with divider, pencil, pen parts and lengthening bar; 6 1/2" self-centering divider; spring bow divider 4 1/2", center wheel adjustment with interchangeable needle points; spring bow pencil and spring bow pen, both 4 1/2" with center wheel adjustment and interchangeable needle point; two 5 1/2" ruling pens; extra handle for pen and pencil parts; adjustment tool; lead case and leads; and spare parts kit, all in velvet lined snap closing case. Shpg. wt., 1 1/2 lbs. 99 E 7003

7.49

UTILITY DRAFTING SET



3.59

- Side Wheel Adjustment
- Made in W/Germany of Nickel Plated Brass
- Professional Quality

Made in Germany of hard rolled, nickel plated brass. All instruments are nested in a fitted, velvet lined case. Contains three side wheel 3 1/2" bow instruments on a divider, one a pencil and one a pen. All have reversible needle point. 5 1/4" compass with pen and pencil parts; - and lengthening bar, 5 1/4" divider with straightening device, 5" ruling pen. Extra handle for use with pen and pencil parts. Capsule with extra leads. Perfect for schools, labs, industrials. Shpg. wt., 1 lb. 99 E 7164

Net 3.59

HARD MAPLE PANTOGRAPH

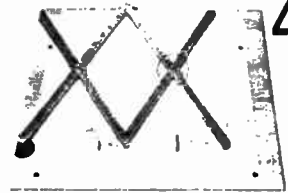

4.50

- Enlarges • Reproduces!

A 21" adjustable pantograph with 21 different ratios from 1 1/8 to 8. Enlarges, reduces or reproduces drawings, etc. Most rapid, accurate means of reducing or enlarging to scale. Lacquered highly finished bars are 21" long and 3/16" wide. Heavy ball bearing standard. Chrome plated hardware, ratio thumb screws and nuts. Complete with lead, accessories and detailed instructions. Shpg. wt., 2 lbs. 15 E 5602

Net 4.50

SUPER DRAWING KIT

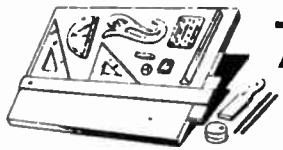

7.95

Contains all the necessary equipment for drafting, mechanical drawing, designing. Study accurate components. Includes --- 18x24" drawing board, 24" T square, 10" 30°/60° triangle, 8" 45° triangle, french curve, 12" triangular rule, 6" 180° protractor, 4 pencils, pencil pointer, erasing shield, thumb tacks, and art gum. 15 E 5701 Shpg. wt., 10 lbs. Net 7.95

TACRO

TACROGRAPH SET



4.49

- Complete with Three Nibs

A top quality drawing pen for all lettering and drawing work. Uses both India and drawing inks. Precision point for constant flow lines. Comes with 3 color coded nibs. Fine (Size 0, Grey nib), Light Medium (Size 1 Yellow nib), Very Broad (Size 3, Blue nib). Shpg. wt., 8 oz. 15 E 8002

Net 4.49

DYMO Label Makers



AS LOW AS **9⁹⁵** MODEL M-14

- Embosses 42-5/32" Characters on 1/4 and 3/8" Tape
- Includes Additional Optimum Size 38-3/16" Character Wheel

MODEL M-10 DELUXE 1/4" & 3/8" TAPE WRITERS

A handy tapewriter which will change tapes internally by the simple movement up or down of only one selector pin. Also has wide letter-spacing as well as regular. Rapid change embossing wheels to fulfill instantly any special labeling need. Handsome chrome steel finish. Complete with 14" roll of tape. Shpg. wt., 2 lbs.

14 E 4141 Net 14.95

MODEL M-14 1/4" & 3/8" TAPE WRITER

Same as above, less optimum 3/8" character wheel.
14 E 4140 Blue finish steel Net 9.95



Complete Kit **9⁸⁸**

M-6 1/4" And 3/8" TAPEWRITER KIT

- 2-Snap-In Embossing Wheels For Large And Small Characters
- Convenient Tape Cut-Off

Low-Cost tapewriter kit for home, office, store or workshop. Makes raised-letter labels that are self-adhesive, permanent and waterproof. Set dial to letter, number, or symbol and squeeze the handle. When label is completed, squeeze trigger to snap off tape. Kit includes: High-impact plastic embossing tool, two wheels, three 3/8" and two 1/4" rolls of tape plus carrying case. Shpg. wt., 1 1/2 lbs.

14 E 4148 Net 9.88
14 E 4149 Tool Only. Shpg. wt., 1 lb. Net 6.88

EMBOSSING TAPES

1/4 INCH		3/8 INCH	
Each contains 144" Shpg. wt., 1/4 lbs.		Net. ea., .89 in lots of three, .75 each	
Stock No.	Stock No.	Stock No.	Stock No.
14 E 4102 Blue	14 E 4105 Clear	14 E 4106 Brown	14 E 4111 Brown
14 E 4103 Green	14 E 4131 Yellow	14 E 4107 Black	14 E 4112 Black
14 E 4104 Red	14 E 4132 Gold	14 E 4130 Orange	14 E 4113 Red

1/4 INCH		3/8 INCH	
Contains 144" Shpg. wt., 1/4 lb.		Net ea., .99 in lots of three, .89 each	
Stock No.	Stock No.	Stock No.	Stock No.
14 E 4102 Blue	14 E 4105 Clear	14 E 4106 Brown	14 E 4111 Brown
14 E 4103 Green	14 E 4131 Yellow	14 E 4107 Black	14 E 4112 Black
14 E 4104 Red	14 E 4132 Gold	14 E 4130 Orange	14 E 4113 Red

THERMOGRIP HOT-MELT GLUE GUN

60 Second Bonding

- Neat
- Clean
- Easy

Electric glue gun hot-melts sticks of solid glue which are inserted in rear of gun. Glue is fed from gun by pressing thumb on glue stick as tool is moved along surface. Pieces are then just pressed together. Takes only 60 seconds for a permanent, waterproof bond. Perfect for bonding wood, pottery, leather, metal, fabric and many other materials. Bond is slightly flexible allowing some "give." Ideal for caulking boats, installing tile, repairing furniture.



5⁹⁵

115V, AC-DC. Shpg. wt., 1 lb.
13 E 9413 Net 5.95
13 E 9414 Pkg. of 7 glue sticks Net ea. .49
13 E 9415 Pkg. of 7 sealer sticks Net ea. .49

HEAVY DUTY STAPLE GUN **5⁹⁹**

Drives 5 sizes of staples. Snap open load. Exclusive power dot and tandem springing deliver super power. Loading takes only a moment, built in extractor. Accepts 1/4" to 3/4" staples including special Loktite staples for firm holding of ceiling tiles. Shpg. wt., 1 1/2 lbs.



13 E 5812 Net 5.99
Model 800-X. Same as above with all chrome body.
13 E 5819 Net 6.75
1000 staples for #800 Swingline staple Gun.

Stock No.	Leg Length	Net	Stock No.	Leg Length	Net
13 E 5813	1/4"	.42	13 E 5816	1/2"	.53
13 E 5814	3/8"	.45	13 E 5817	5/8"	.58
13 E 5815	3/4"	.45	13 E 5818*	3/4"	.64

*Special Loktite Staples

BVI AUTOMATIC ELECTRIC PENCIL



6⁵⁰

- Writes on Metal, Plastic, Wood
- No Heat Vibrating Point. Permanently Engraves.

Handy, useful... mark, identify and engrave names, design decorator effects on luggage tags, toys, sporting goods, tools and kitchenware. Automatic with built-in mercury switch. You pick it up—it turns on. Put it down and it turns off. Easy as a pencil. Marks won't erase, smear or rub off. Tough hardened steel point vibrates 7200 strokes a minute. Lightweight. 7x3x2". 110 V, 50-60 cycle AC motor. Shpg. wt., 5 lbs.
13 E 8054 Net 6.50

BURGESS VIBRO TOOL KIT

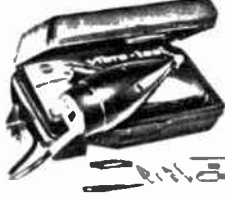

14⁹⁵

- Versatile Multi-Purpose Tool
- Heavy-Duty 2-Speed Motor
- Complete With 6 Accessories

Performs many operations on nearly any kind of material with its accessories. Features motor control switch plus dial setting for engraving depth. Heavy-duty 2-speed motor delivers 3600 and 7200 strokes per minute. Rugged nylon housing. Molded plastic case with accessory storage area. Complete with accessories: Carbide tipped engraving point, knife blade, saw blade, half round chisel 1/2 inch tool, hammer and abrasive point. Shpg. wt., 1 1/2 lbs.
13 E 8053 Net 14.95

DREMEL MOTO-TOOL KIT

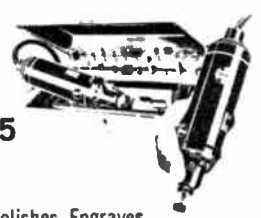

23⁹⁵

- Grinds, Polishes, Engraves, Sands
- 6 oz. Moto-Tool; Accessories
- 65 Amp Motor, High Speed Steel Cutters and Wheel Points

Model 2 Pocket-size machine shop. Oil-less sealed bearing Moto-Tool; hardened ground, polished armature shaft. Collets 1/16", 1/8", 3/32". Fingertip attachment. Four emery wheel points, 8 cutters, dressing stone, steel saw, 4 brushes, 1/2" drum sander, mandrels, sturdy case. For 100-120V, AV/DC. Shpg. wt., 4 lbs.
14 E 4304 Net 23.95

Depend on Lafayette for Complete Stocks, Lowest Prices, Fastest Service

Lafayette Cat. No. 672 31

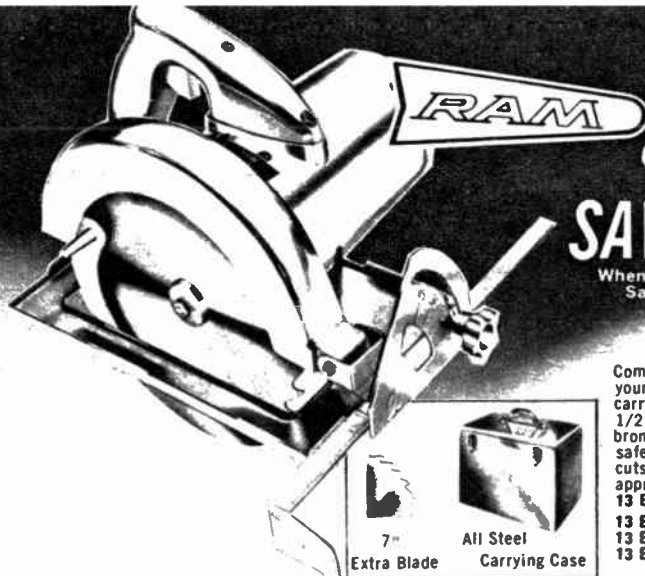

RAM fury Circular Saw

WITH 1½ HP MOTOR

SAVE \$5.64

Saw	Only 19.95
Case	8.95
Blade	1.69
		30.59

When you buy combination Saw-Case-Extra Blade

COMBINATION OUTFIT 24.95

Combination outfit to take on the most demanding cutting jobs in your home or shop. Includes model F-7 saw with 7" blade, self carrying case and extra 7" all purpose combination blade. Saw has 1/2 HP universal AC-DC 115 Volt 8 amp motor, self lubricating bronze bearing, floating blade guard, safety retractable handle, safety slip clutch and 3-wire plug and cord. Makes vertical or angle cuts to 45°; maximum depth of cut 2¼". Bright Mirror finish. UL approved.

13 E 9029M	Shpg. wt., 18 lbs.	Net 24.95
13 E 7103 Model F-7 Saw	Shpg. wt., 15 lbs.	Net 19.95
13 E 7105 Extra combination 7" blade.	Shpg. wt., 1 lb.	Net 1.69
13 E 7127 Steel carrying case	Shpg. wt., 3 lbs.	Net 8.95



7" Extra Blade All Steel Carrying Case

HEAVY-DUTY 10" POWER CHAIN SAW

54⁹⁵

No Money Down



POWERED WITH G.E. MOTOR

- 2 H.P.—10 Amps
- With Oregon "Omark" Chain & Bar

A powerful, top-quality chain saw designed for professional or industrial use. This rugged, multi-purpose tool will also do dozens of jobs for the home craftsman, carpenter, contractor, or on the farm. Positive chain adjustment eliminates slack. Chain travels at 2650 feet per minute for fast, true cuts up to 10 inches deep. Cool running quiet helical cut gears in a sealed grease chamber. Self lubricating bearings. Beautifully balanced, weighs only 12 lbs. Motor develops 2 H.P. 10 amps. 115V. 25-60 cy., AC/DC. 3-wire, 6-ft. cord. Shpg. wt., 14 lbs.
14 E 4804 \$5 Monthly Net 54.95

HEAVY-DUTY SABRE SAW

19⁹⁵

POWERED WITH G.E. MOTOR



- Cuts up to 6" in Wood
- With 5 Blade Assortment

Versatile one tool workshop, capable of handling dozens of cutting jobs, from rough cutting to finished work in wood, metal or plastic. Use as rip, cross-cut, coping or keyhole saw. Powerful, precision, air cooled 3.5 amp motor to handle 6" cuts in wood. Extra large adjustable base enables accurate bevel cuts up to 45° angle. Sawdust blower removes sawdust as you cut. Makes its own starting hole. 4800 strokes per minute. With grounded 3-wire 6-ft. rubber covered cord. For 115V., 60 cycles AC/DC. UL and CSA approved.

14 E 4806 Shpg. wt., 4¼ lbs.	Net 19.95
As above with Variable Speed Control.	
14 E 4805	Net 26.95

RAM fury SABRE SAW

12⁹⁵

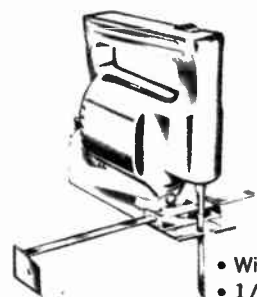

- With Rip Guide
- 1/4 HP Motor

MODEL F-8: A rugged, multi-purpose sabre saw. Can be used as a rip, crosscut, jig saw, hack saw, band, coping, keyhole and scroll saw. Easily cuts 2x4's, plywood plastic, composition board, aluminum and a host of other materials. Powerful 1/4 H.P. motor with a built-in cooling system, produces 3500 strokes 11/16" long per minute. Also has adjustable base, rip guide and mitre gauge.

Bevel cuts from 0° to 45°. Positive action, long-life "On/Off" slideswitch. Complete with 3-assorted blades. For 115V., 60 cycles AC/DC. Has mirror finish. Shpg. wt., 4 lbs.
13 E 7116 Net 12.95



RAM 2-WAY ELECTRIC SANDER

16⁹⁵

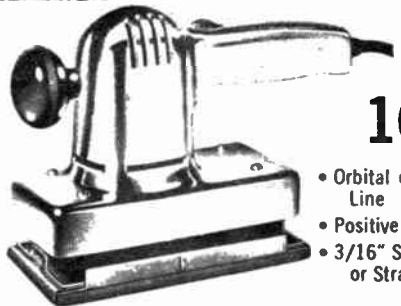

- Orbital or Straight Line
- Positive Slide Switch
- 3/16" Stroke Orbital or Straight

Model R-120: A heavy-duty electric sander with ¾" stroke in orbital or straight line. Features 2.4 amp. universal series wound motor. Heavy-duty ball bearing and self-lubricating sleeve bearings. Pad size: 3¼x7¼"; sandpaper size: 3½x9". Industrial mirror finish. 6-ft. UL approved cord. 115V, 60 cycles, AC-DC. Shpg. wt., 5 lbs.
13 E 7102 Net 16.95

SPRAYIT 600-6 PROFESSIONAL-TYPE SPRAY UNIT

29⁹⁵



- Integral Compressor-Motor
- Sprays Oils, Paints, Stains, Insecticides, Liquid Wax

All-purpose spray unit that gives professional results from the start. Provides uniform adjustable pattern from "dime" size to a fan 10" wide. Precision made with sealed ball bearings, never needs oiling. Easy-to-use 2-finger trigger gun. Air delivery: 1.5-2 CFM at 15-20 lbs. Complete with 6 ft. cord and plug, 8-ft. air hose, spray gun and Viscosimeter which takes the guess-work out of mixing for best spray results. For 115 v, 60 cycles AC. Shpg. wt., 11 lbs.

14 E 8405	Net 29.95
MULTI-COLOR KITS: For best results in spraying multi-color paints.	
14 E 8402	Net 2.25
AIR TOOLS KIT: For inflation and dusting. Includes chuck for all tires—footballs, basketballs, toys, air mattresses "dusting" attachment.	
14 E 8403 Shpg. wt., 4 oz.	Net 2.10

SKIL Reversing Drive-R-Drills

WITH TRIGGER SPEED CONTROL

- Operates Both Forward and Reverse By Trigger Finger Pressure
- Burnout Protected Motor
- Drives—Drills, Plus

Unique, all-purpose drills which can tackle most any drilling job with precision and accuracy. Just squeeze the trigger for any drilling speed from 0 to maximum rpm plus reverse speed! Using a driver bit or socket you can drive or remove screws and nuts quickly and easily without accessories. Taps holes in metal too! Has powerful burnout protected motor, high torque helical gears and geared key chuck. Locking button for sustained operation. Lightweight aluminum housing. With 6 ft. 3-wire cord and plug. For 115 v., 60 cycles AC., U.L. listed. Less Bit

As Low As
21⁸⁸

EXCLUSIVE TRIGGER SPEED CONTROL
0-Max. RPM Forward
0-Max. RPM Reverse



1/4" DRIVE-R-DRILL

MODEL 596 rated at 2.5 amps, 0-2000 rpm Forward/Reverse. Capacity 1/4" in steel, 1/2" in wood. Shpg. wt., 4 lbs. Net 24.88
13 E 6927

MODEL 501TSC. As above less reversing. Net 21.88
13 E 6901 Shpg. wt., 4 lbs.

3/8" DRIVE-R-DRILL

MODEL 597 drill has extra capacity chuck; 0-1000 rpm, forward/reverse 3-amp motor. Double reduction gears. Capacity: 3/8" in steel, 3/4" in wood. Removable handle. Shpg. wt., 4 1/2 lbs. Net 26.88
13 E 6928

MODEL 569TSC as above less reversing. Net 26.88
13 E 6917 Shpg. wt., 4 1/2 lbs.

1/2" DRIVE-R-DRILL

MODEL 598 Heavy-duty-deluxe 3 amp 0-750 rpm forward/reverse, no load speed. Heavy-duty double-reduction gears multithrust bearings. Capacity: 1/2" in steel, 1 1/4" in wood, removable handle. Shpg. wt., 4 1/2 lbs. Net 28.88
13 E 6929 \$5 Monthly
MODEL 545TSC as above less reversing. Net 28.88
13 E 6919

RAM fury 1/4" DRILL

7⁹⁵



- 2-Amp UL Approved Motor
- Jacobs Geared Chuck & Key
- Multiple Thrust Bearings

Model F-11. 1/4" geared chuck drill rated at a full 2.0 amps. UL approved. 1/4" capacity in steel, 1/2" in hardwood. 1200 RPM speed under full load; 2000 RPM no load speed. Precision anti-friction bearings. Automatic trigger switch. Specially designed gear train for maximum torque transfer. For 115 volts. AC/DC. Shpg. wt., 3 lbs. Net 7.95
13 E 7101

Model F-12S. Same as above but with 2-speed selection. Pressure on trigger switch determines speed. Shpg. wt., 3 lbs. Net 10.95
13 E 7120

Black & Decker

U-124 HUSKY 3/8" DRILL

13⁹⁹



- 1/2 HP 1000 RPM
- Double Reduction Gear System
- 2.3 Amp. UL Approved Motor

Model U-124 Heavy duty capacity 3/8" drill incorporates a double reduction gear that permits a wide range of drilling needs. Perfect for grinding, buffing, mixing and all types of heavy and light drilling chores. Heavy duty UL approved 2.3 amp motor and precision gears combine to give maximum torque at all drilling speeds. "Cyclac" handle provides positive grip at all times. Jacobs geared chuck and key for quick change of bits. Handy trigger switch, with locking button, permits use in awkward places. 3 wire cord plug. Uses 115V AC. Shpg. wt., 5 lbs. Net 13.99
12 E 6850

CENTURY 12 PC. HIGH SPEED DRILL SET with Center Punch

Only
4⁸⁸



- 12 Sizes: 1/16" - 1/4"
- Made in U. S. A.

Precision ground high speed drills and center punch placed in unbreakable flexible plastic case which opens and closes like a book! Drill Sizes: 1/16"-1/4". Handy center punch assures exact position of drill bit. Net 4.88
13 E 1850

SPEED REDUCER SCREWDRIVER

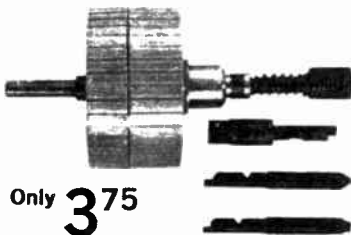

Only
3⁷⁵

- Includes Slotted Bit-Phillips Bit—1/4" Socket Adapter

The Warren Model W-400 speed reducer can be fitted to any power drill quickly and easily. 11 to 1 speed reduction through the use of a planetary gear system. Easy stop-start action with hand clutch control. Includes slotted bit with finer #2 Phillips, 1/4" socket adapter. Shpg. wt., 1 lb. Net 3.75
14 E 7903

6-PC. SCREWDRIVER BIT SET

Converts Any Variable Speed Drill To A Power Screwdriver



Only
2⁹⁹

- For All Electric Screwdriver And Variable Speed Drills

Versatile set provides a variety of bits and finders to speed-up assembly and service work. For slotted and Phillips head screws. Kit includes 3-slotted bits and finders for screw sizes 6-8, 8-10 & 10-12; 3-Phillips bits No.'s 1, 2, & 3. All have 1/4" Hex shank. Shg. wt., 1/2 lb. Net 2.99
14 E 7904



Sabre-Lathe Multi-Purpose Shop Tool

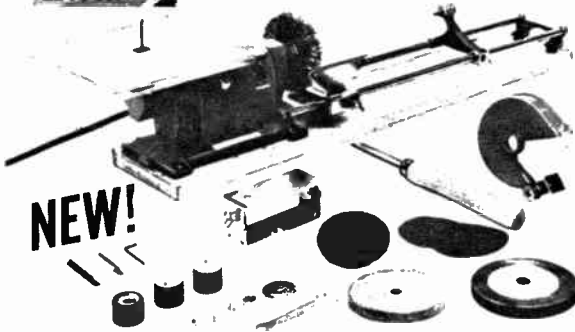

NEW!

ONLY
29⁹⁵

It's a . . .

Wood Turning Lathe
Sabre Jig Saw
Bench Grinder

Disc or Drum Sander
Buffing or Polishing
Horizontal Drill

A home shop tool that will excite the interest of every home craftsman! Powerful, 3-speed motor provides plenty of drive for every operation... unit changes for any purpose in just seconds. Complete with wood turning chisel, sanding discs, sanding drum discs, 3 sabre saw blades, 45° adjustable sanding table. Entire unit is mounted on wooden base for easy portability and stability. Lathe has 18" bed, 4" throat, can be used for spindle or face plate turning. 115 volt, approximately 1/3 h.p. motor, AC only. Output speeds 3,700, 3,300 and 3,100 rpm. With illustrated instruction booklet. Mounted on 32" x 6" board.

13 E 3850W Shpg. wt., 16 lbs. Net 29.95

18" BENDING AND FORMING BRAKE

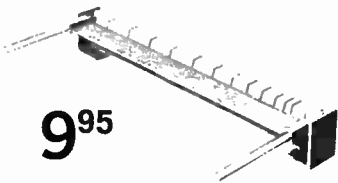

9⁹⁵

- For Experimenters—Servicemen—Shops
- Clean Smooth Bends
- Forms Up To 90°
- Handles Up To 18" Width In Up To 16 Gauge Thickness

Unique design permits forming chassis, boxes, covers, trays, etc. by means of 1" deep slots in brake-bar which allow corners to fold in. Provides flange edges up to 1" high. Easy to adjust for thickness, accuracy, angle of bend. Rugged construction offers a life time of service. Shpg. wt., 14 lbs.

99 E 8064WX

Net 9.95

NEW COPY CAT CONTOUR GAGE

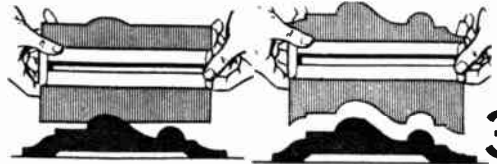

3⁷⁵

- Match and Outline Any Irregular Shape

For home, shop and industrial use. Simplifies measurement and copying of irregular shapes. Uses include: measuring pillar contour for fitting floor tile, carpeting and linoleum; duplicating patterns for wood mouldings; checking tire thread wear, etc. Press the gage's 175 steel teeth against any irregular surface to exactly match and hold the shape taken. Mark and cut the material for perfect fit. Tool is 6" long. Shpg. wt., 1/2 lb.

13 E 4150

Net 3.75

NEW! SELF-ADJUSTING SOCKET WRENCH



2⁹⁹

- Adjusts Automatically from 1/4" to 1/2"

Now one tool replaces five socket wrenches! Simplifies your work. Press this wrench on any bolt or nut from 1/4" to 1/2" in size and it automatically selects the right socket to fit, no other adjustments needed. High tensile strength sockets minimize slippage, provide high torque. Accommodates bolt extensions up to 1 1/4" long. Chrome plated steel housing, insulated handle. Length 7". Shpg. wt., 1 lb.

13 E 1904

Net 2.99

VARIABLE MOTOR SPEED CONTROL



8⁵⁰

- Varies Speed on AC-DC Motors From 0 RPM To Full Speed
- Ideal For Electric Drills, Saws, Polishers

Dependable motor speed control ideal for workshop power tools using universal AC-DC and series DC motors. Assures constant speed variation from zero rpm to maximum speed. Has built-in circuit breaker. 7.5 amps no-load rating. Input: 120 volts 50-60 cycles AC. 3-wire receptacle and 6' cord.

13 E 2700 Shpg. wt., 1 lb.

Net 8.50

3 DRAWER TOOL CHEST

Only

11⁹⁵

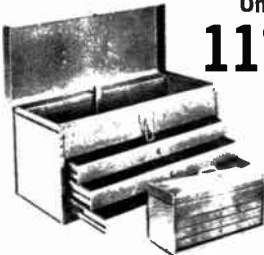

- Electrically Welded Heavy Gauge Steel
- Baked Enamel Silicone Treated Finish

All purpose ruggedly constructed 3 drawer carrying type chest. Drawers have full suspension slides. Drawers may be locked in place even if cover is closed. Dimensions: Box—8 1/2"D x 10 1/4"H x 20" L; 3 Drawers—7 1/2"D x 1 1/2"H x 18 1/4" L. Shpg. wt., 18 lbs.

13 E 1950

Net 11.95

PISTOL GRIP FLEXI-SHAFT HOBBY TOOL WITH VARIABLE SPEED FOOT CONTROL



- 1/4" Chuck

10⁵⁰

- Pistol-Grip 36" Flexible Shaft
- 1/15th H.P. Hobby Motor
- Variable Speed Foot Control

Ideal for all grinding, polishing, drilling, butting and engraving. The powerful 1 amp. motor delivers 5000 RPM at full load and 15,000 RPM at no load and has permanent oilite bearings. Accommodates shanks up to 1/4" diameter and accepts all 1/4" drills. Foot control has a variable speed from 0 to maximum speed of the motor. Shpg. wt., 4 lbs.

12 E 9001M

Net 10.50

Motor only. Shpg. wt., 1/2 lb.

19 E 2410

Net 5.95

17 PIECE 1/4" DRIVE SOCKET SET



4⁴⁹

- DROP FORGED STEEL
- CHROME PLATED

Heavily chrome plated socket set. Contains 6 Pt. socket: 3/16", 1/8", 1/4", 3/8", 1/2", 5/8". Plus 2" extension, 6" extension, 5 1/4" flex handle, 4 1/2" crossbar, 5 1/2" reversible ratchet. Each set packed in heavy gauge lacquered metal box. Imported. Shpg. wt., 2 lbs.

13 E 5564

Net 4.49

CRAFTOOL

ALL PURPOSE VACUUM CLEANER

REPEAT OF OUR
FABULOUS
CHRISTMAS CATALOG
OFFER

5 and 10 Gallon Steel Drums

- Excellent for the Home, Garage, Yard, School or Workshop

- 6 Ft. 2 1/2" Diameter Hose

Can be used for rough cleaning nearly anywhere! Excellent for picking up pebbles, wood chips, sawdust and other debris. Also attaches to woodworking machines for chip & sawdust removal. Reversible air flow—use it as a blower too! Perfect for winter oil burner cleaning. Complete with 6 ft. 2 1/2" diameter hose & nozzle. UL Approved. Shpg. wt., 17 lbs.

5 Gallon unit plus caster set. 3.4 HP. Shpg. wt., 17 lbs.

13 E 9027WXM Net 28.95

10 Gallon unit plus 13-3550W accessory kit. Develops 1 HP, 60% more power than 5 gallon unit. Shpg. wt., 25 lbs.

13 E 9028WXM Net 36.90

Caster Sets

13 E 3553 for 5 gal. unit. Shpg. wt., 1 lb. Net 4.29

13 E 3555 for 10 gal. unit. Shpg. wt., 1 lb. Net 4.29

13 E 3551 45" Extension Handle. Shpg. wt., 3 1/2 lbs. Net 3.95

ACCESSORY KIT: Includes 1 14" floor nozzle with brush, 30" extension handle, and adapter which permits use with ordinary vacuum hose and accessories. Shpg. wt., 5 1/2 lbs. Net 9.95

13 E 3550W Net 9.95

Paper Filter Bags (6) for extra dirty jobs... slips over permanent cloth bag. Shpg. wt., 1/2 lb. Net .89

13 E 3556 Pk. of 6 Net .89

Replacement cloth bag Net 1.39

13 E 3557 Net 1.39



ACCESSORY KIT

36⁹⁰ with accessory kit
Save 13.00
from our 670 catalog price

28⁹⁵ with casters
Save 5.29
from our 670 catalog price



STEEL STORAGE UNITS

As Low As **5⁹⁵**

For stores, offices, garages, basements, pantries, closets — just what you need to solve your storage problems, you'll find dozens of uses for these rugged racks. Available in two sizes to fit virtually anywhere — 30Wx12Dx60"H with 4 shelves, or 36W12Dx72"H with 5 shelves. Corner post and all edges are rounded and snag-proof with back and side braces providing added strength and rigidity. Gray enamel finish. Shipped unassembled with all necessary hardware for fast easy assembly. Size: 12x30x60". Shpg. wt., 25 lbs.

13 E 2301WX 4 Shelf Unit Net 5.95

Size 12 x 36 x 72". Shpg. wt., 33 lbs.

13 E 2302WX 5 Shelf Unit Net 6.99

Extra Shelves for above

13 E 2303 12" x 30" shpg. wt., 2 lbs. Net ea. 1.25

13 E 2304 12" x 36" shpg. wt., 2 1/4 lbs. Net ea. 1.35

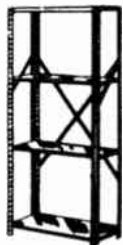

TINY TIGER PORTABLE GENERATOR

- 115V A C 350 watts Electric Power
- 12V D C 12 amps

89⁹⁵

No Money Down

- Only 12 lbs.
- 12VDC for Battery Charging
- Economical Gas-Driven Motor—.85 HP
- Automatic Overload Relief—for Tools, Appliances, Boats

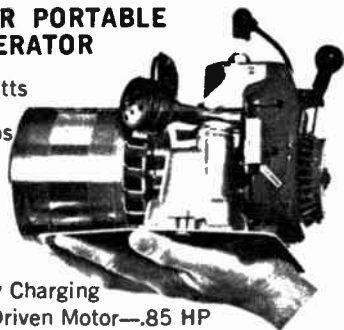

A revolutionary generator in size and power. The lightweight, 12 lb., gas driven unit provides up to 350 watts of 115VAC for electric power anywhere . . . camping, boating, at home or in emergencies. Also produces up to 12 amps of 12VDC for charging your auto battery or starting cars, boats, and trucks. Features a dependable 2 cycle Ohlsson & Rice air cooled engine delivering .85 HP, which operates at full power continuously for 2 1/2 hours. Directly driven. Incorporates an automatic overload relief system. 2 1/2 hour fuel capacity with standard outboard mixture (gas-oil). Light enough to carry anywhere . . . small enough to carry in one hand.

12 E 3550 \$5 Monthly. Shpg. wt., 13 lbs. Net 89.95

12 E 3551 Handy Carrying Case Net 5.95

ALL-PURPOSE BENCH FRAME 5⁵⁰

It's easy to make a bench for every purpose—in the garage, store, house, laundry room, playroom, etc. Heavy gauge steel, completely pre-drilled, ready-to-assemble—just add the top. For larger benches, combine 2 or more. Overall: 22 1/2x47 1/2x34" high. Shpg. wt., 19 lbs.

13 E 3501W Net 5.50

TOOL RACK. Prepunched to fit frame. 46"L. 4 1/2"H.

13 E 3502 Shpg. wt., 2 lbs. Net 1.95

CASTERS For easy moving. Sets of 4.

13 E 3503 Shpg. wt., 1 lb. Net 1.49

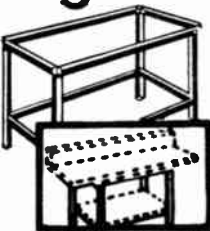

240 GPH SUBMERSIBLE PUMP

- Will Not Corrode or Rust
- Hermetically Sealed Motor
- For Circulating and Dispensing Water

12⁷⁵



It's the all-new Delron aluminum pump for underwater use. Guaranteed not to corrode or rust; hermetically sealed motor. Circulates and dispenses water and mild acid solutions, for use in fountains, beverage dispensers, aquariums, photo developing, air conditioning, etc. Gallons per hour delivery: 240 @ 1 ft.; 180 @ 3 ft.; 125 @ 5 ft.; shut off @ 12 ft. Outlet 3/8"; inlet 1/2" pipe O.D.; height 4 1/2"; depth 4 1/4"; 6 ft. safety cord. 115V, 60 cy, AC. 49 watts load; .67 amps load. Shpg. wt., 3 1/4 lbs.

13 E 6901 Net 12.75

5 1/2" FLUSH CUTTING DIAGONAL PLIERS

Only **89^c**

- Drop Forged Steel

A must for every tool box and work bench. Heavy duty drop forged steel construction with hardened and hand honed cutting edges. Cutting edge is angled for flush, smooth cuts. Handles are vinyl insulated for comfort and provide 10,000 volt protection. Shpg. wt., 10 oz. Imported.

99 E 6044 Net .89



LAFAYETTE Automotive Test Equipment

6½" DWELL TACHOMETER



28⁵⁰

- Tunes up Electronically, Any Car Ever Made
- Three Dwell Scales
- Giant 6½" Easy-to-Read Scale
- Use to Adjust Carburetors
- Use to Adjust Points

3½" DWELL TACHOMETER



16⁹⁵

- Tune Up Electronically Any Car Ever Made
- 3½" Double Jeweled D'Arsonval Meter
- For 4, 6 or 8 Cylinder Engines
- For 6 or 12 Volt Systems
- Point Resistance Check

A complete ready-to-use Dwell Meter and Tachometer which will operate on any car ever made. Tests cam Dwell angle and engine RPM on 4, 6 or 8 cylinder cars, 6 or 12 volt right on the engine. Giant 6½" easy-to-read meter makes it simple for anyone to adjust points and carburetors to insure maximum gas economy and quiet engine running. RPM readings are also essential to properly service automatic transmissions. Three dwell angle scales are provided: 0 to 45 degrees, 0-60 degrees, and 0 to 90 degrees. This instrument is suitable for dwell angle adjustment on all foreign and domestic cars. Dual range tachometer 0 to 1000 rpm for precise carburetor adjustments. 0 to 5000 rpm, suitable for making all other tests at high engine speeds. Complete with instruction manual. Shpg. wt., 4 lbs.

11 E 0101W Net 28.50

Electronically tune your car! This Dwell-Tachometer permits setting the carburetor for maximum efficiency, gas economy and greater power; indicates the correct point gap setting electrically (even if the points are pitted or corroded); permits setting points with the distributor cap off and engine cranking, and permits setting points on "Window" distributors with engine running. It also locates defective spark plugs; permits correct engine RPM setting for automatic transmission adjustments, throttle linkage and idle adjustment. RPM scale: 0-30 8-cylinder dwell: 5-45°; 6 cylinder dwell: 20-40°. 4 cylinder readings obtained by doubling 8 cylinder scale reading. Two-color scale. Small and compact—measures only 6¼x3¾x2". Shpg. wt., 2 lbs.

11 E 0105 Net 16.95



DYNAMIC AUTO-MATE AUTO ANALYZER

- No Installation—Plugs in Cigarette Lighter
- Checks Battery, Generator/Alternator, Regulator
- Color-Coded, Self-Explanatory Dial

Now you can check the electrical systems of your car from the front seat without digging into the parts of the engine. Plug furnished with large dial meter fits cigarette lighter and tests battery condition, current produced by alternator or generator and proper voltage regulator setting. Measures current flow in the electrical system during starting and running with color coded meter. Permits positive identification and isolation of electrical trouble. For 12v neave systems. Shpg. wt., 1 lb.

11 E 7230 Net 9.95



TUNE UP KIT 988

- Tunes Engine For Maximum Efficiency
- For Accurate Ignition Timing of Any Engine

A complete kit to tune up the important systems of your car, truck or marine engine. Permits maximum efficiency for more economical operation. Kit includes compression tester, vacuum fuel pump tester and deluxe timing light with remote starter switch. Compression tester locates valve, ring, piston and cylinder troubles. Big 2½" dial is calibrated 0-300 lbs. pressure. Vacuum and fuel pump tester checks pressure and suction of fuel pump and vacuum system. 2½" dial calibrated in 0-30 inches and 0-3 lbs. Comes with rubber tubing for easy connections. Brilliant prefocused timing light features remote starting switch. For 6, 12 or 24 volt systems.

11 E 4208 Shpg. wt., 5 lbs. Net 9.88

TIMING LIGHT WITH REMOTE STARTER

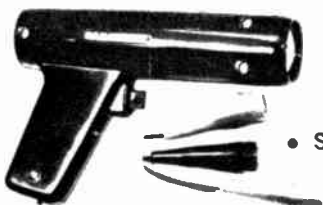

Only
4⁹⁵

- Starts Engine From Outside

Deluxe neon prefocusing light. Cranks engine from the outside—checks points, bearings and tappets. The remote starter is also useful in testing the fuel pump, generator, compression and electrical system. For 6, 12 or 24 volt systems. Shpg. wt., 1½ lbs.

11 E 4208 Net 4.95

LAFAYETTE AMPERE & OIL PRESSURE GAUGE



Only
3⁹⁹

- Illuminated Dials

The ammeter calibrated in a 60-0-60 scale Exact oil pressure from 0 to 80 lbs. is indicated. Easily installs in any 6 or 12 volt car without drilling. 1¾" diam. black dial faces with calibrations in white. Size 5¼Wx2¾Rx2¼"D. Supplied with 6 and 12 volt bulbs and wire, all necessary fittings plus full instructions. Imported. Shpg. Wt., 1½ lbs.

99 E 8501 Net 3.99
11 E 8004 T Fitting Net .49

Capacitive Discharge Ignition System

WITH SILICON CONTROLLED RECTIFIER

- Quick, Easy Installation
- Constant Spark to 10,000 RPM
- Extremely Low Input Power—Less Load On The Engine

Combines all the advantages of capacitive discharge with those of solid state circuitry. Patented circuitry eliminates point bounce problems and positively fires plugs regardless of point condition. Fast rise time spark prevents fouling from three to ten times. Point contacts last indefinitely. Elimination of mis-firing, reduces oil contaminants, prolonging engine life. Provides smoother and more efficient operation at all speeds; constant spark up to 10,000 RPM; with dramatically improved acceleration and economy. Provides faster, easier starting in all weather. Reliability and performance proven on thousands of military, commercial and private vehicles from Alaska to Cape Town. Unit operates with all commercial and original equipment tachometers. Installs immediately with two simple connections to the existing coil, leaving the standard system intact. No temperature limitations—mounts anywhere. Requires only a very small amount of input power—reduces load on engine and electrical load. For 12 volt negative ground system only. Shpg. wt., 2½ lbs.



39⁹⁵

No Money Down

11 E 8450 \$5 Monthly Net 39.95

PRECISION "RALLY" TACHOMETERS — GAUGES

(A) 270° CHAMPION RACING II TACH

- Extra Wide Sweep
- 0-10,000 RPM—6 or 12 Volts

"Custom" looking full 270° sweep tach designed for the most rugged racing treatment. Large accurate dial face with O'Arsonval movement calibrated from 0 through 10,000 RPM. One-piece unit finished in deluxe chrome zinc die cast housing. 360° mounting permits installation in any position... on the dash, column, etc. Large 3 inch face with heavy calibration marks visible from any position. An attractive addition to any dashboard. Complete with installation kit.



Net 29.50

(B)

(A)

29⁵⁰

15⁹⁵

(B) CHAMPION TRANSISTORIZED TACH

- Regular or Transistorized Ignition Systems

An attractive, fully transistorized tachometer, factory calibrated for 0-8000 RPM. Large, easy-to-read 3" illuminated dial finished in protective chrome zinc die cast. Precision one-piece tach unit unaffected by vibration. Transistorized magnetic amplifier for constant accuracy. Universal 360° mounting. Complete with installation kit. For 6 or 12 volt positive or negative systems. Shpg. wt., 2 lbs.

11 E 4218 For 8 cylinders Net 15.95

11 E 4219 For 6 cylinders Net 15.95

(C) OIL-AMP-WATER GAUGE

- All Electric—No Tubing

End guesswork and space problems with this beautiful three-in one gauge. Gives accurate, individual readings of oil pressure, amperage and water temperature. Fits all cars, generator or alternator systems. Amp. gauge reads —60 to +60; oil pressure registers 0 to 80 lbs.; water temperature indicates 100° to 220°. With necessary wire, adjustable mounting ring, senders. Shpg. wt., 2½ lbs.

11 E 4203 Net 19.95

OIL AND AMPMETER GAUGE

Similar to above less water temperature gauge. (Not illustrated). 11 E 4204 Shpg. wt., 2 lbs. Net 14.95

(D) GAS SAVER-VACUUM GAUGE

- Automatically Shows Miles Per Gallon

Stop gas waste! Handsome chrome plated Gas Saver gauge shows you exactly how to drive for the best economy or power. Works all seasons of the year and during all types of traffic conditions. Meter reads actual miles per gallon. Also checks your engine constantly by measuring its manifold pressure on the clear four color dial. Complete with 6 ft. vacuum line tubing, T connector, steering column mounting ring and instruction. Shpg. wt., 2½ lbs.

11 E 4205 Net 11.95



19⁹⁵

11⁹⁵

(C)

(D)

LAFAYETTE HOT CAR-GO

- Starts Wet or Cold Motors Instantly
- Saves Battery and Gasoline
- Installs Easily and Quickly
- 6 and 12 Volt Cars

2⁹⁵



Avoid excess wear and tear on your motor and battery—install Lafayette's Hot Car-Go. Provides 5 times the normal spark for fast starting in any weather, and automatically disconnects when engine is running. Will not damage plugs or distributor. Simple to install—Instructions included. Imported. Shpg. wt., 1 lb. Net 2.95

89 E 8511 Net 2.95

LECTRA-SCOPE ENGINE ANALYZER

FOR ALL CARS & TRUCKS

3⁹⁹

- Tests Ignition & Engine Performance

Shows what's going on in any 6 or 8 cylinder engine. Individual lights for each plug... glows with each spark. Steady glow all o.k.; weak flickering light shows dirty contacts, wasted gas; bright light shows heavy engine load, dragging brakes. Installation instructions. Shpg. wt., 1 lb.

11 E 7650 8 Cylinders Net 3.99

11 E 7651 6 Cylinders Net 3.99



Automotive Accessories & Specialties

PROFESSIONAL SIREN-OPERATED BURGLAR ALARM

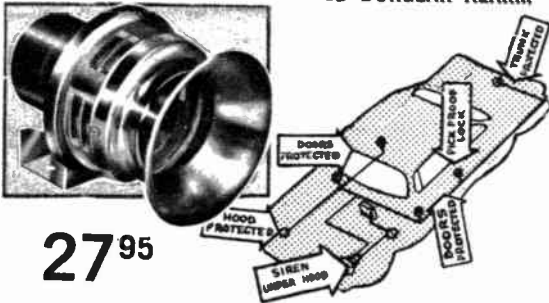

27⁹⁵

- Loud, Police-type Siren Gives 3-Way Protection—All Doors, Trunk and Hood
- Pick-Proof On-Off Key Lock Mounts on Outside of Auto
- Complete—Easy To Install

Get 24-hour protection on your car, station wagon or truck with this complete burglar alarm system. The sharp penetration sound of the police-type siren will scare thieves away. The siren blasts off when anyone opens a door, the hood or trunk. The alarm can be shut off only with the alarm key. Complete system includes siren with trumpet, 4 door switches, hood switch, trunk switch, 2 brackets, electrical lock with 2 keys, wire, mounting hardware, instructions and 2 warning decals. For 12-volt cars only. Shpg. wt., 6 lbs.

11 E 6201

Net 27.95

RADAR SENTRY Warns of Traffic Zones!



29⁹⁵

- Gives Advance Warning Within 1/2 Mile Range
- Miniature and Completely Transistorized
- Complete With Long Life Mercury Batteries
- Clips Easily on Sunvisor
- Rugged Printed Circuit

Miniature electronic detector warns you of radar traffic zones up to 1/2 mile away. Dual-Band circuit detects all commonly used police radar speed meters and traffic control devices to promote safer driving. Miniaturized and completely transistorized. Top quality components; printed wiring; 8 transistors; two 1,000 hour mercury cell, self-testing batteries (equivalent to 35,000 miles of driving at 35 M.P.H.) Magnesium case eliminates radio, TV and other interference. Weighs only 13 ozs., measures 3 3/4" x 2 1/4" x 3 1/4" D; clips to sunvisor. Complete with batteries, sunvisor clip. Instructions included. Shpg. wt., 1 1/2 lbs.

11 E 4201

Net 29.95

*This item not intended for resale in States where its use is forbidden in motor vehicles by public regulation.

AUTO BATTERY CLOCK

As Low As **9⁷⁵**



- Walnut Finish—Luminescent Dial and Hands

A smartly designed and ruggedly constructed battery-operated clock designed for use in the automobile or cabin cruiser. Two-piece magnetic base for swivel mounting . . .

Operates A Year On Single "D" Cell

holds tight to all surfaces INCLUDING padded dashboards and is detachable for use in motel or hotel when traveling. Unbreakable polypropylene housing for extra ruggedness. Lustrous silver finished metal dial and trim. Size: 3 1/4" x 3 3/4" x 1 1/4". Walnut finish with luminescent dial and hands. Shpg. wt., 1/2 lb. Less battery.

11 E 8152

Net 10.75

Same as above except with ebony and lustrous silver finished metal dial and trim.

11 B 8150

Net 9.75

Same as above but with St. Christopher emblem.

11 E 8151

Net 9.75

99 E 6256 Battery for above

Net .13

DELUXE 4-WAY EMERGENCY FLASHER

3⁷⁵



- Built-in Heavy-duty Flasher and Fuse
- All 4 Directionals Blink On and Off
- Flashing Pilot Light with Audible Click

Simply pull out the switch and all 4 directionals start blinking, along with pilot light in switch. Completely separate heavy-duty system cannot overload or damage car's existing light system. Unbreakable mounting bracket for mounting through or under dash. Easy to install; self-insulating connectors. Instructions included.

11 E 8203 Shpg. wt., 1 lb.

Net 3.75

CUSTOM-FIT HEADREST

6⁹⁵ • Makes Any Car Seat a Contour Chair!



Now you can make your car seat really comfortable with this advanced design headrest. Helps prevent whiplash too. Dorsal cantilever design keeps headrest snug against back of neck and head. Locks to seat automatically. 3 Knobs, finely calibrated gives 4-way adjustment to custom fit any individual, chair or car seat. Full 5" vertical adjustment; 4" forward and back. Looks like original equipment. Made of soft vinyl plastic with molded wing rests.

11 E 1201 Black only. Shpg. wt., 2 lbs.

Net 6.95

AH-000-GAH!

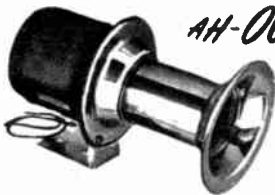

HORN 10²⁹

- Chrome Plated Bell
- With Horn Button

A real joy for the sports car enthusiast. An authentic motor driven horn approved as an exact reproduction in sound and appearance by members of antique car, hot rod, and horseless carriage clubs the world over. Chrome plated bell with black wrinkle painted housing. With horn button, wire, bracket and instructions. Shpg. wt., 1 lb.

11 E 3001 6-volt

Net 10.29

11 E 3002 12-volt

Net 10.29

For Compacts and Sports Cars

11 E 3007 12 Volt

Net 10.29

11 E 3008 6 Volt

Net 10.29

"TWO TOOTER" FRENCH POLICE HORN CONVERTER



SALE!

9⁹⁵

- Makes Any Auto Horn A French-Type Dual Horn
- Variable "Tooting" Speed Control Inside Car
- Easy to Connect in Minutes

Save 5.00

Solid-state converter—converts the paired sound of your car's two horns to a commanding dual-note European sound. Inside control permits a friendly salute or an urgent warning. Fits 6 or 12-volt systems. Size: 6 1/2" x 1 3/4" x 1 1/4". Shpg. wt., 2 lbs.

11 E 1525

Net 9.95

CAR MAP LIGHT

1⁹⁹



- For Map or General Illumination

A portable lamp which can be plugged into any 12-volt cigarette lighter receptacle. Has 5 3/4 inch gooseneck making completely adjustable to any position you desire. Ideal for reading road maps, light ash tray or ignition switch. Has convenient on-off switch, bulb. 99 E 8517 Imported. Shpg. wt., 1/2 lb.

Net 1.99

Auto Accessories For Better Car Care

DELUXE REVOLVING BEACON

NEW! LOW FUEL LEVEL LIGHT



5⁹⁵

- Rotates Like a Light-house Beacon

A red warning light that rotates 360 degrees and flashes in all directions. Suction mount holds the beacon firmly in place. Signals for help for miles around; creates a safety zone during a traffic emergency; with cigarette lighter adapter plug. Shpg. wt., 2 lbs.

For use on autos, boats, trucks, docks, etc. For 12 volt use; complete with cigarette lighter adapter plug. Shpg. wt., 2 lbs. **11 E 1304** Net. 5.95

BLUE TURRET LENS

Converts Revolving Beacon for use by emergency vehicles, volunteer fire depts., CD units, etc. Shpg. wt., 1 lb. **11 E 1305** Net .90

LAFAYETTE SUPER POWER SKYLITE

- 60,000 Candle Power Searchlight Beam
- Automatic Red Blinker
- Completely Waterproof Housing and Switches
- For Boaters - Campers - Truckers - Hunters

A deluxe, all-purpose searchlight which throws beams over 1,000 yds. Specially designed 4" reflector concentrates beam to penetrate heavy fog, murky water. High impact plastic case and rugged switches are completely waterproof... Ideal for skindivers. Three beam colors: White, Red, Green with separate switches. Operates on 6 standard size "D" cells. With bulbs, less batteries. Shpg. wt., 2 lbs. Imported **99 E 9135** Net 9.95

Extra set of 3 bulbs for Skylite. **99 E 9136** Net .85
1 1/2 volt "D" batteries, 6 required. **99 E 9256** Net ea. .13



9⁹⁵

AIRWAY COMPASSES

Universal mounting bracket with pressure sensitive base for dash or windshield. Aviation-type geared regulators, cunife magnets. Built-in battery light on illuminated models. Dial calibrated each 15 degrees. Black and chrome. Shpg. wt., 1 lb. **11 E 8501** Illuminated Net 2.25

NAVIGATIONAL DIAL CALIBRATED EACH 5 DEGREES
11 E 8502 Non-illuminated Net 3.19
11 E 8503 Illuminated Net 3.79



- No Holes to Drill
- No Wiring

TRIPOD BUMPER JACK

4⁹⁵

- Lifts Cars Weighing Up To 5000 lbs.
- Torsion-Spring Hook Fits All Model Cars

Provides strong stable support to grip bumper and simultaneously hold it from three ground supports. Triple leg design permits use on a hill or on soft shoulders. Protects you and your car. Universal design virtually fits all cars. 3-inch wide bumper hook rides on a main channel constructed of heavy steel. Utilizes quality ball bearings and acme threaded screw. Insures easy cranking. Designed to lift most cars on the road weighing 5000 lbs. or less. This 3 legged jack with chains between legs belongs in every car. Lifts up to 28 1/2 inches. Shpg. wt., 15 lbs. **11 E 8350W** Net 4.95



AUTO HOOD LOCK KIT



3²⁹

- Prevents Theft of Battery and Engine Parts

Hood can only be opened from inside of car. Protects battery generator, distributor, etc. Complete with all parts for installation. Fits following cars:

61 Buick	64-66 Mercury
64 Cadillac	64-65 Mustang
61-66 Chev.	60-66 Pontiac
65 Comet	62-65 Rambler (not Classic)
63-66 Ford	63-66 Tempest
63-66 Falcon	64-T-Bird
and other cars with striker bolt in hood.	

11 E 5301 Net 3.29

For All Model Cars

New! Accurate, solid-state fuel level indicator light that functions independently of your factory installed fuel gauge. This unique alerting device will tell you when gas level is low—brilliant red light flashes when it's time to gas up. Light can be adjusted to flash at any level from empty to 3/4 full. Mounts under dash for quick easy installation. For 12-volt system. Size: 1 3/8 x 1 3/4 x 2". Shpg. wt., 1 1/2 lbs. For all G.M. cars and Chrysler Motors prod. 1957-59. **11 E 8850** Net 4.95

For All Others **11 E 8851** Net 4.95



CAR CLEAN—DELUXE VACUUM CLEANER

- Super Suction Power
- Self Contained Dust Bag
- Compact, Lightweight and Rigidly Built For Long Use

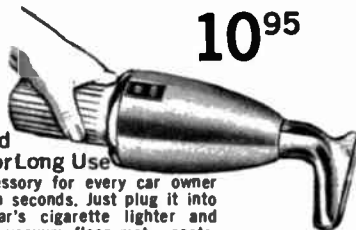

10⁹⁵

A smart portable accessory for every car owner... cleans your car in seconds. Just plug it into the socket of the car's cigarette lighter and switch it on to easily vacuum floor mats, seats, headliners, crevices and other hard-to-clean spots. The self contained dust bag assures convenient, clean and sanitary use. The high-powered motor produces strong suction with least possible noise. Beautifully designed of sturdy, high impact plastic with two-tone pastel color finish. Comes complete with 14 foot cord (with on/off switch) and two attachments (one for easy to reach places, one for crevices and other hard-to-clean spots). Power Source: 12V., DC battery. Imported. Size: 3 1/2" Dia., 13" Length. Shpg. wt., 2 lbs. **11 E 5125** Net 10.95

LAFAYETTE 4-LITE EMERGENCY WARNING SWITCH KIT

1³⁹

Just flip the emergency warning switch and all four directional signals on your car flash on and off setting up a safety zone around your car. Ideal for use during emergency road stops. Underlight that flashes when unit is on. Complete with installation instructions. Imported. Shpg. wt., 1 lb. **99 E 8514** Net 1.39



- Fits All 6V and 12V Cars

NEW! POWER HOUSE AUTO ANTENNA

3⁶⁹

- Built-in Booster



New! 3-section universal mount (for all cars) auto antenna designed to increase the range and signal strength of your auto radio. Built-in booster coil lets you tune twice as many stations, **TWICE AS STRONG!** Stainless steel spring mount withstands severe shock, eliminates constant replacement of broken antenna staffs. Swivel base permits mounting at any surface angle. Comes with 48" lead cable. Wt., 1 lb. **11 E 7107** Net 3.69

Depend on Lafayette for Complete Stocks, Lowest Prices, Fastest Service

World Radio History

Auto Battery Chargers - Accessories

SURE FIRE 10 AMP HEAVY DUTY BATTERY CHARGER



15⁹⁵

- For 6 & 12 Volts
- Colored Meter Scale
- Automatic Reset Circuit Breaker For Overload Protection

Heavy duty air cooled, 10 amp (max 13½ amps) battery charger for 6 and 12 volt automotive batteries. Uses selenium rectifier and features automatic reset circuit breaker. Ammeter shows exact charge entering the battery. Also features a 6' power cord, two neoprene battery leads with sure grip 50 amp clips and wall mounting bracket. For operation from 105-125 volt, 50/60 cycles AC. UL approved. 10 x 6½ x 7½". Shpg. wt., 15 lbs.

11 E 7606

Net 15.95

3 AMP 6 & 12 VOLT BATTERY CHARGER



7⁹⁹

- Built-in Meter
- UL Approved

Edge view colored meter shows actual rate of charge and indicates battery condition. Reset circuit breaker gives automatic overload protection. Has 6 and 12 volt selector switch. Delivers tapering charge. Vented steel case; may be wall mounted. 6 ft. battery leads with 50 amp clips. Size 6 x 4½ x 5¾". For operation from 105-125 Volt. 50-60 cycle A.C. Shpg. wt., 5 lbs.

11 E 7604

Net 7.99

BATTERY BOOSTER CABLES



Standard equipment for starting stalled cars, charging batteries, etc. Made with heavy duty, flexible rubber-covered cable. Rugged copper-clad positive action grips identified by Black and Red heavy vinyl covered handles. Shpg. wt., 3 lbs.

AS LOW AS **1¹⁹**

- | | |
|--|----------|
| 11 E 2901 8 ft. long, set of 2 | Net 1.19 |
| 11 E 2902 12 ft. long, set of 2 | Net 1.89 |
| 11 E 2903 12 ft. long Heavy Duty 6 gauge copper cable | Net 3.29 |
| 11 E 2905 Set of Battery Booster Cable Clips (Red & Black) | Net .49 |

INFRA-RED WINDSHIELD DEFROSTER



2⁷⁵

- Cleans Front or Back Windshield in Seconds
- Plugs into Cigarette Lighter
- Suction Cups Mount to Windshield in Seconds

New infra-red electric windshield defroster utilizes the concept of penetrating infra-red instant heat to quickly melt away mist, ice, and snow. You no longer have to wait for car to warm up before cleaning windshield—just plug it into your cigarette lighter, and start defrosting windshield immediately. Complete with 12 foot cable for reaching back windshield. Two suction cups make mounting fast and easy. Length: 15". Shpg. wt., 1 lb.

11 E 1307

Net 2.75

CAR DEFROSTER GUN AND SCRAPER



3³⁹

- Plugs into Cigarette Lighter

Made of hi-impact red plastic with 10 foot cord and plug. 200 watt heat capacity gun plugs into cigarette lighter. For 12 volt cars only. Imported. Shpg. wt., 1 lb.

11 E 1402

Net 3.39

SCHAUER BOOSTER-CHARGER

COMBINATION BATTERY CHARGER and BOOSTER

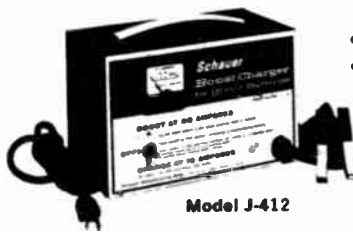

- 50 Amp Booster
- 10 Amp Charger

29⁹⁵

Model J-412

Perfect for starting cars with discharged 12 volt batteries. Develops a boost charge up to 50 amperes when attached to AC line and battery, sufficient to turn over the average engine. Charges 12 volt batteries at 10 ampere rate in 2½ to 3 hours. Temperature controlled circuit breaker protects rectifiers and charger. Size: 9¼ x 5¼ x 5¾". Shpg. wt., 13¾ lbs.

11 E 5515

Net 29.95

TRIPP LITE 150-WATT TRANSISTORIZED INVERTER



- Delivers 150 Watts Continuously
- Provides Household Current Anywhere
- Fused to Protect Battery

29⁹⁵

Model PV-150

A low-cost transistorized inverter which changes 12-volt DC to 115-volt 60 cycle AC. Delivers 150-watts continuously; 175-watts intermittently for shavers, recorders, radios, TV and many other appliances. Has on-off switch and replaceable fuse. Rugged construction. Size: 5x5x3½". Shpg. wt., 5½ lbs.

11 E 8950

Net 29.95

TERADO "DYNAMO" DC TO AC INVERTER

Convert Your Table Model Radio to a Car or Boat Radio



Operate any small radio in any 12 volt car, truck, boat or trailer. No installation—just plug into cigar lighter. Will also operate electric shaver or any electric appliance up to 20 watts. Complete with generator condenser and ignition noise suppressor. Measures only 2x2x3¾". Shpg. wt., 2 lbs.

11 E 6317

Net 9.95

WINDOW DEFROSTING FAN



- Harmless 6" Rubber Blades
- Plugs in Cigarette Lighter

A practical automotive accessory which keeps windshield free from frost or fog while you drive. High speed 3,000 rpm motor controlled from drivers seat by 2-speed switch. Complete with cord; universal swivel joint on sturdy base. 2½ lbs.

11 E 3401 For 6 volt cars

Net 7.95

11 E 3402 For 12 volt cars

Net 7.95

For Rear Windows

11 E 3403 For 12 volt only

Net 8.95

ELECTRO-DIP DIPSTICK HEATER

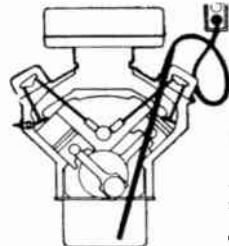

- For Fast Cold Weather Starts

2³⁹

Designed to keep crankcase oil warm while your car is turned off for the night. Permits easier starts in cold weather and faster engine warm-up. Uses about the same amount of electricity as a 100-watt light bulb. Costs only pennies a night to operate. Shpg. wt., 1½ lbs.

11 E 7601

Net 2.39



A 3rd Dimension In Sound



Only **24⁹⁵** Complete with 6x9" speaker and chrome grill.

DELUXE LAFAYETTE SOLID STATE CAR, REVERBERATION SOUND SYSTEM

- For 12 Volt Negative Ground AM and FM Auto Radios—Convenient Under Dash Mounting

Tuneable . . . Electronic Tuning Control. "Custom Fits" the Sound to your Car . . . to your Ear.

Deluxe solid state tuneable reverberation unit converts your present car radio into a magnificent sound system offering concert hall realism. Beautifully styled to enhance the decor of your car. Consists of the tuneable amplifier control unit which easily mounts under the dash panel of your car by means of adjustable brackets, 6x9" dynamic speaker and chrome grill for rear seat mounting, and all connecting cables. Includes simple instructions for connecting the reverb unit to your regular car radio system and for separate rear seat speaker. Reverberation is an entirely different approach to sound reproduction. Normal sound reproduction from

a single source has a flat, one dimensional effect; with proper sound delay thru "REVERBERATION," tones are created with a truly third dimension for concert hall originality. The LRE unit features complete sound control—simplified controls permit balance of sound between front and rear seat speaker. Verb-A-Tone control adjusts the amount of reverberation to your taste. Specifications for 12 volt negative ground cars, peak audio output—4 watts, 2 transistors. Size: 17x4x9". Shpg. wt., 5 lbs.

17 E 0109 Net 24.95

NEW! ECONOMY PRICED CAR REVERB UNIT



Only **13⁹⁵** For All 12-Volt Negative Ground Cars

Amazingly easy to install. Our lowest price ever for a car reverb unit. Can be permanently mounted under dash in seconds with adjustable brackets. Transforms the monaural sound of car radios into sparkling concert hall realism. All solid state circuitry. Requires rear-seat speaker. (See below listing). Beautiful chrome bezel with walnut grained panel, brush aluminum control plate. Dim: 6 1/2 x 3 1/4 x 1 5/8". Imported. Shpg. wt., 2 lbs.

Net 13.95

BLAUPUNKT SOLID STATE 4 BAND FM/AM/SW/MB PORTABLE CAR RADIO

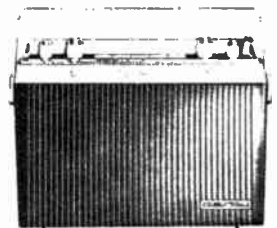

ONLY **84⁹⁵**

No Money Down

- Use It As a Portable—Install It in Your Car
- 4 Bands—FM, AM, Shortwave and Marine Band
- 11 Transistors

Retractable, pivoting telescopic antenna for shortwave /FM reception. Has push/pull output stage and sockets for earphone, tape recorder and record player. Features AFC with defeat switch, 2 watts power output. Also has a variable tone control for true hi-fi music reproduction. Attractively housed in a black leatherette case. Size: 9 3/4 x 7 3/4 x 3 1/4". Shpg. wt., 7 lbs. Made in West Germany.

17 E 1510X \$5 Monthly Net 84.95

Universal Mounting Bracket, with lock, for auto use (6 or 12 volts—reverse polarity) Shpg. wt., 2 lbs.

17 E 1516 Net 19.00

"D" size flashlight battery for portable use. (6 req.) 99 E 6256 Net ea. .13

REAR SPEAKER KITS FOR TRANSISTOR AUTO RADIOS



As Low As **3³⁹**

Complete kits for adding second speaker in rear of your car. Includes a full range P.M. speaker; fader control which controls volume of both speakers simultaneously, gradually reducing volume on one speaker while increasing volume on the other speaker; chrome grill, mounting hardware, wire and wiring instructions. Speakers have multi-impedance voice coils to match 40, 20, 8-10 ohms or less; enabling it to work with all transistor auto radios. Simple to install. Shpg. wt., 4 lbs.

Stock No.	Speaker	Grille	Net
32 E 2202	6 x 9	Chrome	4.69
32 E 2213	6 x 9=	Chrome	6.95
32 E 2203	6"	None†	3.39

†This kit for installation in autos with recess between seats in rear. No grille supplied. =Deluxe speaker plus quick assembly harness.

NEW! LAFAYETTE "VARY-MOUNT" SPEAKER FOR CAR RADIOS AND TAPE PLAYERS

Deluxe flush-mounting speaker with beautiful chrome grill. Ideal for use as an auto speaker or anywhere shallow depth is required. Full range speaker has heavy magnet and offers outstanding sound quality. Can also be used as a ceiling or wall mount speaker in your home. Impedance, 8 ohms. Overall diameter: 6 1/4". Imported. wt., 3 lbs.



Only **4⁴⁴**

99 E 0179 Net 4.44
2 for 7.99

Slim Decorator Styled Underdash Car Radios

DELUXE SOLID STATE AM CAR RADIO

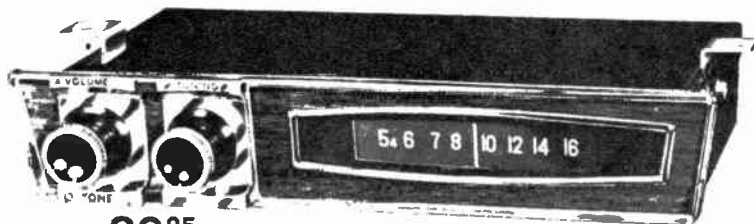

ONLY **29⁹⁵**

- For 6 or 12 Volts Negative or Positive Ground

New superb quality in a completely self-contained universal AM radio. Features all-transistor circuitry for instant action, continuously variable tone control, built-in speaker, and slide rule dial for fast accurate tuning. AVC assures stable, fade-free reception of distant stations. Sensitivity: 10 mv; peak audio out: 2 watts; speaker: 3 1/2" round; 6 transistors, 2 diodes. Size: 1 7/8" x 4 1/2" x 9". For 6 or 12 Volt Negative or Positive ground. Shpg. wt. 5 lbs. **17 E 7417** Net **29.95**

DELUXE SOLID STATE FM CAR RADIO CONVERTER



- Converts Your Existing 12 Volt Negative Ground AM Radio to the FM Band

Complete auto radio entertainment at a minimum cost. All solid state circuit (6 transistors, 8 diodes) gives instant operation. Built in AFC permits drift-free reception of distant FM stations. AM/FM switch allows instant selection of AM or FM stations. Simplified installation. Sensitivity: 4 mv. Size: 1 7/8" x 4" x 9". Shpg. wt., 4 lbs. **17 E 7420 \$5 Monthly** Net **39.95**

DELUXE SOLID STATE AM/FM CAR RADIO

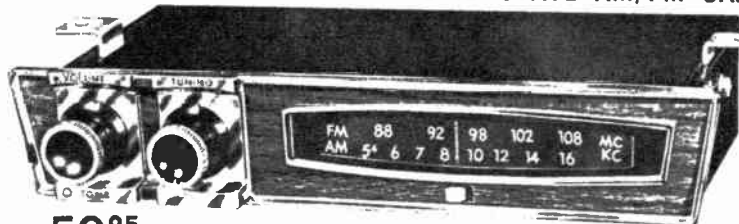

59⁹⁵ No Money Down

- For 12 Volt Negative Ground

Complete auto radio entertainment in one compact unit. All solid state circuitry gives superb sound quality on both AM and FM bands. This trim unit features a continuously variable tone control, FM Multi-plex plug for adaption to FM stereo, and an external 5x7" heavy duty speaker for crisp, clear tone. 11 transistors, 1 thermistor, 8 diodes, RF stage, AVC, and AFC. Dimensions: 1 7/8" x 4" x 9". For 12 Volt Negative Ground. Shpg. wt., 6 lbs. **17 E 7418 \$5 Monthly** Net **59.95**

UNIVERSAL 6 OR 12 VOLT SOLID STATE AM CAR RADIO



24⁹⁵

- For 6 and 12 Volt Negative or Positive Ground
- Built-in Speaker.

Universal AM radio, that is easy to install under the dash, offers fine sound reproduction. Features built in speaker, and tone control slide switch. 7 transistors, 2 diodes, RF stage, AVC. Size: 2x4 3/4 x 6 1/2". Shpg. wt., 3 lbs. **17 E 7416** Net **24.95**

NEW VOLKSWAGEN PUSH-BUTTON SOLID STATE AUTO RADIO with VW ANTENNA

• Designed For All Models Up To 1967

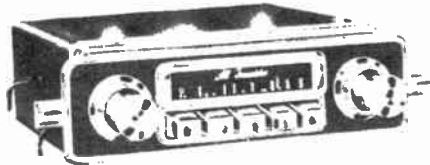

39⁹⁵
No Money Down

- 5 Watts Superb Audio Power
- 5" External Speaker

Rich, radiant chrome and elegant appointments blend beautifully with the car's interior. Features all-transistor circuit of advanced design which gives a full 5 watts of superb audio power. Automatic volume control provides constant, even, "comfort-lever" listening. Continuously variable tone control. Five quick-set push buttons permit finger-tip station tuning. Seven tuned circuits, including RF stage, give maximum sensitivity. Installed in minutes. Includes a free antenna which is designed for the Volkswagen. Shpg. wt., 7 1/2 lbs. **17 E 7421** \$5 Monthly Net **39.95**

Now for use with all 6 or 12-volt Volkswagen models

DELUXE PUSHBUTTON AM-FM CAR RADIO with Free Antenna



69⁹⁵
No Money Down

- For 12 Volt Negative-Positive Ground

Full transistorized AM-FM auto radio with Hi-Fi features. 11 transistors, 8 diodes, 2 thermistors. Push-pull Hi-Fi output. AFC for FM drift-free performance. High sensitivity for long distance reception on both AM and FM. Four I.F. stages on F.M. for maximum noise limiting. Continuously variable tone control. Large 5x7" external speaker. Radio mounts neatly under dash. Overall size: 6 1/2" x 2 3/8" x 6 3/8" D. Shpg. wt., 6 lbs. Imported. **17 E 7412** \$5.00 monthly Net **69.95**

EXCITING RADIO VALUES

LAFAYETTE "MIGHTY-15" 15-TRANSISTOR POCKET RADIO

SALE!

7⁹⁵

WAS 8.95

Complete with Carrying Case, Battery, Earphone



- Operates on 9-Volt Battery or 110V 60 Cycle AC Household Current with Optional AC Adapter
- Powerful Superheterodyne Circuit

Precision-made powerful 15-transistor pocket radio. Features an AC jack—so you can save your battery by operating this fine radio on 110V AC house current with the optional AC adapter listed below. Outstanding tonal quality from push-pull audio output circuit and 2 1/4" speaker. Earphone included for private listening. You also get a leather carrying case and one 9-volt battery. Size: 4 1/4 x 2 1/2 x 1 1/2". Imported.

17 E 4211L Shpg. wt., 1 lb. Net 7.95
17 E 3101 AC Adapter for above radio, wt., 1/2 lb. Net 3.95
99 E 6021 Extra 9V battery for above radio Net .21

BEAUTIFULLY STYLED 12 TRANSISTOR AM/FM POCKET RADIO

NEW!



ONE OF OUR **Only 12⁹⁵** With Strap, Earphone, and Battery
GREATEST OFFERS

Never before have we offered a 12-transistor AM-FM radio with so many fine features at this unbelievable low-price. 12-transistor 2-diode superheterodyne circuit, slide rule dial for precision tuning, large 2 1/2" dynamic speaker for superb tonal quality, ferrite core AM and telescoping FM antennas. Size: 5 1/4 x 3 1/4 x 1 3/4". Imported. Shpg. wt., 1 1/4 lbs.

17 E 7605L Net 12.95
99 E 6021 Extra 9V battery for above radio ea. Net .21

NEW! 8 TRANSISTOR "MICRO" RADIO

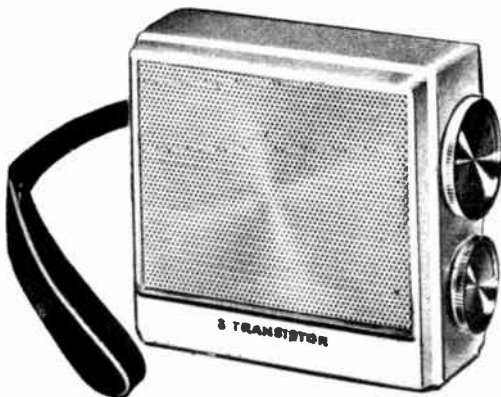

LOOK AT THIS PRICE!

5⁹⁵

With Carry Strap, Earphone, and Battery

Our smallest pocket radio. Precision crafted, ultra-smart styling, remarkably low priced. Fine performance from 8-silicon transistors. Gift boxed—with wrist strap, earphone for private listening and battery. Size: 2 1/2 x 2 1/2 x 1/4". High impact white plastic case. Imported. Shpg. wt., 8 oz.

17 E 7825L Net 5.95
99 E 6021 Extra 9V battery for above radio ea. Net .21

NEW! 8 TRANSISTOR AC/BATTERY OPERATED PORTABLE RADIO

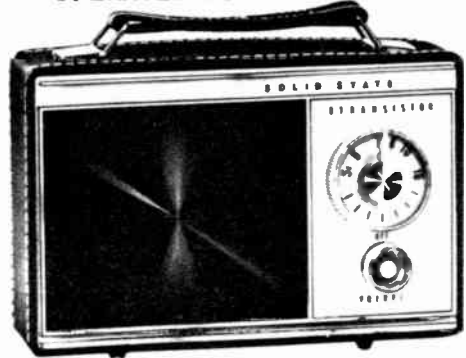

So Practical! **Only 12⁹⁵** with battery
So Low Priced!

Use a battery when playing this exciting radio outdoors—indoors just plug the handy self-storing AC line cord into your 110VAC outlet. Fine tonal quality, 8 transistor superheterodyne circuit, 2 stage IF, push-pull output amplifier, Ferrite core antenna, attractive simulated red leather cabinet. Size: 7Lx4 1/2Hx2"D. Imported.

17 E 7826L Shpg. wt., 2 lbs. Net 12.95
99 E 6021 Extra 9V battery for above Radio ea. Net .21

Depend on Lafayette for Complete Stocks, Lowest Prices, Fastest Service

Lafayette Cat. No. 672 43

Our Best Selling AM-FM Portable



Engineered To The
Highest Electronic Standards

- Full Size 9x6½x3½"—Not Pocket Sized
- 11 Powerful Transistors, 6 Diodes, 1 Thermistor
- Large 4" Speaker Offers Life-Like Hi Fidelity Sound Reproduction
- AFC Locks-In FM Stations

24⁹⁵ With Earphone, AC Adapter, and Batteries

DELUXE LAFAYETTE CRITERION® I AC AND BATTERY OPERATED FM-AM PORTABLE

Enjoy the remarkably static-free tone of FM and the great variety of AM stations which this superb low-cost portable has to offer. This deluxe full-size "set." (9x6½x3½"D), features one RF and 3 IF stages to give you real pulling power of stations both near and far. Big 4" speaker delivers full-tone high-fidelity sound. AFC circuit makes drift virtually non-existent. Geared tuning with large circular tuning dial pinpoints FM and AM stations easily. Built-in carrying handle is recessed to hold 33" telescoping FM antenna. Spacious interior contains 7" ferrite antenna for powerful AM reception and

4-cell battery compartment. Economical home use is available with accessory 6-volt power supply which connects to 110-120 volt AC house line. Luxurious break-resistant black plastic case with satin chrome grille. Complete with earphone, AC adapter, and batteries. Imported. Shpg. wt., 3½ lbs.

99 E 3519L Net 24.95

Extra "C" Batteries (4 required) Net ea. .13
99 E 6257

TOP QUALITY SOLID STATE 3 BAND AM-FM-MARINE BAND PORTABLE

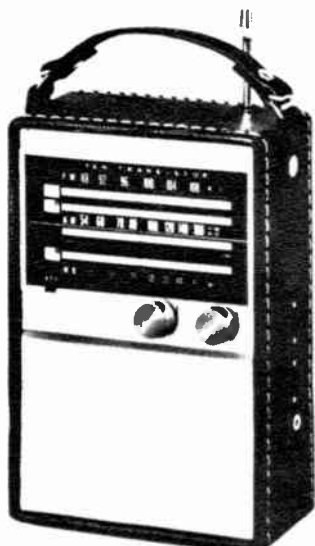

SALE!

29⁹⁵

Was 33.95

SAVE 4.00

Price in Effect
Thru March 15, 1967

Complete with
1 Yr. supply of
12 batteries,
Plug in AC Adapter,
Earphone



For superb performance on the AM, FM and Marine bands this rugged radio uses 10 transistors, 7 diodes and 1 thermistor. Slide rule and vernier tuning provide 11:1 tuning ratio. Also features telescoping whip antenna for FM and Marine band, AFC for driftless FM, tone control, earphone jack for private listening, local/long distance switch, and 3½" dynamic speaker. AC adapter permits you to play radio using 117V AC. Complete with rugged vinyl case with shoulder strap, earphone, batteries. Imported. Shpg. wt., 3 lbs.

17 E 6917L \$5 Monthly Net 29.95

9 TRANSISTOR AM/SW/MB PORTABLE

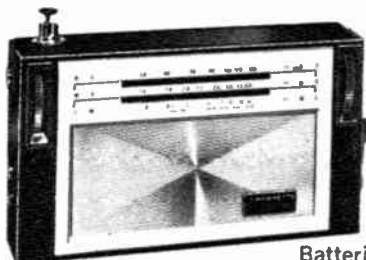

SALE!
12⁹⁵

Was 18.95
1966 Catalog 670

• Includes
Batteries and Earphones

Enjoy SW and Marine broadcasts along with entertaining standard AM reception. Covers 540-1600kc. 1.6-4.0mc. and 4-12mc. in three ranges. Super sensitive ferrite-core and 12 section whip antenna draw in distant signals. Delivers clear audio reproduction. Smart black leatherette covered cabinet has a gleaming silver front grill. Size: 7¾Wx4½Hx2"D. Complete with batteries and earphone. Imported. Shpg. wt., 5 lbs.

17 E 7904L Net 12.95
99 E 6258 Extra Z cells for above; 4 required Net ea. .09

ROYAL DELUXE 15 TRANSISTOR 4 BAND PORTABLE

Tunes AM, FM, SW, & MARINE BANDS

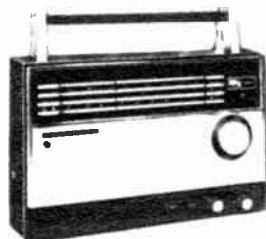

49⁹⁵

No Money Down

With 1 Year
Supply of
12 Batteries,
AC Adapter,
Earphone

Tunes the standard broadcast band 50-1600 Kc; marine band—1.7-4.7 mc.; shortwave band 5-12 mc., and FM band 88-108 mc. Powerful push-pull audio output circuit, and Separate Tone Control. Telescopic antenna "brings in" distant stations. AC adapter permits operation on 117 VAC. Case is trimmed in elegant walnut veneer finish. Size 10x8x3". Imported. Shpg. wt., 6 lbs.

17 E 6912L \$5 Monthly Net 49.95

Thrill to World-Wide Short Wave Broadcasts

LAFAYETTE 11 BAND 18 TRANSISTOR SHORTWAVE PORTABLE

- FM/AM/MARINE/LONG WAVE and 7 SW BANDS
- Operates on 6 "C" Cell Batteries or 117V AC Household Current with optional AC Adapter

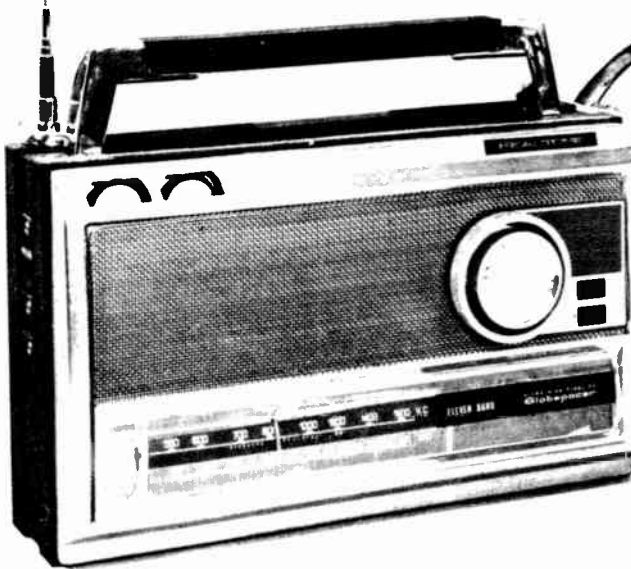

BBC

★
Radio Peking

Radio Vatican

Radio Moscow

Radio Berlin

Radio Australia

Only **99⁹⁵** NO MONEY DOWN

with Earphone and batteries

Worldwide radio listening pleasure and excitement is yours with this superb portable. 7 SW Bands (4.9Mc, 5.92-6.2Mc, 9-12 Mc, 9.5-9.7 Mc, 11.7-11.9 Mc, 15-15.5 Mc, 17.7-17.9 Mc) for thrilling shortwave broadcasts as well as 4 bands for FM, AM, Marine (2-4 Mc), and long wave (150-400 Kc). Horizontal slide rule dial with rotating cylindrical dial scale for precise and accurate tuning. Features tone control and AFC to eliminate drift on FM. For improved audio reproduction, extended side band reception can be switched in to produce hi-fi sound by means of a "Hi-Fi-DX" switch. Large ferrite bar antenna for LW and MW bands, and a multisection whip

for SW and FM bands. 2-way speaker system consists of a 4" woofer and 1 1/2" tweeter. 18 Transistors, 9 diodes, and 1 thermistor. Separate jacks for external antenna, earphone, AC (with optional adapter), speaker and phono. Size: 13x8x5" with batteries and earphone. Imported. Shpg. wt., 12 lbs. 17 E 6915WX \$5 Monthly Net 99.95

Extra "C" batteries for above. 6 required. Net ea. .13
99 E 6257

AC Adapter for playing radio on 117V AC. Net 4.95
17 E 6916

10-TRANSISTOR AM/MB/VHF SOLID-STATE PORTABLE

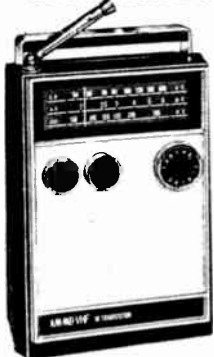

29⁹⁵
with earphone and batteries

Covers: AM Broadcast Band 54-160 KC; Marine Band 2 to 6 MC; VHF Aircraft Band 108-135 MC

Listen to aviation control towers, monitor aircraft frequencies, hear marine weather reports as well as standard AM broadcasts. Large 3 1/2" full-range speaker offers fine sound reproduction. Slide rule tuning dial. Operates on 4 penlight batteries as well as 110 VAC house current with optional AC adapter listed below. Beautiful black leather-like plastic cabinet. Dimensions: 6 3/4 x 4 5/8 x 2 1/2".

17 E 7816L Net 29.95

AC Adapter, Wt., 1/2 lb. Net 3.95

17 E 7817L Net 3.95

Extra Batteries, 4 required Net ea. .09

99 E 6258 Net ea. .09

NEW LAFAYETTE 5 BAND 16 TRANSISTOR PORTABLE

Only **59⁹⁵**

With Earphone & Batteries
No Money Down

RECEIVES:
AM
SW
FM
MARINE BAND
AIRCRAFT VHF



Superb Tonal Quality

One of the most versatile multi-band portable radios we've ever offered. You can listen to standard AM and FM broadcasts, thrilling international shortwave programs on the 4 to 12 MC band, marine navigation and weather reports on the 1.6 to 4.5 MC band, and lastly tune in the aircraft band (108 to 135 MC) and hear pilots and aircraft control towers. Marvelous reception from large 6 x 4" full range speaker powered by 16 Transistors, 5 diodes, and 1 thermistor. Twin ferrite and telescopic antennas assure superb sensitivity on all 5 bands. Features

Fine Tuning Control, AFC Lock, Dial Light, and continuous Tone control. Richly styled padded black leatherette cabinet. Earphone for private listening. Also includes Phono input jack for play phonograph thru the radio. AC Jack for playing radio of 117 VAC 60 cycle household current with optional AC adapter. Size: 11 x 7 1/2 x 3 1/4". Shpg. wt., 6 lbs. 17 E 0140L \$5 monthly Net 59.95
Extra "D" Batteries 4 required Net .13 ea.
99 E 6526 Net 4.95
17 E 0141L AC Adapter for above Net 4.95

Radios Are Available on Easy Pay Plan—No Money Down

Lafayette Cat. No. 672 45

Top Quality Performing Table Radios



NEW! SOLID STATE AM TABLE RADIO

Look At Our Low, Low Price

Only 7⁹⁹

Priced so low—you can now have a table radio in every room. Ideal for the kitchen, den, playroom. Powerful 11 semiconductor circuit. Provides fine sound quality through a big 3" speaker. Push-Pull audio power output, 2 IF stages, built-in ferrite core antenna. Attractive high-impact white plastic cabinet. For 117V, 60 cycles AC. U.L. approved. Size: 5½ x 6½ x 2½". Imported. Shpg. wt., 2 lbs.
17 E 7624 Net 7.99



Only 34⁹⁵
No Money Down

LAFAYETTE SOLID STATE TWIN-SPEAKER FM-AM TABLE RADIO

- Deluxe Oil Walnut Veneer Cabinet with Brush Gold Panel
- Twin 4" Full-Range Speakers Offer Magnificent Sound Reproduction
- AFC Lock Prevents Drift on FM

Deluxe Lafayette twin-speaker FM-AM table radio offers magnificent performance and handsome styling. Two large 4" speakers provide room filling high-fidelity sound with exceptional clarity. Powerful 16-semiconductor circuit has an output of 1 watt. Automatic Frequency Control (AFC) lock prevents drift on FM. Has big slide rule dial for precision tuning. Four controls: Selector (AM-FM-FM/AFC), On/Off Volume, Tone, and Tuning. Housed in a handsome oiled walnut veneer wood cabinet with brushed gold control panel and rich grill cloth. Size: 6¾ x 14½ x 4¾". Operates on 105-120 V AC, 50/60 cycles or 105-120 V DC. Imported. Shpg. wt., 7 lbs.
17 E 0110W \$5 monthly Net 34.95

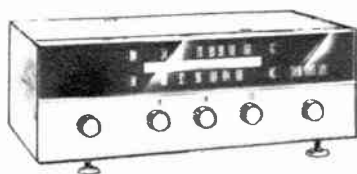

SOLID STATE FM-AM TABLE RADIO

29⁹⁵

- Handsome "Jet Age" Styling
- Powerful 3"x5" Speaker
- AFC Prevents Drift On FM

Lovely to look at, delightful to hear, this top quality FM-AM table radio with "Jet-Age" styling features all solid-state circuitry for instant-on operation. Powerful 3" x 5" full range speaker. Separate tone control to emphasize bass or treble response. Automatic frequency control (AFC) on FM locks in stations for drift-free reception. Beautiful walnut veneer cabinet with chrome face plate. Size: 10¾ x 5¾ x 3½". For 110-115V AC 60 cycles. Imported. Shpg. wt., 4 lbs.
17 E 6920 Net 29.95



SUPERB 3-BAND SOLID-STATE FM/AM/SW TABLE RADIO

39⁹⁵

No Money Down

- 2 6x4" Dynamic Twin Speakers For Full Dimensional Sound
- Precision Slide Rule Dial with Logging Scale
- Functional Indicator Lights

Smartly styled 3-band FM/AM/SW table radio. All solid-state circuitry features instant on operation. Listen to thrilling SW broadcasts as well as brilliant FM and standard AM broadcasts. 2 6 x 4" dynamic twin speakers offer outstanding sound reproduction. AFC control prevents drift on FM. 4 controls: On/Off Volume, Tone, Tuning, and

4-Position Selector (AM, FM, FM-AFC, SW). Function indicator lights for mode of operation. Attractive plastic walnut grain cabinet with plastic louvered speaker grill. Size: 21¼" x 8¾" x 7¾". For 110-120V 50/60 cycles. Imported. Shpg. wt., 8 lbs.

17 E 7814W \$5 monthly Net 39.95

Radios Are Available on Easy Pay Plan—No Money Down

Our Best Selling Clock Radios and Color TV

DELUXE LAFAYETTE SOLID STATE AM & FM-AM CLOCK RADIOS

in Beautiful Walnut Veneer Cabinets, —Magnificent Rich Sound



A FM-AM Clock Radio
39⁹⁵
 No Money Down

B AM Clock Radio
24⁹⁵

A DELUXE FM-AM CLOCK RADIO. One of the finest FM-AM clock radios we have ever offered. Powerful 15 semi-conductor solid state circuit has an undistorted output of 1 watt—gives you instant sound without any warm-up time. Continuous tone control plus slide rule dial for precision tuning. AFC lock prevents drifting off stations while listening to FM. Large 4", wide-range dynamic speaker for magnificent rich sound. Full Feature Telechron clock has a lighted dial for telling time in the dark. Sleep Switch lets you fall asleep to music (can set sleep switch up to 60 minutes), and after you are asleep radio can automatically turn itself on at a preset time. If you then wish to catch an extra few winks of sleep, just press the snooze button and the radio will turn off for 10 minutes. Radio is housed in a beautiful walnut veneer cabinet with a brushed gold control panel. Built-in FM and AM antennas. Dim: 6 $\frac{1}{2}$ "x14 $\frac{1}{8}$ "x4 $\frac{7}{8}$ ". Operates on 117V AC 60 cps. Imported. Shpg. wt., 6 lbs.
17 E 0107 \$5 Monthly Net **39.95**



B DELUXE AM CLOCK RADIO. Handsomely styled with all the features of the above FM-AM clock radio, but without FM. Dim.: 11 $\frac{1}{4}$ "x 6 $\frac{1}{4}$ "x4 $\frac{3}{4}$ ". Operates on 117V AC 60 cps. Imported. Shpg. wt., 5 lbs.
17 E 0108 Net **24.95**

NEW! SOLID STATE BATTERY OPERATED AM CLOCK RADIO

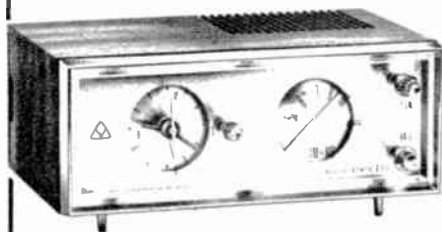

Elegant Traveling Companion Only
 3 $\frac{1}{8}$ " x 6 $\frac{3}{4}$ " x 4 $\frac{1}{4}$ "

Our Low Price **29⁹⁵**

Miniature solid state AM clock radio operates on 3 batteries (supplied). Ideal traveling companion. Includes earphone for private listening. Large 2 $\frac{1}{4}$ " speaker for fine tonal quality. Wakes you up to beautiful music at any preset time. High-impact walnut grain plastic cabinet with chrome trim. Imported.

17 E 6550L Shpg. wt., 2 lbs. Net **29.95**
 Replacement Batteries
99 E 6258 Penlite (AA) 2-required Net ea. **.09**
99 E 6257 "C" 1-required Net ea. **.13**

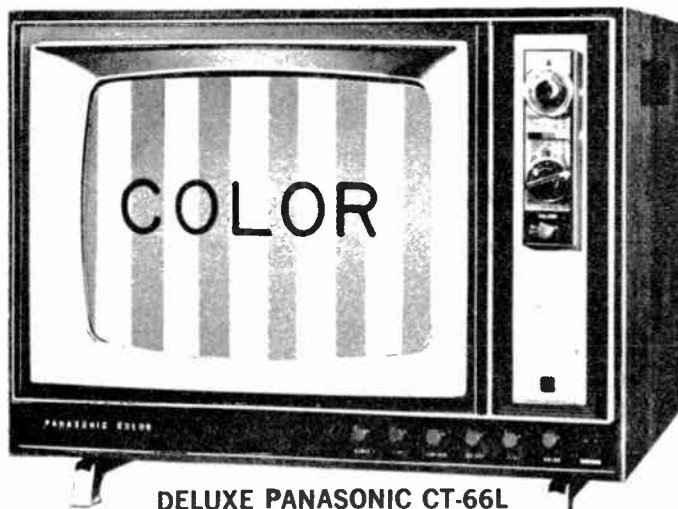

DELUXE PANASONIC CT-66L VHF-UHF TABLE MODEL COLOR TV

399⁹⁵
 No Money Down

- Big 176 Square Inch Viewing Area
- Beautiful Color Fidelity and Brightness
- Built-In Automatic De-Gaussing System

Beautiful Color TV set of enduring beauty featuring a rectangular color picture tube that gives you a big 176 square inch viewing area and an automatic de-gaussing system. Bright, rich color fidelity. Keyed AGC provides a brilliantly clear, sharp, and steady picture. Luxurious walnut cabinet, elegantly slim compact styling. Advanced circuitry—28 tubes, 1 transistor, 13 diodes, 4 silicon power rectifiers. Front mounted speaker provides superb sound reproduction. Front controls for easy, fast, convenient tuning. With earphone for private listening, dipole VHF antenna and matching console legs. Dim: 21 $\frac{1}{8}$ " x 26 $\frac{1}{2}$ " x 20 $\frac{1}{8}$ ". Imported. Shpg. wt., 100 lbs.
17 E 3012WX \$19 monthly Net **399.95**

Deluxe Musical Instrument Amplifiers

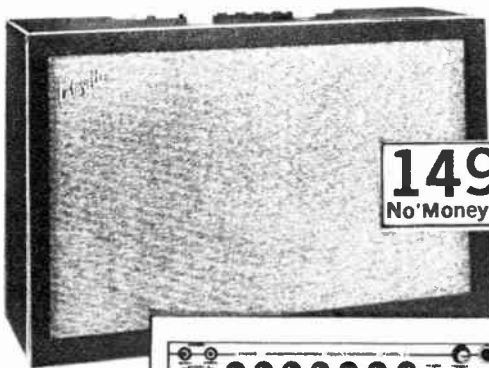

149⁵⁰
No Money Down

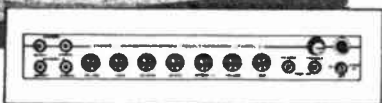

40 WATT "TREMOLO"-"REVERB" AMPLIFIER

- Hammond "Reverb" Unit For Echo-Like Effect
- Pulsating "Tremolo" For "Go-Go" Effect
- 2-12" Heavy Duty Special Design Jensen Speakers
- Enjoy "Reverb" and "Tremolo" Separately or Together With Foot Switch Control
- Two Channel, 4 Instrument Inputs

Remarkable reproduction, finest craftsmanship, make up this 40 watt dual amplifier. It produces "tremolo" and "reverb" effects separately or simultaneously. Crisp lively sound is produced by 2-12" Jensen musical instrument speakers and 8 dual tubes, used to provide 13 tube design. "Tremolo" has 'speed' and 'intensity' controls for maximum effect. "Reverb" has 'intensity' control. 4 inputs for 'normal' or 'bright', handles up to 4 instruments. Separate volume and tone controls for channel 1 and 2. Inputs for "reverb" and "tremolo" foot operated switch. 3-position switch for power/on/off and standby. Large red lamp for "power on" indication. Large output transformers for heavy-duty operation. Full 1/2" plywood cabinet, covered in black textured scuff resistant vinyl with handle. "T" nut factory installed for easy mounting of "dolly." Size: 18 3/4" H x 30 3/4" W x 10 3/4" D. Shpg. wt.. 45 lbs.

13 E 0136WX \$8 monthly Net 149.50

Dual Foot Switch For Remote Control of Tremolo and Reverb

12 E 6708 Shpg. wt., 1 lb. Net 4.50

13 E 0138WX Dolly for above amplifier Net 11.95

25-WATT MUSICAL INSTRUMENT AMPLIFIER WITH TREMOLO

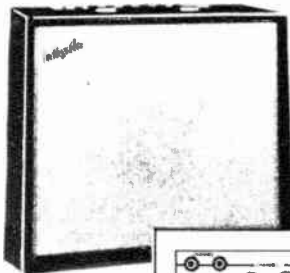

89⁹⁵
No Money Down



- Two Channel Amplifier
- Big 12" Jensen Speaker With Large 14.7 Ceramic Mag.
- 4 Instrument Inputs
- Jack For Remote Tremolo Control

A complete 25-watt, 2-channel audio amplifier! Features a built-in heavy duty Jensen speaker with a 14.7 oz. Ceramic magnet, four instrument inputs, 2-volume and 2-tone controls—one for each channel, a remote control foot switch jack for tremolo operation, plus two tremolo controls for speed and intensity. Also has On/Off switch, pilot light, top mounted fuse, carrying handle and factory installed "T" nut for easy mounting of "dolly." Constructed of 1/2" plywood covered in shimmering black vinyl. Size: 17 1/2 x 10 1/2 x 21" W. For 117V., 50/60 cycles. AC. Shpg. wt., 30 lbs.

13 E 0133WX \$5.00 monthly Net 89.95

12 E 6701 Remote foot switch. Shpg. wt., 1 1/2 lbs. Net 2.99

13 E 0138WX Dolly for above amplifier Net 11.95

50 WATT BASS GUITAR AMPLIFIER

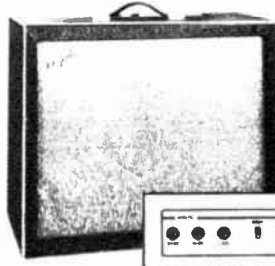

119⁹⁵
No Money Down

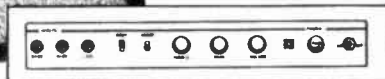

- Powerful 15" Special Design Jensen Speaker with 27 oz. Magnet
- Projects "Big Bass Sound"
- Excellent For Use With Regular Guitar, Accordion and Combo-Organ
- Rugged 3/4" Plywood Cabinet, Covered With "Shimmering" Black Vinyl
- "Easy-Reach" Top Mounted Control Panel

Fabulous, full bass sound with a minimum of distortion. Durable specially designed speaker, response from 40 to 40,000 cycles. Brushed aluminum control panel with handle up to 3 instruments. Inputs: bass, high and low. 2 slide switches for 'deep' or 'sharp' bass. 3 controls: treble, bass and volume. Neon pilot lamp indicates power/on. Fuse and 3 position switch for power/on/standby/off. Super power chassis has powerful 5 tube circuit. 3 dual purpose tubes used to provide 8 tube design, plus heavy duty transformers, provide greater output. Cabinet has attractive gray and silver acoustical cloth plus ribbed vinyl carry handle. Factory installed "T" nut makes dolly mount simple. 117 volt 50/60 cycle AC. Size: 19 1/4 x 23 1/2 x 12 3/4" deep. Shpg. wt., 37 lbs.

13 E 0137WX \$6 monthly Net 119.95

13 E 0138WX Dolly for above amplifier Net 11.95

15 WATT MUSICAL INSTRUMENT AMPLIFIER WITH TREMOLO

- Big 12" Jensen Speaker
- 3 Instrument Inputs

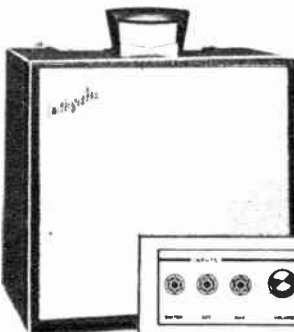

54⁹⁵
No Money Down

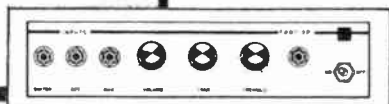

A deluxe 15-watt tremolo amplifier with big 12" specially designed speaker by Jensen. Provision for three instrument inputs. Jack provided for tremolo foot switch. Handy carrying handle. Controls: volume, tremolo speed, tone. AC chassis utilizing 4-tube circuitry. 3 dual purpose tubes, used to provide 7 tube design. Handsome brushed aluminum top mounted control panel for "easy reach." 1/2" plywood cabinet covered in luxurious black vinyl. On-off switch activates pilot light. Size: 15 1/2 H x 16 1/2 W x 10" D. For 117 volts 50/60 cycles AC. Shpg. wt., 20 lbs.

13 E 0135WX \$5 monthly Net 54.95

Foot switch for remote control of tremolo control. Shpg. wt., 1 1/2 lbs.

12 E 6701 Net 2.99

Enhance Any Music Amplifier with Dynamic

NEW

(((((**SOUND EFFECTS**)))))))

NEW

"FUZZ SOUND"

- Make your guitar or bass produce the harmony of several wind instruments!

26⁹⁵



Add more instruments to your small combo with the "Fuzz" Sound! Create a wide variety of synthesized tones such as those produced by a baritone, or bass saxophone. Battery powered, it easily connects between your guitar, or bass and the amplifier and is operated by an On/Off foot switch. Has two variable control knobs; one for regulating the "fuzz" effect and one for volume and intensity. A supplementary On/Off switch is combined with the volume control to conserve battery life. Fully transistorized, the unit is built for heavy duty use and operates on a single penlight battery. A rugged metal case protects inside circuitry. Overall size: 6¼Lx 4½Wx3"H. Shpg. wt., 1¾ lbs.

12 E 6720 Net **26.95**
 99 E 6258 Battery for above Net **.09**

LAFAYETTE "ECHO-VERB" REVERBERATION

- "Add-on" Reverb Unit for any Musical Instrument Amplifier or P.A. System

29⁹⁵



Simulates the full sound top artists get! Compact, lightweight, transistorized reverberation unit creates a new dimension in audibility to overcome dull, flat, ordinary sound. Can be used with any instrument amplifier, or P.A. system. Minutes to connect, the "Echo-Verb" may be used for sound effects. Has inputs for mike and/or instrument—plus a foot switch input to cut reverberation in or out from a remote location, pilot light and a reverb mix control that lets you select whatever intensity of reverberation you desire. With reverb mix control in the "Off" position, standard sound will be heard from the amplifier. For 117v., 50/60 cycles AC. Size: 3¾Hx11½Wx6½"D. Shpg. wt., 5 lbs.

13 E 0143 Net **29.95**

PORTABLE 8-WATT SOLID STATE TREMOLO AMPLIFIER

- Self-Contained Battery Pack/ Or May Be Operated On Household AC
- All Transistor Circuitry

39⁹⁵
 No Money Down

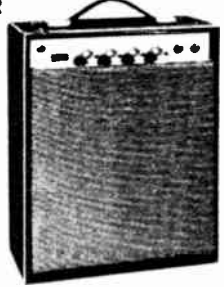

Lightweight transistorized guitar amplifier for use anywhere. Heavy-duty cabinet with handle, covered in black vinyl. Front panel contains: Pilot light, On/Off switch, 2 inputs for 2 guitars, 4 controls: Tremolo has "depth" and "speed"; Tone and Volume. Full size high quality speaker. Back panel has input for foot operated tremolo switch, plus switch for battery or AC operation. Takes 8 batteries. Size: 14Hx11¾Wx6"D. Imported. Shpg. wt., 12 lbs.

99 E 9142WX \$5 monthly Net **39.95**
 Batteries for above, 8 Required. Net ea. **.13**
 99 E 6256

FOOT-OPERATED REMOTE CONTROL for tremolo 12 E 6701 Shpg. wt., 1 lb. Net **2.99**

10-WATT TREMOLO/"REVERB" AMPLIFIER

- Tremolo Speed Strength Controls
- "Reverb" Control
- Top Mounted Controls for "Easy-Reach"

49⁹⁵
 No Money Down

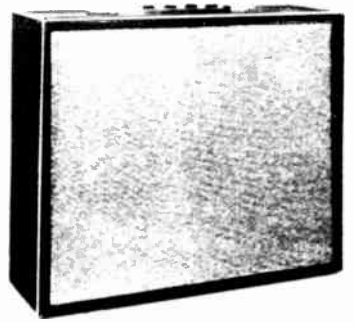

A deluxe "Reverb" amp with full dynamic sound! That no guitarist or novice should be without. Smartly styled, sturdy vinyl covered wood cabinet, with carry handle and attractive grille cloth. Top mounted controls: Off/On/Volume control with indicator lamp, tone controls, reverb control; Tremolo with intensity and speed controls. Inputs for 2 instruments plus specially designed 8" speaker for that "swingin'" sound. Powerful 1 watt amplifier has AC isolation through a heavy-duty power transformer. Size: 18½Wx15½Hx6"D. Imported. Shpg. wt., 14 lbs.

99 E 9141WX \$5 monthly Net **49.95**

"BUDGET PRICED" MUSICAL AMPLIFIER

- 3 Instrument Inputs
- 3 Tube Amplifier With Built-in Speaker

19⁹⁵

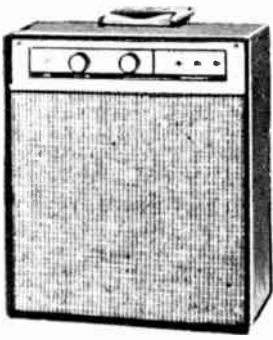

Now anyone can enjoy the sounds of an amplified guitar, with this simple "budget-priced," guitar amplifier. Brushed aluminum control panel has on/off switch, separate volume and tone, plus 3 inputs for other musical instruments. Smartly styled, wooden case, covered in pebble grained finish of black vinyl, with tweed textured baffle cloth in front. Plus sturdy carry handle of plastic. Shpg. wt., 8 lbs.

13 E 0139W Net **19.95**

5-WATT HEAVY-DUTY BASIC AMPLIFIER

- Top Mounted Controls For "Easy Reach"
- Two Instrument Inputs
- Separate Volume & Tone Controls

29⁹⁵



A dynamically designed 5-watt straight AC musical instrument amplifier. Top mounted controls and panel for "easy reach" operation. Separate volume and tone controls. Full size high-quality speaker. Speaker cone is specially treated for full brilliance of tone and long trouble-free life. AC isolation achieved through a rugged power transformer. Sturdy wood cabinet covered in beautiful black leatherette. Inputs are provided for two instruments. Pilot light operates with on-off switch. Uses no-slip rubber feet and useful carrying handle. Size: 11Hx13Wx6¼"D. For 117 volts 50/60 cycles AC. Imported. Shpg. wt., 11 lbs.

99 E 9101W Net **29.95**

Buy Now! Pay Later . . . Use Lafayette's Easy Pay Plan. No Money Down

Lafayette Cat. No. 672 49



LAFAYETTE

Guitars

"Fast Action"



A "VALUE" CUTAWAY
SOLID BODY ELECTRIC GUITAR

28⁹⁵

No Money Down

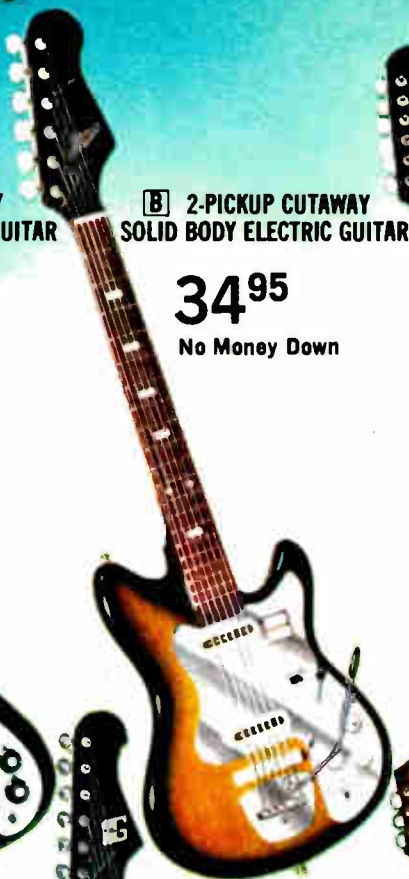

B 2-PICKUP CUTAWAY
SOLID BODY ELECTRIC GUITAR

34⁹⁵

No Money Down



C 3-PICKUP DUAL CUTAWAY
SOLID BODY ELECTRIC GUITAR

44⁹⁵

No Money Down



D "CAPRI" DOUBLE CUTAWAY
2 PICK-UP ELECTRIC GUITAR

Sale!

49⁹⁵

Save \$5.00

No Money Down

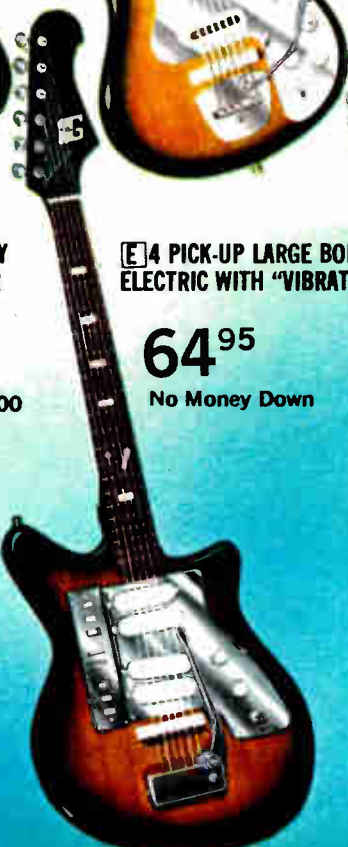

E 4 PICK-UP LARGE BODY
ELECTRIC WITH "VIBRATO"

64⁹⁵

No Money Down



F PROFESSIONAL CUTAWAY
HOLLOW BODY ELECTRIC

49⁹⁵

No Money Down

Electric Guitars



A "VALUE" CUTAWAY SOLID BODY ELECTRIC GUITAR

- Sensitive Magnetic Pick-up
- Steel Reinforced Neck
- Individual Volume and Tone Controls

The perfect instrument for the budget-minded musician, be he beginner or advanced. Features double cut-away solid body construction for that true "twangy" electric guitar sound. Other features are a sensitive magnetic pick-up with individual tone and volume controls. 20 frets with 6 marked positions. Comes complete with neck strap, cord and highly polished sunburst finish. Size: 39x12Wx14" Deep. Imported. Shpg. wt., 12 lbs.
99 E 9022WX Net 28.95

CARRYING CASE for above. Shpg. wt., 3 lbs.
13 E 8712WX Net 8.95

D "CAPRI" DOUBLE CUTAWAY 2 PICK-UP ELECTRIC GUITAR

- 2 Powerful Adjustable Pickups
- 7 Controls for Maximum Versatility
- "Hi-Response" Tremolo Tailpiece

Styled for a professional look and feel. Mahogany body with contour cut back. Rosewood fingerboard has 20 frets, celluloid binding, and seven inlaid pearl position markers. Laminated neck with steel reinforcing rod. Adjustable compensating roller bridge. Deep sparkle pickguard. Dual volume controls, tone control, and individual switches including rhythm/solo switch. 39" Long, 12" Wide, 1 3/4" Deep. Cool "mint green" and metallic teal-blue finish—hand rubbed to a super gloss. Imported. Shpg. wt., 12 lbs.
99 E 9107WX \$5 monthly Net 49.95
99 E 9143WX Molded Vinyl Case Net 10.95

B 2-PICK-UP CUTAWAY SOLID BODY ELECTRIC GUITAR

- True Vibrato Tailpiece
- Steel Reinforced Neck
- Individual Volume Controls

Vibrant, dynamic tone! Smooth body of top quality solid mahogany. Thin, 26 3/4" graceful neck of reinforced maple. Fancy rosewood fingerboard with 20 fret and 6 inlaid pearl position markers. Individual machines, adjustable bridge and chrome striped pickguard. 2 adjustable pick-ups, 2-position switch (solo-rhythm), 2 volume and 1 tone control plus input jack. Durable sun burst finish. Chrome and black tailpiece. Size: 38 1/2"H x 12W x 1 1/4"D. Imported. wt. 10 lbs.
99 E 9137WX \$5 monthly Net 34.95

CARRYING CASE for above. Shpg. wt., 3 lbs.
13 E 8715WX Net 8.95

E 4 PICK-UP LARGE BODY ELECTRIC WITH "VIBRATO"

- Genuine Mahogany Body-Contour Cut Back
- 4 Controls, 6 Switches, 4 Pickups
- Adjustable Steel Reinforced Neck

Slick! solid! professional sounding 4-pickup guitar with fast, slim neck, 6 machine heads, plus adjusting screws for each string. 7 "pearl" markers and 20 frets, on rosewood fingerboard. Adjustable bridge, 2 volume controls, 2 tone controls, plus slide switches for channel 1 and 2 with selection of mic 1 or 2, solo or rhythm positions. Heavy duty tremolo bar and chrome pick guard plus input jack. Hand rubbed, shaded finish on select mahogany. Complete with neck strap and cord. Imported. Shpg. wt. 13 lbs.
99 E 9140WX \$5 Monthly Net 64.95

Solid Molded Vinyl Case
99 E 9143WX Shpg. wt. 3 lbs. Net 10.95

C 3-PICK-UP DUAL CUTAWAY SOLID BODY ELECTRIC GUITAR

- 3 Powerful Adjustable Pick-ups
- Detachable, Steel Reinforced Neck
- Tremolo Tailpiece—Adjustable Bridge

Sleekly styled, dual cutaway solid body of select mahogany. Slim neck for fast fingering. Shaped, white celluloid-bound rosewood fingerboard, with 20 frets and 7 pearl position markers. Precision individual machines. Adjustable bridge, tremolo tailpiece, 3 magnetic pick-ups with individual rocker switches. 2 volume controls plus input jack. High-gloss hand-rubbed finish. Complete with neck strap and cord. Size: 39Lx12Wx1 1/4"D. Imported. Shpg. wt. 7 lbs.
99 E 9138WX \$5 monthly Net 44.95

CARRYING CASE for above. Shpg. wt., 3 lbs.
13 E 8715WX Net 8.95

F PROFESSIONAL CUTAWAY HOLLOW BODY ELECTRIC

- "Hi-Response" Tremolo Tailpiece
- Auditorium Size—42 1/2" x 17 1/2"
- Laminated Arched Top and Back

True professional design. Laminated maple neck with oval rosewood fingerboard. Six large inlaid position markers and nickel silver frets. White, pin-striped celluloid binding on top and back edges. Nickel plated hardware, de luxe machine heads, two sensitive pickups with individually adjustable pole pieces. Five controls permit choice of units, vary tone and volume, select between bridge pick-up for solo and forward pick-up for rhythm work. Shaded walnut finish with golden sunburst. Size 42 1/2 x 17 1/2 x 3 1/2". Imported. Shpg. wt., 18 lbs.
99 E 9121WX \$5 Monthly Net 49.95

Sturdy Case for Above
12 E 6150WX Shpg. wt. 4 lbs. Net 9.95

COMPLETE OUTFITS

SAVE UP TO 25.70

From Individual Catalog Prices

Each electric guitar outfit consists of a guitar, amplifier, case plus—neck strap, pick-up cord, extra set of 5 steel strings, 16 page instruction book with chords, illustrated fingering position, and "strum-along" favorite songs, instruction record, (*) plus tremolo foot switch. See page 48-49 for listings of amplifiers.

Outfit No.	Guitar	Amplifier	Watts	Shpg. wt.	Net
99 E 9148WXM	99 E 9022WX	99 E 9101W	5	25 Lbs.	59.95
99 E 9149WXM	99 E 9137WX	99 E 9101W	5	25 Lbs.	69.95
99 E 9150WXM	99 E 9138WX	99 E 9101W	5	25 Lbs.	78.95
99 E 9145WXM	99 E 9022WX	99 E 9142WX	8	26 Lbs.	72.95
99 E 9146WXM	99 E 9137WX	99 E 9142WX	8	26 Lbs.	77.95
99 E 9147WXM	99 E 9138WX	99 E 9142WX	8	26 Lbs.	87.95
99 E 9151WXM	99 E 9022WX	99 E 9141WX	10	33 Lbs.	81.95
99 E 9152WXM	99 E 9137WX	99 E 9141WX	10	33 Lbs.	86.95
99 E 9153WXM	99 E 9138WX	99 E 9141WX	10	33 Lbs.	95.95
99 E 9160WXM*	99 E 9140WX	13 E 0135WX	15	38 Lbs.	122.95
99 E 9163WXM*	99 E 9107WX	13 E 0135WX	15	37 Lbs.	108.95
99 E 9169WXM*	99 E 9121WX	13 E 0135WX	15	43 Lbs.	108.95
99 E 9161WXM*	99 E 9140WX	13 E 0133WX	25	48 Lbs.	154.95
99 E 9164WXM*	99 E 9107WX	13 E 0133WX	25	47 Lbs.	138.95
99 E 9170WXM*	99 E 9121WX	13 E 0133WX	25	53 Lbs.	138.95
99 E 9162WXM*	99 E 9140WX	13 E 0136WX	40	63 Lbs.	208.95
99 E 9165WXM*	99 E 9107WX	13 E 0136WX	40	62 Lbs.	194.95
99 E 9171WXM*	99 E 9121WX	13 E 0136WX	40	68 Lbs.	194.95



The Professional Look



(A) BEGINNERS CHOICE

19⁹⁵

(B) 4-PIECE OUTFIT

119⁹⁵

No Money Down



5-PIECE OUTFIT

174⁹⁵

No Money Down



(C) 19⁹⁵

(E) 49⁹⁵

No Money Down

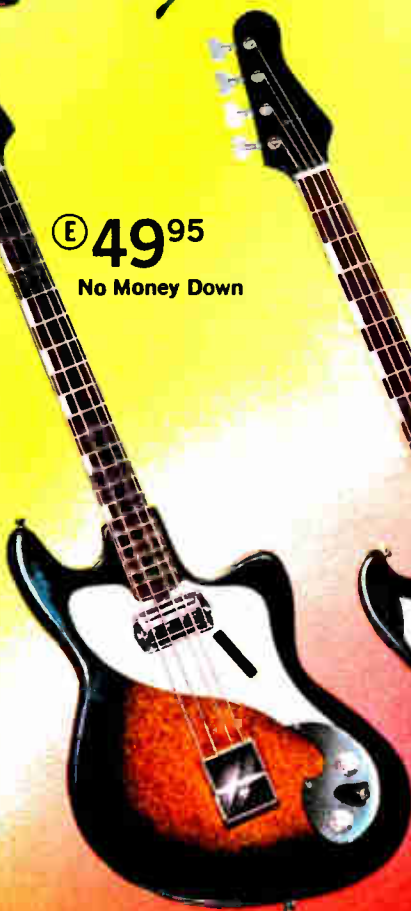

(D) 34⁹⁵

No Money Down

(F) 64⁹⁵

No Money Down



(G) 14⁹⁵



and "BIG BEAT" Sound



A 7 PIECE "ECONOMY OUTFIT"

- Everything You Need Including A Beginner's Record Course to Start You Off Right

7-piece special guitar outfit with beginner's instruction book and record course. You get: guitar, guitar bag, instruction book and record course, 3 guitar picks, extra set of strings, neck cord. Guitar has hardwood body with spruce top, highly polished finish with steel reinforced neck. White striping around top edge and sound hole. Imported. Shpg. wt., 9 lbs.
 13 E 8723WX Complete Outfit Net 19.95
 Guitar Only. Shpg. wt., 7 lbs.
 13 E 8724WX Net 14.95

B 4-PC "COMBO" DRUM OUTFIT

- Complete With Brushes/Sticks

14" x 20" single-tension bass drum with permanent-type tom-tom and cymbal holders. 14" x 5 1/2" snare drum with separate tension flanged hoop, metal snare, professional throw-off. 12" x 8" tom-tom with separate tension, flanged hoops. 12" cymbal, drum pedal with adjustable beater and springs, disappearing spurs, snare-drum stand, holder for tom-tom sticks. Metal parts are highly nickel plated. Bright sparkle finish. Imported. Shpg. wt., 45 lbs.
 13 E 8701WX \$6.50 monthly Net 119.95

5-PC "PRO" DRUM OUTFIT

- Complete with 16"x16" floor tom-tom

Meets professional demands for sound and quality in every way. Each drum has completely adjustable tension rods for quick and easy tuning. The set consists of: Bass drum with double fast action pedal (14" x 20"). Snare drum (5 1/2" x 14"). Tom-tom (9" x 13"). Floor tom-tom (16" x 16") and 14" brass cymbal; plus handy shelf mounted tom-tom holder and cymbal holder with tilter. Snare features non-creep flush base stand. Complete set of brushes and sticks with every set. Drums have long-lasting scuff-resistant sparkling finish. Imported. Shpg. wt., 55 lbs.
 12 E 8713WX \$9 monthly Net 174.95

C CONCERT SIZE CLASSIC GUITAR

Quality sound at a moderate cost. Steel reinforced neck, rosewood fingerboard with pearl position markers, slotted headpiece keeps strings in place. 6 tuning machines with plastic rollers. Finely finished mahogany, back and sides, complete with clear spruce top. Intricate pearl inlay around sound hole. Sturdy reinforced bridge of rosewood. Imported. Shpg. wt., 10 lbs.
 12 E 8711WX Net 19.95
 Sturdy Case For Above. Shpg. wt., 4 lbs.
 13 E 87 41 Net 8.95

D SNARE DRUM OUTFIT

- Complete with Stand, 10" Cymbal Brushes, Sticks

An exciting snare drum at a low Lafayette price. 14" x 15 1/2" separate tension snare drum with metal snares, tone modulator, heavy duty throw-off, flanged hoops, rolled rims, nickel plated hardware. Bright sparkle finish. Complete with deluxe flat base stand. 10" cymbal, sticks, brushes, instruction book. Imported. Shpg. wt., 15 lbs.
 13 E 8705WX \$5 monthly Net 34.95

E SOLID BODY ELECTRIC BASS

- "Hi-Response" Magnetic Pick-up
- Adjustable Steel Reinforced Neck
- Fully Adjustable Bridge
- Contoured Cut Solid Body of Mahogany

Clear, true bass tones are yours, with this finely constructed bass. 4 individual chrome-plated machine heads for precise and accurate tuning. Sturdy 3 piece laminated neck, celluloid bound rosewood fingerboard, 20 frets, 6 large white inlay markers for easy positioning. Beveled, contoured body in shaded mahogany finish. "Pearlized" pick guard, volume and tone controls. Complete with neck strap and cord. 46L x 15 1/2 W x 1 3/4" D. Imported. Shpg. wt., 15 lbs.
 99 E 9124WX \$5 monthly Net 49.95
 Sturdy Case for above bass. Shpg. wt., 3 lbs.
 12 E 8710WX Net 10.95

SAVE \$18¹⁵

ELECTRIC BASS OUTFIT: Includes 99 E 9124WX electric bass, 13 E 0137WX 50 watt bass amplifier, 12 E 8710WX case plus "Modern Electric Bass Guitar Method" book. Shpg. wt., 57 lbs.
 99 E 9173WX \$9 monthly Net 163.95

F DELUXE 2 PICK-UP ELECTRIC BASS

- Long Slim-Fast Action Neck
- Adjustable Steel Reinforced Neck
- Individual Volume Controls

Lively, attractively contoured, beveled body of select mahogany woods, with hand-rubbed shaded finish. 4 chrome-plated machines, celluloid bound rosewood fingerboard with 20 fret positions and 6 white inlay markers. Chrome pick guard, 2 powerful magnetic pick-ups with individual controls, adjustable bridge, tone and 2 volume controls plus input jack. Complete with neck strap and cord. 46L x 15 1/2 W x 1 3/4" D. Imported. Shpg. wt., 15 lbs.
 99 E 9123WX \$5 monthly Net 64.95
 Sturdy Case for above. Shpg. wt., 3 lbs.
 12 E 8710WX Net 10.95

SAVE \$19⁸⁰

2 PICKUP ELECTRIC BASS OUTFIT: Includes 99 E 9123WX 2 Pickup electric bass; 13 E 0137WX 50 watt base amplifier; 12 E 8710WX case, plus "Modern Electric Bass Guitar Method" book. Shpg. wt., 57 lbs.
 99 E 9174WX \$9 monthly Net 177.95

D SNARE DRUM OUTFIT

- Complete with Stand, 10" Cymbal Brushes, Sticks

An exciting snare drum at a low Lafayette price. 14" x 15 1/2" separate tension snare drum with metal snares, tone modulator, heavy duty throw-off, flanged hoops, rolled rims, nickel plated hardware. Bright sparkle finish. Complete with deluxe flat base stand. 10" cymbal, sticks, brushes, instruction book. Imported. Shpg. wt., 15 lbs.
 13 E 8705WX \$5 monthly Net 34.95

G PROFESSIONAL TUNABLE BONGOS

Pure white perfect calfskin heads for best rhythm effect. Sparkling color finish. Sturdy construction with heavy plated hardware. Four tuning-lugs on each bongo. Head sizes: 7 3/4" and 8 1/2". Overall 7" deep. Complete with Tuning Key. Imported. Shpg. wt., 5 lbs.
 13 E 8704W Net 14.95

SETH THOMAS KEYWOUND METRONOME

11⁵⁰

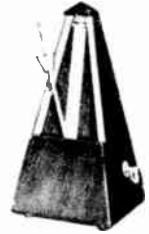

The original Seth Thomas metronome, from America's first and only manufacturer of keywound metronomes. A useful aid in music and dancing instruction, or wherever beat timing is important. Adjustable pendulum permits selection of beat tempo from 40 to 208 beats per minute. Selected hardwood case finished in walnut. Height 8 5/8", Base 4 1/2".
 13 E 4450 Shpg. wt., 2 lbs. Net 11.50
 Above but mahogany finish. Net 11.50
 13 E 4452 Net 11.50

SETH THOMAS ELECTRONIC METRONOME

16⁹⁵



Precision instrument, contains 2 complete electronically calibrated beat systems; audible and visual. 40 to 208 beats per minute. Single knob control, calibrated radial dial plus neon light. Wooden cabinet, operates on 115 V AC 60 cycles. Shpg. wt., 3 lbs.
 13 E 4453 Walnut. Net 16.95
 Mahogany Shpg. wt., 3 lbs. Net 16.95
 13 E 4454 Net 16.95

HOW TO PLAY THE GUITAR

3⁵⁰

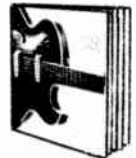

The easy way to learn all the chords and rhythms on your guitar. Has vocal accompaniment; ballad styles; folk, country and western; rhythm and blues; shuffle beats. Features guitar demonstration and text by George Barnes, spoken commentary by Bob Mersey. Shpg. wt., 1 lb.
 24 E 4506 Net 3.50

RETRACTABLE GUITAR CORDS WITH PLUGS

As Low As

1⁴⁹



Shpg. wt., 4 oz. Net 1.49
 99 E 9127 10 Ft. Net 1.99
 99 E 9128 16 Ft. Net 1.99
 99 E 9129 20 Ft. Net 2.49

To Speed Your Mail Order - Please Give Your Zip Code Number

Lafayette Cat. No. 672 53



LAFAYETTE

Walkie-Talkie

Our Walkie Talkies A Snap To



Our low, low Price **5⁹⁹** each
 No License Required, FCC Regulation Part 15

MODEL HA-70C ALL TRANSISTOR "SPACE COMMANDER" CB WALKIE TALKIE

- Not a Kit—Completely Wired
- Crystal Transmit
- Sensitive Superregenerative Circuit
- Interstage Driver Transformers... More Audio, Huskier Modulation

Excellent for countless short range applications up to 1/4 mile. This compact Lafayette Walkie Talkie is a 3-transistor transceiver with crystal control on transmit and with efficient super-regenerative receiver — has minimum external ignition noise pickup when voice signal is being received. Has Push-to-Talk button, on-off volume control and efficient speaker that is also used as microphone. Complete with built-in telescopic antenna, crystal, 9-volt battery and plastic carrying case. Size: 5½x2½x1¾". Imported. Shpg. wt., 1 lb.

*Does not have plug in crystals.
99 E 3080L Model HA 70C _____ Net ea. **5.99**
99 E 6021 Replacement Battery _____ Net .21

Optional 9-Volt Lead-Acid Rechargeable Battery Plus Charger. Imported. Shpg. wt., 6 oz.
99 E 9016 _____ Net **2.69**

Replacement 9-Volt Lead-Acid Rechargeable Battery. Imported. Shpg. wt., 2 oz.
99 E 6026 _____ Net **1.49**

54 Lafayette Cat. No. 672

10⁹⁵ each
 No License Required, FCC Regulation Part 15

MODEL HA-130 A 5-TRANSISTOR SUPERHETERODYNE CB WALKIE-TALKIE

**Superheterodyne —
NOT SUPERREGENERATIVE**

- Power Packed Distance Spanning Transmit Circuitry
- Greater Sensitivity and Selectivity with Less Receiver Noise

5 transistor, 2 diode circuit employs crystal-controlled superheterodyne receiver for clear, crisp reception and extra powered 100 milliwatt transmitter using plug-in, easy-to-change crystals. Simple to operate—only a push-to-talk switch and on/off volume control, collapsible 34-inch antenna. Housed in durable black and silver simulated leatherette plastic case. Supplied with channel 10 transmit and receive plug-in crystals and 9 volt battery. Size: 2¾x5¾x1½"D. Imported. Shpg. wt., 2½ lbs.

99 E 3089L _____ Net ea. **10.95**
 Transmit Crystal (specify channel)
42 E 0907C _____ Net ea. **2.25**

Receive Crystal (specify channel)
42 E 0137C _____ Net ea. **2.25**

99 E 6021 9 Volt Battery _____ Net .21
 Optional 9-Volt Lead-Acid Rechargeable Battery Plus Charger. Imported. Shpg. wt., 6 Oz.
99 E 9016 _____ Net **2.69**

Replacement 9-Volt Lead-Acid Rechargeable Battery. Imported. Shpg. wt., 2 Oz.
99 E 6026 _____ Net **1.49**

ONLY 14⁹⁵ each
 No License Required, FCC Regulation Part 15

MODEL HA-62 2-CHANNEL 6-TRANSISTOR SUPERHETERODYNE CB WALKIE-TALKIE

**Increased Sensitivity—
Increased Selectivity—
Minimum Receiver Noise!**

- New Power-Boost Transmitter Circuit for Super Talk Power!
- 6 Transistors Plus 2 Diodes
- Push-Pull Audio

Small lightweight transceiver includes a selective superheterodyne receiver section which incorporates capacitor fed reflex circuitry. Design yields the equivalent of 9 transistor functions! This combines with push-pull audio and 2 channel operation to permit greater flexibility, higher sensitivity, and extended range. Applications are virtually unlimited. Case features beautiful die-cast chrome high-lighted front panel. Supplied with built-in earphone jack, carrying strap, telescoping antenna, battery, and crystals for channel 9. Size: 5¾x1¾x4x2¾"W. Imported. Shpg. wt., 3 lbs.

99 E 3079L _____ Net ea. **14.95**
99 E 6021 Replacement Battery _____ Net .21

Transmit Crystal (specify channel)
42 E 0907C _____ Net **2.25**

Receive Crystal (specify channel)
42 E 0137C _____ Net **2.25**

Optional 9-Volt Lead-Acid Rechargeable Battery Plus Charger. Imported. Shpg. wt., 6 Oz.
99 E 9016 _____ Net **2.69**

Replacement 9-Volt Lead-Acid Rechargeable Battery. Imported. Shpg. wt., 6 Oz.
99 E 6026 _____ Net **1.49**
99 E 2541 Earphone for HA-62 _____ Net **1.29**

Prices & Specifications Subject to Change Without Notice.
 World Radio History

Feature Plug-In Crystals ... Operate 23 Channels



ONLY 19⁹⁵ each
No License
Required,
FCC Regulation
Part 15

**MODEL HA-295 2-CHANNEL
8-TRANSISTOR SUPERHET
WALKIE TALKIE with RANGE BOOST**

- Extra Efficient Transmitter For Real Talk Power
- Push-Pull Audio and Modulator
- Range Boost for Greater Range

Powerful 8-transistor, 3-diode circuitry, combined with push-pull audio provides dependable talk-listen power over extended range. Special transmitter circuitry gives clear crisp audio under adverse conditions: RF stage improves reception. Housed in a "high impact plastic case." Excellent for any commercial or recreational use: indoor or outdoor activities. Supplied with hand carrying strap, telescopic whip antenna, earphone jack and 9V battery plus crystals for channel 10. Size: 6¼Hx1¾Wx2¼"D. Imported. Shpg. wt., 1½ lbs.

99 E 3078L Net ea. 19.95
9 Volt replacement battery. Shpg. wt., 3 oz.
99 E 6021 Net ea. .21
Transmit Crystal (specify channel)
42 E 0907C Net 2.25
Receive Crystal (specify channel)
42 E 0137C Net 2.25
9-Volt Lead-Acid Rechargeable Battery Plus
Charger
99 E 9016 Imported. Shpg. wt., 6 oz. Net 2.69
Replacement 9-Volt Lead-Acid Rechargeable
Battery
99 E 6026 Imported. Shpg. wt., 2 oz. Net 1.49
40 E 7901 Earphone for HA-295 Net .59

ONLY 24⁹⁵ each
No license
required,
FCC regulation
part 15

**MODEL HE-210
2-CHANNEL 10-TRANSISTOR
RANGE BOOST™ WALKIE TALKIE**

**NOW with B-E-E-P TONE
CALL ALERT**

- Two Channels For More Versatility
- Built-in Range Boost For Greater Range
- 10-Silicon Transistors For Dependable Power

Complete Portable 2-way communications for everyone, everywhere: Hunting, fishing, boating, construction, warehouse, office and on the farm. Weighs only 16 ounces and easily slips into your pocket. Powerful transmitter with built-in Range Boost circuitry gives greater effective range. Incorporates efficient, economical Call-Alert system. Just leave walkie talkie in low battery drain, receive position. You will receive an alert tone when you are called, switch to voice and communicate in normal push-to-talk manner. In professionally designed black and brushed aluminum metal case. Supplied with antenna, 6 penlight batteries and a pair of crystals for channel 10. Imported. Size: 6¾x2¼x1¾". Shpg. wt., 2½ lbs.

99 E 3104L Net ea. 24.95
Replacement Dry-Cell Batteries (6 req.)
99 E 6258 Net ea. .09
Heavy Duty Alkaline Battery (6 req.)
32 E 4888 Net ea. .325
Extra Transmit Crystal (specify channel)
42 E 0907C Net 2.25
Extra Receive Crystal (specify channel)
42 E 0137C Net 2.25

29⁹⁵ each

**MODEL HA-99
2-CHANNEL 300MW
SUPER POWER WALKIE TALKIE**

**9-Transistors, 3-Diodes,
2-Thermistors**

- 300 Milliwatts Power
- Two Switchable Channels
- Range Boost For Greater Range
- Push-Pull Audio and Modulator
- With Leather Carrying Case

Beautifully styled Walkie Talkie features 300 Milliwatts input and built in Range Boost circuitry increasing effective range. Crystal controlled transmitter and superhet receiver. RF stage improves reception. Push-Pull audio for better sound. Two switchable channels give multiple channel versatility at the flip of a switch. Supplied with pair of crystals for channel 10, batteries, leather carrying case telescoping antenna. Handsome black and silver metal case. Complete with F.C.C. License application Form 505, per regulation 95. Size: 2¾W x 7½H x 1½"D. Imported. Shpg. wt., 2¾ lbs.

99 E 3072L Net ea. 29.95
Extra Transmit Crystal (specify channel)
42 E 0907C Net ea. 2.25
Extra Receive Crystal (specify channel)
42 E 0137C Net ea. 2.25
Replacement Batteries for HA-99 (8 required)
99 E 6258 Net ea. .09
External DC Power Cord for HA-99
99 E 3077 Net .89

Prices and Specifications Subject to Change Without Notice



NEW!

ONLY

39⁹⁵

No Money Down
MODEL GT-50A

with



**TONE
ALERT**

**MODEL GT-50A 500 MILLIWATT
2-CHANNEL 13-TRANSISTOR
CB WALKIE TALKIE**

Range Boost™ For Greater Range

- Separate Microphone and Speaker for More Efficiency
- 500 Milliwatts For Plenty of Sock!
- 2-Channel For Greater Versatility
- 13-Transistor Superheterodyne Circuitry
- Battery Indicator Meter
- Variable Squelch and Automatic Noise Limiting
- Automatic Volume Control
- Push-Pull Audio Power

Simple to operate, use it for sports or business purposes. Offers 2-channel crystal controlled operation. Self contained automatic noise limiting circuitry, and variable squelch control to reduce background noise. Beep tone signals incoming calls. No need to waste time monitoring air for calls. Has range boost for greater effective signal strength, coupled with 500 milliwatts output power for added range. Other features include: meter to indicate condition of batteries, automatic volume control to prevent audio distortion at close range, 2-transistor push-pull audio amplifier. Power is supplied by 8 penlight batteries, or, optional 117-volt AC power pack. Unit is housed in a durable hi-impact plastic base. Supplied with FCC License Application Form 505 per Regulation 95, 44-inch telescopic antenna, batteries and crystals for channel 10. Size: 2 1/4" W x 9 7/8" H x 2 1/2" D. Imported. Shpg. wt., 3 lbs.

99 E 3126L	\$5 monthly	Net ea.	39.95
99 E 6258	Replacement batteries (8 req.)	Net ea.	.09
44 E 4204C	Extra Transmit Crystal (specify channel)	Net	2.25
42 E 4205C	Extra Receive Crystal (specify channel)	Net	2.25
99 E 3105	AC Power Pack 117-Volt AC. Shpg. wt., 1 lb.	Net	12.95

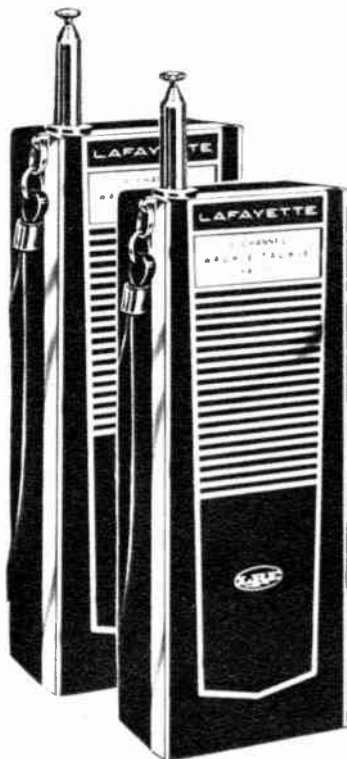

ONLY

47⁹⁵ each

No Money Down
**MODEL
HA-711**

**MODEL HA-711 3-CHANNEL
1 WATT CB WALKIE TALKIE**

- 1 Watt For Superior Walkie Talkie Power!
- 3-Channels For Extra Versatility
- 12-Transistors, 2-Diodes, Thermistor
- Variable Squelch and Automatic Noise Limiting
- Sensitive, Selective Superheterodyne with AVC
- Push-Pull Audio For Plenty of Listening Power
- With Carrying Strap

Efficient 12-transistor, 2-diode circuit for dependable, trouble-free performance. Provides excellent service between units in 2-way communications. 3-Channel capability for added versatility, 1-watt power for huskier signal strength. Ideal for mobile communications! Easy to operate, just select 1 of 3-channels, set volume and squelch controls to desired level, push button to talk, release to listen. Sensitive selective superheterodyne circuit and temperature compensating components (thermistors) eliminate frequency fade-out. Equipped with earphone jack, external antenna jack and telescopic antenna. Supplied with 8 "Z" cell penlight batteries, carrying strap and earphone jack. Complete with FCC Commission License Application Form 505 per Regulation 95, and pair of crystals for channel 7. Size: 3" x 8" x 1 3/4". Imported. Shpg. wt., 2 1/2 lbs.

99 E 3081L	\$5 monthly	Net ea.	47.95
99 E 6258	Replacement Dry Cell Batteries (8 req.)	Net ea.	.09
	Heavy Duty Alkaline Replacement Batteries (8 req.)		
32 E 4886		Net ea.	.325
42 E 4204C	Transmit Crystal (specify channel)	Net ea.	2.25
42 E 4205C	Receive Crystal (specify channel)	Net ea.	2.25
	Model HA-711 Modified for Gov't. Frequency 27.575mc.		
99 E 3093YL	(specify 27.575mc) \$5 monthly	Net ea.	57.95
	Model HA-711 Modified for C.A.P. Frequency 26.62mc.		
99 E 3092YL	(specify 26.62mc) \$5 monthly	Net ea.	57.95
40 E 7901	Earphone for HA-711	Net	.59

Batteries

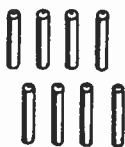

A LAFAYETTE

BREAK-THROUGH!

**5 WATTS of POWER
YOU CAN HOLD IN
YOUR HAND!**

Only **DYNA-COM 5**
99⁹⁵
No Money
Down
with leather Shoulder Strap

3 CHANNELS



Approved in Canada
D.O.T. No. 169 361 116

- Superheterodyne Receiver With Less Than 1 Microvolt Sensitivity for 10 db S-N Ratio
- Mechanical Filter for Superior Selectivity
- Automatic Compressor Range Boost — Assures High Talk Power
- Variable Squelch and Automatic Noise Limiting for Minimum Noise
- Battery Condition and Automatic Relative RF Power Output Indicator

The Dyna-Com 5 is small in size—BIG in performance and versatility. A Lafayette exclusive, this amazing 2-way radio has every feature you have ever wanted in a compact walkie-talkie. The unique, removable battery pack facilitates charging ni-cad batteries on or off the walkie-talkie. You always have a fresh supply of batteries on hand. In addition, an optional portable dry cell power pack keeps reserve power on tap when you need it. The unit may be connected to your auto, boat or tractor battery and external antenna for the ultimate

- ★ 3 Switchable Crystal Controlled Transmit and Receive Channel Positions for All 23 Channels
- ★ 5-Watt FCC Maximum Input... with the Power of the Most Powerful Base and Mobile CB Transceivers
- ★ 13 Transistors, 6 Diodes
- ★ 7-Stage Transmitter for Extra Transmit Sock!
- ★ Operate Mobile in Your Car with Optional Cigarette Lighter plug-in Adapter

- External Antenna Jack Permits Use with Base Station and Mobile Antennas
- Provision for External Battery Pack, Mobile Battery and Battery Charger
- Pi-Network Antenna Matching for Maximum Output
- Push-pull audio/modulator circuit for more powerful speech transmission and reception

in portable convenience. Attractive die-cast brushed aluminum case with shoulder carrying strap. Measures only 3 3/4" W x 10 1/4" H x 2 1/4" D. Supplied with transmit and receive crystals for channel 10, telescoping whip antenna and FCC license application Form per regulation 95. Imported. Shpg. wt., 5 lbs. See optional accessories. Less batteries.

99 E 3087L \$5 monthly Net 99.95

ACCESSORIES

- Extra Crystals, Specify Channel
- 42 E 0907C Transmit Net 2.25
 - 42 E 0137C Receive Net 2.25
- DYNA-COM 5—Modified for 26.62 Mc (CAP)
- 99 E 3107YL \$6 monthly Net 109.95
- DYNA-COM 5—Modified for 27.575 Mc (Gov't)
- 99 E 3108YL \$6 monthly Net 109.95

Extra Battery Pack
Consists of extra removable back of walkie-talkie plus battery holder and 12 nickel cadmium rechargeable batteries. Permits charging of complete Battery Pack outside of walkie-talkie while another Pack is in use with DYNA-COM 5. Imported. Shpg. wt., 2 lbs.
99 E 3099 Net 27.50

- Battery Accessories for DYNA-COM 5**
Nicaid Rechargeable Batteries.
- 32 E 4740 (12 required) ea. Net 1.93
- Alternate Heavy-Duty Alkaline Batteries
- 32 E 4886 (12 req.) ea. Net .325

- DYNA-PACK**
Neatly designed external battery pack with 10 "D" size dry cell batteries. Plugs into DYNA-COM 5 to assure reserve power when required in the field. Imported 3 x 3 1/8 x 7 1/2". Shpg. wt., 4 lbs.
99 E 3101 Net 5.95
- Replacement "D" Dry Cell Batteries
- 99 E 6256 (10 required) Ea. Net .13
 - lots of 10 Ea. Net .125
- Replacement "D" Heavy Duty Alkaline Batteries for DYNA-PACK
- 32 E 4884 (10 req.) Ea. Net .65

DYNA-CHARGE

- Efficient nickel cadmium battery charger capable of charging from 8 to 15 nickel cadmium "Z" size cells. Recharging current, 40 milliamps. 117v. 60 cycle AC input. Plugs directly into DYNA-COM 5 charge jack and into jack of Extra Back Battery Pack. Size 3 1/4" x 2 3/4" x 2". Imported. Shpg. wt., 2 lbs.
99 E 3100 Net 9.95
- ANTENNA ADAPTER - CABLE** Connects PL-259 plug of external antenna to Dyna-Com's external antenna jack.
- 42 E 0920 Net 2.95
- Mobile cigarette lighter cable** assembly permits operation of Dynacom from car 12 volt DC cigarette lighter.
99 E 4605 Net 2.95

Buy Now! Pay Later . . . Use Lafayette's Easy Pay Plan. No Money Down

LAFAYETTE
Walkie-Talkie

HA-300B 2-Watt 3-Channel 18 Semiconductor CB Walkie Talkie

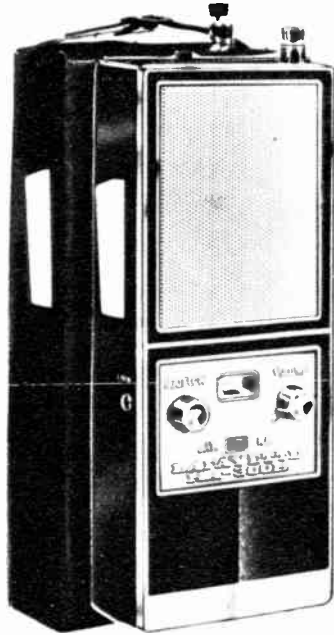

NEW!



3-Channel Switch



Battery Indicator



Battery Eliminator
Charger

Only
62⁹⁵
No Money Down

- 2-Watts Input for Super Power
- 3-Crystal Controlled Switchable Transmit and Receive Channels
- Automatic Range Boost™
- 13 Transistors, 5 Diodes
- Push-Pull Modulator and Audio Output
- Full Variable Squelch • ANL • AVC
- Battery and RF Indicator

With Genuine Leather Case, Earphone, Battery Holder

Powerful 2-watt transmitter combined with extra sensitive superheterodyne receiver make this an ideal portable 2-way communications instrument for industry, as well as camping, fishing and hunting. Deluxe features include 3 switchable crystal control channels for greater versatility; automatic Range Boost on transmit mode for more effective range; variable squelch control and automatic noise limiter for quieter communications. Has battery condition and relative RF power meter indicator. Complete with leather carrying case, strap, earphone, set of crystals for channel 7, 52" telescoping whip, battery holders for 8 1/2 Volt pen cells or 10 1/4 Volt nickel cadmium batteries, jack for external base or mobile antenna and FCC license application Form 505, per regulation 95. Attractive, die-cast metal case, 9 H x 3 1/2 W x 1 3/4" D. Imported. Shpg. wt., 3 1/2 lbs.

99 E 4886 Heavy duty Alkaline Pencil battery (8 req.) Ea. Net	.325
Battery Pack. Consists of holder plus 10 NiCad Batteries.	
99 E 3085	Net 19.95
32 E 4740 Replacement Nickel Cadmium Batt.	Ea. Net 1.93
AC Battery Eliminator for HA-300B plus Charger for Nickel Cadmium batteries. Fused. 12v DC output imported.	
99 E 3083 Shpg. wt., 4 lbs.	Net 13.95
42 E 0907 C Transmit Crystal (Specify Channel)	Net 2.25
42 E 0137 C Receive Crystal (Specify Channel)	Net 2.25
Model HA-300B Modified for operation on C.A.P. 26.62 mc	
99 E 9176YL	Net 72.95
Model HA-300B Modified for Gov't 27.575 mc	
99 E 9177YL	Net 72.95



Model HA-303 2-Watt 3-Channel CB Walkie Talkie

NOW WITH **B-E-E-P** **TONE CALL ALERT**

Only
54⁹⁵
No Money Down

- 13-Transistors, 4-Diodes
- Push-Pull Modulator and Audio Output
- Superhet Receiver plus RF Amplifier
- Battery Condition Indicator
- Variable Squelch
- Automatic Noise Limiting • AVC
- With Leather Carrying Case
- External Antenna Jack
- Battery Eliminator Socket

3-Crystal Controlled Transmit and Receive Channels!
2-Watts Input for Super Walkie Talkie Power!
Range Boost with Switch for Greater Audio Range!

Powerful, dependable walkie-talkie features 3 channel operation for flexible communications. Keeps you in contact with the office, home, or members of your hunting or fishing party. The HA-303's superhet receiver has a tuned RF amplifier to pull in weak signals with ease. Selective circuits virtually eliminate annoying electrical and ignition interference. Can transmit or receive an altering tone signal with tone slide switch in CALL or NORM positions respectively. Operates on batteries or 117 Volts AC with optional battery eliminator. Other quality features include; built-in battery condition meter, jack for connecting any existing mobile or base station antenna and attractive metal case with die-cast front panel. Supplied with telescoping antenna, battery holder (less batteries), one set of crystals for channel 11, and FCC License Application Form 505, per regulation 95. Size: 3 1/4 W x 8 1/4 H x 1 3/4" D. Shpg. wt., 3 1/2 lbs. Imported. Less batteries.

99 E 3091L \$5.00 Monthly	Net ea. 54.95
32 E 4740 Nickel Cadmium Battery (10 req.)	Net ea. 1.93
Heavy Duty Alkaline Penlight Battery (10 req.)	
32 E 4886	Net ea. .325
99 E 3109 Battery Eliminator-Charger	Net 13.95
42 E 0907 C Transmit Crystal (Specify Channel)	Net 2.25
42 E 0137 C Receive Crystal (Specify Channel)	Net 2.25
Model HA-303 Modified for C.A.P. 26.62 mc (less batteries)	
99 E 3095YL (Specify 26.62 MC) \$5.00 Monthly	Net ea. 64.95
Model HA-303 Modified for Gov't 27.575 mc (less batteries)	
99 E 3096YL (Specify 27.725 MC) \$5.00 Monthly	Net ea. 64.95

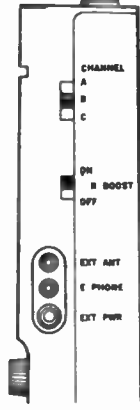
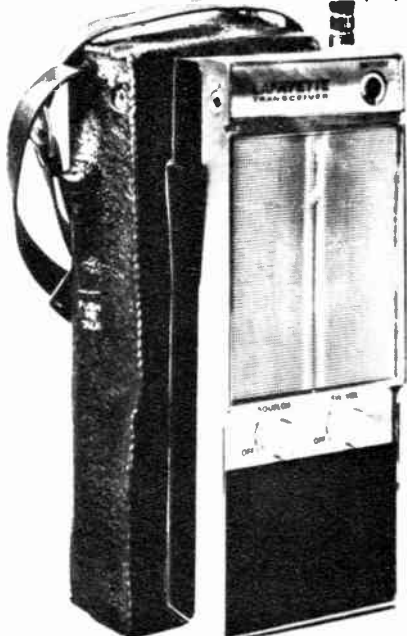

NEW! LAFAYETTE HB-525A Solid State Mobile 2-Way Radio

23 CB Plus 2 Reserve Crystal Controlled Channels*

All Crystals Supplied!

Now ... Accepts Priva-Com® Plug-in Private Tone Caller

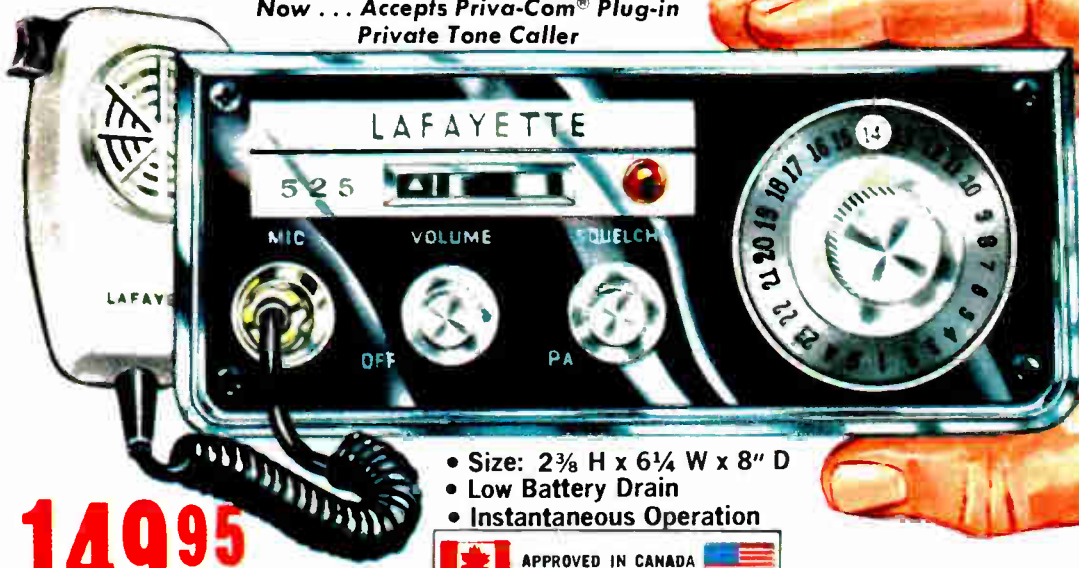

149⁹⁵

No Money Down

- 19 Transistors, 7 Diodes, Thermistor
- Pi-Network for Optimum RF Output
- Dual Conversion for Extra Selectivity and Sensitivity
- 3-Position Crystal Delta Tune for Accurate Fine Tuning

Compact 2-Way radio blends elegant die cast front panel craftsmanship with dependable temperature compensated solid state circuitry to achieve a new high in engineering excellence. Frequency synthesizer includes crystals for all 23 CB plus 2 Highway Emergency Locating Plan (HELP)* channels. **NO EXTRA CRYSTALS ARE NEEDED!** Top notch 19 transistor, 7 diode, 1 thermistor design consumes less than 1 ampere of current on full transmit and permits instant-on operation.

Dual conversion superheterodyne receiver features a 455 KC mechanical filter for superior selectivity and high sensitivity. Greatly suppresses adjacent channel interfer-

- Size: 2 3/8 H x 6 1/4 W x 8" D
- Low Battery Drain
- Instantaneous Operation



- Mechanical 455 KC Filter for Superior Selectivity
- Variable Squelch plus Series Gate Automatic Noise Limiting
- Range Boost Circuitry for Added Talk Power

ence. Three position crystal delta tuning facilitates reception of off-channel stations. Series gate noise limiter minimizes noise. Variable squelch stage assures silent standby operation. 3 x 5 inch PM speaker with audio directive louvered grill provides clean, clear sound reproduction.

Transmitter offers full legal 5 watt input RF power. Efficient Pi-Network provides optimum output. Range Boost modulating circuitry greatly increases real talk power. Automatically switched indicator light shows RF output and modulation peaks or comparative signal strength on reception. Built-in TVI filter is designed to effectively minimize television interference.

- Serves as A Public Address Amplifier with External Speaker
- 12-Volt DC Operation (Positive or Negative Ground) (6-Volt DC Operation with Optional DC to DC Supply)
- Transmit and Modulation Indicator Light

Operates on 12V DC positive or negative ground. May be used as a 2.5 watt public address amplifier with external speaker. Supplied complete with mobile mounting bracket, fused DC cable, Push-to-Talk plug-in dynamic microphone with coiled cord, and FCC Form 505 CB License application as per FCC Regulation 95. Dimensions: 2 3/8 H x 6 1/4 W x 8" D. Shpg. wt., 10 lbs.

99 E 3125WX \$8 Monthly Net 149.95

MODEL HB-502 AC POWER SUPPLY for 117 V.A.C. base station operation of HB-525 and HB-525A. Dimensions: 6Wx7 7/8 D x 2 3/4" H. Shpg. wt., 8 lbs.

99 E 3086 Net 16.95

*The Automobile Manufacturer Association's application for 27.235MC and 27.245MC channels for their H.E.L.P. (Highway Emergency Locating Plan) program is pending before the Federal Communications Commission. The HB-525A is designed for obsolescence-proof performance by featuring two presently

inoperative reserve channels A & B for the H.E.L.P. frequencies. Instructions on how to activate these channels will be supplied after the F.C.C. allocates and approves these channels for the H.E.L.P. program.

ECONOMY SOLID STATE CB SYSTEMS WITH HB-525A



HB-525A



Body Mount Whip



Cable Assembly



"Range Boost™ II" Antenna



HB-525A ON HB-502

MOBILE SYSTEM

Model HB-525A Solid State CB Transceiver	149.95
Stainless Steel Body Mount Whip Antenna	6.95
20 Ft. RG-58/U Coaxial Cable Assembly	2.75
TOTAL	159.65

Package Price ONLY **152⁵⁰** Save **7.15** from individual catalog prices.
42 E 9094WXM Shpg. wt., 15 lbs. \$8 monthly Net 152.50

BASE SYSTEM

Model HB-525A Solid State CB Transceiver	149.95
Model HB-502 117 VAC Solid State Power Supply	16.95
High Gain "Range Boost II" 1/2 Wave Length Base Station Antenna	19.95
50 Ft. RG-8/U Low-Loss Coaxial Cable Assembly	8.50
TOTAL	195.35

Package Price ONLY **184⁹⁵** Save **10.40** from individual catalog prices.
42 E 9095WXM Shpg. wt., 35 lbs. \$10 Monthly Net 184.95



Comstat® 19 5-Watt Two-Way Radio

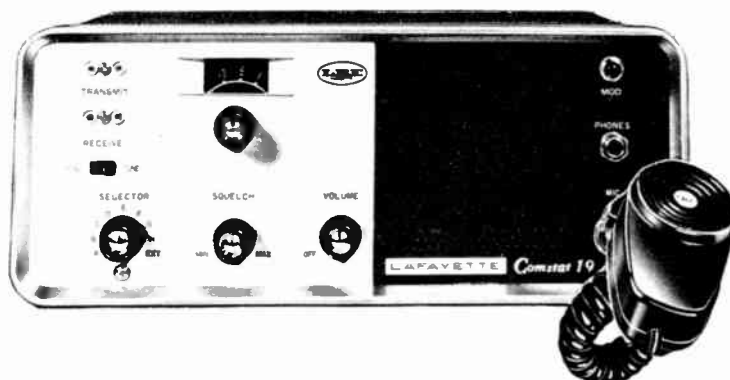

SAVE 10⁰⁰
on the
LAFAYETTE CB Value Leader
Now Only
59⁹⁵
No Money Down

- 9 Crystal Controlled Transmit and Receive Channels
- Front Panel Transmit and Receive Crystal Sockets Permit Easy Operation on 23 Crystal-Controlled Channels
- Push-To-Talk Ceramic Mike with Coiled Cord and Positive Lock Plug
- Pi Network Antenna Matching
- Convenient Variable Squelch Control
- Sensitive 23 Channel Tuneable Receiver

Advanced electronic circuitry utilizes 7 tubes and 3 diodes to achieve 13 stages of dynamic performance. Sensitive superheterodyne receiver permits reception of weak distant stations even in problem areas. Effective series gate limiter minimizes ignition and other noise pick-up. Receiver can be manually tuned or crystal controlled. Variable squelch control permits quiet automatic stand-by operation. Powerful audio stage delivers up to 100% AM plate modulation for real talk power. Monitor allows visual indication of modulation. Built-in 117 VAC power supply and optional 12 VDC power supply (see below) permit virtually unlimited applications. Front panel receive and transmit crystal sockets combine with 9 switched crystal positions to provide the flexibility of full 23 channel crystal coverage. Intermediate frequency: 455 KC. Receiver sensitivity: 1 μ v @ 10 db signal to noise ratio. Output impedance: 50 ohms. Supplied complete with push to talk ceramic microphone with coiled cord and positive lock plug, bracket for mobile or shelf mounting, 117 VAC power cord, and a pair of crystals for channel 9. Size: 12 $\frac{1}{4}$ Wx8 $\frac{1}{4}$ Dx5 $\frac{1}{2}$ H. Shpg. wt., 11 $\frac{1}{2}$ lbs.

99 E 3067WX \$5 monthly	Net 59.95
42 E 4701C Extra Transmit Crystal (Specify Channel)	Net 2.25
42 E 4702C Extra Receive Crystal (Specify Channel)	Net 2.25
HA-19 POWER SUPPLY Adapts Comstat 19 for 12 volt mobile operation. Size 6Wx4Hx4 $\frac{1}{2}$ D.	
42 E 4704W Shpg. wt., 4 lbs.	Net 11.50

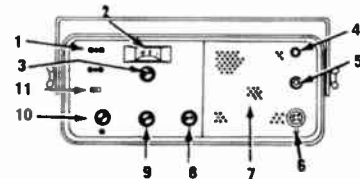

1. Front Panel Crystal Sockets
2. Illuminated Vernier Tuning Dial
3. Tuneable Receive Dial Control
4. Modulation Monitor
5. Phone Plug for Private Listening and External Speaker
6. Microphone Socket
7. Front Panel 4" Speaker
8. Volume Control/Power Switch
9. Variable Squelch Control
10. 9-Channel Crystal Transmit-Receive Selector Switch
11. Xtal-Tune Receiver Mode Switch

ECONOMY COMSTAT 19 CITIZEN BAND 2-WAY SYSTEMS

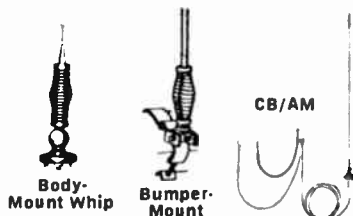

MOBILE SYSTEMS

Comstat 19 CB Transceiver	59.95
Stainless Steel Body Mount Whip Ant	6.95
20 Ft. RG-58/U Coaxial Cable Assembly	2.75

Package Price 66⁵⁰ TOTAL 69.65

- 42 E 9059WXM Shpg. wt., 16 $\frac{1}{2}$ lbs. \$5 monthly Net 66.50
Above except with bumper mount instead of body mount antenna.
42 E 9075WXM Shpg. wt., 15 $\frac{1}{2}$ lbs. \$5 monthly Net 67.95
SAVE 3.70 from individual catalog prices.
Same as above except with CB/AM Combination Broadcast and CB cowi mount antenna instead of Bumper Mount antenna.
42 E 9076WXM Shpg. wt., 15 $\frac{1}{2}$ lbs. \$5 monthly Net 64.95
SAVE 2.95 from individual catalog prices.



SAVE 3.15

from individual catalog prices

SAVE 3.90

from individual catalog prices

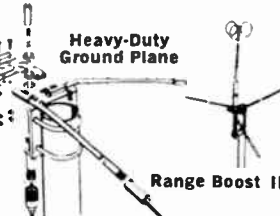

BASE SYSTEMS

Comstat 19 Citizens Band Transceiver	59.95
Heavy Duty Ground Plane Antenna	9.95
50 Ft. RG-8/U Low-Loss Coaxial Cable	8.50

Package Price 74⁵⁰ TOTAL 78.40

- 42 E 9057WXM Shpg. wt., 22 $\frac{1}{2}$ lbs. \$5 monthly Net 74.50
Same package as above except with Lafayette Range Boost II" 1/2 wave length high-gain base station antenna instead of Ground Plane antenna. Shpg. wt., 28 $\frac{1}{2}$ lbs.
42 E 9077WXM \$5 monthly Net 83.95
YOU SAVE 4.45 from individual catalog prices.

Model HE-20T Solid State CB Two-Way Radio with PRIVACOM® Private Tone Caller Socket



**Famous CB
Favorite ...
Now All Solid
State**

Only
89⁹⁵
No Money Down

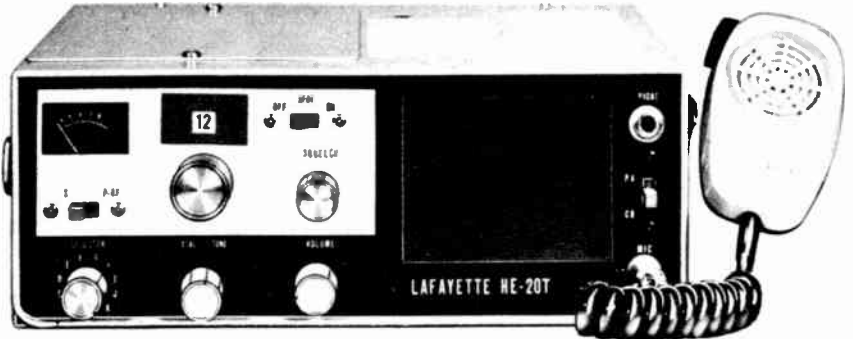

With 7-Stage Transmitter For Extra Transmitting Sock!

- 12-Channel Crystal-Controlled Transmit & Receive
- 23-Channel Tuneable Receive
- 13-Transistors, 10-Diodes
- Push-Pull Audio Modulator
- Spotting Switch for Accurate Tuneable Reception

- 117 VAC & 12 VDC Negative or Positive Battery Ground
- Pi-Net Output
- TVI Trap
- Cool, Instantaneous Operation
- Also a Public Address Amplifier with External Speaker

Newest addition to the popular HE-20 series of CB transceivers. A remarkable achievement in CB communications. This "ALL" Solid State transceiver is ideal for fixed and mobile communications over a distance of 20 miles or more depending on the terrain and antenna height. It incorporates a Pi-network for matching the output to 30-100 ohm antennas. Solid State circuitry features low battery drain and provides instant operation; full 5-watt transmitter input with efficient push-pull audio modulator; an extra-sensitive super-heterodyne receiver for a powerful signal to push through interference of crowded channels. Fine selectivity and adjacent channel rejection is obtained through a 455KC mechanical filter. Sensitivity: .7µv for 10db signal-to-noise ratio; image rejection: 15db. Receiver also incorporates automatic floating series-gate noise limiter and variable squelch control resulting in virtually no background noise between calls. Other features: dust-free transmit/receive relay, ear-phone jack for headphones or external extension speaker for CB/PA application. TVI trap, mobile mounting bracket, front panel mounted

4" speaker, a rear mounted low-loss antenna jack accepts SO-239 connector used with ground plane and direct mounting antennas. Also features Priva-Com private tone caller socket which accepts Lafayette Priva-Com III. Complete with fused DC, line cord for negative ground battery, push-to-talk mike and set of crystals for channel 9. Includes FCC License application form 505, per regulation 95. Size: 8¼Dx4¾Hx1¼"W. Imported. Shpg. wt., 13½ lbs.
99 E 3088WX \$5.00 monthly Net 89.95

99 E 3106 Positive ground fused 12 VDC cord Net 1.50
42 E 0907C Extra transmit crystal (specify channel) Net 2.25
42 E 0137C Extra receive crystal (specify channel) Net 2.25

HE-20T Modified for 27.575MC (GOV'T.) operation.
99 E 3103YWX \$5.00 monthly Net 99.95

HE-20T Modified for 26.62MC (C.A.P.) operation.
99 E 3102YWX \$5.00 monthly Net 99.95

HE-20T ECONOMY CITIZEN BAND 2 WAY SYSTEM



MOBILE SYSTEMS	
Model HE-20T Solid State CB Transceiver	88.95
Stainless Steel Body Mount Whip Antenna	6.95
20 Ft. RG-58/U Coaxial Cable Assembly	2.75
Package Price	94⁹⁵
TOTAL	99.65

SAVE 4.70
from individual catalog prices

SAVE 4.90
from individual catalog prices

BASE SYSTEMS	
Model HE-20T Solid State CB Transceiver	89.95
Heavy Duty Ground Plane Antenna	9.95
50 Ft. RG-8/U Low-Loss Coaxial Cable Assembly	8.50
Package Price	103⁵⁰
TOTAL	108.40

42 E 9070WXM Shpg. wt., 19 lbs. Net 94.95
Same 2-way system as above except with bumper mount instead of body mount antenna. Shpg. wt., 18 lbs.
42 E 9071WXM \$5 monthly Net 96.95
SAVE 4.70 from individual catalog prices.
Same system as above except with CB/AM Broadcast and CB cowl mount antenna instead of body mount antenna. Shpg. wt., 18 lbs.
42 E 9072WXM \$5 monthly Net 93.95
SAVE 3.95 from catalog component prices.

42 E 9073WXM Shpg. wt., 25 lbs. \$6 monthly Net 103.50
Same system as above except with Lafayette "Range Boost II" high-gain ½ wave length base station antenna instead of Ground Plane antenna. Shpg. wt., 31 lbs.
42 E 9074WXM \$6.50 monthly Net 112.95
SAVE 5.45 from individual catalog prices.



Model HB-555 Mobile-Ade™

5-Watt Solid State Mobile CB Two-Way Radio

★ DUAL CONVERSION ★ ACCEPTS PRIVA-COM® PLUG-IN PRIVATE TONE CALLER only 2 1/2" High



- ★ 14 Transistor, 4 Diode Circuitry
- ★ 12 Channel Crystal-Controlled Transmit and Receive
- ★ Full 5-Watt Input—FCC Max.
- ★ Double Conversion Superhet with 455 KC Mechanical Filter
- ★ Push-Pull Audio Amplifier-Modulator

FOR: Business — Personal Use — Emergency



Approved in Canada
D.O.T. No. 169361093



- Variable Squelch Control Plus Automatic Series Gate Floating Noise Limiter
- Push-To-Talk Microphone
- Large Self-Contained 3 x 5 Inch Speaker

This 12 channel diminutive crystal-controlled transmit and receive CB transceiver provides dependable two-way communication for cars, taxis, trucks, boats and even motorcycles. Full 5-Watt transmitter input with highly efficient push-pull audio modulator and extra-sensitive double conversion superheterodyne receiver gives you a husky signal to punch through the interference of crowded channels. Razorsharp selectivity and adjacent channel rejection is achieved by the 455-KC mechanical filter. Sensitivity: .7 μ v for 10 db signal-to-noise ratio. Dynamic push-to-talk microphone activates dust-free enclosed transmit/receive relay. PA Speaker/Earphone jack provides listening or public address amplifier operation. Also has socket for direct use with Lafayette PRIVA-COM III Selective Call unit. Complete with microphone, sturdy mobile mounting bracket, power cable, pair

SAVE \$10.00
Now Only
89⁹⁵
No Money Down

NOW YOU TOO CAN
OWN THIS MIGHTY MINIATURE
SOLID-STATE 2-WAY RADIO!

- For 12 Volts DC Negative or Positive Ground or 117 Volts AC with Optional AC Power Supply
- With Pair of Channel 9 Crystals for CB and Emergency Mobile Aid through H.E.L.P.

of channel 9 crystals, and FCC License Application Form 505, per Regulation 95. Size 5 1/4"W x 7 7/8"D x 2 1/4"H. Shpg. wt., 7 lbs.
99 E 3049WX \$5 monthly
42 E 9070C Extra Transmit Crystal (Specify Channel) Net 2.25
42 E 0139C Extra Receive Crystal (Specify Channel) Net 2.25

POWER SUPPLIES

HB-502 Solid State AC Power Supply For Operating As Base Station
99 E 3086W Shpg. wt., 10 lbs. Imported Net 16.95
HB-505 6-Volt DC to 12-Volt DC Converter. Permits mobile operation on 6-Volts negative or positive ground battery. Size: 5 1/4"W x 4 1/8"D x 2 1/4"H. Imported.
99 E 3084 Shpg. wt., 5 lbs. Net 19.95

MODEL HB-555 SOLID STATE ECONOMY CB 2-WAY SYSTEMS

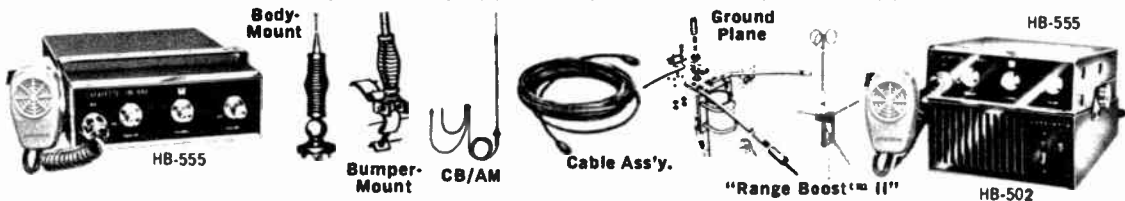

MOBILE SYSTEMS

Model HB-555 Solid State CB Transceiver	89.95
Stainless Steel Body Mount Whip Antenna	6.95
20 ft. RG-58/U Coaxial Cable Assembly	2.75
TOTAL	99.65

Package Price **94⁹⁵**
No Money Down

42 E 9022WXM Shpg. wt., 12 lbs. \$5 monthly 94.95
Same system as above except with bumper mount instead of body mount antenna.
42 E 9062WXM Shpg. wt., 11 lbs. \$5 monthly 666 Net 96.95
SAVE 4.70 from individual catalog prices.
Same as 42 E 9022WXM except with CB/AM AM broadcast and CB cowl mount antenna instead of body mount antenna. Shpg. wt., 12 lbs.
42 E 9024WXM \$5 monthly Net 93.50
SAVE 4.40 from individual catalog prices.

BASE SYSTEMS

Model HB-555 Solid State CB Transceiver	89.95
Model HB-502 117 VAC Solid State Power Supply	16.95
Heavy Duty Ground Plane Antenna	9.95
50 Ft. RG-8/U Low-Loss Coaxial Cable Assembly	8.50
TOTAL	125.35

Package Price **119⁹⁵**
No Money Down

42 E 9063WXM Shpg. wt., 28 lbs. \$6.50 monthly Net 119.95
Same system as above except with Lafayette "Range Boost™ II" high-gain 1/2 wave length base station antenna instead of Ground Plane antenna. Shpg. wt., 34 lbs.
42 E 9064WXM \$7 monthly Net 128.95
SAVE 6.40 from individual catalog prices.

Comstat® 25 Crystal Controlled Range Boost™ Two-Way Radio



23 CB plus 2 Reserve *Channels — ALL CRYSTALS Supplied!

Wired To Accept Priva-Com® Private Call Unit



139⁹⁵

No Money Down

- 15 Tube Performance with 10 Tubes, 2 Transistors and 9 Diodes
- Built-in 117 VAC, 12 VDC Solid-State Power Supply
- Dual Conversion Receiver Features 8/10 μ V Sensitivity
- Pi-Network and Low Pass Filter for Maximum Power Output

Pace-setting Comstat 25 transceiver features high performance circuitry for superb mobile and base station operation. "RANGE BOOST" greatly increases the average talk power and raises the overall modulation percentage. 2.5KC total spread simplifies zeroing in on frequency. Highly selective circuits greatly suppress adjacent channel interference (-45db). Variable squelch quiets receiver between calls. Transmitter gives the full 5-watt legal power limit. Pi-network final tank circuit and low-pass filter combine to provide efficient power transfer into the antenna with superior harmonic suppression. Crystal frequency synthesizer enables operation on all 23 CB channels with crystals supplied. No extra crystals

FEATURES

- Range Boost Switch ● Illuminated S/R/F Meter ● Illuminated Channel Indicator ● Single-Knob Channel Selector ● Modulation Indicator Light ● CB/Public Address Switch ● Head-phone/External Speaker Jack ● Positive-Lock Mike Connector ● 2.5 KC Fine Tuning Vernier ● Adjustable Squelch Control with Standby Switch for Low Drain Instant Operation ● PTT Ceramic Microphone

are necessary! Built-in dual purpose power supply allows 12-VDC mobile and 115-VAC base station operation. Front panel switch converts transceiver to a handy 4.5-watt public address amplifier. A convenient front panel jack for headphones or external extension speakers for CB/PA is provided. Comstat 25 also features push-to-talk relay switching and plug-in ceramic microphone with coiled cord. Rear socket is prewired to accept Lafayette Priva-Com selective call unit. Complete with vari-tilt mounting bracket. With FCC License Application Form 505 per Regulation 95. Size: 12Wx8½Dx 5"H. Imported. Shp. wt., 16 lbs.

99 E 3065WX \$7.50 monthly Net 139.95

*The Automobile Manufacturer Association's application for 27.-235MC and 27.245MC channels for their H.E.L.P. (Highway Emergency Locating Plan) program is pending before the Federal Communications Commission. The Comstat 25 is designed for obsolescence-proof performance by featuring two presently in-

operative reserve channels A & B for H.E.L.P. frequencies. Instructions on how to activate these channels will be supplied after the F.C.C. allocates and approves these channels for the H.E.L.P. program.

COMSTAT 25 ECONOMY CB 2-WAY SYSTEMS



MOBILE SYSTEMS
 Comstat 25 CB Transceiver 139.95
 Stainless Steel Body Mount Whip Ant 6.95
 20 Ft. RG-58/U Coaxial Cable Assembly 2.75
TOTAL 149.65

SYSTEM PRICE 142⁹⁵

42 E 9052WXM Shpg. wt., 21 lbs. \$8 monthly Net 142.95
 Same system as above except with Bumper Mount instead of Body Mount antenna. Shpg. wt., 20 lbs.
 42 E 9078WXM \$8 monthly Net 144.50
 YOU SAVE 7.15 from individual catalog prices.
 Same as above except with CB/AM combination Broadcast and CB Cowl Mount antenna instead of Bumper Mount antenna.
 42 E 9079WXM \$8 monthly Net 141.95
 SAVE 5.95 from individual catalog prices.

SAVE 6.70

From Individual Catalog Prices

SAVE 7.90

From Individual Catalog Prices

BASE SYSTEMS

Comstat 25 CB Transceiver 139.95
 Heavy Duty Ground Plane Antenna 9.95
 50 Ft. RG-8/U Low-Loss Coaxial Cable 8.50
TOTAL 158.40

SYSTEM PRICE 150⁵⁰

42 E 9051WXM Shpg. wt., 27 lbs. \$8 monthly Net 150.50
 SAVE 7.90 from individual catalog prices.
 Same package as above except with "Range Boost II" high gain 1/2 wave length base station antenna instead of Ground Plane antenna Shpg. wt., 33 lbs.
 42 E 9080WXM \$8 monthly Net 159.95
 SAVE 8.45 from individual catalog prices.

Buy Now! Pay Later . . . Use Lafayette's Easy Pay Plan. No Money Down

Lafayette Cat. No. 672 63



Model HB-444/25A Deluxe Crystal Controlled Range Boost 2-Way Radio

23 CB Plus 2 Reserve* Channels—All Crystals Supplied!

WIRED To Accept
Priva-Com®
Private Call Unit

Only
179⁹⁵
No Money Down

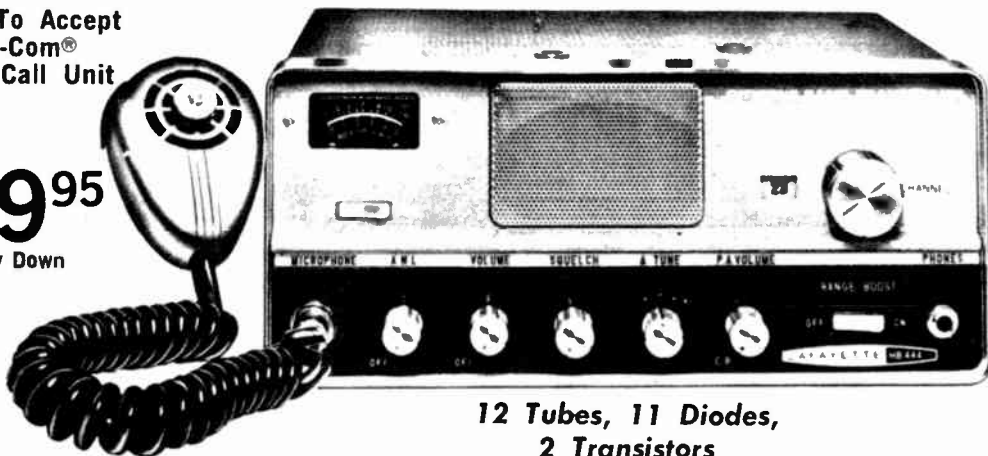

**12 Tubes, 11 Diodes,
2 Transistors**

- Dual Conversion Receiver with 3/10 μ v Sensitivity.
- 16 Tube Performance with 12 Tubes (2 Nuvistors) 11 Diodes, and 2 Transistors

Advanced design of this frequency synthesis CB Transceiver permits instant selection of any one of the channels! NO EXTRA CRYSTALS TO BUY! A dual diode full-wave Range Boost circuit increases the average depth of modulation with effective greater range during transmission. Uses 12 tubes (including two nuvistors) and 11 diodes, as well as a pi-network output for top performance. Dual conversion receiver has .3 μ v sensitivity and low noise figure plus a variable Delta fine tuning network for maximum reception and adjacent channel rejection. The receiver also has a variable noise limiter, variable squelch and an Automatic Volume Control. Equipped with a CB-P.A. volume control and switch the HB-444/25A can also be

- Low Noise Nuvistor "Front End"
- Built-in Solid State 117 VAC & 12 VDC Power Supplies
- Deluxe Metal Cased PTT Ceramic Microphone

operated as a public address amplifier to an external plug-in speaker. The transmitter is equipped with a metal-cased ceramic push-to-talk microphone. Operates with equal ease in both fixed and mobile locations—contains a built-in solid-state power supply for 117 VAC and 12 VDC operation. A built-in Selective Call socket accepts the Lafayette Priva-Com for silencing the receiver between calls. With deluxe microphone, two power cables, FCC license Application Form 505, per Regulation 95. Size: 12Wx8 $\frac{1}{2}$ Dx5" H. Imported. Shpg. wt., 20 lbs.

99 E 3074WX \$9 monthly Net 179.95

*The Automobile Manufacturers Association's application for 27.235MC and 27.245MC channels for their H.E.L.P. (Highway Emergency Locating Plan) program is pending before the Federal Communications Commission. The HB-444/25A is designed for obsolescence-proof performance by featuring two presently

inoperative reserve channels A & B for H.E.L.P. frequencies. Instruction on how to activate these channels will be supplied after the F.C.C. allocates and approves these channels for the H.E.L.P. program.

HB-444/25A ECONOMY CB 2-WAY SYSTEMS

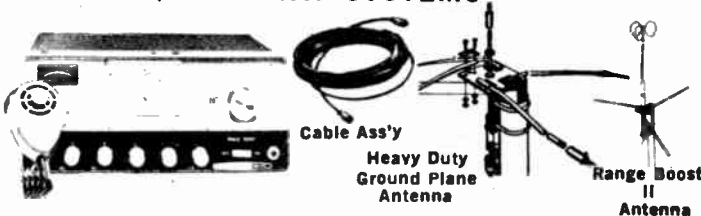
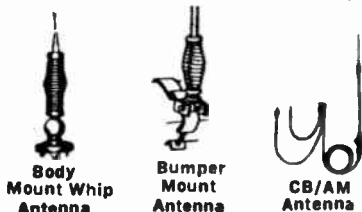

MOBILE SYSTEMS

Model HB-444/25A CB Transceiver 179.95
Stainless Steel Body Mount Whip Ant 6.95
20 Ft. RG-58/U Coaxial Cable Assembly 2.75
TOTAL 189.65

Package Price **182⁹⁵**

42 E 9081WXM Shpg. wt., 25 lbs. \$10 monthly Net 182.95
Above with Bumper Mount instead of Body Mount antenna.
42 E 9082WXM Shpg. wt., 24 lbs. \$10 monthly Net 184.50
SAVE 7.15 from individual catalog prices.

Same system as above except with CB/AM combination Broadcast and CB Cowl Mount antenna instead of Bumper Mount antenna.
42 E 9083WXM Shpg. wt., 24 lbs. \$10 monthly Net 181.95
SAVE 5.95 from individual catalog prices.

SAVE 6.70

from individual catalog prices

SAVE 9.90

from individual catalog prices

BASE SYSTEMS

Model HB-444/25A CB Transceiver ... 179.95
Heavy Duty Ground Plane Antenna ... 9.95
50 Ft. RG-8/U Low-Loss Coaxial Cable 6.50
TOTAL 196.40

Package Price **188⁵⁰**

42 E 9084WXM Shpg. wt., 31 lbs. \$10 monthly Net 188.50
Same package as above except with Lafayette "Range Boost II" high gain $\frac{1}{2}$ wave length base station antenna instead of Ground Plane Antenna, Shpg. wt., 37 lbs.
42 E 9085WXM \$10 monthly Net 197.95
SAVE 10.45 from individual catalog prices.



Model HB-600 Solid State "CB Commander" Range Boost 2-Way Radio

S9 Magazine 1965
"At the least, the HB-600 is a major
breakthrough in CB communications..."

**23 CB Channels
plus
Choice from 5
Business Band*
Channels**

Separate license is required for
CB and Business Band.



APPROVED IN CANADA
D.O.T. No. 169361101

*FCC Type Accepted

219⁹⁵
No money down

- Unique RF Noise Silencer (Pat. Pend.)
- 21 Transistors, 13 Diodes—Draws 1 ampere Maximum On Full Transmit!
- Mechanical Filter for Ultra Selectivity and Adjacent Channel Rejection
- Ultra-Stable Circuit Uses A Separate Crystal for Each Transmit/Receive Channel—All 27 CB Crystals Supplied!

- Plug-in Dependable Sealed Relay Switching
- 0.5 μ v Dual Conversion Receiver with 3-Crystal "Delta" Fine Tuning
- Pi-Network Output With Low Pass Filter
- Plug-in Facilities for Lafayette Selective Call Unit
- Operates As a PA Amplifier with External PA Speaker
- Built-in Solid State 117 Volt AC and 12 Volt DC Power Supply

- RANGE BOOST. For greater "talk-power."
- SQUELCH/PA. "Quiets" the receiver between calls—adjustable to suit operating conditions. Full counter-clockwise for PA operation.
- PHONE JACK. For headphones or speaker.
- NOISE LIMITER. Provides choice of noise reduction circuits—(A) Audio Noise Limiter, (B) Audio Noise Limitor plus RF Noise Silencer.

The "CB Commander" offers every feature you'll ever want in a 2-way CB radio—PLUS provision for Business Band* operation! You get 23 crystal-controlled CB channels with an ultra-stable circuit that uses a separate crystal for each transmit/receive channel. And every crystal is supplied for CB—27 in all! There's even provision for 2 extra channels—lets you choose from 5 Business Band* frequencies—27.235, 27.245, 27.255, 27.265, or 27.275 Mc. Business Band* operation permits increased antenna height...gives you greater range and coverage—and less crowding! Range-Boost circuit increases average modulation and lets your voice cut through noise to reach further... gives you more "talk-power"! Reception is incomparable too. A dual conversion receiver provides high sensitivity—pulls in even the weak signals! RF Noise Silencer (Pat. Pend.) provides excellent ignition noise reduction—you learn what quiet operation really means! Other

top features include a costly mechanical filter that offers razor-sharp selectivity, Delta tuning, Variable Squelch, effective Automatic Noise Limiter, Push-Pull audio, plus provision for Public Address operation with external speaker. Built-in solid-state AC and DC power supply permits low drain operation on 117V AC or 12V DC (Neg. or Pos. Gnd). Supplied with push-to-talk dynamic microphone with coiled cord, AC and DC power cables, "quick-release" mounting bracket and hardware, microphone bracket. Dimensions: 4 $\frac{1}{2}$ " high, 11 $\frac{1}{4}$ " wide, 8" deep. Shpg. wt., 11 lbs. Imported.

99 E 3071WX \$11.00 monthly Net 219.95
Business Band Crystals.* Specify one of the following frequencies for which you have received Business Radio License—27.235, 27.245, 27.255, 27.265, or 27.275 MC.
42 E 0132C (Specify Frequency—only 1 Crystal Required) Net ea. 3.95

Model HB-600 Solid State Economy CB Systems



MOBILE SYSTEMS

Model HB-600 CB Transceiver 219.95
Stainless Steel Body Mount Whip Ant 8.99
20 Ft. RG-58/U Coaxial Cable Assembly 2.75
TOTAL 229.65

SAVE 4.70
from individual catalog prices

SAVE 8.45
from individual catalog prices

BASE SYSTEMS

Model HB-600 CB Transceiver 219.95
Heavy Duty Ground Plane Antenna 9.95
50 Ft. RG-8/U Low-Loss Coaxial Cable 8.50
TOTAL 238.40

System Price 224⁹⁵
No Money Down

42 E 9046WXM Shpg. wt., 16 lbs. \$11.50 monthly Net 224.95
Above with Bumper Mount instead of Body Mount antenna.
42 E 9086WXM Shpg. wt., 15 lbs. \$11.50 monthly Net 226.50
SAVE 5.15 from individual catalog prices.

Same as above except with "CB/AM" Combination Broadcast and CB Cowl Mount antenna instead of Bumper Mount Antenna.
42 E 9087WXM Shpg. wt., 15 lbs. \$11.50 monthly Net 223.95
SAVE 3.95 from individual catalog prices.

System Price 229⁹⁵
No Money Down

42 E 9088WXM Shpg. wt., 22 lbs. \$11.50 monthly Net 229.95
Same as above except with Lafayette "Range Boost II" 1/2 wave length high gain base station antenna instead of Ground Plane antenna. Shpg. wt., 28 lbs.
42 E 9089WXM \$11.50 monthly Net 239.95
SAVE 8.45 from individual catalog prices.

Citizens Band Equipment Is Available on Easy Pay Plan—No Money Down Lafayette Cat. No. 672 65

LAFAYETTE Model HA-450 2.5 Watt 6-Channel Crystal-Controlled Solid State Portable And Mobile CB Transceiver

SAVE 10.00
Now Only **79⁹⁵** No Money Down



- 6-Channel Crystal Controlled Transmit & Receive
- Powerful 2.5 Watt Input • 12 Transistors, 4 Diodes
- External Plug-in Push-to-Talk Dynamic Microphone
- "S" and Battery Meter, ANL, and Variable Squelch
- Operates with 8 "D" Batteries Supplied
- Complete with Leather Carrying Case and Antenna

Use it as a powerful walkie-talkie with its self-contained "D" size batteries, or simply detach battery pack and switch to external antenna for ultra-compact under dash mobile installation. All-transistor circuit (8 Silicon, 4 Germanium) utilizes Automatic Noise Limiter and Adjustable Squelch for quiet communication. Motorola-type antenna jack for external antenna, with mobile/built-in telescopic whip antenna switch, mobile mounting bracket and cable make mobile installations quick and easy. Operate at 12 volt DC positive or negative ground from portable or mobile (car, boat, etc.) batteries. Size: with battery pack, 10^{3/8}"L x 6D x 2^{3/4}"H. Mobile, 10^{1/2}"L x 4^{1/2}"D x 2^{3/4}"H. With FCC License Application Form 505 per Regulation 95 and pair of channel 9 crystals. Imported.

99 E 3063L \$5.00 Monthly, Shpg. wt., 8 lbs.	Net 79.95
99 E 6256 Replacement "D" Cells (8 required)	Net Each .13
32 E 4884 Heavy duty "D" Alkaline Batteries (8 req'd) ..	Net Ea. .65
Rechargeable Long Life Nicad Batteries, "D" Size	
32 E 4889 (8 required)	Net Ea. 5.69
42 E 0907C Extra Transmit Crystal (Specify Channel)	Net 2.25
42 E 0135C Extra Receive Crystal (Specify Channel)	Net 2.25
42 E 3206 Adapter PL259 Plug to Motorola Plug	Net .54

LAFAYETTE HA-150 2-CHANNEL 1-WATT ALL-TRANSISTOR PORTABLE CB TRANSCEIVER

Now Only **49⁹⁵** Each **SAVE 10.00**
No Money Down



- Meter for Indicating Battery Strength & Modulation Level
- An External Plug-in Push-to-Talk Dynamic Microphone
- Complete with 2-Pair Plug-In Transmit/Receive Crystals
- 13-Transistor 5-Diode Circuit
- Push-Button Operated
- Self-Contained Batteries or can be Powered by an External 12-Volt DC Supply
- Lightweight—Weights only 4 lbs.
- Squelch and Automatic Noise Limiter

Full 1-watt RF input...up to 6-mile range...quick-release battery compartment. 4 convenient push buttons give you complete control. It can be carried, or used on a desk, table, car or boat. Receiver has high 1 μ v. sensitivity, push-pull audio, and large 3-inch speaker for clear, full-tone reproduction. Complete with channel 10 and 15 plug-in crystals (2 transmit, 2 receive), batteries, push-to-talk dynamic microphone, leather carrying case, earphone, external battery socket and telescoping whip antenna. Dimensions: 9^{1/2}"W x 2^{1/4}"H x 5^{1/2}"D. Imported. S.p.g. wt., 7 lbs.

99 E 3014L \$5 Monthly	Net 49.95
99 E 6257 1.5-volt "C" cell (8 required)	Net ea. .13
42 E 0907C Extra transmit Crystal. Specify Channel	Net 2.25
42 E 0137C Extra Receive Crystal. Specify Channel	Net 2.25
42 E 3206 Ext. Antenna Socket Adapts PL-259 to HA-150	Net .54

LAFAYETTE PRIVA-COM® III SOLID STATE PRIVATE TONE CALLER



34⁹⁵
No Money Down

With Dual Tone Ceramic Transducer and Resonant Tuning Fork Circuitry

For Lafayette 12 Volt Solid State CB Transceivers!

Real Tiny: 1^{1/4}" H x 3^{3/8}" W x 6^{3/8}" D.

- 9-Transistors plus 2-Diodes • For Quiet, Private Communications • Incoming Call Indicator Light • Mates Directly with Lafayette HB-555, HB-525A, HB-500A, HB-600, HB-600A and HE-20T.

Its tiny size makes it a handsome mate for even the smallest solid state CB Transceivers. The Privi-Com III mutes the receiver. When its call switch is activated, either at base or mobile stations, the transmitted dual tone is received by the other Privi-Com III. The CB receiver is activated and the indicator light goes on. Supplied with a sturdy mobile bracket for mounting under dash, under transceiver, etc; and 2 plug-in selective ceramic and resonant tuning fork filters. Over-all size: 1^{1/4}"H x 4"W x 5^{3/4}"D. Imported. Shpg. wt., 3 lbs.

99 E 3117 \$5.00 Monthly	Net 34.95
--------------------------------	-----------

LAFAYETTE PRIVA-COM® V PRIVATE TONE CALLER

For Lafayette Tube-Type CB Transceivers



34⁹⁵
No Money Down

- Compatible with Lafayette Privi-Com II and Privi-Com
- Incoming Call Indicator Light
- Operates Horn or External Alarm
- 10 Dual-Tone Frequency Capability

For use with Lafayette Comstat 25 (up to and including serial No. 21350), Comstat 23, HB-444/25, HB-444/25A (up to and including serial No. 12100), HB-444, HE-20, A, B, C, HE-90, HB-111, HB-222, HB-333, and HB-400. 4^{1/8}" x 2^{1/8}" x 5^{1/8}". Shpg. wt., 3 lbs.

42 E 0149	\$5 monthly	Net 34.95
-----------------	-------------	-----------

Improve Your CB Performance With LAFAYETTE Accessories

A. LAFAYETTE BOOM MIKE. Perfect answer to your CB mobile needs. For use with VOX or foot switch for transmit-receive changeover. Lightweight and comfortable. 8 ohm earphone has cushion for comfort and outside noise suppression. Crystal mike for high output and full modulation. Boom and headband adjusts to individual preference. Smartly styled mike head mounted on swivel for maximum pick up. For tube-type CB transceivers. With 5 ft., 4 conductor cable.

99 E 2565 Imported. Shpg. wt., 1 lb. Net 3.98

B. LAFAYETTE "MITEY-MITE" CB MIKE. Expertly designed and professionally styled for real performance. Fits snugly in palm of hand for effortless operation. Features a "Long Life" ceramic element for truly dependable communications. Three conductors plus shield connected for electronic switching. Includes instruction sheet for conversion to relay switching. For all high impedance input CB transceivers (tube type). 1 7/8"Wx1 1/4"Dx3 1/4"H. Imported.

99 E 4579 Shpg. wt., 8 oz. Net 4.95

C. LAFAYETTE CB LOW PASS FILTER. Attenuates radiated spurious and other undesirable harmonic signals higher than 50 MC approximately 50 db or more; Minimizes interference with your own or your neighbor's TV set. Simple to install with two built-in SO-239 connectors. Impedance is 50-75 ohms and connections may be reversed for same impedance match. Max. power rating is 100 watts. Size: 5x2 1/4". Shpg. wt., 1 1/2 lbs.

42 E 0123 Net 6.95

D. LAFAYETTE AUTHENTIC MECHANICAL FILTER. Cope with today's crowded bands. Provides a steep-skirted, flat top, ideal band pass response for superior selectivity. At 2.5 Kc on either side of the center frequency, the filter provides 60 db attenuation. Easily installed between mixer and 1st I.F. stages. Specifications: Center Frequency, 455 kc; 6 db bandwidth 2 kc; 60 db bandwidth 6 kc; Input/Output Impedance 10K ohms; Insertion Loss, 1.5-3 db. Size: 2 3/8"Wx5/8"Hx1 3/8"D (overall). Imported. Shpg. wt., 8 oz.

99 E 0123 Net 9.95

E. LAFAYETTE CB NUVISTOR PREAMPLIFIER. Can be added to virtually any CB transceiver to improve gain and noise figure. Covers a frequency range of 26.96 to 27.225MC and employs a nuvistor tube in a neutralized circuit. Tuned circuitry is employed for both the grid and plate. Gain is 20 db and noise figure of 2.0 db at 27MC. Power requirements are 6.3 volts at 135 ma. and 100-250 volts DC at 8 ma. Only 2 1/2"x3 1/2"x1 1/2". Shpg. wt., 2 lbs.

42 E 0127 Net 9.95

F. LAFAYETTE CB AUDIO COMPRESSOR AMPLIFIER. Final power input remains within the legal 5-watt limit but effective talk power is increased many times by increasing average CB transmitter modulation. Requires very little power for operation hence existing power supplies may be utilized. With operating and installation instruction. Size: 3Hx3 7/8"Wx5"D. Shpg. wt., 2 lbs.

Not for HB-222 and solid-state (transistor) CB transceivers. 42 E 0117 Net 25.95

G. LAFAYETTE AUTO-MARINE ENGINE NOISE SUPPRESSOR KIT. A must for mobile CB and Ham Operators! Effectively suppress ignition, generator and voltage regulator noise. Kit includes: 8 spark plug suppressors; 1 distributor suppressor, 1 voltage regulator suppressor; 4 coaxial capacitors; shielded cable and braid for wiring filter system. All necessary hardware and instructions for installation are included. Shpg. wt., 2 lbs.

42 E 0905 Net 9.45

H. LAFAYETTE GENERATOR NOISE FILTER. Enables quiet receiver operation for Citizen Band, Amateur and Industrial frequencies. Standard frequency range 3-30 mcs. Maximum current 25 amps. Imported. Shpg. wt., 1 lb.

99 E 6018 Net 2.49

I. ALTERNATOR NOISE FILTER. A highly effective filter for alternator equipped automobiles. Attenuates alternator noise by 50 db. Can operate up to 32 volts DC. Results in quiet mobile receiver operation. Shpg. wt., 8 oz.

42 E 4900 Net 3.29

J. LAFAYETTE CB TRANSCEIVER TESTER. Easily and quickly evaluate and improve operating efficiency in both fixed and mobile installations. Permits aural monitoring of local transmitters; visual transmitter monitoring with scope. Measures: RF power output, relative field strength, SWR, % modulation, and crystal activity. Generates: controlled RF signal, modulated audio signal and 1 Kc audio signal. Also has in-circuit connection to antenna without removing cables from transmitter. Sensitive D'Arsonval meter. Sturdy attractive molded case with brushed aluminum front panel. Includes 9V battery; 30" telescoping antenna. 7 7/8 x 5 3/8 x 2 7/8". Shpg. wt., 4 lbs. 42 E 0126 \$5 Monthly Net 37.95

K. LAFAYETTE 6-VOLT DC TO 12-VOLT DC SOLID STATE CONVERTER. Now you can install a mobile communications system using your present 6 VDC system. Operate your HB-500, HB-500A, HB-525, HB-555, HB-600, HB-600A and any other Solid State CB transceiver drawing less than 1-Amp during transmission. Converter fits neatly under the dashboard, or on the firewall. Attractive miniature remote control panel has On-Off switch and pilot light indicator. Size: 5 1/4"W x 4 1/8"D x 2 1/4"H. Imported. Shpg. wt., 4 1/2 lbs.

99 E 3084 Net 19.95

L. LAFAYETTE NICKEL CADMIUM BATTERY CHARGER AND ELIMINATOR. Battery eliminator permits 117VAC operation of 12 volt walkie talkies rated up to and including 2 watts input. Also includes plug-in battery holder for charging 10 "Z" size nickel cadmium batteries. Imported. Shpg. wt., 4 lbs.

99 E 3136M Net 13.99

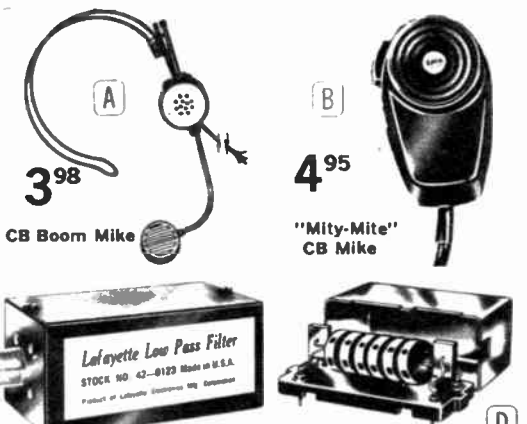

3.98 CB Boom Mike
4.95 "Mity-Mite" CB Mike
6.95 CB Low Pass Filter
9.95 Authentic Mechanical Filter

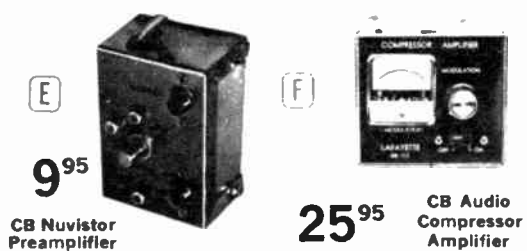

9.95 CB Nuvistor Preamp
25.95 CB Audio Compressor Amplifier



9.45 Auto-Marine Engine Noise Suppressor Kit
2.49 Generator Noise Filter



3.29 Alternator Noise Filter
37.95 CB Transceiver Tester

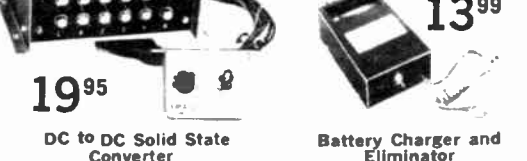

19.95 DC to DC Solid State Converter
13.99 Battery Charger and Eliminator

Deluxe LAFAYETTE Citizens Band Antennas

BASE STATION

MOBILE

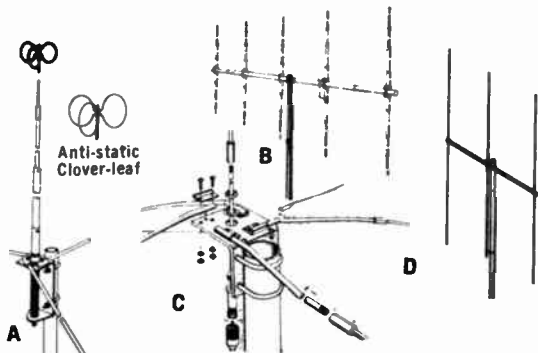

(A) DELUXE LAFAYETTE "RANGE-BOOST/11" END FED 1/2-WAVE CB ANTENNA. Specially designed anti-static cloverleaf ball drastically reduces receiver noise by continuous dissipation of static discharge. Offers a 3.75 db true omni-directional gain. Tremendous signal to noise ratio improvement of 6-20 db. VSWR is 1.17-1. Includes a phasing transformer, rubber covered for moisture resistance. Vertical radiator consists of 3 seamless aluminum tube sections topped by a solid aluminum 108" top section. 3 5/4" radials provide proper transmission line decoupling. New heavy duty mounting bracket. Direct ground lightning protection. 50 ohm, 17'6" over-all length. Accepts up to 1 1/2" masts PL-259 cable connector. Shpg. wt. 10 lb. Less mast and coax cable. **42 E 0144WX** Net 19.95

(B) FAMOUS LAFAYETTE DELUXE 5-ELEMENT CB VERTICAL BEAM ANTENNA. One of the most powerful CB antennas ever offered by Lafayette! Tremendous 10 db forward gain multiplies your effective radiated power by as much as 10 times. Front-to-back ratio 25 db. V.S.W.R. under 1.5:1. Gamma matched to 52 ohm coax-transmission. All aluminum construction for greater weather resistance. Boom length 17 ft. Reflector element (highest 18 1/2 feet.) Mounts on masts up to 2" in diameter. Turning radius 8'6". Vertical wind load 125 lbs. With complete mounting instructions. Less mast and coax cable. Shpg. wt., 15 lbs. Made in U.S.A. **42 E 0114WX \$5 Monthly** Net 39.95

(C) LAFAYETTE DELUXE HEAVY-DUTY GROUND PLANE ANTENNA. High efficiency ground plane antenna constructed of four solid aluminum 108" heat treated radials and one radiator. Elements supplied in two 54" lengths joined by threaded coupling nuts. Accepts 1 1/4" tubing, RG-58U 50 ohm coaxial cable and PL-259 coaxial connector. Less mast and coax. Imported. Shpg. wt., 4 lbs. **99 E 3031W** Net 9.95

(D) LAFAYETTE'S 3-ELEMENT VERTICAL BEAM CB ANTENNA. An exceptionally high gain, directional antenna which develops a forward gain of 8 db. Front-to-back ratio is 25 db; front-to-side, 40 db. 50 ohm feedline match for maximum efficiency. Comes with bracket for vertical or horizontal mounting. 1 1/4" O.D. aluminum boom is 8 feet long. 3/4" to 1/2" O.D. aluminum elements are approximately 16 1/2 ft. long. All steel hardware is irridite treated to MIL specs. Accepts up to 1 1/2" mast. Completely factory pre-tuned, and furnished with instructions. Made in U.S.A. Less mast and coax cable. Shpg. wt., 11 lbs. **42 E 0113WX** SALE 16.95

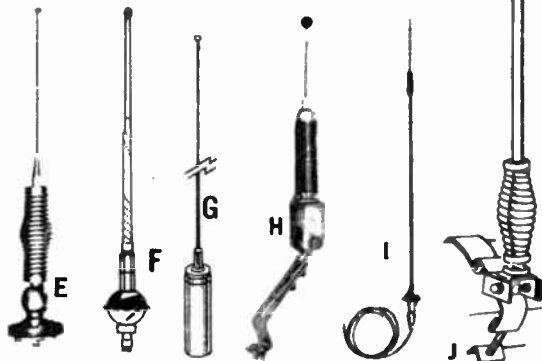

(E) FAMOUS LAFAYETTE ALL STAINLESS STEEL CB MOBILE ANTENNA Full quarter wave 102-inch stainless steel whip, heavy-duty chrome plated stainless steel spring and swivel ball jointed base designed for mounting on any surface. Base has lug terminals for 42-7002 cable assembly. Perfect for rear deck mobile mounting. Less cable. Imported. Shpg. wt., 4 lbs. **99 E 3034WX** Net 6.95

(F) LAFAYETTE CENTER-LOADED FIBERGLASS CB COWL MOUNT ANTENNA. Only 48" high but performs like 102" antennas. Four foot whip eliminates the possibility of striking overhead objects and black plastic whip covering protects against shorting. Specially designed rocker support assures 8-point grounding and permits up to 35° mounting angle on fender, cowl, or rear deck—fits any 1 1/8" to 1 1/4" mounting hole. Complete with 5' RG-58/U cable. Shpg. wt., 3 lbs. Made in U.S.A. **42 E 0112W** Net 7.50

(G) LAFAYETTE BASE LOADED "AUTO-TOP" CITIZENS-BAND ANTENNA. The Lafayette Base Loaded "Auto-Top" Citizens-Band antenna offers the CB'er the ideal omni-directional signal pattern with very low signal to noise. This quality antenna consists of an inconspicuous base loaded, neutral gray weatherproof phasing transformer (only 4" high, and 1" in diameter), a 39" stainless steel whip, and all mounting hardware including complete and simple mounting instruction sheets. Antenna mounts in 3/4" hole. Comes less cable. Shpg. wt., 2 lbs. Made in U.S.A. **42 E 0120** Net 7.99

(H) LAFAYETTE BASE LOADED TRUNK MOUNT MOBILE ANTENNA. Exciting mobile antenna from Lafayette permits the CB'er to mount his antenna without any visible holes on his car. Special trunk groove mount requires just two tiny 2/32" holes in groove of car trunk lid. Installs in seconds. Antenna holds securely and is adjustable to all cars. Features base loaded, weatherproof phasing transformer (only 4" high, 1" diameter) and a 39" stainless steel whip. Complete with all mounting hardware, a simple mounting instructions. Less cable. Shpg. wt., 5 lbs. **42 E 0145** Net 9.99

(I) DELUXE LAFAYETTE HEAVY DUTY MOBILE CB-AM ANTENNA. Deluxe top loaded cowls mounted antenna doubles as Citizens Band antenna and AM broadcast antenna. Eliminates two antennas on your car. Sturdy construction with heavy chrome plate. 46" long collapsing to 31". Fits the 7/8" to 1 1/4" space left by auto antenna. Includes automatic dividing harness. 1' cable to AM set, 2' cable to CB rig and 5' cable with PL-259 plug to antenna. Small divider unit fits under dash. Imported. Shpg. wt., 4 lbs. **99 E 3060** Net 7.95

(J) LAFAYETTE CB BUMPER MOUNT ANTENNA WITH STAINLESS STEEL STRAP. Features a full one-quarter wavelength 102" stainless steel whip and a fully adjustable chrome plated mount with a specially designed stainless steel strap to fit most cars. No loading coil—maximum efficiency! Heavy-duty chrome plated steel spring is built for extremely rugged mobile use. Imported. Shpg. wt., 3 lbs. **99 E 3032WX** Net 8.95

POLYFOAM COAX CABLE ASSEMBLIES

• PL-259 Connectors on Both Ends

Stock No.	Type	Length	Wt.	Net
42 E 0910	RG8/U-50 ohms	50 ft.	7 lbs.	8.90
42 E 0911	RG8/U-50 ohms	100 ft.	11 lbs.	14.95

DELUXE CORNELL-DUBILIER MODEL AR-22R AUTOMATIC ROTOR FOR CB ANTENNAS

Heavy-duty rotor unit will handle antennas up to 150 lbs. Simply set the control unit pointer to the desired direction, and the antenna will automatically rotate to this position and stop. Rotor will take masts from 7/8" to 2" O.D. Control unit is marked in compass points. N.S.E.W. NW. NE. SW. and SE. For 110-120 volts. 50-60 cps AC. Requires 4 conductor cable. Shoe. wt., 14 lbs. **42 E 8607WX \$5 monthly** Net 33.27
100' coil of 4 conductor cable for AR-22R **32 E 8910** Net 2.82



33.27 No Money Down

COAXIAL CABLE ASSEMBLIES FOR MOBILE ANTENNA APPLICATIONS



TYPE A—Consists of 20 ft. RG-58/U cable with PL-259 plus UG-175/U on both ends. Required for Ground Plane, Coaxial and Mobile Antennas terminating in a coaxial plug. Shpg. wt., 8 oz. **42 E 7001** Net 2.99

TYPE B—Same as Type A except one end is terminated with PL-259 plus UG-175/U and other end with universal ring type terminal lugs for mobile antennas. Shoe. wt. 8 oz. **42 E 7002** Net 2.75

LAFAYETTE — World's Largest Seller of CB Equipment and Accessories

LAFAYETTE MOBILE AM to CB ANTENNA CONVERTER

6⁹⁵

- 1 Antenna Now Does the Job of 2 Antennas
- Converts Any AM Automobile Antenna to a Highly Efficient Combination CB and AM Antenna

Specially designed Lafayette AM to CB antenna converter consisting of a weather-proof loading coil with a universal mount and adjustable matching 7/8" stub. Covers entire 27 MC Citizens Band. Easily attaches to your existing AM automobile antenna. Includes dividing harness which couples your new combination AM and CB antenna directly to your Citizens Band Transceiver and AM auto radio. Imported. Shpg. wt., 2 lbs.

99 E 3116 Net 6.95

10 FT. SUPER HEAVY DUTY ALUMINUM MAST

For mounting all CB Base Station antennas. Heavy gauge aluminum, 1/8" wall thickness. O.D. is 1 1/2". Length 10 ft. Shpg. wt., 6 lbs.

18 E 5626WX Net 7.10

UNIVERSAL LAFAYETTE CB ANTENNA ACCESSORIES

UNIVERSAL LAFAYETTE CHROME PLATED SWIVEL BALL MOUNT BASE with lug terminals for use with mobile antennas. Can be mounted vertically or horizontally on any surface. With lug terminals for use with mobile antennas. Imported. Shpg. wt., 3 lbs.

99 E 3030 Net 1.95

UNIVERSAL LAFAYETTE HEAVY DUTY CHROME PLATED STAINLESS STEEL SPRING. Provide maximum support for long whips and heavy centerloaded whips. Imported.

99 E 3036 Wt., 2 lbs. Net 2.79

LAFAYETTE CENTER-LOADED MOBILE CB GUTTER CLAMP ANTENNA

ONLY **10⁹⁵**

Made in USA

Easily removable when not in use — prevents theft or damage. Gutter clamp snaps on rain gutter of automobile. Heavy spring assures positive grip. Clamp is heavily plated to resist corrosion. Only 20 inch in length—outstanding 11 meter performance SWR 1:1. Furnished with 12 ft. of RG58/U cable with PL-259 Connector. Shpg. wt., 3 lbs.

42 E 0125 Net 10.95

BLITZ BUG LIGHTNING PROTECTOR

Only **3⁹⁵**

Designed to fit any standard coaxial cable, the "Blitz Bug" employs the spark gap principle to eliminate static build up on coaxial cables. Provides a constant drain off, reducing chances of a direct lightning strike and in many cases eliminating noise problems. Constructed of 3/4" O.D. brass by 2 1/4" long. Employs one PL-259 plug and one DKCB connector (takes PL-259 plug). Wt., 1 lb.

42 E 2001 Model LAC-1 Net 3.95

LAFAYETTE CHROME PLATED MOBILE BUMPER MOUNT

with Stainless Steel Strap **3⁹⁵**

- Completely Adjustable For Use with Most Types of Automobile Bumpers
- Highly Reliable and Durable!

An outstanding Lafayette mobile Bumper Mount featuring chrome plated mount and stainless steel strap which is completely adjustable for vertical mounting on most types of automobile bumpers. Eliminates need of cumbersome link type chain mounts. Shpg. wt., 1 1/2 lbs.

99 E 3035 Imported Net 3.95

ANTENNA SPECIALIST'S "SUPER MAGNUM"

29³⁵

- Deluxe CB Base Station Antenna
- Stati-Lite Ball for Additional Dissipation of Static Electricity

Rigid aluminum vertical radiator provides; minimum improvement in signal-to-noise of 6 db, a 3.75 db of true gain as compared to a flat ground plane antenna. Top mounted orbital ball drastically reduces static discharge noise. Full 1/2 wavelength 108" radials offer maximum RF coupling... low radiation angle intensifies signal coupling. Includes powerful phasing transformer and mounting hardware to take up to 1 1/2" masts. Treated against corrosion. Easy to install. Shpg. wt., 14 lbs.

42 E 1001WX Net 29.35

LAFAYETTE TELESCOPIC ANTENNA CB WHIP

SALE 3³³

Price in effect thru 3/15/67

Sturdy, attractive chrome plated whip antenna that telescopes from approx. 45" fully extended to only 15" to facilitate portability and storage. Ideal for shorter distances up to several miles. Has enclosed base loading coil for proper impedance matching. Complete with removable PL-259 connector that permits direct top, side or rear mounting to transceiver. Imported. Shpg. wt., 1 lb.

99 E 3015 Net 3.33

CB SIGNAL-HUNTER DIRECTION FINDING ANTENNA

ONLY **12⁹⁵**

- Track Down CB Interference
- Locate Stations in Distress
- Plugs Into Your CB Set

Tracks down sources of CB interference, TVI, stranded motorists, boats in distress, unknown transmitters, etc. Mounts with suction cup and bracket. Tunes quickly with knob on loop. Indications are made on receiver's S-meter and volume output as loop is rotated. Can be used for transmitting over short distances. 8 ft. cable permits mounting on either side of the car. 50 ohms impedance. Complete with PL-259 connector and RG-58/U cable. Shpg. wt., 4 1/2 lbs.

42 E 2101W Net 12.95

LAFAYETTE Citizens Band Walkie-Talkie Antenna Replacement Guide

- Fits All Lafayette and Many famous name Walkie-Talkies

Designed for the various Lafayette "Walkie-Talkie" portable CB Transceivers indicated. Will also fit many of the other "Walkie-Talkie" units manufactured by companies other than Lafayette. Check the specs of the antennas listed on the chart below for the antenna best suited to your present "Walkie-Talkie". All measurements are in inches. Imported. Average shpg. wt., 1 lb.

Antenna Stock No.	Sections	Diam. of Base	Col. of lapsed Length	Extended Length	For LAFAYETTE Walkie-Talkie Model	Net Ea.
99 E 3008	12	1/2	6	52 3/4	HE-29, HE-29B	1.95
99 E 3111	11	1 1/2	5 7/8	51 1/4	HE-29D	1.95
99 E 3037	11	1/2	6 1/4	54 1/2	HA-60, HA-61, HE-86, HE-88, HA-100, 100A, 100B	1.95
99 E 3038	9	3/8	7 1/4	52 3/4	HE-25, HE-88, HA-711	1.95
99 E 3039	11	3/8	5 3/4	50	HE-66, HE-82, HE-83	1.49
99 E 3040	9	3/8	5 7/8	43 1/4	HA-20, HA-70	.98
99 E 3112	8	3/8	5 7/8	36 1/2	HA-70B, HA-70C	.98
99 E 3041	11	3/8	5 3/4	51	HE-29C	1.95
99 E 3113	11	3/8	4 5/8	38	HA-130, HA-130A	1.49
99 E 3114	6	1/4	6	30	GT-3	.98
99 E 3017	10	3/8	7	58	HA-150	1.95
99 E 3007	11	3/8	7 1/4	62 3/4	HA-300, HA-300A	2.25
99 E 3115	11	3/8	7	58	HA-99, HA-303	2.95
99 E 3137	9	3/8	7 1/4	54	HA-62	1.49
99 E 3138	11	3/8	7	58	HA-300B	2.25

COMSTAT® 9 5-WATT CITIZENS BAND TRANSCEIVER KIT

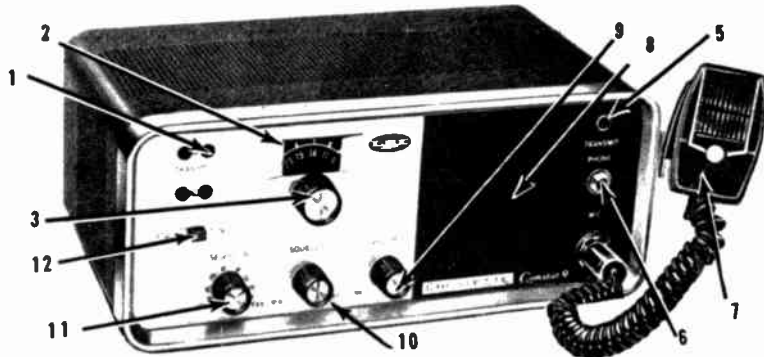

1. Front Panel Crystal Sockets
2. Illuminated Vernier Tuning Dial
3. Tuneable Receive Dial Control
4. 5-Watt or 100 Milliwatt Switch (Rear)
5. Modulation Indicator
6. Phone Plug for Earphone Listening
7. Plug-In Push-to-Talk Ceramic Mike
8. Front Panel Speaker
9. Volume Control/Power Switch
10. Variable Squelch
11. 9-Channel Crystal Transmit-Receive Selector Switch
12. Xtal-Tune Receiver Mode Switch

- 9-Crystal-Controlled Transmit and Receive Channels
- Front Panel Transmit and Receive Crystal Socket
- 23-Channel Tuneable Receiver
- High-Efficiency 7-Tube Circuit
- 115 VAC and 12 VDC Power Supply
- Pi-Network Antenna Matching

59⁹⁵

NO MONEY DOWN

Efficient 7-tube circuitry, top quality parts, plus Lafayette's famous easy-to-follow directions give you a CB transceiver with excellent performance. Incorporates 9 crystal controlled receive and transmit channels with an integrated tuneable 23-Channel receiver section for exceptional operating flexibility. Sensitive superheterodyne receiver features series floating gate noise limiter and a tuned RF amplifier for high gain and low noise reception. Sensitivity .8 μ v for 10 db. S/N ratio. Selectivity: —26 db at 8 KC. Adjacent Channel Rejection: —31 db. Adjustable squelch circuit insures quiet stand-by operation. Transmitter provides full 5-watt input with up to 100% plate modulation. Front panel light indicates modulation. Short range operation for use as intercom at CB jamborees, etc. is facilitated by a 100 milliwatt switch. Output impedance: 50 ohms. Ceramic microphone features plug-in push-to-talk operation and coiled cord. External crystal sockets mounted on front panel for added flexibility. Built-in power supply operates on 117 VAC or 12 volts DC.

Kit comes complete with parts: wire, solder, easy-to-follow manual, microphone, and sturdy attractive metal cabinet. Less crystals and vibrator. Shpg. wt., 20 lbs.

42 E 0915WX \$5 monthly	Net 59.95
42 E 4701C Transmit Crystal (Specify Channel)	Net 2.25
42 E 0914C Receive Crystal (Specify Channel)	Net 2.25

OPTIONAL DC ACCESSORIES

42 E 0916 Mobile Mounting Bracket	Net 2.50
42 E 0917 DC Cable Assembly for 12V DC	Net 1.85
32 E 5603 Standard 12V Vibrator	Net 1.59
42 E 0121 Solid-State ALTERNATE Vibrator. Ship. wt., 1 lb.	Net 5.85

LAFAYETTE "EXPLOR-AIR"™ 4-BAND RECEIVER KIT

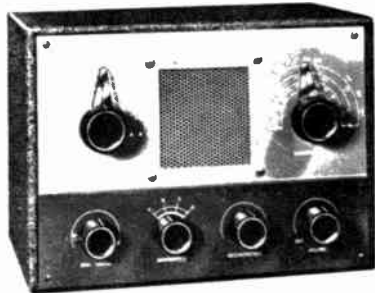

MADE IN U.S.A.

Lafayette's sensational shortwave receiver kit is a complete shortwave and standard broadcast set which covers the entire region from 550 kilocycles to 30 megacycles. Four whole bands of fascinating programming. Perfect for language students and shortwave listeners.

Only a regenerative circuit can offer such amazing performance and yet be so simple to build. Building this fine kit is an absolute pleasure—it's so well designed, you can't go wrong. Kit includes all the parts you need, and the detailed step-by-step instruction book with its giant pictorial drawings shows you just how to put them together. One front panel knob does all the bandswitching, immediately taking you from band to band. All coils are prewound for

- 4 Bands for Total Coverage
- Covers 10, 15, 20, 40, 80, 160 Meter Amateur Bands
- Tunes International Broadcast, Citizens Band, Maritime, Aeronautical and WWV Time Signals
- Complete Band Switching from Front Panel
- Bandsread Tuning
- Built-in 4" Speaker

22⁹⁵

greater accuracy. Complete 4 band coverage of broadcast stations, international broadcast bands, amateur, maritime, and WWV time signals. Big 4" speaker and sensitive circuit with 50C5 output stage and 12AT7 regenerative detector and amplifier stages give you all the volume you want. Phone jack for privacy automatically disconnects speaker. All controls are on the front panel: On-Off Volume, Main Tuning, Band Spread, Bandswitching, Antenna Tuning, and Regeneration. 110 volt 50-60 cycle AC-DC power supply. Size: 10x7x5".

19 E 0905 (Less Cabinet) wt., 5 lbs.	Net 22.95
Leatherette covered Wooden Cabinet for above. 1 lb.	
19 E 0906	Net 2.85

LAFAYETTE KT-92 5-WATT PUSH-PULL AMPLIFIER KIT

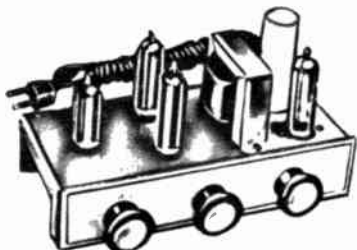

- Push-Pull Audio Output Stage—Inverse Feedback Circuit
- Separate Volume, Bass & Treble Controls ● AC or DC Operation

11⁹⁵

Made in U.S.A.

Here in kit form is an AC-DC hi-fi amplifier that presents deluxe features despite its amazingly low price. The separate bass and treble controls permit adjustment of both low and high frequency response and balance. Works equally well with both crystal or ceramic cartridges. Tube line-up consists of a 12AX7 amplifier and phase inverter, a pair of 35C5's in push-pull, having a power-packed low-distortion output plus a 35W4 rectifier. The circuit utilizes an inverse feedback loop to reduce the level of hum and distortion. Kit is complete containing all essential parts, tubes and detailed instruction manual showing pictorial and schematic diagrams.

19 E 0101 Shpg. wt., 4 lbs.	Net 11.95
-----------------------------	------------------

Outstanding LAFAYETTE Hi-Fi Amplifier Kits

LAFAYETTE MODEL KT-630 30-WATT STEREO AMPLIFIER KIT

LAFAYETTE MODEL KT-645 45-WATT STEREO AMPLIFIER KIT

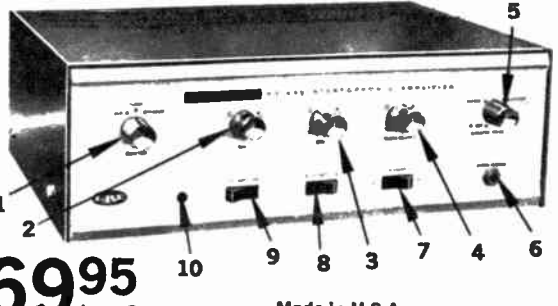
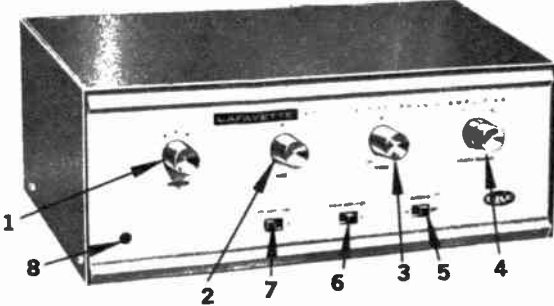

44⁹⁵ Less Case Made In U.S.A.

FRONT PANEL CONTROLS

- | | |
|---------------------------------|--|
| 1 Selector: Aux, Tuner, Phono | 6 Right Amplifier Mode Selector Slide Switch |
| 2 Bass Control | 7 Left Amplifier Mode Selector Slide Switch |
| 3 Treble and AC Off Control | 8 AC Indicator Light |
| 4 Concentric L/R Volume-Balance | |
| 5 Loudness On/Off Slide Switch | |

Enjoy exciting, wide-range stereo reproduction anywhere in your home or office. The KT-630 features built-in equalized preamplifiers, DC on the filaments in the preamp stage to minimize hum and noise, and 4 pairs of stereo inputs—magnetic and ceramic cartridge, tuner, and auxiliary. Also, the full 30-watt output may be switched for monaural reproduction to either speaker by means of slide switches on the front panel. An attractively styled brushed aluminum gold anodized extruded front panel with matching gold knobs complements the superior electrical specifications. For 110 to 125 Volts, 50-60 cycles AC; Size 12³/₈Wx1¹/₈Dx5¹/₄"H., overall. Less cabinet. Shpg. wt., 20 lbs.

SPECIFICATIONS

Input Jacks: Magnetic phono, Ceramic phono, Auxiliary, and Tuner; AC Convenience outlet on rear; Rated Power Output: 12¹/₂ watts RMS per channel; 15 watts per channel; Sensitivity: Phono (magnetic): 2 mv; Phono (ceramic) 70 mv; Tuner and Aux. 65 volt; Frequency Response: 20-60,000 cps. \pm 1.5 db at 1 watt; Harmonic Distortion: 1% at 12¹/₂ watts RMS per channel; Hum and Noise: Aux. and Tuner—72 db below rated output, Phono—50 db below rated output; Output Impedance: 4, 8, 16 ohms; Tube Complement: 2—ECC83/12AX7, 4—ECL82/6BM8, 1—EZ81/6CA4. Power Requirements: 110-120 V, 60 cycles AC;

21 E 0930WX \$5 monthly Net 44.95
Brown metal case for KT-630. Shpg. wt., 4 lbs.
21 E 0931W Net 3.95

LAFAYETTE MODEL KT-615 15 WATT MONAURAL HI-FI KIT

- Easy-to-Build—All Parts, Wire, Solder, and Instructions Included
- Inputs for Magnetic or Ceramic Phono, AM FM Tuner, and Auxiliary Equipment
- Attractive Two-Tone Gray Panel with Silver Trim

ONLY **22⁹⁵**

Specifications: Power Output 15 Watts IHFM, 12.5 watts RMS; Frequency Response: 15-60,000 cps \pm 2 db at 1 watt (average listening level), 35-25,000 cps \pm 2 db at full 15 watt output; Harmonic Distortion: 1.1% at full output; Hum and Noise: Phono—45 db, Aux/Tuner—75 db; Input Sensitivity: Aux/Tuner .5 volt, Mag Phono 1.5 mv, Ceramic 25 mv; Tubes: 2—ECL82/6BM8, EZ81/6CA4, ECC83/12AX7.

KT-615 offers versatility and flexibility. Three separate inputs for a fully integrated hi-fi system. Separate bass and treble controls provide full tonal quality. Push-pull ECL82 output stage for clean, wide response. Hum Balance control for minimum hum and

noise. 4, 8, and 16 ohm output. Less case listed below. Size 11¹/₈Wx7¹/₂Dx4¹/₂"H. Shpg. wt., 9 lbs.

19 E 0912 KT-615 less case Net 22.95
Attractive Gray Case for KT-615
19 E 0913 Shpg. wt., 2 lbs. Net 3.95

ASSURANCE OF COMPONENT QUALITY ONE YEAR PARTS GUARANTEE

All Components in this unit are conservatively engineered to operate well within their performance capabilities. As assurance of this quality, Lafayette will replace any parts, including tubes, which fail to perform properly due to defects of material or workmanship.

MONEY BACK GUARANTEE

Your Lafayette Kit when properly wired must meet our specifications or you may return it for FULL REFUND of the purchase price



Made In U.S.A.

69⁹⁵ Less Case

Made In U.S.A.

FRONT PANEL CONTROLS

- | | |
|---------------------------------|-------------------------------|
| 1 Selector: Aux, Tuner, Phono | 7 Loudness Switch |
| 2 Concentric L/R Bass | 8 Right Amplifier Mode Switch |
| 3 Concentric L/R Treble | 9 Left Amplifier Mode Switch |
| 4 Concentric L/R Volume-Balance | 10 AC Indicator Light |
| 5 AC Off/Speaker Phase | |
| 6 Stereo Phone Jack | |

Forty-five watts of beautiful stereo for only a few evenings of pleasurable, interesting, and educational kit building! And the KT-645 is so flexible—it offers virtually every control needed in the modern stereo system. Features instant selection of any one of 3 program sources, dual preamps for low level phono inputs—RIAA equalized for flat response, handy front panel Speaker Phase/AC off switch for proper phase selection without disconnecting speaker cables, concentric volume control for independent or simultaneous level adjustment of both channels, and front panel stereo headphone jack. Attractive brushed aluminum gold anodized extruded front panel with matching gold knobs: Size: 14³/₈Wx12³/₈Dx5¹/₄"H., overall. Less cabinet. Shpg. wt., 24 lbs.

SPECIFICATIONS

Rated Power Output: IHFM 45 watts, 22¹/₂ watts per channel; Inputs: Aux, Tuner, Ceramic Phono, Magnetic Phono, and Tape cut; Sensitivity: Phono (magnetic): 3 mv. for rated output per channel, high level inputs: .4v. for rated output per channel. Frequency Response: 10-25,000 \pm 1/2 db at 1 watt; Harmonic Distortion: Less than .15% at normal listening level at 1 KC; IM Distortion: Less than .3% Hum and Noise, high level inputs: 70 db below rated output per channel, Phono—50 db below rated output per channel; Output Impedance: 8 and 16 ohms; Tube Complement: 4—EL84, 2—7199, 3—12AX7, 2 silicon diodes; Power Requirements: 110-125 V, 50-60 cycle AC.

21 E 0945WX \$5 monthly Net 69.95
Brown metal case for KT-645
21 E 0946W Net 4.95

Easy To Build Educational Kits

LAFAYETTE 20-IN-1 TRANSISTOR EXPERIMENTERS KIT

Fun To Build — Educational — and all 20 projects result in a useful working instrument!

PROJECTS YOU BUILD **17⁹⁵**

1. TRANSISTOR TESTER
2. VOICE ACTUATED ALARM
3. PHOTO TIMER
4. AUDIO AMPLIFIER
5. CRYSTAL SET
6. SOLAR RADIO
7. RAIN ALARM
8. TIMER
9. ONE TRANSISTOR RECEIVER
10. CODE PRACTICE OSCILLATOR
11. METROPHONE
12. TWO TRANSISTOR RECEIVER
13. ELECTRONIC RELAY
14. HOME BROADCASTER
15. PHOTO ELECTRIC RELAY
16. BURGLAR ALARM
17. WIRELESS TRANSMITTER
18. REGENERATIVE RECEIVER
19. CITIZENS BANO MONITOR
20. AUDIO OSCILLATOR

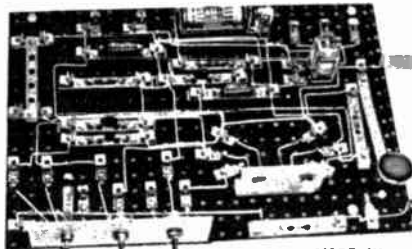

MADE IN U.S.A.

SHORTWAVE AND SUPERHET BROADCAST RADIO KIT



17⁹⁵

2 bands cover both standard broadcast 540-1700 KC and shortwave 5.8-18 MC which includes international broadcast, 40 and 20-meter ham bands and some of the aeronautical and marine bands. Superheterodyne circuit has high gain IF's, built-in broadcast band loop antenna. Comes complete with walnut cabinet, 4" PM speaker, tubes (12BE6, 12BA6, 12AV6, 50C5, plus 35W4 Rectifier) and all parts. Easy to follow step-by-step instructions. Shortwave band requires external antenna (not supplied). Size 9 1/2" x 6 1/2" x 4 1/2" D. For 110V AC or DC. Shpg. wt., 6 lbs.

19 E 4007

Net 17.95

Excellent for beginners as well as advanced experimenters, this kit enables you to build and learn about 20 interesting and useful transistor circuits. By utilizing "Breadboard" construction, each project can be simply wired and traced. After building the basic circuit, any of the 20 projects can be built by simply inserting a few preassembled component blocks and interconnecting leads between them. A soldering iron is only required for the basic wiring and not for subsequent projects. All wiring is covered in a step-by-step manner by the instruction manual. Each of the 20 projects is clearly presented with step-by-step instructions, large easy-to-read pictorial wiring diagrams, schematic diagrams, and an explanation of the circuit behavior. The kit is complete with perforated mounting board, 2-transistors, 1-diode, earphone, and all other parts required for construction. The detailed 28-page instruction manual contains a wealth of information about each project. Less batteries.

19 E 0902 Complete. Shpg. wt., 6 lbs. Net 17.95

99 E 6258 Z Cell Battery for Kit projects Net .09

32 E 4723 22 1/2 Volt Battery for Kit projects Net 1.61

LAFAYETTE WIRELESS BROADCAST/AMPLIFIER KIT

Treat yourself and your family to hours of fun with this Lafayette Kit. Make your own radio programs, announcements, etc., through AM radios anywhere in the house, without wires or extra gadgets. Designed for easy construction by youngsters or adults, it combines in one compact unit a powerful 3-tube wireless broadcaster and an audio amplifier. Clearly written instruction manual makes it a cinch to build. Operates on any frequency between 900 and 1600 kilocycles on your radio dial. It will accept any crystal or magnetic microphone. In addition, it may be used directly as a phono or microphone amplifier. No external preamp is required. Simple slide switch permits either form of operation. Just connect it to a PM speaker (4-16 ohms). Conforms to FCC regulations and is designed to provide high quality voice or record broadcasts. No license or permit is necessary. Complete with crystal clear instruction manual. Less Mike. For 105-125V AC or DC. Attractively styled metal cabinet. Size 4x8x4 1/4" D. Shpg. wt., 3 lbs.

19 E 0903 Net 13.95

Same as above, but factory wired and tested.

19 E 0908 Net 17.95

Crystal microphone for above. Desk or hand held. 5 ft. cable. Imported. Shpg. wt., 1 lb.

99 E 4543 Net 1.95

ONLY
13⁹⁵

Made in U.S.A.



Use it either as a
Wireless Broadcaster or AM Audio Amplifier!

- Clean, Modern Styling • Powerful Signal
- Works With All Crystal and Magnetic Mikes and Phono Cartridges
- Plays Through All AM Radios

LAFAYETTE SUPER-SENSITIVE PHOTOCCELL ELECTRONIC RELAY KIT

- With Sensitive Cadmium Sulphide Photocell
- Adjustable Super Sensitivity—Works With Just A Flashlight At 250 Feet!
- Needs No Special High-Intensity Lights
- Instantaneous Or Sustained Operation On The Flip Of A Switch!

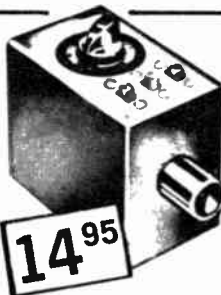

14⁹⁵

Made in U.S.A.

Ideal for sustained operation required for burglar alarms, door buzzers and for instantaneous on-off operation required for counters, packaging, door opening, motor activation plus countless industrial applications. Switch converts unit from instantaneous "on-off" to sustained "on" operation. "RESET" switch opens the external circuit and turns off the alarm. The unit operates on 110 volts AC and incorporates the efficient 5823 cold cathode tube. A simple change in wiring (in instructions), as well as convenient input terminals, enables you to supply the external circuit with any desired voltage. Relay contacts rated at 3 amps permitting up to 300 watts external load on 110 Volts AC. Complete with all parts, photocell, tube chassis, silkscreened metal cabinet and easy-to-follow illustrated instructions. Size: 3x4x5". Shpg. wt., 3 lbs.

19 E 0904 Complete Kit Net 14.95

ACCESSORIES FOR ABOVE

99 E 9023 Electric Bell, 110V AC Imported. Shpg. wt., 2 oz. Net 1.75

99 E 9024 Electric Buzzer, 110V AC Imported. Shpg. wt., 10 oz. Net 1.45

99 E 9011 6 Digit Electric Counter Imported. Shpg. wt., 1 1/2 lbs. Net 9.95

LAFAYETTE LIGHT SOURCE KIT For Electronic Relay Kit

8⁹⁵



MADE IN U.S.A.

Used to actuate electronic relay. Unlike units using sealed beam, this light source is carefully designed to throw a narrow beam of light so relatively small objects and people will "break" the beam. Unit includes adjustable focus and infra-red filter to make beam practically invisible. Range: white light—70', infra-red 45'. With instructions. Size—6Lx5Hx4"W. Shpg. wt., 5 lbs.

19 E 0911 Net 8.95

Tune in The World...with LAFAYETTE

5 Bands—Broadcast Band +
4 Exciting International
Shortwave Broadcast Bands

- 550 to 1600KC
- 5.9 to 6.25MC • 9.45 to 9.8MC
- 11.45 to 12MC • 15.05 to 15.5MC

Not A Kit... Completely Wired!
Transformer Operated... Not AC/DC
Superheterodyne—
Not Superegenerative
Superior Selectivity—
Superior Effective Sensitivity

Lafayette's great new shortwave receiver permits you to enjoy actual broadcasts from major news centers of the world! Hear programs in English and foreign languages; BBC, Radio Moscow and many others. Receiver is transformer powered and features superheterodyne circuitry with individual tuned circuits for each band. Also has big slide rule dial calibrated for easy reading and a built-in 4" PM speaker. For 105-125V., 50/60 cycles AC. 14W x 8D x 6"H. Imported. Shpg. wt., 11 lbs. 99 E 2585WX \$5.00 Monthly...Net 49.95

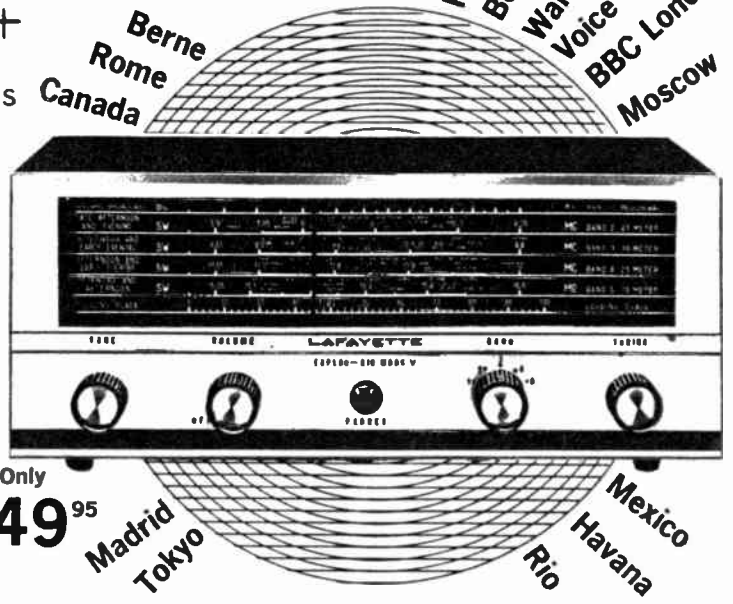

Only
49⁹⁵

Bring History-Making News Into Your Home

5-TRANSISTOR PUSH-PULL AUDIO AMPLIFIER

ONLY 3 1/16" x 1 1/16" x 1 1/16"

- 360 MW Output
- Completely Wired
- Direct Wiring



5⁸⁵

This amplifier employs 3 stages of audio driving a push-pull output stage. Designed especially for speakers with a voice coil impedance of 8-11 ohms. Low impedance input has sensitivity of 300 microvolts. Comes with leads for low impedance input, speaker, volume control/on-off switch. Battery clips and leads supplied for 9 volt battery. Imported. Shpg. wt., 5 oz.

99 E 9037	Net 5.85
99 E 6021 9 Volt Bat. 2 oz. wt.	Net .21
32 E 7364 10,000Ω Pot/Sw. 2 oz.	Net .69
99 E 6032 8Ω 3" Spkr. 10 oz. wt.	Net .99
99 E 6036 8Ω 2" Spkr. 8 oz. wt.	Net .99
Matching Transformer (high imp. to amp.)	
99 E 6034 Shpg. wt., 4 oz.	Net .89

NEW! 3 WATT 4 TRANSISTOR PUSH-PULL AUDIO AMPLIFIER

7⁹⁵

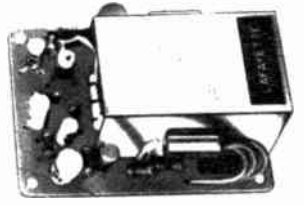

Sensitive 4 transistor push-pull circuitry has 3 watt output, requiring a 9 volt DC source. Frequency response 150-10,000 cps; Input impedance 2,000 ohms; Output impedance 8 and 16 ohm terminations. Components neatly laid out on printed circuit board with pre-drilled holes for horizontal or vertical mounting. Heat sink for power transistors. Dimensions: 3Lx2 1/2"Wx1 3/8"H. Imported. Wt., 9 oz.

99 E 9132	Net 7.95
10K Volume Control w/switch. Shpg. wt., 2 oz.	
32 E 7364	Net .69
99 E 6032 8 ohm 3" speaker. Shpg. wt., 10 oz.	Net .99

TRANSISTORIZED MINIATURE AMPLIFIER AND TUNER APPLICATIONS

By Rufus P. Turner

An Exclusive LAFAYETTE Publication

1⁵⁰



An inspiring new book written by a registered professional engineer and author. Deals primarily with over 60 challenging and interesting applications of the Lafayette transistorized miniature amplifiers and tuners described on this page. 6 chapters—Audio, Amateur & Citizens Band, Controls, Test Instruments, Tuners, Hearing Aids, Intercoms, etc. 96 pages with 60 illustrations.

10 E 0101 Shpg. wt., 6 oz. Net 1.50

5-WATT STEREO AMPLIFIER PRINTED CIRCUIT BOARD

- 2 1/2 Watts Per Channel
- 800K Input Impedance
- 8 Ohm Output Impedance
- Requires 15-volt DC Power Supply

New! Factory built, 5-watt, 10 transistor stereo amplifier! In prime application ideal for loudspeaker reproduction from phonographs with crystal or ceramic pick-up cartridges. May also be used in conjunction with AM/FM and FM/MPX tuners. Fully transistorized circuit for operation that is free from hum, microphonics, and heat; low current drain, light-weight and complete portability. Flexible color coded leads are provided for battery. On/Off switches for Mode and Input. Push-pull output is directly coupled to the speaker leads. Complete with instructions. 5 1/2"Wx1 1/4"Hx2 3/4"D. Imported. 99 E 6285 Shpg. wt., 1/2 lb. Net 10.95

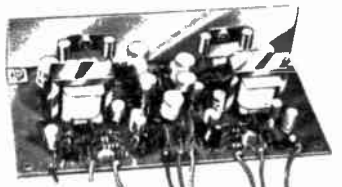

10⁹⁵

Volume Control (500K) one for each Channel	
33 E 4346 2-required	Net ea. 1.02
Tone Control (dual 500K) control	
33 E 4345 Single section	Net ea. 1.02
33 E 4417 Add-on section	Net ea. 1.35
DPDT Slide Switches for Power, Mode & Input	
34 E 3912 (3-required)	Net ea. .19



Deluxe VHF Communications Receivers

MONITOR CALLS FROM:

STATE, COUNTY AND MUNICIPAL POLICE — FIRE DEPARTMENT — CIVIL DEFENSE — RAILROADS — TRUCKING — HIGHWAY MAINTENANCE —

FORESTRY — AVIATION — CONSERVATION — PETROLEUM AND INDUSTRIAL ACTIVITIES

MODEL HA-520 DUAL BAND FM RECEIVER

TWO RECEIVERS IN ONE! DUAL BAND: 30-50 Mc and 152-174 Mc

ONLY

89⁹⁵

No Money Down



- Variable Squelch
- Solid State Power Supply
- 10 Tubes
- Nuvistor RF Amplifier (152-174 Mc)
- Built-in 4" PM Speaker
- Front Panel Phone Jack
- Illuminated Slide Rule Dial
- Attractive Green Metal Cabinet

The HA-520 provides outstanding performance on the 2 VHF FM communication bands with a sensitivity of 3 μ V for 20 db quieting. The HA-520 pulls in calls from miles away. Adjustable squelch control silences receiver during periods of no signal — reduces monitoring fatigue. With a squelch circuit the receiver "jumps to life" when

a signal comes on the frequency. Excellent for volunteer firemen to monitor calls. Uses ten tubes plus a full-wave silicon diode transformer operated power supply. Power requirements: 117 volts, 50/60 cps AC, 47 watts. Dimensions: 11 $\frac{1}{2}$ "x5 $\frac{1}{4}$ "xHx7 $\frac{3}{8}$ "D. Shpg. wt., 11 lbs.
 99 E 2572WX \$5 Monthly Net 89.95

POPULAR FM EMERGENCY RADIO RECEIVERS



Model HA-50A 30-50 MC	Model HA-52A 152-174 MC
--------------------------	----------------------------

- Nuvistor Front End* • 3 IF Stages, Fully Tuned RF Circuit

Two deluxe FM communications receivers for the office, field or home. Excellent sensitivity of 4 μ V or less for 20 db quieting and built-in adjustable squelch for dependable all-day monitoring of emergency, commercial or industrial communications. Both units feature 3 IF stages and fully tuned RF stage. Model HA-52A incorporates 6CW4 nuvistor "front-end". A built-in 4" speaker gives clear voice reproduction... and as a special feature a front panel phone jack may be used for private listening. Large, easy-to-read slide rule dial is illuminated for night operation. Housed in attractive blue-grey metal cabinet... makes a handsome addition to any home or office. Power requirements: 117 volts AC at 50/60 cps. Size: 11 $\frac{1}{2}$ "x5 $\frac{1}{4}$ "x7 $\frac{3}{8}$ ". Imported. Shpg. wt., 14 lbs. *Model HA-52A Only.
 99 E 2561WX Model HA-50A 30-50 mc \$5 monthly Net 59.95
 99 E 2562WX Model HA-52A 152-174 mc \$5 monthly Net 69.95

Only **59⁹⁵** each
 No Money Down.



MONEY-SAVING RECEIVER-ANTENNA PACKAGES

MODEL HA-520 PACKAGE



Save **9⁹⁵**

Model HA-520 dual band FM receiver plus Dual Band "Range Boost" ground plane antenna. Shpg. wt., 17 lbs.
 40 E 9010WXM Net 99.95
 "Range Boost" Dual Band Antenna only.
 40 E 0105WX Wt., 6 lbs. Net 19.95

MODEL HA-50A PACKAGE



Save **7³⁴**

Model HA-50A 30-50 Mc. FM emergency radio plus window and ledge mount antenna. Shpg. wt., 17 lbs.
 40 E 9008WXM Net 59.96
 Antenna only. Wt., 3 lbs.
 40 E 1301W Net 7.35

MODEL HA-52A PACKAGE



Save **6²¹**

Model HA-52A 152-174 Mc. FM emergency radio plus high band ground plane antenna. Shpg. wt., 16 lbs.
 40 E 9009WXM Net 59.96
 Antenna only. Wt., 2 lbs.
 40 E 1302W Net 6.22

LAFAYETTE 100-Watt Mobile Linear Amplifier

**SMALL... COMPACT
ONLY 2 INCHES HIGH!**

**CONVERT FLEA POWER
TO REAL POWER!**



**Model HA-250 79⁹⁵ Made in U.S.A.
\$5 Monthly
No Money Down**

- Covers 20-54 MC... 6, 10, 11 and 15 Meters (Not Permitted on 11 Meters Class D (CB) Operation in U.S.A.)
 - No External Switching Required
 - Will Work On Any Signal of 1 Watt or More—AM, FM, SSB or DSB, and CW
 - Completely Self-Contained 12 Volt Power Supply
- Boost flea power to real high power for extended range and better readability. Provides up to 100 watts PEP (50 Watts DC) input into a 50 ohm load (with 8 watts RF Drive) (max 10 watts). For use with all low power rigs having 1 watt or more of output power. Unique RF sensing circuit automatically switches in linear when transmitter is activated. This radio frequency sampling stage switches the linear's B plus voltage which instantaneously energizes the linear. Absolutely no external switching is necessary. Built-in relay directly connects antenna to input SO-239 coaxial socket when receiving. No internal connections are required to your existing equipment. Circuitry is broadbanded so only one tune-up is necessary on any

band. Illuminated front panel meter indicates relative RF strength of linear's output signal when linear is on or exciter's RF strength when linear is off. Self contained power supply utilizes a high efficiency toroid power transformer. Power Requirement: 11.5-14.5 Volts DC (Negative Ground Only). Power Consumption: 12 Watts Idling (1 Ampere at 12 Volts), 96 Watts at Full Input (8 Amperes at 12 Volts). Size: 7dx9wx2"H. Ruggedly designed chassis with over sized heat sinks assure sturdy and cool operation. Supplied with comprehensive manual, fused DC power cables, and mounting bracket. Made in U.S.A. Shpg. wt., 3½ lbs.
40 E 0106WX 12 Volt DC Negative Ground Only Net 79.95

DELUXE LAFAYETTE MODEL HA-225 SSB/CW/AM 14-TUBE AMATEUR COMMUNICATIONS RECEIVER

Dual Conversion On 6 Meters

5 BANDS:

- 150-400 Kc
- 1.6-4.8 Mc
- 4.8-14.5 Mc
- 10.5-30 Mc
- 48-54 Mc

**SALE!
SAVE 10.00
Now Only
109⁹⁵
No Money Down**



Price in effect thru 3/15/67

- 14-Tube Superheterodyne Circuit
- Extra RF Stage and Mixer/Osc. for Dual Conversion on 6 Meters
- New Product Detector Circuit for Improved SSB Reception
- Crystal Calibrator for Checking Receiver Calibration Markings

"ALWAYS ON" FILAMENT VOLTAGE IN MIXER AND OSCILLATOR STAGES FOR FREQUENCY STABILITY!

The HA-225 features full amateur band coverage of 80 through 6 meters plus the marine beacon band. Calibrated electrical bandspread on amateur bands 80 thru 10 meters (6 meters is tuned with main tuning controls). Dual conversion on 6 meters provides average of 50 db image rejection. Other features include antenna trimmer for optimum performance on all bands, built-in edgewise "S" meter, special recording jack in rear permits easy connection to tape recorder, headphone jack, remote control socket on the back allows simultaneous control of HA-225 with a transmitter. Sensi-

tivity: .5 Microvolt for 10 db s/n ratio, Output Impedance—8 and 500 ohms (speaker not supplied). Tubes: 4-6AQ8, 3-6BA6, 2-6BE6, 1-6BL8, 1-6AL5, 1-6AQ5, 1-OA2 plus 6CA4 rectifier. Size: 17Wx7½Hx 10"D. Imported. Shpg. wt., 28 lbs.
99 E 2523WX Less Calibrator, Crystal \$6.50 Monthly Net 109.95
Optional Calibrator Crystal, 100KC, Type HC/13U Net 3.95
40 E 0901L Net 3.95
Model HE-48A Matching 3x5" Speaker. Shpg. wt., 4 lbs. Net 7.95
99 E 2569 Net 7.95

LAFAYETTE DELUXE SELF-POWERED VFO

SALE

SAVE 5.00

Now Only **24⁹⁵**



- Covers 80 through 10 Meter Amateur Bands
- High Output to Drive Any Modern Transmitter

Employs a high "Q" series tuned Clapp oscillator, remarkable for its low drift. A VR tube eliminates frequency shift due to variations in line voltage. Features large easy-to-read illuminated slide rule dial with smooth tuning drive. Dual output impedance. Low heat silicon diode power supply. Tubes 6AU6, 6AQ5, OA2. Size: 6½Wx5¼Hx7½"D. For 117 volts 50/60 cps AC. Imported. Shpg. wt., 7½ lbs.
99 E 2501 Net 24.95

Amateur Equipment Is Available on Easy Pay Plan—No Money Down

World Radio History

LAFAYETTE ALL-BAND VERTICAL TUNEABLE 10 TO 80 METERS ANTENNA

- 10 To 80 Meters
- For Fixed Operation
- Omni-Directional, Vertically Polarized
- Irridite Treated To Mil Specs

14⁹⁵

Our best buy multi-band antenna. Can be tuned to any amateur band 10 through 80 meters by a single adjustment. Has amazing efficiency for DX or local contacts. Ground or roof top or tower installation. Can survive winds in excess of 50 mph. Overall height 18'; knocks down to only 5'. Uses 3½" diameter air wound coil as matching inductor. All steel parts irridite treated to Mil Specs. Impedance 52 ohms. Maximum power 1000 watts AM or CW—2 KW PEP. Omni-directional; vertically polarized. Shpg. wt., 5 lbs.
40 E 0104WX Net 14.95



Net 14.95

Lafayette Cat. No. 672 75

MODEL HA-144 2-METER SOLID STATE PORTABLE TRANSCEIVER

For 12V DC Mobile or Portable Operation

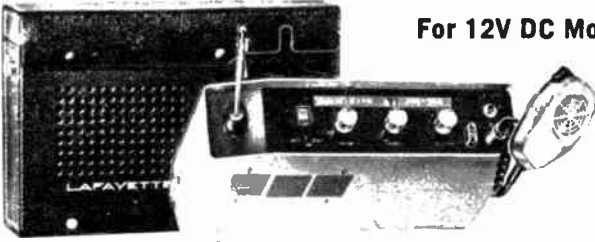

189⁹⁵

No Money Down

with 12V Mobile Power Cable, Carrying Case, Whip Antenna, Shoulder Strap, 10 Batteries

- For 144 to 148Mc Operation
- High Efficiency 2.5 Watt Input
- 6 Crystal Transmit Positions with Front Panel Jack for Crystal or VFO
- Tuneable Dual Conversion Superhet Receiver
- Uses Standard 8 MC Crystals
- 10 Transistors, 7 Diodes

Features a highly selective 144-148 MC tuneable dual conversion receiver with 1 μ v sensitivity for 10 db signal to noise ratio. 10.7 megacycle mechanical filter effectively eliminates QRM from "near frequency" stations (Selectivity: 40 db down at 30 KC). Series gate limiter automatically suppresses bothersome noise. Efficient push-pull high level modulated transmitter delivers over 1 watt of RF output power—enough for most line of sight applications. Provides five internal and one front panel switched crystal positions. May be used with standard 8 MC crystals or external VFO. Spotting switch permits positive frequency identification. Convenient front panel SO-239 coaxial connector accepts 19 inch whip or external antenna. 3-Way Switched Front panel meter indicates "S" units on Receive and Spotting, and battery condition. Supplied with leather carrying case, whip antenna, shoulder strap, 12V mobile power cable,

and 10 "D" size batteries. Less Crystal. Size: 12Wx7 $\frac{1}{4}$ Hx3"D. Less Crystal. Shpg. wt., 8 lbs.
 99 E 2581WX \$10 Monthly Net 189.95
 99 E 6256 "0" Cells (10 Required) Net ea. .13
 In lots of ten (Total Shpg. wt., 2 lbs.) Net ea. .125
 32 E 4804 "D" Size Alkaline Battery (10 required) ... Net ea. .65
Model HB-501 Solid State AC Power Supply
 Allows use of HA-144 on 117 VAC. Shpg. wt., 10 lbs.
 99 E 3628W Net 16.95
 8 MC Fundamental Crystal (Divide operating frequency by 18)
 Will supply to nearest 5 KC.
 40 E 5403C Specify Frequency Net 2.95

DELUXE MODEL HA-1200 2-METER AMATEUR TRANSCEIVER



16 Tube
4 Transistors
7 Diodes

Only
189⁹⁵
No money Down

NOT A KIT—
COMPLETELY WIRED

TRIPLE CONVERSION RECEIVER

- Tuned Nuvistor Front End
- 25 Watt DC Final Input
- Integrated Voltage Regulated VFO
- Built-In 12 VDC and 117 VAC Solid State Power Supplies

New Lafayette 2 meter VHF transceiver features a 25 watt DC input transmitter and carefully integrated sensitive triple conversion receiver with crystal-controlled mixer. 16 tube, 4 transistor, 7 diode circuitry utilizes separate receiver and VFO frequency controls for full flexibility. Receiver's tuned nuvistor front end boasts less than 1 μ v. sensitivity for 10 db signal to noise ratio. Effective series gate noise limiting combines with variable squelch to provide quiet reception—ideal for net operations. Powerful transmitter incorporates high level push-pull transformer coupled plate modulation. Output frequency may be crystal controlled with standard 8 MC crystals. Spot control permits precise frequency selection. Illuminated meter indicates S units on receive and relative RF output on transmit. Front panel light serves as a handy modulation indi-

cator. Fully fused internal solid state power supplies facilitate 117 VAC and 12 VDC negative ground operation. Supplied with rugged push-to-talk ceramic microphone with coiled cord. AC and DC power cables, and mobile mounting bracket. Size: 11 $\frac{7}{8}$ Wx12 $\frac{3}{4}$ Dx 5 $\frac{7}{8}$ H. Imported. Shpg. wt., 25 lbs.
 99 E 2582 \$10 Monthly Net 189.95
 Crystals for HA-1200. Specify Fundamental Frequency (Divide Operating Frequency by 18). Will supply to nearest 5 KC.
 40 E 5403C Specify Frequency Net 2.95
MODEL HA-94. Speaker mate for HA-1200. 8-inch heavy duty 8 ohm speaker. Size: 7 $\frac{7}{8}$ Wx5 $\frac{1}{4}$ Dx7 $\frac{3}{8}$ H.
 99 E 2571 Shpg. wt., 5 $\frac{1}{2}$ lbs. Net 12.95

2-METER 125 WATT MOBILE LINEAR AMPLIFIER

Now . . . Real Power For Your Low Power 2 Meter Rigs!



MODEL HA-260

A completely self contained VHF linear amplifier designed specifically for mobile use. Will efficiently boost a 1.5 watt signal up to 125 watts of plate input. Efficient RF amplification stage utilizes a special purpose mobile application Amperex DX296/8637 twin tetrode. RF sampling relay automatically switches linear in the instant the exciter is energized. No external switching, wiring, or muting circuits are necessary. Antenna is automatically connected directly to input socket in off or standby modes. Front panel controls permit full flexibility of tuning and power level selection. Illuminated relative RF power output meter simplifies linear and exciter tuning. Built in power supply features high efficiency transistor and toroid transformer circuitry. Oversized heat sinks assure

Only **139⁹⁵** No Money Down

125 WATTS DC INPUT TO FINAL

- Covers 144 to 148 MC
- No External Switching Required
- Built-in 12 VDC Toroid Power Supply
- Works with any AM Exciter with 1 or more watts output cool operation. Supplied with manual, fused DC power cable, and mounting bracket. Made in U.S.A. Shpg. wt., 3 $\frac{1}{2}$ lbs.
 40 E 0108WX 12 Volt DC Negative Ground Only Net 139.95

SPECIFICATIONS: Minimum RF Drive: 1 Watt. Input Impedance: 50 Ohms. Output Impedance: 50 Ohms. Amplification Mode: AM. Controls: Grid Tuning, Plate Tuning, Antenna Loading, Passive Grid Input. Power Requirements: 11.5-14.5 Volts DC (Negative Ground Only). Power Consumption: 12 Watts Idling (1 Ampere at 12 Volts), Input 144 Watts at Full Input (18 Amperes at 12 Volts). Size: 80x 10Wx2 $\frac{1}{2}$ "H.

6 and 10 Meter Amateur Transceivers



Model HA-460	Model HA-410
50-52Mc	28-29.7Mc

**COMPLETELY WIRED
BUILT-IN VFO**

Only 149⁹⁵

No Money Down

- Tuned Nuvistor Front End
- 20 Watts DC Input — 2E2B Final
- Built-in Low Pass Television Interference Filter
- Dual Conversion with Crystal Controlled 2nd Converter
- Built-in Solid State 12 V.D.C. and 117 V.A.C. Power Supplies



Air Variable Antenna Lead Control
Air Variable Plate Tuning Control
Calibrated VFO Frequency Control
Illuminated "S" and RF Output Meter
Calibrated Receiver Frequency Control
Transmitter Frequency Spotting Switch

Front Panel Communications Speaker
Front Panel Standard Earphone Jack
Positive Contact PTT Microphone Socket
Volume Control
Crystal-VFO Operation Mode Selector
Front Panel Crystal Socket

Exciting 400 series transceivers feature a powerful plate modulated 20 watt DC input transmitter and stable VFD with its own frequency control knob. Tune up is fast and efficient with driver and multiplier automatically tuning with VFD. Shielded low pass filter minimizes TVI problems. Dual conversion receiver utilizes a crystal controlled 2nd converter. Nuvistor RF amplifier's sensitivity is less than 1 μ v. for 10 db signal to noise ratio. Selectivity at 8 KC is 35 db. SCR controlled noise limiter effectively eliminates most types of QRM. Other features include spotting switch, use of standard 7 and 8 mc. Crystals with front panel crystal socket; illuminated meter that reads 5 units on receive and RELATIVE RF output on transmit; plug-in encapsulated dust free relay switching; front panel earphone jack; push-pull audio amplifier; and rugged push-to-talk ceramic mike with coiled cord and plug. Going mobile? The 400's come with both 117 V.A.C. and 12 V.D.C. (positive or

negative ground) built-in solid state power supplies. Supplied with: AC + DC power cords, mike and mobile mounting bracket. Size: 12 $\frac{1}{2}$ "Wx5 $\frac{1}{2}$ "Hx3 $\frac{3}{4}$ "D. Imported. Shpg. wt. 22 lbs.
Lafayette Model HA-400—6 Meter/50.0-52.0 MC Amateur Transceiver
99 E 2579WX \$8 monthly Net 149.95
Crystals for HA-460. Specify Fundamental Frequency (divide operating frequency by 6). Will supply to nearest 5 KC.
40 E 5403C Specify Frequency Net 2.95
Lafayette Model HA-410—10 Meter/28.0-29.7 MC Amateur Transceiver
99 E 2575WX \$8 monthly Net 149.95
Crystals for HA-410. Specify fundamental frequency (divide operating frequency by 4). Will supply to nearest 5 KC.
40 E 5402C Specify Frequency Net 2.95

6-Meter Solid-State Transceiver Model HA-650

**COMPLETELY PORTABLE AND MOBILE —
TAKE IT WITH YOU EVERYWHERE!**



119⁹⁵

No Money Down

- 2.5 Watts Input Using Built-In Battery Supply
- RF Output Efficiency Better Than 50%
- 6 Crystal-Controlled Transmit Positions
- Tuneable Superheterodyne Receiver
- Optional Power Supply Allows Fixed Station Operation Using 115 VAC
- Complete with Leather Carrying Case, Shoulder Strap and Batteries

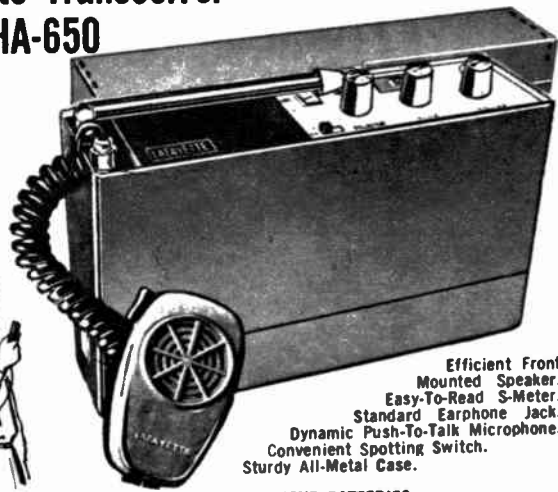

Efficient Front Mounted Speaker.
Easy-To-Read S-Meter.
Standard Earphone Jack.
Dynamic Push-To-Talk Microphone.
Convenient Spotting Switch.
Sturdy All-Metal Case.

REPLACEMENT BATTERIES

99 E 6256 "D" Cells (10 req.)	Net ea.	.13
Lots of 10	Net ea.	.125
Heavy Duty Alkaline Battery "D" Size	Net ea.	.85
32 E 4884	Net ea.	.85
MODEL NB-501 SOLID STATE AC POWER SUPPLY. Allows use of HA-650 on 117 VAC for convenient fixed station use. Shpg. wt., 10 lbs.	Net	16.95
99 E 3028W	Net	16.95
8 MC Fundamental Crystal (divide operating frequency by 6). Will supply to nearest 5 KC.	Net	2.95
40 E 5403C Specify Frequency	Net	2.95
ADAPTER CABLE ASSEMBLY		
4 Ft. RG-58/U cable assembly. Adapts Motorola type external antenna connector of HA-650 for input to SO-239 jack of external antenna. Linear Amplifier, etc.	Net	1.69
40 E 0904	Net	1.69

Great for field days! All solid-state craftsmanship delivers more than 50% efficiency into the antenna. Push-pull modulated 2.5-watts input final assures consistently high modulation level for greater talk power. Oscillator features 6 crystal positions and uses standard 8 mc fundamental crystals. Convenient spotting switch allows zeroing transmit frequency on tuneable 8-stage receiver. Receiver sensitivity 1.2 μ v. for 10 db quieting. Built-in series gate noise limiter allows quiet operation. Zener diode power supply circuitry used as voltage regulator in RF and mixer stages. Relay transmit-receive switching actuated by efficient plug-in push-to-talk dynamic microphone. Tunes popular low section of 6 meters (50 to 52 MC). Fixed station operation facilitated by external antenna connector. Supplied complete with leather carrying case, telescopic whip antenna, mobile power cable, shoulder strap, and 10 "D" cells. Dimensions: 11 $\frac{1}{2}$ "Wx6 $\frac{1}{2}$ "Hx3"D. Less crystal. Shpg. wt., 8 lbs. 99 E 2570WX \$6.50 monthly Net 119.95



Model HA-500 SSB/AM/CW 80 Through 6 Meter Receiver

FOR: NOVICE—GENERAL—TECHNICIAN

10 TUBES,
DUAL CONVERSION

Only **149⁹⁵**

NO MONEY DOWN

- 10 Tube Superheterodyne Circuit
- Product Detector for CW/SSB—Diode Detector for AM
- Two 455 KC Mechanical Filters for Sharp Selectivity
- Illuminated Calibrated S-Meter
- Dual Conversion On All Bands
- Built-In 100 KC Crystal Calibrator
- "Always-On" Oscillator Filament



6 HAM BANDS INCLUDING 6 METERS

80 Meters 3.5-4.0 MC	40 Meters 7.0-7.3 MC	20 Meters 14.0-14.35 MC	15 Meters 21.0-21.45 MC	10 Meters 28.0-29.7 MC	6 Meters 50-54 MC
-------------------------	-------------------------	----------------------------	----------------------------	---------------------------	----------------------

Outstanding new Lafayette Model HA-500 receiver features tuned RF and 1st mixture stages which provide maximum sensitivity and front end selectivity for high signal to noise ratio with superb image rejection. Dual intermediate frequency circuits utilize two ceramic 455 KC mechanical filters for additional wave shaping. Product detector and BFO combine for crisp and clear CW and SSB. OB2 voltage regulator supplies oscillator with regulated B plus voltage for virtually driftless operation. Full time automatic volume control is automatically set to provide standard operation on AM and fast attack-slow decay on CW and SSB. Illuminated slide rule dial is calibrated for easy reading. Accurate built-in 100 KC calibrator assures precise calibration. "Always On" oscillator filament increases stability and reduces warm-up time. Controls: Tuning, Calibration off/on. Automatic Noise Limiter off/on. Antenna Trim, RF Gain, AF Gain (volume control), Bandswitch, BFO

Frequency, and Function Switch. Sensitivity: less than 1 μ v. for 10 db signal to noise ratio on all bands. IF Rejection: —40 db. Image Rejection: —40 db. Audio Output: 1 watt. Intermediate Frequencies: 1st IF 2.608 MC, 2nd IF 455 KC. Output Impedance: 8 and 500 ohms. Tube Complement: 6BZ6 RF Amplifier, 6AU6 1st Mixer, 6AQ8 Local Oscillator, 6BE6 2nd Mixer, 2nd Local Oscillator, 6BA6 1st IF, 6BA6 2nd IF, 6AQ8 Product Detector and BFO, 6AQ8 AM Noise Limiter and 100 KC Crystal Calibrator, 6BM8 Audio Amplifier, OB2 Voltage Regulator. Power Requirements: 117 VAC (65 watt Power Consumption). Size: 15Wx7½Hx10"D. Shpg. wt., 25 lbs. 99 E 2574WX \$8 Monthly Net 149.95 Model HE-48A 3x5 Inch Speaker Mate for HA-500. Net 7.95 99 E 2569 Shpg. wt., 4 lbs. Net 100KC Calibrator Crystal for HA-500 Net 3.95 40 E 0901L

LAFAYETTE 10-80 Meter SSB/AM/CW Amateur Receiver

5 HAM BANDS
PLUS WWV

3.5— 4.0Mc	21.0—21.5Mc
7.0— 7.5Mc	28.0—29.7Mc
14.0—14.5Mc	WWV at 15Mc

TRULY FINE HAM GEAR

Amazing
Low
Price

ONLY
129⁹⁵

No Money Down

- Mechanical Filter for Exceptional Selectivity
- 12 Tubes Dual Conversion • Automatic Noise Limiter
- Product Detector for Selectable Upper and Lower Sideband Reception
- Complete with Crystals for 80, 40, 20, 15 and 10 Meters
- 100 KC Crystal Calibrator and Crystal BFO
- "S" Meter—Calibrated in "S" Units 1-9 and to +40 db

Lafayette's professional quality communications receiver. Dual conversion circuitry features an image and IF rejection of more than 40 db. A product detector, providing selectable upper or lower sideband, solves the problems in SSB reception. Tuneable preselector circuit gives sensitivity of less than 1 microvolt for 10 db signal-to-noise ratio. Selectivity: Bandwidth of 2 KC at 6 db down and 6 KC at 60 db down using mechanical filter. Front panel 100 KC crystal calibrator reset control used in conjunction with the 15 MC WWV station assures accurate calibration. CHECK THESE SPECIFICATIONS! Audio output: 1-watt maximum. Speaker impedance: 8; 500 ohms (speaker not supplied). Front panel controls: Preselector; Cal—On/off; Band Selector; Receive/Send; Tuning Cal Reset; Function—OH/AM/SSB1-CW/SSB2; RF gain; AF Gain; ANL; Phone jack. Tube



Model HA-350
Mechanical Filter

Ultra-sharp selectivity is achieved by means of a true mechanical bandpass filter in the 455 KC IF section. The filter consists of three sections—an input transducer, 6 non-corrosive nickel alloy resonators and an output transducer.

Model HA-94
Speaker Mate (Optional)

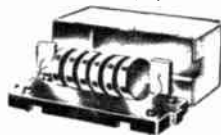

complement: 6BZ6—RF amp.; 6BL8—Xtal controlled 1st mixer; 6BE6—2nd mixer; 6BA6—VFO; 6BA6—1M amp.; 6BA6—1F amp.; 6AL5—AVC rectifier and AM noise limiter; 6AQ8—product detector and crystal calibrator; 6AV6—1st audio amplifier; 6AQ5 audio output; 6BA6—BFO; OB2—regulator, Silicon Full Wave rectifier. Size: 15Wx7½Hx10"D. For 115V 50/60 cps AC. Imported. Shpg. wt., 25 lbs. Less Calibrator Crvstal. 99 E 2524WX \$7 Monthly Net 129.95 100KC Calibrator Crystal for HA-350. Net 3.95 40 E 0901L Net 3.95 Model HA-94. Speaker mate for HA-350. 8-inch heavy-duty 8ohm speaker in matching cabinet. Size: 7½Wx5¼Dx7¾"H. 99 E 2571 Shpg. wt., 5½ lbs. Net 12.95

Model HA-700 AM/CW/SSB Amateur, SWL Receiver



Sharp selectivity, high sensitivity and exceptional stability keynote the HA-700 general coverage receiver. Continuous filament voltage on critical oscillator/mixer stages maintain frequency stability for faster warm-up. Superheterodyne circuitry features two mechanical filters for superior signal selectivity. Sensitive RF stage incorporates antenna trimming controlled from front panel. Assures peak performance on any operating frequency. Silicon diode automatic noise limiter and automatic volume control circuitry provide efficient noise and audio blasting suppression. Built-in BFO and product detection stages permit clear reception of code and sideband signals. Variable BFO tone control aids in reception of CW on crowded ham bands. Electrical bandspeed calibrated at 10 KC per division on 80 meters, 5 KC per division on 40 meters, and 50 KC per division on 10, 15, and

Only
89⁹⁵
\$5 Monthly

No Money Down

5 BANDS
BAND A—150-400KC
BAND B—550-1600KC
BAND C—1.6MC-4.8MC
BAND D—4.8MC-14.5MC
BAND E—10.5MC-30MC

- Includes 150-400 KC Weather and Marine Band
- Easy-To-Read Illuminated, Slide Rule Dial
- "Always-On" Oscillator/Mixer Filament
- Silicon Diode Noise Limiter
- Two Mechanical Filters
- Illuminated Edgewise "S" Meter
- 6 Tubes Plus Rectifier for 9 Tube Functions

20 meters. Fused transformer and solid state rectifier power supply operates from 105 to 125 volts at 50 to 60 cps. Huge slide rule dial with edge illumination and logging scale permits easy frequency read-out. Tuning dials are flywheel operated for smooth fast tuning. Sensitivity: 1 μ v. for 6 db signal to noise ratio. Antenna impedance: 50-400 ohms. Speaker Impedance: 4 or 8 ohms. Size: 7 $\frac{1}{2}$ "x15 $\frac{1}{2}$ "x10"^D. CONTROLS: Main Tuning, Bandspeed Tuning, Function-Off/AM/ANL/Send/CW-SSB, AF Gain, BFO Frequency, Band Selector, RF-IF Gain, Antenna Trim, and Meter Adjust (on rear apron). Imported. Shpg. wt., 25 lbs.
99 E 2580WX \$5 monthly Net 89.95
99 E 2569 HE-48A Matching Speaker for HA-700 Net 7.95

7-TUBE AMATEUR AND SWL RECEIVER MODEL HA-63A



Provides full fingertip coverage of AM broadcast, marine and aeronautical bands, civil defense, WWV, amateur and foreign frequencies. The BFO permits code (CW) reception too. Full electrical bandspeed with 0-100 logging scale and built in "S" meter assures you of accurate tuning. Superheterodyne circuit includes RF amplifier and three-section tuning gang condenser with separate tuning coils for each band. Big slide-rule dial is easy-to-read. Other features are switchable AVC/MVC to reduce blasting or fading; automatic noise limiter (ANL) for maximum noise rejection;

4 BANDS:

- 550-1600 Mc
- 1.6-4.8 Mc
- 4.8-14.5 Mc
- 10.5-31 Mc

Only **59⁹⁵**

No Money Down

- Electrical Bandspeed on the 80, 40, 20, 15, and 10 Meter Bands
- Superhet Circuit with RF Amplifier Stage
- Illuminated "S" Meter
- 3-Section Tuning Capacitor
- Antenna Trimmer for Optimum Performance
- Front Panel AVC-MVC Selector, ANL and BFO
- AC Transformer Operated
- Big Slide Rule Dial

and an antenna trimmer control which assures optimum reception on all bands. All controls are conveniently located on front panel. Headphone jack for private listening. Beautifully styled in modern steel cabinet. Tubes: (2) 6BA6, (2) 6BE6, (2) 6AV6, (1) 6AR5 plus selenium rectifier. AC transformer operated. 117 volts 50/60 cycles AC. Size: 13Wx7 $\frac{1}{2}$ "x10"^D. (Less Speaker.) Imported. Shpg. wt., 19 lbs.
99 E 2584WX \$5 monthly Net 59.95
99 E 2569 Matching Speaker Net 7.95

MODEL HE-48A SPEAKER MATE

Only **795**

Matching 3 x 5 speaker in handsomely styled cabinet for HA-700, HA-63, 63A, HA-500. Impedance: 8 ohm. Size: 7 $\frac{1}{2}$ "x3 $\frac{1}{2}$ "x5 $\frac{1}{4}$ "^D. Imported. Shpg. wt., 4 lbs.
99 E 2569 Net 7.95

MODEL HA-226 SHORTWAVE COMMUNICATIONS RECEIVER WITH BUILT-IN SPEAKER



Only
44⁹⁵

No Money Down

- 550-1600 Mc
- 1.6-4.8 Mc
- 4.8-14.5 Mc
- 10.5-30 Mc

4 BANDS

**Tune In Standard AM Plus
World-Wide Shortwave Broadcasts**

- Sensitive Superheterodyne Circuit
- Front Panel Headphone Jack
- Built-in 4" Speaker
- Illuminated S-Meter
- Receives Code Signals
- 0-100 Logging Scale
- Easy Tune Slide Rule Dial
- AC Transformer Operated

Hear world-wide short wave marine, aeronautical and the 80, 75, 40, 20, 15 and 10 meter amateur bands plus your favorite music and news programs on the standard AM broadcast band. Front panel controls: On/Off Volume, Band Selector, Main Tuning and CW/Phone switch. Illuminated S-meter shows signal strength and correct tuning for best reception. Large slide rule dial face with red dial pointer makes station tuning easy. Has 0-100 logging scale for instant station location. AVC reduces fading and blasting

—keeps signal on even keel. Built-in 4-inch speaker provides lots of room filling volume. Low impedance headphone jack for private listening. Speaker automatically disconnects when headphones are used. Handsome light blue all metal case. Size 10 $\frac{1}{2}$ "x6 $\frac{1}{2}$ "x8"^D. For 110-120 volts. 50/60 cycles AC. Imported. Shpg. wt., 12 lbs.

99 E 2520WX \$5 monthly Net 44.95

DELUXE LAFAYETTE AMATEUR ACCESSORIES FOR EVERY HAM SHACK

Lafayette SWR
and Field
Strength
Meter*



(A)

Lafayette Radio
Field Strength
Indicator*



(B)

Lafayette SWR
Bridge and RF
Power Meter*



(C)

Lafayette Grid
Dip Meter *



(D)

Code Practice
Oscillator*



(E)

Superox Amateur
Headphones



(F)

* Imported.

(A) Lafayette SWR and Field Strength Meter—Measures SWR (1:1 to 3:1), relative forward and reflected power to 1 KW, reads field strength, impedance 52 ohms. With coax fittings. Wt., 1 lb.
99 E 2537 Net 9.77

(B) Lafayette Field Strength Indicator—Continuously indicates transmitter output. Features 200 μ a. meter with variable sensitivity control. Wt., 7 oz.
99 E 2509 Net 6.75

(C) Lafayette SWR Bridge and RF Power Meter—Measures up to 15 watt output. Highly accurate SWR indications (1:1 to 1:10). For up to 50 MC. For 52 and 75 ohm. Wt., 2 lbs.
99 E 2508 Net 19.95

(D) Lafayette Nuvister Grid Dip Meter—Covers 1.7 to 180 Mc. in 6 bands. Complete with plug-in coils. Wt., 2 lbs.
99 E 2503 Net 19.95

(E) Lafayette Code Practice Oscillator—3 way operation—light indicator, variable pitch control, earphone tone operation. With batteries. $6\frac{1}{2} \times 3\frac{3}{4} \times 2\frac{1}{2}$ ". 1 $\frac{1}{4}$ lbs.
99 E 2560 Net 7.95

(F) Superox Amateur Headphones—Comfortable dual impedance design (600 and 4-16 ohms).
40 E 8501 Wt., 2 lbs. Net 24.95

NEW REGENCY MODEL 601 "STANDBY 1" PORTABLE AVIATION VHF TRANSCEIVER



As Low As
179⁰⁰
No Money Down

- FCC Type Accepted
- For Use In Aircraft And On Ground
- Tunable 118-127MC Receiver
- 10 Channel Capability Transmitter
- Solid State Circuitry—Battery Operated

Deluxe pocket-sized, portable aviation communications system; features 118 to 127 MC receiver coupled with a 10 channel capability transmitter, speaker-microphone and a dipole antenna. Receiver section meets Part 15 requirements of FCC rules and regulations—Transmitter section is FCC Type Accepted under Part 87 aviation services. Specifications: Receiver Audio Output 10 watts, Sensitivity 5 μ v; Transmitter Power Output 0.5 watts nominal; Crystal Positions 10; Transmitter Freq. range 120.00 to 124.00 MC. Self-contained Model 601 includes 10 crystals for 121.5, 121.7, 121.9, 122.1, 122.5, 122.7, 122.8, 122.9, 123.01, and 123.6 MC, built-in battery pack with 3 rechargeable nickel cadmium batteries, conversion unit for operation from 14 VDC airplane cigarette lighter, and removable dipole antenna. 14 Transistors, 4 diodes, less batteries. Size: 8 $\frac{1}{2}$ x 3 $\frac{3}{4}$ x 1 $\frac{1}{4}$ ". Shpg. wt., 2 lbs.
40 E 6631XL \$13.50 Monthly Net 269.00

Model 601 less built-in battery pack and with only 1 crystal for 121.5MC.
40 E 6626XY \$9.00 Monthly Net 179.00

Package of Nine Crystals for 121.7, 121.9, 122.1, 122.5, 122.7, 122.8, 122.9, 123.0, and 123.6 MC. Wt., 1 lb.
40 E 6627Y \$5.00 Monthly Net 68.00

Single Crystal—Specify exact freq. between 120 to 124 MC.
40 E 6628Y Net 10.00

Battery Pack, with 3 rechargeable nickel cadmium batteries.
40 E 6629Y Shpg. wt., 2 lbs. Net 24.00

AC Battery Charging Unit—117 VAC Adapter for ground operation and recharging NI-CAD battery pack.
40 E 6630L \$5.00 Monthly Net 30.00

DELUXE LAFAYETTE "MPI SERIES" 6 STATION INTERCOM SYSTEMS

In Attractive Hand Rubbed Oiled Walnut Cabinets

MPR
REMOTE
9⁹⁵
ea.

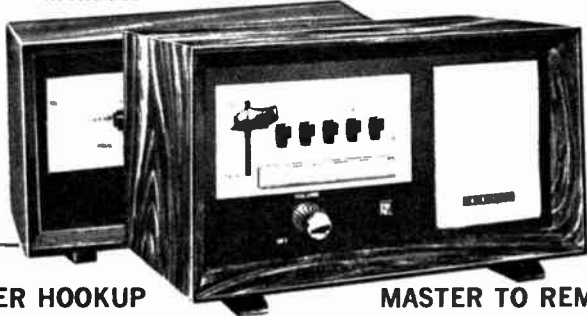

MPI-6
MASTER
22⁹⁵
ea.

MASTER TO MASTER HOOKUP

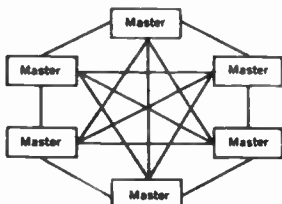

All-Master Intercom System incorporates up to six separate master stations enabling 3 private conversations or a 6-station conference to be held. Utilizes a three-position switch for listening, momentary talking, or Stand by; and a five-station selector-call switch.

MASTER TO REMOTE HOOKUP

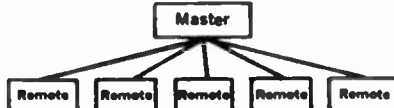

Master-to-Remote Intercom System enables master station to communicate with up to five remotes either separately or in a six-station conference. Master's 5-station selector-call switch permits private or non-private conversations. Calls may be originated by remote stations as well as master.

Lafayette's Multi-Purpose 6-Station Intercom Systems in attractive oiled walnut cabinets offer a wide range of applications for home or office use. May be hooked-up in All-Master installation containing up to six separate master stations or Master-Remote system containing one master station and up to five remotes. Master unit has 5-station selector control, three-way talk-listen-standby switch, and volume control. Remote unit has Talk-Listen switch. Wiring instructions: For Master-to-Remote system, each remote is connected to the master by a 3-conductor unshielded cable. For Master-to-Master installations, each unit is intercon-

ected by an unshielded cable containing one more conductor than the total number of master units in the system. For 115V 60 cps AC. Dim: Master and Remote: 6Hx9 $\frac{1}{2}$ Wx5 $\frac{7}{8}$ "D. Imported.
99 E 4565 MODEL MPI-6 6-Station Master wt., 8 lbs. Net ea. 22.95
99 E 4566 MODEL MPR Remote for above wt., 6 lbs. Net ea. 9.95
CABLE FOR ABOVE SYSTEMS
Belden 8443. 100 Ft. 3-conductor unshielded cable Net 2.70
32 E 1452 Shpg. wt., 2 lbs. Net 2.70
Belden 8447. 100 Ft. 7-conductor unshielded cable Net 6.85
32 E 1456 Shpg. wt., 4 $\frac{3}{4}$ lbs. Net 6.85

Top Quality—Low Priced



FAMOUS LAFAYETTE 2-STATION SOLID STATE INTERCOM SYSTEM



2 Stations
9⁹⁵

- Inter-Unit Tone Calling
- Push-Button Operation

Solid-state miniature 2-station intercom. Operates from one inexpensive 9-volt battery. System consists of one master and one remote with 66 feet of lightweight cable. Plug at each end speeds up connection—no tools needed! Master unit has power on/off/volume control and listen-talk switch—you can listen or talk to the master without operating any buttons. Master and remote can call each other even when master is switched off. Housed in a high impact plastic case with cable and 9-volt battery. Dimensions: 3Wx1¾Hx4"D. Imported. Shpg. wt., 1½ lbs.

99 E 4578	Net 9.95
99 E 6021 Extra 9-volt battery	Net .21
AC power supply and battery charger for above.	Shpg. wt. 2 lbs.
33 E 7702	Net 2.99

POPULAR 4-STATION SOLID-STATE INTERCOM SYSTEM



4 Stations
19⁹⁵

- 4-Way Selector Switch
- Remote Tone Call

High quality battery powered 4-station intercom system. Push-button listen-call switch on all units. Call signal operates even when master switch is "off". Simple coded interruption of buzzer signal lets master operator know which remote is calling. Master unit has its own volume control with "on-off" switch. Includes three 60 foot lengths of 2-conductor wire with jacks at each end. Just plug in and talk. For additional wire see below. Complete set consists of master control unit, 3-remote units, 9-volt battery and wire. Size: Master: 4½Wx3½"D; Remotes: 2Wx4"D. Imported Shpg. wt., 2½ lbs.

99 E 4555	Net 19.95
Replacement 9-volt Battery (1 Req.)	
99 E 6021	Net .21
Additional wire, 100 Ft. Coil	
32 E 3052	Net .94

SOLID STATE WIRELESS INTERCOM SYSTEM

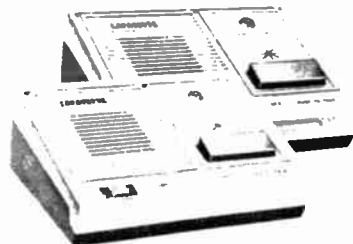

2-Stations **27⁹⁵**

- Instant On Operation—
No Warm-up

Solid-State 2-station intercom system at an amazingly low, low price. Ideal for use in the home, office, factory, etc.—will connect any two places that are serviced by the same electric company 117V power line transformer. No wiring required, simply plug each unit into the AC outlet and start talking—4-transistor circuit. Each unit is a "Master" can use as many as you need. Features a Volume/On-Off control, Push-to-Talk Bar with a "lock-bar" for continuous talking, and a pilot light. 2-tone gray-colored plastic case has rubber-tipped base that will not scratch furniture. Overall 6½"x5"x2½"H. For 110-120V 60 cycle AC. Imported. Shpg. wt., 2 lbs.

99 E 4573M	Net 27.95
Additional Intercom Stations	
99 E 4572	Net ea. 14.95

DELUXE WIRELESS INTERCOM SYSTEM

- Operates from any 117V AC/DC Outlet
- No Wires to Connect
- Ideal for Home or Office
- Add as Many Extra Stations as Desired

Handsomely styled, these units offer quality performance for home or business use. Each unit features a 3-position bar-control lever: Dictate (for use as "baby sitter," lengthy talking), Talk (has spring return to Listen position), and Listen. No wires to connect—simply plug into any 117V AC/DC outlet. Front panel volume control and pilot light; adjustable squelch control at rear reduces interference during quiet periods. Dependable 3" speaker. Add as many remotes as needed. Imported. Shpg. wt., 10 lbs.

99 E 4547M 2-Station Intercom System	Net 32.95
Additional Stations. Shpg. wt., 5 lbs.	
99 E 4544	Net 16.95

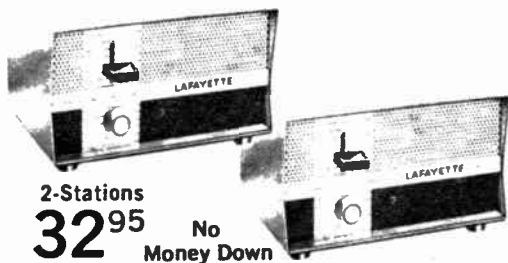

2-Stations
32⁹⁵ No
Money Down

DELUXE 2-CHANNEL SOLID STATE WIRELESS INTERCOM SYSTEM

- For 2 Simultaneous but Independent Communications
- Squelch Circuit for noise-free operation

Deluxe compact and fully transistorized 2-channel wireless system. Each unit is a "master"—you can use 2, 3, 4, or as many units as required. Two channels (160 & 200 KC) for maximum flexibility. Ideal when 2 pairs are used — each pair can be used for simultaneous but independent communication using separate channels, or for communication between all units using the same channel. No wires to connect—just plug each unit in a regular AC outlet. Perfect anywhere in the home or office—can even be used between adjacent homes or buildings on the same electric company power line transformer. Controls: Volume/on-off. Press-to-talk bar with "lock-talk" feature, and channel selector (A-B). Circuit includes Squelch for noise-free operation, 5-transistors, 3 diodes. Ivory high-impact plastic case 5x6¼x3". For 117V, 60 cycles AC. Imported. Shpg. wt., 4 lbs.

99 E 4584 2-Station Intercom System.	Net 39.95
99 E 4585 Additional Stations. Shpg. wt., 2 lbs.	Net ea. 21.95



2-Stations
39⁹⁵ No Money Down
\$5 monthly



LAFAYETTE GUARANTEE
 If you are not satisfied with your Lafayette Sound System you can return it at once for full refund less only transportation charges. 1 YR. AMPLIFIER GUARANTEE. All parts guaranteed against defects in material and workmanship for 1 year. Ship defective part to us prepaid for prompt replacement.



No Money Down **64⁹⁵**

MODEL PA-645 45-WATT P.A. AMPLIFIER

An outstanding P.A. amplifier that incorporates a low frequency filter which acts as an anti-feedback network and trumpet protector. Two handy outputs are provided; one at 25 volts and the other at 70.7 volts. Separate bass and treble controls. Master gain control eliminates chance errors when making volume adjustments. Outputs: 4, 8, and 16 ohms. Comes complete with Amphenol 75MCIF connector and phone plug. Handsomely styled metallic green case with aluminum and green front panel. For 115V. 50/60 cps AC. 15 1/4 x 10 1/4 x 5 1/4". 44 E 0130WX \$5 monthly. Shpg. wt., 30 lbs. Net 64.95
 44 E 0119 Phonotop for above. Shpg. wt., 8 lbs. Net 16.95

PA-645 SPECIFICATIONS

POWER OUTPUT: 45 watts RMS (90 watts peak)
FREQUENCY RESPONSE: ±2 db, 30 to 20,000 cps.
INPUTS: 2—Microphone; 2—Auxiliary (high gain phono, tuner, or tape recorder)
CONTROLS: 2—Microphone; 1—Auxiliary fader; 1—Bass, 1—Treble; 1—Master gain, 1—Anti-Feedback; 1—On-Off
OUTPUTS: 4, 8, 16 ohms; 25 and 70.7 volts
TUBES: 2—12AX7; 1—6AV6; 2—6L6GC; 1—SAR4/GZ-34

MODEL PA-675 75-WATT P.A. AMPLIFIER



No Money Down **84⁹⁵**

Provides a full 75 watts of clear audio signal power (150 watts on peaks). Controls: separate bass and treble, master gain, separate mixer and inputs for 2 separate microphones, common mixer for both auxiliary inputs that control phono tuner or recorder. Switchable anti-feedback network attenuates lowest frequencies to minimize feedback and prevent speaker burnout. Response: 30-20,000 cps ± 2 db. Inputs: 2 auxiliary (phono, tuner, or tape), 2 microphone. Output: 8 and 16 ohms, 70.7 and 25 volt constant voltage outputs for a constant level sound system. Comes complete with 75 MCIF mike connector and 1 phono plug. Rugged case is of a light metallic green with aluminum and green front panel. Tubes: 1-12AX7A; 6AV6, 2-6CA7; 5AS4A, 5Y3GT. Size: 5 1/4 x 10 1/4 x 5 1/4". 44 E 0135WX \$5 monthly. Shpg. wt., 39 lbs. Net 84.95
 44 E 0119 Phonotop for above. Shpg. wt., 8 lbs. Net 16.95

MODEL PA-612 12-WATT P.A. AMPLIFIER

34⁹⁵



- Offers 1 Mike and 2 Auxiliary Inputs
- Up To 5500 Sq. Ft.
- 12-Watt P-P Output

A low priced, high quality, P.A. Amplifier — Controls are provided for 1 mike and 2 auxiliary inputs (phono, tuner, or recorder); master tone control. Inverse feedback circuit delivers 40-20,000 cps response; effectively reduces hum and distortion. Output for 4, 8, 16, ohms, 25 and 70.7 volts. Aluminum and green panel with handsome metallic green case. Size: 12 3/8 x 8 3/4 x 5 1/4". For 110-120 volts, 50-60 cps AC. Shpg. wt., 12 lbs.

44 E 0120WX Net 34.95

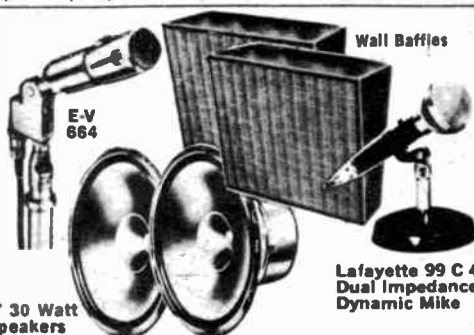

12" 30 Watt Speakers

45-WATT INDOOR PA SYSTEMS

As Low As **109⁹⁵**
 • Lafayette 45-Watt Popular PA Amplifier • 2-12" Special Heavy Duty 30-Watt PA Speakers, Each with 1 1/4 lb. Ceramic Magnet and 20-14,000 CPS Range
 • 2 Sturdy Attractive Walnut Wall Baffles for Speakers
 • Choice of Deluxe Dynamic Mikes • 2-35' lengths of Speaker Cable

Above system with Lafayette 99-4598 versatile dynamic microphone with dual impedance and desk stand. Can also be hand-held or used with standard floor stand. Shpg. wt., 60 lbs. For 110-130 volts. 50/60 cycle AC.

44 E 9081WXM \$6 monthly Net 109.95
 Same as above except with Electro-Voice Model 664 dynamic cardioid microphone instead of Lafayette 99-4598.
 44 E 9084WXM \$7.50 monthly Net 139.95

75-WATT INDOOR PA SYSTEMS

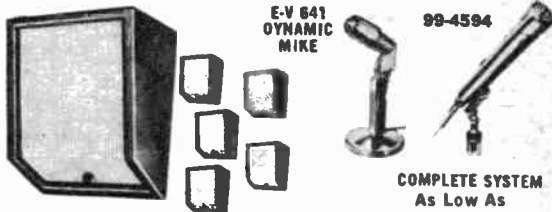

LAFAYETTE 8" 10-WATT SPEAKER BAFFLE COMBINATIONS PRE-WIRED WITH MATCHING TRANSFORMER & VOLUME CONTROL

COMPLETE SYSTEM As Low As **164⁹⁵**
 No Money Down

Lafayette PA-675 75-Watt P.A. Amplifier; 6 ea. Lafayette 8" Speaker, Baffle Combinations With 70 Volt Line Tapped For 10, 5, 2.5, 1.25 And .625 Watts Per Speaker; And Electro-Voice 641 Dynamic Microphone With 18' Cable. Shpg. wt., 95 lbs.

44 E 9091WXM \$9 monthly Net 176.95
 Same as above except with Lafayette 99-4594 high impedance dynamic microphone with talk switch, stand adapter and 7 ft. plug-in cable instead of EV 641 microphone and stand.
 44 E 9090WXM Shpg. wt., 95 lbs. \$9 monthly Net 164.95
 Additional Speaker Baffle Units. Shpg. wt., 7 lbs. 99 E 4552W Net ea. 14.95

12-WATT FIXED P.A. SYSTEM



ONLY **42⁹⁵**

High quality, low cost system engineered for smaller permanent installations. Complete system includes: PA-612 12-Watt P.A. Amplifier; Lafayette 99-4587 crystal microphone with on-off switch, supplied with desk stand, lavalier cord, cable, and detachable swivel-type floor stand and desk stand adapter. 8" heavy duty PM speaker; 35' speaker cable and plug; and walnut finish speaker wall baffle. For 110-120 volts, 50-60 cps AC operation. Shpg. wt., 25 lbs. 44 E 9072WXM \$5 monthly Net 42.95

Selected Electronic Specialties

TRANSISTORIZED STEREO MIKE MIXER

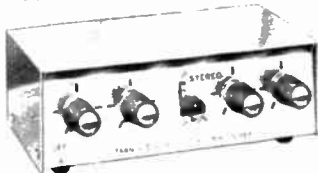

9⁹⁵

- Transistorized No Warm-up
- Matches High Impedance Microphones
- Up to 4 Input Channels

Now a stereo version of the popular LAFAYETTE mono mixer. Combines up to four microphones professionally into one stereo output. Each mike control independent of the other, permits fading of one input while increasing others. Controls high impedance microphones, recorders, phonographs or tuners. Output jack fits standard circuit phone pin plugs (RCA). Inputs are standard 2-circuit phone plugs. Requires single 9 volt battery (not supplied). Size: 6Wx2½Hx3½D. 99 E 4563 Shpg. wt., 1¼ lbs. Imported. Net 9.95
99 E 6021 Battery for above Net .21

LAFAYETTE TRANSISTORIZED MIKE MIXER



4⁸⁵

- Up to 4 Channels
- Matches High Impedance Microphones
- Modern Solid State Design

Mixer controls high impedance signals from mikes, phonos, recorders or tuners. Standard 2-circuit phone inputs, standard RCA phone plug output. 9 volt battery. Imported. Net 4.85
99 E 4535 Shpg. wt., 1¼ lbs. Net .21
99 E 6021 Battery for above

LAFAYETTE MINIATURE HORN PAGING SYSTEM



7⁹⁵

- Mounts Easily
- 90° Dispersion
- Weatherproof

An excellent general purpose paging speaker of amazingly compact size. Ideal for portable PA systems, patios, etc. Long-throw projection of 90° dispersion offers maximum speech intelligibility in high noise areas. Compact size enables it to be mounted anywhere in almost any position. Frequency response 400-12,000 CPS. Impedance 8 ohms. Power handling capacity 5 watts, 8 watts maximum. Complete with mounting bracket, 2-conductor cable. Horn diameter 5¼". Depth 4¾". Imported. Shpg. wt., 1½ lbs. Net 7.95
99 E 4508

CONCORD CLOSED CIRCUIT TV CAMERA

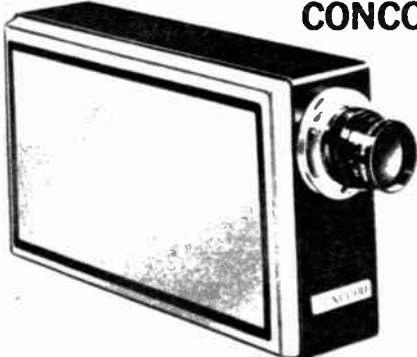

Only
299⁹⁵

- For Security—For Surveillance— For Sales Promotion
- Output Signal: RF Over 30 mV Video: 1.4V P-P
- Use with any Home TV Set or Commercial Monitor



ELEVATOR



SUPERMARKET



BANK

Just hook the Concord Automatic TV camera to the antenna input of any home TV set, commercial monitor or the 12" portable below and you open up a world of unlimited uses for business, industry and the home. A closed circuit TV system is particularly useful in surveillance, sales training, teaching, in-store promotion, watching the family swimming pool, baby's room, or the front door at home. Its special lens system which automatically adjusts for any light intensity, its low cost solid state design, compact size, and simplicity of operation make it a practical and useful tool for unattended operation everywhere. Turn it on and forget it — just watch the receiver! Specifications: video output RF over 30 mV, video: 1.4VP-P. Video Bandwidth: 5 MC; RF Carrier Frequency: TV channel 5-6; Output Impedance: 75 ohms; Camera Tube: Vidicon 7735A; Lens: F1.8 C mount (will accept other lenses) Power Supply: 117 volts, 60 cps

KINEMATIX "IMP II" FM WIRELESS MIKE

SALE! 34⁹⁵
SAVE \$5.00



Model 222

Sale Price in Effect
Thru March 31, 1967.

- Transmits Clearly Up To 200 Ft.
- Can Be Used With Any 88—108 Mc FM Tuner, FM Radio, FM Portable, FM Auto Radio

- Compact—Fits Into Shirt Pocket

A transistorized FM transmitter and microphone, so small it can be concealed in shirt pocket or cigarette box, yet transmits up to 200 feet with perfect clarity to any 88-108 MC FM receiver. Ideal for PA systems, security and surveillance work, babysitter, survey work and many other applications requiring remote sound pick-up without bothersome wires. Comes complete with leather case and built-in super-sensitive pin-head mike. Also has input for any low impedance (1000 ohms) mike. Tunable between 88-108 MC. freq. response 30-20,000 cps. Size: 3x1½x2¾". Requires 1 battery (listed below). Shpg. wt., 1 lb. Net 34.95
44 E 4301L \$5 monthly Net 1.05
32 E 4671 Battery for above units. Shpg. wt., 1 oz.

DELUXE LAFAYETTE PISTOL-GRIP POWER MEGAPHONE



29⁹⁵

- Weighs only 4¼ lbs. complete with batteries
- Ideal for coaches, construction gangs, sporting events, etc.

A lightweight megaphone notable for its extreme economy in battery power despite its high sound volume output. Uses 4 size D flashlight batteries and has a patented non-linear current-limiting device to give maximum possible battery life. The reflexed air column in the horn plus its special shape serve to concentrate and direct the amplified sound and throw it for a considerable distance! The rubber-rimmed horn is of lightweight spun aluminum and construction is extremely sturdy throughout. Microphone is built into the base of the horn. Unit measures 12½" long; mouth diameter is 8¼". Imported. Shpg. wt., 6 lbs. Net 29.95
99 E 4504 Power Megaphone Net 1.03
Batteries For Above (4 "D" Cells Required) Shpg. wt., 1 oz. ea.
99 E 6256 Net ea.

SALE!

Microphone Clearance

Save up to 41% QUANTITIES LIMITED

SALE!

LAFAYETTE UNIDIRECTIONAL DYNAMIC MIKE



- Dual Impedance—600 and 50K Ohms
- Unidirectional Pick up Pattern
- Hand Held or Stand Mounted

12⁹⁰ Was 21.50

This mike's highly desirable cardoid pattern suppresses noise, reverberation and feedback by a significant front to back ratio. Frequency response from 90-10,000 cps. With dual impedance. Complete with 2 conductor balanced type shielded wire. Attractive black and silver case equipped with on-off switch. Imported. Shpg. wt., 2½ lbs. 99 EX 4541 Net 12.90

SALE!

VERSATILE DYNAMIC MICROPHONE



- For Desk-Top, Hand Held, or Lavalier Use
- High Impedance—50,000 Ohms
- Response—40-9,500 cps

4⁹⁵ Was 6.95

High impedance, light weight dynamic microphone with swivel mount that permits horizontal and vertical rotation for most convenient angle. Baked enamel case with chrome finished base, grille and fittings. Ruggedly constructed to withstand plenty of handling. 3" long x 1¼" diam. housing with 5 ft. shielded cable. Shpg. wt., 2 lbs. Imported. 99 EX 4524 Net 4.95

SALE!

LAFAYETTE DYNAMIC CB HAND MICROPHONE



SALE! 3⁴⁹ Was 5.95

A high quality dynamic communications microphone engineered to the requirements of CB, amateur or commercial users. Dynamic elements provide superior speech intelligibility; unaffected by temperature extremes, either mechanically or electrically. In high-impact, lightweight plastic case with attractive spun aluminum grille. Heavy-duty push-to-talk switch. Has hang-up button, 5 ft. 3-conductor cord. Impedance 50k. Output: 200 mv. Imported. 99 EX 4564 Shpg. wt., 14 oz. Net 3.49

ARGONNE ALL-PURPOSE DYNAMIC MICROPHONE



- Ideal For Tape Recording, Paging, Communications
- Dual Impedance—250 and 50,000 ohms

9⁹⁵ Was 13.95

Popular, ruggedly constructed microphone with 360° ball joint and an adapter for standard ¼"-27 thread. Perfect as desk or floor mounted or hand held mike with 8' cable. Dual Impedance; 250 ohms and 50,000 ohms unbalanced. Output—70db; Freq. Response practically flat 80-10,000 cps ± 5db 70-13,000 cps. 9" high, 2" diameter tapering to ¾". Imported. Shpg. wt., 6 lbs. 99 EX 4501 Net 9.95

SALE!

LAFAYETTE STUDIO DYNAMIC MICROPHONE



SALE! 6⁹⁵ Was 11.95

- Frequency Response 50-11,000 cps
- High impedance 50,000 Ohms
- High Output

Omni-directional microphone completely sealed and gasketed against high humidity and temperature conditions. The 360° stirrup shaped bracket provides for mounting with any ¼"-27 thread stand. Finished in an attractive gunmetal grey with 4½" shielded cable. Shpg. wt., 1 lb. Imported. 99 EX 4525 Net 6.95

3 WAY SLIM CRYSTAL MICROPHONE



SALE! 2⁹⁵ Was 3.95

- Response 60-10,000 cps
- On-Off Switch

Here is a fine slim-line design, only 4¼" x 1¼" diam. Comes complete with swivel adapter to fit all standard mike stands, and lavalier cord and bracket which leaves both hands free. Smooth wide range response. Locking type on-off slide switch. Detachable 7 ft. cable and connector. Shpg. wt., 2 lbs. Imported. 99 EX 4515 Net 2.95

NEW! LAFAYETTE COILED MICROPHONE CABLES



- Extends To 5 Feet, Retracts To 10 Inches

FIG. A 3-CONDUCTOR COILED CORD. A durable coiled cord having three conductors, one of which is shielded. Each conductor is vinyl insulated. All leads are 3", with ½" stripped and tinned. Perfect communication replacement cord. Imported. Shpg. wt., 7 oz. 99 E 4601 Net 1.09

A



FIG. B 4-CONDUCTOR COILED CORD. All four conductors are vinyl insulated and terminated with metal spade lugs at each end. Ideal for telephone, push-to-talk microphone, headphones and many other applications. Imported. Shpg. wt., 7 oz. 99 E 4600 Net 1.19

B

1⁰⁹

1¹⁹

SLIM CRYSTAL MICROPHONE with STAND



SALE!



- May be hand-held or used with desk-top stand

Was 3.95
only 2⁶⁵

Ingenious swivel mounting permits horizontal and vertical rotation for most convenient angle of use. Microphone easily removed from base for holding in hand. Microphone, base, grill and all fittings are chrome finished. Has a wide range smooth frequency response and an omni-directional polar pattern. Built-in locking type on-off slide switch. Microphone is only 5" long x 1" max. dia. Shpg. wt., 2 lbs. Microphone Complete with Stand. Imported. 99 EX 4522 Net 2.65

Telephones and Detection Devices

DIAL PHONE

Have your own
Private Intercom

6⁹⁵

- For Intercoms,
Private Systems



Popular modern dial phone. Can be used to make complete private systems. Equipment taken from service, reconditioned and ready to work. Simple 3-wire hook-up. Complete with handset, dial bell, induction coil and connecting cable. General appearance may vary slightly from catalog illustration. Shpg. wt., 8 lbs.

44 E 1801 Net 6.95

DELUXE LAFAYETTE EASY-PHONE TELEPHONE AMPLIFIER

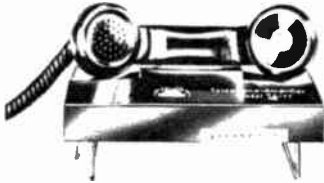

12⁹⁵

- Amplifies Telephone
To Room Volume
- Battery Operated

The Easy-Phone amplifier is ideal for group conversation with one telephone in the room. Easy to operate: simply place the telephone on the amplifier, adjust the volume and everyone can listen, leaving both hands free for writing or typing. The Easy-Phone is a 4 transistor battery powered amplifier and inductive pick-up, in an attractive plastic case. Features: 3" speaker, volume control; on/off switch activated by telephone's weight sturdy chrome plated runners. 8 3/4" x 3 1/2" x 2 1/2" H. Supplied with miniature plug and jack for recorder input. Imported. Shpg. wt., 3 lbs.

99 E 9020 With batteries Net 12.95
99 E 6258 Replacement Penlite Batteries (4 req.) Net ea. .09

"PRIVATE EAR" TELEPHONE DETECTOR



- No Wires Connected to Phone

Only 9⁹⁵

Now a pickup amplifier operating independently of your telephone. No wires connected, nothing put under the receiver. Simply place the unit next to your telephone for clear reception. Operates on its own battery power. Some practical uses are: an extension receiver, increases reception in noisy areas and for the hard of hearing, for detective use, and listening on extensions without lifting receiver. Ideal for all telephones except some push button models. Imported. Shpg. wt., 8 oz.

99 E 9096 Net 9.95
99 E 6021 Extra Battery for above Net .21

"PRIVATE EYE" ONE WAY DOOR VIEWER

- 24-Hour Protection
- One Way Extra Wide-Angle View

Only 1⁴⁹

The "Private Eye" permits thru-the-door identification without being observed. Has fine quality genuine optical lenses. One way viewing only—you can look out, no one can see in. Provides extra wide-angle view—you can see anyone standing or crouching even at the side of the door. Installs quickly with a simple hand drill. "Private Eye" is 1/2" in diameter, length adjusts to fit any standard door thickness of 1 1/4" to 1 3/4" thick. Rust-resistant plastic construction. Cannot be removed from the outside. Imported. Shpg. wt., 4 oz.

99 E 9099 Net 1.49

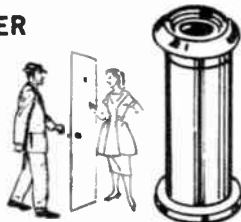

DELUXE ULTRA SELECTIVE 10 STATION HIGH SPEED TELEPHONE INTERCOM SYSTEM



24⁹⁵

12⁹⁵

Per Phone Power Supply

- 100% Privacy—Up to 5 Simultaneous Conversations
- Immediate Operation—No Dialing
- Selective Ring—Selective Talk
- Battery or AC Operated

Completely private 10 station ultra-selective intercom system. Unit is styled like regular telephone, complete with coiled cord and junction box. Its functional design permits positioning on desk or hanging from the wall. No need to waste time dialing, simply set pointer to desired station, push ring button and speak. Interruptions or listening in by other stations is impossible. Handles up to 5 simultaneous conversations. Conference calls are available by one station calling another until all are on the line. Frees your regular telephone lines for outside calls. Power for all units in the system is obtained from a central location, either from a battery source or the AC power adapter listed below. Low power consumption on either AC or DC: 100ma calling, 25ma talking. Finished in black plastic.

99 E 4560 10 Station Lafayette phone. Imported. Shpg. wt., 3 3/8 lbs. Net ea. 24.95

99 E 4561 AC Power Supply for system Net 12.95

1 1/2 V Battery for DC operation—6 required Shpg. wt., 3 lbs. 32 E 4868 Net ea. .91

WIRING INSTRUCTIONS

The total number of unshielded conductors common to each phone is 2 more than the total number of phones in the system.

32 E 1490K Belden 8456, 10 cond. unshielded Net per ft. .08

32 E 1491K Belden 8457, 12 cond. unshielded Net per ft. .085

30 FT. TELEPHONE EXTENSION CORD

- Ideal Extension Cord for Use
With Phones
Listed on This Page

2⁷⁵

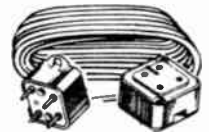

Add flexibility to your telephone intercom. Now be able to move your telephone intercom from room to room. 30 feet of telephone extension cord with standard 4-pin plug and jack. Color-coded cord to match screw terminals on plug and socket. Imported

99 E 4539 Net 2.75

THRU-THE-WALL LISTENER



- Sensitive Stethoscopic Detector
- Attaches to Recorder
- Operates on One Penlite Battery

12⁹⁵

Simply attach to wall by the suction cup and listen through the stethoscopic earphones. Exceedingly sensitive with high amplification. Amplifier has volume control with switch, jack for the earphones and jack for connecting tape recorder. Earpiece may be disconnected from stethoscopic tubes and placed directly in ear. Ideal for detecting intruders or as an electronic babysitter. Uses one penlite battery. Size: Suction cup 4" dia., amplifier 1 1/2" deep. Complete with headset, cord and plug and battery. Shpg. wt., 3 lbs.

99 E 9133 Net 12.95

99 E 6258 Replacement battery Net .09

Batteries — Chargers — Speakers

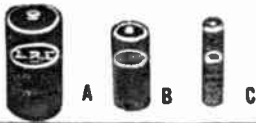

FLASHLIGHT BATTERIES

Stock No.	Volt-age	Figure	Replaces		Shpg. Wt.
			RCA	Bur- Evd- gressready	
99 E 6256 99 E 6280	1½ (D) 1½ (D)	Singly .13 Pkg. of 2 .25 5 Pkg. of 2 1.20	A	VS036 2 950	4 oz ea.
99 E 6257 99 E 6281	1½ (C) 1½ (C)	Singly .13 Pkg. of 2 .25 5 Pkg. of 2 1.20	B	VS035 1 935	3 oz ea.
99 E 6258 99 E 6282	1½ (AA) 1½ (AA)	Singly .09 Pkg. of 4 .30 2 Pkg. of 4 .58	C	VS034 2 915	2 oz ea.

9-VOLT TRANSISTOR RADIO BATTERY



Replaces RCA VS323, Burgess 2U6, Eveready 216, Zenith Z216, Ray-O-VAC 1604, NEDA 1604. Imported. Shpg. wt., 2 oz.

99 E 6021 Net ea. .21
99 E 6279 Package of 2 Net Per Pkg. .40
5 Packages of 2 Net 1.89

"STORAGE CELL" for TRANSISTOR RADIOS!

ONE CHARGEABLE BATTERY OUTLASTS DOZENS OF CONVENTIONAL BATTERIES



- Replaces 2U6, BL-006P and BA-2
- Fluid Storage Type
- Plays About 15 Hours on One Charging
- Battery Recharges Overnight
- Battery Can Be Used Over and Over Again
- Complete—Battery Plus Charger

9V Battery complete with charger. Battery 1½x1½; charger 3¾x1¼x¾". Imported. Shpg. wt., 6 oz.

99 E 9016 Battery and Charger Net 2.69
99 E 6026 Battery Replacement for above Net 1.49

PRIVATE RADIO-TV LISTENER



- Control Either Private Earphones or Remote Speakers

Simply installed unit allows normal use of TV or radio while adding controllable earphones or extension speakers. The hard of hearing may control their volume while others may listen at normal listening levels. May be operated up to 17 feet from set. Supplied complete with instructions, one earphone, and two earphone jacks. Imported. Shpg. wt., 1 lb.

99 E 9172 Net ea. 1.79
99 E 2548 Extra Earphone ea. .59

LAFAYETTE REMOTE CONTROL TV SPEAKERS

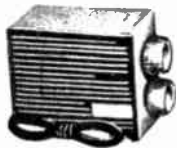

As Low As **3⁸⁸**

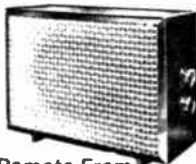

- Control Both TV Set Speaker and Remote From Your Armchair
- Ideal Personal Speaker For The Hard of Hearing
- Listen To Either One Alone or Both Together

Fig. A. Miniature remote speaker in attractive moulded case measures only 4W x 2½H x 1¾"D. Ideal for home or office use. Complete with 20' cable. Imported. Shpg. wt., 1½ lbs.

99 E 4548 Net 3.88

Fig. B. Larger version of the above incorporates 4" x 6" speaker in a walnut finished cabinet measuring 9¾L x 6¼H x 3¾"D. Speaker has a 1.27 oz. magnet affording fine tonal quality. Includes 20 ft. of cable. Imported. Shpg. wt., 4 lbs.

99 E 4596 Net 5.95

CHARGATRON HOME BATTERY CHARGER

3⁹⁵

- Recharge Batteries Up to 15 Times
- Battery Tester Included
- "D", "C", "AA" and 9v Transistor Sizes

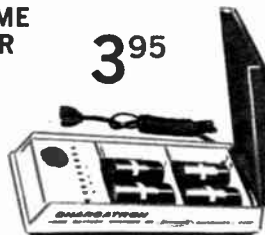

Recharge from one to four batteries at one time. Safety is assured since charger is in operation only when lid is closed. Plugs into standard 110-120 volt, 60 cycle AC outlet. With free battery tester. Shpg. wt. 2 lbs.

34 E 4202 Net 3.95

CHARGATRON AUTOMATIC BATTERY CHARGER

U.L. APPROVED

Fully automatic version of above charger. Safe-T-Plug gives safe low voltage operation and prevents overcharging of batteries. For 110-120V, 60 cycle AC. Shpg. wt. 2 lbs.

34 E 4203 Net 5.95

LAFAYETTE 9-VOLT TRANSISTOR RADIO BATTERY CHARGER AND ELIMINATOR

- Charge Battery, Operate Set On AC, or Both
- Transformer Isolation—Shock-Proof

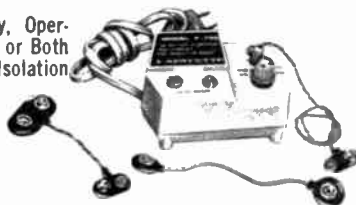

3⁶⁹

Just plug into any 117-volt AC receptacle and recharge your old 9-volt battery for many hours of extra use; or operate your set indoors without using the battery at all; or you can both charge battery and operate set at the same time. Has 4-position switch for above functions plus off position and pilot light. Size 4Wx1½Hx 3¾"D. Imported. Shpg. wt., 1 lb.

99 E 9021 Net 3.69

NICKEL CADMIUM BATTERY CHARGER

- Charges Two or Four Penlight (AA) Batteries At A Time



Take advantage of the extremely long life of nickel-cadmium batteries. Two of four can be fully charged within sixteen hours. No chance of overcharge. Simple operation from any 117VAC source. Indicator light protects against incorrect insertion of batteries. Imported. Wt., 1 lb.

99 E 9180 ea. 3.99

Batteries for above ea. 1.93
32 E 4740

3⁹⁹

LAFAYETTE ECONOMY-LINE PM SPEAKERS

As Low As

98^c

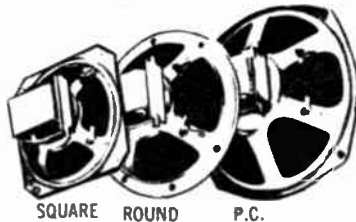

SQUARE ROUND P.C.

Top quality replacement speakers. Selected for universal application rugged construction-standard configurations. All have 3.2 ohm voice coils. Made in U.S.A. except 99 Series are imported.

STOCK NO.	SIZE	SHAPE	MAG. WT.	PEAK WATTS	SHPG. WT.	NET. EA.
99 E 6268	4"	Square	.60 oz	3.0	1	.98
99 E 6269	5"	P.C.	.68 oz	4.0	1	1.04
99 E 6270	6"	Round	1.0 oz	8.0	1½	1.64
99 E 6271	8"	P.C.	2.05 oz	10.0	2¼	2.06
32 E 0108	12"	Round	3.16 oz	12.0	5	3.75



Color LVL-UV TV F/M Antennas

SALE!

PRICES CUT
UP TO \$3.00

LOG PERIODIC

3 ANTENNAS IN 1
UHF-VHF-FM
CHANNELS 2-83

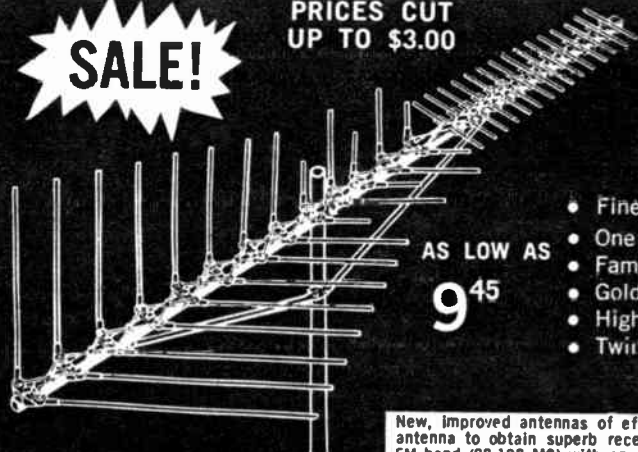

AS LOW AS
9⁴⁵

- Finest for Color or Black-White Pictures Plus FM
- One Down Lead for All 3 Signals
- Famous Log Periodic Design
- Goldenized Finish For Long Lasting Protection
- High Front-to-Back Ratio—High DB Gain
- Twin Brace Boom Supports

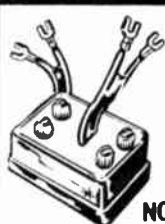

Complete with
VHF-UHF-FM
Splitter/Coupler

NO EXTRA CHARGE!

New, improved antennas of efficient log periodic design. Now you can easily install one antenna to obtain superb reception on VHF channels 2-13, UHF channels 14-83, and the FM band (88-108 MC) with one down lead. Does the job of three antennas! Ends unsightly roof clutter while providing strong, clear signals to improve the performance of any TV or FM set. Best for Color TV and Stereo FM (multiplex). All antennas are preassembled with dowel reinforced aluminum snap-lock elements and goldenized finish for long lasting protection. Features rugged 1" square boom, 24 and 28 element models utilize twin brace boom supports for superior rigidity. Supplied with a specially designed 3-way splitter for good isolation with low signal loss.

Stock No.	Elements	Maximum Range (miles)			Boom Length	Shpg. Wt. (lbs.)	Net
		VHF	UHF	FM			
18 E 0100WX	28	225	100	100	14"	15	31.95
18 E 0101WX	24	175	85	90	11 1/2"	12	26.95
18 E 0102WX	18	150	80	85	8 1/4"	9	19.95
18 E 0103WX	12	125	65	75	6"	7	14.95
18 E 0104WX	10	60	30	30	30"	5	9.45

20 ELEMENT STACKED SNAP OPEN CONICAL ANTENNA

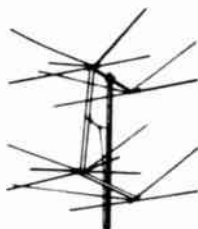

5²⁵
Lots of 3

- All Aluminum
- No Loose Parts
- Fastest Installations

GOLDENIZED

Best antenna deal yet for servicemen—dealer and installation specialists. All the most wanted features. Quickest, easiest installation possible. No loose hardware. All elements snap open and lock in without tools. Most efficient conical design for all reception areas. Two complete bays with Q bars, less mast. Shpg. wt., 8 lbs.

18 E 0105WX Singly ea. Net 5.49
Lots of 3 ea. Net 5.25

"MULTIPLEX 10" EXTENDED RANGE FM ANTENNA

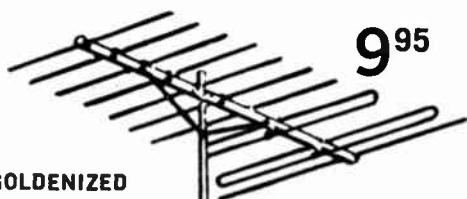

9⁹⁵

GOLDENIZED

Ideally suited to Multiplex FM reception. This 10-element, double-driven, yagi array has the necessary added gain, sensitivity and directivity to compensate for the lack of signal strength. All-aluminum gold anodized construction. Fiberglass insulators. Torsion lock hardware, sure-lock mast clamp. Shpg. wt., 7 lbs.

18 E 0120WX Net 9.95

PARABOLIC UHF ANTENNA

Powerful UHF Fringe Antenna

12⁹⁵

- Positive Big Screen Ghost Rejection
- 18 db Gain at Translator Frequencies
- 13 db Gain over UHF Spectrum
- Quick, Strong Installation

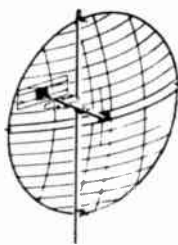

The most powerful UHF fringe antenna—proven by performance in the toughest fringe and translator UHF areas. Unique parabolic design exceeds the capture area of 12 and 16 bay car's whisker type arrays. Single dipole provides maximum signal without phasing harness. All metal construction reduces signal loss due to weather deterioration. Pre-assembled screen and dipole are installed in minutes for maximum performance and reliability. Shpg. wt., 10 lbs.

18 E 2401WX Net 12.95

4-BAY BOW-TIE UHF ANTENNA



3⁹⁵

- Highest Gain on 70 UHF Channels
- Completely Preassembled

Four bay, UHF bowtie antenna. Exceptionally high (12db) gain—relatively flat across the entire spectrum. Fully factory assembled. Quickest and easiest to install. High efficiency screen grid reflector boosts front to back ratio. Unique "cross-over" phasing bars—open V elements, Rugged—rigid—corrosion resistant construction. Shpg. wt., 5 lbs.

18 E 0142WX Net 3.95

UHF "TRANSLATOR" 4-BAY ANTENNA
Four bay bow-tie and screen reflector—tuned to the UHF translator frequencies. Average 16db gain on channels 70-83. Completely preassembled. Shpg. wt., 5 lbs.

18 E 0143WX Net 3.95

Color LVL-TV F/M Antennas

LOG PERIODIC

**FOR CHANNELS 2-13
PLUS FM STEREO**
OUR "HIGH POWER" ALL-
CHANNEL (2-13) *LAFAYETTE
"VECTOR-LOG"® SWEPT-ELEMENT
ANTENNA DESIGNED FOR VHF-TV
AND FOR DYNAMIC FM

27⁵⁰



PRICES CUT
UP TO \$3.50

SALE!



- The finest For Color or Black-White Pictures . . . Plus FM
- Excellent Front-to-Back Ratio . . . High dB Gain
- Sharp-Narrow Gain Pattern and Selectivity
- Flat TV Color Response—Plus Stereo, Mono FM Signal
- Protective Goldenized Finish

Lafayette's powerful, revolutionary LVL*—designed specifically for (VHF) true-to-life color reception plus black and white. Also reaches out to pull in static-free FM and stereo FM signals. Five models to choose from for ideal performance. Offers such exceptional quality features as: Heavy aluminum reinforced insulator cups—heavy duty aluminum rivets—special back-up brackets and square boom! Triple thick combination swept elements assure great ruggedness. Double contact drive line and air-insulated spacers provide maximum signal delivery to set. Less mast and twin lead.

Stock No.	Range	Elements	Boom Length	Shpg. wt.	Net
18 E 0185WX	up to 75 miles	5	4'5"	5 lbs.	8.50
18 E 0186WX	up to 100 miles	7	6'6"	7 lbs.	11.95
18 E 0187WX	up to 150 miles	10	9'8"	10 lbs.	16.95
18 E 0188WX	up to 175 miles	15	13'2"	13 lbs.	23.50
18 E 0189WX	up to 200 miles	18	14'8"	16 lbs.	27.50

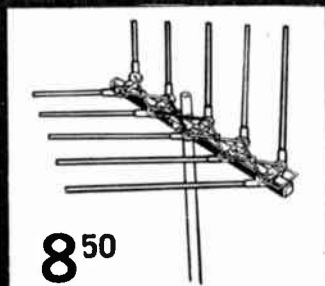

8⁵⁰

ANTENNA INSTALLATION KITS



AS LOW AS
3⁹⁵

VHF KIT includes 3-3" galvanized mast sections, 1 lightning arrestor, 2 mast standoffs; 5 screw-in standoffs, 100 ft. 300-ohm twin line, 20 ft. aluminum ground wire. Shpg. wt., 6¾ lbs.

- 18 E 6721W Net 3.95
UHF/VHF-KIT same as above, except has 100 ft. tubular twin lead. Recommended for use with all combination VHF-UHF-FM antennas. Shpg. wt., 7 lbs. Net 8.20
18 E 6722W Net 8.20

ANTENNA MOUNTS

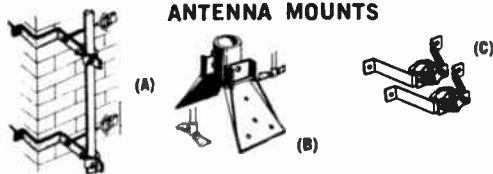

(A) CHIMNEY MOUNT. An ideal chimney mount for life-long satisfactory service under the most severe conditions. "Z" type heavy gauge aluminum brackets. Complete mounting kit of two 12" stainless steel ¾" straps and stainless steel seals. Rugged, corrosion resistant mount accommodates masts up to 1½" O.D. Perfect for TV and FM antenna systems. Shpg. wt., 2 lbs.
18 E 6306 Net 2.95

(B) PEAK ROOF MOUNT. A heavy gauge steel peak roof mount. Heavily plated to resist corrosion. Will accommodate masts up to 1½" in diameter. Fully adjustable, can be easily rotated. Complete with all necessary hardware. Shpg. wt., 5 lbs.
18 E 6308 Net 1.39

(C) 4" STAINLESS STEEL WALL BRACKET. All stainless steel construction for extremely long life. Provides 4" clearance from wall. With special shaped U-bolt to hold masts up to 1½" O.D. (Set of 2). Shpg. wt., 2 lbs.
18 E 6310 Net 1.55

ALLIANCE TENNA-ROTORS

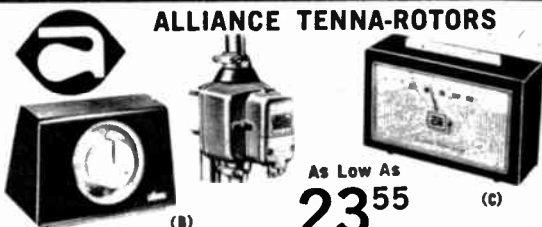

As Low As
23⁵⁵

- External Hardware Stainless Steel or Corrosion Resistant Materials
- Rotation Speed 1 R.P.M.
- Magnetic Brake for Instant Stops with No Drift

(B) Model U-100 Rotator unit will handle the largest color TV antennas in winds in excess of 90 MPH. If an individual can lift and install his antenna, this Tenna-Rotor will support it, hold it, and rotate it. Accepts masts to 1-¾" O.D. Guy wire accesses provide secure installation. Control Box fully automatic, just set control knob and antenna rotates to desired position and stops automatically. Indicator shows position of antenna. Has positive mechanical stop at the end of rotation. Size: Rotator 7¾x4½x8". Control Case 7x4½x4". 100 V. 60 cps AC at 65 watts. Uses 4 Cond. Cable. Shpg. wt., 12 lbs.
18 E 1403W Net 28.20

(C) Model T-45 Rotator unit will handle the largest color TV antennas in winds in excess of 90 MPH. Slight pressure on the control bar rotates antenna through its full 360° cycle and stops at any point by releasing the bar. New, patented 5-wire circuit provides a precision system that is unaffected by motor current, cable length and line voltage variations. Improved electrical system with expanded meter scale, assures pin-point accuracy and easy-to-read antenna direction indication. 115 V. 60 cycle AC at 70 watts. Size: Rotator 7¾x4½x8". Control Case 6½x4½x2½". Uses 5 Cond. Cable. Shpg. wt., 12 lbs.
18 E 1402 Net 23.55

4 Conductor flat cable. Shpg. wt., 3 lbs. per 100 ft.	Net 2.82
32 E 8910 per 100 ft.	Net .04
32 E 8911K less than 100 ft. per ft.	Net .028
over 100 ft. per ft.	
5 Conductor Cable Shpg. wt., 4 lbs. per 100 ft.	Net 3.54
32 E 3631 per 100 ft.	Net .05
32 E 3630K less than 100 ft. per ft.	Net .035
over 100 ft. per ft.	

TV Antenna Boosters — Accessories

LAFAYETTE RANGE BOOST™ TRANSISTORIZED TV/FM COLOR BOOSTER

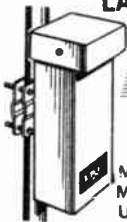

MAST MOUNTED UNIT

12⁹⁵



INDOOR POWER SUPPLY

- Gain 12 db • Built-in 3 Set Coupler • Low Noise, High Gain Transistorized Circuit • Use with Any Outdoor TV Color TV or FM Antenna

Add better performance to your existing outdoor TV/FM antenna. Boost reception for B&W and color TV, plus FM stereo. Solid state design with 1 silicon transistor & 1 diode permitting a gain of better than 12 db on high band, 9 db on low band and 7 db on FM. Compact styling, lightweight for mounting on mast for greatest transfer of energy. Metal case is weatherproof. Circuit protected against lightning. Separate power supply plugs into any 117 volt outlet. Consumes less power than an electric clock. Economical to use where units are in continuous operation. Uses 300 ohm twinline. May be used for 3 sets. Complete with mounting hardware, instructions. Imported. Shpg. wt., 2 lbs.

99 E 4023

Net 12.95

LAFAYETTE COLOR-AMP TRANSISTORIZED TV/FM ANTENNA BOOSTER COLOR BOOSTER

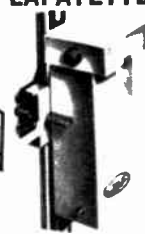

MAST MOUNTED UNIT

24⁹⁵



INDOOR POWER SUPPLY

- Gain 20db/Up • Built-in 2-Set Coupler • Uses Low Noise, High Gain Solid-State Circuit • Use With Any Outdoor TV or FM Antenna • AC Isolation Transformer—No Shock Hazard

Improve the performance of any new or existing outdoor TV/FM antenna. Efficient solid-state design utilizes reliable silicon transistors for more than 20 db gain across the entire band. Compact, lightweight construction permits mast mounting for maximum transfer of energy. Metal case is weatherproof with built-in lightning-protected circuit and high-pass filter which rejects CB and other interference. Separate power supply plugs into any 110-volt house outlet. . . . No batteries required. Consumes less power than an electric clock. Handles up to 2 TV or FM receivers. Uses standard 300 ohm twinline. Imported. Shpg. wt., 2 lbs.

99 E 4018

Net 24.95

TRANSISTORIZED 4-SET TV/FM BOOSTER

14⁹⁸

- Amplifies Signals for Top Reception on Up to 4 Sets
- Easy to Connect and Economical to Operate

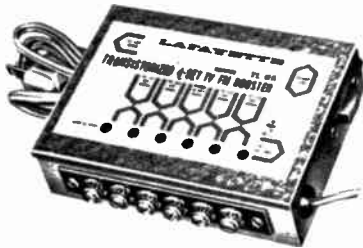

If your antenna isn't pulling in signals of sufficient strength then this Lafayette Booster Amplifier is just what you need. Screw-on terminals make wire connections easy, no cutting is necessary. Transistor circuit runs cool, draws little current. Signal strength is boosted 3 to 5 times. Will operate up to 4 TV and or FM sets on the same antenna. Input impedance is matched to antenna impedance. Needs no adjustment. Isolated outputs insure maximum set separation. Can be mounted in any convenient location where adequate ventilation is provided. Size 4 3/4" x 1 1/4" x 3 1/2" D. For 117 volts, 60 cps AC. Imported. Shpg. wt., 1 lb.

99 E 4011

Net 14.98

LAFAYETTE COLOR TV/FM COUPLER

1⁴⁹



- Low Signal Loss
- For Two Set Operation

Ideal for operating two TV and/or FM receivers from a single antenna. Has low loss and high isolation between sets. Easy to connect with one antenna downlead. Supplied with indoor/outdoor universal mounting hardware. Imported. Shpg. wt., 1/2 lb.

99 E 4018

Net 1.49

LAFAYETTE 4-SET COLOR TV/FM COUPLER

2⁹⁵

- For Up To 4 TV/FM Sets
- Mounts On Set, Wall or Baseboard



For operation of up to four TV and/or FM sets with a single broadband antenna connection. Gives complete isolation between sets. Low forward loss makes it ideal for use with color TV and FM stereo sets. Imported. Shpg. wt., 1/2 lb.

99 E 4020

Net 2.29

LAFAYETTE TV/FM SPLITTER - COUPLER

2²⁹

- Splits TV and FM Signals From All-Band TV Antenna
- Low Signal Loss



Splits TV and FM signals with minimum loss to either signal from a single broadband antenna. Also combines separate TV and FM antennas into one line. Gives complete isolation between sets. For indoor or outdoor mounting. Imported.

99 E 4022 Shpg. wt., 1/2 lb. Net 2.95

LAFAYETTE UHF/VHF ANTENNA COUPLER

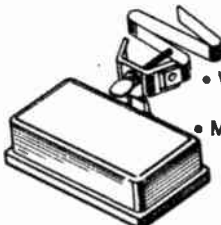

- Weatherproof Plastic Case
- Mounts on Mast

Only 1⁹⁹

This efficient UHF/VHF coupler combines the signal from the separate UHF and VHF antennas into a single transmission line. Features maximum signal transference with extremely low insertion loss. Mounts easily on mast. Sturdy, weatherproof plastic case with metal clamp. Imported. Shpg. wt., 1/2 lb.

99 E 4016

Net 1.99

FOAM TV TWIN LEAD

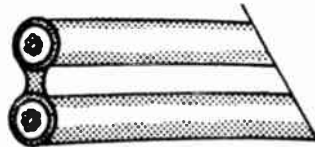

- For UHF-VHF and Color TV

A flat 300-ohm twin lead with each conductor encased in polyethylene foam with an outer black polyethylene jacket. Has high resistance to ultra-violet rays, oil, fumes, moisture, salt air and abrasion. 20-gauge stranded copper conductors. Available only in lengths listed below. Shpg. wt., 2 1/2 lbs. per 100 ft.

32 E 3603 50-ft. Coil Net 2.03
32 E 3604 100-ft. Coil Net 3.57

BELDEN 8290 SHIELDED PERMOHM COLOR TV LEAD-IN

- Exceptional Low Loss



Designed for 82 channel color TV reception, 8290 Permohm combines the strong signal strength of twin-line with the clean signal of shielded cable. Shielded to eliminate ignition and other interference caused by line pick-up. Weatherproof! Shpg. wt., 2 lbs. per 100 ft.

32 E 1535 50 ft. Net 5.80
32 E 1536 75 ft. Net 7.80
32 E 1537 100 ft. Net 9.90
32 E 1534K Over 100 ft. per ft. Net .098

UHF Converters-Antenna Accessories



BLONDER TONGUE BTX-11A UHF CONVERTER/AMPLIFIER

28⁹⁵

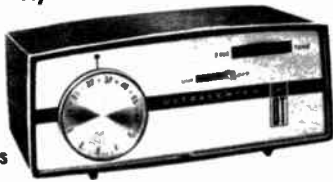

- Amplifies Signal 3 Times
- Illuminated Dial for Precise Channel Tuning

Adds all UHF channels (14-83) to your TV set anywhere within the range of a UHF station. Features a new dual speed 100 to 1 fine vernier and illuminated dial for easy tuning; double tuned UHF input circuits and shielded oscillator section for interference-free reception. AC convenience outlet. Complete with UHF loop antenna. Rugged, reliable patented tuner; spliceless, stripless terminals. For 110-120 volts. 60 cps. AC. Shpg. wt., 2 lbs. Net 28.95



MODEL U-VERT 200



18⁵⁷

- Electronic Circuit for Local and Suburban Reception
- Illuminated Dial for Easy Tuning

A deluxe, all transistor converter featuring a powerful electronic circuit that makes it ideal for use in local as well as suburban areas. Features an exclusive ultra-clear, fine tuning dial to insure easiest possible channel selection. Handsomely styled, durable plastic cabinet looks "just right" on top of the TV unit—complementing any room decor. Installation is simplified—the only tool you need is a screwdriver. Uses a sensitive circuit to provide low noise and picture perfect reception, AC convenience outlet. Overall size 8x5x3 1/4". Meets all FCC requirements. Operates on 110-120 volts, 60 cps. AC. U.L. App. Shpg. wt., 2 1/4 lbs. Net 18.57

LAFAYETTE 7" COLOR TV DEGAUSSING COIL

2⁴⁹



- Improves Color Quality

Sharpens color reception through demagnetization of the picture tube. Simply turn on the set, plug in the purifier, and with switch depressed rotate unit in front of the TV screen. Use regularly to keep your color reception sharp and clear. Save yourself dollars by degaussing your own color TV set. Supplied with line cord and plug. Convenient clip for hanging on back of set when not in use. Imported. Net 2.49

LAFAYETTE TUNABLE UHF ANTENNA

- Completely Tunable—Channels 14-83
- Solid, Padded Base



2⁹⁸

A completely tunable UHF antenna. Specifically spaced elements for maximum UHF signal transfer. Bracket with chrome-plated elements slides along graduated scale for precise tuning. Helps clear "ghosts" and eliminates interference. Excellent directivity and stable 300 ohm impedance match. Quick, easy installation. Imported. Shpg. wt., 2 lbs. Net 2.98

TELESCOPING TV MASTS

Heavy-duty telescoping masts, ideal for any TV antenna array. Hotdip zinc galvanizing inside and outside provides unusual ruggedness and impervious corrosion resistance. Designed for easy installation and assembly. Husky bolts lock sections automatically. No slipping, no twisting. Precision fitting assures lasting service. 18 and 20 gauge walls. Supplied complete with all guy rings, clamps and necessary hardware. Total 5 10-ft. sections for height up to 50 ft.: O.D.: #1 (1 1/4"), #2 (1 1/2"), #3 (1 3/4"), #4 (2"), #5 (2 1/4"). Shipping express only.

50-FT. MAST—Consists of all 5 sections listed above: Nos. 1, 2, 3, 4 and 5. Height 50 feet. Shpg. wt., 39 lbs. Net 15.79

40-FT. MAST Consists of 4 sections: Nos. 1, 2, 3 and 4. Height 40 feet. Shpg. wt., 28 lbs. Net 11.79

30-FT. MAST—Consists of 3 Section. Nos. 1, 2 and 3. Height 30 feet. Shpg. wt., 21 lbs. Net 8.95

20-FT. MAST. Consists of 2 sections. Nos. 1 and 2. Height 20 feet. Shpg. wt., 14 lbs. Net 4.95

ALUMINUM ANTENNA MASTS

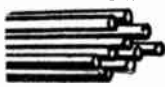

- Gold Anodized
- Lightweight
- Strong and corrosion proof

This Golden Anodized aluminum mast will outlast any antenna. Made of a tough 19 gauge extra strong, drawn aluminum alloy. Two or more masts may be telescoped together.

18 E 3817W 5' wt. 1 1/2 lbs. Net 1.25

18 E 5614WX 10' wt. 2 1/2 lbs. Net 2.39

ALUMINUM MASTS. 19 gauge-heavy wall-high tensile strength. Rust and corrosion proof. Swaged for stacking.

18 E 3818W 5' wt. 1 1/2 lbs. Net .99

18 E 3819WX 10' wt. 2 1/2 lbs. Net 1.89

GOLDENIZED STEEL MASTS. Heavy 18 gauge, made of rigid welded steel tubing with rugged high tensile strength. Highly protective gold colored baked enamel finish for lasting beauty and endurance. Perfect with modern goldenized antennas. Heavy-duty for permanent corrosion resistant installations.

18 E 5621W 5' wt. 3 lbs. Net 1.09

18 E 5622WX 10' wt. 6 lbs. Net 1.80

LAFAYETTE 75/300 OHM MATCHING TRANSFORMERS

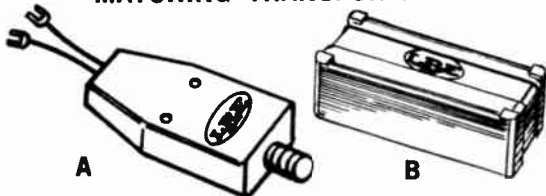

- Ideal for Color Reception

Matching transformers for converting 300-ohm TV and FM antenna installations for 75-ohm coaxial cable.

(A) Indoor transformer, matches 75-ohm cable to 300-ohm TV or FM sets. Imported. Shpg. wt., 6 oz. Net 1.49

99 E 4028

(B) Mast Mounted (with mounting bracket). Matches 300-ohm antenna to 75-ohm coaxial cable. Imported. Shpg. wt., 3/4 lb. Net 1.79

99 E 4027

Matching Transformer Kit. Consists of mast mounted and indoor set mounted transformers. Shpg. wt., 1 1/2 lbs. Net 2.95

99 E 9190M

75-OHM RG-59U LOW-LOSS CABLE WITH CONNECTORS.

18 E 5807 50' Shpg. wt. 1 1/2 lbs. Net 4.95

18 E 5808 75' Shpg. wt. 2 1/4 lbs. Net 6.49

18 E 5809 100' Shpg. wt. 3 lbs. Net 7.69

TV GHOST ELIMINATOR

5⁹⁵

- Filters Out Interference
- No Installation Problem
- Improves Color Reception
- Receives from All Directions



Electrically rotates the polar-receiving pattern of your existing antenna and phases the ground wave picked up by the electrical wiring system with the sky wave picked up by the antenna. Improves any existing antenna; indoor, outdoor, master or built-in. Boosts pick-up power of any antenna—old or new. Just a flick of the selector control tunes out ghosts—filters out interference—tunes in those "hard-to-get" problem channels. Automatically amplifies TV signal strength for "snow" free, brighter, clearer pictures. Works on every channel—in any location—with any antenna—for any TV set—and plugs into 100V AC/DC socket. Complete satisfaction guaranteed or your money back. Shpg. wt., 2 lbs. Net ea. 5.95

ALL ANGLE MOUNT

Mounts on any flat slant, peak or wall. Heavy gauge steel. Takes mast up to 2 1/4" O.D. Complete with hardware. Net 1.10

18 E 5618

110



Make Lafayette Your One Dependable Source for Everything in Electronics

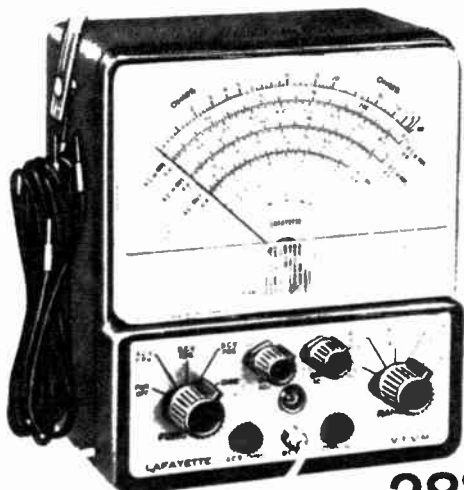

MADE IN U.S.A.

28⁹⁵

LAFAYETTE VTVM with GIANT 6½" METER

- Accurately Measures AC Peak-to-Peak Voltage, AC RMS Voltage, and Resistance without Additional Probes or Accessories
- Wideband RMS Measurements on any Waveform from 30 cps to Over 5 MC
- Direct Reading DB Scale

A high quality, accurate VTVM employing a giant 6½" easy reading 400µA meter. 11 megohm input resistance. AC RMS voltages may be read directly up to 1500 volts and resistance from 0 to 1,000 megohms in 5 overlapping ranges. Has zero-center scale for alignment of FM and TV detector circuits. Push-pull amplifier electrically isolates the meter movement — meter is virtually impossible to burn out. Precision 1% multiplier resistors. SPECIFICATIONS: DC VOLT-METER RANGES: 0 to 3, 30, 150, 300, 1500 volts. Input resistance: 11 megohms (1 megohm in probe) on all ranges. A.C. VOLTMETER RMS RANGES: 0 to 3, 30, 150, 300, 1500 volts. PEAK-TO-PEAK RANGES: 0 to 8, 80, 400, 800 volts. DECIBEL RANGES: -10 to +5, +6 to +25, +26 to +45 db. Response: 30 cps to above 5 Mc. OHM-METER RANGES: 0 to 1000 megohms in 5 overlapping ranges. ZERC CENTER VOLTMETER RANGES: 0-1.5, 15, 75, 150, 750 volts. Complete with 1½ V battery, instructions, and 3 probes: Common, AC volts/ohms and DC volts probe. Size 7½Hx6½Wx5"O. For 110-120 V 60 cycle AC. Shpg. wt., 7 lbs.

38 E 0101W Net 28.95

38 E 0103 Accessory RF Probe 1 lb. Net 3.95

38 E 0106 H.V. Probe, Extends range to 30,000 V. 1 lb. Net 5.85

38 E 1501 Leather Case for VTVM. 1 lb. Net 2.95



19⁹⁵

Tests for Cathode Emission, Leakage and Shorts plus Filament Continuity.

LAFAYETTE TUBE TESTER

For HOME, SHOP BENCH or LABORATORY

- Checks Compactrons, Nuvistors, T-9 Types 7-pin Miniatures, Octals, Lock-ins and 9-pin Miniatures
- Accurately Checks Over 1800 Different Tubes

A modern, dependable tube checker designed for fast, accurate testing—the ideal low-cost tube tester for any radio-TV serviceman, experimenter, technician. Tests most of the tube types employed in Radi, Mi-Fi, Monochrome, and Color TV, including the 12-pin compactrons, nuvistors, T-9s, 7, and 9-pin miniatures—actually tests over 1800 different tubes! A special alligator clip lead is furnished to test tubes with top caps. Slide switches connect the various tube elements to their respective test circuits. 3-position tube slide switch for checking shorted elements, cathode emission and filament continuity. A leakage indicator light indicates an interelement short or leakage. Large easy-to-read meter calibrated 0-100 has a red-green "Replace-Good" scale, plus a special scale for checking diodes. A handy slide out metal tray contains tube charts which facilitate rapid selection of test settings. Metal case is attractively finished in cream and steel gray. Completely portable—weighs only 6 lbs. and measures 8¼Ox9¾Wx2½"H. Supplied with carrying case. For 105-125 volts, 60 cycle AC. Imported. Shpg. wt., 7 lbs.

99 E 5063 Net 19.95

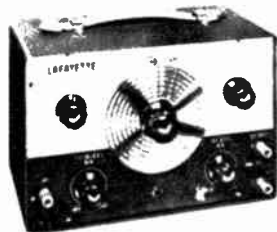

LAFAYETTE RF SIGNAL GENERATOR

27⁹⁵

- Six Bands: 120 Kc to 260 Mc
- Dual Output RF Terminals

A stable, wide range signal generator engineered to fill the need for an accurate low cost service instrument. Full frequency range: 6 Fundamental bands—120-320 Kc 320-1000 Kc. 1-3.5 Mc, 3.2-11 Mc, 11-38 Mc, 36-130 Mc. One harmonic band 120-260 Mc. Frequency Accuracy: ±2%. Audio Output: to 8 volts. Large 4¼" Etched Circular Dial (Vernier tuned) High-Low RF Output Terminals. Tube Complement: 12BH7A, 6AR5, Selenium Rectifier. Power Requirements: 105-125VAC 50/60 Cps., 12 Watts. Attractive gray wrinkle steel case with leather carrying handle. With test leads. 7Hx10½Wx5¾"O. 99 E 5015 Shpg. wt., 9 lbs. Imported

Net 27.95



LAFAYETTE SINE/SQUARE WAVE GENERATOR

35⁹⁵

No Money Down

- Frequency Range—Sine Wave: 20-200,000 cps in 4 Bands, Square Wave: 60-30,000 cps

Signal generator for testing audio amplifiers, determining the frequency and transient response of loudspeakers, and TV or radio audio circuit testing. Easy-to-read vernier dial permits precise calibration. Variable attenuator allows adjustment of output signal amplitude. Carefully designed full wave power supply is incorporated for low distortion and output regulation. Frequency range: 20 to 200,000 cps in 4 bands. Output voltage: 7 volts (1 megohm load). Accuracy: ±3%. For 117 volts 50/60 cps. AC. With instructions and test leads. Size: 10½Wx7½Hx5¾"O. Imported. Shpg. wt., 10 lbs.

99 E 5014 \$5 monthly

Net 35.95

Service, Low Prices



LAFAYETTE 20,000 OHMS-PER-VOLT VOM with GIANT 6" METER

26⁹⁵

- 20,000 Ohms-per-volt DC
- 1% Multiplier Resistors
- DC Volts: 0-5000V in 8 Ranges
- AC Volts: 0-5000V in 6 Ranges



A precision VOM for accurate measurement of voltage, current, resistance and decibels. Expanded 6" meter scale in red and black. 50-microamp meter sensitivity. Wide-range frequency response measures 10 to 100,000 cycles within ± 0.5 db. SPECIFICATIONS: SENSITIVITY: 20,000 ohm/volt DC, 5000 ohms/volt AC. RANGE: AC; 0-5000 volts (in 6 ranges): 2.5, 10, 50, 250, 1000, 5000V; DC; 0-5000 volts (in 8 ranges): 0.25, 1, 2.5, 10, 50, 250, 1000, 5000V. DC Current, 0-10 amps. OHMMETER: 0-20 megohms (in 3 ranges): 0-2K, 200K, 20M. DECIBELS: -20 to +50 db. ACCURACY: DC; $\pm 3\%$ Full Scale. AC; $\pm 4\%$ Full Scale. RESISTANCE: $\pm 3\%$ Full Scale. Heavy gauge steel case with high impact plastic panel. Includes test leads, batteries and leather carrying handle. Size 6 $\frac{1}{4}$ "x7 $\frac{3}{4}$ "x4 $\frac{3}{8}$ "D. Imported. Shpg. wt., 4 $\frac{1}{2}$ lbs. 99 E 5013 Net 26.95

LAFAYETTE 30,000 OHMS PER VOLT MULTITESTER

16⁸⁸

- 30,000 Ohms Per Volt DC, 15,000 Ohms per Volt AC
- 1% Precision Resistors
- Unique "Buzzer" for Fast Short Tests
- 27 Meter Ranges
- Built-in Overload Protective Circuitry



A deluxe portable VOM with a high order of accuracy. Provides wide voltage, current, resistance and db ranges clearly visible on a large 4" meter with 2-color calibrations. Sensitive 33 microamp meter provides full scale readings down to $\frac{1}{4}$ volt on DC and 0.05 milliamps. Ranges: DC volts 0-.25, 1, 2.5, 10, 25, 100, 250, 500, 1000; AC volts 0-2.5, 10, 25, 100, 250, 500, 1000. DC Current: 0-0.05, 5, 50, 500 mA; 0-12 amps. Ohmmeter: 0-60K, 6 Meg., 60 Meg. DB's: -20 to +56 db. Controls: Range Switch, Ohms Adjust, Audio output jack with DC blocking capacitor, Built-in overload protective circuitry. With leads, batteries. 4 $\frac{1}{2}$ "x6 $\frac{1}{2}$ "x2 $\frac{1}{4}$ "D. Imported. Shpg. wt., 2 lbs. 99 E 5004 Net 16.88

38 E 0108 Pigskin Carrying Case for above Net 1.95

LAFAYETTE 20,000 OHMS PER VOLT MULTITESTER

- 20,000 Ohms/Volt DC, 10,000 Ohms/Volt AC
- 1% Precision Resistors
- Easy-To-Read 3" Meter
- Built-in Overload Protective Circuitry

9⁹⁵



40 μ A. D'Arsonval meter movement permits a high input resistance on all ranges. Rugged high impact plastic case. Ranges (DC Volts): 0-3, 30, 60, 300, 600, 3000V. AC Volts: 0-6, 60, 120, 1200V. DC Current: 0-60 μ A, 0-12, 0-300 mA. Resistance: 0-60K, 0-6 megohms. Decibels: -30 to +63 db. Audio output jack. With test leads and 1 $\frac{1}{2}$ V battery. Size: 3 $\frac{1}{4}$ "x4 $\frac{1}{2}$ "x1". Imported. Shpg. wt., 1 lb. 99 E 5008 Net 9.95

Pigskin Carrying Case for above Net 1.95

38 E 0107

LAFAYETTE "SUPER MIDGET" AC-DC VOM

- Pocket Size: Only 2 $\frac{1}{4}$ "x3 $\frac{1}{8}$ "x1 $\frac{1}{8}$ "
- 1000 Ohms Per Volt Sensitivity
- Mirror Scale
- Reads: 0-1000V AC-DC, 0-100K Ohms, 0-150MA

4⁹⁵



For trouble-shooting electronic circuits and appliances as irons, lamps, radios, television, hi-fi equipment. 1,000 ohms per volt sensitivity. 1% precision resistors and mirror scale to insure precise readings. Easy to operate, no switching required. Ranges: AC and DC volts: 0-15-150-1000V. Ohms: 0-100,000. Current: 0-150 MA. Plastic covered panel lettering. High impact plastic case. Complete with battery and test leads. Shpg. wt., 10 oz. Imported. 99 E 5064 Net 4.95

99 E 5066 Case for above. Shpg. wt., $\frac{1}{2}$ lb. Net 1.95

LAFAYETTE MULTILAB 7 in 1 TESTER

Only 13⁹⁵

- R-C Substitution
- IF, RF, Audio Generator
- AC & DC Voltmeter
- RF Field Strength Indicator

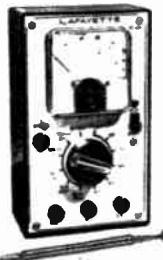

Combines seven of the most wanted test functions in one compact easy-to-carry unit. SPECIFICATIONS—Resistance Substitutions: 100 Ω , 1K Ω , 10K Ω , 100K Ω , 1M Ω . Capacitance Substitution: .002 μ F, .005 μ F, .02 μ F, .1 μ F (600 volt-ohm), 10 μ F (350 V, electrolytic). IF and RF Generator Frequency: 455KC (variable) Audio Generator Frequency: Approximately 400 cps. AC & DC Voltmeter Ranges: 0-15, 50, 150, 500, (200 μ A meter movement). RF Field Strength Freq. Range: 1-140 mc. With 5 section antenna, test leads, and battery. 6 $\frac{1}{4}$ "x3 $\frac{3}{4}$ "x2 $\frac{1}{2}$ ". Imported. Shpg. wt., 2 lbs. 99 E 5067 Net 13.95

LAFAYETTE IN CIRCUIT CAPACITOR CHECKER

ONLY 14⁹⁵

- Magic Eye Indicator
- Wide Range 10 MMF to 2000 MMF



Allows you to check most capacitors from 10 mmf to 2000 mmf for open or shorted conditions without unsoldering. Just connect the test leads across the component you wish to test, press the switch and note the eye tube's face for an open or short condition. Checks coupling, by-pass, filter and blocking capacitors. Accurate readings are made in seconds—an important factor in today's complex electronic equipment. It also indicates capacitor leakage. Tests for opens on capacitors of 10 mmf. or more; for shorts up to 2,000 MF. Shunted by not less than 10 ohms. Complete with test leads and instructions. For 117 VAC. Size: 7 $\frac{1}{2}$ "x5 $\frac{1}{2}$ "x4 $\frac{1}{2}$ ". Shpg. wt., 5 lbs. Imported. 99 E 5022 Net 14.95

LAFAYETTE SOLID-STATE DC POWER SUPPLY

16⁹⁵



- AC Ripple Less Than .025%
- Transistorized Regulation Circuitry

Provides continuously variable voltage and current with low ripple. Excellent for operation of transistorized devices. Panel meter reads either current or voltage. SPECIFICATIONS—Output voltage: 0-20 volts DC (continuously variable). Output Current: 0-20 MA, 0-200 MA (in two ranges). AC Ripple: less than .025%. Power Input: 110-120 volts, 50-60 cps. AC. Fully fused. Size: 6 $\frac{1}{4}$ "x1 $\frac{1}{4}$ "x3 $\frac{3}{4}$ ". Imported. Shpg. wt., 4 lbs. 99 E 5068 Net 16.95

IDEAL TEST INSTRUMENTS For the Student and Technician

PROTECT YOUR METER with METERGARD

2⁹⁵



- Easily Installed
- No Overload Damage

Newly-Developed, fully tested device to protect your meter, regardless of make, against overloads. No more bent pointers, damaged pivots, or burnt out coils. Installation of metergard will allow your meter to withstand as much as a 10,000% overload. Shpg. wt. 1 lb.
38 E 6801 Net 2.95

LECTROCELL DC POWER SUPPLY FOR VTVM's

3⁹⁵



Quickly replaces 1½ volt battery used in VTVM's for resistance measurements. Regular battery must be replaced at regular intervals. If it is forgotten the instrument may be ruined by chemical corrosion. Eliminate trouble by installing this power supply. Install it and forget it. Shpg. wt., 2 lbs.
38 E 6802 Net 3.95

SENCORE CG10 PORTABLE COLOR BAR GENERATOR

- 10 RCA Type Color Patterns, NTSC Phased Colors
- Compact, Solid State, Battery Operated

89⁹⁵ Less Batteries

No Money Down



Portable, easy to use, a mighty midget, yet a giant in performance. All the patterns... crosshatch, individual vertical and horizontal lines, and adjustable white dots at the flick of a switch. 14 horizontal and 10 vertical lines, interlace control stops dot bounce. Uses standard RCA licensed patterns. Quick warm up time. Solid State design with batteries provides patterns instantly. Rugged

all-steel construction with scuff-resistant vinyl finish. Unusually compact for easy handling on the job, (slightly larger than a cigar box). Long battery life. Uses 8 "C" cells, not supplied. 10x3¼x5¼" Shpg. wt., 7 lbs.

38 E 5316 Model CG10 \$5 Monthly Net 89.95

99 E 6257 "C" Batteries (8 req.) Net ea. .13

LAFAYETTE LAB TYPE MULTITESTER WITH MIRROR SCALE

Highly accurate, compact multimeter provides wide voltage, current, resistance and db ranges on large, easy-to-read 2 color scale. 1% precision resistors. 16-position selector switch, and zero-adjust switch. Lightweight, high impact case. Sensitivity: 2,500 Ω/volt AC & DC. DC volts, 5 ranges: 0-6, 12, 60, 300, 1200V. AC volts, 5 ranges: 0-6, 12, 60, 300, 1200V. DC amps 3 ranges: 0-300μA, 3mA, 300mA; DC ohms, 3 ranges: 0-20K, 200K, 2 Meg. Decibels: From -20 to +17 1½x2¾x6¾". Imported.
99 E 5069 Shpg. wt. 1½ lbs. Net 9.95



9⁹⁵

WITH AUTOMATIC OVERLOAD PROTECTION

Easy-to-Build Test Equipment Kits

LAFAYETTE TRANSISTOR ANALYZER KIT

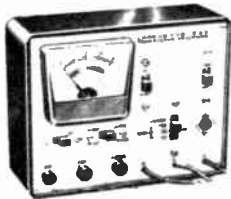

Only 13⁵⁰

ACCURATE 6-IN-1 TESTER

- In-Circuit and Out-Of-Circuit Transistor Checker (Including Power Types)
- Diode and Rectifier Checker
- Signal Generator
- Battery Tester
- Voltmeter
- Milliammeter

Tests transistors of all types including power types. In-circuit test provides an actual performance check. Externally the transistor is checked for leakage on a multi-colored scale and for beta gain in 3 ranges up to 200. Supplies a 5kc test signal with harmonics for checking the RF, IF and AF circuits. Also checks the condition of diodes and rectifiers. Features a voltmeter for testing transistor radio batteries. This analyzer can check current drain up to 80 ma. Complete with test leads and step-by-step illustrated instructions. Black case and anodized aluminum front panel. 6¾x5¾x2¾". Shpg. wt., 3½ lbs.
19 E 0901 Net 13.50

Extra 1½ volt Battery (2 req.)
99 E 6257 Net ea. .13

94 Lafayette Cat. No. 672

MERCURY MODEL 1101K PORTABLE TUBE TESTER KIT



34⁹⁵ No Money Down

- Tests for Dynamic Cathode Emission, Shorts, Grid Leakage, and Gas
- Tests Decals, Magnavals, and 7 Pin Nuvistors

Assemble this easy to build kit and save on wiring costs without sacrificing performance. Makes dynamic cathode emission test on Novars, Nuvistors, Compactrons, 10-pin types and others. Shorts are detected fast. Tests all sections of multi-section tubes, guards against obsolescence. Has sensitive 3½" D'Arsonval meter, protected against burnout. Sockets are of long lasting phosphor bronze construction. Includes pin straighteners, CRT cable and scuff-proof carrying case. Supplied with complete step-by-step instructions. Size: 8¾x11¾x3¼". Shpg. wt., 64 lbs.

38 E 3704 \$5 monthly Net 34.95

Mercury 1101 Same as above but factory wired.

38 E 3709 \$5 monthly Net 59.95

DELUXE EICO MODEL 460K 5" WIDE BAND SCOPE KIT



89⁹⁵ No Money Down

- For Color
- Black & White
- 10 MV RMS/CM Sensitivity
- DC to 4.5 MC Flat Response
- TV-V and TV-H Sweeps

Excellent Lab precision scope featuring Push-pull direct coupled vertical amplifier with high sensitivity: 25 mv/in. Response flat from DC to 4.5 MC, useful to 10 MC, ideal for reproduction of 3.58 MC color TV sync. burst. 4-step freq.-compensated attenuator in both AG, DC positions. Also internal voltage calibration. Automatic sync. limiter and amplifier. 2X-full screen horizontal positioning. Sweep-freq.: 10 to 100K cps with external capacitor for lo-freq. sweeps. Preset TV V & H sweep positions (30 and 7875 cps). Variably lit graphed 5" screen. Very hi-input impedance. Complete with all components and instructions for easy assembly. 13x8½x16". For 105-125 VAC. 50-60 cycles. Shpg. wt., 30 lbs.

38 E 2643WX Kit. \$5 Monthly Net 89.95

Model 460. As above, but factory wired.

38 E 2644WX \$7 monthly Net 129.50

To Speed Your Mail Order - Please Give Your Zip Code Number

Mail This Card Today For Your

FREE!

1967 Lafayette Catalog 670



672

Name _____

Address _____

City _____ State _____ Zip Code _____

Please Give Your Zip Code Number

Do A Friend a Favor . . .

If you have a friend who would be interested in getting a copy of the new 1967 Lafayette catalog No. 670, just give him this card . . . or fill in his name and address and mail this card to us. He will get a catalog absolutely FREE, no charge or obligation.



672 A

Name _____

Address _____

City _____ State _____ Zip Code _____

Please Give Your Zip Code Number

PLACE
STAMP
HERE

**LAFAYETTE
RADIO ELECTRONICS**

**P.O. Box 10
Syosset, L. I., N. Y. 11791**

Dept. 672

PLACE
STAMP
HERE

**LAFAYETTE
RADIO ELECTRONICS**

**P.O. Box 10
Syosset, L. I., N. Y. 11791**

Dept. 672A

Selected Popular Specialties

LAFAYETTE BINOCULAR MAGNIFIER

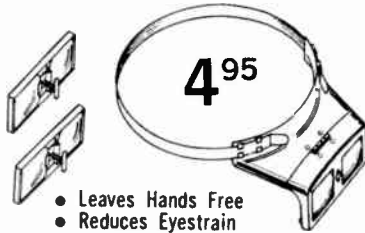

- Leaves Hands Free
- Reduces Eyestrain

Ideal for technicians, inspectors and hobbyists. Precision ground and polished lenses for very close work without eyestrain. Headband adjusts to any head size. Lenses can be changed with pushbutton ease for three magnifying powers. Flip-up viewer, may be worn over eyeglasses. Imported. Shpg. wt., 7 oz.

99 E 7203	2X, 4½" working distance	Net 4.95
99 E 7204	2.5X, 3½" working distance	Net 4.95
99 E 7205	3X, 2" working distance	Net 4.95
99 E 7206	With set of lenses: Range 2X-to-3X, Shpg. wt., 9 oz.	Net 9.95

MINIATURE PUMP & MOTOR

- Powerful, Raises Liquid up to 12'
- High Capacity—1 ½ Gallons per Minute
- Waterproof, Lightweight Construction
- Industrial Quality

3⁹⁸



A motorized, miniature pump for the hobbyist and "Do-it-Yourselfer." Pumps liquids from container to container at the rate of up to 1½ gallons per minute and raises liquids up to 12 feet. Ideal for fountains, water house plants, aquariums, science projects, waterfalls, etc. Pumps water, chemicals, viscous liquids. Requires just 3 to 12 volts DC. Shpg. wt., 1 lb.

13 E 1903	Net 3.98
-----------	----------

"THE BIG EAR"

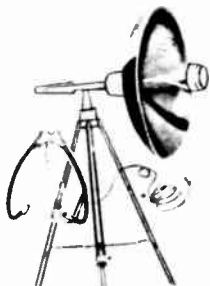

12⁹⁵

- Big 18" Reflector Disk Concentrates Sound Waves Into Transistor Unit Which Amplifies Them Loud and Clear

Powerful new transistorized listening device. Not just a toy—works on the same principle as the fabulous Missile Tracking Antennas. Pick up sounds too distant for you to hear. Make your own wildlife recordings or carry on long range 2-way communications (using a "Bull Horn"). Ideal for experimenters, etc. Complete with sturdy tripod and stethoscope-type earphones. Uses one 9V battery (not supplied). Shpg. wt., 5 lbs.

13 E 2510W	Net 12.95
99 E 6021 9V Battery for above	Net .21

ALERT BURGLAR ALARM SYSTEM

PROTECTION FOR Yourself, Family, Property
39⁹⁵
 No Money Down
 PROTECT AGAINST Intruders, Thieves, Vandals



LOUD PULSATING BLASTS AND FLASHING RED LIGHT

Alert system consists of transistorized warning system, 750 feet of hair thin wire, 12 contact switches for doors and windows, mounting pins. Extra switches and wire are available to expand the system to cover as many areas as desired. Warning stickers included to notify potential intruders your property is protected. Once this alarm is set your key is needed to stop its operation. Built-in delay operation allows enough time to set the alarm and secure the premises before the system goes into operation. Battery operated unit is independent from AC power interruption. Protect orchards, boats, camp sites, etc.—use it anywhere. Set of lantern batteries last approximately one year under normal use. Light and horn operate for more than twelve hours unless unit is turned off. Less batteries. Shpg. wt., 8 lbs.

14 E 1301	\$5 monthly	Net 39.95
14 E 1302	Pkg. of 6 Extra Switches	Net 1.50
14 E 1303	Extra spool of wire (750 feet)	Net 1.50
32 E 4869	Batteries (Two Required)	Net ea. .85

BY-PASS SWITCH LOCK KIT. Permits cut-off of one doorway so that you may gain access to protected area without setting off the alarm. Complete with instructions. Shpg. wt., 6 oz.

14 E 1304	Net 7.50
-----------	----------

MAXIMUM-MINIMUM THERMOMETER



For weather enthusiasts—gardeners—farmers, etc. Gives three readings at a glance—maximum, minimum and present temperatures. Self-registering—no knobs—magnets—or push buttons needed for reset. Magnifying lens ease for ease of reading. Maintains automatic check on temperature variations. Makes you the local weather expert. Shpg. wt., 1 lb.

13 E 1603	Net 4.70
-----------	----------

REMOTE READING THERMOMETER. Same as above but with remote for comfortable indoor reading of outdoor temperature. Includes mounting bracket and instructions.

13 E 1604	Net 7.49
-----------	----------

NOVATRON

A SCIENTIFIC INSTRUMENT FOR THE EXPERIMENTER

- Powerful 110 Volt AC/DC Motor
- Miniature Atom Smasher
- Produces 75,000 Volts
- Absolutely Safe Completely Wired (Not A Kit)



A scientific instrument capable of producing 75,000 volts—makes sparks up to 2" long—yet it is absolutely safe because the current is infinitesimal. The science-teacher—science lover—or hobbyist can perform experiments to astound students—friends—family. Makes smoke disappear—defy gravity—turns propellers at a distance—transforms atomic energy into light—makes artificial lightning—smashes atoms—demonstrates ionic space ship drive—and many other experiments. Includes an experimental kit and illustrated experiment manual. A fine research tool that will give years of beneficial service to the institution or individual who owns one. 110 V. AC or DC. Imported. Assembled—Shpg. wt., 4 lbs.

99 E 9008	Net 12.95
-----------	-----------

PROJECT-A-SCOPE

- Projects Giant Pictures in Color or Black & White
- Films or Negatives Not Needed



5⁹⁵

Handsome projector molded of heat and abuse resistant hi-impact plastic for long life. Casts sharp, giant-size enlargements on any white wall or screen in brilliant color or black and white. Simple to operate. Can be used by students, artists, lecturers and demonstrators. Children can project comics or story books to amuse themselves and their friends. Uses ordinary household bulbs. U/L approved. 110 volts, AC-DC. Shpg. wt., 2 lbs.

15 E 5001	Net 5.95
-----------	----------

ALL-TRANSISTOR BULL HORN

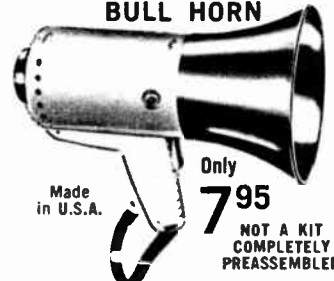

Made in U.S.A.

Only **7⁹⁵**

NOT A KIT COMPLETELY PREASSEMBLED

- Weighs only 2½ lbs.
- Range up to 400 feet
- For Hunting, Camping, Boating, Sports

A fully transistorized directional megaphone at Lafayette's low price. Lightweight, it carries your voice over 100 yards or above noise. Just press the trigger and talk. Features variable volume control and carrying strap. Uses 4-standard "D" cells (not supplied with unit). 11" long. Shpg. wt., 3 lbs.

44 E 1509	Net 7.95
1½-volt D batteries, 4 required. Imported.	
99 E 6526	Net ea. .13

To Speed Your Mail Order — Please Give Your Zip Code Number

Lafayette Cat. No. 672 95

LAFAYETTE Binoculars-Scopes



As Low As
16⁹⁵

VERSATILE BINOCULARS

- All Lenses Are Coated!
 - Sealed Against Dust & Moisture
- Precise design, quality material and expert workmanship. All center focus; adjustable right eye-piece. Leather case, neckstraps included. Imported.
- 7x35 Popular, versatile, all-purpose binoculars.
- 99 E 7018 Shpg. wt., 3 lbs. Net 16.95
- 7x50 Navy style night glasses. Favored for marine use.
- 99 E 7016 Shpg. wt., 3½ lbs. Net 19.95
- 20x50 King of the long range.
- 99 E 7020 Shpg. wt., 4½ lbs. Net 27.95



Only **24⁹⁵**

EXTRA WIDE-ANGLE BINOCULARS

- Doubles the Field of Ordinary Binoculars
- Multi-purpose 7x35mm binoculars which are especially useful in field studies. Wide angle view allows brilliant and close-up views of sporting events without cutting the image as regular narrow angle binoculars do. Field of view at 1000 yards, is 580 feet! Center focus and right eye adjustment insures perfect focus. All optics are coated. Lined leather case provides protection when not in use. Imported. Shpg. wt., 5 lbs.
- 99 E 7019 Net 24.95

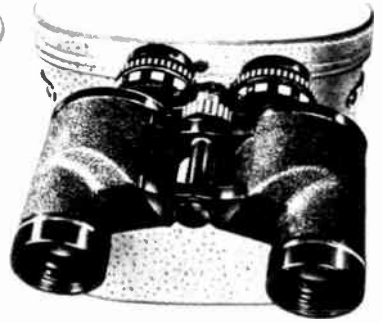

Only **44⁹⁵** No Money Down

WIDE ANGLE TRU-ZOOM™

- Not a "Vari-Power," One Control Zooms Both Barrels!
 - Center Focus, Adjustable Right Eyepiece, plus Single Synchronous Zoom Control!
- Sight in subject at 7 power—then Zoom up to 12 power (or any four in between) for closeup viewing power. 40 mm objective lenses are hard coated achromats. Field of view is 323 feet at 1000 yards at 12 power (5.5"). Prisms in shock-resistant mounts. Lightweight alloy frame and body. Includes lined hard leather case and straps. Shpg. wt., 5 lbs. Imported.
- 99 E 7108 \$5 Monthly Net 44.95

900X "ZOOM" STUDENT LABORATORY

Sale! **17⁹⁵**

Save **5.00** Sale Ends March 15th

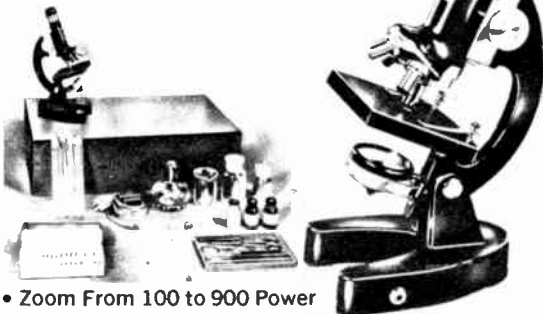

- Zoom From 100 to 900 Power
- All Dissecting and Mounting Materials
- Prepared and Blank Slides
- Includes AC/DC Substage Illuminator

A complete microscope laboratory for the student and enthusiast. Provides all necessary material to explore the interesting field of microscopic research. The 900X microscope offers various combinations of magnification from 100X to 900X with four objective lenses (10X, 20X, 40X, 60X). Combined with the fine ocular which "zooms" from 10X to 15X, the scope provides clear, sharp images. Tube movement governed by adjustable downstop with a locking screw...prevents costly slide breakage. The 900X features an optical condenser, plano mirror and built-in 3-volt light using the AC adapter included, or 2 penlight batteries. Laboratory includes a dissecting kit with hand lens, blunt-end scissor, scalpel and probe; glassware (test tubes, specimen bottles, alcohol burner). There are several prepared slides, blank slides, cover glasses, mounting balsam, Methylene Blue and Rhodamine stains. Imported. Shpg. wt., 7 lbs.

99 E 7195 Microscope kit Net 17.95
 99 E 7106 Replacement bulb Net .11
 99 E 6258 Battery (2 required) Net ea. .09

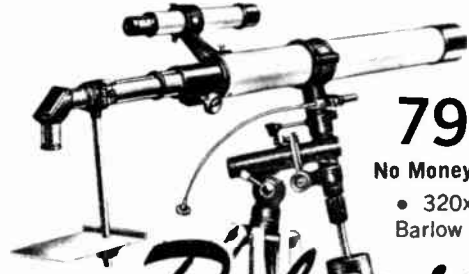

79⁵⁰

No Money Down
 • 320x with Barlow Lens

Polaris

2.4" EQUATORIAL REFRACTOR

- Eyepieces for 160x, 88x, 40x, Barlow Lens gives 320x, 176x, 80x
 - 800-mm. focal length • 62-mm objective • Micromotion adjustments on both axes • Coated optics throughout • Equatorial mount
- Objective: Fraunhofer-type achromat, hard coated, 62.5-mm., Collects about 75 times as much light as the naked eye, resolving power 2 seconds. Finder scope is 6x, 30-mm. Tripod head with latitude adjustment. Clamp lever for declination and inclination. Accessories include sunglass, star diagonal, erecting prism, sun projection screen, field tripod, wooden case. Imported. Shpg. wt., 30 lbs.

99 E 7032WX \$5 Monthly Net 79.50
 99 E 7043L 4-mm. orthoscopic eyepiece for 200x (400x with Barlow Lens) Net 8.95

4X RIFLESCOPE



Sale! **4⁹⁵**

- Lightweight—only 6½ ozs.
 - Internal Adjustments
 - Hard Coated Lenses
 - Cross Hair Reticule
- Popular, all-around scope for the small game hunter. Bright field, approx. 30 feet at 100 yards. Eye relief distance from 3¼ to 4½ inches. Eyepiece diameter, 1" tube diameter 3/4". Hard coated, achromatic lenses reduce glare. Internal windage and elevation adjustments for positive "zero-in". Fine, cross hair reticule pinpoint target. Featherweight, weather-resistant precision built. Easy, fast installation with all .22's. with grooved receivers, some air rifles. Imported. Shpg. wt., 1 lb.
- 99 E 7160 Net 4.95

LAFAYETTE RECORDING TAPES

LAFAYETTE'S FAMOUS MONEY-BACK GUARANTEE

YOU BE THE JUDGE!

Lafayette's tape is made by outstanding nationally known manufacturers. It is first quality, splice free, red oxide coated, with full frequency response, uniform output and no "drop-outs." Resistant to moisture, heat, cold and abrasion.

We guarantee absolute satisfaction or your money back. If for any reason you are dissatisfied, return the tape at once and we will refund your money less only transportation charges. You are the sole judge.



LAFAYETTE ACETATE RECORDING TAPE

Acetate base magnetic recording tape with uniform standard red oxide coating provides wide range high fidelity response over the audio spectrum. Features noise free reproduction, low abrasion and uniform output. In 1 mil and 1 1/2 mil thickness.

Stock No.	Feet	Reel	Mils	Wt. Lbs.	Net Per Reel		
					1-4	5-24	25 Up
28 E 0102	600	5"	1 1/2	1/2	.99	.90	.85
28 E 0103	900	5"	1	3/4	1.20	1.10	.99
28 E 0101	1200	7"	1 1/2	1	1.59	1.49	1.35
28 E 0104	1800	7"	1	1 1/4	1.98	1.88	1.79

LAFAYETTE MYLAR RECORDING TAPE

Mylar base is especially strong, durable and break resistant, and is virtually impervious to heat, cold or humidity. All in clear plastic reels, individually boxed.

Stock No.	Feet	Reel	Mils	Wt. Lbs.	Net Per Reel		
					1-4	5-24	25 Up
28 E 0105	1200	5"	1 1/2	3/4	1.75	1.58	1.42
28 E 0106	1800	7"	1	1 1/4	2.49	2.25	2.13
28 E 0107	2400	7"	1 1/2	1 1/4	3.10	2.79	2.51

LAFAYETTE TENSILIZED MYLAR TAPES

These tapes are of the same high quality as the standard acetate and mylar Lafayette tapes with the added advantages of the tensilized mylar base. Super-strong mylar is prestretched and is highly resistant to breakage, moisture, heat, cold, and humidity. Highly polished, splice-free, quiet, non-abrasive finish. Smooth output throughout the entire audio spectrum. Tensilized mylar gives you the most permanent type of base and is therefore ideal for your most treasured recordings. All are 1/2 mil, thus permitting the maximum amount of footage per reel. Individually boxed + in self-mailing box.

STOCK NO.	FEET	REEL SIZE	WT., LBS.	NET PER REEL		
				1-4	5-24	25-UP
28 E 0109	300+	3"	1/2	.69	.63	.59
28 E 0110	600+	3 1/4"	1/2	1.20	1.09	.99
28 E 0111	1200	5"	1/2	2.25	2.03	1.83
28 E 0108	2400	7"	1/2	3.69	3.39	3.05

LAFAYETTE BULK TAPE ERASER AND DEMAGNETIZERS

PROFESSIONAL MODEL

- Completely Erases Tape
- Two Erasing Coils
- Erases up to 1" Tapes
- Erases 1/4" Tapes in One Operation—No Reversing
- For 3", 5", 7" or 10 1/2" Reels

1250

Standard Model

2295

Professional Model

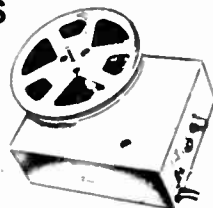

A carefully designed and precisely manufactured tape "degausser" for complete erasing of tapes. Just place the tape reel on spindle of demagnetizer, slowly rotate 2 or 3 turns, take off, and that's all. Reduce tape hiss to the level of new "virgin" tape. Two completely separate coils are used for doubly-effective erasures, even of large, 10 1/2" reels. Will erase 1" wide tape. An extra powerful unit for heavy-duty use—draws over 9 amperes. Can be used to demagnetize tape, magnetically stripped film, plus tools and watches. Has a heavy, custom finished case, a rugged non-magnetic top, heavy duty on-off switch and power cord. Has built-in fuse. Pilot light prevents accidentally leaving it turned on. Size 6 1/4 x 7 7/8 x 3 1/2". 105-125V, 60 cycle. Imported. Shpg. wt., 14 lbs. Net 22.95
99 E 1516 Professional Model

STANDARD MODEL

Similar to professional model for all size reels but handles only standard size 1/4" tapes or smaller and reel must be turned over once. Has separate spindle positions for 10 1/2" and 3, 5, and 7" reels; non-magnetic bakelite plate for reel rest. One powerful coil consumes 5 amps. Metal case 7 1/2 x 4 3/4 x 3 1/2". Imported. Shpg. wt., 9 lbs. Net 12.50
99 E 1518

LAFAYETTE TAPE HEAD DEMAGNETIZER WITH SWITCH

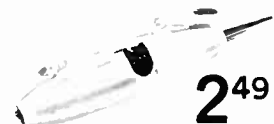

249

Pencil shaped head demagnetizer with one extending probe. Styling allows you to reach all heads in all positions. Features switch control . . . no need to leave unit on constantly. Turn on when needed and off to conserve units life. Operates on standard 110-120v 60 cycle AC. Imported. Shpg. wt., 1 lb. Net 24.99
99 E 1533

1200 FT. LEADER TAPE ON 7 INCH REEL



- For Indexing and Cueing

Lafayette brings you this jumbo reel of leader tape at a tremendous savings over the cost of leader tape at a tremendous savings over the cost of leader tape customarily available in 100 ft. quantities. 1 1/2 mil white mylar tape. 1200 ft. x 1/4" wide on 7" clear plastic reusable reel. Individually boxed. Shpg. wt., 1 lb. Net 2.79
28 E 7701

1200 FT. 1 1/2 MIL MYLAR BASE RECORDING TAPE



AS LOW AS

79¢

Lots of 25

Lafayette brings you this 1 1/2 mil mylar base quality recording tape at an unbelievable low price. This 1 1/2 mil mylar tape features the exceptional strength and resistance to heat, cold, humidity and abrasion that are characteristic of mylar. 7" reel. Shpg. wt., 1 lb. Net 1.99
28 E 0113

Lots of 5, ea. .89 . . . Lots of 25, ea. .79

LAFAYETTE TAPE SPLICER



198

- Two Operations—Cuts & Trims
- Clean Splices in Seconds
- For Monaural or 2 and 4-Track Stereo
- Splicing Tape Supplied

A sturdy precision instrument for professional use in all splicing and editing applications. Gives clean, quick cuts on all tapes without losing a significant portion of the sound track. Splicing tape fed from below will not foul and waste tape. Sharp long lasting blades provide trouble-free operation. A must for professionals and demanding audio hobbyists. Imported. Shpg. wt., 3/4 lb. Net 1.98
99 E 1535

TELEPHONE PICKUP FOR RECORDING TELEPHONE CONVERSATIONS



149

Induction telephone pick-up for cradle or upright phones. Picks up conversations without wire tapping or special circuitry. Simply place phone base on pickup and connect leads to high impedance input of an audio amplifier or directly to a tape recorder. Imported. Shpg. wt., 8 oz. Net 1.49
99 E 1034

To Speed Your Mail Order — Please Give Your Zip Code Number

Lafayette Cat. No. 672 97

Tape Recording Accessories

NEW! LAFAYETTE VOICE-ACTUATED MICROPHONE

IDEAL FOR USE WITH LAFAYETTE RK-30, RK-55 AND RK-60 TAPE RECORDERS

- Tape Recording Automatically Controlled By Sound
- 6-Transistor Circuitry • Electronically Controlled Relay
- Adjustable Threshold Sensitivity Control
- Also Operates As Remote Control Dynamic Microphone

Allows a transistorized portable tape recorder to start automatically when sound is picked up by the microphone and stop a few seconds after the sound stops. Designed for recorders having a remote jack for a remote Start/Stop switch equipped microphone. The electronically controlled relay has a current handling capacity of 0.5 amps at 30 volts DC maximum. Has 3-position switch for voice CONTROL-OFF-REMOTE. Threshold sensitivity control adjustable for use in varying noise level

locations. When in "Voice-Control" position 6-transistor circuitry operates electronic relay and amplifier. In "Remote" position, microphone operates as a dynamic microphone with remote control switch. Complete with cord, plugs and instructions. Requires 9V battery (not supplied). Imported. Shpg. wt., 1 lb.

99 E 4604 (Less Battery) Net 14.95
99 E 6021 9V Battery For Above .. Net .21

14⁹⁵



NEW! LAFAYETTE CASSETTE CARTRIDGE

- For Cassette Type Tape Recorders
- Up to One Hour Record and Play Time
- Quick Change No-Tape-Thread Cartridge

A permanently enclosed cassette cartridge for use in Norelco Carry-Corder 150, Norelco 350, Wollensak 4100, Panasonic 3100, Aiwa Snap-O-Matic, Mercury and all other tape recorders using the Norelco-Type cassette cartridge. Records up to 1 hour per cartridge (2 tracks) at 1 7/8 ips. Tape automatically moves from one reel to the other. Imported. Shp. Wt., 4 oz.

99 E 1540 Net 1.95

HEAD CLEANING TAPE CARTRIDGE FOR 8-TRACK PLAYERS



1⁹⁵ NEW!

A must for removing coating deposits from tape heads to restore high frequency response and volume. For use in any 8-track player accepting RCA Stereo — 8 Cartridge tape. Easy to use and reuse. Simply run the cartridge for a short period. Shpg. wt., 8 oz.

28 E 1292 Net 1.95

"MICROMEDIA 25" LONG PLAY TAPE

- Records Four Times More Than Ordinary Tape



An ultra-thin recording tape with a heavy-duty high-density magnetic coating on 1/4 mil tensilized polyester base. Outstanding performance with capstan-drive recorders.

1200 Ft. on 3 1/4" Reel. Greatly extends recording time of 3 1/4" battery operated recorders. Records 4 hours (2-tracks) at 1 7/8 ips; 2 hours at 3 3/4 ips. Shpg. wt., 12 oz.

28 E 6400 Net 4.25

2300 Ft. on 5" Reel. Records 8 hours (2-tracks) at 1 7/8 ips; 4 hours at 3 3/4 ips. Comes on low-torque, large hub 5" reel and with similar additional blank reel. Shpg. wt., 1 1/2 lbs.

28 E 6401 Net 7.95

CARRYING CASE FOR AUTO TAPE CARTRIDGE



Keep tape cartridges for your car neat, orderly, dust free. Compact 9x6x6" case stores 10 tapes of any standard brand. 2 lbs.

28 E 2012 Net 2.65

AUTO TAPE SYSTEM MAINTENANCE KIT



1⁹⁵

An all-in-one maintenance kit for your auto tape system . . . keeps heads in top operating condition. Contains cleaner, lubricant, applicators, brush and convenient storage case. Simple operation with descriptive instructions. Brushes fit together to reach depths of player system. Ideal for all 4 and 8 track systems. Shpg. wt., 1/2 lb.

28 E 7801 Net 1.95

LAFAYETTE RECORDER PATCH CORD 67c



Ideal for Making Connections From Radio, Phono or TV To Tape Recorder

Handy 6 ft. lead has insulated alligator clips at one end and RCA phono plug at the other. Supplied with shielded phono plug adapter to adapt the RCA phono plug to standard phono plug if necessary. Attach alligator clips to speaker terminals and simply plug other end into tape recorder. Ideal for recording from Radio, Phono or TV. Imported. Shpg. wt., 8 oz.

99 E 1517 Net .67

18c METAL STORAGE CANS

Cans are ribbed for easy storage. Precision fit. Finished in grey. Av. shpg. wt., 8 ozs.

28 E 6305 3" Can lots of 6, Ea. .18

..... Singly, Ea. .20

28 E 6306 5" Can lots of 6, Ea. .27

..... Singly, Ea. .30

28 E 6307 7" Can lots of 6, Ea. .36

..... Singly, Ea. .39

CLEAR PLASTIC REELS

14c IN LOTS OF 4

Sturdy, non-warp plastic reels for recording tape. Avg. shpg. wt., 4 oz. singly.

28 E 2301 3 1/4" reel lots of 4, Ea. .14

..... Singly, Ea. .17

28 E 2302 5" reel lots of 4, Ea. .22

..... Singly, Ea. .24

28 E 2303 7" reel lots of 4, Ea. .27

..... Singly, Ea. .29

LOW TORQUE 7" REEL

Professional type plastic reel with 4 inch hub for smooth tape feed and reduced flutter. Holds 960 ft. 1 1/2 mil. 1440 ft. 1 mil or 1920 ft. 1/2 mil tape.

28 E 2304 lots of 4, Ea. .36

..... Singly, Ea. .39

REEL LOCKS

45c Set of Two



Holds tape recorder reel in place by locking spindle to reel. Especially useful if recorder is in vertical position. Will not interfere with normal operation of reels. Easily removable. Imported. Shpg. wt., 6 oz.

99 E 1519 Set of two Net .45

METAL TAPE STORAGE CHEST

2⁹⁹



STANDARD CASE: Sturdy all steel carrying case. Holds 12 7" or 5" reels and cans. Twin snap locks. Platinum gray hammerloid finish. Metal separators. Includes index cards. Shpg. wt., 5 lbs.

28 E 1501 Net 2.99

"DIMENSION 48" Solid State Compatible 4 and 8 Track Car Stereo Tape Player

Only **89⁹⁵**
No Money Down

Plus **FREE TAPE***

*Choose 1 Tape From Below
RCA and Herb Alpert Listings

For All 12 Volt
Neg/Pos. Ground Cars



- Plays Either 8 Track or 4 Track Tapes Instantly

Outstanding, compatible car stereo tape player plays both 4 and 8 track stereo and monaural tapes. Superb tape reproduction. Fully automatic—tapes play instantly—no extra switches or levers to select choice of cartridge—removal of cartridge from player automatically turns unit off. High styling enhances decor of your car. Features Electronic Program selection—channel automatically transfers at end of program. Selector bar permits instant change of tracks (program), illuminated dial indicates the channel that is playing.

- Includes Four 5" Wide Range Speakers and Grills.

separate tone and volume controls. Dust proof door seals cartridge opening when player is not in use. 12 transistors, 2 thermistors, 4 ohm output. Peak audio output 8 watts (4 per channel). Includes four 5" round wide range speakers, 4 grills, and all connecting cables.

Size: 1½Hx7¾Wx8"D. For 12V neg/pos. ground cars. Imported.
17 E 7415WX \$5 monthly. Shpg. wt., 12 lbs. Net 89.95
17 E 7422 Alternator Noise Filter for DIM. 48. 4 oz. Net 1.25

SALE! - RCA 8 Track Stereo Tape Cartridges - SALE! SAVE up to \$1.00

28 E1337 Lafayette's Complete Listing of Over 200 RCA 8 Track Tape Cartridges FREE!

Stock No.	Title	Net	Stock No.	Title	Net
28 E 1102	Many Moods of Belafonte	5.95	28 E 1151	Lena Horne—Lovely And Alive	5.95
28 E 1202	Belafonte at Carnegie Hall*	9.95	28 E 1179	Elvis Presley—Gold Records	5.95
28 E 1212	Original Cast—South Pacific	6.95	28 E 1141	Best of Al Hirt	5.95
28 E 1214	Original Cast—Sound of Music	6.95	28 E 1250	Beethoven Sym No 5—Reiner	5.95
28 E 1206	Original Cast—Fiddler On A Roof	6.95	28 E 1220	Beethoven "Emperor" Van Cliburn	5.95
28 E 1208	Original Cast—Hello Dolly	6.95	28 E 1225	Boston Pops—Gaité Parisienne	5.95
28 E 1283	Music From Mary Poppins	4.44	28 E 1262	Carmen Highlights—Price And Corelli	5.95
28 E 1269	Girl From Ipanema	4.44	28 E 1247	Tchaikovsky—Sym 4, Monteaux	5.95
28 E 1166	Mancini—Pink Panther	5.95	28 E 1293	The Monkees†	5.95
28 E 1169	Melachrino—Music of Rodgers*	6.95	28 E 1294	Stan Getz Greatest Hits‡	5.95

*Twin Pak

†Colgems Label

‡Kapp Label

LEAR JET STEREO 8 8 TRACK HOME CARTRIDGE TAPE DECK

79⁹⁵
No Money
Down



- Provides Brilliant Stereo Reproduction Of The New Lear "Stereo 8" Cartridge Through the Amplifier and Speakers Of Your Present Home Stereo System

Enjoy long playing 8 Track stereo cartridges in your home. Simple to operate—push in cartridge to start, pull out to stop. Outstanding features: Pushbutton track selector, automatic endless play of entire cartridge. Solid state stereo amplifier. "On" indicator light. Tape speed 3¾ ips. Handsome simulated walnut metal cabinet. Size: 9Wx10¼Dx3¾"H. For 110 VAC 60 cycles. Shpg. wt., 12½ lbs. 17 E 1803WX \$5 monthly Net 79.95

HERB ALPERT & THE TIJUANA BRASS 8 TRACK STEREO TAPE CARTRIDGES

Only
5⁹⁵
ea.



Stock No.	Title	Net
28 E 2101	Going Places	5.95
28 E 2102	Tijuana Brass—Vol II	5.95
28 E 2103	Lonely Bull	5.95
28 E 2104	South of the Border	5.95
28 E 2105	What My Love	5.95
28 E 2106	Whipped Cream & Other Delights	5.95

Deluxe Selection of Quality Portable Recorders

PANASONIC RQ-3100 SOLID STATE BATTERY POWERED CARTRIDGE RECORDER

Complete with remote control mike, blank cartridge, earphone, batteries, carrying case.

Only **69⁹⁵** \$5 Monthly
No Money Down

Truly portable battery powered tape recorder...simple and easy to operate...just slip a tape cartridge into the recorder and you are ready to play or record for up to 1 hour. Goes anywhere, plays anywhere. Big PM dynamic speaker assures rich, high quality sound reproduction. External, slim dynamic microphone assures excellent recording fidelity. Other features are; VU meter recording level indicator, single lever play, fast forward and rewind function, earphone monitor and tape erasing system. Size: 9 x 4 $\frac{1}{2}$ x 2 $\frac{1}{4}$ ". Shpg. wt., 4 lbs.

27 E 1205L \$5.00 monthly Net 69.95
99 E 6267 Batteries for RQ-3100, 5 req. Net .13 ea.
LAFAYETTE 60 Minute Blank Tape Cartridge For Model RQ-3100.
Imported. Shpg. wt., 1/2 lb.
99 E 1540 Net 1.95

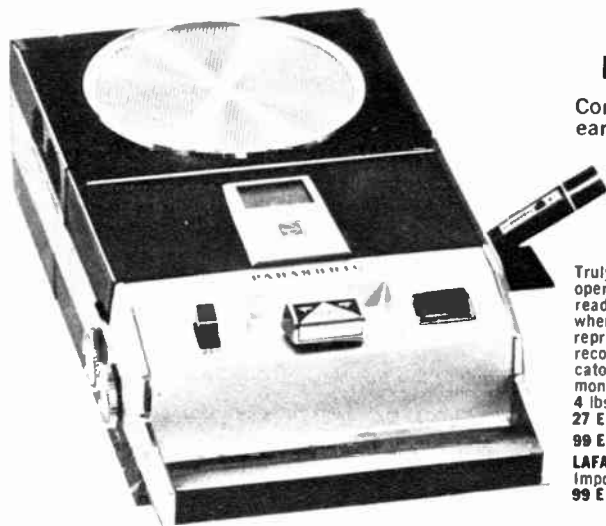

NEW! 10-TRANSISTOR FM/AM "RADIO/RECORDER"



- Direct Listening/Recording From Built-in FM-AM Radio
- Operates On Batteries or 110VAC Household Current
- 60 Full Minutes of Recording Time

Superbly performing constant speed "capstan driven" tape recorder with built-in AM/FM radio in one compact easy-to-carry unit. Perfect for on the go taping for business, home, school and pleasure. 10-transistor solid state circuitry allows simultaneous recording and monitoring of your favorite AM/FM programs with superb tonal quality. Records up to 1 hour on a 2 $\frac{1}{2}$ " reel of tape. Has "big recorder" features—pushbutton controls for Play, Stop, Rewind and Record; Volume and Tuning; dual purpose meter for record level and battery-life check. Additional features include a convenient window in the cover to let you see the amount of tape on reels with the cover closed; built-in interchangeable AC adapter; built-in Ferrite AM antenna; telescoping FM antenna; collapsible carrying handle; AC-on light and dynamic microphone. Tape speed: 1 $\frac{1}{2}$ ips. Radio Frequency Range: AM; 535-1650Kc, FM; 87-108Mc. Power Source: six 9V penlight batteries or 117V, AC. Output Power: 350mw. Size: 8 $\frac{1}{2}$ x5 $\frac{1}{4}$ x2 $\frac{3}{8}$ ". Imported. Shpg. wt., 4 lbs.

27 E 7201L \$5.00 Monthly Net 79.95
27 E 3505 Extra 2 $\frac{1}{2}$ " Reel of tape Net .59 ea.
3 or more Net .55 ea.
99 E 6258 Extra Penlite Batteries—(6 req.) Net .09 ea.

Only **79⁹⁵** No Money Down
with Mike, 2 $\frac{1}{2}$ " Reel of Tape,
Empty Take-up Reel,
Batteries, AC Adapter

NEW! DELUXE SOLID STATE FM WIRELESS PORTABLE TAPE RECORDER



Only **159⁹⁵**
No Money Down

with Wireless Mike,
Remote Control Mike,
Patch Cord, Batteries,
Telephone P.U., Earpiece

- FM Wireless Tape Recording (Meets FCC Specs)
- 4 Hours of Recording and Hi-Fi Sound on Batteries or AC
- Direct Listening/Recording From Built-in FM Radio

Advanced solid state, 15-transistor, 2-speed capstan drive portable tape recorder. Features "built in FM radio receiver", "wireless control and recording" and "automatic record level control" 3-transistor FM wireless mike remotely operates recorder. Starts and stops recorder and allows you to record from a distance of up to 100 ft. without a microphone cord or extension line. Meets FCC specifications. The exact program material received on the FM radio can be recorded and monitored at the same time. Controls for Forward (record/play), Rewind, Fast Forward, Record Safety and AC/Battery power source, radio Off/On, Volume, Monitor/Tone, and Vernier Tuning Dial for selecting FM stations or tuning into the transmitter frequency of the wireless mike. Unit also has Auxiliary jack, Remote microphone jack Earphone jack, Record Level Indicator, AC-on light and a telescoping FM antenna. Specifications: Six \square batteries or built-in 117V., 6C cycles AC adapter; 5" reels, up to 4 hours 16 minutes recording time; 88-108MC FM tuning range; 1 $\frac{1}{2}$ and 3 $\frac{3}{4}$ ips tape speeds; and built-in 3 x 5" wide-range speaker. With wireless mike; start-stop remote mike, earphone, 5" reel tape, batteries and telephone pickup. 4 $\frac{1}{2}$ x11 $\frac{1}{4}$ x10 $\frac{3}{8}$ ". Imported. Shpg. wt., 11 lbs.

27 E 7202WX \$8.00 Monthly Net 159.95
99 E 6256 Extra "D" batteries (6-req.) Net .13 ea.
99 E 6258 Extra "AA" batteries (2-req.) for FM mike Net .09 ea.

NEW! PANASONIC Model RS-780 Professional Type Solid State Stereo Tape Recorder with Auto Reverse

Only
299⁹⁵
No Money Down

- Automatic Reverse on Playback and Record
- Pushbutton Operation
- Separate Speaker System



Exceptionally fine quality all pushbutton solid state stereo tape recorder. Records and plays 4 track stereo or mono at 3-speeds (7½, 3¾, and 1⅞ ips.) Deluxe features: Automatic record and playback in either direction—plays up to 12 hours on stereo (24 hours on monaural); cueing button; 4-digit counter with push reset; two VU meters; separate volume controls for each channel; 4 matched and balanced full range hi-fidelity speakers (two in each speaker enclosure); sound monitoring can double as a P.A. system. Inputs: 2

mikes, 2 auxiliary. Outputs: 2 extension speakers 2 line, and monitor. Music Power Output: 16 watts. Response: 50-18,000 cps at 7½ ips; 100-7,000 cps at 3¾ ips. Flutter/Wow: Less than 0.2% at 7½ ips. With 2 dynamic mikes, 7" tape, 7" empty reel, 2 patch cords, 2 reel holders, and a splicing tape. For 117V., 60 cycles AC. 12½x12½x12". Imported. Shpg. wt., 45 lbs.

27 E 1206WX \$15 Monthly

Net 299.95

SONY MODEL 250-A SOLID STATE STEREO TAPE DECK



Only **135⁰⁰** No Money Down

- Beautiful Walnut Finished Base
- Two VU Meters
- 4 Track Mono and Stereo Record and Playback

A completely transistorized stereo tape deck with a black and brush satin chrome finish on a walnut base. Includes 4 track mono as well as 4 track stereo playback and record. Features true Capstan drive, FM stereo inputs, pause control, automatic shut off and tape counter. Also an automatic tape lifter for longer head life. Specifications: Speeds—7½ and 3¾ ips., Response — 5-15,000 cps ±2db, S/N better than 50db. Flutter and Wow less than 0.15%. Takes reels up to 7" Inputs for two mikes 117V 60 cycle AC. Size: 14½Wx11¾Dx 27 E 6008WX \$7.50 monthly Net 135.00
27 E 6015 F96L mike for 250-A 1 lb. Net 10.50

NEW! SONY MODEL OP-25 DUST COVER FOR MODEL 250-A TAPE DECK

Only **3⁹⁵**

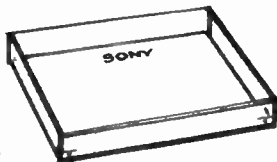

Beautiful, transparent, smoked plastic dust cover with a contemporary flair for the Model 250-A. Shpg. wt., 2 lbs. 27 E 6019W Net 3.95

WOLLENSAK MODEL 5730 SOLID STATE 4 TRACK STEREO RECORDER



Only **199⁹⁵**

No Money Down

- 3 speeds 7½, 3¾, 1⅞ ips

Fully Solid-State, designed for use in either vertical or horizontal operation. Features: Separate VU meters, Tone/Volume controls; 4-digit tape counter; automatic Head Demagnetization, and 2-self-contained 4 x 6" Elliptical speakers. Specifications: Freq. response 40-17,000 cps @ 7½ ips, 40-10,000 cps @ 3¾ ips; S/N—Greater than 48 db @ 7½ ips, 45 db @ 3¾ ips; Wow/Flutter—Less than 0.25% @ 7½ ips, 0.3% @ 3¾ ips; Power output—3w EIA, 5w peak per channel. Complete with cover lid, dynamic microphone, 7" reel of tape and one self-threading take-up reel. 16W x 10H x 7D. 27 E 5030WX Shpg. wt., 30 lbs. \$10 Monthly Net 199.95

Model 5720—Tape Deck version of Model 5730. Does not include Power Amplifiers and Speakers. Shpg. wt., 26 lbs. 27 E 5031WX \$10 Monthly Net 189.95



7" TWIST-LOCK STYRENE TAPE CANS

- Buy the set — save and GET THE CHEST FREE!

12 dust-free, moisture-proof unbreakable styrene tape cans in storage chest. Can has foolproof twist lock feature and is ribbed for convenient stacking. Center locking stud prevents reel movement on all 7" reels and most 3" and 5" reels. Shpg. wt., 6 lbs. 28 E 6510W Net 4.75

TWIST LOCK CANS ONLY

28 E 6511

Lots of 6 ea. 40 Single ea. .45

Tape Recorders Are Available on Easy Pay Plan—No Money Down

Lafayette Cat. No. 672 101

Deluxe LAFAYETTE Solid State Tape Recorders



MODEL RK-60 AC AND BATTERY OPERATED RADIO RECORDER

- Record Direct From Quality Built-in AM Radio
- 2 Speeds—3¼ and 1½ ips.
- Plays Up To 3 Hours On A 5-Inch Reel
- Built-in 5 x 3 Inch Hi-Fi Speaker
- Record Level and Battery Condition Meter

Only **69⁹⁵**

No Money Down
\$5 Monthly

Model RK-55 less Radio **49⁹⁵**

An exciting recorder for people on the go! Make candid recordings indoors or out in addition to direct recording from its own high quality AM radio. Lightweight, it operates on 4 "D" type batteries or built-in 117v 60 cycle AC power supply for full portability. Frequency response of 100 to 8,000 cps assures good voice and music reproduction. One watt audio output and 3" x 5" speaker combine with a variable tone control to tailor sound to your taste. Capstan drive for both 1½ and 3¼ ips speeds assure constant speed recording and playback of tape—even with other machines. Sensitive dynamic mike has stop/start switch for remote operation. Other features include: high speed Fast Forward; rotary switch for Play,

Stop, Rewind; safety Record button and jack for external 8-ohm speaker. Wow and Flutter is less than 0.35%. Supplied with dynamic mike, patch cord, batteries, 5" take-up reel and reel of tape. Size: 11¾W x 4H x 10"D. Imported. Shpg. wt., 10½ lbs.

99 E 1537W \$5 Monthly

Net 69.95

MODEL RK-55. As above, but less AM radio. Imported.
99 E 1536W \$5 Monthly

Net 49.95

MODEL RK-142T PORTABLE TAPE RECORDER

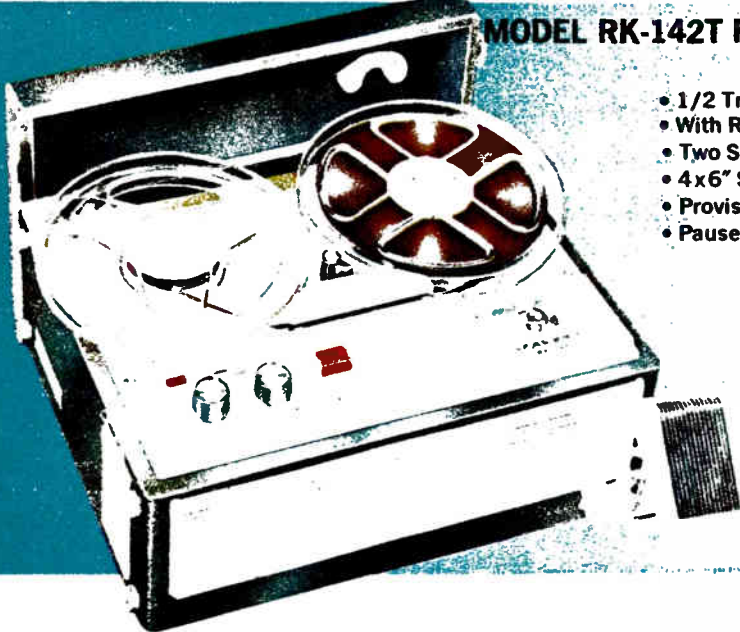

- 1/2 Track Doubles Play and Record Time
- With Recording Level Indicator
- Two Speeds—3¼ or 7½ ips
- 4x6" Speaker for Fine Tonal Reproduction
- Provision for External Speaker
- Pause Control for Editing

59⁹⁵

No Money Down

ACCESSORIES INCLUDED
Dynamic microphone, shielded connecting cable with clip leads, empty 7" reel.

Takes Reels up to 7"

SPECIFICATIONS

TAPE SPEED: 7.5 and 3.75 ips.
S/N RATIO: ---42 db or better at 7.5 ips tape speed. REWIND TIME: 5 min. for 7" reel. FAST TAKE-UP TIME: 3 min. for 7" reel. RESPONSE: Record playback response essentially flat with tone at max. treble. WOW-FLUTTER: 0.2% or better at 7.5 ips; 0.3% at 3.75 ips. POWER OUTPUT: 2 watts. CONTROLS: on/off-tone; volume, record interlock button, speed selector, motor shift control with pause feature.

Perfect for home, school or office. At home, the RK-142T proves ideal for parties or recording your favorite musical performance. A specially designed lever-type record switch completely eliminates the chance of accidental erasure for fool-proof operation. Pause control for editing and instant switch speed selection. At 3¼ ips, the RK-142T provides more than 4 hours of recording on long play 1/2 mil 2400 ft. tape reel. A special 4x6-inch heavy duty permanent magnet speaker

furnishes an exceptionally fine tonal quality. Record level indicator facilitates recording by showing you when the volume control is correctly set. Jacks provided for microphone, phono and extension speaker (special alligator clip cord is supplied). Complete with sensitive dynamic microphone. Finished in attractive scuff-resistant material. Dimensions: 11¾x9¾x7¼". For 117 volts, 60 cycles AC. Shpg. wt., 22 lbs. Imported.
99 E 1526WX \$5 monthly Net 59.95

Low Priced, Top Quality Solid State Recorders

LAFAYETTE COMPACT PORTABLE TAPE RECORDER

SALE! 12⁹⁵ was 14.95
1966 Cat. 671

- Efficient All Solid-State Amplifier
- 2 Track Recording with up to 3" Reel
- Goes Anywhere... Use Anyplace

Smart styling places a tape recorder in a case which appears to be a regular book when closed. Perfect for recording classroom lessons without having the recorder visible. Everyone acts natural with this hidden recorder—eliminates microphone nervousness. Efficient solid-state circuitry utilizes 4 transistors to achieve satisfactory frequency response. Standard 3-inch reel allows 2 track recording. Power is supplied by two "C" cells and one 9 volt battery. Supplied with 100 ft. of recording tape on a 3-inch reel, extra empty 3-inch reel, crystal microphone, and batteries. Imported. Shpg. wt., 4 lbs.

99 E 1525 Net 12.95

Replacement 9 volt battery for above (1 req.)

99 E 6021 Net ea. .21

Replacement "C" battery for above (2 req.)

99 E 6257 Net ea. .13

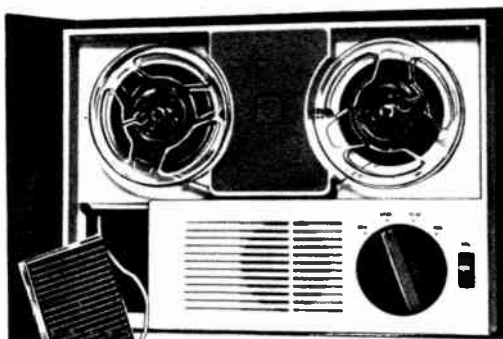

Complete With: mike, batteries,
3" reel of tape.

NEW SMARTLY STYLED PORTABLE TAPE RECORDER

Only **19⁹⁵**

- With Remote Control Mike; Earphone
- Takes Reels Up to 3 1/4"

Handsome, jetage styling and solid-state circuitry combine with a low Lafayette price makes this a natural "fun" recorder for the whole family. Carry it everywhere with its "foldaway" handle to record and playback speeches, classroom work, and parties. Operates on batteries or on standard household current with optional AC adapter. Remote control microphone lets you start and stop tape when you're ready to speak. Volume, Rewind/Stop/Play/Record and Speed control to adjust for weak batteries. Size: 10 1/4 W x 7 3/4 D x 2 1/4". Imported. With remote mike, 200 ft. tape, 3" take-up reel, earphone and batteries. Shpg. wt., 3 lbs.

27 E 0402L Net 19.95

99 E 6256 Extra "D" batteries. (2 req.) Net ea. .13

27 E 0403 AC Adapter for above recorder Net 3.95



LAFAYETTE MODEL RK-30 PUSHBUTTON AC AND BATTERY OPERATED RECORDER



Only **39⁹⁵**

with Remote Control Mike

- Constant Speed Capstan Drive
- ARL-Automatic Record Level Control

Lightweight, compact, quality capstan drive 2-speed recorder—3 3/4 and 1 7/8 ips. Takes reels up to 3 1/4". Dynamic mike has remote start/stop switch; prevents tape waste. Easy-to-use piano key controls for rewind, stop, play plus pushbutton safety record switch. ARL automatic record level keeps sound from distorting. Also has record level and battery life meter; self-contained dynamic speaker and jack for external speaker. All controls are accessible with the cover on. Built-in 117v, 60 cycle AC power supply or four "C" batteries. With dynamic mike, patch cord, batteries, 3" take-up reel, 3" reel of tape. Size 9 3/4 W x 2 3/4 x 9 1/4". Imported. Shpg. wt., 7 lbs.

99 E 1538L \$5 monthly Net 39.95

99 E 6257 Extra batteries (4 required) Net ea. .13

FAMOUS PANASONIC MODEL RQ-555 5" PORTABLE TAPE RECORDER



SALE! 44⁹⁵

Was 49.95
1966 Cat. 664

- VU Meter, Tone Control, 6" x 3" Speaker

Compact with 5" reel capacity. Accurate 2-speed capstan drive records and plays 2-tracks at 3 3/4 and 1 7/8 ips up to 2-hours. Other features include: separate record-playback erase heads; VU meter for positive control of recording input level; safety interlock to prevent accidental erasure. Frequency response: 70-7,000 cps at 3 3/4 ips, 70-4,000 cps at 1 7/8 ips. Fast forward and rewind time, less than 3 minutes: For 110-120v, 60 cps, AC. 9 1/2 x 5 7/8". With dynamic mike, 5" takeup reel, 1-roll splicing tape, 1-reel recording tape, 1-patch cord and input jacks on each end of the machine for fast, easy direct recordings from radio, phono, and TV. Imported. 7-transistors, 1-diode, 1-thermistor and 1-multiple power rectifier.

27 E 1203W \$5 monthly Shpg. wt., 10 lbs Net 44.95

Get The Tape Recorder You Want Now! No Money Down

Lafayette Cat. No. 672 103



LAFAYETTE'S Finest Solid State



Model 820
2-Head 4-Track
Stereo Record-
Playback Tape Deck

109⁹⁵

No Money Down

Complete with
4 connecting cables,
2 rubber reel caps,
7" take-up reel.

Model 830
3-Head 4-Track
Stereo Record-
Playback Tape Deck

159⁹⁵

No Money Down

Complete with
4 connecting cables,
2 rubber reel caps,
7" take-up reel.

Optional Dynamic Mikes
for Recorder Models
820 and 830



7⁹⁵
ea.

Deluxe Professional
Model RK-880 3-Head
4-Track Stereo
Record/Playback Tape Deck

249⁹⁵

No Money Down

Complete with
4 connecting cables,
2 rubber reel caps,
7" take-up reel.

Optional Dynamic
Mikes



14⁹⁵
ea.

EXCLUSIVE FEATURES

- Record/Playback Selector Button for VU Meters
- 4 Playback Tape Equalizations for All 3-Speeds
- 4 Recording Tape Equalizations for All 3-Speeds
- 2 Variable Record Bias Controls for Optimum Recording With any Brand of Tape



Stereophonic Tape Decks



RK-820 SOLID STATE 4-TRACK STEREO RECORD/PLAYBACK TAPE DECK

- 4-Track Stereo and Monaural Record/Playback
- 3-Speeds: 7½, 3¾ and 1⅞ IPS.
- Built-in Solid-State Record/Playback Stereo Preamplifiers

- Records 4-Track Stereo or Mono from FM, AM, FM Stereo Radio or Phono Sources, Live from Mikes
- Sound-with-Sound, Sound-on-Sound

Low-priced stereo tape deck of uncompromising quality. It is the successor to our famous, best selling Model RK-650 stereo tape deck which was acclaimed by high fidelity critics. With this improved deck you can add the brilliance of 4-track stereo tape reproduction to your music system. Features instant "on" solid-state stereo record/play preamps with dual illuminated VU meters for accurate record/play level settings. Single-lever control selects fast-rewind, stop, run and fast-forward plus "pause" for precise editing. Automatic end-of-reel shutoff. Digital tape counter with fast pushbutton zero reset, ideal for editing, cueing and indexing tape selections. Rear panel preamp outputs, auxiliary inputs and front panel mike input jacks are all readily accessible for easy hook-up. Frequency Response: ±3 db, 40-18,000 cps at 7½ ips; ±3 db, 40-12,000 cps at 3¾ ips. Wow and Flutter: less than 0.15% rms at 7½ ips; less than 0.25%

rms at 3¾ ips. Signal-to-Noise: 50 db or better. Bias & Erase Frequency: 96 kc. Crosstalk: over 60 db. Inputs: (Each Channel) microphone, 0.9 mv, 10K ohms; auxiliary, 300 mv, 500K ohms. Outputs: (Each Channel) external amplifier, 0.9 mv, 3K ohms. Takes 7" reels. In sturdy utility wood base ready to play, or install in custom installation. Size: 11¾W x 9¼H x 5¼D; in wood base, 12¾W x 10¾H x 6"D. Imported. For 117 V, 60 cycles AC. Shpg. wt., 18 lbs. 99 E 1528WX \$6 monthly Net 109.95

Deluxe Oiled Walnut Wood Base for RK-820. Shpg. wt., 4 lbs. 24 E 1214W Net 9.95

Dynamic mike with stand. Shpg. wt., 1½ lbs. 99 E 4802 Net 7.95

RK-830 SOLID STATE 3-HEAD 4-TRACK STEREO RECORD/PLAYBACK TAPE DECK

- Tape and Input Source Selector Switch for Tape and Input Source Monitoring
- 3-Speeds: 7½, 3¾ and 1⅞ IPS
- Sound-on-Sound—Sound-with-Sound

- 2 Studio-Type Record/Playback VU Meters
- 4-Track Stereo and Mono Record/Playback
- Record and Playback Stereo Preamps
- 3-Head Tape Transport with 4-Pole Motor

Now, from Lafayette, a 3-head 4-track stereo tape deck at a sensible low, low, price. Enjoy thrilling sound-on-sound and sound-with-sound plus complete 4-track stereo and monophonic record and playback facilities. Operates vertically or horizontally with styling to match any custom hi-fi music system. Single lever control selects fast-rewind, stop, run, and fast forward plus "pause" for precise editing and cueing. Other professional features include: dual illuminated VU meters for accurate record/playback settings; digital tape counter with pushbutton reset; individual record safety buttons; monitor switch for tape and input source monitoring; separate record volume controls; automatic shut-off at end of play and rugged 4-pole motor. The stereo preamps have low level inputs for microphones; high level for radio, TV, phono. Outputs for external amplifier. Frequency Response: ±3 db, 40-18,000 cps at 7½ ips; ±3 db 40-12,000 cps at 3¾ ips. Wow and Flutter: less than 0.15% rms at 7½ ips; less

than 0.25% at 3¾ ips. Signal-to-Noise: —50db or better. Bias and Erase Frequency: 96 kc. Crosstalk: over 60 db. Inputs (each channel): microphone, 0.9 mv 10k ohms; auxiliary, 300 mv, 500k ohms. Outputs (each channel): external amplifier, 0.9 mv, 3k ohms. Takes 7" reels. Solid-state complement: 12 transistors, 6 diodes. In sturdy utility wood base, ready to play. Size: 11¾W x 9¼H x 5¼D; in wood base, 12¾ x 10¾ x 6" deep. For 110-120v, 60 cycles AC. Imported. Shpg. wt., 18 lbs. 99 E 1534WX \$8 monthly Net 159.95

Deluxe Oiled Walnut Wood Base for RK-830. Shpg. wt., 4 lbs. 24 E 1214W Net 9.95

Dynamic Mike with stand. Shpg. wt., 1½ lbs. 99 E 4802 Net 7.95

DELUXE PROFESSIONAL RK-880 3-HEAD SOLID STATE 4-TRACK STEREO RECORD/PLAYBACK TAPE DECK

- Full Facilities for Stereo/Mono Record from Dynamic Mikes, Record Player with Magnetic Pick-Up, FM Stereo Tuner, and Playback through an External Amplifier and Speakers

- Sound-with-Sound, • Sound-on-Sound
- Separate Record and Playback Solid State Stereo Preamps
- 4-Pole Hysteresis Synchronous Motor—No Speed Deviation

The finest Lafayette stereo tape deck ever offered. Our ultimate performer, suitable for use with the very best in hi-fi components. Features professional variable bias and equalization controls to effect the optimum combination of extended frequency response, low distortion and high signal-to-noise ratio with virtually any recording tape. Three heads for 4-track stereo and mono record and playback plus sound-on-sound and sound-with-sound. Monitor directly from tapes or source. Separate record and monitor volume controls for left and right channels. Has 4 built-in solid-state stereo preamps; dual record-playback VU meters; digital tape counter with zero-reset button; hysteresis-synchronous motor and separate safety record buttons. Single-lever controls selects fast rewind, stop, run and fast-forward plus "pause" for precise editing. Front panel stereo headphone output jack. Frequency Response: ± 3 db, 30-22,000 cps at 7½ ips; ± 3 db, 40-12,000 cps at 3¾ ips. Wow and Flutter:

less than 0.15% at 7½ ips; less than 0.25% at 3¾ ips. Signal-to-Noise: over 53 db. Bias & Erase Frequency: 96 kc. Variable Bias: 0.3 ma to 1.5 ma. Cross-talk: over 60 db. Equalization: (playback) 4 position 50, 70, 90 and 140 μ/sec; (record) 4 position 20, 16, 12 and 8 kc. Inputs: (both channels) mike — 0.4 mv, 10 k ohms; mag. phono — 2.0 mv, 50 k ohms; Aux. — 200 mv, 500 k ohms. Outputs: (both channels) external amp., low impedance headphones. Handsome polyester walnut finish wood cabinet. Size: (in case) 15¾W x 13H x 7¾D; 11¾W x 11¼H x 7"D. For vertical or horizontal operation. 110-120 v., 60 cycles. Imported. Shpg. wt., 25 lbs. 99 E 1531WX \$12.50 monthly Net 249.95

Deluxe Dynamic Microphone with stand and lavalier. 99 E 4588 Shpg. wt., 3 lbs. Net 14.95

Tape Recorders Are Available on Easy Pay Plan—No Money Down

World Radio History

LAFAYETTE'S Famous Best Selling

SUPERB QUALITY MODEL RK-810 STEREOPHONIC TAPE RECORDER

Featuring **4** —Track Stereo Playback*
—Track Monaural Record/
Playback

- 3-Speeds: 1½, 3¾ and 7½ IPS
- Record/Playback VU Level Meter
- 3-Digit Tape Counter with Reset Button

Successor to our best selling and widely acclaimed Model RK-137 series recorders, the all-transistor Model 810 now has an improved audio output of 2.5 watts. Compact and lightweight, makes an ideal "take-along" recorder. Easy-to-operate, the unit features: 5 position Selector control for rewind, Stop, Run, Fast Forward. Includes "Pause" and instant reset digital counter for editing, cuing and tape indexing; safety record button to insure against accidental tape erasure; speed selector, push-button channel selector, and master volume and tone control. Record/playback VU meter makes tape recording about as easy as tuning your radio. *Playback stereo tapes when used with a second channel external amplifier containing a tape head input. Built-in 5" x 3" speaker. Also includes external speaker jack, stereo tape head output jack, inputs for mike and auxiliary. Frequency Response: 40-15,000 cps at 7½ ips, 40-10,000 cps at 3¾ ips. Provides full fidelity for making recordings of FM, or "live"... Great for stereo playback of 4-track pre-recorded tapes. Wow and Flutter: Less than 0.25% rms at 7½ ips; less than 0.35% at 3¾ ips. Signal to Noise Ratio: 40 db or better. Bias and Erase: 60 kc. Crosstalk: 55 db or better. Sensitivity: Mike, 0.6 mv; Aux, 200 mv; External speaker, 16 ohms. Front panel stereo headphone output jacks. Takes 7" reels. Textured solid vinyl case with built-in accessory compartment. For 110-120 v., 60 cycles AC. 11½" W x 12¼" H x 6¾" D. Imported. Shpg. wt., 18 lbs. 99 E 1527WX \$5 monthly Net **\$9.95**



89⁹⁵

NO MONEY DOWN

Complete with
dynamic microphone
3 connecting cables,
2 rubber reel caps,
7" empty take-up reel.



MODEL RK-815 OUR LOWEST PRICED SELF-CONTAINED STEREO RECORDER

- 3 Tape Speeds—1½, 3¾ and 7½ IPS
- Sound-with-Sound
- Sound-on-Sound
- 3-Digit Tape Counter with Preset Button

Top quality, low price 4-track stereo recorder to fit everybody's budget. Solid-state circuitry permits instant stereo or monophonic record and playback... no warmup required. A total of 10 transistors and 5 diodes deliver an impressive 5-watts of audio output power through two built-in 5" x 3" full range speakers. Illuminated VU meter indicates the exact record and playback level for top stereo sound results. Single knob tape motion control for Rewind, Stop, Run, Fast Forward plus "Pause" for editing and cuing. Uses quality laminated 4-track record/play head and double gap erase head for superb performance. Records sound-on-sound, sound-with-sound for music, language training and sound effects. Other features include: separate push-button Interlock to prevent accidental tape erasures; individual volume and tone controls for each channel; digital counter; front panel output jack for external speakers or stereo headphones and smooth running 4-pole motor. The RK-815 operates at 7½, 3¾ and 1½ ips and plays in either a vertical or horizontal position. Full high fidelity response is ±3 db 40-15,000 cps at 7½ ips and ±3 db, 40-10,000 cps at 3¾ ips. Wow and Flutter: under 0.25% rms at 7½ ips; under 0.35% at 3¾ ips. Signal-to-Noise: better than 45 db. Bias and Erase Frequency: 60 kc. Crosstalk: better than 55 db. Input Sensitivity: Mike, 0.2 mv; Aux., 100 mv. Takes up to 7" reels. Housed in a handsome, easy-to-carry, solid vinyl case with built-in accessory compartment. Measures a compact 11½" W x 12¼" H x 6¾" D. For 110-120 v., 60 cycles AC. Imported. Shpg. wt., 22 lbs. 99 E 1532WX \$7 Monthly Net **129.95**

129⁹⁵

NO MONEY DOWN

**Our Lowest Price
Full Stereo Recorder**

Complete with
2 dynamic
microphones,
4-connecting cables,
2-rubber reel caps,
7" empty take-up reel



Tape Recorders Are Available on Easy Pay Plan—No Money Down

World Radio History

Solid State Stereo Tape Recorders

MODEL RK-840 4-TRACK SOLID STATE STEREO PUSHBUTTON RECORDER

- Sound-with-Sound
- Sound-on-Sound
- Direct Record/Playback from Record Player with Magnetic Pickup

An extraordinary, precision, quality engineered 4-track stereo high fidelity tape recorder offering you the breath-taking realism of full-range stereophonic sound. Records and plays back stereo and monophonic tapes at three speeds, 7½, 3¾ and 1½ ips. Also features two 1/4-track heads-lamination type record/playback; double gapped high efficiency erase head; front panel jack for stereo headphone monitoring. Uses a rugged 4-pole motor for smooth tape operation and automatic shut-off. 5-position single lever motor control with "pause" and instant reset 3-digit tape counter for precise editing, cueing and tape indexing; volume controls for each channel, master tone control, and separate safety interlocking record buttons. Frequency Response: ± 3 db, 40-18,000 cps at 7½ ips; ± 3 db, 40-12,000 cps at 3¾ ips. Wow and Flutter: less than 0.2% rms at 7½ ips; less than 0.3% rms at 3¾ ips. Signal-to-Noise: 48 db or better. Bias & Erase Frequency: 96 kc. Crosstalk: over 58 db. Input Sensitivity: 2-Mike phono, 0.2 mv, 0.7 mv; 2-Aux., 100 mv. Outputs: 2-external amplifier; 2-external speaker; stereo headphones. Solid-State Circuitry: 12 transistors, 4 diodes. Two illuminated VU meters assure accurate indication of record/playback levels. Hi-Fi sound is provided by 2 full-range 5" speakers and 6-watt output. Takes up to 7" reels. In black leatherette covered wood case, 15¾" W x 14" H x 7¾" D. For 105-125 v, 60 cycles AC. Imported. Shpg. wt., 27 lbs. 99 E 1529WX \$9 monthly Net 169.95



169⁹⁵
NO MONEY DOWN

- Complete with
- 2 dynamic microphones,
 - 4-connecting cables,
 - 2-rubber reel caps,
 - 7" empty take-up reel.



PROFESSIONAL MODEL RK-860 4-TRACK STEREO RECORDER

- Powerfull 12-Watts Output
- Sound-on-Sound— Sound-with-Sound
- Sound Monitoring
- Direct Record/Playback from Record Player with Magnetic Pickup

Our finest stereo tape recorder. The distinguished Model RK-860 offers everything you could possibly want in self-contained home recording equipment—fabulous performance, superb quality and brilliant styling. Records and plays back 4-track stereo and monophonic tapes at three speeds, 7½, 3¾ and 1½ ips. Features direct record and playback from a stereo record player with a magnetic pickup. 5-position motor control with "pause"; instant reset digital tape counter; 2 studio-type illuminated record/playback VU level meters; automatic shut-off; dual volume and tone controls; pushbutton monitor speaker switches; stereo headphone monitoring facilities; safety interlocking record buttons and Mike-Aux/Mag phono selector button. 12-watts power output through 2 full-range 5" x 7" speakers. Frequency Response: ± 3 db, 30-22,000 cps at 7½ ips; ± 3 db, 40-12,000 cps at 3¾ ips. Wow and Flutter: less than 0.15% at 7½ ips. Signal-to-Noise: 53 db or better. Bias and Erase Frequency: 96 kc. Crosstalk: over 60 db. Input Sensitivity: 2-Mike, 0.2 mv, 0.7 mv; 2-Aux., 100 mv. Outputs: 2-external amplifier, 2-external speaker, stereo headphones. Equalization: NAB for 7½ and 3¾ ips; RIAA for magnetic phono. Heads: 1/4-track lamination-type stereo record/playback; 1/4-track double-gapped high efficiency erase head. Takes up to 7" reels. Black leatherette covered wood case with silver metal trim. Size: 15¾ W x 14 H x 7¾" D. Solid State Circuitry: 14 transistors, 8 diodes. For 105-125v, 60 cycles AC. Imported. Shp. wt., 29 lbs. 99 E 1530WX \$11 Monthly Net 219.95

Deluxe Dynamic Microphone. Imported. Wt. 2 lbs. 99 E 4588 Net 14.95



219⁹⁵
NO MONEY DOWN

- Complete with
- 4 connecting cables,
 - 2 rubber reel caps,
 - 7" take-up reel.

Optional Dynamic Mikes

14⁹⁵
ea.



LAFAYETTE
RADIO
ELECTRONICS
 111 JERICHO TURNPIKE
 SYOSSET, L.I., N.Y. 11791

401206 R9 710028 1969
 J H EMERY
 9111 MEMBOTA
 DETROIT MICH 48204

BULK RATE
 U.S. Postage
PAID
 LOUISVILLE
 KENTUCKY
 Permit No. 599

**POSTMASTER
 IF UNDELIVERABLE DO NOT RETURN**



THRILLING NEW TAPE CARTRIDGE PLAYER

ONLY **21⁹⁵** Less Batteries

**BIG NAME TAPE CARTRIDGES SELL
 AT THE LOW, LOW PRICE OF ONLY 1⁴⁹ ea.**

**JUST INSERT THE CARTRIDGE
 PLAYS INSTANTLY ANYWHERE**

Now you can play music of your choice anywhere you go with this exciting portable, battery-operated 2-Track Tape Cartridge Player. Operation is so simple—even a child can operate this marvelous player. Powerful all solid-state circuitry delivers rich, pleasing sound instantly when you insert the cartridge. Each tape plays for 10 to 12 minutes. Get together—have a party anywhere—player operates on just 4 low-cost "C" type batteries. Only 2 controls—Volume and Track Selector. Features high impact plastic case with built-in carrying handle. Uses 3 1/4 x 3 x 1/2" pre-recorded magnetic tape cartridges sealed in shatter-resistant plastic cases (see listing below). Size: 10 x 6 x 2 3/4". Less batteries. Imported. Shpg. wt., 3 lbs.

27 E 1702L Net 21.95
 "C" Type Batteries for above (4 req.)
 99 E 6257 Net ea. .13

POPULAR PRE-RECORDED 2-TRACK TAPE CARTRIDGES FOR ABOVE PLAYER 1⁴⁹ ea.

- 27 E 1703L ANIMALS—It's my Life, I'm Crying, plus 2 other selections.
- 27 E 1704L LOVING SPOONFUL—Daydream, There She Is, plus 2 other selections.
- 27 E 1705L LOVING SPOONFUL—Do You Believe In Magic, My Gal, plus 2 other selections.
- 27 E 1706L BLUES PROJECT—Catch The Wings, The Way My Baby Walks, plus 2 other selections.
- 27 E 1707L HERMAN'S HERMITS Vol. I—Hold On, I Got A Feeling, plus 2 other selections.
- 27 E 1708L HERMAN'S HERMITS Vol. II—Leaning On A Lampost, Wild Love, plus 2 other selections.
- 27 E 1709L RIGHTEOUS BROS.—Soul and Inspiration, Hey Girl, plus 2 other selections.

- 27 E 1710L SAM THE SHAM AND THE PHAROHS—Wooly Bully, plus 3 other selections.
- 27 E 1711L FANTABULOUS STRINGS—Thunderball, Goldfinger, Whats New Pussycat.
- 27 E 1712L ELLA FITZGERALD—All the Things You Are, plus 3 other selections.
- 27 E 1713L BOBBY RYDELL—Wild One, Kissin' Time, Volare, Sway.
- 27 E 1714L CONNIE FRANCIS—Everybody's Somebody's Fool, plus 3 other selections.
- 27 E 1715L DAVID ROSE—The Stripper, Soft Lights and Sweet Music, Night Train.
- 27 E 1716L GIGI—Overture, Thank Heaven for Little Girls, plus 2 other selections.
- 27 E 1717L HANK WILLIAMS—Hey Good Looking, Your Cheating Heart, plus 2 other selections.

- 27 E 1718L HENRY MANCINI—Moon River, Days of Wine and Roses.
- 27 E 1719L HERMAN'S HERMITS Vol. III—I'm Henry VIII I am, Can't You Hear My Heartbeat, plus 2 more.
- 27 E 1720L RAY CHARLES SINGERS—September in the Rain, plus 3 more.
- 27 E 1721L ASTRUÐ GILBERTO—Take Me To Arnanado, Love Theme from Sandpiper, plus 2 more.
- 27 E 1722L BATMAN.

FREE BROCHURE OF LISTINGS OF OVER 55 FAMOUS NAME PRE-RECORDED TAPE CARTRIDGES STOCKED BY LAFAYETTE.
 27 E 9900L **FREE**