

SETTING THE STANDARDS

15  
YEARS

Product Focus: Beyond VGA PAGE 178

# BYTE

NOVEMBER 1989

A MCGRAW-HILL PUBLICATION

*Detailed Coverage  
of the New 32-bit Bus Standard*

# EISA *arrives!*



CHEETAH GOLD 33  
PAGE 107

ALR POWERFLEX  
PAGE 110

How EISA Works  
page 417

HP's EISA-Based  
Vectra 486  
page 93

Poqet's DOS-Based  
Hand-Held Computer

In Depth: 32 Bits  
and Above

Mach Unix

Digital Type

## REVIEWS

1-2-3 release 3.0

Interleaf TPS

DECstation 3100

Two Diskless  
Workstations



\$3.50 U.S.A./\$4.50 IN CANADA  
0360-5280

World Radio History



**THE DELL SYSTEM® 310**  
20 MHz; 386.

The best combination of performance and value available in its class.

**STANDARD FEATURES:**

- Intel 80386 microprocessor running at 20 MHz.
- Choice of 1 MB, 2 MB, or 4 MB of RAM\* expandable to 16 MB (using a dedicated high-speed 32-bit memory slot).
- Advanced Intel 82385 Cache Memory Controller with 32 KB of high speed static RAM cache.
- Page mode interleaved memory architecture.
- VGA systems include a high performance 16-bit video adapter.
- Socket for 20 MHz Intel 80387 or 20 MHz WEITEK 3167 math coprocessor.
- 5.25" 1.2 MB or 3.5" 1.44 MB diskette drive.
- Dual diskette and hard drive controller.
- Enhanced 101-key keyboard.
- 1 parallel and 2 serial ports.
- 200-watt power supply.
- 8 industry standard expansion slots (6 available).

\*\*Lease for as low as \$131/month.  
△ Extended Service Plan pricing starts at \$251.

40 MB TTL Monochrome System	\$3,599
40 MB VGA Color Plus System	\$4,099
100 MB VGA Color Plus System	\$4,699
100 MB Super VGA Color System (800x600)	\$4,799

Prices listed reflect 1 MB of RAM. 150 and 322 MB hard drive configurations also available.

\*Performance Enhancements (Systems 325, 310, 316 and 220): within the first megabyte of memory, 384 KB of memory is reserved for use by the system to enhance performance. 4 MB configurations available on all systems. Call for pricing.



**THE DELL SYSTEM® 316**  
16 MHz; 386SX.\*\*

Expandable, affordable access to 386 architecture.

**STANDARD FEATURES:**

- Intel 80386SX microprocessor running at 16 MHz.
- Choice of 1 MB, 2 MB, or 4 MB of RAM\* expandable to 16 MB (8 MB on the system board).
- Page mode interleaved memory architecture.
- VGA systems include a high performance 16-bit video adapter.
- LIM 4.0 support for memory over 1 MB.
- Socket for 16 MHz Intel 80387SX math coprocessor.
- 5.25" 1.2 MB or 3.5" 1.44 MB diskette drive.
- Integrated high performance hard disk drive interface and diskette controller on system board. (ESDI based systems include a hard disk controller.)
- Enhanced 101-key keyboard.
- 1 parallel and 2 serial ports.
- 200-watt power supply.
- 8 industry standard expansion slots (7 available).

\*\*Lease for as low as \$98/month.  
△ Extended Service Plan pricing starts at \$234.

40 MB TTL Monochrome System	\$2,699
40 MB VGA Color Plus System	\$3,199
100 MB VGA Color Plus System	\$3,799
100 MB Super VGA Color System (800x600)	\$3,899

Prices listed reflect 1 MB of RAM. 150 and 322 MB hard drive configurations also available.



**THE DELL SYSTEM® 220**  
20 MHz; 286.

It's faster than many 386 computers, and has a smaller footprint.

**STANDARD FEATURES:**

- 80286 microprocessor running at 20 MHz.
- Choice of 1 MB, 2 MB, or 4 MB of RAM\* expandable to 16 MB (8 MB on system board).
- Page mode interleaved memory architecture.
- LIM 4.0 support for memory over 1 MB.
- Integrated diskette and VGA video controller on system board.
- Socket for Intel 80287 math coprocessor.
- One 3.5" 1.44 MB diskette drive.
- Integrated high performance hard disk interface on system board.
- Enhanced 101-key keyboard.
- 1 parallel and 2 serial ports (integrated on system board).
- 3 full-sized 16-bit AT expansion slots available.

\*\*Lease for as low as \$109/month.  
△ Extended Service Plan pricing starts at \$264.

40 MB VGA Monochrome System	\$2,999
40 MB VGA Color Plus System	\$3,299
100 MB VGA Monochrome System	\$3,599
100 MB VGA Color Plus System	\$3,899

Prices listed reflect 1 MB of RAM. External 5.25" 1.2 MB diskette drive available.



**THE NEW DELL SYSTEM® 210**  
12.5 MHz; 286.

The price says this is an entry-level system. The performance says it's a lot more.

**STANDARD FEATURES:**

- 80286 microprocessor running at 12.5 MHz.
- Choice of 512 KB, 640 KB, †† 1 MB, or 2 MB of RAM expandable to 16 MB (6 MB on system board).
- Page mode interleaved memory architecture.
- LIM 4.0 support for memory over 640 KB.
- Integrated diskette and high performance 16-bit VGA video controller on system board.
- Socket for Intel 80287 math coprocessor.
- 5.25" 1.2 MB or 3.5" 1.44 MB diskette drive.
- Integrated high performance hard disk interface on system board.
- Enhanced 101-key keyboard.
- 1 parallel and 2 serial ports.
- 3 full-sized 16-bit AT expansion slots available.

\*\*Lease for as low as \$64/month.  
△ Extended Service Plan pricing starts at \$190.

20 MB VGA Monochrome System	\$1,699
20 MB VGA Color Plus System	\$1,999
40 MB VGA Monochrome System	\$1,899
40 MB VGA Color Plus System	\$2,199

Prices listed reflect 512 KB of RAM. ††640 KB versions of the above systems are available for an additional \$80. 100 MB hard drive configurations also available.

All prices and specifications are subject to change without notice. Dell cannot be responsible for errors in typography or photography. \*\*Payments based on a 36-month open-end lease. † Leasing arranged by Leasing Group, Inc. In Canada, configurations and prices will vary. DELL SYSTEM is a registered trademark of Dell Computer Corporation. Microsoft, MS-DOS and XENIX are registered trademarks owned by Microsoft Corp. Intel is a registered trademark; 386 and 386SX are trademarks of Intel Corporation. UNIX is a registered trademark of AT&T. Dell UNIX System V is based on INTERACTIVE Systems Corporation's 386ix. †† Signifies trademarks of entities other than Dell Computer Corporation. † Service provided by Xenix Corporation. Service in remote locations will incur additional travel charges. © 1989 Dell Computer Corporation. All rights reserved.

**SAVE NOW ON THE DELL SYSTEM® 325 25 MHz 386.**  
AN EVEN BETTER VALUE AT THESE NEW LOW PRICES.

**STANDARD FEATURES:**

- Intel 80386 microprocessor running at 25 MHz.
- Choice of 1 MB, 2 MB, or 4 MB of RAM\* expandable to 16 MB (using a dedicated high-speed 32-bit memory slot).
- Advanced Intel 82385 Cache Memory Controller with 32 KB of high speed static RAM cache.
- Page mode interleaved memory architecture.
- VGA systems include a high performance 16-bit video adapter.
- Socket for 25 MHz Intel 80387 or 25 MHz WEITEK 3167 math coprocessor.
- 5.25" 1.2 MB or 3.5" 1.44 MB diskette drive.
- Dual diskette and hard drive controller.

- Enhanced 101-key keyboard.
- 1 parallel and 2 serial ports.
- 200-watt power supply.
- 8 industry standard expansion slots (6 available).

\*\*Lease for as low as \$178/month.  
△ Extended Service Plan pricing starts at \$370.

40 MB VGA Monochrome System	\$4,899
100 MB VGA Color Plus System	\$5,799
100 MB Super VGA Color System (800x600)	\$5,899
150 MB Super VGA Color System (800x600)	\$6,399

Prices listed reflect 1 MB of RAM. 322 MB hard drive configurations also available.

All systems are photographed with optional extras.



# SO HOW COME YOU NEVER CALL?



*"The new  
top-of-the-line  
Dell System 325 is  
a flagship worth  
putting out in front  
of the fleet."*

February 14, 1989

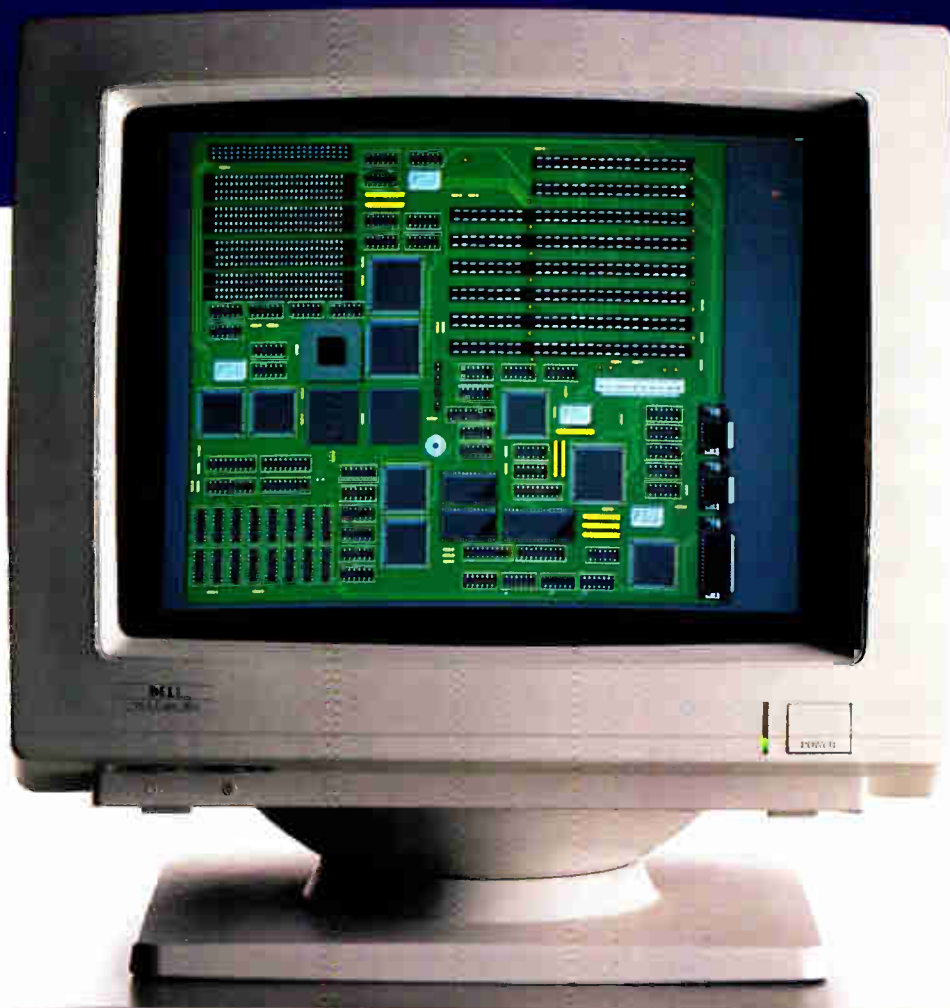

Technically speaking, the Dell System<sup>®</sup> 325 is one of the most advanced 386™ computers available. And, according to PC Magazine, it's one of the most advanced 386 computers they've ever tested.

In benchmark after benchmark, the 25 MHz Dell System 325 ran circles around

## **THE FIRST PERSONAL COMPUTER THAT'S REALLY PERSONAL.**

Of the more than 150,000 personal computers we've sold to date, each one has been individually configured to fit the needs of its owner.

The System 325 takes that idea

to its logical extreme.

For example, it runs either MS-DOS<sup>®</sup>, OS/2<sup>®</sup>, or our own Dell UNIX<sup>®</sup> System V. Which is compatible with AT&T's System V Interface Definition. And the world of XENIX<sup>®</sup> applications.

If speed is of the essence, we can include an optional Intel<sup>®</sup>

**THE DELL 386 SYSTEM 325 HAS A 25 MHz CLOCK RATE, CACHE MEMORY CONTROLLER, IDE OR ESDI HARD DISK DRIVE, PAGE MODE INTERLEAVED MEMORY, AND 100% COMPATIBILITY WITH MS-DOS, OS/2 AND UNIX SYSTEM V.**

a field of 386-based systems. A field that included the Compaq<sup>®</sup> 386/25.

A show of prowess that earned the System 325 PC Magazine's Editor's Choice award.

It was a goal we set for ourselves from the very beginning. And an objective anyone with a penchant for power and performance can appreciate.



80387 or WEITEK 3167 math coprocessor. And since nothing about this system is lightweight, the standard mass storage is a 100 MB hard disk drive. Or we can configure it with a 40, 150 or 322 MB hard drive.

As you might expect, the output is just as intense. You can choose between VGA Monochrome with





paper-white screen, VGA Color Plus, or Super VGA for high resolution colors displayed on a larger screen.

Even though the 325 gives you all this performance, it still leaves you six open slots for whatever else you might want to add.

And once you've told us what you want, we'll make sure what you want works—by burning-in the entire system unit.

### **COMPUTER RETAILERS ARE NO KNOWS.**

There are some good reasons computer retailers won't know much about the System 325.

First, with all the new and increasingly sophisticated systems they have to keep up with on a daily basis, you can hardly expect them to know everything.

Second, because Dell sells direct.

Which means you now have the unique opportunity to talk directly with the people who make them. And ask things like, "What is page mode interleaved memory?" or, "How much SIMM RAM should I add?"

In other words, the kinds of details that are important to people who make computers and people who use them.

So dealing direct not only can save you up to the 35% mark-up, but 100% of the frustration.

### **WE COME WHEN WE'RE CALLED.**

One of the things that very clearly sets Dell systems apart from other computers is not

just how they're sold but how they're supported.

Overkill was one description used in a recent PC Week article.

Perhaps.

But then, we think you'll agree, when something goes wrong, you want as much help as possible, right?

### **MAYBE YOU SHOULDN'T BUY ONE AFTER ALL.**

No matter how many reasons we give you to buy a Dell system, sometimes it makes more sense to lease one instead.

Whether you need a single computer, or an entire office

**BEST OF ALL,  
YOU WON'T HAVE TO  
EXPLAIN TO A  
COMPUTER RETAILER  
WHAT ALL  
THAT MEANS.**

Which is why every Dell system comes with a toll-free technical support line and self-diagnostic software. We're able to solve 90% of all problems right over the phone. The other 10% receive next-day, desktside service. Thanks to our new alliance with Xerox Corporation.

And you get all this help for a full year—whenever you need it—at no extra charge.<sup>Δ</sup>

As you've probably guessed, one of the things that drives us most is customer satisfaction.

So we'd like to give you the ultimate guarantee:

Try a System 325 in your office for a month. Run your toughest applications. Put it through its paces, at your pace. If you're not completely satisfied, send it back anytime within 30 days. And we'll refund your money.

No questions asked.

full, there is a leasing plan for your business that is just like 100% financing.

And just as we can custom configure your computers, we can see to it you get a custom designed lease plan to fit your exact business needs.<sup>†</sup> A fact that has not gone unnoticed. Especially by the Fortune 500. Over half of whom now own or lease Dell systems.

And just as we welcome their business, we welcome your business, too.

Just call us, toll-free. And don't be afraid to ask us the tough questions.

That's the part we like best.

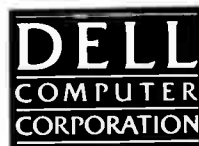

TO ORDER, CALL

**800-426-5150**

IN CANADA, CALL 800-387-5752  
IN GERMANY, CALL 06103/701100  
IN THE U.K., CALL 0800 414535



# power<sup>4</sup>...The most advanced Cache What else would you expect



**PC MAGAZINE, January 1989,**  
*"In a field of powerhouse machines  
 there can only be one winner, and  
 ALR's FlexCache is it."*

**INFO WORLD, July 1989,**  
*"ALR Systems Unleash 486 Power. The  
 PowerCache 4 shines in the CPU-  
 specific portion of the InfoWorld Auto-  
 mated Benchmark Test, gaining a score  
 of 16.3."*

**PC WEEK, July 1989,**  
*"Based on a series of benchmarks run  
 last week on Advanced Logic Research,  
 Inc.'s prototype 486 desktop system,  
 ALR will enter the 486 market with a  
 bang."*

At ALR, we will never rest on our laurels. We strive to be the best, as proven by our past achievements. Now with the introduction of the new ALR PowerCache 4™, we've designed a system that is far beyond comparison. Again, we have taken PC-microprocessing power a step further by designing a unique proprietary PowerCache 4 cache controller using ALR's custom ASIC chips which deliver the fastest processing speed ever.

More important, PowerCache 4 is the first PC to fully utilize 128-bit burst mode and a "read and write-back" 128KB cache design, providing a better than zero wait state performance as compared to the i386. Furthermore, the ALR PowerCache 4 is 100% IBM® PS/2™ Micro Channel™-compatible supporting bus mastering devices and giving

	<b>ALR M130 Desktop</b>	<b>ALR M150, M350 M650 Floor-Standing</b>	<b>IBM M70-A21 Power Platform™</b>
<b>CPU</b>	25 MHz i486	25 MHz i486	25 MHz i486
<b>Bus</b>	MCA	MCA	MCA
<b>External Cache</b>	128 KB cache Read and Write-Back	128 KB cache Read and Write-Back	None
<b>Video Opt. on board</b>	640x480 1024x768	640x480 1024x768	640x480 None
<b>I/O Slots</b>	6 expansion slots	6 expansion slots	3 expansion slots
<b>Storage Expansion</b>	4-3 1/2"	1-full height 2-1/2"-height 2-3 1/2" drives	3-3 1/2" drives
<b>Disk Capacity</b>	130 MB-260 MB	150 MB-650 MB	110 MB
<b>Price</b>	\$9,990	Starting at \$11,490	\$12,990



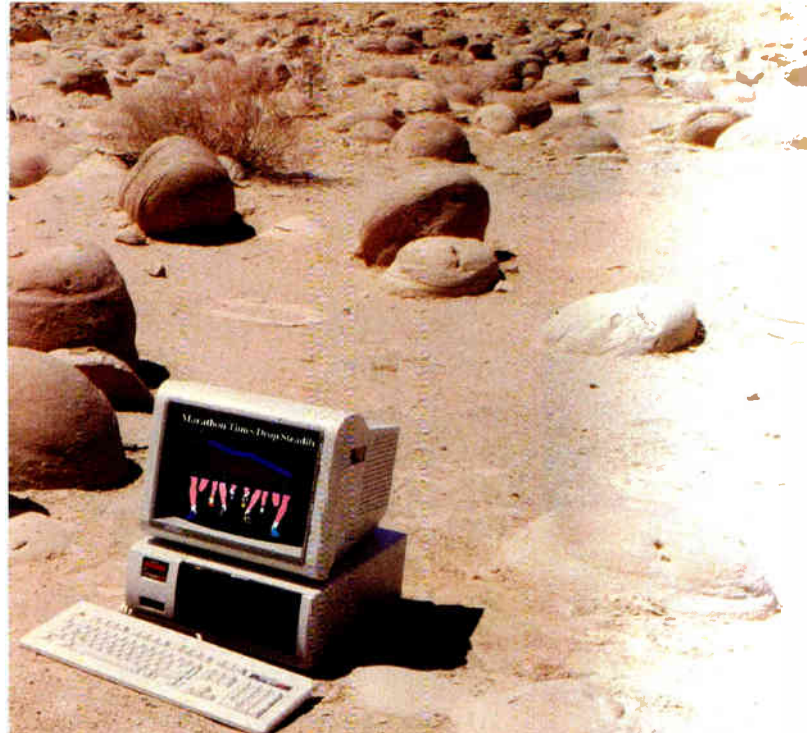

**California Anza-Borrego  
Desert State Park**

*(Cannonball-shaped sandstone.  
These concretions are  
formed of onion-skin layers of  
minerals resistant to erosion.)*

# i486™ system in the world. from the leader in 386™ technology.

you a more efficient system for a variety of multi-user and fileserver applications. Like most ALR computers, the PowerCache 4 is a truly balanced system. The fastest power is achieved by enhancing our PowerCache 4 design with the industry's fastest disk drives and interface. The PowerCache 4 systems come standard with a high-speed 15MHz ESDI and 32 KB hard disk cache on the disk controller. What more could you possibly need.

It's no wonder ALR remains ahead of the pack with our innovative design expertise. As far back as 1986, we've been recognized in the industry as a leader in performance. Recently, the highly acclaimed 386/220 won us "Best of 1987" from *PC Magazine*. 1988 brought us the honor of receiving the *PC Magazine Award* for Technical Excellence for designing the industry's most advanced cache architecture. As for 1989 we've already begun to excite the industry with the PowerCache 4.

Now, what else would you expect from a company who is so committed to innovation and high-performance technology that we take you a step beyond. At ALR, we are concerned with your processing needs. Our technical support staff is available to assist you by one simple phone call. All our systems are backed by a one year warranty. Call today for more information on the new PowerCache 4 and the name of an authorized reseller nearest you.

**1-800-444-4ALR**

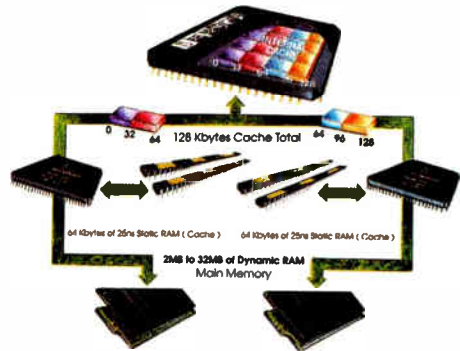

**PowerCache 4 is the first PC to fully utilize 128-bit burst mode and a "read and write-back" 128KB cache design, providing better than zero wait state performance as compared to the i386.**



Advanced Logic Research, Inc.  
9401 Jeronimo Irvine, CA 92718  
(714) 581-6770 FAX: (714) 581-9240  
For our Canadian office:  
1-800-443-4CAN  
For our UK office:  
0 635-521 844 FAX: 0 635-521 844  
For our Singapore:  
(65) 258-1286 FAX: (65) 258-1285

## PRODUCTS IN PERSPECTIVE

### 49 What's New

### 81 Short Takes

**Excel for OS/2 with Presentation Manager**,  
*Microsoft's spreadsheet for OS/2*  
**Cornerstone SinglePage XL**,  
*a monitor for desktop publishing*  
**Prograph 1.2**,  
*a pictorial development system from Gunakara Sun Systems*  
**TekColor for the Macintosh**,  
*a color-matching system from Tektronix*  
**FormWorx System 2**, *an updated forms-processing package*

## FIRST IMPRESSIONS

- 106 Two Affordable 486s**  
**Psst! Wanna Buy an 80486 Cheap?**  
*by Michael E. Nadeau and Frank Hayes*  
Cheetah's and ALR's new 80486 systems offer more performance for less money.
- 115 A PC in Your Pocket**  
*by Nick Baran*  
The Poqet PC has all the power of an IBM PC, yet it's as small as a videocassette.



## COVER STORY

### EISA Arrives

*by Nick Baran*  
page 93

Introducing the  
Hewlett-Packard Vectra  
386, one of the first  
EISA machines.

## REVIEWS

- 178 Product Focus:**  
**The Brains Behind the Graphics**  
*by Steve Apiki, Howard Eglowstein, and Rick Grehan*  
The BYTE Lab looks at 11 intelligent graphics controllers that bring new speed and flexibility to PC graphics.
- 201 DEC's RISC Powerhouse**  
*by Ben Smith and Rob Mitchell*  
The DECstation 3100 shows strength as a number-crunching workstation.
- 211 The LAN Terminal Alternative**  
*by Bill Catchings and Mark L. Van Name*  
Looking for a diskless PC? These two 80286-based machines from Wyse and TeleVideo might fit your needs.
- 219 LAN Aid: Mac Booster Modules**  
*by Tom Thompson*  
Enhanced connection modules from Dayna and TOPS offer a boost for LocalTalk networks.
- 225 DAT Drive Eases Mac Backups**  
*by Don Crabb*  
GigaTrend's pioneering DAT drive helps monied Mac users easily store gigabytes of data.
- 233 X.25 Pads Performance**  
*by Stephen Satchell*  
Hayes' X.25 modem produces installation headaches, but its accuracy and speed are worth the fuss.

## EXPERT ADVICE

### 121 Computing at Chaos Manor: The Installation Blues

*by Jerry Pournelle*  
Jerry looks at disk-based reference materials, a floppy disk controller, and educational software.

### 139 The Unix /bin: Customizing for Comfort

*by David Fiedler*  
A series of environment variables let you tailor Unix to your own liking.

### 147 Down to Business: Serving Business

*by Wayne Rash Jr.*  
Sharing a database doesn't require a mainframe anymore.

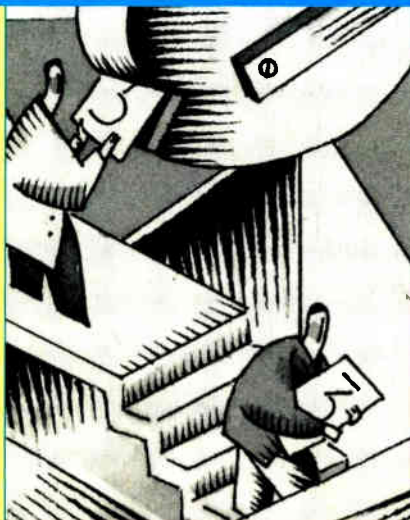

### 153 Macinations: Research à la Mac

*by Don Crabb*  
Don gets a new scientific CD-ROM and uses the new Macs.

### 159 OS/2 Notebook: Getting Your Priorities Straight

*by Mark J. Minasi*  
Fine-tuning OS/2's multitasking priorities.

### 167 NetWorks: Everyone into the Pool

*by Barry Nance*  
The most common LAN gateways are "modem-pooling" devices used over common dial-up lines.



- 241 Ease into Mac Programming**  
by *Ray Valdès*  
Master the Mac Interface with Prototyper from SmethersBarnes.
- 247 microExplorer in Action!**  
by *Alex Lane*  
Texas Instruments' microExplorer turns the Mac II into a Lisp machine.
- 255 For Power Users Only**  
by *Edward Reno*  
Lotus 1-2-3 release 3.0 has a lot of welcome changes, but did Lotus go far enough?
- 265 Alpha Four: No Programming Required**  
by *Malcolm C. Rubel*  
Alpha Four from Alpha Software provides a menu-driven alternative to dBASE file formats.
- 271 The Power of the Press**  
by *Jon Udell*  
Interleaf's Technical Publishing Software 4.0 for Unix systems is a peek at high-end publishing.
- 287 Reviewer's Notebook**  
Three price/performance systems, tools that make Windows painless, a mouse for 1-2-3, and more.

**IN DEPTH**

- 296 Introduction: 32 Bits and Above**
- 299 Are 32 Bits Enough?**  
by *Steve Krueger*  
One prediction for the future.
- 307 Seeking a Wide Berth**  
by *Ron Sartore*  
Wider memory isn't necessarily faster memory.
- 323 Revenge of the CISCs**  
by *Michael Slater*  
and *John H. Wharton*  
Will the 80486 and the 68040, heirs to the dynasties built by Intel and Motorola, slow the RISC bandwagon?
- 341 A Virtual Crowd**  
Learn how PC, Mac, and Unix systems let you use your hard disk as program memory.
- 342 Virtual Memory: The Next Generation**  
by *Robert Moote*
- 350 Mac VM Revealed**  
by *Phil Goldman*



A New Twist on an Old Technology/380

- 361 DOS at RISC**  
by *Colin Hunter*  
and *John Banning*  
Binary porting lets you run DOS applications on the latest Unix workstations.
- 371 Clearing the Air**  
by *Bill Blagdan*  
Some 32-bit software issues to consider, including 80386-specific versus 32-bit software and various aspects of OS/2.
- 376 Upward Mobility**  
Turn your present computer into a 32-bit powerhouse.

**FEATURES**

- 380 A New Twist on an Old Technology**  
by *Jay Bretzmann*  
With agreements on digital audio tape near, manufacturers are teaching an old technology new tricks.
- 391 Paper, Magnets, and Light**  
by *Robert R. Gaskin*  
A quick tour through almost 100 years of off-line computer mass storage.

- 403 The ABCs of Digital Type**  
by *John Collins*  
The advent of digital type has brought variety, flexibility, and a few problems to publishing.
- 411 Mach: The Model for Future Unix**  
by *Avadis Tevanian Jr.*  
and *Ben Smith*  
Will a new, object-oriented kernel change the face of Unix?

**HANDS ON**

- 417 Under the Hood: Inside EISA**  
by *L. Brett Glass*  
The Extended Industry Standard Architecture emerges from the lab to challenge IBM's Micro Channel Architecture.
- 427 Some Assembly Required: Two Tin Cans and Some String, Part 2**  
by *Rick Grehan*  
The investigation of network interfaces continues, this time with the popular NetBIOS.

**DEPARTMENTS**

- 8** Editorial: What Slump?  
**17** Microbytes  
**32** Letters and Ask BYTE  
**47** Chaos Manor Mail  
**475** Coming Up in BYTE  
**484** Print Queue  
**488** Stop Bit

**READER SERVICE**

- 474** Editorial Index by Company  
**476** Alphabetical Index to Advertisers  
**478** Index to Advertisers by Product Category  
Inquiry Reply Cards: after **480**

**PROGRAM LISTINGS**

From BIX: See **400**  
From BYTEnet:  
call (617) 861-9764  
On disk:  
See card after **416**

BYTE (ISSN 0360-5280) is published monthly with an additional issue in October by McGraw-Hill, Inc. Postmaster: Send address changes, USPS Form 3579, and fulfillment questions to BYTE Subscriptions, P.O. Box 551, Hightstown, NJ 08520. Second-class postage paid at Peterborough, NH 03458, and additional mailing offices. Postage paid at Winnipeg, Manitoba. Registration number 9321. Printed in the United States of America.  
Not responsible for lost manuscripts or photos. Opinions expressed by the authors are not necessarily those of BYTE.  
Copyright © 1989 by McGraw-Hill, Inc. All rights reserved. Trademark registered in the United States Patent and Trademark Office.



Subscription questions or problems should be addressed to: BYTE Subscriber Service, P.O. Box 551, Hightstown, NJ 08520.

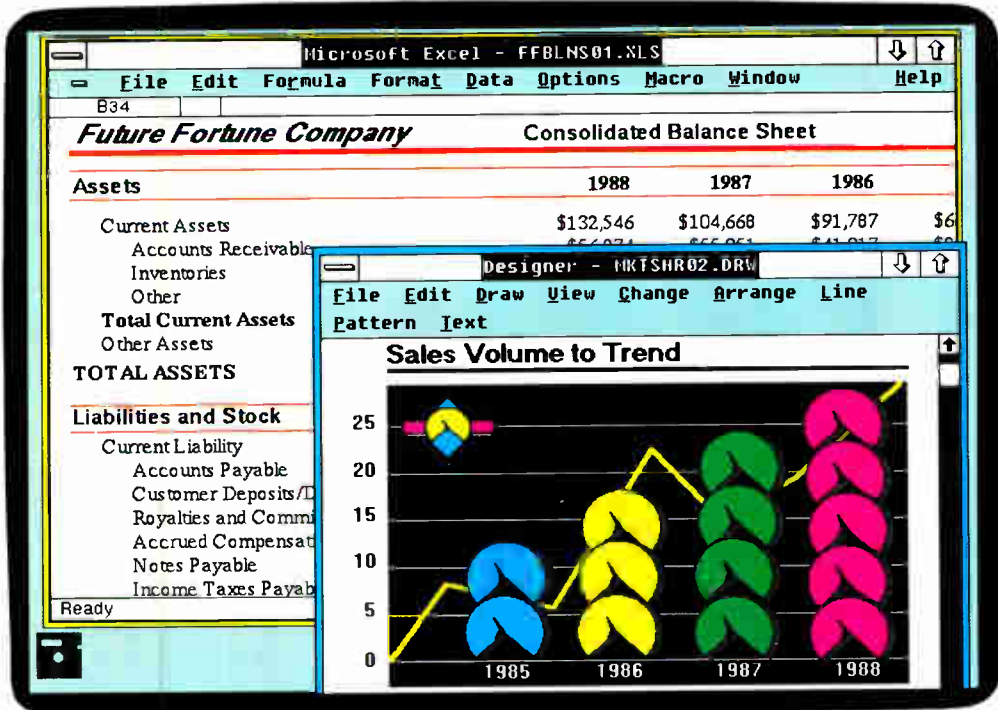

By no small coincidence, Microsoft Windows works the way you do: On more than one thing at a time.

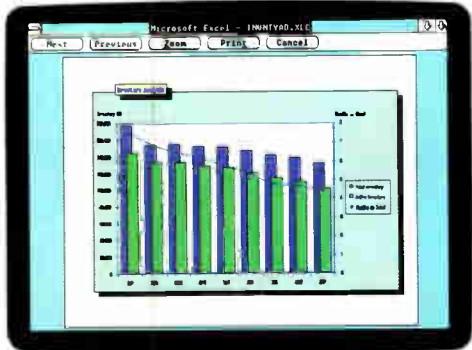

WYSIWYG. What you see on screen...

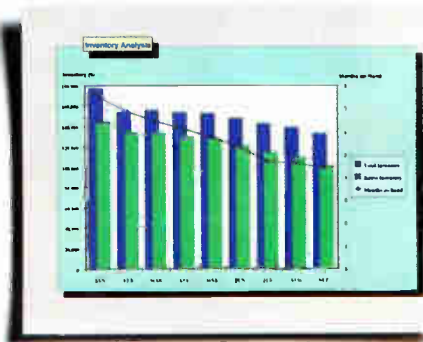

...is exactly what you get on paper.

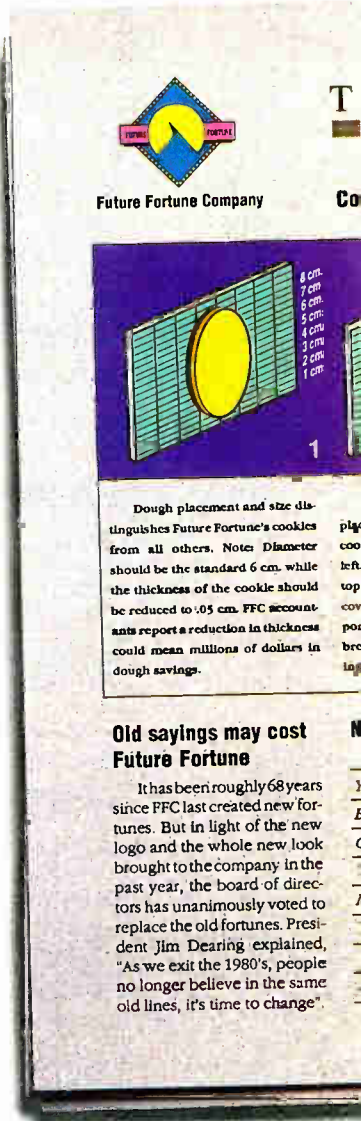

**Old sayings may cost Future Fortune**

It has been roughly 68 years since FFC last created new fortunes. But in light of the new logo and the whole new look brought to the company in the past year, the board of directors has unanimously voted to replace the old fortunes. President Jim Dearing explained, "As we exit the 1980's, people no longer believe in the same old lines, it's time to change."

An entire environment that let...



More good news: Hundreds of great Windows applications are available right now, as you read.



## Fortune Teller

1984

### Cookie Standards, rolling in the dough

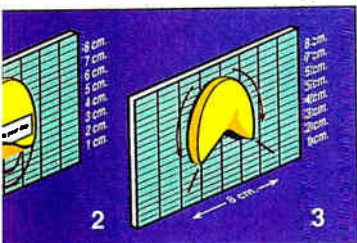

...the, the fortune is  
...ver third of the  
...ad slightly to the  
...atom is folded, the  
...fortune should be  
...acement is all-in-  
...vs the consumer to  
...ookie without tear-

The last, and the most intricate, step in Putme Fortune Cookie making is when our trade dimple is placed on the cookie. As the arrows indicate, it is important to pull down on both sides of the cookie as the dimple is pushed in from the bottom.

### Fortunes for the month of August

- ...i a reliable air pair.*
- ...portant call on your car phone.*
- ...gery lifts spirits as well as wrinkles.*
- ...ll never return from maternity leave.*
- ...is a thing of the past. Invest in a car soon.*
- ...t in real estate will only lead to frustration.*
- ...per as will your accountant.*
- ...bes second nobody remembers.*

...do amazing things—like this—simply.



# We'd like everyone who's using Windows applications on a part-time basis to please stop.

The trouble with using Windows™ applications every once in a while, is that you're only amazingly productive every once in a while.

This has got to stop. Which is why there's the Microsoft® Windows environment—the first and only graphical environment to let you work with multiple Windows or DOS applications without ever closing a single file, or quitting a single program.

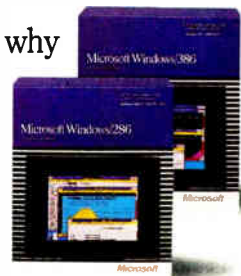

You may never see your C prompt again. Just give Microsoft Windows a 40-hour work week and you'll be pointing, clicking, cutting, pasting and flying through your work with the greatest of ease. Cut from a spreadsheet and paste onto a word processing document—without scissors and a copy machine. Exchange information, link files and programs, then watch your data get updated automatically, or if you prefer, at your command.

Call us at (800) 541-1261, Dept. J89 for more facts about how Windows can open up doors, and for our free Windows Shopping Catalog.

And see how the only way to get the most out of your Windows, is to look into ours.

**Microsoft**  
Making it all make sense™

Customers inside the 50 United States, call (800) 541-1261, Dept. J89. In Canada, call (416) 673-9811. Outside the U.S. and Canada, call (206) 882-8661. ©1989 Microsoft Corporation. All rights reserved. Microsoft and the Microsoft logo are registered trademarks and *Making it all make sense* and Windows are trademarks of Microsoft Corporation.

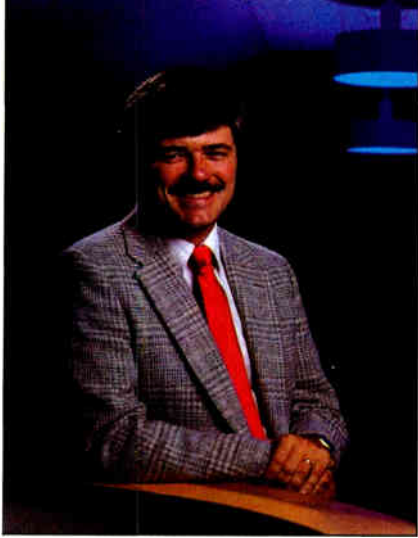

# WHAT SLUMP?

The end of the year produces a flood of new products

**Y**ou've probably heard naysayers speaking of a slump in the computer industry. One aspect of a slump is a drop in sales volume, a critical issue to vendors, but not what matters most to end users.

Rather, it's the drop-off in innovation and a slowing in the pace of product announcements that can be unsettling to those of us who are hungry for ways to improve our own productivity and that of our companies.

On toward midyear, there were three or four months where nothing much seemed to be happening. We saw some minor upgrades arrive, some new niche products emerge, a couple of disappointing releases of long-delayed major products, and a relative handful of really interesting, meaningful new products. I don't know about you, but toward the end of the summer, I was thinking dark thoughts about the state of innovation in our industry.

## 50 EISA and/or 80486 Machines?

But with the arrival of fall, new products and technologies are crawling out of the oxide. Just one example: By the end of this month, we expect to see something like 50 new machines using either the new Extended Industry Standard Architecture bus or the 80486. Some, like the Hewlett-Packard Vectra 486 machine that appears on this month's cover, use both.

Machines based on the 80486 are springing up in such abundance that we're already seeing price wars: See this month's First Impressions of amazingly low-cost 80486 boxes from Cheetah and ALR.

## A Unix Workstation for Cheap

Innovation isn't limited to Intel-architecture machines, however. Although the 68040 is still not available to compete against the 80486, some nice 68030-based systems are appearing.

For example, Apollo (which is now a subsidiary of Hewlett-Packard) recently introduced the first full-featured 68030-based Unix (System V version 3) workstation priced at less than \$4000.

The new Apollo Series 2500 personal workstation "entry-level" system, which lists for \$3990, includes a 20-MHz Motorola 68030, a 68882 floating-point coprocessor, 4 megabytes of RAM, and a 15-inch paper-white display with a maximum resolution of 1024 by 780 pixels. All the features of the 2500 are built onto a single motherboard that is approximately the size of a full-size IBM PC AT board.

This model comes without a disk drive because most 2500s will be networked: Apollo built Ethernet, IBM Token Ring, and Apollo Token Ring support into the 2500. (You can, however, add a drive if you choose.)

Consulting editor Stan Miastkowski, who covered the story for *BYTEweek* and *Microbytes Daily*, reports that Apollo hopes to ship the new system by the end of this year.

## Chip Advances

There's some welcome activity at the chip level, too, which portends some interesting new products in the not-too-distant future.

For example, Intel announced a new version of its 80960 embedded microprocessor, one that can execute up to three instructions at a time. The result, according to Intel, is a 33-MHz CPU with a top speed of nearly 100 million instructions per second and a routine speed of some 66 MIPS.

The microprocessor is likely to begin showing up in some computation-intensive PC peripherals in the next year, in-

cluding scanners and laser-printer controllers. That should radically improve the speed of laser printers when they're printing using page-description languages like PostScript.

Rival Motorola announced the 68302 Integrated Multiprotocol Processor, a low-power CMOS package that runs at 16.67 MHz and includes a 68000 processor, a microcoded RISC-based communications controller, three independent serial I/O channels (each with two on-chip direct-memory-access channels), RAM, and a special-purpose synchronous communications port that allows the 68302 to interface directly with components like microcontrollers, digital signal processors, and coders/decoders. The 68302 will be used in a wide range of applications, including LANs, fax machines, modems, telephone switching equipment, computer I/O systems, and even satellite communications equipment.

## Speaking of LANs...

Recent LAN developments include some amazing software from VXI: The software can transform a LAN into a parallel-processing "network supercomputer." The software currently works only on TCP/IP networks, but VXI says the connected configuration can consist of IBM PC compatibles, Macs, Unix workstations, and mainframes.

VXI claims that using its software, a 25-node network of PCs and Macs can deliver the effective processing power of an IBM 3090 mainframe. With 25 RISC workstations, you could have the power of a Cray supercomputer, the company says.

There's lots more—and that's the good news. There is indeed *lots* more. The midyear slowdown is over, and it looks like we're in for some interesting times in the months ahead.

—Fred Langa  
Editor in Chief  
(BIX name "flanga")



# At last, an assistant that follows your directions

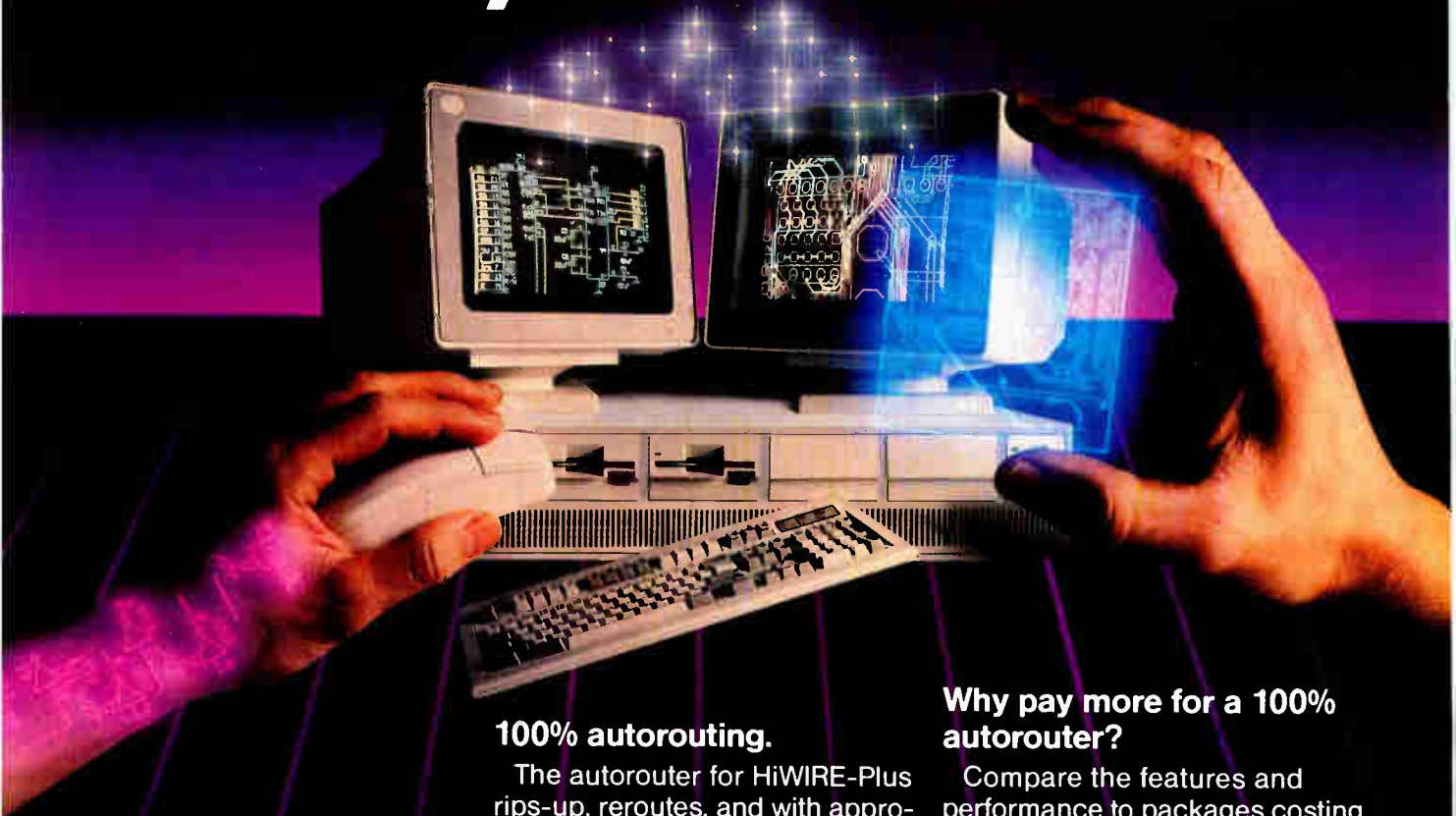

## Wouldn't it be great to delegate your routing?

You can! We know your time is valuable. That's why Wintek pioneered comprehensive and affordable CAD packages for IBM personal computers. HiWIRE-Plus continued that tradition, integrating schematic-capture features and printed-circuit-artwork capabilities into one versatile package.

## New autorouter.

The Autorouter for HiWIRE-Plus is powerful enough to handle the most demanding design problems, yet simple enough for a casual user. Just turn it loose on your design. It's hassle free because it works long hours, without supervision or errors.

## 100% autorouting.

The autorouter for HiWIRE-Plus rips-up, reroutes, and with appropriate design rules, racks up 100% completion.

- Forget gridded routers. This autorouter places vias and traces anywhere your design rules allow. With 1-mil resolution.
- Vary trace width and spacing for individual networks. Route 1, 2, 3, or more tracks between IC and connector pins.
- Set up boards from 1 to 250 layers, up to 60" x 60".
- Specify shape, size, and type of vias, layer-by-layer: through-hole, blind, buried, micro. Specify via types for individual networks.
- Use fewer vias and layers than comparably priced autorouters.
- For use on your IBM PC, XT, AT, PS/2, or compatible with 640K RAM.

## Why pay more for a 100% autorouter?

Compare the features and performance to packages costing five times more. HiWIRE-Plus and the Autorouter for HiWIRE-Plus sell for \$895 each. Both have a no-nonsense, 30-day money-back guarantee. With unlimited, toll-free, no-charge technical support.

Let HiWIRE convince you that it makes a great assistant. Call us toll-free at (800) 742-6809 today and put HiWIRE-Plus and the Autorouter for HiWIRE-Plus to work for you tomorrow.



Wintek Corporation  
1801 South Street  
Lafayette, IN 47904-2993  
Fax: (317) 448-4823  
Phone: (317) 742-8428 or

**(800) 742-6809**





# The least a local area network can give you is time for lunch.

Some food for thought.

Getting all the information from all your equipment to all your people can occupy all your time.

That's where the IBM Token-Ring Network can help.

With our new 16-megabit bandwidth, it provides remarkable new speed in moving everything from bulk data to mail to graphic images.

IBM's Token-Ring Network fits into most existing environments. It's compatible with today's popular software, connecting your workstations, including PCs and PS/2s®, midrange computers, mainframes and peripherals.

We've also designed it for reliability. With IBM software, it's easy to diagnose, isolate and correct problems, without affecting the rest of your network.

It's another reason why no other company connects more companies with more equipment to more people than IBM.

For more information on IBM local area network solutions, contact your local IBM Advanced Product Dealer or your IBM marketing representative.

We can help your entire organization run more smoothly and productively. And that means you can devote your time to other important matters.

Bon appétit.



# BYTE

## EDITOR IN CHIEF

Frederic S. Langa

## PUBLISHER/GROUP VICE PRESIDENT

J. Burt Totaro

## OPERATIONS

Glenn Hartwig Associate Managing Editor

## REVIEWS (Hardware, Software, Product Focus)

Michael Nadeau Associate Managing Editor, Dennis Allen Senior Technical Editor, Software, Richard Grehan Director, BYTE Lab, Stephen Apiki Testing Editor, BYTE Lab, Stanford Diehl Testing Editor, BYTE Lab, Howard Eglowstein Testing Editor, BYTE Lab, Stanley Wszola Testing Editor, BYTE Lab

## NEWS AND TECHNOLOGY (Microbytes, What's New, Short Takes)

New York: Rich Malloy Associate Managing Editor, Andrew Reinhardt Associate News Editor  
Peterborough: D. Barker Senior Editor, News and Technology, Anne Fischer Lent Senior Editor, New Products, Roger Adams Associate News Editor, David Andrews Associate News Editor, Martha Hicks Associate News Editor  
San Francisco: Nicholas Baran Bureau Chief, Frank Hayes News Editor, Jeffrey Bertolucci Associate News Editor

## SPECIAL PROJECTS EDITOR

Gene Smarte

## SENIOR TECHNICAL EDITORS

Ken Sheldon Features, Jane Morrill Tazelaar In Depth, Tom Thompson At Large, Jon Udell At Large

## TECHNICAL EDITORS

Janet J. Barron, Alan Joch, Robert Mitchell, Robert M. Ryan, Ben Smith

## SENIOR CONTRIBUTING EDITOR

Jerry Pournelle

## CONTRIBUTING EDITORS

Don Crabb, David Fiedler, L. Brett Glass, Hugh Kenner, Mark Minasi, Wayne Rash Jr.

## CONSULTING EDITORS

Jonathan Amsterdam, Laurence H. Loeb, Trevor Marshall, Stan Miaszkowski, Dick Pountain, Phillip Robinson, George A. Stewart, Mark L. Van Name, Peter Wayner

## COPY EDITORS

Lauren Sticker Chief, Cathy Kingery Copy Administrator, Susan Colwell, Jeff Edmonds, Judy Grehan, Nancy Hayes, Margaret A. Richard, Warren Williamson

## EDITORIAL ASSISTANTS

Peggy Dunham Office Manager, Linda C. Ryan, June N. Sheldon, Lynn Susan Valley

## ART

Nancy Rice Director, Joseph A. Gallagher Assistant Director, Lisa Nardecchia Assistant, Jan Muller Assistant, Alan Easton Technical Artist

## PRODUCTION

David R. Anderson Director, Virginia Reardon Senior Editorial Production Coordinator, Barbara Busenbark Editorial Production Coordinator, Denise Chartrand Editorial Production Coordinator, Michael J. Lonsky Editorial Production Coordinator

## TYPOGRAPHY

Sherry Fiske Systems Manager, Donna Sweeney Applications Manager, Christa Patterson

## ADVERTISING/PRODUCTION (603) 924-6448

Lisa Wozmak Director of Advertising Services, Linda Fluhr Customer Service Supervisor, Lyda Clark Senior Account Coordinator, Dale Christensen, Karen Cilley, Roxanne Hollenbeck, Rod Holden, Susan Kingsbury Creative Services Manager, Wai Chiu Li Quality Control Manager

## EDITORIAL AND BUSINESS OFFICE:

One Phoenix Mill Lane, Peterborough, NH 03458, (603) 924-9281.

West Coast Branch Offices: 425 Battery St., San Francisco, CA 94111, (415) 954-9718; 3001 Red Hill Ave., Building #1, Suite 222, Costa Mesa, CA 92626, (714) 557-6292.

New York Branch Editorial Office: 1221 Avenue of the Americas, New York, NY 10020, (212) 512-3175.

BYTEnet: (617) 861-9784 (sat modem at 8-1-N or 7-1-E; 300 or 1200 baud).

Editorial Fax: (603) 924-2550. Advertising Fax: (603) 924-7507.

SUBSCRIPTION CUSTOMER SERVICE: Outside U.S. (609) 426-7070; inside U.S. (800) 232-BYTE.

For a new subscription—(800) 257-9402 U.S. only, or write to BYTE Subscription Dept., P.O. Box 555, Hightstown, NJ 08520.

Officers of McGraw-Hill Information Services Company: President: Walter D. Serwatka. Executive Vice Presidents: Kenneth E. Gazzola, Aerospace and Defense; Ira Herenstein, Computers and Communications; Russell C. White, Construction; Robert P. McGraw, Healthcare; Brian H. Hall, Legal. Senior Vice Presidents—Publishers: Laurence Altman, Data Communications; David J. McGrath, Engineering News-Record. Senior Vice Presidents: John W. Fink, Finance; Michael J. Koeller, Human Resources. Group Vice Presidents: J. Burt Totaro, BYTE; Norbert Schumacher, Energy/Process Industries. Vice Presidents: George Elsing, Circulation; Julia Lenard, Systems Planning and Technology; Elisabeth K. Allison, Planning and Development.

Officers of McGraw-Hill, Inc.: Joseph L. Dionne, Chairman, President, and Chief Executive Officer; Robert N. Landes, Executive Vice President, General Counsel, and Secretary; Robert J. Bahash, Executive Vice President and Chief Financial Officer; Frank D. Penglase, Senior Vice President, Treasury Operations.

## ADMINISTRATION

Donna Nordlund Publisher's Assistant

## MARKETING AND PLANNING

L. Bradley Browne Director  
Patricia Petrakos-Wilson Marketing Communications Manager, Dawn Matthews Public Relations Manager, Lisa Jo Steiner Assistant Promotion Manager, Stephanie Warnesky Marketing Art Director, Sharon Price Associate Art Director, Julie Perron Senior Market Research Analyst  
Faith Kluntz Copyrights Coordinator, Cynthia Damato Sands Reader Service Coordinator, Carol Pitman Marketing Assistant

## FINANCIAL SERVICES

Philip L. Penny Director of Finance and Services, Kenneth A. King Business Manager, Marilyn Parker, Diane Henry, JoAnn Walter, Jaime Huber, Agnes Perry

## CIRCULATION

Dan McLaughlin Director  
Vicki Weston Assistant Manager, Karen Desroches Distribution Coordinator, Louise Menegus Back Issues

## PERSONNEL

Patricia Burke Human Resources Administrator, Beverly Goss Receptionist

## BUILDING SERVICES

Tony Bennett Manager, Cliff Monkton, Mark Monkton, Gary Graham

## BIX

BYTE INFORMATION EXCHANGE

## DIRECTOR

Stephen M. Laliberte

## EXECUTIVE EDITOR

George Bond

## MANAGING EDITOR

Tony Lockwood

## MICROBYTES DAILY

D. Barker Coordinator, Peterborough, Rich Malloy New York, Gene Smarte Costa Mesa, Nicholas Baran San Francisco, Rick Cook Phoenix, Frank Hayes San Francisco, Martin Heller Boston, Jason Levitt Austin, TX, Laurence H. Loeb Wallingford, CT, Brock N. Meeks San Francisco, Stan Miaszkowski Peterborough, Wayne Rash Jr. Washington, DC, Andrew Reinhardt New York, Sue Rosenberg Washington, DC, David Reed Lexington, KY

## GROUP MODERATORS

David Allen Applications, Leroy Casterline Other, Marc Greenfield Programming Languages, Jim Howard Graphics, Gary Kendall Operating Systems, Steve Krenek Computers, Brock N. Meeks Telecommunications, Barry Nance New Technology, Donald Osgood Computers, Sue Rosenberg Other, Jon Swanson Chips

## EXCHANGE EDITOR

Laurence H. Loeb Macintosh Exchange Editor, Barry Nance IBM Exchange, David Reed User Group Exchange

## BUSINESS AND MARKETING

Patricia Bausum Secretary, Denise A. Greene Customer Service, Brian Warnock Customer Service, Tammy Burgess Customer Credit and Billing

## TECHNOLOGY

Clayton Lisle Director, Business Systems Technology, ISCo., John Spadafora Programmer/Analyst

## ADVERTISING SALES

Steven M. Vito Associate Publisher, Vice President of Marketing

Sara Lyon Administrative Assistant

Arthur H. Kossack Eastern Regional Sales Manager, (312) 751-3700  
Jennifer L. Bartel Western Regional Sales Manager, (214) 844-1111  
Susan Vernon Sales Assistant

## NEW ENGLAND

ME, NH, VT, MA, RI, ONTARIO, CANADA & EASTERN CANADA

John C. Moon (617) 282-1160

## ATLANTIC

NY, NYC, CT, NJ (NORTH)

Kim Norris (212) 512-2645

## EAST

PA, KY, NJ (SOUTH), MD, W. VA, DE, DC

Thomas J. Brun (215) 498-3833

## SOUTHEAST

NC, SC, GA, FL, AL, TN, VA, MS

(404) 252-0826

## MIDWEST

IL, MO, KS, IA, ND, SD, MN, WI, NE, IN, MI, OH

Kurt Kelley (312) 751-3740

## SOUTHWEST, ROCKY MOUNTAIN

CO, WY, OK, TX, AR, LA

Karl Heinrich (713) 482-0757

## SOUTH PACIFIC

SOUTHERN CA, AZ, NM, LAS VEGAS, UT

Ron Cordek (714) 557-8292

Tom Harvey (213) 480-5243

## NORTH PACIFIC

HI, WA, OR, ID, MT, NORTHERN CA, NV (except LAS VEGAS), WESTERN CANADA

Bill McAfee (408) 879-0371

(415) 382-4600

## INSIDE SALES

Liz Coymann Director

Susan Boyd Administrative Assistant

## NATIONAL SALES

Scott Gagnon (603) 924-4380

Mary Ann Goulding (603) 924-9281

Elisa Lister (603) 924-2598

## BYTE BITS (2x3)

Mark Stone (603) 924-8830

## THE BUYER'S MART (1x2)

Lisa Higgins (603) 924-3754

## REGIONAL ADVERTISING SECTIONS

Larry Levine (603) 924-4379

Barry Echavarría (603) 924-2574

## BYTE POSTCARD DECK MAILINGS

## BYTE DECK

Ed Ware (603) 924-6166

## COMPUTING FOR DESIGN & CONSTRUCTION

## COMPUTING FOR ENGINEERS

Dan Harper (603) 924-2598

## INTERNATIONAL ADVERTISING SALES STAFF

See listing on page 477.

Founder: James H. McGraw (1860-1948). Executive, editorial, circulation, and advertising offices: One Phoenix Mill Lane, Peterborough, NH 03458, phone (603) 924-9281. Office hours: Monday through Thursday 8:30 AM-4:30 PM, Friday 8:30 AM-1:00 PM, Eastern Time. Address subscriptions to BYTE Subscriptions, P.O. Box 551, Hightstown, NJ 08520. Subscriptions are \$29.95 for one year, \$54.95 for two years, and \$74.95 for three years in the U.S. and its possessions. In Canada and Mexico, \$31.95 for one year, \$59.95 for two years, \$79.95 for three years. \$50 for one-year surface delivery to Japan, \$30 surface delivery elsewhere. Air delivery to selected areas at additional rates upon request. Single copy price is \$3.50 in the U.S. and its possessions, \$3.95 in Canada, \$4.50 in Europe, and \$5 elsewhere. Foreign subscriptions and sales should be remitted in U.S. funds drawn on a U.S. bank. Please allow six to eight weeks for delivery of first issue. Address editorial correspondence to: Editor, BYTE, One Phoenix Mill Lane, Peterborough, NH 03458. Unacceptable manuscripts will be returned if accompanied by sufficient postage. Where necessary, permission is granted by the copyright owner for libraries and others registered with the Copyright Clearance Center (CCC) to photocopy any article herein for the flat fee of \$1.50 per copy of the article or any part thereof. Correspondence and payment should be sent directly to the CCC, 29 Congress St., Salem, MA 01970. Specify ISSN 0360-5260/83, \$1.50. Copying done for other than personal or internal reference use without the permission of McGraw-Hill, Inc. is prohibited. Requests for special permission or bulk orders should be addressed to the publisher. BYTE is available in microform from University Microfilms International, 300 North Zeeb Rd., Dept. PR, Ann Arbor, MI 48106 or 18 Bedford Row, Dept. PR, London WC1R 4EJ, England.

BYTE and **BYTE** are registered trademarks of McGraw-Hill, Inc.





## PC WEEK POLL: C COMPILERS

	Overall Weighted Score	Overall Reliability	Complete of Command Descript.	Overall Perform.	Complete & Organiz. Document.	Document Clarity	Compiling Process Efficiency	Product Support Quality	Value Relative To Cost	Product Support Access.
Turbo C 2.0 (Borland International)	81	87	79	84	77	78	86	72	70	93
C Optimizing Compiler 5.1 (Microsoft Corp.)	76	83	80	81	78	74	76	68	67	70
C++ 1.07 (Zortech Inc.)	66	68	64	71	63	63	69	60	58	76

"Microsoft was No. 1, but they have been unseated by Borland." PC Week, May 8, 1989

## PC WEEK POLL: SOFTWARE DEBUGGERS

	Overall Weighted Score	Overall Reliability	Effective. Programmer Interface	Document. Clarity	Complete. Command Descript.	Complete. & Organize. Document	Overall Perform.	Integration Within Programming Environment	C Compiler Compatibility	Product Support Quality	Product Support Access	Value Relative To Cost
Turbo Debugger 1.0 (Borland International)	84	89	90	81	81	81	89	88	81	73	72	93
Codeview 2.2 (Microsoft Corp.)	73	80	71	72	74	74	74	74	78	67	64	72

"Borland's Debugger outshines Microsoft's Codeview." PC Week, May 15, 1989

# It's two winners in one.

Turbo C,\* the core of Turbo C Professional, was the outright winner in PC Week's Poll of Corporate Satisfaction on C compilers. Overall, Borland won with 81. Microsoft\* placed second.

Turbo Debugger,\* also included in Turbo C Professional, was the outright winner in EVERY category in PC Week's Poll Of Corporate Satisfaction on Debuggers. And, once again, we topped the score with 84, overall. Microsoft came in second-best, 11 points behind.

Get Borland's Turbo C Professional and get the best of both worlds: our top-rated C compiler and our top-rated Debugger.

Call (800) 345-2888\* and we'll send you both PC Week polls and technical specifications on Turbo C and Turbo Debugger.

Turbo C Professional includes both Turbo C 2.0 and Turbo Assembler® & Debugger.

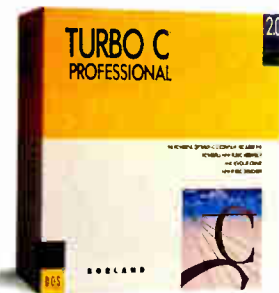

# B O R L A N D

CODE: MC38

\*From Canada, Call (408) 848-4391. Reprinted from PC Week, May 8, 1989; PC Week, May 15, 1989. Copyright © 1989 Ziff Communications Company. Turbo C, Turbo Debugger, and Turbo Assembler are registered trademarks of Borland International. Copyright © 1989 Borland International, Inc. All rights reserved. BI 1328

Circle 60 on Reader Service Card (DEALERS: 61)

World Radio History

Document created using Aldus PageMaker® and Microsoft® Windows. Microsoft is a U.S. registered trademark of Microsoft Corp. PageMaker is a U.S. registered trademark of Aldus Corp. © 1989 Hewlett-Packard Company PE12922

# At last! A new HP LaserJet just for you.

**At only \$1495\*, it's got your name on it.**

The HP LaserJet printer family has expanded—in a small way.

The new HP LaserJet IIP (as in Personal) fits right on your desk. And, with a price almost half of the multi-user LaserJet Series II\*, into most budgets.

Its simple front panel gives you easy, push-button control over the menu, the 14 internal fonts, form feed and other functions. It handles four different paper sizes: letter, legal, executive and A4, as well as envelopes. In portrait

\*Suggested U.S. list prices:  
LaserJet IIP \$1495;  
LaserJet Series II \$2695.  
Dealer prices vary.



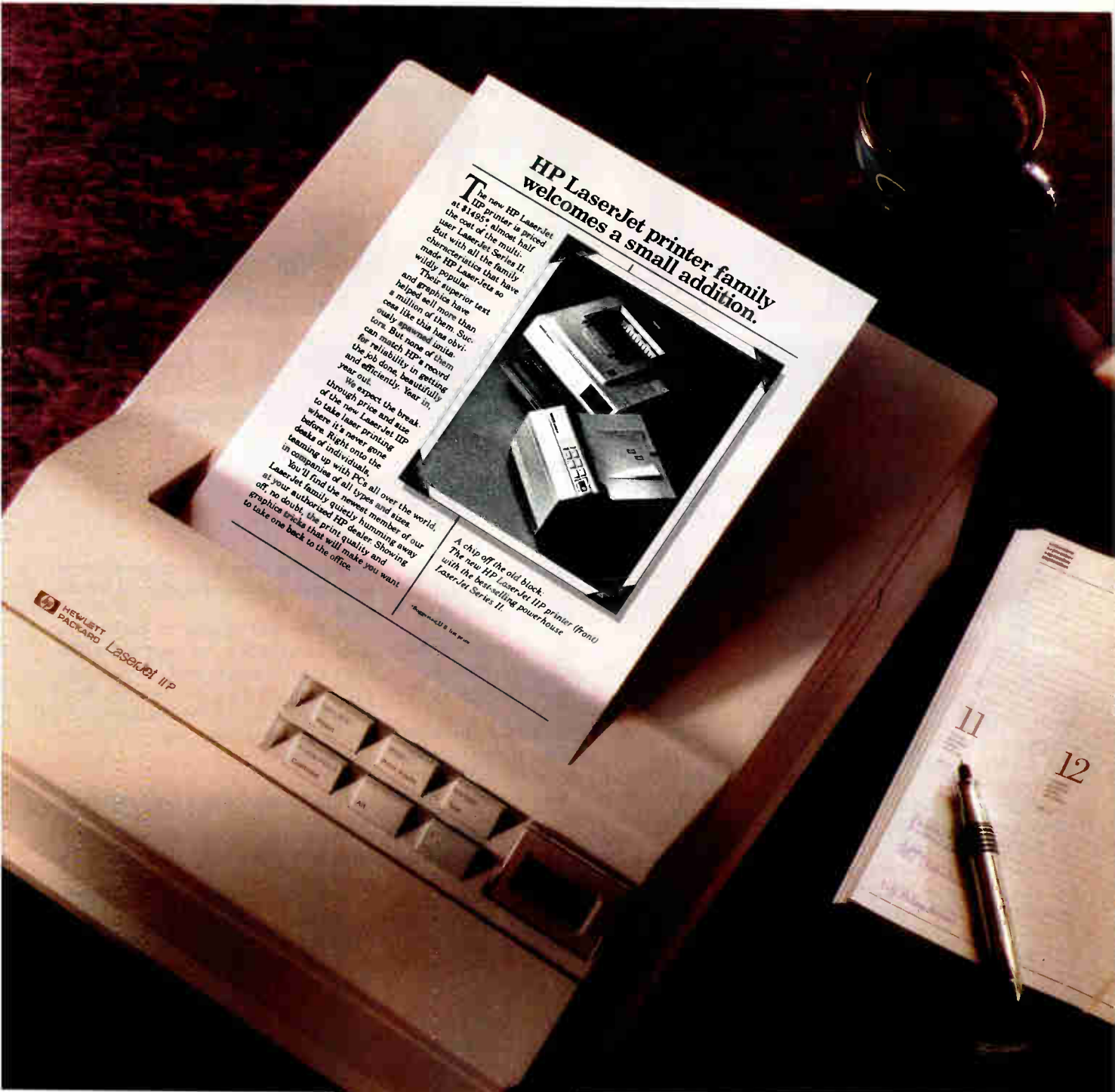

**HP LaserJet printer family  
welcomes a small addition.**

**T**he new HP LaserJet IIP printer is priced at \$1495, almost half the cost of the multi-user LaserJet Series II. But with all the family-made HP LaserJets that have wildly popular characteristics that have

Their superior text and graphics have helped sell more than a million of them. Success like this has obviously spawned imitators. But none of them can match HP's record for reliability in getting the job done, beautifully and efficiently. Year in, year out.

We expect the breakthrough price and ease to take the LaserJet IIP where it's never gone before. Right onto the desks of individuals, in companies of all sizes, and among the newest and oldest members of our LaserJet family quietly humming away at your authorized HP dealer. Showing graphics tricks that will make you want to take one back to the office.

You'll find the new HP LaserJet IIP printer (front) in companies of all types and sizes. You'll find the newest member of our LaserJet family quietly humming away at your authorized HP dealer. Showing graphics tricks that will make you want to take one back to the office.

*A chip off the old block. The new HP LaserJet IIP printer (front) with the best-selling powerhouse LaserJet Series II.*



HEWLETT  
PACKARD LaserJet IIP



*The new HP LaserJet IIP printer.*

or landscape configurations. At four pages a minute. From one or two paper bins (the second is optional).

The 512K standard memory is upgradable to 4.5 Mbytes for more complex graphics and publishing programs.

And, of course, our new printer is compatible with the HP LaserJet Series II and virtually all popular PC software.

So call **1-800-752-0900, Ext. 277J** for your nearest authorized HP dealer. Then

introduce people at your company to their very own HP LaserJets.

**There is a better way.**



Circle 163 on Reader Service Card

World Radio History





## Creative License.

**If you've ever tried to combine windows, menus, forms, and text entry to create an effective user interface, you know how challenging can be.**

Perhaps you've turned to a third-party library for help. Only to run into restrictions, limitations, and dead ends. So you had to compromise your design. Or modify the library source code. Or start over.

Which is precisely why we designed Vermont Views™, the new generation of Windows for Data®, the best-selling library for user interfaces.

Vermont Views offers unbridled, unrestricted creative license.

### The Human Interface Of Your Dreams

Vermont Views offers an unparalleled set of interface building blocks that you can combine in unlimited ways:

- Menus can be created in any style you choose, made scrollable vertically and horizontally, and nested to any level. Features include n-th character selection, checkmarks, and unavailable items.

- Data entry forms can be bigger than their display windows, have scrollable regions for the entry of variable lines of items, lists of choices for data entry, context sensitive help, and special decimal, date, time, and toggle fields.

- A mini word processor can be attached to a field window in a form or

used as a pop-up note taker.

### You're In Charge

Because you can write and attach functions to the beginning and end of menus, forms, fields, and to keys, you're always in control.

Use these control functions to call up subsidiary forms and menus, change field values and the active field, exit or abort a form, do almost any task you can imagine.

All interactive capabilities of Vermont Views use a unique system of accessible keytables, so you can easily change or disable key assignments - even add to the functions provided for menus, forms, text entry, and windows.

### One For All

Vermont Views is available for DOS, OS/2, UNIX, XENIX, and VMS. Maintain the same user interface on all of these operating systems with the same source code.

Vermont Views provides international portability as well, with full support for IBM international characters, flexible date and time formats, and changeable decimal and thousands separators.

### Novice Or Expert

Despite its depth and flexibility, Vermont Views is easy to learn and use. Each major facility is covered in a single, self-

contained section of the manual, so you only need to learn capabilities as you use them.

To help you become an expert in no time, we include a free copy of the Norton Guides™ Engine and our own comprehensive Pop-Up Reference™. You'll have immediate, on-line access to function names, reference pages, structures and tables.

### No-Time-Limit Guarantee

We've only touched on a fraction of what makes Vermont Views special. The only way to know it is to use it.

Try Vermont Views on your **hardest** problems.

For as long as you want. At no risk.

If not fully satisfied, return for a full refund. Anytime.

### To Order Today Call 1-800-848-1248

Call to order Vermont Views today. And we'll send your "creative license" right away.

Prices: DOS \$395; with Source \$790. UNIX, XENIX, VMS, OS/2 please call.



Vermont  
Creative  
Software

Pinnacle Meadows, Richford, VT 05476

800-848-1248, 802-848-7731 Fax: 802-848-3502 Telex: 510-601-4160 VCSOFT

# MICROBYTES

*Staff-written highlights of developments in technology and the microcomputer industry, compiled from Microbytes Daily and BYTEWEEK reports*

## Computer Scientists Warn of Physical Limits

Conquering the future frontiers of computing won't be easy, especially with something as big as physics getting in the way. That's the message four researchers delivered to fellow computer scientists at the eleventh World Computer Congress held in San Francisco recently.

Tommaso Toffoli of MIT said that in about 10 years, ICs simply won't be able to get any smaller. Toffoli and Teuvo Kohonen, of the Helsinki University of Technology, both pointed out that the density of microprocessors has been increasing by a factor of 10 every five years. That means that in 10 years, each transistor in a CPU will be one one-hundredth of its current size. But as those transistors get smaller, designers will face the problem of "tunneling"—electrons that won't behave in the expected ways—which means that physical CPU errors would become much more common.

To make computers work accurately beyond that level, Toffoli said, they'll have to depend on the microscopic physics of two electrons rather than the statistical mechanics of millions of electrons. "Maybe in 20 or 40 years we'll have computers where each bit is a quark, and then they will be reliable again," he said.

Kohonen proposed leaving conventional deterministic computers behind in favor of neural networks, using analog systems and a statistical description of data. But, Kohonen admitted, "You wouldn't want to use a neural net to keep your bank account; they're not accurate enough for that."

Gen Matsumoto, of Japan's

Electrotechnical Laboratory, offered another alternative: "biocomputing." While neural networks mimic brain activity in computers, biocomputing attempts to electronically duplicate the actual structure of the brain. Matsumoto said that biocomputing work has been going on for five years as part of Japan's "fifth-generation computer project," but at \$2 million it's only about 1 percent of the ambitious endeavor's budget.

In an informal poll, Toffoli asked the audience of researchers if they thought that within 10 years it would be possible to hold an extended intelligent conversation with a computer. Almost no one in the audience said yes.

Although digital computers have changed greatly in form over the centuries, said Vladimir Cerny of Comenius University in Czechoslovakia, they haven't changed in function. "We've called it accounting, then calculating, then computing, and now data processing—but the way we do it hasn't changed that much," he said. "Perhaps there is a bigger variety of dynamical systems that can be used for computing." The question isn't whether a machine can compute numbers, Cerny said, but whether it processes information; that's what makes them interesting, he added.

And what happens when machines get much, much better at processing information of all kinds? As Toffoli put it, "Eventually some computers may be interesting enough that they will be able to say, 'Look, leave me alone and let me think about what I want to think about.'"

## TI Chips Will Cut Cost of 33-MHz 80386 Systems

Texas Instruments (Dallas) has developed a set of chips that will cut considerably the number of components that it takes to build a 33-MHz 80386-based computer. Most computer makers currently have to design their own discrete logic components to drive the high-speed

80386, and that means from 30 to 60 chips on the system board. But TI's new TACT83000 reduces that chip total down to eight (plus the 80386 CPU). The TACT83000 package is also suitable for 80386SX-based computers, in which case only three "glue-

*continued*

### NANOBYTES

Government and industry are placing too much emphasis on "mission-oriented projects" and not providing enough funding for basic research, renowned computer scientist **Donald Knuth** told the World Computer Congress. The scientific community "faces a crisis," the Stanford University professor said, because scientists can't get funding for projects unless they "subscribe to somebody else's agenda" telling them what to do. We need a lot of small projects devised by many scientists, instead of concentrating most of our resources on a few huge projects with predefined goals.

**Apple Computer** (Cupertino, CA) says that it will work with outside developers of "interactive" Mac products to define a framework for accessing information from devices such as VCRs and videodisk and compact disk players. The computer maker says the **Apple Media Control Architecture** specifications will be available to developers by the end of this year. ABC News Interactive, *Newsweek*, Boston's WGBH-TV, Datapro, and the British Broadcasting Corp. have brought out products, on various media, that tap into the Mac's video and audio capabilities.

The U.S. Department of Commerce has revised its list of **computers that can be exported** to Soviet-bloc nations to include most 80286-based laptops. The Department of Defense, concerned that portable computers could have wider military applications, has opposed their export to certain countries. The major laptop manufacturers welcomed the move. "It gives us a level playing field internationally," Zenith spokesperson Glenn Nelson told Microbytes Daily. "Naturally, our first step is to evaluate how to pursue these markets. And our next step is to see how we can use the opportunities presented."



## NANOBYTES

Send lawyers, guns, and money, but **no computers**: With the recent lifting of restrictions on computer exports to some countries, the **prohibited list** has gotten shorter. According to rules published in the Federal Register, American computer makers cannot legally send computers to Cuba, Cambodia, North Korea, Vietnam, Libya, South Africa, or Namibia.

**Seiko Instruments** (San Jose, CA) now has a Macintosh model of its **color thermal printer**. The new QD5500 printer incorporates a QuickDraw device driver that supports a set of 35 scalable outline fonts, similar in concept to the fonts that Apple says it will supply with System 7.0 next year. (Seiko will support Apple's outline fonts when they become available, a Seiko official said.) Resolution is 300 dpi. Seiko claims the unit has a print speed of 1 page per minute. Depending on page size and memory capacity, the printers range in price from \$7000 to \$14,000. The Seiko printer costs about \$2000 less than comparable color thermal units from Tektronix and QMS, but it doesn't have its own processor and doesn't support PostScript.

**Hewlett-Packard** (Palo Alto, CA) and **Samsung** (Seoul, Korea) plan to jointly develop **low-priced workstations** based on HP's Precision Architecture. The RISC-based Unix systems will start at about \$5000, an HP official said. The deal calls for Samsung to manufacture the products that result from the shared development work, which will then be sold by HP on an OEM basis. HP and Samsung say they'll have their first codeveloped workstations by 1992.

**Intel** (Santa Clara, CA) is sampling its 32-bit LAN coprocessor chips for file servers, multiuser systems, and workstations. The 82596 uses the same bus interface signals as the 80386 and 80486 processors; it off-loads the host CPU and transmits data at the 32-bit bandwidth of the system bus. The chips are designed for being built right into the system board.

logic chips" are required.

The new four-chip set requires only four additional off-the-shelf glue-logic chips to form a complete 80386 system. The TACT83000 package will make it possible to build a complete 33-MHz 80386 system on a 4- by 5-inch board, according to TI product manager Gerald Wineinger. The chip set will also allow manufacturers to reduce their design and production costs, Wineinger says.

The chip set consists of the memory control unit (MCU), the data path unit (DPU), and the AT bus interface unit (ATU), a single 208-pin chip that drives the standard AT bus. The ATU is "truly asynchronous," Wineinger said, requiring no wait states or slower clock frequencies. The DPU is a "cascadable" 16-bit unit, allowing multiple DPUs to be configured to form wider data paths. The 32-bit 80386 implementation requires four chips rather than three because two 16-bit DPUs are needed. Since the ATU is a separate chip, TI says that it

will be easy to offer "sibling" chip sets that support the new Extended Industry Standard Architecture (EISA) and the Micro Channel architecture bus interfaces. TI is also working on a version that will support the "burst-mode" 64-bit data transfer capability of Intel's 80486 chip.

TI will be competing with Chips & Technologies and Headland Technology, which have 33-MHz 80386 chip sets under development. But TI marketing manager Stephen Tang-Kong says that TI will be the first to deliver. "We're already working with beta boards and will have customers demonstrating systems at Fall Comdex," he says. Tang-Kong claims that the competitors' offerings will require from 9 (Headland) to 30 (C&T) additional logic chips for a complete system.

TI hopes to woo the "HPs, NCRs, and Olivettis of the world" with this new chip set, Tang-Kong says. He claims the chip set could cut prices of 33-MHz 80386 systems in half.

## Cypress Claims 40-MHz Chip Fastest SPARC Yet

**C**ypress Semiconductor (San Jose, CA) has developed what it claims is the fastest RISC processor based on Sun Microsystems' SPARC design. The chip maker says that its new 40-MHz 7C601 RISC chip is capable of performing 29 MIPS.

The new CMOS chip is 20 percent faster than the 24-MIPS version Cypress introduced earlier this year, according to Steve Goldstein, director of marketing of Cypress's Ross Technology subsidiary. Increased performance is a "result of enhancements in clock frequency," he said.

The 7C601 incorporates a large windowed register file (136 general-

purpose 32-bit registers), which reduces the number of load and store operations and frees up bus bandwidth, Goldstein said.

In 100-piece quantities, the 7C601 costs \$895.

Cypress sees bright days ahead for the SPARC chip, which Sun is trying to establish as the standard architecture for RISC workstations. According to Goldstein, SPARC will eventually be the top RISC choice because of the relatively large number of software applications already running on SPARC-based workstations. Goldstein predicted that the number will climb to 1000 by the end of this year.

## After ISDN, We Can Wait for IBCN

**A**lthough ISDN has barely penetrated the communications structure, work is under way to develop the next step beyond: a more functional system called Integrated Broadband Communication Network.

ISDN runs on standard telephone cable at 9600 bps, while IBCN would run on broadband cable at up to 150 million bps by 1995 or so, says P. J. Kuehn of the Institute for Communi-

cations Switching and Data Techniques in West Germany. That speed will reach 600 million bps sometime after the year 2000, Kuehn predicts. With the greater bandwidth, users could see such functions as TV and radio programs, videoconferencing, voice or video mail, and interactive videotex delivered to their house, Kuehn says.

*continued*



# Until now there was only one way to integrate C and Assembler.

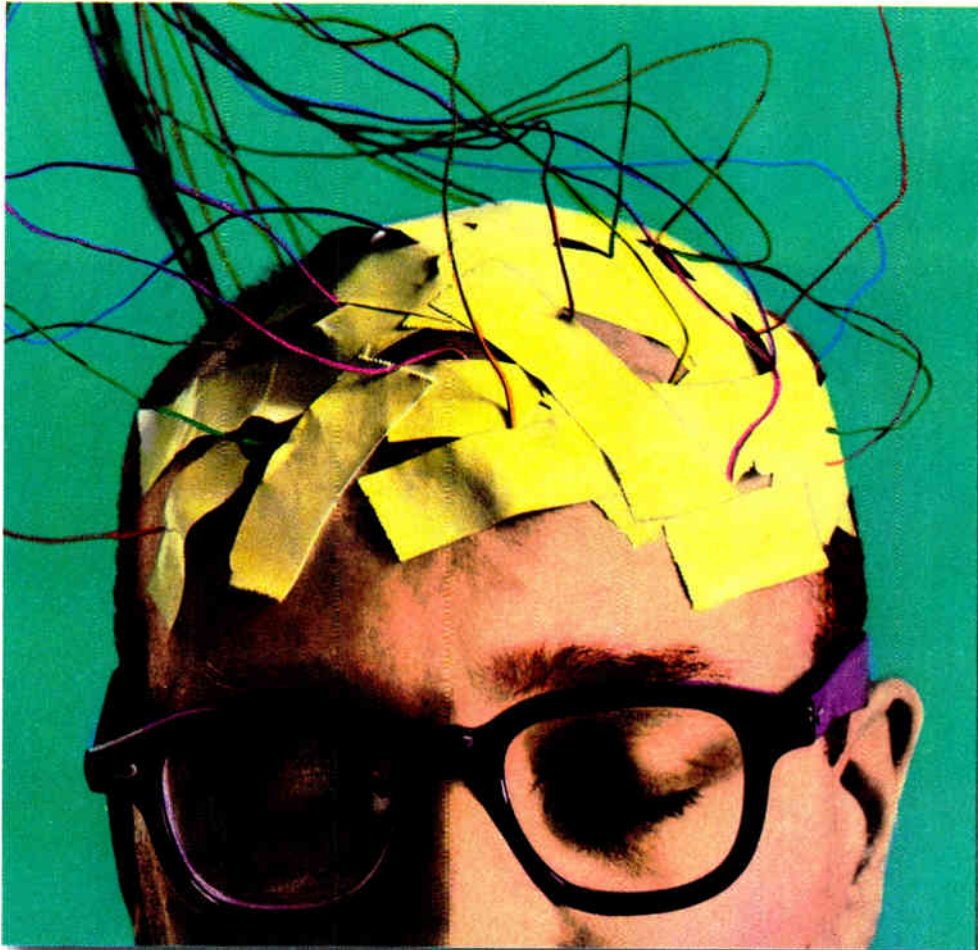

While C and Assembler give you power to burn, switching back and forth between them can leave your brain feeling a little fried.

All that stopping. And starting. And constantly retracing your steps.

Well, relax. Now there's Microsoft® QuickAssembler. Available with our clever QuickC® Compiler in one location: the first integrated environment for C and Assembler.

For the first time, you can save time with an integrated editor, compiler, assembler and debugger that let you create C programs, mixed C and Assembler programs, or Assembler programs that stand alone.

To make sure you feel at home in your new environment, we've designed Microsoft Quick Advisor, a hypertext electronic manual that coaches, coaxes and guides you on screen.

Quick Advisor gives you access to information on all ROM BIOS and MS-DOS® calls. And it even lets you cut and paste sample programs, so you can make both C and Assembler subroutines part of your routine in no time.

For more details on the incredible integrated power of QuickAssembler and QuickC Compiler, call (800) 426-9400. If you own QuickC Compiler version 2.0 already, we'll tell you how to add on QuickAssembler quick.

And take a load off your mind.



**Microsoft**  
Making it all make sense.®



*You can easily add extra memory,  
a modem, AT® expansion board, plus  
additional 20MB or 40MB removable  
hard drives whenever you see fit.*



**Epson Equity LT/286e.** Intel 80C286 processor, 8/12MHz clock speed, 1MB of standard RAM, expandable to two megabytes with Epson "snap-slot" board, 17 lbs. with snap-on battery unit, registered trademark of Seiko Epson Corporation. 286 is a trademark of Intel Corporation. Equity is a trademark of Epson America, Inc. 2780 Lomita Blvd., Torrance, CA 90505 (800) 922-8911.

# NOW YOUR DECISION ON WHICH LAPTOP TO BUY DOESN'T HAVE TO BE FINAL.

Epson's new laptop computer doesn't just go with you, it grows with you. The new Equity™ LT/286e starts with a 3.5" floppy drive, easy-to-read "paper-white" display, 286™ processor and one megabyte of RAM, all standard. You decide between a 20 megabyte or 40 megabyte removable hard drive. Where you take it from there is entirely up to you. Add more memory, a modem, expansion card or change hard drives, whenever your business demands it.

The new Equity LT/286e is part of a growing line of quality laptop computers from Epson.® The final word in value.

**EPSON**

**WHEN YOU'VE GOT AN EPSON,  
YOU'VE GOT A LOT OF COMPANY.™**



13 lbs. without battery, one AT-compatible expansion slot (2/3 size), optional internal 2400 baud modem and 5.25" external FDD, one year limited warranty. ©1989, Epson America, Inc. Epsoo is a



## NANOBYTES

**Neuron Data Systems** (Palo Alto, CA) has developed a **HyperCard front end** for its Nexpert Object program, allowing the "expert" to input the rules and objects of the expert system as a series of HyperCard stacks. The company also has announced a **Presentation Manager front end**. Neuron Data has designed a "client/server architecture" for Nexpert Object that will allow PCs and workstations to access knowledge bases residing on a server or host mainframe. According to company official Patrick Perez, a key element in LAN-based expert systems is the use of "shareable image technology," in which a snapshot of the centralized database and knowledge system is processed locally on the network station or PC.

**Tumbling price: Dell Computer** cut the price of its 80386SX system by \$430 to \$2839. **Sanyo** lowered its 8088-based 16EX computer to \$905 and its 80286-based 17Plus5E to \$1689. **Boca Research** eased the pain of memory by dropping its 8-megabyte BocaRAM/AT Plus memory board down to \$2195, from \$3395; the 4-megabyte board is now \$1195 instead of \$1795; the 2-megabyte model is now \$695, \$300 less than before. **Orchid Technology** also lowered memory board prices; its 2-megabyte RamQuest Extra 16/32 dwindled from \$1499 to \$1179. **Applied Engineering** cut 26 percent off the price of its MS-DOS coprocessor board for the Apple II series; the PC Transporter is now \$499.

**Microtec Research** (Santa Clara, CA) said at UniForum in Boston that it will come out with a C compiler and other **programming tools** supporting the Motorola 88000 RISC processor. The tools will run on Sun-3, VAX/VMS, and IBM PC-compatible hardware.

**AT&T** is going to start letting colleges produce and distribute binary copies of AT&T's C++ **Language System 2.0** to students for \$25 each. A license for C++ source code will cost \$300 per CPU. For more information, dial (800) 828-8649.

Although critics of ISDN charge that it's already outdated in terms of data capacity, even IBCN won't be able to support such high-volume data generators as high-definition TV, Kuehn says. HDTV already requires a capacity of more than 150 million bps.

During this migration from ISDN to IBCN, different countries will stress certain communications functions above others, says H. Ikeda, of Nippon Telephone & Telegraph in Japan. The U.S., for example, is likely to stress data transmission capabilities over voice or video transmission, Ikeda

says. Consequently, evolution scenarios will differ from country to country, but vendors and standards bodies have to make sure that the underlying architecture works with all of them, Ikeda notes.

So what about ISDN? Although ISDN has been used little so far, that's going to change, says R. G. F. Aitchison, of ICL Network Systems. While ISDN lines cost 1.3 to 1.7 times the price of standard telephone lines, that's a "trivial element" compared to the technologies ISDN can provide, Aitchison says.

## Computers Get Good Grades in This Study

**M**aybe it depends on whom you ask. Researchers and teachers attending the National Educational Computing Conference this summer indicated uncertainty about the usefulness of computers in the classroom (see October Microbytes, page 17). But in a study released more recently, most of the teachers questioned gave computers good grades. Two-thirds of the teachers in the U.S. say that use of computers in school should be drastically increased, according to a study published by IBM and conducted by The Wirthlin Group. Titled "Computer Report Card: How Teachers Grade Computers in the Classroom," it's "the most extensive study ever done of teachers' attitudes about computers in the classroom," IBM says.

Here are some of the results from the study: 82 percent of teachers polled said that the use of computer-based writing and reading programs could improve the illiteracy problem; 85 percent said that computers have already had a positive effect on the quality of education; 82 percent said that computers improve student

motivation; 74 percent said that students who are not "computer literate" won't be adequately prepared for college; 60 percent of the teachers said that they feel inadequately trained in computer use, and 52 percent said that their students are more computer-literate than they are; 88 percent said that some sort of government funding should exist to expand the use of computers in the classroom, while 70 percent said that the greatest roadblock to more effective use of computers in schools is limited finances.

James Dezell, IBM's vice president of Educational Systems, said that by the time the average student graduates from high school, he or she has spent 20,000 hours in front of the TV and only 12,000 hours in the classroom. He claims that computers give teachers the resources to compete for students' attention "and win."

The nationwide telephone survey of 1100 teachers was conducted in July. All 1100 respondents in the survey were full-time teachers of grades between kindergarten and high school; 66 percent said they currently use computers for instruction.

## Quarterdeck Eases RAM Cram with QRAM

**Q**uarterdeck (Santa Monica, CA) has developed a new PC utility designed to squeeze more memory out of DOS computers. QRAM (Quarterdeck pronounces it "cram") is a \$59.95 utility for XT and AT compatibles with expanded memory conforming to the EMS 4.0 or EEMS specifications. QRAM can locate unused space in "high memory"—the

area above DOS's 640K-byte limit, but below the 1-megabyte limit of the 8088 microprocessor—and lets you load device drivers and TSR programs there.

The idea is to ease "RAM cram." Ordinarily, drivers and TSR programs take up part of the 640K bytes of memory that's available to DOS

*continued*

# Introducing the everything- but-the-kitchen sync.



Presenting a multiscanning color monitor so advanced it's compatible with virtually all the video standards to date. And with video standards to come, like SuperVGA and IBM® 8514/A.

It's the C1391 PanaSync™ color monitor. And whether your office PCs are running Hercules™, CGA, EGA or VGA, this 14" Panasonic® monitor will display each to its best advantage.

Of course, the PanaSync monitor is comfortable in virtually any IBM or [with an optional cable] Apple Mac™ II environment. And we've given as much thought to your comfort, as well. With an ergonomic design. Featuring front-mounted controls. Tilt/swivel stand. And text color switching from green to amber to paper white in TTL modes. The affordable PanaSync C1391 monitor. The future on display.

For more information, or the name of your authorized dealer, call toll-free **1-800-742-8086**.

*Peripherals, Computers, Printers, Copiers  
Typewriters and Facsimiles*

**Panasonic**  
Office Automation 

PanaPro™ Monochrome Desktop Publishing Monitors



PanaSync™  
Multiscanning Color  
Monitor



*IBM is a registered trademark of International Business Machines Corporation. Mac II is a trademark of Apple Computer, Inc. Hercules is a trademark of Hercules Computer Technology.*



Work Areas

TWORFILE  
 LETTERS

Now	Ext	Size	Last Modified	Attr
CUSTOM1	LRW	329	01-Sep-99	0:294
CUSTOM1	LRW	178	01-Sep-99	0:294
HOW	PPY	2011	15-Jul-99	0:150
FINHELP	PPY	995	15-Jul-99	0:550
FOXP90	EXE	108304	05-Sep-99	6:116
FOXP90	EXE	400000	05-Sep-99	6:116

Invo	Quan	Item	Price	Company	Contact	Address	City	St	Zip	Det
10002	2636	MC344	5.90	Mund Hard	Larry Davidson	Attn: Mr P	Dubee	OH	43121	None
10003	5604	HF002	417.00	Conground	Russ Aviable	Main Office	Woodlawn	OH	43070	None
10003	5616	1B+2G	18.00	Mariner's	Willby Delibera	Main Office	Twin Pines	OH	43040	None
10004	5104	WITY	237.00	French War	Skippy Erickson	Dept 300 B	Speedway	OH	43040	None
10005	0976	MINDY	18.00	Tall Man's	Brian Dehrower	Unit #13 7	Pella	OH	43065	None
10006	5600	PCP20	417.00	Pools R Mr	David Lehos	Main Office	Pushington	OH	43070	None
10006	5700	DISC	18.00	Office Fur	Chris Bahglag	Main Office	Sumner	OH	43041	None
10007	5600	SLBT	695.00	Helping Pa	Sally Emory	Na				
10007	5692	CSC	695.00	Reporting	Kerry Waits	Na				
				Production	Janet Straller	Na				
				Ciderville	Marty Mack	Na				

September 1999

1	2	3	4	5	6	7	8	9	10	11	12	13	14	15	16	17	18	19	20	21	22	23	24	25	26	27	28	29	30
---	---	---	---	---	---	---	---	---	----	----	----	----	----	----	----	----	----	----	----	----	----	----	----	----	----	----	----	----	----

9:30 Staff Meeting, be prepared to discuss the UK 1-2 plan.  
 1:00 Lunch with Erickson at Le Mahian.  
 6:00 Meet with field personnel.  
 9:25 Flight to Toledo.

Company	Phone	Address1	Contact	Address2	City	State	Zip
USA Insurance	606/261-4100	Attn: Mr Froehlich	Larry Davidson	200 6th Ave, Ste 904	Dubee	OH	43001
Margante Systems	419/293-75	Richard Hill Assoc	Henry Toss				
Smith and Assoc.	100/871-06	Software Inc.	Computers Plus				



# New FoxPro

## *Shifting the Balance Of Power in Database Management*

There's a new leader in the relational database management world. Its name is FoxPro.

FoxPro is the first and *only* microcomputer database management system that combines astonishing performance with a sleek interface of amazing power and beauty.

- FoxPro offers all the elegance and accessibility of a graphic-style interface, yet operates at the stunning speeds possible only with character interfaces.
- FoxPro is so easy to learn and use, even beginners can become productive immediately; yet it's powerful and sophisticated enough to satisfy the needs of the most demanding developers and power-users.
- FoxPro gives you choices instead of limits: use a mouse or a keyboard; type commands or use the object-oriented interface; run in one window, or hundreds.
- FoxPro is so efficient, it runs in a 512K PC-XT, yet it's able to take advantage of the speed, expanded memory and extended video modes of the most advanced machines available. You don't even need a graphics card or special windowing software.

### ***Nothing is Faster***

Fox Software products are famous for their unmatched execution speed. FoxPro extends that tradition.

FoxPro is up to eight times faster than dBASE IV—more than 15 times faster than dBASE III PLUS!

And that blazing speed translates into unprecedented power. Now you can efficiently process gigantic databases with hundreds of thousands—even *millions*—of records.

### ***Protecting Your Investment***

With FoxPro, your existing FoxBASE+ or dBASE III PLUS programs will run perfectly—first time, every time, no excuses. And



FoxPro is language-compatible with dBASE IV. But FoxPro doesn't stop there. It has over 140 language enhancements not found in any version of dBASE. We've outdone ourselves by adding more than 200 language enhancements you won't find in FoxBASE+.

Best of all, FoxPro opens up whole new worlds for your applications by letting you move them onto a variety of different platforms.

### ***The Tradition Continues***

Fox Software is committed to excellence—our products prove it.

We've been producing superb database management software since 1983. And our products for both the PC and the Macintosh continue to win awards worldwide.

We've taken everything we know about software engineering, databases and interface design, and focused it into one remarkable product—FoxPro.

### ***FREE Demo Disk***

Shift the balance of power in *your* favor by trying FoxPro for yourself.

Call (419) 874-0162 now to get your free demo disk. Or ask for the FoxPro dealer nearest you. See for yourself: *Nothing Runs Like The Fox.*

### ***FoxBASE+ Users:***

### ***Call About Our Liberal Upgrade Offer!***

**System Requirements:** FoxPro operates in 512K RAM (640K recommended) with MS/PC-DOS 2.0 or greater and an 8086/8088, 80286 or 80386 microprocessor. For optimum performance, FoxPro takes complete advantage of any available EMS (expanded memory) or a math coprocessor.

**Trademark/Owner:** FoxPro, FoxBASE+/Fox Software; dBASE III PLUS, dBASE IV/Ashton-Tute.

See us at Booth H4 & H5

 **COMDEX/Fall '89**

November 13-17, 1989. Las Vegas Hilton Hotel

## **Fox Software**

***Nothing Runs Like The Fox.***

Fox Software, Inc. (419) 874-0162, Ext. 320  
134 W. South Boundary FAX: (419) 874-8678  
Perrysburg, Ohio 43551 Telex: 6503040827 FOX

Circle 144 on Reader Service Card

## NANOBYTES

**Tandy** (Fort Worth, TX) expected to start selling this month a new **portable word processor** that's based on a 5.5-MHz Z80 chip, weighs 3.1 pounds, and is priced at \$350. The new WP-2 is physically reminiscent of the Tandy Model 100/102 but has a bigger screen (an 80-character by 8-line LCD) and a 62-key QWERTY keyboard. Built into the computer is a word processing program (more sophisticated than the simple text editor in the Model 100, Tandy says), a 100,000-word spelling checker, and a 200,000-word thesaurus. Using the two function keys in combination with number keys, you can cut, copy, and paste; search and replace; center and justify text; send output to a printer; and initiate telecommunications. The diminutive unit has 32K bytes of memory, of which 22K bytes can hold documents. The WP-2 is powered by four AA batteries; Tandy estimates the operating battery life to be 12 hours. A lithium battery backs up the RAM.

While most of the specialized software used to gather and analyze the data from the **Voyager** spacecraft during its recent Neptune encounter was custom-written, scientists at the **Jet Propulsion Laboratory** (Pasadena, CA) used several off-the-shelf applications to make their work easier. With a Unix package called **DataViews** from **V. I. Corp.** (Amherst, MA), running on a Sun-3/260 workstation, they were able to graphically display live data on solar wind, atmospheric conditions, and various energy parameters. **DataViews** is a set of graphical interface application and development tools; the JPL scientists used it to create images for internal use and for the TV networks of nongraphic data using flow patterns, histograms, and spectrograms. They were "essentially doing two-dimensional representations of three-dimensional data in real time," JPL programming manager Pat Liggett told *Microbytes Daily*. The billions and billions of bits of data coming from the spacecraft were stored using a standard SyBase relational database manager.

programs. Unfortunately, that leaves less and less space for applications. Quarterdeck says that QRAM adds "load-high" capability on top of EMS or EEMS drivers.

But one of the most interesting parts of QRAM isn't the memory manager itself. It's a utility called **Manifest**, which Quarterdeck is bundling with QRAM and QEMM. Quarterdeck systems architect Dan Spear says **Manifest** "tells you everything it's possible for software to find out about your hardware." The menu-driven program compiles configuration information, monitors memory usage, and generally provides every facility you're likely to ask for in tracking down hardware and software problems, particularly when you're trying to spot conflicts between programs.

**Manifest** is a critical part of the QRAM package, Spear says, because

with the endless variety of PC clone configurations, it's almost impossible to be sure a TSR program or driver loaded into high memory won't conflict with a video board or other pseudomemory outside the range of standard RAM. For example, video cards that automatically switch between CGA, EGA, and VGA might collide with a driver that QRAM thinks is loaded into unused video memory. **Manifest** lets you monitor memory use and spot the collision. It also allows mundane explorations, such as checking the **CONFIG.SYS** and **AUTOEXEC.BAT** files.

Much of what **Manifest** does isn't new. Many of the capabilities have been available in bits and pieces for years, in public domain and shareware utilities. Spear says he duplicated every diagnostic utility he could find and then added every remaining tool he could think of.

## Speech More Important Interface Than Graphics, Media Lab's Negroponte Tells SIGGRAPH

**N**icholas Negroponte, director of MIT's Media Lab, came to the year's biggest computer graphics show and pronounced that the most significant development in the human/computer interface during the next five years will be in speech technology and not in computer graphics. In his keynote address at **SIGGRAPH '89**, Negroponte said that in the future, "the primary means of communication with computers will be through speech, not through graphics."

Part of the reason that speech-recognition capabilities have not advanced to the point where people can converse with their computers is that "people in the speech-recognition industry are fundamentally not interested in communication," Negroponte said. Because so many people involved in computer research are "not interested in communication," the computer remains "sensory deprived," he said.

Negroponte urged the **SIGGRAPH** audience, which consisted of researchers, scientists, engineers, designers, and artists at the forefront of computer graphics, to be more concerned with "how people communicate with computers instead of drawing teapots." ("Teapots" was a reference to the half-solid/half-wire-frame kettle in the **SIGGRAPH** logo, which had been

shown rendered with various surfaces in a presentation preceding Negroponte's talk.)

Another development in what Negroponte calls "the sensory apparatus of computing" will be vision capabilities that will enable the computer to receive and interpret visual clues from the user. Right now, if we take our hands off the keyboard, the computer doesn't know if we're just pausing or leaving for the weekend, he said.

Although the desktop metaphor is dominant in the human/computer interface today— "Some people even have the temerity to go to court over it," Negroponte said—that's going to change because the desktop metaphor doesn't work. "Any quantity of data and it starts to fall apart," he said. Negroponte described a day when the interface will simulate efficient procedures that people are already familiar with. Finding a stored document, for example, won't involve "mousing around," he said; it will be similar to what he does now: He calls his secretary through the speaker-phone and asks her to please bring in a copy of the needed document. But instead of asking his secretary to find the document, he'll use his voice to ask his computer.

*continued*



# ZORTECH

**NEW!** AT&T C++ RELEASE 2.0 SPECIFICATION

**NEW!** MS WINDOWS COMPATIBILITY

**NEW!** EASY PORTABILITY FROM MICROSOFT C

**NEW!** C++ DEBUGGER & EXPANDED C++ TOOLS

**NEW!** OS/2 UPGRADE AVAILABLE NOW!



We listened carefully to what you wanted in a next generation MS DOS C++ compiler. The answer is Zortech C++ V2.0 Developer's Edition.

You wanted the latest AT&T V2.0 features with the power offered by multiple inheritance and type safe linkage, so here it is.

You wanted compatibility with MS WINDOWS, we added it.

You repeatedly asked for easier portability from Microsoft C, we got the message, and have written the library functions you need.

You wanted the world's first MS DOS C++ source level

DEBUGGER, and now the wait is over.

You wanted expanded and improved documentation,

we both listened and delivered.

You wanted to be able to upgrade to an

OS/2 version compiler supporting Presentation Manager, you did not want it to cost a fortune, so it's available for \$150.

You want to look at the standard library SOURCE CODE, so we are including it.

**SAVE \$200**  
Get the Developer's Edition for only \$450 comprising:

C++ Compiler	(\$199.95)
C++ Debugger	(\$149.95)
C++ Tools	(\$149.95)
Library Source	(\$149.95)
<b>Total Value</b>	<b>\$649.80</b>

**Here is our list of highly recommended C++ books:**

C++ Language/Stroustrup	\$32.25
C++ Answer Book/Hansen	\$26.95
C++ for C Programmers	\$29.95
C++ Primer/Lippman	\$30.25

Ask about our new C++ Video Tutorial

For many, EMS programming support, built into the compiler is important, so it's in there too.

You were happy using the 18 classes provided in C++ TOOLS, but we revised and expanded it anyway.

You never asked for a free TSR library to be included, but we knew you'd love to use our neat little package, so we included it free.

You liked our FLASH GRAPHICS package for its speed, but wanted a C++ Class interface, so we've written it.

**How To Order:**

Already own Zortech C++? Call the order hotline for details of our low cost upgrades.

To order Zortech C++ for the first time, just call the order hotline. We accept payment by Mastercard/Visa/COD.

Alternatively, mail the coupon below with your check or credit card details.

ZORTECH INC.,  
1165 Massachusetts Avenue, Arlington, MA 02174, USA  
Voice 617-646-6703  
Fax 617-643-7969

ZORTECH LTD.,  
106-108 Powis Street, London, SE18 6LU, ENGLAND.  
Voice (44)-1-316-7777  
Fax (44)-1-316-4138

**CALL 1-800-848-8408**

**Yes!** Please rush me the following C++ V2.0 items:

Name \_\_\_\_\_  
Address \_\_\_\_\_  
City \_\_\_\_\_ State \_\_\_\_\_ Zip \_\_\_\_\_  
Visa/MC# \_\_\_\_\_  
Exp. Date \_\_\_\_\_ Tel \_\_\_\_\_

- DEVELOPER'S EDITION \$450 (Save \$200)
  - C++ COMPILER \$199.95
  - C++ DEBUGGER \$149.95
  - C++ TOOLS \$149.95
  - LIBRARY SOURCE CODE \$149.95
  - COMPILER & LIBRARY SOURCE \$299.95
  - OS/2 COMPILER UPGRADE \$149.95
  - C++ VIDEO COURSE \$499.95
  - C++ Language /Stroustrup \$32.25
  - C++ Answer Book/Hansen \$26.95
  - C++ for C Programmers/Phol \$29.95
  - C++ Primer/Lippman \$30.25
- For US orders please add \$5.05 shipping  
Overseas orders at international mail rates.

All MicroSoft trademarks are acknowledged.

**1** The NeXT™ Computer System is the first computer in the world (and so far the only) to use read/write/erasable optical storage. While PCs today are typically equipped with Winchester drives that store 20 to 40 MB, a single optical disk can store 256 MB. Plus, it is removable, for portability and added security. This dramatically new technology provides storage that is simultaneously vast, reliable and cost-effective—a combination unmatched by computers of any size.



**2** NeXT has made the power of UNIX® usable by mere mortals. UNIX is the high-performance operating system used by workstations to achieve true multitasking and superior networking. Unfortunately, it has always been the antithesis of user-friendly. NeXT has given UNIX a revolutionary new interface—one that is both visual and intuitive. Now computer users of every level can instantly wield this tremendous power, with no technical knowledge whatsoever.



**3** To achieve the power needed for the 90s, NeXT bypassed traditional workstation architecture and went directly to that of a mainframe. This eliminates bottlenecks and attains an extraordinary level of system “throughput”—the true measure of computer performance. Only through the use of VLSI (Very Large Scale Integration) technology could this architecture be reduced in size so that it could fit inside a desk-top computer. It’s a mainframe on two chips.

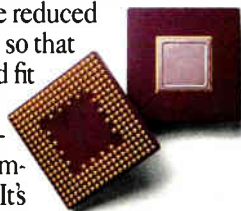

**4** While PostScript® has long been the industry standard for printing, NeXT has made it fast enough to also be used on the display. This “unified imaging model” ensures that what you see on the display is precisely what you will get on paper. All your work, in any size type and any degree of rotation or magnification, appears with perfect 92-dots-per-inch clarity on the NeXT MegaPixel Display. And with laser precision at 400 dpi on the NeXT Laser Printer.



# IN THE 90s, WE'LL ONLY TEN REAL BREAKTHROUGHS. HERE ARE SEVEN.





**5** The NeXT Computer System is the first to be capable of producing CD-quality sound. Without requiring any additional equipment. This feat is made possible by a chip that has been specifically designed for the task of manipulating sound—the Digital Signal Processor (DSP). Because this processor is standard in every NeXT machine, software developers will be able to call upon its power to enrich programs we use every day. Now computers will not just be seen, but heard.



**6** NeXT Mail takes electronic communications beyond anything you've seen on a personal computer before. Now you can send and receive multimedia mail—including text (with varied type fonts, styles and sizes), graphics and voice messages. And despite its high level of sophistication, NeXT Mail is so intuitive, you may not ever need to open the manual. NeXT Mail is built into the system, along with Ethernet and TCP/IP, so the NeXT machine can quickly become a part of existing networks.



machine can quickly become a part of existing networks.

**7** Programmers can create software on the NeXT Computer up to ten times faster than on any other computer—the result of a breakthrough called NextStep.® It gives software developers the power to create the graphical user interface portion of their applications (often the most time-consuming and difficult part) without any programming at all. This revolutionary environment means we will see more programs, and better ones, in less time than ever possible before.

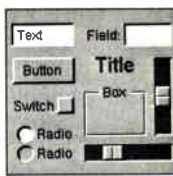

These seven breakthroughs will change the way we use computers in the 90s. Which is why Businessland, the leading supplier of computers to corporate America, chose the NeXT Computer System as the workstation they will offer. Call us at 800-848-NeXT, and we'll send you a 28-page brochure describing the NeXT Computer. We'll also give you the address of your nearest Businessland Center. There, you can experience for yourself the first seven breakthroughs of the 90s. And get a good idea where the next three will come from.



# YOU'LL PROBABLY SEE BROOKINGS IN COMPUTERS. NONE OF THEM.



© 1989 NeXT, Inc. NeXT is a trademark of NeXT, Inc. NextStep is a registered trademark of NeXT, Inc. PostScript is a registered trademark of Adobe Systems, Inc. UNIX is a registered trademark of AT&T.

Circle 254 on Reader Service Card

## NANOBYTES

Meanwhile, as Voyager brushed past Neptune, earthlings were able to see images of the distant planet and its moons on IBM PS/2s at several museums around the U.S. The computers were running DOS-based image management software called **PicturePower**, from **PictureWare** (Bala Cynwyd, PA). The software stores and indexes images and lets the user annotate and manipulate them. Images can be imported in several formats and tied to textual dBASE records. The latest version of PicturePower sells for \$1995. An optional image compression board, which uses the TI DSP 320C10, is \$2000.

Although **Logitech** (Fremont, CA) thinks its **TrackMan** "stationary mouse" will be popular, "it will not replace the mouse" as the standard pointing device, company president Pierluigi Zappacosta said. So what will? **Doug Engelbart**, who invented the mouse in 1962, was at Logitech's briefing when it rolled out the new trackball-equipped TrackMan; he said he is a "great believer in evolution. Eventually the mouse will probably pass, and something else will replace it."

The operating environment that dominates desktop computing in the next decade will have to be able to handle four things, **Quarterdeck** president **Terry Myers** says: "communications, graphics, video, and voice." Those in the running right now, Myers said in an interview, are DOS, Digital Research's DR DOS, Microsoft Windows, OS/2, and Unix.

**Apple's new \$1.5 million corporate TV studio** occupies the building where the **Macintosh design team** once roosted. In those days, they flew a pirate flag from the roof. The remodeled building now houses Apple TV, which will produce in-house training programs and videos for employee inspiration. Apple is currently installing a fiber-optic network throughout its buildings; combined with real-time video cards, such as the new Micro TV from Nolan Bushnell's Aapps, every Mac at Apple could be an Apple TV set.

## Vortex Controller Takes Different Approach to Reconstructing Disks After Disaster

**V**ortex Systems (Pittsburgh) has designed a new disk drive controller card that could significantly affect disk backup systems. Vortex says that its new **RetroChron** controller will continuously back up data and will allow system administrators to restore a disk to the exact state it was in at any previous time. Although the first version of the board will be expensive—about \$5000 in single-unit quantities—the **RetroChron** could be useful on large network file servers, and its technology will surely migrate to less expensive controllers.

The **RetroChron** is essentially an enhanced SCSI disk drive controller for AT-compatible systems. The board has a small cache and can control three SCSI drives, which can appear to system software as one giant "perfect" virtual drive. It differs from other disk drive controllers in that it keeps a time-stamped record of every sector of this virtual drive, and it records every new version of the sector that the system writes to the drive.

With this information, the **RetroChron** can reconstruct a state of the virtual drive at any previous time by

returning the version of each sector that was current at that time. As in the case of a disk-mirroring system, backup is continuous. And, like a tape cartridge system, the Vortex approach maintains a chronological record of the state of the disk. Every time a new version of a sector is written, it must be written twice—once on the primary drive and once on the backup drive.

Vortex officials claim that, in most cases, the disk-caching memory of the **RetroChron** board offsets this overhead and that users won't notice any drops in speed. However, during massive disk writes (e.g., copying a whole directory), speed degradation will be noticeable. The company says that it is planning a future model that will improve disk performance by replacing the card's 80186 processor with an 80386 and 4 megabytes of disk-cache memory.

In addition to a backup disk drive, the **RetroChron** board requires its own 40-megabyte disk drive for queuing disk writes, and a terminal or a PC running terminal-emulation software, by which the system administrator controls the controller.

## Mac's a Part of the Puzzle, AT&T Unix Exec Says

**P**icture vast and glorious networks of multibrand computers, desktop systems and engineering workstations and giant file servers, DOS machines here, OS/2 and Unix machines there, swapping documents and programs, sharing resources and data in an open and harmonious environment. Does this computing pastoral look familiar?

But there's something wrong with this picture of interoperability, according to AT&T's executive in charge of Unix: There's no Macintosh in it.

Unix vendors have to become more concerned with the Macintosh, AT&T's Larry Dooling told an audience at UniForum in Boston.

"How come nobody's worried about the Mac interface?" asked Dooling, president of AT&T's Unix Software Operation. "I'm worried about it," he said. Although computer users are currently concerned with interoperability between Unix systems and IBM-compatible systems, they will soon start demanding that these connected environments include the Mac. It's "the most important user interface today on the desktop," Dooling told his audience of Unix users and developers. "I think we've got users out there who are going to demand that we address interoperability with those systems as well."

### NEWS STAFF SEEKS NEWS. DIAL (603) 924-9281.

*The BYTE news staff is always interested in hearing about new developments that might affect microcomputers, the way they work, or the way people work with them. If you know of a project that could shape the state of the art, please give us a call at (603) 924-9281 or write to us at One Phoenix Mill Lane, Peterborough, NH 03458. An electronic version of Microbytes, offering a wider variety of computer-related news on a daily basis, is available on BIX.*



## NOW YOUR SOFTWARE CAN TEST ITSELF.

**Y**our customers expect software that works. All the time. The key to software quality is exhaustive testing. It's also an engineer's worst nightmare. But it doesn't have to be. Because now you can automate your software testing.

Introducing the Atron Evaluator. The first and only non-intrusive automated PC-based software testing tool.

The Atron Evaluator automatically runs your software regression testing programs. All of them. All day. All night. Giving you thoroughly tested, higher quality software.

The Atron Evaluator is hardware-based. And since it's non-intrusive, software behavior is tested without the risk of alteration. Once your tests have run, you can refer to automatically generated test reports to double-check test results.

The Atron Evaluator saves time. And time makes you money. Development cycles are shortened, so your software gets to market sooner. And while your test programs are running, you can be more productive. Start a new project. Or go home.

For more information about the Atron Evaluator, call us at **1-800-283-5933**. And put an end to your worst nightmares. Automatically.



Saratoga Office Center  
12950 Saratoga Avenue  
Saratoga, California 95070

**In Europe, contact:**  
Elverex Limited, Enterprise House  
Plassey Technology Park, Limerick, Ireland  
Phone: 353-61-338177

QA Training Limited, Cecily Hill Castle  
Cirencester, Gloucestershire, GL7 2EF, England  
Phone: (0285) 655888

Have you ever wished that WordPerfect could format complicated equations, use 150+ high quality fonts and hundreds of special symbols on almost any monitor or printer?

# NEW FASE

Font And Science Extensions

makes your wish come true

- Requires**
- IBM PC 640K
  - MS DOS 2.00+
  - WordPerfect 5.00

- Supports**
- HP LaserJet +, II
  - Epson 9 & 24 pin
  - NEC PinWriter
  - HP DeskJet
  - ProPrinter
  - PostScript
  - Toshiba

ans-Serif  
Dunhill  
Roman  
Italicized  
Monospaced

$\sqrt{2} + \sqrt{3} + \sqrt{4} + \sqrt{\pi}$

Prices start from \$149. Demo Diskette \$3. For more information or to order call or write to

**MICROPRESS inc**  
67-30 Clyde Str. #2N  
Forest Hills, NY 11375  
(718) 575 1816

WordPerfect is a trademark of WPC. NewFase is a trademark of MicroPress

# LETTERS

and Ask BYTE

## Package Deal

I read Don Crabb's "Smalltalk Can Be Cheap" (April) with great interest, and I'm looking forward to the appearance of the course next year. Of course, not having the product is something of a deterrent. Consequently, I suggest that Crabb put together a good book or reference material to be sold with Smalltalk/V for either the Mac or an IBM PC or clone. The possibility of the 80286 should also be kept in mind. In this way, many versions of Smalltalk could be sold, and we'd be able to follow more closely what is being presented in the course. Making object-oriented programming available would be a great service.

C. Metelmann  
Hellerup, Denmark

## Ultimate or Penultimate System?

I just finished reading "The Ultimate Upgrade" by Stanford Diehl (June). As an avid (sometimes rabid) hobbyist, I was very surprised at the upgrade approach that Diehl took—and even more by the total cost.

In May, I completed the upgrade of an old XT clone to a mighty 80386-based machine. My goal was speed with lots of capacity and room to grow. Here's what I got for less than half what you paid. Aside from the Ethernet abilities of your machine, there's not a lot of difference in what yours and mine will do.

I started with an XT form-size 80386 motherboard by Hauppauge Computer Works. This board has a 20-MHz 80386 processor and 1 megabyte of RAM, a Phoenix BIOS, a coprocessor slot, an in-

ternal clock, and all the other normal goodies. It cost me \$1895. In the 32-bit slot, I added a card for up to 8 megabytes of memory and loaded it with 4 megabytes of 80-nanosecond RAM for \$1080.

For storage, I settled on the Seagate 4096 hard disk drive with 80 megabytes of storage and a 28-millisecond access time for \$549; I chose it mainly due to price and my knowledge of the product. I replaced the standard 5¼-inch floppy disk drive with a TEAC 360K-byte 5¼-inch dual floppy disk drive for \$110. To make backups easier, I added an Everex 40 AT 40-megabyte tape streamer for \$349.

For a controller to run the floppy disk drive, hard disk drive, and streamer, I chose the Western Digital WDL1006V-MM2 (it controls two hard disk drives and two floppy disk drives with an 89K-byte look-ahead cache, has a 1-to-1 interleave, and is 16-bit) for \$255.

Most of my work is text-related, so I wanted a graphics adapter and monitor that would not give me eyestrain. I selected the combination of a 14-inch color Taxan 770 Plus Monitor (multisync) and an ATI EGA Wonder adapter. These give me all the colors I need in WordPerfect, Lotus 1-2-3, and Harvard Graphics, as well as 132 columns in Lotus 1-2-3. I paid \$248 for the card and \$930 for the monitor.

I dropped in an I/O card with two parallel ports and two serial ports (\$28) to take my printer and mouse and leave me some spares. For long-distance communication, I added the ATI 2400 modem for \$152.

Just to make sure that there wouldn't be any problems in the power department, I replaced the XT power supply (175 watts) with a 220-W model for \$46. As a last present to myself, I added a 20-MHz 80387 coprocessor for \$395.

The only remaining piece of the XT is the flip-top case. Everything else is different.

Total price: \$6037 plus 2½ hours for assembly and setup.

For the hobbyist willing to take the

*continued*

WE WANT TO HEAR FROM YOU. Please double-space your letter on one side of the page and include your name and address. We can print listings and tables along with a letter if they are short and legible. Address correspondence to Letters Editor, BYTE, One Phoenix Mill Lane, Peterborough, NH 03458.

Because of space limitations, we reserve the right to edit letters. Generally, it takes four months from the time we receive a letter until we publish it.



# Introducing the first color PostScript printer priced to keep you in the black.

The QMS  
ColorScript 100  
Model 10.  
Just \$9,995.

Show-stopping presentations, powerful projections and crystal clear calculations in hard copy or transparency form. Everything your business needs to stand out from the crowd. All in a full spectrum of color for just \$9,995. The QMS ColorScript™ 100 Model 10 easily connects to your Mac® or PC to add full color and the power of true Adobe® PostScript to your business — and, at this price, it helps you stay in the black! It's another first from QMS® and a breakthrough in color PostScript® printers.

**Limitless Possibilities.** The new QMS ColorScript 100 Model 10 allows you to have total control over the final appearance of your hard copies and transparencies. The Model 10 includes 35 resident typefaces that, thanks to PostScript, can be scaled to virtually any size and shape. Put that together with its ability to print over 16 million color variations and you'll see an entirely new dimension to composition.

**Exclusive Advantages.** The compact Model 10 gives you advantages you won't find with the competition. For example, PC users can put the Model 10 to work without adding any additional boards. And Mac users simply plug the Model 10 into the AppleTalk® port. The Model 10 prints at 300 dpi for near typeset quality presentations that spring to life in colors that adhere to PANTONE®\* Color Standards. If you need to expand your printing capabilities or memory, the Model 10 is designed to easily accept a 1 MB or 4 MB RAM upgrade. The Model 10 also features a SCSI interface that makes adding enough memory to store the entire PostScript typeface library as simple as plugging in a lamp.

**1-800-523-2696.** If improving your business edge is important to you, call our toll free number for the nearest Laser Connection® dealer. Your Laser Connection dealer can give you a demonstration and show you how the QMS ColorScript 100 Model 10 will add a colorful dimension to your presentations — *and* help keep you in the black.



The following are trademarks of their respective companies: QMS, QMS ColorScript, Laser Connection of QMS, Inc. PostScript, Adobe of Adobe Systems, Inc. Mac, AppleTalk of Apple, Inc. PANTONE of Pantone, Inc.

\*Pantone, Inc.'s check-standard trademark for color reproduction and color reproduction materials.

**LASER  
CONNECTION®**

A QMS® Company

**1-800-523-2696**

©1989 Laser Connection

Circle 300 on Reader Service Card (DEALERS: 301)

World Radio History

time to investigate the equipment on the market and match it to his or her needs, it is possible to build a machine as good as or better than a brand-name machine.

Mark E. Hazlewood  
Middes, Switzerland

### OS/2 on the Cheap

In his article entitled "OS/2 for Cheap" (April), Mark Minasi went to great lengths building an "inexpensive workstation that supports Presentation Man-

ager," yet his total price for a 10-MHz 80286 machine was \$3444. Cut me a break!

First of all, why would anyone buy a slow 80286 when he or she could buy a 20-MHz 80386 for less money than Minasi spent? I would suggest that he carefully read Steve Apiki and Stanford Diehl's article "80386s for the Masses" (October 1988).

Second, Minasi spent \$300 extra on an 80-megabyte hard disk drive (the approx-

imate price difference between a 40-megabyte and an 80-megabyte hard disk drive) when a 40-megabyte drive would have done just fine.

Third, everyone knows that PM and all the application software being written for it will be graphics-based, yet Minasi chose to save money by buying a monochrome monitor.

I suggest that Minasi forget the 80-megabyte hard disk drive and buy a VGA monitor, recheck the mail-order prices for 20-MHz 80386 machines, and read his copies of BYTE more carefully.

William Vantine  
Arlington, VA

# Finally, A Trackball for your PC

## Two High Performance Mouse Alternatives



### PC-TRAC™

Serial version \$119  
Bus version \$139

The standard in PC Trackballs for direct mouse replacement



### FastTRAP™

Serial version \$149  
Bus version \$169

Trackball with Trackwheel™ for third axis pointing capability in advanced applications

Attention PC users. Introducing two products that have been quietly appearing on desks of thousands of PC users for over a year: MicroSpeed's PC-TRAC™ and FastTRAP™ trackballs.

- Uses 1/3 the desk space of a mouse  
Free up your desk space to do what it was designed to do — hold your coffee cup and stacks of incoming work.

- **Plug and play compatibility**

MicroSpeed's advanced pointing device driver is fully compatible with application software supporting Microsoft™, Logitech™, and other popular mice. Also included is a Windows™ driver and a utility for use with non-mouse driven software.

- **PC-TRAC and FastTRAP work where you put them**

No more "row, row, row the mouse" when you run out of desk space before you run out of screen. Scroll across spreadsheets with finger tip



**MICROSPEED™**  
INCORPORATED

control. Page up and down documents without so much as moving your wrist. Control CAD programs to a single pixel. All in a space less than 4 1/4" wide.

- **Pinpoint accuracy automatically**

MicroSpeed's pointing device driver has "self adjusting" resolution from 50 to 1,000 dpi. Speeding across the screen or working with precision graphics, the MicroSpeed driver automatically adjusts to the resolution you need.

- **PC-TRAC and FastTRAP require no cleaning**

Our quiet, durable opto-mechanical design requires no cleaning or maintenance.

Looking for a proven mouse alternative for your PC? Give us a call. We're rolling!

**1-800-232-7888**

In California call (415) 490-1403  
FAX (415) 490-1665

MicroSpeed, PC-TRAC, FastTRAP and Trackwheel are registered trademarks of MicroSpeed, Inc. Microsoft and Windows are registered trademarks of Microsoft Corporation. Logitech is a registered trademark of Logitech, Inc.

*You seem to be saying three things: Buy an 80386, because it will be cheaper than the 80286 that I recommended; buy a VGA graphics system; and don't buy an 80-megabyte drive—buy a 40-megabyte drive and save \$300. I'll cover these points one at a time.*

*First, I said that a 4-megabyte 80286 system with a hard disk drive controller, keyboard, and 1.2-megabyte floppy disk drive would cost about \$2390. Sure, you can find 20-MHz 80386s for about \$2000, but you've got to add 3 megabytes more of RAM at that point, which cost about \$1600 in December 1988, when I wrote the first column. In "Electing the PM" (February), I said, "To simply boot the PM with the compatibility box requires 2.6 megabytes, and you're best with a minimum of 4 megabytes." Refer to point 3 in your letter.*

*Second, you seem to be confusing the notion of a monitor type with a graphics board type, which is a common and quite understandable confusion. You see, merely having a monochrome monitor does not imply that you do or do not have graphics capabilities: It is the video board that determines what level of graphics you can support. As I said in my column, the Paradise Monochrome EGA card, as you would expect, supports full EGA graphics on a monochrome monitor. You get the full functionality of an EGA card and monitor—the only difference is that you see shades of gray rather than colors. Sure, VGA monitors are nice, but they're also pricey. The Paradise board and a monochrome monitor can be found discounted for about \$270. For a little more money, my fellow columnist L. Brett Glass speaks highly of the MultiSync GS, a monochrome multiscanning monitor that can display VGA as shades of gray.*

*Third, how large a hard disk drive to buy is a matter of personal preference.*

*continued*



# The Ultimate Business Computers



Model 212D 80286-12MHz / Model 210D 80286-10MHz  
Model 316SX 80386SX-16MHz

Model 320 80386-20MHz

Model L325C 80386-25MHz

Model 325CT 80386-25MHz

Sparrow I/16 80286-16MHz

*"...When it comes to the basics, price, performance...capacity...CLUB American Technologies...delivers outrageous value."*  
PC WORLD September 1989

**Come see us at  
the Sahara Hotel,  
COMDEX/Fall,  
Booth 9718**

## The Ultimate Business Computers

In 1986, CLUB American Technologies introduced the first personal computers designed for heavy industrial and commercial use. Since then, over 175,000 CLUB computers have been installed worldwide and have been well accepted by the **Fortune 500, Government Institutions and thousands of small businesses.**

This overwhelming success in CLUB's computers is a result of excellence in engineering during which no details are overlooked from the initial design to the final product. Also during manufacturing, each system is subject to an intensive SCBI process followed by In-Circuit Simulation Field Testing.

If your business computer that can in today's competitive and find out more about the Computers from CLUB American Technologies.



is looking for a give you the edge marketplace, call today Ultimate Business

**(415) 683-6600**

In Canada, PC Centre: (416) 470-0560  
International: (415) 683-6659  
Technical Support: (415) 683-6580



The reason that I recommended 80-megabyte drives is that they seem, at the moment, to be an excellent buy in terms of bucks per megabyte. For example, the advertisement on page 358 of the June BYTE for Mead Computer shows that a Seagate 4096 80-megabyte drive sells for \$649. And Mead sells its 40-megabyte 4053 for \$519. Paying \$180 for 40 megabytes is a deal that I just can't refuse. And the Seagate 4096 can be had for even less—the one in the machine that I'm now working with cost me \$550.

Remember, hard disk space is like all the good things in life—you just can't get enough of it. —Mark Minasi

### Nectar in a Sieve

Nick Pelling's letter describing a more efficient algorithm for the Sieve of Eratosthenes ("Algorithm Optimizing," May) fired my imagination, with startling results.

In the Sieve, all multiples of numbers greater than 1 are cleared in an array of flags. The remaining flags are prime numbers.

Pelling made the following points: In choosing numbers whose multiples to

test, only prime numbers need to be used; each prime number used can begin the search at its own square; and the highest prime to use in this way is the square root of the size of the array.

This was the fastest prime-number algorithm I'd ever seen, and I got excited. After a while, this led to an inspiration: While each prime is testing its way through the array, every second test is against an even number. If these are eliminated, the speed of the algorithm doubles.

Pelling's BASIC program was similar to this (I've added line numbers for reference):

```

1 max=8192 : root=INT
  (SQR(max)) : DIM flags(max)
2
3 FOR num=1 to max
4   flags(num)=TRUE
5 NEXT num
6 FOR num=2 TO root
7   IF flags(num) THEN
8     FOR mult=num*num TO max
7       STEP num
8       flags(mult)=FALSE
9     NEXT mult
10

```

```

11 END IF
12 NEXT num

```

I changed three of the lines:

```

2 flags(2)=TRUE
3 FOR num=1 to max STEP 2
8   FOR mult=num*num TO max
   STEP num*num

```

The altered program runs twice as fast as the original.

A second idea is to compress the array. The new algorithm never uses the even-numbered flags, so they don't have to be there. By having the flag array represent successive odd numbers, twice as many primes can be found in the same amount of memory.

Milton Pope  
Bakersfield, CA

### Patents Aren't Panaceas

I have seen enough of these shortsighted pieces extolling the virtues of patents ("Quarterdeck Patents Multitasking Technique," BYTE Special News Supplement, July).

continued

# Travel Companions.



The WorldPort 2400™ and the WorldPort 1200™ modems are the perfect travel companions for your portable computer. They work virtually anywhere in the world, including hotel rooms and phone booths, allowing you to connect in a few million more locations than other modems.

With features superior to internal units, the WorldPort line of modems is the smart choice for all your communication needs. WorldPort modems operate from their own internal battery,

drawing no power from your laptop. Cutting edge technology brings you features such as Bell and CCITT standards, direct connect and acoustic interface (300 and 1200 bps), tiny size and a tiny price. The WorldPort 1200™ can be easily upgraded to 2400 bps and both the WorldPort 2400™ and the upgrade come with Carbon Copy PLUS™ communications software.

Find out more about the travel companions that won't tie down your portable computer. Call us

today for more information about the WorldPort line of modems, or the name of your nearest dealer, at **800-541-0345**. (In New York, 516-261-0423.)



Touchbase Systems, Inc.  
160 Laurel Avenue  
Northport, NY 11768  
(516) 261-0423  
TELEX: 6502848020  
FAX: (516) 754-3491

WorldPort 1200 and WorldPort 2400 are trademarks of Touchbase Systems, Inc., Carbon Copy PLUS is a trademark of Meridian Technology Inc.



# Intelligent Database Tools are Here!

## Is your Database an Asset or just a File?

As your database grows, its potential value increases. Your challenge is to keep it error-free, understand it, and use it to make effective decisions. These are the tools you need:

### **SUPERVISOR**

Maintain data quality and data integrity. Keep your database error-free. Database/Supervisor analyzes your databases and identifies *suspicious data items*, and patterns which are out of the ordinary. It automatically detects errors which violate statistical or logical integrity constraints. *If your database is being corrupted, Database/Supervisor will show you where.*

### **IXL** The Machine Learning SYSTEM

Discover *hidden patterns and unexpected relationships* in your large database. IXL analyzes your database and generates easy-to-read rules using artificial intelligence and statistical techniques. While Database/Supervisor detects errors, IXL produces rules and decision-making insight. *The solutions you are looking for may already be in your database, waiting to be discovered.*

### **NEURAL/QUERY**

Don't deny yourself inexact, but potentially valuable, answers to your database queries. Close matches are more valuable than *no response*. IXL and Neural/Query are perfect partners. IXL generates rules which can be exported. However, Neural/Query analyzes your large database, builds a network of partial matches, and provides the closest matching answer to your database queries. *Use the full informational content of your database.*

### **Intelligence COMPILER**

The highest-level, easiest-to-use intelligent database environment today. Build dialogs automatically, link them with rules, frames and hypertext *in minutes*. Develop your intelligent application quickly and efficiently, then run it on multiple operating systems. The built-in relational database combines expert system logic with SQL-based object oriented queries. *Accomplish in hours what would otherwise take weeks.*

Experts love our software:

#### Experts love our software:

The Intelligence/Compiler is a powerful state of the art system for real-world applications. Its intelligent editing and debugging facilities are a bonus. *AI/Expert Magazine*, February 1988.

Considering the variety of features that the Intelligence/Compiler provides, it is hard to believe that you can get better value for your money. *PC/AI Magazine*, June 1989.

Having used IXL on a large database of geological test data, we were surprised by the many relationships it found. This has greatly helped us to interpret our Oil Company database. *Mr. James Brown*, Oil Industry Consultant, July 1989.



Will your database errors live forever?

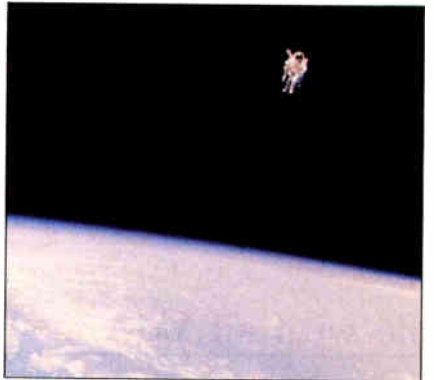

Alone in a universe of data? Let IXL be your guide.

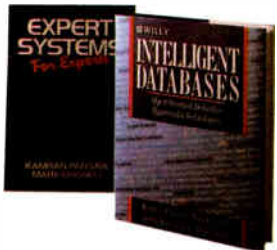

Our leadership in this field of technology is unsurpassed. Ask for our books *Intelligent Databases* and *Expert Systems for Experts* by K. Parsaye, et al., published by John Wiley.



Are you sure you have no listing for the Vite House.



**IntelligenceWare**  
The Next Level in Computing  
Circle 178 on Reader Service Card

**Yes,** I want to win with your easy-to-use intelligent database tools.

Send me your complete collection of intelligent database tools for \$1,490.

Send me the three components: \_\_\_\_\_, \_\_\_\_\_, \_\_\_\_\_, for \$990.

Send me the single component: \_\_\_\_\_ for \$490.

Computer system:  IBM/PC  PS/2  Macintosh

Name \_\_\_\_\_

Company: \_\_\_\_\_

Address: \_\_\_\_\_

Telephone: \_\_\_\_\_

Also available on VMS, Unix and OS/2

Check enclosed, Charge to:  Visa  MC  AMX

Card No: \_\_\_\_\_ Expiration \_\_\_\_\_

**IntelligenceWare**  
9800 S. Sepulveda Blvd.  
Los Angeles, CA 90045-5228  
Telephone: (213) 417-8896  
Telefax: (213) 417-8897

For telephone orders call (800) 888-2996  
Shipping and handling: US \$9, Canada and Hawaii \$20,  
Overseas Air \$50. California residents please add 6.5% sales tax.



# We make a super VGA monitor



NEC presents the MultiSync<sup>®</sup> 2A, the best VGA monitor you can buy.

It's the first monitor from the leader in the color monitor industry that's been customized to

the needs of the VGA user.

The MultiSync 2A is affordable and uncompromised. And compatible with all VGA modes. In short, it performs brilliantly. But what's equally important, it allows you to move effortlessly to the next major graphics standard: SuperVGA. That's something fixed-frequency monitors like IBM and Compaq can't do.

All this in a monitor that gives you a 14" non-glare screen on a tilt-swivel base, for nearly 30% more viewing area than standard 12"

VGA mode shown at 320 x 200.

screens, as well as a new, ergonomically designed cabinet.

MultiSync is a registered trademark of NEC Home Electronics (USA) Inc.

MultiSync 2A. One super VGA monitor.

IBM is a registered trademark of International Business Machines Corporation.



that's also a SuperVGA monitor.

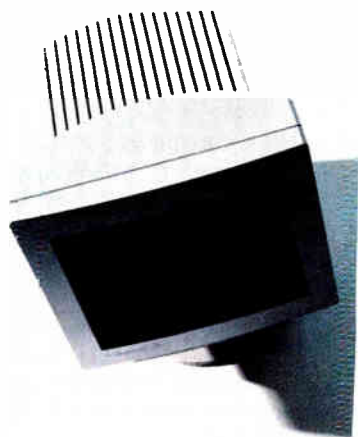

But that's only part of the story. NEC also presents the best SuperVGA monitor you can buy. MultiSync® 2A.

The monitor that senses the software you're using and makes the switch from a VGA monitor to SuperVGA, the new standard developed by NEC and recognized by VESA. SuperVGA delivers a maximum resolution of 800 x 600, which is 56% higher than VGA.

After all, since you're most likely buying a board that goes beyond VGA, your monitor should too.

The MultiSync 2A is also available in a gray-scale version called the MultiSync GS2A monitor, with a 14" paper-white flat surface screen.

Compaq is a registered trademark of Compaq Computers Corporation.

Either way, it's one super SuperVGA monitor. For literature call 1-800-826-2255. For information call NEC at 1-800-FONE-NEC.

VESA is the Video Electronics Standards Association.

MultiSync 2A. One SuperVGA monitor.

©1988 NEC Home Electronics (USA) Inc

Circle 251 on Reader Service Card

**NEC**

Digitron Telecommunications is a small computer engineering company specializing in audiotex and automated telemarketing systems. Since it is our innovative technology that sets us apart from our much larger and well-established competition, we viewed patents as a logical way to protect our innovative technologies. After consulting with patent attorneys, we soon found that the picture wasn't nearly so rosy as the article would have us believe.

Obtaining a patent for a piece of software typically costs between \$3000 and \$10,000. This is more expensive than patents for mechanical devices because of the flow charts and other software-specific documentation required. Most companies, even small ones like ours, can afford this price. However, once you have obtained the patent, you are not out of the woods yet. If one of your competitors challenges your patent, the costs of defending it can easily run into several hundreds of thousands of dollars. If one of the megacompanies (e.g., IBM, Computer Associates, or Microsoft) comes after a little software company, it can bury the small company in the legal costs of defending the patent.

Also keep in mind that by patenting a technology, you release your trade secrets, so that everyone has access to the details of your work.

In the end, we decided not to patent our software, since we don't want to give it away for free and we couldn't afford several hundred thousand dollars in legal fees to defend our patents.

Like so many things in our litigious society, the patent process defends the mighty at the expense of the weak. The eventual outcome of widespread software patents will be to kill innovative small companies and to ensure a software monopoly for the few megacompanies who can outspend everyone else in court.

Steven Marc Abrams  
Westbury, NY

### Praising the Pioneers

I enjoyed Rick Grehan's "Directory Assistance" (Parts 1 and 2, May and June) but lamented his omission of the pioneer TRS-DOS and LS-DOS systems on the TRS-80s. While these veteran operating systems may not hold the market share they once did, they provide many useful and sophisticated features that their more popular contemporaries sorely lack.

For instance, file specifications are hashed to an 8-bit value and indexed in a table occupying one directory sector. Once it has located the information, the disk operating system goes directly to the

directory entry and wastes no time wading through all the other directory entries. Thus, the TRS-80 has faster file access than many of its 16-bit rivals.

Directory sectors use a unique data address mark so that the system can distinguish them from data sectors, making it nearly impossible for an application inadvertently to destroy the directory.

The flexibility that TRS-DOS and LS-DOS afford is also noteworthy. Though it predates 3½-inch floppy disks, it automatically recognizes them in a system (there's no need for CONFIG.SYS device specifications). The directory is normally located on the center cylinder, but the user can specify any cylinder at format time (BOOT.SYS on track 0 points to the directory). Until I learned of MS-DOS's insistence on putting the directory on track 0, I wondered why the drives chugged so much before doing anything!

From the user's perspective, however, the most important feature of any disk operating system is the friendliness and utility of its file-handling features. Here the TRS-80 disk operating systems surpass many popular systems. TRS-DOS and LS-DOS go far beyond simply assigning attributes and access levels to files. Owner and user password protection is provided, and a password may be assigned to protect the entire disk as well.

BACKUP outperforms many commercial backup products I've used under MS-DOS. An irritating feature of MS-DOS (and CP/M) is the archaic need to "log into" a drive and then set up a path to overcome this deficiency. TRS-DOS and LS-DOS will automatically search all on-line drives until the file is found (this means there can be no subdirectory structures, but that's easily overcome by disk partitioning). The meager MS-DOS DIR display has always irked me; TRS-DOS and LS-DOS use the full video display width to show useful information like the number of extents, number of records, protection level, logical record length, and end of file (in addition to the usual stuff).

The TRS-80 Z80-based family has never received the recognition that it deserves for efficiency and functionality. I only hope that the new Z-280 isn't too late to change that.

Jeff Joseph  
Wheeling, IL

### Sony Singled Out?

We were quite distressed to read Hugh Kenner's review of Fred Warshofsky's *The Chip War* (June).

Warshofsky's original text was incor-

rect. Although his quote was based on an interview with William Taylor, we suspect that Taylor may have been using the Sony name as being symbolic of all Japanese manufacturers. The bottom line in the story Taylor relates is not "how Sony got into the [TV] business," since Sony never sold private-label TVs to either Sears or RCA.

Jason Farrow  
Senior Vice President  
Corporate Communications  
Sony Corp. of America

### Growing Old Gracefully

May the Macintosh never grow old gracefully.

The day that Apple implements Don Crabb's suggestions ("The Mac Interface: Showing Its Age," *Macintosh Special Edition*, June)—most notably the command-line interface that he seems so fond of—is the day I stop buying and recommending Apple computers.

It's not that I wouldn't appreciate some way to batch up repetitive tasks, but I already have that in any of several macro tools (including one that comes with the computer). I cannot think of anything that grep will do for me that direct manipulation or a quick HyperCard program won't do better (with a lot less chance of destroying more data than any virus ever did).

Tom Pittman  
San Jose, CA



ASK BYTE

### High-Energy Help

I am a computer science major interested in robotics and high-energy physics. I am seeking any information regarding what past issues of BYTE may have had Circuit Cellar projects concerning those subjects. My local libraries and school libraries carry BYTE only from 1985 on. I remember several years ago reading an article in BYTE that dealt with the technical aspects and considerations of constructing a robot manipulator arm. I cannot recall what issue that was in.

Jim Burke  
Carrollton, TX

*There have been precious few Circuit Cellar articles on topics in high-energy physics. In fact, that's a subject we rarely cover in detail anywhere in BYTE. As for robot manipulator arms, a search through BYTE's back issues revealed "A*

*continued*



**Price**  
**Quality**  
**Service**

**This is where it all  
comes together.**



## Quality

Gateway 2000's quality standards set us apart from our competition. From the top quality name brand components used in our systems to the painstaking quality assurance tests we run on our machines, you are guaranteed a top quality computer. Our complete line of computer systems are hand built in our factory located just outside Sioux City, Iowa. State of the art technology is used to provide you with a combination of performance, compatibility, and reliability that few vendors can match. One customer recently wrote: *"The quality of your work is exemplary and frankly has made a lot of others jealous because they bought systems which were comparable in quality but with a stiff price difference"*—George Syty.

## Service

Gateway 2000's service policies are the best in the industry. We stand behind all of our systems with a **30 Day Money Back Guarantee** and a **1 Year Warranty**. We also offer **Lifetime Toll-Free Technical Support**, and **Free Federal Express Shipping** of replacement parts. If our technicians can't solve your problems over the phone or Fed-X you a solution we can dispatch a technician to most locations to provide **Free On Site Service**. Our policies are great, but it's our people that really set us apart from the competition. Look at what our customers write:

*"Thank you very much for kind attention and help. I am highly recommending your corporation to colleagues for your quality and service"*—Herbert Markley.

*"I've always heard your forte is customer service, and now you have definitely proven it to me"*—Jose De Jesus.

*"I am really glad I chose Gateway 2000"*—Jerry Langland.

*"I feel compelled to express my gratitude to your company for the impeccable service and support I received"*—Andrei Weizsmann.

*"It is a pleasure indeed, to work with a computer sales company that exhibits a genuine desire to satisfy the customer"*—Ror. L. Kinney.



GATEWAY 2000 • P.O. BOX 2000  
SERGEANT BLUFF, IOWA 51054  
800-523-2000 • 712-943-2000  
FAX 712-943-2023

*Due to the volatility in the DRAM market, all prices are subject to change.*



## This is where it all comes together.

We founded Gateway 2000 on this farm located near Sioux City, Iowa to provide top quality computers at unbeatable prices with uncompromising service after the sale. No other company offers you the combination of *Price, Quality, and Service* that we do. We want you to be completely satisfied with your decision to purchase a Gateway 2000 computer system, and you have our personal pledge that you will be. We look forward to you joining our thousands of satisfied customers, and establishing a long lasting business relationship.

Sincerely;

Ted Waitt  
President

Norm Waitt Jr.  
Vice President

## Price

Gateway 2000 offers the most aggressive prices in the industry. We offer fully loaded machines for the same price as most vendor's stripped down models. One customer wrote *"I'm surprised that the computer media haven't mentioned anything about your prices relative to the rest. You don't merely edge them out you blow them away"*—Clarence Larson. Look at our prices on the **back page** of this ad, shop around, compare apples to apples, then call Gateway 2000's knowledgeable sales staff to discover the **GATEWAY DIFFERENCE**. *"I chose Gateway after much research because I felt that the product was the best value for the money and the sales staff was very patient with my never ending list of questions and and inquiries"*—Keith Lazan.

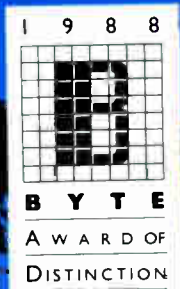

### 20 MHZ 386 VGA

- 1 Meg RAM
- 1.2 Meg 5¼" Drive
- 1.44 Meg 3.5" Drive
- 80 Meg 28ms Drive
- 16 Bit VGA Board
- 14" Multisynch Monitor
- 1 Parallel & 2 Serial Ports
- 101 Key Keyboard
- MS DOS 3.3 or 4.01

**\$2995.00**

Upgrade to 4 Megs \$400  
64K Cache Add \$250

### 25 MHZ 386 VGA

- 4 Megs RAM
- 1.2 Meg 5¼" Drive
- 1.44 Meg 3.5" Drive
- 150 Meg 16.5ms ESDI Drive
- 16 Bit VGA Board
- 14" Multisynch Monitor
- 1 Parallel & 2 Serial Ports
- 101 Key Keyboard
- MS DOS 3.3 or 4.01

**\$3995.00**

64K Cache Add  
\$500

### 33 MHZ 386 VGA

- 64K Cache RAM
- 4 Megs RAM
- 1.2 Meg 5¼" Drive
- 1.44 Meg 3.5" Drive
- 150 Meg 16.5ms ESDI Drive
- 16 Bit VGA Board
- 14" Multisynch Monitor
- 1 Parallel & 2 Serial Ports
- 101 Key Keyboard
- MS DOS 3.3 or 4.01

**\$5495.00**

### GATEWAY 386SX

- 2 Megs RAM
- 1.2 Meg 5¼" Drive
- 1.44 Meg 3.5" Drive
- 40 Meg 28ms Drive
- 16 Bit VGA Board
- 14" Multisynch Monitor
- 1 Parallel & 2 Serial Ports
- 101 Key Keyboard
- MS DOS 3.3 or 4.01

**\$2395.00**



GATEWAY 2000 • P.O. BOX 2000  
SERGEANT BLUFF, IOWA 51054  
800-523-2000 • 712-943-2000  
FAX 712-943-2023

Due to the volatility in the DRAM market, all prices are subject to change.

### 12 MHZ 286 LAPTOP

- Gas Plasma Display Screen
- 2.6 Megs RAM
- 1.44 Meg 3.5" Floppy Drive
- External Port for 5¼" Drive
- 40 Meg 28ms Hard Drive
- 1 Parallel & 1 Serial Port
- Expansion Slot (16 Bit)
- External EGA Monitor Port
- 84 Key Keyboard
- MS DOS 3.3 Installed

**\$2995.00**

### 12 MHZ 286 VGA

- 80286-12 Processor
- 2 Megs RAM
- 1.2 Meg 5¼" Drive
- 1.44 Meg 3.5" Drive
- 40 Meg 28ms Drive
- 16 Bit VGA Board
- 14" Multisynch Monitor
- 1 Parallel & 2 Serial Ports
- 101 Key Keyboard
- MS DOS 3.3 or 4.01

**\$2195.00**

### 16 MHZ 286 VGA

- 80286-16 Processor
- 2 Megs RAM
- 1.2 Meg 5¼" Drive
- 1.44 Meg 3.5" Drive
- 40 Meg 28ms Drive
- 16 Bit VGA Board
- 14" Multisynch Monitor
- 1 Parallel & 2 Serial Ports
- 101 Key Keyboard
- MS DOS 3.3 or 4.01

**\$2295.00**

### 20 MHZ 286 VGA

- 80286-20 Processor
- 2 Megs RAM
- 1.2 Meg 5¼" Drive
- 1.44 Meg 3.5" Drive
- 40 Meg 28ms Drive
- 16 Bit VGA Board
- 14" Multisynch Monitor
- 1 Parallel & 2 Serial Ports
- 101 Key Keyboard
- MS DOS 3.3 or 4.01

**\$2395.00**

Circle 147 on Reader Service Card



*Hobbyist Robot Arm*" in our February 1979 issue. Perhaps that's the article you recall. The most recent construction article on robotics that *BYTE* presented was in our April and May 1987 issues: "Build BERT, The Basic Educational Robot Trainer."—R. G.

**Desktop Publishing**

I am the computer operator for a small realty company, and we need a good, powerful desktop publishing system and a hand-held graphics scanner. We have an IBM PS/2 Model 50 with 1 megabyte of memory, a 1.44-megabyte 3 1/2-inch floppy disk drive, a 20-megabyte hard disk drive, and a monochrome monitor. We also have an Okidata Microline 320 printer.

Kevin C. Redden  
Vanceburg, KY

The Model 50 should be more than capable of handling either PageMaker or Ventura Publisher, both of which are excellent desktop publishing software packages. To install PageMaker, you will also want to buy a full copy of Microsoft Windows 286. PS/2 mice are available from a number of sources.

The Okidata Microline 320 can be purchased as either Epson FX-80-compatible or IBM Graphics-compatible. If you choose PageMaker/Windows, you could try either the IBMGRX driver or the EPSON9 driver. As I recall, Ventura Publisher supports the printer directly.

Take a look at "Handy Scanners" in the June *BYTE* for a review of popular hand scanners. After you scan your image, convert it to either PCX or TIFF. From there, either PageMaker or Ventura Publisher can merge your scanned images into your layout. The only problem you might run into is disk space—desktop publishing programs and files take up a lot of it.—H. E.

**Pass the Drives, Please**

I have a Compaq Portable 386 with an internal 3 1/2-inch floppy disk drive. I have looked all over for a way to install an external 5 1/4-inch disk drive in this system. Any inspirations?

Scott Kirkwood  
Minneapolis, MN

According to Compaq, your Compaq Portable 386 provides for only one floppy disk drive, which can be your choice of either 3 1/2-inch or 5 1/4-inch. The only way to get the second drive connected is through a second floppy disk drive controller. You'll need one that responds to a

*continued*

# From purple graphic majesties to floppy waves of data. \$69.95

Instant access to charts and tables showing detailed demographics, history, facts and figures.

A single, efficient source for time zones, zip codes, area codes and other specifics.

Cross-compare states or regions automatically with the simple touch of a key or click of a mouse.

Simple pull-down menus allow for easy access to state facts, maps and charts.

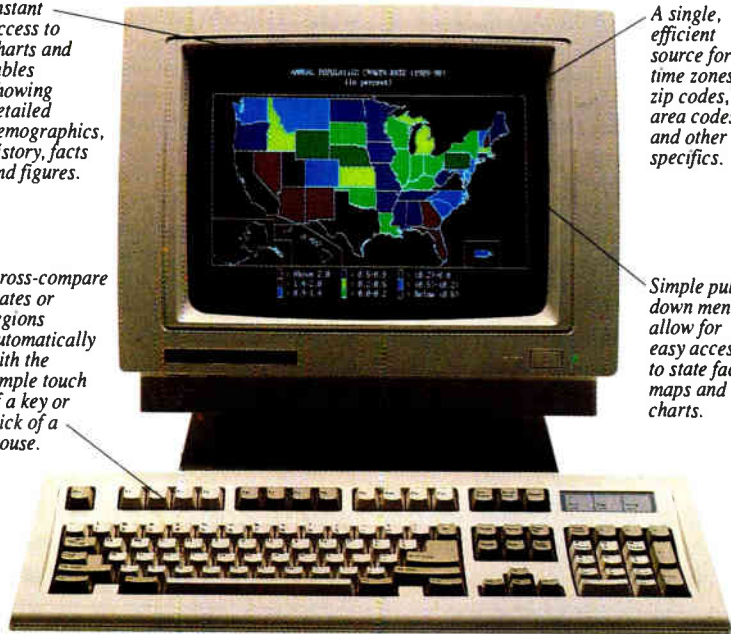

**"See us at COMDEX, Booth W606, Westhall."**

Finally, an invaluable resource tool that brings the United States into better focus.

Beginning now, business-people, travelers and educators will have immediate access to a single, complete source of maps and data for every state. And for nearly every need.



Stunning comparative maps of the entire country as well as regions and individual states. Populations, average incomes, tax rates, state economies and even school enrollments are instantly defined.



Bar charts and graphs display data on every state ranging from demographics, education, employment and industrial statistics to electoral data, state history, climate information and tourist attractions.



Beautiful maps of all 50 states and Puerto Rico. View major natural features, elevations and locations of each state's largest cities.

PC USA is a simple to use "Electronic Atlas." An instant guide to geographical and demographic information allowing businesses an efficient means to gather facts.

What's more, PC USA text and graphics can easily be exported to other programs.

Available at Egghead, Electronics Boutique, Software, Etc. and Software City, or call us directly.

**1-800-255-2789**



**PC Globe**

4435 S. Rural Rd., Suite 5-333  
Tempe, Arizona 85282  
(602) 894-6866  
Facsimile (602) 968-7196

Also available: PC Globe with instant profiles and cross comparisons for 177 countries. \$69.95.

Works with IBM® PC/XT/AT/PS2 and compatibles with a minimum of 512K RAM. Supports Hercules® monochrome, CGA, EGA and VGA displays, DOS 2.0+. Single floppy or hard disk. "PC USA" is a trademark of PC Globe, Inc. "PC Globe" is a registered trademark of PC Globe, Inc. © 1989.

secondary device address. The *Compati-Card 1* from *Micro Solutions* (132 West Lincoln Hwy., De Kalb, IL 60115, (815) 756-3411) may be just the beast you're looking for.

To install it, you need a card slot. On the *Portable 386*, that means buying the expansion box that bolts onto the back of your computer. On the drive side, you'll have to locate a 5¼-inch disk drive in an external housing with a power supply. Find or make a cable that attaches to the external connector on the *CompatiCard*.

The only hard part here is finding the external drive. The expansion box comes from a Compaq dealer. The dealer may be able to get you the external floppy disk drive. A number of mail-order places advertise here in *BYTE*, or you can probably find what you want at a local computer flea market.—H. E.

**Bad Drives**

I own an 8-MHz IBM AT compatible that I bought in the U.S. in May 1986. I would like to add an internal 3½-inch floppy disk drive to this machine. I tried installing a 1.44-megabyte Chinon drive but ran into serious problems.

After configuring the system with *SETUP* (I told it I had a 720K-byte drive, since it doesn't know about newer 1.44-megabyte drives), I discovered that only *DIR* and *CHKDSK* would recognize the drive. Copying files to or from the drive produced a "Sector not found" error, while *FORMAT* complained, "Invalid media or Track 0 bad—disk unusable." The disk I used had been previously formatted for 1.44 megabytes on an IBM *PS/2 Model 80*. Trying other disks didn't help, either.

Since the same drive functions flawlessly in an MCI AT compatible, I am assuming that my disk drive controller is at fault. It could be that I have an older model that can't handle these drives properly. Judging from all the "WD" part numbers on the chips, it is probably a Western Digital controller. It is labeled "FIXED DISK - FLOPPY DISKETTE ASSY. 61-031099-00 Rev. X7A."

Assuming that the controller is otherwise in order, is there any way (e.g., jumper settings or some work with a soldering iron) to make it work with a 1.44-megabyte drive? Is it possible that a drive from another manufacturer might work?

Failing all the above, is there a cheap floppy disk drive controller that I could add just for the new drive? I'd hate to junk an otherwise perfectly functioning controller for the added convenience of 3½-inch disks, despite the recent low prices for such drives.

Dr. A. C. Kridiotis  
Köln, West Germany

*In describing your problem, you failed to mention which versions of DOS are running on your AT and MCI AT compatibles. I'd guess that you are running PC-DOS 3.1 or an even earlier version of DOS on your PC AT. If so, upgrade your system to PC- or MS-DOS 3.3. This newer DOS has the DRIVER.SYS device driver that will enable DOS to recognize add-on disk drives.*

*Once the newer DOS is on your system, you can add the following line: DEVICE =DRIVER.SYS /D:N (where D is 2 for the new second drive and N is 3 for a 1.44-megabyte 3½-inch floppy disk drive) to your CONFIG.SYS file. The new drive will then be assigned as drive D.—S. W.*

*continued*

# Buying an expensive book...

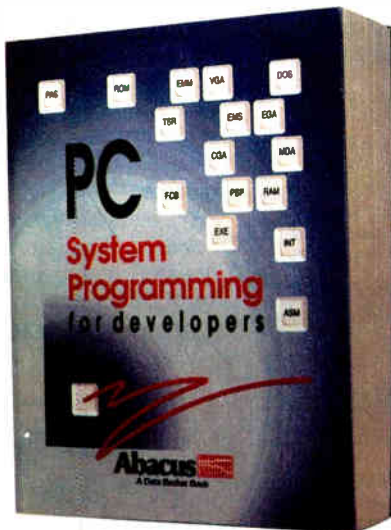

...doesn't guarantee that it will answer all of your DOS programming questions unless that book is readable, comprehensive and contains dozens of clear programming examples and explanations.

This new book **PC System Programming for Developers** is a literal encyclopedia of knowledge for the DOS programmer. It clearly explains all of the technical aspects of programming the PC, whether you write in BASIC, C, Turbo Pascal or assembly language. Some of the topics covered include:

- PC memory organization
- COM and EXE programs
- TSR programs
- Programming graphics cards
- Handling program interrupts in C, BASIC, Turbo Pascal and assembly language
- DOS structures and functions
- Hardware and software interrupts
- Writing device drivers
- Fundamentals of the BIOS
- Using extended and expanded memory



Dept. B11, 5370 52nd Street SE  
Grand Rapids, MI 49512  
Phone: (616) 698-0330  
Fax: (616) 698-0325

ISBN 1-55755-035-2: 940 page book **\$39.95**

ISBN 1-55755-036-0: 940 page book and 2 disks with 1MB compressed programs **\$59.95**

In US and Canada add \$4.00 postage. Foreign orders add \$12.00 postage per book.

To order direct call TOLL FREE: 1-800-451-4319

Available at B Dalton Booksellers, Waldens and Software Etc. nationwide. In the UK contact Computer Bookshops 021-706-1188. Write for our free catalog.



# Faster computers sooner... from FORTRON.



NetSet™ 286  
12, 16, 20 MHz

NetSet™ 325, 333 DeskTop or Power

Desktop 286 or 386  
12, 16, 20 MHz

As fast as products are designed, that's about how fast you can get them from Fortron. In early 1987 we were one of the first to ship an Intel 386™ based personal computer.

Now we're ready to dazzle you with speed again: the **NetSet™ 325** and **NetSet™ 333** personal computers, based on Intel 386™ 25 MHz and 33 MHz microprocessors. Designed for optimum performance of **CAD/CAM, UNIX, XENIX, and network server** applications.

Like all our other personal computers, these come with **one full year of service, free, at your site (USA)**. We're that sure of the reliability. And because we manufacture the computers ourselves, right here in California, you know exactly who to call with any technical questions; and if they do need service, we can fix them fast. **Speed, service, and savings. That's Fortron.**

#### BASIC SYSTEM PRICES START AT:

NetSet 286-12	386-16	386-20	NetSet 386-325	NetSet 386-333
\$995	\$1,550	\$1,650	\$2,700	\$3,900
1MB	2MB	1MB	1MB	1MB

To Order Call Toll Free  
**1-800-821-9771**

In CA 415-373-1008

Leasing Program Available  
International Distributors Wanted

Fortron is a subsidiary of World Corp.  
World is a subsidiary of Fortron/Source Corp.

## FORTRON

**Fortron/Source Corp.**  
6818-G Patterson Pass Road  
Livermore, CA 94550  
Tel: 415-373-1008  
FAX: 415-373-1168 TELEX: 559291

- Please have a sales representative call me.
- Please send me more information.
- 1. I am most interested in
  - A.  286-based systems
  - B.  386-based systems
- 2. I am a
  - A.  End User
  - B.  VAR
  - C.  Corporate Purchaser
  - D.  DP/MIS.

Name \_\_\_\_\_

Title \_\_\_\_\_

Company \_\_\_\_\_

Address \_\_\_\_\_

City \_\_\_\_\_

State \_\_\_\_\_

Zip \_\_\_\_\_

Phone No. \_\_\_\_\_

11/89

**Bits Across the World**

Our newspaper, *YABALASH*, in the State of Qatar on the Arabian Gulf, has a circulation of 50,000 worldwide. Consequently, our office does a lot of corresponding with remote locations daily.

We are looking for a good computerized system to manage our day-to-day office work. We would like to feed it all incoming and outgoing mail and would like to be able to access mail by date and company category. A scanner would also

be helpful in handling the mail. Do you have any suggestions?

A. S. Ahmed  
Doha, Qatar

*A custom application written for any good database system should be able to manage the mail flow. If this seems unworkable, look around for an office automation consultant. This is a relatively new field, made up of people who specialize in installing office management*

systems. One of these consultants should be able to point you toward a vertical application specifically geared toward mail management.

As for the scanner, one of the best low-cost optical character recognition systems we've seen here at *BYTE* is the TrueScan system from Calera Recognition Systems (2500 Augustine Dr., Santa Clara, CA 95054, (408) 986-8006). It's an OCR board and software that work with many flatbed scanners. We've tested it on the Hewlett-Packard ScanJet.

The project you suggest is not a simple one—it will take some time to identify the issues and pick your solutions. A good consultant will make that much easier.

—H. E.

**Another Task for Hercules**

I have an IBM PC AT-compatible system (AdvanTech SP/AT-800) with a Samsung MA256 monochrome display and a Juko G7-A multidisplay I/O adapter. I have set the adapter to Hercules monochrome graphics mode. My GWBASIC supports monochrome text but does not support Hercules graphics mode. I use the computer mainly for scientific calculations and word processing, so this is not a serious problem. However, my son is crazy about graphics.

Where can I get a version of GWBASIC that supports both the monochrome text and the Hercules graphics modes? Also, can I set the multidisplay adapter to CGA mode without damaging my monochrome monitor?

Ren Yanru  
Beijing, China

*GWBasic does not support the Hercules graphics modes, but many of the compilers do. You should take a look at Microsoft's QuickBASIC or Borland's Turbo Basic. Both of these products are GWBASIC-compatible and extend the graphics support to include the Hercules card.*

*I've been unable to dig up any information on your display card. I've seen other CGA-compatible cards that handle the monochrome monitor perfectly. What does the Juko documentation say about it? The street price on a monochrome monitor around here is less than \$60. At that price, I'd risk trying it.*

*Other multidisplay cards that I've seen require DIP switches to select either Hercules or CGA emulation. Switching to CGA mode will let you run GWBASIC and your son's games, while losing the ability to use the higher-resolution Hercules mode available in QuickBASIC and Turbo Basic.*—H. E. ■

**SUNDAY 10-5**

**PROMPT DELIVERY**

**COMPUTERS**  
 AST 286/386 1099.99  
 512K 1.27 40MB  
 AST PEEK 286 512K  
 1.27 40 MB HD  
 Dos 3.3 10V D  
 AST PEEK 386 C 2499.99  
 20MB 1 MB 1.27 D  
 AST 386/25 3599.99  
 2MB Ram 1.27 D  
 AST 386/33 4099.99  
 2MB Ram 1.27 D

**APPLE**  
 Mac SE/30/40MB 3299.99  
 Mac II GX 40 MB 3049.99  
 Mac Color Mon 429.99  
 Image I/O 599.00  
 UniGel D  
 20MB Ext. F/APP  
 40MB Ext. F/APP  
 FAX/MODEM 449.99  
 World Port 2499  
 Holmes II 699.00

**SOFTWARE**  
 M.S. DOS 4.01 79.99  
 M.S. Windows 286 99.99  
 M.S. Works IBM 219.99  
 M.S. Excel IBM 219.99  
 Lotus 123 2.2 219.99  
 PC Tools Deluxe 5.5 239.00  
 M.S. Word IBM 5.0 249.00  
 M.S. Word Mac 4.0 249.00  
 Lotus 123 3.0 249.00  
 Lotus Agenda 72.00  
 Lotus Symphony 49.00  
 Manage Y. Money 219.99  
 Norton Comm. 119.00  
 Norton Perfect 5.0 259.00  
 World Perf. Library 259.00  
 Carbon Copy Plus 259.00  
 Harvard Graphics 259.00

**CANON COPIERS**  
 PC 31 99.00  
 PC 7 99.00

**EXECUTIVE ORGANIZER**  
 Call  
 SF 4000  
 SF 7500 B O S S  
 SF 8000 B O S S

**OPERATING SYS**  
 ELS Level I  
 Adv. Mkt. V2 15  
 Slt. Mkt. V2 15  
 3+ Open ENT  
 3+ Open Adv

**HARDWARE**  
 Novell NE 1000  
 Novell NE 2000  
 3 com EtherNet  
 WD Ether Card c  
 Archet Adapter Kit  
 Active Hub  
 3 com TokenRing  
 UPS 1000 Watts

**SEAGATE DRIVES**  
 20 MB WinCh  
 40 MB 39 MS  
 40 MB 40 MS  
 Mk. 3+ 144 DR  
 Tan. 3+ 720K

**HAND SCANNERS**  
 HS 3000 Plus  
 OCR Software  
 OCR Software DLX  
 Logitech Scanman  
 Logitech for MAC

**LASER PRINTER**  
 Apple Laser Jet NT  
 HP Desk Jet Plus  
 HP Desk Writer  
 HP Laser Jet II  
 HP Laser Jet III  
 1 MB RAM for HP  
 2 MB RAM for HP  
 NEC LC 690

**PRINTERS**  
 Dicom 150 plus  
 Dicom 300  
 Epson FX 950  
 Epson FX 1050  
 Epson LQ 510  
 Epson LQ 850  
 Epson LQ 950  
 Epson LQ 1050  
 Epson LQ 2550  
 Epson LX 810  
 Fujitsu DL 3400  
 NEC 5200  
 NEC 5300  
 Ok 320  
 Ok 321  
 Ok 390  
 Ok 391  
 Ok 393  
 Panas KXP 1190  
 Panas KXP 1124  
 Panas KXP 1524  
 Panas KXP 1595  
 Panas KXP  
 Toshiba 301

**INTELCO. PROC**  
 Toshiba 311  
 139.99  
 179.99  
 219.99  
 359.99  
 359.99  
 479.99

**GRAPHIC CARD**  
 Paradise VGA Plus  
 Paradise VGA Pro  
 Video 7 VGA B  
 Video 7 Ram 512K  
 Video 7 Ram 1024K

**MONITORS**  
 Mitsu Diam. Scan  
 NEC MultiSync 2 A  
 NEC MultiSync 3D  
 NEC Mac Sync  
 Seiko CM 1430  
 Zenith 14" Flat

**MODEMS**  
 Everes 2400 Ext.  
 U.S. MODULICS  
 Courier HST 2400  
 Courier HST 9600  
 World Port 2400 Baud

**ZENITH**  
 184 2.20 MB  
 286 1.50 20 MB  
 286 1.50 40 MB

**WORLDWIDE INQUIRIES PROMPTLY FILLED**

**GUARANTEED LOWEST PRICES**  
**1-800-874-1235**

**TOLL FREE OUT OF N.Y. : 1-800-874-1235**  
**IN N.Y.S. (800) 223-6779 — N.Y.C. (212) 463-8330**  
**IN CANADA TOLL FREE 1-800-666-1668 FAX # 212-463-8335**  
**S & W COMPUTERS & ELECTRONICS**  
**31 West 21 Street, New York, N.Y. 10011**  
 HOURS: Sun. 10-5, Mon-Thurs. 9-6, Fri. 9-2, Sat. Closed  
 \* DISCOVER, M.C., VISA C.O.D. SH Add.  
 \* Not responsible for type errors.  
 Prices subject to change without notice.  
 Prices are for consumers.  
 Returns w/out written authorization.  
 Qty. Ltd.

**ALL MERCHANDISE SHIPPED IN FACTORY SEALED CARTONS. 100% GUARANTEED**



# Now QuickPascal makes this software go even faster.

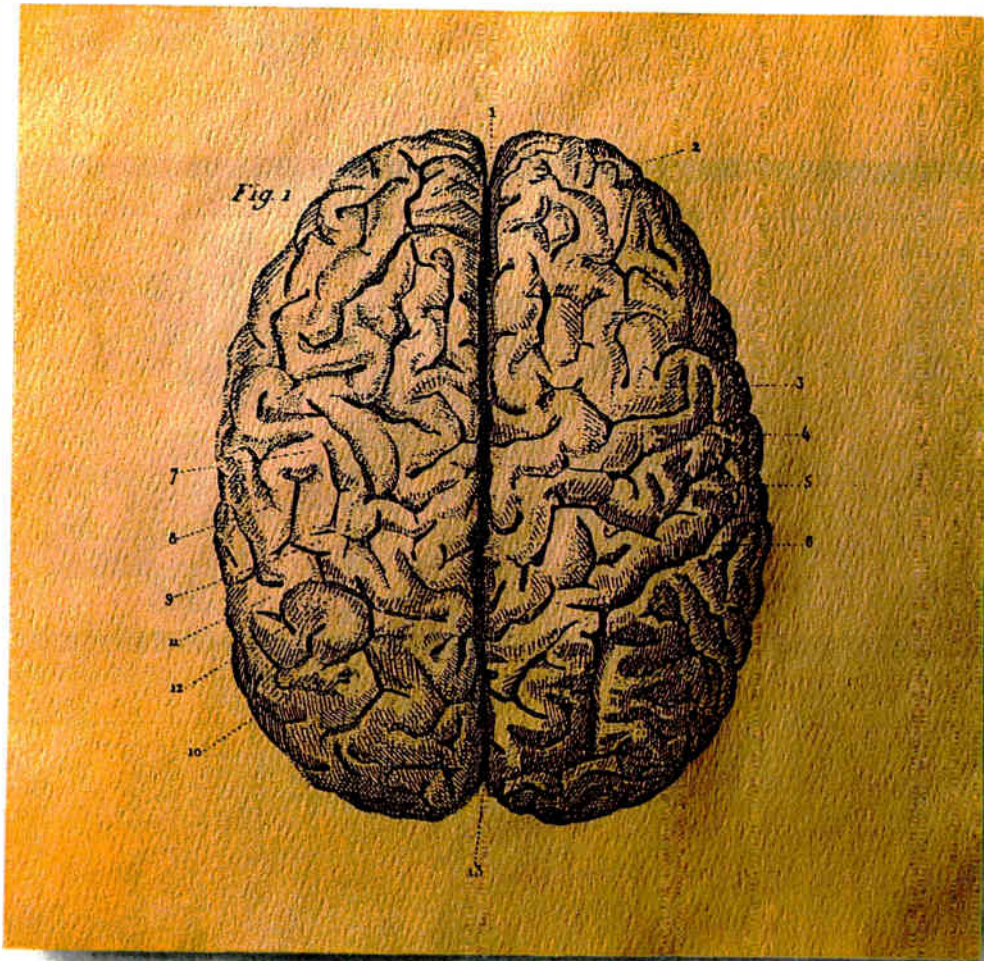

Even the quickest minds tend to brake suddenly when confronting new languages.

Enter new Microsoft® QuickPascal Compiler.

The first Pascal that is not only powerful but easy, intuitive and 100% headache-free.

For example, our new hypertext QuickPascal Advisor offers on-the-job training: by cutting and pasting sample code you can learn to program in Pascal from scratch. And if you do hit a snag, the Quick Advisor can straighten everything out right on the spot.

To accelerate your thought processes even more, all of our processes are seamlessly integrated; no other Pascal offers you easier

access to your editor, debugger and compiler.

What's more, QuickPascal is the first PC Pascal to offer Object Oriented Programming, or OOP. With objects, you can easily assemble whole programs from modular building blocks of code and data. And once you know Pascal, OOP is a snap. Which means, you get maximum productivity with minimum effort.

Naturally, our Pascal is also fully source compatible with Turbo Pascal®.

So stop by your Microsoft dealer soon.

You'll find our software is on the same wavelength as yours.

**Microsoft**  
Making it all make sense.

Customers in the U.S. call (800) 426-9400. In Canada, call (416) 673-7638. Outside North America, call (206) 882-8661. © Copyright 1989 Microsoft Corporation. All rights reserved. Microsoft and the Microsoft logo are registered trademarks and *Making it all make sense* is a trademark of Microsoft Corporation. Turbo Pascal is a registered trademark of Borland International.



# Top Performers.



## H.I.M.S. 386SX/16 MHz

- INTEL 80386SX MICROPROCESSOR RUNNING AT 16 MHz
- SOCKET FOR 16 MHz 80387SX MATH COPROCESSOR
- 5.25" 1.2 MB OR 3.5" 1.44 MB DISKETTE DRIVE
- DUAL DISKETTE AND HARD DISK DRIVE CONTROLLER (1:1 INTERLEAVE)
- 1 MB 80 NS MEMORY (OR 2 MB, 4 MB EXPANDABLE TO 16 MB)
- 40 MB HARD DISK 38 MS, 800 KB DATA TRANSFER RATE
- HI-SPEED 2 SERIAL PORT(S), 1 PARALLEL PORT
- 101 ENHANCED TACTILE "CLICK" TOUCH KEYBOARD
- 200 WATT SWITCHING POWER SUPPLY
- 8 EXPANSION SLOTS (2-FAST SLOTS/8 BIT, 1-8BIT, 5-16 BIT)
- HI-PERFORMANCE 16-BIT VGA CARO (800 x 600) OR OPTIONAL (1024 x 768)
- 6 LAYER H.I.M.S. (U.S.A.) MOTHER BOARD
- LATEST AMI 386 BIOS (BUILT-IN DIAGNOSTICS, SETUP, AND HARD DISK FORMATTING UTILITY SOFTWARE)
- 10 YEAR BATTERY WITH CLOCK CALENDAR
- DISK CACHE AND EMS UTILITY SOFTWARE
- H.I.M.S. SMALL FOOT PRINT, 4 BAYS CASE

# \$1750

HIMS 386SX 16 MHz WITH NO MONITOR

HARD DISK DRIVE	1 MB	2 MB	4 MB
66 MB 22 MS (800KB DTR)	1895	2095	2395
100 MB 22 MS (800KB DTR)	2095	2295	2595
120 MB 28 MS ESDI 1MB DTR	2550	2695	2995



## H.I.M.S. PAGE MODE SERIES 16 AND 20 MHz 386

- INTEL 80386 MICROPROCESSOR RUNNING AT 16 MHz (OR 20 MHz)
- SOCKET FOR 20 MHz INTEL 80387 OR 20 MHz WEITEK 3167 MATH COPROCESSOR
- 5.25" 1.2 MB OR 3.5" 1.44 MB DISKETTE DRIVE
- DUAL DISKETTE AND HARD DISK DRIVE CONTROLLER (1:1 INTERLEAVE)
- 1 MB OR (4 MB OPTIONAL) 80 NS PAGE MODE MEMORY
- 66 MB 23 MS HARD DISK, 800 KB DATA TRANSFER RATE
- HI-SPEED 2 SERIAL PORT(S), 1 PARALLEL PORT
- 101 ENHANCED TACTILE "CLICK" TOUCH KEYBOARD
- 230 WATT POWER SUPPLY (110/220) FCC, UL, CSA, TUV APPROVED
- 8 EXPANSION SLOTS (2-32/8-BIT, 1-8-BIT, 6-16-BIT)
- HI-PERFORMANCE 16-BIT VGA CARD (800 x 600) OR OPTIONAL (1024 x 768)
- 6 LAYER H.I.M.S. (U.S.A.) MOTHER BOARD
- LATEST AMI 386 BIOS (BUILT-IN DIAGNOSTICS, SETUP, AND HARD DISK FORMATTING UTILITY SOFTWARE)
- 10 YEAR BATTERY WITH CLOCK CALENDAR
- DISK CACHE AND EMS UTILITY SOFTWARE
- 5-BAY STURDY DESKTOP CASE (6 BAY VERTICAL CASE OPTIONAL)
- FCC CLASS B ON TOWER & DESKTOP

# \$2150

HIMS PAGE MODE 386/20 MHz WITH NO MONITOR

HARD DISK DRIVE	1 MB	4 MB
100 MB 22 MS 800 KB DTR.	2350	2650
120 MB 28 MS 1 MB DTR. ESDI	2750	3250
150 MB 16 MS 1 MB DTR. ESDI	2995	3495
330 MB ESDI 14 MS 1 MB DTR.	3795	4295



## H.I.M.S. PROFESSIONAL SERIES CACHE PRO 386 20, 25 AND 33 MHz

- INTEL 80386 MICROPROCESSOR RUNNING AT 20 MHz (OR 25 AND 33 MHz OPTIONAL)
- SOCKET FOR 80387 OR WEITEK 3167 MATH CO-PROCESSOR
- 64 K 25 NS CACHE UPGRADABLE TO 256 K. READ AND WRITE CACHE WITH WRITE BACK CACHE
- PAGE MODE MEMORY ARCHITECTURE
- 1 MB 80 NS MEMORY UPGRADABLE TO 2, 4, 8 MB ON MOTHER BOARD, 16 MB WITH 32-BIT MEMORY CARD
- 5.25" 1.2 MB OR 3.5" 1.44 MB DISKETTE DRIVE
- QUAL DISKETTE AND HARD DISK DRIVE CONTROLLER, 1:1 INTERLEAVE
- HI-SPEED, 2 SERIAL, 1 PARALLEL PORT
- 250 WATT HEAVY DUTY POWER SUPPLY
- 101 ENHANCED TACTILE "CLICK" TOUCH KEYBOARD
- 8 EXPANSION SLOTS (1-32 BIT, 1-8 BIT, 6-16 BIT)
- LATEST AMI 386 BIOS (BUILT-IN DIAGNOSTICS, SETUP, AND HARD DISK FORMATTING UTILITY SOFTWARE)
- HIGH PERFORMANCE 16-BIT VGA CARD (800 X 600) OR OPTIONAL (1024 X 768)
- 6 LAYER H.I.M.S. 64/256 CACHE MOTHER BOARD
- 66 MB 23 MS HARD DISK 800KB DATA TRANSFER RATE.
- 6 BAY VERTICAL OR 5 BAY DESKTOP CHASIS (SUPER VERTICAL 10 BAY WITH 375 WATT POWER SUPPLY OPTIONAL)
- FCC CLASS B ON DESKTOP OR TOWER
- DISK CACHE, EMS UTILITY SOFTWARE

# \$2595

25 MHz Add \$350  
33 MHz Add \$1300

CACHE PRO 386/20 MHz WITH NO MONITOR

HARD DISK DRIVE	1 MB	4 MB
100 MB 22 MS 800 KB DTR.	2795	3295
120 MB (ESDI) 28 MS 1 MB DTR.	3195	3695
150 MB (ESDI) 16 MS 1 MB DTR.	3495	3995
330 MB (ESDI) 14 MS 1 MB DTR.	4395	4795

IBM, COMPAQ, ALR, EVEREX, UNIX, XENIX, NOVELL ARE TRADEMARKS OF THEIR RESPECTIVE COMPANIES.

See us at Comdex Booth #S-9309 At Sahara Hotel

Circle 166 on Reader Service Card

# Rock Solid. HIMS

## COMPANY

H.I.M.S. TECHNOLOGIES has been manufacturing hi-performance computers in California under OEM label for a number of years; and now H.I.M.S. is manufacturing under its own label the same hi-performance computers 286,386SX, 386 Page Mode and Cache 386 to satisfy your needs in price, performance and after the sale service, which seems to be a missing feature with most of our competitors. Just compare our competition and you will find the obvious, then add our One Year On-Site Service at no extra cost.... SURPRISE!!

## PRODUCT

H.I.M.S. manufactures a complete breadth of 286, 386SX, Page Mode 386 and Cache 386 systems. H.I.M.S. is the only company currently supplying the industry with 386 Cache Pro in verticle, super verticle or desktop with FCC Class "B" approval. How about our 256K Write Back Cache Design at down to earth pricing? You can actually afford the high speed luxury! All the H.I.M.S. Systems can be custom configured to fit your needs, so call our expert sales executives to discuss your specifications. All H.I.M.S. Systems come assembled, tested and burned-in from the factory for 72 hours at 60° Centigrade. The Hard Disk is pre-compsurfed and formatted. H.I.M.S. carries a wide variety of options like: Video Cards for CAD/CAM and desktop publishing, printers, monitor's 14" to 25", Opto magneto drives, math coprocessors, plotters, pointing devices and software.

## SERVICE

All H.I.M.S. computers come with a One-Year On-Site Service included. This gives you an immediate back-up just in case a problem may arise a technician can be in your location within 4 to 8 hours from our 414 service locations, including Puerto Rico and Canada. All products are made in the U.S.A.!!!

**H.I.M.S. TECHNOLOGIES is the Price, Performance and after sales service leader in the Fast Group.**

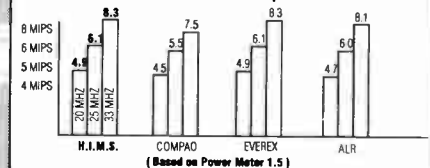

# 800-367-2924

## H.I.M.S. TECHNOLOGIES

368 Montague Expressway • Milpitas, CA 95035  
Phone: (408) 946-9711 • FAX: (408) 946-9744



# CHAOS MANOR MAIL

*Jerry Pournelle answers questions about his column  
and related computer topics*

## Supporting Supercomputers

Dear Jerry,

I noted a bit of incredulity in your April Computing at Chaos Manor with regard to the fact that computer science and mathematics departments account for only 1 percent of the academic use of the National Science Foundation (NSF) supercomputer centers. It shouldn't be that surprising. Computer scientists, like mathematicians, develop basic computing concepts and techniques that are applied in other fields. It doesn't take a supercomputer to test most new algorithms, just a good workstation. The engineers, physicists, and biologists, on the other hand, have massive amounts of data to be processed; thus, they use far more time on supercomputers and always want more.

For computer scientists like myself, who work in computer vision, or those who work in other data-intensive research areas, such as speech recognition, information retrieval, and knowledge-based systems, the type of processing power provided by the supercomputing centers is inappropriate. Our work requires the manipulation of large amounts of symbolic data instead of double-precision floating-point calculations. The supercomputing centers also do not support the interactive capabilities (e.g., real-time image I/O) required or the languages and tools that we need (e.g., Lisp, Prolog, and X Window).

Unfortunately, Congress was sold the idea of the supercomputer centers as the way to advance computer science in this country and to keep our technological edge against foreign competition. What's amazing about all this is that nobody consulted with the computer scientists for advice. The people who were consulted were the engineers, physicists, and biologists. If Congress had asked the computer science community how to bolster computer research, we would have seen a much different program—a program that involved enhanced nationwide networks, advanced display devices like high-definition TV, and parallel processors, such as the Connection Machine

and the Cosmic Cube.

Sadly, Congress is now convinced that it is heavily supporting computer science research through the supercomputing centers. It is unwilling to provide significant additional funding for computer science; thus, while ours is the discipline with the greatest expansion in total researchers in the last 20 years, it has seen a net decrease in available federal research funding. The only agency that currently supports any large, focused programs in computer science is the Defense Advanced Research Projects Agency, through its Information Sciences and Technology Office. However, DARPA's budget is also being heavily cut, since the current military cutbacks, as always, are being concentrated on programs with short-term contracts to save those with long-term obligations, such as aircraft carriers and stealth bombers.

Thus, your call for support of increased funding for the supercomputing centers, while it may give the physicists some new toys to help them design their new Superconducting Super Collider, is likely to result in further reductions to the basic research that makes supercomputers work. The \$100 million that you told people to ask their representatives to allocate will likely be used to buy the next generation of supercomputers from Japan.

Your efforts would better serve the long-term interests of the country if they were directed at increasing support for basic computing research. \$100 million per year would move 10 of our better computer science departments into the upper echelon of research currently inhabited only by MIT, Carnegie Mellon, and Stanford. Alternatively, it could be

*continued*

*Jerry Pournelle holds a doctorate in psychology and is a science fiction writer who also earns a comfortable living writing about computers present and future. He can be reached c/o BYTE, One Phoenix Mill Lane, Peterborough, NH 03458, or on BIX as "jerryip."*

**situation:**

**Puzzled over  
which Pascal  
compiler is best  
for you?**

**solution:**

**BLAISE  
COMPUTING  
INC.**

**Our tools support both  
QuickPascal and Turbo Pascal.**

**POWER TOOLS PLUS/5.0 \$149**

**Full featured function library**

- ◆ Features context sensitive help screens
- ◆ window oriented pick lists
- ◆ multiple-line edit fields with fully configurable edit keys
- ◆ moving bar pull-down menus and windows
- ◆ in-memory sort routines
- ◆ EMS support
- ◆ TSRs and ISRs
- ◆ and much more!

**ASYNCH PLUS \$129**

**Asynchronous communication manager**

- ◆ Features speeds to 19.2K baud
- ◆ XON/XOFF protocol
- ◆ support for up to 4 comm ports
- ◆ hardware handshaking
- ◆ XModem file transfer
- ◆ I/O buffers up to 64K
- ◆ and much more!

**POWER SCREEN \$129**

**Screen I/O manager**

- ◆ Features screen painter
- ◆ virtual screens
- ◆ data validation
- ◆ context sensitive help
- ◆ unlimited screens
- ◆ definable keys
- ◆ and much more!

**Fast, flexible and affordable!**

Blaise Computing offers programming tools that are fast, flexible and affordable. Call now to order or to ask for a free brochure on our full line of products for C and Pascal.

**FREE with these products!**

Source code, complete sample programs, a comprehensive reference manual with extensive examples, the Norton Guides Instant Access Program, and a comprehensive online database.

**Supports QuickPascal and Turbo Pascal!**

All of these products support Turbo Pascal 4.0, 5.0, and 5.5 and Quickpascal 1.0.

**Put Blaise tools to the test!**

If at any time during the first 30 days you are not completely satisfied with their speed and flexibility, we'll refund your money.

**Call (800) 333-8087 today!**

**FAX: (415) 540-1938**

**BLAISE COMPUTING INC.**

2500 Ninth Street, Suite 310, Berkeley, CA 94710 (415) 540-5444

Turbo Pascal is a registered trademark of Borland International. QuickPascal is a registered trademark of Microsoft Corporation.

used to build a fiber-optic network that would allow real-time transmission of digitized images across the country, or to buy 20 of the largest parallel processors for computer science and AI research.

I hope that in the future you will use some of your broad influence to encourage others to back increased support of computer science research in addition to computational support for other sciences. Senator Albert Gore is one key official who is leading such a drive, and he

would probably welcome additional popular exposure of his plans.

Dr. Charles Weems  
Senior Research Scientist  
University of Massachusetts  
Amherst, MA

*I suspect you exaggerate my influence, although one of Gore's key people turns out to be a former student of mine.*

*I'm not sure how one goes about "supporting computer science"; a lot of gov-*

*ernment programs tend to have effects opposite to what was intended. After all, we have the Connection Machine. As to ARPANET, I agree that it was a Good Thing, but I can't write about it any longer: They closed out my account.*

*The problem, it seems to me, isn't my support of the supercomputers; it's that scientists see the science budget as a zero-sum game. That's the wrong approach. Go convince them that support of your project is a good investment.—Jerry ■*

## PC XNET THE CARD THAT BRINGS X.25 PERFORMANCE TO YOUR PERSONAL COMPUTER THINK ABOUT IT!

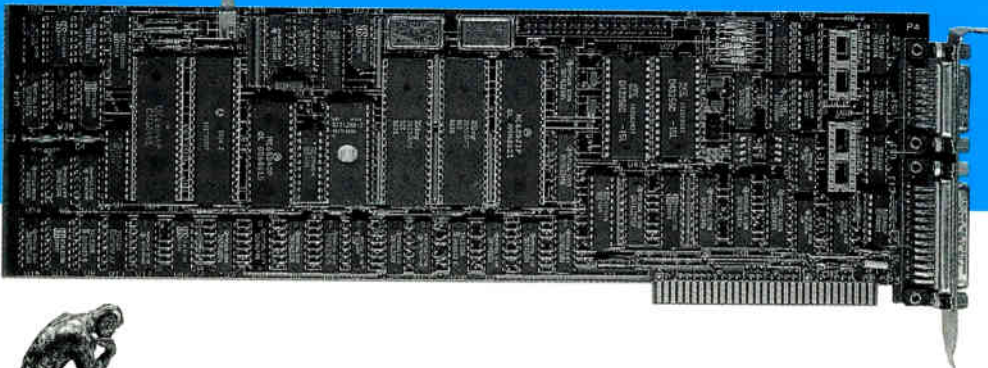

And think about OST, the European leader in the field of private X.25 networks! Our PC XNET card, an option/adaptor card for personal computers, provides two channels, each supporting 128 virtual circuits and speeds to 64 kbps. The PC XNET card provides a level of performance never before reached in a personal computer.

Easy access via MS DOS, XENIX and NETBIOS makes the PC XNET card the perfect tool for emulating terminals and file servers or providing a gateway to Local Area Networks. Fully compatible with many protocols such as X.25, X.32 and X.21, the PC XNET card enables computers to be connected to any type of network.

Furthermore, applications programs you develop on the PC XNET card can be transferred to the PC SNET card, OST's ISDN interface card.

So, if you are thinking of X.25 capability for your computer think about OST.

**OST, SA**

Rue du Bas-Village. Z.I. Sud-Est  
35515 Cesson-Sévigné Cedex  
Tel. : (33) 99.32.50.50  
Fax : (33) 99.41.71.75. Telex : 730 839



**OST, Inc**

14225 - F Sullyfield Circle  
Chantilly, VA 22021  
Tel. : (1) 703 817 0400  
Fax : (1) 703 817 0402

Networking Intelligence



Don't let ordinary computers hold up  
your information anymore.



No mission-critical maybes.

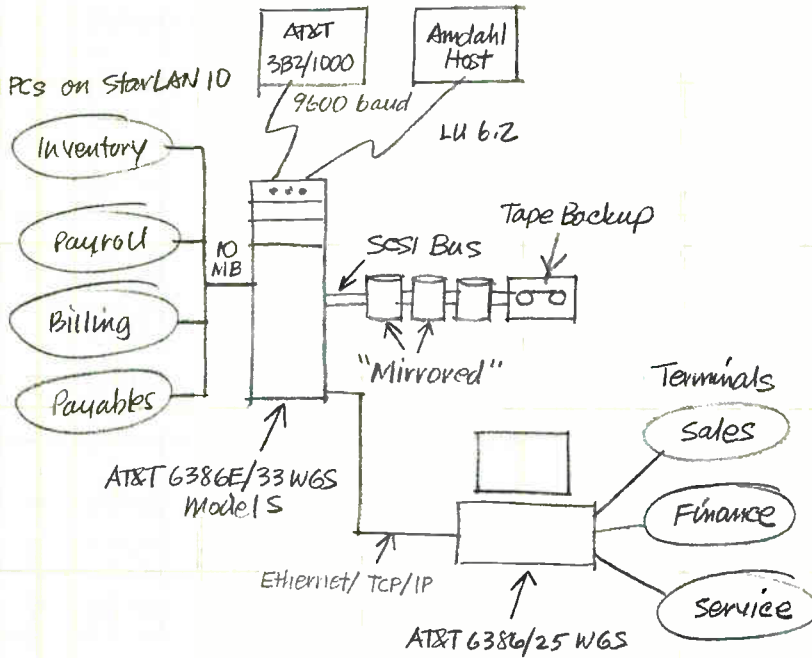

of information from people in one department can trigger action by people in another.

To protect all that information, we include a special "disk mirroring"

feature that performs automatic, instantaneous backups. And since the Model S comes with SCSI, you get seven times more storage than non-SCSI 386 products.

On top of that, we test and warrant\* each element of the package, then assemble the complete system, including SCSI devices, UNIX System V operating system, StarLAN 10 networking hardware, and StarGROUP™ software.

Let's talk. You'll find the Networked Computing experts make good listeners. We can customize,

install and integrate the Networked Computers in as many different ways as you have needs. To learn more, simply call your AT&T Authorized Reseller or AT&T Account Executive. Or just turn the page.



AT&T 6386 E/33 WGS Model S



AT&T

Computer Systems



# Computers. From AT&T.

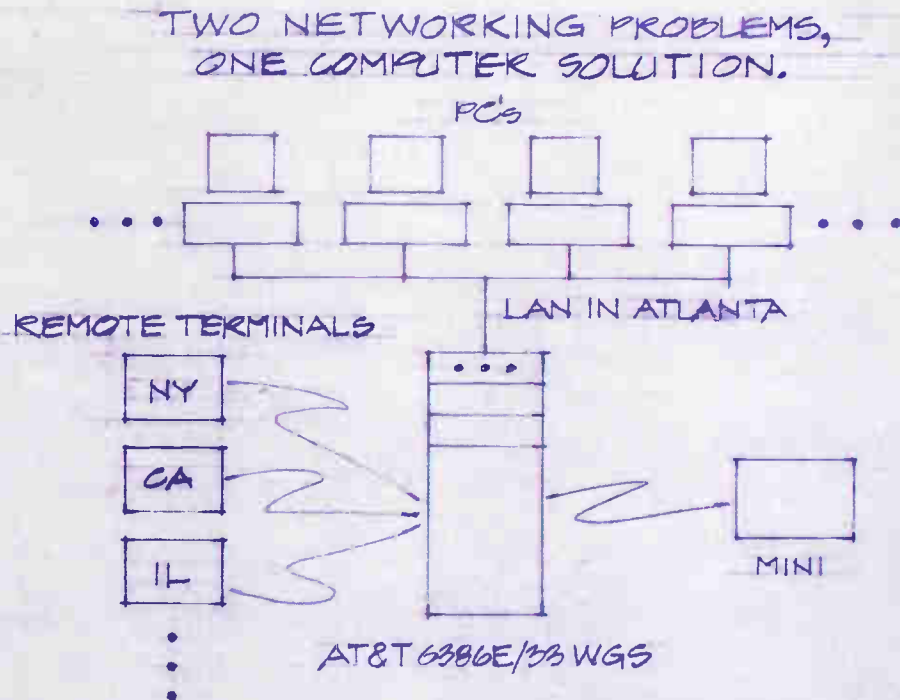

**Simultaneous solutions.** Chances are you need a server to support information sharing in a local PC network. Fair enough. But here's a Networked Computer that will also manage

a nationwide database at the same time.

With headquarters in Atlanta, you have people in two dozen offices scattered across the U.S. Because geography makes interoffice agreement difficult, you feel more like twenty-five little companies than one big one.

In Atlanta, put 600 MB of data into the disk space of an AT&T 6386E/33 WGS. Place asynch terminals in your field offices, and connect them directly to the 6386E/33 WGS. Suddenly, everyone's working with the same num-

bers, the same names, everything. Which, at about 7.7 MIPS, is power that would make some mainframes blush.

Now, shift into high gear by connecting the PC LAN you already have in Atlanta. We provide the systems and expertise you need to support LAN *and* remote terminal applications at the same time.

**And for mission-critical** Networked Computing, our solution is the AT&T 6386E/33 WGS Model S. It shines in networks like the one shown in the final diagram—where every bit



\*One-year, on-site warranty.

# Show us your networked computing problem.

Draw or explain it below, and then Fax it to us at 1 800 833-6386, and a sales representative will call you. Or call your AT&T Authorized Reseller, AT&T Account Executive, or 1 800 247-1212, Ext. 162, for more information.



**Please give us the following information so we can best help you.**

Name \_\_\_\_\_

Company \_\_\_\_\_

Address \_\_\_\_\_

City \_\_\_\_\_ State \_\_\_\_\_ Zip \_\_\_\_\_

Phone (     ) \_\_\_\_\_

Type of business  
and number of locations \_\_\_\_\_

Purchase interest time frame \_\_\_\_\_

Publication ad appeared in \_\_\_\_\_



**AT&T**

Computer Systems



# The Networked Com

New applications for old PCs.

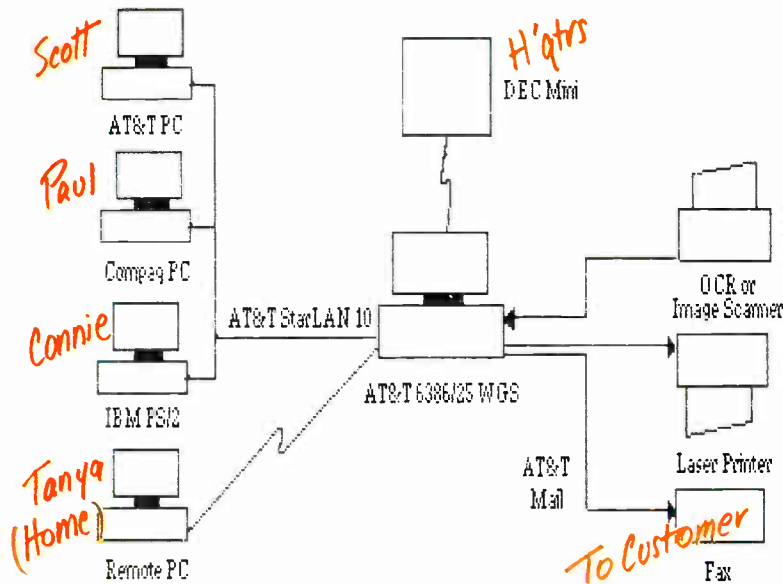

dards (SNA in this case) that let AT&T's new Networked Computers work smoothly with the systems you already have.

### How to share new applications and precious resources.

Take the case of Scott, Paul, Connie and Tanya in the second diagram. They each rely on expensive peripherals, but you can't afford to get them individual sets. And their complex, networked application would really strain your existing DOS server.

Enter the AT&T

6386/25 WGS, our entry-level UNIX® System V server. UNIX System V is the only desktop operating system *designed* for communication-intensive applications. And since it also supports AT&T's OPEN LOOK™ Graphical User Interface, life can be visibly easier.

We've given the 6386/25 features that exploit the UNIX system's natural ability. So it's perfect for resource-sharing, database management and other applications DOS and OS/2™ just can't handle efficiently.

In fact, AT&T has con-

figured, packaged and tested solutions including communications, database and image servers. Just let us show you.



AT&T 6386/25 WGS

WE haVE

The

inforMation,

anD gettiNG it

bAcK will

COSt you.



# AA AIRLEASE INC.



1570 AIRPORT ROAD  
SKYVILLE, PA. 15032  
TEL. (412) 555-4000

J.M. MORRISON  
VICE PRESIDENT  
MARKETING

## AN END TO VENDOR BOUNDARIES



### Introducing Four New Networked Computers

Your information systems are supposed to help people make the most of the information they have. But how often do ordinary computers hold up that very information?

We offer a solution: Four new desktop systems and servers designed by AT&T to *thrive* as networked systems.

These are *interpersonal* computers. AT&T's new systems (ranging from a

simple PC-to-mainframe package to a "connoisseur's" server for mission-critical applications) bring together more than information. They bring together the people behind it.

**Meet your other systems.** Sharing information among people using different manufacturers' equipment has always been a problem.

Now the solution's as simple as the example in the first drawing above. A new AT&T 6386/SX Work-Group System links to an existing IBM® host and gives your people access to

important corporate data held there.

The key lies in a network builder's oasis called the AT&T Application Operating Environment (AOE). AOE offers a unique collection of industry stan-



AT&T 6386/SX WGS





# WHAT'S NEW

HARDWARE • SYSTEMS

## Wallaby Gets Mac-Compatible with Laptop

The trick to the Wallaby's Macintosh compatibility is that you must take the ROM chips out of your Macintosh Plus or SE and put them into the laptop system. This feat is performed by the dealer when you purchase the laptop. A connector board is then installed in your Mac.

The fully configured 15-MHz 68000-based Laptop System from Wallaby Systems weighs less than 10 pounds, including the battery, the keyboard, the backlit LCD, and the optional 20-megabyte hard disk drive.

The 12- by 8- by 4-inch unit is also IBM-compatible, in the sense that the standard 800K-byte Wallaby floppy disk drive can read and write IBM-formatted disks as well as Macintosh-formatted disks, the company claims.

In portable mode, you take the Laptop System on the road and leave your Mac at home or in the office. In the office, you boot your Mac SE or Plus from the Wallaby.

Programs can also be stored in a proprietary "silicon disk" that is based on nonvolatile RAM. Up to 16 megabytes (using 4-megabyte single in-line memory modules) of program storage is possible on the Laptop System without the use of a hard disk.

Besides a full megabyte of RAM (upgradable to 4 megabytes), the Wallaby laptop comes with a printer, printer and communications ports, an 800K-byte 3 1/2-inch floppy disk drive, and an Isopoint device instead of a mouse.

The Wallaby keyboard is linked to the monitor through

infrared signals. The monitor has a 640- by 400-pixel black-on-white display.

**Price:** \$2995.

**Contact:** Wallaby Systems, Inc., 2540 Frontier Ave., Suite 109, Boulder, CO 80301, (303) 444-4606.

**Inquiry 1105.**

## Compute on the Commute

The Electronic Portable Information Center (EPIC) appears to be a 23-pound leather briefcase. But tucked inside is a communications center, complete with a 12-MHz AT compatible; a keyboard; an 11-inch, paper-white, VGA-compatible, backlit LCD; a cellular phone; a 1200-bps Hayes-compatible modem; and, later this year, optional fax capabilities.

The AT compatible has 1 megabyte of RAM, a 1.44-megabyte 3 1/2-inch floppy disk drive, and a 20-megabyte hard disk drive.

EPIC comes with DOS and software for word processing, database, spreadsheet, communications, graphics, and general business functions.

**Price:** \$8495.

**Contact:** Cellular Computer Systems Corp., 550 Pine Tower Rd., Suite 270, Ft. Washington, PA 19034, (215) 628-3749.

**Inquiry 1108.**

## SEND US YOUR NEW PRODUCT RELEASE

*We'd like to consider your product for publication. Send us full information, including price, ship date, and an address and telephone number where readers can get further information. Send to New Products Editor, BYTE, One Phoenix Mill Lane, Peterborough, NH 03458. Information contained in these items is based on manufacturers' written statements and/or telephone interviews with BYTE reporters. BYTE has not formally reviewed each product mentioned. These items, along with additional new product announcements, are posted regularly on BIX in the microbytes.sw and microbytes.hw conferences.*

## NEC Announces Three Desktop Systems

PowerMate 286, NEC's low-end system, has its own Super EGA built into the motherboard. It comes with a 10-MHz microprocessor with one wait state (software-switchable to 8 MHz), 512K bytes of RAM (expandable to up to 16 megabytes), a 1.2-megabyte 5 1/4-inch floppy disk drive, a keyboard, and room for one 3 1/2-inch half-height and two 5 1/4-inch half-height drives and four full-size, 16-bit, add-in cards.

Ports include the keyboard port on the front panel, a parallel printer port, a serial printer port, and an RGB video port. Its dimensions are 14 by 16 by 5 inches, and it weighs 21 pounds. Optional equipment includes an 80287 math coprocessor, your choice of floppy and hard disk drives, and your choice of tape backup systems.

The PowerMate 286 Plus is the same as the standard 286 except that it features a faster (12-MHz) zero-wait-state microprocessor (switchable to 8 MHz and one wait state), 1 megabyte of RAM (expandable to 4 megabytes of 80-ns or 12 megabytes of 120-ns RAM), and 640- by 480-pixel resolution in 16 colors built into the motherboard. The 286

Plus also includes DOS 3.3.

The PowerMate SX includes 2 megabytes of RAM (upgradable to 16 megabytes), a 1.2-megabyte 5 1/4-inch floppy disk drive, and a keyboard.

**Price:** 286, \$1299; with Super VGA, \$1499; 286 Plus with one 1.2-megabyte 5 1/4-inch floppy disk drive, \$1999; with 42-megabyte hard disk drive, \$2899; SX, \$2699; with 42-megabyte hard disk drive, \$3599.

**Contact:** NEC Information Systems, Inc., 1414 Massachusetts Ave., Boxborough, MA 01719, (508) 264-8000.

**Inquiry 1109.**

## The Short Tower with Pizazz

The CCS 286-12 is a 12-MHz 80286 system in a short tower chassis. It's big enough for two floppy disk drives of your choice (1.2-megabyte 5 1/4-inch or 1.44-megabyte 3 1/2-inch), a hard disk drive, and three 16-bit slots and an 8-bit slot.

Standard equipment includes 512K bytes of RAM (upgradable to 4 megabytes), a Phoenix BIOS, an EGA video controller, a floppy disk drive controller with your choice of two 5 1/4-inch or 3 1/2-inch floppy disk drives, a parallel port, two serial ports, and a PS/2 mouse port.

Also standard is a 101-key keyboard and a monochrome monitor.

**Price:** Basic configuration, \$1399; with a 20-megabyte hard disk drive, \$1629.

**Contact:** Custom Computer Systems, Inc., 191 Woodport Rd., Sparta, NJ 07871, (201) 729-6762.

**Inquiry 1107.**

*continued*

## N/Hance Introduces Operating-System-Independent Drive

The 5120 is a 1280-megabyte random-access WORM (write once, read many times) optical drive that's designed to be operating-system- and processor-independent.

The Write-Once File System software is compatible with DOS 3.0 and higher, Xenix, Unix, and OS/2.

The 5120 features 640 megabytes per side (the average access time is rated at less than 90 ms) and removable disks. It weighs 4 pounds and measures 5 1/4 by 7 by 1 1/4 inches.

**Price:** \$7695.

**Contact:** N/Hance Systems, Inc., 908R Providence Hwy., Dedham, MA 02026, (800) 289-9676 or (617) 461-1970. **Inquiry 1114.**

## Erasable Optical Drive Features 1 Gigabyte

Storage Dimensions says its plug-and-play version of Maxtor's Tahiti 1 rewritable magneto-optical disk system is the fastest example of this new technology on the market.

The LaserStor, for the IBM PC and PS/2s, the Mac, and NetWare servers, is rated at an average seek time of 35 ms. It's available only as an external unit with its own power supply, fan, and SCSI connector to the host micro-computer. The full-height drive uses removable 5 1/4-inch optical cartridges that can hold either the industry-standard 650 megabytes or Storage Dimensions' proprietary 1 gigabyte of data on two sides, depending on the format used. PC and PS/2 models are supplied with AT- or Micro



*N/Hance makes its WORM drive operating-system-independent.*

Channel-bus SCSI boards, and all versions appear as a standard hard disk drive to the operating system.

For PCs and PS/2s, LaserStor comes with SCSI host bus adapters and SpeedStor software that permits DOS to address the drive as a single partition or as several volumes. With the Macintosh, the LaserStor plugs directly into the external SCSI port and is supported with MacinStor Installer software.

**Price:** \$7995; 650-megabyte cartridges, \$295; 1-gigabyte cartridges, \$395.

**Contact:** Storage Dimensions, Inc., 2145 Hamilton Ave., San Jose, CA 95125, (408) 879-0300. **Inquiry 1112.**

## A Gigabyte of Storage Space for Your Mac

For Mac aficionados with a need for really large storage space, MicroNet Technology has introduced the first 1-gigabyte hard disk drive for the Mac. The SBX-1000, based on Imprimus Technology's Wren VII drive, is a full-height 5 1/4-inch SCSI drive with an average access time of 15 ms.

You can install the SBX-1000 inside a Mac II or IIX, or it can also be mounted in an external box for use with other Macs.

**Price:** \$9850.

**Contact:** MicroNet Technology, Inc., 20 Mason, Irvine, CA 92718, (714) 837-6033. **Inquiry 1115.**

## QMS Ships Low-Priced Color PostScript Printer

The ColorScript 100 Model 10 is a color PostScript printer that uses thermal-transfer technology and can attach to either IBM or Macintosh computers.

It can produce a 300-dpi four-color page in about 1 minute, the company says, with the help of the Mitsubishi G370 print engine. The G370 can create up to 16 million color combinations.

The printer, about the size of the original Apple LaserWriter, includes an internal controller based on a 16-MHz 68020 processor, plus 4 megabytes of RAM (expandable to 8 megabytes), and 1 megabyte of ROM containing 35 fonts. Standard interfaces are RS-232C serial, Centronics parallel, and AppleTalk/RS-422 ports, and an external SCSI port that allows connection of up to seven hard disk drives.

The Model 10 uses rolls of wax-based ink for the color thermal-transfer process and requires special paper that costs roughly 6 cents per sheet. It can also print on transparencies.

**Price:** \$9995; extra memory, \$595 (1 megabyte) and \$1495 (4 megabytes).

**Contact:** QMS, Inc., One Magnum Pass, Mobile, AL 36618, (205) 633-4300. **Inquiry 1111.**

## Color Your Computer Overheads

In Focus Systems claims that its 480C PC Viewer is the first LCD panel that projects full-color computer images through an overhead projector. It sits atop your overhead projector and delivers eight-color presentations at VGA resolution.

The PC Viewer uses subtractive LCD color technology similar to color photography. Starting with a white pixel, the display selectively subtracts primary colors to produce a full spectrum of hues. This technique detracts little from the brightness of the original image, In Focus claims.

The PC Viewer also has a rotating palette that lets you select color mapping and manipulate the color display to suit your preference. A built-in temperature compensation system comprises heat filters and a multispeed fan.

You interface the PC Viewer through the monitor port of your IBM XT, AT, or compatible. For Macs, you'll need optional adapters that attach to graphics boards. And, if you want to see the image on your computer screen as well as on the projection screen, you'll need an optional "loop-through" adapter, which doubles as the Mac II adapter.

**Price:** \$4995; Mac Plus and SE adapters, \$119.95; "loop-through" adapter, \$249.95. **Contact:** In Focus Systems, Inc., 7649 Southwest Mohawk St., Tualatin, OR 97062, (800) 327-7231 or (503) 692-4968.

**Inquiry 1113.**

*continued*



# After centuries of practice, mankind perfects engineering calculations: MathCAD.

## Announcing MathCAD 2.5: The Dawn of a New Age.

What the historians will call it, only time will tell.

Perhaps the Century of Speed, or the Era of Ease. But whatever the name, this is the age of MathCAD 2.5, the only math package that looks and works the way you think.

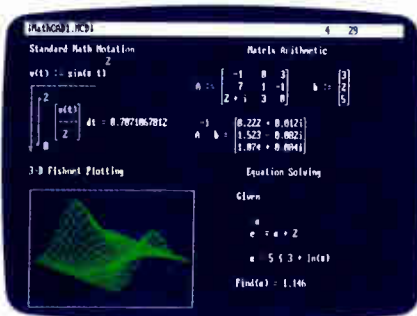

MathCAD 2.5 includes 3-D plotting, HPGL sketch import, and PostScript output.

MathCAD is far and away the best-selling math package in the world. Because it lets you perform engineering and scientific calculations in a way that's faster, more natural and less error-prone than the way you're doing them now—whether you're using a scratchpad, calculator, spreadsheet or program that you wrote yourself.

And now we've made the best even better. MathCAD 2.5 is a dramatically improved version that includes three-dimensional plotting, enhanced numerical analysis, and the ability to import HPGL files from most popular CAD programs, including AutoCAD.® And now you can print on PostScript® compatible printers.

And like before. MathCAD's live document interface™ lets you enter



equations anywhere on the screen, add text to support your work, and graph the results. Then print your analysis in presentation-quality documents.

It has over 120 commonly used functions built right in, for handling equations and formulas, as well as exponentials, differentials, cubic splines, FFTs and matrices.

No matter what kind of math you do, MathCAD 2.5 has a solution for you. In fact, it's used by over 60,000 engineers and scientists, including electrical, industrial, and mechanical engineers, physicists, biologists, and economists.

But don't take our word for it; just ask the experts. PC Magazine recently described MathCAD as "everything you have ever dreamed of in a mathematical toolbox."

And for Macintosh® users, we present MathCAD 2.0, rewritten to take full advantage of the Macintosh interface. Entering operators and Greek letters into equations is pure simplicity!

Look for MathCAD 2.5 at your local software dealer, or give us a call. For more information, a free demo disk, or upgrade information, dial 1-800-MATHCAD (in MA, 617-577-1017).

Available for IBM® compatibles and Macintosh computers.

TM and ® signify manufacturer's trademark or manufacturer's registered trademark respectively.



March 14,  
1989 issue.  
Best of '88  
Best of '87

# MathCAD®

MathSoft, Inc. One Kendall Square, Cambridge, MA 02139

Some pointing devices  
feel quite alien.







**Not every kind of pointing device fits your kind of hand.**

**TrackMan is built  
the way you are.**

*When we put our minds to designing the next generation of pointing devices, we started with our hands. It turns out that thumbs have over twice the muscle and agility of other fingers—which only go up and down.*



*We tested dozens of prototypes. None beat the body you see before you. A trim 4.25" x 5.25" fully equipped with a low-inertia, lightweight ball (placed under the thumb), three buttons (under the fingers), and room to rest the hand.*

*TrackMan is smart, too:  
adjustable from 50 to over*

*15,000 d.p.i. resolution  
(default at 300);*

*on-the-fly ballistic driver; lots of built-in  
menus to speed up popular keyboard based  
applications. Even a shell for Lotus 1-2-3™*



*Simple to install, this stationary mouse is  
compatible with all other top-selling mice.  
TrackMan is guaranteed to work with any  
application on a 256K IBM (or compatible)  
personal computer. Price? \$139\* complete  
with Satisfaction Guarantee, and 7-Days-  
A-Week Product Support.*

**For further information call:  
800-231-7717**

*In California: (800) 552-8885*

*In Canada: (415) 795-8500*

*In Europe: ++41-21-869-9656*

**LOGITECH**



\*Serial version. Bus version is \$149.™1-2-3 is a trademark of Lotus Corp.

**Circle 209 on Reader Service Card (DEALERS: 210)**

## MCA QuickCapture Now Has AT Counterpart

**D**ata Translation's Micro Channel architecture-based QuickCapture frame-grabber board now has an AT-based counterpart.

Like the PS/2 version, the QuickCapture AT captures, stores, and displays images from video cameras, VCRs, and still-video cameras. Both cards use the same software drivers.

QuickCapture AT captures video images in real time (one-thirtieth of a second) and includes a phase-locked loop circuit for jitter-free image capture from VCRs. And when it's used with external video devices, QuickCapture automatically genlocks to the video source or to a separate composite synchronous signal. It can also supply a synchronous signal to display stored images.

You can display the images in real time on any RS-170 RGB (National Television System Committee) analog monitor, with 256 shades of gray and VGA resolution. Each board includes 512K bytes of RAM and an on-board processor. An overlay processor lets

*QuickCapture AT captures images in real time.*

you mix text and graphics. **Price:** \$1995. **Contact:** Data Translation, 100 Locke Dr., Marlborough, MA 01752, (508) 481-3700. **Inquiry 1121.**

## Audio Comes in Three Channels with Sound Master

**T**he Sound Master PC is an inexpensive audio board and speaker system that lets you mix sound files with moving graphics on your IBM AT or XT.

It features a music/sound chip from Micro Chip, a direct-memory-access-driven 8-bit digitizer, a stereo amplifier, and dual digital joystick ports. Sample rate is variable from 10 Hz to more than 100

kHz. The frequency range has 16 bits of resolution and is adjustable from 50 Hz to ultrasonic.

There are three independently programmable analog output channels with separate frequency and envelope controls for each channel.

The audio amplifier produces 250 mW per channel into 8 ohms. Frequency response is flat to 5 kHz. Total harmonic distortion is 0.2 percent. Each channel has separate, digitally controlled, 4-bit gain stages for adjusting volume or for panning. You can connect the board to an external stereo, booster speakers, or headphones.

The 2¼-inch speakers have an impedance of 4 to 8 ohms and a maximum input of 0.3 W. Frequency response is 50 Hz to 12 kHz.

**Price:** \$89.95. **Contact:** Covox, Inc., 675-D Conger St., Eugene, OR 97402, (503) 342-1271. **Inquiry 1122.**

## Mac II Graphics Acceleration to 600 Percent

**T**he Radius QuickColor Graphics Accelerator board for the Mac II works in tandem with Radius video boards to boost the performance of Apple's 32-Bit QuickDraw by as much as 600 percent, Radius claims.

QuickColor Accelerator uses both the modular design of QuickDraw and capabilities built into Radius video display boards to speed drawing on a Mac II.

The QuickColor board moves the bulk of the drawing operations onto the NuBus by patching some of the QuickDraw bottleneck procedures and using a 5-million-instruction-per-second RISC processor. It loads multitasking code into the RISC processor's static RAM.

**Price:** \$795. **Contact:** Radius, Inc., 1710 Fortune Dr., San Jose, CA 95131, (408) 434-1010. **Inquiry 1120.**

*continued*

## Big Blue Goes Multimedia

**I**BM's Audio Visual Connection (AVC) software, coupled with two new Micro Channel add-in boards, brings multimedia capabilities to PS/2s.

They let you combine, edit, and store high-resolution still pictures along with text and full-range audio for multimedia presentations in educational and business applications.

In addition to creating presentations, you can use AVC

to develop applications that manipulate business data, such as an audiovisual home database for realtors.

The AVC software offers exact synchronization and mixing of audio, video, and text, plus 256-color image enhancement. You can also change the size and location of screen images, move text over an image without disturbing the graphics, and even animate the image by rapidly displaying a series of

graphics. The package uses a hypertext-like technique that lets you link text with related images and audio.

AVC requires an IBM PS/2 with at least 2.5 megabytes of RAM and OS/2 1.1 or DOS 4.0 or higher. It's also IBM Token Ring-compatible. AVC is designed to work with the PS/2 Video Capture Adapter/A, which captures, digitizes, and stores individual images from standard video or com-

puter graphics sources. For the audio side, you'll need IBM's PS/2 Audio Capture/Playback Adapter for analog audio input.

**Price:** Audio Visual Connection, \$495; Video Capture Adapter/A, \$2250; Audio Capture/Playback Adapter, \$565.

**Contact:** IBM Corp.; check your local telephone book's white pages or call (800) 426-2468.

**Inquiry 1119.**



# If You Want To Talk Fast DBMS Call 1-800-db-RAIMA™ And Start Screaming

You'll be screaming, all right. db\_VISTA III from Raima Corporation combines the flexibility of a relational DBMS and the lightning speed of the network database model.

**C** db\_VISTA III is written for C Programmers.

**Source code available.** The interactive database utilities and outstanding documentation make db\_VISTA III easy to learn. All applications are portable to VMS, UNIX, OS/2, MS-DOS, even Macintosh. No royalties.

**db\_VISTA III is *Fast*.** Using benchmarks originated at PC Tech Journal Laboratories, db\_VISTA III measured 3 to 12 times faster than the average relational database! Call us and we'll send you the results.

**Relational and Network Model Technology for Programming Flexibility.**

Retrieve a record fast using the relational keyed access method

db_VISTA III Database Management System		
Features	Yes	No
<b>db_VISTA 3.1 High Performance DBMS:</b>		
Single and Multi-User available	✓	
Relational B-tree Indexing	✓	
Network Database Model	✓	
Multiple database access	✓	
Referential integrity	✓	
Automatic recovery	✓	
Record & File locking	✓	
RAM resident		✓
<b>db_QUERY 2.1 SQL-based Query:</b>		
Relational Query & Report Writer	✓	
<b>db_REVERSE 1.0 Database Restructure Program:</b>		
Total database redesign/restructuring	✓	
Operating Systems*: VMS, ULTRIX, UNIX	✓	
BSD 4.2, SunOS, XENIX, MS-DOS,	✓	
Macintosh and MS Windows, OS/2 compatible	✓	
C Compilers*: Most compilers supported	✓	
C++ compatible	✓	
LANs*: 3COM, Novell, Banyan, AppleShare	✓	
<b>WKS Library:</b>		
Read & Write WKS, WK1 & DBF files	✓	
SOURCE CODE AVAILABLE:	✓	
ROYALTIES: (Absolutely not!)		✓✓

\*Other environments are supported; call for complete list.

and all related records can be immediately available using the network model. You decide how to combine these for best application performance.



**SQL Support** with SQL-based db\_QUERY, db\_VISTA III's relational query and report writer.

**db\_VISTA Puts You in Some Fast Company.**

Thousands of C programmers in over 50 countries worldwide use db\_VISTA III, including APPLE, ARCO, AT&T, EDS, Federal Express, Hewlett-Packard, IBM, NASA...

Don't wait. Call Raima for more information about how you can build applications that are *screaming-fast!*

**Call 1-800-db-RAIMA**  
(That's 1-800-327-2462)

**db\_VISTA III™**  
Database Management System

See us at  
**COMDEX/Fall '89**  
Bally's Casino Resort  
Booth # B1732

**RAIMA™**  
CORPORATION

Raima Corporation 3245 146th Place S.E., Bellevue, WA 98007 USA (206)747-5570 Telex: 6503018237 MCI UW FAX: (206)747-1991 Texas: (214)231-3131 International Distributors:  
UK: (0)933-300919 Germany: 07127/5244 Switzerland: (01)725 0410 France: (1)46092828 Benelux: 31(02159)46 814 Sweden: (013)124780 Italy: 045/584711 Norway: 47 244 88 55  
Denmark: (2)887249 Singapore: 468 3888 Australia: (02) 959 5122 Japan: (03)473 7432 Taiwan: (02)511 3277 Mexico: (83) 57 35 94 Central America: (506) 28 07 64  
Caribbean: (809) 834 4069 Colombia: 57 1 218 9245 Argentina: 54 1 313 5371 Chile: 56 2 696 4308 Uruguay: 92 19 37 Brazil: (0192) 52 9770 © Copyright Raima Corporation 1989

## Kurzweil Reading System Available on PC Platform

**T**he groundbreaking Kurzweil reading machine, which uses a scanner, optical character recognition, and speech synthesis to read documents to the blind and disabled, has finally migrated down from a stand-alone product and is available on a conventional IBM PC platform.

The new PC/KPR products include software, a desktop scanner, and an XT- and AT-compatible interface card. They require a PC with 640K bytes of RAM, DOS 3.0 or higher, and a hard disk drive. The only thing missing that was on the original stand-alone reading machine is a speech synthesizer, which you must purchase separately.

Like its stand-alone predecessors, the PC/KPR reads aloud scanned documents and can store text files for conversion to Braille or transfer the files into standard word processing applications.

Models 15 and 25 both use



*Kurzweil's PC/KPR reading machine reads scanned documents aloud, just like the original proprietary system.*

300-dpi Ricoh scanners. **Price:** Model 15, \$3995; Model 25, \$4995, optional document feeder, \$595; Model 35, \$7995; optional document feeder, \$1595. **Contact:** Kurzweil Computer Products, 185 Albany St., Cambridge, MA 02139, (617) 864-4700. **Inquiry 1124.**

## Add Two Parallel Ports to Your PC

**T**he LPT:123 is a two-thirds-size 8-bit card that adds two parallel ports to the IBM PC, XT, AT, or com-

patibles. It is compatible with DOS, Windows, and Xenix, and it is supported by the popular programming languages. You can add up to four LPT:123 adapters to a single personal computer.

Features include I/O address and interrupt-register select switches for each channel. Output is through DB-25 connectors.

**Price:** \$179. **Contact:** Commtech, Inc., 8622 Mt. Vernon Court, Wichita, KS 67207, (316) 651-0077. **Inquiry 1128.**

## PostScript Emulation in a Font Cartridge

**P**acificPage is a font cartridge that inexpensively turns your LaserJet Series II printer into a PostScript-compatible printer, Pacific Data claims.

You just plug in PacificPage, and, with PostScript interpreter emulation from Phoenix Technologies, it takes over the LaserJet II's 8-MHz processor for PostScript printing. There's no need for adding boards, cables, or software manipulation, the company reports.

PacificPage gives you access to 35 Apple LaserWriter-equivalent fonts in many

point sizes. It also provides all the PostScript capabilities: reversed text, scaled fonts, text rotation, and graphics such as arcs, circles, screens, patterns, and halftone images, according to Pacific Data.

You need at least 2 megabytes of RAM in your printer, and you're limited in print speed because the code in the font cartridges works off the LaserJet's 8-MHz three-wait-state processor.

**Price:** \$695. **Contact:** Pacific Data Products, 6404 Nancy Ridge Dr., San Diego, CA 92121, (619) 552-0880. **Inquiry 1125.**

## Reduce Macintosh Fan Noise with the Fan Controller

**I**f you're tired of the loud fan noise from your Macintosh II or IIx, you might try the Nova Fan Controller from Nova International. The company claims that by continuously varying the fan speed, the Controller can reduce your fan noise by as much as 50 percent.

Nova says that the Mac II fans are factory-set to cool a fully configured system, but a less-equipped system doesn't require the fan's default speed. The Fan Controller installs on the power supply, and a separate sensing unit attaches to your hard disk drive.

**Price:** \$79. **Contact:** Nova International, Inc., 435 North 34th St., Seattle, WA 98103, (206) 548-9339. **Inquiry 1130.**

*continued*

## Key Tronic Replaces Your Mac's Keyboard

**T**he MacPro is an inexpensive replacement for Apple's high-end keyboard. It features Key Tronic's capacitance key-switch technology and programmable macro software, and it's compatible with the Macintosh SE, SE/30, II, IIx, and IIcx.

The MacPro looks much like the standard Macintosh keyboard except for a larger L-shaped Return key. The backslash key has been moved from above the Return key to just below it.

The keyboard plugs into any Apple Desktop Bus con-

necter and has its own ADB connector for use with a mouse or other ADB-compatible peripheral. The 105-key MacPro comes bundled with Tempo II, Affinity Microsystems' keyboard macro software, which lets you program any key. And if you don't like the feel of the MacPro's keys, you can purchase a Key Tronic kit to adjust their stiffness.

**Price:** \$197; key-stiffness kit, \$15. **Contact:** Key Tronic Corp., P.O. Box 14687, Spokane, WA 99214, (509) 928-8000. **Inquiry 1126.**



"SCO Sets UNIX Standard for PCs."  
—COMPUTER DEALER NEWS (U.K.)

First, they built the  
world's standard.

Then they added standards  
no one else had.

And that was just  
the beginning.

THE SANTA CRUZ OPERATION, INC. PRESENTS

# UNIX NOW!

## THE SCO LEGEND CONTINUES

AN SCO™ PRODUCTION IN EXCLUSIVE ASSOCIATION WITH MICROSOFT CORPORATION AND AT&T • SCO'S BLOCKBUSTER 3.2 RELEASE OF UNIX™ SYSTEM V/386 FOR ISA, EISA, AND MCA SYSTEMS "UNIX NOW!"

STARRING FIPS POSIX™ • X/OPEN™ • C2 TRUSTED SECURITY • MICROSOFT™ C, MASM, AND CODEVIEW™

CO-STARRING AT&T FILE SYSTEM SWITCH, STREAMS, SHARED LIBRARIES, PCC, AND SOB • BERKELEY SELECT • DOS, OS/2™, AND XENIX™ CROSS-DEVELOPMENT • COMPUTER GRAPHICS INTERFACE

ONLINE MANUALS • EXTENSIBLE CONSOLE, MOUSE, AND SCSI DRIVERS • ALL SCO XENIX FEATURES INCLUDING MULTISCREEN™, SERIAL CONSOLE, AND AUTOMATIC POWER FAIL RECOVERY

AND INTRODUCING AUTOMATIC INSTALLATION • ACER™ FAST FILE SYSTEM • TRANSPARENT DOS FILE SYSTEM • DEVICE DRIVER WRITER'S GUIDE (WITH ANNOTATED SAMPLE SOURCE CODE)

SYSADM SHELL AS THE EASY-TO-USE SYSTEM MANAGER • MULTIPLE GROUPS, JOB CONTROL, AND RELIABLE SIGNALS AS THE FIPS POSIX EXTENSIONS • MMDF II AS THE MAIL DELIVERY AGENT

SUPPORTING CASES SCO EROFF™ • SCO MULTIVIEW™ • SCO XSIGHT™ X WINDOW SYSTEM™ • SCO NFS™ • SCO TCP/IP • SCO VP/ix™ • SCO uniPATH™ SNA-3270

PLUS HUNDREDS OF SUPPORTED PERIPHERALS INCLUDING TERMINALS, PRINTERS, SERIAL CARDS, TAPE DRIVES, AND ST506, RLL, ESDI, AND SCSI CONTROLLERS

PLUS THOUSANDS OF PROVEN APPLICATIONS SUPPORTED EXCLUSIVELY ON SCO SYSTEM V INCLUDING THE SCO PORTFOLIO™ FAMILY, SCO FOXBASE™, MICROSOFT WORD, AND 

PRODUCED, DEVELOPED, AND DIRECTED BY THE SANTA CRUZ OPERATION, INC. "UNIX" TRADEMARK CONFORMANCE SPECIFICATION BY AT&T

NOMINATED FOR MOST OPEN-SYSTEM STANDARDS! ★ EASIEST-TO-USE UNIX SYSTEM! ★ FASTEST 386/486 UNIX SYSTEM! ★ BEST XENIX COMPATIBILITY!  
MOST APPLICATIONS SUPPORTED! ★ MOST PERIPHERALS SUPPORTED! ★ MOST COMPLETE DEVELOPMENT SYSTEM! ★ BEST INTERNATIONALIZATION!  
BEST UNIX SYSTEM DOCUMENTATION! ★ BEST SUPPORT! ★ BEST TRAINING! ★ BEST WORLDWIDE DISTRIBUTION! ★ MOST WORLDWIDE OEM SUPPORT!

**OS OPEN SYSTEM**  
RECOMMENDED FOR AUDIENCES  
WITH STANDARDS

**SCO**  
THE SANTA CRUZ OPERATION

 OPEN  
DESKTOP.  
IS BASED ON SCO UNIX SYSTEM V386

SCO, the SCO logo, MultiScreen, SCO MultiView, SCO Portfolio, Open Desktop, and the Open Desktop logo are trademarks of The Santa Cruz Operation, Inc. • UNIX is a registered trademark of AT&T in the USA and other countries. • POSIX is a trademark of The Institute of Electrical and Electronics Engineers (IEEE). • X/Open is a registered trademark of X/Open Company Ltd. • Microsoft, CodeView, and XENIX are registered trademarks of Microsoft Corporation. • OS/2 is a registered trademark of International Business Machines Corporation. • Acer is a registered trademark of Acer International. • Eroll is a trademark of Etran Computer Group Inc. • Xsight is a registered trademark of Locus Computing Corporation. • X Window System is a trademark of Massachusetts Institute of Technology. • NFS is a trademark of Sun Microsystems, Inc. • VP/ix is a trademark of Phoenix Technologies Ltd. and Interactive Systems Corporation. • uniPATH is a trademark of Pathway Design Inc. • FoxBASE is a trademark of Fox Software Inc. • AutoCAD is a registered trademark of Autodesk, Inc.

© MCMLXXXIX The Santa Cruz Operation, Inc. All Rights Reserved. The Santa Cruz Operation, Inc. 400 Encinal Street, P.O. Box 1900, Santa Cruz, California 95061 USA. The Santa Cruz Operation, Ltd. Croyley Centre, Hatters Lane, Watford WD1 8YN, Great Britain. +44(0)923 816344, FAX +44(0)923 817781, TELEX 917372 SC01 ON G

**NOW SHOWING AT SCO AUTHORIZED RESELLERS!**

(800) SCO-UNIX (726-8649) • (408)425-7222 • FAX: (408)458-4227 • E-MAIL: ...!uunet!sco!info info@sco.COM

COME SEE US AT COMDEX (ROOM 4) AND UNIX EXPO!

Circle 320 on Reader Service Card

World Radio History

# November's NOVELL month in

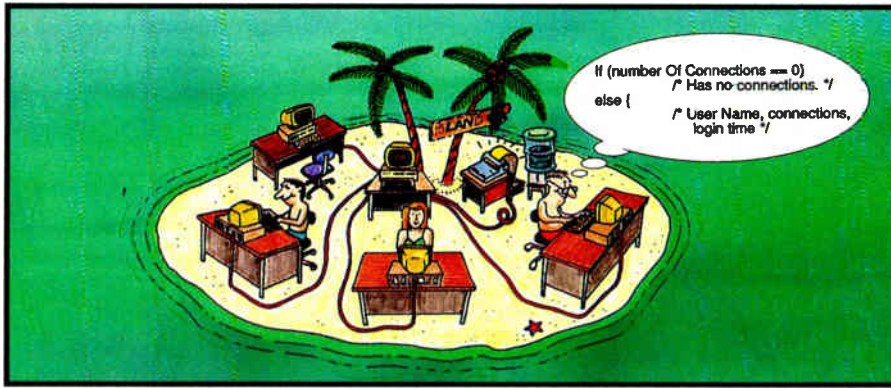

**Novell**, the technology leader in the network industry, provides a full array of programming tools designed to streamline the development of distributed applications. Novell's data management tools, connectivity tools, system-level application programming interfaces, and network compilers are optimized for the NetWare environment, so you and your users enjoy the flexibility, reliability and performance you expect from NetWare. When you are ready to build applications that fully exploit the power and flexibility of the NetWare environment, turn to Novell and Programmer's Paradise!

## SQL and NetWare SQL

NetWare SQL is an open interface relational database engine that has been tightly integrated with the NetWare operating system to provide back-end database services to a wide variety of front-end applications including database managers, 4GLs, accounting systems and spreadsheets.

Build your own front-end applications for NetWare SQL using XQL, an open programming interface that provides you with relational access to NetWare SQL databases through two programming levels: ANSI-standard Structured

Query Language (SQL) statements and powerful, low-level relational database primitives.

By making simple subroutine calls from C, Pascal, BASIC or COBOL, you can access data by field name, move forward or backward through the database, compute fields from other fields or constants, and even manipulate composite records built from multiple, joined data files. XQL provides a wide range of data types and application-defined buffering for fast data retrieval.

## NetWare RPC

NetWare RPC (Remote Procedure Call) is a set of sophisticated tools designed to assist you in creating distributed network applications. NetWare RPC extends application procedure calls across a network by automatically generating a set of subroutines that allow remote procedure calls to look and act like local procedure call routines.

NetWare RPC raises your development efforts above communication details and frees you from writing to complex IPC interfaces, thereby shortening the development cycle and decreasing the cost of developing distributed applications.

## C Network Compiler

C Network Compiler gives you a direct link into NetWare, the leading network operating system with the world's largest installed base of network application users.

Using standard programming techniques and this complete development kit, you can build applications that take full advantage of the NetWare environment.



This 100% ANSI C optimizing compiler is based on technology from WATCOM Systems Inc., and produces object code that out-performs any other C compiler for DOS.

In addition, the C Network Compiler kit includes Express C, a C Graphics Library, a Network Application Design Tutorial, an enhanced text editor, linker, debugger, and other utilities, plus a library of over 300 NetWare application programming interfaces (APIs), including those for the Btrieve record manager.

### **SPECIAL OFFER!!**

The **Novell C Network Compiler** gives you a direct link into NetWare, the leading network operating system with the world's largest installed base of network application users.

**Order the C Network Compiler from Programmer's Paradise before November 30 and save \$95 on the purchase of any other software we carry!**

**CALL FOR DETAILS!!**

## Novell Product Line

Btrieve Single-User	245	185
Btrieve for DOS 3.1 Networks	595	459
Btrieve for OS/2	595	459
Btrieve for XENIX	595	459
C Network Compiler	695	559
C Network Compiler/386	995	799
NetWare C Interface for DOS	295	239
NetWare MHS	100	79

LIST	OURS
245	185
595	459
595	459
595	459
695	559
995	799
295	239
100	79

NetWare MHS Interface Guide	145	129
NetWare RPC (Remote Proc. Calls)	CALL	CALL
NetWare RPC for OS/2	CALL	CALL
NetWare SQL	595	459
NetWare System Calls for DOS	195	159
XQL	795	599
Xtrieve PLUS	595	459
Xtrieve PLUS for OS/2	595	459

LIST	OURS
145	129
CALL	CALL
CALL	CALL
595	459
195	159
795	599
595	459
595	459



# Programmer's Paradise (800) 445-7899

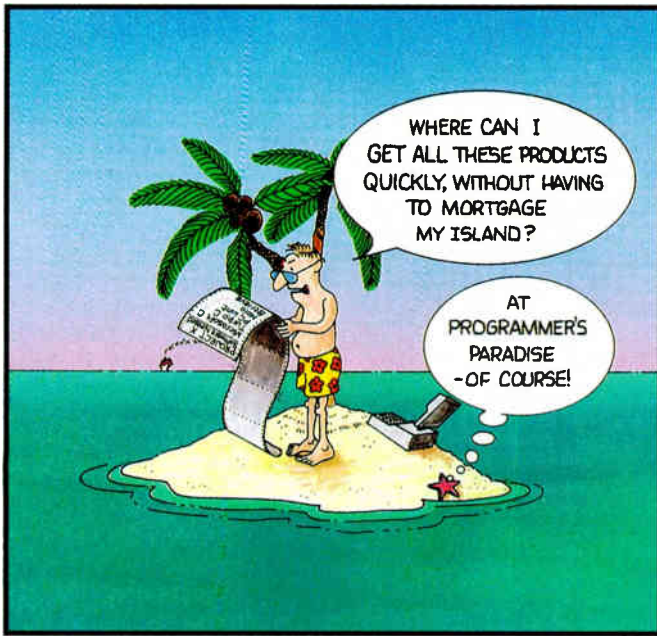

WE'LL MATCH NATIONALLY ADVERTISED PRICES.

	LIST	OURS
<b>386 DEVELOPMENT</b>		
386 ASM/LINK	495	435
386MAX	75	66
386MAX PROFESSIONAL	129	115
C Network Compiler/386	995	799
DESQview 386	190	169
Lahey F77L-EM/32	895	795
Paradox/386	895	625
VM/386	245	209
VM/386 Multi-User	895	759
VM/386 NetPak	150	129
<b>ASSEMBLY LANGUAGE</b>		
Advantage Disassembler	295	279
MS Macro Assembler	150	105
Sourcer w/ BIOS Pre-Processor	140	125
Turbo Assembler/Debugger	150	105
Visibie Computer: 80286	100	89
<b>C COMPILERS</b>		
C Network Compiler	695	559
Lattice C 6.0	250	199
Microsoft C	450	299
MS QuickC	99	69
MS QuickC w/ QuickAssembler	199	135
Turbo C	150	105
Turbo C Professional	250	175
WATCOM C 7.0	395	319

**NEW RELEASES**

**XVT by GSS**  
Library of C functions providing a common programmer interface across the Apple Macintosh, MS Windows, and MS Presentation Manager. XVT supports events, windows, graph primitives, fonts and text output, cursors, carets, menus, modal and modeless dialogs, file handling, printing, clipboard and a help system.  
List: \$595 **Ours: \$519**

**Dr. Switch by Black & White**  
Memory switching utility. Call any program of any size from any other program all within the limits of 640K. Applications are swapped in and out of memory at lightning speed whether you are using expanded memory, a RAM disk, or saving to disk. Easy to use. Needs less than 15K.  
List: \$60 **Ours: \$55**

**C Video Course by Zortech**  
Learn C without having to spend hundreds of dollars in seminar tuition fees. You get ten one-hour tapes containing 36 lessons from beginner's to advanced. Includes 365-page workbook and free Zortech C Compiler.  
List: \$300 **Ours: \$269**

	LIST	OURS
<b>C++</b>		
Guidelines C++	295	269
M++	495	CALL
Zortech C++	150	129
w/ source	250	209
Zortech C++ Tools	100	89
Zortech C++ Video	CALL	CALL
<b>C-COMMUNICATIONS</b>		
Breakout II	125	99
C Asynch Manager 3.0	189	139
Essential Communications	249	199
Greenleaf Comm. Library	299	209
Greenleaf ViewComm	559	475
Lattice Communication Library	250	209
<b>C-FILE MANAGEMENT</b>		
Btrieve	245	185
CBTREE	159	135
C Index + (Microsoft C)	195	179
C Index + (Turbo C)	99	89
Codebase IV	295	219
c-tree	395	318
d-tree	495	395
r-tree	295	241
CQL plus PASS	395	349
dBc III	250	219
db_FILE Bundle	295	249
Essential B-Tree (w/ source)	198	159
pBase	149	135
<b>C-GENERAL LIBRARIES</b>		
C TOOLS PLUS/6.0	149	109
C Utility Library	199	159
Greenleaf Functions	229	165
Greenleaf SuperFunctions	299	209
Turbo C TOOLS/2.0	149	115
<b>C-SCREENS</b>		
C-Worthy w/ forms and source	495	CALL
Facelt	99	89
Greenleaf DataWindows	395	279
JAM	595	529
Panel Plus	495	395
Vermont Views	395	CALL
w/ source code	790	CALL
Vitamin C	225	165
VC Screen	149	125
Vlib	149	129
<b>C-SOURCE ANALYSIS</b>		
Autoflow-C	299	269
C/Analyst	150	135
Clear +	200	169
C:Lines/C:Tree	80	75
<b>C-UTILITIES/OTHER</b>		
Code Master v. 2	289	259
Csource	395	359
C-Terp	300	219
Heap Expander	80	70
JAKE	495	429
Norton Guides for C	100	65
PC-lint	139	105
PRO-C	675	569
TimeSlicer	295	279
VmenVc	189	169

	LIST	OURS
<b>COBOL LANGUAGE</b>		
Micro Focus:		
COBOL/2 w/ Toolset	1800	1499
COBOL/2 Toolset	900	749
Personal COBOL	149	129
MS COBOL	900	629
Realia COBOL	995	849
<b>DATABASE DEVELOPMENT</b>		
Clarion 2.0	695	499
Clear+ for dBASE	200	169
Clipper 5.0	695	439
dBASE IV	795	489
FoxBASE+	395	249
Paradox 3.0	725	509
R&R Report Writer	150	129
w/ Clipper/ FoxBASE module	200	159
R&R Code Generator	150	129
Say What!	50	39
SilverComm Library 2.0	189	165
SilverComm "C" Interface	99	89
Tom Rettig's Library	100	80
<b>DEBUGGERS</b>		
Periscope Debuggers	CALL	CALL
Sherlock	195	179
<b>EDITORS</b>		
BRIEF	195	CALL
Epsilon	195	159
KEDIT 4.0	150	125
MKS Vi	149	129
SLICK Editor	195	175
SPF/PC	245	199
VEDIT	69	59
VEDIT PLUS	185	115
<b>FORTRAN LANGUAGE</b>		
Lahey F77L	595	529
Lahey Personal FORTRAN 77	95	89
MS FORTRAN	450	299
<b>GRAPHICS LIBRARIES</b>		
Baby Driver	250	225
Essential Graphics	299	239
Font-Tools	150	135
Graf-Text	89	79
Graphic 5.0	395	322
Graphics-MENU	195	175
GSS Graphics Devel. Toolkit	595	509
HALO	395	279
HALO Window Toolkit	595	419
Icon-Tools/Plus	150	135
MetaWindow	195	159
FontWindow	95	85
Menuet	250	225
PCX Effects	99	89
PCX Programmer's Toolkit	195	175
PCX Text	149	135
XVT	595	519
<b>LANGUAGE DEVELOPERS</b>		
LALR	99	90
MKS LEX & YACC	249	209
PCYACC Professional	395	359
<b>LINKERS/LIBRARIANS</b>		
Plink86plus	495	419
PolyLibrarian II	149	135
.RTLlink	195	185
<b>MODULA-2</b>		
LOGITECH Modula-2:		
Compiler Pack	99	75
Development System	249	199
Repertoire	149	135
TopSpeed Modula-2:		
B-Tree Toolkit	80	72
Communications Toolkit	80	72
Compiler Kit	100	89
DOS 3-Pack	200	179
TechKit	60	55
VID	60	55

International: 201-389-8950  
Customer Service: 201-389-8950  
Fax: 201-389-9227

Call or Write for Latest Free Catalog!

**1-800-445-7899**

Programmer's Paradise

A Division of Voyager Software Corp  
1163 Shrewsbury Ave., Shrewsbury, NJ 07702

	LIST	OURS
<b>PASCAL LANGUAGE</b>		
Asynch PLUS	149	115
B-tree Filer	125	99
MS QuickPASCAL	99	69
Object Professional	150	119
Power Screen 1.1	149	115
Power Tools PLUS/5.0	149	115
Topaz	75	67
Turbo Analyst	99	79
TurboMAGIC	199	179
Turbo Pascal 5.5	150	99
Turbo Pascal 5.5 Professional	250	169
Turbo-Plus 5.5	150	129
Turbo Professional 5.0	125	99
<b>SMALLTALK LANGUAGE</b>		
Smalltalk-80 (386)	595	535
Smalltalk/V	100	85
Goodies Libraries	50	45
Smalltalk/V 286	200	169
Smalltalk/V PM	CALL	CALL
<b>VERSION CONTROL SYS.</b>		
MKS RCS	189	159
Professional PVCs	395	335
Seidl Version Manager	300	269
TLIB	100	90
<b>WINDOWS (MS) TOOLS</b>		
Actor	495	429
C-Talk/Views	450	375
dBFast/Windows	249	229
MS Windows Development Kit	500	319
Whitewater Resource Toolkit	195	169
WinTrieve	395	339
<b>ADDITIONAL PRODUCTS</b>		
Baler v. 5.0	495	429
Derive	200	179
Dr. Switch	60	55
Matrix Layout	150	129
MKS Make	249	209
MKS Toolkit	249	209
Opt-Tech Sort	149	129
Paginate	100	90

**Vendor of the Month:**  
**PERISCOPE**

	LIST	OURS
Periscope I/OK	545	439
Periscope I/512K	795	639
Periscope II	175	125
Periscope II-x	145	105
Periscope III/10 MHz	1395	1115
Periscope III PLUS/OK	1745	1399
Periscope III PLUS/512K	1895	1519
Periscope IV/16 MHz	1995	1599
Periscope IV/20 MHz	2295	1839
Periscope IV/25 MHz	2595	2079

**TERMS AND CONDITIONS**

- We accept American Express, MasterCard, VISA - no additional charge.
- Purchase Orders welcome! (subject to credit approval)
- Mail/FAX orders must include phone #.
- 30-day return policy. Call for details.
- We welcome DEALER and INTERNATIONAL orders.
- Prices subject to change without notice.

CALL US IF YOU DON'T SEE THE PRODUCT YOU WANT--WE CARRY THOUSANDS OF TITLES!





## InterLan Software Links NetWare to LAN Manager

**L**MN Server allows Novell NetWare nodes transparent access to an OS/2 LAN Manager file server, InterLan claims.

LMN Server runs as a service under OS/2 on any OEM version of LAN Manager. Features include command-line utilities that are similar to NetWare utilities and limited support for NetWare menu utilities, such as SYSCON and FCONSOLE.

Transparent access from LAN Manager nodes to NetWare files, however, isn't yet an LMN Server feature, InterLan concedes, although there is an LMN Server utility for simple file transfer.

Requirements for the LMN Server include an IBM AT, Compaq, or compatible with 4 megabytes of RAM, an InterLan data-link controller (add-in board for 802.3 Ethernet), OS/2 1.0, LAN Manager 1.1, and Novell NetWare 286 version 2.15.

**Price:** \$1295.

**Contact:** InterLan, 155 Swanson Rd., Boxborough, MA 01719, (800) 526-8255; in Massachusetts, (800) 835-5526.

**Inquiry 1131.**

## Microsoft Adds Store-and-Forward Messaging to E-Mail

**M**icrosoft Mail 2.0, for Macs and IBM PCs, features store-and-forward messaging to send E-mail even when another server isn't available.

The Mail 2.0 server keeps trying at specified intervals and returns the message with an error if it's not received in a specified time. This method,



*NetWare and LAN Manager meet with InterLan.*

which Microsoft says is also used on global networks such as Internet, means that users don't need a permanent connection to every mail server.

The servers, rather than the users, also handle directory management. When servers are brought onto the mail system, they automatically exchange directory information with the other servers. Microsoft says that Mail 2.0 works on any networking hardware or software that supports AppleTalk networking protocols, including AppleTalk and Ethernet hardware.

Mail 2.0 ships in five packages: a starter kit (Mac server and one workstation), a single-node pack, a 20-node pack, a gateway to MCI Mail, and a gateway to AppleLink.

**Price:** Mail 2.0 server starter kit, \$395; node pack, \$125; 20-node pack, \$1495; MCI Mail gateway, \$595; Apple-Link gateway, \$295.

**Contact:** Microsoft Corp., 16011 Northeast 36th Way, P.O. Box 97017, Redmond, WA 98073, (206) 882-8080.  
**Inquiry 1135.**

## MacRing SE Runs as a Token Ring Node or Bridge

**B**ecause Apple Computer's recent connectivity announcements included NuBus adapters and nothing for Mac SEs, h-three Systems has made that SE connection.

The MacRing runs your SE as a Token Ring node, giving you the benefits of 4-

megabit-per-second data rates and AppleTalk applications. It also runs your SE with Apple's AppleTalk Internet Router software bridge to transparently tie your AppleTalk network to your Token Ring and Ethernet networks.

Each MacRing board includes 128K bytes of RAM and Texas Instruments' 4-Mbps Token Ring networking chip. Software requirements include Macintosh System 6.0.1 or higher.

**Price:** \$895.

**Contact:** h-three Systems Corp., 100 Park Dr., Suite 204, P.O. Box 12557, Research Triangle Park, NC 27709, (919) 549-8334.

**Inquiry 1134.**

## DMA Links DOS and Macintosh

**p**cMacTerm II and pcMacTerm II/Network give you fast data transfer and remote control of PCs and Macs.

The basic products give you bidirectional file transfer between Macintosh computers running System 6.0.2 or higher and PCs and compatibles equipped with at least 256K bytes of RAM. Data transfer is rated at up to 57,600 bps. Graphics to the VGA level are supported, as is a chat window for on-line conversations. Or you can use your computer's on-board LANs for additional communications.

The Network version of the software is for AppleTalk networks, supporting background file transfer under MultiFinder.

**Price:** pcMacTerm II, \$195; pcMacTerm II/Network, \$395.  
**Contact:** Dynamic Microprocessor Associates, Inc., 60 East 42nd St., New York, NY 10165, (212) 687-7115.  
**Inquiry 1136.**

## Mac Connection for Sharp's Wizard

**T**he new Organizer Link for the Macintosh lets you transfer your Macintosh files to your hand-held Sharp Wizard computer and vice versa. File transfer was previously possible only with DOS-based machines.

The physical link is through the Macintosh's

modem port, and the data transfer rate is 9600 bps. Cables are included in the package.

**Price:** \$149.99.

**Contact:** Sharp Electronics Corp., Sharp Plaza, Mahwah, NJ 07430, (800) 237-4277.

**Inquiry 1133.**

*continued*



# Here's How We Protect Your Software And Profits Better.



## We'll Never Tell.

Because our key-interrogation routines are *encrypted*, and our hardware is custom-wired to distinguish each of our clients' keys, our clients have the highest degree of security available.

Unlike other manufacturers, our routines assume responsibility for all hardware, software and timing issues.

And what this means is that your engineering time and money won't be wasted reinventing protection schemes.

We offer two high security products for copy control: the KEY and the MEMORY KEY.™

Our protection devices can also be used for serialization techniques, software leasing,

modular software management, creative revenue collection, demo control and a path for future upgrades.

The information stored in the MEMORY KEY can be conveniently reprogrammed by your application software or at the end user's site via software disk or modem.

All our products attach conveniently to the printer port, are transparent and allow for unlimited back up copies.

For serious software protection, call now. And start protecting your profits. Hands down, we're better.

*Encrypted routines provide the highest degree of security*

*Custom hardware and software for each developer*

*No batteries to fail or replace*



*No programming adapters necessary*

*Can be dynamically reprogrammed at the user site via diskette or modem.*

*Over 55 languages supported in DOS, XENIX and OS/2*



**PROTECH**  
MARKETING, INC.  
1-800-843-0413

*Se Habla Español*

**In Europe:** Microphar, 42, Ave. Sainte Foy 92200, Neuilly Sur-Seine France  
Tel: 33-1-47-38-21-21 Fax: 33-1-46-24-76-91, Call to obtain distributor addresses in:  
Belgium, Ireland, Italy, Netherlands, Portugal, Spain, Switzerland, U.K. & W. Germany.

**In the Americas and the Pacific:** ProTech, 9600-J Southern Pines Blvd. Charlotte, NC 28217  
Tel: 704-523-9500 Fax: 704-523-7651 Hours: Mon-Thurs: 8:30-7:00 ET, Fri: 8:30-5:30 ET  
FOR A DEMONSTRATION PACKAGE OR ADDITIONAL INFORMATION, PLEASE WRITE OR CALL.

*For Europe circle 292 on Reader Service Card*

*For Americas & Pacific circle 293 on Reader Service Card*

World Radio History

## DNA Adds Abilities to Its LANs

**D**NA's new LAN offerings have many of the same basic features of the company's flagship product: proprietary hardware, proprietary software incorporating poll-process collision elimination, a daisy-chain physical configuration, and twisted-pair wiring.

Enhancements to DNA 3.36, with the resulting product dubbed MicroNet, include a menu system; NetBIOS compatibility; messaging capabilities; support for shareable fax machines, fax boards, and modems; and the ability to farm out program executions to other workstations. Memory requirements are 120K bytes at the file server and 12K bytes at the workstation, or you can load parts of both programs in either extended or expanded memory.

Enhancements to the company's hardware include increasing the data transfer rate from 1.25 megabits per second to 2 Mbps. A MicroNet file server can theoretically handle 64 users, but DNA suggests the average installation of 16 users. MicroNet is also available as a two-user kit, which includes a file server card, software, and a workstation card. You can also purchase the workstation card separately.

An entirely new product, which also works with DNA 3.36, is MegaNet. It's a 10-Mbps network for up to 256 users. As with MicroNet, the cards support distances of 500 feet with unshielded twisted-pair cable, and 5000 feet with shielded twisted-pair cable. **Price:** MegaNet file server, \$695; MegaNet workstation, \$395; MicroNet file server, \$295; workstation, \$195; MicroNet two-user kit, \$345.



*DNA offers MicroNet for small businesses.*

**Contact:** DNA Networks, Inc., 351 Phoenixville Pike, Malvern, PA 19355, (800) 999-3622 or (215) 296-7420. **Inquiry 1132.**

## Speedy Network Backup for Your Macintosh

**T**he MaxStream MS2200e is a SCSI-based tape backup system that stores up to 2.2 gigabytes of information on 8-mm cassettes the size of audio cassettes. Data transfer is rated at 233K bytes per second.

Features include compatibility with AppleShare, TOPS, 3Com, and Novell 286, and software for automatic backup. It comes ready to install, the company says, with all the necessary cables and terminators.

**Price:** \$6695.

**Contact:** Archive Corp., Data Storage Division, 1650 Sunflower Ave., Costa Mesa, CA 92626, (800) 237-4929.

**Inquiry 1118.**

## Mark 386 Unix-Based System Supports 64 Users

**T**he 25-MHz Mark 386 is a Unix-based, 64-user desktop (or optional tower) system that's built for what used to be classified as mini-computer applications.

Standard equipment includes 4 megabytes of RAM (upgradable to 24 megabytes), a 1.2-megabyte 5 1/4-inch floppy disk drive, two serial ports, a parallel port, an AT-style keyboard, and room for up to five half-height storage devices. Model 10 is the bare-bones system. Model 40 adds a 170-megabyte ESDI hard disk drive, a controller, and a 150-megabyte streaming tape drive. Models 60 and 80 feature 382- and 765-megabyte ESDI drives. The tower chassis lets you have three additional half-height storage devices.

**Price:** Model 10, \$7400; Model 40, \$11,100; Model 60, \$12,400; Model 80, \$16,300; add \$1000 for tower style.

**Contact:** Point 4 Data Corp., 15442 Del Amo Ave., Tustin, CA 92680, (714) 259-0777.

**Inquiry 1110.**

## NETremote + 4.0 Adds Graphics, Security

**V**ersion 4.0 of NETremote+, a LAN remote-control program, provides CGA/EGA/VGA graphics support and requires only 15K bytes of RAM.

Version 4.0 works through LANs, across bridges, and even across wide-area networks to let you view the screen, control the keyboard, and even access peripherals of any other IBM PC or compatible. Brightwork Development claims that you can perform bridging and WAN functions twice as fast as you could with previous versions.

You can also use it to monitor large processing jobs. Brightwork says it has also added better security; now the "listening" PC is able to refuse access.

You can now hot-key from an active call to the local PC and back without disconnecting the call. New dial-in features include keyboard chat, a billing log, session recording, call-back, and voice-first (a feature that lets you set up a modem connection on the same line on which you started the voice connection).

Version 4.0 runs on DOS systems (3.1 or higher) and on NetWare 286 version 2.0 or higher, IBM Network Control Program, 3Com's 3+ and 3+Open, AT&T's StarLAN, Banyan's VINES/386, and TOPS. Also new is compatibility with IRMA boards.

**Price:** One-server version, \$350; multiserver version (for up to four file servers), \$695. **Contact:** Brightwork Development, Inc., P.O. Box 8728, Red Bank, NJ 07701, (201) 530-0440.

**Inquiry 1137.**

*continued*





# QNX<sup>®</sup>

## The OS for over-achievers<sup>™</sup>

QNX programmers have a decided advantage.

You see, people who use QNX enjoy the freedom that comes only with a flexible, modular OS. They appreciate the elegance of a **message-passing architecture**. And they marvel at the fact that QNX runs so lean—under 150K—yet out-performs any other PC operating system.

QNX users never worry about whether their applications will make it at runtime, because they know QNX has proven itself again and again in the real world.

It's no wonder that QNX users have achieved so much since the product was first released for the PC in 1982: over 80,000 systems installed in 47 countries world-wide, in all kinds of applications—from making cars to selling books to handling online credit card transactions.

One reviewer dubbed QNX "The multi-everything OS." Now, you might expect

multiuser and multitasking, but realtime? *And* integrated networking? *And* true distributed processing? Best of all, these terms take on a new meaning with QNX.

**Multiuser**, for instance, means up to 32 terminals per micro. **Multitasking** cashes out as 150 tasks per machine.

**Realtime** means not only priority-driven, preemptive task scheduling, but also speed: at 6,896 task switches/sec on a 16MHz 286, QNX is at least a full order of magnitude faster than a typical UNIX system. **Integrated networking** means you won't need yet another layer of software to set up a LAN, and you can use *any mix* of Intel-based micros—from vintage '81 PCs to PS/2s.

**Distributed processing** with QNX sounds too good to be true. But it is: *Any task can access any resource*—programs, files, devices, even CPUs—without going through the bottleneck of a central file server.

Besides the satisfaction that QNX developers get from using a fast, powerful, and flexible OS, did we mention that they also enjoy *free technical support*?

If you're wondering why you don't already know all about this great OS, you could try asking the over-achievers who are smugly guarding the secret of their success.

Better yet, give us a call. We'll tell you everything you need to know to become an over-achiever yourself.



Circle 305 on Reader Service Card

For more information or a free demo disk, please phone (613) 591-0931.

Quantum Software Systems Ltd., 175 Terrence Matthews Crescent, Kanara, Ontario, Canada K2M 1W8  
QNX is a registered trademark of Quantum Software Systems Ltd. UNIX is a registered trademark of AT&T. PS/2 is a registered trademark of International Business Machines Corporation. © 1989 Quantum Software Systems Ltd.

World Radio History

SEE US AT COMDEX!  
BOOTH H8732

# Finally. An input device based on your input.



## Introducing SummaSketch® II.

The new SummaSketch II tablets have been created with one thing in mind — you, the people who use tablets every day. You told us what you wanted in the ultimate tablet, and we put it all into SummaSketch II.

We kept all the features that have made SummaSketch the industry standard — features that have led to more SummaSketch tablets being used today than any other brand.

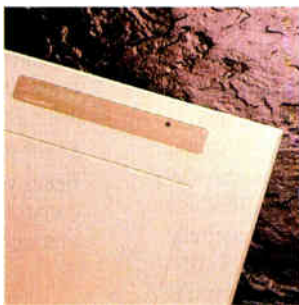

**The industry standard.**

You said you wanted a complete plug and play package, not a basic tablet with a list of optional extras. So we're giving you the works — both in PC and Macintosh® SE and II versions. A 12" by 12" or 18" by 12" active area tablet; your choice of a four-button cursor and two-button stylus or 16-button cursor; utilities diskette and more. The PC version includes interface cables for the IBM® PC, PS/2, AT and compatibles, while the Macintosh version has a unique Apple® Desktop Bus interface device to connect the tablet to the computer.



**A complete plug and play package.**

When asked about the one key benefit you look for in deciding on an input device, your answer was productivity. And SummaSketch II delivers.

Unlike a mouse, our stylus gives you a more natural "pen-to-paper" feel for free-hand drawing. Our 4- and 16-button cursors can be programmed to move you quickly through the most sophisticated software. For the PC market, we offer a free tablet template (US and Canada only) that puts hundreds of software commands in view . . . and at your finger tips. No need to memorize commands or scroll through two or three screen menus to use the functions you want.



**Push-button productivity.**

*IBM Compatible inquiries circle 342; MAC inquiries circle 343, and dealer inquiries circle 344 on Reader Service Card.*





No tablet offers more software compatibility than SummaSketch. Our tablets work with over 250 PC programs and all Macintosh SE and II software written under the Apple Software Developers guidelines.

Since we are the standard, most competitive tablets offer software compatibility by emulating Summagraphics tablets (just look it up in their manuals). In fact, in a recent article comparing IBM PC version tablets, all nine competitive tablet manufacturers emulated Summagraphics in order to provide software compatibility.

But that's not all. Our PC version utility diskette also includes diagnostic test and reset software, an Autodesk® Device Interface™ driver, Universal Mouse Emulator™ and a Microsoft® Windows driver.



**The most software compatibility.**

When it comes to digitizing, the one deciding factor every tablet buyer wants (and every tablet manufacturer touts) is accuracy. SummaSketch II tablets have an accuracy measurement of  $\pm 0.015$  inches. This figure is based on the average accuracy found over the entire SummaSketch II surface — not just a "sweet spot" found in the center of the tablet. And both the 4- and 16-button cursors come with an easy-to-view cross-hair sight for precise tracing.

SummaSketch II tablets also come with high proximity so you can trace from documents up to 1/2" thick. And selectable resolution of up to 1,016 lines per inch (or twice the degree of resolution needed for most graphics applications).



**High accuracy and control.**

Add up all the benefits, then add in convenience features such as a power/proximity light, on-off switch, wedge shape design for easy use, lightweight construction for portability — and it's easy to see why SummaSketch has been, and will continue to be, the best selling tablet in the world.

Whatever the application — CAD/CAM/CAE, business or design graphics, animation, cartography, cost estimating and more — SummaSketch is the overwhelming choice of today's computer professionals. Simply stated, you can't go wrong or be "second-guessed" when you choose SummaSketch, which is why more people make that buying decision than any other.



**The choice of professionals.**

The deciding question — price. Would you pay more to get a tablet that has everything in the box, that gives you the most software compatibility, a choice of cursors and includes added productivity tools?

That's the one decision you don't have to make, because SummaSketch II tablets come with everything you need, all at an affordable price. And that makes our new SummaSketch II tablets the easiest buying decision you have to make.

Why not find out more about SummaSketch II today? For literature and the name of a local dealer call 1-800-888-2028, Ext. 304. For technical information call 203-881-5400.



**Price/performance leader.**



**Summagraphics™**

Every decision should be this easy.™

© 1989 Summagraphics Corporation All rights reserved

## Tools and Utilities for the DSP96002

Intermetrics' newest version of InterTools, the optimizing C compiler, assembler, cross debugger, and utilities library, will support the DSP96002, Motorola's 32-bit, IEEE-standard, floating-point digital-signal-processing (DSP) chip. The new version of InterTools and the DSP96002 should be available in the first quarter of 1990, both companies report.

The 32-bit 96002 is an architectural superset of Motorola's 24-bit 56001 chip. The DSP96002 is compatible with Motorola's 56001 fixed-point products, but it offers speeds of up to 40 million floating-point operations per second and on-chip test and debugging functions, Motorola reports.

The InterTools compiler supports embedded systems development, and the macro cross-assembler provides an interface between 96002 assembly language and C. Utility programs include a linker, a locator, a formatter, a librarian, a symbol lister, and a symbol mapper.

Intermetrics reports that the first development platforms that InterTools will support will be the IBM PC and Sun workstations. Versions will follow about a month later for other platforms, including other Unix workstations, the VAX Ultrix, and the VAX/VMS. Running on the IBM PC, InterTools' compiler requires about 260K bytes of RAM and DOS 3.1 or higher.

**Price:** \$3500.

**Contact:** Intermetrics, Inc., 733 Concord Ave., Cambridge, MA 02138, (617) 661-1840.

**Inquiry 1157.**

Intermetrics' cross debugger gives real-time diagnostics in C or assembly language for Motorola's 32-bit DSP chip.

## Compile Applications for the NeXT Computer

Absoft's FORTRAN 77 compiler is optimized to run on the NeXT system, allowing you to port programs written for the VAX/VMS, IBM/VS, Sun, and Apollo machines to the NeXT. You can use the program to compile and execute from the standard Unix interface, or you can add a graphical interface to a standard FORTRAN program with the NeXT Interface Builder and the object-oriented superset of FORTRAN 77.

An object created with Object-Oriented FORTRAN can be used the same way as an object created in Objective-C, Lisp, or the Interface Builder, Absoft reports. The compiler uses the same function-calling interface, allowing it to work with C functions.

FORTRAN 77 currently supports version 0.9 of the NeXT operating system; Absoft reports that it will support 1.0 when that is released.

**Price:** Universities, \$750; retail, \$1000.

**Contact:** Absoft Corp., 2781 Bond St., Rochester Hills, MI 48309, (313) 853-0050.

**Inquiry 1158.**

Oasys, an established provider of compilers for Unix, VMS, and DOS, now has three native compilers for C, Pascal, and FORTRAN on the NeXT system. The Green Hills compilers have language-specific front ends with common back ends that allow you to mix and match different programming languages in the same application.

All three compilers are switch-selectable to emit assembly code for the 68000 family of processors and instructions for the 68881 floating-point coprocessor.

**Price:** \$1500 each.  
**Contact:** Oasys, Inc., 230 Second Ave., Waltham, MA 02154, (617) 890-7889.

**Inquiry 1159.**

## Help for HyperCard Programmers

COM Simulations' HyperTMON lets you single-step through HyperTalk scripts line by line, including XFCN and XCMD extensions, so that you can detect mistakes and set multiple breakpoints to isolate bugs before they cause problems. Once you discover a bug, you can

immediately modify the offending code.

Once you've installed HyperTMON in HyperCard or the Home Stack, two new menu items appear on the menu bar: HyperTMON and Debug. After you've invoked HyperTMON, HyperCard-like floating windows appear, letting you examine a button's script or examine the contents of variables. You can set breakpoints in the script or single-step through it.

If a script is called by another script, HyperTMON follows it up the hierarchy. As the script executes, the Expressions window updates and displays the present value of local and global variables. You can enter any HyperTalk expression for HyperTMON to evaluate in real time.

**Price:** \$99.95.

**Contact:** ICOM Simulations, Inc., 648 South Wheeling Rd., Wheeling, IL 60090, (312) 520-4440.

**Inquiry 1160.**

Somak's ScriptEdit improves the script-editing capabilities of HyperCard's basic script editor. With ScriptEdit, you can open and edit as many script windows as your available memory can handle, and you can use Find and Replace functions to search through the open scripts. You can also use the Find and Replace functions on all scripts of the current card.

Other HyperCard functions, including all navigation commands, are available while ScriptEdit is open, and the program saves all font, size, and window positions for each script. Script windows contain an index to all stack objects and are instantly updated when changing cards.

**Price:** \$79.

**Contact:** Somak Software, Inc., 535 Encinitas Blvd., Suite 113, Encinitas, CA 92024, (619) 942-2556.

**Inquiry 1161.**

*continued*



This is all  
the space  
you need  
to operate  
the new  
Microsoft  
Mouse.

Here's the first thing you should do with the new Microsoft® Mouse.

Bring up the expanded control panel. Set it for "Fast." And then, with a very slight movement of your hand, watch the cursor scoot all the way across the screen.

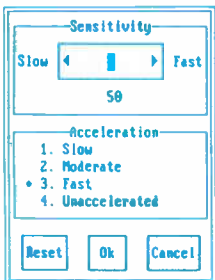

*You're in complete and total control with the new, expanded control panel.*

You'll be hooked. And don't worry about control. We upped the resolution to an extremely accurate 400 points per inch. In other words, the cursor practically reads your mind.

To help even more with accuracy, the tracking ball is in front. And the patented design fits comfortably in your hand.

What it all means is you get more out of your software. By being able to quickly and efficiently click through even the most sophisticated applications.

In fact, we put OS/2 support in our up-

graded driver. Making the Mouse ready for whatever the future of software brings.

To complete the package, you also get a choice of Microsoft Windows/286™ or Microsoft Paintbrush™, two useful Mouse programs.

So visit your Microsoft dealer for more details and a complete demonstration.

Now, you may not want to let your boss know just how little room you need for a Microsoft Mouse. You could lose your shot at a bigger desk.



**Microsoft®**  
Making it all make sense®

# NOVAS

See us at  
COMDEX/Fall '89  
November 13-17  
Riviera Hotel #R8621  
Las Vegas, Nevada

The Leader in High Performance Since 1982

## NOVAS NEAT 286-20MHz 40MB VGA SYSTEM

- 1 MB SIMM Module RAM
- 1.2 MB or 1.44MB Diskette Drive
- High Speed 1:1 Dual Controller
- Enhanced 101 Tactile Keyboard
- 200W Power Supply
- Mini-Tower Case
- 40MB 28ms Hard Drive
- 16 Bit High Speed VGA Controller
- High Resolution VGA Monitor
- DOS 3.3 w/GW Basic
- 80286 Harris CMOS
- 16MHz CPU Running at 20MHz
- Chips & Technologies 286 Neat Chipset
- Interleave/Page Mode 0 Wait
- Shadow RAM, Clock, Battery, AMI BIOS
- 8 I/O Expansion slots, EMS 4.0 support
- Expandable to 8MB on Motherboard
- 287 Socket, 2 Serial, & 1 Parallel Port

POWER METER MIPS = 3.38

**\$2195**

\*Option: 80MB VGA System \$2375

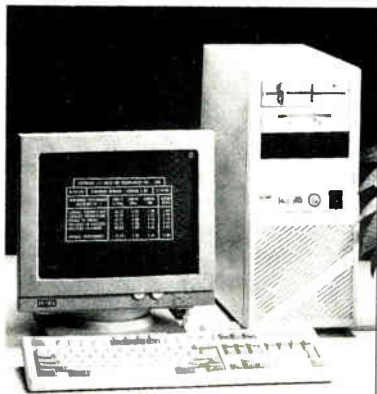

## NOVAS 386-25MHz W/CACHE 80MB VGA SYSTEM

- 1 MB SIMM Module RAM
- 1.2 MB or 1.44MB Diskette Drive
- Chips & Technology 82C307 Cache
- High Speed 1:1 Dual Controller
- Enhanced 101 Tactile Keyboard
- 200W Power Supply
- Tower Case
- 80MB 28ms Hard Drive
- 16 Bit High Speed VGA Controller
- High Resolution VGA Monitor
- DOS 3.3 w/GW Basic
- 80386 Intel 25MHz CPU
- Chips & Technologies 386 Chipset
- Interleave/Page Mode 0 Wait
- Shadow RAM, Clock, Battery, AMI BIOS
- 8 I/O Expansion slots, EMS 4.0 support
- Expandable to 16MB on Motherboard
- Socket for 287/387/Weitek
- 2 Serial, & 1 Parallel Port

POWER METER MIPS = 5.87

**\$3495**

\*Option: 150MB ESDI VGA System \$4295

1. Baby Neat 286-14MHz (12MHz CPU) Motherboard W/OK ..... \$315
2. Baby Neat 286-20MHz (16MHz CPU) Motherboard W/OK ..... \$425
3. Baby 386-20MHz (20MHz CPU) W/OK ..... \$645
4. AT 386-25MHz (25MHz CPU) W/OK W/Chips 82C307 Cache Controller ..... \$1395
5. NOVAS 4000 SUPER 16 Bit VGA 1MB INSTALLED 1024 x 768, 16 COLORS 800 x 600, 256 COLORS ..... \$295
6. Baby 386 SX Motherboard W/OK ..... \$375

"...FULLY LICENSED TO UTILIZE **IBM** PATENTS..."

# NOVAS

Quality Products From  
**COMPUTRADE CO.**  
1841 Zanker Road  
San Jose, CA 95112

**SPECIAL PRICING FOR OEM, VAR, & DEALERS**  
Corporate & University Discounts

\*VGA, XT, AT & IBM are trademarks of International Business Machines  
\*Prices & specs subject to change

**U.S. SALES:(408) 441-6500**  
**U.S. FAX:(408) 441-6811**

## WHAT'S NEW

SOFTWARE • BUSINESS

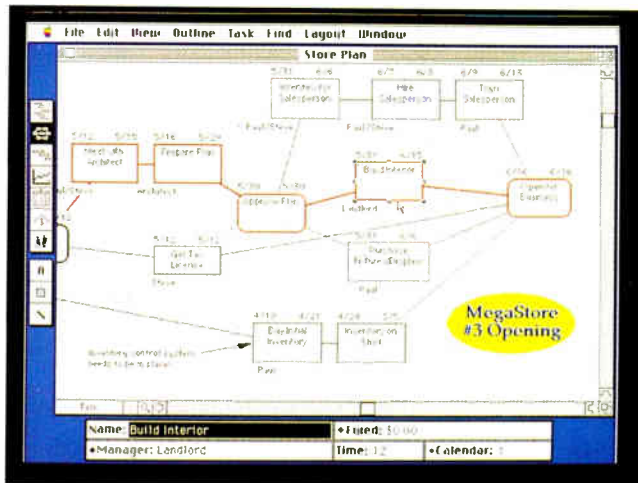

To build a network view with KeyPlan, you pull your topics from the outline.

## Project Management on the Mac

According to Symmetry, the problem with most project management programs is that they are designed for those who already know how to manage a project. If you're new to the profession, project management programs have a steep learning curve. With that in mind, the company developed KeyPlan, which lets you start your project management with nothing but a to-do list.

KeyPlan's integrated outliner lets you outline and attach data to tasks that you can then convert to a PERT or Gantt chart. To create charts, you select and drag tasks, bars, headings, and other elements into place. The program creates a Gantt chart automatically from your outline.

The program lets you track actual against planned time lines. When you plot your data in a bar chart, you can highlight a peak area (e.g., an inordinate number of delays) and click on it to display the cause.

KeyPlan supports color, all installed fonts (including PostScript), and the Clipboard. It works on the Mac

Plus or higher.

**Price:** \$449.

**Contact:** Symmetry Corp., 225 East First St., Suite 107B, Mesa, AZ 85201, (800) 624-2485 or (602) 844-2199.

**Inquiry 1138.**

Micro Planning International, known for its project management programs that run on the Macintosh and on the IBM PC under Windows, recently released a new version for the Mac that can handle multiple projects and subprojects, and up to 10,000 activities.

Called Micro Planner X-Pert, the program includes earned-value analysis costing and the ability to break down work structures to eight levels. You can use up to four different cost rates per resource and compare actual cost information with budgeted cost. X-Pert can handle up to 200 calendars per project; 100 zone, responsibility, and cost labels; and 50 subprojects with 1364 records.

Micro Planner X-Pert runs on the Mac SE and II with at least 2 megabytes of RAM.  
**Price:** \$1995.

**Contact:** Micro Planning International, 235 Montgomery St., Suite 840, San Francisco, CA 94104, (415) 788-3324.

**Inquiry 1139.**

continued



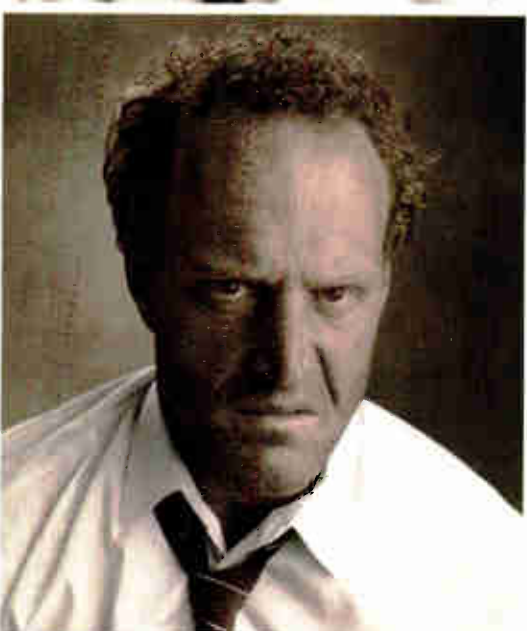

Swell.

The developers are all over your mini. Which is all well and good, as long as you have another machine for production stuff. But you don't. So your mini bogs down. And who do people complain to? You. Before you know it, the whole world's on your case to buy another mini.

No problem. What's another \$500,000 out of your budget?

Professional ORACLE® on a PC is exactly like ORACLE on a mini or mainframe. Same tools, same documentation, same everything.

Which means anything developers can do on the mini, they can now do on a PC. Only faster. And without slowing down the production system.

And with no changes, they can port the new application to the mini.

You can have Professional ORACLE for only \$1,299. Or the Trial Version for \$199.

Which frees up the mini to be what it was meant to be—a production platform.

And if, after 30 days, you're not happy, send it back for a full refund.

Call 1-800-ORACLE 1, Ext. 4955 to order. And enter the computing environment of the 90's.

**ORACLE®**  
Compatibility · Portability · Connectivity

Develop with ORACLE on the PC, instead. Call 1-800-ORACLE 1, Ext. 4955.

Offer valid in U.S. only. Professional ORACLE. Requirements: MS-DOS—80286/80386 PC with MS-DOS V3.1+, hard disk, 640KB of memory and 386K+ extended memory required. 2.5MB of extended memory recommended (required for: SQL\*ReportWriter™). OS/2—80286/80386 PC w/ OS/2 V1.0+, hard disk, 3MB memory. SQL\*ReportWriter™ not available for OS/2 and is replaced by SQL\*Report®. Copyright © 1989 by Oracle Corporation. ORACLE and SQL\*Report are registered trademarks of Oracle Corporation. SQL\*ReportWriter is a trademark of Oracle Corporation. MS-DOS is a trademark of Microsoft Corp. OS/2 is a trademark of International Business Machines Corp.

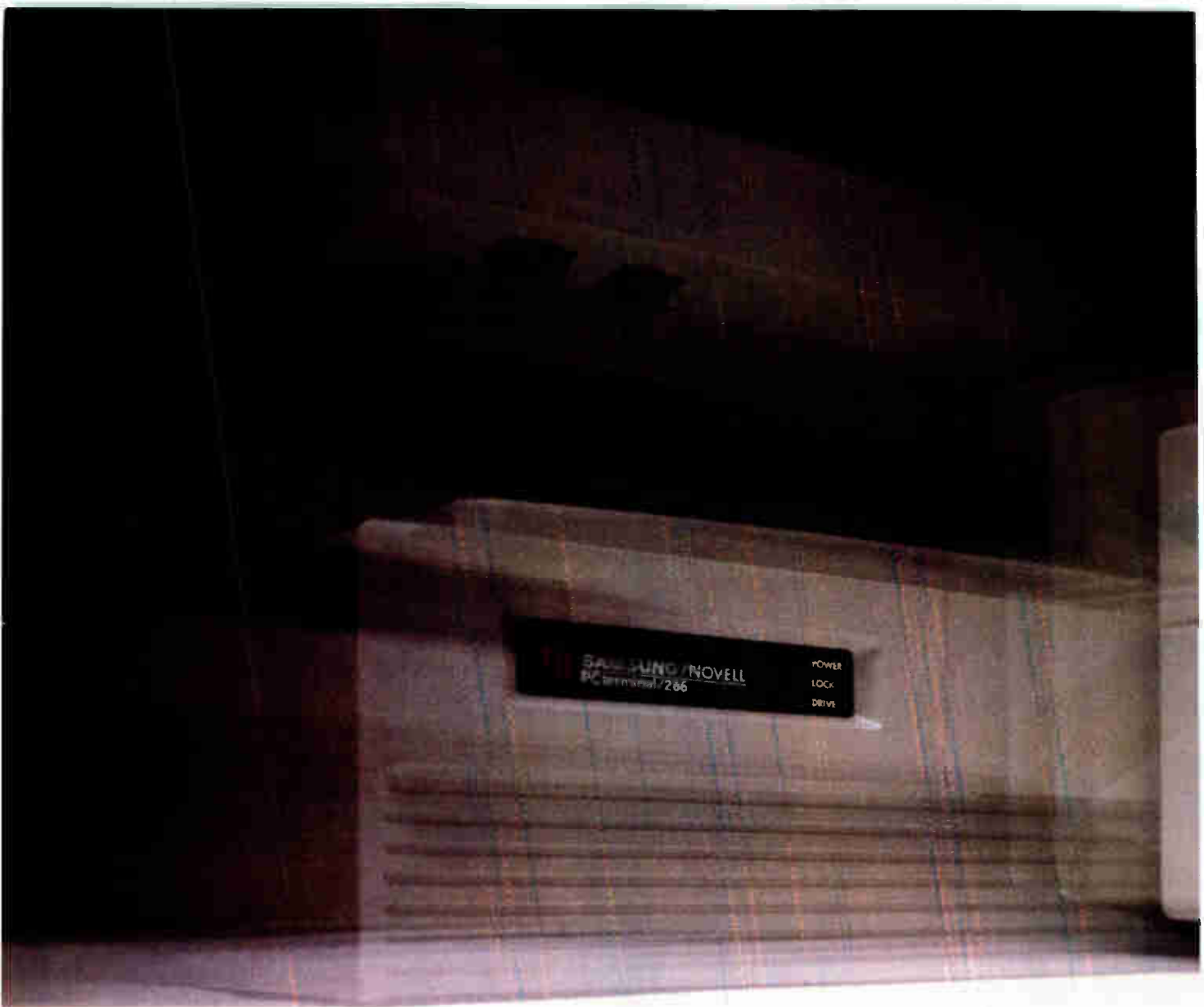

## What better way to run Novell's 386 NetWare .

Novell's new 386 NetWare® will do for networking what gunpowder did for negotiating leverage. Provided you've got a 386 machine that's designed to be 100 percent compatible with it.

Not to worry.

Samsung's LAN hardware was co-designed by Novell®. Which should put any compatibility concerns to rest. That's why the Samsung/Novell co-label is on our 386AE Fileserver and our PCterminal/286 LAN workstation.

### NETWORKING vs. NOTWORKING.

Both the Samsung 386AE and PCterminal/286 have been tested exhaustively by Novell for compatibility with popular networking hardware and NetWare products. In fact, no other LAN hardware

has ever undergone such extensive testing.

But then Samsung and Novell didn't set out to design just another make-do desktop computer.

Samsung's 386AE Fileserver, for example, was designed from the bus up to be a high-performance fileserver, starting with its Novell-developed BIOS. It also sports eight expansion slots for the inevitable inventory of interface and controller cards. Plus an oversize power supply capable of driving the requisite 100 megabyte-plus hard disk, tape backup system, etc. And it includes 4 megabytes of high-speed RAM for disk caching.



### A TOTAL LAN SOLUTION.

To maintain NetWare compatibility throughout





your network, choose Samsung's PCterminal/286, a Novell-tested LAN workstation. Inside you'll find a built-in Ethernet interface adapter, and functional features like Novell's NetWare Autoboot EPROM.

**THE NO BOTTLENECK ETHERNET CARD.**

Our new SE2100 Ethernet interface eliminates the network bottleneck. Designed by Samsung, this high-performance 16-bit card provides twice the throughput of other Ethernet interfaces. And you can retrofit your existing workstations and file servers with the SE2100 for dramatic improvements in your network's productivity.

**LOOK FOR THE CO-LABEL.**

The partnership between Samsung and Novell has

created a hardware/software compatibility standard unparalleled in the industry. That means your network can experience all the speed of Novell's new 386 NetWare without being subjected to a lot of hardware hiccups.

Just look for the Samsung/Novell co-label. You'll find it at your nearest reseller. For the location, call **1-800-366-7472**.



# INTELLIGENT SERIAL I/O CARDS WITH DYNAMEMORY™!

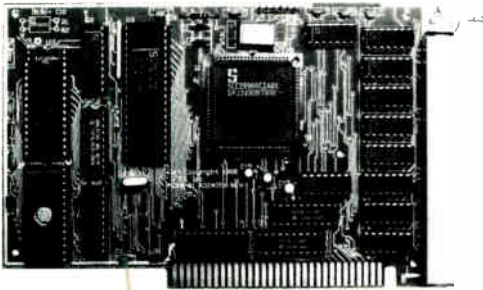

The PCSS-81 is GTEK's most popular intelligent serial I/O card. It provides 8 channels for PC/XT/AT/PS2-286 and is DOS compatible. The PCSS-81 has 32K of *Dynamemory*, user upgradeable to 128K bytes.

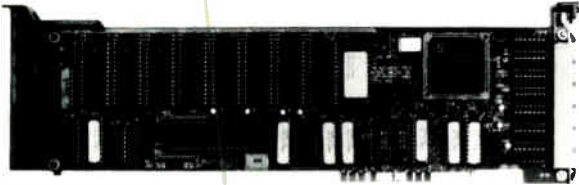

The MCSS-91M is GTEK's newest intelligent card for the Micro-Channel. The MCSS-91M provides up to 9 serial channels and up to 1 Megabyte of memory. The MCSS-91M comes with 32K of *Dynamemory*, and is user upgradeable to 1 Megabyte.

## Fast - Intelligent - Affordable

### MODEL 9000 EPROM PROGRAMMER

If speed is what you want, GTEK's Model 9000 Eeprom Programmer will never let you down. Its quick and intelligent programming algorithms give you *super fast speed*, and you can program the chip of your choice, including MPUs, erasable bipolar prom equivalents and Megabit parts.

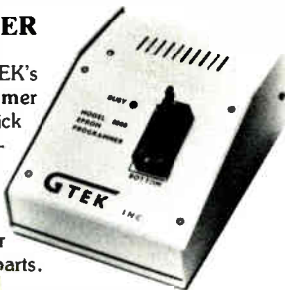

Call Toll Free 1-800-255-GTEK (4835) for details on these and other quality GTEK products.

# GTEK®

Development Hardware & Software  
P. O. Box 2310  
Bay St. Louis, MS 39521-2310

Fax: 1-801-487-0935 MS & Technical Support 1-801-487-8048

Micro-Channel & PC/XT/AT/PS2 are Registered Trademarks of IBM Corp  
Dynamemory is a trademark of GTEK, Inc

## WHAT'S NEW

### SOFTWARE • BUSINESS

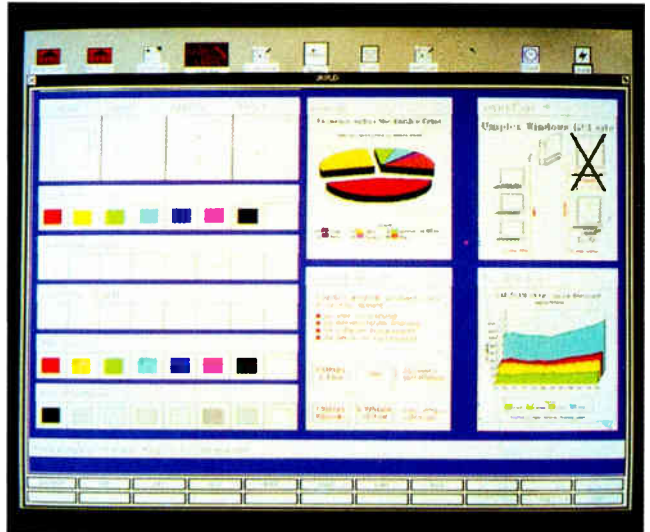

*Uniplex Windows will support any X Window 11.3-based implementation, Uniplex reports.*

### Uniplex to Run Under X Windows

**U**niplex, the Unix multi-user office system with word processing, spreadsheet, E-mail, and relational database capabilities, is now available running under the X Window graphical user interface (GUI). The new version will allow X Window or compatible terminals to display Uniplex Business Software through multiple overlapped windows with icons and mouse commands.

Uniplex Windows works like a terminal emulator: What you see is a view of the program through an X Window GUI. The same Uniplex application that runs on character terminals drives the X terminals, with Uniplex Windows acting as the intermediary between Uniplex source code and what you see on the terminal. If you have terminals that support X Window, and others that support character-based programs, Uniplex Windows will let you use both, the company reports.

The program will support any X Window 11.3 implementation, and the new release uses the Athena Toolkit and technology from IXI

Limited for the GUI. Uniplex reports it is also working on a version to support Motif. **Price:** \$175 to \$300 per user.

**Contact:** Uniplex, 150 West Carpenter Freeway, Irving, TX 75039, (214) 717-0068. **Inquiry 1144.**

### Database for Legal Case Notes

**F**or Legal Case Notes is a database that lets you track case notes and statutes of note. You can use the program to find cases and statutes by topic, case name, or subject. You can print reports on cases and statutes by criteria that you specify. Home-Craft reports that the program, which is designed for people who aren't DBMS experts, can handle up to 10,000,000 cases and allows you to cross-reference notes. For Legal Case Notes runs on the IBM PC with 256K bytes of memory.

**Price:** \$99.95. **Contact:** HomeCraft Computer Products, P.O. Box 974, Tualatin, OR 97062, (503) 692-3732. **Inquiry 1143.**

*continued*



# PHOTOGRAPHY FOR THE COMPUTER GENERATION.



Canon's RC-470 Still Video Camera.

2-inch floppy disk.



Computer graphics. Desktop publishing. They're the hottest things going. And Canon has the hottest way to make the most of them; the Canon Still Video System.

A Canon Still Video Camera like the new RC-470, looks, feels and works just like the 35mm Canon cameras you know and love.

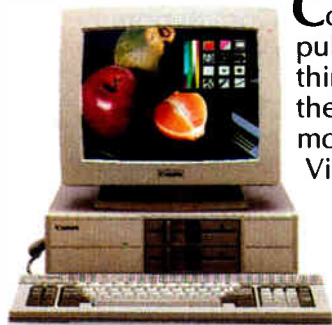

Introducing computer *photographics*.

Except that you don't use film—you use video floppy disks that store up to 50 images. Then with a Canon Still Video Player, these images can be downloaded into any computer that has a compatible NTSC video interface board.

Then you're ready to use your computer's graphic capabilities. Make better presentation



Canon Xap Shot Still Video Camera/Player

graphics, expand your desktop publishing abilities, create an image library; the applications are limited only by your imagination.



The Canon FP-510 Printer.

Canon has a wide range of still video cameras. There's the Xap Shot, a basic combination recorder/player that's easy to use. There's the RC-470, with extra high resolution that can potentially raise horizontal resolution to 400 lines! And there's the RC-760, with a 600,000 pixel CCD—the highest of any still video camera.

When you want hard copy, Canon has a full color printer that connects directly to the system.

Best of all, Canon Still Video systems are within your reach. If you would like some more information, call 1-800-221-3333, ext. 313.

The Canon Still Video System; it's photography for the computer generation.

CRT images are simulated.



Enjoy easy extended payments with the Canon Credit Card. Ask for details at participating Canon dealers and retailers. Available only in the U.S.

# Canon

Canon U.S.A. Inc., One Canon Plaza, Lake Success, NY 11042 © 1989 Canon U.S.A. Inc.

**New!**

# Monitor & Control The World FROM YOUR PC



**SOLUS**, an integrated system, includes monitor, datalog and control software which features "Programming By Selection." You can create applications easily, with no prior programming experience.

**ONLY \$895**  
Hardware Only  
VISA/MC/AmEx



The all new SOLUS™ Personal Control Computer™ lets you monitor and datalog just about any condition in the real world. Then, based on these monitored conditions, SOLUS lets you control a wide variety of electrical devices.

SOLUS makes it possible for any PC user to create powerful monitor and control applications. Quickly. Easily. Inexpensively. And with no prior programming experience.

SOLUS comes with a 30-day satisfaction guarantee.

**Call toll free now:  
800-247-5712**

Discover SOLUS today. And control the world around you!

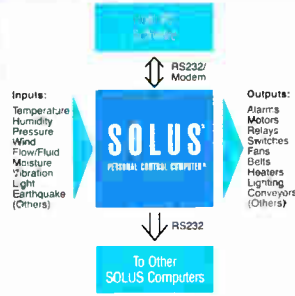

36 digital/analog input/output channels are compatible with standard sensors and output devices. SOLUS can be located on site, or remotely via modem.

**Solus Systems, Inc.**  
4000 Kruse Way Place, 2 • 285  
Lake Oswego, OR 97035 U.S.A.  
Phone: 503-635-3966  
FAX: 503-635-3004

© 1989 Solus Systems, Inc. SOLUS™ and Personal Control Computer™ are trademarks of Solus Systems, Inc.

SCIENCE AND ENGINEERING



The Surveyor, a coordinate geometry program for surveyors and civil engineers, can handle sites as large as San Francisco.

## Survey and Coordinate Geometry Program

D.C.A. Engineering developed the Surveyor for civil engineers and surveyors who need a coordinate geometry program to process raw field data and use it to develop site plans. After you've manually entered the data from field notes or downloaded it from a hand-held computer through your IBM PC's serial port, the Surveyor's sub-routines will perform all necessary geometric calculations, such as intersection points and traverse adjustments.

After the program has reduced the raw data, you can use it to subdivide a lot into smaller lots, design rights-of-way, and position houses. The Surveyor can handle up to 250,000 lots; other capabilities include complete point protection, automatic calculation of lots, building ties, and setbacks, lot and polygon storage, and automatic lot recalculations.

The stand-alone program is compatible with D.C.A.'s civil engineering programs, such as Design, DTM, and EarthWork (for site design, digital terrain modeling, and earthwork calculations). The

Surveyor runs on the IBM PC with DOS 3.0 or higher and 640K bytes of RAM.  
**Price:** \$2995.  
**Contact:** D.C.A. Engineering Software, Inc., P.O. Box 955, Henniker, NH 03242, (603) 428-3199.  
**Inquiry 1151.**

## Customizable Unit Conversion on the Mac

UNITize 1.3 is a modifiable unit-conversion utility that performs almost 200 conversions (e.g., ounces to pounds, or feet to inches) that scientists and engineers must make. If it doesn't handle the conversion you need, you can add the needed units to the program's quantity set.

UNITize 1.3 runs on the Mac 512KE or higher.  
**Price:** \$79.95.  
**Contact:** Rainbow Bridge Software, Inc., 4243 Hunt Rd., Suite 210, Cincinnati, OH 45242, (800) 548-8871 or (513) 984-6861.  
**Inquiry 1155.**

*continued*



# More Powerful Than Ever ...Up To 5 KVA



## STANDBY UPS MODELS

- 250 To 1600 Watt Output
- Synchronized Sinewave with 1 msec Switching Time
- Full One Year Warranty

## ON-LINE UPS MODELS

- 1000 To 5000 VA Sinewave Output
- True On-Line — Total Isolation
- Static Bypass Switch Standard

## SHUTDOWN SOFTWARE

- Auto Shutdown of Local Area Networks for Unattended Operation
- Compatible with SCO XENIX 2.2.3 and above
- Novell ELS 2.12 and above  
Advanced Netware 2.11 & above  
SFT Netware 2.11 and above

**MINUTEMAN**<sup>®</sup>  
UNINTERRUPTIBLE POWER SUPPLIES



## STANDBY UPS MODELS

Power Output	120 Volt Models	208-240 Volt Models
250 WATT	\$ 379.00	\$ 429.00
300 WATT	\$ 549.00	N/A
500 WATT	\$ 699.00	\$ 799.00
600 WATT	\$ 899.00	\$1049.00
900 WATT	\$1249.00	N/A
1200 WATT	\$1499.00	\$1749.00
1600 WATT	\$1999.00	\$2299.00

## TRUE ON-LINE UPS MODELS

Power Output	120 Volt Models	208-240 Volt Models
1000 WATT	\$2249.00	Available
3000 WATT	\$5495.00	Available
5000 WATT	\$8950.00	Available



FOR L.A.N.  
NOVELL LABS  
TESTED AND  
APPROVED  
NetWare Compatible

**PARA SYSTEMS, INC.**

1455 LeMay Drive  
Carrollton, TX 75007

Telephone:  
(214) 446-7363

**1-800-238-7272**

FAX: (214) 446-9011

TELEX: 140275 OMEGA

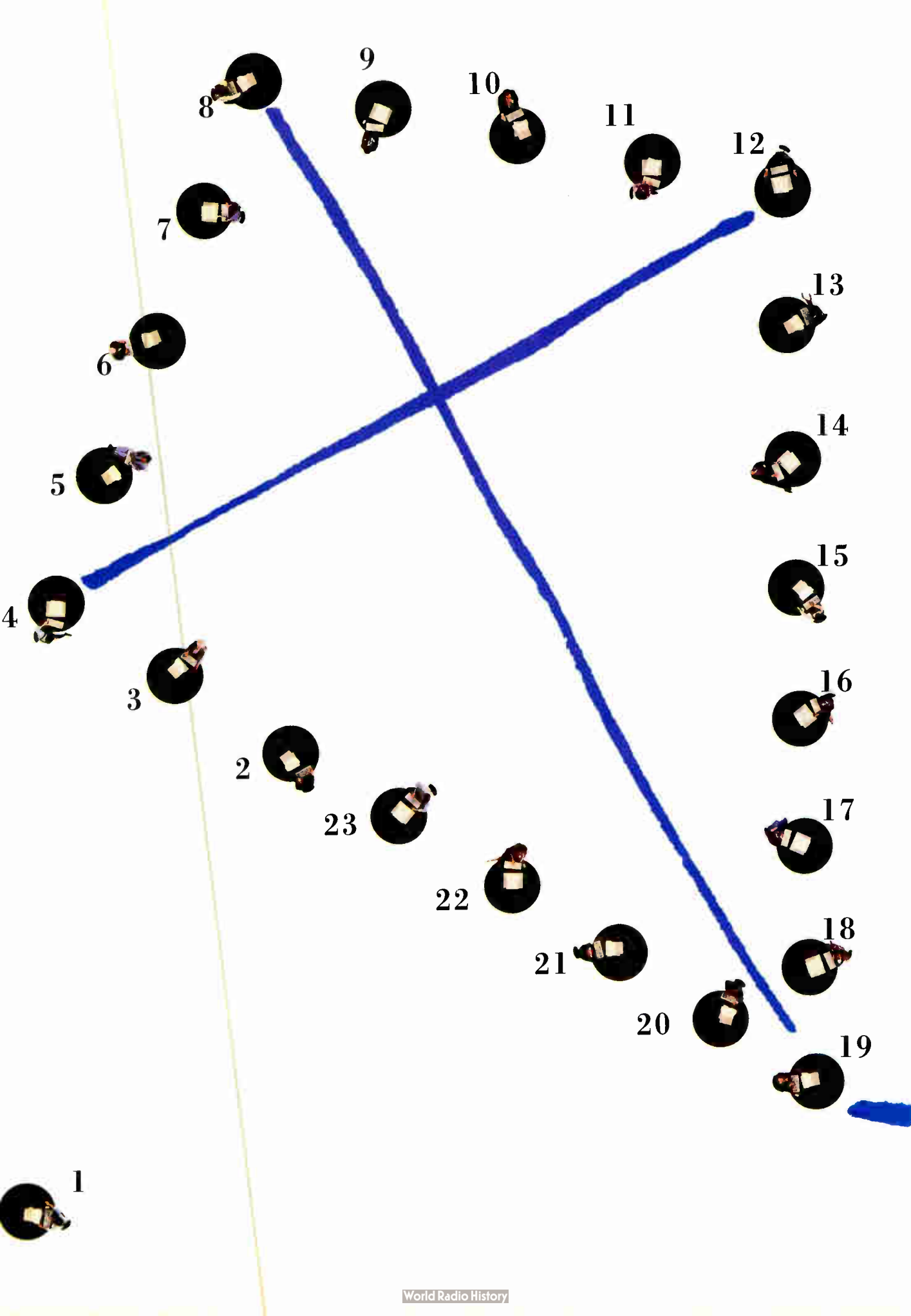



# Your plans to connect up all your systems will fly a lot easier with AIX.

Getting a network off the ground is easy with AIX.<sup>™</sup> Because AIX, IBM's enriched version of the UNIX<sup>®</sup> operating system, brings a whole new standard of performance, documentation and security to the open systems environment.

*AIX gives you a very high degree of flexibility.* AIX lets you create a transparent network between platforms from a broad range of vendors—from SUN<sup>®</sup> to DEC<sup>®</sup> to AT&T<sup>®</sup> and HP<sup>®</sup>.

It also lets you link up a broad range of IBM systems—from the PS/2<sup>®</sup> to the RT<sup>®</sup>, all the way up to the System/370<sup>™</sup>.

*All for one, and one for all.* AIX can integrate a network so effectively, you'd swear it was a single system.

Distributed Services on the RT lets everyone in the network share files, programs and devices. And to optimize your PS/2 and System/370 investment, AIX's Transparent Computing Facility lets you shift power from one processor to another, as the need arises.

And since AIX allows you to merge DOS and UNIX functions, you protect your software investment, too.

*AIX's ease of use also sets a new standard.* AIX is well documented, easy to learn and provides connectivity through multiple communications protocols.

So if you want to raise the quality of your networking, connect with your IBM marketing representative or IBM Business Partner today about AIX. The one system that connects the flexibility of open standards with all the classic strengths of IBM.

For more information, call 1 800 IBM-2468, ext. 148. AIX from IBM. Making your business come together.

The IBM logo, consisting of the letters "IBM" in a bold, blue, sans-serif font, with a registered trademark symbol (®) to the upper right.

IBM, PS/2 and RT are registered trademarks and System/370 is a trademark of International Business Machines Corporation. AIX is IBM's Advanced Interactive Executive which is a trademark of International Business Machines Corporation. AT&T and UNIX are registered trademarks of American Telephone and Telegraph Company. DEC is a registered trademark of Digital Equipment Corporation. SUN is a registered trademark of Sun Microsystems, Inc. HP is a registered trademark of Hewlett Packard Company. © 1989 IBM Corp.

## \* SPECIAL \*

## IBM PS/2 MODEL 50-021

FEATURES: 1MB RAM, 80286 BASED PROCESSOR, 10MHZ, (1) 1.44MB 3.5" FLOPPY, 20MB FIXED DISK, VGA ADAPTER, PS/2 101 KEY K/B, PARALLEL & SERIAL PORT, CABLES & MANUALS, 100% IBM PRODUCT

\*\*REMANUFACTURED\*\*

SUGG. RETAIL NEW \$3,595.00  
OUR PRICE \$1,888.00

INCL. 90 DAY DEPOT WARRANTY,  
JUST LIKE NEW UNITS!

FREE NEW AMDEK MODEL 432 VGA  
MONITOR INCL. WITH EVERY UNIT  
\$245.00 VALUE AT NO CHARGE!

**EXSEL, INC.**

VISA 1-800-624-2001 MC  
716-272-8770 FAX 716-272-8624

## SCSI Storage Subsystems

286/386, Sun Microsystem, Macintosh,

Apple II, Tandy, Atari, Amiga

A-Hive—enclosure for SCSI drives

30watts \$119 65watts \$169

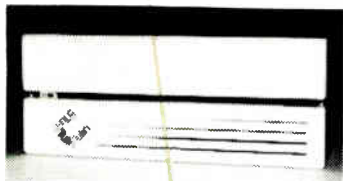

Hermit Crab—small portable hard drive

32MB \$429 200MB \$1999

SCSI Hard drive 32MB to 760MB

SCSI Tape drive 155MB

2HD/4 Floppy Controllers for 286/386

MFM/RLL 1:1 16Mhz

**Tulin Corporation**

2393 Qume Dr., San Jose, CA95131

Tel: 408-432-9025

Fax: 408-943-0782

## WHAT'S NEW

## SCIENCE AND ENGINEERING

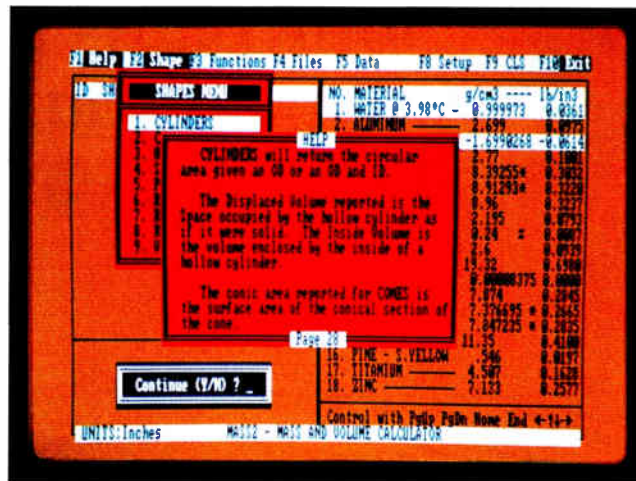

Mass2 can calculate the weight of a container, what's inside it, and the combined weight of both.

### What Does It Weigh?

Mass2 is a mass and volume calculator that you can use to calculate the weight of an object or a shape. The program calculates the volume of any geometrically defined shape and uses its database of materials to calculate the final weight.

The program accepts input in decimal, fractional, or scientific notation. It has a center-of-gravity calculator and can determine mass if the volume is already known. The program's database has over 700 entries, including construction materials, gases, plastics, rocks, and minerals.

Mass2 works on the IBM PC with 384K bytes of RAM. Price: \$69.

Contact: Dempsey's Forge, Software Division, Route 2, Box 407, Gladys, VA 24554, (804) 283-4602.

Inquiry 1154.

### Engineering and Drafting on the Mac II

Ashlar says that Vellum, its new Mac II design and drafting program, is software that thinks. It simplifies me-

chanical engineering, design, drafting, graphics, and technical illustration tasks with the Drafting Assistant.

The Drafting Assistant automatically pinpoints and aligns geometry as you draw. For example, if you're drawing a symmetrically shaped object, Ashlar Vellum will pick up midpoints, intersections, perpendiculars, and so on, and align them based on the geometry already entered. You can make rough sketches of an object, and Vellum will align it for you and let you attach values to it. You can also enter variable dimensions into a drawing and then store the variable parameters for repeated use.

With Vellum, you can create and edit nonuniform rational B splines. It gives you double-precision floating-point accuracy to 16 decimal places. Other features include 256 layers, seven colors, eight line widths, and 11 line styles. The program supports drawing sizes A through E.

Vellum requires a Mac SE/30 or higher with 4 megabytes of memory and a hard disk drive.

Price: \$995.

Contact: Ashlar, Inc., 1290 Oakmead Pkwy., Suite 218, Sunnyvale, CA 94086, (408) 746-3900.

Inquiry 1152.

continued



# The Wait is Over.

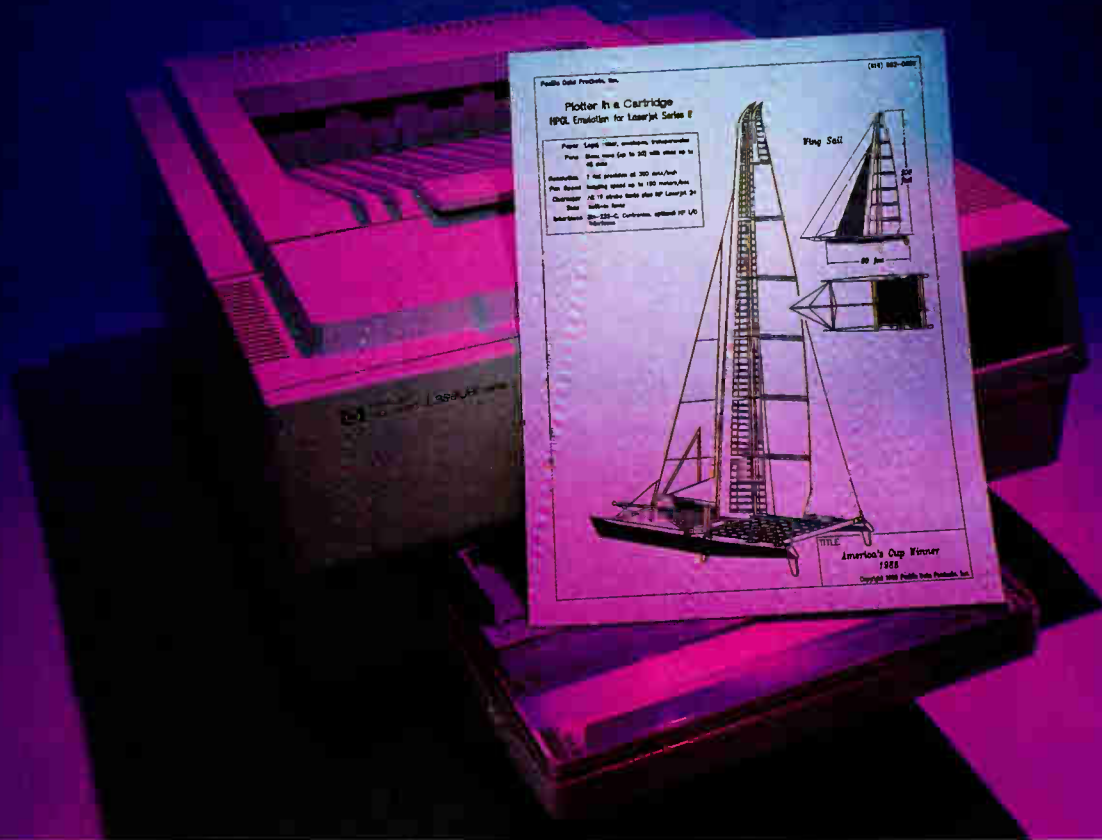

HPGL  
Emulation for HP's  
LaserJet Series II

Now you can produce precise, high quality plots without the wait required by pen plotters or PC-based emulations. Pacific Data's *Plotter in a Cartridge* is the newest and fastest way to emulate HPGL on your laser printer. In fact, it's as much as 100 times faster! Complex engineering or architectural plots taking 10 to 20 minutes on a plotter can be completed within 10 seconds! Crucial when multiple revisions and check plots are needed.

But there's more to *Plotter in a Cartridge* than speed. In addition to standard pen plotter features, *Plotter in a Cartridge* enables you to define 20 pens and 48 widths, automatically scales to fit envelopes, letter and legal size paper and improves resolution to 1/300 inch. And, you can produce up to 99 quality copies and use virtually any media source.

Because the cartridge plugs right into your printer, you can plot directly from CAD/CAM, engineering, or graphics software.

**Plotter in a Cartridge combines plotter precision with laser speed.**

**PACIFIC**  
DATA PRODUCTS

6404 Nancy Ridge Drive, San Diego, California 92121  
Tel: (619) 552-0880, Fax: (619) 552-0889

Pacific Data Euro, Ltd., Europe  
Tel: (44-0734) 391222, Fax: (44-0734) 393871

Mitsui Computer Ltd., Australia  
Tel: 61 02 452 0452, Fax: 61 02 452 0481

Pacific Technology, Singapore  
Tel: 2615609, 2654888, Fax: 2640371

Plotter in a Cartridge is an unregistered trademark of Pacific Data Products, Inc. HPGL and LaserJet Series II are registered trademarks of Hewlett-Packard. Copyright 1989 Pacific Data Products.

Circle 265 on Reader Service Card (DEALERS: 266)

## Fishing for Ideas on the Mac and PC

IdeaFisher, the database that helps you generate new ideas when you've reached a mental block, will be available in a Macintosh version this month, Fisher Idea Systems reports. The program consists of 60,000 idea words and phrases linked into 373 broad categories, such as "controversy" or "action/motion." Each category points to a list of subsidiary words and other categories, letting you cross-tabulate entries from different categories. With the cross-reference ability, you can link more than 675,000 direct associations. The program is already available for the IBM PC.

The program's developer says the program is good for coming up with a new idea or product name. If the problem is hazy or you're having trouble framing exactly what you want, you can use the program's QBank.

QBank asks you a series of up to 3700 questions to clarify the exact problem you're trying to solve and compare the ideas it generates with the original objective. After you've developed a list of central ideas, you use the IdeaBank to generate idea associations.

On the Macintosh, you'll need a Mac Plus or higher with about 6 megabytes of storage and 1 megabyte of RAM. On the IBM PC, you'll need DOS 3.1 or higher, 640K bytes of RAM, and 14 megabytes of free space on your hard disk drive.

**Price:** \$495.

**Contact:** Fisher Idea Systems, Inc., 18881 Von Karman, Suite 100, Irvine, CA 92715, (714) 474-8111.

**Inquiry 1145.**

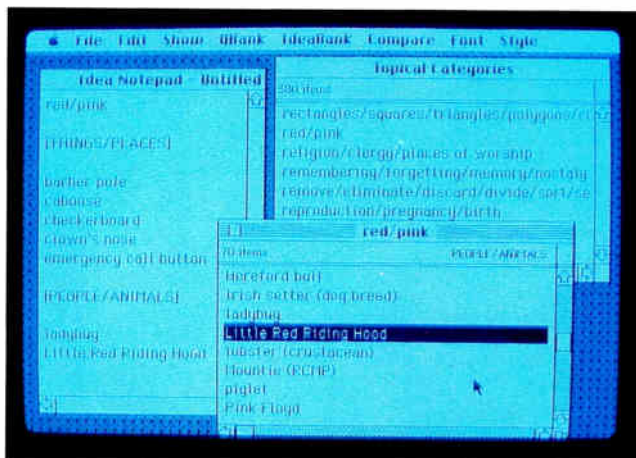

*IdeaFisher can prevent you from seeing red when you have a mental block.*

## Xerox to Add Foreign Language Options to AccuText

Xerox is adding seven foreign language options to its AccuText recognition software. Each foreign language option will have its own 50,000-word lexicon, which you can customize by adding an additional 10,000 words. Xerox says it will ship versions designed specifically for the French, Spanish, Italian, and German languages in the fourth quarter of this year. Dutch, Swedish, and Norwegian versions are expected for the first quarter of 1990.

AccuText is based on Kurzweil AI technology. With a supported scanner, you can use the program to scan text in its original format, including tabs, and the program can be set to automatically avoid graphical images. Six expert modules work on the text. The program can handle fonts from 8 to 24 points, and when scanning, it opens up the font in your word processor that most closely resembles the font of the scanned document.

AccuText now supports the Hewlett-Packard ScanJet Plus scanner and works with Microsoft Word, MacWrite, Excel, and WordPerfect for the Mac. The program works

on the Mac II or SE/30 with a hard disk drive and 4 megabytes of memory.

**Price:** \$995.

**Contact:** Xerox Imaging Systems, 1215 Terra Bella Ave., Mountain View, CA 94043, (415) 965-7900.

**Inquiry 1146.**

## Scalable Fonts at 300 dpi Without Big Bucks

Express Publisher, Power Up!'s low-end desktop publishing program for IBM PCs, offers scalable fonts, support for 300-dpi scanned images, and the ability to link text frames and pour copy across multicolumn, noncontinuous pages.

AGFA Compugraphic developed the fonts, which are device-independent. You can change font styles, attributes, and type sizes (from 6 to 144 points) for everything from a single letter to an entire page on the fly, the company reports.

You can import clip art and graphical images in TIFF, PCX, EPS, IMG, and ART format into a document and then crop, flip, or rotate the image. Express Publisher can wrap text around irregularly shaped images.

The program's import filters can import text with formatting intact from Microsoft Word, WordPerfect, WordStar, DisplayWrite, and ASCII and DCA (Document Content Architecture) text. The program also works directly with Microsoft Works.

You can run Express Publisher on any IBM PC with 640K bytes of RAM, a hard disk drive, and DOS 3.0 or higher.

**Price:** \$149.95.

**Contact:** Power Up! Software Corp., 2929 Campus Dr., San Mateo, CA 94403, (415) 345-5900.

**Inquiry 1149.**

## Switch Among 100 Programs and Files

PC task switching is not a new product category, but Better Software's Switch-It program lets you switch among 100 programs on a standard IBM PC. The program itself uses only 24K bytes of RAM and doesn't require an 80286-based machine with 3 or 4 megabytes of memory to run efficiently, the company reports.

When you install Switch-It, the program automatically scans your hard disk for programs it recognizes and builds a list of applications among which you can navigate. The program is compatible with Microsoft Windows, Ventura Publisher, and OS/2 in real mode. With Switch-It, you can execute any DOS command as you run an application. It also remembers your last 30 commands, which you can recall, execute, or edit.

Switch-It supports extended and expanded memory. **Price:** \$79.95.

**Contact:** Better Software Technology, 55 New York Ave., Framingham, MA 01701, (508) 879-0744.

**Inquiry 1147.**



# MANCHESTER & EPSON® EQUIPMENT COMPANY

OFFER YOUR CHOICE OF  
COMPUTERS AND PRINTERS  
FROM THE ONLY CHOICE FOR

## SERVICE & SUPPORT

**\$75 REBATE**  
on EQUITY™ 1e  
**\$50 REBATE**  
on EQUITY™ 1+  
purchased through  
Dec. 31, 1989

**\$200 REBATE**  
on EQUITY™ LT with  
Hard Disk through  
Oct. 31, 1989

**\$200 REBATE**  
on EQUITY™ 386/20  
**\$150 REBATE**  
on EQUITY™ II+  
purchased through  
Dec. 31, 1989

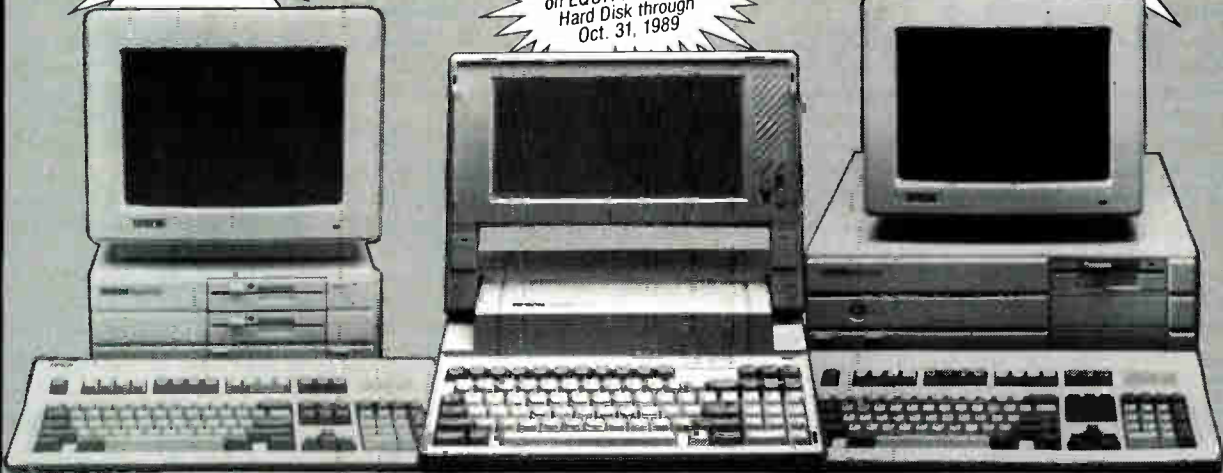

EQUITY™ 1+

EQUITY™ LT

EQUITY™ 386/20

Epson's EQUITY™ computer line offers you exceptional speed, features, and price/performance benefits. Epson printers are industry leaders, positioned to suit your special needs. Select unique features such as SmartPark™, dual paper path, and mainframe connectivity. At Manchester, we live up to our motto, "The Computer Supply and Equipment Experts", with the best service, top quality Epson products, and unbeatable prices.



DFX5000

Let Manchester be your one stop shopping center for all your Epson computer and printer needs. Call us now.



LQ2550

**FREE GIFT**  
Just place an order  
and mention this Ad  
through Dec. 31, 1989



LQ850

EPSON® is a registered trademark of Seiko Epson Corporation. EQUITY™ and SmartPark™ are trademarks of Epson America, Inc.

Authorized EPSON® Computer and Printer Dealer

# MANCHESTER EQUIPMENT CO., INC.

"The Computer Supply and Equipment Experts"

SYSTEMS INTEGRATION ■ NETWORKING ■ CONNECTIVITY ■ CAD/CAM ■ DESKTOP PUBLISHING  
50 MARCUS BOULEVARD ■ HAUPPAUGE, NEW YORK 11788

(516) 435-1199 ■ (516) 434-8700 ■ FAX (516) 435-2113

New York City  
(212) 629-6969

Ft. Lauderdale  
(305) 491-7660

Boston  
(617) 739-1555

For additional information, ask for Dan Kalata



# WHAT'S NEW

METRO NEW YORK • NEW ENGLAND

## Technology Conference and Seminar Nanobytes

**T**he Thirteenth Annual Symposium on Computer Applications in Medical Care will take place at the Sheraton Washington Hotel in Washington, D.C. The symposium provides a forum for medical professionals to exchange ideas for solving health-care computing problems. SCAMC will be held on November 5-8. **Price:** Members, \$260; nonmembers, \$310; students, \$90. **Contact:** SCAMC, Office of Continuing Medical Education, The George Washington University Medical Center, 2300 K St. NW, Washington, DC 20037, (202) 994-8928.

**B**ISCAP International will sponsor a conference on new developments in digital scanners, automatic digitizers, and document distribution on November 8-10 at the Boston Cambridge Marriott. **Price:** \$895.

**Contact:** BISCAP International, P.O. Box 68, Newtonville, MA 02160, (617) 893-9130.

**T**he 1989 Winter Simulation Conference will happen on December 4-6 at the Capitol Hilton Hotel in Washington, D.C. The focus will be discrete-event simulation and how it is used to model computer, manufacturing, communications, and other systems. The conference is sponsored by seven technical societies. **Price:** Society members,

\$195; nonmembers, \$250; students, \$30.

**Contact:** Kenneth J. Musselman, Pritsker Corp., 1305 Cumberland Ave., P.O. Box 2413, West Lafayette, IN 47906, (317) 463-5557.

**A** database conference and exposition will be held at Boston's Hynes Convention Center on December 5-7. The conference will address database subjects in five different tracks. Also, tutorials will be held on December 4 and December 8.

**Price:** Three days, \$695; two days, \$595; one day, \$395. **Contact:** Digital Consulting, Inc., 6 Windsor St., Andover, MA 01810, (508) 470-3880.

**T**he 1989 AEC Expo, intended for architects and engineers, will take place at

the Javits Convention Center in New York City on December 12-14. A section of the floor will be devoted to AutoCAD-compatible products. A concurrent conference will offer topics of special interest to architects, engineers, construction professionals, and facility managers. **Price:** Exhibits: free in advance; \$20 at the door. Conference: from \$95 to \$200. **Contact:** Expoconsul International, Inc., 3 Independence Way, Princeton, NJ 08540, (800) 873-3976 or (609) 987-9400.

**T**he Baltimore Convention Center will be the site of the Baltimore Computer Conference and Exposition, which is organized by the Maryland Association of CPAs

*continued*

**SPECIAL**

MS DOS 4.01... \$69.00



## POINTECH DISTRIBUTORS

36 West 22 Street, New York, NY 10010

Orders: (800) 666-8324 (212) 633-1530  
Tech Support: (212) 633-1531 Fax: (212) 633-1532

**NOVELL AUTHORIZED DEALER**

## SYSTEM KITS

### XT SYSTEM

10 MHz 8088 Motherboard  
AT Style Case with LED  
150 Watt Power Supply  
256K RAM  
360K Floppy Drive  
Multi I/O with FDC  
Clock and Calendar  
84-Key Keyboard

**\$340**

### AT SYSTEM

12 MHz Baby 286 Motherboard  
AT Style Case with LED  
200 Watt Power Supply  
512K RAM  
1.2M Floppy Drive  
Dual Hard/Floppy Controller  
Clock and Calendar  
101 Enhanced Keyboard

**\$600**

### 386 SYSTEM

20 MHz 386 Motherboard  
AT Style Case with LED  
200 Watt Power Supply  
1 MEG RAM  
1.2M Floppy Drive  
Dual Hard/Floppy Controller  
Clock and Calendar  
101 Enhanced Keyboard

**\$1500**

### PRINTERS

Panasonic KXP 1180 ..... 169  
Panasonic KXP 1124 ..... 309  
Olivetti 163 (132 Col) ..... 250  
Brother M1709 (132 Col) ..... 359  
Fujitsu DL3400 (132 Col) ..... 549  
HP DeskJet Plus ..... 699  
HP LaserJet II ..... 1585

### HARD DRIVES

20M Seagate ST225 w/Ctrl ..... 249  
30M Seagate ST238 w/Ctrl ..... 269  
40M Seagate ST251-1 ..... 369  
60M Seagate ST277RP ..... 499  
80M Seagate ST4086 ..... 599  
20M CMS Hardcard ..... 329  
30M CMS Hardcard ..... 399  
80M CDC ..... 639  
155M CDC (ESDI) ..... 1199  
330M CDC (ESDI) ..... 1999

### FLOPPY DRIVES/CONTROLLERS

360K TEAC 5.25" ..... 75  
1.2M TEAC 5.25" ..... 99  
720K TEAC 3.50" ..... 89  
1.44M TEAC 3.50" ..... 109  
40/120M Colorado Tape Back Up ..... 289  
360/720K Controller ..... 24  
1.2/1.4M Controller ..... 49  
Dual Hard/Floppy Ctrl (MFM) ..... 89  
SR2 Hard/Floppy Ctrl (RL) ..... 109  
Dual 1:1 Hard/Floppy Ctrl (MFM) ..... 109  
ESDI Controller ..... 249  
SCSI Controller ..... 399

### MONITORS

GoldStar Amber 12" ..... 75  
GoldStar VGA Multi Sync 14" ..... 449  
Samsung PaperWhite 14" ..... 119  
Samsung CGA 14" ..... 239  
Samsung VGA 14" ..... 349  
Imtec EGA 14" ..... 339  
Imtec VGA Mono 12" ..... 127

### KEYBOARDS

84 Key ..... 39  
101 Key Enhanced ..... 49  
101 Key Tactile ..... 59

### MICE

Genius GM w/DrHalo ..... 29  
Genius GM6000 ..... 29  
Hi-Res w/DrHalo ..... 49  
Logitech Bus w/Software ..... 89  
GeniScan GS4500 ..... 199  
Scanner w/OCR ..... 199  
Joystick (IBM/Apple) ..... 25

### I/O CARDS

Mono Graphics Printer Card ..... 39  
Color Graphics Printer Card ..... 39  
GTk EGA Card ..... 109  
GTk VGA Card (8 Bits) ..... 116  
Smart One VGA (16 Bits) ..... 179  
Serial/Parallel/Game Card ..... 39  
Parallel Card ..... 19  
Serial Card ..... 23  
2nd Serial Chip Set ..... 20  
XT Multi I/O (w/FDC & Clock) ..... 39  
Clock Card ..... 23  
XT 640K RAM Card ..... 39  
Everex 3MEG RAM Card ..... 99

### MODEMS 2-Year Warranty

Turbo 4X Software ..... 15  
Smart One 1200 Int ..... 45  
Smart One 2400 Int ..... 89  
Smart One 2400 Ext ..... 109  
Smart One 2400 Mac Ext. .... 169  
Smart One 2400 PS2 Int. .... 179

### POWER SUPPLY

150 Watt XT (110/220) ..... 49  
200 Watt AT (110/220) ..... 69  
250 Watt UPS ..... 219  
500 Watt UPS ..... 399

## TERMS AND POLICY

Prices based on COD Cash or Certified Check. Everything shipped Factory Fresh and Warranted. No non-defective returns. No returns without a RMA #. Minimum S/H \$5.00 per order.



# The Winning Combination



## Incredible Prices, Outstanding Quality, Unmatched Service

All EPS Systems are backed by a one-year, on-site service warranty. Included are all parts, labor and technical support.

EPS 80286 - 12 MHz	EPS 80286 - 20 MHz	EPS 80386 - 20 MHz	EPS 80386 - 25 MHz
<ul style="list-style-type: none"> <li>Intel 80286 12 MHz Microprocessor Hardware and Software Suitable Between 5 MB and 12 MB</li> <li>MS DOS and OS 2 Compatible</li> <li>1 Meg 0 Wait State RAM</li> <li>80287 Math Co-Processor Socket</li> <li>Phoenix ROM BIOS Plus V-3.10 with Built-In Set Up</li> <li>2 Serial/1 Parallel Game Port</li> <li>Eight Expansion Slots (6-16 Bit and 2-8 Bit)</li> <li>200 Watt Power Supply</li> <li>Real Time Clock/Calendar, with CMOS RAM Buffer and Battery Back Up</li> <li>Both Teac 1.2 MB and 1.44 MB Floppy Disk Drives</li> <li>High Performance Toshiba 60 Meg (25 MS) Hard Drive</li> <li>1 to 1 Interleave 2 Hard/2 Floppy Controller (800 KB/Sec Transfer Rate)</li> <li>Mitsubishi 14" Diamond Scan Monitor 800 x 600 resolution</li> <li>Paradise 16 Bit Plus VGA Card</li> <li>101 Enhanced Keyboard (3-Year Warranty)</li> <li>MS DOS 3.3 or 4.01 With GW Basic</li> <li>FCC Class B Approved</li> <li>Norton S.I. Test 13.2</li> <li>1 Year On-Site Service Contract</li> <li>Full 1 Year Warranty (30 Day Money-Back Guarantee)</li> </ul>	<ul style="list-style-type: none"> <li>Intel 80286 20 MHz Processor Hardware and Software Suitable Between 5 MB and 20 MB</li> <li>MS DOS and OS 2 Compatible</li> <li>80287 Math Co-Processor Socket</li> <li>2 Meg 0 Wait State RAM</li> <li>Phoenix ROM BIOS Plus V-3.10 with Built-In Set Up</li> <li>2 Serial/1 Parallel Game Port</li> <li>200 Watt Power Supply</li> <li>Eight Expansion Slots (6-16 Bit and 2-8 Bit)</li> <li>Real Time Clock/Calendar, with CMOS RAM Buffer and Battery Back Up</li> <li>Both Teac 1.2 MB and 1.44 MB Floppy Disk Drives</li> <li>High Performance Toshiba 60 Meg Hard Drive (25 MS)</li> <li>1 to 1 Interleave 2 Hard/2 Floppy Controller (800 KB/Sec Transfer Rate)</li> <li>Mitsubishi 14" Diamond Scan Monitor 800 x 600 Resolution</li> <li>Paradise 16 Bit Plus VGA Card</li> <li>101 Enhanced Keyboard (3-Year Warranty)</li> <li>MS DOS 3.3 or 4.01 with GW Basic</li> <li>FCC Class B Approved</li> <li>Norton S.I. Test 22.5</li> <li>1 Year On-Site Service Contract</li> <li>Full 1 Year Warranty (30 Day Money-Back Guarantee)</li> </ul>	<ul style="list-style-type: none"> <li>Intel 80386 20 MHz Microprocessor Hardware and Software Suitable Between 5 MB, 16 MB and 33 MB</li> <li>MS DOS, MS-DOS 3.31, XENIX and PC DOS Compatible</li> <li>1 Meg 0 Wait State With Transient ON Board Memory (Up To 8 MB, 1 MB, 2 MB when using 256K DRAM, 4 MB, 8 MB when using 1 M Bit DRAM, Expandable to 16 MB)</li> <li>Socket Support for 80287, 80357 and Wentek Co-Processors</li> <li>AMI 386 BIOS with and IN ROM Set-up</li> <li>200 Watt Power Supply</li> <li>One 32 Bit Slot (5-16 Bit Slots and 2-8 Bit Slots)</li> <li>2-Serial/1-Parallel Game Port</li> <li>Real Time Clock/Calendar with Battery Back Up</li> <li>Both Teac 1.2 MB and 1.44 MB Floppy Disk Drives</li> <li>High-Performance Toshiba 60 Meg Hard Drive (25 MS)</li> <li>1 to 1 Interleave 2 Hard/2 Floppy Controller (800 KB/Sec Transfer Rate)</li> <li>Mitsubishi 14" Diamond Scan Monitor 800 x 600 Resolution</li> <li>Paradise 16 Bit Plus VGA Card</li> <li>101 Enhanced Key Board (3-Year Warranty)</li> <li>MS DOS 3.3 or MS DOS 4.01 with GW Basic</li> <li>1 Year On-Site Service Contract</li> <li>FCC Class B Approved</li> <li>Norton S.I. Test 22.7</li> <li>Full 1 Year Warranty (30 Day Money-Back Guarantee)</li> </ul>	<ul style="list-style-type: none"> <li>Intel 80386 25 MHz Microprocessor Hardware and Software Suitable Between 5 MB, 20 MB and 33 MB</li> <li>MS DOS, MS-DOS 3.31, XENIX and PC DOS Compatible</li> <li>4 Meg 0 Wait State RAM Standard, ON Board Memory (Up To 8 MB, 1 MB, 2 MB when using 256K DRAM, 4 MB, 8 MB when using 1 M Bit DRAM, Expandable to 16 MB)</li> <li>Socket Support for 80287, 80357 and Wentek Co-Processors</li> <li>AMI 386 BIOS with and IN ROM Set up Routine</li> <li>220 Watt Power Supply, Tower Case</li> <li>One 32 Bit Slot (5-16 Bit Slots and 2-8 Bit Slots)</li> <li>2-Serial/1-Parallel Game Port</li> <li>Real Time Clock/Calendar with Battery Back Up</li> <li>Both Teac 1.2 MB and 1.44 MB Floppy Disk Drives</li> <li>High-Performance Toshiba 105 Meg Hard Drive (25 MS)</li> <li>1 to 1 Interleave 2 Hard, 2 Floppy Controller (800 KB/Sec Transfer Rate)</li> <li>Mitsubishi 14" Diamond Scan Monitor 800 x 600 Resolution</li> <li>Paradise 16 Bit Plus VGA Card</li> <li>101 Enhanced Key Board (3 Year Warranty)</li> <li>MS DOS 3.3 or MS DOS 4.01 with GW Basic</li> <li>1 Year On-Site Service Contract</li> <li>FCC Class B Approved</li> <li>Norton S.I. Test 28.1</li> <li>Full 1 Year Warranty (30 Day Money-Back Guarantee)</li> </ul>
<b>\$2,395.00</b>	<b>\$2,695.00</b>	<b>\$2,895.00</b> CALL FOR SX SYSTEM	<b>\$3,695.00</b>

Order Toll Free 1-800-447-0921

### Terms and Conditions

- Mastercard, Visa, and Discover Accepted — No Surcharge
- Allow 2 Weeks for Personal and Company Checks to Clear
- Leasing Available — Call for Details



P.O. Box 278  
Jefferson, SD 57038  
Local 605-966-5586  
Wats 800-447-0921  
Fax 605-966-5482

†The brands or product names mentioned are trademarks or registered trademarks of their respective holders. Prices and specifications are subject to change without notice.

and National Trade Productions. MACPA and NTP plan to make the conference an annual event. It will be held on December 13-14.

**Price:** Conference: one day, \$35; both days, \$50. Exposition, free.

**Contact:** National Trade Productions, Inc., 313 South Patrick St., Alexandria, VA 22314, (800) 638-8510 or (703) 683-8500; Maryland Association of CPAs, 1300 York Rd., Suite 10, P.O. Box 484, Lutherville, MD 21093, (301) 296-6250.

**T**he fourth annual technical conference on the X Window System will be held on January 15-17 at the Boston Marriott, Copley Place. The conference will consist of tutorials the first day, presentations the second and third

days, and special "birds of a feather" sessions throughout the conference. There won't be any vendor exhibits.

**Price:** \$50.

**Contact:** X Technical Conference, MIT Conference Services, Room 7-111, 77 Massachusetts Ave., Cambridge, MA 02139, (617) 253-1700.

**T**he Usenix Association is holding its Winter 1990 Unix Technical Conference at the Omni Shoreham Hotel in Washington, D.C., on January 22-26.

**Price:** Sessions: members, \$150; nonmembers, \$190. Tutorials: \$225; two tutorials, \$395.

**Contact:** Judith DesHarnais, Usenix Conference Office, 22672 Lambert St., Suite 613, El Toro, CA 92630, (714) 588-8649.

**U**sers of KBMS, an expert-system development tool, and the Intellect Natural Language System will gather at KnowledgeShare '89, an annual user conference.

The conference will be held on November 5-9 at the Westin Hotel, Copley Place, in Boston.

**Price:** \$795.

**Contact:** AICorp, 100 Fifth Ave., Waltham, MA 02254, (617) 890-8400.

**M**essaging '89, the conference for integrated messaging applications, systems, and services, will take place on November 6-8 at the New York Hilton in New York City.

**Price:** Exhibits only, no charge; full conference, \$795.  
**Contact:** Messaging '89, In-

formation Publishing Corp., 3721 Briar Park, Suite 100, Houston TX 77042, (800) 777-4442 or (713) 974-6637.

## Westchester PC Users Group

**T**he Westchester PC Users Group meets on the first Thursday of each month at the Scarsdale Public Library in Scarsdale, New York. The group has 440 members, a conference on the Executive Network Bulletin Board, and several special interest groups (e.g., investment, database, and desktop publishing).

**Annual Dues:** \$25.

**Contact:** Michael Friedlander, P.O. Box 349, White Plains, NY 10602, (914) 923-1337.

DIAL (617)

**L · A · P · T · O · P · S**  
**527-8677**

### NEW ENGLAND'S AUTHORITY ON LAPTOPS AND PORTABLE COMPUTING

OVER 20 LAPTOPS ON DISPLAY  
OVER 300 LAPTOPS IN STOCK

**FREE LOANERS DURING SERVICE\***

**Mitsubishi w/Modem & Case:**  
**SPECIAL PRICE**

**TOSHIBA**—T-5200, T-1600, T-5100,  
T-3200, T-3100e, T-1200 & T-1000

**NEC**—ULTRALITE, CASE  
DICONIX PRINTER, & CABLE \$1995

**ZENITH**—NEW MINISPORT:  
20 IN STOCK

Laptop Rentals • GSA Schedule Pricing • Lease • 30-day exchange policy

**Zenith Preferred Service Center**    **Toshiba Service Center**    **NEC Premier Service Center**

\* If CPU is purchased from us

**LAPTOPS, etc. 164 HAMPSHIRE STREET, CAMBRIDGE, MA 02139 (617) 527-8677**

In MA dial 1-800-966-METRO for service

**Other Store Locations:**    Falls Church, VA    •    Washington, D.C.    •    Baltimore, MD



# SUPER BOWL 34.5 Mhz

# \$945

## Super Bowl Bare Bone

- Vertical Case, Speed Display, Turbo Reset Buttons, 4 LED, Light, Fan, 5 Opening, 1 Full High Hidden, 1 Half High Hidden, Security Lock Diskette Holder, 8" x 27" x 17"
- Intel 386-20 CPU Motherboard Landmark = 34.5Mhz (2Mb) 8 Mb Expand on Board AMI BIOS, 80287, 80387 Socket Chips Tech. Chipset

FCC Class A .....\$945

## Super Bowl 386

- For Heavy Duty or Business Use
- 18 Months Labor & Parts Warranty
- Vertical Case, 250 Watts Power Supply
- 1 Mb RAM, 8 Mb expandable on board
- W.D 1:1 Dual Hard Floppy Controller
- 8 Expansion Slot, 1-32Bit, 5-16Bit, 2-8Bit
- Teac 1.2 High Capacity Floppy Drive
- 250 Watt UL Listed Heavy Duty Power Supply
- Clock, Calendar with Battery Back-Up
- 101 Tactile/Click Keyboard/Copy Holder
- OS/2, Xenix, MS-DOS, PC-DOS, Novell Compatible

## Call for Lowest Price!

### Best Quality

We use Name Brand Parts, Fancy Case, Heavy Duty Components Only.

- We accept Master & Visa, 3% surcharge.
- COD Order based on Cashiers Check, Money Order.
- 10% Restocking fee within 30 days from invoice date.
- All returns are subject to our approval.

### Best Service

18 Months Labor & Parts Warranty. We issue UPS "Call Tag" to Pick Up Computer for Repair.

We build computers for Consultants, VARS, Resellers, Dealers, Corporate Buyers, Universities, APO, FPO. All Fancy Case, Top Quality Motherboard, Reliable add-on cards, Teac Floppy Drive, Keyboard Networking Supply, ARcent Card, Ethernet Card, Diskless Workstation, Large Quantity in Stock!

# Mascot Computer Corp.

Wholesale: Tel: (718) 321-1944 Fax: (718) 321-0136  
42-20 College Point Blvd., Flushing, NY 11355 (5 minutes from Shea Stadium)  
Retail: Tel: (212) 766-0955 Fax: (212) 385-4010 Open: Mon.-Sat. 10-6:00



*"It takes everything I throw at it and comes back for more..."*

## YOU'VE BEEN SAYING OUTRAGEOUS THINGS ABOUT OUR 386-33MHZ COMPUTER.

Recently, when customers, potential customers and industry experts called us, they said something strange. They said, "Your PC-Link 386-33MHz computer *works!*" This was hardly cause for celebration. But then we heard that the other 386 machines have bugs. And that they're very expensive. (Now *that's* outrageous.) And that even compared to the Compaq Deskpro 386/33, our computer was the best choice for a 386-33MHz.

**Get a Copy of our Report Card**  
In InfoWorld's 386/33 product comparison, we were rated "Excellent" in categories including CPU Speed and Hard Disk Access (sequential and random). "Very Good" described our software compatibility. And we shared the top rating for Value. Call us for a reprint of the InfoWorld report card and judge for yourself.

**Ready to Work at \$5995**  
PC Link features a 33MHz PC/AT compatible—complete with 4MB of RAM and a 159MByte hard drive with 16ms access time and a 16MHz ESDI interface—for \$5995. For those with a large byte appetite, we also offer a 33MHz system with a 16ms 330MByte hard drive for \$7495\*.

**Compatibility**  
Thanks to its data bus speed of 8.33MHz, the PC Link 386-33MHz is fully compatible with IBM PC/AT expansion connectors. Which means our computer runs expansion cards for the PC/AT such as VGA cards, modems, network cards and the Bernoulli Box. Our compatibility list

goes on to include DOS, OS/2, Windows/386, UNIX V, DESQview 386 and off-the-shelf software. This computer takes everything you throw at it!

### Speed

With the Intel 80386 microprocessor running at 33MHz, you can make very, very fast work of spreadsheet, desktop publishing and CAD/CAM applications. (To boost your math intensive applications, get our optional 33MHz 387 math coprocessor or Weitek Abacus chip.) Get your hands on our mighty zero wait state system with 64K Cache RAM—and never look back.

### Quality

**(Critics Love Our Product Line)**  
We've assembled an all-star team of Made in U.S.A. components for our 386-33MHz model. It features the acclaimed Hauppauge 386 Motherboard/33MHz (with one 32-bit, six 16-bit and one 8-bit expansion slot) and the Award Software Modular 386 ROM BIOS.

In addition to our new 386-33MHz PC, we offer the 386-16MHz and the 386-20MHz. Our customer David Graves at Westinghouse Broadcasting said it best: "The performance of these machines is everything we could ask for—and terrific for the price. The reliability has been excellent. No breakdowns to date!"

### 33MHz Standard Features:

- Intel 80386-33 microprocessor
- 4MB of RAM expandable to 64MB using a dedicated high-speed 32-bit memory slot
- 159MB 16 ms ESDI Hard Disk
- 64KB of high-speed static RAM cache
- 64K Shadow (BIOS) memory
- 16-bit VGA Adapter
- Sockets for 33MHz 80387 and 33MHz WEITEK 3167 math coprocessors
- 5.25" 1.2 MB or 3.5" 1.44 MB diskette drive
- Dual diskette and hard disk drive controller
- Enhanced 101 key keyboard
- 1 parallel and 1 serial port
- 220-watt power supply
- MS DOS 3.3 or 4.0

### 16 and 20 MHz Standard Features:

- Intel 80386-16 microprocessor or 80386-20
- 640K DOS Memory
- 320K Extended memory
- 64K Shadow (BIOS) memory
- Award Software connector BIOS
- 4-way interleaved RAM
- 0 wait states
- PC/AT compatible
- One 8/32-bit expansion slot
- Four 8-16-bit expansion slots
- Three 8-bit expansion slots
- 3 Programmable timers
- One 5.25" 1.2 MB or 3.5" 1.44 MB disk drive
- Dual diskette and hard disk drive controller
- Enhanced 101 key keyboard
- 1 parallel and 1 serial port
- 220-watt power supply
- Bundled with public domain utility, disk caching and system set-up software.

### PC LINK Warranty

PC Magazine said: "The components are good enough to make you forget about the 1-year parts-and-labor warranty."\*\* Still, it's here if you need it.

Call PC Link for a true 386-33MHz computer that actually works. Ask for a reprint of InfoWorld's 386/33 Report Card. Call: 1-800-221-0343. In New York: (212) 730-8036. For information on our complete product line, request our brochure!

# PC LINK

PC Link Corp. 29 West 38th St., New York, NY 10018, (212) 730-8036

\*Monitors not included with systems \*\*Reprinted from PC Magazine, May 30, 1989 Copyright ©1989 Ziff-Davis Communications Company  
Trademarks: IBM PC, XT, AT, PS/2; IBM, Intel, Windows; 386; Microsoft; DESQview; Quarterdeck





# MEMORY PRODUCTS & MORE

ONE STOP SOURCE FOR ALL PC MEMORY UPGRADES

2808 Lafayette • Newport Beach, CA 92663

(714) 723-4510 • (800) 222-8861 • FAX: (714) 723-0732

## Compaq Memory Upgrades

MODEL	MEMORY ADDED	PRICE
DESKPRO 386/33	2MB MODULE	\$ 834
DESKPRO 386/25	1MB MODULE	318
	4MB MODULE	954
DESKPRO 386/20	1MB MODULE	318
	4MB MODULE	954
DESKPRO 386 \$	1MB BOARD	420
	4MB BOARD	1194
	1MB MODULE	318
	4MB MODULE	954
DESKPRO 386/20E	1MB BOARD	420
	4MB BOARD	1194
	1MB MODULE	318
	4MB MODULE	954
DESKPRO 386/16	1MB KIT	252
	1-2MB BOARD	CALL
	4-8MB BOARD	1500
PORTABLE 386	1MB KIT	474
	4MB BOARD	1434
PORTABLE III	512K KIT	137
	2MB KIT	354
COMPAQ SLT/286	1MB MODULE	474
DESKPRO 286/E	1MB BOARD	552

## IBM Memory Upgrades

MODEL	MEMORY ADDED	PRICE
PS/2 30-286	512 KIT	\$ 119
	2MB KIT	432
PS/2 50 AND 60	512 KIT	119
	2MB KIT	432
PS/2 50Z	2MB MODULE	594
	512 KIT	119
	2MB KIT	432
PS/2 55-SX	2MB MODULE	594
PS/2 70-F61	1MB MODULE	330
	2MB MODULE	594
PS/2 70-121	1MB MODULE	330
	2MB MODULE	594
PS/2 70-A21	2MB MODULE	594
(THE ABOVE MODULE GOES ON THE MOTHER BOARD)		
	1MB MODULE	330
	2MB MODULE	594
(THESE MODULE GO ON THE ADD-ON CARD)		
PS/2 80-041	1MB MODULE	330
PS/2 80-111	2MB MODULE	714
PS/2 80-311	2MB MODULE	714

## Apple Memory Upgrades

MODEL	MEMORY ADDED	PRICE
Mac 11	256K X 8 SIM	\$ 54
	1MEG KIT (4 SIMS)	216
	1MEG X 8 SIM	151
	4MEG KIT (4 SIMS)	605
MAC PLUS	256K X 8 SIM	54
	1MEG KIT (4 SIMS)	216
	1MEG X 8 SIMS	151
	2MEG KIT (2 SIMS)	302
	4MEG KIT (4 SIMS)	605
MAC SE	256K X 8 SIM	54
	1MEG KIT (4 SIMS)	216
	1MEG X 8 SIMS	151
	2MEG KIT (2 SIMS)	302
	4MEG KIT (4 SIMS)	605
MAC 11CX	256K X 8 SIM	54
	1MEG KIT (4 SIMS)	216
	1MEG X 8 SIMS	151
	4MEG KIT (4 SIMS)	605
MAC SE/30	256K X 8 SIM	54
	1MEG KIT (4 SIMS)	216
	1MEG X 8 SIM	151
	2MEG KIT (2 SIMS)	302
	4MEG KIT (4 SIMS)	605

## Sun Micro Systems Memory Upgrades

MODEL	MEMORY ADDED	PRICE
SUN 360/60	4MB KIT	\$ 708
SUN 360/1	4MB KIT	708
SUN 410	4MB KIT	744
SUN 4/10	4MB KIT	744
SPARC STATION	4MB KIT	708

## AT & T Memory Upgrades

MODEL	MEMORY ADDED	PRICE
6386 WGS	1MB KIT	\$ 235
	4MB KIT	708
6386 EWGS	1MB KIT	235
	4MB KIT	708
6286	2MB KIT	354

## Everex Memory Upgrades

MODEL	MEMORY ADDED	PRICE
386 STEP 16	1MB KIT	\$ 235
	4MB KIT	708
386 STEP 20	1MB KIT	235
	4MB KIT	708
386 STEP 25	1MB KIT	235
	2MB KIT	708

## Zenith Memory Upgrades

MODEL	MEMORY ADDED	PRICE
386/25	1MB KIT	\$ 354
	2MB KIT	714
386/33	1MB KIT	390
	2MB KIT	750

## Hewlett Packard Memory Upgrades

MODEL	MEMORY ADDED	PRICE
VECTRA RS/25C	1MB KIT	\$ 274
	4MB KIT	744
VECTRA RS/25	1MB KIT	274
	4MB KIT	744
VECTRA RS/20	1MB KIT	274
	4MB KIT	744
VECTRA RS/20C	1MB KIT	235
	4MB KIT	708
VECTRA QS/20	1MB KIT	235
	4MB KIT	708
VECTRA QS/16	1MB KIT	235
	4MB KIT	708
HP LASER JET 11	1MB KIT	359
	2MB KIT	479
	4MB KIT	839
HP LASER JET 11D	1MB KIT	359
	2MB KIT	479
	4MB KIT	839

## AST Memory Upgrades

MODEL	MEMORY ADDED	PRICE
BRAVO/286	128 KIT	\$ 62
	512K KIT	113
	2MB KIT	354
	4MB KIT	708
AST PREMIUM 386	1MB KIT	274
	4MB KIT	744
AST PREMIUM 386C	1MB KIT	235
	4MB KIT	708
AST PREMIUM 386/16	1MB KIT	235
	4MB KIT	708
AST WORKSTATION 286	512K KIT	113
	2MB KIT	354
AST WORKSTATION 386	512K KIT	113
	1MB KIT	235
	2MB KIT	354
	4MB KIT	708
AST PREMIUM 386/25	1MB KIT	270
AST PREMIUM 386/33	1MB KIT	294

## Epson Memory Upgrades

MODEL	MEMORY ADDED	PRICE
EQUITY 386	1MB KIT	\$ 252
	2MB KIT	420

## HP Laser Jet Series II & IID Memory Upgrades

MEMORY	PRICE
1MB	\$ 359
2MB	479
4MB	839

COMPAQ • IBM • APPLE • HEWLETT PACKARD • AST • AT & T and More...  
• 5 Year Guarantee • Same-Day Shipping • Full Technical Support

**ANNOUNCING VERSION 2.6!**

# The Best Gets Better.

## KNOWLEDGE man/2<sup>®</sup>

THE UNIVERSAL KNOWLEDGE MANAGEMENT SYSTEM



In one seamlessly integrated package, KnowledgeMan/2 provides information management and application development capabilities unmatched by any other software package on the market.

KnowledgeMan/2 combines a relational dbms, SQL support and a fourth-generation programming language with:

- Forms management with painter
- Custom report generator
- Natural-language interface
- Full-color graphics
- Text processing
- Remote communications
- Full-featured spreadsheet
- Context-sensitive help
- On-line tutorial
- And much, much more!

All these features can be combined to create powerful applications never before thought possible. You never need to exit one component before using another.

KnowledgeMan/2 is a registered trademark of mdba, Inc. Other trademarks are proprietary of their respective manufacturers.

### More Than 40 New Features and Functions

KnowledgeMan/2 Version 2.6 offers new features and functions that can dramatically reduce your development time and costs:

- Real-time event-handling capabilities
- Powerful Microsoft CodeView<sup>®</sup>-style debugger
- Extensible through any Microsoft-supported language
- Smaller load image (320K)
- Permits windowed applications

And the price for all this power? An incredibly low \$795 for the single-user MS DOS version! KnowledgeMan/2 is also available for the IBM OS/2, most popular LANs and the DEC VAX/VMS<sup>®</sup>.

To learn more about how KnowledgeMan/2 can work for you, or to find out how to upgrade from your current version, call or fax **mdba**.

*"Comparing KnowledgeMan/2 with packages such as Oracle, Informix, and PC Focus may be more appropriate, as they supply similar analytical, decision support, programming, and SQL features. Even in this comparison, KnowledgeMan/2 proves itself to be the better product."*

—Datapro, April 1989



THE KNOWLEDGE MANAGEMENT COMPANY

**mdba, Inc.**  
P.O. Box 248  
Lafayette, IN 47902

(800) 344-5832

(317) 463-2581

FAX: (317) 448-6428

TELEX: 5106017487 (MDBS LAF UQ)



# How does FOUNTAIN 386SX compare with a true 386?

	Landmark	SI advanced	Integer Add Loop	Integer Multiply Loop	String Sort and Move	Prime Number Sieve	802086 Instruction Set
FOUNTAIN 386SX	21.2	18.0	.88	.60	1.20	1.76	4.07
COMPAQ 386/16	20.0	17.6	.99	.60	1.37	1.87	4.23

PC Magazine Benchmark Tests (Time in Seconds)  
Compaq is a trademark of Compaq Computer Corp.

## FOUNTAIN 386SX. The Smart Choice.

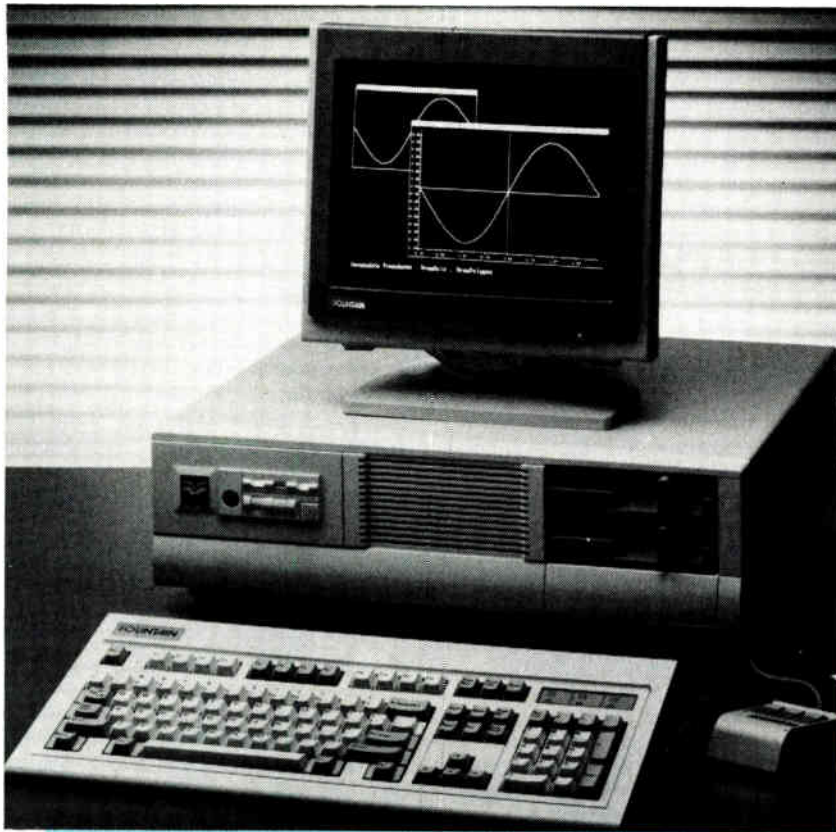

**PROCESSOR** Intel 32-bit 386SX at 16 MHz; socket for Intel 387SX coprocessor; real time clock/calendar.

**MEMORY** 1 MB of DRAM standard, zero-wait state; maximum 4 MB on board; expandable to 16 MB.

**EXPANSION** Six 16-bit and two 8-bit expansion slots.

**POWER SUPPLY** 200 watts standard; 110 VAC at 60 Hz; 220 VAC at 50 Hz.

**KEYBOARD** Enhanced 101-key layout.

**FIXED-DISK CONTROLLER** High-performance AT-type 1:1 interleave or ESDI controller.

**STORAGE** 5 1/4" 1.2 MB floppy disk drive standard; 3 1/2" 1.44 MB optional; choice of 40, 80, 110 or 320 MB hard disk drive.

**OPTIONS** Monochrome display; FTN Hercules-compatible display board, FTN 1451 14-inch flat-screen monitor; VGA display; FTN VGA Extender™ with 800x600 resolution.

## \$1995.

*FTN-386SX with*

- 1 MB memory at zero-wait state;
- 1.2 MB floppy disk drive;
- 1:1 interleave hard-disk controller;
- 40 MB hard disk drive; and
- Monochrome display package.



**FOUNTAIN TECHNOLOGIES INC.**

12K WORLD'S FAIR DRIVE  
SOMERSET, NJ 08873  
TEL: (201) 563-4800

## An Ethernet/VT100 Interface in Your Monitor

The LANTerm Model E (for Ethernet) is a smart diskless workstation that includes VT100 terminal emulation and features an 8-MHz V40 microprocessor.

It comes ready to boot itself on your Novell network through a built-in, thick coaxial, multiaccess unit, the company says, although you can use it with other Ethernet-compatible operating systems.

Features include 768K bytes of RAM, a 64K-byte EPROM in the white-phosphor 14-inch monitor, and an AT-style keyboard.

In PC mode, you get HGA graphics and Monochrome Display Adapter text. There's also a serial port and a parallel port.

**Price:** \$1195.

**Contact:** Esprit Systems, Inc., 2115 Ringwood Ave., San Jose, CA 95131, (408) 954-9900.

**Inquiry 994.**

## Security System for Stand-Alone PCs

Hands Off the Program is a security utility that protects your hard disk drive, subdirectories, and files by preventing unauthorized persons from booting off the hard disk drive, using the DOS FORMAT command, and other DOS file-based access. The program also automatically locks the hard disk drive when someone boots the PC from drive A.

The program establishes a security system for up to 64 subdirectories. Each user receives a security rating between 0 and 8. Access to a private subdirectory is allowed only if you have a higher



*Esprit's VT100 terminal emulation with local DOS and LAN capability doesn't force you to make a choice between dumb terminals and networks.*

number than the private subdirectory. You can also designate important system files as read-only, or hidden, and no DOS command or utility can change the file attribute, according to Systems Consulting, the utility's developer.

Other features include an automatic or manual keyboard lock. In automatic mode, the program will freeze your keyboard after a set period of inactivity; only by entering the correct password can you regain control.

Hands Off the Program works on the IBM PC with DOS 3.0 or higher and uses about 7K bytes of RAM. The company reports that it is developing a new Toolbox program that will let you run Hands Off on a network.

**Price:** \$89.95.

**Contact:** Systems Consulting, Inc., P.O. Box 111209, Pittsburgh, PA 15238, (412) 963-1624.

**Inquiry 996.**

## Meet Marvin, the Scanning Assistant

Scanning text and graphics from documents is becoming much more commonplace with lower-cost and higher-quality scanners.

Marvin is a Windows-based utility that offers a user interface, database functions, and compression techniques to assist you in processing scanned text and graphics.

Marvin also lets you save documents in a variety of formats, including TIFF and CCITT, so you can pop documents into your scanner and send them out as faxes.

Upcoming products from ImageTech include Marvinet and Marvin Jr. Marvinet runs on Novell networks, supports 25 hand-held and desktop scanners, and exports and imports PC Paintbrush, Dr. Halo, and TIFF files, according to the company. Marvin Jr. is a single-user version of Marvin, intended for laptop users.

Marvin works with all 80286-based IBM PCs and higher and requires a document processing card or 2 megabytes of memory, EGA or VGA, and 640K bytes of RAM. A mouse is also recommended. Marvin Jr. will work with floppy-disk-drive-only systems and will also require 640K bytes. Marvin Jr. is scheduled for release in the first quarter of 1990.

**Price:** Marvin: \$1995. Marvinet: 5-user, \$9500; 10-user, \$16,500; 20-user, \$27,500. Marvin Jr.: price not set.

**Contact:** ImageTech, Inc., 1864 Northwood Dr., Troy, MI 48084, (800) 451-7566.

**Inquiry 998.**

## Accelerate AutoCAD on the PS/2s

Panacea's DLD-8514/A for AutoCAD transparently replaces the 8514/A driver that's included with AutoCAD release 10, resulting in a performance increase of up to 15 times in redrawing, panning, and zooming, the company reports. The DLD-8514/A supports IBM's 8514/A graphics adapter at the register level and will work with any hardware that's 100 percent compatible with the 8514/A.

The DLD-8514/A also has built-in support for AutoShade and AutoSketch.

**Price:** \$149.

**Contact:** Panacea, Inc., Londonderry Sq., Suite 305, 50 Nashua Rd., Londonderry, NH 03053, (603) 437-5022.

**Inquiry 997.**

## Take a Shortcut Through the Mac

Aladdin Systems' ShortCut is for Macintosh users who want to navigate more quickly among frequently used folders, find documents and folders, and decompress documents within StuffIt archives.

The utility will also tell you how much free disk space you have, and it lets you rename, delete, and lock files or folders without requiring you to leave the application.

ShortCut runs on the Mac Plus or higher.

**Price:** \$79.95.

**Contact:** Aladdin Systems, Inc., 217 East 86th St., Suite 153, New York, NY 10028, (212) 410-3080.

**Inquiry 995.**





# HARMONY COMPUTERS

1801 FLATBUSH AVE. (BET. AVES. J & K) BKLYN. NY 11210

ORDER DEPT. ONLY 800-441-1144 OR 718-692-3232 — INFORMATION 718-692-2828

## 10th Anniversary Specials

**TOSHIBA T-1000 LAPTOP**  
**\$629.00**  
\*\*\*  
**H.P. LASERJET II**  
**\$1579.00**

**PANASONIC 1180**  
**\$159.00**  
\*\*\*  
**IBM PS/2 #30 (286) 20 Meg**  
**\$1749.00**

**WORD PERFECT 5.0**  
**\$214.00**  
\*\*\*  
**NEC MULTISYNC 3D**  
**\$599.00**

## "PRINTER SPECIALS"

Apple Image Writer II	429
Diconix Ink Jet 150 plus	299
Epson LX810	189
Epson FX 850	334
<b>Epson FX 1050</b>	<b>439</b>
Epson LQ 510	329
Epson LQ 850	519
Epson LQ 950	539
Epson LQ 1050	729
Epson LQ2550	929
Hewlett Packard Desk Jet Plus	679
Hewlett Packard Laser Jet II P	Call
Hewlett Packard Laser Jet II	1579
IBM Proprinter 3	459
IBM Proprinter X24E	599
IBM Proprinter 3XL	589
IBM Proprinter XL24E	799



<b>IBM AND COMPATIBLES</b>	
IBM PS/2 #30 (286) 512k, 1.44 Meg Dr.	1449
As above w/ IBM 20 Meg	1749
IBM PS/2 Model 50Z (30 Meg)	2249
IBM PS/2 Model 50Z (60 Meg)	2549
512K Upgrade for IBM PS/2	199
IBM PS/2 #55 SX 30 Meg (386)	2799
IBM PS/2 #55 SX 60 Meg (386)	3099
IBM P/S 2 Mono Monitor (8503)	199
IBM P/S 2 Color (8512) Monitor	449
IBM P/S 2 Color (8513) Monitor	539



<b>TURBO 386 (20 MHZ) 1.2 Drive 1 Meg Serial Parallel</b>	<b>1849</b>
<b>TURBO AT 286 12 MHZ, 1.2 Meg Drive Serial Parallel, 512K w/Monitor</b>	<b>849</b>
<b>EVEREX XT 12 MHZ w/ Monitor</b>	<b>549</b>
<b>Headstart 2 640K, 10MHZ, 5 1/4 &amp; 3 1/2 Floppy Drives, Color/Mono, Serial, Parallel, Game, DOS 3.3</b>	<b>799</b>
<b>Headstart 3 One Meg, 12 MHZ 5 1/4 &amp; 3 1/2 Floppy Drives, 32 Meg H.D., Serial, Parallel, Game, Mouse, DOS 3.3, VGA Monitor</b>	<b>2299</b>

<b>PC BOARDS, DRIVES, MEMORY CHIPS</b>	
IBM Original 5 1/4 Disk Dr (360K)	89
Toshiba 5 1/4 Floppy Disk Dr (360 K)	89
Toshiba 3 1/4 Floppy Disk Dr (720 K)	89
Toshiba 3 1/4 Floppy Disk Dr (1.44 Meg)	109
Toshiba 5 1/4 Floppy Disk Dr (1.2 Meg)	99
PS/2 5 1/4 360K External Drive	199
PS/2 5 1/4 1.2 Meg External Drive	249
AST Six Pack Plus 64K	129
<b>AST Rampage Plus (288) 512K</b>	<b>379</b>

Intel above board 286 plus w/512K	379
Intel above board 286 Plus I/O Parallel/Serial	429
Intel above PS/2 (50,60)	299
AST Rampage PS/2 (50,60)	399
64K DRAM chips	Call
256K DRAM chips	Call
256K Simm Module	Call
One Meg. DRAM chips	Call
One Meg. Simm Module	Call

<b>MONITORS</b>	
Amdak 410A	149
Amdak 732 (VGA)	399
Princeton Max 15	249
Princeton Ultra Sync (16 Inch)	849
Princeton Ultra Sync (14 Inch)	499
NEC Multisync G.S. (Paperwhite)	229
Packard Bell (Paperwhite) VGA	149
<b>NEC Multisync 2A (VGA)</b>	<b>479</b>
<b>NEC Multisync 3D</b>	<b>599</b>
Sony 1304 Multiscan (1024x768)	649
Sony 1302 Multiscan	579
Sony 1320 VGA	469
<b>Seiko #1430 (Res. 1024 x 768)</b>	<b>499</b>
Zenith 1490 Flat Screen	579
Mitsubishi Diamondscan #1381A	479
Goldstar Superscan#1440 (800 x 600)	399
Packard Bell (EGA) #1431	369
Packard Bell TTL Amber 12 Inch #1272A	89
Packard Bell TTL Amber 14 Inch #1472A	129
Packard Bell (RGB) #1452	249
Magnavox (RGB, Composite) 8CM515	269
Magnavox VGA	349



<b>INTEL MATH COPROCESSORS</b>	
Intel 8087-3 (PC, PC XT up to 6 MHZ)	89
Intel 8087-2 (PC, PC XT up to 8 MHZ)	119
Goldstar Superscan#1440 (800 x 600)	399
Intel 8087-1 (PC, PC XT 10 MHZ and faster)	154
Intel 80287-3 (PC, AT up to 8 MHZ)	129
Intel 80287-8 (PC, AT up to 10MHZ)	189
Intel 80287-10 (10 MHZ and faster)	199
Intel 80387-16 (PCAT up to 16 MHZ)	224
Intel 80387-20 (PC AT up to 20 MHZ)	379
Intel 80387-25 (PC AT 25 MHZ and faster)	479
Intel 80387 SX (All 80387 SX Computers)	299
Intel 80C287	274

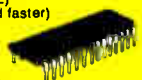

<b>NEC P2200XE</b>	<b>329</b>
NEC P5200	489
NEC P5300	669
NEC P5XL	899
Okidata 380	359
Okidata 183 (W/de Carriage)	249
Okidata 172	199
Okidata 182 Turbo	224
Okidata 183 (Wide Carriage)	249
Okidata 320	329
Okidata 321	469
Okidata 390	469
Okidata 391	639
Okidata 393	999
Panasonic 1180	159
Panasonic 1191	199

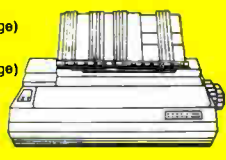

<b>LAPTOPS</b>	
NEC Ultralite One Meg.	1749
NEC Ultralite 2 Meg.	1949
<b>NEC Prospeed 286 20 Meg.</b>	<b>3199</b>
NEC Prospeed 286 40 Meg	3599
Toshiba T 1000	629
Toshiba 1200 2 Drive (Backlit)	1399
Toshiba 1200 20 Meg (Backlit)	1899
Mitsubishi 286L (20 Meg.)	2249
Mitsubishi 286L (40 Meg)	2899
Dataview Spark EL (20 Meg)	1769
Dataview Spark EL (2 Drives)	1099
Bondwell 286 20 Meg. (w/Case and Modem)	2149
Zenith 184-1 Supersport (2 Drive)	1349
Zenith 184-2 Supersport 20 Meg	2049
Zenith Supersport 286 (20 Meg.)	2699
Zenith Supersport 286 (40 Meg.)	2979
Toshiba 301 (24 Pin Portable Printer)	219
Diconix 150 Plus Portable Ink Jet Printer	219
Fastwire II (Data Transfer Software 3 1/2 to 5 1/4)	49
<b>Laptop Modem 1200 Baud</b>	<b>139</b>
<b>Laptop Modem 2400 Baud</b>	<b>179</b>



<b>MODEMS</b>	
Hayes 1200	269
Hayes 1200B w/Smartcom 2	269
Hayes 2400	409
Hayes 2400B w/Smartcom 2	409
Hayes 2400P (PS/2 50,60,70,80)	429
Everex Smartcom II Software	89
Everex Internal 1200B	79
Everex 2400 Plus Internal	149
<b>Everex 2400 E Plus External</b>	<b>189</b>
Everex Macintosh 2400 External	229
Packard Bell 1200 External	89
Prometheus 2400 External	169
Prometheus 2400 Internal	139
Prometheus 2400 Plus Internal	199
Laptop Modem 1200 Internal	139
Laptop Modem 2400 Internal	179
Cardinal 2400 Internal	109
Falcon 2400 External	129



<b>IBM SOFTWARE</b>	
Aldus Pagemaker 3.0	449
Lotus 123 Release 3	324
Lotus 123 Version 2.2	324
Funk Always (For Lotus 1-2-3 Ver. 2.0)	49
D Base 4	429
Multimate Advantage II	269
Borland Paradox 3.0	429
Microsoft Excel	269
Microsoft Word 5.0	209
Microsoft Windows 286	Sale Sale Sale 39
<b>Microsoft Windows 386</b>	<b>129</b>
<b>Word Perfect 5.0</b>	<b>214</b>

<b>Word Perfect Library 2.0</b>	<b>69</b>
Q & A 3.0	199
PFS Professional Write (2.1)	129
PC Tools Deluxe 5.5	79
Norton Utilities 4.5	54
Fastback Plus	99
Norton Utilities Advanced 4.5	84
Copy 2 PC Deluxe Board	99
Microsoft Mouse	99
Microsoft Mouse w/easy Cad	119
Microsoft Mouse with Windows	139
Logitech Scanman	189
Genius 3 Button Hi Res Mouse	89
Logitech New Hi Res mouse (320 DPI)	84
Logitech with Publisher	129
Logitech with Cad	139
Wordstar Professional Rel. 5.5 (After \$55 Rebate)	149
Ventura Desk Top Publishing ver 2.0	489
Managing Your Money - Release 5	119
Fast Wire II (Data Transfer Software and cables)	49
MS DOS 3.3 w/Basic	89
MS DOS 4.01 w/Basic	89



Master Card and Visa welcome at no additional charge. For your protection we check for stolen credit cards. Shipping & handling extra. Defective merchandise will be replaced or repaired at our discretion within the terms of our warranty. Price and availability subject to change without notice. We do not allow non-defective returns. For defective merchandise inquiries call customer service at (718) 692-2828.

<b>Panasonic 1124</b>	<b>269</b>
Panasonic 1592	349
Panasonic 1595	399
Panasonic 1524	489
Panasonic 3131	299
Star XR-1000	329
Star XR-1500	429
<b>Star NX 1000R (color)</b>	<b>209</b>
Star NX-2400	284
Star NX 1000	159
Star NX15	299
Toshiba 301 (24 Pin Portable Printer)	349
Toshiba Expresswriter 311	399
Toshiba 321 SL	589
Toshiba 341 SL	549
Toshiba 351 SX	949



<b>VIDEO CARDS</b>	
Hercules Monographic Plus w/Ramfont	154
<b>Hercules VGA Card</b>	<b>169</b>
Genoa Super Hi Res Plus	169
Genoa 5400 VGA w/512K	249
Video 7 VGA	209
Video 7 VGA Fastwrite 256K	329
Video 7 VGA Fastwrite 512K	359
Video 7 VGA VRAM (512K)	399
Orchard Pro Designer (VGA) 256K	229
Orchard Pro Designer (VGA) Plus 512K	299
STB VGA Extra EM 256K	229
STB VGA Extra EM 512K	299
ATI VGA Wonder 512K	289
<b>ATI VGA Wonder 256K</b>	<b>219</b>
ATI VGA Wonder 256K w/Mouse	249
ATI VGA Wonder 512K w/Mouse	319
Paradise Auto Switch (480)	199
Paradise VGA Plus	159
Paradise VGA Plus (16 Bit)	229
Paradise VGA Professional 512K	289
Everex Auto Sync (480) Deluxe	149
Everex EVGA	219
Everex Viewpoint VGA 256K	249
Everex Viewpoint VGA 512K	319
Harmony VGA (800 x 600)	149

<b>HARD DRIVES</b>	
Seagate 20 Meg. w/controller	249
Seagate 20 Meg.	229
Seagate 30 Meg. w/controller	274
Seagate 30 Meg.	254
Seagate 40 Meg. #251-1	339
<b>Seagate 80 Meg. #4096</b>	<b>579</b>

Western Digital XT Controller (20, 40, 80 Meg.)	79
Western Digital (AT) Controller	149
Miniscribe 20 Meg. Hard Drive Card	299
Miniscribe 30 Meg. Hard Drive Card	319
Mountain 30 Meg Hard Drive Card	319
Tandon 20 Meg Hard Drive Card	279
Seagate 20 Meg External (for Macintosh)	479
Seagate 20 Meg 3 1/2 inch #125N SCSI Adapter	599
Seagate 20 Meg 3 1/2 inch #125	259
Seagate 30 Meg 3 1/2 inch #138N SCSI Adapter	339
Seagate 30 Meg 3 1/2 inch #138MFM	299
Seagate 50 Meg 3 1/2 inch #157NS SCSI Adapter	369
Seagate 50 Meg 3 1/2 inch #157	349
Seagate 80 Meg 3 1/2 inch #296N SCSI Adapter	519
Host Adapter for IBM PS/2	49

<b>FAX MACHINES</b>	
Ricoh RF-850	699
Ricoh RF-900	829
Sharp UX-180	649
Sharp FO 220	919
Sharp FO 330	919
Sharp UX 350	1049
Sharp FO 420	1049
Sharp FO 520	1449
Panafax #150 w/Answering Machine	879
Panafax #135	599
Panafax #140	799
Panafax #145	699
Panafax #250	1189
Panafax #260	1379
Cannon Fax #15	649
Cannon Fax #20	899
Toshiba #3300	799
Toshiba #3600	999
<b>Epson Priority Fax #1000</b>	<b>799</b>
<b>Epson Priority Fax #2000</b>	<b>899</b>
We Carry A Full Line of Fax Paper	



# We make Dac-Easy™ look darn hard AND Peachtree® full of pits.

A small business workhorse —  
thousands of users  
worldwide agree.

Some accounting packages sound easy to use until you start to use them. Then you find out about the extras that come with them — like consultant time you'll probably end up paying for, expensive forms, and long learning curves. All you really want is an easy way to get your **bills out on time plus easy-to-read reports.**

The **Invoicer with Accounts Receivable** was designed by a small business owner who knew exactly what was needed. Now, **thousands of satisfied users** agree that this affordable, menu-driven program is the answer to their billing problems, too.

Before you commit to an "Easy" solution that turns out to be another hard lesson, give **The Invoicer** a **30-day money-back trial.\***

- Free 60-day support line.
- Custom modifications available.
- Runs on IBM and compatibles, Apple II, and Macintosh.
- Accounts Payable and Sales Tracking/Inventory modules also available.

## The Invoicer with Accounts Receivable™

**Only \$149**

(Plus \$7.50 shipping and handling.)

Texas residents add 6.5% sales tax.

Visa, Master Card, American Express accepted.

\* \$15 restocking fee if disk seal is broken.

**Call**

**1-800-950-7943** To Order

OR 512-629-4341

Or send check to MiccaSoft, Inc.  
406 Windsor Lane, New Braunfels, Texas 78132

Dac-Easy is a trademark of Dac Software, Inc. Peachtree is a registered trademark of Peachtree Software. IBM is a registered trademark of IBM Corp. Apple and Macintosh are registered trademarks of Apple Computer, Inc. The Invoicer with Accounts Receivable is a trademark of MiccaSoft, Inc.





# Adtech's 33 MHz\* 286... 386 Performance at a 286 Price!



## 16 MHz\* 286

**\$699**

- 8 / 16 MHz selectable
- 1 MB Exp. to 4 MB on board
- 80287 socket
- Space saving AT style minicase
- 200 watt P/S
- 1.2 MB Teac floppy

## 27 MHz\* 286

**\$999**

- 80286-20 C.P.U.
- 1 MB Exp. to 4 MB on board
- 80287 Socket
- Shadow RAM Enable
- Space saving AT style minicase
- 200 watt P/S
- 1.2 MB Teac floppy

## 33 MHz\* 386

**\$1399**

- 80386 ΣΣ C.P.U. running at 25 MHz
- 1 - 32 bit, 5 - 16 bit, 2 - 8 bit slots
- 80287 and 80387 sockets
- 1 MB Exp. to 8 MB on board
- Shadow RAM Enable
- Space saving AT style minicase
- 200 watt P/S
- 1.2 MB Teac floppy

## 33 MHz\* 286

**\$1049**

- 80286 CPU running at 25 MHz
- 1 MB Exp. to 8 MB on board
- 80287 socket
- Shadow RAM Enable
- Space saving AT style minicase
- 200 watt P/S
- 1.2 MB Teac floppy

### Standard System Features

- 1:1 Dual floppy / HD cont.
- Parallel, 2 serial, game, clock
- Keytronics 101 keyboard
- 24 hour burn-in

### System Options

Includes Monitor & Adapter Card	
Monographics (Hi-Res) . . . . .	.129
Color Graphics (RGB) . . . . .	.249
EGA (640 × 350) . . . . .	.488
VGA (16 bit) . . . . .	.599
Multisync (16 bit) . . . . .	.699

### Mother Boards

16 MHz* 286 . . . . .	.219
33 MHz* 286 . . . . .	.399
33 MHz* 386 . . . . .	.799

### System Upgrades

1:1 RLL . . . . .	.25
Full Size Case . . . . .	.25
Full Size Vertical Case . . . . .	.100
Mini Vertical Case . . . . .	.50

### Hard Drives

20 Meg - Seagate ST-125 (30ms) . . . . .	.259
30 Meg - Seagate ST-138 (30 ms) . . . . .	.309
40 Meg - Seagate ST251 (38ms) . . . . .	.349
40 Meg - Seagate ST251-1 (28ms) . . . . .	.359
66 Meg - Toshiba (23ms) . . . . .	.439
66 Meg - Seagate ST-151 (23ms) . . . . .	.399

### Miscellaneous

5.25" 360k (Fujitsu) . . . . .	.59
5.25" 1.2 MB . . . . .	.85
3.5" 1.44 MB . . . . .	.89
Logitech Hi-res Mouse (New) . . . . .	.89
2400 Baud Modem . . . . .	.99
16 bit VGA (1024 × 768) . . . . .	.199



# Adtech

(408) 954-8038 1 (800) 326-6548

(408) 954-1647 FAX

2003 O'Toole Ave., San Jose, CA 95131

Circle 526 on Reader Service Card (DEALERS: 527)

Terms and conditions. Returns subject to 20% restocking fee. Prices and availability subject to change without notice. RMA # required for all returns. CA residents add 7% sales tax. No surcharge MasterCard and Visa. \* Landmark speed test.

**ONE YEAR PARTS AND LABOR WARRANTY ON ALL SYSTEMS!**

World Radio History

SYSTEMS

STAR ARCNET

FOR PS/2

SWITCH BOX

AA44 CEI 286/12MHz Baby (U wait) . . . \$849
1MB memory, 2 serial and 1 parallel ports
Hard and floppy drive controller
1.2MB floppy drive, 101 key enhanced keyboard
FCC class B, base system made by DTK
Also available in limited (altim) size w/ 4 exp. slots (\$948)

K72 Plus + Plus Arcnet 8 bit . . . \$599
K35/37 Cnet Arcnet 8 bit/16 bit . . . \$89/219
K11 25' Arcnet Cable 93 Ohm RG62, Coaxial . . . \$25
K08/03 Hub Active 8's/Passive 4's . . . \$289/30

P04 EMS 4MB OK (Everex) . . . \$319
P19/20 Ext 360K for (PS/2)/(PS/2M30-286) . . . \$179/219
P16/17 Ext 1.2MB for (PS/2)/(PS/2M30-286) . . . \$199/259
P45/46 Ext 1.44MB for (PS/2)/(PS/2M30-286) . . . \$269/299
P50/51 Irwin 40MB Tape Drv VP60 Int/Ext \$599/759
P56/57 Archive 60MB Tape Drv VP60 Int/Ext \$599/1199
P21/27 HD Int, for Model 30 (CMS) 200MB/30MB \$399/479
P22/28 HD Int, for Model 50 (CMS) 4085MB \$599/999
P35 60MB Int 27ms HD for Model 50z, 70 (CMS) . . . \$999
P24/28 HD ESDI, for Mod 60.80 70/115MB . . . \$899/1359
P30 60MB HD 23ms for Model 60 (P/riam) . . . \$799
P31/32 HD 1.2MB, 20ms, for Model 60, 80 (P/riam)
130MB/330MB . . . \$1799/2699
P40 CD ROM \$40MB (NEC) . . . \$1199

TU1/02 2 Wty (2CN36F, 1DB25F)/(1CN36F, 2DB25F) 16/18
TU03/04/11 2 Wty (3CN36F, 3DB25F)/(3DB25F, 20/20/20)
TU05/06 2 Wty Cross (4 DB25F)/(4CN36F) . . . \$33/35
T10 2 Wty 2-9 Pin F & 2-5 Pin F (Monitor, KBD) . . . \$35
T07/08 2 Wty (3B11F) (3 P45) . . . \$30/30
P170/171 2 Wty 4 Wty (Monitor & Kbd) for PS/2 . . . \$35/50
T12/13/16 4 Wty (3CN36F, 3DB25F)/(3DB25F, 33/35/35)
T14 ABCD Multiser (40DB25M, 10DB25F) . . . \$45
T15 4 Wty (4CN36F, 10DB25F) . . . \$45
T20/21 4 Wty (5RJ11F)/(5RJ45F) . . . \$50/50
T18/19 W Type 2 In-3 Out (DB25F)/(CN36F) . . . \$55/55
T31/33 Printer Buffer 256K Parallel/Serial . . . \$199/269
T40/41 4 Wty Auto-Scan Switch, Parallel/Serial \$129/149
T30/32 8 Wty Auto-Scan Switch, Parallel/Serial \$179/199
T50/51 Converter (Par to Ser)/(Ser to Par) . . . \$69/69

AA50 CEI 286/16MHz Baby . . . \$999
1MB RAM, Hard and floppy drive controller
1.2MB floppy drive, 101 key enhanced keyboard
FCC class B

K71 Plus + Plus Arcnet 8 bit . . . \$129
K36/39 Cnet Arcnet 8 bit/16 bit . . . \$119/239
K09 Bus Terminator 93 ohms . . . \$8

COPROCESSOR & CHIPS

PRINTER CABLES/ADAPTERS

AA51 CEI 386/20MHz Baby . . . \$1399
1MB RAM, expandable to 4MB
Hard and floppy drive controller
1.2MB floppy drive, 101 key enhanced keyboard
Base system made by DTK

TWISTED PAIR ARCNET

M11/12 80287-8 10 . . . \$219/239
M10/10/07 8087-3-2-1 . . . \$99/139/189
M14/15/16/17 80387-16/-20/-25/-33 \$339/399/499/599
M18/18387S-16 . . . \$319
M20/21 20/40-10 . . . \$10/14-50
M60/61 2764-200/27128-250 . . . \$47/5-75
M30/31/33 DRAM 64-15/12/10 . . . \$22/30/2.65
M32/34 4464-12/10 . . . \$5/5.50
M40/41/42 256-12/10/-8 . . . \$3.65/3.99/5.50
M45/46 256x4 DRAM 8-10 . . . \$14/13
M78/79 1MBx1 DRAM 10/-8 for A15 & A18 . . . \$13/15
M83/84 1MB SCRAM Set for CSS A32/A60 \$299/299
M55 1MB SCRAM Set for CSS A35 . . . \$359
M80/87 SIPP 1MBx9 -10-8 . . . \$179/199
M81/75 SIPP 256x9 -10-8 . . . \$53/59
M90/91 SIMM 256x9 for PS/2 Mod 30 -12/-10 . . . \$69/79
M89 SIMM 256x9 80ns . . . \$69
M92 SIMM 1MBx9-10 for PS/2 Mod 30-286 . . . \$179
M93/70 SIMM for PS/2 60 & 80 1MBx9/2MB \$162/99/499
M94/95 SIMM 1MBx9 for Mod 70 E51/A21 \$259/259
M96 SIMM 1MBx9 for PS/2 Mod 80 . . . \$279
M97/71 SIMM 2MBx9 (A) for PS/2 70 E61/A23/499/499
M98/72 SIMM 2MB (A) for PS/2 80-111/311 \$499/499

N01/12/73/74 Printer 6/10/15/25 . . . \$71/20/30
N53/54 6 to HP Laser Printer from AT\*XT\* . . . \$15/15
N04 6 Centronic 36P M/M Parallel switchbox . . . \$10
N39/37 DB25F-CN36M/DB25M-CN36M . . . \$8/8
N36/38 DB25F-CN36F/DB25M-CN36F . . . \$8/8

AA52 CEI 386/25C . . . \$1999
1MB RAM, expandable to 8MB, 64K Cache
Hard and floppy drive controller
1.2MB floppy drive, 101 key enhanced keyboard
Base system made by DTK

ETHERNET

M01/12 80287-8 10 . . . \$219/239
M10/10/07 8087-3-2-1 . . . \$99/139/189
M14/15/16/17 80387-16/-20/-25/-33 \$339/399/499/599
M18/18387S-16 . . . \$319
M20/21 20/40-10 . . . \$10/14-50
M60/61 2764-200/27128-250 . . . \$47/5-75
M30/31/33 DRAM 64-15/12/10 . . . \$22/30/2.65
M32/34 4464-12/10 . . . \$5/5.50
M40/41/42 256-12/10/-8 . . . \$3.65/3.99/5.50
M45/46 256x4 DRAM 8-10 . . . \$14/13
M78/79 1MBx1 DRAM 10/-8 for A15 & A18 . . . \$13/15
M83/84 1MB SCRAM Set for CSS A32/A60 \$299/299
M55 1MB SCRAM Set for CSS A35 . . . \$359
M80/87 SIPP 1MBx9 -10-8 . . . \$179/199
M81/75 SIPP 256x9 -10-8 . . . \$53/59
M90/91 SIMM 256x9 for PS/2 Mod 30 -12/-10 . . . \$69/79
M89 SIMM 256x9 80ns . . . \$69
M92 SIMM 1MBx9-10 for PS/2 Mod 30-286 . . . \$179
M93/70 SIMM for PS/2 60 & 80 1MBx9/2MB \$162/99/499
M94/95 SIMM 1MBx9 for Mod 70 E51/A21 \$259/259
M96 SIMM 1MBx9 for PS/2 Mod 80 . . . \$279
M97/71 SIMM 2MBx9 (A) for PS/2 70 E61/A23/499/499
M98/72 SIMM 2MB (A) for PS/2 80-111/311 \$499/499

SERIAL CABLES/ADAPTER

AA16 CEI 386/33C (40 wait) . . . \$4299
4MB static column memory
ESDI hard and floppy drive controller
32K cache, expandable to 64K
1.2MB floppy drive, 101 key enhanced keyboard
Also available at 25MHz (AA15 \$3999)
FCC Class A, base system made in USA by CSS

COAX ACCESSORIES

G01 Smartone 1200 Int w/ Bitcom . . . \$59
G20/21 Smartone 2400 Int/Ext . . . \$99/115
G10 Everex 1200 w/ Bitcom Int . . . \$65
G11/12 Everex 2400 Int/Ext . . . \$129/169
G16 Everex 2400 Int for PS/2 . . . \$219
G17/18 Everex 2400 with MNP Level 5 Int/Ext \$169/219
G19 Everex 9600 . . . \$Cull
G01 Everex Faxmodem External . . . \$259

DRIVE CABLES/ADAPTERS

AA36 Chiclynup Laptop 286-16MHz . . . \$3199
Gas Plasma, NEAT Chipset
600x400 EGA Mode, 1MB RAM
Par, Ser Ports, 1.44MB FDD
40MB Hard Drive, M/F/CDD
FCC Class B

MULTIUSER

MODEMS

All systems have 6 months limited warranty on parts and labor.
After 20 days from shipping date, all monitors & printers warranties are carried out by the manufacturer.

COAX ACCESSORIES

SCANNERS

AA38 Chiplynup Laptop 286-16MHz . . . \$3199
Gas Plasma, NEAT Chipset
600x400 EGA Mode, 1MB RAM
Par, Ser Ports, 1.44MB FDD
40MB Hard Drive, M/F/CDD
FCC Class B

ETHERNET

MONITOR & KBD CABLES

AA38 Chiplynup Laptop 286-16MHz . . . \$3199
Gas Plasma, NEAT Chipset
600x400 EGA Mode, 1MB RAM
Par, Ser Ports, 1.44MB FDD
40MB Hard Drive, M/F/CDD
FCC Class B

ETHERNET

DRIVE CABLES/ADAPTERS

AA38 Chiplynup Laptop 286-16MHz . . . \$3199
Gas Plasma, NEAT Chipset
600x400 EGA Mode, 1MB RAM
Par, Ser Ports, 1.44MB FDD
40MB Hard Drive, M/F/CDD
FCC Class B

ETHERNET

MONITOR & KBD CABLES

AA38 Chiplynup Laptop 286-16MHz . . . \$3199
Gas Plasma, NEAT Chipset
600x400 EGA Mode, 1MB RAM
Par, Ser Ports, 1.44MB FDD
40MB Hard Drive, M/F/CDD
FCC Class B

ETHERNET

DRIVE CABLES/ADAPTERS

AA38 Chiplynup Laptop 286-16MHz . . . \$3199
Gas Plasma, NEAT Chipset
600x400 EGA Mode, 1MB RAM
Par, Ser Ports, 1.44MB FDD
40MB Hard Drive, M/F/CDD
FCC Class B

ETHERNET

MONITOR & KBD CABLES

AA38 Chiplynup Laptop 286-16MHz . . . \$3199
Gas Plasma, NEAT Chipset
600x400 EGA Mode, 1MB RAM
Par, Ser Ports, 1.44MB FDD
40MB Hard Drive, M/F/CDD
FCC Class B

ETHERNET

DRIVE CABLES/ADAPTERS

AA38 Chiplynup Laptop 286-16MHz . . . \$3199
Gas Plasma, NEAT Chipset
600x400 EGA Mode, 1MB RAM
Par, Ser Ports, 1.44MB FDD
40MB Hard Drive, M/F/CDD
FCC Class B

ETHERNET

MONITOR & KBD CABLES

AA38 Chiplynup Laptop 286-16MHz . . . \$3199
Gas Plasma, NEAT Chipset
600x400 EGA Mode, 1MB RAM
Par, Ser Ports, 1.44MB FDD
40MB Hard Drive, M/F/CDD
FCC Class B

ETHERNET

MONITOR & KBD CABLES

AA38 Chiplynup Laptop 286-16MHz . . . \$3199
Gas Plasma, NEAT Chipset
600x400 EGA Mode, 1MB RAM
Par, Ser Ports, 1.44MB FDD
40MB Hard Drive, M/F/CDD
FCC Class B

ETHERNET

MONITOR & KBD CABLES

AA38 Chiplynup Laptop 286-16MHz . . . \$3199
Gas Plasma, NEAT Chipset
600x400 EGA Mode, 1MB RAM
Par, Ser Ports, 1.44MB FDD
40MB Hard Drive, M/F/CDD
FCC Class B

ETHERNET

MONITOR & KBD CABLES

AA38 Chiplynup Laptop 286-16MHz . . . \$3199
Gas Plasma, NEAT Chipset
600x400 EGA Mode, 1MB RAM
Par, Ser Ports, 1.44MB FDD
40MB Hard Drive, M/F/CDD
FCC Class B

ETHERNET

MONITOR & KBD CABLES

AA38 Chiplynup Laptop 286-16MHz . . . \$3199
Gas Plasma, NEAT Chipset
600x400 EGA Mode, 1MB RAM
Par, Ser Ports, 1.44MB FDD
40MB Hard Drive, M/F/CDD
FCC Class B

ETHERNET

MONITOR & KBD CABLES

AA38 Chiplynup Laptop 286-16MHz . . . \$3199
Gas Plasma, NEAT Chipset
600x400 EGA Mode, 1MB RAM
Par, Ser Ports, 1.44MB FDD
40MB Hard Drive, M/F/CDD
FCC Class B

ETHERNET

MONITOR & KBD CABLES

AA38 Chiplynup Laptop 286-16MHz . . . \$3199
Gas Plasma, NEAT Chipset
600x400 EGA Mode, 1MB RAM
Par, Ser Ports, 1.44MB FDD
40MB Hard Drive, M/F/CDD
FCC Class B

ETHERNET

MONITOR & KBD CABLES

AA38 Chiplynup Laptop 286-16MHz . . . \$3199
Gas Plasma, NEAT Chipset
600x400 EGA Mode, 1MB RAM
Par, Ser Ports, 1.44MB FDD
40MB Hard Drive, M/F/CDD
FCC Class B

ETHERNET

MONITOR & KBD CABLES

AA38 Chiplynup Laptop 286-16MHz . . . \$3199
Gas Plasma, NEAT Chipset
600x400 EGA Mode, 1MB RAM
Par, Ser Ports, 1.44MB FDD
40MB Hard Drive, M/F/CDD
FCC Class B

ETHERNET

MONITOR & KBD CABLES

AA38 Chiplynup Laptop 286-16MHz . . . \$3199
Gas Plasma, NEAT Chipset
600x400 EGA Mode, 1MB RAM
Par, Ser Ports, 1.44MB FDD
40MB Hard Drive, M/F/CDD
FCC Class B

ETHERNET

MONITOR & KBD CABLES

AA38 Chiplynup Laptop 286-16MHz . . . \$3199
Gas Plasma, NEAT Chipset
600x400 EGA Mode, 1MB RAM
Par, Ser Ports, 1.44MB FDD
40MB Hard Drive, M/F/CDD
FCC Class B

ETHERNET

MONITOR & KBD CABLES

AA38 Chiplynup Laptop 286-16MHz . . . \$3199
Gas Plasma, NEAT Chipset
600x400 EGA Mode, 1MB RAM
Par, Ser Ports, 1.44MB FDD
40MB Hard Drive, M/F/CDD
FCC Class B

ETHERNET

MONITOR & KBD CABLES

AA38 Chiplynup Laptop 286-16MHz . . . \$3199
Gas Plasma, NEAT Chipset
600x400 EGA Mode, 1MB RAM
Par, Ser Ports, 1.44MB FDD
40MB Hard Drive, M/F/CDD
FCC Class B

ETHERNET

MONITOR & KBD CABLES

AA38 Chiplynup Laptop 286-16MHz . . . \$3199
Gas Plasma, NEAT Chipset
600x400 EGA Mode, 1MB RAM
Par, Ser Ports, 1.44MB FDD
40MB Hard Drive, M/F/CDD
FCC Class B

ETHERNET

MONITOR & KBD CABLES

AA38 Chiplynup Laptop 286-16MHz . . . \$3199
Gas Plasma, NEAT Chipset
600x400 EGA Mode, 1MB RAM
Par, Ser Ports, 1.44MB FDD
40MB Hard Drive, M/F/CDD
FCC Class B

ETHERNET

MONITOR & KBD CABLES

AA38 Chiplynup Laptop 286-16MHz . . . \$3199
Gas Plasma, NEAT Chipset
600x400 EGA Mode, 1MB RAM
Par, Ser Ports, 1.44MB FDD
40MB Hard Drive, M/F/CDD
FCC Class B

ETHERNET

MONITOR & KBD CABLES

AA38 Chiplynup Laptop 286-16MHz . . . \$3199
Gas Plasma, NEAT Chipset
600x400 EGA Mode, 1MB RAM
Par, Ser Ports, 1.44MB FDD
40MB Hard Drive, M/F/CDD
FCC Class B

ETHERNET

MONITOR & KBD CABLES

AA38 Chiplynup Laptop 286-16MHz . . . \$3199
Gas Plasma, NEAT Chipset
600x400 EGA Mode, 1MB RAM
Par, Ser Ports, 1.44MB FDD
40MB Hard Drive, M/F/CDD
FCC Class B

ETHERNET

MONITOR & KBD CABLES

AA38 Chiplynup Laptop 286-16MHz . . . \$3199
Gas Plasma, NEAT Chipset
600x400 EGA Mode, 1MB RAM
Par, Ser Ports, 1.44MB FDD
40MB Hard Drive, M/F/CDD
FCC Class B

ETHERNET

MONITOR & KBD CABLES

AA38 Chiplynup Laptop 286-16MHz . . . \$3199
Gas Plasma, NEAT Chipset
600x400 EGA Mode, 1MB RAM
Par, Ser Ports, 1.44MB FDD
40MB Hard Drive, M/F/CDD
FCC Class B

ETHERNET

MONITOR & KBD CABLES

AA38 Chiplynup Laptop 286-16MHz . . . \$3199
Gas Plasma, NEAT Chipset
600x400 EGA Mode, 1MB RAM
Par, Ser Ports, 1.44MB FDD
40MB Hard Drive, M/F/CDD
FCC Class B

ETHERNET

MONITOR & KBD CABLES

AA38 Chiplynup Laptop 286-16MHz . . . \$3199
Gas Plasma, NEAT Chipset
600x400 EGA Mode, 1MB RAM
Par, Ser Ports, 1.44MB FDD
40MB Hard Drive, M/F/CDD
FCC Class B

ETHERNET

MONITOR & KBD CABLES

AA38 Chiplynup Laptop 286-16MHz . . . \$3199
Gas Plasma, NEAT Chipset
600x400 EGA Mode, 1MB RAM
Par, Ser Ports, 1.44MB FDD
40MB Hard Drive, M/F/CDD
FCC Class B

ETHERNET

MONITOR & KBD CABLES

AA38 Chiplynup Laptop 286-16MHz . . . \$3199
Gas Plasma, NEAT Chipset
600x400 EGA Mode, 1MB RAM
Par, Ser Ports, 1.44MB FDD
40MB Hard Drive, M/F/CDD
FCC Class B

ETHERNET

MONITOR & KBD CABLES

AA38 Chiplynup Laptop 286-16MHz . . . \$3199
Gas Plasma, NEAT Chipset
600x400 EGA Mode, 1MB RAM
Par, Ser Ports, 1.44MB FDD
40MB Hard Drive, M/F/CDD
FCC Class B

ETHERNET

MONITOR & KBD CABLES

AA38 Chiplynup Laptop 286-16MHz . . . \$3199
Gas Plasma, NEAT Chipset
600x400 EGA Mode, 1MB RAM
Par, Ser Ports, 1.44MB FDD
40MB Hard Drive, M/F/CDD
FCC Class B

ETHERNET

MONITOR & KBD CABLES

AA38 Chiplynup Laptop 286-16MHz . . . \$3199
Gas Plasma, NEAT Chipset
600x400 EGA Mode, 1MB RAM
Par, Ser Ports, 1.44MB FDD
40MB Hard Drive, M/F/CDD
FCC Class B

ETHERNET

MONITOR & KBD CABLES

AA38 Chiplynup Laptop 286-16MHz . . . \$3199
Gas Plasma, NEAT Chipset
600x400 EGA Mode, 1MB RAM
Par, Ser Ports, 1.44MB FDD
40MB Hard Drive, M/F/CDD
FCC Class B

ETHERNET

MONITOR & KBD CABLES

AA38 Chiplynup Laptop 286-16MHz . . . \$3199
Gas Plasma, NEAT Chipset
600x400 EGA Mode, 1MB RAM
Par, Ser Ports, 1.44MB FDD
40MB Hard Drive, M/F/CDD
FCC Class B

ETHERNET

MONITOR & KBD CABLES

AA38 Chiplynup Laptop 286-16MHz . . . \$3199
Gas Plasma, NEAT Chipset
600x400 EGA Mode, 1MB RAM
Par, Ser Ports, 1.44MB FDD
40MB Hard Drive, M/F/CDD
FCC Class B

ETHERNET

MONITOR & KBD CABLES

AA38 Chiplynup Laptop 286-16MHz . . . \$3199
Gas Plasma, NEAT Chipset
600x400 EGA Mode, 1MB RAM
Par, Ser Ports, 1.44MB FDD
40MB Hard Drive, M/F/CDD
FCC Class B

ETHERNET

MONITOR & KBD CABLES

AA38 Chiplynup Laptop 286-16MHz . . . \$3199
Gas Plasma, NEAT Chipset
600x400 EGA Mode, 1MB RAM
Par, Ser Ports, 1.44MB FDD
40MB Hard Drive, M/F/CDD
FCC Class B

ETHERNET

MONITOR & KBD CABLES

AA38 Chiplynup Laptop 286-16MHz . . . \$3199
Gas Plasma, NEAT Chipset
600x400 EGA Mode, 1MB RAM
Par, Ser Ports, 1.44MB FDD
40MB Hard Drive, M/F/CDD
FCC Class B

ETHERNET

MONITOR & KBD CABLES

AA38 Chiplynup Laptop 286-16MHz . . . \$3199
Gas Plasma,



# PERFORMANCE PRICE SERVICE

## FIND THEM ALL AT ON LINE COMPUTER

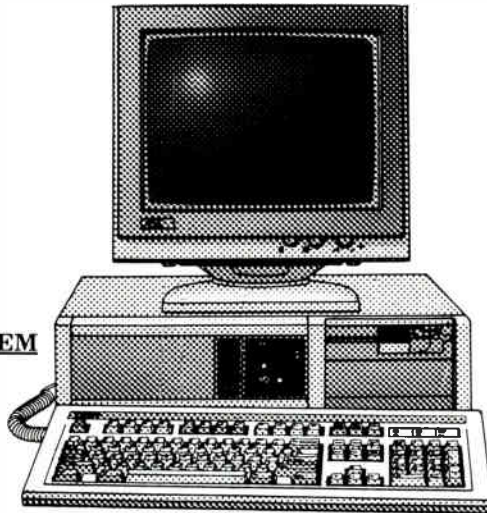

### ON LINE 286 MULTISYNC COLOR SYSTEM

- 12 MHz Motherboard
- 80286 - 12 CPU
- Seagate 20MB Hard Drive
- 1:1 Interleave Hard Drive Controller
- 1.2 MB Floppy
- 1MB RAM (Expandable to 4MB)
- 2 Serial Ports • 1 Parallel Port • 1 Game Port
- 8 Expansion Slots • 200w Power Supply
- 101 Key Keyboard • Reset Button
- 14" VGA Multisync Monitor • Keyboard Lock
- VGA Multisync Graphic Adapter Card
- Clock/Calendar with battery backup
- Socket for 80287 Math Coprocessor

### ON LINE 386 MULTISYNC COLOR SYSTEM

- 20 MHz Motherboard
- 80386 - 20 CPU
- Seagate 40MB Hard Drive (28ms)
- 1:1 Interleave Hard Drive Controller
- 1.2 MB Floppy
- 1MB RAM (Expandable to 16MB)
- 2 Serial Ports • 1 Parallel Port • 1 Game Port
- 8 Expansion Slots • 200w Power Supply
- 101 Key Keyboard • Reset Button
- 14" VGA Multisync Monitor • Keyboard Lock
- VGA Multisync Graphic Adapter Card
- Clock/Calendar with battery backup
- Socket for 80387 Math Coprocessor

COMPLETE SYSTEM ONLY

**\$1895**

COMPLETE SYSTEM ONLY

**\$2795**

### **BOTH SYSTEMS COME WITH A LIMITED 2 YEAR WARRANTY**

On Line Computer is a full service store serving the public for more than 6 years. We carry a large assortment of software for: IBM (and compatibles), Atari, Macs, & Commodore 64. We also carry a full line of supplies & accessories at low prices.

**QUANTITY DISCOUNTS FOR SCHOOLS AND CORPORATE ACCOUNTS**

AUTHORIZED DEALER FOR:



AT&T

ATARI



AT&T STARLAN AND NOVELL NETWORKING

**ON LINE COMPUTER**

**STORE WIDE SAVINGS ALWAYS AVAILABLE AT TWO CONVENIENT LOCATIONS:**

280 Main Street (RT 28)  
Colonnade Building  
North Reading, MA  
Across from Atlantic Plaza

**(508) 664-1110**

450 South Broadway  
Newman Plaza  
Salem, NH  
Next to Newman Ford

**(603) 894-6314**

## Entry-Level Word Processor Features Multilaunching

New Horizons' WordMaker, an entry-level word processor for the Macintosh, is now available in a multilaunch version, allowing several users on a network to use the program simultaneously.

WordMaker is compact enough to run off a single disk if your Mac doesn't have a hard disk drive. Its features include a WYSIWYG display, print merge, multiple-line headers and footers for left and right pages, color, multiple document support, and a 100,000-word spelling checker. You can also wrap multiple lines around irregularly shaped graphics.

The program supports all available system fonts. It supports only one column, but it can read and write MacWrite files and is compatible with PageMaker. WordMaker runs on the Mac 512KE or higher.

**Price:** Single-user version, \$124.95; multilaunch version available only through site licensing.

**Contact:** New Horizons Software, Inc., P.O. Box 43167, Austin, TX 78745, (512) 328-6650.

**Inquiry 1008.**

## MNP Software Now Includes More Utilities

MagicSoft's MTE 2.1 is a communications program that adds Microcom Networking Protocol error control and data compression (to MNP 5) to ordinary modems. New add-ons now allow special terminal emulations and file transfer protocols that are necessary for mainframe and CompuServe communications.

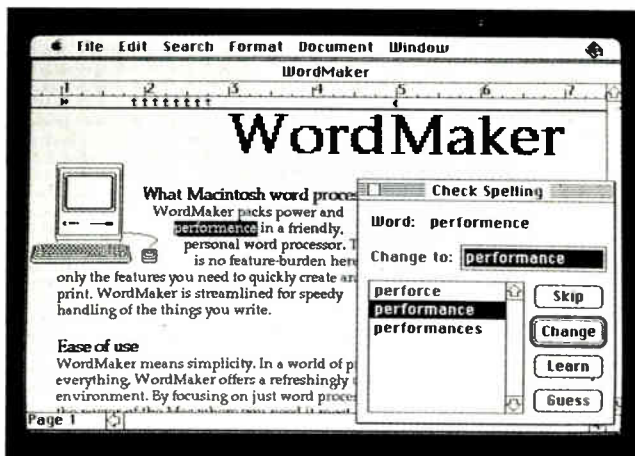

*WordMaker uses a pull-down menu for search-and-replace and other word processing operations.*

MTE 2.1 lets all modems appear to be an MNP modem, while also doubling the data rate, according to MagicSoft.

**Price:** MTE 2.1, \$79; new add-ons, \$19.  
**Contact:** MagicSoft, Inc., P.O. Box 396, Lombard, IL 60148, (312) 953-2374.  
**Inquiry 1002.**

## Networking from the Field with GRiD

The FieldNet series is a wide-area-network store-and-forward system designed to link field-service personnel with portable computers to office-based networks.

It operates on Banyan's VINES network operating systems as a Unix service. GRiD software replaces the protocol and application layers.

The resulting software lets traveling professionals do batch processing when they can get access to a telephone line. The FieldNet Secretary function compiles all the necessary information in a form for quick processing.

FieldNet servers are available in three models. The 20-MHz 80386 and the 80386SX both support six (standard) to

12 (optional) modems. The FieldNet/EXP (a GRiDCase 1535 EXP laptop) is for one-to-one communications in the field.

**Price:** FieldNet/386, \$25,950; FieldNet/EXP, \$21,450; FieldNet/SX, \$19,450; GRiDMail Plus, \$175; FieldNet API, \$1950 per developer.

**Contact:** GRiD Systems Corp., 47211 Lakeview Blvd., P.O. Box 5003, Fremont, CA 94537, (415) 656-4700.  
**Inquiry 1009.**

## Express Your Opinions Honestly at Board Meetings

You're at the board meeting or presentation, and a fellow worker is presenting the marketing strategy for the company's next big product. You know the person worked long and hard on the presentation, but your experience tells you the strategy will surely fail. The president asks the group what they think about the strategy. What do you do?

A company called Option Technologies thinks it has the answer for ensuring 100 percent honest feedback for business questions with political baggage. OptionFinder consists of a software program

and keypads that let meeting attendees respond to up to 52 items developed before or during the meeting. You can present questions, which can be projected on a wall with a video projector, in several forms: yes or no; traditional rating scales; true/false; and multiple choice. You can connect up to 120 participants.

OptionFinder works on the IBM PC with 640K bytes of RAM, DOS 3.2 or higher, and two floppy disk drives or a hard disk drive.

**Price:** Software, \$89.95; eight keypads and software driver, \$1325; eight additional keypads, \$800.

**Contact:** Option Technologies, Inc., 200 Carleton Ave., East Islip, NY 11730, (800) 645-2287 or (516) 277-7000.  
**Inquiry 1011.**

## CodeTrack Shames Software Pirates

A program for software publishers and other businesses fights the illegal duplication of software programs with the weapon of embarrassment. The first time you run an application called CodeTrack, it runs you through a registration procedure. To qualify for customer support, you must send a registration card to the respective software publisher and quote the serial number and password for each call.

What CodeTrack does is display in big, bold letters on the IBM PC's screen the customer's name every time the program or a copy of it executes.

**Price:** \$195.  
**Contact:** EliaShim Microcomputers, Inc., 520 West Hwy. 436, Suite 1180-30, Altamonte Springs, FL 32714, (407) 682-1587.  
**Inquiry 1012.**



# THE SLASHER



has slashed prices  
on all of our printer  
and typewriter  
ribbons up to 50%.

## RIBBONS!

DEALER INQUIRIES ARE INVITED

**Buy direct from the manufacturer and save!!**

### NYLON RIBBONS

NO.	DESCRIPTION	PRICE EACH	NO.	DESCRIPTION	PRICE EACH	NO.	DESCRIPTION	PRICE EACH
100	ANADEX 9500	4.25	580	IDS 3/4" BLACK	4.58	1040	IBM 6240	1.95
110	APPLE IMAGEWRITER 4 COLOR	9.25	590	IDS 3/4" PROCESS	10.50	1050	MANNESMAN TALLY SP. 80	4.50
120	APPLE IMAGEWRITER LQ	17.00	600	MANNESMAN TALLY MT 85	5.00	1060	NAKAJIMA	3.40
130	BROTHER 1409	5.00	610	MANNESMAN TALLY MT 86	5.84	1070	NEC SPINWRITER 5500	3.16
140	BROTHER 1509	5.70	620	MANNESMAN TALLY 160	5.00	1080	NEC 3500 FLIP	6.00
150	BROTHER HR 15	4.50	630	MANNESMAN TALLY 180	5.42	1090	OLIVETTI ET121	4.00
160	CANON A 1200	3.70	640	NCR 2140	4.55	1100	QUME I 3/5	1.95
170	CENTRONICS 101	4.15	650	NCR 499	6.00	1110	QUME II	2.65
180	CENTRONICS 350	9.30	660	NEC 3500	4.60	1120	QUME IV	3.15
190	CENTRONICS 6000	9.10	670	NEC P 2200	5.90	1130	RICOH 1300/1600	3.10
200	CENTRONICS 704	4.95	680	NEC P 5	4.20	1140	WANG 5	2.60
210	CENTRONICS M 150	2.91	690	NEC PINWRITER P2	4.30	1150	XEROX 610	3.17
220	CITIZEN 120 D	4.95	700	NEC PINWRITER P3	5.00	<b>CORRECTABLE RIBBONS AND LIFT OFF TAPES</b>		
230	COMMODORE MPS 801	3.50	710	NEC SPINWRITER 5500	3.75	1300	ADLER 1010/5010	3.45
240	COMMODORE MPS 803	3.82	720	OKIDATA 182	4.20	1310	BROTHER EM 200	2.50
250	C. ITOH 8500	3.10	730	OKIDATA 292	6.00	1320	BROTHER AX 10-12	2.72
260	COMREX 420	7.55	740	OKIDATA 293	5.45	1330	BROTHER 701	3.85
270	DATA GENERAL LP 2	5.50	750	OKIDATA 393	19.00	1340	CANON AP 100	3.00
280	DATA PRODUCTS 8010	4.50	760	OKIDATA MICROLINE 80/82	1.35	1350	DAISY WHEEL LOT SUPER DRY	.60
290	DATA PRODUCTS 8020	5.50	770	OKIDATA MICROLINE 84/94	3.34	1360	IBM WHEELWRITER	3.30
300	DATA PRODUCTS B 300	5.50	780	PANASONIC 1090	4.50	1370	IBM WHEELWRITER LOT	2.90
310	DATA PRODUCTS B 1000	7.15	790	PANASONIC 1524	6.00	1380	IBM SELECTRIC II	1.50
320	DATA PRODUCTS M 200	4.20	800	PRINTRONIX P 300	6.00	1390	IBM SELECTRIC II LOT DRY	.60
330	DIABLO HT II	3.25	810	QUME I 3/5	3.00	1400	IBM SELECTRIC II LOT TACKY	.60
340	DIGITAL LA 30	3.00	820	QUME IV	4.40	1410	IBM SELECTRIC II TECH III	2.10
350	DIGITAL LA 34	3.20	830	RADIO SHACK 3/5	4.10	1420	IBM SELECTRIC II CUT	.80
360	DIGITAL LA 120	3.85	840	RADIO SHACK 6/8	3.25	1430	IBM ACTIONWRITER	2.50
370	EPSON ERC 03	3.00	850	SEIKOSHA SP 1000	4.30	1440	NAKAJIMA	2.68
380	EPSON LQ 800	3.80	860	STAR NX 10000	5.00	1450	OLIVETTI LEXICON LOT	1.00
390	EPSON LQ 1000	4.90	870	STAR MICRONICS NB 15	6.50	1460	OLIVETTI ET 121	2.55
400	EPSON LQ 1500	3.60	880	STAR MICRONICS NX 10	3.95	1470	OLIVETTI 111/115	4.00
410	EPSON LQ 2500	4.95	890	STAR MICRONICX NX 15	5.75	1480	OLIVETTI PRAXIS	2.50
420	EPSON LQ 2550	5.25	900	STAR MICRONICS SD 10	6.00	1490	OLIVETTI PRAXIS LOT	.90
430	EPSON LX 80	2.75	910	STAR MICRONICS SD 15	7.00	1500	OLYMPIA ESW 3000	3.15
440	EPSON MX 80	3.80	920	TALLY MANNESMAN 1000	3.50	1510	PANASONIC RKT 40	3.00
450	EPSON MX 100	4.90	930	TELETYPE 43	5.85	1520	ROYAL ALPHA 600	2.61
460	FUJITSU DMPG 9	4.30	940	TEXAS INSTRUMENTS 850	3.95	1530	SHARP ZX 400/500	3.55
470	HEWLETT PACKARD 2631	12.00	950	TEXAS INSTRUMENTS 860	5.00	1540	SILVER REED EX 42/44	2.25
480	IBM 1/2" HARMONICA	4.25	965	TOSHIBA 1350	3.20	1550	SILVER REED EX 42/44 LOT	.90
490	IBM 3/4" HARMONICA	4.58	960	TOSHIBA P 321 SL	5.00	1560	XEROX 610	2.35
500	IBM 3262	6.25	970	TRITEL/DATA ROYAL	3.67	1570	XEROX 610 LOT	.90
510	IBM 5211	4.80	980	WANG BEARCLAW	7.00	1580	XEROX 610 LOT DOUBLE PASS	1.25
520	IBM 5242 LG. HANDBAG	3.50	<b>MULTI STRIKE RIBBONS</b>			1590	XEROX 6010	4.80
530	IBM 5256 SM. HANDBAG	2.75	1000	BROTHER HR 15	3.55	1600	SHARP PA 3100	3.25
540	IBM BASEBALL BAT	14.50	1010	COMMODORE 1526	4.50	*\$.00 shipping and handling charge on all orders under \$50.00. For orders over \$50.00 actual freight is charged.		
550	IBM PROPRINTER	4.15	1020	DIABLO HT II	2.25			
560	IBM PROPRINTER XL	4.95	1030	IBM DISPLAYWRITER	7.00			
570	IBM SILVER \$ CUP	1.95						

516-767-0178

800-645-6113

FAX 516-767-0585

103 HARBOR ROAD

PORT WASHINGTON, NY 11050

**MSC**  
MOLTY STRYK CORPORATION

# MORE POWER TO YOUR PC'S

## SUMMA WARE

**The PC-Based LAN  
total accounting  
solution.**

Ideally suited for manufacturing  
and distribution operations.

## AND YOUR XT's, AT's, 386's, PS/2's AND HP's.

**SUMMAWARE contains the most powerful networking and operating system on the market today.**

It is designed to bring more power to your computer network, no matter what type of IBM or IBM compatible you use. So you're not limited to the hardware you can use with SUMMAWARE. SUMMAWARE runs on any mix of machines, either standalone or in a network. With SUMMAWARE you get the power, expandability and flexibility not found in other operating systems.

### **MULTI-TASKING**

SUMMAWARE's speed in switchover, changing from one program to another, is unsurpassed. And it does not require a dedicated file server.

### **MULTI-USER**

With SUMMAWARE you have the power to spare and the power to share. All programs, data and resources such as printers, terminals, modems and CPUs can be shared across the entire network. And it can support up to 255 nodes.

### **MULTI-WINDOWING**

SUMMAWARE uses standard windows so it is easy to learn, easy to use. On-screen help is always just one keystroke away. View up to four processes operating concurrently.

### **TRULY DISTRIBUTED PROCESSING**

SUMMANET features 100% distributed processing, 100% back-up and resource sharing across the entire network. Any computer on your network can make its disks, printers, serial ports and CPUs available for all tasks.

**Start with SUMMANET, the most powerful operating system available.**

Based on the QNX® operating system, SUMMANET is the heart and brains of the SUMMAWARE package. And it's lean and quick, taking up a mere 148K. SUMMANET is capable of supporting 512 disk drives with virtually unlimited storage.

**Built-in features for increased office efficiency.**

- SUMMADATE allows you to keep track of all your appointments and the appointments of your associates.
- SUMMAMAIL is the solution to your electronic mail problems. It allows you to send normal, confidential, encrypted or registered messages to any and all on your network. High security and fast-efficient communications, across the hall or around the world.

**Add SUMMACOUNT, a powerful distribution and manufacturing accounting system.**

Suited to diverse businesses with varying levels of accounting complexity, SUMMACOUNT is based on MCBA® Accounting Software, the recognized leader in accounting software.

**Optional additional packages include: word processing, spread sheet programs and a 4 GL/Data Base Management System. Call SUMMA for in-depth information on the SUMMAWARE family.**



215 East Water Street, Syracuse, NY 13202  
Call Toll-free: 1-800-255-1133 Ext. 320

IBM XT, AT & PS/2 are registered trademarks of International Business Machines. QNX is a registered trademark of Quantum Software Systems Ltd. The UNIX Operating System is a registered trademark of AT&T. HP is a registered trademark of Hewlett-Packard Co. MCBA is a registered trademark of MCBA®, Inc. SummaDate and SummaMail are licensed software products from Quantum Software Systems Ltd.



# IF YOU ARE LOOKING FOR QUALITY, RELIABILITY, AND SERVICE



## LOOK NO FURTHER!!! WE ARE PC-PLUS TECHNOLOGIES, INC.

We accept MasterCard, Visa, American Express, and Discover (no surcharge)

PC-PLUS XT 8088-12	PC-PLUS AT 286-12	PC-PLUS 386-20	PC-PLUS 386-25
<ul style="list-style-type: none"> <li>* 4.7712 MHZ Motherboard</li> <li>* Phoenix Bios</li> <li>* 8 Expansion Slots</li> <li>* 150 Watt Power Supply</li> <li>* 640K of Memory</li> <li>* 360K Floppy Drive</li> <li>* 12" Monochrome Monitor</li> <li>* Monographics Card (Hercules Compatible)</li> <li>* Parallel-Serial-Game Ports</li> <li>* Clock Calendar</li> <li>* 101 Key Keyboard</li> <li>* MS DOS 4.01 &amp; GWBasic</li> <li>* 2 Year Warranty</li> </ul> <p><b>\$699</b></p> <p><i>XT Mono</i></p> <ul style="list-style-type: none"> <li>* 20MB Seagate Hard Drive ..... \$989</li> <li>* 30MB Seagate Hard Drive ..... \$1019</li> <li>* 40MB Seagate Hard Drive ..... \$1129</li> <li>* 65MB Seagate Hard Drive ..... \$1219</li> </ul> <p><i>XT CGA Color System</i></p> <p><b>\$859 with:</b></p> <ul style="list-style-type: none"> <li>* 20MB Seagate Hard Drive ..... \$1159</li> <li>* 30MB Seagate Hard Drive ..... \$1189</li> <li>* 40MB Seagate Hard Drive ..... \$1299</li> <li>* 65MB Seagate Hard Drive ..... \$1389</li> </ul> <p><i>XT EGA Color System</i></p> <p><b>\$1099 with:</b></p> <ul style="list-style-type: none"> <li>* 20MB Seagate Hard Drive ..... \$1399</li> <li>* 30MB Seagate Hard Drive ..... \$1429</li> <li>* 40MB Seagate Hard Drive ..... \$1539</li> <li>* 65MB Seagate Hard Drive ..... \$1629</li> </ul>	<ul style="list-style-type: none"> <li>* 6/12 MHZ Motherboard (0 wait state)</li> <li>* Phoenix Bios</li> <li>* 8 Expansion Slots</li> <li>* Landmark 15.9 MHZ</li> <li>* 220W Power Supply</li> <li>* 640K of Memory (exp. to 4MB)</li> <li>* 1.2MB 5.25" or A 1.44MB 3.5" Floppy Drive</li> <li>* 12" Monochrome Monitor</li> <li>* Monographics Card (Hercules Compatible)</li> <li>* Parallel-2 Serial-Game Ports</li> <li>* 101 Key Keyboard</li> <li>* MS DOS 4.01 &amp; GWBasic</li> <li>* 2 Year Warranty</li> </ul> <p><b>\$889</b></p> <p><i>286/12 Mono</i></p> <ul style="list-style-type: none"> <li>* 20MB Seagate Hard Drive ..... \$1229</li> <li>* 30MB Seagate Hard Drive ..... \$1279</li> <li>* 40MB Seagate Hard Drive ..... \$1399</li> <li>* 65MB Seagate Hard Drive ..... \$1489</li> <li>* 80MB Seagate Hard Drive ..... \$1869</li> </ul> <p><i>286-12 EGA Color System</i></p> <p><b>\$1279 with:</b></p> <ul style="list-style-type: none"> <li>* 20MB Seagate Hard Drive ..... \$1629</li> <li>* 30MB Seagate Hard Drive ..... \$1679</li> <li>* 40MB Seagate Hard Drive ..... \$1799</li> <li>* 65MB Seagate Hard Drive ..... \$1889</li> <li>* 80MB Seagate Hard Drive ..... \$2089</li> </ul> <p><i>286-12 VGA Color System</i></p> <p><b>\$1529 with:</b></p> <ul style="list-style-type: none"> <li>* 20MB Seagate Hard Drive ..... \$1879</li> <li>* 30MB Seagate Hard Drive ..... \$1929</li> <li>* 40MB Seagate Hard Drive ..... \$2049</li> <li>* 65MB Seagate Hard Drive ..... \$2139</li> <li>* 80MB Seagate Hard Drive ..... \$2319</li> </ul>	<ul style="list-style-type: none"> <li>* 6/20 MHZ Motherboard</li> <li>* Supports 80387 Math Co-processor</li> <li>* 8 Expansion Slots</li> <li>* Landmark 26.7 MHZ</li> <li>* 220W Power Supply</li> <li>* 1024 of Memory (Exp. to 8MB)</li> <li>* 1.2MB 5.25" or A 1.44MB 3.5" Floppy Drive</li> <li>* 12" Monochrome Monitor</li> <li>* Monographics Card (Hercules Compatible)</li> <li>* Parallel-2 Serial-Game Ports</li> <li>* 101 Key Keyboard</li> <li>* MS DOS 4.01 &amp; GWBasic</li> <li>* 2 Year Warranty</li> </ul> <p><b>\$1649</b></p> <p><i>386/20 Mono</i></p> <ul style="list-style-type: none"> <li>* 20MB Seagate Hard Drive ..... \$1999</li> <li>* 30MB Seagate Hard Drive ..... \$2049</li> <li>* 40MB Seagate Hard Drive ..... \$2169</li> <li>* 65MB Seagate Hard Drive ..... \$2259</li> <li>* 80MB Seagate Hard Drive ..... \$2439</li> </ul> <p><i>386-20 EGA Color System</i></p> <p><b>\$2039 with:</b></p> <ul style="list-style-type: none"> <li>* 20MB Seagate Hard Drive ..... \$2389</li> <li>* 30MB Seagate Hard Drive ..... \$2439</li> <li>* 40MB Seagate Hard Drive ..... \$2559</li> <li>* 65MB Seagate Hard Drive ..... \$2649</li> <li>* 80MB Seagate Hard Drive ..... \$2829</li> </ul> <p><i>386-20 VGA Color System</i></p> <p><b>\$2289 with:</b></p> <ul style="list-style-type: none"> <li>* 20MB Seagate Hard Drive ..... \$2529</li> <li>* 30MB Seagate Hard Drive ..... \$2589</li> <li>* 40MB Seagate Hard Drive ..... \$2709</li> <li>* 65MB Seagate Hard Drive ..... \$2799</li> <li>* 80MB Seagate Hard Drive ..... \$2979</li> </ul>	<ul style="list-style-type: none"> <li>* 6/20 MHZ Motherboard</li> <li>* 32K Cache Memory</li> <li>* 8 Expansion Slots</li> <li>* Landmark 43.5 MHZ</li> <li>* 220W Power Supply</li> <li>* 1024K of Memory (Exp. to 8MB)</li> <li>* 1.2MB 5.25" or A 1.44MB 3.5" Floppy Drive</li> <li>* Monographics Card (Hercules Compatible)</li> <li>* 12" Monochrome Monitor</li> <li>* Parallel-2 Serial-Game Ports</li> <li>* 101 Key Keyboard</li> <li>* MS DOS 4.01 &amp; GWBasic</li> <li>* 2 Year Warranty</li> </ul> <p><b>\$2599</b></p> <p><i>386/25 Mono</i></p> <ul style="list-style-type: none"> <li>* 20MB Seagate Hard Drive ..... \$2949</li> <li>* 30MB Seagate Hard Drive ..... \$2999</li> <li>* 40MB Seagate Hard Drive ..... \$3119</li> <li>* 65MB Seagate Hard Drive ..... \$3209</li> <li>* 80MB Seagate Hard Drive ..... \$3389</li> </ul> <p><i>386-25 EGA Color System</i></p> <p><b>\$2989 with:</b></p> <ul style="list-style-type: none"> <li>* 20MB Seagate Hard Drive ..... \$3389</li> <li>* 30MB Seagate Hard Drive ..... \$3389</li> <li>* 40MB Seagate Hard Drive ..... \$3509</li> <li>* 65MB Seagate Hard Drive ..... \$3599</li> <li>* 80MB Seagate Hard Drive ..... \$3779</li> </ul> <p><i>386-25 VGA Color System</i></p> <p><b>\$3239 with:</b></p> <ul style="list-style-type: none"> <li>* 20MB Seagate Hard Drive ..... \$3589</li> <li>* 30MB Seagate Hard Drive ..... \$3639</li> <li>* 40MB Seagate Hard Drive ..... \$3759</li> <li>* 65MB Seagate Hard Drive ..... \$3849</li> <li>* 80MB Seagate Hard Drive ..... \$4029</li> </ul>

TOLL-FREE  
TECHNICAL SUPPORT

MONEY-BACK  
SATISFACTION  
GUARANTEE

2 YEAR  
LIMITED WARRANTY

QUALITY AND  
RELIABILITY

# TWO-YEAR WARRANTY

**PC-PLUS TECHNOLOGIES**  
**CALL TOLL FREE 1-800-422-4947**  
 Loft Plaza ■ 65 Southbridge Street ■ Auburn, MA 01501  
**PHONE: (508) 831-9826 ■ FAX: (508) 799-9941**

**PAYMENT TERMS:**

We accept MasterCard, VISA, Am Ex., Discover, Certified Checks, Money Orders, Personal Checks (allow 7-10 days for processing). We also accept Corporate, Equivalent, Governmental P.O.'s.

\*Massachusetts residents add 5% sales tax.

\*Prices subject to change without notice.



## Explore the Universe on Your Macintosh Desktop

Carina Software calls Voyager 1.2 a "desktop planetarium" because it re-creates the features of a planetarium on the screen of your Macintosh. With the program, you can view the sky of the past, present, and future; simulate the motion of the planets; or travel across the solar system.

Voyager gives you three views of the sky. The Star Atlas View lets you explore the heavens from pole to pole, using your screen as a window into a large star atlas. Local View displays the sky and horizon from an earth-bound location of your choice. It changes with the passage of time and the seasons. Finally, the Celestial Sphere View displays an entire hemisphere of the sky.

Written in MacForth and assembly language, Voyager is the fastest commercial astronomy program available, its maker claims. At its heart is a database of some 14,000 objects, including the 9100 stars in the Yale Bright Star Catalog, 3000 deep sky objects, 88 constellations, 1600 binary stars, and 160 variable stars. A real-time rotating earth will show a solar eclipse path across the surface of the earth, and lunar eclipses can be shown with the moon passing through the earth's shadow.

The Voyager window is resizable, to take advantage of large-screen monitors, and you can save any screen display as a MacPaint document. Voyager runs on the Mac Plus and higher and requires 1 megabyte of RAM and one 800K-byte floppy disk drive. **Price:** \$124.50.

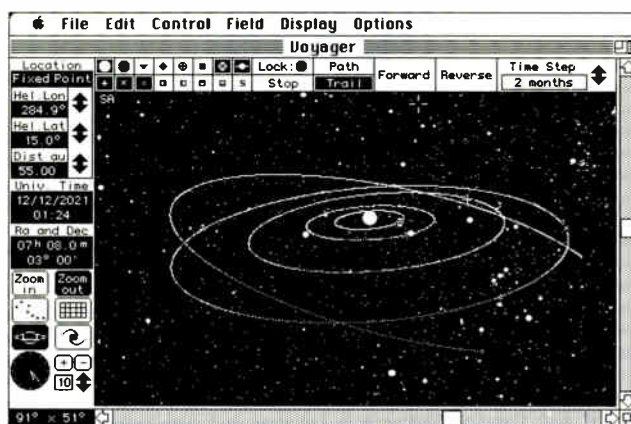

*Pluto and the outer planets from 55 astronomical units as displayed by Voyager 1.2.*

**Contact:** Carina Software, 830 Williams St., San Leandro, CA 94577, (415) 352-7328.

**Inquiry 1003.**

## CD-ROM en Masse Made Simple

You and seven colleagues can simultaneously use any of Hewlett-Packard's CD-ROM information products through a Microsoft or Hewlett-Packard OfficeShare network with the HP LaserROM/LAN.

It includes a 5 1/4-inch-form-factor, half-height, CD-ROM drive and Microsoft Extensions software. The drive attaches like any other peripheral device. The retrieval software must reside both at the server and at each networked PC.

**Price:** HP 3000 version, \$3935; HP 9000 version, \$3335.

**Contact:** Hewlett-Packard Co., Customer Information Center, Inquiry Fulfillment Department, 19310 Pruneridge Ave., Cupertino, CA 95014, or phone HP sales office listed in your telephone directory's white pages.

**Inquiry 1005.**

## Stop Squinting at Phone Lists

Complementary Solutions developed TeleMate-Phone Book for companies that have a computer on most desktops but still distribute phone lists the old-fashioned way—on a computer printout that's often outdated by the time it reaches your desk. TeleMate-Phone Book lets you put a phone directory on your PC or network that you can pop up in an application when you need to call someone in your company.

TeleMate-Phone Book lets anyone in a company access the phone list. However, only the system administrator can make changes to it, preventing unauthorized edits. The program provides fields for name, job title, extension, department, division, cost center, company, and mailing address. Other fields are provided for alternate phone numbers and comments.

You distribute the inquiry disk on your LAN or, if your office isn't networked, via disk. The inquiry disk automatically updates only those numbers that have changed since the last update. The program can search by partial name, extension, and department.

TeleMate-Phone Book is a TSR program that needs 30K bytes of RAM on your IBM PC with a hard disk drive and DOS 3.0 or higher. The administrator module needs 340K bytes of free RAM. TeleMate-Phone Book is compatible with any DOS-compatible network and comes in two versions: a site license and a single version for a switchboard operator.

**Price:** Single-user version, \$299; site license, \$799.

**Contact:** Complementary Solutions, Inc., 4470 Chamblee-Dunwoody Rd., Suite 202, Atlanta, GA 30338, (404) 454-8033. **Inquiry 1007.**

## Banyan Makes VINES/386 MCA-Compatible

A new version of VINES/386, which includes Unix under the VINES 3.10 network operating system, lets you use Micro Channel-based systems as file servers. Banyan simply added Micro Channel architecture device drivers.

The immediate technical advantage of VINES/386 on MCA is better 16-Mbps Token Ring performance than is possible by using IBM PC ATs with 16-Mbps Token Ring hardware, Banyan says. VINES/386 for ATs (as well as the version for Banyan's proprietary file-server hardware) already takes advantage of 32-bit central processing and 32-bit memory addressing—something only NetWare/386 can do.

**Price:** \$4995.

**Contact:** Banyan Systems, Inc., 115 Flanders Rd., Westborough, MA 01581, (508) 898-1000.

**Inquiry 1006.**





# Electrified

WE WILL TRY TO BEAT ANY PRICE ON ANYTHING FROM ANYWHERE !!!  
A TRULY PROFESSIONAL STAFF WITH A COMMITMENT TO SERVICE !!!

**MULTIMATE**  
Professional Word Processing Software  
Version 3.31  
BRAND NEW For IBM & Compatibles  
LIST \$495 - COST

**\$99**

## ★ COMPUTER COUNTRY ★

**COMPARE!!! ★ THE AWESOME AT ★ BRAND NEW!!!**

**QUADRANT — AT — 80286 FULLY IBM — AT COMPATIBLE**

**SYSTEM OPTIONS:**

Controller — Dual HD/FD	\$ 79
1.2MB — 5¼ Drive	79
360K — 5¼ Drive	99
720K — 3½ Drive	99
1.44MB — 3½ Drive-Requires DOS 3.3	119
20MB — Hard Drive	199
30MB — Hard Drive — 30MS Fast	249
40MB — Hard Drive	299
Larger Hard Drives Available	Call
IRWIN 20MB-Tape Back-Up System for AT Model 125-BELOW COST!!!	199
15" Mono Monitor and Card	99
14" Color Monitor—Hi Res with Color Card	229
DOS 3.1/3.2/3.3/4.01	39/49/69/79
Parallel Card	19
Serial Card	19
AT-Par Serial Card	29

**512K INSTALLED** • Full Size AT Case • 6Mghz • 200 Watt Power Supply • 80287 Socket • Phoenix BIOS • 84 Key-AT Style-True IBM Style Click Keyboard • Clock/Calendar with Battery Backup • 6-AT and 2-XT Slots • Diagnostic Disk • 6 Month Warranty

**\$499 COST**

**SPECIAL 512K MEMORY BOARD UPGRADE - 1 MB OF SYSTEM MEMORY ONLY \$99**

## ★ THE SUPER SYSTEM ★

**XT-TURBO COMPUTER SYSTEM** SUPER INEXPENSIVE!! SUPER VALUE!!!

**1-DRIVE IBM COMPATIBLE SYSTEM WITH 256K MEMORY!!!**

**SYSTEM INCLUDES: 256K INSTALLED 8088-2 Processor**  
• 1-Half Height, 360K, 5¼ Drive INSTALLED • Dual Speed — 4.77Mghz and 8Mghz  
• **TURBO** • 8 slots • 8087 Socket • 150 Watt Power Supply • Deluxe Keyboard  
• Full Size Case for 4-½Ht. Drives • 1 Year Parts and Labor Warranty on Base Unit (Hard Drives 90 Days)

**IMPOSSIBLE PRICE: \$299**  
Quantity Pricing Available!

**SYSTEM OPTIONS:**

ADD a 2nd 360K 5¼ Drive	\$ 79
<b>ALL HARD DRIVES INCLUDE CONTROLLERS</b>	
ADD a 10MB Drive	149
ADD a 20MB Drive	199
ADD a 30MB Drive	299
ADD a 40MB Drive	369
15" Mono Monitor and Card	99
14" Color Monitor—Hi Res with Color Card	229
Serial Card	19
Parallel Card	19
Clock/Calendar Card	29
Par/Ser/Clk/Game Card	49
DOS 3.1	39
DOS 3.2 with Basic	49
DOS 3.3 with Basic	69
Memory Upgrade to 512K (For 4.77Mghz Systems Only)	69
Memory Upgrade to 640K	99

## ★ HARD DRIVE DEAL ★

**SEAGATE ST-238 \$169**  
30MB • ½Ht • 5¼" Drive • RLL

REFURBISHED—BRAND NEW CONDITION—3 MONTH WARRANTY

**WESTERN DIGITAL \$59** NEW—1-Year Warranty  
RLL Controller for XT and Seagate ST-238 Complete with Cables

★ **CHEAP MEMORY — IBM 256K MEMORY CARD • FULLY POPULATED • ONLY WORKS AT 4.77MHz SPEED • ONLY \$69** ★

## ★ PRINTER POWER ★

**SAVE IBM 5182 COLOR PRINTER**

★ BRAND NEW • HEAVY DUTY ★ LIST \$1995

**\$499**

- WIDE CARRIAGE (132 Column)
- 200 CPS Draft, 110 CPS Correspondence, 35CPS NLO
- Prints Black, 4 Colors, and 8 Colors • Bi-Directional Dot Matrix
- 9 Wire-Parallel Interface • Tractor Included

FRONT BOTTOM REAR FEEDS

PAPER RACK AVAILABLE—Stacks Printed Paper - ONLY \$12.95  
Easy Change Cartridge Ribbons - AVAILABLE  
★ ★ QUANTITY PRICING — CALL !!! ★ ★

30 DAY WARRANTY

## CITIZEN MSP-50

BRAND NEW! - COLOR OPTIONAL!!

**300 CPS**, 50 NLQ - Narrow Carriage, 9 - Wire  
Epson/IBM Compatibility - Push or Pull Tractor  
Zero Tear Off - Top or Bottom Feed,  
Automatic Paper Loading - 8K Buffer

18 Month Manufacturers Warranty - Parallel Interface

**MSP-50 Options**

Color Kit (7 colors)	\$59	Quantity Prices
Serial Interface	\$49	3 (a) \$249
Font Card Sans Serif/Orator	\$59	6 (a) \$245
Black or Color Ribbons Available - Call!!!		12 (a) \$239
		24 (a) \$229

**Amazing Only \$269**

## CENTRONICS GLP

BRAND NEW!! 100 CPS — 25NLQ  
with Tractor  
Parallel/Serial Interface  
Narrow Carriage

**ONLY \$139**

FULL WARRANTY!!

Quantity Pricing  
6 = \$129  
12 = \$125  
Over 12 - CALL!!

List = \$349

## ★ ★ MONITOR MANIA ★ ★

**PRINCETON GRAPHICS ULTRASync**

12" Multisync - Ultra Hi-Res  
.28 Dot Pitch - 800 x 600  
Demo Product - MINT CONDITION

LIST \$349

**\$399** ONLY

FULL WARRANTY 1-YEAR!!! BRAND-NEW CONDITION!!!

Monitor Cards on Special Also!!!

**THE BEST MONITOR DEALS IN THE USA!!** LIST = \$963

**MAJOR Manufacturer 14" CGA COLOR MONITOR**

BRAND NEW SUPER Hi-Res - 640 x 400  
**COLOR CARD INCLUDED**

**BETTER THAN EGA RESOLUTION!!**

**.31 Dot Pitch** - Anti Glare Screen - Includes Graphic Memory Upgrade Kit - 90 Day Warranty

**Unbelievable! LIST \$963**

**THE BEST CGA RESOLUTION YOU CAN BUY!!!**

★★ **Electrified Discounters** ★★

1066 SHERMAN AVENUE  
HAMDEN, CT 06514  
FAX 203-248-8680

\$2 refund on all telephone orders over \$100

**(203) 287-1976**

DEALER INQUIRIES INVITED

CATALOG SENT WITH ALL ORDERS

MasterCard VISA AMERICAN EXPRESS

Prices listed are Cash Discounts. Add 2 1/2% for MasterCard, Visa or AmEx. Not responsible for typographical errors. Prices are subject to change without notice. Conn. residents add 6% sales tax. Quantities are limited! Prices do not include freight. Allow 3 weeks for person-to-person transfers. 20% discounting this minimum on a return. Items are not guaranteed. Some items may be returned for a refund. © 1984 by International Business Machines Corp.

# DON'T BYTE AT THE WRONG PRICE

If you're in the market for a solution, give us a call today and we'll show you why, byte for byte, our prices can't be beat.

## 286-16

- Full AT case
- 2 MB (exp. to 16 MB)
- 2p/2s
- 1.2 MB floppy
- 14" mono monitor
- 200 watt p/s
- 40 MB/28ms HDD
- DOS 3.3



**\$4699.95**

## 386-25-"CAD/CAM"

- 64 KB cache on board
- 2 MB (exp. to 16 MB)
- 14" VGA
- VGA card
- Standard mouse
- Ideal for CAD/CAM
- 2p/2s
- 1.2 MB floppy
- 200 watt p/s
- 40 MB/28ms HDD
- DOS 3.3



## 386-20-"LAN Server"

- 4 MB (exp. to 16 MB)
- 2p/2s
- 1.2 MB floppy
- 14" mono monitor
- 200 watt p/s
- 40 MB/28ms HDD
- DOS 3.3

**\$2799.95**

**\$1899.95**

(508) 475-5886 Service (508) 470-1391 Fax

- 2 Year Warranty
- Quick Delivery
- Quality Products
- Service and Support
- On-site Service Available
- 30-Day Satisfaction Guarantee



3 Dundee Park, Andover, MA 01810

Stop by our Booth #A/0376, at Cashman Field Center

Order line: 800-448-1461

## Exclusive Software

High Quality Software! Great Prices!  
Zephyr Originals, NOT Public Domain  
Pick the Ones You Want:

❑ **Financer Plus** - 16 most needed financial calculations. Menu selectable for: amortization schedule, present values, future values, simple & compound interest, installment loan, & much more. Output to screen or printer. \*FINANCER is best\*. G.W., Montana IBM & compat. **\$24.95**

❑ **AstroInfo** - High accuracy data for the Sun, Moon and all planets. Most results accurate to seconds of arc. Select any date from 9999BC to 4000AD and any latitude and longitude. Provides position in sky, brightness, rise/set times, & much more. Do searches for conjunctions of objects, distances, and locations in the sky. Generates location tables to screen, printer or ASCII files on disk for later use. IBM & compat. **\$49.95**

❑ **FormMachine** - Easily create, print and save forms for later use. Ideal for message forms, expense reports, invoices, personal data records, etc. Just design what you need on screen and then you are ready to print and use. Include text with regular or condensed print, add boxes, lines, drawings. Create the forms you need as you want them! IBM & compat. **\$29.95**

❑ **MortgageMaster** - Analyze mortgage terms for a variety of situations. Specify and printout mortgage tables. Use irregular payments or additional payments. Make yearly, monthly, quarterly, weekly, biweekly, etc. payments. Generate tables of rate or term variations. Do 4 factor analysis of interest, length, amount and rate for missing value. IBM & Compat. **\$39.95**

❑ **SpanishHelper** - Learn the Spanish language with your computer. Developed by language experts to contain the 2000 most essential words and phrases to know basic Spanish. Includes introduction to grammar and syntax. With graphics you get to play a game as reward for your progress (graphics not required to run program). FrenchHelper also available. Each **\$29.95**

❑ **AlgeTutor** - Teaches you algebra and how to apply it. Starts from the easiest level to more advanced topics. Includes example problems with solutions. Learn as you review concepts and then apply them. Ideal for student or as refresher course. Use at your own pace to master this valuable part of math. IBM **\$29.95**

❑ **TimeChecker** - Now you can always have high accuracy time on your PC or for other needs. TimeChecker automatically calls, logs on and sets your PC system time using the US government standard time service. Also displays correct time and date for all 25 world time zones. You can also access other data related to time and astronomy. IBM, 1200b modem **\$39.95**

❑ **TideMaster** - Calculates and prints tide tables and graphs for any U.S. coastal state for any day in 1989 or 1990. Includes all US government tide locations. "If you sail, fish, go to beach, TideMaster is a must! Excellent." PC Magazine. Specify for which state. IBM & compat. **\$39.95 per US state**

❑ **ArtPack** - Generate 10 types of computer art to provide hours of entertainment for you or your kids. Supports CGA, EGA or VGA color monitors for complex & brightly colored creations. Fractals, Moire patterns, Roses from polar equations, Serendipitous circles, Spirographs, 1 and 2 dimensional "life" patterns, Wallpaper art, Sierpinski curves. Picture generation from names or text. Give your computer a real graphics workout! IBM. **\$29.95**

❑ **StatCalc** - Key statistical functions for student or experienced user. Includes Correlation & Regression, Normal, T, Poisson, Binomial, Chi-square, distributions, data handling for sorts, mean, standard deviation, range, median. Save data to disk. Manual on statistics and program use with examples. IBM, Apple II **\$39.95**

❑ **SuperCat** - Professional level cataloging for up to 5,000 books per directory with hard disk or 1000 per floppy (300 for Apple). Multiple subjects & authors, call #, title, publisher, etc. for 13 field types. Print 3x5 index cards & reports in various formats. Sort & retrieve data by any field. Fast and easy to use. IBM & Compat., Apple II **\$49.95**

❑ **HoroScopes II** - For your birthdate, time & location sky conditions calculated. Get Natal horoscope chart printed or on screen, with zodiac, sun, moon & all planets. Gives astrological reading, sun & moon sign, ascendant, conjunctions & oppositions, other aspects, table of houses & planets (Placidus & Equal house). "Accurate, a software bargain!" PC Mag. IBM **\$29.95**

❑ **MyDraftsman** - Create detailed drawings on screen and print in variable scale on dot-matrix or laser printers. Use circles, lines, boxes, arcs in a variety of widths and styles. Add text in different fonts and sizes. Use multiple layers for complex drawings. Create objects to save/use later. Works with or without a mouse. Ideal for design work, illustrations, architecture or creative fun! Supports printers and plotters. IBM CGA/EGA **\$39.95**

❑ **GraphMaster** - Create bar, line, pie, scatter and text charts or graphs, box, circle & line drawing; correlation & regression analysis & curve fitting; scatter plots. Translate data into meaningful graphic pictures, on screen or printed out, in minutes. Use at pixel level and produce drawings and illustrations or just enter a set of data and have GraphMaster create the chart you need. Plot any math function. Save graphs & revise later. IBM **\$39.95**

❑ **LabelWorks** - Create and maintain mailing lists. Print labels 1, 2, 3, or 4 across. Get reference listings printed in 9 different formats. Easy to use fill-in form on screen to add, revise, or delete names. Also print general labels as tags, labels, etc. IBM & Compat., Apple II **\$29.95**

❑ **SunTimes** - Generates monthly or yearly sunrise and sunset tables for any year and for any location on Earth. Get output to screen or printer. Also calculates the times of twilight (Civil, nautical and astronomical) the maximum altitude of the sun and the hours of sunshine for each day. Accurate, easy to use. IBM. **\$29.95**

Do you have a professional quality original program? We may want to publish it. Write for our programmer's guidelines. Please do NOT send any software.

❑ **Write n' Tell** - Analyzes handwriting to reveal personality traits. For business testing or fun with family, friends. Developed by certified graphologist. Easy to answer questions yield multi-page report on personality drives, intellect, emotions. Analyze signatures or text. Detailed manual & handwriting samples provide guidance for accurate use. IBM/Apple II **\$39.95**

❑ **DietHelper** - Great for weight control, menu planning, special diets, recipe analysis. Tracks intake of calories, sodium, cholesterol, fiber & 20 others for over 1000 foods, & calories for 100 exercises. Add your own foods or recipes. Tutorial disk included teaches you the program. "Extremely easy to use. Highly recommended." Creative Computing. IBM **\$39.95**

❑ **LodeStar** - The Ultimate Sky Machine! Get an accurate, variable size view of the sky for any date (9999BC to 9999AD) & location on Earth. Investigate the past, present and future with LodeStar! Includes over 9,000 stars, Messier objects & the Sun, Moon & all planets. Any size view from 180 deg. to 0.18 deg. See solar eclipses, planetary conjunctions, occultations, transits, etc. Zoom in or out. Get printouts for field or desk. IBM or compat., 384K, CGA/EGA/VGA. Works with/without co-processor. **\$89.95**

❑ **LifeLines** - Input the facts on your ancestors, near and far from distant generations to the present, then generate various reports and listings to make clear your family heritage. Pedigree charts, descendant charts, marriage lists, family groups, alphabetical listings & more. You needn't be a genealogical expert, just select from menus for reports. IBM **\$39.95**

❑ **PhysiCalc** - Introduction to Physics for high school/college level. Includes mechanics, gravity, electricity, light, quantum mechanics & relativity. 30 key equations explained with easy on screen calculations. Example problems and answers, physics terms and history. IBM or Apple II **\$29.95**

❑ **DiskAtlas-USA** - Over 29,000 US cities. Plots cities on state or US maps. Zoom in or out to scale needed. Locates all cities a given distance from another city or along a line specified by user. Includes national parks, monuments, etc. Calculates distances between 2 cities. Practical, educational, fun! IBM CGA/EGA **\$39.95**

Plus 55 More Excellent Programs!



Order Today!



1-800-533-6666

9-9 MON - SAT Orders Only  
For Info or in PA Call 412-422-6600

By phone or mail. Check, M.O., credit card(&expir.). Add \$3 shipping(\$5 overseas). PA add 6%. Give computer type. Add \$1/ prog. for 3.5"IBM. Join tens of thousands of satisfied customers in 50 states & 86 countries. Fast shipment!

## ZEPHYR SERVICES

1900 Murray Ave. Dept. E Our  
Pittsburgh, PA 15217 8th  
FREE Catalog-Call or Write Year



**Save  
Time &  
Money**

# Network Your PCs Using Standard Telephone Connectors and Cables!

That's right the NET-127 PC Network board, telephone cable and standard RJ11 jacks are all you need to be up and running. NET-127 gives you all the power you'd expect from a high-quality low-end network, without the hassle and expense of traditional network cabling.

- Allows Sharing of Hard Disks, Printers, Plotters, Tape Back-ups, etc.
- Supports Spreadsheets, Word Processing, CAD/CAM & More
- Connect Up to 127 Stations Without Additional Accessories
- Easy-to-use Multitasking O/S on Each Machine
- Throughput Speed of 10,000 Bytes/Second
- Low Memory Requirement — 4 to 32K
- 30 Day Money-Back Guarantee
- No File Server Required

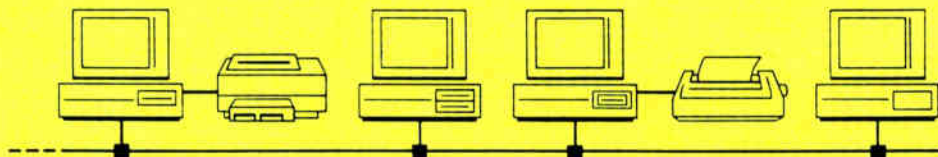

*We take pride in our  
customer service.*

**TRANS-M CORP.**

28 Blacksmith Drive  
Medfield, MA 02052

**508-359-5144**

Call for free information

## Improve Data Acquisition, Communication and Control by 1000 Times or More!

HPB RS-485 SDLC communication interface,  
for PC/XT/AT/80386

- Save time and money using twisted pair wiring scheme
- Cut development costs and time by at least 50%
- Cut programming development effort by 50%
- Easily connects up to 255 controllers/stations/file servers
- No complex data switches
- Real time multiuser access
- 99% CPU time available for processing controls \*

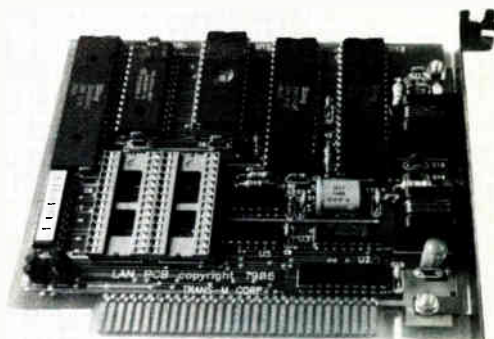

- Buffered messages (512 byte / message) • 250K bps data transfer rate • RS-485 interface with SDLC protocol
- Handles up to 255 station IDs • 255 drivers, 255 receivers on the network • 8K memory buffer
- Ethernet-like network OS with CSMA/CD/CA • Programming interface supports Assembly, C, Pascal, Basic
- 4000 ft. bus length with 2 wire twisted pair • Communication software source code available

\* Host CPU interrupts 1000 times less on a three station network; more efficient on larger network.

For Free Information CALL NOW **508-359-5144**



**We take pride  
in our  
customer service.**

**TRANS-M CORP.**

28 Blacksmith Drive  
Medfield, MA 02052

# Problem

# Solving

## Locate the Problem Fast with System Sleuth™

Your computer is a unique harmony of hardware and software. When things run smoothly, everything's terrific. When they don't...you have to guess at a solution as well as the problem! Stop the guessing.

Get System Sleuth, an easy-to-use but powerful toolbox of valuable system diagnostic aids all rolled into a single software utility.

Now you can troubleshoot system problems in a flash. For the first time you can get fast, accurate information about the current status of your entire system as well as any or all installed devices.

Novice or expert users can finally locate problems on their own and be able to talk intelligently with tech support staffs. You can even identify potential conflicts with your new add-in boards BEFORE opening your computer!

Accidents can't happen with System Sleuth. Explore your system with the peace of mind that everything is left just as it was discovered. View the contents of files knowing that no slip of the cursor can change a thing.

System Sleuth retails for only \$149.00.

*"...System Sleuth, an absolutely wonderful new utility... It shows an even better idea than IBM's on how to help the PC user and those who try to keep him up and running."*

—Jim Seymour, PC Week, Dec. 1988

*"...a Great Tool for technical analysis..."*

—Info World, Oct. 1988

*"...This is one of those programs that I didn't know I needed until I got it; now, what with all the hardware I try out around here, I use it all the time, and I can't think how I got along without it."*

—Jerry Pournelle, Byte Magazine, May, 1989

**For Orders call: (714) 994-7400**

23704-5 El Toro Road, Suite 348  
El Toro, CA 92630  
Telephone: (714) 587-2226

**DTG**



**SYSTEM SLEUTH™**

PC Diagnostic Software

## Get Automatic Formatting and Increased Speed with FloppyDRIVER™ The Final Floppy Drive Solution.

For the first time since diskette met data, you can actually update your floppy disk drive into the next century!

Get complete automatic formatting and 500% increased disk drive efficiency with FloppyDRIVER, the unique software utility solution from DTG, Inc.

Imagine formatting diskettes without exiting your application program. FloppyDRIVER's convenient pop-up feature allows you to continue your work AND automatically format at the touch of a button.

FloppyDRIVER takes care of the media specifics, even 3.5" drives without BIOS support. It is also intelligent enough to inspect each diskette and automatically format the disk ONLY if it is unformatted. Even proprietary formats will not be reformatted unless you choose to.

Whether you are reading, writing, creating, saving or copying files, FloppyDRIVER gives you dramatic improvements in speed. Reduce the time required to read disk data by as much as 85%. Imagine your diskettes working up to 500% faster without any special commands.

FloppyDRIVER retails for \$89.95. At that price, FloppyDRIVER has to be the greatest value in software today!

*"It's rare to find a utility that you can't live without. But I found one... FloppyDRIVER sold by DTG, Inc. is such a program."*

—Info World, Vol. 11, Issue 7  
*"...few products can provide such obvious performance improvement at such a low price."*

—Mark Brownstein, Info World

*"It lets you use unformatted disks with impunity, because it absorbs data into its buffer and lays that data on the disk as it formats... it lets you format floppies in the background, and even read and write them as they are being formatted... not a byte of data was lost."*

—Winn L. Rosch, PC Week

**For Orders call: (714) 994-7400**

23704-5 El Toro Road, Suite 348  
El Toro, CA 92630  
Telephone: (714) 587-2226

**DTG**

**FloppyDRIVER™**

Diskette Utility Software

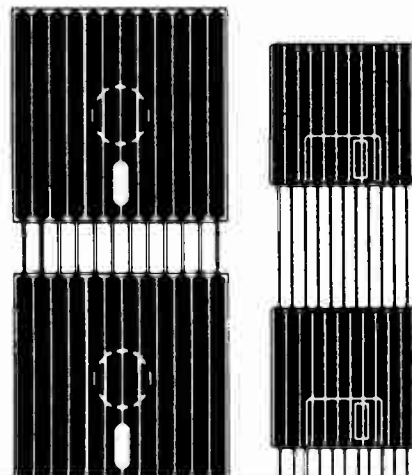

System Sleuth is a trademark of DTG, Inc. FloppyDRIVER is a trademark of Concept Technologies, Inc. Other brands and product names are trademarks of their respective holders

Visa/MasterCard



# CompFax Puts Efficiency at Your Fingertips

# A

re you planning to add a FAX machine to your office?

Then you already know the advantages . . . increased efficiency, better productivity, lightning-fast communications with cross-town or cross-country customers and suppliers.

Now, consider the benefits of buying your unit from CompFax:

- the most competitive prices
- a full line of FAX machines to fit individual needs
  - expert technical service and support
  - fast delivery
  - flexible credit terms
  - service contracts
  - price protection warranty

CompFax puts it all at your fingertips!

## Sharp FO-220

Incorporates many networking feature of higher-priced models, such as confidential transmission and relay broadcast request.

**\$799.99/List: \$1595.00**  
Blow out price!

## Sharp FO-300

Incorporates high end features like rapid transmission, confidential reception. Increased half-tone transmission abilities.

**\$1049.00/**  
List \$1995.00

## Sharp FO-330

Features an automatic cutter, 10-page automatic feeder, timer transmission and polling, halftone and auto-contrast controls.

**\$1149.00/**  
List \$1795.00



# CompFax

Customer Support Line and Orders  
Dealer inquiries welcome

**1-800-243-7775**

**Call Today!**

**Illinois**

312-394-3334 FAX 312-394-5235

Circle 530 on Reader Service Card (DEALERS: 531)

## Boca Research Throws Its Hat into the VGA Ring

The VGA by Boca board is register-level-compatible with the IBM VGA and fits into the 16-bit slot for accelerated performance compared to an 8-bit connection, Boca Research reports. You can use either an 8- or 16-bit connection on your 80286- or 80386-based computer.

The board comes with 256K bytes of RAM and provides 640- by 480-pixel resolution with 16 colors. An optional resolution of 320 by 200 pixels is available if you want to display 256 colors from the palette of 262,144 colors. A diagnostic test program is included with the board.

**Price:** \$345.

**Contact:** Boca Research, Inc., 6401 Congress Ave., Boca Raton, FL 33487, (407) 997-6227.

**Inquiry 999.**

## Display Adobe Fonts On-Screen with Draw 1.1

Corel Draw 1.1, the illustration package that runs under Microsoft Windows, now lets you display and manipulate Adobe font outlines on your screen in WYSIWYG format. The program's typeface-conversion program, WFNBOSS, converts typefaces for on-screen kerning, special effects, text curving, and letter editing. Once the text is converted, you can print to any Windows-supported output device, a PostScript printer, plotters, and film recorders. Corel has also added Windows clipboard support and a CGM (Computer Graphics Metafile) import/export utility to Draw 1.1.

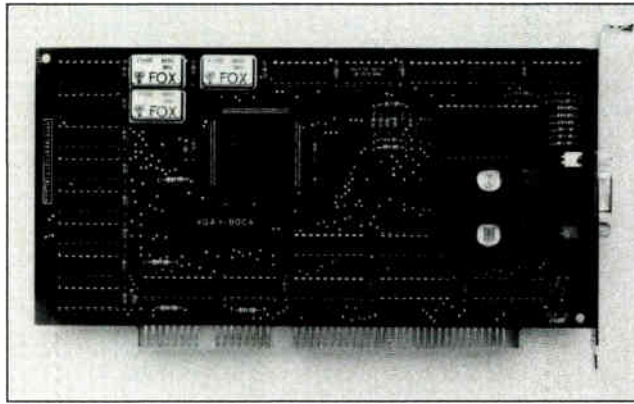

*The VGA by Boca board works best with a 16-bit connection on your 80286- or 80386-based computer, but you can also use an 8-bit connection.*

Prior to Draw 1.1, when working with fonts on-screen, you had to show Adobe fonts with a bit-map approximation. That approach often resulted in jagged-edge fonts on-screen. Draw 1.1 lets you show, stretch, manipulate, and refine the fonts on-screen before you print them.

WFNBOSS also supports the Bitstream Fontware, Agfa Compugraphic, and Digi-Fonts libraries. If those aren't enough fonts, Corel has added 45 typeface outlines from 14 type families.

Other additions to Draw 1.1 include 300 clip-art images and support for SCODL (Scan Conversion Object Description Language). By supporting SCODL, Draw 1.1 can create a slide for a presentation if you have a Matrix or Genographics film recorder.

Draw 1.1 requires an IBM PC AT or higher with Windows 2.0 or higher, 640K bytes of RAM, and a Hercules, EGA, or VGA graphics adapter.

**Price:** \$595.

**Contact:** Corel Systems Corp., 1600 Carling Ave., Ottawa, Ontario, Canada K1Z 8R7, (613) 728-8200.

**Inquiry 1001.**

## GOfer 2.0 Goes 50 Percent Faster

GOfer 2.0, a text-search-and-retrieval program for the Macintosh, searches 50 percent faster than the previous version, Microlytics reports. The company also added a wild-card function, a search-set feature, and compatibility with FullWrite Professional, MacWrite II, Word 4.0, and Microsoft Works 1 and 2.

Microlytics says the speed increase is due in part to the new version's ability to search for text strings without converting the entire document. The search-set feature lets you retrieve information on a certain subject from a variety of sources, without requiring you to sift through an entire downloaded document. You could, for example, download all weekly stories on a topic into a separate file and then perform a more-specific search of the document.

GOfer 2.0 runs on the Mac 512KE or higher and supports HyperCard and MultiFinder.

**Price:** \$79.95.  
**Contact:** Microlytics, Inc., One Tobey Village Office Park, Pittsford, NY 14534, (716) 248-9150.

**Inquiry 1000.**

## Program for Advertising Agencies

Working Computer has updated its Clients & Profits for Advertising Agencies 4 program to include enhanced financial accounting, custom invoices, estimates and purchase orders, and multiuser support for Ethernet and Novell NetWare users. The program, an accounting and trafficking package, is now compatible with MultiFinder.

Clients & Profits uses a worksheet metaphor called a job ticket, which tracks specifications, schedules, budgets, estimates, purchase orders, and other agency functions for each client. The company added year-to-date and percentage-to-total report capabilities to version 4, and accounts no longer must be closed at the end of the month. A job's profit or loss is updated automatically.

Clients & Profits 4 lets three users work simultaneously over any AppleTalk network. The number of potential users is limited by system memory. The purchase of additional workstations lets you increase the multiuser capacity of the system. The program requires a Mac Plus or higher with 1 megabyte of RAM, a hard disk drive, and an ImageWriter or LaserWriter printer.

**Price:** \$3795; additional workstations, \$295; single-user version, \$2495.

**Contact:** Working Computer, P.O. Box 87, San Luis Rey, CA 92068, (619) 721-0501.

**Inquiry 1004.**



# X-BANDIT

*Break the 640K DOS barrier and utilize the Advanced Features of the LIM 4.0 standard while using only one motherboard slot!*

*"should be very useful for DOS users who are straining the limits of the 640K barrier"*  
—BYTEweek June 12, 1989

## DESIGN PHILOSOPHY

• The Teletek X-Bandit was specifically designed to utilize the advanced features of the Lotus/Intel/Microsoft EMS 4.0 Specification. Further, the X-Bandit's Segmented Memory Mapping capability allows the user to extend DOS size beyond the 640K barrier. It is available in both 8 and 16 bit versions for use in the IBM XT, AT, and compatibles.

## MEMORY

- Segmented Memory Mapping allows the user to fill out unused memory segments between 640K and 1024K. By "claiming" unused portions of memory in 16K increments, the user effectively increases TPA size. LAN or custom software modules, for example, can be loaded into these high memory areas thus relieving the lower 640K of TPA for other application programs.
- Split Memory Addressing allows the user to fill out conventional memory to 640K.
- Extended Memory Addressing is available for the PC/AT version.
- 2 MB capacity in a single slot. Up to 8 MB per system.
- Parity checking.

## SOFTWARE

- Easy menu-driven auto configuration software.
- Device driver includes print spooler and RAM drive.
- Supports multitasking with the appropriate shell-resident software package.

## SPEED

- 6/8/10 MHz speed with 0 wait states. 12 MHz speed with 1 wait state.

## WARRANTY

- One year parts and labor.
- Now includes SYSTEM SLEUTH™ from DTG, Inc. A \$149.00 value.

# TELETEK

4600 Pell Drive  
Sacramento, CA 95838  
(916) 920-4600  
Fax (916) 927-7684

Circle 569 on Reader Service Card (DEALERS: 570)  
World Radio History

# SUPER VGA, NO COMPROMISE ... ALL GUTS!

*Supercharged 16 bit speed, uncompromised compatibility and performance!*

This is the Super VGA card you've been hearing about. Fully compatible with all VGA, MCGA, EGA, CGA and MDA modes at the register level! Turbo 16 bit design means you can write to the screen up to 500% faster. Super sharp 16 x 16 SUPERFONT. Supports 132 columns with up to 60 lines! Up to 256 colors from a palette of 256,000! 256k of RAM (512k opt.). Supports 800 x 600 with 16 colors, and 1024 x 768. Works on 8 or 16 bit bus. Both analog and digital output. Novell, Unix, OS/2, protected mode, 8088 through 80386.

More colors, feature, resolutions and speed than any other card in its price class or YOUR MONEY BACK! It's as simple as that. Our special introductory price includes OVERNIGHT delivery anywhere in the 48 contiguous States at NO EXTRA CHARGE! Order by 6 p.m. EASTERN time and you'll have your new card TOMORROW!

- VGA, MCGA, EGA, CGA and MDA compatible at the register level!
- All 17 standard VGA Modes and 17 extended VGA modes!
- Super VGA resolution up to 1024 x 768!
- Up to 5 times faster than Paradise!
- Drivers for Autocad, Windows, Wordperfect, Gem, Ventura, Autocad, 1-2-3, etc.
- Trident Graphics chip!

Nationwide Toll Free Order Line:  
**800-747-9069**

Info: 612-823-4111  
Toll Free 24 hr. Order Fax  
800-728-8412  
Fax: 612-823-7057

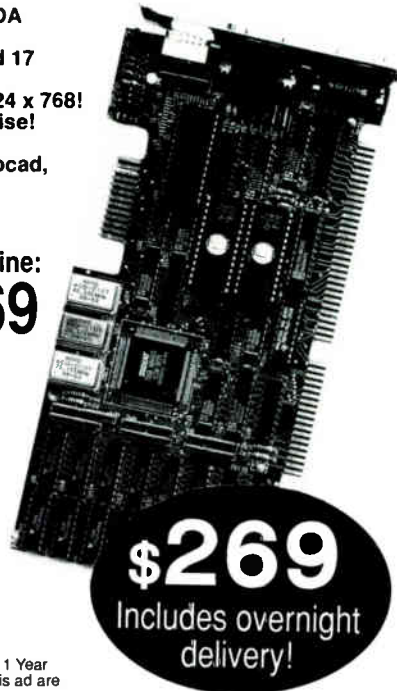

*Now that you've chosen the right card, choose the right monitor: the 3 Lynx Intellisync 14" monitor. Brilliant colors and crisp clarity, it handles SUPER VGA resolutions with ease. Enjoy true, lush colors for only \$479.00 plus shipping! Call us!*

## Blue Circle Group, Inc.

5253 Chicago Ave. S.  
Minneapolis, MN 55417

Terms: Mastercard, Visa, COD. 15 day moneyback guarantee. 1 Year Warranty. 512k upgrade: add \$99. Trademarks appearing in this ad are trademarks of their respective companies.

# Quality In... Quality Out

No matter how well acquainted you are with making important personal computing decisions—decisions that may involve hundreds of thousands of dollars—the value of those decisions is only as good as the value of your information. Without quality information—it's hard to make quality decisions.

BYTEweek, McGraw-Hill's new weekly newsletter for professionals in the personal computer industry, is devoted to giving you that quality information through its timely and compact one-stop news format. And BYTEweek interprets this news with in-depth commentary and analysis.

Subscribe to BYTEweek for quality information. Remember, quality in . . . quality out.



Take advantage of the special one-year charter subscription rate of \$395 (\$495 outside the U.S. and Canada)—a savings of \$100 off the regular rate. Your subscription includes 50 issues plus a free three-month subscription to BIX—a \$49 value.

Don't miss this opportunity! In the U.S., call BYTEweek's toll-free number: **1-800-258-5485**, in N.H. and outside the U.S., call: 1-603-924-9281.

BYTEweek offers a *money-back guarantee* if you're not completely satisfied.

## BYTEWEEK

News and Analysis for Professionals in the  
Personal Computing Industry  
One Phoenix Mill Lane, Peterborough, NH 03458



# REPLACE YOUR MOTHER.

PC WORLD

"Upgrade Product of the Year."



PC  
MAGAZINE  
EDITOR'S  
CHOICE

**Installed in minutes, the Renegade 386 motherboard transforms any IBM or compatible PC, XT or AT into an astoundingly powerful new computer with both old software AND new OS/2 releases. Available with 16/20/25/33 MHz Intel 80386 chips.**

Is this you? Would you like to have extraordinary computing speed and power? You want number crunching ability. You need complex CAD capabilities. Or networking. Or multi-tasking.

And you haven't got it. And you don't want to spend a fortune to replace good equipment with the latest industry standard.

You can turn your present system into the latest, high-performance system that will equal or exceed the best of the new computers.

## Renegade 386. A new heart and brain for your computer.

Renegade offers designers, engineers, architects and computer dependent businesses a simple and reliable alternative to obsolescence. Or the unreasonable expense of a new system.



Multi-task with Lotus 1-2-3 and other applications running Microsoft Windows/386.

Simply replace the "motherboard" of your present system with a Renegade 386 motherboard.

It takes a screwdriver and less than 20 minutes.

Renegade gives you more than just the latest industry standard. You can run your old software on it. Virtually anything you use now.

Thanks to the compatibility of the Renegade 386, you can run the new generation of DOS, OS/2, Windows/386, UNIX V, DESQview 386, and XENIX/386 Plus. The Renegade 386 can be configured with either a

16/20/25 or 33 MHz Intel 80386 chip.

The Renegade 386 is available with an Intel 82385 Cache controller and supports both the Intel 387 and Weitek coprocessors to maximize overall system performance.



Faster, easier presentation graphics with newest breakthrough software releases.

**Renegade 386 gives you a full-featured new computer.**

The Renegade 386 includes a 32 bit RAM expansion slot allowing you to populate your system with up to 16 megabytes of RAM.

In practical terms, that simply means programs like Lotus 1-2-3, AutoCAD, Aldus PageMaker and Microsoft Windows will run faster than anything you have ever seen.

So plug in your new Renegade 386 Motherboard and run your programs at the speed God intended.

from  
**\$1495**

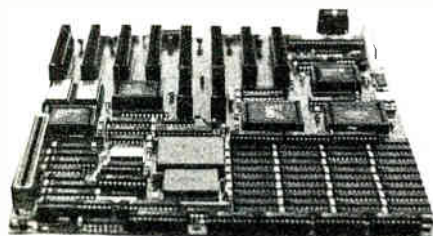

## 30 DAY TRIAL OFFER AND OUR NO-RISK GUARANTEE

We understand perfectly that you have no reason to believe anything you read. Including this ad. We read too.

So we invite you to evaluate the Renegade 386 yourself. Call and order one today. We'll send it with clear detailed instructions. Use it in your own system, on your own work for 30 days. Try it for brilliant presentation graphics, make massive and instant spreadsheet recalculations, run huge memory-hungry CAD programs. Write it out on anything your software is up to.

After 30 days, if it isn't for you, for any reason, we'll take it back and refund your full purchase price.

Call toll-free today. You have nothing to lose but yesterday's computer system.

**1-800-922-4130**

**Renegade**

We do it all.

IBM PC, XT, AT, Microsoft Windows, AutoCAD, Lotus 1-2-3, Aldus PageMaker, Intel and other brands and products are trademarks or registered trademarks of their respective holders.

Circle 565 on Reader Service Card

NOVEMBER 1989 • B Y T E 80NE-29

# 多功能 高品質 全相容

## COSTS LESS.\*

### Introducing Minta Computers. Maximum Systems. Minimum Cost.

Listen to the language of Minta – a complete line of powerful, reliable PCs for less. Minta means the maximum PC for the money and higher profit margins for you.

Minta's unique, slim all-in-one design, its high speed performance, its excellent professional service – Minta is the only PC with a 2-year warranty – all have made Minta a best seller in Europe and the Far East for years.

To introduce Minta to America, we're offering incentives to resellers and distributors nationwide: complete advertising and service support and an opportunity to work with the highest possible margins – at a price point you can pass on to consumers to introduce them to the PC people are talking about all over the world.

Because in any language, Minta means more – and costs less.

**Add Minta to your product line. Call 1-800-82-MINTA**  
**Make more with Minta today! Tel: (201) 417-0388**  
**Fax; (201) 417-0389**



**MINTA MEANS MORE.**

See us at COMDEX/Fall '89  
November 13-17, 1989

Las Vegas Convention Center – West Hall  
#W1074, 1076

95 Newfield Ave.  
Raritan Center  
Edison, NJ 08837  
TEL: (201) 417-0388  
FAX: (201) 417-0389

Taipei, Taiwan  
TEL: 783-3847,  
783-6095, 783-6418  
FAX: 886-2-7821815,  
886-2-7820840

Hamburg,  
West Germany  
TEL: (040) 51 80 67, 51 80 68  
FAX: (040) 51 53 68  
TLX: 21 25 96 MINTA



**\*Powerful. Compatible.  
Reliable.**

**競爭性强**



# THE SOLUTION TO YOUR BUSINESS!

Halskar Offers High Performance Personal Computers and Industrial Control Systems

## 80386/386SX/286/88 Desk-Top Systems

High-performance 0-wait system board;  
Floppy disk drive &  
Dual FDD/dual HDD controller card;  
101-key Keyboard, 200W power supply;  
Serial, Parallel & Game ports;  
Hard disk drive optional;  
Monitor & controller card are optional;  
Cache memory size = 32K (386 cache system only.)



CONFIGURATION	16MHz	20MHz	25MHz	33MHz
80386 Cache System (M:1MB, F:1.2M)	N/A	\$1945	\$2395	\$3195
80386 Basic System (M:1MB, F:1.2M)	\$1365	\$1445	\$1755	\$2595
80386SX Basic System (M:1MB, F:1.2M)	\$1275	\$1365	N/A	N/A

CONFIGURATION	8MHz	10MHz	12MHz	16MHz	20MHz
80286 NEAT System (M:1MB, F:1.2M)	N/A	N/A	\$995	\$1075	\$1195
80286 Basic System (M:1MB, F:1.2M)	\$695	\$895	\$925	\$1090	N/A
80286 Basic System (M:640K, F:1.2M)	\$645	\$845	\$880	N/A	N/A

CONFIGURATION	4.77MHz	8MHz	10MHz
8088 Basic System (M:640KB, F:360K)	\$495	\$525	\$565
8088 Starter System (M:256KB, F:360K)	\$345	\$365	\$385

## Plasma And LCD Laptop Computers

High-performance 0-wait system board;  
3.5" floppy disk drive &  
Hard disk drive (28ms);  
Built-in keyboard & Numeric keypad;  
110/220VAC power supply;  
Serial, Parallel, monitor & FDD ports;  
External or Internal Modem module



CONFIGURATION	MEM	MM SPC	FDD	HDD	BATTRY	DSP CMLP	PRICE
80286 12MHz VGA Plasma	1M	5M	1.44M	40M	None	MG/CG/VG	\$3795
80286 12MHz CCFT EGA LCD	1M	4M	1.44M	40M	2 hr	MG/CG/EG	\$3195
80286 12MHz Plasma	640K	4.6M	1.44M	40M	None	MG/CG	\$2665
80286 12MHz Plasma	640K	4.6M	1.44M	20M	None	MG/CG	\$2445
8088 10MHz LCD	1M	1M	2 x 720K	None	8 hr	MG/CG	\$1025

## 386/386SX/286/88 Portable Computers

High-performance 0-wait system board;  
Floppy disk drive with dual H/FDD controller;  
Built-in display and keyboard;  
110/220VAC power supply;  
Serial and parallel ports;  
Expansion slots;



CONFIGURATION	9" EGA	9" AMB	PLASMA	HR-LCD	EG-LCD	VG-PLM
80386 16MHz Prtbl (F:1.2M, M:1MB)	\$3195	\$1995	\$3055	\$2395	\$2785	\$3650
386SX 16MHz Prtbl (F:1.2M, M:1MB)	\$2925	\$1875	\$2780	\$2275	\$2675	\$3375
80286 12MHz Prtbl (F:1.2M, M:1MB)	\$2775	\$1525	\$2625	\$1925	\$2325	\$3225
8088 10MHz Prtbl (F:360K, M:640KB)	\$2345	\$1095	\$2195	\$1475	\$1865	\$2785
Note: Gross Weight (lb)	42	38	26	23	23	26
Expansion slot	3	3	2	2	2	2

System Board Speed: 8, 10, 12, 16, 20, 25, 33MHz available, please call.

## DESK-TOP & PORTABLE COMPUTER UPGRADE OPTIONS

	3/286, 88	3/286	88
12" Mono (Amber/Green)/MG/P card:	\$115	360KB Flpy Drv:	\$60
14" Mono (Amber/White)/MG/P card:	\$140	720KB Flpy Drv:	\$80
14" RGB Color (640x240)/CG/P card:	\$250	1.2MB Flpy Drv:	\$85
14" EGA Color (640x350)/EGA card:	\$450	1.44MB Flpy Drv:	\$90
14" VGA Color (800x480)/VGA-16 card:	\$590	Mini Tower/200W	\$50
14" Multisync (800x600)/SEGA card:	\$610	Full Tower/230W	\$110
14" VGA Color (1024x768)/VGA-16 card:	\$880	Full Tower/275W:	\$160

## HARD DISK DRIVE (FORMATTED) OPTIONS

CAPACITY	MODEL #	SIZE	SPEED	TYPE	HEAD/CYL	386	286	88
20 MB	ST225	5.25"	65 ms	MFM	4/615	\$225	\$225	\$275
20 MB	ST125	3.50"	40 ms	MFM	4/615	\$255	\$275	\$305
30 MB	ST238R	5.25"	65 ms	RLL	4/615	\$270	\$270	\$310
30 MB	ST138	5.25"	40 ms	MFM	6/615	\$315	\$345	\$365
40 MB	ST251-1	5.25"	28 ms	MFM	6/820	\$355	\$385	\$405
44 MB	MK134FA	3.50"	25 ms	MFM	7/733	\$425	\$455	\$475
62 MB	MK134FA	3.50"	25 ms	RLL	7/733	\$475	\$505	\$515
60 MB	ST277R	5.25"	40 ms	RLL	6/820	\$465	\$495	\$505
80 MB	ST4096	5.25"	28 ms	MFM	9/1024	\$595	\$625	\$645
150 MB	MK156FA	5.25"	23 ms	ESD1	10/830	\$1200	\$1200	N/A

## 8088 Based Multi-User Terminal

CONFIGURATION	4.77MHz	8MHz	10MHz
8088 Basic Terminal (M:256KB, F:360K)	\$399	\$429	\$459
8088 Minimum Terminal (M:64KB, F:None)	\$249	\$269	\$289

## HK-7000 Industrial Control Terminal

CONFIGURATION	DIG-IN	DIG-OUT	A-TO-D	D-TO-A	PRICE
8088 Industrial Remote Control	32	8	8	3	\$1295
80286 Industrial Remote Control	32	8	8	3	\$1695

## Multi-User Controller Cards

HK-774P Eight-port intelligent SrL Adap for PC/MOS	\$545
HK-774U Eight-port intelligent SrL Adap (UNIX/XENIX)	\$695
HK-775 Enhanced Ethernet Controller Card (8-bit)	\$229
HK-776 Enhanced Ethernet Controller Card (16-bit)	\$324
HK-778 3278/3279 Emulation Card	\$279

## Accessories

MODEL	FUNCTION	PRICE
HK-420S/B	Enhanced 101 Keyboard with Mouse (S/B)	\$89/\$92
HK-484	External Drive Case w/Cable (1HH)	\$75
HK-485	Extrnl Drv Case w/60W Pwr Supl (2HH)	\$95
HK-631	300W Uninterruptable Power system	\$245
HK-620	6 Outlets Power Pad (6 switches)	\$23
HK-850	Parallel Printer Cable (6ft/10ft)	\$8/\$10
HK-680	Keyboard Storage Drawer (metal)	\$32
HK-683	Monitor Cover (upto 325 lb)	\$60
HK-754	Logitech C7 Serial Mouse	\$68
HK-766	Bar Code Reader Module	\$195
HK-769	Handy Scanner Module (4.125")	\$225
HK-781M/782M	Mini Modem (1200/2400 BAUD)	\$75/\$110
HK-781U/782U	Internal Modem (1200/2400 BAUD)	\$64/\$98
HK-781E/782E	External Modem (1200/2400 BAUD)	\$74/\$108

## DATA ACQUISITION & INDUSTRIAL CONTROL CARDS

HK701	12bit AD/DA (50KHz, 2DAC, 16DAC, 24Di/Do, RTC, DMA)	\$975
HK702	12bit AD/DA (HK701 + Current Loop + Prgm Gain)	\$1195
HK703	12bit AD/DA (HK701 + Programmable Gain)	\$1135
HK706A	Low Cost 12-bit ADC (30KHz, 16ADC, 16Di, 16Do, 12-24v)	\$685
HK706B	Low Cost 12-bit ADC (30KHz, 8ADC, 4Di, 4Do)	\$339
HK707A	Low Cost 12-bit DAC (30KHz, 20AC, 4Di, 4Do)	\$685
HK707B	Low Cost 12-bit DAC (30KHz, 4DAC, no interrupt)	\$475
HK711T	TTL Digital I/O (1MHz, 16Di, 16Do, 5v)	\$215
HK711L	Opt. Isolt Digital I/O (1KHz, 16Di, 16Do, 12-24v)	\$290
HK711H	Opt. Isolt Digital I/O (1KHz, 16Di, 16Do, 48-60v)	\$340
HK712L	Opt. Isolt Digital I/O (1KHz, 24Di, 24Do, 12-24v)	\$215
HK712W	TTL Digital I/O (1MHz, 48Di, 48Do, 5v)	\$145
HK712C	TTL Digital I/O (1MHz, 48Di/Do, 5v, 3 counters)	\$175
HK712R	TTL Digital I/O (1MHz, 48Di/Do, 5v, 1 RS232C port)	\$290
HK713W	TTL Digital I/O (TTL, 1MHz, 96Di/Do, 5v)	\$225
HK714T	TTL Digital Input (TTL, 1MHz, 32Di, 5v)	\$225
HK714L	Opt. Isolt Digital Input (1KHz, 32Di, 12-24v)	\$290
HK714H	Opt. Isolt Digital Input (1KHz, 32Di, 48-60v)	\$340
HK715T	TTL Digital Input (TTL, 1MHz, 32Do, 5v)	\$225
HK715L	Opt. Isolt Digital Input (1KHz, 32Do, 12-24v)	\$290
HK715H	Opt. Isolt Digital Input (1KHz, 32Do, 48-60v)	\$340
HK721	Counter/Frequency Generator (10 channels, 5MHz)	\$585
HK722	4 Channels Counter/Timer (1MHz)	\$440
HK725	CR-NET Distrb Data Acquist & Control (2 ports)	\$1180
HK726	Stepping Motor Control Brd	\$985
HK730	IEEE-488 (GPIB) Board (300KB/S)	\$265
HK759	EPROM Eraser (w/Timer, 20 chips)	\$98
HK760	EPROM Writer Bd (4 sockets)	\$120
HK762	EPROM & PAL Programmer (2 sockets)	\$350
HK763	848 Single Chip Comp Prog'mer (8741, -42, -48)	\$150
HK764	851 Single Chip Computer Prog'mer (for 8751)	\$125
HK765	100MHz Logic Analyzer Module (24 Chnl, 4KB)	\$950

We Supply a Complete Line of Components,  
Please Call for Complete Price List.

WE WILL MEET OR BEAT ANY REASONABLE  
PRICES!!

**HK HALSKAR SYSTEMS**

Personal Computers & Industrial Control Systems

TEL: (415) 490-4009 FAX: (415) 490-4069  
45260 INDUSTRIAL DRIVE, FREMONT CA 94538 USA

Circle 541 on Reader Service Card (DEALERS: 542)

See us at  
COMDEX/Fall '89  
November 13-17, 1989  
Bally's Las Vegas Booth #B-946  
Las Vegas, Nevada



NOVEMBER 1989 • B Y T E 80NE-31



# Magitronic's Basic XT Starter Package

## CGA, 20MB Hard Drive

# \$1429

### BASIC SYSTEM COMES WITH THESE GREAT FEATURES:

- 8088-12 Processor
- 4.77 MHz Hardware/Software Switchable Speeds
- 640 KB RAM on Board
- 8 Expansion Slots
- 20 MB Hard Drive
- 360 KB, 5.25" Floppy Drive
- Hard Disk Controller
- Multi I/O w/ 1 Serial, 1 Parallel, 1 Game Port & Floppy Disk Controller
- CGA Card
- XT Case with Turbo, Reset Switches
- 150 Watt Power Supply
- 101 Key Enhanced Keyboard



### MONITOR SAMSUNG CK4644

- 14" Color Monitor
- 640 x 200 Resolution
- 0.41 mm DP

### PRINTER, STAR NX1000 MULTI-FONT

- 9 Pin Dot Matrix
- 144 CPS Draft, 36 CPS NLO
- High Resolution Text and Graphics
- Four Built-in Fonts
- Standard Friction and Tractor Feeds
- Paper Parking Mechanism

### MOUSE PROCORP MOUSE PACKAGE

- Setup & User's Guide
- Setup Disk & Drivers
- ProCorp Mouse Dr. Halo III Program Disk and Manual
- 9 - 25 Pin Adapter

### MS-DOS 4.01 OR 3.3 WITH GW BASIC

### DISK STORAGE BOX

- Holding 100 pcs. of 5.25" Diskette
- 3M 5.25" DS/DD Diskette (10 Pcs)

### 6 OUTLET UL LISTED SURGE PROTECTOR



### VIDEO CARDS

- AA MAGITRONIC
- A-B133H Mono Graphic Card \$47
- A-B103H Mono Graphic w/PP \$49
- A-B104H Color Graphic Card \$42
- A-B111H Color Graphic w/PP \$44

### VIDEO SEVEN

- A-VRAM-VGA Full length VGA compatible, 256K VRAM, 1024x768 4-color, 800x600 16-colors, and 640x400, 256 colors \$413
- A-FW-VGA Full Length VGA Compatible, 256K DRAM, 800x600 16-color & 640x400 256-color \$289
- A-VEGA-VGA Short Card 800x600 & 720x540 16-color \$259
- A-VEGA-DELUXE Short Card 800x600 & 752x410 16-color \$199

### PARADISE

- A-EGA302 EGA Auto Switch, 640x480 \$195
- A-VGA402 VGA Plus, 800x600 Resolution in 16 Colors \$269
- A-VGA403 VGA Plus 16 Card, 800x600 Resolution in 16 Colors \$309
- STB A-EGA301 EGA Card, Auto Switch, 640x350 \$169
- Renaissance A-VGA405 16 Bit VGA, 800x600 Resolution in 16 colors \$255

### KEYBOARDS

- D-K151L 84 Key XT/AT Switchable \$45
- D-K156 101 Key Enhanced XT/AT Switchable \$55
- D-K158 Small Footprint, 101 Key Full Function, PC/XT, AT Compatible \$54

### INTERFACE BOARDS

- AA MAGITRONIC:
- A-B208 AT 2 5MB RAM Card \$59
- A-B231 AT I/O Card P/S/G \$39
- A-B231-2 AT Serial/Parallel Card \$45
- A-B132H Multi I/O Card w/S/P/G/CLC/FDC 2 Drives \$37
- A-B131 XT I/O Plus I Card with S/P/G/CLC \$29
- A-B113 640KB RAM Card \$29
- A-B235 XT/AT 2 MB EMS Card \$79

### TAPE BACK-UP SYSTEMS

- A-FW-VGA Full length VGA Compatible, 256K DRAM, 800x600 16-color & 640x400 256-color \$289
- A-VEGA-VGA Short Card 800x600 & 720x540 16-color \$259
- A-VEGA-DELUXE Short Card 800x600 & 752x410 16-color \$199

### SYSGEN Bridge Series

- B-SYS2260 External 5 1/4" 360 KB/1.2 MB Floppy Drive \$219
- B-SYS2261 External 3 1/2" 720 KB/1.44 MB Floppy Drive \$229
- B-SYS2294 Adapter Card to Interface Bridge Drive on PC/AT & Compatible \$52
- B-SYS2381 Adapter Card to Interface Bridge Drive on PC/XT & Compatible \$52

### RELIANT SERIES

- B-SYS310 Internal 5 1/4" 60MB \$465
- B-SYS315 External 5 1/4" 60MB \$685
- B-SYS356 Internal 5 1/4" 125MB \$770
- B-SYS355 External 5 1/4" 125MB \$899

### MONITORS

- 8 SAMSUNG
- C-55-AA2565 12" Amber Monochrome Monitor w/Swivel Base, 720 x 350 \$75
- C-55-CW4644 14", RGB Monitor, 640 x 200 \$229
- C-55-CM4531 14", EGA Monitor, Tilt & Swivel Base, 640 x 350 \$339
- C-55-MZ4571 14" Paper white, Flat Screen Mono Monitor, 720 x 350 \$109
- C-55-CQ4551 14", Analog Color Monitor, 720 x 400 \$359
- C-55-CN4551 14", Multisync Stand, 800 x 580 \$439
- C-55-MP5671 15", Full Page Monochrome Monitor w/Video Board, Tilt & Swivel Stand, 1006 x 1048 \$839

### Seiko

- C-SK-CM1430 14" VGAs Monitor, 1024 x 768 \$609

### POWER SUPPLY

- AA MAGITRONIC:
- D-P150 150 Watt for XT \$45
- D-P200 200 Watt for AT \$59
- D-P900 200 Watt for Baby AT \$59
- D-F500 230 Watt for AT \$69
- Vericle Case, D-P103 6 Outlet Surge Protector \$95

### Standby Power System

- D-TPB C450 450 Watt, 5 ms Transfer Time, 34 mins Backup Time @ 1/2 Load, 26 AH Battery \$339
- D-TPB C325 325 Watt, 5 ms Transfer Time, 35 mins Backup Time @ 1/2 Load, 26 AH Battery \$275
- D-TPB8 6 Outlet with 3 Individual 6' Cord \$54
- D-TPB4 4 Outlet with 2 Individual Filters, 6' Cord \$45

### DISK DRIVES

- Seagate Hard Drives
- B-HD-225 20MB, 65 ms, MFM \$219
- B-HD-238R 30MB, 65ms, RLL \$275
- B-HD-238R w/Western Digital Controller \$239
- B-HD-251 40MB, 40ms, MFM \$299
- B-HD-251-1 40MB 28ms, MFM \$339
- B-HD-277R 60 MB, 40ms, RLL, 1/2 Ht. \$389
- B-HD-4096 80MB, 28ms, MFM, Full Ht. \$399
- B-HD-4144R 122 MB, 28ms, RLL, Full Ht. \$599
- B-HD-4144R 122 MB, 28ms, RLL, Full Ht. \$679

### TOSHIBA Floppy Drives

- B-FD-04DT 360KB, DS/DD XT/AT Beige \$69
- B-FD-04DEG 360KB, DS/DD XT/AT Beige \$69
- B-FD-08DEG 1.2 MB High Density \$85
- B-FD-352 3 1/2" 1 MB Formatted) with Installation Kit \$720KB \$80
- B-FD-356 3 1/2" 2 MB (1.44 MB Formatted) with Installation Kit \$95

### MOUSE

- LOGITECH Serial Mouse with Software \$69

### MODEMS

- AA MAGITRONIC:
- A-MD1200-1 1200 Baud Internal \$59
- A-MD2450-1 2400 Baud Internal \$99
- A-MD2400-EX Cardinal 2400 Baud External \$129

### PRINTERS

- STEARX E-NX1000 Multifont 9 Pin 144 CPS Draft, 36 CPS NLO \$159
- E-NX1000 Rainbow 9 Pin, 144 CPS Draft, 36 CPS NLO 7 Color Printing \$229
- E-NX15 9 Pin, 120 CPS Draft, 30 CPS NLO \$290
- E-NB2410 24 Pin, 216 CPS Draft, 72 CPS NLO \$419
- E-NX2400 24 Pin, 170 CPS Draft, 57 CPS NLO \$339
- E-NX1000 Black Ribbon \$695

### Panasonic

- E-P1180 9 Pin, Narrow Carriage, 192 CPS Draft, 38 CPS NLO \$179
- E-P1191 9 Pin, Narrow Carriage, 240 CPS Draft, 48 CPS NLO \$245
- E-1592 9 Pin, Wide Carriage, 216 CPS Draft, 45 CPS NLO \$389
- E-P195 9 Pin, Wide Carriage, 288 CPS Draft, 61 CPS NLO \$445
- E-P1124 24 Pin, Narrow Carriage, 192 CPS Draft, 63 CPS NLO \$315
- E-P4450 Loser Printer 11 PPM, 300 DPI, 5 Emulations, Standard Serial or Parallel Interface \$1345

### CONTROLLERS

- WESTERN DIGITAL
- A-WDXT-GEN2 Winchester XT Controller with Dynamics Bios \$59
- A-WDXT-GEN2R XT RLL Controller \$69
- A-WD27X XT Compatible Winchester RLL Controller \$69
- A-WD-V-MM2AT Compatible Winchester/Floppy Controller, 8/20 MHz \$119
- A-WD-V-SR2 AT RLL Enhanced Winchester/Floppy Controller \$139

## Orders Only 1-800-227-5454

### TERMS

All prices reflect cash discount. We accept Mastercard and Visa, cashiers check, cash or certified check. Personal and company checks require 3 weeks to clear. Add \$3 handling charge per box plus additional shipping charges. COD orders - add \$3 per carton. All defective merchandise must have RMA number. Allow 2 to 3 weeks for replacement. All defective items will be replaced or repaired at our discretion within the limits of the manufacturer's warranty. All return items must be shipped prepaid and insured. Complete 1 year Warranty on system, 1-year Warranty on Floppy Drive. Full service in-house technical support throughout and beyond Warranty.

## CALL FOR SPECIAL MAGITRONIC DEALER PRICES ON ORDERS OF 10 SYSTEMS +

All systems fully assembled, tested, burned in & shipped in computer shipping carton. IBM, PC, XT, AT, Samsung, Toshiba, Microsoft, Seagate, Video Seven, Paradise, Renaissance, Triplate, Seiko, Colorado, Star, Panasonic, Western Digital, Sysgen are registered trademarks of their respective companies.

Prices and availability subject to change without notice.

### NEW YORK ORDERS & GENERAL INFO CALL 516-454-8255

### FOR TECHNICAL SUPPORT ONLY CALL 1-800-347-5454 516-454-8255

### LEASING PROGRAM AVAILABLE TO CORPORATE ACCOUNTS 516-454-8255

MAGITRONIC TECHNOLOGY INC  
10 HUB DRIVE, MELVILLE, N.Y. 11747

# CALL 1-800-227-5454 IN NY CALL 1-516-454-8255 FAX NO. 1-516-454-8268

# MAGITRONIC TECHNOLOGY INC.





# SHORT TAKES

*BYTE editors' hands-on views of new and developing products*

Excel for OS/2 with  
Presentation Manager

Cornerstone  
SinglePage XL

Prograph 1.2

TekColor for  
the Macintosh

FormWorx System 2

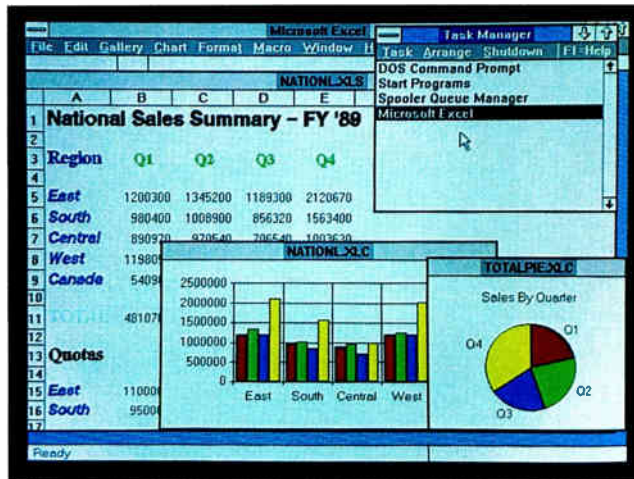

commands permit greater customization of the work environment. New commands necessary to interact with OS/2 (e.g., a menu item to call the Control Task Manager) have been added, while several macro functions have been modified to comply with PM. The file load and save commands will support the 32-character filenames in OS/2 1.2. And Q+E, Microsoft's new SQL querying tool for Excel, will ship with every copy of the PM version.

In performance, the beta version of Excel PM that I tested was comparable to the Windows version in recalculations—sometimes faster, sometimes slower, but never by more than 10 percent—but its speed was substantially slower in two key areas: file loading and saving, and screen movement. Loading a 600K-byte file under OS/2 took 70 percent longer than under Windows, and a test of scrolling right took 31 percent longer. In all comparable benchmarks, Excel PM was much slower than the 2.x DOS versions of Lotus 1-2-3 (using the same files converted to .XLS format) and was a little slower than Lotus 1-2-3 release 3.0.

Is Excel PM worth it for DOS/Windows users looking to upgrade? When you consider that you will need an 80286 machine or higher (an 80386 really helps), at least 2.5 megabytes of RAM, a large hard disk drive with 12 megabytes of free space, OS/2, and the application itself, the cost may not be justified now. But when OS/2 becomes a standard, and more applications that use multitasking and DDE enter the market, this new Excel will likely be a must-have program. □

—Andrew Reinhardt  
*continued*

## OS/2 Gets a Spreadsheet

The new Excel, an upgrade to the powerful spreadsheet, joins the OS/2 bandwagon. After testing a prerelease version, I came to the conclusion that **Excel for OS/2 with Presentation Manager** is distinguished from its DOS ancestor less by its feature set than by the underlying benefits of OS/2.

Among those benefits are large memory addressing, support for virtual memory, built-in Dynamic Data Exchange (DDE), multitasking, and a richer graphical environment, including more fonts, more accurate screen representation, and an IBM common-user-access-compliant interface. Large memory permits a different working style, in which many spreadsheets are loaded and open at the same time. With multitasking, you can be sorting a database and printing a file in the background while working on Excel in the foreground.

However, operating in single-user mode on an AT-class machine, and without many other PM applications with which to share data, the advantages of OS/2 are not immediately apparent. In fact, even the larger memory ad-

ressing (I had 3 megabytes installed, plus room on my disk for virtual memory) didn't prevent me from getting warning messages that some of my operations were too big and would require giving up Undo in order to proceed.

Excel for Windows is a fine application, distinguished by its graphical power and, through Windows, its ability to link spreadsheets to one another and to other documents. The PM version carries on this tradition, adding support for up to 256 fonts (in both a faster, less-accurate screen mode and a slower but more WYSIWYG representation) and a new Data Consolidate feature that emulates the

three-dimensional capabilities that are found in competing spreadsheets.

The new Excel doesn't permit a single file to contain multiple worksheets, as does Lotus 1-2-3 release 3.0. However, with Data Consolidate, you can "summarize" worksheets by pointing and clicking on areas in each sheet that are then dynamically linked to a summary sheet. To my disappointment, this feature was not intuitive nor well documented.

Other additions in Excel PM are quite minor. A nice menu item called Window Show Clipboard lets you see the contents of the clipboard, and modifications to existing

### THE FACTS

**Excel for OS/2 with Presentation Manager**  
\$495; upgrade from Windows, \$50

**Requirements:**  
IBM PC AT, 80286, PS/2, or compatible with 2.5 megabytes of RAM, OS/2 1.1 Standard Edition or higher, a hard disk drive with 3 megabytes

free (not including the space used for OS/2), and EGA or VGA graphics.

Microsoft Corp.  
16011 Northeast 36th Way  
P.O. Box 97017  
Redmond, WA 98073  
(206) 882-8080  
**Inquiry 988.**

## A Cornerstone for Building Documents

After writing for years about the advent, and finally the arrival, of the new age of desktop publishing, it was time to install a DTP program of my very own. But my old-faithful IBM PC AT clone was slow, lacked sufficient memory, and had a tiny amber monitor—definitely not suited for the rigors of Windows/286 or PageMaker. The solution to that problem was to increase speed with a new motherboard, beef up the memory with an expanded memory board, and add a full-page monitor.

I chose the **Cornerstone SinglePage XL** subsystem, complete with a four-shade gray-scale portrait monitor that measures 15 inches diagonally and includes a Hercules-compatible add-in card and associated software. TrueFonts, Cornerstone's proprietary screen fonts, include Helvetica, Times Roman, Courier, and Symbols. My four-shade system uses smoothing for crisp on-screen characters. However, a less-expensive two-shade monochrome system is also available.

The installation was easy. There's only one jumper on the two-thirds-length add-in card (for single or multiple monitors), which, although it requires an AT, fits into any 8- or 16-bit expansion slot. From



### THE FACTS

**Cornerstone SinglePage XL**  
\$1295 for two-shade monochrome version;  
\$1495 for four-shade gray-scale version

**Basic system:**  
A 15-inch monitor, video interface, video cable,

110-V AC power cord, display drivers, and gray-scale fonts (on gray-scale monitor only).

Cornerstone Technology  
1883 Ringwood Ave.  
San Jose, CA 95131  
(408) 453-9800  
**Inquiry 990.**

there, I just hooked up the video cable and power and turned the computer on.

Software installation is also

uncomplicated. Drivers are included for Microsoft Windows, GEM/3, Ventura Publisher, AutoCAD, Auto-

Sketch, AutoShade, Lotus 1-2-3, Symphony, WordPerfect, and WordStar. A DOS driver allows other DOS applications to run in full-page mode. But because many programs bypass the BIOS and write directly to the screen, don't expect wonders. For example, Norton Commander and Xy-Write refused to run in anything but their normal 25-line configuration.

After I finished installing Windows/286, its custom driver, and PageMaker, I was eager to see how a full page looked on-screen, and I wasn't disappointed. The screen surface is flat, with no obvious glare or distortion, and the noninterlaced resolution (768 pixels horizontally by 1008 pixels vertically) more than meets my DTP needs.

Cornerstone is an apt name for this monitor. It measures 16½ inches high and 12¾ inches wide, with a depth of 13¾ inches. It looks great on my desk and has attracted the curiosity of many (jealous) fellow editors. The only small complaint I have about the SinglePage XL is the contrast, which I haven't been able to adjust to my liking. But that's something I can live with, and I realize it's not completely the fault of the monitor, since it's competing with the extensive light in my office.

If you need to work with text and graphics, as in DTP, and can do without color, the Cornerstone SinglePage XL is for you. □

—Anne Fischer Lent

## Pictorial Programming on the Mac

**Prograph 1.2** from Gunkara Sun Systems is a pictorial development system that radically changes the rules of the game. You build Prographs with a pictorial diagram editor similar to what many computer-aided software engineering tools provide. However, while CASE diagrams typically specify code, Prographs are code.

An application builder, an interpreter, and a debugger support the pictorial language. The key elements of Prograph are object orientation, data flow, and a well-integrated environment. The object orientation is, in some respects, not too different from what you find in C++ or Object Pascal.

Class icons have left and

right mouse-sensitive regions. Double-click on the left one, and an object editor reveals attributes that belong to the class at large and to the current instance of the class. Double-click on the right one, and another editor shows the methods in the class. The System Classes window is where you create new classes and—by rubber-banding them to exist-

ing ones—specify inheritance relationships.

There's virtually nothing in the system that corresponds to the normal concept of a variable. Thus, there are no variable names to invent, type, and misspell. It also means, however, that you'll spend much time in object editors unpacking attributes—since that's the

*continued*





Embedded systems designers have already used CrossCode C in over 413 different applications.

# How to choose a 68000 C compiler for your ROMable code development

These twelve important CrossCode C features could make the difference between success and failure

It's hard to know ahead of time what features you'll be needing in a 68000 C compiler. But if you're using CrossCode C you won't need to think ahead, because CrossCode C is already equipped with these twelve important features for your ROMable code development:

- 1. A 100% ROMable Compiler:** CrossCode C splits its output into five memory sections for easy placement into ROM or RAM at link time.
- 2. Integrated C and Assembler:** You can write your code in any combination of C and assembly language.
- 3. Readable Assembly Language Output:** The compiler generates assembly language code *with your C language source code embedded as comments*, so you can see each statement's compiled output.
- 4. Optimized Code:** CrossCode C uses minimum required precision when evaluating expressions. It also "folds" constants at compilation time, converts multiplications to shifts when possible, and eliminates superfluous branches.
- 5. Custom Optimization:** You can optimize compiler output for your application because *you* control the sizes of C types, including pointers, *floats*, and all integral types.

- 6. Register Optimization:** Ten registers are reserved for your register variables, and there's an option to automatically declare all stack variables as *register*, so you can instantly optimize programs that were written without registers in mind.

- 7. C Library Source:** An extensive C library containing over 47 C functions is provided in source form.

- 8. No Limitations:** No matter how large your program is, CrossCode C will compile it. There are no limits on the number of symbols in your program, the size of your input file, or the size of a C function.

- 9. 68030 Support:** If you're using the 68030, CrossCode C will use its extra instructions and addressing modes.

- 10. Floating Point Support:** If you're using the 68881, the compiler performs floating point operations through the coprocessor, and floating point register variables are stored in 68881 registers.

- 11. Position Independence:** Both position independent code and data can be generated if needed.

- 12. ANSI Standards:** CrossCode C tracks the ANSI C standard, so *your* code

will always be standard, too.

### There's More

CrossCode C comes with an assembler, a linker, and a tool to help you prepare your object code for transmission to PROM programmers and emulators. And there's another special tool that gives you symbolic debugging support by helping you to prepare symbol tables for virtually all types of emulators.

CrossCode C is available under MS-DOS for just \$1595, and it runs on all IBM PCs and compatibles (640K memory and hard disk are required). Also available under UNIX, XENIX, and VMS.

CALL TODAY for more information:

**1-800-448-7733**  
(ask for extension 2001)

Outside the United States, please dial

PHONE: 1-312-971-8170  
FAX: 1-312-971-8513

SOFTWARE DEVELOPMENT SYSTEMS, INC.  
DEPARTMENT 21  
4248 BELLE AIRE LANE  
DOWNERS GROVE, ILLINOIS 60515 USA

CrossCode™ is a trademark of SOFTWARE DEVELOPMENT SYSTEMS, INC. MS-DOS® is a registered trademark of Microsoft. UNIX® is a registered trademark of AT&T. XENIX® is a registered trademark of Microsoft.



## Does *CHAOS* Lurk In Your System?

### DYNAMICAL SYSTEMS, INC.

**DYNAMICAL SOFTWARE:** A complete package for the practical application of nonlinear dynamics and chaos to real world data and theoretical studies.

Easily interfaced with instrumental output and your own programs. Use *DYNAMICAL SOFTWARE* to study scientific, medical, engineering and economics time series.

Written manuals include comprehensive introduction to nonlinear dynamics and chaos for the chaotic novice.

**CHAOS IN THE CLASSROOM:** Self-contained programs for use in the classroom and independent study.

For IBM PC's and Compatibles.  
*Dynamical Software (Two Package Set)* \$550;  
*Chaos in the Classroom* \$49.95.

**JOIN THE NONLINEAR REVOLUTION!**

DYNAMICAL SYSTEMS, INC.  
P.O. Box 35241 • Tucson, AZ • (602) 292-1962

## SHORT TAKES

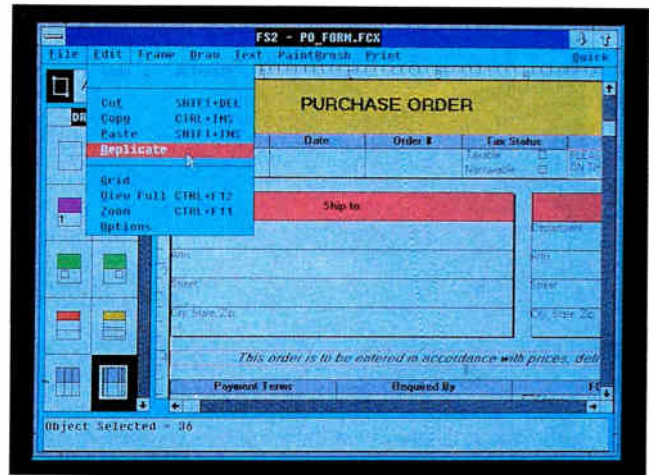

that they use object-oriented constructs, the reality is often different. With FormWorx System 2, "object-oriented" is more than a buzzword. Objects are the key to the package's surprisingly literate user interface. Laying out a form is simplified because the company has included about a dozen constructs that it calls *common form objects*. These go beyond the simple grids used in competing products. There are objects for all the common form areas (e.g., headers, lists, and signature blocks). I found that I could quickly design a form without the steep learning curve that was needed with other packages I've used.

A form in FormWorx System 2 consists of four planes: draw, edit, paintbrush, and data. This separation of pow-

ers makes a great deal of sense, and it's one of the main reasons why the package is so easy to use. After I worked with the individual planes, they all came together in a finished product.

Another stunning feature of the package is its forms-filling abilities. Other forms packages let you import data from dBASE (or delimited ASCII) files, letting you print out a bunch of finished forms at one time. But FormWorx System 2 takes the concept much further. The company has essentially designed an easy-to-use front end to dBASE III Plus (or dBASE IV), and you don't even need dBASE to use it.

But FormWorx System 2's biggest surprise came when I exited the program. Because it stores forms as a combination of pointers to objects, the amount of space needed to store your finished forms is minuscule. For example, a standard invoice file took up only 548 bytes of storage. This is a far cry from other forms packages, which store forms as bit-mapped images, often taking up as much as 300K bytes for a single form.

FormWorx System 2 is a package that shows what careful design coupled with the latest wave of object-oriented programming technology can do for software. And for only \$299, it's a software system that delivers even more than it promises. ■

—Stan Miastkowski

## WE ABSOLUTELY LEAD THE COMPETITIVE QUALITY, DELIVERY & PRICE

EXCELLENCE IS NOT THE LARGEST, NOT THE ELDEST, BUT WE ARE EQUIPPED WITH THE LATEST EFFICIENT TOOLS TO CREATE OUR PRODUCTS APPROACHING OPTIMUM.  
COMPETITIVE QUALITY, DELIVERY & PRICE ARE OUR THREE OBJECTIVES.



EXCELLENCE MULTI-LAYER  
P.C.B. MFG CO., LTD.

3RD FL., 35, LANE 246, SIN MIN RD., NEI HU,  
TAIPEI, TAIWAN, R.O.C.  
TEL: 886-2-7941223~5 FAX: 886-2-7910397

### THE FACTS

**FormWorx System 2**  
\$299

**Requirements:**  
IBM PC or compatible  
with 640K bytes of RAM,  
DOS 3.0 or higher, and  
Microsoft Windows  
2.03 or higher.

FormWorx Corp.  
Reservoir Place  
1601 Trapelo Rd.  
Waltham, MA 02154  
(617) 890-4499  
**Inquiry 992.**



# SEND AWAY FOR YOUR VERY OWN COMPUTER STORE.

When you buy a computer, about 35% of your money goes to the store.

But we'd much rather see your money go to somebody who deserves it a lot more.

You.

So we give you a completely different kind of computer store.

The Dell Computer Store.

Instead of a crowded, high-overhead showroom, you get our brand new 44-page catalog. Which gives you a full line of 386™ and 286 systems, printers, peripherals, software, and accessories.

And since you buy direct from the manufacturer, you save about 35%.



WE'RE THERE WHEN YOU CALL

SUMMER 1989  
DELL  
COMPUTER SYSTEMS  
FOR  
PRODUCTIVITY & PERFORMANCE

DELL

But there's a lot more to it than saving money. We offer you the most complete service and support in the industry. Including a 30-day money-back guarantee. A toll-free technical support hotline. Self-diagnostic software. And next-day deside service from

Xerox Corporation. If you read our ad in the front of this magazine, it will tell you a lot more about the systems we offer. And the service we put behind them. So if you'd like a much more intelligent way to buy a personal computer, have a look at our ad. Or call us at 800-426-5150. Or send us the card on this page.

And we'll send the best computer store you've ever seen.

One you don't have to set foot in.

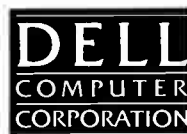

TO ORDER, CALL US.

**800-426-5150.**

FOR DELL IN CANADA, CALL 800-387-5752.





## TUESDAYS, THE SHIPMENT OF TIME ARRIVES EARLY.

---

*But what if they needed more? What then?*

■ If time could be manufactured, you'd buy it. Weitek's Abacus 3167 math coprocessor comes close. It can give a 386-based computer 2X to 3X its normal speed—workstation-level performance—for less than \$1,000. It's quickly installed in machines from Compaq, H-P, AST, Zenith, Dell, Everex and numerous other manufacturers. It's supported by high-end CAD, CAM, engineering and math applications like VersaCAD, Anvil-5000pc, CADKEY, Mathematica and many more. And by the most widely used programming tools—from vendors like Phar Lap, MetaWare and MicroWay. To learn more about the 2X to 3X speed that means twice as much time for you, call Weitek Corporation at 1-800-HOT-3167 or see your dealer. Soon.



WEITEK is a registered trademark of WEITEK CORPORATION. All other company and product names are trademarks or registered trademarks of their respective holders. ©1989 WEITEK CORPORATION

*Circle 376 on Reader Service Card*  
World Radio History

# We'll give you 30 days to plug our product.



Try our multi-user/multi-channel communication boards (and our promises) for 30 days with no risk.

You're looking at multi-user systems. You want high performance. High reliability. Great service and technical support. And real value. Trouble is, that's what every board company promises.

But whose promises can you afford to stake your reputation on? Ours. Because only DigiBoard dares to let you try us in the real world. With no risk.

With DigiBoard you can order any DigiCHANNEL multi-channel communications board and evaluate its performance

**DigiBoard**  
Plugging you into tomorrow

for a full 30 days. Choose basic boards or the industry's fastest intelligent boards. PC-Standard or Micro Channel. Four, eight or 16 ports. Even a Synchronous option on some models.

While you're evaluating the performance of our boards, we hope you'll benchmark our technical support too. Customers tell us it's as great as our engineering. But enough talk. The only way to see how good we are is to try

us. And now, you can plug us in without risking a penny. Just plug into your nearest DigiBoard distributor.

Ask your DigiBoard distributor for our FREE booklet, *How to Do Multi-User Right*.

#### NATIONAL DISTRIBUTORS

SOFTSEL COMPUTER PRODUCTS, East 800-645-7779, Central 800-645-7775, West 800-645-7778;  
ARROW ELECTRONICS INC., COMMERCIAL SYSTEMS DIVISION, 800-323-4373 U.S., 516-391-1762 N.Y.;  
INGRAM-MICRO D, 800-642-7631; ROBEC DISTRIBUTORS, 800-223-7081 Request Ann Brady

#### CANADIAN DISTRIBUTORS

CDI COMPUTER DISTRIBUTION, 604-984-0641; EMJ DATA SYSTEMS LIMITED, 519-837-2444;  
SOFTSEL COMPUTER PRODUCTS, 800-268-1220; INGRAM-MICRO D, 416-738-1700

#### REGIONAL DISTRIBUTORS

MULTI COMPUTER PRODUCTS, South East Region, 800-456-8588#  
ICOM SYSTEMS INC., Central Region, 312 506-1444;  
MP SYSTEMS, Central & Western Regions, 800-624-1688 U.S., 800-322-6411 CA  
AIS INC., Central Region, 800-950-2471;  
COMPUTER SOURCE INTERNATIONAL, North East Region, 800-222-5022;  
TRICOM, North East Region, 800-TRICOM-1; REDLAW, South East Region, 305-791-5450

DigiBoard Inc., U.S. 800-344-4273, MN 612-922-8055

Circle 111 on Reader Service Card

See us at COMDEX



# EISA Arrives

HP leaps to the forefront with an 80486-based system built around the controversial EISA bus

**A**fter its unsuccessful attempt to take the lead in the PC market with its touchscreen HP-150 back in 1983, Hewlett-Packard settled for the role of builder of solid, reliable PC clones, while leaning heavily on its entrenched positions in the mini-computer and electronic equipment markets. Now, however, the company is embarking on a new strategy of product innovation and market leadership.

On the software side, HP has taken the lead in developing the Unix-based Motif user interface for the Open Software Foundation. It has also started shipping its innovative NewWave user environment for Microsoft Windows.

On the hardware side, the first evidence of HP's new strategy is its Vectra 486 PC, a powerful 80486-based desk-side system that may be the first machine on the market to feature the long-awaited Extended Industry Standard Architecture bus. (For more details on the EISA bus, see this month's Under the Hood column.)

HP gave BYTE an early look at a preliminary version of the Vectra 486, and it is indeed an impressive machine, offering excellent performance and broad flexibility. The Vectra 486 is equally well suited for use as a high-performance CAD workstation, a network server, or a host for a multiuser system. And, as you'd expect, it can run Unix, DOS, and OS/2.

From the outside, the Vectra 486 looks  
*continued*

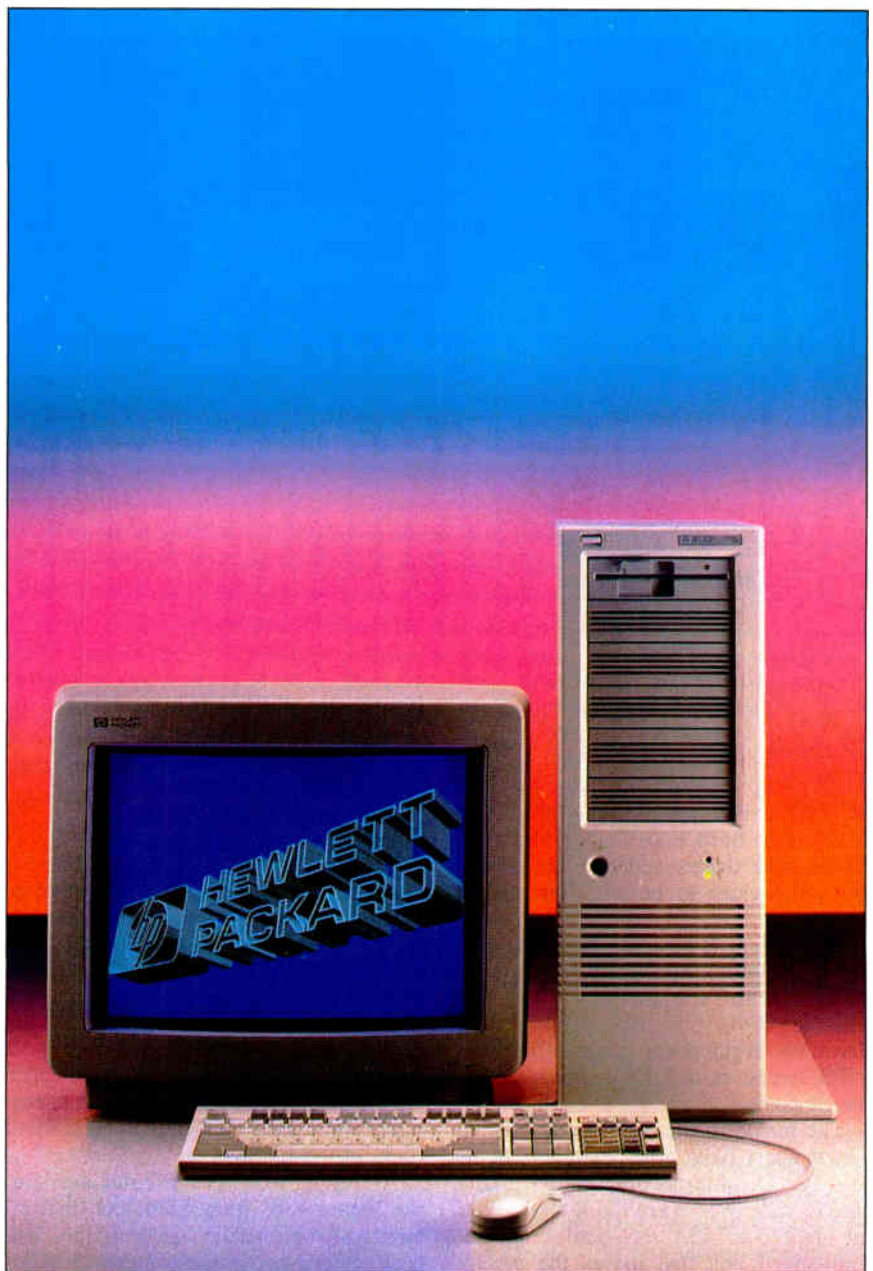

## VECTRA 486 CPU ARCHITECTURE

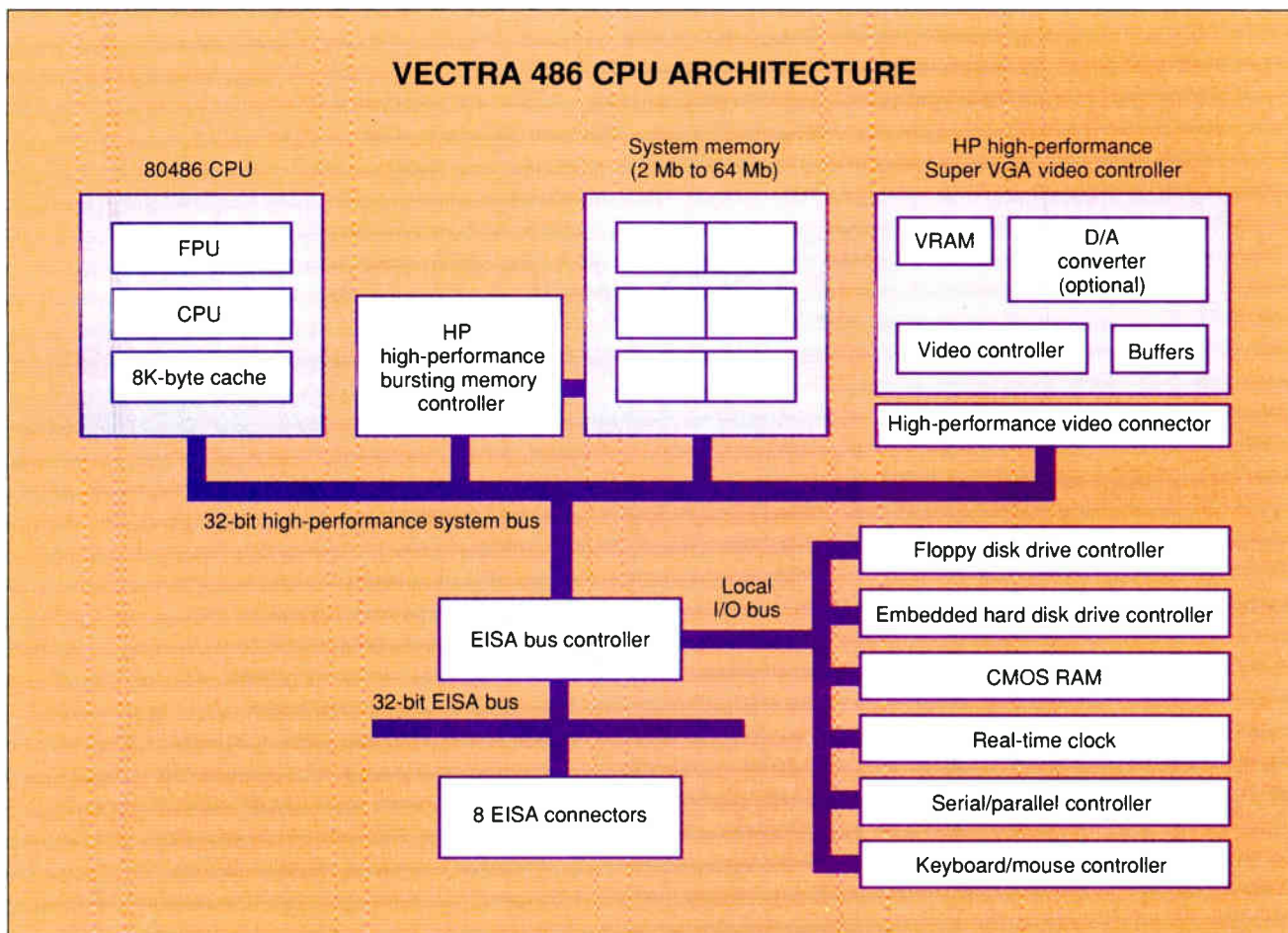

The Vectra 486 system diagram. Note the high-performance system bus (the host bus) that drives the system and video memory.

identical to the Vectra RS/20C and RS/25C (the 80386 desktop models of the Vectra series). The floor-standing, 24-inch-high system cabinet weighs in at a hefty 60 pounds and includes six half-height storage bays, allowing up to two full-height hard disk drives and four floppy disk drives and/or tape backup storage devices to be installed in the system.

The system is powered by a 360-watt power supply. The Vectra 486 comes standard with 2 megabytes of RAM, one 1.2-megabyte 5¼-inch floppy disk drive, two serial ports, one parallel port, a PS/2-type mini-DIN keyboard, and mouse ports.

The inside of the Vectra 486 is what sets it apart from other members of its family. The main components of the Vectra 486 system are the 80486 CPU, an eight-slot EISA bus, and a special high-speed bus that drives the system memory and the high-performance Super VGA video controller. The system

diagram of the Vectra 486 is shown in the figure, and the main system board is shown in photo 1. Note that the 80486 is located on a separate CPU board that plugs into the high-speed bus.

#### The 80486 CPU

The heart of the Vectra 486 is Intel's new 80486 CPU, which features on-chip floating-point and memory management units, as well as an internal 8K-byte cache (for an overview of the 80486, see Microbytes, June BYTE). Unlike some of the other recently announced 80486 machines (e.g., those from Apricot and Advanced Logic Research), the Vectra 486 does not include an external cache but relies entirely on the 8K-byte internal cache of the 80486.

According to HP's R&D manager for the Vectra 486, Rich Archuleta, the internal 8K-byte cache "gave us the best cost/performance trade-off on a 25-MHz system." Archuleta added that a "pretty big" external cache is needed to obtain a

significant gain in performance. I'll discuss the performance of the Vectra 486 later in this article.

I should mention that the system board does not include a socket for an auxiliary floating-point coprocessor such as the Weitek 4167, which supports the 80486 and is reportedly much faster than the FPU built into the 80486 (see Microbytes, July BYTE, page 26). According to Archuleta, the system board was already in its final design stages when Weitek announced the 4167; HP will support the 4167 in a later version of the system board.

#### High-Performance Host Bus

The Vectra 486 uses a custom, 32-bit high-performance system bus, or "host bus," to access system memory as well as HP's Super VGA video controller. The host bus operates synchronously at the clock speed of the CPU, allowing a theoretical data transfer bandwidth of 100 megabytes per second (25 MHz, or mil-



lion cycles per second multiplied by 4 bytes per cycle). Of course, the actual bandwidth is limited by transfer protocols, CPU resets and interrupts, and other performance penalties. But HP claims that the host bus can access system memory with a bandwidth of 50 megabytes per second using the burst mode of the 80486.

The system memory comes on a separate memory board (see photo 2), which plugs into the host bus. HP custom-designed its own memory controller chip that takes advantage of the burst mode of the 80486. System memory is available in 80-nanosecond, 1-megabit single in-line memory modules, allowing a maximum of 32 megabytes of RAM (in 1- or 4-megabyte packages), or in 4-megabit SIMMs (8-megabyte packages), which allows a maximum of 64 megabytes of RAM.

#### HP's New VGA Controller

As I mentioned earlier, the Vectra 486's host bus supports high-speed access to HP's new Super VGA video controller. The video controller plugs directly into the host bus but also takes up one EISA bus slot (the board extends across one of the EISA slots). The new VGA adapter is actually a "superset" of the VGA standard, supporting resolutions of 800 by 600 pixels and 1024 by 768 pixels, as well as the standard VGA resolution of 640 by 480 pixels. The controller displays 8 bits per pixel for a maximum of 256 simultaneous colors (16 colors in 1024- by 768-pixel mode) and includes 512K bytes of video RAM.

I did not have a chance to see the new video controller because it was still in production at the time of this writing. However, HP's Archuleta told me that it would offer about 10 times the performance of a standard VGA controller. The machine I saw used a standard 16-bit, AT-type VGA board plugged into the EISA bus.

Before moving on to other features of the Vectra 486, I want to point out that the high-speed host bus is a critical component of this system, particularly because of its high-performance graphics capabilities. Unlike the EISA bus—or other I/O buses, for that matter—HP's host bus offers a much faster and more efficient path to the CPU because it does not have to bother with bus arbitration protocols and other performance penalties associated with bus I/O. Thus, the system can support much higher block transfer rates from system and video memory. In high-resolution graphics sys-

*continued*

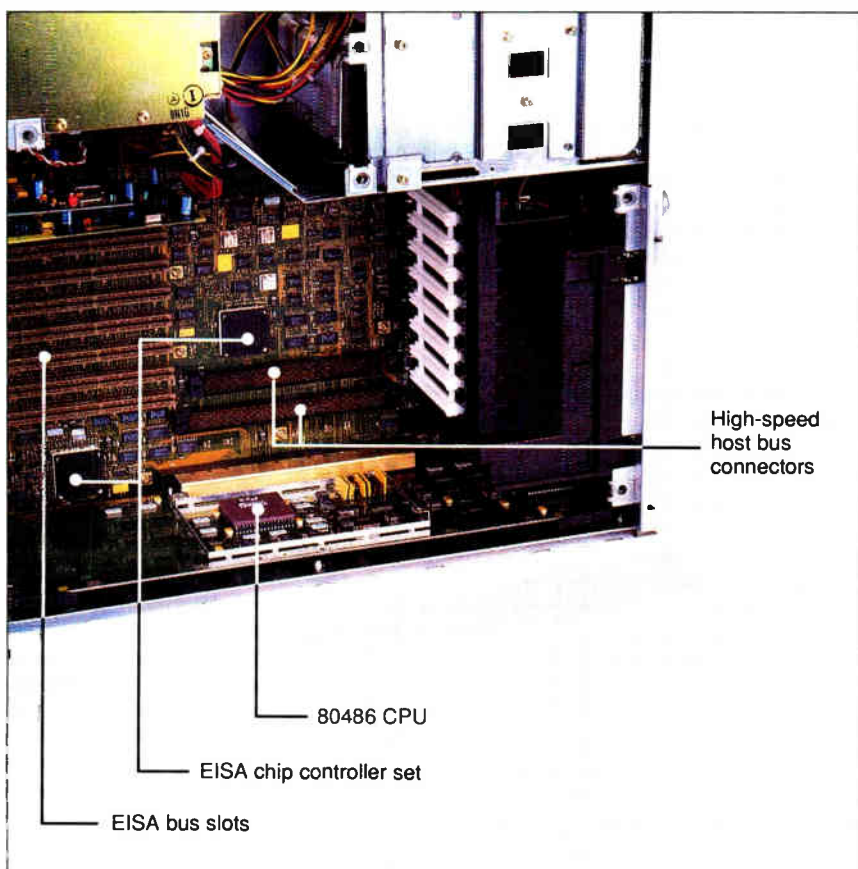

**Photo 1:** The main system board of the Vectra 486. Note that the 80486 is located on a separate CPU board that plugs into the high-speed host bus. The two large connectors above the CPU board are host bus interfaces for the memory and Super VGA board. The EISA bus slots are on the left side of the main system board (seven of the eight slots are visible in the photo).

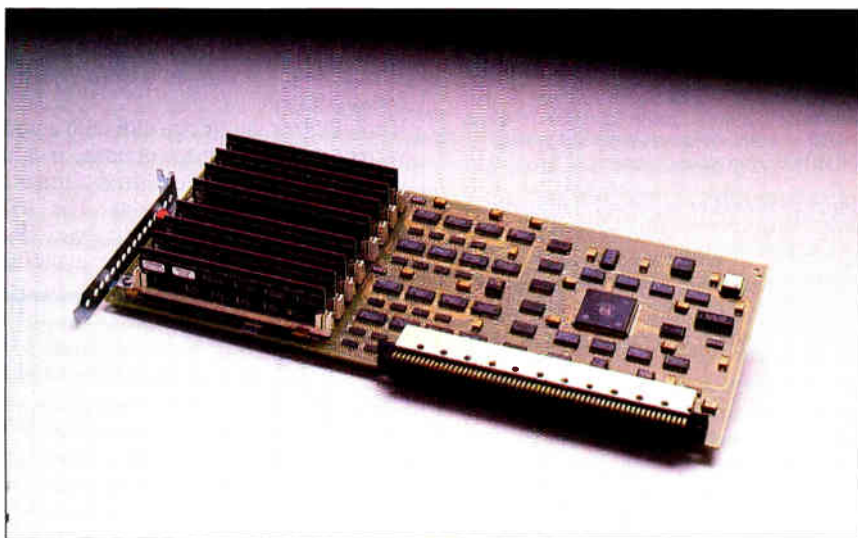

**Photo 2:** The Vectra 486 system memory board. Memory can be configured with 1-megabit or 4-megabit single in-line memory modules, allowing up to 64 megabytes of system memory. The large chip on the right side of the memory board is HP's custom memory controller (the bursting memory controller shown in the figure).

# See Your Data



MapInfo software can find, display and analyze your data geographically. See your prospects, customers, facilities—anything in your database. Find addresses by street, ZIP code, city, etc. (We can even supply the maps.)



Any point or region on the map can have a complete record of data behind it. See your *actual* dBASE data in a window to view, edit, and print. Draw your own boundaries. Add titles and legends for high quality presentations.



Perform analyses on your data to sum, average, or count your database records by location. Color sales territories by volume of orders, ZIP codes by numbers of leads, countries by your demographic data.

From street-level to worldwide, MapInfo can merge your databases with maps. Play visual "what if" with your data. See patterns, trends, and opportunities you never knew existed. If you need to map your data, MapInfo can do it for as little as \$750.

MapInfo now includes a map of the world and the U.S. with all ZIP code locations. Runs on IBM PCs or compatibles with 640K memory, a hard disk drive, and graphics, and comes network-ready.

**MapInfo Corp.**  
Changing The Way The World  
Looks At Information™

200 Broadway, Troy NY 12180  
To order, call 1-518-274-8673  
or 1-800-FASTMAP Toll free.

MapInfo is a trademark of MapInfo Corp. dBASE is a trademark of Ashton-Tate.

tems, high-speed block transfers are extremely important for ensuring adequate performance (e.g., consider the amount of data that must be transferred to refresh a screen displaying a 1024- by 768-pixel CAD model).

The Vectra 486 designers claim that the host bus will be able to support sustained block transfer rates of 25 megabytes per second, a performance figure in the class of the graphics engine used in Sun's SPARCStation. In addition, because the host bus is 32 bits wide, high-performance color boards and three-dimensional accelerators are sure to be offered as options instead of the VGA video controller.

### The EISA Bus

And then there's the EISA bus. As mentioned earlier, the Vectra 486 includes eight EISA slots that use the double-row EISA connector, allowing both AT-type (ISA) and EISA-type adapter cards to be plugged into the bus. Unfortunately, there were no EISA-type cards installed in the system that I looked at. At this point, with the EISA bus still in its infancy, there are no add-in cards available that utilize the bus's performance features.

Suffice it to say, then, that the Vectra 486 does indeed have an EISA bus and that 32-bit EISA cards will become available for it within the next year. According to HP's product manager, Steve Keilen, HP will offer a high-performance EISA hard disk drive controller board within the next year. And several network vendors are working on Ethernet and other network controllers for the EISA bus.

### Mass Storage

HP will offer the Vectra 486 with a wide variety of mass storage options, including a line of hard disk drives ranging from 108 to 670 megabytes. The 330-megabyte and 670-megabyte hard disk drives are brand new and are manufac-

tured by HP. The lower-capacity hard disk drives are available with embedded ESDI controllers that plug directly into the Vectra 486 system board, saving a bus slot. However, an ESDI controller card (AT-type) is also available for running the 330- and 670-megabyte hard disk drives. The ESDI hard disk drive controller features a data transfer rate of 20 megabits per second. The hard disk drives offer an average access time of about 16 milliseconds.

The Vectra 486 system board also includes a built-in floppy disk drive and tape drive controller, which can support up to four tape drives or floppy disk drives. The controller supports 5 1/4-inch and 3 1/2-inch drive formats, including the HP-150's 710K-byte format.

### Performance

I had an opportunity to run BYTE's low-level benchmarks for 80286 machines on a Vectra 486 equipped with 4 megabytes of RAM, the 330-megabyte hard disk drive, and a standard 16-bit VGA board. The results are shown in table 1. It must be emphasized that the machine I tested was a preproduction model using an early version of the 80486 CPU and a beta version of HP's new hard disk drive. According to Archuleta, the performance of the 80486 should improve substantially in its final production version. He also said that HP's hard disk drives will run faster in the final version. And, as I mentioned earlier, I was unable to test the new high-speed VGA controller that will ship with the production version of the machine.

In any case, the Vectra 486 yielded results comparable to those of other 80486-based systems BYTE has tested. The CPU index is somewhat lower than the results for the Apricot because the Vectra does not include an external cache. But the Vectra is faster than IBM's Power Platform 486.

The hard disk and video numbers were

*continued*

**Table 1:** According to early results on BYTE's low-level benchmark tests, the new HP system's greatest strength appears to be its disk performance.

System	SYSTEM PERFORMANCE			
	CPU	FPU	Disk I/O	Video
HP Vectra 486 PC	6.0	21.6	3.4	4.5
Apricot VX FT Server	6.7	21.8	2.3	5.2
IBM Power Platform 486	5.3	21.4	1.8	4.3

Note: Indexes show relative performance. For all indexes, an 8-MHz IBM PC AT = 1. For a full description of all the benchmarks, see "Introducing the New BYTE Benchmarks," June 1988 BYTE.



# Take Our Course In C And The First Lesson You'll Learn Is In Economics.

NTSC  
or  
PAL  
Formats



"I heartily  
recommend...  
...an excellent  
bargain."  
GARY RAY  
PC WEEK

C's power, and portability make it the language of choice for software developers.

Unfortunately, learning C can be a very costly proposition. Classroom instruction is, in a word, expensive. And many C video courses carry hefty price tags.

## The top C video course at the lowest possible price

But now, there's The Complete C Video Course from Zortech. It's the ultimate C training tool for home or work. And all it costs is \$295.



You get ten videos with 36 lessons covering all levels of programming skill. A comprehensive, easy-to-follow 365 page workbook. And even a free C compiler.

## Free C compiler included

Yes, that's right. The Complete C Video Course includes our famous C compiler (it runs on any MS-DOS machine) with linker, library manager, full graphics library and on-line help. It's the choice of professional programmers everywhere for fast code, fast development and fast debugging.

```
#include <stdio.h>
#define NAMLEN 15
#define NUMMARK 4
struct person
{
    char name[NAMLEN];
    int mark[NUMMARK];
};
```

## Learn C in as little as two weeks

Speaking of speedy, with The Complete C Video Course you can learn C in only two weeks.

Compare that with the up to four months it can take to learn C in class.

Each lesson averages 17 minutes of clear, concise instructions. Used in conjunction with our workbook you'll find they provide everything you need to know to become proficient in programming in C.

## Save your company thousands

If you think The Complete C Video Course is a great way for you to save money learning C, think about how much it could save your company. Use it instead of sending programmers to school and you'll save thousands. What's more, The Complete C Video Course is even tax deductible. C is unquestionably the most valuable programming language you can master. And now you can get everything you need to become productive in it from course to compiler to tools for an economical \$295. Mail the coupon or call our hotline to receive it ASAP.

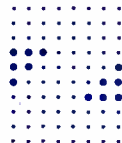

ZORTECH

## Look at all these C video pluses

- ★ Only \$295 complete.
- ★ Ten videos with 36 lessons.
- ★ Comprehensive 365-page workbook.
- ★ Free C compiler with linker, library manager, full graphics library and on-line help.
- ★ Compiler and hardware independent.
- ★ Designed to help you learn C in as little as two weeks.
- ★ Tax deductible.



Zortech Inc.  
366 Massachusetts Ave.  
Arlington, MA, 02174  
Tel: (617) 646-6703  
Fax: (617) 643-7969

- ★ Yes, rush me The Complete C Video Course including free C compiler for \$295.00 (VHS only)
- ★ Please include (No. ) extra workbooks at \$29.95 each.
- ★ I'd like to order (No. ) extra C compilers with this course at the special price of \$49.95.

Name/Company .....

Address .....

Phone .....

City .....

State ..... Zip .....

Here's my check for .....

VISA/MC# .....

Exp. Date .....

Prices do not include shipping

# The Complete C Video Course \$295

## Order Hotline (800)848-8408

Circle 389 on Reader Service Card

World Radio History

**\$69500**

**A "Plug In" 32 Bit RISC workstation with  
1024 x 768 display spells VOOM for  
PCAD™, OrCAD™, PADS-PCB™ and PROTEL™ software.**

The VectorScan RISC is the only 32 bit RISC co-processor that includes 1024 x 768 (or 768 x 544) video display system. By combining the RISC and video display on a single PC card set, access to both PCB layout structures and video display memory are free of limitations imposed by bus bandwidth or 640K DOS limits. This combination provides faster screen redraw, zoom and searches through the megabyte data structures required in PCB layout software.

DOS video compatibility is insured since the VectorScan RISC uses your EXISTING display adaptor for DOS compatible modes. On board video switches allows a single monitor to support both RISC and DOS operation. For OEM and VAR applications, Applied Data Systems can provide primitives and development tools, custom interfaces, options, and software.

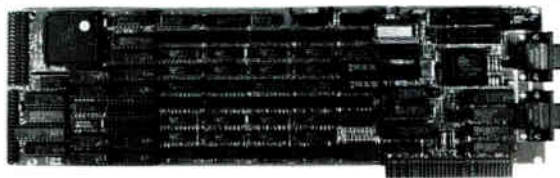

1 Megabyte, 4 Megabyte, 8 Megabyte Memory Options Available. Call for current pricing.

**Applied Data Systems, Inc.**      **OutSide USA: 301-576-0335**  
409A East Preston St.                      **FAX: 301-576-0338**  
Baltimore, MD 21202-3922 USA      **Toll Free: 800-541-2003**

PCAD is a Trademark of Personal CAD Systems, Inc.  
OrCAD is a Trademark of OrCAD Systems Corporation.  
PADs is a Trademark of CAD Software, Inc.  
PROTEL is a Tradename of Protel Technology Inc.



### COMPANY INFORMATION

**Hewlett-Packard**  
19091 Pruneridge Ave.  
Cupertino, CA 95014  
(408) 725-8900  
**Inquiry 1177.**

among the fastest of any of the 80486 systems that we've tested so far. And the video test does not reflect the performance of the high-performance video controller.

### A High-End System for High-End Applications

It's probably clear by now that the Vectra 486 is aimed at the high end of the PC market and is actually capable of replacing much-higher-priced minicomputers as a network server or multiuser host. The 32-bit EISA bus opens up possibilities for high-performance networks and hard disk drive controllers, which would make the Vectra 486 ideal for multiuser and network environments. The high-speed host bus and the new VGA controller make the machine an excellent choice as a high-performance CAD and engineering workstation.

But in spite of its promise, the Vectra 486 is a little ahead of its time. As BYTE goes to press, the 80486 is still being tested for bugs and there are no third-party EISA cards available. By the time you read this, I doubt that this situation will have changed much.

In my estimation, it will be the middle of 1990 before the 80486 and EISA are fully operational with a good base of third-party support. But HP is certainly to be congratulated for taking such a bold step with its release of the Vectra 486. With HP's reputation for reliability and strong customer support, the Vectra 486 is sure to be one of the strongest competitors in the Intel-based workstation and high-end PC markets.

At the time of this writing, HP had not finalized prices for the Vectra 486. It was willing to give an approximate price range of about \$10,000 for a system with 2 megabytes of RAM and one floppy disk drive, about \$15,000 for the same system with a 330-megabyte hard disk drive and the high-performance VGA controller, and about \$18,000 for a system with a 670-megabyte hard disk drive and the VGA controller. ■

*Nick Baran is the BYTE bureau chief in San Francisco. He can be reached on BIX as "nickbaran."*

Call us for a free AnthroCart catalog: **800-325-3841**



**ANTHRO**

**Anthro®  
Technology Furniture®**  
3221 N.W. Yeon St.  
Portland, Oregon 97210  
(503) 241-7113

*Anthro, AnthroCart and Technology Furniture are registered trademarks of Anthro*



# Breakthrough \$899 Offer—Now You Can Drive CD-ROM

Until December 31, 1989 Compact Disk Products (CDP) is packaging the just released third generation Hitachi CD-ROM drive with Microsoft's most popular CD-ROM software:

**Package A**—For \$899, includes **Microsoft Bookshelf**, a coupon to purchase both **Microsoft Stat Pack** and **Microsoft Small Business Consultant** for only \$50 each, a **FREE** copy of **CD-Play Demo** and **FREE** Federal Express delivery.\*

**Package B**—For \$1189 also includes **Microsoft Programmer's Library**

**YOU SAVE OVER \$670!**

Buy CD-ROM now! CDP sells over 200 quality CD-ROM titles for libraries, schools, legal and medical professionals, programmers, and many others. Over 25 new titles are being published each month. With IBM, NEC, and HP announcing new CD-ROM based PC's or Mini's, a CD-ROM drive is becoming as necessary as a floppy drive.

"I believe more than ever that CD-ROM products will be a major force in the expansion of the information industry." **Bill Gates.**

**CDP** is the largest specialized supplier of CD-ROM products in the U.S. Since 1987, CDP has supplied you with prompt service and expert advice... at the best prices. CDP is committed to CD-ROM and it shows. Our Unconditional Guarantee is unmatched. Our **FREE** Federal Express delivery is an industry first. Call now and tomorrow you will be driving these power CD-ROM products.

## UNCONDITIONAL GUARANTEE

- 1) If FOR ANY REASON you are unhappy with your purchase you may return it within 30 days for a FULL REFUND.
- 2) CDP will extend the Hitachi 90 day warranty period to 180 days and, during the warranty period, will ship replacement drives overnight.

**ORDER NOW! 800-MEGABYTE (634-2298)**

(Order line open M-S, 9AM-9PM EST)

Fax Orders 212-737-8289 • Inquiries/Free tech. Support 212-737-8400  
DEALER INQUIRIES WELCOME

**FREE CD-ROM:** Mail in your order and receive the CD-ROM Source Disk **FREE.** Includes demos of many popular CD-ROM products and retails for \$89.  
\*Federal Express delivery free for phone fax orders within continental U.S. only.

Please send the package I've checked below.

- Package "A"**—Complete Hitachi CD-ROM drive kit (internal or stand-alone) plus **Bookshelf** and **CD-Play Demo** (includes a coupon to purchase both **Stat Pack/Small Business Consultant** for \$50 each) for only \$899!
- Package "B"**—Complete Hitachi CD-ROM drive kit (internal or stand-alone) plus **Bookshelf**, **CD-Play Demo** and **Programmer's Library** (includes a coupon to purchase both **Stat Pack/Small Business Consultant** for \$50 each) for only \$1199!

Please send the following drive configuration with my order:

- Stand-alone Hitachi CD-ROM drive; Select  PC/XT/AT/386  
or  Microchannel (add \$100)

- Internal Hitachi CD-ROM drive (PC/XT/AT/386 Only)



**Microsoft**



**H**itachi CD-ROM drives retail (\$995): Hitachi's second generation drives, the 1503 and the 3500, captured over 60% of the market with superior functionality and reliability. The third generation 3600 model (internal or stand-alone) released in September 1989 is Hitachi's powerhouse for the 1990's. Superior speed comes from a look-ahead cache and a linear pickup head motor. Powerful standard features include 8 drive daisy chaining, slim vertical or horizontal mounting, and full audio CD capabilities (accessible with CD Play Demo).

**M**icrosoft **Bookshelf** (retail \$295): An indispensable collection of writers' references for word processor users. This is the most popular CD-ROM title published. You get instant access to: **The World Almanac, Chicago Manual of Style, Bartlett's Familiar Quotations, Roget's II: Electronic Thesaurus, American Heritage Dictionary, Business Information Sources, The U.S. Zip Code Directory, Houghton Mifflin Spell Checker and Usage Alert** and more! All Microsoft CD-ROM's are RAM resident and include powerful cut and paste features for popular word processing packages.

**M**icrosoft **Stat Pack** (retail \$125): Now you have easy access to the abundance of statistics published by the Federal Government—census data, business statistics, agricultural surveys and much more, plus Microsoft Excel and Lotus 1-2-3 spreadsheet files for all tables. A must for marketers and planners.

**M**icrosoft **Small Business Consultant** (retail \$149): The most popular publications of the Small Business Administration and Deloitte, Haskins and Sells on running a small business. Answer tax, accounting, legal, personal, AND financing questions in an instant. A gold mine for businessmen, accountants, and consultants.

**M**icrosoft **Programmer's Library** (retail \$395): All the critics are raving "... a masterpiece of simplicity and function." *PC World*, May '89. A complete library (over 20,000 pages) of the latest releases of Microsoft's Technical Reference Manuals covering OS/2, Windows MS-DOS, C, MASM, etc. with 8 megabytes of source code. Also includes **FREE CD ROM** Networking software. PC Professionals need this **NOW!**

Compact Disk Products, Inc.  
223 East 85th Street, New York, New York 10028  
(212) 737-8400

- Please send me a **FREE** CDP Encyclopedia of CD-ROM Products  
 Corporate / personal check / money order enclosed  
Charge my (circle one) American Express Optima VISA  
MasterCard Diner's Club

Acct. # \_\_\_\_\_ exp. date \_\_\_\_\_

Signature \_\_\_\_\_

Name \_\_\_\_\_

Company \_\_\_\_\_

Address \_\_\_\_\_

City/State/Zip \_\_\_\_\_

Phone \_\_\_\_\_

Prices include Federal Express shipping and handling.  
N.Y. residents add 8.75% sales tax.

Now! Get  
CD-Play Demo FREE  
Use Your CD-ROM Drive  
as an Audio CD Player!

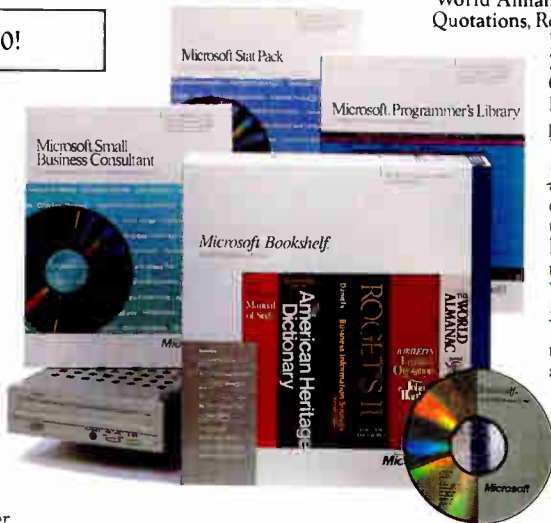

# ACCESS MICRO SYSTEMS... CUSTOM ASSEMBLED.

## THE POWER.

ACCESS--proven, powerful systems, with thousands in use today. ACCESS is the centerpiece of your computer-office management system. ACCESS reduces your workload--increases productivity.

Call CMO about the ACCESS 386/20 Tower system, rated 32% faster than the Compaq 386/16.

**800-233-8950**



**\$895**

### ACCESS 286/12

- 16-bit 80286 Main System Board Processor.
  - Dual 6 1/2 MHz switchable CPU speed.
  - 512K RAM, expands to 4MB on motherboard.
  - Eight slots: (6-16 bit, 2-8 bit).
  - Supports 80287 Math Coprocessor.
  - One parallel, serial and game port.
  - 102-key "AT" style enhanced keyboard.
  - 1.2MB Hi-density 5.25" floppy disk drive
  - Five 1/2 height drive bays.
  - Western Digital 2:1 interleave controller.
  - 220 watt high capacity power supply.
  - Desktop case with Turbo and Power LED Display, keyboard lock, hardware and Turbo switch.
  - Norton SI Rating V4.0: 15.3.
  - Industry standard Phoenix compatible BIOS.
  - One and Zero Wait State operations.
  - Clock/Calendar with Battery Back-up.
  - Monitor not included in above price.
- Also available in small footprint and Tower case.  
See chart for Video and Hard Drive Options.*



**\$1395**

### ACCESS 286/20

- 16-bit 80286 Main System Board.
  - Dual 10/20 MHz switchable CPU speed.
  - 1MB RAM, expands to 5MB on motherboard.
  - Eight slots: (6-16 bit, 2-8 bit).
  - Supports 80287 Math Coprocessor.
  - One parallel, serial and game port.
  - 102-key "AT" style enhanced keyboard.
  - 1.2MB Hi-density 5.25" floppy disk drive.
  - Five 1/2 height drive bays.
  - Western Digital 2:1 interleave controller.
  - 220 watt high capacity power supply.
  - Desktop case with Turbo and Power LED Display, keyboard lock, hardware and Turbo switch.
  - Norton SI Rating V4.0: 22.5.
  - Industry standard Phoenix compatible BIOS.
  - One and Zero Wait State operation
  - Clock/Calendar with Battery Back-up.
  - Monitor not included in above price.
- Also available in Tower case.*

See chart for Video and Hard Drive Options.

### CUSTOMIZE YOUR ACCESS 286.

Select any of the Video and Hard Drive options and allow us to CUSTOM CONFIGURE Your ACCESS 286 System.

(Add to the base price above)

	40MB-28ms	80MB-28ms	159MB-23ms
Mono	\$599.00	\$799.00	\$1399.00
EGA	\$899.00	\$1099.00	\$1699.00
VGA	\$999.00	\$1199.00	\$1799.00

ASSEMBLED • TESTED • GUARANTEED

FREE ACCESS Software Utilities Provided.

## THE FLEXIBILITY.

Your ACCESS system is custom-configured to fit your needs, your work style, and your budget. Your hand-assembled system is put through an exhaustive technical checklist and bench-tested a grueling 48-hours to insure that your system will work the first time--every time. To order call today:

**800-233-8950**



**\$1595**

### ACCESS 286/25

- 16-bit 80286 Main System Board.
  - Dual 10 2/5 MHz switchable CPU speed.
  - 1MB RAM, expands to 5MB on motherboard.
  - Eight slots:(6-16 bit, 2-8 bit).
  - Supports 80287 Math Coprocessor.
  - One parallel, serial and game port.
  - 102-key "AT" style enhanced keyboard.
  - 1.2MB Hi-density 5.25" floppy disk drive
  - Five 1/2 height drive bays.
  - Western Digital 2:1 interleave controller.
  - 220 watt high capacity power supply.
  - Desktop case with Turbo and Power LED Display, keyboard lock, hardware and Turbo switch.
  - Norton SI Rating V4.0: 31.6.
  - Industry standard Phoenix compatible BIOS.
  - One and Zero Wait State operations.
  - Clock/Calendar with Battery Back-up.
  - Monitor not included in above price.
- Also available in Tower case.  
See chart for Video and Hard Drive Options.*



Computer Mail Order. Since 1981—Low Prices, Large Selection, Fast Service.



# MONEY BACK GUARANTEE 3 YEAR WARRANTY.

## THE CONFIDENCE.

We offer what the competition doesn't—a 3-year limited warranty on parts, free technical support and computer consultant toll-free "hotlines"—where you'll receive clear answers to any **ACCESS** questions. Go ahead, give us a try:

**800-233-8950**



**\$1695**

### ACCESS 386/16

- 32-bit 80386 Main System Board.
  - Switchable 6/8/16 MHz CPU speed.
  - 1MB RAM, expands to 10MB on motherboard.
  - Eight slots: (1-32bit, 5-16 bit, 1-8 bit).
  - Supports 80387 Math Coprocessor.
  - One parallel port, serial and game port.
  - 102-key "AT" style enhanced keyboard.
  - 1.2MB Hi-density 5.25" floppy disk drive.
  - Five 1/2 height drive bays.
  - Western Digital 1:1 interleave controller.
  - 220 watt high capacity power supply.
  - Desktop case with Turbo and Power LED Display, keyboard lock, and hardware switch.
  - Norton SI Rating V4.0: 18.7.
  - Industry standard Phoenix compatible BIOS.
  - Zero Wait State operation.
  - Clock/Calendar with Battery Back-up.
  - Monitor not included in above price.
- Also available in Tower case.*  
See chart for Video and Hard Drive Options.



**\$1995**

### ACCESS 386/20

- 32-bit 80386 Main System Board.
  - Switchable 6/8/20 MHz CPU speed.
  - 1MB RAM, expands to 10MB on motherboard.
  - Eight slots: (1-32 bit, 5-16 bit, 1-8 bit).
  - Supports 80387 Math Coprocessor.
  - One parallel, serial and game port.
  - 102-key "AT" style enhanced keyboard.
  - 1.2MB Hi-density 5.25" floppy disk drive.
  - Five 1/2 height drive bays.
  - Western Digital 1:1 interleave controller.
  - 220 watt high capacity power supply.
  - Desktop case with Turbo and Power LED Display, keyboard lock and hardware switch.
  - Norton SI Rating V4.0: 24.0.
  - Industry standard Phoenix compatible BIOS.
  - Zero Wait State operation.
  - Clock/Calendar with Battery Back-up.
  - Monitor not included in above price.
  - 32K Static Cache Memory (optional).
- Also available in Tower case.*  
See chart for Video and Hard Drive Options.

### CUSTOMIZE YOUR ACCESS 386.

Select any of the Video and Hard Drive options and allow us to CUSTOM CONFIGURE Your **ACCESS 386** System.  
(Add to the base price above)

	80MB-28ms	159MB-23ms	338MB-18ms
Mono	\$799.00	\$1399.00	\$1899.00
EGA	\$1099.00	\$1699.00	\$2199.00
VGA	\$1199.00	\$1799.00	\$2299.00

**ASSEMBLED • TESTED • GUARANTEED**  
Free **ACCESS** Software Utilities Provided.

## THE PRICE.

Check our features. Check our competition. You'll receive not only the amazing price, but a full 30-day money-back guarantee—no questions asked when you order an **ACCESS** Micro System. Call today:

**800-233-8950**



**\$3795**

### ACCESS 386/33

- 32-bit 80386 Main System Board.
  - Switchable 6/8/33 MHz CPU speed.
  - 1MB RAM expands to 16MB on motherboard.
  - Eight slots: (1-32 bit, 5-16 bit, 1-8 bit).
  - Supports 80387 or Weitek Math Coprocessor.
  - One parallel, serial and game port.
  - 102-key "AT" style enhanced keyboard.
  - 1.2MB Hi-density 5.25" floppy disk drive.
  - Five 1/2 height drive bays.
  - Western Digital 1:1 interleave controller.
  - 220 watt high capacity power supply.
  - Desktop case with Turbo and Power LED Display, keyboard/lock and hardware switch.
  - Norton SI Rating V4.0: 40.1.
  - Industry standard Phoenix compatible BIOS.
  - Zero Wait State operation.
  - Clock/Calendar with Battery Back-up.
  - Monitor not included in above price.
- Also available in Tower Case.*  
See chart for Video and Hard Drive Options.



Computer Mail Order. Since 1981—Low Prices, Large Selection, Fast Service.

Circle 80 on Reader Service Card

A111

# CMO And Access Micro Systems

## Power System Or File Server



**ACCESS TURBO XT/10**

- 8-bit 8088 Main System Board.
  - Dual 4.77/10 MHz switchable CPU speed.
  - 512KB RAM, expands to 640KB on motherboard.
  - Eight 8-bit slots.
  - Supports 8087-10 Math Coprocessor.
  - One parallel port, serial port and game port.
  - 102-key "AT" style enhanced keyboard.
  - 360KB 5.25" floppy disk drive.
  - Four 1/2 height drive bays.
  - Dual floppy controller, supports 720K format.
  - 150 watt high capacity power supply.
  - Desktop case with Turbo and Power LED Display, keyboard lock, hardware and Turbo switch.
  - IBM XT compatible EROS BIOS.
  - Clock/Calendar with Battery Back-up.
  - Monitor not included.
- Low profile case available.*

30 Day Money Back Guarantee  
1 Year Limited Warranty.

**\$539**

See chart below for Video and Hard Drive Options for ACCESS Turbo XT/10 (Add to Purchase Price)

	1 Floppy	20MB-65m	40MB-28ms
Mono	\$139.00	\$409.00	\$589.00
CGA	\$339.00	\$599.00	\$779.00
EGA	\$499.00	\$769.00	\$959.00

### The Workstation

In addition to operating as a stand alone computer system, the **ACCESS Turbo XT/10** is an ideal solution for your multi-user applications. The **ACCESS Turbo** can be configured as a Workstation on the Novell, 3Com, Unix and Xenix environments. Call TOLL FREE **800-233-8950** and talk with our trained and authorized sales and support staff. Look at our Networking section for a sample of products offered in the Novell Networking Arena.



### ACCESS 386/20 TOWER

- 32-bit 80386 Main System Board.
- Dual 8/20 MHz switchable CPU speed.
- 1MB 32-bit DRAM subsystem.
- System memory expandable to 9MB.
- Eight slots: Two 32-Bit, Five 16-Bit, One 8-Bit.
- 8MHz bus clock, wait state selectable.
- Supports 80387 Math Coprocessor.
- One parallel port and two serial ports.
- 102-key "AT" style enhanced keyboard.
- 1.2MB Hi-density 5.25" floppy disk drive.
- Five 1/2 height drive bays.
- Western Digital 1:1 interleave controller.
- 200 watt high capacity power supply.
- Vertical Tower case with Turbo and Power LED Display, keyboard lock, hardware and Turbo switch.
- COMPAQ compatible, 32% faster than COMPAQ 386.
- Landmark V0.99: 26.5 - 27.3
- Norton SI Rating V4.0: 22.5
- 64K Bios, setup and diagnostic utility built-in.
- Zero Wait State Operation.
- Clock/Calendar with Battery Back-up.
- Monitor not included.

**\$2099**

See chart for Video and Hard Drive Options for ACCESS 386/20 Tower (Add To Purchase Price)

	40MB-28ms	159MB-23ms	338MB-18ms
Mono	\$599.00	\$1399.00	\$1899.00
EGA	\$899.00	\$1699.00	\$2199.00
VGA	\$999.00	\$1799.00	\$2299.00

FREE ACCESS Software Utilities Provided.

### NETWORKING

**ACCESS 386/20 Tower File Server with 2MB, 10MHz, 512K Workstations, Monochrome Displays, Arcnet Interfaces, Loaded Novell Network.**

**ASSEMBLED • TESTED • CERTIFIED**

Ready to Turn ON!

- 4-User 40MB Server ELS I...\$6,899.00
- 6-User 80MB Server ELS II...\$9,699.00
- 8-User 159MB Server ELS II...\$12,499.00

For larger systems call us. We can custom configure any size network.

Call Our Trained Networking Staff To Help You Today.

### Novell Software

- ELS 4-User Level I.....\$499.00
- ELS Level-II V2.15.....\$1,099.00
- Advanced NETWORK 286 V2.1...\$1,995.00
- SFT NETWORK 286 V2.15.....\$3,095.00

### Interface Cards

- ARCNET (8-bit) PC/XT.....\$129.00
- ARCNET (16-bit) 286/386.....\$299.00
- ARCNET MCA PS/2.....\$299.00
- Active Hub.....\$299.00
- ETHERNET (8-bit) PC/XT.....\$239.00
- ETHERNET (16-bit) 286/386.....\$289.00
- ETHERNET MCA PS/2.....\$359.00
- Standard Micro Systems.....Call

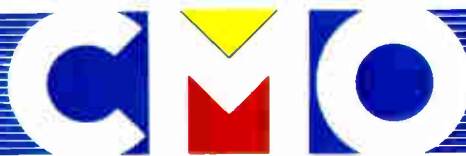

Computer Mail Order. Since 1981—Low Prices, Large Selection, Fast Service.



# ...Price and Power!

**Great  
Packages  
Ready  
To GO!**



**NO ONE HAS PROVIDED  
BETTER SERVICE  
TO MORE CUSTOMERS  
FOR AS LONG AS CMO.**

**8 YEARS  
AND STILL GROWING**

**AT CMO, GOOD SERVICE  
AND LOW PRICE  
ARE A TRADITION.**

## THE COMPANY

CMO is proud to be one of the few companies approved to represent the **ACCESS** Micro System product line. Thousands of **ACCESS** Micro Systems have been sold and they have a proven record of performance in homes and offices just like yours.

Our **ACCESS** systems utilize state-of-the-art components and are custom-assembled to fit your needs, your workstyle, and your budget. Plus all 286's and 386's come with a 3 year limited warranty.

Each and every **ACCESS** system goes through an extensive quality control checklist and is burned-in a minimum of 48 hours, assuring you trouble free performance.

Whenever you have questions or need technical support, our toll free lines put you in touch with **CMO's** knowledgeable computer consultants.

**Call  
CMO Today  
800-233-8950**

THE COLLEGIAN	THE ACCOUNTANT
<p><b>ACCESS Turbo XT/10 Computer.</b> 512K Ram installed on the Motherboard. Dual 360K 5.25" floppy disk drive. 102-key "AT" style enhanced keyboard. One parallel, serial, and game port.</p> <p><b>Epson LX-810 Printer.</b> 9-Pin, impact dot-matrix.</p> <p><b>Collegian Monitor.</b> Monochrome TTL display and adapter. 12" diagonal screen display.</p> <p><b>Collegian Software.</b> PFS: First Choice.</p> <p style="text-align: right;"><b>\$979</b></p>	<p><b>ACCESS 286/12MHz Computer.</b> 512K RAM installed on the Motherboard. 40MB Hard Disk Drive w/controller. 1.2MB 5.25" floppy disk drive. 102-key "AT" style enhanced keyboard.</p> <p><b>Epson FX-1050 Printer.</b> 264cps 136 column dot matrix.</p> <p><b>Accountant Monitor.</b> Monochrome TTL display and adapter. 12" diagonal screen display.</p> <p><b>Accountant Software.</b> Lotus 1-2-3</p> <p style="text-align: right;"><b>\$2199</b></p>
THE SECRETARY	THE PUBLISHER
<p><b>ACCESS Turbo XT/10 8088 Computer.</b> 512K RAM installed on the Motherboard. 20MB Hard Disk Drive w/controller. 360K 5.25" floppy disk drive. 102-key "AT" style enhanced keyboard.</p> <p><b>Brother HR-20</b> Daisywheel 20cps print speed.</p> <p><b>Secretary Monitor</b> Monochrome TTL display and adapter. 12" diagonal screen display.</p> <p><b>Secretary Software.</b> PFS: Write</p> <p style="text-align: right;"><b>\$1299</b></p>	<p><b>ACCESS 386/16MHz Computer.</b> 1MB RAM installed on the Motherboard. 40MB Hard Disk Drive w/controller. 1.2MB 5.25" floppy disk drive. 102-key "AT" style enhanced keyboard.</p> <p><b>Hewlett-Packard LaserJet II</b> 8 Page per minute.</p> <p><b>Publisher Monitor.</b> Monochrome VGA FlatSquare Display. 14" diagonal screen display.</p> <p><b>Publisher Software</b> PFS: First Publisher</p> <p style="text-align: right;"><b>\$4199</b></p>



*Computer Mail Order. Since 1981—Low Prices, Large Selection, Fast Service.*

Circle 81 on Reader Service Card

World Radio History

# Your Low Price Leader

## NETWORKING

**CMO HAS THE BEST SOLUTIONS TO YOUR MULTI-USER APPLICATIONS.**

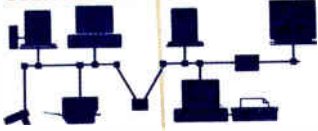

If you are looking for a Complete Solution, our trained staff of Networking Specialists can assist you in designing your multi-user system. We configure, test and provide on-going support for a full line of Networking software, hardware and connectivity products such as:

<b>Novell Netware</b>	
ELS Level-I 4-User	\$499
ELS Level-II V2.15	1099
Advanced NETWARE 286 V2.15	1999
SFT NETWARE 286 V2.15	3099
<b>Orchid</b>	
PCNet Adapter Card	339
Standard Micro Systems	
8-Bit Arcnet PC Boards	179
16-Bit Arcnet Board	399
<b>Tiara</b>	
8-Bit Arcnet Boards	129
16-Bit Arcnet Boards	299
8-Port Active Hub	299
MCA Ethernet Boards	389
<b>Thomas Conrad</b>	
8-Bit Arcnet Boards	179
16-Bit Arcnet Boards	329
16-Port Active Hub	795
<b>Tops</b>	
Tops for Dos 2.1	119
Tops for Mac	149
InBox Starter Kit	339
<b>Western Digital</b>	
EtherCard Plus	249

\*Novell trained and authorized sales and support.

Our ACCESS family of 8088, 80286, and 80386 based computers can be configured around your needs for workstations and file servers.

Ask us how to design the ACCESS 386/20 Tower around your networking and/or multi-user application.

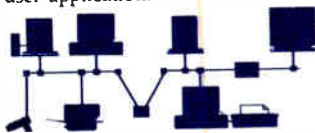

## MULTIFUNCTION

<b>AST</b>	
Six Pak Plus Board	\$129
VGA Plus Adapter	389
Rampage/286 512K	399
<b>Boca Research</b>	
Boca TopHat 128K RAM	119
BocaRam/XT 0-1MB Board	119
BocaRam/XT 0-4MB Board	149
Boca MCA Serial/Parallel	145
Boca Dual Graphics Adptr	69
Boca MultiEGA	149
<b>DCA</b>	
Irma Convertible 3	469
Irma 2 3278 Emulation	729
<b>Emerald</b>	
3XTwin Local 5251 Emulation	Call
<b>Everex</b>	
Ram 3000 Deluxe 0-3MB Bd	89
Micro Enhancer EGA	149
View Point VGA 256K	279
<b>5th Generation</b>	



**ORCHID Designer 800 VGA Adapter \$169**

Logical Connection 512K	499
<b>Headland</b>	
Vega VGA Adapter	249
FastWrite 800x600	319
V-RAM VGA Adapter	389
<b>Hercules</b>	
Graphics Card Plus	169
VGA Card	199
<b>Intel</b>	
AboveBoard Plus w/512K	429
AboveBoard Plus I/O w/512K	499
Inboard 386/PC 80386 CPU	579
Visual Edge	449
8087 PC/XT Coprocessor	89
80287-8 8MHz Coprocessor	209
80387-16 16MHz Cop.	369
<b>Orchid Technology</b>	
TinyTurbo 286	229
TinyTurbo Xtra 12MHz	279
ProDesigner VGA 256K	279
ProDesigner VGA 512K	369
<b>Renaissance</b>	
RVGAI 640x480 256K Pal	179
RVGAI 800x600 256K Pal	239
<b>Sysgen</b>	
Omni Board Controller	79

## STORAGE DEVICES

<b>Archive</b>	
Archive/XL 40MB Internal	\$339
Archive VP60 External	979
<b>Micropolis</b>	
159MB 23Msec ESDI	1299
338MB 18Msec ESDI	1899
<b>Miniscribe</b>	
8425 20MB 3½" 40Msec	249
3650 40MB 5¼" 61Msec	329
6085 70MB 5¼" 28Msec	599
<b>Mountain Computer</b>	
TD-4000 40MB Int. Tape	369
TD-8000 80MB Int. Tape	449
TD-7000 150MB Tape	1499
<b>Plus Development</b>	
20MB HardCard	519
35 40MB PassPort	579
<b>Seagate</b>	
ST-225 20MB w/cont	249
ST-238 30MB w/cont	289
ST-251-I 40MB 28ms	349
ST-177N 60MB 24Msec	589
ST-1096N 80MB 24Msec	699
<b>Sysgen</b>	
Bridge-File 5¼" External	249
Bridge-Tape 40MB External	449
Reliant Model-215 60MB	469
Reliant Model-519 72MB	499
<b>Toshiba</b>	
1.44MB 3½" Floppy Drive	99
<b>WELTEC Laptop Subsystems</b>	
360K 5¼" External Floppy	199
1.2MB 5¼" External Floppy	219

## COMPUTERS

<b>AST</b>	
Bravo 286 Model 5	888
Premium 286 Model 140X	1999
Premium 386/25 Model 5	Call
<b>Compaq</b>	
DeskPro 286 Model 1	1699
DeskPro 386/20e Mdl.-110	5999
SLT-286 Laptop 40MB	4499
<b>IBM</b>	
PS/2 Model-30/286 w/20MB	1999
PS/2 Model-50Z 30MB	2499
PS/2 Model-60 70MB	3899
<b>NEC</b>	
ProSpeed Laptop 286/386	Call
UltraLite Laptop	Call
<b>Panasonic</b>	
Business Partner 1650	599
Business Partner 1750	Call
<b>Toshiba</b>	
T1000 80C86 Laptop	639
T1200 Dual Floppy Backlit	1549
T1200 20MB Backlit	2199
T1600 20MB 286	3499
T3200 40MB 12MHz	3599
T5200 40MB 20MHz 386	4999
<b>Zenith</b>	
MiniSport 1MB Laptop	NEW
SuperSport & SuperSport 286	Call
Z-248/12MHz Model-I	1599
Z-386/16MHz Model-40	4999

## MONITORS

<b>Amdek</b>	
Video 210Plus TTL Amber	\$99
Video 410 TTL Monochrome	145
Color 732 PS/2 VGA	399
Color 632 14" VGA	379
SmartScan 735 MultiScan	489
1280 15" Hi-Res White	699
<b>Cornerstone</b>	
Single Page Monochrome	699
Dual Page PC 16 Shade	2399
<b>Magnavox</b>	
7BM623 12" TTL Amber	89
7BM749 14" Flatsquare VGA	149
CM8762 14" Comp/RGB	249
8CM515 14" RGB Analog	279
9CM053 14" HiRes EGA	339
9CM032 14" VGA Color	339
9CM080 14" MAC II Color	489
<b>Mitsubishi</b>	
XC-1410C 14" EGA Display	349
XC-1429C 14" PS/2 VGA	439
DiamondScan 13" Display	499
<b>NEC</b>	
Multisync 2A	499
Multisync 3D VGA	699
Multisync 4D 16" VGA	1299
Multisync 5D 20" VGA	2399



**WELTEC Portable 20MB Fixed Disk \$799**

<b>Packard Bell</b>	
PB-1272 12" TTL Mono	89
PB-1422EG 14" HiRes EGA	359
PB-1472 14" TTL Mono	99
PB-8541 14" VGA Display	299
<b>Polaroid</b>	
Palette Plus	2199
<b>Proxima</b>	
EGA Data Display	999
VGA Data Display	1599
<b>Taxan</b>	
KX-123 12" Amber TTL	99
<b>Wyse</b>	
Wyse-30 14" ASCII Display	329
Wyse-50 14" ASCII Display	399
Wyse-60 14" 7-page memory	349
Wyse-85 ANSI Data Display	429
<b>Zenith</b>	
ZFM-1490 14" VGA Analog	629

Call Today 800-233-8950

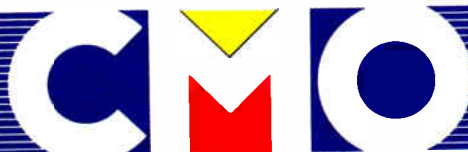

Computer Mail Order. Since 1981—Low prices, Large Selection, Fast Service.



# ...For Over 8 Years

## COMMUNICATIONS

<b>Anchor</b>	
1200 Baud External	\$ 99
2400 Baud External	159
2400 Baud Ext. w/MNP 5	269
<b>Everex</b>	
Evercom 24+ 2400 Baud Int	149
Evercom 24E+ 2400 Baud Ext	269
<b>Hayes</b>	
Personal Modem 1200	129
SmartModem 1200 Baud	275
SmartModem 2400 Baud	419
<b>Intel</b>	
2400B Classic Internal	169
PS/2 2400B Internal	249
2400EX External	199
<b>Murata</b>	
M1200 Facsimile	599
<b>Panasonic</b>	
UF-140 Panafax	799
<b>Practical Peripherals</b>	
1200 Baud Stand Alone	84
2400 Baud Internal	135
2400 Baud Stand Alone	179

## PRINTERS

<b>Alps</b>	
ASP-1000 9-Pin Dot-Matrix	\$169
Allegro 24 24-Pin Flatbed	319
P2000 9-Pin 250cps 136 Col.	699
P2100 9-Pin400 cps 136 Col.	1099
LPX-600 Laser Printer	1399
<b>Brother</b>	
M-1709 240cps, 132 Col.	369
M-1809 360cps, 80 Col.	399
M-1824L 24-Wire 80 Col.	499
HR-20 20cps Daisywheel	329
HL-8 Laser Printer	1999
<b>Epson</b>	
LX-810 200cps, 80 Col.	179
FX-850 264cps, 80 Col.	339
FX-1050 264cps, 132 Col.	Call
LQ-510 180cps, 24-Wire	329
LQ-850 330cps, 24-Wire	Call
LQ-950 254cps, 24-Wire	529
LQ-1050 330cps, 132 Col.	Call
LQ-2550 500 cps, 24-Wire	Call
<b>Hewlett Packard</b>	
Thinkjet 2225	329
Pacific 25-in-One HP Font	279
Pacific 1-2-4 HP-LJ Memory	339
<b>NEC</b>	
P2200 Pinwriter 24-Wire	359
P5200 Pinwriter 265cps	519
P5300 Pinwriter 136 Col.	669
LC-890 PostScript Laser	3295
<b>Okidata</b>	
ML-172 180cps, 80 Col.	199
ML-182 Turbo 220cps	239
ML-320 300cps, 80 Col.	359
ML-390 270cps, 24-Wire	499
ML-393 450cps 24-Wire	1049
<b>Panasonic</b>	
KX-P1180 192cps, 80 Col.	185
KX-P1191 280cps, 80 Col.	239
KX-P1524 24-Wire, 132 Col	559
SK-P4450 Laser	1399
<b>Seikosha</b>	
SP1600A1 160cps, 9-Pin	179
SK-3000A1 300cps, 136 Col.	369
<b>Star Micronics</b>	
NX-1000 II 140cps, 9-pin	169
NX-2400 24-Wire 170cps	349
<b>Toshiba</b>	
ExpressWriter 301	349
ExpressWriter 311	439

## Super Savings Special



Seiko  
CM1430 14"  
VGA Display

**\$499**

## Buyers Special



CHIION  
DS-3000 Flatbed  
Scanner **\$549**

<b>Sharp</b>	
FO-220 Facsimile Machine	699
<b>The Complete PC</b>	
Complete Fax 4800 Board	259
Complete Answering Machine	269

## I/O DEVICES

<b>Houston Instruments</b>	
9012 HiPad + 12"x12"	399
PC695 4-Pen A&B Plotter	599
<b>IMSI</b>	
IMSI Mouse	75
<b>Logitech</b>	
New Logitech Mouse M9	79
ScanMan 400DPI HiRes	189
<b>Microsoft</b>	
Serial or Bus Mouse	119
<b>MSC</b>	
PC Mouse Serial	69
<b>Seiko</b>	
DT-3503 Digitizer	379
<b>Summa Graphics</b>	
Summa Sketch + 12"x12"	389
<b>The Complete PC</b>	
Complete PC Page Scanner	579

## Hot Special



PANASONIC  
KX-P1124 24-Wire  
**\$309**

## SOFTWARE

<b>Aldus PageMaker</b>	\$469
<b>Ashton-Tate dBase IV</b>	459
<b>Ashton-Tate MultiMate II</b>	289
<b>BLOC Form Tools</b>	55
<b>Borland Paradox</b>	449
<b>Borland Quattro</b>	159
<b>Borland Turbo Pascal V5.5</b>	99
<b>Broderbund Print Shop</b>	38
<b>Central Pt. PC Tools Deluxe</b>	50
<b>Central Pt. PC-II Opt. Board</b>	119
<b>DAC-EASY Accounting</b>	60
<b>DataStorm ProComm Plus</b>	49
<b>Delrina Per: Form</b>	159
<b>5th Generation FastBack +</b>	98
<b>FoxBase + Development</b>	199
<b>Funk Sideways</b>	40
<b>Harvard Graphics V2.1</b>	289
<b>IMSI TurboCAD</b>	59
<b>Intuit Quicken</b>	33
<b>Lotus 1-2-3</b>	299
<b>MECA Managing Your Money</b>	119

## SOFTWARE

<b>Microcom CarbonCopy +</b>	\$109
<b>MicroPro WordStar 5.5</b>	239
<b>Microrim R:BASE For DOS</b>	439
<b>Microsoft Windows 286</b>	70
<b>Microsoft Quick Basic V4.5</b>	69
<b>Nantucket Clipper</b>	419
<b>Nolo Press For The Record</b>	38
<b>PaperBack VP-Planner +</b>	119
<b>Peachtree Accounting</b>	169
<b>Peter Norton Adv. Utilities</b>	80
<b>Peter Norton Commander</b>	89
<b>Quarterdeck DESQView 2.02</b>	80
<b>SPC: 1st Choice 3.0</b>	90
<b>SPC: Professional Write</b>	149
<b>SPC: 1st Publisher 2.0</b>	80
<b>Symantec Q &amp; A</b>	249
<b>Traveling Lap-Link +</b>	85
<b>Lifetree Volkswriter</b>	119
<b>WordPerfect 5.0</b>	219
<b>WordPerfect Office</b>	249
<b>Xerox Ventura Publishing</b>	485

Over 500,000 Satisfied Customers



# 800-233-8950

In Canada call: 800-233-8949

All Other Areas call: 717-327-9575 Fax call: 717-327-1217

Educational, Governmental and Corporate Organizations

Call toll-free: 1-800-221-4283

CMO, 101 Reighard Ave., Dept. A1, Williamsport, PA 17701

POLICY: Add 3% (minimum \$7.00) shipping and handling. Larger shipments may require additional charges. Personal and company checks require 3 weeks to clear. Credit cards are not charged until we ship.

Pennsylvania and Maryland residents add appropriate sales tax. All prices are U.S.A. prices and are subject to change. All items are subject to availability. We cannot guarantee compatibility. We are not responsible for typographic or photographic errors.

**MMC**  
MICROCOMPUTER  
MARKETING COUNCIL  
The Software Marketing Association



Computer Mail Order. Since 1981—Low Prices, Large Selection, Fast Service.

Circle 82 on Reader Service Card

World Radio History

A111

# Psst!

## Wanna Buy an 80486 Cheap?

Cheetah and ALR alter the price/performance ratio in the buyer's favor

**W**hen the power goes up, you expect the price to follow. It happened with the first 80286-based machines and the first 80386-based machines. But the crop of personal computers based on Intel's new 80486 CPU might buck this trend, if companies like Cheetah International and Advanced Logic Research (ALR) have their way.

Cheetah's new 25-MHz 80486 tower system comes standard with 4 megabytes of memory, a 60-megabyte hard disk drive, a VGA controller and monochrome VGA monitor, and a 1.2-megabyte 5¼-inch floppy disk drive. For this you pay \$4995.

ALR's PowerFlex Model 40 begins life as a \$1495 12-MHz 80286 system with a 40-megabyte hard disk drive and 1 megabyte of memory standard. With the addition of a \$2995 plug-in module, it becomes a \$4490 80486-based system, albeit one with a 16-bit data bus.

If these prices don't impress you, check out what similarly configured 25- and 33-MHz 80386 systems cost. You'll find that you could pay several hundred to several thousand dollars more. With the prospect of inexpensive 80486 systems, you could see significant price restructuring in some vendors' product lines—good news indeed for consumers.

### COMPANY INFORMATION

Advanced Logic Research, Inc.  
9401 Jeronimo  
Irvine, CA 92718  
(714) 581-6770  
**Inquiry 1164.**

Cheetah International, Inc.  
1003 West Cotton St.  
Longview, TX 75604  
(214) 757-3001  
**Inquiry 1165.**



# Cheetah Gold 33: An Economical Powerhouse

Michael E. Nadeau



**Photo 1:** *The Cheetah Gold 33. The image on the screen is an AutoCAD rendition of the Cheetah GPX-486 CPU board.*

My first impression of the Cheetah Gold 33 was that it is a well-engineered system that uses top-shelf components. Its designers also added thoughtful extras, such as a detachable wide plastic base and a speed-adjustable cooling fan. In short, it looked like a good \$8000 to \$10,000 system. Cheetah, however, seems perfectly happy to sell its new 25-MHz 80486 tower computer for \$4995.

This is not a "stripper" system. The price includes 4 megabytes of 1-megabyte-by-1-bit-SIMM (single in-line memory module) RAM, a 1.2-megabyte 5¼-inch TEAC floppy disk drive, a 60-megabyte Mitsubishi hard disk drive and Adaptec controller, a Trutec VGA controller, one serial and one parallel port, and a Samsung monochrome VGA monitor. You wonder how Cheetah can sell the system for so little and make a profit.

Several factors are working in Cheetah's favor. Hardware prices, most notably memory prices, have been going down recently, and Cheetah is keeping its profit margin small. The 80486 itself, with its built-in cache and math coprocessor, is actually cheaper than a 33-MHz 80386 with those options added. (See the text box "ALR's Other 80486s: the PowerCache 4 Duo" on page 112 for more information about the 80486 versus the 80386.)

## Cheap, But No Slouch

The prototype system we saw had a 106-megabyte Imprimis hard disk drive, an optional DPT SmartCache controller with 4.5 megabytes of RAM, a second 1.44-megabyte 3½-inch floppy disk drive, another serial port, a beta version of Video Seven's 1024i VGA adapter, and a Seiko CM-14 VGA monitor (see photo 1). Cheetah prices this configuration at a modest \$8495. The DPT controller dramatically improves disk I/O speed and, consequently, its overall application performance. The BYTE disk I/O index was 9.49, the fastest we've seen, but you pay a hefty premium for that speed.

Since the 80486 CPU in the Cheetah was itself a prototype, the BYTE CPU index of 6.52 should be considered tentative (see table 1). That rating is not the

*continued*

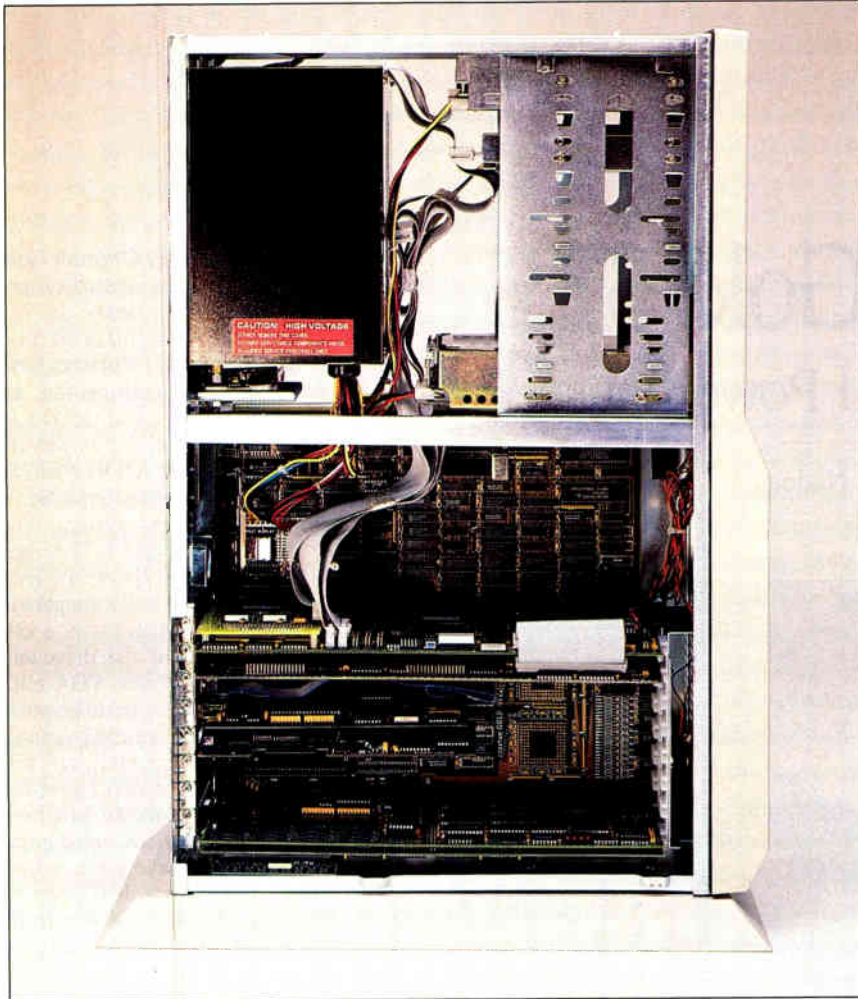

**Photo 2:** The inside of the Cheetah Gold 33 reveals a sturdy steel frame, a hefty power supply, and ample room for expansion. Note the detachable base.

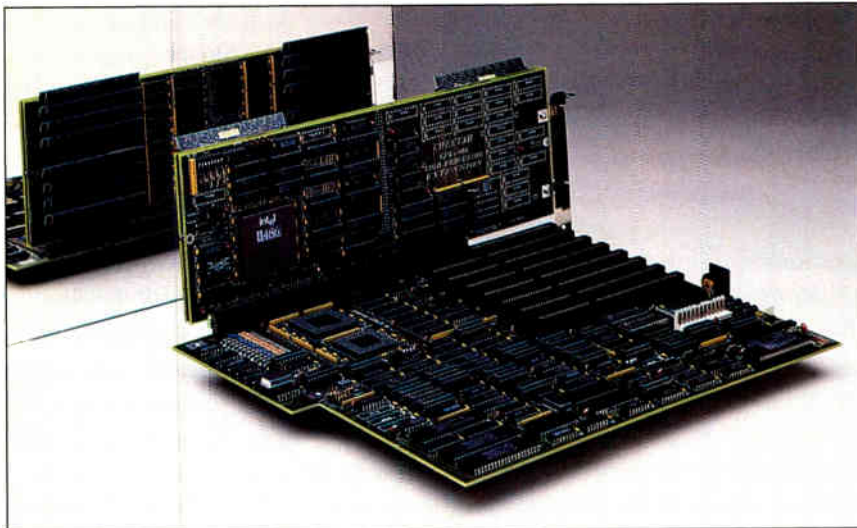

**Photo 3:** The GPX-486 CPU board, burst-memory-array memory board, and main system board. The system design supports up to 33-MHz 80386 or 80486 operation.

fastest—ALR's PowerCache 4 tower system holds that honor—but it is respectable. The BYTE FPU index of 21.49 is consistent with those of other 80486 systems we've tested, and the BYTE video index of 5.57 is very good.

We did not run the BYTE application benchmarks on the Cheetah, but judging from the low-level indexes, we estimate that it would easily beat the current champ, the SIA 386/33, which also used the DPT controller with 4.5 megabytes of RAM. The SIA's cumulative application index is 32.64.

Cheetah takes advantage of the 80486's burst mode. The burst mode keeps the 8K-byte on-board cache filled, making memory accesses faster. Cheetah chose the burst-mode route over an external cache; ALR and Apricot have used external caches in their 80486 prototypes and seem to achieve better CPU speed as a result. With 8 megabytes of system RAM, the burst mode allows for zero-wait-state operation. (For more information on the 80486's burst mode, see "The 80486: A Hardware Perspective," *IBM Special Edition*, Fall 1989.)

### Lots of Chips

The Cheetah's entire cover lifts off in cowl-like fashion, revealing all the system components and the tower's rugged frame (see photo 2). The main system board takes up the bottom half of the unit. The 80486 CPU card, which also holds all the 70-nanosecond SIMM memory—up to 16 megabytes—installs in its own 32-bit slot at the bottom of the system board (see photo 3). Eight more 16-bit slots are available for expansion, although one is for internal use only.

A 250-watt power supply and fan (the only fan in the system) reside in the upper rear corner, behind the six mass storage device bays.

The system board has a high chip count. Cheetah prefers the flexibility of designing its own discrete logic over using ready-made third-party chip sets; this allows for more experimentation while designing the system and for making mid-production changes if necessary. Cheetah also claims that using a third-party chip set would be more expensive.

Cheetah uses the Award BIOS, modified for the 80486 CPU. The BIOS is cached in memory to boost performance. A power-on self test utility in the BIOS feeds a two-character LED readout on the system board; if the system fails, the code on this LED indicates where the problem lies.

The CPU board is actually two boards

*continued*



# Image Processing for the PC AT or PS/2. Software identical in every respect.



—Fred Molinari, President



## QuickCapture gives you a choice of host platforms.

Now you can keep your options open when it comes to choosing a computer platform for image processing.

Because QuickCapture™ on the PC AT® and PS/2™ is strictly software, file, and function compatible.

Just think, applications developed on one machine can be used instantly without modification on the other.

So, add QuickCapture to your choice of platform and you've just added the industry's

most versatile frame grabber for all your scientific and commercial applications.

QuickCapture for the PC AT or PS/2. The likeness is uncanny.

	DT2953	DT2855
640x480 resolution	yes	yes
Input/Output LUTs	yes	yes
Input type	RS-170, NTSC	RS-170, NTSC
File formats	TIFF, PCX	TIFF, PCX
Compatible bus	MCA	PC AT

Call (508) 481-3700  
In Canada, call (800) 268-0427

FREE 1989  
Image Processing  
Handbook



# DATA TRANSLATION®

**World Headquarters:** Data Translation, Inc., 100 Locke Drive, Marlboro, MA 01752-1192 USA, (508) 481-3700 Tlx 951546

**United Kingdom Headquarters:** Data Translation Ltd., The Mulberry Business Park, Wokingham, Berkshire RG11 2QJ U.K. (0734) 793838 Tlx 94011914

**West Germany Headquarters:** Data Translation GmbH, Stuttgart-Strasse 64, 7120 Bietigheim-Bissingen, West Germany 07142-544925

**International Sales Offices:** Australia (2) 662-4255; Belgium (2) 466-8199; Canada (416) 625-907; China (1) 868-721x4017; Denmark (42) 274511; Finland (0) 372144; France (1)-69077802; Greece (1) 361-4300; Hong Kong (5) 448963; India (22) 23-1040; Israel (52) 545585; Italy (2) 824701; Japan (3) 502-5550, (3) 348-8301, (3) 555-1111; Korea (2) 756-9954; Netherlands (70) 99-6360; New Zealand (64) 9-545313; Norway (2) 43 12 50; Portugal (1) 545313; Singapore (65) 779762; South Africa (12) 8037680, 93; Spain (1) 455-8112; Sweden (8) 761-7820; Switzerland (4) 723-1410; Taiwan (2) 702-0405.

Data Translation is a registered trademark of Data Translation, Inc. All other trademarks and registered trademarks are the property of their respective holders.

Circle 103 on Reader Service Card  
World Radio History

sandwiched together: The GPX-486 CPU board is on one side, and the BMA (for burst-memory array) memory board is on the other. Cheetah engineered the two-board unit to minimize distance between components, providing a small performance gain. This design will become more significant as the clock speed on the 80486 increases.

An important feature of the Cheetah design is its flexibility. Installing a faster CPU or slower memory requires changing a DIP switch—adding a wait state. This allows all the various components to synchronize to the faster clock speed.

Although the Cheetah has eight slots, you have only five free once you've installed the serial/parallel I/O board, the VGA controller, and the hard disk drive controller. But for most applications, five slots will be adequate.

The case itself is a clean, attractive design, but with one potential flaw. The on/off switch is located on an extended portion on the front and is vulnerable to errant legs, feet, or other moving objects. Cheetah said that the switch design is not final and might be changed in the production version.

#### Power to the Proletariat?

The high end of the Intel-based personal computers have served mainly the most power-hungry users: engineers and architects using CAD, financial analysts, software developers, and so on. But Cheetah has priced its state-of-the-art screamer within reach of small-business users.

Small-business folk generally don't need 80486 power; given the software that they tend to use and their applications, small businesses won't see enough productivity gain to justify buying the top of the line. But once the Cheetah and other low-priced 80486 systems become available, developers might see an opportunity for more powerful software on the low end of the application scale. In short, consumer acceptance of a low-cost high-end system would raise the lowest common denominator for basic computer applications software.

Oddly enough, the low price might be Cheetah's biggest problem. The concept of "perceived value" comes into play; potential customers might think that it isn't as good as Brand X's personal computer because it costs less. Judging from what we've seen, that would be an unfortunate assumption.

*Michael E. Nadeau is BYTE's associate managing editor for reviews. He can be reached on BIX as "miken."*

# PowerFlex: A Versatile, Upgradable AT Clone

Frank Hayes



**Photo 4:** The ALR PowerFlex Model 40. This low-cost system features a clean design and an easy upgrade path.



The PowerFlex Model 40 is an IBM AT compatible that uses a 12.5-MHz 80286 CPU—hardly big news in a world glutted with AT clones. What's news is that you can upgrade this inexpensive system to either a 16-MHz 80386SX or a 25-MHz 80486. With prices starting at \$1495 and running up to about \$4500 for an 80486 system, the PowerFlex is the most versatile system on the market.

The entry-level version of the PowerFlex is a standard small-footprint AT clone (see photo 4). It comes with 1 megabyte of RAM standard, upgradable to 5 megabytes on the motherboard and a maximum of 16 megabytes using memory boards. The Model 40 also has a socket on the motherboard for an 8-MHz 80287 math coprocessor, and it has built-in parallel and serial ports and floppy and hard disk drive controllers.

The system comes with a high-density 3½-inch floppy disk drive and a 40-megabyte, 40-millisecond hard disk drive. The built-in controllers can handle a second drive of each kind—there is space for a total of four. ALR offers optional floppy disk drives (5¼- or 3½-inch) and a 150-megabyte tape backup system.

There are six expansion slots—one 8-bit and five 16-bit. You'll have to fill one with a video card, leaving five free for additional expansion.

But the PowerFlex also has a slot for plug-in processor cards. For \$395 you can get a 16-MHz 80386SX card, which includes a socket for an optional 16-MHz 80387SX math coprocessor (which costs another \$300 to \$350). Once the 80486 is available in quantity (probably by the end of this year), ALR will also offer a 25-MHz 80486 plug-in card for \$2995 (see photo 5). That's twice the price of the computer itself, but the total cost of about \$4500 will still make it one of the least-expensive 80486s on the market. If you decide to upgrade to the 80486 card from an 80386SX card, ALR will buy back the 80386SX card for the full purchase price.

### The No-Cache Catch

There is a catch, though: Being an AT clone, the PowerFlex has a standard AT-style 16-bit bus. That doesn't hurt the machine's performance with the SX upgrade, of course; the SX was always intended as a 16-bit version of the 80386. The BYTE benchmarks (see table 1) show that with the 80386SX upgrade, the PowerFlex is a reasonable, though not spectacular, performer.

However, the benchmarks also show how the narrow bus bottles up much of

**Table 1:** ALR's two PowerCache 4 models take the number 1 and number 2 spots for the fastest CPU index. The indexes for the 80286 and 80386SX versions of the ALR PowerFlex are also included. The Cheetah Gold 33's excellent disk index is courtesy of a DPT SmartCache controller with 4.5 megabytes of RAM. We've listed the Apricot, IBM, and Everex systems for comparison.

BENCHMARK RESULTS				
Computer	CPU	FPU	Disk	Video
Cheetah Gold 33	6.52	21.49	9.49	5.57
PowerFlex 486	4.18	21.85	4.54	3.80
PowerCache 4 (desktop)	7.34	21.62	2.40	5.16
PowerCache 4 (tower)	7.37	21.80	2.63	5.16
PowerFlex 286	1.59	1.85	3.26	1.35
PowerFlex 386SX	1.89	4.09	4.05	1.61
Apricot VX FT	6.72	21.95	2.66	5.40
IBM Model 70-A21/486	5.29	21.39	1.75	4.34
Everex 386/33	6.84	15.48	2.45	4.26

For a full description of all the benchmarks, see "Introducing the New BYTE Benchmarks," June 1988 BYTE.

the 80486's power. Compared to the other 80486 computers and upgrade boards we've seen, the PowerFlex with an 80486 runs the BYTE CPU benchmarks slower than any other 80486, and barely half as fast as its larger cousin, the PowerCache 4.

There are two reasons for this. First, every memory access through the PowerFlex's 16-bit bus takes twice as long as through a 32-bit bus. Second, the PowerFlex has no external cache; it depends entirely on the 80486's 8K-byte internal cache. Although the on-board cache helps performance, we've found that 80486 machines with a large external

cache simply run faster than those without, especially when working on real-world applications in which all data won't fit in the 8K-byte on-board cache.

But although it's the slowest 80486, its CPU index is still higher than those of most 25-MHz 80386 machines. FPU performance, which isn't significantly affected by cache size, is more than twice as fast as a 25-MHz 80387—and 40 percent faster than the 33-MHz version.

### Plug and Play

The PowerFlex CPU upgrades are, for the most part, remarkably simple to in-

*continued*

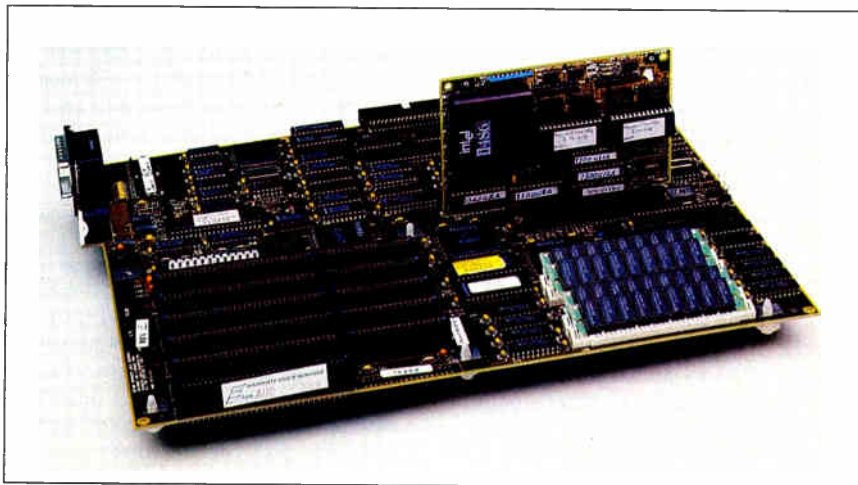

**Photo 5:** The PowerFlex 80486 CPU upgrade module, installed on the motherboard. The hardest part of installing this card is removing the 80287 math coprocessor, if necessary.

## ALR's Other 80486s: the PowerCache 4 Duo



The 80486 screamers are beginning to pile up. First, IBM showed its Power Platform upgrade for the Model 70-A21. Then British computer maker Apricot demonstrated an 80486-based machine with prices starting at around \$18,000. Now, we've seen Advanced Logic Research's first entries in the sweepstakes, the PowerCache 4 line—a set of speedy number-crunchers that start at \$9990.

From the outside, there's nothing but a nameplate to indicate anything unconventional about ALR's PowerCache 4 machines. The PowerCache 4 Model 130 is a small-footprint desktop machine with PS/2 styling; Models 150, 340H, and 650H are larger, tower-style versions (see photo). Inside, all the PowerCache 4 models use a 25-MHz 80486 CPU with a 128K-byte external cache and 2 megabytes of RAM, six Micro Channel architecture expansion slots, and the usual collection of built-in ports and controllers.

The six MCA expansion slots consist of two 32-bit slots and four 16-bit slots. Two of the 16-bit slots are taken up by a VGA video card (640- by 480-pixel

graphics in 16 colors) and a disk drive controller card; the rest of the slots are free. On the motherboard are ports for a printer, a mouse, a keyboard, and one serial device (e.g., a modem or a graphics tablet).

ALR's proprietary memory-expansion slot lets you expand the system RAM to 32 megabytes. All versions of the PowerCache 4 come with a 1.44-megabyte 3½-inch floppy disk drive. The Model 130 includes a 130-megabyte SCSI hard disk drive with an 18-millisecond access time and a 32K-byte disk cache. There's room for as many as three removable-media drives, and a total of four bays for floppy and hard disk drives.

The tower versions have room for larger hard disk drives: a 150-megabyte, 18-ms ESDI drive (Model 150), or a 340- or 650-megabyte, 16-ms drive with a 15-MHz ESDI disk drive controller (Models 340H and 650H). Like the desktop version, these all come with a 32K-byte disk cache. Tower models have a total of five bays for one full-height, two half-height, and two 3½-inch drives. In short, these PowerCache

4 models look like conventional IBM PS/2 clones until you run software and the 80486 CPU starts working its magic.

### When the Magic Begins

That magic showed up when we ran the BYTE benchmarks. The PowerCache 4 tower models ran the CPU benchmarks with an index of 7.37, while the desktop version ran with a CPU index of 7.34.

That makes them the fastest PC-compatible computers we've ever clocked—about 10 percent faster than any other 80486-based machine, and 7 percent faster than the previous speed champ, Everex's 33-MHz 80386 machine. As we've seen in the past, the 80486 difference is even more dramatic with floating-point benchmarks. The tower version achieves an index of 21.80 on the FPU tests, while the desktop version has an FPU index of 21.62. That's more than 35 percent faster than any 33-MHz 80387 we've seen.

How does the PowerCache do it? Like the 80486-based Apricot VX FT, the PowerCache gets its speed advantage from a large external cache—something



that, six months ago, neither Intel nor computer makers thought they'd need with the 80486. Here's why: The 80486 has an 8K-byte on-chip cache that, Intel says, can handle 85 percent to 90 percent of normal memory reads.

Software typically accesses memory on an 85/15 basis—that is, 85 percent of memory accesses involve reading the contents of memory, and only 15 percent involve writing to memory. Most memory accesses are reads. But if the 80486's on-chip cache handles most of the reads, the percentages break down differently. Out of every 100 software memory accesses, about 13 will be memory reads, 15 will be memory writes, and the other 72 will be handled by the on-chip cache.

In other words, with the 80486, there are far fewer actual memory accesses, and reads and writes are much more balanced. Intel originally thought that would make an external cache unnecessary, but designers are finding that an external cache can give 80486 performance a significant boost. However, they're also finding that the more balanced read/write ratio changes the rules for designing an efficient cache. ALR's solution is a "write-back" cache that uses a pair of custom cache-controller chips working in parallel and 128K bytes of 25-nanosecond static RAM.

Combining this cache design with the 80486's burst mode, the PowerCache 4 machines are fast enough to outrun everything else we've ever tested.

### Just Another Fast Clone?

At \$9990 for the desktop version with a 130-megabyte hard disk drive, the PowerCache 4 is more affordable than some 33-MHz 80386 machines, and it offers much better floating-point performance—making it a good choice for many scientific and CAD applications. And the tower versions (with a 150-megabyte hard disk drive for \$11,490; with a 340-megabyte drive for \$14,490; with a 650-megabyte drive for \$16,490) should be good choices as network servers. It's odd to describe one of the first 80486 machines as "just another (extremely) fast 80386 clone," but that's what the PowerCache 4 is: a conventional PC with a very speedy CPU inside.

It looks like ALR's commitment is to putting that speed on (or next to) lots of desktops, and that suits us just fine.

stall. The 80386SX upgrade card is about the size of a short expansion card; the slot that it plugs into is keyed and the card is notched, so it's impossible to put the card in backward. A small plastic support runs through a hole in the card, helping to hold it in place. The prototype 80486 card we saw is similar, though longer—but still much smaller than IBM's Power Platform upgrade.

The CPU cards go in and come out of the computer quickly. With the cover off, it took just seconds to convert from a plain-vanilla AT clone to an 80386SX or an 80486 semi-screamer—with just one exception.

The most complicated part of the upgrade process is installing or removing the 80287 math coprocessor, if that's necessary. The 80287 goes into a DIP socket on the motherboard. Although the socket is not completely inaccessible, the math coprocessor still requires a good eye and a steady hand to install, and a chip-puller to remove—more equipment than the CPU upgrades require. However, ALR recommends removing the 80287 if you're using an 80386SX upgrade card with an 80387SX math coprocessor installed, or with an 80486. (You can also use the 80386SX upgrade without an 80387SX and with an 80287 installed on the motherboard.)

Except for removing the 80287, swapping CPUs took about 10 seconds—less time than it took to change video cards. ALR claims that its CPU upgrades are "plug and play," and we think that's a fair description. You probably won't want to do it every day—but when you need to, it won't take long.

### The Ferrari Syndrome

These days, an AT clone isn't considered a high-performance number-cruncher. It's more like the Volkswagen Beetle of desktop computers—cheap and reliable, but not exactly a thrill machine. Adding an 80486 is like dropping a Ferrari engine into that VW—it runs faster, but it'll never be a Ferrari.

On the other hand, the PowerFlex offers the widest upgrade path that's currently available. You can start with an AT clone and—without major surgery on your computer—work your way up to a much more powerful system. The idea—an ambling AT clone that can be upgraded to a rocket-on-a-desktop—may be crazy. But it's the kind of craziness we like to see. ■

Frank Hayes is *BYTE's* West Coast news editor. He can be reached on BIX as "frankhayes."

**ATTENTION!**  
DEALERS/VOLUME BUYERS  
SAVE \$\$\$

**IBM**

PS/2 Model 30-021	1539
PS/2 Model 30-286	1789
PS/2 Model 50-031	2149
PS/2 Model 60-041	3049
PS/2 Model 70-E61	3369
PS/2 Model 80-041	3979

**Apple**

MAC PLUS	1239
MAC SE/30 1 F/D	2989
MAC II 40 MB	3949
IMAGEWRITER II	429
LASERWRITER II NT	3489
LASERWRITER II NTX	4689

**COMPAQ**

DESKPRO 286E Model I	1759
DESKPRO 286E Model 40	2339
DESKPRO 386/20E Mod I	3569
DESKPRO 386/20E Mod 110	5669
PORT SLT/286 Model 20	3629
PORT SLT/286 Model 40	3789

**hp HEWLETT  
PACKARD**

LASERJET II W/TONER	1599
LASERJET IID W/TONER	2669
DESKJET PLUS	679
SCANJET	979
HP 7475A PLOTTER	1289
HP 7550A PLOTTER	2779

## SOFTWARE

PAGEMAKER /IBM	449
PAGEMAKER /MAC	349
LOTUS 1-2-3	289
LOTUS SYMPHONY	399
MICROSOFT "EXCEL"	199
MICROSOFT "WORD"	199

## MEDIA PRODUCTS

## Branded Diskettes

BASF	5.25" DS/DD 10/BDX	4.59
3M	5.25" DS/DD 10/BDX	5.49
MAXELL	5.25" DS/DD 10/BDX	5.29
DYSAN	5.25" DS/DD 10/BOX	6.29
VERBATIM	5.25" DS/DD 10/BOX	5.29
PRECISION	5.25" DS/DD 10/BOX	3.29

(Call for other products)

AST • CALCOMP • CANON •  
DEC • OKIDATA • EPSON •  
NCR • TOSHIBA • INTEL •  
NEC • NOVELL • ZENITH  
STAR • SEAGATE • PANASONIC  
(Call for lowest prices!!!)  
QUANTITY DISCOUNT AVAILABLE



**STARTECH** International  
Division of HMB Trading Group

8604 Samantha Lane  
Spring Valley, California 92077 USA  
TEL FAX TLX

619-466-9110

619-466-9932

415779

# OMRON



Le Mans. Twenty-four hours at speeds over 125 mile. Conditions that leave no room for hesitation. Our error. Where the only certainty is risk.

Your OEM-VAR business faces the same competition each and every day. Where one bad decision could mean a critical setback.

Choose Omron and put your worries to rest. We can supply high-quality OEM-VAR components, with service to match. Because your success puts us in the winner's circle.

Contact us for information on how you can become an OEM-VAR of Omron products.



## WINNING TECHNOLOGY

### OMRON'S UNIX WORKSTATION SETS THE STANDARD

#### ■ The LUNA Unix Workstation

Compact desktop size. 68030 CPU. Processing speed 4 MIPS. Incorporates UNIX components such as 4.3 BSD. 16 MB Max. of main memory plus 250 MB Max. built-in disk. Choice of built-in streamer or optional 3.5 inch floppy disk. Basic unit with the above standard features only \$5950 (OEM price).

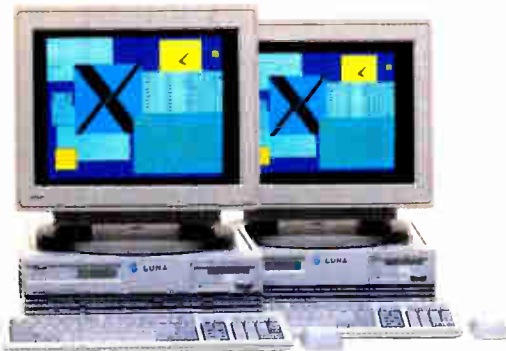

Contact us at:

**OMRON ADVANCED SYSTEMS, INC.**  
10201 Torre Ave. 330, Cupertino, CA 95014 U.S.A.  
Tel: (408) 996-3088

### ADVANCED OFFICE AUTOMATION PERIPHERALS

#### ■ HAND-HELD COLOR IMAGE SCANNER

Wide-format means quality images in one scan. Shading controller for consistent illuminance and presentation quality.



#### ■ HAND-HELD REAL HALFTONE IMAGE SCANNER

Wide-format unit with accurate 8 bit grey scale. Upto 800 DPI scaled output for presentation quality.



#### ■ FULL-PAGE IMAGE SCANNER

Easy full-page scanning in a compact, desktop unit. Accurate red tones. User-selectable resolution.



#### ■ DIGITIZER

Innovative pressure-sensitive ink system ensures fast solid-line input and excellent resolution.



#### ■ INTELLIGENT MODEMS

Choose from a product line-up that ranges from a compact 1200 bps unit to a 2400 bps model meeting MNP specifications.



Contact us at:

**OMRON ELECTRONICS, INC.**  
One East Commerce Drive, Schaumburg, Illinois 60173 U.S.A.  
Tel: (312) 843-7900

See us at: COMDEX/Fall, Booth A236, Cashman Field Center

Circle 349 on Reader Service Card



# A PC in Your Pocket

The Poqet PC has all the power of an IBM PC—including a full-screen display—yet is as small as a videocassette

**L**ast August we featured the latest in portable machines from Zenith and Agilis. In fact, the title on the cover of that issue was “Small Wonders.” But wonders never cease. Recently, a new start-up company called Poqet Computer introduced a full-fledged equivalent of an IBM PC that is small enough to fit into your coat pocket. Despite its size, the Poqet PC includes 512K bytes of memory, a 7-inch monochrome LCD screen, and a power supply reportedly capable of powering the system for about 100 hours.

The Poqet PC's power supply is one of the most interesting parts of the system. It consists of just two ordinary AA alkaline batteries. The 100-hour battery life translates into an average power consumption of only about 60 milliwatts—a truly remarkable accomplishment, considering that the Poqet PC powers a considerable amount of memory and a fairly high-resolution LCD display.

According to Poqet's vice president of engineering, John Fairbanks, who came to Poqet from Texas Instruments' calculator design group, the major breakthrough in the design of the Poqet PC was an order-of-magnitude (10 to 1) reduction in the amount of power required to drive the display, as compared to other laptop computers (about 10 mW versus the 100 or more mW required in other laptop designs). Poqet is in the process of applying for patents on its power man-



**Photo 1:** *The Poqet PC, shown unfolded. The small nonbacklit LCD screen can display 25 rows of 80 columns and CGA-compatible graphics. The keyboard features 77 keys, with each key measuring about one-half inch square, and has an embedded numeric keypad.*

agement design and declined to disclose to us the technical details behind the design of the display power driver.

In appearance, the Poqet PC has the basic clamshell design used by most laptop systems (see photo 1). The machine folds up to about the size of a VHS tape cartridge (see photo 2). Its dimensions when folded are 0.925 by 8.75 by 4.3 inches. The price tag for the 1-pound system is about \$2000.

The nonbacklit monochrome display measures 6.8 by 2.7 inches and has a fairly flat aspect ratio. It supports 80 columns by 25 rows with 640- by 200-

pixel resolution in both CGA and MDA modes.

The machine has a 77-key keyboard with 12 function keys. The keyboard includes an embedded numeric keypad, which is accessed via a special “Poqet” function key. The keys are about one-half inch square and have a springy tactile response.

Inside is an Intel 80C88 microprocessor running at a clock speed of 7 MHz (40 percent faster than that of the original IBM PC). The BIOS and processor-support chip sets were custom-designed by

*continued*

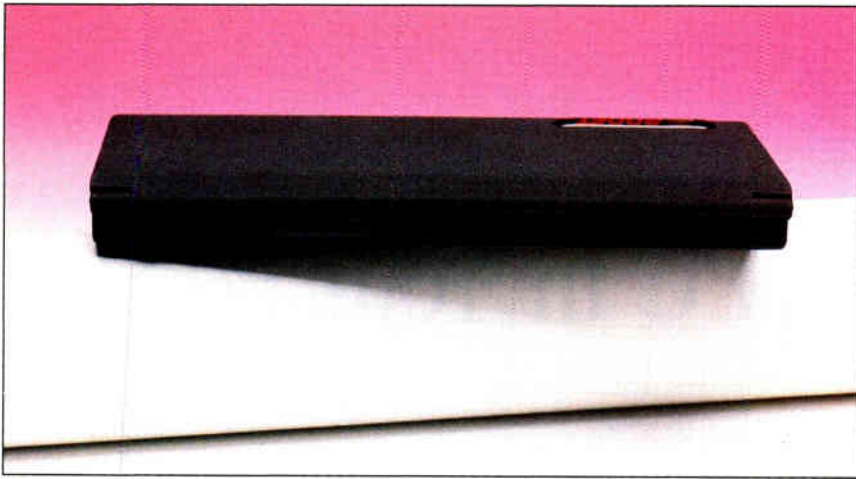

**Photo 2:** Rear view of the Poquet PC, folded for traveling. When folded, it's about the size of a videocassette.

#### COMPANY INFORMATION

Poquet Computer Corp.  
650 North Mary Ave.  
Sunnyvale, CA 94086  
(408) 737-8100  
Inquiry 1163.

Poquet. The Poquet PC uses credit-card-size memory cards as its storage medium and comes with 640K bytes of ROM and 512K bytes of RAM. The ROM is one of the key features of the Poquet PC, because it includes MS-DOS 3.3, GWBASIC, and a set of simple software applications developed in-house by Poquet.

These ROM-resident applications include a calculator, a simple text editor, a scheduler with calendar and alarm functions, a communications program for accessing data by modem, an address book, and a file manager and file transfer program. Because this software is all in ROM, it runs at the speed of the memory bus (there is no performance loss due to disk access). You can access the built-in applications via a hot-key sequence, which activates a pop-up menu.

Memory cards are the primary storage medium for the machine. The machine has two slots for sliding in cards, providing the equivalent of two floppy disk drives, with memory capacities ranging from 32K to 512K bytes. The memory cards come in two versions—RAM cards for storing data, and ROM cards for running software applications.

An important feature of the system is that software applications supplied on ROM cards will execute directly from the ROM cards. Conventional PCs load the applications from disk into RAM, but the Poquet PC leaves most of its 512K bytes of RAM available for data storage.

There are a couple of problems with these memory cards, however. The biggest problem is the price. The RAM cards cost about \$1 per 1000 bytes of storage capacity, making a 512K-byte card cost over \$500 (lower-capacity cards actually cost closer to \$1.50 per 1000 bytes). Software applications written for Poquet's ROM cards will also be expensive. ROM cards will be sold to software developers in volume for about \$50 apiece. According to Bob Gerwer, Poquet's vice president of sales, ROM-executable applications will cost about

**T**he Poquet PC's power supply is one of the most interesting parts of the system. It consists of just two ordinary AA alkaline batteries.

15 percent more than their floppy disk equivalents.

Another hitch is that software developers must rewrite their applications to run on the ROM cards. Although you will be able to run standard DOS applications off RAM cards, which load the code into the Poquet PC's RAM, you won't get the performance and memory-saving benefits of ROM-executable software.

However, Poquet's chief software engineer, Ian Cullimore, told me that third-party software vendors are enthusiastic about porting their applications to the Poquet PC. He also said that applications written with "modern C compilers" or in assembly language are easy to port, requiring "basically a recompilation." An inside source at Lotus Development confirmed that Lotus "has been working very closely with Poquet." One advantage to ROM-card applications from the point of view of software developers is that they are automatically copy-protected (you can't run a program that has been copied from ROM into regular memory).

The Poquet PC includes an 80-pin XT-bus card connector and comes with a special cable for connecting the connector to another PC or peripheral. The bus connector can attain RS-232C serial communications at up to 19,200 bits per second. The special cable has a Y connector at one end, with both DB-9 and DB-25 serial port connectors.

The Poquet PC's \$2000 price includes the 640K bytes of ROM, the 512K bytes of RAM, the special bus and peripheral connector cable, and the built-in DOS, GWBASIC, and ROM-resident desktop applications. For an additional \$395, Poquet is offering an external, battery-powered 1.44-megabyte 3½-inch floppy disk drive, with a battery life of about 20 hours.

Poquet is working on a memory-card reader that will plug into PC compatibles so that data can be copied directly onto the memory card from the host machine. The memory-card reader was scheduled to be available shortly after the Poquet PC began shipping in September and will cost a "few hundred dollars," according to Bob Gerwer.

The Poquet's memory is powered all the time to conserve data. Much of the system, however, stays in "sleep mode." According to Poquet, its special BIOS puts most of the system to sleep between keystrokes. The screen stays powered and the user doesn't notice anything unusual, but the CPU is put to rest until the next key is pressed. The only really active circuit is the keyboard scanner. After 2 minutes of inactivity, the display is



powered down as well. A red key labeled "I/O" powers up the microprocessor and display when you want to use the computer again.

The screen has a set of visual indicators at the bottom, which include a low-battery warning indicator, as well as memory-card access, alarm clock, and function-key indicators. The system also includes a capacitor that keeps the system powered up for about 5 or 10 minutes while you change batteries. The memory cards have their own lithium backup batteries, which have a life expectancy of one to two years.

I had a chance to work with a prototype version of the Poqet PC. The screen on the unit that I tried was readable but suffered from lack of contrast. This should be improved on the final production unit by a tighter-fitting screen overlay. The keyboard was remarkably easy to use considering the size of the machine. Not all the built-in ROM applications were working in the unit that I tried, but a version of Lotus 1-2-3 ran normally. (In the near future, BYTE will follow up this article with a full review of a production version of the system.)

This machine has enormous potential for business travelers and others needing computing power on the road, in the field, or in the classroom. Basically, the Poqet PC brings the power and capabilities of a personal computer into the realm of pocket calculators. Indeed, the design of the Poqet PC is the result of a joint design effort involving specialists in consumer electronics, semiconductor packaging, and computer systems design.

Having worked with only a prototype, I find it difficult to pass judgment on the Poqet PC's reliability and performance. The high cost of memory cards, the machine's primary storage medium, is certainly a drawback. But this machine breaks new ground in portability and power consumption. And, as volume increases, memory-card prices will drop.

The Poqet PC could be a smashing success. This is, after all, a consumer electronics product. As with other breakthrough products, however, the keys to success are the degree of consumer acceptance and the time it takes to gain that acceptance. Although \$2000 seems a fair price for the Poqet PC, it may not be cheap enough to attract large sales volumes. But we wish Poqet the best of luck. The Poqet PC is certainly the result of some brilliant engineering. ■

Nick Baran is the BYTE bureau chief in San Francisco. He can be reached on BIX as "nickbaran."

# Oh, No!! They squashed the monitor!

*"It's the first laptop with a screen as readable as a CRT. . ."*

**SPECIAL  
Introductory Price  
\$3995**

*Viewable from  
all angles.*

- Fast 80286 CPU
- Upgradable to 80386
- Fast 40MB Hard Disk

*Revolutionary technology – less than an inch thick, yet looks like a hi-res amber monitor. . .*



See us at COMDEX Booth 539 at Bally's



Exclusive Sales Agent

**WisComp Computers, Inc.** 414 - 652 - 5477  
2604 Washington Rd. 414 - 694 - 5477  
Kenosha, WI. 800 - 438 - 5477  
53140-2375 (Fax) 414 - 694 - 2441

## THE EASY WAY TO SHARE PRINTERS, PLOTTERS AND MODEMS

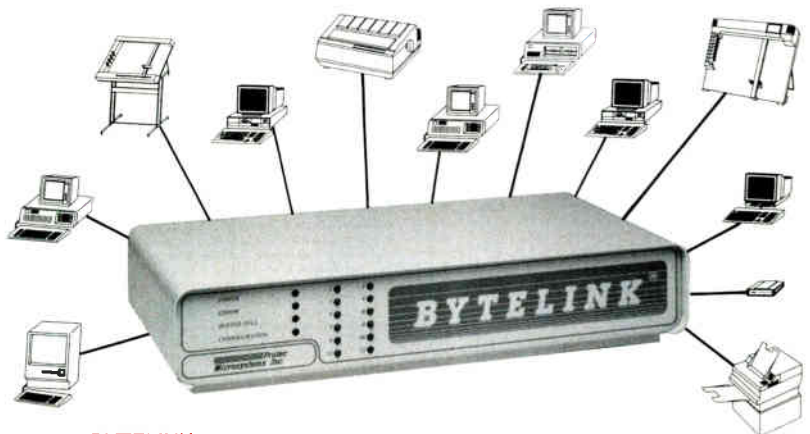

### BYTELINK

- 12 ports • 4 convenient port configurations
- (12 parallel, 8 parallel and 4 serial, 4 parallel and 8 serial, or 12 serial)
- 256K, 512K, 1M or 2M buffer

### BYTEWAY 1000 PLUS

- 8 ports • 3 convenient port configurations
- (8 parallel, 4 parallel and 4 serial, or 8 serial)
- 256K, 512K or 1M buffer

### BYTEWAY 1000

- 4 ports • 2 convenient port configurations
- (4 parallel or 4 serial)
- 256K, 512K or 1M buffer

- All parallel ports configurable "input" or "output"
- All serial ports bi-directional
- Easy to follow configuration software
- Pop-up menu for user commands

**Call (800) 777-5568  
Today!**

**FAX (512) 323-5584**



**Mag-Rabbit**

See us at  
**COMDEX/Fall Booth H7065**



## If work is hell, here's one personal computer built

The temperature of hell, according to experts, is about 117° Fahrenheit.

With no air conditioning. Or coffee breaks.

That kind of work environment might seriously upset some personal computers.

But not a Tatung.

Because before we ship any Tatung computer, Tatung engineers actually roast, test and run every Tatung computer board at 117° Fahrenheit for 72 hours.

If it doesn't survive, it's not a Tatung.

You don't have to work in hell, of course, to appreciate the superior performance of Tatung computers. Let's say you just want to work faster.

Our new Tatung 386SX personal computer introduces a fast 386-class machine that runs all of the latest 386-based applications.

At a 286-class price.  
And because Tatung

The Tatung 386SX  
It's hot

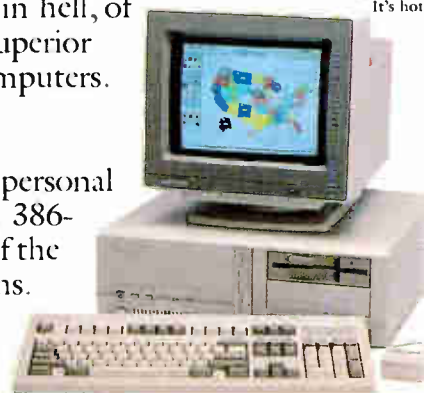





Novell and SCO certified for file server and multi-user UNIX server applications.

## to take it.

engineers didn't simply wire a new 386 processor onto an old 286 motherboard, you'll find the Tatung 386SX design significantly improves total system performance.

Plus you'll like the many extra 386SX features, like a *flexible* memory-mapping architecture that's user-selectable. So you don't have to add extra RAM just to run your favorite spreadsheet or O/S.

The point is, whether your priority is exceptional reliability or uncommon

performance, your first choice in computers is Tatung.

For complete information call, toll-free, 24 hours: 1 (800) 765-2345. Tatung Company of America, Inc., 2850 El Presidio St., Long Beach, CA 90810.

Tatung. It's hot.



**TATUNG**  
Engineering at its best.

See us at COMDEX Booth 2012.

# KAYPRO COMPUTERS

## THE PRICE LEADERS:



**KAYPRO  
KC-1**

**\$625\***

\*Base System with Single Floppy Drive, No Video

8088/10	Video Options (includes monitor & video adapter)		
	12-Inch Mono	Color Graphics CGA EGA	
Disk Drive Options			
Dual Floppies	845	1075	1345
20MB (40ms)	1100	1333	1600
30MB (40ms)	1125	1355	1625

Affordable computing power, ideal for small businesses or budget-conscious students, featuring Kaypro's rugged, reliable, reputable design.

Standard Features	KC-1	KC-2
CPU	8088 V-20	80286
Speed (MHz)	10	12
Standard RAM	640KB	640KB
Keyboard	101 Key	101 Key
Expansion Slots (16-Bit)	-	6
Expansion Slots (8-Bit)	8	2
Serial Ports	1	1
Parallel Ports	1	1
Device Bays	4	4
Power Supply	150W	150W
Operating System†	Free	Free
Warranty	1 Year	1 Year

Ask about Kaypro's full line of "Price Leaders", including the new KC-3, an 80386, 20 MHz microcomputer.



**KAYPRO  
KC-2**

**\$930\***

\*Base System with Single 1.2MB Floppy, No Video

80286/12	Video Options (includes monitor & video adapter)		
	12-Inch Mono	Color Graphics CGA EGA	
Disk Drive Options			
20MB (40ms)	1405	1640	1905
40MB (28ms)	1680	1915	2180
70MB (28ms)	1990	2220	2490

## THE PERFORMANCE LEADERS:



**KAYPRO  
286/20  
1MB RAM**

**\$3145\***

\*Base System with Single 1.2MB Floppy, No Video

80286/20	Video Options (includes monitor & video adapter)		
	12-Inch Mono	True .31 Dot Pitch VGA VGA Plus	
Disk Drive Options			
40MB (28ms)	4185	5090	5150
70MB (28ms)	4645	5550	5610
150MB (18ms)	6155	7060	7120

No-compromise computing for all those demanding business or scientific applications, featuring Kaypro's rugged, reliable, reputable design.

Standard Features	286/20	386/25
CPU	80286	80386
Speed (MHz)	20	25
Standard RAM	1MB	1MB
Keyboard	101 Key	101 Key
Expansion Slots (16-Bit)	6	4
Expansion Slots (8-Bit)	2	3
Serial Ports	1	1
Parallel Ports	1	1
Device Bays	6	6
Power Supply	200W	200W
Operating System†	Free	Free
Warranty	1 Year	1 Year

Ask about Kaypro's full line of "Performance Leaders", including the 386/33, a new 80386, 33 MHz microcomputer.



**KAYPRO  
386/25  
32KB CACHE  
MEMORY**

**\$4170\***

\*Base System with Single 1.2MB Floppy, No Video

80386/25	Video Options (includes monitor & video adapter)		
	12-Inch Mono	True .31 Dot Pitch VGA VGA Plus	
Disk Drive Options			
40MB (28ms)	5205	6115	6175
70MB (28ms)	5665	6575	6635
150MB (18ms)	6995	7895	7955

**30-Day Money-Back Guarantee**

**CALL TOLL-FREE**

**1-800-289-9899**

**FAX: 619-481-4369**

**Phone: 619-481-4302**

**Hours:** Mon - Fri, 8:00 am - 4:30 pm PDT  
**Payment:** MasterCard, Visa, or Cashier's Check preferred. Terms available on approved credit.

**Shipping and Handling:** Within USA, 3% minimum for UPS Ground. Call for shipping charges with alternate carriers.  
**Sales Tax:** California residents, add 7%.

**KAYPRO  
COMPUTERS**

533 Stevens Avenue  
Solana Beach, CA 92075  
**Dealer & Corporate Inquiries Welcome**

† Kaypro computers receive Digital Research DR-DOS 3.41, an MS-DOS-compatible operating system that runs up to 25% faster. Prices, terms, & specifications subject to change without notice.

Circle 193 on Reader Service Card (DEALERS: 194)





# THE INSTALLATION BLUES

The quest for on-line reference materials is never smooth

Long ago, I reviewed a CP/M database program called Vulcan that caused me to invent the rating “infuriatingly excellent”; meaning that the program did something I very much wanted done, but I had to fight it every step of the way. The algorithms were far better than the user interface. Incidentally, that was the first review of the program that became dBASE II. George Tate once told me he bought Vulcan (and renamed it) as a result of my review.

This month I have another program I can only call infuriatingly excellent. I don't expect it to become another dBASE II, but showing why it's infuriating may prove to be a good object lesson for program designers.

## Dictionary on a Disk

It started in Boston at the National Education and Computers Conference. There wasn't much good educational software. With few exceptions, what we saw either wasn't impressive for its educational value or wasn't well designed as software. I'm not sure why.

One thing that did impress me was a dictionary program. It ran on a hard disk, rather than a CD-ROM, and thus needed a lot of hard disk space; on the other hand, it was very fast. Better yet, it had a whole raft of dictionaries, including *Funk & Wagnall's Standard Desk Dictionary*, with all the auxiliary stuff (e.g., the *Secretary's Handbook*); a 26-language dictionary; and the McGraw-Hill science dictionaries, including computers, physics, chemistry, biology, and various engineering disciplines. All this information takes up disk space, but since I have a Priam 330-megabyte hard

disk drive, I *have* disk space.

I didn't have time to spend looking at the demonstration, but that hardly mattered, because, as I explained to them, I don't write about stuff I don't have running at Chaos Manor. They collected my card, and I went on to the next booth.

A few weeks later there arrived a dozen boxes: one for each of the dictionaries. Each proclaimed itself part of the Inductel Reference Series, and on the back cover each had in boldface type the sentence, “So easy to use, you don't have to refer to the manual.” All I need, it says on the box, is 5 megabytes of disk storage, 256K bytes of RAM, and DOS 2.0 or higher. Wonderful.

It wasn't clear whether the various special dictionaries worked alone or were add-ons to one of the main dictionary programs, but that didn't seem important. (It turns out they will work together, but each is a separate stand-alone product.) I knew where to start: I opened the Funk & Wagnall's box. Inside was a reasonably thick manual. There were also 16 5¼-inch floppy disks, which wasn't too surprising—the box did say I needed 5 megabytes of disk space—but it was a bit intimidating.

A quick look through the manual made one thing clear: they'd better be right when they claim you don't need the manual to work the programs. The first 15 pages or so are in legalese and proved to be the license agreement, one so long that I doubt anyone but me has ever read it. Underneath all the jargon, it's pretty reasonable. After pages of legalisms, there were two pages about the theory of knowledge acquisition. The manual insists on explaining inductive and deductive reasoning before it tells how to use the program. It doesn't explain why I would want to know this stuff. If the purpose was to discourage me from reading the manual, it nearly accomplished that.

Finally, way back in the manual were the installation instructions: take the first of the 16 floppy disks, put it in drive

A, log onto that, and type Install. The program would do the rest.

Install produces a couple of screens of inquiries about colors and then gets down to business. What hard disk drive do you want this installed on? I told it drive D. What floppy disk will you install it from? Since Big Cheetah has only one 5¼-inch drive, that had to be A. Then Install displays a screen with four choices: standard-density 5¼, high-density 5¼, standard-density 3½, or high-density 3½. You choose one. Looking into the manual yields this advice: “Use the cursor key to highlight the desired entry, then hit the Enter key to select it.”

Well, all right, Big Cheetah has a high-density 5¼-inch drive, so that's what I selected.

The Install program trundled for a while, in the process displaying the message, “Consult the license agreement in your user's manual to be sure you are not violating it.” I thought that a rather unfriendly thing to say, but what the heck. After a while, it told me to insert disk 2. Then disk 3. Then disk 4. When it finished disk 4, it dropped me out of the Install program and into the new D:\KAS (Knowledge Acquisition System) directory it had created. No error message. No “finished” message. There I was, with 12 disks left over.

Try again. You have to start all over, of course. The Install program is not a batch file, so you can't even get inside and inspect it. Just start over.

That worked no better than the first time.

Well, I thought, maybe it knows something I don't. Might as well install the physics dictionary. It's only six disks.

The physics dictionary package had a manual identical to the one in the Funk & Wagnall's package. Obviously the instructions for installing it were also the same: insert disk 1, log onto it, and type Install.

It asked the same questions. This time

*continued*

it wanted only two of the six disks before it dropped me out of the program and back to DOS. Curiouser and curiouser.

It was time to try the program.

**Lockup Time**

I thought I'd see what definition the physics dictionary had for the word *force*. First I had to figure out how to ask. The KAS program interface is strange. It uses terms I don't understand and isn't well explained in the manual. There are no error messages. I did what I thought was appropriate—and locked up the machine. Thoroughly. No way out but reset. Hardware reset.

I tried again. Same thing. No error messages. Just no results, and the machine hangs.

I got out the manual and tried following its instructions. Unfortunately, the example in the manual is for the 26-language dictionary, and I didn't much feel like installing that, so I had to infer what to do with the dictionaries I did have installed. It was pretty clear I was doing things right, but the program hung the machine anyway. Three more resets, and I gave up.

**Could They Have Meant . . .**

I was ready to put the program away when an idea struck me. Suppose—just suppose—when the Install program asked me about floppy disks, it didn't want me to describe my drive at all? Suppose it was asking what kind of disk I was using to install the dictionaries? Suppose it had no way of knowing that I hadn't loaded the entire 16 disks' worth? . . .

"Naaah," I thought. No one would be *that* stupid. But just in case, I got out the physics dictionary and went through the tedious Install program again. This time I told it I was installing from standard-density 5¼-inch floppy disks.

Voilà! This time it wanted all six disks. Quickly I reinstalled the chemistry and computer science programs, noting that each time it copied the access program and then what it called "the decompression code" before copying the database.

When I tested the program, the machine hung again.

Well, I thought, there is that partial Funk & Wagnall's dictionary on there; best to reinstall that, although the prospect of feeding the machine 16 floppy

disks wasn't very appealing. Still, it had to be done, so have at it.

I got out the box, put disk 1 into drive A, and began the imbecile Install program. It went along for five disks, flashed an error message about being unable to open a data file, and dropped me back into DOS. Now what?

**Try Again**

The Inductel manual says installation might fail for one of several reasons. First, you might not have enough memory. That wasn't a problem. Second, not enough disk space. That wasn't a problem either. Third, "the computer's disk head is out of alignment." I have never had any problem with my high-density drive *reading* a standard 360K-byte floppy disk. You can get into difficulties trying to write to a 360K-byte disk with a 1.2-megabyte floppy disk drive, but reading always worked before.

Finally, the manual states that if all else fails; "then chances are you have a 'marginal' or 'faulty' disk in your software package." You can return it and get an exchange. The only problem is, this

*continued*

**Elevate Your Printer Capabilities!**

**Get Laser Capability for InkJet and Dot Matrix Printers with LaserTwin™ from Metro Software**

**Also Available from Metro. Metro SuperFonts 25/1™ gives you HP's 25 cartridges on disks! Introductory Price: \$149**

If you own an ink jet (like the HP DeskJet™) or dot matrix printer, you probably have felt left behind from the laser market. With LaserTwin™ you can expand your printer's capabilities up to laser height.

LaserTwin makes your printer behave like an HP LaserJet Series II™ and even includes HP's fonts and symbol sets. Now you can also take advantage of software for the HP LaserJet like downloadable soft fonts.

Using LaserTwin, your software (including tax, forms, and graphic programs) prints at the highest resolution. And with LaserTwin's text formatting language and your word processor, you can access desktop publishing features. You can also print sideways! So you never looked better!

If you've got a mix of dot matrix, ink jet and laser printers, use LaserTwin and see the same results! Plus, LaserTwin lets you print directly from within your application and its spooler speeds up background printing.

So, rather than feeling tied to the ground with your printer, get LaserTwin and expand your horizons. Act before December 31, 1989, and buy LaserTwin at the **SPECIAL INTRODUCTORY PRICE OF \$149!** Call us today at 1-800-621-1137.

**With LaserTwin You Can Now Use All HP - Compatible Downloadable FONTS (Landscape, too!)**

**METRO METRO SOFTWARE, INC.**  
2509 N. Campbell Avenue, Suite 214  
Tucson, AZ 85719  
(602) 292-0313 Fax (602) 292-1563

LaserTwin and Metro SuperFonts 25/1 are registered trademarks of Metro Software, Inc. All other trademarks are of their respective manufacturers. Copyright © 1989



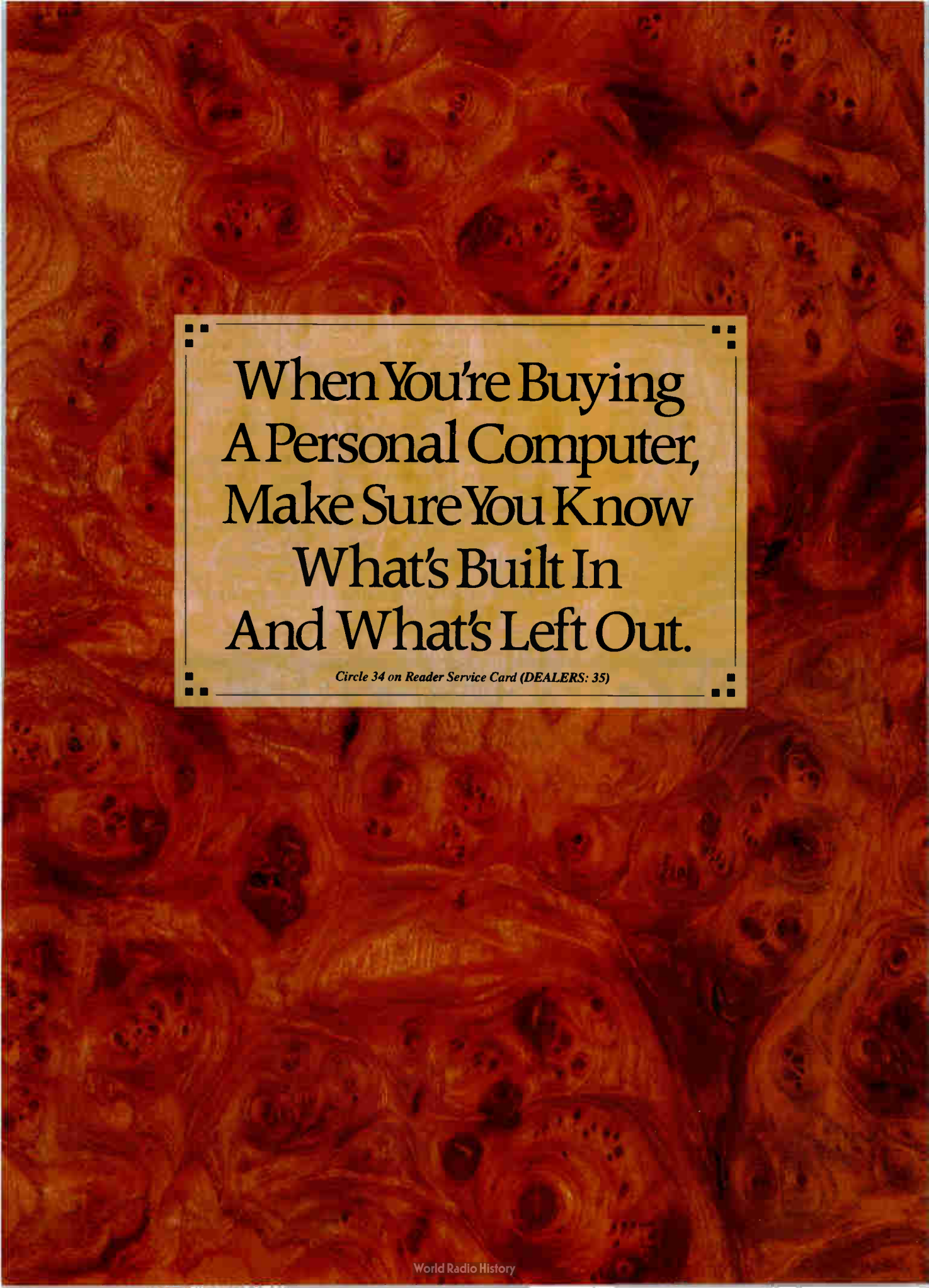

When You're Buying  
A Personal Computer,  
Make Sure You Know  
What's Built In  
And What's Left Out.

*Circle 34 on Reader Service Card (DEALERS: 35)*

column is due Monday morning and it's Saturday night.

I have a 360K-byte floppy disk drive on my Zenith Z-386. Moreover, I've got a WORM (write once, read many times) drive on both the Z-386 and Big Cheetah; I figured that if I got it all installed on the Z-386, I could make a safety copy onto the Maximum Storage WORM and then bring that WORM cartridge over to Big Cheetah and transfer the files.

It took about an hour to install all those dictionaries on the Z-386. I had a mild moment of panic: after going through the 16 disks of Funk & Wagnall's dictionary, the program very briefly flashed an error message and dropped into DOS. Of course, it also erased the error message, so I didn't know what it was; and I wasn't interested in feeding 16 floppy disks in yet one more time. This was getting as tedious as trying to install Microsoft Windows.

Fortunately, the program seemed to work. I decided this was just another imbecility of the Install program: it detects some kind of error to tell it that it's done with its job. Why not? I got out the other boxes of dictionaries. Eventually they

were all installed. By then, it was 5:00 a.m. I'd used up hours installing the thing. Now to test the program.

**Look It Up**

It works surprisingly well. Once you tell it what you want it to do, the program is very fast. The problem is telling it what to do: it has as awkward a user interface as I have ever seen. Inductel's KAS manages to make the Oxford English Dictionary on CD-ROM (see my October column) look positively user-friendly.

What you must do is use the arrow keys (there's no mouse capability) to move among menus until you select a mode of operation. Then you go down into another part of the screen to select which dictionary you want to consult. Then you input the word you want looked up. That can also be a complex job using arrow keys, but fortunately you can shorten it: you type in the word with wild-card characters, get a list of terms it understands, and use the arrow keys to select the term; or, you can just type in the term yourself.

Once that's done, the answer is almost instantaneous. This thing is *fast*.

There's also a TSR mode: load the KAS as a TSR program and then go into your favorite word processor, put the cursor on a word, and press Alt-M. You will find yourself in the KAS command system. Now select a dictionary and input your word; or, possibly, it will already have a dictionary selected. That may be the wrong one, but as long as you're in the KAS command system, you can change the "active" dictionary to another. This is important because some terms will have quite different definitions depending on whether you are looking them up in the physics, biology, Funk & Wagnall's, or 26-language dictionary.

This all works very rapidly and very well on the Z-386.

**Blowups Happen**

By now I was almost ready to forgive Inductel for their imbecile Install program. I have paper copies of many of those science dictionaries, and I use them; this looked very useful. Moreover, I sometimes have a need to look up foreign words, and the foreign-language dictionary aspect of this thing is *near*:

*continued*

# LAPTOPS \$385 FAX

TOSHIBA T1000 . . . \$635	NecUltralite 2meg. \$2289	CANON Fax 20 . . . \$949	AVATEX 110/220V . . \$625
" T1200F . . . . . \$1299	Prospeed 286/20 . \$3049	" Fax 225 . . . . . \$1545	NISSIE 320 . . . . . \$495
" T1200FB . . . . . \$1385	" 286/40 . . . . . \$3399	" Fax 270 . . . . . \$1795	" 303 . . . . . \$495
" T1200H . . . . . \$1795	" 386/40 . . . . . \$4395	" Fax 350 . . . . . \$1995	MURATA 1200 . . . \$569
" T1200HB . . . . . \$1895	Mitsubishi 286-219 \$1995	" Fax 450 . . . . . \$2349	" 1600 . . . . . \$669
" T1600 . . . . . \$3045	" 386-290 . . . . . \$2299	" Fax 630 . . . . . \$2699	" F30 . . . . . \$1399
" T3100E . . . . . \$2565	" 386-240 . . . . . \$2795	" Fax 705 . . . . . \$2999	RICOH RF800 . . . \$649
" T3200/40 . . . . . \$3299	SHARP 7241/40mb \$1999	" Fax 730 . . . . . \$3499	" Fax 15 . . . . . \$1155
" T5100 . . . . . \$4099	" 4602 . . . . . \$1445	PANASONIC	" Fax 25 . . . . . \$1295
" T5200 40 . . . . . \$4795	" 4641 . . . . . \$2295	KXF 100 . . . . . \$825	" Fax 35 . . . . . \$1545
" T5200 100 . . . . . \$5299	" 5541 . . . . . \$3599	KXF 120 . . . . . \$975	" Fax 65 . . . . . \$1595
ZENITH Z-184-10 . \$1495	PANASONIC PRINTERS	PANAFAX UF 135 . \$799	SHARP FO 220 . . \$699
" Z-184-20 . . . . . \$2129	KXP1180 . . . . . \$179	" UF 145 . . . . . \$895	" FO 300 . . . . . \$849
" Z-286-20 . . . . . \$2949	KXP1191 . . . . . \$229	" UF 250 . . . . . \$1299	" FO 330 . . . . . \$999
" Z-286-40 . . . . . \$3388	KXP1124 . . . . . \$325	" UF 260 . . . . . \$1549	" FO 550 . . . . . \$Call
" Z-384-40 . . . . . \$4799	KXP1592 . . . . . \$395	SANYO SF 100 . . \$765	" UX 350 . . . . . \$1099
COMPAQ 286-20mb \$call	LASER KXP 4450 \$1369	" SF 200 . . . . . \$929	TOSHIBA 30100 . . \$745
" 286 40 MB . . . . \$call	KXP1595 . . . . . \$425	" SF 515 . . . . . \$1145	T3300 . . . . . \$799
NEC MLTSPD HD. \$1949	KXP1524 . . . . . \$509	SHARP UX 50 . . . \$535	T3600 . . . . . \$965
" MLTSPD EL . . . . \$1499	CANON Fax 8 . . . . \$619	Remfg. UX 30 . . . \$385	T3700 . . . . . \$1099

PREPAY PRICES: VISA/MC/COD + 2.9% Restock 20% Handling Chg. 5.95 No Exchange/Returns.

T.P.C. 12603 Hoover St.  
Garden Grove, CA 92641

714/898-8262  
FAX 714/891-1202

**1-800-383-3199**



# We Built In The Speed The Others Left Out.

## Introducing The AST Premium® 386SX/16.

When we designed the AST Premium 386SX/16, we had our sights set on building the best 386SX™-based computer you could find.

Why? Because with faster processing and the ability to run 32-bit software, at a cost that's comparable to 80286 computers, 80386SX™ computers will quickly become the workhorses of the business computing world.

And that's what the AST Premium 386SX/16 is, a workhorse of the highest standards. To begin with, we've built in a high-speed memory cache, making this SX computer one of the fastest you can buy. Then, we added VGA graphics and support for EMS 4.0.

We also built in a future. The Premium 386SX/16 features AST's Cupid-32™ architecture. So, when your needs grow, your computer can grow with you. From 25 or 33 MHz 80386™ computing, all the way to i486™ processing power, with a single board swap. You don't have to buy a new computer, or lose your investment in peripherals.

### COMPARE FOR YOURSELF

Feature	AST Premium 386SX/16	COMPAQ DESKPRO® 386s	COMPAQ DESKPRO® 286e	IBM® PS/2™ Model 55
Processor				
Type	386SX	386SX	286	386SX
Speed	16 MHz	16 MHz	12 MHz	16 MHz
Available Slots	5	4	4	3
EMS Support Software Included	4.0	3.2	4.0	No
Landmark Benchmarks*	23.1	15.4	11.6	15.3
List Price** One-Floppy System	<b>\$2,695</b>	\$3,299	\$2,699	\$3,895***

\* Landmark Software version 1.1 benchmarks — a generalized index used to compare one machine to another. The higher the number, the better.

\*\* List price is MSRP.

\*\*\* List price with 30 MB hard drive; one-floppy system not available with this model.

So, if you're considering an 80286- or 80386SX-based computer from a manufacturer like Compaq® or IBM®, make sure you compare it to the AST Premium 386SX/16. After all, if your needs require a workhorse, shouldn't you buy a thoroughbred?

**AST**  
RESEARCH INC.

Circle 36 on Reader Service Card (DEALERS: 37)

when you look up a word in, say, French, it gives you the translation to not only English, but Spanish, Finnish, Esperanto, Greek, and 20 other languages simultaneously! I was actually enthusiastic as I saved this huge subdirectory off onto the WORM cartridge. It took quite a while—there are over 14 megabytes of dictionary files—but eventually it was done. I put the cartridge into Big Cheetah's WORM drive and copied the whole mess into the D:\KAS subdirectory.

The program didn't work. It said it couldn't find any database files. None. Zero. I mean, there they were, 14 megabytes' worth of them, but the program couldn't find any. Some kind of "copy protection"?

Nothing for it, then: back to Install. I selected the computer science dictionary, since it was the smallest. Put disk 1 into drive A. Answer the dumb questions. Swap disks. Get done with it, and test the program.

It worked. Try it in a DESQview window. It worked there, too. Now try it in TSR mode.

The machine hung. Time to reset.

For the next hour, I tried to get the program to work in TSR mode on Big Cheetah. I tried with and without DESQview. I tried doing things to the CONFIG.SYS file. I tried everything I could think of, each time having to fight the dumbest Install program in the free world. Then I'd try TSR mode, and the machine would hang. Finally, in desperation, I decided to reinstall the original Funk & Wagnall's dictionary, all 16 disks of it. This time I was able to get it to read them all, so the job was merely tedious.

With every disk swap came the message, "Consult the license agreement in your user's manual to be sure you are not violating it." The problem was, by then, I *wanted* to violate the license agreement. Then I wanted to find and beat senseless the person who invented that horrible Install program.

So...

The bottom line is this: the program works wonderfully on the Z-386. It works in direct command mode on Big Cheetah, including within a DESQview window; but for some reason, it will not work in TSR mode on Big Cheetah, with or without DESQview. Perhaps Big Cheetah is too fast for the program. Perhaps QEMM is interfering with it. Perhaps I haven't properly installed something. Perhaps any number of things; but frankly I am too weary of fighting that moronic Install program to care.

If you want a very large and incredibly fast set of on-line dictionaries, this program will do the job. The user interface is horrible, and the Install program is worse; it might not work in TSR mode on your machine.

But once you do have it up and running, it's little short of amazing. If they'd put the work into user convenience that they did in developing those access algorithms, they'd have a wonderful program. As I said earlier, infuriatingly excellent.

#### Bribes

The most interesting bribe I've received recently was a package containing a split of champagne, a package of pumpernickel, a jar of pâté de foie gras, cookies, and a CD-ROM of over 7000 public domain, freeware, and shareware programs, every one of them tested by the Chicago RBBS-PC. Quanta Press sells

*continued*

## ARE YOU STILL DRAWING FLOWCHARTS BY HAND?

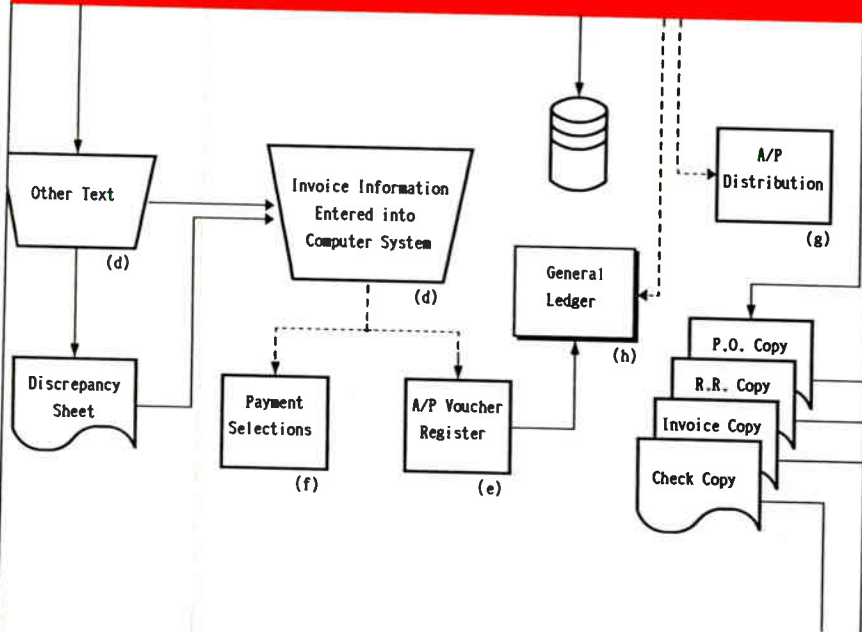

## FLOW CHARTING II+

Flow Charting II+ will *amaze* you with its speed, power and simplicity.

- Update and print charts as fast as the situation changes
- See your revisions right away—no long wait for charts to be hand drawn
- Select 26 standard shapes; 10 text fonts
- Tutorial manual makes learning easy
- Runs on IBM or compatibles
- Produces excellent organizational charts!
- Only \$229!

# PATTON & PATTON

Software Corporation

*Excellence in charting the flow of ideas*

For more information, see your local retailer or call  
 1-800-525-0082, ext. 47 (outside Calif.) 408-629-5376 (Calif./Int'l.)  
 81 Great Oaks Blvd., San Jose, CA 95119



# We Built In The 33 MHz Performance The Others Left Out.

## The Best 386/33 Available.

The fastest class of 386™ computers runs at 33 MHz. But at the head of this high-performance class of machines is the AST Premium® 386/33.

In a recent InfoWorld magazine report card, the AST Premium 386/33 overwhelmed a selection of 33 MHz computers from vendors like Compaq®.



We weren't surprised. After all, the AST Premium 386/33 offers exceptional performance in a feature-packed, stylish chassis. Features like: zero wait-state cache, support for up to 36 MB of memory, support for 80387 and Weitek 3167 coprocessors and much more.

It's too bad that InfoWorld doesn't have a category for upgradeability. With a natural upgrade path to i486™ power using AST's Cupid-32™ architecture, the AST Premium 386/33 would be sure to earn even higher marks.

That's because Cupid-32 is AST's enhancement to the Industry Standard Architecture (ISA) that allows you to upgrade to new technology without buying a new computer.

So, if your company is looking for a 33 MHz computer, why not take a lesson from InfoWorld. Go straight to the head of the class.

### REPORT CARD

### INFO WORLD

	AST Premium 386/33	COMPAQ DESKPRO® 386/33
CPU speed	Excellent	Excellent
Expandability	Excellent	Excellent
Hardware compatibility	Excellent	Excellent
Documentation	Excellent	Good
Technical support	Very Good	Unacceptable
Value	Good	Satisfactory
Final Scores	8.5	7.1

Source: InfoWorld, July 24, 1989

**AST**  
RESEARCH INC.

Circle 38 on Reader Service Card (DEALERS: 39)

this for \$149 and "guarantees" the disk to be "virus free," although what such a guarantee means I don't know.

In any event, the Quanta Press RBBS-PC in a Box CD-ROM certainly contains the shareware of the month: word processors, games, communications stuff (including programs to let you run your own BBS), databases—you name it, it's all in there. I've had more fun digging through the programs on the disk than I did eating the cookies.

### Disk Drive Blues

Back in CP/M days, we were plagued by an enormous variety of floppy disk formats. Not only were there 5¼- and 8-inch drives, but each hardware vendor had its own proprietary data format and density. Then came IBM, and whatever else you could say about the PC, at least there was some standardization of the disk formats.

Now it's a mess again: we have double- and high-density 5¼-inch formats, and

ditto for 3½-inch. There are even a few oddball variations, like the Twister format for Atari 3½-inch disks, a trick that will get a bit more on each disk, although at the cost of being unreadable to those who don't have the tricky little program.

The worst mess is in the 5¼-inch size: as I noted above, while a high-density (AT-style, 1.2 megabytes per disk) drive can read double-density floppy disks (PC and XT style, 360K bytes per disk), when you use a high-density drive to write to a 360K-byte disk, the results are unreliable. It works, in that the file is written in 360K-byte format and often can be read by the machine that wrote it; but transferability to any other machine, high- or double-density, is something else again.

The situation is similar but not quite so bad with 3½-inch disks; and there's the problem of transferring files from 5¼- to 3½-inch disks and vice versa.

One remedy is to put several floppy disk drives in the same machine. The problem with this is that while most disk drive controllers will handle all the different formats, some won't talk to more than two drives in the same machine. As a result, Chaos Manor has several machines with various types of 5¼- and 3½-inch drives, but no single machine has every type of floppy disk drive.

Thus, we can manage, but it's awkward. However, help is at hand: I just received the Northgate Universal Floppy Drive Controller (NUFDC). This board takes a separate slot from your hard disk drive controller; but once it has done that, it will run as many as four different floppy disk drives, and each one can be different; thus, we could have a machine with one of each of the four kinds of drives if we wanted to, and I may just do that. Connect that machine to the others with a network, and it won't matter what format I've got to read or write to.

The NUFDC is also capable of handling 8-inch floppy disk drives formatted as 1.2 megabytes; that takes a special cable, and I have not set that up yet, but I've no reason to assume it won't work. The manual doesn't say whether this will read the old "standard" single-sided single-density 128K-byte 8-inch disks some of us started with. I guess I don't care: when I really need an 8-inch disk read, or for that matter need files off an old CP/M weird-format 5¼-inch disk, I let Barry Workman take care of it.

The NUFDC works about as you'd expect it to. The setup is fairly tedious—I won't say complicated—but it comes with a well-illustrated booklet that shows

*continued*

# All the advantages of Ampro's Little Board/286. Now in a single slot.

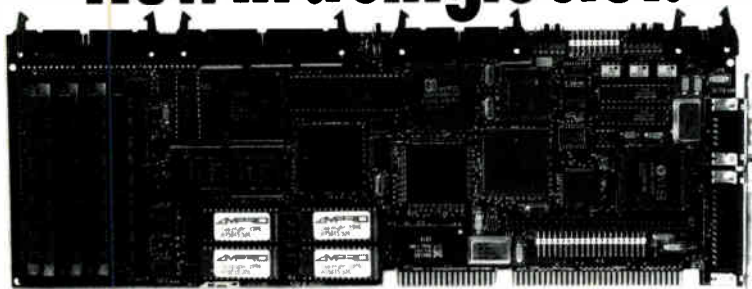

## Slot Board/286.

**One philosophy. Two systems.** Ampro's new Slot Board/286, like the Little Board/286, is a complete AT-compatible single board system. Each is equivalent to an AT motherboard and four expansion cards. Now, you can choose between stackable systems with the Little Board/286 or passive backplane systems with the Slot Board/286.

### PC/AT Software compatible.

Supports all standard PC/AT operating systems. DR-DOS is included with each board.

### Everything you need.

StackPlane™ or backplane. 512K to 4 MB on-board DRAM. Bootable Solid State Disk. Disk controllers. Display controllers. A selection of I/O ports. Card cages and passive backplanes for easier system implementation.

**Better answers for embedded systems.** Bolt-in or plug-in. Little Board/PC and Little Board/286 with their compact, easy to build-in StackPlane architecture. Slot Board/286 with its passive backplane for I/O and peripheral intensive applications.

**Available worldwide.** Call Ampro or any of the distributors listed below for complete details on Ampro Little Boards or Slot Board/286.

### Slot Board/286 Features

- IBM PC/AT compatible
- 12 or 16 MHz 80C286 CMOS CPU
- Up to 4MB DRAM
- On-board Bootable Solid State Disk
- 2 serial ports (RS232C/RS422/RS485)
- Parallel printer port
- AT Bus hard disk interface
- Floppy disk controller
- SCSI controller
- Enhanced Award ROM BIOS
- Math co-processor support
- Real time clock
- Low power (approx. 8 Watts)
- Wide operating temp. range: 0 to 60° C
- Low parts count. High reliability
- Optional Mini Modules: Video controllers LCD Display Driver Serial/Parallel expansion Modem ... and more

All trademarks are the property of their respective owners

**(408) 734-2800**

**AMPRO**  
SINGLE BOARD SYSTEMS

Ampro Computers, Inc., 1130 Mountain View/Alviso Road, Sunnyvale, CA 94089. Telex: 4940302 FAX: (408) 734-2939

Reps: USA - contact AMPRO for the name of your nearest rep. Australia - 61 3 720-3296; Austria - 43 1/45 4510-0; Canada - (604) 438-0028; Denmark - 45 3 66 20 30; Finland - 358 0 585-322; France - 331 4502-1800; Germany, West - 49 89 611-6151; Hong Kong/PRC - 5 8613118; Israel - 972 3 49-16-95; Italy - 39 6 811-9406; Japan - 81 3 257-2630; Netherlands - 31-10-411 8521; Sweden - 46 8 55-00-65; Switzerland - 41 1 740-41-05; United Kingdom - 0296-435511



# We Left Out The Obsolescence The Others Built In.

## Computers That Grow With You.

Until now, advances in PC technology have left you with a single, all important decision. Move up and benefit from increased performance. Or, stay put and try to capitalize on the investments you've already made.

AST is announcing the end to this difficult decision. Our Cupid-32™ architecture allows you to upgrade your computer as your needs grow. All the way to i486™ technology.

That's right. Our Premium 386SX/16 and Premium 386 (33 and 25 MHz) computers incorporate a natural upgrade path. A path that doesn't force you to sacrifice your investment in already-owned systems and peripherals.

With Cupid-32, you can add the performance you need to add more users to a multi-user system. Add more nodes to a network file server. Or, add more power to a standalone situation, like CAD/CAM. All it takes is a simple, single board swap with one of our FASTboards™ when you are ready for more power.

So, in place of the difficult decision, we have a simple one for you. Why buy a computer from anyone else, when you can own an AST Premium Computer? After all, they're the only computers that grow with you.

For more information call 1-800-876-4AST. Or, use our Bulletin Board Service Number (714) 852-1872.

**AST**<sup>®</sup>  
RESEARCH INC.

## The Power Of Choice.

AST is a leading supplier to government agencies. General Service Contract no. GSOOK89AGS6418. AST markets products worldwide — in Europe and the Middle East call: 44 1 568 4350; in Japan call: 81 3 818 0710; in the Far East call our Hong Kong office at: 852 5 806 4333; in Canada call: 416-826-7514; in Australia call: 02 906 2200. AST, AST logo and AST Premium registered and Cupid-32 and FAST-board trademarks AST Research, Inc. All other brand or product names are trademarks or registered trademarks of their respective companies. Copyright 1989 AST Research, Inc. All rights reserved.

Circle 40 on Reader Service Card (DEALERS: 41)

# Quarterdeck

## DESQview 2.2 and DESQview 386. The multitasking, windowing environments that work with your favorite software.



DESQview lets you run your favorite programs in windows side-by-side.

DESQview™ is the operating environment that brings OS/2™ power to DOS. And it lets you, with your trusty 8088, 8086, 80286, or 80386 PC, leap into the next generation in PC productivity. For not much money. And without throwing away your favorite software.

### Introducing DESQview 2.2

And now, DESQview 2.2 adds capabilities, performance, and compatibility enhancements you've been asking for:

Like being able to fine tune DESQview performance "on the fly." Run Lotus Express and Metro. And the Intel Connection Co Processor. Even use the DOS 4.0 shell with DESQview. Have DESQview automatically install Quattro, Sprint, Aldus PageMaker, Microsoft Excel, Word Perfect, Dataease and as many as 80 other programs. And using the DESQview API, be able to dynamically link them.

### More bang; less bytes

While other programs get bigger, we've worked to make DESQview smaller. And we've succeeded in a big way on PCs and PS/2™s with extended, EMS 3.2 (AboveBoard), EEMS and EMS 4.0 memory—as well as on 386 PCs and

PS/2s. For example, DESQview overhead on EMS 4.0 and 386 PCs can be as low as 10K on EGA/VGA PCs. And DESQview actually *increases* memory 30K on CGA PCs; 20K on monochrome and Hercules PCs. That's good news for users of big desktop publishing, CAD and database programs.

### Introducing DESQview 386

For users of 80386 PCs and PS/2s (or PCs with 80386 add-in boards, such as the Intel Inboard 386), there's DESQview 386 (a combination of DESQview 2.2 and the new QEMM-386

Quarterdeck Expanded Memory Manager, version 4.2).

DESQview 386 gives you extraordinary power. Run text, CGA, EGA, VGA, and Hercules programs in windows and in the

background. Run 32-bit 386 programs, like Paradox 386, and IBM Interleaf simultaneously with your favorite DOS programs. All with the speed and performance you expect out of your 386. And with protection against 'misbehaved' programs.

### Promise and performance

And, of course, both DESQviews have all the features that made prior versions the popular choice in operating environments. The ability to multitask in 640K and beyond. View programs in windows or full screen. Transfer data. Access DOS via menus. Dial your phone. And create keystroke macros within and between programs.

### Our story gets better and better

If there's any doubt about our commitment to your PC and PS/2 productivity, just look at our accomplishments over the years. We think you will understand why GE, Ford, Aetna, Monsanto, and so many other major corporations use DESQview.

And why PC Magazine twice gave DESQview its Editor's Choice Award for "The Best Alternative to OS/2," why readers of InfoWorld voted DESQview "Product of the Year" three times. Why, by popular vote at Comdex Fall for two years in a row, DESQview was chosen "Best PC Environment" in PC Tech Journal's Systems Builder Contest, and just won their "Professional Solutions" Award.

DESQview lets you have it all now.





# Quarterdeck Delivers.

## QEMM. Break the 640K barrier for \$59.95

Your 80386 PC, IBM Personal System/2 Model 80, PC or AT with 80386 add-in board, as well as your IBM Personal System/2 Models 50 or 60 can all break through the DOS 640K barrier. Now you can have maximum use of your memory—whether you have one megabyte or 32—with the Quarterdeck Expanded Memory Manager. All without having to purchase special expanded memory boards.

QEMM uses hidden features within your existing memory to make it compatible with the Lotus-Intel-Microsoft Expanded Memory Specification (EMS) version 4.0.



Now you can run colossal spreadsheets, databases, and CAD models designed for expanded memory, using Lotus 1-2-3, Symphony, Framework, Paradox, AutoCAD, Excel and more.

And if you'd like to use these programs all together—multitasking beyond 640K—QEMM works with our popular DESQview multitasking environment.

If you are one of the 12 million or so 8088, 8086 or 80286 PC users who feel left out, don't despair. We have options that let you keep your computer and favorite programs and give you today what the newest PCs and operating systems are promising for the future.

Visit your dealer for more information on barrier-breaking Quarterdeck products.

## DESQview API Toolkit. New C and Pascal Libraries, Debugger. Panel Designer. And more.

### API Reference Manual

The key to the power of the DESQview API, our Reference Manual contains all you need to know to write Assembly Language programs that take full advantage of DESQview's capabilities. And there's an 'include' file with symbols and macros to aid you in development.

### API C Library

Here are C language interfaces for the entire set of API functions. It supports the Lattice™ C, Metaware™ C, Microsoft® C, and Turbo C compilers for all memory models. Included with the C Library package is the API Reference Manual and source code for the library.

### API Pascal Library **NEW!**

The Pascal library provides interfaces for the entire set of API functions. It supports Turbo Pascal V4.0 and V5.0 compilers. Included are the API Reference Manual, source code for the library, and example programs.

### API Debugger

The DESQview API Debugger is an interactive tool enabling the API programmer to trace and single step through API calls from several concurrently running DESQview-specific programs. Trace information is reported sym-

bolically along with the program counter, registers, and stack at the time of the call. Trace conditions can be specified so that only calls of interest are reported.

### API Panel Designer

This interactive tool helps you design windows, menus, help screens, error messages, and forms. It includes an editor that lets you construct an image of your panel using simple commands to enter, edit, copy, and move text, as well as draw lines and boxes. You can then define the characteristics of the window that will contain the panel, such as its position, size, and title. Finally, you can specify the locations and types of fields in the panel.

The Panel Designer automatically generates all the DESQview API data streams necessary to display and take input from your panel. These data streams may be grouped into panel libraries and stored on disk or as part of your program.

### More Tools are Coming

Quarterdeck is committed to adding tools as needed by our users. To that end we have been working with Ashton Tate and Buzzwords International on dBASE III and dBASEIV translators. And in the works, we have BASIC and DOS Extender libraries.

# Quarterdeck

Quarterdeck Office Systems, 150 Pico Blvd., Santa Monica, CA 90405 (213) 392-9851  
FAX: (213) 399-3802

exactly how to set it up. After that, it's a mere matter of installing the board and drives and connecting the cables. I expect what I'll do is put this into the generic XT so that we can transfer from any disk to any other.

If you're still having disk format problems, Northgate has the answer.

**Keyboards**

The latest shipment from Northgate also included a big box of keyboards.

I have said for years that the best key layout ever invented was on the old IBM Selectric typewriter. Unfortunately, no one made a proper PC keyboard with that

layout. First, IBM had their peculiarly dumb design, with extra keys between the Z and Shift keys, but with the function keys grouped on the left side. Then they changed to a keyboard with a reasonably standard layout, but the function keys were across the top, where you couldn't get at them easily. Then they changed to something else.

Somewhere along the line it got frozen into concrete that the Backspace key is way up in the upper right, where you cannot reach it from the home keys; while the bracket and brace keys were put just above the Return key, where they are in the way if you go after Backspace. There

were various other tomfool "innovations," all caused by the fact that IBM engineers are not touch-typists. And IBM being the kind of company it is, no one ever bothered to ask the customers what they wanted. Meanwhile, other companies followed IBM's lead.

The result is a series of miserable keyboards all designed to make extra work. Every one of them, for example, has the less-than and greater-than keys as Shift-comma and Shift-period, which has the effect that when you're writing, you end up with U>S>A> instead of U.S.A., and stuff like that; and when you go to

*continued*

**McGraw-Hill Bookstore**

**Master Computer Graphics —  
By the Book**

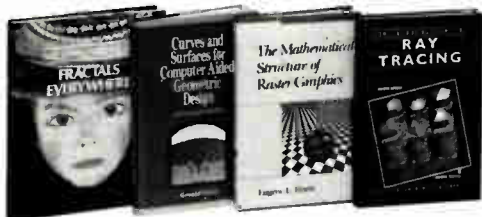

Published by  
Academic Press

**1 Fractals Everywhere: The First Course in Deterministic Fractal Geometry**

By Michael Fielding Barnsley

If you have a graphics-capable computer and some familiarity with calculus, this pioneering work can show you how to use fractal geometry to generate everything from full-color images to models of ocean spray. "Carves a niche in a new field ... I know of no other book like it." — Marc A. Berger, *CHANCE* *Illus.*, 424 pp., \$39.95

**2 Curves and Surfaces for Computer Aided Geometric Design: A Practical Guide**

By Gerald Farin

Emphasizing Bézier and B-spline methods for curve and surface fitting, Farin presents a unified treatment of the major ideas in computer aided geometric design. Ideal for CAD/CAM software developers, graphics programmers, and modeling researchers, his intuitive, geometric approach is complemented with over 150 diagrams and color plates. 334 pp., \$39.95

**3 The Mathematical Structure of Raster Graphics**

By Eugene L. Fiume

Accessible to anyone with a basic computer graphics background, this concise volume is the first to define mathematically the basic structural elements of raster graphics, 3-D scenes, and 2-D images. It provides succinct discussions of rendering, visibility, bit-mapped operations, illumination, and other properties shared by most graphics systems. *Illus.*, 240 pp., \$29.95

**4 An Introduction to Ray Tracing**

Edited by Andrew S. Glassner

Six computer graphics authorities give you the tools to understand and apply essential ray tracing algorithms and methods and to write your own ray tracer. Their coverage includes concepts of surface physics, stochastic sampling and distributed ray tracing, and ray tracing acceleration techniques. Heavily illustrated with color and black-and-white figures. 327 pp., \$49.95

Clip or copy this coupon and return to:

**McGraw-Hill Bookstore**

1221 Avenue of the Americas  
New York, NY 10020  
Tel. 1-212-512-4100

YES! Please send me —

- \_\_\_\_\_ copies of book #1 (Barnsley)
- \_\_\_\_\_ copies of book #2 (Farin)
- \_\_\_\_\_ copies of book #3 (Fiume)
- \_\_\_\_\_ copies of book #4 (Glassner)

Check, money order, or credit card only:

- VISA  MasterCard  AMEX

Acct. # \_\_\_\_\_  
Exp. Date \_\_\_\_\_  
Name \_\_\_\_\_  
Address \_\_\_\_\_  
City \_\_\_\_\_  
State \_\_\_\_\_ Zip \_\_\_\_\_

Please add applicable sales tax,  
plus \$2.50 postage and handling.

BYT 11B



**The Professionals' Information Center—Since 1961**



# THE NEW STANDARD FOR HIGH PERFORMANCE STATISTICAL SOFTWARE

# CSS

COMPLETE STATISTICAL SYSTEM

WITH DATA BASE MANAGEMENT

AND GRAPHICS

A powerful, comprehensive, elegant, and super-fast statistical package for IBM (PC, AT, PS/2) and compatible computers. ■ The CSS optimized user interface with fast hierarchical menus incorporates elements of artificial intelligence; even complex analyses require only a few keystrokes (batch processing is also supported). ■ CSS features comprehensive, state of the art implementations of: *Basic statistics, Multi-way frequency tables, Nonparametric statistics, Exploratory data analysis with analytic graphs, Multiple regression methods, Time series analysis with modeling and forecasting (incl. full ARIMA), General ANOVA/ANCOVA/MANOVA, Contrast analysis, Discriminant function analysis, Factor analysis, Principal components, Multidimensional scaling, Item analysis/Reliability, Log-linear analysis, Cluster analysis, Non-linear estimation, Logit/Probit analysis, Canonical analysis, Survival and Failure Time analysis (Censored data), Quality Control analysis, and much more.* ■ All statistical procedures are integrated with fast data base management and instant, presentation quality graphics (over 100 types); full support for all mono and color graphics boards (incl. VGA) and over 100 plotters and printers (incl. the HP and Postscript standards). ■ All CSS screen output is displayed via customized Scrollsheets™ (i.e., dynamic, user controlled, multi-layered tables with cells expandable into pop-up windows); all numbers in a Scrollsheet™ can be instantly converted into a variety of presentation quality graphs; contents of different Scrollsheets™ can be instantly aggregated, combined, compared, plotted, printed, or saved. ■ The flexibility of the CSS input/output is practically unlimited: CSS offers an intelligent interface (read/write) to all common file formats (Lotus, Symphony, dBI, dBIII+, DIF, SYLK, ...) and special utilities to easily access data from incompatible programs; graphics can be saved in files compatible with desktop publishing programs (Aldus, Ventura). ■ CSS data files can be as large as your operating system (DOS) allows; OS/2 version coming soon. ■ CSS precision exceeds the standards of all common precision benchmarks. ■ *Technical note: The CSS user interface and all I/O were written in Assembler and bypass DOS; graphics and data management were written in Assembler and C; the computational algorithms were written in Assembler and optimized Fortran.* ■ \$495 (plus \$5 sh/h); 14-day money back guarantee.

Circle 336 on Reader Service Card



## StatSoft

2325 East 13th Street ■ Tulsa, OK 74104 ■ (918) 583-4149

Fax: (918) 583-4376

Overseas Offices: StatSoft of Europe (Hamburg, FRG), ph: 040/4200347, fax: 040/4208274, StatSoft UK (London, UK), ph: 0438/310056 or 316561, fax: 0438/310001 StatSoft Pacific (Melbourne, Australia), ph: 613-663-6580, fax: 613-663-6117, StatSoft Canada-CCO (Ontario), ph: 416-849-0737, fax: 416-849-0918 Available From: CORPORATE SOFTWARE and other Authorized Representatives Worldwide: Holland: Lemax BV 02968-94210; France: Concepter (1) 45669700; Sweden: AkademiData 018-696201; Korea: Geul Bang (02) 272-1973





**PS/2® MEMORY**

**Introducing OS/RAM4™**

- ✓ 4 megabytes of memory.
- ✓ Extended and expanded memory. LIM 4.0.
- ✓ Works with all of your programs.
- ✓ Run DOS or OS/2 effortlessly.
- ✓ Fast and simple switchless installation.
- ✓ Auto-configuration for all operating systems.
- ✓ Works in all Micro Channel™ computers.
- ✓ Expanded memory 10 times faster than Intel.
- ✓ Risk free guarantee. Two year warranty.
- ✓ IBM approved ID. \$349 0K.

Call today 1-800-234-4232 or 617-273-1818

**cec** Capital Equipment Corp.  
Burlington, MA. 01803

PS/2 and Micro Channel are trademarks of IBM

backspace, you get ]]]] and once again have to go back and fix that. This breaks one's train of thought and makes small computers a bit less useful for creative writers than they otherwise would be.

Various companies have worked on this problem. DataDesk International makes very good after-market keyboards that many users like a lot, and which I used to swear by; but the keys didn't have the positive feel that the old Selectric did, nor was the layout the Selectric's.

Finally, Art Lazere of Northgate Systems designed a keyboard just for me. The function keys are grouped on the left side. The Control key is to the left of the A key, where God intended it to be. The Escape key is in the upper left, where it was on the old terminals we all started with. The keys have a wonderful positive click to them. There's a separate arrow-key cluster and a numeric keypad.

Best of all, the Backspace key is oversize and just above Return, so I reach it handily with my fingers on the home keys; and the bracket and brace keys are in the upper right, where I can get at them if I want them, but aren't in the way. There's an asterisk key next to the reverse backslash and vertical rule key; and while less than and greater than remain shifted comma and period, Lazere commissioned a 20-byte TSR program called POURVOUS.COM that fixes that

(I do Alt-Shift-comma and -period to get less than and greater than). The result is the perfect keyboard—for me.

Apparently I am the only one who thinks so; Northgate hasn't sold many of the "Pournelle" layout keyboards. They sell a lot of their standard ones, which, I have to say, would be my favorites if I didn't have the "Pournelle" layout. Anyway, it works out well for me: because almost no one bought the keyboards configured the way I like them, there were a number of them in the Northgate warehouse; and I now have five of them, which you can pry away from my cold dead fingers.

### The Gadget War

In *The Mote in God's Eye* (Larry Niven and Jerry Pournelle, Pocket Books, 1974; now in the thirty-sixth printing, he said preening), the characters all carry pocket computers that have a great deal of on-board capability and also link by radio to the rest of the world. These gadgets keep track of schedules, record conversations, and generally do the kind of management that makes life simpler.

Our book takes place in the far future; the fictional supercomputers have few limits on their performance. Back in reality, we ought to have about half that capability before the end of the century. Today, reasonably useful pocket com-

puters are available, with more coming all the time; and thanks to Traveling Software, you can link them to your PC, meaning to the rest of the world.

The two leading pocket computers at the moment are Sharp's Wizard Electronic Organizer and Casio's BOSS (Business Organizer Scheduling System). Both are intriguing, although neither is what I'd like it to be; indeed, what I really wish is that I could combine features of the two.

Sharp's Wizard has the neat capability of accepting program cards, which lets third-party developers add features to the Wizard. It's slightly larger than the BOSS, and it makes good use of the extra space: there's a numeric keypad, and the function keys are very well labeled. On the other hand, the Wizard has a serious (some would say fatal) flaw: the alphabetic keys are laid out in ABCDEF fashion, so that people used to a typewriter find it between difficult and impossible to make entries on it.

Casio's BOSS, by contrast, has a QWERTY key layout; but, alas, there is no separate numeric keypad, and I find it extremely difficult to use as a simple calculator. The Wizard is very easy to use as a calculator. The BOSS's screen is a bit larger than the Wizard's, but despite the BOSS's contrast control, I find that its screen is not as easy to see as the Wizard's, no matter what the lighting. Neither has a backlit screen, of course.

Some of the calendar and schedule software seems subjectively easier to use on the BOSS than on the Wizard; and when you're on the road, it's a lot easier to get data into the BOSS than the Wizard. At home you use Traveling Software's link system to connect it to your PC and put data in that way.

My—purely subjective—conclusion is that unless you're quite devoted to gadgets, you may not use either the Wizard or the BOSS; but if you are, you'll probably like either one. I'm mildly used to the Wizard and will probably go on carrying it; but I'm not sure, and besides, Roberta will probably inherit the BOSS, so we'll have that with us anyway.

One thing is certain: if you get either of these gadgets, get the Traveling Software link system for it.

### Electric Chemistry

One of the most impressive educational programs I've seen was also on display at the National Education and Computers Conference. The Electric Chemistry Building package from Snowbird Software calls itself "a large-scale micro-world simulation of a group of chemistry



## CHAOS MANOR

laboratories, each representing a major subdiscipline such as inorganic, physical, or organic chemistry." Each "laboratory" has various rooms, including a storeroom, the lab itself (complete with equipment and hoods and Bunsen burners), and a library.

The user interface is simple, if a bit cute: you use the arrow keys to move a block representing yourself through a vestibule into the laboratory. You can then go to the storeroom and get chemicals—only three at a time—and take them to the lab, where you can add them to a flask. You can then heat or cool the flask or go get more chemicals. Since this is inorganic chemistry, I wasn't able to make nitroglycerin.

The chemistry stocks are fairly complete compared to the top-of-the-line chemistry set I was given for Christmas. Anyway, you get your chemicals and go mix them. If you're a bit puzzled about some of the chemicals, you can look them up in the library. Once you start mixing, the program takes over and shows the result.

Sometimes there isn't a result, as when I put hydrochloric and nitric acids in with some mercury. However, you can also light the Bunsen burner under your reaction flask. I did, and sure enough, as the stuff got hotter, I got mercuric chloride.

The Electric Chemistry Building isn't as much fun as a real chemistry lab, because you can't do anything with what you make. I recall that we poured a couple of quarts of nitrogen tri-iodide into the manicured grass in front of Central High, so that we spelled out words; when the stuff dried, it gave off clouds of purple smoke and considerable heat, so that not only did "Go CBC" appear briefly in the smoke (for my high school alma mater, Christian Brothers College), but a week later the words were spelled in dead grass. Of course, that was a foolishly dangerous stunt, and I don't advise anyone to try it.

Like nearly all educational software, this one is copy-protected: they use the key-disk method, which is considerably more acceptable than one of the miserable schemes that partially reformat your hard disk. Educational software publishers tell me they have no choice: there are just too many teachers out there who persuade themselves their students "need" programs the school can't afford to buy. If the programs weren't copy-protected, they'd be distributed everywhere within a week of publication. Snowbird features a scheme whereby many students can use the program one at a time, each student having a disk to record results.

**PS/2® MEMORY**

Introducing OS/RAM8™

- 8 Mbytes of memory + 2 serial ports.
- Extended and expanded memory. LIM 4.0.
- Works with all of your programs.
- Run DOS or OS/2 effortlessly.
- Fast and simple switchless installation.
- Auto-configuration for all operating systems.
- Works in all Micro Channel™ computers.
- Expanded memory 10 times faster than Intel.
- Risk free guarantee. Two year warranty.
- IBM approved ID. Best price. Fast delivery.

Call today 1-800-234-4232 or 617-273-1818

**cec** Capital Equipment Corp.  
Burlington, MA. 01803

PS/2 and Micro Channel are trademarks of IBM

I haven't seen Snowbird's physical chemistry program. An organic chemistry program will be available in May 1990. I have been very impressed with the inorganic chemistry simulator.

### Humit

Dr. Petr Beckmann is professor emeritus of electrical engineering at the University of Colorado, and he publishes one of the most interesting newsletters in the country: *Access to Energy* (\$25 for 12 monthly issues). Fair warning: Beckmann is committed to both science and free enterprise. He is relentlessly logical and writes in a polemic style that spares no one. When he states a fact, it's a fact; when he catches an enemy in a falsehood or misunderstanding, he nails him.

A recent sample: "Like a rain dance that does not bring any rain, Bush's clean air proposals do have one characteristic that, in the dearth of positive features, deserves to be mentioned: they are not going to degrade the environment significantly." On ethanol as fuel: "If only 10 percent of U.S. fuel needed to be ethanol, the necessary corn would have to be grown on 500 million acres. . . a cool 105 percent [of the total arable land in the U.S.]."

Beckmann is a former resident of Czechoslovakia, the home of the original legend of the golem, which is likely why

he calls his publishing venture The Golem Press. It has produced such works as *A History of PI* and *The Health Hazards of Not Going Nuclear*.

Now Beckmann has turned to software. The blurb for Humit asks, "Can you hum the Minuet of Mozart's 40th symphony? You will recognize it when you hear it, of course. . . but in the meantime, let your computer whistle it for you." Humit will do that; indeed, there are some 800 classical themes "from Bach to Dvorak." The musical quality isn't much because the PC isn't capable of much; but the tunes are definitely recognizable.

On the same disk are the Play and Whatisit programs. Play converts your PC into a keyboard instrument, sort of, with the middle row of keys corresponding to white keys, and the row above it to black. Whatisit does the same thing, except that if you can manage to play the first 10 notes of one of the classical themes in Humit, the program will tell you which tune you just played. At least it says it can do that. Since I can't possibly manage to play 10 consecutive notes and the program doesn't guess, all I got was a series of "Not on file" responses.

I don't quite know what to make of these programs. Humit does what it says it will, but I confess I wouldn't pay \$60

*continued*

ITEMS DISCUSSED

**Cardiovascular Systems and Dynamics** .....\$150  
**Learning Tools**  
 P.O. Box 3158  
 Eugene, OR 97403  
 (503) 345-7749  
**Inquiry 981.**

**Electric Chemistry Building**  
 inorganic .....\$139.50  
 physical .....\$249.50  
 Snowbird Software  
 71A Leland St.  
 Hamilton, Ontario  
 Canada L8S 3A1  
 (416) 521-9667  
**Inquiry 982.**

**IDS NYCode** .....\$695  
**IDS NYCode Two** .....\$495  
 Intermedia Design Systems, Inc.  
 15 Century Hill Dr., Suite 100  
 Latham, NY 12110  
 (518) 783-1661  
**Inquiry 983.**

**Inductel Reference Series**  
 Funk & Wagnall's ..... \$79.95  
 all others ..... \$49.95  
 Inductel, Inc.  
 18661 McCoy Ave.  
 Saratoga, CA 95070  
 (408) 866-8016  
**Inquiry 984.**

**Mac Gallery** ..... \$49.95  
 Dream Maker Software  
 4020 Paige St.  
 Los Angeles, CA 90031  
 (213) 221-6436  
**Inquiry 985.**

**Northgate Universal Floppy Drive Controller** ..... \$99  
 Northgate Computer Systems  
 13895 Industrial Park Blvd.,  
 Suite 110  
 Plymouth, MN 55441  
 (800) 548-1993  
 (612) 553-0111  
**Inquiry 986.**

**RBBS-PC in a Box CD-ROM** ....\$149  
 Quanta Press  
 2239 Carter Ave.  
 St. Paul, MN 55108  
 (612) 641-0714  
**Inquiry 987.**

index—every word except conjunctions and prepositions—makes access to the code fairly easy. I can't recommend what I don't understand; that is, the program works fine in that it lets you browse around the code and find anything you're likely to want, but I can't testify as to how complete it is, just as I can't of my knowledge tell you how well IDS NY-Code simulates a building inspector. I like what I see, though, and if you're in the building business, you ought to be aware of this stuff.

**Winding Down**

I'm out of space, and there's still a huge stack on my desk. I didn't get to Borland's Reflex 2, but if you have Reflex, you know how good that was; the upgrade is even better. There's Dream Maker Software's Mac Gallery, some 400 Macintosh clip-art images ranging from dinosaurs to Santa Claus, including a neat haunted house. It sure dresses up party invitations.

I have some new medical-simulation software from Learning Tools; their Cardiovascular Systems and Dynamics program is in use in about 200 medical schools, and by me it ought to be in all of them: students will learn more from experimenting with this than by cutting up animals, and it's cheaper to boot.

There are two books of the month: *Deception* by Edward J. Epstein (Simon & Schuster, 1989), perhaps the most important book I've read about international conflict since *Survival Is Not Enough* by Richard Pipes (Simon & Schuster, 1984); and *The Control of Nature* by John McPhee (Farrar, Straus & Giroux, 1989). McPhee writes about efforts to save New Orleans now that the Mississippi wants to wander elsewhere; cooling lava with fire hoses in Iceland; and flood control in the Los Angeles mountains. It's good classic McPhee, and as soon as I get this column on the wire, I'll finish it. While I'm at it, I'll open my split of champagne and munch on pâté with pumpernickel. ■

for it, especially since similar programs (though with far less of a library) are available on BBSes as shareware. On the other hand, it can sure startle someone to hear "The Ride of the Valkyries" burst out of Big Cheetah.

Beckmann's policy is consistent with his philosophy: to buy the program, you are supposed to sign a declaration that you undertake not to make copies for use by others (there is no copy protection), and when you bring up Humit, there's a not very subtle reminder of that. His pricing is predictable: Humit is available from The Golem Press (P.O. Box 1342, Boulder, CO 80306) at \$60 for individuals, \$120 for private corporations, and \$240 for tax-subsidized institutions like governments and state universities.

**Experts on Codes**

The IDS NYCode Two is another program I'm not really competent to evaluate, since the heart of the program is a database of the New York State Fire Prevention and Building Code that comes on five disks. IDS has been developing pro-

grams for architects and builders for a number of years; I'm told they began with an Osborne computer and JRT Pascal. Most of their software is intended for use by municipalities, particularly building departments. Their two hottest items are IDS NYCode and IDS NYCode Two, the first being an expert-system program that asks the same questions about your building that a code official would ask when conducting a code review. It's written in Turbo Pascal.

IDS has other architect and contractor programs, including pcTRAQ: Building Permits, a database management program that generates information and reports about building permits; it's intended for use by a building department, and it generates the reams of forms and reports, like the monthly C404 Federal Bureau of the Census Building Activity Report. There's another program to handle property complaints.

Since until recently the New York Code wasn't indexed at all, and the index now provided by the state isn't very complete, IDS NYCode Two with its absolute

*Jerry Pournelle holds a doctorate in psychology and is a science fiction writer who also earns a comfortable living writing about computers present and future. Jerry welcomes readers' comments and opinions. Send a self-addressed, stamped envelope to Jerry Pournelle, c/o BYTE, One Phoenix Mill Lane, Peterborough, NH 03458. Please put your address on the letter as well as on the envelope. Due to the high volume of letters, Jerry cannot guarantee a personal reply. You can also contact him on BIX as "jerry."*



# TOPSPEED C

## The next generation



**TopSpeed C.** Compiler and library conform 100% with proposed ANSI standard. Source compatible with MS C and Turbo C (where ANSI compatible). Library is a superset of both MS and Turbo C's libraries. Extensions include: Time-sliced scheduler for concurrent functions. Powerful text window management. Borland text windows supported. MS's graphics, plus: Bar chart & polygon plotting, standard formatted text IO to graphics windows. Interface to Borland's Graphics Interface (BGI). Mouse support. All BIOS and DOS calls supported. Common UNIX calls. 6 memory models plus user-definable memory models. Smart linker includes only functions and data used in the final program. Optional run-time checks include overflow, stack, array bounds, and pointer checks. Run-time and compilation errors automatically pinpointed in source code.

**Common optimizing code generator.** All compilers produce highly optimized code using the same code generator. 8086/286/386 specific code. Automatic optimal register allocation. Common Sub-expression Elimination. Expand any function as inline code. Pass parameters in registers (optional). Inline 80x87 code or emulation.

**Automatic make.** Fully automatic make with version control recompiles and rebuilds EXE, LIB and DLL files as necessary without the need of a make script. Make dependencies are described by project files, which simply list the objects to be included, as

well as the names of other dependent projects. One single make can result in multiple compilations using different compilers and/or assemblers, linking and building of libraries, DLLs and an EXE file.

**Seamlessly integrated environment.** Up to 10 active editor windows, each with a capacity of 1/2 MB source code. Compiler errors and warnings pinpointed in source code; automatic file-switch when stepping between errors or warnings. All menus and hot-keys redefinable. By default, editor commands compatible with Turbo and SideKick. Keyboard macros ala SuperKey. Cut and paste between editors, help system, and directly from screen memory. Multi-file search commands, programmer's calculator, built-in ASCII, key scancode, and color tables. HyperText help system with library reference.

**DOS and OS/2 Professional Editions.** Professional Editions include: Support for Microsoft Windows. DOS Dynamic Link Libraries. Full source code to libraries. Start-up assembler code. High-speed Assembler is fully integrated in the environment. Disassembler. Program execution profiler. Code locator for embedded systems programming. Watch utility for viewing any selection of DOS calls as they are executed. Programmer's interface to debugger. Post Mortem Debugger. And more. OS/2 Professional Edition has full support for Presentation Manager.

TopSpeed and TechKit are trademarks of Jensen & Partners International. Other brand and product names are trademarks or registered trademarks of their respective holders.

### TOPSPEED C:

**Standard Edition \$199**  
(DOS Compiler & VID)

**DOS Prof Edition \$395**

**OS/2 Prof Edition \$495**

Call on TopSpeed Modula-2 (with objects) compiler & toolkit prices.

### TO ORDER:

In the U.S., call:

**1-800-543-5202**

In Canada, call:

**1-800-543-8452**

Call on shipping & handling charges & volume discounts. VISA/MC accepted.

**30-day unconditional money-back guarantee.**



Jensen & Partners  
International

1101 San Antonio Road, Suite 301  
Mountain View, CA 94043  
Phone: (415)967-3200  
FAX: (415)967-3288

### In England & Europe contact:

Jensen & Partners UK Ltd., 63 Clerkenwell Road, London EC1M 5NP.  
Phone: (01)253-4333. FAX: (01)251-1442. C Standard Edition £149; C DOS Prof Edition £295; C OS/2 Prof Edition £370. Call on handling & VAT charges, and TopSpeed Modula-2 product prices.

When we started selling MKS products in 1986, the Tax Collectors were among the first to notice. They assessed our promise to bring the power and flexibility of a UNIX environment to the DOS desktop.

And then they came to call.

We're happy to report that the Tax People\* quickly decided that MKS products were the perfect way to train users on UNIX operating systems using the PCs everyone was already familiar with. And the perfect way to speed development of new programs and procedures.

#### Get the new - but don't give up the old

The MKS Programming Platform gives programmers the best of both worlds - virtually unrestricted access to the power and flexibility of UNIX operating systems, and full DOS or OS/2 capabilities. With MKS your PC becomes a powerful and productive UNIX workstation, whenever you need it.

The Platform includes four proven members of the MKS family of software: *MKS Toolkit*, *LEX & YACC*, *RCS*, and *Make*.

The heart of the Platform is the *MKS Toolkit*. It provides a complete set of utility programs and over 150 commands compatible with UNIX System V.3. It also includes the MKS Korn Shell, a command interpreter, MKS Vi editor, and the MKS AWK programming language.

Next is *MKS LEX & YACC*, which work together as a

highly efficient program generator, simplifying the creation of languages and compilers for DOS and OS/2. The set is completed with *MKS RCS* (Revision Control System), which gives total control of text file revisions, and *MKS Make*, which provides an efficient way to automate the production and maintenance of any size project.

All together they are the most efficient, most productive, and friendliest way to cross the bridge between DOS or OS/2, and UNIX.



#### Beyond multiple platform support

The Programming Platform performs on standard PC networks like Novell NetWare and PC NFS with the illusion of a complete UNIX timesharing system. This means you can hook your PC to PC NFS, allowing it to be used as a UNIX workstation.

MKS is an active participant on the POSIX standards committee, and we track the shell and utilities standard to the fullest extent. We take care to build the underlying POSIX kernel functionality on DOS and OS/2 into MKS software before moving utilities. That's why the Platform gives you 100% UNIX and POSIX compatibility, with no surprises.

#### Ideal training tools

Fast, painless training is another benefit of the Programming Platform. Developers can use their familiar PC keyboards while moving effortlessly to UNIX on the desktop, and exposure to new commands and functionality becomes part of the novice's working day.

#### The Taxman adds it up

When you stack up all the advantages of the Programming Platform - access to powerful development tools, time-saving management functions, full portability, easy training, and our unswerving dedication to the POSIX standard - it's no wonder that the people with the toughest jobs to do, like the Taxman, turn to MKS.

To learn more about The Programming Platform and other MKS productivity and development tools, call us today. Maybe we can make your job a little less taxing.

# After Long Investigation, The Taxman Came To Talk To Us

#### 30 day money-back guarantee

MKS Programming Platform prices are:

DOS \$665  
OS/2 \$1225

In Continental USA call: 1-800-265-2797  
Outside Continental USA call: 1-519-884-2251  
Fax: 1-519-884-8861

#### Authorized MKS Dealers:

Belgium 2-736-6064  
England 364-53499 or  
1-833-1022 or  
0763-73455

Netherlands 20-14-24-63  
West Germany 551-792488 or  
061-214908 or  
721-886-664

#### Head Office:

35 King Street North  
Waterloo, Ontario  
Canada, N2J 2W9

## More Power to You

\*We're not allowed to use their official name. But you know who we mean.  
MKS is a trademark of Moritice Kern Systems Inc. Other trademarks have been cited and MKS acknowledges them.





# CUSTOMIZING FOR COMFORT

A series of environment variables lets you tailor Unix to your liking

**W**hether you're running Unix on a personal computer, an engineering workstation, or a mainframe, you'll get the most from your Unix user account if you customize it. Most people like their desk chair and car seat set up a certain way; it's the same with your computer environment. The Unix shell environment is one of the first things you can start customizing.

Begin by finding out what you already have. Execute the command `env` (it may be `printenv` on some systems; set should also work, though slightly differently). This command displays a list of environment variables (which might be startling in its length) that you can set at any time. Application programs, including the shell itself, can read these variables and modify the way they operate as a result of the environment that you specify.

Often, the information about the environment variables is hidden somewhere deep in the Unix documentation. For example, if you read the manual page for the `lp` command carefully, you'll find a reference to the `LPDEST` environment variable. You can set this to designate your printer as the default printer, as opposed to the system default (which is set by the system administrator or print spooler administrator). You set it once when you log in and forget it.

Listing 1 is the result of running `env` on my system. It shows some of the environment variables that have proved useful for the programs that I run. Naturally, some of these reflect my personal taste (such as the contents of the `EXINIT`

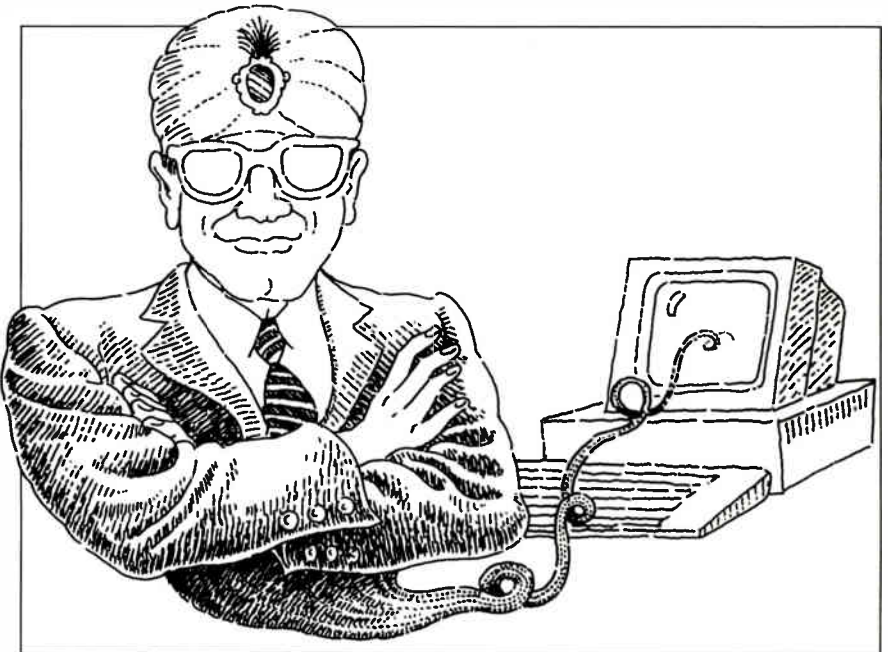

variable, which consist of the start-up commands for the `vi` editor).

More commands and programs than you might think check for the presence of such variables as `EDITOR`, `MAILER`, `PAGER`, `SHELL`, `TERM`, and `TERMCAP`. The first four of these inform applications of your favored programs for use as an editor, a mailer, a screen pager, and a Unix shell. Some people might prefer `EMACS` over `vi` as an editor, or more over `pg` as a paging program. While I generally use `csh` rather than the standard Bourne shell, the `SHELL` variable is generally used when "escaping" out of a program, and at such times I don't want the extra overhead time of starting up `csh`, so I specify the Bourne shell instead.

## Why They Call It Curses

If you're new to Unix, you might have a bit of a problem running screen-oriented programs. Unlike a personal computer with its own dedicated screen software, a

Unix system can have almost anything plugged in as a terminal. To answer the problems of running screen-oriented programs in a world of variable and unknown screen controls, a standard set of terminal-independent driver routines, known as the `curses` library, exists. The idea is to define a specific terminal's capabilities and to control the codes to a `curses`-compatible program. The terminals are described in the `/etc/termcap` file. Many Unix and most Xenix systems use the name `ans1` to refer to the console on an IBM compatible; this can generally be used by IBM PC users dialing into a Unix machine.

The `TERM` variable should contain the proper name for your terminal; the `TERMCAP` variable generally should contain the name of the `termcap` file. While (as noted above) this is generally the system file `/etc/termcap`, you can also make it point to the name of your own file. This is useful if you are testing

*continued*



# SOFTWARE SAMPLER CLUB

is giving away

## \$250,000.00

### in Bonus Gifts

to SSC members before Dec. 31, '89

If you own an IBM PC/AT/386 or Compatible computer, you must join the Software Sampler Club.

As an SSC member, you can

- \* Save thousands of dollars on your commercial software purchases.
- \* Influence the development of future software products.
- \* Receive FREE SOFTWARE and SSC NEWS.
- \* Be accurately informed about new software being marketed.

Yes, I want more information about Software Sampler Club.

Please send me:

- SSC Demo diskette
- SSC IBM PC Software Product Catalog

**FREE - NO OBLIGATION**

Name: \_\_\_\_\_

Address: \_\_\_\_\_

City: \_\_\_\_\_

State: \_\_\_\_\_ Zip: \_\_\_\_\_

Telephone: \_\_\_\_\_

See us at Fall Comdex '89 A676

## Software Sampler Club

16580 Harbor Blvd., Ste. D,  
Fountain Valley, CA 92708  
(714) 775-0695, Fax: (714) 531-8546

Attention: Computer Dealers please ask us about our "SSC Authorized Dealer Guaranteed Sales" program.

## THE UNIX /bin

**Listing 1:** *The env command lists all your environment variables and their values.*

```
EDITOR=/bin/vi
EXINIT=set beautify nomesg showmode wm=6 al shell=/bin/sh|ab u UNIX
LPDEST=ok1
MAILER=mail
NAME=David Fiedler
ORGANIZATION=InfoPro Systems, publishers of ROOT and UNIQUE
PAGER=less
PATH=:/bin:/usr/bin:/usr/games:/usr/local:/usr/lbin:/own/david/bin
ROGUEOPTS=jump,autorun,flush,noterse,fruit=prune,name=Fafhrd
SHELL=/bin/sh
TERM=ansi
TERMCAP=/etc/termcap
```

a new termcap entry, or if the administrator won't let you modify the system file to add an entry for your homemade terminal.

On some systems, the contents of the TERMCAP variable may contain the terminal's actual termcap entry (rather than the name of the file to find it in). Hint: If you have only a few types of terminals on your system, move their entries to the top of /etc/termcap. This will save start-up time for screen-oriented programs.

Naturally, such a beautifully simple idea was destined to be made more complicated. AT&T came up with its own terminfo database, which has each terminal's termcap-type information in a separate file under the /usr/lib/terminfo directory. The administrator has to make sure that the files are available in the right places and that they are properly "compiled"; the user merely has to identify his or her terminal to the system with the proper name using the TERM variable. This design for terminal information loads more quickly than termcap entries but is more difficult to set up and maintain.

### Setting Environment Variables

Let's say you're ready to actually do some of this. If you're just sitting at the regular Bourne shell prompt (\$), then you can simply type

```
TERM=foobar
```

and the contents of the TERM variable will be set to the string foobar. You can verify this by typing set.

But wait! The value will *not* be automatically inherited by other commands spawned from this shell. To prove this, type env, which prints the values of the variables actually set in the environment. It will show your TERM variable as still set to "ansi" (or whatever it was previously). To reflect your change in the

shell's environment, you must explicitly export it:

```
export TERM
```

Now when you type env, foobar will show up as your TERM type. This little exercise is meant to show how important it is to remember to export all the changes that are made to the Bourne shell environment.

Setting the variables is usually relegated to your session initialization when you log in. If your default shell is the Bourne shell, then you put the desired commands in your .profile file in your home directory, like this:

```
PATH=$PATH:/u/david/bin
TERM=ansi
NAME="David Fiedler"
PAGER="more -c"
LPDEST=laser
export PATH TERM NAME PAGER\
LPDEST
```

If your default shell is the Berkeley/C shell (%), then you put this in your .cshrc file:

```
setenv PATH "$PATH":\
/u/david/bin
setenv TERM ansi
setenv NAME "David Fiedler"
setenv PAGER "more -c"
setenv LPDEST laser
```

(C shell users also have the option of creating both .login and .logout files, which are executed when you log in and out, respectively.)

Notice that strings with spaces in them have be surrounded with the double-quote character. Also notice the syntax of the first line, which takes the current default value of PATH (the system's idea of the order of directories to search for executable files) and tacks on a reference

*continued*



# AW... What the Heck!

## We REFUSE to Raise Our Prices!

### DesignCAD 3D \$ 399

#### WE REFUSE TO RAISE PRICES!

We have dealers—even from foreign countries—call and tell us they could sell a lot more DesignCAD 3D at higher prices because some of their customers can't conceive a true 3D solid modeling program costing only \$399. They ask us to raise our prices because they know it's worth more, much more. But look at the history of our company: We just don't believe in inflated prices! An excellent CAD system shouldn't cost any more than a good word processor. So we still say, "Aw...What the heck! We refuse to raise our prices! Let's see the other guys beat this deal!"

#### WHY BUY THIS ONE?

There is a very important reason to buy DesignCAD 3D other than price: PERFORMANCE. DesignCAD 3D provides complete 3-Dimensional drawing capabilities. It's not a "warmed-over" 2D program. DesignCAD 3D allows you to draw any entity in 3-D space. This means, for example, that you can draw a curve in the shape of a spring. You can draw a circle or arc at ANY angle on ANY plane.

DesignCAD 3-D gives your Personal Computer the power of a mainframe CAD system! With DesignCAD 3-D, you can produce complete 3-dimensional models and drawings that were once considered impossible on a microcomputer!

Complete 3-Dimensional design features make it easy for you to construct realistic 3-D models. With full solid-object modeling capabilities you can analyze your drawing to determine the volume, surface area or even center of gravity. DesignCAD 3-D even permits you to check for interference between objects! Aeronautical Engineers can now find the center of gravity for a new airplane design with a couple of keystrokes. The Architect can determine the surface area of a roof for decking in a matter of minutes. The Civil Engineer can calculate the volume of a lake or dam in seconds. The Mechanical Engineer will know for sure if certain parts fit together without interference. The uses for DesignCAD 3-D are only limited by YOUR imagination!

DesignCAD 3-D supports more than 400 different peripheral devices, including more than 250 printers (dot-matrix, laser printers, color printers, etc.), 80 plotters, most mice and digitizing tablets, and a wide variety of graphics cards and displays.

Once again, American Small Business Computers has proved that you don't have to spend a lot of money to get quality software. DesignCAD 3-D provides features such as Shading, Solid Object Modeling, Hidden Line Removal, and Cross Sectioning capability. All for only \$399. No other 3-Dimensional CAD system can come close to providing the price/performance of DesignCAD 3D.

#### VERY EASY TO USE!

DesignCAD 3-D has consistently proven itself to be faster and easier to use than most competing CAD systems. In a national competition DesignCAD 3-D was matched in drawing speed by only one other CAD system. It cost \$3,000. DesignCAD 3-D was able to perform a given drawing in nearly half the time as packages costing up to \$5,000.

Customers frequently remark at how quickly they are able to learn DesignCAD. Many also comment about the power of DesignCAD.

Dr. Stephens of NASA states: "One of the things I like best [about DesignCAD 3D] is that I can pick it up and go with it." Dr. Stephens, who evaluates and recommends software for purchase by NASA, says software must meet certain criteria: "One, it must work. Two, it must be user friendly and easy to use. I push it [DesignCAD 3D] as far as I can push it. We're not using it as a toy down here, and I resent the fact that some people believe that a product's ability is substandard because of its price."

Jan Hallett, an engineer at Allied Chemical states: "We use it extensively here and are really sold on it. Plant layouts, pipe runs, fabrications, along with a lot of other things are drawn and designed. I've got AutoCAD, but very seldom if ever use it anymore."

#### PC MAGAZINE SAYS...

*DesignCAD 3D, the latest feature-packed, low-cost CADD package from American Small Business Computers, delivers more bang per buck than any of its low-cost competitors and threatens programs costing ten times as much. For a low-cost, self-contained 3D package... DesignCAD's range of features steals the show."*

#### HOW DO I GET ONE?

DesignCAD 3-D and DesignCAD 2D are available from most retail computer stores, or you may order directly from us. If you have questions about which program to purchase please give us a call. All you need to run DesignCAD 3-D is an IBM PC or compatible computer with 640 K RAM memory and a hard disk. Both products support most graphics cards, printers, plotters and digitizers. Free Information and a demo disk are available.

Circle 28 on Reader Service Card

**American**  
Small Business Computers, Inc.

327 South Mill Street  
Pryor, OK 74361  
(918) 825-4844 • FAX: (918) 825-6359

#### VERY POWERFUL!

DesignCAD 3-D version 2.1 is as powerful as most CAD systems costing \$5000-\$10,000! Features like: Complex Extrusions, a true 3D color-coded cursor, full shading or rendering capability, Blending of Surfaces, Complex Sweeps and Translations, and Boolean Operations make DesignCAD 3-D one of the most powerful 3-D CAD systems available...at any price! Engineers, Architects, and Consultants constantly tell us that they use CAD systems costing thousands of dollars which are not as powerful as DesignCAD 3-D.

**BYTE MAGAZINE SAYS...**  
*"At \$399, DesignCAD 3D was the least expensive package we saw, yet it was one of the more powerful. ...Don't be fooled by the remarkably low price, this program can really perform!"*

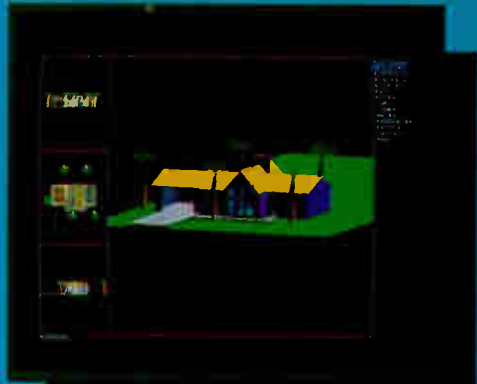
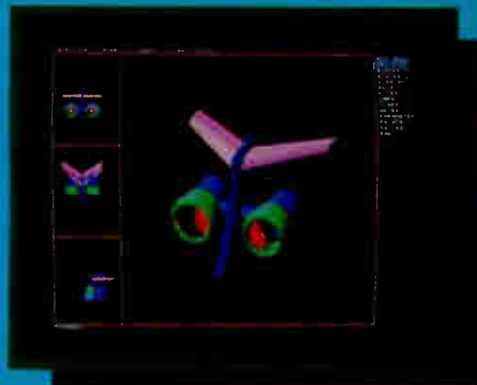

# TPU for UNIX and DOS.

Introducing nu/TPU from a/Soft.

nu/TPU gives you one hundred powerful TPU subroutines for faster and easier UNIX and DOS applications development. EVE, EDT, and VI interfaces are all included plus multiple windows, its own programming language, and unlimited extensions. You can import your customized VAX TPU programs to your UNIX or DOS system without change. nu/TPU comes with one year of free hotline support, 30 day money-back guarantee, free TPU library exchange, our technical bulletin board for news, interface code samples, and our TPU open forum. Call us for more technical details.

(508) 683-4369



a/Soft Development, Inc.  
1353 Salem Street  
North Andover, MA 01845



nu/TPU is a trademark of a/Soft Development. VAX is a trademark of Digital Equipment Corporation. UNIX is a trademark of AT&T. MS-DOS is a trademark of Microsoft.

## THE UNIX /bin

to the /u/david/bin directory at the end.

In this way, I can add commands to my own private directory at any time, and they will be executed just like system commands. A colon is used to separate directory names, and two colons (or a colon as the first character after the equals sign) means "search the current directory now."

### System Administrators and the Environment

You can use many of these same ideas as a system administrator. For instance, if you wanted to add another directory or two to the default search path, you would just do this in the one place where users will execute it when their shell starts up: in the /etc/profile file, which is examined *before* the user's own .profile. I suggest that you name the full directory path to be searched, just to avoid any confusion:

```
PATH=/bin:/usr/bin:/usr/local::
PAGER=more
TZ=PST8PDT
export PATH PAGER TZ
```

A similar entry must be made in /etc/cshrc for the C shell users. All systems should have at least one directory for "home-grown" commands (/usr/local in the example above). This makes it easy to keep them separate for backup and maintenance purposes. And this directory should appear in the search path *after* the system directories, to prevent confusion in case someone names a local command the same as a system command.

Why did I set PAGER and TZ above? The PAGER variable will allow certain programs to use the more command when it's necessary—something that unsophisticated users will thank you for. And explicitly setting the TZ variable (to whatever your local value should be) will prevent certain time-related bugs from appearing. Setting other variables can also save you a great amount of user support time; think of how you can set EXINIT to some reasonable defaults, for instance.

The "search current directory now" feature mentioned above should be *turned off* when you are logged in as root, since it makes the "Trojan Horse" security hole possible. You just explicitly change this in the .profile file (root's initialization file), and while you're at it, you should add the /etc directory to root's PATH to make your life easier. Some versions of the C shell take care

of both of these security measures automatically.

### Me and My RC

Just as each user has a file that is executed when he or she logs in, so the system has a way of changing its default behavior when it's booted up. The system executes the /etc/rc file when it first

**S**etting  
variables can save you  
a great amount  
of user support time.

comes up into multiuser mode. For years, this has been the place to put system-specific code (e.g., loading special device drivers at start-up). If you're running into strange problems with a new system, it doesn't hurt to make sure that this file is setting important environment variables properly. Things like TZ, PATH, HZ (do *not* set this to your power-line frequency!), and even SHELL can be set here for the system.

In the most recent releases of Unix, /etc/rc does little more than go into a set of numbered subdirectories under /etc/rc.d and execute all the files it finds. Each of these directories has a designated function. But you find that the file /etc/rc.d/8/userdef has been reserved just for you!

The only thing left to do to customize the system is to set up the cron facility using the /usr/lib/crontab file (on newer systems, this is now a set of files in the directory /usr/spool/cron/crontabs) for events that should repeat at specific times. If you're running UUCP (Unix-to-Unix copy), make sure that at least one of the daemon programs found in the /usr/lib/uucp directory is being executed once per hour or so, or your E-mail may never get sent. ■

David Fiedler is editor and publisher of the Unix newsletters Unique and Root and coauthor of the book Unix System Administration. He can be reached on BIX as "fiedler."

Your questions and comments are welcome. Write to: Editor, BYTE, One Phoenix Mill Lane, Peterborough, NH 03458.



UNIX WORLD AWARDS  
 VOTED #1 BEST OF  
 COMMUNICATIONS SOFTWARE

# ONE COMMUNICATIONS PROGRAM THAT MAKES ALL OF OUR INCOMPATIBLE COMPUTER SYSTEMS COMPATIBLE?

## I CALL THAT UNLIKELY.

### They call it TERM.

#### TERM runs identically under DOS, UNIX, XENIX, VMS, BTOS and MAC?

TERM is keystroke-for-keystroke compatible across all of our different computer systems and offers features like automatically restartable file transfers, data compression and CRC error detection.

#### But, can it be customized?

TERM's built-in script language is so sophisticated that it allows exact solutions to be tailored to our specific needs. In fact, there are over 25 pre-built scripts provided for solving problems like unattended file transfers, remote system polling, and error logging. TERM script allows building customized menus, data entry screens and pop-up windows designed for your unique applications.

#### And it talks to non-TERM systems?

Fluently. TERM comes with nine protocols and thirteen terminal emulations... that's enough to communicate with a wide variety of different systems.

#### DEC Terminal Emulation?

Wait till you see it. TERM's VT220 emulator meets the needs of all of our divisions by providing exact VT220 and VT102 emulation on all terminals. We've got full graphics character support even under Unix...not to mention Televideo, SCO color console and the other emulations.

#### Where did you find it?

I called: 801-268-3088

Circle 72 on Reader Service Card  
 (DEALERS: 73)

United Kingdom: Systems Marketing Ltd. (0685) 247 031  
 France: Tauris Data (331) 30 21 55 05, Top Log (331) 42 04 21 18  
 Benelux: Top Log (222) 672 22 40  
 Italy: ESA (0541) 741113  
 Australia: Quinx (07) 831 8666

All orders shipped 2nd Day Air

#### TERM. Powerful Communications.

##### Features:

- ✓ Automatically restartable file transfers
- ✓ State-of-the-art Lempe-Ziv-Weich data compression
- ✓ Exact VT220, VT102, and VT100 Emulation on ALL systems
- ✓ Fully remappable keypad support
- ✓ Full color support
- ✓ 38.4K file transfers
- ✓ KERMIT Protocol for mainframes
- ✓ XMODEM and YMODEM Protocols for bulletin boards
- ✓ Remote PC execution
- ✓ Powerful script language for customized applications
- ✓ Wildcard file send/receive capability
- ✓ Auto-login, dial/real modem control
- ✓ Unlimited autodial directory
- ✓ Performs unattended file transfers
- ✓ Remote maintenance capability
- ✓ Online User's Manual for instant help
- ✓ Electronic mail/TELEX/FAX
- ✓ Easylink/MCI Gateway

TERM is available now on Altos, Apple Macintosh, Aris/Arête, AT&T, British Telecom, Bull, Burroughs, CCI, Celerity, Convergent Technologies, Counterpoint Systems, Cubix, DEC VAX, Fortune, Gould Harris, Heurikon, Hewlett Packard, Honeywell, IBM, ICL, ICON, IMP, Integrated Solutions, Intel, Jarogate, Lanier, Masscomp, Momentum, Motorola, NCR Tower, Nixdorf Targon, Northern Telecom, Plexus, Prime, Pyramid, Ridge Computer, Sequent, Sigma Designs, Sun Workstation, Tandy, Unisys, Victor, Wang PC, Zenith and Zilog. Find out how easy it is to get your VMS, UNIX, XENIX and MSDOS machines all together.

# TERM

COMMUNICATIONS SOFTWARE

Call or write for complete information

 **CENTURY**  
SOFTWARE

5284 South 320 West, Suite C134 Salt Lake City, Utah 84107 (801) 268-3088



**S**malltalk/V<sup>®</sup> PM.  
 Think of it as a bold,  
 “seat-of-the-pants” solution  
 that cuts to the heart of the  
 OS/2 Presentation Manager  
 complexity challenge. Thus  
 unlocking the potential of this  
 powerful operating system.

With the introduction  
 of Smalltalk/V PM, object-  
 oriented programming

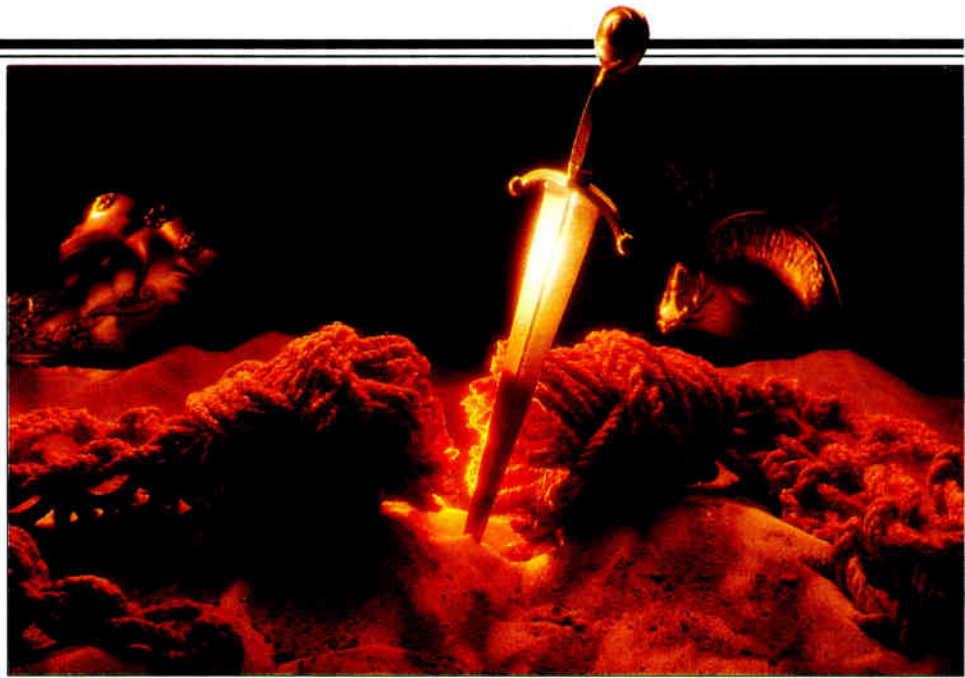

# Introducing Smalltalk/V PM. The to fulfill the promise of OS/2.

moves out of the realm of mystery  
 and into a new era of breakthrough  
 applications that promises to be of  
 legendary proportions.

OS/2 PM is designed to push

“user friendly” to a whole new level  
 of sophistication. If you compare it  
 to an orchestra, OS/2 has capabili-  
 ties no ordinary assemblage of in-  
 struments has ever dreamed of

possessing. Yet to tap

its potential, OS/2  
 PM demands a con-  
 ductor capable of true  
 genius. That conduc-  
 tor is Smalltalk/V  
 PM.

You’ll find Small-  
 talk/V PM a perfect  
 language for repre-  
 senting and manipu-  
 lating high-level  
 information. Because

you go from designing to prototyp-  
 ing to delivering a completed appli-  
 cation in one seamless step, you  
 cleanly avoid the old costly “crash  
 and burn” delays so common with  
 languages born in the age of main-  
 frames.

## UNLEASHING THE AWESOME POWER OF OS/2 PM

Smalltalk/V PM. It helps stop  
 the natural drift toward vaporware  
 so common in software develop-  
 ment today. It lets you dive right in  
 and get to the creative parts with-  
 out the usual grunt work. For ex-  
 ample, if you want to ignore the  
 complexities of understanding  
 OS/2 PM details you can immedi-

### Is The Most Important Part Of Your Developer’s Kit Missing?

OS/2 PM offers you a powerful, rich environment  
 loaded with advantages like a Graphics Program-  
 ming Interface (GPI), a LAN manager, multitask-  
 ing, SQL, just for starters. And all of these  
 components are accessible in a standard way using  
 Smalltalk/V PM through Dynamic Link Libraries  
 (DLLs). Combined with DDE (Dynamic Data  
 Exchange), you can call and exchange data with  
 other PM services or applications. Seamlessly.  
 Now developers can write truly reusable compo-  
 nents, which greatly increases their value. And  
 you’ll find Smalltalk/V PM the perfect “glue”  
 between applications written in other languages.







**T**he Gordian Knot. A legendary case of complexity. It had baffled and stymied the best minds of the ancient world until Alexander the Great cut through the convoluted challenge with one bold, swift stroke of his sword. This "seat-of-the-pants" solution set in motion the prophecy that whoever unraveled the knot would one day rule Asia.

**"THIS IS THE RIGHT WAY TO DEVELOP APPLICATIONS FOR OS/2 PM. OS/2 PM is a tremendously rich environment, which makes it inherently complex. Smalltalk/V PM removes that complexity, and lets you concentrate on writing great programs. Smalltalk/V PM is the kind of powerful tool that will make OS/2 the successor to MS/DOS."**

*Bill Gates, Chairman  
Microsoft Corp.*

grammer struggling with the complexities of Presentation Manager should take a close look at this product."

*Charles Petzold, Contributing Editor,  
PC Magazine*

"Digitalk's Smalltalk/V PM is dazzling! This product makes Presentation Manager pay off."

*Jeff Duntemann, Contributing Editor,  
Dr. Dobbs Journal*

"Smalltalk/V PM is an excellent tool for rapid delivery of prototypes which have all the functionality and user interface of a complete PM application."

*Richard A. Landsman,  
System Architect, Lotus Development*

"Smalltalk/V PM from Digitalk is the greatest! This is an incredible product."

*J.D. Hildebrand  
Editor-in-Chief, Computer Language*

# fast, seat-of-the-pants way



**THE FIRST FULLY-COMPILED SMALLTALK.**  
*Because Smalltalk/V PM is fully compiled it provides you with a more responsive environment than ever before. Now you'll be able to generate stand-alone applications (.EXE).*

debugger simplifies application development and gives you instant response when you implement an idea. Our extensive user manuals and tutorials have earned us high praise.

**SMALLTALK/V PM. THE TALKING HAS**

**ALREADY STARTED.**

"Digitalk's Smalltalk/V PM is a masterful implementation of a classical object-oriented programming language and a state of the art graphical user interface. Any pro-

ately start creating without any limitations on your efficiency.

However, if you're the curious type, we have tools called browsers to help you fathom the masterpiece called OS/2 PM. You'll also find our incremental program development capability and push-button

**THE BEST PM INVESTMENT YOU'LL EVER MAKE.**

**Smalltalk/V PM \$499.95**

Prices and information on these and other Digitalk products are available on request:

Smalltalk/V, Smalltalk/V 286, Smalltalk/V Mac

Smalltalk/V. A product of Digitalk Inc., 9841 Airport Blvd., Los Angeles, CA 90045. For information or to find a dealer near you call:

**1-800-922-8255**

**1-213-645-1082**

CompuServe 71361,1636

FAX 1-213-645-1306

Smalltalk/V is a registered trademark of Digitalk Inc. Prices subject to change without notice. Other product names are trademarks or registered trademarks of their respective holders.

# Smalltalk/V



# QUALITY BY DESIGN



## GV286/120

- 80286 running at 12 MHz zero wait state.
- Proprietary, 32KB on-board RAM cache circuit using high speed (35ns) static RAM.
- 640KB RAM, expandable to 1MB on motherboard.
- Socketed for 8MHz 80287 math coprocessor.
- 5.25" 1.2MB or 3.5" 1.44MB floppy drive.
- Western Digital 1:1 interleave dual controller.
- Enhanced 101-key keyboard.
- Graphics adaptor features a full 256K of video RAM and 16-bit interface for full VGA capabilities.
- 200-watt power supply.
- 2 serial/1 parallel port standard (on add-in card).
- ROM based set-up and diagnostics.
- Motherboard designed and manufactured in the U.S.A.
- Toll-free technical support.
- One-year factory warranty, parts and labor. Overnight parts replacement available.



## GV286/20

- Choice of slimline or Baby "AT" desktop, space-saving footprints available.
- Top performance at lower cost.
- VLSI technology for increased reliability.
- 80286 running at 20 MHz zero wait state.
- Paged-interleave Memory Architecture.
- 1MB RAM standard, expandable to 2MB or 4MB configurations on motherboard.
- Socketed for 10MHz 80287 math coprocessor.
- 5.25" 1.2MB or 3.5" 1.44MB floppy drive.
- Western Digital 1:1 interleave dual controller.
- Enhanced 101-key keyboard.
- Graphics adaptor features a full 256K of video RAM and 16-bit interface for full VGA capabilities.
- 200-watt power supply.
- 2 serial/1 parallel port standard (on add-in card).
- ROM based set-up and diagnostics.
- Motherboard designed and manufactured in U.S.A.
- Toll-free technical support.
- One-year factory warranty, parts and labor. Overnight parts replacement available.



## GV386/20 PLUS

- 80386 running at 20 MHz zero wait state.
- 1MB RAM on motherboard.
- System is capable of expanding to 16 MB of 32-bit RAM.
- Proprietary, 64KB on-board RAM cache circuit using high speed (35ns) static RAM.
- Socketed for 20MHz Intel 80387, or 20MHz Weitek 3167 math coprocessors.
- 5.25" 1.2MB or 3.5" 1.44MB floppy drive.
- Western Digital 1:1 interleave dual controller.
- 2, 8-bit, 4, 16-bit and 2, 32-bit memory expansion slots.
- Graphics adaptor features a full 256K of video RAM and 16-bit interface for full VGA capabilities.
- 2 serial/1 parallel port standard (on add-in card).
- ROM based set-up and diagnostics.
- Motherboard designed and manufactured in U.S.A.
- Toll-free technical support.
- One-year factory warranty, parts and labor. Overnight parts replacement available.



## GV386SX

- Run 32-bit operating systems, applications software, or Windows 386 at a lower cost.
- Slim-line, space-saving desktop configuration.
- 80386SX running at 16 MHz zero wait state.
- 2MB RAM standard, 4MB capacity on motherboard.
- Socketed for 16MHz Intel 80387SX, math coprocessor.
- 3.5" 1.44MB floppy drive.
- Western Digital 1:1 interleave dual controller.
- VLSI technology for increased reliability.
- Graphics adaptor features a full 256K of video RAM and 16-bit interface for full VGA capabilities.
- 2 serial/1 parallel port standard (on add-in card).
- ROM based set-up and diagnostics.
- Motherboard designed and manufactured in U.S.A.
- Toll-free technical support.
- One-year factory warranty, parts and labor. Overnight parts replacement available.

### OPTIONS

- RAM upgrades.
- Intel 80287 math coprocessor.
- On-site service agreement.
- MS-DOS 3.3. or 4.01.
- 256 Video upgrade \$99.



### OPTIONS

- RAM upgrades.
- Intel 80287 math coprocessor.
- On-site service agreement.
- MS-DOS 3.3. or 4.01.
- 256 Video upgrade \$99.

### OPTIONS

- RAM upgrade to 3 MB add \$725 to 5 MB add \$955.
- 20MHz Intel 80387 and 20MHz Weitek 3167 math coprocessors.
- On-site service agreement.
- MS-DOS 3.3. or 4.01.
- 256 Video upgrade \$99.

### OPTIONS

- RAM upgrade to 4MB add \$390.
- 16 MHz Intel 80387SX math coprocessors.
- On-site service agreement.
- MS-DOS 3.3. or 4.01.
- 256 Video upgrade \$99.

NEW PRICES	VGA	Extended
	Mono	VGA Color
44MB, 23ms, ST506	\$2,149	\$2,499
71MB, 27ms, ST506	\$2,409	\$2,769
155MB, 18ms, ESDI	\$3,299	\$3,599
320MB, 18ms, ESDI	\$4,099	\$4,399

NEW PRICES	VGA	Extended
	Mono	VGA Color
44MB, 23ms, ST506	\$2,695	\$3,095
90MB, 18ms, ESDI	\$3,395	\$3,795
155MB, 18ms, ESDI	\$3,995	\$4,395

NEW PRICES	VGA	Extended
	Mono	VGA Color
44MB, 23ms, ST506	\$3,399	\$3,699
71MB, 27ms, ST506	\$3,659	\$3,959
155MB, 18ms, ESDI	\$4,399	\$4,799
320MB, 18ms, ESDI	\$5,199	\$5,599

NEW PRICES	VGA	Extended
	Mono	VGA Color
44MB, 23ms, ST506	\$2,795	\$3,195
90MB, 18ms, ESDI	\$3,495	\$3,895

Circle 274 on Reader Service Card

Ask about our "Lease/Purchase Agreement"

# PC Designs

Since 1985

2000 North Harder & Carson, Broken Arrow, Oklahoma 74012

For Export call: (410) 231-5000 • Local: (410) 231-7000 • Sales: (410) 231-5300 • (410) 627-4248 • FAX: (410) 231-7057 • E-Mail: (410) 231-5100

CALL DIRECT TODAY!

# 1-800-627-4248







# SERVING BUSINESS

Networks let dedicated database servers bring SQL power to personal computers

**I**n last month's column, I discussed the role that IBM's OfficeVision and Systems Application Architecture (SAA) will have in the corporate world. As you will recall, IBM's plans for your future are based on a mainframe acting as a Structured Query Language server. (SQL is a "truly" relational database system tracing back to circa 1970 IBM.)

This solution works, of course, only if you have such a mainframe. Although IBM will be pleased to sell you one, for many small businesses this just doesn't make sense.

What *does* make sense is to use the guts of SAA—that is, the user interface and the SQL server—without using SAA itself. This way, you can still have the communications, the data handling, and the centralized data storage, while using equipment that may otherwise meet your needs a lot better.

## Serving You Right

In essence, the corporate database is simply a collection of information. Many companies place this information on a mainframe. This decision is often made more for reasons of capacity and security than for performance. Company data is much of what makes the company, and it must be protected.

With the maturing of LANs, these same benefits can now extend beyond the mainframe world into the realm of the personal computer. This is made possible by the introduction last year of SQL database engines that reside on dedicated database server machines attached to the networks. No longer is database work on

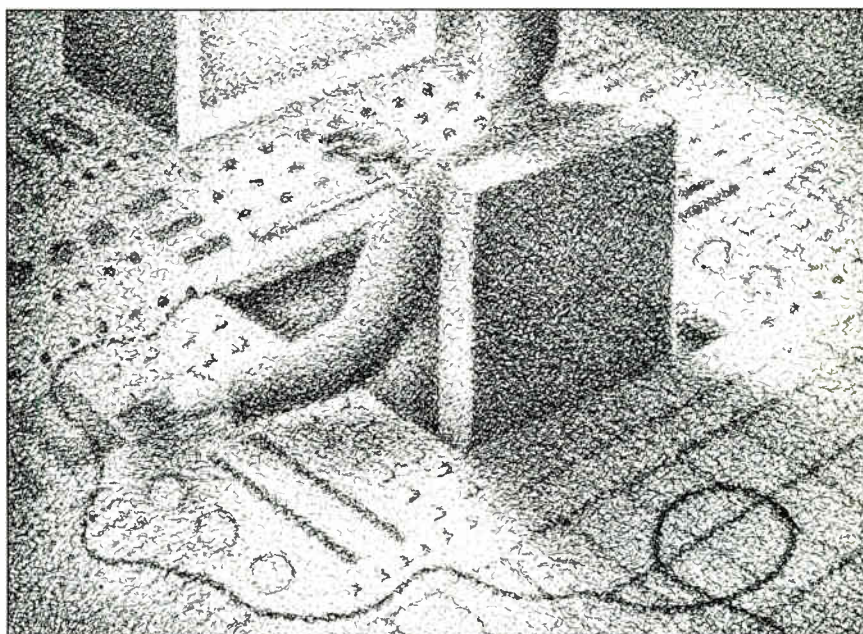

microcomputers restricted to a single machine. The database software waits for the workstation software to ask it for a task.

As a user, you may never know that there is a SQL (pronounced "sequel") server out there. The workstation software presents the screens, performs initial edits, and validates entries. Once the user of the workstation software completes a screen, that screen is changed into a SQL query, which is then sent down the LAN to the database server. The server, in turn, finds the requested information and returns the results to the user.

This method of working has two advantages. First, it reduces the workload on the workstation, allowing that computer to be less powerful and, therefore, less expensive. Second, it also reduces traffic on the LAN significantly over software such as dBASE, which requires data, not just commands, to flow both ways.

## The SQL Approach

The past year has seen the development of several SQL database server products. All offer the same flexibility IBM offers in the SAA world. The difference is that they don't require IBM hardware. Each product approaches the task of being a SQL server in a slightly different way.

Gupta Technologies' SQLBase server, for example, will work with nearly any network. Gupta also makes other software that provides connectivity to mainframe SQL databases and other external database products. Gupta gives you a complete solution.

Microsoft, on the other hand, offers only the database engine—that is, the part of the SQL server that actually receives queries and provides answers. Other companies, including Ashton-Tate, provide the front end that allows the database engine to be used.

Novell even manages to do without the dedicated database server. Its database

*continued*

# BLACKSHIP

Your "BEST BUY" Company

## 386 SYSTEM

"Blackship 386/25: Reliability at a Good Price... the only machine tested that was entirely trouble-free."

— PC WORLD, August 1989

"The Blackship offers low price 33-MHz performance... we rate it a very good value."

— INFOWORLD, July 1989

"Blackship's 386/25 is low price leader."

— INFOWORLD, May 1989

"... one of the 80386-based clones that offer a revolutionary new feature — affordability."

— BYTE, October 1988

"... remarkably strong performance at bargain prices."

— PC WORLD, June 1988

386/33 Mhz System .....	\$3395
386/25 MHz System .....	\$2595
386/20 MHz System .....	\$1795
386/16 MHz System .....	\$1595

## 286 SYSTEM

"Well-built newcomer is value leader among superfast ATs we tested."

— INFOWORLD, February 1989

"... its price/performance ratio easily justifies PC WORLD's Best Buy recommendation."

— PC WORLD, August 1988

286/25 MHz System .....	\$1295
286/20 MHz System .....	\$1195
286/16 MHz System .....	\$1095
286/12 MHz System .....	\$945
286/10 MHz System .....	\$895

## ALL SYSTEMS INCLUDE

- 1 Mb Memory
- 2 Serial, 1 Parallel, and 1 Game Port
- 2 FD / 2 HD
- 1.2 Mb 5¼" Floppy Drive
- Keytronic 101-Key Keyboard
- 8 Expansion Slots
- Math Coprocessor Socket
- Clock/Calendar with Battery Backup
- Room for Up to 5 Half-Height Drives
- 220 Watt Power Supply

## OPTIONS

- Memory
- Video
- Plotters
- Hard Drives
- Modems
- More... CALL
- Tape Backup
- Digitizers
- Printers

## ORDERS

1-800 431-6249 (USA)  
1-800 654-7955 (CA)



**BLACKSHIP**  
COMPUTER SYSTEMS, INC.



4031 Clipper Court  
Fremont, CA 94538  
415-770-9300  
FAX 415-770-8674

server product runs as an additional process in the file server and supports the data files there. This has the advantage of not requiring you to buy a separate machine for the database server, but it does add an additional load to the file server, which can be a problem in the case of a busy LAN where there is a lot of disk activity. In that instance, you might find yourself waiting for your database query while someone else plays Novell's SNIPES game.

### Competing with SAA

Each of the three approaches will work to support a LAN with workstations that must share information for their applications. In the case of Novell's NetWare SQL and Microsoft's SQL Server, that's about all you can do right now. Gupta Technologies has provided capabilities that come close to competing with SAA. Microsoft has stated its intention to do this, also, but to date, the software support is lagging, and Microsoft's LAN restrictions make an immediate remedy for this unlikely.

Gupta has arranged for a variety of options for the user interface and for applications interfaces. This means you may be able to use all or most of your current application, or you can design a Microsoft Windows application that can be upgraded to Presentation Manager (PM). Gupta wisely chose to make arrangements with Nantucket Corp. and Wordtech Systems, the makers of the two major dBASE language compilers, to create workstation front ends for its SQL engine.

Gupta was likewise perceptive to

choose Microsoft Windows as its graphical user interface. This gives SQL users a path to the future with a DBMS that's available now. Unlike much of what is planned for SAA, you can run Gupta's SQLWindows under MS-DOS on IBM PC AT-class machines that you already have. You don't need to wait for IBM or anyone else to deliver on promises in the coming years.

Gupta says that its Windows product will be upgradable to PM in the future. Whether that will ever happen remains to be seen, but it seems likely. Gupta is already working in the OS/2 environment with its database engine, and the company seems to understand the operating system.

What Gupta means is that the applications created by using SQLWindow's fourth-generation language will be upgradable to OS/2. Gupta's language for use with its database server is unusually complete, allowing users to create the full range of Windows screen devices. In other words, you can have dialog boxes and radio buttons to your heart's content.

### Microsoft's Contribution

Microsoft has taken a different tack in the effort to bring a SQL server to market. Instead of designing the user interface itself, the company has arranged with Ashton-Tate and Borland to create versions of their DBMS products that will work with SQL Server. These products are expected around the end of this year.

In the meantime, SQL Server suffers

*continued*

## ITEMS DISCUSSED

<b>dBXL</b> .....	\$199
<b>Quicksilver</b> .....	\$595
Wordtech Systems P.O. Box 1747 Orinda, CA 94563 (415) 254-0288 <b>Inquiry 1101.</b>	
<b>NetWare SQL</b> .....	\$595
Novell, Inc. 122 East 1700 South Provo, UT 84601 (801) 379-5900 <b>Inquiry 1102.</b>	

<b>SQLBase</b>	
single-user .....	\$1295
multiuser .....	\$2995
<b>SQLNetwork</b>	
SQL Gateway .....	\$1995
SQL Host .....	\$20,000
<b>SQLWindows</b>	
single-user .....	\$1295
multiuser .....	\$2995
Gupta Technologies, Inc. 1040 Marsh Rd., Suite 200 Menlo Park, CA 94025 (415) 321-9500 <b>Inquiry 1103.</b>	

<b>SQL Server</b> .....	\$2495
Ashton-Tate 20101 Hamilton Ave. Torrance, CA 90502 (213) 538-7755 <b>Inquiry 1104.</b>	



## Seagate's ST157 Family

T H E F I N E A R T O F D I S C D R I V E S

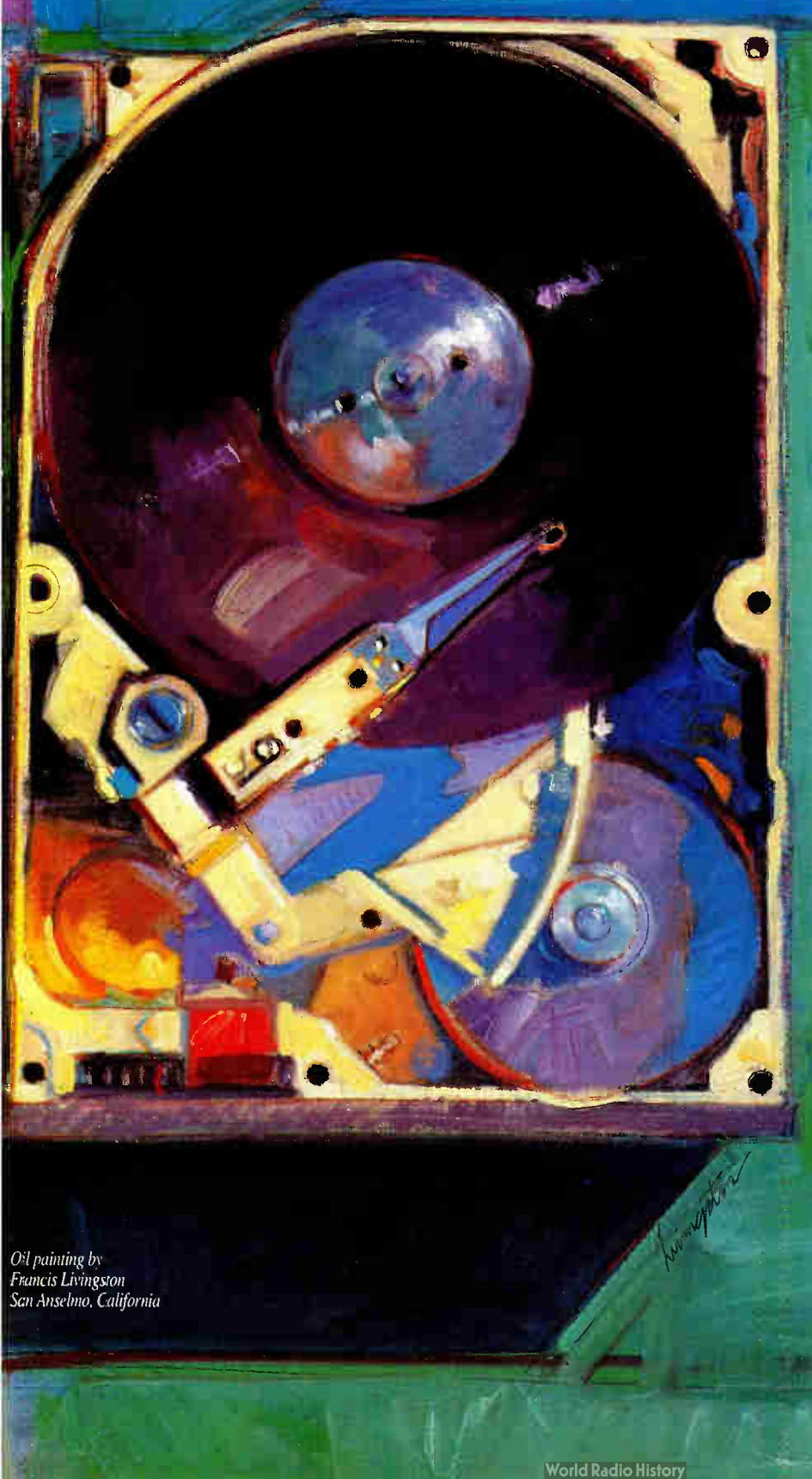

**A**s the storage and retrieval device for

valuable information, a disc drive plays a critical role in a personal computer's overall operation. Building hard disc drives that deliver both high performance and high reliability requires the same degree of precision employed by skilled artists.

This precision is reflected in every Seagate ST157 family drive. Using our own stepper motor processes, each drive is auto-tuned for optimum performance every time the drive is powered up.

This 21-49 megabyte 3.5" drive family is a skillful blend of performance and reliability. With access times of 28 msec, these drives feature an MTBF of 70,000 hours, and are available in SCSI, ST412 and AT<sup>®</sup> interfaces.

Like the artist who spends years perfecting his craft, Seagate has spent the past decade mastering the fine art of disc drives. For more information on our palette of high quality storage solutions, contact your authorized Seagate distributor, or call Seagate directly at 800-468-DISC, or 408-438-6550.

 **Seagate**

AT is a registered trademark of International Business Machines Corporation. Seagate and the Seagate logo are registered trademarks of Seagate Technology, Inc. © 1989 Seagate Technology, Inc.

from some significant limitations. Because of Microsoft's approach, few development tools are available now. If you plan to do work with SQL Server, you'd better plan to be a C programmer. While this might be acceptable for new project development, conversion of mainframe systems to work with a SQL server usually involves the use of COBOL, and that's not something that is well supported by Microsoft.

Perhaps more critical, Microsoft's SQL Server works only with Microsoft's LAN Manager. Considering that network operating system's minor position in the LAN marketplace, the limitation can be crippling. The majority of LAN installations (approximately 60 percent, according to a BYTE survey) are running Novell NetWare. Most of the rest are running 3Com.

In its current incarnation, Microsoft's LAN Manager is a poor choice, both because of its limited use and because of its significant security problems. While this may change someday, it's unlikely that moving this way now would be a wise business decision.

#### Novell's Dual-Purpose Server

If you already have a Novell LAN and it's not heavily taxed, Novell's NetWare SQL will save you the cost of another machine. This is because it runs as a value-added process in the file server itself.

That means, of course, that you can't use any other network operating system besides NetWare. It also means the file server will have to split its time between

serving files and serving the database.

To make matters even less attractive, you have very little choice of how you will use the database server. Wordtech

**G**upta's  
language for use with its  
database server is  
unusually complete.

Systems has a version of its DBMS software that will work as a front end, but you'll have to program it yourself.

#### Wordtech's Role

Wordtech Systems doesn't sell a SQL server product, but it has found a way to provide workstation software that will use the dBASE programming language and still work with SQL databases. Because Wordtech's products allow the creation of some very acceptable user interfaces, and because dBASE programmers are easier to find than C programmers, this makes system implementation easy to accomplish. In addition, conversion from applications written for dBASE is simplified.

At this writing, Wordtech's products are in the final testing stages. They should be released by the end of the year.

#### A Replacement for SAA?

As you can see, none of these solutions is as well integrated as IBM's SAA is supposed to be. On the other hand, at least some of it is available now, and none of it requires you to buy an IBM mainframe or minicomputer. If your business is based on personal computers or on a non-IBM minicomputer, at least you have the option to gain most of the benefits that IBM promises. You will have to do more work, of course, but you won't have to run a mainframe, and that's a considerable savings in hardware and personnel.

At this point, the only realistic solution to the needs of a business that is moving to SQL is Gupta's SQLBase. For one thing, it's a complete solution. You don't have to wonder when your user interface is going to be available. For another, it allows great flexibility in the operating environment, supporting an AT-based database server on the low end and IBM's DB2 on the other. In other words, you can use the low-cost solution even if you *do* eventually end up in the IBM mainframe world. ■

*Wayne Rash Jr. is a contributing editor for BYTE and a member of the professional staff of American Management Systems, Inc. (Arlington, VA). He consults with the federal government on microcomputers and communications. You can contact him on BIX as "waynerash," or in the to.wayne conference.*

*Your questions and comments are welcome. Write to: Editor, BYTE, One Phoenix Mill Lane, Peterborough, NH 03458.*

## Neural Networks are Solving Real Problems

### Here's What NeuroShell Users are Doing:

Circuit board problem diagnosis • Psychiatric evaluations • Stock market predictions • Sales forecasts • Oil exploration • Optimizing biological experiment results • Price forecasts • Analysis of medical tests • Optimizing scheduled machine maintenance • Predicting student performance • Horse racing picks • Factory and shop problem analysis • Optimizing raw material orders • Spectral analysis • Selection of criminal investigation targets • Employee selection • Process control • and much, much more.

Since NeuroShell learns by example, handles fuzzy logic, can give tight data fits, and doesn't try to capture knowledge in rules, it is also being used as an alternative in many cases to expert systems, the ID3 algorithm, and regression analysis.

NeuroShell is ready to use for real problems on your IBM PC or compatible, and still only \$195. Math coprocessor recommended. No programming or Ph.D. required! Shipping free by mail in US, Canada, and Mexico (\$9 elsewhere). Add 5% tax in MD.

#### Ward Systems Group, Inc.

228 West Patrick St. / Frederick, MD 21701  
TEL (301) 662-7950 FAX (301) 663-6656

## NeuroShell™

*Taking AI Beyond the Expert System™*

NeuroShell is a trademark of Ward Systems Group, Inc. IBM PC is a registered trademark of International Business Machines

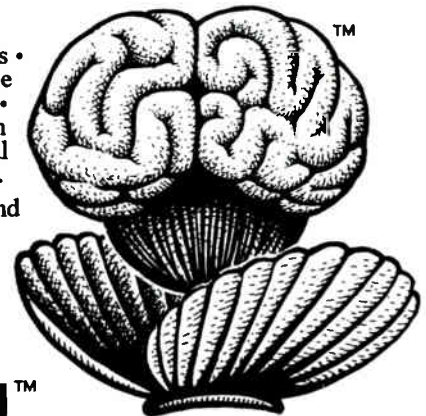



# How an upside down idea made the mouse obsolete.

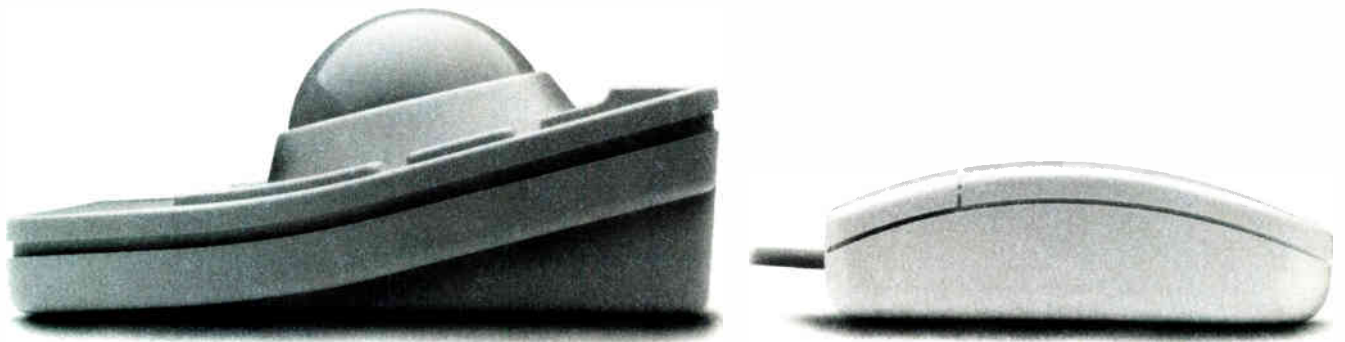

Frankly, we thought any input device that operated by dragging it across an already cluttered desk was great technology misapplied. We took a different approach.

Now RollerMouse makes the conventional mouse obsolete.

## Control Without Bending Your Elbow

All the pointing accuracy and speed you only hoped for from your old mouse is right at your fingertips. Moving from point to point with our oversized trackball is fluid, effortless and fast at 200 CPI resolution.

Using our exclusive four-button control, you have maximum click and click lock versatility. With programmable pop-up menus, RollerMouse works with software written with or without a mouse in mind. And RollerMouse technology means you never need to disassemble it for cleaning.

## More Application Productivity

If you work with the latest graphics-based applications, such as desktop publishing, CAD/CAM/CAE or any object-oriented PS/2, PC or Mac operating system, don't be held back by old mouse technology.

Buy from the leader in precision pointing devices. CH Products perfected computer control technology more than 25 years ago. And the latest technology is at a dealer near you.

For more information, call:  
(619) 744-8546

8:00 a.m. - 4:30 p.m. PST

For credit card orders, call:

USA (800) 624-5804

CA (800) 262-2004

8:00 a.m. - 4:30 p.m. PST



A Division of Joystick Technologies, Inc.  
1225 Stone Drive, San Marcos, CA 92069

All product names are registered trademarks of their respective owners. All rights reserved.

Circle 75 on Reader Service Card  
(DEALERS: 76)

## RollerMouse™ The other kind of mouse.



## High Performance Systems

Enjoy extra performance from your computer with Eltech!

Starting Price: \$2480

**"One of the  
best numeric  
performers  
of the bunch"**

-----MIPS Magazine,  
August 1989



The Eltech 9870 386 computer utilizes the best technology available today. Featuring the Floating Point Processor 80387-25/Weitek 3167, Eltech is now offering one of the fastest affordable computers that can be shipped to you TODAY! The 9870 also includes Cache Memory: 64 or 256KB S-RAM ; Expansion RAM: 4 or 8MB on 32-bit Board; Maximum RAM: 16MB Data Bus Width: 32-bit; Zero Wait States and 1 Serial and 1 Parallel Ports.

**30-Day Money-Back Guarantee.  
Next Day Free On-Site Service.  
Next day delivery available.**

- One year free on-site service
- Consulting service program
- Leasing and financing program



1725 McCandless Drive  
Milpitas, CA 95035  
Telephone: 408-942-0990  
FAX: 408-942-1410 Technical Support: 408-942-1067

**Distributors & VAR inquiries welcome  
Call for details.**

Circle 124 on Reader Service Card

World Radio History





# RESEARCH À LA MAC

Apple aims at the scientific research market and announces two new Macs

**A**pple has always had an affinity for the higher education and scientific research community. The Apple University Consortium, a group of prestigious U.S. universities, has been an important Apple partner, even before the introduction of the Macintosh. If it weren't for the AUC's early adoption of the Mac, Apple would have pulled the plug on the machine by 1985. Sales of Macs to AUC members and the AUC's work in developing new software and hardware for the Mac have fostered much of the Mac's acceptance in business environments.

A current reminder of just how closely Apple works with the AUC members is the Apple Science CD, volume 1. This CD-ROM disk was previewed at the annual AUC meeting in July and is available at no cost through Apple's higher education sales representatives to any researchers and teachers interested.

The CD contains over 500 megabytes of scientific data covering hundreds of different scientific phenomena, including atmospheric and weather information, astrophysical data, biomedical data, scientific images, animations, and dozens of simulations.

It also has the complete suite of data-visualization and data-analysis tools developed by the National Center for Supercomputer Applications (NCSA) at the University of Illinois. Analysis software from the National Institutes of Health completes the disk. These tools let you take apart the data on the CD and demonstrate techniques to your colleagues. Also, you can use data-visualization methods that make it easy to

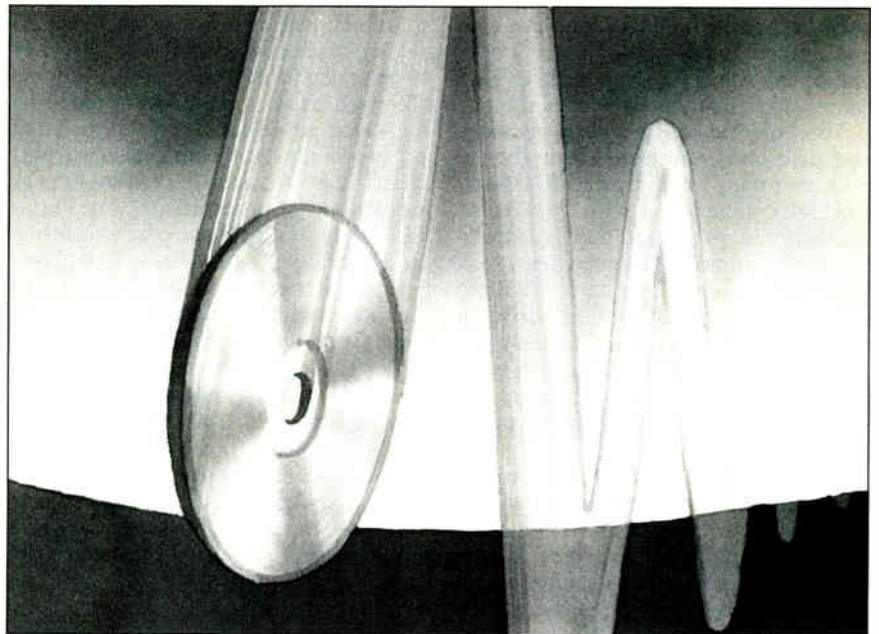

“see” trends in the data that numerical methods alone often miss.

The value of the Apple Science CD lies in the “realness” of the data, making it an amazing teaching resource. You can now see what happens when a hurricane comes ashore, or what happens when two large air masses collide over land, or what happens when a star burns out. The Apple Science CD includes data for these events and many more, plus a series of simulations and animations that have been constructed based on direct measurements. It even has three-dimensional renderings that almost come alive when you view them with a standard pair of red/blue three-dimensional glasses.

The data on the disk was collected over a four-month period from research scientists across the country. The Apple Science CD owes its existence to several people, including Kurt Schmucker and Rob Wolf, research scientists at Apple; Brand Fortner, manager of applications software at NCSA; and Katie Povejsil,

manager of academic solutions at Apple.

The Apple Science CD is Apple's third major CD-ROM disk. The first two, the Apple Education CD sampler and Phil and Dave's Excellent CD, are good examples of how important CD-ROMs can be to the Mac market. They remind us that desktop media and multimedia authoring need a source of high-quality images and sound, and CD-ROM disks are an inexpensive way to fill that need.

Apple covers a lot of ground with the Apple Science CD and deserves major-league kudos for distributing this resource for free. We should thank those involved in its production for having the foresight and guts to pull this off, especially in such a short period of time. I can't wait until volume 2!

## The Soul of the New Machines

I can now talk about the two new machines that Apple announced in September, both of which I've used extensively

*continued*

in prerelease versions.

The first machine is the Mac Portable. The Portable is a new "design center" for Apple; that is, it uses new components configured in new ways and manufactured on new factory lines. Unless you've been in a cave for the last year, you've probably got the basic specifications for the Portable memorized: a 16-MHz 68000-based machine of the familiar laptop/clamshell configuration made famous by Zenith and Toshiba. The Portable includes a fancy active-matrix LCD (where each pixel is controlled by a separate "transistor") that's not backlit, a keyboard, and a trackball (you can also use a mouse). The keyboard and trackball can be repositioned in the case to accommodate right- or left-handed users.

The Portable sports several memory and disk configurations, including a basic unit with 1 megabyte of RAM and one FDHD floppy disk drive. You'll also see units with two floppy disk drives; another configuration has one floppy disk drive and a 40-megabyte hard disk drive (with an 80-megabyte hard disk drive on the horizon). RAM will ultimately top out at 9 megabytes. For now, however, there's only a 1-megabyte RAM expansion board available, boosting total memory to 2 megabytes.

The Portable contains a single processor expansion slot that is incompatible with NuBus or the current Mac SE and Mac SE/30 slots. Apple seems to love mangling its own bus standards. The Portable includes the usual ports: one Apple Desktop Bus port (e.g., for external keyboards, mice, and x,y digitizers), two serial ports, a SCSI port, and a sound port. A 2400-bps internal modem will be an option.

Apple built the Mac Portable with the smartest power-management circuitry I've ever seen. The lead-acid gel battery in the unit I used could run the Portable for over 8 hours, unless you're doing constant disk updates. The power pack continuously monitors the state of the Portable, turning off unused components. It also acts as a power filter/surge protector. Unfortunately, the power pack is also an integral unit; you can't separate the battery from it to save weight. This means that the Portable must have the power pack installed even when the machine is using wall current.

With a 40-megabyte hard disk drive and 2 megabytes of RAM, the Portable checks in at over 15 pounds, a lot to lug around an airport. Still, it's not as heavy as some of the Zenith behemoths I've carried, like the Z-183 and the TurboPort 386. Compared to the NEC Ultra-

**E**ven at  
a price over \$6000,  
Apple will sell  
every Portable it makes.

Lite, the Zenith MinisPort, or the Toshiba T1000, though, the Portable seems enormous.

Its physical dimensions heighten the feeling of largeness, because it's actually wide enough to fit on your lap without the need to wire your knees together. This is an advantage when you're sitting on one of those uncomfortable airport chairs, but it's a distinct disadvantage when working on an airplane. The Portable simply won't fit on a coach-class tray table, and it just barely fits in first class.

Pricing speculation for the Portable has been rampant, since such decisions aren't usually made until just before the official announcement. A loaded machine (i.e., with 2 megabytes of RAM, a 40-megabyte hard disk drive, and a 2400-bps modem) will likely sell for over \$6000, street price. Even at such a high price, Apple will sell every Portable it makes. In fact, I'd be surprised if the machine isn't such a hit that orders get backlogged right away.

### The Mac IICI

The other new Mac is the 25-MHz IICI, called the IICI. This machine is the second small modular-design-center unit. The IICI includes built-in 1-bit and color video on the motherboard, so you don't have to buy a NuBus video card to drive a monitor. New ROMs and custom application-specific ICs complete the revamped motherboard, which uses considerably more surfaced-mounted components than the Mac IICx, making it a reliable design.

Otherwise, the 25-MHz IICI should be similar to the 16-MHz machine. It incorporates the usual ports and an FDHD floppy disk drive, along with room for an 80-megabyte internal hard disk drive (larger hard disk drives are on the way). Three NuBus slots complete the system.

Pricing for this fastest Mac is completely up in the air, since it's likely to poach sales from the existing Mac IIX and IICx configurations, not to mention the Mac II. The figures being tossed about as I write this in July are 15 percent higher than the IICx. If those prices hold,

most Mac II buyers will opt to buy the IICI, since it is noticeably faster at almost every computing task you throw at it. Spreadsheets update faster. Word processing documents open, close, and scroll faster. Multiple applications can be serviced faster under MultiFinder. You'll find the performance improvement of the IICI over the IICx and IIX to be much more noticeable than you'd think.

### The Mac Product Line

With the release of the 25-MHz IICI, the older Mac II becomes a product-line luxury. Since it costs more to manufacture than the IIX or IICx while coming in last in the performance derby of Mac IIs, the Mac II is expendable. Apple is likely to cease manufacturing the Mac II this year, if it hasn't already.

What about the compact Macs? The SE/30 is a big hit. It packs a lot of computing punch and RAM capacity into a small box for a good price. Apple will surely keep it around for some time. The company might consider goosing its speed by going to a 25-MHz 68030, but I doubt that will happen for a while.

The Mac Plus is a different story. The Plus is a tired design that's a pain to manufacture and service. With System 7.0 on the horizon and requiring 2 megabytes of RAM just to boot, the basic 1-megabyte Mac Plus seems like an antique. I had considered the Mac SE to be in the same boat as the Plus, but in August Apple reduced the SE's list price by \$300, while adding the FDHD floppy disk drive as standard equipment. It's the first time I've seen Apple both lower a price and add a feature to the same Mac, so it seems the Mac SE will stay around.

As happened with the Apple II, though, I can see Apple continuing to manufacture the Mac Plus well into 1991, unless it builds the Mac Classic. As long as this machine is a cash cow that isn't stealing sales from the higher-end Macs, Apple would do well to keep cranking it out, especially for the student market. This is a market where word processing and programming needs don't argue for virtual memory, blinding speed, and giant hard disk drives. ■

*Don Crabb is the director of laboratories and a senior lecturer for the computer science department at the University of Chicago. He is also a contributing editor for BYTE. He can be reached on BIX as "decrabb."*

*Your questions and comments are welcome. Write to: Editor, BYTE, One Phoenix Mill Lane, Peterborough, NH 03458.*



# GOD DIDN'T MAKE LITTLE BLUE APPLES. KMW DID.



**KMW brings Apple and Big Blue together.** KMW makes your Macintosh more versatile – more *productive* – by linking it to your IBM midrange. Our line of TwinAccess™ protocol converters connects any Macintosh to your System/3X or AS/400.

**New board connection for the Mac II.** For a simple, cost-effective board solution, choose our TwinAccess for the Mac II. This easy-to-install card plugs into any member of the Mac II family, with connection to your host through twinax cable.

**Field-proven multiprot products.** Our TwinAccess Series II and Series III protocol

converters are ideal when you need remote attachment capabilities, or when you need support for up to seven devices. TwinAccess system-level protocol converters provide midrange connections for any Macintosh, as well as IBM PCs and compatibles, laptops, ASCII terminals, and most popular printers. We can also help you connect to a mux, a data PBX, AppleTalk, or DECnet.

**Powerful features on every level.** TwinAccess protocol converters benefit your Macs, your

other peripherals, and your host, with these features:

- file transfer to and from your host
- terminal emulation
- manipulation of IBM midrange data within software programs such as Excel, Lotus 1-2-3, and MacWrite
- access to your host's mass storage capabilities
- printer pass-through to ImageWriter and LaserWriter

We'd like to give you more information on all of our connectivity choices. Call KMW today at our toll-free number below.

**(800) 531-5167**

In Texas, (512) 338-3000

In Europe, 44 1 844 1525



**KMW  
SYSTEMS  
CORPORATION**

# Prove to your boss why you need an HP ScanJet Plus.

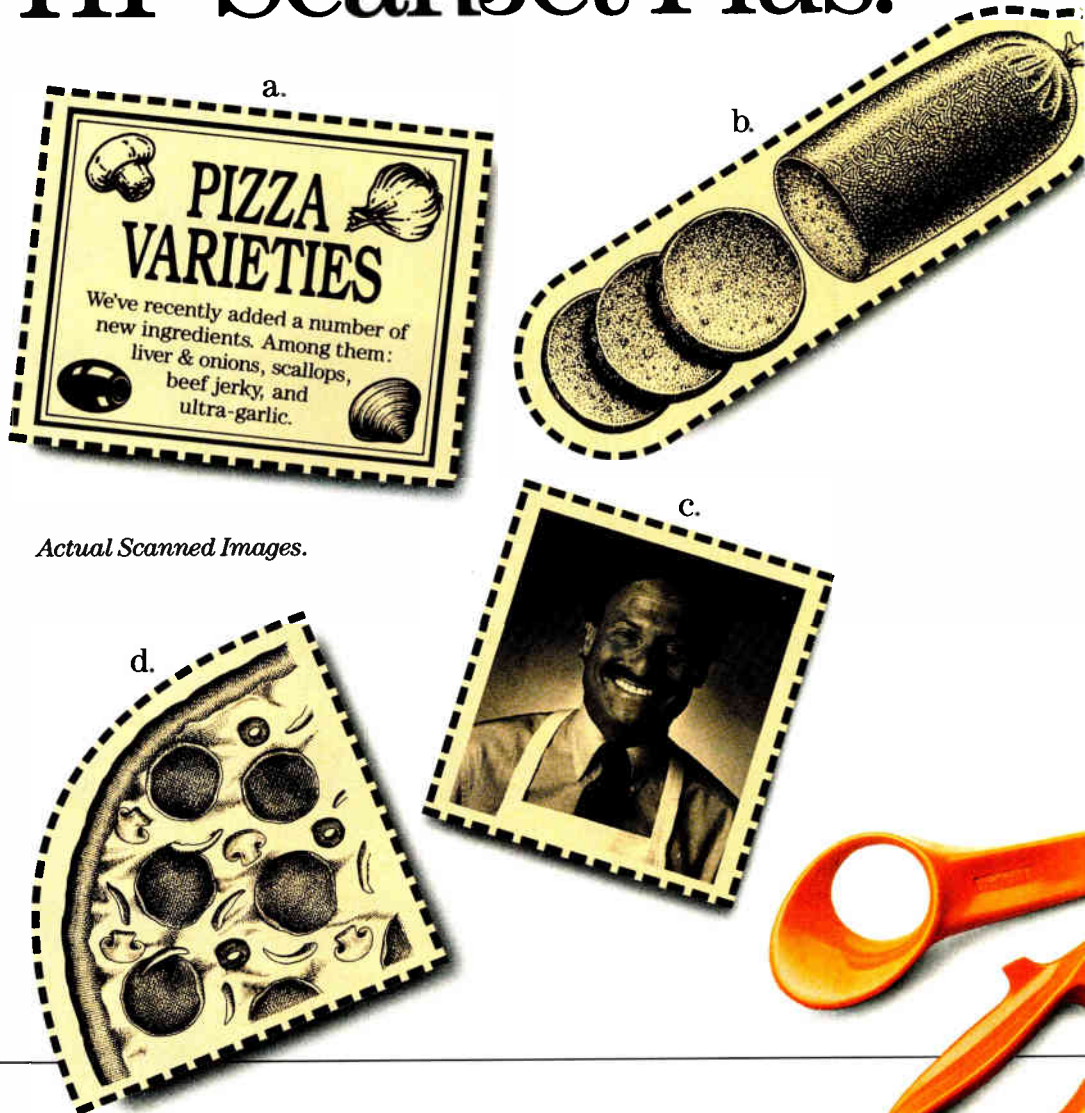

*Actual Scanned Images.*

\*U.S. suggested list price. © 1989 Hewlett-Packard Company PE12918

1. Cut out the photo and illustrations on the left.
2. Put that dull, wordy document down in front of the boss.
3. For the clincher, lay the graphic elements in place.

Presto! The page comes to life, almost as easily as if you'd scanned the images in with an HP ScanJet Plus scanner. Which you can do for just \$2,190\* (In fact, all those images came fresh from our scanner.)

This is a small, but tasty, example of how much you can spice up your communications. With photos, illustrations, and, thanks to OCR, text. Its 8-bit power provides 256 levels of gray and lets you scale images from 4 to 200% in 1% increments.



# CHEESE LOUISE PIZZA COMPANY

We need to do something to liven up Cheese Louise Pizza sales. People love our pizzas, once they sink their teeth into them. But we're having trouble getting more customers into the parlors.

What's the problem here? We have fresh, natural ingredients. Friendly people. Authentic Sicilian decor, with

a.

*Have we got some winners here?*

Mount Etna erupting every hour on the hour. Our salads

b.

flyers, the best deal in town. But so far, only Frankie's grandmother has come in to get ten for the price of five.

Maybe the flyers are too dull.

Maybe

the ingredients should jump right off the page and say: Hey, take a bite! But how do we do that? Any ideas?

*The best salami. No baloney!*

have Frankie's great-grandmother's secret dressing, and people keep telling us they've never tasted anything like it.

Now, for the past two months, we've been handing out 2-for-1

d.

*This month's special: CLP TLC*

c.

*Joe Louise wants your knockout ideas.*

Our scanner also raises the quality of OCR. (And the optional sheet feeder raises the quantity.) And it's equally at home in DOS or Macintosh environments.

So call 1-800-752-0900, Ext. 714G for your nearest authorized HP dealer. You'll

get much more appetizing documents, any way you slice it.

There is a better way.



HEWLETT  
PACKARD



Circle 164 on Reader Service Card

World Radio History

# C\_talk/Views™

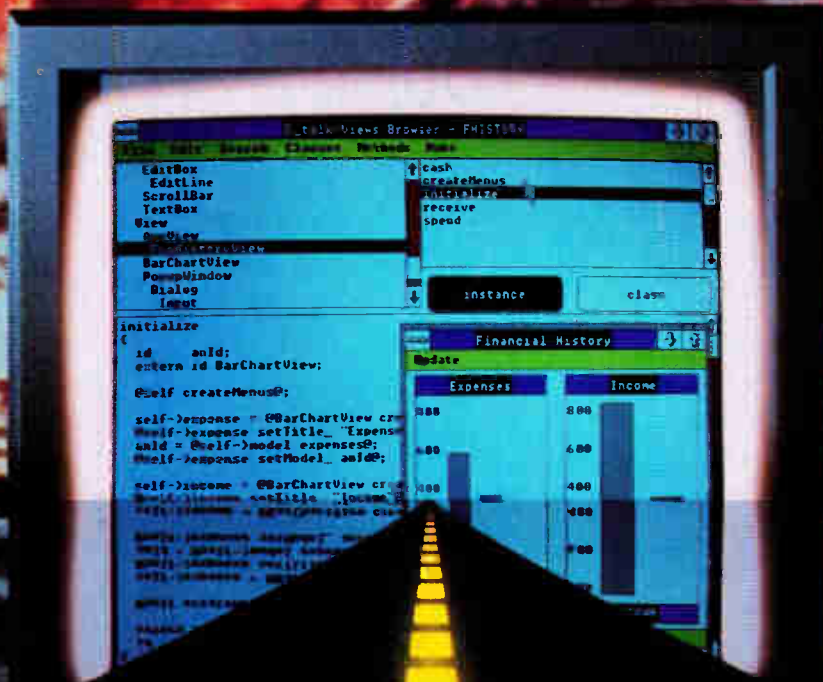

## The Microsoft Windows development tool that delivers from start to finish.

**C\_talk/Views** is a development tool for C programmers that not only reduces the complexity of Microsoft Windows but also slashes development time by up to 75%.

### ***Delivers on the promise of Object Oriented Programming.***

Encapsulates more MS Windows functionality than any other tool on the market today. Get MS Windows applications off to a fast start with a framework of over 50 tested and ready-to-go object classes.

### ***Provides support for the entire project.***

Comes with *Browsers*, *Intelligent Make*, *Application Streamliner*, and an *Interface Generator*.

### ***Gives you complete control.***

Programming is still in C - use existing C libraries or call Microsoft Windows functions directly.

### ***Offers real Object Oriented Programming.***

Supports inheritance, encapsulation, and dynamic message binding. It is fully polymorphic - write less code than with other Microsoft Windows tools.

### ***Pays for itself on even the smallest project.***

Only \$450.00 with no royalties.  
Comes complete with source code.

Watch for: C\_talk/Views for OS/2 PM, the Apple Macintosh and X Windows. Develop one program for all platforms.

## **C\_talk/Views**

From CNS, Inc.

CNS, Inc., Software Products Dept.  
7090 Shady Oak Road, Minneapolis, Minnesota 55344  
(612) 944-0170, Fax (612) 944-0923

© Copyright 1989 CNS, Inc. All rights reserved. Microsoft is a registered trademark of Microsoft Corporation. C\_talk/Views is a trademark of CNS, Inc. C\_talk is a registered trademark of CNS, Inc.

Circle 83 on Reader Service Card  
World Radio History







# GETTING YOUR PRIORITIES STRAIGHT

How to fine-tune OS/2's multitasking behavior with the use of time slicing

**H**ow does OS/2 manage to do several things at the same time? Of course, no single CPU can truly do multiple things simultaneously; it just fools you into thinking that it can by quickly switching from task to task. And therein lie some subtleties I've recently been exploring.

## Trickery

There are actually two parts to the trickery: peripheral scheduling and time slicing. Peripheral scheduling works for the most part by exploiting the tremendous differences in speed between a CPU and its peripherals.

Time slicing is concerned with how the operating system doles out CPU time among computer tasks, and this will be the focus of my column this month. I'll take up peripheral scheduling in another column.

Here, I'm concerned with CPU-bound programs. Programs are generally constrained by a single item in the computing system. The print-formatter programs found in word processors are held up by printer speed. Thus, these programs are print-bound—no matter how fast the computer is that they're running on, they'll run only at the speed of their printer.

Database managers like dBASE spend most of their time waiting for the disk drive. Run dBASE from floppy disks, and it's not much faster on an 80386 than on an IBM PC XT, which makes it disk-bound.

A Lotus 1-2-3 recalculation, on the other hand, isn't waiting for the disk or

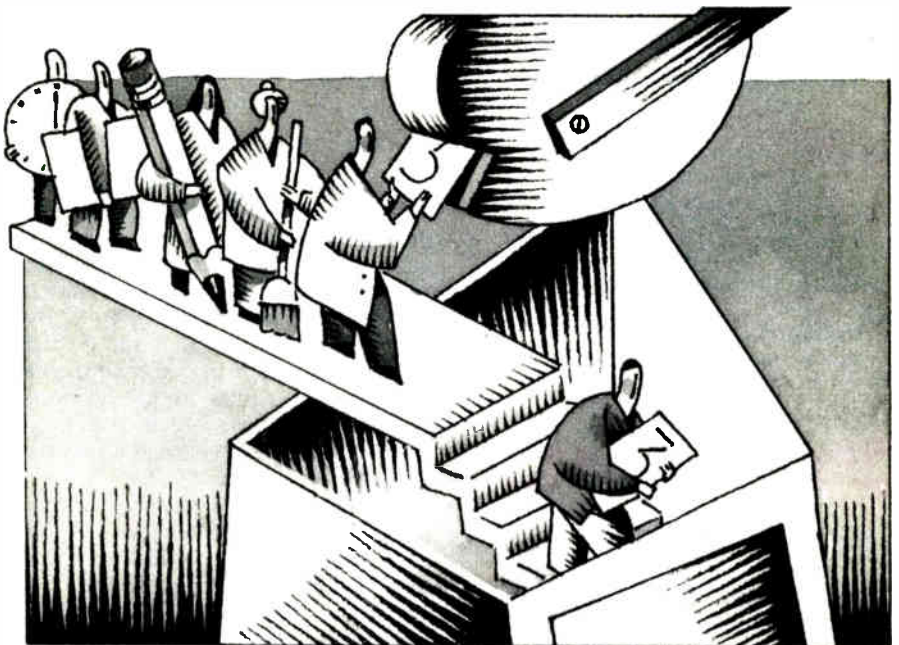

the printer. It's merely directing the CPU to pick up numbers, perform mathematical operations on them, and put them back. In other words, it's CPU-bound.

Consider a simple case of two such CPU-intensive programs. You want two spreadsheets to appear to recalculate simultaneously on a computer. All you need to do is give a little time to spreadsheet program 1, a little time to spreadsheet program 2, a little more time to program 1, and so on.

In "OS/2's Multitasking Dashboard" (November 1988), I discussed how the length of "a small amount of CPU time" affected OS/2's performance. That span of time is called a time slice, and its duration can be set with a CONFIG.SYS command called `timeslice=nnn`, where `nnn` is a value in milliseconds (32 ms minimum).

A little experimentation that I did in that column suggested that a time slice of about 512 ms—about one half of a sec-

ond—seemed about right for maximum throughput.

## Priorities

Once you've set the time slice to one half of a second, spreadsheet program 1 gets one half of a second, spreadsheet program 2 ditto, back to spreadsheet program 1, and so on. Is this necessarily the way you want it? Not in most situations. Some jobs are more important than others, and they should get a greater proportion of the CPU's time. That's why OS/2 includes the notion of *priorities*. Each OS/2 task has a two-part priority value: the priority *class* and the priority *delta*.

There are three priority classes, numbered from 1 (lowest) to 3 (highest). Most OS/2 applications run at number 2 because it's the default class. Number 3 is the time-critical priority.

Number 1 is for jobs that should run only when nothing else wants the system.

*continued*

# OS/2

and  
~~or~~  
DOS?

## MultiBoot is the answer.

### BYTE May 1989

#### MultiBoot Brings OS/2 Back to Earth

Bolt Systems has come to the rescue with a program called **MultiBoot**, which does away with the dual-boot problem for good. . . .

**MultiBoot** is simple, inexpensive, and foolproof, and it works flawlessly. It's a good example of a utility that fills a much-needed niche.

—Stan Miastkowski

#### OS/2 NOTEBOOK

Once you've spent thousands of dollars on OS/2 and an OS/2-ready work station, what's another \$49.95 to have easy access to DOS? Highly recommended.

—Mark Minasi

Not all DOS programs work in the OS/2 compatibility box. **MultiBoot** lets you install both systems in your computer. **MultiBoot** works with DOS versions 3.0-4.01 up. And OS/2 versions 1.0 and 1.1.

#### TO ORDER:

Send \$49.95\* + \$3.00 shipping and handling (check or money order) to:

**MultiBoot**, Bolt Systems, Inc.  
4340 East-West Highway  
Bethesda, Maryland 20814  
or call 1-301-656-7133

**FAX: 1-301-907-8736** to order by Visa/Mastercard. Specify 3.5" or 5.25" diskettes.

\*Maryland residents add 5% sales tax. Ask about our volume discounts

A Product of **BOLT** systems Inc.

## Setting Task Priorities with DOSSETPRTY

As explained in the text, OS/2 programs can instruct OS/2 to increase or decrease their execution priorities with an OS/2 entry point (application programmer interface) called DOSSETPRTY:

```
ret_code=DosSetPrty
(Scope,Class,Delta,PID)
```

Scope defines how far-reaching the request is: 0 (just the indicated process and its threads are affected), 1 (the process and its descendants are affected), or 2 (just one thread of the indicated process is affected).

Class and Delta are the desired values for class and delta.

PID is the ID of the code whose priority is altered: a process ID if Scope is 0 or 1, a thread ID if Scope is 2.

As is the case with all DOS or OS/2 calls, the return code will be 0 if the request is executed successfully; the return code will be anything else if there's an error.

For example, imagine a program that keeps track of what files you use and how often you use them. This could unfragment your files in the background, like the popular Disk Optimizer and Norton Utilities' Speed Disk programs. By keeping track of what files you do and don't use, it could also rearrange the files' directory entries so that the most-used files would have their directory entries toward the front of the directory for faster access.

Less-used files could be recommended for roll-off to floppy disks or could be automatically squeezed, as the ARC-type programs do. These files would automatically be unsqueezed if ever needed. Such a program would actually give you *more* room on your hard disk as time went on and the lesser-used files were squeezed.

You wouldn't want CPU time wasted on these housekeeping tasks while you were busy doing some heavy spreadsheet work, but you wouldn't mind the system doing this while you were on the phone or scratching your head. That's the value of priority 1. Such a background task would be assigned the low priority, and the system wouldn't even consider the task for execution unless there were nothing else to do.

More specifically, you could say that a class 3 beats a class 2, which beats a class 1. If there is a single job of class 3, none of the class 2s or 1s get any time at all, except when the class 3 job is waiting for I/O. If there are no class 3s in the system, the class 2s take all the CPU time. Only when there are no class 3s or 2s, or when the class 3s and 2s are all waiting for I/O, do the class 1 jobs get any time.

Within classes are deltas. A delta is an integer from -31 to +31. If a program

doesn't request a delta, it gets the middle-of-the-road value of 0. A program's default class and delta are, then, 2 and 0, respectively. Deltas matter only in the case of ties. If there are no class 3 jobs in the system, but several class 2 jobs, the class 2 job with the highest delta gets the lion's share of the time. Otherwise, they share time equally, unless you specify *priority=dynamic*, in which case the foreground program gets a bit more time. (Refer to my November 1988 column for more information.)

Deltas don't affect job performance across classes. A class 3, delta -31 program still gets more time than a class 2, delta +31 program.

Programs get priority class 2 unless they ask for a different class. That's all it takes—they just ask. I keep fearing that a software vendor will program its package to set its own priority to class 3, mainly to ensure that it will look good in magazine benchmarks or the like. Such an action would make the rest of the system stop dead, except when the package was waiting for I/O; the entire system would be enslaved to a single application. Pretty scary, in my opinion.

#### Changing Priorities

How does a job change its priority? Simple: with an application programmer interface called DOSSETPRTY. For the details, see the text box "Setting Task Priorities with DOSSETPRTY" above. Basically, you just specify the process ID of the program whose priority you want to change, specify the new class and delta, and call DOSSETPRTY.

Not just anyone can change a priority. A program can change the priority of only itself or one of its child processes, a

*continued*





# We protect the ones you love.

Who could have imagined, a decade ago, the power you now have at your fingertips?

Tiny chips that compute at clock speeds approaching 50 MHz. Memory in millions of bytes that you can hold in your hand. Enormous jobs done in minutes on your desk instead of days down the hall.

All at a fraction of the cost.

Emerson Electric is making that same kind of revolution happen in the UPS equipment that protects these computers from erratic electric power.

Technology innovations are enabling us to bring costs down so low you simply can't afford not to have UPS protection.

And not just for your larger computers and PC network applications, but for every computer you own down to the smallest PC.

Emerson is growing the broadest computer power protection product line in the world. It now ranges from internal board-level UPS' to massive systems for supercomputers.

You buy UPS systems for reliability — to keep your data secure, your people working and your computer networks healthy. Emerson UPS systems won't let you down even when the power does.

And we're backing these new products with new direct customer support and service nationwide, new distribution channels, and most of all, our energetic people.

That's Emerson UPS today. Protecting the computers you depend on. It's our only business.

Watch us fly.

## **EMERSON UPS**

*We protect the ones you love.*

For information on new products or on becoming a distributor, call **1-800-Back-UPS**.

# LightSpeed 9624E 9600 baud modem

# LightFax 9624 superior fax/modem



shipping \$7.00

**\$799.00**

- True 9600 bps modem, V.32, full duplex.
- 9600/4800/2400/1200/300 bps
- MNP Class 5 error correction & data compression for data flow up to 19.2 Kbps
- Fully CCITT V.32/V.22bis/V.22, Bell 212A/103J compliant.
- Auto speed detection
- Extended AT command set
- Non volatile memory storage
- Cable and software included (specify PC or MAC)
- Synchronous and asynchronous modes



shipping \$7.00

**\$499.00**

- 9600 baud fax compatible with all Group 3 fax machines
- 2400 baud modem 100% Hayes™ compatible. Switch from fax to modem with one command
- Excellent picture quality, superior to standard fax
- Fax directly from application or from flexible text/graphics editor
- Full status lights in fax or modem mode
- Compatible with all PCs and MACs
- Powerful software for scheduled sending, broadcasting, file queuing etc.
- Complete with fax and modem software and cable (specify PC or MAC)

## Never buy another ribbon! with MacInker™

over 100,000 sold

Re-ink  
ANY  
fabric  
ribbon

- Universal Cartridge MacInker re-inks most cartridges with appropriate adapter. Universal Spool MacInker re-inks all spools
- Operation is very simple and automatic
- Extra dark, lubricated ink yields better than new print quality
- Ink's cooling and lubricating effect extends printhead life
- Average cartridge can be re-inked 60-100 times at 5 cents/re-inking
- Multicolor Adapters for multiband cartridges (Rainbow, Imagewriter, Epson, NECs, Okidata etc.)
- Dedicated MacInkers available for special cartridges and Band Printers
- Customers vary from individuals to Fortune 500 Corporations, reporting documented savings of \$30,000/year with MacInker



shipping \$4.50

Universal Cartridge MacInker shown with Epson cartridge

**\$68.50**

- Universal Cartridge MacInker .....68.50
  - Multicolor Adapter (specify printer).....40.00
  - Epson only MacInker mod. 271EP .....42.00
  - Imagewr. only MacInker mod. 234 IM..42.00
  - Universal Spool MacInker .....68.50
  - Heat Transfer Adapter .....25.00
  - Extra Ink bottle, black .....3.00 pint.....18.50
  - Colored ink bottle .....4.00 ex. reservoir. 5.00
- All MacInkers delivered complete with bottle of ink, ink meter, reservoir, reservoir cover.  
**Go color !!** Single & multicolor, standard and heat transfer cartridges available: red, green, blue, brown, purple, yellow, orange, white, silver and gold. Indelible and OCR ink cartridges available.

**Call for free catalog**

Satisfaction or 30 day refund - Immediate shipment - Major credit cards - POs from national accounts

**Computer Friends, Inc. Order Toll Free 1-800-547-3303**

14250 NW Science Park Dr.  
Portland OR 97229

in Oregon (503)626-2291  
fax (503)643-5379 telex 4949559 CF

program that it started executing. Lotus 1-2-3, for example, could not change dBASE's priority unless 1-2-3 had actually started dBASE on your system—not a likely prospect. The only program that could change every program's priority is the first OS/2 program, the Presentation Manager, which leads me to the following gripe.

The Task Manager window lets you see some of the programs that are running on your system. You can even terminate a program from the Task Manager. Why can't you view and change a program's priority? It can't be that hard to rewrite the Task Manager so that you see all programs running, not some of them, and to allow user manipulation of program priorities. Something simple and mouse-oriented would be a tremendous boon to OS/2's power. Heck, you can do it with Unix, why not with OS/2?

And applications developers, you're just as guilty. Remember that any application can change its own priority. Why not include it as a user-adjustable parameter? The only OS/2 application that I know of that does this is one of the least expensive, the Logicom communications program that I've mentioned before. Logicom lets you change the priority of the system while in the process of file transfer. Why no others? End of gripe.

### An Update

I see that I'm almost out of space. Before I conclude, however, here's a BIOS update. I mentioned months ago that the AMI BIOS won't run OS/2. Since then (as several readers have let me know—I'd already heard, but thank you to all who wrote), AMI has remedied the problem. The latest AMI BIOS runs OS/2 with no troubles. And if you have a clone that just won't run IBM's OS/2, you might try AST Research's OS/2 1.1. It seems more forgiving than other vendors' OS/2s. I run it on an old Micronics motherboard that seems unable to run any other version of OS/2.

Coming up: a program to exercise OS/2's priority-adjustment features, the High Performance File System stuff, and more on applications. ■

*Mark J. Minasi is a managing partner at Moulton, Minasi & Company, a Columbia, Maryland, firm specializing in technical seminars. He can be reached on BIX as "mjminasi."*

*Your questions and comments are welcome. Write to: Editor, BYTE, One Phoenix Mill Lane, Peterborough, NH 03458.*





# Our Printer Sharing Unit Does Networking!

### **An Integrated Solution**

Take our **Master Switch™**, a sophisticated sharing device, combine it with **MasterNet™** networking software for PCs, and you've got an integrated solution for printer and plotter sharing, file transfer, electronic mail, and a lot more. Of course you can also share modems, minis, and mainframes or access the network remotely. Installation and operation is very simple.

### **Versatile**

Or you can use the Master Switch to link any computer or peripheral with a serial or parallel interface. The switch accepts over 20 commands for controlling the flow of data. It may be operated automatically, by command, or with interactive menus. Its buffer is expandable to one megabyte and holds up to 64 simultaneous jobs. The

**MasterLink™** utility diskette for PCs comes with every unit and unleashes the power of the switch with its memory-resident access to the commands and menus.

### **Other Products**

We have a full line of connectivity solutions. If you just want printer sharing, we've got

it. We also have automatic switches, code-activated switches, buffers, converters, cables, protocol converters, multiplexers, line drivers, and other products.

### **Commitment to Excellence**

At Rose Electronics, we're not satisfied until you're satisfied. That's why we have thousands of customers around the world including large, medium, and small businesses, factories, stores, educational institutions, and Federal, state, and local governments. We back our products with full technical support, a one-year warranty, and a thirty-day money-back guarantee.



**Call now for literature or more information.**  
**(800) 333-9343**

*Give a Rose to your computer*

P.O. Box 742571 • Houston, Texas 77274 • Tel (713) 933-7673 • FAX (713) 933-0044 • Telex 4948886

Circle 311 on Reader Service Card

World Radio History

*“When Fosberry said a PS/2 with Micro Channel would let him juggle ten things at once and still have time to break for lunch, he meant it.”*



# How're you going to do it?

These days, no matter what size your company, you've got to be able to keep a lot of balls in the air to stay competitive.

**The Genius Of Micro Channel.** Which is why IBM developed the Personal System/2<sup>®</sup> with Micro Channel<sup>™</sup>. Micro Channel can support multiple operating microprocessors. So you can, for example, separately manage peripherals, while freeing up the main processor to crunch numbers. A bus master can even be sending a fax while another manages traffic on a network, all with greater reliability.

Naturally, every PS/2<sup>®</sup> with Micro Channel runs DOS and OS/2<sup>™</sup>. So with OS/2 Presentation Manager<sup>™</sup>, you can do multiple tasks concur-





# PS/2 it!

rently, all with an easy-to-use graphical interface. What's more, with Micro Channel, there are no DIP switches to set, for simpler, more reliable installation. You can find and reset cards anywhere in the network—right from your desk!

**The Solution Is IBM.** So, to manage lots of information, jobs, hardware and software, invest in the PS/2 with Micro Channel. Contact your IBM Authorized Dealer or IBM marketing representative. For a dealer near you, call 1 800 IBM-2468, ext. 142. You'll learn there's almost nothing you can't do if you PS/2 it!



# The Only Character Recognition System



## That Outperforms Ours

Nature's character recognition system can be trained to read any language. Flagstaff Engineering's **SPOT OCR Text Reader** is also trainable. It has read text printed in thousands of typefaces in over 130 different languages!

The SPOT OCR Text Reader works just like a typist who reads a page, then uses a keyboard to transfer the information on the page into a computer file—except SPOT uses a scanner for eyes and outputs the text directly into standard text files. SPOT is also faster. It can read up to 35 characters per second on a 16MHz AT, and up to 65 characters per second on a 25MHz machine (that's 780 words per minute). SPOT supports most major makes of scanners.

Using sophisticated statistical techniques, SPOT recognizes characters like the brain does: by examining their shape and context. Like nature's original, SPOT is very flexible. It can glance over an entire page or zoom in on a few lines of text. SPOT can read newspapers,

magazines, books, manuals, invoices, contracts, government documents, columns, tables . . . just about any printed text. And SPOT keeps getting better. The **new Version 3.0** is faster, more accurate, easier to use, and better documented than its predecessors.

Since 1982, Flagstaff Engineering has provided visionary data conversion solutions for thousands of companies worldwide. SPOT is already increasing productivity and making life easier for many publishers and researchers, accountants and telemarketers, medical and legal offices, archival and transcription services.

Wouldn't *your* business benefit from fast, accurate, and low-cost OCR software? Give us a call and let our application specialists explain how you can save time and money with SPOT, *the* OCR text-entry solution.



Join Flagstaff Engineering's  
BIX conference: flageng

Circle 138 on Reader Service Card



*Helping People Read a World of Information*

1120 Kaibab Lane • Flagstaff, AZ 86001  
602-779-3341 • FAX 602-779-5998





# EVERYONE INTO THE POOL

## Making sense out of asynchronous gateways

**L**AN gateways come in many different varieties, but the most common are asynchronous gateways, or “modem pooling” devices used over dial-up lines.

In most asynchronous gateways, one or more computers act as the communications server, or gateway device. They contain the shareable communications hardware, along with special communications software that acts as a two-way link between the other LAN workstations and the communications hardware. Most often, this link uses NetBIOS to route workstation communications data to and from the actual communications hardware. On the workstation side, something other than the usual stand-alone communications software is required—the technique of talking directly to a communications interface adapter won't work in a gateway environment, since the workstations don't have any communications hardware of their own.

### Dedicating Resources

The gateway computer is often dedicated to the task of managing communications links and may service multiple ports and modems. Some gateway implementations, however, are nondedicated, so you can use the gateway computer as a regular workstation.

Dedicated gateways typically display a “control panel” on the screen that shows current call status and session usage information. A menu or command-line interface provides the ability to perform functions like forcing disconnection of an orphaned session or, if multiple lines exist, taking a modem out of service by disabling one of the serial ports. The software may also be able to keep a log of communications activity that you can use



for departmental accounting and troubleshooting.

A nondedicated gateway computer usually uses a TSR program that operates in the background. The gateway software can't take up much memory, because the computer will also be used as a normal workstation.

The gateway software also has to be well-behaved; unfortunately, most TSR programs fare badly on a LAN. The software must also be bug-free, because a system crash not only will kill the communications session but will affect the workstation user as well. Finally, the gateway software has to be time-critical: It can't soak up too much of the CPU, it can't lose characters, it has to prevent interrupt latency (i.e., failing to handle a subsequent interrupt because the servicing of the current interrupt takes place with interrupts masked), and it must handle the possibility of reentrancy (this happens, for example, when the same gateway software services multiple com-

munications ports, and portions of the software are common to both ports; if the common code is executing when a new interrupt occurs and the new interrupt also needs to execute that common code, the code must be written to be reenterable). These are formidable issues for a personal computer.

### Inside the Gateway

In a nutshell, here's how gateway software works. On start-up, the software initializes the COM ports and resets the modems. It establishes a unique name for itself on the LAN by performing a NetBIOS Add Name call. If the gateway serves multiple ports, it may take the approach of establishing a unique name for each port. The application then makes itself available by issuing a Listen command to NetBIOS for each unique name.

In a dedicated gateway, the gateway computer is idle while Listen commands are outstanding. Only when a

*continued*

workstation issues a NetBIOS Call command to a gateway's unique name does it go to work.

In a nondedicated (background) gateway, the DOS prompt reappears once you've loaded the gateway software, and you can run other applications. The gateway software uses the NetBIOS "no wait" option on its Listen command, along with the Post address of a routine to handle a Call from a workstation, and thus it can relinquish control of the computer until activated by another computer's Call. This means that each Call will interrupt applications running in the foreground on the gateway computer. The routine at the Post address takes control, saves the caller's name and the NetBIOS-assigned Local Session Number, and sets up a Receive Network Control Block containing the Post address of a routine to handle messages sent from the workstation. The gateway software then performs a Return-From-Interrupt instruction to allow the application in the foreground to continue. If the program is written properly, the person using the gateway computer as a workstation never notices that the computer's serial ports

are being shared.

Similar processing takes place in a dedicated gateway, and it may even use the no-wait option on the Listen command. If so, the software monitors the Final-Return-Code field of the Network Control Block to determine when the command is complete. The difference is that the dedicated gateway software doesn't have to worry about coexisting with other applications. However, both the nondedicated and the more sophisticated dedicated gateways have characteristics that make them multithreaded.

In dedicated and nondedicated gateways, once you've created a NetBIOS session, the dialogue consists of the workstation asking the gateway, "Do you have characters you've received from the modem?" "Is the carrier still active?" or "Can you send these characters through the modem?" The gateway processes each of these messages by honoring the request and sending back received characters and a result code.

Stand-alone communications programs typically poll the keyboard and serial port in a tight loop: "Is there a keyboard character I should send to the

modem? If not, is there an incoming serial port character I should show on the screen? OK, go back and check the keyboard again." As you can imagine, the polling of the serial port (or, more accurately, the buffer of received characters) happens many times per second.

If, in a gateway environment, each workstation sent its polling request to the gateway as a NetBIOS message, the LAN would begin to creak and groan under the strain. A better approach is to have the workstation and gateway be a little smarter than the average stand-alone communications package. The workstation sends a message containing the entire dialing command and phone number. It also issues a single "Any incoming characters?" request and assumes that there aren't any until the gateway replies with a message packet containing one or more received characters. If you're sending multiple characters across the line, as in the case of an X-MODEM file transfer, the workstation sends each data block of characters as a single NetBIOS message. Reporting a lost carrier is the responsibility of the

*continued*

**IN SOME WAYS WE DON'T STACK UP**

FROM 6 REMOTE PCs

MODEMS

"FUSS" BASED

NETWORK CONTROLLER IN EACH PC HUB

**IN SOME WAYS WE DO!**

QL 1002 - 2 PCs per board

FROM 6 REMOTE PCs

MODEMS

BUS-BASED

NOVELL LABS TESTED AND APPROVED NetWare Compatible

**Remote Communications Made Easy**

The QL 1000 PC-on-a-board Series is the elegant, low-cost alternative to standalone dial-in, dial-out communication servers for Novell NetWare and CBIS Network-OS networks.

Instead of dedicating noisy, bulky standalone PCs to specific network tasks, QL 1000 Series computers-on-a-card install neatly inside the fileserver chassis — not visible, but ready to process tasks upon demand.

Each user's processor, memory and I/O are on an AT bus based add-in board. Data travels at bus speed. Compatible with Ethernet, ARCnet, or Token Ring.

**By using QL 1000 boards, you don't need a stack of money AND a stack of PCs to install remote communications and high speed networking.**

**Call 1-800-648-2130 for details**

Novell NetWare is a trademark of Novell, Inc.  
CBIS Network OS is a trademark of CBIS, Inc.

Cubix Corporate Offices • 2800 Lockheed Way, Carson City, Nevada 89706  
Tel (702) 883-7611 • Fax (702) 882-2407





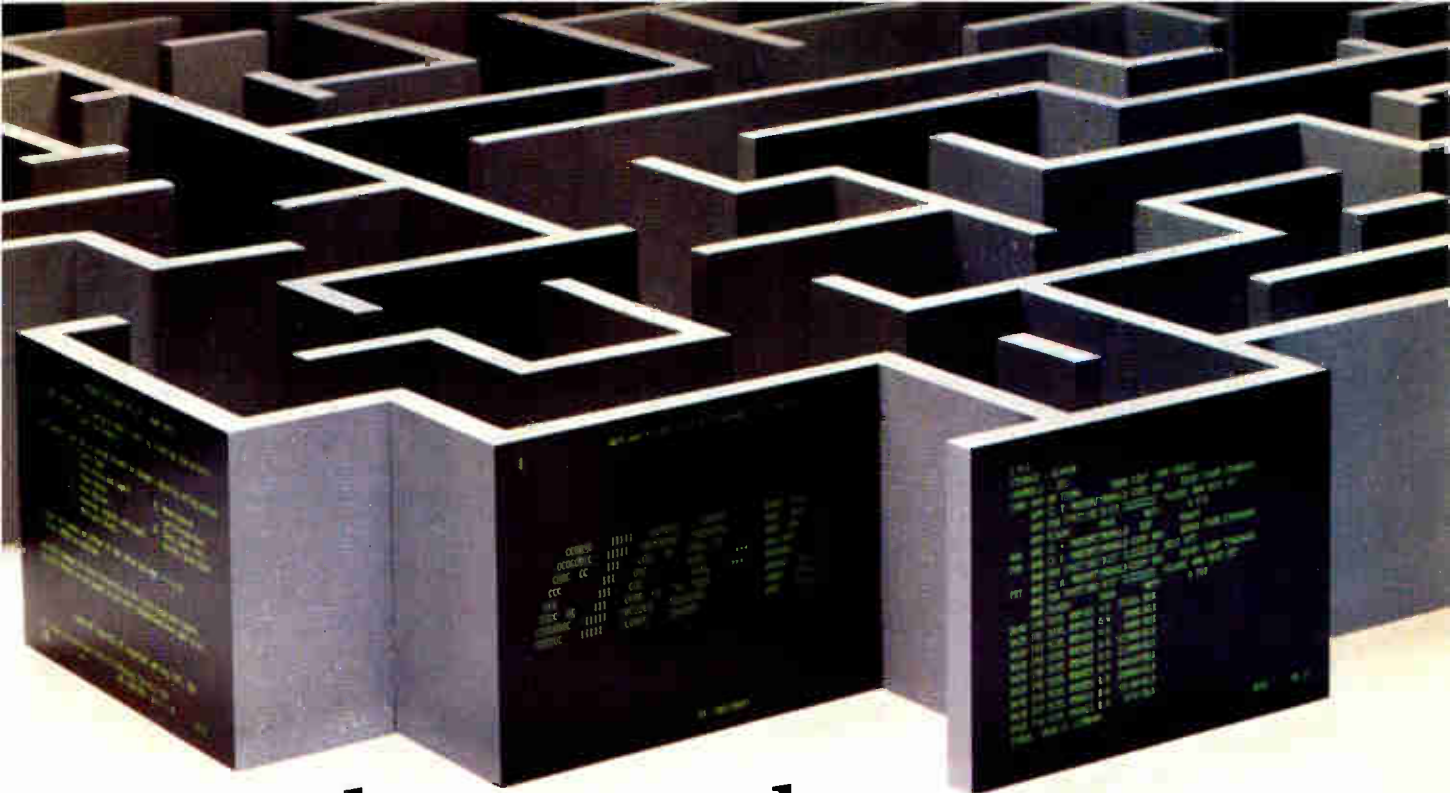

# Is this your only route to mainframe information?

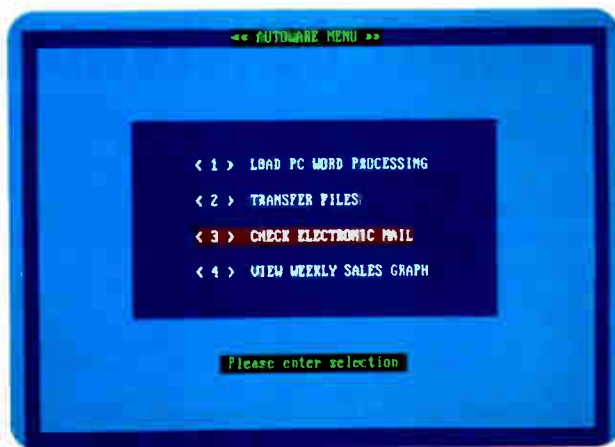

## Escape to Autoware: NOW!

When you need mainframe access, why endure a frustrating labyrinth of screens? Especially when Attachmate software delivers simple single-menu access.

It frees you to select E-mail, transfer files and retrieve data with single-keystroke ease. It's so automated, we call it Autoware. So fast,

we had to call it NOW!

NOW! lets you customize menus for specific procedures or applications, such as

**Attachmate**

Attachmate Corporation 13231 S.E. 36th Street Bellevue, WA 98006 (206) 644-4010

NOW! and Autoware are trademarks of Attachmate Corporation

Circle 45 on Reader Service Card  
World Radio History

unattended file transfer. Within minutes, even non-programmers can automate most repetitive mainframe chores.

Make mainframe access a direct path, not a mindless maze. Let Autoware do the work for you—NOW! Call for your free demo disk: 800-426-6283.

gateway software; it's not a polling function within the workstation.

LAN communications software on both the workstation and gateway have to deal with NetBIOS return codes and unusual error conditions not found in a stand-alone environment. For example, what should a gateway do if it has an active, carrier-present communications session with a remote computer and it suddenly finds that the workstation that it's serving is no longer talking back? The programmer must decide whether the gateway software should hang up or wait for the workstation to resume the dialogue.

**Troubleshooting**

Some problems with gateway computers are easy to pinpoint. If usage increases, you may have to add more capacity in the form of additional modems or gateway machines. Other problems are more subtle. A gateway may be capable of managing multiple NetBIOS sessions with multiple workstations, but you may need to increase the default NetBIOS session limit (commonly six sessions) on the gateway computer. Fortunately, most

NetBIOS emulators allow command-line parameters.

If you're in the midst of a communications session through a gateway and someone accidentally reboots the gateway or kicks its power cord, you'll get an error message and lose the connection. Since the gateway is out of sight somewhere, error messages usually mean that it's time to get up and take a walk to see what's happening. Unless it's only for occasional dial-out use, a gateway should receive some of the same security precautions you give to file servers. These include physical isolation from the normal work area, a sign near the machine warning people to avoid rebooting the gateway, and a written, posted procedure for starting the LAN that also contains directions for activating the gateway computer.

**Selecting a Product**

If you decide to add a gateway to your LAN, you almost certainly won't be able to go down to the local computer store to see demonstrations of each of the types of gateways. Although LANs are proliferating rapidly, LAN products like gateways

aren't yet considered off-the-shelf items.

A good place to start your research is with the manufacturer of your particular LAN hardware and software. The vendor will have its own gateway product or will recommend a third-party package.

The next step is to know what questions to ask. For instance, can you configure the software for dedicated or non-dedicated operation? Can you use your existing communications software with the gateway, or will you need to buy new software? How many users does the software license allow? Does the software support terminal emulation, file transfers, scripts, and macros? Does the communications server support NetBIOS? XNS? IPX?

Only when you have fully defined your requirements can you select a product that's right for you. ■

*Barry Nance works in the R&D department at Programming Resources Co. in Hartford, Connecticut. He can be reached on BIX as "barryn."*

*Your questions and comments are welcome. Write to: Editor, BYTE, One Phoenix Mill Lane, Peterborough, NH 03458.*

**THE SMART**

**ETHERNET CONNECTION**

**10Mbps over unshielded Twisted-Pair Wiring**

**The Quick-Net™ 3000 Ethernet Series from Intellicom provides Novell Netware®, 3Com3+Share® and IBM® PC Networking compatibility with unshielded twisted-pair wiring operation at 10Mbps. Complete integrated solution for XT, AT, PS/2 or MACII computers or compatibles.**

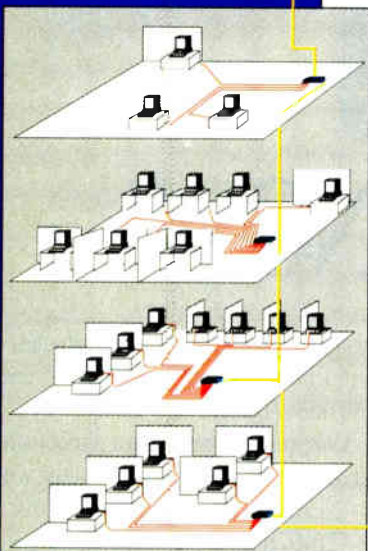

- Total compatibility with Standard or Thin Ethernet coax based LAN's. Expand your network or establish a new one using our twisted-pair wiring solution with no performance degradation.
- Complete range of industry compatible Media Access Units/ Network adapter cards available to establish star-based network topologies using low-cost telephone wiring; IBM® Type 3 or AT&T® PDS cabling.
- The Quick-net solution is cost effective for both small and large networks offering full compatibility with most popular network operating systems.
- MAU's located on each building floor inter-connect via an Ethernet 10Mbps coax backbone. Connect up to 256 PC's on a single coax cable using multiple MAU's. Installation is easy as plugging in a telephone.

Intellicom is an established manufacturer of high performance communication products with over 75,000 units installed worldwide. The Quick-net 3000 series is simply the best way to establish a low cost and flexible 10Mbps twisted-pair Ethernet LAN.

**Call or write Now**, and let us share our extensive networking expertise with you to meet your networking needs today, and into the future.



Distributor, VAR, System Integrator & Dealer inquiries welcome.

9259 Eton Avenue,  
Chatsworth, California 91311  
Telephone: (818) 882-8877  
Toll Free (800) 992-2882  
FAX (818) 882-2404

**Intellicom**  
The Smart Solution

Novell and Netware are trademarks of Novell. 3Com3+Share is a trademark of 3Com Corporation. IBM, IBM PC, AT, XT, PS/2 and IBM PC Network Program are trademarks of International Business Machines Corporation. MAC II is a trademark of Apple Computers, Inc. Ethernet is a trademark of Xerox Corporation. Quick-net is a trademark of Intellicom, Inc.



# PC BRAND Chosen #1 For Customer Service and Support.

"PC BRAND is the LL Bean of the personal computer mail order.

PC BRAND wants no unhappy customers, and it's service and support policies help to insure that."

*-Personal Computing's 10 Best Mail Order Companies, Feb, 1989*



**PC** BRAND™

## PC BRAND offers you more...

Welcome to PC Brand. Your *first* place to shop. Your *best* place to shop for top quality IBM compatible systems, custom configured to your exact specifications, and thousands of quality name brand peripherals and accessories.

Choose from over 10,000 items in stock... all at unbeatable prices!

## Free Freight, Toll-Free Support, 5-Year Warranty and more...

Everyone promises you great service. We deliver the tangibles.

- Free freight • Fast delivery
- No credit card surcharges
  - A 30-day Money-Back Guarantee on every system we sell
  - Toll-Free Customer Service and Technical Support that will stay with you until your questions are answered and your problem is solved
  - And our exclusive 5-Year Warranty on all PC Brand products, call for details.

## Call PC Brand today.

For the best selection... the best products...at the best price, you can't do better than PC Brand.

Call PC Brand today!

TURN PAGE  
FOR PC BRAND SYSTEMS  
...AND NAME BRAND  
PERIPHERALS

Circle 296 on Reader Service Card

# Outstanding Quality

**PC BRAND Chosen #1 For Customer Service and Support.**

*"PC BRAND is the LL Bean of the personal computer mail order...PC BRAND wants no unhappy customers, and it's service and support policies help to insure that."*

*-Personal Computing's 10 Best Mail Order Companies, Feb, 1989*

**PC BRAND**

Your Best Choice  
for Quality Systems  
Toll-Free Support  
Toll-Free Service  
Free Freight  
5-Year Warranty



**PCV20 AD-II \$539**

15 MHz Throughput in an XT. Norton SI 4.0  
512K, 360K Drive, 84-Key Keyboard

**Standard System Features:**

- 10MHz Nec V20 CPU with 1.5 times the power of the 8088!
- 512K RAM standard. Expandable to 640KB
- One 360K Floppy Drive • 84-key AT Style Keyboard
- 8 Slots. Serial, Parallel, Game Ports, and Clock Standard
- AT Style Case with Keylock, Turbo, Power and Hard Drive LEDs.  
Accommodates up to 4 HH Mass Storage devices
- Set-up & Operating instructions.

**Standard Pre-Built Configurations:**

PCV20 AD-II With 512K, Hard Disk Drive, Monitor & Video Card				
Drive	1 Floppy	2 Floppy	40MB-45MS	66MB-25MS
Video				
Mono	\$664	\$739	\$944	\$1094
VGA/Mono	\$824	\$899	\$1104	\$1254
EGA	\$1004	\$1079	\$1284	\$1434
VGA/Color	\$1054	\$1129	\$1334	\$1484

**PC BRAND 286/12 \$799**



Now Using C & T  
"Neat" Chip Set

12 MHz Clock, Zero Wait Operation,  
Norton SI 15.3 • Landmark™ Speed 15.1MHz  
512K, 1.2MB or 1.44MB Drive, 101- Keyboard

**Standard System Features:**

- 80286-12 Processor Operating at 12MHz with Zero Wait States delivering 15.1MHz Effective Throughput
- 512K RAM expandable to 4MB on the System board using 256K or 1MB 100ns RAM
- 1.2MB 5.25" or 1.44MB 3.5" Diskette Drive
- 1:1 Interleaving Dual Hard Drive/Floppy Drive Controller
- Enhanced 101-key AT Style Keyboard
- High Capacity System Power supply
- Real Time Clock/Calendar with 5 Year Battery
- 80287 Co-Processor Support
- AMI BIOS with full MS/DOS, OS/2, XENIX, UNIX, NOVELL, 3COM and PCNET compatibility
- Built-in System Board LIM 4.0 EMS hardware drivers
- User configurable I/O timing permitting compatible operation with older peripherals or faster I/O for newer devices
- 8 Slot motherboard design (5 16Bit & 3 8Bit)
- Medium foot print case with 5 Disk Drive bays

**Options:**

- Factory Installed RAM Upgrades
- Custom configurations w/Name Brand peripherals of your choice
- Compaq® Style LCD or Plasma Portable
- Mini Size Tower Case®

**Standard Pre-Built Configurations:**

286/12 With 512K, Hard Disk Drive, Monitor & Video Card				
Drives	40MB-45MS	66MB-25MS	71MB-18MS	110MB-25MS
Video	1:1 RLL	1:1 RLL	1:1 MFM	1:1 RLL
Mono	\$1207	\$1432	\$1572	\$1672
VGA/Mono	\$1402	\$1627	\$1767	\$1867
EGA	\$1547	\$1772	\$1912	\$2012
VGA/16Bit	\$1637	\$1862	\$2002	\$2102



# Unbelievable Price

**PC BRAND 286/20 \$999**



*Ideal Novell Server!*

**PC BRAND 386/SX-16 \$1099**



20 MHz Clock, Zero Wait Operation  
Norton SI 23.0 • Landmark™ 26.7MHz  
512K, 1.2MB or 1.44MB Drive, 101-Key-board

**Standard System Features:**

- 80286 Processor Operating at 20MHz w/Zero Wait States in interleave mode delivering 27MHz Effective Throughput
- 512K RAM expandable to 8MB on the System board using 256K and/or 1MB 100ns RAM
- 1.2MB 5.25" or 1.44MB 3.5" Diskette Drive
- 1:1 Interleaving Dual Hard Drive/Floppy Drive controller
- Enhanced 101-key AT Style Keyboard
- High Capacity 200 Watt System Power Supply
- Real Time Clock/Calendar with 5 Year Battery
- 80287 Co-Processor Support
- AMI BIOS with full MS/DOS, OS/2, XENIX, UNIX, NOVELL, 3COM, and PCNET compatibility
- Built-in System Board LIM 4.0 EMS hardware drivers
- User configurable I/O timing permitting compatible operation with older peripherals or faster I/O for newer devices
- 8 Slot motherboard design ( 5 16Bit & 3 8Bit)
- Medium foot print case with 5 Disk Drive bays

**Options:**

- Mini Size Tower ® Case • Factory Installed RAM Upgrades
- Custom configurations w/Name Brand peripherals of your choice
- Compaq® Style LCD or Plasma Portable

**Standard Pre-Built Configurations:**

286/20 w/512K, Hard Disk Drive, Monitor & Video Card							
Video	Drives	40MB-45MS 1:1RLL	66MB-25MS 1:1 RLL	71MB-18MS 1:1 MFM	110MB-25MS 1:1 RLL	150-17MS 1:1 ESDI	320-16MS 1:1 ESDI
Mono		\$1407	\$1632	\$1737	\$1862	\$2357	\$2817
VGA/Mono		\$1602	\$1827	\$1932	\$2057	\$2552	\$3012
EGA		\$1747	\$1972	\$2077	\$2202	\$2697	\$3157
VGA/16Bit		\$1837	\$2062	\$2167	\$2292	\$2787	\$3247

16 MHz Clock, Zero Wait Operation  
Norton SI 18.7 • Landmark™ 18.3MHz  
512K, 1.2MB or 1.44MB Drive, 101-Key-board

**Standard System Features:**

- 80386SX Processor Operating at 16MHz delivering 18MHz Effective Throughput
- 512K RAM expandable to 8MB on the System board using 256K and/or 1MB 80ns RAM
- 1.2MB 5.25" or 1.44MB 3.5" Diskette Drive
- 1:1 Interleaving Dual Hard Drive/Floppy Drive controller
- Enhanced 101-key AT Style Keyboard
- High Capacity 200 Watt System Power Supply
- Real Time Clock/Calendar with 5 Year Battery
- 80387SX Co-Processor Support
- AMI BIOS with full MS/DOS, OS/2, XENIX, UNIX, NOVELL, 3COM, and PCNET compatibility
- 8 Slot motherboard design ( 5 16Bit & 3 8Bit)
- Medium foot print case with 5 Disk Drive bays (Shown with optional Mini Size Tower ® Case)

**Options:**



- Mini Size Tower ® Case • Factory Installed RAM Upgrades
- Custom configurations w/Name Brand peripherals of your choice
- Compaq® Style LCD or Plasma Portable

**Standard Pre-Built Configurations:**

386SX-16 w/512K, Hard Disk Drive, Monitor & Video Card							
Video	Drives	40MB-45MS 1:1RLL	66MB-25MS 1:1 RLL	71MB-18MS 1:1 MFM	110MB-25MS 1:1 RLL	150-17MS 1:1 ESDI	320-16MS 1:1 ESDI
Mono		\$1507	\$1732	\$1837	\$1962	\$2457	\$2917
VGA/Mono		\$1702	\$1927	\$2032	\$2157	\$2652	\$3112
EGA		\$1847	\$2072	\$2177	\$2302	\$2797	\$3257
VGA/16Bit		\$1937	\$2162	\$2267	\$2392	\$2887	\$3347

TURN PAGE FOR MORE PC BRAND SYSTEMS...  
FOR NAME BRAND PERIPHERALS SEE OUR AD ON FOLLOWING PAGES...

## To Order Call 1-800-PC BRAND

(Call 1-800-722-7263) In All 50 States FAX# 1-800-722-7392 New Winter Extended Hours     
PC Brand, Inc. 954 W. Washington St., Chicago, IL 60607 Int'l Fax# 312-226-6841 Int'l Voice# 312-226-5200. Open Mon thru Fri.: 8am to 8pm Central. MasterCard, VISA, Discover, Checks, & Approved P.O.s Accepted. Prices and specifications subject to change. Customer Service Inquiries Call: 1-800-662-SERV BYTE 14-11

# Amazing Performance

*"Faster Than a Speeding Bullet!"*

*-Computer Shopper Cover Story Nov, 1988*

*"PC Brand offers the best low cost alternative around"*

*-PC Magazine Feb.14, 1989*

**PC BRAND 386/20 \$1489**



20 MHz Clock, Zero Wait Operation  
Norton SI 23.0 • Landmark Speed 26.1MHz  
1024K, 1.2MB or 1.44MB Drive, 101-Keyboard

**Standard System Features:**

- True 20MHz Intel 80386-20 CPU Operating with Zero Wait States delivering up to 26.1MHz Effective Throughput
- 1024K RAM standard expandable to 16MB using 256K and/or 1MB 100ns RAM
- 1.2MB 5.25" or 1.44MB 3.5" Diskette Drive
- 1:1 Interleaving Dual Hard Drive/Floppy Drive controller, 977.6 KB/SEC Caching Controller w/ESDI Configurations
- Enhanced 101-key AT Style Keyboard
- High Capacity 200 Watt System Power Supply
- Real Time Clock/Calendar with 5 Year Battery
- 80287, 80387 Co-Processor Support
- AMI BIOS with full MS/DOS, OS/2, XENIX, UNIX, NOVELL, 3COM and PCNET compatibility
- 8 Slot motherboard design (5 16Bit & 3 8Bit)
- Medium foot print case with 5 Disk Drive bays

**Options:**

- Full or Mini Size Tower @ Case
- Custom configurations w/Name Brand peripherals of your choice
- Compaq® Style LCD or Plasma Portable • Weitek Co-processor

**Standard Pre-Built Configurations:**

386/20 With 1024K, Hard Disk Drive, Monitor & Video Card							
Drives	40MB-45MS	66MB-25MS	71MB-18MS	110-25MS	150-17MS	320-16MS	
Video	1:1 MFM	1:1RL	1:1 MFM	1:1 RLL	1:1ESDI	1:1ESDI	
Mono	\$1995	\$2095	\$2220	\$2330	\$2860	\$3305	
VGA/Mono	\$2170	\$2270	\$2395	\$2505	\$3035	\$3480	
EGA	\$2280	\$2380	\$2505	\$2615	\$3145	\$3590	
VGA/16Bit	\$2370	\$2470	\$2595	\$2705	\$3235	\$3680	

**PC BRAND 386/25 \$1689**



25 MHz Clock, Zero Wait Operation  
Norton SI 28.2 • Landmark Speed 33.6MHz  
Norton SI 31.6 • Landmark Speed 43.5 w/Cache  
1024K, 1.2MB or 1.44MB Drive, 101-Keyboard

**Standard System Features:**

- Intel 80386 Processor Operating at 25MHz with Zero Wait States in interleave mode delivering 34 to 44 MHz Effective Throughput
- 1024K RAM standard expandable to 16MB using 256K and/or 1MB RAM
- 1.2MB 5.25" or 1.44MB 3.5" Diskette Drive
- 1:1 Interleaving Dual Hard Drive/Floppy Drive controller, 977.6 KB/SEC Caching Controller w/ESDI Configurations
- Enhanced 101-key AT Style Keyboard
- High Capacity 200 Watt System Power Supply
- Real Time Clock/Calendar with 5 Year Battery
- 80287, 80387 or Weitek Co-Processor Support
- Industry Standard BIOS with full MS/DOS, OS/2, XENIX, UNIX, NOVELL, 3COM and PCNET compatibility
- User configurable I/O timing permitting compatible operation with older peripherals or faster I/O for newer devices
- 8 Slot motherboard design
- Medium foot print case with 5 Disk Drive bays (Full size case w/cache)

**Options:**

- 32KB or 64KB Cache Processor • Weitek Co-processor • Tower @ Case
- Custom configurations w/Name Brand peripherals of your choice
- Compaq® Style LCD or Plasma Portable • 8MB 32Bit RAM Card

**Standard Pre-Built Configurations:**

386/25 With Hard Disk Drive, Monitor & Video Card							
Drives	40MB-45MS	66MB-25MS	71MB-18MS	110MB-25MS	150-17MS	320-16MS	
Video	1:1MFM	1:1RL	1:1 MFM	1:1RL	1:1ESDI	1:1ESDI	
Mono	\$2182	\$2332	\$2462	\$2592	\$3162	\$3412	
VGA/Mono	\$2387	\$2537	\$2667	\$2797	\$3367	\$3617	
EGA	\$2502	\$2652	\$2782	\$2912	\$3482	\$3732	
VGA/16Bit	\$2577	\$2727	\$2857	\$2987	\$3557	\$3807	

CRT display is courtesy of RIX Softworks, Inc. Irvine, CA.



# Exceptional Support

**386/33 CACHE**

**\$2799**

*Worlds Fastest  
Personal Computer!*



**33 MHz Clock, Zero Wait Operation**

Norton SI 45.9 • Landmark 58.7MHz w/32K or 64K Cache

1024K, 1.2MB or 1.44MB Drive, 101-Key-board

**Standard System Features:**

- True 33 MHz INTEL 80386-33 CPU operating with Zero Wait States Delivering up to 58.7 MHz Effective Throughput
- Intel 82385-33 Cache Processor with 32K 25NS Static RAM Standard, Field Upgradable to 64K
- 1024K RAM Standard Expandable to 16MB
- 1.2MB 5.25" or 1.44MB 3.5" Diskette Drive
- 1:1 Interleaving Dual Hard Drive/Floppy Drive Controller, 977.6 KB/SEC Caching Controller w/ESDI Configurations
- Enhanced 101-key AT Style Keyboard
- High Capacity 200 Watt System Power Supply
- Real Time Clock/Calendar with 5 Year Battery
- 80387 or Weitek Co-Processor support
- Phoenix BIOS With Full MS/DOS, OS/2, XENIX, UNIX, NOVELL, 3COM and PCNET compatibility
- 8 Slot motherboard design
- Full size case with 5 Disk Drive bays  
(Shown with Optional Full Size Tower ® Case)

**Options:**

- Custom configurations w/Name Brand peripherals of your choice
- Weitek Co-Processor • Tower ® Case • Factory Ram Upgrades

**Standard Pre-Built Configurations:**

386/33 With Hard Disk Drive, Monitor & Video Card						
Drives	40MB-45MS	66MB-25MS	71MB-18MS	110MB-25MS	150MB-17MS	320MB-14MS
Video	1:1 MFM	1:1 RLL	1:1 MFM	1:1RLL	1:1ESDI	1:1 ESDI
Mono	\$3259	\$3454	\$3554	\$3679	\$4124	\$4634
VGA/Mono	\$3454	\$3649	\$3749	\$3874	\$4319	\$4829
EGA	\$3599	\$3794	\$3894	\$4019	\$4464	\$4974
VGA/16Bit	\$3689	\$3884	\$3984	\$4109	\$4554	\$5064

+ Norton SI 3.0

CRT display is courtesy of RIX Softworks, Inc. Irvine, CA.

**PC BRAND**

Your Best Choice  
for Quality Systems  
Toll-Free Support  
Toll-Free Service  
Free Freight  
5-Year Warranty

**286/386 PORTABLES from \$1745**

286 & 386 Systems  
• 512K, 1.2MB Drive,  
Combo Controller,  
LCD Backlit Display  
Optional VGA  
Plasma Display



**All feature:**

- 640 x 400 Backlit Supertwist LCD by TOSHIBA (VGA 16 Grey Scale Plasma version Now Available)
- Monographic & Color operating modes, VGA Optional
- External Monitor Support
- 2 Available expansion slots
- 86-key keyboard
- Accommodates two 5.25" or 3.5" Floppy/Hard Disk Drives
- 200 Watt 112/220 Autoswitch Power
- Serial, Parallel, Game Port, Clock/Calendar Standard



**Standard Pre-Built Configurations:**

Portable System Processor and Drive Options						
Drive	CPU	286-12	286-20	386/SX-16	386-20	386-25
1 Floppy		\$1745	\$1945	\$2045	\$2595	\$2795
40MB		\$2175	\$2375	\$2475	\$3025	\$3225
66MB		\$2275	\$2475	\$2575	\$3125	\$3325
150MB		\$3140	\$3340	\$3440	\$3990	\$4190

\*386/20 and 386/25 Systems come with 1024K.

SAVE ON NAME BRAND PERIPHERALS... SEE OUR AD ON FOLLOWING PAGES...

## To Order Call 1-800-PC BRAND

(Call 1-800-722-7263) In All 50 States FAX# 1-800-722-7392 New Winter Extended Hours



PC Brand, Inc. 954 W. Washington St., Chicago, IL 60607 Int'l Fax# 312-226-6841 Int'l Voice# 312-226-5200. Open Mon thru Fri.: 8am to 8pm Central. MasterCard, VISA, Discover, Checks, & Approved P.O.s Accepted. Prices and specifications subject to change. Customer Service Inquiries Call: 1-800-662-SERV BYTE 14-11

Circle 298 on Reader Service Card

NOVEMBER 1989 • BYTE 175

# Shop PC Brand Today.

## LAPTOP COMPUTERS\*

NEC	
Multispeed HD .....	\$1995
Ultralite w/1MB .....	Call
<b>TOSHIBA</b>	
1000; 512K, 80C88, 1 FDD .....	\$679
1600 BACKLIT, 80C86-12, 1MG, 20MB HD, FDD ...	3240
3100E GAS PLASMA 80C86-12, 1MB, 20MB HD, FDD .....	2805
3200; EGA, 80286-12, 1MB, 40MB HD, FDD .....	3595
5200/40 VGA, 80386-20, 2MB, 40MB HD, FDD, ...	6115
<b>ZENITH</b>	
Supersport 286, 20Meg .....	Call
Supersport 286, 40Meg .....	Call
Supersport 88, 20Meg .....	Call
Other Makes and Models Call	

## MONITORS\*

<b>MAGNAVOX</b>	
7BM623 12" Amber TTL Monochrome .....	\$79
7BM749 14" VGA White Flat Screen .....	135
CM8762 13" RGB (640x200) Color .....	230
CM9043 13" EGA (640x400) Color .....	339
9CM082 14" VGA (640x480) .31DP Color....	415
<b>MITSUBISHI</b>	
XC-1410 14" EGA (640x350) .....	\$369
AUM-1381 14" Diamond Scan .....	499
HL6605 15" CAD Monitor .....	1295
HL6905 19" CAD Monitor .....	2325
<b>NEC</b>	
Multisync 2A 14" (800x600) VGA .....	\$499
Multisync GS 14" Mono .....	249
Multisync 3D 14" (1024x768) EGA/VGA ...	679
Multisync 4D 16" (1024x768) .28DP .....	Call
Multisync 5D 20" (1280x1024) .31DP .....	Call
<b>PRINCETON GRAPHICS</b>	
Max 15 15" Multifreq. Monochrome ....	\$249
Ultra 16 16" Multifreq. EGA/VGA .....	879
Ultrasync 14" Multifreq. EGA/VGA .....	520
<b>PRINCETON PUBLISHING LABS</b>	
Multiview 15" Full Page Monitor w/adapt..	\$890
<b>RELISYS</b> (Top Rated by Infoworld and PC World)	
RE-9513 14" VGA(720x480).31DP Color .....	\$369
<b>SEIKO</b>	
CM1430 14" (1024x768) Dualfreq .....	\$549
<b>SONY</b>	
CPD1304 14" .25DP(1024x768) Multiscan ..	\$689
CPD1320 13" (640 x 480) VGA .....	485
<b>ZENITH</b>	
ZCM-1490 14" Flatscreen Enhanced .....	\$619

## NEC 14" Multisync 2A

800x600 Resolution Super VGA Monitor



**\$499**

Freight Free!

## MODEMS

<b>A.T.I.</b>	
2400ETC Internal Modem w/MNP5 ...	\$165
2400ETC External Modem w/ MNP5 ...	205
<b>HAYES</b>	
1200B Int. w/Smartcom .....	\$285
2400B Int. w/Smartcom .....	429
1200 Ext. Modem .....	285
2400 Ext. Modem .....	429
<b>PC BRAND 100% Hayes Compatible!</b>	
1200 Baud Internal w/Bitcom .....	\$49
1200 Baud External .....	70
2400 Baud Internal w/Bitcom .....	89
2400 Baud External .....	129
<b>US ROBOTICS</b>	
Courier HST/9600 .....	\$599
Courier V.32 9600 Baud Ext.w/MNP5 ..	889
Courier HST Dual Standard Modem.....	995
Courier HST/IX 9600 Modem .....	925

## Internal Modems

100% Hayes Compatible. Free Software!

1200BPS **\$49**  
2400BPS **\$89**



## TAPE BACK-UP SPECIAL

80/40MB Internal Tape Back-Up\*

**\$279**



Uses DC2000 Series Micro Cartridges  
\*When used with CMS Backup Software

## VIDEO CARDS

<b>ATI</b>	
VGA Wonder w/256K .....	\$279
VGA Wonder w/ 512K .....	Call
<b>PARADISE</b>	
Autoswitch 480 EGA .....	\$179
VGA+ .....	265
VGA+ 16 16 Bit Version NEW .....	299
VGA Professional w/512K .....	399
<b>PC BRAND</b>	
Mono Graphics w/Printer Port .....	\$55
Color Graphics w/Printer Port .....	49
EGA (640x480) Autoswitch .....	135
VGA .....	159
VGA 16 Bit .....	195
<b>VIDEO SEVEN</b>	
Fastwrite VGA .....	\$279
VRAM VGA .....	450
VRAM VGA w/512K .....	Call

## DISK DRIVES

### FLOPPY DISK DRIVES:

360K 5.25" HH Black .....	\$75
720K 3.5" HH w/5.25" Mounting .....	80
1.2MB 5.25" HH Grey .....	85
1.44MB 3.5" HH Grey w/5.25" Mounting	95

### PS/2 FLOPPY DRIVES

CMS 5.25" 360K/PS/2 Ext.Floppy ..... \$199

### HARD DISK DRIVES:

#### IOMEGA

B120I Single 5.25" 20MB Int .....	\$765
B144I Single 5.25" 44MB Int .....	995
B244X Dual 5.25" 44MB Ext.....	1995

#### MINISCRIBE

71MB 18MS M3085 .....	\$595
150MB 17MS M3180E ESDI 1/2 Hgt ..	1195
320MB 16MS M9380 ESDI Full Hgt. ....	1550
640MB 16MS M9780 ESDI Full Hgt. ....	2850

#### PRIAM

130MB 20MS ID130AT Full Height ....	\$1395
160MB 28MS ID160EC ESDI w/CNTRL	1650
330MB 20MS ID330PS INT. for PS/2 ...	1895
330MB 20MS ID330EC ESDI w/CNTRL	2250

#### SEAGATE

20MB 65MS ST225 w/XT Controller ...	\$249
20MB 65MS ST225 .....	209
20MB 35MS ST125 w/XT Controller .....	299
20MB 35MS ST125 .....	245
30MB 65MS ST238 w/XT Controller .....	269
30MB 35MS ST138 .....	310
30MB 35MS ST138 w/XT Controller .....	355
40MB 28MS ST251-1 .....	349
40MB 24MS ST151 .....	419
80MB 28MS ST4096 Full Height .....	590

#### TOSHIBA

66MB 25MS MK134 RLL .....	429
110MB 25MS MK72 RLL .....	669
156MB 23MS MK-156FA ESDI Full Hgt ...	1095

If the drive you require is not listed here please contact our sales department for a quote!

## TAPE BACKUPS

60MB Archive Int. or Ext. w/Cntrl. ....	\$590
60MB Maynard Maynstream Portable ..	889
150MB Archive Internal .....	925
150MB Archive External .....	1250
150MB Maynard Maynstream Portable .....	1395
2.2GB Maynard Maynstream Portable .....	4350

## PC BRAND 16Bit VGA

Ultra Hi-performance VGA Card, compatible w/ VGA, EGA, monochrome, and multisync monitors, Analog and Digital output, upgradable to 512K resolution to 1024x768, many software drivers



**\$195**



# Save Time. Save Money.

## SCANNERS/DIGITIZERS

Complete PC Half Page Scanner .....	\$189
Complete PC Full Page Scanner .....	575
DFI HS3000 Plus Gray Scale Hand Scan .....	219
Hewlett Packard Scanjet Plus .....	Call
Microtek MS II .....	1050
Microtek MSF300G w/256 Grey Levels ...	1495
Microtek MSF300Q w/64 Grey Levels .....	1275
Summasketch 12X12 .....	378
Summasketch 12X18 .....	599

## PRINTERS\*

### BROTHER

HL 8E Laser (HP LJII, HPGL) ..... \$1875

### EPSON

LX810 180/30.....189 LQ510 180/60.....329

FX850 330/88.... 345 FX1050 264/54.....445

LQ850 330/88...Call LQ1050 330/88...Call

LQ950 264/88...Call LQ2550 400/108...Call

### KODAK DICONIX

150Plus 150/50...315 300WP 310/73 .....439

### HEWLETT PACKARD

Deskjet Plus .....710 Laserjet II.....1720

### LASER JET ACCESSORIES

CPI Superfont Cart. adds 150 fonts.....295

CPI 1MB Memory Kit. 319 CPI 2MB MemoryKit. 549

### PRINCETON PUBLISHING

PS-388 Postscript board .....2250

*Adds Postscript to your HP LASERJET!*

### NEC

P2200XE192/54 335 P9XL 400/140 ....1030

P5200 265/90 ....530 P5300 Wide .....675

LC890 Laser ....3190 LC890XL Laser ..4495

### OKIDATA

ML320 300/62 ..345 ML321 300/62 .....479

ML380 180/60... 359 ML390 270/90 .....475

ML391 270/90 ..655 ML393 450/120... .995

### PANASONIC (New Models Listed)

1180 192/38 .....189 1191 240/48 .....245

1124 192/63 .....339 1524 240/80 .....545

### TOSHIBA

321SL 216/72...Call 341SL Wide Carr...Call

351SX 360/120.Call Express 311 .....Call

## EPSON FX 1050

15" Carriage 264 CPS Draft 54 CPS Letter Quality



**\$445**

Other Epson models comparably discounted

## PC BRAND-YOUR #1 LAN SOURCE!



Call for Custom Server Configurations

## NOVELL NETWORKING

### NOVELL

4 User ELS 286 Level 1 .....\$429

8 User ELS Level II (Version 2.15) .....899

Advanced Netware 286 (Ver. 2.15) .....1795

SFT Netware 286 (Ver. 2.15) .....2809

Netware 386 .....Call

Disc Coprocessor Board .....379

NE2000 Ethernet File Server Board .....399

NE1000 Ethernet Card .....269

### GATEWAY (PC Magazines Editors Choice)

G/ Ethernet AT .....\$435

G/NET .....269

G/ Ethernet for PS/2 .....Call

### STANDARD MICRO

PC130 Arcnet Board .....\$135

PC270 Twisted Pair Arcnet Card .....130

PC500-WS 16 Bit Work StationBoard ....375

PC550-WS 16 Bit Twisted Pair Work Station Bd ....395

PC550-FS 16 Bit Twisted Pair File Server Bd 495

PS110 Arcnet Board for PS/2 .....439

PC500-FS 16 Bit File Server Board .....449

ARCNET Passive Hub .....72

ARCNET Active Hub .....359

ARCNET Twisted Pair Active Hub .....429

### TIARA

4 Port Passive Hub .....\$49

8 Port Active Hub .....285

Lancard/A 8Bit ARCNET Board .....89

Lancard/E 8Bit ETHERNET Board .....199

Lancard/E 8Bit Twisted Pair ETHERNET 329

### WESTERN DIGITAL

Ethercard+ w/Novell Drivers .....\$219

Ethercard+ Twisted Pair Ethernet Board.....319

Ethercard+ A for PS/2 .....320

### UNINTERRUPTABLE POWER

#### ELGAR

IDS1100 1000 Watt UPS .....Call

IPS 500 Watt UPS .....Call

#### PTI

DataShield Turbo/2 625 Watt .....595

## PC BRAND™

Free Freight

30-Day Money-Back Guarantee

Toll-Free Service and Support

No Credit Card Surcharges

We carry over 10,000 different hardware and software products, Call for prices on products not listed.

## SOFTWARE

ALDUS Pagemaker .....	\$479
ASHTON-TATE DBASE IV .....	449
BORLAND Quattro .....	149
CENTRAL POINT PC Tools Deluxe 5.5 .....	79
LOTUS 123 3.0 .....	339
MICROSOFT Excel 2.1 .....	235
MICROSOFT Windows 386 .....	125
MICROSOFT Word 5.0 .....	205
SYMANTEC Q&A 3.0 .....	199
WORD PERFECT Word Perfect 5.0 .....	220
XEROX Ventura Publisher 2.0 .....	479

## SERIAL MOUSE

High Resolution (250DPI) Microsoft Compatible



## CO-PROCESSORS/BOARDS

### INTEL

Aboveboard Plus w/512K .....\$419

Aboveboard Plus I/O 512K .....469

Inboard 386 for PC w/IMB .....595

Inboard 386 AT .....859

8087-2 .....129 8087-1 .....189

80387-16 .....349 80287-10 .....229

80387-25 .....495 80387-20 .....399

80387-SX .....339 80387-33 .....659

\*Oversized Monitors, Laser Printers, Laptops and Plotters are excluded from free freight.

# To Order Call 1-800-PC BRAND

(Call 1-800-722-7263) In All 50 States FAX# 1-800-722-7392 New Winter Extended Hours



PC Brand, Inc. 954 W. Washington St., Chicago, IL 60607 Int'l Fax# 312-226-6841 Int'l Voice# 312-226-5200. Open Mon thru Fri : 8am to 8pm Central. MasterCard, VISA, Discover, Checks, & Approved P.O.s Accepted. Prices and specifications subject to change. Customer Service Inquiries Call: 1-800-662-SERV BYTE 14-11

Circle 299 on Reader Service Card

NOVEMBER 1989 • B Y T E 177

# The Brains Behind the Graphics



Coprocessor-based display controllers bring new speed and flexibility to PC graphics

Steve Apiki, Howard Eglowstein, and Rick Grehan

In the days when the C > prompt was common, handling the video display was not a big deal. You worked with a grid of 80 by 25 characters most of the time, switching to 640-by-350-pixel graphics mode to draw the odd introduction screen—nothing an 8088 or 80286 couldn't handle along with the rest of its chores.

Alas, those days are gone. Today's graphical user interfaces, windowing environments, CAD, and desktop publishing applications can put quite a strain on the CPU, even if it's an 80386. The dumb frame-buffer approach taken by VGA and previous graphics adapters can no longer support the higher resolution and higher speed that exacting applications demand.

The future of microcomputer graphics lies with intelligent display controllers. Manipulating the display space of even a medium-resolution (1024-by-768-pixel), noninterlaced display can mean modifying 768K bytes of memory—a lot to ask of the already harried CPU. Move up to 1280 by 1024 pixels, and the requirement goes up to 1.25 megabytes. As resolutions and color depths grow, the time the CPU spends updating the display grows along with them. The most effective solution is to relieve the CPU of this burden and to put control of display memory in the hands of a dedicated pro-

cessor. Boards built around graphics-oriented chips also benefit from the processor's hard-wired graphics functions.

This month, the BYTE Lab examines 11 intelligent graphics controllers with an eye toward their performance in CAD and desktop publishing applications. We'll also get a glimpse at how some of these boards perform under the TIGA (for Texas Instruments Graphics Architecture) interface standard (see the text box "Benchmarking the TIGA" on page 188).

All these cards support at least 256 simultaneous colors (8-bit pixel depth) and either 1024-by-768-pixel or 1280-by-1024-pixel resolution. Two of them are designed for the Micro Channel architecture (MCA); the rest are AT-compatible. They fall into a broad price range, from around \$1000 to close to \$4700, with a corresponding range in capability and support software (see table 1).

Each of the 11 cards shares the same basic design: at the heart of the board, a TMS34010 GSP (for Graphics System Processor) from Texas Instruments (TI); some video memory to hold the display map; and circuitry to drive the monitor.

## On-Board Intelligence

TI's TMS34010 is probably the most popular graphics processor in the current PC market. Its powerful graphics capabilities have earned it a place in everything from frame grabbers to printer controllers, including, of course, display controllers.

What makes the 34010 so well-suited to graphics is not immediately obvious. A quick glance at the instruction set reveals a typical repertoire: arithmetic operations, logical operations, comparisons, jumps—nothing surprising. There are the usual addressing modes: register-to-register, immediate-value-to-register, and absolute- or indirect-address-to-register.

Look a little more closely, however, and you'll find some instructions with

unfamiliar mnemonics. These are the dedicated graphics instructions. They are hardware implementations of essential graphics functions, such as filling a pixel array, drawing a line, pixel block transfers, and comparing a point to a window.

There's also a graphics-oriented register indirect in *x,y* addressing mode. In this mode, a register holds a pixel's address in *x,y* form—the pixel's Cartesian coordinates on the screen. The mode relieves the software of the time-consuming job of working out the mapping of each pixel's memory address to its screen location.

Delve even deeper into the 34010's architecture, and you'll find that the device is built for graphics from the ground up. It has 30 32-bit registers divided into an A bank and a B bank. The A bank registers are general-purpose; software can use them for temporary storage during computation. B bank registers are specialized; they hold information like the location and dimensions of the current clipping window or the current foreground and background colors.

While the 34010 would make a credible stand-alone processor, the designers built in special provisions for working in a coprocessing environment. Twenty-eight I/O registers map to high memory locations in the 34010's address range. Some of these registers are directly accessible by the host processor via external pins. Hardware designers were relieved to see this; it made it easier for them to design a microcomputer-to-34010 interface. The programmer's job was also made easier; through these I/O registers, the host microcomputer can read from and write to the coprocessor board's memory, halt the 34010, and restart it at a known address.

## The Rest of the Story

A coprocessor, no matter how powerful, does not a graphics controller make.

*continued*



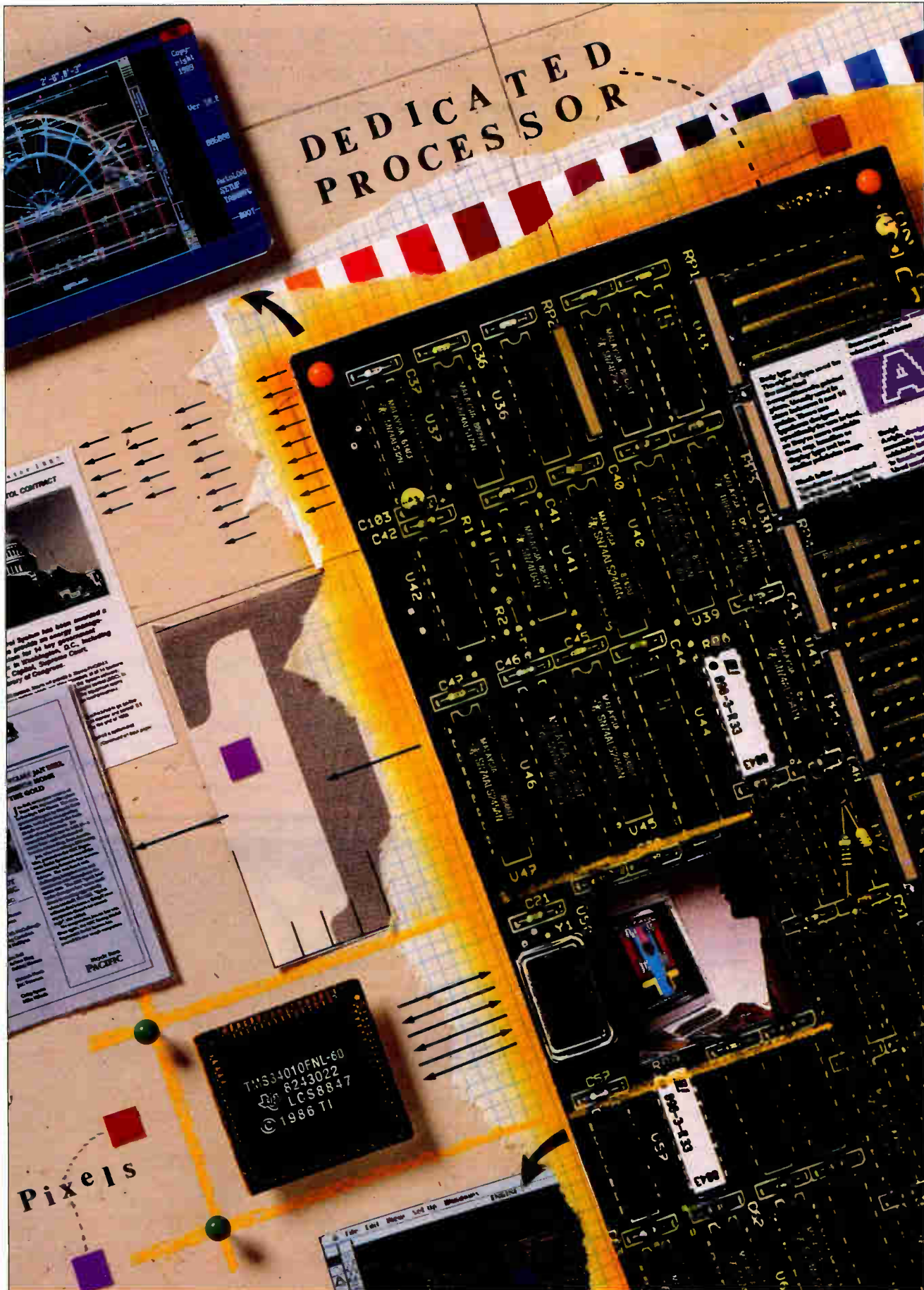

These boards also require video memory, a color lookup table, and video D/A converters (DACs). Most also include DRAMs for local code and data storage, and instruction ROMs.

The size of the video memory usually determines the resolution/color-depth combinations that a board can achieve. Each pixel requires at least 1 bit; in 256-color mode (2<sup>8</sup>), each pixel requires 8 bits. For example, a 1280-by-1024-pixel card operating in 256-color mode requires 1280 × 1024 × 8 bits, or 1.25 megabytes. Cards that have more video memory than a single display page requires can use it to retain off-screen images that it may need for smooth scrolling or other quick recall.

The value of each pixel, stored in video memory, is indexed to a video DAC through a color lookup table. Video DACs typically have far greater color resolution than video memory can support—a typical value is 8 bits each for red, green, and blue, or 24 bits. A 24-bit lookup table allows the board to select, in 256-color mode, 256 of the possible 16.7 million colors that 24 bits allows. The lookup table/DAC combination, therefore, determines the size of the complete color palette.

On the other side of the DAC lies the analog monitor connection. The board's output scan frequency and bandwidth, which vary with resolution, determine whether or not a monitor is compatible. Typically, a high-frequency or multi-scanning monitor is required.

With the exception of the Enertronics Aurora 1024, each of these devices includes some local DRAM. DRAM can hold downloaded 34010 instructions or screen-related data. When running some CAD programs, including AutoCAD, on-board DRAM might contain a *display list*. A display list records vector positions in a drawing, dramatically speeding redraw and similar operations by relieving the CPU of repeated vector calculations. Display lists can also be maintained in system memory or even on disk.

One of the more interesting features offered by several manufacturers is VGA pass-through capability, which allows you to hook to VGA hardware via the VGA extension on the MCA bus, or a special cable between the coprocessor card and the VGA card's top connector.

**Photo 1:** The large AutoCAD drawing used in our tests, at 1024 by 768 pixels. This drawing file requires a display list of more than 512K bytes.

**Table 1:** Features of the graphics adapters that we reviewed, grouped by resolution. Although all the boards are designed around the same processor, other components and different clock speeds give them widely varying capabilities.

**SUMMARY OF FEATURES FOR 34010-BASED GRAPHICS BOARDS**

	Price <sup>1</sup>	Hardware platforms supported	Color palette	34010 speed (in MHz)	Video memory (in bytes)
<b>1280 x 1024 resolution</b>					
Control Systems Artist T112	\$4695	AT	16 M	50	1.25 M
IMAGraph TI-1210-8	\$4195	AT	16 M	40	1.25 M
Matrox PG-1281 C/8/1.5M	\$4595	AT, PS/2s, Multibus II, VMEbus, Multibus I	16 M	50	2 M
Number Nine Pepper Pro1280	\$2995	AT	4 K [16 M]	50	1.25 M
<b>1024 x 768 resolution</b>					
Compaq Advanced Graphics 1024 (with add-on memory card)	\$2098	Deskpro 286/386 or compatible	16 M	50	1 M
Enertronics Research Aurora 1024 <sup>6</sup>	\$995	XT, AT	256 K	40	1 M
NEC MultiSync Graphics Engine	\$1999	AT	256 K	50	1 M
Number Nine Pepper Pro1024/MC	\$2495	PS/2s	16 M	60	1 M
PC Tech Color 34010 Board	\$1600	PC, AT	256 K	40	768 K
Vermont Microsystems Cobra Plus HS	\$3395	AT	256 K	60	768 K
Vermont Microsystems Cobra/2 HS	\$3395	PS/2s	256 K	60	768 K

<sup>1</sup> As tested; some boards include optional memory.

<sup>2</sup> Interface drivers included with board.

<sup>3</sup> VGA pass-through supported.

<sup>4</sup> Support announced but not available when reviewed.

<sup>5</sup> One of two included; additional driver is \$100.

<sup>6</sup> Interlaced.

[ ] = Indicates optional feature.

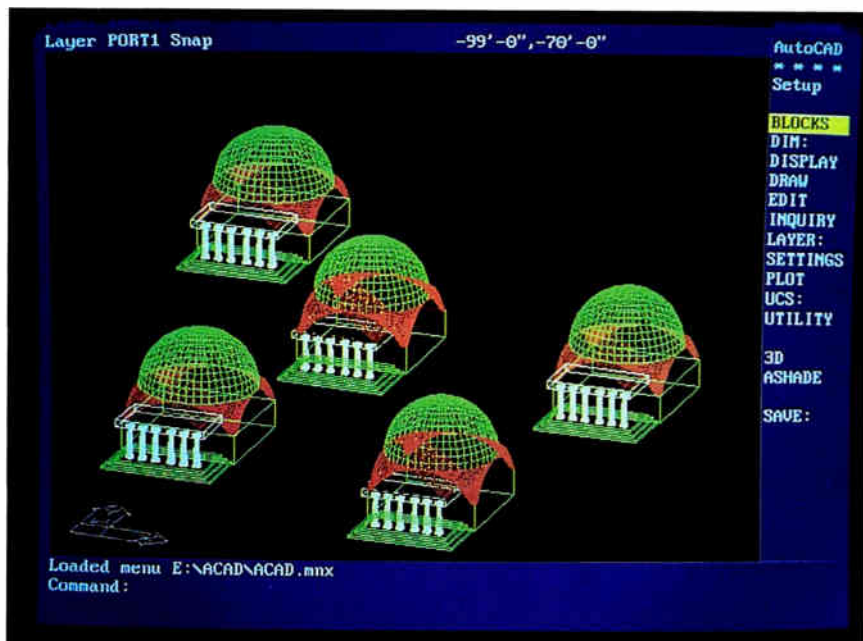



Additional RAM (in bytes)	Standard modes	Application interfaces <sup>2</sup>	Application drivers included	Horizontal scan frequency (in kHz)	Video bandwidth (in MHz)
1 M	VGA <sup>1(3)</sup>	PGL, TIGA-340	Windows for TIGA, ADI for TIGA	64	108
512 K	MDA, CGA, Hercules <sup>1(3)</sup>	DGIS, TIGA-340 <sup>4</sup>	None	64	108
1.5 M	CGA, EGA Text	PGA <sup>5</sup> , [CGI], LIBShell <sup>5</sup>	None	64	110
128 K	CGA, MDA	NNios, TIGA-340	Windows for TIGA, ADI for TIGA	64	107
128 K	None <sup>3</sup>	Halo, [DGIS], TIGA-340 <sup>4</sup>	ADI, Windows/286/386	54	41
None	CGA/EGA Text <sup>3</sup> [VGA]	8514/A AI	ADI, Windows/286	35.5	44.9
768 K	VGA	DGIS, CGI, TIGA-340 <sup>4</sup>	ADI, PM <sup>4</sup> , Windows/286/386, GEM	48-64	64
512 K	None <sup>3</sup>	NNios, TIGA-340	Windows for TIGA, ADI for TIGA	48.5	64
1 M	None [CGA]	DGIS, TIGA-340	Windows for TIGA, ADI for TIGA	49	64
512 K	None <sup>3</sup>	PGL, 8514/A AI	Windows/286/386, ADI, Computervision, VersaCAD, Microcadam, PCAD	48.8	64
512 K	None <sup>3</sup>	PGL, 8514/A AI	Windows/286/386, ADI, Computervision, VersaCAD, Microcadam, PCAD	48.8	64

You then run the output of the intelligent card to a multiscanning monitor that can handle both high-resolution and VGA frequencies. Whenever the board is not active, it allows the VGA card to drive the monitor; when the board becomes the active display controller, it takes over the connection.

Other common components include controller ROMs, which may include IBM standard-mode (e.g., CGA or MDA) emulation firmware. Without emulation, add-on VGA modules, or VGA pass-through, you'll require a dual monitor configuration. Some manufacturers put proprietary operating systems or software interfaces, such as DGIS (for Direct Graphics Interface Standard), on-board as well.

### Application Tests

Currently, CAD and desktop publishing applications represent the most likely uses of these graphics boards. We ran several tests under the two most popular of these packages, Autodesk's AutoCAD release 10 and Aldus PageMaker 3.0; the results are graphed in figure 1. PageMaker runs under Microsoft Windows, so results of the PageMaker test also give a good feel for the effectiveness of the Windows driver.

All our tests on AT-compatible cards were carried out on a Compaq 20-MHz 80386, and we tested the MCA boards on a 16-MHz IBM PS/2 Model 80. We completed the test system with one of three monitors: either NEC's MultiSync XL, which covered the lower-resolution (hence lower-frequency) controllers; or a Hitachi HM-4319 or Mitsubishi HL-6905, which both span the 30- to 65-kHz frequency range and worked with all these graphics boards.

Our AutoCAD tests were designed to test both display list and non-display list performance. Since many of these cards require expanded memory for display-list storage, we portioned out 512K bytes from extended memory using the Compaq Expanded Memory Manager (CEMM) on the Compaq or the Quarterdeck Expanded Memory Manager on the Model 80.

We used two files for the AutoCAD tests, one medium-size (300K bytes on disk and requiring a display list between 256K bytes and 512K bytes) and one large (453K bytes on disk with a display list larger than 512K bytes). The large

*continued*

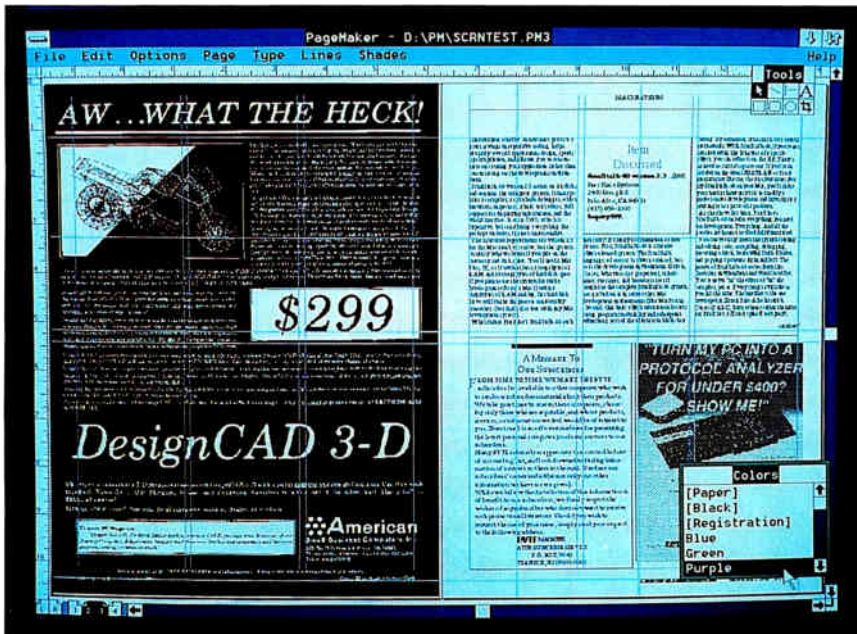

Photo 2: Our PageMaker test file, also at 1024 by 768 pixels. It combines text objects with bit maps of varying size.



**Figure 1:** Graphs of our benchmark results: Each graph shows actual time in seconds, so smaller bars mean better performance. Times for Compaq's VGA card are included for comparison. (a) The small AutoCAD drawing, designed to require a display list of less than 512K bytes, tracks the effectiveness of each display-list processor. (b) Most boards couldn't hold the display list of the large AutoCAD drawing in memory, but boards with disk-overflow capability (Compaq 1024 and Pro1280) handled redraws gracefully. (c) PageMaker Zoom and Scroll tests reflect the effectiveness of a card's Windows driver.

file was sized so that it would force display-list overflow on boards that relied on expanded memory or had less than 512K bytes free on-board.

For each file, we timed redraw, pan, and zoom operations. The display-list drivers of some boards provide enhancements to the standard AutoCAD command set, with special commands to activate display-list functions. Where these enhancements were used, we timed the three operations using the dedicated display-list commands; if these were not available, we used standard AutoCAD functions. Photo 1 shows the large AutoCAD display.

We also timed two simple, graphics-bound functions in PageMaker. Our sample file included two facing magazine pages (see photo 2), which incorporated large and small bit maps, as well as text. The Zoom test is merely a Control-W key sequence in PageMaker, which sizes the facing pages to fit in the display window. It reflects the time required to display both pages.

Our second PageMaker test, Scroll, measures the time it takes to scroll from one side of the set of pages to the other. We scrolled across the window by holding down the arrow at one end of the scroll bar, forcing the display to update rapidly. To eliminate time wasted on disk access, we set up a large EMS disk cache and primed it by selecting the test pages several times.

A closer look at each board reveals qualities that a glance at the graphs and tables can't show. A description of each board follows; products are grouped alphabetically within resolution categories.

*continued*

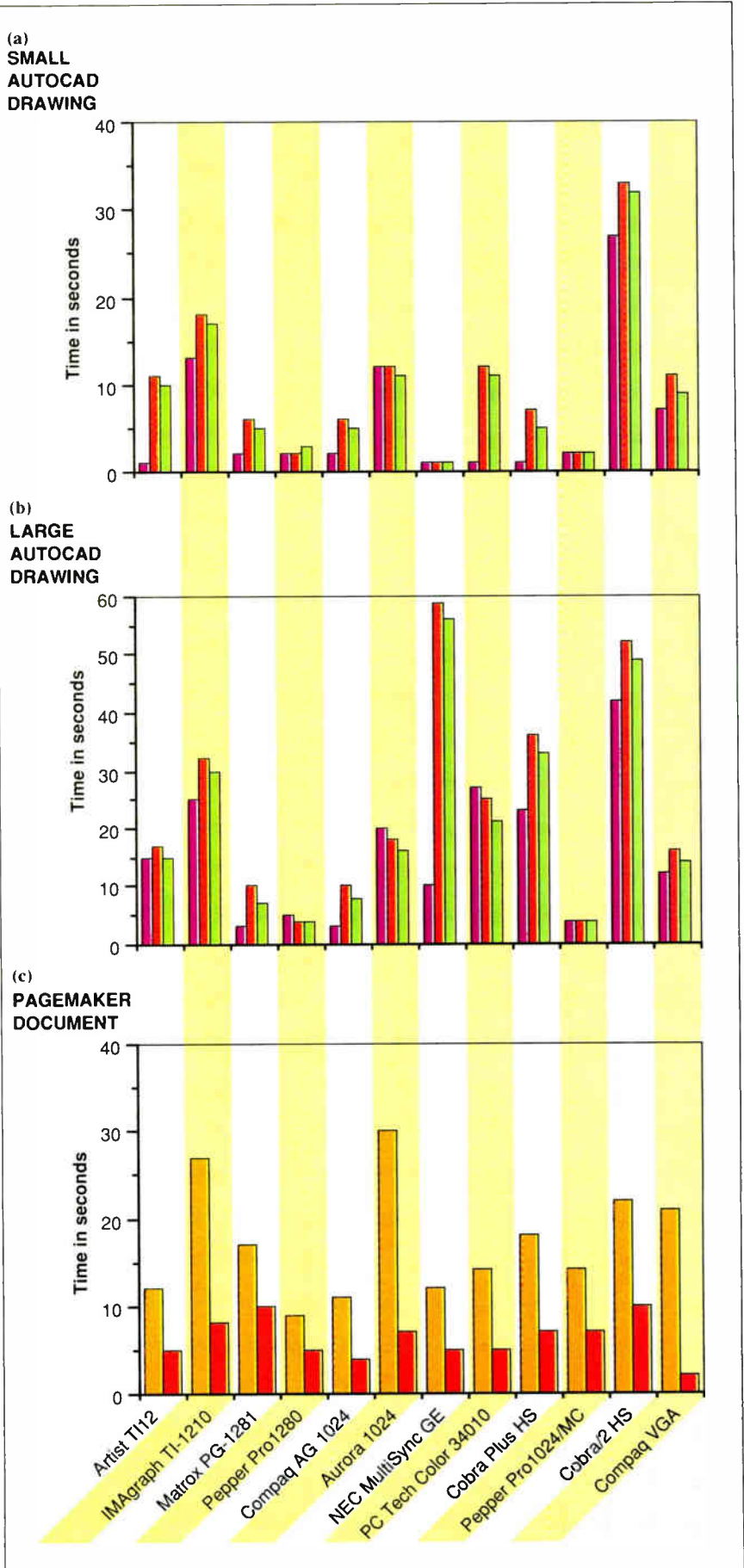





If these images didn't catch your eye, then why are you reading this ad?

Images that leap out at you, especially in a magazine like this, have to be powerful. And whether you need to present your business information more effectively or you want to expand into multi-media, you need strong visuals. Together with Truevision, you can develop that power for presentations, CAD, training, video production and more. And it's easier than you think. You can bring photo-realism and multi-media to your presentations by using a TARGA board with compatible software and peripherals from over 200 companies.

With a TARGA videographics board and your PC\*, XT\* or AT\*-class machine, you can capture images in real-time from a video source, merge them with other images

or add text and graphs, even create stunning broadcast-quality animations, and then output the result to video, tape, slides or paper prints. That's how to maximize your presentation efforts into multi-media.

Truevision videographics cards are ready for you today. Contact us at **800/858-TRUE** for more information, or visit your local Authorized Truevision Reseller for a demonstration. We'll show you how to visualize your data in a way that no one else can.



7340 Shadeland Station, Indianapolis, IN 46256

INTERNATIONAL: Canada 416/499-9400

France 33-952-13-6253

Italy 39-2-242-4551

Switzerland 41-1-825-0949

U.K. 44-1-991-0121

West Germany 49-89-612-0010 Other 617-229-6900

PC, XT and AT are registered trademarks of International Business Machines Corp.

© 1989, Truevision Inc.

Circle 361 on Reader Service Card

World Radio History

## GRAPHICS COPROCESSOR BOARDS



## Turn your printer



## into a plotter

Imagine your present printer turning out crisp, high resolution plots while you continue to work, *without interruption*, at your PC.

The EOgraph Plus add-on board lets you do that, and more.

You have total control over eight different line widths, and as many colors as your printer offers.

You can produce drawings 15 feet long, and longer, in any carriage width.

How about multiple plots, or automatic queuing of text and plots? Yes, the EOgraph Plus lets you do that, too—with ease.

Think of it! Using virtually *any* CAD or graphics program, you can work at your PC while your printer generates plotter-quality drawings with nearly incredible detail.

Best of all, you get all of this without the headaches, or expense, of baby sitting a plotter.

Thousands of users agree: No other PC add-on can increase your productivity, or pay for itself so quickly, as the EOgraph Plus.

It may sound too good to be true, until you call for the facts, toll-free, at 1-800-548-5780.

DEALER INQUIRIES  
WELCOME

**EOgraph  
Plus™**

Eotron Corp / 121 Westpark Road / Dayton, OH 45459

Please send information and independent test reports to:

NAME

ADDRESS

CITY

STATE ZIP

BVT

### 1280 by 1024 Pixels

Control Systems Artist TI12

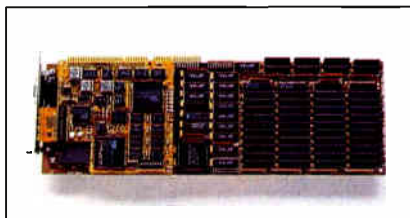

Although the Artist TI12 demonstrated good performance, it could not live up to expectations set by its high price. At \$4695, the Artist TI12 was the most expensive board we reviewed, and it is less well equipped than a few less costly cards. Upgrades don't come cheaply, either: It costs \$895 for a 1-megabyte DRAM upgrade and \$1695 for 2 megabytes, \$795 for a VGA Module, and \$249 for a VGA pass-through kit.

The Artist package includes diagnostic software, PGL (for Professional Graphics Language) drivers, and the TIGA driver package. Control Systems does not provide any separate application drivers, so we tested the board exclusively under TIGA. If you choose to communicate with AutoCAD through PGL, you'll have to forgo display-list processing.

TIGA's AutoCAD driver supports a display list in expanded memory, but it does not have some of the slicker display-list features demonstrated by the other packages. More important, the driver is written for AutoCAD release 9 and does not support display-list-based pan and zoom functions.

The driver intercepts standard AutoCAD commands; if the display list overruns the allotted expanded memory, all display-list processing is disabled. This is hardly a weakness of Control Systems' product, but it causes the Artist TI12 to suffer in comparison with boards like the Matrox PG-1281 and Pepper Pro1280.

The display list was enabled for the small drawing and disabled for the large drawing. While the board was very responsive when doing redraws with the display list, pan and zoom functions suffered from using the TIGA driver. Non-display-list drawing times were excellent, so if you lack the memory to use the display list, the penalty won't be that great.

All installation and testing went without a hitch. We did notice a bug in the TIGA Windows driver that keeps it from properly displaying dragged bit maps, but the problem can be corrected by forcing a redraw. Performance under Win-

dows and PageMaker was generally very good.

The Artist TI12's only glaring weakness is in the critical category of price versus performance. While the hardware seems to be in excellent shape, software support is limited, and the current early versions of TIGA drivers do not manage to squeeze out all the performance that they could.

IMagraph TI-1210-8

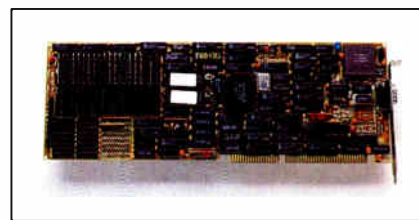

The IMagraph is a solidly built board that provides full Hercules- and CGA-emulation modes in addition to its high-resolution graphics. The board's installation instructions make the setup and configuration as easy as falling out of bed.

One of the nicest things about the IMagraph board is the optional ACAD ADI display-list driver. The standard driver gives you full resolution and color but no display-list capability. The \$195 IMAzoom package buys you display lists and real-time display of pans and zooms. Clicking on the IMAzoom Shutter brings up a smaller window and a submenu. An overview of the screen is shown within the window, and you use the digitizer to control the interactive zoom and pan functions.

In spite of the display-list support, the IMagraph board consistently turned in some of the slowest times in our AutoCAD tests. The TI-1210-8 keeps all display lists in local memory. Unfortunately, the on-board memory was too small for either the small- or large-file display lists—IMAzoom with our files required more than 512K bytes, so we lost display-list capability. If you do a lot of work with AutoCAD, you may find that IMAzoom is such a useful addition that a RAM upgrade may be a worthwhile investment.

The optional Microsoft Windows driver handles the IMagraph board nicely. The text and menus are clear and easy to read. The display driver handles bit maps rather slowly, a handicap if you need to move a lot of high-resolution images. One of the two pages on our PageMaker

*continued*





July 1989  
VGA WONDER



# VGA WONDER



**Fabulous Offer**

**VGA WONDER Bundle Includes HARVARD Graphics**



for an additional **\$150.00\***

While quantities last  
\*M.S.R. \$495.00

## FASTER THAN THE AVERAGE BEAR

Are you asking yourself what a bear has to do with super speed, remarkable resolution and fabulous colors? We did, too. How can anyone bear to work with less than incredible speed, we asked ourselves. How can anyone bear to work without extraordinary resolution? Bear to work with less than 256 spectacular colors? We got so beared out, we decided to share one with you. Along with the bear facts about ATI's award-winning board.



Such as:

- high resolution 800x600 and 1024x768 graphics
  - fast 16-bit bus support
  - 100% register-level compatible in VGA®, EGA®, CGA®, MDA®, and Hercules® modes
  - analog and digital monitor support
  - easy, switchless installation
  - high resolution and 132 column drivers
  - Microsoft® compatible bus mouse and mouse port included
  - available in 256K and 512K versions
- Oh, and bear this in mind – when it comes to VGA WONDER®, you'll be getting a honey of a price!

See us at Booth H8224  
**COMDEX/Fall '89**  
November 13-17, 1989  
Las Vegas Hilton Hotel  
Las Vegas, Nevada

For more information, contact your supplier or

ATI Technologies Inc.  
3761 Victoria Park Avenue  
Scarborough, Ontario  
Canada M1W 3S2  
Tel: (416) 756-0718  
Fax: (416) 756-0720



Registered trademarks are as follows: ATI, VGA WONDER - ATI Technologies Inc.; Microsoft - Microsoft Corp.; Hercules - Hercules Computer Technologies Inc.; VGA, EGA, CGA, MDA - International Business Machines Corp.

Circle 42 on Reader Service Card  
World Radio History

# TAKE CHARGE!

## Does What All These Utilities Do Plus Task Switching...

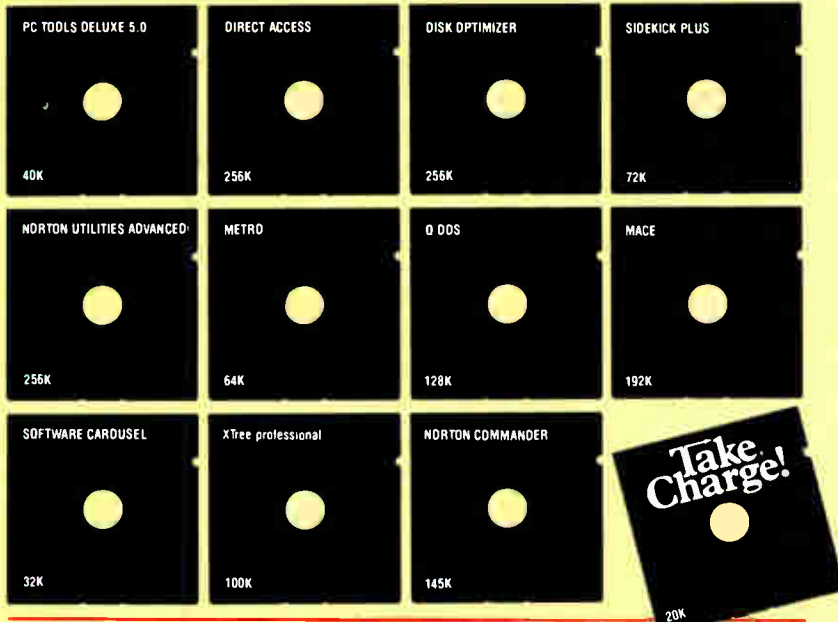

## IN ONLY 20K OF RAM!

This power packed integrated program has received one great review after another. It is the utility of choice and most used by the industry's top PC review editors when it comes to serving their own personal computing needs. The reasons are simple. Take Charge! packs just about every utility you're likely to need in just 20K of RAM. The built in Task Switching feature will allow you to suspend one program and pop up another from within the current running program and return you to the exact location you left. Go from lotus to dbase and back. Take Charge! even Task Switches other well behaved TSR's and utility programs like PC Tools Deluxe 5.1, Advanced Norton, Xtree Pro and more in only 20K of RAM by making them part of Take Charge!.

Take Charge! is intuitive. It's easy to use and easy to learn, and best of all it requires no knowledge of DOS commands. Simply point, shoot and press function keys.

Take Charge! Includes: Menu program, Task Switching, Disk Services, File Management, Communications, DOS Shell, Disk Optimizer, Data recovery, RPN Calculators, appointment calendar, Rolobase/autodialer, screen blanker, Virtual memory text editor and more.

Call your local dealer to order or contact:

DEPARTMENTAL TECHNOLOGIES, INC.

PO Box 645, Andover, NJ 07821 Tel 201-786-6878/FAX 201-786-5868

**Take Charge!**  
LIKE NOTHING IN RECENT MEMORY

**\$99.95** Plus \$5.00 Shipping and Handling  
Major Credit Cards Accepted

SEND \$3.00 FOR TAKE CHARGE! DEMO DISK

System Requirements: IBM™ PC, XT, AT, PS/2, or 100% IBM compatible. Requires hard disk. MS/DOS 2.0 or greater. 320K minimum. Network compatible. Product RAM estimated. All product names are trademarks of their manufacturers. Copyright 1988. Departmental Technologies, Inc. All rights reserved.

test document is a full-screen bit map, digitized at 300 dots per inch. When this page is redrawn, the display bogs down considerably handling the bit map. Objects belonging to Windows, such as lines, rectangles, and text, are displayed much faster. Pull-down menus suffer the same fate as large bit maps. When you select a menu from the menu bar, it appears very slowly. We found this rather annoying.

At \$4195, the TI-1210-8 costs much more than the Number Nine Pepper Pro1280, but it's competitive with the other 1280- by 1024-pixel boards. We wouldn't choose this board for Windows, but the AutoCAD/IMAZoom combination makes the IMAGraph board (with sufficient memory) worth a look.

### Matrox PG-1281 C/8/1.5M

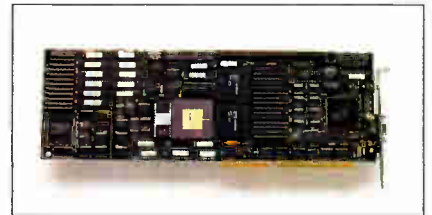

The Matrox PG-1281 provides CGA emulation in addition to full PGA compatibility. We tested the version for the AT, but the board is also available for the PS/2s, Multibus, and VMEbus computers. We tested the optional drivers for AutoCAD release 10 and Windows.

The installation manual is very detailed. It's a good thing, too, as the evaluation unit came without a video cable. After several minutes of poking through the manual, we found the description of the video connector and located a suitable cable. Matrox sells video cables and monitors as options.

AutoCAD really likes this board. Our tests placed the Matrox as one of the fastest 1280- by 1024-pixel boards. Memory may have something to do with it. The unit we tested was equipped with the standard 3.5 megabytes of memory. There are 2 megabytes provided for video, and 1.5 megabytes handle the downloading of 34010 programming and display-list support. It takes a lot of horsepower to handle that much memory, and Matrox gave this card three custom gate arrays to boost the performance of the 50-MHz 34010 processor. The AutoCAD drivers are easy to install and provide support for the basic AutoCAD set—no fancy extras.

*continued*



# WHAT OUR REMOTE LAN BRIDGE CAN DO FOR YOUR WORLD.



Bringing people and information together is what a Microcom LAN Bridge is all about. And, with our unique MNP<sup>®</sup> Data Compression feature, remote LANs can be connected at unprecedented performance levels. MNP squeezes twice the performance out of your wide-area link compared to other bridges at a fraction of the price.

In fact, the Microcom LAN Bridge is the only remote bridge on earth that uses data compression to move oceans of data between LANs. And, it's the first

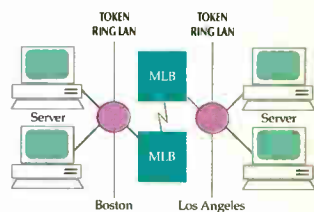

to support Token Ring networks, in addition to the Ethernet LAN standard.

Think about it. A fully integrated transparent MAC-level bridge built around the IBM PC/AT bus. In four fully upgradeable, multi-line models with speeds from 9600 bps to 1.544 Mbps (T-1). And with prices beginning at \$6,198, the only thing a Microcom LAN Bridge can't squeeze is your budget.

The Microcom LAN Bridge. It brings information and people closer together, no matter where in the world they are.

Call toll-free, 800-822-8224 for more information.

500 River Ridge Drive  
Norwood, MA 02062

Telex:  
710-336-7802 Microcom NWD.

U.S. FAX: 617-551-1006

Worldwide Distribution.

International FAX: 617-551-1007



MNP is a registered trademark of Microcom, Inc. Microcom LAN Bridge and MNP Data Compression are trademarks of Microcom, Inc. IBM Token Ring and IBM/AT are trademarks of International Business Machines Corp. Ethernet is a trademark of Xerox, Inc.

## Benchmarking the TIGA

In addition to the obvious price barrier, the major obstacle keeping coprocessor-based graphics systems from every user is a lack of suitable standards. A separate driver for each board/application combination is fine when you dedicate a board to a single CAD package, currently a likely scenario. But when your intelligent graphics board becomes your primary adapter, such an arrangement becomes intolerable.

The migration from the high end to every desktop has just begun, but already the battle for standards has been joined. Texas Instruments and 8514 supporters Western Digital and Headland Technologies are currently wrangling over the next great mainstream graphics standard (see "Clash of the Graphics Titans," *IBM Special Edition*, Fall 1989). TI touts its own 340x0 family and TIGA-340, while its rivals champion their versions of IBM's 8514 processor and the 8514 Application Interface (8514 AI).

Texas Instruments' Graphics Architecture, or TIGA, is a new software interface—the first released version (1.1) began shipping in early June. Still, its list of announced supporters from both the software and hardware development communities is impressive, and its emergence as a standard seems likely. To get a feel for the relative performance of the reviewed boards under TIGA, we developed a suite of benchmark tests, described below.

### TIGA's Role

From the user's perspective, TIGA-340 is a library of graphics routines that

allow application programs to communicate with boards built around chips in TI's 340x0 family. Furthermore, TI has rigorously defined the behavior of each routine in the TIGA library, so that a programmer developing an application on one TIGA board can rest easily in the certainty that his or her application will also run on any other TIGA-compatible system.

From the developer's perspective, TIGA is really two pieces of software: the communications driver, which runs on the host PC, and the graphics manager, which runs on the 34010 coprocessor board. The communications driver is actually a TSR process that usually installs itself in interrupt 7F hexadecimal. Application-generated TIGA calls pass down to the TSR process, which puts them into a kind of graphics message packet and sends them to the coprocessor board. The graphics manager then picks up the messages, determines which operation is to be performed, and executes that operation.

Any TIGA-compatible board is expected to support a minimal set of graphics operations (primitives). These are the routines that a programmer can expect to find available on all TIGA boards. The primitives are divided into two groups—core and extended. Core primitives are always available; they are loaded onto the coprocessor board when TIGA is installed (typically at boot-up). Extended primitives are optional; an application program may opt to load them only as required.

One of TIGA's strengths is that it doesn't bury that hardware under an in-

flexible application programming interface. Applications developers can define their own primitives, referred to as user-extended. So, if you determine that your graphics algorithms execute more efficiently when running on the 34010, you can write the routines in 34010 code (TI sells developer's kits for doing this) and build your own library of primitives. Then, at run time, your application can request that TIGA download your customized primitives to the coprocessor board. Applications can even switch libraries on the fly, deleting one set of user-extended primitives and loading another in its place.

### The Benchmarks

Our TIGA benchmarks measure combined board-and-driver performance in executing common graphics tasks. They make extensive use of the TIGA 1.1 library, and they don't attempt to wring out every drop of performance through the use of user-extended primitives. Benchmarks work with objects sized in pixels, so they are independent of screen resolution.

*Bit-block transfer (BitBlt)* is more or less a test of memory-move operations. The BitBlt benchmark is in three parts. The first part moves a rectangular region of pixels from one region of the screen to another. The location of the source and destination regions were purposely chosen to overlap, so that the on-board transfer routine would have to set the direction pointers correctly. The second test copies a rectangular region from on-screen memory to off-screen memory and then repeatedly copies the block from off-screen memory back to

**Table A:** TIGA benchmarks measure low-level performance on common graphics operations. (All times are in seconds.)

#### TIGA-340 1.1 BENCHMARK RESULTS

	Clipped lines	Clipped ellipses	Filled polygons	BitBlt	Zoom	Monochrome text	Color text
Control Systems Artist TI12	33	62	71	75	42	44	58
Number Nine Pepper Pro1280 (8-bit)	34	62	N/A	75	45	46	58
Number Nine Pepper Pro1280 (4-bit)	34	62	68	40	33	41	45
PC Tech Color 34010 Board	35	67	91	97	39	73	94
Number Nine Pepper Pro1024/MC (8-bit)	28	44	60	62	25	54	76
Number Nine Pepper Pro1024/MC (4-bit)	28	44	57	33	19	43	52



on-screen memory. The times for these two benchmarks were always identical, so we combined the results under the "BitBlt" heading in table A. The final test gauges the TIGA driver's zoom capabilities. By means of a BitBlt, the program first transfers a region from off-screen memory to successively larger regions on the screen. It then copies the bit block from the off-screen source into successively smaller on-screen regions. The effect is a box that first grows to fill most of the screen and then shrinks back to its original size.

*Clipped lines* and *clipped ellipses* test the clipping capabilities of the TIGA hardware. The program first defines a clipping rectangle on the display and then repeatedly draws lines whose endpoints are chosen at random. Many of the lines have endpoints that lie outside the clipping rectangle; the board is therefore forced to perform clipping on such lines. The software rotates through the color palette as it draws the lines. Next, the program clears the screen, re-establishes the clipping rectangle, and repeatedly draws ellipses whose bounding rectangles are chosen at random. (The bounding rectangle of an ellipse defines that ellipse's center location and major and minor axis lengths.) Again, portions of the ellipses lie outside the clipping rectangle. The program rotates through the color palette as it draws the ellipses.

*Filled polygons* tests the speed with which the board can draw pattern-filled and solid-color-filled polygons. We defined four polygons of various shapes—one with holes in it—to give the filling algorithms something to think about. We also defined four fill patterns. The benchmark repeatedly draws each polygon, randomly selecting its size and location. On each iteration, the program alternates between drawing the polygon filled with a solid color or with one of the defined patterns.

*Text* tests each board's capabilities at drawing clipped text. The program reads a string of 5000 characters from a data file and then formats that string so that it will fit into a block defined to be a set number of pixels wide and high. The formatted text is kept in main memory. Next, the program establishes a clipping rectangle and then repeatedly writes the text out to the screen at random loca-

tions; hence, portions of the text block fall outside the clipping region. The program executes the test twice. In the first part, it displays the text in a single color with an opaque background; in the second, it cycles through the entire palette while displaying text with a transparent background.

### Gauging Performance

The results of these tests on the boards in this review that support TIGA 1.1 are shown in table A. Where a board had more than one pixel depth configurable through TIGA, we ran it in both 4- and 8-bit modes. We tested AT boards on a Compaq 386/20, and the MCA boards on a 16-MHz IBM PS/2 Model 80.

Each board showed consistent performance from test to test. Results were surprisingly unlike those generated by our PageMaker application tests, despite these boards' use of the same TIGA Windows driver. The PageMaker tests seem more dependent on the ability of the Windows driver to properly utilize the 34010.

The MCA-based Pepper Pro1024/MC demonstrated outstanding speed. Its bus and 60-MHz processor contributed to excellent performance on all but the text benchmarks. The results are even more impressive when you consider that the board was run on a machine with a slower main processor than any of the others and that the text benchmarks are relatively main processor-dependent.

Number Nine's Pepper Pro1280 and the Control Systems Artist TI12 ran at nearly a dead heat. Although the two boards turned in virtually identical times on most benchmarks, the Control Systems board had a slight edge. The Pepper Pro1280 did not have enough DRAM to store the polygon definitions in 8-bit mode, and so it could not execute the Polygon benchmark. PC Tech's Color 34010 Board ran noticeably slower than the others, as its lower processor clock rate (40 MHz versus 50 MHz) might lead you to predict.

Differences between 4- and 8-bit modes were only apparent on benchmarks that had a high ratio of pixel manipulation to calculation. The calculation-intensive clipped lines and clipped ellipses tests, notably, did not seem pixel-depth-dependent at all.

Windows is not the Matrox board's strong suit. It's rather slow in redrawing bit maps and appears to have coarse control over its color selection. As for speed, it ranked near the bottom, along with the IMAgraph board.

Overall, we liked the Matrox PG-1281. It would be a good choice for serious AutoCAD users due to its speed and exceptionally clear display. The list price of \$4595 includes more memory than any other board we tested. OEMs and value-added resellers will like the complete documentation, which makes it easier to install in complex CAD systems.

### Number Nine Pepper Pro1280



The Pepper Pro1280 is a veteran among 34010-based graphics cards. Introduced in December 1986, the Pro1280 is still a top performer despite its limited DRAM capability. The board as we tested it sells for \$2995; a unit with a larger lookup table and a 16-million-color palette costs \$3495. The board ships with TIGA and proprietary NNIO drivers; current versions also bundle in TIGA drivers for Windows and AutoCAD. One drawback of this older unit is its inability to work with VGA cards. Not only does it not support pass-through, it can't even coexist with a VGA in the same system.

Prices are fairly low because the board includes only 128K bytes of instruction memory; the next lowest in the 1280- by 1024-pixel class is the IMAgraph board's 512K bytes. And while other models provide for RAM expansion, the Pro1280's DRAM capacity is fixed. This kept us from running our Polygon benchmark under TIGA and may restrict other programs that require an on-board (but off-screen) memory workspace.

Number Nine's Power9 display-list driver does not even attempt to use on-board memory for display-list storage. It keeps the display list either in expanded memory or on disk. One sharp feature that we found surprisingly rare among these boards was the ability to use the disk as necessary if the expanded-memory display list overflows. Most drivers simply disable display-list processing

*continued*

# EFFORTLESS EDITING

between files —  
across applications —



If you work with  
more than one file,  
you need *Vq2*  
— the editor for  
multi-file processing.

If you begin Monday trying to remember what you were doing Friday, you need *Vq*. Just a few keystrokes bring up the file set you were working on, with each file positioned where you left it. Even if Friday was so bad you just pulled the plug and ran, *Vq* will bring back the changes you forgot to save.

Load files by name, location, date, even file content — you can search whole disks, directories, or file sets, to find and automatically load just what you want. Simple AND/OR/NOT/WITH/WITHIN pattern specifiers combine to find just about anything on a disk. *Vq* will even search and load word processor and desktop publisher files.

*Vq* is EASY to learn and EASY to use. Pulldown menus do the whole job... instantly. You probably won't even read the manual. Full multi-window mouse support, of course!

Features include programmable keyboard, 43/50-line and 132-column video modes, hot links to executable programs, compile with find-next-error, and macro compile/decompile. Optional auto-indent, tab, column shift, and margin settings. Your choice of screen colors.

100+ commands include Multiple edit windows with window Zoom and multi-speed scrolling; Block copy, cut, paste, delete, box, fill, print, write, shift left or right, cap and uncap; Mark lines, columns or fragments of text; Search/search-and-replace with token search, find-function, and regular expression options (select block or entire document); Goto/Push/Pop/Restore Line; Find matching {(or)} levels; Format, Center, and Timestamp; Query, resume query, find next/previous query file/match; Full DOS shell or command execute — *Vq* shrinks to 7Kb. Full Undo capability lets you change your mind — while editing!

OS/2 & DOS versions... both for \$150

If *Vq2* sounds too good to be true,  
call for our NO RISK OFFER —

## 1-800-284-3269



**GOLDEN BOW SYSTEMS**  
2665 ARIANE DRIVE, #207  
SAN DIEGO, CA 92117  
(619) 483-0901

FAX (619) 483-1924 TELEX 201520 GBSUR  
MC/VISA US shpg/hdlg \$5 CA orders add 7%  
*Vq* and *Vq2* are trademarks of Golden Bow Systems

entirely if the drawing is too complex.

Power9 for AutoCAD costs an additional \$250, but it adds far better performance than the standard TIGA driver. When handed 512K bytes of simulated expanded memory and using the driver's overflow-to-disk capability, the board and driver performed consistently well, especially with the large file. Power9 adds its own zoom, pan, and other display-list commands to AutoCAD. These commands duplicate the drawing (the section covered by the display list) in a small viewport at the corner of the screen. To pan or zoom, you drag or resize a highlighted box within the viewport. If you use these commands, you need to click and drag to select views; you lose AutoCAD's command-line-entry precision.

The Pepper Pro1280 runs under the TIGA Windows driver. Except for the bit map-dragging bug experienced by all boards using this driver, the tests ran smoothly. The Pepper Pro1280 tied the far more expensive Artist TI12 on one PageMaker test and topped the entire field on the other.

### 1024 by 768 Pixels

#### Compaq Advanced Graphics 1024

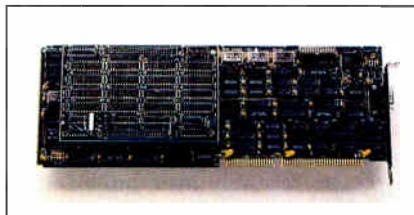

Our AG 1024 board was equipped with the optional 512K-byte memory-expansion module. The standard board supports 16 colors in its highest resolution. The optional memory brings the number up to 256. This board prefers to coexist with a VGA card and comes with a connection cable to pass the VGA video through to a single monitor.

AutoCAD's performance on this board was quite respectable. Redraw times were among the fastest of any of the display boards. Pan and zoom performance was in the low to middle of the pack. The AutoCAD drivers provide QZOOM and QPAN, display-list versions of the standard AutoCAD functions. QZOOM uses the display list and your mouse to handle local zooming in geometric progression. Unlike AutoCAD's zoom, which allows for an arbitrary window, QZOOM provides a zoom

"box" that you can set from 2x to 32x. QPAN lets you slide the QZOOM box around within the window. Overall, it improves on the standard zoom and pan, but not as much as IMAzoom does.

Display lists are stored outside the board, in expanded memory. The driver configuration program lets you allocate from 0 to 32 megabytes of expanded memory. Most boards we tested disable the display-list handling when they run out of memory. The Compaq driver is one of two that can overflow the display list to a disk file. The combination gives AutoCAD a real performance boost.

Windows and PageMaker work very well on the AG 1024. The board is the fastest of the 1024- by 768-pixel boards, although one of the 1280- by 1024-pixel boards was faster. The color display was crisp, and the text was easy to read.

Compaq is known for many things—excellent quality, compatibility, and reliability, to name a few. The AG 1024 has all this, and at a reasonable price to boot. The AG 1024 isn't quite the cheapest board we tested, but it's close to the fastest. It would be a good choice for people who feel comfortable buying hardware with a household name on it.

#### Enertronics Research Aurora 1024

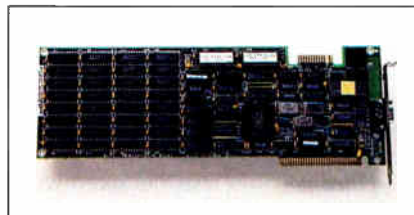

Only a few 34010-based boards support IBM's 8514/A AI software interface specification. The Aurora 1024 is the only board in this review that uses the 8514/A AI as its exclusive connection to software applications. In fact, with its 1024- by 768-pixel interlaced resolution and no instruction memory, the Aurora 1024 is essentially an 8514/A clone. Since IBM markets its 8514/A adapters exclusively for the PS/2 series, the Aurora 1024 represents one of the few ways that current users can get 8514/A graphics on XT- or AT-class machines.

We tested the Aurora 1024 using ADI and Windows drivers provided by Enertronics, although you have the option of using standard 8514/A drivers. Enertronics actually ships two ADI drivers—one that supports an expanded-memory display list and one that does not. The

*continued*





## Somewhere Over The VGA Clutter Lies a Clear Choice

Finding the right VGA card can be a long and confusing journey, so follow the name you can trust. Hercules, the company that defined PC graphics, brings you the Hercules VGA Card. At just \$299\* it's everything you need to enter the kingdom of color.

**Compatible.** The Hercules VGA Card delivers all 17 IBM standard video modes so your EGA and CGA software will be at home. And it will work with any color or monochrome analog video VGA monitor.

**Simple.** The Hercules VGA Card is easy to install and use with no switches, jumpers or custom software drivers. And since the Hercules VGA Card is faithful to the VGA standard, you'll use future software without needing extra drivers.

**Beautiful.** Over 256,000 colors will brighten your workday routine. And the Hercules VGA Card's 1/1 aspect ratio makes a square look like a square and a circle look like a circle.

**Adaptable.** VGA has set the course for operating systems of the future. Windows, OS/2 Presentation Manager and DESQview depend on the Hercules VGA Card's readable registers for multi-tasking ease.

To find out where to catch the Hercules road to VGA satisfaction, call 800 532-0600, ext. 180 (US) or 800 323-0601, ext. 181 (Canada).

There's no place like

# Hercules

\* Suggested retail price

©1989 Hercules Computer Technology, Inc.,  
921 Parker Street, Berkeley, California 94710,  
415 540-6000. Hercules is a registered trademark  
of Hercules Computer Technology, Inc. All other  
product names are trademarks of their respective holders.

Circle 162 on Reader Service Card

# FREE CATALOG

## 1-800-547-5444

In Canada, Call Toll Free 1-800-387-2173

Call today, and get the Inmac Computer Products Catalog!

- Guaranteed Delivery
- Instant Credit
- Over 3000 Products To Choose From
- 45 Day Product Trial



**YES,** Please send my first Inmac catalog today!

Name \_\_\_\_\_ Title \_\_\_\_\_

Company \_\_\_\_\_

Street Address/P.O. Box \_\_\_\_\_

City \_\_\_\_\_ State \_\_\_\_\_ Zip \_\_\_\_\_

Area Code \_\_\_\_\_ Phone No. \_\_\_\_\_ 5558

**inmac**

"Your Worldwide Source for Computer Supplies, Furniture, and Data Communications Products."

Mail To: Inmac  
2465 Augustine Drive,  
Santa Clara, CA 95054

# Definitions on disk

Language Master gives you instant access to more than 80,000 dictionary definitions plus 470,000 synonyms from Merriam-Webster—the English language authority.

The dictionary contains definitions, usage notes and hyphenation points. The thesaurus contains synonyms, meanings for each synonym group and properly inflects all responses.

Language Master, formerly Choice Words for the IBM PC, works with most popular MS-DOS word processors and is now available for the Apple Macintosh.

Whether you're writing, reading, or simply want to explore the English language in a new and exciting way, Language Master is for you.



**LANGUAGE MASTER™**

**\$99**



See your local software dealer. Or order directly by calling 1-800-323-0023, (305 566-3511 in FL) or write: Franklin Software, 3511 N.E. 22nd Avenue, Fort Lauderdale, FL 33308

**Franklin™**  
Software

## GRAPHICS COPROCESSOR BOARDS

display-list driver requires at least 1 megabyte of expanded memory, and our tests were constrained to run in 512K bytes; we ran the benchmarks with the non-display-list version. As a result, AutoCAD test results were generally poor for the small file. On the large file test, where almost all boards ran without a display list, the Aurora's times were very good. A qualitative look at the display-list drives showed good performance.

Performance under Windows was disappointing. The Aurora board finished last on the PageMaker Scroll test and tied for last among the 1024- by 768-pixel boards on the PageMaker Zoom test.

While the Aurora 1024's lack of DRAM and exclusive 8514/A support mean limited flexibility, at \$995 it's also the least expensive unit we looked at. Display quality was comparable to that of an IBM 8514/A. A \$200 plug-in VGA module adds VGA capability to the supported text emulations, and the board supports VGA pass-through. The Aurora board won't give you ultra-high-end display power, but it does offer medium-high resolution, IBM compatibility (and the attendant software support), and an attractive price.

### NEC MultiSync Graphics Engine

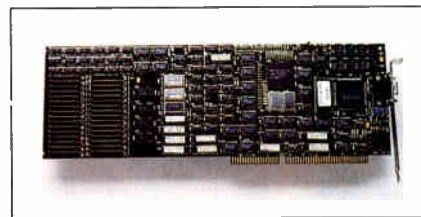

NEC's relatively new MultiSync Graphics Engine is, at \$1999, likely to be one of the boards that leads medium- to high-resolution graphics into the mainstream. The card has built-in VGA and supports DGIS and CGI software interfaces. NEC has also announced TIGA support, and although drivers are not available at this writing, they should ship before you read this.

One of the likely tasks for a mainstream intelligent graphics card is managing graphical user interfaces like Windows and Presentation Manager (PM). The NEC board has a good start there, with a strong performance on our Windows test—only Compaq's AG 1024 was faster among 1024- by 768-pixel adapters. The driver also worked without a hitch. NEC also claims to have a driver almost ready for release that accelerates

*continued*



# High Resolution and Wide Screen for PCs and Apple Mac

## FLEXSCAN™ MODEL 9400

Increasing sophistication in the use of personal computers for general business applications, CAD and DTP has led to a growing demand for better resolution and larger display devices. Combining wide compatibility and functionality with the latest ergonomic design, the FLEXSCAN 9400, with a maximum resolution of 1280 dots X 1024 lines, will not only meet these requirements but those of the next generation of advanced business PCs.

### Wide compatibility

With a wide Horizontal scan frequency range (30-65kHz), the FLEXSCAN 9400 is compatible with most signal sources, including standard VGA, extended VGA, 8514/A, Ultra Hi-Res Graphics controllers for PCs, as well as the Macintosh II and its Hi-Res Graphics Adapters.

With the FLEXSCAN 9400, future compatibility is assured.

### Latest Technology

By adopting a DBF (Dynamic Beam Forming) Electron Gun CRT, resolution, convergence and brightness in the screen corners have been improved over a standard CRT. By combining this with Dynamic Focusing Circuitry,



the FLEXSCAN 9400 will give a sharp and bright display image over the entire screen.

The 9400 also has 2 input terminals (BNC X5 and D-sub 9 pin) which can be easily selected from a front mounted switch. This convenient feature enables the professional user to have a one-monitor solution even if

he runs both Ultra Hi-Res and general business applications.

### Ergonomics and Utility

The CRT of the 9400 has a special coating which not only reduces reflection but also the static electricity generated on the surface of the screen.

## Specifications

<b>CRT Trio Pitch</b>	0.31mm(Dot)
<b>CRT Size</b>	20" (19V) 90° deflection
<b>CRT Face Treatment</b>	Dark face, Non-glare screen
<b>Input Signals</b>	Sync: Separate, TTL, positive/negative. Composite, TTL, positive/negative.
	Video: Separate, RGB, Analog 0.6~1.0Vp-p/75ohm positive Separate, RGB, Analog, Sync. on Green
<b>Scan Frequency</b>	H: 30kHz ~ 65kHz (Automatic adjustment) V: 55Hz ~ 90Hz (Automatic adjustment)
<b>Standard Display Size</b>	360mm X 270mm
<b>Recommended Resolution</b>	1280dots X 1024lines
<b>Video Band Width</b>	120MHz
<b>Linearity</b>	± 5% max. (for Horizontal scan frequency ranges 30 ~ 37/48 ~ 50/63 ~ 65kHz only)
<b>Dimensions</b>	496mm(W) X 561mm(D) X 471mm(H) (at tilt 0°)
<b>Net Weight</b>	37kg

# NANAO®

## NANAO USA CORPORATION

23510 TELO AVE., SUITE 5 TORRANCE, CA 90505  
PHONE (213) 325-5202 FAX (213) 530-1679

Specifications are subject to change without notice.

APPLE and Macintosh II are registered trademarks of Apple Computers, Inc.  
PageMaker is a registered trademark of Aldus Corporation  
FLEXSCAN and NANAO are registered trademarks of NANAO USA CORPORATION

Circle 246 on Reader Service Card (DEALERS: 247)

World Radio History

PM performance.

Under AutoCAD, benchmark results were mixed. As a caveat to all these results, we were using the only NEC driver available, which only supported release 9 functions. A release 10 driver is on the list of planned enhancements. NEC's display-list driver adds additional commands to AutoCAD and uses expanded memory exclusively. On the small file, where the display list fit within our 512K-byte limit, performance was outstanding. Redraw, pan, and zoom operations all executed in around 1 second.

Where the display-list commands could not be used, however (on the large file test), pan and zoom performance was abysmal. This is because the driver forces AutoCAD to regenerate the drawing when zooming on a three-dimensional display.

Another glitch that may or may not be related to differences between release 9 and release 10 came in mixing AutoCAD and NEC extended commands. If you mix NEC pan and zoom commands with standard AutoCAD pan and zoom commands, AutoCAD will lose track of the proper image position.

Overall, the NEC board seems to offer great potential at a good price. Although the driver will limit you if you're using AutoCAD release 10, the underlying hardware performs solidly. If NEC puts all the planned software support in place, the MultiSync Graphics Engine should be an outstanding product.

#### Number Nine Pepper Pro1024/MC

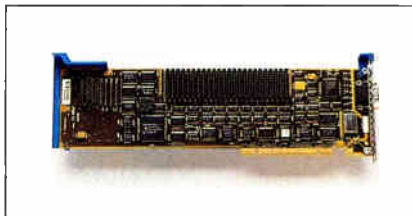

This is one of two MCA boards that we looked at. We don't have any way of comparing it to most of the other boards in this review, nor can we compare it to its AT-bus cousin, the Pepper Pro1280. The only fair comparison is to the other MCA board we reviewed, the Vermont Microsystems Cobra/2 HS. In our AutoCAD

tests, the Pro1024/MC blew the doors off the Cobra/2 HS. The drivers are very similar, if not identical, to those provided with the Pepper Pro1280. We definitely recommend using the optional (\$250) Power9 display-list driver.

Installing the Pro1024/MC is simply a matter of plugging the board into the MCA slot with the VGA pass-through. Once that's done, you boot the computer with the reference disk and set the slot configuration, and you're set. Batch files handle installing the required driver software.

PageMaker ran well, and the display was clear and comfortable to look at. Windows installed easily and ran with no surprises.

Our low-level TIGA tests also ran without a hitch. It's interesting to note that even though the Model 80 is slightly slower than the Compaq 386/20, the Pepper Pro1024/MC completed the TIGA benchmarks faster than any other board in the test.

The list price of \$2495 includes 512K bytes of memory and standard drivers for AutoCAD and Windows. Those who use

*continued*

## SUBSCRIPTION PROBLEMS?



*We want  
to  
help!*

*If you have a problem with your BYTE subscription, write us with the*

*details. We'll do our best to set it right. But we must have the name, address, and zip of the subscription (new and old address, if it's a change of address). If the problem involves a payment, be sure to include copies of the credit card statement, or front and back of cancelled checks. Include a "business hours" phone number if possible.*

**BYTE MAGAZINE**  
ATTN: SUBSCRIBER SERVICE  
P.O. Box 555  
HIGHTSTOWN, NJ 08520



# Teach your HP LaserJet Series II<sup>®</sup> the powerful PostScript<sup>®</sup> language. In one easy lesson.



## PACIFICPAGE<sup>™</sup> PostScript<sup>®</sup> Language Fluency Quiz

- 100%
- What applications can be enhanced with PACIFICPAGE's PostScript language compatibility?
    - A. Desktop Publishing
    - B. Word Processing
    - C. Presentation Graphics
    - D. Click Art Graphics
    - E. All of the Above, and More!**
  - Which font control capabilities do you get with PACIFICPAGE?
    - A. SCALING
    - B. Reverse Type
    - C. BOLD and ITALIC
    - D. All of the Above, and More!**
  - How many Apple<sup>®</sup> LaserWriter<sup>™</sup> II NT equivalent font families come with PACIFICPAGE?
 

35
  - Check the features that come standard with PACIFICPAGE.
 

<input type="checkbox"/> High Resolution Graphics	<input type="checkbox"/> Smooth Circles
<input type="checkbox"/> Screens and Patterns	<input type="checkbox"/> Rotated Type
<input type="checkbox"/> Smooth Arcs	<input checked="" type="checkbox"/> All of the Above, and More!
  - PACIFICPAGE is compatible with...
    - A. IBM<sup>®</sup>
    - B. IBM<sup>®</sup> Compatible
    - C. All of the Above**
  - Fill in the blank...
 

PacificPage

is the easiest to use PostScript language compatible product on the market.

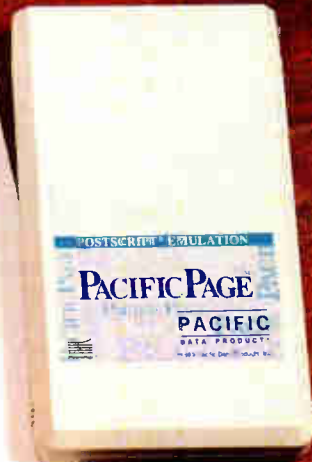

## PACIFICPAGE<sup>™</sup> the PostScript<sup>®</sup> Language Compatible Plug-in Cartridge

It's never been this easy. Now, you can turn your HP LaserJet Series II into a PostScript language compatible printer simply by plugging in Pacific Data Products' PacificPage cartridge. That's all. No other add-ins, software or cables are required.

Immediately start printing PostScript language output from Ventura Publisher<sup>®</sup>, Aldus PageMaker<sup>®</sup>, WordPerfect 5.0<sup>®</sup>, Microsoft Word<sup>®</sup> as well as many other graphics and business application software packages. And PacificPage is compatible

with IBM<sup>®</sup> and IBM-compatibles.

PacificPage is the result of the proven cartridge-based technology—*Plotter in a Cartridge<sup>™</sup>, 25 Cartridges in One!<sup>™</sup>*—from Pacific Data Products and the innovative PostScript emulation skills of Phoenix Technologies, Ltd.

Authorized Dealer:



USA 800-233-8950 • Canada 800-233-8949  
All Other Areas (717) 327-9575 • FAX (717) 327-1217

**PACIFIC**  
DATA PRODUCTS

6404 Nancy Ridge Dr., San Diego, CA 92121 • (619) 552-0880 FAX (619) 552-0889 • PacificPage, 25 Cartridges in One!, and Plotter in a Cartridge are trademarks of Pacific Data Products, Inc. PostScript is a registered trademark of Adobe Systems Inc. PhoenixPage is a registered trademark of Phoenix Technologies, Ltd. Copyright: 1987, 1988 Phoenix Technologies Ltd. All other company and product names are trademarks of the company or manufacturer respectively. Copyright: 1989 Pacific Data Products, Inc.



Circle 267 on Reader Service Card (DEALERS: 268)

AutoCAD will want to add the optional Power9 software, bringing the total to about \$2750. Still, it's cheaper than the Vermont Microsystems Cobra/2 HS and runs markedly faster.

#### PC Tech Color 34010 Board

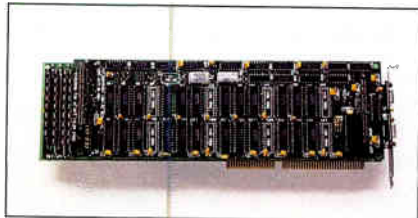

PC Tech is a relatively low-volume manufacturer that caters to the OEM market. The company offers end-user products as well, including the TIGA-compatible Color 34010 Board. The board has a list price of \$1600; an additional 256K bytes of video RAM is available for \$250, and 4 megabytes of add-on DRAM will set you back \$1200. If you need CGA emulation, PC Tech will add the appropriate ROM at no additional

charge, but the company makes no guarantees about complete software compatibility.

The board is bundled with both TIGA and DGIS software interface drivers. We ran AutoCAD and PageMaker tests through the TIGA interface. Because the Color 34010 Board used the same TIGA ADI driver as the Artist TI12 did, pan and zoom functions were handicapped. Still, the board is clearly not as fast as most of its competition. The same trend showed on our low-level TIGA benchmarks—in both cases, we attribute the slow runs to the relatively slow 40-MHz TMS34010.

If you're looking for an off-the-shelf speed demon, you're probably looking at the wrong board. In addition to its slow performance, the Color 34010 Board is poorly documented by end-user standards.

On the other hand, the board seems ideally suited for the user who doesn't require a lot of hand-holding. The no-frills price is very attractive, and the fact that it runs glitch-free is appealing. PC Tech custom-configures boards on an order-by-order basis.

#### Vermont Microsystems Cobra Plus HS

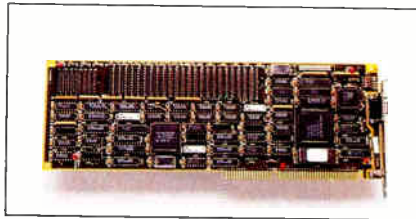

Vermont Microsystems, Inc. is no newcomer to the world of high-resolution graphics. In fact, the company wrote the book on PGA compatibility. VMI designed the PGL language that drives the PGA and designed IBM's original PGA. Our tests included two major applications, but dozens more support PGA and compatible cards. Add to that number the countless other vertical-market and custom applications developed for the PGA, and it's enough to make your head swim. The Cobra Plus isn't the only PGA-compatible card we tested, but, because it comes from VMI, we would be willing to believe that it's the most compatible.

*continued*

# Outline: The infinite font-cartridge.

Imagine: You have a font-cartridge for your laserprinter. You need more fonts. You can tell this cartridge to do it and use them immediately in your textprocessor.

**Large fonts, small fonts, decorative fonts, shadow fonts...**

You want to change something? Just tell your font-cartridge. The font change is made in the font selection menu automatically.

You want a new cartridge? Save the old and select the fonts for a new one.

**As many times as you want. An infinite number of soft-cartridges. An infinite number of fonts.**

## THAT'S OUTLINE.

**s.a.x. software**

Roonstr. 32 • D7500 Karlsruhe • Tel. 01049/721/814078

Outline supports all HP and compatible laserprinters.  
Outline supports MS Word\*, WordPerfect\*, Windows\* (PageMaker\*, Excel\*)  
\* registered trademark

Please contact in USA  
Digital Type Systems Ltd  
38 Profile Circle • Nashua NH 03063  
Tel. (603) 880-7541



Times 00-09/911/270087



# BEST PICTURE OF THE YEAR\*

\*Readers Poll, Data Based Advisor, February 1989

BUSINESS GRAPHICS FOR 'C' USERS

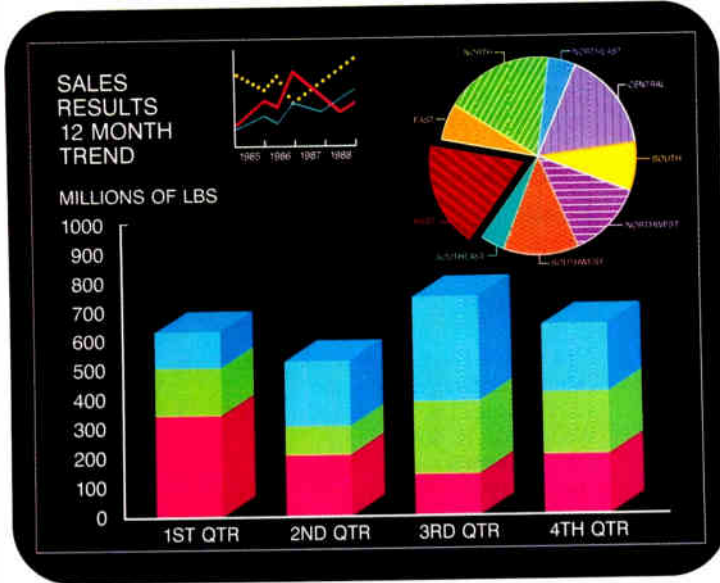

## CATEGORY: BEST DATABASE MANAGEMENT GRAPHICS PACKAGE.

**GE** the most powerful database graphics package on the market, has just been voted the **best graphics tool for a database manager**, according to the readers of Data Based Advisor. You think that's impressive, consider this: the vote was based on dGE 2.0.

dGE 3.0 is here.

### dGE 3.0 is better than ever.

The Graphics Design Center, included in the new 3.0 version, supports the creation of graphic charts and pictures in a free-form menu driven environment.

So instead of requiring you to program in dBASE source code, the Graphics Design Center writes the code for you: you've designed the image using pull-down menus and WYSIWYG editing screens. There's more good news. Version 3 also adds a print editor, expanded printer support, 3-D bar charts and more.

### Impress your boss, your clients, and yourself. Easily.

dGE does what you want. And it does it with the dialect of your choice. Consider the possibilities:

#### GRAPHS:

- Bar
- 3-D Bar
- High-low-close
- Pie
- Polar
- Polyline figure
- Polyvector
- Time series
- Cartesian



#### DIALECTS:

- dBASE III+
- dBASE IV
- Clipper
- FoxBASE+
- R:BASE Compiler
- Quicksilver
- dBFast
- Eagle
- Microsoft C
- Quick C
- Turbo C



dGE comes complete with interface to all dialects listed.

What's more, dGE 3.0 works with: CGA, EGA, VGA and Hercules monitors, IBM PC, XT, AT, PS/2 and compatibles. Supports the most popular printers and plotters including HP-G/L language plotters. PCX/PCC support now also included.



For more information and your **FREE DEMO DISK** just call 1-800-231-1293 or 1-206-941-2300 or write Pinnacle Publishing, P.O. Box 8099, Federal Way, WA 98003.

When you're ready for the best, you're ready for dGE.

Price: \$195.00; contact Pinnacle Publishing or your local software dealer.



#### GUARANTEE

dGE is backed by a thirty-day money back guarantee.

**Pinnacle Publishing Inc.** | P.O. Box 8099  
Federal Way, WA 98003  
206/941-2300  
800/231-1293  
FAX 206/946-1491  
© 1989 Pinnacle Publishing, Inc.

*The Database Enhancement Expert™*

dGE is a trademark of Bits Per Second. Other brand and product names are trademarks of their respective holders.

**Come Visit Us At Comdex Booth #C-740**

Circle 285 on Reader Service Card (DEALERS: 286)

COMPANY INFORMATION

**Compaq Computer Corp.**  
(Advanced Graphics 1024)  
20555 SH 249  
Houston, TX 77070  
(713) 370-0760  
**Inquiry 1071.**

**Control Systems Corp.**  
(Artist TI12)  
2675 Patton Rd.  
St. Paul, MN 55113  
(612) 631-7800  
**Inquiry 1072.**

**Enertronics Research, Inc.**  
(Aurora 1024)  
5 Station Plaza  
1910 Pine St.  
St. Louis, MO 63103  
(314) 421-2771  
**Inquiry 1073.**

**IMagraph Corp.**  
(TI-1210-8)  
11 Elizabeth Dr.  
Chelmsford, MA 01824  
(508) 256-4624  
**Inquiry 1074.**

**Matrox Electronic Systems Ltd.**  
(PG-1281 C/8/1.5M)  
1055 St. Regis  
Dorval, Quebec H9P 2T4, Canada  
(514) 685-2630  
**Inquiry 1075.**

**NEC Home Electronics (USA), Inc.**  
(MultiSync Graphics Engine)  
1255 Michael Dr.  
Wood Dale, IL 60191  
(312) 860-9500  
**Inquiry 1076.**

**Number Nine Computer Corp.**  
(Pepper Pro1024/MC, Pepper  
Pro1280)  
725 Concord Ave.  
Cambridge, MA 02138  
(617) 492-0999  
**Inquiry 1077.**

**PC Tech, Inc.**  
(Color 34010 Board)  
907 North Sixth St.  
Lake City, MN 55041  
(612) 345-4555  
**Inquiry 1078.**

**Vermont Microsystems, Inc.**  
(Cobra Plus HS, Cobra/2 HS)  
11 Tigan St.  
Winooski, VT 05404  
(802) 655-2860  
**Inquiry 1079.**

Unfortunately, our tests showed disappointing performance. AutoCAD release 10 runs flawlessly on the Cobra Plus, although it turns in the slowest times of any board with full release-10 drivers. We had hoped for better performance from a 60-MHz 34010. The board is easy to install, and VMI's installation program takes care of the device and application drivers.

Windows is something else altogether. The Cobra Plus and Cobra/2 are the only two boards that displayed any serious problems running our PageMaker tests. Windows does its scrolling by copying large blocks of display memory from place to place. Several times, we noticed that the Cobra Plus had difficulty scrolling a window that was overlapped by another window. Parts of the lower (moving) windows would sporadically appear within the white spaces of the stationary upper window.

In the scheme of things, that's far from disastrous. But several PageMaker utility windows rely on tiny icons of arrows and triangles to control different aspects of operation. VMI's Windows/286 driver was unable to render many of these little objects, replacing them with much larger black rectangles. Setting tabs was the worst case. It's hard enough to grab a 1-pixel-wide arrow with the mouse when you can see it. [Editor's note: *Since this was written, VMI has announced a new Windows driver that it claims fixes the pixel-wide arrow problem. The driver should be available by the time you read this.*]

The Cobra Plus could be faster. At

\$3395, it's not inexpensive. On the other hand, the display quality was excellent, and we feel confident that if anyone can build a 100 percent PGA-compatible board, VMI can.

*Vermont Microsystems Cobra/2 HS*

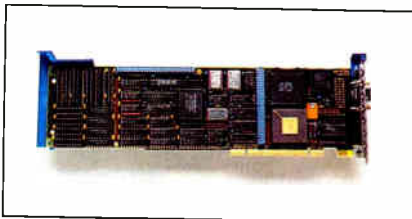

This is the MCA version of the Cobra Plus board. It is based on the same 60-MHz 34010 as the Cobra Plus, and, with nearly the same drivers as on the Cobra Plus, it performs identically.

The Cobra/2 costs \$3395. For less money, the Number Nine Pepper Pro1024/MC runs much better. If you need absolute PGA compatibility, this card is a safe bet, but otherwise, the Number Nine board is a better deal.

**A Perspective**

In terms of performance, all these boards exceed VGA. Not so surprisingly, prices are also in a different league. But before you buy, get the latest information from each vendor—these boards are still fairly young, and capabilities and software support change rapidly.

The Number Nine Pepper Pro1280 seems to be the best overall choice for an

off-the-shelf, high-resolution board. While it's an older design and lacks some on-board DRAM, its capable display-list driver makes good use of other system resources, so AutoCAD performance is excellent. The Pepper Pro1280 is also comparatively inexpensive.

If you need a top-of-the-line platform for development, you may want to consider Matrox's PG-1281. While significantly more expensive than the Pepper Pro1280, this board has powerful hardware enhancements and comes with a vast 1.5 megabytes of DRAM on-board.

For medium to high (1024- by 768-pixel) resolution, Compaq's Advanced Graphics 1024 is a fine choice. Its combination of speed, price, and ease of use is hard to beat. Unfortunately, Compaq cannot guarantee compatibility if you don't have a Compaq 80286 or 80386.

Of the two MCA cards we looked at, The Number Nine Pepper Pro1024/MC gets the nod. It performed well under standard applications and showed great promise for use under TIGA.

Two of the stumbling blocks in achieving such high-resolution displays have been the cost of memory and the processing power that's needed to manipulate it. 34010 boards are one way to get superior graphics without crippling your CPU. Large display memories move you more than a bit beyond VGA. ■

*Steve Apiki and Howard Eglowstein are BYTE Lab testing editors. Rick Grehan is director of the BYTE Lab. You can reach them on BIX as "apiki," "heglowstein," and "rick\_g," respectively.*



# “Xerox this memo.” “FedEx this proposal.” “LapLink these files.”

When something becomes a standard, using it becomes second nature. That's true about LapLink. It's so effective that it has become the most popular laptop-to-desktop and desktop-to-desktop file transfer program ever.

And now Release III improves on the original with added power—while preserving the simple design that has made LapLink the choice of more major corporations.

LapLink III offers both serial and parallel file transfer, and you can take advantage of parallel transfer speeds of 500,000 baud or higher. It comes with a “six headed” universal cable that provides you with everything you need to use both serial and parallel modes.

And LapLink III will even install itself automatically on a remote computer.

That's in addition to ease-of-use and productivity features like our popular split screen design, flexible transfer options, and disk and printer sharing.

For the same fast, error-free file transfers between PCs and Macintoshes, get LapLink Mac. And for more information about any Traveling Software product, call us at (800)662-2652.

LapLink III. The standard in file transfer software.

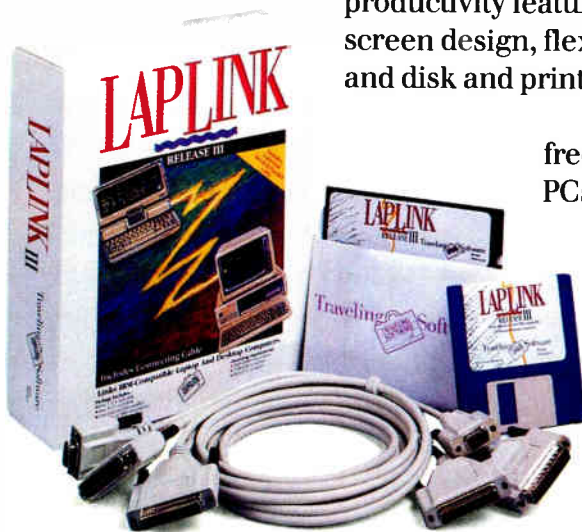

Suggested Retail Price \$139.95

## LAPLINK III



Traveling Software, Inc.  
18702 North Creek Parkway, Bothell, WA 98011  
(206) 483-8088

Traveling Software Europe  
Lords Court, St Leonards Road, Windsor  
Berks, SL4 3DB, England  
(44) 0753 831855

LapLink is a reg. trademark of Traveling Software, Inc., Xerox is a reg. trademark of Xerox Corporation, FedEx is a reg. trademark of Federal Express Corporation. © 1989 Traveling Software, Inc. All Rights Reserved

Circle 360 on Reader Service Card

World Radio History

Now! Larger Data Sets.  
Upgrades Available

MODEL FITTING RESULTS FOR: YIELD

INDEPENDENT VARIABLE	COEFFICIENT	STD. ERROR	T-VALUE	SIG. LEVEL
CONSTANT				0.0018
time	-3977.847583	747.932209	-5.3185	0.0016
time^2	17.862499	3.288094	5.4325	0.0386
temp	-0.021469	0.008136	-2.6386	
temp^2	44.997502	9.614533	4.6802	
time*temp	-0.124651	0.032546	-3.8300	
	-0.0975	0.020297	-4.8037	

FURTHER ANOVA FOR VARIABLES IN THE ORDER

SOURCE	SUM OF SQUARES	DF	MEAN SQ.
time	15.3890909	1	15.389091
time^2	15.6011921	1	15.601192
temp	1.0765657	1	1.076566
temp^2	60.4298606	1	60.429861
time*temp	95.0625000	1	95.062500
Model	187.559209	5	

CHEMICAL YIELD AS A FUNCTION OF TIME AND TEMPERATURE  
(POINTS REPRESENT ACTUAL OBSERVATIONS)

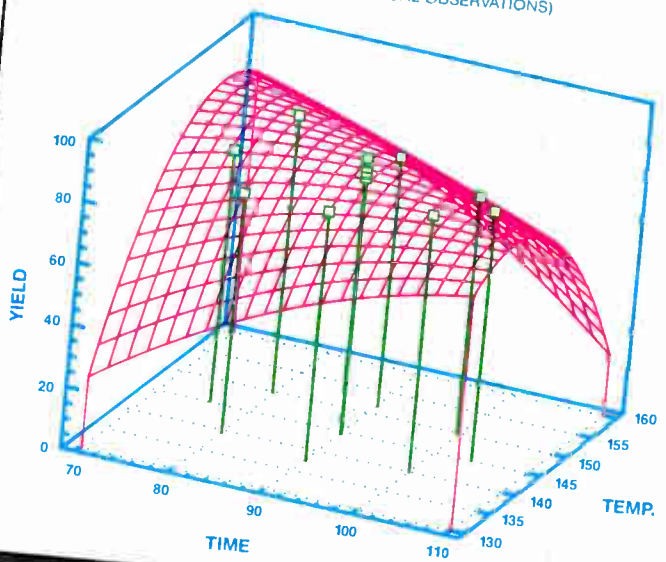

# BRAINS & BEAUTY

STATGRAPHICS®. Sophisticated Data Analysis and Gorgeous Graphics — In An Easy-to-Use PC Statistics Package.

Get the best of both worlds with STATGRAPHICS — sophisticated data analysis *and* a dazzling array of graphics in an easy-to-use PC statistics package.

**Powerful Statistics.** Realize the full potential of your analytical skills. STATGRAPHICS gives you over 250 statistical procedures including ANOVA, regression analysis, quality control procedures, experimental design, multivariate techniques, nonparametric methods, exploratory data analysis, forecasting, time series analysis, and more.

**Incredible Graphics.** Turn the "Ho-Hum" into the "Ah-Ha!" STATGRAPHICS includes over 50 types of graphs that allow you to analyze your data visually and communicate your results brilliantly!

**Easy To Learn and Use.** Enter your data using our full-screen editor, or import data directly from your ASCII, dBASE®, Lotus®, or DIF files. STATGRAPHICS is completely menu-driven and includes online HELP, a self-paced tutorial,

handy reference cards, and a user's guide complete with examples and sample data sets. No wonder *InfoWorld* said STATGRAPHICS "makes interactive data analysis and knock-your-socks-off graphics easy."

Why compromise? Get the power of sophisticated data analysis *and* gorgeous graphics with STATGRAPHICS — all for only \$895.\* For more details or to order today, call:

**(800) 592-0050 ext. 400**  
In Maryland, (301) 984-5123;  
Outside the U.S., (301) 984-5412 for  
the name of the dealer nearest you.

Ask about our money-back guarantee!



**STSC** STSC, Inc.  
2115 East Jefferson Street  
Rockville, MD 20852

Circle 341 on Reader Service Card

\*Suggested retail price in U.S. and Canada. International prices vary. STATGRAPHICS, dBASE, and Lotus are registered trademarks of Statistical Graphics Corp., Ashton-Tate, and Lotus Development Corp., respectively.





# DEC's RISC Powerhouse

The DECstation brings RISC power to Unix workstations at PC prices

Ben Smith and Rob Mitchell

**T**he DECstation, Digital Equipment Corp.'s lowest-priced high-performance Unix workstation yet, represents a radical approach to development and marketing for the world's second largest computer manufacturer. It also represents a new era in personal computing and a new competitive challenge for low-end workstation vendors.

The DECstation is the first machine from DEC designed to run *only* Unix. It's also the first DEC workstation to use a CPU from an outside vendor (the MIPS R2000 RISC CPU). These facts alone make the DECstation noteworthy, but it is a groundbreaking machine in other ways as well.

With a starting price of \$7950, the DECstation is one of the first RISC-based workstations that are in the price range of personal computers; its introduction has hit the workstation community like a bombshell. Dubbed the "Sun Killer," the DECstation has an excellent price/performance ratio, and its functionality is equivalent to Sun's SPARCStation 1 (see "Two Powerful Systems from Sun," May BYTE).

## Heavy Metal

DEC sells two versions of the DECstation: the 2100 and the 3100. With the exception of CPU and memory speed, these machines are identical. The entry-level 2100 is a diskless workstation. It in-



*The DECstation's RISC-based performance and low starting price of \$7950 are turning heads in the workstation world. Its keyboard, however, is disappointing. It has no Escape key, and many keys are in nonstandard positions or have no function.*

cludes an R2010 FPU, 8 megabytes of memory, a 15-inch monochrome monitor, a SCSI connector, switch-selectable "thick-wire" and "thin-wire" Ethernet interfaces, two serial ports, a mouse, a keyboard, and Ultrix Workstation Software for \$7950 (\$11,900 for the 3100). The price tag for our test machine, a fully configured DECstation 3100, was \$39,300—more than three times the 3100's base price.

At the heart of the DECstation lies a

MIPS R2000 RISC CPU, an R2010 math coprocessor, and an R2020 write buffer (see photo 1). The CPU runs at 12.5 MHz on the DECstation 2100 and at 16.67 MHz on the 3100; DEC rates the machines at 10 and 14 million instructions per second, respectively. The FPU puts in a double-precision LINPACK performance of 1.2 million floating-point operations per second on the 2100 and 1.6 MFLOPS on the 3100.

*continued*

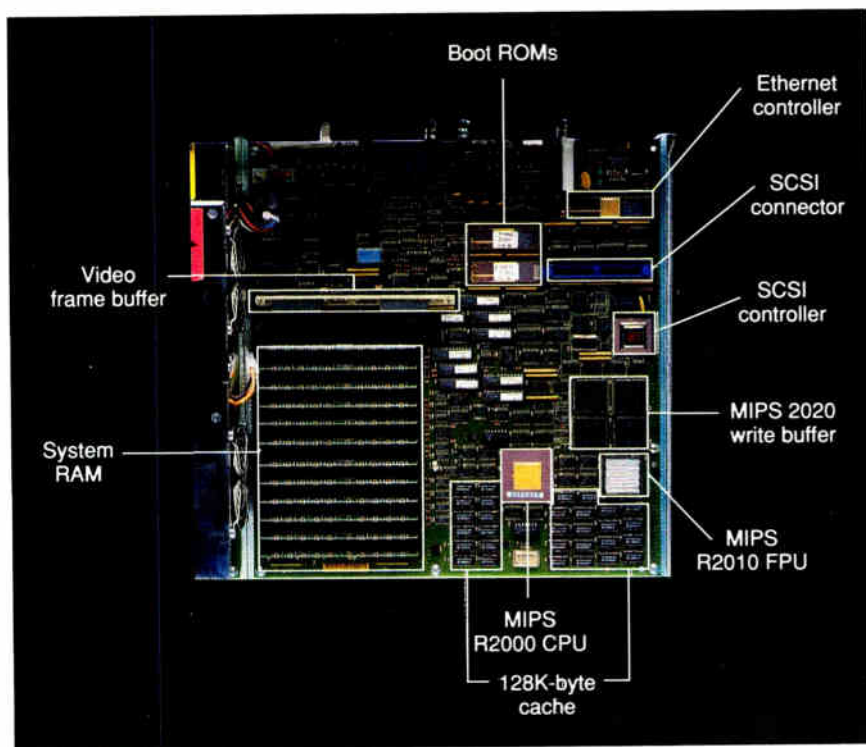

**Photo 1:** With the exception of its CPU clock speed and its faster cache, the DECstation 3100 is exactly the same as the 2100. Note the double-mounted single in-line memory modules and the heat sink on the FPU.

Unlike Sun's SPARCStation 1, the DECstation's 32-bit memory bus doesn't support direct memory access, and it doesn't have any expansion slots.

System memory consists of 120-nano-second parity DRAMs mounted on double-sided, single in-line memory modules; you can upgrade in 4-megabyte increments up to the 24-megabyte maximum. Our DECstation 3100 review machine came fully populated. Also standard are a 64K-byte data cache and a 64K-byte instruction cache. DEC uses 35-ns static RAM (SRAM) chips in the 2100 and 23-ns chips in the 3100.

Hidden inside the box is a small shelf that can hold two 104-megabyte SCSI hard disk drives (\$2400 each) that have an average access time of 33 milliseconds. DEC recommends using these for page swapping in a Network File System (NFS) environment, but you can also use them to store data. A SCSI connector lets you attach additional devices. Our unit included one internal hard disk drive, a 330-megabyte 5¼-inch external hard disk drive with an average access time of 24 ms (\$6500), and an external 95-megabyte streaming-tape subsystem (\$3500). A 600-megabyte CD-ROM drive is also available for \$1600. The DECstation supports up to four storage devices.

The external hard disk drive can run asynchronously or synchronously. In synchronous mode, it has an aggregate transfer rate of 4 megabytes per second. (The DECstation can only retrieve data at up to 1.25 megabytes per second, so this performance is noticeable only if you're running multiple disk drives.)

Our test machine included a 1024- by 864-pixel, 60-Hz, noninterlaced 15-inch analog color monitor (a 15-inch monochrome monitor is standard). DEC also offers 19-inch color and monochrome monitors. The 8-bit color system uses a 1-megabyte frame buffer to display up to 256 colors simultaneously from a palette of 16.7 million. In monochrome mode, the DECstation uses a 256K-byte single-plane frame buffer. The graphics subsystem doesn't include a video controller, relying instead on the CPU.

In addition to the SCSI connector, a complement of I/O ports graces the back of the system unit, including both standard Ethernet interfaces, a 15-pin D-sub video port, mouse and keyboard interfaces, and two serial ports (designated as printer and modem ports). Regrettably, the DECstation lacks a parallel port, and the serial ports use a proprietary six-wire interface that looks like a modified RS-442 jack. You'll need a special DB-25

adapter and cable (\$37) to use the ports with non-DEC serial devices.

Aesthetically, the DECstation is sleek and attractive; the system unit has an 18- by 15½-inch footprint and rises just 4 inches off the desktop. The external hard disk drive and tape systems are housed in stackable boxes that measure 12½ by 11½ by 5½ inches. Each external device includes its own power supply. A handle at the rear of each unit makes the drives easy to carry; it snaps down over the power and SCSI cables when not in use, locking them into place.

Only the DECstation logo and green power light adorn the front of the unit; the power and reset switches are on the rear panel. The nonstandard 105-key keyboard is a bit of a kludge; it's essentially a VAXstation keyboard that DEC has adapted for use in a Unix environment—with mixed results. For example, it has no Escape key; to generate an Escape, you must press the Control and left bracket keys. Many other commonly used keys are located in unusual positions, and many keys are specific to DEC's VMS operating system and have no function at all under Ultrix.

## Ultrix

The DECstation's Ultrix Workstation Software includes Ultrix-32, Ultrix/DECwindows, a C compiler, X Window System 11, X User Interface (XUI), and implementations of TCP/IP and NFS.

Ultrix-32, the DECstation's operating system, is a robust implementation of BSD Unix that also includes library routines and commands from System V.3. Ultrix has its own versions of `/bin/sh` and `/bin/csh`. DEC also provides the standard Unix shells, but having both means that you must pay careful attention to which shell you're running. The obvious advantage to having two versions is the enhancements that DEC provides. The disadvantage is that it's difficult to move between Ultrix machines and other Unix machines. Enhancements are barbed hooks for new users who don't realize what they're getting into. The adoption of the AT&T Korn shell would offer far more to everyone.

Ultrix for DEC's RISC machines contains special commands for optimizing program execution. Two examples are `pixie`, a program for analyzing program block use, and `cord2`, a program that takes information that `pixie` generates and rearranges the basic blocks to facilitate better cache mapping. Also included are many utilities for E-mail, network mail, and *message handling* (the Ultrix

*continued*



# DR DOS. THE CHOICE IS OBVIOUS, MORE OR LESS.

## DR DOS

- Full DOS application support
- Large disk partitions - greater than 32 megabytes
- LIM 4.0 expanded memory support
- Graphical icon-based user interface (optional)
- Fully executable from ROM
- Quick and easy installation
- Password protection for files and directories
- Full screen text editor
- Multiple command line recall
- Built-in help for utilities
- Backed by the Digital Research commitment to quality service and support

## THE OTHER DOS

- Full DOS application support
- Large disk partitions - greater than 32 megabytes (DOS 4 only)
- LIM 4.0 expanded memory support (DOS 4 only)
- Graphical character-based user interface (DOS 4 only)

You don't have to look too closely to see how DR DOS stacks up against the competition. With an added set of features and capabilities, DR DOS gives you proven capability *and* flexibility in a superior alternative for any system. Whether you use a hand-held computer, a laptop, a diskless workstation,



a portable or a powerful full-sized system with specialized applications, DR DOS gives you everything you need to make the right choice. Obviously.

**Contact your local reseller for systems sold with DR DOS. OEMs call Digital Research at 800-443-4200.**

 DIGITAL RESEARCH®

**DR DOS™**  
THE BEST CHOICE.

# Seven ~~bit~~ Five easy ways to boost your BASIC

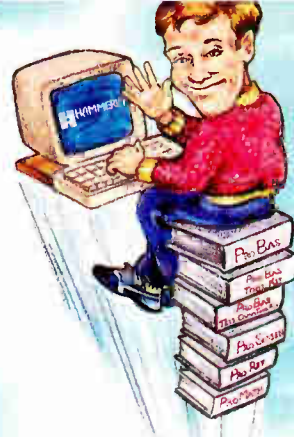

**UPDATED**

## PROBAS™ Basic Programming Library

So who cares that BYTE magazine calls PROBAS a "Supercharger for QuickBASIC" or that PC Tech Journal says that PROBAS is a "high-quality, high-quantity package"? Who buys a product just because Jerry Pournelle said "Anyone doing serious QuickBASIC programming would do well to get [PROBAS]"? And who cares that Wayne Hammerly calls PROBAS "The greatest thing since sliced bread"?

Who?--Only those who want to write better, faster, slicker programs and save hundreds of programming hours in the process. With all of that hoopla out of the way, we are formally announcing the momentous release of PROBAS Version 3.1, now with over 400 assembly routines to make BASIC programs faster and more powerful than you ever dreamed with features like:

- A 1,000-page two-volume manual
- Full mouse support
- Extended and EMS memory support
- Full-featured windowing
- Moveable, resizable windows
- Screen snapshots (text & graphics)
- Virtual screens in memory
- Lightning-fast file I/O
- Critical error handling
- String, array, and pointer sorts
- Search directories and archives

Create dazzling screens in text, CGA, EGA, VGA, and Hercules graphics modes with windows that can overlay one another and be moved and resized on the fly. Store megabytes of string, data, or screen snapshots in extended or EMS memory. Draw complex text or graphic screens to memory and snap them on in an eyeblink. The PROBAS file I/O routines allow you to read or write huge chunks of data at a clip, far faster than with BASIC.

PROBAS also has over 300 other essential services, including handy string, date, time, directory, and array manipulation routines; string, screen, and data compression routines; valuable equipment and input routines; and faster replacements for many BASIC commands.

Whether you are a professional or a novice, PROBAS will boost your BASIC in ways you never thought possible. PROBAS allows the professional to write faster, tighter code in much less time and allows novices to quickly and easily write professional-quality programs that would be impossible with BASIC alone. The bottom line is PROBAS adds power and saves time. After all, how much is a few hundred hours of your time really worth?

For all DOS versions of QuickBASIC and BASCOM. **Just \$149.00!**

**UPDATED**

## PROREF™ On-Line Help For PROBAS

PROREF provides on-line help for the routines in the PROBAS library. This hypertext manual links directly to the QB Advisor in QuickBASIC 4.5 so that the PROBAS reference becomes an integral part of your QuickBASIC on-line manual. Includes information and examples on PROBAS routines and helpful hints on programming in BASIC. **Just \$50.00!**

**UPDATED**

## PROSCREEN™ Screen Management

PROSCREEN is a full-featured screen generator/editor that will save you more design and coding time than you ever thought possible. PROSCREEN treats screens like a word processor treats text to provide complete control over characters, colors, and placement. Design input screens with up to 130 fields, 19 pre-defined and 2 user-defined masks. Save screens to screen files or .OBJ files and use the tight BASIC/Assembly code that comes with PROSCREEN to access the screens. There's no kludgy code generator here! Access hundreds of input screens with less than 25k of total code. **Just \$99.00!**

## PROMATH™ Mathematics Library

PROMATH is a collection of over 150 high-level routines that provide mathematical functions and operations for programmers who often work in mathematics, science, or engineering. Complex variables, real and complex matrices, real and complex trigonometric and hyperbolic functions and their inverses, solution of linear equations, integration, differential equations, Fast Fourier transforms, graphics support, and many other useful routines are provided.

For years Fortran has been the language of choice for scientific and engineering applications, but it lacks many of the useful features of QuickBASIC. PROMATH contains most of the Fortran mathematical and numeric functions and allows you to easily translate Fortran code to BASIC or write new programs in BASIC, while retaining Fortran's numerical prowess.

The PROMATH manual is over 200 pages and provides a complete description of each routine, including any algorithm and the mathematical formula the routine uses, shown in standard notation. For QuickBASIC 4 and BASCOM 6 only. **Just \$99.00!**

**UPDATED**

## PROBAS™ TOOLKIT

The TOOLKIT is a collection of high-level BASIC and assembly modules that use the routines in the PROBAS library to save you even more hours of grunt work. Why spend hundreds of hours re-inventing the wheel when you can just plug in TOOLKIT modules like:

- Super-fast B-Tree indexing
- Ring, Bar, Pop-Up, Pull-Down menus
- Scroll-bar tag windows
- Dialog boxes with radio buttons
- Two mini-editors with word wrap
- BCD math routines
- Julian date & calendar routines
- Patch .EXE files
- Protected memory storage area

The TOOLKIT now supports EGA and VGA graphics modes for menus, windows, editors, calendars, and more. Complete with BASIC source code and an all-new comprehensive manual. The TOOLKIT requires the PROBAS library and helps conserve your greatest asset of all—time! **Just \$99.00!**

## PROBAS™ TELECOMM TOOLKIT

The PROBAS TELECOMM TOOLKIT is a collection of high-level communications modules that you plug into your code to provide popular file transfer protocols, terminal emulations, login scripts and baud rates up to 115,200 baud. You get:

- Xmodem/Modem7/Xmodem-1k
- Ymodem (single and batch)
- CRC-16 and Checksum
- VT52, VT100, ANSI, BBS etc.
- Auto Dialer & data base
- Documented BASIC source

Why use clumsy SHELLs to complex terminal programs when you can plug just the communications routines you need into your code? Implement just the features and commands you want. Requires PROBAS. **Just \$75.00!**

Our thirty-day, money-back guarantee assures you the highest quality and our technical support staff is always ready to help.



9309 JASMINE COURT • LAUREL, MD 20707

**(800) 343-7484**

INT'L. ORDERS: (301) 953-2191 FAX: (301) 725-8147  
BBS: (301) 953-7738

Add \$5.00 per item (\$8.00 Canada) for shipping per order. Europe: \$39.00 for 1st item plus \$5.00 for each additional item. Visa, M/C, C.O.D. (US Only) checks and approved POs accepted. Trademarks PROBAS, PROREF, PROSCREEN, PROMATH: Hammerly Computer Services, Inc. QuickBASIC, BASCOM: Microsoft Corp.



## DEC'S RISC POWERHOUSE

label for a collection of single-purpose programs that send, receive, save, and retrieve E-mail messages). As with most Unix utilities, you can freely use these commands in shell scripts, thereby simplifying the task of crontab mail management scripts.

**XUIstation**

The DECstation is not intended to be a Unix process server; it's designed exclusively as an XUI server workstation. In that vein, it is DEC's brightest star, and at the moment it's the most affordable machine of its type.

Built on top of the X Window System, XUI is the distributed client/server windows standard developed at MIT. XUI is the graphical user and programming interface at the core of the Open Software Foundation's Motif (see "A Guide to GUIs," July BYTE). XUI is the precursor of Motif on DECstations.

XUI consists of a window manager; a Session Property Manager, which is a user's work environment with file and task management; a style guide for developers; and a graphical user interface compiler and resource manager to simplify development of the user interface for applications. XUI gives the DECstation its feel.

XUI is consistent with DECwindows, another implementation of the X Window System that runs under VMS. The user interface is consistent and simple to grasp. However, some of the standard utility programs aren't properly integrated. For example, when you select a file in the User Executive window and select the Notepad application, the selected file should appear; instead, the Notepad window comes up empty.

**Performance**

Performance is the DECstation's major selling point. Benchmark data supplied by DEC shows the DECstation 3100 outperforming both Sun's SPARCStation 1 and Hewlett-Packard's HP 9000/835. Our tests show the DECstation 2100 offering up to 85 percent of the performance of the 3100.

We subjected the DECstation 3100 to a preliminary version of the new BYTE Unix benchmarks, currently under development in the BYTE Lab. We compared both the 2100 and 3100 against our baseline development machine, an Everex 386/33 running SCO Xenix 2.3.1. Unlike our MS-DOS and Mac benchmarks, Unix benchmarks reflect not only hardware performance but also the performance of the version of Unix and the particular compiler optimization.

## DECstation 2100/3100

**Company**

Digital Equipment Corp.  
146 Main St.  
Maynard, MA 01754  
(508) 897-5111

**Features**

Processor: 12.5- or 16.67-MHz 32-bit R2000 RISC CPU; MIPS R2010 math coprocessor  
Memory: 24 megabytes of 120-ns parity-checked DRAMs on double-sided SIMMs (DECstation 2100 has 8 megabytes); 64K bytes of 23-ns SRAM write-through data cache; 64K bytes of 23-ns SRAM instruction cache (SRAMs in DECstation 2100 are 35-ns)  
Mass storage: External 330-megabyte SCSI hard disk drive; SCSI tape backup system; 104-megabyte internal SCSI hard disk drive  
I/O interfaces: Two serial ports; thin-wire and thick-wire Ethernet ports; DB-15 video port; mouse port; SCSI port

**Size**

18 x 15½ x 4 inches

**Price**

Base DECstation 2100: \$7950  
Base DECstation 3100: \$11,900  
DECstation 3100 as reviewed: \$39,300

**Inquiry 851.**

We found that the Everex actually outperformed the DECstation on low-level, integer-type operations (register, short, int, and long). But the DECstation was nearly five times faster on low-level floating-point operations (float and double). In random and block (sequential) memory operations, the DECstation outperformed the Everex by 10 percent to 20 percent. File operations showed similar performance. Note, however, that RISC processors do not show their true advantage over complex-instruction-set computer (CISC) processors until the compiler optimizes for RISC. The BYTE benchmarks don't reflect performance with normal RISC optimization.

Surprisingly, the margin of performance that the DECstation exhibited on the low-level operations wasn't as significant when we tested more all-inclusive operations. Our shell script test loads the system with various Unix commands and uses intermediate files for reading and writing. In these tests, the DECstation's performance was only fractionally better than the Everex's. And when it came down to our C compiler test, the Everex actually outperformed the DECstation.

*continued*



## Unleash the BASIC Power of Hypertext!

Our latest BASIC-booster includes the first hypertext engine designed to be called from BASIC. With the **PROBAS HYPERHELP TOOLKIT** you can use the hypertext engine to put one or more manuals on-line with full hypertext search facilities. Imagine having one or more manuals on-line with all of the fantastic hypertext abilities in the QuickBASIC 4.5 compiler and then some:

- Choose single- or multi-window display
- Specify window colors and placement
- Move and resize windows with mouse or keys
- Sophisticated mouse and keyboard interface
- Up to 40 bookmarks to move between hyperlinks

In less than a dozen lines of code you can pop-up context-sensitive help at any time. Your users can then jump to related help, examples, or just browse the manual(s) in one or more windows that they can move or resize at will. The text will automatically wrap within the window to stay fully visible!

**Create HyperCard Applications**

Use the **HYPERHELP** engine to create full-blown hypercard applications. Create sophisticated multi-window, multi-thread hypercard stacks. Mix cards and manuals for total data integration. Moving from link-to-link or card-to-card is instantaneous and the speed will amaze you.

Adding hypertext to your applications takes less than about a dozen lines of BASIC code. Converting ASCII text to hypertext is just as easy—just put delimiters around keywords, hyperlinks, and items you want to display in boldface.

**Multiple Help Subsystems**

The hypertext engine is just a part of the **HYPERHELP TOOLKIT**. There is a wide selection of help subsystems with various displays, user interfaces, and memory requirements to suit almost any need. Want a small, window-oriented, keyword help system? It's in there! Need a Terminate & Stay Resident help system? It's in there! How about a lightbar indexing system that then pops-up the selected text? It's in there!

The **HYPERHELP TOOLKIT** gets its blinding speed by using the low-level routine in our **PROBAS** Professional Basic Programming Library. **HYPERHELP** requires the **PROBAS** Library. See our ad on the opposite page for information on **PROBAS**, shipping rates, and our thirty-day money-back guarantee.

**Special Introductory Price**—For a short time this powerful hypertext engine and collection of help subsystems is available for **just \$99.00!**

**HAMMERLY**  
COMPUTER SERVICES, INC.

9309 JASMINE COURT • LAUREL, MD 20707

**(800) 343-7484**

INT'L. ORDERS: (301) 953-2191 FAX: (301) 725-8147  
BBS: (301) 953-7738

Add \$5.00 per item (\$8.00 Canada) for shipping per order. Europe: \$39.00 for 1st item plus \$5.00 for each additional item. Visa, M/C, C.O.D. (US Only) checks and approved POs accepted. Trademarks **PROBAS**, **PROREF**, **PROSCREEN**, **PROMATH**: Hammerly Computer Services, Inc. QuickBASIC, BASCOM: Microsoft Corp.

What this means is that the DECstation is exceptional at crunching numbers. However, when it comes to the more mundane operations of office and software development applications, its performance is good, but not what we would have expected.

### Big- and Little-Endian

DEC stirred up a controversy when it decided to use "little-endian" memory-mapping byte order in the DECstation, as

it does in the VAX. Most other workstations, such as Sun's SPARCStation 1, use "big-endian" order, the reverse byte order. Most minicomputers, mainframes, and microcomputers based on the Motorola microprocessors (such as the Macintosh) use big-endian ordering. IBM PCs, Xenix machines, and other microcomputers that use Intel processors use the little-endian method. MIPS processors can run either way.

Byte order isn't significant for execut-

able binary files (compiled programs), because very few executables run on a different architecture than the one for which they were compiled. But many data files are binary. If you move them to another machine that uses the reverse byte order, the data is scrambled. In a heterogeneous computing environment, byte order is a major factor in ensuring data portability.

It would seem to be a trivial task for the data transfer program to reorder the bytes, but since the algorithm needs the size of the data structure in order to figure where to begin and end the reordering, this isn't a problem that a general-purpose data transfer program can solve. The only solution is to limit the data in a heterogeneous network to a maximum data element of a single byte. In other words, you convert all data to ASCII before moving it out to the network.

This is how file transfers are traditionally done in the Unix environment. But this approach slows down the data operations of applications running on different kinds of machines. Still, the little-endian approach makes sense for DEC, since it's more likely that its users will network the DECstation with other DEC machines than with non-DEC computers.

### The Good and the Bad

The DECstation is an excellent high-performance, single-user workstation, but it's not a good choice as a compute server or file server because it doesn't handle heavy disk I/O or user loads well. DEC markets the DECstation for office or engineering use, but the documentation is oriented toward the engineer, and the machine is best suited for this type of user. You don't need a DECstation for most office applications; inexpensive terminals running off general-purpose machines can perform those tasks perfectly well.

The DECstation is ready to network using either type of Ethernet. But it can't handle more than two serial I/O devices, its lack of a parallel port prevents its use with a wide variety of printers, and its unusual keyboard is a significant limitation.

However, if outstanding performance is what you're after, the DECstation won't disappoint you. It offers more horsepower than 80386-based systems can muster, at a very competitive price. And it provides strong competition for Sun and other workstation vendors. ■

*Ben Smith and Rob Mitchell are BYTE technical editors. You can reach them on BIX as "bensmith" and "rob\_mitchell."*

# (T)EXPERTISE.

For document typesetting and formatting quality, PC  $\text{\TeX}$  is the difference between average and expert. It's the next step beyond standard desktop publishing.

Of PC  $\text{\TeX}$ , *INFOWORLD* said: "... No non- $\text{\TeX}$ -based program has such typographical aesthetics... enormously flexible..."

And *PC MAGAZINE* wrote: "(With PC  $\text{\TeX}$ ) ... you can achieve incredible precision in formatting text, especially mathematical expressions."

For a free PC  $\text{\TeX}$  demo diskette, product catalog and information on a configuration for your system, call **415/388-8853**. Then give your next job the (t)expert touch.

PC  $\text{\TeX}$  is a registered TM of Personal  $\text{\TeX}$ , Inc.  $\text{\TeX}$  is an American Mathematical Society TM. Inquire about PTI distributorships. Site licenses available to qualified organizations. This ad was typeset using PC  $\text{\TeX}$  and Bitstream fonts.

## (T)EXPERT TYPE

Name	Definition
Gamma	$\Gamma(z) = \int_0^{\infty} t^{z-1} e^{-t} dt$
Sine	$\sin(x) = \frac{1}{2i}(e^{ix} - e^{-ix})$
Error	$\text{erf}(z) = \frac{2}{\sqrt{\pi}} \int_0^z e^{-z^2} dz$
Bessel	$J_0(z) = \frac{1}{\pi} \int_0^{\pi} \cos(z \sin \theta) d\theta$
Zeta	$\zeta(s) = \sum_{k=1}^{\infty} k^{-s} \quad (\Re s > 1)$

## (T)EXPERT FORMULAS & MATH

$\text{\TeX}$  for PCs = Personal  $\text{\TeX}$ , Inc.

12 Madrona Avenue  
Mill Valley, CA 94941





# BEST BUYS FOR 14 YEARS!

## JADE COMPUTER



**\$498**

—A PROVEN BEST SELLER—

- 8088 microprocessor running at 10 MHz or 4.77
- 640KB
- 5.25" 360KB RAM Drive
- Dual diskette drive controller
- Parallel printer port
- Eight XT expansion slots
- 150 watt power supply
- 8087 socket
- Front panel display
- 101 Key enhanced keyboard
- Serial RS-232C port
- Game port
- Clock/Calendar

### Monitor & Hard Drive Options

Floppy Only	20 Megabyte	30 Megabyte
<b>\$598</b>	<b>\$798</b>	<b>\$848</b>
Complete Monographics System		
<b>\$748</b>	<b>\$898</b>	<b>\$948</b>
Complete Color System		
<b>\$898</b>	<b>\$1098</b>	<b>\$1148</b>
Complete VGA System		

## JADE COMPUTER



**PRO-286**

12 MHz  
**\$798**

20 MHz  
**\$1098**

Monitor Optional

—286 POWERHOUSE—

- 80286 processor running at 12 MHz or 20 MHz
- Zero wait state
- 1 Megabyte of RAM
- 1.2 MB or 1.44 MB drive
- Hard/Floppy controller
- Six 16-Bit & Two 8 Bit expansion slots
- 80287 socket
- Clock/Calendar
- 101-key enhanced keyboard
- 200 watt power supply
- Norton S.I. 13.7/20.3
- Landmark 16/25.9
- One Year Warranty

### Monitor & Hard Drive Options (12 MHz)

Floppy Only	40 Megabyte	80 Megabyte
<b>\$898</b>	<b>\$1268</b>	<b>\$1498</b>
Complete Monographics System		
<b>\$1198</b>	<b>\$1598</b>	<b>\$1798</b>
Complete VGA System		

For 20 MHz System Add \$298

## JADE COMPUTER



**Super-386**

20 MHz  
**\$1498**

25 MHz  
**\$1698**

Monitor Optional

25 MHz Cache **\$2198** 33 MHz Cache **\$2898**

—FIRE BREATHING 386—

- 80386 processor running at 20 MHz, 25 MHz, 33 MHz
- 1 MB RAM expands to 6 MB
- 384K Shadow RAM
- 1.2 MB or 1.44 MB drive
- 1:1 Interleave Hard Disk /floppy Disk controller
- 80387 socket
- Full size case
- One 32-Bit, Five 16-Bit
- Two 8-Bit slots
- 101 key enhanced keyboard
- 200 watt power supply
- Clock/Calendar
- Norton S.I. 23/31.6/31.6
- Landmark 25.5/32.6/43.5

### Monitor & Hard Drive Options (20 MHz)

Floppy Only	40 Megabyte	80 Megabyte
<b>\$1648</b>	<b>\$1998</b>	<b>\$2198</b>
Complete Monographics System		
<b>\$1968</b>	<b>\$2298</b>	<b>\$2398</b>
Complete VGA System		

For 25 MHz Add \$198 For 33 MHz Cache Add \$1398

## EPSON Panasonic

- LX-810 ... \$178
- FX-850 ... Call
- FX-1050 ... Call
- LQ-510 ... \$328
- LQ-850 ... Call
- LQ-950 ... Call
- LQ-1050 ... Call
- LQ-2550 ... Call
- KX-1180 ... \$178
- KX-1191 ... \$238
- KX-1124 ... \$318



## HEWLETT PACKARD

- New LaserJet IIP ... \$1098
- H.P. LaserJet II ... \$1698
- H.P. DeskJet ... \$598
- H.P. DeskJet Plus ... \$698
- H.P. DeskWriter ... \$848
- 4 MB RAM Card w/1 MB ... \$298
- 172 Fonts in a Cartridge ... \$288
- Plotter in a Cartridge ... \$268
- PostScript Cartridge ... \$498
- Extra Toner ... \$98
- Extra Ink Cartridge ... \$19

- Surge Protector**
- S.L. Waber 6 outlet ... \$18
- Isobar 4 outlet ... \$48
- Isobar 8 outlet ... \$68
- Isobar modem protector ... \$24



California  
Torrance, Costa Mesa, Woodland Hills  
Kearny Mesa, Sunnyvale

Texas Georgia Arizona  
Addison, Houston Smyrna Phoenix

Not all items in stock at our nine retail locations.

- TrippLite Line Stabilizer**
- 600 Watt Line Conditioner ... \$98
- 1200 Watt Line Conditioner ... \$158
- 1800 Watt Line Conditioner ... \$188

- TrippLite Battery Back-up**
- 450 Watt UPS ... \$398
- 750 Watt UPS ... \$498
- 1200 Watt UPS ... \$698

### VGA Package

Card **\$178**

Monitor **\$298**



640 x 480 Hi-Res Card

Plotter **\$688**

List Price \$1795

### Roland DXY-980

- 8 PEN 230mm/SEC
- .05mm Resolution
- HPGL Compatible
- Electrostatic Hold Down
- Parallel and Serial Input
- Digitizing Capacity

## intel

- 8087 ... \$88
- 8087-2 ... \$118
- 8087-1 ... \$158
- 80287 ... \$128
- 80287-8 ... \$198
- 80287-10 ... \$228
- 80287-12 ... \$278
- 80387-SX ... \$318
- 80387-16 ... \$348
- 80387-20 ... \$388
- 80387-25 ... \$488
- 80387-33 ... \$598

Better Than Intel  
IIT Coprocessors In Stock Call

- Hard Disk Sale**
- 20 MB 60ms \$198 \$248
- 20 MB 35ms \$248 \$298
- 30 MB 60ms \$218 \$268
- 30 MB 35ms \$288 \$338
- 40 MB 40ms \$298 \$348
- 40 MB 28ms \$348 \$398
- 60 MB 40ms \$388 \$448
- 80 MB 28ms \$538 \$598
- 120 MB 28ms \$698 \$768
- 150 MB 23ms \$998 \$1098
- CMS 40 MB Tape Back-up ... \$268

### Modem

- 1200 internal w/software ... \$48
- 2400 internal w/software ... \$88
- 1200 baud external ... \$88
- 2400 baud external ... \$148
- 2400 PS/2 internal ... \$198
- Intel 2400B for PS/2 ... \$278

### Daisywheel Printer

40 CPS

**\$199**

### Logitech

- LogiMouse Serial ... \$68
- LogiMouse Hi-Rez. Bus ... \$88
- LogiMouse Hi-Rez Serial ... \$98

### Mouse

Opto Mechanical With Software

**\$29**

### Scanner

- Complete hand Scanner ... \$98
- Complete Half Page ... \$218
- Complete Full Page ... \$548
- Logitech Scan Man ... \$248
- Diamond Flower HS-3000 Plus ... \$198

# JADE COMPUTER

4901 W. Rosecrans Ave. Box 5046, Hawthorne, California 90251-5046 213-973-7707

Continental U.S.A. 1-800-421-5500

Inside California 1-800-262-1710



We accept checks, credit card or purchase orders from qualified firms and institutions. No surcharge on credit card orders. CA., TX, GA. & AZ. residents add sales tax. Prices and

availability subject to change without notice. Shipping and handling charges via UPS ground 50¢/lb. UPS air \$1.00/lb. Minimum charge \$4.00. Fax machine 1-213-675-2522

*Engineered for the office. Designed for people.*

After you ooh-ed and aah-ed over the letter quality output, 3-way paper feed, ease-of-use, 2-year limited warranty, and 9 pin price on our KX-P1124 printer, somebody said, "Great. Now do it with a wide-carriage."



*Introducing the Panasonic® KX-P1624. Our newest 24 pin wide carriage printer.*

It's fast. Flexible. And fully-featured. Everything most offices are looking for in a dot matrix printer. At a price within most office budgets.

The features you'll use most often are available at a touch. Seven resident fonts to vary the look of your documents. Formatting for different document sizes.

Draft Pica  
Draft Elite  
Courier Pica  
Prestige Elite  
Bold Proportional  
Space  
Sans Serif Pica  
Script Pica

True letter quality, high-resolution graphics, and seven resident fonts, so it's ideal for all your office applica-

tions. You'll find the 1624's letter-quality mode as fast, or faster, than most popular 9 pins. Up to 63 LQ characters per second. With its 360 x 360 dpi bit-mapped graphics, you can incorporate special printed effects into your documents. Like company logos and line art.

20 features, including 4 macros, right at your fingertips. What could be simpler?

Even macros that recall all the settings for a particular document at the touch of a single key.





# Done.

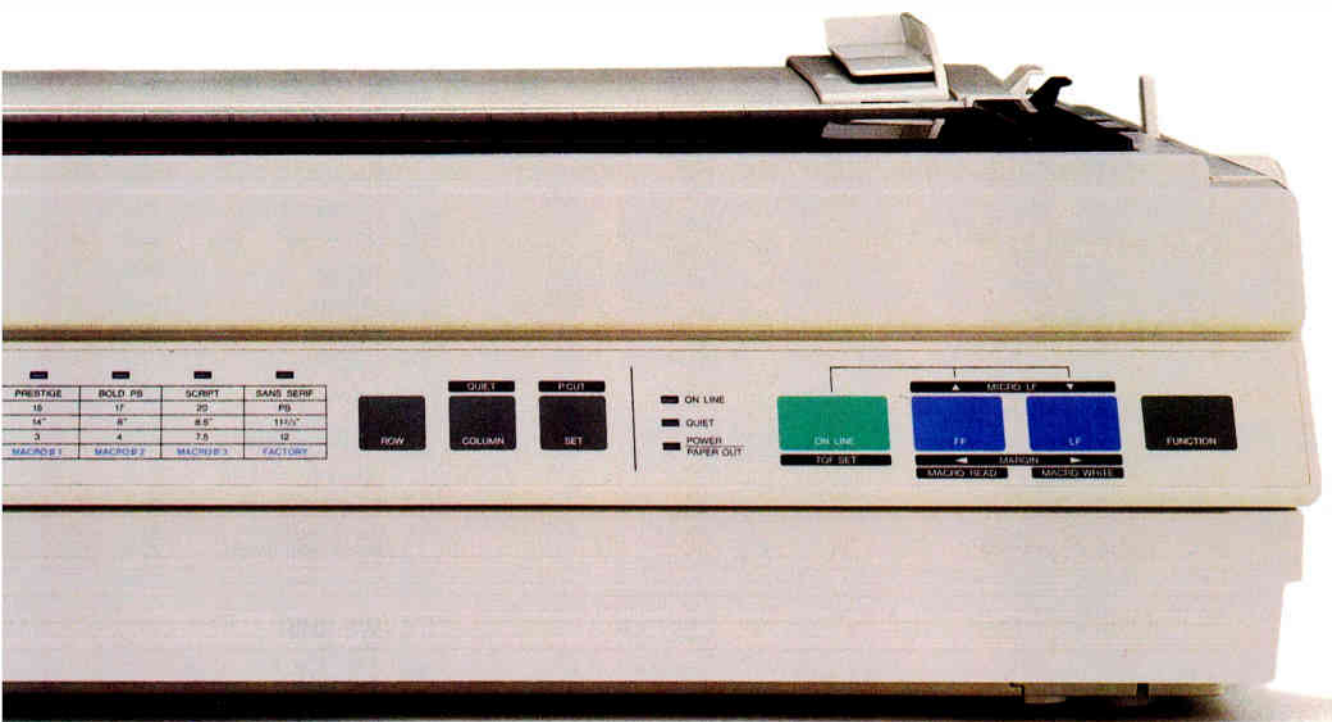

PRESTIGE	BOLD PB	SCRIPT	BAUD SERIF
15	17	20	PB
14"	8"	8.5"	110"
3	4	7.5	12
MACRO#1	MACRO#2	MACRO#3	FACTORY

ON LINE  
 QUIET  
 POWER PAPER OUT

ROW  
 COLUMN  
 SET

MICRO LP  
 ON LINE  
 TOP SET

FP  
 MARGIN  
 MARGED HEAD

LF  
 MARGIN  
 MARGED WHITE

FUNCTION

Multiple paper paths mean you can put this printer exactly where you want it. There aren't many places in an office to conveniently put a printer.

So the 1624 gives you a choice of 4 different paper paths: single sheets from the top, and fanfold from the front,



Only one paper path is available at any given time for continuous paper.

bottom or rear. A special 'Paper Park' feature even lets you feed single sheets from the top, without removing rear-fed fanfold.

A 2-year limited warranty in this day and age? That's investment protection, Panasonic-style. You'll find 2-year warranties rather rare in the printer industry. But standard with the Panasonic 1624.

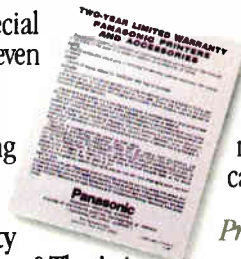

See your dealer for details.

So if you've been waiting for the ideal multi-purpose office printer, it has arrived. For the name of your nearest Panasonic printer dealer, call toll-free 1-800-742-8086.

*Printers, Computers, Peripherals, Copiers, Typewriters and Facsimiles*

**Panasonic**  
Office Automation 

# CompuClassics

## SOFTWARE

### ABOVE SOFTWARE

Above Disk	
<b>ACCOLADE</b>	
Test Drive II	26.00
<b>ADDUCE</b>	
Illustrator/Windows	409.00
<b>ALDUS</b>	
Pagemaker	479.00
<b>ALPHA</b>	
Alpha/4	319.00
<b>AMERICAN SMALL BUSINESS</b>	
Design Cad	159.00
Design Cad 3D	209.00
<b>APPLAUSE</b>	
Perfect Addition	39.00
<b>APPLICATION TECHNIQUES</b>	
Pizazz Plus	69.00
<b>ASHTON-TATE</b>	
DBase IV	485.00
Framework III	455.00
DBase III Plus	455.00
Multimate Advantage II	295.00
<b>ASK SAM</b>	
Ask Sam 4.21	179.00
<b>AUTODESK</b>	
Autosketch 2.0	95.00
<b>BANNER BLUE</b>	
Org Plus	52.00
<b>BITSTREAM</b>	
Bitstream Fonts	Call
<b>BLOC PUBLISHING</b>	
FormFiller 2.0	85.00
Formtools	59.00
<b>BLAISE</b>	
Turbo C Tools	92.00
Turbo Power Tools Plus	92.00
<b>BORLAND</b>	
Turbo C	99.00
Turbo Pascal	99.00
Turbo C Pro	169.00
Turbo Pascal Pro	169.00
Quattro Pro	349.00
Reflex 2.0	165.00
Sidekick Plus	135.00
Paradox	479.00
<b>BOURBAKI</b>	
1Dir Plus	49.00
<b>BRIDGEWAY</b>	
Fast Trax	35.00
<b>BRIGHTBILL-ROBERTS</b>	
Hynerpad	95.00
<b>BRODERBUND</b>	
Print Shop	39.00
Memory Mate	45.00
<b>BUMBA EBBE</b>	
DB Fast/DOS Plus	145.00
<b>BUTTONWARE</b>	
PC File DB	69.00
<b>CALIFORNIA SCIENTIFIC</b>	
Brainmaker	145.00
<b>CENTRAL POINT</b>	
PC Tools Deluxe	79.00
Copy II PC	24.00
<b>CHRONOS</b>	
Who-What-When	115.00
<b>CLARION</b>	
Professional Developer	409.00
<b>COREL SYSTEMS</b>	
Corel Draw 1.1	349.00
<b>COMMAND TECHNOLOGY</b>	
SPF PC	185.00
<b>COMPUTER ASSOCIATES</b>	
Supercalc V	305.00
Superproject Expert	449.00
<b>CONCENTRIC DATA</b>	
R & R Report Writer	109.00
<b>CORE</b>	
Corelast	69.00
<b>CROSSTALK</b>	
Crosstalk Mark 4	145.00
Remote 2	115.00
<b>CUSTOM APPLICATIONS</b>	
Freedom Of Press	335.00
<b>DAC</b>	
Lucid 3D	60.00
DAC Easy Bonus Pack	115.00
DAC Easy Accounting	59.00
<b>DATABASE</b>	
Database 4.0	499.00
<b>DATABORM</b>	
Proccom Plus	55.00
<b>DELFINIA</b>	
Perform	172.00
<b>DELTA TECHNOLOGY</b>	
Direct Access	55.00
<b>DIGITAL RESEARCH</b>	
Gem Artline	285.00
Gem Presentation Team	285.00
<b>DIGITALK</b>	
Smalltalk V286	139.00
<b>DYNAMIC MICROPROCESSOR</b>	
PC Anywhere III	72.00
<b>ELECTRONIC ARTS</b>	
Backup Pro	62.00
Deluxe Paint II	45.00
<b>ENABLE SOFTWARE</b>	
Enable	449.00

### FIFTH GENERATION

Fastback Plus	109.00
<b>FORMWORX</b>	
Formwork w/Fill & File	89.00
<b>FOX</b>	
Foxbase Plus/LAN	295.00
Foxbase Plus	199.00
<b>FUNK</b>	
Sideways	42.00
Always (1-2-3 or symphony)	85.00
<b>GAZELLE</b>	
QDOS II	39.00
<b>GENERIC</b>	
Generic CADD Level 3	169.00
<b>GIBSON</b>	
Spinnite	49.00
<b>GOLDEN BOW</b>	
V Cache	45.00
<b>HAVENTREE</b>	
Interactive Easy Flow	109.00
<b>HELIX</b>	
Headroom	79.00
<b>IBM</b>	
DOS 4.01	125.00
Displaywrite IV	289.00
<b>INDIVIDUAL</b>	
101 Macros For WordPerfect	45.00
<b>INSET</b>	
Inset Plus	125.00
<b>INSIGHT DEVELOPMENT</b>	
Laser Control	85.00
Print-A-Plot	105.00
<b>INTUIT</b>	
Quicken	40.00
<b>LASERGO</b>	
Go Script	139.00
Go Script Plus	269.00
<b>LASERTOOLS</b>	
Lasertorg	85.00
<b>LEARNING COMPANY</b>	
Reader Rabbit	25.00
<b>LOTUS</b>	
Agenda	275.00
1-2-3 v 3.0	355.00
1-2-3- v2.2	355.00
<b>MATHSOFT</b>	
Mathcad	305.00
<b>MECA</b>	
Managing Your Money	119.00
<b>MERIDIAN</b>	
Carbon Copy Plus	119.00
<b>MICROGRAFX</b>	
Windows Graph Plus	329.00
Designer	449.00
<b>MICROLOGIC</b>	
Tornado	52.00
<b>MICROLYTICS</b>	
Golfer	45.00
<b>MICROPROSE</b>	
F19 Stealth Fighter	45.00
<b>MICROSOFT</b>	
RBase For DOS	489.00
<b>MISCALARE</b>	
Balance of Power 1990	29.00
<b>MULTISOFT</b>	
PC Kwik power pack	72.00
Super PC Kwik	49.00
<b>MICROSOFT</b>	
Quickbasic	67.00
Quick C	67.00
Excel	285.00
Windows 286	67.00
Windows 386	135.00
Quickpascal	55.00
Macro Assembler	99.00
C Compiler	299.00
Word	225.00
Flight Simulator	35.00
<b>MICROTEK</b>	
Spectrum	49.00
<b>NANTUCKET</b>	
Clipper	499.00
<b>NEW ENGLAND</b>	
Graph-In-The-Box	75.00
<b>NLO</b>	
Willmaker	35.00
<b>NORTH EDGE</b>	
Timeslips III	169.00
<b>NOVELL</b>	
Advanced Net 2.15	1995.00
<b>OWL</b>	
Guide	169.00
<b>PAPERBACK</b>	
VP Planner Plus	129.00
<b>PATTON &amp; PATTON</b>	
Flowcharting II Plus	139.00
<b>PAUL MACE</b>	
Mace Utilities Gold	85.00
<b>PEACHTREE</b>	
Compte Acting W/Data Query	235.00
<b>PERSOFT</b>	
Ize	259.00
Smarterm 240	205.00
<b>PERSONICS</b>	
Ultrasision	79.00
See More 1-2-3	49.00
<b>PETER NORTON</b>	
Norton Utilities	59.00
Norton Commander	52.00
Norton Utilities Advanced	85.00

**WE ARE JUST A FAX AWAY!**  
**(818) 347-9977**

<b>POLARIS</b>	
Packrat	259.00
<b>PRECISION SOFTWARE</b>	
Superbase 2 For Windows	175.00
<b>PRIME SOLUTIONS</b>	
<b>PRIMETIME</b>	
Primetime	115.00
<b>PROXIMITY TECHNOLOGY</b>	
Choice Word	65.00
<b>PUBTECH</b>	
File Organizer	59.00
<b>QUAD</b>	
QUAD	165.00
Copywrite	59.00
<b>QUALITAS</b>	
386 To The Max	55.00
386 To The Max Pro	95.00
<b>QUARTERDECK</b>	
Desqview	79.00
QEMM 386	37.00
<b>REFERENCE</b>	
Grammatik III	52.00
<b>RIGHTSOFT</b>	
Rightwriter	52.00
<b>RIX</b>	
Colorix VGA Paint	105.00
<b>ROYKORE</b>	
Opus One	265.00
<b>SAMNA</b>	
Ami	129.00
Ami Professional	319.00
<b>SANTA CRUZ OPERATIONS</b>	
SCO Operating System 386	469.00
<b>SCITOR</b>	
Project Scheduler 4	429.00
<b>SIERRA ON-LINE</b>	
Leisure Suit Larry #2	32.00
Kings Quest IV	32.00
Space Quest III	39.00
<b>SIMON &amp; SCHUSTER</b>	
Typing Tutor IV	29.00
Webster Prof Thesaurus	75.00
<b>SOFTKLONE</b>	
Mirror III	55.00
<b>SOFTLOGIC</b>	
Disk Optimizer	45.00
<b>SOFTWARE DIRECTIONS</b>	
Print Q	85.00
<b>SOFTWARE MASTERS</b>	
Flash	49.00
<b>SOFTWARE PUBLISHING</b>	
Harvard Graphics	289.00
PFS 1st Publisher	85.00
PFS 1st Choice	105.00
PFS 1st Graphics	89.00
Professional Write	145.00
<b>SOLUTION SYSTEMS</b>	
Bnel	165.00
<b>SPECTRUM HOLOBYTE</b>	
Teltris	24.00
Falcon-AT	32.00
<b>STSC</b>	
Statorgraphics	569.00
<b>STORAGE DIMENSIONS</b>	
Speedstor	35.00
<b>SUBLOGIC</b>	
Jet	32.00
Scenery Disks	CALL
<b>SYMANTEC</b>	
Q & A	219.00
Timeline	369.00
Grandview	189.00
<b>SYMISOFT</b>	
Hotshot Graphics	149.00
<b>SYSTAT</b>	
Systat With Graphics	689.00
<b>SYSTEMS COMPATIBILITY</b>	
Perfect Exchange	50.00
Software Bridge	85.00
<b>THREE D GRAPHICS</b>	
Perspective Jr.	99.00
<b>TIMESWORKS</b>	
Publish It!	115.00
<b>TRAVELING SOFTWARE</b>	
Laplink III	85.00
Viewlink	85.00
<b>TURBO POWER</b>	
Turbo BTree Filer	79.00
Turbo Professional	79.00
<b>UNISON WORLD</b>	
Printmaster Plus	35.00
<b>V COMMUNICATIONS</b>	
Sourcer With Bios	119.00
<b>VERSAOFT</b>	
DB Man V	219.00
<b>WHITE CRANE</b>	
Brooklyn Bridge	79.00

<b>WOLFRAM RESEARCH</b>	
Mathematica 386	599.00
<b>WORDPERFECT</b>	
Word Perfect	239.00
Word Perfect Library	65.00
Word Perfect Network	349.00
<b>WORDSTAR</b>	
Wordstar Professional 5.5	235.00
<b>WORDTECH</b>	
Quicksilver Diamond	349.00
DBXL Diamond 1.3	145.00
<b>XEROX</b>	
Xerox Formbase	319.00
Ventura Publisher	499.00
Xerox Presents	309.00
<b>XTREE</b>	
Xtree Pro	75.00
<b>ZSOFT</b>	
Publishers Paintbrush	169.00

## HARDWARE

<b>AST RESEARCH</b>	
5251/11 Enhanced	599.00
Six Pak Plus 64K	129.00
<b>ATI</b>	
VGA Wonder 256	335.00
<b>BELKIN/DATASPEC</b>	
Cables/Switchboxes	Call
<b>CENTRAL POINT</b>	
Copy II PC Option Board Deluxe	119.00
<b>CURTIS</b>	
Ruby Plus	69.00
<b>EVEREX</b>	
Internal 2400 Modem	155.00
Computers	Call
<b>FIFTH GENERATION</b>	
Logical Connection 512K	579.00
<b>HAYES</b>	
Smartmodem 2400	459.00
<b>INTEL</b>	
Above Board Plus 512K	455.00
Coprocessors	Call
<b>KENSINGTON</b>	
Masterpiece Plus	109.00
<b>KEYTRONIC</b>	
KB101 Plus Keyboard	99.00
<b>LOGITECH</b>	
Scanman Plus PC	199.00
New Mouse	89.00
<b>MICROSOFT</b>	
Bus or Serial Mouse With Paint	109.00
<b>MICRO SPEED</b>	
Fast Trap Serial	95.00
<b>MOUSE SYSTEMS</b>	
Bus or Serial Mouse II	95.00
<b>NEC HOME ELECTRONICS</b>	
Multisync 3D	759.00
<b>ORCHID</b>	
Prodesigner VGA Plus	409.00
<b>PANASONIC</b>	
KXP 1124 Printer	369.00
<b>PARADISE</b>	
VGA Plus	295.00
<b>POLAROID</b>	
EGA Palette	2399.00
<b>PLUS</b>	
Hardcard 40	709.00
<b>PRACTICAL PERIPHERALS</b>	
2400 External Modem	195.00
<b>SEAGATE</b>	
Hard Disks	Call
<b>SOTA TECHNOLOGY</b>	
386i Accelerator Board	429.00
VGA/16 512K w/ Mouse	349.00
<b>SUMMAGRAPHICS</b>	
Summasketch Plus 12x12	419.00
<b>SYGEN</b>	
Bridge File With Adapter	289.00
<b>TOUCHBASE</b>	
Worldport 2400 Modem	265.00
Worldport 2496 Fax Modem	519.00
<b>VIDEO 7</b>	
Vram VGA 256K	509.00

**WE SHIP TO FPO & APO BOXES**

**WE WELCOME CORPORATE ACCOUNTS AND INTERNATIONAL ORDERS**

Immediate Shipment On Purchase Orders From Government And State Agencies, Cities, Counties, School And Universities.

Prices subject to change with out notice and while stocks last. We ship the latest versions. We accept Visa, Master Card, American Express, 2% Surcharge on American Express. Please Call (818) 347-9977 for an Authorization # for defective goods or your return will not be accepted. Due to copyright laws we cannot take back any software where the seal has been broken. \$5 minimum shipping per item less on bulk orders. 9 Blue shipping. \$3.50 C.O.D. charge. Heavier items charged accordingly. We do not guarantee compatibility. Call for prices for any software item not listed in this ad. Order desk open 7 A.M. to 5 P.M. (PST), Saturday 10 A.M. 2 P.M. (PST). P.O. Box 10598, Canoga Park, CA 91309. Showroom: 7969 Deering Ave. Canoga Park, CA 91304. Customer Service (818) 347-9400. General Office (347) 7500.

**INTERNATIONAL ORDERS 818 347 2444**

**ORDERS CALL 800 733 3888**



# The LAN Terminal Alternative



Two diskless 80286-based PCs offer different options for LAN users

Bill Catchings  
and Mark L. Van Name

**D**iskless PCs make a certain amount of sense on a LAN. Rather than using local storage, a diskless PC boots from a LAN server and stores all its data on a server. With all the data in a central place, backups are easier, and, so diskless PC vendors claim, the network is more secure because workstations have no local disk drives. Diskless PCs also should cost less than standard PCs because they don't have disk drives and can use smaller power supplies.

To test these claims, we looked at two 80286-based diskless PCs: the TeleVideo TS2 TeleStation and the Wyse WY-212. Both units house a monitor and motherboard in one compact case and use ROMs to boot from a Novell NetWare file server. Both also include 1 megabyte of 120-nanosecond DRAM on the motherboard. From there, however, the configurations diverge.

The TS2 is a 10-MHz 80286 machine that includes an 8-bit Ethernet adapter and Novell boot ROM for \$1695 (\$1429 without the Ethernet adapter and boot ROM). The unit comes with a socket for an Intel 80287 math coprocessor; a built-in green-phosphor, 14-inch, Hercules-compatible monitor; two RS-232C serial ports; one parallel port; and a 101-key Enhanced AT-style keyboard. The network interface card occupies the unit's



*The Wyse WY-212 (left) and the TeleVideo TS2 TeleStation.*

single 8-bit expansion slot.

The TS2's memory configuration is expandable. Two of its four banks of 256K-byte, parity-checked memory come in single in-line memory modules. You can replace those SIMMs with 1-megabyte SIMMs to bring the memory to its maximum of 2.5 megabytes.

Our test unit also included MS-DOS and GWBASIC 3.3 (\$85) and a 10-MHz 80287. TeleVideo doesn't sell an 80287, so we assumed the common list price of \$250 to calculate a total system cost of \$2030.

The WY-212 has a 12.5-MHz 80286 CPU and 1 megabyte of RAM for \$1799. The Wyse system delivers a little more performance than the TS2 and has monochrome VGA rather than Hercules graphics. It includes a socket for either a

6- or 10-MHz Intel 80287 math coprocessor (we tested the machine with a 10-MHz 80287); a built-in, 14-inch, white-phosphor VGA monitor; a Wyse 8-bit VGA card; one parallel port; two RS-232C serial ports; and an Enhanced AT-style keyboard. The VGA card and the network interface card fill the system's two 16-bit AT-bus expansion slots.

Wyse sells the WY-212 through distributors; you can also buy the identical machine through retail channels as the Amdek System/286N from Wyse's Amdek subsidiary.

The WY-212 includes two VGA utility disks, but it doesn't come with a LAN adapter or DOS. You'll have to buy the adapter from a third party. Wyse does, however, sell Novell NetWare and 3Com

*continued*

# Rack & Desk PC/AT Chassis

Integrand's new Chassis/System is not another IBM mechanical and electrical clone. An entirely fresh packaging design approach has been taken using modular construction. At present, over 40 optional stock modules allow you to customize our standard chassis to nearly any requirement. Integrand offers high quality, advanced design hardware along with applications and technical support *all at prices competitive with imports*. Why settle for less?

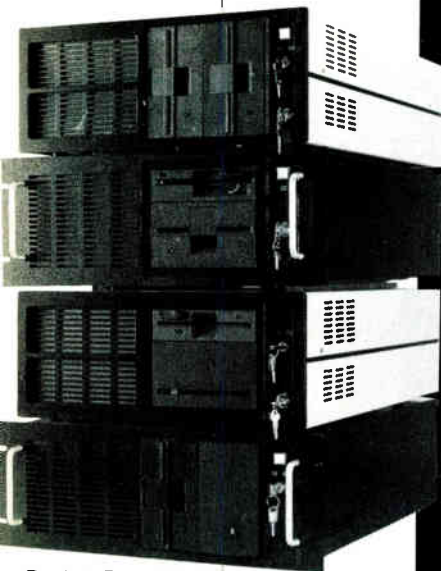

## Rack & Desk Models

Accepts PC, XT, AT Motherboards and Passive Backplanes

Doesn't Look Like IBM

Rugged, Modular Construction

Excellent Air Flow & Cooling

Optional Card Cage Fan

Designed to meet FCC

204 Watt Supply, UL Recognized

145W & 85W also available

Reasonably Priced

Now Available

Passive Backplanes



# INTEGRAND

RESEARCH CORP.

Call or write for descriptive brochure and prices:  
8620 Roosevelt Ave. • Visalia, CA 93291

209/651-1203

TELEX 5106012830 (INTEGRAND UD)

FAX 209/651-1353

We accept Bank Americard/VISA and MasterCard

IBM, PC, XT, AT trademarks of International Business Machines.  
Drives and computer boards not included.

## REVIEW

### THE LAN TERMINAL ALTERNATIVE

#### Wyse WY-212/Amdek System/286N

##### Company

Wyse Technology  
3471 North First St.  
San Jose, CA 95134  
(800) 438-9973  
(408) 473-1200

Amdek Corp.  
3471 North First St.  
San Jose, CA 95134  
(800) 722-6335  
(408) 922-5700

##### Components

**Processor:** 12.5-MHz Intel 80286; socket for 6- or 10-MHz Intel 80287 math coprocessor  
**Memory:** 1 megabyte of 16-bit 120-ns DRAM; 32K bytes of BIOS ROM  
**Network adapter:** Not available from Wyse  
**Display:** Built-in Wyse monochrome, white-phosphor, 14-inch VGA monitor; Wyse 8-bit VGA card  
**Keyboard:** 102-key IBM Enhanced  
**I/O interfaces:** Two RS-232C serial ports with DB-9 connectors; DB-25 parallel port; RJ-11 keyboard connector; two 16-bit AT-bus expansion slots for video board and LAN adapter card

##### Size

13 x 13 x 14 inches (height includes built-in monitor); 32 pounds

##### Software

VGA drivers and utilities disks

##### Documentation

User's guide; GWBASIC manual; MS-DOS manual

##### Price

Base system: \$1799  
System as reviewed: \$2487

##### Inquiry 863.

3+ Share boot ROM chips for \$40 each. These chips fit into a socket in the Western Digital EtherCard Plus 8-bit Ethernet board (WD8003EBT); a spokesperson from Wyse said that the chips will often work in other network adapters as well. Our evaluation unit included the \$438 WD8003EBT card with a Wyse NetWare boot ROM. Wyse doesn't sell an 80287, so we added \$250 to get a total system price of \$2487.

The WY-212's memory is fixed; it limits you to 1 megabyte with no parity checking. That's not much memory these days, but Wyse at least lets you configure the 384K bytes of it above 640K bytes as extended memory.

Neither system compares well on price

#### TeleVideo TS2 TeleStation

##### Company

TeleVideo Systems, Inc.  
550 East Brokaw Rd.  
San Jose, CA 95161  
(408) 954-8333

##### Components

**Processor:** 10-MHz 16-bit Intel 80286; socket for 8- or 10-MHz Intel 80287 math coprocessor  
**Memory:** 1 megabyte of 16-bit 120-ns DRAM, expandable to 2.5 megabytes on the motherboard; 64K bytes of BIOS ROM  
**Network adapter:** TeleVideo 8-bit, Novell NE-1000 compatible, Ethernet adapter with NetWare boot ROM  
**Display:** Built-in TeleVideo monochrome, green-phosphor, 14-inch Hercules-compatible monitor; video circuitry on motherboard  
**Keyboard:** Modified 101-key IBM Enhanced  
**I/O interfaces:** Two RS-232C serial ports with DB-9 connectors; DB-25 parallel port; AT-style DIN keyboard connector; 8-bit AT-bus expansion slot for LAN adapter card

##### Size

12½ x 12¾ x 15½ inches (height includes built-in monitor); 26 pounds

##### Software

MS-DOS and GWBASIC 3.3 (\$85)

##### Documentation

User's guide

##### Price

Base system: \$1695  
System as reviewed: \$2030

##### Inquiry 864.

with many low-cost AT clones. Furthermore, in this day of 20-MHz 80286s, neither system is especially fast: Both units run with one wait state.

##### A Look Inside

The first thing you notice about these systems is how small they are. Both monitors attach directly to bases on necks that tilt and swivel. Those bases have a small footprint—13 inches square for the WY-212, and 12½ by 12¾ inches for the TS2.

The TS2 is no harder to open than a standard PC, although the monitor makes the task a bit awkward. Fortunately, once you remove the six screws from the bottom and the two from the back,





# Wyse WY-212, TeleVideo TS2 TeleStation

## LOW-LEVEL PERFORMANCE<sup>1</sup>

Wyse WY-212

CPU	WY-212	TS2	VIDEO	WY-212	TS2
<b>Matrix</b>	7.40	7.89	<b>Text</b>		
<b>String Move</b>			Mode 0	12.10	N/A
Byte-wide	50.99	53.65	Mode 1	12.10	N/A
Word-wide:			Mode 2	11.86	N/A
Odd-bnd.	51.01	53.60	Mode 3	11.85	N/A
Even-bnd.	25.52	26.84	Mode 7	N/A	12.31
<b>Sieve</b>	46.74	44.87	<b>Graphics</b>		
<b>Sort</b>	36.77	35.04	CGA:		
<b>Index:</b>	<b>1.68</b>	<b>1.64</b>	Mode 4	3.39	N/A
<b>FLOATING POINT</b>			Mode 5	3.40	N/A
<b>Math</b>	<b>WY-212</b>	<b>TS2</b>	Mode 6	3.57	N/A
Error <sup>2</sup>	34.29	39.62	EGA:		
<b>Sine(x)</b>	13.97	16.60	Mode 13	5.77	N/A
Error			Mode 14	6.30	N/A
<b>e<sup>x</sup></b>	12.19	14.28	Mode 15	N/A	N/A
Error			Mode 16	6.30	N/A
<b>Index:</b>	<b>1.40</b>	<b>1.19</b>	VGA:		
			Mode 18	6.61	N/A
			Mode 19	3.66	N/A
			Hercules	N/A	3.10
			<b>Index:</b>	<b>1.01</b>	<b>1.24</b>

N/A=Not applicable.

<sup>1</sup> All times are in seconds. Figures were generated using the 8088/8086 version (1.1) of Small-C.

<sup>2</sup>The errors for Floating Point indicate the difference between expected and actual values, correct to 10 digits or rounded to 2 digits.

For a full description of all the benchmarks, see "Introducing the New BYTE Benchmarks," June 1988 BYTE.

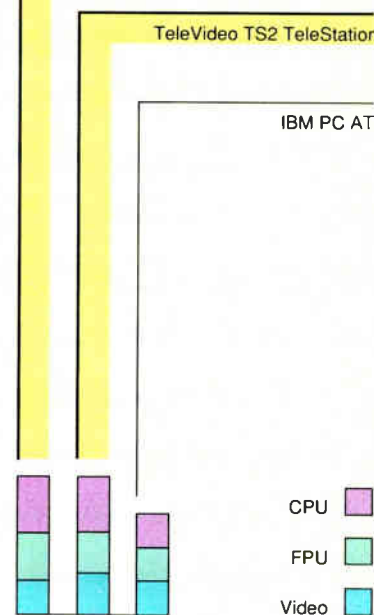

you can put the monitor portion of the case aside.

Inside, however, the TS2 is very different from most PCs. There are no drive bays, no fan, and only one horizontally mounted expansion slot. That slot holds the LAN adapter. It's easy to see why these units are among the quietest PCs you'll find.

The TS2's TeleVideo Ethernet adapter includes a NetWare boot ROM. The adapter is compatible with Novell's NE-1000, so installing the TS2 on a NetWare LAN is a snap.

The WY-212 opens much like the TS2, but it has nine screws on the bottom of the base. The main difference between the two systems is the two 16-bit expansion slots present in the WY-212. They're mounted above the motherboard, one to the left and one to the right. The LAN adapter is in the left slot, and the VGA board is in the right slot. The standard 8-bit Wyse VGA card uses chips from Tseng Labs. The CPU has a compatibility speed of 8 MHz, which you can set with SETUP. Jumpers let you run the 80287 at 6 or 10 MHz.

The motherboard is a tiny 10¼ inches wide by 9¼ inches deep. Ours had no visible trace cuts or jumpers. On it were a total of 78 chips, 32 of which were for memory. Four application-specific ICs (ASICs) from VLSI do most of the job of

emulating an IBM AT. With so few chips and no mechanical components, the WY-212 should be reliable.

The TS2's motherboard is even smaller (8 inches wide by 7 inches deep, with a 1½- by 4½-inch notch in the back left corner) and has mostly surface-mounted chips. Like the WY-212 board, its design is mature—there was only one jumper wire. Of its 70 chips, 36 of them are for memory. One NCR ASIC and six VLSI ASICs provide the Hercules and AT emulation—an AT and video adapter in only 34 chips. The TS2's 80286 has a compatibility speed of 8 MHz that you can set with an external DIP switch.

Neither machine gives you many options; these units are basically smart terminals with no free expansion slots. You couldn't add a disk drive even if there were room in the cases, because the power supplies run at only around 50 watts. Other than the TS2's few memory choices, the only real option is MS-DOS 3.3. Currently, you also cannot run OS/2 on either machine; that will have to wait until vendors offer OS/2 remote-boot software.

### Performance

We tested both diskless PCs on a thin-wire Ethernet LAN with a 16-MHz 80386-based Samsung file server running Novell's NetWare 2.15 SFT (for

System Fault Tolerant). The server included a 150-megabyte hard disk drive, a Novell NE1000 Ethernet adapter, and 4 megabytes of RAM. The server's hard disk drive delivers excellent performance by combining a SCSI disk drive with an intelligent controller that has an on-board 8K-byte cache. NetWare further speeds disk accesses by prefetching sectors on most reads and by caching recently read sectors.

Because neither of these systems has a hard disk drive, their disk performance depends largely on the speed of the network and the file server. We chose, therefore, not to run any of the application benchmarks, which depend heavily on disk access and so could be misleading. We discarded the low-level disk I/O benchmarks for the same reason.

The network interface cards in each machine also affect overall performance. We tested both machines with 8-bit Ethernet adapters. Unlike the TS2, however, the WY-212 could use potentially faster, 16-bit LAN adapters.

We ran all the tests on an unloaded network. They showed just how hard it is to benchmark disk-oriented tests on a LAN: Both systems received a disk index over 10 times that of a standard AT, courtesy of the unloaded network and the speedy file server. While the disk test

*continued*

# IEEE-Z

IOtech offers the widest selection of **easy-to-use** IEEE 488 (GPIB) interfaces for the Macintosh.

- NuBus IEEE board for the Macintosh II

- SCSI / IEEE controller for the Macintosh Plus, SE & II

- Serial / IEEE controller for long-distance applications

- Serial / IEEE plotter converter for HP-IB plotter interfacing

- Desk accessory software for IEEE control from any application

- Language drivers for IEEE control from Basic, C, Fortran, Pascal, Hypercard and more

- Menu-driven software for scientific analysis and graphics

- **30 day money-back guarantee**

- **2 year warranty**

- **Call or send for your FREE Technical Guide**

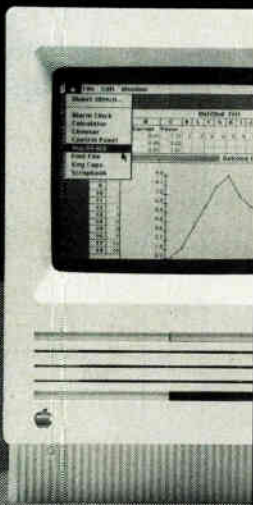

**P**rice  
remains a big question:  
*These two systems  
cost as much as,  
or more than, many  
AT clones that include  
hard disk drives.*

results are meaningless in absolute terms, it's clear from our tests that network-based systems aren't intrinsically slower than disk-based ones.

Surprisingly, despite its faster CPU clock speed, the WY-212 didn't score significantly higher than the TS2 on the CPU tests. The similarity in scores probably stems in part from the fact that both machines run with one wait state.

In the FPU tests, however, the WY-212 beat the TS2 by about 15 percent. The TS2 lost here because it runs its 10-MHz 80287 at only 6.7 MHz. (A TeleVideo spokesperson said that the TS2's coprocessor speed is limited to a maximum of 6.7 MHz, one-third the speed of the unit's 20-MHz oscillator.)

The TS2 won the video tests by about 20 percent. That difference is potentially misleading, however, because the results come from two different sets of tests—the WY-212's for VGA, and the TS2's for a Hercules-compatible display.

### Compatibility

Both systems fared well in compatibility testing. With no expansion slots, we couldn't test much hardware. Two external serial devices, a USRobotics Courier 2400 modem and a Microsoft Serial Mouse, worked with both systems.

There were also no major software problems. Both flawlessly ran a wide range of applications, including Borland's Quattro 1.0, Reflex 1.14, Turbo C 2.0, and Turbo Pascal 4.0; Digitalk's Smalltalk/V 1.2; Kermit 2.32/A; MicroPro's WordStar 3.3 and 4.0; Lotus's Symphony 2; Microsoft's PC Paintbrush 2.0 and Word 4.0; Novell's NetWare 2.15; and Symantec's Q&A 1.1.

The TS2 did have a problem with Microsoft Windows 1.01. That software ran fine on the WY-212, but on the TS2 it got caught in an endless loop before it could completely come up on the screen.

Every minute or so it would give the error that it "could not access the drive NET-WORK." A spokesperson for TeleVideo said that a newer Windows version (2.03) works fine.

### Bits and Pieces

The TS2 comes with a Fujitsu Limited FKB4700 AT Enhanced keyboard, which we've tested on other systems. It has an enlarged Return key and uses the standard AT DIN connector. The Fujitsu keyboard has a soft mechanical click and feel that we've come to like.

The WY-212 uses Wyse's own keyboard, which is fully compatible with IBM's AT Enhanced keyboard. Like Wyse's terminal keyboards, however, it has a tightly coiled telephone-type (RJ-11) cable connecting it to the base. The keyboard is a little stiff for our tastes.

Both machines include a one-year, mail-in, parts-and-labor warranty. The manufacturer pays for return shipping. Wyse offers on-site service through several firms, including TRW's Customer Service Division. Both companies also provide unlimited telephone support—but neither, unfortunately, has a toll-free support number.

### To Disk or Not To Disk?

Both systems are well built and attractive and score high marks for their ease of installation and compatibility. With the right network adapter installed, you can just take them out of the box and hook them to a network, and you're ready to go. Depending on your LAN, you might need to build a boot disk on the server for your first diskless PC; after that, however, you can connect as many additional workstations as you like.

Price remains a big question: These two systems cost as much as, or more than, many AT clones that include hard disk drives. Furthermore, the absence of local hard disk drives hardly makes these two machines secure—it's easy to get at server data via their serial and parallel ports.

If you want a diskless PC, either system is a reasonable choice. The TeleVideo TS2 TeleStation is cheaper and has more memory capacity, while the Wyse WY-212 offers a VGA display and supports higher-performance, 16-bit network interface cards. ■

*Bill Catchings and Mark L. Van Name, a BYTE consulting editor, are independent computer consultants and freelance writers based in Raleigh, North Carolina. You can reach them on BIX as "wbc3" and "mvanname," respectively.*



*IOtech...the choice is easy*

# IOtech

**(216) 439-4091** Telex 6502820864  
Fax (216) 439-4093

25971 Cannon Road • Cleveland, Ohio 44146

London (0734) 86-12-87 • Paris (1) 34810178 • Zurich (01) 821 944  
Milan 02-4120360 • Linköping 013 11 01 40 • Goringham 01830-35333  
Sidney (2) 452 3831 • Seoul 784-9942 • Munich and other European,  
North African and Middle East countries not listed (089) 710020.



Available at  
Entre' Computer  
Centers, T.C.B.C.,  
Computer Factory  
and other retailers  
and other retailers  
nationwide!

(plus: Datamex in Canada)

# The SYSTEMIZER PLUS

**The Universal  
External Network**

## Up to 31 users can...

- Share Printers
- Share Plotters HP-GL Emulation built in!
- Share a Modem
- Share a FAX
- Exchange E-MAIL
- Transfer Datafiles

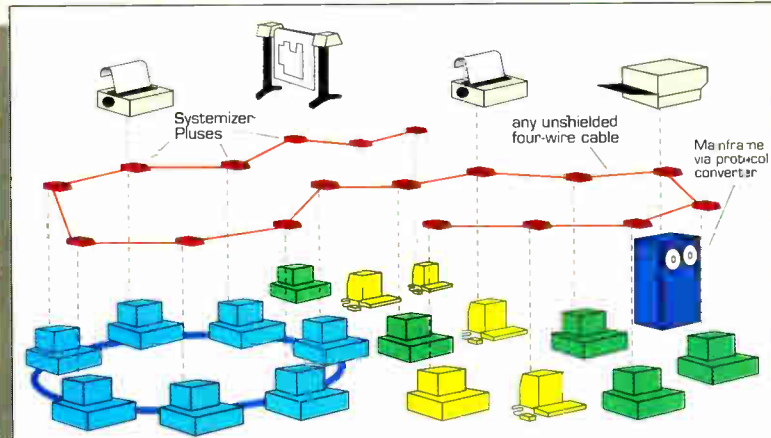

Example: 17 micros (mixed brands, some on a LAN) and a mainframe, each equipped with a Systemizer Plus, sharing 3 printers, a plotter, and EMAIL.

Systemizing has become the connectivity standard at many of the world's largest corporations and throughout the federal government. Ten's of thousands are already in use. The new Systemizer Plus is the latest model in Applied Creative Technology's line of Systemizing products, and it delivers what 95% of corporate computer users want from a Local Area Network— at far less cost and complexity, and yet with much more versatility.

Corporate computing managers prefer Systemizing over other connectivity methods because it offers:

- Up to 62 IO ports, each parallel *and* serial capable.
- Compatibility. Mix PC's, LAN's, mainframes, laptops.
- Easy owner installation. Low cost cabling.
- 5 min. user training with no support needed after.
- Flexibility; readily accomodates growth and changes.
- Powerful distributed buffering (up to 31 Megabytes)
- Distributed processing for high speed and reliability.

**Call 1-800-433-5373  
to get a FREE demo!**

The **CONNEXPERTS**<sup>SM</sup>

A Division of Applied Creative Technology Inc.

8333 Douglas Ave., Suite 700

Dallas, Texas 75225 U.S.A.

(214) 358-4800



# JACKPOT

OVER \$79,000,000 IN CASH PRIZES.  
WIN UP TO THREE TIMES ON A TICKET.  
\$1 Massachusetts State Lottery

RUB ALL 9 SPOTS. MATCH 3 LIKE DOLLAR AMOUNTS IN THE SAME ROW OR SAME COLUMN TO WIN THAT PRIZE.

GAME 1	GAME 2	GAME 3
\$	\$	\$
\$	\$	\$
\$	\$	\$

# QUAHOGS

Rhode Island Lottery \$1

Win \$5,000 (Clams) Instantly!

VOID IF REMOVED

Rub off quahogs in prize area. Match three like cash amounts exactly and win that amount.

Subject to conditions on reverse side of ticket.

# LUCKY DUCK

WIN UP TO \$25,000 INSTANTLY!

# California Match

WIN \$50,000 INSTANTLY!

Get 3 like amounts, win that amount.  
BIG SPIN: Instantly.

\$1

# THE MONEY GAME

WIN \$1,000 INSTANTLY!

GET 3 LIKE AMOUNTS - WIN THAT AMOUNT. GET 3 TV'S AND BE A CONTESTANT.

# WIN \$5,000 ON TV!



# YOU'RE MORE LIKELY TO WIN ALL THESE THAN HAVE A SINGLE ERROR IN OUR TAPE BACKUP.

What does it mean when we say Mountain tape backup systems have an unrecoverable error rate of 1 in  $10^{14}$  bits? Well, think of it this way. Statistically, you're more likely to hit the jackpot in the Massachusetts, Rhode Island, Oregon, California and Colorado lotteries. All of them. Before you would lose a single bit of data while backing up your computer with Mountain.

That's just one reason people think of Mountain more often than any other for error-free tape backup solutions. Mountain reliability. From 40 megabytes to 2.2 gigabytes.

Call (800) 458-0300 Dept. 100C for more information.



## Mountain®

Circle 243 on Reader Service Card (DEALERS: 244)

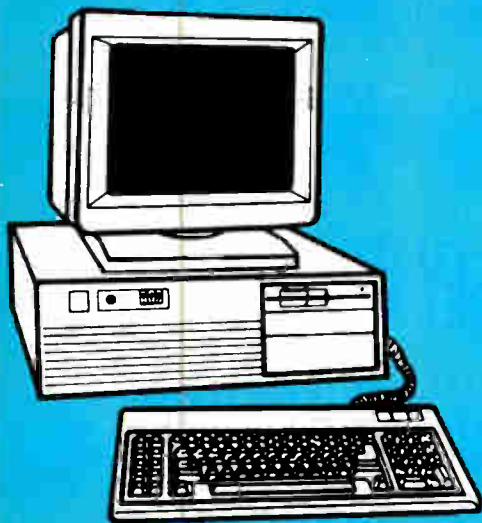

### S Systems 10 MHz XT

- Intel 8088-1 CPU
- Phoenix BIOS
- 640K on board
- TEAC 360K floppy drive
- Multi I/O w/1P, 1S, 1G, fdc, clock
- Enhanced 101 key keyboard
- XT style case
- 165W power supply

XT/10 Drives	Video Options			
	Mono	CGA	EGA	VGA
Single	650	775	1045	1115
Dual	675	855	1125	1195
20MB	975	1150	1425	1495
40MB	1125	1305	1575	1645

### S Systems 286/12

- Intel 80286-12 CPU
- Ami or Phoenix BIOS
- 1MB RAM on board
- TEAC 1.44 3.5" floppy drive
- Hard/floppy drive controller
- Enhanced 101 key keyboard
- Baby AT style case
- 200W power supply
- Multi I/O card w/1P, 2S ports

AT 286-12 Drives	Video options		
	Mono	EGA	VGA
Single	855	1305	1375
20MB	1190	1640	1715
40MB	1345	1795	1865

### S Systems 386-20

- Intel 80386-20 CPU
- Ami BIOS
- 1MB on board
- TEAC 1.44 & 1.2MB floppy drives
- Hard/floppy controller (1:1)
- Enhanced 101 key keyboard
- AT full style case
- 220W power supply
- 1P, 2S ports

AT 386-20 Drives	Video options		
	Mono	EGA	VGA
	1795	2225	2305
20MB	2028	2475	2545
40MB	2325	2625	2700
80MB	2450	2885	2965

### Monochrome Monitors

Amdek V210A	\$85
Amdek V410A	150
NEC Multisync GS	220
Samsung mono-12 flat	105
Samsung mono 14	105

### Color/EGA Monitors

Amdek C732	\$445
Amdek C722	515
AST EGA	515
Mitsubishi 1410C	345
Mitsubishi 1430C	405
Samsung EGA 14	375

### VGA/CAD Monitors

Mitsubishi 1381A	\$515
NEC Multisync 11A	505
NEC Multisync 3D	675
NEC Multisync plus	915
NEC Macsync	600
Sony 1302P	Call

### Printers

NEC P2200	\$330
NEC P5200	525
NEC P5300	695
Okidata 320P	375
Okidata 321P	520
Okidata 390	520
Okidata 391	705
Okidata 393	1105
Okidata 393C	1185
Toshiba 301	315
Toshiba 311	380
Toshiba 341SL	650
Toshiba 351SX	985

### Laser Printers

NEC LC 890	\$3405
Toshiba Pagelaser	2785
HP Laserjet 11/11D	Call

### Plotters

HI DMP52	\$2495
HI DMP52MP	2945
HI DMP61	3245
HI DMP62	4000

### Video Boards

Hercules Colorcard	\$155
Hercules Incolorcard	210
Hercules VGA	189
Paradise EGA-350	195
Paradise EGA-480	210
Paradise VGA-Plus	280
Paradise VGA-Plus-16	320
Paradise VGA-Prof	470
Quadram Quadega	250
Video 7 Vega Deluxe	225
Video 7 Vega VGA	300
Video 7 Fastwrite VGA	380
Video VRAM-VGA	475

### Multifunction/Memory Boards

AST Rampage 2-256	\$290
AST Rampage-286	Call
AST Rampage Plus-286	420
Intel Above 286-Plus	435
Intel Above PS286 Plus	485

### Accelerator Boards

Intel Inboard 386-PC	650
Intel Inboard 386	900

### Floppy Drives

Toshiba 360K	\$70
Toshiba 1.2MB	85
Toshiba 720K	75
Toshiba 1.44MB	90
TEAC 360K	75
TEAC 1.2MB	90
TEAC 720K	80
TEAC 1.44MB	90

### Hard Drives

Seagate 20MB	\$225
Seagate 40MB	410
Seagate 80MB	600
Plus Hardcard-20	535
Plus Hardcard-40	670
Plus Passport-20	415
Plus Passport-40	560

### Tape Drives

Archive 5240	\$325
Archive 5540	345
Archive VP601	675
Mountain 4340	400

### Math Co-processors

Intel 80287-8	\$225
Intel 80287-10	260
Intel 80387-16	415
Intel 80387-20	470
Intel 80387-25	590
Intel 80387SX	375
Intel 80c287	315

### Software

Aldus Pagemaker	\$455
dBASEIV	450
Lotus 1-2-3 v. 3	310
Lotus Symphony	415
Microsoft Windows 286	70
Microsoft Windows 386	130
Microsoft Excell	285
Microsoft Word	215
Microsoft Works	105
Paradox 3.0	415
PFS First Publisher	70
Ventura Publisher	485
Word Perfect 5.0	220
Symantec Q&A 3.0	215

### Mice

Logitech Serial Mouse	Call
Logitech Bus Mouse	Call
Microsoft Mice	Call

### Modems

US Robotics 1200	Call
US Robotics 2400	Call
Okitel 1200B int	125
Okitel 2400B int	200
Okitel 2400B Plus int	285

### Laptop Computers

Toshiba 1600-20	\$3375
Toshiba 1600-40	3775
Toshiba 3100E	2800
Toshiba 3200	3500
Toshiba 5100-40	4275
Toshiba 5100-100	4925
Toshiba 5200-40	5185
Toshiba 5200-100	5475
Zenith Supersport 286	Call

### Scanners

HP Scanjet	Call
Logitech Scan Man	225
Niscan OCR	395

### Surge Protectors

Curtis Diamond	Call
Curtis Emerald	Call
Curtis Ruby	Call
Kensington Masterpiece	100

### Fax Machines

Sharp FO-220	\$750
Sharp FO-300	1025
Sharp FO-330	1075
Murata 1200	650
Murata 1600	875

To order call 1-800-837-3573; Fax # 708-495-2629

- Lease Available
- Certified & Cashiers Check
- Wire-Transfer, Money Orders
- Personal & Co. checks allow 10 days to clear.
- No returns without RMA#
- 30 Day Return Policy
- No returns on Software
- Prices subject to change without notice.

**ELS ENTERPRISES, LTD.**  
15 E. Madison, Lombard, IL 60148

Hours: Monday-Friday, 8am-6pm CST  
Saturday 10am-4pm



# LAN Aid: Mac Booster Modules



DaynaTALK and FlashBox connection modules provide fast pickup for sluggish LocalTalk networks

Tom Thompson

**C**an you improve the performance of your sprawling Macintosh network without scrapping the whole thing and starting from scratch? Dayna Communications and Sun Microsystems' TOPS Division say yes. Both offer products with modified network drivers and enhanced connection modules that will boost the data transfer rate of existing LocalTalk networks. Dayna claims that DaynaTALK can increase transfer rates to a maximum of 850 kilobits per second, while TOPS says that its FlashBox kit will provide a maximum transfer rate of 768 kbps.

By themselves, DaynaTALK and FlashBox don't give a Mac any extra networking capabilities, such as transferring files. Each Mac and file server must be equipped with either the Dayna or TOPS product to be able to operate at the higher transfer rate. But both products work with Apple's networking software, AppleShare 2.01, and install easily on Macs acting as AppleShare file servers. The faster DaynaTALK and FlashBox modules can coexist with devices running at the slower, standard LocalTalk transfer rate, such as Macs without enhanced connectors, laser printers, and certain network bridges.

Although similar in design and identi-



*DaynaTALK (left) and FlashBox promise to triple network performance.*

cal in price (\$189), the products showed subtle differences in our tests. With its collision filters, DaynaTALK seems targeted for networks with a centralized server. FlashBox, with its TOPS/Macintosh networking software, is more suitable for distributed networks without servers.

## Common Roots

These two products are similar solutions for the same problem. To Apple's credit, each Macintosh system includes basic AppleTalk networking protocols and drivers. LocalTalk, Apple's low-cost connector module and cabling option, lets you link Macs and laser printers together with transfer rates of 230.4 kbps. Add networking software (e.g., AppleShare), and you can establish a dedicated Mac as a file server.

Because LocalTalk lets Mac users into the networking game cheaply and easily, chaos often results. Soon, the network becomes a maze of cables strung from cubicle to cubicle, and perhaps through the ceiling. Some users begin launching applications stored on the file server.

Others regularly transfer huge files back and forth. One department attaches a color PostScript printer to the network. Soon all that activity slows down the network, and 230 kbps doesn't seem like such a fast transfer rate after all. If you're delegated to beef up that rate, you'll face a big headache: new and costly upgrade hardware, and worse, the prospect of ripping out the existing network wiring to add new cables.

Enter the Dayna and TOPS enhanced connection modules. To install either one, you turn off the Mac and attach the existing network connection module to the enhanced module, which in turn attaches to the Mac. Next, you restart the Mac, run the installation software to install the new network driver, and make any adjustments (e.g., you can set the DaynaTALK driver for transfer rates from 600 kbps to 850 kbps). You then reboot.

Both of these kits contain test applications that "exercise" the network connection by sending and receiving test packets between two nodes. The standard

*continued*

### DaynaTALK

#### Company

Dayna Communications, Inc.  
50 South Main St., Fifth Floor  
Salt Lake City, UT 84144  
(801) 531-0600

#### Features

Boosts LocalTalk data transmission to a range of rates from 600 kbps to 850 kbps; SpeedGuard timing and filters for avoiding data collisions during high-speed transmissions

#### Hardware Needed

Mac Plus, SE, or II; LocalTalk or PhoneNet-type connection module attached to a network

#### Software Needed

System 6.0.2/Finder 6.1 or higher

#### Documentation

User's guide

#### Price

\$189 per kit (each kit contains one enhanced module, software, and manual) SpeedGuard Collision Filter: \$69.95

#### Inquiry 854.

DaynaTALK or FlashBox software replaces AppleTalk's Link Access Protocol (ALAP). Network operations, such as calling a file from the server, don't change; they just proceed at the higher transfer rate.

#### Talking DaynaTALK

Roughly the size of a cigarette package, the DaynaTALK connection module has a mini-DIN-8 cable at one end that attaches to the Mac's printer port. A female mini-DIN-8 socket at the other end accepts the cable from a network connection module.

The software disk contains the ubiquitous read-me-first file, the DaynaTALK driver, and a network diagnostic application. Several Apple files also reside on the disk: the Network cdev (used to select the network driver via the Control Panel desk accessory), the Responder INIT (which responds to packets sent by the diagnostic network software), the Installer application, and Apple System software version 6.0.3.

Installation is a breeze because you simply boot the Mac with the disk and run the Installer. Once the Installer is launched, you just click on a mouse button to add or remove the DaynaTALK software.

To alter the Mac's network transfer rate, you just click on the DaynaTALK

### TOPS FlashBox

#### Company

Sun Microsystems  
TOPS Division  
950 Marina Village Pkwy.  
Alameda, CA 94501  
(800) 445-8677

#### Features

Enhanced LocalTalk data transfer rates of 768 kbps; LED indicator that shows when data is being transmitted; accommodates FlashBox-compatible Macs and PCs in the network

#### Hardware Needed

Mac Plus, SE, or II; LocalTalk or PhoneNet-type connection module attached to a network

#### Software Needed

System 4.1/Finder 5.5 or higher

#### Documentation

Installation guide

#### Price

\$189 per kit (each kit contains one enhanced module, software, and manual)

#### Inquiry 855.

"sneaker" icon inside the Network cdev's display. A dialog box with several buttons appears. When you click on a Configure button, a new dialog box offers you a range of transfer rates: 850, 768, 740, and 600 kbps. The rate you select depends on the system you're using. The entire Mac II family, the Mac SE/30, and some Mac SEs can operate at 850 kbps. Mac SEs made prior to mid-1988 can manage only 740 kbps. The 600-kbps setting accommodates marginal networks where low-quality cabling or widespread nodes degrade the signals.

The user's manual thoroughly explains DaynaTALK, the test applications, troubleshooting, and how to avoid network collisions (see the text box "DaynaTALK Option: Collision Control" on page 223). The manual's step-by-step procedure might be overdone for experts, but it serves novices well.

#### FlashBox Speed

The TOPS FlashBox connector module is slightly larger than the DaynaTALK unit. FlashBox requires external power to operate its electronics, so, unlike with DaynaTALK, every FlashBox user needs to have an extra power outlet. But FlashBox offers something that DaynaTALK doesn't: an LED indicator that shows when it's transmitting. This is a welcome feature when you find yourself puzzling

over whether the Mac is talking to the network or not.

A female DIN-8 port for the network connection sits at one end of the module; at the other end is a six-pin female socket that accepts an adapter cable for the Mac's printer port. Adapter cables have the male DIN-8 connector; cables with a male DB-9 connector for use with the Mac 512KE are planned. While this adds a measure of flexibility to the design, it can also cause trouble. If you're not careful, you might plug the network's connection-module cable into this six-pin socket, damaging the FlashBox.

The software disk contains several versions of the network driver, an installer application, a network diagnostic application, an INIT, and a file with various installation resources. It also includes Apple's Network cdev and an AppleTalk file that provides a new version of the AppleTalk driver for a Mac Plus.

The disk is not bootable, but the custom installer application manages nicely as is. I recommend that you make a boot floppy instead (there's room on the disk for a stripped-down system) to minimize the risks of modifying a live System file. A click on the appropriate mouse button installs or removes FlashBox software. The package doesn't offer configuration options for network speeds, and it only allows transfer rates of 768 kbps or 230 kbps. Also, no collision filters are available. However, the DaynaTALK's optional Collision Filter is compatible with the FlashBox.

The FlashBox manual, like DaynaTALK's, offers detailed installation instructions for novices and a quick start-up guide for experts, and it has a section on diagnostic testing and topology mistakes. The manual is terse in some areas, but it doesn't scrimp on troubleshooting hints—a plus for any network manager.

#### Acid Test

We measured relative data transfer rates of the modules in real-world tests with BYTE's LAN. We also copied files between two Macs in isolation (to eliminate network traffic) and over an "ideal conduit" (a network link consisting of a short length of phone wire between two PhoneNet connection modules).

To minimize the effects of machine performance on the transfers, we used a Mac IIcx equipped with an 80-megabyte internal hard disk drive and a Mac II with a 40-megabyte internal hard disk drive. Both disks were empty except for the system and benchmark files necessary to conduct the tests. We used 6.0.3 System

*continued*



# Our MAJOR ADVANTAGE-Supplying you with the Broadest Range of Software Ammunition.



## ADVANTAGE SOFTWARE

LIST OURS

### APPLICATION SOFTWARE

#### COMMUNICATIONS

Carbon Copy plus	195	115
Close-Up		
Customer	195	135
Support	245	165
Co/Session	249	182
Crosstalk XVI	195	99
Mirror III	100	67
PC Anywhere III	145	79
Procomm Plus	75	49

#### DATABASE

Clarion	695	409
Clipper	695	439
dBASE IV	795	489
dBXL	249	145
FoxBASE+	395	199
FoxBASE+/MAC	395	199
Paradox 3.0	725	479
PFS:Professional File	299	189
Q&A	349	229
R&R	149	109
R:Base for DOS	725	489

#### DESKTOP PUBLISHING

Adobe Illustrator '88	695	409
Adobe Illustrator '88 (MAC)	495	300
Corel Draw!	CALL	CALL
Draw Applause	495	315
First Publisher	99	79
First Publisher Art Gallery	129	82
GEM Artline	495	285
GEM Desktop Publisher	299	183
PageMaker	795	489
PageMaker (MAC)	595	299
Ready, Set, Go (MAC)	495	320
Springboard Publisher	139	80
Ventura Publisher	895	539

#### GRAPHICS

Chart-Master	375	239
Freelance Plus	495	CALL
GEM Graph Present. Team	495	305
Graph Plus	495	329
GraphWriter II	495	CALL
Graph-in-the-Box	140	75
Harvard Graphics	495	289
Micrografx Designer	695	459
Microsoft Chart	395	270
Perspective Junior	149	109
Pinsripe Presenter	200	CALL
PIXIE	295	177
Powerpoint (MAC)	395	265
Xerox Presents	495	319

#### INFORMATION ORGANIZERS

Agenda	395	CALL
askSam	295	179
GOfer	80	45
GrandView	295	189
Memory Mate	70	43
SideKick Plus	200	135
Tornado	100	55
Who-What-When	190	119
Zyindex Professional	295	159

#### PROJECT MANAGEMENT

Harvard Project Manager	695	439
InstaPlan 2.0	99	95
Microsoft Project	495	329
SuperProject Plus	395	255
Time Line v. 3.0	595	359
Time Line Graphics	195	135

#### SPREADSHEETS

Legend Twin Level III	249	195
Lotus 1-2-3	CALL	CALL
Lucid 3-D	149	CALL
Microsoft Excel	495	239
Microsoft Excel (MAC)	395	270
Microsoft Multiplan 4.0	195	125
Microsoft Multiplan (MAC)	195	125
PFS:Professional Plan	99	CALL
PlanPerfect	395	199
Quattro	248	165
SuperCalc5	495	319
Symphony	695	CALL
Wingz (MAC)	495	299

#### Terms & Policies

All prices subject to change without notice. We accept Visa, MC, AMEX (2% surcharge on AMEX). Shipping \$4 per item sent UPS Ground. Allow 14 days for personal/company check clearance. Returns subject to 15% restocking fee. RA # required. PO's welcome from Fortune 1000 and other qualified organizations.



## ADVANTAGE SOFTWARE

A Division of Voyager Software Corp

Circle 16 on Reader Service Card  
World Radio History

LIST OURS

### SCIENCE/ENGINEERING

#### CAD

AutoCAD Release 10	3000	CALL
AutoShade	500	389
AutoSketch	150	95
DesignCAD	CALL	CALL
DesignCAD 3-D	399	209
Dratix CAD Ultra	395	259
Generic CADD Level 3	300	179
Generic 3-D Solids Modeling	349	195

#### PCB ARTWORK/SCHEMATICS

HiWIRE Plus	895	805
Micro-CAP III	1495	1269
Schema II	495	450
smARTWORK	895	805
Tango-CAD Pack	995	949
Tango-PCB Series II	595	559

#### DATA ACQUISITION/ANALYSIS

Asystant Plus	995	849
DADISP	795	719
LABTECH Notebook	995	799

#### MATHEMATICAL TOOLBOXES

Derive	200	166
Eureka: The Solver	167	115
Eureka: The Solver (MAC)	195	134
Gauss Math & Stat System	395	350
Mathematica 386	695	CALL
AT 386/7	995	CALL
Mathematica (MAC)	795	CALL
PC MathCAD 2.5	495	315
Appl. Packs (for MathCAD)	99	89
PC-Matlab	695	559
Control System Toolbox	495	399
System ID Box	495	399
TK! Solver Plus	395	319

#### PLOTTING AND GRAPHING

Grapher	199	149
Grapher/Surfer Bundle	600	499
Surfer	499	379
TECH*GRAPH*PAD	395	319
Temple Graph	299	259

LIST OURS

#### SPREADSHEET UTILITIES

3-D Graphics	145	129
4Views	150	119
4Word	100	61
@BASE	195	119
@ Liberty	295	199
Allways	150	85
Baler	495	449
Graph-in-the-Box	140	75
Hal	150	CALL
Impress	140	CALL
Inword	100	59
Look & Link	100	60
Note-It Plus	80	55
Noteworthy	80	49
PanaView	145	129
See More	80	49
Sideways	70	43
SmartNotes	80	48
Spellin!	80	49
SQZ Plus	100	63

#### WORD PROCESSING

Ami	199	129
DisplayWrite 4	495	342
Grammatik III	99	52
Manuscript	495	CALL
MaxThink 89	89	71
Microsoft Word	450	249
Microsoft Word (MAC)	395	249
MultiMate Advantage II	695	299
Office Writer 6.0	495	302
PFS:Professional Write	199	129
Q & A Write	199	135
RightWriter	95	52
Samna Word IV	595	316
Sprint	200	139
WordPerfect 5.0	495	239
WordPerfect (MAC)	395	231
WordPerfect Library	129	69
WordStar 2000+ Personal	495	302
WordStar Professional Rel 5	495	239
XyWrite III Plus	445	256

#### LANGUAGES

Lahey F77L	595	535
Micro Focus COBOL	CALL	CALL
Microsoft C	450	299
MS FORTRAN	450	299
MS Macro Assembler	150	99
MS QuickPASCAL	99	69
Smalltalk/V 286	200	149
Turbo C 2.0	150	99
Turbo C 2.0 Professional	250	169
Turbo Pascal 5.0	150	99
Turbo Pascal 5.0 Professional	250	169

LIST OURS

#### OPERATING SYSTEMS/CONTROL PROGRAMS

Concurrent DOS 386 2.0	395	235
DESQview 386 (w/QEMM)	190	115
Interactive 386/IX	1095	989
QEMM 386	60	39
MS Windows/386	195	125
PC-MOS 386 (single user)	195	179
PC-MOS 386 (five users)	595	539
SCO 386 UNIX Sys V (comp)	1495	1195
SCO UNIX Sys V (comp)	1295	999
VM/386	245	199
VM/386 Multi-User	895	759
VM/386 NetPak	150	129

### Harvard Graphics Draw Partner Accessory

Harvard Graphics has been selected as the company standard by more corporations than any other PC-based business graphics package. Ease-of-use and powerful features make Harvard Graphics the manager's preferred solution for business presentation needs.

Now Software Publishing Corporation takes power one step further with the addition of **Harvard Graphics Draw Partner** to the accessories team. Draw Partner offers you advanced drawing tools such as Zoom, Rotate, Flip, and Align to help you spice up your Harvard Graphics business presentations.

List: CALL Ours: CALL

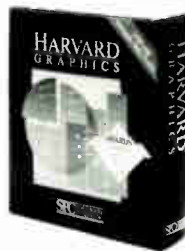

\* **FREE Draw Partner Accessory when you buy Harvard Graphics!!**

\* Applicable to purchases made after 9/18/89 only.

#### UTILITIES

Brooklyn Bridge	140	85
Copy II PC	40	25
Disk Technician Advanced	190	119
FASTBACK Plus	189	109
Laplank 3	140	85
MACE GOLD	150	88
Magellan	195	CALL
MKS Toolkit	249	209
Norton Commander	89	52
Norton Utilities	100	59
Norton Utilities Advanced	150	89
PC Tools Deluxe	129	80
Software Carousel	80	49
Spinrite	59	49
V feature Deluxe	120	95
XTree	70	39
XTreePro	129	79

#### SCIENTIFIC TEXT PROCESSING

ChiWriter	150	129
EXP	150	129
PC TEX	249	226
T <sup>3</sup>	595	479

#### STATISTICS

CSS	495	469
Microstat II	395	336
NWA StatPak	495	366
P-Stat	695	639
SPSS/PC+	795	727
StatGraphics	895	599
StatPac Gold	595	549
Statview II (MAC)	495	345
SYSTAT	595	449
SYSTAT (MAC)	595	449
SYSTAT (w/ SYGRAPH)	795	595

In the U.S. call:

**1-800-333-3141**

International: 201-389-8950

Fax: 201-389-9227

1163 Shrewsbury Ave., Shrewsbury, NJ 07702

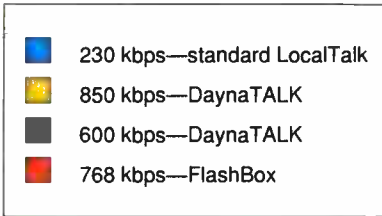

**Figure 1:** Note that in the file transfer tests, subsequent file copies took less time to complete than the initial one. Subsequent copies benefited because the file structure was already built. FlashBox is, at worst, only 12 percent slower than DaynaTALK in these tests.

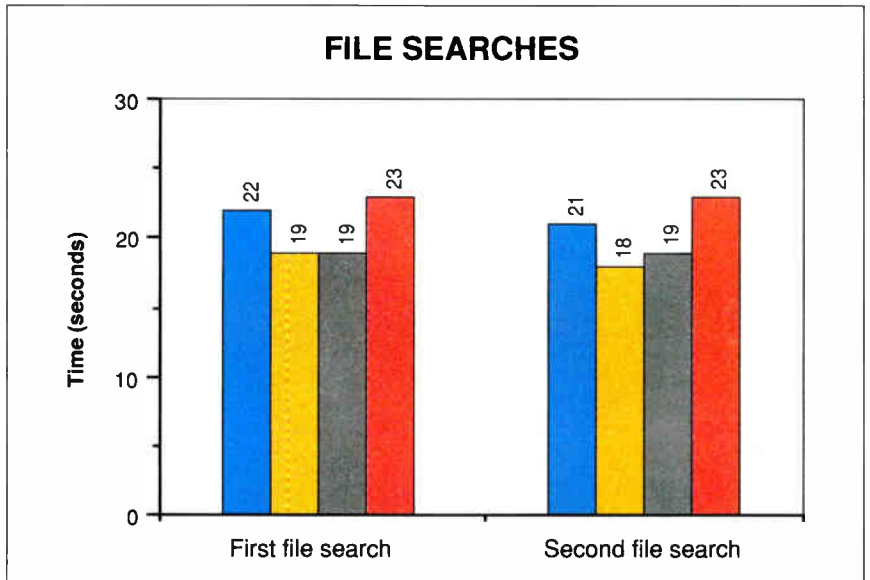
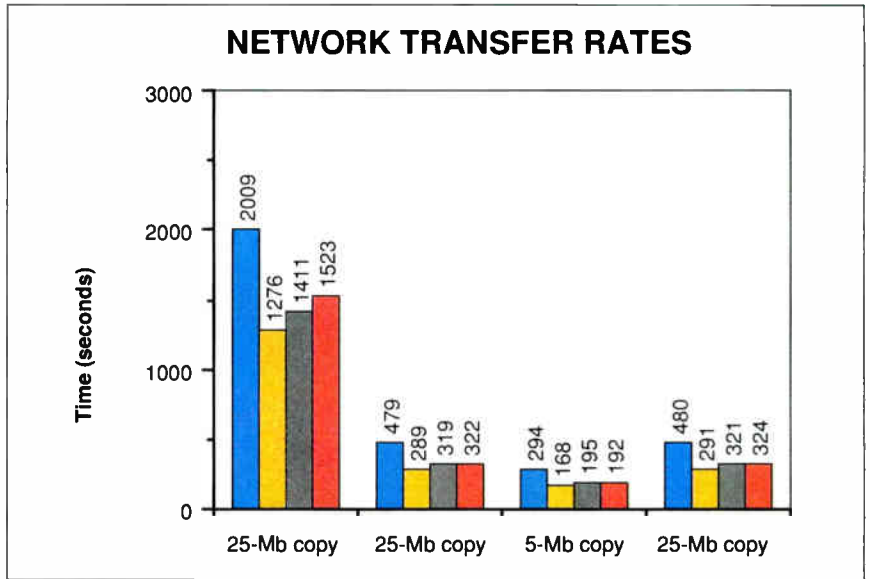

**Figure 2:** In searches for a file among lots of files, FlashTalk was slower than even standard LocalTalk.

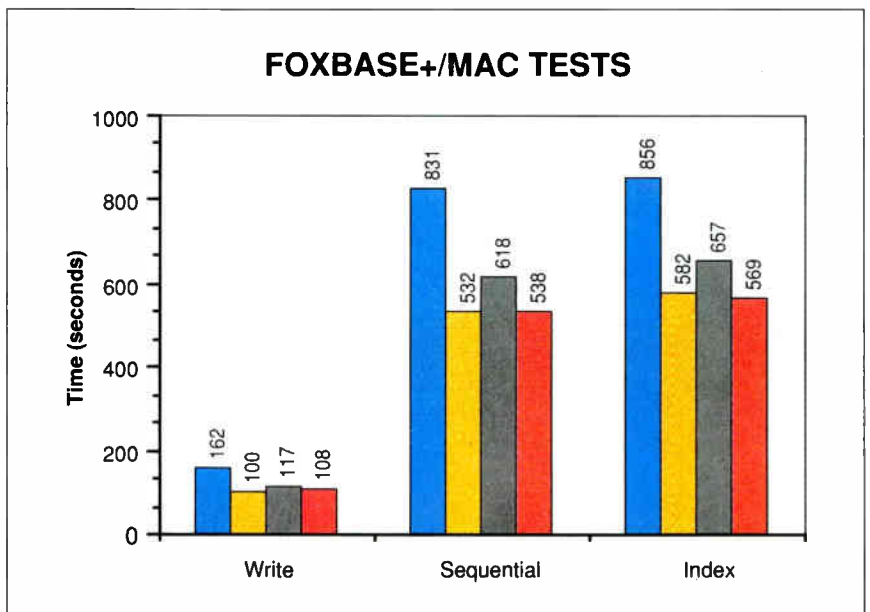

**Figure 3:** In database tests, FlashTalk operating at 768 kilobits per second performed nearly as well as, or equal to, DaynaTALK operating at its maximum rate of 850 kbps.



## DaynaTALK Option: Collision Control

**D**aynaTALK's first line of collision defense in high-speed networks is SpeedGuard timing, a standard feature in DaynaTALK software.

Collisions occur in LocalTalk networks because only one node can transmit at a time. Slower nodes (operating at 230 kilobits per second) sometimes don't recognize high-speed transmissions in progress. A slower node may inadvertently broadcast on the network, "stomping" on a high-speed transmission and causing a *collision*. If slower nodes cause frequent collisions, network throughput degrades because high-speed nodes spend too much time retransmitting information.

SpeedGuard timing simply places an irregular clock signal on the network (this signal is created by stopping the clock signal's transmission for 10-microsecond intervals). The irregular clock generates an error condition in the Mac's network communications hardware, the serial communications chip. Certain implementations of AppleTalk read this error as a sign that the network is busy. In this way, DaynaTALK's timing scheme tricks slower devices into thinking that the network is in use and thus prevents collisions.

However, Mac IIs, Mac SE/30s, the LaserWriter Plus, and LaserWriter IINT and IINTX printers use a new ver-

sion of AppleTalk that doesn't treat this error as a busy condition. Dayna's response to this is the SpeedGuard Collision Filter. This \$69.95 option acts like a standard LocalTalk connection module with additional electronics to detect the high-speed signals. It resembles the DaynaTALK connection module, but instead has a DB-9 cable connector (a DB-9-to-DIN-8 adapter cable is included) and uses a small external power supply that's similar to a calculator-battery charger. When the SpeedGuard Collision Filter detects a high-speed transmission, it generates signals that the Macs and the printers see as a network busy condition.

software running under the Finder with no special INITs installed.

Benchmarks consisted of abbreviated tests used to evaluate SCSI WORM (write once, read many times) drives (see "The Optical Option," October BYTE). The first set of tests (see figures 1 and 2) used an automated MPW script to copy many large files from one system to another and search for individual files. The second set of tests (see figure 3) used FoxBASE+/Mac 1.0 to perform database searches on a single file. DaynaTALK ran AppleShare 2.01 with the Mac IIcx acting as the file server, while FlashBox used TOPS/Macintosh 2.1 to publish the Mac IIcx's hard disk.

When you examine the results shown in the figures, remember that DaynaTALK was running under AppleShare, whereas FlashBox ran with TOPS/Macintosh. Although FlashBox can work with AppleShare, the intent here was to show how well FlashBox fared when using its own networking software. Notice also that even though data can move through LocalTalk several times faster, file transfers aren't greatly accelerated. They're stalled by the network overhead of links and protocols that ensure an error-free data transfer.

The DaynaTALK finished first on throughput, but even at its peak transfer rate of 850 kbps, the tests ran only 32 percent to 43 percent faster than standard LocalTalk speeds. TOPS FlashBox was, at worst, only 12 percent slower than DaynaTALK at its maximum on the file copy tests. On the FoxBASE database tests, TOPS performed about as well as DaynaTALK on the write and sequential

operations, and was even a fraction faster than DaynaTALK on the index test.

While these increases don't seem like a big improvement, there is another factor to consider: network traffic. Since only one node can use LocalTalk at a time, many operations stall while waiting for network access on a high-traffic network. If every node can finish its job faster, more networking jobs get done in the same amount of time, which adds up to better use of the network. Since network traffic varies from network to network, it's something we couldn't measure and doesn't show up in the figures.

In real-world tests with BYTE's network, the enhanced modules helped us run applications off the file server faster. At DaynaTALK's maximum speed, we'd occasionally experience delays on file transfers, probably due to the quality of our network cabling (standard phone wire arranged in a Gordian Knot topology). The problem went away when we switched to FlashBox's speed. We also used DaynaTALK, its collision filters, and TOPS FlashBox on the same network without trouble.

### Tough Choices

Both DaynaTALK and FlashBox provide higher network transfer rates. While DaynaTALK offers the faster rate, you can't take advantage of it unless your network is in good shape. DaynaTALK overcomes this with a choice of several lower transfer rates to deal with marginal networks. Dayna's efforts to minimize network collisions and offer compatibility with FlashBox are commendable.

TOPS FlashBox comes close to match-

ing DaynaTALK's maximum transfer rate, and, on slightly marginal cabling, DaynaTALK's edge can disappear. The FlashBox software seems better crafted than DaynaTALK's.

Although DaynaTALK connection modules don't require a power supply, be aware that the design isn't compliant with Apple's use of the printer port, while the FlashBox connection modules are compatible. This will become a design issue for you if your network is strapped for power outlets.

Neither kit provides networking software to handle file transfers. DaynaTALK requires a file server and additional software to accomplish this. TOPS offers its TOPS/Macintosh software, which provides this capability without the need for a server. While TOPS/Macintosh isn't cheap, for small networks it's far less than the price of a PC server.

If I had my choice, I would combine Dayna's multispeed network driver and collision filters with the TOPS network diagnostic software and TOPS/Macintosh software to manage file transfers.

Both DaynaTALK and FlashBox are designed to boost an existing network's performance, but they won't solve all your networking problems. They both deliver higher network throughput, although the boost is relatively small for the price. Nevertheless, each is worth considering if data transmission on your LocalTalk network is becoming a waiting game. ■

*Tom Thompson is a BYTE senior technical editor at large. He can be reached on BIX as "tom\_thompson."*

# Whose ad is this, anyway?

That's a very good question.

Because, instead of being an ad for the 20 very different companies you see here, it's actually an ad for the one industry standard that makes them very much alike.

The PostScript® language from Adobe Systems.

Choose a printer or typesetter from one of these companies and you can make the choice for PostScript. Because each of these manufacturers have licensed Adobe's page description language.

Why did they do it?

For one thing, PostScript delivers the ultimate in output quality and capability. Whether you're printing simple text for everyday correspon-

dence or complex graphics for electronic publishing, PostScript makes it easy.



PostScript also gives you absolute freedom to select the best hardware and more than 4,000 software programs for your needs and budget. That's called compatibility and Adobe PostScript guarantees it.

So even though different PostScript printers and typesetters offer different resolutions, paper handling options and output speeds, you can be sure they all speak the same language.

The language of PostScript.

If you still have questions, call 1-800-952-6300 (Dept. #111) for all

the answers, along with a free copy of the PostScript Product Catalog.

You'll be glad you asked.



This ad is presented by Adobe Systems Incorporated, which encourages you to look for the PostScript symbol on computers, printers and other products that include PostScript software from Adobe Systems; it's your guarantee of quality and compatibility. Adobe, PostScript and the PostScript logo are registered trademarks of Adobe Systems Incorporated in the U.S.A. The logos of the original equipment manufacturers supporting PostScript are the trademarks or registered trademarks of their respective companies. ©1989 Adobe Systems Incorporated. All rights reserved.





# DAT Drive Eases Mac Backups

The pioneering Gigapack-Mac lets moneyed Mac users effortlessly store gigabytes of data

Don Crabb

I've had nothing but problems with every DC-2000 tape I've ever made, and I'm tired of it. My headaches range from hard-read errors and unintentional overwrites, to tapes being just too small to back up an entire disk. If this sounds familiar, then the Gigapack-Mac DATA/DAT drive may be a welcome, if expensive, solution for your nasty back-up problems.

The Gigapack-Mac stores data as bit streams on digital audio tape (DAT), an interesting technology that so far has not set the world on fire (see the text box "Defining DAT: Formats and Standards Lack Consensus" on page 230). First developed for high-quality audio recordings, DAT's role in computer data storage is still evolving.

DAT drives approximate a read/write tape equivalent of CD-ROMs. One of DAT's biggest advantages is the tremendous amount of information (roughly 1.2 gigabytes) that can reside in a single 2-by-3-inch cassette.

The Gigapack-Mac, by GigaTrend, is one of the first commercial DAT drives to ship, although a host of others is expected to be released this fall. The Gigapack-Mac serves Macintosh II, Plus, and SE users. GigaTrend imports DAT drive mechanisms from its West German parent, GigaTape GmbH.



Storing 1.2 gigabytes costs \$6000 with the Gigapack-Mac and a 120-minute cassette.

The Gigapack-Mac consists of the drive, custom electronics, and two SCSI ports. Four touch-sensitive front-panel switches help users load and unload tapes, test the unit, and set up the SCSI ID (the drive comes preset to SCSI 4). A four-digit LCD status panel and two LEDs monitor on-line status and errors. A separate LED indicates power-on and is placed next to the tape-loading slot. Tape loading and unloading are power-assisted, much like a front-loading VCR.

My review unit arrived with a DB-25-to-DB-50 SCSI cable, a SCSI terminator, a power cord, a software disk, and two BASF DAT 120 cassettes that were certified by GigaTrend for data service. Completing the expensive (\$5950) package was a thin and completely inadequate manual. It does only the weakest job of explaining how to use the hardware and software. A \$6000 hunk of hardware deserves better.

## A Drive Test-Drive

I connected the drive to three different systems: an 8-megabyte color Mac II with an internal Apple HD40SC hard disk drive, a 1-megabyte Mac SE with an internal Apple HD20SC hard disk drive, and an 8-megabyte color Mac II with an internal Apple HD40SC hard disk drive and an external Jasmine DirectDrive 140 hard disk drive. In all three cases, the Gigapack-Mac was the only additional SCSI device connected. Besides everyday use, I tested the Gigapack-Mac using timed backup and restore tasks.

GigaTrend claims backup speeds of 10 megabytes per minute. At no time during any of my testing did my results come close to that (see table 1). Nevertheless, the Gigapack-Mac proved to be a reasonably fast tape drive, averaging a transfer rate of better than 1 megabyte per minute in most situations. Many DC-2000 and

*continued*

**Gigapack-Mac**

**Company**

GigaTrend, Inc.  
2234 Rutherford Rd.  
Carlsbad, CA 92008  
(619) 931-9122

**Features**

1.2-gigabyte storage capacity per 4-mm DAT 120 cassette; DATA/DAT logical tape format with save, restore, and random access; SCSI, Pertec, and QIC-02 computer interfaces; 0.32-inch-per-second tape speed; search time of 20 seconds (average)

**Size**

9½ × 4½ × 9¾ inches; 12½ pounds

**Hardware Needed**

Macintosh Plus, SE, SE/30, II, IIx, or IIcx

**Documentation**

Hardware and software manuals

**Price**

\$5950 (quantity discounts available)  
10-pack of data-certified DAT cassettes:  
\$260

**Inquiry 853.**

DC-600 tape backup units that I've used fall considerably below this rate.

For example, the Jasmine DirectTape DC-2000 tape drive holds 38.5 megabytes on a single DC-2000 tape. Its average transfer rate runs slightly under 1 megabyte per minute on both file-by-file and image backups. (The Gigapack-Mac doesn't provide for image backups.)

The Jasmine's burst transfer rate is about 1.5 megabytes per minute. My tests placed the DAT drive's burst transfer at about 4 megabytes per minute. Overall, the Gigapack-Mac performed at least as fast as the DC-2000 drive, and sometimes twice as fast or more. (DAT has the added advantage of holding, in one cassette, enough data to fill 31 DC-2000 tapes.)

I've also had some recent experience with the Canon read/write optical disk drive in the NeXT cube. Canon claims an average access of 85 milliseconds, but I've found it to be much slower. On average, my transfer rates ranged from 5 to 9 megabytes per minute for large-scale (more than 100 megabytes) file-by-file copies from the NeXT's built-in 660-megabyte hard disk drive to the optical

disk drive, which makes it faster than the Gigapack-Mac.

**Snappy Tape Shuttles**

Overall, the Gigapack-Mac performed solidly. Even though the DAT cassette is small, it quickly shuttles tape back and forth during a backup or restore operation, making the unit suitable for quick restores of single files.

During my testing, the time to access and restore a single file in a data set was about 30 seconds; it never took longer than 55 seconds or less than 15 seconds. The exact times depended on the position of the file in the data set.

The supplied backup-and-restore software admirably handled file-by-file operations. A filtering scheme for selecting a specific file, an updated file, or all files meant that I could easily back up only what I needed.

File restoration performed equally well. I could restore the entire data set or parts of it at will. I could even set the dialogue to automatically overwrite my restored files, never overwrite them, or let the software prompt me each time. In all

*continued*

**WT386-25B**

- TRUE 25MHz CPU & CHIP SET
- UP TO 8 MB ON BOARD
- BABY SIZE BOARD FIT MOST ANY CASE
- 80387 CO-PROCESSOR SOCKET
- AMI BIOS FOR FULL COMPATIBILITY
- 1 32-BIT 5 16-BIT & 2 8-BIT SLOT
- LANDMARK = 34.5

**\$ 725 qty.3**

**WEDGE-VGA**

- TRIDENT SUPER VGA CHIP 8/16-BIT AUTO SWITCH
- UP TO 1024x768 RESOLUTION
- 40,80,132 COLUMN SUPPORT
- ANALOG & DIGITAL OUTPUT
- UP TO 3 TIMES FASTER THEN PARADISE PLUS 16
- EXPANDABLE TO 512K
- REGISTER COMPATIBLE

**\$169 qty.3**

**WT286-24B**

- HARRIS 80C286 CPU
- UP TO 8MB ON BOARD
- C&T NEAT CHIP SET
- AMI BIOS FOR FULL COMPATIBILITY
- BABY SIZE FIT MOST ANY CASE
- SUPPORT LIM MEMORY
- LANDMARK = 32.6

**\$435 qty.3**

**COMIDEX SPECIAL BOOTH BALLY'S B421**

COME AND SEE THE NEW 80486 & 80386 CACHE

**WIT WEDGE SINCE 1981 TECHNOLOGY**

1587 McCandless Drive, Milpitas, CA. 95035

SALES: (408)283-9888, TECH: (408)283-0225, FAX: (408) 283-9888

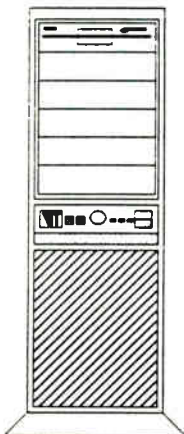



*The New 25 Mhz Executive 325ET combines all the latest technologies in the most advanced 386 computer available. And it's transportable.*

## MAINFRAME TO GO

### \$10 PER MEGABYTE OF DRAM

The 325ET has a hard drive access speed almost undetectably different from that of dynamic memory. For the first time, the large capacity of a hard drive is accessible at an access time of **one millisecond (1 ms)**. Why limit yourself to 2, 8 or 16 megabytes of fast memory and pay \$500 per megabyte, when you can have up to 160 megabytes at a cost as low as \$10 per megabyte?

### 50 TIMES FASTER

Instead of waiting for the 65 millisecond (ms) access time of an MFM drive, or even the 17 ms of an ESDI drive, you can have instantaneous access to your data. The 325ET is blindingly fast with an average disk access time of 1 ms. In addition, the system architecture allows data transfer speeds that match drive capabilities. (That's *really* fast!). In fact, the overall read/write performance of the 325ET is 50 times faster (5,000%) than the Compaq® 386. 25.

### 53,000 PORTABLE PAGES

The 325ET, when located along side of a monitor, takes little desk space. The compact design of the 325ET lets you carry it onto an airplane and easily stow it under your seat. Imagine bringing the equivalent of seven four-drawer filing cabinets worth of valuable information to your next meeting - accessible in just 1 ms.

The Executive 325ET is small enough and light enough to make it the most powerful transportable ever.



### 25 Mhz - 80386 1 ms HD ACCESS

### EXECUTIVE 325ET

#### Standard features:

- Intel 80386 processor running at 25 Mhz.
- 0 wait state operation.
- Enhanced intelligent controller for **1 ms hard disk access** time and a transfer rate of 4 MB per second.
- 2 MB of RAM expandable to 16 MB (8 MB on board).
- High performance 16-bit VGA video adaptor.
- 3.5" 1.44 MB diskette drive.
- Sockets for 20 Mhz Intel 80387 coprocessor and 10 Mhz Intel 80287 coprocessor.
- 6 industry standard expansion slots (ISA).

**\$3799** or just **\$114** per month

	Mono VGA	Color VGA
40 MB	<b>\$4295<sup>†</sup></b>	<b>\$4650<sup>†</sup></b>
80 MB	<b>\$4645<sup>†</sup></b>	<b>\$4995<sup>†</sup></b>
160 MB	<b>\$5695<sup>†</sup></b>	<b>\$5995<sup>†</sup></b>

<sup>†</sup> Includes system, monitor, Hard Disk and on-site warranty.

#### PRIORITY ONE COMPUTER SUPER STORE LOCATIONS

**California:** Bakersfield, Burbank, Fullerton, Irvine, San Jose, Sunnyvale, Westminster, Woodland Hills.  
**Kansas:** Lenexa, Wichita  
**Missouri:** St. Louis  
**Oklahoma:** Stillwater  
**Tennessee:** Memphis

### AND THERE'S MORE...

- 1. Toll-Free Technical Support**  
Our friendly and knowledgeable factory trained engineers are just a phone call away. And we can solve most problems right over the phone.
- 2. Free on-site service**  
The 325ET comes with a full year warranty. Supported by Universal Protection Plan with a network of hundreds of service engineers, instant help is just a phone call away. Service is also available at any of our Super Stores, or at any of the hundreds of UPP service centers.
- 3. Trade up and save more**  
Now you can put that older and slower IBM®, Compaq®, or Apple® to better use. Your old system may be worth a thousand dollars or more. Our new Trade-Up program allows you to move up to the latest technology for less. Call one of our systems consultants for complete details.
- 4. 30 day money back guarantee**  
Your total satisfaction is our goal. If for any reason you are not completely satisfied with the 325ET you may return it within 30 days for a full refund.
- 5. Easy financing available**  
We offer both consumer credit for individual purchases, and leasing for business customers. Call us today and find out how easy it is to own the next generation of computers.

To Order or Inquire, Call:

**800-423-5922**

**PRIORITY 1 COMPUTERS**

©Copyright 1989 Priority One Computer Corporation. All rights reserved. Executive, 325ET, and the Priority One logo are registered trademarks. IBM is a registered trademark of The IBM Corporation. 386. 25 is a registered trademark of Compaq Computer Corporation. 386 is a registered trademark of Intel Corporation. Apple is a registered trademark of Apple Computer, Inc.

# A MESSAGE TO OUR SUBSCRIBERS

FROM TIME TO TIME we make the BYTE subscriber list available to other companies who wish to send our subscribers material about their products. We take great care to screen these companies, choosing only those who are reputable, and whose products, services, or information we feel would be of interest to you. Direct mail is an efficient medium for presenting the latest personal computer goods and services to our subscribers.

Many BYTE subscribers appreciate this controlled use of our mailing list, and look forward to finding information of interest to them in the mail. Used are our subscribers' names and addresses only (no other information we may have is ever given).

While we believe the distribution of this information is of benefit to our subscribers, we firmly respect the wishes of any subscriber who does not want to receive such promotional literature. Should you wish to restrict the use of your name, simply send your request to the following address.

## BYTE MAGAZINE

ATTN: SUBSCRIBER SERVICE  
P.O. Box 555  
HIGHTSTOWN, NJ 08520

cases, file restoration was a snap.

Unfortunately, version 1.06 lacks a mirror-image capability (although it is present in the menus as a dimmed item), so I couldn't do volume image backups. This is an important omission. Any medium that stores 1.2 gigabytes as quickly as the Gigapack-Mac needs an image backup mode. (GigaTrend says it intends to offer this capability in the future.)

Another drawback was my review unit's SuperLock copy-protected software. This annoying copy-protection scheme has since been removed from all copies of the Gigapack-Mac software.

### Torture Tests

GigaTrend claims that the cassettes provide stable, long-term storage of large

files, such as graphics images or font files. To test short-term stability, I carried a full cassette (containing 1.2 gigabytes of Mac files) in my soft-sided briefcase for about three weeks. The cassette received significant magnetic and environmental abuse (e.g., from airport metal detectors) and never failed.

I also shipped this same cassette from my office to my home and back again via overnight mail. I used the standard next-day-letter cardboard envelope, and I didn't pad the cassette in any special way. The cassette still worked fine after making the round trip from Chicago to the carrier's Memphis headquarters and back.

Finally, I placed the same full cassette

*continued*

**Table 1: In backup and restore tests using internal and external hard disk drives, the Gigapack-Mac provided average data transfer rates of better than 1 megabyte per minute. Times are in minutes:seconds.**

### BACKUP AND RESTORE TESTS

#### Macintosh II<sup>1</sup>

Backups to Apple HD40SC:	
41,399,296 bytes, 1002 files in 162 folders	27:30.44
10,410,003 bytes, 1002 files in 162 folders	07:11.13
41,210,050 bytes, 2004 files in 324 folders	31:11.09
Restore of Gigapack-Mac files to a clean Apple HD40SC:	
41,210,050 bytes, 2004 files in 324 folders	38:40.01

#### Macintosh SE<sup>2</sup>

Backups to Apple HD20SC:	
20,105,123 bytes, 1002 files in 162 folders	19:48.20
5,372,090 bytes, 1002 files in 162 folders	07:29.19
20,101,495 bytes, 2004 files in 324 folders	22:11.50
Restore of Gigapack-Mac files to a clean Apple HD20SC:	
20,101,495 bytes, 2004 files in 324 folders	25:19.30

#### Macintosh II with external hard disk drive<sup>3</sup>

Backups to Jasmine DirectDrive 140:	
137,405,729 bytes, 1002 files in 162 folders	87:35.10
65,210,045 bytes, 1002 files in 162 folders	45:20.51
138,004,167 bytes, 2004 files in 364 folders	92:22.38
Restore of Gigapack-Mac files to a clean Jasmine DirectDrive 140:	
138,004,167 bytes, 2004 files in 324 folders	97:06.20

<sup>1</sup> 8-megabyte Mac II with Apple RGB 256-color video in 2-bit black-and-white mode, two internal floppy disk drives, and one internal Apple HD40SC hard disk drive; system software was installed on the HD40SC drive. No other SCSI drives were connected except the Gigapack-Mac. The backed-up drive was the start-up disk.

<sup>2</sup> 1-megabyte Mac SE with one internal floppy disk drive and one internal Apple HD20SC hard disk drive; system software was installed on the HD20SC drive. No other SCSI drives were connected except the Gigapack-Mac. The backed-up drive was the start-up disk.

<sup>3</sup> 8-megabyte Mac II with Apple RGB 256-color video in 2-bit black-and-white mode, two internal floppy disk drives, one internal Apple HD40SC hard disk drive, and one external Jasmine DirectDrive 140 hard disk drive; system software was installed on the HD40SC drive. No other SCSI drives were connected except the DirectDrive and the Gigapack-Mac. The backed-up drive (DirectDrive) was not the start-up disk.

**Note:** Tests ran with System 6.0.2, Finder 6.1, and the other system software from the 6.0.2 System Tools package. Only the desk accessories, fonts, INITs, and cdevs supplied with the Apple system were kept. MultiFinder didn't run. LocalTalk/AppleTalk was disconnected. During all testing, the CPU's data cache was disabled. I installed Gigapack-Mac's version 1.06 software on the start-up disks for file backup and restore testing. Each timing reflects the mean of 10 repetitions of each benchmark.



# 4GL or C?

**We have an interesting proposition for you.**

**Don't Choose. Use the Faircom® Toolbox and get both: 4GL development speed and C source code power!**

Whether you need the development speed and convenience of 4GL programming or the low-overhead power capabilities of C source code, the Faircom Toolbox can meet the requirements of any professional developer!

**The Toolbox contains the industrial strength tools to develop applications the way you want!**

- Development Environment by d-tree™
  - Prototype generation
  - Data dictionary
  - Dynamic resource swapping
  - Screen management
  - Overlapped windows
  - File restructuring
  - Runtime portability
  - Menu management
- File Management by c-tree®
  - Variable length records
  - Key compression
  - Client/Server architecture

- Ascending/Descending key segments
- Dynamic space reclamation
- Portable. Used in over 100 environments
- Variable length key fields
- High speed B+ trees

- Report Generation by r-tree®
  - Complex multi-line reports
  - Multi-file access
  - Complete layout control
  - Conditional page breaks
  - Nested headers and footers
  - Unlimited control breaks
  - Dynamic format specifications
  - Horizontal repeats
  - Powerful set functions

**And NOW Faircom introduces the Toolbox Special Edition with the power and flexibility you need for only \$695!**

Now you can create applications using the methods you like — whether it's 4GL convenience or C source code power! And at \$695 you get this power at a price you can afford.

**Order today! No risk, money back guarantee!**

Order the Faircom Development Toolbox and use it for 30 days. If you don't think it's the best development tool available, just return the entire package for a full refund.

**Call 1-800-234-8180 TODAY for your Faircom Toolbox!**

The Toolbox Professional Edition . . . \$1095.00  
DOS, Unix, Xenix, VMS, OS2  
Full source, single and multi-user support

The Toolbox, Special Edition . . . . . \$ 695.00  
Microsoft, Borland, Xenix, OS2  
Object libraries, single user only

Upgrade to Professional Edition . . . \$ 400.00  
Includes overnight delivery



**FAIRCOM**  
corporation

4006 West Broadway  
Columbia, MO 65203  
Phone • 314-445-6833  
FAX • 314-445-9698

Circle 134 on Reader Service Card (DEALERS: 135)

# Don't Move!

without telling

# BYTE

Clip out form below  
and mail to:

**BYTE Magazine**  
**P.O. Box 555**  
**Hightstown, NJ 08520**

At least 8 week *before* you move,  
please give us your new address and/or  
name change

(Please Print)

New address, name	_____
Name	_____ Apt. _____
Address	_____ Zip _____
City	_____ State _____
Current address, name	_____
Name	_____ Apt. _____
Address	_____ Zip _____
City	_____ State _____

Print current name and address  
(or affix the mailing label from your current issue of BYTE here)

## Defining DAT: Formats and Standards Lack Consensus

Digital audio tape (DAT) technology uses helical-scan recording to store information as a digital bit stream. That bit stream can be digitally sampled music with a signal-to-noise ratio rivaling that of compact disks, or it can be plain old computer data bits.

DigitalTrend's Gigapack-Mac uses a logical tape format known as DATA/DAT. Also championing this format are 11 other companies, including Apple, Fujitsu-Ten, Hitachi, JVC, Kenwood, Panasonic, Sanyo, TEAC, and Toshiba. DATA/DAT distinguishes itself by its ability to do both random reads and writes to a tape. In other words, DATA/DAT can update the tape in place.

This format competes directly with digital data storage, which permits random tape reads, but not writes, so it cannot update a tape in place. DDS is sponsored by a committee of 10 companies, including industry giants Hewlett-Pack-

ard and Sony. So far, IBM has not come down on either side of the DAT format debate.

DATA/DAT has not yet made it through the ANSI standardization process. The only part of DATA/DAT that its supporters have agreed on is the process for updating a tape in place. DDS, on the other hand, is a more mature technology that offers slightly higher storage capacities.

Partly because formats and standards are still evolving, immediate DAT sales may be modest. According to Hinda Chalew, an industry analyst with the market researcher Dataquest, 3800 DAT drives should ship this year, generating \$5.6 million in revenues. Of these, only about 1000 drives will be full-price commercial units. But by 1993, shipments are expected to jump to 123,500 units, with revenues exceeding \$74.1 million, according to Dataquest.

1 foot from a commercial bulk-tape eraser and then switched the unit on and off several times. Proximity to the strong magnetic field caused no apparent damage to the files, as repeated restore operations proved. This indicates high short-term reliability; however, long-term, archival storage remains to be tested.

### Bottom Line

Compared to other mass-storage technologies, the Gigapack-Mac reigns as the big-ticket item. For example, DC-2000 tapes cost about \$30 apiece (formatted) and hold 38.5 megabytes. A typical DC-2000 tape drive costs \$1095. Storing 1.2 gigabytes of data requires more than 31 DC-2000 tapes, at a cost of almost \$1000 (not to mention hours of time spent loading tape after tape). But the total storage cost for 1.2 gigabytes comes to only about \$2095.

Optical disk drives, like the Canon unit, hold 256 megabytes per side and cost about \$100 each for double-sided 512-megabyte disks (\$50 for single-sided 256-megabyte disks). The drive sells for nearly \$5000. Storing 1.2 gigabytes, then, commands a total media and machine outlay of about \$5300.

The Gigapack-Mac sells for \$5950, and 120-minute cassettes cost \$26 each in their data-certified format. That puts the total cost of storing 1.2 gigabytes at about \$5976—the highest cost of these three options.

Is there a Gigapack-Mac in your future? That depends on your needs. For individual Mac users, the answer is probably no. You'd be better off with a cheaper backup technology, like DC-2000 tape or shadow directories recorded to another hard disk drive.

But if you have many small Mac hard disk drives, you might consider the Gigapack-Mac as a shared device used to back up all of them. And where large Macintosh disk drives and file servers hold many megabytes, the Gigapack-Mac also makes sense because it's easy to set up and use, and because the media is easy to store. Now, if only the price could come down a bit! ■

*Don Crabb is the director of laboratories and a senior lecturer for the computer science department at the University of Chicago. He is also a contributing editor for BYTE. He can be reached on BIX as "decrabb."*





# Low Price. Technical Support. Integrity!

... Talk to the Reliable Team at Warehouse Data!

## HARDWARE

COMPUTERS	
Hyundai 12MHz	\$1065
MIT	
10MHz w/40MB 28ms	979
10MHz XT	569
12MHz 286 w/1MB	929
12MHz 286 w/1MB & 40MB	1359
16MHz 286 w/1MB & 40MB	1699
16MHz 286 w/1MB	1748
25MHz 386 w/1MB RAM	2569
33MHz 386 w/1MB RAM	3600
DIGITIZER	
Kurta IS/One 12 x 12	\$295
FLOPPY DRIVES	
TEAC 1/2 HT 360K	\$72
TEAC 1.2 Floppy	89
Toshiba 3.5" 1.44MB	104
Toshiba 3.5" 720K	89

I/O GAME, MULTI I/O CARDS	
C&H XT & AT Game Card	\$45
Copy II PC Deluxe Option	109
DFI I/O AT P/S/G	45
LAPTOPS	
Toshiba T 1200FB 2FDD	\$1479
Toshiba T1200HB w/20MB	1999
Toshiba T1600	3299
Toshiba T3100E	2839
Toshiba T3200 w/40MB	3525
MEMORY BOARDS	
AST Rampage 286 w/512K	\$412
DFI 2MB Above Board for AT	79
Everex 3MB Above Board AT	89
PACIFIC DATA PRODUCTS	
1-2-4 Plus w/1MB	\$279
25 Cartridges in One	279
Headlines in a Cart	279
Plotter in Cartridge	259
Postscript Emulation	499

MONITORS	
Hyundai 12" Amber w/Tilt	\$79
Hyundai 14" CGA w/Tilt	249
Hyundai 14" EGA	335
Hyundai 14" VGA	339
Mitsubishi Diamond Scan	499
NEC Multisync 2A	519
NEC Multisync 3D	659
Princeton Mono VGA (Qty Ltd)	99
Princeton Ultrasync 16	859
Seiko 1430 VGA	539
Zenith 14" Flat VGA	629
MODEMS	
ATI Internal 2400B	\$169
Everex Available	Call
US Robotics	
Courier 2400	289
Courier 2400E	335
Courier HST 9600	609
Sportster 1200B	102
Sportster 2400B Ext	163
Sportster 2400B Int	145

MASS STORAGE	
Everex 60MB Int Tape	
AT/PC	\$599
Miniscribe 30 MB Kit	289
Miniscribe 32MB ESDI Kit AT	1749
Miniscribe 40MB Kit	320
Refurb Seagates	Call
Seagate 20MB w/Cont	259
Seagate 30MB w/Cont	279
Seagate 40MB ST-251 40ms	311
Seagate 40MB ST-251-1	367
Seagate 80MB (AT) ST-4096	585
VIDEO CARDS	
ATI EGA 800 Wonder	\$169
ATI VGA Wonder w/512	345
Generic Color w/Ptr	45
Orchid Pro Designer	299
Paradise EGA 350	115
Paradise EGA 480	125
Paradise VGA 16 Plus	249
Vega VGA	255

PRINTERS	
Citizen HSP 550	\$470
NEC P2200	329
NEC P5200	519
NEC P5300	669
Okidata 321	479
Okidata 390	489
Okidata 391	649
Star NX 15	319
Citizen HSP 500	323
Okidata 182i Turbo	235
Okidata 320	349
Panasonic 1124	329
Panasonic 1180	185
Star NX 1000	169
Star NX 1000 Rainbow	229
MATH CO-PROCESSORS	
Low Prices	Call
Chips	Call
HAND HELD SCANNERS	
DFI Handyscanner HS-300 +	\$189
Logitech Scanman Hi-Res	179

## SOFTWARE

SPREADSHEETS	
Lotus 1,2,3 Ver 2.2	\$349
Lotus 1,2,3 Ver 3.0	349
Lotus Upgrade	129
Microsoft Excel	269
Quattro	159
Supercalc 5	289
COMMUNICATION PROGRAMS	
Carbon Copy PC-Plus	\$106
Laplink III	79
PC Anywhere III	65
Pro Com Plus	51
DATABASE MANAGERS	
Clarion Professional	\$379
Clipper	419
DBase IV	469
Fox Base Plus	199
Genifer	189
Lotus Agenda	255
Paradox	449
PFS Professional File	165
Power Base	169
Q and A	209
RBase for DOS	459
OOS	
Microsoft DOS 3.3	\$85
Microsoft DOS 4.1	89

CAD & ENGINEERING	
Auto Sketch Enhanced	\$89
Design Cad 2D 3.0	219
Easy Cad 2.05	109
Generic Cad Level 3	159
UTILITIES	
Always	\$85
Copy II PC	23
Copy Write	55
Fastback Plus	104
Lotus Magellan	99
Microsoft Windows 286	63
Norton Advanced	79
PC Tools Delux 5.5	75
Sideways	39
Spinwrite	49
XTree Pro	64
LANGUAGES	
Borland Turbo Basic	\$65
Borland Turbo C Pro	165
Borland Turbo Pascal Pro	162
Brainmaker	137
Microsoft Fortran	295
Microsoft Macro Assem	99
Microsoft Quick Basic	65
Microsoft Quick C	65
Microsoft Quick Pascal	45

ACCOUNTING	
Bedford Accounting	\$139
DAC Easy Accounting 3.0	59
Managing Your Money 5.0	119
Peachtree w/PDQ	220
Quicken Ver. 3.0	36
DESKTOP PUBLISHING	
Pagemaker	\$499
PFS First Publisher	73
Ventura Publisher	519
GRAPHICS	
Corel Draw New Ver	\$335
Harvard Graphics	264
Printmaster	34
INTEGRATED	
Enable	\$359
Microsoft Works	99
PFS First Choice	89
Smartware	439
WORD PROCESSING	
Grammatik II	\$49
Microsoft Word 5.0	209
PFS Professional Write 21	129
Right Writer	49
Wordperfect 5.0	219
Wordstar 5.5	229
VP Expert	129

SPECIAL THIS MONTH!

16 MHz AT COMPUTER

- 1 Year On Site (Home or Office) Warranty, Provided by TRW
- 30 Day Satisfaction Guarantee

All Of This For Only \$1,699

**SPECS:**

- 80286 16 MHz CPU
- 1 MB Ram - Expandable to 8 MB
- 1.2 MB 5.25" Floppy
- FAST! 40 MB 28ms Hard Drive
- 8 Expansion Slots

- Parallel, Serial, Game ports included
- 200 Watt Power Supply
- 101 Key Enhanced Keyboard
- 640 x 480 EGA Card
- Entire System Burned in for 4 DAYS!

Call For Other Models

Order Status Technical & Other Info: **1-800-421-3135**  
Fax (602) 246-7805 / Call for items not shown.

FREE!

Air Express Shipping  
You Pay the Ground Shipping  
We Pay the Air Difference.

# WAREHOUSE DATA PRODUCTS

A DIVISION OF AZ COMPUTER CORP. 2727 W. GLENDALE AVE. PHOENIX, AZ 85051

**USER FRIENDLY TERMS & CONDITIONS:**

- We welcome international accounts, please call for special pricing.
- Volume discounts for corporate and institutional orders.
- We do not charge your credit card until your order is shipped.
- Shipping minimum is \$5.00. Arizona orders + 6.7% sales tax.
- You pay our regular ground shipping rates (1-20 lbs.). We pay the air difference (excludes Alaska and Hawaii.) Free air applies only to orders over \$100.

- Personal/company checks allow fourteen (14) days to clear.
- All shipments insured at no extra cost.
- All prices are subject to change without notice.
- We do not guarantee compatibility.
- No charge for Visa or MasterCard

Technical Support: (602) 246-2222  
FAX (602) 246-7805  
Phone Hours:  
Monday thru Friday 6:30 a.m. - 6:00 p.m. MST  
Saturday 9:00 a.m. - 5:00 p.m. MST

Circle 375 on Reader Service Card

BY 1189

# Don't Let the Desktop Programming Revolution Start Without You.

## Presenting Matrix Layout 2.0

The Desktop Programming revolution has begun. More and more people are maximizing the productivity of their desktop computers without learning to write a line of code. It began with Matrix Layout. And continues with Layout 2.0.

### More Power to the People

Matrix invented Desktop Programming to let you create your own programs right on your own PC. Now, Layout 2.0 makes it even easier to create your own powerful, professional-quality applications.

Start with Layout's tools window. Everything you'll need to build your program can be accessed by mouse or keystroke.

Next, use Layout's graphics and text tools to build a flowchart model of your program. Create your own windows, icons, and buttons. Cut and paste functions from other Layout programs. Or use the BlackBox Manager to add a BlackBox—a pre-built capability such as telecommunications or dBase support—to your Layout program. All, without writing a line of code.

Layout 2.0 is also a hypertext tool, allowing you to build Hypercard®-like cards, with text and graphics, and link them to related cards in any file. Use it to create cards for your flowcharts or to

create hypertext applications that will run on any IBM-compatible PC.

### Power to the Professional

Once your program is complete, Layout 2.0 can automatically create a ready-to-run .EXE file for use by any IBM PC. Or have Layout 2.0 write it in Turbo C, Lattice C, Microsoft C, Turbo Pascal or QuickBASIC. The result: you've got a professional, stand-alone program that does exactly what you want it to. Use it, share it, modify it. You've got the power.

### And a Powerful Bargain

For just \$199.95 you get the entire Layout 2.0 package, including free technical support, and more programming power than you've ever had on your desktop. For more information, the location of your nearest Matrix dealer, or a copy of the Matrix Layout 2.0 VHS demonstration video (just \$9.95 for shipping & handling), call today.

1-800-533-5644

(in Massachusetts, 617-567-0037)

Join the Desktop Programming revolution. Order Matrix Layout 2.0, today!

**MATRIX**  
MATRIX SOFTWARE TECHNOLOGY

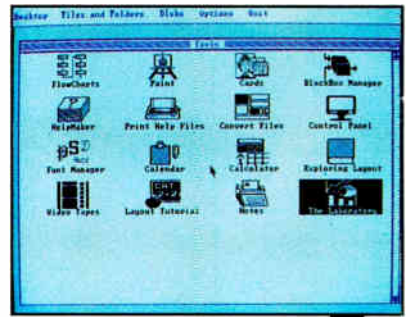

With Layout 2.0, getting started is as easy as choosing a tool.

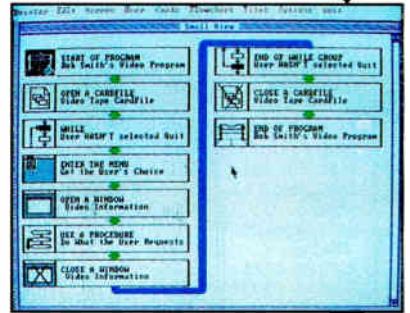

Design and build your programs by using a simple flowchart.



Create Hypercard®-like cards, linked to information in any file.

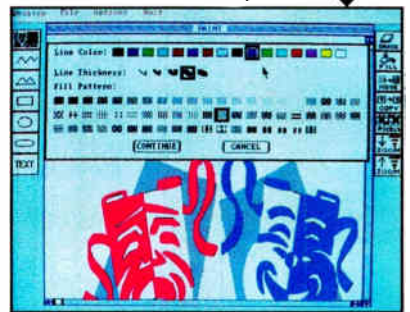

Use the Paint tool to create powerful graphics and buttons.

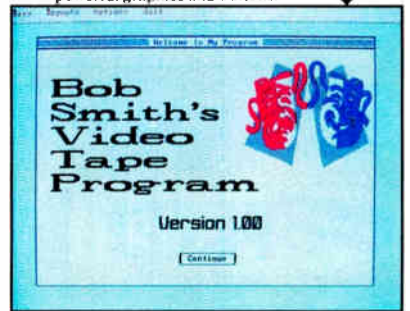

Layout creates finished, stand-alone programs for any IBM PC.

BT 89/11

Matrix Software Technology Corporation • One Massachusetts Technology Center • Harborside Drive • Boston, MA 02128 • (617) 567-0037

Matrix Software / UK • Matrix House, Derriford Business Park • Derriford, Plymouth • Devon PL4 5QZ, England • (0752) 796-363.

Matrix Software / Europe • Geldenaaksebaan 476 • 3030 Leuven, Belgium • 016202064

The following are registered and unregistered trademarks of the companies listed: Matrix Layout, Matrix Software Technology Corporation, Hypercard, Apple Computer, IBM, International Business Machines Corporation, dBase, Ashton Tate.





# X.25 Pads Performance

Although tricky to install, Hayes's V-series modems with X.25 PADs boost data accuracy and throughput speed

Stephen Satchell

If you need to communicate with the outside world through Tymnet or Telenet and you value your time and money, Hayes Microcomputer Products' X.25 modems and modem enhancers offer you messages of hope. The company is now shipping X.25 PAD (which stands for packet assembler/disassembler) firmware with its V-series Smartmodem 2400, V-series Smartmodem 9600, and V-series Modem Enhancers. (X.25 is the CCITT-recommended standard for synchronous packet-switching networks.)

With X.25 firmware, the Hayes modems provide access to as many as four "virtual" connections. This means that, for example, you could simultaneously read three BBSes and an electronic conferencing system, if all these systems are connected to the same X.25 network.

The X.25 firmware also promises error control from source PADs to target PADs or host systems. Packets are built once in the source, and the information stays inside the packet until it reaches its ultimate destination. Data that is transmitted through asynchronous methods, like MNP and V.42 (see the text box "Origin of the Protocol: X.25's Evolution" on page 234), can sometimes be

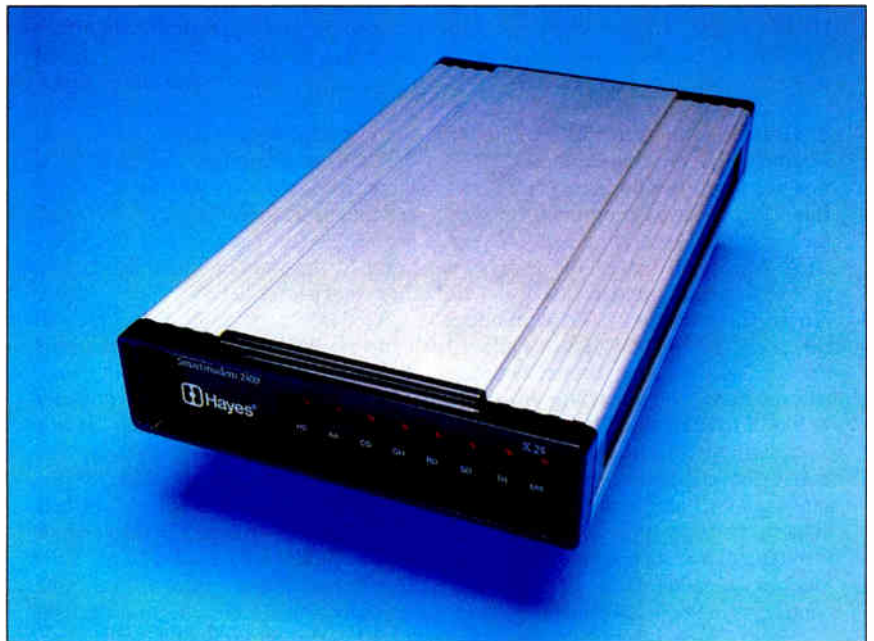

The Hayes V-series Smartmodem offers X.25 PADs at a relatively affordable price.

lost as packets flow between the two environments.

Because X.25 links the network and the source PAD using synchronous connections and high-level data-link control (HDLC), data pops through about 10 percent faster than if you used a standard asynchronous connection. Even without multiple-session support, your on-line time should drop significantly.

To see just what the Hayes X.25 PAD can do, I tested the V-series Smartmodem 2400 with a variety of public data networks. [Editor's note: *This review will concentrate on the X.25 PAD enhancement. For a complete review of the V-series Smartmodem 2400, see "4800 Bits, No Errors," June BYTE.*]

## Manual Omissions

The weakest part of the Hayes product is the X.25 manual. It is disorganized, and

it's missing a section covering Macintosh and other computer systems without flow control. The manual also lacks a translation dictionary to help set up the CALL command and understand X.25 jargon. If digging out details about how to dial into the services that you use is not your forte, save yourself the headache and hire someone to do the dirty work. Once you have the information, perhaps safely stored in calling scripts, you are in business.

Properly setting up the X.25 modem presents other installation battles. The V-series Smartmodem 2400 comes preset for flow control using the request-to-send and clear-to-send leads on an RS-232C port. Macintosh users must change flow control to use XON/XOFF before trying to issue PAD commands or make an X.25 connection; otherwise, the

*continued*

## Origin of the Protocol: X.25's Evolution

In the beginning, modems simply converted digital data into telephone-line signals at one end and reconverted those signals back to digital data at the other end. Any error control took place outside the modem. Then desires for error control gave birth to a number of mutually incompatible software- and hardware-based protocols, including HDLC/SDLC, BiSync, Kermit, and XMODEM. But under duress, most of these protocols proved ineffective.

In 1983, Microcom introduced the Era 2 internal modem with MNP (for Microcom Networking Protocol). MNP was supposed to eliminate errors outside of application programs, making the programs easier to create. A year later, Microcom moved the link-layer protocol into the modem itself and licensed the technology. Other modem makers latched onto MNP as a standard solution for data error control between two modems, so application programs wouldn't have to be designed to handle data disruption. Since then, MNP has been extended to reduce the overhead of sending data, incorporate data compression to further increase end-to-end throughput, and control the switching of modulation methods to adapt to line conditions in 9600-bps modems.

Users of packet-switching networks,

such as Tymnet and Telenet, know that garbled bits are only one of a variety of transmission problems. Many asynchronous network interfaces assume that you are using dumb (non-error-control) modems or that you're directly connected to terminals. Because of these assumptions, the interfaces offer no way to control data flow.

Even if you upgrade the interface hardware to recognize flow control (using the request-to-send and clear-to-send RS-232C leads), you'll still endure many packet conversions. The host builds network packets and then sends them through the network to the packet assembler/disassembler. The PAD disassembles the packets and transmits them to the modem, which rebuilds them into packets again.

Wouldn't it be more sensible—and safer—to build the packets just once? This is the X.25 philosophy. In this approach, the PAD at the host computer builds the packets (no modems in the middle) and sends the packets the way the network wants to see them. When you need to access the network, you call in, making the PAD part of the network only as long as you need it to be. This approach saves the cost of a leased line and allows one access port on the network to serve multiple sites.

modem will appear dead. The frustrating part of this is that the modem works just fine when you use it with a normal connection.

Before making a virtual connection using the PAD-to-user interface, you must know exactly what the network and the target PAD want to see. This can vary.

For example, when using Tymnet's Tyndial X.25, I accessed CompuServe and MCI Mail according to Tymnet's instructions, but my call to BIX required me to set up the CALL command in a specific manner. (Try this: CALL -D BIX. If you are using Smartcom III 1.1, you'll need to define the string "BIX" in the field "User Data.")

In addition to Tymnet, Telenet offers X.25 in-dial access through X.25 Dial. (As this article went to press, CompuServe reported that it was developing, but had not yet introduced, similar X.25

services.) X.25 in-dial is not limited to public networks; if your company has a private X.25 computer network, the same hardware setup will work with that system as well.

Each network and each host on the network has its own special requirements. Finding out what those requirements are may not be easy, because X.25 modems are new, and many network representatives are unfamiliar with X.25 specifications. Be prepared to face some puzzled voices on the other end of the support call. Or you may end up listening to someone talking "X.25-ese," so have your glossary handy.

Fortunately, the advantages of the Smartmodem with X.25 are worth the installation fuss. For example, when accessing BIX, I was able to download files using XMODEM-1K and Smartcom III with far less trouble and more speed than with a standard Tymnet access number.

Reading messages interactively, I noticed far smoother performance using the X.25 connection. I'm just sorry I have to make a long-distance call to get that kind of access right now. (Tymnet is planning to link additional cities to X.25 in-dial. You should check the status for your location.)

### Padded Packets

Speed and efficiency are only two benefits of having a Hayes modem with its own X.25 PAD. Many public-access PADs have limited RAM, so the packets transferred between the host and your computer can be quite small. With your own PAD, however, you can ask for blocks as large as 512 bytes. If you're charged by the packet, the ability to handle large packets can save you a bundle of money.

The X.25 in-dial services allow you to make one call into the network and as many "virtual calls" as you want without redialing. The number of concurrent virtual connections is limited only by the capabilities of your PAD. And if you add Smartcom III 1.1 or use software that supports Hayes AutoStream, you can simultaneously transfer data on all four virtual connections. Even with these multiple connections, your communications software will continue to perform as if you were using a standard dial-in line.

To set up multiple virtual connections, I established two links to CompuServe, one to BIX, and one to MCI using Smartcom III 1.1 on an 80386SX-based computer. I was able to transfer files in the "background" while working interactively, but Smartcom III was clumsy to use. I would have been far happier with a communications program running on a Macintosh (with a 19-inch screen, of course) with each session in its own window.

### Affordable PAD

Hayes has managed to bring X.25 PADs to market at a relatively affordable price. The V-series Smartmodem 2400 with X.25 support lists for \$899, while the V-series Smartmodem 9600 with X.25 is \$1299.

If your modem isn't a V-series, you can achieve compatibility with a Hayes Modem Enhancer for \$349; this is handy if you are using V.32-based (9600-bps full-duplex) X.25 access ports. Hayes offers the option of choosing V.42 for error control at the same prices. (X.25 and V.42 are standard features, not options.)

So who needs X.25 in-dial? Not every-



## X.25 PADS PERFORMANCE

## V-series Smartmodem 2400 X.25

**Company**

Hayes Microcomputer Products, Inc.  
P.O. Box 105203  
Atlanta, GA 30348  
(404) 441-1617

**Features**

Error control during transmission of data packets; synchronous connections and HDLC links for fast data throughput; large, 512-byte packets; simultaneously handles four virtual connections to a data network

**Size**

5½ × 9½ × 1¾ inches; 2 pounds

**Documentation**

V-series Smartmodem 2400 manual;  
X.25 manual supplement

**Price**

V-series Smartmodem 2400 X.25: \$899  
V-series Smartmodem 9600 X.25:  
\$1299  
V-series Modem Enhancer X.25: \$349  
Unit as reviewed: \$1148  
Smartcom III 1.1: \$249; upgrades from  
older versions of Smartcom II and III  
range from free to \$75

**Inquiry 852.**

one, that's for sure. Since it's new, X.25 in-dial won't be fully incorporated by service providers like Delphi, Dialog, CompuServe Information Service, and BIX for some time.

In addition, many potential users may flinch at today's public-network access prices. Tymnet imposes a prime-time surcharge of \$2 per hour (\$1 per hour non-prime-time) for X.25 access. Telenet doesn't add surcharges, but its per-hour access charges range from \$6 to \$9 per hour, depending on your location. Both Tymnet and Telenet bill each virtual connection at the same rate as an individual connection using the same line speed.

On the other hand, for businesses and others who are willing to pay for higher accuracy and shorter transmission times, the Hayes X.25 products deserve a close look. ■

*Stephen Satchell has evaluated computer products for 17 years. His company, Satchell Evaluations in Incline Village, Nevada, tests microcomputer hardware and software. He can be reached on BIX as "ssatchell."*

\* SPECIAL \*

## IBM PS/2 MODEL 50-021

FEATURES: 1MB RAM, 80286 BASED  
PROCESSOR, 10MHZ, (1) 1.44MB 3.5"  
FLOPPY, 20MB FIXED DISK, VGA  
ADAPTER, PS/2 101 KEY K/B,  
PARALLEL & SERIAL PORT, CABLES  
& MANUALS, 100% IBM PRODUCT  
\*\*REMANUFACTURED\*\*

SUGG. RETAIL NEW \$3,595.00  
OUR PRICE \$1,888.00

INCL. 90 DAY DEPOT WARRANTY,  
JUST LIKE NEW UNITS!

FREE NEW AMDEK MODEL 432 VGA  
MONITOR INCL. WITH EVERY UNIT  
\$245.00 VALUE AT NO CHARGE!

**EXSEL, INC.**

VISA

1-800-624-2001

MC

716-272-8770 FAX 716-272-8624

## People are talking about us.

**F77L-EM/32**

Port 4MB mainframe programs to 80386s with this 32-bit DOS compiler. Winner of *PC Magazine's* 1988 Technical Excellence Award. \$895\*

**F77L**

The compiler of choice among reviewers and professionals. New Version 4.0 includes an Editor, Profiler, Linker, Make Utility, Weitek Support, Graphics. \$595

**F77L-EM/16**

Write 15MB programs on 80286s with this award winning extended-memory compiler. \$695

**Lahey Personal FORTRAN 77**

Full ANSI 77, Microsoft C and Borland C interfaces, Debugger, at an unbeatable price. \$95

\* Requires DOS Extender (\$195)



When people talk about FORTRAN  
the name mentioned most often is



Contact us to discuss our products and your needs. (800) 548-4778  
Lahey Computer Systems, Inc. P.O. Box 6091, Incline Village, NV 89450  
Tel: (702) 831-2500 FAX: (702) 831-8123 Tlx: 9102401256

**FORTRAN IS OUR FORTE**

# Our Swans make waves.



The Swan line of computers is creating waves of excitement among computer users. One reason is price. Swan computers are true bargains, offering you the most for your investment. But price doesn't tell the complete value story.

Swan computers are solid, reliable performers ... assembled by Tussey Computer Products, a solid, reliable company with a tradition of unsurpassed customer satisfaction.

Swan computers are highly compatible. In fact, all Swan computers feature the top-rated Phoenix ROM BIOS to assure 100% PC compatibility.

And the benefits keep coming, wave after wave . . .

### 30-Day Satisfaction Guarantee

If you're dissatisfied with any Swan brand name product, you can return it within 30 days from the date of shipment and get your money back. No questions asked.\*

### Toll-free Technical Support

When you own a Swan, you can call our toll-free number and be in touch with our expert technical and service staff. They'll answer your questions and help you take fullest advantage of your system's capabilities.

### Full 1-Year Warranty

Every Swan brand name product is backed by a full 1-year warranty on parts and labor. A second year of coverage is available through the Swan Extended Warranty (SEW). Ask for details when you order your Swan.

### Fast, Sure Delivery

You want your Swan up and running and doing its job for you. Fast. So any order we receive before 4 p.m. EST is shipped the same day. Even orders received after 4 p.m. are shipped within 24-hours.\*\*

We also insure your order at no cost to you. And we don't charge your credit card until your order is actually shipped.

### Convenient On-Site Service

Swan offers you the valuable option of on-site service from Sorbus®, a Bell Atlantic™ Company. When your computer needs serviced, an experienced technician will be dispatched to your site quickly, minimizing downtime, maximizing convenience and value.

### Swans make waves in business and education.

Swan offers a full line of services tailored to the needs of educational and corporate computer users. Call our Educational & Corporate Sales Department toll-free at 1-800-468-9044. Learn how a Swan can be a business animal ... or a teacher's pet.

### Swans make waves in the computer industry.

With their compatibility, reliability and performance, Swans add up to value for their owners. So it's no surprise that Swans are making waves in the computer industry. Waves that may make some competitors run for safer ground.

Read what computer journals are saying ...

"... If you enjoy getting the most performance for your dollar, the Swan ... is a good alternative" to showy, more expensive brand names.

— *Computer Shopper, April 1989*

"The excellent manual and 30-day money-back guarantee both indicate that Tussey Computer Products values customer service." — *PC Resource*



## Swan 386/20D

"Tussey's Swan 386/20 flies."

— *Computer Shopper, April 1989*

Gracefully combining power and performance, this Swan has soared to the upper limits of today's technology.

- 80386-20 20/8 MHz Norton SI 22.0
  - MS-DOS®, OS/2® & UNIX® Compatible
  - Phoenix BIOS
  - 1MB of 32-Bit RAM Expandable to 16MB of 32-Bit RAM
  - Shadow RAM for Video & BIOS
  - Memory Interleave for near 0 Wait State
  - 80287 & 80387 Co-processor Socket
  - 200W Power Supply
  - 5 Device Bays: 3 Exposed, 2 Internal
  - 1.2MB 5.25" or 1.44MB 3.5" Floppy Drive
  - Dual Floppy/Dual H.D. Controller w/1:1 Interleave
  - Ports: 2 Serial, 1 Parallel
  - 8 Expansion Slots: 1) 32-bit, 4) 16-bit, 3) 8-bit
  - Enhanced 101 Key Keyboard
  - Clock Calendar w/Battery Backup
  - Swan Setup & Utilities Diskette
- Options:**
- 80287 or 80387 Co-processor
  - Upgrades: 2, 4, 8, 10 or 16MB
  - GW BASIC/MS-DOS add \$89

# \$1899

Base System with Single Floppy, No Video

386/20D	VIDEO OPTIONS Include Monitor & Video Adapter			
	Mono	14" Flat Mono	VGA Mono	VGA Color
w/48MB (28ms) & 1:1 Interleave	\$2399	\$2448	\$2598	\$2898
w/80MB (28ms) & 1:1 Interleave	\$2749	\$2798	\$2948	\$3248
w/150MB (18ms) ESDI w/1:1 Interleave	\$3394	\$3443	\$3593	\$3893

Tower Case Option for 386/20 w/230W power supply add \$300

\* Items returned must be as-new, without modification or damage. All warranty cards, manuals and packaging must be included. Return shipping must be prepaid and insured, bearing a RA (Return Authorization) or the shipping label. Sorry ... shipping charges and upgrade fees are not refundable.

\*\* Custom configured systems may take longer.

S=BTK1





## Swan 386SX

This system gives you 386 compatibility, power and performance ... at a 286 price.

- 80386SX 16/8 MHz Norton SI 17.6
- MS-DOS<sup>®</sup>, OS/2<sup>®</sup> & UNIX<sup>®</sup> Compatible
- Phoenix BIOS
- 1MB RAM Expands to 3MB on Systemboard
- Shadow BIOS
- Memory Interleave for near 0 Wait State
- 80387SX Co-processor Socket
- 200W Power Supply
- 4 Device Bays: 3 Exposed, 1 Internal
- 1.2MB 5.25" or 1.44MB 3.5" Floppy Drive
- Dual Floppy/Dual H.D. Controller w/1:1 Interleave
- Ports: 1 Serial, 1 Parallel
- 8 Expansion Slots: 6) 16-bit, 2) 8-bit
- Enhanced 101 Key Keyboard
- Clock Calendar w/Battery Backup
- Swan Setup & Utilities Diskette

**Options:**

- 80387SX Co-processor
- Upgrades: 1, 5, 2, 3, 4, 5, 6 or 8MB
- GW BASIC/MS-DOS add \$89

# \$1399

Base System with Single Floppy, No Video

386SX	VIDEO OPTIONS Include Monitor & Video Adapter			
	Mono	14" Flat Mono	VGA Mono	VGA Color
Drive Options				
w/32MB (40ms) & 1:1 Interleave	\$1799	\$1848	\$1998	\$2298
w/48MB (28ms) & 1:1 Interleave	\$1899	\$2048	\$2198	\$2498
w/80MB (28ms) & 1:1 Interleave	\$2249	\$2298	\$2448	\$2748
w/168MB (15ms) ESDI w/1:1 Interleave	\$2894	\$2943	\$3093	\$3393



## Swan 286/12

You probably never thought you could get into a reliable business system this inexpensively. But with the 286/12, you can. Now.

- 80286 12.5/6.25 MHz Norton SI 12.3
- MS-DOS<sup>®</sup> & OS/2<sup>®</sup> Compatible
- Phoenix BIOS
- 512K RAM Expands to 5MB on Systemboard
- Shadow BIOS
- 0 Wait State
- 80287 Co-Processor Socket
- 200W Power Supply
- 5 Device Bays: 3 Exposed, 2 Internal
- 1.2MB 5.25" or 1.44MB 3.5" Floppy Drive
- Dual Floppy/Dual H.D. Controller
- Ports: 1 Serial, 1 Parallel
- 8 Expansion Slots: 6) 16-bit, 2) 8-bit
- Enhanced 101 Key Keyboard
- Clock Calendar w/Battery Backup
- Swan Setup & Utilities Diskette

**Options:**

- 80287 Co-processor
- Upgrade to 640K, 1, 2, 3 or 5MB
- GW BASIC/MS-DOS add \$89

# \$899

Base System with Single Floppy, No Video

286/12	VIDEO OPTIONS Include Monitor & Video Adapter			
	Mono	14" Flat Mono	EGA	VGA
Drive Options				
w/32MB (40ms) & 1:1 Interleave	\$1299	\$1348	\$1698	\$1798
w/48MB (28ms) & 1:1 Interleave	\$1399	\$1448	\$1798	\$1898
w/80MB (28ms) & 1:1 Interleave	\$1749	\$1798	\$2148	\$2248



## Swan XT10

The perfect budget-priced home computer. A solid, reliable, compatible performer.

- 10/4.77 MHz 8088-1
- Phoenix BIOS
- 640K of RAM
- 0 Wait State
- 8087 Co-Processor Socket
- 150W Power Supply
- 4 Device Bays: 2 Exposed, 2 Internal
- Single 360K Floppy Drive
- Ports: 1 Serial, 1 Parallel, 1 Game
- 8 Expansion Slots
- Enhanced 101 Key Keyboard
- Clock Calendar w/Battery Backup
- Swan Setup & Utilities Diskette

**Options:**

- 8087 Co-processor
- 3.5" Floppy Drive
- GW BASIC/MS-DOS add \$89

# \$549

Base System with Single Floppy, No Video

XT10	VIDEO OPTIONS Include Monitor & Video Adapter			
	Mono*	CGA	EGA	VGA
Drive Options				
Single Floppy	\$699	\$869	\$1098	\$1198
Dual Floppies	\$779	\$949	\$1178	\$1278
*w/32MB (40ms) Hard Drive	\$979	\$1149	\$1378	\$1478

\* Includes Single 360K Floppy Drive

† Upgrade from 12" to 14" Flat Screen, add \$49

To order: No surcharge on Discover, Visa, MasterCard or AMEX.  
 • Your credit card is not charged until your order is shipped.  
 Shipping: 3% or \$5 minimum for UPS Ground. Call for shipping charges on Express Air, APO, FPO, AK, HI and all foreign orders.  
 • If part of your order is backordered, the remainder will be shipped UPS Ground. • Allow 2 weeks for personal and company checks to clear. • Defective items replaced or repaired at our discretion. • PA deliveries add 6% sales tax. • Prices and terms subject to change without notice.



Open: 8a.m.-11p.m. M-F, 10a.m.-8p.m. Sat, 12p.m.-8p.m. Sun



Order Now Toll-Free  
**1-800-468-9044**

FAX: 814-237-4450 • International: 814-234-2236



TUSSEY COMPUTER PRODUCTS

3075 RESEARCH DRIVE • STATE COLLEGE, PA. • 16801

Circle 363 on Reader Service Card  
 World Radio History

# Make a mating

Get real compatibility. Call our toll-free number and our expert staff will mate you with hardware, software, or peripherals to fit your unique needs. And at a price you'll love.

And when you shop Swan, you'll get the benefits of a strong, supportive relationship:

- We won't charge your credit card until your order is shipped.
- Orders received before 4 PM EST will be shipped same day ... and each order is insured at no cost to you.
- You'll deal with a financially sound, respected company.
- We'll be here after the sale to help you.
- Software orders over \$100 and accessories under 6 pounds will be shipped Federal Express.



## PRINTERS

### Panasonic



**1180** (192 cps, 80 col, 9-pin) ..... \$179

- 1191 (240cps, 80 col, 9-pin) ..... \$Call
- 1124 (192cps, 80 col, 24-pin) ..... \$Call
- 1595 (240cps, 132 col, 9-pin) ..... \$439
- 1524 (240cps, 132 col, 24-pin) ..... \$569
- 1624 (192cps, 132 col, 24-pin) ..... \$Call
- 1450 (11ppm laser printer) ..... \$1375



**NX-1000II** (180cps, 9-pin) \$Call

- NX-1000 Rainbow (144cps, 80 col, 9-pin) ..... \$229
- NX-15 (120cps, 132 col, 9-pin) ..... \$349
- NX-2400 (170cps, 80 col, 24-pin) ..... \$Call



**LASER PRINTERS**

- Panasonic**
- KX-P4450 ..... \$1375
- Hewlett-Packard**
- LaserJet Series II
- 8 ppm/512K ..... \$1749
- LaserJet Series IID ..... \$Call

### EPSON



**LX-810** (180 cps, 80 col, 9-pin) \$189

- FX-850 (264cps, 80 col, 9-pin) ..... \$Call
- FX-1050 (264cps, 132 col, 9-pin) ..... for
- LQ-510 (180cps, 80 col, 24-pin) ..... Best
- LQ-850 (264cps, 80 col, 24-pin) ..... Price
- LQ-1050 (264cps, 132 col, 24-pin) ..... on
- LQ-2550 (400cps, 132 col, 24-pin) .. Epson

### OKIDATA



**320** (300 cps, 80 col, 9-pin) ..... \$339

- 172 (180 cps, 80 col, 9-pin) ..... \$Call
- 182 Turbo (220 cps, 80 col, 9-pin) ..... \$Call
- 321 (300cps, 132 col, 9-pin) ..... \$469
- 380 (180 cps, 80 col, 24-pin) ..... \$Call
- 390 (270cps, 80 col, 24-pin) ..... \$469
- 391 (270cps, 132 col, 24-pin) ..... \$659
- 393 (450cps, 132 col, 24-pin) ..... \$Call

- Citizen**
- 120D (120 cps/9-pin) ..... \$159
- 180D (180cps, 80 col, 9-pin) ..... \$179

- Kodak/Diconix**
- 150+ (180cps, 80 col) ..... \$345
- 300 (300cps, 80 col) ..... \$399



- HEWLETT PACKARD**
- Deskjet (240cps, 80 col) ..... \$599
- Deskjet Plus (240cps, 80 col) ..... \$Call
- Paintjet (167cps, 80 col) ..... \$1049



**MONITORS**

- TTL Monochrome**
- Magnavox 7623 Amber ..... \$99
- Packard Bell with tilt/swivel
- Amber or Green ..... \$89
- Samsung 14" Mono Flat ..... \$139
- Swan Monochrome SW525 ..... \$89

- RGB/CGA**
- Magnavox 8762 ..... \$249
- Magnavox 8515 ..... \$289
- Samsung SC452C ..... \$219
- Swan RGB ..... \$219

- EGA**
- Imtec 1453 ..... \$349
- Magnavox 9053 ..... \$359
- Packard Bell 1431 ..... \$349

- Multisync**
- Imtec 1455N Multi ..... \$419
- Mitsubishi Diamond Scan ..... \$499
- NEC Multisync 3-D ..... \$679
- NEC Multisync Plus ..... \$Call
- Sony 1304 ..... \$699

- VGA**
- Amdek 732 ..... \$429
- Imtec 1453 Q ..... \$349
- Magnavox 7749 (Grey Scale) ..... \$129
- Magnavox 9082 ..... \$429
- NEC Multisync 2a ..... \$Call

## PC ADD ON BOARDS

- Boca**
- RAM Card XT or AT ..... \$Call
- I/O card XT or AT ..... \$79

- Micron**
- RAM Card (MB-28-DH) populated w/2MB RAM ..... \$699

- TOPS**
- TOPS/DOS 2.1 ..... \$119
- Flashcard ..... \$169
- Net Print ..... \$119
- Teleconnector ..... \$39

intel	
8087	\$84
8087-1	\$159
8087-2	\$119
80287	\$129
80287-8	\$189
80287-10	\$214
80387SX	\$297
80387-16	\$339
80387-20	\$379
80387-25	\$479
80387-33	\$Call
AboveBoard Plus	\$399
AboveBoard Plus I/O	\$449
Connection Co-processor	\$Call
InBoard 386/PC	\$589

Call for Daughterboard Pricing



**SWAN TECHNOLOGIES** a division of tcp

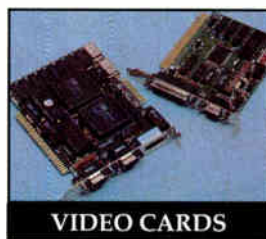

**VIDEO CARDS**

- ATI**
- EGA Wonder 800 ..... \$199

- Paradise**
- Autoswitch 480 ..... \$169

- Swan**
- EGA Card ..... \$149

- VGA**
- ATI
- VGA Wonder (256K) ..... \$299
- VGA Wonder (512K) ..... \$359

- Orchid**
- Pro Designer VGA ..... \$279
- Pro Designer VGA + ..... \$369

- Paradise**
- VGA + ..... \$219
- VGA Professional ..... \$349
- VGA + 16 ..... \$269
- Swan**
- VGA Card ..... \$179
- Video 7**
- VEGA VGA ..... \$249
- Fast Write VGA ..... \$319
- VRAM VGA ..... \$469

## MISC.

- Swan**
- Switchable (Mono/CGA) ..... \$69

TOSHIBA LAPTOPS	
T1200 (10MHz)	\$1379
T1600 (12MHz/20MB)	\$3259
T3100e (12MHz/20MB)	\$2749

Call for other Toshiba models

## DISKS

	3.5"	5.25"
BONUS DS/DD	—	\$6.95
MAXELL DS/DD	\$19.95	\$9.95
VERBATIM DS/DD	\$19.95	\$9.95
SONY DS/DD	\$19.95	\$10.95

Call For Pricing on Memory Chips!

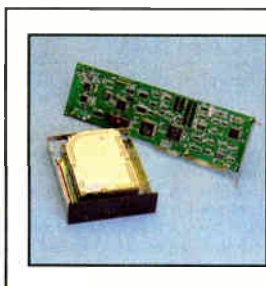

**Seagate ST 157R Hard Drive**

- 48 MB formatted
- 3.5" Technology with Adaptec RLL Controller
- 1:1 Interleave
- Supports 2 Hard Drives & 2 Floppy Drives

**\$489**



**FLOPPY DRIVES**

- Mitsubishi**
- 3.5" (720K) ..... \$89
- 3.5" (1.44MB) ..... \$109

- Roctec**
- 5.25" (360K) ..... \$74
- 5.25" (1.2MB) ..... \$89

- Sony**
- 3.5" (720K) ..... \$79
- 3.5" (1.44MB) ..... \$99
- Teac**
- 5.25" (360K) ..... \$85
- 5.25" (1.2MB) ..... \$95



**PC HARD DRIVES**

- KLÖK**
- KL320 20MB (40 ms) ..... \$219/\$259\*
- KL330 32MB (40 ms) ..... \$249/\$299\*

- MiniScribe**
- 8438 30MB (68 ms) ..... \$249
- 3650 40MB (61 ms) ..... \$299
- 3053 40MB (25 ms) ..... \$449

- Seagate**
- ST-225 20MB (65 ms) ..... \$219/\$259\*
- ST-238 30MB (65 ms) ..... \$249/\$299\*
- ST-125 20MB (40 ms) ..... \$249/\$299\*
- ST-151 40MB (24 ms) ..... \$439
- ST-157R 48MB (28 ms) ..... \$349
- ST-251-1 40MB (28 ms) ..... \$349
- ST-4096 80MB (28 ms) ..... \$629

- IMPRIMIS**
- CONTROL DATA
- 80MB (28 ms) ..... \$629
- 150MB ESDI (16.5 ms) .. \$1299/\$1495\*

\*Kit Price - includes cables, controller and mounting screws.

**Seagate ST 157R Hard Drive**

- 48 MB formatted
- 3.5" Technology with Adaptec RLL Controller
- 1:1 Interleave
- Supports 2 Hard Drives & 2 Floppy Drives

**\$489**

Call Today & Ask For Our Free Catalog

Order Now Toll-Free

**1-800-468-9044** S=BTk2

FAX: 814-237-4450 • International: 814-234-2236

Open: 8a.m.-11p.m. M-F, 10a.m.-8p.m. Sat, 12p.m.-8p.m. Sun

**TUSSEY COMPUTER PRODUCTS**

3075 RESEARCH DRIVE • STATE COLLEGE, PA. • 16801

World Radio History



# call. 1-800-468-9044



## SOFTWARE



## Swan Peripherals ... Feather your nest for less.

Top-quality Swan peripherals can make your PC an even better place to work and play ... and at prices that won't crack your nest egg.

Every Swan brand name product comes with a 30-day, money-back trial guarantee. And every Swan product is backed by a full one-year warranty on parts and labor. You also get toll-free technical support and customer service.

You'll be tickled when you discover what a reliable Swan add-on can do for your home or office PC system.



### Swan Modems

Make the world your partner. With the Swan Modem, you'll be able to communicate with other PCs and information services around the world through your pulse or touch tone phone. You'll tap into a world of data and broaden your horizons. Every Swan Modem comes complete with communication software and full documentation.

- Hayes\* compatible • Auto answer/dial
  - Include PC Talk III software
- |                   |       |
|-------------------|-------|
| 2400 bd internal* | \$99  |
| 1200 bd internal  | \$69  |
| 2400 bd external  | \$149 |
| 1200 bd external  | \$89  |
- \* includes Bit Com v 3.5 software



### Swan Tape Backups

Protect that nest of important data stored on your hard drive. Swan Tape Backups store 40MB on a single tape cartridge ... reliably, conveniently and economically. A Swan tape drive can be installed on any Swan computer and most XT- or AT-compatibles.

- |                        |       |
|------------------------|-------|
| 40MB XT or AT Internal | \$299 |
| 40MB XT or AT External | \$399 |

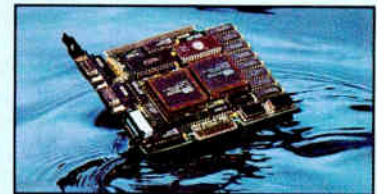

### Swan Video Cards

Different people have different uses for their PC's ... from everyday uses like word processing and spreadsheets to today's more demanding applications, such as desktop publishing and presentation graphics. A Swan video card can help you better meet your needs today ... or help you ride the wave of technology into tomorrow.

- Switchable Card • Hercules\* to CGA
- Parallel Port ..... \$69
- EGA Card • EGA/CGA/TTL
- 640 x 480 Resolution ..... \$149
- VGA Card • Register-level compatible
- 256K RAM • 17 VGA Modes ..... \$179

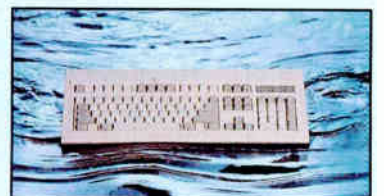

### Swan Keyboards

It's important to have choices. So Swan gives them to you. You can depend on the Swan family of tactile keyboards for reliable typing with either the reassuring audible feedback of the "touch and click" or the quiet response of the "silent" keyboard.

- |                                 |      |
|---------------------------------|------|
| 101 Key Touch & Click or Silent | \$79 |
| 84 Key Touch & Click            | \$69 |

<b>AMERICAN</b> Design CAD 3.0/3-D ..... \$155/\$209	<b>LOGITECH</b> Finesse ..... \$89
<b>ASHTON-TATE</b> dBase III+ /IV ..... SCall/\$459	<b>LOTUS</b> Agenda ..... \$269
<b>BEDFORD</b> Integrated Accounting ..... \$159	123 v 2.2/3.0 ..... SCall
<b>BLOC PUBLISHING</b> Personal Lawyer ..... \$39	Freelance Plus ..... \$339
Popdrop ..... \$34	Magellan ..... SCall
Formfiller ..... \$89	Symphony ..... \$439
Formtool ..... \$55	<b>MERIDIAN</b> Carbon Copy Plus ..... \$112
<b>BORLAND</b> Paradox 3.0 ..... \$449	<b>MICROSOFT</b> Excel ..... SCall
Quattro ..... \$169	Flight Simulator 3.0 ..... \$35
Turbo C 2.0 ..... \$107	MS-DOS & GW BASIC ..... SCall
Turbo C Professional ..... \$159	Quick BASIC ..... \$67
Turbo Lighting ..... \$69	Quick C ..... \$67
Turbo Pascal 5.5 ..... \$99	Quick Pascal ..... SCall
Turbo Pascal Professional ..... \$169	Windows 286/386 ..... \$64/\$129
<b>BRODERBUND</b> Print Shop/Companion ..... \$34/\$37	Word 5.0 ..... SCall
<b>CENTRAL POINT</b> Copy II PC ..... \$27	Works ..... \$99
Deluxe Option Board ..... \$109	<b>PETER NORTON</b> Norton Commander ..... \$54
PC Tools Deluxe 5.5 ..... \$79	Norton Utilities ..... \$55
<b>COMPUTER ASSOCIATES</b> SuperCalc 5 ..... SCall	Norton Advanced Utilities ..... \$79
<b>COREL</b> Corel Draw 1.1 ..... SCall	<b>QUARTERDECK</b> DESQView/DESQView 386 \$79/\$119
<b>DAC SOFTWARE</b> Dac Bonus Pack ..... \$119	QEMM ..... \$39
Dac Easy Accounting 4.0 ..... SCall	<b>REFERENCE SOFTWARE</b> Grammatik III ..... \$54
Dac Easy Payroll 4.0 ..... SCall	<b>SAMNA</b> Ami/Ami Pro ..... \$99/\$Call
Lucid 3-D ..... \$69	<b>SOFTWARE PUBLISHING</b> First Publisher ..... \$79
<i>Call for Pricing on Tutors</i>	Harvard Graphics ..... SCall
<b>DELTRINA</b> Perform ..... SCall	PFS First Choice 3.0 ..... \$89
<b>FIFTH GENERATION</b> Fastback Plus ..... \$104	PFS Professional Write ..... \$135
<b>FOX</b> Foxbase+/386 ..... \$199/\$299	<b>SYMANTEC</b> Grandview ..... \$195
<b>FUNK</b> Allways for 123/Symphony ..... \$89/\$89	Q & A ..... \$209
Sideways ..... \$42	Q & A Write ..... \$129
<b>GENERIC SOFTWARE</b> Generic CADD Level 3 ..... \$169	Timeline 3.0 ..... \$359
<b>INTUIT</b> Quicken 3.0 ..... \$37	<b>THREE D GRAPHICS</b> Perspective Junior ..... \$99
<b>LASERGO</b> GoScript/GoScript + ..... \$125/\$239	<b>WORD PERFECT</b> Library ..... \$69
	Word Perfect 5.0 ..... \$219
	<b>WORDSTAR</b> Wordstar Professional v 5.5 ..... \$199
	Wordstar v 5.5 Upgrade ..... SCall
	<b>XEROX</b> Ventura Publisher 2.0 ..... SCall



### MODEMS

<b>ATI</b> 2400 etc Internal ..... \$159
<b>Hayes Smart Modem</b> 1200 bd Internal/External ..... \$259/\$289
2400 bd Internal/External ..... SCall
<b>Practical Peripherals</b> 2400 bd Internal/External ..... \$149/\$199
2400 bd MNP Int./Ext. .... \$149/\$199
<b>Swan Technologies</b> 1200 bd Internal/External ..... \$69/\$89
2400 bd Internal/External ..... \$99/\$149



### MICE

<b>IMSI</b> Optical Mouse w/Dr. Halo III ..... \$72
<b>Microsoft</b> Mouse ..... \$109
Mouse with Windows ..... \$139
<b>Logitech</b> Bus Mouse (320 dpi) ..... \$75
Serial Mouse (320 dpi) ..... \$79
with Paint add ..... \$10
ScanMan ..... \$185

To order: No surcharge on Discover, Visa, MasterCard or AMEX.  
 • Your credit card is not charged until your order is shipped.  
 Shipping: 3% or \$5 minimum for UPS Ground. Call for shipping charges on Express Air, APO, FPO, AK, HI and all foreign orders.  
 • If part of your order is backordered, the remainder will be shipped UPS Ground. • Allow 2 weeks for personal and company checks to clear. • ALL SALES (except Swan products) ARE FINAL.  
 • Defective items replaced or repaired at our discretion. • PA deliveries add 6% sales tax. • Prices and terms subject to change without notice.



S=BTK2



Circle 364 on Reader Service Card  
World Radio History

TUSSEY COMPUTER PRODUCTS

# VIDEO SEVEN™

## Seven great reasons to own the newest high-resolution Super VGA graphics card: the Video Seven VGA 1024i.

**1** It's sharp. Our new graphics card dramatically improves the performance of all your applications. You can choose up to 800 x 600 or 1024 x 768 resolution with 16 on-screen colors, or 256 colors at 640 x 480\*. Plus, 132-column text support helps you get the most from your spreadsheet applications.

\*1024 x 768 resolution is interlaced; 1024 x 768 x 16 and 640 x 480 x 256 resolution requires 512K DRAM configuration.

**2** It's fast. 50% faster than standard VGA. True 16-bit technology increases the speed of all your graphics and text applications on an IBM PC/AT/XT, PS/2 Model 30 or compatible.

**3** It's versatile. It works in an 8-bit or 16-bit slot. You can easily upgrade it from 256K to 512K DRAM. And it lets you get the most out of today's popular MultiSync, Multiscan and 8514 monitors, including the MultiSync 3D and Seiko CM-1430.

**4** It's 100% compatible. Guaranteed to run all your VGA, EGA, CGA, MDA and Hercules software applications. It's even easy to install. 3 easy steps is all it takes.

**5** It supports more software. No graphics card gives you more high-resolution drivers, including Windows/286, Windows/386, Presentation Manager, AutoCAD, AutoShade, P-CAD, VersaCAD, GEM/3, Ventura Publisher, Lotus 1-2-3, Symphony, WordPerfect, and WordStar.

**6** It comes with a full 7-year warranty. We can do that because we build all our products using our own Headland Technology chip and card design capabilities to ensure they will live up to our reputation for quality and performance.

Plus, the new VGA 1024i card comes with the exclusive *Best of Seven* support package that InfoWorld rates a "hearty excellent." You'll get free disk and BIOS updates, bulletin board service, and our unlimited toll-free technical support.

**7** And it's affordable. The new Video Seven VGA 1024i, a very sharp, very fast high-resolution Super VGA graphics card for only \$397 with 256K DRAM. \$497 with 512K.

So before you settle for just any VGA card, ask to see the big news in high-resolution graphics: the new VGA 1024i from Video Seven.

For more information and the name of the dealer nearest you, call toll-free (800) 238-0101. From within California, call (800) 962-5700. Or call (415) 623-7857.

Some restrictions apply to Headland Technology's warranty and compatibility guarantee. Video Seven is a trademark of Headland Technology Inc. All other brand and product names may be trademarks of their respective companies.



# VIDEO SEVEN

## Best of Seven



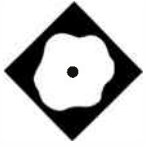

# Ease into Mac Programming

Prototyper 2.1  
gives Mac programmers  
a jump start

Ray Valdés

**P**rototyper is an interactive tool for creating prototypes of Macintosh programs. It's aimed at two audiences: It helps nonprogrammers design prototype applications in an interactive, nontechnical manner to help visualize product ideas, and it enables programmers who are not familiar with the Macintosh Toolbox to create skeleton applications that can be fleshed out over time. Prototyper's code generator produces the drudge code needed to support a complex Mac interface with nested menus and intricate dialog boxes.

The program's centerpiece is a Prototype window. In this window, you manage the interface objects that constitute an application. The window contains three icons that represent the major categories of interface objects available, and a scrolling portion that lists those that you have created for your prototype. The interface objects are menus, windows (including dialog and alert boxes), and a demo window that's the basis of Prototyper's simulation capability.

Clicking on the icons invokes the appropriate editor for that class of interface object. For example, clicking on the menu icon invokes a menu editor, while clicking on the window icon lets you create and modify windows, dialog boxes, and alert boxes. Each interface object owns a window on the desktop; you can leave the windows open and switch back and forth between them. This is a very Mac-like approach to pro-

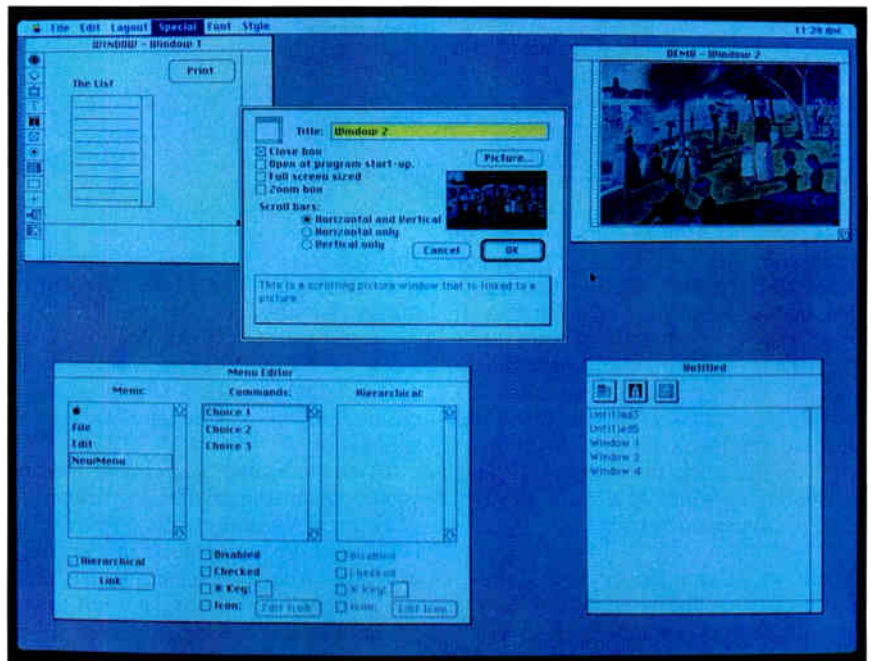

*SmethersBarnes' Prototyper lets you interactively build menus and link menu choices to window displays.*

totype creation. You work interactively and iteratively—creating and editing the application's menu bar, and switching over to tinkering with the details of a dialog box. You then return to the menu for further adjustments.

You can run your prototype at any time with Command-R. The simulated application's menu bar appears at the top of the screen, replacing that of Prototyper. You can select menu choices, open application windows that have been linked to those choices, click on buttons, and view dialog boxes. The application's Quit item brings you back to Prototyper.

Prototyper includes a short tutorial in one of the folders on the distribution disk, but it's almost unnecessary—this product is extremely accessible. A friend of mine—a software developer who'd spent

months writing the core of an application—used Prototyper to design and build his application's interface in just a few days, without ever consulting the manual or the tutorial.

## The Menu Editor

Your application's menu bar is the logical place to begin the prototyping process. Prototyper's menu editor is a window that contains three scrolling lists. The first scrolling list holds menu headings for your application—Apple, File, Edit, and so on. The next contains items for each heading (e.g., Edit might contain these items: Cut, Copy, Paste, Clear, and Undo). The last helps you build hierarchical menus.

It is very easy to define the menus for

*continued*

your application. You just type a list of the menu headings into the first scrolling list. By clicking on any one of these headings, you can type the respective menu items in the second list box. This process takes longer to describe than it does to do. While you are working on a particular menu heading, the heading is temporarily added to Prototyper's main menu bar. This lets you pull down a list of items from the menu bar and check on spacing, spelling, and visual appearance as you enter the items. To check the entire menu bar, you would choose Run or Quick Look from Prototyper's menu. For a particular rmenu item, you can also define a sublist of choices in the hierarchical style that Apple introduced not long ago. In Prototyper, you get only one subordinate list of menu items; you can't nest to arbitrary depth.

In the realm of Mac programming, writing menu-handling code is one of the more straightforward tasks. You can also use Apple's ResEdit to modify menu resources. In this area, Prototyper's quick and easy interactive tool, although enjoyable, does not save you that much time. It does, however, exemplify Prototyper's approach to creating a simulated application: Everything is accomplished interactively and visually, with as much immediate feedback to the designer as possible. But it's in the realm of creating and managing windows and dialog boxes that Prototyper earns its keep.

### Windows, Dialog Boxes, and Zones

If you click on the window icon in the main Prototyper window, you invoke a dialog box with which you can specify the kind of window object you want to create. You can create six types of windows, two types of dialog boxes, and three types of alert boxes. These window types are all standard Macintosh window types. As such, they can differ in the style of their borders, in the use of close boxes and title bars, and in whether or not a dialog box is modal.

Once you specify the kind of window you want to create, Prototyper presents what it calls a worksheet—a window similar to that found in many drawing programs. The window features a palette of interface objects called *zones*. These zones are icons, scroll bars, editable text areas, noneditable text (static text), pictures (graphics imported from other Macintosh drawing programs), round-cornered buttons, radio buttons, check boxes, scrolling lists, pop-up menus, rectangles, and lines. Some of these are objects with which you can interact (e.g., pop-up menus, radio buttons, and edit-

### Prototyper 2.1

#### Company

SmethersBarnes  
520 Southwest Harrison St., Suite 435  
Portland, OR 97201  
(503) 274-2800

#### Hardware Needed

Mac Plus, SE, or II with 1 megabyte of RAM; a hard disk drive is recommended

#### Software Needed

Apple's System 6.02 or higher; Think C 3.0, MPW C 2.0, MPW C 3.0, Think Pascal 2.0, Turbo Pascal 1.10, MPW Pascal 3.0, or TML Pascal II

#### Documentation

User's manual

#### Price

\$295

#### Inquiry 881.

able text zones). Others, such as static text, rectangles, and lines, serve informational or cosmetic purposes.

At any time, you can choose Quick Look, which simulates the window or dialog box that you are currently working on, or Run, which simulates your entire application.

To create a zone, you choose the one you want from the palette and click on the worksheet. Working with zones is similar to working with objects in a drawing program. You can select, resize, and drag them—singly or in temporary groups. Double-clicking on any object brings up a dialog box that lets you change that object's characteristics. This dialog box includes a brief, helpful description of the object, obviating the need for a context-sensitive Help function. Objects can snap to a grid.

Prototyper also provides some basic alignment commands (e.g., Align Top, Bottom, Center, Left, and Right). These are useful, but I wish there were more of them—for example, an Align Middle function or a Distribute function, as found in MacDraw II or MacDraft.

You can specify a text zone's font and size. Presently, you cannot specify the text style (i.e., bold, italic, or underline). The choices are tantalizingly present on one of Prototyper's menus, but for some reason, they are not supported in this version. As with most Mac programs, there is an undo function. Although it's workable and helpful in its present form, this function could be expanded further. In the course of creating a prototype, I encountered situations that I thought

should be undoable but were not. However, none of these was of major import.

One nice feature is the ability to export a window definition into a separate Prototyper file. You can then incorporate this file into some other prototype application. You can also import resources, such as menu definitions or dialog box specifications, from any Mac application that has these in its resource fork.

### Simulating an Application

Real applications, of course, have dynamic behavior. It isn't enough to view a dialog box; you need to be able to choose items or enter the parameters that the dialog box requests. Prototyper provides a simple mechanism for simulating this dynamic behavior.

For any interface object in your application (i.e., a menu item or zone), you can specify an action that will occur when you click on the object. Prototyper calls this feature *linking*. For example, you can link a button to the action of closing one of the windows in the simulation, or you can link a menu item to a sequence of different actions, such as closing one window, opening another, and disabling (graying out) other menu items. It is this linking feature that makes Prototyper a tool for simulating applications, as opposed to merely being a friendlier version of ResEdit.

Links in Prototyper are vaguely similar to links in HyperCard. HyperCard goes much further in allowing you to associate a HyperTalk script with an object and thus describe a much wider range of behaviors for that object. But this then becomes more like programming, which Prototyper seeks to avoid.

Prototyper can also simulate a real application through the use of demo windows. These are standard Mac document windows (with a title bar, a drag region, a close box, and scroll bars) that are linked to either a text file or a Macintosh graphic (i.e., a PICT resource). When a demo window gets displayed (either automatically at program start-up or through a link to a button or other object), you see the corresponding text or graphic in the window. You can scroll, resize, move, or close the window. Of course, that's all you can do. But with the appropriate choice of content, this feature can go a long way toward simulating a variety of applications—from a spreadsheet to a three-dimensional graphics program.

### Code Generation

Prototyper can generate C and Pascal source code. You save your file from

*continued*



# Mass Storage Is No Longer A Peripheral Issue.

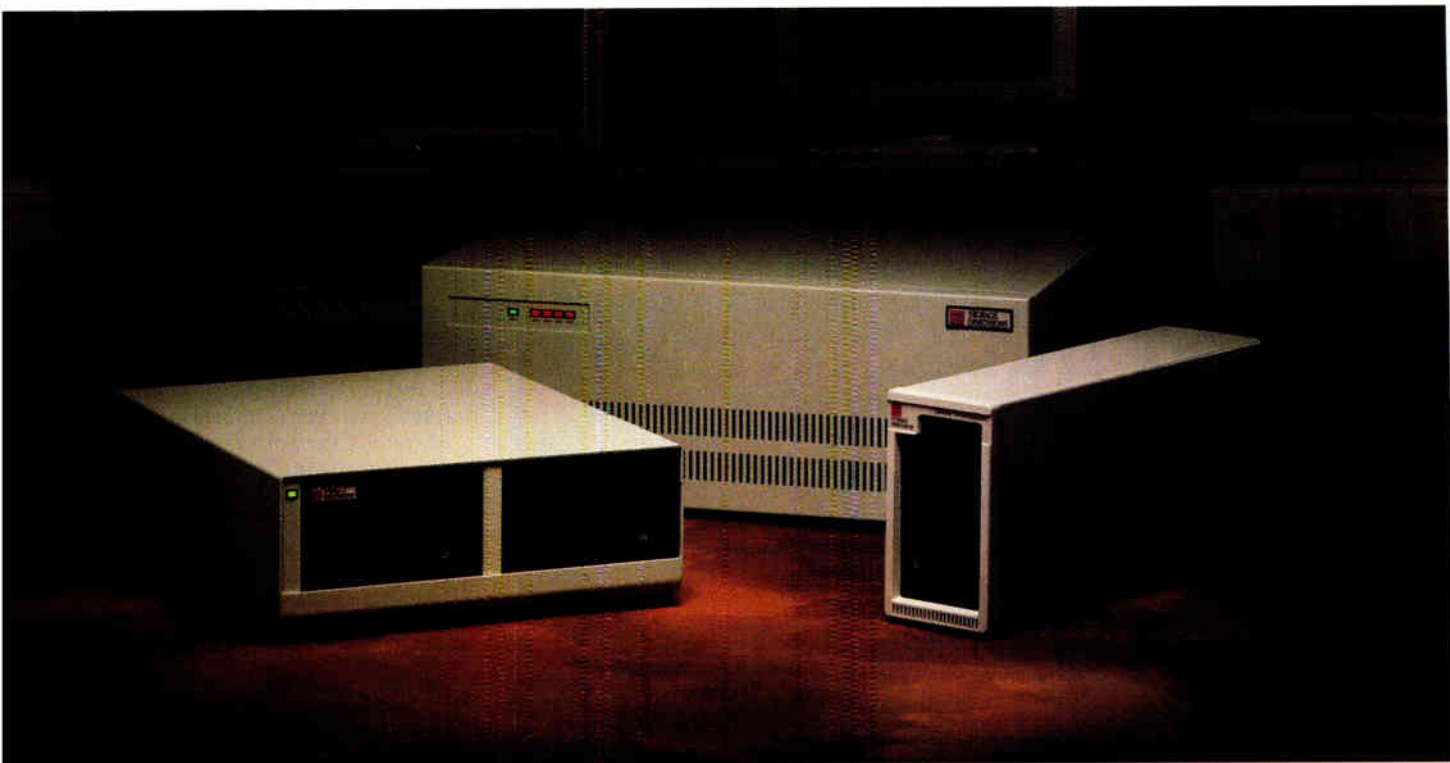

## It's The Central Issue.

And it should be. Today's top end computer platforms have created dazzling new dimensions in CAD/CAE, data bases, networking and specialized DOS applications. More than ever, storage performance and capacity are central concerns.

And more than ever, Storage Dimensions is the logical solution.

With our SpeedStor™ hard disk subsystems, you get the best possible performance specs. But you get more than 14 ms access times and 15 Mbit transfer

MICRO CHANNEL™

COMPAQ®

HIGH-SPEED 386s

rates. You get our expertise in translating those specs into maximum system throughput—delivering to your application all of the performance it can handle. And all of the capacity it will ever demand. In configurations that include single 650 MB internal storage systems, external enclosures that expand to four drives and 2.6GB, and many more.

To get the most from today's most powerful desktops, start at the center. Start with Storage Dimensions. Call (408) 879-0300. Or write us at 2145 Hamilton Avenue, San Jose, CA 95125.



### STORAGE DIMENSIONS

A MAXTOR COMPANY

SpeedStor is a trademark of Storage Dimensions, Inc. ©1989 Storage Dimensions

*Circle 339 on Reader Service Card (DEALERS: 340)*

World Radio History

within Prototyper, launch the appropriate code generator for your target language (C or Pascal), and then tell that program to generate code for a particular language processor. For C, the choices are Think C 3.0 (formerly Lightspeed C), MPW C 2.0, and MPW C 3.0. For Pascal, they are Think Pascal 2.0, Turbo Pascal 1.10, MPW Pascal 3.0, and TML Pascal II.

SmethersBarnes rightfully assumes that it is your responsibility, if you are

going to be working with source code, to get a copy of one of these language processors and learn how to use it. The manual includes a section with brief summaries on how to operate the particular compiler you have chosen. The descriptions are concise but sufficient to build an executable file.

The code generated consists of one file for each of the windows or dialog boxes in your application, a main file containing the event loop, and two files for ini-

tializing and handling menus. There are also appropriate header files. For C, these header files contain function prototypes per the ANSI standard.

Examining the code that this program produced, I found it well-written, well-commented, and logically structured—more so than many programs that people write. The names are long and descriptive. You can specify two levels of commenting (minimal comments or more extensive ones). For both C and Pascal, you have choices in how to format the code—how much to indent (if at all) the various language elements, such as IF statements, switch and case statements, function argument declarations, variable declarations, beginning and ending brackets, and even comments.

At each of the points in the generated code where you might want to add functionality, there is a comment to that effect. One disappointment is that many of the features present in the interactive simulation disappear when you move to compiled code—e.g., demo windows, hierarchical menus, buttons in windows (as opposed to buttons in dialog boxes), and certain kinds of linked actions. Another problem is that once you edit the generated files and add your code, it is difficult to go back to the interactive tool and add features there. When you generate code a second time, Prototyper isn't smart enough to preserve your handwritten application code. You'll have to wait for future versions of Prototyper to fix these limitations.

Legend has it that the first version of Lotus 1-2-3 was prototyped over a week-end and then completed over the next year. Now the most recent version of 1-2-3 has consumed over 100 person-years of programmer effort. To cope with this changed world, software developers need to expand their repertoire of tools and techniques. One valuable technique is interactive, dynamic simulation of applications.

Prototyper is a well-conceived, accessible, and worthwhile tool that supports this technique. It would benefit from a few improvements: more drawing operations (i.e., better alignment functions, more graphics objects, and more text styles), an extension language like HyperCard's, and a smarter code generator. Nevertheless, it's a valuable tool. ■

*Ray Valdés is president and founder of Sapphire Software, a technology consulting firm in San Francisco, California, that specializes in the design and development of graphics software. He can be reached on BIX c/o "editors."*

# Space-Saver Keyboard



**T**he new **microtype** space-saver keyboard saves an amazing 60% of the desk space used by equivalent standard keyboards. Without loss of functionality or ability to touch type!

**microtype** is ideal for CAD systems, point-of-sale, mobile or imbedded applications or anywhere the keyboard must compete for valuable desk or counter space.

Space is saved by compressing rows (not columns) and eliminating wide borders. Re-arranging and elevating the function key clusters also saves space while improving accessibility with reduced eyescan and head movement. Keys have full travel with a light tactilely responsive touch. All standard features such as auto-repeat, caps, num and scroll lock are included on the **microtype**.

The **microtype** works with most PC, XT, AT and 386 IBM compatibles. IBM PS/2's require an adapter.

Actual size 10.75" x 6.0" • Full One Year Warranty • Guarantee—Full Refund if Returned in 15 Days! • OEM's and Volume Purchases—Call for special terms.

Order Toll Free 800-782-7177 or FAX 703-435-1837 Hours Mon.-Fri. 8 am-5 pm EST Shipment within 72 hours.



Microtype Space-Saver Keyboard	\$124.50
PS/2 Adapter (if required)	9.00
UPS shipment by ground	6.00
2nd day air	11.00
Overnight	19.00



461 Carlisle Drive  
Herndon, Virginia  
22070  
703-435-9496





# CompuStar II



## IT EATS IBM'S LUNCH... AND SERVES DELL FOR DINNER!

Introducing Wells American's CompuStar II. It's one *hungry* machine. Feed it the toughest applications you can dish out and it's ready for "seconds" before IBM, Dell and all the others even get started.

### IT FEEDS ON THE COMPETITION.

CompuStar II's enormous appetite for devouring the competition comes from its unique, modular design. Interchangeable, plug-in CPU "modules" are available in 80286, 80386SX, 80386 and soon —



80486 configurations. The modules are remarkably inexpensive — as little as \$695 for a '286 module, and incredibly powerful. The 33MHz '386 module achieves a stunning MIPS rating! Best of all, for up to one full year after purchase, you can trade in the module you originally select toward the purchase of any of the other more powerful modules.

### IT DEVOURS OTHER COMPACTS.

Unlike other small footprint micros, CompuStar II won't put your computer expansion needs on a diet. Each system features an amazing six bus slots — four of them available in a fully configured VGA system. That's 25% more than IBM or Dell gives you. Better yet, you can have up to 11 slots with CompuStar II's exclusive bus expansion chassis. No other compact system available offers this much room for growth. And no other comparably sized system can accommodate that growth better than CompuStar II.



BUS EXPANSION CHASSIS

Its whopping 200 watt power supply gives you more than twice as much reserve power as IBM or Dell.

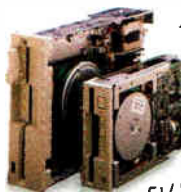

And CompuStar II has more room for disk/tape drives — *four* compartments in all; three accessible from the front panel. IBM and Dell give you just three compartments and only two are accessible from the front. CompuStar II also accommodates 5 1/4" and 3 1/2" disk drives. IBM and Dell restrict you to 3 1/2" drives only.

### IT'S ALSO WELL-MANNERED.

Worried about quality and reliability? Don't! Wells American has been making PCs longer than IBM or Dell! Each CompuStar II is money back guaranteed for 31 days, factory warranted for a full year and can be field serviced from hundreds of locations worldwide.

When you think about it, buying an IBM or Dell system instead of our new CompuStar II is sort of like eating hamburger when you could have had steak — and paid less for it. CompuStar II. . .from Wells American. It makes "mincemeat" of everything else.

To receive a CompuStar II product information kit, call 1-803-796-7800. VAR inquiries welcome.

 **Wells American.**

Corporate Headquarters: 3243 Sunset Boulevard • West Columbia, South Carolina 29169 • 803/796-7800 • FAX 803/796-7029

IBM is a trademark of International Business Machines Corporation. Dell refers to Dell Computer Corporation.

\*CompuStar II's CPU performance is so incredible you won't believe it! Call or write for complete benchmark information. Certified FCC Class A. For business use only.

Wells American Corporation 1989

Circle 377 on Reader Service Card (DEALERS: 378)

World Radio History



## **New application. New network. You know the drill.**

You made it. You built a distributed application that takes full advantage of the power of your network. You faced incredible obstacles. And you swore if you survived, you'd never do it again. Guess what?

They want you to do it again.

This time, take a short cut. With Netwise® Our RPC TOOL™ lets you sidestep the obstacles by providing access to a common platform for the development of distributed applications. You write the application, then specify the network. Netwise automatically generates your distributed processing code. All of it. Every time. That means your application can easily migrate to any environment in the future. Banyan, Novell, Sun, 3Com and major software suppliers have endorsed this technology as a standard for building distributed applications. Now it's your turn.

Call us for a free educational diskette. Or order the RPC TOOL for a free thirty day try out. The development tool that lets your application be all it can be.



**Put an end to the grunt work. Call us. 303/442-8280**

2477 55th Street, Boulder, Colorado USA 80301

Netwise is a registered trademark. RPC TOOL is a trademark of Netwise, Inc. Banyan is a registered trademark of Banyan Systems Incorporated. Novell is a registered trademark of Novell, Inc. Sun is a registered trademark of Sun Microsystems, Inc. 3Com is a registered trademark of 3Com Corporation.

*Circle 252 on Reader Service Card*  
World Radio History



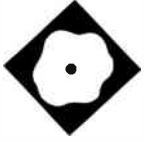

## TI and ExperTelligence make the Mac II a Lisp machine

Alex Lane

**T**exas Instruments' microExplorer is a Lisp machine on a NuBus board. Installed in a Mac II, the microExplorer acts as a coprocessor: It handles an application's Lisp internals, and the Macintosh takes care of I/O. The resulting machine looks like a Mac, but it's really a horse of a different color. Although the microExplorer has a slower clock and smaller memory than its big brother, TI's Explorer, it is, in all other respects, every bit as powerful.

Of course, to look like a Mac program, a microExplorer application has to use the Macintosh Toolbox. That's where ExperTelligence's Action! comes in. ExperTelligence developed the original Common Lisp interface to the Toolbox that's still part of the microExplorer's development environment. Action! embeds that Toolbox interface into a visual shell, thus hiding the details of the Toolbox from the Lisp developer.

The Explorer processor on the microExplorer circuit board is a microprogrammed device specifically designed for symbolic processing. The chip features a 32-bit data path and has a 128-megabyte virtual address space with demand-paged memory mapping. Many Lisp primitives and system functions—including device handling, garbage collection, and memory management—are implemented in microcode that's loaded into a control store every time the microExplorer starts up. The writable con-

trol store makes for an elegant way to upgrade the system without having to swap hardware.

The distinguishing feature of the Explorer processor—which to me makes the microExplorer a Lisp machine—is its tagged architecture for typed data. Since Lisp is by nature a dynamic and heuristic language (as opposed to static and algorithmic), it's often not feasible to type-check arguments to functions in advance, so typing occurs at run time. Lisp machines, including the microExplorer, implement this type checking in hardware.

The microExplorer arrived complete with a TI representative who did the installation. Apparently, that's standard procedure—and given the system's \$15,000 price tag, probably not a bad idea. The standard microExplorer board comes with 4 megabytes of RAM, but mine came with an additional 8 megabytes of RAM on a piggyback board. The software comes on an external 80-megabyte hard disk drive.

The physical installation of these two components—TI calls them “the board and brick”—was straightforward. The external drive contained a folder called *microExp* with more than 60 megabytes of material, including the microExplorer application, a start-up file, paging files, and the start-up Lisp environment. After ensuring that my Mac was running a post-6.0 OS and that MultiFinder was installed on the external drive, the TI representative spent a couple of hours setting up the software (which included setting up Action!) and giving me the tour.

In addition to the “board and brick,” the minimum hardware requirements for a microExplorer system are a Macintosh II chassis, a 640- by 480-pixel monitor, an Apple extended keyboard and a single-button mouse, 2 megabytes of RAM, a tape drive or a floppy disk drive, and an 80-megabyte hard disk drive with 70 megabytes of free space (needed for swapping). But that doesn't leave much

headroom on the Macintosh side of the machine. Launching the microExplorer in that configuration left just 128K bytes of memory free. After I boosted the Mac II to 4 megabytes of RAM, memory worries evaporated—as well they should have, in a machine with a total of 14 megabytes of RAM.

### Exploring the microExplorer

The microExplorer launches like any Macintosh application. But from then on, it's almost all microExplorer and very little Mac. What comes up is a Lisp Listener window (i.e., the agent that reads Lisp expressions, evaluates them, and prints the results). The Listener also displays the amount of memory available to the microExplorer, and the names and versions of software tools it can access. At the bottom of the screen is a graphical display of current CPU, disk, and garbage-collection activity.

Garbage collection is a technique for reclaiming memory occupied by objects that are no longer accessible. In some Lisp systems, garbage collection is performed on a batch basis, which means that periodically the system appears to lock up while it scavenges for free space in memory. On advanced Lisp systems (including the microExplorer), garbage collection is nearly invisible so that the user never feels it happening. I had to look hard at the garbage collection tell-tale (at the bottom of the microExplorer screen) to catch the microExplorer in the act. The microExplorer system offers two options for garbage collection: temporal (sometimes called generational scavenging) and batch (which is useful, for example, when preparing clean disk images).

Next to the status display, the system shows the current user and the current package. (A Lisp package is a collection of symbol names; it's analogous to a C library.) The display feature I liked best was the mouse documentation window. It

*continued*

microExplorer/Action!

**Company**

Texas Instruments  
P.O. Box 202230  
Austin, TX 78720  
(800) 527-3500

ExperTelligence  
5638 Hollister Ave.  
Goleta, CA 93117  
(805) 967-1797

**Hardware Needed**

Mac II or IIx with 2 megabytes of RAM  
and an 80-megabyte hard disk drive

**Software Needed**

System 6.0 or higher or MultiFinder  
6.0.1 or higher

**Price**

microExplorer processor with  
4 megabytes of RAM and supplied  
software: \$11,995  
Additional 4 megabytes of RAM: \$3495  
Additional 8 megabytes of RAM: \$5995  
Development software: \$3995  
Action! software: \$1995

**Inquiry 883.**

shows what mouse-selectable functions are available in different regions of the screen, and it describes those functions. Symbolics and Xerox Lisp machines work like this. It's an effective way to make users productive quickly.

The microExplorer's interface closely follows that of the TI Explorer. On the Macintosh, the Option key plays the role of the microExplorer's Meta key, and F5 serves as the System key. To simulate the microExplorer's three-button mouse, you use the Option and Apple keys in conjunction with a mouse-click to access functions attached to the second and third buttons.

Major software components in addition to the Listener include a Lisp compiler, an interactive debugger, several Inspectors, the ZMACS text editor, and a Macintosh Toolbox interface. The compiler converts Lisp functions into *macro-code*. The debugger helps you examine the environment in which an error occurs. The Listener uses a text-based debugger; there's also a window-based debugger that performs substantially the same functions, but graphically. Inspectors view data structures. There's one Inspector for examining standard Lisp structures, and another for examining *flavors*.

Flavors are part of an object-oriented facility featured in all Explorer systems. A flavor defines a data type and a set of operations (methods) that operate on that data type. You can combine flavors to yield a new flavor that inherits the properties of its constituents; object-oriented programmers call this "multiple inheritance." Both Inspectors support the examination of several flavors concurrently in separate panes, and they maintain an inspection history so that previously inspected objects can be easily reexamined.

The ZMACS editor is a clone of Richard Stallman's EMACS—the traditional text-editing tool for Lisp environments. As such, it provides hundreds of useful functions. One function I liked was the ability to select and compile parts of a ZMACS buffer. This came in handy when working with a body of Lisp code I'd acquired by means of a hand scanner. The file I loaded into ZMACS contained several errors that resulted from the scanning process. I was able to compile the buffer in manageable chunks, and by applying the debugger to the resulting errors, I sorted things out with remarkable speed.

The Macintosh Toolbox interface gives Lisp code the ability to access the Toolbox routines. Prior to the advent of Action!, that was how microExplorer developers gave their applications the look and feel that Macintosh users expect. The *tb* package is organized along the lines of *Inside Macintosh*; the Mac's ROM calls and arguments have been Lispified in a way that will be transparent to experienced Macintosh programmers. Of course, you wouldn't use a microExplorer for serious Mac-specific development; rather, the point is to deliver a powerful Lisp application that presents a Mac-like face to the world. That's where Action! comes in.

**Ready for Action**

Although Action! doesn't openly proclaim itself to be a CASE tool, that's what it is. It has five components: the User Interface Objects, the Smart Editor, the User Interaction Manager, the Menu and Keyboard Management System, and the Development Tool. Users spend most of their time with the first two of these.

The User Interface Objects are a group of Lisp flavors that represent the elements of the Macintosh interface—menus, dialog boxes, scroll bars, icons, and fields. These flavors all derive from the root flavor *Rect* (for rectangle); they're subdivided into the flavors *Dis-*

*playObject* (for pictures and text) and *ControlObject* (for buttons and scroll bars). The Smart Editor instantiates these flavors and, by way of dialog boxes and menus, helps you position, size, and align the interface objects and specify the actions associated with them. An *Action* field is usually associated with an interface object; the field is where you put the name of the Lisp form that should fire up when a user clicks on the object.

The User Interaction Manager and the Menu and Keyboard Management System work behind the scenes, trapping system events and dispatching messages to appropriate objects. The Development Tool builds a text file that documents the components of the interface under development. You launch Action! by double-clicking on its icon or by invoking it from the Listener. Once it's launched, you're operating in a dual mode. That is, the Mac's menu bar includes items that belong to Action!—as you begin to construct an application—items that belong to the application you're building. To keep the categories distinct, Action!'s items appear in red, prefixed by a bullet. If you press Command-Space, you switch modes; Action!'s menu items disappear, and you're no longer editing your application—you're running it.

When you choose the New item from Action!'s File menu, a window appears in which you can begin assembling User Interface Objects. You place these objects in the window with the aid of the Action! keypad. The keypad is a calculator-like device whose buttons represent interface objects. To select an object, you drag the mouse to the object's icon and release the button; an instance then appears in the window. You can move, group, ungroup, and align objects in the window—in short, you can arrange them any way you want.

One example in the Action! manual constructs a slide show with buttons labeled "start," "advance," and "reverse," and a *PictObject* that represents the slide. The *PictObject* is named *:proj*, and the code linked to the start button is this Lisp form:

```
(tb:set-value :proj  
(setq *cnt* 6000))
```

In English, this expression sets the value of the *\*cnt\** (associated with *:proj*, the *PictObject*) to 6000—the resource ID of the first picture in the slide show. Expressions linked to the advance and reverse buttons increment (or decrement) that resource ID, wrapping around

*continued*



**Windows menu system** means you'll learn fast. If you can use Windows you can quickly use Windows CAD.

**Multiple viewports** allow you to work on up to four views of your drawing at the same time.

**Sophisticated drawing features** include associative dimensioning/cross-hatching and much more.

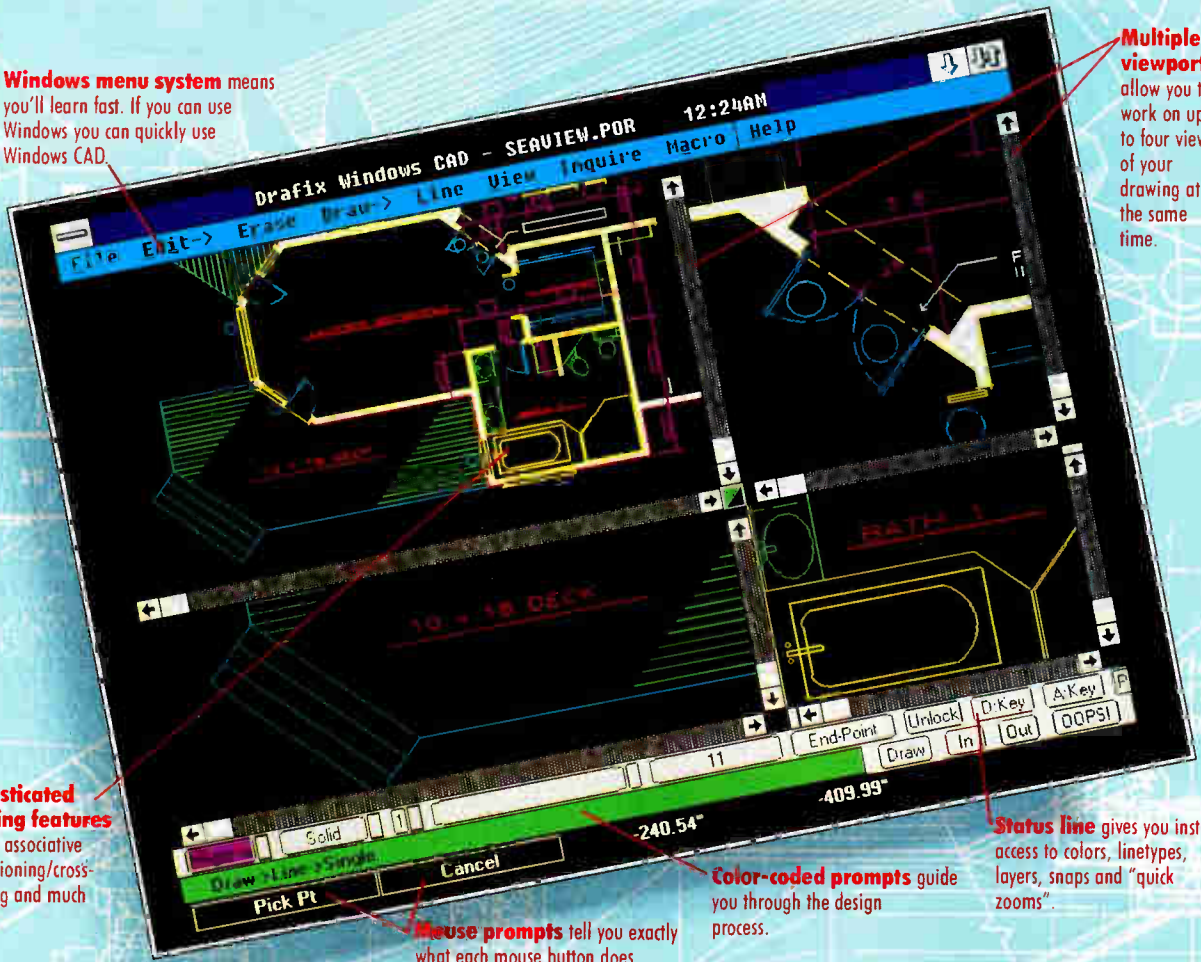

**Mouse prompts** tell you exactly what each mouse button does.

**Color-coded prompts** guide you through the design process.

**Status line** gives you instant access to colors, linetypes, layers, snaps and "quick zooms".

# FINALLY, CAD FOR WINDOWS. DRAFIX™ WINDOWS CAD.™

At last the power of true, high performance CAD is available for Windows. Drafix Windows CAD. With features that take you far beyond any Windows drawing package you currently use.

**Powerful CAD.** Windows CAD is the first and only Windows software to provide all of the designing and editing functions demanded by engineers, drafters, architects and other serious CAD users. It offers multiple interactive viewports, allowing you to work in four views simultaneously. Associative dimensioning, associative crosshatching and a powerful macro programming language are just a few of its features—and that's just the beginning.

**Quick to learn, easy to use.** Windows CAD lets you take full advantage of your Windows experience. If you already use Excel, Pagemaker, Micrografx Designer, or any Windows package, Windows CAD will have you doing precise, accurate CAD design in no time. And of course you can use all of the plotters, printers and video devices that work with Windows.

**From a proven line of CAD products.** Windows CAD is the latest in a full line of highly rated CAD software that includes Drafix CAD Ultra, Drafix CAD QwkStart and Drafix 3-D Modeler.

**Order your copy of Drafix Windows CAD today!** Now if you have Windows, you can have the full power of true CAD. Drafix Windows CAD. Only \$695. For more information call us today at 1-800-231-8574.

**Drafix Windows CAD has features you usually find in packages costing 5 times as much!**

**Item Attributes**  256 layers  8 colors  
 9 linetypes  Up to 60 database attributes to any entity  Multiple line widths

**Drawing Features**  Lines: single, double, tangent, parallel, perpendicular, multiple width  
 Arcs/Circles  Curves/Splines  Polygons and Polylines  Ellipses  Pointmarkers  
 Freehand sketching

**Input Methods**  Windows menu system  Keyboard equivalents  Ortho lock  10 item and grid snaps, including endpt, midpt, tangent and more  Keyboard entry of coordinates  
 OOPS (Undo) feature  Dynamic Drag  
 Quick zoom/pan  Multiple viewports, all active

**Powerful Editing Features**  Trim entities to each other  Snerch  Fillet (round)  
 Chamfer (bevel)  Erase  Copy  Move  
 Mirror  Rotate  Arrays  Select items by region, entity, attribute or combinations

**Associative Dimensioning**  Linear, Radius, Diameter  Single, Continuous, Baseline  
 Ordinate, Elevation or Bearing format  
 23 terminator types  Any alignment  
 Tolerancing  English and metric  
 Fraction or Decimal

**Associative Crosshatching and Solid Fill**  15 crosshatch patterns, ANSI specs  
 64 solid fills

**Text Editing**  Word processing window  
 Multiple font styles

**On-Line "Help" system**

**Macro Programming Language**

**System Requirements**  '286 or '386 processor  Microsoft Windows 2.11 or later  
 1 Mb internal memory or greater  
 Windows-supported mouse

**File Compatibility**  Autocad DXF  
 Drafix CAD  HPGL  CDF, SDF for database information



Foresight Resources Corp.  
**1-800-231-8574**

See us at COMDEX/FALL!

Excel, Pagemaker and Micrografx Designer are trademarks of their respective companies.





## REAL-TIME MULTI-TASKING KERNEL

**for protected mode 80386**

- No royalties
- C language support
- Preemptive scheduler
- Time slicing available
- Configuration Builder
- List Manager
- 20 us task switch at 16 MHz (no waits)

- Intertask messages
- Message exchanges
- Dynamic operations
  - task create/delete
  - task priorities
  - memory allocation
- Event Manager
- Semaphore Manager

**Source Code Included**

Manual only **\$75 US**  
AMX 386 **\$3995 US**  
(shipping/handling extra)

Also available for 8086, 80286,  
8080, Z80, 68000.

**KADAK Products Ltd.**  
206 - 1847 W. Broadway  
Vancouver, B.C., Canada  
V6J 1Y5  
Telephone: (604) 734-2796  
Fax: (604) 734-8114

### YOUR LAN CONNECTION ACCESSORIES LET "GOOD WAY" TO RESPOND

FACE PLATE & SURFACE MOUNT BOX FOR IBM TYPE 1 & 2



**MAIN PRODUCTS:**  
NETWORK ACCESSORIES. COMPUTER CABLE. GENDER CHANGER.  
DATA SWITCH. ARCNET PASSIVE HUB

**GOOD WAY INDUSTRIAL CO., LTD.**  
P.O. Box 91-202, Taipei, Taiwan, R.O.C.      Factory: No. 14-1, Dah Her Lane 2, Taichung, Taiwan, R.O.C.  
Office 3F, 309, Fu Hsing N. Rd., Taipei, Taiwan, R.O.C.      Fax: 886-4-2542648  
Tel: (02)1717-7688 (Rep.)      Fax: 886-2-7189807  
Telex: 12445 SUWORS

to the beginning (or end) of the list of IDs if necessary.

Another, more complicated example creates an address book. Here, several `FieldEditObjects` are used to represent name and address fields, and `ButtonObjects` handle New, Save, and Find actions. Find's action searches the address list for an entry that matches the fields specified in the main window. If that fails, an alert appears. Interestingly, the alert runs as a separate Action! application. This confused me at first, but it turns out that because an Action! application owns just one window, you must build multiwindow programs out of separate components that you store together in a folder.

Once you've got things working properly, you'll want to create a stand-alone, double-clickable application. The Lisp function `define-mac-application` does that. Of course, real applications aren't quite so simple. Action! can only help you build an interface. You're on your own when it comes to writing the `microExplorer` Lisp application to which that interface grants access. But Action!'s graphical, object-oriented approach makes the Mac-specific part of the project a breeze. You don't need a lot of Mac-specific knowledge—Action! successfully shields you from that. The documentation takes you through the development of several sample interfaces, and it does a good job of describing the User Interface Objects included with the package.

I tested the `microExplorer` at work, in the midst of a crowd that's done quite a bit of development work in Lisp on a variety of platforms. The souped-up Macintosh received a uniformly positive reception. Veteran Lisp hackers found that the `microExplorer` offers many of the capabilities they'd grown familiar with on Symbolics and Xerox Lisp workstations. Those who had worked with the Explorer saw the `microExplorer` as a less-expensive, code-compatible version of its big brother. Of course, less expensive is by no means inexpensive, but the `microExplorer` does offer the option of a scaled-down delivery system. You can develop on a 12-megabyte `microExplorer`, but you can deliver on a 4-megabyte `microExplorer`. That should put the benefits of hybrid Macintosh/Lisp technology within the reach of more users. ■

*Alex Lane is a senior knowledge engineering consultant for Technology Applications, Inc., and lives in Jacksonville, Florida. He can be reached on BIX as "a.lane."*





## When you pick a printer for the office, the only thing you have to fear is being wrong.

An office printer can cost a few hundred dollars, or it can cost as much as a small car. And depending on how well it does (or doesn't do) what everybody in the office wants it to do, it can cost you a lot of sleep.



That's why when AEG Olympia talks about printers, the feature we talk about most is good technology. Which may explain why we're one of the leading business machine companies in our native Germany, where technology is a leading passion.

So before an AEG Olympia dealer tells you about all our dot matrix and daisywheel and laser printers, he'll probably show you how beautifully they all work. We live and breathe solid engineering, sensible design and dependable mechanics for printers, just as we do for our typewriters,

facsimiles, copiers and shredders.

For the name of our nearest dealer, call 1-800-999-6872. Or write AEG Olympia, Box 22, Somerville, NJ 08876-0022. You can't go wrong with good technology. **Where technology counts, business counts on us.**

**AEG**  
OLYMPIA

# We develop products on the premise that



*Page Laser12: 12 ppm, up to 3 paper bins, 750 sheet capability, Toshiba/Qume, Diablo, IBM & HP emulations.*



*T1000: 6.4 lbs, 4.77MHz 80C88, 512KB RAM expandable to 1.2MB. MS-DOS in ROM, 720KB 3 1/2" diskette drive. Built-in RGB, parallel, serial and external drive ports.*



*P341SL: Wide carriage (up to 270CPL), 216/72 cps, advanced paper handling, 4 part forms.*



*TL200FB: 9.8 pounds, 9.54MHz 80C86, 1MB RAM, 2 720KB 3 1/2" floppy drives, removable/rechargeable battery pack.*



*T3100e: 12MHz, 80286, internal IBM slot, 20MB hard disk, gas plasma display, 1MB RAM expands to 5MB, 1.44MB 3 1/2" diskette drive.*

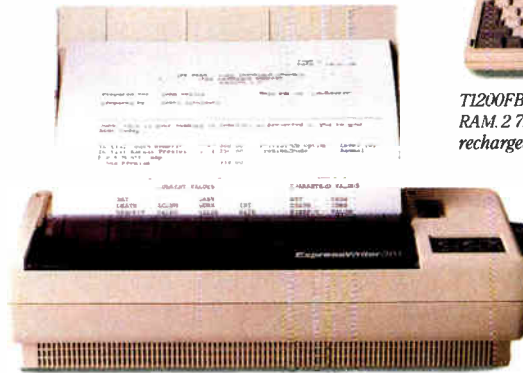

*ExpressWriter 301: 4 lbs, letter-quality 24-dot print head, 60 cps, Toshiba/Qume and Epson LQ emulations, 5 resident fonts.*



*T5100: 16MHz 80386 microprocessor, 40 or 100MB hard disk, 2MB RAM expandable to 4MB, 14.6 lbs. Built-in EGA display with high resolution gas plasma screen.*



*P351SX: 360/120 cps, 24-pin letter quality, color option, Toshiba/Qume and IBM emulations standard, Epson & Diablo emulations optional.*



# great minds don't think alike.

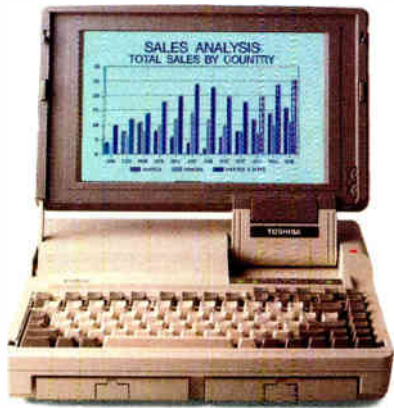

*T1600: 11.6 lbs. Battery-powered 12MHz 286, 20MB hard disk, 1.44MB floppy, 1MB RAM expands to 5MB, backlit EGA LCD, removable/rechargeable battery packs.*



*T5200: 20MHz 80386 processor, 2 internal IBM compatible expansion slots, 40 or 100MB hard disk, VGA display with external VGA monitor port, 2MB RAM expandable to 8MB.*



*T3200: 12MHz 286, 2 IBM compatible slots, 40MB hard disk, 1.44MB floppy, 1MB RAM expands to 4MB, EGA screen.*

© 1989 Toshiba America Computer Systems Division



*Carrying cases: available in leather or fabric, make our portable PCs even more portable.*



*ExpressWriter 311: 24-pin dot matrix, 180 cps draft/60 cps letter quality, 3 resident emulations (Toshiba/Quume, Epson LQ, IBM Proprinter), 16K buffer, 5 resident fonts plus card slots, 11 lbs.*

*Numeric Keypad: full function, 15 or 17 keys, for many of our portable PCs.*



*T1200HB: 10.8 lbs, 9.54MHz 80C86, 20MB hard disk, 1MB RAM, includes 384KB LIM-EMS. Removable/rechargeable battery pack.*



*P321SL/SLC (color): 216/72 cps, 24-pin letter quality, up to 360x360 DPI graphics, Toshiba/Quume and IBM emulations standard, Epson and Diablo emulations optional, 32KB print buffer, front panel controls, advanced paper handling.*



People have their own quirky ways of doing things. Some think fast. Some slow. Some are deliberate. Some intuitive. Some work from 9 to 5. Others never stop.

That's precisely why we offer so many different products.

Including the widest range

of truly portable PCs anywhere.

And a line of printers that includes everything from a high volume laser to a four-pound, letter-quality, battery-operated portable.

All of which can be easily networked. But all of which are designed to meet the specific needs

of each of our individual users.

Because the fact is, at Toshiba, we have an incredibly diverse and sophisticated customer base.

And from what we've been able to determine they have only one thing in common.

They're all different.

In Touch with Tomorrow  
**TOSHIBA**

Toshiba America Information Systems, Inc., Computer Systems Division

Circle 356 on Reader Service Card (DEALERS: 357)

World Radio History

# THE BEST JUST KEEP GETTING BETTER...AND BETTER.

**ANOTHER  
TECHNOLOGICAL  
BREAKTHROUGH**



See us  
at COMDEX Booth #III6

## BROTHER 1800 AND 1900 SERIES PRINTERS

This is the printer series that's so good, it truly can please all of the people all of the time.

Choose the 24-pin M-1824L or M-1924L dot matrix printers and you get a top printing speed of 337 cps, 360 x 360 dpi for high resolution graphics, a 24k buffer and 64k RAM and emulations that include IBM's ProPrinter™ X24, Epson's LQ850 and Diablo's 630.

For the budget-minded, see our 9-pin M-1809 and M-1909 printers. They feature speeds up to 360 cps, graphic resolution of 216 x 240 dpi, a 9k buffer and 32k RAM plus Epson EX and IBM 9-pin printer emulations.

Whether you choose our 80-column 1800 models or 136-column 1900

models, you'll get the friendliest control panel in the business. With a 6,000 hour MTBF, you won't break down mid-job, either. And Brother's Paper Parking™ feature will let you switch from sheet to form paper and back in mere seconds.

If you need even more speed and higher resolution, don't miss the Brother HL-8e with its many emulations and 44 internal fonts or the HL-8PS PostScript®-compatible laser printer.

Brother...fast, friendly, flexible, affordable printers for everyone. What could be better? For the name of your nearest dealer, call: 1-800-284-2844, Ext. 4616. Brother International, Somerset, NJ 08875-6714.

PostScript is a registered trademark of Adobe Systems, Inc.

**HL-8e Laser Printer**



**We're at your side.**

# brother®

BROTHER INDUSTRIES, LTD. Nagoya, Japan

Circle 62 on Reader Service Card  
World Radio History



# For Power Users Only

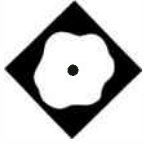

The power and flaws of Lotus 1-2-3 release 3.0 make it a program for the few of us

Edward Reno

**A**t the risk of giving a false impression of my high regard for Lotus 1-2-3 release 3.0, I want to tell you about its major drawbacks. It has three: namely, slowness, hidden expense, and incomplete presentation graphics enhancements.

The biggest problem with 3.0 is that it is slow. However, the standard BYTE benchmark tests (see table 1) show that 3.0 was only marginally slower than releases 2.01 and 2.2 in basic calculation speed. In the Scroll Right test, 3.0's screen refresh capability blew 2.01 and 2.2 away. (That advantage will bring consolation only to those who still don't use the End key to navigate around the spreadsheet.)

When I used 3.0 on my real-world spreadsheets, I got a different view. I ran the Calc, File Retrieve, and File Save tests on 3.0 using a 927K-byte spreadsheet, which is what I commonly work with. Here, the real difference between 3.0 and 2.01 became obvious.

I used both an 80386- and an 80286-based system. On the 80386 machine (a PS/2 Model 80-111), 3.0 took over 40 percent longer to calculate my spreadsheet than did 2.01 or 2.2. That difference was amplified on the 80286 machine (an AT), where 3.0 took nearly four times longer than 2.01 and over 10 times longer than 2.2.

However, in saving and retrieving a

file from disk, the results were mixed. On the PS/2, 3.0 and 2.01 took about the same time to retrieve the file, and 2.2 was the hands-down winner. Times for saving the file under DOS were also about the same, but 3.0 saved the file notably faster under OS/2. Release 3.0 didn't fare well at all on the AT, taking six times longer to retrieve a file.

I suppose I could run a theoretical calculation that would show that, during the course of my life expectancy, I would end up sacrificing several weeks because I used 3.0 rather than 2.01 on an 80386 machine. But I can live with that—as long as my spreadsheets don't get too big.

What I cannot live with, however, is 3.0 running on an 80286 machine—at least not on an 8-MHz machine configured similarly to mine. The 185-second Calc test that takes 39 seconds using the old version of 1-2-3 is a bit much. And a

File Retrieve discrepancy of 386 seconds under 3.0 to just 56 seconds under 2.01 is intolerable. Those few weeks running 3.0 rather than 2.01 on an 80386 machine could easily become several years on an 80286 machine.

Part of the problem is that—unlike 2.0—Lotus wrote 3.0 in C rather than in assembly language. Release 3.0's speed is further compromised by its use of overlays in DOS and virtual memory in OS/2. In both cases, this means that disk swapping of code occurs in many operations, even in the Calc test.

## Minimal Recalc and Background Calculation

Two features in 3.0 try to mask some of 3.0's loss of calculation speed. One feature, Minimal Recalc, was available as a Lotus-supplied add-in for 2.01. It causes

*continued*

INCOME STATEMENT 1989: Sloane Camera and Video, Chicago					
	Q1	Q2	Q3	Q4	YTD
Net Sales	\$10,000.00	\$13,000.00	\$16,000.00	\$19,000.00	\$58,000.00
Costs and Expenses:					
Salary	1,500.00	1,500.00	1,500.00	1,500.00	6,000.00

INCOME STATEMENT 1989: Sloane Camera and Video, Boston					
	Q1	Q2	Q3	Q4	YTD
Net Sales	\$12,000.00	\$19,000.00	\$16,000.00	\$22,000.00	\$69,000.00
Costs and Expenses:					
Salary	2,000.00	2,000.00	2,000.00	2,500.00	8,500.00

INCOME SUMMARY 1989: Sloane Camera and Video					
	Q1	Q2	Q3	Q4	YTD
Net Sales	\$22,000.00	\$32,000.00	\$32,000.00	\$41,000.00	\$127,000.00
Costs and Expenses:					
Salary	3,500.00	3,500.00	3,500.00	4,000.00	14,500.00

*Lotus 1-2-3 release 3.0 uses a rigid windowing format.*

**Lotus 1-2-3 release 3.0**

**Company**

Lotus Development Corp.  
55 Cambridge Pkwy.  
Cambridge, MA 02142  
(617) 577-8500

**Hardware Needed**

IBM PC AT or compatible or 80386 machine with 1 megabyte of RAM (under DOS) or 4 megabytes of RAM (under OS/2) and a hard disk drive

**Software Needed**

DOS 3.0 or higher or OS/2 1.0 or 1.1

**Documentation**

Reference manual, user's manual

**Price**

\$495 (\$595 after January 1, 1990)

**Inquiry 885.**

the spreadsheet to recalculate only those cells affected by a particular change.

In addition, 3.0 also has background calculation, which lets the program continue to calculate as long as it is not being preempted by keyboard input. Since there are many pauses in all but the most intensive keyboard input, the theory is that your spreadsheet will be continuously updated.

The theory works fine on small or otherwise simple spreadsheets. But any-

one with large and complex spreadsheets will find these features practically useless. On my 927K-byte spreadsheet, for example, when editing a formula that contained only a single-cell reference, I pressed Return to move the cursor out of that cell and on to another operation. I had to wait 8 seconds for 3.0 to write the new value of the cell to the screen. On the AT it was much worse; it took 133 seconds to write the data to the screen. I promptly turned off background calculation.

**Requirement for Extended Memory**

There are also some memory management issues for 80286-based systems. When Lotus says you need at least 1 megabyte of available RAM to run 3.0 under DOS, the word *available* hides a dual requirement.

First, the additional 384K bytes over a base 640K bytes must be extended, not expanded, memory. Depending on your system, this could mean reconfiguring 384K bytes of your expanded memory (assuming you already run large spreadsheets) for use as extended memory.

I also found that a 927K-byte 3.0 .WK3 file took only 884K bytes in .WK1 format. If you are playing at the ragged edge of expanded memory with some of your files, you may have to add more memory.

An 80386 machine can easily escape these problems. It just has to run a memory manager that conforms to the Virtual Control Program Interface (VCPI) speci-

fication. Some examples are Qualitas's 386Max, Compaq's Extended Memory Manager (CEMM), and Quarterdeck's Extended Memory Manager (QEMM).

These problems have a conceptually simple solution: Buy an 80386 system with lots of memory. Lotus is offering an upgrade to 3.0 for \$150 until the end of the year. But the real expense of upgrading to 3.0 will be for new hardware. None of the release 2.01 add-ins will run with the add-in manager that Lotus has built into 3.0. The problem is that the power user who really needs 3.0 is also the one who is most likely to have add-ins in the first place. In my case, unless Symantec comes out with a 3.0-compatible version of SQZ! pretty soon, I may be forced to upgrade my hard disk drive.

**Incomplete Presentation Graphics Enhancements**

The good news about 3.0's graphics is that you can display graphs on the same screen with cell entries and print graphs directly without going through the Print-Graph program.

A new automatic graphing feature allows 3.0 to guess what data it thinks you are looking to graph. There are also new types of graphs, some of which are wholly new, such as the High-Low-Close-Open graph, for those who cheat a little on their corporate CompuServe or Dow Jones subscriptions and load in the stock prices for their own portfolios. In addition, a new mixed graph lets you

*continued*

**Table 1: Lotus 1-2-3 release 3.0 proved to be too slow for large spreadsheets on an 80286-based IBM PC AT. All times are in seconds.**

	BENCHMARK RESULTS							
	PC AT <sup>1</sup>				PS/2 <sup>2</sup>			
	DOS 3.3/ 1-2-3 2.01	DOS 3.3/ 1-2-3 2.2	DOS 3.3/ 1-2-3 3.0	DOS 4.01/ 1-2-3 2.01	DOS 4.01/ 1-2-3 2.2	DOS 4.01/ 1-2-3 3.0	OS/2 1.1/ 1-2-3 3.0	
Savage	3.4	3.8	4.0	1.2	1.2	1.3	1.1	
Recalc	2.1	2.9	4.0	0.8	1.0	1.2	1.1	
Scroll Right	35.0	34.5	2.3	10.3	9.1	0.3	0.3	
Large Spreadsheet <sup>3</sup>								
Calc	39.0	16.0	185.0	8.7	6.0	12.4	12.2	
File Retrieve	56.0	66.0	386.0	97.2	35.0	84.0	98.0	
File Save	47.0	46.1	113.0	61.2	61.2	59.3	40.0	

<sup>1</sup> IBM PC AT 5170 with an 8-MHz 80286, an 80287 math coprocessor, 512K bytes of RAM on a system board, a 2-megabyte Intel AboveBoard AT, an AST Advantage! with 640K bytes of extended memory, and a 71-megabyte MiniScribe 6085 hard disk drive.

<sup>2</sup> IBM PS/2 Model 80-111 with a 20-MHz 80386, an 80387 math coprocessor, 4 megabytes of RAM, a QEMM memory manager, and a 110-megabyte hard disk drive.

<sup>3</sup> Worksheet is a forecasting model that was built for business use using Lotus 1-2-3 release 2.01. In .WK1 format, the worksheet takes up 884,117 bytes. In .WK3 format, the worksheet takes up 926,982 bytes.

**Note:** Tests run under 2.01 and 2.2 used the .WK1 format. Tests run under 3.0 used the .WK3 format.





# Terminal emulation doesn't have to be this way.

We've all been there. Trying to remember whether the "Do" key is really <Ctrl-F1>. Or was it <Alt-F1>? And the editing keypad. Can you be absolutely sure you're about to press the "Select" key and not the "Remove" key? The results can be disastrous.

That's why KEA developed the PowerStation. The PowerStation, an exact VT200 layout keyboard bundled with VT240 or VT220 terminal emulation software, turns your IBM PC or compatible into a key-by-key replica of a DEC terminal - without messy labels!

But what does that get you?

**Peace of mind.** The PowerStation keyboard takes the frustration out of switching between a DEC terminal and a PC *because each key is right where you'd expect it to be.* And our "Gold Key" version makes ALL-IN-1 and WPS a breeze.

**Savings.** If you think you can't afford both emulation software and a keyboard, think again! The PowerStation can actually save you money by eliminating the time you waste every day translating between VT and PC keystrokes. And with the PowerStation, *startup training costs are virtually eliminated.*

**Consistency.** The PowerStation keyboard provides a consistent interface for both VT emulation and regular PC applications. In emulation mode you get the 105-key functionality of a real DEC keyboard and in PC mode you get a super enhanced keyboard. *And you can use the PowerStation on virtually any PC! Move between an XT, AT, PS/2, AT&T PC and a DEC terminal without missing a keystroke.*

PowerStation and ZSTEM are trademarks of KEA Systems Ltd. All other brand and product names are trademarks or registered trademarks of their respective holders.

**The best in terminal emulation software.** With the PowerStation keyboard you get the fastest, most precise, DEC terminal emulation software available: ZSTEM. You have the choice between two popular software packages: ZSTEM 240, our VT241/VT340 graphics emulator and ZSTEM 220, our VT220 text emulator. Both packages will impress you with their speed and feature-by-feature accuracy.

To top it off, the PowerStation gives you all this at a surprisingly low price. But find out for yourself why Digital Review Labs says "the PowerStation 240 is a godsend." Call us at 800-663-8702.



See us at DEXPO and COMDEX.



KEA Systems Ltd., 2150 West Broadway, Suite 412  
Vancouver, B.C., Canada V6K 4L9  
Telephone: 604-732-7411 Fax: 604-732-0715

Circle 195 on Reader Service Card  
World Radio History

# THINK BIG

## Phar Lap Virtual Memory Manager.

It will let you write applications up to 5, 10, 15 megabytes or more for any 386 PC running MS-DOS\*. *Forget about RAM limitations.* Your application can run on a machine with as little as 1 or 2 megabytes of memory.

Only Phar Lap 386IVMM\* gives you demand-paged virtual memory capability so you can write mainframe-sized applications for the PC. Applications your customers can run on their 386 PCs now with no additional memory. No kidding. All you need is 386IVMM and our family of 386 development tools. Existing programs developed with our 386IDOS-Extender can be easily expanded with 386IVMM too.

Our tools let you take full advantage of the 386 protected mode architecture. Break the DOS 640K limit in the language of your choice; C, Fortran, Pascal, or Assembler.

For fast compact code, use 386IASM, our 80386 assembler that's upwardly compatible with the MASM\* 8086 assembler. Existing DOS and mainframe applications written in a high level language are easily ported by recompiling. And 386LINK, our 32-bit native mode linker, puts it all together.

Debugging is made easy too. With our 386 symbolic debugger you can debug applications written in assembler or any high level language. Best of all, with Phar Lap's 386IDOS-Extender\* you can run your native mode program on any 386-based PC running MS-DOS. And you have full access to DOS system services through INT 21.

### NO COMPATIBILITY PROBLEMS

Phar Lap's tools are compatible with the industry's leading systems: DESKPRO 386\*, IBM Model 70/80\*, 386 clones and accelerator boards. Not only will your new applications be compatible with the leading systems, they'll run alongside all other DOS applications.

### NO ROYALTY PAYMENTS

Once your 386 application is complete, all you pay is a low one-time fee to license 386IDOS-Extender for redistribution.

386IVMM is also developer friendly. Call to find out about our flexible run-time pricing.

You can unlock the entire DOS market now. Don't wait for OS/3.

- \$495 386IASM / LINK-Package includes 386 assembler, linker, MINIBUG debugger and the developer version of 386IDOS-Extender
- \$895 MetaWare 80386 High C\* compiler
- \$595 MicroWay NDP Fortran-386\* compiler
- \$195 386IDEBUG symbolic debugger
- \$295 386IVMM - developer version of the Phar Lap Virtual Memory Manager

**(617) 661-1510**

PHAR LAP SOFTWARE, INC.  
60 Aberdeen Avenue, Cambridge, MA 02138  
Fax: (617) 876-2972  
"THE 80386 SOFTWARE EXPERTS"



Phar Lap and 386IDOS-Extender and 386IVMM are trademarks of Phar Lap Software, Inc. MS-DOS and MASM are registered trademarks of Microsoft Corp. DESKPRO 386 is a trademark of Compaq Corp. NDP Fortran-386 is a trademark of MicroWay, Inc. High C and Professional Pascal are trademarks of MetaWare Incorporated. IBM Model 70/80 is a trademark of IBM Corp.

combine a line and clustered bar graph. Other features include the ability to create horizontal graphs, stacked graphs that convert into surface charts, and double y-axes graphs.

Added to these goodies are enhanced color, hatching, and gray-scale capabilities. Text is a bit easier to work with; you can add up to two footnotes per graph, and, similar to Lotus's Symphony, you can do logarithmic scaling on any axis.

The bad news for this three-dimensional spreadsheet is that, strangely, a 3-D graphing capability is missing. Also missing is the ability to have directly interactive and nameable settings sheets, as in Symphony. The irritation is compounded by all these capabilities having been built into 2.2.

The one significant exception involves print settings, which you can save and retrieve by name in 3.0, although you cannot view these settings in tableau format on the screen. Curiously enough, however, you can print them out.

Finally, although 3.0 has some print enhancements, it has no full-featured presentation printing features like those in Funk Software's Allways. The rub is that those features are included in 2.2.

### The Glass Is Really Half-Full

Release 3.0 contains new features that will delight named-range addicts. One of the most satisfying is the ability to use as-yet-undefined range names in a formula you are composing. You can place a range name where you think it belongs, even before you've defined the coordinates for the name. You can also point and shoot range names when you are building formulas and when you are editing. These features also let you create a new range name whenever you want, even if you are far into a formula.

Formulas can be up to 512 characters long. You can also attach a note of up to 512 characters to any range name. This will ease the pain of your not being able to use Note-It or similar cell annotation add-ins in 3.0.

Finally, you can name macros directly, not just in branching statements, with any name of up to 15 letters. This allows you to exceed the previous limit of 27 master macros.

### New @ Functions

Release 3.0 has 14 new @ functions. The maximize-the-cash-flow crowd will revel in @VDB, which lets you simultaneously compute double-declining-balance method and straight-line method depreciation and then automatically select whichever

*continued*



# FINALLY. A debugging tool tough enough to handle the DOS Nasties.

New Version 2.0

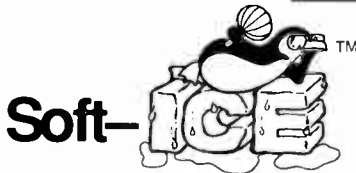

## Nasty over-write? No sweat!

Soft-ICE memory range break points help you track down memory over-write problems whether you are doing the over-writing or another program is over-writing you.

## Hung program? No problem!

When the system hangs, you now have hope. With Soft-ICE you can break out of hung programs no matter how bad the system has been trashed. And with Soft-ICE's back trace ranges you can re-play the instructions that led up to the crash.

## Program too large? Not with Soft-ICE!

Soft-ICE runs entirely in extended memory. This means you can debug even the largest DOS programs. And since your program runs at the same address whether Soft-ICE is loaded or not you can find those subtle bugs that change when the starting address of your code changes.

## System debugging? Soft-ICE is a natural!

Soft-ICE is ideal for full source level debugging of TSRs, interrupt service routines, self booting programs, DOS loadable device drivers, real-time kernels, non-DOS O/Ss and ROMs. Soft-ICE can even debug within DOS & BIOS.



## How Soft-ICE Works

Soft-ICE uses the power of the 80386 to surround your program in a virtual machine. This gives you complete control of the DOS environment, while Soft-ICE runs safely in protected mode. Soft-ICE uses the 80386 to provide real-time break points on memory locations, memory ranges, execution, I/O ports, hardware & software interrupts. With Soft-ICE you get all the speed and power of a hardware-assisted debugger at a software price.

## Don't want to switch debuggers?

### You don't have to!

Soft-ICE can run stand-alone or it can add its powerful break points to the debugger you already use. Use your favorite debugger until you require Soft-ICE. Simply pop up the Soft-ICE window to set powerful real-time break points. When a break point is reached, your debugger will be activated automatically.

## MagicCV with Soft-ICE

Using Soft-ICE with CodeView gives you the features necessary for professional level systems debugging. MagicCV and Soft-ICE can work in concert with CodeView to provide the most powerful debugging platform you will find anywhere.

**"These may be the only two products I've seen in the last two or three years that exceeded my wildest expectations for power, compatibility and ease-of-use."**

— Paul Mace  
Paul Mace Software

Soft-ICE	\$386
MagicCV	\$199
MagicCV for Windows	\$199
Buy Soft-ICE & MagicCV(W)	—Save \$86.
Buy MagicCV and MagicCVW	—Save \$100.
Buy All 3	—Save \$186.

30 day money-back guarantee  
Visa, MasterCard and  
AmEx accepted



## New Soft-ICE 2.0 features

- Back Trace Ranges
- Symbolic & Source level debugging
- EMS 4.0 support with special EMS debugging commands
- Windowed user interface



CALL TODAY (603) 888-2386  
or FAX (603) 888-2465

## RUN CODEVIEW IN 8K

### MagicCV



CodeView is a great integrated debugger, but it uses over 200K of conventional memory. MagicCV uses advanced features of the 80386 to load CodeView and symbols in extended memory. This allows MagicCV to run CodeView in less than 8K of conventional memory on your 80386 PC.

NEW—Version 2.0 includes EMS 4.0 driver.  
**Attention Windows Developers!**  
Version available for CVW.

P.O. BOX 7607 ■ NASHUA, NH ■ 03060-7607

I found two relatively minor bugs with 3.0 that Lotus is addressing.

value is greater.

Statistical gurus will appreciate the addition of @STDS and @VARS and their related database statistical functions, @DSTDS and @DVARs. These features let you calculate the sample standard deviation and variance, in addition to the population standard deviation (@STD and @DSTD) and variance (@VAR and @DVAR), which 1-2-3 has always allowed users to calculate.

I think everyone will be grateful for the reappearance of the simple, old-fashioned @TODAY, which succumbed between 1985 and 1989 to the roundabout @INT(@NOW). Release 3.0 also has some worksheet auditing functions—particu-

larly useful with 3-D spreadsheets.

A new database function, @DGET, lets you go into a database and pluck out a specific detail in a record. Finally, the @DQUERY function will, if more fully implemented through optional DataLens drivers, have the ability to take an entire database query language (e.g., Structured Query Language, or SQL) as its arguments—that's a powerful feature.

### Printing Features

A new range of printer layout options is controlled from the Print menu. You can now point to and select print styles and fonts from the Print menu. If you don't like the preset options, you can use the setup string in the Print menu.

Release 3.0 also handles background printing. You can specify more than one print range in a single-range statement, the cell reference for the contents of headers and footers, and a particular number for starting pages. You can even print the number and letter coordinates in the worksheet frame along with your data.

Perhaps the most significant print enhancement in 3.0 is the ability to directly

print graphs from the Print menu and on the same page as worksheet data. You can print the graph from the Print menu, but you cannot make any changes in its settings at this point. Instead, you must exit the Print menu and go back into the Graph menu, where you can fiddle with the settings until you have them the way you want them, and then go back to the Print menu.

To get graphs on the same screen as cell data, 3.0 goes to bit-mapped screen presentation in EGA and VGA mode. The somewhat jagged-looking font that results is not as pleasing to look at as the older-style full-character font. At installation, you can also specify two displays.

### Gotcha!

I found two relatively minor bugs with 3.0 that Lotus says it is addressing. First, if you run a reverse @SUM function over a range of just two rows, top to bottom, or two columns, left to right, you are asking for trouble. When 3.0 gets down to the limit of two rows or columns, it hiccups when you delete the upper or left boundary in a reverse @SUM, or any other @range function. For example, instead of

## The Past

Mice come in many shapes, colors, and styles. But when you get right down to it, they all work pretty much the same. At least they did until now. Now there's a real choice - PowerMouse™

# You Have





making the expected adjustment from @SUM(A3..A2) to @SUM(A2..A2), it returns the value for @SUM(A2..A1). To add to the confusion, the bug asserts itself in 3-D contexts as well. I don't consider this bug serious since, as a matter of prophylactic work habits, I avoid reverse @ range functions. But other users may get into a pile of trouble over this.

Another problem occurs when you use the Data Fill command with dates. The problem is that if you begin a sequence with February 28 or 29 and try to step it out by monthly, quarterly, or yearly intervals, the command fails. Admittedly, the likelihood of this bug affecting any spreadsheet in a material way is probably beyond 3.0's new 18-decimal floating-point range.

### Multiple Worksheets, Multiple Files

The most important enhancements in 3.0 revolve around its 3-D and new database management capabilities. Depending on your memory configuration, you can get up to 256 separate 1-2-3 worksheets into active memory. These worksheets can be all in one file or, through the new File Open command, in as many as 256 sepa-

rate files, all active in the same session.

The integration between multiple worksheets, even when they run across files, is seamless. You have to get used to the 3-D coordinate references that are cluttered up by worksheet letter references (e.g., A:A1..C:B6, which cuts across three worksheets, A, B, and C). Where different files are being referenced, you have the extra baggage of file path and filename in double-angled brackets.

But 256 active worksheets is not the end of it. Release 3.0 can now link to files on the disk, and you can reference them in formulas that also include active files. (This is a technology that Multiplan had in 1982.)

My only complaints about 3.0's 3-D capability have to do with the window management and the translation utility. When working in 3-D mode, you are restricted to three rigidly formatted, overlapping windows. You can, however, zoom to full size in a single window and then divide that window in the conventional horizontal and vertical ways.

The problem with the translation utility, which converts 3.0 worksheet files

for use with 2.0, is its speed. The translation utility does its job, appropriately flagging those 3.0-specific parts of a file that won't translate fully into a 2.0 environment. But the process is terribly slow.

### Database Management: The Secret Revolution

Release 3.0 supports database structures that are effectively relational. Its database structure lets you retrieve records across multiple databases. The program organizes data in a row-column table, with each row corresponding to a record and each column to a field within the record. Thus, retrieving across multiple databases means retrieving from more than one such table with a single command or formula and criterion range. (Of course, the target records in the different database tables must share a common data element.)

Because of 3.0's 3-D architecture, those different tables can exist on different worksheets in the same file, with the criteria and output ranges themselves existing on still other worksheets in that same file. The databases can even be

*continued*

# Two Choices

## The Future

The ProHance™ PowerMouse is a mouse and a whole lot more. So before buying any mouse, you owe it to yourself to try it out.

The built-in keypad puts not only mouse keys but number keys, function keys, and up to 240 commands at your fingertips, greatly reducing going back-and-forth to the keyboard, or up-and-back to the command line. And since the commands are macros, lengthy keystrokes are reduced to the press of a button, letting you work faster and with far less hassle than you ever thought possible.

And these benefits are not limited to just your new mouse-driven programs. PowerMouse provides an entirely new level of speed and ease-of-use to your existing keyboard-driven programs. Without additional drivers. And without changing the look or feel of your programs. Programs like Lotus 1-2-3, Symphony. Quattro, word processing software, and more.

Intimidating? Not at all. The keyboard is clearly labeled and about as easy to use as a calculator. As one of our users put it, "It's just so intuitive."

PowerMouse will pay for itself in a few hours. And we back that with a money-back guarantee. PowerMouse sells for \$225. Call our toll free number to place your order, and we'll rush one to you. You'll quickly see why PowerMouse is the choice for the future.

1-800-345-9111 ext. 18

 **ProHance**

ProHance Technologies, Inc.  
1307 S. Mary Avenue #104  
Sunnyvale, CA 94087

System Requirements: IBM PC, AT, PS/2 or 100% compatible; DOS 2.0 or higher; RS232 Serial Port (9 or 25 pin); 20K RAM. PowerMouse and ProHance are trademarks of ProHance Technologies, Inc.

Circle 290 on Reader Service Card

World Radio History

## WE COULDN'T HAVE SAID IT BETTER...

### "Microstat-II: Speed and More

I have used statistical packages since the bad old mainframe days, and I now own and regularly use six microcomputer stat packages, one of which is Ecosoft's Microstat-II. If Microstat-II had been my first stat package, the other five would have belonged to somebody else.

Do you want speed? Microstat-II is a racehorse that makes the highly touted [name deleted] look like a Clydesdale. Do you want coverage? Microstat-II provides you more tools at less than half the competition's price. Do you want to see a very nice and easy-to-use menu system? If you've used Lotus 1-2-3, you will find Microstat-II's menu bars to be very simple. Do you want to see some nice file structures? Take a look at Microstat-II."

Peter Robb  
Review Responses  
InfoWorld, Aug. 28, 1989

"Installation of Microstat-II is simple... The user interface is clean... a pleasant package to use..."

PC Magazine

"...one of the fastest IBM-PC statistical packages we have tested... using Microstat-II is a breeze."

InfoWorld

When it comes to ease-of-use, accuracy, and speed, Microstat-II is the statistics package of choice for IBM-PC's and compatibles. For more information, call or write:



**Ecosoft Inc.**  
6413 N. College Ave.  
Indianapolis, IN 46220  
Orders: 1-800-952-0472  
Tech. Info: 1-317-255-6476  
FAX: 1-317-251-4604



# ECOSOFT

spread over different files. With file linking, you can also access 1-2-3 files that are not active, but only disk resident.

In addition, external databases are accessible, in principle, to 3.0 through what Lotus calls DataLens drivers. Lotus supplies a single DataLens driver for dBASE III database tables. It also supplies a sample table in dBASE format so that you can try out the driver.

The DataLens technology is currently incomplete, however. In particular, the new @DQUERY function, which supposedly will allow you to nest entire foreign database query languages under it, is not yet operational. If and when it is fully implemented, and if Lotus can persuade other DBMS software vendors to use DataLens drivers, 1-2-3 stands a chance of maintaining its commanding position in the power-user market.

Other major enhancements to 3.0's database management facilities are fully complete, however. The most powerful is the Data Table 3 functionality. Its concept is simple enough; it's a Data Table 2 with a z-axis. It is no more complicated than that in its simplest "what-if" form.

Moreover, you can draw input from databases and use database statistical functions such as @DSUM, @DMAX, and @DSTD for sifting the contents of databases into three dimensions. When combined with the ability of 3.0 to query multiple databases—on disk as well as in active memory—there is little limitation for what you can do with database management in 1-2-3. Other significant database management enhancements include a free-form version of data tables and sorts on up to 256 keys.

### Does It All Add Up?

Release 3.0's improvements—particularly the database management and 3-D worksheets—are worthwhile. But those improvements come with a sacrifice in speed, additional hardware costs, and disappointing graphics. Furthermore, program developers using the new Lotus Development Environment have yet to produce any add-ins.

An imperfect instrument, Lotus 1-2-3 release 3.0 is still in the process of formation. Despite its flaws, I like 3.0 and have decided to upgrade. In my opinion, 1-2-3 has always been the most important thing happening on the desktop—3.0 has only confirmed that opinion. ■

*Edward Reno is vice president of planning and development for the Computers and Communications Information Group at McGraw-Hill. He can be reached on BIX as "ereno."*

# TAKE CONTROL.

## VGA 16-BIT GRAPHICS ADAPTER

**\$299<sup>00</sup>**

MFG. SUGG. RETAIL

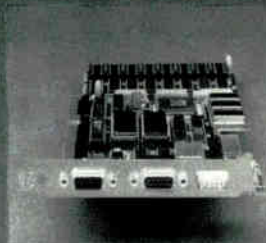

### SPECIFICATIONS:

- ▶ Supports TTL and Analog
- ▶ Resolutions up to 1024 x 768 (Needs 512K)

### DRIVERS SUPPORT:

AutoCAD, Framework II, GEM Desktop, Ventura Publisher, Lotus 1-2-3, Microsoft Windows, WordPerfect, WordStar

## FINALLY, VGA MADE AFFORDABLE!

The IOCOMM VGA16/256 graphics card lets you TAKE CONTROL of your computing needs.

It offers truly hardware register-level compatibility with all popular graphics modes including EGA, CGA, MDA and Hercules, and boasts on-chip 8- or 16-bit bus support with auto sensing.

Come visit us at Comdex—Booth #C107

CALL NOW! **(213) 644-6100**

12700 Yukon Ave., Hawthorne, CA 90250 • Fax (213) 644-6068





# WHETHER REPORT.

Whether you're a software developer writing new applications for the IBM or Mac, or a PC user securing proprietary data files, software and data protection has never had a brighter silver lining. For a number of very good reasons.

Beginning with the 'whether-expert' Rainbow Technologies. And ending with its Software Sentinel family of hardware keys. Starring five models that fit virtually any software program or data file you need to protect.

There's the best-selling SentinelPro for the IBM PC/XT/AT, PS/2 and compatibles, and even the Atari ST. Known worldwide for its virtually unbreakable security. And its ASIC technology. And its invisible operation. A close relation, the Sentinel-C stands at-the-ready for custom configurations and multiple software packages.

In the Apple market, security-minded Mac software developers turn to Eve. For completely transparent operation and world-class security of the protected software. Just by plugging Eve into the Mac ADB connector.

PC users wanting a low cost, user-friendly solution to the problem of securing sensitive data can call on the DataSentry. Using a proprietary Rainbow algorithm or DES, the DataSentry encrypts data files on individual PCs, protects modem transmissions and secures data on local area networks.

Rainbow's latest protection strategy is the SentinelShell – that lets users place a 'shell' around existing, off-the-shelf programs. Because access can be limited to those issued a key, libraries, universities and corporations can very simply guard their software investments.

Whatever your whether, Rainbow Technologies has the software and data protection products that make the difference. For more information, call 714-261-0228 in the U.S., or contact Rainbow Technologies Ltd. in the United Kingdom for the distributor nearest you. Whethercasters are standing by.



**RAINBOW TECHNOLOGIES**

18011-A Mitchell South, Irvine, CA 92714 • (714) 261-0228 • TELEX: 386078 • FAX: (714) 261-0260  
Rainbow Technologies, Ltd., Shirley Lodge, 470 London Rd., Slough, Berkshire, SL3 8QY, U.K., Tel: 0753-41512, Fax: 0753-43610

© 1989 Rainbow Technologies. All product names are trademarks of their respective manufacturers.

Circle 308 on Reader Service Card (DEALERS: 309)

World Radio History

- Runs under DOS, OS/2 and Xenix
- Algorithm technique (Never a fixed response)
- External parallel port installation
- Minimal implementation effort
- Higher level language interfaces included
- 100 times faster than fixed-response devices (1 ms)
- ASIC design for reliability



- Protects multiple packages with one device
- 126 bytes of non-volatile memory programmed before shipment of the software
- Rainbow supplies a unique adapter for programming the unit
- Higher level language interfaces included
- Runs under DOS, OS/2 and Xenix
- External parallel port installation



- For the Macintosh SE and II
- Complies with Apple Desktop Bus Interface requirements
- Rainbow-assigned developer passwords to prevent tampering by other developers or sophisticated "hackers"
- 7 locks per key, usable individually or in combination, on one or up to seven applications



- Completely user-installable
- Pocket-sized external device
- Menu-driven, user-friendly interface
- Single- or multi-user security system
- Audit trail, log-on identifiers and automatic encryption/decryption of entire directories
- Secures data transmitted by modems
- Prevents recovery of data by utility programs

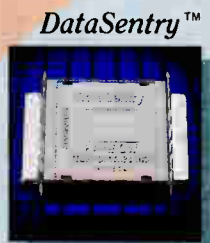

- Runs under DOS on IBM PCs and compatibles
- Protects without requiring access to the source code
- Completely transparent to the end user
- User-friendly software
- Pocket-size key attaches quickly to any standard PC parallel port
- ASIC design for reliability





## SOME THINGS IMPROVE WITH AGE

Unlike fine wine, few 4GL's improve with age. Especially when so many trendy software products have gone sour in so short a time.

Yet filePro has timeless qualities—staying power, and the kind of growth and adaptability that make it fittest to survive. filePro Plus is a complete Application Development Environment (4GL) whose pioneering efforts and refinements have stood the tests of time.

### SIMPLICITY, POWER & PERFORMANCE

What's filePro's secret? filePro Plus makes Application Development easy. Mainly because filePro is easy to learn. (Ask any developer or end user who has experienced it.) A powerful editor, built-in debugger, and built-in capability to prototype screens and reports make the development cycle short. Applications are developed faster, outperforming products like Informix, Oracle, dBASE III & IV, Advanced Revelation and FoxBASE Plus.

### FILEPRO'S 4 "P's"—POWER, PERFORMANCE, PORTABILITY, PRODUCTIVITY

Our customers were the first to benefit from portability. (Actually, filePro is portable between DOS, OS/2, Networks, Xenix, Unix, AIX, Ultrix, HP-UX, SUN OS and DEC VMS.) They realized that there is no need to redevelop or redesign applications. That files and applications are so easily transferred. And finally, that filePro saves on two of their most valuable resources—time and money.

### filePro Plus. The Timeless Investment.



The Small Computer Company, Inc. 41 Saw Mill River Rd., Hawthorne, NY 10532 (914) 769-3160 • 800-847-4740

filePro is a registered trademark of the Small Computer Company, Inc. Informix, Oracle, dBASE III & IV, Advanced Revelation, FoxBASE Plus, DOS, OS/2, Networks, Xenix, Unix, AIX, Ultrix, HP-UX, SUN OS and DEC/VMS are trademarks of their respective manufacturers.

Circle 353 on Reader Service Card (DEALERS: 354)

World Radio History



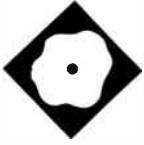

# Alpha Four: No Programming Required

This relational DBMS features dBASE compatibility and ease of use, but at a performance cost

Malcolm C. Rubel

**A**lthough dBASE is popular, it has never been easy to use. Alpha Four may solve this problem. It provides almost complete compatibility with dBASE III Plus files while also providing a full range of screen, report, label, mail merge, and other capabilities that are already set up.

With all that it does, Alpha Four takes a lot of hard disk space—2.4 megabytes, to be exact. I also found a little hitch in it while installing it. The program modifies the existing CONFIG.SYS file, or it creates a new one with Alpha Four's file and buffer requirements; however, when I installed the program on drive F, the installation program made a CONFIG.SYS file on drive F instead of on drive C.

Alpha Four comes with over 120 different printer configurations, covering the most popular printers. Special configurations are available for printing envelopes on a Hewlett-Packard LaserJet. The only important item missing is a generic PostScript printer driver.

Alpha Four includes an excellent tutorial that provides good examples of both simple and complex database management tasks. The documentation is also well written and complete.

The program is almost totally menu-



Unlike dBASE IV, Alpha Four is totally menu-driven.

driven, and moving from one menu to another is logical and intuitive. A person with little or no database management experience won't have any trouble figuring out what comes next. I wish that other programs were laid out as well. Good on-line help is also available.

### dBASE Compatibility

Alpha Four can use dBASE III Plus data files directly. It works with database files (.DBF), memo files (.DBT) and index files (.NDX). However, Alpha Four cannot use dBASE IV files, because it does not support the master index file type (.MDX) or the memo file (.DBT) that dBASE IV uses.

I did find one incompatibility between Alpha Four and dBASE—it has to do with templates. With dBASE, you can choose not to store formatting characters, which are used as a part of a tem-

plate, as data. The picture function @R handles this. With Alpha Four, the picture-formatting characters are automatically part of the field value when it is stored. In other words, in dBASE you can store the telephone number "(212) 555-1212" in a character field with a length of 10 (just the digits) using the picture function, while with Alpha Four, you must specify a length of 14. If you try to create a template for the field, you will run out of space before you run out of numbers. In this case, you will have to suffer the extra 4 bytes per record that this implies.

Although Alpha Four and dBASE share the same database file structure and the same indexing routine, little else about the two programs is similar. Alpha Four cannot run user programs. There is no "dot prompt" to contend with or use.

*continued*

**Alpha Four 1.05**

**Company**

Alpha Software  
One North Ave.  
Burlington, MA 01803  
(617) 229-2924

**Hardware Needed**

IBM PC, XT, AT, PS/2, or compatible with 512K bytes of RAM and a hard disk drive with a minimum of 2.4 megabytes of free space

**Software Needed**

MS-DOS 2.1 or higher

**Documentation**

User's manual; tutorial; on-line help

**Price**

\$595

**Inquiry 884.**

Instead, you define the necessary pieces of an application from different specification screens and work surfaces. Alpha Four can use the individual pieces, or you can integrate them into a complete application. Database tables are related

to other database tables in sets, with the links defined and established only when the set is constructed. You define data-entry screens, reports and labels, filters, and mail merges from their own modules, and you can call them independently or as part of a larger application.

As with dBASE, you can set ranges and filters with Alpha Four. You can change the active index, set a filter, and save it all from within one screen. While Alpha Four does not provide you with a point-and-shoot filter builder, it does provide you with access to all fields, functions, and logical operators while you are building your filter expression. Alpha Software is also good enough to recognize and tell you that filters slow down processing and that you should, where possible, try to index on the filter expression, set that as the active index, and then indicate the range for the desired data.

**Forms Design and Field Rules**

The Alpha Four forms feature lets you design screen-entry forms visually. The forms designer is WYSIWYG, and it lets you print directly from the forms design.

With this feature, you don't have to create the same design twice, once for the screen and once for printing.

A major difference between the Alpha Four forms designer and dBASE is that with Alpha Four, you don't use any editing rules in the screen form, the way you do with dBASE. To handle this necessary function, Alpha Four uses the "field rules" option from the Database/Set Design utility. With dBASE, you must specify the acceptable values as a part of the data-entry screen, and you must also specify the format template for output as a part of your report program. While this gives you the flexibility to handle the same piece of data differently in different areas of the program, in most instances, it simply means more work. Alpha Four has gotten around this by designating the formats and editing parameters as an integral part of the database design process.

The field rules act more like a data dictionary than anything else. You can create calculated fields, enforce case for alpha data, and supply the editing template and the mask and print template for

*continued*

# AutoKey 400 programmable macro keys !

Simplify DOS, D-base, Lotus 1-2-3.  
Boost your CAD performance.  
Automate word processing.

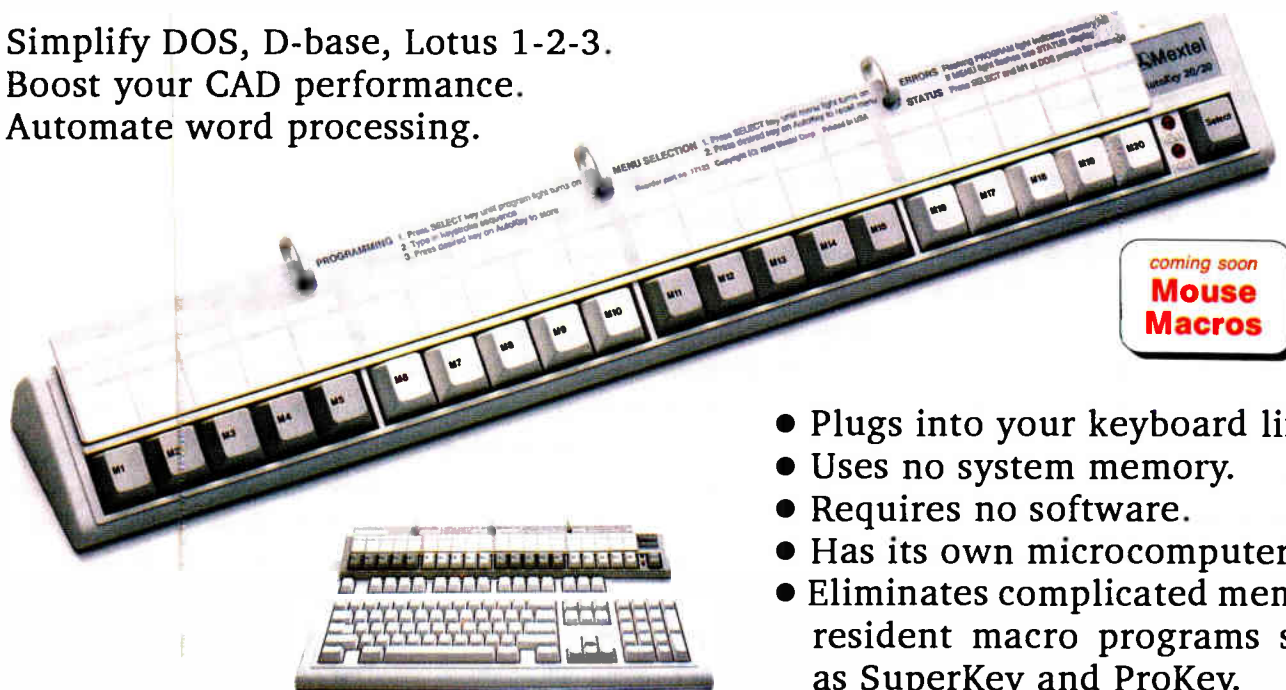

coming soon  
**Mouse  
Macros**

- Plugs into your keyboard line.
- Uses no system memory.
- Requires no software.
- Has its own microcomputer.
- Eliminates complicated memory resident macro programs such as SuperKey and ProKey.

**Call 1-800-888-4146**  
(inside IL call 312-595-4146)

AutoKey 40 ..... \$139.00  
AutoKey 20/20 ..... \$289.00      Visa/MC/AmEx.

Mextel Corp. 159 Beeline Road  
Bensenville, Illinois 60106

AutoKey is trademark of Mextel Corp. All other product names are trademarks of their respective manufacturers. ©1989 MEXTEL CORP.



# NEW FROM PERISCOPE

## Real-Time Debugging for 386s and 286s

*User Jeff Garbers, Crosstalk Communications' Director of Software Development, has been debugging with Periscope® Model IV and says, "The hardware really makes Periscope shine, especially when you've got timing-related problems. I can now track down changing pointers and altered buffers on my 386. I've been using it to debug Crosstalk® Mk. 4 and there's just no better way to do it."*

Periscope IV gives you the ability to debug time-sensitive programs, hardware-interrupt routines, and programs with intermittent errors. You can run your program at full speed while tracking down unwanted memory overwrites. You can use the information captured in Periscope IV's real-time trace buffer to see EXACTLY what the system is doing, and to improve its performance.

Periscope manual, disk, quick-reference card, and 512K Plus board that provides write-protected RAM for Periscope Models I, III, and IV



### A New Generation of Hardware-Assisted Debugging

Compatible with virtually any 286 or 386 with an AT-style bus, Periscope IV works on machines running up to 25MHz with any number of wait states. Because it gets information directly from the CPU, instead of from the system bus, Model IV is not sensitive to bus compatibility issues.

Periscope IV collects CPU information in its hardware trace buffer while the CPU runs at full speed. Whether you tell Periscope IV to capture just selected information or to capture everything, you can use its powerful trace buffer commands to search for and display the execution history the way you need to see it. And you can use the CPU cycle count information to get the last bit of performance out of your code.

With Periscope IV you can set hardware breakpoints on memory accesses (within the first 16MB), I/O ports, and data. You can also set breakpoints on the occurrence of specific sequences of events, such as "watch for the routine FOO to begin executing, then while it is, watch for the variable BAR to be written." This capability, called sequential triggering, enables you to define complex conditions, then stop your program and examine what has happened when these conditions occur.

If you're developing a large application that needs all of the lower 640K, you can use the optional Plus board to keep Periscope totally out of normal DOS memory. The Plus board requires the use of a second slot.

The Periscope IV software is an extension of the software that comes with all models of Periscope. So, along with Periscope IV's powerful hardware, you get a full-function software debugger with source and symbol support for most popular PC compilers and linkers, Microsoft® Windows support, PLINK overlay support, dual monitor support, support for debugging device drivers and TSRs as well as regular programs, DOS independence, crash recovery, ease-of-use, and much more.

Prices on Periscope range from \$145 for software-only Model II-X to \$2,995 for a 25MHz 386 hardware-assisted Model IV. Call 800/722-7006 for pricing details, free information, to talk about your debugging needs, or to order your Periscope.

**Order Your Periscope, Toll-Free,  
Today! 800-722-7006**

MAJOR CREDIT CARDS AND QUALIFIED  
COMPANY PURCHASE ORDERS ACCEPTED



"No matter what your debugging needs, a single call to the Periscope Company has always sufficed..."

Ross Greenberg  
"Best of 1988" (Development Tools)  
PC Magazine, January 17, 1989

The  
**Periscope**  
Company, Inc.

1197 PEACHTREE ST.  
PLAZA LEVEL  
ATLANTA, GA 30361  
404/875-8080  
FAX 404/872-1973

**Table 1:** My tests showed that Alpha Four is somewhat slower in large or compound indexes than dBASE IV. All times are in minutes:seconds.

## ALPHA FOUR VS. dBASE IV

	Alpha Four	dBASE IV
Locate on numeric field (1000 records)	0:04	0:02
Locate on character field (1000 records)	0:03	0:02
Index 1000 records on numeric field	0:04	0:03
Index 5000 records on numeric field	0:30	0:24
Index 10,000 records on numeric field	1:06	0:48
Index 1000 records on compound key	0:10	0:03

each field. You can also indicate whether the mask is to be strictly enforced or whether exceptions can be made to it. You can supply either a default value or a calculated default expression as a part of the field rules.<sup>1</sup>

Field rules also let you elect whether or not a field requires an entry. You can even make the field rule dependent on a value in another field. You also have the option of using a valid expression that must evaluate to a logical "true" before the program accepts the entry.

You can specify a condition for which the field is skipped and no entry is required (e.g., if you have a male patient, you don't ask if he's pregnant). You can have the user enter critical data twice to make sure that it's right, and you can supply a prompt for each field. The program lets you perform field lookups either from a table in memory or from a database on disk. You can set the size of the window that pops up and whether it pops up automatically or only on entry of illegal data. Bad data can be that which is already in the table or that which is not. All this is available without any programming.

Alpha Four has even tamed memo fields, which have long been the toughest aspect of screen design with dBASE. Alpha Four simply lets you choose a window for editing memo fields.

### Reports, Labels, and Browsing

The report writer included in Alpha Four is powerful. Reports can have up to nine levels of detail and include calculated fields. You can print data in either regular or compressed mode, or with bold, underlining, and italics to highlight important parts of the report. You can even have memo and character fields wrap in specified spaces. Summary reports are also supported.

Probably the most impressive part of the report portion of Alpha Four is that you can make two passes through a re-

port. On the first pass you can generate summary statistics. On the second pass, you can use these numbers (e.g., sales per region as a percent of total sales).

The label-printing program lets you determine the size of a label, how many labels you want across a sheet, how many spaces you need between labels (across and down), the number of copies you want to print, and the labels' contents. You can specify what information goes where and what to do with blank information.

One of Alpha Four's best features is its ability to define up to 26 different browse tables for each set of data. You can define fields to be included in the browse, and you can select the order in which they are to appear. You can also include calculated fields. Unlike dBASE, you can show the contents of memo fields in the browse table.

### Macros and Other Good Stuff

Alpha Four provides a keyboard macro capability so you can record and edit any series of keystrokes. This comes in handy when developing applications and in circumstances like data entry, where repetitive keystrokes become a burden.

The product also includes a complete set of import and export file specifications, letting you get at data stored in other programs and also letting you write data to them. You can import data from Alpha Software's Alpha Data Base Manager II (the company's flagship product), from Lotus .WKS and .WK1 worksheet files, and from Microsoft SYLK and VisiCalc DIF files, as well as from dBASE II, PFS: File, and ASCII tables and character-delimited format files. Alpha Four will export in these file formats as well as in MultiMate and WordPerfect merge file formats.

Alpha Four includes the ability to develop and print form letters. As with everything else about Alpha Four, this feature is powerful but still easy to use.

Along with all the basic features, Alpha Four lets you pause for operator entry during printing, using calculated fields in the middle of your letter and printing information conditionally. For example, you can automatically generate a different type of form letter that thanks contributors based on the amount they gave.

Last, but certainly not least, Alpha Four contains the ability to define custom menus that let you call submenus, run macros, call another application, or run another application. The generator also allows you to add a prompt line and a help file, if desired. While not terribly sophisticated in its design, the Alpha Four applications generator lets you develop good, solid, basic applications.

### The Downside

Alpha Four does a better job than most of the competitive products I've seen. This doesn't mean that I'm a complete fan of the product. Alpha Four is, by definition, limited in what it can do. With a database management product, such as dBASE, which includes a programming language, you will always be able to do things that a defined product like Alpha Four cannot.

Alpha Four does not have a programming language and is not designed to execute even a single line of user program code, so you cannot do anything that's not built into the product. It would help if Alpha Software could put a RUN command in the product that allowed you to swap Alpha Four out of memory and run another program.

On the other hand, if you have heard anything about Alpha Four's lack of indexing speed, you can discount most of it. Version 1.05 is five to 10 times faster than 1.0 and, as you can see from the benchmark times in table 1, close to the speed of dBASE IV for simple indexes but still slower for a compound index.

Overall, Alpha Four represents an excellent alternative approach to handling data management tasks. But at \$595, it's not that much of a bargain. I wish the program was a bit peppier than it is, but it's still an excellent ad hoc query device for small databases. I would definitely consider the program for an environment where I had nonprogrammers and novice computer users who want to look at data for themselves. ■

*Malcolm C. Rubel is president of Performance Dynamics, a New York consulting firm that specializes in DBMS software. His latest book, dBASE IV Power Tools, has just been published by Bantam. You can reach him on BIX c/o "editors."*



# THE EASY WAY OUT.



## DISK TRACER AUTOMATES DISKETTE COPYING.

Put time-consuming formatting and copying tasks behind you with the new Disk Tracer. Now you can format and copy diskettes easily and automatically. Just as the paper copier eliminated messy carbon paper, now Disk Tracer eliminates the slow, tedious task of copying diskettes manually.

Simply place your original diskette and blank diskettes in the top tray, select the quantity desired, press COPY and walk away. Don't walk too far, Disk Tracer produces a perfect copy every 24 seconds... without your effort or attention! Disk Tracer does it all automatically, *fast*, freeing you and your computer. And by reducing your labor cost, it quickly pays for itself.

Disk Tracer is one of many state-of-the-art diskette copiers brought to you by Trace, with a product family that answers every need from high volume industrial diskette copying to our inexpensive desktop copiers. Trace is the number one choice of professionals worldwide. Call us today for more information or the name of a distributor near you.

Information Hotline: 1-800-366-5560



WORLD LEADER IN DISKETTE AND TAPE DUPLICATION SYSTEMS  
TRACE PRODUCTS 2190 Bering Drive, San Jose, CA 95131

Circle 359 on Reader Service Card

World Radio History



CAD



RAD

Introducing software that thinks. There has never been personal computer design and drafting software this powerful, this fast or this intuitive. Vellum thinks. Its radical new technology automatically pinpoints and aligns geometry as you draw. Built-in intelligence allows you to draw virtually freehand, yet set precise dimensions at any time. Finally, the days of complex commands and weeks of training are gone. Vellum has made industrial-strength design click on the Macintosh. For a demonstration see your Ashlar dealer or call (408) 746-3900.



**ASHLAR**  
Software That Thinks.

Circle 33 on Reader Service Card



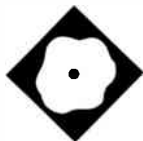

# The Power of the Press

Interleaf's publishing software keeps getting better

Jon Udell

Interleaf's Technical Publishing Software (TPS) blends two styles of computer-based publishing. The first, represented by troff and TEX, is stream-oriented and works with a global description of a document's format. The second (and newer) style, best exemplified by PageMaker, works in a WYSIWYG mode with individual pages.

Both methods have advantages: troff and TEX powerfully automate the pagination of large documents, and PageMaker shines when you need to lay out custom pages that mix text and graphics. TPS's union of the two styles is, for the most part, a happy one that has made it one of the most interesting desktop publishing packages around. The latest version, release 4.0, enhances both halves of TPS's personality.

Release 4.0, ranging in price from \$2500 for the core version to \$15,000 for the full version, runs under Unix on Sun, Apollo, and DEC workstations. I used the full version on a Sun386i. That's a heady combination of hardware and software, but there's hope for PC and Mac users.

Interleaf has already ported release 3.0 to PCs and Macs. These versions, known respectively as IBM Interleaf Publisher and Interleaf Publisher, have recently dropped into the sub-\$1000 price range.

The advent of DOS extenders with built-in virtual memory (on 80386 PCs) and System 7.0 with virtual memory (on

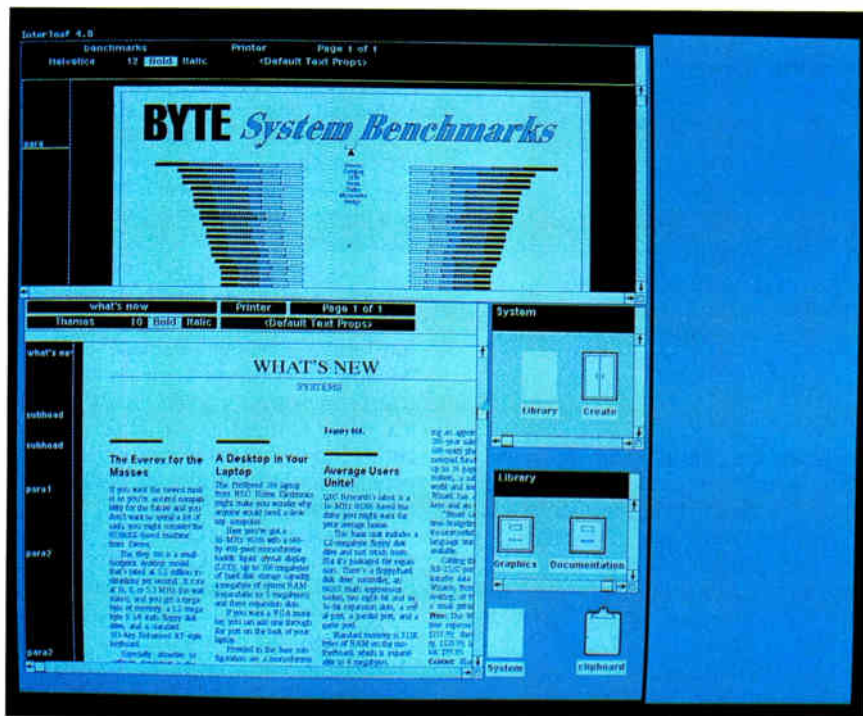

Interleaf's Technical Publishing Software lets you easily mix text and graphics in a document.

68030 Macs or on 68020 Macs equipped with paged-memory-management units) might tempt Interleaf to move its latest version over to these platforms. The company isn't making any promises, however.

## First Impressions

On the Sun workstation, TPS can run in a SunView window using your choice of Sun or Interleaf conventions for mouse-button behavior, or it can claim the workstation's entire screen (again, with your choice of mouse conventions). I preferred the SunView approach, which let me iconify and de-iconify the TPS application and switch among windows containing other tasks, such as Unix and DOS terminals and SunView's Organizer.

That flexibility, however, requires you to think in terms of two different windowing models and two different desktops. Moving or sizing the SunView window that contains TPS (or any other SunView application) works one way. Within the TPS window, moving or sizing the window that contains a TPS document works another way.

Although the mechanics of TPS's desktop differ from those of Sun's, the two share a common philosophy that I find less congenial than the Mac's. Both turn what are simple click or click-and-drag operations on the Mac into menu-driven affairs. For example, to close a TPS document window, you click on the document's name to pop up a menu that

*continued*

Technical Publishing Software 4.0

**Company**

Interleaf, Inc.  
10 Canal Park  
Cambridge, MA 02141  
(617) 577-9800

**Hardware Needed**

Sun-2, -3, -4, or Sun386i; Apollo DN series; DEC VAXstation or DECstation; HP 9000

**Software Needed**

Depends on hardware: SunOS, Apollo Domain, DEC VMS or Ultrix, or Hewlett-Packard HP-UX

**Documentation**

User manuals; tutorial; application guides

**Price**

Core TPS: \$2500  
Advanced Graphics: \$4500  
Book Catalog: \$2500  
Full TPS: \$15,000

**Inquiry 882.**

includes the Close item. To move an icon, you click to select it and then click another button to bring up a menu that includes the Move item. Fortunately, the software is often smart enough to anticipate and highlight the appropriate choice in these situations. But still, everything's modal.

Chief desktop icons are cabinets, drawers, folders, and documents. Cabinets, drawers, and folders are directories; their icons differ, so you can metaphorically classify what you store in them, but they behave identically. Documents are where the action is. To create a document, you click in empty desktop space (or in an open cabinet, drawer, or folder) to pop up the menu of actions that are available, select Create->, slide right to pop up the submenu signified by the arrow, and select document. Such telescoping hierarchical submenus appear everywhere and are one of the hallmarks of Interleaf's interface.

The document window is bounded by Header boxes, a component bar, and horizontal and vertical scroll bars. Each Header box acts as a gateway to menus that control sets of document properties. The Name box's pop-up menu accesses the Rename, Close, and Save commands. The Printer, Font, Page, and Text boxes each govern other sets of properties.

**Style, Structure, and Content**

You use the vertical, left-aligned component bar to view and edit the components of a document. In the default empty document, there is a single component name: para. When you click in the document's main window and start typing in text, the text appears on the screen as 12-point Thames Roman (similar to Times Roman) spaced 1.16 lines apart.

These properties flow from the default para component. To change them, you select the component's name in the component bar, activate a pop-up menu, and open a set of linked *property sheets* associated with the component. Here you can specify a para's margins, font family and size, indentation, horizontal justification, display attributes (underlining and strike-through), kerning (intercharacter spacing), leading (interline spacing), color (for spot color separation), and even hyphenation and spelling dictionaries.

The component bar is a more powerful version of what Microsoft Word calls a style sheet. But it also serves as a structure editor that complements the main window's text editor. To delete a range of text from within a para, you'd use the text editor to highlight the range and then cut it. But to delete the entire para component, you'd highlight its name in the component bar and cut it.

The component editor also gives access to the component masters that lie behind the *instances* that appear in the component bar. The para component in the default document is one such instance. You can create a second para in the text editor by pressing the Line Feed key, or in the component editor with the Create->para command. Now select the new para in the component bar, access its property sheet, and change its font. The ensuing pop-up menu prompts you to apply the change locally or globally. The first choice affects only the para whose property sheet you've accessed. The second affects all existing paras and, because it updates the master that's used to stamp out new instances, all future paras as well.

Working with masters takes some getting used to. They're reclusive: You cannot edit them directly; you can only transfer properties to them by way of instances. However, the component bar's Create-> menu lists all the masters in a document. In addition to para, the default document provides masters that govern subheads, lists, bullets, and tables. To add a new master, you create an instance of one of the known masters, adjust its properties to fit your needs, re-

name it, and globally apply the change. This procedure simultaneously creates a new master and that master's first instance.

Although masters normally transmit style to the instances that derive from them, they can also transmit content. Take a look at one of the pages in the What's New section of this magazine. In the design of a template for that section, I used a shared-content master to define a firstpara component that includes the bold divider at the beginning of each article. Once that was done, the Create->firstpara command (TPS adds the new component to the Create menu on the fly) conjured up a new component that contained the divider. Because all the dividers in the document shared the master's content, a change to any of them—for example, in color, width, thickness, or vertical offset—propagated through the master to all the others.

**Text in Graphics in Text**

That bold divider was a graphical, not a textual, element. TPS graphics live in *frames* that are, in turn, tied to components. You create frames in the document window, not in the component bar—they're part of the content of components, not components themselves. As such, frames anchor to the text of your document. But, like components, frames have adjustable properties. For example, you can specify that a frame will appear at its anchor's location, after the text in which the anchor occurs, or at the top or the bottom of the anchor's page. Frames can also fill the page, and they can overlay or underlay text and other frames on the page.

Other useful frame properties include width and height, which you can specify in terms of a column of text, a whole page, or absolutely, and offset, which fine-tunes the placement of the frame either horizontally or vertically, depending on the method of anchoring. Like components, frames are instances of masters. Once you adjust one to your liking, you have built a frame master that you can name and reuse.

When you select and open a frame, you enter the diagram editor—a highly sophisticated, object-oriented drawing program. The basics will be familiar to anyone who's used MacDraw or Adobe Illustrator—lines, ovals, boxes, and fill patterns behave much as they do in these popular Macintosh applications. But the power of the TPS diagram editor is simply breathtaking. The arc and spline

*continued*



**How To Bring  
Minicomputer Power  
To Your PC**

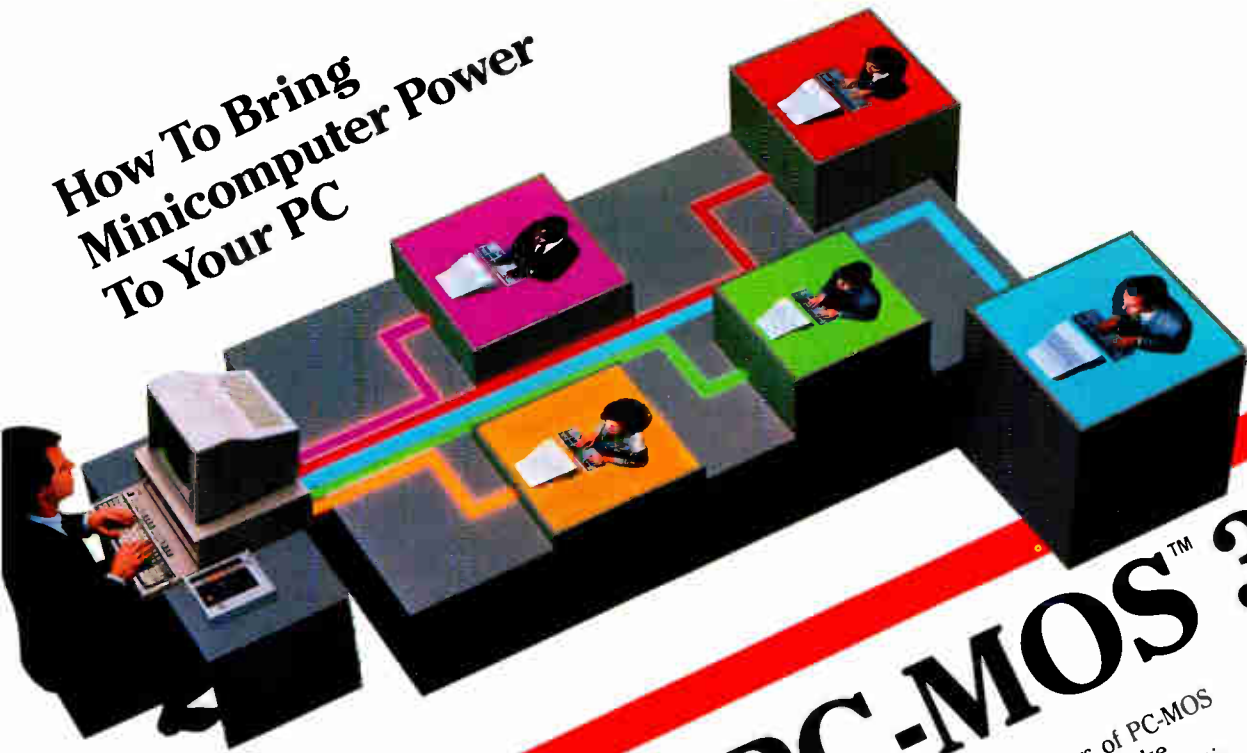

# Introducing PC-MOS™ 3.0

A multiuser system no longer means only a mainframe or minicomputer. Today's 386- and 286-based PCs are more powerful than the minicomputers of just a few years ago. And they often provide more desktop power than one person can use effectively. That's why you need PC-MOS 3.0. It harnesses the power of your 386- or 286-based PC and turns it into a powerful multiuser, multitasking computer. PC-MOS is the multiuser operating system that lets you run popular DOS applications such as Windows™, Lotus 1-2-3™, dBase IV™ or WordPerfect™—without modification.

PC-MOS is the perfect solution for a small business or a department of a large company that needs users to easily and affordably share programs, databases or peripherals. It takes full advantage of the hardware's power—and saves you money in the process! For example, instead of replicating PCs, each user can have an expensive terminal or monitor that acts like a PC.

**DOS Compatibility Means Minimal Training And Support**  
Since PC-MOS is DOS compatible—unlike UNIX™ or OS/2™—there's no need for users to learn a "new" operating system or be retrained on the application programs they already know. And unlike most LANs, PC-MOS is easy to install and even easier to maintain. No hassle, no expensive wiring and no network management headaches.

There are now more than 100,000 users of PC-MOS worldwide, but if you haven't seen it lately, take another look. We've broadened our base of compatible applications and added multi-level security, faster disk performance and larger LANs, 3270 mainframe also interfaces with Novell products and The Software Link's LANLink™ local area network.

Call us today for more information about PC-MOS 3.0 and the location of your nearest multiuser dealer. We'll show you how to easily and affordably turn your PC into a powerful multiuser system.

**Terminals and Workstations Supported**  
Wyse 150™; Link MC5™; Kimtron KT-70™; IBM 3151™; AT&T 605 Business Communications Terminal™; Sun River Cygnal/386™; Video Network Adapter™ and others.



**THE SOFTWARE LINK**  
3577 Parkway Lane Norcross, GA 30092  
1-800-451-LINK (404) 448-5465  
Fax: (404) 263-6474 Telex: 4996147 SWLINK

PC-MOS and LANLink are trademarks of The Software Link, Inc. All other products referenced are trademarks of their respective companies.

**Your connection to  
advanced technology**

Circle 328 on Reader Service Card (DEALERS: 329)

editors are a joy to use. In addition to the rectangular grid, an isometric grid helps you create objects that look three-dimensional. You can supply numeric input for nearly all operations, and you can be as precise as you want (that's true throughout the TPS system). You can even specify a scaling factor for numeric input, so that if you're drawing, say, a floor plan, you can express distances in feet or in inches.

I particularly liked the suite of tools

that align a set of selected objects to one another's top, bottom, left, or right edges, vertical or horizontal centers, or the frame. For finer adjustments, you can use grid alignment and gravity. Objects respond quite sensitively to one another's gravity points, and you can even adjust the gravity radius if congestion makes that necessary.

Another handy feature is subediting, which enables you to recursively edit a group of objects. With subediting, you

don't have to undo a group to change something in it. This feature makes groups extremely useful.

Three kinds of text can appear in a frame: raster text, outline text, and microdocuments. Raster text objects use the same fonts as the regular text-processing system. You can rotate them in 90-degree increments, and they interact intelligently with other kinds of objects. For example, while adding labels to a chart, I found it easy to lay down a series of construction lines, snap the baselines of the text labels to those lines, and then center the text labels horizontally with respect to the lines.

You can convert a raster text object to its equivalent in a Bitstream-supplied outline font. It's a one-way conversion—if you've misspelled something, you'll have to throw the conversion away and start over. But once the text is in outline form, you can size or rotate it arbitrarily, change the weight of its edges, fill it with a pattern, and twist it into unusual (and, you hope, artistic) shapes.

Microdocuments are TPS documents that live within bounding rectangles inside graphical frames, which, in turn, live inside components of regular TPS documents. Confusing? Well, yes, there are a lot of Chinese boxes here, but microdocuments are an intriguing invention. The problem with raster and outline text objects is that, while they're fine for short phrases and one-liners, you often need more text than that in a diagram, and you'd like that text to behave as text, not as graphical objects. Microdocuments do that. Nearly all TPS's text-processing power is available within the microdocument editor. Microdocuments can even participate in the main document's table of contents and index processing. That makes them a good choice for captions and legends.

#### Layout Problems

With this formidable collection of tools, I set out to produce templates for a few pages of BYTE. To my surprise, I was unable to solve a layout problem satisfactorily. Look again at the What's New section. See how the columns run around the photograph at the top of the page? In a multicolumn format, TPS doesn't do well with that sort of text/graphics interaction.

Frames work beautifully when they're no wider than a single column; the frame anchors to and flows with the text. When the frame gets wider than a column, there are a couple of possibilities: It can straddle the page (the straddle acts as a

*continued*

## INTRODUCING THE



**\$35 CURE FOR  
FEAR OF MATH**

## **S** STATISTICS

At last, PC users can master statistical analysis without a masters in math.

It's Victory Over Statistics, a 200-page manual, published by GTE Data Services, Inc. Written in everyday English, Victory Over Statistics with its menu-driven diskware will take you from the basics, such as averages and variance, all the way to double exponential smoothing and regression analysis. Step by step, at the pace you choose.

All you need is an IBM PC or compatible with a 5.25 disk drive and 128K memory plus \$35.00.

That's one set of numbers even a math hater can love.

**GTE Data Services**

THE POWER IS ON

To order, send the coupon and a check, payable to GTE Data Services, Inc. Please allow four weeks for delivery.

Here's my check for \$35.00, plus \$4.00 for postage and handling. Florida residents please add 6% sales tax. Please rush my Victory Over Statistics manual and disk.

Victory Over Statistics, F1M  
GTE Data Services, Inc.  
P. O. Box 290152  
Temple Terrace, FL 33687-0152

Name \_\_\_\_\_

Address \_\_\_\_\_

City \_\_\_\_\_ State \_\_\_\_\_ Zip \_\_\_\_\_

Telephone Number (\_\_\_\_) \_\_\_\_\_



# GET THE PC NETWORK ADVANTAGE

Join Today -- Receive A FREE Surprise Package of Gifts, and More...

## 9 Reasons Why You Should Join The Club...

Over 100,000 Satisfied Club Memberships. PC Network Members come to us for everything from basic software/hardware to complex computer system needs. We answer tough questions, offer great merchandise selection, and provide excellent service. When you join you receive...

### 1. Red Carpet Service

Club members receive exclusive privileges, plus special merchandise offers, streamlined 24-hour order processing, shipping, and service.

### 2. Warehouse Pricing

Club members get low warehouse-to-you prices every day. (Just take a "peek" at our specials.)

### 3. Exclusive PC Network Credit Card.

Now you can apply for a credit card devoted to your computing needs. Great when you need fast warehouse-to-you shipments.

### 4. Used Computer Hardware Exchange

Sell your used computer hardware to other Club members. Upgrade your system. Available to Club members at a nominal cost.

### 5. Members ONLINE Bulletin Board

Download "Freeware" and "Shareware" from our massive collection of Public Domain software. Place orders. Get information. Not just a bulletin board, but a complete member information network.



### 6. Club Leasing — Business Option

With other computer companies, if you wanted to lease computer hardware, you had to be a big business. Now small businesses and professional Club members have this option available.

### 7. Dow Jones Information Retrieval

Have access to this information service at members only discount rates plus receive special discount certificates, worth over \$50.00 in FREE services.

### 8. No Minimum Purchase-EVER!

That's right. Club members have no pre-set purchase requirements. No complicated forms. No unwanted or un-ordered merchandise-ever. You pick and choose what you want-when you want it.

### 9. Exceptional Service-Unequaled Privileges.

You have toll-free direct lines to PC Network whenever you need to talk to a Technical Consultant or Computer Consultant. Plus, your very own Club Representative to answer your computer questions.

## Members Take Advantage Of Specials Like These



SEAGATE  
ST-251-1  
40MB Hard  
Drive 28MSec  
**\$299**

HEADLAND  
Video 7  
FastWrite VGA  
**\$279**



SEIKOSHA  
SP-1600AI  
160cps Dot Matrix  
**\$155**

## Accept Our Invitation

Join today and receive our latest Buyers Guide and your New Members kit, with personalized I.D., PLUS--if you're one of the first 1,000 new members, you will automatically receive a special FREE surprise package of gifts. Open a world of exceptional service and unequalled privileges--all for only \$19.95 a year. Join now, find out for yourself why "Personal Computing" magazine ranked PC Network, "Best for Overall Pricing-Overall Value!"

**Join Now, 1-800-621-7283**



P.O. BOX 386, MONTGOMERYVILLE, PA 17754 HOURS: MONDAY-FRIDAY 8:00 AM - 9:00 PM SATURDAY 9:00 AM - 5:00 PM

Circle 276 on Reader Service Card

text-flow barrier), or it can overlay the page (but then the frame won't obstruct text flow).

A text-shaping feature lets you manually push text around an overlay frame, but that's a custom operation and can't be made part of a reusable template. A final option, used in the newsletter example provided with the software, is to put each column's text into a separate microdocument; then it's easy to put the columns where you want them. But again, that's a custom operation that doesn't yield a reusable template. Text can't flow between microdocuments, so in a production environment, you'd be stuck doing lots of electronic paste-up.

I was trying to get TPS to do something it wasn't designed to do. It's not really a layout system, and it's not intended for newspaper and magazine work. The essence of layout is that each page gets special treatment. But TPS's dominant mode is document-oriented rather than page-oriented. True, its diagram editor is so powerful that you can ignore the document mode and create highly customized mixtures of text and graphics within frames. Nevertheless, in document mode TPS's strength is automatic pagination, not custom layout.

Who needs this capability? Technical documenters, business folk, scientists, engineers, commercial book publishers, database publishers—anyone who produces lots of pages, needs high quality and fast turnaround, wants to define and reuse design standards, and doesn't want to fuss over each individual page.

### Charts, Tables, and Equations

TPS supports its diverse users with several additional special-purpose tools. Three that I haven't mentioned are the equation, chart, and table editors. The equation editor does mathematical typesetting. It parses expressions made of letters, digits, parentheses, brackets, and mathematical keywords, and it produces typeset equations.

The chart editor is the nicest that I've worked with. It's data-driven—you cut tab- and new-line-delimited sets of numbers from a text file and paste them into a chart's data sheet. The system supports the usual collection of chart styles but offers excellent control over variation within those styles. Using data on 66 machines that have been tested in the BYTE Lab, I developed a stacked-bar chart that displayed nearly 600 data points. The result was clear and precise on-screen and even better when printed on a LaserWriter IINT.

TPS's attention to detail is such that you can set the width and length of the hash marks along a chart's axes (among other chart properties) in terms of whimsically named *rsus* (for "ridiculously small units"). An *rsu* is equal to a millionth of an inch. The manual notes dryly that you have to add 3000 *rsus* to a chart parameter to see even a slight difference in 300-dot-per-inch printed output.

Charts inhabit frames, so it's easy to add further embellishments using the diagram editor. You can move and size charts and lay pictures or microdocuments on top of them. I even found a way to mimic the BYTE format for benchmarks. Sometimes application benchmarks are shown as left-to-right bars and system benchmarks as mirror-image right-to-left bars on the same page. The diagram editor couldn't flip the system benchmarks to the other orientation, but TPS's screen-capture tool turned the chart into a raster image, which I then flipped and aligned to achieve the desired result.

Tables are interesting hybrids. When you create a table in the component bar, you specify the number of rows and columns that it contains. The result isn't a single component name, however, but rather a list of names—one for each row. From any row component, you can access property sheets that govern that row instance, the row master (and, by extension, all rows), or the whole table. When you click in a cell, you can access property sheets that govern that cell, and you can apply changes to only that cell or to its whole column. Text wraps within cells, and a row grows automatically when the contents of any of its cells require it to do so.

### Document and Project Management

TPS recognizes that the kinds of documents it does well usually represent the work of a team rather than an individual author, and it works hard to support the team approach. The *book* is a meta-document implemented as a special directory that joins into a single entity a collection of documents that may have been produced by multiple authors on multiple workstations. The *book's* documents retain their individuality, but they can also behave as an aggregate for purposes of pagination, indexing, and printing. A *catalog* is to a book what a component bar is to a document. Catalogs can export properties to the documents in a book; that's a useful way to control the style of a collection of documents.

A set of what Interleaf calls "effectivity tools" aids in the control of versions,

and annotations. The mechanism entails tagging components with attributes and then applying control expressions to select components that match one or more attributes. For example, if you have to maintain a software manual for a product that runs under multiple operating systems, you might use the attributes "Unix" or "VMS" to mark the variable parts of the book. Or, if several editors are reviewing a document, you might use the attributes "Frank" and "Sylvia" to selectively show or hide their comments.

Not everyone on a writing team needs a TPS workstation. The system happily imports ASCII files that intersperse component names (e.g., <para>) with textual content. That's an important point to bear in mind. For example, a single TPS workstation run by a competent artist/typesetter might be adequate to serve a team of PC-based technical writers.

### Toward an Open Architecture

TPS 4.0 takes a small step in the direction of what the company calls an "open architecture": A Lisp interpreter is embedded in the system, and a small set of Lisp programs comes with the installation. The names of these programs appear on the Custom pop-up menu; icons in the Custom cabinet contain the Lisp code.

These "Leafware" utilities can run Unix commands from within the TPS desktop or set TPS system parameters. It's an embryonic capability, but one that holds much promise.

Building extensibility into TPS—as most CAD vendors have done with their products—invites third-party developers to customize the product for more specialized markets than Interleaf itself can address. It's a great idea, although it's not yet clear that Leafware will open up the TPS product to the extent that AutoLisp has opened up AutoCAD.

TPS 4.0 is a remarkable product. From a PC or Mac perspective, it's like having TEX, PageMaker, Adobe Illustrator, and Microsoft Chart all rolled into a single package. There's so much there, I'll bet many users will tap only a fraction of its capacity. But for those who deal heavily in the kinds of documents that TPS does well—from display advertisements to textbooks—TPS 4.0 will get the job done with speed, style, and precision. ■

*Jon Udell is a BYTE senior technical editor at large. He can be reached on BIX as "judell."*



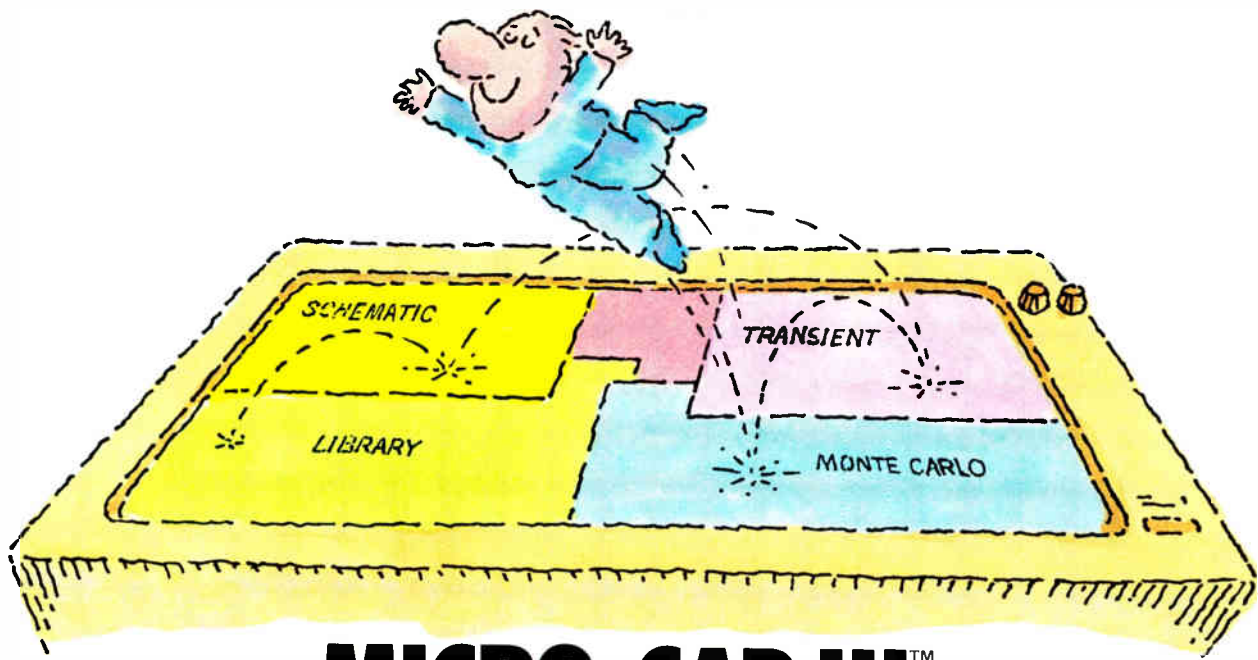

## MICRO-CAP III.™

# THIRD-GENERATION INTERACTIVE CIRCUIT ANALYSIS. MORE POWER. MORE SPEED. LESS WORK.

MICRO-CAP III,™ the third generation of the top selling IBM® PC-based interactive CAE tool, adds even more accuracy, speed, and simplicity to circuit design and simulation.

The program's window-based operation and schematic editor make circuit creation a breeze. And super-fast SPICE-like routines mean quick AC, DC, Fourier and transient analysis—right from schematics. You can combine simulations of digital and analog circuits via integrated switch models and macros. And, using stepped component values, rapidly generate multiple plots to fine-tune your circuits.

We've added routines for noise, impedance and conductance—even Monte Carlo routines for statistical analysis of production yield. Plus algebraic formula parsers for plotting almost any desired function.

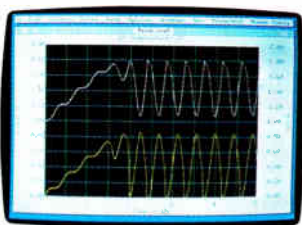

*Transient analysis*

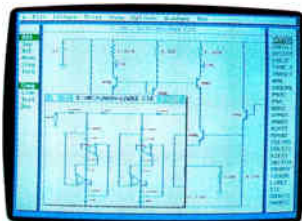

*Schematic editor*

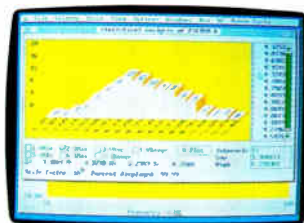

*Monte Carlo analysis*

Modeling power leaps upward as well, to Gummel-Poon BJT and Level 3 MOS—supported, of course, by a built-in Parameter Estimation Program and extended standard parts library.

There's support for Hercules,® CGA, MCGA, EGA and VGA displays. Output for laser plotters and printers. And a lot more.

The cost? Just \$1495. Evaluation versions are only \$150.

Naturally, you'll want to call or write for a free brochure and demo disk.

**Spectrum**

1021 S. Wolfe Road,  
Sunnyvale, CA 94086  
(408) 738-4387

MICRO-CAP III is a registered trademark of Spectrum Software.  
Hercules is a registered trademark of Hercules Computer Technology.  
IBM is a registered trademark of International Business Machines, Inc.

Circle 334 on Reader Service Card

# ZEOS<sup>®</sup> 386SX

## ZEOS Smashes the '386

**Your best reason yet to move up to a '386. Now you can own a complete ZEOS '386SX 16MHz hard drive system for *less* than comparable '286 systems.**

**The ZEOS '386SX. ZEOS performance, quality and support. ZEOS value. The Choice is Clear.**

**If you plan to buy a 16- or 20MHz 286 machine, think again.**

A fundamental change in computing is about to take place. Systems based on the 80286 processor will be replaced by systems based on the 80386SX.

As America's premier manufacturer of 80386 based systems, we've designed the new ZEOS 386SX to provide everyone with a window to the future. A future of '386 speed and performance at a fraction of what you would expect to pay.

And ZEOS knows '386 systems better than anyone. After all, PC Magazine chose ZEOS above 57 other companies for "*For Overall Excellence*" in their recent '386 Blockbuster issue.

The new ZEOS 386SX simply runs circles around '286 based machines. PC magazine noted that the ZEOS 16MHz 386SX compares "favorably with the 20MHz '286 machines reviewed in 'The 80286: Unsafe at Higher Speeds?'" (PC Magazine, December 27, 1988).

So forget those 16- and 20MHz '286 machines forever. The ZEOS '386SX-16 "blows 'em right out

of the water." As PC Magazine says, "386SX-based machines are the right choice..." and the new ZEOS 386SX is the right choice for you.

**30 Day Absolute Satisfaction Guarantee. One Full Year Limited Warranty.**

If a company believes in their product, they should stand Rock Solid behind it. That's why your new ZEOS 386SX hard drive system includes our famous 30 Day Absolute Satisfaction *Money Back* Guarantee, One Full Year Limited Warranty and Express Parts Replacement Policy.

**24 Hour a Day Sales and Toll Free Technical Support!**

And talk about service! ZEOS is the only computer company in America standing by ready to help you *Toll Free, 24 hours a day, 365 days a year*. Nobody supports their customers like ZEOS!

Order your new ZEOS 386SX now with confidence. Your choice of ZEOS quality and performance is *Guaranteed*. Order now by calling 800-423-5891.

All prices and specifications are subject to change without notice. Please call for current pricing and warranty details.



# Only \$1695. Price Barrier!

**The New ZEOS  
386SX Hard Drive  
System. Below  
'286 Prices!**

**Only \$1,695**

*The future is now!*

*Why be left behind with yesterday's '286 technology? This fast new ZEOS 386SX system is your high performance ticket to '386 computing power. It's actually faster and yet less expensive than comparable '286 systems.*

- 80386SX-16 CPU, 8/16MHz Dual Speed Keyboard Selectable. Reset/Turbo Buttons.
- 512K DRAM, expandable to a System Total of 16MB.
- Shadow RAM and EMS capability.
- Fast 32MB Seagate 138R Hard Drive with autopark, 1.2MB Teac floppy drive.
- Ultra high speed Hard/Floppy controller. 1:1 interleave, High Speed transfer.
- Genuine Hercules® brand graphics controller. High-Res Amber Display with Tilt/Swivel.
- ZEOS/RS Enhanced Tactile/Click keyboard.
- 2 High Speed Serial Ports plus one Parallel and one Game Port.
- 6-16, 2-8 bit expansion slots. 80387SX support.
- Rugged ZEOS space saver case. Security lock and LED indicators.
- Includes ZEOS 24 Hour a Day Toll Free Technical Support and Customer Satisfaction package.



**Order Now Toll Free  
800-423-5891**

FAX Orders Dial: 612-633-1325  
In Minnesota Call: 612-633-4591  
MasterCard, VISA, ZCARD, COD  
Open 24 Hours a day, 365 Days  
a year.

# ZEOS '386 Systems

# "For Overall Excellence..."

PC Magazine, May 30, 1989

Complete ZEOS 20MHz '386 System. 80MB SCSI Drive!

**Only \$2995**

16MHz systems from \$2295!

The standard by which others are measured! Featuring 64K CACHE (twice that of most competitors) providing Zero-Wait State performance vastly superior to page/interleave memory schemes. Incredible Value.

- High speed Zero-Wait 64K read and write-back SRAM CACHE. The fastest method known.
- Genuine 32-bit Intel 80386-20MHz CPU.
- 1MB of Zero-Wait DRAM Expandable to 16MB.
- Fast 80MB, 28ms SCSI Seagate Hard Drive, Teac® 1.2MB Floppy Drive.
- High speed HDD/FDD SCSI Host Adaptor with Software.
- Genuine Hercules® brand graphics controller. High-Res Amber Display with Tilt/Swivel.



Performance Comparisons using PC Labs Benchmark Series Release 4:

	80386 Instruction Mix	Floating Point Calculation	Conventional Memory
ZEOS 386/16 Desktop	3.58	13.62	0.58
ZEOS 386/20 Desktop	2.87	10.82	0.38
IBM PS/2 Model 70-E61	4.08	16.04	0.75
Compaq Deskpro 386/16	4.12	15.47	0.75

- 101 Key ZEOS Tactile/Click keyboard.
- 2 High Speed Serial Ports plus one Parallel and one Game port.
- 1-32, 6-16 and 1-8 bit slots.
- 80387 math coprocessor support.
- Rugged ZEOS 5-bay case. Including Security Lock and LED indicators.
- Includes ZEOS 24 Hour a Day Toll Free Technical Support and Customer Satisfaction package.

Options Galore: Including 14" VGA, add only \$595. And an incredible selection of hard drives: SCSI, RLL, ESDI or MFM and virtually any other add-on you could want!

Order Now Toll Free  
**800-423-5891**

FAX Orders Dial: 612-633-1325  
In Minnesota Call: 612-633-4591  
MasterCard, VISA, ZCARD, COD  
Open 24 Hours a day, 365 Days a year.

All prices and specifications are subject to change without notice. Please call for current pricing and warranty details. ZEOS is a publicly traded company; MPLS/St. Paul Local OTC.



"Out of 104 machines from 58 companies... For overall excellence we selected ZEOS International's 386-16 and 386-20" *PC Magazine, May 30, 1989*

The Editors of *PC Magazine* came to this conclusion after investing "25,000 hours of work by 60 people testing and reviewing 104 '386 PCs." The review was thorough and their conclusion specific. Simply, that out of all the manufacturers in the world, ZEOS offers you the very best '386 Value.

In *all* areas, ZEOS machines are top performers. With uncompromising attention to quality and detail throughout. Not only do ZEOS systems themselves afford you the very best *Values* in computing today, they're backed up by the strongest after sales support in the industry.

At ZEOS we feel that if a company believes in its products it should stand Rock Solid behind them.

That's why ZEOS offers *Toll*



**"Price is always a consideration. So are benchmark test results. But both factors can be deceiving, which is why we consider them in the context of other aspects that will make the difference months and years down the road. Things like quality of construction, reliability, expandability, and ease of service."**

*PC Magazine, On "What Makes an Editor's Choice"*

*Free Technical Support 24 Hours a day, seven days a week, 365 days a year!* At ZEOS, we believe in standing by our customers whenever they need us.

Then add our 30 Day Absolute Satisfaction *Money Back* Guarantee, One Full Year Limited Warranty and Express Parts Replacement Policy. You've got the best.

And when you order your ZEOS '386 you can have your pick from the industry's broadest selection of options. As *PC Magazine* said, ZEOS offers "more options than even the most configuration hungry hound could possibly need."

Quality, Performance, Reliability and Support. *Overall Excellence.* That's why ZEOS is *PC Magazine's #1* choice. And that's why ZEOS is *your best choice as well.* So pick out that dream machine today and order it now with confidence. Your choice of ZEOS excellence is Guaranteed. Order now by calling 800-423-5891.

**Complete 25MHz '386 Vertical System. 80MB SCSI Drive!**

**Only \$3995**

*Complete 33MHz systems only \$4995!*

*ZEOS 25MHz and 33MHz 80386 systems are the fastest, most advanced available anywhere. Government Computer News calls the ZEOS '386-33 "arguably the fastest MS-DOS and OS/2 micro in the world." Review after review, these ZEOS systems are selected as the best price/performance buys. A power user's dream!*

- Ultra High speed Zero-Wait 64K SRAM CACHE.
- Genuine 32-bit Intel '386-25 or 33MHz CPU.
- 1MB of Zero-Wait DRAM Expandable to 16MB.
- Fast 80MB, 28ms SCSI Seagate Hard Drive, Teac® 1.2MB Floppy Drive.
- High speed HDD/FDD SCSI Host Adaptor with Software.



Performance Comparisons using PC Labs Benchmark Series Release 4:

	80386 Instruction Mix	Floating Point Calculation	Conventional Memory
<b>ZEOS 386/25 Desktop</b>	2.29	8.37	0.33
<b>ZEOS 386/33 Desktop</b>	1.67	6.43	0.27
<b>IBM PS/2 Model A</b>	2.27	8.33	0.60
<b>Compaq Deskpro 386/25</b>	2.35	8.59	0.37

- Genuine Hercules® brand graphics controller: High-Res Amber Display with Tilt/Swivel.
- BIOS and Video Shadow RAM plus EMS support.
- ZEOS Tactile/Click keyboard.
- 2 High Speed Serial Ports plus one Parallel and one Game port.
- 1-32, 6-16 and 1-8 bit slots.
- 80387 math coprocessor support.
- Rugged ZEOS 5-bay case. Security Lock, LED indicators.
- Includes ZEOS 24 Hour a Day Toll Free Technical Support.

*Many options available: Including 14" VGA, add only \$595. Plus a large selection of SCSI, RLL, ESDI or MFM hard drives and more.*

**Order Now Toll Free  
800-423-5891**



©1989 ZEOS International, Ltd., 530 5th Avenue, N.W., St. Paul, MN 55112. All product and company names are trademarks or registered trademarks of their respective holders.

# Comput

## Right Now. Guaranteed!\*

Yes, we can ship your new ZEOS® '286 or '386 today! We've built up an extra supply of the hottest selling computers in America. The celebrated ZEOS 286-12 and PC Magazine's Editors Choice—the ultra fast ZEOS 386-20.

Take your pick now for immediate delivery. These are both *complete*, genuine ZEOS Zero-Wait state systems. Both include an ultra-fast Seagate hard drive and all the other goodies. And they're ready to ship. *Right Now.*

Here's how it works. We have these extra systems pre-built and ready to ship. They include both High Resolution Monochrome and VGA systems. While supplies last, we will ship either of these systems to you *the day you order* subject to these conditions:

1. Your order must be received by 1PM Central Time.
2. Credit Cards are subject to credit card authorization.
3. Orders must be for our standard 286-12MHz system or 386-20MHz system, either monochrome or VGA. Any other systems or upgrades are custom built and will take slightly longer.

## \*Our Guarantee to You:

If we fail to ship your system under the conditions outlined, we will ship it *at our expense* as soon as it is ready. All systems are fully burned in and tested. Each system includes our 30 day Money Back Guarantee and One Full Year Limited Warranty. Plus 24 Hour a day Toll Free technical support and Express Parts Replacement are included too!

This offer is good only as long as these pre-built

**Complete ZEOS 12MHz '286 with 32MB Hard Drive!**

**Only \$1,395**

For VGA color add \$595

*FREE Shareware Disks Too!  
25 Software Programs Included  
Every system will include 25 ready to run Shareware programs on free disks. Included are programs for Word Processing, Spread Sheets, Educational, Financial, Business, Games and more. With Shareware you can try the programs first before you register them with the author. What a great idea!*

### Standard Features Include:

- 80286-12 CPU, 6/12MHz Dual Speed keyboard/hardware selectable. Reset and Turbo buttons right up front.
- Zero-Wait State DRAM, 512K expandable to 4MB on the mother board (16MB System Total). EMS Capability on board.



Performance Comparisons using PC Labs Benchmark Series Release 4:

	80286 Instruction Mix	Floating Point Calculation	Conventional Memory
ZEOS 286/12 Desktop	4.78	18.84	0.72
IBM PC AT (8MHz)	8.96	35.60	1.32
IBM PS/2 Model 50	7.20	28.34	1.05

- Fast 32MB Seagate 138R Hard Drive with auto-park, 1.2MB Floppy Drive.
- Ultra high speed Hard/Floppy controller. 1:1 interleave, 800 KB/sec transfer rate.
- Genuine Hercules® (Yes, Hercules!) Brand graphics card. High-Res Amber Display with Tilt/Swivel Base.
- ZEOS Enhanced 101 Key Keyboard with our Pleasant Tactile/Click Feel.
- Serial and Parallel Printer Ports.
- Clock/Calendar with Battery Backup.
- 6-16 and 2-8 bit expansion slots.
- 80287 support, up to 12 MHz.
- Heavy Duty Case Complete with Security Lock and LED indicators.

**Order Now Toll Free  
800-423-5891**



# ers Now! <sup>SM</sup>

systems remain in stock; please give us a call to verify availability. This offer does not apply to other ZEOS systems or custom configurations.

*Immediate shipment is only part of the story.*

ZEOS builds Rock Solid computers. That's why we offer you our 30 Day Money Back Guarantee, Toll Free technical support and Full One Year Limited Warranty. Compare that to the others. Then compare performance.

Performance is what ZEOS is all about. If you're buying a computer you may as well buy the fastest. The ZEOS 286-12 is *the fastest* in its class. It features true Zero-Wait state operation with speeds close to many 386 systems!

Or select the ZEOS 386-20. The Editors of *PC Magazine* did. In fact, they said "Out of 104 machines

from 58 companies... for overall excellence in both the 16- and 20MHz categories, we selected ZEOS International's 386-16 and 386-20." And ZEOS '386 systems have racked up *three PC Magazine Editor's Choice awards so far this year!*

*PC Resource Magazine* put it this way "ZEOS... provides quality comparable with the IBM or Compaq and does so for about 70% of the cost." *Personal Computing* simply says "The best value we've come across so far"

We couldn't have said it better ourselves.

And these are the machines that we have ready to ship to you *right now*. Rock solid block buster ZEOS machines with quality and performance that is, in a word, *Guaranteed*. Order now by calling 800-432-5891.

**Complete ZEOS 20MHz '386 with 80MB 28ms SCSI Drive!**

**Only \$2,995**

For VGA color add \$595



Standard Features Include:

- Genuine 32-bit Intel 80386-20MHz CPU.
- High speed Zero-Wait 64K SRAM CACHE.
- 1MB of Zero-Wait DRAM Expandable to 16MB system total.
- Fast 80MB, 28ms SCSI Seagate Hard Drive, 1.2MB Floppy Drive.
- Ultra high speed Hard/Floppy SCSI controller.
- Genuine Hercules® Brand graphics card. High-Res Amber Display with Tilt/Swivel Base.



Performance Comparisons using PC Labs Benchmark Series Release 4:

	80386 Instruction Mix	Floating Point Calculation	Conventional Memory
ZEOS 386/20 Desktop	2.87	10.40	0.39
IBM PS/2 Model 70-121	3.24	12.72	0.61
Compaq Deskpro 386/20e	2.91	10.54	0.40

- 101 Key ZEOS Tactile/Click keyboard.
- High speed Serial and Parallel Ports.
- 1-32, 5-16 and 2-8 bit slots.
- 80387 math co-processor support.
- ZEOS 5-bay case with security lock and LED indicators.

**Order Now Toll Free  
800-423-5891**

FAX Orders Dial: 612-633-1325  
In Minnesota Call: 612-633-4591  
MasterCard, VISA, Z Card and COD  
Open 24 Hours a day!  
ZEOS International, Ltd.  
530 5th Avenue, N.W.  
St. Paul, MN 55112 USA



# Take Your Pick.

Only ZEOS lets you decide between two great keyboard styles. Choose the ZEOS/RS with standard Enhanced key spacing yet a 25% smaller footprint. Or choose the ZEOS/F12 with all the function keys *on the left*. ZEOS gives you the choice. Two great keyboards, one great price!

# Only \$89.95

Please add \$5.00 for shipping & handling. Your ZEOS keyboard comes with the standard 6' coiled cable. For an additional 10' cable extension (16' total) add \$10.00. ZEOS keyboards use the standard DIN type connector as do most compatibles. If you're not sure what you need, contact your computer retailer. For PS/2 style connectors add \$15.00. XT, AT and PS/2 are trademarks of IBM Corporation. Prices are subject to change without notice. Call for complete warranty details. Available in 12 languages, call to verify stock. ZEOS is a publicly traded company, MPLS/ST PAUL Local OTC.



ZEOS/F12



ZEOS/RS

## Your favorite Keyboards. Guaranteed.

**ZEOS/F12, "F" Keys on the Left!**  
Many people prefer their function keys on the left. That's why we developed the ZEOS/F12. If you use your "F" keys frequently, then definitely give the F12 a try. You'll never go back.

**ZEOS/RS, 25% smaller footprint!**  
We made it 25% smaller yet kept the standard Enhanced key size and spacing. People love it by the thousands. You will too. Just decide what you're going to do with all that extra desk space!

Who said typing can't be both fast and fun! Now it's both. ZEOS gives you your choice of *two* great keyboards.

Choose the ZEOS/RS (Reduced Size) keyboard. It's 25% smaller! Or select the ZEOS/F12. All 12 function keys are on the left, where a lot of us learned to use them. It's great for Function-intensive applications. It's fantastic for typing!

Either way you get that great ZEOS Mechanical Tactile feel with the perfect "Click."

Plus, you will also get that extra ZEOS value. Like an anti-static dust cover included at no additional charge. Our famous ZEOS 30 day Money Back guarantee, Full One Year Warranty, Toll Free Technical Support and Expedited Replacement policy are yours too.

So take your pick and start enjoying your new ZEOS keyboard right away. Order yours now by calling 800-423-5891.

Order Now Toll Free  
800-423-5891



Open days, evenings and weekends.  
Fax Orders Dial: 612-633-2310.  
In Minnesota Call: 612-633-4591.  
MasterCard, VISA and COD  
530 5th Avenue NW, St. Paul, MN 55112



# Announcing the Z-CARD!

## Apply Now for your own ZEOS® Revolving Charge Account

### Send For Your ZEOS Credit Card

Now you can send for your own ZEOS Credit Card. It works just like a MasterCard or Visa for ZEOS purchases. Fill out your Z-CARD Personal Information Organizer and mail it today. We'll give you a call as soon as your credit line is established!

Mail the completed Personal Information Organizer to:  
**ZEOS International**  
**Z-CARD Processing Center**  
**530 5th Avenue, N.W., St. Paul, MN 55112**

#### a. Your Personal Information

Requested Line of Credit \$ \_\_\_\_\_

Your Name \_\_\_\_\_ Date of Birth \_\_\_\_\_  
First Initial Last Mo. Day Yr.

Present Address \_\_\_\_\_  
Street Apt. # City State Zip

Social Security Number \_\_\_\_\_  
( ) Home Phone

Date of Residence \_\_\_\_\_ Monthly Payment \$ \_\_\_\_\_  
Month Year Buy Rent Other

Previous Address \_\_\_\_\_

Dates of Residence \_\_\_\_\_  
From To

Your Employer \_\_\_\_\_  
(If self-employed, see rear panel.)

Date of Employment \_\_\_\_\_ Position \_\_\_\_\_  
Mo. Yr.

Monthly Income \_\_\_\_\_  
Gross \$ Net \$

Employer's Address \_\_\_\_\_  
Street

City \_\_\_\_\_ State \_\_\_\_\_ Zip \_\_\_\_\_  
( ) Business Phone

Previous Employer \_\_\_\_\_ Address \_\_\_\_\_

Dates of Employment \_\_\_\_\_  
From To

Other Income \_\_\_\_\_ I have received since (Date) \_\_\_\_\_  
Income from alimony, child support or separate maintenance payments need not be disclosed if you do not wish to have it considered as a basis for repaying this obligation.

Monthly Income \_\_\_\_\_  
Gross \$ Net \$

Name and Address of Nearest Relative Not Living With You \_\_\_\_\_

Relationship \_\_\_\_\_

#### b. Credit Information

Include joint information, if joint account requested.

Bank Account \_\_\_\_\_  
Bank Name Checking Savings

Address \_\_\_\_\_

Bank Account \_\_\_\_\_  
Bank Name Checking Savings

Address \_\_\_\_\_

Bank Loan Reference \_\_\_\_\_  
Bank Name Address

Payment \_\_\_\_\_ Balance \_\_\_\_\_

Bank Card Reference \_\_\_\_\_  
Bank Name Address

Payment \_\_\_\_\_ Balance \_\_\_\_\_  
 VISA  Mastercard

(please check appropriate box):

- Joint Credit** with another person. Complete all information.
- Individual Credit** but rely on income or assets of another person as a basis for repaying the credit requested. Complete all information
- Individual Credit** Complete sections "a" and "b" only.

Please complete all appropriate sections, *providing at least two years' residence and employment history*. This will enable your information to be processed as quickly as possible. If you are self-employed, please be sure to complete section "d" below.

Other Credit Card Reference \_\_\_\_\_  
Bank Name Address

Payment \_\_\_\_\_ Balance \_\_\_\_\_

Other Credit References \_\_\_\_\_  
Payment Balance

Account No. \_\_\_\_\_ Expires \_\_\_\_\_

Driver's License No. \_\_\_\_\_ State \_\_\_\_\_ Expires \_\_\_\_\_

#### c. Joint Personal Information

Joint Name \_\_\_\_\_  
First Initial Last

Date of Birth \_\_\_\_\_ Social Security Number \_\_\_\_\_  
Mo. Day Yr.

Address \_\_\_\_\_  
Street Apt. #

City \_\_\_\_\_ State \_\_\_\_\_ Zip \_\_\_\_\_

Date of Residence \_\_\_\_\_ Home Phone ( ) \_\_\_\_\_  
Mo. Yr.

Employer \_\_\_\_\_

Date of Employment \_\_\_\_\_ Position \_\_\_\_\_  
Mo. Yr.

Monthly Income \_\_\_\_\_  
Gross \$ Net \$

Employer's Address \_\_\_\_\_  
Street

City \_\_\_\_\_ State \_\_\_\_\_ Zip \_\_\_\_\_  
( ) Business Phone

#### d. Self-Employed Information

Complete this section only if you are self-employed.

Business Name \_\_\_\_\_

Business Address \_\_\_\_\_

Proprietorship  Corporation  Partnership Business Phone ( ) \_\_\_\_\_

Description of Business \_\_\_\_\_

Your Position \_\_\_\_\_ In Business Since \_\_\_\_\_

Your annual income from business \_\_\_\_\_ Business' annual income \_\_\_\_\_  
(gross) (net)

You must provide at least one of the following:

1. Business Bank \_\_\_\_\_

( ) Telephone \_\_\_\_\_ Personal Banker's Name \_\_\_\_\_

2. Accountant's Name \_\_\_\_\_

( ) Telephone \_\_\_\_\_

3. Financial statement on business attached.

(EXC. AK, & HI)

# Cause®

Personal Programmer. Object-Oriented.  
Mac-to-PC. PC-to-Mac. Automatic User Manual.  
No Royalties. Relational. Language Free.

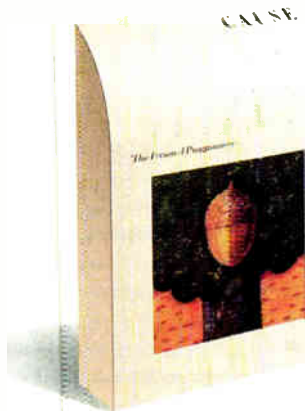

# Effect®

Vertical Applications. Source Included.  
PC-to-Mac. Mac-to-PC. Under \$100. Fast.  
Efficient. Graphical. Powerful.



Fixed Assets



Loan Processing



Legal Time and Billing



Agency Billing



Personnel



Budgeting



Shipping and Receiving



Order Entry/Inventory



Point of Sale



Accounts Payable



Payroll



General Ledger



Job Estimating



Electronic Mail



Job Costing



Problem Tracking



Tax Preparation



Church Accounting



Medical



Chiropractic

etc.

CAUSE is a personal programming tool that allows you to create applications without a programming language. With CAUSE, applications can be created on the PC or Macintosh, transferred to the other platform, compiled and run. CAUSE employs object-oriented design utilizing icons, graphics, windows and the mouse. CAUSE has a built-in relational data base and tools for creating reports and windows. Predefined functions, program trace, and the automatic generation of end-user documentation help decrease development time. The Professional version of CAUSE includes an unlimited runtime license. Applications can be submitted to Maxem for consideration as EFFECTs with royalties paid to the author through the Maxem Authorship Program. For More Information Call 1-800-336-6296 or Write Maxem, 7855 South River Parkway, Tempe, AZ 85284

**Maxem®**

Circle 217 on Reader Service Card



# Reviewer's Notebook

*Reviewer's Notebook is a compilation of brief reviews and updates to previously published evaluations. BYTE will publish Reviewer's Notebook each month on a space-permitting basis.*

## Lab Report: Three Singular Systems

Of the slew of systems that the BYTE Lab benchmarked this past month, we found three worthy of note: the AST Premium/386C, the Swan 386SX, and the Wedge Turbo 286.

We've come to expect quality from AST, and the Premium/386C doesn't disappoint us. The system features a 20-MHz 80386, switchable to 8 or 4.77 MHz, plus an efficient memory architecture, an AST trademark. A proprietary interface board supports up to 16 megabytes of dedicated 32-bit memory. Four banks of sockets for single in-line memory modules on the board can support four 256K-byte or 1-megabyte SIMMs each. It also delivers the cache: 64K bytes of 25-nanosecond static RAM.

Our unit came with a 90-megabyte hard disk drive. The floppy disk drive controller supports up to three floppy disk drives. A 1.2-megabyte 5¼-inch floppy disk drive is standard. One parallel and two serial ports are built into the system board, saving an expansion slot. The system sports a total of four 16-bit and two 8-bit slots, with two 16-bit and two 8-bit slots free. Two slots are occupied by the floppy disk drive controller and the 16-bit AST VGA Plus card that

was shipped with the unit we received.

The AST expansion slots can take advantage of an extended bus architecture. The extra pins allow intelligent peripherals to share control of the system bus to relieve some of the processing load from the main CPU.

The system's benchmark results (see table 1) place it in the upper tier of 20-MHz machines. Although it falls behind the Dell System 310, the ALR Flex-Cache, and the Compaq Deskpro, it leads most of the 20-MHz pack with a CPU index of 3.26 and an overall application index of 16.14.

The quality of the Premium/386C shows in its sturdy construction and the system documentation. AST's comprehensive manual comes complete with glossary, index, and technical appendices. It even covers software utilities bundled with the system. These utilities include disk caching, memory management, print spooling, low-level disk formatting, and system setup.

But quality doesn't come cheap. The Premium/386C's basic configuration (without a hard disk drive or monitor) costs \$4395. Add \$800 for a 40-megabyte drive and controller, or \$1750 for a

90-megabyte ESDI drive and controller.

If you're searching for a 32-bit hybrid at 16-bit prices, the Swan 386SX is worth a look. At \$1399, its price competes with that of most 80286s, while its performance matches that of many 16-MHz 80386 machines.

Like most SX vendors, Swan Technologies optimized space inside the Swan box. The 40-megabyte hard disk drive, mounted vertically, attaches to the standard drive bays. This leaves two half-height bays free beneath the 1.2-megabyte 5¼-inch floppy disk drive. A 16-bit Adaptec modified frequency modulation disk drive controller card with 1-to-1 interleave manages the drives.

The extra space means that the Swan is ready for future enhancements. In addition to the extra drive bays, the unit provides two 8-bit and six 16-bit expansion slots. Our unit had both 8-bit slots filled with an I/O controller and an 8-bit VGA card. The disk drive controller occupied one of the 16-bit slots. That still leaves plenty of room for expansion cards.

The motherboard uses SIMM architecture for memory upgrades. Our unit came with 1 megabyte of 100-ns RAM.

*continued*

**Table 1: The AST Premium/386C's CPU and application indexes place it among the fastest of the 20-MHz 80386s. The Swan 386SX posted respectable benchmarks for a machine base-priced at \$1399. The Wedge Turbo 286's CPU index was well below that of comparable 20-MHz machines.**

### BENCHMARK RESULTS

	Low-level indexes				Application-level indexes					
	CPU	FPU	Disk I/O	Video	Word processing	Spreadsheet	Database	Scientific/engineering	Compilers	Cumulative
AST Premium/386C	3.26	7.42	2.31	2.28	3.12	2.60	2.61	4.50	3.31	16.14
Swan 386SX	1.90	3.06	2.07	1.23	2.25	2.23	2.01	2.38	2.14	11.02
Wedge Turbo 286	1.58	1.60	1.40	1.07	1.92	2.02	1.40	1.82	1.62	8.78

For a full description of all the benchmarks, see "Introducing the BYTE Benchmarks," June 1988 BYTE.

Tucked beneath the vertical drive bay, the SIMM modules are hard to get at even after you remove the hard disk drive. As with many 80386SX models, no memory caching is available. The Swan 386SX uses the Chips & Technologies NEAT (for New Enhanced AT) CHIPSet for bus, memory, and peripheral control.

Benchmark results (see table 1) place the Swan 386SX in the middle of the SX pack, behind the Compaq 386s and ahead of the IBM PS/2 Model 55 SX. But its price undercuts that of any 80386SX machine we've seen yet. A Swan 386SX with VGA and a 32-megabyte hard disk drive sells for \$2298. A 40-megabyte model goes for \$2498. Utilities, including Disk Manager for formatting your disk, and a well-structured (though unindexed) manual come with the package.

Competing with the new 80386SX machines is a flock of souped-up 80286-based systems. The **Wedge Turbo 286** employs a 20-MHz Harris 80C286 processor running at 24 MHz. Unfortunately, the Turbo 286 does not deliver a performance advantage.

It's hard to figure out why this machine is so lackluster (see table 1). We might blame the 10-MHz FPU for the poor cumulative application index (8.78) that places the system below every other

20-MHz machine we've tested; that hurt it in the scientific/engineering applications. And the generic disk drive controller limits disk-intensive applications.

But neither of these factors accounts for the CPU index of 1.58, well below that of other 20-MHz 80286s such as the Wells American 286/20 (2.74) and the Dell System 220 (2.72). We tried changing the CPU speed by the CMOS setup, by hot-key switching, and by software utilities. Nothing provided the extra boost. We could switch speeds between slow and fast, but the fast setting just wasn't fast enough.

The Wedge comes standard with 1 megabyte of memory (expandable to 8 megabytes), a 1.2-megabyte 5¼-inch floppy disk drive, a 40-megabyte hard disk drive, an NEC MultiSync GS monitor, a 101-key Enhanced keyboard, and DOS 4.01. The system also offers three 8-bit and five 16-bit slots for future expansion. The disk drive controller takes up a 16-bit slot, and the VGA card occupies an 8-bit slot. Another 8-bit card delivers a parallel port and a 9-pin serial port, as well as an additional 25-pin serial port and a game port accessible from rear-panel cutouts. Component manufacturers have provided documentation.

Presumably, the Wedge Turbo 286 is

designed to counter the 80386SX onslaught with greater performance at a cheaper price, but at \$2595, a fully configured Turbo 286 is nearly the price of the Swan 386SX. The Wedge we reviewed didn't deliver the goods.

—Stanford Diehl

**AST Premium/386C**

AST Research, Inc.  
2121 Alton Ave.  
Irvine, CA 92714  
(714) 863-1333  
\$6540 as reviewed  
**Inquiry 856.**

**Swan 386SX**

Swan Technologies  
A division of Tussey Computer Products  
3075 Research Dr.  
State College, PA 16801  
\$2795 as reviewed  
**Inquiry 857.**

**Wedge Turbo 286**

Wedge Technology, Inc.  
1587 McCandless Dr.  
Milpitas, CA 95035  
(408) 263-9888  
\$2480 as reviewed  
**Inquiry 858.**

## 400-dpi Printer Shines in Graphics

**W**hat can an extra 100-dot-per-inch resolution from your laser printer do for you? Plenty, if you use complex graphics or scanned images in your work. For this reason, 400-dpi laser printers have sprung up like mushrooms after a rainstorm. One of the latest offerings comes from Gemicom, whose 6100 Series laser printers offer a wealth of features without resorting to PostScript.

An 8-page-per-minute Canon LPB-SX laser engine drives the unit, which has both a Centronics parallel port and connector, and an RS-232C serial port using a DB-25 connector. The printer supports IBM Graphics Printer, Diablo 630, Hewlett-Packard LaserJet Series II, and HP 7475A plotter emulation modes. It comes with 15 ROM-resident outline fonts supplied by URW, a German typeface foundry.

The \$4295 Model 6140 comes with 1 megabyte of RAM; the \$4995 Model 6142, which I looked at, comes with 3 megabytes. A \$699 plug-in card supplies



*An 8-page-per-minute Canon engine drives the Gemicom 6142 laser printer.*

22 additional font outlines.

The printer uses the ASCII Coded Escapement page description language working with an ACE driver on the computer. Like PostScript, ACE is device-independent, but it relies on concise operators (many are only two characters long) to describe the page. The company supplies drivers for Windows 1.04, 2.01, and 2.03; AutoCAD 2.62 releases 9 and 10; GEM 3.0; Ventura Pub-

lisher 1.0 and 1.1; and Microsoft Word 3.x and 4.0.

Using a 33-MHz PC Link 386 running Windows 286 version 2.1, I printed from many Windows applications. A three-column Aldus PageMaker 3.0 document using many fonts and a simple graphic printed in 40 seconds. A Micrografx Designer 2.0 drawing of a silhouetted image printed in a minute.

My version of AutoCAD (2.52) was incompatible with the Gemicom driver, but I configured AutoCAD to use the ADI plotter driver, set the printer to HP 7475A plotter mode, and coaxed plots out of AutoCAD. I even got plots with fill patterns out of MacDraw 1.1 on a Mac II by configuring the MacPlot plotter driver for a Hewlett-Packard plotter.

I scanned in several images on an HP ScanJet scanner using Hewlett-Packard's Scanning Gallery software at 300 and 400 dpi. I saved these images as TIFF files and imported the images into PageMaker. The quality of the printed 400-dpi images looked worlds better than the 300-dpi images. However, because 400-dpi images contain more information, I couldn't print out either a full-page scan

*continued*





# IT Hz SO GOOD!

## INTRODUCING HAUPPAUGE'S 33MHz SYSTEM BOARDS.

If your computer feels slow, we know where it hertz. For a fast cure, get our new 386 MotherBoard/33MHz. We've built in 4 Megabytes of high speed RAM, 64K of RAM cache, and both 387 Weitek math coprocessor sockets. This board makes your 386 computer the fastest PC available!

**Network Savvy.** With the 386 MotherBoard/33MHz, you can build a file server or workstation that makes Novell networks *scream*. Enjoy compatibility with Token Ring, Arcnet, Ethernet, and other network cards.

**The UNIX Engine.** Great for VARS, Systems Integrators and UNIX OEMs, the Hauppauge 386 MotherBoard/33MHz runs SCO Xenix, Interactive 386/ix and AT&T's UNIX System V. With its PC/AT compatible I/O system, our 33MHz board accommodates the latest in disk control, graphics, and network I/O cards.

**CAD Capability.** Do your AutoCAD and other CAD programs seem slow? The 386 MotherBoard/33MHz boosts your math and graphics applications, and supports the high speed 387-33 and 33MHz Weitek math coprocessors.

**Technical Features.** The 386 MotherBoard/33MHz includes:  
 ■ 4 Megabytes of high speed 32-bit memory, expandable to 64 Megabytes  
 ■ 64K of 20 nsec cache memory ■ Six 16-bit expansion slots, one 8-bit and one 8-bit/32-bit slot ■ PC/AT compatible I/O system for support of OS/2 and UNIX.

### Yes, send me your product information!

Name

Company

Address

City, State, Country

Telephone  Zip Code

#### Mail Coupon to:

Hauppauge Computer Works, Inc. 175 Commerce Drive Hauppauge, New York 11788, U.S.A. Tel: 01-516-434-1600 Fax: 01-516-434-3198	or: Hauppauge Computer Works, GmbH Hansaallee 201 4000 Dusseldorf 11, West Germany Tel: 0211-594320 Fax: 0211-593908
---	--

For more information call Hauppauge,  
(516) 434-1600. In Europe: (49) 211-594320.

**Hauppauge Computer Works**  
Your high performance 386 Supplier

*Hauppauge!*

or a complex graphic with shading unless the printer had 3 megabytes of RAM.

Since this printer costs as much as a decent PostScript printer, you must first decide if the extra resolution is worthwhile. If you're printing newsletters that have only text, the answer is no—the additional detail is hardly noticeable. But if

you're working with scanned images, it certainly will make a difference.

Budget yourself for the Model 6142 with the extra memory. As long as Genicom supplies printer drivers for popular applications (an OS/2 driver would be nice), lack of PostScript compatibility shouldn't be an issue. —Tom Thompson

**Genicom Model 6142**

Genicom Corp.  
One Genicom Dr.  
Waynesboro, VA 22980  
(800) 443-6426  
\$4995  
**Inquiry 865.**

## Windows Made Clearer

Microsoft Windows, like all graphical user interfaces, is an acquired taste. GUI or no, it forces you to contend with plenty of pull-down text windows, and you still need to know what filenames start what applications.

Now several products are attempting to take the pain out of using Windows. I looked at two of them: ClearView from Wang Laboratories and PubTech File Organizer (PFO) from Publishing Technologies. Both replace Windows' MS-DOS Executive.

At \$79, Wang's ClearView is the less expensive of the two. It marks the company's first move into mass-market software. The name "ClearView" pretty much says it all. When you start Windows, it gives you a *very* clear view of your applications. Instead of a long list of filenames, ClearView puts Macintosh-like icons on the screen—and little else.

You can, of course, add icons for your own applications, using a choice of standard icons. ClearView's Windows Organizer let me set up custom menus using both icons and (optionally) text. You can also customize the placement and sizing of the windows that appear when you start applications. Since I almost always use my editor when I first start Windows, I set up a custom start-up file that immediately opens the editor in one window while displaying additional application choices in another.

PFO outperforms ClearView, but at \$199.95, it's also considerably more expensive. PFO's opening screen looks strikingly similar to a Macintosh Desktop. It has icons for applications and disk drives, folders for files and subdirectories, and even a "garbage can."

The Macintosh analogy doesn't stop there. When you click on a text file icon, the document automatically opens in PFO's own text editor, a fuller version than Windows' limited editor. You can also click on and drag icons across the screen to copy, move, or delete individ-

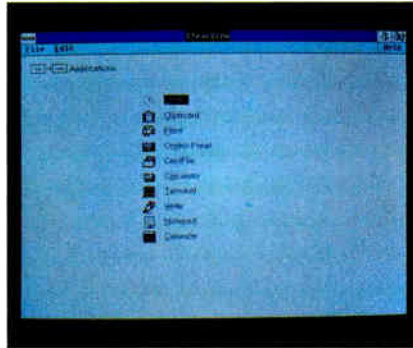

*At \$79, Wang's ClearView is an inexpensive Windows enhancement.*

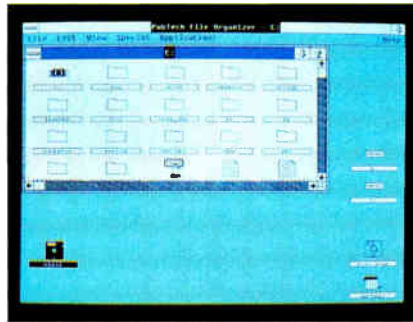

*PubTech File Organizer mimics a Macintosh Desktop.*

ual files or groups of files. If you want to print a text file, you just drag the file icon to the printer icon.

Like ClearView, PFO lets you customize window size and placement and set up multiple standard application configura-

tions. I especially liked the ability to set up my common applications so that I could call them with a hot key. There's even an automatic screen blanker that actually works with Windows (unlike most commercial blankers).

I'm not an icon fan, but I admit that these two icon-based products make Windows easier to use. Deciding which one's for you will be tough. Besides a lower price, ClearView's simplicity makes it easier to learn, especially if you work with only a couple of applications.

PFO's sophistication recommends it for those working with large hard disks chock-full of applications and data files. If you like the Macintosh look and feel, PFO's definitely the choice. Either way, these products improve on the standard Windows interface, making Microsoft's GUI truly easier to use.

—Stan Miastkowski

**ClearView**

Wang Laboratories, Inc.  
One Industrial Ave.  
Lowell, MA 01851  
(508) 459-5000  
\$79  
**Inquiry 859.**

**PubTech File Organizer**

Publishing Technologies, Inc.  
7719 Wood Hollow Dr., Suite 260  
Austin, TX 78731  
(512) 346-2835  
\$199.95  
**Inquiry 860.**

## PowerMouse Courts 1-2-3 Users

The PowerMouse 100 from ProHance combines a mouse and a programmable keypad to make editing Lotus 1-2-3 spreadsheets a snap. Just don't throw away your conventional mouse if you also run graphics programs.

This slick-looking critter plugs directly into a serial port. Its 40 labeled keys can be programmed with one or more

combinations of keystrokes and mouse movements. The mouse ships with a 9- to 25-pin adapter, a program disk, a user's manual, and instructions for 1-2-3 use.

At first, the mouse's size and array of buttons made it awkward to handle. But the more I used it, the faster my fingers found the right buttons.

*continued*



# *“Is there something we missed?”*



Is there anything missing in the ACCEL-500 24-pin dot matrix printer?

Not performance. The ACCEL-500 can zoom through drafts at 480 cps. Print charts and graphs in dazzling color. And combine letter quality with high resolution color graphics.

Not versatility. The ACCEL-500 is compatible with most popular printers. So it's equally at home on Macintosh® and IBM®-compatible PCs. There's a paper-handling option for every office application, too.

Not convenience. The ACCEL-500's innovative Select-Dial™ makes paper handling a snap. And plug-in Intelli-Cards™ add fonts and printer emulations instantly.

Not reliability. The ACCEL-500 is a 'round-

the-clock workhorse that takes even the most demanding workload in stride.

And certainly not value. The ACCEL-500 is priced below leading printer brands that offer far less capability.

In fact, it seems that the only thing missing from the ACCEL-500 is you.

## **ACCEL-500™**

**Advanced Matrix Technology**

765 Flynn Road, Camarillo, CA 93010

(800) 992-2264 (805) 388-5799

ACCEL-500, Select-Dial and Intelli-Card are trademarks of Advanced Matrix Technology, Inc. Macintosh is a trademark of Apple Computer, Inc. IBM is a registered trademark of International Business Machines Corporation. Drawing courtesy of Wingz.

*Circle 48 on Reader Service Card*

Installation is quick: You plug in the mouse and run the install program, and you're ready for a spreadsheet. The PowerMouse works beautifully in Lotus 1-2-3, allowing you to move around easily within a large spreadsheet. It takes time to learn how to enter numbers. I'd choose the keyboard over the PowerMouse when keying in lots of digits.

PowerMouse shines once the information is in the spreadsheet. Clicking one button allows you to move and copy data, insert rows or columns, and set up and move between windows. You can do @SUM(.) functions by clicking and dragging the mouse. The Fn key plus 1 through 0 emulates the F1 through F10 keyboard commands. All the preprogrammed keys are stored on a disk in files called *key definition tables*.

ProHance software allows you to edit the tables while you're in 1-2-3 or with the vendor's off-line editor. This lets you personalize existing table files or create new tables for other programs. PowerMouse worked with all the text-based non-mouse-driven software that I tried.



*PowerMouse's programmable keys play into the hands of spreadsheet users.*

Once you create a table, PowerMouse can work its magic.

However, the software drivers are the mouse's downfall. The software version that I tested worked only with non-mouse-driven software. When you move

the mouse up, down, left, or right, the software generates keyboard cursor keys. Although this works well with 1-2-3 and other nonmouse software, the product just isn't usable with graphics software. The absence of a Microsoft-compatible mouse driver is a conspicuous omission.

ProHance says that it is integrating Microsoft compatibility with programmable drivers and plans to provide free updates to registered users when the software becomes available later this year.

Overall, PowerMouse worked like a champ with 1-2-3 and my other text-based software. But \$195 is a lot to spend for a mouse that can't do graphics. Lotus users, however, will probably think the price is right. —Michael Wiggins

**PowerMouse 100**  
ProHance Technologies, Inc.  
1307 South Mary Ave., Suite 104  
Sunnyvale, CA 94087  
(408) 746-0950  
\$195  
Inquiry 861.

## QuickC Smooths QuickAssembler Programming

Now that Microsoft is bundling QuickC with The QuickAssembler, programmers can write, debug, and execute assembly language programs within the comfort of a Windows-like interface. When more speed is needed in a C language program, developers can write assembly code in a separate module called from the C program. Also, QuickC's online help system, the Quick Advisor, has been enhanced to allow the inclusion of QuickAssembler instructions, directives, operators, and MS-DOS and IBM PC ROM BIOS services. C language programmers still have access to help on the C run-time library functions.

Microsoft also boosted the environment's debugging capabilities by adding support for viewing registers and the numeric processor's status. Unfortunately, you can't mix C language source code and assembly language displays. Users needing this feature will have to rely on Microsoft CodeView. Also, the debugger supports only C language syntax for expressions. This is inconvenient because users must enter all hexadecimal values in the debugger with a leading 0x.

The QuickAssembler supports the full syntax of the latest version of Microsoft Macro Assembler, as well as a few enhancements. The QuickAssembler

.STARTUP directive, for example, now automates the process of setting up the DS, SS, and SP registers during initialization of assembly language programs.

Microsoft now includes a history-oriented debugger that creates a script of actions during program execution and a program "builder" utility. Both of these tools fit seamlessly into the environment.

A setup program typical to most Microsoft products installs the package. I ran into some snags, however. The README file in my copy claimed that the segmented-executable linker could be used with the QuickC environment. But this linker version spilled text onto the

QuickC windowed display and didn't complete the LINK process. README also claimed that the libraries installed by QuickC could safely replace the standard Microsoft C Compiler's libraries. This caused problems when I tried to use these libraries with the standard compiler to recompile a Windows application. A barrage of "unreferenced externals" messages appeared.

The environment works at speeds equivalent to those of previous releases of QuickC, which is disappointing to users who expected QuickC and QuickAssembler to rival the speed of Borland's Turbo environment. For others, the Quick Advisor more than makes up for this loss. Nevertheless, cautious buyers may want to wait for the next release or two when the compile speeds should more closely resemble Borland's. ■

—Michael Blaszczyk

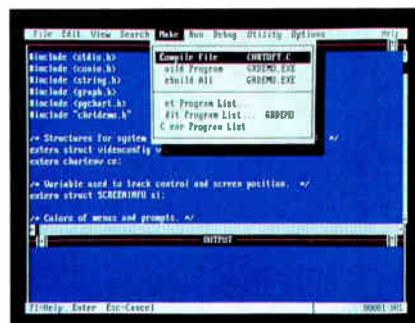

*QuickC gives programmers a Windows-like interface.*

**The QuickAssembler with QuickC**  
Microsoft Corp.  
16011 Northeast 36th Way  
P.O. Box 97017  
Redmond, WA 98073  
(206) 882-8080  
\$199  
Inquiry 862.





See us at **BOOTH 2620**  
**COMDEX/FALL '89**  
 November 13-17, 1989  
 Las Vegas Convention Center  
 Las Vegas, Nevada

# Micro Channel and AT-bus 386SX Micros --Only From Mitac

**Mitac is the first to give you a choice of architectures on the 386SX platform.**

Whether you use the "industry standard" (AT) architecture or the up-and-coming Micro Channel of IBM's new PS/2s, Mitac's 386SX-based computers assure you the power of Intel's future-compatible 80386SX microprocessor.

The power you need to affordably run today's (and tomorrow's) most advanced

32-bit applications. Of course, you don't need both the MPS2386 and the MPC2386, but whichever system you choose, you get a compact micro with 386 performance and a host of built-in features. On-board VGA-compatible graphics controller, space for both 5-1/4" and 3-1/2" diskette drives, room for four storage devices and a total of six expansion slots assure you maximum flexibility with room for growth.

And, as with all Mitac microcomputers, the MPS2386 and MPC2386 are backed by a one-year warranty and Mitac's complete service and support programs. For more information on Mitac's full range of AT- and Micro Channel-compatible computers and the name of your nearest authorized dealer, call today **800-648-2287 Extension 348.**

**mitac**  
 When reliability is a decisive factor

Mitac's microcomputers are distributed in the U.S. by Microamerica and Schweber Electronics. Canadian distribution is handled through TLS.



I don't get it!

Right, you *would* say that!

Gee, I wish I could say that.

#%@!.

Got it.

# GET IT?

On your left, our competitor...for obvious reasons has asked us to conceal his identity.

On your right, we'd like you to meet our bold new Elite/1600™ monitor, a complete ultra high resolution 20-inch monochrome display system with a 1600 x 1280 pixel resolution.

The same resolution as the Sun-4 workstation monitor. A picture so stable and flicker-free it can only be called extraordinary. For you, this means drawings that are pin-point precise and razor sharp images that are perfectly aligned.

© 1989 Elite Microsystems Inc., Bensalem, PA



Simply put... I have a picture display that is a real knockout the *finest* you'll find on any monitor... Mac or PC.

I didn't say it, Publish Magazine said it...

... and though I'm part of an *elite* class I come with a lower price including a 60 day money back guarantee, 3 year warranty, higher resolution, custom screen fonts... say are — are you OK?

Now do you get it?

**Good!**



# GOT IT! GOOD!

It offers the highest quality two-page display system available for the IBM PS/2 Series, and IBM PC and compatible.

Each display system comes complete with a high resolution monitor, video interface card, and software drivers.

The Elite/1600™ is part of our extensive family of display products for the IBM compatible and Macintosh computers.

We carry a complete line of high resolution monochrome, gray-scale, and color display systems. Any other monitor simply pales by comparison.

So call our toll free number today, for our free information package and discover for yourself how beautiful a big monitor can be.

1-800-343-5532

The monitor you've got in mind is probably in our warehouse right now!

**Got the picture?**



4201 Remo Crescent, Bensalem, PA 19020 USA  
Phone: (215) 639-1636 FAX: (215) 639-3420

# 32 Bits and Above

- 299 Are 32 Bits Enough?**  
*by Steve Krueger*
- 307 Seeking a Wide Berth**  
*by Ron Sartore*
- 323 Revenge of the CISCs**  
*by Michael Slater  
and John H. Wharton*
- 341 A Virtual Crowd:**  
**Virtual Memory:  
The Next Generation**  
*by Robert Moote*  
**Mac VM Revealed**  
*by Phil Goldman*
- 361 DOS at RISC**  
*by Colin Hunter  
and John Banning*
- 371 Clearing the Air**  
*by Bill Blagdan*
- 376 Upward Mobility**

In the last 15 years, the microcomputer industry has moved from 8-bit machines to 16-bit machines to 32-bit machines, and a lot of us are wondering: Where do we go from here? Will this binary progression continue? Are 64-bit machines next? Then 128-bit? Or have we reached some sort of reasonable limit, a plateau, beyond which the return isn't worth the investment?

These questions and others are answered in this special In Depth section on 32 bits and above. In "Are 32 Bits Enough?" Steve Krueger looks at the overall question and then divides systems down into logical, functional areas, such as buses, memories, instructions, and addresses, and discusses the pros and cons of raising the width of each.

When it comes to memory interfaces, wouldn't logic say that wider is always better? But it isn't. In "Seeking a Wide Berth," Ron Sartore tells you when and why it isn't and discusses 32-bit memory architectures in detail.

It would be hard to discuss 32-bit hardware without exploring the latest offerings from Intel and Motorola. In "Revenge of the CISCs," Michael Slater and John H. Wharton provide a definitive examination of Intel's 80486. They also look at Motorola's 68040 in as much detail as was available at press time.

One element that 32-bit systems seem to share is an increased capability for virtual memory. In a special series article, "A Virtual Crowd," BYTE explores virtual memory on DOS, OS/2, Macintosh, and Unix systems. In "Virtual Memory: The Next Generation," Robert Moote describes in detail the demand-paging virtual-memory capabilities of Intel's 80386 and 80486 processors. In associated text boxes, Julie Anderson examines "VM Under OS/2" while Ben Smith looks at "VM in Unix." And then Phil

Goldman looks at the new capability for virtual memory on the Mac in "Mac VM Revealed."

No discussion of 32-bit and above systems would be complete without mentioning the RISC arena. RISC machines have long been "off limits" to DOS users, but no more. In "DOS at RISC," Colin Hunter and John Banning describe a binary compiler that lets you run DOS software on RISC machines and take advantage of their 32-bit capabilities as well.

Finally, in "Clearing the Air," Bill Blagdan talks about the various issues to consider with 32-bit software. What does it buy you? How well does it use the capabilities of the 32-bit hardware? Should you consider DOS extenders? In other words, what do the words "32-bit software" mean to you?

The future may well look to 64 bits or beyond, but for many of us, the investment involved in a 32-bit system is as much as we can even think about. For now, getting the most out of 32 bits offers challenge enough.

—Jane Morrill Tazelaar  
Senior Technical Editor, *In Depth*



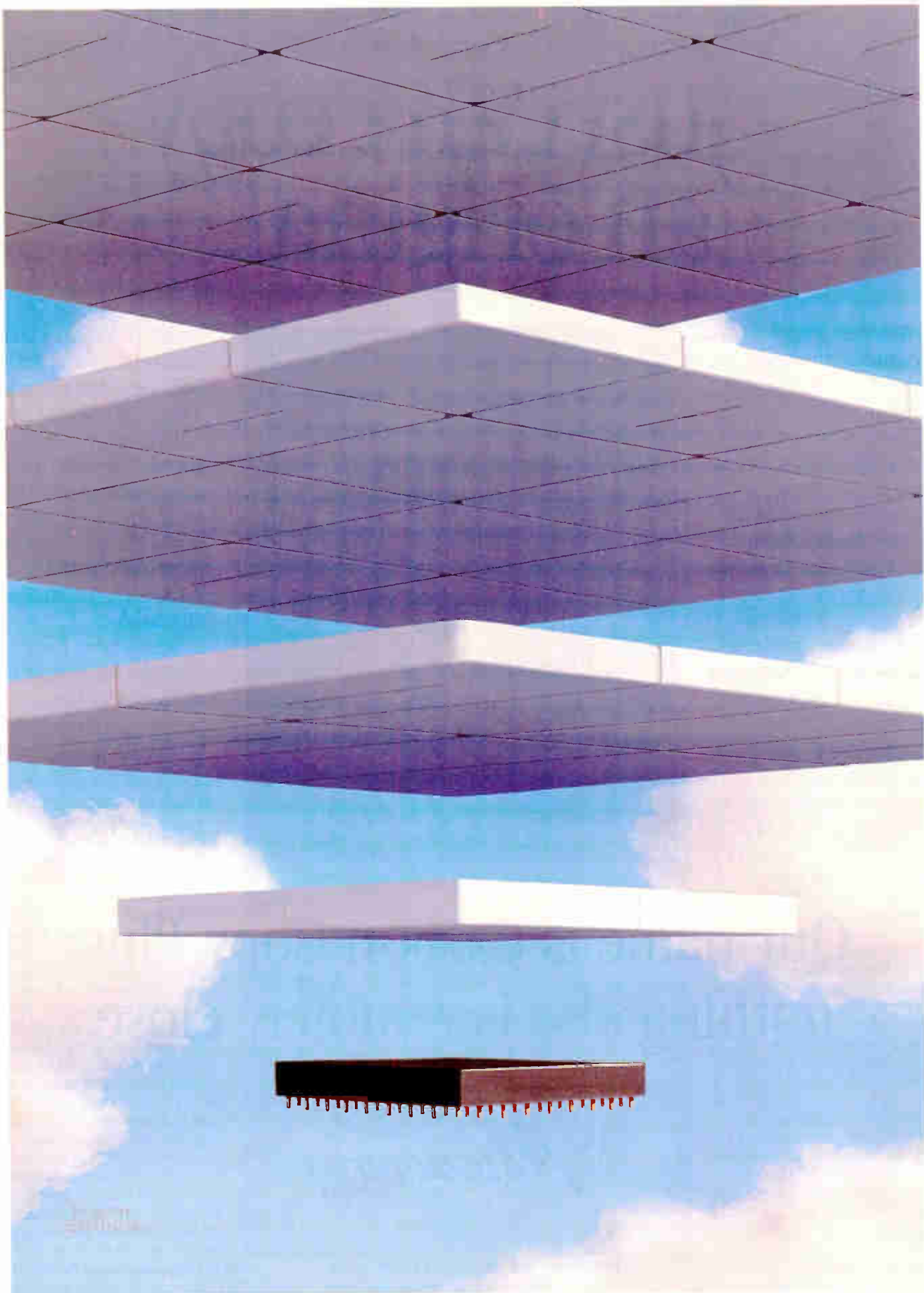

ILLUSTRATION: ROBERT TINNEY © 1989

memory speeds. Memory sizes have increased a thousandfold. Microcomputer hard disk drives are available in the capacities and performances that were to be found in the minicomputers of the 1970s.

We divide systems into different parts for ease of discussion: CPU data, instructions, and addresses, and other vital parts of the system—cache memory, main memory, buses, and I/O devices.

(see table 1). Since standards govern the character and floating-point types, they aren't subject to variations (although character representations for some other  
*continued*

ILLUSTRATION: ROBERT TINNEY © 1989

# Sometimes, you just can't copy

## ALL YOU NEED TO COMMUNICATE IN SPANISH IS ONE WORD OF ENGLISH. TRANSLATE.

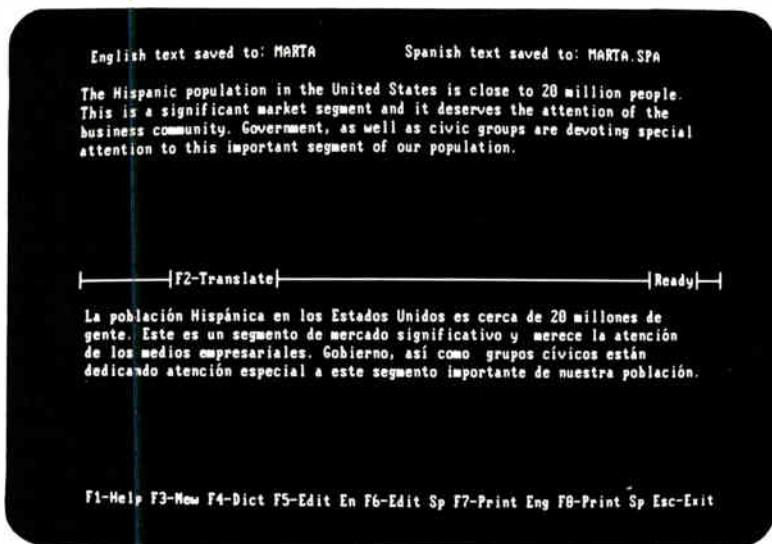

With Translate, Spanish is no longer a foreign tongue.

All your thoughts, all your documents, all your messages are quickly converted into language America's 20 million Hispanics can understand.

With this revolutionary software program, all you do is input an ASCII text file written in English. Virtually instantaneously, you'll have the Spanish equivalent. With a straightforward English text, no editing is necessary. In more complex sentence structures, Translate can be used to edit the final version.

Translate utilizes an 85,000 term English-to-Spanish dictionary. You can make your dictionary even more functional, too, by adding as many words or phrases as you like. Corporate jargon and specific terminology may all be incorporated into the system via its dictionary update and maintenance editor.

Translate isn't the only program of its kind available on the market. But the others cost thousands of dollars; our special introductory price is only \$399.00 (regular price, \$495.00). That's a terrific value in any language.

**Take advantage of the \$399 price by ordering now. Call toll free at 1-800-232-8228.** In Florida (305) 477-2703, 9-5 EST. Visa and MC accepted 30-day money-back guarantee on direct orders. Add \$5.00 shipping and handling. Florida residents add 6% Sales Tax. Free technical support. Dealer inquiries welcomed. Finalsoft Corporation, 3900 N.W. 79 th Avenue, Suite 215, Miami, FL 33166.

**Translate**  
Breaking the language barrier  
A product of **FINALSOFT**

System requirements: IBM<sup>®</sup> XT<sup>®</sup> /AT<sup>®</sup>, PS/2<sup>®</sup> or compatible (8 Mhz. or higher recommended), DOS 3.0 or higher, hard disk, and 512K RAM. © Copyright 1989 Finalsoft Corporation. All rights reserved. Finalsoft is a registered trademark of Finalsoft Corporation. IBM, XT and PS/2 are registered trademarks of International Business Machine Corporation.

IN DEPTH  
ARE 32 BITS ENOUGH?

Table 1: Standards determine the size of some of C's data types.

### SIZES OF C DATA TYPES

Type	Number of bits	Standard
char	8	ASCII
short	16	
int	16-32	
long	32	
float	32	IEEE
double	64	IEEE
pointer	16-32	

languages, such as Japanese, use more bits). Binary integers are represented in 16 to 32 bits. A few implementations of C provide a *long long* type of 64 bits.

Since this structure of data typing is the most common, most CPU architectures will stick with a primary data size of 32 bits, but they will also support 8-bit data, at least for characters, and 64-bit data for double-precision floating-point numbers and, possibly, double-precision integers (long long).

### CPU Instructions

CPU instruction-set architectures have split into a CISC camp that offers variable-length instructions with a short average length and a RISC camp that features fixed-length instructions that are easy to fetch and decode. The RISC instructions have only moderate pressure to expand beyond the nearly universal 32 bits, while CISC instructions already vary in size from 8 to 96 or more bits in increments of 8 or 16 bits (which can be thought of as the basic instruction size). The CISC scheme is under no pressure to change, either.

Only the very-long-instruction-word (VLIW) computers are currently pushing beyond 32-bit instructions (see "VLIW: Heir to RISC?" in the August BYTE). The Multiflow Trace computers (an example of VLIW) use instructions as large as 1 kilobit. However, it will be more than five years before this technology has an impact on the CPU market.

What will happen soon in microprocessors is *superscalar* execution. In superscalar execution, the microprocessor attempts to start two or more conventional instructions on each cycle. The decode logic must test for resource conflicts and data dependencies to schedule the few

*continued*



Now Available  
**Activator/M™**  
 with  
**Programmable  
 Memory**



*Natural selection provides unique passive protection for the porcupine.*

# The Activator - Natural Selection For Software Protection



*Inventor and entrepreneur Dick Erett explains how "The Activator" provides sane protection for your intellectual property.*

**"I**n any industry, just as in nature, the process of natural selection raises one solution above another. Natural selection is the most elegant of engineers.

In the area of software protection The Block has been selected by the marketplace as the solution that works. Over 500,000 packages are protected by our device.

For the past 4 years our philosophy has been; *'You have the right and obligation to protect your intellectual property.'*

## A New Ethic For Software Protection

In allowing end-users unlimited copies of a software package and uninhibited hard disk and LAN operation, The Block has created a new ethic for software protection.



By removing protection from the magnetic media we remove the constraints that have plagued legitimate users.

They simply attach our key to the parallel port and forget it. It is totally transparent, but the software will not run without it.

## A New Technology For Software Protection

Our newest model, The Activator, builds on our current patented design, and establishes an unprecedented class of software protection.

We have migrated and enhanced the circuitry of The Block to an ASIC (Application-Specific Integrated Circuit) imbedded in The Activator.

This greatly improves speed and performance, while reducing overall size. Data protection can also be provided.

## Programmable Option

The Activator allows the software developer the option to program serial numbers, versions, or other pertinent data known only to the developer, into the circuit, and access it from the program.

Once you program your part of the chip, even we have no way to access your information.

The ASIC makes emulation of the device  
 Circle 330 on Reader Service Card

virtually impossible. It also presents an astronomical number of access combinations.

## Full 100% Disclosure

Since The Activator is protected by our patent we fully disclose how it works. Once you understand it, endless methods of protection become evident.

Just as no two snowflakes are the same, no two implementations of The Activator are identical. And like the snowflake the simplicity of The Activator is its greatest beauty.



We never cramp your programming style or ingenuity. Make it as simple or complicated as you desire.

Let us help safeguard what's rightfully yours. Please call today for additional information or a demo unit. *It's only natural to protect your software."*

**1-800-333-0407 ext.105**  
 In Connecticut 203-329-8870  
 Fax 203-329-7428

**Software  
 security inc.**

870 High Ridge Road  
 Stamford, CT 06905

**Unlimited Copies • Programmable • No Batteries • Small Size • Fast • Patented • Data Protection**

instructions currently available without changing the result of the program. A superscalar processor will become starved for instructions unless several instructions are fetched in each cycle.

Basically, I see no pressure to increase instruction word size in microprocessors in the foreseeable future.

### CPU Addresses

Address architecture is one area where there is real pressure to grow beyond 32 bits. Already, the operating system can set up most microprocessor memory management units to have a separate 32-bit address space for each process. The combined memory addressed by all the

processes can be considerably larger than 32 bits. In fact, the physical memory addresses that most MMUs generate are larger than 32 bits.

But even the 32-bit address space of a single process is under some pressure to grow. This pressure comes from applications with large data spaces where it's important to keep all the data within the virtual address space rather than split between virtual memory and files.

CAD/CAE is one such application area. With the growth of design complexity and of tool complexity and function, address-space crunches will be inevitable. Within five years, ICs that have more than 10 million transistors will be

under development. If each transistor and wire is represented by just 20 bytes in virtual memory, such a design will take about a gigabyte of virtual memory. The sophisticated applications that make a design of this scale possible will themselves be tens of megabytes large; the temporary storage used in operating on the design as a whole will require hundreds of megabytes. So, by 1995 some large CAD applications will need 2 gigabytes of process address space, and 2 gigabytes is close enough to the 4 gigabytes per process limit of most 32-bit machines that some address-extension techniques will be needed.

However, for the majority of applications, 4 gigabytes of address space per process is more than enough. With that much space, a text editor could edit a 1-million-page document, and spreadsheets could be thousands of times larger than on a 640K-byte IBM PC. Thus, I don't think address extension within a process will be a crucial issue in the early 1990s.

When longer addresses become an issue, engineers won't choose to lengthen the machine word. Instead, they will use a variety of tricks to give larger addresses to those few processes that need them without increasing the size, complexity, or run time of the more common small processes. This is a continuation of the "small model" and "large model" used in compilers for Intel 80x86 architectures for the same reasons: size, complexity, and speed.

One of the tricks would be to provide long\_ptr forms of memory-reference instructions that use a register pair to contain a 40-, 48-, or 64-bit address (see figure 1a). These could be loaded and

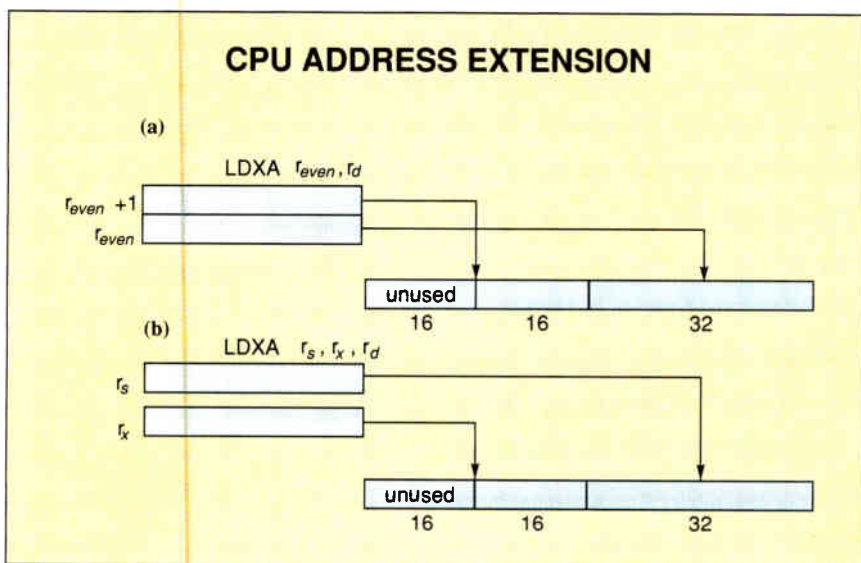

**Figure 1:** Two registers are combined to produce a 48-bit address: (a) 48-bit extended address in a register pair; (b) 48-bit extended address in two registers.

**Table 2:** You can calculate the processor's memory bandwidth requirement with the equation  $MIPS \times (SZI + (FRW \times SZD)) = PMB$ . You can also determine the main memory bandwidth requirement with the equation  $PMB \times CMR = MMB$ .

### SYSTEM BANDWIDTHS

Native processor MIPS	SZI <sup>1</sup>	FRW <sup>2</sup>	SZD <sup>3</sup>	PMB <sup>4</sup>	CMR <sup>5</sup>	MMB <sup>6</sup>
3.8	2.2	0.5	4.5	16.9	1.2-8.0%	0.20-1.35
5.1	2.0	0.5	4.2	20.9	1.2-8.0%	0.25-1.67
10	4.0	0.3	3.8	51.4	1.2-8.0%	0.62-4.11
22	4.0	0.3	3.8	113.1	1.2-8.0%	1.36-9.05
45	4.0	0.3	3.9	232.6	1.2-8.0%	2.79-18.61

<sup>1</sup> SZI = The average instruction size in bytes.

<sup>2</sup> FRW = The fraction of instructions that read or write memory data.

<sup>3</sup> SZD = The average size of data access in bytes.

<sup>4</sup> PMB = The megabytes per second of instructions and data at the processor.

<sup>5</sup> CMR = The cache-miss rate.

<sup>6</sup> MMB = The megabytes per second of memory traffic.



stored with `long_ptr` data if a 64-bit integer type is supported.

Another trick (especially appropriate for load/store architectures like RISC machines) uses an extra source register for the most significant part of the address (see figure 1b). This allows those applications that can statically allocate regions of the extended address space to certain classes of data (e.g., like types, or groups of data referenced together) to treat extended address space as segments, possibly saving many loads and stores of the high-order address word.

The compiler would generate ordinary memory references for small model programs and the majority of the references in gargantuan model programs. These would reference the first 4 gigabytes of the process's address space, the same part referenced if the high-order part of the address is zero.

### System Bandwidth

The system bandwidth requirements govern the widths of the various data paths outside the processor. Table 2 shows the bandwidth requirements from the processor to cache memory and from cache memory to main memory points within the system.

The PMB column of table 2 shows the memory-access bandwidth created by several realistically hypothetical processors. The first two are similar to currently common CISC processors. The rest are similar to RISC processors, current and future. Notice that the volume of data that must be supported grows from about 17 megabytes per second with a processor similar to current ones to over 230 megabytes per second with a high-speed RISC processor such as may be expected in the future. Main memory will be able to supply only about 40 megabytes per second if you assume a 32-bit-wide main memory and a 100-nanosecond access time. Cache memories can fill the gap.

Cache memory is a fast memory that stores recently referenced data. If a subsequent reference needs the same data, the cache can supply it much more quickly than main memory. Today, cache memories for microprocessors range from 256 bytes to 64K bytes. With this range of sizes and when processing an average program, the cache can supply the needed data on over 90 percent of the memory references.

The percentage of references that the cache memory can satisfy is called the *hit rate*. For the most common sizes (4K bytes to 64K bytes), you can expect the hit rate to be in the range of 92 to 98.8

percent. Conversely, the *miss rate* is the percentage of references where the cache memory cannot supply the needed data. The hit rate and miss rate always total 100 percent, so a hit rate of 92 percent corresponds to a miss rate of 8 percent.

If a high-speed cache memory can satisfy 92 percent of the references, then main memory need only satisfy about 8 percent. Thus, from the 232.6 megabytes per second of traffic generated by the fastest processor in table 2, the main memory needs to supply only about 18.6 megabytes per second (see figure 2). Often, however, several requests that the cache memory can't satisfy arrive in quick succession, placing a much higher peak demand on memory performance. As a rule of thumb, the main memory

should be able to supply two to three times the average bandwidth required.

### Cache Memory

Three design trends are apparent in cache memories. First, almost every system will have caches. Second, the caches will be integrated onto the chip with the CPU. And third, in many of the highest-performance systems, the on-chip caches will be too small for the system performance desired, so a second level of cache will be connected directly to the CPU's pins.

The data width of on-chip instruction and data caches will be at least as wide as the CPU needs and may be wider to support the bandwidth required. If the CPU supports only 8-, 16-, and 32-bit data,

*continued*

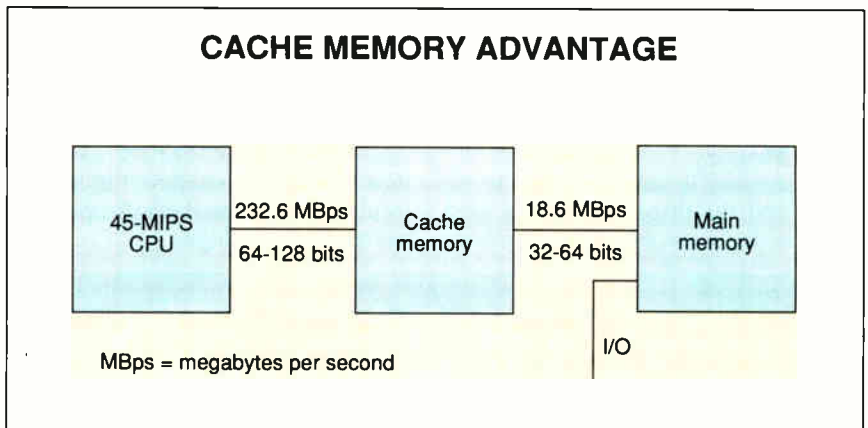

**Figure 2:** Cache memory cuts main memory bandwidth by satisfying most memory requests.

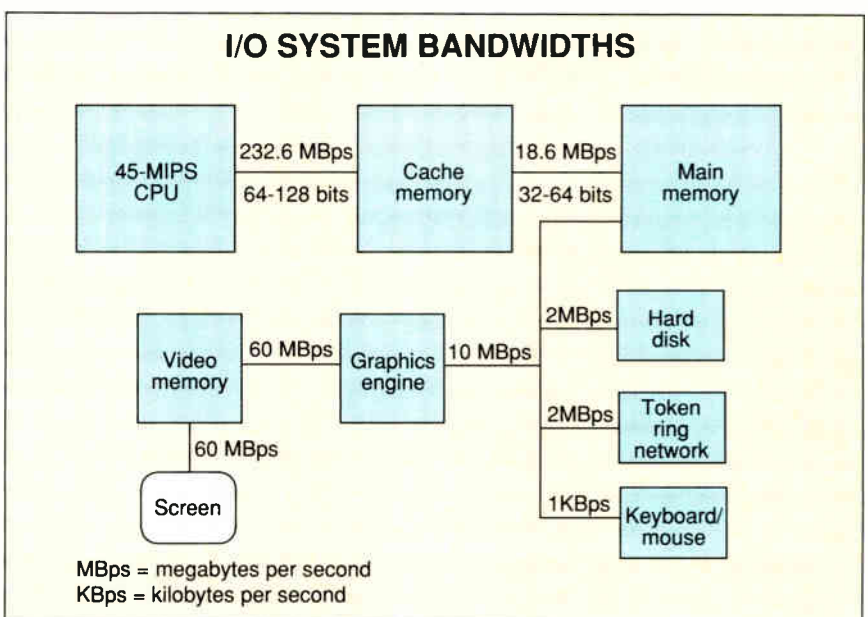

**Figure 3:** Different I/O devices have different bandwidth needs.

the data-cache width will be 32 bits. If the CPU also supports 64-bit data, the data-cache width will need to be 64 bits.

The data width of the cache memories may be wider to accommodate the higher bandwidth requirements of superscalar, vector, or other high-performance architectures. Extra data width costs little in on-chip cache memories where connections between the CPU and the cache are easily provided. Extra data width is more expensive in external caches, which are constrained by the cost of providing additional data pins on the CPU chip.

And yet, a large difference in speed exists between internal and external signals so that an external cache is slow compared to an on-chip cache. To reclaim the bandwidth lost over slow pins, engineers are likely to widen the path from the CPU to external first- or second-level cache memories to 64 bits and eventually to 128 bits, in spite of the higher cost of the resulting high-pin-count chips.

#### Main Memory

Main memory is slow compared to the CPU, and the disparity will get even worse in the future, even though memory

itself will continue to get faster. Main memory will have difficulty supplying the bandwidth that high-speed processors need, even after the caches have reduced it. A 32-bit-wide memory system constructed out of 80-ns DRAM chips will have an access time of about 150 ns for a bandwidth of about 27 megabytes per second, just enough for the 22-million-instruction-per-second RISC processor in table 2. In practice, the system bus will add at least 100 ns to the access time and reduce the bandwidth to 16 megabytes per second, enough for the 10-MIPS processor but not enough for the higher-performance processors.

For systems with processors faster than 20 MIPS, memory will be 64 bits wide, doubling the bandwidth available from memory. Memory-systems designers will further increase memory bandwidth by providing fast block transfer of 4 to 16 words between main memory and cache memory. The combination of these will supply enough bandwidth for processors up to about 75 MIPS, where further increases, possibly 128-bit-wide memory, will be needed to keep the system performance high.

#### System Buses

System buses are another place where you can lose bandwidth. The amount of time that the system bus adds to a memory access will decrease the memory bandwidth available. The system bus adds time for arbitration, address propagation, and data propagation. The physical size and electrical properties of the bus limit the minimum propagation times, which won't get below 50 ns on expansion buses with several slots.

Engineers designing system buses can lessen the effect of propagation time by using wider buses and by including block transfers. Wider buses transfer more data on each bus cycle, effectively doubling the bandwidth available. Expansion buses have grown from 8 bits to 32 bits as memory and I/O performance needs have dictated. Block transfers send several words of data in a single bus transaction, saving the arbitration and address propagation delays after the first word. If the memory system can supply data that quickly, the average time per word decreases and the bandwidth increases.

The last design trend is already firmly entrenched in the industry and will cer-

# Word Publishing...Word Processing &

DeScribe™-Word Publisher bridges the gulf between word processing and desktop publishing—the next generation word processor. DeScribe is the first WYSIWYG word processor for IBM's powerful OS/2 Presentation Manager. What's on the screen is what prints on the paper. And you control it all with a friendly point and click

**DeScribe, Inc.**

IBM® is a registered trademark and Operating System/2™, OS/2™, and Presentation Manager™ are trademarks of the International Business Machines Corporation. DeScribe™ is a trademark of DeScribe, Inc.

Circle 110 on Reader Service Card

World Radio History



tainly continue: separating the memory bus from the I/O or expansion bus. Because memory bandwidth is so crucial to high-performance computers, engineers will pay close attention to high-performance memory buses within the cost constraints of the final system. 64-bit memory buses will be common. On the other hand, I/O buses will be limited to 16 or 32 bits to control costs and match the width of I/O devices. In servers and other systems where I/O bandwidth is crucial to performance, multiple I/O buses, not wider data paths or higher speed, will supply the needed bandwidth.

#### I/O Devices

I/O devices don't need wide buses (see figure 3). Even a SCSI-2 disk peripheral transfers at a maximum of only 2 megabytes per second, which is also the peak transfer rate for a 16-megabyte-per-second token ring. An FDDI (fiber distributed data interface) network, at 12 megabytes per second, will tax today's slower I/O buses but is easily supported on the Micro Channel, the NuBus, or EISA.

Probably the only I/O device that taxes a high-performance I/O bus is a graphics

frame buffer. Fast redraw of the video screen is important to the perception of high performance. One simple benchmark is to copy a full-screen image from memory to the screen buffer. For a system with adequate performance (and reasonable crispness), the copy should take less than  $\frac{1}{10}$  second; for a high-performance system, less than  $\frac{1}{60}$  second.

For a megapixel display with 8-bit pixels, this image consumes a megabyte. So for a  $\frac{1}{10}$ -second copy time, the CPU must access the frame buffer with at least 10 megabytes per second of bandwidth. For a  $\frac{1}{60}$ -second copy time, the CPU needs at least 60 megabytes per second of bandwidth to the frame buffer, far beyond the attainable bandwidth on the Micro Channel, the NuBus, or EISA.

An even tougher benchmark is a full-screen move from the frame buffer to itself, as when you move a window on the screen. With the same megapixel display, this would require over 20 megabytes per second of bandwidth to the frame buffer for the lowest acceptable performance. This is barely attainable with the Micro Channel, the NuBus, or EISA. As a result, engineers will have to

choose either to attach frame buffers to the systems-memory bus, or to use a graphics processor directly attached to the frame buffer and communicate with the main processor over the I/O bus.

#### Strike Up the Bandwidth

Systems will grow in bit width in a number of places, but there is little reason for CPU designers to make major changes in CPU architecture in the next few years and probably the next decade. By 1995, however, almost every CPU will have some minor changes to support extended addressing beyond 32 bits per process.

Many CPUs will support double-precision floating-point processing with 64-bit data paths and arithmetic. Memory and memory buses will expand to accommodate the higher bandwidth demands of high-performance CPUs. Bandwidth issues will dominate systems design. ■

*Steve Krueger is a senior member of the technical staff at Texas Instruments (Houston, TX). He has a B.S.E.E. and an M.S. in computer science, both from MIT. He can be reached on BIX c/o "editors."*

# Desktop Publishing Together At Last.

mouse and menu interface in multiple windows. Use DeScribe to create professional quality documents—anything from a quick memo to a textbook. Price: \$595. Thirty-day money back guarantee. DeScribe, Inc.; 4047 North Freeway Blvd. Sacramento, CA 95834. Tel: (916) 646-1111 Fax: 923-3447

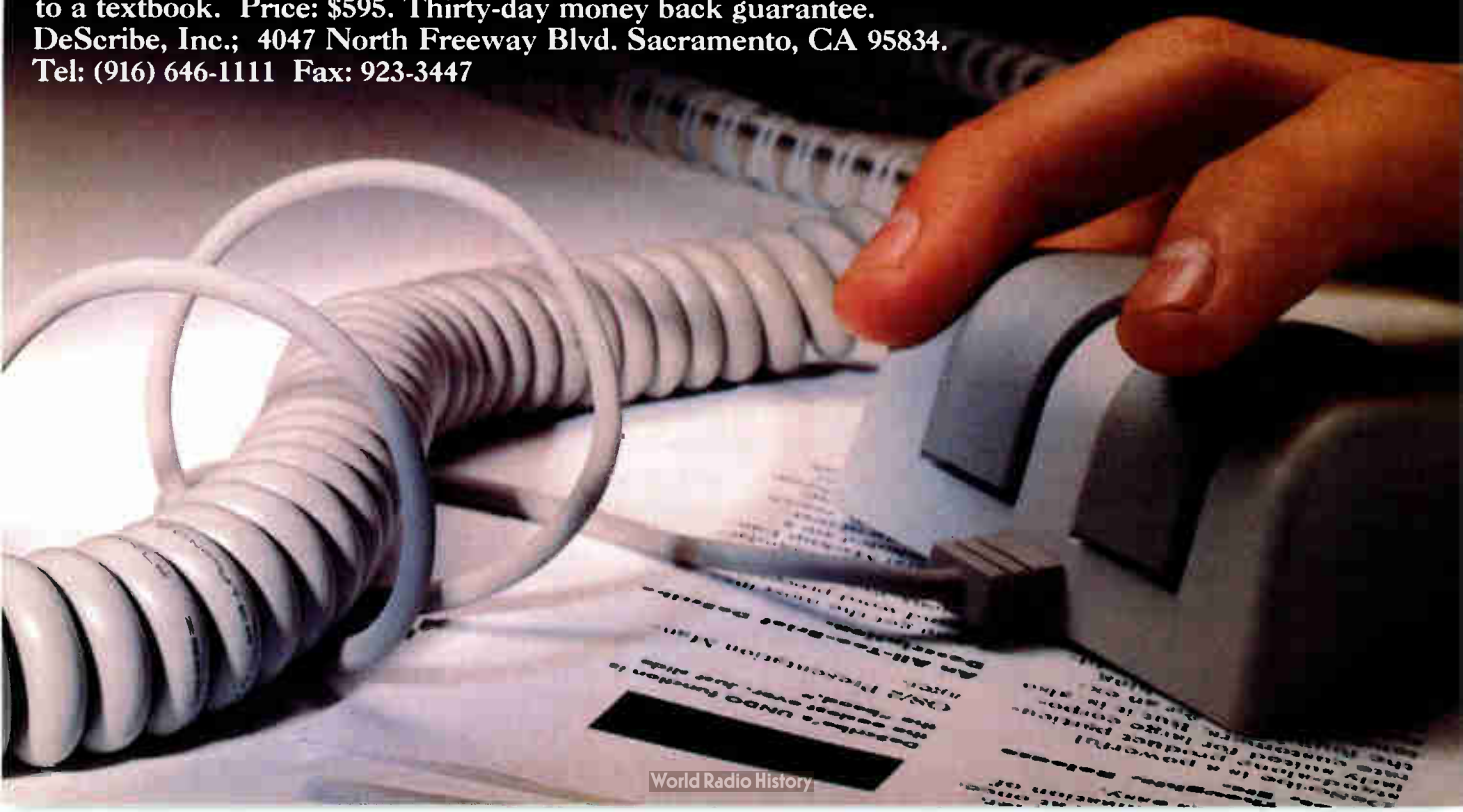

# Discover Parallel Processing!



## Monoputer/2™

The World's Most Popular  
Transputer Development System

Since 1986, the MicroWay **Monoputer** has become the favorite transputer development system, with thousands in use worldwide. Monoputer/2 extends the original design from 2 to 16 megabytes and adds an enhanced DMA powered interface. The board can be used to develop code for transputer networks or can be linked with other Monoputers or Quadputers to build a transputer network. It can be powered by a 20 or 25 MHz T800 and is priced from \$1295.

## Parallel Languages

Fortran and C Make Porting a Snap!

MicroWay stocks parallel languages from 3L, Logical Systems and Inmos. These include one Fortran, two Cs, Occam, Pascal, and Ada. We also stock NAG libraries for the T800 and ParaSoft's debugger, profiler, and Express Operating Environment. A single T800 node costs \$2,000, yet has the power of a \$10,000 386/1167 system. Isn't it time you considered porting your Fortran or C application to the transputer? It's easier than you think!

For further information, please call MicroWay's Technical Support staff at (508) 746-7341.

## Quadputer™

Mainframe Power For Your PC

MicroWay's **Quadputer** is the most versatile multiple transputer board on the market today. Each processor can have 1, 4 or 8 megabytes of local memory. In addition, two or more Quadputers can be linked to build large systems. One MicroWay customer reduced an 8 hour mainframe analysis to 15 minutes with five Quadputers, giving him realtime control of his business. Quadputer is priced from \$1995.

## COSMOS™/M

Finite Element Analysis Running on the Quadputer

One of the most fruitful areas for parallel processing is finite element analysis. Problems which can be broken into small pieces run naturally on systems built up of many processors. **COSMOS/M** running on a Quadputer took just 300 seconds to solve a problem which ran in 12,000 seconds on an AT. Even very large mainframe problems run fast on the Quadputer; a system with 12,000 degrees of freedom took just 806 seconds while another that had 23,000 DOF ran in just 40 minutes. Contact MicroWay for information on COSMOS/M.

# Micro Way

Circle 239 on Reader Service Card

## World Leader in PC Numerics

Corporate Headquarters: P.O. Box 79, Kingston, MA 02364 USA (508) 746-7341  
32 High St., Kingston-Upon-Thames, U.K., 01-541-5466  
USA FAX 508-746-4678 Italy 02-74.90.749 Holland 40 836455 Germany 069-75-2023

World Radio History



# Seeking a Wide Berth

*Wider memory isn't necessarily faster; application demands, memory design, and control logic all affect performance*

*Ron Sartore*

**A**lthough 32 bits has now become synonymous with power and performance in today's microcomputers, the truth about wide memory is subtler and more complex than many people realize. It's true that when moving blocks of wide data from one part of the system to another, 32-bit memory architectures easily outrun 8- and 16-bit designs. But transporting data is only a part of what computers do. Many operations and data types don't require 32 bits: ASCII characters, for example, are only 8 bits wide, and some operands are only 1 or 2 bytes wide. In these cases, the extra memory width is wasted and can even introduce inefficiency into the system.

Designing wide memory is not conceptually difficult: Think of it as stacking the bytes side-by-side instead of one on top of the other. In principle, wider memories provide more data faster and more easily. Yet doubling or quadrupling memory width is riddled with trade-offs: When you're operating on small pieces of data, it can seem like doing surgery with a bulldozer. Applications that don't mate well with the memory architecture may find their perfor-

mance crippled, even when running on the fastest processors. How can this be? Can the memory interface actually be *too* wide?

The answer requires an analysis of what you do with memory. Wider memory is good when the proper memory control is in place. The most fundamental issue is that no matter how wide the memory is, high performance for byte



operations must still be maintained. Thus, the trick in memory-system design is to provide both quick byte manipulation and fast wide-data movement. It is counterproductive to focus on one and ignore the other.

## Sizing Things Up

Memory-controller design is not greatly influenced by the total size of memory or the data-path width. In fact, the most important design factors are how many controllers are used and what section of memory they watch.

Controller sophistication can vary from a simple step-and-fetch-it approach to complex schemes involving more control logic than memory components. Different memory-control algorithms for the same memory board can affect the result of a benchmark program by more than 10 percent.

For example, it's possible to keep a DRAM chip accessed (i.e., keep the row address strobe [RAS] active on completion of an access) on the hunch that the next access will be within the same row. (To enable this scheme, the controller must contain address comparators.) If the hunch is right, you will have a zero-

*continued*

## Explaining DRAM

**Access time** After the initiation of row address strobe (RAS), this is the minimum time required for the DRAM to return data that is guaranteed to be valid.

**CAS (column address strobe)** This control signal performs several functions. First, it indicates that the address pins to the device contain a desired column address. Whether the address is latched or passes through directly determines clocked page mode and static column mode, respectively. Second, CAS is used to enable the data output driver for read cycles. To access a column, a row access (RAS is active) must be performed first and persist throughout one or more column accesses.

**Cycle time** The access time plus the RAS precharge equals the total cycle time for the DRAM. This means that a 100-nanosecond chip, for example, will take 100 ns to return valid data, but it can be accessed only once every 150 to 180 ns.

**RAS (row address strobe)** This control signal is the major activator to a DRAM component, initiating a complex series of events within the chip. On initiation, it latches the state of the ad-

dress pins to be used for the row access. Once initiated, it must then be followed through, because an aborted cycle will corrupt the contents of an entire DRAM row.

**RAS precharge** After a completed access, RAS needs to take a "breathing spell" to ramp up for the next access. The duration of this delay is typically half the access time; thus, an 80-ns DRAM might require 40 to 60 ns for precharge.

**Refresh** The charge of each bit within a DRAM is held by a very small capacitor (on the order of 50 femtofarads). When the bit isn't accessed, the charge slowly decays and will be lost if not refreshed. A refresh cycle is a type of read cycle that reenergizes a whole row of bits. About one in 100 cycles must be devoted to this task.

**Row, column addresses** Internal to the DRAM, the memory cells are organized as a two-dimensional array, rows and columns. Externally, to reduce the component package size, these address inputs share the same physical pins. Control signals RAS and CAS determine which address is selected at any time.

chips permitted you to access two (or four) rows simultaneously, you could then treat DRAM as both main storage and cache and eliminate wait states when changing from one memory area to another.

### DRAM vs. SRAM

Since much of the discussion on large memories involves DRAM, it's necessary to understand the terms and concepts of the device itself (see the text box "Explaining DRAM" at left). What makes DRAM chips attractive is their high ratio of storage density to price: Because DRAM uses one transistor per bit, whereas static RAM uses four to six transistors per bit, DRAM will provide four times the storage of SRAM for an equivalent price, at any given technology level. DRAM chips also offer better board-packing density because they double up address pins (row and column), while SRAM chips receive all addresses at once, which requires more physical pins but is faster.

In fact, the major disadvantage of DRAM is speed, especially compared to SRAM. The access time for DRAM is two to three times longer than it is for SRAM of the same technology, and DRAM performance is further hampered by the time consumed for RAS precharge and refresh cycles.

Many memory-system architectures revolve around optimizing DRAM usage through techniques such as interleaving and burst transfers. Interleaving hides the RAS precharge delay by alternating memory addresses in different DRAM devices, so that one DRAM device is accessed while the other is precharging. The result of interleaving is that the system-memory cycle time equals the DRAM access time, just as it would for

*continued*

wait-state transfer; but if it's wrong, there will be a penalty of at least two wait states while a new row is accessed. In short, this approach will improve some benchmarks while hurting others.

One reason this scheme doesn't produce more benefits is that the memory

used by the code most likely lies in a different region, or DRAM page, than the program data. This means that your hunch is only correct when accessing memory cells within the same DRAM row, and it's always wrong if the cells are in a different row or region. If DRAM

## WIRELESS DATA COMMUNICATIONS

Local and Wide Area Networking At 9600 BPS

### PC-9600 RADIO MODEM

Available Now

- PC/XT/AT compatible
- 406 - 470MHz Band
- Encryption capable
- Up to 15-mile range; hundreds of miles with repeaters/amplifiers
- User software included
- Voice option
- FCC CERTIFIED 450-470MHz

## MEGADATA

35 Orville Drive, Bohemia, NY 11716-2598 • TEL 516-589-6800 • FAX 516-589-6858





Networks are wonderful—but they can also be a lot of work. An increasingly popular and economical alternative is a multiuser system, where a number of people share one 386 computer.

VM/386 MultiUser makes it simple. Add a multiport or graphics card to your 386, and up to 32 users can continue to work with their familiar DOS graphics and text programs. Each user has their own copy of

DOS and 640K of RAM. Best of all, every user is *totally independent* of all the others.

VM/386 MultiUser is based on VM/386 Multitasker™, the bulletproof multitasking program which has won both the Technical Excellence award and the Editor's Choice award from PC Magazine.

Get the benefits of a network—without the work! Call toll-free, 800-458-9108, or 408-986-8373.

Yes! Send me information on VM/386 MultiUser!

Name \_\_\_\_\_

Title \_\_\_\_\_

Company \_\_\_\_\_

Address \_\_\_\_\_

City, St, Zip \_\_\_\_\_

Telephone \_\_\_\_\_

IGC, 4800 Great America Parkway,  
Santa Clara, CA 95054-1221.

# The No Work Network

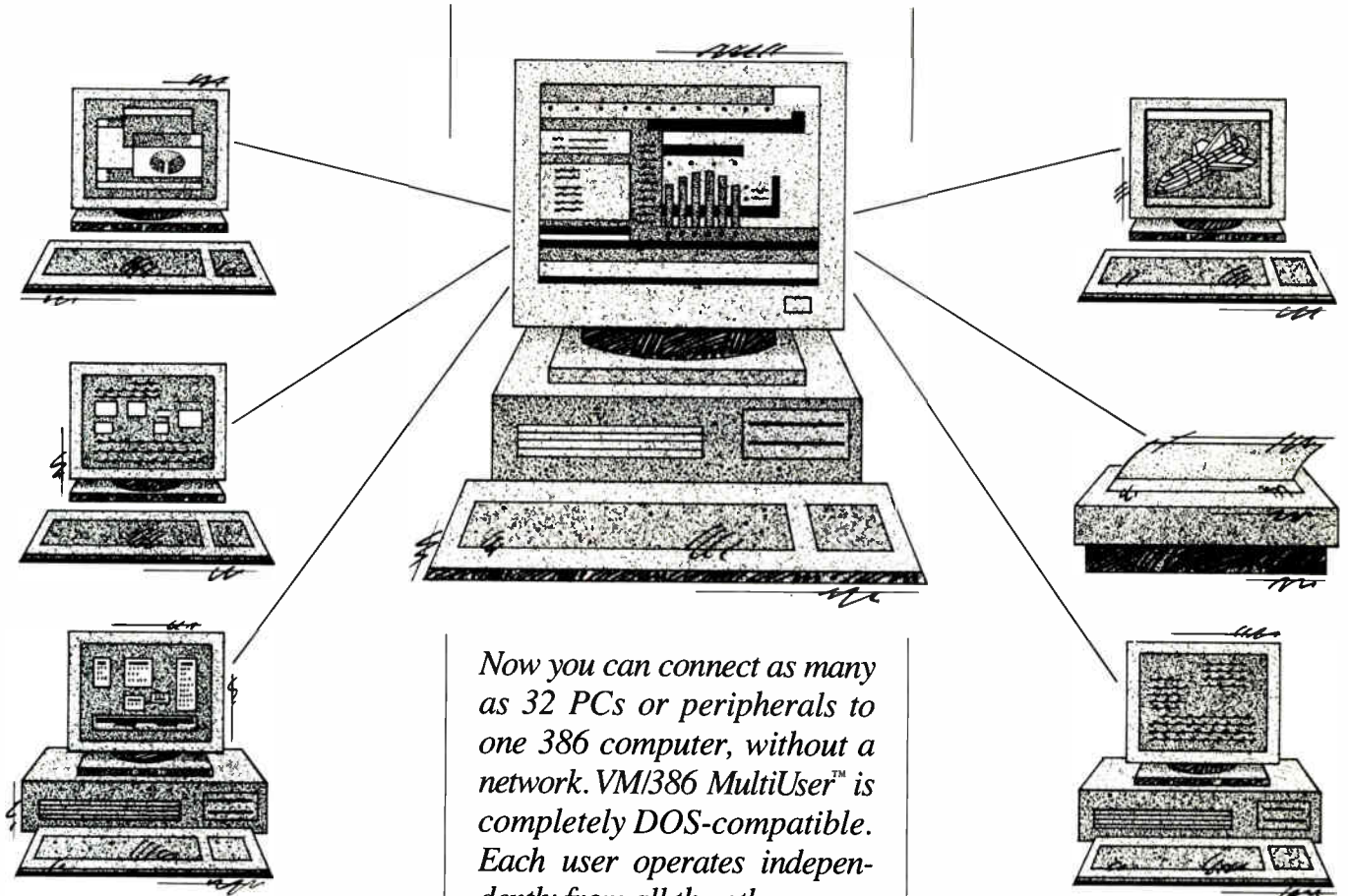

*Now you can connect as many as 32 PCs or peripherals to one 386 computer, without a network. VM/386 MultiUser™ is completely DOS-compatible. Each user operates independently from all the others.*

**IGC**  
Incredibly Great Computing™

BY 1189

Circle 171 on Reader Service Card  
(DEALERS: 172)

See us at COMDEX/Fall '89  
West Hall Booth #856

© 1989 IGC.  
VM/386 MultiUser and VM/386 Multitasker are trademarks of IGC.  
386 is a trademark of Intel Corp.

## EIGHT MODEL MEMORY ARCHITECTURES

Case 1: Byte interface, simple control

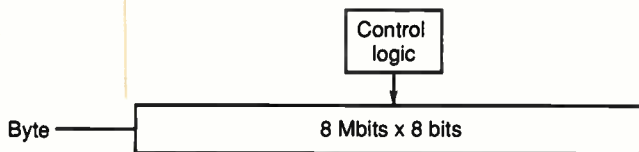

Case 2: Byte interface, byte interleave control

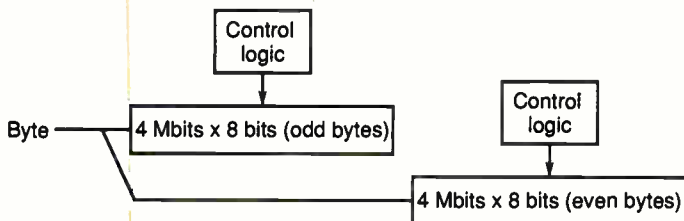

Case 3: Word interface, simple control

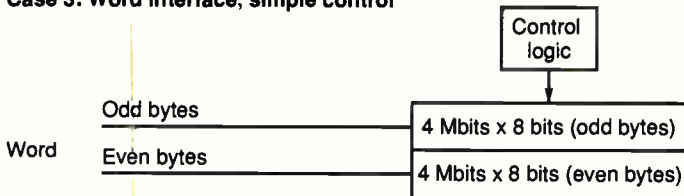

Case 4: Word interface, word interleave control

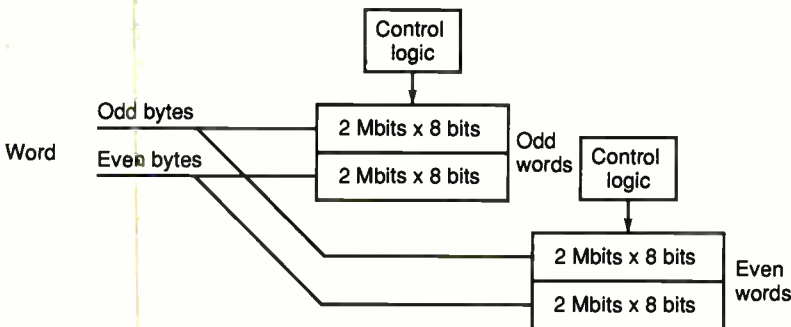

Case 5: Doubleword interface, simple control

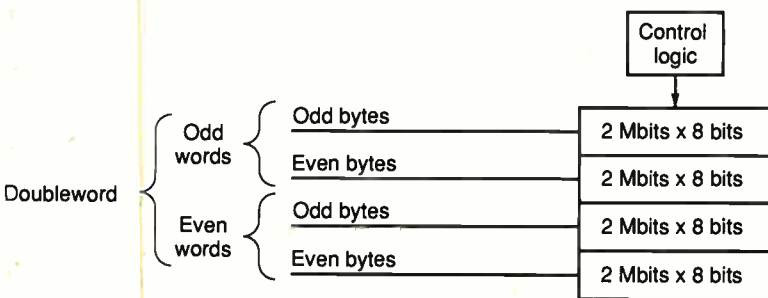

SRAM. Burst transfers boost performance by moving blocks of data from DRAM to a high-speed SRAM cache or to the processor.

### Choosing Configurations

Assuming that DRAM chips are a desirable component in the construction of a system's main storage, how should they be arranged? Within a given system, the designer can specify any number of bits as the memory-access width. So how is an optimal memory word defined?

If a computational problem involved operating on a single bit, a designer might wish the processor permitted a memory-word interface that was only 1 bit wide! As absurd as that sounds, the rationale would be that to set or clear a single bit, the system wouldn't waste time or energy doing a read-modify-write cycle for a memory area wider than the desired bit.

In the past, many different memory-addressing schemes were tried. For example, Sperry-Univac's successful 1100 series mainframe was based on a 36-bit word: Characters were 6 bits wide—enough to handle the uppercase and lowercase alphabet plus numbers and symbols—and certain addressing modes permitted retrieving 3-bit half-characters. And that wasn't very long ago!

Today, memory addressing has standardized on the 8-bit byte. Characters use 8 bits, not 6, and half-characters, or nibbles (4 bits), must be transferred to and from storage by the processor in 8-bit bytes. This is great news for text-editing programs, but not for number-crunching scientific calculations.

Along with the definition of a byte has come de facto standardization on the 16-bit word, the 32-bit doubleword, and the 64-bit quad word. But the 16-bit "word" is a misnomer, because a memory word is simply the bit width of memory access, which can be 32 bits as easily as 16 bits. The confusion would be alleviated if 16

*continued*

Figure 1a: Eight different model memory architectures:

- (Case 1) An 8-bit (byte) noninterleaved memory (akin to that of an IBM PC XT).
- (Case 2) An 8-bit (byte) two-way interleaved memory, or "pseudo 16."
- (Case 3) A 16-bit (word) noninterleaved memory (akin to that of an IBM PC AT).
- (Case 4) A 16-bit (word) two-way interleaved memory, or "pseudo 32."
- (Case 5) A 32-bit (doubleword) noninterleaved memory (like most found in 80386 machines).



# REMOVABLE. ERASABLE. OPTICAL. REMARKABLE!

REO-650 single-drive system  
\$4,995

REO-1300 dual-drive system  
\$9,990

650/600 Meg optical cartridges:  
\$250 each

Interface kits for Macintosh,  
Sun, HP, IBM-AT, XT, PS/2  
and compatibles:  
\$995 each

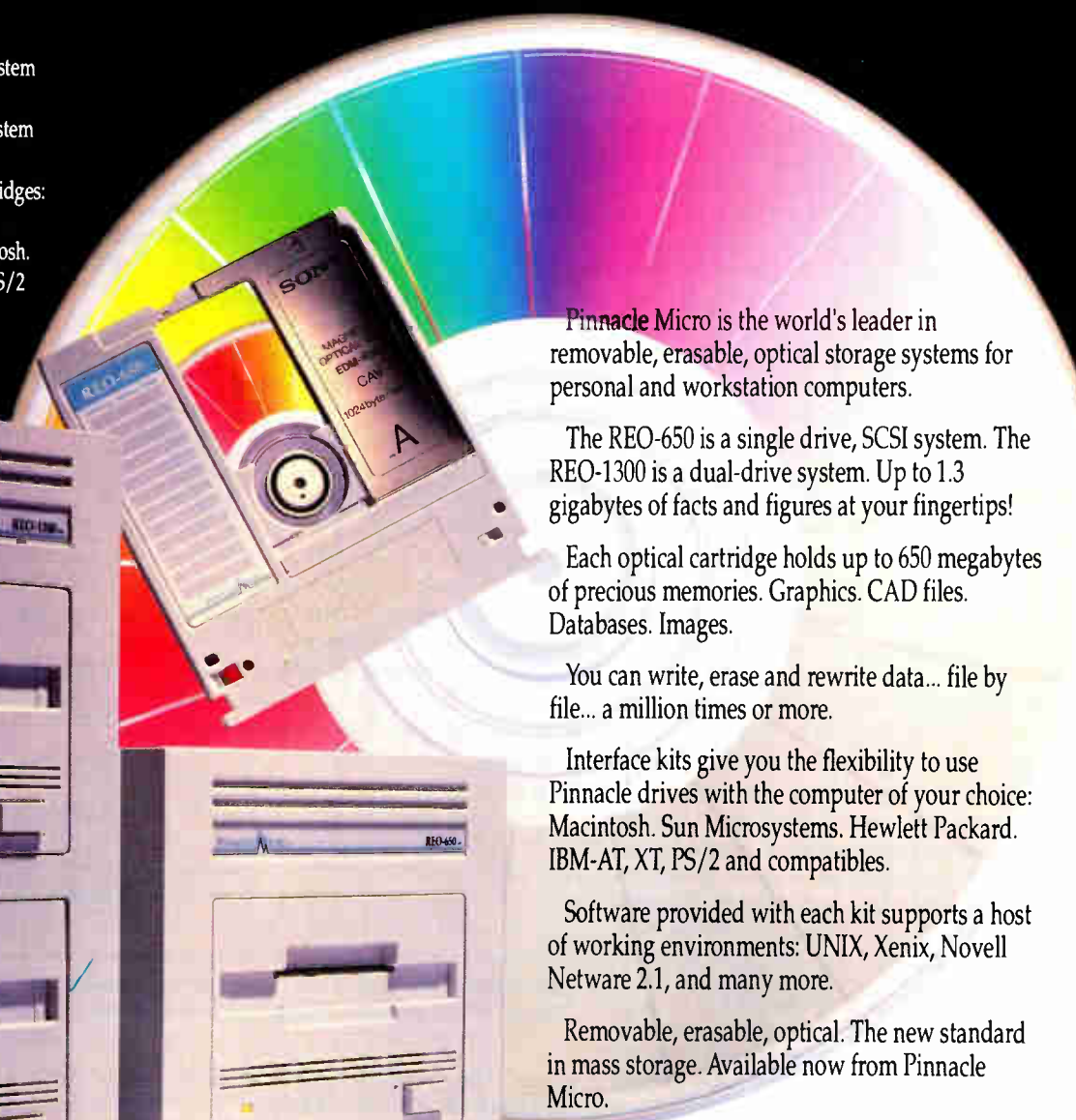

Pinnacle Micro is the world's leader in removable, erasable, optical storage systems for personal and workstation computers.

The REO-650 is a single drive, SCSI system. The REO-1300 is a dual-drive system. Up to 1.3 gigabytes of facts and figures at your fingertips!

Each optical cartridge holds up to 650 megabytes of precious memories. Graphics. CAD files. Databases. Images.

You can write, erase and rewrite data... file by file... a million times or more.

Interface kits give you the flexibility to use Pinnacle drives with the computer of your choice: Macintosh. Sun Microsystems. Hewlett Packard. IBM-AT, XT, PS/2 and compatibles.

Software provided with each kit supports a host of working environments: UNIX, Xenix, Novell Netware 2.1, and many more.

Removable, erasable, optical. The new standard in mass storage. Available now from Pinnacle Micro.

Call today for the location of your sales representative or authorized dealer.

 (800) 553-7070

**PINNACLE MICRO**

THE ERASABLE OPTICAL STORAGE COMPANY™

Trademark owners: REO-650, REO-1300 and Pinnacle Micro of Pinnacle Micro, Inc. Sun of Sun Microsystems. HP of Hewlett Packard. AT, Xenix, IBM, PS/2 of International Business Machines Corporation. Netware of Novell. Macintosh of Apple Computer, Inc.

15265 Alton Parkway • Irvine, CA 92718 • In CA (714) 727-3300 • FAX (714) 727-1913

Circle 283 on Reader Service Card (DEALERS: 284)

bits of data were called a double byte.

At the same time that the industry was resolving text-character representation between EBCDIC and ASCII (guess which won), a similar turmoil was brewing over number representation. Here, the IEEE stepped in to coordinate matters. Currently, IEEE standard 754 (version 10) specifies a 32-bit representation for single-precision floating-point num-

**M**emory performance is too much a function of application requirements and controller design to be easily improved with a quick fix.

bers (a 23-bit significand with an 8-bit exponent plus 1 sign bit). Double-precision floating-point numbers use 64 bits of memory, and extended double-precision floating-point numbers use 80 bits.

Another driving force behind larger memory widths has been in the representation of the program itself. Both program control (such as jumps or calls) and data access require address content within the code: If a program is to access large amounts of memory, it also needs to be able to retrieve and operate on large addresses. This holds true for direct addressing, indirect access (where memory contains the next address), and indirect access with a code offset.

### The Dilemma

Many of today's personal computer benchmarks (including BYTE's) use the term *word* to denote 16 bits. In doing so, a benchmark that measures 16-bit-word moves to an even- or odd-word boundary encounters memory-transfer inefficiency when it communicates with non-word-width memories. If you want to compare 8088s with 80286 and 80386/80486 machines, you must have rules and consistent tests; but choosing a stock word width doesn't really seem fair when comparing machines that use different

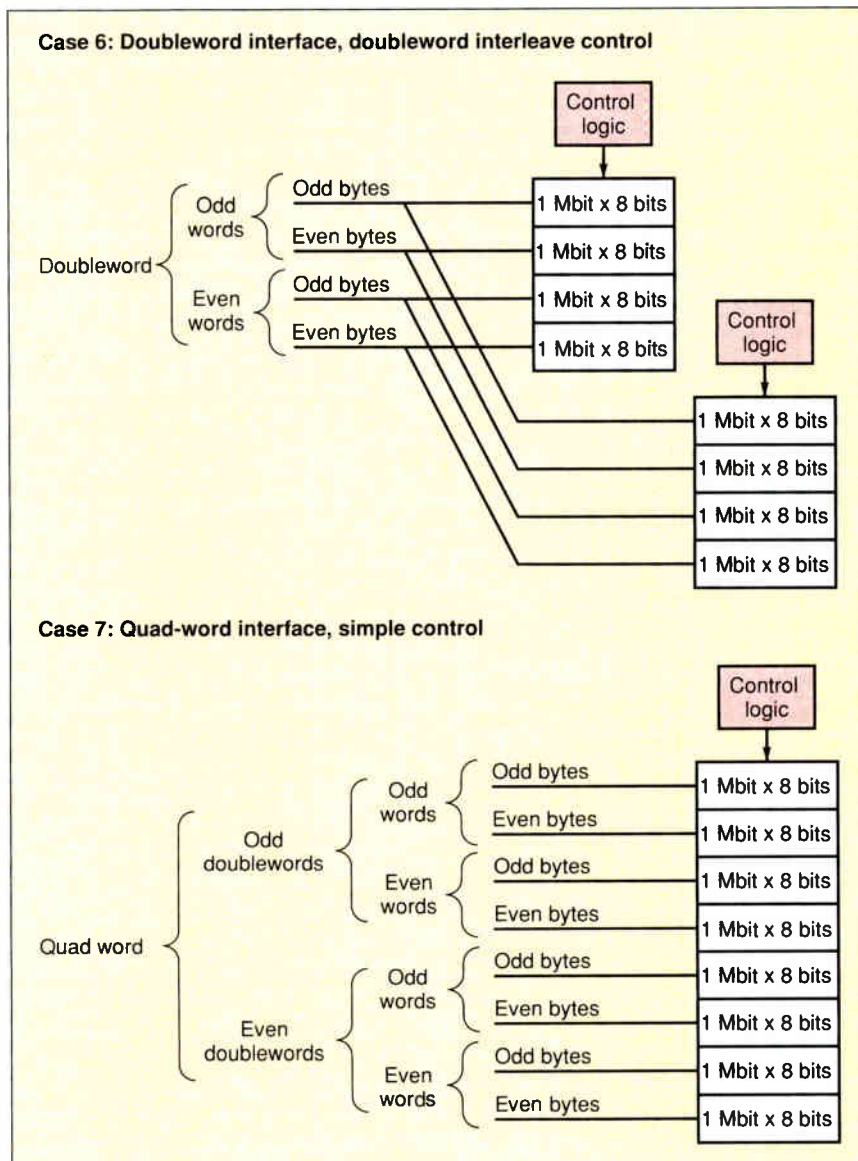

Figure 1b: (Case 6) A 32-bit (doubleword) two-way interleaved memory, or "pseudo 64." (Case 7) A 64-bit (quad-word) noninterleaved memory.

widths. The examples that follow demonstrate the implications of this.

To really understand the trade-offs inherent in the choice of memory width, you can construct a series of imaginary memory architectures and test them in different situations to compare their performance. The simulated memory can be accessed in two "ticks" of the clock and has a three-tick cycle time.

The simplified example uses eight different memory architectures. Block diagrams representing the eight imaginary memory organizations are shown in figure 1. Case 8 doesn't exist in any personal computer and is a perfect example of control-logic chips rivaling the num-

ber of memory chips.

For the first scenario, imagine handling a byte string move in an address transition of 1 byte. To keep it fair, start all systems "ready to access," and for brevity, transfer only 8 bytes. You can also assume that the starting address is a common word boundary for all systems and that data is moved to an adjacent (lower) byte. A symbolic representation for each case will use the following notation:

C = cycle (intermission between accesses to the same memory element)  
 $n$  = first half of read cycle, byte  $n$



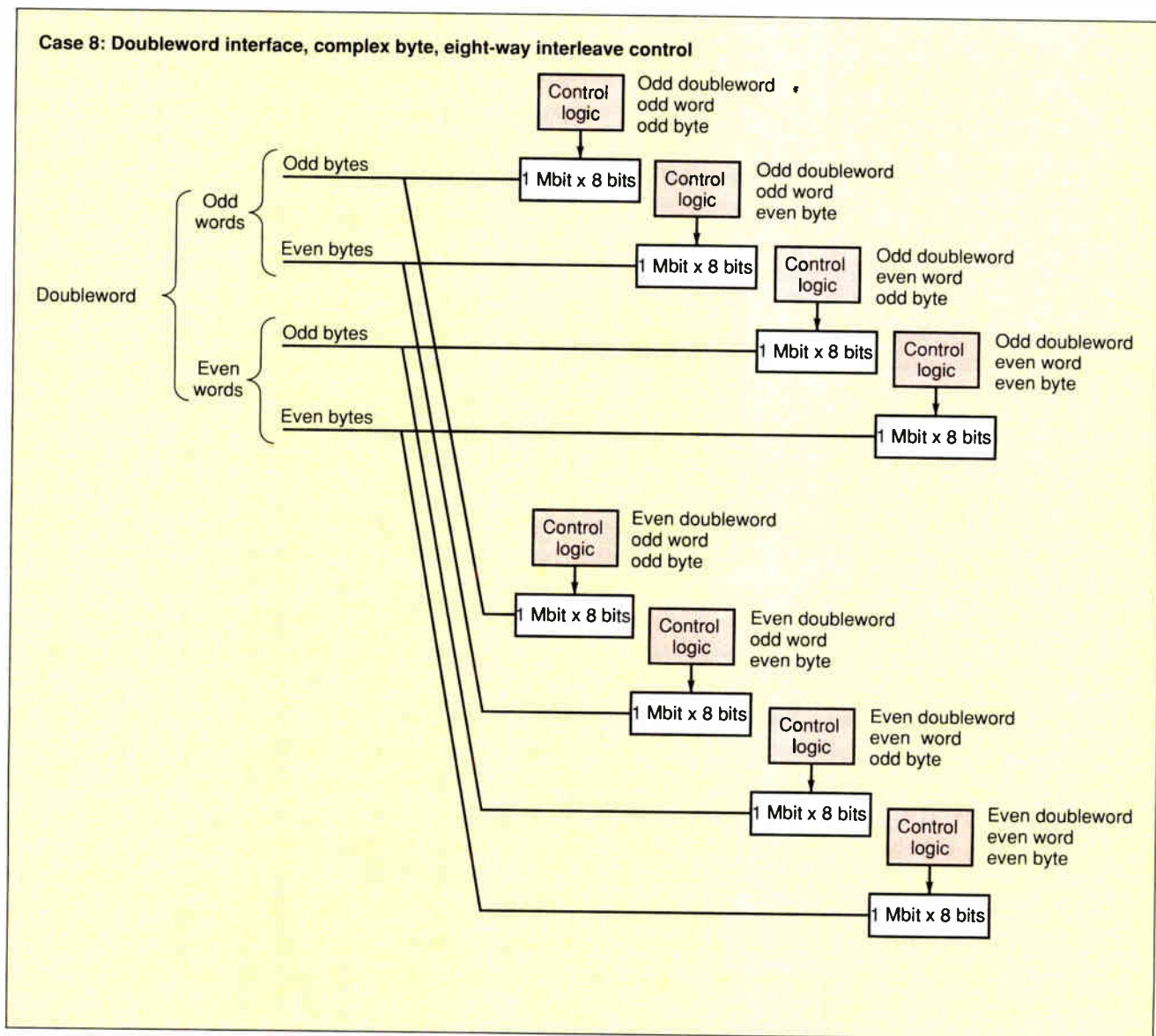

Figure 1c: (Case 8) A 32-bit (doubleword/word/byte) eight-way interleaved memory, or pseudo 64.

$R_n$  = second half of read cycle, byte  $n$   
 $w_n$  = first half of write cycle, byte  $n$   
 $W_n$  = second half of write cycle, byte  $n$   
 \*\*\* = operation complete

In the first test, the 8-bit interleaved memory (case 2) would be the fastest among the existing architectures, quicker even than wider memory organizations (see table 1). But if you move each byte by an offset of 2 bytes (as shown in table 2), the 16-bit interleaved structure (case 4) is fastest, with 8- and 32-bit interleaved organizations (cases 2 and 6) tied for second place. Memory width and interleaving control yield benefits that are dependent on two things: the operand

data width (8, 16, or 32 bits) and the offset and alignment that data traverses.

Although wider memories are slower, they produce benefits. Processors such as the 80386 and 80486 can use 32-bit operands; when they do, they outstrip systems with narrower memories. To demonstrate this, move two 32-bit words by an offset of one 32-bit word.

The scenario depicted in table 3 shows a fivefold improvement for the 32-bit interleaved memory over the 8-bit non-interleaved memory. This strongly suggests that if your processing requires 32-bit floating-point calculations, you should choose a machine that excels in 32-bit performance. Ignore the bench-

marks that compare machines on byte operations; they may be misleading.

But if wider memories aren't necessarily better for handling small chunks of data, such as characters or byte operands, why use them? The answer points to a drawback in the simulation: The tests it runs are just a subset of what typically goes on within a system. If, in a real computer, every other CPU operation were a write to memory, then caching wouldn't do much good.

In reality, the ratio of memory-write operations to memory reads rarely exceeds 1-to-4, because the code portion of memory isn't written to except when

*continued*

## Computers For The Blind

Talking computers give blind and visually impaired people access to electronic information. The question is how and how much?

The answers can be found in "The Second Beginner's Guide to Personal Computers for the Blind and Visually Impaired" published by the National Braille Press. This comprehensive book contains a Buyer's Guide to talking microcomputers and large print display processors. More importantly it includes reviews, written by blind users, of software that works with speech.

This invaluable resource book offers details on training programs in computer applications for the blind, and other useful information on how to buy and use special equipment.

Send orders to:  
National Braille Press Inc.  
88 St. Stephen Street  
Boston, MA 02115  
(617) 266-6160

\$12.95 for braille or cassette, \$14.95 for print. (\$3 extra for UPS shipping)  
NBP is a nonprofit braille printing and publishing house.

**Table 1:** The 8-bit interleaved memory (case 2) is the fastest among the existing architectures, even faster than wider memory organizations.

**TRANSFERRING 8 BYTES BY A 1-BYTE OFFSET**

Tick	Case 1	Case 2	Case 3	Case 4	Case 5	Case 6	Case 7	Case 8
1	r1	r1	r1	r1	r1	r1	r1	r1
2	R1	R1	R1	R1	R1	R1	R1	R1
3	C	1	C	w1	1	1	1	w1
4	w1	W1	w1	W1	w1	W1	w1	W1
5	W1	r2	W1	r2	W	W1	W1	r2
6	C	R2	C	R2	C	r2	C	R2
7	r2	w2	r	C	r2	R2	r	w2
8	R2	W2	R2	w2	R2	C	R2	W2
9	C		C	W2	C	W2		r3
10	w2	R3	w2	r3	w2	W2	w2	R3
11	W2	w3	W2	R3	W2	C	W2	w3
12	C	W3	C	w3	C	r3	C	W3
13	r3	r4	r3	W	r3	R3	r3	r4
14	R3	R4	R3	R4	R3	C	R3	R4
15	C	w4		R	C		C	w4
16	w3	W4	w3	C	w3	W3	w3	W4
17	W3	r5	W3	w4	W3		W3	5
18	C	R5	C	W4	C	r4	C	R5
19	r4	w5	r4	r5	4	R4	r4	w5
20	R4	W5	R4	5	R4	C	R4	W5
21	C		C	w5	C	4	C	r6
22	w4	R6	w4	W5	w4	W4	w4	R6
23	W4	w6	W4	r6	W4	r5	W4	w6
24	C	W6	C	R6	C	R5	C	W6
25	5	r7	r5	r5	w5	w5	r5	r7
26	R5	R7	R5	w6	R5	W5	R5	R7
27	C	w7	C	W6	C			w7
28	w5	W7	w5	r7	w5	r6	w5	W7
29	W5	r8	W5	R7	W	R6	W5	r8
30	C	R8	C	w7	C	C	C	R8
31	r6	w8	r6	W		w6		8
32	R6	W8	R6	r8	R6	W6	R6	W8
33	C	***	C	R8	C	C	C	***
34	w6		w6	C	w6	r7	w6	
35	W6		W6	w8	W6	R7	6	
36	C		C	W8	C	C	C	
37	r7		r7	***	r7	W7	r7	
38	R7		R7		R7	W7	R7	
39	C		C		C	C	C	
40	w7		w7		w7	r8	w7	
41	W7		W7		W7	R8	W7	
42	C		C		C	C	C	
43	r8		r8		r8	w8	r8	
44	R8		R8		R8	W8	R8	
45	C		C		C	***	C	
46	w8		w8		w8		w8	
47	W8		W8		W8		W8	
48	***		***		***		***	

loading, and even then it's treated as data. The model also assumed that you could move a known portion of data without regard to computational considerations, such as source/destination address generation or length of transfer.

**Burst Mode: Feature of the Future?**  
Often, main memory isn't the direct interface to the processor. It has become

customary for high-performance systems to incorporate an SRAM cache. The basic principle behind a main-memory cache is that when a given address for data or code is requested, it's very likely that the same or nearby addresses will be requested again. Since the cache controller maps precious SRAM in blocks or sets of words, main-memory operations become either block transfers to fill the



**Table 2:** If you move each byte by an offset of 2 bytes, the 16-bit interleaved structure (case 4) is fastest, with the 8- and 32-bit interleaved organizations (cases 2 and 6) tied for second place.

MOVING 8 BYTES BY A 2-BYTE OFFSET

Tick	Case 1	Case 2	Case 3	Case 4	Case 5	Case 6	Case 7	Case 8
1	r1	r1	r1	r1	r1	r1	r1	r1
2	R1	R1	R1	R1	R1	R1	R1	R1
3	C	C	C	w1	C	w1	C	w1
4	w1	w1	w1	W1	w1	W1	w1	W1
5	W1	W1	W1	r2	W1	r2	W1	r2
6	C	r2	C	R2	C	R2	C	R2
7	r2	R2	r2	w2	r2	w2	r2	w2
8	R2	C	R2	W2	R2	W2	R2	W2
9	C	w2	C	r3	C	r3	C	r3
10	w2	W2	w2	R3	w2	R3	w2	R3
11	W2	r3	W2	w3	W2	C	W2	w3
12	C	R3	C	W3	C	w3	C	W3
13	r3	C	r3	r4	r3	W3	r3	r4
14	R3	w3	R3	R4	R3	C	R3	R4
15	C	W3	C	w4	C	r4	C	w4
16	w3	r4	w3	W4	w3	R4	w3	W4
17	W3	R4	W3	r5	W3	C	W3	r5
18	C	C	C	R5	C	w4	C	R5
19	r4	w4	r4	w5	r4	W4	r4	w5
20	R4	W4	R4	W5	R4	r5	R4	W5
21	C	r5	C	r6	C	R5	C	r6
22	w4	R5	w4	R6	w4	w5	w4	R6
23	W4	C	W4	w6	W4	W5	W4	w6
24	C	w5	C	W6	C	r6	C	W6
25	r5	W5	r5	r7	r5	R6	r5	r7
26	R5	r6	R5	R7	R5	w6	R5	R7
27	C	R6	C	w7	C	W6	C	w7
28	w5	C	w5	W7	w5	C	w5	W7
29	W5	w6	W5	r8	W5	r7	W5	r8
30	C	W6	C	R8	C	R7	C	R8
31	r6	r7	r6	w8	r6	C	r6	w8
32	R6	R7	R6	W8	R6	w7	R6	W8
33	C	C	C	***	C	W7	C	***
34	w6	w7	w6		w6	C	w6	
35	W6	W7	W6		W6	r8	W6	
36	C	r8	C		C	R8	C	
37	r7	R8	r7		r7	C	r7	
38	R7	C	R7		R7	w8	R7	
39	C	w8	C		C	W8	C	
40	w7	W8	w7		w7	C	w7	
41	W7	***	W7		W7	***	W7	
42	C		C		C		C	
43	r8		r8		r8		r8	
44	R8		R8		R8		R8	
45	C		C		C		C	
46	w8		w8		w8		w8	
47	W8		W8		W8		W8	
48	***		***		***		***	

cache (read main memory—write to cache) or single-cycle write operations to update main storage. This is how Intel's 80486, with its built-in 8K-byte cache, interfaces to external memory. A line in the 80486's cache is 4 doublewords wide (128 bits); when the 80486 needs to fill that line, it can use burst-mode transfer.

The memory dialogue for this opera-

tion using the simulated memory architectures would look like this. First, you have to alter the conditions slightly. You fill the 80486's on-chip cache using DRAM page mode in 16-byte bursts. With the 80486's 25-MHz clock rate, and assuming that the memories are now implemented with 100-nanosecond

*continued*

# Programmers Save 30 Hours

... the first 3 months you use **Logic Gem** or send it back for a full refund! Less than 1% of our users have returned it. The other 99% use it often and love it!

**Jerry Pournelle** says, "It has already saved me several hours, and I haven't had it a week. Highly recommended." (Chaos Manor, BYTE, March 1989)

**Logic Gem** is completely different from any other programmer's tool. It's all software, requires no special systems or boards. **Best of all, the single language edition is now only \$49.95.** And the multi-language edition is only \$99.

Or try it first for free: Down-load a demo of **Logic Gem** from our electronic bulletin board. You'll love it!

**Logic Gem**, a proven programmer's tool, helps you avoid bugs in three ways:

- ◆ **Catches logical errors before you code the program.** Saves hours of debugging time.
- ◆ **Automatically generates flawless code** for the "guts" of your program... in C, BASIC, Pascal, FORTRAN, and dBASE.
- ◆ **Automatically produces written documentation** of your logic, which insures good communications between designer and coder. (And helps remind you of the logic from one work session to the next.)

**Logic Gem** works with whatever compiler you are using. The only change: with **Logic Gem** you catch and correct the logic bugs before you write the program.

## SINGLE LANGUAGE EDITION

**\$44.95**

## MULTI-LANGUAGE EDITION

**\$99.00**



Sterling Castle, Inc.  
702 Washington St. #174  
Marina del Rey, CA 90292  
1-800-722-7853  
1-800-323-6406 (in CA)  
1-213-306-3020  
1-213-821-8122 FAX

See us at Comdex - B1149

# Download demo

(213)453-7705 • 3/12/24,8,N,1

**“We’re looking for retired managers who want to get back into action.”**

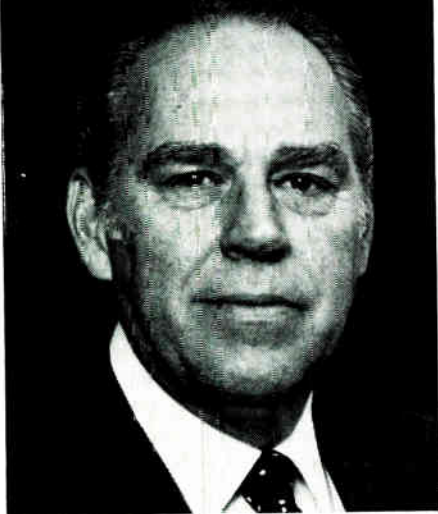

Harold W. McGraw, Jr.,  
Chairman, McGraw-Hill, Inc.

I'm a volunteer supporter of the International Executive Service Corps, a not-for-profit organization with a vital mission:

We send retired U.S. managers overseas to help businesses in developing countries, which often respond by increasing their imports of U.S. goods. In fact, developing countries consume about 40 percent of U.S. exports.

As an IESC volunteer, you would not get a salary. But you would get expenses for you and your spouse, plus a world of personal satisfaction. IESC leads the field in this kind of work. We've done over 9,000 projects in 81 countries. We could have a project that's just right for you. To find out, send this coupon to: Harold W. McGraw, Jr., Chairman, McGraw-Hill, Inc., P.O. Box 10005, Stamford, CT 06904-2005.



**Dear Mr. McGraw:** Tell me more about becoming an IESC volunteer. I am a recently retired manager or technician—or am about to retire—from a U.S. company. I'm free to accept an overseas assignment. I understand that volunteers receive expenses for themselves and their spouses, but no salary.

Name \_\_\_\_\_

Address \_\_\_\_\_

City \_\_\_\_\_ State \_\_\_\_\_ Zip \_\_\_\_\_

M1

**Table 3: This scenario shows a fivefold improvement for the 32-bit interleaved memory (case 6) over the 8-bit noninterleaved (case 1).**

**MOVING TWO 32-BIT DOUBLEWORDS BY A 4-BYTE OFFSET**

Tick	Case 1	Case 2	Case 3	Case 4	Case 5	Case 6	Case 7	Case 8
1	r1	r1	r1-2	r1-2	r1-4	r1-4	r1-4	r1-4
2	R1	R1	R1-2	R1-2	R1-4	R1-4	R1-4	R1-4
3	C	r2	C	r3-4	C	w1-4	C	w1-4
4	r2	R2	r3-4	R3-4	w1-4	W1-4	w1-4	W1-4
5	R2	C	R3-4	w1-2	W1-4	r5-8	W1-4	r5-8
6	C	R3	C	W1-2	C	R5-8	C	R5-8
8	R3	R4	w1-2	w3-4	r5-8	w5-8	r5-8	w5-8
9	C	w1	C	r5-6	C	***	C	***
10	r4	W1	w3-4	R5-6	w5-8		w5-8	
11	4	w2	W3-4	7-8	W5-		W5-8	
12	C	W2	C	R7-8	***		***	
14	W1	W3	r5-6	w5-6				
15	C	w4	C	w7-8				
16	w2	W4	r7-8	W7-8				
17	W2	5	R7-8	***				
18	C	R5	C					
19	w3	r6	5-6					
20	W3	R6	W5-6					
21	C	r7	C					
22	w4	R7	w7-8					
23	W4	r8	W7-8					
24	C	R8	***					
25	r5	W5						
26	R5	W5						
27	C	w6						
28	r6	W6						
29	R6	w7						
30	C	W7						
31	r7	w8						
32	R7	W8						
33	C	***						
34	r8							
35	R8							
36	C							
37	w5							
38	W5							
39								
40	w6							
41	W6							
42	C							
43	7							
44	W7							
45	C							
46	w8							
47	W8							
48	***							

DRAM chips, you'll need two ticks to read the next DRAM page for non-interleaved organizations, and one tick for interleaved. (The interleaved cases burst in one tick because they can initiate the access for subsequent data concurrently with an ongoing data transfer.)

The memory dialogues for the 80486 burst transfer in each of the cases are

shown in table 4. The results show that the most efficient and practical memory architectures for supporting burst transfer are the 64-bit or 32-bit interleaved (pseudo 64) organizations.

**How to Improve Performance**

The examples above clearly illustrate that memory performance is too much a



function of application requirements and controller design to be easily improved with a quick fix, such as increasing word width. If you want a 32-bit memory interface on a 32-bit machine, then you must compromise subword access, such as byte moves, by creating a memory organization that hampers such operations. Or you have to create elaborate, sophisticated control structures, which are expensive and space-consuming. And even these have performance drawbacks: Case 8 in the simulation, for all its apparent advantages, would be crippled by a simple byte operation with an 8-byte offset.

The best solution may lie in changing the design of DRAM. If a small SRAM were integrated right into the DRAM chip and used as a high-speed cache, the result would be substantially better than separate DRAM/SRAM arrangements. Thousands of bytes of data could be burst from the DRAM to the on-chip cache in a single cycle, and write operations would be easier. The reason for this bears some explaining.

In every DRAM component, a few hundred to a few thousand bits are retrieved with every access. Most of the bits, of course, are ignored. At present, few systems take advantage of this very wide data word, and only the video RAM implementation of dynamic memory uses it to solve a specific problem. How does this wide data word work? Figure 2 shows a conceptual representation of a 1-megabit by 1-bit DRAM.

The number of bits actually accessed  
*continued*

**Table 4:** These results show that the most efficient and practical memory architectures for supporting burst transfer are the 64-bit or 32-bit interleaved (pseudo 64) organizations (cases 6, 7, and 8).

80486 BURST TRANSFER								
Tick	Case 1	Case 2	Case 3	Case 4	Case 5	Case 6	Case 7	Case 8
1	r1	r1	r1-2	r1-2	r1-4	r1-4	r1-4	r1-4
2	R1	R1	R1-2	R1-2	R1-4	R1-4	R1-4	R1-4
3	r2	R2	r3-4	R3-4	r5-8	R5-8	R5-8	R5-8
4	R2	R3	R3-4	R5-6	R5-8	R9-12	R9-12	R9-12
5	r3	R4	r5-6	R7-8	r9-12	R13-16	R13-16	R13-16
6	R3	R5	R5-6	R9-10	R9-12	***	***	***
7	r4	R6	r7-8	R11-12	r13-16			
8	R4	R7	R7-8	R13-14	R13-16			
9	r5	R8	r9-10	R15-16	***			
10	R5	R9	R9-10	***				
11	r6	R10	r11-12					
12	R6	R11	R11-12					
13	r7	R12	r13-14					
14	R7	R13	R13-14					
15	r8	R14	r15-16					
16	R8	R15	R15-16					
17	r9	R16	***					
18	R9	***						
19	r10							
20	R10							
21	r11							
22	R11							
23	r12							
24	R12							
25	r13							
26	R13							
27	r14							
28	R14							
29	r15							
30	R15							
31	r16							
32	R16							
33	***							

# World Class Software Security



Parallel Port Interface (PPI)

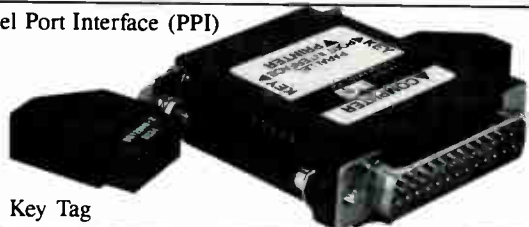

Key Tag

The parallel port interface (PPI) connects between the printer port on a PC and the printer cable. The PPI holds two Key Tags, one on each side. Each Key Tag contains a secure custom chip which is pre-programmed by Glenco to only work with the assigned software package. A second Key Tag can be employed to protect another package, or may be used to turn other software packages "on", remotely or on-site.

- STANDARD KEY TAG - Software is protected for an unlimited number of executions. They are pre-programmed to include a sequentially assigned S/N.
- COUPON KEY TAG - Software is valid for a preset number of executions. The Coupon count can be reset remotely or on the customer's site by using a second update Key Tag.

- READ/WRITE KEY TAG - With programmable memory. Perfect for companies which have multiple products or a product with several optional modules. By having several packages protected using one Key Tag, your costs are lowered.
- DURATION KEY TAG - Has a clock on board. (Available late '89)

## Secure software and data with reliable, effective protection products that won't burden honest users.

Glenco is a world leader in the area of software security products and services. Our copy protection products and data security products are second to none. They are designed to function on a wide variety of third party hardware. We have over 3500 satisfied software firms utilizing our products. We also have a full line of disk based protection systems.

- MACHINES SUPPORTED - IBM PC/XT/AT & PS/2, Macintosh
- OPERATING SYSTEMS - MS-DOS, XENIX, Network, Finder, & Multifinder.
- LANGUAGES/COMPILER - Over 50, including runtime packages, data bases and spread sheets. We have a non-programmers interface as well.

Call or write for more information.

## GLENCO ENGINEERING INC.

SERVING THE SOFTWARE INDUSTRY SINCE 1979

721 W. Algonquin Road, Arlington Hts., IL 60005, (312) 364-7638, FAX 364-7698

In Europe contact: SDC Security Systems, The Netherlands  
Tel: +31-45-441535, FAX: +31-45-444747



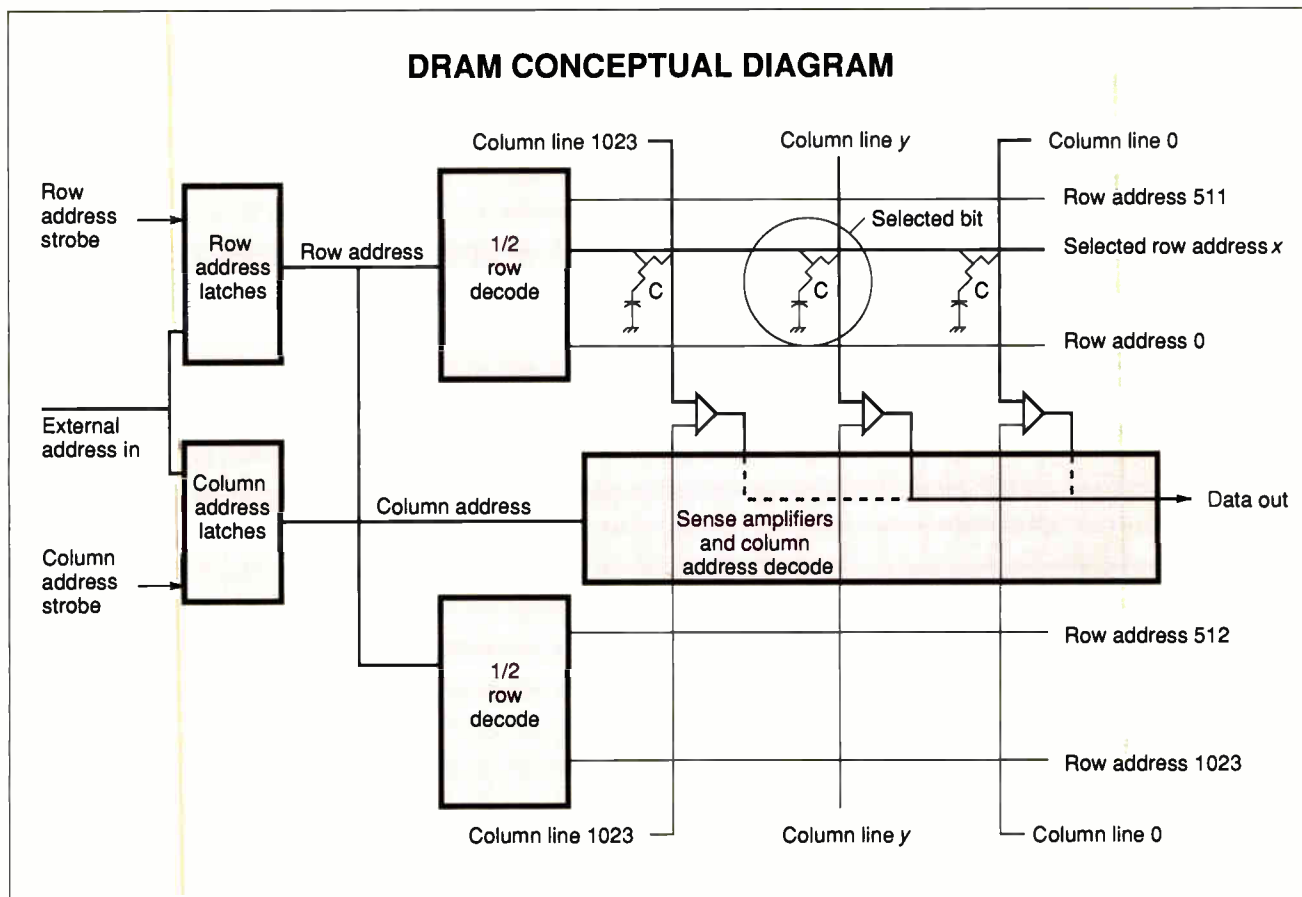

**Figure 2:** A conceptual representation of a 1-megabit by 1-bit DRAM. A major access starts by presenting a row address on which a single row line is decoded. The active row then electrically connects 1024 capacitors to their respective column lines. Sense amplifiers ascertain the intended logic level for each of the 1024 columns and then latch the result. Because this process depletes the charge within each bit capacitor on reading, the row must then be rewritten.

inside memory chips is even greater in wide memory organizations. A 32-bit memory system reads 32,768 bits, or 4096 bytes, at a time! If an SRAM were integrated at this stage, the interconnection between main memory and the cache would be extremely wide. A single cache line would be thousands of bytes long and could be loaded or swapped out in one DRAM cycle. Cache management for write operations, including avoiding stale data when multiple copies of an address exist within the system, would be easier and faster to perform.

The raw ingredients are now present within DRAMs to integrate a cache; all that would have to be added is 4K bits (4 rows) of high-speed SRAM and a few pins. This scheme is not impossible: One large DRAM supplier is considering it for a 4-megabit chip. In fact, the obstacles to achieving the caching DRAM are more political than technical. If each DRAM supplier should implement a different solution to the component, large

manufacturers would shun the devices. Prices would be high, and each implementation would be a critical, sole-source component. Manufacturers avoid single-source components at all costs.

Fortunately, there is an industry committee that defines memory standards—JEDEC, or the Joint Electrical Device Engineering Council. Ten years ago, JEDEC successfully adopted and propagated the x4 DRAM standard; now it should work on coordinating suppliers in the standardization of a caching DRAM design.

#### What the Future Holds

The pace of development in the computer industry makes predictions approximate, at best. After all, just a little more than 20 years ago, mainframes such as the IBM System/360 Model 50 (a medium-to large-scale member of the 360 product line) had a basic storage of 64K bytes (with a maximum of 512K bytes), a memory cycle time of 2000 ns, and a

memory width of 32 bits (the same as the 80386 or 80486).

Processor speed improvements have placed greater and greater demands on main storage and will continue to in the future. Within the next 10 years, you're likely to see personal computers that are equipped with 64 megabytes of 64-bit-wide memory cycling at 20 ns. Data-path width will continue to grow, perhaps more so in silicon than on printed-circuit-board copper. To achieve these fabulous specifications, the industry will need continually improved control logic and memory organization, caching DRAM and multiple row accessing, and, most of all, coordination and standardization among suppliers. ■

*Ron Sartore is the president of Cheetah International, a computer systems design and manufacturing company. He received his B.S.E.E. from Purdue University. You can contact him on BIX c/o "editors."*



# We've got the guts, you get the glory.

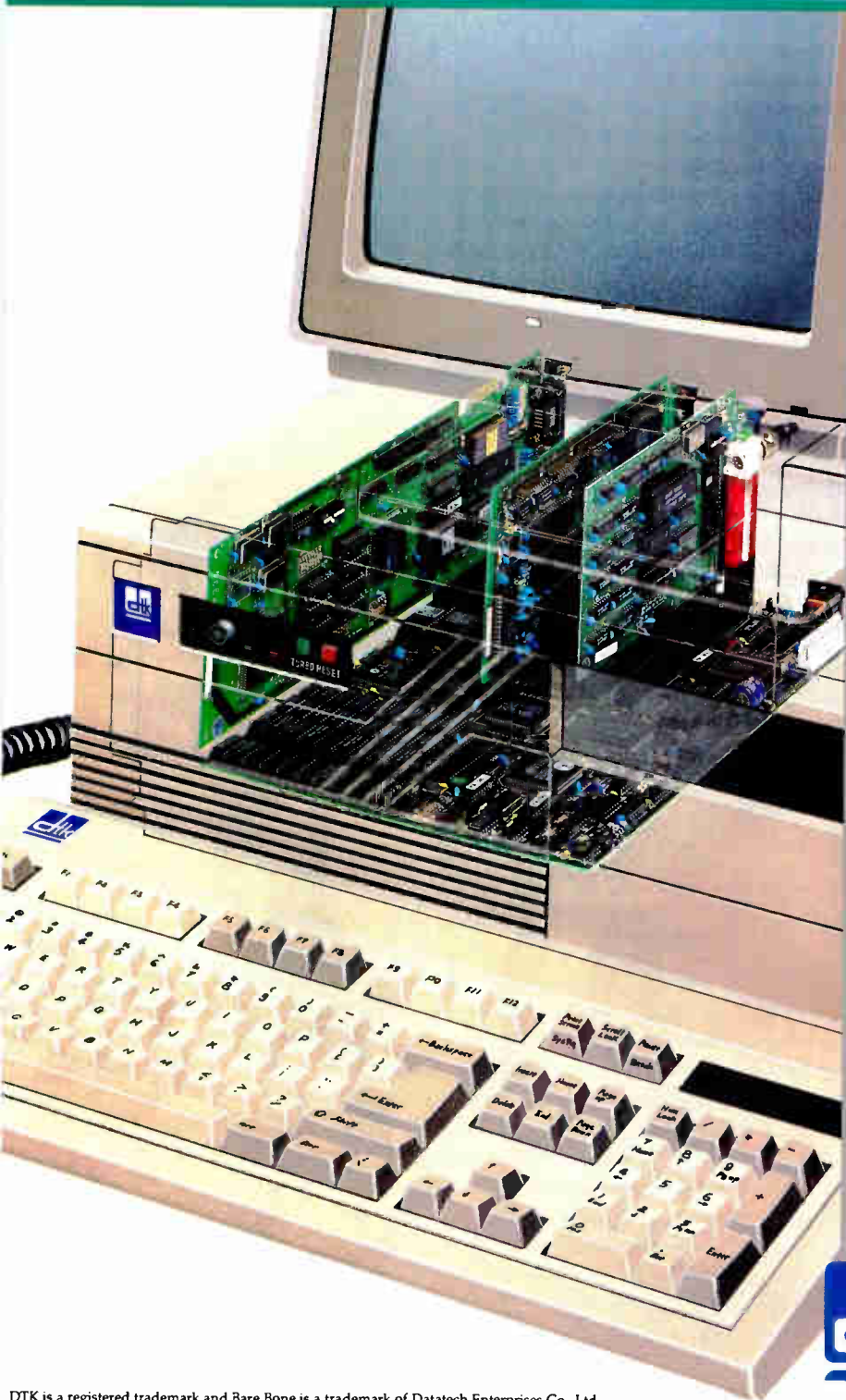

Whether you're building systems or simply upgrading existing hardware, you can bet your reputation on DTK.

We offer clearly superior 80386, 80286 and 8088-based Bare Bone™ systems with FCC, UL, CSA and TUV certification. Plus motherboards and fully compatible add-on cards. All built to deliver the performance and reliability today's sophisticated computer users demand.

**More Guts.** Choose from a dozen Bare Bone systems designed to fit every need—and every desk. Including a 33MHz 386 file server with cache memory. Or select from an extensive line of motherboards (our XT and AT compatible models are widely regarded as industry standards).

Want LAN adapters? Or VGA, I/O, or disk controller cards? Maybe you need to gain an extra slot or two with multiple function cards. DTK can provide the solutions.

At prices you'll really like.

**Better Quality.** Our substantial R & D capabilities and stringent QC procedures mean you can depend on us for the most reliable, highest performance products available today. And tomorrow. Our inspection conforms with MIL-STD-105D, and our boards enjoy an overall reliability rate of 98%.

So why take chances? We've got all the guts you need at prices that are hard to beat. Go for the glory.

Call or write DTK COMPUTER, Inc., 15711 E. Valley Blvd., City of Industry, CA 91744. Tel: (818) 333-7533 Fax: (818) 333-5429 BBS: (818) 333-6548.

Chicago, IL (312) 593-3080  
Edison, NJ (201) 417-0300  
Houston, TX (713) 568-6688  
Miami, FL (305) 477-7440  
West Germany (0211) 656031



Clearly superior.

DTK is a registered trademark and Bare Bone is a trademark of Datatech Enterprises Co., Ltd.  
Intel 386 is a trademark of Intel Corporation. XT and AT are registered trademarks of IBM Corporation.

Circle 118 on Reader Service Card



RE: 08/17/89  
ON OR AFTER  
05/01/89  
1,487.50  
.00  
.00  
.00  
.00  
.00  
584.97  
31,041.26  
.00  
54.52  
1,188.80  
281.50  
.00  
829.83

.00  
739.43  
.00  
40,079.78  
.00  
.00  
.00  
4,982.83  
11,643.41  
.00  
.00

You've



# got to work on several jobs at once. OS/2 can do!

Until now, working on several jobs at the same time was next to impossible. But with OS/2<sup>®</sup>, you don't have to wait for your computer to complete one job before starting another. So working on several jobs at once is easy.

While you're recalculating a spreadsheet or printing a document under OS/2, you can also start one or more communications sessions with another office. Your computer can continue to work on those jobs in the background while you do something else, like write a report or check your on-line calendar.

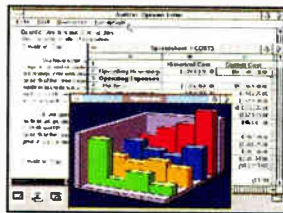

You can take OS/2's multitasking ability even further with IBM's Micro Channel<sup>™</sup>. Its multiple lanes can handle the heavier flow of information and make your computer one of the most reliable and versatile business tools you can get your hands on.

Want to juggle several things at once? With OS/2, the solution is IBM.

Find out more about OS/2. Contact your IBM Authorized Dealer or marketing representative. For a dealer near you, call 1 800 IBM-2468, ext. 107.

**Buy OS/2 now and get rebates on memory and software. For a free V1.2 upgrade, return an upgrade order form by 12-31-89.**



# Be prepared to meet your maker.



**Our PCs have worn some of the biggest brand names in the business.**

For years, Goldstar has been manufacturing computer and communications equipment for some of the leading companies in the industry. In fact, chances are good that some of your trusted peripherals and perhaps even your whole PC were made in one of our factories.

## **Computers, Monitors, Fax Machines**

Now, we're offering a complete line of Goldstar products under our own name. Frankly, we think it's about time we took a little more credit for our effort.

Moreover, by selling our products under the Goldstar label, we can offer customers the backing of a 20 billion dollar plus international corporation, as well as the reliability and expertise that come with over 30 years of experience in the electronics field.

Visit our exhibit at COMDEX/  
FALL '89.

**Meeting your maker has never  
been so easy.**

*Circle 366 on Reader Service Card*



**COMDEX Fall '89**

November 13-17, 1989  
Las Vegas, Nevada

Booth No.  
H75427642

## **GoldStar**

**The Brightest Star in Electronics**

Yoido P.O. Box 335/Seoul Korea  
Tel: (2) 787-3731  
Cable: GOLDRADIO SEOUL  
Tlx: GSRADIO K23751/3  
Fax: (2) 787-3400

**Overseas Network** ■ U.S.A. GOLDSTAR TECHNOLOGY, INC. HEAD OFFICE Tel: (408) 432-1331 Fax: (408) 432-6053  
GOLDSTAR TECHNOLOGY, INC. NEW YORK OFFICE Tel: (201) 460-8870/9 Fax: (201) 460-1097 GOLDSTAR TECHNOLOGY,  
INC. LOS ANGELES OFFICE Tel: (213) 404-1224 Fax: (213) 404-4636 ■ U.K., C&C LONDON OFFICE Tel: (753) 691888 Fax: (753) 693061  
■ W/GERMANY, C&C DUSSELDORF OFFICE Tel: (2154) 492167 Fax: (2154) 427777 ■ FRANCE, C&C PARIS OFFICE Tel: (1) 47-66-1111  
Fax: (1) 47-66-1341 ■ HONGKONG, C&C HONG KONG OFFICE Tel: (5) 8456787 Fax: (5) 8459416 ■ JAPAN, C&C JAPAN OFFICE  
Tel: (3) 505-0929 Fax: (3) 582-7948



# Revenge of the CISCs

*Will the 80486 and the 68040, heirs to the dynasties built by Intel and Motorola, slow the RISC bandwagon?*

*Michael Slater and John H. Wharton*

**T**he first commercial microprocessors contained thousands of transistors; the 8086 and the 68000, tens of thousands; and the 80386 and the 68030, hundreds of thousands. The logical next step is millions, and indeed the 80486 and the 68040 weigh in with over a million transistors each.

The increased complexity of each generation has allowed word widths to expand from 4 bits to 32 bits, and addressing ranges to jump from a few kilobytes to 4 gigabytes. Memory management units, included in more recent generations of microprocessors, have eased the implementation of multiuser, multitasking operating systems and virtual memory. For the most part, however, until the most recent generation of microprocessors, you needed external chips for cache memory and floating-point processing.

Now, for the first time, it's possible to build a complete, high-performance CPU with floating-point and memory management functions on a single chip. The first microprocessors of this latest generation are Intel's 80860 and 80486 and Motorola's 68040. The 80860 is In-

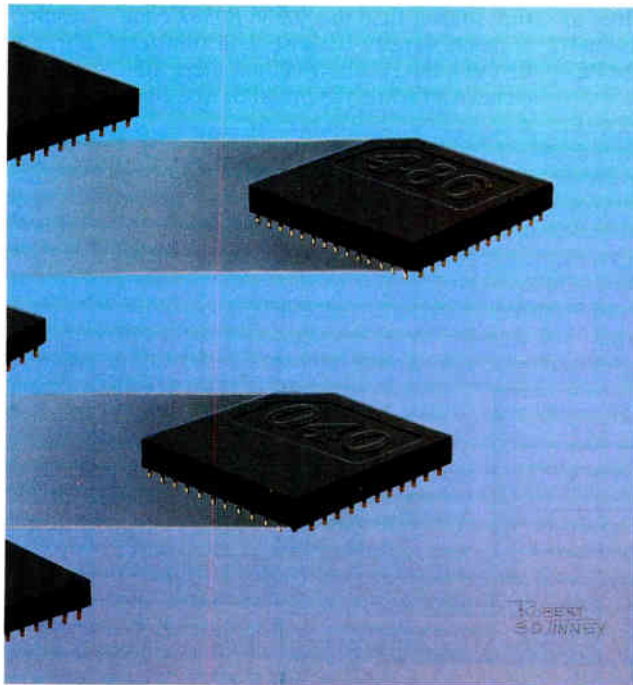

tel's first true RISC processor, and while it has an intriguing architecture, it's too new to have much of a software (or hardware) base.

This article will focus on the 80486 and 68040, the heirs to the dynasties built by Intel and Motorola. These chips are very similar in terms of general features (e.g., cache, memory management, pipelining, and burst-mode bus),

although they execute different instruction sets and thus have different application software bases.

As of this writing, Intel had shipped some samples of the 80486, but Motorola was still awaiting the first 68040. Intel had released full details on the 80486, while Motorola had issued only general information about the 68040. Thus, this article covers the 80486 in much more detail simply because little information about the 68040 was available.

## **The Intel 80486**

Contained in the 80486 are a highly optimized integer unit compatible with the 80386, an FPU compatible with the 80387, a complete virtual memory management and protection system, 8K bytes of unified program and data

cache, bus snooping and other multiprocessor support hooks, and several minor additions to the family architecture and instruction set (see figure 1). The die measures 619 by 414 mils using 1-micron high-speed CMOS technology, and it contains 1.18 million transistors, edging out the short-lived record of 1 million in the 80860.

*continued*

Intel claims that performance of the 80486 at 25 MHz will be about 37,000 Dhrystones, 6.1 million Whetstones (double-precision), or performance relative to the VAX 11/780 of about 15 to 20 VAX MIPS. This places the microprocessor squarely in competition with many RISC chips. Samples of 25-MHz chips have already been distributed, and Intel promises 33-MHz and 40-MHz versions to follow in 1990.

The 80486 implements essentially the same instruction set, memory organization, programming model, process-management facilities, and so forth as the original 80386, although the 80486 significantly outperforms its predecessors. Intel made no significant changes to the 80386 architecture except for six new instructions required for cache support and multiprocessing functions.

The 80486 appears to have been designed with four key objectives:

- Remain 100 percent software-compatible with existing 80x86 processors;
- Improve the performance of existing programs by 2 to 4 times;
- Add hardware and software facilities to support multiprocessing applications; and
- Increase the level of integration for PC-class systems.

Why didn't Intel reopen the architecture to add a slew of new instructions or to revise the programming model? Because the plan for the 80486 is to cement the 80386 family's domination of the personal computer industry. By retaining the same programming model for the 80386 and 80486 CPUs, Intel can promise third-party software developers a consistent programming environment on computation engines spanning a wide price/performance range. Intel hopes that the new product announcements will ensure that all future high-end PC software will be targeted to the 80386/80486 family, relegate the 80286 and its predecessors to lower status, and shut out the various "upstart" RISC builders.

### Meeting Performance Goals

The 80486's claimed performance enhancement of 2 to 4 times that of the 80386 results from several factors. The fully redesigned integer unit (IU) and on-chip cache reduce the average number of clock cycles per instruction by a factor of about 2.5. The on-chip FPU executes floating-point instructions about three times faster than the 80386/80387 combination, largely because data transfers between the IU and FPU are more efficient. And while the initial device clock

speed is 25 MHz, the 80486 is designed to scale to clock rates higher than those that the 80386 can achieve.

The instruction execution unit is designed to process loads, stores, and simple integer operations (i.e., those present in most RISC architectures) in as few clock cycles as practical. Less commonly encountered operations, such as multiplication, division, and process-context switches, received less design attention and require essentially the same number of clock cycles as—and occasionally more than—they do on an 80386.

If cache alignment and system timing conditions are propitious, data loads, stores, and simple register-to-register arithmetic operations do indeed complete in a single clock cycle (see table 1). There are no load-delay slots; the instruction immediately following a load can use the newly loaded data with no pipeline stall. No RISC machine has yet achieved this feat.

Arithmetic operations that implicitly reference memory-based variables need an extra clock cycle to retrieve data from the cache; operations that store computed results back in memory generally take three clock cycles total, as would a simple RISC load/operate/store instruction

*continued*

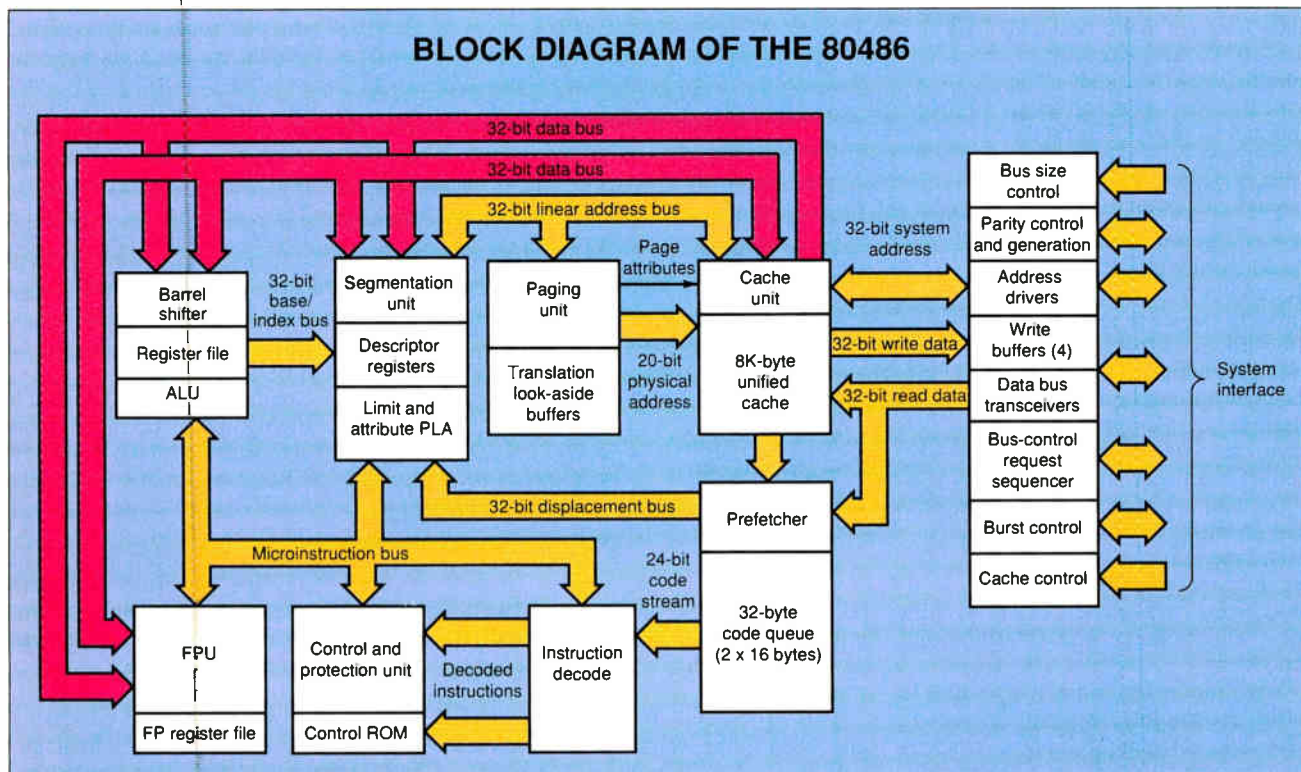

Figure 1: The 80486 chip uses 1-micron high-speed CMOS technology and contains 1.18 million transistors. Its performance relative to a VAX 11/780 will lie between 15 and 20 VAX MIPS.



# Cure Hayes fever.



**2400etc/e**

**V.42 compliant**

## Get fast relief from high prices with AT1's high-performance, error-free modem for a fraction of the price.

See us at Booth H8224  
**COMDEX/Fall '89**  
November 13-17, 1989  
Las Vegas Hilton Hotel  
Las Vegas, Nevada



Allergic to high modem prices? Here's news that will clear your head, not your budget.

AT1® Technologies' 2400etc/e® external modem\* meets the competition feature for feature...and then some! Remarkably, it costs just a fraction of the price.

Relief is fast. With MNP® level 5 data compression, the 2400etc/e's throughput speed exceeds 4800bps, thereby lowering transmission costs.

The 2400etc/e complies with the CCITT V.42 error-control standard, including LAP-M and MNP, for 100% error-

free data transfer. As well as offering synchronous operation, it's fully compatible with the standard and extended Hayes® 'AT' command sets. Plus, AT1's easy-set front panel controls provide convenient access to frequently used commands.

Don't suffer from high prices. The AT1 2400etc/e external modem cures Hayes fever for only **\$299.\*\*** And that's nothing to sneeze at.

You'll be relieved to know that AT1 also offers a high-performance internal modem, the 2400etc/i, at an equally non-allergic price. Only **\$239.\*\***

For more information, contact your supplier or

AT1 Technologies Inc.  
3761 Victoria Park Avenue  
Scarborough, Ontario  
Canada M1W 3S2  
Tel: (416) 756-0718  
Fax: (416) 756-0720



**TECHNOLOGIES INC.**  
*Technology you can Trust.*

\*Conforms to CCITT V.22, V.22bis, Bell 103 and Bell 212A standards. ©AT1 and 2400etc are registered trademarks of AT1 Technologies Inc.; Hayes is a registered trademark of Hayes Microcomputer Products, Inc.; MNP is a registered trademark of Microcom, Inc. \*\*Manufacturer's suggested retail price.

Circle 43 on Reader Service Card

World Radio History

**Table 1:** *If cache alignment and system timing conditions are just right, data loads, stores, and simple register-to-register arithmetic operations really do complete in one clock cycle on the 80486. There are no load delays; the instruction immediately following a load can use the new data immediately. (N/A = not applicable.)*

**INSTRUCTION EXECUTION TIME COMPARISON**

Instruction	Optimum number of clock cycles		
	8088/8087	80386/80387	80486
Register-to-register add	3	2	1
Memory load (16-bit)	21	2	1
Memory store (16-bit)	22	4	1
Memory-to-register add (16-bit)	22	6	2
Register-to-memory add (16-bit)	33	7	3
Integer multiply (16-bit; min.-max.)	128-154	12-25	13-26
Unconditional jump	15	8	3
Branch (taken/not taken)	16/4	8/3	3/1
Call	23	8	3
Return	20	11	5
Enter level-1 procedure	N/A	12	17
Floating-point load (64-bit)	87	25	3
Floating-point add (80-bit)	70-100	23-31	8-20
Floating-point multiply (80-bit)	130-145	29-57	16
Floating-point divide (80-bit)	193-208	88	73

sequence. The penalty on cache misses is held to two clock cycles, assuming zero-wait-state external memory.

**Instruction Pipelining**

Achieving this level of performance required a complex five-stage instruction-execution pipeline. The instruction fetch and alignment stage is part of a semi-autonomous prefetch unit. Instructions in the cache are retrieved 16 bytes at a time into a 32-byte instruction-prefetch queue. Instruction fields can be extracted from the queue as needed, since instructions range from 1 to 11 bytes long, not counting override prefixes.

Decoding is performed in two stages. The first stage classifies the instruction, selects the microprogram ROM entry point, and determines whether a memory reference is needed. Operand address information (if relevant) is dispatched to a separate address-calculation unit.

The op-code bits are dispatched to a second-level decoder and microcode ROM, which expands the macroinstruction into one or more fully decoded microinstructions. The ALU executes the expanded microinstructions in the fourth pipeline stage, and the fifth stage stores the computed values back to the register file. If the instruction requires a memory update, it needs an extra clock cycle to transfer the destination address and data to the data cache or bus interface logic.

The first decode stage detects any branch instructions and initiates a speculative prefetch of the destination op code. The branch op code isn't interpreted until the execution stage, so a two-clock-cycle pipeline delay occurs when a branch is taken. If a conditional branch is not taken, instruction execution continues from the original prefetch point, incurring no additional delay.

To further enhance performance, the 80486 contains an intricate system of ALU and register-file bypass gates. Hard-wired comparators detect whether either of an instruction's source operands comes from a register that the preceding instruction has modified or loaded. If so, the ALU output bus or register-file input bus is routed directly to the appropriate ALU input. This eliminates the clock cycle that moving the data through the register file would otherwise have consumed. (Many RISC designs also use this same technique.)

Unlike RISC processors such as the 88000, the 80486 doesn't implement register scoreboarding. When conditions aren't right for immediate instruction completion, the entire ALU pipeline stalls. Existing 80x86 programs tend to use each memory operand immediately after it's loaded or retrieve it as part of the instruction it's used in. In such cases, register scoreboarding would simply stall the ensuing instruction anyway.

The 80486 also doesn't use branch delay slots or conditional-branch prediction clues. The existing 80x86 software base doesn't use these techniques either, since neither one had entered microprocessor-design methodology 12 years ago when the 8086 architecture was defined.

**Cache Characteristics**

The on-chip cache is fundamental to achieving the high performance level of the 80486. Although the cache is considerably smaller than the 32K-byte external caches built with the 82385 in many 80386-based PCs, it's considerably more sophisticated. Its line size is 16 bytes, rather than 4 bytes, and its organization is four-way set associative, not two-way. Wide buses from the cache let the instruction prefetcher grab blocks of code 16 bytes at a time. Cacheable memory reads always fill an entire cache line, using an optimized four-word burst transfer.

In contrast to most processors with on-chip caches, the 80486 cache is unified to hold both code and data. This generally provides more efficient cache utilization than would, for example, separate 4K-byte code and data caches. It also solves problems that might otherwise arise in executing application programs that include self-modifying code, a questionable programming technique that is used by some significant DOS software. Cache addresses are physically mapped.

The most-often cited disadvantage of a unified cache design is that code and data fetches can collide, stalling instruction execution. The 80486 prefetch system avoids this hazard in two ways. Prefetching instructions 16 bytes at a time reduces the frequency of collisions; and, when collisions do occur, the data request is serviced first. The execution unit can generally keep busy finishing instructions already in the prefetch queue. (For more details on the inner workings of the 80486's cache, see the text box "Caching In" on page 328.)

**Cache Effects on Bus Operation**

The 80486 is the first microprocessor to include an on-chip cache with complete bus-snooping logic. The inclusion of these functions causes a considerable change in the nature of the memory interface, and the 80486 bus structure is thus quite different from that of the 80386.

The inclusion of caches on any microprocessor leads to a curious reversal in the nature of the traffic on the external bus. In noncached systems, most of the activity on the external bus involves pro-

*continued*



# C THE LIMIT!

MicroWay is your best source for the software and hardware you need to get true 32-bit performance from your 386. Our NDP C compiler takes the original C concept of writing lower level code with a higher level language to the limit by providing an inline assembly language interface that lets the programmer specify which register is used to store a variable. This feature makes it possible to use ports or perform interrupts or block moves inline, instead of through calls. The use of register aliased variables to control hardware reduces the size of critical code sequences by a factor of 3 to 10 and keeps the 386's pipelines full by eliminating costly calls. If you are interfacing DOS or the ROM BIOS, or writing graphics routines, a device driver, operating system kernel, or an embedded application, you owe it to yourself to try NDP C-386.

## Our Users Report:

*Milt Capsimolis of Ithaca Software in Ithaca, NY, developer of HOOPS, the highly regarded 3D, object-oriented graphics library, reports, "We ported a huge library — well over 100,000 lines — without a hitch, in less than a day! NDP C-386 was the fastest 386 compiler we used... We also liked the enormous advantage it offers through its support of the Weitek coprocessor."*

*Fred Ziegler of AspenTech in Cambridge, Mass. reports, "I ported 900,000 lines of FORTRAN source in two weeks without a single problem! AspenTech's Chemical Modeling System is in use on mainframes worldwide and is probably the largest application to ever run on an Intel processor."*

Please call (508) 746-7341 for more information.

NDP C is also the language of choice if you are combining C with FORTRAN or Pascal, are planning to use any one of four coprocessors that run with the 80386, or require the highest globally optimized code attainable. MicroWay's C, FORTRAN and Pascal compilers come with a 70 function, device-independent graphics library that automatically supports Monochrome, Hercules, CGA, EGA, and VGA adapters and makes it easy to interface memory-mapped peripherals such as digitizers or serial devices such as mice. We make it possible for you to write your own numeric exception handler and include examples written in C, FORTRAN and Pascal. Finally, our C is not only one of the easiest to use, but supports two dialects: ANSI and UNIX. In fact, our UNIX implementation is so close to the standard, that our best customer has become AT&T!

## 386 Compilers and Tools

NDP Fortran-386™, NDP C-386™, and NDP Pascal-386™ compilers generate globally optimized, mainframe quality code that runs on the 386 or 486 in protected mode under UNIX, XENIX or Phar Lap extended DOS. The compilers address 4 gigabytes of memory while supporting the 80287, 80387 and Weitek coprocessors. They all come with a library of over 70 device-independent graphics, keyboard and sound routines. Applications can mix code from all three compilers and assembly language. The DOS versions allow the user to write his own numeric error handlers and interface 386 real mode programs from protected mode. The VM versions use Phar Lap's Virtual Memory Manager to run programs which exceed the size of your system memory. NDP Fortran-386 is a full FORTRAN 77 with FORTRAN 66, BSD 4.2, DOD and VMS extensions. NDP C-386 is a full K&R C with both MS and ANSI extensions. It is 100% compatible with UNIX C and is substantially faster than the C which comes with UNIX. NDP Pascal-386 is a full ANSI/IEEE Pascal, with extensions from C and BSD 4.2 Pascal.

DOS versions (require Phar Lap Tools) . . . \$595  
 VM version (requires VMM) . . . . . \$695  
 UNIX/XENIX versions . . . . . \$795  
 Phar Lap Development Tools . . . . . \$495  
 Phar Lap Memory Manager (VMM) . . . \$295  
**NDPWindows™** — 80 functions which create, store, and recall menus and windows. Works with NDP C and drives all popular graphics adapters . . . . . Library: \$125, C Source: \$250  
**NDP HOOPS™** — An NDP port of Ithaca Software's HOOPS, this 3D object-oriented graphics library, callable from NDP C, makes it possible to develop full-featured 386 CAD packages and front ends . . . . . \$575  
**NDP Plot™** — Calcomp compatible plot package, callable from NDP Fortran. Includes drivers for popular plotters and printers. Works with MDA, CGA, EGA and VGA . . . . . \$325  
**NDP/FFT™** — The fastest running FFTs on a PC! 40 hand-coded routines that handle 1 and 2 dimensional data arrays. Includes an in core solver that spills to disk for arrays too large to fit in memory.  
 8088/87/286/287/386/387 version . . . \$250  
 Protected mode NDP version . . . . . \$250

## NEW! C++

NDP C++ is a MicroWay port of the UNIX C++ preprocessor version 1.2. It runs in protected mode on DOS, UNIX or XENIX, and is ideal for writing numerics and graphics applications. The product comes with an example of how to support complex numbers in C++ . . . . . \$495

## Parallel Processing

**Videoputer™** — The highest performance graphics card on the market. Uses a T800 and TI 34010 in conjunction with an 80 MHz BrookTree DAC . . . . . With one meg \$4495

**Monoputer™** — Includes one T800 and up to 16 meg of RAM for parallel code development. The four MWhetstones T800 makes this the ideal FORTRAN engine for cost-effective execution of your mainframe programs. \$1295

**Quadputer™** — This board for the AT or 386 can be purchased with 1 to 4 transputers and 1 or 4 meg of memory per transputer. Two or more Quadputers can be linked together to build networks of up to 100 or more transputers providing mainframe power . . . . . from \$1995

## Transputer Compilers and Applications

These parallel languages are designed for use with either a Monoputer or Quadputer.

**Logical Systems Parallel C** . . . . . \$595  
**3L Parallel C, FORTRAN, or Pascal** . . . \$895  
**ParaSoft EXPRESS Package:** — Includes transputer communications libraries, C source level debugger and system Performance Monitor . . . . . \$1500  
**COSMOS/M** — Finite element analysis. Comes bundled with a Quadputer. Performs at near supercomputer speeds . . . . . from \$5995  
**T800/NAG™** — Features a library of 268 engineering and scientific numerical algorithms. Callable from 3L Fortran . . . . . \$2750

**NDP to HALO '88 Graphics Interface** — Lets you call HALO '88 from NDP compilers . . . \$100

**387BASIC™** — Our 16-bit MS compatible compiler introduces numeric register variables to produce the fastest running 80x87 code on the market . . . . . \$99

## 386 Your AT

**386/387Turbo-AT™** — This board plugs into the 80286 socket, allowing your IBM AT to run 32-bit protected mode code written for the 80386. Includes an 80387 socket. The most cost-effective AT upgrade!  
**386/387Turbo- AT 16MHz** . . . . . \$495  
**386/387Turbo-AT 25 MHz** . . . . . \$695

## Weitek-Based Coprocessor Boards

mW1167™ and mW3167™ coprocessor boards are built at MicroWay using Weitek components. Each includes an 80387 socket.  
**mW1167-16** . . . . . \$895  
**mW1167-20** . . . . . \$1095  
**mW1167 Microchannel-16/20** . . . from \$995  
**mW3167 Microchannel-25/33** . . . from \$1795  
**3167-20** . . . . . \$995  
**3167-25** . . . . . \$1295  
**3167-33** . . . . . \$1695  
**mW3167/80387 Board** . . . . . \$1500

## Intel Coprocessors and RAM

All coprocessors include our 87Test program.  
**8087** . . . . . \$84    **8087-2** . . . . . \$120  
**80287-8** . . . \$195    **80287-10** . . . . \$220  
**80387-16** . . \$350    **80387-16SX** . . . \$310  
**80387-20** . . \$400    **80387-25** . . . \$500  
**80C287A (CMOS)** . . . . . \$280  
**287Turbo-12 (for AT compatibles)** . . . \$350  
**RAMPak™** - one meg 32-bit memory module for Compaq 386 20/25 . . . . . \$395  
**RAMPak™** - four meg module . . . . . \$1495  
 Please call for our 100 and 80 ns RAM prices.

## Multi-User Accelerators

MicroWay's AT8™ and AT16™ intelligent serial controllers run 8 to 16 terminals under UNIX or XENIX without bogging down your AT, 80386 or PS/2.    AT8: \$895    AT16: \$1295

## 12 MHz PC Accelerators

**SuperCACHE-286 12 MHz** . . . . . \$399  
**FastCACHE-286 12 MHz** . . . . . \$299  
**FastCACHE-286 9 MHz** . . . . . \$199

**NUMERICS HOTLINE**  
 (508) 746-7341

**MicroWay**

**World Leader in PC Numerics**

Corporate Headquarters: P.O. Box 79, Kingston, MA 02364 USA (508) 746-7341  
 32 High St., Kingston-Upon-Thames, U.K., 01-541-5466

USA FAX 508-746-4678 Italy 02-74.90.749 Holland 40 836455 Germany 069-75-2023

## Caching In

Intel projects cache hit rates for the 80486 of 96 percent for DOS applications and 92 percent for Unix and OS/2 applications. (These estimates are from trace-driven simulations, not measurements, but are presumably close to what typical real values will be.) Thus, the number of read cycles that appear on the external bus is drastically reduced, and write cycles dominate bus activity.

When a cache miss occurs on a read cycle, the 80486 fills an entire four-word (16-byte) cache line. Thus, most memory-read cycles are four-word bursts. Single-word reads occur only for noncacheable areas and for input ports. (Accesses to the I/O address space are never cached.)

To support cache refills efficiently, the 80486 bus interface provides a special burst mode, but this is activated only when the system logic requests it. The processor indicates the start of the cache fill by asserting ADS# and providing the address of the first word. The system logic responds by asserting KEN# (cache enable) if the access is to a cacheable location. KEN# is then checked by the processor in the first cycle to determine whether or not to perform a four-word transfer.

The 80486 also provides cacheability control in the page table, but existing operating-system software doesn't support these bits. Systems designed with the 80386 and 80385 cache controller decode noncacheable regions in external hardware, and the KEN# input lets the 80486 use this same mechanism.

Figure A shows the timing for a maximum-speed burst transfer. This four-word transfer requires only five clock cycles, as compared to eight cycles for the fastest possible nonburst cache-line fill. The system logic indicates that it can perform a burst transfer by asserting BRDY# (burst ready). The processor then performs successive transfers as fast as one per clock cycle. Just as in regular transfers, wait states can be added to transfers within the burst by delaying the assertion of BRDY#.

The 80486 asserts (sets low) the BLAST# (burst last) signal during the last cycle of the burst and during nonburst (single-word) accesses to indicate to external logic that the processor isn't ready to begin a burst cycle. You can also think of BLAST# as "ready to

burst." It is high whenever the processor is ready to perform a burst transfer.

Burst transfers aren't limited only to cache-line fills, and they don't have to consist of four transfers. The 80486 will offer to perform a burst transfer (by negating BLAST#) whenever it's reading 64 bits or more of data (e.g., a 64-bit floating-point read). If the addressed device asserts BS8# or BS16#, the processor performs the required number of transfers in a single burst. For example, a cache-line fill from a 16-bit device produces a burst of eight 16-bit words.

Burst-mode transfers take advantage of the fact that both page-mode and static-column DRAMs are much faster on successive accesses within a page than on the first access. However, even successive transfers aren't fast enough with common DRAMs to keep up with the 80486's maximum rate of one transfer per clock cycle (40 ns at 25 MHz, or 30 ns at 33 MHz). The solution is to provide two interleaved memory banks. Thus, each bank needs to provide only one word every two clock cycles to maintain the maximum transfer rate.

### Snooping and Cache Coherency

Caches present a potential data-coherency problem in systems using direct memory access or multiple processors. If another processor or a DMA controller writes to a location whose contents are stored in the cache, the cache copy must be invalidated. The 80486 has logic to perform this function for the on-chip cache. To make this possible, 80486 address pins are bidirectional.

Snooping is required whenever a device other than the 80486 writes to a memory location that may be in the 80486's cache. When this occurs, the system logic must generate a cache-invalidation cycle (see figure B). System logic first asserts AHOLD (address hold) to the 80486, which disables its address outputs on the next clock cycle. This differs from a normal HOLD request in that only the address bus is disabled and the request is not delayed until completion of the current bus cycle. The system logic then drives the address on the 80486's address pins and asserts EADS# (external address). The 80486 compares the supplied address to the cache tags and, if there's a match, invalidates that cache line.

Normal data bus activity can continue while AHOLD is asserted. In figure B, RDY# is asserted and a word of data is read into the processor in the first cycle of the invalidate transaction.

BREQ (bus request) is an output from the 80486 that's asserted whenever the 80486 is ready to perform a bus transaction. BREQ can be used in multiprocessor systems to control access to the system bus.

Since cache-invalidate cycles require access to the cache tags, they can interfere with the processor's access to the cache. The 80486 reads code from the cache 16 bytes at a time, and these 16 bytes are fed into a 32-byte prefetch queue, so code fetches from the cache are relatively infrequent. But if the 80486 must perform a data access to the cache (or must fetch code because the prefetch queue is empty) in the same clock cycle as the invalidate request, the CPU stalls for one or more clock cycles.

In a multiprocessor system, this stalling can cause a significant degradation in performance. To minimize the degradation, you can use external logic to identify shared-memory areas and inhibit snooping on all but these areas. Second-level caches also reduce the degradation from snooping.

### Second-Level Cache Support

A cache-hit rate of 92 percent may seem very good. But if the time to process a miss is very long, the misses can significantly reduce performance. For a given-speed main memory, the miss penalty (in clock cycles) increases as the processor's clock rate increases. Thus, the performance loss due to cache misses is lowest for 25-MHz systems.

Faster 80486 systems, operating at 33 MHz and eventually at 40 MHz and up, are likely to use external second-level caches, which are typically much larger than first-level (on-chip) caches. The majority of misses in the first-level cache will hit in the second-level cache, keeping the penalty for such misses to a minimum. Only when a miss occurs in the second-level cache will the 80486 need to access main memory.

The 80486 provides two signals to support a second-level cache: PWT (page write-through) and PCD (page-cache disable). These signals are copies of the corresponding bits in the page



table and allow the operating system to control cacheability on a page-by-page basis. If PCD is set, the internal cache is disabled, and a second-level cache must be disabled as well. The PWT bit has no effect on the internal cache because it's always write-through. It's provided to selectively force write-through operation on an external write-back cache.

### Cache-Support Functions

Minor changes to the 80386 architecture were made to support the cache facilities. Two reserved bits of each memory-page-table entry were redefined to control cacheability characteristics on a per-page basis. When the PCD bit for a page is cleared, internal caching of data from that page is allowed. If the bit is set, internal caching is disabled. On each external memory access, the states of the PCD and PWT bits for the referenced page are copied to external pins. Off-chip logic can monitor these pins to control the write-back policy of an external second-level cache. The internal cache ignores PWT since all writes are write-through.

Two new input pins control internal cache operation. When a cache miss occurs, the 80486 tries to fetch the required data from external memory. As the data is returned, the chip tests the KEN# pin. If KEN# is negated on the first transfer cycle, the value fetched bypasses the on-chip cache and is processed directly, regardless of the state of the PCD bit. If KEN# is asserted, the memory cycle is transformed into a four-word burst transfer to fill the cache line. Asserting the FLUSH# input pin invalidates all internal cache tags.

The cache controller implements streaming and wraparound burst transfers for instructions and data. The first memory word returned contains the value needed by the unit that initiated the transfer; this value is passed to and digested by the requesting unit as soon as it arrives. The 80486 retrieves ensuing words in an order that ensures optimum use of 64-bit-wide interleaved memory systems, and it stores them temporarily into a four-word staging register. If external logic indicates that all four words fetched are cacheable, the cache is updated. Otherwise, the holding register is abandoned without affecting the cache.

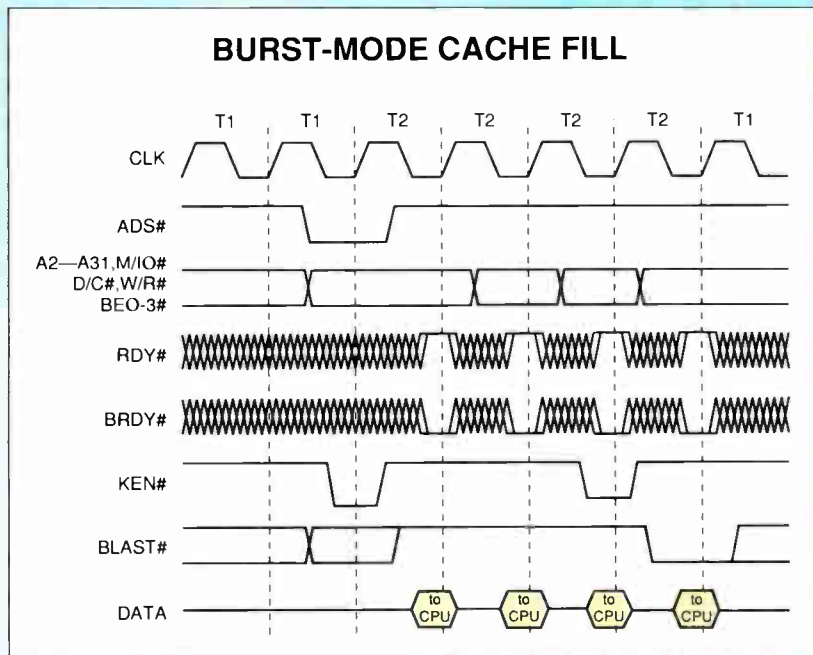

**Figure A:** The timing for a maximum-speed burst transfer. This four-word transfer requires only five clock cycles; the fastest possible nonburst cache-line fill requires eight cycles.

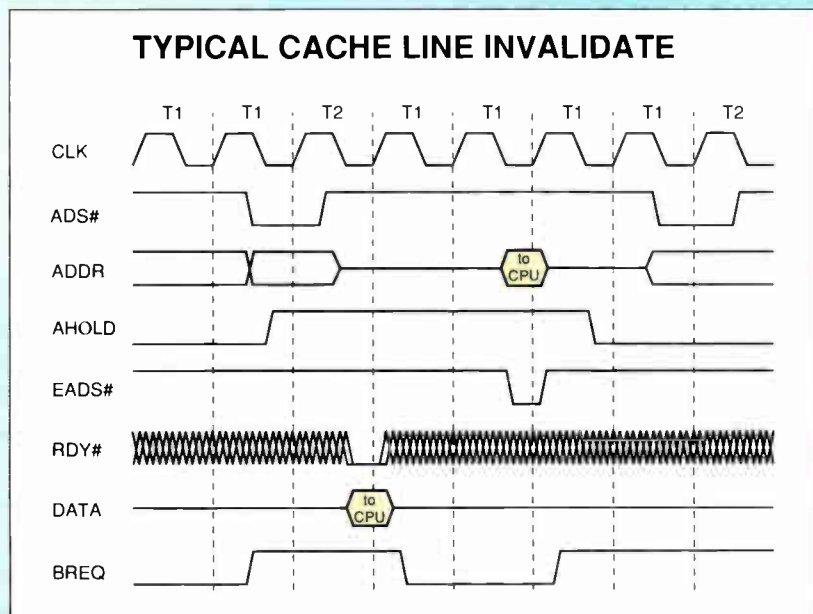

**Figure B:** System logic first asserts AHOLD (address hold); then the 80486 disables its address outputs on the next clock cycle. System logic then drives the address on the 80486's address pins and asserts EADS# (external address). If the supplied address matches the cache tags, the 80486 invalidates that cache line.

You could buy a new  
**DELL** SYSTEM **210** with  
512K of RAM  
20 Mbyte Hard Drive  
12.5 MHz Processor Speed

**\$1699<sup>00</sup>**



**OR Northgate's™ New 212**





# Microstation<sup>TM</sup> with...

How can Northgate afford to offer a 286/12 with 32MB hard drive and one full megabyte of RAM when Dell's newest Series 210 system, for the same money doesn't match up?

Maybe it's the high cost of color advertising. We use two colors and pass the savings on to our customers. Would you rather get more computer for the money...or be entertained with color pictures?

**Here's a fresh idea...** Make Northgate and Dell's money-back guarantee program meaningful. Order from both companies.

**30 days later send back the loser.** Or keep life simple and place your order with Northgate. Odds are it's the one you'll keep anyway.



*"We hear you!"* Northgate Computer Systems, Inc.  
13705 First Avenue North  
Plymouth, Minnesota 55441

Phone Northgate for full details and pricing

## 800-548-1993

Canada Toll Free Order Hotline: 800-338-8383



**FINANCING:** Use the Northgate "Big N" revolving credit card instead of tying up Visa or MC credit. Millions in financing available, easy to qualify. OR...Lease Northgate with up to five-year terms. Ideal when cash flow is important. Phone for details.

Northgate, 212 Microstation, and OMNIKEY/102 are registered trademarks of Northgate Computer Systems, Inc. ©1989.

©1989, Northgate, OMNIKEY/102, OmniKey PLUS, and the Northgate 'N' logo are trademarks of Northgate Computer Systems, Inc. All other product and brand names are trademarks and registered trademarks of their respective companies.

Prices and specifications are subject to change without notice. Northgate reserves the right to substitute components of equal or greater quality or performance. All items subject to availability.

Northgate offers flexible purchase plans including a lease program to fit your individual financing needs.

P.S. Ask about OmniKey PLUS, the new Northgate Keyboard designed the way you want!

1 Full Megabyte RAM  
**100% GREATER!**

32 Mbyte Hard Drive  
**50% LARGER!**

12 MHz Processor Speed

# \$1699<sup>00</sup>

### BUYER'S SCORE SHEET.

Read the Specs. Check the Leader.  
Total the winning checks and make your decision.

Standard Features	DELL	✓	NORTHGATE	✓
Processor	12.5 MHz 80286		12 MHz 80286	
Memory	512K		One Megabyte	
Video Interface	16 Bit Built-In (Factory Fixable) Only		16 Bit Add-on (On-Site Fixable)	
Display	12" VGA Mono .31 DP		12" VGA Mono .31 DP	
Floppy Drive	One - 1.2 or 1.44		None - 1.2 or 1.44	
Std. Hard Drive Capacity	20 Mbyte		32 Mbyte RLL	
Hard Drive Type	IDE Built-In		Can use - RLL, MFM, IDE, ESDI	
I/O Capabilities	2 Ser., 1 PP		2 Ser., 1 PP	
Keyboard	"Mushy Touch" 101		Famous OmniKey/102	
Software	Diagnostic		On-Line Help, MS-DOS	
Space Saver Case	15"W, 15"L, 4"H		14.5"W, 16.5"L, 5.5"H	
Moneyback Period	30 Days		30 Days	
Warranty	1 Yr. Parts & Labor		1 Yr. Parts & Labor	
Phone Tech Support	Unlimited, Toll Free		Unlimited, Toll Free	
Hours Open - Sales	Standard Daytime, Eve		24 Hrs. All Day Every Day - Effective 9/1/89	
Hours Open - Tech	Standard Daytime, Eve		24 Hrs. All Day Every Day - Effective 9/1/89	
Total	\$1,699		\$1,699	
SCORE	DELL		NORTHGATE	

And the winner is...

Call NOW!

Circle 257 on Reader Service Card

World Radio History

## Microcomputer News On-Line

In this fast paced industry, can you afford to wait a week or a month for information that may affect you today?

MicroBYTES Daily is an electronic news service covering the latest developments in the micro-computer industry. If it concerns MS DOS machines, Macintosh, Unix workstations, Amigas, Atari STs, peripherals, networks or software, you will find it in MicroBYTES.

### Fast and Easy

Read the items as they break or use the powerful search command to quickly locate your information. Best of all you can download the text and print it or use it in your favorite word processor.

Whether you are a developer, marketer, or researcher, you need reliable information and you can count on MicroBYTES. Backed by the combined resources of BYTE Magazine, BYTEweek, and BIX, MicroBYTES gives you access to our world-wide network of reporters and the integrity and experience of our editorial staff.

In your position as a leader in new technology, you cannot afford to be just one of the crowd. Get ahead with MicroBYTES.

Call now and subscribe today.

# BIX

One Phoenix Mill Lane  
Peterborough, NH 03458  
1-800-227-2983

**Table 2: The 80486 includes six new instructions not present in the 80386. The last three are new instructions to help maintain the cache state.**

#### 80486 INSTRUCTION SET ADDITIONS

Instruction	Mode	Function
BSWAP	A/S	Swaps byte order within 32-bit register; simplifies sharing of big-endian databases.
XADD	A/S	Performs atomic exchange-and-add to memory operand; retains original value.
CMPXCHG	A/S	Performs atomic compare and conditional exchange with memory-based operand.
INVD	S	Invalidates full instruction/data cache.
WBINVD	S	Invalidates cache; signals secondary cache to write back dirty cache lines.
INVLPG	S	Invalidates matching TLB entry, if present.

A = application-level software; S = system-level software; TLB=translation look-aside buffer

gram fetches, and most of the remaining data transfers are reads. A cached system satisfies most fetch and read cycles internally, so they don't appear on the bus. All 80486 writes, on the other hand, pass through to the external bus, so the majority of the bus traffic is outbound.

To decouple write operations from the performance of external memory systems, the 80486 contains four internal write buffers. If the external bus is busy, data writes simply save their data and destination addresses in the write buffer and complete in a single clock cycle. If all four buffers are in use, the instruction stalls. (The MIPS Computer Systems R3000 family has a similar facility but requires external write-buffer chips.)

As a further performance enhancement, Intel recommends that memory systems latch the write data and address information externally and implement a delayed write-memory cycle to free up the address and data buses as quickly as possible.

#### New Instructions

The 80486 includes six new instructions that are not present in the 80386 (see table 2). Three new protected-mode instructions help maintain the cache state: INVLPG (invalidate the translation look-aside buffer [TLB] entry), INVD (invalidate data cache), and WBINVD (write back and invalidate data cache). The latter two are identical from the 80486's perspective, since the on-chip cache never contains dirty data to be written back. The only difference be-

tween them is that the second form asserts an output signal to control optional external write-back caches.

Two previously reserved bits in control register 0 have been defined to globally enable the cache replacement and write-through facilities. Three new 32-bit test registers have also been added, to let the operating system test operation of the cache tag and data memory blocks.

Two new instructions support multiprocessing systems. The CMPXCHG (compare and exchange) and XADD (exchange and add) instructions perform atomic memory read/modify/write cycles and simplify the implementation of software semaphores in multiprocessing applications.

The sixth new instruction, BSWAP (byte swap), reverses the byte order of a 32-bit operand. This lets the 80486 share data structures and on-line databases more easily with big-endian processors, such as the 680x0 and IBM mainframes, in coprocessing systems and networked installations. It will also be a boon to the execution of programs written in COBOL, still the most widely used of all computer programming languages. COBOL uses big-endian data structures and binary coded decimal (BCD) strings throughout. (You can use the original 8086 XCHG instruction to reverse the order of 2-byte operands.)

#### Pipeline Operations

In most RISC microprocessors, each pipeline stage is tightly coupled to its

*continued*



# Now Northgate Gives You Credit and No Payments Until 1990\*

(Payments begin 90 days from the date your Northgate Computer System is delivered to you.)

Payments as low as \$40/month\*\*

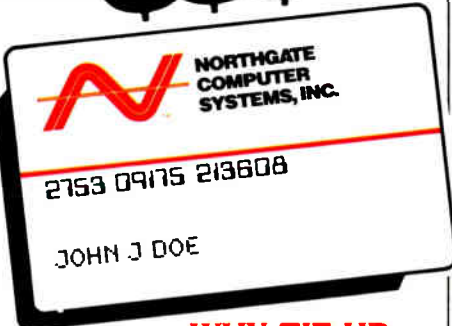

## WHY TIE UP YOUR OTHER CREDIT CARDS?

Use the Northgate, "Big N" credit card, and avoid the "payment crunch."

Simply fill out the "Big N" application, and send it in. Prompt approval assured!

Once you're approved, simply call our TOLL FREE number and one of our expert system consultants can help you design the Northgate System which will best suit your needs, and it will be shipped to you right away.

Best of all, there will be no payments due on your Northgate System for a full 90 days starting from the day you take delivery!

Northgate also offers flexible long term leasing plans too. You can choose the plan that will best fit your needs, with terms up to 5 years.

Phone Northgate Now!...

**800-548-1993**

HOURS: Monday - Friday 7 a.m. - 8 p.m. Central  
NEW EXTENDED SAT. HOURS: 8 a.m. - 4 p.m. Central  
Canada Toll Free Order Hotline: 800-338-8383

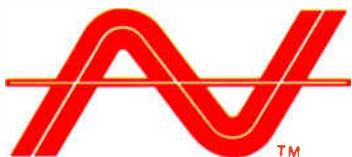

**NORTHGATE COMPUTER SYSTEMS, INC.**  
13705 First Avenue North, Plymouth, Minnesota 55441

### BIG 'N' REQUEST FOR CREDIT

#### NOTICE TO WISCONSIN APPLICANTS

You must disclose your marital status

- married
- unmarried
- legally separated

A married person may apply for individual credit. I am applying for (please check appropriate box):

- JOINT CREDIT** with another person. Complete entire application.
- INDIVIDUAL CREDIT** but rely on income or assets of another person as a basis for repaying the credit requested. Complete entire application.
- INDIVIDUAL CREDIT**. Complete sections "a" and "b" only.

Please complete all appropriate sections, providing at least two year's residence and employment history. This will enable your application to be processed as quickly as possible. If you are self-employed, please be sure to complete section "D" on back.

Applicants must be 18 years of age or older.

<b>a. Your Personal Information</b>										Requested Line of Credit \$ _____					
Your Name: First			Initial		Last			Date of Birth: Mo. Day Yr.		Social Security Number:					
Present Address: Street		Apt. #		City		State		Zip		Home Phone ( )					
Date of Residence: Month		Year		Monthly Payment: \$				Buy		Rent Other					
Previous Address:		Date of Residence: From		To		Gross \$		Net \$							
Your Employer: (if self-employed, see rear panel.)										Date of Employment: Mo. Yr.		Position:		Monthly Income: Gross \$ Net \$	
Employer's Address: Street			City		State		Business Phone: ( )								
Previous Employer:			Address:			Dates of Employment: From			To						
Income from alimony, child support or separate maintenance payments need not be disclosed if you do not wish to have it considered as a basis for repaying this obligation			Other Income:			I have received since: (Date)		Monthly Income: Gross \$		Net \$					
Name and Address of Nearest Relative Not Living With You:										Relationship					

<b>b. Credit Information</b>										Include joint applicant's information, if joint account requested.	
Bank Account:		Bank Name				Address				<input type="checkbox"/> Checking <input type="checkbox"/> Savings	
Bank Account:										<input type="checkbox"/> Checking <input type="checkbox"/> Savings	
Bank Loan Reference:						Payment		Balance			
Bank Card Reference: <input type="checkbox"/> VISA		Other Credit Card Reference									
Other Credit Card Reference:		Account No.		Expires:							
Driver's License No.		State:				Expires:					

<b>c. Joint Applicant's Personal Information</b>										*If you are a married Wisconsin applicant, you must provide your spouse's information below, even though your spouse may not be signing this contract.	
Joint Applicant's Name: First			Initial		Last			Date of Birth: Mo. Day Yr.		Social Security Number:	
Address: Street		Apt. #		City		State		Zip		Date of Residence: Mo. Yr. Home Phone ( )	
Employer:			Date of Employment: Mo. Yr.		Position:		Monthly Income: Gross \$		Net \$		
Employer's Address: Street			City		State		Business Phone: ( )				

<b>d. Self-Employed Information</b>										Complete this section only if you are self employed	
Business Name			Proprietorship		Corporation		Partnership				
Business Address			Business Telephone ( )								
Description of Business			Your Position		In Business Since						
Your annual income from business:			Business' annual income (gross)		(net)						
You must provide at least one of the following:											
1. Business Name		Telephone ( )		Personal Banker's Name							
2. Accountant's Name		Telephone ( )									
3. Financial statement on business attached.										BY1189	

**Complete this application and mail to Northgate today!**

\* Interest will accrue during deferred period. 1.5% per month. 18% APR.  
\*\* Based on purchase price of \$1,299.00 on the "Big N" revolving charge. Prices subject to change without notice. Offer not valid for APO or FPO customers.

©1989 Northgate. OMNIKEY/102. OmniKey PLUS. and the Northgate 'N' logo are trademarks of Northgate Computer Systems, Inc. All other product and brand names are trademarks and registered trademarks of their respective companies.

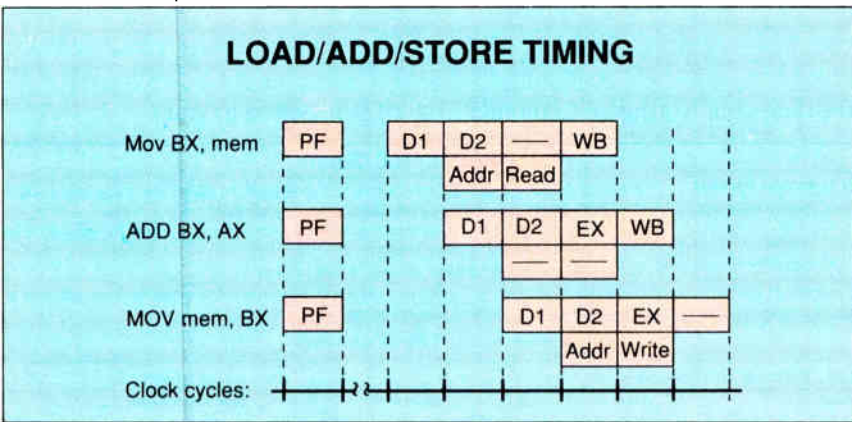

**Figure 2:** The pipeline stages for a series of three single-cycle instructions. The first is a simple load from memory and assumes a cache hit; the boxes below the D2 and EX pipeline stages show the actions of the EU and cache logic during each clock cycle. The second instruction performs a register-to-register add, using the just-loaded data, and the third stores the result back to the same memory location. Note that all three instructions are prefetched together, and that each spends a single clock cycle in each of the other pipeline stages.

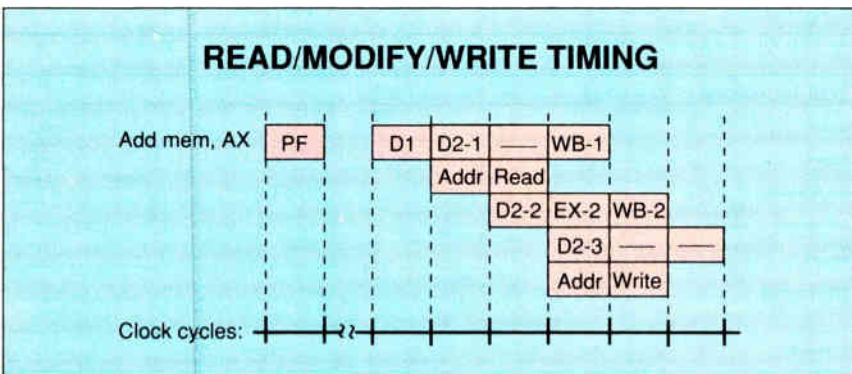

**Figure 3:** A register-to-memory add instruction equivalent to the sequence in figure 2. While this form takes the same number of clock cycles to complete, it requires 4 instruction bytes instead of 10 and doesn't corrupt a temporary register.

neighbors. With few exceptions, each instruction spends exactly one clock cycle in each stage. So in a system with a four-stage pipeline, most instructions complete in four clock cycles total. One instruction enters and another instruction exits the pipeline during each clock cycle.

Exceptional conditions cause the entire pipeline to stall until the condition is corrected. The simplified nature of a RISC instruction set and the uniform instruction encoding that this allows are what make it possible to overlap instruction execution so efficiently. The difficulty of fitting complex instructions into a highly regular pipeline has been a key justification for removing certain instructions from traditional RISC architectures.

The 80486 design extends the concept

of pipelining in several ways. For one thing, the main execution unit (EU) pipeline expands to five stages: prefetch (PF), two decode stages (D1 and D2), execution (EX), and register-file write-back (WB). For another, the simple lock-step progression of instructions through a typical RISC pipeline has been made far less restrictive. "Slip-joints" between pipeline stages can in some cases let ensuing stages advance while blocking earlier stages.

The PF stage typically retrieves four or more instructions at a time, several clock cycles before any of them begin executing. While single-cycle instructions pass through the pipeline much as they would through conventional RISC designs, more complex instructions can consume a varying number of additional clock cycles in each stage. Interstage in-

terlocks prevent each stage from advancing unless ensuing stages will be ready to absorb the resulting data when it arrives.

Furthermore, the 80486 operates a second, two-stage data retrieval pipeline in parallel with the decode and execution stages. The data pipeline contains dedicated logic needed to compute virtual and physical memory addresses, access the cache, and control the external bus interface. In some ways, the data pipeline is more intricate than that of the EU.

Many RISC processors have four-stage pipelines. The 80486 has a five-stage pipeline, with two decode stages. The D1 pipeline stage "cracks" the 80486 encoding scheme: When a prefetched instruction is ready to begin, D1 logic examines its op code and determines the instruction class into which it falls. For simple, single-cycle instructions, the D1 stage determines what operation the execution stage will perform later. D1 also determines the entry point within a microinstruction ROM that contains the control word for the first execution cycle. If the instruction requires a memory-address calculation, the D1 stage also retrieves the information needed to compute the address and passes it on to the segmentation unit.

The D2 stage expands each 80x86 macroinstruction into control signals for the ALU. For single-cycle macroinstructions, this is simply a function of the original op-code bits. The D2 stage also controls the computation of the more complex addressing modes.

During the EX stage of the 80486 pipeline, the ALU in the IU performs calculations appropriate to the instruction. Unlike a conventional RISC pipeline, the 80486 may take up to several dozen EX clock cycles to execute a complex macroinstruction or to manipulate complex data structures. In such cases, a conventional microcode engine controls the ALU. In other cases, such as memory loads and stores, the ALU remains idle.

Finally, the WB stage, if needed, disposes of the register data and status flags modified during the preceding EX stage. If the current instruction updates memory, the computed value is sent to the cache and to the bus-interface write buffers at the same time. If a hit occurs, the cache is updated immediately so as not to slow down the execution unit; bus-write cycles can safely be deferred until the bus becomes available later. Figure 2 shows the pipeline stages for a series of three single-cycle instructions: load, add, and store.

The 80486's nonreduced instruction set also supports a full range of opera-



tions that reference memory-based operands as their source or destination. Figure 3 shows a register-to-memory add instruction equivalent to the sequence shown in figure 2.

For optimum performance, 80486 programs should follow the same data alignment guidelines recommended for 80386 systems. Specifically, 32-bit (or smaller) data objects should reside within a single 32-bit word. If a data object isn't properly aligned, control logic immediately initiates two successive access cycles. This simplifies the cases in which the object is split between separate cache lines or when it combines cached and noncached data.

Unaligned references still work, but at the expense of three extra stall cycles as the second access is performed and mated with the first. (To optimize the execution of virtual-mode 8086 programs, unaligned 16-bit data objects that fit within a 4-byte address boundary don't incur this penalty.) If any part of a requested data object isn't present in the cache, control logic will initiate an external memory-read cycle and insert stall cycles as needed.

### Refilling the Prefetch Buffers

As sequential instruction execution proceeds, each half of the prefetch queue periodically becomes empty. Prefetch logic attempts to refill empty buffers with the next sequential instruction block. If the required instructions are in the cache, the buffer will be refilled in one clock cycle.

If the cache misses, prefetch logic requests a burst of instruction fetch cycles from external memory. In the meantime, the EU can generally keep busy for a handful of clock cycles—Intel says about eight—processing instructions that remain in the alternate prefetch buffer. External prefetches are performed in ascending order, with each word copied both to the prefetch buffer and to the cache as it's received. Thus, performance is minimally impaired, even for external prefetches.

The instruction pipeline unit monitors its own copy of the code-segment limit register. Prefetch cycles that would exceed the limit are automatically suppressed, so as not to reference nonexistent memory. Attempted branches past the end of the code segment produce limit-check errors.

### 80486 Pin Functions

Figure 4 shows the 80486 pin functions. The 32-bit address bus is implemented as 30 address bits, plus four byte enables

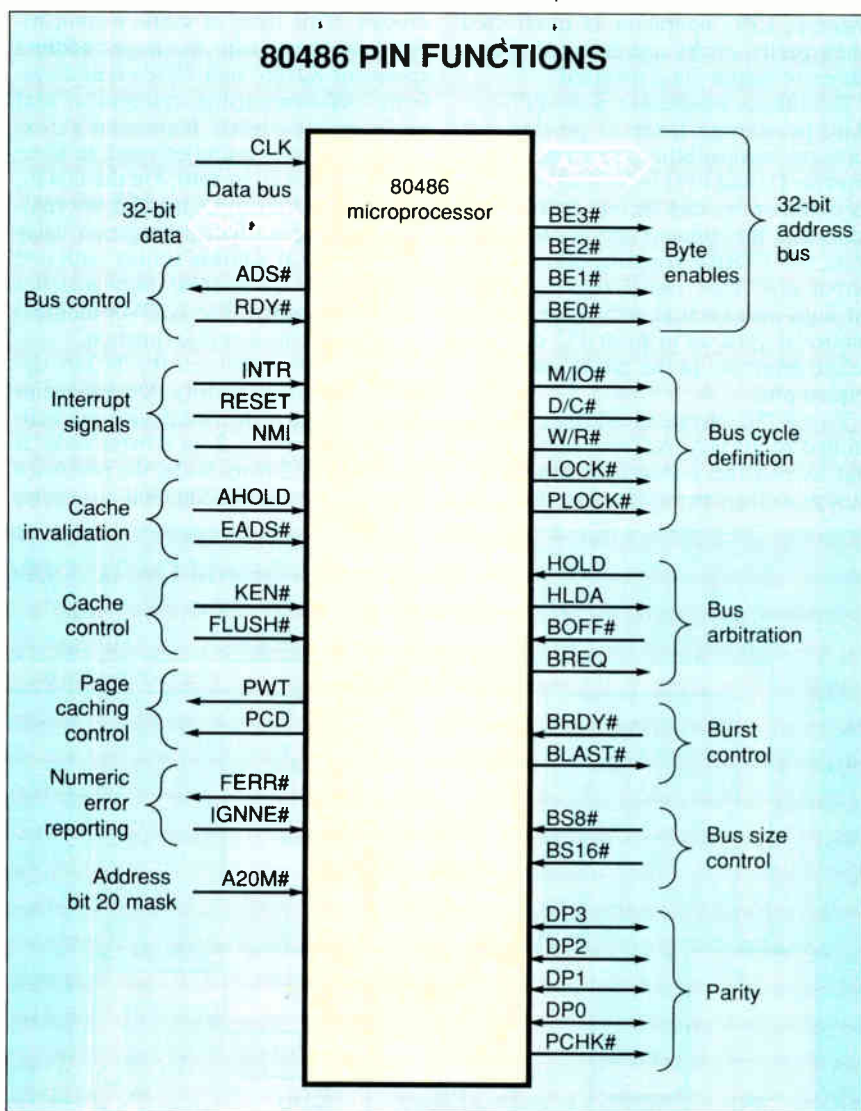

**Figure 4:** The 32-bit address bus is implemented as 30 address bits, plus four byte enables that encode the two least-significant address bits and the transfer width. Many of the control signals and inputs are similar to their 80386 counterparts.

that encode the two least-significant address bits and the transfer width. Many of the control signals, including M/IO# (memory/IO), D/C# (data/control), W/R# (write/read), RDY# (ready), LOCK#, HOLD, and HLDA (hold acknowledge) are similar to their 80386 counterparts, as are the RESET, NMI, and INTR inputs. The 80386 provides dynamic bus sizing for 16-bit devices via the BS16# (bus size 16 bits) signal; the 80486 adds a BS8# (bus size 8 bits) signal as well, to support byte-wide devices. The remainder of the signals represent new features in the 80486.

Intel processors have historically required an external clock that is two or more times faster than the processor's in-

ternal clock. The 80486 implements a single-phase clock, so the internal and external clocks have the same frequency. This technique, first tested by Intel with the 80860, should simplify system design and may make it easier to meet FCC emissions standards.

### PC Integration Improvements

A number of 80486 bus-interface facilities simplify the design of IBM-style PCs and workstations. An extra pin for each byte of the data bus produces and verifies bus parity. This eliminates the need for off-chip parity logic, saving money and, more important, reducing delays in the critical timing path of external memory

*continued*

systems. CPU operation is unaffected when parity errors are detected, but a bus-error output pin is asserted.

Despite the integration of the FPU on-chip, pains were taken to provide full software compatibility. Separate inputs reset the IU and FPU individually. Floating-point errors can be reported in several ways; the simplest option simply asserts the FERR# (floating-point error) output pin. This signal can be routed through an external 8259A interrupt controller, just as in prior PC designs, before returning to the 80486 interrupt-request pin.

The 8086 physical address bus is limited to 20 bits. Address calculations that exceed the 1-megabyte limit overflow gracefully to produce low-order ad-

resses. This leads to subtle incompatibility problems with the larger address spaces of 80286- and 80386-based systems. AT-compatible systems in real mode must currently implement an external software-controlled mask to force address line A20 to zero. On the 80486, this address bit can be masked internally, removing a slight propagation delay from a critical address timing path and ensuring that the internal cache matches external memory. The A20M# (address bit 20 mask) invokes this function.

The 80486 enhances the 80386 dynamic bus-sizing facility. On any memory cycle, the addressed device can indicate whether it's 1, 2, or 4 bytes wide. If it's only 1 or 2 bytes wide, the processor immediately issues additional bus cycles

as needed to retrieve any required higher-order bytes. This lets the 80486 boot itself from a single byte-wide EPROM, simplifies peripheral interfacing, and eliminates the external state machine required to perform byte-wide transfers on the XT, AT, and Micro Channel buses.

The four parity bits, DP0 through DP3, serve as inputs on read cycles and as outputs on write cycles. If parity is incorrect on a read cycle, PCHK# (parity check) is asserted. This doesn't affect the operation of the processor in any way; systems that use parity will normally connect PCHK# to NMI. PCHK# isn't valid until the clock cycle that follows the end of the read cycle. Because of the cache operation and instruction prefetching, bus activity is quite decoupled from

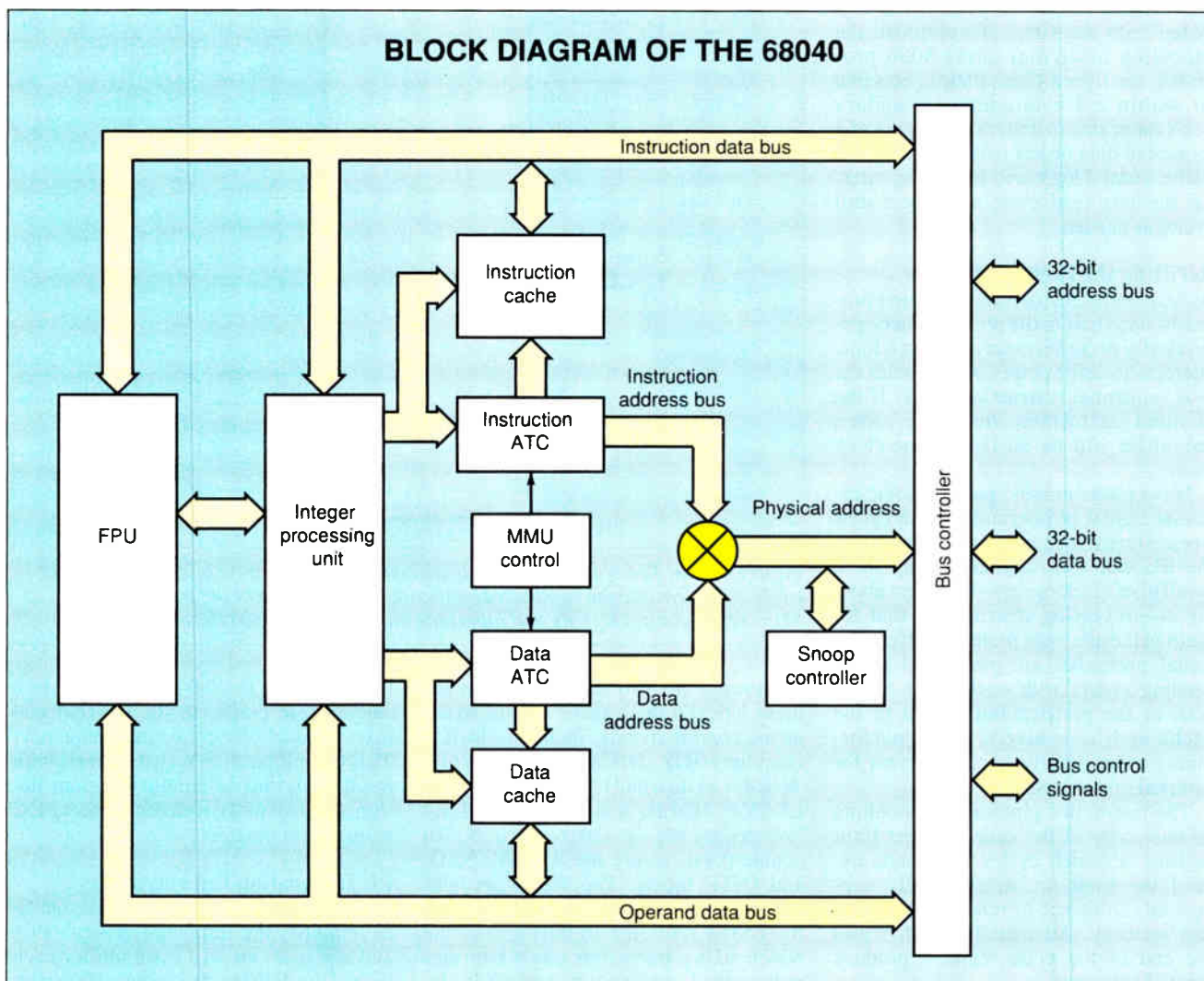

**Figure 5:** The instruction unit of the 68040 executes the same instruction set as the 68030, with perhaps a few additions to support new hardware features. The implementation is completely new, however, with a redesigned ALU and pipeline to decrease the average number of clock cycles required per instruction. The design increases the size of on-chip caches from 256 bytes to 4K bytes each and integrates the FPU onto the chip.





ly. [Editor's note: *Some capability now exists to convert DOS software to run on RISC machines with the help of a "binary compiler."* See "DOS at RISC" on page 361 for more on this subject.]

### Unix Meets DOS

The 80486 provides the best of both worlds. As a Unix engine, its performance should match that of low-end RISC-based systems. Furthermore, the 80486 will run both DOS and OS/2 soft-

ware—within a Unix window if desired—and run it fast. This ability will be very valuable in convincing DOS users to move to a Unix system. If you can have top-of-the-line DOS performance and good Unix performance at the same time, it's not nearly so hard to decide to buy a Unix box.

The 68040 will also compete for the workstation market. Although it can't run DOS applications directly, it has the benefit of having the largest existing base

of workstation applications software. While 80386 Xenix systems outnumber 68000-family Unix systems, most Xenix applications are business-oriented and not comparable to the technical workstation applications that are the 68000's strength. Nevertheless, the 68000 family's workstation application base is now being rapidly ported to RISC architectures.

The 68000 family's other key software assets, the Macintosh system software and applications, are an asset only to Apple. The future of the 68040 (and the future of the Macintosh itself) would be far brighter if Apple would license the Macintosh Toolbox. The 68040 will inherit Apple's high-end Macintosh business and a 68000-family compatibility-oriented segment of the workstation business, but these markets will not approach the size of the 80386 and 80486 systems market.

### Playing Catch-Up

Some RISC advocates have claimed that CISC is doomed, since (they say) complex instructions have irregularities and external memory dependencies that inherently limit their performance. Nevertheless, by combining a finely tuned mix of brute force (multiple wide internal data buses and a huge transistor budget) and finesse (regularized instruction pipelining and an optimized bus interface), the architects of the 80486 and the 68040 have achieved near-RISC performance levels.

It now seems clear that CISC can catch up to RISC performance. However, it's important to note that this is indeed a game of catch-up. The 68040 and the 80486 will begin volume shipments in 1990; both SPARC and MIPS chips have been shipping with comparable performance levels for nearly two years. By 1991, a new generation of RISC chips will be doubling the performance of current implementations, and CISC will have to play catch-up again (probably in 1992) with the 68050 and the 80586. ■

*Michael Slater is president of Micro-Design Resources, Inc. (Palo Alto, CA), editor and publisher of Microprocessor Report, author of Microprocessor-Based Design (Mayfield Publishing, 1987), and organizer of the annual Microprocessor Forum conference. He can be reached on BIX as "mslater."*

*John H. Wharton is technology director at Applications Research, Inc. (Sunnyvale, CA), and a contributing editor to Microprocessor Report. He can be reached on BIX c/o "editors."*

C compiler  
software simulator  
source level debugger  
macro assembler—development board  
IBM-PC MSDOS—Sun, Apollo,  
Dec UNIX—VAX VMS—Apple Macintosh

# AVOCET

68000 68010 68015 68020  
68030 68040 68050 68060  
68070 68080 68090 680100

## AVOCET SYSTEMS, INC.

The Source For Quality Embedded-System Tools

Avocet Systems, Inc., 120 Union St., P.O. Box 490, Rockport, ME 04856

In Maine, or outside U.S., call (207) 236-9055

TLX: 467210 Avocet CI / FAX: (207) 236-6713

Call today for free catalog 1-800-448-8500



# NINE REASONS TO BUY CLIPPER WITHOUT A MOMENT'S HESITATION!

The Clipper language offers two compelling reasons to adopt it as your application development standard: open architecture and .EXE file generation. Clipper 5.0 boasts even more. We think you'll be convinced before you reach number nine.

## **1** Open Architecture.

Clipper is both powerful and easy to use, with the most comprehensive command and function set available. Want more? Extend the Clipper language with user-defined functions written in Clipper, Assembler, C and other languages.

## **2** User-defined Commands.

Even more extensibility is available in Clipper 5.0. Support for user-defined commands allows you to tailor your command set to a specific business or industry.

## **3** .EXE File Generation and LAN Support.

Clipper's compiler yields stand-alone .EXE files for unrestricted distribution, requiring no LAN-PACKS™, no run-time modules and no licenses of any kind!

## **4** Break the 640K DOS Limit!

Improved memory management in Clipper 5.0, made possible by an exclusive version of Pocket Soft's .RTLink™, lets you run applications larger than 640K, without overlays!

## **5** It's Faster.

Clipper dramatically reduces development time, but accelerates program execution and large network performance beyond any system you're using now!

## **7** New, More Powerful Features.

Clipper 5.0 introduces new variable types, user-modifiable GETs and multi-dimensional arrays that can contain arrays!

## **8** New Documentation, Including an On-line Guide.

New and expanded documentation will make you immediately productive in Clipper 5.0. And you can access it all on-line through the included Guide to Clipper™ and Norton Guides™ Engine.

## **9** You Can Get It First!

Buy the current version of Clipper after June 1, 1989, register your copy, and be among the first to get Clipper 5.0—*Free!* You'll even save \$100 off the suggested retail price of Clipper 5.0.

So, don't hesitate! Give us a call for the name of your nearest authorized dealer, and make your commitment to Clipper, today.



## **6** Use What You Already Know.

Integrate existing routines from C, Assembler, Fortran, Pascal or dBASE®. They're all more powerful with Clipper!

*Clipper*®

The Application Development Standard

213/390-7923

 **Nantucket**®

Nantucket Corporation, 12555 West Jefferson Boulevard, Los Angeles, CA 90066. 213/390-7923 FAX: 213/397-5469 TELEX: 650-2574125. Nantucket, the Nantucket logo and Clipper are registered trademarks of Nantucket Corporation. Other brand and product names are used for identification purposes only and may be trademarks or registered trademarks of their respective holders. Entire contents copyright © 1989 Nantucket Corporation.

# Introducing a whole new approach to data storage and retrieval.

If you need to carry information but like to travel light, the Mitsubishi Plastics "BEE CARD" is for you. It's an IC MEMORY CARD offering convenience, versatility and economy that make slow-access cassette tapes and floppy disks obsolete.

## Features

- Convenient. Credit card size.
- Durable and economical.
- High-volume memory. From 10 times magnetic card memory to near floppy disk capacity.
- Wide range of applications. Can use it almost anywhere.

## Applications

### Commercial

- Personal computers (video games, educational and business software).
- Digital sound sources for electronic musical instruments.
- Printer and typewriter font storage.
- Electronic equipment maintenance records.

### Industrial

- FA (data logging, machinery process control, industrial robot programs).
- SA (off-line systems).

### Other

- Medical chart creation and updating.
- Electronic ID cards.

## IBM Compatibility BC Reader/Writer for IBM PC/AT/XT

- Designed to implement the IC Memory Card technology available to your IBM PC/AT/XT.
- Fast-access. Reads and writes all memory types (MASK, OTP, EEPROM, SRAM).

## For further information

(USA) MITSUBISHI INTERNATIONAL CORPORATION Palo Alto Office  
2483 East Bayshore Road, Suite 210 Embarcadero Corporate Center  
Palo Alto, CA 94303 Tel: 415-494-1545 Fax: 415-493-0318 (ATTN: JR-P)

(GERMANY) MITSUBISHI INTERNATIONAL GMBH Düsseldorf  
Tel: 0211-4397-396 Fax: 0211-4397-397

(ENGLAND) MITSUBISHI CORPORATION (UK) LIMITED  
Tel: 01-822-1712 Fax: 01-822-1713 (ATTN: JR-P)

### MITSUBISHI CORPORATION

Tokyo Tel: 03-210-3792 Fax: 03-210-3353 (ATTN: JR-P)  
Singapore Branch Tel: 321-9126 Fax: 225-6047 (ATTN: JR-P)  
Taipei Branch Tel: 2-507-3456 (ex. 205) Fax: 2-504-6264 (ATTN: JR-P)

Circle 240 on Reader Service Card

 **MITSUBISHI PLASTICS INDUSTRIES LIMITED**





# A Virtual Crowd

*Why pay money for RAM chips when virtual memory will do?*

**V**irtual memory gives you the ability to run programs that are larger than the amount of physical memory installed on your computer. First used in the Atlas computer system at the University of Manchester, England, in 1960, VM today is almost universally available on mainframes, minicomputers, and workstations.

A distinguishing feature of VM is its low profile—you need not be concerned with the details of fitting your program into memory. Contrast this with, for example, program overlays. Overlays require you to indicate explicitly which parts of the program must be in memory simultaneously, and which parts are disjoint and need not coexist. Each time a new version of the application is released, these decisions must be revisited.

With a VM system, you simply build your multimegabyte application, oblivious to the amount of memory installed on the computer. If the computer has more memory, the application runs faster; less memory, and it runs slower—but it always runs, with no extra programming required.

How is this sleight of hand accom-

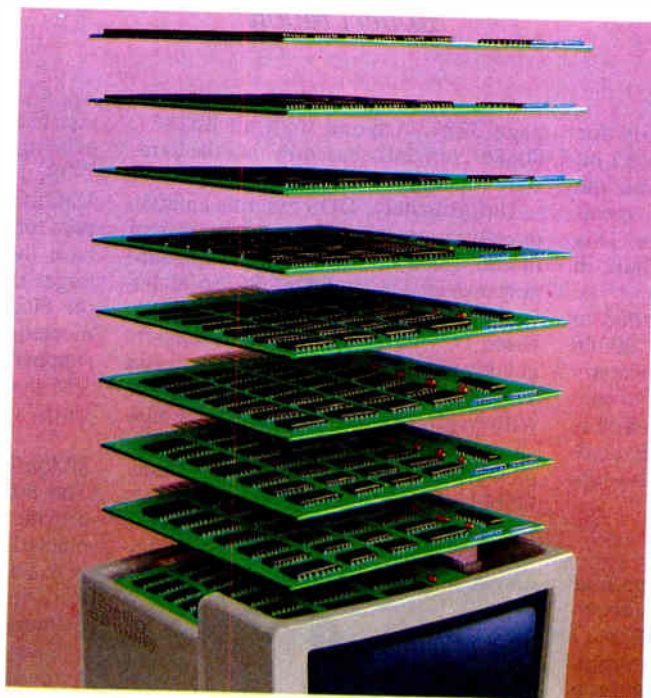

plished? At any given moment during the execution of a program, some portion of it is in physical memory, and the rest is swapped to disk. As the program executes, it continually references code and data in other parts of the program. If the referenced code or data is in memory, program execution continues uninterrupted. If the program references something that is not in memory, the operat-

ing system gets control. The referenced code or data is brought into physical memory (if necessary, causing some other part of the program to be swapped to disk); the application program continues executing, oblivious to all this activity.

To use VM, a program must be divided into pieces. Individual pieces of the program can be either in memory or swapped to disk at any given time, and the VM subsystem of the operating system must keep track of each piece. If the pieces are variable in size, they are called *segments*, and they usually relate in some way to the organization of the program (in the simplest case, the program has one code segment and one data segment). If the pieces are always the same size, they are called *pages*. In either

case, hardware assistance is required to enable the VM system to bring referenced pieces into memory without the knowledge of the application program. It's generally accepted today that paging offers performance benefits over segmentation, and most commercially available VM systems offer some form of demand-paged VM. The term *demand*

*continued*

aging means pages are brought into memory as they are referenced, as opposed to *anticipatory paging*, in which the VM system attempts to predict the pages that a program will need next.

A VM system is a clearly delineated subsystem of an operating system. The VM system allocates and frees memory, maintains the data structures necessary to perform the virtual-to-physical-address translation, and brings program pieces into memory as they are refer-

enced. VM can, of course, be implemented for both single-tasking and multitasking operating systems, and it is essentially the same in either environment. The only additional consideration required for multitasking is separate tracking of the virtual address space for each process, to implement working set management at the process level.

The following two articles discuss the details of VM implementations on 80386 and 80486 systems and on the Macin-

tosh. The first discusses how Intel's hardware has evolved to make demand-paged VM possible. The second describes how Macintosh System 7.0 implements VM while maintaining compatibility with applications written before VM was even considered for the Mac. The arrival of VM on the two most popular computing architectures signals another important advance in the capabilities of personal computers.

—Robert Mootoos

# Virtual Memory: The Next Generation

*Intel's 80386 and 80486 microprocessors  
bring demand-paged virtual memory to your desktop*

*Robert Mootoos*

**A**lthough noted primarily for their raw power, Intel's 32-bit processors also give you the ability to address more memory than your computer contains. This capability is a result of their built-in hardware support for VM.

Software support is also required to provide demand-paged VM on 80386 and 80486 machines. You can currently find VM implementations in 80386-specific versions of Unix and Xenix, and in Phar Lap Software's 386|DOS-Extender. Future versions of OS/2 will also support demand-paged VM.

## Hardware Roots

IBM based its original PC on the Intel 8088, a variant of the 8086 microprocessor. When Intel introduced the 80286, it built in hardware support for segmented VM. Thus, the 80286 has two modes of operation: real mode, in which it looks like a fast 8086 to ensure backward compatibility with DOS, and protected mode, which provides (among other things) the hardware support necessary to build a segmented VM system. With the 80386, Intel added hardware paging support and 32-bit operation. Recently, Intel introduced the 80486, which, from a software point of view, is largely a fast 80386 (see "Revenge of the CISCs" on

page 323). Anyone with an 80286-, 80386-, or 80486-based PC has the hardware capability to run VM programs.

Unfortunately, DOS remains an 8086 operating system and must run in real mode, where all the VM hardware support provided by the 80286/80386/80486 is disabled. When 80286 and then 80386-based PCs were introduced, developers quickly made versions of Xenix and Unix available, providing 80286 machines with segmented VM and 80386 machines with paged VM. OS/2 also implements VM (see the text box "VM Under OS/2" on page 344), but it is restricted to segment swapping because OS/2 is an 80286-specific operating system. 80286- and 80386-specific DOS extenders have

also been available for years. In addition to being able to run large programs under DOS, these extenders usually support VM. (OS/2 and Unix also provide support for large programs, but they do not have the ability to run DOS programs larger than 640K bytes.) As with Unix, the 80286 DOS extenders provide segmented VM, and 80386 DOS extenders support paged VM. (For more on Unix VM systems, see the text box "VM in Unix" on page 348.)

## 80386/80486 Memory Architecture

The 80386 and 80486 microprocessors provide hardware support for both segmentation and paging when the processor is executing in protected mode. As the term implies, this mode also provides memory-protection benefits.

The design outlined here uses the hardware segmentation facilities for program protection, and the paging facilities for VM. This division of labor is a common choice in a combined paged/segmented architecture.

## Segmentation

80386 and 80486 programs are divided into segments; at a minimum, a program has one code segment and one data segment. Code segments can't be modified, and data segments can't be executed.

**A**nyone  
with an 80286, 80386,  
or 80486 PC has the  
hardware capability to  
run VM programs.



This allows easy detection of a common class of programming errors. Each segment has a limit, and any attempt to access code or data beyond the segment limit is prohibited.

A program segment on the 80386 or 80486 has its own base address, segment limit (its length), and protection information (whether it is a code or data segment, whether it is read only or read/write, and so on). This information is contained in either a global descriptor table or a local descriptor table maintained by the operating system. Each entry, or *segment descriptor*, in the GDT or the LDT identifies one segment.

When a program references a memory location, it's always a location within a segment. Usually the segment is implied; that is, it's a location within the current code or data segment for that program. The 80386 and 80486 processors contain segment registers that are loaded with values—called *segment selectors*—that select a specific entry in the GDT or the LDT. The program can then reference memory as an offset within the selected segments and need only reload the segment registers when it's necessary to address a different program segment. (For programs written in a high-level language, the program segmentation and the loading of segment registers is handled entirely by the compiler, so you need not even be aware of it.)

A segment selector, plus an offset within the segment, is referred to by Intel as a *logical address*. (The logical address is called a *virtual address* on most systems because it's the address that the application program sees.) This logical address is converted by the processor's segment-translation unit into a *linear address*. The linear address is equal to the base address of the segment (obtained from the segment descriptor) added to the segment offset (see figure 1).

Because it would be expensive to read the segment descriptor in the GDT or the LDT for each memory reference, the processor caches the descriptor in an internal register whenever a segment register is loaded with a segment selector. This allows the translation operation depicted in figure 1 to be performed efficiently.

**Paging**

The 80386 and 80486 processors have 32-bit internal and external address buses. The maximum size of both virtual and physical memory is therefore 4 gigabytes. The physical memory on the system is divided up into 4K-byte pages, *continued*

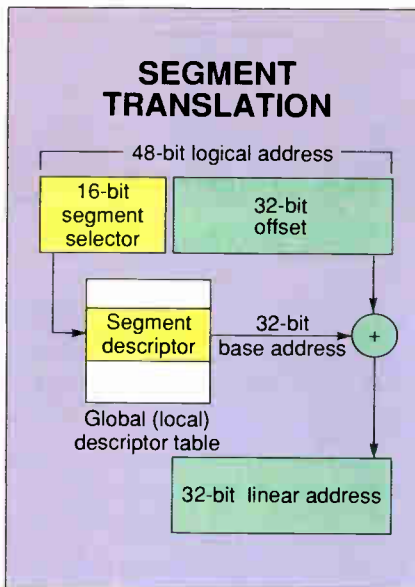

**Figure 1:** The segment selector points to the entry in the descriptor table that contains the base address of the segment. When added to the offset, this produces the linear address.

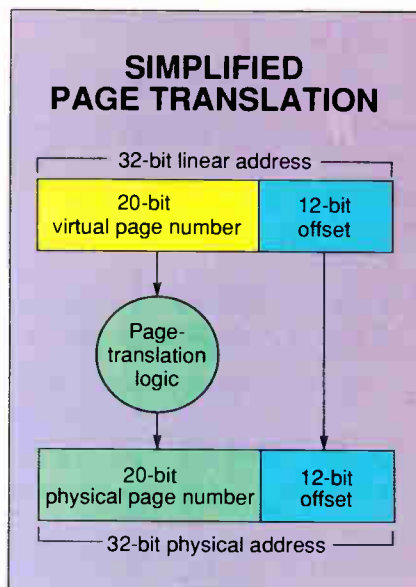

**Figure 2:** The 12-bit offset provides the range needed to address any location in a 4K-byte page.

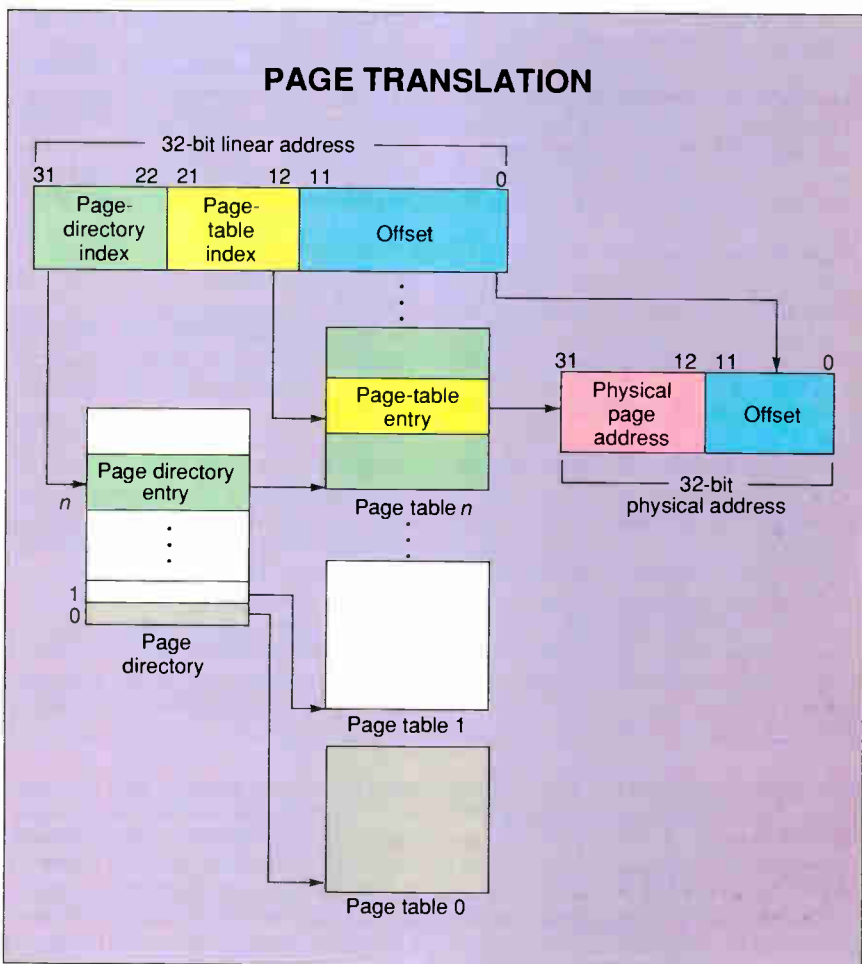

**Figure 3:** The 20-bit virtual-page number actually consists of two 10-bit fields; the page-directory index and the page-table index. The most frequently accessed page-table entries are cached by the processor to optimize the translation process.

## VM under OS/2

Julie Anderson

Because OS/2 was originally designed for the 80286, its use of virtual memory is restrained by the capabilities of the 80286 hardware. Thus, you can run one highly restricted DOS application in real mode, and multiple segmented 16-bit applications. The latter can address up to 16 megabytes of physical memory and 1 gigabyte of virtual memory. Two years after the release of OS/2 1.0, Microsoft is completing work on its 80386 version, presently called OS/2 for the 386. Microsoft expects to release the Software Development Toolkit for this product at the end of this year, with the production release following in the first half of 1990.

OS/2 for the 386 is the OS/2 everyone's been waiting for. It will support applications written to the 32-bit flat address space of the 80386 and will let multiple DOS applications execute concurrently with both 16- and 32-bit applications. OS/2 for the 386 will also use demand paging to simplify and expedite memory management and swapping.

### The 80286 Blues

Microsoft originally chose to write to the 80286 environment because of the 80286's large installed base. Although a logical decision, it required Microsoft to face some serious hardware limitations in providing compatibility for DOS applications. The 80286 architecture supports 8086 (and 8088) DOS applications in real mode only, and it is designed to run either in real mode or protected mode, but not to multitask applications running in both modes. (To switch from real to protected mode, you set the protection enable bit in the machine status word, but to switch from protected to real mode, you must reset the system.)

with pages aligned on 4K-byte address boundaries. Thus, you can think of the physical memory on the computer as an array of pages starting at physical address 0. Pages are not related in any way to the organization of the application program; instead, they are used for memory management and implementation of VM.

Actual memory pages in the computer are referred to as *physical* pages (often called *page frames*). For example, on a PC with 2 megabytes of memory, there

Faced with these design deficiencies, Microsoft built the compatibility box—where one DOS application could run in real mode—and developed a faster method for switching from protected to real mode.

Unfortunately, Microsoft had to pass on the hardware restrictions to the end user. Because most DOS applications write directly to video memory, a compatibility-box application must suspend execution when switched to the background so that its video output will not be mixed with the video output of the current foreground task. This means that communications programs cannot run in the compatibility box because they will lose interrupts when suspended in the background. Moreover, an application running in real mode can write freely to the lowest megabyte of memory, a situation that makes it impossible for the operating system to protect other applications—including itself—from corruption. It's possible for an application running in the DOS compatibility box to hang or crash the system.

### Virtual 8086 Mode

Virtual 8086 mode on the 80386 solves all these problems. OS/2 for the 386 can create multiple, 1-megabyte virtual address spaces in which DOS applications can run in protected mode while supporting real-mode-style addressing (segment:offset pairs). OS/2 for the 386 will use this mode of addressing to run multiple DOS applications concurrently with 16-bit and 32-bit protected-mode applications. Each application has its own logical copy of the lowest 1 megabyte of memory. An application running in virtual 8086 mode that writes directly to video memory can continue to execute when switched to the back-

ground because it's writing to its logical copy of video memory. Changes made to an application's logical address space won't affect either the operating system or applications, which have their own versions of the same logical memory addresses.

In addition, the 80386 quickly switches into and out of virtual 8086 mode on a task-by-task basis, depending on the value of the TM86 flag in the Task State Segment. On an interrupt, the 80386 switches out of virtual 8086 mode, meaning that device drivers can exist outside the application's address space. OS/2 for the 386 uses this feature to map out device drivers—including network software—thus leaving as much as 600K bytes for the DOS application. In contrast, OS/2 1.1 gives the DOS application only 500K bytes. Although DOS applications that reprogram the hardware (e.g., some backup utilities) are still forbidden, any program that runs under an 80386 control program like DESQview or Windows/386 should run successfully under OS/2 for the 386.

### Demand Paging

OS/2 for the 386 maps the application's logical addresses to physical memory addresses using the 80386's paging hardware, which divides the machine's physical memory into a series of 4K-byte page frames. The operating system assigns a page of virtual memory to each 4K bytes of an application's logical address space. Pages don't have to be contiguous in memory; OS/2 for the 386 keeps track of the location of an application's pages through entries in the page tables.

Demand paging, which the 80386 supports in protected mode as well as

are 512 physical pages. Pages allocated to a program are called *virtual* pages. The maximum number of both physical and virtual pages in the system is 1,048,576 pages, or 4 gigabytes of memory. (A multitasking system can support a larger system-wide virtual address space by maintaining separate page tables for each process in the system.) As a practical matter, the physical memory on a PC is much less than 4 gigabytes. While the virtual address space can be

much larger than the available physical memory, it, too, is limited—in this case by the available disk space—because virtual pages must be kept either on disk or in physical pages.

The segment-translation logic yields a 32-bit linear address. The page-translation logic translates this linear address into the physical address that the processor places on the external memory bus (see figure 2 for a simplified view of this process). The linear address contains a



virtual 8086 mode, makes memory management on the 80386 faster and simpler than on the 80286. On the 80286, OS/2 allocates memory in variable-size segments, and then must track both the physical location and the size of an application's segments. As applications are loaded, grown, shrunk, and terminated, many variable-size segments are allocated and freed. Physical memory becomes fragmented, and OS/2 may need to move segments to free up enough contiguous memory to satisfy an allocation request. When physical memory is exhausted, OS/2 chooses a segment to swap to disk. It may need to rearrange segments in the swap file to free up enough space to write the segment. Later, when an application references the swapped segment, OS/2 must again find an appropriately sized area of physical memory into which it can read the segment from the disk.

On the 80386, the 4K-byte page frame removes much of the complexity. With this fixed-size memory-allocation unit, neither physical memory nor the swap file becomes fragmented, and moving pages is never necessary. Like segments on the 80286, developers can designate memory blocks in OS/2 for the 386 as "discardable." In this case, the page is not swapped; its space is merely reused.

Working hand-in-hand with the operating system, the 80386 hardware is optimal for demand paging. The 80386 speeds page lookups by caching on-chip, in the translation lookaside buffer, which contains the page-table entries for the 32 most recently accessed pages. When an application reads or writes to a page, the 80386 sets the accessed bit in the page-table entry. This

helps the operating system determine which of the pages have been accessed recently.

On the 80386, attribute bits in page-table entries (similar to segment management on the 80286) indicate whether or not the page is present in memory and the types of accesses that are valid. To deny write access to a page, the operating system can reset the read/write attribute bit; application code is customarily marked read-only.

One additional attribute bit in the 80386 is the dirty bit. The 80386 sets this bit whenever the application writes to the page. The operating system can test this bit to determine whether or not a page should be written to disk. If the page already exists in the swap file and it hasn't changed, it can be discarded. In addition, for a page that isn't present, the operating system can use the other 31 bits of the page-table entry (all bits except the present bit) to store the disk address of the swapped page. Although it's fairly safe to assume that OS/2 for the 386 will exploit the 80386 hardware, Microsoft has not announced what use, if any, OS/2 for the 386 makes of these attribute bits.

#### Flat Address Space

OS/2 for the 386 supports the flat, or linear, address mode of the 80386, which allows an application to specify a segment selector and a 32-bit offset. In this mode, the 80386 supports 4 gigabytes of physical memory and 64 terabytes of virtual memory. Both 16-bit and 32-bit applications will run concurrently. To accomplish this, OS/2 for the 386 will add a dynamic link library (DLL) with a new set of application-programmer-interface calls. Those OS/2 API calls that reference 16-bit seg-

ment:offset addressing will be replaced with a 32-bit version. Because both APIs are provided in DLLs, an application simply loads the appropriate library to run.

Although a 16-bit application asks the operating system for memory in terms of segments, OS/2 for the 386 translates the request into the corresponding number of pages. Although their addressing schemes may be different, concurrent 16-bit and 32-bit applications can communicate with each other using the usual interprocess communications mechanisms, including shared memory; each application will simply use different API calls to reference them.

#### OS/2 for the 386

Although it's been a long wait (and it isn't over yet), OS/2 for the 386 will, by exploiting the capabilities of the 80386, address the current complaints against OS/2. More than one DOS application will run with true concurrency.

An efficient memory page-swapping technique will reduce the amount of physical memory you need to add to the system for acceptable performance. Most important, having access to the 80386's flat address space may entice developers to port applications from other unsegmented architectures, opening up the potential for a new class of OS/2 applications.

*Julie Anderson, former editor of PC Tech Journal, has an M.S. degree in computer science from Johns Hopkins University and 14 years' experience as a systems developer. She is manager of Standard Components and Tools at RoadNet Technologies (Baltimore, MD). She can be reached on BIX c/o "editors."*

12-bit offset ( $2^{12}$  equals 4096, the page size) and a 20-bit virtual-page number.

The processor looks up the virtual-page number in page tables maintained by the VM system. This process generates a 20-bit physical-page number. When concatenated with the offset, the result is the physical memory address. For example, if virtual page 8 (linear addresses from 32K to 36K) is mapped to physical page 1 (physical addresses from 4K to 8K) in the page tables, then the lin-

ear address 33K (00008400 hexadecimal) maps to physical address 5K (00001400 hexadecimal); the 20-bit virtual-page-number 8 is mapped to the 20-bit physical-page number 1.

Figure 3 shows the page-translation process in more detail. The 20-bit virtual-page number is composed of two 10-bit fields: a page-directory index and a page-table index. The VM system maintains one page directory and multiple page tables. The page directory and page

tables are 4K bytes in size, each containing 1024 32-bit entries. Each entry in the page directory contains the physical address of a page table. Each entry in a page table contains the address of a physical page. Thus, the page-translation logic uses the page-directory index to obtain the address of the appropriate page table, and it uses the page-table index to look up the address of the physical page.

The contents of a page-table entry for a

*continued*

**PAGE-TABLE ENTRY**

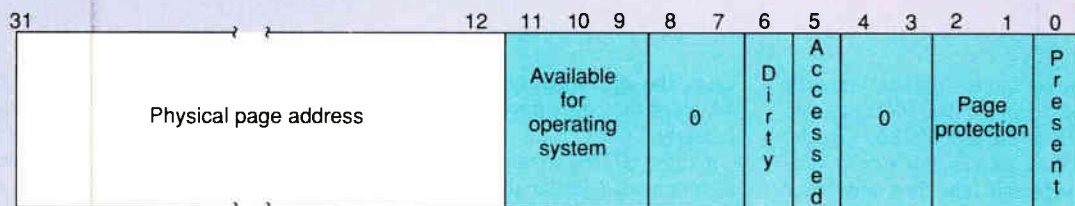

**Figure 4:** Twelve bits in the page-table entry provide information about the page to the processor and to the VM subsystem of the operating system. Four bits on the 80386 (2 on the 80486) are unused and reserved.

**VIRTUAL-PHYSICAL MAPPING**

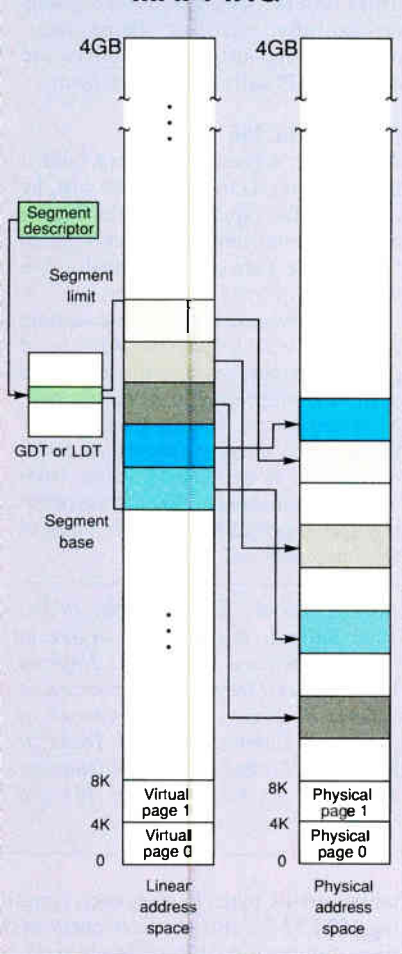

**Figure 5:** When combined, segmentation and paging result in a system that provides protection without causing memory fragmentation. Segments are used for program protection, and paging is used to map programs into physical memory in fixed-size chunks.

page present in physical memory are shown in figure 4. The 20-bit physical-page address leaves 12 bits available for additional information. Bit 0 is the present bit; it indicates whether the page is in memory or swapped to disk. For present pages, bits 1 and 2 are used for page protection; they mark a page either read only, read/write, or supervisor access only. Bit 5—the accessed bit—is set by the processor each time the page is accessed, and bit 6—the dirty bit—is set when the page is modified. The dirty bit and accessed bit are crucial for the implementation of VM. Bits 9 through 11 are available for use by the VM system, and the remaining 4 bits are reserved in the 80386 for use in future processors. Two of those 4 bits (bits 3 and 4) are used in the 80486 processor to control memory caching at the page level.

If a page is marked “not present” (the present bit is 0), the VM system can use all the other 31 bits in the page-table entry.

The page-translation process appears expensive, since it involves two memory accesses—one to the page directory and one to the appropriate page table—to obtain the address of the physical page. The 80386 or 80486 processor therefore keeps a four-way set-associative cache of recently referenced page-table entries. This cache is called the translation look-aside buffer. Since programs tend to exhibit localized referencing behavior, most page references result in a hit in the TLB. Thus, extra memory references are usually not required to obtain the needed page-table entry. Normally, software can ignore the operation of the TLB. However, VM system software must flush the TLB after making changes to the page tables to ensure no stale page-table entries remain.

The combined effects of segment translation and page translation are shown in figure 5, which demonstrates

one possible mapping for a segment five pages (20K bytes) in size. In this example, the segment base address is aligned on a page boundary, and the segment spans exactly five virtual pages. Note that the segment is contiguous in the linear address space; this is mandatory. The five virtual pages are mapped by the page-translation logic to five noncontiguous physical pages.

**VM Management**

The job of a VM system is to allocate and free VM for use by programs, write virtual pages to a swap file on the disk if there are too many virtual pages to fit in physical memory, and bring pages back into memory as page faults occur, so the program can continue to execute. This is primarily a bookkeeping job. Part of this job requires the use of an algorithm that decides which page is to be replaced (swapped to disk) when a page fault occurs and a physical page is required to bring the referenced virtual page into memory. The choice of this algorithm can have considerable impact on the performance of an application program.

The VM system must maintain the data structures (the GDT, the LDT, and the page tables) so the processor can do address translation. It must also keep any additional information required to perform the rest of its tasks.

**VM Data Structures**

The VM system must keep track of free (unused) physical memory. Since pages are a fixed size and need not be contiguous (because contiguity is preserved in the linear address space, not the physical address space), this is a trivial task. A one-way linked list of free physical pages is all that is necessary.

When a segment is allocated or extended, it requires a contiguous region in the 4-gigabyte linear address space (see figure 5). The VM system must therefore



keep track of allocated and free regions in the linear address space. This is most efficiently done by means of a bit map, one bit for each page in the linear address space.

The VM system must also maintain certain information about pages in memory (see table 1) and pages not in memory (see table 2) in the page-table entry.

When a virtual page is marked "not present," there are 31 bits available for use by the VM system in the page-table entry. However, if the page is present, only 3 bits are available. It's possible to maintain all the information listed in table 1 in one 32-bit page-table entry if (a) just the accessed bit and the dirty bit are used for the page-replacement algorithm, (b) in-memory pages don't need an address in the swap file, (c) no process ID is needed, and (d) statistics are not kept on a per-page basis.

If more information is required (for more sophisticated swap-file management, a better page-replacement algorithm, or keeping paging statistics), the VM system must maintain an additional data structure in parallel with the page tables. For example, the parallel data structure could allocate an additional 32 bits of information for each virtual page, so that a total of 64 bits is available.

A virtual page marked "present" could then use the 3 VM system bits in the page-table entry for a page-locked flag, a system-page flag, and a mapped-page flag. The parallel data structure might contain a page-on-disk flag, a swap-file address, page-aging information, and statistics information.

A virtual page marked "not present" would use a present bit and a page-replaced flag in the page-table entry. The remaining 30 bits would be available for other information (such as a time stamp for when the page was replaced). A page marked "not present" would contain the same information as a present page in the parallel data structure.

### Handling Page Faults

A page fault occurs when a reference is made to a virtual page that is marked "not present" in the page tables. It is the page-fault handler's responsibility to allocate a physical memory page, bring the virtual page into memory, and then restart the instruction that caused the page fault.

Usually, when a page fault occurs, all physical pages are in use. The page-fault handler must select a virtual page that is in physical memory and swap it out to disk, thereby freeing a physical page for

*continued*

**Table 1: Besides address information, the VM system needs to keep track of present-page characteristics and information for the page-replacement algorithm.**

#### INFORMATION REQUIRED FOR PRESENT PAGES

1. The address of the physical page to which it is mapped (bits 12-31 of the page-table entry).
2. Page-aging information, used to decide which virtual page to replace (swap to disk) when a page fault occurs. The not-recently used (NUR) strategy needs only the accessed and dirty bits in the page-table entry to make this choice; other replacement algorithms require more detailed aging information.
3. A flag marking the page as locked or unlocked. Locked pages cannot be paged to disk. This is required for operating-system pages, and sometimes for application program pages (e.g., for hardware interrupt handlers).
4. A flag identifying the page as owned by the operating system or by an application program. This is not always required (often it's sufficient merely to mark operating-system pages locked). On multitasking systems, a process ID may be needed.
5. A flag identifying the physical page as allocated (the usual case) or mapped. Programs sometimes need to map a region of the physical address space to access memory-mapped hardware devices. Mapped memory is not physical RAM memory, and the VM system must be able to make the distinction so it doesn't attempt to return mapped memory to the free physical-page list when it's deallocated.
6. A flag for whether the virtual page is also in the swap file, and if so, the address within the swap file where it is stored. This is used to enhance system performance when the page is replaced. If it is already in the swap file and has not been modified (the dirty bit is not set), then the expensive disk-write operation needed to put the page in the swap file can be avoided.
7. Optional paging-statistics information kept for performance analysis (and working set management, in a multitasking system). Typically kept information includes the number of times each page has been replaced, the paging rate (the number of page faults per second processed by the system), the page-reclaim rate (the number of page faults per second on previously replaced pages, as opposed to program pages being referenced for the first time), and a complete history of a program's paging activity.

**Table 2: Swapped pages keep track of their location on disk, indicate whether they are yet present on disk, and keep various statistics.**

#### INFORMATION REQUIRED FOR SWAPPED PAGES

1. The address of the virtual page in the swap file.
2. A flag indicating whether the virtual page is in the swap file. In a commonly used optimization, a virtual memory page newly allocated by a program is simply marked "not present" and "not in the swap file." It's not desirable to allocate a physical page immediately, because programs commonly allocate large amounts of virtual memory at a time. The first time the page is referenced, the VM system allocates a physical page and zeroes it. This avoids a disk write needed to put a zeroed page in the swap file when the virtual memory page is allocated, and it also avoids a disk read to bring the page in from the swap file the first time it's referenced. The page is only allocated and written to the swap file when (and if) it's finally swapped out to disk.
3. Additional statistics information. This typically includes a flag used to keep statistics on the page-reclaim rate that specifies whether the page is in the swap file because it's been replaced or because it hasn't yet been referenced by the program. More elaborate schemes might also time-stamp the page when it's replaced, so that the VM system can calculate the elapsed time between when the page is swapped out and the next time it's referenced.

# A MESSAGE TO OUR SUBSCRIBERS

**F**ROM TIME TO TIME we make the BYTE subscriber list available to other companies who wish to send our subscribers material about their products. We take great care to screen these companies, choosing only those who are reputable, and whose products, services, or information we feel would be of interest to you. Direct mail is an efficient medium for presenting the latest personal computer goods and services to our subscribers.

Many BYTE subscribers appreciate this controlled use of our mailing list, and look forward to finding information of interest to them in the mail. Used are our subscribers' names and addresses only (no other information we may have is ever given).

While we believe the distribution of this information is of benefit to our subscribers, we firmly respect the wishes of any subscriber who does not want to receive such promotional literature. Should you wish to restrict the use of your name, simply send your request to the following address.

---

## BYTE MAGAZINE

ATTN: SUBSCRIBER SERVICE  
P.O. Box 555  
HIGHTSTOWN, NJ 08520

## VM in Unix

Ben Smith

**P**rogrammers at the University of California at Berkeley first introduced virtual memory to Unix in 1978. The impetus was the VMS operating system on Digital Equipment Corp.'s VAX computer, which had the ability to address and use 1 gigabyte of memory when it had as little as 1 megabyte of physical memory. Earlier DEC machines required that all users have separate memory (limited to 64K bytes), private to their individual processes. The result of the Berkeley programming effort was 3BSD (and 4BSD in 1980). The spread of BSD Unix can be attributed, more than anything else, to this one feature. Now, all modern versions of the Unix kernel have either swapping or paging, which are two versions of virtual memory.

### Swapping

Although in some contexts the terms *swapping* and *paging* refer to the same thing, in the Unix environment, *swapping* refers to moving entire processes in and out of physical memory. It's obvious that if each user process is going to be allowed to use a major part of memory, the only way to support multiprocessing is to swap these processes out of active memory to allow space for the next process. Each process is brought back into active memory when it's time for it to continue processing. A separate area of the disk (or a separate disk) is reserved just for swapping. This area does not require management by the file system, but instead is managed by the kernel, which is more tuned to the needs of swapping.

The limitation on swapping is that a

single process must always use less than the system's physical memory capacity. (Some memory must be held for the kernel.) However, swapping is simple to implement and therefore requires little operating-system overhead.

### Paging under Unix

The incorporation of memory management units into most modern computers has provided virtual addressing, a necessary element of paged virtual memory. The virtual address space is divided up into units called *pages*. If the operating system takes advantage of these facilities, it will properly handle page faults by moving virtual memory in and out of active memory as required. Since a page is smaller than the process or its data area, there is a finer control of memory. Only parts of a process need to be moved out to storage, not the whole process. There can be enough of it left in physical memory to continue the process while the data and nonactive sections of the program are moved back and forth between active memory and storage.

Because pages are a fixed size, the memory management at the page level doesn't relate to what the memory is being used for. The operating system can determine what a particular area of memory is being used for by looking at the structure of the executable file or process. Pages can be grouped into logical segments for each kind of use. Memory management at this level can relate to what the memory is being used for, as well as which memory is least-recently used. All processes and their data can be handled similarly, with the exception

the virtual page that is being brought into memory.

Page-replacement strategies have been the subject of considerable debate. Obviously, the best choice is the virtual page that the program will not reference for the longest time into the future. Since programs cannot predict the future, the page-replacement algorithm must be based on a heuristic about typical program behavior. Any such algorithm will occasionally make bad decisions; the objective is to select a strategy that makes reasonably good decisions most of the time and doesn't incur a lot of overhead.

Perhaps the most popular algorithm is least-recently used (LRU) replacement. This strategy selects for replacement the page that hasn't been referenced for the longest time. This is based on the heuristic that the recent past is a good indicator of the immediate future. Supporting this are common program constructs such as looping, subroutine calls, stacks, and repetitive array traversals.

Implementation of a full LRU algorithm requires time stamping a page each time it is referenced. This support is not provided by most hardware (including the 80386 and 80486). Thus, an approxi-



of the Unix kernel. The kernel serves all other processes and therefore must reside in physical memory at all times. So, even with virtual memory, the physical memory must exceed the size of the kernel. With some of today's kernels in excess of 2 megabytes, this is not a trivial requirement.

### Mach to the Rescue

The Mach kernel (from Carnegie Mellon University) solves many of the memory problems that are inherent in standard Unix schemes. Mach doesn't require device drivers to be linked into the kernel, and therefore the kernel is much smaller.

Mach splits the concept of a process into two elements, *tasks* and *threads*. A task provides the physical environment to its threads. A thread can be created or destroyed, or started or stopped without adversely affecting its task. By having the operation of device drivers incorporated into threads of the kernel task, drivers are loaded into physical memory only when needed.

Mach's virtual memory implementation is significant. It's object-oriented, it has hooks for the implementation of virtual memory concepts at the user level rather than just at the kernel level, and it uses copy-on-write algorithms for efficiency. A task can allocate and deallocate arbitrary regions of virtual memory and change the protections and inheritance of allocated regions. Mach's virtual memory runs on both paged and unpaged memory management hardware. From the start, Mach was designed for undefined parallel-processor machines; it is building memory management for the

computers of the future.

This hardware independence makes Mach an attractive design for developers. However, it has only been fully implemented on the NeXT Computer. (There are other implementations under development.) Mach is most significant as the guiding light for future Unix kernel design. It is influencing the designs of the OSF and AT&T Unixes (see "Mach: The Model for Future Unix" on page 411).

### Designs of the Future

Virtual memory methods are particularly valuable to Unix developers. Because of the wide spectrum of Unix platforms, it's important that they appear identical to all the applications that run across them. Particularly now that Unix network nodes are so varied, standards need to be established to which all members of the network adhere.

The future designs of Unix systems will include vagrant processes or tasks moving around from server to server as the needs of the task change and the resource loads vary. Virtual memory in Unix will no longer pertain to physical memory and devices close at hand, but will extend to all resources in the network. The network will become one large virtual machine with aggregate resources beyond those of any single machine of today. The implementation and standardization of virtual memory methods is crucial to the designs of future Unix systems.

*Ben Smith is a BYTE technical editor. You can contact him on BIX as "bensmith."*

mation of an LRU algorithm is usually selected.

### LFU Page Replacement

One common approximation to LRU is least-frequently used (LFU) replacement. This scheme maintains a frequency count of references to each page. The page tables are scanned periodically, and the frequency count for each page that has been accessed is incremented (the scan also clears the accessed bit for each page, so the next scan will have fresh information available). The page with the lowest frequency count (the LFU page) is

selected for replacement.

Two problems with this algorithm are that pages that are used heavily during the program initialization phase tend to remain in memory even after initialization is completed, and a page is vulnerable to replacement immediately after it is brought into memory (because its frequency count is 1, and all other in-memory pages may have been referenced more than once). A refinement of this algorithm increments the frequency count if the page is accessed, and decrements it if the page is not accessed, so that pages no longer being used gradually become

more vulnerable to replacement. When a page is brought into memory, it's given an initial frequency count at the midpoint of the possible range of frequency-count values.

### NUR Page Replacement

The not-used-recently (NUR) approximation to LRU is attractive because of its low overhead and its ability to make surprisingly good choices, considering the small amount of information on which its decisions are based. This algorithm uses the accessed and dirty bits maintained for each page to choose a page for replacement. When a program is first loaded, none of the pages has been accessed or modified. As program execution proceeds, code pages are accessed, and data pages are accessed or modified (marked dirty). Based on the values of the accessed and dirty bits, each page is placed in one of four categories, as shown in table 3.

The lower the category a page falls in, the more attractive the page is for replacement. The ordering of the categories is based on the heuristic that pages that haven't been accessed aren't likely to be needed in the near future. It is also based on the observation that unmodified pages are more attractive for replacement than dirty pages, because unmodified pages need not be written out to the swap file. Since there are typically many pages in each category, the algorithm performs a circular scan of the linear address space, starting with the page immediately following the last page swapped, and selects the earliest occurrence of the lowest category encountered.

As program execution proceeds, most pages tend to fall into categories 2 and 3, and the VM system loses the ability to make good choices. Therefore, the VM system periodically scans all the pages and clears the accessed bit for each page. This resetting of the accessed bits explains how pages fall into category 1 (modified but not accessed), which otherwise would describe an unrealistic situation. Immediately following the page-table scan, all pages are vulnerable to replacement; but not for long, as actively referenced pages quickly are marked as "accessed" again.

### The Page-Swap File

Virtual pages that are not in physical memory are kept in a page-swap file on disk. Since pages are of fixed size, you can think of the swap file as an array of virtual pages. In the simplest case, the swap file is always as large as the virtual

*continued*

**Table 3:** *When a program references a physical page in a not-used recently (NUR) system, its accessed bit is set. If the program writes to the page, its dirty bit is set: Pages in category 0 are the ones first swapped to disk.*

**NUR PAGE-REPLACEMENT CATEGORIES**

Category	Accessed	Dirty
0	0	0
1	0	1
2	1	0
3	1	1

address space, and there is a one-to-one correspondence between virtual pages and their addresses in the swap file. The virtue of this design is its simplicity, along with the fact that a swap-file address need not be kept with each virtual page, reducing the overhead for data structures. The primary problem of the design is its consumption of disk space. Since programs often allocate huge amounts of VM, the disk space required may be prohibitive. For some operating systems, a swap-file region of fixed size is allocated on the disk when the system is configured. The decision of how large

to make the swap file limits the maximum size of the virtual address space, thus determining the largest program that can be run.

Disk space is often a prime consideration on personal computers. Thus, it's often desirable to keep the swap file smaller than the virtual address space and to dynamically increase the size of the swap file as the program runs. This eliminates the one-to-one correspondence between virtual pages and swap-file addresses, however, so a swap-file address must be kept with each virtual page. In addition, when an application frees virtual pages, the space allocated to them in the swap file must be reclaimed. Because of this, the VM system must maintain a data structure for allocated and free pages in the swap file (usually a bit map, 1 bit per page in the swap file, is the best choice). So the decision to reduce the swap-file size comes at the expense of additional VM data structures and complexity.

Swap-file management can become complex, with many trade-offs involved.

**The Bottom Line**

The primary benefit of paged VM is the ability to run large programs regardless of the physical memory configuration of the computer system. Secondary benefits are the ability to place a program any-

where in physical memory without affecting how it executes, using fixed-size pages to eliminate the problem of physical memory fragmentation, and the ability to keep a program contiguous in virtual memory without requiring contiguous physical memory.

The main cost of VM is disk space—the portions of the program that are not in memory must be kept in a swap file on disk. A secondary cost is a slowdown in the program response time due to swapping; however, you must remember that a program large enough to require swapping couldn't run at all without VM.

With the hardware support for paged VM provided by the 80386 and 80486 processors, this capability is now possible on personal computers. Demand-paged VM is available today on 80386s running Unix or an extended DOS application program. With this development, the line between high-end personal computers and low-end workstations and minicomputers, already blurred, has all but disappeared.

*Robert Moote, vice president of software at Phar Lap Software, Inc. (Cambridge, MA), is the author of 386/DOS-Extender and 386/VMM. He earned B.S. degrees in mathematics and electrical engineering from the University of Rochester. He can be reached on BIX c/o "editors."*

# Mac VM Revealed

*Virtual memory comes to the Mac: Small in scope, efficient, transparent, and, above all, compatible*

*Phil Goldman*

**A**s Macintosh applications grow larger and more complex, and as multitasking permits more than one application in memory at a time, RAM has become a scarce and precious commodity. One way to satisfy your Mac's ever-growing appetite for memory is to buy more. This is an expensive solution, however, and one that is still limited by the physical design of your computer. A less expensive and

more elegant solution is to use your disk drive as RAM.

**Mac-Flavored VM**

The Macintosh virtual memory manager (which I will hereafter call Mac VM) is included as part of version 7.0 of the Mac System software. It allows the Mac to access up to 14 megabytes of memory using today's 24-bit ROMs. On newer 32-bit ROMs, it allows the Mac to address up to

1 gigabyte of memory. Practically speaking though, the VM size is constrained by how much disk space you have available; today, this is usually 300 megabytes or less, typically 40.

Mac VM runs on any Macintosh that contains a memory management unit (MMU). This unit is built into the Motorola 68030 CPU used in the Mac IIX, IICx, and the Mac SE/30. It is an add-on

*continued*



# For your European profit in 1992. Don't wait. Contact Aashima today!!

Ensure your sale expansion in the biggest growth market after 1992. Europe without borders – no borders for your turnover.

**Europe 1992.** A continent without borders. A market with a bigger sale potential than the USA. A market with 330 million consumers against 270 million in the USA. Europe, the hometown of Aashima Technology.

**Aashima Technology.** Now already one of Europe's largest distributors of computer peripherals and accessories (printers, monitors, add-on cards, hard discs, disc drives and many other appliances). With a present turnover of 65 million USD, which in 1992 will exceed to 150 million USD. In 1992 Aashima Technology will be a more powerful organisation for your sales and distribution throughout Europe.

COMDEX/Fall '89

The South Hall of the Las Vegas Convention Center Booth RM 25, RM 27.

Partnership with Aashima Technology now, is the best base for European expansion in 1992. Aashima Technology. For better sales and bigger profits. Don't wait. Contact Aashima today.

## It's a short way to Aashima



# AASHIMA

---

## TECHNOLOGY

**Aashima Technology B.V.**

Nikkelstraat 8-10  
2984 AM RIDDERKERK  
THE NETHERLANDS  
Tel. no. 31 1804-30833  
P.O. Box 4133  
2980 GC RIDDERKERK  
THE NETHERLANDS  
Fax no. 31 1804-2 72 31 buying department  
Fax no. 31 1804-2 72 33 sales europe  
Fax no. 31 1804-3 11 58 product management

**Aashima Deutschland GmbH**

Dieselstrasse 11  
D-4190 KLEVE  
WEST GERMANY  
Tel. no. 49 2821-12041  
Fax no. 49 2821-20574

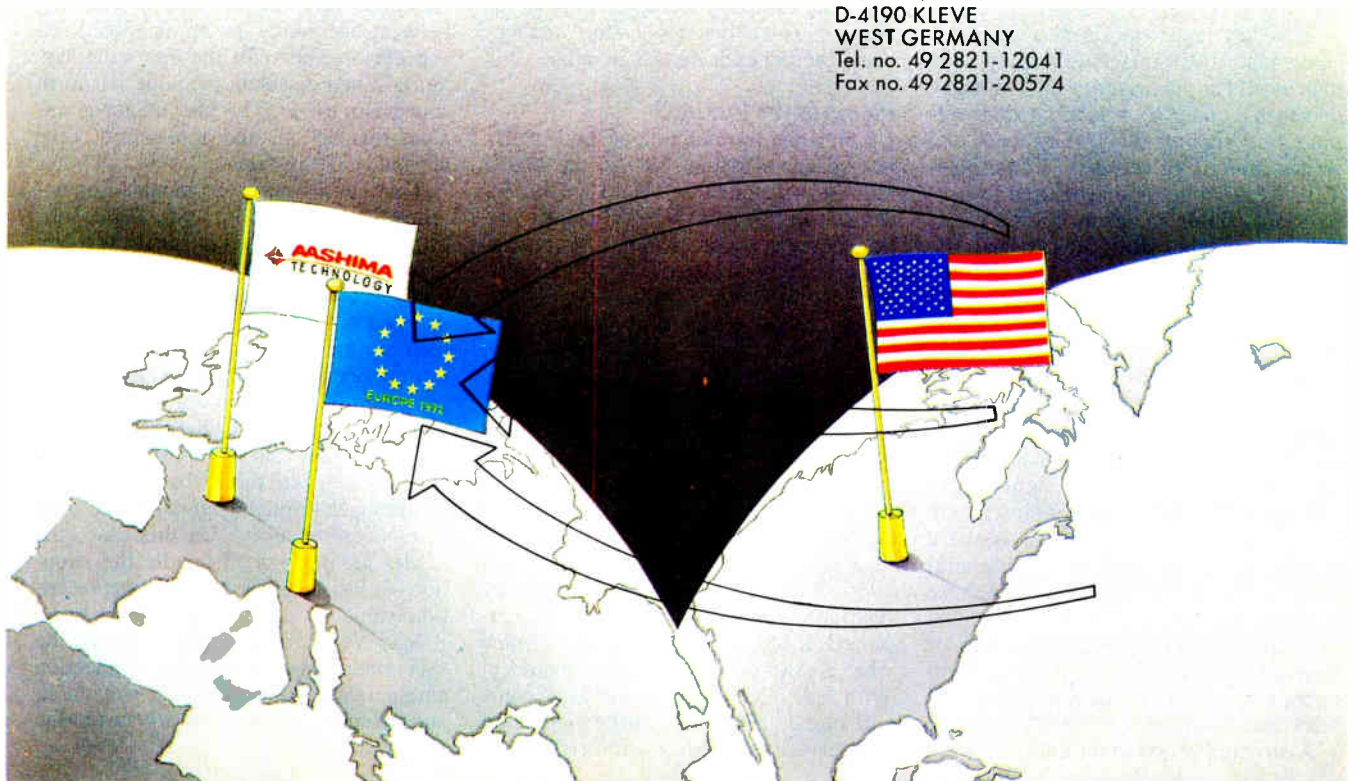

Circle 11 on Reader Service Card

World Radio History

## Finding Fault

In a virtual memory system, memory is divided into pieces called *pages*. At any time, some of an application's virtual pages will be in memory; others will be stored on disk. To make logical memory appear larger than physical memory, each virtual page must be distinguished by whether or not it is in physical memory. If it is, the page-table entry for the page contains the address of the physical page frame.

However, if the page referred to in the table entry is not in physical memory, a page fault occurs, and the memory management unit yields control to the memory manager. This is where your hard disk comes in. If the page accessed

is not in physical memory, then it is contained on disk—specifically, in a portion of the disk (often a file) known as the *backing store*.

When a page fault occurs, the memory manager first frees up physical memory space by selecting a physical page frame and writing the virtual page that it contains onto the backing store. It then reads the page data for the desired virtual page into the frame and changes the new page's table entry to show that the page is in physical memory and located in the page frame stolen from the displaced page. Likewise, the entry for the page written to disk is updated; it is marked "not in physical memory." Fi-

nally, the memory manager returns control to the CPU, which retries the access that caused the page fault. The entire process is known as *page-fault handling*.

You can think of the backing store as an image of virtual memory; a particular page's data is found at the same offset in the backing store as it is in virtual memory. Pages are brought into physical memory as needed, but reside on disk. (In fact, they need to be written back to disk only if they have been changed since last being read from the disk). Because of this, the amount of virtual memory is limited to the disk space available for the backing store.

option for the Mac II, which uses the 68020 CPU.

Another requirement is a reasonable amount of disk space for the backing store—the disk file that stores pages not currently in memory. You must set aside an amount of backing store equal to the amount of memory desired. All this space must reside on the same disk volume, which must be a Hierarchical File System volume. You can't use an external file system, such as MS-DOS, nor a remote one, such as AppleShare, for the backing store.

This last restriction is necessary because Mac VM transfers to and from the disk mostly at the driver level. Thus, any driver that underlies a backing-store volume must support block-level reads and writes directly to the disk. The AppleTalk filing protocol driver used by AppleShare volumes doesn't do this direct mapping; neither do most external file systems. Eventually, Mac VM will provide an interface to allow it to use an external file system as the backing store.

Of course, compatibility is always a concern for any new piece of system software. Mac VM should be transparent to typical applications. However, there are certain types of applications that may run into problems. For instance, applications that access the SCSI manager directly are not guaranteed to work. This is not a large concern because only peripheral utility programs would do so, and those correctly written will access the SCSI manager through the SCSI driver or through their own driver if the peripheral is not a disk; both of these methods will work correctly.

Also, applications that alter the CPU

interrupt vectors directly will crash under Mac VM. This, too, is a forbidden practice (as defined by Apple's guidelines for software developers), but it may be Mac VM that exposes the problem. Fortunately, this practice is ancient, and the applications that adopted it—mainly for copy-protection purposes—have long since ceased and desisted.

Note that both of these practices, while strictly "illegal," will still work for drivers. In general, the only type of code that could possibly break goes directly from the interrupt vectors to application memory (i.e., the application memory heap, the stack, or the A5 globals).

### Pieces of the Puzzle

Up until the introduction of the Mac IIx last year, no Macintosh had the MMU built in as a standard. The MMU is necessary to implement VM efficiently and transparently. Transparency is crucial because of the huge existing base of software for the Mac.

Also, Mac VM's backing store can take up a considerable amount of disk space. For the first few years, the Mac had little or no extra disk space. The average amount of disk space has recently increased greatly and should continue to do so.

In contrast, the average amount of RAM per Mac has increased very slowly. When the Mac 512K first came out in 1985, it had such a surplus of memory relative to disk space that many users employed RAM disks—they didn't know what else to do with so much memory! With Mac VM, the Mac world has come full circle. Now, disk space is pressed into service as RAM. It's unfortunate, as

the first situation is definitely preferable to the second.

### Retrofitting the Mac OS

When the Mac OS was originally developed, VM was not a goal—not even a long-range one. Consequently, many shortcuts were taken in the architecture and implementation that have made the development of VM very difficult.

For instance, the Mac OS implicitly assumes that an application has complete control over the machine. The 68000 has an option that divides CPU processing between user mode (for applications) and supervisor mode (for the operating system). When disabled, all code is run in supervisor mode. The Mac OS never enables this option, and applications take advantage of this fact.

This causes many problems. For example, it makes robust page-fault handling extremely difficult (see the text box "Finding Fault" above). When a page fault occurs, an exception frame is dumped onto the supervisor stack. The memory manager uses this frame to determine exactly which page the CPU is accessing. If the user-mode option is disabled, the exception frame is dumped on the same stack that the application uses. The problem with this is that the memory for the stack might be *paged out* (i.e., not in physical memory). In this case, the MMU has no way to handle the situation—it has no place to dump the exception frame—and the machine locks up.

Mac VM solves this by enabling the user-mode option. Then the application automatically runs on its own user stack, and the supervisor stack is private to Mac

*continued*



**Turn your favorite  
C compiler into a  
powerful database  
manager with the**

# **C/Database Toolchest**

The **C/Database Toolchest™** adds sophisticated file management functions to your Power C™, Turbo C®, QuickC®, or Microsoft® C compiler. With the **C/Database Toolchest™**, your data requires much less disk space than with programs like dBASE®, and you can access your data much faster. Of course the full power of C provides you with an unlimited amount of programming flexibility.

The **C/Database Toolchest™** includes three major components:

- 1) An advanced B+tree library gives you instant access to your data.
- 2) A high-level ISAM library provides you with an easy-to-use C interface, and

- 3) A complete database manager (with C source code included) shows you how to create impressive applications.

You also receive a comprehensive 350 page manual and a utility for converting dBASE® files.

The **C/Database Toolchest™** supports features that you'd expect to find only in products costing ten times as much. Advanced features include variable length records, variable length keys, multiple keys per index, and multiple indexes stored in a single file. Your data files can contain an unlimited number of records, and each record can be as large as 32K bytes in length.

About the only thing that the **C/Database Toolchest™** doesn't do is cost you a lot of money. We've kept our price low so you can manage your budget as easily as your data.

**Now Only \$19.95!**

Order now by calling our toll free number or mail the coupon to:

**Mix Software**  
1132 Commerce Drive  
Richardson, TX 75081

**1-800-333-0330**

**60 Day Money Back Guarantee**

Not Copy Protected ■ Royalty Free

For technical support, please call:

1-214-783-6001



## **Order Coupon**

Name \_\_\_\_\_  
 Street \_\_\_\_\_  
 City \_\_\_\_\_  
 State \_\_\_\_\_ Zip \_\_\_\_\_  
 Telephone \_\_\_\_\_  
 Paying By  Money Order  Check  
 Visa  MC  AX  Disc.  
 Card# \_\_\_\_\_  
 Exp. Date \_\_\_\_\_  
 Disk Size  5 1/4"  3 1/2"

Qty.	Product	Price	Subtotal
_____	C/Database Toolchest.....	\$19.95	_____
_____	C/Database Library Source.....	\$10.00	_____
_____	B+tree & ISAM library source code	_____	_____
_____	Add Shipping (\$5 USA, \$20 Foreign).....	_____	_____
_____	Texas Residents Add 8% Sales Tax.....	_____	_____
_____	Total Amount of Your Order.....	_____	<b>B</b>

**Table 1:** *Mac VM's public interface consists of calls that let applications hold data in memory and calls used by NuBus peripherals.*

MAC VM PROGRAMMING INTERFACE	
Command	Description
DeferUserFn	Allows a given user-code routine to be called as soon as it is OK to page fault (usually immediately).
GetPhysical	Given a range of held virtual memory, returns a table of physical memory extents to which they map. It returns an error if the entire range is not locked.
HoldMemory	Holds a given range of virtual memory in physical memory.
LockMemory	Holds a given range of memory in physical memory and makes sure it does not move within physical memory.
LockMemoryContiguous	Same as LockMemory, except that the physical pages chosen are one contiguous range. Memory may need to be moved to accommodate this request.
UnholdMemory	Releases a given range of virtual memory from being necessarily held in physical memory. It is now fair game for page replacement.
UnlockMemory	Undoes the effect of LockMemory.

VM and held in physical memory. Mac VM handles applications that wish to make use of supervisor-mode instructions by emulating the instructions in software.

### Double Faults

The exception-frame dilemma is just one special case of a more general problem. Mac VM must ensure that in processing a page fault it doesn't generate a new one. This is the main reason that Mac VM doesn't use the file system to transfer pages between memory and the backing-store file.

The file system contains a large number of hooks—low-memory addresses that point to routines it calls. Sometimes, applications replace these hooks with ones that point to their own routines. The problem is that the memory occupied by these routines may be paged out to disk when Mac VM starts processing a page fault.

Thus, calling the file system in the midst of page-fault handling could conceivably cause additional, infinitely recursive page-faulting. Because of this, Mac VM uses the underlying driver and avoids the file system. Luckily, drivers don't have low-memory hooks, so Mac VM must only ensure that the memory it passes to the driver is kept in physical memory.

This last situation is trickier than it seems. Because current SCSI drivers are

not reentrant (i.e., callable more than once concurrently), Mac VM must make sure that a backing driver (usually the SCSI driver) will never page-fault. If it does, you end up with the situation where Mac VM needs the driver during page-fault handling but can't get it because it is already being used. The solution is to trap all calls to the driver, made via the `_Control`, `_Status`, `_Read`, and `_Write` traps, and to hold a few things in physical memory—namely the parameter block, the application-supplied transfer buffer (for reads or writes), and the part of the stack that the driver might use (the few hundred bytes underneath the current stack pointer).

### Deadly Interrupts

In addition to keeping the driver from page-faulting, Mac VM must ensure that no interrupt code page-faults while the backing driver is in use. This includes such code fragments as VBL (for vertical blank) tasks, time-manager tasks, I/O-completion routines, and raw interrupt code. All of these happen asynchronously with respect to the driver, so even careful monitoring of the driver won't catch them.

One simple solution is to turn off interrupts while using the driver. This isn't very satisfactory because it cripples the machine whenever the driver is used, which could be for many seconds at a time during file transfers. The cursor

will be jerky (because the mouse won't be sampled often), AppleTalk will drop packets, and serial communications may fail. All in all, using the machine would be very frustrating.

A much nicer solution—the one that Mac VM adopts—is to be selective about which code will run at interrupt time when the driver is in use. Mac VM differentiates between user code and system code (which is somewhat ironic, as the distinction is being made 5 years after the fact instead of during the Mac OS's design).

System code is composed mostly of Apple system software, or third-party code that enhances or replaces it. System code usually exists in the system heap, which is always kept in physical memory. It keeps both its private data storage and all external data that it accesses within the system heap. System code that must touch application memory at interrupt time can make use of special Mac VM calls (see table 1) to temporarily hold such memory in physical memory. Examples of system code include the floppy disk driver, AppleTalk, the SCSI manager, the Apple desktop bus drivers (mouse and keyboard), and INITs.

User code typically comes from an application and resides mostly within an application's MultiFinder partition. It might run at interrupt time. User code includes application-spawned VBL and time manager tasks, AppleTalk link access protocol handlers, and completion routines, as well as application code. User code is allowed to cause page faults.

With a well-defined division of user and system code, Mac VM can simulate turning off interrupts by suspending all user code while the backing driver is in use. This avoids reentrancy problems without disabling system interrupts. Because system code remains resident, it cannot page-fault at interrupt time. Thus, the system response will remain smooth; the cursor code will always run, as will AppleTalk. The only difficulty lies in the fact that Mac VM must treat each type of user code as a separate case. The method for suspending VBL tasks is very different from the one that delays completion routines.

Of course, the best solution to the reentrancy problem is to use a reentrant backing-store driver. With this in mind, the SCSI manager for System 7.0 facilitates reentrancy in the drivers that use it, and the new Apple SCSI driver, also available with the system, will take advantage of it. Mac VM will check the backing driver to see if it's reentrant. If it is, Mac VM will not suspend user code at



## THE CLOCK PAGE-REPLACEMENT ALGORITHM

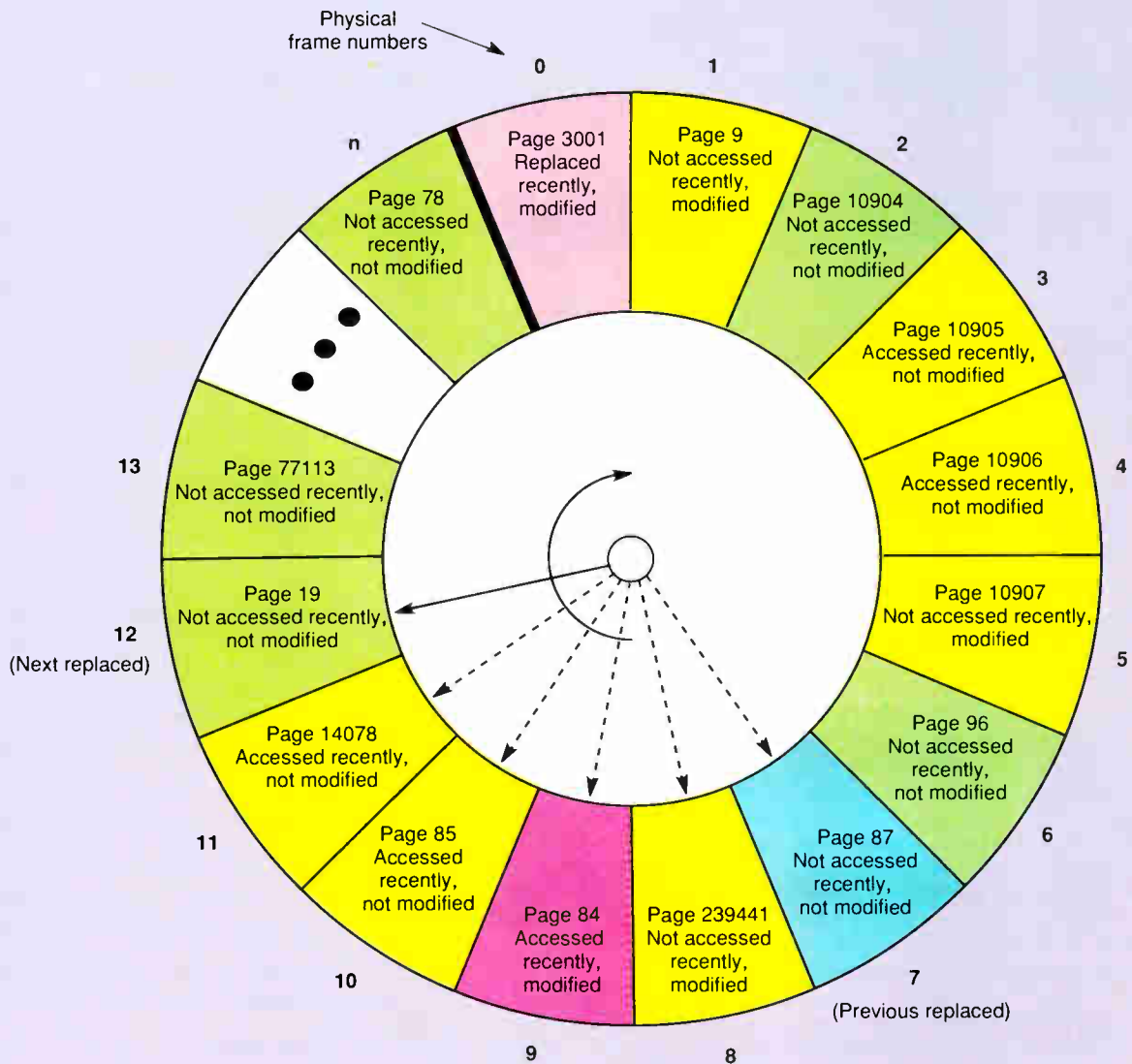

**Figure 1:** The clock hand starts from the last frame replaced (blue) and examines each frame to find the first that has not been accessed recently and has not been modified (green). If no such frames exist, the hand does successive sweeps searching for frames (yellow and red) that meet successively less restrictive replacement criteria.

all. Other types of drivers might be reentrant already; to work with Mac VM, all they would have to do is set the flag that Mac VM checks.

### Design Decisions

Mac VM has been performance-tuned using a variety of techniques. It has been tested with different values of the classical VM parameters. For instance, a number of page-replacement algorithms have been tried. Page replacement is the

process by which the memory manager decides which page to send to the backing store when it needs to bring a new one into physical memory.

The page-replacement algorithm currently used is a modified version of the Clock algorithm (see reference 1), so called because it simulates the movement of a clock. It involves keeping a circular queue of physical page frames. Implicitly linked and made circular by the algorithm rather than by a data structure, the

frames in the queue are accessed sequentially by page-frame number.

Each page frame in memory is automatically marked by the MMU indicating whether it has been accessed recently by the CPU. Mac VM keeps a pointer (known as the clock hand) to the last page frame that it replaced. At a page fault, the pointer sweeps around the frames looking for a page frame that hasn't been modified since it was read from disk and

*continued*

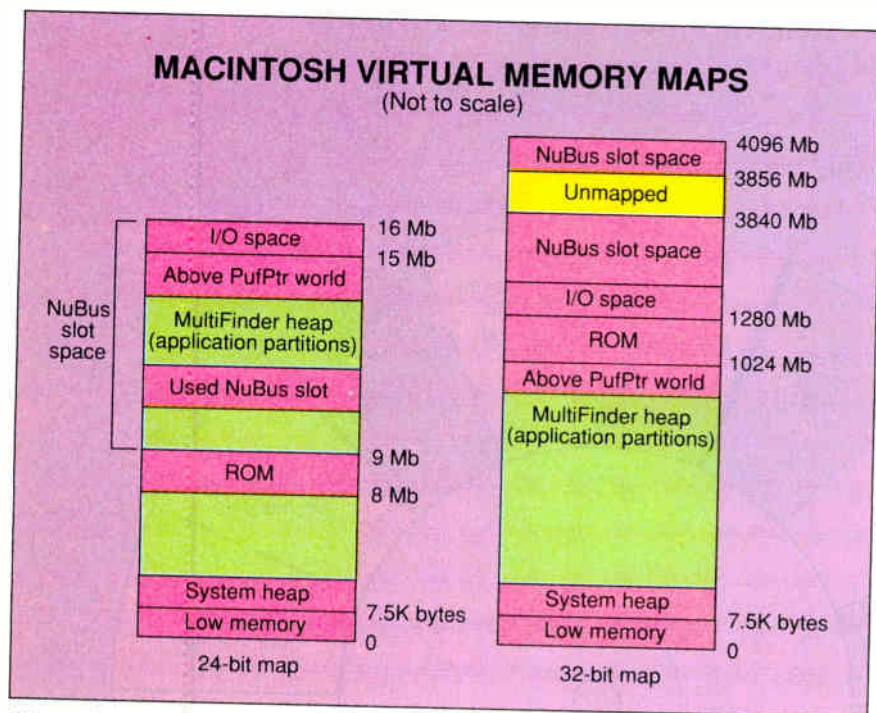

**Figure 2:** In Macs with 24-bit address spaces, Mac VM uses leftover NuBus slot address space to augment the memory space below system ROM. With 32-bit ROMs, Mac VM uses a contiguous 1-gigabyte address space.

hasn't been accessed recently (see figure 1). As it tests each frame, it clears the marking in the corresponding page that signifies that the frame has been recently accessed.

If the page-replacement system finds an unmodified, not-recently accessed page, it returns this information to the memory manager. The physical frame for this page is then stolen. If no such page can be found, the clock hand sweeps through the page frames again, this time looking for a page that has been modified but not replaced recently. If none of these can be found, the hand sweeps around once more, looking for the first frame that does not contain a page held in physical memory, as one in the system heap might be. The held pages are exempt from previous passes as well.

The Clock algorithm is well suited to Mac VM's needs. It is a global page-replacement algorithm; it doesn't require knowledge about different applications and their relative virtual and physical requirements and histories. Also, it's simple and efficient, yet still gives a good approximation to the more complex LRU algorithm. Finally, it is extremely space-efficient. The size of the circular queue is small and is proportional only to the amount of physical memory, not the virtual memory.

The generic Clock algorithm assumes

that, on the first pass, modified pages contained in page frames swept by the clock hand will be written out to disk and have their entries marked as not modified and not accessed. However, this only works well on machines that contain disk drives with direct memory access (DMA). Such drives can read or write concurrently with the CPU, so the writing scheme makes sense: At no cost to the CPU, it can minimize the number of pages that are in physical memory and modified. This minimizes the risk that the CPU will be forced to replace such a page. Such a replacement would have to happen synchronously, at least in the current Mac OS, because processing cannot continue until the page fault has been handled.

Because of this, Mac VM's general strategy is to put off writing modified frames until it absolutely must. This is coupled with a variety of techniques that are used to convert modified pages into clean ones. Eventually, Mac VM will have replaceable algorithms, and it will know how to pick one based on the characteristics of the backing driver (the driver transfer speed, latency, and whether it has DMA).

Another parameter that has been tuned is page size. Mac VM currently uses a 4096-byte page size. This size has yielded the best empirical results. Not

coincidentally, it is the minimal optimal transfer size for the SCSI manager. Also, since it's relatively large, it keeps the page table smaller; fewer entries are needed. A page size of 4096 bytes is one of the few sizes allowed on next-generation MMUs.

You have one simple choice to make about disk space: You need to choose between keeping the entire virtual memory image on disk, or only those pages that are not in physical memory. In the latter scheme, there would no longer be a mapping between a VM address and its location on disk. Instead, the page's entry in the page table would contain the page's frame in the backing store if it wasn't in memory.

This would be very useful in terms of saving disk space. If you have 2 megabytes of RAM and want to use 5 megabytes of VM, you need only 3 megabytes of disk space. The problem with this is the loss in speed.

If a complete virtual image is not kept on disk, then every time a page is replaced, it must be written to the backing store, even if it hasn't been modified. For example, consider a page of data in physical memory. This page must always exist somewhere, or the data will be lost. In the disk-saving scheme, the page can't be both in physical memory and on disk simultaneously. Thus, when it's replaced during a page fault, the page must be written to disk even if it hasn't been modified. Because most of the time during page-fault handling is spent in transferring to and from the backing store, this doubles the average page-fault handling time. Mac VM keeps a complete image of virtual memory on disk: It sacrifices disk-space savings for the sake of speed.

### Inside Story

Many of the optimizations in Mac VM involve topics related to the Mac OS. Mac VM runs beneath the Mac OS and takes advantage of as many peculiarities of the Mac OS as it can. Most of the advantage comes from being able to determine whether the Mac is dependent on the data in a given page. If not, Mac VM can treat such a page as if it had uninitialized data and mark it "uninitialized."

These pages don't need to be written to disk when they are replaced, and they don't need to be read from the backing store when access to them causes a page fault. Therefore, page-fault handling for these pages is extremely fast. And page replacement in general is very fast, too; the modified Clock algorithm actually looks for uninitialized pages first. Ac-

*continued*



# The Era of the Personal Workstation

When in 1981 the first personal computer from IBM was introduced to the market, no expert predicted its success. After only one year, this computer set a new standard, the PC standard. Of course, there were other computers, like the Apple II. Some of these computers were faster and more reliable than the IBM PC. But the standard was set by this machine. And it was set by the users, who bought this computer and demanded applications, programs, peripherals and services. A whole industry grew up with this one machine. The personal computers of today are the great-grandchildren of this little computer. One can find its roots in nearly every personal computer that works with MS-DOS. When the IBM PC was introduced, it worked with MS-DOS, too. It was MS-DOS 1.1, the first release. And it became standard as an operating system, just like the PC became standard as THE personal computer.

The technology today is far more advanced than it used to be in 1981. This an effect of the tremendous market power, which was unleashed by the PC standard. But know, the great history of this standard has become a burden, it slows down any development in this industry, which is bound to be "compatible". Today's microprocessors have more processing power than the big mainframe computers in 1981. But they use only 5-10 percent of their real abilities for the users, because of the existing industry standards. We at Bauer Systems think it's time for a new standard, it's time for the PERSONAL WORKSTATION!

Stop! This is not a break with the reported history of computers. It's a break with compromises, which were made to have the highest grade of compatibility. We have found a way to have the best of both sides: Unforeseen processing power and user friendliness and compatibility with existing industry standards. We cannot promise that your most beloved word processor will run on our new machine, and we cannot promise either that your beloved screen will work with our machine. But we can promise you that if you ever try our new system, you will not try another existing computer again.

The TESS IV PERSONAL WORKSTATION is based on the Intel i486 microprocessor. This microprocessor combines the features of the 80386 microprocessor and the 80387 arithmetic coprocessor together with a sophisticated cache management unit on one chip. The i486 microprocessor has a raw processing power of 14-15 MIPS. In the TESS IV PERSONAL WORKSTATION, this microprocessor is combined with 8 Megabyte of 70 ns dynamic random access memory. The system has a clock rate of 25 MHz. Early benchmarks indicated a processing power of 12 MIPS for the whole system. We developed a configuration for this system, which represents the best combination of available options. The TESS IV PERSONAL WORKSTATION is equipped with our i486-computer. We chose a SCSI host adapter as storage interface. In the standard configuration, one 200 megabyte hard disk drive and one 3.5" Floptical disk drive are connected to the host adapter. It offers a sustained data transfer rate of 1 megabyte per second and it can handle up to seven SCSI devices. The hard disk drive has an access time of 16 ms. The Floptical disk drive is a newly developed 3.5" floppy disk drive that is able to store up to 20.8 megabyte of data on a 3.5" Floptical diskette. It can also format, write and read standard 3.5" diskettes in the PS/2 formats. The Floptical disk drive has an access time of 65 ms. The graphics subsystem of our TESS IV PERSONAL WORKSTATION contains its own Texas Instruments TI 34010 graphics processor, clocked at 40 MHz. At this clock rate, the TMS 34010 has a processing power of 6 MIPS. The processor is combined with 1 megabyte VRAM for a maximum screen resolution of 1024 x 768 pixels in 256 out of 262.144 colors. Our display features a 21" flat-type screen offering the user an optimal viewing area. The etched, non-glare 0.31 mm dot pitch CRT allows for brilliant FULLSCREEN graphics and text. A built-in dynamic focus circuit provides crisp images on-screen. The keyboard of our TESS IV PERSONAL WORKSTATION is connected to the screen and contains a standard 102 keys AT-layout. A 3-key mouse is connected to the keyboard as the standard pointing device.

The TESS IV PERSONAL WORKSTATION is equipped with four serial and two parallel external interfaces. It can be expanded by plug-in expansion cards compatible to the ISA-bus interface. The complete system except the desktop devices is mounted in a trim desk-side tower case in a unique design. It is powered by a 300 W switching power supply with build-in battery backup and surge protection.

To unleash the full processing power of the i486 microprocessor, we chose the newly developed Open Desktop from SCO as operating system. Open Desktop features the full 32-bit, multiuser, multitasking capabilities of the UNIX System, a graphical user interface offering Presentation Manager-compatible "look and feel", the industry-standard X Window System, SQL database management, TCP/IP networking to dissimilar systems, full data sharing between DOS and UNIX Systems, and instant access to thousands of existing DOS and UNIX System applications. Open Desktop delivers the multitasking computing power, friendly graphical interface, and seamless connectivity required for today's demanding business and technical professionals who require dedicated personal productivity systems. And it's equally well-suited as a multiuser, multitasking platform for workgroups of 8, 16, 32 or even more users.

To meet the high standards we set ourselves by designing this computer, we developed a sophisticated distribution and service system. The TESS IV PERSONAL WORKSTATION will be distributed by the microtronics Trade Service through field consultants. Your computer will be set up at your site and configured to your demands. The microtronics Trade Service will provide worldwide on-site service for one year. If your system can't be repaired on-site, you will receive a equal replacement for the repair time.

To receive more information or to purchase your TESS IV PERSONAL WORKSTATION, please contact the microtronics Trade Service. We hope you will be with us in the era of the personal workstation!

microtronics Trade Service, Bettendorfer Str. 36, 5173 Siersdorf, Federal Republic of Germany, phone +49-2464-2147, fax: +49-2464-8280

*All trademarks used in this advertisement are property of the respective companies.  
All information contained herein is subject to change without prior notice.*

*Designed by H. Bauer, set by HGB Druck, Jülich*

**Circle 238 on Reader Service Card**







"Mary had a 4GL  
who's performance  
was very slow  
and everywhere  
that Mary went  
the run-times  
had to go."

**PRO-C**  
The C Source Code Applications Generator

# Accelerate Your Productivity

Pro-C gives you the greatest gift in the computer world--time. You get high quality, fully commented, error free C source code in a fraction of the time it would take to write it by hand.

Pro-C will increase your ability to create programs quickly by generating the source code for menus, reports, screens, windows, and multi-file batch updates. Textbook quality C code is written by us, while the elegant system solutions and exciting new algorithms are created by you.

Pro-C looks and feels like a 4GL, but it's not. You can do prototyping, layout, design and generation of applications without learning a proprietary language, needing massive amounts of memory, or ending up with slow running programs. Best of all Pro-C doesn't require any run-time licenses. Finally, a company that treats you like royalty instead of forcing you to pay them.

Pro-C--the programming partner that does the boring, repetitive coding without complaint, pays for itself every time you use it, and doesn't argue with your obviously brilliant program designs.

**PRO-C** Order yours to-day. Call **1-800-265-2682**  **VESTRONIX**

necessarily map directly to physical addresses (see figure 3), and because some system and INIT software resides in a memory area bounded between addresses referenced by the low-memory globals `BufPtr` and `MemTop`, it's important that Mac VM be installed before such software. The Mac OS uses `BufPtr` as the upper bound on application memory.

The first piece of replaceable software that runs when the Mac starts up (not including the disk driver itself) is the debugger, if there is one installed. Developers frequently use the debugger `MacsBug`, but most users use none at all. When Mac VM is enabled (using the Mac VM interface in the Control Panel), it writes the name "Mac VM" to the debugger entry in the boot blocks of the system disk. It also writes the name of the debugger into the entry for the disassembler, which is the second piece of software executed. In this way, the debugger can still run, but only after Mac VM. This is very important, because `MacsBug` wants to install itself in the high memory above `BufPtr`.

However early the Mac VM installs, a system heap will already exist, since the driver for the system disk, as well as other structures already created by the ROM, must be located there. Therefore, Mac VM must guarantee that all addresses within the system heap are the same in virtual memory as they are in physical. It must ensure that the page-table entries for these pages have identical page-frame virtual-page numbers. This is a bit tricky to maintain, because under `MultiFinder` the system heap is resized dynamically.

When Mac VM starts up, it must also create the MMU page tables on the fly, since it doesn't know how much RAM is in the system or how large the system heap is.

### Programmer Interface

Mac VM provides a limited number of routines available to applications programmers (see table 1). The first three calls are useful for system code that must access application code at interrupt time. The code can hold the memory, access it, and then release it. Since Mac VM keeps a reference count on each page, the `unhold` will not undo the effect of previous holds on other ranges of memory; the same is true for locking. The `DeferUserFn` call is useful when a routine is called whose size (including the routines it calls) is indeterminate; you can use this instead of holding the memory.

The last four calls are especially useful for smart NuBus cards. These cards

can access physical memory, but they don't go through the MMU. Therefore, the card must get the page-table mapping so it can manually make the same translations that the MMU does. It uses the `LockMemory` call to ensure that the mapping doesn't change.

The Mac VM interface has purposefully been made as small as possible. Mac VM itself has been made as efficient and transparent as possible, negating the need for an extensive array of calls.

### No Frills

The philosophy behind Mac VM is to keep it small in scope, extremely efficient, transparent, and, above all, compatible with existing software. It's important to limit the scope precisely because of the complexities that compatibility requires. Achieving compatibility with existing applications requires a little empirically derived code and a lot of testing. Compatibility with the Mac OS forces Mac VM to plug up the holes wherever a VM environment has been ignored. Another good reason to limit scope is time.

Future versions of Mac VM will include many more complex features. One such feature is memory protection. Protection ensures that one application running amuck cannot modify the memory of another.

Two problems are inherent in any protection scheme. First, it is difficult to implement a great deal of software without altering it. Second, Mac VM can't differentiate between applications. Therefore, `MultiFinder` would have to be changed to turn the protection to different applications on and off when switching between them, based on calls provided by Mac VM (`ProtectMemory` and `UnprotectMemory`, probably).

But this arrangement still has problems because system-wide linked lists exist that are threaded through multiple application heaps. For example, the port list keeps track of all open `QuickDraw` `GrafPorts`. The code that walks and maintains these lists will touch memory from multiple applications. Still, Mac VM might be able to allow for these types of lists since it catches the access violations and can recognize the offending piece of code. It can subsequently open up the desired protected area and restart the access. This will be very tricky, though, since third-party software unknown to Mac VM keeps such lists, too.

For all this trouble, the gain is not that great. The system heap is a huge area that is shared by all applications. Therefore,

an illegal modification to the system heap can still crash the Mac. However, it might be possible to minimize the portion of the system heap that is shared and modifiable.

Another useful feature would be to have separate address spaces. In this scheme, each application has a separate page table and therefore separate mapping between virtual and physical memory. This automatically provides memory protection, but also carries with it all the problems associated with protection. In fact, these problems are now more severe than ever. The linked lists are now impossible to deal with, since some of the addresses (those not referring to objects in the current space) aren't valid, although they might map to valid addresses in the current address space. The type of bug this aliasing causes is very difficult to track down.

The one especially nice characteristic of maintaining separate address spaces is that it would allow for a much larger total amount of VM. Instead of 14 megabytes of VM total, Mac VM could allow perhaps 13 megabytes of VM per application, plus about 1 megabyte of shared memory. For a system running 6 applications, this would amount to as much as 79 megabytes of VM.

However, in the time it would take to implement separate address spaces, 32-bit ROMs will be plentiful, most applications will (hopefully) run with the 32-bit ROMs, and there will be unlimited amounts of VM for all. If this is not the case in the future, then perhaps Mac VM will indeed implement separate address spaces.

### Beyond 7.0

Future versions of Mac VM will implement many of the features I've mentioned. The most exciting feature, however, is a tighter integration of `MultiFinder` and Mac VM. Intrinsicly, these two belong together; they represent the key components of a mature operating system: task handling, task communication, and memory management. Integration will allow for a more efficient, elegant, and robust interplay among these components. ■

### REFERENCES

1. Corbato, F. J. "A Paging Experiment with the Multics System." *MIT Project MAC Report MAC-M-384*, May 1968.

*Phil Goldman is a member of the Macintosh OS Group at Apple Computer and coauthor of Mac VM. He can be reached on BIX c/o "editors."*



# DOS at RISC

*Enjoy the best of both worlds—  
DOS software running at RISC speeds*

*Colin Hunter and John Banning*

**T**he advent of 32-bit microprocessors—the 80386, the 68030, and RISC chips—has led to a performance revolution in computer design, affecting workstations, midrange systems, and large multiuser systems. But, ironically, the impact of that revolution has barely been felt on the desktop, where the 16-bit 8088 and 80286—continue to dominate.

RISC-based systems are the performance champs among desktop computers. But their acceptance has been slow—largely because of a lack of applications software. Millions of business users have grown accustomed to the wide range of DOS spreadsheets, word processors, department-level database management systems, and other personal productivity tools. With a multibillion-dollar training and data investment in these programs, DOS users aren't about to switch to RISC if they can't take their software with them. The solution is to let them run their DOS software on RISC machines.

Making DOS software run on RISC machines isn't easy, and several traditional strategies have failed to overcome the portability problem. But a new tech-

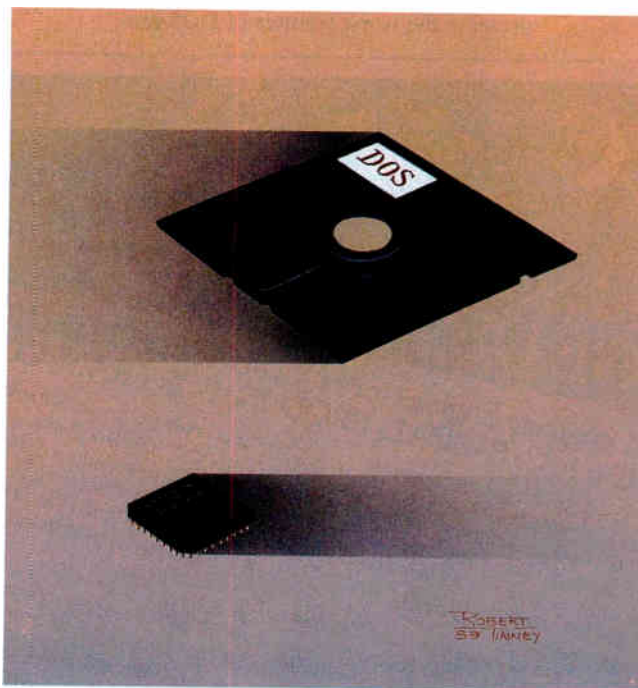

nology called *binary porting*, which converts the binary 8086 instructions of a DOS program into high-performance RISC code, means hundreds of DOS programs—and millions of DOS users—could soon make the leap to RISC.

## **RISC Side Story**

The first RISC CPUs were developed in the late 1970s and early 1980s by com-

puter researchers at IBM, the University of California at Berkeley, and Stanford University. Instead of following traditional computer designs, which packed as much processing power as possible into each CPU instruction, these computer architects built machines with much simpler instructions that executed more quickly.

The resulting performance gain was so striking that RISC ideas quickly found their way into commercial CPU designs, including the Motorola 88000, the MIPS R2000 and R3000, and the Sun SPARC. These RISC processors use instructions that execute in as few clock cycles as possible, generally only one.

RISC processors also rely on optimizing compilers to generate the fewest possible instructions for each program and to organize the instructions to minimize pipeline delays. The marriage of optimizing compilers and RISC architectures means that a RISC program can often execute much faster than its conventional equivalent, even though the RISC program may be longer.

RISC has the speed—but it doesn't  
*continued*

have the business software. And duplicating familiar DOS business software on RISC workstations is no simple task. This is not only because RISC processors are incompatible with old-fashioned CISC (complex-instruction-set computer) CPUs such as the 8086, but also because all RISC computers introduced to date are based on the Unix operating system, which is incompatible with DOS.

Meanwhile, millions of PC users have reached the performance limits of their DOS-based IBM PCs, XTs, and ATs, and need more power. RISC workstations would be a logical upgrade path but for the lack of compatibility. How can we bridge this compatibility gap?

### Movable Software

For the last 25 years, two main strategies have allowed software written for one computer to run on a second, incompatible machine. *Emulation* means that a program running on the second computer mimics the first computer's hardware and operating system. *Porting* requires rewriting or otherwise modifying the first computer's software to run on the second machine.

The problems with these two approaches have remained the same for 25 years, too: Emulators are too slow, and porting takes too long.

An emulator is essentially an instruction set interpreter. It fetches, decodes, and executes the instructions of the DOS program, one instruction at a time. This process consumes a great many RISC instructions for each 8086 instruction performed, and a great many clock cycles. Thus, an emulator runs DOS software relatively slowly. Emulating DOS code on a RISC is more of a problem because of the mismatch between the 8086 CISC instructions and the RISC instructions. Since each 8086 instruction must be decoded on the fly, there is no opportunity to use the compiler optimization techniques that give RISC its performance advantages.

Emulators have other disadvantages for DOS programs running on RISC Unix systems. They produce a single-user environment on the target system and thus fail to take advantage of the multiuser features of Unix (a real problem for database programs). They also preserve the worst features of DOS pro-

grams on the Unix system—for example, keyboard polling loops, which are a real performance drain in multiprocess systems, since idle programs consume CPU cycles by polling the keyboard. And they tend to make very inefficient use of cache memory.

Porting, by contrast, has traditionally required the software vendor to rewrite the source-language version of the program. Porting is great for the user—if it happens. Unfortunately, it almost never does. A port of the program you're interested in is almost never available for the RISC Unix computer you're using. The reasons are partly technical and partly economic.

For performance reasons, most DOS programs contain relatively large sections written in assembly language. Porting a program requires that these sections be rewritten in another language. From that point on, the software vendor must support, maintain, upgrade, and keep in sync at least two versions of the program—or three versions if there's a second port, four if there's a third, and on and on. This rewriting takes a long

*continued*

# PCYACC™

Version 2.0

## PROFESSIONAL LANGUAGE DEVELOPMENT TOOLKIT

Includes "Drop In" Language Engines for SQL, dBASE, POSTSCRIPT, HYPERTALK, SMALLTALK-80, C++, C, PASCAL, PROLOG, FORTRAN, COBOL, and ADA.

PCYACC Version 2.0 is a complete Language Development Environment that generates ANSI C source code from input Language Description Grammars for building Assemblers, Compilers, Interpreters, Browsers, Page Description Languages, Language Translators, Syntax Directed Editors, Language Validators, Natural Language Processors, Expert System Shells, and Query languages.

Complete Grammars, Lexical Analyzers, and Symbol Table Management for ANSI C, K&R C, ISO Pascal, FORTRAN, dBASE III/Plus and IV, SQL, C++, Smalltalk-80, APPLE HyperTalk, C&M Prolog, YACC, LEX, FORTRAN-77, COBOL, ADA, and POSTSCRIPT are included. DOS, OS/2, QNX, SUN, AIX, and Macintosh versions are available.

Example application sources are provided to be used as skeletons for new programs. Examples include a desktop calculator, an Infix to Postfix Translator, a DBASE and SQL

Syntax analyzer, an implementation of the PIC[tur]e language, and a C++ to C translator.

- Quick Syntax analysis option
- Optional Abstract Syntax Tree
- Manual "Compiler Construction with PCS" included
- Lexical Analyzer generator ABRAXAS PCLEX is included
- Fully compatible with UNIX YACC grammars
- 30 day money back guarantee
- No charge for AIR Shipping anywhere in the world

■ **Advanced ERROR HANDLING, RECOVERY, and REPORTING Provided**

Professional Version \$495.00—Personal Version \$249.00

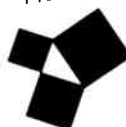

**ABRAXAS™  
SOFTWARE, INC.**

7033 SW Macadam Ave. Portland, OR 97219 USA

TEL (503) 244-5253 · FAX (503) 244-8375  
AppleLink D2205 · MCI ABRAXAS



# Because Resources Should Be Shared

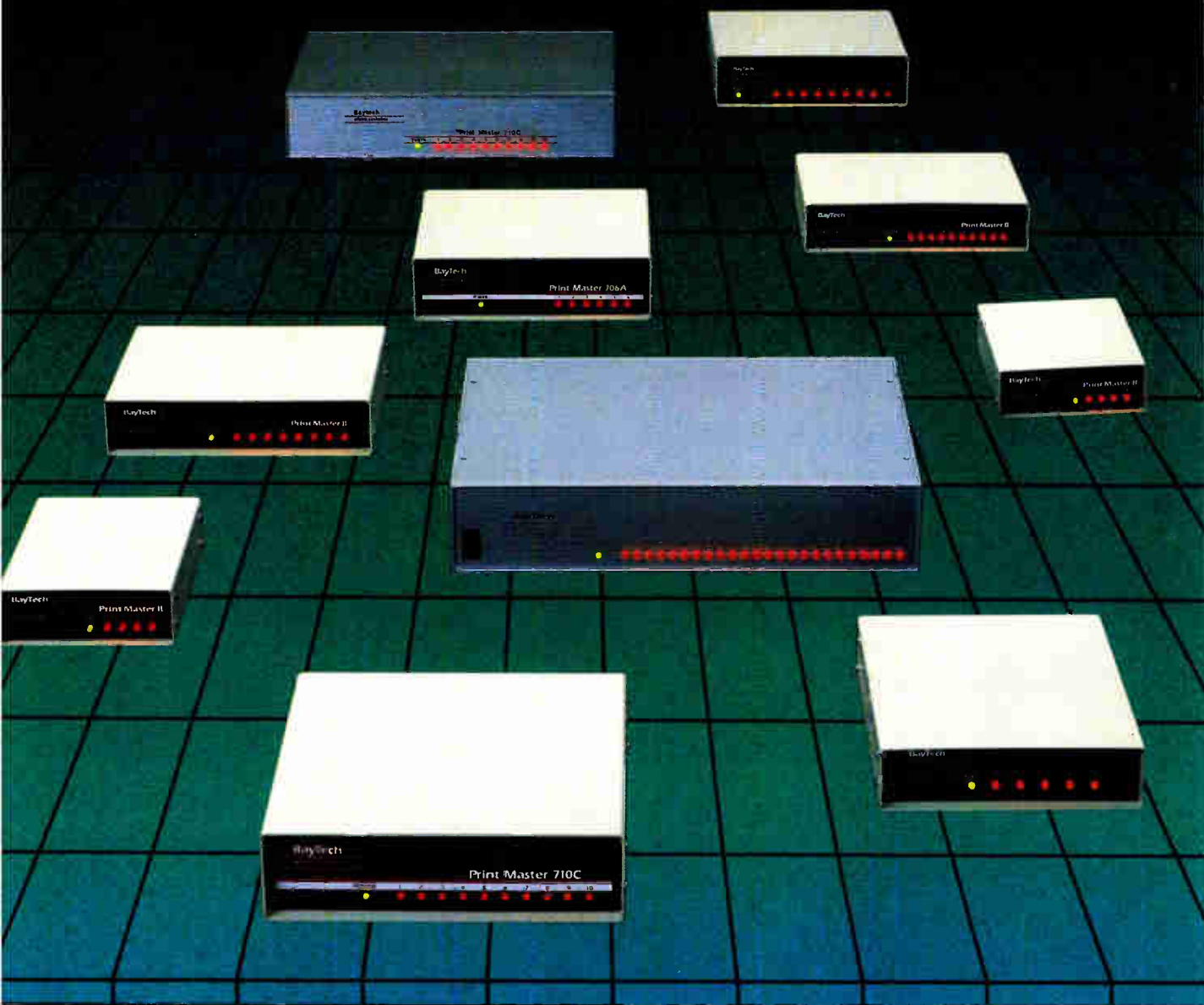

## BayTech engineers resource sharing solutions.

Because we know your applications for sharing printers, plotters, modems and data are unique, BayTech has developed over 30 resource sharing products, which offer you a broad range of solutions for sharing your resources.

We realize that you shouldn't have to fit your application to the specifications of a single product. With BayTech, you select the

model that meets *your* needs.

From simply sharing one or more printers between computers, to creating a complete network of computers, printers, plotters and modems, BayTech has a product designed for you.

Call us toll-free today. Our technical support staff will show you how to make the most of your resources.



*Bay Technical Associates, Inc.  
Data Communications Products Division  
200 N. Second Street, P.O. Box 387  
Bay St. Louis, MS 39520 USA  
FAX: 601-467-4551  
Telex: 910-333-1618 BAYTECH  
Phone: 601-467-8231 or toll-free*

**800-523-2702**

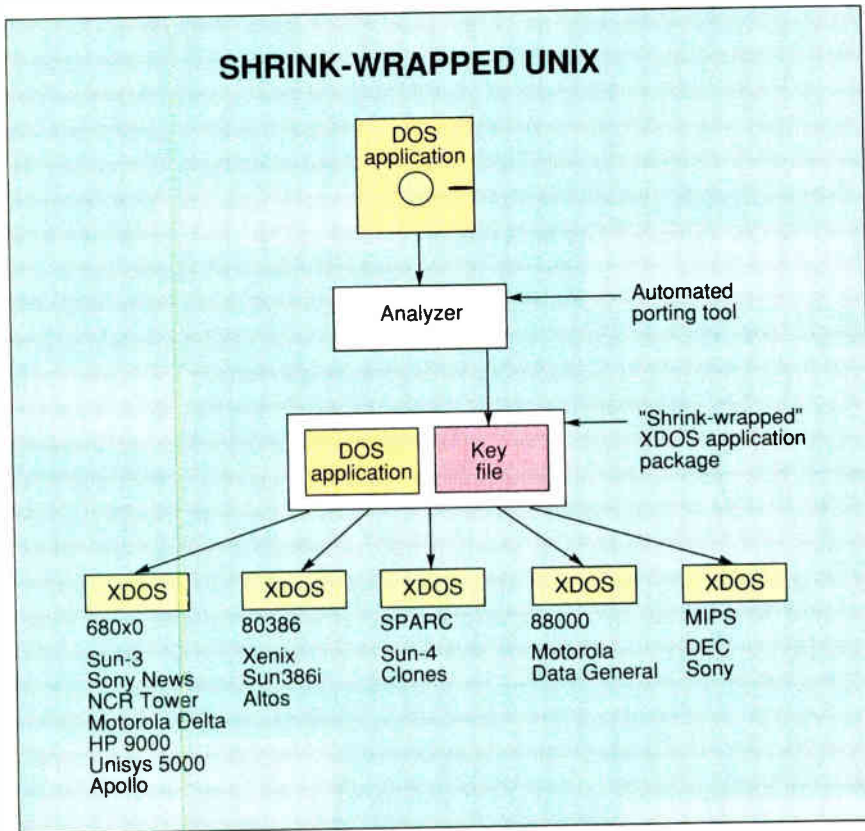

Figure 1: The first step in supplying DOS applications for high-end Unix workstations is to create a common key file. The key file can then be distributed, with the application, to XDOS-equipped Unix systems.

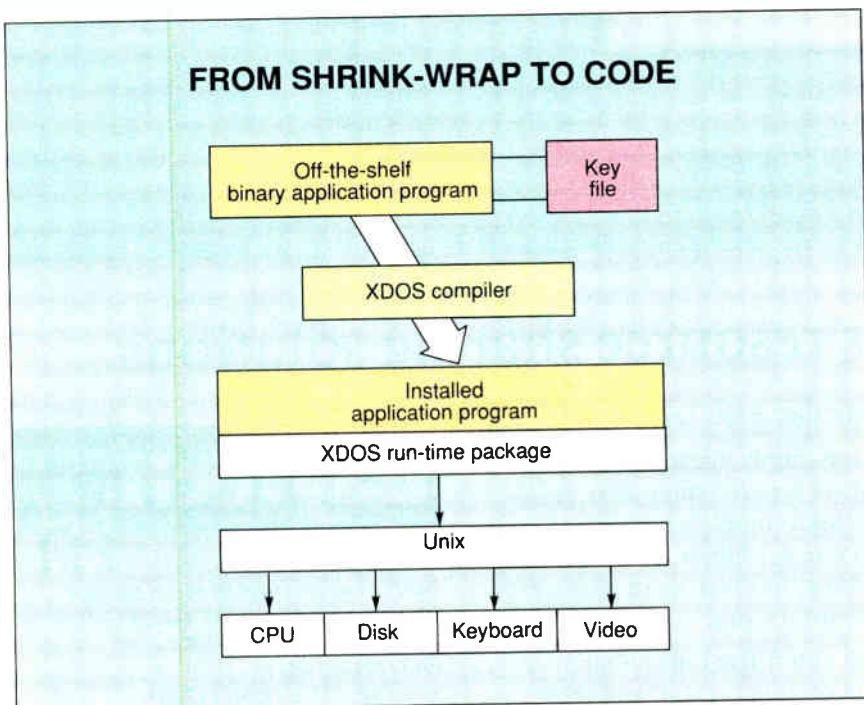

Figure 2: Step 2 in the binary porting process is to install the application on the target system.

time—often several years—and maintaining multiple versions of a program is very costly.

And for what? The DOS market has 25 million users. The entire Unix market has 4 to 5 million. But the Unix market consists of dozens of incompatible machines, each requiring a separate port. And of the fewer than 5 million Unix users, only about 30,000 use RISC workstations. Given these market realities, it's no surprise that most DOS software vendors choose to invest their precious engineering resources on upgrading their current DOS products or introducing new ones rather than porting their source code to RISC Unix computers.

**The Binary Porting Strategy**

Hunter Systems has recently developed a new porting technology called *binary porting*, which does not require making any changes to the source code of a program. It uses advanced optimizing compiler technology to convert executable binary code directly into a program that will run on the target machine.

A binary port produces a program that has the same performance and functionality as a source port, but performing a binary port takes considerably less time. Moreover, once the binary port to Unix is complete, the program is available on all Unix machines—CISC as well as RISC. Successively porting the program to each type of computer is no longer necessary.

Binary porting is a two-step process. The first step is *binary analysis*. This step is time-consuming; it corresponds to conventional source porting. However, binary analysis takes only a few days or weeks, instead of the months or years that source porting usually requires. The binary analyzer reads the executable code of the DOS program and performs a sophisticated global data-flow analysis on the program. The analyzer then produces a *key file* containing the results of the data-flow analysis.

The key file can then be combined in a "shrink-wrapped" package with the original DOS program. This package can be distributed to any Unix user, with almost any type of computer: RISC or CISC, System V or Berkeley Unix. For all practical purposes, the package is a "universal binary" that all Unix machines can run (see figure 1).

The second step is called *binary compilation*. This is essentially an automatic installation process. The end user needs to do it only once, and it takes only a few minutes using a program called a *binary*

*continues*



# Aurora 1024™

GRAPHICS  
BOARD

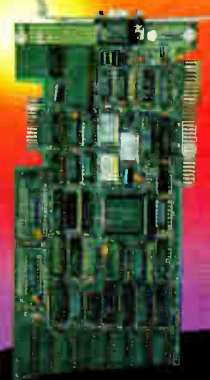

THE DAWN OF  
A NEW GRAPHICS AGE

TI 34010 COPROCESSOR  
8514/A COMPATIBLE BOARD  
**1024 x 768 with 256 COLORS!**

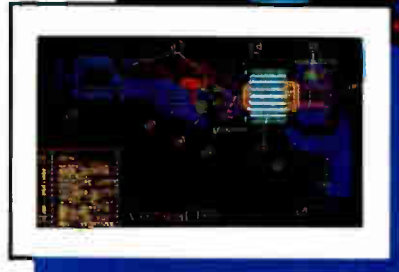
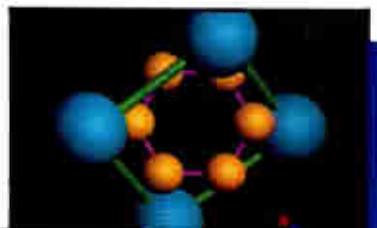

The Aurora 1024™ brings the graphics user into the new age of graphics processing. By adding the Aurora 1024 high resolution graphics card to your XT or AT, you will have unparalleled processing power with 100% IBM 8514/A compatibility. The Aurora 1024 is a full-featured TI 34010-based board that runs at resolutions up to 1024 x 768 x 256 colors.

## HIGH SPEED

The Aurora 1024 is fast! It runs 20-50 times faster than VGA and 10-50% faster than IBM's 8514/A. But that's not all! With the specially designed ADI driver, you will see AutoCAD re-draw 20 times faster than IBM's 8514/A and other industry-leading boards (as shown below).

## WIDE COMPATIBILITY

With the Aurora 1024, you also get industry-wide software compatibility. That's because IBM's new graphic standard, the Adapter Interface (AI) used for the 8514/A, is included with every board. And for AutoCAD users, we also include our specially designed ADI driver—as well as the hottest performing Windows and VENTURA driver available. These interfaces give ready access to a wide range of important non-CAD application programs, such as Lotus 1-2-3®, Wordperfect®, Quattro®, PS/RIO®, PS/TOPAS®, EXCEL®, EnerGraphics™ and Pagemaker® ... plus hundreds of other titles.

## AFFORDABLE PRICE

The Aurora 1024 sets a new standard of value and performance at about half the price of most comparable high-resolution graphic boards. You simply won't find a better price anywhere! **\$995**

**ORDER TODAY**

**CALL TOLL FREE  
1(800) 325-0174**

**ENERTRONICS**

*Innovator in Graphic Solutions*

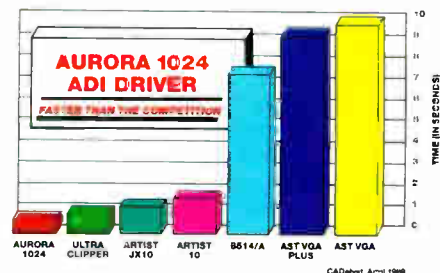

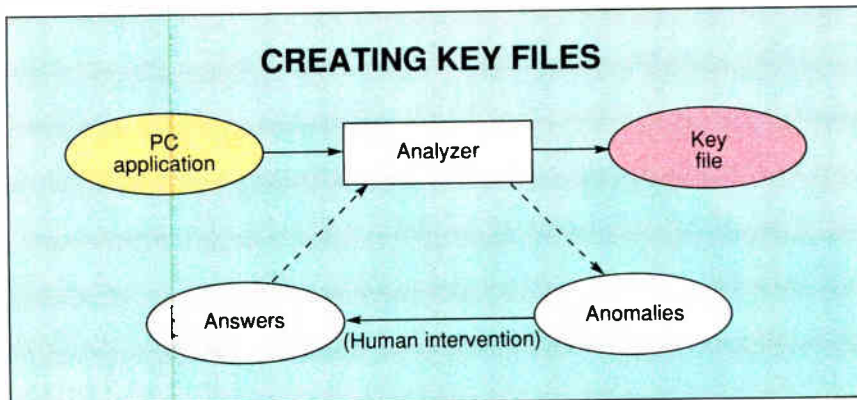

**Figure 3:** Creating the key file requires human intervention when execution paths are blocked by anomalies created by self-modifying code and computed jumps.

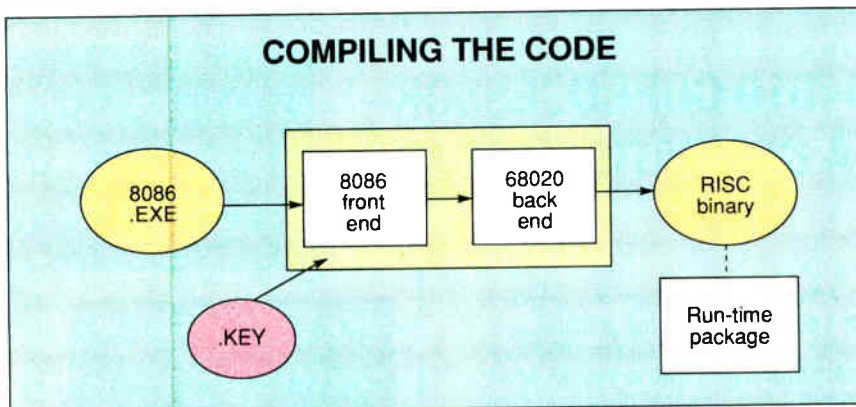

**Figure 4:** An XDOS binary compiler is specific to each target machine. Traps and hardware calls in the original application are converted into calls to the Unix run-time library, which in turn calls the appropriate Unix resource to handle these situations.

compiler. The binary compiler reads the DOS program and key file and converts them into a RISC Unix program, using the key file's flow data for code optimization. The installed program is a real Unix program, with the performance and functionality of a source port (see figure 2).

All architectural and operating-system dependencies of a particular RISC Unix system are incorporated in its version of the binary compiler. The binary compiler can be ported to many different Unix platforms, and each new port inherits all the currently available DOS programs with key files.

### Binary Analysis

The basic problem for the binary analyzer is finding all the executable code of the application that it's analyzing and then creating a complete flow graph for the code. Once this is done, the analyzer uses a series of relatively mechanical steps (e.g., global flow analysis) to

create the information for the key file.

To find the code and create a flow graph, the analyzer traces execution paths and decodes instructions, starting with the application's entry point. This process will easily find all the executable code in the program, as long as the program doesn't use either self-modifying code or computed jump or call destinations. Unfortunately, real programs use both of these techniques. The binary analyzer handles them by a combination of automatic procedures and human intervention (see figure 3).

When the analyzer encounters these constructs, it generates an anomaly report and proceeds until all execution paths are blocked by anomalies. Then a human analyst must figure out the construction that caused the anomaly and provide the answer to the analyzer. To aid the analyst, the analyzer has an interactive mode in which it prints out the instructions, propagated values, and flow graphs of partially analyzed programs

and indicates the parts that cannot be analyzed.

Once the binary analyzer has constructed a complete flow graph for a program, it performs a number of analysis and optimization steps, including live/dead analysis of registers and condition codes. The analyzer uses this information in subsequent optimization steps. The binary compiler will also use it to help generate good code.

Once all this analysis is complete, the analyzer produces the key file. The key file consists mainly of directions to the binary compiler indicating where to decode instructions. The analyzer outputs this information in an order that will allow the binary compiler to process all the application-program files in a linear way. In general, a key file is about 20 percent the size of the corresponding executable application file.

### Binary Compilation

The binary compiler uses the information in the key file to convert the code in the original binary image into the machine code of a target system. Each binary compiler is designed for a particular target architecture. The binary compiler contains a front end that reads the DOS program and key file, a back end that generates optimized code, and a run-time library that provides the interface to the Unix operating system (see figure 4).

The compiler starts by reading in the binary application program, using the transformation routines in the key file, if necessary, to put it into usable form. Under the direction of the key file, the compiler then converts the binary code into an intermediate representation, one block of instructions at a time. The compiler first decodes each block of code and then applies any modifications that are called for in the key file. The dead register and flag information from the key file is propagated from the end of the block back through to the beginning. Then the compiler performs a number of optimizations on the intermediate code.

Following optimization, the compiler generates target-system code for each intermediate instruction. The code generators use the dead register and flag information to eliminate unnecessary flag computations and improve the efficiency of computations involving overlapping registers. Code generators also assign target-machine registers at this point.

The binary compiler converts DOS and BIOS traps and direct hardware accesses into calls to the Unix run-time library. This library's functions then

*continued*



# Why Experienced Computer Users Don't Think Very Much About Modems

Our research shows that knowledgeable MIS managers, PC coordinators, and end users simply don't want to think of modems at all.

Not exactly what modem makers relish hearing! But it's hardly surprising that you want to save your thinking for bigger and more important things.

Modems are a lot like plumbing. As long as the data is flowing, they're practically invisible. However, when something goes wrong, those little boxes are just lavished with attention.

By then, you've lost data, time, money, and perhaps an opportunity. Both senders and receivers are dismayed and disarrayed.

Fortunately, there are simple ways to limit this aggravation. Our research suggests a few points to keep in mind.

## The cost of the modem is not the modem's cost.

The fixed price of the modem is relatively insignificant. Ongoing costs matter far more.

In the long run, for example, a high-speed modem can save you a small fortune on phone bills. More data sent in less time means less money to the phone company.

You can also save with more reliable and robust modems that communicate over a wide range of telephone line conditions.

Resending data costs both time and money. The less time you spend transmitting data, the more time you have to spend on your business.

Downtime and adaptation time can also cost you dearly.

Be sure to ask if the modems are compatible with their earlier generations. You don't want to start with suppliers who regularly obsolete their own products, or who don't offer you an upgrade path.

## Modem support can be a real hassle with the wrong vendor.

Setting up and installing your modem can affect both your budget and your sanity. Many manufacturers forget to make their modems easy to use!

This becomes expensive when you want to start up fast or need to support a large number of users.

Dip switches, on-line help screens, and easy-to-use manuals should be demanded. It also helps to have a quick-reference guide printed on the bottom of the case.

In sticky situations, it's vital to have toll-free support and applications engineering.

## Bottom line: The data must get through.

A bit of data traveling from your computer is converted by your modem and sent to your local telephone office.

From there, it is exposed to the vagaries of phone lines, various transmission media, and weather patterns.

They all conspire to corrupt your data and slow down your throughput.

All modems are not created equal; some are less sensitive to noise and have better error-correcting protocols.

Some are simply more robust and have better filters.

Modems are more than mere commodities — technology does count.

## "When things go wrong, I want the supplier there."

That's when you need the *right* supplier on board. Look for one who gives fast turnaround time on repairs and adjustments, and who doesn't vanish after the sale.

Look for a company with history and promise — one that's here today and here tomorrow.

## Not everyone needs the same modem.

The best way to keep modems from wasting your time and money is to buy them from a reliable supplier with a broad product line. Those with limited lines sometimes try to cram square pegs into round holes.

People with differing applications have differing requirements. Dealing with a broad-line supplier simplifies ordering, reduces training/support time and cost, and limits hassle and coordination.

In the end, if you give enough consideration to choosing the right supplier, you'll hardly have to give modems any thought at all.

U.S. Robotics has been making modems and communications equipment for discerning customers since 1976.

## U.S. Robotics®

The Intelligent Choice in Data Communications

Call us toll-free at 1-800-DIAL-USR  
(In Illinois, 312-982-5001)

U.S. Robotics is a registered trademark of U.S. Robotics, Inc.

In Canada, call 1-800-553-3560.

In the United Kingdom, Miracom Technology, Ltd. (0473) 233-888

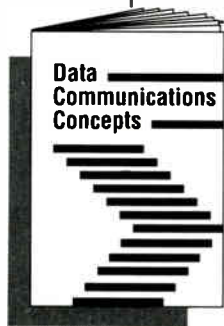

### FREE REFERENCE BOOK

Please send me the 108-page **Data Communications Concepts** — filled with illustrations, diagrams, and clear explanations — absolutely free and without obligation.

Print Name \_\_\_\_\_

Title \_\_\_\_\_

Company \_\_\_\_\_

Address \_\_\_\_\_

City \_\_\_\_\_ State \_\_\_\_\_ Zip \_\_\_\_\_

Phone (\_\_\_\_) \_\_\_\_\_

Mail to: U.S. Robotics, Inc., Attn: Marketing Dept. 8100 N. McCormick Blvd., Skokie, IL 60076, or call us toll-free at 1-800-DIAL-USR (In Illinois, 312-982-5001).

BY 11/89

# MONTGOMERY GRANT

BYTE  
11/89

OUTSIDE USA & CANADA.....CALL  
**(718)692-0790**

For Customer Service  
Call Mon-Thurs:9:30am-4:30pm  
Fri:9am-3:30pm (718) 692-1148

Retail Outlet: Penn Station, Main Concourse  
(Beneath Madison Square Garden) New York City, NY, 10001  
Store Hours: Mon-Thurs, 8:30am-8pm/Fri,8:30am-3pm/Sat.,Closed/Sun,9:30am-7pm  
FOR ORDERS & INFORMATION IN USA & CANADA CALL TOLL FREE

## 1-800-759-6565

OR WRITE TO:  
Montgomery-Grant Mail Order  
Department, P.O. Box 58,  
Brooklyn, N.Y., 11230

FAX NO. 7186923372  
TELEX 422-132 MGRANT

EXTENDED HOLIDAY SEASON ORDER HOURS: Mon-Thur 8:30am-8pm/Fri 8:30am-4pm/Sat, CLOSED/ Sun, 9:30am-6:00pm  
NO SURCHARGE FOR CREDIT CARD ORDERS / WE INVITE CORPORATE AND EDUCATIONAL CUSTOMERS  
CORPORATE LEASING & PERSONAL FINANCING AVAILABLE /DISCOUNTS FOR QUANTITY ORDERS/TOLL FREE TECHNICAL SUPPORT

**EPSON EQUITY 1+**  
IBM XT COMPATIBLE  
640K RAM w/Clock Calendar • 4.77 - 10 MHz • 360K Drive • Serial & Parallel Ports • MS DOS 3.3 • GW Basic

**\$619**

SAME w/SEAGATE 20MB HARD DRIVE.....\$869  
SAME w/SEAGATE 30MB HARD DRIVE.....\$899  
SAME w/SEAGATE 40MB HARD DRIVE.....\$969  
SAME w/TWO 360K FLOPPIES.....\$729

**EPSON EQUITY II+**  
IBM AT COMPATIBLE  
640K RAM • 80286 Microprocessor  
1.2MB Floppy Drive • Serial & Parallel Ports • MS DOS 3.3

**\$999**

SAME w/SEAGATE 20MB HARD DRIVE.....\$1249  
SAME w/SEAGATE 30MB HARD DRIVE.....\$1279  
SAME w/SEAGATE 40MB HARD DRIVE.....\$1349

**EPSON EQUITY 386/20**  
80386 Microprocessor • 20MHz • 1MB RAM Expandable  
to 16MB • 1.2MB Floppy Drive • MS DOS 3.3 • GW Basic

**\$2349**

WE CAN RECONFIGURE ANY OF OUR COMPUTER PACKAGES TO FIT YOUR SPECIFICATIONS. CALL FOR INFORMATION. ALL COMPUTER SYSTEMS SUPPORT MDA, CGA, EGA, VGA, & MULTISCAN. WE CARRY MODEMS, HARD DRIVES, CARDS, MONITORS, MEMORY UPGRADES & ALL OTHER ACCESSORIES FOR YOUR COMPUTER.

**LEADING EDGE MODEL D**  
IBM XT COMPATIBLE PKG.  
512K RAM Expandable to 768MB • 8088-2 Microprocessor • 360K Floppy Drive • 4.77-7.16 MHz • MS DOS 3.3 & GW Basic • 12" Monitor

**\$599**

SAME w/SEAGATE 20MB HARD DRIVE.....\$829  
SAME w/SEAGATE 30MB HARD DRIVE.....\$869  
SAME w/SEAGATE 40MB HARD DRIVE.....\$929

LEADING EDGE MODEL D2+ w/30MB.....\$1599

**AST AST 286 IBM AT COMPATIBLE**  
80286 Processor • 512K Expandable to 4MB • 1.2MB Floppy Drive • Serial & Parallel Ports • Video Card

**\$799**

SAME w/SEAGATE 20MB HARD DRIVE.....\$1049  
SAME w/SEAGATE 30MB HARD DRIVE.....\$1079  
SAME w/SEAGATE 40MB HARD DRIVE.....\$1149

AST PREMIUM 286 MODEL 70.....\$1199  
AST PREMIUM 386/16 MHz.....\$2199

AST 386/25 MHz.....\$475  
AST 386/33 MHz.....\$4199

### LAPTOP COMPUTERS

AMSTRAD PPC-512 512K, 1 FLOPPY.....	\$499	NEC ULTRALITE 2MB.....	\$2279
AMSTRAD PPC-640, 640K 2 DRIVES, MODEM.....	\$699	NEC MULTISPEED HD.....	\$1949
TOSHIBA 1000.....	\$625	NEC PROSPEED 286-20MB.....	\$3099
TOSHIBA 1600.....	\$3179	NEC PROSPEED 286-40MB.....	\$3299
TOSHIBA 1800 w/40MB.....	\$3569	NEC PROSPEED 386 w/40MB.....	\$4499
TOSHIBA 3100e.....	\$2699	ZENITH 184 w/2 FLOPPIES.....	\$1469
TOSHIBA 1200H.....	\$1849	ZENITH 184-2 w/20MB.....	\$2199
TOSHIBA 3200.....	\$1969	ZENITH 286 w/20MB.....	\$2999
TOSHIBA 5100.....	\$3299	SPARK EL.....	\$949
TOSHIBA 5100 w/100MB.....	\$4199	COMPAQ SLT 286-20.....	\$2799
TOSHIBA 5200.....	\$4799	COMPAQ SLT 286-40.....	\$4199
TOSHIBA 5200 w/100MB.....	\$5299	BONDWELL 286-20.....	\$2169

MODEMS, EXTERNAL DRIVES, & ACCESSORIES AVAILABLE FOR ALL LAPTOPS.

**AMIGA 500 2500 2000 COMPUTERS**

Amiga 500 w/Built-in 5.25" Drive **\$549**

Amiga 500 w/1084 Monitor **\$829**

Amiga 2000 w/Built-in 3.5" Drive **\$1459**

Amiga 2500 **\$3299**

Amiga 1084 RGB Monitor **\$289**

Amiga 1010 Disk Drive **\$179**

### PRINTERS

**STAR**

NX-1000.....\$164.95  
NX-1000.....\$164.95  
RAINBOW.....\$214.95  
NX-2400.....\$284.95  
XR-1000.....\$339.95  
XR-1500.....\$429.95  
XR-2410.....\$429.95  
XR-2415.....\$549.95

**CITIZEN**

180 D.....\$149.95

**DICONIX**

150+.....\$329.95

**OKIDATA**

OKIMATE 20.....\$139.95  
OKIDATA 180+.....\$219.95  
OKIDATA 183.....\$249.95  
OKIDATA 320.....\$319.95  
OKIDATA 321.....\$459.95  
OKIDATA 390.....\$439.95  
OKIDATA 391.....\$599.95

**EPSON**

FX-1050.....\$429.95  
FX-850.....\$334.95  
LQ-510.....\$329.95  
LQ-850.....\$509.95  
LQ-950.....\$569.95  
LQ-1050.....\$719.95  
LQ-2550.....\$999.95  
LX-810.....\$179.95

**NEC**

P-2200.....\$319.95  
P-5200.....\$489.95  
P-5300.....\$649.95

**PANASONIC**

KXP-10921.....\$289.95  
KXP-1524.....\$519.95  
KXP-1595.....\$409.95  
KXP-1124.....\$309.95  
KXP-1180.....\$177.95  
KXP-1191.....\$229.95  
KXP-3131.....\$294.95

**TOSHIBA**

301.....\$329.95

**HEWLETT PACKARD**

DESKJET.....\$599  
DESKJET PLUS.....\$679  
PAINTJET.....\$959

**LASER PRINTERS**

HP LASERJET SERIES II **\$1629**

1MB EXPANDER.....\$279  
2MB EXPANDER FOR.....\$399  
LASERJET II.....\$399  
4MB EXPANDER.....\$699  
HP LASERJET IID.....\$2799  
PANASONIC KXP-4450.....\$1349  
BROTHER HL-8E.....\$1859  
BROTHER HL-8EPS.....\$3199

### MONITORS

MAGNAVOX EGA.....\$319  
MAGNAVOX VGA.....\$449  
MAGNAVOX VGA.....\$349  
w/VGA Card.....\$539  
NEC 1490.....\$629  
NEC MULTI SYNC IIA.....\$509  
NEC MULTI SYNC IID.....\$619  
PARADISE VIDEO CARDS.....IN STOCK!

**NEC POWERMATE 286**  
IBM AT COMPATIBLE  
80286 Microprocessor • 10 MHz • 512K RAM Expandable to 16MB • 1.2MB Floppy Drive • Serial & Parallel Ports • MS DOS 3.3 • GW Basic

**\$899**

SAME w/SEAGATE 20MB HARD DRIVE.....\$1149  
SAME w/SEAGATE 30MB HARD DRIVE.....\$1179  
SAME w/SEAGATE 40MB HARD DRIVE.....\$1249

**NEC POWERMATE 286 PLUS**  
IBM AT COMPATIBLE  
1MB RAM Expandable to 16MB • Zero Wait State • 8-12 MHz • 1.2MB Floppy Drive • Serial & Parallel Ports • MS DOS 3.3 • GW Basic • 80286 Microprocessor • VGA

**\$1149**

SAME w/SEAGATE 20MB HARD DRIVE.....\$1399  
SAME w/SEAGATE 30MB HARD DRIVE.....\$1439  
SAME w/SEAGATE 40MB HARD DRIVE.....\$1499

**NEC POWERMATE 386 SX PLUS**  
80386 SX Microprocessor • 2MB RAM Expandable to 16MB • 1.2MB Floppy Drive • Serial & Parallel Ports • MS DOS 3.3 • VGA

**\$1699**

NEC HARD DRIVE PACKAGES AVAILABLE  
NEC POWERMATE 386/20.....\$2899

**VENDEX HEADSTART III**  
8-12 MHz • 1MB RAM • 5.25" 1.2MB Floppy Drive  
3.5" 1.44MB Floppy • 30MB Hard Drive • VGA/EGA/CGA  
MDA Included • Serial & Parallel Ports • Mouse  
MS DOS 3.3 • 12" VGA Monitor

**\$2099**

\$1000 SOFTWARE INCLUDED

**Panasonic FX-1750**  
640K RAM Expandable to 768K • 3.5" 720K Floppy • 80286 Microprocessor • Parallel & Serial Ports • MS DOS 3.3 and GW Basic

**\$699**

SAME w/SEAGATE 20MB HARD DRIVE.....\$949  
SAME w/SEAGATE 30MB HARD DRIVE.....\$979  
SAME w/SEAGATE 40MB HARD DRIVE.....\$1049

**IBM PERSONAL SYSTEM 2**  
ALL MODELS IN STOCK.....CALL

5.25" 360K EXTERNAL DRIVE for IBM PS/II-30.....\$129  
PACIFIC RIM 5.25" 1.2MB EXTERNAL DRIVE for IBM PS/II.....\$259

**HYUNDAI MODEL 286E**  
640K RAM Expandable to 1MB • 80286 Microprocessor • 12 MHz • 1.2MB Floppy Drive • Serial & Parallel Ports • MS DOS 3.3 • GW Basic

**\$899**

SAME w/SEAGATE 20MB HARD DRIVE.....\$1149  
SAME w/SEAGATE 30MB HARD DRIVE.....\$1179  
SAME w/SEAGATE 40MB HARD DRIVE.....\$1249

**EVEREXSTEP 386 IS**  
386 SX Microprocessor • 16MHz  
1MB RAM • 1.2MB Floppy Drive

EVEREX 386/20 MHz.....\$2899  
EVEREX 386/20MHz, w/4MB.....\$3799  
EVEREX 386/25 MHz.....\$3499

**Apple IIGS COMPUTER PKG.**  
Apple IIGS Computer • 512K Upgrade  
RGB Color Monitor • Apple 3.5" Disk Drive

**\$1499**

IMAGEWRIGHT II PRINTER.....\$439  
ALL OTHER APPLE MODELS.....CALL

**COMPAQ DESKPRO 286**  
640K Expandable to 2.1MB • 8-12MHz  
80286 Microprocessor • 1.2MB Floppy Drive • Serial/Parallel Ports

**\$1629**

SAME PKG. w/SEAGATE 20MB.....\$1879  
SAME PKG. w/SEAGATE 30MB.....\$1919  
SAME PKG. w/SEAGATE 40MB.....\$1979

**COMPAQ 286e**  
80386 SX Microprocessor • 1MB RAM Expandable to 13MB • Serial/Parallel Ports • 16 MHz • 1.2 MB Floppy Drive

**\$1849**

**DESKPRO 386S**  
80386 SX Microprocessor • 1MB RAM Expandable to 13MB • Serial/Parallel Ports • 16 MHz • 1.2 MB Floppy Drive

**\$2399**

COMPAQ 386/33 w/84MB **\$7499**

**DESKPRO 386-20e**  
80386 SX Microprocessor • 1MB RAM Expandable to 16MB • Serial/Parallel Ports • 20 MHz • 1.2 MB Floppy Drive

**\$3699**

COMPAQ Brand Monitors & Hard Drive Packages in Stock!

CUSTOM CONFIGURATIONS AVAILABLE FOR ALL COMPUTERS



RUSH SERVICE AVAILABLE. CALL FOR DETAILS.

Certified Check, Bank Check, Money Orders, Approved P.C.'s, Visa, Mastercard, Am-Ex, Diner's Club, Carte Blanche, & C.O.D.'s accepted. Please call before submitting P.O.'s. No additional surcharge for Credit Card orders. Non-certified checks must wait 4-6 weeks for clearance. N.Y. residents add applicable sales tax. Prices and availability subject to change without notice. Not responsible for typographical errors. Return of defective merchandise must have a price authorization number or returns will not be accepted. IBM/XT/AT are registered trademarks of International Business Machines Corp. Please add 5% shipping & handling. Volume orders over \$2000 are discounted to 3% shipping & handling (Canadian orders please add additional 5%). APO/FPO orders please add 30% shipping and handling. All APO/FPO orders are shipped first class priority air. All orders can be shipped Air Express. Call for details. DCA #800231



# Clearing the Air

*What are the issues to consider with 32-bit software?  
Will 32 bits solve all your problems?*

*Bill Blagdan*

Choosing all your hardware by how well it can run the software you need is much easier said than done. Many 80386-based computers are currently being used as fast 80286-based machines because the vast majority of popular software applications on the market are compiled for 16-bit execution. 80386-based microcomputers don't have a price/performance advantage over 80286-based PCs unless they are running 32-bit software.

It's true that 32-bit software can move more data in fewer clock cycles and has access to more memory than 16-bit software. These are the factors that provide increased performance for 32-bit applications. However, there are not yet many 32-bit applications available that can take advantage of these capabilities. Understanding the issues as well as the technology surrounding 32-bit software will provide you with the insight you need to make educated microcomputer-buying decisions. Some of the issues include 80386-specific software versus 32-bit software, DOS extenders, various aspects of OS/2, and the 80386SX microprocessor.

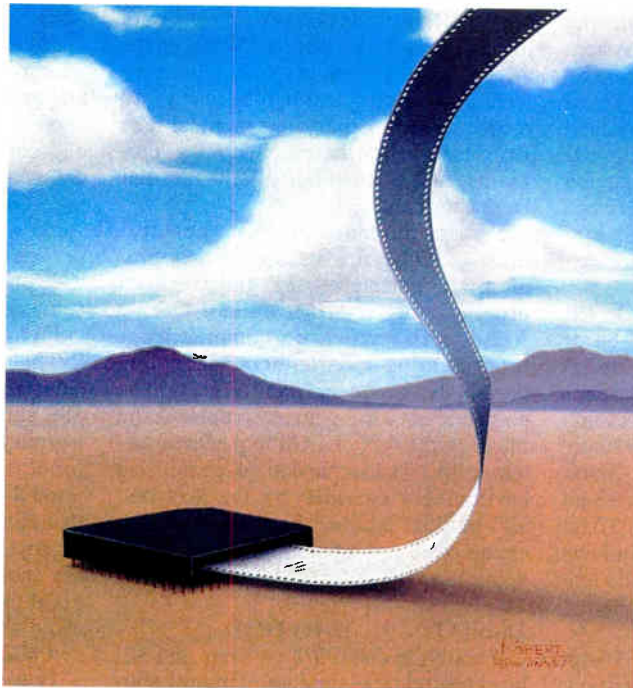

## 80386-Specific vs. 32-bit Software

80386-specific software uses features of the 80386 CPU not available on the 8086, 8088, and 80286. But to be truly classified as 32-bit software, applications must execute 32-bit instructions. Thirty-two-bit instructions can manipulate data and memory in 32-bit chunks and provide 32-bit addressing of up to 4 gigabytes of memory.

The 80386's *real*, *protected*, and *virtual 86* operating modes also complicate things. When executing in real mode, the 80386 is operating as a fast 8086 processor executing 16-bit instructions. None of the advanced features of the 80386, including 32-bit instructions, are employed in real mode, and memory access is limited to 1 megabyte. On the other hand, virtual 86 mode enables simultaneous multiple 8086 sessions, each in its own protected memory partition, or *virtual machine*. However, this multitasking of 16-bit sessions occurs only with the proper operating environment to function as an arbitrator.

Windows/386 is specific to the 80386, but it is *not* a 32-bit application. It is a 16-bit application that enables semi-protected multitasking of other 16-bit applications through its windowing graphical interface. It offers only partial protection because it doesn't provide true crash-isolation of its multitasking programs. When one of its multitasking applications crashes, Windows/386 lets you save the data in the other multitasking sessions before rebooting. It's also important to note that Windows/386

*continued*

doesn't run concurrently with, or allow multitasking of, 32-bit DOS applications. This is because they run in the protected mode of the 80386, which conflicts with the Windows/386 memory management structure.

The 80386 microprocessor's protected mode provides the means to access the advanced features of the 80386, such as 32-bit instruction execution, 32-bit addressing, and multitasking of 32-bit applications. However, to take advantage of all the features of the 80386's protected mode, operating systems and software applications must be written for it. Currently, DOS is a real-mode operating system that doesn't permit protected-mode execution! So, how do you create 32-bit DOS software that runs in protected mode and takes advantage of the advanced features of the 80386?

### DOS Extenders

DOS extenders are software tools used to create applications that run partially in protected mode under DOS. An *extended application* is only partially protected because it switches back and forth between real and protected modes during execution and can crash the whole system when it is in real mode. Applications created with DOS extenders look like ordinary DOS programs. However, hidden from the user is a kernel that starts under DOS, switches the processor to protected mode, and provides an interface between the application and DOS operating-system services, via a keyboard, for example.

To produce software with a DOS extender, you need a compatible 16-bit or 32-bit compiler. The compiler determines whether the application executes 16-bit or 32-bit instructions. To develop software that exploits the 32-bit instructions of the 80386, you need a 32-bit compiler that is compatible with a 32-bit DOS extender. Both 16-bit and 32-bit versions of DOS extenders are available to take advantage of protected-mode features of the 80286 and 80386 processors, respectively.

If you can compile familiar 16-bit DOS applications for 32-bit execution, why are there so few 32-bit versions of 16-bit software packages? First of all, DOS extenders have some very important limitations. When executing an extended DOS application, all DOS system services, including I/O, must run in real mode. Therefore, every time an extended application performs an I/O instruction, such as reading the keyboard, it switches to real mode, performs the I/O function, and returns to protected

mode. This switching between modes costs valuable clock cycles and decreases application performance.

Second, you may have to significantly rewrite 16-bit source code to run in protected mode. You can port well-behaved software from the 16-bit DOS environment to a 32-bit, protected-mode, extended-DOS environment.

Third, the market for an 80386-only product is much smaller than for an 80286/80386 product due to the massive installed base of 80286 machines. Many of the 32-bit DOS applications available today are mainframe or minicomputer software ported to the 80386 and recompiled with a DOS extender. And many of them address small, vertical markets and don't offer any solutions to the broad base of IBM-compatible personal computer users.

### The OS/2 Challenge

Another factor contributing to the small number of 32-bit DOS applications is the challenge to create OS/2 versions of popular programs. OS/2 is a 16-bit operating system that was designed to take advantage of all the protected-mode features of the 80286 microprocessor. Some of the advanced features include true protected-mode multitasking, access to 16 megabytes of memory, a graphical user interface, better harmony among programs, and compatibility with familiar DOS commands.

Perhaps the most important new features of OS/2 are its application programming interface (API) and graphical programming interface (GPI). OS/2's API and GPI provide a comprehensive programming environment, including thousands of built-in function calls. You no longer have to set up interrupts via the interrupt 21 API of DOS to perform system calls. The enhanced programming environment provided by the API and GPI of OS/2 provide the tools needed to create more functional and easier-to-use applications.

### 16-bit OS/2 vs. 32-bit DOS

Currently, 16-bit OS/2 versions and 32-bit extended DOS versions of many popular software packages are under development. For those packages with *both* versions under way, you might expect the 32-bit version to be faster. Tests have shown, however, that 16-bit Paradox OS/2 outperforms 32-bit Paradox/386. Unlike DOS, which is a real-mode operating system, OS/2 runs exclusively in protected mode. Thus, OS/2 applications don't waste time switching between real and protected modes. So, if you compare

different program incarnations, you must do it carefully.

A 16-bit OS/2 application also may outperform a 32-bit DOS version because of OS/2's ability to use *threads*. A thread is the smallest unit of execution within an OS/2 application. Every OS/2 application has at least one thread, but several threads can run at the same time.

OS/2 programmers can use these threads to create applications that employ multitasking within themselves by overlapping program functions with user input. For example, an OS/2 spreadsheet program could perform recalculation as a separate thread when you hit the Recalculate key, freeing up the keyboard so you can go on working with the spreadsheet.

### OS/2 vs. OS/2 for the 386

The production release of a new 80386-specific, 32-bit version of OS/2, tentatively called OS/2 for the 386, is scheduled for the first half of 1990. Two important issues must be addressed when comparing this version with the original: 32-bit instruction execution and segmentation.

Although 32-bit instruction execution will be available under OS/2 for the 386, any applications released for the current version of OS/2 will have to be rewritten and compiled with a new 32-bit OS/2-compatible compiler to gain this advantage. Given this complication, many software vendors may never release 32-bit versions of OS/2 applications. Instead, they may simply package them as 16-bit versions to run under both OS/2 and OS/2 for the 386.

The second important issue to consider regarding OS/2 and OS/2 for the 386 surrounds segmented versus linear memory addressing. The 80386 microprocessor's memory architecture supports a linear, or "flat," memory model that enables direct addressing of up to 4 gigabytes of memory. With a flat memory model, you can set up one huge 4-gigabyte code-and-data segment and avoid the extra work required by 8086 and 80286 segmented architectures.

However, memory segmentation is required with a protected-mode, multitasking operating system such as OS/2 or OS/2 for the 386. Multiple code and data segments are kept for each application running concurrently in a multitasking environment to enable hardware-assisted protection by the microprocessor. Therefore, while OS/2 for the 386 won't do away with segmentation, it will enable you to use data and code segments that

*continued*





# If Looks Could Kill...





## The ViVa24 Modem knocks 'em dead with style and convenience.



Finally! An affordable, state-of-the-art modem designed to maximize any workstation or desktop and take up minimal space. The new 2400 baud modem from Computer Peripherals, Inc. is a 100% Hayes compatible external modem which boasts more high-tech features than its competition at an unbelievable price tag. 

The compact, distinctively sleek tower design simplifies placement, and it's easily accessible, front panel power switch eliminates fumbling around the back of the unit. The handsome weighted base holds the ViVa24 firmly in place, and sharp LED indicator lights are aligned for comfortable viewing, utilizing international graphic icons that make the ViVa24 simple to understand. 

The small tower design creates a natural flow of air over the surface of the board, allowing the ViVa24 to run cooler and affording you 24-hour, worry-free operation. The Viva24 modem provides the user compatibility with IBM PC, XT, AT, IBM PS/2, Apple Macintosh computers and any computer that supports RS-232C. 

The ViVa24 modem represents innovation from its footprint up with features such as: use of the Hayes "AT" command set, asynchronous data format, auto-dialing, auto answer, adaptive equalization, non-volatile memory, automatic tone and pulse dialing, remote access while your computer is unattended, self-test and built-in diagnostics. Best, of all, the ViVa24 is fully backed with a five-year limited warranty. 

Before investing in an ordinary modem, be sure to investigate the ViVa24. For more details, call your Ingran MicroD representative now at:

1-800-456-8000 (East)  
1-800-642-7631 (West)

# HIGH FIDELITY™

By Computer Peripherals, Inc.  
667 Rancho Conejo Blvd.  
Newbury Park, CA 91320  
TEL: (805) 499-5751

Trademarks: IBM, International Business Machines, Corp.; Hayes Microcomputer Products; Apple Macintosh; High Fidelity, Computer Peripherals, Inc.

Circle 90 on Reader Service Card (DEALERS: 91)

World Radio History

are larger than the 64K bytes that is permitted under OS/2.

### The 80386SX Microprocessor

The 80386SX is a low-end version of the 80386 that can run 32-bit software but is hindered by a 16-bit data bus. In most cases, the 80386SX operates in the same 16-bit environment as the 80286.

However, tests show that the 80386SX is slower than the 80286 when running 16-bit applications, and slower than the 80386 when running 32-bit applications. Compared to the 80286, the 80386SX is also slow at multitasking 16-bit applications under OS/2.

### Easier Said Than Done

Software continues to be one of the most important factors to consider when purchasing personal computers. You have a wide range of choices of IBM PC-compatible hardware platforms, ranging in price from less than \$1000 for 8088, 8086, or 80286 processors to more than \$10,000 for the latest 80386 or 80486 processors.

Not all 80386-specific applications are 32-bit applications. DOS extenders are an important option to consider, as are the performance differences between 16-bit OS/2 applications and 32-bit extended DOS applications. And the new

32-bit version of OS/2 has its advantages as well.

Which IBM PC-compatible personal computer platform you choose should be determined by two primary factors: the software you need, and the hardware's ability to run that software effectively. Just because a program claims to be "32-bit software" doesn't mean that it is the best program to run your particular application. ■

*Bill Blagdan is a product marketing engineer at Advanced Micro Devices in Austin, Texas. He can be reached on BIX c/o "editors."*

## McGraw-Hill Bookstore

# Discover the Shape of Computing to Come

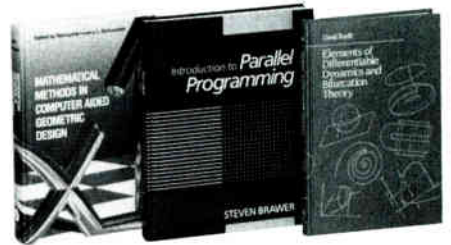

Published by Academic Press

### 1 Mathematical Methods in Computer Aided Geometric Design

Edited by Tom Lyche and Larry L. Schumaker

Nearly 50 papers from distinguished international researchers show you the latest mathematical techniques for designing and interpolating univariate and multivariate splines, algebraic curves, rational curves and surfaces, Bézier curves and surfaces, finite elements, and more. Topics treated include scattered data interpolation, geometry processing, convexity and shape preservation, subdivision, knot insertion and removal, knot selection for parametric curves, geometric continuity, and cardinal interpolation. 628 pp., \$49.95

### 2 Introduction to Parallel Programming

By Steven Brawer

Complete with examples in simplified Fortran, this first-of-a-kind self-tutorial guides you step by step through the basics of parallel programming — from creating multiple processes and scheduling memory sharing to dealing with data dependencies. And it presents such useful applications as discrete-time, discrete-event simulation, numerical integration, and Gaussian elimination — plus parallel versions of the traveling salesman problem and maze exploration. 438 pp., \$39.95

### 3 Elements of Differentiable Dynamics and Bifurcation Theory

By David Ruelle

A rigorous introduction to the mathematical theory underlying chaos and strange attractors — emphasizing infinite dimensional systems, non-invertible maps, attractors, and a general theory of bifurcations. Includes detailed problems. 187 pp., \$27.50

Clip or copy this coupon and return to:

## McGraw-Hill Bookstore

1221 Avenue of the Americas  
New York, NY 10020  
Tel. 1-212-512-4100

YES! Please send me —

- \_\_\_ copies of book #1 (Lyche/Schumaker)  
\_\_\_ copies of book #2 (Brawer)  
\_\_\_ copies of book #3 (Ruelle)

Check, money order, or credit card only:

VISA  MasterCard  AMEX

Acct. # \_\_\_\_\_

Exp. Date \_\_\_\_\_

Name \_\_\_\_\_

Address \_\_\_\_\_

City \_\_\_\_\_

State \_\_\_\_\_ Zip \_\_\_\_\_

Please add applicable sales tax, plus \$2.50 postage and handling.



BYT11A

The Professionals' Information Center—Since 1961



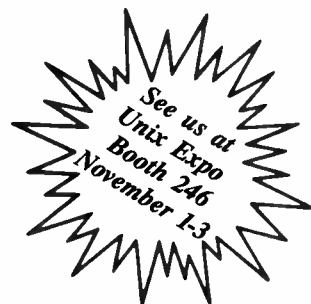

## How to match the best front end with the best back end.

You've invested in the best hardware, operating system and database products. You have a staff of programmers ready to go. But to build great looking applications with the sophisticated features today's users demand, you need a powerful front end development tool—JAM.™

JAM, the most advanced user interface management system on the market, does it all—from prototyping to implementation. And, because it works with any database

or file manager, you get the best front end *and* the best back end.

JAM is hardware independent, so it isn't limited to one computer, database or operating system. In fact, JAM runs on everything from PC's to super-minis, works under 7 operating systems and provides access to a host of database products. Using JAM you can create a consistent user interface across multiple systems and hardware platforms.

JAM works under the following operating systems:

- UNIX®
- VMS®
- RMX™
- MS-DOS®
- XENIX®
- VOS™
- AOS/VS™

JAM makes it easier than ever to design and revise complex applications. Using features like context-sensitive help, procedural command language (JPL), shifting and scrolling fields, extensive data validations, on-line testing, and a variety of visual attributes, you'll be amazed how quickly your applications spring to life.

JAM is fast, as well as flexible. Development time is reduced significantly thanks to JAM's powerful screen drawing utilities and comprehensive library of sub-routines. You can easily create and link together screens, windows, and menus to develop an application shell. Then simply attach the processing routines, and your application is complete.

Plus, if your back end is an SQL-compatible relational database like Oracle,® SQLbase,® Informix® or Britton Lee,™ you'll really appreciate JAM/DBi, JAM's optional database interface. With JAM/DBi, you can develop entire applications using only industry-standard SQL statements and JAM's authoring tools.

So if you're programming in a 3GL like C or FORTRAN, follow the lead of the many Fortune 1000 companies who have already discovered JAM.

JAM from JYACC. It gives you the best at both ends.

Call for more information about JAM and our demo diskette. **800-458-3313**  
 JYACC, Inc.  
 116 John Street  
 New York, NY 10038  
 212-267-7722 FAX No. 212-608-6753



*Use SQL to retrieve and display data.*

# JAM

JYACC Application Manager. *The Composer for Sophisticated Applications.*

Circle 190 on Reader Service Card (DEALERS: 191)

## Upward Mobility

*If the price of a new 32-bit computer system is beyond reach, you should consider a used computer—the computer you're using now. The products listed below let you upgrade your 8- or 16-bit computer with a 32-bit processor and, in most cases, 32-bit memory. Don't let the 32-bit bandwagon pass you by. Climb aboard!*

**AOX**  
486 Totten Pond Rd.  
Waltham, MA 02154  
(617) 890-4402

**Master 386**  
16 MHz..... \$1195  
20 MHz..... \$1395  
*80386 processor card for the IBM PC AT and compatibles. Accesses 1 to 15 megabytes of memory.*

**MicroMaster 386**  
20 MHz..... \$1495  
25 MHz..... \$1795  
*80386 processor for Micro Channel machines; comes with 1 to 8 megabytes of memory.*  
**Inquiry 1180.**

Applied Reasoning  
86 Sherman St.  
Cambridge, MA 02139  
(617) 492-0700  
**PC-elevATor 386** ..... \$1795  
*16-MHz 80386 processor board with 1 megabyte of RAM for the IBM PC, XT, and compatibles.*  
**Inquiry 1181.**

Artek Computer Systems  
780 Montague Expy.,  
Suite 203  
San Jose, CA 95131  
(408) 433-9208  
**Abacus 386/25** ..... \$1200  
*25-MHz 80386 processor board for the IBM PC AT and compatibles; contains up to 4 megabytes of memory.*  
**Inquiry 1182.**

AST Research  
2121 Alton Ave.  
Irvine, CA 92714  
(714) 863-1333  
**Premium FASTboard/386** ... \$1095  
*16-MHz 80386 CPU module for*

*AST Premium ATs; comes with 1 to 8 megabytes of memory.*  
**Inquiry 1183.**

Daystar Digital  
5556 Atlanta Dr.  
Flowerbranch, GA 30542  
(800) 962-2077  
(404) 967-2077  
**Daystar 33/030** ..... \$2995  
*33-MHz 68030 processor for the Mac SE. Optional 68882 math coprocessor for \$900.*  
**Inquiry 1184.**

Dove Computer  
1200 North 23rd St.  
Wilmington, NC 28405  
(800) 622-7627  
(919) 763-7918  
**FastNet LAN 020** ..... \$1499  
*16-MHz 68020 processor for the Mac SE with 1 to 5 megabytes of memory.*  
**Inquiry 1185.**

Eclipse Computer Solutions  
1 Intercontinental Way  
Peabody, MA 01960  
(508) 535-7510  
**386 HummingBoard**  
20 MHz..... \$1995  
25 MHz..... \$2495  
*80386 processor for the IBM PC, XT, and compatibles. Available with 1 to 24 megabytes of memory.*  
**Inquiry 1186.**

GCC Technologies  
580 Winter St.  
Waltham, MA 01254  
(617) 890-0880  
**HyperCharger 020** ..... \$999  
*16-MHz 68020 accelerator for the Mac SE that carries 1 to 4 megabytes of memory.*  
**Inquiry 1187.**

Intel Corp.  
Personal Computer Enhancement  
Operation  
5200 Northeast Elam Young Pkwy.  
Hillsboro, OR 97124  
(503) 681-8080  
**Inboard 386**..... \$1295  
*16-MHz 80386 processor board for the IBM PC AT and compatibles; comes with 1 megabyte of RAM.*

**Inboard 386/PC**  
*16-MHz 80386 processor board for IBM PC, XT, and compatibles; comes with 1 megabyte of RAM.*  
**Inquiry 1188.**

Irwin Magnetic Systems  
2101 Commonwealth Blvd.  
Ann Arbor, MI 48105  
(800) 412-1879  
(313) 930-9000  
**XL 20/XL 25**

XL 20..... \$995  
XL 25..... \$1695  
*20- and 25-MHz 68020 processor boards for the Mac SE; come with 1 to 8 megabytes of memory.*  
**Inquiry 1189.**

Levco Sales  
6181 Corner Stone Court E,  
Suite 101  
San Diego, CA 92121  
(619) 457-2011  
**Prodigy SE** ..... \$1499  
*16-MHz 68020 processor board for the Mac SE with 1 to 4 megabytes of memory.*  
**Prodigy 4** ..... \$2995  
*16-MHz 68020 processor board for the Mac Plus with 4 megabytes of memory and a SCSI port.*  
**Inquiry 1190.**

Novy Systems  
2341 South Ridgewood Ave.  
Edgewater, FL 32032  
(904) 427-2358  
**MAC20MX Series**  
16 MHz..... \$895  
25 MHz..... \$1795  
*68020 accelerators for the Mac Plus and Mac SE; available with 1 to 4 megabytes of RAM.*  
**Inquiry 1191.**

Orchid Technology  
45365 Northport Loop W  
Fremont, CA 94538  
(415) 683-0300  
**Jet 386**..... \$1299  
*16-MHz 80386 board for the IBM PC and XT.*  
**Inquiry 1192.**

Quadram L.P.  
(Q/Cor)  
One Quad Way



# BBS Sysops



Are you looking for ways to improve your board? Something that will set you apart from other boards in your area? Are your subscribers interested in microcomputers? Listen to this!

## Announcing the Bulletin Board EXchange

The Bulletin Board Exchange allows you to become a publisher of MicroBYTES Daily, an on-line news service from BYTE. It is a custom package of news and features designed specially for local BBSes, and is available only to sysops.

Every Monday through Friday you get articles about developments in microcomputing, telecommunications and selected new product announcements. Get the latest news about MS DOS machines, Macintoshes, Unix workstations, Amigas, Atari STs, peripherals and software. All the stories are reported, written, and edited by the staff of BYTE Magazine, BYTEweek and BIX, and our world-wide network of reporters and editors.

Not only do you get a great resource for your subscribers, but you also get access to BIX which will cut your cost of exchanging information and conducting BBS network business.

**All this is just \$49 a quarter.**

Your one-year subscription to the Bulletin Board Exchange (billed quarterly) may be cancelled any time without further charge; just notify us. If you prefer, you may subscribe for three months only, at just \$69.

If you call BIX directly, you pay no hourly telecommunications charge. If you call using Tymnet, the rates are only \$2/hour on evenings and weekends and \$8/hour on weekdays. You may also purchase unlimited off-peak Tymnet for just \$15 a month in the U.S. (lower 48 states). International Tymnet access is provided by your local PTT.

**Subscribe today.**

# BIX

One Phoenix Mill Lane  
Peterborough, NH 03458  
1-800-227-2983  
In NH (603) 924-7681

Norcross, GA 30093  
(404) 923-6666

### Quad 386XT

16 MHz..... \$1195  
20 MHz..... \$2295

80386 processor board for the IBM PC, XT, and compatibles; available with 1 to 3 megabytes of memory.

**Inquiry 1193.**

### Radius

404 East Plumeria Dr.  
San Jose, CA 95134

(408) 434-1010

**Accelerator 16** ..... \$795

16-MHz 68020 board for the Mac Plus and SE; 68881 available for \$300.

**Accelerator 25** ..... \$1395

25-MHz 68020 board for the Mac SE; 68882 available for \$500.

**Inquiry 1194.**

### Total Systems

99 West 10th Ave.,  
Suite 333

Eugene, OR 97403

(800) 874-2288

(503) 345-7395

### Gemini 020/030

16-MHz 68020 ..... \$795

20-MHz 68030 ..... \$1395

Accelerator board for Mac 128, Mac 512, Mac Plus, and Mac SE that lets you use either a 68020 or a 68030 processor; includes a SCSI port.

**Inquiry 1195.**

*This resource guide is intended to provide a reasonable cross-section of available products, companies, and services. Due to space limitations, we cannot list all companies and products. Inclusion in the resource guide should not be taken as a BYTE endorsement or recommendation. Likewise, omission from the guide should not be taken negatively. The information here was believed to be accurate at the time of writing, but BYTE cannot be responsible for omissions, errors, or changes that occur after compilation of the guide.*

# Spreadsheet Rivalry Heats Up

meet the... products are not enough if software products are not displayed in computer stores.

officials... the new... that the... ver-... in-... ty

**'Things are getting down and dirty,' a computer analyst observes.**

Dealers who have seen what will be...



# We Interrupt T War For This Im

To all those unlucky enough to be stuck smack in the middle of the current spreadsheet confusion, take heart.

There is, at last, a viable alternative to war: revolution.

One that delivers even more performance than you have (ahem) been waiting for, but without demanding expensive new hardware or extensive retraining. And without abruptly cutting you off from any user in your company, even those on mainframes.

The name of the spreadsheet is SuperCalc<sup>®</sup> 5.

And what it can do for you is, frankly, quite revolutionary.

Let's begin at the end. Stand-alone quality graphic capabilities have been built in.

Offering hundreds of presentation treatments from word charts to three-dimensional bar, pie, scatter, and polar graphs.

And with SuperCalc5, you select fonts, lines, boxes, grids and shading. All of which can be used to produce the highest quality customized reports.

Plus, SuperCalc5 actually makes productivity easier. An integrated Undo feature simply reverses unwanted commands. And a truly comprehensive system of debugging highlights costly errors and analyzes macro logic.

Perhaps even more impressive

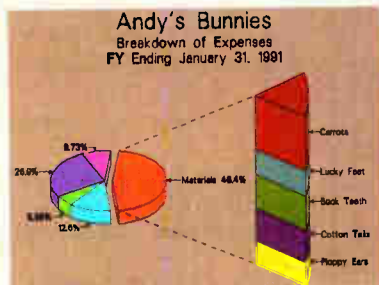

Present a state-of-the-art picture of your work.

Andy's Bunnies  
Mid-War Consolidation

	North	South	East	West	Total
Revenue	\$464,189	\$388,445	\$399,551	\$219,317	\$2,481,422
Expenses	\$141,816	\$159,268	\$197,661	\$194,777	\$683,522

Quarter 2 Results

	North	South	East	West	Total
Revenue	\$291,443	\$229,881	\$441,898	\$81,431	\$1,444,753
Expenses	\$84,367	\$76,821	\$77,621	\$79,256	\$320,065

Quarter 1 Results

	North	South	East	West	Total
Revenue	\$254,665	\$299,442	\$445,661	\$111,889	\$1,411,657
Expenses	\$26,389	\$81,184	\$188,042	\$9,222	\$324,837

Link just about everything in sight.

is the way SuperCalc5 can link spreadsheets. Up to 255



Catch bugs before they come back to bite you.



**POWER  
TION**

...the field had been ranked and the odds  
...al computer spreadsheet software...

**New program  
...es to fend off  
Spreadsheet war**

**Spreadsheet  
Ready to Pounce**

January 28, 1989

**at Gain  
on River**  
...creating a spreadsheet

# The Spreadsheet Important Update.

to be precise. Linking either in memory or on disk, either pages of the same spreadsheet or independent, either SuperCalc5's files or Lotus® 1-2-3's.

and compatible computers but also takes full advantage of 286 and 386 machines when you decide to make that transition.

And if all that isn't enough to make you run out today and join the revolution, there's even more incentive.

Which brings us to the "L" word. SuperCalc5 not only reads and writes Lotus® 1-2-3® files, it totally coexists with Lotus.

Like our free demo disk offer through July 31, 1989. And our \$100 upgrade offer for just about any spreadsheet you're using. Call 1-800-531-5236. In Canada call 1-800-663-6904.

Which finally brings us to our admittedly biased outlook for the much touted spreadsheet war. With SuperCalc5, peace is at hand.

Andy's Bunnies  
Income Statement  
FY Ending January 31, 1991  
Unaudited

Revenue	1990	1991
Sales	\$3,776,633	\$4,289,672
License	\$1,464,775	\$477,153
Supplier Discounts	\$634,980	\$470,280
Rate-a-Rabbit Fees	\$273,981	\$126,527
	\$1,462,729	\$1,074,240
Cost of Sales	\$966,331	\$554,712
Opening Inventory	\$109,814	\$129,164
Purchases	\$86,027	\$4,306
Freight In	\$9,232,392	\$589,138
Ending Inventory	\$2,361,111	\$2,684,340
Cost of Materials	\$2,096,781	\$2,655,200
Direct Labor	\$1,641,391	\$1,677,243
Employee benefits	\$28,590	\$33,649
Rent supplies	\$175,444	\$63,652
Total Cost of Sales	\$4,912,767	\$8,879,901
Gross Profit	\$2,536,442	\$1,769,317
Less selling, general and admin expenses	\$2,049,297	\$1,953,724
Earnings (Loss) from operations	\$487,145	\$815,593
Other income (deduction)		
(Interest) Income	\$11,309	\$6,745
Other Income	\$17,899	\$15,686
Gain (Loss) on sale of fixed assets	\$279	\$0
Other income (deduction)	\$28,829	\$25,431
Provision for income taxes:		
Current income taxes	\$1,043,387	\$469,772
Deferred income taxes	\$1,004,337	\$662,279
Net earnings (Loss) for period	\$1,200,587	\$809,279

Produce annual-report quality output everyday

Letting you easily move 1-2-3 macros into SuperCalc5 and back again. Even toggling between menus is a snap for SuperCalc5.

But not for Excel®. Which now brings us to the "E" word. Unlike Excel, SuperCalc5 runs on all IBM®

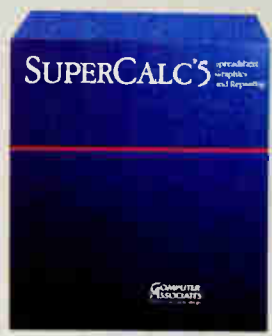

**COMPUTER ASSOCIATES**  
Software superior by design.

Microsoft, IBM is a registered trademark of International Business Machines.

# A NEW TWIST ON AN OLD TECHNOLOGY

*Helical-scan technologies—including DAT—provide tape storage systems with gigabytes of data storage*

*Jay Bretzmann*

**B**ecause today's personal computers are powerful enough to run large and complicated applications, users need enormous storage capacity. Helical-scan tape storage offers multi-gigabyte capacities that most other personal computer storage systems can't achieve. Helical-scan techniques also provide higher transfer rates and cost-efficient, removable data storage. Currently, users can't obtain these benefits from tapes recorded by traditional techniques.

## By Any Other Name

Helical-scan recording isn't really new. What is new is the name and the fact that, until about 16 years ago, this technology wasn't used for computer applications.

Otherwise known as *slant-track* or *diagonal* (versus *longitudinal*) recording, helical-scan technology has been used in video recording applications since 1956, when Ampex introduced the first commercial videotape recorder. Adaptations of the technique for computer data storage began about 18 years ago. Once again, Ampex was the pioneer when it introduced its Terabit Data Recorder in 1972, but IBM drew significant attention to the format.

In 1973, IBM purchased the rights to the technology from Ampex for \$13 million, and in 1974, it introduced the IBM 3850 as the ultimate solution to data-storage problems. The aim was to eliminate the manual handling (and resultant human error) associated with tape reels and disk packs. The 3850 could essentially put all your data on-line by storing between 35 and 472 gigabytes. The 3850 was able to record this much data by using helical-scan technology and a large-width tape.

For various reasons, including the move from batch to transaction processing, in 1985, IBM discontinued support of the 3850. Generally, there was a move to smaller machinery and increasing electronic (versus mechanical) complexity. As video recording technology evolved, tape widths shrank, recording heads started to slant, and, by and large, companies began developing a helical tape format known as VHS, which

was adopted first for commercial and then for consumer video recording.

As engineers experimented with this technology for data-storage applications, the form factor changed (from 8-inch to 5-inch), limiting the acceptance of this format and causing most serious tape suppliers to shy away from its use.

## Mostly Good News

"Conventional" tape devices write data longitudinally in a pattern parallel to the edge of the tape. In helical-scan recorders, the recording head tilts at a slight angle, causing the tape to wrap around it in a barber-pole fashion. The spinning head writes data tracks as portions of a continuing spiral or segments of a helix—thus the name. Figures 1a and 1b show the differences in track layout and head design for typical recording devices, such as the quarter-inch drive and the helical-scan product.

The first helical-scan tape machines used 2-inch-wide tape, but now helical-scan products are produced in several widths, including 4-mm digital audio tape (DAT), 8-mm, quarter-inch, half-inch, and a few nonstandard widths. The 4-mm DAT, which is potentially one of the best tape-storage formats, has been plagued with ongoing controversy that has held back its implementation. (See the text box "The DAT Controversy" on page 384.) DAT technology involves the ability to put well over 1 gigabyte of almost totally pure data on a cassette the size of a credit card (see "DAT Drive Eases Mac Backups" on page 225).

Of course, as with any beneficial technology, along with the advantages come some trade-offs. For instance, as yet, not all the helical-scan standards are in place. Some are here and others are on their way, though, via organizations such as QIC (Quarter-Inch Cartridge) and DDS (Digital Data Storage), which make recommendations and decisions concerning standard tape drive features and formats.

An additional problem has been that because sound can be

*continued*



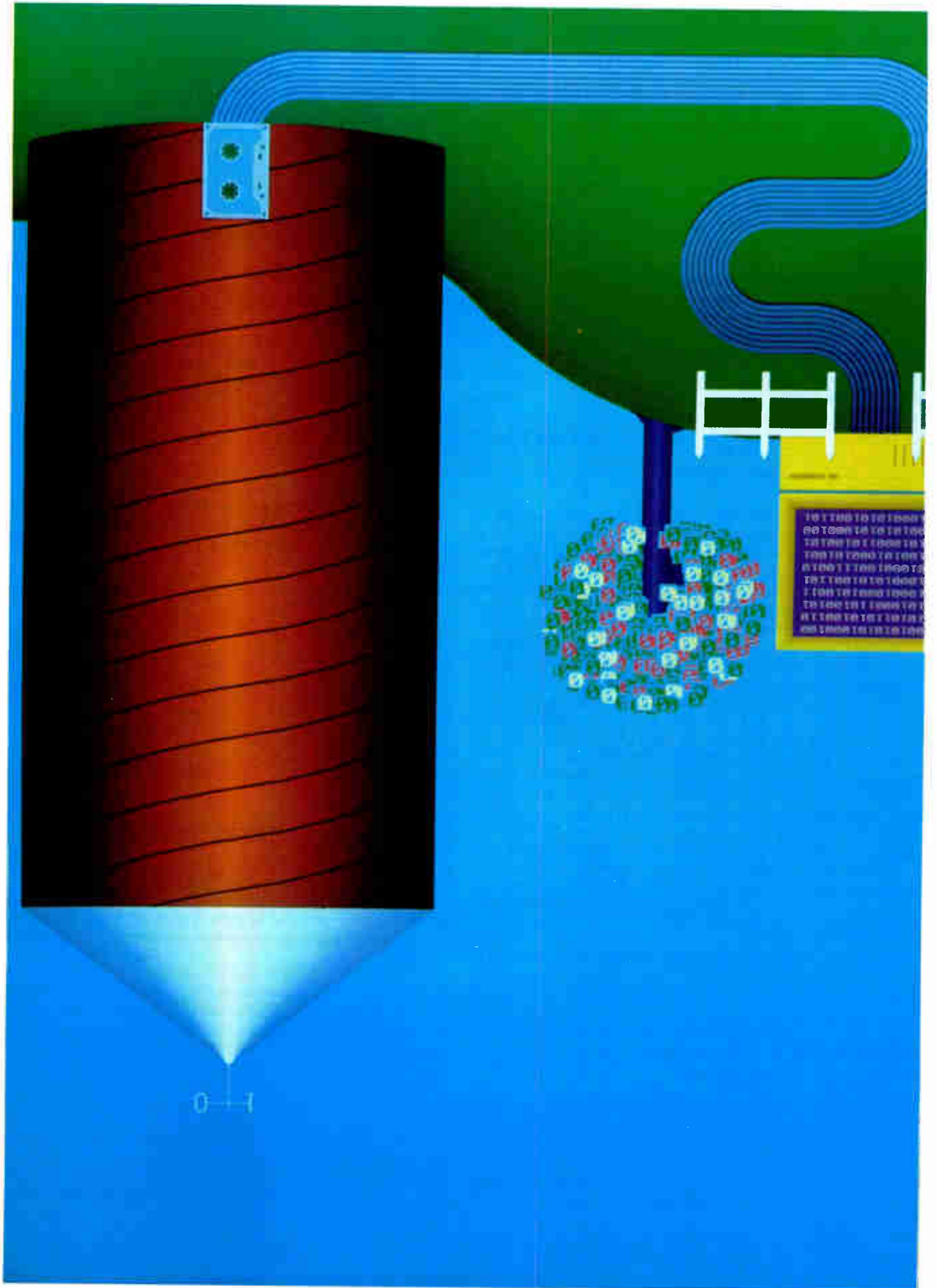

reproduced onto DAT with almost 100 percent integrity, compact disk manufacturers introduced legislation to forestall the production of DAT recorders without safeguards against the copying of prerecorded music. Thus, until recently, firms that make computer storage devices haven't been able to mass-produce DAT drives to offer to the public at low, economy-of-scale prices. Some vendors, though, such as Hewlett-Packard, Giga-Trend, Wangtek, and WangDAT, are not content to wait. They have already introduced DAT data recorders, albeit at rather high introductory prices (around \$1500), to OEMs. You can expect that prices will be between \$4000 and \$5000 by the time the recorders reach your local computer store.

### Enormous Capacity

The principal difference between current and previous computer tape recording devices used on personal computers is the orientation of the data on the medium. Helical-scan techniques

can achieve higher recording capacities in a smaller physical package than any other computer storage device, including optical disks.

VHS devices can store from 2.5 to 5.2 gigabytes per tape; 8-mm products store 2.3 gigabytes. Presently, there is only one source for purchasing 8-mm computer products: Exabyte Corp. (Boulder, CO). Thus, in this format, a de facto industry standard exists. DAT products yield between 0.9 and 1.3 gigabytes per unit. Future DAT capacity increases will depend largely on the incorporation of compression algorithms. DAT minimizes, and even eliminates, capacity loss due to track spacing. Progressions in quarter-inch and half-inch tape capacities have been accomplished through media formulation changes and through dividing the tape width into more and more discrete tracks.

### Design and Media Considerations

Helical-scan tape drives, which can be used for high-capacity disk backups, including distributed network operations, use a low-cost, cartridge-tape design available for under \$10. These drives use guides to provide the necessary precision for passing the tape by the head. Units consistent with the longitudinal QIC standard, however, depend on a relatively expensive cartridge design for proper tape positioning. This mechanism adds cost to the tape cartridge instead of the drive. Thus, there is a fundamental difference in the cartridge design between helical scan and QIC.

The 8-mm product features an embedded SCSI connection and fits into the 5¼-inch full-height form factor. The first available DAT drives will occupy the same space, but they may one day be made in the 3½-inch form factor.

While moving the tape at a rate of almost one-half inch per second, the 8-mm product achieves a 246K-byte-per-second sustained data transfer rate. DAT designs pass the tape at similar speeds and feature a maximum of 192K bytes per second. Most QIC drives achieve 90K bytes per second, with the QIC 320 products achieving 240K bytes per second.

Some helical-scan designs can provide a high-speed search *continued*

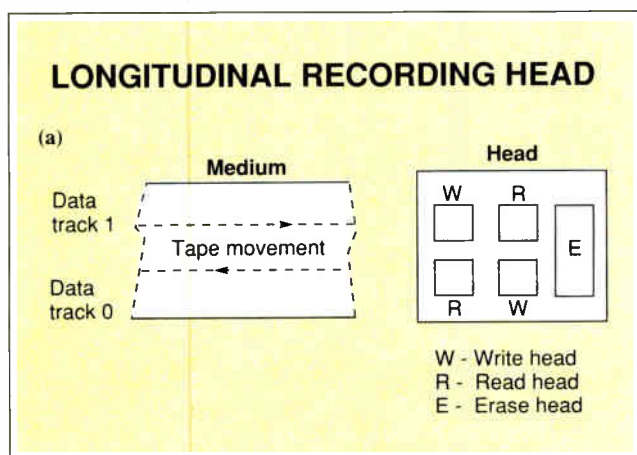

**Figure 1a:** The basic head design for a longitudinal, single-track tape recorder uses two sets of parallel write-and-read heads to enable drive operations in both tape directions.

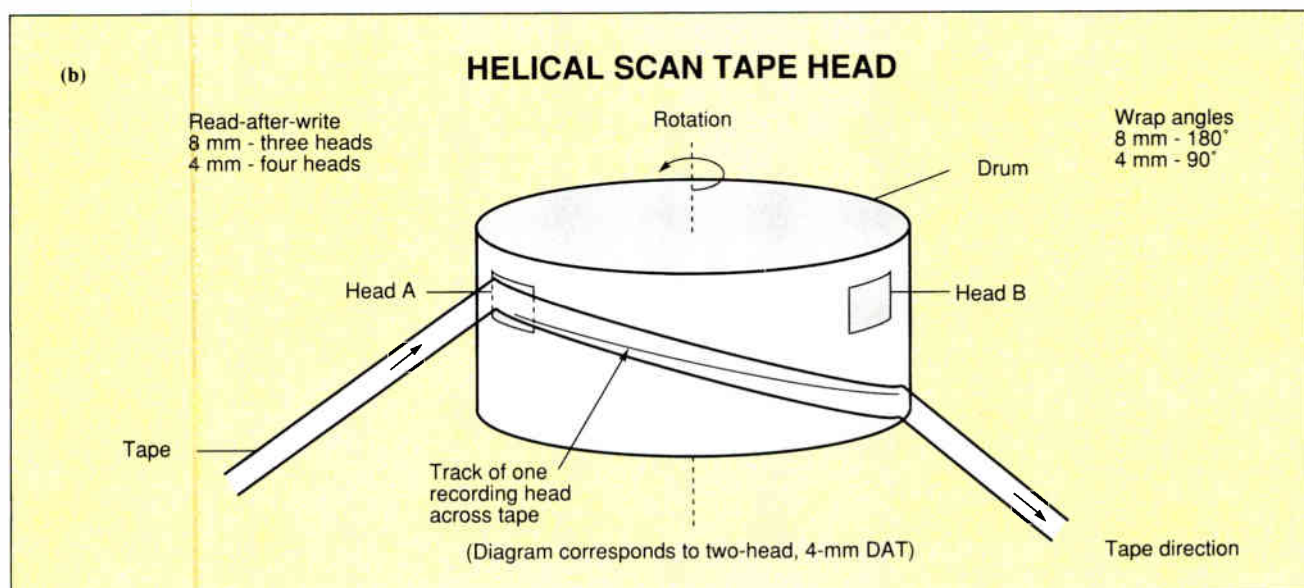

**Figure 1b:** Depending on the format, a helical-scan tape head may contain two, three, and even four heads inside the rotary drum. The tape is wrapped around the head barber-pole-style to create a longer overall data track.





## Numonics Untangles the Mouse!



### The Cordless Manager Mouse

**BUY IT...just \$149.95** (\$175 Value).

The mighty Manager Mouse has no tail to tie you down or hold it back. It's all pure untangled freedom. Plus variable resolution, from 10-1000 dpi, and the maintenance-free performance you'd expect from any well-bred Numonics mouse. Compatible with all popular application software.

**BREAK FREE – GET MANAGER MOUSE!**

Circle 260 on Reader Service Card



# NUMONICS

Numonics Corporation, 101 Commerce Drive, Montgomeryville, PA 18936  
 FAX: (215) 361-0167 or Call: 1-800-247-4517

**\$149.95**

Plus \$4.50 shipping & handling per unit.  
 PA residents add 6% sales tax.

**The Cordless  
 Manager Mouse  
 from Numonics**

**LIMITED  
 OFFER**

# of Units \_\_\_\_\_ Payment:  VISA  MC  AMEX  CHECK  
 Card No. \_\_\_\_\_ Expiration Date \_\_\_\_\_  
 Name \_\_\_\_\_  
 Company Name \_\_\_\_\_  
 Address \_\_\_\_\_  
 City \_\_\_\_\_ State \_\_\_\_\_ Zip \_\_\_\_\_  
 Daytime Telephone \_\_\_\_\_ Amount Enclosed \_\_\_\_\_

## The DAT Controversy

Until recently, the recording industry associations have blocked Japanese companies' attempts to import digital audio tape (DAT) recorders for consumer use. The issue has been one of mechanically preventing the reproduction of compact disk (CD) recordings. Organizations such as the Recording Industry Association of America (RIAA) are lobbying for more time in order to develop better laws governing music copyrights.

With DAT, consumers would, for the first time, be able to reproduce digital-quality music and sounds. Thus, it is feared that a new rash of illegal recordings would be triggered, with the focus being on the lucrative CD market. The RIAA is also against the introduction of rewritable CDs or any other device capable of reproducing professional-quality recordings.

Citing fears of lost revenues from bootleg music reproductions, the RIAA is threatening to take legal action against any company selling a DAT product in the U.S. consumer market without including circuitry that would prevent mass copying. The RIAA is not, however, opposed to DAT recorders being sold for professional recording applications; the Association even has one of its own.

A CBS attempt to thwart would-be pirates has been quashed by the National Bureau of Standards (NBS). This technique blanked out the audio signal around 3840 Hz. If special decoding circuitry detected this "notch" for 15 seconds, the recording would be halted for the next 25 seconds. The NBS found that the scheme didn't work between 40 percent and 90 percent of the time, and that certain harmonics associated with violins, synthesizers, and organ music tended to activate the copy protection.

R. Miller & Associates of Glenview, Illinois, is developing a second scheme involving the addition of subcodes to all commercially produced music. The inaudible subcode could be sensed only by a DAT recorder equipped with special circuitry. Having detected the subcode, the recorder would shut itself off. The National Academy of Recording Arts and Sciences has tested this method and believes it to be workable, but some artists are against adding any tones to music recordings.

A compromise between the Japanese manufacturers and the recording industry may have been reached. The Japanese have agreed to add extra circuits to defeat unlimited copying, while the recording industry has eased restrictions against copying original recordings. In this scheme, a digital subcode identifies the input source of the information and prevents copying except from the original DAT tape. The category code is located at the beginning of the tape and therefore does not interfere, add, or subtract from the music.

Consumer products arriving early next year will have the ability to duplicate CDs but not DAT recordings. The industry associations believe that few people will be interested in creating multiple copies of the same source material for distribution.

Significantly less turmoil was raised over the introduction of the analog cassette recorder years earlier. Many of these units were unable to fully reproduce an LP's range of sound. In addition, their recordings contained "tape hiss," and each playback added to the degradation of the signal quality. Consequently, the effect on record sales was relatively slight.

No such undesirable characteristics are associated with digitally recorded

music. The recording is virtually indistinguishable from the original, and since the music is created from converting a digital bit stream into an analog signal instead of amplifying previously recorded modulations, each playback remains crisp.

Until now, the music industry has had a monopoly on digital recording methods. It has been able to charge a premium for the CD format, which is less expensive to produce and distribute than the vinyl LP. The CD has a higher perceived value since its signal is superior to that of the LP. This advantage is certain to diminish in the years to come, however, as digital circuits continue to replace earlier analog designs.

In some ways, the RIAA's struggle resembles the efforts of software developers to devise effective copy-protection schemes. Over time, most major developers abandoned these programs in favor of an honor system.

Right now, unless you operate a professional recording studio, the only place you can buy a DAT recorder for home use is in Europe and Japan. To date, some 25,000 units have been sold worldwide, mostly to professional recording studios. Prices are high, around \$3500, because of the small volumes that manufacturers are currently producing. The economies of scale necessary to reduce unit prices to an affordable level are only possible with the product's acceptance in the U.S. market.

Computer storage versions of DAT are already becoming available from a wide group of manufacturers. This device holds much promise for users seeking to achieve unattended backup operations on desktop computers. But until the products are qualified by system OEMs, volumes will remain low and prices high.

capability. DAT technology provides two subfields per track containing information that can be indexed and read many times faster than the actual tape speed. Any spot on the tape can be accessed in 20 seconds or less. Because of this feature, DAT technology is particularly appealing for value-added system development requiring low-cost mass storage.

Both the 4-mm and the 8-mm units depend on a digital recording format; the QIC designs are analog devices. Digital recording is regarded as the more accurate and is required for voice and image representations.

Most camera stores already sell 8-mm tape, and DATs seem destined for widespread consumer distribution. If you purchase from uncertified sources for use in backup operations, be care-

ful not to obtain poor-quality tape. If you plan to use a helical-scan device, you need the best tape available, because as bit densities increase, tape defects become magnified. Head clogs are another source of error and will occur more often in a tape containing surface variations.

### Error Correction

Defects of the medium are a common source of error in tape-based recording, and there's a big difference in the way helical-scan and longitudinal recorders deal with the problem. By using the read-after-write verification process, both drives are capable of sensing bad blocks—those containing more errors

*continued*



All the power of The Software Link's PC-MOS operating system. All the benefits of both individual and networked PCs.

All in one high-performance, low-cost, multi-tasking system. With no terminals and no additional PCs — unless you want to optionally use your old XTs or ATs.

### The UnTerminal™ UnNetwork.™

It's the ideal multiuser system for personal computer users.

UnTerminal monitor-keyboard workstations cost less than terminals. Less than text-only "intelligent I/O" solutions. Less than fiber-optic graphics solutions.

An independently operating UnTerminal workstation outperforms them all. With faster

# UnNetwork.

Inexpensive monitor-keyboard workstations replace costly terminals and PCs on the UnTerminal™ UnNetwork.™ Run multiuser and popular PC programs at the same time — with no terminals or PCs — or use any XTs and ATs you happen to have.



The UnTerminal Video Network Adapter™ supports up to 4 Hercules-compatible workstations.



The UnTerminal Video Network Graphics Adapter™ supports up to two color graphics workstations — resolution up to 800 x 600.

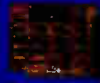

The UnTerminal Connect Card makes an XT or AT into a multitasking, multiuser workstation.

screen refresh — text *and* graphics. Instant switching between single and multiuser screens. Running popular DOS applications. And making every user feel like the only user.

**Just add PC-MOS, monitors & keyboards.**

The Software Link's PC-MOS multiplies the power of your PC. Why pay extra just to get the boxes? You can run up to eight color or 16 monochrome UnTerminal workstations per system — and save thousands.

*Distributed by  
The Software Link, Inc.*

For more information, call:  
The Software Link, Inc. at (800) 451-LINK or (404) 448-5465.



**Hercules compatible graphics using the UnTerminal (VNA).**



**Color graphics embedded in database using the UnTerminal (VGNA).**



**800 x 600 VGA graphics using the UnTerminal (VGNA).**



**Now XTs and ATs can be UnTerminals, too. Hotkey between local and host applications using the UnTerminal (VCCA).**



## The UnTerminal

PC-MOS MULTIUSER SYSTEMS WITHOUT TERMINALS

The Software Link, Inc., 3577 Parkway Lane, Norcross, GA 30092.  
Phone: (800) 451-LINK or (404) 448-5465, FAX: (404) 263-6474, Telex: 4996147 SWLINK.

PC-MOS is a trademark of The Software Link, Inc. UnTerminal, UnNetwork, Video Network Adapter, Video Connect Card Adapter and Video Graphics Network Adapter are trademarks of Advance Micro Research, Inc.

*Circle 398 on Reader Service Card (DEALERS: 399)*

World Radio History

## **D** *development of a standard file format would facilitate software distribution on tape.*

than can be corrected by the error-correction coding (ECC).

But the longitudinal designs simply rewrite the data farther down the tape, up to 16 times. This rewrite usually takes place on the same track, a process that may not circumvent the problem if the errors were caused by a longitudinal scratch. The design of the 8-mm drive causes it to rewrite bad blocks 11 blocks farther down the tape, a procedure that serves to position the data away from the same horizontal path. The device can rewrite a block up to 12 times. If, after 12 tries, its efforts are still unsuccessful, you should throw out the tape.

Helical-scan recorders possess better error-correction capabilities than just about any other mass storage device, partly because the higher bit densities mandate more sophisticated error-correction algorithms to account for dropouts, or flaws, in the recording area of the tape.

Helical-scan tracks are recorded at an angle of about 5 degrees to the edge of the tape in order to create a longer overall track length. In DAT, the incoming signal is split between two adjacent tracks, referred to as a *frame*; for error-correction purposes, frames are arranged into groups. The 8-mm drive, however, doesn't use the frame or the group concept. Instead, it writes data as a set of continuous blocks, and detects and corrects all errors within the data block structure.

One factor further compounding errors is that with helical-scan techniques, the spinning head can create helical scratches (on top of the longitudinal scratches already caused by the tape guides regardless of head design). With helical technology, tape defects are magnified over those found with longitudinal recorders with lower surface or overall recording densities.

Tracking, however, is generally more precise with helical-scan devices, which incorporate an additional head for reading a servo (positional reference) track. It is not yet necessary for most quarter-inch designs to include these capabilities in the drive design; however, future capacity increases will create the need. Since its inception, many improvements have been made to the data cartridge medium that address earlier problems that users encountered with these longitudinal recorders.

An 8-mm format track contains a servo zone (positional reference bits) and eight data blocks, each capable of storing 1024 bytes. The drive's read-after-write design can handle burst errors of up to 246 bytes within each block, and up to 80 additional single-byte errors—an extremely high level of ECC that results in a nonrecoverable error rate of less than one in  $10^{-13}$  bits read.

Products based on 4-mm DAT technology achieve an even higher level of data integrity using various correction techniques in addition to read-after-write. The first two levels of ECC, called C1 and C2, are based on industry-standard Reed-Solomon algorithms. They are a holdover from the audio format. C1 and C2 are designed to handle horizontal error patterns up to 0.3 mm wide.

Data-storage formats include a third algorithm, called C3, for correcting diagonal errors affecting any two frames within the same group. Finally, *n*-group writing (i.e., rewriting the same

block *n* times) can be used to further enhance data reliability, but the trade-off is a decrease in tape capacity. DAT products achieve an uncorrectable error rate of 1 in  $10^{-15}$  bits read.

Products based on the DAT technology also incorporate a scheme known as *alternate azimuth recording*, which maximizes capacity by allowing the overlapping of adjacent tracks. The magnetic cores are mounted in the drum at different angles: The first head is aligned at +20 degrees to horizontal center, the second at -20 degrees. This design permits *interleaving*, a technique in which incoming data is divided between two tracks so that no major sections of the signal are lost. Alternate azimuth recording also minimizes crosstalk.

### **Benefits of a New Technology**

Increasingly, new personal computers are being marketed with tape drives designed into their peripheral storage systems. Manufacturers developing 4-mm products may decide to adhere to a standard low-end file-interchange format. The result will be that, besides being able to use tape devices as backup storage, you will be able to use them to share large data sets among fellow users without regard to the drive's manufacturer.

Vendors of 4-mm products are in the process of addressing this key data-cartridge problem involving file-recording formats. QIC developers have long recognized this deficiency, but they have only recently taken significant corrective actions—possibly due to the pressure from DAT.

Development of a standard file format would also facilitate software distribution on tape, a process that heretofore has been limited to floppy disks. Once again, helical-scan technology may have a leg up on existing longitudinal machines.

Because these products use tape formulations with the ability to hold a stronger magnetic signal, software vendors may soon be able to implement a replicating process referred to as *contact printing*—the process of transferring a signal through the contact of a master tape against a clone tape. By using contact printing for updates rather than sending multiple disks, vendors could achieve significant savings and, hopefully, pass them along to users.

A new technology often adds some more desirable product attributes missing from current systems. On some of the DAT format designs, you will find a feature known as "update-in-place." With this provision, you can insert new information on a tape as long as the storage requirements for the new data do not exceed the requirements for the data being replaced.

DAT formats also provide an area on the tape called the *system log*. Information stored in the log, including C3 error activity, is used to indicate the level of data integrity found within the volume. If the log contains a high level of C3 activity, then the tape is bad.

### **Market Realities**

With earlier, longitudinal recording devices, the mechanical parts accounted for most of a tape subsystem's cost. The use of rotary heads in helical-scan technology shifts much of the cost to the electronic components. Thus, electronic sophistication and tolerances are substituted for mechanical sophistication and tolerances.

To obtain capacities and transfer rates similar to those of helical recorders, companies that make longitudinal recorders will need to develop new heads, stronger motors, and so forth. But these improvements will add cost to an already costly device. Therefore, if capacities and transfer rates remain about equal, there will be a growing disparity between the costs associated with these formats.

*continued*



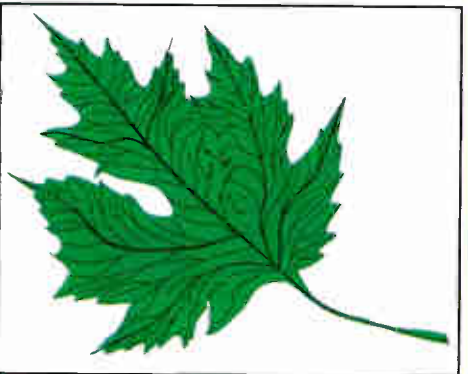
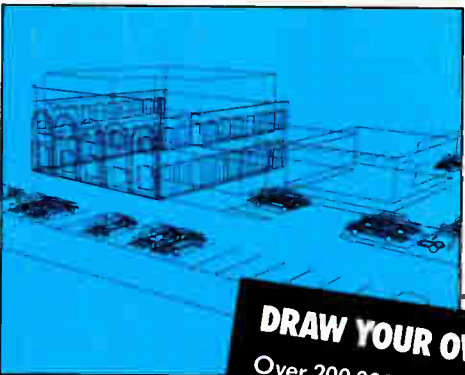
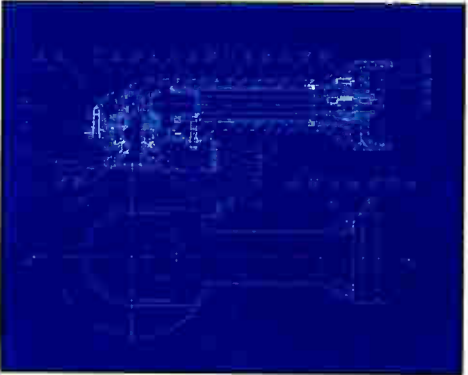
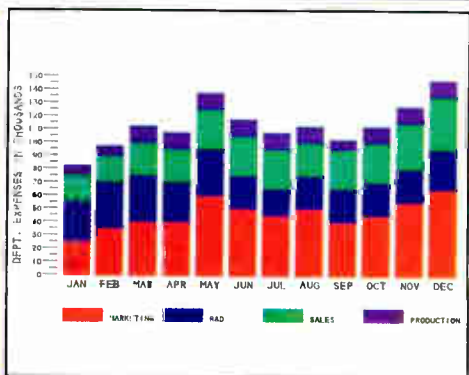
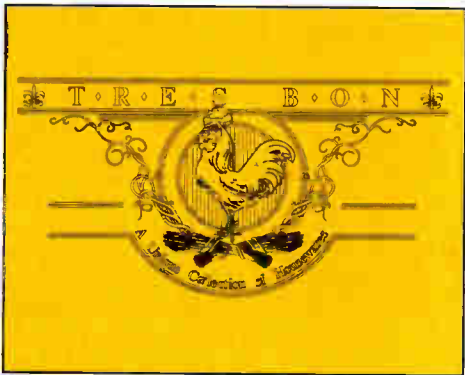
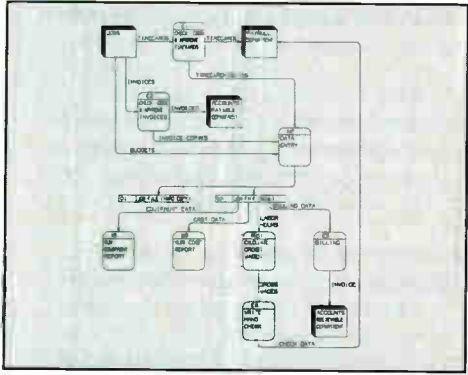
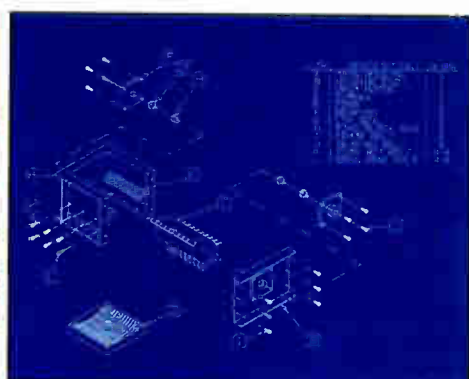
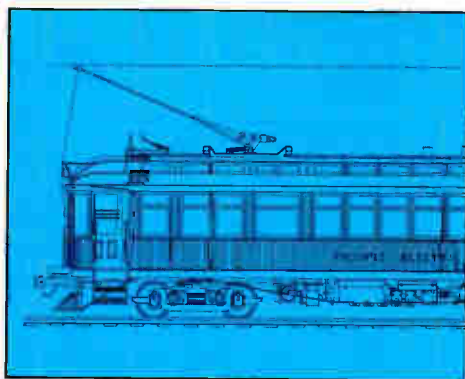
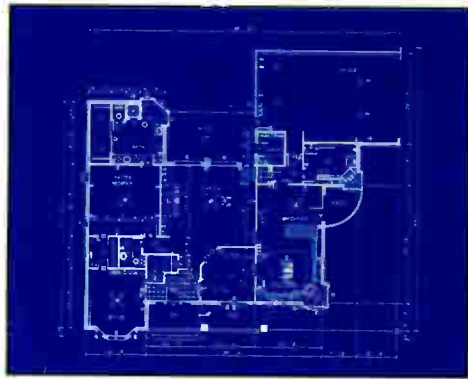

**DRAW YOUR OWN CONCLUSIONS.**  
 Over 200,000 people have discovered that Generic CADD is the most versatile and accurate drawing tool on their desk. Call for our new Generic CADD Sneak Preview™ disk (\$9.95) or our free CADDalog® and see why it's the #1 selling low-cost CADD program. Then start drawing a few conclusions of your own.

**1-800-228-3601**

**Generic**  
 SOFTWARE

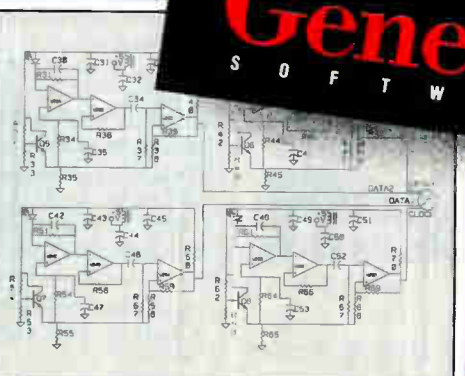
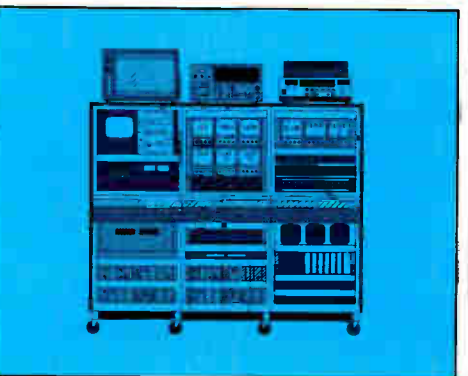

Want to save Time, Money,  
& Headaches?

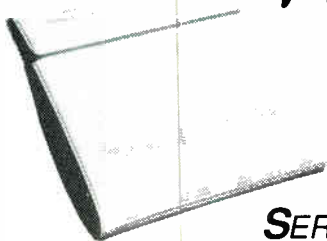

GET SUPERSOFT'S  
SERVICE DIAGNOSTICS

All the software, alignment diskettes, parallel/serial wrap-around plugs, ROM POSTs and extensive, professional documentation to provide the most comprehensive testing available for IBM PCs, XTs, ATs and all compatibles under DOS or Stand Alone. No other diagnostics offers such in-depth testing on as many different types of equipment by isolating problems to the board and chip level.

**NEW:** SuperSoft's **ROM POST** performs the most advanced **Power-on-Self-Test** available for system boards that are compatible with the IBM ROM BIOS. It works even in circumstances when the Service Diagnostics diskette cannot be loaded.

**NEW:** 386 diagnostics for hybrids and **PS/2s!**

For over nine years, major manufacturers have been relying on SuperSoft's diagnostics software to help them and their customers repair microcomputers. End users have been relying on SuperSoft's Diagnostics II for the most thorough hardware error isolation available. Now versions of Service Diagnostics are available to save everyone (including every serious repair technician) time, money, and headaches in fixing their computers, even non-IBM equipment.

All CPUs & Numeric Co. processors	All Color Graphics & Monochrome Monitors
System Expansion & Extended Memory	Parallel & Serial Ports
Floppy, Fixed & Non-standard Disk Drives	Mono, CGA, Hercules & EGA Adapters
Standard & Non-standard Printers	All Keyboards & the 8042 Controller
System Board: DMA, Timers, Interrupt, Real-time Clock & CMOS config. RAM	

Join the ranks of XEROX, NCR, CDC, SONY, PRIME, ... who have bundled SuperSoft's diagnostics with their microcomputers at no risk because of our 30 day money back guarantee.

Service Diagnostics for PC, PC/XT, and compatibles only	\$169
Alignment Diskette for PC, PC/XT and compatibles (48 tpi drives)	\$ 50
Wrap-around Plug for PC, PC/XT and compatibles (parallel and serial)	\$ 30
Service Diagnostics for AT and compatibles only	\$169
Alignment Diskette for AT and compatibles (96 tpi drives)	\$ 50
Wrap-around Plug for AT (serial)	\$ 15
ROM POST for PC, PC/XT and compatibles only	\$245
ROM POST for AT and compatibles only	\$245
<b>Service Diagnostics: The KIT (Includes all of the above—save \$502)</b>	<b>\$495</b>
Service Diagnostics for 386 or V2, V30, or Harris, etc. (please specify)	\$195
Diagnostics II is the solution to the service problems of users of all CP/M-80, CP/M-86 and MS-DOS computers	\$125
ROM POST for PS/2 and compatibles only	\$245
Alignment Diskette for PS/2 and compatibles (3.5 inch)	\$ 50

To order, call 800-678-3600 or 408-745-0234  
FAX 408-745-0231, or write SuperSoft.

*your microcomputer repair solution*

**SuperSoft**

FIRST IN SOFTWARE TECHNOLOGY P.O. Box 611328, San Jose, CA 95161-1328 (408) 745-0234 Telex 270365

SUPERSOFT is a registered trademark of SuperSoft, Inc.; CDC of Control Data Corp.; IBM PC, AT & XT of International Business Machines Corp.; MS-DOS of Microsoft Corp.; NEC of NEC Information Systems, Inc.; PRIME of PRIME INC.; Sony of Sony Corp.

VHS and 8-mm recorders are already available, but they are too large and too expensive to use for personal computers. VHS drives have won acceptance, but only for niche applications on a few minicomputers and workstations. The 8-mm product is slowly gaining acceptance within this same general group. Exabyte claims to have shipped 15,000 units in the last year, and that was before it signed contracts with NCR, Northern Telecom, Motorola, and Data General.

There's no question about the immediate need for helical-scan recorders in the workstation market. There is a trend toward the use of 32-bit processors, especially for graphics-intensive applications requiring high-capacity storage devices. Of late, the 380-megabyte hard disk drive has been the OEM drive of choice, but a gradual shift is taking place to the higher-capacity 760-megabyte device. Quarter-inch technology, on the other hand, will be just reaching 320 megabytes in the fourth quarter of this year.

DAT drives for mass storage applications on workstations have recently become available. Expect smaller, half-height products to follow shortly. Early units will be relatively expensive, but they will most assuredly be acquired by system vendors looking to design-in these products. Following the normal one-year development lag, by mid- to late 1990, these DAT drives should be offered as standard equipment on workstation systems. In 1992, expect to see affordable, commercially available 3½-inch-form-factor recording devices for personal computers.

While the 8-mm product is positioned to increase its performance and capacity, the 4-mm drive will continue to shrink in both size and cost, making it a viable personal computer product within the next two to three years. In the meantime, value-added resellers will be building attractive new image processing systems based on Intel's 80386 and Motorola's 68030 chips and the DAT mass storage device.

You will also find DAT on LANs created for peripheral sharing. In the past, the principal motivation for networking was to share a laser printer or a large hard disk storage device. The implementation of tape storage devices with gigabyte capacities adds the ability to share backup resources. For some time yet, DAT may not be cost-justifiable for single personal computer systems, but it could easily be added to a LAN for use as a centralized backup device.

### Down the Helical Road

Although you probably will have to wait until early next year to use helical-scan technology, including DAT, investments by Sony, Hitachi, Hewlett-Packard, and others foreshadow an eventual shift to the slant-track recording technique. Helical-scan recorders should soon be cropping up on workstations and personal computers as depositories for images in such applications as CAD/CAM drawing systems, document processing systems, geophysical data-collection systems, and a myriad of other uses.

What does all this mean to you? For one thing, you may someday find that backing up your hard disk, regardless of its capacity, will be much easier. With helical-scan technology, you can be assured of a 1-to-1 disk-to-tape capacity ratio even if storage requirements continue to increase at the current rate of 30 percent to 40 percent per year. The trend is toward unattended backup operations, even on personal computers with disk capacities in excess of 150 megabytes. ■

*Jay Bretzmann is a senior analyst for International Data Corp. in Framingham, Massachusetts. He can be reached on BIX c/o "editors."*



# CSR makes the best built, best backed 286 and 386 systems. Period.



Also available in slim line model.

As a national PC repair and maintenance organization, we've repaired every major brand of computer – systems like IBM,<sup>†</sup> Compaq<sup>†</sup> and NEC.<sup>†</sup> Now, after years of fixing their best, we've built ours better.

**...and we back them up with the industry's best 2 year warranty.**

There's one exclusive feature of every CSR PC that you should know about: CSR's commitment to customer service. Other PC manufacturers don't even come close to matching the support you get with a CSR system – the industry's best 2 year warranty.

For the first year you'll receive complete on-site service on all parts and labor. During the second year we'll repair or replace any parts that fail. Calling our toll-free support hotline connects you to a highly trained Customer Engineer (CE). Your CE will resolve your problem over the phone or dispatch a Service Engineer to your site within 24 hours of your call – guaranteed.

## High performance without a high price.

CSR delivers high performance in every machine we make. Like our 286/20: Using an Intel<sup>®</sup>-based 80286 chip running at a blazing 20 MHz, the 286/20 actually outperforms most 386 based PCs.

More proof: Every CSR PC is fully MS-DOS<sup>®</sup> and OS/2<sup>®</sup> compatible. Standard equipment on each system includes a high-speed VGA controller, a 101 key tactile response keyboard and a totally IBM-compatible disk controller featuring the latest in track-buffer technology – boosting drive performance by an amazing 30% to 50%! And, all CSR PCs offer either a 3.5" or 5.25" drive as standard equipment. Take a look at the specification chart. We're sure you'll agree that no one tops our PC's features.

## Built for your needs and your budget.

Whether you require a stand-alone system or an advanced LAN installation, want to purchase outright or take advantage of our comprehensive leasing and credit card programs, CSR has the systems and expertise to provide all of your computing needs. Tell us the details. Then tell us your budget. We'll build you a system that's compatible with both.

<sup>†</sup>The brands or product names mentioned are trademarks or registered trademarks of their respective holders. MS-DOS and OS/2 are registered trademarks of Microsoft Corporation.

### CSR 286/14 SL CSR 286/14

- 80286 Intel based microprocessor running at 14 MHz.
- 1 MB RAM expandable to 16 MB (8 MB on the system board).\*
- Socket for math coprocessor.

\*SL model features a slimline case.

- Page mode interleave memory architecture.
- 1 parallel, 1 serial port and 1 mouse port.
- Real time clock with battery backup.
- High-speed 16 bit VGA.
- Track buffer hard disk drive controller.

### CSR 286/20SL CSR 286/20

- 80286 Intel based microprocessor running 20 MHz.
- 1 MB RAM expandable to 16 MB (8 MB on the system board).\*
- Page mode interleave memory architecture.
- Socket for math coprocessor.

NOTE: \*Up to 8 MB in SL case.

- 1 parallel, 1 serial port and 1 mouse port.
- 3 speed selectable 8 MHz, 16 MHz or 20 MHz speed.
- Real time clock with battery backup.
- High-speed 16 bit VGA.
- Track buffer hard disk drive controller.

### CSR 386/20

- Intel 80386 microprocessor running at 20 MHz.
- 1 MB RAM expandable to 16 MB on the system board.
- Page mode interleave memory architecture.
- Socket for math coprocessor.

- 1 parallel, 1 serial port and 1 mouse port.
- 200 watt power supply.
- Real time clock with battery backup.
- High-speed 16 bit VGA.
- Track buffer hard disk drive controller.

### CSR 386/25c

- Intel 80386 microprocessor running at 25 MHz.
- 1 MB RAM expandable to 16 MB on the system board.
- Advanced Austek Cache memory controller with 32K of high speed static RAM Cache.

- High-speed 16 bit VGA.
- Page mode interleave memory architecture.
- Socket for math coprocessor.
- 1 parallel, 1 serial port and 1 mouse port.
- 200 watt power supply.
- Real time clock with battery backup.
- Track buffer hard disk drive controller.

All models come standard with tactile keyboard and your choice of either 3.5" or 5.25" disk drive.

Call us at:  
**800-366-1277**  
We accept MasterCard, VISA and certified checks



Computer Systems Research

We build ours better.

# If you're thinking of putting an IBM monitor on your PS/2, you're not seeing the big picture.

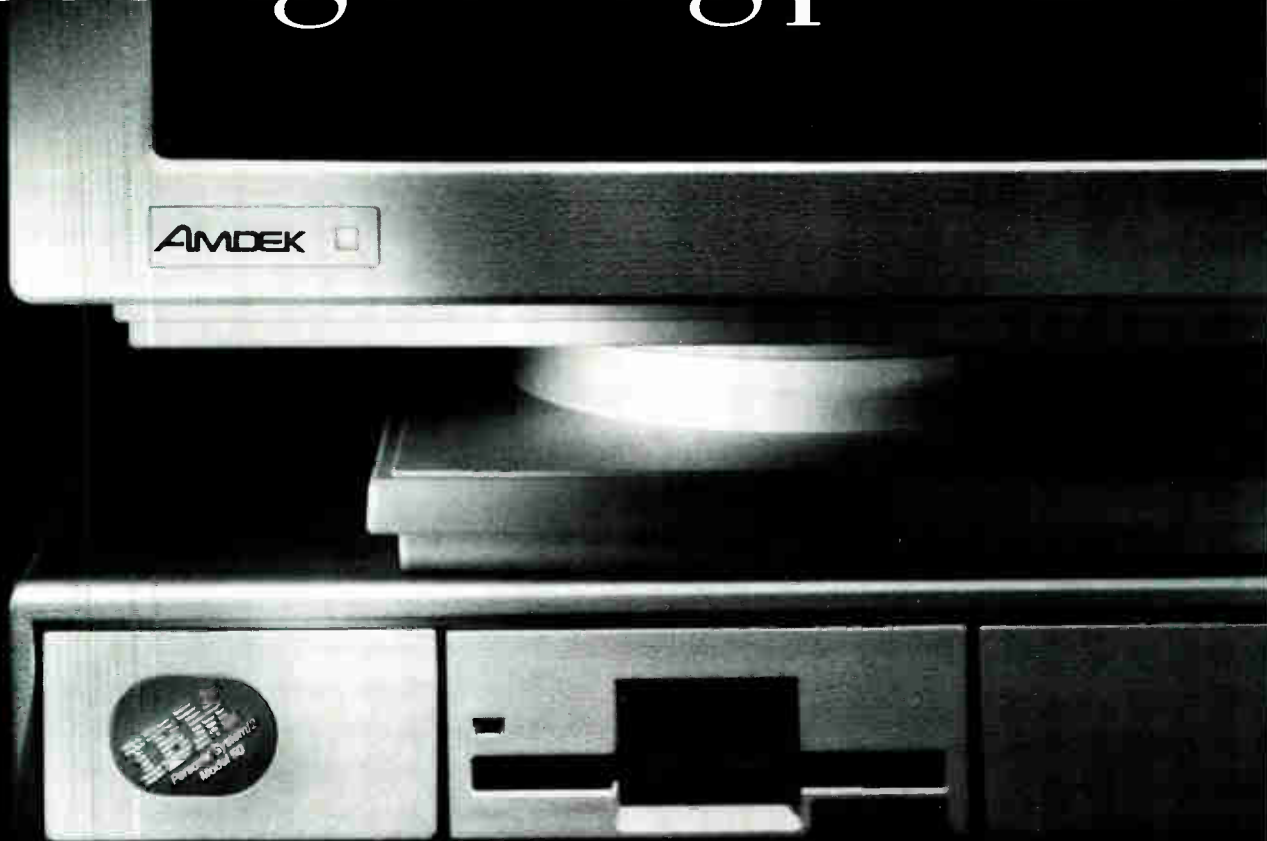

When it comes to displays, bigger is better. That's one reason why the Amdek Monitor/432 monochrome VGA has a big edge over IBM's own standard PS/2 monitor.

But it's not the only reason. Because the 432 is, after all, from Amdek. A company with over 12 years experience in the computer monitor business, and the leading independent monochrome supplier.\*

The 432's 14" etched-surface, flat screen produces hardly

any glare or distortion. And far less eyestrain than Big Blue's PS/2 monitor with its smaller, 12" curved screen.

What's more, IBM's smaller screen also carries a bigger price tag.

So, if you're choosing a monochrome monitor for a PS/2 or any AT compatible, remember the company that hasn't lost sight of the big picture. Amdek. For the dealer nearest you, call 1-800-PC AMDEK.

 **AMDEK**

Amdek is a registered trademark of Amdek Corporation. Other trademarks/owners: PS/2, VGA, IBM/International Business Machines. \*1989 Stanford Resources, Inc.

**Circle 25 on Reader Service Card**  
World Radio History



# PAPER, MAGNETS, AND LIGHT

*The long history of data storage devices is intertwined with the more recent, meteoric rise of personal computers*

*Robert R. Gaskin*

**S**torage devices used with today's desktop and laptop personal computers are derived from a long history of large and often cumbersome devices. Many storage technologies of the past predominated for a time and then faded from the scene.

The earliest storage device for controlling machines was the punched paper card. It was used as early as 1804 for controlling silk-weaving looms. The first computer-like application was in machines that tabulated the 1890 U.S. census. The inventor of that tabulation machinery was Herman Hollerith, and the media has been called Hollerith cards ever since (see photo 1). The "modern" form of the card was introduced by IBM in 1928 and remained a mainstay of the computer industry through the 1960s.

## On the Way There

When computers were in their infancy, many types of esoteric volatile memory appeared on the scene as precursors to the nonvolatile mass storage devices that we know today. The Williams Tube (1948), used on some of the earliest IBM mainframes, was a CRT similar to that found in today's personal computer monitors. Instead of being used as a display, however, it was used as memory. The Williams Tube was not very reliable and was soon abandoned for other schemes.

In 1949, mercury delay lines were used as volatile memory in the EDSAC (for Electronic Delay Storage Automatic Calculator) computer. In 1953, ferrite core memory appeared in the MIT Whirlwind computer (see photo 2) and the IBM 704. Core memory used tiny doughnut-shaped pieces of ferrite to store a single bit. When wired together in what is known as a *coincident current array*, core memory provides completely random access to any bit location without going through any other bit locations to get there. In addition, core memory is nonvolatile and retains data indefinitely when the power goes off.

The original cores were 80 mils in outside diameter; the di-

ameter was reduced to 14 mils by the late 1970s. Although no longer used in commercial computers, core memory is still used in some military applications. Core memory was expensive and slower than the semiconductor RAM memory that replaced it. The closest that core memory got to being used for everyday applications was its use as the song-selection memory in the early Seeburg jukeboxes.

## Drum and Bubble Memory

Off-line storage in the form of drum memory appeared in 1951. Drum memory was made up of magnetically coated rotating cylinders with multiple read/write heads (see photo 3). The IBM version had 58 tracks, with 100 characters per track. Fifty tracks were used for storage, and eight were used as an I/O buffer to the card machine or printer. The drums were fast but couldn't be stacked like disk platters, and they faded away in the 1960s.

Bubble memory caused quite a stir in the early 1970s because it was all solid-state, yet nonvolatile. In the presence of a bias field, the bubbles formed cylindrical magnetic domains in a thin film of magnetic material on a garnet-based substrate. Bubble memory faded away in the 1980s, largely because of long design times and cost. One product that still uses this technology, produced by Magnesys, is a floppy disk drive emulator for personal computers used in rugged environments. A 720K-byte version of it for the IBM 7552 Gearbox industrial computer costs \$2000.

## On to Tape

Of all the magnetic storage devices, tape drives have been around longest. They first appeared as half-inch reel-to-reel audio recording devices in 1934. The first model was made by the German company AEG using tape media made by BASF. By 1945, IBM had developed digital reel-to-reel versions.

The Univac Uniservo reel-to-reel drive, which used 1200 feet of metal tape, was introduced in 1951 (see photo 4). This

*continued*

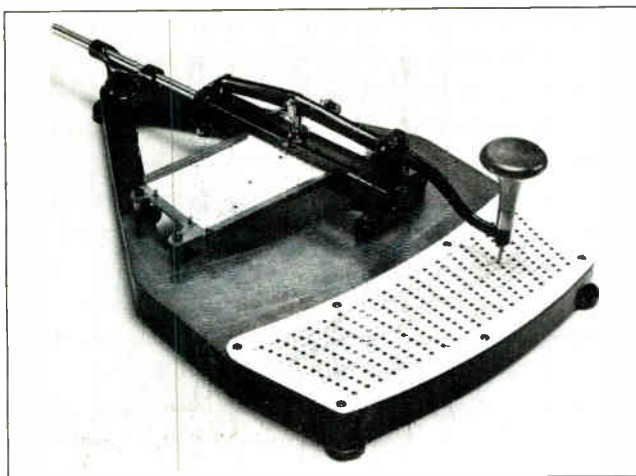

**Photo 1:** A Hollerith machine with card. First used in the nineteenth century for controlling silk-weaving looms and tabulating the U.S. census, Hollerith cards were punched on a machine like the one shown. (Photo courtesy of The Computer Museum, Boston)

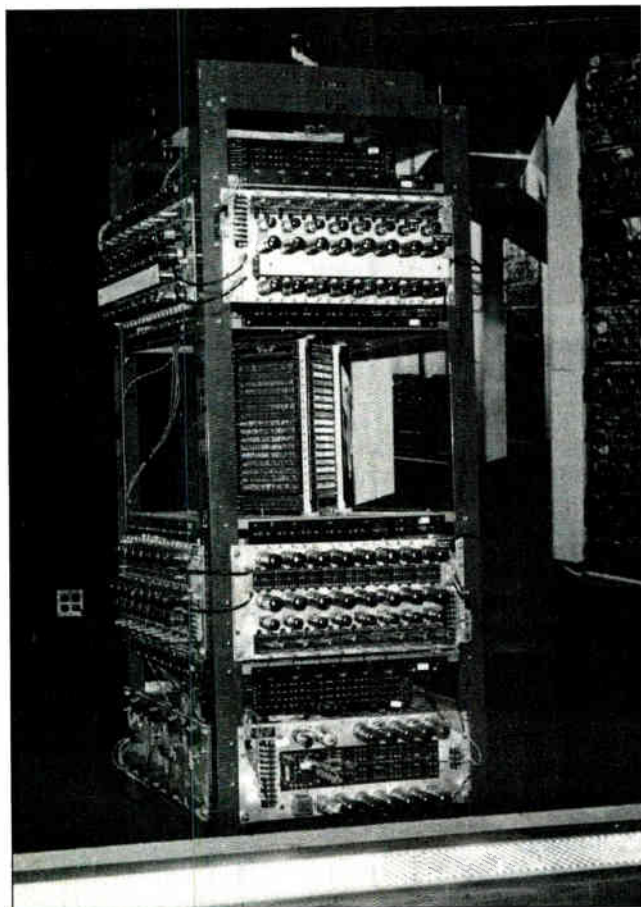

**Photo 2:** Core memory was used in the Whirlwind project, a wind-tunnel experiment carried out at MIT. In this 1953 photo, you can see the Whirlwind Core Stack, providing 16K bytes of core memory. (Photo courtesy of The Computer Museum, Boston)

was followed in 1952 by IBM's 701, which used plastic-backed tape. IBM followed with several more models through 1971 that pioneered first the NRZI format, then phase encoding, and, finally, group coding. It remained for 3M to introduce the quarter-inch drive and cartridge media in 1971, which made desktop use of tape drives a practical reality. However, the first major use of quarter-inch tape drives did not come about on computers; in 1975, Western Electric endorsed their use by selecting them to handle the storage needs of PBX systems. Quarter-inch drives have since been made smaller, cheaper, and with larger capacities, to the point that 320-megabyte versions are expected to ship this year. The capacity of the drives in 1971 was only 30 megabytes.

In 1985, Irwin Magnetics introduced a low-cost drive based on the  $\frac{1}{8}$ -inch DC1000 cartridge that utilized a floppy disk drive interface. The combination of these features in a tape drive proved to be extremely popular.

Ampex developed rotary-head tape drive technology for the broadcast industry in 1956 and added the Terabit model for computer applications in 1972. These were the forerunners of the tiny digital-audio-tape recorders that use 4-millimeter tape and are about to enter the personal computer market today (see the article "A New Twist on an Old Technology" on page 380). The DAT format will store over 1 gigabyte of data on a cartridge about the size of an audio cartridge. Helical-scan tape drive technology for personal computers has been most successfully pursued by Exabyte Corp., which makes a helical-scan tape drive that uses a \$10, 8-mm video cassette-based cartridge that stores about 2.5 gigabytes. The drive price is in the \$3000 range, so it is more suited for high-end business applications than for the average user.

### Floppy and Hard Disk Drives

IBM invented the floppy disk drive as an 8-inch-diameter read-only single-sided device in 1971. The model 23FD was used as a program load device. It was followed in 1973 by the 33FD (code-named Igar), a read/write 8-inch drive with an unformatted capacity of 400K bytes double-sided (formatting consumes about 28 percent to 30 percent of the usable capacity). The 33FD was used as a replacement for punched cards on the 3740 data-entry system. Shugart Associates announced the SA901, an OEM version of the 33FD, that same year. Shugart's modest pricing set the stage for the use of floppy disk drives in personal computers. In 1975, Shugart announced a double-density version of its drive that could store up to 800K bytes (unformatted) and leapfrogged IBM's efforts.

The first IBM hard disk drive was the RAMAC 350, introduced in 1956. It stored 4.4 megabytes on 50 24-inch platters—a capacity chosen because it equaled 50,000 punched cards. IBM produced the first 14-inch drive (the 1311) in 1963, and the first removable-pack drive (the 2314) in 1966. In 1975, the only hard disk drives available were 14-inch-diameter devices that were totally unsuited for personal computers. Therefore, the early personal computers used floppy disk drives, not hard disk drives, for storage.

### Then There Were PCs

The first microprocessors, such as the Intel 8008 and 8808, became available in 1975. Their advent marked the beginning of the personal computer era. These pivotal inventions made the downsizing of computers and their storage devices possible.

The peripheral storage devices available in 1975 did not fit personal computer needs very well. The 3M quarter-inch

*continued*



# TAIPEI



## COMPUTEX '90

June 6-12, 1990

Discover the fastest rising stars on the international horizon at Asia's biggest computer event.

*Taiwan*

•  
The world's No.1 supplier  
of computer monitors

•  
No.2 in terminals

•  
No.3 in personal computers

#### Organizers:



Venue: TWTC EXHIBITION HALL  
5 Hsinyi Road, Section 5, Taipei 10509, Taiwan  
Republic of China

Tel: (02)725-1111 • Fax: 886-2-725-1314  
Telex: 28094 TPEWTC

#### Branch Offices:

- New York-CETRA, Inc.  
Tel: (212)532-7055 • Fax: (212)213-4188
- San Francisco-Far East Trade Service  
Tel: (415)788-4304 • Fax: (415)788-4304
- Chicago-Far East Trade Service,  
Tel: (312)321-9338 • Fax: (312)321-9338

Circle 74 on Reader Service Card

World Radio History

cartridge drive was a step in the right direction, but it was still too large and expensive. Thus, early microcomputer users converted many audio tape cartridge drives into "home brew" storage systems.

Hard disk drives were unsuitable in both size and cost to be used on personal computers from 1975 until 1980. The 8-inch

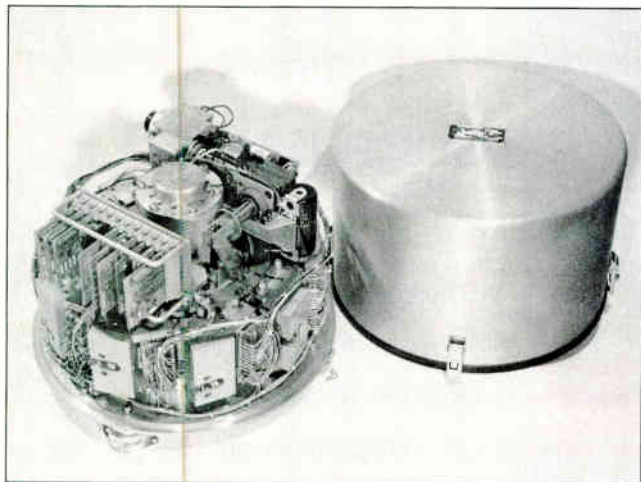

**Photo 3:** Drum-memory off-line storage came into use in 1951. Drums were magnetically coated rotating cylinders with multiple read/write heads. They were fast but couldn't be stacked like disk platters, and they faded away in the late 1960s. (Photo courtesy of Vermont Research, North Springfield, Vermont)

drives announced in 1979 by both IBM and International Memories were of no help. During these five years, the floppy disk was king.

But Al Shugart and Finis Conner had learned a crucial lesson about product form factor while operating Shugart Associates (before Xerox bought the company). Al Shugart later formed yet another company called Shugart, with Finis Conner as part of the team. Xerox soon persuaded Shugart to change the company name, and it was reborn as Seagate.

Seagate's product was a 10-megabyte 5¼-inch hard disk drive that used trailing-edge technology to make it inexpensive and easy to manufacture for the personal computer market. The product was an overnight success in all distribution channels, including retail aftermarket sales. Seagate has been the top producer of affordable hard disk drives ever since, although others, such as MiniScribe, are now challenging Seagate's position.

Several companies, including Maxtor, Micropolis, and Prim, entered the business on the high end of capacity and price, offering drives that now range up to 760 megabytes in the 5¼-inch form factor. A number of companies were formed to offer removable cartridges for the hard disk personal computer market, and most of them failed. Exceptions are SyQuest Technology, which makes a 44-megabyte cartridge drive, and Iomega, with its 44-megabyte Bernoulli cartridge, which uses flexible media but performs like a hard disk drive.

### The Shrinking Disk

In 1975, Shugart Associates was well positioned in the new 8-inch floppy disk drive market and had little competition. In 1976, Jim Adkisson, one of Shugart Associates' engineering

*continued*

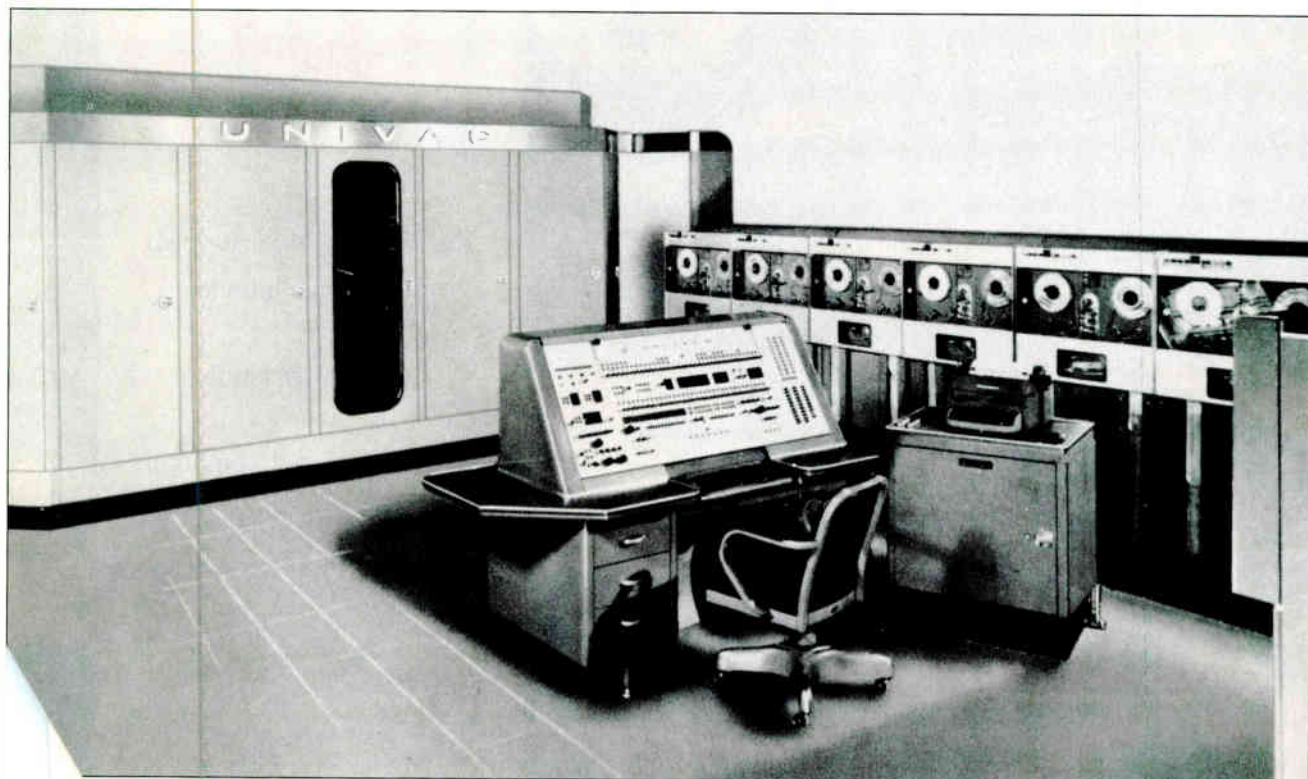

*In the 1950s, when companies first began using the Remington Rand Univac computer, several megabytes of mass tape 'ed entire rooms. (Photo courtesy of The Computer Museum, Boston)*



# Windows/386 OS/2 Lotus 3.0

## Don't Trash Your PC Because of the Software Revolution

SOTA's family of award winning Enhancement Products extends the life of any PC into the 1990s!

Any IBM, Amstrad, Olivetti, AT&T 6300, Zenith, Compaq, and other 8088/86 PC compatibles combined with the SOTA 286i or SOTA 386si and the Memory/16i will allow you to run any of the next generation of advanced software.

Salvage your PC from obsolescence.

- **SOTA 386si**, 16 MHz PC accelerator with 16K cache
- **SOTA 286i**, 12.5 MHz PC accelerator with 16K cache
- **Memory/16i**, up to 8 MB of 16-bit LIM 4.0 accelerator memory
- **Floppy I/O Plus**, floppy controller for all 3.5" & 5.25" floppies plus serial/parallel ports.

For details on how to receive 1MB of Memory **FREE**, contact your authorized SOTA dealer or distributor.  
1-800-237-1713,  
in CA, 408-745-1111.

### SOTA Technology, Inc.

559 Weddell Drive, Sunnyvale, CA 94089  
Tel: 408-745-1111, Fax: 408-745-1640

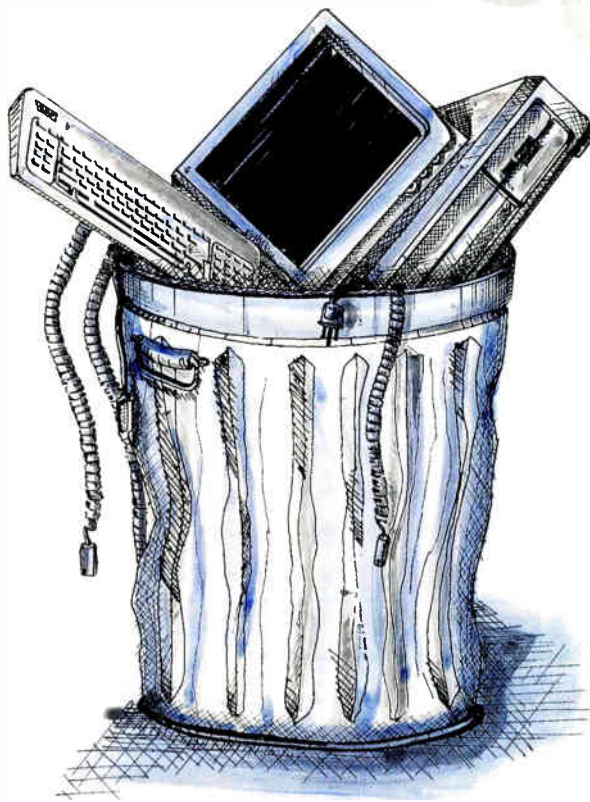

**SOTA**  
STATE OF THE A

ALL IN

SOTA 286i, SOTA 386si, Memory/16i, Floppy I/O Plus are trademarks of SOTA Technology, Inc. All other products mentioned are trademarks of their respective manufacturers.

For PC-AT software blues, come and see the SOTA solution at COMDEX, booth #W862.

Circle 332 on Reader Service Card  
World Radio History

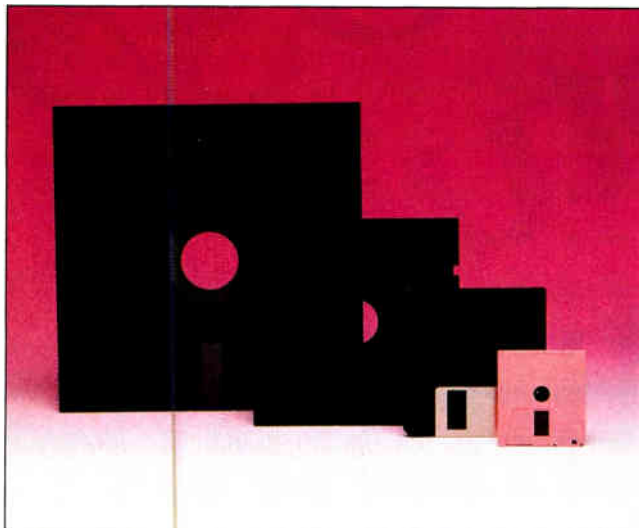

**Photo 5:** Shown are 8-, 5 1/4-, 3 1/2-, and 2-inch floppy disks for use with personal computers. At first, as floppy disks decreased in size, so did their capacities. Now they've gone in the opposite direction. The 2-inch floppy disk shown stores 720K bytes, more than the 8-inch disk could hold at one time.



**Photo 6:** Optical disks are known for their extremely large capacities. Shown here are a WORM (write once, read many times) disk, a CD-ROM, and a magneto-optical erasable NeXT cartridge. You can store almost a gigabyte of information on the WORM disk, 550 megabytes on the CD-ROM, and 256 megabytes per side on the NeXT disk.

managers, was approached by a customer who was in the personal computer business. Over lunch, the customer told Adkisson that the 8-inch floppy disk drive was far too large to go into a personal computer (see photo 5). Adkisson asked the customer how large he thought the disk should be. The customer pointed to a cocktail napkin on the table and said, "About that size." Adkisson picked up the napkin and took it back to the lab, where he proceeded to design the 5 1/4-inch floppy disk drive.

That drive, introduced in 1976, was the Model SA400, which had a 110K-byte capacity—the first of its kind. The synergism between the 5 1/4-inch floppy disk drive and the per-

sonal computer was so great that ultimately, at its peak, Shugart Associates was shipping about 4000 drives per day, most of them 5 1/4-inch units. The 5 1/4-inch production was farmed out to Matsushita in Japan (a move that ultimately led to Matsushita's becoming the largest floppy disk drive manufacturer in the world).

But it was Alps Electric of Japan that blew Shugart out of the water at one of Shugart's biggest 5 1/4-inch accounts: Apple Computer. The loss of this contract is what started Shugart's demise in the floppy disk industry. By 1979, another manufacturer—Tandon—had become a major competitor for the 5 1/4-

*continued*

## EDC Electronic Design Center

High Tech in Perfection  
Transputer Products

### Transputer Boards

EDC-B016	Motherboard for 1-16 TRAM
EDC-4T4MB-T414	Transputer board with 4 x T414
EDC-4T4MB-T800	Transputer board with 4 x T800
EDC-4T4MB-ITEM	Rack for 10 EDC-4T4MB cards
EDC-4T4MB-TDS	Software Development System

### Transputer Module Series 501

EDC-501-128KS*	Transputer module with T414 or T800 and 128K SRAM
EDC-501-256KS*	Transputer module with T414 or T800 and 256K SRAM
EDC-501-1MD-T414-70	Transputer module with T414 and 1MB DRAM (70ns)
EDC-501-1MD-T414-100	Transputer module with T414 and 1MB DRAM (100ns)
EDC-501-1MD-T800-70	Transputer module with T800 and 1MB DRAM (70ns)
EDC-501-1MD-T800-100	Transputer module with T800 and 1MB DRAM (100ns)

\*transputer modules pin-compatible with INMOS TRAMS.

### Transputer Interface Module

EDC-UBX1	UNIBUS interface card
EDC-TVM1	VME-Bus interface card
EDC-TQB1	Q-Bus interface card.

### Transputer Software

EDC-SWMS1	Mathematical and statistical package in OCCAM
EDC-SWVDOT	RAM-Disk for Transputer boards

### EDC Memory Module

EDC-SX32-064	64K x 8 SRAM module
EDC-SX32-256	64K x 32 SRAM module
EDC-DX32-256	256K x 32 DRAM module
EDC-DX40-256	256K x 40 DRAM module

EDC GmbH, Taunusstr. 51/III, 8000 Munchen 40

Tel.: (89) 350 70 76 Fax: (89) 359-61-80 Tx.: 521 25 99



# Finally, Somebody With All The Answers.

Why is the sky blue? How much does Isaac Asimov weigh? Why won't my Macintosh talk to my laser printer? How do you fold fitted sheets? How's the weather up there? Who put the bop in the bop-sh-bop-sh-bop? Where can I find the best steak in Chicago? How much is that doggy in the window? How is OS/2 going to affect me? Which hard drive is best for me? Will you marry me?

When you join CompuServe, your computer becomes a communications link between you and over 500,000 CompuServe members. That's more than a half million different jobs, skills, experiences, interests, senses of humor, hobbies, and interesting peccadillos.

The possibilities are endless. Because CompuServe's communications services

include everything from special interest forums to electronic mail and fax services. They let you ask questions (our forums, for instance, can sometimes solve hardware and software problems faster than the manufacturers can), give answers, and make just about any kind of contact you want. (It's true. We've already had several online marriages.)

So become a member of CompuServe. Because let's face it, 500,000 heads are better than one. Any questions?

To join CompuServe, see your computer dealer. To order direct or for more information, call 800 848-8199.

## **CompuServe**

Circle 87 on Reader Service Card

World Radio History

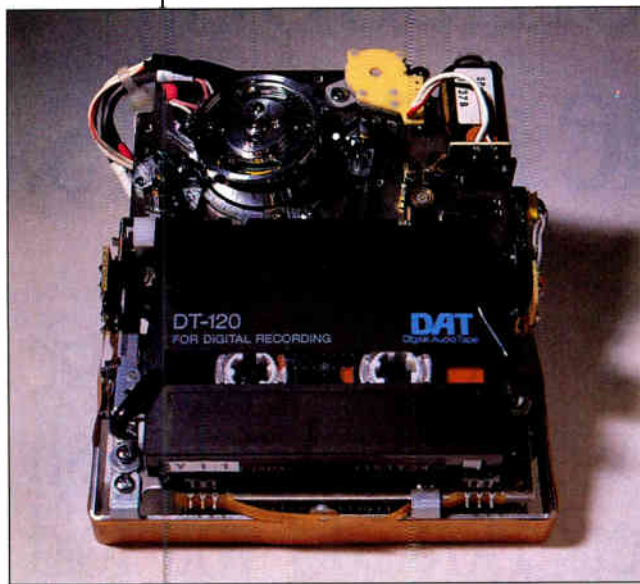

**Photo 7:** A digital-audio-tape mechanism, showing tape wrapped around 90 degrees of the drum's circumference. This 90-degree wrap angle improves reliability and enables fast repositioning. (Photo courtesy of Hewlett-Packard)

inch disk drive business, but it rapidly lost market share to the Japanese and soon after changed its emphasis from peripherals to personal computers. In 1982, various Japanese companies announced half-height versions of the 5¼-inch floppy disk drive, and U.S. production decreased almost to the vanishing point.

During 1981, Sony had introduced a 3½-inch floppy disk drive that could store 438K bytes with a 600-rpm spindle speed. Sony submitted it to ANSI for approval as a new standard. Sony's arguments were that the smaller disk, with its hard case and its shutter over the head access area, was much better protected than the 5¼-inch disk, and that this new product would fit into a shirt pocket. The ANSI committee ultimately accepted the product as standard, but in a revised form. The capacity was increased to 1 megabyte (720K bytes formatted), and the spindle speed was reduced to 300 rpm—but it still would fit into a shirt pocket. Thus, the garment industry unwittingly contributed to floppy disk standards.

During 1982, several manufacturers challenged Sony's 3½-inch form factor. Hitachi proposed a 3-inch floppy disk with a 250K-byte capacity (later raised to 1 megabyte) in a similar hard cartridge. Tabor Corp. (with Dysan backing) proposed a 3½-inch miniature version of the 5¼-inch floppy disk. IBM proposed a 4-inch "demi-diskette," one-half the diameter of the company's original floppy disk, but its drive had deficiencies, a very poor system interface, and an ultraslow access time.

All three companies lost out—Hitachi because it lacked the lobbying power of Sony and had no U.S. computer manufacturers as champions; Tabor because its product, with its flexible jacket and wide-open head-access slot, was just as vulnerable to damage as the original 5¼-inch product; and IBM because of the inadequacies of its drive and because it had an unprotected disk.

Early acceptance of the 3½-inch format by Apple and Hewlett-Packard got it off to a good start, and its use in the IBM PS/2s in 1987 put it over the top. The shipments of 3½-inch

floppy disk drives now exceed those of 5¼-inch floppy drives worldwide. Zenith has recently introduced a 2-inch, hard-shell "mini-disk" for its MinisPort portable computer (see "The Ever-Shrinking, Ever-Expanding Laptops," August BYTE). The 2-inch drive stores 720K bytes.

### Let There Be Laser Light

The idea of optical storage has been around a long time. In 1927, John L. Baird demonstrated a "Phonovision System" based on a waxed disk with information displayed by an optical scanner. During 1935, Baird Radiovision offered for sale, through a London department store, 6 minutes of video display pictures from the stored images. In 1961, 3M started work on optical recording and, by 1965, was granted several patents.

In July 1971, the *Bell System Technical Journal* published a paper by D. Maydon entitled "Micromachining and Image Forming on Thin Film by Laser Beams." It was a harbinger of things to come. In 1974, Philips demonstrated a laser recording and playback system. The company followed this with a 1979 demonstration of the CD audio disk system, which has since made the phonograph record obsolete.

The first optical drives for computer use began shipping in 1983. These were 12-inch WORM (write once, read many times) products that are still priced out of the range of the personal computer market. Somewhat more affordable 5¼-inch WORM products began shipping in 1985 (see photo 6).

The audio CD formed the basis of the computer CD-ROM, which started shipping in 1985 and has slowly developed into a new form of publishing via storing information, such as encyclopedias, on optical disks. At first, CD-ROM drives were expensive, and disks were few. But this situation is rapidly changing. New titles, such as Microsoft's Office, are now appearing. This program is designed to provide on CD-ROM all the software applications that are needed by the typical small business using a Macintosh environment. NEC and Amdek are now offering CD-ROM drives for \$600. The NEC unit is portable and plays CD audio disks, as well as reading CD-ROM disks.

In 1988, Sony, Canon, Ricoh, and Maxoptix introduced 5¼-inch rewritable optical products. Like the early WORM drives, these are expensive and, for the time being, will appeal only to the high-end workstation portion of the personal computer market.

### Tomorrow's Mass Storage

During the next five years, you can expect to see the following improvements to personal computer storage products.

**Tape drives.** Quarter-inch cartridge drives will have more than 1 gigabyte of storage. Eastman Kodak has already demonstrated such drives, as has 3M. DAT drives (see photo 7) will provide over 1 gigabyte on a 4-mm tape cartridge, about the size of a credit card but thicker.

**Hard disk drives.** 5¼-inch drives will store up to 1.6 gigabytes. High-end 3½-inch drives will be storing 600 megabytes in full-height versions. Notebook-size computers will commonly use 2½-inch hard disk drives that are three-eighths of an inch high and store 50 megabytes.

**Floppy disk drives.** The "floptical" drive from Insite Peripherals will store 20 megabytes on a 3½-inch floppy disk, using a combination of optical and magnetic storage techniques (see photo 8). Insite's president is the same Jim Adkisson who invented the 5¼-inch floppy disk. The Brier Technology magnetic drive will store 20 megabytes and holds promise of storing as much as 50 megabytes on a single 3½-inch disk. A whole stable of floppy magnetic drives will be available from



Japan in the near future, offering storage capacities of from 4 to 27 megabytes per disk.

The catch in all of this is that none of the present or foreseeable future offerings are compatible with the present interchange standards. This incompatibility will rule out one of the main functions of floppy disks: software distribution. It could eventually lead to software distribution on CD-ROM, which already has an interchange standard.

The 2-inch floppy disk drive, already seen on the Zenith MinisPort and DynaBook notebook-size computers, will prevail among these machines—and possibly among the coming pocket-size computers. The pocket-size machine may be the one that provides the demand for IC memory cards for loading programs.

**Optical disk drives.** The write-once drive will continue to exist for high-end applications that benefit from a permanent audit trail. Capacity will stabilize at around 1 gigabyte for the 5¼-inch WORM product.

The prices of CD-ROM drives will drop to the \$300 range during the next five years, and many personal computer vendors will offer them as options—if not as standard equipment. Write-once CDs (essentially, another type of WORM) will be more widely available than they are now, and rewritable versions will finally appear within five years.

The capacity of 5¼-inch rewritable drives—just beginning to arrive in forms such as the hard disk shell in the NeXT computer—will be mostly 650 megabytes, the present International Standards Organization standard, because most suppliers are adhering to it. Manufacturers will also offer proprietary formats ranging from 1 to 2 gigabytes for users who do not care about data interchange.

A new class of rewritable optical 3½-inch drives will soon appear and will drop in price to less than \$1000. At this price level, such drives make sense for personal computer users who could benefit from having a removable disk drive in addition to a magnetic hard disk drive. Capacity will be as high as 280 megabytes on the removable disk.

**Laser cards.** After years of selling licenses to the technology but not producing drives, the Drexler LaserCard may be getting close to real-world use in the field of medical record keeping for clinics and medical insurance companies. The LaserCard stores up to 2 megabytes of data on a credit card-size card containing an optically written strip (see photo 9). Under development are optical drives and compatible "laser cards" that can store around 40 megabytes.

**Digital paper.** A write-once Bernoulli Box from Iomega will become available. This 5¼-inch drive will use flexible optical write-once media called digital paper (see photo 10) from Imperial Chemical Industries in a cartridge that stores 1.2 gigabytes (see "Digital Paper," February BYTE). The cartridge's target price is about \$50. The drive price has not been announced, but it should be affordable for the personal computer business user.

**Solid-state disk drives.** The products available in the current market tend to cost around \$1000 per megabyte—sometimes even higher. They have value in speeding up systems that otherwise would need to be replaced, but the systems that use them are normally in the minicomputer category. Development efforts are under way to bring them down in cost and to make them suitable for the personal computer environment. ■

*Robert R. Gaskin is a senior industry analyst at Dataquest, Inc., in San Jose, California. He specializes in and writes about the computer storage industry. He can be reached on BIX c/o "editors."*



**Photo 8:** A "floptical" disk is a 3½-inch floppy disk that uses optical and magnetic recording technologies and can hold 20 to 25 megabytes.



**Photo 9:** Drexler's wallet-size LaserCard contains a 35-mm strip that can permanently store several megabytes of data. Its current use is storing medical and insurance data.



**Photo 10:** "Webs" of digital paper, a removable optical data storage medium, can either be split into lengths as tape or stamped into disks and inserted into cassettes.

# BIX CALENDAR

# NOVEMBER

# N O V E

Display this month's  
BIX activities

# R

## Writers Exchange Opens

BIX now has a Writers Exchange, featuring conferences for professional writers and journalists, people who aspire to be professionals, and people who are just interested in the subject. The Exchange, edited by BYTE columnist Wayne Rash, Jr., features conferences run by professional writers and journalists including Hugh Kenner, Jan Ziff, Rick Cook, Jon Hall, and Guy Kewney. Participants may discuss all phases of writing with these and other professionals, gather tips from the pros, and learn how to improve and sell their own writing.

Most Writers Exchange conferences are open to the public, although journalism.pro and writers.pros are reserved for practicing professionals only. A special conference—sfwa—serves as a private forum for members of the Science Fiction Writers of America. Other conferences include: journalism, new.writers, poetry.prose, writers, write.fiction, and writers.talk.

## Special Events

### THURSDAY, 11/2, 8:30–9:30 PM EST. Talking big, with Ada

Randy Brukardt and Dan Stock of R.R. Software continue their discussion of the Ada language and answer such questions as “how do 32-bit and larger machines make Ada more practical for personal use?” (join janus.ada/cbix)

### TUESDAY, 11/7, 9 PM EST. First Tuesday “This LAN belongs to you and me . . .”

Discuss Local Area Networks and networking. (join main cbix, channel 1, band b)

## All-Month Conferences and Special Events

**macintosh exchange**—We'll discuss 16- and 24-bit color and test a Radius 19-inch, 24-bit monitor and graphics accelerator card.

**photo conference**—Moderated by Dana Hudes, this conference covers all areas of photography, including video and electronic imaging. Larry White and Herbert Keppler of *Popular Photography* magazine join us on line to offer advice and answer questions on photography. Other guests include representatives from Rainbow Graphics, Media Cybernetics, and Rix Software. Rainbow Graphics is lending the conference an Imapro scanner and a Targa-24 color graphics card, and Media Cybernetics and Rix Software are lending software. (The latter two firms have their own conferences on bix.) Another firm, Compubyte, is lending a 386 personal computer. Using this equipment, Dana has scanned some of his photos and uploaded them to the “photo” listings area, where they've joined more than 200 other files.

**blue tuesdays**—Join the IBM Exchange moderators for a cbix session every Tuesday night at 9 PM EST. (join main cbix, channel 1, band b)

**games people play**—Here's the Interactive Games Exchange schedule for November. Watch for specials, as well:

*Sundays, 9 PM EST*—Poetry, art, music and stories. (join fun.n.games/game.room)

*Sundays, 9:30 PM EST*—Learn about role-playing games on line and off line at Fantasy Foundation College. (join ff/ff.col)

*Mondays, Thursdays, and Saturdays, 9 PM–Midnight EST*—Meade & Mirth. (join mnm/inn)

*Tuesdays, Wednesdays & Saturdays, 9:30 PM EST*—Ledinworld. (join lworld/ledinworld)

*Thursdays, 10:15 PM EST*—Pandemonium. (join fun.n.games/game.room)

*Fridays, 9 PM EST*—Trivia. (join fun.n.games/game.room)



# Finally. An on-line service that doesn't nickel and dime you.

## It's BIX's flat-fee service.

BIX is short for BYTE Information Exchange. The on-line information service that's yours for an unheard-of flat fee of just \$39 for three months\*—an amount you could easily waste in just two to four hours with an *hourly rate*, on-line service. (Not to mention the fact that you'd be nickel-and-dimed for its monthly minimums.)

And here's another distinction: BIX is strictly for microcomputer pros; it contains no "fluff." As a subscriber, here's what you've got coming to you:

- All the information and ideas exchanged in more than 150 microcomputer-related conferences—a give-and-take in which you can participate.

- Microbytes Daily*—up-to-the-minute industry news and new product information.
- Plus support from hardware vendors and software publishers, access to extensive software libraries, and the use of our electronic mail service—which allows *binary attachments*.

## Subscribe to BIX right now—using your computer and modem.

Set your telecommunications program for full duplex, 8 bits, no parity, 1 stop bit, or 7 bits, even parity, 1 stop bit. Now dial BIX at 617-861-9767, hit the return key, and respond as follows:

<b>Prompt:</b>	<b>You Enter</b>
login (enter "bix"):	bix
Name?	bix.flatfee

You can charge your BIX subscription to major credit cards, or have it billed to your company. You may also purchase unlimited off-peak access via Tymnet for just

\$20 per month, or \$3 per off-peak hour, in the continental US.\*\* For more information, including your local Tymnet access number, call 800-227-2983 (in New Hampshire and outside the United States, call 603-924-7681).

*\*Based on a \$156 annual fee, billed quarterly — a subscription you may cancel at any time without future charges. You may also subscribe for a 3-month trial at just \$59.*

*\*\*For international rates, please consult your local PTT. Our international packet network address is 310690157800.*

*No extra charge for 2400 Baud access. Tymnet prices are subject to change.*

# BIX

One Phoenix Mill Lane  
Peterborough, NH 03458  
800-227-2983. In NH 603-924-7681.





**YOUR CHARGE CARD IS WELCOME**

# EXECUTIVE PHOTO & SUPPLY CORP.

**HOURS: Mon. Tru. Thurs. 9AM Till 6PM, Fri. 9AM Till 2:00PM, Sun. 9:30AM Till 5PM, Closed On Sat.**

**FOR COMPUTER & ACCESSORIES  
CALL TOLL FREE: 1-800-882-2802  
FOR FAX, TYPEWRITERS & DICTATION EQUIPT.  
CALL TOLL FREE: 1-800-223-7323  
IN N.Y. STATE CALL: 1-212-947-5290**

## LAPTOPS

**EPSON**



**Equity LT**  
10MHz, 640K, 2-3.5 720K Drives,  
Supertwist Backlit Display  
w/Free Laplink  
**999.00**

Equity LT w/20MB Hard Drive 1589.00

**SPARK by Datavue**  
Spark-EL, 640K, 2-3.5 Drives. 1019.00  
Spark-EL w/20MB 1769.00

**MITSUBISHI**

286L w/20MB Hard Drive 2269.00  
286L w/40MB Hard Drive 2777.00

**SHARP**

PC-4502 w/640K, 2-Floppy Drives & Backlit Monitor 894.75

**TOSHIBA (sold in Store Only)**

T-1000 CALL T-1200HB CALL  
T-1600 CALL  
New! T-1600 w/40MB CALL  
New! T-3100e w/40MB CALL  
New! T-5200 CALL

**ZENITH**

184-1 1399.00 184-2 2089.00  
Supersport 286 Model 20 w/20MB Hard Drive 2799.75  
286 w/40MB Hard Drive 3139.75

**NEC**

PROSPEED 386 3997.00  
ULTRAFLIGHT 2MB 2399.75  
PROSPEED 286 w/40MB CALL

**BONDWELL**

Bondwell Laptop 286, 10MHz, 20MB Hard Drive w/1200 Modem, Rechargeable Battery & Case 2149.00

## DESKTOPS

**COMPAQ**



New! DESKPRO 286e, 12MHz, 1.2 Floppy Drive, 40MB Hard Drive w/VGA. 2349.00  
COMPAQ Portable III with 40MB Hard Drive 3849.00

**AST**



**AST PREMIUM 286**  
10 MHz, 512K, 1.2 Floppy Drive,  
Seagate 40MB Hard Drive (28ms)  
**1578.75**

New! AST BRAVO 286 8MHz, 1.2 Floppy, 40MB Hard Drive (28ms). 1198.75

**EPSON**

EQUITY II+, 1-1.2 Floppy Drive, 1-40MB Hard Drive. CALL

**COMPATIBLES**

IBM-XT Compatible, 1-360 Floppy Drive, 1-20MB Hard Drive 699.95  
IBM-AT Compatible, 12MHz, 512K, 1.2 Floppy Drive, Seagate 40MB Hard Drive (28ms) 1114.75  
VENDEX Headstart III System w/VGA Color Monitor 2409.75

**Laptop Accessories**

WDRLD PDRT 2400 Modem 235.00  
TARGUS Nylon Case 57.95

## PRINTERS

**EPSON**



**FX-1050**  
9 Pin, Wide Carriage, 290 CPS  
Draft (10cpi), 60 CPS NLQ, Advanced Paper Handling Capabilities  
**469.75**

LX-810 187.95 LQ-510 CALL  
LQ-850 543.50 LQ-950 542.50  
LQ-1050 767.95 LQ-2550 859.99  
FX-850 352.00  
New! EPL-6000 Laser CALL

**PANASONIC**

KX-P 1181 175.75 KX-P 1191 203.75  
KX-P 1124 279.95  
KX-P 1595 415.75  
PANASONIC Laser Printer 1319.00

**CANON**

BJ-130 735.00  
LBB-3 Laser 1649.00

**NEC**

2200 307.95  
P5200 493.95  
P5300 648.95  
LC-890XL Postscript Laser CALL

**OKIDATA**

OKIDATA 183 Wide Carriage 217.75  
OKIDATA 320 339.00  
New! OKIDATA 360 CALL

**PRINTER SALE!**

STAR NX-1000 CALL  
New! DICONIX 150 Plus Printer 309.75  
New! H.P. Deskjet Plus 669.90  
H.P. Laserjet II w/Toner CALL  
APPLE Imagewriter II 439.00

## HARDWARE SOFTWARE



**LOGITECH**

New! Logitech PS/2 Mouse 69.99  
Logitech Scanman I/PS2 199.75  
INTEL 80387-SX 289.75  
INTEL 80387-20 369.99  
DFI HS-3000 Plus Scanner 164.75  
AST 6-Pack 286 CALL  
MICROSOFT Mach 20 315.75  
MICROSOFT Mouse 99.95  
PLUS 20MB Card 523.75  
CPU Implants CALL  
TOSHIBA 3 1/2" 720K Drive w/Kit 79.75

**Display Cards & Monitors**

PARADISE VGA Plus 16 174.95  
PARADISE VGA Plus 16 234.75  
PARADISE VGA Professional 289.75  
VEGA V-Ram VGA 256K 395.00  
VEGA VGA 204.75  
VENDEX VGA Color Monitor 424.75  
MITSUBISHI Monitors CALL  
NEW! NEC Multisync IIA Monitor 496.75  
NEC Multisync 3D 599.00  
PACKARD BELL Monitors CALL  
SONY 1302 Monitor w/Stand 650.00  
SONY 1304 Multisync Monitor 669.00

**Modems/Fax Cards**

EVEREX 2400B Modem CALL  
EVEREX Fax/Modem 229.75  
QUADRAM J1 Fax Internal 4800 184.75

**PRINTER RIBBONS**

OKIDATA 292 Ribbon 5.49  
EPSON Original EX-800/1000 Color/13.99  
NEC P7/P3 Ribbon 4.59

**DISKETTES**

FUJII MF2/D Rainbow 10.49  
BONUS 5 1/4 DS/DD 4.99  
MAXELL Diskettes CALL

WORDPERFECT 223.95  
KO-Pilot I/Word Perfect 56.75  
Xy Write III w/1A Carta 215.75  
VOLKSWRITER 4 CALL  
NEW! SAMMA AMI 116.75  
NOTA BENE 3.0 235.00  
GRAMMATIK III 48.99  
Z-Soft PC Paintbrush IV 57.75  
GO SCRIPT Plus 234.75  
BITSRAM Fonts CALL  
SOFTACT Font Solution Pack 337.75  
AUTOSKETCH by Autodesk 85.75  
New! COREL Draw 1.1 329.95  
ALDUS Pagemaker 445.00  
HARVARD Graphics 268.75  
PFS First Publisher 72.75  
NEW! LUCID 3D 59.00  
IMPRESS 68.75  
New! LOTUS 1-2-3 3.0 338.75  
LOTUS Agenda 247.75  
SYMANAC Grandview 173.75  
Q & A 205.75  
ASK Sam 165.00  
D'Base IV CALL  
FOXBASE Plus 187.75  
PARADOX 3.0 438.00  
FRAMEWORK III 419.00  
New! INTLUT Quicken 3.0 35.95  
DAC Easy Accounting 56.75  
ONE Write Plus 84.75  
WEALTH Builder by Realty 139.75  
New! Mirror III 49.00  
Hot Line II 49.75  
PROCOM Plus CALL  
NOLO Will Maker 30.95  
FASTBACK Plus 99.75  
SPINRITE 39.95  
386 MAX Professional 68.75  
NORTON Advanced Utilities 78.75  
MICROSOFT Quick C/W/Assembler/133.75  
BORLAND Turbo C Pro 157.00  
DESKVIEW 75.00  
FAST by Future Computer 57.75  
SUPER PC w/Mini Phones 48.75  
HYPERPAD by Brighthouse 56.75  
ACCOLADE Grand Prix 23.75  
CHESSMASTER 2100 29.95  
SIERRA Space Quest III 33.75  
Where in Time is Carmen S.D. 27.95

## FAX MACHINES

**PANAFAX**



UF-135 CALL UF-140 CALL  
UF-145 CALL UF-150 IN STOCK  
UF-250 IN STOCK UF-260 IN STOCK

**SHARP**

FO-220 CALL FO-300 CALL  
FO-330 CALL FO-420 CALL  
FO-510 CALL FO-700 CALL

**Canon FAXPHONE**

FaxPhone 8 CALL FaxPhone 15 CALL  
FaxPhone 20 CALL FaxPhone 25 CALL  
FX-F 225 CALL FX-F 270 CALL  
FX-F 350 CALL FX-F 450 CALL  
FX-F 630 CALL FX-F 705 CALL

**RICOH**

FAX-25E CALL FAX-35 CALL  
FAX-65E CALL FAX-75E CALL

**MURATA**

M-900 CALL M-1200 529.90  
M-1400 CALL M-1600 629.90  
M-1800 CALL

**PANASONIC**

KX-F 80 CALL KX-F 100 CALL  
KX-F 120 CALL KX-F 120 CALL  
KX-F 320 CALL

**TOSHIBA Price Break**  
3300 CALL 3700 CALL  
Model 30100 CALL

**BROTHER**

FAX 200 CALL  
FAX 210 w/Answering Machine CALL

**FAX PAPER**

8 1/2"x9" 49.95 8 1/2"x11" 59.90  
8 1/2"x328" 74.95  
FAX Cleaning Kit 29.95

## TYPEWRITERS & Word Processors

**SMITH CORONA**



**WORD PROCESSORS**

PWP-2000 CALL PWP-3000 CALL  
PWP-5000 CALL PWP-1000 CALL  
PWP-7000LT Laptop CALL

**TYPEWRITERS**

XL-1500 CALL XL-4600 CALL  
XD-5600 CALL XD-7600 CALL

**WP & Typewriter Access.**

PWP Start-Rite Kit 39.95  
Typewriter Start-Rite Kit 39.95  
Printwheels ea. 10.95  
Multi Strike Film Dz. 74.95  
Correctable Film Dz. 34.95  
Lift-Off Correcting Cassette Dz. 44.95  
Cover-Up Correcting Cassette Dz. 46.95  
Data-Disks Dz. 34.95  
CoronaCalc 44.95  
Sheet Feeder I/PWP-5000 139.90

**Panasonic**

KX-W1000 Word Processor CALL  
KX-W1500 Word Processor IN STOCK  
KX-W1510 WP w/Sheetfeeder CALL  
KX-R430 CALL KX-R440 CALL  
KX-RB00 Word Processor Typewriter CALL  
Accessories

**brother**

WP-60 Word Processor CALL  
WP-75 Word Processor CALL  
WP-80 Word Processor CALL  
AX-26 CALL AX-28 CALL  
Accessories

## Dictation Equipment

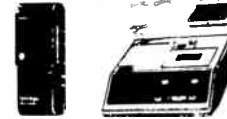

**OLYMPUS Pearlcarder**  
L-200 129.90 S-907 35.90  
S-911 59.90 S-930 99.90  
T-1010 Transcriber 169.90  
S-804 119.95 S-811 CALL  
T-100 CALL T-2020 CALL

**PANASONIC**

RN-15 119.90 RN-36 179.90  
RN-89 79.90 RN-105D 29.90  
RN-106D 34.95 RN-115D 39.90  
RN-125 52.90 RR-900 179.90  
RR-970 249.90 RR-980 279.90

**SANYO**

TRC-6100 CALL TRC-5680 79.90  
TRC-2550 149.90  
TRC-5200 229.90 TRC-5020 179.90  
TRC-4300 227.90 TRC-4030 178.90  
TRC-8000A 237.90 TRC-8010A 165.90  
TRC-8700 229.90 TRC-8070 185.90  
TRC-9100 239.90 TRC-9010 199.90

**SONY**

M-100B 219.90 M-740 35.90  
M-750I 49.90 TCM 5000EV 369.90  
BM-12 CALL BM-17 CALL  
BM-560 CALL BI-500 CALL  
BM-75 CALL BM-80 CALL  
BM-815T CALL BM-820 CALL

**NORELCO**

585 99.90 592 119.90  
NT-11e 134.95 NT-V 199.95  
NT-VI 219.90 NT-VII 247.90  
MC-III 164.95 MC-IV 199.95  
2595 119.90  
205 289.90 505 319.90  
510 397.90 805 629.90  
MC-3000 299.90 MC-4000 379.90  
2505 399.90 2510 334.95

## COPIERS

**Canon PC**



PC-3 II 349.90 PC-5 II 453.90  
PC-5L II Legal Size w/Stand 619.90  
PC-6 779.90 PC-6RE 859.90  
NEW! PC-7 Zoom Copier CALL  
Black Cartridges 79.95  
8 1/2"x11 Paper (5000 sheets) 49.50

## CALCULATORS & DATABANKS

**HEWLETT PACKARD**  
HP-10B Business 38.45  
HP-12C Financial 59.90  
HP-14B Business 58.90  
HP-17B Business 75.90  
HP-19B Business Consultant II 125.90  
HP-20S Scientific 39.90  
HP-22S Algebraic Scientific 43.90  
HP-27S Scientific 74.95  
HP-28S Advanced Scientific 162.90  
HP-32S RPN Scientific 52.95  
HP-41CV 119.90 HP-41CX 169.95  
HP-42S RPN Scientific 88.90  
HP Infrared Printer 99.90

**PSION**

ORGANISER II-XP 198.90

**SHARP**  
OZ-7000 WIZARD IN STOCK  
WIZARD Accessories CALL  
EL-6230 Auto Dialer 39.90  
EL-6250H Dial Master 53.90

**CASIO**  
SF-4000 32K Digital Diary 89.90  
SF-7000 B.O.S.S. 32K Digital Diary 179.90  
SF-7500 B.O.S.S. 64K Digital Diary 169.90  
SF-8000 B.O.S.S. 64K Digital Diary 199.90  
FC-1000 Financial Consultant CALL

## TELEPHONES

**Panasonic**

Feature Telephones 49.90  
KX-T 2365 55.90 KX-T 2366 59.95  
Multi-Line Phones  
KX-T 3122 56.90 KX-T 3145 67.90  
KX-T 3155 75.90 KX-T 3170 139.90  
INTEGRATED PHONES  
KX-T 2385D 65.90 KX-T 2390 79.90  
KX-T 2630 107.90 KX-T 2634 134.90  
KX-T 2429 135.90 KX-T 2430 108.90  
Answering Machines Specials  
KX-T 1450 59.90 KX-T 1455 65.90  
KX-T 1460 79.90 KX-T 1470 99.95  
KX-T 1624 78.90 KX-T 1740 109.90  
CORDLESS PHONES  
KX-T 3000 119.90 KX-T 3807 59.90  
KX-T 3823 70.90 KX-T 3824 89.90  
KX-T 3832 93.90 KX-T 3880 125.90  
KX-T 3900 w/2-Keypads 123.90  
KX-T 4200 w/Answering Machine 145.90

## Freedom Phone

FF-1700 Cordless "Top Rated" 109.90

## Business Key Systems PANASONIC

2 Line Integrated Intercom System  
VA-9200 System (1-9210, 2-9230) 369.90  
VA-9210 Electronic Controller 124.90  
VA-9230 2 Line phone w/Speaker 124.90  
VA-614 4-Line System  
VA-61410 Key Service Unit CALL  
VA-61421 Phone w/Speakerphone CALL  
VA-61422 Speakerphone w/LCD CALL  
VA-61423 Speakerphone w/BLF CALL  
VA-208 2-Line System  
VA-20810 Key System Unit CALL  
VA-20821 Phone w/Speaker CALL  
KX-T616 6-Line System  
KX-T61610 Control Unit CALL  
KX-T61620 Phone w/Speaker CALL  
KX-T61630 Speakerphone w/LCD CALL

## FREEDOM PHONE

FS-246 6-Line Service Unit CALL  
FS-800 Basic Station CALL  
FS-900 Executive Station CALL

**VISA, MASTERCARD, AMERICAN EXPRESS, OPTIMA & DISCOVER CARDS ACCEPTED**  
OUR GUARANTEE: Defective goods will be replaced or repaired if returned within 10 Days in original packing, mint condition, blank warranty card, detailed letter of explanation & copy of invoice. No return privilege on software. If found defective, we will advise customer how to consult manufacturer for warranty service. For Customer Service: Please Call (212) 947-5295. Prices are for Mail Order Only. Store Prices May Vary. We reserve the right to limit quantities.  
TD ORDER BY MAIL: Please send money order or certified check for UPS shipment on most items. Personal check delays your order by 15 days.  
Shipping & Handling: Handling Charge; 2% plus 5.95. Shipping Charge; 0.65 per lb. Estimate minimum shipping 5.95. Total charge at time of order. Shipping & Handling charges are not refundable.  
INQUIRE about NEXT DAY AIR or 2nd DAY AIR Shipment. N.Y. State Residents add TAX.

# EXECUTIVE PHOTO & SUPPLY CORP.

MAIL ORDER: Dept BY, 120 West 31st Street, N.Y., N.Y. 10001 (Tel. 1-212-947-5290)  
MANHATTAN STORE: 120 West 31st Street, N.Y., N.Y. 10001 (Tel. 1-212-564-3892)  
SCARSDALE, NY STORE: 485 Central Ave. (Scarsdale Plaza) SCARSDALE, N.Y. 10583 (Tel. 1-914-723-1331)  
N.Y.C. Consumer Affairs License Number: 800193

Circle 131 on Reader Service Card



# THE ABCS OF DIGITAL TYPE

*Digital type—like its ancestor, movable type—is revolutionizing the way we publish documents*

*John Collins*

**I**n the beginning was Gutenberg, setting pieces of lead into a press and so mechanizing the process of printing—formerly a laborious job done by hand, one document at a time. (See the text box “Gutenberg Had It Easy” on page 404.) The typesetting machine and the typewriter succeeded Gutenberg’s press, and now the personal computer has largely replaced the typewriter.

At first, all personal computer displays and output devices emulated the look and feel of the typewriter. Characters were generated by specialized hardware that wrote a matrix of bits into a computer’s video memory. Characters appeared on the screen made up of spots corresponding to these bits. Needless to say, the type of font you got was determined solely by the characteristics of the computer’s character-display hardware.

Things really got interesting when you attempted to print the document, because the font used by the printer to print characters onto the page seldom matched the characters in your computer’s video hardware. If you were really resourceful, you might be able to coax out of your printer condensed, expanded, bold, or underlined text. However, there was little chance that what you printed out would match what you saw on your computer’s screen. WYSIWYG it wasn’t.

The Macintosh changed this by merging the imaging operations of the computer screen and the printer. The Mac has no character-display hardware or character-based screen mode—it operates entirely in graphics mode. The System file stores a bit map of a typeface and the point size used. Characters are assembled from a “library” of bit maps—the actual pattern of dots that makes up the shape of each character. When you print a document, the printer operates in the graphics mode and draws the characters in much the same way they’re drawn on the Mac’s screen. This method has important consequences.

Text output is no longer coupled to display hardware; characters can be larger than the typical 9×7 matrix. Moreover, since stored bit maps are used to generate the characters, the type style can be anything—for example, Times Roman, Old En-

glish, Courier, Cyrillic, kanji, or Arabic.

When you use this process, whatever climbs out onto the printer tray closely matches what you have on the Mac’s screen. Making bit maps appear on a screen or from a printer simply requires copying the data to the output device, so it is virtually instantaneous.

One trade-off with bit maps is that a different one is required for each type style and point size. Furthermore, additional bit maps may be required to handle the resolutions of different output devices. Another major disadvantage of bit maps is that they require enormous storage capacity, especially for large sizes.

## Digital Type—Fonts Are Us

With the advent of digital type (i.e., typefaces represented as electronic data) came the potential of using a single typeface master on a wide variety of—perhaps all—output devices produced by different manufacturers. With this technique, you can easily produce output in just about any type style and size you choose on a variety of machines for a variety of applications.

Font portability makes it easier and more economical to create and distribute fonts for use in a variety of devices. It also provides users with a greater availability and wider variety of typefaces. Device-independent digital fonts significantly reduce compatibility problems. As more and more devices are networked together, this device independence becomes particularly important. Finally, portability preserves your investment in type when you upgrade to new devices.

Digital type can be provided in three forms: Bit maps, outlines, and stroke fonts. For situations where only a few faces and point sizes are needed, bit maps are ideal because of their simplicity and high performance. Bit maps can be hand-edited and customized to produce the best-possible type quality on various kinds of output devices (see figure 1).

Where typographic flexibility (e.g., several faces, several point sizes, and rotation) is required, outlines are the preferred form. An outline is a mathematical description of the shape of a

*continued*

## Gutenberg Had It Easy

When Gutenberg introduced movable type 500 years ago, fonts were simple and portable. Hand-cast hot metal type from any one foundry could be easily mixed with that of another foundry. This flexibility gave users great freedom and variety in specifying fonts.

When typesetting became mechanized, about 100 years ago, things got more complicated. Each typesetter manufacturer required—and most designed and sold—a particular kind of type for its equipment. Users who changed from one manufacturer to another had to purchase another library of type for the new device.

With the emergence of phototypesetting 20 years ago, type became even more machine-specific. Phototypesetting machines created type by projecting light through negative images of let-

ters onto photographic paper. The type required for these machines was unique to each model. Even if you wanted to upgrade within the same line of typesetters, you usually had to purchase a completely new library of fonts. While this situation was good business for typesetter manufacturers, it limited users in their choice of type to those styles and formats made for their particular device.

When phototypesetters became digital in the 1970s, type was often encrypted so it would work only within a single installation. This is analogous to compact disks that are specially encoded to be played on one particular CD player. Music lovers would never go for this when their records historically could be played on any phonograph.

What we've seen over the last 500 years is a series of major technical advances in the mechanization of typeset-

ting. These advances, unfortunately, have gradually stripped type of its initial portability to the extent that it has become very specialized and localized. The irony here is that digital type has greater potential for portability on a number of different machines than any other form that type has taken during its evolution.

Because it has been so long since type was truly portable and device-independent, users have become accustomed to closed font architectures. We are, however, at a stage where technological advances in digital typography are beginning to provide the freedom of choice and open market that existed in the early days of movable type. More and more users are becoming aware of this. As a result, the demand for open and portable font architectures is growing rapidly.

character (see figure 2). As outlines can be scaled and rotated, only one outline is needed to represent a character in any size and for any device resolution. Thus, outlines are much more compact than bit maps, especially where many sizes are required. Their major disadvantage is that a significant amount of computation is required to convert them into the bit-map form eventually required by the output device. As a result, going from an outline to an image on the screen or printer is a relatively slow process. To do so at high speed takes a significant amount of processing power.

The third representation that is occasionally used is stroke fonts (see figure 3). Stroke fonts, sometimes called vector fonts, describe the spine of a character. Drawing a character from a stroke font onto the screen or into the printer memory can be as simple as drawing a series of pixels along the strokes

that make up the character. For large point sizes, a thicker path of pixels needs to be drawn to prevent the character from looking stick-like. Like outline fonts, stroke fonts are size- and resolution-independent and can be rotated to any angle.

Less computation is required to image a stroke font than is needed for outlines, so the results are faster. Stroke fonts also require a relatively small amount of storage—typically 50 percent less than outline fonts. The catch with stroke fonts is that only a tiny percentage of the world's typefaces can be effectively represented as stroke fonts. Only those faces with even stroke weights and simple round or square ends of strokes can be represented (e.g., Courier). Attempts to represent other faces will produce results that require more storage and take more time to draw than outline data.

There is more to digital fonts than just the shape of the characters. For an application program to lay out the characters on a page, it needs to know how much space each character takes up. The height of a character is determined simply by the point size that the user specifies. But the width of each character is not so straightforward. Most typefaces in general use are proportionally spaced; that is, each character has a different width. The program needs this information so it can decide how the characters fit side by side, how many characters fit in the line, and where the line should be broken. Character widths are unique to each font.

Merely describing the widths of each character does not ensure the highest-quality reproduction. Certain character pairs, such as "To" and "AV," look much better when the spacing between them is reduced; others look better when the spacing is increased. This technique is known as  *Kerning*. Most fonts contain kerning data that describes spacing adjustments to be applied to certain character pairs as they occur in the text.

Other data, such as scale factors for making small caps, superscripts, and subscripts, and instructions for building fractions, is sometimes provided with fonts. This data, along with character widths and kerning data, is called *font metrics*.

### BIT-MAPPED FONT

#### Font summary:

Lines per em: 41  
Lines below baseline: 10  
Blinker width: 0  
Blinker height: 0  
Default space width: 12  
Track kerning values:  
(1,2,3,4): 0,0,0,0  
Point size: 10.0  
Vertical resolution: 300  
Horizontal resolution: 300

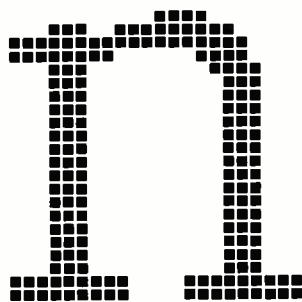

**Figure 1:** Bit maps define the actual pattern of dots that composes a character. For optimal quality, bit maps can be hand-edited.



Another aspect of fonts concerns character sets—groups of letters, figures, symbols, and so on. If there were one universal character set, all fonts would provide the same collection of characters. Unfortunately, it's not that simple. There are character sets associated not only with different countries, but also with different printers (e.g., LaserWriter and LaserJet), operating systems (e.g., Macintosh and DOS), page-description languages (e.g., PostScript and QuickDraw), and application programs (e.g., WordPerfect and Lotus 1-2-3). A great number of character sets is in common use today. Hewlett-Packard's LaserJet, for example, supports more than 40 sets for its resident fonts.

### But Are They Portable?

Even though bit-map output devices are the most common type of output device used today, the manner in which they work with fonts varies widely. Graphical displays can handle a wide range of typographic styles. It is the responsibility of the application program or the operating system to copy the bit-map character data from the font into the appropriate place in the display buffer. The font format required is therefore determined by the application program or the operating system.

Dot-matrix printers operating in graphics mode have capabilities similar to those of graphical displays. They depend on the application program or operating system to build a bit-map image of the page in memory. The resulting data is then output to the printer. As with graphical displays, the font format required for dot-matrix printers depends on the application program or operating system.

Laser printers, on the other hand, have the processing ability to use resident fonts or additional user-installed fonts. Laser printers accept instructions from the host computers by means of a page-description language. The two most common PDLs in use today are Hewlett-Packard's Printer Control Language and Adobe's PostScript. PCL devices use bit maps that are either resident or downloaded from the host. Additional fonts may be made available for PCL devices in the published PCL bit-map font format.

PostScript devices expect fonts in outline format. Because PostScript is a programming language, it is possible to encode fonts in various forms. Thus, you can use PostScript fonts from a variety of vendors with PostScript typesetters and laser printers. (See the text box "Open Fonts: A Break for Users?" on page 406.)

### Managing Your Fonts

Although MS-DOS is a widely used operating system, it provides no font-management capabilities. That function is left to the application programs. As a result, MS-DOS software developers have chosen different approaches to handling fonts, font metrics, character sets, and other typographical data. Therefore, font formats and font-metric data required for one application program are likely to be different from those required for another.

Graphical user interfaces (GUIs) that are compatible with MS-DOS, such as Microsoft Windows and Digital Research's GEM, have brought some order to this chaos by managing fonts for displays and dot-matrix printers. Applications that take advantage of these facilities, therefore, use a common font format. Increasing acceptance of these operating environments has helped the IBM PC improve its ability to handle fonts. OS/2 and Presentation Manager promise to accelerate this trend as they become established in the PC environment.

In the Macintosh environment, fonts are managed within the operating system itself. Thus, there is standardization among

Mac application programs that use fonts. From the perspective of the independent font vendor, this is a much simpler environment for which to provide fonts. Apple recently announced its System 7.0, which will bring dramatic increases in font capability with future Mac releases.

Unix was late in providing a GUI, let alone any kind of font management. Recent developments along this line, though, should create a trend toward standardization in the way fonts, character sets, and font-metric information are handled for application programs running under future extensions of Unix.

### A Font Is Born

Fonts are conceived by type designers, who start with an idea for a typeface design, make sketches, and then do detailed

*continued*

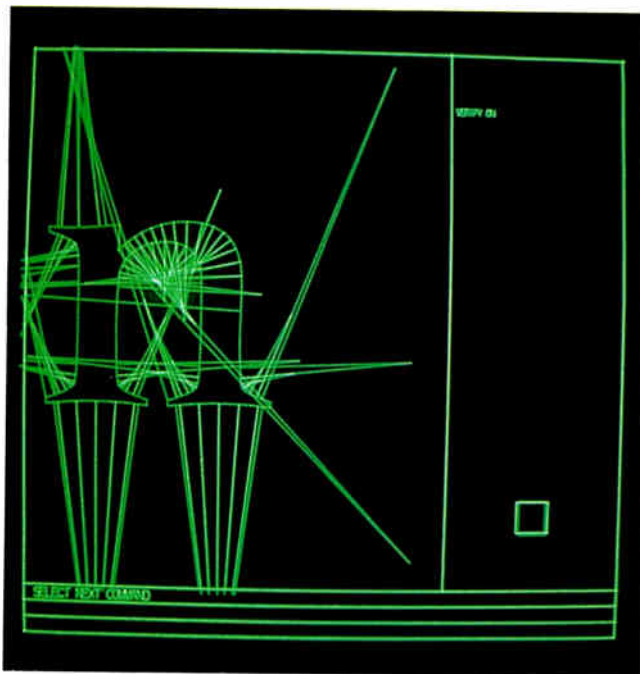

**Figure 2:** An outline font, mathematically plotted as a series of lines and arcs. Outlines are scalable to a range of sizes and are resolution-independent.

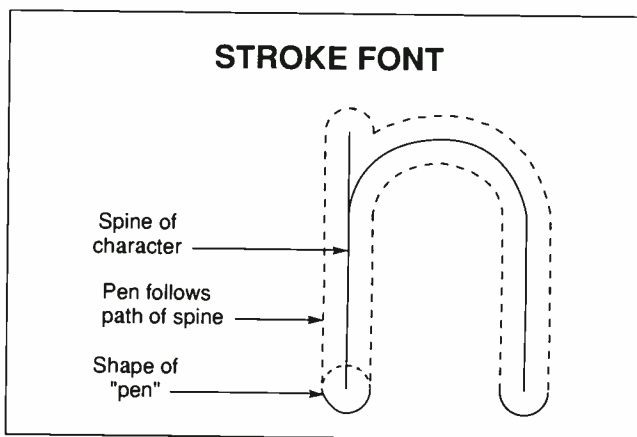

**Figure 3:** A stroke font. Stroke fonts are defined by a pen of a certain width that follows the spine of a character.

## Open Fonts: A Break for Users?

Marlene Nesary

While Adobe's PostScript has been a boon to electronic publishing or to those who just want the flexibility of using a variety of fonts in their work, the atmosphere surrounding the use of its technology has been, shall we say, a bit close-ended. Until recently, users had to have a PostScript-licensed printer to read Adobe-encrypted fonts. A couple of events occurred this past spring, however, that changed things for the better—as far as users are concerned, that is.

In an apparent bid to wrest control of Adobe's proprietary technology, Sun Microsystems announced its own font-scaling system, called OpenFonts. According to a Sun spokesperson, the system is a "self-contained font-scaling module that lives independent of the imaging model." In other words, the product (developed by Folio, a company that Sun acquired last summer) is "software that automates the font-description and scaling process. It won't be an end-user

program; you will license the technology like you would PostScript and put it into your printer software or your Windows driver." At this writing, however, OpenFonts isn't available and remains an unknown.

About the same time that Sun made its announcement, a Boulder, Colorado, company called Raster Image Processing Systems let loose another salvo at Adobe. RIPS stated that it had broken the encryption scheme used by Adobe's PostScript fonts. Both the character description and the so-called hints were decoded, said company president Lynn King.

What this means is that users can now "purchase Adobe fonts off the shelf and run them on clone printers," stated a RIPS representative. He added that "while others have cracked the PostScript code, we have made it possible for users to run Adobe fonts on less-expensive printer controllers." Until now, because only Adobe-licensed printer

controllers could decipher the company's code, the only way you could use Adobe fonts was to run them on more-expensive PostScript-licensed printers.

But this activity hasn't put a damper on Adobe's marketing efforts. If anything, they've ramped up. This past spring, the company announced that it had increased the number of licensed PostScript printers and expanded its PostScript-compatible font library through licensing agreements with three major type foundries—agreements that may yield as many as 600 new typefaces by the end of 1989.

Adobe has also released its font-scaling technology as a separate product for displays. The subset of Display PostScript, a new software utility called Adobe Type Manager, is due to become available this fall to computer and system software OEMs and to Macintosh users, who should be able to purchase ATM directly from their usual retail channels.

drawings to flesh out the idea into the form of a complete typeface. Font foundries take these designs and digitize them. There are two classes of font foundries. First, there is the dedicated foundry that creates fonts only for machines made by the company in which the foundry exists. This is the common situation with typesetter manufacturers. Obviously, such dedicated foundries don't have to produce fonts in the different formats and character sets in use elsewhere.

In contrast, independent font foundries are not tied to a specific piece of hardware. They must make fonts that can work with any and all devices. Therefore, it becomes a much more complicated task to accommodate all the different application programs, devices, operating environments, and font formats. Some form of conversion or enabling software is needed to ensure the availability and quality of the fonts with all these different combinations.

There is a third source of fonts—the various do-it-yourself software found mainly in the Macintosh environment. With this type of software, many users are themselves designing fonts. Most people, however, underestimate the difficulty of designing a typeface, thinking that creating 26 letters is just 26 times the trouble of creating one. However, the essence of good typography lies in a high level of consistency among all the characters in the typeface. The type designer's goal is to create a pleasing overall look to the words, sentences, and pages created from the individual letters—not just to make those individual letters look good.

Do-it-yourself font software cannot replace a professional type designer's training and experience, just as music software cannot replace a musician's conservatory education and actual performance experience. Such programs, however, are useful

for creating logos and other special characters that may be missing from generally available fonts or character sets.

### The Font Store

Some printers and typesetters have fonts built right in. PostScript printers, for example, generally come equipped with 35 resident fonts. But many users want a much wider variety than can be accommodated by resident fonts, particularly now that desktop publishing is so popular and people are realizing how many thousands of typefaces exist. User-installed fonts offer a much wider variety of faces than can be provided as resident fonts. They are available from numerous vendors.

A number of such fonts are available that are device-specific. The best known are cartridge fonts for use in printers such as the LaserJet. While these are by far the easiest to use, they have major disadvantages. Cartridge fonts work with only one model of printer, offer limited styles and point sizes, and don't provide fonts for use with screen displays. Font-metric information must be built into the applications or printer drivers or supplied with the cartridge.

Somewhat more flexible device-specific fonts are soft fonts, which consist of a downloadable bit map sent to the printer by the application program or printer driver. Unfortunately, most prepackaged soft fonts are configured for one particular printer and offer a limited set of point sizes for each typeface.

A third kind of device-specific font is the PostScript font. While not quite as device-specific as the others—it works with a wide variety of PostScript printers and typesetters—it will not, of course, work on non-PostScript devices. User-installed PostScript fonts are generally provided in downloadable outline form, and, like soft fonts, they are sent by the driver or the



THE ABCS OF DIGITAL TYPE

application program to the printer for rasterization.

There are two classes of PostScript fonts. One class, often called Type I fonts, makes use of Adobe's proprietary mechanisms built into the output device. The other class, called user-defined or Type III, makes use of only the published PostScript language. Type I fonts offer significant advantages over user-defined fonts in terms of data size, performance, and typographic quality.

Several soft-font vendors provide a software utility that can scale typeface outlines and convert them into bit maps for sup-

**A** RAM-based printer controller will provide an upgrade path to new font-scaling technologies and PDLs as they become available.

ported printers. Glyphix, from Swfte (Wilmington, DE), offers 16 typefaces that work with one of its utilities, called Font Manager. There are separate Font Managers for Microsoft Word 4.0, WordPerfect 5.0, PageMaker 3.0, and Ventura Publisher 2.0. Font Manager scales the outlines from 6 to 60 points for LaserJets and compatibles. The utility can also oblique (i.e., slant) and alter the weights (e.g., boldface) of the fonts. Glyphix fonts can also be used with Lotus Manuscript 2.0, WordStar 2000, and other applications.

Bitstream's Fontware Installation Kit is a menu-driven utility that scales typeface outlines from 2 to 144 points and rasterizes them into bit maps especially configured for the user's devices. For PostScript devices, the outlines are simply converted to the required PostScript format and can then be scaled to any point size. The program handles font management by building and updating directories for font files.

Fontware installation kits are available for most popular desktop publishing, word processing, graphics, and spreadsheet programs. (They are generally offered to users directly by the applications developer.) The library of 52 Bitstream typeface packages works with any of these kits. Hewlett-Packard and Compugraphic together offer a similar utility called Type Director that works with their typeface packages.

Some vendors offer editing programs that let users customize fonts. With these programs, you can create logos, special characters, and additional weights and styles of existing and original typefaces. SoftCraft (Madison, WI) offers the Font Solution Pack, an IBM PC program that uses Bitstream typefaces or Hewlett-Packard-compatible bit-map fonts. You can install, scale, curve, rotate, reverse, and edit typefaces, and create custom character sets and special styles.

Fontographer, a product for the Macintosh from Altsys Corp. (Plano, TX), enables users to create characters from scratch. Six typefaces are also available that can be user-customized by adding special effects such as variable tints and outline weights. You can configure the fonts, logos, and characters created into bit maps for the ImageWriter LQ or LaserWriter

*continued*

Industrial Control Systems  
Intelligent Terminals  
Diskless Systems  
LANs

**ROMDISK™**

For the IBM  
PC, XT, AT PS/2  
and PC DOS\* or MS DOS\*

**SOLID STATE DISKETTE AND DRIVE EMULATORS  
New Dual Disk Models**

- PCE/2 single disk emulation of 5¼" or 3½" diskettes up to 1.2MB, read/write up to 770K.
- PCE/2 dual disk emulation—primary disk up to 770K read only and secondary diskette to 770K of SRAM.

**ROMDISK PCE MODEL STANDARD FEATURES**

- In-board and interchangeable Cassette models using EPROM, Flash EPROM and SRAM technology.
- On-board EPROM programmer—simply copy a diskette to program the EPROMs. Flash EEPROM remotely programmable on LANs.
- Two Autoboot modes, a File (read) and a Programming mode—automatic disk drive designation set-up during booting.
- Flash EPROM models are electrically erasable. SRAM models are battery backed. EPROM models are ultraviolet erasable.
- List prices with memory ICs from \$295. OEM prices and models available OEM with or without memory ICs.



**CURTIS, INC.**  
2837 North Fairview Ave. • St. Paul, MN 55113  
612/631-9512 Fax 612/631-9508



\* IBM PC, XT, AT, PS/2 and PC DOS are trademarks of IBM; MS DOS is a trademark of Microsoft

**C for the 8051  
Compare:**

**Benchmark Results** —Sample program: Eratosthenese sieve  
Program from BYTE (1/83) expanded with I/O and interrupt handling.

	Archimedes		
	ICC51 v2.20A	MCC51 v1.2	FRANKLIN C51 v2.1
Compilation time	12 sec ✓	18 sec	17 sec
Linkage time	29 sec	9 sec	6 sec ✓
Execution time	11.45 sec	9.00 sec	0.88 sec ✓
Total code size	5318 bytes	3798	1726 ✓
Sieve module size	736	1021	541 ✓

Call now for your free DEMO disk.



888 Saratoga Ave. #2 • San Jose, CA 95129  
(408) 296-8051 • FAX (408) 296-8061

Europe A: (0222) 25 36 26 B: (010) 22 34 55 CH: (032) 41 01 11 D: KEIL (089) 46 50 57 DK: (02) 65 82 00 F: (1) 64 07 85 64 GB: (0962) 73 31 40 NL: (01858) 16133 S: (040) 92 24 25 Far East: Aust: (61) 04 65 41 873 R.O.C.: (02) 76 40 2156 N.Z. (64) 04 694 129 (fax).

## Read Mac Disks in a PC MatchMaker

— the best way to share data between a PC and a Mac. The **MatchMaker** card lets you plug a Macintosh floppy drive into a PC.

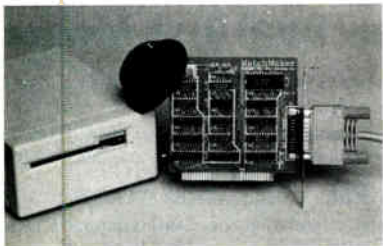

- Easy-to-install half-size card.
- Use any external Macintosh drive.
- DOS-like command software included.
- 1 year warranty, Made in USA.
- Also available; **MatchPoint-PC** to read/write Apple II disks.

"...by far the most cost effective solution..." *PC WEEK*

**MicroSolutions**  
Computer Products

132 W. Lincoln Hwy.  
DeKalb, IL 60115  
(815) 756-3411

## Introducing Smallest 80386 based PC Compatible Single Board Computer

Now  
Available  
DR DOS®



Only  
4" x 6"

### Quark/PC® II

- EGA® Video/Color LCD Controller
- SCSI Hard Disk Control • Floppy Disk Control
- Up to 4 Mbytes Memory and much more. . . .

To order or enquire call us today.

**Megatel Computer Corporation**

(416) 245-2953 FAX (416) 245-6505

125 Wendell Ave., Weston, Ontario M9N 3K9

REPS: Italy 39 331 256 524

Austria 43 222 587 6475

W. Germany 49 6074 98031

Finland 358 0757 1711

U.K. 44 959 71011

Sweden 46 40 78 078

Netherlands 31 838 529 505

Norway 47 986 9970

Australia 61 03 568 0988

Denmark 45 244 0488

Trademarks: Quark - F + K. Mfg. Co. DRDOS - Digital Research Ltd. EGA - IBM Corp.

COMDEX Booth #H7060

**megatel**

IISC, or into user-defined PostScript fonts for PostScript compatibility.

With Publisher's Type Foundry by ZSoft Corp. (Marietta, GA), you can create custom fonts, logos, and symbols from scanned typefaces or from scratch. Publisher's Type Foundry has both a bit-map editor and an outline editor. Fonts can be translated to formats required for PostScript printers, as well as for applications such as Aldus PageMaker and Ventura Publisher. Running under Microsoft Windows, Publisher's Type Foundry requires scanned type to be entered into PC Paintbrush and then transferred into one of the font editors. With Type Foundry, users can also oblique and boldface the characters.

These are only a sampling of the font products on the market. There are obvious differences that users should examine closely for variety, flexibility, availability, and compatibility.

### A Font's Golden Years

Most laser printers today come with built-in printer controllers. Thus, they can accept instructions from a PDL, together with downloadable fonts, in order to generate the page image. In the future, more and more laser-printer controllers will be resident in the hosts to which they are attached. Installing the printer controller in a workstation or personal computer simplifies communication to the printer and speeds loading of fonts from a disk. The disk can also be used for caching bit maps, thereby greatly improving the controller's performance.

Printer controllers, which are currently almost all ROM-based, will most likely become RAM-based in the future. This will provide a much higher level of flexibility. It's practical to have a RAM-based controller because it can be quickly booted from the disk. A RAM-based controller will provide an upgrade path to new font-scaling technologies and PDLs as they become available. This architecture will create a much higher level of openness than exists in today's ROM-based printer controllers.

Font management will, in time, become a standard feature of operating environments. With this enhancement, and without having to delve into the intricacies of font technology, software developers will find it easier to develop word processing, desktop publishing, and other application programs requiring fonts. At the same time, they will create a level of standardization that will encourage and improve typeface portability.

There is a trend toward more openness in digital fonts. So you can expect more and more operating environments, printers, and typesetters to have open font architectures that will allow all font vendors, as opposed to multiple and independent font vendors, to provide their products for those devices. More standardization of font formats will minimize the need for format conversion.

It's interesting that even today, some typesetter manufacturers continue to build devices that accept only type made by the manufacturer itself. But it's likely that users will demand more openness with respect to the source of fonts, especially as different pieces of equipment from different manufacturers get connected and used together. A trend toward openness and standardization will hasten the day when there is complete portability of digital fonts across application programs, operating environments, and output devices. Gutenberg would surely approve. ■

*John Collins is vice president of technical development for Bitstream (Cambridge, MA). He holds a Ph.D. in electrical engineering from the University of London. He can be reached on BIX c/o "editors."*



# WITHOUT EXCEPTION, PROTOFINISH IS THE BEST SYSTEM ON THE MARKET.

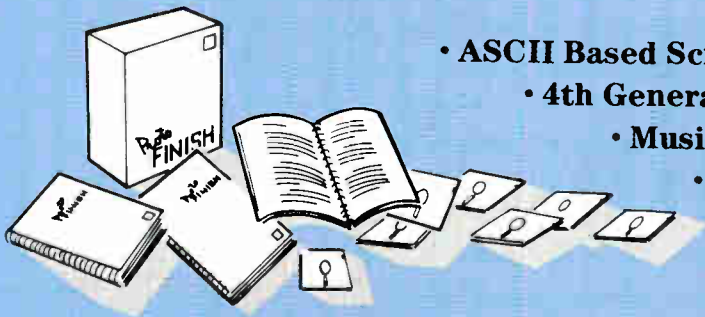

- ASCII Based Screen Design Module
- 4th Generation Prototyping Language
- Music Design Module
- Screen Capture Utility
- Programmers' Power Tools
- Samples & Utilities

## Prototypes

Model the look and feel of your program before writing the code.

Quickly create your own program screens in the screen design module. Use "what if" editing features to experiment with layout and color. All screens are saved to disk and may be edited repeatedly. Simulate your program in action, including menu structure, user input, file I/O, windowing, scrolling and more with our easy-to-use 4GL. Incorporate your screens into C, PASCAL, BASIC, Clipper, or Assembler program code.

## Demos

Show off your product's best features.

Capture screens from your application with a memory-resident utility. Edit them in the screen design module and create any additional screens you may need. Use simple 4GL commands for interactive or timed screen display. Add animation to make your demo come alive. Run .BAT, .COM, or .EXE files as subprograms. Distribute your demo using our compact run-time utility, with no additional fees or mandatory copyright screen.

## Tutorials

Provide a controlled environment for learning your program.

Capture screens, then modify and supplement them with the screen design module. Use versatile 4GL commands to interact extensively with your user. Build a realistic tutorial with the added benefits of pop-up help windows, prompts, error messages, etc. Distribute your tutorial using our run-time utility, with no additional fees or mandatory copyright screen.

## Presentations

Get their attention and get your point across—quickly and easily.

Use fast ASCII-based screen design to express your ideas. Build an exciting "slide show" with easy 4GL commands for special effects such as wipes, dissolves and animation. Add captured graphics. Control display by pressing a key, or time it to synchronize with a recording. Even add music with a music module.

# 800-777-1437



8415 Washington Place NE  
Albuquerque, NM 87113  
(505) 821-9425  
FAX (505) 821-9695

System Requirements: IBM PC, PS/2 or compatible; 256K; DOS 2.0 or higher

Circle 150 on Reader Service Card (DEALERS: 151)

World Radio History



# The HASP Family: Software protection you can trust. Software protection you can afford.

As a software producer, you can't market your software without protecting it. Aladdin Knowledge Systems is a leading company in the field of software protection: during the last four years we have enabled hundreds of software producers in more than 30 countries to protect their software.

We, at Aladdin, believe that software protection is a serious business which demands a high level of knowledge and expertise in order to give you a reliable and lasting protection for your intellectual property.

Basing our research on the experience we accumulated with HASP-II, we are now launching two new HASP plugs designed to protect your software through the coming decade -

**HASP-3 and MEMOHASP:**  
software protection for the nineties.



**HASP-3**™ connects to the parallel port\* of PC/XT/AT and PS/2 computers and compatibles.

HASP-3's advanced technology prevents reverse engineering, making the plug virtually un-crackable.

• **Access Password** - A unique password supplied to the software developer is needed in order to access the plug's code. The number of available codes and passwords is enormous (more than 256,000 billion!).

• **The Highest Compatibility** -

The plug is transparent to the operation of the computer and the printer.

• **Full Software Support** -

All the software required to link HASP-3 to all high-level languages - including the most sophisticated anti-debugging protection and a utility program to protect EXE/COM files - is supplied.

• **Daisy-chaining** - Several plugs can be connected one behind the other.

• **There is no Battery in the Plug!**

\* A serial RS232 HASP is available as well.

**MEMOHASP**™ is the last word in software protection.

In addition to all of HASP-3's advantages, MEMOHASP's 1000 bits of read/write memory enable you to:

- Assign a unique code to every software user.
- Control access to different software modules or different software packages.
- Distribute demos which can be activated only a certain number of times.
- Rent or lease software.
- Save passwords or other sensitive information.

**Most important of all: all the above operations are performed on the PC without any special programming equipment!**

For further information contact us at

**ALADDIN**  
KNOWLEDGE  
SYSTEMS LTD



130 Dizengoff St., Tel-Aviv  
P.O.Box: 11141 Tel-Aviv 61110, Israel  
Tel: (972) 3 226286. 3 241603  
Tlx: 35770/1 COIN IL Ext. JBL  
Fax: (972) 3 243540

Spain Format Computers S.A., Santalo 120. 08021 Barcelona, Phone: (93) 209 5344, Fax: (93) 201 5169 • The Netherlands Akkermans Service B.V., Valkenbergstraat 1, Eygelshoven 6471 VL, Phone: (045) 352 753, Fax: (045) 461 822 • West Germany, CSS GmbH, Am Westbahnhof 2. 4300 Essen 1. Phone: (0201) 707 041/42 Fax: (0201) 748 644 • Greece, Unibrain Ltd., Bousgou 2, Pedio Aeros, Athens 114 73, Phone: (1) 646 5195. Fax: (1) 642 3648

Circle 18 on Reader Service Card  
World Radio History



# MACH: THE MODEL FOR FUTURE UNIX

*Will a new, object-oriented kernel  
change the face of Unix?*

*Avadis Tevanian Jr. and Ben Smith*



Unix is over 20 years old. While the computer hardware for Unix has radically changed since Unix was first designed, the basic concepts of the operating-system kernel have remained the same.

The Mach kernel is designed to take advantage of new computer architectures and provide for the needs of modern programs. It is also a return to the original Unix concept of having only the most essential functions in the kernel—a concept that has been lost in the versions of Unix from the big-iron computer manufacturers, whose kernels can exceed 2 megabytes.

## Great Ideas from a Small Team

A small group of researchers at Carnegie Mellon University started the design of Mach in 1984. They wrote the first lines of code in 1985. Originally, Mach was intended to support large-scale parallel computation. However, early on in the design phase, the team decided that designing only for large-scale parallel computation would be of limited life and utility. So they changed the design to make it independent of the hardware architecture. Mach was initially implemented on the VAX-11/780 and now runs on a wide range of hardware, including almost all VAX processors, the IBM RT PC, Sun-3 workstations, the Encore Multimax, the Sequent Balance 21000, various 80386 machines, and the NeXT Computer.

Mach is designed to handle problems associated with both parallel programming on multiprocessor machines and distributed programming, where the work is done by several separate computers communicating over a network. The concept of multiple threads of control executing in parallel within a single task facilitates parallel computing. A capability-based interprocess communication mechanism eases distributed programming. Finally, an extremely powerful virtual memory system allows applications of all sizes to efficiently share the memory resources of these complex architectural designs. With Mach, these very same concepts work equally well on inexpensive, single-processor machines.

To derive Mach, the Carnegie Mellon team extended the model of Unix computing by adding five abstractions: the *task*, the *thread*, the *port*, the *message*, and the *memory object*. Obviously, the language and concepts of object-oriented programming permeate the design of Mach. Many people call Mach an "object-oriented operating system."

The Mach kernel maintains only the most basic services: processor scheduling, interprocess communication, and management of virtual memory. All other services are *service tasks*, independent user-level programs.

## Tasks and Threads

Mach splits the traditional Unix abstraction of a process into a task and threads. A task is the environment in which threads run. It includes protected access and control of all system resources, including the CPUs, the physical I/O ports, and memory (virtual and real). The structures associated with files are in the domain of the task. A task address space uses a structured map of memory objects (see below).

A thread is an entity (an object) capable of performing computation, and for low overhead, it contains only the minimal state necessary. Another term for a thread is a *lightweight process*. A thread contains the processor state, the contents of a machine's registers. All threads within a task share the virtual memory address space and communications privileges associated with their task. The Unix abstraction of a process is simulated in Mach by combining a task and a single thread. However, Mach goes beyond this abstraction by allowing multiple threads to execute simultaneously within a task. On a multiprocessor, multiple threads can, in fact, execute in parallel on separate processors, whereas on a uniprocessor they only conceptually execute in parallel.

## Ports, Port Sets, and Messages

A port is a communications channel, a sort of object reference for tasks, threads, and other objects. Application programs

*continued*

## Mach on the NeXT Cube

While most current users of Mach are content to rely on Unix compatibility, NeXT has found the basic functionality of a Unix system to be insufficient to produce high-quality end-user applications software. NeXT utilizes the Mach functionality for communication between applications and window servers, sound playback and recording servers, and other applications.

Applications on the NeXT Computer convey information to a user according to the NextStep User Interface, which comprises several components: The Window Server manages all the windows on a display; the Application Kit is an implementation of the classes that de-

fine the user interface; the Interface Builder is a tool that allows the user interface for NextStep-conforming applications to be built with little or no programming; finally, the Workspace Manager provides a graphical user interface to a user's files and applications.

Two major types of communication occur between NextStep applications. First, applications communicate with the Window Server in order to implement a graphical user interface according to the client/server model. Second, applications communicate with each other using the Workspace Manager as a rendezvous point. Both types of communication are performed using Mach's

intertask message-passing primitives.

Sound playback and recording make extensive use of Mach features. On a NeXT machine, compact-disk-quality sound can be synthesized in a digital signal processor. The device driver responsible for controlling the DSP and the sound direct-memory-access channels is accessed using Mach's message-passing primitives. This allows great flexibility in how the hardware can be accessed and provides network-transparent access to the driver. Threads are also used by high-level sound software to control sound I/O for an application that needs to perform normal processing while playing or recording sounds.

communicate with objects managed by the kernel and server tasks through the objects' ports. This is the software counterpart to the communications ports on the hardware. An object is said to have "access rights" to a port if it has dealings with that port. A port can move around from object to object, like moving a board and the cables connected to it from one machine to another.

The object that has the port screwed into it is said to have *receive access rights* to the port. Receive access rights imply send access rights as well. More than one thread may concurrently attempt to receive messages from a given port, but all the threads must be within the same task. In other words, only one task can have receive access rights to the port.

The object intending to pipe messages to the port has *send access rights*. More than one thread and more than one task can hold send access rights to any port. Messages travel from the object with send access rights to the port on the object with receive access rights.

For the time being, there is also a third port access right, *ownership*, which determines which object gains receive rights when these rights are relinquished. The Mach documentation implies that ownership rights will probably not be implemented in future releases—a definite discouragement for using this privilege.

Both tasks and threads have a special *kernel port* by which the kernel recognizes them.

Some special types of ports are associated only with tasks: the *notify port*, through which the task receives messages from the kernel about its port access rights and the status of messages it has sent; the *exception port*, through which the task receives messages from the kernel when an exception occurs (see "Exception Handling," below); and the *bootstrap port*, with which new tasks attach to any services that they need.

Threads also have some special types of ports: the *thread reply port*, for early messages from a young thread's parent and early remote procedure calls (RPCs); and the *thread exception port*, similar to the task exception port. Ports can be strung together into *port sets*, through which several objects can grab any messages from a single message queue.

A message is a string of data prefixed by a header. The header describes the message and its destination. The body of the message may be as large as the entire address space of a task.

There are *simple messages*, which don't contain any references to other ports; and *non-simple messages*, which can make reference to other ports—conceptually similar to indirect addressing.

Messages are the primary way that tasks communicate with each other and the kernel. They can even be sent between tasks on different computers.

### The Memory Object

Each Mach task can use up to 4 gigabytes of virtual memory for the execution of its threads. This space is used for the memory objects but also for messages and memory-mapped files.

When a task allocates regions of virtual memory, the regions must be aligned on page boundaries. The task can create memory objects for use by its threads; these can actually be mapped onto the space of another task. Spawning new tasks is more efficient because memory does not need to be copied to the child. The child needs only to touch the necessary portions of its parent's address space. When spawning a child task, it is possible to mark the pages to be copied or protected (the child is prohibited access).

Since messages are actually mapped into the virtual memory resources of tasks, intertask (interprocess) communication is far more efficient than old-time Unix implementations where the messages are copied from one task to the limited memory space of the kernel and then to the task receiving the message. In Mach, the message actually resides in the memory space shared by the communicating tasks.

Memory-mapped files facilitate program development by simplifying memory and file operations to a single set of operations for both. However, Mach still supports the standard Unix file read, write, and seek system calls.

### Virtual Memory

The Mach virtual memory system provides the programmer with a clean interface, which allows virtual memory to be allocated and deallocated at arbitrary addresses and sizes, restricted only by the page size of the underlying hardware. Applications can, on a page-by-page basis, specify access modes such as read-only, read/write, or shared. Finally, also on a page-by-page basis, virtual memory can be shared between

*continued*



**The PERFECT LAN FRONT-END!**

# Meet Perfect Menu. The Perfect LAN Front-End.

**(Complete with E-Mail!)**

Menu Program, System Administrator, Electronic Mail System, Usage/Project Tracker, Security Watchdog, and much more... all in one program for your DOS LAN or stand-alone.

Perfect Menu is a total LAN Front-end solution—compatible with ALL DOS LANs (Novell, 3COM, PC-MOS, Network-OS, Banyan, you name it). For all its power, **Perfect Menu is completely Non-Memory Resident**, and self-installs across any network, to any local, redirected and virtual drive of any size.

Perfect Menu gives you access to 640 individual menu selections with over 10,000 command options for each user. Menus can even be nested up to 32 levels deep! Perfect Menu lets you create a Common Integrated User Interface—tailor it to your specifications and needs.

Perfect Menu gives you System Administrator sophistication, power and ease-of-use with features like advanced security control, innovative usage and project tracking, handy PIM tools and much more. Perfect Menu's autonomous System Administrator program sports more tools than we have room to explore. Suffice to say—it defines power and convenience.

And, if all of the above is not enough, Perfect Menu comes with a full feature E-mail system! You have to see Perfect Menu to believe it, check it out today!

## PERFECT MENU Family

### ◆ LAN PAK/UNLIMITED Users Per File Server.

If you're looking for best value in network front-end, menu, E-mail, usage/project tracking, security and productivity software—then this is the perfect selection! Easy to setup, administer and use, yet completely customizable and extremely powerful and sophisticated. It's simply perfect.

**Retail Price: \$349.95**

### ◆ LAN PAK/FIVE User Network.

If you have a PC-based network or applications, then our five user version sets the standard for small networks! Not only is it easy-to-use, it's easy-to-administer and has all the power of its Unlimited Big Brother. Of course, if you have growth in mind, all versions are fully upgradeable.

**Retail Price: \$195.95**

### ◆ BUSINESS PAK/Stand-alone.

With our single user BUSINESS PAK, many users share one stand-alone computer. You can have all the power of the PERFECT MENU network versions as you administer productivity—not headaches!

**Retail Price: \$84.95**

### ◆ BASIC SYSTEM/Single User.

Want perfection at home? PERFECT MENU BASIC SYSTEM is as powerful as it is easy to use. At a \$49.95 suggested retail, it's one of the best values in its class.



**International Computer Group, Inc.**

1820 Office Park Drive

Gaithersburg, MD 20879

**(800) 833-2324**

(301) 670-7007 in MD, (301) 330-7274 fax

\*Trademarks are registered per their respective manufacturers.

Circle 179 on Reader Service Card

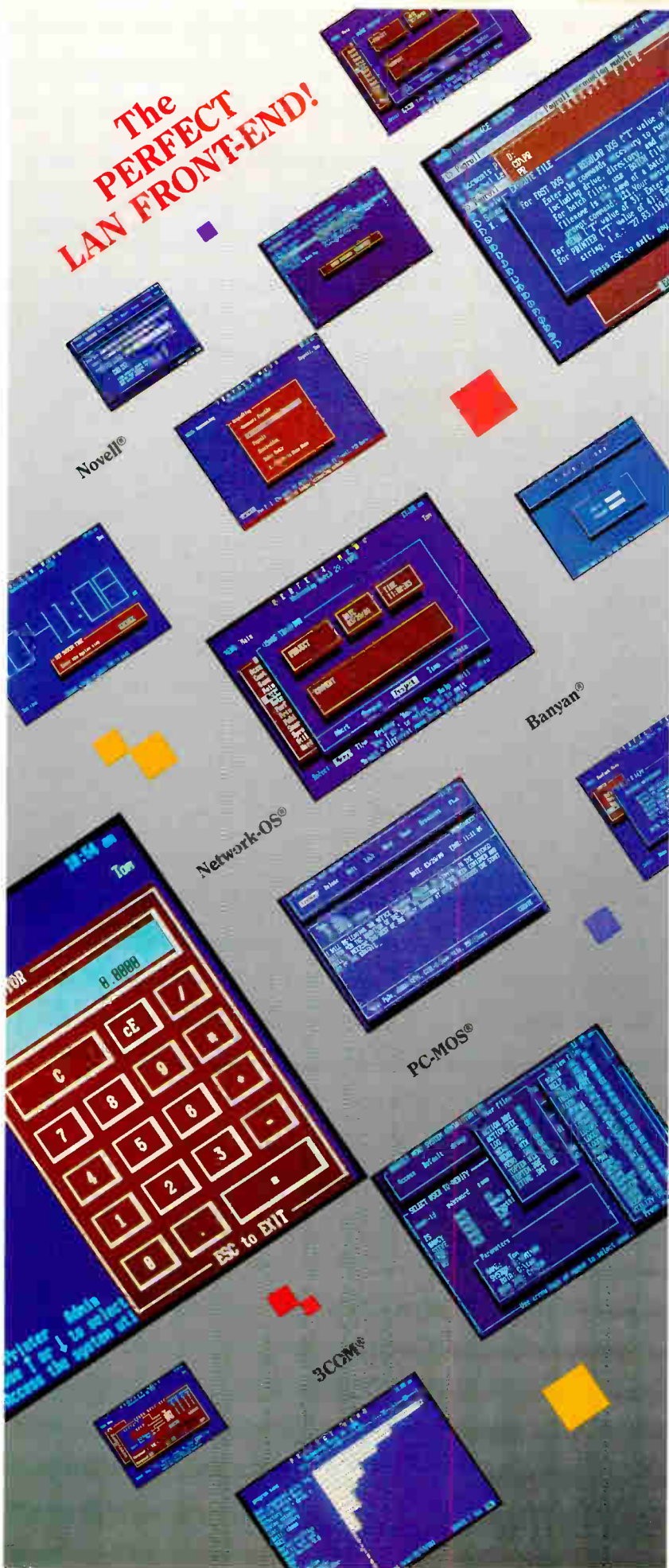

tasks in a controlled fashion that is based on inheritance.

The virtual memory system achieves portability by splitting its implementation into two parts. The first part, the architecture-independent part, is common to all implementations of Mach. The second part, the architecture-dependent part, is specific to each hardware architecture that Mach runs on. This split makes it possible for Mach to provide a consistent, high level of functionality on all hardware architectures with only a minimal porting effort.

### Open Memory Management

Instead of limiting virtual memory semantics to those defined by the kernel, Mach provides an interface that allows user-level

**T**he Mach kernel guarantees that only authorized senders can send messages on a particular port.

programs (external memory managers) to define the exact semantics of virtual memory that can be mapped into any task's virtual address space. Such programs are responsible for handling operations such as "page in" (when a page of memory is referenced) and "page out" (when a page of memory is moved out of the normal working set). In addition, external memory managers can instruct the Mach kernel to take special action on memory, such as restrict access to data in order to provide data consistency and security.

External memory management allows Mach to be extended in powerful ways without changing the base Mach kernel. For example, network-consistent shared memory can be implemented by an external memory manager. The shared memory manager can use the external memory interface to control which pages of memory can be accessed by which machines at various times in order to guarantee control. Not only does this remove that complexity from the kernel, but it allows the shared memory manager to choose which algorithms it uses to enforce consistency and security.

### The Mach Kernel and IPC

The kernel functions can be classified into the following five groups:

- Task and thread management
- Port management
- Message queuing and support
- Virtual memory management
- Paging management

The kernel is responsible for the creation and management of all tasks and threads, the structure of ports associated with the tasks and threads, the messages between objects (through the object ports), and the allocation of physical and virtual memory. It manages what and how port capabilities are used. The kernel guarantees that only authorized senders or receivers can send or receive messages on each particular port. Thus, the

Mach kernel guarantees secure interprocess communication (IPC) within a host.

The Mach kernel automatically queues messages for tasks executing on its machine. However, transmission of messages between separate Mach hosts is performed transparently by an intermediate server task.

The intermachine-process-server task is the *network message server*, and it maintains the mapping of local "proxy" ports to global "network" ports. It forwards messages using network protocols of its choice. In addition, it is free to make decisions related to security, or lack of it, depending on the environment in which it is run.

### Exception Handling vs. Signal Handling

In traditional Unix, *signals* are used for notifying programs of events external to the program. The handling of signals is done within the program, but the semantics vary from one kind of signal to another. Signals come from only a portion of the events that affect a program from the outside. Bus errors, segmentation and protection violations, arithmetic processor errors (e.g., underflow, overflow, and divide by zero), and events associated with debugging also need to be able to communicate with programs. External events that affect the execution of a program are called *exceptions*. The traditional ways of handling exceptions (through application program signal handling and kernel handling of hardware errors) separate the application program or service program from the hardware that caused the exception and assume that there is only one processor (no longer a valid assumption).

Mach has taken a generalized view of all exceptions. An exception requires suspension of the "victim" thread that caused the event and the notification of an exception handler. The handler performs some operations as a result of the exception, and then the victim is either revived or terminated. Because the handler is never within the victim thread, all the exception handling involves a form of RPCs. Mach ports and messages are the elements through which all this happens. The handler's port for communicating with the task is the thread (or task) exception port.

This design provides a single facility with a consistent method of handling all exceptions, a simple interface, full support for debuggers and error handlers, and no duplication of functionality within the kernel. In addition, and of great interest to developers and researchers, this design allows for user-defined exceptions.

### System Layers

The Mach kernel provides only the basic primitives needed for building distributed and parallel applications. Although Unix is an operating system, it is also a complete environment suitable for use by developers and end users. Mach is just a kernel. The operating-system environment is built on top of it. But, since Mach makes few traditional operating-system decisions within the kernel itself, it is possible to build a completely different operating-system environment on top of it.

Currently, the Mach kernel is the basis for a BSD 4.3 Unix-compatible system. In this system, the Mach kernel implements the features particular to an operating-system kernel and the features provided by the Mach kernel interface. Unix compatibility is provided by the original BSD 4.3 implementation, modified for use with Mach. In effect, many of the internals of BSD 4.3 have been replaced with Mach equivalents. This technique yields a highly compatible system with performance often exceeding that of the original BSD 4.3 system.

*continued*



THAT'S WHY WE CAN OFFER  
A GREAT RATE ON A CADILLAC.

# We Don't Just Work Here... We Own The Place.

When we, the employee-owners of Avis, Inc., say, "We're trying harder than ever," we have to prove it. Over and over. Because we know that our success depends on your satisfaction.

That means giving you the competitive rates and well-maintained GM cars that make you come to Avis in the first place. Plus all those important services that keep you coming back. Like Avis Express® for fast check-outs. And Roving Rapid Return™ for even faster check-ins.

For more proof, call us at 1-800-331-1212 or call your travel consultant about our special Cadillac rate. Talk to an owner and discover how we make Avis work for you.



We're trying harder  
than ever.™



# Protects while you type!

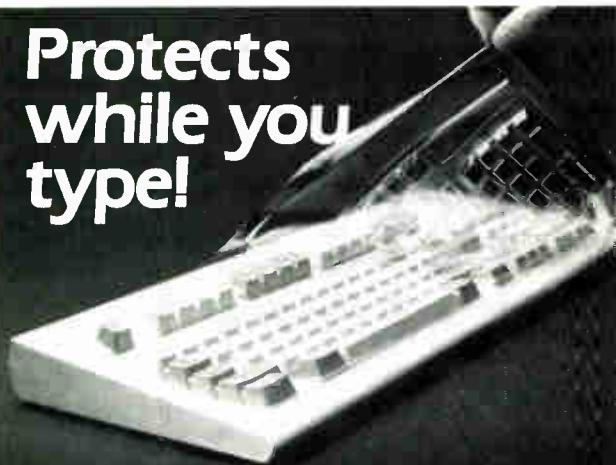

- **Remains In Place** while you use your computer.
- **Avoids Costly Repairs.** Protects delicate electronics from dust, spills, smoke, ashes, staples.
- **Soft, Flexible,** retains normal keyboard feel.
- **Washable, Durable High-Tech Polymer** lasts years.
- **Hundreds of Models.** SafeSkin is available for most PCs, laptops, workstations and clone keyboards.
- **Office • Home • Factory • Classroom • Laboratory**

List Price \$29.95. Please call or write for free color brochure. Dealer Inquiries encouraged.

## SafeSkin™

KEYBOARD PROTECTOR

Merritt Computer Products, Inc. 5565 Red Bird Center Drive  
Suite 150, Dallas, Texas 75234/(214) 339-0753 • FAX (214) 339-1313  
In Canada call 1-800-663-1061

# Custom Key Imprinting

Create a keyboard  
so easy to use, costly training time turns  
into instant productivity!

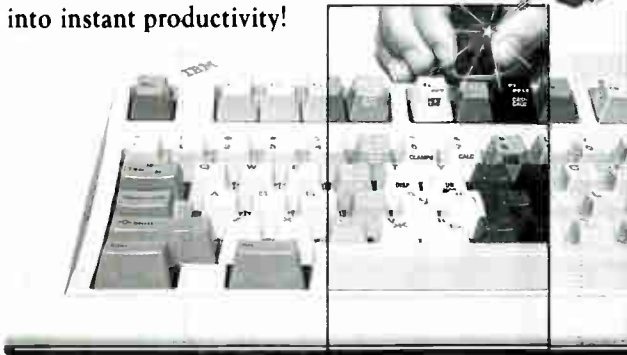

**Custom Keys and Snap-On IBM KeyCaps:** Available in a wide variety of colors and imprinted in your choice of colors and fonts. **Keypop and Keyfront Labels:** Supporting emulation, word processing or custom made to your specs. Won't wear out or come off keys until intentionally removed. **FlexShield Keyboard Protectors:** Extend keyboard life. Protect from dirt, liquid and damaging environments without restricting keyboard operation. Call for your **FREE CATALOG** of Custom Keyboard Enhancements.

## Hooleon

CORPORATION

For orders or custom info, call:  
**602 634-7515**  
FAX: 602 634-4620

P.O. Box 201, Dept. BYTE, Cornville, AZ 86325

SEE US AT FALL COMDEX IN THE RIVIERA - BOOTH R8534

## OS/2 and Mach

Like Mach, OS/2 supports threads, virtual memory, and message-passing mechanisms. Although Mach and OS/2 provide similar types of functionality at the lowest levels, they differ in important ways.

OS/2 threads, for example, have some unusual semantics. Instead of the Mach model of all threads being equal, OS/2 treats some threads (e.g., the first thread in a process) specially. It manages virtual memory in segments, rather than pages—a finer grain and more flexible control than segments. Also, OS/2 imposes some other restrictions, such as the use of different memory allocators for different-size memory regions. Rather than provide one coherent mechanism for interprocess communication, OS/2 provides many different mechanisms (e.g., semaphores, pipes, queues, and signals). OS/2 lacks multiuser operations. Finally, OS/2 was designed to run on Intel 80286/80386 processors and is not portable to other processor families. This is not to say that OS/2 doesn't do well in its own niche, but it is not as complex or universal as Mach.

## The Future of Mach

Unix compatibility makes Mach attractive to a wide audience by allowing it to transcend its role as a research project and emerge as a viable commercial operating system. The NeXT Computer already provides an excellent example of how to tie visual displays to audio input and output. The primitives of Mach were essential for NeXT to implement this functionality efficiently in a true multitasking environment. (See the text box "Mach on the NeXT Cube" on page 412.)

Mach is also influencing how other systems evolve. In the future, more and more systems are likely to support Mach features. Mach has become the platform for experimental Unix operating-system work. For instance, Trusted Information Systems, under a Defense Advanced Research Projects Agency contract, evaluated Mach as a possible base for a verifiably secure operating system, a "trusted system" meeting the B3 level of security as specified in the National Computer Security Center's "Orange Book." (See "Safe and Secure?" in the May BYTE.) Researchers at Trusted Information Systems ascertained that Mach's design made implementation of classification labels and access control lists much easier than in traditional Unix. The design separation of the kernel and services made modification of the operating system much more straightforward and easier to verify as being a trusted system. They have gone on to build a proof-of-concept prototype trusted system. But until Mach is free of BSD code, a truly trusted Mach operating system will not be possible. Meanwhile, they are working with the Mach team at Carnegie Mellon to ensure that facilities for trusted systems be properly implemented in future releases.

Work on Mach continues at Carnegie Mellon and organizations such as NeXT. Eventually Mach will stand on its own and be completely free of BSD code. It will have been shaped by the tortuous tests of many other institutions, including industry and government. Thanks to the availability of Mach on the NeXT Computer, the ideas of thousands of researchers and students will add to its clever design and continue to shape it for modern computer design and software. It's a great example for all developers of applications and operating systems. But as operating systems go, Mach is very young, and few people understand all the possibilities it really provides. ■

*Avadis Tevanian Jr. is the chief operating-system scientist at NeXT, Inc. He can be reached on BIX c/o "editors." Ben Smith is a BYTE technical editor and can be reached on BIX as "bensmith."*



# INSIDE EISA

## Probing the mysteries of the newest industry standard for IBM PCs

**T**his fall marks the advent of an important new standard in the Intel/IBM PC-compatible marketplace: the Extended Industry Standard Architecture, or EISA (pronounced "ee-sa"). Created by a consortium of computer, peripheral, and chip vendors ranging from Compaq to AST Research to Intel, EISA machines are built around a unique 32-bit-wide bus structure that's downward-compatible with older Industry Standard Architecture (ISA, or "eye-sa") peripheral cards (i.e., cards intended to work in the IBM PC, XT, or AT).

When IBM announced the PS/2 series of computers, it announced that these machines used a new 16-/32-bit bus—the Micro Channel—which was not compatible with the ISA bus. Users balked at the high cost and limited availability of peripheral cards for the Micro Channel, and manufacturers balked at IBM's demands for licensing fees—which included not only a percentage of revenue acquired from using the new bus design, but also a retroactive fee for use of the ISA bus that IBM was putting out to pasture.

The result was the formation of the EISA consortium—centered around a group of clone makers, the "Gang of Nine" (i.e., Wyse, AST Research, Tandy, Compaq, Hewlett-Packard, Zenith, Olivetti, NEC, and Epson—mnemonically, watchzone). Struggling to finish their EISA specification while the Micro Channel gained market share, this group kept information on EISA mostly under wraps. You could obtain detailed information about the bus only by signing a nondisclosure agreement and paying \$2500.

The lack of publicly available information on EISA has led some to call it a "vapor bus." However, by the time this issue of BYTE arrives on the newsstand, the wait will be over, and EISA systems—and the specification—will be available to everyone. See "EISA Arrives" on page 93.

What's inside EISA? And how does it work? The best way to understand EISA is to trace its evolution from its earliest roots: the 8-bit backplane of the original IBM PC.

### Recapitulating Phylogeny

The original PC and XT bus was introduced in the first IBM PCs in 1981. It's a relatively simple synchronous 8-bit bus with parity protection and edge-triggered interrupts, which means that each interrupt line can be used by only one adapter card (see table 1).

The original PC bus had no provision for an external bus master; either the host CPU or the direct-memory-access (DMA) controller on the motherboard controlled the bus at all times.

Enter the IBM PC AT, circa 1984. IBM wanted to extend the 8-bit IBM PC bus to 16-bit operation in a compatible way, so all the signals on the original 62-pin connector were maintained and a new connector was added at the bottom. Table 2 shows the additions that created the AT bus.

IBM added a number of features to the AT for downward compatibility. Because the AT's 80286 ran faster than the original PC's 8088, the company added a wait-state generator to lengthen bus cycles. Also, the one previously unused line was assigned a function: Pin B8 became the  $\overline{OWS}$  (zero wait state) line. When this line is pulled low, some or all of the wait states generated by the AT motherboard are removed. By putting this signal on the 62-pin connector, IBM let manufacturers make fast 8-bit boards as well as fast 16-bit boards.

The new connector, which had two

rows of 19 pins each, added four new address lines (LA20–LA23), plus copies of three lower address lines (LA17–LA19). Why the duplication? Because the address lines on the original PC bus were latched, and the latching process caused propagation delays that would slow down peripheral boards. (See the glossary on page 423 for definitions of *latched* and other bus-related terms.) By providing these unlatched address lines, the AT bus let 16-bit cards find out early in the cycle whether they were being addressed. They could then activate special signals that said, "I'm a 16-bit card; please make this a 16-bit cycle, if you can."

Those special signals—MEM CS16 and I/O CS16—are key to the AT bus's downward compatibility. If the 80286 attempts to perform a 16-bit access to a board and one of these signals is not asserted, special hardware on the motherboard takes over and causes two 8-bit cycles to be performed.

Alas, there was a catch. Only seven unlatched address lines could fit on the connector, meaning that this "early warning" could tell the board only which 128K-byte region of memory was being addressed. Thus, memory boards that didn't consume a full 128K-byte block of scarce real-mode address space could not activate the signal, and thus couldn't do 16-bit transfers. In practice, this meant that most EMS boards and memory-mapped peripherals were forced to do transfers 8 bits at a time, even over the 16-bit AT bus.

### Enter EISA

Like the AT bus before it, the EISA bus was built on the older standard by adding more address lines, more data lines, and more control signals. Before this could be done, however, its designers had to generate a firm specification for the ISA bus.

The timings of the PC and AT backplanes were never formally specified in

*continued*

**Table 1: Because of its simple design, each interrupt line can be used by only one adapter card.**

**PC AND XT BUS SIGNAL LINES**

Lines	Description
A0-A19	Twenty system address lines. During I/O cycles, only the lowest 10 lines are actually used.
D0-D7	Eight bidirectional data lines.
ALE	Address latch enable. This signal goes high to indicate that a valid address is present on A0-A19 during a memory access.
IRQ2-IRQ7	Six maskable interrupt request lines.
DRQ1-DRQ2, DACK1-DACK3	DMA request and acknowledge lines. There's no DRQ0 on the bus; DMA channel 0 is used for DRAM refresh on the PC and the XT.
IO CH RDY	A signal used by a memory or peripheral board to generate wait states.
IOR, IOW SMEMR, SMEMW	I/O and memory read and write strobes.
OSC	A 14.31818-MHz clock used by some video boards. It's not synchronized with respect to the rest of the bus.
CLK	The bus clock signal (4.77 MHz in the original PC and proportionately faster on later machines). This clock is synchronized with respect to the read and write strobes.
AEN, TC	Address enable and terminal count. These control signals are used during DMA cycles.
IO CH CHK	Alerts the processor to parity and other errors via a nonmaskable interrupt.
RESET DRV	Indicates that the system is being reset.
+5VDC, -5VDC, +12VDC, -12VDC GND	Power-supply rails.

any published IBM document. EISA, which was to extend the bus yet again, could not be so lax. It needed to rigorously define not only the new standard, but also a set of timings that would retain compatibility with the older ones. Fortunately, the participants in the EISA consortium were old hands at IBM clone design and probably the best people to do the job.

As the specification developed, the developers exchanged timing information as spreadsheet files. The spreadsheet format let them watch what happened to the worst-case timings as they tuned the specification, and it helped them flag problems.

Table 3 shows the resulting new signals. The new pins for the EISA bus were placed physically between the pins of the ISA bus. (See figure 1 for a comparison of the lines.)

**Covering All the Bases**

Now that I've listed the signals that EISA adds to the standard PC bus, I'll look at some of the features they provide. A key feature of EISA is that the host or any bus master can access any memory device or peripheral in the system, even if their bus widths differ.

The EISA bus controller can adapt accesses from the host CPU, a 32- or 16-bit EISA master, or even an ISA bus master to any of five kinds of slaves on a cycle-by-cycle basis. These include EISA 32-bit slaves, EISA 16-bit slaves with burst capability, EISA 16-bit slaves without

**Table 2: New signal lines added in the AT's 16-bit bus. By duplicating some of the address lines, the AT bus maintains backward compatibility while providing unlatched address lines for faster cards.**

**ADDITIONAL SIGNAL LINES FOR THE 16-BIT ISA BUS**

Lines	Description
D8-D15	The eight new data lines.
SBHE	System bus high enable, which indicates when these data lines are being used.
IRQ10-12, IRQ14-15	More interrupt lines. IRQ13 is absent because that interrupt is reserved for the math coprocessor.
DRQ0, DACK0, DRQ5-DRQ7, DACK5-DACK7	More DMA control lines for new DMA channels. On the AT, DMA channel 0 is no longer used for refresh and is therefore available for other purposes.
MEMR, MEMW	Memory read and write strobes. These signals are active on all memory cycles, while SMEMR and SMEMW are active only on cycles that fall within the address space of the PC for compatibility reasons.
MASTER	A new signal that lets a board become a bus master on the AT bus. A bus handoff using this signal requires several cycles, and the master must relinquish the bus periodically to allow memory refresh (or do the refresh itself).
MEM CS16, I/O CS16	Signals used by a peripheral board to tell the motherboard that it's capable of handling a 16-bit data transfer.



burst capability, ISA 16-bit slaves, and ISA 8-bit slaves. How is this accomplished? The answer lies in a key feature of the EISA bus—and its controller—called *cycle translation*.

Suppose that a 32-bit EISA bus master card wants to do a write into a memory location on an 8-bit ISA card. The bus master will begin by requesting the bus, setting up the address and data, and asserting the **START** signal. It will then look at the signals **EX32**, **EX16**, **MEMCS16** (called **MT16** in the EISA specification), and **OWS**. As these signals return, the bus controller samples them, too.

When the bus master and the bus controller see that the cycle can't be completed with a simple 32-bit transfer, the bus controller takes over. Having sampled the address and data from the bus master, the bus controller begins to drive the same signals onto the bus while the bus master is still doing so. (There's no conflict and no glitch because both are driving each line the same way.) Then, half a cycle of the bus clock later, the bus master bows out by turning off its drivers. The bus controller, now in charge of the cycle, executes four separate ISA byte transfers to deliver the data, much the same as the AT motherboard can break up a word access into two byte-size accesses.

The beauty of this "handoff" facility is that none of the DMA peripherals or bus masters need to contain the byte-shifting and cycle-generating logic to handle the wide variety of possible transfers. For example, Intel's 32-bit bus master chip, the Bus Master Interface Controller (BMIC), can handle only 32- and 16-bit burst transfers without help, but the other combinations are neatly handled by the EISA Bus Controller (EBC) chip (see table 4).

Another novel situation occurs when a 16-bit master addresses the upper word of a 32-bit memory location on a 32-bit slave. The EBC handles this situation by copying the information from the lower two byte-wide lanes of the data bus up to the higher two lanes, so that the information arrives at the right place. This procedure is known as *copy-up*, and it lets a 16-bit master access a 32-bit slave without containing drivers for all 32 data lines.

### Fast Transfers

One of EISA's key selling points is raw speed. Under the right conditions, EISA peripherals can do 32-bit burst transfers at up to 33 megabytes per second. This sort of bandwidth is necessary when a machine is servicing a high-speed LAN

(e.g., Fiber Distributed Data Interface, or FDDI), a fast disk drive (e.g., IPI or SCSI-2), or a high-resolution graphics display.

But not all bus transactions will fall into this category. If you're using ISA peripheral cards, they will exhibit lackluster performance compared to EISA-specific cards.

### Shared Interrupts

One of the most common and frustrating

problems you encounter when expanding an IBM PC or compatible is a lack of available interrupt lines. ISA machines do not allow sharing of interrupt lines; each is edge-triggered and driven by a TTL tristate driver.

EISA, however, provides pull-ups on the interrupt lines and can make them level-sensitive. This means that EISA cards, which use open-collector drivers to drive the interrupt lines, can share

*continued*

**8051 68HC11**  
THE LEADING IN-CIRCUIT EMULATOR TECHNOLOGY.

See us at  
Wescon '89  
Booth 902

Nohau EMUL-PC, the PC based in-circuit emulators which find bugs other emulators can't.

- Very easy to learn and use.
- Source Level Debugging in C or PL/M.
- 48 bits wide 16K deep trace buffer.
- Complete 8051 family and 68HC11 family support.

CALL TODAY FOR YOUR FREE VIDEO AND SOFTWARE DEMO (408) 866-1820.

**NOHAU**  
Nohau Corporation  
51 E. Campbell Ave.  
Campbell, CA 95008  
Tel. (408) 866-1820  
Fax (408) 378-7869

Australia (02) 654 1873, Austria (0222) 38 76 38, Benelux +31 1858-16133, Denmark (02) 65 81 11, Finland 90-452 1255, France (01)-69 412 801, Great Britain 0962-73 31 40, Israel (03) 48 48 32, Italy (011) 771 00 10, Korea (02) 784 784 1, New Zealand (09) 392-464, Portugal (01) 83 56 70, Sweden, Norway (040) 92 24 25, Singapore 065 743-2086, Spain (93) 217 2340, Switzerland (01) 740 41 05, Taiwan (02) 7640215, West Germany 01831-1687, USA FAX (408) 378-7869.

Circle 255 on Reader Service Card

NOVEMBER 1989 • B Y T E 419

# QUALITY IN... QUALITY OUT

No matter how well acquainted you are with making personal computing decisions—decisions that may involve hundreds of thousands of dollars—the value of those decisions is only as good as the value of your information. Without quality information—it's hard to make quality decisions.

BYTEweek, McGraw-Hill's new weekly newsletter for professionals in the personal computer industry, is devoted to giving you that quality information in a timely and compact one-stop news format. And BYTEweek interprets this news with in-depth commentary and analysis.

Subscribe to BYTEweek for quality information. Remember, quality in . . . quality out.

Take advantage of the special one-year charter subscription rate of \$395 (\$495 outside the U.S. and Canada)—a savings of \$100 off the regular rate. Your subscription includes 50 issues plus a free three-month subscription to BIX—a \$49 value.

Don't miss this opportunity! In the U.S., call BYTEweek's toll-free number: **1-800-258-5485**, in N.H. or outside the U.S., call: 1-603-924-9281.

BYTEweek offers a *money-back guarantee* if you're not completely satisfied.

**BYTEWEEK** 

News and Analysis for  
 Professionals in the Personal  
 Computing Industry  
 One Phoenix Mill Lane,  
 Peterborough, NH 03458

**Table 3: Signal lines added to ISA to create EISA. The addition of the new lines, including 32-bit data and address lines, almost doubles the total number of lines.**

### SIGNAL LINES ADDED TO ISA TO CREATE EISA

Lines	Description
BE0-BE3	Byte enables. These signals indicate which byte lanes of the 32-bit data bus are involved in the current bus cycle. They're analogous to the BE0 through BE3 signals on the 80386 and 80486 microprocessors.
M-IO	Distinguishes between an EISA memory cycle and an EISA I/O cycle.
START	Indicates the start of an EISA bus cycle.
CMD	Provides timing control within an EISA bus cycle.
MSBURST	Indicates that a master is capable of performing burst cycles.
SLBURST	Indicates that a slave is capable of accepting burst cycles.
EX32, EX16	Indicate that a slave is an EISA board and can support a 32- or 16-bit cycle, respectively. If neither of these signals is asserted at the beginning of a cycle, the bus falls back to an ISA-compatible mode for that cycle.
EXRDY	Indicates that an EISA slave is ready to terminate a cycle.
MREQn	Asserted by potential master number <i>n</i> to request the bus.
MAKn	Indicates to master <i>n</i> that it has been granted the bus.
D16-D31	The new data lines that, combined with the data lines on the ISA bus, make the EISA 32-bit data bus.
LA2-LA16, LA17-LA31	New address bus lines. Like LA17-LA23, these lines aren't latched on the motherboard and so provide a fast path to the peripheral boards. Note that there's no need for an LA1 or LA0; the byte enable lines indicate which of the four byte lanes are used. Also note that there are now 32 address bits, supporting the full address range of the 80386 (rather than the 24-bit address range of the 80286). This lets system RAM grow above 16 megabytes.

these scarce resources. Beware of mixing EISA and ISA cards on the same interrupt line, however; an ISA card cannot share an interrupt, even when plugged into an EISA backplane.

#### Taking Turns

The memory refresh controller, the highest-priority DMA channel, and candidates for bus mastership compete for ownership of the EISA bus via a three-way rotating arbitration scheme. This scheme guarantees that no bus master will ever starve, although it is possible for a low-priority DMA channel to be

starved for use of the bus. It also ensures that memory will be refreshed on a regular basis. In addition, the Intel chip set contains a special watchdog timer that makes sure no one entity retains control of the bus for too long. If this timer expires, the master is removed from the bus and a nonmaskable interrupt is generated on the host CPU.

#### The EISA Connector

The EISA connector, developed by Burndy, is designed to be 100 percent compatible with existing ISA cards. The

*continued*



## Words of Caution and Encouragement for Those Choosing a CASE Tool

Your software projects are growing more complex, and maintenance is growing more expensive. You think that CASE tools could help, but some say CASE is more trouble than it's worth. What should you believe? Should you jump in? Be cautious. Expensive CASE tools with rigid methodologies demand a commitment of time and money so large that anything short of revolutionary success can seriously damage your budget and your career. Now, however, you can eliminate methodology grid-lock with an affordable, flexible, world-class CASE tool. Literally every programmer and analyst in your company can have the power of vsDesigner™ on their PS/2 or PC.

### The Price/Performance Leader

vsDesigner costs only \$495 for a single-user license, but don't be fooled by its low price — vsDesigner has the features and power of CASE tools costing over ten times more. The Expert version of vsDesigner costs \$1,995 for a single-user license and includes all vsDesigner features plus LAN support, design database reporting and the ability to modify or create methodologies.

### Use Multiple Methodologies

vsDesigner supports the structured design methods you prefer: Yourdon, Gane-Sarson, Warnier-Orr, Ward-Mellor Real-Time, Entity-Relationship, Flow Chart, etc. It supports multiple methodologies or "syntaxes" simultaneously so that a design can contain layers (nodes) using different syntaxes. For example, you can use Data Flow Diagrams for the

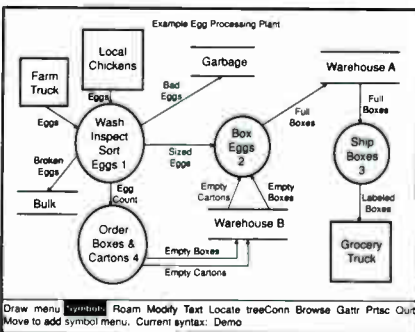

*Data Flow Diagrams are just one of the standard methodologies supported*

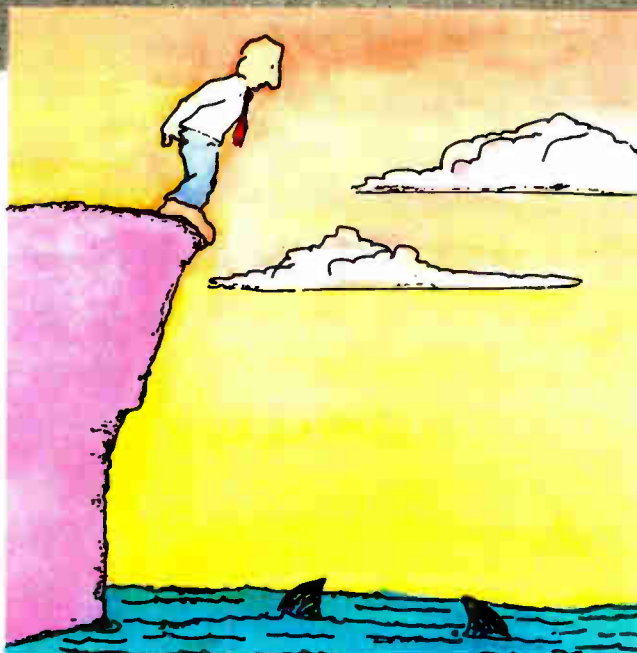

**Look Before You Leap.**  
*You Can Have A Flexible,  
 Powerful, Affordable CASE Tool.*

top level of your design and then decompose each module into Structure Charts, State Diagrams, Entity-Relationship Diagrams, etc.

### Customize Methodologies Or Create Your Own

With the Expert version of vsDesigner, you can modify the syntaxes we supply, or you can even create your own syntaxes for ultimate flexibility. We believe that the tool should adapt to and then enforce your team's standards and practices rather than vice versa.

### Quality Code From Quality Design

Although many CASE tool users have had significant productivity gains, structured design improves quality even more than productivity. The design checking programs included with vsDesigner allow you to check the logical integrity of your designs before you begin writing code. The resulting code will be more reliable, and maintenance costs will be much lower because operations are logically consistent.

### Collaborate over a LAN

The Expert version of vsDesigner also adds LAN support so that all your designers can simultaneously work on the same design. Node locking allows

## vsDesigner

design collaboration while preventing conflicting changes to the shared design.

The Expert version of vsDesigner also provides the database and reporting capabilities necessary to predict lines of code, number of modules, completion dates, responsibilities and project complexity.

### One Picture Is Worth A Thousand Meetings

vsDesigner enhances the communication among team members by giving managers, team leaders, programmers and analysts a visual picture of your system's architecture making it faster and easier to communicate design changes throughout the team.

### Fast Learning Curve

vsDesigner has powerful on-line help, and the User's Manual has an extensive tutorial. Your choice of Lotus-style menus or pop-up menus make command selection easy. The built-in word processor even emulates popular word processors to reduce learning time. Color graphics make your designs easier to understand.

### A World-Class Design/Analysis Tool From The Best-Rated CASE Vendor

When you choose vsDesigner, you become a valued customer of Sage Software, the "Best-Rated CASE Vendor" in the Donohue 1989 Fortune 1000 Software Industry Report. Sage is committed to meeting your needs with excellent customer support, training and best-in-class tools including APS/PC and APS/MVS Application Generators, PVCS, PolyMake and vsDesigner.

Both versions of vsDesigner require an IBM-compatible PC or PS/2 with 640K RAM, EGA monitor and a hard disk. A mouse is recommended. Printers supported are: Epson FX85, FX286 & MX80; HP LaserJet+ and LaserJet Series II.

### 30-Day Money-Back Guarantee

### To Order 1-800-547-4000

Outside North America call (301) 230-3307. Send checks and P.O.s to SAGE/POLYTRON, 1700 NW 167th Place, Beaverton, OR 97006. FAX: (503) 645-4576. Prices are N. American only.

**SAGE**  
 SOFTWARE

Circle 789 on Reader Service Card

## BUS EVOLUTION

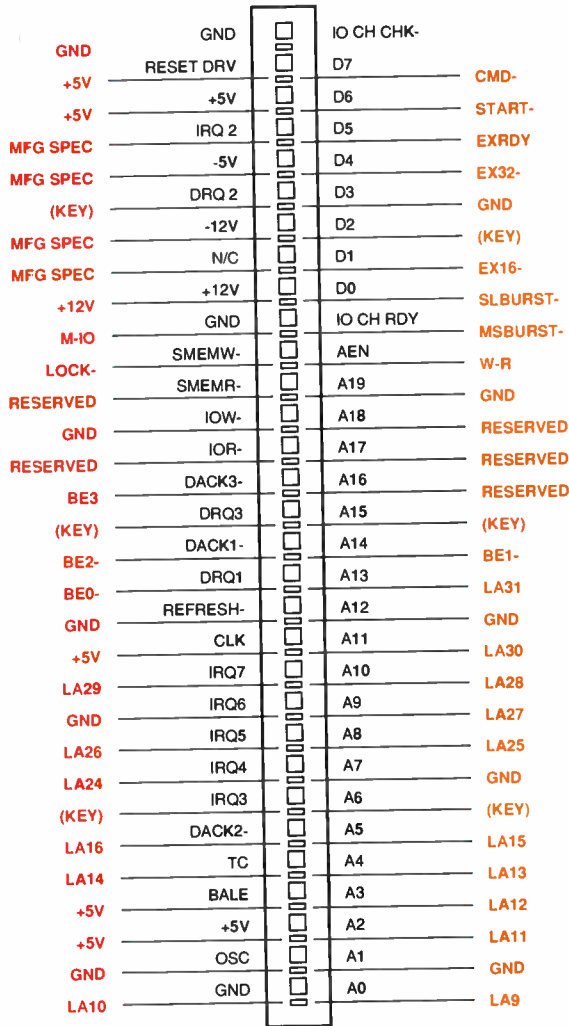

### Extension for AT bus

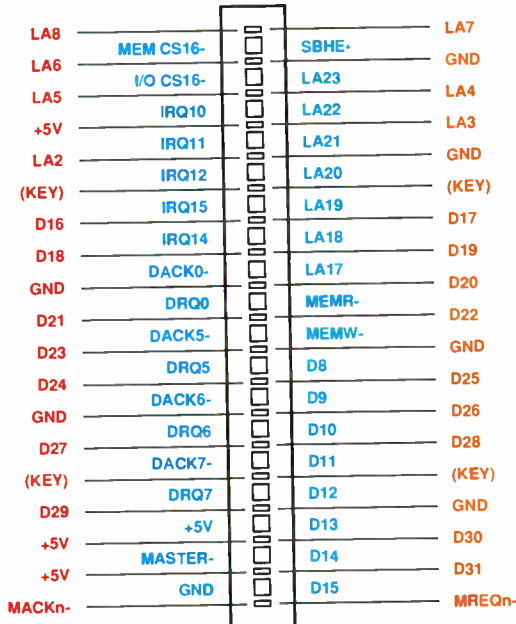

contacts in the card edge connector are arranged in two tiers: an upper tier, which carries all the ISA signals, and a lower tier, which carries all the new EISA signals (see figure 2).

Plastic keys prevent an ISA card from descending far enough into the slot to connect with the EISA signals but slide smoothly into notches in an EISA card. The metal "fingers" on the edge of an EISA card are thinner than those on an ISA card, and the new signals are interleaved with the old. This arrangement lets nearly twice as many leads reach the card edge.

Skeptics originally voiced concern that the insertion and removal forces of the EISA connector would be extremely high, but this has not turned out to be the case. I found that I was able to insert and remove EISA cards with one hand with relatively little effort.

### The Intel Chip Set

Intel's EISA chip set—currently the only game in town—consists of three key components (see figure 3): the Integrated System Peripheral (ISP) and the aforementioned BMIC and EBC.

The EBC generates cycles on the EISA bus and manages the buffers that connect it to the host CPU's local bus. The EBC also provides reset signals for the CPU and the cache controller, and it supports snooping on the EISA bus for either the 82385 or the 80486's internal cache. (It's not clear, however, whether it's possible to use the EBC with a more powerful cache controller or with a write-back cache.)

The EBC is closely coupled to (and, in fact, can't run without) the ISP. The ISP

*continued*

**Figure 1:** The evolution from PC to AT to EISA. The expansion bus has contacts for both sides of the expansion cards. The original PC bus (black) had only 62 lines. The ISA 16-bit (AT) bus (blue) changes only line 8A of the PC bus but extends the bus with 36 new lines. The EISA bus (red) added 59 new lines at a different card depth from the ISA bus. Otherwise, the basic 62 lines stayed the same. Note that EISA attempts to "wrap" power and ground lines around clock lines and to position power rails so that they can be combined into thick traces on a motherboard. EISA nearly doubles ISA's number of bus lines.



## EISA vs. the Micro Channel

**I**BM announced its Micro Channel architecture in 1987. Because EISA is being released more than two years later, its designers have had the benefit of being able to track industry experience with IBM's design. (Intel has developed both a Micro Channel chip set and the first EISA chip set.)

Some similarities are found between the two standards. As is true with Micro Channel systems, EISA systems can do full 32-bit transfers and can configure themselves automatically. (EISA systems can even tell you how to set the DIP switches on older ISA-type cards). But unlike the Micro Channel, the EISA bus is fully synchronous and can perform cycles in long rapid-fire bursts. (The maximum throughput of the Micro Channel is 20 megabytes per second,

while the EISA bus can support a maximum burst transfer rate of 33 megabytes per second.)

It may be easier to manufacture EISA boards than Micro Channel cards. They sport nearly double the surface area, making expensive surface-mount technology less of a necessity. An EISA adapter can use more than twice the power of a Micro Channel card. This will make peripherals like on-the-card hard disks, relay boards, and intelligent I/O boards with a large amount of RAM (e.g., disk-caching controllers and laser printer controllers) simpler and cheaper to implement on EISA than on the Micro Channel.

IBM makes Micro Channel machines with both 16- and 32-bit CPUs today. But while it's possible to build an EISA

system with a 16-bit host processor (e.g., a 16- or 20-MHz 80286), it may be a while before you see such systems on the market. Intel—in an attempt, perhaps, to discourage the use of these second-sourced processors—supports only the 80386 and 80486 with its EISA chip set. Since Intel's chips are, at this writing, the only ones available to support the EISA bus, users may have to wait for silicon from other vendors before they can enjoy the economic benefits of the 80286—or even Intel's own 80386SX.

EISA's main advantage is that it does not have to "catch up" to the Micro Channel right away in order to be useful. Users can install cards designed for ISA machines while waiting for fast EISA cards to appear.

## Glossary

**bus master** The entity that drives the address lines and the control signals for a bus cycle; with EISA, the bus controller can operate some of the lines on behalf of the bus master.

**DMA** Direct memory access, the process by which information is transferred between two slaves on the bus (e.g., a memory card and an I/O device), under the supervision of a DMA controller.

**edge-triggered** An edge-triggered interrupt is one that is activated by a transition in an interrupt signal on the backplane. Compare to **level-sensitive**.

**ISA** The Industry Standard Architecture, an unofficial designation for the bus upon which the IBM PC AT and compatible systems are built.

**latched** A signal is latched when its logic level is sampled into and held by a flip-flop. The flip-flop, or latch, is a memory element that is guaranteed to maintain its current output until explicitly set to a different value.

**level-sensitive** A level-sensitive interrupt is triggered by a specific level (high or low) of that signal. Electrically, it is possible for more than one

source to drive a level-triggered interrupt line, but not an edge-triggered one. Compare to **edge-triggered**.

**open-collector** An open-collector bus line is one that is normally held at a logic high level by a pull-up resistor. Such a line can be pulled low by a chip output that presents a substantially smaller resistance between that line and a low logic level (ground). An output that drives an open-collector line usually consists of a single transistor whose collector is attached to the pin and nothing else (hence the name open-collector). The transistor is driven to saturation (i.e., turned on all the way) to present the necessary low resistance between the signal line and ground.

**parity protection** A system with parity protection includes 1 or more bits that accompany the data and indicate whether the number of ones (or zeros) in the data is odd or even. Parity bits can be used to check the integrity of the data. Virtually all IBM PC-compatible memory has 1 parity bit for each 8 bits.

**refresh** The process by which the

DRAM chips are continuously recharged, without which they will lose the data they contain.

**reset signals** Signals that reset chips (e.g., the CPU) to their power-on conditions.

**snooping** The process in which a memory cache watches to see how peripherals are accessing memory. (See "Caching in on Memory Systems," March BYTE.)

**synchronous** In a synchronous system, all state transitions, including changes in the states of bus lines, are synchronized with the transitions of a clock signal. In an asynchronous system, objects can change state at any time.

**tristate** A driver whose output can be at a low logic level, a high logic level, or high impedance—which means that it does not control the bus line at all.

**wait-state generator** A circuit that causes a CPU (or other bus master) to increase the length of a bus cycle to accommodate slow memory or peripherals.

# One Of America's Best Run Companies Gives 95% Of Its Money To Charity.

CARE was recently named the best run, best managed charity in America.

We aren't surprised. 95% of every dollar we receive goes to help impoverished people. Only 5% goes to run our organization.

No other company could survive on margins like that. But a lot of starving people can.



We're Helping People  
Learn To Live Without Us.  
1-800-242-GIVE

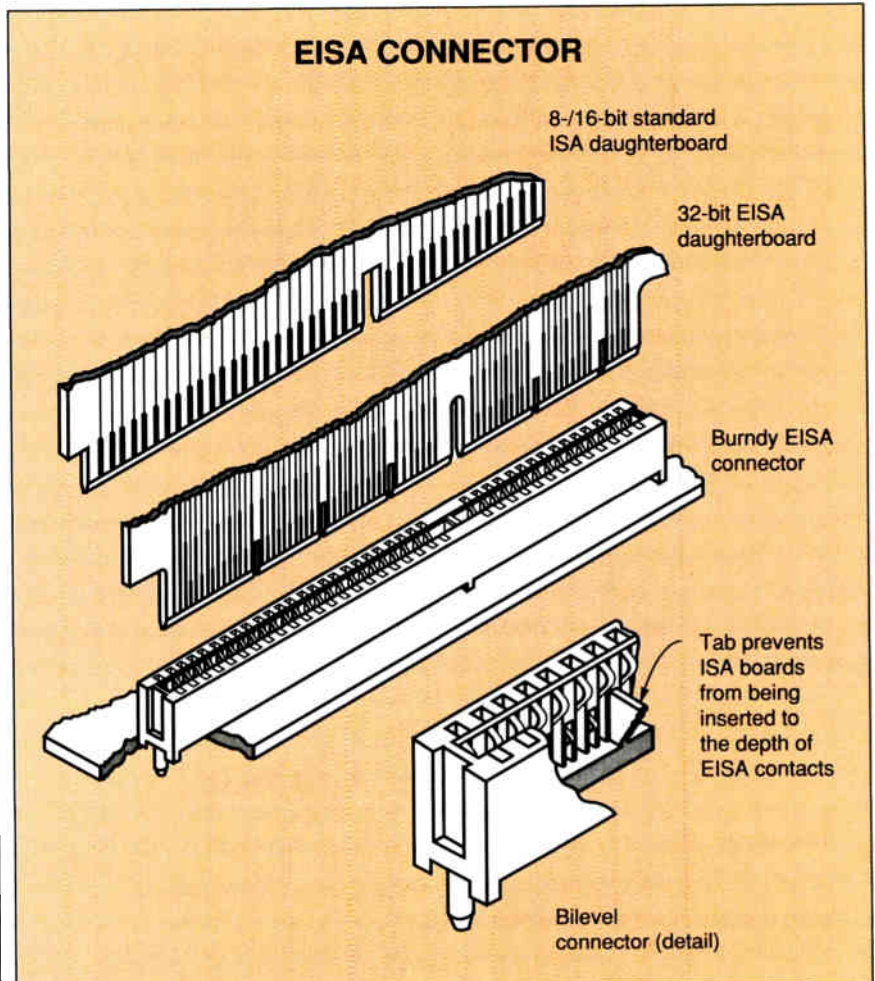

**Figure 2:** The EISA two-level expansion card connector allows backward compatibility with the ISA card in the same slot, while letting EISA cards have twice as many signal lines.

**Table 4:** The EISA bus controller needs to step in to help a bus master complete a cycle. The Intel Bus Master Interface Controller has a downshift feature that lets it do 16-bit transfers by itself, even if it's configured as a 32-bit master. A board that can do this is called a "downshiftable master."

MasterSlave	WHEN THE BUS CONTROLLER STEPS IN			
	32-bit EISA	16-bit EISA with burst capability	16-bit EISA	ISA
32-bit EISA	B	M	M	M
16-bit EISA	C	B	B	M
Intel BMIC (32-bit with "downshift" capability)	B	B	M	M

B = Burst-mode cycle possible.

C = Copy-up cycle. EBC copies the contents of the lower two byte-wide lanes onto the upper two byte lanes, so the 16-bit slave does not need to drive them directly.

M = Mismatch. EBC performs one or more cycles on behalf of the master.



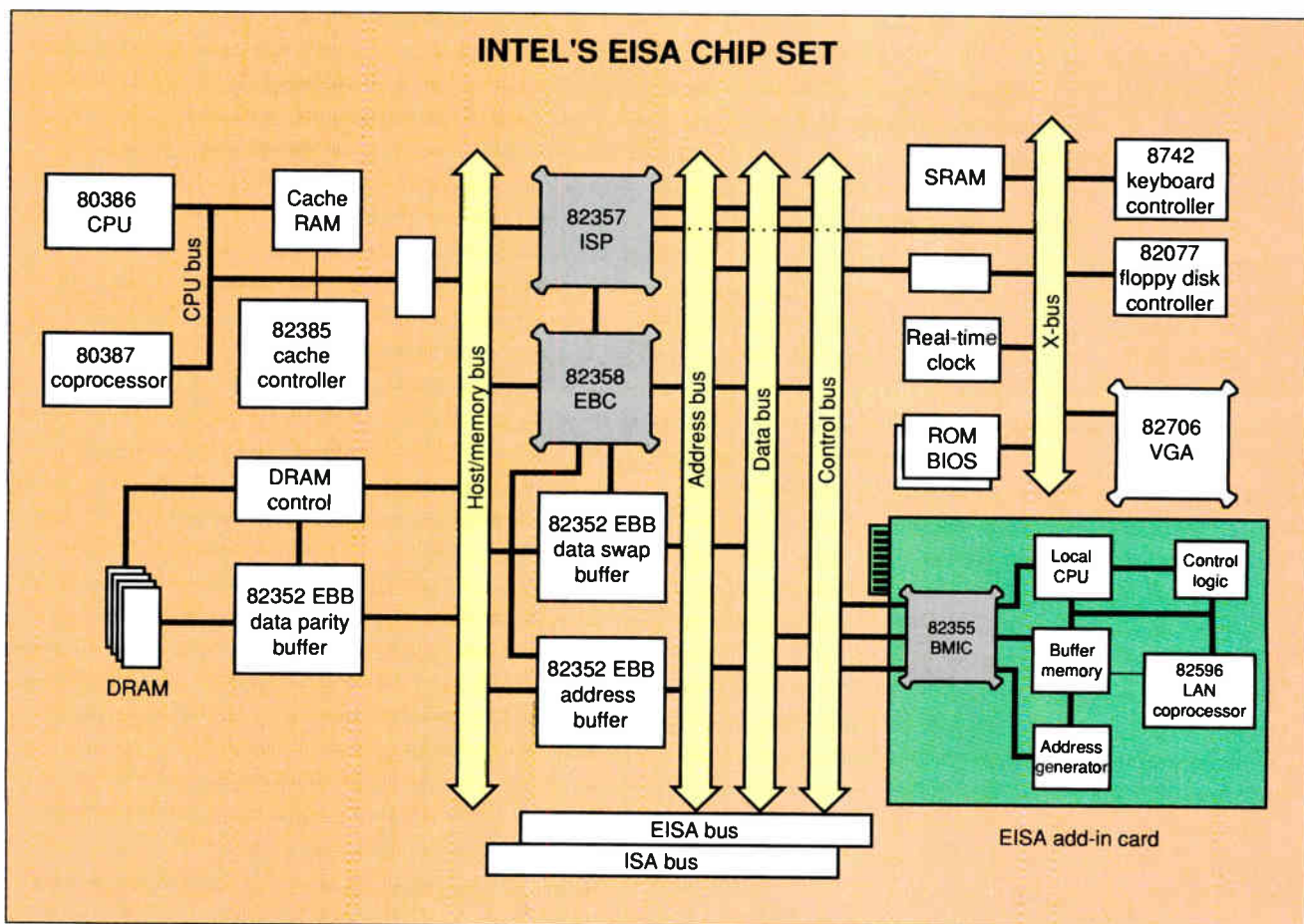

Figure 3: The Intel chip set for supporting EISA consists of the 82358 EISA Bus Controller, the 82357 Integrated System Peripheral, and the 82355 Bus Master Interface Controller.

provides the host CPU with an interrupt controller, a DMA controller, counters, and timers. It also manages DRAM refresh, performs EISA bus arbitration, and tests for memory parity errors. The ISP even has a "slowdown" mode that delays the CPU and makes it appear to be running at a slower speed—a necessary feature for certain copy-protected software.

Because these two chips integrate so many necessary system components along with the EISA functions, manufacturers who use them are unlikely to use third-party AT chip sets (e.g., those made by Chips & Technologies) in the same machines. Thus, these companies will most likely have to develop their own complete chip sets to cash in on the market for EISA machines.

The final component in the Intel chip set is the BMIC. It's intended to be used as a bus master interface on intelligent peripheral cards, and it has a local bus interface that's specifically tailored for use with the 80186. The host can com-

municate with the processor on the peripheral card using "mailbox" and "doorbell" registers and/or via an interface that lets an entity on the EISA bus access the peripheral card's local address space. It's also possible to use the BMIC on a card that doesn't have a local CPU.

#### Identifying EISA Products

Every EISA card supports a product identifier, which is accessible at a pre-assigned address determined by the slot the card is in. EISA product identifiers identify a peripheral card the same way that Micro Channel card IDs do, but with one important difference: EISA's product identifiers are not centrally managed, as IBM's are. The manufacturer creates them, following guidelines published by the EISA consortium.

#### Which to Buy?

The mysteries of EISA have fostered a wait-and-see attitude in the industry. Many corporate customers, unsure

which standard will win, have deferred computer purchasing decisions until they know more about EISA.

By the time this article goes to press, there should be real EISA machines that users can see, benchmark, and compare to systems that use the Micro Channel (see the text box "EISA vs. the Micro Channel" on page 423) and other bus architectures. ■

#### ACKNOWLEDGMENT

Many thanks to Kristin Bailey, Steve Spangler, Rob Kubick, Amaresh Kumar, Chris McAfee, Erez Carmel, and Michael Slater for their help in compiling this article.

L. Brett Glass is a freelance programmer, author, and hardware designer residing in Palo Alto, California. He can be reached on BIX as "glass."

Your questions and comments are welcome. Write to: Editor, BYTE, One Phoenix Mill Lane, Peterborough, NH 03458.

# Wise Guide.

## Dvorak's Guide to PC Telecommunications

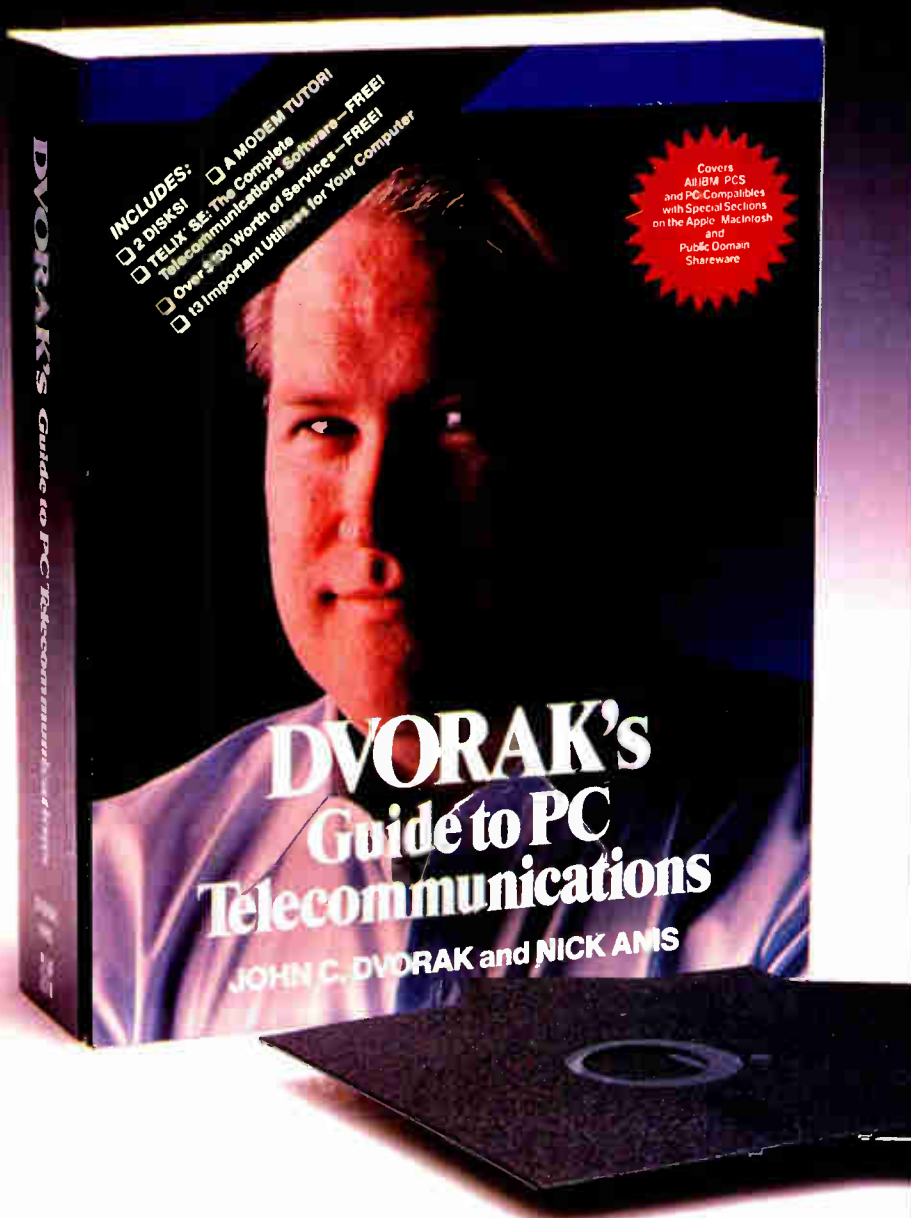

by John C. Dvorak and Nick Anis • Foreword by Peter Norton

Circle 261 on Reader Service Card

*"Dvorak's style and humor make this a refreshing and accessible sourcebook with an incredible breadth of coverage." Peter Norton*

TELECOMMUNICATIONS JUST GOT SIMPLE—

Plug into the world of electronic databases, bulletin boards, and on-line services. All you need is your computer, a modem, and this outstanding book and disk package by internationally acclaimed columnist John C. Dvorak and programming wiz Nick Anis.

With this book and software package you can:

- Send and receive electronic mail, memos, and reports to and from your office, hotel room, beach resort, or home.
- Set up an efficient home-office.
- Schedule airline reservations electronically.
- Download over 10,000 software programs right into your computer over regular phone lines.
- Get instantaneous stock quotes.
- Tap into most major newspapers and newsletters electronically.

For **Only \$49.95** you get a comprehensive, easy-to-read guide on everything you ever wanted to know about telecommunications plus TWO diskettes loaded with outstanding free programs. This book is written for experts and novices alike.

### INCLUDES:

- Two 5-1/4" Disks
- A Modem Tutor
- TELIX/SE —The complete Telecommunications Software - FREE!
- Over \$1500 in Discounts and Services
- 13 Important Utilities for Your Computer - FREE!

\$49.95. ISBN: 0-07-881551-7. 750 pp. Quality Paperback. 2 5-1/4" Disks (IBM PC/Compatible).

(3-1/2" Disks available through a coupon offer.)

Available Now at Book Stores and Computer Stores

**ORDER TODAY!**  
**CALL TOLL-FREE**  
**1-800-262-4729**



Osborne McGraw-Hill  
2600 Tenth Street  
Berkeley, CA 94710

(Available in Canada through McGraw-Hill Ryerson, Ltd. Phone: 416-293-1911)

1989 McGraw-Hill, Inc.



## Part 2

# TWO TIN CANS AND SOME STRING



The investigation of network interfaces continues, this time with the popular NetBIOS

**W**hether you've got a Macintosh, an IBM PC, a Unix system, or whatever, there's a slot or a connector somewhere on your machine begging to be hooked into a network. The begging has probably gotten louder—some networks are down to just a couple hundred dollars per connection. Soon, you may find yourself capitulating; you'll be bent over your machine, screwing a coaxial umbilical into an adapter card. There, you're jacked in. Now what?

In last month's installment, I described a simple file transfer application as a means of exploring the capabilities of two popular network systems: AppleTalk and NetBIOS. I began with AppleTalk, so now it's time for NetBIOS to show its stuff. I should warn you now, I'll frequently refer to Part 1 to draw parallels between the mechanics of NetBIOS and those of AppleTalk. You may want to keep your October issue on hand.

I spent a good portion of last month's article discussing the *layers* of functions of which AppleTalk is composed. It's important to be clear about layers, since the AppleTalk Transaction Protocol, which I used in my program last month, resides one floor down from NetBIOS. Specifically, ATP operates at the transaction layer, while NetBIOS operates at the session layer.

After reading this two-part series, you might conclude that NetBIOS has superior capabilities and that ATP should thus be scorned as inferior by comparison. That would be a mistake, for the simple

reason that ATP is a transaction-layer protocol and is not meant to include functions from the session layer. For many applications, the transaction-handling functions of AppleTalk are more than sufficient for the task. AppleTalk does have a set of session-layer functions that I intend to cover in a future column.

As in AppleTalk, the upper-layer functions of NetBIOS call on functions in the lower layers. Unlike AppleTalk, most NetBIOS installations hide the lower layers from applications. For simplicity, I'll split the layers of NetBIOS into upper and lower. This division is of my own doing, and it's merely to group the layers into manageable portions.

## Upper Layers

The NetBIOS Session Management Protocol (SMP) handles sessions (which I'll describe in a moment) between named processes on the network. A named process is similar to AppleTalk's socket client: a program that has made itself accessible to other programs on the network via a network-visible name.

The Name Management Protocol is the counterpart to AppleTalk's Name Binding Protocol (NBP). NMP allows the user to create unique, symbolic names that are made visible on the network. On AppleTalk, a name is associated with a socket client; in NetBIOS, a name is associated with one end of a session.

AppleTalk names are also more versatile than NetBIOS names. AppleTalk names consist of three fields: zone, object, and type. These fields could be used as filters, or as a mechanism for dividing a physical network into logical subnets (departments). NetBIOS names are flat strings of 16 characters, and NetBIOS provides no filtering or partitioning. For example, you can't perform wild-card searches to locate all the names on the network beginning with "Print." Application programs have to add their own wild-card-matching capabilities.

The NetBIOS User Datagram Protocol

is analogous to AppleTalk's Datagram Delivery Protocol. As with AppleTalk's DDP, UDP manages packet transmission from source to destination with no guarantee of delivery. UDP packets can be up to 512 bytes long. There are some advantages to using DDP. Its usage does not require you to first set up a session; you just pick the name you want to send the datagram to and fire away. Also, you can use DDP to send broadcast datagrams, which are sent to all names on the network. The file transfer program I'll present makes no use of UDP functions; for an application of datagrams, see "Understanding NetBIOS" in the January BYTE.

Finally, the NetBIOS Diagnostic and Monitoring Protocol has no real counterpart in AppleTalk (except, perhaps, the AppleTalk Echo Protocol, AEP). DMP commands allow a program to acquire status information from local as well as remote nodes on the network. You can also obtain traffic information, along with data such as the number of cyclic-redundancy-check errors that have occurred, the number of collisions that have occurred, and more.

## Lower Layers

The lower layers are less clear than the upper and depend largely on the hardware in use. The transport layer on the PC Network uses IBM's proprietary Reliable Stream Protocol. Other network systems use the Transmission Control Protocol. You can find the Datagram Transport Protocol at the transport layer, as well; UDP and DMP use it heavily.

Beneath the transport layer resides the network layer, which often becomes confused with the layer beneath it. IBM PC networks use the Packet Transfer Protocol, which more or less calls the Link Access Protocol directly. Other vendors may use XNS (Xerox Network Systems), TCP/IP, or—in the case of Novell's NetBIOS emulation—IPX.

Finally, the physical layer is inhabited

*continued*

by a diversity of creatures. Here you'll find token rings, Ethernets, or even RS-232 connections.

As confusing as all this seems, the reality is that unless you're in the business of actually building network hardware, you usually don't have to work in the catcombs of the lower layers. I'll focus on the upper layers (the SMP and NMP), since this month's program deals with them.

### Transactions and Sessions

Aside from the fact that NetBIOS and AppleTalk run on completely dissimilar

machines, the main difference in the kinds of commands available under these two network systems can be traced to the difference between a transaction and a session. In last month's column, I went into some detail concerning an AppleTalk transaction: Communication between network entities in ATP takes place as a series of request/response cycles. The requester says "Give me some data," and the responder replies with "Here it is." The relationship between applications on ATP does not go beyond this request/response exchange. This is no surprise, since ATP is, after

all, a transaction-layer protocol.

Applications under NetBIOS, however, establish a session between one another. A session is like a telephone call. First, both parties must make themselves visible on the network using the ADD NAME command—analogue to providing all phone system subscribers with a universal phone book. Next, one party calls the other using the NetBIOS CALL command. The second party answers using the LISTEN command. Once they have established the session, both sides can talk or listen using the commands SEND and RECEIVE. In fact, both sides can simultaneously send and receive; hence, NetBIOS is said to support full-duplex operation.

NetBIOS, then, is a step up from the transaction layer of ATP. A NetBIOS session can contain numerous request/response transactions. Furthermore, either side can play the role of requester and responder. The dialog continues until one (or, preferably, both) of the parties issues the HANG UP command and terminates the connection.

### Talky Talk

You issue commands to NetBIOS via a data structure known as the NetBIOS control block (see table 1 for a description of the NCB's fields). The NCB's function is roughly equivalent to that of AppleTalk's parameter block, although this is more coincidental than intentional. Each NCB is a message sent to NetBIOS describing a command that the calling application needs carried out. The NCB remains the property of NetBIOS while the command is in progress. (I'll present NetBIOS commands in up-*percase*.)

Ordinarily, conjuring up NetBIOS involves loading up the fields of the NCB with the information appropriate for whichever command you want NetBIOS to perform, executing an INT 5CH, and examining the RETCODE field of the NCB when NetBIOS returns. (If you're in assembly language, the AL register mirrors the contents of the RETCODE field.) NetBIOS commands issued in this fashion are referred to as "wait" commands; your program waits for the command to complete before proceeding—not the best use of the computer's time.

If you set the high bit of the NCB's COMMAND field to a 1, that command becomes a "no-wait" version. NetBIOS will return immediately and multitask with your application. Your program can be performing computations while NetBIOS twiddles its thumbs, waiting for

*continued*

**Table 1: Format of the NetBIOS control block (NCB). In some literature, you may see this referred to as the message control block (MCB).**

#### FIELDS IN THE NETBIOS CONTROL BLOCK

Field name	Description
COMMAND	(1 byte) The command field, which tells NetBIOS which function to execute. If the high bit is set, the command is a "no-wait" command (see text).
RETCODE	(1 byte) Returned by NetBIOS when the command completes, this field is 0 if all went well. Otherwise, this field holds an error code.
SESSION NUMBER	(1 byte) When a CALL or LISTEN command completes, this field holds the number of the established session. If you issue a SEND or RECEIVE command, you must load this field with the appropriate session number.
NAME NUMBER	(1 byte) When an ADD NAME or ADD GROUP NAME command completes, this field holds the number associated with that name; used with UDP commands.
BUFFER	(4 bytes) For SEND commands, this field holds the offset and segment of the buffer holding the message to be transmitted. For RECEIVE commands, this field points to the buffer where incoming data is to be stored.
LENGTH	(2 bytes) The number of bytes in the buffer pointed to by the BUFFER field.
CALL NAME	(16 characters) Used by the CALL and LISTEN commands to hold the name of the remote station that will become your session partner.
NAME	(16 characters) Holds the local name (i.e., holds your name) for ADD NAME and DELETE NAME commands.
RECEIVE TIMEOUT	(1 byte) Indicates the time-out in 1/2-second increments for RECEIVE commands.
SEND TIMEOUT	(1 byte) Indicates the time-out in 1/2-second increments for SEND commands.
POST	(4 bytes) This field points to a post routine, which NetBIOS executes after completing a no-wait command; should be set to 0 if not used.
ADAPTER NUMBER	(1 byte) Network adapter number; indicates which network adapter card the command should be issued to.
COMMAND COMPLETE	(1 byte) A value of 255 in this field indicates that the command specified by the NCB has not completed. NetBIOS sets this field to 0 when the command is finished.
RESERVED	(14 bytes) Reserved by NetBIOS.



# JC BOARDS,

## WORLD CLASS HIGH PERFORMANCE PRODUCTS

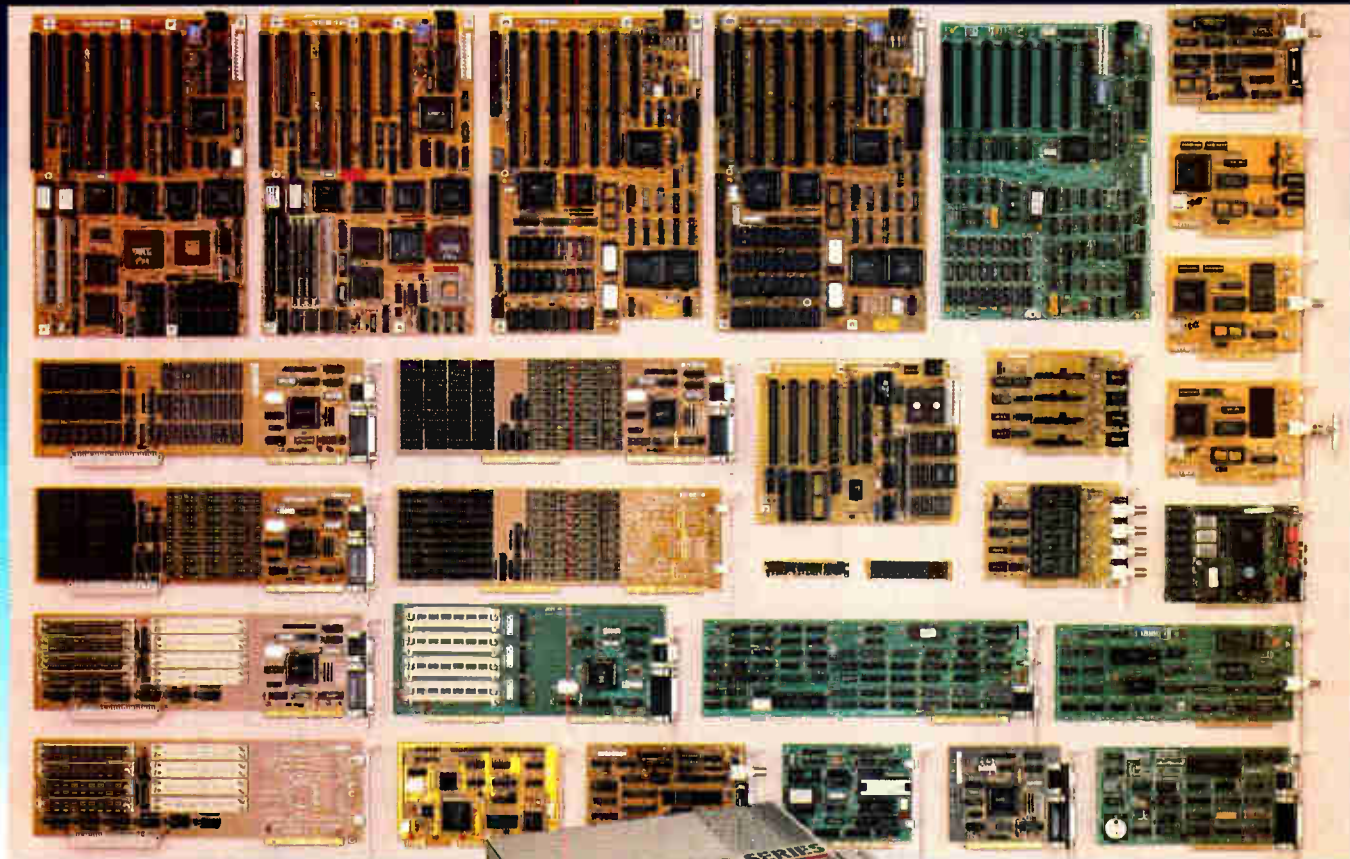

**P**ictured above is a portion of the products made by JCIS. Our factories in California have been producing boards for VARs and OEMs since 1979. These boards have been designed by JCIS for performance and reliability.

Our boards are used by OEMs worldwide as the basis for many of their own systems. More than 1/4 million end users are using JCIS designed products. More than 450 dealers offer our boards and systems to their clients.



JC Information Systems Corp.  
*High Performance Company Since 1979*  
161 Whitney Place  
Fremont, CA 94539  
Tel: (415) 659-8440  
FAX: (415) 659-8449

Our experienced engineering staff have designed-to-spec, many products using the latest technology, for OEMs that do their own manufacturing. And we can provide you as well, with a design that offers world class performance.

Call or FAX for a complete catalog of our current products. Experience the extraordinary quality, performance and engineering that goes into each JCIS product.

What can we build for you?

Circle 189 on Reader Service Card  
World Radio History

response packets and such.

If you've pointed the POST field to an interrupt-handling routine (i.e., one that concludes with an IRET instruction), NetBIOS will call that routine when the command has completed. The post routine can examine the RETCODE field and take appropriate action. Alternatively, you can clear the POST field, call NetBIOS using a no-wait command, and simply monitor the COMMAND COM-

plete field. NetBIOS will set COMMAND COMPLETE to 0 when the job is done. (Sharp-eyed readers will recognize these two ways of handling no-wait commands as being interrupt-driven and polled techniques, respectively.) The sample program I've written this month completely wimps out and uses nothing but the wait version of commands. I apologize for my cowardice.

To be fair to AppleTalk, most of its

commands can be executed in no-wait fashion, as well. AppleTalk refers to no-wait commands as *asynchronous*. Calling a routine asynchronously causes an immediate return to your program, whereupon AppleTalk does its work in the background. (For assembly language programmers, you signify an asynchronous command by setting bit 10 of the trap word of the call.) The parallels to NetBIOS go further: You can either poll the AppleTalk command's parameter block, looking at the ioResult field (typically at offset 16 in the parameter block) and waiting for it to change from 1, or you can specify a *completion routine* whose job is identical to NetBIOS's post routine.

### The Real Stuff

The code fragment in listing 1 shows most of the source code for the sending side of my NetBIOS application. I'm not including the receiver's source code for the simple reason that it is virtually a twin of the source in listing 1. The major difference is that the receiver issues a LISTEN command instead of a CALL, and a RECEIVE command instead of a SEND. (You'll notice functions in listing 1 corresponding to NetBIOS commands. It should be easy to match the function with the command.)

In NetBIOS, both ends of the session log a name on the network using the ADD NAME command. You'll understand this requirement in a moment. (This is in contrast to ATP, where only the responding side of a transaction must use the NBP to place its name on the network. See last month's column for details.) As you might expect, each name must be unique. The examples that I've provided allow you to define the names as command-line arguments. This permits numerous versions of the same program to run simultaneously on the network.

When a program calls ADD NAME, NetBIOS's first job is to make certain that no other program has laid claim to the name. It does this by broadcasting a name claim packet across the network. Actually, it broadcasts the packet several times as a fail-safe measure. If no other station contests the name claim, NetBIOS adds the name to its local name table. As with AppleTalk, a single station on the network can be known by several names—aliases, if you will. A typical NetBIOS installation can handle up to 12 names per station.

Once each side has added its name to the network's name table, it's time to

*continued*

**Listing 1: C code fragment for the operations used to establish a file-send on NetBIOS. The receive code is very similar.**

```

/* Open the file.*/
filehand=getfilename(argv[3]);

/* Delete your session name to make sure it's not
** hanging around. */
NBios_DelName(myname);

/* Add your session name to the name table.
** Variable 'myname' contains your local name. */
if((rcod=NBios_AddName(myname))<0)
{
    printf(">>>Error adding name: %d\n",rcod);
    exit(0);
}

/* Open a session for the transmit using the CALL command.
** Timeout is 30 seconds.
** This routine tries indefinitely...it keeps trying
** in spite of command time-out (error 5) as well as
** a "no answer" error (error 20).
** Variable 'hisname' is the name of our session
** partner. */
do
{
    rcod=NBios_Call(hisname,myname,200,200);
    if ((rcod<0) && (rcod != -5) && (rcod != -20))
    {
        printf(">>>Error calling session: %d\n",0-rcod);
        exit(0);
    }
} while ( (rcod == -5) || (rcod == -20));
sessnum=rcod;
/* Read file, transmitting 1K-byte blocks.
** Xblock is the message buffer. */
Xblock.Text[0]='D'; /* Data block */
count=0;
while (blen = getrec(filehand,Xblock.Text+1,BLOCKSIZE))
{
    Xblock.TextLength=blen+1;
    printf("Sending. %d\n",count++);
    if(rcod=NBios_SessionSend(sessnum,&Xblock))
    { printf(">>>Send error: %d\n",rcod);
      NBios_Hangup(sessnum);
      exit(0);
    }
}

/* Send EOF block. */
Xblock.Text[0]='E';
Xblock.TextLength=1;
if(rcod=NBios_SessionSend(sessnum,&Xblock))
{ printf(">>>Send error: %d\n",rcod);
  NBios_Hangup(sessnum);
  exit(0);
}

/* Hang up the session. */
NBios_Hangup(sessnum);

/* Delete your name. */
if(rcod=NBios_DelName(myname))
{ printf(">>>Error deleting name: %d\n",rcod);
  exit(0);
}

/* Transmit went ok. */
printf("DONE!\n");
close(filehand);
exit(0);

```





# COMPUTER DISCOUNT WAREHOUSE™



Emerson

**CDW™ LETS YOU BRING THE FAMOUS EMERSON EC800 BUSINESS MACHINE HOME**

Comes Ready to Use with a 30 Meg Hard Drive, Loaded with the Following Software: Menu Magic, Home Accountant, Sidekick, Window Works, Borland Quattro

CDW™ price **\$849.53**

Your Choice of Color or Mono Monitor. ADD \$199.00 for Color, \$84.10 for Mono

## SAMSUNG

S-3000, 4.77/10 MHz	\$592.11
S-330, 2.0 Meg/40 Meg	745.50
S-550 AT Comp., 8/12 MHz	994.95 / 109.52
S-550, 20 Meg/40 Meg	1056.45
S-800, 386 20 MHz	1425.80 / 1499.45
S-800, 386 20 MHz	2093.69
S-800, 40 Meg/80 Meg	2498.01 / 2760.00



# WHY PAY RETAIL?

# CDW™ Sells For Less

AND SERVICES YOU BETTER



## INTEL BOARDS & CO-PROCESSORS

INTEL Above Board Plus	\$410.68
INTEL Inboard 386 PC	569.53
INTEL Visual Edge	448.39
INTEL Connect Co-processor	712.43

**SPEED UP YOUR PC UP TO 500%!**



## MATH COPROCESSORS

INTEL 80287 8	\$206.55
INTEL 80287-10	223.55
INTEL 80387-16	389.60
INTEL 80387-20	390.65
INTEL 80387-25	541.92
INTEL 80387-SX	362.82
INTEL 80387-33	575.20
INTEL 80C86-A	395.50

# HARDWARE, SOFTWARE & PERIPHERALS AT DISCOUNT PRICES

## COMPUTERS

MDL 70... CALL CDW™	MDL 390C... IN STOCK
MDL 140... FOR ALL	MDL 3150C... & READY
MDL 300C... AST	MDL 386 PS... TO SHIP
MDL 340C... PRICING	MDL 386/33... CALL

AST 105X	ALL AST
AST 386SX Model 5 / Model 45	WORKSTATIONS
AST 386SX Model 45	IN STOCK
SAMSUNG PC Terminal 286	\$1054.60
EARTHSTATION V400 or 286, Arcnet or Ethernet...CALL	

PB1000, 12MHz	\$1219.70
PB1000, 40Meg	\$1614.61
PB800, 12MHz	\$1198.65
PB800, 16MHz	\$1368.70

MDL 30, 20 Meg \$1655.17	MDL 55SX 30 Meg \$2899.59
MDL 60, 40 Meg \$3440.15	MDL 55SX 60 Meg \$3178.39
MDL 60, 70 Meg \$3644.52	MDL 70, 60 Meg \$3747.20
MDL 30286, 1 D.R. 1412 MHz	MDL 70, 121 Meg \$259.84
MDL 30286, 20 M1835.50	MDL 80, 40 Meg \$4374.40
MDL 50Z, 30 Meg \$265.75	MDL 80, 70 Meg \$5069.37

286E, MDL 1	\$1549.95
286E, MDL 20	1899.50
386E, MDL 40	2172.45
386E, MDL 40	2452.11
386E, MDL 40	2718.33
386E, MDL 40	3092.84

T-1000	\$657.95
T1200, 2 Drive	1455.74
T1200, 20 Meg	1959.60
T1300e	2688.76
T3200	3392.92

MDL 2108	\$895.50
MDL 2112	1271.20
MDL 2214	\$1921.30
MDL 3216	2060.37

Supersport 88, 2 D/20 Meg	CALL CDW™
Supersport 286, 20/40 Meg	FOR LOWEST
Turboport 386, 40 Meg	ZENITH LAPTOP
Turboport 386, 40 Meg	w/modem PRICING

Z 288 12 MHz	ALL
Z 286LP 12 MHz Mod. 1	ZENITH
Z 386 25 MHz Mod. 1	DESKTOPS
Z 386 33 MHz Mod. 1	IN STOCK

WYSE 50/60 Amber or Green	\$373.40 / \$300.16
WYSE 85 / 30 Amber	375.90 / 294.10
WYSE 90CT	394.82

1023	\$3745.38
1043	6477.15
1044	9915.06

1212S1	\$349.06
12 x 17	499.35

Scanman PC	\$168.89
Scanman PS/2	\$225.50

12 x 12	\$367.40
12 x 18	\$599.50

HP7440A	\$968.30
HP7475A	1389.89
HP7550	1795.50
HP7570 LOWEST PRICE	
HP7575 EXT. CALL	
HP7575A	1049.66

HIJUNCTION INSTRUMENT	
HI DMP-52	DMP 52MP
HI DMP-56A	DMP 56A
HI DMP-62	DMP 62
HI DMP-62	Image Maker

MINI 8425	\$239.40
MINI 8438	299.85
MINI 3005	\$729.40
MINI 6005	599.52

SEAGATE 20 Meg	\$265.58
SEAGATE 30 Meg	279.32
SEAGATE 4096 80	559.95
SEAGATE ST 251	325.23

1335 70 Meg	\$542.40
1375 153 Meg	1469.85
1355 142 Meg	\$1017.40
1558 338 Meg	1512.52

321SL	\$468.95
341SL	592.84
351SX	949.95

M-172AL	\$579.64
HR20	340.60
ML 182 Turbo	\$234.48
ML 172	199.95
ML 380	NEW ML 391
LASERLINE 6	1292.69
ML320	329.68

1124	\$138.18
1595	463.45
1180	193.95
1191	222.12

BROTHER HL 6e	\$1799.90
H-P LaserJet Model 2 / IID	1699.95 / 2744.95
H-P Deskjet Plus	679.33
CALL	
NEC LC830	3095.20
PACIFIC DATA 25 in 1 Cartridge	283.86
TOSHIBA Page Laser 12	2475.58

## PRINTERS

LX810	CALL
LO850	CDW™
FX850	FOR BEST
FX1050	PRICE EVER
CDW™	stocks all cut sheet feeders and ribbons.

P2200	\$344.65
P5200	509.12
P5300	568.63
P960XL	1039.24

321SL	\$468.95
341SL	592.84
351SX	949.95

M-172AL	\$579.64
HR20	340.60
ML 182 Turbo	\$234.48
ML 172	199.95
ML 380	NEW ML 391
LASERLINE 6	1292.69
ML320	329.68

1124	\$138.18
1595	463.45
1180	193.95
1191	222.12

1124	\$138.18
1595	463.45
1180	193.95
1191	222.12

1124	\$138.18
1595	463.45
1180	193.95
1191	222.12

1124	\$138.18
1595	463.45
1180	193.95
1191	222.12

1124	\$138.18
1595	463.45
1180	193.95
1191	222.12

1124	\$138.18
1595	463.45
1180	193.95
1191	222.12

1124	\$138.18
1595	463.45
1180	193.95
1191	222.12

1124	\$138.18
1595	463.45
1180	193.95
1191	222.12

1124	\$138.18
1595	463.45
1180	193.95
1191	222.12

1124	\$138.18
1595	463.45
1180	193.95
1191	222.12

1124	\$138.18
1595	463.45
1180	193.95
1191	222.12

1124	\$138.18
1595	463.45
1180	193.95
1191	222.12

1124	\$138.18
1595	463.45
1180	193.95
1191	222.12

1124	\$138.18
1595	463.45
1180	193.95
1191	222.12

1124	\$138.18
1595	463.45
1180	193.95
1191	222.12

1124	\$138.18
1595	463.45
1180	193.95
1191	222.12

1124	\$138.18
1595	463.45
1180	193.95
1191	222.12

1124	\$138.18
1595	463.45
1180	193.95
1191	222.12

1124	\$138.18
1595	463.45
1180	193.95
1191	222.12

1124	\$138.18
1595	463.45
1180	193.95
1191	222.12

1124	\$138.18
1595	463.45
1180	193.95
1191	222.12

1124	\$138.18
1595	463.45
1180	193.95
1191	222.12

1124	\$138.18
1595	463.45
1180	193.95
1191	222.12

1124	\$138.18
1595	463.45
1180	193.95
1191	222.12

## NOVELL NETWORKING

SOFTWARE STARTER KITS	
Entry-Level 286 Starter Kit, 4 Users	\$429.90
Entry-Level 286 Starter Kit, 8 Users	899.89
NOVELL NetWare V 2.11	1831.85
NOVELL SFT NetWare V 2.11	2986.60
NOVELL NETPRO	1120.50

INTERFACE CARDS	
3COM ETHERLINK	\$375.45
ARCNET PC110 LANboard PS-2	412.50
ARCNET PC130 LANboard	164.27
ARCNET PC160 LANboard	189.50
ARCNET SMC 16 Bit Workstation Board	437.55
ETHERNET Interface Connector (NE1000)	298.90
ETHERNET Plus Card (for 286) (NP600)	635.35
G-Net Interface Card w/Cable	298.52
NOVELL NE2000	394.15
ARCNET SMC 16 Port Hub	814.25
THOMAS CONRAD 8 Port Hub	378.85
Ethernet Terminators	39.50

Novell trained and authorized sales and support. See WORKSTATIONS under Computers.	
--	--

EVEREX 1200B / 2400B	
EVEREX 2400 Ext / 2400 PS/2	\$97.90 / 184.15
INTEL 2400 Internal	149.75
INTEL 2400 External	176.94

HAYES	
HAYES 1200	\$278.60
1200B	269.20
2400	416.08

2400 for ZENITH	\$167.10
1200 for COMPAQ SLT	\$259.80
2400 for NEC	225.88
2400 for TOSHIBA	183.74

Counter 1200	\$278.60
Counter 2400	278.60
1200B	108.45
Dual 14400 HST	952.65

1200 External	\$129.10
1200B	108.45
Dual 14400 HST	952.65

1200 External	\$129.10
1200B	108.45
Dual 14400 HST	952.65

1200 External	\$129.10
1200B	108.45
Dual 14400 HST	952.65

1200 External	\$129.10
1200B	108.45
Dual 14400 HST	952.65

1200 External	\$129.10
1200B	108.45
Dual 14400 HST	952.65

1200 External	\$129.10
1200B	108.45
Dual 14400 HST	952.65

1200 External	\$129.10
1200B	108.45
Dual 14400 HST	952.65

1200 External	\$129.10
1200B	108.45
Dual 14400 HST	952.65

1200 External	\$129.10
1200B	108.45
Dual 14400 HST	952.65

1200 External	\$129.10
1200B	108.45
Dual 14400 HST	952.65

1200 External	\$129.10
1200B	108.45
Dual 14400 HST	952.65

1200 External	\$129.10
1200B	108.45
Dual 14400 HST	

GLOSSARY

*A brief list of the NetBIOS commands mentioned in the article. Note that there are many more NetBIOS commands available than are presented here.*

**ADD NAME** Requires a 16-character name in the NAME field. This name is added to your local name table and is associated with your station. NetBIOS verifies that the name is complete.

**CALL** Requires a remote user's name in the CALL NAME field; attempts to establish a session and assumes the other party is executing a

**LISTEN** command with your local name in his CALL NAME field.

**DELETE NAME** Deletes any local names added by ADD NAME.

**LISTEN** The other end of the CALL command.

**RECEIVE** The catcher's mitt for a SEND command.

**SEND** Requires the session number returned by a successful CALL or RECEIVE; also requires a pointer to a buffer. The contents of the buffer are transmitted to the session partner.

to use the ADD NAME command?)

Both the CALL and LISTEN commands return a session number. This 8-bit number is similar in function to a file handle. As you call NetBIOS commands, you indicate which session partner the command is meant for by using the session number. This is more than just a convenience; a single computer can have several simultaneous sessions active. When one command has completed, your program has to figure out which one completed in order to know what action to take next. With no session number, your program would have to scan tables of 16-character names for the one matching the completed NCB. It boils down to this: 8 bits are easier to carry from routine to routine than a 16-character name.

You send a message to your session partner with the SEND MESSAGE command. This command takes as input the session number and a pointer to the buffer holding your message. A message can be up to 64K bytes long. The program on the receiving end calls the RECEIVE MESSAGE command to accept the message. Again, this will require a session

*continued on page 482*

establish the session. Harking back to the telephone call analogy, one station—the computer sending the file in my application—issues a CALL. This command requires as one of its parameters the name of the station being called (variable hisname in the listing). The system at the

other end of the session—the computer receiving the file—issues a LISTEN command. This command takes as a parameter the name of the station to listen to. When the station listening “picks up” on the station calling, a session has begun. (You see why *both* stations need

# The Professional Library for Object-Oriented Pascal

Object-oriented programming multiplies your productivity by promoting reuse of proven software modules. Don't start from scratch! Use **Object Professional 1.0**, a powerful library of over 30 object types containing over 1000 methods.

## Powerful User Interfaces

The window object types let you use multiple overlapping and resizable windows. The windows provide capability for ■ mouse support ■ scroll bars ■ menus ■ text editing ■ dialog boxes ■ pick lists ■ scrolling data entry screens ■ printed forms ■ help capability, and more. The window classes are incredibly flexible — you can create text-mode PM look-alikes or your own unique look and feel.

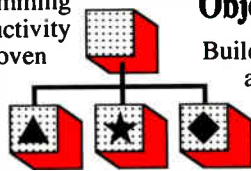

## Object Oriented Data Too

Build your programs from proven and documented object types like stacks, linked lists, virtual arrays, and more. Make your own custom data types by simply inheriting from one of the provided types and adding your own methods and instance variables.

## The Impossible, Made Easy

System-oriented routines provide ■ swappable TSRs in only 6K of RAM ■ DOS and BIOS capabilities ■ EMS management ■ keyboard macros ■ interrupt management ■ swapping Exec manager, and much more.

## Complete Documentation, Full Source

Object Professional has three volumes of complete documentation, online reference guide, free technical support, and full source code. You pay no royalties. Hot demo programs show you how to use the power of Object Professional. You'll get up to speed fast with OOP!

Object Professional is the successor to the acclaimed Turbo Professional:

“A superbly crafted toolbox.”  
Kent Porter, DDJ, 4/88

“The range of this toolkit is simply astonishing.”  
Jeff Duntemann, DDJ, 5/89

**Object Professional 1.0**  
**only \$150**

Call toll-free to order.

**1-800-333-4160**

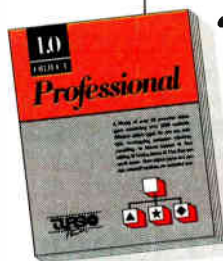

Satisfaction guaranteed or your money back within 30 days. Turbo Pascal 5.5 is required. Add \$5 for shipping in U.S. and Canada. Elsewhere add \$35 per unit. Turbo Professional 5.0 customers may upgrade for \$60, include your serial number.



8AM - 5PM PST Monday through Friday, USA & Canada.  
For more information call (408) 438-8608.  
TurboPower Software PO Box 66747 Scotts Valley, CA 95066-0747



# PRODUCT SHOWCASE

■ BUYER'S MART

■ BYTE BITS

■ PRODUCT SPOTS

■ MICRO PRODUCT CENTER



# THE BUYER'S MART

## A Directory of Products and Services

THE BUYER'S MART is a monthly advertising section which enables readers to easily locate suppliers by product category. As a unique feature, each BUYER'S MART ad includes a Reader Service number to assist interested readers in requesting information from participating advertisers.

RATES: 1x—\$525 3x—\$500 6x—\$475 12x—\$425  
Prepayment must accompany each insertion. VISA/MC Accepted.

AD FORMAT: Each ad will be designed and typeset by BYTE. Advertisers must

furnish typewritten copy. Ads can include headline (23 characters maximum), descriptive text (250 characters is recommended, but up to 350 characters can be accommodated), plus company name, address and telephone number. Do not send logos or camera-ready artwork.

DEADLINE: Ad copy is due approximately 2 months prior to issue date. For example: November issue closes on September 8. Send your copy and payment to THE BUYER'S MART, BYTE Magazine, 1 Phoenix Mill Lane, Peterborough, NH 03458. For more information call Brian Higgins at 603-924-3754.

### ACCESSORIES

#### CUT RIBBON COSTS!

Re-ink your printer ribbons quickly and easily. Do all cartridge ribbons with just one ink! For crisp, black professional print since 1982. You can choose from 3 models: Manual E-Zee Ink — \$39.50  
Electric E-Zee Ink — \$94.50  
Ink Master (Electric) — \$189.00  
1000s of satisfied users. Money-back guarantee.

#### BORG INDUSTRIES

525 MAIN ST., JANESVILLE, IA 50647  
1-800-553-2404 Fax: 319-987-2251

Inquiry 576.

### ACCESSORIES

#### HP LASERJET II M-E-M-O-R-Y

1MB-2MB-4MB MEMORY EXPANSION BOARDS

Save 50%—60%

2-YEAR WARRANTY

#### STARION CORPORATION

(800) 782-8297 CA: (714) 750-2627

Inquiry 581.

### BAR CODE

#### PRINT BAR CODES/BIG TEXT FROM YOUR PROGRAM

Add bar codes and big graphics characters to your program. Print from ANY MS-DOS language. Bar codes: UPC, EAN, 2 of 5, MSI, Code 39, Epson, Oki, IBM dot matrix text up to 1/2". LaserJet up to 2". Font cartridges not required. \$179—\$239. 30-day \$\$ back.

#### Worthington Data Solutions

417-A Ingalls St., Santa Cruz, CA 95060  
(800) 345-4220 In CA: (408) 458-9938

### COMPANION AND EXTENDER

Place a keyboard and monitor up to 600' from your CPU with EXTENDER and COMPANION products. Keep a second Keyboard/Monitor at the CPU with COMPANION. Supports MDA, CGA, EGA, VGA, PS2. Uses single 3/4" cable.

Prices start at \$149.00 for EXTENDER and \$219.00 for COMPANION 25 ft. unit complete.

#### CYBEX CORPORATION

2800-H Bob Wallace, Huntsville, AL 35905  
205-534-0011 International Fax #205-830-1947

Inquiry 577.

### ARTIFICIAL INTELLIGENCE

#### MANA

Intelligent Computing for 286/386

Transform your PC into an AI-based workstation. Expert systems, AI, knowledge base applications, rapid prototyping, object oriented, multi-tasking, virtual memory, LISP/PROLOG etc. modes in multi-language compiler, mouse driven, multi-windowed, fully integrated environment.

#### BMS, Inc.

700 E. Ogden Avenue, Westmont, IL 60559  
Tel: (312) 789-8160 Fax: (312) 789-0253

Inquiry 582.

### PORTABLE READER

Battery-operated, handheld reader with 64K static RAM, 2x16 LCD display, 32-key keyboard, Real-Time-Clock. Wand or laser scanner. Program prompts and data checking through its own keyboard. Easy data transfer by RS-232 port or PC, PS/2 keyboard. Doubles as On-Line Reader. 30-day \$\$ back.

#### Worthington Data Solutions

417-A Ingalls St., Santa Cruz, CA 95060  
(800) 345-4220 In CA: (408) 458-9938

### FREE CATALOG

A complete source for computer supplies at low prices. Fast Service. Call, write or circle inquiry card for a FREE CATALOG.

Use your VISA, MC or COD to order the following bulk discounts:

5.25" DS/DD (Min 50) 26¢  
5.25" DS/HD (Min 50) 62¢  
3.5" DS/DD (Min 30) 89¢

#### GAAN COMPUTER SUPPLIES

186 B East Sunnyside Ave., Campbell, CA 95008  
(800) 523-1238, In Calif. (408) 370-8747

Inquiry 578.

### NATURAL LANGUAGE C LIBRARY

Increase your market share! Use JAKE to add a natural language front end to your application. JAKE translates English queries and commands into C function calls and data structures. JAKE offers context-sensitive semantic processing; interfaces easily, <64K mem.

JAKE \$495. INTERACTIVE DEMO \$10

#### ENGLISH KNOWLEDGE SYSTEMS, INC.

5525 Scotts Valley Dr. #22, Scotts Valley, CA 95066

(408) 438-6922

Inquiry 583.

### PRINT BAR CODES AND BIG TEXT

On EPSON, IBM, Oki dot matrix or LaserJet. Flexible design on one easy screen. Any format size. Up to 120 fields/label. 13 text sizes to 1" readable at 50'. AIAG, MIL-STD, 2 of 5, 128, UPC/EAN, Code 39. File Input & Scanned logos/symbols (PCX)—\$279. Other programs from \$49. 30-day \$\$ back.

#### Worthington Data Solutions

417-A Ingalls St., Santa Cruz, CA 95060  
(800) 345-4220 In CA: (408) 458-9938

### CUSTOM KEYBOARDS

Connect to KEYBOARD, SERIAL or PARALLEL port. Features external interface board. Connect to our keys or yours, our case or yours. Full travel keys or membrane. Custom keytops, software, case, etc. Low one-time costs. Quantities of one to thousands. Fast turnaround time. Many standard models. Call for quote.

#### GENOVATION INC.

1415 E. Edinger Ave., Santa Ana, CA 92705 USA  
Tel (714) 285-0304 Fax (714) 285-0302

Inquiry 579.

### NanoLISP \$99.99

An MS-DOS Common LISP interpreter that supports most Common LISP operations and strictly adheres to the standard. Numerous advanced and extra features, excellent debugging facilities, sample AI programs, fully-indexed manual, free technical support.

#### Microcomputer Systems Consultants

P.O. Box 6648, Santa Barbara, CA 93160

(805) 967-2270

Inquiry 584.

### BAR CODE READERS

For PC, XT, AT, & PS/2, all clones, and any RS-232 terminal. Acts like 2nd keyboard, bar codes read as keyed data. With steel wand—\$399. Top rating in independent reviews. Works with DOS, Xenix, Novell, Alloy, -ALL software. Lasers, magstripe, & slot badge readers. 30-day \$\$ back.

#### Worthington Data Solutions

417-A Ingalls St., Santa Cruz, CA 95060  
(800) 345-4220 In CA: (408) 458-9938

### REFILL LASER PRINTER & COPIER CARTRIDGES

Don't throw away that used laser printer or copier cartridge. Refill it and save over 75%. It's easy. For use with Canon EP & EPS cartridges, HP LaserJet & LaserJet II, Apple Laserwriter & Laserwriter II, Canon LPB, FAX, and many others. Also kits for Canon Copiers. We have colors for laser printers. Dealers welcome. VISA/MC

COMPLETE REFILL KIT \$29.95

Includes toner, left pad, and instructions.

VIDEO TAPE PROGRAM \$45.00

Shows disassembly, cleaning, and re-manufacture.

#### MORACK INC.

9132 Windsor Dr., Palos Hills, IL 60465 (800) 837-9896  
For order or information (708) 598-0530 FAX: (708) 598-9203

Inquiry 580.

### PARLOG LANGUAGE SYSTEMS \$300

With MacPARLOG and PC-PARLOG you can run PARLOG on Macintosh (1MB) or MS-DOS (640K). Package includes software, manual and a copy of Tom Conlon's tutorial book *Programming in PARLOG*. Superb tools for AI, experiments in 5th Generation computing, multiprocessor prototyping. Discounts for Colleges.

#### Parallel Logic Programming Ltd.

PO Box 49, Twickenham TW2 5PH, UK

+44 454-201652

Inquiry 584.

### BAR CODE SOFTWARE SOLUTIONS

ISD has software solutions that allow you to use bar codes for most anything. Like identifying products. Labeling packages. Or even managing assets and paperwork. You'll be able to speed and simplify data collection. Track products dock-to-stock. Streamline inventory control. And more.

#### Integrated Software Design, Inc.

171 Forbes Blvd., Mansfield, MA 02048  
TEL: (508) 339-4928 FAX: (508) 339-2257

©1989 Integrated Software Design, Inc.

Inquiry 585.



# THE BUYER'S MART

## BAR CODE

### BAR CODE SOLUTIONS

Bar coding is so easy with our complete line of readers. Our PC-Wand readers emulate your PC keyboard or ASCII terminal, and are carried around taking inventory, entering road sales and clocking time. Our bar code label printing software packages work with DOS and most matrix or laser printers. We also sell pre-printed labels. Our hardware can work with nearly every computer in the world.

**International Technologies & Systems Corp.**  
635-C North Berry St., Brea, CA 92621  
(714) 990-1880 FAX: (714) 990-2503 TLX 6502824734 MCI

Inquiry 586.

### WHEN EASE-OF-USE COUNTS

Reading bar codes should be as easy as a "quick flick of the wrist." But many bar code readers require you to flick and flick and Flick and FLICK until the bar code label is finally read. PERCON designed bar code readers that *really* are as easy as a "quick flick of the wrist."

## PERCON

2190 W. 11th Ave., Eugene, OR 97402

Phone: (800) 873-7266 FAX: (503) 344-1399

### PERCON: THE BAR CODE SPECIALISTS

If you have questions about bar code technology, it's nice to know an experienced, friendly bar code specialist is only a phone call away. Want to know where to start or where to find hard-to-find bar code accessories? Call PERCON for answers.

## PERCON

2190 W. 11th Ave., Eugene, OR 97402

Phone: (800) 873-7266 FAX: (503) 344-1399

### 5-YR. WARRANTY AT PERCON

PERCON decoders are now covered by a five-year limited warranty. That means you won't spend one cent replacing your PERCON bar code decoder for five full years. That's reliability you can count on!

## PERCON

2190 W. 11th Ave., Eugene, OR 97402

Phone: (800) 873-7266 FAX: (503) 344-1399

### PC BAR CODE SPECIALISTS

Bar code readers designed for fast, reliable, cost effective data entry. Looks just like keyboard, data Choose from stainless steel wand or laser interface. Also, powerful Bar Code and Text printing software. Great warranty. Dealer inquiries welcome.

## Seagull Scientific Systems

15127 N.E. 24th, Suite 333, Redmond, WA 98052  
206-451-8966

### BAR CODE READERS

Among the best and most widely used bar code decoders. Reads all major codes (39, 1 2/5, S 2/5, UPC/EAN/JAN, CODABAR, MSI). Connects between keyboard and system. IBM, PS/2, MAC, DEC-VT compatible. OS & software independent. Same day ship. 2 Year Warranty (pen incl).

Large Reseller Discounts.

## Solutions Engineering

4705 Langdrum Lane, Bethesda, MD 20815  
(800) 635-6533 (301) 652-2738

Inquiry 587.

## BAR CODE

### DATA INPUT DEVICES

Bar Code, Magnetic Stripe Readers & SmartCard Encoder/Reader for microcomputers & terminals, including IBM PS/2 & others, DEC, Macintosh, AT&T, CT, Wyse, Wang. All readers connect on the keyboard cable & are transparent to all software. UPC & 39 print programs, magnetic encoders, & portable readers are also available.

## TPS Electronics

4047 Transport, Palo Alto, CA 94303  
415-856-6833 Telex 371-9097 TPS PLA  
FAX: 415-856-3843

Inquiry 588.

### VARIANT MICROSYSTEMS BAR CODE READERS DELIVER

#### WAND/LASER/MAGNETIC CARD CONNECTIVITY

- Keyboard wedges (Internal/External) for IBM PC/XT/AT, PS/2 and portables.
- RS232 wedges for WYSE, Link, Kimtron terminals
- Bar code and label printing software
- Full two-year warranty
- 30-Day Money-Back Guarantee
- Extensive VAR/Dealer Discounts

3140 De La Cruz Blvd., Suite 200/Santa Clara, CA 95054/(408) 980-1880  
FAX: (415) 823-1372

Inquiry 589.

## BBS/PUBLIC DOMAIN

### MedCom BBS

Use your modem to call

800/445-4BBS (800/445-4227)

81 lines, 3/12/24, 8N1

Group & private chat. Many games, including the new multi-player, fast-action full-color graphics & sound, "Flash Attack" from Galacticom! Chess/Checkers/Othello. E-Mail, 1000s of d/l, message base, online news & entertainment. Free time & downloads.

6312 E Santa Ana Cyn Rd #361, Anaheim, CA 92807  
Voice (714) 996-9999

## BRILLE

### BRILLE PUBLISHING

Whether you have occasional word-processed memos or full-length textbooks, a Duxbury Translator enables conversion to properly contracted and formatted braille. The choice of professional publishers worldwide since 1975. Duxbury software for MSDOS, Macintosh, Unix and other systems supports: English Braille and Computer Braille (bidirectionally), Textbook Format, French, Spanish, Arabic, and others.

## Duxbury Systems, Inc.

435 King St., P.O. Box 1504, Littleton, MA 01460 USA  
508-486-9766

Inquiry 590.

## CASE

### FILL A TABLE, FORM A PROGRAM

Fill in a state table formed by The COMPEDITOR and it creates finite state source programs in: Ada, Basic, C, Fortran and Pascal. Table driven by programs that develop faster, use less memory & execute quicker. Price: \$300 (Per lang. with Primer) For IBM PC. Sampler \$75 (With manuals & Credit)

AYECO 5025 Nassau Circle, Orlando  
INCORPORATED FL 32808 (407) 295-0930

Inquiry 591.

## CD-ROM

### CD-ROM Drives & Titles

Largest selection for PC & Mac.  
Microsoft Programmers Library & Drive \$995  
Computer Library \$695 • Public Domain S/W \$99.

Drives from \$699. Hundreds of titles from \$29  
MC/VISA/AMEX, Money-back Guarantee.  
Call or write for free 100-page catalog.

Get it all from "The Bureau"

**Bureau of Electronic Publishing**  
121 Norwood Ave., Upper Montclair, NJ 07043  
(201) 746-3031

Inquiry 592.

## CD-ROM

### CD-ROM/WE'LL BEAT ANY PRICE

All IBM/MAC drives/titles. Call for price list, monthly specials, POs, international orders welcome. Special library, school, government pricing. COD, Visa, MC, Amex

## CD-ROM SHOPPER

(201) 866-1666

1168 Elm Terrace  
Rahway, NJ 07065

24-HR AUTO ORDER LINE

Inquiry 593.

Hitachi CD ROM 3600 PC/XT/AT internal kit	\$839
Hitachi CD ROM 1503S PC/XT/AT external kit	\$679
NEC CD ROM PS/2 Internal Kit	\$799
NEC CD ROM Macintosh external kit	\$799
Laser Drive 510 WORM kit (654MB)	\$3,995
REO-650 Magneto-optical kit (650MB)	\$5,795
Clip Art by NEC (IBM & Mac)	\$349
Image Fido by NEC (IBM)	\$349
Spectrum Clip Art by Aids (IBM)	\$299
Mac Guide USA by Kava (Mac)	\$199
PC Guide by Kava	\$299

Free Brochures, Dozens and Dozens of DISCS

## CD ROM, INC.

1120-B 10th St., Golden, CO 80401 303-278-8550  
FAX: 303-279-4322 Compuserve 72007544

Inquiry 594.

### CD-ROM Publishing Services

Complete CD-ROM publishing services including custom software interface. Reasonable rates, fast turnaround. Call for quote.

Titles published: Food/Analyst, Econ/Stats, Consu/Stats, Agri/Stats.

## Hopkins Technology

CD-ROM Publisher  
421 Hazel Lane  
Hopkins, MN 55343-7117  
(612) 931-9376 CIS 74017,614

Inquiry 595.

### CD WORM OULET

Call BBS and FAX 716-854-3076  
Widest Selection for PC's and MAC's

Microsoft Programmer's Library & Drv	960	(STAT PACK & SBC	100
PC SIG & DRV	850	CD-ROM DRV from	500.
BKSHLF.WDRV	799.		

For XT, AT's, 386's 1yr. Parts & Labor Free

RBBS in a Box—Be a Sysop in 15 min.  
Portables available with CD-ROM DRVS  
MC/Visa/Amex/COD While Supplies Last!

## Jason Enterprises

218 Pine St., Buffalo, NY 14204, CALL 716-852-6711

Inquiry 596.

### CD-ROM Developer's Lab

Multimedia production resource for Mac & PC developers & managers. Proven design, management, data prep, programming, premastering, and manufacturing techniques & specs from 18 leading companies. Demos of off-the-shelf tools for imaging, audio, animation (Mac). Real applications using Media-Mixer source tools. CD-ROM XA. PC or Mac \$795; Transportable \$845. Visa or MasterCard.

## Software Mart, Inc.

4131 Spicewood Springs Road I-3, Austin, TX 78759  
512-346-7887

Inquiry 597.

## COMPUTER INSURANCE

### INSURES YOUR COMPUTER

SAFEWARE provides full replacement of hardware, media and purchased software. As little as \$39 a year provides comprehensive coverage. Blanket coverage; no list of equipment needed. One call does it all. Call 8 am-10 pm ET. (Sat. 9 to 5)

**TOLL FREE 1-800-848-3469**

(Local 614-262-0559)

**SAFEWARE, The Insurance Agency Inc.**

Inquiry 598.

# THE BUYER'S MART

## COMP. MAINT. CHEMICALS

### Buy Direct

A full line of Computer Maintenance chemicals: Pressurized Duster, CRT Screen Cleaner, Hood & Housing, Anti-Static, Head & disc, Freon T.F. Solvent, Cleaning Diskettes, Wipes, Swabs. All at wholesale prices. Call Data-Chem at:

**1-800-FON-6698**

Inquiry 599.

## COMPUTER SUPPLIES

### COLOR RIBBONS

COLORS: Black, Red, Blue, Green, Brown

	BLACK	COLOR
NEC P2200	\$7.75	\$12.00
Okidata 390/391	7.00	9.00
Panasonic KXP-1124	6.75	7.75
Toshiba P351	5.00	6.00

PRICE & SPEC. SUBJECT TO CHANGE W/O NOTICE. FOR OTHER RIBBONS CALL FOR CATALOG

### RAMCO COMPUTER SUPPLIES

P.O. Box 475, Manteno, IL 60950  
(USA) 800-522-6922 \* (CANADA) 800-621-5444 \* 815-468-8081

Inquiry 600.

## COMPUTERS & PRINTERS

### LAPTOPS \* APPLE \* IBM

COMPAQ SLT	IBM PS2
ZENITH	MACINTOSH
SHARP	LASERWRITER
TOSHIBA	IMAGEWRITER
NEC	HP LASERJET
PLOTTERS	EPSON
HARD DRIVES	FAX MACHINES

Call UCC 213-921-8900 For Prices  
13738 E. Artesia Blvd. 150, Cerritos, CA 90701  
Fax 213-802-0831 International Orders Welcome

Inquiry 601.

## CROSS ASSEMBLERS

### CROSS ASSEMBLERS

Universal Linker, Librarian

Targets for 36 Microprocessors

Hosts: PC/MS-DOS, micro VAX, VAX 8000

### ENERTEC, INC.

BOX 1312, 811 W. Fifth St.  
Lansdale, PA 19446

Tel: 215-362-0966 Fax: 215-362-2404

Inquiry 602.

### Professional Series

PseudoCode releases its PseudoSam professional Series of cross assemblers. Most popular processors. Macros, Conditional Assembly, and Include Files. Virtually unlimited size. For IBM PCs, MS-DOS 2.0 or greater. With manual for \$50.00. (MI res. 4% tax). Simulators and disassemblers also available. Shipping \$5. Canada \$10. Foreign \$15. Visa/MC.

### KORE Inc.

3510 Plainfield NE, Grand Rapids, MI 49505 616-361-3668  
30-Day satisfaction guaranteed or purchase price refunded.

Inquiry 603.

## CROSS ASSEMBLERS

### MACINTOSH CROSS ASSEMBLERS

$\mu$ ASM\*—available for most 8-bit MPUs. Fast. Full Mac interface. S or Hex output downloads to most EPROM programmers. Features macros, conditional ass'y, local and auto labels, symbol table cross-reference, module sectioning. Editor included. \$129.95 each plus S/H. MC/VAE. Technical bulletin available.

### MICRO DIALECTS, INC., Dept B

P.O. Box 30014, Cincinnati, OH 45230  
(513) 271-9100

Inquiry 605.

### CROSS ASSEMBLERS

Macros, PC Compatible, Relocatable, Conditionals, Fast, Reliable . . . . . from \$150  
also: Disassemblers  
EPROM Programmer Board

### MICROCOMPUTER TOOLS CO.

Phone (800) 443-0779

In CA (415) 825-4200

912 Hastings Dr., Concord, CA 94518

Inquiry 606.

### 6800-Family Development Software

Our C Compilers for the 6800, 6801, 6809, & 68HC11 feature a complete implementation (excluding bit fields) of C as described by K&R and yield 30-70% less code than other compilers. Our Assemblers feature macros and conditional assembly. Linker & Terminal Emulator included.

### Wintek Corporation

1801 South St., Lafayette, IN 47904

(800) 742-6809 or (317) 742-8428

Inquiry 607.

## CROSS COMPILERS

### 68000 C Compiler

Available under MS-DOS, UNIX and VMS  
CrossCode C generates ROMable code for all members of the Motorola 68000 family. It comes with an optimizing compiler, Motorola-compatible assembler, linker, librarian, symbol lister, and universal downloader. For more info, see our display ad on page 83.

Call today: 1-800-448-7733

### Software Development Systems, Inc.

4248 Belle Aire Lane, Downers Grove, Illinois 60515 USA  
Outside USA dial 1-312-971-8170. FAX: 1-312-971-8513

Inquiry 608.

## DATA CONVERSION

### MEDIA CONVERSION/DATA TRANSLATION

More than just a straight dump or ASCII transfer!  
Word Processing, DBMS, and Spreadsheet data on Disk or Tapes transferred directly into applications running on Mainframes, Minis, Micros, Dedicated Word Processors, Typesetters, and Electronic Publishing systems.

IBM PS/2 & Macintosh supported  
#1 in the translation industry!

### CompuData Translators, Inc.

3325 Wilshire Blvd., Suite 1202, Los Angeles, CA 90010

(213) 387-4477 1-800-825-8251

Inquiry 609.

## DATA ENTRY

REPLACE DEDICATED KEY-TO-DISK SYSTEMS with PC-based ENTRYPOINT 90. Table lookup, range checking, text fields, automatic export options, LAN module. Menu-driven developer system with powerful procedural language, excellent tech support, award-winning manuals. FREE demo disks and application catalogs.

### DATALEX

100 Pine St. #1600, San Francisco 94111  
(800) 962-8888 (415) 362-4466

Inquiry 609.

## DATA/DISK CONVERSION

### 10x FASTER EASIER TO USE IBM PC TO HP FILE COPY

Update version uses windows: Call for free demo! IBM PC to HP File Copy allows IBM PCs, PS/2, compatibles to interchange files with Hewlett-Packard Series 70, 80, 200, 300, 1000, 9000s.

### Oswego Software

Box 310  
Oswego, IL 60543

312/554-3567

FAX 312/554-3573

Telex 858-757

Inquiry 610.

## RESULTS

### You Can Depend On!

- Data Conversion
- Disk Duplication
- Optical Scanning

### Computer Conversions

9580 Black Mountain Rd., Suite J, San Diego, CA 92126  
619-693-1697

Inquiry 611.

## DISK CONVERSIONS

Media transfer to or from: IBM, Xerox, DEC, Wang, Lanier, CPT, Micom, NBI, CT, Exxon, WRDPLEX also WP, WS, MS/WRD, DW4, MM, Samna, DEC DX, MAS 11, Xerox-Writer, ASCII.

### FREE TEST CONVERSION CONVERSION SPECIALISTS

531 Main St., Ste. 835, El Segundo, CA 90245  
(213) 545-6551 (213) 322-6319

Inquiry 612.

## DISK INTERCHANGE SERVICE COMPANY

DISC specializes in transferring files between incompatible disk formats, and between disk and 9-track tape.

- Dedicated Word Processors
- Mini, Micro & Mainframe Computers
- 9-Track Tape (800, 1600 and 6250 BPI)
- MSDOS, CP/M, UNIX, DOS, PRODOS, TSX+, RT-11

2 Park Drive • Westford, MA 01886

(508) 692-0050

Inquiry 613.

## BUY YOUR OWN CONVERSION SYSTEM!

With nearly a decade of experience in data conversion, you can work with the industry leader in 9-track tape, cartridge tape and diskette conversion systems. Enjoy the convenience of your own conversion system. Call today to discuss your application!

### Flagstaff Engineering

1120 Kalbab Lane, Flagstaff, AZ 86001  
(602) 779-3341

MasterCard - Visa - American Express Accepted

Inquiry 614.

## THE #1 CHOICE

### In disk & tape conversion

for many leading corporations, government agencies, law firms, and companies in every industry—world-wide.

Free test • Satisfaction guaranteed

### Graphics Unlimited Inc.

3000 Second St. North, Minneapolis, MN 55411

(612) 588-7571 or (612) 520-2345

FAX: (612) 588-8783

Inquiry 615.



# THE BUYER'S MART

## DATA/DISK CONVERSION

### CONVERSION SERVICES

Convert any 9-track magnetic tape to or from over 2000 formats including 3 1/2", 5 1/4", 8" disk formats & word processors. Disk-to-disk conversions also available. Call for more info. Introducing OCR Scanning Services.

**Pivar Computing Services, Inc.**  
165 Arlington Hgts. Rd., Dept. #8  
Buffalo Grove, IL 60089 (800) HI-Pivar

## DISK DUPLICATION

### SOFTWARE PRODUCTION

- Disk duplication
- All formats
- EVERLOCK copy protection
- Label/sleeve printing
- Full packaging services
- Warehousing
- Drop shipping
- Fulfillment
- 48-hour delivery
- Consultation & guidance

**Star-Byte, Inc.**  
2880 Bergey Rd., Hatfield, PA 19440  
215-997-2470 800-243-1515

Inquiry 621.

## FAX SWITCH

### EXPAND YOUR FAX LINE!

Include VOICE on the SAME phone line as your Fax (machine or card); and ALSO either your MODEM or your PHONE ANSWERING MACHINE! The BIT PHAXSWITCH™ automatically, transparently, and silently correctly connects your phone calls to the intended device!

1-800-443-0791 FAX: 1-915-772-4733  
Chalder, Inc. 1033 Humble Place Unit 208, El Paso TX 79915

Inquiry 627.

## DATABASE MGMT. SYSTEMS

### dBASE file access from C

Code Base 4 is a library of C routines which gives complete dBASE or Clipper functionality and file compatibility. Use DOS, Unix, OS/2 or MS Windows.

\$295 with Source! FREE DEMO

**Sequiter Software Inc.**  
Call (403) 439-8171 Fax (403) 433-7460

Inquiry 616.

## DUPLICATION SERVICES

### SOFTWARE DUPLICATION

- One-Stop Shopping
- Custom Packaging
- Copy Protection
- Technical Support
- Drop Shipping
- Fast Turnaround
- Competitive Pricing

**SATISFACTION GUARANTEED**  
800-222-0490 NJ 201-462-7628

**MEGAsoft**  
P.O. Box 710, Freehold, NJ 07728

Inquiry 622.

## FLOW CHARTS

### Flowchart/State Diagram for Engineers

Draw flowcharts or state diagrams with this MacDraw-like program on your IBM PC/AT/PS2 or compatible. All flowchart symbols are prebuilt and can be stretched to any size. Add your own symbols to the symbol library. Ellipses, curves with ending arrowheads, cut/paste, enlarge/reduce, drag, zoom out, undo, etc. Output to most printers, plotters, and desktop publishing software. Complete with Logitech Mouse for \$89. See our larger ad every other month.

**Daytron Electronics Inc.**  
610 S. Sherman #104, Richardson, TX 75081 214-669-2137

Inquiry 628.

## DEMOS/TUTORIALS

### INSTANT REPLAY III

Build Demos, Tutorials, Prototypes, Presentations, Music, Timed Keyboard Macros, and Menu Systems. Includes Screen Maker, Keystroke/Time Editor, Program Memorizer, and Animator. Rec'd Great Reviews! Simply the BEST. Not copy protected. No royalties. 60-day satisfaction money-back guar. IBM and Compat. \$149.95 U.S.Chk/Cr. Crd. Demo Diskette \$5.00.

**NOSTRADAMUS, INC.**  
P.O. Box 9252  
Salt Lake City, Utah 84109 (801) 272-0671

Inquiry 617.

## EDUCATION

### B.Sc. & M.S. in COMPUTER SCIENCE

The American Institute for Computer Sciences offers an in-depth correspondence program to earn your Bachelor of Science and Master of Science degrees in Computer Science at home. BSc. subjects covered are: MS/DOS, BASIC, PASCAL, C, Data File Processing, Data Structures & Operating systems. MS program includes subjects in Software Engineering and Artificial Intelligence.

**AMERICAN INST. for COMPUTER SCIENCES**  
1704-BY 11th Ave. So., Birmingham, AL 35205  
TOLL FREE 1-800-872-AICS

Inquiry 623.

### Flow Charting II+

For IBM and compatibles. It will amaze you with its speed, power and simplicity. 26 standard shapes with over 120 sizes — 10 text fonts — 4 line styles. Place text, lines and shapes anywhere on your chart. For only \$229 you'll never draw another chart by hand.

**Patton & Patton**  
81 Great Oaks Blvd., San Jose, CA 95119  
1-800-525-0082 Ext. 42 (Outside CA)  
408-629-5376 Ext. 42 (CA/Int'l)  
See our ad on page 126.

Inquiry 629.

## DISASSEMBLERS

### 80x86 .EXE/.COM to .ASM

- Accurately reconstruct, study & modify [64K+] programs with a minimum of input or editing of output.
- Assembly language output is MASM 5.x-compatible.
- Exhaustive flow-trace distinguishes code from data.
- Best formats for each. Commented BIOS calls/DOS functions. SEGMENT/PROC/other vital pseudo-ops.

**PC-DISnDATA** (5 1/4" disk & manual) \$165  
**PRO/AM SOFTWARE**  
220 Cardigan Road, Centerville, OH 45459  
(513) 435-4480 (9 A.M.—5 P.M. EST M-F)

Inquiry 618.

## EDUCATIONAL TRAINERS

### 16 and 32 BIT MICROS

**EDUCATIONAL TRAINING SYSTEMS:** Each one in a notebook with power supply—for the Motorola 68000/68020/68881, TMS32010 DSP, Intel 8086/8087, A/D-D/A Converters, cross assemblers, serial interfaces with software, complete systems, documentation, schematic, operating system, cables. Starting Prices — \$230.00

**Phone URDA, Inc.**  
1-800-338-0517 or 412-683-8732

Inquiry 624.

### WINDOWS FLOWCHARTER \$79

RFFlow is a professional drawing tool for flowcharts & org charts (requires Microsoft® Windows). 75 shapes automatically adjust in size. Move, copy, delete groups of objects. 7 levels of zoom. Move flowcharts to other applications via the Clipboard. Supports Windows printers, plotters, and cartridge or soft fonts. Call for free trial disk.

**RFF ELECTRONICS**  
1053 Banyan Court, Loveland, CO 80538  
(303) 663-5767

Inquiry 630.

## ENTERTAINMENT

### NEMESIS™ Go Master®

Go, a game of strategic elegance, has been a way of life in the Orient for over four thousand years. Many consider Go to be the secret of the Japanese businessman's success. "While chess is a game of war, Go is a game of market share" (President of Nikko Hotels). "If you are interested in Go, buy this program."

Game of the Month J. Pournelle BYTE 7/87  
**Toyogo, Inc.** The Leader In Computer Go.  
78 Bedford St. #34-Y, Lexington, MA 02173, (617) 861-0488

Inquiry 625.

### STRUCTURED FLOW CHART

NSChart creates Nassi-Shneiderman (structured) flowcharts from a simple PDL. Key words define structures & text strings appear in the chart. Easy to create, even easier to revise! Automatic chart sizing, text centering. Translators from many languages available. For Mac and IBM PC.

**SILTRONIX, INC.**  
P.O. Box 82544, San Diego, CA 92138  
1-800-637-4888

Inquiry 631.

## DISK DRIVES

### PS/2 DRIVES FOR PCs ATs

CompatKit/PC ..... \$279  
CompatKit/AT ..... \$219

Built-in floppy controllers—no problem. Supports multiple drives and formats. Lets your computer use IBM PS/2 1.4M diskettes plus more! Call for further information or to place an order. VISA/MC/COD/CHECK.

**Micro Solutions Computer Products**  
132 W. Lincoln Hwy., DeKalb, IL 60115 815/756-3411  
See our ad on page 406.

Inquiry 620.

## EUROPEAN CONSULTANCY

### EUROPE 1992

A high tech market larger than USA + Japan—What plans have you made to be there? Our London Consultants can offer a unique service to get your high-tech product into this market. Initial product evaluation thru to factory/office. We provide a complete service designed to meet the needs of U.S. computer hardware/software companies. Send your details to:

**AXTON USA**  
Suite 1600, 175 South Main Street, Salt Lake City, Utah 84111  
Tel: (801) 322-5445 Fax: (801) 328-3095

ATTN: J. Samsel

Inquiry 626.

## FOREIGN LANGUAGES

### LEARN SPANISH! LEARN JAPANESE!

A new, easy way to learn a foreign language. Complete interactive learning environment with pop-up dictionary, hypertext language reference, and full mouse support. Conversational emphasis. IBM compatible. Each course includes disks, manual, and pronunciation tape. Call for Demo disk or free brochure!

**Traveler's Guild**  
315 W. Washington St. Dept B9, Marquette, MI 49855  
24-hour order desk: (906) 228-5030

Inquiry 632.

# THE BUYER'S MART

## FORTRAN TOOLS

### TAME YOUR FORTRAN CODE! Programming tools for MS-DOS

**FORWARN**—an invaluable aid to Fortran program development! Finds common programming errors such as mismatched parameter lists and common blocks, and uninitialized variables. Prints detailed cross-references and call-tree diagrams. \$329

**FORTTRAN DEVELOPMENT TOOLS**—includes Pretty (indents, renumbers, changes GOTOs to IF-THEN-ELSEs, etc.) and 6 more tools. \$129.

**Qulbus Enterprises, Inc.**  
106 N. Draper Avenue, Champaign, IL 61821  
(217) 359-8876

Inquiry 633.

## GRAPHICS

### RAINDROP™

FAST, compact PrtScr Utility for end users AND developers. Hardcopy as fast as 10 secs. Average binary size - 6 kbyte. 12 video graphic standards. Scale, rotate, colorize and more. "CALL" from user-written programs. Complete 9- and 24-pin dot-matrix, inkjet, and laserjet library \$39.95+\$3 s/h.

### RAINBOW TECHNOLOGIES

8106 St. David Ct., Springfield, VA 22153  
(703) 440-0064

Inquiry 634.

## HARD DRIVE REPAIR

### HARD DRIVE REPAIR

WE WILL REPAIR YOUR HARD DRIVE AT A FRACTION OF THE COST OF REPLACING IT. FAST TURNAROUND!!! CALL FOR DETAILS.

### H & W micro, Inc.

528-C FOREST PARKWAY  
FOREST PARK, GA 30050  
(404) 366-1600

Inquiry 635.

### DISK DRIVE REPAIR DATA RECOVERY

SALES of new, remanufactured and removable disk drives

### FULL TECHNICAL SUPPORT ROTATING MEMORY SERVICE

1506 Dell Avenue, Campbell, CA 95008  
(408) 370-3113

We buy used drives good or bad

Inquiry 636.

## HARDWARE

### CHIP CHECKER

- 74/54 TTL + CMOS
- 8000 Nat. + Signetics
- 144000 CMOS
- 9000 TTL
- 14-24 Pin Chips
- .3" + .6" IC widths

Tests/Identifies over 650 digital chips with ANY type of output in seconds. Also tests popular RAM chips. IBM-compatible version \$259. C128 + C64 version \$159.

### DUNE SYSTEMS

2603 Willa Dr., St. Joseph, MI 49085  
(616) 983-2352

Inquiry 637.

### Equipment Monitor And Control

Ideal cost-effective computer can be used to perform data acquisition and control using a dumb terminal or create data files on a PC. Features 16 chan. A/D, 64 digital I/O lines, 4 timer/counters and 4 serial ports. Options 4 chan. D/A, clock, CMOS, Forth OS, and networking.

E-PAC 1000 + \$249.00 E-PAC 2000 + \$449.00

### EMAC INC.

P.O. Box 2042, Carbondale, IL 62901  
Phone: 618-529-4525 Fax: 618-457-0110

Inquiry 638.

## HARDWARE

### FREE CATALOG

Protect your computer power from black-outs, brown-outs, audio/video hash and surges! Complete line of low-cost Emergency Power Supply units, Line Conditioners and Surge Suppressors prevent damage and loss of valuable data. Prevent errors, malfunctions and false printouts! Send for money-saving catalog today.

### INDUS-TOOL

730 W. Lake St., Chicago, IL 60606  
Phone 312-648-2191

Inquiry 639.

### LATEST AWARD BIOS! PC/XT ☆ 286 ☆ 386

Support for:

- Enhanced Keyboards
- EGA & VGA Graphics
- 3.5 inch Floppies
- Custom Drive Tables

Authorized AWARD Distributor

1-800-423-3400 or (412) 782-0384

### KOMPUTERWERK, INC.

851 Parkview Blvd., Pittsburgh, PA 15215

Inquiry 640.

### Macintosh® Parts & Repairs

Programs for the corporate, government, dealer and educational buyer. Call for list.

### Save up to 55% on Mac II CPU

800-274-5343 / 617-891-6851

### Pre-Owned Electronics, Inc.

30 Clematis Ave. • Waltham, MA 02154  
Macintosh is a registered trademark of Apple Computer, Inc.

Inquiry 641.

### NEED AN EXTRA SLOT FOR YOUR 8-BIT PC?

Add: LAN MODEM, Accelerator Card or Fixed Disk and/or 3 1/2" Diskette

RMT's 2001-F2H2 Single Card Controller:

- Uses only one expansion unit
- Supports two 3 1/2" and/or 5 1/4" diskette drives
- Supports two fixed disk drives (up to 140 MB each)
- On-board BIOS, automatically handles any comb. of drives

RMT 2001-F2H2 . . . . . THE SPACE ODYSSEY

RMT SYSTEMS, INC. (714) 863-1092

Inquiry 642.

## HARDWARE/ADD-ONS

### The World's First Highest Density Module!

- \* 18 Meg on the smallest surface
- \* Organization: 2x1024Kx8 bit
- \* Package: OIL 64 pin Jedec-Standard
- \* Technology: CMOS, hybrid, 18xHMS1100JP-10
- \* Compatibility: With two Hitachi HB56A 19-10
- \* Suitable for extension of basic memory
- \* Engineers take notice. This product can be manufactured on large scale

For more information please write or call:

### ThermoTrol Corp.

1888 Century Park East, Suite 1800, L.A., CA 90067  
Tel: 213-284-3242

Inquiry 643.

## HARDWARE/COPROCESSOR

### DIGITAL SIGNAL PROCESSOR

DSP products for the IBM PC/XT/AT based on the TI TMS32010 and TMS320C25 up to 12 MIPS operation. Designed for applications in communications, instrumentation, speech, and numeric processing. Offered with 12 bit 110 KHz A/D and D/A and continuous-to-disk data acquisition & playback option. From \$650.

### DALANCO SPRY

89 Westland Ave., Rochester, NY 14618  
(716) 473-3610

Inquiry 644.

## HARDWARE/COPROCESSOR

### EMBEDDED SYSTEMS CONTROLLERS

**SC/FOX:** PCS (Parallel Coprocessor System) and PCS32 are PC/XT/AT plug-in boards, 16 and 32 bit, 15 MIPS average, 50 MIPS burst. PCS uses the Harris RTX 2000\* 16-bit RISC CPU with multiplier, 14 interrupts, 3 timer/counters, 8-channel I/O bus. PCS32 uses the new SC32 RISC 32-bit cpu. Prices start at \$2,295.

**SC/FOX SBC (Single Board Computer)** is an 18 MIPS average, 60 MIPS burst, eurocard size stand-alone computer for \$1,495.

**SC/FOX SCSI I/O** is a plug-in PCS or SBC daughter board with software for \$995. Forth development software included. Ideal for embedded real-time control, signal processing, and data acquisition.

**SILICON COMPOSERS, INC.** (415) 322-8763  
208 California Ave., Palo Alto, CA 94306

Inquiry 645.

## IMAGE PROCESSING

### ZIP Image Processing

ZIP brings affordable, sophisticated image processing to the PC. Capture video from camera/VCR. HERT 512x512, serial imageWise (for PC/laptop/PS2) frame grabbers.

Call (314) 962-7833 to order (VISA/MC). ZIP starts at \$79, frame grabbers, \$398. 30-day money-back guarantee.

### Hogware Company

470 Bellevue, St. Louis, MO 63119  
(314) 962-7833

Inquiry 646.

## INVENTORY MANAGEMENT

### STOCK-MASTER 4.0

Commercial grade inventory management software at micro prices.

- Supports all 12 transaction types
- Trend Analysis
- Activity History Analysis
- Purchase Order Writing
- Activity History Analysis
- Bill of Materials
- Purchase Order Writing
- Order Entry
- Material Requirements
- On Line Inquiry
- Multiple Locations
- Purchase Order Tracking
- Open Order Reporting
- Serial/Lot # Tracking

**Applied Micro Business Systems, Inc.**  
177-F Riverside Ave., Newport Beach, CA 92663 714-759-0582

Inquiry 647.

### dFELLER Inventory

Business inventory programs written in modifiable dBASE source code.

dFELLER Inventory \$150.00

Requires dBASE II or III, PC-DOS/CPM

dFELLER Plus \$200.00

with History and Purchase Orders

Requires dBASE III or dBASE III Plus (For Stockrooms)

### Feller Associates

550 CR PPA, Route 3, Ishpeming, MI 49849

(906) 486-6024

Inquiry 648.

## LANS

### The \$25 Network

Try the 1st truly low-cost LAN

• Connect 2 or 3 PCs, XTs, ATs

• Uses serial ports and 5-wire cable

• Runs at 115K baud

• Runs in background, totally transparent

• Share any device, any file, any time

• Needs only 14K of ram

Skeptical? We make believers!

### Information Modes

P.O. Drawer F, Denton, TX 76202

817-387-3339

Inquiry 649.

## LAPTOP COMPUTERS

### Laptop Savings

Laptops: Toshiba • Zenith • Nec • Sharp  
• Epson • Mitsubishi • Compaq

Also Laptop Accessories: Modems, Fax Modems, External Drives, Portable Printers, Memory, Key Pads, Hard Drives, Batteries, and Auto Adapters.

### Computer Options Unlimited

12 Maiden Lane, Bound Brook, NJ 08805

Phone: 201-469-7678 (Fax: 201-469-7544)

Hours: 9am/10pm 7 days Worldwide sales

Inquiry 650.



# THE BUYER'S MART

## LAPTOP PERIPHERALS

### LAPTOP BACKLIGHTS

Factory Installed • 90-Day Warranty  
Toshiba, Amstrad, Sanyo, DG,  
Kaypro, IBM, HP, etc. **\$295**

The Portable Peripherals People

**Axonix Corporation**  
(801) 466-9797

Inquiry 651.

TOSHIBA PERIPHERALS	T1000	T1200	T3100	T3100+
	T1600	10/20	T5100	
Battery AdaptaPAK (12V)	PX25T	PX3T	P80	P80+
Vehicle Battery Adapter	X2.5		A80	A80+
Built-in 2400bps Modem		M24B1		
Internal 2400bps Modem	M24C	M24EC & M24ES		
Single COMMS Port Card	S232T	S232E		
Dual COMMS Port Card		D232E		
SCSI Interface Card		SCSIE		

**PRODUCT R&D Corporation**  
1194 Pacific St., Suite 201, San Luis Obispo, CA 93401  
(805) 546-9713 or (800) 234-5584

Inquiry 652.

## MAC PROGRAMMING TOOLS

### MAC DEVELOPMENT TOOLS

Professional Programmers Extender: Standard Mac interface, lists, printing, graphics, tiling. Extender GraphPac: Quality color graphs. Line, bar, semi-log, customizable symbols.

**INVENTION Software**  
(313) 996-8108

Inquiry 653.

## MEMORY BOARDS

### MEMORY EXPANSION

Intel Above Boards w/LIM 4.0

8 MHz PC/ATs  
IBM, Compaq, Zenith etc.  
1MB \$299.00  
2MB \$399.00  
10 + MHz ATs  
1MB \$499.00  
Prices subject to change

**COUNTERTRADE** (303) 530-5433

Inquiry 654.

## MEMORY CHIPS

### MEMORY CHIPS

41256-15-12-10	Call	51000 (1 Meg)	Call
4164-15	Call	51256 for Compaq 386	Call
4164-12	Call	8087-3-2	Call
41128 Piggy Back for AT	Call	80287-6-8-10	Call
41464-12 (84Kx4)	Call	80387	Call
414256 (256Kx4)	Call	NEC-V-20-8	Call
2764,27128,27256,27512	Call	Mouse	Call

Prices subject to change

**ESSKAY** 718-353-3353

Inquiry 655.

FREE INFORMATION  
DRAM-SIMMS-MATH CO-PROCESSORS

TOLL FREE 24 HRS. 7 DAYS A WEEK  
1-800-338-1531

DEDICATED TOLL FREE FACSIMILE LINE  
24 HRS.—7 DAYS A WEEK  
1-800-242-5751

DIRECT LINE MON-FRI 9-6 CST  
1-402-691-8248  
Best Prices in U.S.A.

**McDonald and Associates**  
WHOLESALE DISTRIBUTOR THE CHOICE OF INDUSTRY PROFESSIONALS

Inquiry 656.

## MEMORY PRODUCTS

### LOW LOW PRICES

256K DRAM 256x8 SIM/SIP  
1 Meg DRAM 1 Megx9 SIM/SIP  
256x9 SIM/SIP 1 Megx8 SIM/SIP

All Speeds  
INTEL  
8087 - 80287 - 80387  
All MHz

**R & R Electronics**  
1-800-736-3644

Inquiry 657.

## MONITOR INTERFACE

### COMPUTER VIDEO GENERATOR

Test EGA, VGA, Multisync & Data Projectors with handheld monitor tester. From 15.7 KHz to 64.0 KHz, battery powered, 4 patterns, all plug-in with no adapter cables.

**NETWORK TECHNOLOGIES INC.**  
800-RGB-TECH In OH: 216-543-1646  
UK: 0244-880478 Paris: 01331-476-32789  
See our Ad on page 462.

Inquiry 658.

## NETWORKING

### NETWORK BUSINESS SYSTEMS

Keycard Eliminator ..... \$99.  
D C B Eliminator ..... \$99.  
ELS Utilities ..... \$59.  
Netcrack (lose password?) ..... \$99.  
Getdisk (get BIOS drives) ..... \$59.  
BIOS Tools (patch drive ibis) ..... \$99.

**NETWORK BUSINESS SYSTEMS**  
1215 Woodhollow Drive, Suite 1104, Houston, TX 77057  
(713) 783-4457

Inquiry 659.

So Far Your Computers Have Been Talking to Each Other NOW Your Staff Can as Well

### CHAT — ACCESS

A Complete Chatting and Messaging Solution for 3Com, Novell, and Other NetBios Networks. CHAT-ACCESS is the ultimate in user friendly software, enabling you to send messages, receive them and engage other logged-in users in full scale conversation. Using only 1 Kbyte of your workstation RAM (for TSR program), CHAT-ACCESS provides a list of logged in users and sends one or all of them a brief message. It also enables you to "CHAT" with another workstation through interactive windows that simultaneously display both sides of the conversation. CHAT-ACCESS operates on 3Com's 3PLUS, 3+OPEN (MS-DOS workstation), Novell NetWare and all other PC LANs that support NetBios.

**Shany Computers Ltd.**  
Rechter Building, 4 Smitansky St., Natanya, Israel 42304  
Tel: (972) (53) 333931 Fax: (972) (53) 342418

Inquiry 660.

SHANY COMPUTERS, SOFTWARE THAT MAKES YOUR NET... WORK

### CO/FILE+

An essential expansion to your MS-DOS and Network operating system so that you can run your existing single user applications with no modifications as multi-user applications running on your network. Using only 1-2 Kbytes of your workstation RAM, CO/FILE+ enables your single user applications to share common files on any MS-DOS 3.10 and higher LANs. Data is protected by automatic file or record level locking and unlocking. Local Area Networks. +Consumes only 2Kbytes of RAM at each workstation for the TSR program. +Supports 3 levels of file sharing + Read Only Sharing. + Write Sharing. + Create Sharing. +Supports automatic record or file level locking and unlocking for Write and Create Sharing.

**Shany Computers Ltd.**  
Rechter Building, 4 Smitansky St., Natanya, Israel 42304  
Tel: (972) (53) 333931 Fax: (972) (53) 342418

Inquiry 661.

## OBJECT ORIENTED TOOLS

### OBJECT-ORIENTED TOOLKIT

TRIPLE your productivity with Complete C"  
The only object-oriented development utility for C with pre-compiled, foundation classes (source code included), integrated make, real-time debugger, Documentation Generator, Application Streamliner. Versions for DOS (\$449), SCO-XENIX (\$495), QNX (\$449) with full technical support. Other ports available upon request.

**Complete Computer Corporation**  
111 West 57th St., Suite 1400, NY, NY 10019  
212-582-2635

Inquiry 662.

## OS/2 UTILITIES

### INTEGRATED OS/2 PACKAGE

- Protected mode • Hot-key activated
- Background/foreground • Multi-sessioned shell
- Lightning fast text/binary forward/backward file lister
- Search directory trees for multiple strings
- Where file finder • Disk usage reports
- EGA/VGA mode support • Configurable colors
- Pop-up clock, calendar • On-line help

\$29.95 Check/MC/VISA

**SASNAK SOFTWARE**  
P.O. Box 56, Dept. B, Lansing, KS 66043  
(913) 651-1728

Inquiry 663.

## PROGRAMMERS TOOLS

### LAN Application Development

NPPC: High performance library routines callable from C and Assembler. High level interface permits rapid development of peer-to-peer, client/server, or multi-server NetBIOS applications under DOS. Synchronous or Asynchronous message control. Compact Code. Source Avail. No Royalty. NPPC \$495

**Applied Software Technology**  
PO Box 397, Dpt. N, Los Gatos, CA 95031  
(800) 678-1111 ext. N1

Inquiry 664.

### HYPERINTERFACE™

Menu Creator™ — A program generator for menu-driven user interface. Excellent for complex menu systems. \$99.95. **Advanced Library** — Extended capability for data entry and advanced text-display control from your programs. \$99.95. FORTRAN, Pascal, C, BASIC supported. **HYPERMATH™** — An application of Menu Creator™ and the Advanced Library. FREE

**Avanpro Corp.**  
P.O. Box 969, Pacific Palisades, CA 90272  
(213) 454-3866

Inquiry 665.

### TLIB™ 4.12 Version Control

"TLIB" is a great system! — PC Tech Journal 3/88. Full-featured configuration mgmt for software professionals. All versions of your code instantly available. Very compact, only changes are stored. Check-in/out locks, revision merge, branching, more. Mainframe deltas for Pansophic, ADR, IBM, Unisys. Only \$99.95 + S&H, or 5-station LAN \$299.95 + S&H. MS-DOS VISA/MC

**BURTON SYSTEMS SOFTWARE**  
PO. Box 4156, Cary, NC 27519 (919) 856-0475

Inquiry 666.

### Have Same 'C' Source for UNIX and DOS

D-ISAM—Unix standard indexed file management library for UNIX DOS and NETWORKS. Manages all locking. UNIX/DOS source \$595 (for both), DOS libs\* \$145.

W—Character windowing with COLORS, Line Graphics, Bells and more. You need not modify DOS code to work WELL on any UNIX terminal. UNIX/DOS source \$295 (for both), DOS libs\* \$95.

### BYTE DESIGNS

P.O. Box F195-76, Btaine, WA 98230  
1-800-663-8547 or (604) 278-5200  
\*DOS libs available for Microsoft or Borland C compilers

Inquiry 667.

### Bsupport for Btrieve

The "Norton Utilities" for Btrieve users.  
Bedit: DISPLAY, UPDATE, COPY, and DELETE.  
EXPORT SDF to dBASE & LOTUS. RECOVER damaged files.  
Edit/insert using Data Dictionary.  
Bug: TSR Btrieve debugger. Displays info in pop-up window.  
Brun: BUTIL replacement with Run-Time and C source.  
Bedit/Bbug: \$120. Brun: \$100. VISA/MC/CODIPO

800-359-2721 FAX: 517/887-2366

**Information Architects, Inc.**  
P.O. Box 4184, East Lansing, MI 48826-4184

Inquiry 668.

# THE BUYER'S MART

## PROGRAMMERS TOOLS

**"The easiest and slickest-looking screen designer I've seen yet."**

That's how one reviewer described the LIAISON Prototyping System. Eliminates all user interface coding & testing. Pull-down Menus. Windows. Data-entry. Help-screens. Mouse and more. \$5 Demo includes complete screen designer. Specify QuickBASIC, MS-C/QuickC, TopSpeed Modula-2, all Turbo languages. VISA/MC

**Liaison Systems, Inc.**

P.O. Box 82720, Kenmore, WA 98028  
(206) 486-4996

Inquiry 669.

## TURBO PLUS \$149.95

Programming tools for use with Turbo Pascal 5.0 & 5.5. Screen Painter, Code Generator, I/O Fields, Dynamic Menus, Programming Unit Libraries, OOP Support, and Sample Programs Included. All routines work in both text and graphics modes! 60-day money-back guarantee! Demo Disk avail. For IBM and compatibles.

**Nostradamus Inc.**

P.O. Box 9252, Salt Lake City, UT 84109-0252  
(801) 272-0671

Inquiry 670.

## Get INSIDE!

The best PC software performance tool is now better than ever with source line timing, caller timing and arbitrary event timing—all with microsecond accuracy and without source modification. The expanded DOS analysis mode identifies I/O bottlenecks. \$125

Call today for a free brochure and the latest list of supported compilers. 30-day guarantee. VISA/MC/COD

**Paradigm Systems**

P.O. Box 152, Milford, MA 01757  
(800) 537-5043 In MA: (508) 478-0499

## FREE BUYER'S GUIDE

Programmer's Connection is an independent dealer representing more than 450 manufacturers with over 1000 software products for IBM personal computers and compatibles. We have serviced the professional programmer since 1984 by offering sound advice and low prices. Call or write today to receive your FREE comprehensive Buyer's Guide.

**Programmer's Connection** US 800-336-1166  
7249 Whipple Ave. NW Canada 800-225-1166  
North Canton, OH 44720 International 216-494-3781

Inquiry 671.

## 'C' DOCUMENTATION TOOLS

- C-CALL \$59 Creates graphic-tree of caller/called structures, and files-vs-procedure table-of-contents
- C-HDR \$59 Creates/inserts/updates headers for each procedure showing caller/called and identifiers
- C-LIST \$39 List, action-diagram, reformat programs
- C-REF \$49 Local/global/parameter cross reference
- SPECIAL \$149 All 4 plus integrated C-DOC version

**SOFTWARE BLACKSMITHS INC.**

6064 St. Ives Way, Mississauga, ONT Canada L5N-4M1  
(416) 858-4466

Inquiry 672.

## PUBLIC DOMAIN

### \$3.00 SOFTWARE FOR IBM PC

Hundreds to choose from, word processors, databases, spreadsheets, games, lotto, communications, business, music, bible, art, education, language and useful utilities for making your computer easier to learn. Most programs have documentation on the disk.

Free 125-page catalog.

**BEST BITS & BYTES**

P.O. Box 8245, Dept-B, Van Nuys, CA 91409  
In CA: (818) 764-9503 800-245-BYTE

Inquiry 673.

## PUBLIC DOMAIN

### \$1 per DISK Sale

20 TOP IBM PC PD/SW DISKS  
(360K) ONLY \$20 +\$3 S&H

QubeCalc, EDRAW, AutoMenu, Math Tutor, PC-DOS Help, Baker's Dozen, Languages, EZ-Form, PC-Style, PackDisk, PC-Stock, KidGames, Best Games, Home Inventory, PC-Outline, Form Letters, ImagePrint, SideWriter, PC-Prompt, Best Utilities.

**BRIGHT FUTURES INCORPORATED**

P.O. Box 1030, East Windsor, CT 06088  
FREE CATALOG (\$1.50 per disk)

Inquiry 674.

## FREE CATALOG PUBLIC DOMAIN/SHAREWARE

• 400 IBM PC & compatibles disks •

• 200 Amiga disks • 125 Atari ST disks

PC disks as low as \$1.25 each, Amiga & ST as low as \$1.60 each! Rent or buy. Free shipping! Call toll free, write or circle reader service for FREE BIG CATALOG with full descriptions. Please specify computer—48-hr. turnaround!

**Computer Solutions**

P.O. Box 354—Dept. B, Mason, Michigan 48854  
1-800-874-9375 (M-F 10-6 EST) 1-517-628-2943

Inquiry 675.

## \$1 DOLLAR DISK SALE!

Add \$3 S&H. SHAREWARE — IBM 5 1/4"

18 DISKS ON SALE: RESUME SHOP, DOS TUTOR, READ-FAST, THESAUR PLUS, PC-STYLE, MENUS for WORD-PERFECT, GRAPHIC CONVERSIONS, EGA DEMO 1, SLIMMER, EDRAW, CHARTS UNLIMITED, SPANISH 1, AUTOMENU, MEDLIN ACCOUNTING, EZ-FORMS, ZIPKEY, PINBALL, MAZE GAMES. (Reg. \$3.00) FREE 64 PAGE CATALOG!

**CWI Information Services**

P.O. BOX 4851, Anaheim, CA 92803  
Phone (714) 879-5423 or 1-800-777-5636

Inquiry 676.

## TOP 10 IBM SOFTWARE - FREE

10 disk set — PC Write, PC Calc+, TheView, DanCad, FileExpress, Mofraff's Revenge, HGCIBM, Novatron, Home Base. Spacewars plus our 1600+ disk catalog

We accept Visa/MC/Amex

**PAY ONLY \$5.00 shipping/handling**

limited introductory offer

**INTERNATIONAL SOFTWARE LIBRARY**

511 Encinitas Blvd. • Ste. 104 • Encinitas, CA 92024

order today toll free 800 669-2669

Inquiry 677.

## FREE IBM SOFTWARE

FREE CATALOG also contains SHAREWARE. 5 1/4 and 3 1/2-inch. All categories. ENGINEERING, CAD, DESKTOP PUBLISHING, LANGUAGES, UTILITIES, BUSINESS, GRAPHICS, SPREAD-SHEETS, WORD PROCESSORS, CHURCH, MEDICAL, HEALTH, EDUCATION, HOME.

**SECTOR SYSTEMS COMPANY, INC.**

Dept. B11, 416 Ocean Avenue, Marblehead, MA 01945  
(617) 639-2625

Inquiry 678.

## FREE CATALOG

\$1 IBM SOFTWARE

For your free 32-page Master Edition catalog featuring the best of IBM Shareware from just \$1 each, call or write today!

**1-800-338-2118**

**SOFSOURCE**

Box 828, East Lansing, MI 48826

Inquiry 679.

## PUBLIC DOMAIN

### FREE SOFTWARE CATALOG

Low as \$1.20/disk

Over 1000 quality IBM software

On 5.25" and 3.5" format

From outside U.S.A., except Canada,

please send US \$2.00 refundable with order.

For fast service, write to

**SOFTSHOPPE**

P.O. BOX 3678, Ann Arbor, MI 48106-3678  
313-761-7638

Inquiry 680.

## REVIEWS

### Find "Hands-on" Reviews in Seconds!

PC Reviews is an easy to use on-line database for NOVICES and PROS who need to locate and read "hands-on" reviews. Byte, Data Based Advisor, PC Today, PC Magazine, Computer Language, Info World and 35 more included. Natural language front-end helps define search terms. A perfect use for a modem. "Wonderful!", say users.

**Compatible Technologies Group, Inc.**

88 Fulton St. #2400, New York, NY 10038

(212) 463-8989 (201) 653-7688 8-N-1 for FREE DEMO

Inquiry 681.

## SECURITY

### EVERLOCK COPY PROTECTION

- ★ Thwarts ALL Bit-copy Software
- ★ Protect any COMEXE w/o Source changes
- ★ Shut down Debug, Tracing & Disassemblers
- ★ Install to Floppy, Hard Disk, or LAN
- ★ Remotely reset Program Install-Count, Expire-Date or #Executes
- ★ No damaged media or I/O plugs

For IBM and clones. \$195 & up. Free info.

**At-Tech Software, Inc.**

305 East Franklin, Richmond, MO 64085

(800) 227-0644 (816) 776-2700  
FAX: (816) 776-8398

Inquiry 682.

### THE ULTIMATE COPY PROTECTION

- Completely Menu Driven
- Defeats all Hardware/Software Copiers
- No Source Code Changes
- Multiple Layering
- No Damaged Media
- Full Hard Disk Support
- Unlimited Metering
- FREE Demo Disk

**STOPCOPY™ \$325\*\* STOPCOPY PLUS™ \$450\*\***

**BBI COMPUTER SYSTEMS® (301) 871-1094**

14106 Heritage Ln., Silver Spring, MD 20906 FAX: (301) 460-7545

Inquiry 683.

### COP's Copylock II

- Protect on standard diskettes
- Cannot be copied by any device incl. Option Board
- Fully hard disk installable
- Normal back-up of protected programs
- LAN-support
- Creates safe demo version of your software

Start Pak \$450

Standard Version \$975, Automatic Version \$1950

**DANCOTEC Computer**

In US: 2635 Sierra Rd., San Jose, CA 95132 408-759-8982 or 1-800-344-2545  
In UK: 2680 Egham, Denmark Phone +45-44400322 Fax: +44407722

Inquiry 684.

### Codesafe Hardware Key

For software developers and MIS managers. Easy to install software protection against unauthorized use of off-the-shelf or custom programs. Places "SHELL" around software without requiring access to source code. Completely transparent to end user (also available for LAN). Key has no battery to wear out. Evaluation Kit \$150 + \$5 SH (applicable toward first order). Also available: a complete line of PC access, data security and encryption products. Call/Write for info. MC/VISA/AMEX.

Gamma Security Products, 710 Wilshire Blvd., Ste. 609, Santa Monica, CA 90401 TEL: 213-394-8622 FAX: 213-395-4214

**Ellashim Inc.**

520W Hwy 436, Suite 1180-30, Altamonte Spgs., FL 32714

TEL: 407/682-1587 FAX: 407/774-8103

Inquiry 685.



# THE BUYER'S MART

## SECURITY

### Programmable PC Security with read/write memory

The *Deadlock II* Security package features: Software to protect your COM and EXE files without the need of the sources, and two executable files for encrypting and decrypting a security device, allowing you to read and write from the memory endlessly, and a programming unit making each *Deadlock II* security device unique.

**Empire Security International Inc.**  
7 Wedgewood Court, Great Neck, N.Y. 11023  
(516) 466-3786

Inquiry 686.

### BIT-LOCK® SECURITY

Piracy SURVIVAL 5 YEARS proves effectiveness of powerful multilayered security. Rapid decryption algorithms. Reliable/small port-transparent security device. PARALLEL or SERIAL port. Complemented by economical KEY-LOCK™ and multifeatured COMPU-LOCK™ including countdown, timeout, data encryption, and multiproduct protection. (Dos/Unix/Mac)

**MICROCOMPUTER APPLICATIONS**  
3167 E. Otero Circle, Littleton, CO 80122  
(303) 922-6410/770-1863

Inquiry 687.

### PC Security "Password"

With All the Computer Security Talk, **PASSWORD** Is the Perfect Security Lock.

Password is a software program providing security for your PC. Password is Easy to understand and Simple to install, requires no reformatting. The boot limit option secures your hard disk. Password provides for up to 100 users with the supervisor controlling access to protected directories. Password is menu-driven with pop-up windows and help screens. The program provides an audit trail of users, and a screen blanking feature.

**PASSWORD \$99.00 US** Visa, M/C, Amex  
**Nasdec International Inc.**  
2704-85 Garry Street, Winnipeg MB Canada R3C 4J5  
PH: (204) 956-2798 FAX: (204) 943-3702

Inquiry 688.

### COPY PROTECTION

The world's leading software manufacturers depend on Softguard copy protection systems. Your FREE DISKETTE introduces you to SuperLock™—invisible copy protection for IBM-PC (and compatibles) and Macintosh.

- Hard disk support
- Customized versions
- No source code changes
- LAN support
- New upgrades available

(408) 773-9680  
**SOFTGUARD SYSTEMS, INC.**  
710 Lakeway, Suite 200, Sunnyvale, CA 94086  
FAX (408) 773-1405

Inquiry 689.

### HANDS OFF THE BOARD™ 1/2 SIZE SECURITY BOARD

Stop floppy boot — Require password to boot PC  
Real-time disk encrypt — prevent boot sector virus  
Prevent DOS FORMAT/FDISK and low-level formats  
Set hard disk READ ONLY or turn ON/OFF  
Turn floppies, printers and COM ports ON/OFF  
IBM XT, AT Bus — DOS V3.0+ — \$149.95 + \$5.00 S/H

**SYSTEMS CONSULTING INC.**  
PO BOX 111209, Pittsburgh, PA 15238  
(412) 963-1624

Inquiry 690.

## SOFTWARE FOR WINDOWS

### TOME™ File Tracking

Keeping track of your files has never been easier. Tome creates and maintains a comprehensive list of disks and files. Use with Floppies or Hard Drives — Sort how you want — easy to use — Online Help — Req. Windows 2+. Ideal for business or personal use!

\$79.95 (orders received by November 15, 1989 just \$59.95; CA residents add 6% sales tax.)

**CC&C Industries**  
6089 Evelyn Avenue, Rohnert Park, CA 94928

Inquiry 691.

## SOFTWARE/ACCOUNTING

### PC TIME CLOCK

AutoTime is an Employee Management System that allows you to turn any PC into an Electronic Time Clock. AutoTime provides Time & Attendance, Job Costing, Payroll Interface, and Labor Distribution reporting. Network compatible. Prices start at \$495. Other Business Products: Network FAX, Absence Call-In, db-EDI.

**Chase Technologies**  
1617 Kingman Ave., San Jose, CA 95128  
(408) 998-2917

Inquiry 692.

### dBASE BUSINESS TOOLS

- GENERAL LEDGER
- ORDER ENTRY
- JOB COSTING
- BILL OF MATLS
- PAYROLL
- PURCH ORD/INVENTORY
- ACCOUNTS RECEIVABLE
- JOB ESTIMATING
- SALES ANALYSIS
- ACCOUNTS PAYABLE

\$99 ea. + S&H

**DATAMAR SYSTEMS** Cred. Card-Check-COD  
4876-B Santa Monica Ave.  
San Diego, CA 92107 (619) 223-3344

Inquiry 693.

## SOFTWARE/BUSINESS

### DATA ENTRY POWERFULLY SIMPLE

Full featured, heads-down data entry with two-pass verification. Designed for the PS/2®, PC, XT, AT or compatibles.

Standalone \$395 LAN version available.

FREE trial.

**Computer Keys** Tel: 206/776-6443  
21929 Makah Rd. Fax: 206/776-7210  
Woodway, WA 98020 USA: 800/356-0203

Inquiry 694.

### BLP88—LP w/BOUNDED VARIABLES

A general-purpose system similar to LP88 for solving linear programs with up to 1000 constraints and 5000 bounded or unbounded variables. Build BLP88 into your own programs with compiled Turbo Pascal units. BLP88 reads/writes LOTUS worksheets. Use 1-2-3/Symphony as a matrix generator or post processor. Many other features including interactive and batch operation, spreadsheet LP display and editing, equation processor, problem/basis storage, primal/dual conversion, file I/O. Simplex restart, report generator, sensitivity analysis. \$149 with manual and 8087 support. \$299 with Turbo Pascal units.

**Eastern Software Products, Inc.**  
P.O. Box 15328, Alexandria, VA 22309  
(703) 360-7600

Inquiry 694.

### LOW COST/HIGH QUALITY

Established, Powerful, Complete, Business Management Software Systems, Point-of-Sale/Inventory Control "SALES-PRO", Service and Repair, Video/Rental Store Management, Church Management, Accounting and Many more starting at \$39. For IBM PC Compatibles and the Atari ST.

**HI-TECH ADVISERS**  
PO. Box 7524, Winter Haven, FL 33883-7524

1-800-882-4310 FOR TECHNICAL INFO (813) 293-3986  
Florida (813) 294-1885 24 HOUR FAX (813) 325-0375

Inquiry 695.

### LOCATE HARD-TO-FIND BUSINESS AND STATISTICAL SOFTWARE

Econometrics • Biometrics • Cluster Analysis • Multivariate Analysis  
• Marketing Statistics • Experimental Statistics • ANOVA • Regression  
• Linear Programming • Project Planner • Forecasting & Time Series  
• Sales & Market Forecasting • Quality Control and Industrial Experiments • Parameter and Tolerance Design • And Many More

SEND FOR FREE PRODUCT GUIDE!

**Lionheart Press, Inc.**  
P.O. Box 379, Alburg, VT 05440  
(514) 933-4918 FAX: (514) 939-3087

Inquiry 696.

## SOFTWARE/BUSINESS

### DATA ENTRY

KeyEntry III®, a complete Data Entry System that provides all the capabilities for designing data entry applications, controlling data flow, & monitoring/reporting operator activity & performance. Supports LAN and stand-alone environments. Evaluation copy (all programs & documentation) available. Call today for information!

**Southern Computer Systems, Inc.**  
2732 Seventh Avenue South  
Birmingham, AL 35233  
(800) 533-6879/(205) 251-2985

Inquiry 697.

## SOFTWARE/CELLULAR AUTO

### SOFTWARE/CELLULAR AUTOMATA

Want to explore an entirely new way to compute? With Autodesk's Cellular Automata Lab and your IBM® PC, creating dazzling animations, stimulating complex physical systems, exploring massively parallel computation, and experimenting with artificial life is just the beginning. CA Lab™ is your passport to the frontiers of computing, including a 250-page introduction to cellular automata by award-winning author Rudy Rucker. \$59.95

### Autodesk, Inc.

2320 Marinship Way, Sausalito, CA 94965  
(800) 525-2763

Inquiry 698.

## SOFTWARE/CONSTRUCTION

### FREE ESTIMATING SOFTWARE DEMO FOR SMALL BUILDERS & REMODELERS

Precision Estimating Light is brand new spreadsheet-based estimating software that combines powerful features in an easy-to-use package. Complete with 800 item database, you'll be estimating more accurately immediately. Call today for the free demo and literature — 503-644-8155.

**Timberline Software**

Inquiry 699.

## SOFTWARE/DEVELOPMENT

### Moby Words™

On 5 1/4" Floppies

<i>Moby Words</i> 530,000 unique words & phrases The largest word list in the world	\$78	<i>Moby Part-of-Speech</i> 150,000 words with parts of speech For razor-sharp language parsing	\$148
<i>Moby Hyphenator</i> 150,000 syllabified words Never give the user a bad break again	\$128	<i>Moby Pronunciator</i> 150,000 words with standard IPA marks For perfect text-to-speech	\$198

All Royalty free. Send check or MO (CA add 6%) to:

**Illumid Unabridged**  
571 Belden St., Ste. A, Monterey, CA 93940-1307  
COD/Info: 1-408-373-1491

Inquiry 700.

## SOFTWARE/ENGINEERING

### SCADA SYSTEM DESIGN

IBM PC or compatible

Supervisory Control And Data Acquisition modular design software includes interactive screens for sizing RTU parameters, modern speed, etc., extensive tutorial, provision for engineering analysis modules, addressing stability & control and alternative technologies for communications subsystems. \$450 Engineering modules priced individually, and described in free catalog.

**AURASTAR INFORMATION SYSTEMS, INC.**  
Suite 820, 12001 N. Central Expressway, Dallas, Texas 75243  
(214) 770-1950 Fax (214) 770-1954

Inquiry 701.

### Handbooks on disk

Gain instant access to engineering/science/math reference information:

- Material Properties tables
- Conversion & financial calculator
- Charts w/eng/sci/math formulas
- IBM PC/XT/AT/compatibles
- \$49.95 + \$3 s/h chk/MC/VISA/PO/COD

**BOOKLINE Technical Publishing**  
P.O. Box 4146, Redondo Beach, CA 90278  
213-542-7553

Inquiry 702.

# THE BUYER'S MART

## SOFTWARE/ENGINEERING

**Affordable Engineering Software**  
FREE APPLICATION GUIDE & CATALOG  
Circuit Analysis • Root Locus • Thermal Analysis • Plotter Drivers • Engineering Graphics • Signal Processing • Active/Passive Filter Design • Transfer Function/FFT Analysis • Logic Simulation • Microstrip Design • PC/MS-DOS • Macintosh • VISA/MC

**BV Engineering Professional Software**  
2023 Chicago Ave., Suite B-13, Riverside, CA 92507  
(714) 781-0252

Inquiry 703.

**MASS & VOLUME CALCULATOR WITH MATERIALS DATABASE**  
Calculate the volume of dozens of shapes easily with *Mass2*. Weights are calculated for over 700 materials. Differential and proportional comparisons made automatically. Flexible input system accepts Decimal, Fractional, and Exponential notation. For IBM PCs and Compatibles with 384K. \$69

**DEMPSEY'S FORGE, Software Division**  
Rt 2 Box 407, Gladys, VA 24554  
Let us FAX you a flier. CALL 804-283-4602

Inquiry 704.

**EXPERIMENTAL DESIGN**  
*Minimize Experimentation While Maximizing Information*

ECHIP™ software chooses only high leverage experiments so that your data is packed with information. ECHIP's highly interactive contour plots of your process make even simultaneous optimization of many responses an easy task. Find out more about this "career enhancer" by calling us today.

**ECHIP, Inc.**  
7460 Lancaster Pike, Suite 6, Hockessin, DE 19707  
TEL: (302) 239-5429 FAX: (302) 239-6227

Inquiry 705.

**Analog Circuit Simulation**

• Schematic Entry  
• SPICE Simulator  
• Model Libraries  
• Monte Carlo Analysis  
• Parameter Sweeps  
• Plotting/Graphics Output

Intusoft has a complete PC based system including everything from schematic entry through SPICE simulation using extended memory to comprehensive interactive post processing. Starting at \$95 for ISpice, the complete system sells for just \$790.

**Intusoft**  
The leader in low cost, full featured CAE software  
P.O. Box 8607, San Pedro, CA 90734  
(213) 833-0710 FAX (213) 831-3956

Inquiry 706.

**MIDNIGHT ENGINEERING™**

A new publication for entrepreneurial hardware and software engineers that will encourage and challenge you to personally develop and market your own products.

• PRACTICAL ARTICLES  
• INSIGHTFUL INTERVIEWS  
• DETAILED PRODUCT REVIEWS

call or write for a FREE copy of the premiere issue of *Midnight Engineering*.

**Midnight Engineering**  
111 E. Drake Rd., Suite 7041, Fort Collins, CO 80525  
303-491-9092

Inquiry 707.

**SIMULATION WITH GPSS/PC™**

GPSS/PC™ is an MS-DOS compatible version of the popular mainframe simulation language GPSS. Graphics, animation and an extremely interactive environment allow a totally new view of your models. If you are contemplating the creation or modification of a complex system you need GPSS/PC to help you predict its behavior. Call now.

**MINUTEMAN Software**  
P.O. Box 171/Y, Stow, Massachusetts, U.S.A.  
(508) 897-5662 ext. 540 (800) 223-1430 ext. 540

Inquiry 708.

## SOFTWARE/ENGINEERING

**Circuit Analysis — SPICE**

Non-linear DC & Transient; Linear AC.  
\* Version 3B1 with BSIM, GaAs, JFET, MOSFET, BJT, diode, etc. models, screen graphics, improved speed and convergence.  
\* PC Version 2G6 available at \$95.

Call, write, or check inquiry # for more info.

**Northern Valley Software**  
28327 Rathrock Dr., Rancho Palos Verdes, CA 90274  
(213) 541-3677

Inquiry 709.

**FREE ENGINEERING MAGAZINE**

*Personal Engineering* is a monthly magazine sent free of charge (USA only) to scientists/engineers who use PCs for technical applications. Topics each month include Instrumentation • Data Acq/Control • Design Automation. To receive a free sample issue and qualification form either circle below or send request on letterhead to:

**Personal Engineering Communications**  
Box 300, Brookline, MA 02146

Inquiry 710.

**ECA-2 Analog Circuit Simulation**

ECA-2 Electronic Circuit Analysis is a high performance, interactive, analog circuit simulator. Available for a wide range of computers and operating systems.

• AC, DC, Transient, Fourier, Temperature  
• Worst-case, Monte-Carlo  
• 2 to 50 times faster than SPICE — Now with multiple plots!

ECA-2 2.40 IBM PC \$775 FREE DEMO.  
Turn-key Systems Available

**Tatum Labs, Inc.**  
3917 Research Park Dr. B-1, Ann Arbor, MI 48108  
313-663-8810

Inquiry 711.

## SOFTWARE/ENTERTAINMENT

**BE FUNNY!**

With the new, improved **Humor Processor Version 2** you can add humor to your speeches, newsletters, or everyday conversation. Create original jokes or select from the indexed, expandable 500-joke database. Only \$49.95 + \$5 S&H. IBM PC or Compatible. 30-day money-back guarantee. Perfect gift. Call today.

**Responsive Software**  
1901 Tunnel Rd., Berkeley, CA 94705  
800-669-4611 VISA/MC

Inquiry 712.

## SOFTWARE/FORTRAN

**EXPAND & EXTEND LIBS**

122 FORTRAN callable routines. **EXPAND** allows DOS compilers access to LIM/EMS 3.2 or 4.0 expanded memory. **EXTEND** provides CGA, EGA, VGA, Hercules, HP, Tektronix, AutoCAD DXF graphics, access to BIOS/DOS functions plus additional utilities. **EXPAND** \$119, **EXTEND** \$149, both \$218.

**DESIGN DECISIONS, INC.**  
P.O. Box 12884, Pittsburgh, PA 15241  
(412) 941-4525

Inquiry 713.

## SOFTWARE/GEOLOGICAL

**GEOLOGICAL CATALOG**

Geological software for log plotting, gridding/contouring, hydrology, digitizing, 3-D solid modeling, synthetic seismogram, fracture analysis, image processing, scout ticket manager, over 50 programs in catalog. Macintosh too! Please call, or write, for Free Catalog!

**RockWare, Inc.**  
4251 Kipling St., Suite 595, Wheat Ridge, CO 80033 USA  
(303) 423-5645 Fax (303) 423-6171

Inquiry 714.

## SOFTWARE/GRAPHICS

**PC TECHNICAL GRAPHICS**

TEKMAR is a graphics library for the VGA, EGA or Tecmar Graphics Master. Similar to PLOT10, includes WINDOW, VIEWPORT, AXIS. Support for HP, HI plotters. Curve fitting, complete plotting program. Log, semi-log, multi-axis, 3-D, contours. Jerry Pourmelle (Aug 86 Byte): "As good as any I have ever seen..." Demo disks, literature available.

**Advanced Systems Consultants**  
21115 Devonshire St. #329, Chatsworth, CA 91311  
(818) 407-1059

Inquiry 714.

**CAD/CAM Programmers!**

You save hundreds of hours of programming and debugging time (and the thousands of dollars this time costs!) when you use the CAD/CAM math and DXF routines in the

**QuickGeometry Library**

All the routines you need for any type of CAD/CAM/CAE program! 250 ready-to-use routines that construct, intersect and offset lines, arcs, circles, ellipses and even splines!

\$199 includes source code and telephone support.  
Call (617) 628-5217 today for information or to order!  
Building Block Software, P.O. Box 1373, Somerville, MA 02144

Inquiry 715.

**PROFESSIONAL GRAPHICS FOR SCIENTISTS AND ENGINEERS**

PC/MS-DOS • Macintosh

**FREE 48-page Catalog**

Linear/Log Scaling • Graphs with error bars • AUTO PLOT • BATCH Mode • Multiple Y-axes • Multiple data files • Auto Forced Scaling • Full labeling • Built-in editor • 1-2-3 Interface • Curve fitting • Statistics • CGA, EGA & Hercules Compatible. 40 pen plotters supported.

**BV Engineering Professional Software**  
2023 Chicago Ave., Suite B13, Riverside, CA 92507  
VISA/MC (714) 781-0252

Inquiry 716.

**Technical Report Graphics**

EDTECH scientific graphics for PC has new laser printer and dot matrix versions.

— Database, worksheet-style data editing  
— Technical XY plots from data for reports  
— Graphics editing on screen, drawing, text  
— Log axes, Greek, symbols, Lotus implex

**DIGITAL ANALYTICS**  
P.O. Box 31430, Houston, TX 77231  
(713) 721-2069

Inquiry 717.

**TurboGeometry Library 3.0**

New 3.0 upgrade! Now over 300 2D & 3D routines. Surfacing, Solids, HiddenLine, Volumes, Areas, Transforms, Perspectives, Tangents, Clipping, Decomp, & more. IBM PC/Comp. MS-DOS 2.0+. Turbo Pascal, Turbo C, MSC. Manual. 30-Day guar. \$199.95 w/source. Foreign S&H extra. VISA, MC, PO. USA funds only.

**Disk Software, Inc.**  
2116 E. Arapaho Rd., #487, Richardson, TX 75081  
214-423-7288/FAX 214-423-4465/800-636-7760

Inquiry 718.

**SEGS 2.0**  
**Scientific Engineering Graphics System**

• Logarithmic, Time/Date & Linear Axes.  
• Easy Curve Fitting and Data Smoothing.  
• 1-2-3 Interface & Numeric Spreadsheet.  
• Supports all Video & Device Standards.  
• 10 Curves with up to 8000 points each.

**Edmond Software, Inc.**  
5900 Mosteller Dr. #1124  
Oklahoma City, OK 73112  
405-942-0558  
800-284-3381

Inquiry 719.



## SOFTWARE/GRAPHICS

### PEN PLOTTER EMULATOR

FPlot turns your dot matrix or laser printer into an HP pen plotter. Fast hi-res output. No jagged lines. Vary line width, color. Works with Autocad, Drafix, etc. Supports NEC P5/P6, IBM Proprinter, Epson LQ/FX, Toshiba, HP Laserjet, Okidata 29K/39K, Hercules/CGA/EGA/VGA. \$64 check/m.o.

#### Fplot Corporation

24-16 Steilway St., Suite 605, Astoria, NY 11103  
718-545-3505

Inquiry 720.

### POPULAR HGRAPH

SCIENTIFIC 2D & 3D graphic routines for IBM PC, VAX, SUN and Macintosh. Powerful, easy to use. Multiple fonts, device and machine independent. Uses max resolution. Links with FORTRAN, Pascal, C, Modula-2 and QuickBasic. \$119.00

Custom software development.  
UGraph—the graphics editor available now!

#### HeartLand Software, Inc.

234 S. Franklin, Ames, IA 50010  
(515) 292-8216

Inquiry 721.

### GRAPHICS PRINTER SUPPORT

AT LAST! Use the PrtSc key to make quality scaled B&W or color reproductions of your display on any dot matrix, inkjet, or laser printer (incl. PostScript). GRAFPLUS supports all versions of DCS with IBM (incl. EGA, VGA, Super VGA), Hercules, or compatible graphics boards. Linkable/OEM versions available. \$99.95.

#### Jewell Technologies, Inc.

4740-44th Ave. SW, Seattle, WA 98116  
800-628-2828 x527 (206) 937-1081

Inquiry 722.

### FORTRAN PROGRAMMER?

Now you can call 2-D and 3-D graphics routines within your FORTRAN program.

GRAFATIC: screen routines \$135  
PLOTATIC: plotter driver 135  
PRINTATIC: printer driver 135

For the IBM PC, XT, AT & compatibles. We support a variety of compilers, graphics bds., plotters and printers.

#### MICROCOMPATIBLES

301 Prelude Dr., Dept. B, Silver Spring, MD 20901 USA  
(301) 593-0683

Inquiry 723.

### COMPLETE NAPLPS/WIDEOTEX SUITE

Fully ANSI X3.110-1983 compliant. Window, view and multiple concurrent device support. Drivers for CGA, EGA, VGA, ICB, TARGA, Hercules and many others.

• MVDI—developer's decoder toolkit \$295  
• MGE—graphics editor \$195  
• Personality+III—terminal emulation \$95

#### Microstar Software Ltd.

34 Colonnade Rd. N., Nepean, Ontario K2E 7J6  
VISA U.S. 1-800-267-9975 Canada (613) 727-5696

Inquiry 724.

### GRAPHIC TOOLS LIBRARY

XGLIB: Fast Window/clip, thick lines and arcs, splines, figure drawing, fill, text scale, rotate, align, keys, mouse, Animation. \$75.  
SCANPRO: Image Capture, from TSR and your program. Multiple Image (.PCK, .KPS, .KPC) formats. EMS support. Fast Bitmap Graphics. Cut, Copy, Paste and more. Auto scale, Rotate, Skew, Mirror, Stencil, and Tile fill Image. Image data base. Compatible with PC\_VDI. \$149.  
PC\_VDI: Complete Graphics. Outline fillable font factory. Plots, charts and splines. \$395.

ALL: ANSI compat. Isotropic Printplot. Hercu. to Super VGA. "C", FORTRAN, MS QuickBASIC.

#### NOVA INC.

PO BOX 68976, Schaumburg, IL 60168 312-882-4111

Inquiry 725.

## SOFTWARE/LANGUAGES

### FORTH with DRUMA FORTH-83

Break the 84K barrier without speed/space penalty. Well designed, attractively priced. \$3 Standard.

- 1Mb+ automated memory management
- On-line documentation, ASCII/block files
- Many powerful and useful features
- Other products: windows, modules, profiler
- IBM PC/XT/AT & all compatibles

Write or call for FREE example diskette.

#### DRUMA INC.

6448 Hwy. 290 East E103, Austin, TX 78723  
Orders: 512-323-0403 BBoard: 512-323-2402

Inquiry 726.

## SOFTWARE MATHEMATICS

### MATH EDITING FOR THE PC

$$x_i^j = \sum_{k=0}^{\infty} [x_k^{2^n} (i)] + \left( \frac{1}{\sqrt{\alpha \pm \beta x}} \right)$$

- MathEdit constructs math equations to be inserted into WordPerfect Text and Manuscript documents.
- User-friendly interface—no new word processor needs to be learned.
- MathEdit—\$149

#### K-TALK COMMUNICATIONS

50 McMillen Ave., Suite 100  
Columbus, Ohio 43201  
(614) 294-3535

Inquiry 727.

### MATHEMATICIANS—ENGINEERS

Have you ever seen functions of a complex variable? Would you like to really understand differential operators like div, grad and curl? How about a peek into the fourth dimension? Call or write for information on our latest PC and Macintosh software.

#### Lascaux Graphics

3220 Steuben Ave., Bronx, NY 10467  
(212) 654-7429

Inquiry 728.

### Derive™

### A Mathematical Assistant

Makes math more inspiration and less perspiration! Combines the power of computer algebra with 2D & 3D plotting and a friendly menu-driven user interface. Does equation solving, calculus, trigonometry, vector & matrix algebra, and more. Derive requires a PC compatible computer & 512K memory.

#### Soft Warehouse, Inc.

3615 Harding Ave., Suite 505, Honolulu, HI 96816  
(808) 734-5801

Inquiry 729.

## SOFTWARE/MEDICAL

### Medical Systems with ECS

PPM offers a complete line of medical software ranging from simple insurance claims processing to comprehensive A/R management. PC CLAIM PLUS—claims processing with ECS to over 100 major insurance carriers—30-day money-back guarantee. THRESHOLD—complete A/R, patient billing, comprehensive practice management statistics.

CLAIM NET—National electronic claims clearinghouse transmits claims to over 100 insurance carriers. Dealer inquiries welcome. Software prices start at \$499.00.

#### Physicians Practice Management

350 E. New York, Indianapolis, IN 46204  
800-428-3515 317-634-8080

Inquiry 730.

## SOFTWARE/PACKAGING

### HARD TO FIND COMPUTER SUPPLIES FOR SOFTWARE DEVELOPERS & POWER USERS

Clot binders & slipcases like IBM's. Vinyl binders, boxes, and folders in many sizes. Disk pages, envelopes, & labels. Low quantity imprinting. Bulk disks. Everything you need to bring your software to market. Disk and binder mailers. Much more! Low Prices! Fast service. Call or write for a FREE CATALOG.

#### Anthropomorphic Systems, Limited

376-B E. Saint Charles Rd., Lombard, IL 60148  
1-800-DEAL-NOW 312-629-5160

Inquiry 731.

## SOFTWARE/PACKAGING

### SAVE SAVE SAVE SAVE LET'S TALK PACKAGING

From Disk Labels to Manuals to Shipping Boxes—We are a complete packaging service. Everything you need to market your software. Call for our free catalog.

#### SOFCOM Printing and Packaging

10305 Reading Rd., Cincinnati, OH 45241  
513-563-7136

Inquiry 732.

## SOFTWARE/PRINTING

### PRINTER GENIUS

Powerful memory-resident printer management • Control printer features from menus or within documents • Print spool-to-disk files or memory • Background print • File & directory browse • Edit small text • and more... • User friendly pop-up screens • 92-page manual • Preset for all printers • Completely flexible • PC MS-DOS • \$89 + \$4 S/H • VISA/MC

#### Nor Software Inc.

527 3rd Ave., Suite 150, New York, NY 10016  
(212) 213-9118

Inquiry 733.

## SOFTWARE/SCANNERS

### Optical Character Recognition

Stop retyping: PC-OCR™ software will convert typed or printed pages into editable text files for your word processor. Works with HP ScanJet, Panasonic and most other scanners. Supplied with 18 popular fonts. User trainable: you can teach PC-OCR™ to read virtually any typestyle, incl. foreign fonts. Proportional text, matrix printer output, Xerox copies OK. \$385. Check/VISA/MC/AmExp/CO.

#### Essex Publishing Co.

P.O. Box 391, Cedar Grove, NJ 07009  
(201) 783-6940

Inquiry 734.

## SOFTWARE/SCIENTIFIC

### TableCurve—TableCode

Curve-Fit 211 Equations In a Single Step

TableCurve™ generates printed reports and Lotus, dBase, Quattro, Harvard Graphics, and Pagemaker/Ventura output. TableCode™ generates functions and calling code for C, Pascal, BASIC, FORTRAN, Modula-2 and dBASE languages.

Demo \$5, TableCurve \$158, TableCode \$149 MC/VISA

#### AIN Software

P.O. Box 32277, Phoenix, AZ 85064  
602-266-1925

Inquiry 735.

### Chaos/Nonlinear Dynamics

\* Ordinary and Delay Differential Equation Solvers • Bifurcation Diagrams \* 2- and 3-D Plotting, Sequential Magnification, Poincaré Sections \* Next Maximum, 1-D & Circle Maps \* Phase Portraits with Multiple Initial Conditions \* Spectral Analysis.

Fractal Dimensions, Lyapunov Exponents

DS-I \$250.00 DS-II \$350.00

CHAOS IN THE CLASSROOM \$49.95

#### DYNAMICAL SYSTEMS, INC.

P.O. Box 35241, Tucson, AZ 85740, 602-292-1962  
See our ad on page 88

Inquiry 736.

## C SCIENTIFIC LIBRARY

Create scientific & engineering tools with this extensive C programming library of over 600 math, matrix, statistics, and graphics functions. Send \$5.00 for 45 page CSL Buyer's Guide

#### EIGENWARE TECHNOLOGIES

13090 La Vista Dr., CA 95070 (408) 867-1184

Inquiry 737.

## SOFTWARE/SCIENTIFIC

### LARGE MATRICES

Solve  $AX=B$  where  $A$  is  $200 \times 200$  and  $B$  is  $200 \times 500$  (all REAL<sup>8</sup>) in under 5 min on your 25MHz 386/387 (23 min on 12MHz 286/287) and check result by matrix multiplication. **No memory required beyond 640K.** Virtual memory capability for matrix multiply, transpose, etc. 80 bit precision. Microsoft, IBM FORTRAN compatible. Full featured demo disk can generate and run large matrices of random numbers \$20.

#### JOYCE NUMERICS INC.

500 Chesterbrook Blvd., Suite 15 C-6, Wayne, PA 19087  
(215) 993-9013

Inquiry 738.

Free catalog includes technical application notes

## 1-800-942-MATH

MicroMath Scientific Software  
Salt Lake City, Utah 84121-3144

Inquiry 739.

Scientific/Engineering/Graphics Libraries  
Turbo Pascal, Turbo + MS C, MS Fortran, Basic  
Send for FREE catalogue of software tools for Scientists and Engineers. Includes: Scientific subroutine libraries, device independent graphics libraries (including EGA, HP plotter and Laserjet support), scientific charting libraries, 3-D plotting library, data acquisition libraries, menu-driven process control software. Versions available for a variety of popular languages.

#### Quinn-Curtis

1191 Chestnut St., Unit 2-5, Newton, MA 02164  
(617) 965-5660

Inquiry 740.

## SOFTWARE/SECURITY

### HANDS OFF THE PROGRAM<sup>®</sup> OPERATING SYSTEM SECURITY

Secures subdirectories, files, printers and floppies  
Keyboard lock — automatic or manual  
Log PC boot, program exec, file opens, login/logout  
Prevents DOS FORMAT and most viruses  
Drive A: Boot Protection / Hard Disk Lock  
IBM PC or 100% comp. — DOS V3.0+ — \$89.95 + \$3.75 S/H

#### SYSTEMS CONSULTING INC.

PO BOX 111209, Pittsburgh, PA 15238  
(412) 963-1824

Inquiry 741.

## SOFTWARE/SORT

### OPT-TECH SORT/MERGE

Extremely fast Sort/Merge/Select utility. Run as an MS-DOS command or CALL as a subroutine. Supports most languages and file types including Bitwise and dBASE. Unlimited file sizes, multiple keys and much more! MS-DOS \$149. OS/2, XENIX, UNIX \$249.

(702) 588-3737

#### Opt-Tech Data Processing

PO. Box 678 — Zephyr Cove, NV 89448

Inquiry 742.

## SOFTWARE/VOICE

### TURBO WATSON

Turbo Watson is a complete set of tools for Turbo Pascal to access all the functions of the WATSON Speech Board. It is also a high level library of procedures to build voice response systems in minutes. A powerful ANSWERING MACHINE program is given as an example with source code. ONLY 99\$ Canadian, Visa/MC accepted.

#### ITI Logiciel

1425 Rene-Levesque W. Montreal, Can. H3G 1T7  
(514) 861-5988

Inquiry 743.

## STATISTICS

### NEW STATISTIX™ 3.0

PC Magazine Editors Choice!

- Superb Data Management • Excellent manual
- Easy to use • Fast, free support
- Range & Depth of Statistics

Buy the **BEST** for 1/2 the price of the competition

**CALL 612-631-2852 Now**

No-risk 30 day money back guarantee

Analytical Software, Box 13204, Roseville, MN 55113

Inquiry 744.

### The BASS System™

Why use up 8 meg and 640K just to run a data step on your PC? Now you can run your data step code and statistical procs with a system that takes only 1 meg and 400K (and costs only \$399)! Free information:

#### BASS Institute, Inc.

P.O. Box 349, Chapel Hill, NC 27514  
(919) 933-7096 or BB: (919) 968-6755 (N,8,1)

Inquiry 745.

### SOLO 3.0 from BMDP

Popular statistics and excellent graphics for the PC. Quick and easy to use. For business professionals, researchers, or students. From the leader in statistical software for over 25 years. Top-notch support. Satisfaction guaranteed! \$199 complete with graphics. Call today, VISA or MC.

#### BMDP Statistical Software, Inc.

1440 Sepulveda Blvd., Suite 316, Los Angeles, CA 90025  
(213) 479-7799

Inquiry 746.

### STAT A

Stat A 2.05 Now Available. More statistics, graphics and an all-new manual. Still only \$590. Quantity Discounts Available. New, lower academic price. \$20 Demo. Call toll-free for more information.

#### 1-800-STATAPC

Computing Resource Center

10801 National Boulevard, Los Angeles, CA 90064  
(213) 470-4341

Inquiry 747.

### DBMS/COPY

CONVERTS YOUR DATA INTO INFORMATION

Now your favorite stat package can access any database. DBMS/COPY can directly convert any database or spreadsheet file (ORACLE, PARADOX, dBASE, LOTUS etc.) into any stat package file (SAS, SPSS, SYSTAT, etc.) and vice versa. The PLUS version allows sorts, selections, and recalculations. \$195. 30-day guarantee. VISA/MC/AMEX/POCCOD.

#### CONCEPTUAL SOFTWARE INC.

P.O. Box 56827, Houston, TX 77256  
(713) 667-4222 FAX: (713) 667-3FAX  
1-800-STATWOW

Inquiry 748.

### Statistical Navigator™

An expert system using AI strategies to help determine appropriate statistical analysis. Based on your answers, Statistical Navigator suggests several analyses ranked by suitability. It explains the analysis and how it fits your research objectives and assumptions. Version 1.1—\$99.95 + s/h. VISA, MC, AMEX, PO, Personal Check accepted.

#### The Idea Works, Inc.

100 West Briarwood, Columbia, MO 65203  
1-800-537-4888 FAX 314-445-4589  
Outside USA 314-445-4884

Inquiry 749.

## STATISTICS

### MINITAB's a PC of a cake!

MINITAB's intuitive commands are easy to use and remember. Features descriptive statistics, regression, time series, chi-square, hi-res graphics, much more. PC version incl. LOTUS Interface, data editor, network pricing. Call for FREE brochure.

#### Minitab, Inc.

3081 Enterprise Dr., State College, PA 16801

(814) 238-3280

Inquiry 750.

### NCSS

Professional, easy to use, menu-driven statistical system. Used by over 5,000 researchers.

- 5.0 Statistical System —\$99
- 5.1 Graphics (2D & 3D)—\$59
- 5.3 Power Pac Supplement—\$49
- 5.4 Exp. Design/QC—\$49
- 5.5 Survival Analysis—\$59
- 5.6 Forecasting—\$69

We accept checks, POs, Visa, MC. Add \$3 s/h.

**NCSS-B 801-546-0445**

865 East 400 North, Kaysville, UT 84037

Inquiry 751.

### SCA STATISTICAL SYSTEM

The *only* statistical software encompassing Forecasting & Time Series Analysis Quality and Productivity Improvement General Statistical Analysis

Available on both DOS and OS/2 operating systems.

Call today for more information

#### Scientific Computing Associates

4513 Lincoln Ave., Suite 106, Lisle, IL 60532, USA  
Phone: (312) 960-1698 FAX: (312) 960-1815

Inquiry 751.

### StatPac Gold™

StatPac Gold is the award-winning statistics and forecasting package that delivers. It's fast, flexible, easy to use and dependable. Time-tested and loaded with features. You be the judge. Get the facts! Call for your FREE brochure.

1-800-328-4907

#### Walonick Associates, Inc.

6500 Nicollet Ave. S., Minneapolis, MN 55423

(612) 866-9022

Inquiry 752.

## UNINTERRUPTIBLE POWER

### HOW TO PROTECT YOUR COMPUTER

And Make It Last Longer

FREE money-saving literature. What you need to know about UPS—uninterruptible power supply. How to get complete protection from power line problems. 350VA through 15KVA models from the world's largest manufacturer of single-phase UPS.

#### Best Power Technology, Inc.

P.O. Box 280, Necedah, WI 54646

(608) 565-7200 ext. 3737

TOLL FREE (800) 356-5794 ext. 3744

See our Ad on page 459.

Inquiry 753.

## UTILITIES

### COPY AT TO PC—BRIDGE-IT 3.5

"COPYAT2PC" RELIABLY writes 360KB floppies on 1.2 MB drives, saving a slot for a second hard disk or tape back-up. Only \$79.00 + S/H

"BRIDGE-IT 35" is a DEVICE DRIVER supporting 3 1/2" 720KB/1.44MB drives for PC/XT/AT without upgrading OOS/BIOS. Only \$39.00 + S/H

BRIDGE-IT 35 BUNDLED WITH INTERNAL 1.44MB DRIVE AT \$129.00 + S/H

VISA/MC/COD UPS B/R

#### MICROBRIDGE COMPUTERS

855 Sky Way Suite 113, San Carlos, CA 94070

1-415-593-8777(CA) 1-415-593-7875 (FAX)

1-514-845-0818 (CANADA) 1-800-523-8777

Inquiry 754.



# THE BUYER'S MART

## UTILITIES

**DELTA**, the better text file comparison tool. Scrollable windowed presentations of file or directory comparisons, with a built-in editor window. Ideal for programmers! Requires DOS 2.0 or higher with at least 384K RAM. A hard disk is recommended. Order now. \$79.

DEMO available on our BBS

### OPENetwork

POWER TOOLS FOR POWER USERS

215 Berkeley Pl. (B-1), Brooklyn, NY 11217

718-638-2240 BBS: 718-638-2239

Inquiry 755.

### Recover deleted files fast!

Disk Explorer now includes automatic file recovery. You type in the deleted file's name. Disk Explorer finds and restores it. Disk Explorer also shows what's really on disk; view, change or create formats, change a file's status, change data in any sector. MS-DOS \$75 U.S. Check/Credit card welcome.

### QUAID SOFTWARE LIMITED

45 Charles St. E. 3rd Fl.  
Toronto, Ontario, Canada M4Y 1S2  
(416) 961-8243

Inquiry 756.

### AppleWorks ↔ IBM

**CROSS-WORKS** transfers both ways between Apple IIe/IIc/IIgs and IBM PC/XT/AT/PS-2 & compatibles. Exchange AppleWorks with WordPerfect (keeps formatting), Lotus 1-2-3 (keeps formulas), and dBase III/IV! Included cable plugs in serial ports for 19,200 baud transfers. Easy menu operation.

Phone (919) 878-7725 for free info packet.  
SoftSpoken Co., PO Box 97623, Raleigh, NC 27624

## UTILITIES

### SAVE TIME and MONEY

with the RED Utilities. Programs include: Batch file compiler speeds batch files. Disk cache speeds hard and floppy disks. Printer spooler. Path command for data files. Wild card exceptions. Sort directories. Over 10 more programs. Only \$79.95. Order today! 30-day money-back guarantee. IBM PC. Visa/MC.

### The Wenham Software Company

5 Burley St., Wenham, MA 01984 (508) 774-7036

Inquiry 757.

## WORD PROCESSING

### We can read 130 languages from Armenian to Zulu

Use SPOT OCR Software with an image scanner and your PC to read 130 foreign languages, typed pages, typeset material, magazines and books into standard text files. Flagstaff Engineering can provide any OCR solution. Call today to discuss your application!

### Flagstaff Engineering

1120 Kaibab Lane, Flagstaff, AZ 86001

(602) 779-3341

MasterCard—Visa—American Express Accepted

Inquiry 758.

## FARSI / GREEK / ARABIC / RUSSIAN

Hebrew, all European, Scandinavian, plus either Hindi, Punjabi, Bengali, Gujarati, Tamil, Thai, Korean, Viet, or IPA. Full-featured multi-language word processor supports on-screen foreign characters and NLQ printing with no hardware modifications. Includes Font Editor, \$355 dot matrix; \$150 add'l for laser; \$19 demo. S/H in U.S. incl'd. Req. PC, 640K, graphics. 30-day Guarantee. MC/VISA/AMEX

### GAMMA PRODUCTIONS, INC.

710 Wilshire Blvd., Suite 609, Santa Monica, CA 90401  
213/394-8622 Fax: 5106008273 Gamma Pro SNM

Inquiry 759.

## WORD PROCESSING

### DuangJan

Bilingual word processor for English and: Armenian, Bengali, Burmese, Euro/Latin/African, Greek, Gujarati, Hindi, Khmer, Lao, Punjabi, Russian, Sinhalese, Tamil, Telugu, Thai, Ukrainian, Viet, ... Only \$109+\$5 s/h (foreign + \$12 s/h). Font editor included. For any IBM compatibles with dot-matrix & LaserJet printer. Demo \$9+\$1 s/h. Visa/MC

### MegaChomp Company

3438 Cottman Ave., Philadelphia, PA 19149-1606

(215) 331-2748 FAX: (215) 331-4188

Inquiry 760.

### PC-Write 3.0 — Shareware

Fast, full featured word processor for IBM PC. Now edits large files & multiple columns. Also spell check, mailmerge, networking, ASCII, and macros. Easy-to-use, optional menus. Supports 500 printers incl. lasers. Software, guide and tutorial on disk: \$18. Registration with manual, support newsletter and 2 free updates: \$99.

90-day money-back guarantee. VISA/MC.

### Quicksoft

1-800-888-8088

219 First Ave. N., #224-BYTC, Seattle, WA 98109

Inquiry 761.

## YOUR SALES MESSAGE

about the special computer product or service that you provide belongs in print.

### THE BUYER'S MART

can help you reach computer professionals and produce valuable inquiries for your company!

Call Brian Higgins for more information

603-924-3754

# BYTE BACK ISSUES FOR SALE

1987 1988 1989

	1987	1988	1989
January			
February			
March			
April			
May			
June			
July			
August			
September			
October			
November			
December			
Inside the IBM PCs Applications Software Today			

Issues Available

### Rates (postage and handling included):

1987-'89 BYTE Issues	\$6.00*	BYTE 1988 Index	\$4.00
BYTE '83-'84 Index	\$4.00	1985 Inside The IBM PCs	\$4.00
BYTE 1985 Index	\$4.00	1986 Inside The IBM PCs	\$5.00
BYTE 1986 Index	\$4.00	1988 Inside The IBM PCs	\$6.00
		Applications Software	
		Today Special	\$4.00

\*June 1988 (Benchmarks) \$3.00

The above prices include postage in the US. Please add \$.50 per copy for Canada and Mexico; and \$2.00 per copy to foreign countries (surface delivery). European customers please refer to Back Issue order form in International Advertising section of book.

Please indicate which issues you would like by checking (✓) the boxes. Send requests with payment to:

BYTE Back Issues, One Phoenix Mill Lane, Peterborough, NH 03458  
(603) 924-9281

Check enclosed Charge:  VISA  MasterCard

Card # \_\_\_\_\_

Exp. Date \_\_\_\_\_

Signature \_\_\_\_\_

Name \_\_\_\_\_

Address \_\_\_\_\_

City \_\_\_\_\_

State \_\_\_\_\_ Zip \_\_\_\_\_

All orders must be prepaid. Please allow four weeks for domestic delivery and twelve weeks for foreign delivery by surface mail.

# 9600bps MODEM



**+FAX**

**\$299**

**2400 bps MODEM \$95 30 DAY FREE TRIAL**  
**ECONOFAX™ OR MNP-5...CALL**

Many low cost modems are faulty or very error prone....**Not ours!!!**  
**PERFORMANCE** "I have recently had a lot of trouble getting 2400 BAUD MODEMS to work...this one is working perfectly." R.T., Moreno Valley CA. **SUPPORT** "I get the impression that your company, indeed, bends over backwards to provide service to its customer." M.F., Selma CA. **SUPERIOR TECHNOLOGY...**The phone connection is the main source of data errors. **DYNAMIC IMPEDANCE STABILIZATION™, DIS™** (invented by CompuCom) improves signal quality and reduces these errors by up to 95% compared to a standard modem. Model 2400 (without DIS) at \$95 outperforms the low cost alternatives, the 24DIS at \$119 outperforms the challengers, regardless of cost. IBM internal, Hayes compatible, made in USA, 6 COM ports, internal speaker, five year warranty, EasyCom software, dealers inquire. *If you aren't totally satisfied, return within thirty days for a full refund!*

March '89 p102 **BYTE MAGAZINE**  
**CompuCom Corporation** "Real deal...worked fine...quite a bargain!"  
 CALL (408) 732-4500 (800) 228-6648

## Connectivity Solutions

<p><b>DCB</b>                  Universal converter; high capacity 64KB to 1 MB printer buffer with parallel / serial input and output ports.                  Frees computer while doing printing. Converts data if required. Connects more than 1 computer to more than 1 printer.</p>	<p><b>DCI</b>                  Internal converter printer buffer for IBM or compatibles computers. Built in microprocessor frees computer while printing. Serial and parallel output. Features include using any type of printer or using 2 printers software selectable.</p>	<p><b>MP</b>                  Parallel interface card for PC, XT or AT with up to 4 output ports. Connect up to four different printers or plotters. Software selectable.  <b>DCU</b>                  Universal data converter serial/parallel, parallel/serial. Completely programmable with software protocol.</p>
---	---	---

<p><b>MOS</b>                  Multi-serial interface for IBM or compatibles. Up to 8 serial ports. Interconnects computers, modems, printers, plotters, etc.</p> <p><b>MIP</b>                  Multi-parallel input ports for PC, XT or AT with 8 ports. Allows up to 64 external data lines, 24 input/output control lines.</p>	<p><b>MAX-E-CON</b>                  Up to 24 serial / parallel input/output ports. System capacity : 512 KB RAM with 20 or 40 MB fast access hard disk. Basic model comes with 512 KB, 8 input ports (serial or parallel) and 4 output ports (parallel). Each port is completely independent and can use different speeds, protocols, etc. System status display (optional).</p>  <p>Ultra high storage capacity suitable for LANs and multiple stand alone computers. Share or switch computers, printers, plotters, modems, etc.</p>
--	---

Call today for details  
 Phone (415) 968-8404  
 FAX # (415) 968-8390

   
 Dealer's inquires welcome

**Maxima Corporation**  
 970 Terra Bella Ave. Bldg. 3  
 Mountain View, CA 94043

# REEL 9-TRACK GENIUS

**OVERLAND DATA** will bring out the **GENIUS IN YOU** when it comes to connecting your PC to the mini/mainframe world. **OUR ENGINEERS DESIGNED** the most successful tape drives, controllers and software in use today. Call the experts...**ODI!**

- PC/XT/AT/386/PS2 & Compat.
- DOS, XENIX, UNIX, NOVELL
- 800, 1600, 3200, & 6250 BPI
- Outstanding Customer Support
- 24-hour delivery available on Cipher, Qualstar, Anritsu & M4



"See us at Comdex #W604"

**Overland Data**  
 "Experience Makes The Difference"

**CALL TODAY AT 1-800-PC-9TRAK!**  
 5600 Kearny Mesa Road • San Diego, CA 92111  
 TEL: 619/571-5555 • FAX: 619/571-0982

## Protect Your Copies of BYTE

**NOW AVAILABLE:** Custom-designed library files or binders in elegant blue simulated leather stamped in gold leaf.

**Binders—Holds 6 issues, opens flat for easy reading.**  
 \$9.95 each, two for \$18.95, or four for \$35.95.



**Files—Holds 6 issues.**  
 \$7.95 each, two for \$14.95, or four for \$27.95.



**Order Now!**

Mail to: Jesse Jones Industries,  
 Dept. BY, 499 East Erie Ave.,  
 Philadelphia, PA 19134

CALL TOLL FREE (24 hours):  
 1-800-972-5858

Please send \_\_\_\_\_ files; \_\_\_\_\_ binders for BYTE magazine.  
 Enclosed is \$\_\_\_\_\_  
 Add \$1 per file/binder for postage and handling. Outside U.S.A. add \$2.50 per file/binder (U.S. funds only please).  
 Charge my: (minimum \$15)  
 \_\_\_\_\_ American Express  
 \_\_\_\_\_ Visa \_\_\_\_\_ MasterCard  
 \_\_\_\_\_ Diners Club

Name: \_\_\_\_\_  
 Address: \_\_\_\_\_  
(No Post Office Box)  
 City: \_\_\_\_\_  
 State: \_\_\_\_\_ Zip: \_\_\_\_\_

Satisfaction guaranteed. Pennsylvania residents add 6% sales tax.  
 Allow 5-6 weeks delivery in the U.S.

Card # \_\_\_\_\_  
 Exp. Date \_\_\_\_\_  
 Signature \_\_\_\_\_





## PC Component Headquarters FALL COMDEX SPECIALS

<b>386-25 MHZ</b>		All Systems Include: Case, Power supply FD/HD Controller 1.2 MB Drive 101 Keyboard 40 MB Harddrive	<b>386 SX-16 MHZ</b>	
25 MHZ 4MB CACHE ONLY <b>\$2774</b>			4 MB ONLY <b>\$1824</b>	
<b>Y.E.S. 286-16MHZ</b>	<b>Y.E.S.-Turbo 10 MHZ</b>		<b>Y.E.S. 286-12 MB</b>	
1 MB ONLY <b>\$1174</b>	640K ONLY <b>\$409</b> - without Hard Disk -		1 MB ONLY <b>\$1024</b>	
<b>- MONTHLY SPECIALS -</b>		<b>VIDEO OPTIONS</b>		
Mono Graphics Printer Card ... <b>\$30</b> Paradise EGA Autoswitch with EGA Monitor ... <b>400</b> 1.44 MB TEAC Floppy with mounting kit ... <b>75</b>		Monochrome ... ADD <b>\$125</b> RBG ... ADD <b>275</b> EGA ... ADD <b>400</b> VGA ... ADD <b>525</b>		
Complete line of Peripherals available - Call for Products not listed				
<b>Y.E.S. Systems Corp.</b> 44829 Fremont Blvd. Fremont, CA 94538 (415) 657-4888 FAX: (408) 656-0118		All orders shipped UPS—COD or prepay. PO's are welcome from universities and qualified companies. Open: Mon.-Sat. 9-7		

## DISC DRIVE REPAIR SPECIAL

Formatted Cap.	Flat Rate	<b>SPECIAL</b>	SHIPPING YOUR DRIVE FOR REPAIR
10-19 mb	\$99	<b>89.10</b>	Pack your drive carefully and fully protected in a sturdy shipping box. Include your name, address and daytime telephone number. Allow \$9 for shipping per drive. <b>WE DO DATA RECOVERY</b> <b>CALL FOR QUOTE</b> <b>FLOPPY 5.25" REPAIR \$45</b> <b>VALID THROUGH 6/30/90</b>
20-29 mb	\$125	<b>112.50</b>	
30-39 mb	\$150	<b>135.00</b>	
40-49 mb	\$175	<b>157.50</b>	
50-85 mb	\$210	<b>189.00</b>	
86-120 mb	\$275	<b>247.50</b>	
121-150 mb	\$325	<b>292.50</b>	
151-275 mb	\$425	<b>382.50</b>	
276-380 mb	\$495	<b>445.50</b>	
<b>TEST &amp; EVALUATION \$25</b>			

## DISC DRIVES LIQUIDATION

<b>XT/AT FLOPPY DRIVES</b>		<b>XT/AT HARD DRIVES</b>	
3.5" ..... 720k ..... new	\$105	5 MB ..... ref.	\$75
3.5" ..... 1.44mb ..... new	115	10 MB ..... unu.	105
5.25" ..... 360k ..... ref.	49	20 MB ..... ref.	159
5.25" ..... 720k ..... ref.	59	30 MB ..... ref.	239
5.25" ..... 1.2mb ..... ref.	89	42 MB ..... unu.	295
<b>KITS FOR IBM AT &amp; COMPATIBLES</b>		72 MB ..... ref.	595
84 MB ..... ST506	\$695	120 MB ..... new	1295
147 MB ..... ESDI	1395	<b>SCSI HARD DRIVES</b>	
230 MB ..... ESDI	1695	20 MB	\$225
320 MB ..... ESDI	1995	30 MB	265
		42 MB	295
		85 MB	\$995
		147 MB	1495
		310 MB	1995

**THOUSANDS OF DISC DRIVES IN STOCK**  
We Feature Technical Support for Everything We Sell  
We Specialize in Disc Drives — Ask for Our Brochure

**jb TECHNOLOGIES, INC.** TEL 818 • 709 • 6400  
FAX 818 • 341 • 2935  
21011 Itasca St., #F Chatsworth, CA 91311 TELEX 678953

# Pay Less \$\$ for more Memory

### ■ SIMM MODULES

AST • APPLE • DELL 310 • EVEREX • PS2 • COMPAQ	
1 Meg x 8 – 10 (Macintosh)	\$105.00
1 Meg x 9 – 10	\$116.00
1 Meg x 9 – 80	\$124.00
PS/2 Model 70 2 Meg Module	\$495.00

### ■ EXPANSION BOARDS

COMPAQ • PS/2 • HP LASERJET

### ■ MEMORY CHIPS

64K • 256K • 1MG

### ■ CACHE MEMORY

### ■ INTEL MATH COPROCESSORS - FULL LINE

To place an order call: **714-855-0411** Ask for our  
(FAX) 714-855-8504 FREE catalog!

23552 Commerce Center Drive, Suite L,  
Laguna Hills, CA 92653

ESTABLISHED 1985 • LOW, LOW PRICES • VISA  
MASTERCARD • SAME DAY SHIPPING •  
CORPORATE & SCHOOL P.O.'S WELCOME

**Dynamic Electronics**

STOCKING DISTRIBUTOR OF SEMICONDUCTORS

# PC COMPATIBLE ENGINEERING

Annabooks gives you the hardware, software, and firmware information you need to design PC-compatible systems faster and better. And you have control of your design from the ground up -- our firmware and software products include **source code!** Plus all the utilities you need.

**AT BiosKit:** an AT Bios with source code you can modify. With setup & debug. 380 pages with disk, \$199

**XT BiosKit:** Includes a debug. 270 pages with disk, \$99

**Intel Wildcard Supplement for XT BiosKit:** Includes ASIC setup, turbo speeds, also useful with many other modern XT boards. 60 pages with disk, \$49

**PromKit:** Puts anything in Eprom or SRAM; DOS, your code, data, you name it! With source on disk, \$179

**SysKit:** Here's a debug/monitor you can use even with a brand X Bios in your desktop. Runs in ROM or TSR in RAM. Includes source, of course. \$69

**XT-AT Handbook:** The famous pocket-sized book jam-packed with hardware & software info. \$9.95 ea. or 5 or more for \$5 each.

Software tools: You need MS C & MASM 5.1 for modifying the Kit products.

**FREE** Mention this ad when you order any publication and get a free XT-AT Handbook by Choisser & Foster! Hurry before we come to our senses and change our minds.

**Annabooks**  
12145 Alta Carmel Ct Suite 250-262  
San Diego, California 92128

(619) 271-9526 Money-back guarantee



**NEC V20 & V30 CHIPS**

Replace the 8086 or 8088 in Your IBM PC and Increase its Speed by up to 30%

Part No.	Description	Price
UPD70108-5	(5MHz) V20 Chip	\$5.25
UPD70108-8	(8MHz) V20 Chip	\$6.95
UPD70108-10	(10MHz) V20 Chip	\$10.95
UPD70116-8	(8MHz) V30 Chip	\$7.95
UPD70116-10	(10MHz) V30 Chip	\$13.49

**7400**

Part No.	1-9	10+	Part No.	1-9	10+
7400	29	19	7474	39	29
7402	29	19	7475	45	35
7404	29	19	7476	45	35
7405	29	19	7483	49	39
7406	39	29	7485	65	55
7407	39	29	7486	45	35
7410	35	25	7489	2.25	2.15
7411	35	25	7490	49	39
7414	49	39	7493	45	35
7416	35	25	74107	29	19
7417	35	25	74121	39	29
7420	29	19	74123	49	39
7427	29	19	74125	49	39
7430	29	19	74147	1.99	1.89
7432	39	29	74150	1.35	1.25
7438	39	29	74151	39	29
7442	49	39	74154	1.35	1.25
7445	75	65	74161	69	59
7446	89	79	74173	79	69
7447	69	59	74174	59	49
7448	1.95	1.85	74175	59	49
7473	39	29	74193	79	69

**74LS**

Part No.	Price	Part No.	Price	
74LS00	26	74LS139	49	39
74LS02	28	74LS151	49	39
74LS03	28	74LS153	49	39
74LS04	28	74LS154	1.29	1.19
74LS05	28	74LS157	45	35
74LS06	59	74LS161	49	39
74LS07	59	74LS163	49	39
74LS08	28	74LS164	59	49
74LS09	28	74LS165	75	65
74LS10	26	74LS166	89	79
74LS11	29	74LS173	45	35
74LS14	49	74LS174	39	29
74LS20	28	74LS175	39	29
74LS21	29	74LS191	59	49
74LS27	35	74LS192	69	59
74LS30	28	74LS193	69	59
74LS32	28	74LS194	69	59
74LS38	35	74LS221	69	59
74LS42	49	74LS240	59	49
74LS47	85	74LS241	59	49
74LS73	39	74LS244	59	49
74LS74	35	74LS245	79	69
74LS75	39	74LS257	49	39
74LS76	39	74LS259	99	89
74LS83	55	74LS273	89	79
74LS85	55	74LS279	49	39
74LS86	29	74LS367	49	39
74LS90	49	74LS373	79	69
74LS93	49	74LS374	79	69
74LS123	49	74LS393	89	79
74LS125	49	74LS541	1.29	1.19
74LS132	49	74LS590	5.95	5.85
74LS138	49	74LS688	2.39	2.29

**74S/PROMS\***

Part No.	Price	Part No.	Price
74S00	25	74S188*	1.49
74S04	25	74S200	1.49
74S32	25	74S240	1.39
74S74	25	74S244	1.49
74S112	25	74S287*	1.49
74S128	1.25	74S288*	1.49
74S134	49	74S373*	1.99
74S153	49	74S377*	1.99
74S163	49	74S387*	1.99
74S174	29	74S472*	2.25
74S175	39	74S571*	2.49

**CD-CMOS**

Part No.	Price	Part No.	Price
CD4001	19	CD4051	59
CD4002	19	CD4052	59
CD4007	19	CD4053	59
CD4011	19	CD4060	65
CD4012	25	CD4066	69
CD4013	29	CD4069	25
CD4015	29	CD4070	29
CD4016	29	CD4071	19
CD4017	49	CD4072	19
CD4018	49	CD4073	19
CD4020	59	CD4081	19
CD4021	59	CD4093	35
CD4024	45	CD4093	35
CD4027	35	CD4094	89
CD4028	49	CD4503	39
CD4029	69	CD4511	59
CD4030	35	CD4518	69
CD4040	69	CD4520	69
CD4042	49	CD4522	69
CD4043	59	CD4528	75
CD4046	65	CD4538	79
CD4047	65	CD4543	79
CD4049	29	CD4544	49
CD4050	29	CD4585	69

**EEPROMS**

Part No.	Description	Price
2816A	2048x8 350ns (9V-15V) 5V Read/Write	5.25
2816A-25	2048x8 250ns (9V-15V) 5V Read/Write	5.49
2817A	2048x8 350ns 5V Read/Write	6.95
2864A	8192x8 300ns 5V Read/Write (Pin 1, No RB)	10.95
2865A	8192x8 250ns 5V Read/Write (Pin 1, No RB)	9.95
86C40	2048x8 250ns 5V Read/Write	10.95
52B13	2048x8 350ns (21V) 5V Read Only	1.49

**MICROPROCESSOR COMPONENTS**

Z80, Z80A, Z80B, SERIES		8000 SERIES Continued	
Part No.	Price	Part No.	Price
Z80	1.25	8155-2	3.75
Z80A	1.29	81C55	4.25
Z80A-CTC	4.65	8205	9.95
Z80A-DART	4.95	82C11	6.95
Z80A-PIO	1.89	8212	1.95
Z80A-SIOO	3.95	8216	1.39
Z80B	2.75	8224	1.49
Z80B-CTC	3.95	8228	1.49
Z80B-PIO	3.95	8237-5	4.25
Z8681B1	4.95	8243	1.95

8000 SERIES		STATIC RAMS		
Part No.	Price	Part No.	Price	
8031	3.95	2016 12	2048x8 120ns	2.95
80C31	8.95	2102	1024x1 350ns	.89
8035	1.25	2112	256x4 450ns MOS	2.49
8039	1.25	2144N	1024x4 200ns Low Power	1.49
8052AHBASIC	24.95	2144N-2L	1024x4 200ns (CMOS)	1.49
8085A	1.95	21C14	1024x4 200ns (CMOS)	1.95
8085A-2	3.59	5101	256x4 450ns (CMOS)	1.95
8086	3.95	6116P-1	2048x8 100ns (16K) CMOS	3.19
8087 (5MHz)	89.95	6116P-1P	2048x8 100ns (16K) LP CMOS	3.59
8087 (10MHz)	129.95	6116P-3	2048x8 150ns (16K) LP CMOS	3.09
8088 (5MHz)	4.95	6264P-10	8192x8 100ns (64K) CMOS	6.29
8088 (10MHz)	6.95	6264P-15	8192x8 150ns (64K) LP CMOS	6.95
8155	2.49	6264P-11	8192x8 120ns (64K) LP CMOS	6.75
		6264P-15	8192x8 150ns (64K) LP CMOS	6.49
		6514	1024x4 350ns CMOS	3.25
		43256-10L	32,768x8 100ns (256K) Low Power	15.95
		43256-15L	32,768x8 150ns (256K) Low Power	14.95
		62256P-10	32,768x8 100ns (256K) LP CMOS	16.95
		62256P-12	32,768x8 120ns (256K) LP CMOS	16.25
		62256P-15	32,768x8 150ns (256K) LP CMOS	15.95

DYNAMIC RAMS/MODULES		
41256A8A-10	262,144x9 100ns 256x9 SIP (Has Leads)	49.95
41256A8B-10	262,144x9 100ns 256x9 SIM	59.95
42100A9A-10	1,048,576x9 100ns 1MEGx9 SIP (Has Leads)	159.95
42100A9B-10	1,048,576x9 100ns 1MEGx9 SIM	159.95
42100A9A-80	1,048,576x9 80ns 1MEGx9 SIP (Has Leads)	169.95
42100A9B-80	1,048,576x9 80ns 1MEGx9 SIM	169.95
TMS5418-12	16,384x4 120ns	5.95
TMS5418-15	16,384x4 150ns	5.49
4116-15	16,384x1 150ns (MM5290N-2)	1.09
4128-15	131,072x1 150ns (Poggyback)	4.49
4164-100	65,536x1 100ns	2.75
4164-120	65,536x1 120ns	2.39
4164-150	65,536x1 150ns	2.15
41256-60	262,144x1 60ns	5.49
41256-80	262,144x1 80ns	5.75
41256-100	262,144x1 100ns	3.95
41256-120	262,144x1 120ns	3.25
41256-150	262,144x1 150ns	3.25
41264-12	64Kx4 120ns Video RAM	10.95
41464-10	65,536x4 100ns	4.49
41464-12	65,536x4 120ns	4.49
41464-15	65,536x4 150ns	4.25
51258-10	262,144x1 100ns Static Column	8.95
51100P-10	1,048,576x1 100ns (1 Meg)	12.95
51100P-80	1,048,576x1 80ns (1 Meg)	13.95
514256P-10	262,144x4 100ns (1 Meg) Column	14.49
514258-10	262,144x4 100ns (1 Meg) Column	26.95

EPROMS		
TMS2516	2048x8 450ns (25V)	4.95
TMS2532	4096x8 450ns (25V)	5.95
TMS2532A	4096x8 450ns (12.5V)	5.25
TMS2564	8192x8 450ns (25V)	6.95
TMS2716	2048x8 450ns (+5V, +5V, +12V)	6.49
1702A	256x8 2K (1µs)	4.25
2708	1024x8 450ns	6.95
2716	2048x8 450ns (25V)	3.49
2716-1	2048x8 350ns (25V)	3.95
2716-2	2048x8 450ns (25V) CMOS	4.25
2732	4096x8 450ns (25V)	3.95
2732A-20	4096x8 200ns (21V)	3.95
2732A-25	4096x8 250ns (21V)	3.75
2762-25	4096x8 250ns (25V) CMOS	5.25
2762A-25	8192x8 250ns (21V)	3.95
2762A-20	8192x8 200ns (12.5V)	4.19
2762A-15	8192x8 150ns (12.5V)	3.95
27128-20	16,384x8 200ns (21V)	5.95
27128-25	16,384x8 250ns (21V)	5.25
27128A-15	16,384x8 150ns (12.5V)	6.95
27128A-20	16,384x8 200ns (12.5V)	4.75
27128B-25	16,384x8 250ns (21V) CMOS	5.95
27256-15	32,768x8 150ns (12.5V)	8.49
27256-20	32,768x8 200ns (12.5V)	5.95
27256-25	32,768x8 250ns (12.5V)	4.95
27256-15	32,768x8 150ns (12.5V) CMOS	7.25
27256-20	32,768x8 200ns (12.5V) CMOS	5.49
27256-25	65,536x8 250ns (12.5V)	7.25
27256-15	65,536x8 150ns (12.5V) CMOS	9.95
27256-20	65,536x8 200ns (12.5V) CMOS	7.49
270010-15	131,072x8 150ns (12.5V) CMOS (1 Meg)	19.95
68764	8192x8 64K 450ns (25V) (Chip Enable)	14.95
68766-35	8192x8 64K 350ns (25V) (Output Enable)	15.95

**8000 SERIES Continued**

Part No.	Price
8286	2.29
8741	3.49
8742	1.45
8746 (25V)	7.95
8748H (HMOS)(21V)	9.95
8749	9.95
8751H (3.5-12MHz)	34.95
8752	13.95
80286-10 (10MHz) CC	25.95
80287-3 (5MHz)	109.95
80287-8 (8MHz)	209.95
80287-10 (10MHz)	239.95
80386-16 PGA	259.95
80387-16 (16MHz)	349.95
80387-20 (20MHz)	399.95
80387-25 (25MHz)	499.95
82284 (8MHz)	5.49
82288 (8MHz)	6.95

**DATA ACQUISITION**

Part No.	Price
ADC0804CN	2.99
ADC0808CCN	5.95
ADC0809CCN	3.69
ADC1205CCJ-1	20.95
ADC0800LCN	1.75
AV-3101SD	4.95
AV-51013A	2.95

**6500/6800 68000 Series**

Part No.	Price
6402	3.75
6502	2.19
6502A	6.95
65C02 (CMOS)	5.95
6520	1.59
6522	2.95
65C22	4.25
6532	2.79
6551	6.29
65C802 (CMOS)	15.95
6800	1.75
6802	2.95
6808	2.49
6810	1.25
6820	2.75
6821	1.75
68B21	2.25
6840	2.75
6845	1.75



# Now Available...Jameco's NEW 1990 Catalog with 82 pages of Computer Peripherals, Components & More!

# 15<sup>th</sup> ANNIVERSARY YEAR 1974 - 1989

## SPECIAL! Monochrome Text Card

### Sperry Monochrome Display Adapter

- IBM PC/XT Compatible
- Use for Text only
- Great for Network Servers and Dedicated Work Stations

TEXT.....\$12.95



## COMPUTER ACCESSORIES

### DFI Handy Scanner

#### and 3 Button Mouse

#### for IBM PC/XT/AT

#### FREE DPE Software

#### with HS3000!

The HS3000 offers a full 4 inch window at 400dpi resolution. Scan photos, logos, drawings, etc. Can be used with today's most popular applications.

HS3000 Handy Scanner ..... \$189.95

DMS200 200DPI 3-Button Ser. Mouse ..... \$39.95

DMS200S 200DPI 3-Button Ser. Mouse with Dr. Halo Software ..... \$59.95

### IBM Compatible Cases and Power Supplies

JE2011 Pictured

JE1030 Pictured

JE1010 Flip-Top Standard PC/XT Case..... \$39.95

JE1018 Slide Baby AT Case..... \$59.95

JE1030 150 watt PC/XT Power Supply..... \$59.95

JE1032 200 watt Baby AT Power Supply..... \$89.95

JE2011 Vertical Case w/300 watt Pwr. Supply. .... \$279.95

JE2014 Flip-Top Baby XT Turbo Case..... \$69.95

JE2019 Flip-Top Baby AT Case..... \$69.95

## Datronics 2400/1200/300 Baud Pocket Size Modems

2400 Baud Pocket-Size Modem...Only \$149.95!

2400P Pictured

1200P 1200/300 Baud Pocket Size Modem With ProComm Shareware Software ..... \$89.95

2400P 2400/1200/300 Baud Pocket Size Modem With ProComm Shareware Software ..... \$149.95

## TEST EQUIPMENT

### Metex Digital Multimeters

- Metex General Specs:**
- Handheld, high accuracy
  - AC/DC Voltage, AC/DC Current, Resistance, Diodes, Continuity, Transistor hFE • Manual ranging w/overload protection
- M3650/B & M4650 only:**
- Also measures frequency and capacitance
- M4650 only:**
- Data Hold Switch
  - 4.5 Digit

M3610 3.5 Digit Multimeter..... \$49.95

M3650 3.5 Digit w/Freq. & Capacitance ..... \$69.95

M3650B Same as M3650 w/Bargraph..... \$79.95

M4650 4.5 Dig. w/Freq., Capacitance and Data Hold Switch ..... \$99.95

M4650 Pictured

1355 Shoreway Road  
Belmont, CA 94002  
24 Hour Order Hotline (415) 592-8097  
FAX's (415) 592-2503 or (415) 595-2664  
Telex 176043 - Ans. Back: Jameco Blmt  
IC Data Sheets - 50c each  
Send \$2.00 Postage for a FREE 1990 Catalog  
© 1989 Jameco Electronics 11-89  
IBM is a registered trademark of International Business Machines

## Jameco 16MHz 80286 NEAT Computer Kit With 2 Megabyte RAM

- Fully IBM AT Compatible
- Free! DR-DOS Disk Operating System Software Included
- Free! QAPLUS Diagnostic Software Included!
- Free! WORDSTAR EASY Word Processing Software Included!

- 2Mb RAM Included, Expandable to 8Mb
- 8 or 16MHz Operation
- AMI BIOS ROMs Included
- Flip-Top Case w/200 Watt Power Supply
- 1.2Mb Disk Drive
- 18.0 Norton SI Rating
- 101-Key (Enhanced) Keyboard



Shown with VGA Option (not included)  
JE2060 Monitor and Adapter Card...\$529.95  
(See Below)

JE3013 16MHz IBM AT Compatible Kit.....\$849.95

## IBM COMPATIBLE DISPLAY MONITORS

AMBER	12" Amber Monochrome .....	\$99.95
HD55H	14" RGB 640x240 .....	\$249.95
TM5154	EGA 14" 720x350 .....	\$369.95
JE1059	EGA Monitor & Card .....	\$459.95
TM5156	14" VGA 720x480 .....	\$399.95
TM5157	14" Multiscan 800x600 .....	\$469.95
JE2060	VGA Monitor & Card .....	\$529.95

## JAMECO IBM PC/XT/AT COMPATIBLE CARDS

JE1043	360K/720K/1.2Mb/1.44Mb Floppy Disk Controller Card (PC/XT/AT).....	\$49.95
JE1050	Monochrome Graphics Card w/Parallel Printer Port (PC/XT/AT).....	\$59.95
JE1052	Color Graphics Card w/Parallel Printer Port (PC/XT/AT).....	\$49.95
JE1055	EGA Card w/ 256K Video RAM (PC/XT/AT).....	\$139.95
GC1500	Orchid 8-Bit VGA Card w/256K Video RAM (PC/XT/AT).....	\$179.95
GC1501	Orchid 8/16-Bit VGA Card w/256K Video RAM (PC/XT/AT).....	\$299.95
JE1060	I/O Card w/ Serial, Game, Printer Port & Real Time Clock (PC/XT).....	\$59.95
JE1062	RS232 Serial Hall Card (PC/XT/AT).....	\$29.95
JE1065	I/O Card w/ Serial, Game and Parallel Printer Port (AT).....	\$59.95
JE1071	Multi I/O Card w/ Controller & Monochrome Graphics (PC/XT).....	\$119.95
JE1077	Multi I/O Card w/ 360K/720K/1.2Mb/1.44Mb Floppy Controller (AT).....	\$74.95
JE1081	2Mb Expanded or Extended Memory Card (zero-K on-board) (AT).....	\$109.95

## SEAGATE HALF-HEIGHT HARD DISK DRIVES

ST225	20Mb Drive only (PC/XT/AT).....	\$224.95
ST225XT	20Mb w/Controller (PC/XT).....	\$269.95
ST225AT	20Mb w/Controller (AT).....	\$339.95
ST238	30Mb Drive only (PC/XT/AT).....	\$249.95
ST238XT	30Mb w/Controller (PC/XT).....	\$299.95
ST238AT	30Mb w/Controller (AT).....	\$389.95
ST251-1	40Mb Fast 28ms (Drive only).....	\$469.95
ST251XT	40Mb w/Controller (PC/XT).....	\$419.95
ST251AT	40Mb w/Controller (AT).....	\$489.95

Your One-Stop Center for Hard Disk Drive Needs!



Seagate 60Mb, 80Mb & 120Mb Hard Disk Drives Also Available!

## HARD & FLOPPY DISK CONTROLLERS

Computer Type	MFM Hard		RLL Hard		MFM Hard/Floppy		RLL Hard/Floppy	
	Part No./ Price	Part No./ Price	Part No./ Price	Part No./ Price	Part No./ Price	Part No./ Price	Part No./ Price	
8088 (PC/XT) 3:1 Interleave	XTGEN \$79.95	1004A27X \$89.95	JE1044 \$109.95	.....	.....	.....	.....	
80286 (AT)/386 2:1 Interleave	1003VMM1 \$129.95	1003VSR1 \$149.95	1003VMM2 \$169.95	1003VSR2 \$169.95	.....	.....	.....	
80286 (AT)/386 1:1 Interleave	1006VMM1 \$149.95	1006VSR1 \$169.95	1006VMM2 \$169.95	1006VSR2 \$189.95	.....	.....	.....	

## IBM PC/XT/AT COMPATIBLE 3.5"/5.25" DISK DRIVES

MF353B	3.5" 720Kb (PC/XT/AT) .....	\$99.95
356KU	3.5" 1.44Mb (PC/XT/AT) .....	\$109.95
JE1020	5.25" 360Kb (PC/XT/AT) Black .....	\$89.95
JE1021	5.25" 360Kb (PC/XT/AT) Gray .....	\$89.95
JE1022	5.25" 1.2Mb (PC/XT/AT) Gray.....	\$99.95



JE1022 Pictured

## MOTHERBOARDS

20MHz 386 Only \$649.95!

All w/ 0K RAM

JE3520 Pictured



JE1001	Jameco 4.77/8MHz 8088 (PC/XT).....	\$89.95
JE1002	Jameco 4.77/10MHz 8088 (PC/XT).....	\$99.95
JE3005	Jameco Baby 8/12MHz 80286 (AT).....	\$199.95
JE3010	Jameco Baby 8/16MHz 80286 (AT).....	\$299.95
JE3020	AMI Baby 16MHz 80386 .....	\$999.95
JE3025	AMI Baby 20MHz 80386 .....	\$1199.95
JE3026	AMI Full-Size 25MHz 80386 .....	\$1899.95
JE3028	AMI Full-Size 33MHz 80386 .....	\$2599.95
JE3520	Jameco Baby 20MHz 80386 .....	\$649.95
JE3525	Jameco Baby 25MHz 80386 .....	\$1299.95

## SUPER SONY SALE

### 720Kb 3.5" Floppy Drive

• For use with IBM PC/XT/AT and compatible computers • Double-sided, double density • 135TPI • 160 tracks • Rotation speed: 300rpm • Size: 4"W x 6"D x 1"H

MPF11 720Kb Drive .... \$69.95

SMK 5.25" Mounting Kit.....\$14.95



## PROTOTYPING PRODUCTS

### Jameco Solderless Breadboards

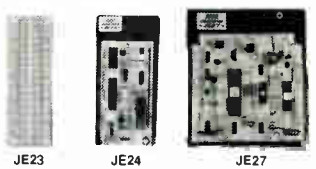

Part No.	Dim. L" x W"	Contact Points	Binding Posts	Price
JE21	3.25 x 2.125	400	0	\$4.95
JE23	6.5 x 2.125	830	0	\$6.95
JE24	6.5 x 3.125	1,360	2	\$12.95
JE25	6.5 x 4.25	1,660	3	\$17.95
JE26	6.875 x 5.75	2,390	4	\$22.95
JE27	7.25 x 7.5	3,220	4	\$32.95

## COMPUTER ACCESSORIES

### Jameco IBM PC/XT/AT Compatible Keyboards

JE2017 Pictured	84-Key Standard AT Layout .....	\$59.95
JE2015	101-Key Enhanced Layout.....	\$69.95
JE2016	111-Key Enhanced w/Solar Calculator ..	\$79.95
JE2017	104-Key Enhanced w/Trackball.....	\$99.95

## Colorado Memory 40Mb Tape Back-Up for IBM PC/XT/AT

DJ10	40Mb Tape Back-Up and Tape.....	\$299.95
TB40	40Mb Tape Cartridge.....	\$24.95

## ENGINEERING/DATA BOOKS

21035	Sams TTL Cookbook (88).....	\$14.95
21398	Sams CMOS Cookbook (88).....	\$19.95
22453	Sams Op-Amp Cookbook (88).....	\$21.95
270645	Intel 8-bit Controller Hndbk. (89).....	\$19.95
270646	Intel 16-bit Controller Hndbk. (89).....	\$19.95
270647	Intel 32-bit Controller Hndbk. (89).....	\$19.95
400026	NSC Linear Data Book Vol. 1 (89).....	\$19.95
400015	NSC Linear Data Book Vol. 2 (89).....	\$11.95
400104	NSC Linear Data Book Vol. 3 (89).....	\$11.95
ICM89	1989 IC Master (3 Volume Set).....	\$119.95



\$25.00 Minimum Order - U.S. Funds Only  
CA Residents Add 6%, 6.5% or 7% Sales Tax  
Shipping - Add 5% plus \$1.50 Insurance  
(May vary according to weight and shipping method)  
Terms: Prices subject to change without notice.  
We are not responsible for typographical errors.  
We reserve the right to substitute manufacturers.  
Items subject to availability and prior sale.  
Products pictured may only be representative.  
Complete list of terms/warranties is available upon request.

24-Hour Order Hotline (415) 592-8097 • The Following Phone Lines Are Available From 7AM - 5PM P.S.T.:

• Customer Service (415) 592-8121 • Technical Assistance (415) 592-9990 • Credit Department (415) 592-9983 • All Other Inquiries (415) 592-7108

# COMPARE OUR NEW LOWER PRICES AND SUPERIOR QUALITY

## PCI-286-12

- 80286-12
- 1.2 MB Floppy Drive
- 640K RAM
- Serial / Parallel / Game
- 101-Key Enhanced Key Board
- SI = 13.3 (1 Wait)
- SI = 15.2 (0 Wait \$100 Option)
- 6/12 MHz Key Bcard Switchable
- WA2 HD & FD Controller
- 80287 SOCKET
- 200W POWER SUPPLY

**MONO SYSTEM**  
 • W/Mono Monitor  
 • 20 MB Hard Disk  
**\$1095**

**VGA COLOR SYSTEM**  
 • W/VGA Card & Monitor  
 • 20 MB Hard Disk  
**\$1580**

**EGA COLOR SYSTEM**  
 • W/EGA Card + Monitor  
 • 20 MB Hard Disk  
**\$1480**



## PCI-386-20

- 80386-20
- W/40 MB HD
- Mono System **\$1795**
- VGA **\$2295**

## GAS PLASMA 286-12 \_\_\_ \$1895

- 80286-12 CPU
- SI = 13.3
- 3 1/2" FD 1.44 MB
- 20 MB HD ST-138
- LCD Screen (640 X 400)
- I/O Card Parallel/Serial/Game
- 640K RAM



## GAS PLASMA 286-20 \$1995

- CPU 80286-20
- SI = 23

## LCD-286-10 PORTABLE \_\_\_ \$1349

- 10 MHZ 80286 SI=10.3
- 12 MHZ SI = 13.3 (Option \$50.00)
- 16 MHZ SI = 18 (Option \$250.00)
- 640K RAM
- LCD Screen 640 X 200 (Option 640 X 400 \$180.00)
- Super Twist & Back Lighting
- 86 Key Board
- External / Parallel / Game
- 1.2 MB Floppy drive
- 20 MB Hard Disk
- 80287 Socket
- 200 W Power Supply
- Side 15 1/4" X 9 1/2" X 8"
- 23 LBS



## LCD-386-16 \_\_\_ \$2095

- 80386-16 MHZ
- 40 MB Hard Disk
- 80387 Socket

## LCD-386-20 \_\_\_ \$2195

- 80386-20 MHZ
- 40 MB Hard Disk
- 80387 Socket

## CRT-PORTABLE-286 \_\_\_ \$1249

- Compaq Type
- 80286 (10 MHz or 12 MHz)
- 12 MHz SI = 13.3 (Option \$50.)
- 16 MHz SI = 18 (Option \$250)
- One 1.2 MB Floppy Drive
- 200 W Power Supply
- TTL Display 9" Amber
- AT Key Board
- Serial / Parallel / Game
- WA2 HD & FD Controller
- 20 MB Hard Disk



## CRT-386-16 \$1795

- 80386-16

## CRT-386-20 \$1895

**PCI PACIFIC COMPUTER**  
 702 S. Del Mar Ave., #B,  
 San Gabriel, California 91776  
 (FAX) 818-286-8662

(818) 571-5548 (Technical support)

(800) 421-1102 (IN CA) ORDER ONLY

(800) 346-7207 (OUT CA)

Mon - Sat  
 9:00 AM - 6:00 PM



\*ALL SYSTEMS COME WITH ONE YEAR PARTS & LABOR WARRANTY

# IIT's 287 Coprocessor

- Twice the speed of Intel's 80287 - 10 Mhz
- 100% Intel Compatible
- CMOS/NMOS Compatible
- Lower power for your laptop

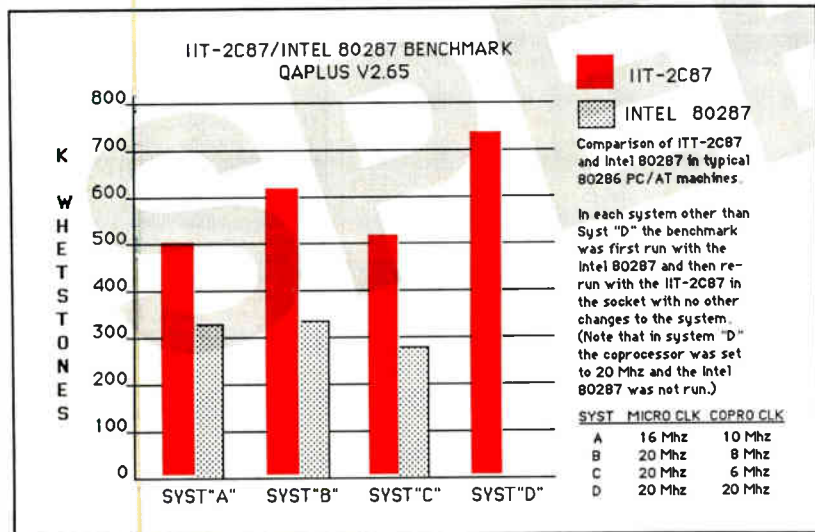

**PSI**  
 2005 Hamilton Ave. #220  
 San Jose, CA 95125  
 800-622-1722  
 408-559-8544



# A-BUS™ MAGIC

Classroom to advanced industrial applications.

Be a Wizard in your Lab, Factory, College, Home...

It used to be difficult and costly to do process control, robotics, data acquisition, monitoring and sensing with your computer. Now the low-cost A-BUS system makes it easy to do almost any project you can imagine.

**Versatility.** A-BUS cards handle most interfacing, from on/off switching, to reading temperatures, to moving robot arms, to counting events, to sensing switches...

**Adaptability.** The A-BUS is modular, allowing expansion well beyond your needs. It works with almost any computer, or even as a remote data station with the new serial adapters.

**Simplicity.** You can start using the A-BUS in minutes. It's easy to connect, and software is a breeze to write in any language.

**Reliability.** Careful design and rugged construction make the A-BUS the first choice in specialized I/O.

An A-BUS system consists of: - An A-BUS adapter plugged into your computer - A cable to connect the adapter to 1 or 2 A-BUS function cards. - The same cable will also fit an A-BUS Motherboard for expansion to up to 25 cards in any combination.

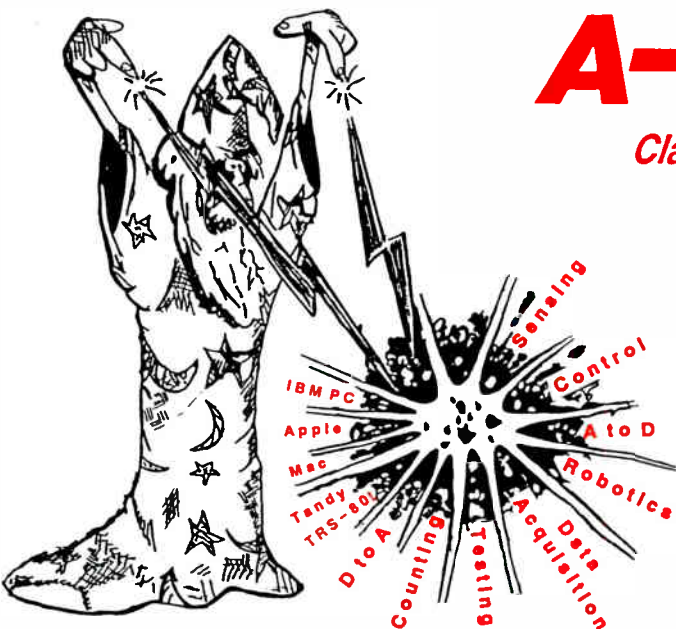

**NEW: REMOTE A-BUS!** Use the new Serial (RS-232) Adapter or Processor to control any A-BUS system. Cards can be up to 500 ft away using phone type cable, or off premises using a modem. Call or send for the new A-BUS Catalog which covers all the products.

## Important

All A-BUS Systems: ♦ Come assembled and tested ♦ Include detailed manuals with schematics and programming examples ♦ Can be used with almost any language (BASIC, Pascal, C, assembler, etc.) using simple "IN" and "OUT" commands (PEEK and POKE on some computers) ♦ Can grow to 25 cards (in any combination) per adapter ♦ Provide jumper selectable addressing on each card ♦ Require a single low cost unregulated 12V power supply ♦ Are usually shipped from stock. (Overnight service is available.)

## About Alpha Products

Founded in 1976 for the purpose of developing low cost I/O devices for personal computers, Alpha has grown to serve over 70000 customers in over 60 countries. A-BUS users include many of the Fortune 500 (IBM, Hewlett-Packard, Tandy, Bell Labs, GM...) as well as most major universities. A-BUS products are U.S. designed, U.S. built, and serviced worldwide. Overseas distributors: England: Cady Science Assoc. Ltd., Merseyside, 051 342 7033. Australia: Brumby Technologies Pty. Ltd., NSW, 759 1638. France: Cosem, Rungis, 46 86 64 75

## Inputs, Outputs, etc.

**Analog Input:** 8 analog inputs. 0-5.1V in 20mV steps (8 bits). 0-100V range possible. 7500 conversions/second. **AD-142: \$142**

**12 Bit A to D:** Analog to digital converter. Input range -4V to +4V, expandable to 100V. On-board amplifier. Resolution 1mV. Conversion time 130ms. 1 channel. (Expand to 8 channels with the RE-156 card.) **AN-148: \$153**

**Relay Card:** 8 individually controlled industrial relays each with status LED's (3A at 120VAC contacts, SPST). **RE-140: \$142**

**Reed Relay Card:** 8 reed relays (20mA at 60VDC, SPST). Individually controlled and latched, with status LEDs. **RE-156: \$109**

**D/A converter:** 4 Channel 8 Bit D/A converter with output amplifiers and separate adjustable references. **DA-147: \$149**

**24 line TTL I/O:** Connect 24 input or output signals (TTL 0/5V levels or switches). Variety of modes. (Uses 8255A) **DG-148: \$72**

**Digital Input:** 8 optically isolated inputs. Input can be 5 to 100V voltage levels or switch closures. **IN-141: \$65**

**Digital Output Driver:** 8 outputs: 250mA at 12V. Drive relays, solenoids, stepper motors, lamps, etc. **ST-143: \$78**

**Clock with Alarm:** Powerful clock/calendar. Battery backup. Timing to 1/100 sec. Alarm relay, LED and buzzer. **CL-144: \$96**

**Touch Tone Decoder:** Each tone is converted into a number which is stored on the board. **PH-145: \$87**

**A-BUS Prototyping card:** 4x4.5" card. Will accept up to 10 I.C.s. With power & ground bus. **PR-152: \$116**

**Counter Timer:** Three 16 bit counters/timers. Use separately or cascade for long (48 bit) counts. **CT-150: \$132**

Call our application engineers to discuss your project.

## Motion Control

**Smart Quad Stepper Controller:** The world's finest. On board microprocessor controls four motors simultaneously. Uses simple English commands like "MOVE ARM 10.2 (INCHES) LEFT". For each axis, you control coordinates (absolute or relative), ramping, speed, units, scale factors, etc. Many inputs for limit switches, etc. On the fly reporting of speed, position... Built in drivers for small motors (such as MO-103 or 105). **SC-149: \$299**  
Options: ▶ 5 amp/phase power booster for 1 motor: **PD-123: \$49**  
▶ Remote "teach" keypad for direct motor control: **RC-121: \$54**

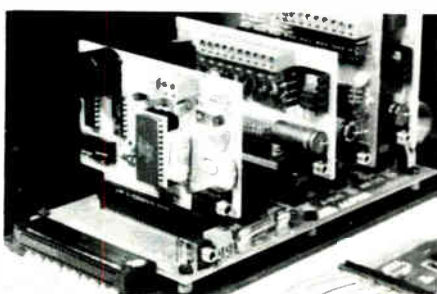

A large A-BUS system with two Motherboards Adapter in the foreground plugs into PC, XT, AT type slot.

**Stepper Driver Kit:** For experimenting with stepper motors. Includes 2 MO-103 motors and a ST-143 dual driver PA-181: **\$99**

**Stepper Motors:** (4 phase, unipolar)  
**MO-103:** 2 1/4" dia, 1/4" shaft, 7.5"/step, 12V, 5 oz-in torque. **\$15**  
**MO-104:** 2" dia, 1/4" shaft, 1.8"/step, 5V, 60 oz-in torque. **\$45**  
**MO-105:** 1.7" square, .2" shaft, 3.75"/step, 12V, 6 oz-in. **\$15**

## A-BUS Adapters

- ▶ Can address 64 ports and control up to 25 A-BUS cards.
- ▶ Require one cable. Motherboard required for more than 2 cards.

### A-BUS Parallel Adapters for:

**IBM PC/XT/AT & compatibles.** Uses one short or long slot. **AR-133: \$69**  
**Apple II, II+, IIe** Plugs into any slot inside. **AR-134: \$52**  
**Commodore 64, 128** Plugs into Expansion Port on back. **AR-139: \$48**  
**TRS-80 Model 102, 200** Uses 40 pin "System bus". **AR-136: \$76**  
**Model 100 (Tandy portable)** Plugs into socket on bottom. **AR-135: \$75**  
**TRS-80 Model 3, 4, 4D** Y-Cable available if 50 pin bus is used. **AR-132: \$54**  
**TRS-80 Model I** Plugs into 40 pin expansion bus. **AR-131: \$39**  
**Tandy Color Computers** Fits ROM slot, Multipak or Y-Cable **AR-138: \$49**

**A-BUS Cable:** Necessary to connect any parallel adapter to one A-BUS card or to first motherboard. 50 pin, 3 ft. **CA-163: \$24**  
Special Cable for two A-BUS cards **CA-162: \$34**

**Serial Adapter:** Connect A-BUS systems to any RS-232 port. Allows up to 500 ft from computer to A-BUS. **SA-129: \$149**

**Serial Node:** To connect additional SA-129/A-BUS systems to a single RS232 serial port (max 16 nodes). **SN-128: \$49**

**Serial Processor:** same as above plus built in BASIC for off-line monitoring, logging, decision making, etc. **SP-127: \$189**  
Use SA-129 or SP-127 with modems for remote data acquisition.

**Motherboard:** Holds up to 5 A-BUS cards in sturdy aluminum frame with card guides. A sixth connector allows (using cables CA-161: \$12) additional Motherboards to be added. **MB-120: \$108**

**Power Supply:** Power pack for up to 4 cards. **PS-126: \$12**

### Complete Catalog Available

For Orders and Info call (203) 656-1806  
Weekdays from 9 to 5 EST or FAX 203 656-0756

Ordering Information: We accept Visa, Mastercard, Checks, and M.O. C.O.D. is \$4 extra. Purchase orders are subject to credit approval. CT residents add 7.5% sales tax. Shipping: \$4 per order (usually UPS ground). UPS 2nd Day Air: \$4 extra. Next Day service available. Canada: \$6 per order (Airmail). Outside US and Canada: Add 10% of order total.

Circle 22 on Reader Service Card



a Sigma Industries Company

# ALPHA Products

242-B West Avenue, Darien, CT 06820

NOVEMBER 1989 • BYTE 451

# THIRD COAST TECHNOLOGIES, INC.

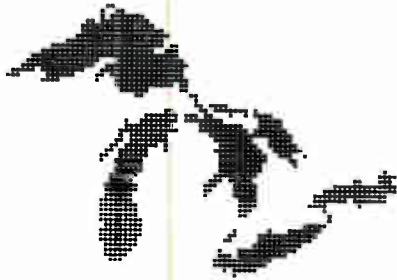

Introducing...  
**First Time Ever**  
**URX™**

## FAULT TOLERANCE OFFERED IN A SUPER-MICRO COMPUTER PLATFORM

Ultra-reliability in a microframe. Audible alarm system. Front panel removal and insertion of all peripherals *while* system is running. Maintenance requires no tools.

- **CPU:** 80386 at 20, 25, 33 MHz.
- **Power Supplies:** Dual-fault tolerant 350 watt each • 110 or 220V UPS connections and rear panel removal, thermal overload sensors, front panel indicators, audible alarm.
- **Enclosure:** all metal tower with 17 1/2 height peripheral bays.
- **Hard Disk Systems:** ESDI 106 MBytes, 2.4 GBytes, 71000KB/Sec. caching subsystem.
- **Tape Storage Systems:** 60 MB to 2.3 GB
- **Floppy Disk Drives:** High Density 1.2 MB dual-speed.
- **I/O:** Internal and external SCSI connections
- **RS-232C:** Intelligent Serial, 38.4 K band, 128 ports maximum.
- **LAN:** Ethernet (thick or thin).

219 N. Milwaukee Street  
 Milwaukee, WI 53202  
 (414) 272-4220  
 Fax: (414) 272-1338

2101 Webster St.  
 Suite 1700  
 Oakland, CA 94612  
 (415) 446-7888  
 Fax: (415) 446-7887

## EZ-ROUTE VERSION II



**SCHEMATIC TO PCLAYOUT \$500  
 INCLUDES AUTO ROUTER**

EZ-ROUTE Version II from AMS for IBM PC, PS/2 and Compatibles is an integrated CAE System which supports 256 layers, trace width from 0.001 inch to 0.255 inch, flexible grid, SMO components and outputs on Penplotters as well as Photo plotters, and printers.

Schematic Capture \$100, PCB Layout \$250, Auto Router \$250.

**FREE EVALUATION PACKAGE**

**30 DAYS MONEY BACK GUARANTEE**

1-800-972-3733 or (305) 975-9515

**ADVANCED MICROCOMPUTER SYSTEMS, INC.**  
 1321 N.W. 65 Place - Ft. Lauderdale, FL 33309

Circle 269 on Reader Service Card



### SEAGATE

ST-225 KIT .....	\$220	Toshiba 3300 .....	\$798
ST-238 KIT .....	\$255	Toshiba 30600 .....	\$1035
ST-251-0 .....	\$311	Panafax F160 .....	\$835
ST-251-1 .....	\$327	Sharp UX .....	\$817

### FAX

### OTHERS

KEYBOARD 102 AT STYLE .....	\$35
KEYBOARD 102 AT STYLE W/CLICK .....	\$44
HAND SCANNER D.F.I. HS3000 PLUS .....	\$171
HAND SCANNER LOGITECH .....	\$169
SERIAL MOUSE LOGITECH .....	\$67
BUS MOUSE LOGITECH .....	\$72
MOUSE D.F.I.3. BUTTONS W/SOFTWARE .....	\$37
MOUSE D.F.I.3. BUTTONS NO SOFTWARE .....	\$31

10 pieces or more, except fax,  
 all products are 100% IBM compatible.  
 Check for more items.  
 1-800-683-2255

Nagan Corporation      Tel: (305) 477-3929  
 8021 N.W. 14th St.      Fax: (305) 477-4326  
 Miami, FL 33126      TLX: 159292NAGAN UT

Circle 245 on Reader Service Card

## THE GENERAL STORE RETAIL OPERATIONS SYSTEM

The premier system for retail store management. Supports cash drawers, barcode readers, receipt printers, customer displays, digital scales and complete online credit card authorization. Controls all types of retail stores both hardgoods and apparel with complete size/color matrix management and reporting. Easy to install and use. Field proven for speed and reliability. Provides all the features needed for today's retail merchant at a price far below comparable systems. Demo system available.



**Accounts Receivable  
 Point of Sale  
 Inventory Control  
 Accounts Payable  
 General Ledger  
 Mailing List**  
 ...Multuser/Network Ready...

**\$995** Complete system  
 Dealer inquiries invited.

**Crichlow Data Sciences, Inc.**  
 (804) 471-0500  
 P.O. Box 6420 - Virginia Beach, VA 23456

Circle 97 on Reader Service Card

World Radio History

## 16-BIT RESOLUTION ANALOG-TO-DIGITAL CONVERTER 12,000 SAMPLES/SEC for IBM PC, XT & AT SINGLE PIECE PRICE **\$475**

We manufacture a broad line of data acquisition and control hardware and software for Apple and IBM computers.

Call for quotes on custom hardware or complete systems.

### LAWSON LABS, INC.

5700 RAIBE ROAD  
 COLUMBIA FALLS, MT 59912  
 800-321-5355 or 406-387-5355



Circle 201 on Reader Service Card

## New EPROM Programmer



At \$495, Wintek's Universal EPROM Programmer is a low-cost and versatile tool for programming most industry-standard EPROMs (2716-27256). Since it can operate with an IBM PC, as well as stand-alone, the Programmer is ideal for use with PC-based microcomputer development software. Credit cards are welcome.

### Wintek Corporation

1801 South St., Lafayette, IN 47904  
 (800) 742-6809 or (317) 742-8428

Circle 380 on Reader Service Card

Advertise your  
 computer products  
 through  
**BYTE BITS**  
 (2" x 3" ads)

For more information  
 call Mark Stone at  
**603-924-6830**

## BYTE

One Phoenix Mill Lane  
 Peterborough, NH 03458

Circle 63 on Reader Service Card



**STAND-ALONE UNIVERSAL  
PLD PROGRAMMER**  
*Costs Less, Performs More*



PALpro-2x™ is an intelligent programmer supporting PLDs from a wide variety of sources. Works with any PC or computer using a serial port. FREE one year device update and warranty. Price \$795.00.

**LOGICAL  
DEVICES, INC.**

1201 N.W. 65th Place  
Ft. Lauderdale, FL 33309  
(305) 491-7404  
1-800-331-7766

Circle 205 on Reader Service Card  
(DEALERS: 206)

**8051 SBC \$99** oem  
qty 1  
Single Board Computer

FEATURES: 8031, RAM and ROM Sockets, 8 bit I/O, RS 232 port, optional UART, and Expansion Bus. Size: 3.5" x 6.0", +5Vdc only. OPTIONS: 8032, CMOS, 18 MHz, NV Memory, Monitor Firmware and High Level Languages. Development Board.....\$199

**8031 ICE \$199**

Our emulator provides most of the features of an 8031 In-Circuit-Emulator at a significantly lower price. It assists in integration, debug and test phases of development. Commands include: disassembly, trace, breakpoints, alter register/memory, and load Intel Hex file.

8051 Simulator Program.....\$99  
IBM PC/XT/AT Software simulation of 8051 µC.



HiTech Equipment Corporation  
9400 Activity Road  
San Diego, CA 92126  
(619) 566-1892

Circle 167 on Reader Service Card

LOW COST, RELIABLE  
**EPROM  
PROGRAMMER**

1 Year  
Warranty



Operates stand-alone or PC based. Shooter™, an intelligent EPROM programmer, uses serial port for communications. No modules to buy. Now includes 512K buffer; \$395 price includes cable, software and manual.

**LOGICAL  
DEVICES, INC.**

1201 N.W. 65th Place  
Ft. Lauderdale, FL 33309  
305-974-0967  
1-800-331-7766

Circle 207 on Reader Service Card  
(DEALERS: 208)

Turn your old XT/AT  
into a **WARPSPEED/386**

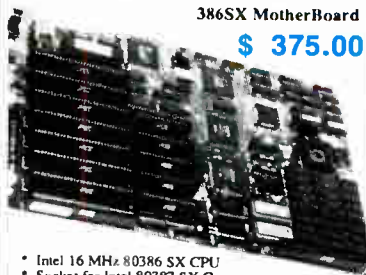

386SX MotherBoard

**\$ 375.00**

- Intel 16 MHz 80386 SX CPU
- Socket for Intel 80387 SX Coprocessor
- Shadow RAM Support
- 8 Expansion Slots 6-16 bits, 2-8 bits
- I/O Speed at 8 MHz to use existing cards
- Interleave w/1Mb RAM
- Fully AT Compatible

**386/20 w/OK .....\$ 575.00**  
**386/25 w/OK .....\$ 725.00**  
**386/25 Cache ....\$1195.00**

*HomeSmart Computing*  
1(800) 627-6998

Circle 168 on Reader Service Card

**Add  
some FUN  
to your PC!**



EYE-GARD is a great novelty for your home or office! The EYE-GARD vision sensor detects anyone simply walking up to your PC. Then it . . .  
... displays any PCX-format picture.  
... displays any message YOU choose.  
... plays music or sound effects.  
... requests a password before letting anyone use your PC.

EYE-GARD can even run other programs. It is perfect for sales or software demos!

EYE-GARD runs on all IBM-compatible computers. Comes with EYE-GARD sensor, software, sound and picture files.

EYE-GARD is a great gift for you . . . or anyone! . . . who uses personal computers.



**CUS RESEARCH**  
P.O. Box 140005  
Dallas, TX 75214  
(214) 826-3353

Order NOW for Christmas!  
**Only \$19.95**  
(plus \$3.50 p/h)  
VISA/MasterCard Accepted

Circle 139 on Reader Service Card

**AVPROM™**  
**\$295**

For IBM-PC's & compatibles, menu-driven AVPROM programs EPROMs up to 8x faster than serially-connected units (20 sec. for 2764).

- Programs 2716 thru 27512A.
- 4- and 10 socket gang versions too. Call for prices.

For complete specs, free 32 pg. development tool catalog, call

**800-448-8500.**  
or 207-236-9055

**AVOCET**

SYSTEMS, INC.  
120 Union St., Rockport, ME 04856

Circle 47 on Reader Service Card



Authorized Distributor Magnetic Media Division

5 1/4" DD  
**6<sup>25</sup>**  
PER BOX

5 1/4" HD  
**11<sup>30</sup>**  
PER BOX

3 1/2" DS  
**11<sup>95</sup>**  
PER BOX

3 1/2" HD  
**25<sup>95</sup>**  
PER BOX

**Dysan**

3.5 DS  
**9<sup>95</sup>**  
PER BOX

5 1/4" DS  
**6<sup>40</sup>**  
PER BOX

3.5 HD  
**22<sup>95</sup>**  
PER BOX

5 1/4" HD  
**10<sup>95</sup>**  
PER BOX

**LASER  
TONER**

- HP LaserJet 2 & 2D
- CANON 2
- HP LaserJet Plus & 500+
- CANON LPB
- APPLE LaserWriter

**84<sup>95</sup>**  
ea.

**Ricoh Toner Kit 80 "CALL"**  
**Ricoh OPC 80,81 or 150 \$139<sup>95</sup>**

**Qume Toner**  
KYOCERA F1000A, F1010  
BROTHER LP 10  
UNISYS 37 **21<sup>95</sup>**

the  
**Diskette  
Connection™**

Delaware **1-800-451-1849**  
P.O. BOX 10247, WILMINGTON, DE. 19850

Oklahoma **1-800-654-4058**  
P.O. BOX 1674, BETHANY, OK. 73008

Nevada **1-800-621-6221**  
P.O. BOX 12396, LAS VEGAS, NV. 89112

Minimum order \$2000. No Surcharge on Visa MasterCard. COD orders add \$3.99. Surface Shipping UPS add \$4.99 per 100 for 3 1/2" or 5 1/4" and \$4.99 per 100 for 8" U.S. Mail delivery add 9%. Prices subject to change without Notice.



FAX-405-495-4598

# VOICE MASTER KEY® VOICE RECOGNITION SYSTEM

FOR PC/COMPATIBLES &  
TANDY 1000 SERIES

A FULL FEATURED VOICE I/O SYSTEM

GIVE A NEW DIMENSION TO PERSONAL COMPUTING. . . The amazing Voice Master Key System adds voice recognition to just about any program or application. Voice command up to 256 keyboard macros from within CAD, desktop publishing, word processing, spread sheet, or game programs. Fully TSR and occupies less than 64K. Instant response time and high recognition accuracy. Voice recognition tool-box utilities are included. A genuine productivity enhancer!

SPEECH RECORDING SOFTWARE. . . Digitally record your own speech, sound, or music to put into your own software programs. Software provides sampling rate variations, graphics-based editing, and data compression utilities. Create software sound files you can add to macros for voice recognition verification response. A complete, superior speech and sound development tool.

SOFTWARE CONVERSION CODES. . . The Voice Master Key System operates a growing list of third party talking software titles using synthesized phonetics (text-to-speech) or digitized PCM, ADPCM, and CVSDM encoded sound files. Voice Master Key System does it all!



EVERYTHING INCLUDED. . . Voice Master Key System consists of a plug-in card, durable lightweight microphone headset, software, and manual. Card fits any available slot. External ports consist of mic inputs and volume controlled output sockets. High quality throughout, easy and fun to use.

**ONLY \$149.95 COMPLETE**

ONLY \$89.95 FOR TANDY 1000 SL/TL MODELS—  
SOFTWARE PACKAGE ONLY.

Requires Tandy Brand Electret microphone.

ORDER HOTLINE: (503) 342-1271

Monday-Friday, 8AM to 5PM Pacific Time

Visa/MasterCard, company checks, money orders, CODs (with prior approval) accepted. Personal checks subject to 3 week shipping delay. Specify computer type and disk format (3½" or 5¼") when ordering. Add \$5 shipping charge for delivery in USA and Canada. Foreign inquiries contact Covox for C & F quotes. 30 DAY MONEY BACK GUARANTEE IF NOT COMPLETELY SATISFIED. ONE YEAR WARRANTY ON HARDWARE.

CALL OR WRITE FOR FREE PRODUCT CATALOG



**COVOX INC.** 675-O Conger St.  
Eugene, Oregon 97402 U.S.A.  
TEL: 503-342-1271 • FAX: 503-342-1283

# MARYMAC®



of Discounting  
Computers, FAX  
& Cellular Phones

Radio Shack® Tandy®  
SCO

We will meet or beat. . .  
**GUARANTEED LOWEST PRICES**

MARYMAC INDUSTRIES INC.  
22511 Katy Fwy.

Katy (Houston), TX 77450

1-713-392-0747 FAX (713) 574-4567

Toll Free 800-231-3680

Circle 213 on Reader Service Card

# EZ-WRITER

(E)EPROM Multiprogrammer™  
DATA I/O 212\* Performance

For Only **\$995.**

100% USA  
Made



- Supports (E)EPROMs up to 40-pins.
- Stand-alone or Remote.
- 40-pin Micros Opt.
- SET/GANG 4 (E)EPROMs Opt.
- Parallel port for Fast Up/Down Load.
- 256K bytes, expandable to 16 megabits.



1-800-523-1565

In Florida (407) 994-3520

Fax: (407) 994-3615

\* DATA I/O is a registered trademark of DATA I/O Corporation

Circle 64 on Reader Service Card

# SIMMS

1 MB X 9 - 80/100NS

256K X 9 - 80/100NS

1Mbit, 41256, 4164, 41464

Get The Memory You Need  
At The Price You've Waited For.

**FAST SERVICE  
LOWEST PRICES IN USA**

**914-565-7080**

VISA C.O.D. M/C

VOLUME DISCOUNTS AVAILABLE  
CALL TODAY FOR LOW PRICE QUOTE

DELTA COMPUTING TECH. CORP.  
292 North Plank Rd. 50136 Florence Italy  
Newburgh NY 12550 50136 Florence Italy  
PH# 914-565-7080 PH# 39 55 676 045  
FAX 914-565-7082 FAX 39 55 668 942

**UPGRADE YOUR  
386 TODAY!!**

Circle 108 on Reader Service Card

# IMAGING CARD



- Dual camera inputs
- Composite video in/out
- 256 x 240 resolution
- Digitize/display at frame speed
- 16 Meg. color palette out (DV-02)
- External trigger input option
- PC/XT/AT compatible
- Complete with software & library

DV-02 8-bit 256 gray levels. \$849

DV-03 6-bit 64 gray levels. \$549

VISA/MC Demo disk available

**Control Vision**

PO Box 596 Pittsburg KS 66762  
800/292-1160 316/231-6647

Circle 95 on Reader Service Card

## Terminal Emulation

**TEK 4105/4010**

- Tektronix 4105
- Tektronix 4010/4014
- VT220, VT102
- Picture files
- VGA and EGA support
- High resolution hardcopy

**VT220**

- VT220, VT102 emulation
- File transfer
- 132 column modes
- Color support
- Hot key

■ ■ ■ **Diversified Computer Systems, Inc.**

3775 Iris Avenue, Suite 1B  
Boulder, CO 80301 (303) 447-9251  
FAX 303-447-1406

Trademarks VT102 VT220 DEC Tektronix Intekrics Inc

Circle 117 on Reader Service Card

## 9-Track Tape Subsystem for the IBM PC/XT/AT



Now you can exchange data files between your IBM PC and any mainframe or mini-computer using IBM compatible 1600 or 6250 BPI 9-Track tape. System can also be used for disk backup. Transfer rate is up to 4 megabytes per minute on PCs and compatibles. Subsystems include 7" or 10½" streaming tape drive, tape coupler card and DOS compatible software. For more information, call us today!

**QUALSTAR®**

9621 Irondale Ave., Chatsworth, CA 91311  
Telephone: (818) 882-5822

Circle 304 on Reader Service Card



We've Built Our Reputation on These Factors for 10 Very Successful Years.

### CLONE 386

# \$1999



- 20MHz, 32MB HARD DRIVE, 1 MB 0 WAIT RAM, AND 14" MONOCHROME MONITOR.
- 14MHz, 1MB RAM, base system ..... **\$1499**
- 14MHz, 1MB RAM, 32K cache, base system ..... **1786**
- 14MHz, 1MB RAM, 32K cache, base system ..... **2094**
- 14MHz, 1MB RAM, 32K cache, base system ..... **2729**

With MS-DOS® 3.3 or 4.01 and GWBASIC \$79 or \$99 Extra.

**CLONE 386 STANDARD FEATURES:**  
 Machine 80386 - 20/25/33 CPU's  
 14" Fast 0 Wait State RAM (32K Cache on some models, see chart)  
 High Performance 1:1 Interleave, 800 Kb/sec Floppy/2 HD Controller  
 1M 5.25" or 1.44M 3.5" Floppy Drive w/choice)  
 1 Key "Click-Tactile" Keyboard  
 Parallel, 1 Serial, 1 Joystick Port  
 0/220 Watt Power Supply  
 387/Waitek Coprocessor (Except Base MHz)  
 On-board Clock/Cal w/Battery Backup  
 Expansion Slots  
 Setup Utility in ROM  
 System Reset Switch on Front Panel  
 14 EMS-D, 0 Drive  
 CPU Speed Switchable  
 Fully Expandable to 16MB RAM  
 IC Certified  
 1 Year Parts & Labor Warranty  
 Complete Software Pack Including  
 -Write - QModem - ExpressCalc - HomeBase - MoneyMaster Index - Hard Disk Cache - Clone Utilities



Clone 386 20MHz monochrome system pictured.

### CLONE 286

# \$1279



- 12MHz, 32MB HARD DRIVE, 1 MB 0 WAIT RAM, AND 12" MONOCHROME MONITOR.
- 12MHz, 1MB RAM, base system ..... **\$784**
- 16MHz, 1MB RAM, base system ..... **983**

With MS-DOS® 3.3 or 4.01 and GWBASIC \$79 or \$99 Extra.

**CLONE 286 STANDARD FEATURES:**  
 • 1MB Fast 0 Wait State RAM  
 • High Performance 1:1 Interleave, 800 Kb/sec 2 Floppy/2 Hard Disk Controller  
 • 2M 5.25" or 1.44M 3.5" Floppy Drive (Your Choice)  
 • 101 Key Enhanced Keyboard  
 • 1 Parallel, 1 Serial, 1 Joystick Port  
 • 200 Watt Power Supply  
 • 80287 Math Coprocessor Socket  
 • On-board Clock/Cal w/Battery Backup  
 • 8 Expansion Slots  
 • Setup Utility in ROM  
 • System Reset Switch on Front Panel  
 • CPU Speed Switchable  
 • Fully Expandable to 4/8MB  
 • FCC Certified  
 • Novell Compatible  
 • One Year Parts & Labor Warranty  
 • Complete Software Package including PC-Write - QModem - ExpressCalc - AutoMenu - HomeBase - MoneyMaster Index - Hard Disk Cache - Clone Utilities

### CLONE VALUE CHART

CLONE 286	12" MONOCHROME	14" EGA COLOR	14" VGA COLOR
12MHz CPU, 32MB 40MS SEAGATE HD	\$1279	\$1690	\$1813
16MHz CPU, 32MB 40MS SEAGATE HD	1479	1890	2013

Add \$20 for "Click/Tactile" 101-key Keyboard. Add \$20 for 14" Monochrome Monitor.

CLONE 386	14" MONOCHROME	14" EGA COLOR	14" VGA COLOR
20MHz CPU, 32MB 40MS SEAGATE HD	\$1999	\$2393	\$2516
20MHz CPU, 32K CACHE, 32MB, 40MS SEAGATE HD	2299	2693	2816
25MHz CPU, 32K CACHE, 32MB 40MS SEAGATE HD	2604	2998	3121
33MHz CPU, 32K CACHE, 32MB 40MS SEAGATE HD	3240	3634	3757

### OPTIONS FOR CLONE 286/386 COMPUTERS:

- Add \$27 for 32MB, 28MS Seagate HD.
- Add \$42 for 48MB, 40MS Seagate HD.
- Add \$69 for 48MB, 28MS Seagate HD.
- Add \$146 for 65MB, 40MS Seagate HD.
- Add \$173 for 85MB, 40MS Seagate HD.
- Add \$203 for 85MB, 28MS Seagate HD.
- Add \$495 for 122MB, 28MS Seagate HD.
- Add \$30 for VGA price for 16 bit VGA card.
- Add \$49 for VGA price for 14" Multi-frequency Monitor.
- Add \$125 for 8 drive lower case.

**OPTIONAL EQUIPMENT FOR CLONE COMPUTERS:**

Star NX-1000 Printer, 144/36cps, NLO	\$179	192/63 cps, LQ, 24 pin	\$349
Star NX-1000 Rainbow Printer, same as above w/color	239	Panasonic KX-PI131 Printer, 240/48 cps, NLO	250
Star NX-2400 Printer, 170/57 cps, LQ, 24 pin	339	Star XB-2410 Printer 240/80 cps, super LQ, 24 pin, 16 fonts	469
Star XB-1000 Printer, 300/76 cps, NLO, 8 fonts	359	Star XB-2415 Printer (same as above with wide carriage)	599
		1200x300 baud int. modem	59

**WARRANTY GUARANTEED!**  
 Get a rock-solid one year guarantee on parts and labor, plus a 30 day money-back satisfaction Assurance guarantee (except software and shipping).

**SERVICE AFTER THE SALE!**  
 Your Clone equipment will be promptly and expertly serviced by our specially trained, knowledgeable technicians who know what they are doing.

**FAST DELIVERY!**  
 Clone Computers are custom-manufactured to their buyers' specifications, burned-in and shipped within one week of their order, in most instances.

**NO ORPHANED CUSTOMERS**  
 We have been supplying our customers with high quality hardware and software since 1980. We enjoy an excellent industry-wide reputation built on providing top quality merchandise, a no-risk guarantee, low price, expert service and fast delivery. Our customers expect and receive no less.

**Buy with Confidence! Our Guarantee Removes All the Risk from Your Buying Decision!**  
 The Clone guarantee is simple and straightforward. You have 30 days after receipt of your Clone to see if you and it are going to be compatible. If you are not satisfied with your Clone for any reason within that time, you may return it for a full refund, less shipping charges.



### TURBO CLONE

AT Style Keyboard **\$699** Save Now!

**Standard Features:**

- 8088 @ 4.77
- 10MHz Turbo-speed Mainboard
- 804K RAM standard
- 8087 Socket
- 150-watt power sup.
- 380K Floppy Drive with Disk Controller
- Hercules Compatible Video Card
- HiRes TTL monitor (green or amber)
- 2-Parallel ports
- 1-Serial port (2nd optional at \$29)
- Game-Joystick port
- Clock/Calendar
- Fully Expandable
- PC-Write - QModem ExpressCalc - Home Base - MoneyMaster - Finder - Clone Utilities - AutoMenu
- FCC Class B Certified Keyboard Lock
- LED's for Power, Turbo and Hard Disk Access
- 1 y parts, lab. war

## SOFTWARE SALE!

LOWEST PRICES - FAST DELIVERY  
 This list is only a small portion of our inventory! Call us for all of our software needs!

<b>IS-DOS/BUSINESS SOFTWARE</b>	Carbon Copy - (need two copies)	\$114
IS-DOS/BUSINESS SOFTWARE	Copy II PC	25
IS-DOS/BUSINESS SOFTWARE	Copy II PC Option Board Deluxe	118
IS-DOS/BUSINESS SOFTWARE	Feedback Plus	113
IS-DOS/BUSINESS SOFTWARE	Grammatik III	53
IS-DOS/BUSINESS SOFTWARE	Microsoft C Compiler 5.1	209
IS-DOS/BUSINESS SOFTWARE	Microsoft Macro Assembler 5.1	99
IS-DOS/BUSINESS SOFTWARE	Microsoft Quick Basic Compiler	67
IS-DOS/BUSINESS SOFTWARE	Microsoft Quick C Compiler	67
IS-DOS/BUSINESS SOFTWARE	Microsoft Windows 286	87
IS-DOS/BUSINESS SOFTWARE	Microsoft Windows 386	127
IS-DOS/BUSINESS SOFTWARE	Norton Commander	53
IS-DOS/BUSINESS SOFTWARE	Norton Utilities 4.5 Advanced Ed.	88
IS-DOS/BUSINESS SOFTWARE	PC Tools Deluxe 5.5	79
IS-DOS/BUSINESS SOFTWARE	Procomm Plus	46
IS-DOS/BUSINESS SOFTWARE	Sideways	42
IS-DOS/BUSINESS SOFTWARE	X-Trend Professional	76
<b>OTHER MS-DOS</b>	Alpha Blaster	\$28
OTHER MS-DOS	Chees Master 2100	32
OTHER MS-DOS	F-19 Stealth Fighter	44
OTHER MS-DOS	Falcon AT	32
OTHER MS-DOS	Quest Quest (I, II, III or IV)	31
OTHER MS-DOS	Leisure Suit Larry II	30
OTHER MS-DOS	Math Blaster Plus	28
OTHER MS-DOS	Mavis Beacon Teaches Typing	32
OTHER MS-DOS	Reader Rabbit	24
OTHER MS-DOS	Where in U.S.A. is C. San Diego?	27
<b>BOOKS</b>	Take advantage of our volume discounts and save a bundle! Buy any 3 books and earn an additional \$3 discount. Buy 4 and deduct \$4. Buy 5 and deduct \$5, etc.	
BOOKS	Using 1-2-3, Special Edition	\$18
BOOKS	dBase III Plus Handbook	17
BOOKS	Managing Your Hard Disk	16
BOOKS	MS-DOS Users Guide	17
BOOKS	Running MS-DOS	19
BOOKS	Using AutoCAD	21
BOOKS	Using Managing Your Money	15
BOOKS	Using Q & A	16
BOOKS	Using Symphony	19
BOOKS	Using WordPerfect 5.0	18

## Save Your Data and Money, Too! Peripherals Sale!

### 60MB TAPE DRIVES

Easy to Install! This is the fastest floppy interface tape drive around!

Up to 150MB Capacity

Add \$10 for Shipping

40MB Tape \$18  
60MB Tape \$30

External model now available for only \$99 extra!

Works on PC, XT, AT's and 100% compatibles. Connects to the internal floppy (B:) connector or the optional adapter card (\$77). Comes complete with installation instructions and the data compression software that allows up to 100MB data storage on a 40MB tape—150MB on the optional adapter card (\$77). Comes now at this low price and save.

### UNINTERRUPTIBLE POWER SUPPLY

As Low As \$279

250 Watt Model Add \$33 shipping in the lower 48 states.

250 Watt	120 Volt	\$279
300 Watt	120 Volt	399
500 Watt	120 Volt	499
600 Watt	120 Volt	639
1200 Watt	120 Volt	1099
1600 Watt	120 Volt	1444*

230 volt units also available. Specify exact input voltage. Shipped motor freight collect.

**Protects Against:**

- Brownouts
- Blackouts
- Overvoltage
- Overload
- Spills/Surges
- EMI

**Features:**

- Two Audible Alarms
- LED Displays
- Optional Network Port
- Transfer Times As Fast As 1 Millisecond (Depends on Model)

### Low Cost Hard Drives

Limited Time Only! Fantastic Prices Now On

For IBM and Tandy

5.25MB 95ms ST-506 MFM XT KH	\$149	21.4MB 65ms ST-225 MFM XT KH	\$239
32.7MB 65ms ST-238 12LL XT KH	\$259	42.8MB 40ms ST-251 MFM XT KH	\$369
41.1MB 40ms ST-157R RLL Bars 28ms Optional	\$319	80.2MB 28ms ST-4096 MFM Bars	\$579
65.5MB 40ms ST-277R RLL XT KH 28ms Optional	\$419	84.9MB 28ms ST-296N SCSI KH	\$539
		122.7MB 28ms ST-4144R RLL Bars	\$639

We provide the best low cost, high quality, fast access hard drives for your IBM, 100% compatible or Tandy computer. Our XT and SCSI kits are complete with drive, controller, cables and installation instructions. We use only brand new genuine Seagate drives so you can be assured of long trouble-free drive life. Data transfer rates as fast as 500KB per second MFM, 800KB RLL and 1MB using SCSI. We provide software to park the heads (some drives self-park). Tandy 1000 requires DMA and ROM 1.01. Not for EX/HX. Please specify the computer brand and model when ordering. ST 506, 4096 and 4144R are full size 5.25". Sizes listed are after formatting. One year parts and labor warranty. Satisfaction guaranteed or your money back, less shipping.

### Save on Low Cost Floppies!

Select the drive or drives you want, pick the enclosure and appropriate cable and we will assemble and test at no additional cost to you. All drives are brand new, not factory seconds, and carry a full one year part and labor warranty. Add \$5 shipping and handling per drive.

380K 5.25" TEAC 55B bare	\$69
720K 5.25" TEAC 55F bare	85
1.2M 5.25" TEAC 55FH bare	79
360K 3.5" TEAC 35B bare	59
720K 3.5" TEAC 35F bare	85
1.44M 3.5" TEAC 35FH bare	79
5.25" mounting bracket for 3.5" drives	10

(Includes rails, signal and power adapter. Specify beige or black faceplate).

Dual 3.5" external case/power supply. Use with one or two 3.5" drives (horizontal) ..... \$49  
 Dual 5.25" same as above-except vertical ..... \$9  
 IBM external floppy cable for C/D. DB37 required ..... \$9  
 (Add \$10 for brushed Stainless Steel cover)

**ORDER TOLL FREE!** Mon.-Fri. 9-7; Sat. 10-3  
 Call from anywhere in the lower 48 states and Hawaii.

# 1-800-527-0347

AD V3

### Save on 32MB & 49MB Hard Cards

32.7MB 40ms RLL **\$329** 40.1MB 40ms RLL **\$429**

These units are completely assembled with brand new drives and come ready to install. For IBM XT's, 100% compatibles and Tandy 1000/1000A, SL, SX, TL, TX. Please specify the exact make and model of your computer. One year parts and labor warranty.

**Circle 78 on Reader Service Card**

# Clone smolD

Reg. U.S. Pat. Off.

**SERVING YOU SINCE 1980**

**CLONE COMPUTERS • 2544 W. Commerce St. • Box 223957**  
 Div. of Analog Corp.  
 Dallas, Texas 75222-3957 • Telex: 882761 • Fax: 214-634-8303

For professional technical assistance on Clone products, call 214-638-8826.

©1989 by Clone Computers. All rights reserved. Prices and specifications subject to change without notice. All prices are in U.S. Dollars. Payments must be in U.S. funds drawn on a U.S. bank.

World Radio History





# Unitex, Inc

Established 1976

Mon-Fri 7am - 5pm  
Sat 8am - 2pm

Corporate Headquarters

2852 F Walnut - Tustin, CA 92680

Phone: 714/730-5232 • FAX#: 714/838-8593

4025 S. Industrial Blvd. - Las Vegas, NV

California Residents call toll free :1-800-843-8414



**Customer Service #: 714/730-9527**  
**TOLL FREE OUTSIDE CA: 1/800/533-0055**



### SIMM / SIPP MODULES

**1 MG X 9- for IBM TYPES**

1 MG X 9-120NS ..\$125  
1 MG X 9-100NS ..\$135  
1 MG X 9- 80NS ..\$140  
1 MG X 9- 70NS ..\$189

**256 X 9- for IBM TYPES**

256 X 9-120NS .....\$39  
256 X 9-100NS .....\$45  
256 X 9- 80NS .....\$55  
256 X 9- 60NS .....\$65

**APPLE SIMM MODULES**

1 MG X 8-120NS ..\$125  
1 MG X 8-100NS ..\$140

256 X 8-120NS .....\$39  
256 X 8-100NS .....\$49

**PS-2 PRODUCT**

256 X 9 (FOR PS2)

256 X 9-120NS .....\$65  
30F5348(KIT-2EA.)\$130

**MODEL 30-286**

1 mg x 9-100 .....\$235  
30F5360 (KIT-2EA.)\$470

**50Z SIMM**

6450603 (1MG) ..\$279  
6450604 (2MG) ..\$589

**PS-2 MODEL 70&80 SIMM**

1 MG X 9-100NS ..\$219  
1MG X 9- 80NS ....\$279

2 MG X 9-80NS ....\$685  
(6450608)  
(For 70A21)

2 MG X 9-80NS ....\$589  
(6450604)  
(For 70E61/ 70-121/ all models)

1 MG X 9-80NS ....\$279  
(6450603)  
(For 70E61 / 70-121)

1 mg(6450375) \$429  
2 mg(6450379) \$929

DIP

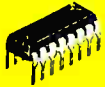

ZIP



SIMM



SIPP



PS-2 SIMM



MATH-CO



Warranty -  
1 year on parts

**D - RAM**

1 MG X 1

1 MG X 1-120NS \$11.00  
1 MG X 1-100NS \$11.75  
1 MG X 1- 80NS \$12.50  
1 MG X 1- 70NS \$15.00

**256 X 1**

256 X 1-150NS ....\$3.50  
256 X 1-120NS ....\$3.75  
256 X 1-100NS ....\$4.20  
256 X 1- 80NS ....\$5.99  
256 X 1- 70NS ....\$6.50  
256 X 1- 60NS ....\$7.20

**256 X 4**

256 X 4-120NS ..\$13.50  
256 X 4-100NS ..\$14.00  
256 X 4- 80NS ..\$18.00

**64 X 1**

4164-150NS .....\$1.39  
4164-120NS .....\$1.99  
4164-100NS .....\$2.20

**64 X 4**

4464-150NS .....\$4.00  
4464-120NS .....\$4.50  
4464-100NS .....\$5.00  
4464- 80NS .....\$6.50

**256 X 4 STATIC COL**

514258-100NS .....\$25

**256 X 1 STATIC COL**

51258-100NS .....\$5.00  
51258- 80NS .....\$6.00  
51258- 70NS .....\$6.50

**ZENITH 386 MODULES**

1 MG X 9-80 NS ...\$299

**AST 386 MODULES**

386/25 .....\$295  
386/33 .....\$329

### HEWLETT- PACKARD LASERJET MODULES

1 MB (for Laserjet II & IID) .....\$279  
2MB (for Laserjet II & IID) .....\$399  
4MB (for Laserjet II & IID) .....\$599

**MATH CO-PRO**

8087-3(5MHZ) .....\$88  
8087-2(8MHZ) .....\$118  
8087-1 .....\$165  
80287-6 .....\$120  
80287-8 .....\$195  
80287-10 .....\$218  
80C287-12 .....\$295  
80C87-16 .....\$310  
80C87-20 .....\$360  
80C87-25 .....\$460  
80C87-33 .....\$599

**ADVANCED MATH CO PRODUCTS**

\* Faster than standard  
MATH CO-Processors  
\* 5 year Warranty

for 286 Machines

2C87-10 .....\$239  
2C87-12.5 .....\$300  
2C87-20 .....\$329

for 386 Machines

3C87-16 .....\$329  
3C87-20 .....\$389  
3C87-25 .....\$499  
3C89-33 .....\$639

**CPU CHIPS**

8088 .....\$5.00  
80286-8 .....\$49  
80286-10 .....\$59  
80286-12 .....\$69  
80386-16 .....\$180  
80386-20 .....\$240  
80386-25 .....\$330  
V-20 (8MHZ) .....\$7.50

**VIDEO RAM FOR VGA CARDS**

64 x 4(150NS) .....\$5  
64 X 4(120NS) .....\$7  
64 X 4(100NS) .....\$10

### EVEREX

**RAM 3000 DELUXE** -Up to 3 MB. Selectable memory addresses.Expanded Memory Specifications (EMS)4.0/OS/2. Can be used to backfill base memory up to 640K and the rest as either Expanded or Extended or both. Uses 256K D-RAM .....\$99.00

**RAM 8000**-Up to 8MB capacity/supports base, extended or expanded memory in any combination. Fully compatible with Lotus/Intel/ Microsoft EMS 4.0/ EEMS. Supports multitasking and DMA multitasking in hardware. Software configurable (no dip switches to set). Full 16MB window for future expansion of Lotus/ Intel/ Microsoft EMS 4.0. 0 wait states, uses 1MG O-RAM (DIP)\$279

**RAM 10000**-Up to 10 MB capacity/supports base, extended or expanded memory in any combination. Compatible with Lotus/Intel/Microsoft EMS 4.0. Operates with no additional wait states. Uses 1MG O-RAM (DIP)\$179

**MINI-MAGIC** - (EV138)-Up to 576K . For PC-AT. Uses 256K & 64K .....\$59

### ORCHID

**RAMQUEST IIZ** -Up to 2MB of 0 wait state memory for the IBM PS/2 Models 50, 50Z & 60 • Guaranteed EMS 4.0 and OS/2 Compatible • Easy 4-keystroke installation. Uses 1MG Dip's .....\$199

**RAMQUEST EXTRA** -The only multifunction card that provides up to 8MB and two serial ports on one board for the IBM PS/2 Models 50, 60 and 80. • Guaranteed EMS 4.0 and OS/2 Compatible. • Easy to install with only 4 key strokes. Uses 256 and/or 1MB SIMM'S. ....\$249

**RAMQUEST EXTRA 16/32** -The only 0-8MB, 0 wait state card for PS/2 Models 50, 50Z, 60, 70 and 80 which fully supports both 16-bit and 32-bit memory access. Includes one serial and one parallel port plus a free serial cable. Guaranteed EMS 4.0 and OS/2 compatible. Easy 4-keystroke installation. Uses 256 and/or 1MB SIMM'S .....\$319

**RAMQUEST XT/AT** -A full size, 0-8 MB, zero wait state card for IBM PC, XT, AT, PS/2 25, 30 and compatibles. Uses 256K and/or 1MB SIMM'S. Automatically supports either 8 or 16-bit bus. ....\$259

**RAMQUEST XT/AT with I/O** - Same as above plus 1-serial and 1-parallel port .....\$319

### COMPAQ MEMORY

ADD-ON MODULES		
MODEL	1MG	4MG
386/20	\$319	\$899
386/25	\$319	\$899
386/20E	\$319	\$899
386/S	\$319	\$899
286 E	\$319	\$899

MEMORY EXPANSION BOARDS		
MODEL	1MG	4MG
386/20E	\$479	\$1349
386 S	\$479	\$1349
386/16	--	\$1429
286 E	\$479	\$1329
SLT/286	\$479	--
PORTABLE 386	--	\$1429

### D-RAM TESTERS

**UNI-001RT** .....\$119  
Tests all parameters but speed  
64 X 1 / 256/1 / 1M X 1  
64 X 4 / 256/4 / 4M X 1

**UNI-002 RT** .....\$149.95  
Tests speed plus parameters  
64 X 1 / 256 X 1 / 1MG X 1

**UNI-003 RT** .....\$199.95  
Tests standard SIMM Modules  
1 Year Warranty

### IBM

1497259 - For PS-2 MOD 50/60 .....\$439  
with OK Expands to 8MB  
Uses 256K SIMMS (IBM only)

6450605 - For PS-2MOD 70/80 .....\$1299  
with 2 MG Expands to 8 MB  
Uses 2MG SIMMS (IBM only)

6450203 - For AT - Has 512K RAM .....\$129

### TERMS AND CONDITIONS

No Surcharge for MC / VISA • Terms: MC • VISA • COD • CASH • AMEX add 4%  
Purchase Orders from qualified firms • 20% restocking fee on non-defective returns  
Prices Subject to Change



## The Easiest Way To Go From Mainframe To Desktop

- The Cipher Series 9000 9-Track Reel-to-Reel Tape Data Conversion Subsystem
- Easy-to-use TARSUS software is menu driven with the ability to selectively manipulate 100+ MB mainframe data on a 10 MB PC
- 5 MB per minute data rate
- Call 1-800-4CIPHER, prompt/6, today for a free demo disk.

**cipher**

© 1989 Cipher Data Products, Inc.

Circle 77 on Reader Service Card

## LOW-LOW-LOW

- Laserjet Printer Series II \$1650
- Scanjet Scanner + interface kit \$1355

**IBM COMPAG Apple ACER EVEREX AST & other**

XT/AT Compatibles & 386 Computers  
CALL for LOW PRICES

Gov't, Corporate, Schools, Dealers, & Export INQUIRIES WELCOME.

**SURAH inc.**

41862 Osgood Road, FREMONT, CA 94539  
PH: (415) 651-5101 FAX: (415) 651-5241  
1-800-543-1001  
VISA, Master Card accepted. w/vc

Circle 346 on Reader Service Card

## 9-Track Tape For Your IBM PC/XT/AT/PS-2™

Read 1600 bpi 9-track tapes from a micro, mini or mainframe in EBCDIC or ASCII as mirror image or by individual files.

Use the 2000 PC™ for disk backup, data interchange or archival storage.

PC/XT/AT/PS-2 are trademarks of IBM. 2000 PC is a trademark of Digi-Data.



DIGI-DATA CORPORATION  
8580 Dorsey Run Road  
Jessup, MD 20794-9990  
(301) 498-0200  
FAX (301) 498-0771  
First In Value

Circle 114 on Reader Service Card

## DYNAMIC RAMS

Part Number	Capacity	Access Time	Price
<b>SIMM</b>	80/100		\$CALL
<b>1MBIT</b>	100ns		\$11.00
<b>514256</b>	100ns		\$11.50
<b>41464</b>	150ns		\$ 3.75
<b>41256</b>	120ns		\$ 3.25
<b>41256</b>	150ns		<del>\$ 3.15</del>
<b>51258</b>	100ns		\$ 4.75
<b>4164</b>	150ns		<del>\$ 2.35</del>

MATH COPROCESSORS		E PROMS	
80387-33	33MHz \$560.00	27C01	250ns \$ 23.00
80387-25	25MHz \$455.00	27C512	200ns \$ 13.00
80387-20	20MHz \$360.00	27S12	250ns \$ 8.00
80387-16	16MHz \$305.00	27C256	250ns \$ 5.25
80387SX	\$295.00	27256	250ns \$ 4.75
80C287A	12MHz \$285.00	27128A	250ns \$ 4.50
80287-10	10MHz \$209.00	27C64A	200ns \$ 4.25
80287-8	8MHz \$186.00	2764	250ns \$ 3.90
8087-1	10MHz \$160.00	<b>GPU</b>	
8087-2	8MHz \$125.00	V-30	8MHz \$ 12.75
		V-20	8/10MHz \$ 8.5/15

## I.C. EXPRESS

15358 Valley Blvd. City of Industry, CA 91746 Tel:818 369-2688  
ORDER TOLL FREE (West Fr. 8-5 P.M.)  
**(800) 892-8889 • (800) 882-8181**  
CALL FOR CURRENT PRICES & VOLUME DISCOUNTS  
Price Shown for Cash. Mass/Car/Visa and MC. Prices are subject to change without notice. \$10.00 Shipping & Handling (West Fr. 8-5 P.M.)  
ALL MERCHANDISE IS 100% GUARANTEED WITH PROMPT DELIVERY.

Circle 183 on Reader Service Card

## EPROM PROGRAMMER CROSS ASSEMBLERS



MODEL SX151

RS232C OR STAND ALONE (all models), Communication protocol; XMODEM, HEX and BIN Programs; EEPROMS 2716 - 27512 and CMOS Programs (w/adaptor), 25XX, 27101 (and above), 68701, 68705, 68764/6, 87412, 8744, 8748/9, 8751/2, 8755, 8752, 870751, 870752 and CMOS. More available soon. Model SX151 \$214 (assembled with case). Other models are available from \$49 (kit).

Cross assemblers by Pseudocorp for IBM-PCs, 550, Z80, 1802, 6502, 6800/12/3/5/8/9/11, 68000/8/10, 8048/9, 8051/2, 8080/5, 8096, and more soon. Simulators and disassemblers also available.



**KORE, Inc.**

3150 Plainfield N.E.  
Grand Rapids, MI 49505  
(616) 361-3666

\$5 for shipping (USA), plus \$3.00 COD.

Circle 198 on Reader Service Card

## Complete Telephone Management System

### TeleGenie™

Sophisticated Voice Mail and Call Processing with High Quality REAL VOICE Digital Recording for your PC, XT, AT or Compatible

## VOICE MAIL

- Forwards to Extensions Beepers/Cellulars
- Individual Greetings and Passwords - Multi-User - Box Capacity - Remote Touch-Tone Access
- Replay/Delete/Record/Edit



This Unique System Also Features...  
**ADVANCED CALL PROCESSING**

- Unlimited Phonebook/Database - AutoDial/Redial
- Search/Sort - Caller/Computer Touch-Tone Interaction
- User-Definable Voice Prompted Menu - Call Forward/Call Distribution - In/Out Call Logging - Outbound Timed Calls - Automatic Attendant and More!

Enjoy the same benefits and features of our system's costing thousands for only **\$279.95**

**800-637-3861**  
In CA 408/438-3883

Multiple Unit Discounts - Dealer Inquires  
250 Technology Circle, Scotts Valley, CA 95066

Circle 15 on Reader Service Card

## LOW COST INTERFACE CARDS FOR PC/XT/AT

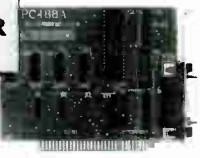

### RS-485/422 Card [PC485] \$95/125

- Serial Async. Communication up to 4,000ft; 2 or 4 wires; NS16450 UART;
- Can be configured as COM1-COM4; Maximum Baud Rate 56KB.
- Flexible configuration options. RTS or DTR control of transmission direction.
- Full/Half duplex operation. Supports hardware handshaking (RTS,CTS).
- Dual drivers/receivers; Handles 64 devices; Compatible with most comm. software.
- High speed version available (supports baud rates up to 256KB) - \$165

### Dual-Port RS-485/422 [PCL743] \$175

- Two independent channels /UARTs; 2 or 4 wire operation. Max. Baud 56KB.
- Dipswitch configurable as COM1-4 (IRQ2-7). On board terminator resistor.

### IEEE-488 Card [PC488A] \$145

- Includes INSTALLABLE DOS DEVICE DRIVERS and support for BASIC.
- Additional Support for ASSEMBLY, C, Pascal and FORTRAN. \$50.
- IRQ (1-4). DMA channel 1 or 2. Up to 4 boards per computer.
- Compatible with most IEEE-488 Software packages for IBM-PC (e.g. ASYSTANT-GPIB, Lotus Measure). Compatible with NI's GPIB-PCIIA.

### IEEE-488 Card [PC488B] With Built-In Bus Analyzer \$345

- Software Support for BASIC, QuickBASIC and GWBASIC.
- Additional libraries for C, Pascal, FORTRAN, Assembly available - \$50 (all)
- Full range of Talker, Listener, Controller, Serial/Parallel Poll, SRO, etc...
- Powerful menu-driven BUS ANALYZER can be run in the background while 488 programs or commands are executed; Features Program Stepping, Break points, Real Time Bus Data Capture (4K buffer), Instant Screen Toggling.
- Complete Controller / Talker / Listener capability. Based on TI's TMS-9914.
- Memory-resident Printer Port Emulation Utility included (LPT1-3).
- NEC-7210 based card (compatible with NI's GPIB-PCII) - \$445.

### DIGITAL I/O Card [PCL720] \$175

- Input: 32 TTL compatible channels; Input load is 0.2 mA @ 0.4V.
- Output: 32 TTL compatible channels; Sinks 24mA (0.5V); Sources 15mA (2.0V)
- Counter/Timer: DC to 2.6MHz; 3 channels; 16 bit counters; 6 counting modes.
- Breadboard area for prototyping. Dipswitch I/O port selection (200-3F8 hex).

## LOW COST DATA ACQUISITION & CONTROL CARDS FOR PC/XT/AT



### 12 BIT A/D & D/A [PCL711s] \$295

- A/D converter: 8 single-ended channels; Device: AD574; Conversion time less than 25µsec; Built-in programmable pacer; Input ranges: ±10V, ±5V, ±1V.
- D/A converter: 1 channel; 12 bit resolution; Output Range 0-5V.
- Digital I/O: 16 Input / 16 Output channels; All I/Os TTL compatible.
- External Wiring Terminal Board with mounting accessories included.
- Utility Routines and Demo/Sample Programs for BASIC and Quick-BASIC.

### 12 BIT A/D & D/A [PCL812] \$375

- A/D converter: 16 single ended inputs; Device: AD574; Conversion time less than 25µsec; Built-in programmable pacer; Input ranges: ±10V, ±5V, ±1V.
- D/A converter: 2 channels; 12 bit resolution; Output Range 0-5V.
- Digital I/O: 16 Input / 16 Output channels; All I/Os TTL compatible.
- Counter: 1 channel programmable interval counter/timer; Uses Intel 8254.
- DMA and interrupt capability. Utility software for Basic included.

### FAST 12BIT A/D/A [PCL718] \$895

- A/D converter: 16 single ended or 8 differential channels; 12 bit resolution; Programmable scan rate; Built-in Interrupt and DMA control circuitry. Conversion speed 60,000 samples/sec (standard), 100,000 samples/sec (optional).
- Input ranges: Bipolar ±10V, ±5V, ±2.5V, ±1V, ±0.5V; Unipolar 0.5, 2.1V.
- D/A converter: 2 channels; Resolution: 12 bits res; Settling time: 5µsec; ±5V.
- Digital I/O: 16 OUT, 16 IN; TTL compatible; All I/Os TTL compatible.
- Counter: 16 bit progr. interval counter/timer; Uses Intel 8254; Pacer clock;
- Software: Utility software for BASIC and QuickBASIC included. Supported by LabDAS (\$195/495), ASYST, LABTECH, IntelScope

### 6 Channel 12 bit D/A [PCL726] \$495

- Output Ranges: 0 to +5V, 0 to +10V, ±10V, ±5V, ±10V or sink 4-20mA.
- Settling time: 70µs. Linearity: ±1/2bit. Voltage output driving capacity: ±5mA.
- Digital I/O: 16 digital inputs and 16 digital outputs; TTL compatible.

### STEPPER MOTOR CARD \$395

- Capable of independent and simultaneous control of up to 3 stepper motors.
- Speed: Programmable from 3.3 PPS to 3416 PPS; Built-in acceleration control.
- Output Mode: One clock (Pulse, Direction) or two clock (CW, CCW pulses)
- Step position Read-back; Opto-isolated output; Crystal based timing.
- Includes 8 bit digital input/output port. Order P/N [PCL-738B]

MC / VISA / AMEX

Call today for datasheets!



**B&C MICROSYSTEMS INC.**

355 WEST OLIVE AVE., SUNNYVALE, CA 94086  
TEL: (408) 730-5511 FAX: (408) 730-5521

Circle 66 on Reader Service Card

# GraphicC™

"gives you all the C language routines you need to write an impressive scientific graphing program of your own. Highly recommended.\*"  
PC Magazine

Orbits correspond to J-constant contours

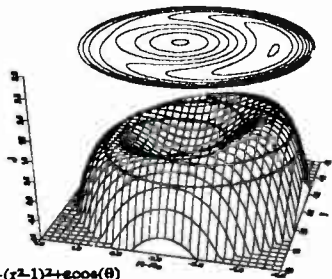

IBM® PC version  
(with source code) \$395  
Circle 323 on Reader Service Card  
Macintosh® version  
(no source code) \$295  
Circle 324 on Reader Service Card  
For personal use only.

# VTEK 4.3™

DEC® VT100/102/52  
& Tektronix®  
4010/4014/4105  
Terminal Emulator

"its ease of use, high resolution graphics, emulation, and price make it a more attractive purchase than the other products.\*"  
MINI-MICRO Systems  
Only \$150

Circle 390 on Reader Service Card

\* Full reprints on request

Scientific Endeavors  
508 North Kentucky Street  
Kingston, TN 37763  
(615) 376-4146

## Cross-16 V2.0 Meta Assembler

Table based absolute cross-assembler using the manufacturer's assembly mnemonics.

Includes manual and MS-DOS assembler disk with tables for all of the following processors:

1802	64180	65C02	6801
6805	6809	68HC11	COP400
COP800	8048	8051	8085
8096	320C1X	TMS370	SUPER8
Z8	Z80	Z180	MORE...

Users can create tables for other processors!

Generates listing, symbol table and binary, Intel, or Motorola hexcode.

Free worldwide airmail shipping and handling.

Check, Money Order or P.O. US\$99.00  
VISA, Mastercard and Canada C\$119.00

Universal Cross-Assemblers  
POB 6158, Saint John, NB  
Canada E2L 4R6  
Voice/Fax: (506)847-0681

Circle 369 on Reader Service Card

SEAGATE New ST251-1 \$296 MOQ 10 ea	<b>Specials!</b> Micropolis New 1335 \$535 ea. MOQ 5 ea.	MAXTOR New XT2190 \$1,310 MOQ 10 ea
SEAGATE Full Line All New ST238 ST251 ST251-1 ST296-N	IMPRIMIS (CDC) New Full Product Line PRINTERS Fujitsu Epson C. Itoh Toshiba Others	MICROPOLIS All New 1588-15 765S 1588-15 765E 1578-15 382S 1558-15 382E 1375 170S 1355 171E
MAXTOR-New XT-2190 XT-4170E XT-4170S XT-4380E XT-4380S XT-8380E XT-8380S XT-8760E XT-8760S Others	TAPE DRIVES Wang-Tek Archive Mountain Syngen Others	MITSUBISHI PRIAM Others Available
COMPAQ/CONNER New CP3024 CP3100 CP3104 CP340 CP340A CP344	LAPTOPS Mitsubishi Toshiba Others	<b>Special!</b> Limited Time MAXTOR XT 8760E 675 MB for \$2,575
	VIDEO BOARDS Amdek Paradise Quadram Others	
Call us last for best pricing		
713-240-4800 Datatronics		
MasterCard VISA		

Circle 104 on Reader Service Card

## Where's the @!# cursor?

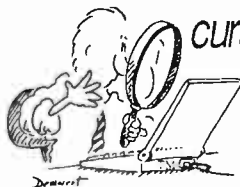

Make the cursor BIG and BOLD and BLINK at any rate! The No-Squint Cursor "is a lifesaving utility for laptop users." -- Computer Digest. Recommended by Peter Lewis in the NY TIMES; Bill Machrone in PC magazine; and Jerry Pournelle in INFOWORLD. No-Squint is \$39.95 + 2.50 shipping from: SkiSoft Publishing, 1644 Mass. Ave., Lexington, MA 02173 (617)-863-1876 Visa/MC/Amex

Circle 326 on Reader Service Card

World Radio History

## PC-Translator™

This machine translation software operates on MS-DOS based personal computers. Menu activated, the program produces first-draft translations of technical documents.

Languages offered:  
• Spanish • French  
• Swedish • Danish

To or From English - \$985  
Both Directions - \$1,485



Linguistic Products  
Language Translation Software

P.O. Box 8263  
The Woodlands, TX 77387  
TEL: (713) 363-9154  
FAX: (713) 298-1911

Circle 202 on Reader Service Card

(1) 100% MONEY BACK GUARANTEE (2) 30 DAY MONEY BACK GUARANTEE (3) 90 DAY MONEY BACK GUARANTEE (4) 180 DAY MONEY BACK GUARANTEE (5) 360 DAY MONEY BACK GUARANTEE (6) 540 DAY MONEY BACK GUARANTEE (7) 720 DAY MONEY BACK GUARANTEE (8) 900 DAY MONEY BACK GUARANTEE (9) 1080 DAY MONEY BACK GUARANTEE (10) 1260 DAY MONEY BACK GUARANTEE	<b>ICs PROMPT DELIVERY!!!</b> SAME DAY SHIPPING (USUALLY) QUANTITY ONE PRICES SHOWN FOR SEPT. 24, 1989
	OUTSIDE OKLAHOMA: NO SALES TAX
	<b>DYNAMIC RAM</b>
	SIMM AST Prem386 33Mhz \$300.00
	SIMM (1) 256Kx36 80 ns 300.00
	SIMM 1Mx9 80 ns 125.00
	SIMM (2) 256Kx9 100 ns 37.50
	1Mbit 1Mx1 100 ns 11.25
	41256 256Kx1 60 ns 5.75
	41256 256Kx1 80 ns 4.40
41256 256Kx1 100 ns 3.15	
41256 256Kx1 120 ns 2.65	
446 64Kx4 120 ns 4.40	
41264 (3) 64Kx4 100 ns 8.25	
<b>EPROM</b>	
27C1000 128Kx8 200 ns \$22.00	
27512 64Kx8 200 ns 7.80	
27256 32Kx8 150 ns 6.50	
27128 16Kx8 250 ns 4.50	
<b>STATIC RAM</b>	
62256P-10 32Kx8 100 ns \$16.50	
6264P-12 8Kx8 120 ns 4.95	
6116AP-12 2Kx8 120 ns 4.50	
OPEN 6 1/2 DAYS, 7:30 AM-10 PM. SHIP VIA FED-EX ON SAT.	
SAT DELIVERY INCLUDED ON FEDEX ORDERS RECEIVED BY: TUE \$2 \$6.25 + 8 FR: \$1 \$14.25 + 8	
MasterCard VISA or UPS CASH COO MICROPROCESSORS UNLIMITED, INC. 24 000 S. Peoria Ave BEGGS OK 74421 (918) 267-4961 No minimum order. Please keep arrival sheet to change quantity. Insurance extra, up to \$1 for packing materials.	

Circle 234 on Reader Service Card

## E/EPROM PROGRAMMER

\$895



- Lifetime FREE updates (1st in the industry)
- EP-1140 includes: software, cable, user's manual, lifetime FREE updates, toll-free technical support, one-year warranty & a unconditional 30-day money back guarantee
- Programs 24-, 28-, 32- & 40-pin E/EPROMs
- Supports 874X & 875X series microcontrollers
- 32-pin model, EP-1132, available for \$695

The Engineer's Programmer™

CALL TODAY 800-225-2102

BP MICROSYSTEMS

713/461-9430 FAX 713/461-7413  
10681 Haddington, #190, Houston, TX 77043

Circle 397 on Reader Service Card



SC 80386-25 Motherboard

# 6.2 MIPS

64K Cache upgradable to 256K Cache

**LANDMARK = 43.5 MHz**

**\$1490**

- Intel 80386-25 MHz CPU
- 256K or 1MB SIMM 0 wait
- Advanced Write Back cache
- Max. 8MB on Board
- OS/2, MS DOS, Xenix, Novell comp.

Mono system w/1meg **\$2020**  
256K cache upgrade **\$ 250**

Schwab Computer  
730-C East El Camino Real  
Sunnyvale, CA 94087  
TEL (408) 245-6666 FAX (408) 245-3103

Circle 322 on Reader Service Card

## 200/100MHz Logic Analyzer

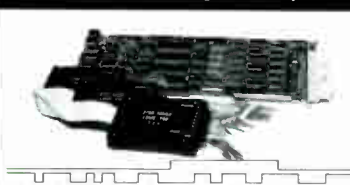

- 24 channels, Timing and State
- Optional expansion to 72 channels
- 200 or 100 MHz max sampling rate
- 16 levels of triggering
- 16K samples/channel (6 channel mode)
- TTL, ECL or Variable threshold
- 3 external clocks with 11 qualify inputs
- Data output to disk or printer
- PC/XT/AT compatible
- \$1299 - LA27100 (100MHz)
- \$1899 - LA27200 (200MHz)

Call - 201-994-6669

**Link Computer Graphics, Inc.**  
4 Sparrow Dr., Livingston, NJ 07039 Fax: 201-994-0730

Circle 203 on Reader Service Card



**SONY 2D \$10.50 300K MIN**

**3.5" SONY High Density 1.44 MB**  
1-4 BOXES OF 10: \$29.50 ..... 5+ BOXES: \$28.90

**5.25" DS/HD 1.2 MB** INCL. Sleeves & tabs, BLACK  
Lots of 100 - 49¢ ..... Lots of 50 - 59¢

**5.25" DS/DD 360K**, INCL. Sleeves & Tabs  
Lots of 1,000 - 21¢ ..... Lots of 200 - 25¢

**3.5" DS/DD 800KB BULK (1MB)**  
Lots of 100 - 59¢ ..... Lots of 50 - 79¢

**3.5" DS/High Density 1.44MB (2MB)**  
Lots of 100 - \$1.95 ..... Lots of 25 - \$2.50

**AMERICAN GROUP**  
**800-288-8025**  
12132 Sherman Way, N. Hollywood CA 91605  
CALL OR MAIL   

Circle 26 on Reader Service Card

## INVENTORY MARKETING CONSULTANTS, INC.

P.O. Box 91659, Long Beach, CA 90809-1659

**IMC OFFERS:**

Full Blown IBM Compatible Micro Computers! Includes full memory complement, hard drives, mono monitor and enhanced keyboard And More!

XT-Turbo 4.77/10 MHZ	Call for pricing
AT 286 6/10 MHZ	Call for pricing
AT 286 12 MHZ	Call for pricing
AT 286 16 MHZ	Call for pricing
AT 386 20 MHZ	Call for pricing

**EMS BOARDS** Supports Lotus/INTEL (EMS) & Software Written To That Standard

DF1 Above Board w/1MB	Call for pricing
DF1 Above Board w/2MB	Call for pricing

**SIMM MODULES**

1MGx9 (120) IBM	Call	256x9 (120) IBM	Call
1MGx9 (100) IBM	Call	256x9 (100) IBM	Call
1MGx9 (80) IBM	Call	256x9 (80)	Call

**D-RAM**

1MGx1 (120)	Call	64x4 (80)	Call
1MGx1 (100)	Call	256x4 (100)	Call
1MGx1 (80)	Call	256x4 (80)	Call
64x1 (150)	Call	256x1 (150)	Call
64x1 (120)	Call	256x1 (120)	Call
64x1 (100)	Call	256x1 (100)	Call
64x4 (100)	Call	256x1 (80)	Call

HM51258 P-10 2526 x 1 Static Call for pricing

Also Available: All PS/2 SIMM Modules.  
Meet or Beat Everyone's Price - Call for Pricing.

Lowest Prices in Town. Fully Guaranteed.  
Toll Free Outside Ca: 1-800-747-1MEG • Ask for Pete (213) 498-0956 • FAX (213) 494-4247  
MASTERCARD & VISA ACCEPTED

Circle 180 on Reader Service Card

## PC-Based Programmer

**\$475**

GAL  
PAL  
EPLD  
EPROM  
EEPROM  
MICROCONTROLLER

TI NS MMI LATTICE CYPRESS  
ALTERA AMD INTEL SAMSUNG...

- 20 AND 24 PIN PAL/GAL/EPLD
- 2716-27101 EPROMS. (High speed to 35ns)
- EEPROMS up to 28256
- MICROCONTROLLERS (with adaptor).
- DSP TI TMS-320 (with adaptor).
- JEDEC, Intel Hex, Binary, Motorola 'S' Files
- Read, Write, Protect, and Verify.
- Full Screen Editing in Hex and Ascii.
- Byte split for 16 and 32 bit systems.

Call- 201-994-6669

**Link Computer Graphics, Inc.**  
4 Sparrow Dr., Livingston, NJ 07039 Fax: 994-0730

Circle 204 on Reader Service Card

**SIMMs**

1 Meg X 9-80 ns	\$115
-----------------	-------

**PS/2 Memory**

1 Meg for 70-E61 & 121	\$245
2 Meg for 70-E61 & 121	\$475
2 Meg for 70-A21	\$495
1 Meg for 80-041	\$375
2 Meg for 80-111, 311	\$875
2-8 Meg, 32-bit Memory Board	\$595

**COMPAQ**

1 Meg & 4 Meg for all models

**Laser Jet**

1MB	2MB	4MB
\$255	\$395	\$695

**SOUTH COAST ELECTRONICS**  
700 S. Flower St. #2200, Los Angeles, CA 90017  
(213) 489-7824 Fax (213) 489-0266  
**(800) 289-8801**

Circle 333 on Reader Service Card

World Radio History



**NEW! Made in USA!**

**PC BASED UNIVERSAL DEVICE PROGRAMMER \$595-845**

- Programs EE/PROMs, PALs, GALs, IPLs, EPLDs, MICROS, BIPOLARS.
- Software drives pin drivers. D/A generated programming voltages.
- Upgradeable for virtually any future programmable devices up to 40 pins.
- Self-sustaining operation. No additional modules or plug-in adapters required.
- Includes user friendly MEMORY BUFFER FULL SCREEN EDITOR.
- Friendly Menu-Driven Interface. Device selection by P/N and manufacturer.
- Supports 8/16/32 bit word. Intelligent I & O, Quick Pulse programming.
- Functional testing, Register-Preload, PUSEMAP EDITOR for logic devices.
- File formats accepted: Intel Hex 86/88, Taltronix Hex, Motorola S, JEDEC.
- Customer support via voice line, dedicated BBS or fax. Full 1 year warranty.
- Base price includes Interface card, cable, Memory device library and 1 year free updates. Additional Device Libraries (Logic, Micros, Bipolars) \$95 ea.
- Libraries updates available every 6 mo. and can be received via floppy or BBS.

**PC BASED 8-SOCKET GANG PROGRAMMER \$595**

- Handles all memory devices to 32 pins. (Upgradeable up to 8 megabit parts).
- FULL SCREEN BUFFER EDITOR plus all applicable features from above.
- Customer support via voice line, dedicated BBS or fax. Full 1 year warranty.
- Includes PC Interface card, Memory device library and 1 year free updates.



**Made in USA!**

**UNIVERSAL RS-232 PROGRAMMER \$345-595**

- Programs EE/PROMs, Flash EPROMs, ZPRams, Intel Micros, Memory Cards.
- Stand-Alone Mode for EE/EPROM and Memory Card Duplication / Verify.
- All 24/28/32 pin EE/PROMs to 4 Mbits (upgradeable to 32 megabits).
- Micros: 8741A/-2/A, -4, -8, -9, -51, -CS1, -CS1FA/B, -52, -53, -55, -CS21, -CS41, 9761.
- Memory Cards: Seiko/Epson/Fujitsu (Integrated Adapter Included)
- Modular design; Firmware easily upgradeable; 4 socket Gang module available
- On-Board Programming capability; Custom interface modules available.
- User friendly Menu-Driven Interface Program for IBM-PC and Macintosh.
- Can be operated with any computer containing an RS-232 serial port.
- Optional built-in Eraser/Timer module (\$50); Top cover conductive foam pad.
- OEM open board programmer configurations available (from \$245).
- Customer support via voice line, dedicated BBS or fax; Full 1 year warranty.

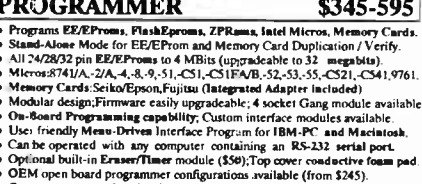

**Made in USA!**

**INTELLIGENT PC ROM EMULATOR \$395**

- Emulates 2716 through 27512 EPROMs (2k to 64k bytes) with a single unit.
- Connects to the standard parallel printer port. Uses standard printer cable.
- Intelligent features include: Reset Output, Address Compare, Address Snapshot, Trigger Input, Memory buffer editing capability. Selectable wordsizes.
- User friendly software. Command set includes: Load, Write, Display, Run, Type, Edit, Fill, Run-Command-File, Monitor, Port, Reset, Help, Calculator.
- FAST data loading via parallel printer port (65k bytes in less than 10 seconds).
- Casuable up to 8 units. Includes interface cable with Trigger and Reset clips.
- CMOS model with NiCad rechargeable 9V battery backup - \$495.
- Built-in battery recharging circuitry. After code downloading from the host computer, this model can be disconnected and used in stand-alone mode.
- File formats accepted: Binary, Intel Hex, Motorola S.



**Made in USA!**

MC / VISA / AMEX Call today for datasheets!

**B&C MICROSYSTEMS INC.**

355 WEST OLIVE AVE., SUNNYVALE, CA 94086  
TEL: (408) 740-5511 FAX: (408) 740-5521

NOVEMBER 1989 • B Y T E 459

**3M** \* FREE! HEADCLEANING KIT on 5.25" 3M diskette order!!

DS-DD	Quantity Discounts Available	DS-HD	
5.69*	5.25" 3M Diskettes 10/Box	10.99	
10.89	3.50" 3M Diskettes 10/Box	24.95	
17.99	8.00" 3M Diskettes 10/Box	19.99	
DC-2000	14.49	DC-600A	20.49
DC-300XLP	18.49	DC-6150XTD	21.49
3M/DEC TK50 Tape		25.95	
3M/IBM 3480 Tape		5.95	
3M Mag. Tape with seal 2400'-min 10		12.70	

**BASF** INCREDIBLE VALUE!!

DS-DD	Quantity Discounts Available	DS-HD
4.79	5.25" BASF Diskettes 10/Box	7.79
9.29	3.50" BASF Diskettes 10/Box	21.79
.29	BASF 5.25" DS-DD No-Logo Bulk with Tyvek sleeves, labels & W/P	
BASF Mag Tape 2400'		10.95

**Verbatim** DataLifePlus Teflon/Preformatted

DS-DD	Quantity Discounts Available	DS-HD
5.29	5.25" DataLife Plus 10/Box	9.99
9.99	3.50" DataLife Plus 10/Box	24.95
6.49	5.25" DataLife Color Disks 10/Box	

**MAXELL R & D** The Gold Standard!!

5.25" DS/DD	5.25" DS/HD	3.50" DS/DD	3.50" DS/HD
5.89	11.29	10.89	24.89

**3M HIGHLAND**

5.25" DS/DD	3M Highland Diskettes	5.25" DS/HD
3.69	10/Box	6.79
3.50" DS/DD	KAO in Plastic Box	3.50" DS/HD
8.95	Brand Name	20.99

**DYSAN PRECISION**

6.29	5.25" DS/DD 10/Box	3.59
10.49	5.25" DS/HD 10/Box	6.49
9.75	3.50" DS/DD 10/Box	8.99
22.75	3.50" DS/HD 10/Box	20.99

**KAO Color Diskettes**

DS-DD	DS-HD	
.34*	5.25" KAO No-Logo Color Disks	*.64
.74	3.50" KAO No-Logo Color Disks	1.85
8.95	3.50 DS/DD KAO Brand in Plastic Box	

\*5.25" Color add 4¢ for sleeves and labels

**No-Logo Bulk Diskettes**

5.25" DS/DD	5.25" DS/HD	3.50" DS/DD	3.50" DS/HD
.27*	.45*	.59	1.79*

\*Bulk diskettes include sleeves, labels and w/p tabs

**TERMS:** No surcharge on VISA, Mastercard or AMEX. Order packaging and processing = \$2.95 per order. COD orders add \$3.95 **SHIPPING:** \$1.95/5 cartridges; \$0.95/50 diskettes. PO's accepted from recognized institutions on Net 30. Bank Draft, T/T or L/C acceptable. Price quoted for case (100 disks or 10 cartridges). For quantities less than 1 case add 5%.

Toll Free Order Line: **1-800-523-9681**  
 Information Line: **1-801-255-0080**  
 TLX-9102404712 FAX-801-572-3327

**DISK COTECH**  
 DISKCO TECHNOLOGIES, INC.  
 213 Cottage Avenue  
 P.O. Box 1339 Sandy, Utah 84091

**SuperSound** New! SoundCard™

**SoundFX™ Editor**

Add SOUND EFFECTS, VOICE, MUSIC to IBM-PC/XT/ATs from \$69.95!

**Best Digital Audio Software/Hardware**  
 SuperSound - Stereo Version \$339 - Mono \$239  
 30 Day Money-Back Guarantee if not Satisfied

- With SoundFX™ - Friendly GUI (Graphical Editor for Fast Easy Record, Play and Special Effects (Lines Mouse or Keyboard) and I/O with SoundCard™
- Full Fidelity - Adjustable Sampling Rate / Recording Time - VLSI A/D D/A
- 82 Functions / Special Effects - 94 Page Manual w/ Digital Audio Tutorial
- 4 Diskette Starter Set of SoundBytes™ - 14 Sample Sounds
- For Business: Training, Point-of-Sale Shows - Works with Grasp, QJbase, etc.
- For Engineering: Built-in Function Generators, Make Clear Voice Alarms, etc.
- For Fun: Create Your Own Mac-like Boot-up Sounds, Error Messages...

**Silicon Shack**  
 5120 Campbell Ave. #112, San Jose, CA 95130  
 PH: (408) 446 - 4521 VISA - MasterCard

Circle 325 on Reader Service Card

**Modular I/O board**

Single-slot Qua Tech PXB-721 for PC-AT has 72 digital I/O lines. Connect three choices of data acquisition modules. Supports Labtech Notebook™

For order info, call:  
**1-800-553-1170**

**QUA TECH**  
 QUA TECH, INC.  
 478 E. Exchange Street  
 Akron, OH 44304

Labtech Notebook is a trademark of Laboratories Technologies Corp.

Circle 302 on Reader Service Card

**PC/XT/AT BUS DATA ACQUISITION**

**Free Catalog!**

AD1000 12-Bit A.O. OIO. Counters	\$295
ADA300 8-Bit A.O. D.A. OIO	\$239
DG24/96 8255-based OIO	\$95 \$239
TC24 Am9513 Counter. OIO	\$189
DA600 2.4 Channel 12-Bit O A	\$179 \$239

All cards made in USA!

We offer a wide range of A.O. D.A. OIO. counters, prototype, extender cards, interfacing books & accessories. 30 day NO RISK return and 1 year warranty on all cards.

**Real Time Devices, Inc.**  
 531 E. Marilyn Avenue  
 P.O. Box 906  
 State College, PA 16804 USA  
**814/234-8087**

Circle 310 on Reader Service Card

**SAVE ON 9 TRACK TAPE SYSTEM**

FOR IBM PC/XT/AT & PS-2

- Mainframe to PC Data Transfer
- High Speed Backup
- All Software, Complete System
- Service and Support, easy Installation

Call (818) 343-6505 or write to:  
**CONTECH Computer Corp.**  
 P.O. Box 153 Tarzana, CA 91356

**CONTECH**

Circle 94 on Reader Service Card

**5218 Printer Interface for PS/2 and AT**

Qua Tech interface cards connect IBM 5218 Display-Writer printer to PS/2 and AT\*. Available now. Hundreds installed.

For order info, call:  
**1-800-553-1170**

**QUA TECH**  
 QUA TECH, INC.  
 478 E. Exchange Street  
 Akron, OH 44304

IBM, DisplayWriter, PS/2, and AT are trademarks of IBM Corp.

Circle 303 on Reader Service Card

**UNIVERSAL PROGRAMMER**

@programs E(E)PROM, PAL, EPLD, GAL, PEEL, FPL, BIPOLAR, 8748/51 SERIES.  
 @tests TTL/CMOS and D/S RAM.  
**\$545 Complete.** (w.o. only)

- programs E(E)PROMs upto 2Mbits and 16 Bit wide.
- 16Bit- and 32Bit- WORD SPLIT & 4-GANG adaptor.
- programs PALs (22V10) from AMD, MMI, TI, NS, SAMSUNG.
- supports PALASM2/CUPL/ABEL/ORCAD JEDEC files.
- supports VERIFICATION using TEST VECTORS.
- programs GALs & FPLs from LATTICE, SGS, NS, SIGNETICS.
- supports RALs in GAL (16V8, 20V8) devices.
- programs EPLDs from INTEL, ALTERA, ATMEL, CYPRESS.
- programs BIPOLAR PROMs.
- programs SINGLECHIPS: 8748, 8751, 87C51 SERIES including 87C451, 87C751, 63701X/Y/V, 63705V with adaptors.
- tests ICs (TTL, CMOS) & MEMOR'S (upto 1MB) with USER-DEFINABLE TEST PATTERN GENERATION.
- High-Speed, Parallel Interface & SW/Upgradable for New Parts.

**XELTEK**  
 473 SAPENA CT. #26  
 SANTA CLARA, CA 95054

1-800-541-1975 (Toll Free Order)  
 TEL: (408) 727-6995  
 FAX: (408) 727-6996  
 COD, VISA, MC, AMEX

Circle 381 on Reader Service Card





PS/2 model 30/286	1895
PS/2 model 50/30 meg	2395
PS/2 model 70/60 meg	3695
PS/2 model 80/40 meg	4395
PS/2 model 70/120 meg	5595
PS/2 model 80/115 meg	Call

Call for other models



386 S 40 meg	Call
386 20E - 40 meg	4195
286E 40 meg	Call
386 110 meg/25 MHz	7295
386 60 meg/25 MHz	5895
Portable III 40 meg/12 MHz	3995

CARD & MONITOR EXTRA  
Call for other models

### Macintosh

Mac IICX/80 Meg, 40 Meg RAM	5095
Mac-II/40 Meg	4095
Mac-SE 30/40 Meg	3695

Call for 60 and 100 Meg  
Lazer NT 3595  
Lazer NTX 4895

# LOW PRICE LEADER

## SINCE 1983

### LAP-TOP

Compaq SLT 286-20/40	3795/Call
Toshiba T1000	Call
T1200F	Toshiba Sale! Call
T1200HB	Call
T1600-20/40 Meg	Call for all!
T3100E	Call
T3200-40 Meg	Call
T5100-40/100	Call
T5200-40/100	Call
Zenith 286-20 Meg	3195/Call
Zenith 8088-20 Meg	Call
Mitsubishi 286-20/40	2395/Call

### Pacific Data (For HP)

25-N-1 Cartridge	265	Pacific Page	459
1 Meg. Memory Board	249	Plotter Cartridge	239



### Everex

Step 286 - 12 & 16 MHz & 20 MHz  
1 Meg RAM  
Set up utility in ROM  
S/P, C/C  
Enhanced keyboard  
1.2 MB floppy  
DOS/BASIC

Call! for your configuration

### Everex

Step 386-20 MHz & 16 MHz & 25 MHz & 33 MHz  
Up to 256K cache of very high speed RAM  
2 Meg RAM, expandable to 16 Meg  
S/P, C/C  
Enhanced keyboard  
1.2 MB floppy  
DOS/BASIC

Call!



AST 286 model 140X	Call
AST 286 model 80	1495
AST 386 model 300c	Call
AST 386 40 Meg	3195

CARD & MONITOR EXTRA  
CALL FOR OTHER MODELS

### WE STOCK

CITIZEN  
OKIDATA  
EVEREX  
GOLD STAR

TOSHIBA  
NEC  
WYSE  
HITACHI

PRINCETON GRAPHICS  
SONY  
ACER  
HOUSTON INSTRUMENTS

AMDEK  
HAYES  
SAMSUNG  
CALCOMP

PC MOUSE  
MICROSOFT MICE  
LOGITECH  
MITSUBISHI

IRWIN & ARCHIVE  
TAPE BACK  
TAXAN  
MAGNOVOX

#### BOARDS

Paradise VGA +	219
Vega VRAM	449
ATI VGA Wonder	285
Everex EGA	149
Tatung 16 bit	239

#### SOFTWARE SPECIALS

dBase IV	455
Wordperfect	229
Aldus Pagemaker	495
Ventura Publisher	495
Clipper	435
WordStar 5.5	219



### NOVELL Authorized Dealer

#### PRINTERS

<b>EPSON</b>	
LX-810/LQ-510	199/339
LQ-850/1050	545/749
FX-850/1050	359/479
<b>OKIDATA</b>	
320/321	359/490
390/391	490/649

#### LASER PRINTERS

HP Laser II	1695
HP Desk Jet ±	695
Panasonic 4450	1395
Brother HL-8-E	1895
Nec LC 890	3195
PageLaser 12	\$\$\$\$\$
Canon Laser	Call

#### MONITORS

Nec Multisync IIA	499
Nec Multisync 3D	639
Magnavox EGA	339
Nec Multisync 5D	2350
Samsung EGA	359
Goldstar VGA	375

#### FAX MACHINES

Sharp FO 220	729
Sharp UX 350	1195
Canon	Call
Brother	Call
Richo	Call
Murata	Call

#### Intel Coprocessors

8087-3	105
8087-2	145
80287-8	225
80287-10	249
80387-16	395
80387-20	425
80387-25	495
80387-33	599

#### TOSHIBA

321-SL/341-SL	419/595
351-SX 350 CPS	929

#### PANASONIC

1524	529
1124	319

Call for others

#### MODEMS

Everex 1200 Int	89
Everex 2400 Int	159
Hayes 1200 B	299
More in Stock	Call

WE ACCEPT CASHIER CHECKS, MONEY ORDERS, VISA, MC, AmEx  
3% charge on VISA, MC & 5% on American Express

EXPORTS Available

# COMPUTERLANE

HOURS:  
M-S 9-6

**1-800-526-3482 (Outside CA)**  
**(818) 884-8844 (In CA)**  
**(818) 884-8253 (FAX)**

22107 ROSCOE BLVD.  
CANOGA PARK  
1/2 BLOCK W. OF TOPANGA  
CA 91304

CORPORATE ACCOUNTS WELCOME  
CALL FOR VOLUME DISCOUNTS  
CONSULTANTS CALL FOR PRICING

Prices subject to change without notice

Compaq is a Registered Trademark of Compaq  
IBM is a Registered Trademark of International Business Machines

1	Exxon
2	General Motors
3	Mobil
4	Ford Motor
5	IBM
6	Texaco
7	E.I. du Pont
8	Standard Oil (Ind.)
9	Standard Oil of Cal.
10	General Electric
11	Gulf Oil
12	Atlantic Richfield
13	Shell Oil
14	Occidental Petroleum
15	U.S. Steel
16	Phillips Petroleum
17	Sun

**27 million Americans can't read. And guess who pays the price.**

Every year, functional illiteracy costs American business billions.

But your company can fight back... by joining your local community's fight against illiteracy. Call the Coalition for Literacy at toll-free **1-800-228-8813** and find out how.

You may find it's the greatest cost-saving measure your company has ever taken.

**A literate America is a good investment.**

**Ad Council** Coalition for Literacy

**4-MEGABIT PROGRAMMER for IBM XT/AT..... \$245**

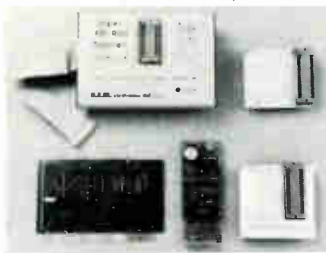

**30-day money back guarantee 2716 to 274001 incl. EEPROM/CMOS High speed programming algorithm Intel/Motorola/Binary files utilities 87C51/51 & 41/42/48/49 adaptors (Optional) Eprom emulator adaptor 2716 - 27256 Industrial Model \$398**

4 Meg eproms available (Concom Restriction) One per customer  
873 E. Hastings Vancouver B.C. CANADA V6A 1R8  
2370 Midland Ave. Unit A-28, Scarborough Ont. CANADA M1S 1P8

**K.E.M.** Tel (604) 251-1514  
Tel (416) 754-7565  
Fax (416) 754-7431

Circle 199 on Reader Service Card

**Data Acquisition Processor™**



- Onboard Intelligence For IBM PC/XT/AT/386**
- 16 MHz 80C186 for general processing
  - 20 MHz DSP56001 for digital signal processing
  - Sustained digital signal processing of 10 MIPS
  - FFT and FIR filtering without programming
  - Acquires analog and digital inputs to 235K s/s
  - Buffers and processes input data as required
  - Updates analog or digital outputs to 250K s/s
  - Over 100 commands without programming
  - Custom commands may be written in C

Call for **FREE Demo Diskette**

**MICROSTAR LABORATORIES** (206) 881-4286  
2863 152 Ave. N.E. Redmond, WA 98052  
FAX (206) 881-5494

Circle 237 on Reader Service Card

**KEYBOARD & MONITOR 500 FEET AWAY - ALSO DRIVE MANY MONITORS AT ONCE — CALL FOR FREE CATALOG**

**NTI NETWORK TECHNOLOGIES, INC.**

19145 Elizabeth St., Aurora, OH 44202  
US 216-543-1646 or 800-RGB-TECH  
UK 0244-880478  
PARIS 331-47632789  
GENEVA 022-431124  
CANADA 416-677-6500  
MUNICH 0130811234

Circle 253 on Reader Service Card

World Radio History

**BLAST Your Message Thru!**



**Voice Messaging • Call Processing Audiotex • Telemarketing Order Processing • Call Distribution**

Powerline transforms your personal computer (PC/XT/AT/386) into a multi-line voice processing command center capable of controlling 16 telephone lines. Intelligently process your sales, inquiries and messages in the background. Give your computer some Punch!

Blast your message through with Powerline! Package includes hardware, software, cables, speaker, 2 year warranty.

**Single Line (approx) \$295.00**  
**Multi-Line \$895.00**  
(Development OEM packages available)  
VISA, MC, AMEX, DISC  
For information or Sales Call: (415) 652-9600  
FAX (415) 652-5311

**TALKING TECHNOLOGY, INC.**  
4383 PIEDMONT AVE., OAKLAND, CA 94611

Circle 348 on Reader Service Card

**ALL NEW !!! 9 TRACK TAPE SUBSYSTEM for IBM PC/AT/386 complete for only \$2,595.00 1 YEAR WARRANTY**

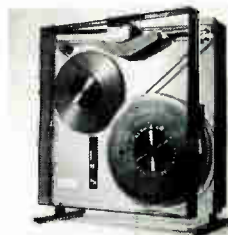

- IBM/ANSI compatible at 800\*/1600/3200 bpi
  - Controller, cables and software included
  - Interfaces for PS/2\*, Xenix\* and DEC\*
  - SCSI\*, AT or MCA\* Bus I/O at 25/50/100 ips.
- \* optional

**AKSystems Inc**  
20741 Marilla St. Chatsworth CA 91311  
TEL:818/709-8100 FAX: 818/407-5889

Circle 20 on Reader Service Card

**PC PRODUCTIVITY**

**NEW**



**Turn your PC into a Tektronix Graphics Terminal**

**FTG DATA SYSTEMS**

(800) 962-3900

10801 Dale St., Stanton, CA 90680

Circle 146 on Reader Service Card





# BITWISE COMPUTERS -MORE THAN JUST A PRETTY FACE

Model	Model 212M	Model 212	Model 325	Model 333	Portable III-212	Portable III-325
CPU	12 Mhz 80286	12 Mhz 80286	25 Mhz 80386	33 Mhz 80386	12 Mhz 80286	25 Mhz 80386
RAM	512K 0 Wait	1 Meg 0 Wait	4 Megs Interleaved	4 Megs Cache	1 Meg 0 Wait	4 Megs Interleaved
DISPLAY	Monochrome	VGA color	VGA color	VGA color	Plasma CGA	Plasma CGA
<b>PRICE</b>	<b>\$1,395</b>	<b>\$1,895</b>	<b>\$3,195</b>	<b>\$4,895</b>	<b>\$2,195</b>	<b>\$3,495</b>

Prices are for complete systems, including Computer, Monitor, Keyboard, Hard Disk, DOS, Documentation, and 1 Year Warranty

### All Desktop Systems Include:

- Compact Case 17" w x 7.25" h x 14" d
- 8 Expansion Slots, 5 Full Length Free
- 5 Drive Slots, 3 free
- Teac 1.2 or 1.4 Meg Floppy (add \$95 for both)
- Trident VGA Card, 100% register compatible, up to 1024x768
- Keytronics 101 Key US Made Keyboard
- 2 Serial Ports, 1 Parallel Port, 1 Game Port
- Seagate 40 Meg 28 ms MFM (ST-251-1) Hard Disk
- MS-DOS 3.3 or 4.01 with Manuals

### Monitor Upgrades

Model	Monitor	Resolution	Dot Pitch	Price
VGA-41	Packard Bell	640x480	.41	Standard
VGA-31	CTX	640x480	.31	Add \$30
VGA-IIA	Nec-IIA	800x600	.28	Add \$290
VGA-3D	Nec-3D	1024x768	.24	Add \$425
Mono	Packard Bell	720x348	.29	Subtract \$450

### All Portable Systems Include:

- Portable Case 15" w x 9" h x 8" d (20 lbs empty)
- High Contrast Plasma Screen (call for LCD prices)
- 5 Expansion Slots, 3 Full Length. 2 slots free in 2 drive system
- 3 Drive Slots, Teac 1.2 or 1.4 Meg Floppy (add \$95 for both)
- 40 Meg ST-251-1 Self Parking 28 ms hard disk standard
- ALL Hard Disk Upgrades available (see table)
- Simultaneous Display on screen and external monitor
- MS-DOS 3.3 or 4.01 with Manuals

### Plasma Display Upgrades

Model	Screen	Resolution	Gray Scales	Price
CGA	640x400	640x200	4	Standard
EGA	640x400	640x350	4	Add \$290
VGA	640x480	640x480	16	Add \$540

### Hard Disk Upgrades

Model	Size	Access Time	Controller Type	Price
ST-125-1	20 MB	28 ms	MFM 1:1	Subtract \$85
ST-251-1	42 MB	28 ms	MFM 1:1	Standard
ST-277N-1	66 MB	28 ms	SCSI 1:1	Add \$60
ST-277R-1	66 MB	28 ms	RLL 1:1	Add \$95
ST-296N-1	85 MB	28 ms	SCSI 1:1	Add \$245
Microscience	121 MB	28 ms	ESDI 1:1	Add \$700



Bitwise — Building and servicing PCs since 1985. Questions? Call Us! we understand what we sell! Shipping — You pay UPS Shipping Charges only, F.O.B. Troy, NY, no surcharges. Full 1 Year Parts & Labor Warranty, 30-day money back guarantee. These are cash or check in advance prices. VISA, MC, DISCOVER, welcomed (2% surcharge). COD, add 1.5%. Personal Financing and Corporate Leasing Available.

1-800-367-5906  
518-274-0755  
Fax 518-274-0764

Bitwise Designs Inc.  
701 River St.  
Troy, NY 12180-1233



**BITWISE**  
DESIGNS, INC.

## UNICORN-YOUR I.C. SOURCE

### COLLIMATOR PEN



A low power collimator pen containing a MOVPE grown gain guided GaAlAs laser. This collimator pen delivers a maximum CW output power of 2.5 mW at 25 °C.

These collimated laser sources are designed for industrial applications such as data retrieval,

telemetry, alignment etc.

The non-hermetic stainless steel encapsulation of the pen is specifically designed for easy alignment in an optical read or write system, and consists of a lens and a laser device. The lens system collimates the diverging laser light. The wavefront quality is diffraction limited.

The housing is circular and precision manufactured with a diameter of 11.0 mm and an accuracy between + and - 11 µm.

LIST PRICE ~~\$180.00~~ PRICE **\$39.99**

Quality Components — Low Prices Since 1983

### LASER DIODE

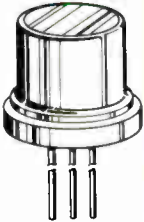

Designed for general industrial low power applications such as reading optical discs, optical memories, bar code scanners, security systems, alignment etc.

The gain guided laser is constructed on a n-type gallium arsenide substrate with a Metal Organic Vapor Phase Epitaxial process (MOVPE).

The device is mounted in an hermetic SOT148D (diameter 9.0 mm) encapsulation.

The SB1053 is standard equipped with a monitor diode, isolated from the case and optically coupled to the rear emitting facet of the laser. This fast responding monitor diode can be used as a sensor to control the laser optical output level.

LIST PRICE ~~\$38.00~~ PRICE **\$9.99**

We Carry A Full Line of Components

CALL FOR FREE CATALOG

### EPROMS

STOCK #	PINS	DESCRIPTION	1-24	25-99	100+
1702	24	256 x 4 1ns	4.79	4.55	4.10
2708	24	1024 x 8 450ns	6.79	6.45	5.81
2758	24	1024 x 8 450ns	3.99	3.79	3.41
2716	24	2048 x 8 450ns (25v)	3.59	3.41	3.07
2716-1	24	2048 x 8 350ns (25v)	3.99	3.79	3.41
TMS2716	24	2048 x 8 450ns	6.79	6.45	5.81
27C16	24	2048 x 8 450ns (25v-CMOS)	4.19	3.98	3.58
2732	24	4096 x 8 450ns (25v)	3.79	3.60	3.24
2732A-2	24	4096 x 8 200ns (21v)	3.99	3.79	3.41
2732A	24	4096 x 8 250ns (21v)	3.79	3.60	3.24
2732A-4	24	4096 x 8 450ns (21v)	3.29	3.13	2.82
TMS2532	24	4096 x 8 450ns (25v)	5.79	5.50	4.95
27C32	24	4096 x 8 450ns (25v-CMOS)	4.79	4.55	4.10
2784-20	28	8192 x 8 200ns (21v)	3.99	3.79	3.41
2784	28	8192 x 8 250ns (21v)	3.59	3.41	3.07
2764A-20	28	8192 x 8 200ns (12.5v)	3.99	3.79	3.41
2764A	28	8192 x 8 250ns (12.5v)	3.59	3.41	3.07
TMS2564	28	8192 x 8 250ns (25v)	6.79	6.45	5.81
27128-20	28	16,384 x 8 200ns (21v)	6.79	6.45	5.81
27128	28	16,384 x 8 250ns (21v)	5.79	5.50	4.95
27C128	28	16,384 x 8 250ns (21v-CMOS)	5.79	5.50	4.95
27256-20	28	32,768 x 8 200ns (12.5v)	6.79	6.45	5.81
27256	28	32,768 x 8 250ns (12.5v)	5.29	5.03	4.53
27C256	28	32,768 x 8 250ns (12.5v-CMOS)	5.99	5.69	5.12
27512-20	28	65,536 x 8 200ns (12.5v)	10.49	9.97	8.97
27512	28	65,536 x 8 250ns (12.5v)	9.49	9.02	8.12
27C512	28	65,536 x 8 250ns (12.5v-CMOS)	9.99	9.49	8.54
27C1024	32	131,072 x 8 200ns (12.5v-CMOS)	27.99	26.59	23.93
68784	24	8192 x 8 450ns	18.99	18.04	16.24
68766	24	8192 x 8 450ns	15.99	15.19	13.67

### UNICORN ELECTRONICS

10010 Canoga Ave., Unit B-8  
Chatsworth, CA 91311

ORDER BY PHONE (TOLL FREE)

(800) 824-3432 (OUTSIDE CALIFORNIA)

IN CALIFORNIA (818) 341-8833

ORDER BY FAX (818) 998-7975



## Sure it's insured?

SAFWARE® Insurance provides full replacement of hardware, media and purchased software. As little as \$39/yr. covers:

- Fire • Theft • Power Surges
- Earthquake • Water Damage • Auto Accident

For information or immediate coverage call:  
**1-800-848-3469**

In Ohio call 1-614-262-0559



SAFWARE, The Insurance Agency Inc.

Circle 392 on Reader Service Card

## 8051 68HC11 EMULATORS



For info call:

Australia	(02) 654 1873
Austria	(0222) 38 76 38
Benelux	+ 31 1850-16133
Denmark	(02) 65 81 11
Finland	90-452 1255
France	(01) 69 412 801
Great Britain	0962-73 3140
Israel	(03) 484832
Italy	(011) 7710010
Korea	(02) 784 7841
New Zealand	(09) 392464
Portugal	(01) 83 56 70
Scandinavia	+ 46 40922425
Singapore	065 743-2086
Spain	(93) 217 2340
Switzerland	(01) 740 41 05
Taiwan	(02) 7540215
West Germany	08131-1687
U.S.A. FAX	(408) 378-7869

See us at Wescon '89, booth 902

**NOHAU**  
CORPORATION

51 E. Campbell Ave.,  
Campbell, CA 95008  
(408) 866-1820

See our ad on page 419

Circle 256 on Reader Service Card

## IEEE 488 Solutions

- Hardware & software interfaces for PC, AT, 386, PS/2, Macintosh, SUN, HP & DEC
- IEEE converters to SCSI, RS-232, RS-422, modem, Centronics, digital I/O & analog I/O
- IEEE extenders, expanders & buffers
- IEEE drivers for DOS, UNIX, Lotus 1-2-3, Symphony & Quattro.

Call or send for your  
**FREE Technical Guide**

Demo disks and application notes available

Please see our ad on page 214.

**Lotek**

(216) 439-4091

Telex 6502820864 • Fax (216) 439-4093  
Lotek, Inc. • 25971 Cannon Road  
Cleveland, Ohio 44146

Circle 182 on Reader Service Card

World Radio History

## FREE CATALOG

### RS-232C INTERFACE & MONITORING EQUIPMENT CATALOG

WRITE OR CALL for YOUR FREE COMPREHENSIVE B & B ELECTRONICS CATALOG TODAY!

Pages and pages of photographs and illustrated, descriptive text for B&B's complete line of RS-232C converters, RS-422 converters, current loop converters, adapters, break-out boxes, data switches, data splitters, short haul modems, surge protectors, and much, much more. Most products meet FCC Part 15J. Your RS-232C needs for quality, service and competitive prices will be more than met by B&B ELECTRONICS. Manufacture to you, no middleman! Money-back guarantee! Same-day shipment! One-year warranty on products! Technical support is available.



Order direct from manufacturer TODAY & SAVE!

Write For Your FREE Catalog Today!

**B & B electronics**  
MANUFACTURING COMPANY

4002L Baker Road, P.O. Box 1040 • Ottawa IL 61350

Phone: 815-434-0846

Circle 788 on Reader Service Card

## CACHE CONTROLLER

WORLDS FASTEST ACCESS TIME 0.3 MB

And you already have the drive!

Perfect for CAD CAM and Desktop

Publishing

hyperSTORE 816 SPU

REVIEW IN THIS ISSUE

### SIMMS

BEST PRICES • 2 YEAR WARRANTY

CALL FOR PRICES

8087	64K	256x9
80287	256K	256x8
80C287A-12	4464	1 MEG x 9
80387DX	VIDEO	1 MEG x 8
80387SX	1 MEG	LOW PROFILE

Dealer and OEM Inquiries Welcome

Tel: (213) 383-9701

FAX: (213) 383-3423

G. Reed, Inc.

258 South Western Avenue, L.A., CA 90004

Shipping and handling charges may apply.

Circle 158 on Reader Service Card

## 8051/8052 BASIC COMPILER!

MCS BASIC52™ compatible  
Runs on IBM-PC or compatible

**\$ 295.00**

Call Now! 603-469-3232

**Binary Technology, Inc.**

Main Street • P.O. Box 07 • Meriden, NH 03770

Circle 53 on Reader Service Card



# Holiday Special All System Pricing Reduced

## CAT™ 10MHZ

### BASE SYSTEM

- 256K (Opt. 640K) • 150 Watt Power Supply • AT Style Keyboard & Case
- 4.77 or 10 MHz Keyboard Selectable
- Floppy Disc Controller
- 8087 Socket • 360K Floppy Drive
- 1 Year Warranty

**\$34900**

IBM XT COMPATIBLE



## CAT 386 SYSTEM

- 12" Amber Monitor with Graphics Interface Card
- 1.2 Meg Floppy Drive (expandable to 8 Meg)
- 1 Meg of Memory
- Parallel, Serial & Clock
- Xenix, Unix, Novell Compatible

20MHz **\$152300**

## CAT™ 286-10MHZ

### BASE SYSTEM

- 512K Exp. to 1 MEG • 200 Watt Power Supply • AT Style Keyboard
- Western Digital Controller • 1.2 Meg Floppy • Legal Bios w/manuals • Systems Documentation • 1 yr. w. Clock/Calc
- 10MHz DTK Motherboard

**\$64900**

11.3 NORTONS SL



8088 XT Compatible		SYSTEM OPTIONS		286, 386 AT Compatible	
640 K Upgrade	129 <sup>00</sup>	Clock Calendar	24 <sup>00</sup>	640 K Upgrade	49 <sup>00</sup>
12" Amber Monitor w/interface	139 <sup>00</sup>	Parallel & Serial Ports	39 <sup>00</sup>	512K Upgrade	108 <sup>00</sup>
DOS 4.01 w/GW BASIC	89 <sup>00</sup>	Additional Drives	See Below	12" Amber Monitor w/interface	139 <sup>00</sup>
				14" EGA Monitor w/interface	549 <sup>00</sup>
				Novell Network. Call 12 Mhz add	100 <sup>00</sup>
				14" Color Monitor w/interface	289 <sup>00</sup>

## COPROCESSORS

8087	5MHz or less	88 <sup>00</sup>
8087-2	8MHz	129 <sup>00</sup>
8087-1	10MHz or less	179 <sup>00</sup>
80287	6-8MHz	139 <sup>00</sup>
80287-8	8-10MHz	199 <sup>00</sup>
80287-10	10MHz	239 <sup>00</sup>
80C287-12	12MHz	299 <sup>00</sup>
80387-16	16MHz	369 <sup>00</sup>
80387-20	20MHz	439 <sup>00</sup>
80387-25	25MHz	549 <sup>00</sup>
90387-33	33MHz	649 <sup>00</sup>
80387SX	16MHz	399 <sup>00</sup>

## RAM CHIPS

Description	150NS	120NS	100NS	80NS
64 x 1	2 <sup>00</sup>	2 <sup>00</sup>	2 <sup>00</sup>	3 <sup>00</sup>
64 x 4	4 <sup>00</sup>	5 <sup>00</sup>	5 <sup>00</sup>	6 <sup>00</sup>
256 x 1	3 <sup>00</sup>	3 <sup>00</sup>	3 <sup>00</sup>	4 <sup>00</sup>
1 Meg x 1	11 <sup>00</sup>	11 <sup>00</sup>	12 <sup>00</sup>	13 <sup>00</sup>
256 x 4	12 <sup>00</sup>	14 <sup>00</sup>	15 <sup>00</sup>	17 <sup>00</sup>
64x4 Video	6 <sup>00</sup>	7 <sup>00</sup>	8 <sup>00</sup>	11 <sup>00</sup>
1 Meg Video	—	24 <sup>00</sup>	—	—
8K x 8 Static	7 <sup>00</sup>	8 <sup>00</sup>	9 <sup>00</sup>	11 <sup>00</sup>
NEC V-20 — 8MHz	—	—	7 <sup>00</sup>	—

The above Memory Upgrades come in DIP Form. Please specify if you need ZIP - Soj - PLCC - Flat Pack or if you need Nibble Mode

## MEMORY FOR ALL COMPUTERS

IBM PS2		COMPAQ	
Description	Part #	For Model #	Meads Low Price
512K Upgrade	30F 5348	386/20/25/20E/286E	149 <sup>00</sup>
2MB Upgrade	30F 5360	Deskpro 386S	459 <sup>00</sup>
1MB Module	6450603	386/20/25/20E/286E	239 <sup>00</sup>
2MB Module	6450604	Deskpro 386S	499 <sup>00</sup>
2MB Mem. Board	6450608	386/20/25/20E/286E	599 <sup>00</sup>
1MB Mem. Board	6450375	Deskpro 386/20e	419 <sup>00</sup>
2MB Mem. Board	6450379	Deskpro 386S	899 <sup>00</sup>
		Portable 386	1399 <sup>00</sup>
		286E	499 <sup>00</sup>
		286E	1399 <sup>00</sup>
		SLT/286	599 <sup>00</sup>
		386/16	1399 <sup>00</sup>

IBM & Compaq boards & Modules come with 1 year warranty and are manufactured on a 2nd party board.

## Seagate HARD DRIVES

ST125	20Meg	40 Mil 1/2 Ht 3 1/2" Drive only	259 <sup>00</sup>
ST138	30Meg	40 Mil 1/2 Ht 3 1/2" Drive only	299 <sup>00</sup>
ST225	20Meg	w/cont. & Cables	259 <sup>00</sup>
ST238	30Meg	w/cont. & Cables	289 <sup>00</sup>
ST251	40Meg	1/2 HT 40 Mil w/software. Drive only	349 <sup>00</sup>
ST251-1	40Meg	28 Mil Sec. Drive only	359 <sup>00</sup>
ST277R	60MB	40 Mil 1/2 Ht.	449 <sup>00</sup>
ST4026	20Meg	Full Ht 40 Mil	299 <sup>00</sup>
ST4038	30Meg	40 Mil Full Ht	399 <sup>00</sup>
ST4053	40MB	28 Mil Full Ht	519 <sup>00</sup>
ST4096	80Meg	Full Ht w/software 28 Mil Sec.	639 <sup>00</sup>

## MODEMS BY EVEREX™

EV-923	EverCom 12 300/1200 bps Bitcom Software	69 <sup>00</sup>
EV-941	EverCom 24 2400 Baud Int. Bitcom Software	139 <sup>00</sup>
EV-945	External 2400 Baud	199 <sup>00</sup>
EV-942	2400 PS2	229 <sup>00</sup>
EX-955	FAX Card	349 <sup>00</sup>
1200 Baud Internal w/Software		54 <sup>00</sup>
1200 Baud External fully Hayes Compatible		99 <sup>00</sup>
2400 Baud Internal 1/2 card w/software CPI		99 <sup>00</sup>
2400 Baud External Fully Hayes Compatible, Zoom		129 <sup>00</sup>

## RAM CHIPS

64 x 1	2 <sup>00</sup>	2 <sup>00</sup>	2 <sup>00</sup>	3 <sup>00</sup>
64 x 4	4 <sup>00</sup>	5 <sup>00</sup>	5 <sup>00</sup>	6 <sup>00</sup>
256 x 1	3 <sup>00</sup>	3 <sup>00</sup>	3 <sup>00</sup>	4 <sup>00</sup>
1 Meg x 1	11 <sup>00</sup>	11 <sup>00</sup>	12 <sup>00</sup>	13 <sup>00</sup>
256 x 4	12 <sup>00</sup>	14 <sup>00</sup>	15 <sup>00</sup>	17 <sup>00</sup>
64x4 Video	6 <sup>00</sup>	7 <sup>00</sup>	8 <sup>00</sup>	11 <sup>00</sup>
1 Meg Video	—	24 <sup>00</sup>	—	—
8K x 8 Static	7 <sup>00</sup>	8 <sup>00</sup>	9 <sup>00</sup>	11 <sup>00</sup>
NEC V-20 — 8MHz	—	—	7 <sup>00</sup>	—

## MEMORY FOR ALL COMPUTERS

IBM PS2		COMPAQ	
Description	Part #	For Model #	Meads Low Price
512K Upgrade	30F 5348	386/20/25/20E/286E	149 <sup>00</sup>
2MB Upgrade	30F 5360	Deskpro 386S	459 <sup>00</sup>
1MB Module	6450603	386/20/25/20E/286E	239 <sup>00</sup>
2MB Module	6450604	Deskpro 386S	499 <sup>00</sup>
2MB Mem. Board	6450608	386/20/25/20E/286E	599 <sup>00</sup>
1MB Mem. Board	6450375	Deskpro 386/20e	419 <sup>00</sup>
2MB Mem. Board	6450379	Deskpro 386S	899 <sup>00</sup>
		Portable 386	1399 <sup>00</sup>
		286E	499 <sup>00</sup>
		286E	1399 <sup>00</sup>
		SLT/286	599 <sup>00</sup>
		386/16	1399 <sup>00</sup>

## WESTERN DIGITAL CONTROLLERS

WX-1	8 Bit 1/2 Sized for XT	79 <sup>00</sup>
MM2	16 Bit Full Sized Hard/Floppy	119 <sup>00</sup>
WD-27X	8 Bit RLL 1/2 Size	89 <sup>00</sup>
WAH	16 Bit Hard Drive Controller	129 <sup>00</sup>
RA2	16 Bit RLL Hard/Floppy for AT	159 <sup>00</sup>
MEAD	Floppy Disk Controller for XT	19 <sup>00</sup>
MEAD	1.2 Meg & 360K Controller for XT, 720K-1.44	69 <sup>00</sup>
Cable Set	for Hard Drive Only	5 <sup>00</sup>

## Mitsumi FLOPPY DRIVES

360K 1/2 Ht. PC Compatible — Mitsumi	69 <sup>00</sup>
1.2 Meg 5 1/4 Mitsumi	89 <sup>00</sup>
720K 3 1/2" Drive w/5 1/4" mounting — Mitsumi	89 <sup>00</sup>
1.44 Meg 3 1/2" Drive w/5 1/4" mounting — Mitsumi	109 <sup>00</sup>
360K Tandon TM100-2 Full Ht (The Original IBM)	89 <sup>00</sup>
160K Tandon TM100-1 Full Ht	59 <sup>00</sup>
External Case w/Power Supply 2, 1/2 HTs or 1 Full	149 <sup>00</sup>

## EVEREX™ TAPE BACKUPS

40MB	Mini Cartridge, 1.8MB/min, XT (DC 2000)	339 <sup>00</sup>
40MB	Mini Cartridge, 3.6MB/min, AT (DC 2000)	339 <sup>00</sup>
60MB	Streaming Cassette, 5MB/min w/cont (CT600)	649 <sup>00</sup>
60MB	Streaming 600A, 5MB/min w/Full cont (DC600)	849 <sup>00</sup>
125MB	Streaming Cartridge, 5MB/min w/Full cont	1119 <sup>00</sup>
DC2000	24 <sup>00</sup> External Add 195 <sup>00</sup>	DC600 24 <sup>00</sup>

## Imtec/SAMSUNG MONITORS

1256A	12" Amber w/Tilt & Swivel Base	89 <sup>00</sup>
1257	12" Amber Flat Screen 720 x 350	109 <sup>00</sup>
1464	14" Color 640 x 200, 16 colors	239 <sup>00</sup>
1453	14" EGA 640 x 350, 64 colors/31	369 <sup>00</sup>
1455N	EGA 720x480 Multisync Compatible	449 <sup>00</sup>

## VIDEO CARDS BY EVEREX™

EGA EV659	640 x 350, Auto Switch	119 <sup>00</sup>
VGA Viewpoint	16 Bit 256 Exp 512K	269 <sup>00</sup>
MORE VIDEO CARDS...		
MonoGraphics or Color Graphics (Hercules Compatible)		44 <sup>00</sup>

## SIMM MODULES

Description	150NS	120NS	100NS	80NS
64 x 9 IBM & Compatibles	19 <sup>00</sup>	29 <sup>00</sup>	34 <sup>00</sup>	39 <sup>00</sup>
256 x 8 For Apple Products	39 <sup>00</sup>	49 <sup>00</sup>	49 <sup>00</sup>	59 <sup>00</sup>
256 x 9 IBM & Compatibles	42 <sup>00</sup>	49 <sup>00</sup>	59 <sup>00</sup>	64 <sup>00</sup>
1Meg x 8 For Apple Products	129 <sup>00</sup>	139 <sup>00</sup>	149 <sup>00</sup>	169 <sup>00</sup>
1Meg x 9 For IBM & Compatibles	139 <sup>00</sup>	149 <sup>00</sup>	159 <sup>00</sup>	169 <sup>00</sup>

HP LaserJet	Memory Boards	
1Meg	0-3Meg	109 <sup>00</sup>
2Meg	0-3Meg PS2	249 <sup>00</sup>
4Meg	0-10Meg	179 <sup>00</sup>
	0-8Meg PS2	399 <sup>00</sup>

## MEAD has done it again!

We Have Located The Following New Equipment Below Everybody's Cost!

## LETTER QUALITY PRINTER

DAISYWHEEL PRINTER MANUFACTURED BY C.I.TOH

Why pay \$1149 for a C.Itoh STARWRITER™ F-10

When our 40 cps letter quality daisywheel printer from the same manufacturer is only

**\$39900** ea.

### OPTIONS

- 6 ft. Serial Cable ..... \$ 19<sup>00</sup>
- Bidirectional Tractor ..... 149<sup>00</sup>
- Cut Sheet Feeder ..... 199<sup>00</sup>
- Serial to Parallel Converter ..... 99<sup>00</sup>

## KROFT MONITOR



FREE TILT SWIVEL BASE

- 14" Flat Screen • Paper White Phosphorus
- TTL Monochrome & RGB Interface

List \$199 Mead **\$9900** 10 for \$890

## HIGH SPEED SCANNER

Ready to go for IDM - Type Machine

Desktop LS300 Scanner  
List Price: 1095<sup>00</sup> Meads: 489<sup>00</sup>

### STANDARD FEATURES

- 300 DPI - Allows for the creation of high resolution graphics/text.
- Automatic Sheet Feeder - Efficient document handling.
- Image Input - Sheet or card (up to 5 sheets can be set with the built-in Automatic Document Feeder).
- Scanning Speed - 12 seconds/page (at 300 dot/inch)
- 6 seconds/page (at 150 dot/inch)
- Gray Scale - 32 shades either pattern or 2 shades.

### OPTIONS

- PC Paint Software ..... 49<sup>00</sup>
- DCR Software ..... 199<sup>00</sup>
- Macintosh Interface ..... 49<sup>00</sup>

## SERIAL MOUSE

- DexxaMouse
- 2 Button Opto-Mechanical • 200 DPI
- Pacemaker, Driver & Menu Software
- PS, XT, AT PS/12 Compatible

List: 99<sup>00</sup> Mead: 49<sup>00</sup>

## SIDEKICK PLUS

- By Borland Version 1.0
- Professional Desktop Manager

List: 199<sup>00</sup> Mead: 79<sup>00</sup> 10 for 59<sup>00</sup> ea.

## PARADISE MONO EGA CARD

Auto Switch Monochrome EGA Card, 640x350 EGA, MDA, CCA, Herc. List 319<sup>00</sup> Mead 99<sup>00</sup>

## FAST TRAX

- The Best Disk Organizer
- Tune Up Your Disks in Seconds
- No Limitations on Directories
- Hard Disk or Floppies
- Helps Prolong Your Hard Disk

List 59<sup>00</sup> Mead: 24<sup>00</sup> 10 for 19<sup>00</sup> ea.

## WORDSTAR PROFESSIONAL 5.0

- Write or Edit Text Based Business Reports as Documents
- Advanced Page Preview To Save Time
- Organize Format & Merge Info From Other Software

List: 485<sup>00</sup> Mead: 149<sup>00</sup> 10 for 129<sup>00</sup> ea.

**800-654-7762**

SALES: 7 a.m.-6 p.m. PST  
**702-294-0204**

TECHNICAL / CUSTOMER SERVICE / ORDER STATUS:

9 a.m.-4 p.m. PST

**FAX 702-294-1168**

Trademarks are Registered with their respective Co's Prices Subject to Change All Products 90 Day Warranty unless stated otherwise.

WE ALSO PURCHASE EXCESS INVENTORY—FAX LIST



- Quantity Pricing Available — CALL
- We Accept International Orders
- Purchase Orders from Universities, Government Institutions, Fortune 1000 and Qualified Firms.

NO SURCHARGE FOR MC/VISA

### TERMS:

- MC • VISA • COD • CASH
- Purchase Orders from Qualified Firms
- Personal Checks • AE add 4% • COD add \$5.00
- 20% Restocking Fee on Non-Defective Returns within 15 days



SHIPPING: (min. 6<sup>00</sup>) UPS

1000 Nevada Hwy. • Unit 101 • Boulder City, NV 89005

## How to Protect Your Computer



### And Make It Last Longer

FREE money-making literature. What you need to know about UPS — uninterruptible power systems. How to get complete protection from power line problems. 350 VA to 15 KVA models from the world's largest manufacturer of single-phase UPS.

**Best Power Technology, Inc.**  
P.O. Box 280, Necedah, WI 54646

**Toll-Free (800) 356-5794, ext. 3783**  
(608) 565-7200, ext. 3783

Circle 347 on Reader Service Card

## VIDEO FRAME GRABBERS



MODEL	RESOLUTION	
HRT 256-4	256 x 256 x 4	495
HRT 256-8	256 x 256 x 8	795
HRT 512-8	512 x 512 x 8	995
HRT 512-24	512 x 512 x 24	1995

- IBM PC/XT/AT COMPATIBLE
- DIGITALIZE IN REAL TIME
- COMPOSITE VIDEO IN
- 24 BIT RGB OUT except model HRT 256-4

16 level gray scale out

- SOFTWARE LIBRARY OF IMAGE ANALYSIS ROUTINES
- FREE SOFTWARE UPGRADES TO REGISTERED OWNERS
- FULL CREDIT ON UPGRADE PURCHASE IN FIRST YEAR
- RETURN OLD BOARD AND JUST PAY DIFFERENCE



HIGH RES TECHNOLOGIES  
P.O. BOX 76  
LEWISTON, N.Y. 14092

PHONE 416-497-6493

FAX 416-497-1988

Circle 165 on Reader Service Card

## Computers for the Blind

Talking computers give blind and visually impaired people access to electronic information. The question is how and how much?

The answers can be found in *The Second Beginner's Guide to Personal Computers for the Blind and Visually Impaired* published by the National Braille Press. This comprehensive book contains reviews, written by blind users, of software that works with speech.

Send orders to:

**National Braille Press Inc.**  
88 St. Stephen Street Boston, MA 02115

(617) 266-6160

**\$12.95 for braille or cassette**  
**\$14.95 for print**

NBP is a nonprofit braille printing and publishing house

## ALLCON Alarm/Control System

### Less than one \$ per channel for PC-AT

176 ch. TTL/sig. 1 board \$199  
320 ch. TTL/sig. 1 board \$399  
656 ch. TTL/sig. 2 boards \$599

3 ch. TTL sig. composit alarm output.  
Standard connector board can be used.  
Prog. time 600 signals about 15 hours.  
Signal name 24 characters.  
Ten operators, 7 key level authority.

## ALLregulator AB

Dagj.gat. 9, S-415 09 Gothenburg, Sweden  
Fax +46 31 43 47 30 Tel +46 31 48 01 80  
US office Mesa AZ Tel (602) 649 1202  
Estab. 1967 VISA/MC CHECK

Circle 21 on Reader Service Card

## 25MHZ 80386 MOTHERBOARD

**Faster Than The Everex Step™ I**  
**6.2 Mips! \$1499 (OK) QTY 1**

### Features:

- \*64K/256K Write Back Cache
- \*Dual Read/Write Cache
- \*Transparent Refresh
- \*8MB maximum on motherboard
- \*Supports 80387/Weitek
- \*Compatible with UNIX, OS/2, and Novell
- \*1 Year Full Warranty
- \*72 HR In-Circuit Burn-In!

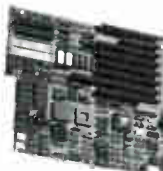

20 MHz also available @ 4.9 MIPS

**SIMM Modules**  
256Kb x 8, 100ns-\$48  
1Mb x 8, 100ns-\$150

Same Day Shipping!

Technology Power Enterprise, Inc.  
46560 Fremont Blvd., Suite 118,  
Fremont, CA 94538  
TEL (415) 623-9182 FAX (415) 623-9462

Novell, OS/2, and UNIX are registered trademarks

Circle 351 on Reader Service Card

## ULTIBOARD COMPUTER AIDED PCB DESIGN



### The ULTimate PCB layout package featuring:

- Real-Time Design Rule Check
- Curved and angular traces
- Trace Shove and Rotate-While-Move
- Full SMT support
- Autoroute by window, component or net
- Powerful placement tools
- 32 layer support: blind & buried vias
- BackAnnotation: pin/gate swap

Estimated memory versus with unlimited design size and 32 bit performance are available

USA/Canada: ULTimate Technology Corp. • tel (408) 438-8944 • Fax: 438-8886  
UK/Ireland: ULTimate Technology (UK) Ltd. • tel (0754) 812030 • Fax: 815323  
Germany: ULTimate Technology • tel (02031) 876228 • Fax: 85915  
Int. Headquarters: ULTimate Technology BV • tel (+312159-44424) • Fax: 43345

**ULTIMATE TECHNOLOGY** ASK FOR YOUR FREE DEMO DISK

See us at Wescon,  
San Francisco, Booth 1546

Circle 249 on Reader Service Card

World Radio History



## Husband. Grandfather. Great American Investor.

When Bob Lawrence joined the railroad nearly 30 years ago, he began buying U.S. Savings Bonds for his retirement. Now he buys them for his grandkids. "Bonds pay good strong rates and they're simple to purchase," he says. Become the next Great American Investor. Call us to find out more.

### U.S. SAVINGS BONDS



THE GREAT AMERICAN INVESTMENT

## 1-800-US-BONDS

A public service of this publication.



# California Digital

17700 Figueroa Street • Carson, California 90248

## OPTICAL WORM

**\$895**

Write Once Read Many... California Digital has just purchased over **PRIAM CORPORATION**, 300 hundreds of Information Storage's ISI/525W optical WORM drive. The WORM's were manufactured for Priam and bare the Priam logo. Chosen "Editors' Choice" by PC Magazine, (March 29, 1988) the 525 provides 230 megabytes of random accessible data on each doubled sided floppy cartridge. (manually flipped).

Optical storage is the perfect medium for maintaining "on line" programs or other static data. Ideal for catalogs, part lists or any application where random accessibility is required. The ISI/525 is available in IBM internal configuration but an external enclosure may be added. Supplied with one cartridge, ESDI/C controller, cable and transparent optical software. For additional information, contact Steven in our technical support department (213) 217-1947. The ISI/525 is a current production drive.



## CD-ROM Complete Kit

**\$539**

Doctor, lawyer, Indian chief... Virtually every industry and profession is disseminating information on CD-ROM. One compact disk, the same size as an audio disk, can store over 500 megabytes of data in High Sierra format. Below is a listing of some of the CD-ROM drives currently available from California Digital. The best value is the Eclipse 430 external drive. The 430 includes PC/XT interface, cables, sampler software and MS/DOS extension. It so offers an audio output feature for multimedia presentations. The system is manufactured in Japan by one of the World's largest producers of magnetic storage equipment. A super value at only \$539.

Eclipse 430 external system	\$539	NEC interface kit for above	159
achi 1503S External system	695	Sony CD/510 internal drive only	559
achi 3500 Internal system	595	Sony 6101 external drive only	795
achi internal drive only	519	Sony 2203 interface kit	159
CD/77 External drive only	695	Panasonic LF5000 "write once"	1895
CD/80 Internal drive only	639	Panasonic interface kit for above	359

## Build Your Own Computer

**\$35**  
AT Case Only

California Digital has all the components needed to customize your own computer. Buy as much computing power as you need now, and up grade when the need arises. Here are some examples of components available:

101 10 MHz Mother board	289	Monochrome card, printer port	19
101 12 MHz baby AT Motherboard	529	MonoGraphics ( Hercules) printer port	45
101 size floppy AT case	35	Color Graphics card	49
101 drive XT case	35	EGA Color Multi Resolution II	139
1/102 AT/XT German mtg. Keyboard	57	I/O card, serial & parallel	35
0 watt AT power supply	59	I/O PLUS, Ser/Par, clock, game	59
C 360K/Byte disk drive	49	Disk I/O, disk control, clock, game	59

## 40 Meg. Tape Back-up

**\$179**

Head Crash, Power Spikes or just poor disk maintenance... don't loose data because you didn't back up. The Alloy/40 is an inexpensive way to save and restore files in the event that your data has been destroyed. This 40 megabyte half height tape back is manufactured by North America's largest producer of data retrieval equipment. It's easy to purchase a separate tape controller... The Alloy/40 attaches directly to your existing floppy disk controller. Supplied software allows your computer back up any time Day or Night. Come back in the morning and 40 megabytes of irreplaceable data has been stored on one Scotch DC/2000 data cassette. Back up entire hard disk, modified files only, or by file name. Loss of data is avoidable but when you are backed up on an Alloy/40 it's not a catastrophe. Model 250 for PC/XT \$179; Model 500 for AT \$239.

## Dest Scanner

**\$559**

Image scanning for OCR text, photographs, and line art. High resolution 300 DPI, the DEST PC Scan Plus/651 is capable of rendering photographs to 32 halftone shades. Also inputs text directly from printed pages to ASCII files or directly into most word processing programs. Electronic status display. Available for both the Macintosh (SCSI) or the IBM/PC. Please specify 115 or 230 volt. Original price was over \$3000, now is your chance to purchase a DEST scanner for only \$559.



## Saba Scanner

**\$359**

The Saba Scanner inputs a printed page of evenly spaced text in less than three seconds. Included OCR software allows your computer to transfer printed pages into ASCII files or directly to spreadsheets and most word processing programs. Archival data, legal briefs... No problem. Simply insert the page into the Saba and in seconds the document is digested into your computer and ready for editing. Also does line drawings that do not require gray tones. Limited quantities available. Original price \$1299; now only \$359.

## SCANNERS

SABA SCANNERS		
page scanner with OCR software	1299	359
hand held scanner with OCR soft.	799	159
DEST SCANNERS		
PC/651 scan + 32 shades	3995	559
2000 edge feed scanner	535	719
MICROTECH3000 256 gray scales	2195	1759
DFI HandiScan 300 with Halo	359	199
PRINCETON GRAPHICS LS-300	1095	789
PANASONIC		
RS505 Image page scanner	1499	999
RS506 Page scanner	1899	1299

## NEC/890 Laser

**\$3095**

PC Magazine has chosen the NEC 890 best laser printer of the year. (Jan. 12, 1988). And its obvious why... the printer is Postscript, Hewlett Packard, and Apple compatible, and comes standard with three megabytes of memory. The 890 accepts data from parallel, serial and Apple-Talk devices.

## PRINTERS

HEWLETT PACKARD		
Laser Printer II, 300x300	2595	1659
Laser Printer II/D double sided	3995	2995
QMS PS/810 2 Meg., 35 fonts, Post/S.	5495	3879
APPLE Laser Writer NT	4550	3659
NEC890 Postscript, 3 meg	4975	3095

## DIGITIZERS

HITACHI		
HDC 1212 Puma 12x12"	595	359
HDC 1515 15x15"	969	659
Tiger 11 11 C, 12x12 stylus extra	727	487
HDC 3648, 36x48"	5357	3995
SUMMAGRAPHICS		
Summa 1201 plus 12x12"	599	379
TB 3648, 36x48"	4748	3729
KYE Genius Tablet w/4 but. mouse	599	279
CALCOMP		
25180, 12x18"	1275	999
91480, 36x48"	4118	3389

## MicroSoft Mouse

Your choice, MicroSoft "Import Buss Mouse" or "Serial Mouse". The industry standard, list price \$150, now available for only \$59. Includes software and manual. Packaged in OEM boxes.



**\$59**



## EGA Color Monitor

**\$219**

Ideal for CAD/CAM and Desk Top publishing applications. The Roland CO/240 color monitor has a resolution of 720 pixels by 400/480 lines on a .31mm dot pitch 12" non-glass screen. VGA specifications in text mode EGA in graphic mode. California Digital has made a special purchase and is able to offer the CO/240 EGA/VGA RGB color monitor for only \$219. Fully featured, 132 column, multi-resolution video card adapter card available for only \$139 additional. Comparable card package would retail for \$1095.

## 40 Megabyte Hard Disk Kit

Forty megabyte internal hard disk drive, controller and cables all for only \$359. The kit includes the a 40 millisecond Miniscribe 3650 drive and a half slot Western Digital controller.



**\$359**

## DISK DRIVES

**\$29**

5" DISK DRIVES		
TEC501 1/2 height sgl. sided	29	
TEC504 1/2 ht. double sided	49	
TANDON 101/4 full ht. 96 TPI	69	
TEAC FDS58R half height	89	
TEAC FDS59R 96 TPI, half ht.	119	
TEAC FDS5GFR for IBM AT	109	
PANASONIC 455 Half Height	89	
PANASONIC 475 1/2 Meg./AT. 96	59	
Fujitsu 5 1/4" double sided	69	
Dual enclosure for 5 1/4" drives	69	
3 1/2" DISK DRIVES		
SONY MP-73W, 1.44 Meg	129	
TEAC 235HF, 1.44 Meg	99	
5 1/4" Form Factor Kit	20	
8" DISK DRIVES		
QUAME 842 double sided	189	
QUAME 841 single sided	99	
SHUGART 857R dbl. sided	319	
SHUGART 801R sgl. sided	259	
SIEMENS 100/8 sgl. sided	119	
REMAX RFD4000 dbl. sided	189	

## Five Inch Winchester Disk Drives

Price does not include controller.	each	two +
SEAGATE 225 20 Meg. 1/2 Ht.	239	229
SEAGATE 238 30 Meg. RLL	259	249
SEAGATE 251/151 M. 28ms.	459	445
SEAGATE 4096 96 M. 35ms.	559	539
MINISCRIBE 8425 25 M 65ms.239	239	
MINISCRIBE 3650 50M 61 ms.	319	309
MINISCRIBE 6085 90 meg.	459	435
MINISCRIBE 3053 25 ms. 1/2 ht.	359	339
FUJITSU 2242 55 M. 35ms. 1299	1299	1229
FUJITSU 2243 86 M. 35ms.	1695	1619
RDDIME RD-204E 53 Meg.	895	859
MAXTOR XT1140 140 Meg.	1495	1450
MAXTOR XT2190 192 Meg.	1919	1875
TOSHIBA MK56 70 M. 30ms.	1289	1275
CONTROL DATA WREN "V"	call	

## Hitachi "B" Plotter

**\$795**

FAST... 22 inches per second. Size "B" four pen with auto pen capping and 128K/byte buffer. HPGL compatible, 19 built-in character fonts and automatic sheet feeder make the Hitachi 673 a super buy at only \$795. RS/232 and centronics parallel.

## PLOTTERS

HOUSTON INSTRUMENTS		
DMP 41 single pen, 3 ips, C&D	2995	2295
DMP 52 single pen, 16 ips, C&D	3295	2495
DMP 56C size A-E, 16 ips	3695	3095
DMP61 single pen, 32 ips, A-D	4295	3095
PC695A 4 pen, size "B" 3 ips	799	595
CALCOMP PLOTTERS		
1023 Artisan A-D, 8 pen, 30 ips	4895	3795
1043GT size A-E, 8 pen, 24 ips	7995	5495
HEWLETT PACKARD		
7475A 6 pen size "B"	1895	1495
7550A 8 pen size "B" 32 ips	3900	2995
7595A 8 pen, size A-E, 24 ips	9990	7595
HITACHI PLOTTERS		
673/BM 4 pen, size "B" auto feed	2455	795
675 size "A-D" 8 pen	5600	2995
FUJITSU Imagegraph, 6 pen, 11x32	1295	895
IOLINE PLOTTERS		
LP3700 size E, 10 ips	4195	3195
LP3700MP 8 pen size "E" 10 ips	4695	3495
ROLAND PLOTTERS		
DPX2000 size "C" 8 pen with stand	2995	2195
DPX3000size "D" 8 pen with stand	4995	3495
ENTER COMPUTER		
SP600 size "B" 6 pen	995	659
SP1000 single pen size A-D	3995	2795
JDL 850, size "C" one meg. memory	3845	2789
VERSATEC 8524 Electrostatic	16,900	13789
NUMONICS		
5460 size "A-D"	2495	1859
5860 size "A-D" 8 pen	7495	5759
CAD SOFTWARE		
AUTODESK		
AutoCAD version 10	2995	2195
AutoSketch Std & Enhanced 2.0	99	79
VERSACAD Designer	2995	1995
GENERIC CAD level 1	49	35
AMERICAN SM. BUS'N. Design Cad	299	179



MMC  
MICROCOMPUTER  
MARKET INC. COUNCIL  
DIRECT MEMBERS ASSOCIATION



8:00 AM to 5:00 PM  
Pacific Time

Every year since 1973, customers from virtually every nation in the free World have chosen California Digital for their data processing requirements. If its computer, California Digital has it... complete minisystem or just one microchip. California Digital offers over 10,000 unique computer products. Regardless of how specialized your data processing requirements... California Digital is your one stop shopping solution.

TECHNICAL & CALIFORNIA  
**(213) 217-0500**  
TOLL FREE ORDER LINE  
**(800) 421-5041**  
Telex • (213) 217-1951



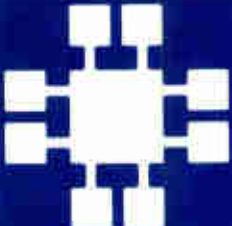

# JDR Microdevices®

30 DAY MONEY BACK GUARANTEE • 1 YEAR WARRANTY ON ALL PRODUCTS • TOLL-FREE TECHNICAL SUPPORT

## MEMORY DYNAMIC RAMS

PART#	SIZE	SPEED	PINS	PRICE
4164-150	65536x1	150ns	16	2.49
4164-120	65536x1	120ns	16	2.89
4164-100	65536x1	100ns	16	3.39
TMS4464-12	65536x4	120ns	16	9.95
41256-150	262144x1	150ns	16	3.99
41256-120	262144x1	120ns	16	4.49
41256-100	262144x1	100ns	16	4.99
41256-80	262144x1	80ns	16	5.49
41256-60	262144x1	60ns	16	7.99
414256-100	262144x4	100ns	20	14.95
414256-80	262144x4	80ns	20	16.95
1 MB-120	1048576x1	120ns	18	13.95
1 MB-100	1048576x1	100ns	18	14.95
1 MB-80	1048576x1	80ns	18	15.95

## SIMM/SIP MODULES

PART#	SIZE	SPEED	TYPE	PRICE
41256A9B-12	256K x 9	120ns	SIMM/PC	49.95
41256A9B-80	256K x 9	80ns	SIMM/PC	59.95
421000A9B-10	1MB x 8	100ns	SIMM/MAC	159.95
421000A9B-10	1MB x 9	100ns	SIMM/PC	159.95
421000A9B-80	1MB x 9	80ns	SIMM/PC	169.95
256KX9SIP-80	256K x 9	80ns	SIP/PC	69.95
256KX9SIP-60	256K x 9	60ns	SIP/PC	79.95
1MBX9SIP-80	1MB x 9	80ns	SIP/PC	179.95

## STATIC RAMS

PART#	SIZE	SPEED	PINS	PRICE
HM6116LP-2	2048x8	120ns	24	4.99
HM6264LP-15	8192x8	150ns	28	8.95
HM6264LP-12	8192x8	120ns	28	9.95
HM43256LP-12	32768x8	120ns	28	21.95
HM43256LP-10	32768x8	100ns	28	24.95

## MATH COPROCESSORS

**8-BIT COPROCESSORS**

8087	5 MHz	89.95
8087-2	8 MHz	129.95
8087-1	10 MHz	169.95

**16-BIT COPROCESSORS**

80287	6 MHz	139.95
80287-8	8 MHz	209.95
80287-10	10 MHz	239.95
80C287	12 MHz	299.95

**32-BIT COPROCESSORS**

80387-16	16 MHz	359.95
80387-SX	16 MHz	319.95
80387-20	20 MHz	399.95
80387-25	25 MHz	499.95
80387-33	33 MHz	649.95

**INTEL 5 YEAR WARRANTY**

INCLUDES MANUAL & SOFTWARE GUIDE

## 74 SERIES LOGIC

7400	.19	74LS32	.18	74LS245	.79
74LS00	.16	74LS73	.29	74LS273	.79
74LS02	.17	7474	.33	74S288	1.69
7404	.19	74LS74	.24	74LS322	3.95
74LS04	.16	74S74	.49	74LS367	.39
74S04	.29	74LS138	.39	74LS373	.79
7406	.29	74LS155	.59	74LS374	.79
7408	.24	74LS163	.39	74LS393	.79
74LS08	.18	74LS240	.69	74LS682	3.20
7432	.29	74LS244	.69	74LS688	2.40

## C.P.U.'s

**8000**

8052AH		1793	9.95
BASIC	34.95	COM8116	8.95
8088	5.99	MC146818	5.95
8250	6.95	MMS8167	9.95
8251A	1.69	INS8250	6.95
8253-5	1.95	NS16450	10.95
8254	9.95	LM317T	.69
8255-5	2.49	NE555	.29
8741	9.95	LM741	.29
8748	7.95	7805T	.49
8749	9.95	7812T	.49
8755	14.95	75150	1.95
		75154	1.95
		14411	9.95

**8500**

65C02	7.95
6522	2.95

**V-20**

V20	6.95
V20-8	8.95
V20-10	11.95
V30	13.95

## MISC

**CRYSTAL OSCILLATORS**

1.0MHz	5.95
1.8432	5.95
20.0	4.95
24.0	4.95

## PALS

16L8	2.95
16R4	2.95
16R6	2.95
16R8	2.95
20L8	4.95
20R4	4.95
20R6	4.95
20R8	4.95
20X8	4.95

**PAL KIT**  
AN ENTRY-LEVEL COMPLETE PAL DEVELOPMENT KIT FROM CUPL. FULL SUPPORT FOR 16L8, 16R4, 16R6, 16R8, 20L8, 20R4, 20R6, 20R8, AND 20X8. MOD-MPL-SOFT \$99.95



## Derick's HIGH-TECH SPOTLIGHT

Call our BBS: (408) 559-0253 for more info in SIG file "Hitech"

What can you expect from adding math co-processor?  
If you run programs that specifically state support from a co-processor, you will realize significant increases in speed from its addition. However, if the program doesn't support a co-processor, then no matter what, the program won't run any faster.

Some programs benefit more than others, in particular, those that make heavy use of Floating Point, Trigonometric, Logarithmic and Exponential calculations show the most improvement. CAD, spreadsheets, some databases, and Mandrel programs are frequently written to use a co-processor if it's available.

How much your application will speed up depends on the ratio of time spent on math calculations versus other operations. A 3 to 10 times improvement is not uncommon certain operations are even faster.

The co-processor you need is specific to the type and speed of processor. For 8088/86 and 80386 based machines, the general rule is to use an 8087 or 80387 of the same speed as the processor, i.e. an 80386-25 requires an 80387-25.

80286 based machines frequently use a co-processor running at 2/3rds the processor speed, i.e. an 80286-12 requires an 80287-8.

Derick Moore, Director of Engineering

## EPROMS

PART#	SIZE	SPEED	Vpp	PINS	PRICE
2708	1024x8	450ns	25V	24	4.95
2716	2048x8	450ns	25V	24	3.49
2716-1	2048x8	350ns	25V	24	3.95
2732A	4096x8	250ns	21V	24	3.95
2764	8192x8	450ns	12.5V	28	3.49
2764-250	8192x8	250ns	12.5V	28	3.69
2764-200	8192x8	200ns	12.5V	28	4.25
27C64	8192x8	250ns	12.5V	28	4.95
27128	16384x8	250ns	12.5V	28	4.25
27128A-200	16384x8	200ns	12.5V	28	5.95
27256	32768x8	250ns	12.5V	28	4.95
27256-200	32768x8	200ns	12.5V	28	5.95
27C256	32768x8	250ns	12.5V	28	5.95
27512	65536x8	250ns	12.5V	28	8.95
27C512	65536x8	250ns	12.5V	28	9.95
27C101-20	131072x8	200ns	12.5V	32	29.95

## EPROM ERASERS

**DATASER II \$39.95**  
- SHIRT POCKET SIZE!  
- ALL SIZES UP TO 4 AT A TIME  
- ERASES MOST EPROMS IN 3 MINUTES

**DATASER II**

Model	Timer	# of Chips	Intensity (uW/cm <sup>2</sup> )	Unit Cost
PE-140	NO	9	8,000	\$69
PE-140T	YES	9	8,000	\$139
PE-240T	YES	12	9,600	\$189
PL-265T	YES	30	9,600	\$255

**SPECTRONICS CORPORATION**

## POWER SUPPLIES

**135 WATT POWER SUPPLY**

- UL APPROVED
- +5V @15A, +12V @ 4.2A, 5V @ 5A, -12V @ 5A
- PS-135 ..... \$59.95
- PS-150 150W SUPPLY ..... \$69.95

**200 WATT POWER SUPPLY**

- UL APPROVED
- +5V @ 20A, +12V @ 7A, 5V @ 5A, -12V @ 5A
- PS-200 ..... \$89.95

**APPLE TYPE SUPPLY**

- WITH APPLE CONNECTOR
- +5V @ 6A, +12V @ 1A, -5V @ 1A, -12V @ 1A
- PS-A ..... \$59.95

## PROTOTYPE CARDS



FR-4 EPOXY GLASS LAMINATE WITH GOLD PLATED EDGE CARD FINGERS AND SILK SCREENED LEGENDS

**FOR XT**

JDR-PR1	WITH +5V AND GROUND PLANE	27.95
JDR-PR2	ABOVE WITH I/O DECODING LAYOUT	29.95
JDR-PR2-PK	PARTS KIT FOR JDR-PR2 ABOVE	8.95

**FOR AT**

JDR-PR10	BIT WITH I/O DECODING LAYOUT	34.95
JDR-PR10-PK	PARTS KIT FOR JDR-PR10 ABOVE	12.95

**FOR PS/2**

JDR-PR32	32 BIT PROTOTYPE CARD	69.95
JDR-PR16	16 BIT WITH I/O DECODING LAYOUT	49.95
JDR-PR16-PK	PARTS KIT FOR JDR-PR16 ABOVE	15.95
JDR-PR16V	15 BIT FOR VIDEO APPLICATIONS	39.95

**EXTENDER CARDS**  
SIMPLIFY PROTOTYPING AND TESTING

EXT-8088	8-BIT FOR 8088 MOTHERBOARDS	29.95
EXT-80286	16-BIT FOR 286/386 MOTHERBOARDS	39.95
EXT-16	MICROCHANNEL 16-BIT	69.95
EXT-32	MICROCHANNEL 32-BIT	99.95

## PC BREADBOARD-ON-A-CARD

62 BUS LINES  
USE UP TO 24 14-PIN ICs  
1940 TIE POINTS  
DB25 D-SUB CONNECT.  
PDS-604 ..... \$49.95

## SOLDER STATION

UL APPROVED  
ADJUSTABLE HEAT SETTING  
TEMPERATURE READOUT  
REPLACEMENT TIPS @ \$2.95  
168-3C ..... \$59.95

## IC SOCKETS/DIP CONNECTORS

SOLDER TAIL	WIREWRAP	ZIF SOCKETS
8 PIN ST .11	8 PIN WW .59	ZIF-14 5.95
14 PIN ST .11	14 PIN WW .69	ZIF-16 5.95
16 PIN ST .12	16 PIN WW .69	ZIF-20 5.95
18 PIN ST .15	18 PIN WW .99	ZIF-24 7.95
24 PIN ST .18	20 PIN WW 1.09	ZIF-28 7.95
28 PIN ST .22	24 PIN WW 1.49	ZIF-40 10.95
28 PIN ST .28	28 PIN WW 1.69	
40 PIN ST .30	40 PIN WW 1.99	

**VOLUME DISCOUNTS CALL!**

## SOLDER-CUP D-SUBS

MALE	FEMALE	ID20
DB09P	.45	DB09S .49
DB15P	.59	DB15S .69
HDB15P	1.49	HDB15S 1.59
DB19P	.89	DB19S .75
DB25P	.69	DB25S .75
DB37P	1.35	DB37S 1.39
DB50P	1.85	DB50S 2.29

## CABLES AND GENDER CHANGERS

MOLDED; GOLD-PLATED CONTACTS; 100% SHIELDED

CBL-PRMTR	6 FT. PC PRINTER CABLE	9.95
CBL-PRMTR-25	25 FT. PC PRINTER CABLE	15.95
CBL-PRMTR-RA	RIGHT ANGLE PRINTER CABLE	15.95
CBL-DB25-M	DB25 MALE-DB25 MALE 6 FT.	9.95
CBL-DB25-MF	DB25 MALE-DB25 FEMALE 6 FT.	9.95
CBL-9-SERIAL	D09 FEMALE-DB25 MALE 6 FT.	6.95
CBL-KBB-EXT	5 FT. KEYBOARD EXTENSION	7.95
CBL-CNT-MM	36-PIN CENTRONICS -MM	14.95
CBL-FDC-EXT	37-PIN EXT. FLOPPY CABLE	9.95
CBL-MNT-9	9-PIN MONITOR EXTENSION	6.95
CBL-MNT-15	15-PIN MONITOR EXTENSION CABLE	9.95
CBL-MODEM	MODEM -DB25-DB25 FEMALE	6.95
GENDER-VGA	DB9-DB15 ADAPTOR	4.95
GENDER-9-25	DB9-DB25 SERIAL ADAPTOR	4.95

**PARTIAL LISTINGS ONLY—CALL FOR FREE 84-PG CATALOG!**

JDR MICRODEVICES AND THE JDR MICRODEVICES LOGO ARE REGISTERED TRADEMARKS OF JDR MICRODEVICES. IBM, AT, PS/2 ARE TRADEMARKS OF INTERNATIONAL BUSINESS MACHINES.





## FULL SIZE SLIDE CASE **\$89**

- DESIGNED FOR FULL SIZE 286/386 MOTHERBOARDS
- USES STANDARD AT-COMPATIBLE POWER SUPPLIES
- DRIVE MOUNTS FOR THREE FLOPPY AND TWO HARD DRIVES
- RESET SWITCH AND KEYLOCK
- POWER-ON, TURBO AND DISK LEDS
- INCLUDES ALL MOUNTING HARDWARE

### CASE-70

FOR 8088 OR MINI-86 MOTHERBOARDS .. \$59.95

CASE-FLIP FLIP-TOP XT-STYLE CASE ..... \$39.95

CASE-SLIDE SLIDE TYPE XT-STYLE CASE ..... \$39.95

CASE-JR ..... \$149.95

WITH 150W POWER SUPPLY. FOR 8088 OR MINI-286 BOARDS.

CASE-JR-200 ..... \$189.95

WITH 200W POWER SUPPLY. FOR MINI-286 BOARDS.

## UPRIGHT CASE

**\$299<sup>95</sup>**

- SLEEK DESIGN SAVES DESK SPACE, ADDS STYLE!
- ACCOMMODATES ALL SIZES OF MOTHERBOARDS
- INCLUDES 250 WATT POWER SUPPLY
- MOUNTS FOR 3 FLOPPY AND 4 HARD DRIVES
- TURBO AND RESET SWITCHES
- SPEED DISPLAY, POWER, DISK LEDS
- MOUNTING HARDWARE, FACEPLATES AND SPEAKER INCLUDED

### CASE-100

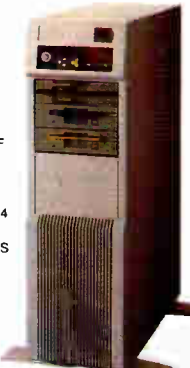

*"I have absolutely no complaints ...I appreciate doing business with you; keep up the good work."*  
 -Garland Charpiot, Beaumont, TX



## INBOARD 386 **\$649**

RUN YOUR XT COMPATIBLE UP TO 10 TIMES FASTER!  
 REPLACES YOUR 8088 PROCESSOR WITH AN 80386 WHILE STILL USING YOUR EXISTING COMPONENTS.

- 16 MHZ 80386 MICROPROCESSOR • 1MB RAM INSTALLED
- SOCKETED FOR 80387 MATH COPROCESSOR • OPTIONAL 1MB OR 2MB PIGGYBACK MEMORY BOARD

### PCIB1200

PCIB1210 1MB PIGGYBACK MEMORY BOARD ..... \$475.00

PCIB1220 2MB PIGGYBACK MEMORY BOARD ..... \$895.00

## EPROM PROGRAMMER

**\$129<sup>95</sup>**

- PROGRAMS 27XX AND 27XXX EPROMS UP TO 27512
- SPLIT OR COMBINE CONTENTS OF SEVERAL EPROMS OF DIFFERENT SIZES

- SUPPORTS VARIOUS PROGRAMMING FORMATS AND VOLTAGES
- READ, WRITE, COPY, BLANK CHECK AND VERIFY
- SOFTWARE FOR HEX AND INTEL HEX FORMATS

### MOD-EPROM



## MODULAR CIRCUIT TECHNOLOGY

**NEW LOW PRICES!**

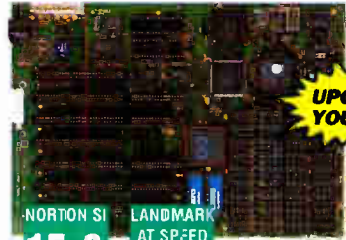

**UPGRADE YOUR XT!**

NORTON SI  
15.6  
X FASTER  
THAN AN XT

LANDMARK  
AT SPEED  
20.7  
MHZ

### 10MHZ 286

THIS 10MHZ 80286-BASED MOTHERBOARD FEATURES THE LATEST VLSI CHIP TECHNOLOGY.

- EXPANDABLE TO 4MB OF RAM • USES 256MB OR 1MB DRAMS • SIX 16-BIT AND TWO 8-BIT EXPANSION SLOTS
- SOCKETED FOR 80287 MATH COPROCESSOR • 6 OR 10MHZ KEYBOARD SELECTABLE • 0 OR 1 WAIT STATE AMI BIOS • SUPPORTS FRONT PANEL LED INDICATORS, KEYLOCK AND RESET SWITCH • BUILT-IN CLOCK/CALENDAR • AUTO RECHARGING NICAD BATTERY • 13" X 8.75" SIZE PERMITS MOUNTING IN XT OR AT CASES

### MCT-M286

MCT-M286-12 12MHZ MINI 286 ..... \$249.95

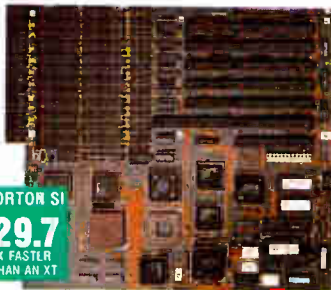

NORTON SI  
29.7  
X FASTER  
THAN AN XT

### 25MHZ 386

THE INTELLIGENTLY DESIGNED BOARD INCORPORATES THE BEST FEATURES OF CURRENT 386 TECHNOLOGY.

- ACCELERATED 80386 MPU RUNS AT 25MHZ • 10MHZ/25MHZ KEYBOARD SELECTABLE SPEEDS • 16MB RAM CAPACITY: 3MB ON BOARD, 8MB USING OPTIONAL RAM CARD (OKB INSTALLED) • USES 256K OR 1MB DRAMS (80NS FOR 1 WAIT, 60NS FOR 0 WAIT STATES) • SHADOW RAM FOR BIOS AND VIDEO • 8 EXPANSION SLOTS (ONE 32-BIT, FIVE 16-BIT, TWO 8-BIT) • ADJUSTABLE BUS SPEEDS • INTERLEAVED MEMORY • NEAR ZERO WAIT STATE OPERATION • AMI BIOS

### MCT-386MB25

MCT-386MB20 20MHZ VERSION ..... \$799.00

MCT-386-M 8MB RAM CARD (OKB) ..... \$149.95

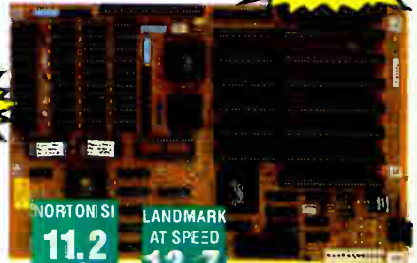

NORTON SI  
11.2  
X FASTER  
THAN AN XT

LANDMARK  
AT SPEED  
12.7  
MHZ

### 16MHZ 286

ADVANCED NEAT TECHNOLOGY CHIP SET GIVES THIS 80286-BASED MOTHERBOARD THE FEATURES YOU WANT. INCORPORATES THE LATEST LOTUS-INTEL-MICROSOFT STANDARD 4.0 RIGHT ON THE MOTHERBOARD! SOFTWARE DRIVER INCLUDED. ALSO SHADOW RAM AND SELECTABLE WAIT STATES.

- EXPANDABLE TO 8 MB OF RAM • USES 1MB OR 256KB DRAMSSIPS • SIX 16-BIT AND TWO 8-BIT EXPANSION SLOTS
- SOCKETED FOR 80287 MATH COPROCESSOR • 8/16MHZ KEYBOARD/SELECTABLE • 0/1 WAIT STATE • AMI BIOS
- SUPPORTS LED INDICATORS, KEYLOCK, AND RESET SWITCH • BUILT-IN CLOCK/CALENDAR • AUTO RECHARGING NICAD BATTERY • 13" X 8.5" SIZE PERMITS MOUNTING IN XT OR AT CASES

### MCT-M286-16

MCT-M286-20 10/20 MHZ VERSION ..... \$429.95

MCT-M286-M 1/2/4/8 MB RAM CARD (OKB) ..... \$119.95



NORTON SI  
2.1  
X FASTER  
THAN AN XT

### 10MHZ 8088

GET IMPROVED RELIABILITY AND LESS POWER CONSUMPTION WITH THIS "SINGLE CHIP" DESIGN!

- XT COMPATIBLE; OPERATES AT 4.77/10MHZ • KEYBOARD SELECTABLE CLOCK SPEEDS • SOCKETED FOR 8087-1 COPROCESSOR • 8 EXPANSION SLOTS • MCT BIOS • 640K RAM CAPACITY (OKB INSTALLED) • SUPPORTS KEYLOCK, RESET AND TURBO SWITCHES • POWER-ON & TURBO MODE LEDS SUPPORTED • ONLY 8 1/2" X 9"

### MCT-TURBO-10

MCT-TURBO 4.77/8 MHZ TURBO MOTHERBOARD ..... \$95.95

MCT-XMB 4.77 MHZ MOTHERBOARD ..... \$87.95

## MODULAR PROGRAMMING SYSTEM

OUR INTEGRATED MODULAR SYSTEM EASILY EXPANDS! ALL THE MODULES USE A COMMON HOST ADAPTOR CARD—USE JUST ONE SLOT TO PROGRAM EPROMS, PROMS, PALS & MORE!

### COMMON HOST

#### ADAPTOR CARD \$29.95

- UNIVERSAL INTERFACE FOR ALL THE PROGRAMMING MODULES!
- SELECTABLE ADDRESSES PREVENTS CONFLICTS
- MOLDED CABLE
- MOD-MAC



#### UNIVERSAL MODULE \$499.95

- PROGRAMS EPROMS, EEPROMS, PALS, BI-POLAR PROMS, 8748 & 8751 SERIES DEVICES; 16V8 AND 20V8 GALS (GENERIC ARRAY LOGIC) FROM LATTICE, NS, SGS • TESTS TTL, CMOS, DYNAMIC & STATIC RAMS • LOAD DISK, SAVE DISK, EDIT, BLANK CHECK, PROGRAM, AUTO, READ MASTER, VERIFY AND COMPARE • TEXTUOL SOCKET FOR 3" TO .6" WIDE IC'S (8-40 PINS)



### MOD-MUP

#### EPROM MODULE

**\$119.95**

- PROGRAMS 24-32 PIN EPROMS, CMOS EPROMS & EEPROMS FROM 14K TO 1024K • HEX TO OBJ CONVERTER • AUTO, BLANK CHECK/PROGRAM/VERIFY • VPP 5, 12.5, 12.75, 13, 21 & 25 VOLTS
- NORMAL, INTELLIGENT, INTERACTIVE & QUICK PULSE PROGRAMMING ALGORITHMS

#### MOD-MEP

MOD-MEP-4 4-EPROM PROGRAMMER .. \$169.95

MOD-MEP-8 8-EPROM PROGRAMMER .. \$259.95

MOD-MEP-16 16-EPROM PROGRAMMER .. \$499.95

#### DIGITAL IC MODULE

**\$129.95**

- TESTS TTL, CMOS, DYNAMIC & STATIC RAM
- AUTO SEARCH FOR UNKNOWN PART NUMBERS
- USER-PROGRAMMABLE TEST PROCEDURES

#### MOD-MIC

#### PAL MODULE

**\$249.95**

- PROGRAMS MMI, NS, TI 20 & TI 24 PIN DEVICES
- BLANK CHECK, PROGRAM, AUTO, READMASTER, VERIFY & SECURITY/FUSE BLOW

#### MOD-MPL

#### CUPL SOFTWARE

**\$99.95**

COMPLETE ENTRY-LEVEL PAL DEVELOPMENT KIT.

#### MOD-MPL-SOFT



**ORDER TOLL-FREE 800-538-5000**

**MON.-FRI. 7 A.M. TO 5 P.M., SATURDAY, 10 A.M. TO 3 P.M. (PST)**

COPYRIGHT 1989 JDR MICRODEVICES

JDR MICRODEVICES 2233 BRANHAM LANE,  
 SAN JOSE, CA 95124 (408) 559-1200  
 FAX (408) 559-0250 TELEX 171-110

RETAIL STORE: 1256 S. BASCOM AVE.,  
 SAN JOSE, CA (408) 947-8881  
 HOURS: M-F 9-7, SAT. 9-5, SUN. 12-4

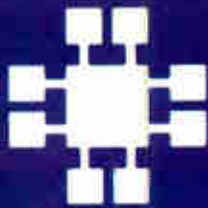

# JDR Microdevices

**MMC**  
MICROCOMPUTER  
MARKETING COUNCIL  
of the Direct Marketing Association, Inc.

30 DAY MONEY BACK GUARANTEE • 1 YEAR WARRANTY ON ALL PRODUCTS • TOLL-FREE TECHNICAL SUPPORT



## RELISYS VGA MONITOR \$359

14" ANALOG VGA MONITOR WITH GLARE-RESISTANT SCREEN • 720 X 480 MAXIMUM RESOLUTION • TILT/SWIVEL BASE • CONTRAST AND BRIGHTNESS CONTROLS  
VGA-MONITOR

## SAMSUNG FLAT \$129.95

ONE OF THE BEST MONOCHROME MONITORS! • 12" FLAT SCREEN REDUCES DISTORTION • AMBER DISPLAY • 720 X 350 RESOLUTION  
MONO-SAMSUNG

## RELISYS MULTISYNCH \$429

AN EXCEPTIONAL VALUE ON AN OUTSTANDING DISPLAY! • 14" NON-GLARE SCREEN • 1024 X 768 MAXIMUM HIGH RESOLUTION • CGA/EGA/VGA COMPATIBLE • TTL OR ANALOG MODE OPERATION  
JDR-MULTI

## NEC MULTISYNCH 3D \$649.95

• 1024 X 768 MAX RESOLUTION • CGA/EGA/VGA/MCGA/PGC COMPATIBLE • HERCULES AND OTHER STANDARD ADAPTORS  
NEC-MULTI-3D

## RGB COLOR \$239.95

• CGA MODE DISPLAYS UP TO 16 COLORS, MONOCHROME MODE FOR TEXT • 14" GLARE-RESISTANT SCREEN • 640 X 200 MONOCHROME • 320 X 200 COLOR RESOLUTION  
JDR-RGB



## CGA CARD \$49.95

IBM-COMPATIBLE ADAPTOR FOR RGB MONITORS • 640 X 200 MONO, 320 X 200 COLOR RESOLUTION • DISPLAYS 4 COLORS SIMULTANEOUSLY • LIGHT PEN INTERFACE  
MCT-CG

MCT-CGP WITH PRINTER PORT ..... \$59.95  
CG-COMP COMPOSITE ADAPTOR ..... \$4.95

## MONO GRAPHICS \$59.95

XT AND AT-COMPATIBLE • HERCULES COMPATIBLE MONOGRAPHICS • SUPPORTS LOTUS 1-2-3 • HIGH RESOLUTION 720 X 348 DISPLAY • VLSI CHIPS • CONFIGURE THE PARALLEL PRINTER PORT AS LPT1 OR 2  
MCT-MGP

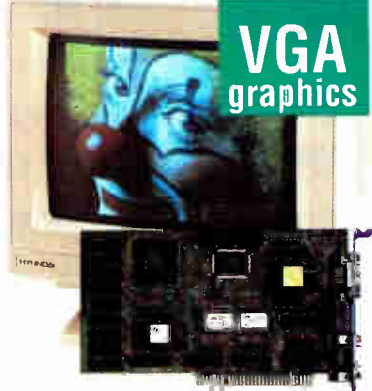

VGA  
graphics

## VGA PACKAGE \$499

VGA COLOR AND CLARITY AT AN EGA PRICE! • 8-BIT VGA CARD IS FULLY COMPATIBLE WITH IBM VGA • 720 X 540 MAXIMUM RESOLUTION, 640 X 480 IN 16 COLORS • 528 X 480 RESOLUTION IN 256 COLORS • HIGH RESOLUTION ANALOG MONITOR • EGA/CGA/MONochrome AND HERCULES COMPATIBLE • DRIVERS FOR WINDOWS, GEM, 1-2-3, SYMPHONY, AUTOCAD AND VENTURA  
VGA-PKG

## EGA MONITOR \$339

• 14" NON-GLARE SCREEN WITH 640 X 350 MAXIMUM RESOLUTION • DISPLAY 16 COLORS SIMULTANEOUSLY  
EGA-MONITOR

## 14" SCREEN MONO \$139

• GLARE-RESISTANT 14" SCREEN WITH AMBER DISPLAY • 720 X 350 RESOLUTION • TILT/SWIVEL BASE • FRONT MOUNTED CONTROLS  
GM-1488

## PAPER WHITE VGA \$119.95

GRAY SCALE MONITOR— PERFECT FOR DESKTOP PUBLISHING! • ULTRA HIGH-RESOLUTION 800 X 480 • 14" GLARE RESISTANT SCREEN • TILT/SWIVEL BASE  
MONO-VGA

## EGA CARD \$149.95

• 640 X 350 HIGH RESOLUTION • DISPLAYS 16 COLORS AT A TIME • COMPATIBLE WITH HERCULES, CGA AND IBM MONOCHROME • SOFTWARE DRIVERS FOR WINDOWS, LOTUS, CAD, AND MORE • 256K VIDEO RAM.  
MCT-EGA

## 16-BIT VGA \$249.95

• 640 X 480 IN 16 COLORS • 256K VIDEO RAM EXPANDABLE TO 512K • 64 LEVELS OF GRAY SCALE  
MCT-VGA-16  
MCT-VGA-8 8-BIT VERSION ..... \$169.95

NEW LOW PRICE!



## ENHANCED 101-KEY KEYBOARD \$69.95

• ENHANCED 101-KEY LAYOUT • EXTRA LARGE SHIFT & RETURN KEYS • AUTO-REPEAT • XT OR AT COMPATIBLE • LEDS FOR SCROLL, CAPS AND NUM LOCK

BTC-5339  
BTC-5339R COMPACT 101-KEY ..... \$79.95  
MAX-5339 MAXI-SWITCH 101-KEY ..... \$84.95  
K103-A AUDIBLE "CLICK" 101-KEY ..... \$84.95

## STANDARD 84-KEY KEYBOARD \$59.95

• AUTO ADJUSTS FOR XT OR AT • AT STYLE LAYOUT • EXTRA LARGE SHIFT AND RETURN KEYS • AUTO REPEAT • LEDS FOR SCROLL, CAPS AND NUM LOCK

BTC-5060  
MAX-5060 MAXI-SWITCH 84-KEY ..... \$64.95  
BTC-5150 XT-STYLE 83-KEY ..... \$59.95

## MODULAR CIRCUIT TECHNOLOGY DRIVE CONTROLLERS

### FLOPPY DISK CONTROLLER \$29.95

• INTERFACES UP TO 4 FLOPPY DRIVES TO IBM PC OR COMPATIBLE • DS/DD AND DS/DQ COMPATIBLE  
MCT-FDC

### 1.44MB FLOPPY CONTROLLER \$49.95

• SUPPORTS 2 FLOPPY DRIVES (360K, 720K, 1.2MB & 1.44MB) • ELIMINATES THE NEED FOR SOFTWARE DEVICE DRIVERS  
MCT-FDC-HD

MCT-FDC-HD4 4 DRIVE CONTROLLER ..... \$59.95

### HARD DISK CONTROLLER \$79.95

• SUPPORTS 16 DRIVE SIZES INCLUDING 10, 20, 30 AND 40MB • CAN DIVIDE 1 LARGE DRIVE INTO 2 LOGICAL DRIVES  
MCT-HDC

### RLL CONTROLLER \$89.95

• SUPPORTS 2 RLL HARD DRIVES • 50% FASTER DATA TRANSFER • DESIGNED FOR XT-COMPATIBLES  
MCT-RLL

### 286/386 F/H CONTROLLER \$149.95

• FLOPPY/HARD DISK CONTROL IN AN AT DESIGN • FOR UP TO 2 FLOPPIES (360K/720K/1.2MB/1.44MB) & 2 HARD DRIVES  
MCT-AFH

### 286/386 RLL CONTROLLER \$199.95

• IMPROVES AT COMPATIBLE'S SPEED & STORAGE • FOR UP TO 2 RLL HDD'S & 2 FDD'S (360K/720K/1.2MB 1.44MB)  
MCT-AFH-RLL

## MULTIFUNCTION I/O CARDS

### MULTI I/O FLOPPY CONTROLLER \$79.95

• SUPPORTS UP TO 2 360K FLOPPIES • SERIAL, PARALLEL, GAME PORT AND CLOCK/CALENDAR  
MCT-MIO

### MULTI I/O CARD \$59.95

• SERIAL PORT • CLOCK/CALENDAR WITH BATTERY • PARALLEL PORT IS ADDRESSABLE AS LPT1 OR LPT2  
MCT-IO

### 286/386 MULTIFUNCTION \$139.95

• ADDS 1.5MB TO YOUR AT 3MB W/ OPTIONAL PIGGYBACK CARD (OK INSTALLED) • SERIAL, PARALLEL PORTS.  
MCT-AMF

MCT-AMF-MC 1.5MB PIGGYBACK BOARD ..... \$29.95

### 286/386 MULTI I/O CARD \$59.95

• SERIAL, PARALLEL AND GAME PORTS • USES 16450 SERIAL SUPPORT CHIPS FOR HIGH SPEED OPERATION  
MCT-AIO

### MONOGRAPHICS MULTI I/O \$119.75

• CONTROL 2 FLOPPIES • SERIAL, PARALLEL, GAME PORT, CLOCK/CALENDAR • RUNS COLOR GRAPHICS SOFTWARE ON YOUR BLACK AND WHITE MONITOR.  
MCT-MGMIO



NEED IT  
TOMORROW?

No problem! Just place your order by 10:00 (PST) today, and ask us to ship it Federal Express® overnight delivery.

CALL OUR 24-HR BBS  
(408) 559-0253

• ON-LINE ORDERING • CONFERENCING • TECHNICAL INFORMATION •

COPYRIGHT 1989 JDR MICRODEVICES. IBM, AT AND PS 2 ARE REGISTERED TRADEMARKS OF INTERNATIONAL BUSINESS MACHINES. APPLE AND MACINTOSH ARE TRADEMARKS OF APPLE COMPUTER INC.



**\$99<sup>95</sup>**

**1.44MB  
3-1/2" DRIVE**

- 80 TRACKS • 135 TPI • ULTRA HIGH DENSITY
- READ/WRITE 720K DISKS, TOO
- INCLUDES ALL NECESSARY MOUNTING HARDWARE

- FDD-1.44X BLACK FACEPLATE
- FDD-1.44A BEIGE FACEPLATE
- FDD-1.44SOFT SOFTWARE DRIVER ..... \$19.95
- FDD-3.5X 3-1/2" 720K (BLACK) ..... \$97.95
- FDD-3.5A 3-1/2" 720K (BEIGE) ..... \$97.95
- MF355A 3-1/2" MITSUBISHI 1.44MB, BEIGE ..... \$129.95
- MF355X 3-1/2" MITSUBISHI 1.44MB, BLACK ..... \$129.95

**5-1/4" FLOPPY  
DISK DRIVE \$69<sup>95</sup>**

- FDD-360 5-1/4" DOUBLE-SIDED DD 360K ..... \$69.95
- M2551A 5-1/4" FUJITSU DOUBLE-SIDED DD 360K ..... \$89.95
- FD-55B 5-1/4" TEAC DOUBLE-SIDED DD 360K ..... \$99.95
- FDD-1.2 5-1/4" DOUBLE-SIDED HD 1.2M ..... \$95.95
- M2553K 5-1/4" FUJITSU DOUBLE-SIDED HD 1.2M ..... \$119.95
- FD-55G 5-1/4" TEAC DOUBLE-SIDED HD 1.2M ..... \$129.95
- FD-55F 5-1/4" TEAC DOUBLE-SIDED, QD720K ..... \$119.95

**ARCHIVE TAPE BACK-UPS**

- AR5240X 40 MB TAPE DRIVE FOR XT'S & AT'S ..... \$369.95
- AR5540A FAST 40 MB TAPE DRIVE AT'S ONLY ..... \$369.95
- AR2020 EXTERNAL CHASSIS & INTERFACE ..... \$159.95
- AR20A ADDITIONAL INTERFACE CARDS ..... \$89.95
- AR340 40 MB TAPE CARTRIDGE ..... \$24.95

**HANDY SCANNER 3000 PLUS**

**\$199<sup>95</sup>**



**DFI**

- NEW IMPROVED IMAGE CLARITY
- NEW ERGONOMIC DESIGN • NOW 2 MORE ROLLERS FOR STRAIGHT TRACKING • NEW SPEED OVERRUN WARNING LIGHT • SCANNER CARD HAS BUILT-IN OPTIONAL MOUSE PORT • INCLUDES ZSOFT'S PC PAINTBRUSH PLUS AND IMAGE TOOLS • QUICKLY SCANS IMAGES UP TO 4" WIDE AT 100, 200, 300, OR 400 DPI IN BOTH DIRECTIONS • B&W AND THREE HALF-TONE MODES • 32 LEVELS OF GRAY SCALE • HERCULES, EGA AND CGA COMPATIBLE
- DON'T MISS THIS EXCELLENT VALUE!
- HS-3000
- OCR-SOFT CHARACTER RECOGNITION SOFTWARE \$99.95

**SERIAL MOUSE \$39<sup>95</sup>**

- 3-BUTTON OPTO-MECHANICAL
- 200 D.P.I. • 5-1/2' CABLE
- USES SERIAL PORT COM 1/2
- INCLUDES SOFTWARE DRIVERS
- DMS-200E
- MOUSE & HALO-DPE SOFTWARE
- DMS-200 ..... \$59.95

**LOGITECH MICE**

- THREE-BUTTON SERIES 9
- 320 DPI RESOLUTION
- SERIAL PS/2 COMPATIBLE.
- LOGITECH
- LOGC9 SERIAL MOUSE ..... \$98.95
- LOGC9-C\* SERIAL MOUSE ..... \$79.95
- LOGC9-PC SERIAL MOUSE WITH PAINTSHOW ..... \$109.95
- LOGC9-P SERIAL MOUSE WITH PAINT/CAD ..... \$154.95
- LOGB9 BUS MOUSE ..... \$89.95
- LOGB9-P BUS MOUSE WITH PAINTSHOW ..... \$104.95
- LOGB9-PC BUS MOUSE WITH PAINT/CAD ..... \$149.95
- \*NOT PS/2 COMPATIBLE

**HARD DISKS**

- 20 MB \$199 60 MB \$389
- 30 MB \$219 80 MB \$569
- 40 MB \$339
- 28 MS \$389



KITS INCLUDE HARD DRIVE, DRIVE CONTROLLER, CABLES & INSTRUCTIONS.

SIZE	MODEL	AVG. SPEED	FORM FACTOR	DRIVE ONLY	XT KIT	AT F/W KIT
20MB	ST-225	65 MS	5-1/4"	\$199	\$249	\$309
30MB RLL	ST-238	65 MS	5-1/4"	\$219	\$279	\$379
40MB	ST-251-1	28 MS	5-1/4"	\$339	\$389	\$449
60MB RLL	ST-277-1	28 MS	5-1/4"	\$389	\$449	\$549
80MB	ST-4096	28 MS	5-1/4"	\$569	—	\$679
120MBRLL	ST-4144R	28 MS	5-1/4"	\$699	\$759	\$859
20MB	ST-125	40 MS	3-1/2"	\$259	\$299	\$373
30MB RLL	ST-138	40 MS	3-1/2"	\$289	\$339	\$429

**KITS**

- 20 MB \$249
- 30 MB \$279



JDR's exclusive detailed manual makes installation worry-free!

**NEW LOW PRICES!**

**Seagate SCSI DRIVES**

SIZE	MODEL	AVG. SPEED	FORM. FACTOR	PRICE
21.5MB	ST-125N	40 MS	3-1/2"	\$299
32.2MB	ST-138N	40 MS	3-1/2"	\$339
48.6MB	ST-157N	40 MS	3-1/2"	\$389
21.3MB	ST-225N	65 MS	5-1/4"	\$329
43.1MB	ST-251N-1	28 MS	5-1/4"	\$419
64.9MB	ST-277N-1	28 MS	5-1/4"	\$489
85MB	ST-296N	28 MS	5-1/4"	\$499

**MODULAR CIRCUIT TECHNOLOGY**

**\$89<sup>95</sup>**

**2400 BAUD MODEM**

- 2400/1200/300 BAUD • FULL HAYES COMPATIBILITY
- BUILT-IN SPEAKER • CONFIGURABLE AS COM1, COM2, COM3 OR COM4 • AUTO FUNCTIONS INCLUDE WAIT-FOR-DIAL TONE & AUTO-REDIAL ON BUSY
- PROCOM M COMMUNICATIONS SOFTWARE
- MADE IN THE USA
- MCT-241
- MCT-121 1200 BAUD VERSION ..... \$59.95



**PROMETHEUS**

**new!**



**9600 BAUD MODEM \$699<sup>95</sup>**

- HIGH SPEED MODEM FEATURES MICROCOM NETWORK PROTOCOL (MNP) AND V.32 COMPATIBILITY • 9600/4800/2400/1200 BPS OPERATION • FULL DUPLEX • CALL BACK SECURITY • NON-VOLATILE RAM STORAGE FOR 10 PHONE NUMBERS • ASYNCHRONOUS/SYNCHRONOUS • FULLY COMPATIBLE WITH CCITT V.32/V.22BIS/V.22, BELL/212A
- MNP-5 FOR 100% ERROR FREE TRANSMISSIONS
- DATA COMPRESSION FOR THROUGHPUT TO 19.2K BAUD
- COMPATIBLE WITH MNP OR NON-MNP MODEMS
- PRO-96E

**INTERNAL 2400 BAUD**

**\$99<sup>95</sup>**

- AUTO DIAL/ANSWER
- SELF-TEST ON POWER-UP
- FULL OR HALF DUPLEX • TOUCHTONE OR PULSE DIALING
- HAYES AND BELL SYSTEMS COMPATIBLE • HALF CARD
- PROCOM M COMMUNICATIONS SOFTWARE

PRO-241  
PRO-121 1200 BAUD 1/2 CARD ..... \$69.95

**EXTERNAL 2400 BAUD**

**\$149<sup>95</sup>**

- 2400/1200/300 BAUD • 8 STATUS LIGHTS • REQUIRES SERIAL PORT AND CABLE
- PRO-24E
- PRO-12E 1200 BAUD EXTERNAL MODEM ..... \$99.95



**MICROPOLIS HIGH SPEED HARD DRIVES**

**150MB 23MS \$949**

- ESDI INTERFACE, 23MS AVERAGE ACCESS TIME.
- 1355
- 1355-PKG DRIVE WITH ESDI CONTROLLER ... \$1049.00
- SCSI INTERFACE, 23MS AVERAGE ACCESS TIME.
- 1375 ..... \$999.00
- 1375-PKG DRIVE WITH SCSI CONTROLLER ... \$1099.00

**340MB 18MS \$1695**

- ESDI INTERFACE, 18MS AVERAGE ACCESS TIME.
- 1558
- 1558-PKG DRIVE WITH ESDI CONTROLLER .... \$1799.00
- SCSI INTERFACE, 18MS AVERAGE ACCESS TIME.
- 1578 ..... \$1619.00
- 1578-PKG DRIVE WITH SCSI CONTROLLER ... \$1799.00

**680MB 16MS \$2499**

- ESDI INTERFACE, 16MS AVERAGE ACCESS TIME.
- 1568
- SCSI DRIVE, 16MS AVERAGE ACCESS TIME.
- 1588 ..... \$2499.00



**JIM'S BARGAIN HUNTERS CORNER**

**\$219<sup>95</sup>**

Jim Wharton  
JDR's VP Sales

**JT FAX INTERNAL**

- REGULARLY \$279.00
- WAITS IN THE BACKGROUND TO SEND/RECEIVE FAXES. USE YOUR COMPUTER UNTIL A FAX IS ACTUALLY SENT/RECEIVED
- 4800BPS COMMUNICATIONS RATE • RAM RESIDENT SOFTWARE • COMPATIBLE WITH PC/XT/AT • USES FAX, ASCII OR PC PAINT FILES • HALF CARD SIZE • MENU-DRIVEN SOFTWARE
- JT-FAX EXPIRES 11/31/89



CALL FOR OUR FREE CATALOG!

**ORDER TOLL-FREE 800-538-5000**

MON.-FRI. 7 A.M. TO 5 P.M., SATURDAY, 10 A.M. TO 3 P.M. (PST)

Terms: minimum order \$10.00. For shipping & handling include \$3.50 for ground and \$4.50 for air. Orders over 1 lb. and foreign orders may require additional shipping charges - contact the Sales department for the amount. Ca residents must include applicable sales tax. Prices subject to change without notice. We are not responsible for typographical errors. We reserve the right to limit quantities and to substitute manufacturer. All merchandise subject to prior sales. A full copy of our terms is available upon request. Items pictured may only be representative.

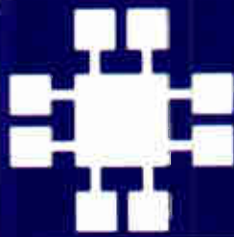

# JDR Microdevices

30 DAY MONEY BACK GUARANTEE • 1 YEAR WARRANTY ON ALL PRODUCTS • TOLL-FREE TECHNICAL SUPPORT

## MODULAR CIRCUIT TECHNOLOGY MINI-SIZED 386 MOTHERBOARDS

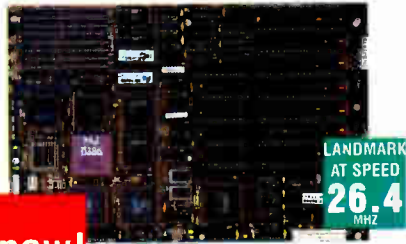

**new!**

### 20MHZ 386

**\$699**

THE MCT-M386 USES MEMORY INTERLEAVING FOR NEAR ZERO WAIT STATES. CLEANLY DESIGNED MOTHERBOARD HAS A 6 LAYER PCB FOR QUIET OPERATION.

- SOCKETED FOR 80387 COPROCESSOR • 16MHZ/20MHZ SELECTABLE SPEEDS • USES 100NS OR 80NS SIP RAMS
- 16MB RAM CAPACITY: 8MB ON BOARD, 8MB USING OPTIONAL RAM CARD (0KB INSTALLED) • STANDARD XT HOLE SPACING • FIVE 16-BIT SLOTS, TWO 8-BIT SLOTS, ONE 32-BIT SLOT FOR PROPRIETARY RAM CARD • AMI BIOS
- MEASURES 8.5" X 13"

MCT-M386-20

MCT-M386-M 8MB RAM CARD, 0KB INSTALLED ..... \$149.95

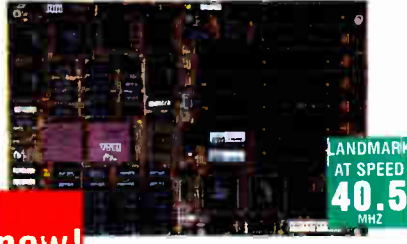

**new!**

### 25MHZ 386 CACHE

**\$1499**

THIS RACEHORSE 386S COMBINES MEMORY CACHING AND MEMORY INTERLEAVING TO REACH 95% CACHE HIT RATIO FOR NEAR ZERO WAITS.

- 25MHZ 80386 • SOCKETED FOR 80387 OR WEITEK 3167 COPROCESSORS • 16MHZ/25MHZ SELECTABLE SPEEDS • EXPANDABLE TO 16MB USING 32-BIT RAM CARD • INTEL 82385 CACHE CONTROLLER W/ 32KB FLEXIBLE CACHE MEMORY • CHIPS AND TECHNOLOGY CHIPSET • USES 80NS SIP RAM • 8.5" X 13" • STANDARD XT HOLE SPACING • FOUR 16-BIT SLOTS, THREE 8-BIT SLOTS, ONE 32-BIT SLOT FOR PROPRIETARY RAM CARD • AMI BIOS

MCT-C386-25



**new!**

### DFI-300 ETHERNET CARD

**\$199<sup>95</sup>**

USE THIS LOW-COST NETWORK CARD WITH JUST ABOUT ANY LAN SOFTWARE DESIGNED FOR ETHERNET PROTOCOLS.

- 100% HARDWARE COMPATIBLE WITH NOVELL NE-1000 ETHERNET CARD • COMPATIBLE WITH THICK OR THIN ETHERNET • 15 PIN ETHERNET CONNECTOR • BNC CONNECTOR FOR THIN ETHERNET • INCLUDES ADDITIONAL DRIVERS FOR OPTIONAL CONFIGURATIONS

DFINET-300

**CALL OUR 24-HR BBS  
(408) 559-0253**

- ON-LINE ORDERING • CONFERENCING • TECHNICAL INFORMATION •

## MINI UPRIGHT CASE

**\$249<sup>95</sup>**

MINIATURE UPRIGHT LETS YOU PUT YOUR CPU WHERE YOU WANT IT.

- SMALL FOOTPRINT (12" X 16" L X 8" W) • COMPATIBLE W/ 8086 OR MINI 286/386 MOTHERBOARDS
- ROOM FOR 6 INTERNAL EXPANSION CARDS
- HOLDS THREE 5.25" DRIVES AND ONE 3.5" DRIVE (HALF HEIGHT) • 200 WATT POWER SUPPLY • 2-DIGIT LED SPEED DISPLAY
- FRONT MOUNTED POWER-ON, RESET AND TURBO SWITCHES, KEYLOCK
- LEDS FOR HARD DISK, TURBO AND POWER-ON

CASE-120

**new!**

## SUPER UPRIGHT CASE

**\$499<sup>95</sup>**

ROOMY CASE WILL HOLD ALL YOUR PERIPHERALS!

- SPACE FOR 11 HALF HEIGHT DRIVES OR 3 FULL HEIGHT AND 5 HALF HEIGHT
- 5 EXPOSED DRIVE BAYS FOR FLOPPY OR TAPE DRIVES • HINGED FRONT DRIVE PANEL RESTRICTS ACCESS TO FLOPPY DRIVES
- KEYLOCK, TURBO AND RESET SWITCHES
- LED SPEED DISPLAY (2 DIGITS) • HARD DISK AND POWER-ON LEDS • 250 WATT POWER SUPPLY
- 2ND FAN FOR ADDITIONAL COOLING • HINGED SIDE PANEL FOR QUICK ACCESS
- STEEL CASE W/ROLLERS

CASE-200

**new!**



**new!**

## MODULAR CIRCUIT TECHNOLOGY

### 4800/2400 BAUD FAX/DATA MODEM

**\$119**

A 2400 4800 BAUD COMBINED DATA/FAX MODEM FOR LESS THAN MOST 2400 BAUD DATA MODEMS ALONE! BY SACRIFICING THE FAX RECEIVE FUNCTION WE CAN OFFER THIS REMARKABLE PRICE!

- 4800 BAUD FAX TRANSMISSION CAPABILITY TO ANY GROUP III FAX • 2400 BAUD V.22BIS DATA MODEM • XT/AT COMPATIBLE HALF CARD • CONVERTS DOS TEXT, PCX, AND TFF FILES FOR FAX GROUP III TRANSMISSION
- EASY TO USE MENJ DRIVEN SOFTWARE • PHONE BOOK
- MULTIPLE FAX TRANSMISSIONS TO GROUPED ADDRESSES • INCLUDES PROFAX FAX SOFTWARE

MCT-FAXM



**new!**

### HIGH DENSITY FLOPPY CONTROLLER

**\$49<sup>95</sup>**

NEED A THIRD OR FOURTH DRIVE CONTROLLER FOR YOUR AT? TRY THIS ONE!

- USE WITH EXISTING CONTROLLER CARDS IN SYSTEM
- XT OR AT COMPATIBLE • INTELLIGENT CONTROLLER KNOWS HOW MANY FLOPPY DRIVES ARE INSTALLED AND AUTOMATICALLY ASSIGNS DRIVE LETTERS WITHOUT RESETTING SYSTEM DIP SWITCH • SUPPORTS 1.44MB, 1.2MB, 720K AND 360K FLOPPY DRIVES (ANY COMBINATION)

MCT-FDC-HD

MCT-FDC-HD4 4 DRIVE VERSION ..... \$59.95



**new!**

### 14" SEIKO MONITOR

**\$599**

THIS DUAL FIXED FREQUENCY MONITOR UTILIZES A SONY TRINITRON TUBE WITH A SINGLE ELECTRON GUN INSTEAD OF THE USUAL THREE TO OBTAIN REMARKABLY WELL-FOCUSED IMAGES AND EXCEPTIONALLY VIVID COLORS.

- 14" NON GLARE SCREEN • ULTRA HIGH RESOLUTION (1024 X 768 MAX) • SUPER-FINE 26 MM DOT PITCH
- COMPATIBLE WITH 8514A, VGA AND MCGA ADAPTERS HAVING PGA, EGA, CGA AND HIGH RES DISPLAY MODES
- AUTOMATICALLY ADJUSTS TO DISPLAY MODE
- TILT SWIVEL BASE

CM-1430



**new!**

### ENHANCED KEYBOARD WITH CALCULATOR

**\$74<sup>95</sup>**

THE NUMERIC KEYPAD ON THIS ENHANCED KEYBOARD DOUBLES AS A CALCULATOR. COMPLETE WITH MEMORY AND TILT-UP LCD DISPLAY.

- SPACE-SAVING 101-KEY KEYBOARD DESIGN • TACTILE FEEDBACK • 12 FUNCTION KEYS • XT, AT AND PS/2 COMPATIBLE • SOLAR POWERED MULTI-FUNCTION BUSINESS CALCULATOR WITH MEMORY FUNCTIONS

FC-3001



**CALL FOR FREE CATALOG!**

JDR MICRODEVICES AND THE JDR MICRODEVICES LOGO ARE TRADEMARKS OF JDR MICRODEVICES IBM PS 2 ARE TRADEMARKS OF INTERNATIONAL BUSINESS MACHINES COPYRIGHT 1989 JDR MICRODEVICES



# EXCITING NEW LAPTOPS FROM JDR



new!

## TOSHIBA LAPTOP \$3695

NOW YOU CAN PURCHASE THE RENOWNED TOSHIBA LAPTOPS FROM JDR THE T3200HD USES A 80286 MICROPROCESSOR AND IS SOCKETED FOR AN 8MHz 80287 COPROCESSOR. WITH BUILT-IN 40MB HARD DRIVE, 1.44MB FLOPPY DRIVE.

- KEYBOARD SELECTABLE 12MHZ, 6 MHZ SPEEDS
  - 2 EXPANSION SLOTS: ONE FULL LENGTH 16-BIT SLOT, ONE HALF LENGTH 8-BIT SLOT • BUILT IN 40 MB 38MS HARD DRIVE AND 1.44MB FLOPPY DRIVE • 1MB RAM, EXPANDABLE TO 4MB (LIM EMS OR EXTENDED)
  - EGA/HERCULES COMPATIBLE GAS PLASMA DISPLAY WITH 4 GRAY SCALES • 80 X 25 TEXT; 720 X 400 GRAPHICS • EGA COLOR/HI RES MONOCHROME MONITOR PORT • PARALLEL PORT, SERIAL PORT • EXTERNAL FLOPPY PORT (5 1/4") AND PORT FOR 101 KEY KEYBOARD
  - MS-DOS 3.3
- T3200HD



new!

\$649

## TOSHIBA T1000 LAPTOP

THE ULTRALIGHT T1000 (JUST 6.4 LBS!) LETS YOU TAKE YOUR WORK ANYWHERE. REFLECTIVE SUPERTWIST 80 X 25 TEXT DISPLAY; 640 X 200 GRAPHICS.

- MS-DOS 2.11 IN ROM • 512K RAM INSTALLED, EXPANDABLE TO 1.2MB • 80C88 RUNNING AT 4.77MHZ
  - BUILT IN 3.5" FLOPPY DRIVE (720K) • PARALLEL & SERIAL PORTS • SLOT FOR OPTIONAL MODEM • EXTERNAL CONNECTOR FOR 5-1/4" FLOPPY DRIVE • RGB AND COMPOSITE MONO MONITOR PORTS
- T1000

## T5100 386 LAPTOP \$4295

- 20MHZ, 8MHZ KEYBOARD SELECTABLE SPEEDS • 16-BIT EXPANSION SLOT • BUILT IN 40 MB 29MS HARD DRIVE, 1.44MB FLOPPY DRIVE • 2MB RAM, EXPANDABLE TO 4MB (LIM EMS OR EXTENDED) • EGA/HERCULES COMPATIBLE GAS PLASMA DISPLAY • 80 X 25 TEXT; 640 X 400 GRAPHICS
  - PORTS FOR EGA, 5-1/4" FLOPPY & SERIAL/PARALLEL
- T5100



new!

\$2179

## BONDWELL B300 LAPTOP

FULL-FEATURED 10MHZ 286 AT COMPATIBLE FOR PRODUCTIVITY ON THE GO! INCLUDES MS-DOS VERSION 3.3, GW-BASIC VERSION 3.22, POWER STATUS SOFTWARE AND EASY 1.5 WORD PROCESSOR WITH DICTIONARY.

- 80286 MICROPROCESSOR • 1MB OF RAM ON BOARD EXPANDABLE TO 1.5MB • BUILT-IN 20MB 3.5" HARD DISK DRIVE, 1200 BPS HAYES-COMPATIBLE MODEM, AND RECHARGABLE BATTERY • 10.5" BACKLIT SUPERTWIST LCD DISPLAY • 1.44MB 3.5" SLIM DESIGN FLOPPY DRIVE ONLY 1" HIGH • REAL-TIME CLOCK CALENDAR INCLUDES COMPENSATION FOR LEAP YEARS • 94 KEYS, INCLUDING 10 FUNCTION KEYS • I/O PORTS INCLUDING CENTRONICS PARALLEL PORT AND RS-232 SERIAL PORT • EXTERNAL 5.25" AND 3.5" FLOPPY DISK PORT • AC POWER ADAPTER • ONLY 15 LBS WITH BATTERY INSTALLED • NYLON CASE
- LAPTOP-286

new!

\$89.95

## LOW COST RAM CARD FOR YOUR HP LASERJET

EXPAND THE MEMORY OF YOUR HP LASERJET II PRINTER UP TO 4 MB! MORE MEMORY ALLOWS MORE DOWNLOADABLE SOFT FONTS, MORE MACROS AND FULL PAGE 300 DPI GRAPHICS.

- USER EXPANDABLE TO 1, 2 OR 4 MB (OK INSTALLED)
  - USES 256K 150NS OR 1MB 120NS DRAMS
  - FULLY COMPATIBLE WITH HP LASERJET II PRINTERS
- MCT-RAMJET

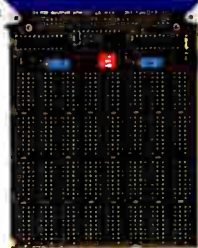

## WESTERN DIGITAL

new!

## AT COMPATIBLE FLOPPY/HARD CONTROLLERS

PART #	HARD DRIVES	FLOPPY DRIVES	INTER LEAVE	CARD SIZE	DATA TRANSFER	ADDITIONAL FEATURES	PRICE
WD1003V-MM2	2 MFM	2	2:1	2/3	5 MBITS/SEC	LOOK AHEADTRACK CACHE, 2K BUFFER	\$159.95
WD1006V-MM2	2 MFM	2	1:1	2/3	5 MBITS/SEC	LOOK AHEADTRACK CACHE, 8K BUFFER	\$169.95
WD1006V-SR2	2 RLL	2	1:1	2/3	7.5 MBITS/SEC	OPTIONAL ON-BOARD BIOS LOOK AHEADTRACK CACHE, 8K BUFFER	\$189.95
WD1007-WA2	2 ESDI	2	1:1	2/3	10 MBITS/SEC	DUAL 8K CACHES	\$249.95
WD1007A-SE2	2 ESDI	2	1:1	2/3	15 MBITS/SEC	DUAL 8K CACHES OPTIONAL ON-BOARD BIOS	\$299.95
7000-FASST2	2 SCSI	2	NA	FULL	16 MBITS/SEC 32 MBITS/SEC	CONTROL UP TO 7 SCSI DEVICES INTERNAL AND EXTERNAL CONNECTORS	\$399.95

new!

## HARD DISK CONTROLLERS

PART #	HARD DRIVES	INTER LEAVE	CARD SIZE	DATA TRANSFER	ADDITIONAL FEATURES	PRICE
WD1002A-WX1 AT COMPATIBLE	2 MFM	2:1	1/2	5 MBITS/SEC	SUPPORTS DRIVES UP TO 1024 CYL/16 HDS BIOS ROM, INTERNAL DIAGNOSTICS	\$89.95
WD1003V-MM1 AT COMPATIBLE	2 MFM	2:1	2/3	5 MBITS/SEC	LOOK AHEADTRACK CACHE, 2K BUFFER	\$139.95
WD1006V-MM1 AT COMPATIBLE	2 MFM	1:1	2/3	5 MBITS/SEC	8K LOOK AHEAD CACHE	\$159.95
WD1007-WAH AT COMPATIBLE	2 ESDI	1:1	2/3	10 MBITS/SEC	DUAL 8K CACHES BIOS, OS/2	\$239.95
WD1007A-SE1 AT COMPATIBLE	2 ESDI	1:1	2/3	15 MBITS/SEC	32K LOOK AHEAD CACHE, BIOS, OS/2	\$289.95



new!

## NEC MULTISYNC XL \$2195

- MULTI-SCAN 20" MONITOR FEATURES MAXIMUM RESOLUTION OF 1024 X 768 • COMPATIBLE W/8514A, SUPER VGA, MAC II, VGA, EGA, CGA • AUTOMATICALLY SCANS HORIZONTAL FREQUENCIES BETWEEN 21.8KHZ AND 50KHZ • SUPPORTS EGA SUPER EGA, EGA, MCGA AND VGA • SWITCHABLE TEXT COLORS: GREEN, AMBER, WHITE • .31MM DOT PITCH • 4 BNC COMPOSITE IN/OUT CONNECTORS • TTL/ANALOG (SWITCHABLE)
- NEC-MULTI-XL

CALL FOR OUR FREE CATALOG!

ORDER TOLL-FREE 800-538-5000

MON.-FRI. 7 A.M. TO 5 P.M., SATURDAY, 10 A.M. TO 3 P.M. (PST)

Terms: minimum order \$10.00. For shipping & handling include \$3.50 for ground and \$4.50 for air. Orders over 1 lb and foreign orders may require additional shipping charges — contact the Sales department for the amount. CA residents must include applicable sales tax. Prices subject to change without notice. We are not responsible for typographical errors. We reserve the right to limit quantities and to substitute manufacturer. All merchandise subject to prior sales. A full copy of our terms is available upon request. Items pictured may only be representative.

# EDITORIAL INDEX BY COMPANY

Index of companies covered in articles, columns, or news stories in this issue  
Each reference is to the first page of the article or section in which the company name appears

INQUIRY #	COMPANY	PAGE	INQUIRY #	COMPANY	PAGE	INQUIRY #	COMPANY	PAGE
1158	ABSOF	66		DIGITAL RESEARCH	403	1126	KEY TRONIC	49
	ADOBE	403	1132	DNA NETWORKS	49	1124	KURZWEIL COMPUTER PRODUCTS	49
1164	ADVANCED LOGIC RESEARCH	104	1185	DOVE COMPUTER	376			
884	ALPHA SOFTWARE	265	985	DREAM MAKER SOFTWARE	121	981	LEARNING TOOLS	121
	ALTSYS	403	1136	DYNAMIC MICROPROCESSOR ASSOCIATES	49	1190	LEVCO SALES	376
863	AMDEK	211					LOGITECH	17
1180	AOX	376	1186	ECLIPSE COMPUTER SOLUTIONS	376		LOTUS DEVELOPMENT	255
	APPLE COMPUTER	17, 153		EDUCATIONAL SYSTEMS	17	1075	MATROX ELECTRONIC SYSTEMS	178
	APPLIED ENGINEERING	17		ELECTROTECHNICAL LABORATORY	17	1139	MICRO PLANNING INTERNATIONAL	66
1181	APPLIED REASONING	376	1073	ENERTRONICS RESEARCH	178	1115	MICRONET TECHNOLOGY	49
1118	ARCHIVE	49		EXABYTE	380	862	MICROSOFT	
1182	ARTEK COMPUTER SYSTEMS	376	1145	FISHER IDEA SYSTEMS	66	988	49, 81, 287, 341, 371, 403	
1152	ASHLAR	66	992	FORMWORX	81	1135	MICROTEC RESEARCH	17
1104	ASHTON-TATE	147	1187	GCC TECHNOLOGIES	376		MIPS COMPUTER SYSTEMS	323, 361
856	AST RESEARCH	287, 376	865	GENICOM	287		MIT	17
1183	AT&T	17	853	GIGATREND	225, 380		MIT PRESS	484
			989	GUNAKARA SUN SYSTEMS	81		MOTOROLA	17, 323, 361
1147	BETTER SOFTWARE TECHNOLOGY	66	1103	GUPTA TECHNOLOGIES	147			
	BITSTREAM	403	1134	H-THREE SYSTEMS	49	1114	N/HANCE SYSTEMS	49
	BOCA RESEARCH	17	852	HAYES MICROCOMPUTER PRODUCTS	233		NATIONAL EDUCATION COMPUTING CONFERENCE	17
	BORLAND INTERNATIONAL	371		HELSINKI UNIVERSITY OF TECHNOLOGY	17	1076	NEC HOME ELECTRONICS (USA)	178
1137	BRIGHTWORK DEVELOPMENT	49	1177	HEWLETT-PACKARD	17, 93, 380, 403	1109	NEC INFORMATION SYSTEMS	49
			1143	HOMECRAFT COMPUTER PRODUCTS	66		NEURON DATA SYSTEMS	17
	CARNEGIE MELLON UNIVERSITY	341, 411		HUNTER SYSTEMS	361	986	NORTHGATE COMPUTER SYSTEMS	121
1108	CELLULAR COMPUTING SYSTEMS	49	1119	IBM	49	1130	NOVA INTERNATIONAL	49
1165	CHEETAH INTERNATIONAL	104	1160	ICOM SIMULATIONS	66	1102	NOVELL	147
1128	COMMTECH	49	1074	IMAGRAPH	178	1191	NOVY SYSTEMS	376
1071	COMPAQ COMPUTER	178	1113	IN FOCUS SYSTEMS	49	1077	NUMBER NINE COMPUTER	178
	COMPUGRAPHIC	403	984	INDUCTEL	121	1159	OASYS	66
1072	CONTROL SYSTEMS	178		INSTITUTE FOR COMMUNICATIONS SWITCHING & DATA TECHNIQUES	17	1192	ORCHID TECHNOLOGY	17, 376
990	CORNERSTONE TECHNOLOGY	81	1188	INTEL	17, 323, 376	1125	PACIFIC DATA PRODUCTS	49
1122	COVOX	49		INTELLIGENT GRAPHICS	371	1078	PC TECH	178
1107	CUSTOM COMPUTER SYSTEMS	49	1131	INTERLAN	49		PHAR LAP SOFTWARE	371
	CYPRESS SEMICONDUCTOR	17	882	INTERLEAF	271		PICTUREWARE	17
1151	D. C. A. ENGINEERING SOFTWARE	66	983	INTERMEDIA DESIGN SYSTEMS	121	1110	POINT 4 DATA	49
	DATA GENERAL	323, 361	1157	INTERMETRICS	66	1163	POQET COMPUTER	115
1121	DATA TRANSLATION	49	1189	IRWIN MAGNETIC SYSTEMS	376	1149	POWERUP! SOFTWARE	49
	DATAVIEWS	17				861	PROHANCE TECHNOLOGIES	287
854	DAYNA COMMUNICATIONS	219		JET PROPULSION LABORATORY	17	860	PUBLISHING TECHNOLOGIES	287
1184	DAYSTAR DIGITAL	376						
	DELL COMPUTER	17						
1154	DEMPSEY'S FORGE	66						
851	DIGITAL EQUIPMENT	201, 323, 361						



INQUIRY #	COMPANY	PAGE
1111	QMS .....	49
1193	QUADRAM L. P. ....	376
987	QUANTA PRESS .....	121
	QUARTERDECK .....	17, 371
1120	RADIUS .....	49, 376
1194		
1155	RAINBOW BRIDGE SOFTWARE .....	66
	SAMSUNG .....	17
	SEIKO INSTRUMENTS .....	17
1133	SHARP ELECTRONICS .....	49
881	SMETHERSBARNES .....	241
982	SNOWBIRD SOFTWARE .....	121
	SOFTCRAFT .....	403
	SOFTWARE LINK .....	371
1161	SOMAK SOFTWARE .....	66
1112	STORAGE DIMENSIONS .....	49
855	SUN MICROSYSTEMS .....	219, 323, 361
857	SWAN TECHNOLOGIES .....	287
	SWFTE .....	403
1138	SYMMETRY .....	66
	TANDY .....	17
991	TEKTRONIX .....	81
864	TELEVIDEO SYSTEMS .....	211
883	TEXAS INSTRUMENTS .....	17, 247
1195	TOTAL SYSTEMS .....	376
	U.S. DEPARTMENT OF COMMERCE .....	17
1144	UNIPLEX .....	66
	UNIVERSITY OF CALIFORNIA AT BERKELEY .....	341
1079	VERMONT MICROSYSTEMS .....	178
	VORTEX SYSTEMS .....	17
1105	WALLABY SYSTEMS .....	49
859	WANG LABORATORIES .....	287
	WANGDAT .....	380
	WANGTEK .....	380
858	WEDGE TECHNOLOGY .....	287
1101	WORDTECH SYSTEMS .....	147
	WORLD COMPUTER CONGRESS .....	17
863	WYSE TECHNOLOGY .....	211
1146	XEROX IMAGING SYSTEMS .....	66
	ZENITH DATA SYSTEMS .....	17
	ZSOFT .....	403

## COMING UP IN BYTE

The following articles are in the works for the December issue. Unless something unexpected happens, we'll be able to present them all.

### PRODUCTS IN PERSPECTIVE:

One of the perennial buzzwords in computing is CASE (computer-aided software engineering). What is it? How well do CASE products perform, and what do they offer? Our December **Product Focus** zeros in on the subject.

**System reviews** will concentrate on two new 80386 machines from Acer and ADC.

In the **hardware review** category, we have a roundup of Macintosh 32-Bit QuickDraw boards and QMS's new ColorScript printer, which promises color PostScript at a groundbreaking price.

**Software reviews** include Common View, a C++ class library for Windows and Presentation Manager, and Watcom 386 C, a compiler that taps the full power of Intel's 80386.

**Scheduled application reviews** are Planet Software's library of functions that links Clipper applications to SQLBase; Hewlett-Packard's Accelerated X Window Display Server (AXDS/PC), an excellent budget saver for departments needing to turn IBM PC ATs into quality color X Window user stations; Publish It for the Mac; and Project Scheduler 4, the first midrange, graphically based project management software for the PC.

Our new **Reviewer's Notebook** section has articles on Aura Systems' ScuzzyGraph II, which gives other Macs the high resolution and color of their Mac II cousins; Visible Software's Dr. Pascal; The Rendition II, a medium-to high-resolution (1024- by 768-pixel) graphics controller for IBM PC ATs and compatibles from Renaissance GRX; and a second look at an updated United Innovations' wall-mount Mural 8000 plotter.

### IN DEPTH:

The elusive dream of AI, something that has yet to materialize in a substantial form, is an ongoing quest for software and hardware designers. But some of our five primary senses have been replicated with mixed results. For some specialized tasks, mechanized "seeing," "hearing," and "speaking" have emerged at levels competitive with—and sometimes beyond those of—flesh and blood. For most other tasks, however, these computer-based "senses" are still woefully inadequate. Our In Depth section will concentrate on this burgeoning field of **sound, voice, and image processing**.

### FEATURES:

This is the tenth anniversary of a product class, **the spreadsheet**, that many credit with first breaking the ice for the personal computer in business situations. How has the spreadsheet fared over the past decade, and what do its developers think now of their electronic progeny? Tune into the December Features section for some interesting answers.

Also slated for December, Dick Pountain has written a piece on the **Occam Transpiler**, now under development, which will make writing software for parallel processing easier.

Also, look for the regulary scheduled features of our columnists in both the **Expert Advice** and **Hands On** departments, industry news in **Microbytes**, new hardware and software of note in **What's New**, and the latest in noteworthy items tested by BYTE staffers in **Short Takes**.

# READER SERVICE

To get further information on the products advertised in BYTE, fill out the reader service card by circling the numbers on the card that correspond to the inquiry number listed with the advertiser. This index is provided as an additional service by the publisher, who assumes no liability for errors or omissions.

\* Correspond directly with company.

## Alphabetical Index to Advertisers

Inquiry No.	Page No.	Inquiry No.	Page No.	Inquiry No.	Page No.	Inquiry No.	Page No.
11 AASHIMA TECHNOLOGY B.V.	351	117 DIVERSIFIED COMPUTER	454	218 MCGRAW-HILL BOOKSTORE	372	326 SKISOFT PUBLISHING CORP	459
12 ABACUS SOFTWARE	42	118 DTK	319	219 MCGRAW-HILL BOOKSTORE	374	327 SOFTWARE DEVELOPMENT SYS	83
13 ABACUS SOFTWARE	42	119 DYNAMIC ELECTRONICS CO.	447	218 MEAD COMPUTER	485	328 SOFTWARE LINK	273
14 ABRAXAS SOFTWARE	362	120 DYNAMICAL SYSTEMS, INC	88	219 MEGADATA	308	329 SOFTWARE LINK	273
15 ACOS COMMUNICATIONS	457	121 ECOSOFT, INC	262	220 MEGADATA	87	398 SOFTWARE LINK	385
16 ADOBE SYSTEMS, INC	224	122 EDC GMBH	398	221 MEGA DRIVE SYSTEMS	408	399 SOFTWARE LINK	385
23 ADVANCED LOGIC RESEARCH	2,3	122 ELITE MICROSYSTEMS	294,295	222 MEGATEL	244	8 SOFTWARE SAMPLER CLUB	140
24 ADVANCED LOGIC RESEARCH	2,3	123 ELS ENTERPRISES, LTD	152	224 MEI	244	8 SOFTWARE SAMPLER CLUB	140
17 ADVANTAGE SOFTWARE	221	124 ELTECH RESEARCH	218	225 MERRITT	416	330 SOFTWARE SECURITY	301
16 AEG OLYMPIA	251	125 EMERSON	161	226 METRO SOFTWARE, INC	122	331 SOLUS SYSTEMS, INC	74
20 AK SYSTEMS	462	126 EMERSON	161	227 METRO SOFTWARE, INC	122	332 SOLUS TECHNOLOGY	395
18 ALADDIN KNOWLEDGE SYS	410	127 ENERTONICS RESEARCH, INC	365	227 MEXTEL	266	333 SOUTH COAST ELECTRONICS	459
21 ALLREGULATOR AB	466	128 EOTRON	184	229 MEXTEL	266	334 SPECTRUM	277
22 ALPHA PRODUCTS	459	129 EOTRON	20,21	230 MICRO PRESS	32	335 STARTECH	113
25 AMDEK	390	130 EXCELLENCE MULTI-LAYER	88	231 MICRO SOLUTIONS COMP PROD	409	336 STATSOFT	315
26 AMERICAN GROUP	459	131 EXECUTIVE PHOTO & SUPPLY	402	232 MICROCOM INC (HARDWARE)	298	337 STERLING CASTLE	315
27 AMERICAN MITAC	293	132 EXSEL	78	233 MICROCOM INC (SOFTWARE)	298	338 STERLING CASTLE	315
28 AMERICAN SMALL BUS.COMP	141	133 EXSEL	235	233 MICROCOMPUTER MKTG CNLS	481	339 STORAGE DIMENSIONS	243
29 AMPRO	128	134 FAIRCOM CORPORATION	229	234 MICROPROCESSORS UNLIMITED	458	340 STORAGE DIMENSIONS	200
269 AMS	452	135 FAIRCOM CORPORATION	229	• MICROSOFT	6,7	341 STS	64,65
30 ANNABOOKS	447	136 FINALSOFT CORP	300	• MICROSOFT	45	343 SUMMAGRAPHS	64,65
32 APPLIED DATA SYSTEMS, INC	98	137 FINALSOFT CORP	300	• MICROSOFT	67	344 SUMMAGRAPHS	64,65
33 ASHLAR, INC	270	138 FLAGSTAFF ENGINEERING	186	• MICROSOFT	85	345 SUPERSOFT	388
34 AST RESEARCH	123	139 FOCUS RESEARCH, INC	249	235 MICROSPD	34	346 SURAH, INC	388
35 AST RESEARCH	123	140 FORESIGHT RESOURCE	249	236 MICROSTAR LABORATORIES	462	348 T&K TECHNOLOGY	462
36 AST RESEARCH	123	142 FORTRON/SOURCE CORP	43	237 MICROTRONICS TRADE SERV.	337	350 T&K TECHNOLOGY	118,119
37 AST RESEARCH	123	143 FORTRON/SOURCE CORP	43	238 MICROTRONICS TRADE SERV.	337	352 TELEPHONE PRODUCTS CENTER	124
38 AST RESEARCH	127	144 FOX SOFTWARE	24,25	239 MICROWAY	306	353 THE SMALL COMPUTER CO	264
40 AST RESEARCH	129	145 FRANKLIN SOFTWARE, INC	192	240 MITSUBISHI PLASTICS	340	354 THE SMALL COMPUTER CO	264
41 AST RESEARCH	129	294 FRANKLIN PROXIMITY	192	241 MIX SOFTWARE	353	10 THIRD COAST TECH, INC	252,253
42 ATI TECHNOLOGIES	185	295 FRANKLIN PROXIMITY	192	242 MKS	358	356 TOSHIBA	252,253
43 ATI TECHNOLOGIES	325	146 FTG DATA SYSTEMS	462	243 MONTGOMERY GRANT	370	357 TOUCHBASE SYSTEMS, INC	36
44 ATRON	169	147 GATEWAY 2000	40A-D	243 MOUNTAIN COMPUTER, INC	216,217	351 TP ENTERPRISE, INC	486
45 ATTACHMATE	169	148 GENERIC SOFTWARE	387	244 MOUNTAIN COMPUTER, INC	216,217	359 TRACE, INC	289
• AT&T	48A-1	149 GENESIS DATA SYSTEMS	387	245 NAGAN CORPORATION	452	360 TRAVELING SOFTWARE	199
• AVIS	338	150 GENESIS DATA SYSTEMS	409	246 NANAO	193	361 TRUEVISION	183
46 AVOCET & QUELO	415	151 GLENCOE ENGINEERING	317	247 NANAO	193	362 TURBOPOWER SOFTWARE	432
47 A.M.T.	291	153 GOLDEN BOW SYSTEMS	190	248 NANTUCKET	339	363 TUSSEY COMPUTER PROD	236,237
48 A/SOFT DEVELOPMENT	142	366 GOLDSTAR TECHNOLOGY	322	250 NATIONAL INSTRUMENTS	339	364 TUSSEY COMPUTER PROD	238,239
50 BAYTECH	363	154 GOODWAY	274	252 NETWSE	246	367 ULTIMATE TECHNOLOGY	466
51 BAYTECH	363	155 GTEK SERVICES	274	253 NETWORK TECHNOLOGIES	462	381 UNICORN ELECTRONICS	464
347 BEST POWER TECHNOLOGY	464	156 GTEK, INC	72	254 NEXT COMPUTER	29,29	386 UNITEK, INC	456
53 BINARY TECHNOLOGY	464	157 GTEK, INC	72	255 NHAU CORPORATION	464	389 UNIVERSAL CROSS-ASSEMBLER	458
55 BIT WISE	463	158 G. REED, INC	464	256 NORDIC CORPORATION	464	370 U.S. VIDEO	367
• BIX	332,377	159 HAMMERLY COMPUTER SERVICE	204	257 NORTHGATE COMPUTER	330,331	• U.S. ROBOTICS	367
450 BIX	400,401	160 HAMMERLY COMPUTER WORKS	289	258 NORTHGATE COMPUTER	333	371 VERMONT CREATIVE SOFTWARE	16
56 BLACKSHIP COMPUTER SYS	148	161 HERCULES COM. TECH.	191	259 NU MEGA	259	372 VESTRONIX	359
57 BLAISE COMPUTING	168	162 HEWLETT-PACKARD PERIPH.	14,15	260 NUMONICS	383	• VIDEO SEVEN	240
58 BOLT SYSTEMS	160	163 HEWLETT-PACKARD PERIPH.	156,157	349 ORACLE	69	373 WARD SYSTEMS GROUP	150
59 BOLT SYSTEMS	160	164 HIGH RES TECHNOLOGIES	466	261 OSBORNE MCGRAW-HILL	426	374 WARD SYSTEMS GROUP	150
60 BORLAND INTERNATIONAL	13	166 HIMS COMPUTERS	453	282 OST	446	375 WARHOUSE DATA PROD	231
61 BORLAND INTERNATIONAL	13	167 HOME SMART COMPUTING	453	283 OVERLAND DATA INC	446	376 WEDGE TECHNOLOGY	226
62 BORLAND INTERNATIONAL	13	168 HOOLEON CORP	365	284 PACIFIC COMPUTERS	446	377 WEITEK	90,91
397 BP MICROSYSTEMS	458	169 HYPERKINETIX	419	285 PACIFIC DATA PRODUCTS	79	378 WELLS AMERICAN	245
62 BROTHER INT'L CORP	254	170 HYPERKINETIX	10,11	286 PACIFIC DATA PRODUCTS	195	379 WELLS AMERICAN	245
63 BYTE BACK ISSUES	445	• IBM-SAA	76,77	287 PACIFIC DATA PRODUCTS	195	380 WINTEK CORPORATION	452
63 BYTE BITS	452	• IBM-PS/2	164,165	288 PANASONIC (MONITORS)	208,209	381 XELTEK	460
• BYTE BUYERS MART.	434-445	• IBM-OS/2	320,321	271 PANASONIC (PRINTERS)	208,209	382 Y.E.S. SYSTEMS CORP	447
• BYTE SUB MESSAGE	228	171 IGC	309	272 PAL SYSTEMS	75	387 Y.E.S. SYSTEMS CORP	447
64 BYTEK COMPUTER CORP	454	172 IGC	192	273 PATTON & PATTON	126	388 ZEOS INTERNATIONAL	278,279
BYTEK NEWSLETTER	487	173 INMAC	210	274 PC DESIGNS	146	389 ZEOS INTERNATIONAL	280,281
788 B&B ELECTRONICS	464	174 INTEGRAND	172	275 PC GLOBE	25	390 ZEOS INTERNATIONAL	282,283
65 B&C MICRO	457	175 INTELICOM INC	210	276 PC NETWORK	267	385 ZEOS INTERNATIONAL	284,285
66 B&C MICRO	457	177 INTELICOM INC	170	277 PERISCOPE	267	389 ZORTECH	97
67 B&C MICRO	457	178 INTELLIGENCEWARE	419	278 PERISCOPE	267	391 ZORTECH	97
• CALIFORNIA DIGITAL	467	179 INTERNATIONAL COMPUTER GR	419	279 PERSONAL TEX	206		
69 CANON STILL VIDEO	134	180 INTERNATIONAL MARKETING	259	280 PHAR LAP	258		
70 CAPITAL EQUIPMENT	135	181 INVENTORY MARKETING	419	283 PINNACLE MICRO	311		
71 CAPITAL EQUIPMENT	135	182 IO TECH	464	284 PINNACLE MICRO	311		
72 CENTURY SOFTWARE	143	183 I.C. EXPRESS	457	285 PINNACLE PUBLISHING	197		
73 CENTURY SOFTWARE	143	184 I.O. COMM	262	286 PINNACLE PUBLISHING	197		
74 CETRA	151	185 JADEO	448,449	287 PINNACLE SALES INT'L	450		
75 CH PRODUCTS	151	186 JAMECO	448,449	288 PRIORITY ONE COMPUTER	227		
76 CH PRODUCTS	151	187 J&B TECHNOLOGIES	447	289 PROGRAMMERS PARADISE	58,59		
77 CIPHER DATA PROD	455	188 JIB TECHNOLOGIES	447	290 PROPHAGE TECHNOLOGIES	260,261		
78 CLONE COMPUTER	455	189 JC INFORMATION SYSTEMS	429	292 PROTECH MARKETING	61		
79 CLON AMERICAN TECHNOLOGY	353	• JENSEN & PARTNERS INT'L	375	293 PROTECH MARKETING	61		
80 CMO	102,103	190 JYACC, INC	375	294 P.C. BRAND	171		
81 CMO	102,103	191 JYACC, INC	375	297 P.C. BRAND	172,173		
82 CMO	104,105	6 J.D.R.	470,471	298 P.C. BRAND	174,175		
83 CNS, INC	158	6 J.D.R.	472,473	299 P.C. BRAND	176,177		
84 COMPACT DISK PRODUCTS	99	7 J.D.R.	472,473	300 OMS	33		
85 COMPUCLASSICS	210	• J.D.R.	488,489	301 OMS	33		
86 COMPUON	446	7 J.D.R.	472,473	302 QUA TECH, INC	460		
87 COMPUSERVE	397	• J.D.R.	488,489	303 QUA TECH, INC	460		
393 COMPUTER ASSOCIATES	378,379	7 J.D.R.	472,473	304 QUALSTAR CORPORATION	454		
88 COMPUTER DISCOUNT WAREHOUSE	431	192 KADAK PRODUCTS	250	305 QUANTUM SOFTWARE	454		
89 COMPUTER FRIENDS	373	193 KAYPRO COMPUTERS	120	306 QUANTUM SOFTWARE	454		
90 COMPUTER PERIPHERALS	162	194 KAYPRO COMPUTERS	120	307 RADIO SHACK	53		
91 COMPUTER PERIPHERALS	162	195 KEA SYSTEMS	117	• RAIMA CORPORATION	55		
396 COMPUTER SYSTEMS RESEARCH	389	196 KISS COMPUTER	155	308 RAINBOW	263		
92 COMPUTERPLANE	461	197 KMW SYSTEMS	454	309 RAINBOW	263		
93 COMPUTRADE	288	19 KNOWLEDGE GARDEN	483	310 REAL TIME DEVICES	57		
91 CONNEXPERTS	215	198 KORE, INC	457	311 ROSE ELECTRONICS	163		
94 CONTECH COMPUTER CORP	460	199 K.E.M. ELECTRONIC	462	312 ROSE ELECTRONICS	163		
95 CONTROL VISION	454	200 LAHEY COMPUTER SYSTEMS	452	313 RUPP CORPORATION	485		
96 COVOX	454	201 LAWSON LABS	235	314 RUPP CORPORATION	485		
97 CRICHLAW	452	202 LINGUISTIC PRODUCTS	459	315 RUPP CORPORATION	485		
100 CUBIX CORPORATION	168	203 LINK COMPUTER GRAPHICS	459	316 RUPP CORPORATION	485		
101 CUBIX CORPORATION	168	205 LOGICAL DEVICES	453	317 RUPP CORPORATION	485		
102 CURTIS, INC	407	206 LOGICAL DEVICES	453	382 SAFARI, INC	464		
103 DATA TRANSLATION	458	207 LOGICAL DEVICES	453	• SAGE/POLYTRON	421		
104 DATATRONICS	458	208 LOGICAL DEVICES	453	318 SAMSUNG	70,71		
105 DELL COMPUTER	CII,1	209 LOGITECH	52,53	319 SAMSUNG	70,71		
107 DELL COMPUTER	89	210 LOGITECH	52,53	320 SANTA CRUZ OPERATION	57		
• DELL COMPUTER	89A-B	211 MAG-RABBIT	117	321 SAK SOFTWARE	196		
108 DELTA COMPUTING TECH	454	212 MAP INFO	96	322 SCHWAB COMPUTER	459		
109 DEPARTMENTAL TECHNOLOGIES	168	213 MARYMAC INDUSTRIES	458	323 SCIENTIFIC ENDEAVORS	458		
110 DESCRIBE, INC	304,305	214 MATHSOFT	51	324 SCIENTIFIC ENDEAVORS	458		
111 DIGIBOARD	92	215 MAXICOM SOFTWARE TECH	232	390 SCIENTIFIC ENDEAVORS	458		
112 DIGITAL RESEARCH	203	216 MAXICOM CORPORATION	446	• SEAGATE	149		
113 DIGITAL	144,145	217 MAXEM CORPORATION	286	325 SILICON SHACK	460		
114 DIGI-DATA CORPORATION	457						
115 DISKOTECH TECHNOLOGIES	480						
116 DISKETTE CONNECTION	453						

INTERNATIONAL SECTION 60 IS 1-64  
No North American Inquiries please.



# READER SERVICE

Advertising Supplements included with this issue:  
Jameco (U.S. and Canada Subscribers)

\* Correspond directly with company.

Inquiry No.	Page No.	Inquiry No.	Page No.	Inquiry No.	Page No.	Inquiry No.	Page No.
436	IS-46	* MICROCOMP MKTG CNCL	MW-7	557	NE-17	494	PC-15
437	IS-46	1202 MICRO DATABASE SYSTEMS	MW-1	558	NE-15	495	PC-2
438	IS-54	1203 MYCOM COMPUTERS	MW-2	559	NE-15	496	PC-2
439	IS-35	1204 MYCOM COMPUTERS	MW-2	560	NE-6	* KEYBOARD COMEDY	PC-25
440	IS-29	1205 NEXT WORKS, THE	MW-3	561	NE-19	498	PC-28
* SCOTTS DALE SYSTEMS	IS-29	1206 NEXT WORKS, THE	MW-3	562	NE-19	499	PC-29
* SOFTLINE CORPORATION	IS-23	1207 SYSTEMS INTEGRATION ASSOC	MW-12	563	NE-2	504	PC-24
441	IS-47	1208 SYSTEMS INTEGRATION ASSOC	MW-12	564	NE-2	505	PC-24
442	IS-59	1211 ZERICON	MW-9	565	NE-29	506	PC-27
443	IS-59			566	NE-18	507	PC-23
444	IS-25			569	NE-27	508	PC-23
445	IS-36			570	NE-27	509	PC-8
446	IS-32			567	NE-23	510	PC-8
447	IS-54			568	NE-23	511	PC-5
448	IS-45			571	NE-23	512	PC-5
451	IS-27			572	NE-23	515	PC-13
452	IS-27			573	NE-22	516	PC-21
449	IS-58					517	PC-21
453	IS-53					513	PC-32
454	IS-9					514	PC-32
455	IS-44					518	PC-9
456	IS-10					519	PC-9
457	IS-54					521	PC-22
							PC-1
<b>INT'L DIRECT RESPONSE POSTCARDS</b>							
* BINARY ENGINEERING	IS						
* C USERS JOYRIDE	IS						
* EAGLE RIVER SOFTWARE	IS						
* INTELLICOM	IS						
* METRABYTE	IS						
* NATIONAL INSTRUMENTS	IS						
* PARA SYSTEMS	IS						
* PROGRAMMERS JOURNAL	IS						
* REASONABLE SOLUTIONS	IS						
* SOFTWARE EXCITEMENT	IS						
* TOUCHBASE SYSTEMS	IS						
* TRANS ERA	IS						
<b>REGIONAL SECTIONS</b>							
<b>Midwest</b> 80 MW1-12							
* BYTEWEEK/NEWSLETTER	MW-4						
1201 DAKOTA COMPUTER	MW-5						
<b>Northwest</b> 80 NE1-32							
526 ADTECH	NE-13						
527 ADTECH	NE-13						
BYTEWEEK/NEWSLETTER	NE-28						
528 BLUE CIRCLE GROUP, INC	NE-28						
529 BLUE CIRCLE GROUP, INC	NE-28						
530 COMPFAX	NE-25						
531 COMPFAX	NE-25						
532 COMPUTER EXPERT, INC	NE-14						
533 DTG, INC	NE-24						
534 DTG, INC	NE-24						
535 ELECTRIFIED DISCOUNTERS	NE-21						
536 ERS TECHNOLOGIES, INC	NE-3						
537 ERS TECHNOLOGIES, INC	NE-3						
538 FOUNTAIN TECHNOLOGIES, INC	NE-9						
539 FUTURA SYSTEMS	NE-22						
540 FUTURA SYSTEMS	NE-22						
541 HALSKAR SYSTEMS	NE-31						
542 HALSKAR SYSTEMS	NE-31						
543 HARMONY COMPUTERS	NE-11						
544 HARMONY COMPUTERS	NE-11						
545 LAPTOPS ETC	NE-4						
548 MAGITRONIC TECHNOLOGY	NE-32						
MANCHESTER EQUIPMENT CO	NE-1						
549 MASCOIT COMPUTER CORP	NE-5						
550 MASCOIT COMPUTER CORP	NE-5						
551 MICCAISOFT, INC	NE-12						
552 MICCAISOFT, INC	NE-12						
553 MICRO DATABASE SYSTEMS	NE-8						
554 MINTA TECHNOLOGY	NE-30						
555 MPM	NE-7						
556 MPM	NE-7						
<b>Pacific Coast</b> 80 PC1-32							
476 3-F ASSOCIATES, INC	PC-31						
477 A-TRONIC COMPUTER	PC-6						
500 BIX	PC-30						
478 BI-LINK COMPUTER	PC-17						
* BYTEWEEK/NEWSLETTER	PC-12						
522 CDS	PC-18						
479 COMPUTER POWER, INC	PC-11						
480 COMPUTER POWER, INC	PC-11						
502 COMPUTER WHOLESALE CLUB	PC-19						
503 COMPUTER WHOLESALE CLUB	PC-19						
481 DATA SOLVERS, INC	PC-18						
482 DATA SOLVERS, INC	PC-18						
483 DATAMAG, INC	PC-24						
484 DATAMAG, INC	PC-24						
485 DAUPHIN TECHNOLOGY, INC	PC-3						
486 DAUPHIN TECHNOLOGY, INC	PC-3						
487 DAYTRON ELECTRONICS, INC	PC-4						
488 DISKTEC	PC-16						
489 DISKTEC	PC-16						
490 DRAGONSLAYER SYSTEMS	PC-7						
491 EXCELOGIC, INC	PC-8						
492 EXCELOGIC, INC	PC-8						
493 HALSKAR SYSTEMS	PC-15						
<b>South</b> 80 SO1-12							
1214 A-TRONIC COMPUTER	SO-11						
* BYTEWEEK/NEWSLETTER	SO-4						
1215 DTG, INC	SO-6						
1216 DTG, INC	SO-6						
1217 MICCAISOFT, INC	SO-5						
1218 MICCAISOFT, INC	SO-5						
1219 MIGHTY MICRO	SO-3						
1220 MIGHTY MICRO	SO-3						
1221 OCTAGON TECHNOLOGIES	SO-7						
1222 OCTAGON TECHNOLOGIES	SO-7						
1223 RESOURCE CONCEPTS, INC	SO-5						
1224 RESOURCE CONCEPTS, INC	SO-5						
1225 SQUARE FIELD CORPORATION	SO-2						
1226 SQUARE FIELD CORPORATION	SO-2						
1227 SUMMA COMPUTER SYS	SO-12						
1228 ZERICON	SO-1						

## BYTE ADVERTISING SALES STAFF:

Steven M. Vito, Associate Publisher/V.P. of Marketing, One Phoenix Mill Lane, Peterborough, NH 03458, tel. (603) 924-9281  
Arthur Kossack, Eastern Regional Sales Manager, 645 North Michigan Ave., Chicago, IL 60611, tel. (312) 751-3700  
Jennifer L. Bartel, Western Regional Sales Manager, 8111 LBJ Freeway, Suite 1350, Dallas, TX 75251, tel. (214) 644-1111  
Liz Coyman, Inside Sales Director, One Phoenix Mill Lane, Peterborough, NH 03458, tel. (603) 924-2518

**NEW ENGLAND**  
ME, NH, VT, MA, RI, ONTARIO  
CANADA & EASTERN CANADA  
John C. Moon (617) 262-1160  
McGraw-Hill Publications  
575 Boylston Street  
Boston, MA 02116  
FAX: (617) 262-6430

**ATLANTIC**  
NY, NYC, CT, NJ (NORTH)  
Kim Norris (212) 512-2645  
McGraw-Hill Publications  
1221 Avenue of the Americas—  
28th Floor  
New York, NY 10020  
FAX: (212) 512-3520

**EAST**  
PA, NJ (SOUTH),  
MD, W. VA, DE, D. C.  
Thomas J. Brun (215) 496-3833  
McGraw-Hill Publications  
Three Parkway  
Philadelphia, PA 19102  
FAX: (215) 496-3828

**SOUTHEAST**  
NC, SC, GA, FL, AL, TN, VA, MS  
(404) 252-0626  
McGraw-Hill Publications  
4170 Ashford-Dunwoody Road  
Suite 420  
Atlanta, GA 30319  
FAX: (404) 252-4056

**MIDWEST**  
IL, MO, KS, IA, ND, SD, MN,  
KY, OH, WI, NB, IN, MI  
Kurt Kelley (312) 751-3740  
McGraw-Hill Publications  
Blair Building  
645 North Michigan Ave.  
Chicago, IL 60611  
FAX: (312) 751-3767

**SOUTHWEST**  
**ROCKY MOUNTAIN**  
CO, WY, OK, TX, AR, LA  
Karl Heinrich (713) 462-0757  
McGraw-Hill Publications  
7600 W. Tidwell Rd.—Suite 500  
Houston, TX 77040  
FAX: (713) 462-6526

**SOUTH PACIFIC**  
SOUTHERN CA, AZ, NM,  
LAS VEGAS  
Ron Cordek (714) 557-6292  
McGraw-Hill Publications  
3001 Red Hill Ave.  
Building 71—Suite 222  
Costa Mesa, CA 92626  
FAX: (714) 557-2219

Tom Harvey (213) 480-5243  
McGraw-Hill Publications  
3333 Wilshire Boulevard #407  
Los Angeles, CA 90010  
FAX: (213) 480-5249

**NORTH PACIFIC**  
HI, WA, OR, ID, MT,  
NORTHERN CA,  
NV (except LAS VEGAS),  
W. CANADA, UT  
(415) 362-4600  
McGraw-Hill Publications  
425 Battery Street  
San Francisco, CA 94111  
FAX: (415) 954-9786

Bill McAfee (408) 879-0371  
McGraw-Hill Publications  
1999 South Bascom Ave.  
Suite #210  
Campbell, CA 95008  
FAX: (408) 879-9067

**BYTE BITS (2x3)**  
Mark Stone (603) 924-6830  
BYTE Publications  
One Phoenix Mill Lane  
Peterborough, NH 03458

**The Buyer's Mart (1x2)**  
Brian Higgins (603) 924-3754  
BYTE Publications  
One Phoenix Mill Lane  
Peterborough, NH 03458

**Regional Advertising**  
Larry Levine (603) 924-2637  
BYTE Publications  
One Phoenix Mill Lane  
Peterborough, NH 03458

Barry Echavarria (603) 924-2574  
BYTE Publications  
One Phoenix Mill Lane  
Peterborough, NH 03458

Patricia Payne (603) 924-2654  
BYTE Publications  
One Phoenix Mill Lane  
Peterborough, NH 03458

**National Sales**  
Scott Gagnon (603) 924-2651  
Mary Ann Goulding  
(603) 924-2664  
Elisa Lister (603) 924-2665  
BYTE Publications  
One Phoenix Mill Lane  
Peterborough, NH 03458

**BYTE Deck Mailings**  
Ed Ware (603) 924-6166  
BYTE Publications  
One Phoenix Mill Lane  
Peterborough, NH 03458

**A/E/C Computing Deck**  
Computing for Engineers  
Dan Harper (603) 924-2598  
BYTE Publications  
One Phoenix Mill Lane  
Peterborough, NH 03458

**Peterborough, NH Office**  
Advertising Fax: 603-924-7507

## International Advertising Sales Staff:

Frank Tanis, European Sales Manager, BYTE Publications,  
Batenburg 103, 3437 AB Nieuwegein, The Netherlands, tel: 31 34 02 49496, fax: 31 34 02 37944

Ros Weyman  
McGraw-Hill Publishing Co.  
34 Dover St.  
London W1X 4BR  
England 01 493 1451  
FAX: 01 493 9896

Alessandro Coari  
McGraw-Hill Publishing Co.  
Via Flavio Baracchini 1  
20123 Milan, Italy  
(2) 89010103  
FAX: (2) 879 400

Mrs. Maria Sarmiento  
Pedro Teixeira 8, Off. 320  
Iberia Mart I  
Madrid 4, Spain  
1 45 52 891

Masaki Mori  
McGraw-Hill Publishing Co.  
Overseas Corp.  
Room 1528  
Kasumigaseki Bldg.  
3-2-5 Kasumigaseki,  
Chiyoda-Ku  
Tokyo 100, Japan  
3 581 9811  
FAX: 81-3-581-4018

Seavex Ltd.  
503 Wilson House  
19-27 Wyndham St.  
Central, Hong Kong  
Tel: 5-260149  
Telex: 60904 SEVEX HX  
FAX: 852 5 810 1283

Seavex Ltd.  
400 Orchard Road, #10-01  
Singapore 0923  
Republic of Singapore  
Tel: 734-9790  
Telex: RS35539 SEAVEX  
FAX: 65 732 5129

Mr. Ernest McCrary  
Empresa Internacional de  
Comunicacoes Ltda.  
Rua da Consolacao, 222  
Conjuntio 103  
01302 Sao Paulo, S.P., Brasil  
Tel: (11) 259-3811  
Telex: (100) 32122 EMBN

# READER SERVICE

To get further information on the products advertised in BYTE, fill out the reader service card by circling the numbers on the card that correspond to the inquiry number listed with the advertiser. This index is provided as an additional service by the publisher, who assumes no liability for errors or omissions.

\* Correspond directly with company.

## Index to Advertisers by Product Category

Inquiry No.	Page No.	Inquiry No.	Page No.	Inquiry No.	Page No.	Inquiry No.	Page No.
<b>HARDWARE</b>							
<b>800</b>	<b>ADD INS</b>	205 LOGICAL DEVICES	453	111 DIGIBOARD	92	485 DAUPHIN TECHNOLOGY, INC	PC-3
401 ACER, INC.	IS-12,13	206 LOGICAL DEVICES	453	415 D-LINK LTD	IS-2	486 DAUPHIN TECHNOLOGY, INC	PC-3
22 ALPHA PRODUCTS	451	207 LOGICAL DEVICES	453	* ELONEX	IS-31	105 DELL COMPUTER	CH1,1
32 APPLIED DATA SYSTEMS, INC	98	208 LOGICAL DEVICES	453	154 GOODWAY	250	107 DELL COMPUTER	89
42 ATI TECHNOLOGIES	185	* MICROWAY	327	* IBM-SAA	10,11	* DELL COMPUTER	89A-B
528 BLUE CIRCLE GROUP, INC	NE-28	1227 SUMMA COMPUTER SYS	SO-12	178 INTELICOM INC	170	118 DTK	319
529 BLUE CIRCLE GROUP, INC	NE-28	380 WINTEK CORPORATION	452	177 INTELICOM INC	170	122 ELITE MICROSYSTEMS	294,295
85 B&C MICRO	457	381 XELTEK	460	211 MAG-RABBIT	117	124 ELTECH RESEARCH	152
66 B&C MICRO	457	<b>804 INSTRUMENTATION</b>		232 MICROCOM, INC (HARDWARE)	187	536 EPS TECHNOLOGIES, INC	NE-3
408 C SOURCE, INC	IS-56	21 ALLREGULATOR AB	466	253 NETWORK TECHNOLOGIES	462	537 EPS TECHNOLOGIES, INC	NE-3
70 CAPITAL EQUIPMENT	134	310 REAL TIME DEVICES	460	282 OST	48	* EPSON	20,21
71 CAPITAL EQUIPMENT	135	331 SOLUS SYSTEMS, INC	74	438 PROCOMP USA, INC	IS-46	142 FORTRON/SOURCE CORP	43
95 CONTROL VISION	454	<b>805 KEYBOARDS/MICE</b>		437 PROCOMP USA, INC	IS-46	143 FORTRON/SOURCE CORP	43
112 C&D TECHNOLOGY, INC	IS-34	75 CH PRODUCTS	151	318 SAMSUNG	70,71	538 FOUNTAIN TECHNOLOGIES, INC	NE-9
421 EDC GMBH	396	78 CH PRODUCTS	151	319 SAMSUNG	70,71	539 FUTURA SYSTEMS	NE-22
127 ENERTRONICS RESEARCH, INC	385	416 EECO	IS-41	388 SOFTWARE LINK	385	540 FUTURA SYSTEMS	NE-22
128 EOTRON	184	418 FOCUS ELECTRONIC CO	IS-37	399 SOFTWARE LINK	385	419 GALAXY	IS-52
129 EOTRON	184	385 HOOLEON CORP	418	567 TRANS-M CORP	NE-23	147 GATEWAY 2000	40A-D
130 EXCELLENCE MULTI-LAYER	66	209 LOGITECH	52,53	568 TRANS-M CORP	NE-23	366 GOLDSTAR TECHNOLOGY	322
491 EXCELOGIC, INC	PC-9	210 LOGITECH	52,53	571 TRANS-M CORP	NE-23	493 HALSKAR SYSTEMS	PC-15
492 EXCELOGIC, INC	PC-9	223 MEI	244	572 TRANS-M CORP	NE-23	494 HALSKAR SYSTEMS	PC-15
146 FTG DATA SYSTEMS	462	224 MEI	244	<b>811 PRINTERS/PLOTTERS</b>		541 HALSKAR SYSTEMS	NE-31
420 GAMMA PRODUCTIONS	IS-4	228 MEXTEL	266	17 AEG OLYMPIA	251	542 HALSKAR SYSTEMS	NE-31
182 HERCULES COMP. TECH	191	* MICROSOFT	87	48 A.M.T.	291	161 HAUPPAUGE COMPUTER WORKS	289
165 HIGH RES TECHNOLOGIES	466	229 MEXTEL	266	62 BROTHER INT'L CORP	254	166 HIMS COMPUTERS	46
168 HOME SMART COMPUTING	453	235 MICRO SPEED	34	163 BROTHER INT'L CORP	254	167 HITECH EQUIPMENT CORP	453
424 INES	IS-40	236 MICRO SPEED	34	163 BROTHER INT'L CORP	254	422 HWA HSIN	IS-30
181 IO TECH	214	280 NUMONICS	383	163 BROTHER INT'L CORP	254	* IBM-PS/2	164,165
182 IO TECH	464	290 PROHANCE TECHNOLOGIES	280,281	211 MAG-RABBIT	117	429 KAYPRO	IS-14
184 I.O. COMM	262	342 SUMMAGRAPHS	64,65	285 PACIFIC DATA PRODUCTS	79	193 KAYPRO COMPUTERS	120
189 JC INFORMATION SYSTEMS	429	343 SUMMAGRAPHS	64,65	266 PACIFIC DATA PRODUCTS	79	194 KAYPRO COMPUTERS	120
197 KMW SYSTEMS	155	344 SUMMAGRAPHS	64,65	271 PANASONIC (PRINTERS)	208,209	196 KISS COMPUTER	117
201 LAWSON LABS	452	<b>806 MASS STORAGE</b>		300 QMS	33	549 MASCOT COMPUTER CORP	NE-5
203 LINK COMPUTER GRAPHICS	459	20 AK SYSTEMS	482	301 QMS	33	550 MASCOT COMPUTER CORP	NE-5
204 LINK COMPUTER GRAPHICS	459	94 CONTECH COMPUTER CORP	460	356 TOSHIBA	252,253	222 MEGATEL	408
216 MAXCIMA CORPORATION	446	483 DATAMAG, INC	PC-24	521 ZERICON	PC-1	238 MICROTRONICS TRADE SERV	357
237 MICROSTAR LABORATORIES	462	484 DATAMAG, INC	PC-24	1211 ZERICON	MW-9	239 MICROWAY	306
239 MICROWAY	306	114 DIGI-DATA CORPORATION	457	1228 ZERICON	SO-1	554 MINTA TECHNOLOGY	NE-30
* MICROWAY	327	221 MEGA DRIVE SYSTEMS	87	<b>812 PRINTERS RIBBONS</b>		504 MULTIS CORPORATION	PC-24
504 MULTIS CORPORATION	PC-24	231 MICRO SOLUTIONS COMP.PROD	408	457 WORLD WIDE COPIER PARTS	IS-54	505 MULTIS CORPORATION	PC-24
505 MULTIS CORPORATION	PC-24	240 MITSUBISHI PLASTICS	340	<b>813 SCANNERS/IMAGE PROCESSORS</b>		1203 MYCOM COMPUTERS	MW-2
255 NOHAU CORPORATION	419	243 MOUNTAIN COMPUTER, INC	216,217	69 CANON-STILL VIDEO	73	1204 MYCOM COMPUTERS	MW-2
256 NOHAU CORPORATION	464	244 MOUNTAIN COMPUTER, INC	216,217	103 DATA TRANSLATION	109	254 NEXT COMPUTER	28,29
282 OST	48	263 OVERLAND DATA INC	446	138 FLAGSTAFF ENGINEERING	166	257 NORTHGATE COMPUTER	330,331
277 PERISCOPE	267	263 PINNACLE MICRO	311	164 HEWLETT-PACKARD PERIPH	156,157	258 NORTHGATE COMPUTER	333
278 PERISCOPE	267	284 PINNACLE MICRO	311	349 OMRON ELECTRONICS, INC	114	1221 OCTAGON TECHNOLOGIES	SO-7
281 PINNACLE SALES INT'L	450	304 QUALSTAR CORPORATION	454	1225 SQUARE FIELD CORP	SO-2	1222 OCTAGON TECHNOLOGIES	SO-7
509 PROCOMP USA, INC	PC-8	339 STORAGE DIMENSIONS	243	1226 SQUARE FIELD CORP	SO-2	349 OMRON ELECTRONICS, INC	114
510 PROCOMP USA, INC	PC-8	340 STORAGE DIMENSIONS	243	<b>814 SOFTWARE SECURITY</b>		558 ON LINE COMPUTER	NE-15
302 QUA TECH, INC	480	394 TULIN CORPORATION	78	18 ALADDIN KNOWLEDGE SYS	410	559 ON LINE COMPUTER	NE-15
303 QUA TECH, INC	480	395 TULIN CORPORATION	78	417 FAST ELECTRONIC GMBH	IS-26	433 OSICOM TECHNOLOGIES	IS-11
312 RUPP CORPORATION	485	<b>807 MISCELLANEOUS</b>		152 GLENCO ENGINEERING	317	270 PANASONIC (MONITORS)	23
313 RUPP CORPORATION	485	77 CIPHER DATA PROD	457	292 PROTECH MARKETING	61	274 PC DESIGNS	146
314 RUPP CORPORATION	485	139 FOCUS RESEARCH, INC	453	308 RAINBOW	283	580 PC LINK CORPORATION	NE-6
315 RUPP CORPORATION	485	175 INTEGRAND	212	309 RAINBOW	283	581 PC-PLUS TECHNOLOGIES	NE-19
316 RUPP CORPORATION	485	427 INWIN	IS-46	311 ROSE ELECTRONICS	183	582 PC-PLUS TECHNOLOGIES	NE-19
317 RUPP CORPORATION	485	225 MERRITT	418	330 SOFTWARE SECURITY	301	507 POLYWELL COMPUTERS	PC-23
325 SILICON SHACK	460	* SCANDEC TRIBUTOR	IS-62	<b>815 SYSTEMS</b>		508 POLYWELL COMPUTERS	PC-23
341 STSC	200	359 TRACE, INC	289	402 ACME TECHNOLOGY CORP	IS-44	307 RADIO SHACK	CIV
518 TELETEK	PC-9	<b>808 MODEMS/MULTIPLEXORS</b>		528 ADTECH	NE-13	585 RENEGADE CORPORATION	NE-29
519 TELETEK	PC-9	43 ATI TECHNOLOGIES	325	527 ADTECH	NE-13	439 SAMSUNG ELECTRONICS	IS-35
569 TELETEK	NE-27	411 CLEO SOFTWARE	IS-33	23 ADVANCED LOGIC RESEARCH	2,3	322 SCHWAB COMPUTER	459
570 TELETEK	NE-27	66 COMPUTUM	446	24 ADVANCED LOGIC RESEARCH	2,3	332 SOTA TECHNOLOGY	395
361 TRUEVISION	183	90 COMPUTER PERIPHERALS	373	403 AGC ELECTRONICS CORP	IS-51	1207 SYSTEMS INTEGRATION ASSOC	MW-12
363 TUSSEY COMPUTER PROD	236,237	91 COMPUTER PERIPHERALS	373	27 AMERICAN MITAC	293	1208 SYSTEMS INTEGRATION ASSOC	MW-12
364 TUSSEY COMPUTER PROD	236,239	425 INTERQUADRAM LIMITED	IS-5	* AMPRO	128	513 SYSTEMS INTEGRATION ASSOC	PC-32
370 U.S. VIDEO	482	219 MEGADATA	308	404 AQUARIUS SYSTEMS, INC	IS-39	514 SYSTEMS INTEGRATION ASSOC	PC-32
* VIDEO SEVEN	240	220 MEGADATA	308	34 AST RESEARCH	123	350 TATUNG	118,119
376 WEITEK	90,91	358 TOUCHBASE SYSTEMS, INC	36	35 AST RESEARCH	123	10 THIRD COAST TECH, INC	452
456 WINTECH ENTERPRISE CO, LTD	IS-10	* U.S. ROBOTICS	367	36 AST RESEARCH	125	446 TOPLINK	IS-32
<b>601 DRIVES</b>		<b>809 MONITORS</b>		37 AST RESEARCH	125	356 TOSHIBA	252,253
102 CURTIS, INC	407	401 ACER, INC	IS-12,13	41 AST RESEARCH	129	357 TOSHIBA	252,253
221 MEGA DRIVE SYSTEMS	87	25 AMDEK	390	* AT&T	48A-H	351 TP ENTERPRISE INC	466
* SEAGATE	149	426 INTERQUADRAM LIMITED	IS-7	40 AST RESEARCH	129	445 TP ENTERPRISE LTD	IS-38
<b>602 FACSIMILE</b>		246 NANAQ	193	41 AST RESEARCH	129	447 TRIANGLE DIGITAL	IS-54
530 COMPFAX	NE-25	247 NANAQ	193	404 AQUARIUS SYSTEMS, INC	IS-39	448 TRIGEM	IS-45
531 COMPFAX	NE-25	251 NEC HOME ELECTRONICS	38,39	34 AST RESEARCH	123	383 TUSSEY COMPUTER PROD	236,237
<b>603 HARDWARE PROGRAMMERS</b>		435 PHILIPS MONITORS	IS-17	37 AST RESEARCH	125	364 TUSSEY COMPUTER PROD	238,239
47 AVOCET & QUELO	453	<b>810 NETWORK HARDWARE</b>		38 AST RESEARCH	127	453 UNIBIT	IS-53
397 BP MICROSYSTEMS	458	15 ACS COMMUNICATIONS	457	39 AST RESEARCH	127	786 WEDGE TECHNOLOGY	226
64 BYTEK COMPUTER CORP	454	50 BAYTECH	383	40 AST RESEARCH	129	787 WEDGE TECHNOLOGY	226
65 B&C MICRO	457	51 BAYTECH	383	41 AST RESEARCH	129	377 WELLS AMERICAN	245
66 B&C MICRO	457	31 CONNEXPERTS	215	* AT&T	48A-H	378 WELLS AMERICAN	245
87 B&C MICRO	459	100 CUBIX CORPORATION	168	1214 A-TRONIC COMPUTER	SO-11	400 WINTEK	9
156 GTEK, INC	72	101 CUBIX CORPORATION	168	406 BEHAVIOR TECH COMP CORP	IS-55	386 Y.E.S. SYSTEMS CORP	447
157 GTEK, INC	72	<b>811 PRINTERS/PLOTTERS</b>		54 BIT WISE	463	387 Y.E.S. SYSTEMS CORP	447
198 KORE, INC	457	17 AEG OLYMPIA	251	55 BIT WISE	463	382 ZEOS INTERNATIONAL	278,279
199 K.E.M. ELECTRONIC	462	48 A.M.T.	291	478 BI-LINK COMPUTER	PC-17	383 ZEOS INTERNATIONAL	280,281
		62 BROTHER INT'L CORP	254	56 BLACKSHIP COMPUTER SYS	148	384 ZEOS INTERNATIONAL	282,283
		163 BROTHER INT'L CORP	254	408 C SOURCE, INC	IS-56	385 ZEOS INTERNATIONAL	284,285
		211 MAG-RABBIT	117	522 CDS	PC-18	<b>816 UPS</b>	
		285 PACIFIC DATA PRODUCTS	79	79 CLUB AMERICAN TECH	35	347 BEST POWER TECHNOLOGY	459
		266 PACIFIC DATA PRODUCTS	79	396 COMPUTER SYSTEMS RES	389	479 COMPUTER POWER, INC	PC-11
		271 PANASONIC (PRINTERS)	208,209	93 COMPUTRADE	66	480 COMPUTER POWER, INC	PC-11
		300 QMS	33	412 C&D TECHNOLOGY, INC	IS-34	125 EMERSON	161
		301 QMS	33			128 EMERSON	161
		356 TOSHIBA	252,253			272 PARA SYSTEMS	75
		357 TOSHIBA	252,253				



# READER SERVICE

Advertising Supplements included with this issue:  
 Jameco (U.S. and Canada Subscribers)

\* Correspond directly with company.

Inquiry No.	Page No.
<b>SOFTWARE</b>	
817	APPLE/MAC — CAD
33	ASHLAR, INC . . . . . 270
818	IBM/MSDOS APPLICATIONS Business/Office
405	ASTA DEVELOPMENT CORP . . . IS-81
409	CLARION SOFTWARE . . . . . IS-43
410	CLARION SOFTWARE . . . . . IS-43
393	COMPUTER ASSOCIATES . . . 378,379
110	DESCRIBE, INC . . . . . 304,305
144	FOX SOFTWARE . . . . . 24,25
178	INTELLIGENCEWARE . . . . . 37
551	MICCASOFT, INC . . . . . NE-12
552	MICCASOFT, INC . . . . . NE-12
1217	MICCASOFT, INC . . . . . SO-9
1218	MICCASOFT, INC . . . . . SO-9
499	MICRO DATABASE SYSTEMS . . . PC-29
553	MICRO DATABASE SYSTEMS . . . NE-8
1202	MICRO DATABASE SYSTEMS . . . MW-1
248	NANTUCKET . . . . . 339
431	NOVELL . . . . . IS-18
275	PC GLOBE . . . . . 41
306	QUARTERDECK . . . . . 130,131
	* RAIMA CORPORATION . . . . . 55
819	IBM/MSDOS APPLICATIONS Scientific/Technical
120	DYNAMICAL SYSTEMS, INC . . . 88
	* ECOSOFT, INC . . . . . 282
214	MATHSOFT . . . . . 51
	* MICROSOFT . . . . . 8,7
250	NATIONAL INSTRUMENTS . . . CII
273	PATTON & PATTON . . . . . 126
323	SCIENTIFIC ENDEAVORS . . . 458
324	SCIENTIFIC ENDEAVORS . . . NE-2
390	SCIENTIFIC ENDEAVORS . . . 458
334	SPECTRUM . . . . . 277
336	STATSOFT . . . . . 133
444	SYSTAT . . . . . IS-25
820	IBM/MSDOS APPLICATIONS Miscellaneous
136	FINALSOFT CORP . . . . . 300
137	FINALSOFT CORP . . . . . 300
150	GENESIS DATA SYSTEMS . . . 409
151	GENESIS DATA SYSTEMS . . . 409
189	HYPERKINETIX . . . . . 369
170	HYPERKINETIX . . . . . 369
	* KEYBOARD COMEDY . . . . . PC-25
202	LINGUISTIC PRODUCTS . . . . . 458
	* MICROSOFT . . . . . 85
573	ZEPHYR SERVICES . . . . . NE-22
821	IBM/MSDOS APPLICATIONS Word Processing
294	FRANKLIN/PROXIMITY . . . . . 192
295	FRANKLIN/PROXIMITY . . . . . 192
413	INT'L DESIGN AUTOMATION B.V. . . IS-24
822	IBM/MSDOS — CAD
26	AMERICAN SMALL BUS. COMP . . 141
269	AMS . . . . . 452
140	FORESIGHT RESOURCE . . . . . 249
141	FORESIGHT RESOURCE . . . . . 249
146	GENERIC SOFTWARE . . . . . 367
149	GENERIC SOFTWARE . . . . . 367
432	ORCAD . . . . . IS-21
506	ORCAD SYSTEMS CORP . . . . . PC-27
789	SAGE/POLYTRON . . . . . 421
249	ULTIMATE TECHNOLOGY . . . . . 466
400	WINTEK . . . . . 9
823	IBM/MSDOS COMMUNICATIONS
72	CENTURY SOFTWARE . . . . . 143
73	CENTURY SOFTWARE . . . . . 143
117	DIVERSIFIED COMPUTER . . . . . 454
195	KEA SYSTEMS . . . . . 257
233	MICROCOM INC (SOFTWARE) . . . 298
346	TALKING TECHNOLOGY . . . . . 462
451	TRITON TECHNOLOGIES . . . . . IS-27
452	TRITON TECHNOLOGIES . . . . . IS-27
824	IBM/MSDOS — GRAPHICS
467	DAYTRON ELECTRONICS, INC. . . . PC-4
212	MAP INFO . . . . . 96
226	METRO SOFTWARE, INC . . . . . 122

Inquiry No.	Page No.
227	METRO SOFTWARE, INC . . . . . 122
285	PINNACLE PUBLISHING . . . . . 197
286	PINNACLE PUBLISHING . . . . . 197
389	ZORTECH . . . . . 97
825	IBM/MSDOS — LAN
490	DRAGONSLAYER SYSTEMS . . . . . PC-7
179	INTERNATIONAL COMPUTER GR 413
252	NETWISE . . . . . 246
566	SUMMA COMPUTER SYS . . . . . NE-18
826	IBM/MSDOS — LANGUAGES
14	ABRAXAS SOFTWARE . . . . . 362
60	BORLAND INTERNATIONAL . . . . . 13
61	BORLAND INTERNATIONAL . . . . . 13
83	CNS, INC . . . . . 158
113	DIGITALK . . . . . 144,145
	* JENSEN & PARTNERS INT'L . . . 137
190	JYACC, INC . . . . . 375
181	JYACC, INC . . . . . 375
200	LAHEY COMPUTER SYSTEMS . . . 235
217	MAXEM CORPORATION . . . . . 286
	* MICROSOFT . . . . . 19
	* MICROSOFT . . . . . 45
	* MICROWAY . . . . . 327
	* ORACLE . . . . . 69
442	STONY BROOK SOFTWARE . . . . . IS-59
443	STONY BROOK SOFTWARE . . . . . IS-59
353	THE SMALL COMPUTER CO . . . . 264
354	THE SMALL COMPUTER CO . . . . 264
369	UNIVERSAL CROSS-ASSEMBLER 458
372	VESTRONIX . . . . . 359
391	ZORTECH . . . . . 27
827	IBM/MSDOS — UTILITIES
14	ABRAXAS SOFTWARE . . . . . 382
44	ATRON . . . . . 31
45	ATTACHMATE . . . . . 169
46	AVOCET . . . . . 338
57	BLAISE COMPUTING . . . . . 47
58	BOLT SYSTEMS . . . . . 160
59	BOLT SYSTEMS . . . . . 160
83	CNS, INC . . . . . 158
109	DEPARTMENTAL TECHNOLOGIES . . 186
488	DISKTEC . . . . . PC-16
489	DISKTEC . . . . . PC-16
414	DR. HUGGLE & PARTNER . . . . . IS-42
533	DTG, INC . . . . . NE-24
534	DTG, INC . . . . . NE-24
1215	DTG, INC . . . . . SO-6
1216	DTG, INC . . . . . SO-6
134	FAIRCOP CORPORATION . . . . . 229
135	FAIRCOP CORPORATION . . . . . 229
153	GOLDEN BOW SYSTEMS . . . . . 190
159	HAMMERLY COMPUTER SERV . . . 204
160	HAMMERLY COMPUTER SERV . . . 205
423	I X I . . . . . IS-52
495	ISLAND SYSTEMS . . . . . PC-2
496	ISLAND SYSTEMS . . . . . PC-2
190	JYACC, INC . . . . . 375
191	JYACC, INC . . . . . 375
217	MAXEM CORPORATION . . . . . 286
498	METAWARE, INC . . . . . PC-28
241	MIX SOFTWARE . . . . . 353
242	MKS . . . . . 138
259	NU MEGA . . . . . 259
280	PHAR LAP . . . . . 256
306	QUARTERDECK . . . . . 130,131
321	SAX SOFTWARE . . . . . 196
326	SKISOFT PUBLISHING CORP . . . . 456
441	SOFTWARE CONSTRUCTION . . . . IS-47
337	STERLING CASTLE . . . . . 315
338	STERLING CASTLE . . . . . 315
345	SUPERSOFT . . . . . 386
353	THE SMALL COMPUTER CO . . . . 264
354	THE SMALL COMPUTER CO . . . . 264
360	TRAVELING SOFTWARE . . . . . 199
362	TURBOPower SOFTWARE . . . . . 432
	* VERMONT CREATIVE SOFTWARE 16
372	VESTRONIX . . . . . 359
373	WARD SYSTEMS GROUP . . . . . 150
374	WARD SYSTEMS GROUP . . . . . 150
391	ZORTECH . . . . . 27
828	OTHER APPLICATIONS Business/Office
97	CRICHLow . . . . . 452
829	OTHER APPLICATIONS Scientific/Technical
49	A/SOFT DEVELOPMENT . . . . . 142

Inquiry No.	Page No.
830	OTHER — CROSS DEVELOPMENT
	* SOFTWARE DEVELOPMENT SYS . . 83
831	OTHER — LANGUAGES
53	BINARY TECHNOLOGY . . . . . 464
145	FRANKLIN SOFTWARE, INC . . . . 407
832	DESKTOP PUBLISHING
	* ADOBE SYSTEMS, INC . . . . . 224
110	DESCRIBE, INC . . . . . 304,305
215	MATRIX SOFTWARE TECH . . . . . 232
230	MICRO PRESS . . . . . 232
267	PACIFIC DATA PRODUCTS . . . . 195
268	PACIFIC DATA PRODUCTS . . . . 195
279	PERSONAL TEX . . . . . 206
321	SAX SOFTWARE . . . . . 196
833	EDUCATIONAL/INSTRUCTIONAL
12	ABACUS SOFTWARE . . . . . 42
13	ABACUS SOFTWARE . . . . . 42
30	ANNABOOKS . . . . . 447
407	BIX . . . . . IS-63
500	BIX . . . . . PC-30
	* BYTE BACK ISSUES . . . . . 445
	* BYTE BACK ISSUES . . . . . IS-50
63	BYTE BITS . . . . . 452
458	BYTE BITS . . . . . IS-52
	* BYTE PUBLICATIONS . . . . . IS-64
	* BYTE SUB MESSAGE . . . . . 228
	* BYTE SUB MESSAGE . . . . . IS-40
	* BYTEWEEK/NEWSLETTER . . . . . 487
	* BYTEWEEK/NEWSLETTER . . . . . MW-4
	* BYTEWEEK/NEWSLETTER . . . . . NE-28
	* BYTEWEEK/NEWSLETTER . . . . . PC-12
	* BYTEWEEK/NEWSLETTER . . . . . SO-4
	* CCM/MCGRAW-HILL . . . . . IS-28
74	CETRA . . . . . 393
155	GTE DATA SERVICES . . . . . 274
119	KNOWLEDGE GARDEN . . . . . 483
	* MCGRAW-HILL BOOKSTORE . . . . 132
	* MCGRAW-HILL BOOKSTORE . . . . 374
261	OSBORNE MCGRAW-HILL . . . . . 426
834	MAIL ORDER/RETAIL
478	3-F ASSOCIATES, INC . . . . . PC-31
11	AASHIMA TECHNOLOGY B.V. . . . 351
16	ADVANTAGE SOFTWARE . . . . . 221
26	AMERICAN GROUP . . . . . 459
477	A-TRONIC COMPUTER . . . . . PC-6
788	B&B ELECTRONICS . . . . . 464
	* CALIFORNIA DIGITAL . . . . . 467
78	CLONE COMPUTER . . . . . 455
80	CMO . . . . . 100,101
81	CMO . . . . . 102,103
82	CMO . . . . . 104,105
84	COMPACT DISK PRODUCTS . . . . . 99
85	COMPUCLASSICS . . . . . 210
88	COMPUTER DISCOUNT WAREHOUSE 431
532	COMPUTER EXPERT, INC . . . . . NE-14
89	COMPUTER FRIENDS . . . . . 162
502	COMPUTER WHOLESALE CLUB . . . . PC-19
503	COMPUTER WHOLESALE CLUB . . . . PC-19
92	COMPUTERLINK . . . . . 481
96	COVox . . . . . 454
1201	DAKOTA COMPUTER . . . . . MW-5
104	DATATRONICS . . . . . 458
106	DELTA COMPUTING TECH . . . . . 454
115	DISKOTECH TECHNOLOGIES . . . . 460
116	DISKETTE CONNECTION . . . . . 453
119	DYNAMIC ELECTRONICS CO . . . . . 447
535	ELECTRIFIED DISCOUNTERS . . . . NE-21
123	ELS ENTERPRISES, LTD . . . . . 218
131	EXECUTIVE PHOTO & SUPPLY . . . . 402
132	EXSEL . . . . . 78
133	EXSEL . . . . . 235
421	GREY MATTER . . . . . IS-57
158	G. REED, INC . . . . . 464
543	HARMONY COMPUTERS . . . . . NE-11
544	HARMONY COMPUTERS . . . . . NE-11
174	INMAC . . . . . 192
160	INVENTORY MARKETING . . . . . 459
426	IPANEMA ENTERPRISES . . . . . IS-8
163	I.C. EXPRESS . . . . . 457
165	JADE . . . . . 207

Inquiry No.	Page No.
186	JAMECO . . . . . 448,449
187	JB TECHNOLOGIES . . . . . 447
188	JB TECHNOLOGIES . . . . . 447
6	J.D.R. . . . . 468,469
6	J.D.R. . . . . 470,471
6	J.D.R. . . . . 472,473
7	J.D.R. . . . . 468,469
7	J.D.R. . . . . 470,471
7	J.D.R. . . . . 472,473
545	LAPTOPS ETC . . . . . NE-4
548	MAGITRONIC TECHNOLOGY . . . . . NE-32
	* MANCHESTER EQUIPMENT CO . . . . NE-1
213	MARYMAC INDUSTRIES . . . . . 454
430	MAYFAIR MICROS . . . . . IS-49
218	MEAD COMPUTER . . . . . 465
	* MICROCOMPUTER MKTG CNSL . . . 481
234	MICROPROCESSORS UNLIMITED . . . 458
1219	MIGHTY MICRO . . . . . SO-3
1220	MIGHTY MICRO . . . . . SO-3
	* MONTGOMERY GRANT . . . . . 370
555	MPM . . . . . NE-7
556	MPM . . . . . NE-7
557	M.S.C . . . . . NE-17
245	NAGAN CORPORATION . . . . . 452
1205	NEXT WORKS, THE . . . . . MW-3
1206	NEXT WORKS, THE . . . . . MW-3
264	PACIFIC COMPUTERS . . . . . 450
434	PACIFIC TECH WONG & CO . . . . . IS-6
276	PC NETWORK . . . . . 275
583	POINTECH DISTRIBUTORS . . . . . NE-2
584	POINTECH DISTRIBUTORS . . . . . NE-2
288	PRIORITY ONE COMPUTER . . . . . 227
289	PROGRAMMERS PARADISE . . . . . 58,59
296	P.C. BRAND . . . . . 171
297	P.C. BRAND . . . . . 172,173
298	P.C. BRAND . . . . . 174,175
299	P.C. BRAND . . . . . 178,177
438	QUOTHA 32 . . . . . IS-54
511	RESOURCE CONCEPTS, INC . . . . . PC-5
512	RESOURCE CONCEPTS, INC . . . . . PC-5
1223	RESOURCE CONCEPTS, INC . . . . . SO-5
1224	RESOURCE CONCEPTS, INC . . . . . SO-5
440	SCOTTSDALE SYSTEMS . . . . . IS-29
327	SN'W COMP & ELECT . . . . . IS-23
	* SOFTLINE CORPORATION . . . . . IS-23
515	SOFTWARE ENGINEERING STORE PC-13
8	SOFTWARE SAMPLER CLUB . . . . . 140
9	SOFTWARE SAMPLER CLUB . . . . . 140
333	SOUTH COAST ELECTRONICS . . . . 459
335	STARTECH . . . . . 113
346	SURAH, INC . . . . . 457
352	TELEPHONE PRODUCTS CTR . . . . 124
363	TUSSEY COMPUTER PROD . . . . . 236,237
364	TUSSEY COMPUTER PROD . . . . . 236,239
367	UNICORN ELECTRONICS . . . . . 464
368	UNIXTEC, INC . . . . . 456
	* UNIXWORLD . . . . . PC-22
454	USA SOFTWARE . . . . . IS-9
375	WAREHOUSE DATA PROD . . . . . 231
835	MISCELLANEOUS
	* ANTHRO . . . . . 98
	* AVIS . . . . . 415
392	SAFWARE, INC . . . . . 464
449	TWINHEAD . . . . . IS-58
836	ON-LINE SERVICES
	* BIX . . . . . 332,377
450	BIX . . . . . 400,401
87	COMPUERVE . . . . . 397
461	DATA SOLVERS, INC . . . . . PC-16
462	DATA SOLVERS, INC . . . . . PC-16
837	OPERATING SYSTEMS
112	DIGITAL RESEARCH . . . . . 203
	* IBM-AIX . . . . . 76,77
	* IBM-OS/2 . . . . . 320,321
171	IGC . . . . . 309
172	IGC . . . . . 309
192	KADAK PRODUCTS . . . . . 250
305	QUANTUM SOFTWARE . . . . . 63
320	SANTA CRUZ OPERATION . . . . . 57
326	SOFTWARE LINK . . . . . 273
329	SOFTWARE LINK . . . . . 273
516	STARPATH SYSTEMS, INC . . . . . PC-21
517	STARPATH SYSTEMS, INC . . . . . PC-21
341	STSC . . . . . 200

# REQUEST FREE INFORMATION BY FAX

Attention **BYTE** Readers!! Now you can fax your requests for free product and advertiser information featured in this issue.

Just fax this page to 1-413-637-4343. You'll save time because your request for information will be processed as soon as your fax is received.

**1** Circle the numbers below which correspond to the numbers assigned to advertisers and products that interest you.

**2** Check off the answers to questions "A" through "C".

**3** Print your name, address, and fax number clearly on the form.

**4** Remove this page or copy this page clearly and fax it to the number above.

Fill out this coupon carefully. PLEASE PRINT.

Name \_\_\_\_\_

Title \_\_\_\_\_

Company \_\_\_\_\_

Address \_\_\_\_\_

City \_\_\_\_\_

State/Province \_\_\_\_\_ Zip \_\_\_\_\_

Country \_\_\_\_\_

(\_\_\_\_\_) (\_\_\_\_\_) \_\_\_\_\_

Phone Number \_\_\_\_\_ Fax Number \_\_\_\_\_

**A. What is your level of management responsibility?**

- 1  Senior-level Management
- 2  Other Management
- 3  Non-Management

**B. What is your primary job function/principal area of responsibility? (Check one.)**

- 4  Administration
- 5  Accounting/Finance
- 6  MIS/DP/Information Center
- 7  Product Design and Development
- 8  Research and Development
- 9  Manufacturing
- 10  Sales/Marketing
- 11  Purchasing
- 12  Personnel
- 13  Education/Training
- 14  Other: \_\_\_\_\_

**C. Please indicate your organization's primary business activity: (Check one.)**

**Computer-Related Businesses:**

- 15  Manufacturer (Hardware, Software)
- 16  Computer Retail Stores
- 17  Consultants
- 18  Service Bureau/Planning
- 19  Distributor/Wholesaler
- 20  Systems House/Integrator/VAR
- 21  Other: \_\_\_\_\_

**Non-Computer-Related Businesses:**

- 22  Manufacturing
- 23  Finance, Insurance, Real Estate
- 24  Retail/Wholesale
- 25  Education
- 26  Government
- 27  Military
- 28  Professions (Law, Medicine, Engineering, Architecture)
- 29  Consulting
- 30  Other Business Services
- 31  Transportation, Communications, Utilities
- 32  Other: \_\_\_\_\_

I subscribe to **BYTE**.  I do not subscribe to **BYTE**.  
 Please send me one year of **BYTE** Magazine for \$24.95 and bill me. Offer valid in U.S. and possessions only.

1	2	3	4	5	6	7	8	9	10	11	12	13	14	15	16	17	18	19	20
21	22	23	24	25	26	27	28	29	30	31	32	33	34	35	36	37	38	39	40
41	42	43	44	45	46	47	48	49	50	51	52	53	54	55	56	57	58	59	60
61	62	63	64	65	66	67	68	69	70	71	72	73	74	75	76	77	78	79	80
81	82	83	84	85	86	87	88	89	90	91	92	93	94	95	96	97	98	99	100
101	102	103	104	105	106	107	108	109	110	111	112	113	114	115	116	117	118	119	120
121	122	123	124	125	126	127	128	129	130	131	132	133	134	135	136	137	138	139	140
141	142	143	144	145	146	147	148	149	150	151	152	153	154	155	156	157	158	159	160
161	162	163	164	165	166	167	168	169	170	171	172	173	174	175	176	177	178	179	180
181	182	183	184	185	186	187	188	189	190	191	192	193	194	195	196	197	198	199	200
201	202	203	204	205	206	207	208	209	210	211	212	213	214	215	216	217	218	219	220
221	222	223	224	225	226	227	228	229	230	231	232	233	234	235	236	237	238	239	240
241	242	243	244	245	246	247	248	249	250	251	252	253	254	255	256	257	258	259	260
261	262	263	264	265	266	267	268	269	270	271	272	273	274	275	276	277	278	279	280
281	282	283	284	285	286	287	288	289	290	291	292	293	294	295	296	297	298	299	300
301	302	303	304	305	306	307	308	309	310	311	312	313	314	315	316	317	318	319	320
321	322	323	324	325	326	327	328	329	330	331	332	333	334	335	336	337	338	339	340
341	342	343	344	345	346	347	348	349	350	351	352	353	354	355	356	357	358	359	360
361	362	363	364	365	366	367	368	369	370	371	372	373	374	375	376	377	378	379	380
381	382	383	384	385	386	387	388	389	390	391	392	393	394	395	396	397	398	399	400
401	402	403	404	405	406	407	408	409	410	411	412	413	414	415	416	417	418	419	420
421	422	423	424	425	426	427	428	429	430	431	432	433	434	435	436	437	438	439	440
441	442	443	444	445	446	447	448	449	450	451	452	453	454	455	456	457	458	459	460
461	462	463	464	465	466	467	468	469	470	471	472	473	474	475	476	477	478	479	480
481	482	483	484	485	486	487	488	489	490	491	492	493	494	495	496	497	498	499	500
501	502	503	504	505	506	507	508	509	510	511	512	513	514	515	516	517	518	519	520
521	522	523	524	525	526	527	528	529	530	531	532	533	534	535	536	537	538	539	540
541	542	543	544	545	546	547	548	549	550	551	552	553	554	555	556	557	558	559	560
561	562	563	564	565	566	567	568	569	570	571	572	573	574	575	576	577	578	579	580
581	582	583	584	585	586	587	588	589	590	591	592	593	594	595	596	597	598	599	600
601	602	603	604	605	606	607	608	609	610	611	612	613	614	615	616	617	618	619	620
621	622	623	624	625	626	627	628	629	630	631	632	633	634	635	636	637	638	639	640
641	642	643	644	645	646	647	648	649	650	651	652	653	654	655	656	657	658	659	660
661	662	663	664	665	666	667	668	669	670	671	672	673	674	675	676	677	678	679	680
681	682	683	684	685	686	687	688	689	690	691	692	693	694	695	696	697	698	699	700
701	702	703	704	705	706	707	708	709	710	711	712	713	714	715	716	717	718	719	720
721	722	723	724	725	726	727	728	729	730	731	732	733	734	735	736	737	738	739	740
741	742	743	744	745	746	747	748	749	750	751	752	753	754	755	756	757	758	759	760
761	762	763	764	765	766	767	768	769	770	771	772	773	774	775	776	777	778	779	780
781	782	783	784	785	786	787	788	789	790	791	792	793	794	795	796	797	798	799	800
801	802	803	804	805	806	807	808	809	810	811	812	813	814	815	816	817	818	819	820
821	822	823	824	825	826	827	828	829	830	831	832	833	834	835	836	837	838	839	840
841	842	843	844	845	846	847	848	849	850	851	852	853	854	855	856	857	858	859	860
861	862	863	864	865	866	867	868	869	870	871	872	873	874	875	876	877	878	879	880
881	882	883	884	885	886	887	888	889	890	891	892	893	894	895	896	897	898	899	900
901	902	903	904	905	906	907	908	909	910	911	912	913	914	915	916	917	918	919	920
921	922	923	924	925	926	927	928	929	930	931	932	933	934	935	936	937	938	939	940
941	942	943	944	945	946	947	948	949	950	951	952	953	954	955	956	957	958	959	960
961	962	963	964	965	966	967	968	969	970	971	972	973	974	975	976	977	978	979	980
981	982	983	984	985	986	987	988	989	990	991	992	993	994	995	996	997	998	999	1000
1001	1002	1003	1004	1005	1006	1007	1008	1009	1010	1011	1012	1013	1014	1015	1016	1017	1018	1019	1020
1021	1022	1023	1024	1025	1026	1027	1028	1029	1030	1031	1032	1033	1034	1035	1036	1037	1038	1039	1040
1041	1042	1043	1044	1045	1046	1047	1048	1049	1050	1051	1052	1053	1054	1055	1056	1057	1058	1059	1060
1061	1062	1063	1064	1065	1066	1067	1068	1069	1070	1071	1072	1073	1074	1075	1076	1077	1078	1079	1080
1081	1082	1083	1084	1085	1086	1087	1088	1089	1090	1091	1092	1093	1094	1095	1096	1097	1098	1099	1100
1101	1102	1103	1104	1105	1106	1107	1108	1109	1110	1111	1112	1113	1114	1115	1116	1117	1118	1119	1120
1121	1122	1123	1124	1125	1126	1127	1128	1129	1130	1131	1132	1133	1134	1135	1136	1137	1138	1139	1140
1141	1142	1143	1144	1145	1146	1147	1148	1149	1150	1151	1152	1153	1154	1155	1156	1157	1158	1159	1160
1161	1162	1163	1164	1165	1166	1167	1168	1169	1170	1171	1172	1173	1174	1175	1176	1177	1178	1179	1180
1181	1182	1183	1184	1185	1186	1187	1188	1189	1190	1191	1192	1193	1194	1195	1196	1197	1198	1199	1200
1201	1202	1203	1204	1205	1206	1207	1208	1209	1210	1211	1212	1213	1214	1215	1216	1217	1218	1219	1220
1221	1222	1223	1224	1225	1226	1227	1228	1229	1230										



# Buy with Confidence

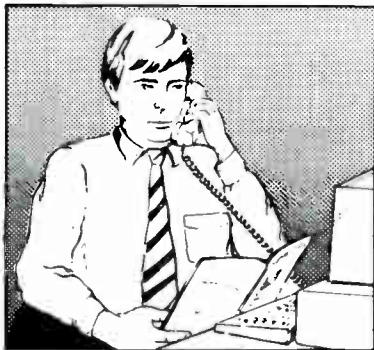

In an effort to make your telephone purchasing a more successful and pleasurable activity, The Microcomputer Marketing Council of the Direct Marketing Association, Inc. offers this advice, "A knowledgeable buyer will be a successful buyer." These are specific facts you should know about the prospective seller before placing an order:

## Ask These Important Questions

- How long has the company been in business?
- Does the company offer technical assistance?
- Is there a service facility?
- Are manufacturer's warranties handled through the company?
- Does the seller have formal return and refund policies?
- Is there an additional charge for use of credit cards?
- Are credit card charges held until time of shipment?
- What are shipping costs for items ordered?

Reputable computer dealers will answer all these questions to your satisfaction. Don't settle for less when buying your computer hardware, software, peripherals and supplies.

## Purchasing Guidelines

- State as completely and accurately as you can what merchandise you want including brand name, model number, catalog number.
- Establish that the item is in stock and confirm shipping date.
- Confirm that the price is as advertised.
- Obtain an order number and identification of the sales representative.
- Make a record of your order, noting exact price including shipping, date of order, promised shipping date and order number.

If you ever have a problem, remember to deal first with the seller. If you cannot resolve the problem, write to MAIL ORDER ACTION LINE, c/o DMA, 6 E. 43rd St., New York, NY 10017.

This message is brought to you by:

the MICROCOMPUTER  
MARKETING COUNCIL  
of the Direct Marketing  
Association, Inc.  
6 E. 43rd St.,  
New York, NY 10017

**MMC**  
MICROCOMPUTER  
MARKETING COUNCIL  
of the Direct Marketing Association, Inc.

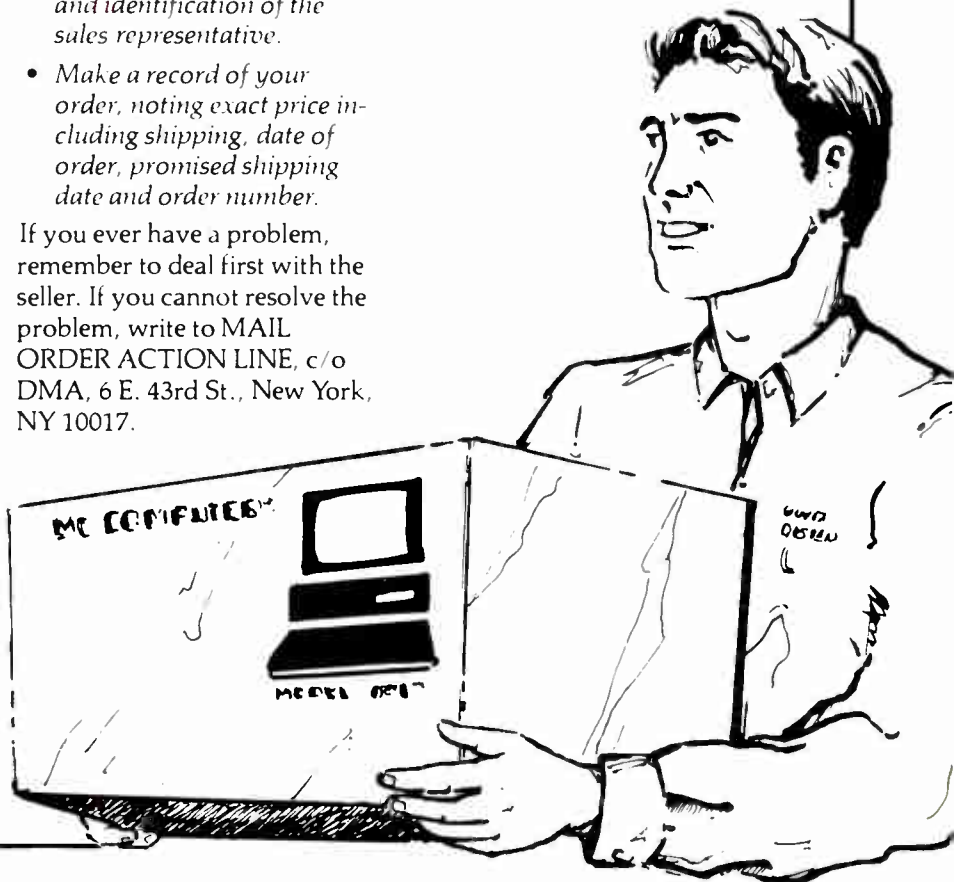

continued from page 432

number and a buffer pointer. In my application, the first character of the message buffer contains either a "D"—indicating that the message buffer holds data—or an "E"—indicating that the message buffer is empty and the complete contents of the file have been transmitted. It's not unlike the way XMODEM works, only I don't supply any error-checking and correcting code. NetBIOS does that.

The heart of the program is a simple loop. The program reads a 1K-byte block from the file, places the data in the message buffer, and sends the message out using the NBios\_SessionSend() function. The receiving end is doing much the same thing: receiving the data and writing it to the file, looping until it receives an EOF (End of File) block.

It's important to note that, once the session is established, the application issuing the CALL command has no special advantage over the application issuing the RECEIVE command. Communication between session partners is bidirectional; both sides of the session can send as well as receive.

Once the business of a session has con-

cluded, both sides terminate the session by calling the HANG UP command. If any RECEIVE commands are pending, they're terminated. If any SEND commands are still awaiting completion, NetBIOS delays the HANG UP until those commands have either completed or timed out. My sample program follows the HANG UP command with a DELETE NAME command, clearing the local session name from the name table.

### Hang Up

This has been only a brief foray into the coaxial-canopied jungles of networking. There's a great deal more to AppleTalk and NetBIOS that I haven't covered here; you'll have to explore it on your own. By now, however, you should be over your fear of network programming being something just this side of alchemy.

I've included a bibliography of some great sources of information on NetBIOS and AppleTalk. Like me, you'll be amazed at what you can do with software and hardware that—seen from the future of fiber-optic LANs stretching across the globe—will surely seem not much more than two tin cans and some string. ■

Editor's note: *This month's program comes in three parts. NETSEND.C sends a file via NetBIOS to the NETREC.C program. Both make use of a library of NetBIOS routines in NETLIB.C. All source code is available in a variety of formats. See page 5 for details.*

### BIBLIOGRAPHY

Haugdahl, Scott. *Inside NetBIOS*. Minneapolis, MN: Architecture Technology Corp., 1986.

Schwaderer, W. David. *C Programmer's Guide to NetBIOS*. Indianapolis, IN: Howard W. Sams, 1988.

Sidhu, Gursharan S., Richard F. Andrews, and Alan B. Oppenheimer. *Inside AppleTalk*. Reading, MA: Addison-Wesley, 1989.

*Rick Grehan is the director of the BYTE Lab. He has a B.S. in physics and applied mathematics and an M.S. in computer science/mathematics from Memphis State University. He can be reached on BIX as "rick\_g."*

*Your questions and comments are welcome. Write to: Editor, BYTE, One Phoenix Mill Lane, Peterborough, NH 03458.*

# WORLDS APART FROM ANY OTHER:

# USVideo™

and designed for today's video generation.  
The world's first 16-bit video card that displays VGA text & graphics on TV or VGA monitors!  
Records presentation & animation software onto VCRs/video tape—conforms to NTSC RS170A broadcast quality. Genlock capability.  
Available at leading computer stores.

MADE IN THE U.S.A.





# Knowledge Processing

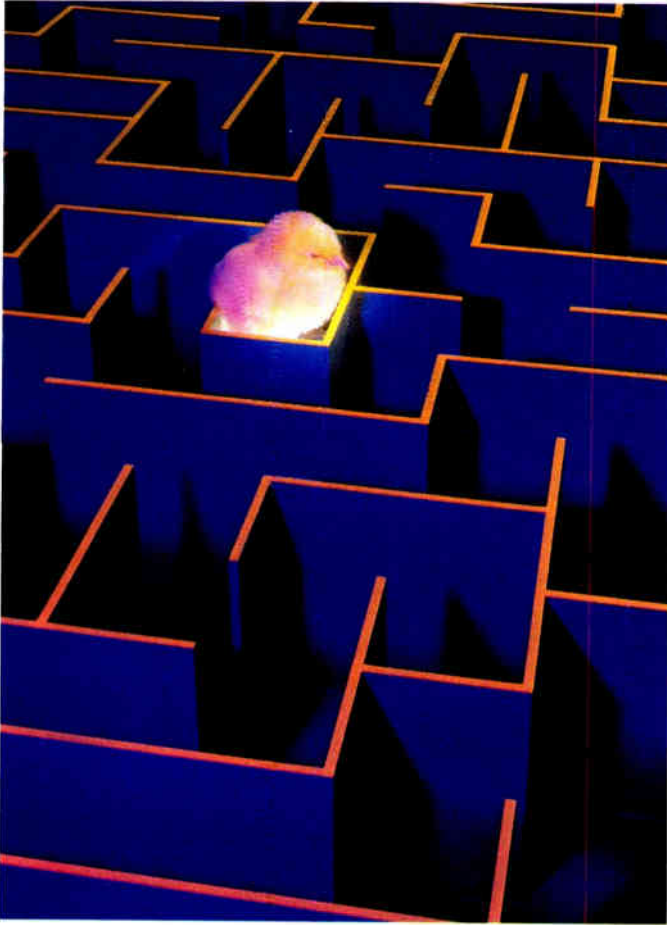

**Don't leave your users  
lost in a maze of  
information!**

A knowledge processor communicates knowledge - the natural extension of everything we do on a computer.

It's the intelligent integration of everyday resources like data, text, logic, graphics, and video that turns information into knowledge.

KnowledgePro is the first knowledge processor. It combines a high-level, object-oriented programming language with hypertext and expert systems technology.

KnowledgePro gives you a total development environment with the tools you need to create intelligent multi-media applications.

**PC Magazine, Holland...** *"KnowledgePro is the first of a new generation of software, the knowledge processor...it has the power of, for example, Pascal or PROLOG, but the programmer isn't troubled with the technical details."*

**PC Week, USA...** *"It's rare, but every so often a PC application comes along that breaks new ground and creates a fundamentally different way to use computers. According to its corporate users...KnowledgePro does just that."*

**Infoworld...** *"We don't live in a computational world. If we're going to move knowledge around we need tools...The same person who will learn macros in Lotus can learn this."*

**KnowledgePro** costs \$495 with no runtime fees. It runs on IBM PC, XT, AT and PS/2 compatible machines with 640k of memory and a hard disk. A working demo with a 100 page manual is available for \$33 including shipping (\$38 foreign) with credit towards purchase of the full system.

**Find out what knowledge processing is all about. Call 518-766-3000** (FAX 518-766-3003) or write to Knowledge Garden Inc., 473A Malden Bridge Rd., Nassau, NY 12123, USA. Amex, Visa or M/C accepted.

**KnowledgePro®**  
**The intelligent way out**

Circle 19 on Reader Service Card

Another  
intelligent  
tool from



# PRINT QUEUE

Hugh Kenner

## Bytes on Wings

BEYOND THE LIMITS:  
Flight Enters the Computer Age

by Paul E. Ceruzzi

About 1800 it occurred to Napoleon that France, which had given the world the metric system, should also sponsor the world's first truly accurate log tables. When he snapped his imperial fingers, lo, it got done! It was done, in effect, by computer. High-level sages chose the algorithms. Programmers (as we'd now call them) worked out sequences of steps to transform each input into a multidigit real number. Now for the hardware....

That consisted of numerous men with quill pens, seated at trestle tables on a vast gymnasium floor. This even pioneered the RISC philosophy, the men having been chosen for deft adding and subtracting, undistracted by any temptation to multiply or divide. The latter were dodges they had somehow never been taught, and specialists of their ilk were at a premium. Someone had observed that a man who added 3.99 to itself five times made fewer mistakes than a wise fool tempted by the highbrow shortcut of just multiplying 3.99 by 6. (The Greeks, by the way, had a word for wise fool: It's *sophomore*.)

Turn now to figure 2.5 of *Beyond the Limits*. In the late 1940s, little seems to have changed. We're in a "bull pen" at McDonnell Douglas, where an airplane is being designed. The photograph, which includes just a part of the room, is something that Franz Kafka might have hallucinated. In shirtsleeves, clutching ballpoints, perhaps 100 people hunch over papers. We're to imagine dozens more out of the frame to left and right; imagine, too, all of them putting in tense 8-hour days.

That's a snapshot of the computational machine that had put away the bad old times when "airplanes with structures too weak crashed, while others flew safely but poorly because they were overweight." For we now have "an adequate theory of structural analysis." Unhappily, it demanded millions of calculations.

Then somebody at Northrop Aircraft noticed in the accounting department an amenity the engineers didn't have: a vacuum-tube gizmo from IBM "that could multiply two numbers together and punch the results on a card in a few seconds." One got borrowed and was connected to another IBM machine that could print results on paper. And at IBM, where the policy of renting, not selling, equipment implied a captive customer unfree to make modifications, they were nonplussed at first, then alerted. Aha! "The basis for a new product they could sell to engineering firms that might otherwise not buy from IBM." That's the understatement of the century. Thus, 1949 gave us IBM's Card Programmed Calculator.

And we're off. The theme of Paul E. Ceruzzi's fascinating book is simply that the American computer industry was aerospace-driven from the very start. It was aerospace that *needed* all that number crunching. As I've noted in a previous column,

astronomers also needed it. Astronomers, though, could never put federal billions on the table. The national interest is more tightly involved with the B-52 than with the orbit of Pluto.

The Pentagon, for years "the largest office building in the world," was built in 1942 to house myriad clerks doing what the erudite serfs in that McDonnell Douglas photo are doing: chores like working out how to "train a maximum number of pilots in a minimum time period with a minimum number of training airplanes and instructors."

That led to SCOOP (scientific computation of optimum problems), which by 1948 George Dantzig had reduced to sets of linear inequalities. Those sets—you guessed it—could finesse the problem, but they entailed scads of computation. (A sample query—what's in the cheapest bag of groceries with your minimum daily requirement of merely nine nutrients?—consumed 21 days at desk calculators.)

*continued*

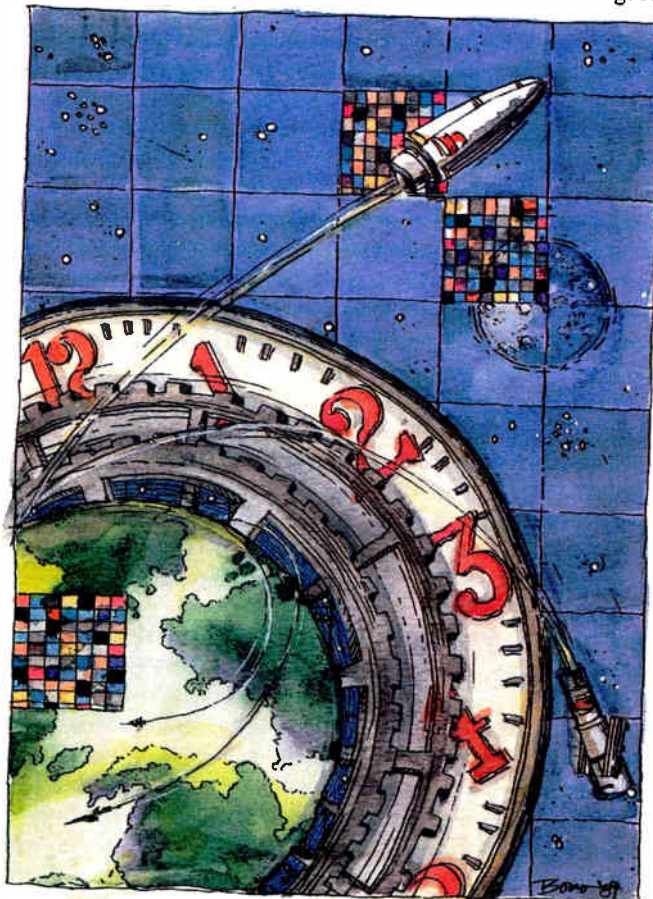



# Rupp Corporation Presents Power Products Showcase No. 22

Circle 317 on Reader Service Card



## XIRCOM

The Xircom Pocket Ethernet Adapter allows you to conveniently connect any IBM compatible personal computer to an Ethernet or IEEE 802.3 local area network. This adapter connects externally to any parallel printer port, eliminating the hassles of installing an internal Ethernet adapter.

It's the only adapter that can easily be used with laptop computers and is also an ideal choice for workstations where board slots or power are at a premium.

The Pocket Ethernet Adapter is also an economical choice for a group of in-

requent network users because it can be quickly and easily moved from computer to computer. It contains no configuration switches, completely avoiding the problems of address and interrupt conflicts common with other Ethernet adapters. Drivers for Novell Netware version 2.0 and 2.1 are included.

**Features:**  
Uses LPT port.  
For all IBM compatibles.  
Network 2.x compatible.  
IEEE 802.3 standard.

**PRICE**

**\$695**

Circle 316 on Reader Service Card

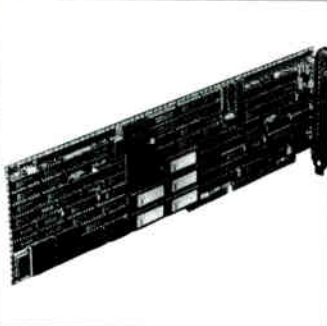

## PM3011 CACHING CONTROLLER

Up to 16MB of hardware implemented cache for ESDI, RLL of ST506 drives.

**Product Profile:** The PM3011 caching controller is the single most effective performance improvement tool available for disk-intensive applications. The PM3011 accesses data in as little as 0.5ms; that's 50 to 150 times faster than a random disk access.

**Advanced Caching Algorithms:** Such advanced caching features as disk read ahead and elevator sorting during cache write-back increase disk performance to levels unattainable by non-caching controllers. The controller's on-board 68000 microprocessor enables it to access the disk

drive at the same time as the computer reads or writes to the controller cache.

**Compatibility:** Since PM3011 caching controllers operate transparently to the operating system, special software drivers or ROM BIOS changes are not required.

**Up to 16MB of Cache:** The PM3011 Cache RAM is expandable from the on-board 512KB to 16MB with the optional Cache Expansion board. The cache is totally independent from system memory and does not require device drivers.

PM3011/70 Caching Controller With 512KB cache. **\$1150**

Circle 315 on Reader Service Card



## FAX LineShare

Why dedicate a phone line for your FAX when FAX LineShare will automatically route incoming voice and FAX calls on one line to their proper destinations?

**Product Profile:** FAX LineShare works by automatically answering all incoming calls and sending a ringback tone to the caller. In the first few seconds, FAX LineShare looks for fax prefix tone. If fax tone is detected, FAX LineShare rings the fax port. Otherwise ringing is applied to the voice port. Once the ringing port is answered, the ringback tone is removed and a connection is made.

Manual fax calls, which do not contain a fax prefix tone, can be easily transferred to the fax port by either the calling or answering person after FAX LineShare answers the call. Unattended modes are provided and should the A.C. power fail, FAX LineShare operates in the voice phone mode.

The need to install a dedicated FAX line is over. The FAX LineShare is the solution to dealing with the Telephone Company.

**FAX LineShare**

**\$219**

\*For pricing on RLL, ST506 controllers and other options please call

New York Phone 212-517-7775  
Fax 212-249-8243

Colorado Phone 303-494-8070

**Dealer Inquiries Welcome**

Charge Cards Accepted: Amex, Visa, MC  
Hours (EST) 9:00 to 5:00



Exceptional Computer Products

Rupp Corporation  
835 Madison Avenue  
New York City, NY 10021

By 1952 a Pentagon UNIVAC, exactly the second UNIVAC to be built, was crunching away at military SCOOPs. It weighed 15 tons, and just moving it into the Pentagon took three months. Today's equivalent sits on a desktop.

In 1953 IBM began shipping its answer to UNIVAC, Type 701. That rented for \$15,000 a month. Of the 19 that were built, aerospace companies took 11. Two years later, the same companies were lining up for its successor, Type 704. You see the pattern.

**W**e now pay  
the small sum we do for  
an IC because Air Force  
and NASA guidance  
drove the development  
of digital circuits.



Then there was missile tracking, which helped decide the analog-versus-digital face-off. To model something happening smoothly—moreover in real time, meaning fast enough for the model to be of any use—analog once seemed just the thing. Your nondigital watch is an analog computer. So, by one of Ceruzzi's neatest examples, is your car's differential gearing, which computes "a continuous weighted average" either when you're running straight or when you're rounding a curve and spinning the outer drive wheel faster than the inner.

Either way, "the differential gear distributes the engine's power so that the sum of the rotations of the two rear wheels is proportional to the rotation of the drive shaft." Now that's computation. And just seven toothed wheels can accomplish it. There's no time lag while we absorb numbers and get sums; and output is just what's wanted: torque, not more numbers.

The parallel with tracking a missile seems perfect: What we want is a correction to apply if it's veering off-course. Yet digital won, for the following two reasons. It suffers less from inaccuracy buildup as the problem gets more complex (and analog adds more gears). And it needn't be torn down and rebuilt from scratch each time we change the equation we want modeled.

Close as we are to the end of what we deem a digital century, it's hard for us to imagine how cogent such an issue could seem in our fathers' lifetime. Well, RAYDAC (1953) embodied a crucial decision: Do things digitally. When Raytheon installed RAYDAC at Point Mugu, it was state of the art: tape data storage, even parity checking! Although it did many things, it never did track missiles, its memory unit (sound pulses a-bounce in a tank of mercury) being too slow for real-time retrieval. But its sibling, Whirlwind, another Navy project, led to the Air Force's SAGE (for Semiautomatic Ground Environment), which was still monitoring North American skies as late as 1982. And "SAGE was the beginning of all systems, hardware and software."

But SAGE was *big*, and cramming a computerized guidance system into a *Snark* missile or, later, an Apollo capsule meant something *small*. True, Bell Labs hadn't developed the transis-

tor with either aerospace or computers in mind. Yet "aerospace engineers will shave weight from anything they can"; by 1957 electronics made up half the cost of any missile, and "Air Force and NASA guidance drove the development of digital circuits in the 1960s." Which is why we now pay the trifling sum we do for an IC: hence the \$10 calculator, the Walkman, and the home computer.

By 1965 IC pricing was down fivefold, to \$12. The Air Force, the largest single purchaser, was arming hundreds of Minutemen at 2000 ICs each. And ICs since 1962 had been MIT's designated decision modules for the Block II Apollo Guidance Computer that it had under development for lunar landings. That happened under an MIT lab director named Charles Stark Draper. Asked (in 1960) when the equipment would be ready, he said, "Before you need it." Asked (incredibly), "How do we know you are telling the truth?," he said, "I'll go along and run it." (They didn't take him up, in any sense; by the time *Apollo 11* moon-landed, Draper was 68. His equipment, though, yes, all worked.)

It worked so well that alarms were set off that resonate yet. Can people and computers safely interact? Apollo (if you remember) meant detaching the lunar module from a vehicle in lunar orbit. The module was to (1) settle down on the moon; (2) stay while astronauts plodded about, took rock samples, and set up a flag; and (3) remount under its own power and rejoin the orbiter for return to earth. That was the choice among several scenarios fiercely debated in the early 1960s; for details, see Charles Murray and Catherine Bly Cox's *Apollo: The Ten-Year Race to Put a Man on the Moon* (Simon & Schuster, 1989), a book that tells the moon-shot story not, Tom-Wolfe-wise, from the astronautic viewpoint, but from what now seems more cogent, the administrative.

Well, in 1969 the very first all-digital autopilot had two jobs. One was deciding about thrust and steering during descent to the moon. The other was aiding rendezvous with the orbiter. And how its memory was limited! Nothing like disk drives—wires wound through ferrite cores. Splice in a feature, slice another out.

Alas, combined functions overloaded it by 13 percent, a glitch that tests failed to reveal. So on the last stages of the descent, an alarm no one could be sure about sounded repeatedly, and Houston went half mad, and Neil Armstrong's pulse rate hit its maximum (I'm not making this up), until he alighted with 24 seconds of reserve fuel. . . .

It was afterward that he thought up his famous words, "That's one small step for a man. . . ." Till then (so he told me in 1976), it hadn't occurred to him he'd better have something ready to say. The sweat must have been still on his brow.

That alarm, though, keeps sounding. The computer's intolerance of ambiguity: Does that interfere with its usefulness to us, our ability to interact with it? That debate rages, muted because it's so seldom that we're dealing with life or death under a spotlight. I'll contribute: The computer is a difference detector. The human mind is a similarity detector. I'll go into what that implies another time.

*MIT Press, Cambridge, MA: 1989, 270 pages, \$35 (hardcover), \$17.50 (paper)*

*Hugh Kenner is a professor of English at Johns Hopkins University. His reviews have appeared in publications like the New York Times and Harper's. His recent books include A Sinking Island and Mazes. He can be contacted on BIX as "hkenner."*

*Your questions and comments are welcome. Write to: Editor, BYTE, One Phoenix Mill Lane, Peterborough, NH 03458.*



# Quality In... Quality Out



No matter how well acquainted you are with making important personal computing decisions—decisions that may involve hundreds of thousands of dollars—the value of those decisions is only as good as the value of your information. Without quality information—it's hard to make quality decisions.

BYTEweek, McGraw-Hill's new weekly newsletter for professionals in the personal computer industry, is devoted to giving you that quality information through its timely and compact one-stop news format.

This new publication provides you with short, easy-to-read selections of the most important news and technological developments of the past week. And BYTEweek interprets this news with in-depth commentary and analysis.

Subscribe to BYTEweek for quality information. Remember, quality in...quality out.

Subscribe now and take advantage of the special one-year charter subscription rate of \$395 (\$495 outside the U.S. and Canada). This special price represents a savings of \$100 off the regular rate. Your subscription includes 50 issues plus a free three-month subscription to BIX—a \$49 value. Through BIX you can directly access the Microbytes Daily news service and communicate with other BIX users.

Don't miss this opportunity! In the U.S., call BYTEweek's toll-free number: **1-800-258-5485**, in N.H. and outside the U.S., call: 1-603-924-9281.

BYTEweek offers a money-back guarantee if you're not completely satisfied.

**BYTEWEEK** 

News and Analysis for Professionals in the Personal Computing Industry  
One Phoenix Mill Lane, Peterborough, NH 03458



# RISCs: UNSAFE AT ANY SPEED

Is the quest for more and more MIPS worth the RISC?

The newest technical workstations are powered by RISC microprocessors. These microprocessors will soon be available as coprocessors for personal computers, to speed up compute-intensive tasks such as image processing. Yet RISC microprocessors remain controversial, and for good reason.

RISC designers increase average instruction execution speeds by eliminating the complex, multiple-cycle instructions (e.g., floating-point arithmetic and character-string manipulation) found in conventional processors. The remaining instructions (typically register-to-register operations) can then be performed in one simplified machine cycle—the minimum number of steps in which an instruction can be executed.

And the discarded instructions? Their functions are taken over by software, auxiliary coprocessors, or cache-resident subroutines. In any case, they no longer detract from the MIPS (for millions of instructions per second) ratings of the RISC processor. RISC architects eagerly sacrifice instruction-set power to increase MIPS. Unfortunately, as Nick Tredennick (a senior IBM researcher who specializes in processor design) put it, "MIPS are like RPM: They tell you

how fast the engine is running, but they don't tell you if it's doing any work."

Whether you think the RISC approach really yields better performance depends on how you measure performance—and there is no general agreement on how to define computer performance, let alone on how to measure it. In any case, processor speed is only one aspect of computer system performance.

Nevertheless, RISC designers focus on processor speed because it is the main determinant of computer performance for their favorite workloads: purely computational tasks. RISC architects make another convenient simplification: They discard instructions that have a low "average frequency of execution."

When an instruction, such as a multiple-character MOVE, is discarded due to low frequency of execution, its function is typically taken over by software. However, that MOVE operation will take much longer to execute as a software subroutine than as a "built-in" processor instruction. This increases the product of (frequency) × (duration) for that operation and reduces overall performance. One result of ignoring duration is that RISC processors sometimes take longer to process a given workload than CISC (complex-instruction-set computer) processors with lower MIPS ratings.

RISC designs also exacerbate the so-called von Neumann bottleneck, which exists when instructions and data are accessed over a single path that connects the processor with its main storage unit. Because a RISC instruction doesn't do much, a processor must access and execute lots of them to accomplish what it could do with a few multicycle instructions in a CISC processor. This consumes processor cycles, main storage accesses, and cache memory space.

To mitigate the effect of RISC's high ratio of instruction-to-operand access, RISC designers introduce complex auxiliary-support mechanisms, such as instruction pipelines and multiple register

sets. These mechanisms, together with weak instructions, make system software for a RISC inherently more complicated, and thus less reliable, than the corresponding CISC software.

To speed instruction execution, RISC designers require all operands to be accessed from typeless registers. Thus, RISC processors acquire artificial operand uniformity at the expense of rendering operands typeless and thereby forfeiting processor-based type- and value-checking. Since incorrect operations on data values are a major source of errors, safety is being sacrificed for speed.

The RISC movement is also repeating the history of processor design, a history that began with simple, register-oriented instruction sets. "Enhanced" RISC processors have already appeared. They "extend" RISC processors with privileged (e.g., cache-resident) subroutines that perform "complex" operations (i.e., operations that actually process data).

RISC chips have had a lasting influence on processor design. In addition to providing tricks for increasing MIPS ratings, the conservative RISC approach has also inspired innovative processor designs. For example, some new mini-supercomputers can execute several instructions per machine cycle due to multiple instruction-execution units, sophisticated synchronization circuitry, and complex compilers.

Safe processor architectures, such as object-oriented designs, are not yet in favor with computer designers. But the same parallelism that lets a processor execute multiple instructions per machine cycle can also support concurrent verification of data and program integrity. When computer designers realize this, they can design safe processors that also have terrific MIPS ratings. ■

Dave Nelson is a senior partner in Information Engineering, a Monument, Colorado, consulting firm. He can be reached on BIX c/o "editors."

Stop Bit is an open forum for informed opinion on topics related to personal computing. The opinions expressed are those of the author and not necessarily those of BYTE or its staff. Your contributions and comments are welcome. Write to: Editor, BYTE, One Phoenix Mill Lane, Peterborough, NH 03458.



# DOS + QuickBASIC or C + Instrumentation Code Generation = ?

There's only one solution...

## LabWindows



Are you using a DOS-based personal computer for controlling instrumentation? Do you want the best available software tools for acquiring and analyzing data using standard DOS programming languages? If your answer to these questions is *yes*, LabWindows® is just the solution you're looking for. The unique LabWindows function panel interface lets you interactively control your instrumentation hardware and collect data, as well as automatically generate Microsoft® C or QuickBASIC program code for your application.

With LabWindows you can control GPIB, RS-232, or VXI instruments, or plug-in data acquisition cards for PS/2 and PC-AT computers. For standalone instrument users, the LabWindows instrument library has over 50 ready-to-use instrument drivers so you can program your instrument using intuitive instrument-specific function panels, without knowing the instrument inside-out.

Because acquiring data is only one element of your application, LabWindows has a complete set of QuickBASIC and C compatible libraries for data analysis, presentation, and storage. Manipulate arrays, create a histogram, or use the optional Advanced Analysis Library to perform operations such as Fast Fourier Transforms, digital filtering, and curve

fitting. Give your programs a big performance boost using the specially optimized LabWindows analysis routines for computers with an 80387 numeric coprocessor. For your data presentation and storage needs, use the LabWindows Graphics Library to create multiplot graphs, bar charts, or scatter plots, and use the Data Formatting Library for data logging and file operations.

If you're looking for the right tools to take maximum advantage of your DOS computer using QuickBASIC or C for data acquisition and analysis, there is only one solution...LabWindows. Call National Instruments at (800) IEEE-488 to speak with a sales or applications engineer about how LabWindows can help you.

**Ask for a *FREE* Catalog**

 **NATIONAL INSTRUMENTS®**  
*The Software is the Instrument™*  
 12109 Technology Blvd.  
 Austin, Texas 78727-6204  
 (512) 794-0100

Circle 250 on Reader Service Card

NATIONAL INSTRUMENTS OF JAPAN (03) 788-1922 •  
 NATIONAL INSTRUMENTS OF FRANCE (1) 486 53370 •  
 NATIONAL INSTRUMENTS UNITED KINGDOM (06) 355-23545 •  
 ARGENTINA (1) 46-5776 • AUSTRALIA (2) 736-2888 • BELGIUM (2) 466-8199 • CANADA  
 (416) 890-2010, (613) 596-9300, (514) 747-7878, (403) 295-0822, (604) 988-2195 • CHILE (2) 225  
 3689 • DENMARK (2) 251-122 • FINLAND (0) 372 144 • GREECE (1) 361-1283 • HONG  
 KONG (2) 0426-2707 • IRELAND (846) 661414, (3) 427-2282 • ISRAEL (3) 324 298 • ITALY  
 (2) 984-91071-2-3 • KOREA (2) 776-5340 • MEXICO (5) 660-4323 • THE NETHERLANDS (7)  
 099-6360 • NEW ZEALAND (9) 444-2645 • NORWAY (2) 53-1250 • PORTUGAL (1) 545-313 •  
 SINGAPORE (65) 336-4713 • SOUTH AFRICA (011) 787-0473 • SPAIN (1) 455-8112 •  
 SWEDEN (8) 792-1100 • SWITZERLAND (6) 552-8949 • TAIWAN/THE REPUBLIC OF  
 CHINA (02) 703-6280 • THAILAND (2) 234-9330 • WEST GERMANY (89) 80-7081

# The New Tandy® 4000 SX

386™ performance  
at a price you'd  
expect from a  
286 system.

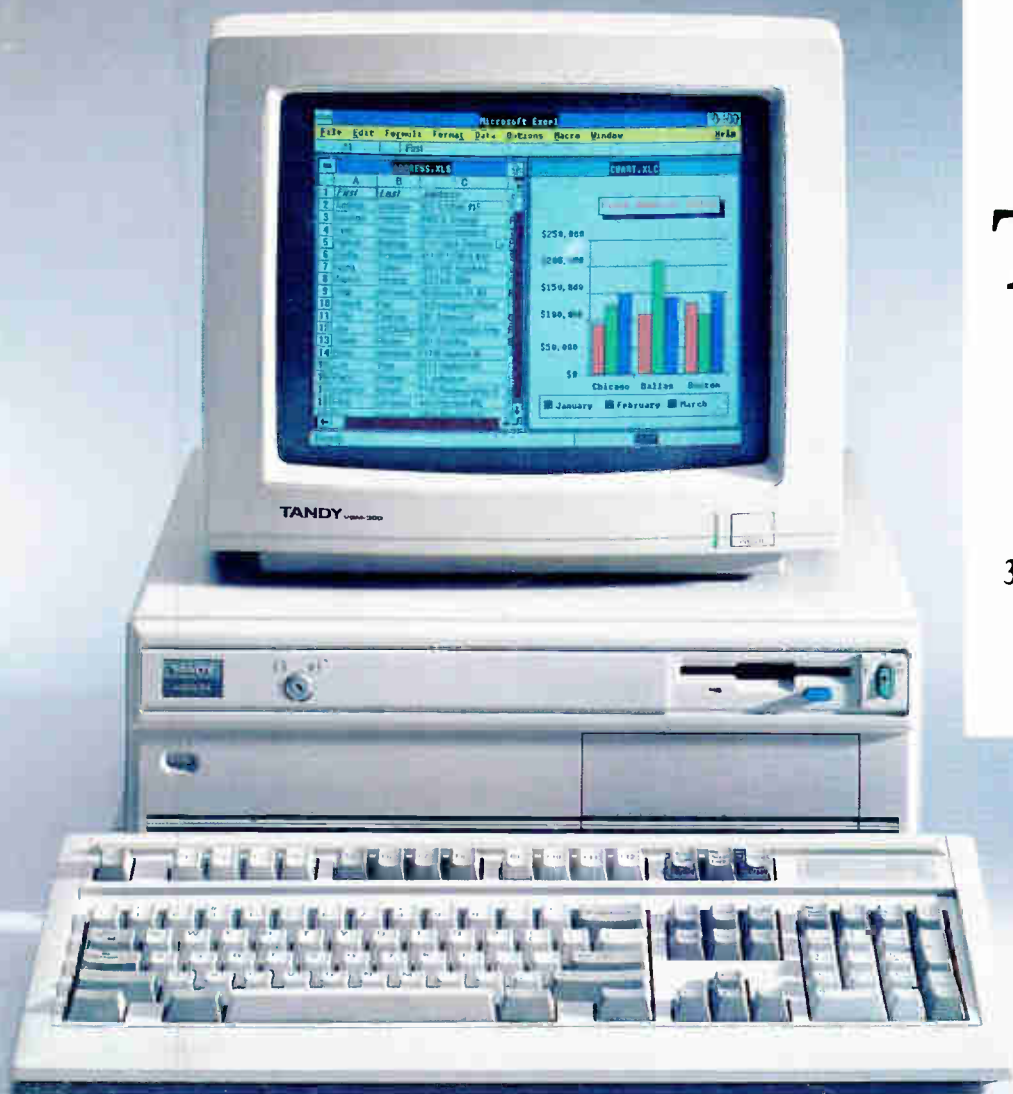

A price/performance breakthrough for 386-based systems, the new Tandy 4000 SX combines more integrated features than ever in a machine at this price.

The Intel® 80386SX microprocessor combines the ability to run high-performance 80386 based software, as well as current 80286 and 8088 based software. You get the best of both worlds—32-bit performance with 16-bit hardware compatibility.

This means the Tandy 4000 SX insures your computer investment for the future. As a low-cost alternative to an expensive 386 system, you won't be left behind when you want to move on to more advanced 386 based applications, like MS® OS/2.

Built-in VGA graphics give you beautifully detailed, high-resolution displays. Add a color analog monitor and create astonishing graphics in up to 256 colors (from a

palette of 256,000) for near-photographic clarity.

The 4000 SX's SmartDrive™ Integrated Drive Electronics (IDE) technology allows you to add high-performance hard disk drives without the need or expense of installing a separate disk controller.

Innovative technology. Quality engineering. Competitive pricing. Come see the new Tandy 4000 SX today. From the best-selling family of PC compatibles made in America.

**Tandy Computers: Because there is no better value.™**

SmartDrive™ Tandy Corp. Intel and 386™ licensed from Intel Corp. MS/ licensed from Microsoft Corp.

**Radio Shack®**  
**COMPUTER CENTERS**  
A DIVISION OF TANDY CORPORATION

Circle 307 on Reader Service Card