

BROADCAST engineering

June 1981/\$3

'81 / Las Vegas Convention Replay



Quality, Reliability, Service...

Excellent Reasons for Choosing ADM[®]



ADM 2400 Series II Console

ADM understands how critical it is for professionals to be assured of unfaltering performance under the most demanding conditions. That's why everything we do at ADM—from initial concept to final production—is geared to providing consoles of unexcelled quality and reliability.

The finest of components are used in ADM consoles to assure long life and trouble-free operation. Our exclusive five-year warranty, the most generous in the industry, attests to this fact. Service—if you ever need it—is prompt and professional.

Find out more about ADM's high-performance standard and custom consoles. Contact ADM Technology, Inc., 16005 Sturgeon, Roseville, Michigan 48066. Phone (313) 778-8400. TLX 23-1114. West Central Sales Representative, Gordon Peters. (817) 467-2990. West Coast Sales Office, (415) 664-2400.

ADM[®]

The Audio Company

NEED A FULLY EQUIPPED 40-FOOT PRODUCTION UNIT?



A MID-SIZE ENG TRUCK
WITH MICROWAVE?

A NEWS
MAGAZINE VAN
WITH ON-BOARD
POWER?



THEN TALK TO **MIDWEST'S**
MOBILE UNIT DIVISION!

Selecting a vendor to supply a \$100 thousand or \$3 million mobile unit is a great responsibility.

MIDWEST CORPORATION, the nation's largest video sales and service organization, is the best choice for meeting your needs, and here's why:

- We handle major lines of all production equipment, so we don't have to charge for two-stepping.
- Our size and volume means cost savings passed on to you.
- More than 20 years in television means expertise and a good reputation.
- As a major division of UNR Industries, we offer the security and stability of a large and financially sound company.

- We are the single source for custom vehicle, equipment, installation and service.

When your mobile unit order calls for QUICK DELIVERY, GOOD QUALITY, and COST EFFECTIVENESS, don't just pick two . . . pick MIDWEST, and get all three.

A PARTIAL LIST OF OUR MAJOR PRODUCT LINES:

Ampex, Cezar International, Conrac, Digital Video Systems, Fernseh, Gerstenschlager, Hitachi, Ikegami, ISI, ITE, Lenco, 3M Minicom, Microwave Associates, O'Conner, Panasonic, Quick Set, RTS Systems, Scientific Atlanta, Sony, System Concepts, Tektronix, Van Ladder, Video-Media, Videotek, Vinten and Wilbert Masts.

Give Carl Raasch, Mobile Unit Sales Manager, a call and allow MIDWEST to quote on your first . . . or next mobile unit requirement.

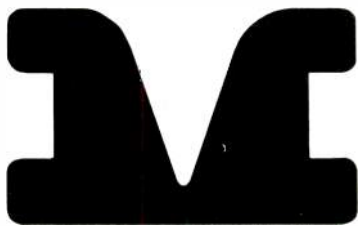

MIDWEST
CORPORATION

1021 West 8th Street
Cincinnati, OH 45203

G A UNR Company

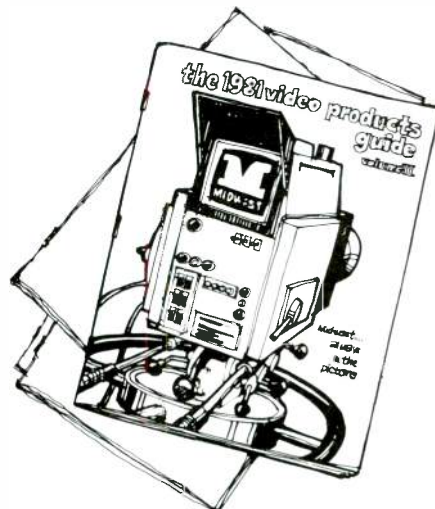

CALL —

800-543-1584
(In Ohio 513-651-1904)

Request a copy

- Mobile Unit Information
- 1981 Video Products Guide
- 1981 CATV Products Guide
- Midwest Capabilities Brochure

Circle (3) on Reply Card

BROADCAST engineering

The journal of broadcast technology

June 1981 □ Volume 23 □ No. 6

6 FCC Update
8 News

NAB '81/Las Vegas Wrap-up

- 10 Another spectacular conference**
By Bill Rhodes, editorial director
and Carl Bentz, engineer, KCPT, Kansas City, MO
- 20 Radio workshops**
By Brad Dick, chief engineer, KANU, University of Kansas,
Lawrence, KS
- 46 TV workshops**
By Joe Manning, chief engineer, KAET, Tempe, AZ
- 54 SMPTE/Digital update**
By Blair Benson, consultant, South Norfolk, CT
- 58 Reflections on NAB '81 technology**
By Bebe McClain, president of B. F. McClain Productions,
Asheville, NC
- 64 Audio processors**
By Gary Breed, consulting engineer, D. L. Markley & Associates,
Peoria, IL
- 70 The world's largest satellite earth station show**
By Dennis Ciapura, general manager of telecommunications,
Greater Media, East Brunswick, NJ
- 76 TV transmitters**
By Donald L. Markley of D. L. Markley & Associates, Peoria, IL;
and Bill Rhodes, editorial director
- 84 Special cameras**
By B. F. McClain, president, B. F. McClain Productions, Asheville, NC;
and Bill Rhodes, editorial director
- 86 Video cameras**
By Bebe McClain, president, B. F. McClain Productions, Asheville,
NC; and Patrick McEntee, ISO Communications, New York, NY
- 100 The video recorder camera**
By Patrick McEntee, ISO Communications, New York, NY
- 106 Teletext and Viewdata**
By Harmon Shragge, Center for Information and Communications
Studies, California State University, Chico, CA
- 118 Other radio and TV equipment**
By Bill Rhodes, editorial director; Rhonda Wickham, managing
editor; and Carl Bentz, engineer, KCPT, Kansas City, MO

185 Classified ads
188 Index of advertisers

©Copyright 1981, by Intertec Publishing Corporation. All rights reserved. Material may not be reproduced or photocopied in any form without written permission of publisher.

BROADCAST ENGINEERING (USPS 338-130) is published monthly by Intertec Publishing Corporation, 9221 Quivira Road, P.O. Box 12901, Overland Park, KS 66212. Postmaster, return form 3579 to the above address.

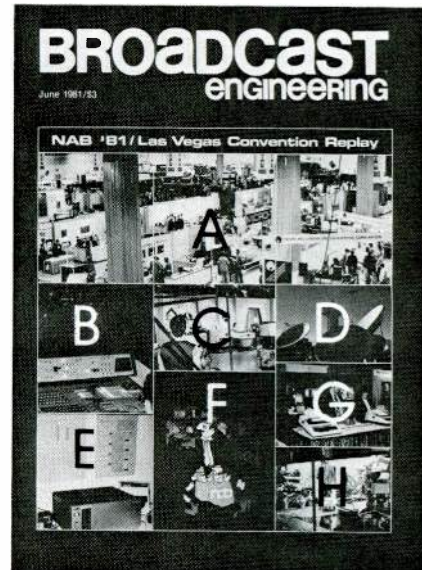

THE COVER briefly captures colorful scenes from NAB '81, the 59th Annual Convention and International Exposition of the National Association of Broadcasters:

A. The top row of pictures are from an elevated vantage point viewing one segment of the convention floor.

B. Video switchers played a key role in the TV exhibit area of NAB '81. *Vital Industries*, as shown here, was on hand to exhibit its American designed-and-manufactured system.

C. This simulated-studio exhibit by *Thomson-CSF* was typical of the excellent booth arrangements for demonstrating color cameras at this year's show.

D. Again this year, the parking lot was filled with dishes for earth-station reception of satellite signals. Shown here is just a narrow view of the antennas exhibited, with the *Microwave Associates'* dish in the foreground.

E. This scene of digital audio equipment was shot in the *Sony* booth, where digital audio was an essential role in the firm's NAB '81 exhibit.

F. This computer-generated graphic depicts a typical conferee at NAB '81. The only cover picture not taken at the convention, the graphic was generated on the electronic graphics system being introduced at NAB '81 by *Aurora Imaging Systems*. (Photo courtesy of *Aurora's* president, Dick Shoup, through the agency, Telegen.)

G. Data handling functions at stations are becoming increasingly important in today's competitive markets. The scene shown here is at the *Cal DataCom* booth, showing the teleprinter that can directly access TLX, TWX and DDD (Direct Distance Dialing) to simplify message transmission.

H. This colorful exhibit at the *Philips Broadcast* booth was created to appeal to all and to provide a wide range of set-up possibilities for experimenters trying out new video cameras.

NEXT MONTH

- Digital technology update
- Replays of NPR and AES conferences
- KCBS' automated newsroom

A Broadcast Breakthrough of Minor Proportions.

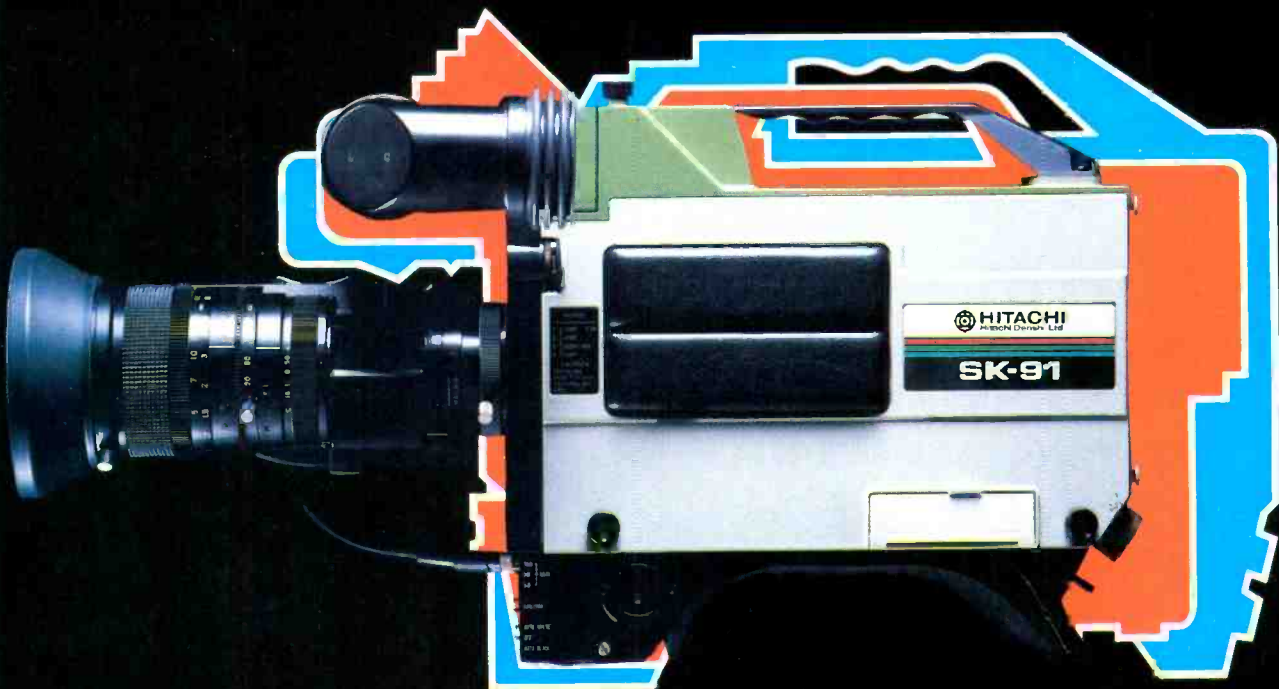

Hitachi SK-91... Critical inches shorter and precious pounds lighter.

Creating the world's smallest, lightest ENG/EFP broadcast camera was no small accomplishment. But making it so without sacrificing a single spec or capability qualified as a genuine breakthrough.

Of course, the beneficiary of our advanced engineering is you. You get all the performance that high technology has to offer in a more compact, efficient package. (Cameramen are amazed at the SK-91's responsive, featherlight handling.)

Image quality naturally adheres to the highest broadcast standards, with your choice of Saticons, Plumbicons®, or diode guns®, attaining up to 57dB and 600-line resolution. Why not call your local Hitachi

regional office and schedule a thorough in-person evaluation of the SK-91? We think you'll agree that a breakthrough of minor proportions can be of major advantage to you.

SK-91 SPECIFICATION HIGHLIGHTS

- Weight: 9-1/2 lbs.
- 57dB S/N ratio and 600-line resolution
- Auto digital white and black balance
- True ABO
- 2 ft. candle sensitivity
- Extremely quiet +9/+13dB gain
- Optional triax/digital unit
- Studio accessories for added versatility
- Suggested List Price \$33,000

®Registered trademarks of N.V. Philips



HITACHI
Hitachi Denshi America, Ltd.

Tomorrow's Technology Today

175 Crossways Park West, Woodbury, N.Y. 11797 (516) 921-7200

• New York • Chicago • Los Angeles • Atlanta • Cincinnati • Dallas • Denver • Seattle • Washington, D.C.

Circle (4) on Reply Card

TEK TELEVISION PRODUCTS



(Actual display)

A growing generation of television products with the same commitment to your signal quality.

If there's one thing in this business that doesn't change, it's your commitment to provide viewers a quality signal. Just as ours is to provide you the products to help you achieve that goal.

Over the years, Tektronix has consistently provided the test, measurement and monitoring equipment to help raise color television signal quality.

This year, three new Tek products exemplify our continuing commitment to signal quality by providing added capabilities and improved performance.

690SR Color

Picture Monitor

If there's a monitor you can believe, it's the 690SR. High resolution, precise convergence and stable color make it your best basis for subjective picture evaluation. With the 690SR, there's no doubt your picture is a correct rendition of input signals.

Monitor set-up is simplified. Logical and non-interactive convergence controls make adjustment a simple, straightforward procedure. And maintenance needs are minimal. Modular design makes troubleshooting easy.

Its adaptability makes the 690SR a long-term investment that fits future

needs. New modules will become available as needed to meet both your own and changing industry requirements.

468 Digital

Storage Oscilloscope

Here's digital storage in a portable scope. You'll know the 468 for its bright, crisp display especially of low duty cycle waveforms. Then look closer. There's stable, sweep triggering of video waveforms in TV line and field rates, plus field selection.

The 468 offers a unique envelope acquisition mode. Ideal for troubleshooting digital equipment, catching glitches, monitoring changing signals and more. A Tek exclusive.

For signal analysis, stored waveforms can be expanded and repositioned vertically and horizontally. Digital cursors offer accurate, repeatable time and voltage measurements of your signal. Storage makes it all easy.

528A Waveform

Monitor

When you're looking for consistent, reliable monitoring of your video signal, you're looking at the 528A.

The 528A enhances features of our widely-used 528. New front panel con-

trols, for example, offer faster, easier operation.

An internal CRT graticule assures parallax-free viewing from a bright easy-to-read display. In short, more accurate overall measurements. With this workhorse around, you'll know for sure levels are right.

TSG7 Color Bar

Generator

If you're considering SMPTE Color Bars for easier, more accurate picture monitor alignment, Tektronix is ready with a new source, the TSG7 Color Bar Generator. The TSG7 installs in the mainframe of our 1410 Signal Generator and turns the task of adjusting color monitors into a precise, easy and objective procedure.

Here you have a growing generation of television products. Changes have come out of our commitment to help you achieve better signal quality. That hasn't changed, and never will.

Our toll-free number stays the same, too: dial 1-800-547-1522 for the full story on the products here.

Tektronix, Inc.
P.O. Box 1700
Beaverton, OR 97075



Production switcher is a GVG 1600-7K with Digital Video Effects and Effects Memory System.

Background photo courtesy of KATU, Portland.

Tektronix
COMMITTED TO EXCELLENCE

FCC update

June 1981



Editor's note: These are excerpts from the farewell speech given by Robert E. Lee, acting chairman of the Federal Communications Commission. Lee addressed attendees of the engineering luncheon held during NAB '81 in Las Vegas.

So Long, Pal
"The time has come," the Walrus said,

"To talk of many things:
Of shoes—and ships—and sealing-wax—
of cabbages—and kings—
And why the sea is boiling hot—
And whether pigs have wings."

This bit of whimsy from Lewis Carroll's "The Walrus and the Carpenter" might well be the way for me to lead into what our friends in the media describe as "a few general, wide-ranging comments." As you no doubt know, I am completing 27 years of service at the Federal Communications Commission. I was first appointed in 1953 by President Eisenhower. And I guess you might say I'm on my last legs—not only as acting chairman but as a commissioner. As the ranking Presidential appointee, I hold still another record; the only chairman to enter and to exit as a lame duck. But today I want to speak from my heart about many things, and I hope I am perceived as being humble and yet I must be wary lest I become proud of my humility.

So now, in 1981, what does your soon-to-be deposed chairman offer you—no gifts this year, only the reminder that your use of the spectrum is your greatest gift from nature and from God to be used in the public interest.

I am especially cognizant of how the commission always discharges its responsibility mindful of that phrase in the Communications Act directing it to regulate as "public convenience, interest or necessity requires."

Through many technological developments and tremendous growth in the broadcast industry since 1934, the FCC has been guided in its deliberations and decisions by the public interest standard.

Regulation—because it usually limits or restricts—implies a negative relationship between an agency like the FCC and the industry it regulates. Our tendency as individuals—not as regulator and regulatee—is to consider all rules bad, when, in fact, we can probably point to many requirements or standards that have helped to improve, protect or more clearly define many aspects of an industry.

Since this may well be my swan song, I have no overwhelming desire to decry the industry or even to draw on all precedents and predict in grandiose terms the great things still to come. You in the industry and we at the regulatory agency have seen numerous decisions come and go during my three decades at the FCC. And now with another administration beginning its labors—many of which you're familiar with by now—we're beginning yet another phase of that relationship. The atmosphere is now that of a beneficent government emphasizing deregulation, a government striving to lick inflation, achieving those objectives through a government retrenchment program unprecedented certainly in our history. This happens to be a windfall to your industry in the economies inherent in less government oversight. But with it, it seems to me an obligation for prudent self-regulation is on our back. You police not only yourself but you exert pressure on your peers to do likewise.

In this atmosphere we at the FCC are carefully examining all the agency's functions. Instead of saying that we can do everything with fewer resources, we are just not going to do as much.

We may need to take bold steps to do our part in reaching goals in this new environment. For example, I

BROADCAST[®] ENGINEERING

Editorial, advertising and circulation correspondence should be addressed to P.O. Box 12901, Overland Park, KS 66212 (a suburb of Kansas City, MO); (913) 888-4664.

EDITORIAL

Bill Rhodes, *Editorial Director*
Rhonda L. Wickham, *Managing Editor*
Karen Arnhart Booth, *Associate Editor*
Mary Thornbrugh, *Editorial Assistant*
Pat Blanton, *Directory Editor*

ART

Dudley Rose, *Art Director*
Joy Viscek, *Graphic Designer*

TECHNICAL CONSULTANTS

Dennis Ciapura, *Technology*
Howard T. Head, *FCC Rules*
Harold L. Kassens, *FCC Rules*
Donald L. Markley, *Facilities*
Art Schneider, A.C.E., *Post-production*

CORRESPONDING ASSOCIATIONS

American Society of TV Cameramen
Association for Broadcast
Engineering Standards
National Association of Broadcasters
National Radio Broadcasters Assn.

CIRCULATION

John C. Arnst, *Director*
Evelyn Rogers, *Manager*
Dee Manies, *Reader Correspondent*

ADMINISTRATION

R. J. Hancock, *President*
Cameron Bishop, *Publisher*

ADVERTISING

Mary Birnbaum, *Production Manager*

Regional advertising sales offices listed near the Advertiser's Index.

Member,
American Business Press



Member,
Business Publications
Audit of Circulation



BROADCAST ENGINEERING (USPS 338-130) is published monthly by Intertec Publishing Corporation, 9221 Quivira Road, P.O. Box 12901, Overland Park, KS 66212. Postmaster, return form 3579 to the above address.

BROADCAST ENGINEERING is edited for corporate management, engineers/technicians and other station management personnel at commercial and educational radio and TV stations, teleproduction studios, recording studios, CATV and CCTV facilities and government agencies. Qualified persons also include consulting engineers and dealer/distributors of broadcast equipment.

SUBSCRIPTIONS: BROADCAST ENGINEERING is mailed free to qualified persons in occupations described above. Nonqualified persons may subscribe at the following rates: United States, one year, \$25; all other countries, one year, \$30. Back issue rates, \$5, except for the September Buyers' Guide issue, which is \$15. Rates include postage. Adjustments necessitated by subscription termination at single copy rate. Allow 6-8 weeks for new subscriptions or for change of address. Second class postage paid at Kansas City, MO.



1981. All rights reserved.
Intertec Publishing Corp.



Dual channel mix



Character Flip/Rotation



Charting capability

Channel 55 Scoreboard		
NBA Standings	W	L
Philadelphia	15	3
New York	12	4
Boston	10	5
New Jersey	8	11
Washington	7	11

Static headline, changing copy



Keyboard logo compose

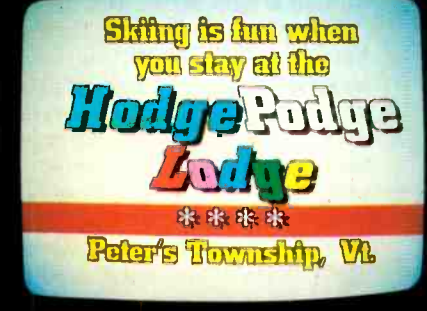

Left and right italics

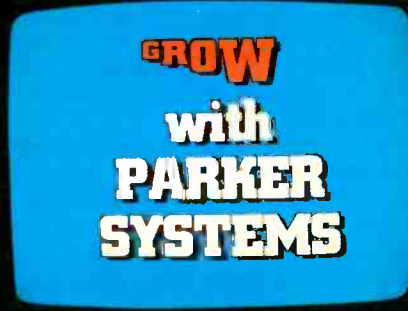

25% and 50% character reduction

State Senate 5th District 20% Pcts.			
Ward	D	Votes	Pcts.
✓ Ward	D	99,876	39%
Roberts	R	84,756	34%
Jameson	I	67,543	27%

WEZY-TV Channel 6

Computer Election Interface

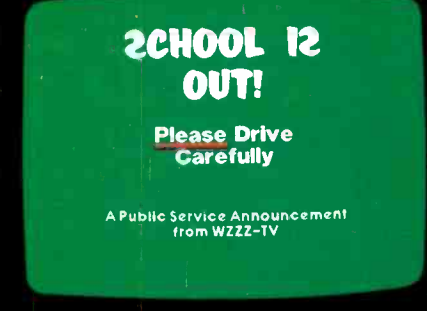

Character reversal

Many of our capabilities aren't even options on other graphic generators.

Which is the do-all, top-of-the-line graphics generator?

It may not be the one you think it is. Unless you specify the D-8800 Graphics Generator System from 3M.

It's the graphics system that gives you almost every creative capability you could want.

Such as the features you see above, photographed from a monitor using graphics generated from the D-8800 keyboard with no external hardware. And dual channel mix. Ten roll and crawl speeds. Eight mask positions. Both horizontal and vertical autocentering. Character reduction and italics



that give you hundreds of fonts to create and store.

And much more.

Plus the D-8800 talks to you in plain English, at the keyboard. Not in codes that so often take weeks, even months to learn to decipher.

Call 3M today at 612-733-8132 and ask for a demonstration. You'll quickly discover the D-8800 is your only real option. Or write on your letterhead to: Video Products/3M, Bldg. 223-5E/3M Center, St. Paul, MN 55144. In Canada contact 3M Canada, Inc., P.O. Box 5757, London, Ontario, N6A-4T1.

3M Hears You...

Circle (62) on Reply Card

think we should stop licensing CB radio and provide for automatic license renewals. When I testified on S. 270, the Radio Deregulation Act of 1981, I suggested this and hoped that nonbroadcast activities would receive legislative attention, but I hastened to suggest that the broadcast bill not be burdened with extraneous matters.

I pointed out that the Commission believes the legislation achieves significant public interest objectives and paves the way for even greater public benefits in telecommunications service. The Commission supports the provisions in S. 270 that establish indefinite license terms for radio and give the Commission discretion to grant certain broadcast applications based on a system of random selection. We did, however, recommend that the bill be enlarged to permit random selection in all Commission licensing efforts, including television, common carrier and private radio. A companion bill, S 601, also has been introduced to increase TV license terms to five years and to ensure license renewal absent specific and serious violations, and to eliminate comparative hearings in new applications.

As to the Commission's recent radio deregulation action, I told the Senate committee that our basic rationale was the development of radio broadcasting into a competitive industry where natural market forces are more effective than Commission regulation in inducing licensees to act in the public interest. These market forces, reflecting the public's tastes, interests and desires, are the reason radio programming is responsive to the public interest and why most Americans can receive many radio signals offering a wide variety of entertainment and nonentertainment programs.

Earlier I quoted from statements made to this body by four other commissioners. Without seeming too immodest, I would like to include an observation I made in addressing an NAB convention in Denver in 1976:

"I don't think broadcasters are responsible for all of society's problems, and I don't think broadcasters should be expected to provide instant cures any more than government should. But it is time for some serious soul searching to be sure judgments are guided by the public interest, not just by ratings. Broadcasters have a lot to contribute. If they contribute all they can, the burden of government regulation may become unnecessary." □

Beneficial management applies for Channel 9 license

Beneficial Management Corporation announced support of the need for the Commission to adopt a proposal for reallocation of Channel 9 to New Jersey, and to open the license application process as quickly as possible. Beneficial will then submit an application for their license for Channel 9 when and if the FCC proceeds as desired.

Beneficial Management Corporation is the managing subsidiary of Beneficial Corporation, an NYSE company which provides consumer financial services throughout the United States and in several other countries.

Central Dynamics acquires assets of ADC and Philips Broadcast

An agreement in principle has been reached between CDL, through its US subsidiary, Central Dynamics Corporation, to acquire for cash the assets of two subsidiaries of North American Philips Corporation: Philips Broadcast Equipment Corporation of Mahwah, New Jersey and American Data Corporation of Huntsville, Alabama. CDC will have exclusive marketing, sales and service responsibility for all CDL, Philips Broadcast and ADC products in the United States.

CDC will move to new and larger headquarters in Northern New Jersey that will include administration and sales offices, equipment servicing and training facilities and an equipment demonstration studio. The broadcast camera and transmitter product support and advanced camera development functions shall continue to be located in northern New Jersey. ADC engineering and manufacturing operations will be expanded and remain in Huntsville, Alabama. ADC's international sales and distribution network will continue to sell ADC's products overseas.

Bishop named publisher of Intertec electronics group

Cameron B. Bishop has been promoted to the position of publisher for Intertec Publishing Corporation's electronics group by R. J. Hancock, president.

Bishop has been with Intertec since March, 1977, in various marketing positions, and was advertising manager, then director of

marketing for the electronics group during the last four years. He assumes the publisher's post for **Broadcast Engineering, Video Systems, Radio y Television and Electronic Servicing.**

Bishop replaces George Laughead who has held various editorial and marketing positions with Intertec since 1977 and has been publisher of the electronics magazines since 1978. Laughead resigns to join Lake Publishing, Libertyville, IL, as publisher of **Insulation/Circuits** magazine.

Wold Communications to install network of Microdyne earth stations

In a purchase agreement that may exceed \$4 million, Wold Communications has contracted with Microdyne Corporation to manufacture and install, ultimately, at least 100 seven-meter receive-only satellite earth stations at designated television stations around the country.

Wold Communications also ordered from Microdyne an 11-meter receive-only antenna to be installed in Honolulu by June 15. The unit will be Wold's second Honolulu receiving station. Its first antenna was installed in 1978.

Metromedia Producers Corporation, distributor of "The Merv Griffin Show," and Wold Communications announced earlier this week an agreement in principle whereby Woldcom will, within the next few months, distribute "The Merv Griffin Show" by satellite and install satellite earth stations on behalf of Metromedia Producers Corporation.

Wold Communications, Inc., a subsidiary of Robert Wold Company, Inc., is licensed as a common carrier by the Federal Communications Commission.

Woldcom currently has operating centers with transmit/receive earth stations in Los Angeles, New York and Washington, D.C.; a receive-only earth station in Honolulu; and a fleet of transportable transmit/receive units used by networks, news services and local broadcasters for news, sports and special-event coverage.

Woldcom leases more than 30,000 hours of satellite transponder time annually on Western Union Westar, RCA Satcom and AT&T Comstar satellites and estimates that it is the largest single user of domestic satellites for commercial television and radio programs. □

... Put A Little "SPACE" Between
Your Weathercast and Theirs ...



Introducing a dynamic new development that
will revolutionize television weather programming.

LiveLine® Color Weather Satellite Computer

- Select pictures of any region of the nation — or the full U.S.!
- Dial-up service to Environmental Satellite Data Inc.'s. NEW high resolution digital data!
- Select your own colors for land, water, and clouds!
- Overlay with graphics, times, and titles!
- Sixteen grey levels — highest digital data resolution available!
- We use nationally known hardware — and supply all schematics!
- Makes previous weaker satellite display systems obsolete!

ColorGraphics Weather Systems, Inc.

5727 Tokay Blvd. • Madison, Wisconsin • 608-274-5786

Circle (5) on Reply Card

SAVE YOUR TUSH with our T.U.S.H.*!

Now Tentel has 3 products to make your video tape recorders work right

1 TENTELOMETER® tape tension gage



If you don't have a TENTELOMETER® for measuring tape tension, you're in worse shape than you know! Thousands are in use throughout the world! Send for our 16-page instruction manual.

2* TENDEL U-matic Spindle Height (T.U.S.H.) gage



Save your valuable tapes from edge damage and binding and breakage problems simply and easily. "Greatest thing since soap," says one customer. U-matic now, BETA and VHS soon.

3 TENDEL TIMER hour meter



For measuring the number of hours of "run" time to allow preventative maintenance to be performed to prevent down time.

Send or call for information and prices on the complete Tentel line. We want to help. We've already helped thousands.

Our toll-free number is
1-800-538-6894

(U.S. not including California)
8 a.m. - 5 p.m. Mon. - Fri.

TENDEL 1506 Dell Avenue
Campbell CA 95008
(408) 377-6588



NAB '81/Las Vegas: Another Record-Setting Convention

By Bill Rhodes, editorial director; and Carl Bentz, engineer, KCPT, Kansas City, MO.

By the time that the 59th Annual Convention and International Exposition of the National Association of Broadcasters (NAB '81/Las Vegas) closed, this year's major event had set all new records: exhibitor registration up by 17%; exhibitor space up by 14%; attendance up by almost 60%. (In truth, the attendance figures may be over-estimated by inclusion of the hospitality suite traffic that was not figured in last year's records. However, deleting these numbers still leaves NAB '81 attendance up by 39% over last year's convention.)

- Las Vegas Convention Center
Las Vegas, Nevada
- April 12-15, 1981
- 5870 Broadcasters
- 11,275 Visitors
- 9890 Exhibitor Guests
- 4000 In Suites
- Total Attendance: 31,035
- 479 Exhibitor Booths
- 227,000 Sq. Ft. Exhibitor Space (under roof)
- Extensive Parking Lot Exhibitor Space Used.

The kickoff for this year's convention was a joint radio/TV opening session featuring an invocation by Berkley Bunker, former US Senator from Nevada; a welcoming address by Thomas Bolger, chairman of NAB Board of Directors; remarks by Senator Howard Cannon, Democrat from Nevada; a keynote address by Vincent T. Wasilewski, president of NAB; the presentation of the Distinguished Service Award to Arch Madsen of Bonneville International, Salt Lake City, UT; and the impersonations of the incomparable Rich Little. The house was packed for the

opening ceremonies, which speaks well for the program and the attendees' interest in preparing for a strong NAB '81 convention.

The theme for this year's outstanding convention was "Directions." And the directions included everything from legislation to improving broadcasting, to workshops that make advances possible and economical.

Wasilewski: The time is now

In his opening address to the industry, NAB President Vincent T. Wasilewski said that "Timing is everything. For broadcasters, the time is now."

Citing examples of new deregulatory support from Capitol Hill, the regulatory agencies, the courts and the marketplace, Wasilewski continued, "The country has rediscovered that the 'business of America is business.'"

Wasilewski told the nation's leading radio and television broadcasters that they "were being freed to formulate their future." He urged them to push for participation in the development of new technologies.

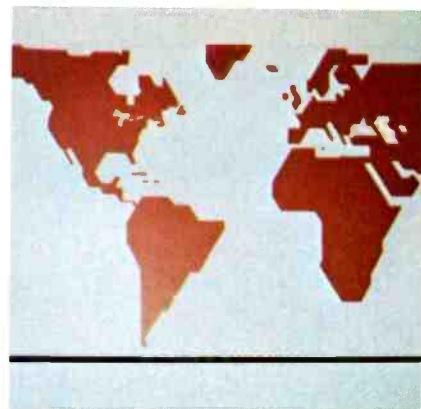

Circle (6) on Reply Card

NECOMM

The New Intercom System for TV Stations & Broadcast Centers

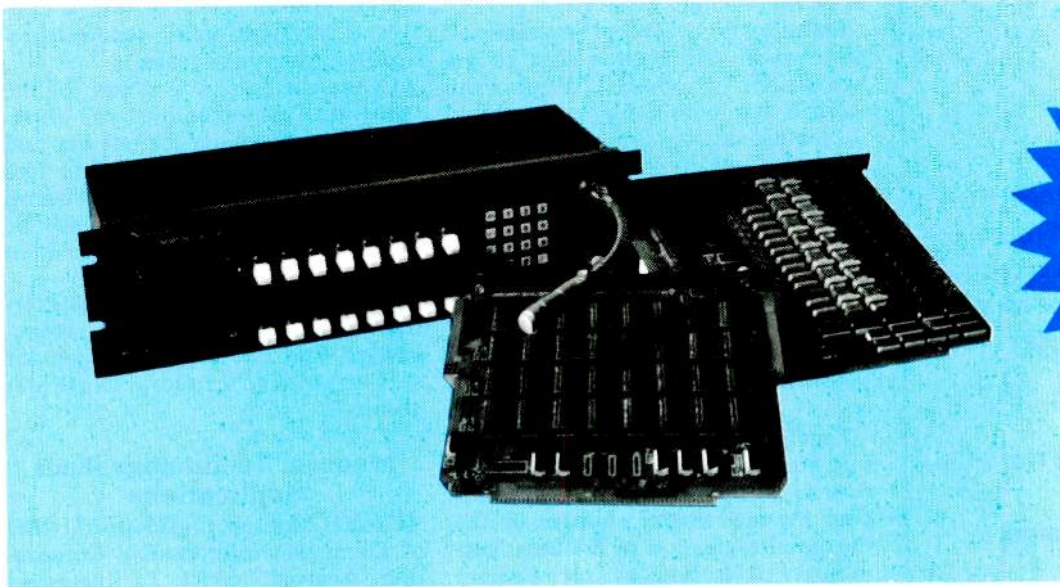

The
Hit of the Show
NAB 1981
Las Vegas

A Better System

Neve is introducing NECOMM, a technically advanced and cost effective family of intercom and audio routing systems. The microprocessor based NECOMM system features virtually unlimited capability for user modification and future expansion. Standard software programs for various broadcast applications are available now, field proven in many television facilities over the past 3 years.

An Economical System

NECOMM is easily and economically configured in systems from 16x16 to 256x256 or larger, with any customer specified level of operational redundancy. A full range of terminals is offered, from cost effective passive panels to intelligent stations. NECOMM is easy and inexpensive to install, in existing as well as new broadcast facilities, occupying much smaller physical space compared with other systems of lesser capabilities.

A System of the Future

NECOMM has been designed as a building block system around a powerful microprocessor and databus standard widely used by the computer industry, assuring you of the ability to easily and economically upgrade and expand as you require larger facilities in the future. NECOMM is manufactured, marketed and supported by the worldwide Neve organization with four sales and service offices in the USA and Canada. Please call or write for detailed NECOMM information.

Call tollfree (800) 243-9206
(excluding Connecticut)



Rupert Neve Incorporated Berkshire Industrial Park, Bethel, Connecticut 06801 Tel: (203)744-6230 Telex: 969638
Rupert Neve Incorporated 7533 Sunset Blvd., Hollywood, California 90046 Tel: (213)874-8124 Telex: 194942
Rupert Neve Incorporated P.O. Box 120907, Nashville, Tennessee 37212 Tel: (615)385-2090
Rupert Neve of Canada, Ltd. 2721 Rena Road, Malton, Ontario L4T 3K1, Canada Tel: (416)677-6611 Telex: 983502
Neve Electronics International, Ltd. Cambridge House, Melbourn, Royston, Hertfordshire, SG8 6AU England Tel: (0763)60776
Rupert Neve GmbH 6100 Darmstadt Bismarckstrasse 114, West Germany Tel: (06151)81764

Circle (7) on Reply Card

June 1981 *Broadcast Engineering* 11



ENG goes airborne with TEAC

TEAC Airborne Videocassette Tape Recorders (AVTR™) are designed and manufactured by TEAC specifically for rough handling and airborne use.

- 3/4" U-Matic
- Uses 28VDC directly from helicopter power
- Wide temperature range
- Radio interference protected
- Remote-Record control
- Fully tested by the USAF and used extensively in US Army helicopters



TEAC VIDEO

TEAC Corporation of America
Industrial Products Division
7733 Telegraph Road
Montebello, CA 90640
(213) 726-8417

Circle (8) on Reply Card

Convention

"It was radio and TV broadcasters who built the cable industry. It was radio and TV broadcasters who experimented with satellites, with audio and videotape and with other electronic advancements. Communications has evolved because of broadcasters." Broadcasters should not "be excluded or limited in our participation in these technologies."

Wasilewski further urged that "the time is now" to "guard against ill-advised governmental schemes to downgrade our existing product," such as the FCC's proposal to shift to 9kHz AM channel spacing.

Mentioning organized movements that would like their voices to be heard above others, Wasilewski warned that "censorship, in any form, is loathsome to those who truly believe in freedom. Many of the issues they foster are worthy, but their method is not."

He urged that broadcasters set the agenda for the industry.

"Our timing is right—and there's no time like the present."

Cannon: Less government involvement

Senator Howard Cannon (D-NV) told broadcasters gathered at NAB '81 that he is "optimistic about the prospect for meaningful changes in the degree of regulation of the broadcast industry exercised by the Federal government."

"Of the various legislative issues pending now in Washington, the greatest strides," Cannon said, "are being made in the area of radio deregula-

tion. A Senate bill, S. 270, will prohibit the FCC from intervening in the programming decisions and plans of individual licensees and eliminate licensing renewal procedures. It will return the decisions of station management back to the stations themselves."

There also is legislation pending for TV broadcasters, Cannon noted, that would extend licenses from three to five years and eliminate the comparative renewal process.

"If stations are adequately serving the public and not violating the law in any serious way," he said, "they will be permitted to continue operating without having to face extremely costly and time-consuming renewal procedures every three years."

Cannon expressed concern for the "ominous resurgence of book-burnings throughout the country and increased cries for censorship and control of the media." The Federal government must not become the ultimate programmer for television and radio.

"The daily programming decisions must be left to you—the broadcasters—and not the government or self-appointed special interest groups."

Madsen: Technology leads applications

Arch L. Madsen, president and CEO of Bonneville International Corporation received NAB's Distinguished Service Award, and claimed that, "our communications technology is light years ahead of its application to effectively link minds in a world seething with crucial human problems."

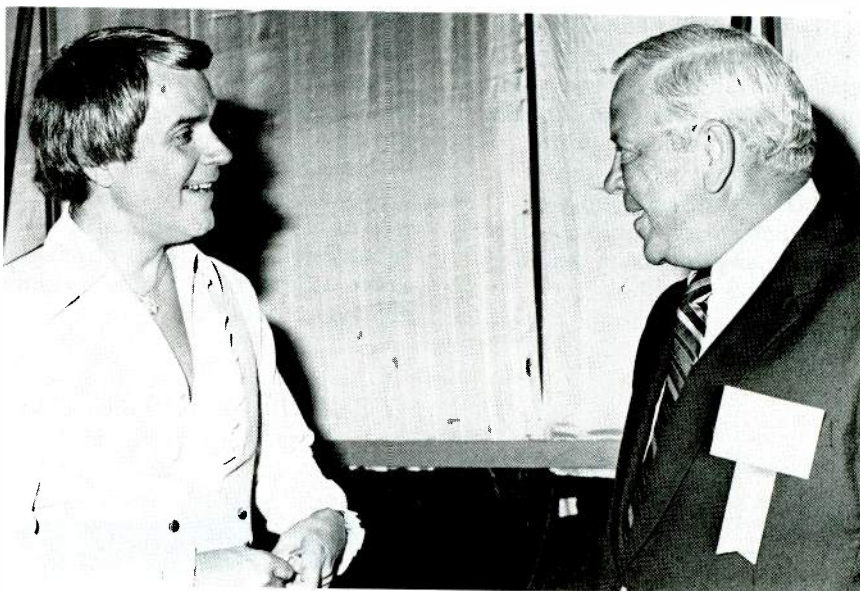

Rich Little and Vincent Wasilewski at NAB '81. (We'll hold a contest to select the best humorous caption for this picture. Readers can mail their entries to the humor editor, **Broadcast Engineering** magazine, and we'll select the winner. Also, we'll publish some of the entries in a future issue and give a small calculator to the winner.

Support your Electronic Field Production with Steadicam.

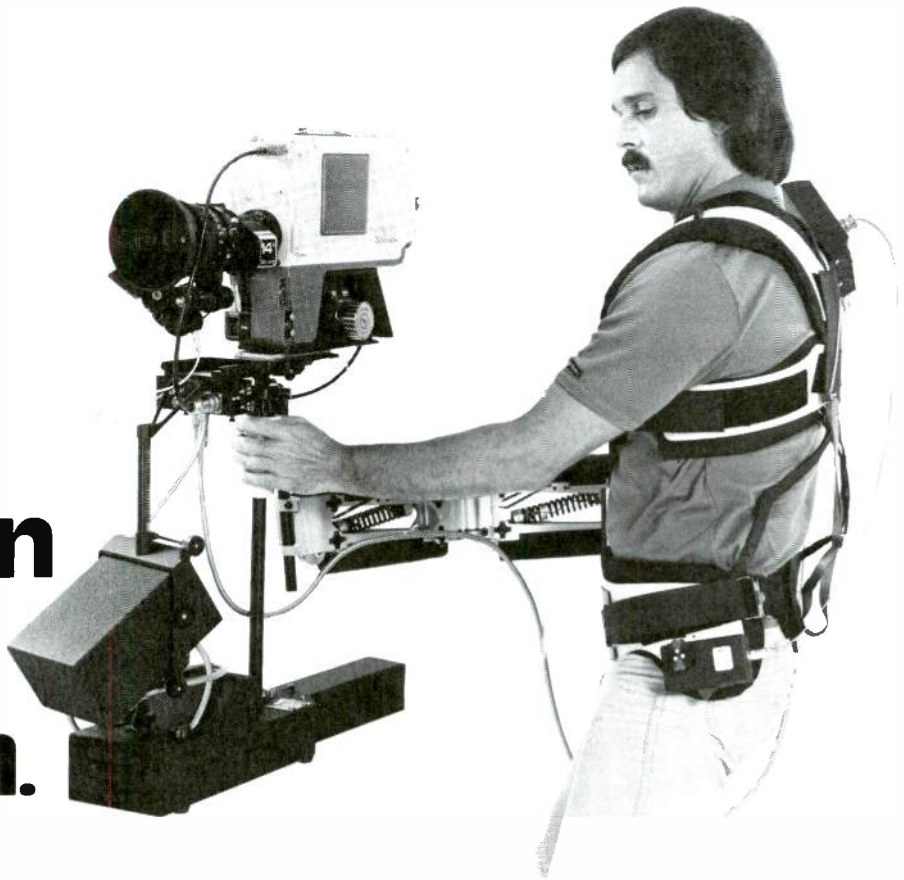

Our Oscar-winning Steadicam video/film camera stabilizing system is a practical all-purpose production tool of enormous versatility. Not at all restricted to running shots or esoteric effects.

On the contrary. Its widespread use on numerous TV specials, documentaries and commercials indicates that Steadicam is now becoming a standard, basic production tool. As elementary as a tripod or a dolly. But with far greater universal applications.

Turning virtually anything that moves into a stable camera platform, Steadicam lets you be wherever the action is—be it the White House, a rock concert, a sports event, or even a used car lot! Enhancing the scene with a heightened sense of fluidity and realism. Lending outstanding production values to all your field production efforts.

And, of course, our unique Steadicam system remains a relative constant in the quickly changing world of video equipment. Steadicam accepts—interchangeably—most portable video cameras* (as well as 35mm and 16mm film cameras) currently in professional use. Which is why so many production companies, television stations and independent operators prefer to own their Steadicam system.

We offer complete Steadicam/camera and accessories package deals to meet your every

requirement. And our exciting “state-of-the-art” lease/upgrade program is custom-tailored to suit your financial needs.

Don't delay. Buy or lease your Steadicam now. And get all the benefits of equipment ownership and tax write-offs, as you enjoy the convenience and immediate rewards of working with your own Steadicam system.

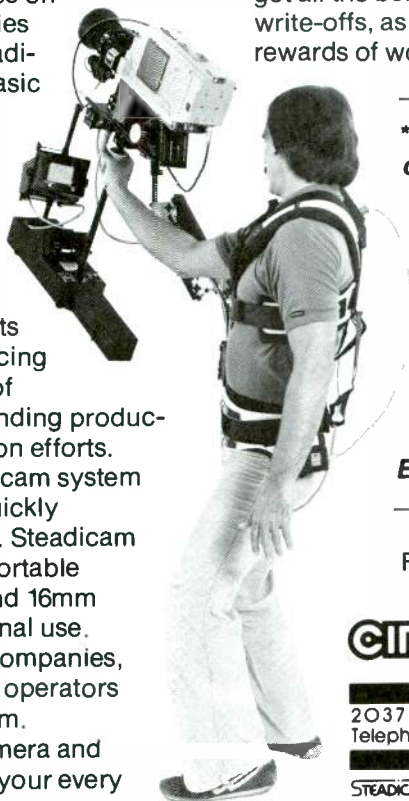

***Our Steadicam system accepts, interchangeably, most portable broadcast-quality video cameras such as: RCA TK-76B, TK-76C and TK-86; Ikegami HL-77 and HL-79A; Philips LDK-14; Hitachi SK-70, SK-80, and SK-90; Toshiba PK-39; Sony BVP-300 and BVP-330; CEI 310; Thomson-CSF MC-601 and MC-701; NEC MNC-71CP and MNC-81A; as well as most of the newest, recently introduced ENG/EFP cameras. Please inquire.**

For full details, call toll-free: 800-421-7468

cinema E products
CORPORATION

Technology In The Service Of Creativity

2037 Granville Avenue, Los Angeles, California 90025
Telephone: (213) 478-0711 • (213) 477-1971 • Telex: 69-1339

STEADICAM® is covered under U.S. Patent No. 4,017,168 and under foreign patents abroad



Arch Madsen (center), president and chief executive officer of Bonneville International, received NAB's 1981 Distinguished Service Award.

Convention

In accepting the award, the highest in radio and TV broadcasting, Madsen emphasized "the responsibility of broadcasters to enhance understanding, to accelerate the emancipation of the goodness in people and to destroy ignorance. Everything else broadcasting does should be of secondary importance."

Madsen, who began his career in broadcasting in 1933 when he got his first job "because he could copy international Morse Code," compared the 50 word per minute "high speed

transmission" available then to the present technology of teletext and its 50,000 word per minute capability.

Teletext is a system of broadcasting print information over existing TV signals for display on home TV sets. Bonneville pioneered teletext development in the US, and has been broadcasting teletext information over its station KSL-TV in Salt Lake City since June 1978.

"Truly, we live in the millenium of communications technology. We have a glittering tool box of communications instruments...instruments beyond our wildest dreams of a few years ago," Madsen said.

When commenting on the imbalance in the explosion of technology, Madsen said, "Not only does the world need technical capability, but, more importantly, it needs competence, commitment and action in community substance."

"Our ever-amazing communications technology has made all peoples of the world next door neighbors. Quoting Frank Stanton, former president of CBS, Madsen said, "Unless technology is used to link minds in a significant way, it is utterly useless."

Madsen expressed his views on the need for Western broadcasters and journalists to become more active in the battle to protect and expand press freedom throughout the world. He referred to the turmoil surrounding the UNESCO conference on international media as, "the persistent Soviet-sponsored attempt to gain, through UNESCO, a declaration that news and information should be controlled by governments."

Madsen became the 30th recipient of the NAB award, joining other broadcast notables such as Edward R. Murrow, David Sarnoff, Lowell Thomas, Bob Hope, William Palley, Billy Graham and President Herbert Hoover (who pioneered the establishment of the FCC).

The Distinguished Service Award is presented each year to a broadcaster who has made "a significant and lasting contribution to the American system of broadcasting by virtue of a single achievement or continuing service for, or on behalf of, the industry."

Madsen, 68, has been the president of Bonneville since its founding in 1964, and has led the growth of the corporation from one station, KSL, in Salt Lake City, to 11 radio and two TV stations from coast to coast. The firm also has extensive production, tape duplicating, radio syndication and TV transmission holdings.

In recent years, Madsen has been active in international broadcasting as the US representative on the Asian, European, African and Arabic broadcast unions as well as other interna-

Case History #437

Electronic News Gathering is one of the toughest environments a microphone will ever encounter.

Every mike we've seen has compromised the demand for low handling noise, fine audio quality and virtual indestructibility.

Credit the NBC Electronic Journalism Department/Operations and Engineering in New York for putting the Electro-Voice DO56 shock-mounted omni in the field. Although originally designed as an on-camera entertainment and MC's microphone, NBC found the DO56 to be the microphone that provides an audio signal commensurate with video in real-life crisis situations. In these situations audio often takes a back seat to video,

Electro-Voice DO56 Shock-Mounted Omnidirectional Microphone

resulting in a final product that doesn't accurately reflect the broadcaster's professional standards. NBC discovered that the DO56 takes the

pushes, the shoves, the rubs and finger taps in stride. And when handling *really* gets rough, the DO56's unique internal shock mount virtually eliminates the bell-like clang transmitted by other shock-mounted mikes.

Congratulations to the NBC Electronic Journalism Department in New York. You found the solution - the DO56.

For an in-depth description of this and other case histories, get on the Electro-Voice "Mike Facts" mailing list. Write on your letterhead to Mike Facts, c/o Electro-Voice, 600 Cecil Street, Buchanan, MI 49107.

EV Electro-Voice[®]
a gulton company



Circle (9) on Reply Card

CREATIVITY TAKES FLIGHT ON AMPEX VIDEO TAPE.



BROADCASTERS AND PRODUCTION COMPANIES DEPEND ON AMPEX TAPE.

From videotape equipment to the video tape itself, broadcasters and production companies throughout the world depend on Ampex. High quality, durability, reliability, and prompt service are just some of the reasons.

Ampex 175 Highband Quadruplex Video Tape has proven itself under every conceivable type of operating condition within every video standard. Excellent color performance, low drop-outs, and a tough durable formulation with low headwear are features which have contributed to this dependability.

And now Ampex 196 High Energy Broadcast Helical Video Tape has been specifically engineered to fill the increasing needs of a particularly demanding group of video professionals—those who have chosen one of the new broadcast helical VTRs.

No matter what your video tape needs are, there's an Ampex video tape for you. And, once you've tried Ampex tape, you'll see why broadcasters and production companies have grown to depend on Ampex.

AMPEX

REFLECTIONS OF REALITY. AND BEYOND.

Ampex Corporation, Magnetic Tape Division,
401 Broadway, Redwood City, CA 94063 415/367-4463

Circle (10) on Reply Card



SOLID, SMOOTH, RELIABLE!

THE P-80

The All New
P-80 Pneumatic
Camera
Pedestal—



21"-58"
HEIGHT
RANGE
Compares
with
any unit
available.

UNPARALLELED STABILITY

Each column guided
by large, precision ball
bearings on four hardened-steel tracks.

**SMOOTH, EFFORTLESS CAMERA
MOVES** 8" Gimbals-mounted wheels
and a single steering and lifting ring.

LONG-TERM RELIABILITY Designed
without compromise for durability, easy
maintenance, and minimum down-time.

30-5/8" -
50-5/8"
HEIGHT
RANGE



THE P-25

Based on our
workhorse P-20,
improved with
features from our
larger
models.

ALL WELDED STEEL CONSTRUCTION

Provides rugged stability,
carries loads up to 270 lbs.

EASY ROLLING 8" WHEELS

Come standard with Gimbals-mounting.

Manufacturers of Pneumatic
Camera Pedestals since 1952



**TELEVISION
PRODUCTS CO.**

9016 Aviation Blvd., Inglewood, CA 90301
(213) 776-3276

Circle (11) on Reply Card

Convention

tional government and industry organizations. He is the vice chairman of the World Press Freedom Committee.

9kHz warms up in Las Vegas

One subject under hot discussion at NAB '81 dealt with the upcoming ITU Conference for Region II and the pending question of reduction of the AM broadcaster's allowed bandwidth from 10kHz to 9kHz. The change in bandwidth would increase available channels for the AM operators, so the argument goes.

According to the NAB stand on the issue, the available channels would number only 12, as reported by Vincent Wasilewski, NAB president. As a trade-off for the 12 channels, broadcasters would be required to alter existing equipment to reduce their transmitted signal bandwidths, estimated to run into the millions of dollars—possibly causing some stations which operate at a marginal profit to cease operation. And, the public can expect to receive inferior radio quality.

Johnson: FCC needs engineering support

Recipient of this year's NAB 1981 Engineering Achievement Award was Wallace (Wally) E. Johnson, previously chief of the FCC Broadcast Bureau. Johnson is one of the nation's leading experts on the 9kHz issues, and is representing the NAB on international matters on this subject. In his awards acceptance remarks, he observed that the importance of

engineering at the FCC has decreased at a time when many basic broadcast technical matters have been under attack and subject to change. He acknowledged that technical requirements in the Commission's rules "caused a problem for the decision makers in achieving their dream of an unlimited number of additional stations." The marketplace should play a major role in determining the limits of new assignments, he suggested, "not those restrictive technical standards."

Johnson expressed concern that the highest offices in the commission were no longer held by engineers, but rather by lawyers. Furthermore, not a single engineer was representing the FCC at the 1981 Convention.

"Before we change the best technical broadcast service in the world, aural and visual," he noted, "we want the impact clearly and fairly identified—what the benefits were going to be, who is going to gain, what the losses are going to be, and who is going to lose. Will there actually be more service available to the public, or more interference? What's going to happen to the technical quality of service provided the public? And it's not a bad idea to consider the cost to the industry which supplies the service. The answers to these questions should be developed on an unbiased basis, not just as support for the predetermined result."

Walker: FCC running scared

Johnson's award acceptance was followed by an address by A. Prose Walker, a prominent expert in international radio engineering and consulting engineer from Tallahassee, FL. Formerly, he was chief of the FCC's

Continued on page 177



Wallace "Wally" E. Johnson (left), recipient of the NAB 1981 Engineering Achievement Award, discusses the occasion with last year's recipient, James D. Parker, of James D. Parker Inc., New York.

IF WE SAID YOU COULD MAINTAIN HIGH PRODUCTION STANDARDS FOR LESS THAN \$2000, YOU'D SAY WE'RE UNBALANCED.

By using a -10 unbalanced system, instead of +4 balanced, we eliminated hundreds of dollars of line amplifiers, transformers and balanced audio cables.

And that's how the Tascam 35-2B recorder/reproducer can save you money.

Without compromising your professional quality one nanoweber.

Unless you're running cable hundreds of feet long, there's no real difference between balanced and unbalanced. Since input/output levels and impedance aren't factors in recording quality.

So it pays to use the Tascam 35-2B in production, where you're

not running long cables.

Which brings us back to quality. We know the most important thing in broadcast production is the signal that goes on the tape. That's why the 35-2B meets NAB standards.

185 nanowebers per meter.

And with a switchable 1/4-track playback head built in, you get greater flexibility at no extra cost.

What's more, the 35-2B features a

rugged three-motor transport system and full IC logic transport controls.

Cue and Edit functions and a flip-up, hinged head cover help make editing easy and effortless.

For more details, see your Tascam Series dealer. He'll be happy to show you how being unbalanced can improve your balance sheet.

Balanced vs. Unbalanced

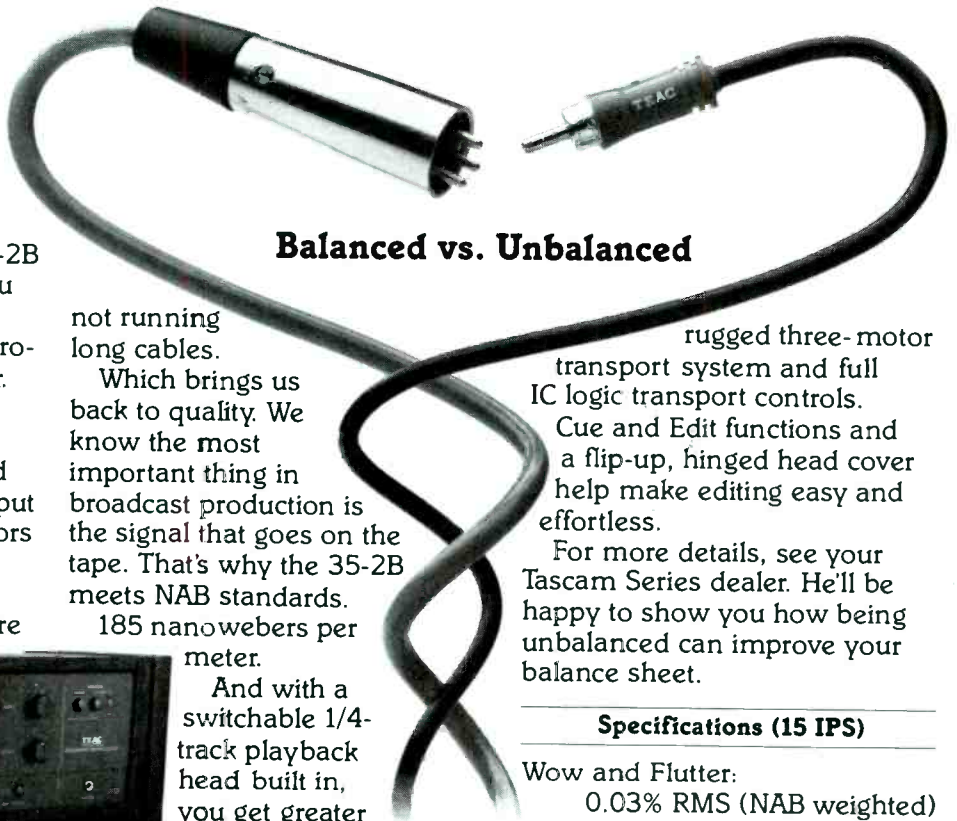

Specifications (15 IPS)

Wow and Flutter:

0.03% RMS (NAB weighted)
±0.05% peak
(DIN/IEC/ANSI weighted)

Frequency Response:

40 Hz-22 kHz, ± 3dB at 0 VU

Signal to Noise Ratio:

Reference 1 kHz at 10 dB above
0 VU (650 nW/m) 65 dB A
weighted (NAB) 92 dB A
weighted with integral dbx*

*"dbx" is a trademark of dbx Incorporated.

TASCAM

Teac Production Products



CS-600 Console optional.

The 32-2B and the compact 22-2 recorder/reproducers can save you even more money.

© 1981 TEAC Corporation of America, 7733 Telegraph Road, Montebello, CA 90640.





The Panasonic Diode-Gun Plumbicon Camera. What better way to say broadcast performance.

Whether you're shooting a 9th inning rally, a political rally or a network special, no other ENG/EFP color camera says broadcast more ways than the new Panasonic AK-760.

The AK-760 combines a high-index prism optical system with three $\frac{2}{3}$ " diode-gun Plumbicon® tubes.

And since the diode-gun Plumbicon tube has a thinner photoconductive

layer than conventional Plumbicons, the AK-760 offers outstanding resolution (600 lines center). Another advantage of the diode-gun system is the low beam resistance it generates. Add to that the AK-760's built-in bias light and the result is low beam temperature performance even at high beam current. And that also says lower lag

The AK-760's feedback beam control reduces comet tailing by stabilizing highlights that exceed normal white levels. What it doesn't reduce is dynamic range or horizontal resolution. And because it's only activated during extreme highlights, feedback beam control helps prolong tube life and preserve edge geometry.

The AK-760 also gives

you the edge with a S/N ratio of 54dB at standard illumination of 200 foot-candles at f/4.0. And with the 18dB high-gain switch, all you need is 5 foot-candles at f/1.8.

Mounted on the AK-760's durable die-cast chassis you'll find an impressive array of circuitry like horizontal aperture correction, 2-line vertical enhancement, automatic



white balance and a built-in color conversion filter.

And whether you use it for ENG or EFP, the AK-760 is fully self-contained, and includes genlock, internal sync, adjustable blanking as well as subcarrier and phase controls.

For studio production, you can add an optional remote control unit, 5" CRT viewfinder and zoom lens conversion kit.

Panasonic also makes broadcast quality easy to afford with the AK-750B 3-tube Plumbicon. At \$16,000* it comes complete with 2-line enhancement, a \$2,000 option last year, plus genlock, a rechargeable battery, microphone and VTR cable.

There's also the AK-710. An electronic news-gathering camera at a news-worthy price, \$10,950* Its

three Saticon® tubes and high-index prism optical system result in horizontal resolution of 500 lines center and a S/N ratio of 52dB.

Audition the AK-760 along with the entire line of Panasonic broadcast quality cameras. You'll see what we mean when we say broadcast.

For more information about Panasonic broadcast equipment, call your

nearest Panasonic office.

Northeast—(201) 348-7620
 Southeast—(404) 923-9700
 Midwest—(312) 364-7936
 Southwest—(214) 258-6400
 West Coast—(213) 655-1111

Plumbicon is a registered trademark of N.V. Philips for TV camera tubes. Saticon is a registered trademark of NHK (Japan Broadcasting Corp.). *Manufacturer's suggested price. (Lenses not included.)

Panasonic
 VIDEO SYSTEMS DIVISION

Circle (13) on Reply Card



Radio Workshops

By Brad Dick, chief engineer, KANU, Lawrence, KS

Implementing Telephone Talk Shows

The 1981 NAB '81 Radio Engineering Workshops began with a topic close to the minds of many engineers—telephone talk shows. The biggest hurdle, according to the panel, according to proper interfacing is that of language: broadcasters don't speak telephone and telephone people don't speak broadcasting.

A short presentation was made showing the basics of a standard key telephone system. The proper method of controlling the key equipment with simple relay or switch contacts was demonstrated in schematic drawings. Proper muting circuits were shown so that the telephone instrument would not be modified in any way. This, of course, prevents trouble with the local repairman when a particular phone needs to be fixed and several modifications are found. The correct method of muting takes place in the trunk room, not at the individual phones.

The panel made the point that the engineer must be aware of system protection. This means that at no time should anything be connected to the telephone system that could either damage the phone system, or possibly injure anyone working on the system. For these reasons, the telephone company insists on "protective couplers." (As one panelist put it, there are two ways to interconnect with the telephone equipment: legally and intelligently.)

There are currently several standard couplers available to the broadcaster. These include: QKT/(POP), manual voice coupler; RDL recorder connector; RDM recorder connector with bi-directional audio; RDMZM station coupler; RCZ recorder coupler with beep tone; FTM music on hold protective arrangement.

Each device has its own particular feature and characteristic. A knowledgeable broadcast engineer should be consulted before deciding which coupler/connector is best suited for the purpose. Characteristics of each unit make it well-suited for

one application, but unsuited for others. For example, the QKT (POP) is in wide use for voice transmission. Although it is not a good transmitter because of distortion, it is a good receiver.

For those stations having RFI problems, it is suggested that the local phone company install the protective arrangements listed in BSP (Bell System Practices) 500-150-100. This practice carefully outlines the steps to take to RFI proof any telephone.

Mark Durenberge, of KSTP, St. Paul, MN, explained the three basic methods of coupling 2-way audio for the broadcast work: speakerphone, hybrid balanced system and balanced level systems. Properly used, the hybrid can provide 6 to 20 dB of isolation, but it must be properly balanced to the particular line in use. Because the impedance of the lines varies greatly, the system needs to be rebalanced for every call if maximum performance is to be achieved. It is possible to obtain satisfactory results with the hybrids currently available from many sources, including the Bell System.

The balanced level system works, but does require close gain riding on the part of the operator. Also, the send and receive impedances are critical to a properly operating system. Durenberge introduced schematic

drawings to show a properly interfaced balanced level system.

The final method of connection for talk shows is that of the speakerphone, and the type-four speakerphone is used by many broadcasters for this purpose with good results. Although the speakerphone has screw terminals located inside the case for connection to the various input and output circuits, the engineer is warned that dc isolation must be provided for on the microphone input so as not to upset the circuitry in the speakerphone.

John Lyons, of WXLO in New York, showed several slides of his custom-built telephone system. Although this system offers many benefits to the user in terms of flexibility and features, Lyons warned against this method unless the engineer is thoroughly familiar with all that is required to install and maintain a telephone system.

Comrex was represented by Tim Brown and, as last year, showed how extended frequency response could be obtained over dial circuits. By shifting the frequency of all of the materials up slightly on transmission and then down by the same amount on receive, a total frequency response can be obtained similar to that of an equalized loop.

Mary Lou Brooks Aiken, representative of Southern Bell Telephone,



Telephone talk show: Moderator William Ruck, KFOG, San Francisco, sits at the far left. Panelists (left to right) are: Tim Brown, Comrex; Mark Durenberg, KSTP, St. Paul; Mary Lou Brooks Aiken, Southern Bell Telephone; and John Lyons, WXLO, New York.

Dolby®

Plug Better Sound Into Your Picture

The Dolby® Cat. No. 155 or 255 module allows you to plug the benefits of a Dolby A-type noise reduction directly into your Sony® BVH-1000/1100 or Ampex® VPR-2 1" VTR* Operation is fully automatic. And at long last the audio performance of your VTR will rival that of professional audio tape recorders.

Dolby A-type noise reduction has been accepted for years throughout the world for high-quality tape recording and other audio transmission and storage media. It provides 10 dB of noise reduction from 30 Hz upwards, increasing to 15 dB at 9 kHz and above, without the audible side effects (such as noise modulation and overshoot distortion) associated

with more conventional techniques. Dolby noise reduction can also lead to lower distortion, as it permits more conservative recording levels to reduce the risk of tape saturation.

Today wide audio bandwidth and low noise are becoming commonplace in many parts of the television origination/transmission chain. Contact us to find out how Dolby noise reduction can prevent the VTR audio track from being one of the weak links.

*Outboard Dolby noise reduction units are available for use with virtually any other video or audio recorder. Circle (14) on Reply Card



Dolby®

Dolby Laboratories Inc.

731 Sansome St.
San Francisco
California 94111
415-392-0300
TELEX 34409

346 Clapham Road
London SW9 9AP
England
01-720-1111
TELEX 919109

SOUND BEFORE ITS TIME



**ULX
2001**

UniPhase Link-Exciter
from

mci

Designed to enhance the performance of conventional STL Systems, the Micro Controls ULX-2001 UniPhase Link-Exciter modulates and multiplies a radio carrier to the 950 MHz STL frequency for transmission to the FM Broadcast Transmitter site. Sampled at I.F. frequency, then heterodyned to the 88-108 FM frequency range, non linearities inherent in the STL receiver-detector and FM exciter-modulator are eliminated. With better phase linearity, total overall sound performance is improved.

F.C.C. type acceptance pending.

OTHER EQUIPMENT AVAILABLE:

Conventional STL — Composite Wideband
Discreet Narrowband

Remote Control — Radio & Wireline
SCA Equipment — Automatic Transfer Units
Antennas — Transmission Line

Call or write today for more
information.

**MICRO CONTROL
ASSOCIATES**

P.O. Box 694
Cleburne, Texas 76031
817/295-7771

Radio workshops

pointed out difficulties with providing the needs of the broadcaster. She said that even with the regulation of the industry and accompanying tariffs, the phone company could still meet the specialized needs of the broadcast station through what is called "special assemblies." These assemblies are specially constructed telephone equipment designed for a particular station. By this method, the station can obtain any equipment it may deem necessary while ensuring that the phone company will be responsible for its installation and maintenance.

There are a couple of stumbling blocks of which the engineer needs to be aware before proceeding with this project. First many people in the phone company will not know about a special assembly. Aiken suggested that you learn to be persistent in your efforts, and begin by speaking with a media marketing representative. These people have been trained to deal with these requests and will know the procedures.

The engineer must carefully study the needs of the system that is proposed. The phone company will design the system to meet just those needs listed and described on the design forms used in the process. She warns that it is time-consuming and expensive to the station if a special feature is forgotten and added after construction has begun. The pricing of the special assembly is based on the engineering construction and maintenance costs and will not be covered by any tariffs.

Moderator William Ruck, of KFOG in San Francisco, provided a useful idea to those stations having trouble with telco disconnects of broadcast circuits. The customer can request a "walk thru" on any circuit by the phone company. This will require that the phone company physically walk through (check) the circuit in question verifying such things as proper terminations, labeling, routing and, in general, ensure that the circuit is properly installed from origination to destination.

These circuits are required to receive SSP (Special Services Protection) and the customer has a right to see that he has it. Ruck warns, however, that the best ally for the broadcaster is not a club but a good working relationship with the local company, and especially the local installer.

For stations contemplating new telephone services, Ruck warned about lack of involvement on the part of engineering. For instance, many

stations have available to them the newer ESS switching systems, and such in-house switching systems as the Dimension and Horizon phone systems. These phone systems provide many operations features, but can they be properly interfaced to your broadcast equipment? Because both of the above systems can be provided without "key phones," does that mean that you cannot obtain the necessary control lines such as the A and A1 leads for line seizure? If so, the engineer could face the expense of special assemblies just to get basic features he would normally build himself. The key, according to Ruck is to be actively involved in the phone selection process and know what is needed in the way of features.

FCC: 9kHz, a hot topic

The FCC panel, one of the best attended sessions, quickly found itself bogged down with disagreement among the panel members. The lead speaker was Dick Schiben, chief of the Broadcast Bureau of the FCC. Heading directly into the throes of the crowd, Schiben called the 9kHz question one of the most difficult issues he has had to face. He related how originally the 9kHz question was simply a matter in which the FCC could add several new channels to the AM band and therefore accommodate many new stations. The impetus at the beginning was from the daytime stations desiring expansion to full-time service.

Schiben said he felt that many broadcasters originally saw the 9kHz question as only relating to expansion of the current system. Now, however, broadcasters must view the question of 9kHz under the premise that the US has 55% of the AM service and that the other countries are now demanding what they see as their fair share.

With the rapid growth of AM broadcasting in the US, many other countries see that growth as having a preclusionary effect on them. For this reason a 5-year plan of needs was drawn up by each country. With this plan came what has come to be known as the Cuban Inventory. Many broadcasters see this Cuban Inventory as a major stumbling block to successful negotiations.

"Unless we can satisfy the needs of these other countries, then we might be required to go to 9kHz merely to keep you (the broadcaster) in business," Schiben said.

He said he felt that many stations should view the problem as one of coverage for their own stations. He listed WNBC and WJR as examples, saying that if their present coverage patterns are viewed as the size of a

Circle (15) on Reply Card

NEW!



VIDEO EDITING LIST MANAGEMENT WITHIN YOUR REACH

Now videotape editing list management is within your reach! Convergence Corporation's easy-to-operate, multi source ECS-104 List Management Editing System offers full auto assembly list management capability at a very affordable price.

Unique Standard features include:

JoyScroll™ Joystick scroll

TimeSearch™ Source & Record
VTR time search

"409" EMMY-winning "409"
program

CleanIt™ Unique auto-clean.

SyncTag™ Special sync roll tag

CheckIt™ Automatic self
diagnostics

TenCom™ Command generator*

The ECS-104 has all of the standard EMMY-winning ECS-100 Series features, and more...

- Auto assembly with audio select.
- Full sync roll with listing.
- 600 edit lines internal storage.
- Add, replace, delete and block moves.
- "Exchange" - Alternate edit register.
- Preview BVB/VBV/In/Out/In-Out/ Open
- Comment entry and storage.*

- dedicated reel number and edit number keys.
- Battery back-up.*
- Utilizes user bits in time code.
- Most popular 1 inch, 3/4 inch, and 1/2 inch interfaces.

OPTIONAL ACCESSORIES AVAILABLE

Floppy Disc System, Command Generator Unit, Special Effects Switcher with optional control panel, Battery backup system, Cutlap and Liplock®.

Contact us today for more information.

*Requires Optional Accessory

 **CONVERGENCE
CORPORATION**

1641 McGaw, Irvine, California U.S.A. 92714, (714) 549-3146, TWX (910) 595-2573
1 Lochaline Street, London W6 92J, United Kingdom, Telephone: 01-741-7211, Telex: 851-27950 MONREF G (Ref. 3801)

For Information Circle (16) on Reply Card
For Demonstration Circle (17) on Reply Card

THE SIGHTS

Chroma Insert Keyer, Model 7011.

A unique comb filter minimizes noise and color-edge crawl from the key signal. It has "zero-H" delay with no installation and retiming problems because the delay is less than 25 nanoseconds. No separate insert keyer or separate RGB switcher is required. Each unit is equipped with remote control and 50 feet of cable.

Color Corrector, Model 5500A.

It is the ENG production tool for adjusting color variations after encoding, and enables a broadcaster to balance varying color values from a variety of program sources. Program materials from cameras, tapes, films or network feeds can be color-balanced to each other after tape playback or microwave receiver during live coverage. Available with an optional automatic sensor for telecine use. Also available in PAL.



Dynamic Presence Equalizer, Model 4500.

Enhances broadcast signal presence automatically. Gives program material more punch and improves sound quality. Compensates for lack of presence caused by poor microphone placement, incorrect equalization, misaligned tape heads and unequalized telephone circuits.

FM VOLUMAX®

Automatic Peak Controller.

Designed especially for the FM broadcaster. Allows maximum signal strength and prevents overmodulation caused by pre-emphasized signals. Full brilliance and dynamic range are maintained without distortion through multi-band processing. Available in monaural or stereo.

THE SOUNDS

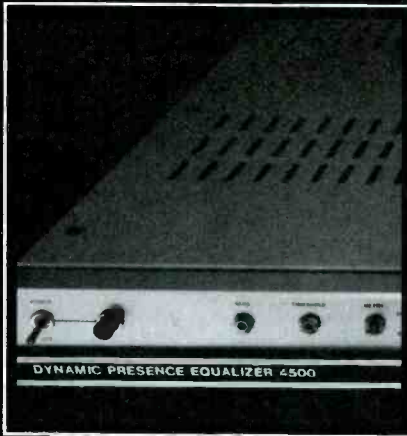

THE SUBSTANCE

Sights and sounds. Thomson-CSF gives them substance. With proven broadcast products that enhance the image, correct the color, ride gain, equalize and distribute the signal. To put these quality products to work for you, contact your nearest Thomson-CSF distributor.

Lake Systems Corp.
Newton, MA 02160
Videosound of Ithaca, Inc.
Ithaca, NY 14850

Sonocraft Corporation
New York, NY 10018

Lerro Electrical Corp.
Philadelphia, PA 19132

Electromedia, Inc.
Pittsburgh, PA 15213

Tele-Measurements Inc.
Clifton, NJ 07014

Landy Associates, Inc.
Cherry Hill, NJ 08003

Slye Electronics, Inc.
Arlington, VA 22201



Image Enhancer, Mark IV Series.

Improved signal-to-noise ratio means better enhancement. Both horizontal and vertical elements are enhanced to eliminate color softness. In-line, three-tube models are available for NTSC, PAL and PAL-M standards. The Model 8010, with automatic control, maintains picture sharpness and resolution of encoded video, without double enhancement when processing a previously enhanced signal.

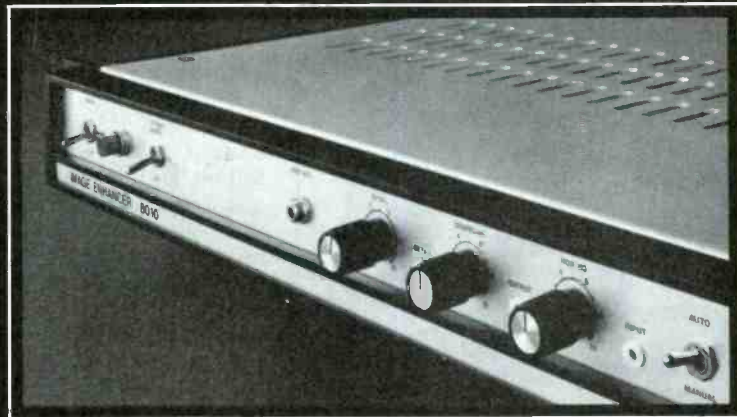

Audio Distribution Amplifier, Model 1602.

Designed for either stereo or monaural use, this model contains two distribution amplifiers, each with eight balanced outputs from one input, strappable to a 1 x 16 unit. Ideal for distributing program and monitor circuits to studios and control rooms. Features differential, balanced inputs, 40 dB gain, and high output isolation.



VOLUMAX® Automatic Peak Controller, Model 4300.

With patented control action, this AM limiter assures maximum utilization of each watt of carrier power without overmodulating the transmitter, and with minimal signal distortion. Automatic peak phasing insures negative asymmetry and is silently inverted for positive modulation to the maximum allowable limit of 125%.



AUDIMAX®

Automatic Level Controller.

Rides gain automatically. Eliminates objectionable swish-up of compressor-type limiters. Features adjustable recovery time. And patented return-to-zero function with low distortion and superb frequency response. Ideal ahead-of-the-limiter for maximum program coverage. Available in mono or stereo.



Technical Video Systems, Inc.
Winston-Salem, NC 27101

A. W. Greeson, Jr.
Greensboro, NC 27403

Quality Media Corp.
Columbus, GA 31908

Gray Communications Consultants, Inc.
Doraville, GA 30340

Gray Communications Consultants, Inc.
Albany, GA 31705

Gray Communications Consultants, Inc.
Tampa, FL 33614

Suministros Gonzalez
Miami Beach, FL 33139

Gray Communications Consultants, Inc.
Harahan, LA 70123

Broadcast Systems, Inc.
Austin, TX 78758

Electrotex
Houston, TX 77006

H. M. Dyer Electronics
Farmington Hills, MI 48024

Swiderski Electronics Inc.
Elk Grove Village, IL 60007

Television Engineering Corp.
Chesterfield, MO 63017

Bennett Engineering Associates, Inc.
Mercer Island, WA 98040

BCD, Inc.
Anaheim, CA 92806

General Electronics Systems, Inc.
Berkeley, CA 94702



THOMSON-CSF BROADCAST, INC.

37 Brownhouse Road, Stamford, CT 06902
Tel. (203) 327-7700 TWX (710) 474-3346

Circle (18) on Reply Card

BEHIND THE LENS OR IN FRONT,



TIFFEN FILTERS ARE THE INDUSTRY'S FIRST CHOICE.

Most major manufacturers of video cameras install Tiffen filters as original equipment in the filter wheel behind the lens.

Most major TV stations and studios use Tiffen filters in front of the lens.

Why? Because cameras are only as good as their components. When quality components are required Tiffen filters meet all the requirements.

They're rugged, reliable, precision-made. And the performance is always outstanding.

Superior technology and quality craftsmanship combine to make Tiffen filters the industry's first choice.

Tiffen Makes Filters For:

Ampex	Harris	Rank Taylor Hobson
Angenieux	Ikegami	RCA
Canon	IVC	Schneider
Fernseh	Marconi	Thompson
Fujinon	Norelco	And Many Others
GE	Phillips	

Write Dept. BE for FREE Professional Brochure and Price List

TIFFEN®

90 Oser Avenue, Hauppauge, N.Y. 11788
(516) 273-2500 Telex 96-7748

Circle (19) on Reply Card

Radio workshops

watermelon, and if the Cubans proceed with their plan and the US doesn't adopt 9kHz, then those stations' patterns would be the size of a pea. He continued by saying that his top priority was to protect the existing broadcasting structure. In response to a question from the audience about the US staying with 10kHz even if the Cubans proceed with their plan, he called that idea cutting off one's nose to spite his face.

Wallace Johnson, executive director, Association of Broadcast Engineering Standards, said he sees the current US system of AM broadcasting as a model for the region to follow, and was concerned that some countries were attempting to destroy that system by their own proposed broadcasting. He said that medium-wave broadcasting was to be used for communication within the country in which the station is located. Now many countries, specifically Cuba, are proposing stations on every frequency except ones with powers that make no sense.

"There is no way we can go into an agreement with a country like Cuba that is going to destroy us," Johnson said. Stating that now the public was going to be faced with absorbing the cost of the increased interference, and obsolete receivers, his comments

drew strong applause.

Harold Kassens, of A. D. Ring & Associates, felt that Schiben might be right and that 9kHz may be the only alternative. He echoed Johnson's comments questioning why the US was even involved in negotiations. "Why are we in a conference where Argentina is telling us what propagation curves we have to use in the United States?"

Kassens suggested that some way must be found to force Cuba to adopt the directional antenna arrays the US has proposed as a solution to the problem. The Cubans have stated that they cannot use directional antennas because of the cost and lack of available land on the island. Kassens also felt that perhaps Cuba was not currently operating according to standards and wondered if they could be counted on to do so under a new system.

Jeff Baumann, of the FCC, outlined the specific types of work in which his department was currently involved. He saw the current FCC's philosophy as continuing the deregulation process, and saw the FCC adopting a much more forward looking and marketplace attitude. Currently his department is involved in several hot topics, the foremost being that of AM stereo. With more than 22 volumes of data involved in the proceeding, the projected date for adoption is not known, but he assured the audience



The FCC on Region 2: Moderator Charlie Morgan, Sesquehanna Broadcasting, is at the podium. Panelists (left to right) are: Harold Kassens, A. D. Ring & Associates; Wallace Johnson, Association for Broadcast Engineering Standards; Jeff Baumann, FCC; and Richard Shiben, FCC.



Zaven "Doc" Masoomian, WQXR, New York, addresses the FCC panel on Region 2 matters.

The Only 2" ATR That's As Advanced As Your 1" VTR

With the Otari MTR-90, your audio can be as good as your video. It has all the advantages of one inch video format: compact size, broadcast quality, essential production features, and fewer dollars. It's the two inch multi-track production machine that's earned the reputation for being *The New Workhorse*. Post production houses, networks and recording studios are discovering that it's the new machine that outpaces the big names.

Here are some of the advantages of *The New Workhorse*:

- Superior Tape Handling — the industry's first three motor, pinch-rollerless two inch tape transport that can keep up with your VTR.
- Advanced Audio — high slew-rate components, active mixing of bias and audio, single card electronics, and a 71 dB dynamic range (24 track).
- Advanced Control Circuitry — digitally controlled



LSI circuitry for reliability and ease of servicing.

- Superior Editing — digitally timed, gapless electronic inserts. The capstan speed is continuously variable from 1 to 400 ips with external control.

The MTR-90 was designed for easy access to virtually any tape controller/editing system: EECO, BTX, ADAM-SMITH, AUDIOKINETICS, CMX and CVC. And, an optional phase compensated wide-band amplifier is available for high speed SMPTE code reading.

The MTR-90. Stay ahead of your competition with *The New Workhorse* — The frontrunner in video sweetening.

OTARI *The New Workhorse*

Otari Corporation, 2 Davis Drive
Belmont, California 94002

(415) 592-8311 Telex: 910-376-4890

Circle (20) on Reply Card

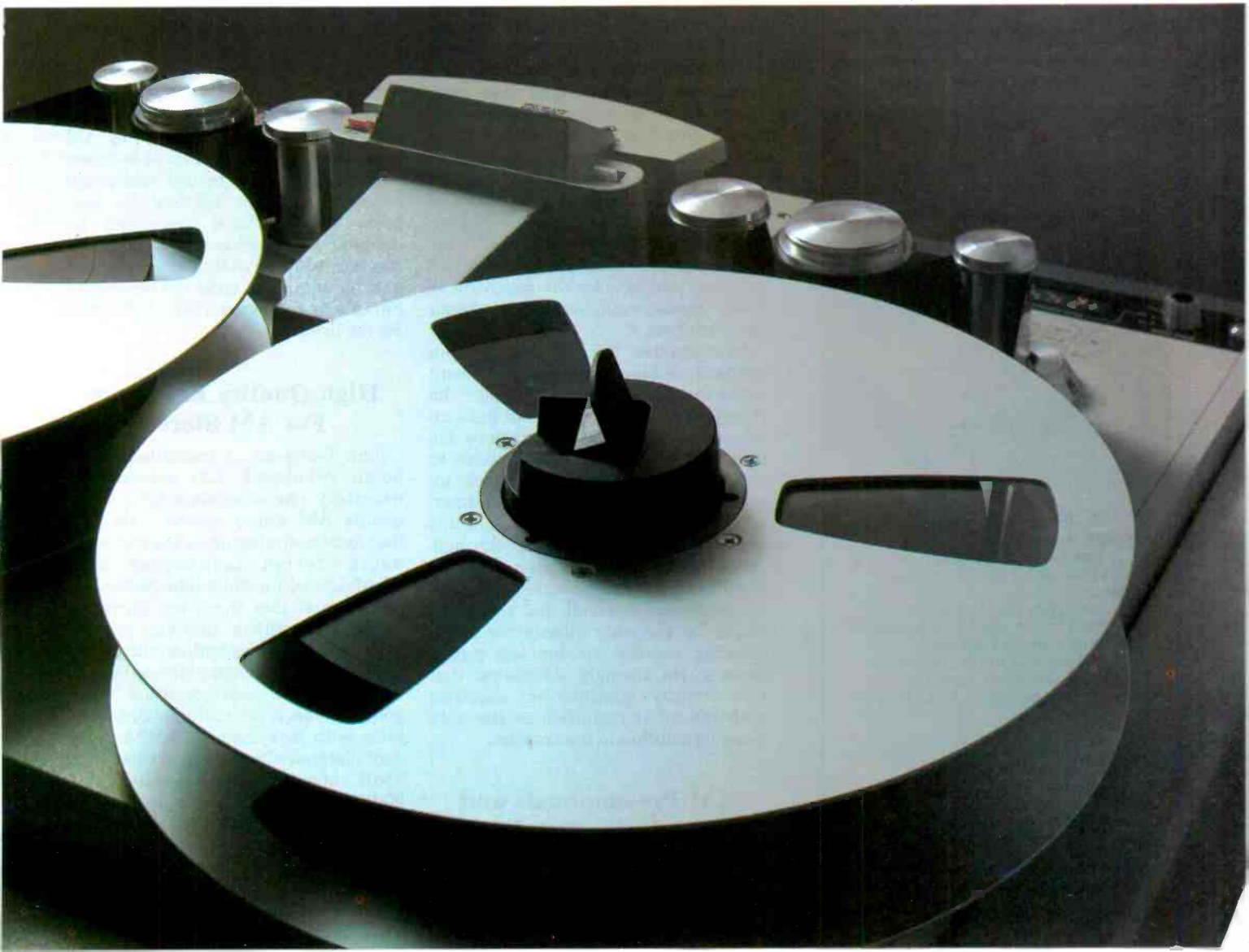

PLAIN

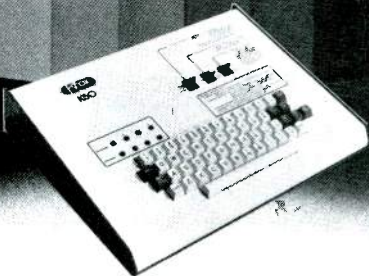

There's nothing fancy about the Knox K50.

It's reliable; it's economical; it's basic; the simplest machine we make.

Come to think of it, it *does* have an independent preview channel... and shadow-edged characters... and a flash function... all as standard features.

Maybe it's fancier than we thought.



A DIVISION OF COMPUTER OPERATIONS, INC.
5001-J Forbes Boulevard, Lanham, MD 20801
301/459-2106 Telex 89-8327

Circle (21) on Reply Card

FANCY fancy FANCY
fancy FANCY fancy
FANCY fancy FANCY
fancy FANCY fancy
FANCY fancy FANCY
ôôôôô ACSIËV ôôôôô



Do it with style. Better still, do it with *three* styles.

Knox calls it Multifont, and it's built into each Mod-16 character generator.

It's upper and lower case. It's accented letters. And it's resolution down to a *single scan line*.

It's just one of the features standard with every Mod-16.

It's also by Knox. Plain enough?



A DIVISION OF COMPUTER OPERATIONS, INC.
5001-J Forbes Boulevard, Lanham, MD 20801
301/459-2106 Telex 89-8327

Circle (137) on Reply Card

Radio workshops

that the matter would receive prompt action by his department. The matter of FM quadratics is currently in review by the commission. He expected that a decision on the subject would be reached in the near future and anticipates a public decision and rulemaking proceeding by late summer.

The commission, during the week before NAB'81, issued a notice of proposed rulemaking (RM 2859), to delete any requirement for the use of VITS. Baumann said he sees this as a significant step by the Commission Broadcast Bureau to concentrate some of its resources and activities outside that of the license renewal process. He saw the Bureau issuing rulemaking petitions dealing with FM blanketing, the use of SID, and TV aural subcarriers. He assured the audience that his department would attempt to resolve many of the petitions made by broadcasters in as short a time as possible.

From the floor, a broadcaster from Puerto Rico said that the United States usually works with a sense of fair play but seldom receives the same. He felt that we could not depend on some of the other countries even to follow the commitments made during negotiations, and that such negotiations were a waste of time. He said he wondered why the band could not simply be expanded instead of adopting another frequency spacing standard. Schiben replied that it might be 10 to 15 years before enough receivers could be in the field to make the frequencies usable. However, Johnson said he saw the receivers as being made available much sooner than Schiben.

In response to a question from Johnson, Schiben said that the recent news that Canada would support the retention of 10kHz would not have an effect on the current US position. He said that the US would still have to look at all of the Region 2 issues, including the 9kHz question; and determine what is in the best interest of this country. Schiben cautioned the audience not to have a closed mind on the 9kHz question. He again called on the audience to recall that this issue might be the only alternative to remaining on the air for US broadcasters. He strongly advocated that this country continue to negotiate with the other countries as the only possible solution to the conflict.

AM Pre-emphasis and Transmission Bandwidth

Chris Payne, National Association

of Broadcasters, presented a paper proposing that AM stations adopt a standard of pre-emphasis common to the industry. He proposes that the standard encompass two general characteristics, wide frequency response with pre-emphasis during daytime operation and limited frequency response with pre-emphasis during night-time operation.

Payne pointed out that the AM broadcaster has, in general, lost out to the FM broadcaster for a number of factors, not the least of which is the high fidelity of FM receiver and signals. He said that more than 50% of current radio listening is FM, and that more than 3% of the audience is switching from AM to FM every year.

These figures are sure to be bad news to any AM station, and Payne suggests that steps be taken to help overcome the situation. He suggests that all stations adopt a uniform equalization curve using fixed value for both day and night transmission. The boost would begin at 1kHz and extend to 5kHz where the signal would be 10dB higher. During the day, the boost would peak at 5kHz and be constant out to 15kHz for full frequency response transmission. At night, however, he suggests that a sharp cutoff filter be installed at 5kHz to minimize adjacent channel interference.

Payne said that although the 5kHz cutoff filter may be difficult for AM broadcasters to accept, most listeners will never be able to use wide-band receivers at night anyway. He suggests that uniform standards be adopted for equalization before AM stereo is adopted so that new receivers can be equipped with the necessary circuits to achieve maximum benefits for the listener.

High Quality Receivers For AM Stereo

John Grosjean, a consultant from South Woodstock, CT, outlined the necessary characteristics for a high-quality AM stereo receiver. He said that most manufacturers are currently using design techniques first standardized for old 5-tube radios. He emphasized that there are currently many ICs available that can provide high quality AM reception with only a little change in design philosophy.

The desired characteristics for a good AM receiver include: 20dB S/N ratio with less than 200mV/M, adjacent channel attenuation greater than 35dB, image rejection greater than 50dB, maximum input signal 1V/M, THD 0.5%, less than 1% THD at 80% modulation, maximum S/N ratio 50dB, and audio response 20Hz to

A Word About Our Product . . . From You!

Instead of boring you with the same claims our competitors are using about "**CLEANER, LOUDER & MORE RELIABLE,**" we thought we would let you react what **YOU** have been saying about **US**.

This month we would like to thank **Bill Spitzer**, Engineering Director of **Instad Broadcasting**, who wrote this letter to us after a stove fire destroyed his transmitter plant.

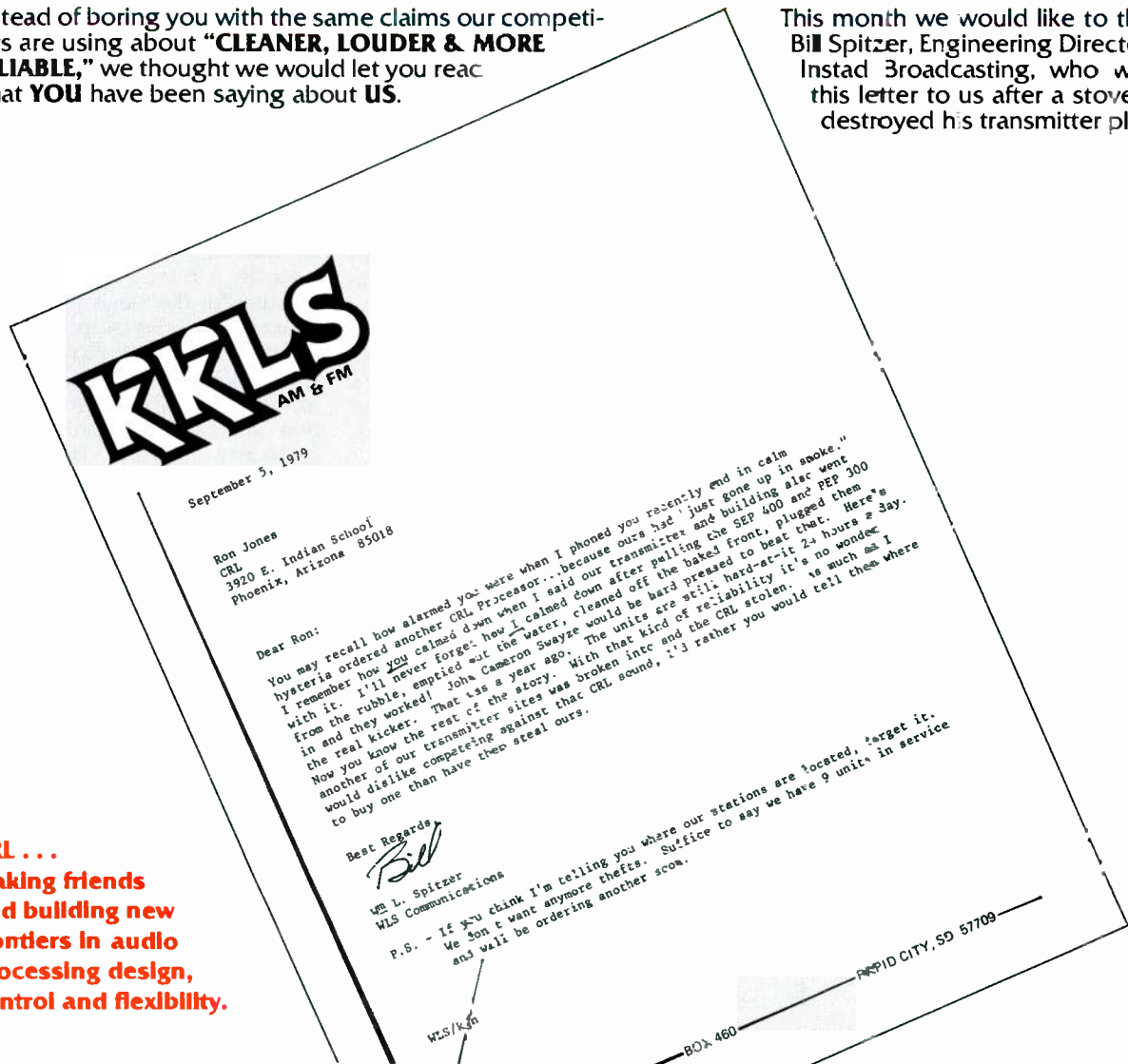

**CRL . . .
making friends
and building new
frontiers in audio
processing design,
control and flexibility.**



Audio Processing of the '80's
CIRCUIT RESEARCH LABS, INC.
3204 S. Fair Lane • Tempe, Arizona 85282
(602) 894-0077

PNEUMATICALLY OPERATED TELESCOPIC MASTS

Convenient
Compact
Portable

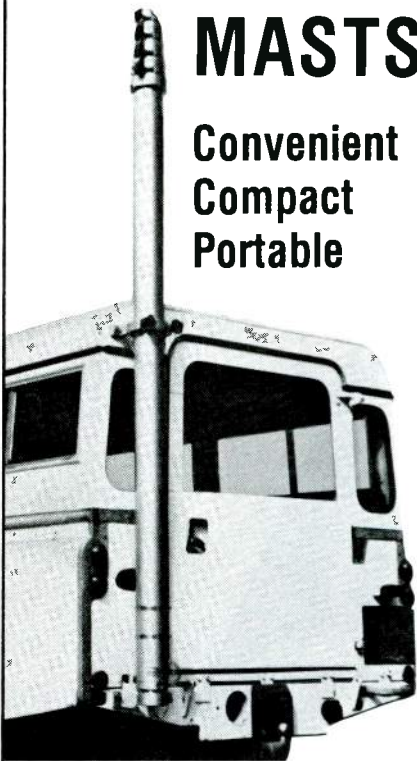

- ENG
- Fixed or Mobile Radio Communications
- Field Strength Measurements
- Camera or Microphone Support
- Noise Level Measurements
- Temporary Flood-lighting
- Environmental Sensors
- Sizes Available:
 - Retracted 5.5 to 15 ft.
 - Extended 20 to 92 ft.

For details contact:

Allen Osborne Associates
5195 N. Douglas Fir Rd.
Calabasas, CA 91302
(213) 888-2772
TWX: 910-494-1710
U.S. Distributor for
Hilomast Ltd., Essex, England

Radio workshops

15kHz. Unfortunately, as he pointed out, the 10kHz channel spacing requires that some compromises be made in the frequency response. He agreed with Chris Payne of the NAB that different bandwidths should be used for day and night transmission. In tests, Grosjean found that a 15kHz bandwidth for the IF was excessive for good reception. A filter with a 10kHz response at -3dB, coupled with a notch filter at 10kHz resulted in an audio response of 7 to 8kHz, for daytime reception. For night reception, the audio response would be restricted to 4kHz.

The antennas themselves pose a problem to the construction of a better quality AM receiver. He said that a simple wire antenna (10-24") be used instead of the ferrite rod antennas currently built in to receivers.

Currently, the industry has the necessary ICs available to it. However, unless manufacturers have the desire to improve on the other necessary circuits, then the better quality tuners will not be marketed.

AM Stereo Decoder IC

Representing National Semiconductor was Al Kelsch describing the LM 1981 integrated circuit stereo decoder chip. He outlined the history of National's involvement in the AM stereo question since 1976. Currently National has produced the necessary decoder chip for AM stereo and production is awaiting an FCC decision.

The integrated circuit represents National's first effort in the area of developing an AM stereo decoder chip. According to Kelsch, National plans on continuing development in the area of AM stereo decoders, and the next line of circuits likely will have the proposed tone decoder scheme on board. He pointed out that this area cannot be approached from a manufacturing standpoint until the FCC decides on the final proponent for AM stereo. Kelsch sees the day coming when the entire AM radio will be contained on a single integrated circuit. As the most complex portion of the circuit is the decoder section, the addition of the necessary circuits to fully receive the AM signal will not be a problem.

ENG

This was the first time in recent years that the NAB had provided an opportunity for discussion on the topic of ENG (Electronic News Gathering) for radio. It turned out to

be one of the most highly attended sessions of the radio workshops.

The panel consisted of moderator Dick Rudman of KFVB in Los Angeles, Marc Wiskoff from Motorola Communications in Whitestone, NY, M.E. McClanahan of Marti Electronics in Cleburne, TX, Jack Miller of WCAU in Philadelphia, and Rick Neace of KDNT in Denton, TX. Each panelist added his expertise to the topic of ENG.

McClanahan led off the discussions by pointing out that only two types of repeaters are currently permitted by the FCC rules. The first type is that of an automatic relay station. This is typically a relay station using a high location for the receive antenna and a directional antenna pointed toward the studio. It is used to relay signals in the 450MHz band from the field units to the studio. Although the relay station must be equipped with proper protective circuitry to prevent accidental tripping from extraneous signals, the necessary equipment is readily available.

The second type of repeater is used with a 2½ W handi-talki and repeats the signal from the handi-talki back to the base location. This type of repeater permits a newsman to leave the car and cover stories short distances from the mobile unit with a good signal still being received by the studio.

Currently, frequencies are in critical supply in the major markets and McClanahan said he felt that there was little chance of additional frequencies being made available soon. As such, he sees the only prevention of chaos is an intensive voluntary frequency coordination effort on the part of the users of the spectrum space.

He then described a new technology called ACB (Amplitude Companded Sideband). If perfected and licensed by the FCC, it could permit a doubling or tripling of the number of available communication channels in any given frequency band. It is basically an SSB signal with a pilot tone transmitted 10dB below peak modulation. The pilot tone is encoded and performs multiple functions — such as squelch, recovered audio reference level, companding reference level, and product detection. The audio uses Type 2 companding for increased signal to noise performance. Should this method of transmission be approved, it would be a welcome addition to the overcrowded 150 and 450MHz bands.

Miller has a lot of experience in developing and installing what is known as "voting systems" for 2-way communications. As he pointed out, one of the keys to successful implementation of a communications plan is to keep it simple.

Introducing PR-99 The Broadcaster's Revox that Studer built.

As a broadcaster you know the value of Studer reliability – and the importance of Revox economy. Now both are built into the Revox PR 99. And what's more, it's designed specifically for *your* needs.

The PR 99 offers balanced inputs and outputs; XLR-type connections, with calibrated or uncalibrated levels; and ASA-VU metering with LED peak indicators.

The rugged die-cast chassis is designed for rack or console mounting. Reel capacity is 10.5 inches and tape speeds are selectable at 3.75, 7.5 or 15 ips with a vari-speed remote control option.

Complete editing facilities include dump editing, full head access and 2-way self-sync which help make the PR 99 the best machine in its class.

The Studer designed transport and die-cast head assembly block and tension arms provide instant smooth start-up and outstanding tape handling.

Here's traditional Studer quality built into the Revox PR 99. Perfect for broadcasters or any professional.

STUDER REVOX

Studer Revox America, Inc. 1425 Elm Hill Pike,
Nashville, TN 37210, (615) 254-5651 Offices: LA (213) 780-4234
NY (212) 255-4452. Studer Revox Canada, Ltd.

Circle (24) on Reply Card



Radio workshops

"If you are expecting a newsman to do more than operate a push-to-talk button and perhaps turn it on, then you are not living in the real world," Miller said.

Consequently, Miller said he decided that the voting system was the only alternative for his station. He said he felt the voting system was the only method that would provide all quieting, which he considered more important than other parameters. He pointed out that you can live with less than full frequency response, if you have full quieting.

Miller's system uses seven antenna sites, which he considered the minimum practical for the Philadelphia location. He said that the interconnection of these antennas with equalized lines was probably the most expensive portion of the total system. He said that a station may be able to obtain the locations for the antennas at no cost to the broadcaster. In his case, the station only pays rental for one of the antennas. The remaining six locations are provided free because of the public service aspect of the system.

WCAU was able to obtain double duty on interconnecting equalized phone lines by using them for live transmissions from the various news bureaus and sports offices throughout the city. The output of the receiver is routed from the antenna location directly to the nearest office through a small mixer and a push-to-talk switch. In this manner, the newsman or sportscaster can broadcast to the studio on the equalized pair normally used for the voting receiver.

It is necessary to use a simple tone encoder system to prevent the live studio transmission from being broadcast over the 2-way radio, however. To the voting system, the studio material looks similar to a good feed from an antenna, and puts it on the air. The push-to-talk switch triggers a small tone generator, which disables the voting module and the signal, is not broadcast over the 2-way channel.

The reason for using a duplex system is that feeding cue back to the remote station is critical to an efficient operation. Even with an equalized loop remote, the station uses the RF cue system rather than a dial-up circuit.

One disadvantage of a repeater system is that the station loses a lot of security. Other stations continually monitor the repeater frequencies of the competition and can hear those stories fed over the system. For this reason, some method is needed to disable the repeater function to pre-

vent off-air monitoring. Miller again uses a tone encoding scheme that defeats the repeater function so the signal is not broadcast but directly relayed to the studio on phone lines.

Miller pointed out a couple of easy ways to improve the quality of material being transmitted over 2-way radios. The first is simply to use a dynamic microphone. The problem here is that the dynamic microphone has such a low output level that the modulation level on the transmitter must be cranked up as high as it will go. The solution is to use a line level microphone, such as the Shure SM 82. The higher level not only provides sufficient level to drive the modulator in the transmitter, but the audio also can be preshaped, if desired, and still have sufficient drive level.

The subject of duplex equipment was covered and, according to Miller, is an absolute necessity. When coupled with mobile repeaters, the operator can use a small handi-talkie in the locker room for post-game interviews and even take phone calls from listeners being relayed from the studio. This provides a unique service to the listener and certainly affords the station a type of immediacy not before available. For those stations using a relay system and needing to provide cue functions to remote locations, the duplex system can be used as a cue channel to a small paging receiver tuned to the cue channel of the station.

The problems encountered by those stations desiring use of aircraft as traffic reporting sources was addressed by Rick Neace of the Wheeler Stations. He suggested that first of all, stations should consider not using helicopters but fixed wing aircraft instead. The heavy maintenance requirements of the helicopters dictated many hours of down time which fixed wing aircraft do not face.

The second item that Neace said he felt was important was that two people were really necessary to do a good

job. The pilot should stick to flying the plane and the reporter should be left free to concentrate on the broadcast reports. In the Dallas area, this is mandatory, as far as he was concerned, because of heavy flight restrictions.

Neace suggested that the aircraft be leased from a fleet to prevent grounding for maintenance. It is important that the equipment easily be movable from aircraft to aircraft as the situation dictates. He warned against drilling any holes in the planes as strict FAA rules apply, and mounting requirements should be checked with a licensed aircraft mechanic.

The Wheeler Stations' equipment uses a single metal box for RF shielding containing a RPT-1, linear amplifier, AM/FM receiver, and 2-way receiver modified with a Marti front end for good selectivity. Also, Neace mounted a voltage meter to monitor the aircraft electrical system, and the total package plugs into the cigarette lighter of the plane. This means that nothing except the transmit antenna is attached to the plane, and changing aircraft is easy.

Wiskoff of Motorola pointed out that one of the major problems with 2-way radio is that of distortion. When coupled with the rapid rolloff of the filters in the transmitters and receivers, the resulting audio is less than desired. There are some steps that can be taken to improve this condition. He demonstrated that the audio quality can be improved on typical 2-way equipment by the addition of external audio response shapers. One easy method is to use a Shure high-level microphone feeding a modified input circuit. Likewise, the receiver is modified by removing the de-emphasis circuit. The net result is a frequency response of 20Hz to 7.5kHz.

Other methods of improving audio quality, suggested by members of the audience, included dbx and Comrex equipment. Each of these systems provides some benefits, but stations



Radio ENG: Moderator Dick Rudman, KFVB, Los Angeles, is at the podium. Panelists (left to right) are: Marc Wiskoff, Motorola Communications and Electronics; M. E. (Mac) McClanahan, Marti Electronics; Jack Miller, WCAU, Philadelphia; and Rick Neace, Wheeler Stations, Denton, TX.

DEFLECTIONLESS.

O'Connor Hydro-Ped. Computer-designed for maximum rigidity during panning and tilting.

VISUAL WHIPLASH.

The Hydro-Ped is the ultimate camera support, designed to replace the conventional tripod and correct the backlash problem inherent in its design.

Backlash often occurs at the end of a pan when the legs of the tripod tend to "unwind" slightly, jerking the camera the other direction. This backlash creates an image deflection subjecting audiences to a visual whiplash. The use of a telephoto lens will tremendously accelerate this problem.

LIGHTHOUSE EXPERIMENT.

An early experiment to solve the backlash problem included the filming of a lighthouse

through a telephoto lens from a mile away using a fluid head and a conventional tripod. The deflection of the image due to tripod backlash was 32 inches on a ten foot screen.

The Hydro-Ped was later put to the same test and the image proved to be virtually deflectionless.

SOLID AS A ROCK.

In torsion and bending,

the Hydro-Ped is four times as rigid as a conventional tripod which hinges at the top of its legs. The Hydro-Ped hinges near the ground and has short legs which lock hydraulically in both directions.

This design not only eliminates deflection, but also enables it to be used in the toughest terrain and tightest places.

SAVES LOTS OF PRIME TIME.

When minutes really count, the Hydro-Ped takes only seconds to position, level and lock.

To adjust camera height, the center column lifts 30 inches vertically with hydraulic assistance for the heavy camera.

BUILT TO TRAVEL.

The Hydro-Ped is made of a sturdy magnesium and aluminum construction weighing only 29 lbs. It folds to 30 inches long and 10 inches in diameter. A single centered handle with comfortable grip makes it easy to carry.



STUDIO PROVEN.

Although the Hydro-Ped is not ordinarily used to replace a studio pedestal, quick release wheels and casters are available and many enjoy its ease of use in the studio.

FLUID HEADS, TRIPODS AND MORE.

O'Connor makes the world's finest line of innovative camera support equipment.

If you're interested in learning more, let us know what camera you have and we'll let you know what we can do to support it.

O'Connor

FLUID CAMERA HEADS

The Official
Fluid Camera
Head of the
1980 Winter
Olympics



O'Connor Engineering Labs., Inc., 100 Kalmus Drive, Costa Mesa, CA 92626 • Phone (714) 979-3993 • TELEX 685 641
O'Connor Engineering Ltd., 11 Rue des Moraines, 1227 Carouge, Geneva, Switzerland • Phone (022) 42 79 38 • TELEX 23 329

Circle (25) on Reply Card

Radio workshops

should examine carefully all of the possibilities before deciding on a plan of action.

Rudman, of KFVB, showed the effects on the channel of a station attempting communication in a congested RF environment. He described some of the problems typically found in the field with improperly installed and maintained land mobile equipment. For locations typical to that of large cities, the problems faced by the station attempting to survive in spite of land mobile communications can be very great. Rudman showed spectrum analyzer pictures of several signals before and after various corrective measures were taken to eliminate interference.

What is the best method to eliminate interference? Ferrite circulators and reject loads can do a lot to improve the dirty output of a transmitter, and close liaison with the site manager can also help. Use of scanners, directional receiving antennas and even a cross reference directory can be of help in tracking down the source of interference.

Another suggestion was that height for the receive antenna is not always in the best interest of good reception. Sometimes, a high location will only pick up more interference and degrade communications. One station told of having lowered its receive antenna by 50% and found that its interference problems practically disappeared. Multiple antenna sites can also be used to improve the receive problems.

The panel pointed out that many SBE chapters are now providing a local frequency coordination service to those broadcasters needing information. If you are contemplating the addition of 2-way equipment, you might want to contact the local chapter to see if that service is being provided.

Audio Processing

As Milford Smith, of First Media Corp., Washington, DC, put it, "Audio processing is the NAB's longest running show." Indeed, the subject of audio processing has for years been at the forefront of engineering and management concern, and always a hot topic at the show. Last year it was audio processing for AM stereo. This year the concern focused on the definite increase in, as one participant put it, "grundge" on radio.

Robert Orban of Orban Associates, San Francisco, began by describing how his company's new processor, the Optimod 8100A, uses a new idea for IM distortion reduction. In any audio

processor for FM, there is always a problem in keeping high levels of modulation without increasing distortion. This is particularly a problem when the frequencies are high, for example, that of cymbals or sibilant speech.

Orban's approach is to shift the IM distortion to higher frequencies. If this can be accomplished, the natural 6dB per octave rolloff of the deemphasis curve of the receiver will reduce that distortion comparably. He said the result is a much more transparent sound, without clipping or aliasing.

Ronald Jones of Circuit Research Labs, Tempe, AZ, a panelist last year, was greeted with chuckles when introduced by the moderator as "a person who would have some surprising opinions for the audience." Since Jones introduced his company's composite clipper, many markets have seen a kind of modulation war develop between stations. In some cases Jones has been called "the primary reason for the modulation battle."

Jones pointed out several interesting aspects of audio processing that surprised many. Foremost was an analysis of why stations use audio processing in the first place. He said that stations use audio processing for any of a variety of reasons, including: pleasing the program director, attempting to cure studio technical problems, making the station sound like the competition, and even attempting to cure transmitter and antenna problems. He pointed out that processing could help, but not cure, coverage problems. It could help reduce the picket fence effect noticed by some FM stations. It also could maintain loudness for a station, and keep that loudness near another station's modulation level if desired.

Jones suggested that the station choose audio processing first of all by format. Naturally, a classical or jazz

station will desire a different type of audio processing than a rock or background music station. It seems that many stations do not approach the audio processing question with format in mind, but rather by the competition's signal level. He suggested that the station have valid reasons for any audio processing decision...and to use common sense. He warned against chasing the other fellow's modulation level.

Al Law, of WYNY in New York represented a different point of view from other panelists. Being a manager, he was able to point out the different perspective used by the program director and manager in suggesting steps the engineer take to obtain the sound desired by the station. He said that program directors don't understand engineers and engineers don't understand programming. He said he felt that most engineers were unaware of the pressure placed on program directors to achieve ratings. He chastized the audience for not speaking English when talking to the program director or station manager. On the other hand, he said he felt that anything beyond a statement of the needs of audio processing by the programming department was excessive. He said he felt that the engineer should be left to obtain the sound desired by the program director.

Law also pointed out a serious problem at many stations in that engineers were not treated as equal to the other department heads — such as program director, news director, and sales manager. He warned management that the problem must be corrected immediately or internal station conflicts will affect station's external sound.

In an effort to overcome some of the difficulties faced by engineers and program directors, Law urged developing an on-going dialog between the individuals. The problem with terminology can be overcome, he



Audio processing: Moderator Milford Smith, First Media Corp., is at the podium. Panelists (left to right) are: Robert Orban, Orban Associates; Ronald Jones, Circuit Research Labs; Mike Dorrough, Dorrough Electronics; and Al Law, WYNY, New York.

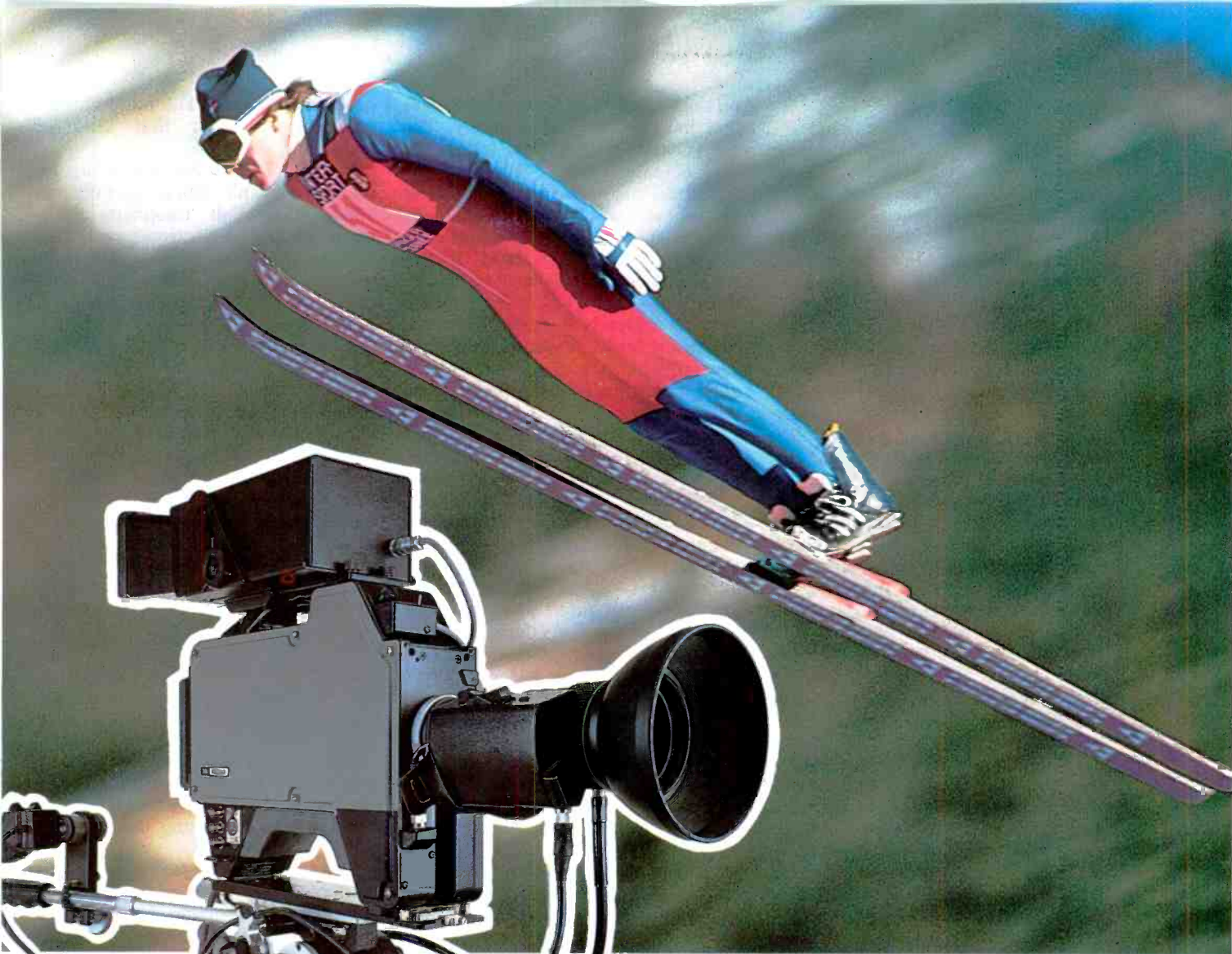

Beyond ENG

Born into ENG, the HL-79A adapts beautifully to EFP. The accepted leader in ENG, the HL-79A, reinforced its position as the preeminent portable camera at the 1980 Winter Olympics. Scores of HL-79As covered the ski slopes, the bobsled and luge runs and the skating rinks for the ABC Network. Their performance brilliantly etched into the world's visual memory, is history. But the industry already knows about the HL-79A's capability.

Today, more and more broadcasters are learning that the HL-79A is a superior EFP color camera. Options such as 4½-inch electronic viewfinder with return video, program and intercom audio plus genlock — among other features —

transform it into the ideal camera for sports and special events, commercials and high quality production. Triax equipped, it ranges nearly a mile from its base station. Near-darkness is its frequent habitat; but it has knee control for brilliantly lit scenes too.

Of course, you may need some of its ENG flexibility for EFP too —like its shoulder action shape, 11.2 pound weight, 6-hour clip-on battery.

The specs and automatic features of the HL-79A are equally outstanding. They're yours, along with an eye-opening demonstration, at your Ikegami distributor. Or contact Ikegami Electronics (USA) Inc., 37 Brook Avenue, Maywood,

N.J. 07607, (201) 368-9171. West Coast: 19164 Van Ness Ave., Torrance, CA 90501 (213) 328-2814; Southwest: 330 North Belt East, Suite 228, Houston, TX 77060 (713) 445-0100; Southeast: 552 So. Lee St., Americus, GA 31709 (912) 924-006L.



Ikegami HL-79A

Circle (26) on Reply Card

Radio workshops

pointed out, even though program directors will always resort to such words as "grundge, kick and punch," it is up to the engineer to work with the programming staff to attempt to put a workable handle on those terms so solutions to questions can be found.

One member of the audience asked why manufacturers make equipment that does not perform as well as it could. For example, some turntable preamps can be improved by the removal of several of the coupling capacitors. Mike Dorrough said that manufacturers have to attempt to protect the small station from catastrophic failure, and they install such things as coupling capacitors, even though some small sacrifice in quality is made. He said that many stations attempt to solve serious technology problems with a cheap fix (i.e., split band audio processing). He said he felt that was especially prevalent in the area of AM audio processing where the station has a limited bandwidth antenna and avoids curing the antenna problem because of the cost involved. Instead, they will purchase a multi-band audio processor and try to retrieve the lost high frequency material with the processor.

The panel spent some time discussing the effect of audio processing on the listener. Law said that the most important effect of audio processing is the psychological effect it has on the audience. If there is significant amount of distortion present on the signal, the audience will tune away, usually resulting in detrimental effects on the ratings.

Just after the panel had discussed the affects of creating "grundge" on the air, a program director from the floor stated that he liked "grundge." He said the audience was not as critical as program directors and engineers, and that they liked *loud*.

Dorrough suggested that stations not band limit at night because the band's being turned into a push-to-talk is not wanted. Orban said that in deference to the good audio processing that is available for AM stations, his research had shown that most AM receivers exhibited a frequency response that is -3dB at 1.8kHz and -20dB at 5kHz. He suggested that few stations would be willing to add wide band signals and give up loudness and coverage when the predominance of receivers is so poor.

Audio Recording and the Broadcaster

Cecil Henocq, of International Tapetronics, Bloomington, IL, spoke

on the topic of audio and the changes that have taken place recently. The most critical change in the industry is that of tape quality. Many people regret the loss of acetate tape because of the ease with which it could be spliced. However, new backings have improved the wow and flutter performance, and the new oxide formulations have resulted in unattainable s/n levels and greatly lowered distortion levels. Even so, there are several deficiencies that handicap the audio recording process. Henocq said the industry has reached a plateau in which more add-ons to the record process — such as dbx and Dolby — cannot further improve the performance of audio tape.

The next step in the improvement of the audio recording process is that of digital recording. Digital audio, although growing slowly, is a developing field, with rapid progress being handicapped by non-standardization. There are many proponents of digital recording, and each has a different tape width, tape speed and encoding. This, of course, makes wide use of the technology impossible.

Henocq said that various technology committees are taking steps to develop a set of standards applicable to all digital recording equipment. He also said that although audio standards are not uniform, they are similar enough that no problems exist with the interchange of audiotapes. He suggested that standards not only be developed for digital tape but also digital audio and videodiscs.

Henocq listed the benefits of digital recording as improved wow and flutter performance, signal-to-noise ratios, perfect stereo phase, and the capability to copy programs with no degradation of signal quality. Among the drawbacks of the new technology is that of increased tape costs, and the requirement for new equipment and techniques for maintenance. The operator will require some new form of editing system, and new sound indicating instruments as VU meters and PPMs will no longer suffice. The whole operation will cost more per hour than the current technology. As the broadcaster sees the developments, he will need "the wisdom of Solomon" to find the right time to jump into the digital field.

Audio Switching Systems: Past, Present and Future

Mike Palmer, of Arrakis Systems, Bolivar, MO, presented a paper outlining the history of audio switching systems from the time of Alexander Graham Bell until today. He pointed out that although the patch bay and mechanical switch were, for the most

part, perfected by 1912, most stations still rely on just that kind of technology.

The true solid-state switch did not become available until around the late 1960s when Bell Telephone introduced its first all-electronic switching system, the ESS-1. Although the technology was available, the cost prevented stations from using it. Even today the cost of an all-electronic switching system is almost \$3000 in comparison to a patch bay which may cost about \$200.

In the area of radio, Palmer reports a real need for expanded switching systems if maximum benefit is to be realized by the advent of satellite transmission. Most stations will now be faced with routing several channels of audio from any of a number of satellite channels. To achieve the flexibility necessary for an efficiently-planned station, an electronic switching system will be necessary.

Of the currently available technologies, only four are sufficiently low enough in cost to warrant consideration by most stations. Those include CMOS ICs, JFETs, LDRs and reed relays. For each device, there is a set of performance criteria, cost analysis and benefits to be weighed by the engineer's thinking of designing an in-house system.

The CMOS switch is the lowest cost of the four and quite easy to interface into a routing switcher. However, the switch is not without its problems. First of all, input and output circuits must limit the levels directed to the switch, because distortion is a function of signal level, supply voltage and control voltage. Distortion can be kept to 0.2% if the signal levels are carefully controlled, although some loss in signal to noise ratio will be encountered. The switch also suffers from switching transients, sometimes as much as 0.4V can be coupled into the switch.

JFETs also can be used with good results. The results will be similar to those obtained with CMOS technology without some of the drawbacks. If the gate signal is RC controlled, then the switching transient can be kept to an inaudible level, which may not be the case with CMOS switches. The JFETs will cost about twice that of CMOS switches, and a buffered arrangement of input and output is necessary.

Phototransistors (or LDRs) have been used for years as switches and audio control devices. Newer LDRs do not suffer from the shortcomings of previous designs as LED lamps are used to drive the photocells. Again, the device requires a buffer stage at the input and output for proper use. The device does not have any switch-

**What
the Shadow
doesn't know
...it learns.**

The BTX Shadow System:

- synchronizes and controls ATRs and VTRs to sprocket-lock, subframe accuracy
- learns each recorder's dynamic characteristics to optimize machine control
- maintains minimal offset during GO TO and CHASE functions
- runs independently, allowing hands-off synchronization in all control modes
- uses standard RS 232C interface to permit present and future computer automation, including electronic editing
- available with optional control console, which displays time and status data and allows keypad entries of destinations, GO TO and FOLLOW commands, and data storage/retrieval
- priced to permit each transport to have its own Shadow

To learn what the Shadow knows, call
1 (800) 225-2253

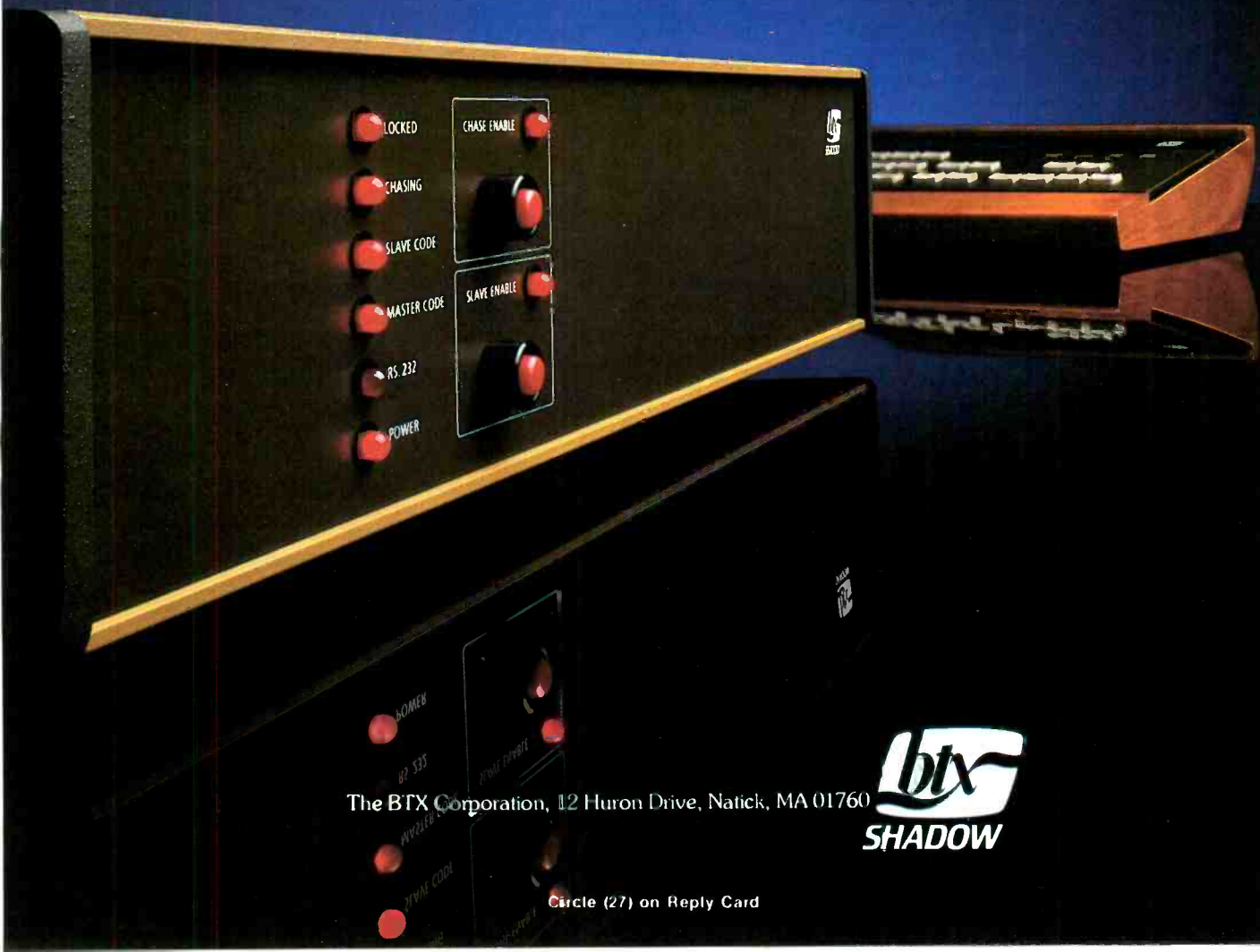

The BTX Corporation, 12 Huron Drive, Natick, MA 01760

btx
SHADOW

Circle (27) on Reply Card

Radio workshops

ing transient, but the cost is around \$5 per switch point.

Most engineers are familiar with the reed relay. It could be considered the ultimate switch. It has no noise or distortion, buffering is not required, and it can accept high signal levels. It is, however, about 20 times more costly than the CMOS switch. If a large switching system is planned, the cost of the system will be high.

Audio Transmission for Audio Systems

Richard Hess, of ABC, New York, spoke on a topic not familiar to many broadcast engineers: voltage transmission systems. Most engineers are acquainted with the more common match systems used for in-house audio distribution. Broadcast stations typically use 600 Ω transmission lines and some networks use 150 Ω systems.

At WABC, Hess uses 0dBu as the standard transmission level, which is 0.775V across an unterminated line. He pointed out some of the effects of using long sections of Belden 8451 cable and difference source impedances of equipment. Using 300 meters (1000 ft), a source impedance of 2 Ω and a load impedance of 200,000 Ω (such as a distortion analyzer), at 20kHz there is a +0.4dB rise in frequency response. This appears to be caused by the transformer effect of the line. A 60 Ω impedance effectively damps this resonance.

At a source impedance of 150 Ω , the frequency response was down 1.2dB, and at 600 Ω the response was down 8.5dB, at 20kHz. When using a power match line at 150 Ω the across the band loss is 0.8dB and at 600 Ω , the loss is 0.3dB. This is not frequency dependent as was the above case, only resistive loss. In addition to the resistive loss there is also a high frequency loss of another 0.3dB. As one can see multiple runs of this length of cable can have several detrimental effects on the performance of a system.

Proper termination of microphones involves careful consideration of the loading impedance. In the case of 10 times the rated source impedance, a load will only drop the rated microphone output 0.83dB, whereas a matched load will drop the output voltage by 6dB. This consideration will improve the s/n ratio of the microphone as well as maintain the highest headroom possible since less current is required of the microphone, and, finally, the frequency response will be independent of minor microphone preamplifier input variations.

One of the problems with audio transmission is the metering used on those systems. The standard VU meter will not indicate properly the levels when those levels are composed of short interval signals. The 200ms integration time will permit levels as much as 10dB over 0VU to pass unnoticed. PPM will help solve this problem if properly used, Hess said.

Radio Program Automation System Maintenance

Dale Bostrom, of the Harris Corp., Quincy, IL, made an analogy between the development of computer technology and that of the automobile. If the car had developed at the same rate as that of computer systems, then the car would be able to travel 400mph, get 1800mpg and cost only \$16.80.

One of the major considerations in the planning of the automation system is that of the technical ability of your staff. Economic considerations show that using an in-house "expert" or an out of house supplier results in similar costs. Normal system failures can be solved by in-house expertise and telephone consultation with the supplier. The necessary equipment for maintenance is similar to that used by most broadcast stations. The station engineer should also plan on taking a training program from the supplier of the system and allow for some shake-down time before air-time is begun.

Technical considerations include sufficient electrical distribution, proper grounding and anti-static flooring. The best maintenance is preventative maintenance. The simplest tasks include cleaning of the recorder pressure rollers and tape heads and lubrication of the roller bearings.

Maintenance of the CPU section of the system consists of using the built-in test programs. However, the proper running of the tests requires that the CPU perform properly so the results of any test may be subject to question. Some manufacturers supply LED displays to aid in these diagnostic tests.

Most system errors result from improper programming or other operator errors. Especially prevalent is that of improper tape cartridge maintenance.

When an error occurs, note the circumstances at the time of the error. Include the machine in use, errors displayed on the CRT, whether machine performed properly the next time, and the possibility of an electrical storm in the area. This information is required if the problem is to be tracked down, even with the aid of the

manufacturer.

Engineers were warned to be delicate with the printed circuit boards. Since PC sockets are ten times more likely to fail than the ICs themselves, sockets are not used in most ICs. In fact, if repeated failures can be traced to a particular IC, it may be preferable to remove the socket and directly solder the IC to the circuit board. The two exceptions to this suggestion, according to Bostrom, are line driver circuits, and the ROM for program control. In both cases, changes may be necessary either from a damage standpoint, or upgrade necessity, in the case of the ROMs.

The Composite Signal: Key to Quality FM Broadcasting

Geoffrey Mendenhall, manager of FM Products, Broadcast Electronics, Quincy, IL, presented his paper to a packed house, saying that FM engineers are finally becoming aware of the critical nature of the composite signal.

The composite baseband FM signal contains four major components: the L+R information extending from 23kHz to 53kHz, and the SCA subcarrier extending from 53kHz to 81kHz. If the station is to be able to transmit quality signals, then this band of signals must be properly transmitted through the complete chain of composite link to the stereo and SCA generators, the FM modulator and, finally, to the receiver. Each of the areas has particular effects on the baseband signal of which the engineer needs to be aware.

It is important that the composite link from the stereo and SCA generators to the FM modulator be linear, both in terms of amplitude and phase. The final stereo performance of the complete system will be the sum of individual amplitude and phase response characteristics of each device in the signal path. Mendenhall suggests that the engineer carefully examine these characteristics before purchasing any new equipment. He suggests that, to maintain a system separation of 45dB, the composite signal characteristics must be:

- ± 0.07 dB or less from 30Hz to 53kHz (amplitude response)
- $\pm 0.45^\circ$ linear phase from 30Hz to 53kHz

New FM modulators provide superior performance over those of even a few years ago. However, because the characteristics of practical varactor diodes are not exactly the square law relationship desired, some form of predistortion must be introduced. This predistortion actually

INNER VIEW 3: A closer look at Conrac Monitors



Comb Filter Separator: Resolution Solution at 3.58 MHz.

Conrac's Comb Filter Separator delivers the high resolution needed for today's high performance camera and taping equipment. It removes color information from the composite video signal without the luminance loss in the 3.58 MHz region produced by notch filters.

Conrac's Comb Filter takes advantage of spectrum interweaving to separate luminance from chroma, without reducing luminance bandwidth.

But the best part of Conrac's Comb Filter is that it gives you this improved picture clarity without the drawback of conventional comb filters. Because, unlike conventional comb filters which exhibit heavy dot patterns in the luminance path, Conrac utilizes non-linear techniques to virtually eliminate these patterns around vertical and horizontal transitions.

Conrac Quality: Computer-controlled for the 80's.

The implementation of a failure analysis documentation system has become an essential new tool in

the quality factor. This system provides the capability of daily test analysis from four different product test and inspection areas. The net results are improvements in product quality and long term reliability.

Conrac Technology: Over 30 years of leadership.

Conrac's track record of technical innovations stretches back nearly three decades; and what we've learned since then goes into every monitor we make today. That is important to you because the more technology we pack into each monitor, the more performance you will receive from it.

Comb filter separator and computer-controlled quality are just two ways Conrac technology can save you time and money.

For the complete inner view of Conrac technology, call or write us today. Conrac Division, Conrac Corporation, 600 North Rimsdale Avenue, Covina, California 91722, Telephone (213) 966-3511, Telex: 67-0437.

Circle (28) on Reply Card



1. Multiburst test signal with conventional bandpass and notch luminance/chrominance separator.



2. Multiburst test signal with Conrac's Comb Filter luminance/chrominance separator.

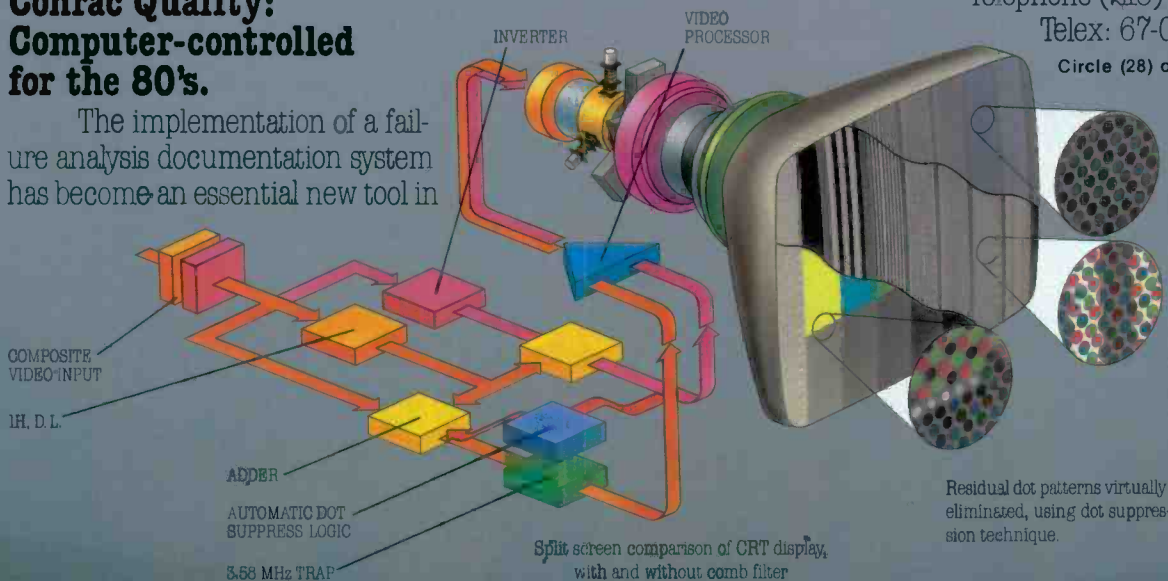

Quality you can take for granted.



With the Digicam™ family, the world is your studio.

Now you can get all the features of a professional studio camera—plus the most professional field camera—in one.

The Ampex Digicam Family of Cameras.

The BCC-21, available as a complete camera or as an assembly for the existing BCC-20, converts quickly and easily between studio and hand-held use. Providing total cable, base station and lens flexibility.

And, add to this, superb studio picture quality with computer in the head, Spatial Error Correction (SEC) and digital automatic setup features.

SEC and ASU: The Digital Difference.

Spatial Error Correction is a revolutionary system developed by Ampex. It adjusts 182 different picture zones, for geometry, registration and shading performance that is virtually perfect.

SEC can be addressed manually from the Master Setup Panel (MSP)—or automatically from the Automatic Setup Unit (ASU). The ASU compares the camera's diascope pattern against a theoretically perfect, electronically generated digital test pattern and corrects each of the 182 picture zones automatically.

The Best of Both Worlds.

In the studio and in the field—the Digicam family gives you the edge in high-quality production. Call your Ampex representative today to get complete information.



BCC-20



BCC-21

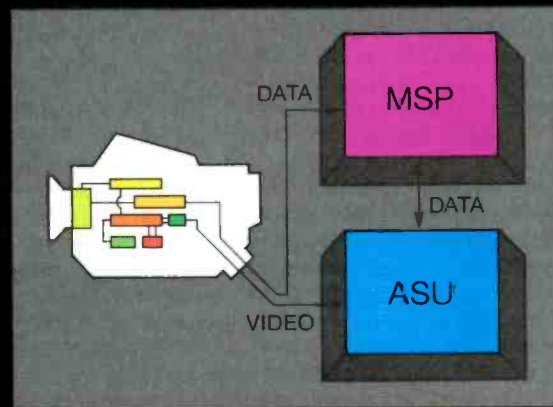

ASU INTERFACE



Ampex Corporation, Audio-Video Systems Division
401 Broadway, Redwood City, CA 94063
415/367-2011

Sales, Spares and Service Worldwide.

Circle (29) on Reply Card

Radio workshops

makes a complementary adjustment on the signal which results in much lower THD and IM than would otherwise be possible. Mendenhall points out that if the harmonic distortion to the baseband is increased from 0.5% to 1.0%, as much as 26dB additional cross-talk into the SCA can be expected.

Since the bandwidth of an FM signal is far greater than the amount of deviation of the carrier signal, the engineer must also be concerned about the bandwidth of his transmitter and antenna. There are four eliminating factors within FM transmitters: total number of tuned circuits; amplitude and phase response of the total RM path; amount of drive (saturation) to each class "C" stage; and any nonlinear transfer function within each amplifier stage.

To minimize the effects of these factors, Mendenhall suggests that one of three methods be used for transmitter adjustment. The least sensitive adjustment is to tune for minimum synchronous AM noise. The next most sensitive adjustment is to tune the transmitter for minimum IMO in either the left or right channel. The most sensitive test to use for adjustment is to tune the transmission system for minimum crosstalk into an unmodulated SCA channel.

Audio Time Base Correction

John Pate, of WSM, Nashville, TN, introduced a new device for audio engineers. For years, television has made use of time-base correctors, and now Pate suggests that a similar device would be useful in the audio field.

He has constructed a device for use at WSM that senses the relative phase of the stereo signal and provides the necessary correction to bring that phase back to a zero level. It corrects for both flutter or cyclic speed error and delay error more commonly known as stereo phase error.

In simplistic terms, the device consists of recording a 19kHz carrier modulated with a 296.875Hz sine wave at -25dB on each cartridge or audio tape. The complementary portion of the system consists of a detector/delay installed across the program line. In operation, the detector senses the relative phase difference between the two channels and delays (via a pair of digital delays) the leading channel until it matches the lagging channel. The net result is improved phase response and, of course, better response for the monaural listener.

The device represents a significant departure from normal audio processing and fidelity correction schemes. It will be interesting to see if the idea catches on.

Satellites for Radio

It used to be easy to connect to a network. Simply arrange for telco to connect your studio with the network feed at the toll office and forget it. Fidelity was not possible, so why worry about distortion, frequency response or noise? If it "sounded" okay, then it probably was. Even when troubles developed, it was not the station engineer's problem, just call telco repair and let them fix it.

Things have changed. Today we talk about multiple channels of high quality audio coming from any of several satellites. We use terms such as SCPC, DBW, Isotropic and, of course, all dishes are classified according to size...in meters, naturally. The advent of satellite communication for the broadcaster has brought at least two things directly home: quality and competition. Networks now talk not only about the quality of their programming, but also the quality of their audio signals. To the station engineer facing the future, all of these topics were ripe for discussion at the *Satellites for Radio Workshop*.

Charles Kelly, of KIUP/KRSJ, Durango, CO, was the panel member intimately familiar with the problems facing the small station engineer needing to install his own satellite receiving system. As Kelly put it, "The only instruction I had was an arrow pointing to the word UP on the dish." From such meager instruction, he put the first station-installed RKO network dish on the air. Although he faced a number of problems, none was insurmountable. The station engineer does need to attend to such details as being sure that his dish has an unobstructed view not only of the primary satellite, but also any backup satellite that network may have. Snow can be a problem, but usually requires that it merely be swept out with a

broom.

One of the pressing problems now being faced at the national and network level is that of satellite spacing. There are many people wanting to use satellite transmission and many companies willing to accommodate them. However, there is a limited amount of space available to position the satellites for proper reception in the US. Currently, the look angles of downlinks are in the area of 70° to 150°. Using the C band of 6.6GHz up and 4.6GHz down, the satellites are spaced only 4° apart from each other. The most obvious answer to the problem of additional satellites is to use closer spacing on the "birds."

As Guy Beakley from Scientific Atlanta explained the obvious answer is beset with compounding problems. Antenna patterns depend on many factors, not the least of which is size. There is an economic advantage to the receive station to use a dish as small as possible while at the same time retaining a usable signal. However, the smaller the dish, the larger the beamwidth, which means the dish may not be able to discriminate between two adjacent satellites. So, if the satellites are moved closer, then the receive locations will experience additional interference.

For example, Beakley said, if the satellite spacing was changed from 4° to 3°, then a 3M antenna would experience an increase in interference in the neighborhood of 1.4dB. However, worst case interference could be 5 to 6dB. Moving the satellites from 3° to 2.5° would cause an additional interference of 2.2dB.

Richard Langhans, of RCA Communications, Princeton, NJ, outlined his organization's plan for digital satellite transmission. He listed the benefits of digital transmission over analog transmission as: minimizing interference, optimized space segment utilization, predictable degrading, wide dynamic range, superior S/N performance, and scrambling for secure communications. The digital transmission system involves time division multiplexing all



Audio time base correction: John Pate, WSM, was swamped with request for reprints of his paper.

The New **it** Benchmark Improved In Four Important Ways!

No. 1 Cart Machine

Today, one out of every two broadcast cartridge machines purchased worldwide is an ITC Premium Line machine.

Now, four new features make this first-choice line an even greater value.

Improved Frequency Response

The head is new. The open-faced design is cylindrically shaped rather than hyperbolic. MuMetal laminations are surrounded by epoxy filler impregnated with aluminum oxide particles for shielding and durability. Core windows are wider than conventional designs. The end result is greatly improved frequency response without low end humps and bumps.



New Cart Hold Down

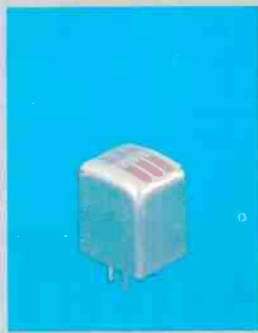

New Head Design



New Pressure Roller

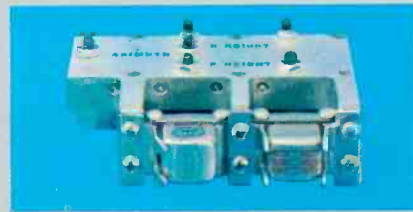

New Removable Head Module

Removable Head Module

True center pivot design. Azimuth, zenith and height adjust independently. Locking one does not affect the others. Steel ball pivots and longer azimuth arms permit finer tuning.

Improved Tape-Head Alignment

New cartridge positioning system assures precise, rigid alignment of tape to head even when insertion is hurried or careless.

Long-Life Pressure Roller

The 525K pressure roller offers twice the pulling power and extended life. Tolerates common cleaning chemicals. Holds its durometer even in high humidity.

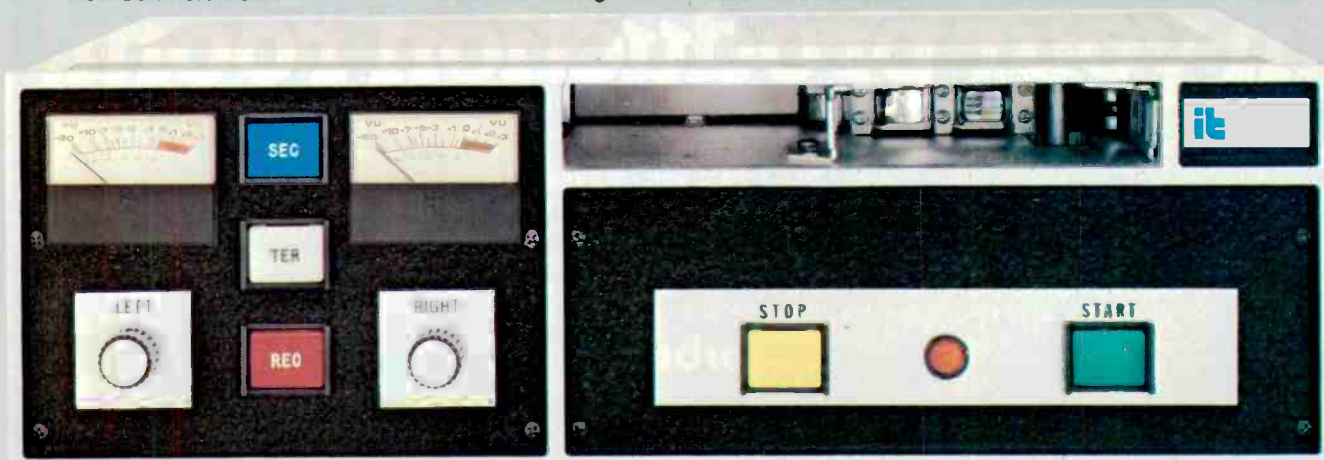

To place a no-risk order
CALL TOLL-FREE
800-447-0414
From Alaska, Hawaii, Illinois
call collect; (309) 828-1381

Circle (30) on Reply Card



International Tapetronics Corporation,
2425 South Main Street,
Bloomington, Illinois 61701

Marketed exclusively in Canada by McCurdy Radio Industries, Ltd., Toronto

Radio workshops

of the satellite signals onto a single uplink signal. This signal could contain twenty 15kHz channels, or sixty 5kHz channels, or 120 data channels at 56kBit transmission rates.

The audio performance was listed to be $\pm 0.5\text{dB}$, 50 to 15kHz, with 0.3% distortion. Stereo crosstalk is listed to



The composite signal: Geoffrey Mendenhall, Broadcast Electronics, delivered a paper on the key to quality FM broadcasting.

be 70dB or better. While the audio performance specifications are good, they appear to be no better than that of a system like NPR (National Public Radio) is using. It was the scrambling aspect that apparently most interested potential customers.

From the competitive aspect, some networks would prefer not to transmit some of their programming over satellites. The capability to encode the signals so only certain downlinks could decode that signal interests many companies. An obvious feature is that a network could select what stations could receive any particular signal. By using a digital encoding scheme along with station-assignable codes, the supplier of programming could transmit a program over the satellite and know that only properly authorized stations would receive the signal. Apparently, interest in the system has been expressed by officials at the three major networks: ABC, CBS, and NBC.

There is one shortcoming to the system. Current technology for analog transmission allows uplinks to be located anywhere in the country for easy access to the satellite. This allows a network to switch from location to location and still maintain the same amount of space on the satellite. In other words, no additional

transponders are required. The digital method of transmission requires that two transponders be used for the transmission of these signals. The origination signal must be sent to the main uplink headquarters for encoding and retransmission before the other network stations can receive it. For these types of transmission, the digital method of transmission requires twice as much satellite space as the analog system.

Joseph Maguire, RKO Radio Network, New York, said the day is coming when stations would require at least two receive dishes, or some method of receiving multiple satellite feeds. If the desired network signals are located on different satellites, then some method must be available to access those signals. There are currently three possible methods of obtaining multiple feeds. The first uses a different dish for each satellite. The second uses a single dish with a motorized drive; this would allow the station to access any satellite when desired, but only one at a time. Finally, a multiple satellite dish could be used which views several satellites at one time. Engineers were warned, however, to be careful in their final selection process to be sure their needs were fully met by the single-dish technology.

Optimod quality in your production room!

Now Orban brings the natural, transparent Optimod-FM sound to a stereo compressor/limiter designed specifically for production work. Set our 418A once and forget it; from then on it guarantees clean, uniform carts regardless of operator skill and experience. The 418A's smooth subtle broadband compressor prevents overload distortion; its separate high-frequency limiter guards against preemphasis-induced tape saturation.

You can use the 418A as a safety limiter or you can use it to drive your microwave STL to your Optimod-FM. Either way, its accurate stereo tracking makes it ideal for FM Stereo today—or AM Stereo tomorrow.

The time-saving 418A gets it right the first time—and *that* savings can mean more consistent quality and healthier ratings! See your Orban dealer for all the details or call for the dealer nearest you.

orban

Orban Associates Inc. 645 Bryant Street San Francisco, CA 94107 (415) 957-1067



Circle (31) on Reply Card



Julius Barnathan, President
Broadcast Operations and Engineering
American Broadcasting Company

CHYRON® IV

PARTNERS IN PRODUCTION

The CHYRON® IV is a vital member of the ABC production team. For most of the leading TV stations and production houses, CHYRON has become their indispensable "canvas, brush and palette."

And, like Picasso, with these tools they create some of the most memorable graphics in the world...

Follow the Leaders with

CHYRON
TELESYSTEMS

A DIVISION OF CHYRON CORPORATION
265 Bethpage-Spagoli Rd., Melville, N.Y. 11747
516-246-3296 • Telex: 144522 Chyron Melv

Ampex International is exclusive distributor for
Chyron Graphics Systems outside the U.S.A.

Circle (32) on Reply Card



TV workshop highlights

By Joseph J. Manning, engineering manager, KAET-TV8, Arizona State University, Tempe, AZ

In recent years, there has been considerable research into the improvement of UHF-TV power efficiency, with much of the research directed toward improving the operating parameters of the Klystron tube. With electric power bills of \$80,000 to \$100,000 annually, every opportunity is welcomed to decrease spiraling costs.

In addition to improved Klystron efficiency, two other presentations warrant consideration—although the economic return on these systems may not be as great: UHF-TV measurement by helicopter and high power RF systems.

"UHF-TV measurement," the presentation by John F. X. Browne, consultant, raises the question "Is my signal getting to the intended target audience, or do the theoretical patterns hold true under actual conditions?" Problem areas in the antenna pattern may be located by UHF-TV measurement by helicopter and some type of corrective action taken before investing in a costly power increase to serve the intended audience.

The antenna performance is measured by comparing predicted data with actual on-site measurement under normal operating conditions. With careful consideration given to the calibration and placement of the equipment in the helicopter, a specific pattern is flown around the antenna, approximately one mile from the center of radiation. Measurements are not made as one would expect in a horizontal pattern, but as a series of vertical measurements from the center of radiation $+3^\circ$ above the horizon to -7° below the horizon at predetermined locations in a 1-mile radius from the antenna. These measurements are then fed into a computer and compared with the predicted or factory data.

A true horizontal or circular pattern is virtually impossible to fly because of controlling the precise radial distance from the antenna as the wind changes and positioning of the helicopter affects the pointing of the directional receive antenna. Using a

vertical measuring approach, with readily identifiable landmarks, the pilot can position the helicopter with fairly close tolerance, producing accurate results for evaluation.

The second area for consideration is the often-forgotten transmission line from the transmitter to the antenna.

In a workshop presented by Spencer Smith of Dielectric Communications, and Dean Sargent, consultant on high power RF systems, the emphasis was on proper selection and maintenance of the transmission line system. Several factors should be taken into consideration when changing or selecting transmission lines for a facility. For a UHF or FM station, coax is the most likely choice. But for UHF, waveguide may be a more efficient alternative. Using the waveguide from the output of the transmitter through any patching and combining networks to the input of the antenna, it is possible to achieve less loss and more efficiency with a waveguide than with coax.

The factors, then, for consideration are: frequency; loss in the line; wind loading; power output; cost; and coax or waveguide. Windloading for waveguide is higher than for coax, therefore the tower must be analyzed to determine if it will handle the additional load.

If a new facility is being designed, this is the logical time to have the consultant plan for a complete system, including the requirements for microwave and communication antenna. Power output of the transmitter will determine the line size and power handling capabilities of the transmission line.

Looking at the specification for coax as power requirements and frequency are increased, the power handling capacity decreases. The opposite is true for waveguide. Coax is basically a broadband device operating from dc to an upper limit. Waveguide tends to have an upper and lower band pass restriction.

At this point, cost estimates can be prepared on the systems.

If the tower structure cannot handle

the additional wind loading of waveguide, and it is desired to increase the power capacity of the coax line, there is an alternative. By using Freon in the transmission line, the power handling capacity can be increased as much as 2:1. The line must be evacuated and the air replaced with Freon (116). Inserting the Freon under pressure without evacuation is not satisfactory as the line first must be evacuated to prevent arcing.

Another important consideration is planned preventive maintenance of the transmission line and associated hardware. If the inside of the line uses a non-captive-type connection between the inner conductor and line and has not been inspected for the past 10 years, an unpleasant surprise may be in store. The older style bullet starts to shave off copper filings as the line expands and contracts, and under the right conditions may cause an arc over to the outer conductor. The newer bullets prevent shaving.

In addition to the inside of the line, the hangers, clamps, expansion joints and elbows should be inspected for fatigue and deterioration. Typically, a thorough inspection should be made every five years. A little prevention can save a lot of grief and costly repairs.



Robert Wehrman, Cox Broadcasting, presided over an engineering session luncheon.

We started with a concept. An abstraction. The pure science. To theoretically synchronize multiple machines for video and audio production. We helped develop, which translates the SMPTE Code, into a practical application. To make theory a reality, a tool engineers could actually use. Simply put, to revolutionize the television production and post production industries. What we did was become the first to make a micro-processor based synchronizer system, the first to make the SMPTE Time and Control Code really work. That's why when we say we're The Innovators, it's more than a slogan. It's a fact.

THE INNOVATORS

The MOS-100A Series. We started with an evolutionary micro-computer based synchronizer that cues and synchronizes any three audio/video transports simultaneously. And went on from there, adding enhancements like three "scratch pad" memories accessible from the keyboard.

The MTG-550 Series Time Code Generators, for precision electronic indexing of video and audio tapes. CMOS/LS TTL logic gives you reduced size, weight and power requirements.

And, slave and user bit input options are now standard.

The TCR-650 Series Edit Time

Code Readers, for reading electronically indexed video and audio tapes from any source. This micro-computer based system also gives you TACH pulse input operation.

It's one thing earning a reputation. And that's why EECO is continually innovating. And our competitors continually imitating. For complete information, write or call us today.

EECO Incorporated,
1601 East Chestnut Avenue,
Santa Ana, California 92701,
Phone: (714) 835-6000.

AMPEX

Amplex is a worldwide distributor for EECO Broadcast Products



EECO
Incorporated
Circle (33) on Reply Card

TV workshops

High power requires that certain items such as patch panels, gas barriers and elbows—be placed so as to receive sufficient air circulation to operate at their rated power. Optimization of the system is important. The transmitter should see a good load in all modes of operation, switching between antennas and load or bypassing sections of the system. The line must accommodate expansion and contraction so that it will not separate at a joint in the shrinking process. The inner conductor should be a non-splitting type to prevent improper installation.

Here are a few suggestions for a good high power RF system.

Regulations affecting new facilities and older facilities undergoing reconstruction can be a major headache if not properly planned for and anticipated. The panel discussing these regulations consisted of Duffey Sasser, NBC, in New York; LeRoy Bellwood, KGTU, in San Diego; Richard Schumeyer, Capitol Cities Communications; Robert Kennard, KDG Architecture and Planning; and Dick Anderson, Metromedia Television.

In planning a new facility, the ap-

plication requires information to be exchanged with the FCC, FAA and local building inspectors. However, this is really only superficial when it comes to getting final approval to build the facility. The list of organizations, committees, civic groups, agencies—local, state and federal, city and state governmental agencies—appears to be endless at times. Some of these groups may also be involved in reconstruction of an existing facility.

The first step in the planning process is to identify and contact the groups that are going to affect the approval of your facility. Identify the local community groups that have informal power but can influence decision-making in the governmental agencies. Environmental groups have long been involved in the decision-making phase. Recently we find two more influences—the handicapped and life safety. The code requirements for the handicapped are well defined. When reconstruction takes place within an existing facility, allowances for the handicapped also apply.

The recent publicity about fires in public structures makes us aware that fire codes will have more of an influence in final building design. In the technical areas, the first reaction is not to put any water on any equipment—protect the equipment

with some other device. The insurance companies argue it is better to dry off wet equipment than replace everything. There are arguments for both chemical and water protection that must be resolved while maintaining compliance with code restrictions.

There is also the problem of two different agencies requiring conflicting codes or new interpretations of codes of operation. The horror stories go on, but if delays are anticipated and plans made accordingly, life can be somewhat less frustrating.

Observe some simple rules when going in:

- Expect to be confronted by many and varied groups.
- Prepare yourself with answers and alternatives.
- Identify potential problem agencies and prepare a presentation in the form they require, with substantial backup material.
- Seek the support of some of the same agencies for future arguments where applicable.
- Don't be surprised if the rules change—particularly if you have an older facility. Variances may have been given at the time of original construction for good reasons, but now the interpretation may be very different.

Microprocessors are finding their

IMPROVE YOUR EDITS ADD EFFECTS, PARTIAL WIPES AND PARTIAL MIXES WITH THE 6403

Your editor can now drive most CROSSPOINT LATCH switchers, with the 6403 Editor-Switcher, active interface unit. This allows you to perform mixes and wipes from any limit to any limit, from any point on the screen to any other point.

The 6403 is flexible. It can be triggered from any editor. For the more complex editors, there are optional "Editor modules" which permit patterns, duration times, etc. to be set up directly from the editor keyboard.

The 6403 is accurate. The start and finish points of an effect can be set precisely. When triggered, it executes the effect between those two exact points in the required number of frames (1 - 999).

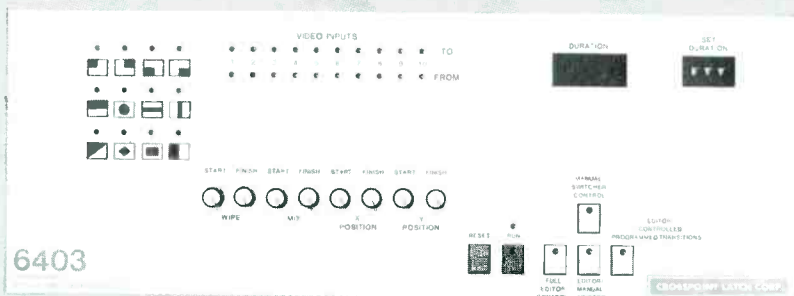

Price 6403 \$2750.

Editor Module \$995.

CROSSPOINT LATCH CORP.

316 Broad Street • Summit, New Jersey 07901 • Tel.: (201) 273-1090

Circle (60) on Reply Card



**“There are consoles...and then there are
Ramko's DC controlled consoles.”**

“It's not enough to be morning D.J. at K-FAZ radio. No, sometimes I feel like I'm running the Johnny P. Shift School of Broadcasting.

“First, I have to educate Uncle Bobby, my station manager, about PhaseMaster, the first cart machines to electronically eliminate phase shift, so he'd get me one for Studio A. Now ol' Johnny has to teach our fledgling engineer, Connie, about consoles. Until recently she thought a console was something you lean across in a sports car.

“So I take the Big Con to Studio B and I explain the difference between ordinary consoles (like ours) and Ramko's DC controlled consoles. I got my eye on the DC38.

“I carefully explain that our current consoles get all this hum and RF pickup, but Ramko's “silent series” consoles eliminate audio wiring from the inputs to the various controlling elements — and the result is reduced external

interference. I tell her to listen to that sucker hum. Connie wonders if it's humming because it doesn't know the words.

“I tell her all the audio switching and mixing is done through DC control so it's less prone to mechanical malfunctions from scratchy pots or noisy switches. And, it provides more inputs per channel than a mechanically switched type console.

“Also, all the inputs are solid state balanced. No transformers to degrade those sweet sounds I send my fans.

“I go on about how only one pot

is needed to control both left and right channel audio simultaneously, eliminating tracking error. And how I can cue by potting down or by simply pushing a button.

“Then I explain how all the function lights make my job easier by telling me how the console is programmed... about the solid-state VU meters that are faster than a mechanical meter so we can keep a tighter, cleaner sound on K-FAZ.

“You know, I really feel like it all sank in. She went to Uncle Bobby and suggested he order a DC38 for me once she figured out what to do with all the switches and dials from our old console.”

All of the 14 different Ramko Research Consoles, single or dual channel, feature DC controlled operation. Get a free two week trial or more information by calling your nearest Ramko sales representative or (916) 635-3600. Collect.



Ramko DC38 Console

TV workshops

way into more and more areas in the broadcast facility. Earl Hatt of Moseley Associates gave a presentation on "Microprocessor Transmitter Controllers," taking remote control one step further to automatic control.

Present day remote control systems can provide 100 or more channels or parameters of information for the technician to observe and record. How this information is used at the time of an emergency condition varies considerably depending on the individual's ability to understand and respond to a given set of conditions. That same individual may respond differently on a different day to the same condition, or additional duties may distract this person from responding immediately. Even though most stations have a plan or routine to respond to particular problems, the human element may produce undesirable results. The interpretation of the parameters takes time and can be confusing; the more redundancy or alternate paths don't always produce the desired results.

What is most desirable is to have the same response to the same condition every time, and have it happen immediately. How this is being brought about is through the application of microprocessors. Many applications are coming from some creative young technicians applying readily-available home microprocessors with appropriate interfaces and from manufacturers through refinement and expansion of their systems. The results are encouraging and have produced savings both in time and revenue.

One of the most important steps in this whole process of implementing microprocessor control is organizing your thoughts in logical sequence of events. When you ask your system to change from one transmitter to the other, start by listing *all* the steps in order. Is the other transmitter on? Do I need to change exciters or lower power? How much will the logic in the transmitter system take care of switching filaments, plates, RF, coax switches, etc. when I initiate a command? Do I want to do it the same for every condition? What condition would I want to deviate from the normal response? This process is really not difficult, but it does make you acutely aware of what you want the system to do. If you don't, it's "garbage-in/garbage-out."

In a system that is presently in use, there are probably some routine tests of all the backup equipment and alternate modes of operation. These tests may or may not be conducted on a regular basis. With the

microprocessor, the tests will be performed the same way each time and print out the results identifying potential or problem areas. The software in the microprocessor also allows the user the advantage of altering the responses and procedures either automatically or through setting of high/low limits and alarms asking for manual response.

As an example, limits could be set for power output of the transmitter at 5 percent low giving one alarm condition and 10 percent low giving another alarm condition, which could then switch to another transmitter or continue to give the alarm while waiting for a manual response. Or the microprocessor could monitor the electrical power lines and, under certain conditions, switch on a standby generator and transfer the facility to that generator. It may not be necessary to switch to the generator but to turn off certain pieces of equipment under "brown out" conditions. The system could also be expanded to controlling other peripheral equipment and the immediate environment, security, smoke detection, air conditioning, lighting, or emergency dial-up phone.

As a side note, it is now possible to purchase a relatively inexpensive speech synthesizer that can give intelligible responses for pre-programmed conditions. Through the use of the microprocessor it can dial a phone number and check to see if the phone has been answered. If not, it can dial another number and give the message. There are now applications where the system dials the fire station and tells them it has detected smoke, or dials the police and tells them someone is breaking into the building.

Automatic control is really nothing new. It has been used in industry and manufacturing successfully for many years. Computers have been controlling machine process down to microns and realtime process controlling many different parameters. What the programmer must be aware of is the choice of language. Is it clear and understandable to the user? Is it flexible and can it be adapted to the system? The same security requirements should also apply to the microprocessor system and its program as to a remote control system. Although unintentional, a small change in a program statement could produce entirely different results.

It also may be necessary to look at the adaptability of the equipment to the microprocessor. When a closed loop is formed, there may be lag time between action and response. It may be necessary to pulse a circuit and then wait for a response rather than apply continuous action and overshoot the limits of the parameter. This

is where the real power of the system comes through in the capability to adapt to a situation and give the same action under normal or panic conditions.

The microprocessor system does not have to be applied all at once. The system can be overridden at any time, or left to operate day after day.

One exciting application of the microprocessor is in the automatic set-up camera. A panel consisting of Joe Kresnicka of WLS-TV in Chicago, Gary M. Sanderson of Harris Broadcast Products in Quincy, IL, Laurence J. Thorpe of RCA Broadcast Systems in Camden, NJ, Ira Goldstone of WCVB-TV in Boston, and Bill Honeycutt of Times-Mirror Broadcasting in Dallas, TX, discussed both design considerations and practical application of the new computer-assisted cameras.

Even though there are differences in design philosophy among available cameras, the main goal is to achieve consistent and repeatable high quality video with minimal human adjustment. The variations in design run from removing virtually all "pots" to the allowing for both manual and microprocessor adjustments. Test charts (diascope) are built into the lense. Set-up varies from 40 seconds to a minute for routine set-up and two to five minutes for full set-up. All of this is accomplished without manual manipulation of potentiometers. The result is reduced set-up time, stability of state-of-the-art IC and LSI technology, minimal drift in registration and color balance—just a few of the advantages of the new camera designs.

Think a moment about the process of how an older technology camera is set up. First, the camera is slightly misadjusted to check registration and color balance and to determine its peak operation. After each camera has been gone through, the technician continues to tweek until someone decides the cameras match; an imperfect system expected to give absolute results. With the computer-assisted camera, a punch of the button starts a programmed sequence setting the camera up to a standard in the lens,—a diascope. The results are repeatable and can be held in memory for future set-ups. In the meantime, the technicians are free for other duties, leaving the camera system to maintain itself with the aid of the microprocessor.

There are several operational differences in the camera designs that offer capabilities applicable to most any facility. Also, accessories are now available that give broadcasters an unprecedented flexibility in choosing the microprocessor-controlled camera that best suits his needs. □



Computer set-up and triax too

Today, broadcasters are classing computer setup and triax as necessities. Ikegami offers you a choice of two such cameras. Both are proven in the studio and field.

- The HK-312, with 1/4-inch pickup tubes, is a proven computer setup camera. More than 100 are in service throughout the ABC Network, at WGBH, and at other major stations.
- The HK-357A with 1" diode gun pickup tubes offers the same high standard of performance along with the convenience of field capability.

Both are extremely stable cameras that can be operated manually. And both accept computer control for automatic setup for on-air readiness in 45 seconds.

Both cameras can be used with multi-core cable. With triax the cameras can be a mile from their base station.

Of course, in colorimetry, automatics, circuitry excellence, and range of options, both are incomparable. But seeing is believing. Experience a demonstration soon at Ikegami Electronics (USA) Inc., 37 Brook Avenue, Maywood, N.J. 07607; (201) 368-9171. West Coast: 19164 Van Ness Ave., Torrance, CA 90501 (213) 328-2814; Southwest: 330 North Belt East, Suite 228, Houston, TX 77060 (713) 445-0100; Southeast: 522 South Lee St., Americus, GA 31709 (912) 924-0061.

Circle (141) on Reply Card



Ikegami



PEIRCE-PHELPS. FOR EVERYTHING FROM PORTABLE VIDEO SYSTEMS TO COMPLETE TELEVISION STUDIOS.

Our small portable video system, the Manpack, is a blessing for small market news operations and freelancers. It's also a good back-up system for major market news operations.

This Manpack has a JVC three tube Saticon camera, a JVC $\frac{3}{4}$ " recorder, monitor, tripod, cables, tapes, three protective suitcases and specially designed long life batteries. The system is sale priced at \$12,990, complete.

On a more sophisticated level, Peirce-Phelps builds complete television studios for broadcasters, satellite teleconferencing centers for corporate head-

quarters, editing facilities for commercial production houses and luxurious production vans for anyone who wants to go in style.

We've accomplished amazing feats for companies ranging from Xerox, NBC and ESPN to the Jim Thorpe Senior High School in Carbon County, Pennsylvania.

We'd like to do something for you.

For information, call Phil Gantt, Peirce-Phelps, Inc., Video Systems Division, 2000 N. 59th Street, Philadelphia, Pa. 800-523-4682. In Pennsylvania, call 215-879-7171.

PEIRCE-PHELPS, INC. VIDEO SYSTEMS DIVISION



The SMPTE digital update

By Blair Benson, engineering consultant, Norwalk, CT

The SMPTE panel discussion provided a well-organized and concise rerun for the NAB '81 audience of the papers presented at the San Francisco Television Conference in February (See **BE**, April, pp. 92-102), and an appraisal of the digital video tests that were conducted in January by the SMPTE with the EBU Technical Committee meeting.

The panel, chaired by Frank Davidoff, formerly of CBS, was comprised of William Connolly of CBS, Kenneth Davies of the CBC, Charles Ginsburg of Ampex, and Roland Zavada of Eastman Kodak, SMPTE's engineering vice president. All their panelists appeared on the San Francisco SMPTE conference panel, and

Benson has long been associated with broadcasting, predominantly with CBS as consultant, project engineer, director of audio-video engineering, and vice president of technical development (CBS Electronic Video Recording). He also has served as vice president and director of engineering, Goldmark Communications; vice president of engineering and technical operations at Video Corporation of America; and editorial vice president of the SMPTE. He is known for his pioneering work in a number of advancing technologies, one being high definition television that is now becoming a reality.

they were joined by Robert Thompson of RCA.

Davies, presently heading the SMPTE Working Group on Digital Standards, on an optimistic note, said that we may reach agreement on compatibility among NTSC, PAL and SECAM standards fairly soon. However, he explained that compatibility is only in digital equipment, not in frame and line scanning standards. He said he foresees agreement on 864 samples per line, locked to horizontal sync, not subcarrier, at a luminance/color component sampling-rate ratio of 4/2/2. For less stringent quality requirements, such as ENG applications, the Working Group's tests indicated the reduced sampling ratios to be of acceptable quality; in fact superior to 3/4-inch videocassette analog recording quality presently being used for ENG.

On the other hand, while 4/2/2 sampling was found to provide good studio quality pictures for mattes, chroma-keys and high-resolution character generator signals, the tests demonstrated it would be advisable to use full-resolution sampling of the col-

or components with a 4/4/4 ratio for these specific applications, with subsequent conversion to the studio standard of 4/2/2.

Connolly said that we should not expect early standardization for digital television, such as was accomplished with the 1-inch Type C videotape format. Work on the 1-inch format started in 1976, one year after Charles Ginsburg's Study Group on Digital Standards was organized. In less than two years, a format was agreed upon. He explained that the development of digital standards is progressing at a much slower pace. First, there is not the base of existing standards and operational experience to build on which benefited the videotape work. Second, the Type C standardization covered only a mechanical format. The digital standardization is more complex. Aside from involving the recording format, for example, there are questions of error protection, data interleaving sequence, and the selection from five or six digital systems presently proposed.

One potentially serious problem in the use of digital television by broad-



The SMPTE Digital Panel. A summary of the papers delivered at the recent SMPTE meeting in San Francisco was presented by C. Robert Thompson (at the podium). He was followed by a panel that discussed the status of the SMPTE digital video component tests and served on that panel as well. The session

was moderated by Frank Davidoff (seated, left) of Frank Davidoff Inc. Panelists (left to right) were: William G. Connolly, CBS Television; Kenneth Davies, Canadian Broadcasting Corporation; Charles Ginsburg, Ampex; and Roland Zavada, Eastman Kodak.



Best Picture:

**SCOTCH ONE-INCH
VIDEO TAPE**

For the second year in a row, Scotch® 479 won the award for the best picture of the year in a test of one-inch video tapes.

We scored well in all of the twelve categories tested, but especially well in the categories that commonly represent picture quality: color dropouts, high frequency dropouts, chroma noise, signal-to-noise ratio and stop motion.

These were scientific, quantitative tests, conducted as you would conduct them yourself, with no room for brand bias. The meters didn't play favorites. The standards were the same for every brand tested. And we tested every brand.

These kinds of test results don't surprise us. We pioneered the invention of video tape. And we've been setting the standard for quality ever since.

Our quality has always been consistent from the first replay to the

last. In fact, our sophisticated binder and oxide coating are more advanced than the binders and oxides on some quad tapes. They had to be advanced to meet the special durability demands of one-inch video production.

So choose Scotch 479 for your one-inch video production. You'll find it looks good from repeated mastering all the way through post production. And we've seen the test results to prove it.



3M

SMPTE update

casters, which was pointed out by Charles Ginsburg, was the fact that common carriers have not planned to provide facilities to handle the bit rates under consideration for standardization. Consequently, some form of bit-rate reduction technique may be necessary. If so, the question remains: Who will bear the cost?

An encouraging/evolution in the standardization process by the United States was pointed out by Rolland Zavada. The recent cooperation between SMPTE and the EBU, as well as other overseas organizations, has resulted in an effort toward international agreement before the adoption of national standards by the United States.

In a discussion between members of the floor and the panel, it was asked if the SMPTE is being railroaded into the use of component, rather than composite coding. Up until recently, this had been favored by most engineers. Davidoff flatly denied this, explaining that initial use of digital equipment was for time base correctors, and other black boxes having analog inputs and outputs and operating in an analog environment. For these conditions, composite coding is preferred. Current stan-

dardization efforts are directed toward an all-digital environment in which component coding provides the maximum quality level and system flexibility.

What is Acceptable?

Will a compatible digital standard be accepted by 525-line countries?

The SMPTE panel presentations seem to indicate an agreement among 525-line manufacturers and broadcasters on a compatible standard. It also seemed as though the standard would be adopted by the EBU and many 625-line countries. However, such unanimity clearly was not evident on the convention floor by many manufacturers or in comments from some of the engineers who attended the SMPTE Digital Standards meeting.

The view was expressed by many manufacturers, primarily those presently producing equipment designed for 14.3MHz (four times sub-carrier sampling) that a SMPTE recommendation of the 13.5 sampling rate would result in two US sample rates. One sample rate would be the official SMPTE Standard, and the other a *de facto* standard of 14.3MHz. Morizono of Sony said the Japanese videotape Recorded Committee supports a choice of 14.3MHz with 825 samples per line. However, because

there is no possibility of the EBU proponents of 13.5MHz agreeing to an NTSC sub-carrier synchronous sampling rate of 14.3MHz, this would result in two incompatible standards.

Another deterrent to the selection of the compatible 13.5MHz, expressed by Charlie Rhodes of Tektronix, was the lack of any experience with this system. He said that further study was in order before any position is taken by the SMPTE, or the US CCIR Delegation. Mike Negri of NBC added that another consideration was the question of obsolescence of existing equipment. Still, with a substantial book value, the write-off of such equipment must be budgeted with the purchase of replacement equipment for the new standard.

It does not appear to be a foregone conclusion that the United States will agree, in practice, with a universal, compatible standard for digital equipment design. It could eliminate costly/additional engineering and manufacturing expense for companies engaged in domestic and overseas sales. Only when the magnitude of this additional cost to the 525-line system users (for equipment usable only on that system) is compared to the cost of compatible digital equipment, will the acceptance or rejection of a new standard be determined. □

We're Better Than Ever!

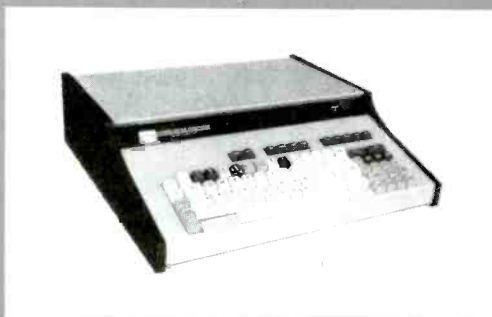

The new TPT-2500 titler offers features not expected in this price range: eight character sizes, upper and lower case, border line, underlining, graphics, flash, crawls, positionable title window, 32 page resident memory and optional 700+ page tape memory.

Operating features include: auto line and page centering, word/line open and close, tab and elastic memory.

Priced at \$4995.00



Video Data Systems

Headquarters, Hauppauge, N.Y. (516) 231-4400
National CATV Sales / Western Regional Office
Salt Lake City, Utah (801) 272-9296

► Innovative Communications

Circle (140) on Reply Card

NEW SPECTRUM ANALYZERS

for monitoring,
service and testing
100 kHz to 2 GHz

The Model 632B-1 compact Spectrum Analyzer provides excellent performance, high accuracy, ease of use and high reliability. It is well suited for modern communications

signal analysis, CATV, CB, wide range distortion and noise measurements, test equipment calibration, EMC tests, and other frequency domain applications up to 2.0 GHz.

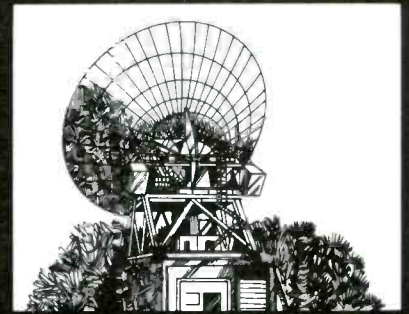
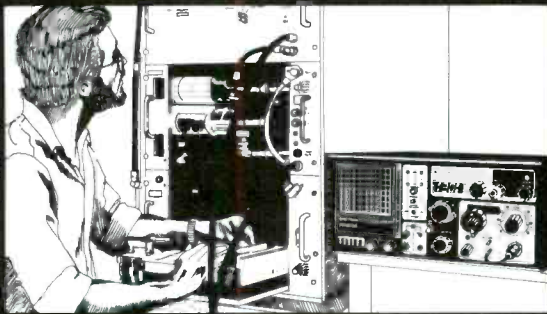

Send for our new brochure.

d polarad polarad polarad po

Polarad Electronics, Inc. 5 Delaware Dr. Lake Success N.Y. 11042 Tel: 516-328-1100 TWX: 510-223-0414

Circle (36) on Reply Card



Reflections on NAB '81 technology

By Bebe F. McClain, president, B. F. McClain Productions, Asheville, NC

NAB '81 set new records for attendance and exhibitor turnouts, and attendees were eagerly reviewing new equipment being introduced. The author sought out a number of industry leaders attending this year's convention and asked what was of special interest to them.

"At this year's NAB, we saw the beginning of some new trends. The 1-piece ENG cameras are in the first step. I think those are good. We also saw the arrival of the auto setup camera. The Ampex Special Effects was way ahead of anything we've seen. There is a significant difference between this unit and everything that has gone before it. They do everything an animation stand can do. They have to do what an Oxberry can do. They produce powerful software. We are seeing the maturing of 1-inch tape, auto setup and new trends in digital switchers."

Joseph Flaherty
Vice President
Engineering & Development
CBS-TV Network, New York

"Sony's BVU-800 is the most interesting machine I've ever seen. A step ahead in technology for edit up to 1-inch."

Richard Sher
Sales Consultant
TriTronics Inc.
Burbank, CA

"Complete broadcast automation was what interested me. What impressed me was the price."

Jon A. Anderson
General Manager
Pacific Telestations
KUAM, Guam

"The amazing quality of the Sony BVP-110 Camera. I've never seen a

Bebe F. McClain is the president of B. F. McClain Productions Inc., an audio-visual production and equipment sales company based in Asheville, SC.

stripped tube of that quality. The price is amazing too. Very little lag—like standard broadcast-quality tubes. Size is another amazing thing."

Wayne Caluger
Ass't. Director of Engineering
WSM Inc.
Opryland

"My overall reaction? No longer waiting, we're truly in the midst of the video revolution! For us at Kodak, the significant technologies on the exhibit floor include film scanning devices, editing systems, and, of course, digital image processing and manipulation systems—all designed to optimize the creativity and efficiency of post-production for film originals. RCA, Bosch-Fernseh, Rank Cintel, Cohu and others are demonstrating spectacular equipment, bringing to bear the most advanced video technology, to convert film's optical image into superior video signals. Kodak's NAB '81 presence as a major supplier of image recording materials is, in a way, a celebration of the film and video marriage, with its promise for future improvements in films, systems and equipment for cost-effective, highest quality, video program production."

Kenneth M. Mason
Vice President
Eastman Kodak

"The Ampex video switcher—really a new production switcher—very flexible. Good for studio use. Remote control of all features is done on data stream."

Frank Flemming
Director of Technical
Operations
Vidtronics
Hollywood, CA

"Most interesting is the small portable camera/videotape recorder combination. We have encouraged the industry to make these. The cable between the two pieces has always been troublesome...trying to coordinate two people."

Phil Godfrey
Manager of Engineering Lab
ABC, New York

"Panasonic's one-piece camera/recorder. All that resolution out of that ½-inch format. From the point of view of ENG—a major innovation and lots of competition for the standard U-matic format."

Dave MacDonald
Director of Cable Group
New York Times

"The highlight of the show is the single-piece camera with cassette recorder built-in. We at ABC expected to see it. We've been talking about it for four years—the concept of reducing it to one unit like the 16mm camera with magazine. It's always inhibiting to go into crowds with the present two pieces. We've always been trying to get rid of the cable. This shows that they're listening to broadcasters. Also, the MCI/Quantel 7000 graphics system, shown in their suite, that uses a light pen. We at ABC are concerned with the look on the air, and graphics are a vital part of that look."

Verne Pointer
Vice President Engineering
ABC, New York

"All those devices that use shrinking and rotating of images. We make the components but it's amazing how they use them."

Peter Drapes
TRW Products, La Jolla, CA

"The digital graphics. Everything has to be refined from what's here. It's still in an early stage of development."

Isaac Hersley
Equipment Planning
ABC, New York

"I'm surprised by all the competition."
Morris Washington
Manager of Broadcast Div.
Panasonic

"That little PK-40AH of Toshiba's is WOW. Even though it's a prototype it's very promising."

Patrick McEntee
President
ISO Communications
New York

TV test equipment from the inventors of the Plumbicon® tube.

At long last a new, reliable source of TV test equipment. One that offers fast, predictable delivery. One with a name all the world trusts—Philips. Four quick examples:

PM5565 Waveform Monitor

Enjoy the luxury of examining one line and one field at a time. On top of this, there's a convenient front probe input so you can use the monitor as a troubleshooting oscilloscope.

PM5567 Vectorscope

If you want more accurate decoding and the ability to have an external reference from composite video signals, choose our vectorscope.

Both waveform monitor and vectorscope mount side by side, fit all existing hardware and use less power than the competition.

PM5539 Color Analyzer

Take it on a quick trip through your studio or control room and adjust all monitors to the same color temperature in a matter of minutes.

With four different memories, there's no problem in quickly calibrating four different phosphors.

Variable full-scale, from less than set up to more than reference white, allows measurement of color tracking as a function of APL.

PM5534 Color Pattern Generator

Our universal pattern contains all the signals needed to verify overall system operation—directly from the picture. No wonder virtually every set manufacturer uses our pattern for their TV set alignment.

Of course our TV test equipment line doesn't end here. Today Philips offers a wide range of equipment including sync and pattern generators, VITS generators and analyzers, and TV modulators and demodulators.

For nationwide sales and service information call 800-631-7172, except in Hawaii, Alaska and New Jersey. In New Jersey call collect (201) 529-3800, or contact Philips Test and Measuring Instruments, Inc., 85 McKee Drive, Mahwah, New Jersey 07430.



Philips, of course.



Test & Measuring
Instruments

PHILIPS

Circle (37) on Reply-Card

Broadcast Production Consoles

GREAT AUDIO STARTS HERE

FEATURES:

Stereo Outputs 8 or 12 Channels

Up to 24 Inputs All Inputs &

Outputs Balanced QM-

8P, 4 Stereo Channels standard, 0,

2 or 6 optional QM-12P, 4

Stereo Channels standard, 0, 2,

6, 8 or 10 optional.

Input Channels: 3 Knob EQ

with In/Out Switch Echo,

headphone and Cue Send

Channel On and Remote

Start High Quality

Conductive Plastic Faders.

Output Channels: 4 Balanced Low

Noise, Low Distortion May be

Stereo or Mono.

Monitoring: 4 Independent Monitors

Flexible Control Room Selection

Talkback to Studio Muting



QUANTUM
AUDIO LABS, INC.

1909 Riverside Dr., Glendale CA 91201
Telephone (213) 841-0970

*Quantum Audio Labs is an independent manufacturer
and is not affiliated with any retail store.*

QUANTUM offers the following options for the QM-8P and QM-12 P:

Phantom Power Supply 104 Point

Patchbay 8 or 12 Channel Input

Expander.

Circle (40) on Reply Card

The Perfect Companions

VSM-5, the latest in a series of professional test equipment from Videotek. A television Vectorscope which provides bright, sharp, easy-to-observe vector displays on a 5-inch CRT. Available as a separate unit, or rackmounted ... *The Perfect Companion* to our popular TSM-5 Waveform Monitor.



Quality Endures



Videotek, Inc.

125 North York Street, Pottstown, Pennsylvania 19464 / Telephone (215) 327-2292
9625 North 21st Drive, Phoenix, Arizona 85021 / Telephone (602) 997-7523

Circle (41) on Reply Card

Reflections

"Take one look at that parking lot...earth stations...that's the wave of the future."

Bob Johnson

Production Manager

WTVD-TV

Durham, NC

"Computer graphics—they have almost tripled since last year. That Ampex Video Art...if I could get it shoved into my pocket, I'd take it home. If I were an artist I could do everything with that that I could do with brushes, cutting and pasting. It virtually replaces the raw materials in the art department."

Carl Guffey

WTVD-TV

Durham, NC

"The big thing that is happening is that video serial signals are rapidly integrating with computer serial signals. The technologies in both industries are becoming inseparable...I envision the major video manufacturers approaching the marketplace much the same as the computer industries did in the '60s and '70s...a business systems approach requiring total commitment, by the people who wish to participate, to train their own personnel."

"The highlights of the show included the new generation of 1/2-inch format machines and the long-awaited marriage between the VTR and the portable camera that will expand, in geometric proportions, the number of end users in ENG and EFP. Also, the vast array of digital-based computer graphics and effect devices and, finally, the wonderful world of space with its ability to communicate from thousands of locations in the universe that is now a reality on a cost effective basis."

Dan Mulhern

Vice President

Cramer Co., Needham, MA

"That Quantel 6000...the way it still stores can really be of use on 'Good Morning America.'"

Duke Struck

Director of Good Morning

America

ABC, New York

"There is a tendency toward high resolution equipment...VTRs and cameras to follow. The production people would really like it. Maybe in five years we could have a really good picture on the screen. There is also a general tendency toward ease of operation...better human engineering

Audio-Technica rewrites the book on professional phono cartridges.

Introducing The Professionals

The new Audio-Technica ATP Series Dual Magnet™ Stereo Phono Cartridges

What do you really need from a professional phono cartridge? Impeccable quality. Reliability. Uniformity. And reasonable cost. The goals we've met with the new ATP Series cartridges.

The new ATP Series are flat, smooth, low distortion performers that will do your station, studio, disco, library, or commercial installation proud. They are also very tough... the next best thing to "bullet proof". Because we know that "needle drop" isn't just a way to pay for music or SFX. It's a fact of life!

Both ATP cartridges and styli are *uniformly* excellent. When you at last need to replace a stylus, you always get "like new" performance again, and again, and again.

Don't confuse the ATP Series with other "professional" cartridges that are merely modified home units. ATP units don't have to be treated with kid gloves. And yet we haven't sacrificed tracking ability to make them rugged.

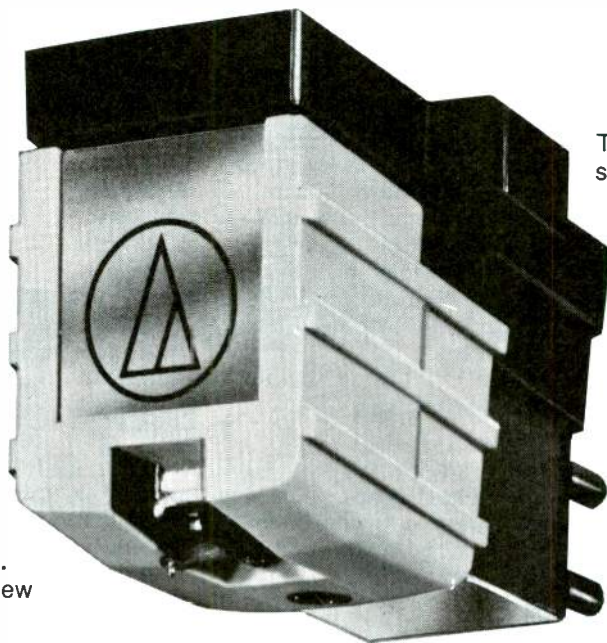

The all-new ATP cartridges were specially developed for the working environment. Three models provide a choice of either spherical or elliptical styli. Each cartridge is hand-tuned for optimum performance, with stereo channels matched within 1.5 dB to eliminate balance problems.

All ATP cartridges feature tapered cantilever tubes that combine high strength with minimum moving mass. There's no problem with back cueing, and the brightly colored cantilever tip is readily visible so that you can spot an LP cut quickly and accurately.

ATP cartridges are priced from \$45.00 suggested professional net. Write for complete specifications. Try the ATP Professionals on your own turntables. We know you'll be pleased with what you hear. From the thoughtful pros at Audio-Technica.



Upgrade your entire record-playing system with new ATP tone arms. Rugged and precise, like ATP cartridges. Professional in every respect. Model ATP-12T or ATP-16T just \$150.00 suggested professional net.

 **audio-technica**
® INNOVATION □ PRECISION □ INTEGRITY

AUDIO-TECHNICA U.S., INC., Dept. 61BE, 1221 Commerce Drive, Stow, Ohio 44224 • In Canada: Audio Specialists, Inc., Montreal, P.Q.

Circle (38) on Reply Card

June 1981 **Broadcast Engineering** 61

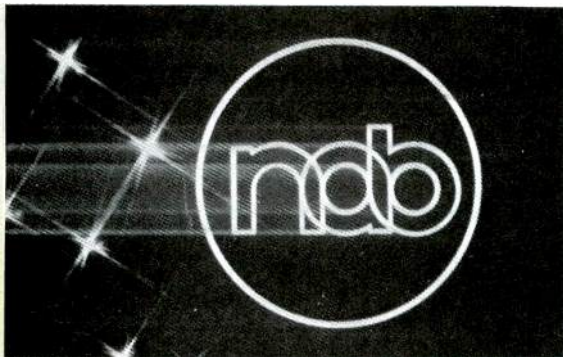

Audio processors

By Gary Breed, consulting engineer, D. L. Markley & Associates, Peoria, IL

As usual, the NAB convention provided a showcase for the manufacturer of audio processing equipment: limiters, AGC units, multiband and multifunction processors, audio reverberation, delay and other special effects devices. Also, a number of the exhibitors used their hospitality suites for listening demonstrations rather than attempting to compete with the high-decibel "buzz" of the convention crowd.

A number of new products were shown at NAB '81. Some were unveiled at Las Vegas, while others have

been out for a few months, but saw their first NAB showing.

A rather impressive attention-getter was the demonstration of the French company, Publison's, model DHM 89B2 digital audio special effects unit, dubbed by its makers as "The French Infernal Machine." Its wide range of functions include reverb with adjustable parameters, time delay, pitch-shifting and harmonizing the original material with a shifted-pitch version of itself. An option in the unit is storage of several seconds of material that can be manipulated in many

ways, including all of the above, plus reversed audio. This unit probably has the most appeal to production houses and those broadcast facilities that do large amounts of commercial production.

Ursa Major, an established reverb unit maker showed a new model, the 8x32 Digital Reverb. This unit will store up to 32 sets of reverb setup parameters in non-volatile memory, saving the time and possible errors of later duplication of a given setting, especially when you consider the complex combinations of delays and decays that can be chosen with this and other current reverb units.

Dolby Laboratories and dbx both showed new additions to their well-known lines of noise reduction equipment.

The new Dolby Labs entry is Catalog No. 221, a plug-in noise reduction module that goes in place of the standard Audio 1 and 2 card of the Sony BVH1000 VTR. Calibration oscillator, automatic record/playback switching and remote control capability are included. Also announced by Dolby was a similar unit for the new RCA TR-800 VTR, available in the fall.

dbx now has plug-in modules for their 900 series mainframe, the 941 and 942 noise reduction encode and decode units. The user can choose which function is necessary, and how many channels are needed and install only what he needs. Also shown by dbx was the model 140 broadcast encode/decode unit for tape use, either totally in-house, or for decoding of previously encoded material.

In the area of on-line AGC and limiter equipment, a few new units showed up this year:

Audio & Design Recording showed its Transdynamic Tri-Band Audio Processing System, with two channels of tri-band processing (two separate mono channels or stereo). This unit has field-adjustable crossover points on the band-splitting filters, a full complement of adjustable parameters, and wide-band "gain riding" AGC available at the input. Pre-emphasis response of the control circuitry is selectable, as is the AM output symmetry. Subaudible and supersonic



Ursa Major

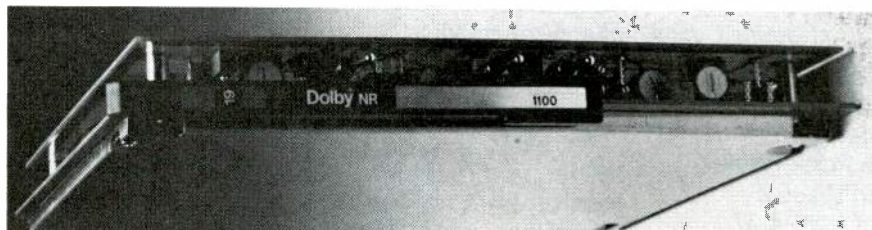

Dolby Laboratories



Audio & Design Recording



Orban Associates

videotape editing system

VANGUARD

by datatron, inc.

SMPTE Editing for 3/4" U-Matic 1" Type C 2" Quads

DATATRON INTRODUCES VANGUARD, A TOTALLY NEW GENERATION OF VIDEOTAPE EDITOR DESIGNED TO GET THE MOST OUT OF THE NEW GENERATION OF VERSATILE TYPE-C VTRs.

Vanguard is the most exciting development in SMPTE videotape editing since the introduction of the Type-C format.

The excitement begins the moment you sit down at the dedicated-function, color coded keyboard with its superbly organized interactive CRT display. From this position, you've got full control over five VTRs and a switcher. VTR motion control is effortless and precise; dual Varascan™ controls allow you to utilize the shuttle capabilities of Type-C VTRs to their fullest — — on two VTRs at once.

You can enter edit and split times on-the-fly or manually. You can perform cues, previews, edits, all automatically. You can even perform A/B/C/D sync'd roll edits involving up to four sources.

But that's just the start; Vanguard lets you set your own preroll and postroll times. It provides variable operator reaction time compensation. The edit list memory can store up to 999 edit events — — enough for even your longest editing sessions. And powerful, easy-to-understand edit list management lets you modify the edit list any way you choose.

Auto assembly from up to four sources is standard, as are paper tape edit list input/output, teletype edit list printout, and scrolled CRT edit list output. And if you wish, floppy disk is available.

It's all here, and at a price that's about half of what you'd pay for just one Type-C VTR with TBC.

And, just in case you're not ready to convert to Type-C, it will probably come as no surprise that Vanguard also interfaces to more than 35 other makes and models of decks, including quads, 3/4 inch cassettes, 1" Type-A/B, multi-track audio recorders, and the Rank Cintel scanner.

(215) 223-8200
Ask for Ed Zwicker

Complete system
capabilities

LERRO
ELECTRICAL CORPORATION
COMMUNICATIONS SYSTEMS DIVISION
3125 North Broad Street, Philadelphia, PA 19132

Serving New York State - Pennsylvania - New Jersey - Delaware - Maryland
District of Columbia and Virginia

Circle (42) on Reply Card



Processors

filters are available at the input. A built-in pink noise source and the LED bar-graph-type metering assists in the setup of this unit.

Orban Associates showed its Optimod 8100A. Introduced last fall, this is the first NAB demonstration of the 8100A. It features adjustable bass coupling for independent bass control, wide-band processing, or somewhere in between. Adjustable mixing of peak limiting or clipping is another feature. The lock-and-key front panel is a practical necessity at some stations.

Harris/Broadcast Products showed the MSP-95 audio CPU, a single-box combination of the MSP-90 FM limiter and its DSM stereo generator. It is intended for use with a composite STL system, or as stereo conversion or upgrading of a transmitter, whether via STL or not.

In the AM processing department, Gregg Laboratories demonstrated a hand-wired prototype AM processor that was designed expressly for the bandwidth and modulation needs of present AM broadcasting. Perhaps someday, after AM stereo has forced receiver manufacturers to make really consistent high fidelity receivers, the differences between the audio processing needs of AM and FM will be smaller. The current method of over-compensating for poor frequency response and bandwidth performance of today's receivers tends to grate on the nerves of the purist, who would like to see higher quality in AM audio.

A number of other manufacturers were on hand to exhibit audio processing equipment and associated systems, including the following: Broadcast Electronics (AM/FM audio processors); Circuit Research Labs (AM/FM audio processors, compressors, limiters, AGCs); Dorrough Electronics (with LPB, showing the 310 processor); Howe Audio (handles Orban and Audio Technologies processors and amplifiers); Inovonics (with Accurate Sound, showing the new multiband MAP-II audio processor); Integrated Sound Systems (TDM-8000 time compressor); Lexicon (new model 1200 audio time compressor, 93 digital audio delay processor/mixer, and 224 digital reverb system); Quintek (digital audio processor, graphic equalizer, reverb system and digital delays); MICMIX Audio Products (Master Room line, reverb systems and audio signal processor); ProTech Audio (compressor/limiter and reverb systems); Quad Eight (System 5 digital reverb processor); Sound Genesis (handles signal processing and effects equipment); Thomson-CSF (Volumax line of

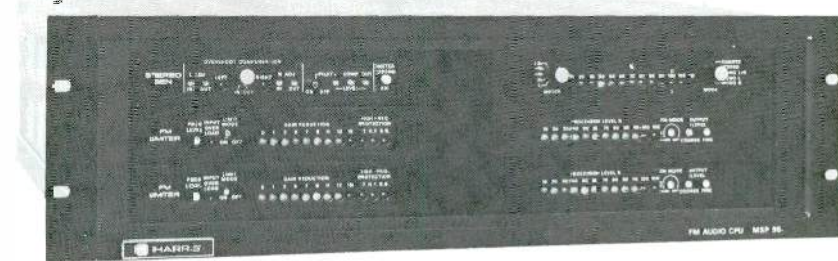

Harris/Broadcast Products



Gregg Laboratories



Broadcast Electronics

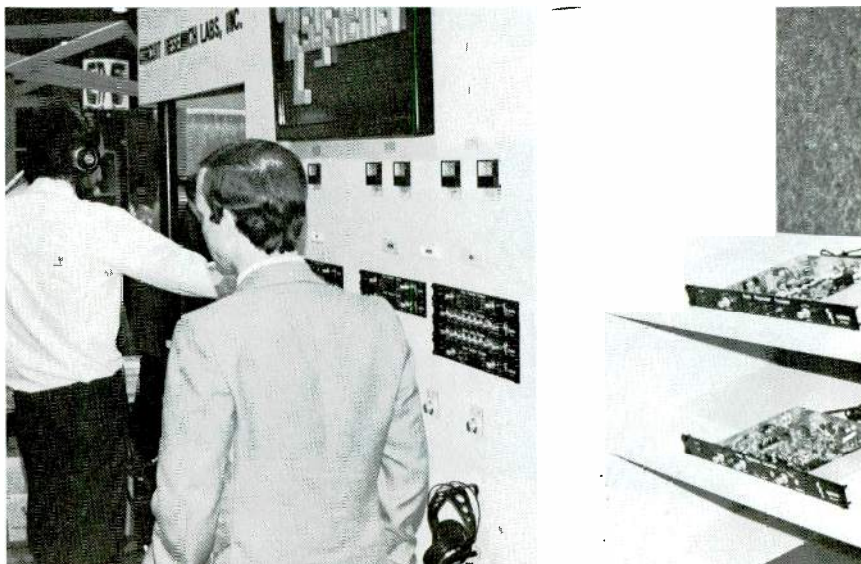

Circuit Research Labs

automatic peak and level controllers, dynamic presence equalizer, and DAs); and UREI (audio signal processing equipment, including limiters, compressors, equalizers and filters).

SONY demos digital audio

At NAB '81 the Sony Corporation presented a dramatic multilevel broadcast demonstration showing the latest achievements in the company's digital audio and professional

telecasting technologies.

For many, this demonstration offered the first opportunity to accurately compare the striking presence of digital audio with live pickups. Two different broadcast situations were demonstrated: a live musical performance incorporating wireless techniques, and a typical studio environment where that same live performance is digitally processed.

Professional studio musicians sang and performed in a simulated location

Compare

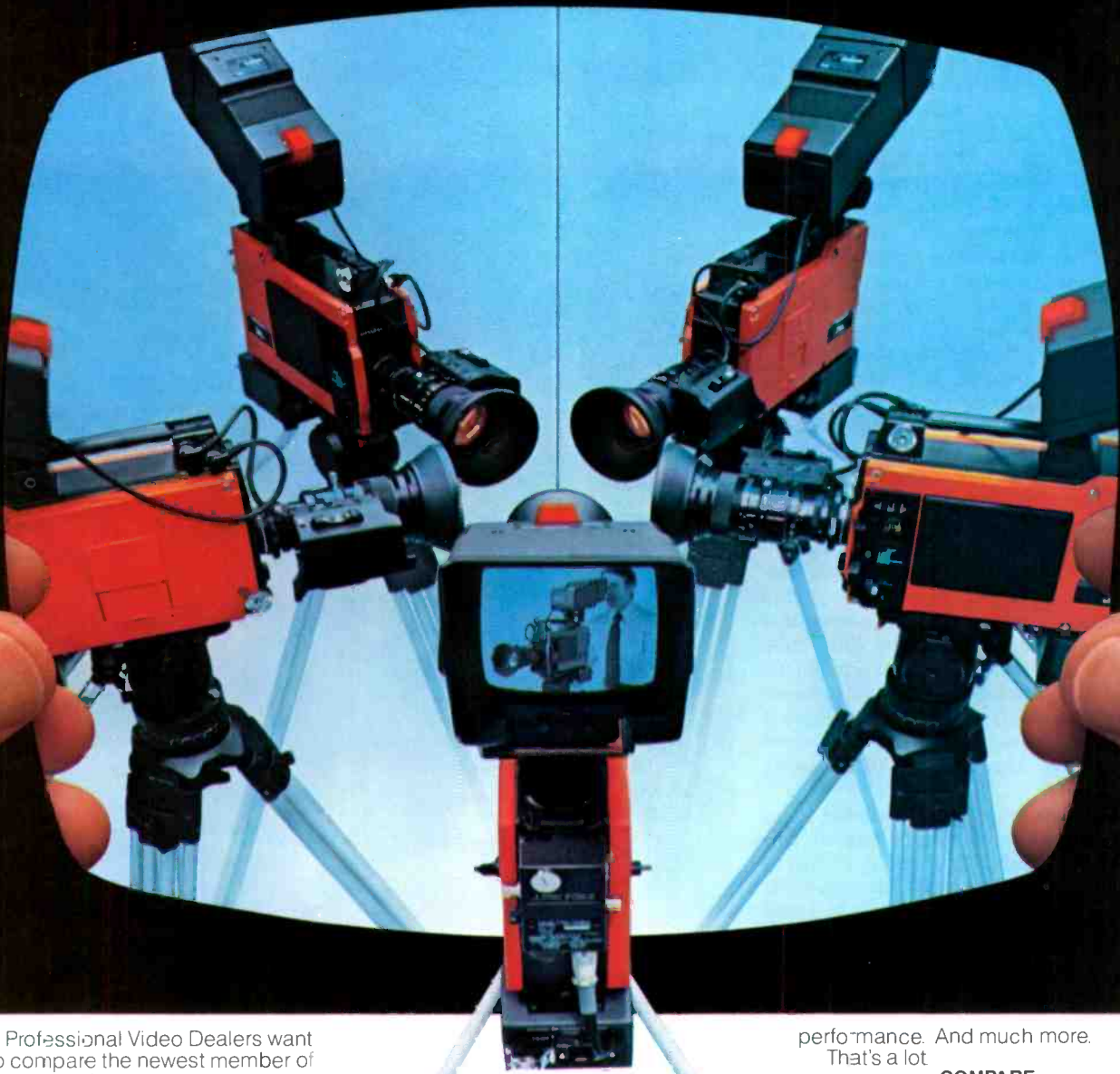

JVC's Professional Video Dealers want you to compare the newest member of the KY family of 3-tube color cameras to *any* other camera you may be thinking of... and to others you may have eliminated because of their high prices.

COMPARE PERFORMANCE:

The KY-2700 holds registration specs to a tight 0.1, 0.4, and 0.8%, for crisp clean pictures. That's stability!

The KY-2700 has dual-edged vertical and horizontal contour correction for the detail and sharpness you require, 500 lines resolution, and for virtually noise-free video. 54db signal to noise. That's performance!

COMPARE FEATURES:

A fast, 14:1 Servo zoom lens, Automatic Beam Control (ABC), Automatic White Balance with memory, Automatic Black Stabilizer circuit (ABS), a low 18 watt power consumption for extended battery operation, "Instant On"

The new KY-2700



performance. And much more. That's a lot.

COMPARE VALUE:

No other professional 3-tube color camera can match these specifications at a price ever near the KY-2700.

That's a pleasure.

Compare it at your JVC Professional Video Dealer NOW!

For more information,

call toll-free 800-821-7700, Ext. 7005.
(in Missouri, 800-892-7655, Ext. 7005.)

Or write US JVC Corp., Dept. BE 6/81
41 Slater Drive, Elmwood Park, NJ 07407.

Available in Canada from JVC
Canada, Inc., Ontario.

Your choice.
Now.

JVC®

US JVC CORP

Circle (43) on Reply Card

Processors

setting. The Sony C-48 condenser microphone, the Sony C-76 shotgun condenser, the ECM-50 lavalier microphone and a variety of other Sony mics operated along with Sony wireless diversity receiver stations.

Audio sources were mixed using the new Sony MX-P42 mixer, a highly portable and ultra-compact unit that combines up to four separate audio sources and provides a superior stereo feed. The battery-powered mixer featured pan pots for precise stereo imaging, high and low cut filters and onboard compression/expansion for enhanced dynamic range.

The live audio signal was then fed through Sony's TA-F70 amplifier directly to a headphones set-up.

Simultaneously, the same audio signal also was processed using the Sony DRE-2000 digital reverberator, a unit that provides unlimited choices of room presence ranging from intimate acoustics to instantaneous "Carnegie Hall" sound qualities.

The all-digital reverberator can interface with both existing analog production facilities as well as digital studios, providing protections against future obsolescence. The DRE-2000 offers reverberation, echo and delay, and also features calculator-size handheld controls and a 10-program memory, valuable in professional recording studios or broadcasting facilities.

Following mic-ing, mixing and reverberation, the audio signal was then digitized with the Sony PCM-100 digital processor and recorded on Sony BVU-200B VTRs. As the trend toward digital simulcasting continues to grow, broadcasters can appreciate the prospects of truly superior audio with the added convenience of digital equipment that immediately interfaces with existing videotape facilities.

Headphones were provided, with a switch to allow an A/B comparison between the actual live audio pickup



Lexicon



Sound Genesis

and the recorded digital sound. Booth visitors were invited to experience the extraordinary mirror-like similarity between live performance and digitally-processed audio achieved with the recording equipment and the versatile professional broadcast tools.



UREI

Processors at NAB '81

Audio & Design Recording	629
Broadcast Electronics	630
Circuit Research Labs	631
dbx Corp.	632
Dolby Laboratories	962
Dorrugh Electronics	963
Gregg Laboratories	964
Harris/Broadcast Products	965
Howe Audio	966
Inovonics	967
Integrated Sound Systems	968
Lexicon	969

MICMIX Audio Products	970
Orban Associates	971
ProTech Audio	972
Publison	973
Quad Eight	974
Quintek	975
Sound Genesis	976
Thomson-CSF	977
UREI	978
Ursa Major	979

Circle the appropriate numbers on the reader service card for NAB '81 exhibitor data. Check listing in other articles for additional data leads and the wrap-up of other products/exhibitors elsewhere in this issue.

The Trend Setter

When It Comes To Professional Editing,
VANGUARD Creatively Does It All

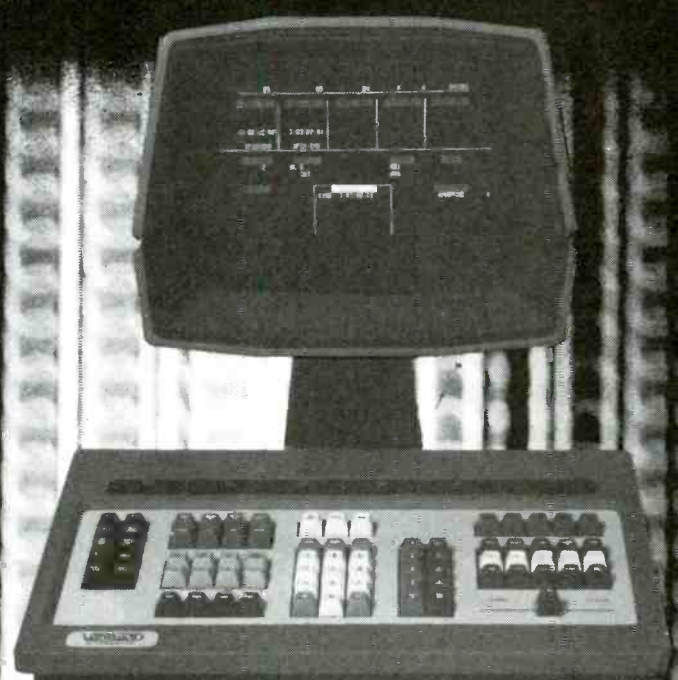

- Controls 5 VTRs plus switcher and DVE
- Performs A/B rolls and A/B/C/D sync'd rolls
- NTSC/PAL/SMPTE/EBU code or control track operation, insert or assembly
- Interfaces for over 40 types of tape decks and film chains
- Dual VaraScan™ variable speed tape search controls
- 999 event edit list memory
- Uncomplicated, powerful edit list management
- Auto-assembly from up to 4 sources

- Paper tape or floppy disk edit list I/O in industry-standard formats
- Five-tier time code scratchpad memory
- Built-in scratchpad time code calculator performs mixed drop/non-drop frame addition and subtraction
- Edit and split times can be marked on-the-fly or keyboard-entered
- Auto-tag, with override
- Well organized editing status display on eye-soothing green CRT screen; dedicated function, color-coded keyboard
- Selectable preroll, pcontrol and reaction time

datatron, inc.
datatron, inc.
datatron, inc.
datatron, inc.
datatron, inc.
datatron, inc.
datatron, inc.

Vanguard leads the way in giving creative editing professionals innovative new editing system features that add new dimensions to the editing craft. Latest in a long list of Datatron firsts is SmartScan™ learn mode variable motion editing. This feature opens the door to a dazzling array of slow-mo, high-speed and freeze-frame edit effects. SmartScan lets you speed the action up, slow it down, freeze it or change directions, all with a single slide control; every move you make is memorized by the Vanguard system, faithfully repeated in your next edit, and reflected in the edit decision list. Perform freeze-frame edits automatically, with or without

subsequent learned motion; compress or expand edit segments to fill time slots — automatically; select exact calibrated play speeds for your VTRs over their full speed range. All this and more can be accomplished quickly and easily with Vanguard's SmartScan feature. There simply isn't another editing system you can buy that comes close to Vanguard's capabilities. BE A TREND SETTER; GET A VANGUARD



Datatron, Inc./Video Systems Division
2942 Dow Avenue, Tustin, Calif. 92680
(714) 544-9970 TWX 910-595-1589

datatron, inc.

MAKING CREATIVE EDITING AFFORDABLE

Circle (44) on Reply Card



The world's largest satellite earth station show

By Dennis Ciapura, general manager of Telecommunications, Greater Media, East Brunswick, NJ.

Each new NAB convention sees satellite exhibits growing more and more prolific, both inside the exhibit hall and on the adjoining parking lot. The '81 show was no exception, and satellite this-or-that seemed to be on the lips of every other broadcaster and vendor in attendance. At most TV stations, the eventual presence of at least a TVRO is a factor in the contemporary formula for success, and radio is red hot on satellite too.

There were sessions and workshops* offering the latest information on satellite operations for both TV and radio people—which is nothing new these days—but what is significant is the number of attendees who came forward to relate their own experience. Not only were there more people at NAB to investigate satellite potential, there were also a lot more “experienced” broadcasters on hand to add to the excitement of it all. This means that the exponential growth that we all predicted is happening, and we are probably on the threshold of an industry explosion.

An informal poll taken at one of the TV sessions exploring satellite problems and potential revealed that 20 percent of the TV broadcasters in attendance were already involved in satellites, and all but one of the remaining group planned eventually to

*See also Radio at NAB '81 by Brad Dick for additional information on satellite workshops.

install a station. The big question appears not to be “Should I?” but rather, “How should I?”

Most broadcasters also feel better about the state of the economy this year, and that positive feeling engendered more active buying on the floor. Several satellite hardware exhibitors reported brisk sales at the convention, and almost all were encouraged by the level of interest displayed.

Scientific Atlanta introduced its new 7500 series receivers and peripheral gear featuring full frequency synthesis and digital control via a standard bus with RS-422/449 interfacing. When matched with the new SA 7 meter motorized dish, the super remote controlled system is capable of sweeping from any transponder on Satcom I to any transponder on Westar III at the other end of the orbital arc in 30 seconds. No external remote control gear is required, and even a dialed-up line can be employed to “talk” to the system.

Microdyne Corporation came to the convention still glowing from the recent announcement of a 100-station contract from Robert Wold. More than 50 of the seven meter units are to be installed by the end of the summer with the distribution of two new TV programs. The company also brought along its 11 meter antenna system to dazzle those interested in the big boys, and samples of its Model 1100 receivers.

Although *Compact Video* has historically done most of its business with TV commercial producers, cablecasters will represent almost 50% of the company's revenue this year, and there certainly was no lack of interest among the broadcasters who visited the huge exhibit. Two complete production trailers and a complete mobile earth station spoke well for *Compact's* capabilities. (To make things even more interesting, *Skirpan Lighting Systems* is now a subsidiary of *Compact Video*.)

The new Model 4200 receiver was a hit at the *Gardiner Communications* exhibit. Equipped to receive four

audio subcarriers at the standard 6.2 and 6.8MHz as well as two others at 5.8 and 7.4MHz, the receiver also features power supply outputs suitable for running remote LNAs. The company's 5.6 meter petalized fiberglass antenna, offering 25% more surface than a typical 5 meter unit, makes a nice companion unit to round out the system.

SCN (Satellite Communications Network) generated more talk with its *Simulstat*® antenna. *SCN* is a satellite common carrier with fixed terminals in Denver and Las Vegas as well as portable systems. The company aspires to construct a nationwide network of earth stations as well as supplying their *Simulstat*® antenna which is capable of pulling in up to 14 satellites at once.

Fort Worth Tower Company was in great shape at the show with its *FWT-5* 5 meter dish and had sold 10 by Monday afternoon. The booth staff reported the best year yet and hoped to hit sales of 30 units by the end of the convention. The motorized antenna takes about an hour to set up or knock down and covers the arc in about a minute. The “show special price” of \$11,000 captured the fancy of a lot of broadcasters.

In addition to an array of great test gear for satellite earth station testing and maintenance, *Telemet* featured an interesting fiber-optics video-audio transmission system. The model 4210-B2 features less than 10 nanoseconds envelope delay and a short fiber-optics run wouldn't even require equalization. The price is competitive with conventional microwave systems. So, many earth station operators may want to look into this state-of-the-art signal delivery system.

Oak Communications really has an effective solution to the satellite signal theft problem in its new *Orion* encryption system. Of particular interest to satellite programmers at the show, this security system requires that a protected signal be greeted by a digital code at the receiving station as well as having the proper digital address attached to it. This means that even if an

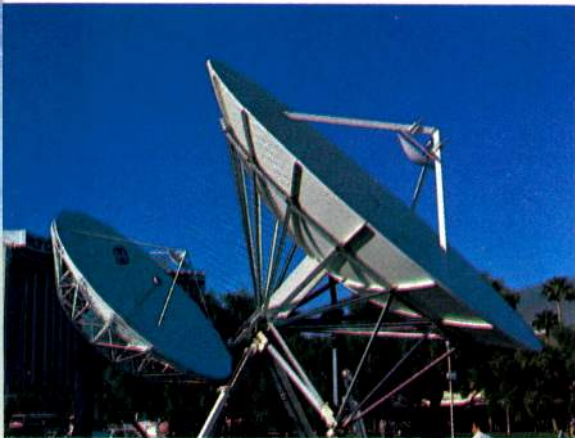

Harris/Broadcast Products

SIX OUTPUTS!

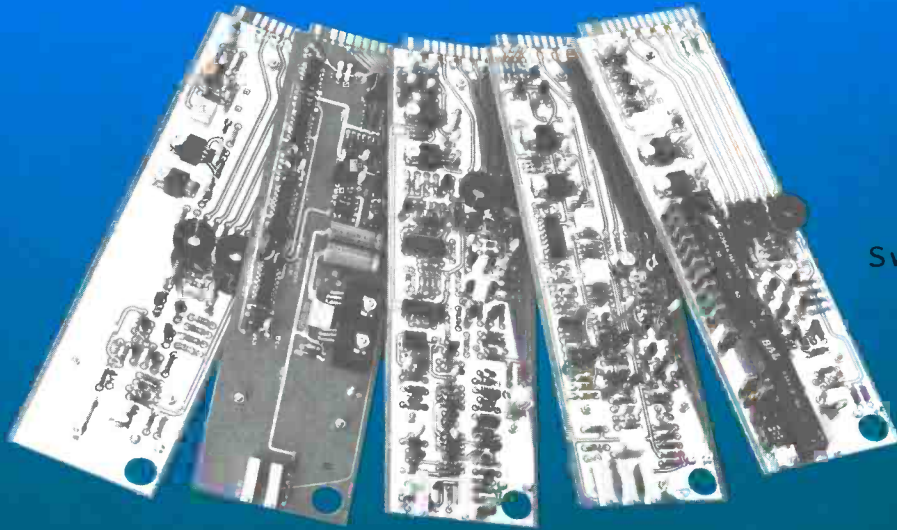

VDA-661
Video Distribution Amplifier

VEA-660
Video Equalizing Amplifier

VCA-660
Video Clamping Amplifier

SVD-660
Switchable Video Delay Amplifier

PDA-660
Pulse Distribution Amplifier

FR-660 MOUNTING FRAME

- Two rack units.
- Two plug-in power supplies.
- Looping inputs.
- Any mix of up to ten amplifiers.

FR-661 MOUNTING FRAME

- One rack unit.
- One plug-in power supply.
- Looping inputs.
- Any mix of up to four amplifiers.

Full compatibility with 600 Series mounting frames and amplifiers.



LEITCH

Progressive Concepts in Television Technology

Leitch Video Limited, 705 Progress Avenue, Scarborough, Ontario, Canada M1H 2X1
Tel: (416) 438-5060 Telex: 065-25420

Leitch Video Inc., 1051 Clinton Street, Buffalo, N.Y. 14206
Tel: (716) 852-1535

Circle (45) on Reply Card

**Growth plan for television products
and services in the '80's.**

CENTRAL DYNAMICS

+

PHILIPS

+



American Data

**Three recognized world leaders
in broadcast equipment have merged
their talents and technologies to meet
the world's television challenge
of the 1980's.**

And that's good news for the whole industry.

Customers in North America will now be served by a much larger integrated organization for fast, efficient service for all products.

With the formation of new U.S. and Canadian organizations, Central Dynamics will market Philips Broadcast and American Data products in the United States and Canada. (Philips will market CDL products throughout the rest of the world, as they have since 1972.) International sales of ADC products will continue through the present overseas network.

In addition, the acquisition of American Data by Central Dynamics doubles the company's manufacturing capacity with plants in the U.S. and Canada. N.V. Philips will concentrate on design and manufacture of advanced cameras, transmitters and equipment for the digital television decade.

This aggressive move establishes a wide range of products available from one source, and represents a long term commitment of these companies to new technology, product and customer service.

The first phase of the plan is already taking place:

- CDL has increased manufacturing capacity 30% in their Montreal plant.
- N.V. Philips Broadcast Products are moving into larger facilities in Eindhoven, Holland.
- An expanded CDL and ADC research and development effort has already been launched.
- And, the new expanded organization will move soon to new headquarters in northern New Jersey staffed for sales, service, parts, product management and support activities.

The compatible products and services of CDL, Philips and American Data are now offered by one U.S.-company dedicated to the television industry:

Philips ENG, EFP and Studio cameras

Teleproduction vans and systems

Video recorders

Production switchers

Digital noise reducers

Master Control switchers and Automation Systems

Machine control and pulse distribution systems

Routing switchers

Terminal equipment

Philips/Pye UHF and VHF transmitters

Plus these corporate services:

- Customized systems for vans and studios.
- Package financing for equipment and systems.

Customers now have access to a single large company for fast, efficient service for all products. That makes good business sense. And this stronger, larger company is committed to meet the industry's growth requirements throughout the '80's.



CENTRAL DYNAMICS

Central Dynamics Corporation
91 McKee Dr., Mahwah, NJ 07430, 201-529-3800

Circle (46) on Reply Card

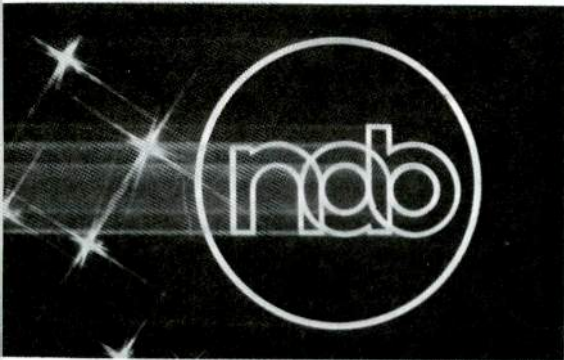

TV transmitters and translators

By Donald Markley of D. L. Markley & Associates, Peoria, IL

Several new transmitters were shown this year, as is to be expected. The most significant of these were VHF with no really new, significant UHF models. However, the most exciting indications for the future were in the area of UHF.

Acrodyne Industries is moving further into the big leagues with a new 10kW single-tube VHF high-band transmitter. This unit is low-level diplexed and IF modulated. The aural and visual drivers are both solid-state. The outputs of the drivers are combined and used to drive a single Thomson-CSF TH561 tetrode operating in AB₁. The tube uses a vapor phase cooling system with a small external heat exchanger. The differential gain and phase are 0.5 dB and 1°, respectively, with in-band spurious beats and intermodulation products down 54 dB.

But, Acrodyne's main attraction this year was a series of practical seminars of LPTV technology. Details of this program are covered in a separate section of "Other Activities at NAB '81."

Canadian General Electric was showing two new transmitters. The biggest of the two was a new 30kW VHF High-Band unit that uses only two tubes. The aural and visual drivers, both totally solid-state, are wide-band devices that required no tuning. The visual drive operates at 1500W via 15 parallel power amplifier modules. While these features will set the chief engineers eyes aglow, the maintenance staff will prefer the fact

that the high voltage power supply and the PA blower assembly roll out for cleaning and service. This is an especially desirable feature as technicians with 6-foot-long arms are scarce.

The second new Canadian General Electric transmitter is a 2kW UHF unit designed for use either as a transmitter or a translator. The system is IF diplexed and uses two tubes. The driver is a grounded-grid triode, and the final tube is a tetrode operating in grounded-grid, grounded-screen configuration. The system is equipped with a full set of control logic and overload protection systems similar to those on its big brothers, making it a professional piece of equipment in its operation.

Comark Communications Inc. (CCI) stressed continued effort to improving UHF broadcasters' profitability in the marketplace and introduced a complete VHF transmitter system product line and a modern mod anode pulser transmitter for UHF-TV visual klystron amplifiers. The CCI line of CTT-U-XX transmitter is available at four power levels and features all solid-state IF modulated exciters; efficient operation, low space requirements, redundant klystron amplifier subsystem, and redundant protective circuitry. The final (XX) digits designate power ratings. Available are: the -110 at 110kW visual/25W aural; the -55 at 55kW visual/12kW aural; the -30 at 30kW visual/6kW aural; and the -10 at 10kW visual/2kW aural.

EMCEE Broadcast Products, a divi-

sion of Electronics, Missiles & Communications Inc., took advantage of the rising interest in low-power TV technology to promote its LPTV translator turnkey systems and hardware. EMCEE's expertise is based on 20 years of designing and building low-power VHF and UHF transmitters for translator service. Being promoted were the solid-state 100W VHF and 1000W UHF TV translators. Both claim high reliability and performance; modular construction; features for automatic unattended NTSC, SECAM or PAL color operation; and 50 dB dynamic range adaptive AGC.

Harris/Broadcast products introduced a 30kW low-band transmitter that has re-introduced the old question of tubes versus solid-state amplifiers. That is, Harris has elected to stay with a tube-type driver for the visual final amplifier. It is their opinion that they achieve a higher degree of linearity with this approach, as opposed to that possible with solid-state amplifiers. Less correction circuitry is necessary as the tube system has fewer inherent distortions than its transistor counterparts. It is refreshing to see a manufacturer not rush head-long into the solid-state conversion if that conversion does not provide improved performance.

The remainder of the transmitter is as one would expect from a major manufacturer, with very good specifications and improved power control that will be a boon to future

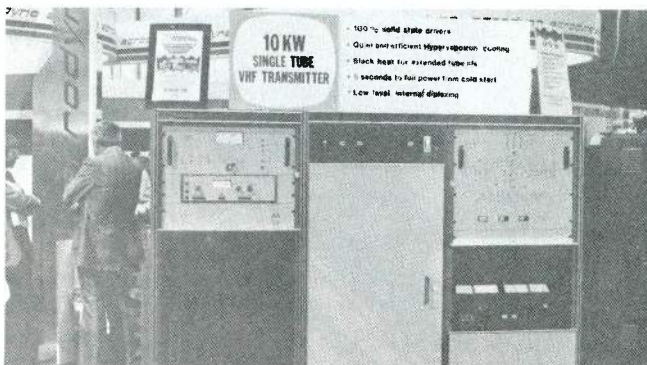

Acrodyne



Canadian General Electric

OUR SWITCHER SPECS SPEAK FOR THEMSELVES

Following is a summary of test data compiled from the final test measurements made on a 50-input by 50-output audio/video switching matrix sold to Capital Cities' Houston outlet KTRK-TV. We invite comparison of these test results with our published specs and with the published specs of routing switchers manufactured by others.

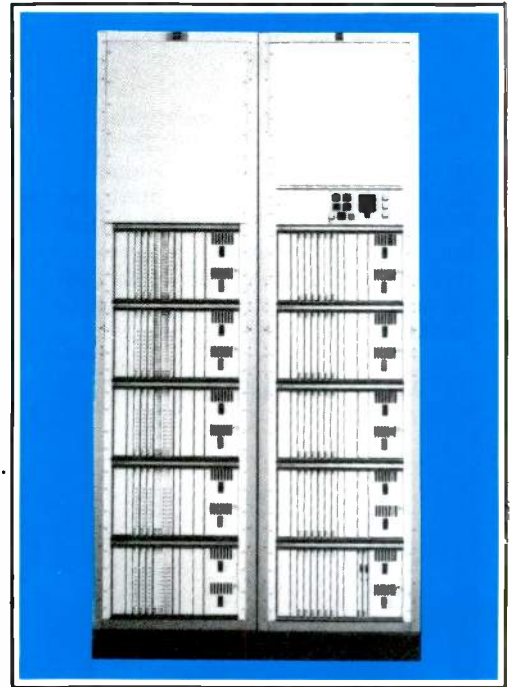

50 x 50 KTRK MATRIX

KTRK TEST DATA BREAKDOWN

	Worst	Mean	95th Percentile	Published Spec
VIDEO				
Crosstalk @ 3.58 MHz	-63	71.1	65	-60 dB
Diff Gain05	.042	.05	0.1%
Diff Phase	0.1	.056	.08	0.12°
Diff Delay	1.0	.89	.95	± 1°
Freq Response05	.02	.05	± .12 dB
Hum & Noise	-79	-84.6	-80	-75 dB
Gain Uniformity, All Paths017	.006	.017	± .07 dB
Input Return Loss	46	51.2	46	40 dB
Output Return Loss	45	48.8	46	40 dB
AUDIO				
Crosstalk @ 20 KHz	-80	-84.7	-81	-75 dB
Hum & Noise	-88	-91.8	-90	-85 dBm
THD 30 Hz - 20 KHz				
@ 0 dBm017	.011	.015	0.1%
@ +24 dBm24	.13	.17	0.5%
Gain Uniformity, All Paths	0.1	.044	.09	0.2 dB
Common Mode Rejection	80	88.3	83	70 dB

Our routing switcher specs are the best in the industry—we test each matrix for conformity and we beat our own specs by comfortable margins.

TRY THAT ON YOUR GRASCOMFERNSAM DYNATEK SWITCHER!

USUTAH SCIENTIFIC, INC.
THE ROUTING SWITCHER PEOPLE.

2276 SOUTH 2700 WEST, SALT LAKE CITY, UTAH 84119
PHONE (801) 973-6840
TWX: 910-925-4037

Circle (48) on Reply Card

TOLL-FREE
IN U.S.A.
(800) 453-8782

TV transmitters

ATS or remote control operations.

NEC Broadcast Equipment Division, for the television market, promoted its PCU-700 series UHF transmitters and PCN-1200 series of VHF transmitters. Both featured advanced features in solid-state technology and unique integrated microcircuitry to provide increased reliability, efficient power

management, and easy maintenance and adjustments. The PCU-700s are available at 10, 30, 40, 55, 60, 80, and 110kW output power ratings. The PCN-1200s are available at 1, 2, 5, 10, 13, 20, 25kW power ratings.

Also, NEC makes it possible to update existing UHF/VHF transmitters through custom installation of its new solid-state exciter/modulator. The HPA-3696IF TV modulator, designed to work with any make of transmitter, has a wide range of power outputs

selectable to meet individual broadcasting needs.

NEC also presented its 10kW, forced air-cooled, high efficiency VHU klystrons. The 1AV57/1AV58/1AV59 klystrons feature external four cavities, are designed for use as the final amplifier tube in UHF-TV transmitters, and are capable of delivering 12kW visual output at 470-578MHz, 574-698MHz, and 694-860MHz ranges. They claim high efficiency (typically, 55% at saturation level), high power gain, long life and high stability.

Philips (Pye TVT) did not show any new transmitters at NAB this year. They had parts of their current models on display and announced a series of new UHF tube-type transmitters that range from 5kW to 25kW. These transmitters are currently being installed internationally and will be further introduced domestically in the near future. The low- and mid-ranged power levels should find a ready market in broadcasters who have given up on low-power TV and seek to construct a regular TV station at a lower power level.

Before it appears that Acrodyne had the only low-level diplexed transmitter of reasonable power, the old masters at RCA introduced a single tube 12kW high band unit. This transmitter is IF modulated and diplexed. An up-converter then is routed to a solid-state driver that provides 400W of drive to the single tube final stage. The final amplifier is a type 8976 tetrode and is air cooled. The intermodulation products are down 56 dB. And the rest of the numbers are what you would expect from this manufacturer.

The big news at the Singer Broadcast Products booth was that just before NAB '81 Singer Products Company announced the formation of the new firm to manufacture AM/FM/VHF/UHF transmitters formerly produced by CCA Electronics and Sintronic. The products will be manufactured in the former CCA facilities at Cherry Hill, NJ, under the management of Donald A. Richardson, executive vice president/general manager, and Joseph T. Consalvi, vice president, sales and marketing.

Television Technology Corporation (TTC) was on hand to describe its expertise in making and installing TV and FM translators and low power transmitters, with 25 years of field experience. TTC presented its 10W VHF LPTV package and its 20W and 100W UHF LPTV packages, and introduced its 1kW UHF translator with high performance, low power consumption.

Although not introducing a new transmitter, Townsend Associates did demonstrate a new mod anode pulser for use in their transmitters. They fur-



Comark Communications

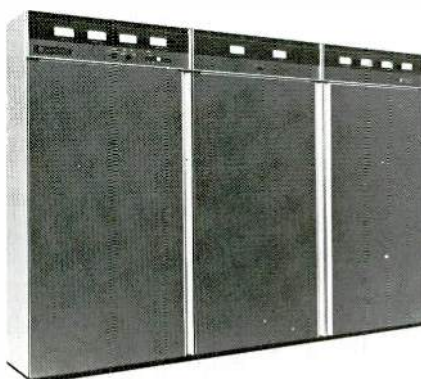

Harris/Broadcast Products

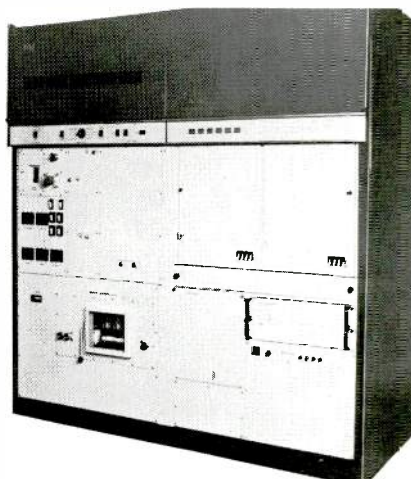

RCA Broadcast Systems



Singer Broadcast Products



Varian/Eimac Division

BROADEN YOUR RADIO PROGRAMMING HORIZONS WITH A NEW SPECTRUM OF SERVICES

Open your doors to world news, stereo and special events and be a superstation in your own market with the leader in satellite-delivered radio programming.

The California Microwave Small Aperture Terminal (SAT) delivers a new spectrum of program diversity and quality right to local studios, no matter where. And that means delivering audience, economically with impressive flexibility at surprisingly low cost.

- Greater than 70 dB audio dynamic range
- Impeccable stereo delivery nationwide
- Cue, automation, hard copy, and wire service data channels
- Multiple channels per carrier (MC²C) for regional sports
- Excellent reception in fringe areas

Be number one with the SAT that's number one. Available now.

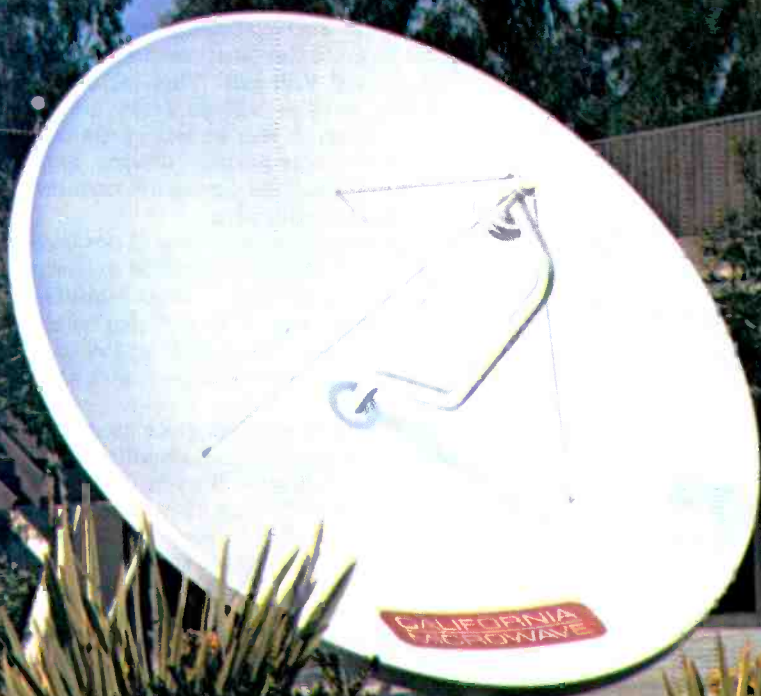

**CALIFORNIA
MICROWAVE**

CALIFORNIA MICROWAVE, INC.
990 Almaden Ave., Sunnyvale, CA 94086
(408) 732-4000 TWX 910 399 9821

Call Jim Smith, SAZ 693

Circle (48) on Reply Card

TV transmitters

ther stated that this pulser can be used on most klystron transmitters using IF modulation. The system uses its own power supplies to establish reference levels rather than coupling to the beam supply of the transmitter. A fiber-optic cable is used to provide the necessary coupling from the video systems to the high voltage circuitry. The rise and fall time of the sync pulse in the pulser is 200 nanoseconds and is easily field adjustable. The bias and pulse voltages are adjustable with motorized variac controls.

Two interesting klystron developments were discussed at the show. The first was the development of an output coupler for Varian integral cavity klystrons. This device effectively changes the load impedance presented to the klystron beam at the output gap. This is done by varying the Q of the output circuit without changing the resonant frequency. Varian claims that this essentially results in an operating efficiency which is as good as is available with external cavity klystrons. We will not enter into that argument, but the device is obviously a welcome addition to the efficiency race. All is not

totally simple in a retrofit to this device, however, as you may have trouble with little things—like closing the transmitter doors after the installation. Still, if you increase the efficiency of your transmitter by several percent, management will probably be happy to buy some new, oddly-shaped doors.

Last, but certainly not least, VALVO presented a paper discussing the merits of a new grid-modulated klystron. The first of these experimental tubes is currently being constructed in Europe and should provide a great deal of data before next year's NAB. In essence, the klystron will be provided a pure CW signal and then grid modulated rather than the IF modulation systems currently popular. The result of this technique, according to VALVO, will be an operating efficiency in the final amplifier of 70 to 72%. This is obviously a significant improvement, but it may present new and different problems. For example, do we now have to go to the back room and drag out the old VSB filter? It is assumed that the cavities will do great things, but how much will be left of the old undesirables requiring filtering and notching? Still, the power bill certainly would be reduced.

The main thrust by Versa Count this year was for its Group 80 FM exciter, modulation monitor, stereo modulation monitor and STL. But also being promoted was its V-213 and V-214 UHF to VHF TV translators at 1 and 10W.

In all, there were no great quantum leaps of technology in transmitters for the convention goer this year. Instead, there were many positive developments that further the state-of-the-art at a reasonable pace. Perhaps the modulated grid klystron will be shown next year to intrigue transmitter engineers. □

An FM Exciter with Fewer Parts

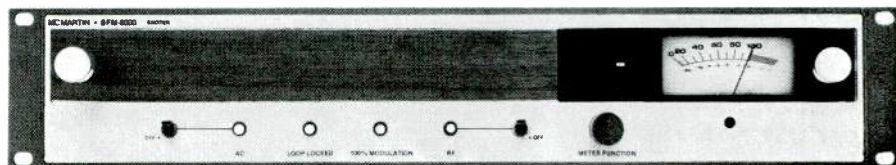

BFM-8000

Gives You More

Lean. Efficient. Responsive. That's the kind of worker you get when you put a McMartin BFM-8000 exciter in your FM transmitter. The secret is skillful use of the latest integrated circuits to produce an FM exciter with nearly half the total parts count of leading competitors.

Fewer parts mean fewer breakdowns. The BFM-8000 will keep you on the air longer with less "down" time. And that's not an idle claim. It's backed up by a **five year warranty** so you know the reliability has got to be built in.

You get performance matched to the needs of today's FM broadcaster. Its loud, clear signal demands attention. The McMartin BFM-8000 has an extremely high signal-to-noise ratio in both the main and SCA channels. DC coupled inputs provide fast rise times and excellent low frequency stereo separation.

Stereo processors and generators that will enhance your FM operation. The McMartin BFM-1514R, stereo processor, for precise control over the FM modulation and the McMartin BFM-1521R, stereo generator, for producing a very high quality signal are available. You can get the whole performance story on the BFM-8000 by writing or calling for catalog information.

1956 • Twenty-five year anniversary • 1981

MCMARTIN

McMartin Industries, Inc. • 4500 S. 76th St. • Omaha, NE 68127 • (402) 331-2000 • Telex 484485

Circle (50) on Reply Card

TV Transmitters/ Translators at NAB '81

Acrodyne Industries	740
Canadian General Electric	741
Comark Communications	742
EMCEE Broadcast Products	743
Harris/Broadcast Products	744
NEC America	745
Philips Broadcast Equipment	746
RCA Broadcast Systems	747
Singer Broadcast Products	748
Television Technology Corp.	749
Townsend Associates	750
Valvo	751
Varian	752
Versa Count	753

Circle the appropriate numbers on the reader service card for NAB '81 exhibitor data. Check listing in other articles for additional data leads and the wrap-up of other products/exhibitors elsewhere in this issue.



THE IMAGE MAKER[®]

Imagine, an incredibly versatile disc recorder which can animate, store stills, and record and playback in real time (30 frames per second) to single frame. Or, at the touch of a button, 24 frames per second for film transfer. Add to this full random access, with preview, of up to 500 images on line and the ability to pre-set 64 locations, standard serial digital interface, and a built-in frame by frame editing/animation previewer. □ That's Arvin/Echo's total production tool: The Image Maker. Whether your requirement is to store still frames, produce exciting animation sequences or preprogrammed motion loops from 16 frames (or less) to 500 frames, this high band color recorder is capable of delivering direct or processed video. Rugged, reliable and portable, The Image Maker is the only real time random access recorder—featuring interchangeable Discassettes[®]—which doesn't break the bank. □ Remember, Arvin/Echo has more video disc recorders operating in the broadcast field than any other manufacturer. Based on this unique experience, we have built The Image Maker to meet the rapidly changing challenges of the professional television industry. Its potential is limited only by your imagination.



ARVIN/ECHO[™]

Echo Science Corporation
485 E. Middlefield Road, Mountain View, California 94043
Telephone: (415) 961-7145, TWX: (910) 379-6499

APPLIED
TECHNOLOGY
GROUP **ATB**
ARVIN

Circle (51) on Reply Card



"Our Sony video recorders have not only traveled the equivalent of fifteen times the circumference of the earth, but they've logged more than 2,500 hours of taping time," says Martin McAndrew, Vice President of Operations for Continental Colour Recording.

"Not one of these machines has ever broken down," McAndrew adds. "What makes that even more impressive is that they're constantly being used by different people with different ideas about how carefully to handle equipment.

"Seventy per cent of the time, our equipment is

used by ABC and NBC, but we also rent it to local television stations and production companies."

Continental Colour, the country's largest video equipment rental company, has specially built trucks and trailer trucks that are virtually television stations on wheels. Two of these trucks are equipped with one-inch equipment, including a total of two BVH-1100 and four BVH-1000 one-inch high-band video recorders. Continental has also purchased additional Sony recorders for its brand-new post-production facility.

"Sony picture quality is excellent," says McAndrew,

“375,000 MILES WITHOUT A BREAKDOWN.”

Martin McAndrew, Continental Colour Recording

“much better than its main competitor. And the slow-motion capability of the BVH-1100's means that each can do the work of two separate machines, in less space, at less expense. No one else's equipment can match these 1100's.

“No wonder our Sonys are almost always on the road. They've covered the World Series, the Winter Olympics, the daytime Emmy Awards, the Tony Awards, operas and symphonies for PBS, and the Pope's visit to the U.S. And we've had zero problems; working with Sony has been delightful!”

If you want one-inch equipment you can really get some mileage out of, find out about Sony's full line. It includes cameras, recorders, editors, and the BVT-2000 digital time base corrector.

Write Sony Broadcast, 9 West 57th Street, New York, N.Y. 10019. Or call us in New York at (212) 371-5800; in Chicago at (312) 792-3600; or in Los Angeles at (213) 537-4300.

SONY[®]
BROADCAST

Sony is a registered trademark of Sony Corp.

Circle (52) on Reply Card



Cameras

Special cameras create a stir

By Bill Rhodes, editorial director, and Bebe F. McClain, president, B.F. McClain Productions, Asheville, NC

Some unique, special purpose cameras were shown for the first time at the 1981 NAB. Although each of them is geared toward a special market, they were of interest to many.

Hitachi's new SK-100 automatic setup studio camera, which was designed to meet the needs of CBS Broadcast Center, was prominently displayed in the Hitachi booth. CBS has bought 30 of these special studio cameras to replace the full complement of color cameras at CBS Broadcast Center.

This camera represents the latest in state-of-the-art improvements by incorporating microprocessor-controlled automatic setup adjustment and self-checking features. All cameras in the system can be set up simultaneously within two minutes, including auto setup of the green channel. Also, any fault diagnosis is read out on both a CRT and a hard copy printout from the setup computer.

Joseph Flaherty, vice president of Engineering and Development at CBS, said "The camera dramatically simplifies operation and mainte-

Bebe F. McClain is the president of B. F. McClain Productions Inc., an audio-visual production and equipment sales company based in Asheville, NC.

nance, and will greatly enhance the overall visual quality of programs produced in our Broadcast Center."

Those visiting the Hitachi booth had a chance to operate the large camera and found it to have applications outside of a large broadcast center.

Chris Curtis, operations manager of video production for Video Visions, a Denver-based sports coverage production company, explained how he could use three such cameras in his 40-foot production truck used for remote production of sports events. "The speed of this computer setup is appealing," he said. "When we go out to shoot something we don't want to spend forever setting up. With this SK-100 we get a printout." He also commented on the ground glass split in the viewfinder saying that it would greatly help in composing shots to be split.

Quality control of such a complex camera presents quite a problem, especially during the manufacture of the prototypes. Dr. S. Takei, managing director of the Engineering Division of Hitachi Denshi, and Dr. S. Hirano, deputy general manager, explained that every component is tested before it is placed on a board. Then all the boards are tested individually. Once

the main parts of the camera are assembled they must pass a "very severe examination." The final camera is taken through another series of tests. They also explained that a prototype camera often then will be taken completely apart, after assembly, for a second examination of individual components.

Because other divisions of Hitachi make many of the electronic components that are used by the Hitachi Denshi Company in the manufacture of broadcast cameras, it is not necessary to test those components. Takei pointed out that each of those components comes with a signed certificate attesting that it has been tested and is of perfect quality. Only those components purchased outside Hitachi are tested. When asked what happens if some defect is traced back to one of those certified components in the final testing of the camera, Takei and Hirano looked at each other incredulously, and after a moment, Takei said, "That just doesn't happen."

When passing the Ikegami booth one might think someone slipped a 35mm film camera into the line-up of HL cameras. The EC-35 certainly has all the features relished by the hard line cinematographer. This new



Chris Curtis of Video Visions was impressed with the new Hitachi SK-100, the Studio Automatic Set Up camera that will replace the full complement of color cameras installed in the CBS Broadcast Center in New York.



Vince Lyons of Editel inspects Ikegami's EC-35, a video camera designed similar to 35mm cameras.

THE ANIMATOR

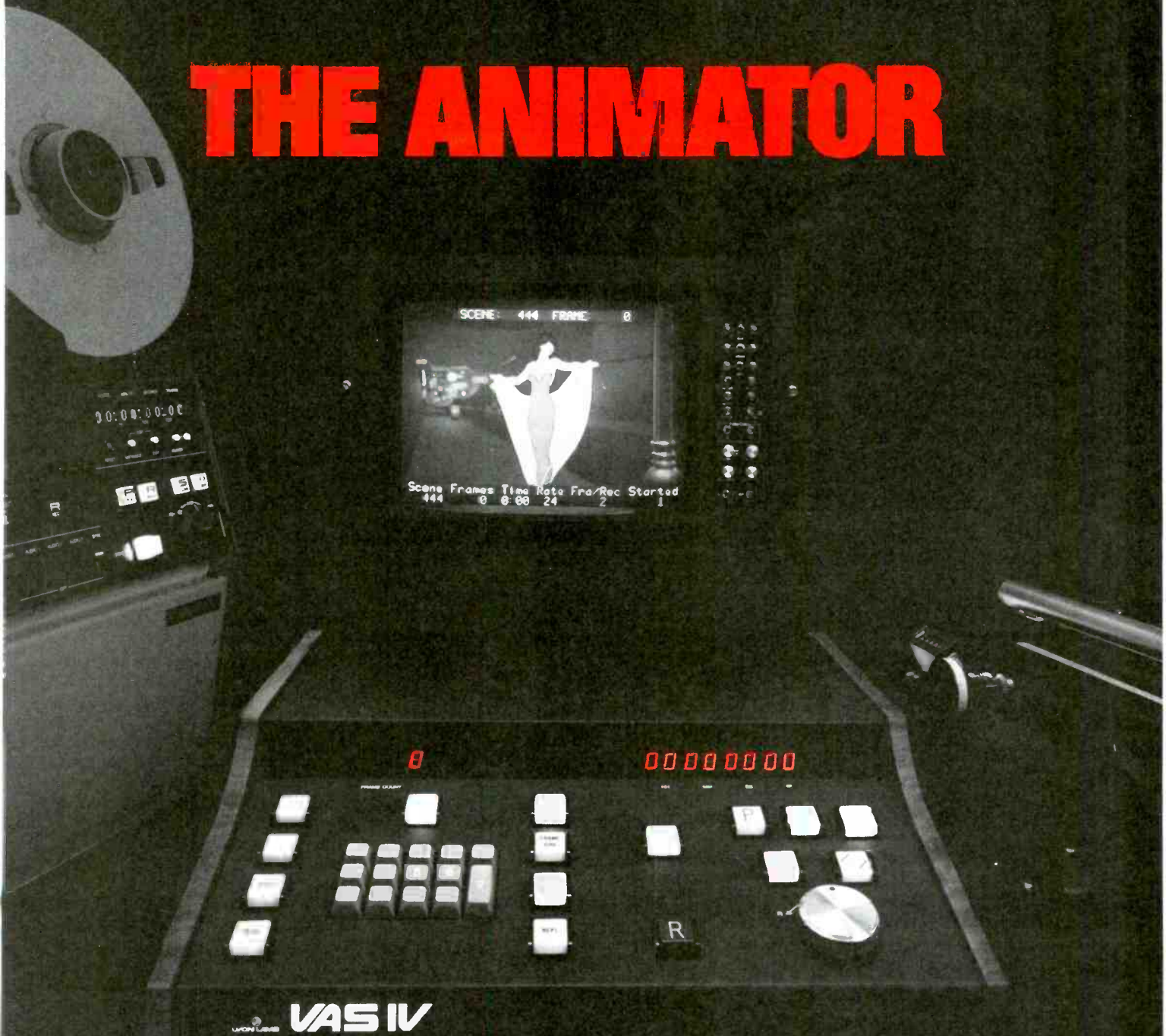

VAS IV from Lyon Lamb Video Animation Systems*

Functions needed by professional animators translated to the video format. Animates camera or computer generated art for broadcast release. Field accurate at 24 and 30 fps with monitor readout of all animation operations.

Call or write Gary Beycler for demonstration and information

LYON LAMB
VIDEO ANIMATION SYSTEMS INC.

8255 Beverly Blvd., Los Angeles, CA. 90048, Tel. 213-655-0866

Circle (53) on Reply Card

*Academy Award, Technical Achievement 1979, for single frame video animation at 24 fps

Special cameras

video camera not only has the shape and feel of a film camera, but it operates similar to one even up to in-

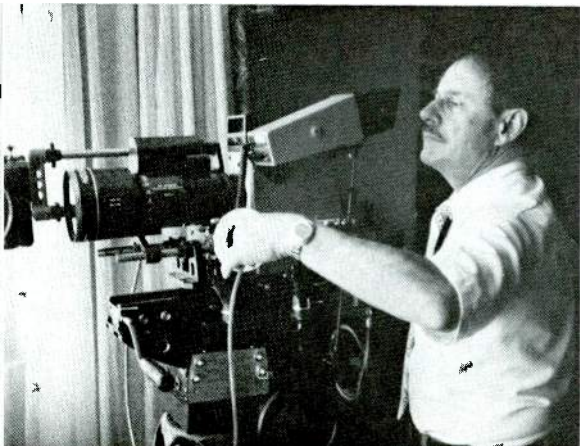

Len Adler, marketing director for CEI, ran the PANACAM electronic cinematography camera through its paces in the CEI suite.

corporating t-stops for exposure in place of f-stops. Also, a matte box is available and the viewfinder is of a film rather than a video style.

This camera is the result of a collaboration with CBS for use in its electronic cinematography project that is being tested out on TV series production in Los Angeles.

Those involved are hoping that this new design and the new look of the end product (image has a definite film look because of use of film lenses and different depth of field) will overcome the resistance many cinematographers have to switching over to video. Vince Lyons, executive vice president of Editel, a post-production house, said of the Ikegami EC-35, "I like it. It's good. I like the resolution, the depth of field and the color reproduction. Eighty percent of our clients are in film and they feel very familiar with these types of arrangements."

Recognizing the gap between users of video and film cameras, CEI and Panavision have cooperated to produce the PANACAM electronic

cinematography camera displayed to a selected audience at the CEI hospitality suite during NAB '81. Robert Gottschal, president of Panavision, and Alan K. Jensen, president of CEI, explained that the product was a collaborative engineering effort. The proved CEI 310 electronic field production (EFP) camera has been improved to accept the full range of Panavision's optical and mechanical system support components currently used with the Panaflex 35-mm film cameras. For the first time, it permits a cinematographer to "shoot" on tape using the same prime lenses, matte boxes, filters, gear heads and camera operations as would be used shooting on film. No longer is the transition from film to tape inhibited by the lack of a camera and lenses optimized for single-camera, film-style shooting.

The new camera will be available only by rental through Panavision outlets following traditional policies. CEI will share in the rental revenues as compensation for the system's development.

High-end cameras for studio and ENG/EFP use

By Patrick McEntee, ISO Communications, New York, NY

Microprocessors taking over

Microprocessors have radically improved the stability and the ease of use among premium cameras during recent years. In the field, the chip allowed almost all ENG/EFP cameras to produce consistent white and black balancing within five seconds. Also, last year auto beam optimization, auto black level and auto gain compensation were added to the microprocessor's duties in portable cameras. The first generation of computer-assisted studio cameras, including the TK-47 from RCA and the HK-312 from Ikegami, have not only created an un-

precedented consistency in professional studios in registration and picture values, but also have fundamentally altered job roles as well.

Top flight video operators can usually compensate for singular peculiarities of an odd tube. However, the average video operator performs the complex, traditional registration and balancing sequences at approximately the same quality as the microprocessor. A special problem of TV news, the total set-up time, has been reduced from 2½ hours for six cameras down to 30 minutes total or five minutes for each camera. This capability allows the networks to cope with the instantaneous, world news environment.

Naturally, computer-controlled devices have their own drawbacks; the most obvious of which is the much more complex training that maintenance personnel must have in order to cope with the new digital circuitry. All of the advanced cameras depend on these complex digital techniques. In emerging nations, it is totally unreasonable to assume that competent, digital maintenance expertise will be available. So manufacturers whose present markets are less reliant on sales in America and Japan for the lion's share of their revenues have

moved more slowly to complicate their maintenance requirements with computer control.

Basically, there are three general areas by which to evaluate cameras. The first is image quality, including resolution, the sensitivity and color symmetry. The second is the flexibility. How effectively can this camera be used to do the shooting it was designed for? An adjunct to this parameter might be how many different shooting situations can this camera be used in? The third crucial aspect of a camera is its maintenance. There has been some astounding progress during the '70s and '80s in areas one and two. However, improvements in maintenance have been lagging. Users have become even more dependent on manufacturers to explain their complex products.

These experiments have led both operations and engineering personnel to pose the question: What should the computer do and what should the person do? Depending on the type and size of television plant you have, the answer to this question may be quite different. The international broadcaster usually anticipates equipment needs for local stations, but in the case of advanced studio cameras this may not hold true.

All considerations were reflected in the products that were offered at NAB '81 in Las Vegas. An excellent example of diverging market needs is the advanced computer-supported television, the SK-100 from Hitachi, built under contract for a multiple sale to CBS. Reportedly, the SK-100 was built



AmpeX



Production Studio, WRBR-FM, South Bend, Indiana.

Electro-Voice's Greg Silsby talks about the Sentry 100 studio monitor

When I first described to Electro-Voice engineers what I knew the Sentry 100 had to be, I felt like a "kid in a candy store." I told them that size was critical. Because broadcast environment working space is often limited, the Sentry 100 had to fit in a standard 19" rack, and it had to fit *from the front, not the back*. But the mounting hardware had to be optional so that broadcasters who didn't want it wouldn't have to pay for it.

The Sentry 100 also had to be both efficient and accurate. It had to be able to be driven to sound pressure levels a rock 'n roll D.J. could be happy with by the low output available from a console's internal monitor amplifier.

The Sentry 100 also had to have a tweeter that wouldn't go up in smoke the first time someone accidentally shifted

into fast forward with the tape heads engaged and the monitor amp on. This meant high-frequency power handling capability on the order of five times that of conventional high-frequency drivers.

Plus it had to have a 3-dB-down point of 45 Hz, and response that extended to 18,000 Hz with no more than a 3-dB variation.

Since it's just not practical for the engineer to always be directly on-axis of the tweeter, the Sentry 100 must have a uniform polar response. The engineer has to be able to hear exactly the same sound 30° off-axis as he does directly in front of the system.

I wanted the Sentry 100 equipped with a high-frequency control that offered boost as well as cut, and it had to be mounted on the front of the loudspeaker where it could only be seen but was accessible with the grille on or off.

I also didn't feel broadcasters should have to pay for form at the expense of function. The Sentry 100 had to be attractive, but another furniture-styled cabinet with a fancy polyester or die-cut foam grille wasn't the answer to the broadcast industry's real needs.

And for a close I told E-V's engineers that a studio had to be able to purchase the Sentry 100 for essentially the same money as the current best-selling monitor system.

I'm happy to report that we've achieved *all* our objectives.

Market Development Manager,
Professional Markets



EV Electro-Voice[®]
a gulton company

600 Cecil Street, Buchanan, Michigan 49107

In Canada:
Electro-Voice, Div. of Gulton Industries (Canada) Ltd.
345 Herbert St., Gananoque, Ontario K7G 2V1

Circle (54) on Reply Card

High-end cameras

to the most exacting set of specifications ever required for a TV product, including a 0.05 registration error any place within the picture area. Each time the SK-100's automatic setup is pushed, the specifications call for each tube to be fully adjusted, including the green channel. Other difficult design criterion had to be met, but diagnostics is the most novel and long term feature included in the SK-100.

Actually, CBS will receive a model SK-110, and this version includes subtle software examining the auto set-up along 20 parameters with a present indication of performance in each category. The auto set-up function in the SK-110 is designed to control 100 cameras.

Also, Ikegami, showing the HK-322 in a private suite, has developed a camera in the ultra-automated class. The HK-322 is specified to meet the 0.05 registration errors in all parts of the picture area. Ikegami created a master control panel capable of controlling 96 cameras. However, the HK-322 offers no diagnostics or hard copy output at this point, but it is planned for the future. While Ikegami appears somewhat behind Hitachi in offering the automated television plant, it has a firm commitment to deliver ultra-automated cameras to the broadcaster.

Slightly less complex are the individually-operated computer-controlled cameras, and seven of this type were offered by manufacturers on the convention floor. With several systems up and running in stations around the country, RCA showed the TK-47 in the booth as the proven product. Its operator simplicity reveals the TK-47 as a mature product, that provides greater consistency using computer control. The technical control center can be configured in several ways to reduce personnel assignments. Also, cameras can be assigned individually to one of the 12 in-

put ports to the same technical control center.

Thomson-CSF showed its TTV-1525 (around which last year's booth was organized, see **BE**, pp. 184-191), and touted the identical registration specifications of 0.05 error throughout the picture area. The TTV-1525 had the unusual capability of being used in portable configuration, with different lens and adaptors making it quite attractive for budget-conscious customers. Both full operational control panels (PR 1525) and the smaller remote control panels (PT 1525) were offered, but the PR 1525 seemed overly complex and confusing. The TTV-1525 is oriented to the world market, and provided for upgrading to computer-control for up to 16 cameras that would be balanced sequentially.

Gary Sanderson, associate principal engineer, Harris Broadcast Products Division, demonstrated a unique approach to one of the special problems with computer control. The new TC-85 requires an individual computer for each camera, providing redundancy compared to a central-computer system. With the individual computer, each can be setup simultaneously, thus minimizing the total setup time for a studio. The TC-85 should establish a strong position for Harris with its middle market audience, and it provides the option of upgrading to fully automated operations in the future.

Fernseh showed its KCK automatic color camera for studio and outdoor applications on the convention floor. However, at the time, the remote CCU was not working so we had no way to observe its automated performance. The KCK uses its microprocessor to complete the full set-up of red and blue channels as well as auto black and white balance. A single line-up control panel can be used up to 200m from the camera amplifier set. The line-up control panel can be supplied in two configurations: either in a modular version or in the rack-mount version.

In addition to the private showing of

its HK-322, Ikegami demonstrated two existing computer-controlled cameras: the HK-312 designed for studio use and the HK-357A created as a field camera that can function in the studio as well. Both of these products use the microprocessor to automate the set-up functions, including balancing and registration. Both have extensive track records of proud performance in professional production.

Marconi demonstrated its Mark IXB using a microprocessor for automating set-up controls, but claimed that the camera could be upgraded for automated operations where that capability was warranted. I. E. Gibson, product engineer, indicated that with Marconi's international market it would be some time before international clients would prefer a fully-automated camera.

Ampex presented its new BCC-21 Digicam designed for studio and field operations. This approach to automation is somewhat different. The basic theory of the BCC-21 is computer assistance rather than computer control. Gerow Brill of Ampex described it this way: "What we have done is to develop a computer-aided manual set-up that can be automated later with no modification." So, although the BCC-21 uses $\frac{2}{3}$ " diode gun tubes which limits its overall studio performance, in the studio configuration the spatial error correction system increases performance visibly. By dividing the frame into 182 picture areas, the Z-80 microprocessor-based digital correction system improves the manual set-up procedure.

Toshiba premiered the PK-40A in the US at NAB'81. Under another name this camera has been used for over a year by NHK in Japan. Each camera in this system functions as a complete and separate unit, but command signals are generated by the centralized Set-Up Control Panel for all cameras. In its present configuration the Set-Up Control Panel allows the operation of six cameras, but it was made clear that Toshiba would



Harris



Ikegami

The new EC-35. World's First Electronic Cinematography Camera. Designed for the cinematographer, it makes network quality features on tape instead of film to substantially cut production costs.



The new HK-302 Studio/Field Camera. Ideal for the sophisticated program originator who wants a high performance camera with the important operational automatics at an affordable price. This compact, high-quality camera, featuring excellent sensitivity and stability, delivers superior colorimetry.

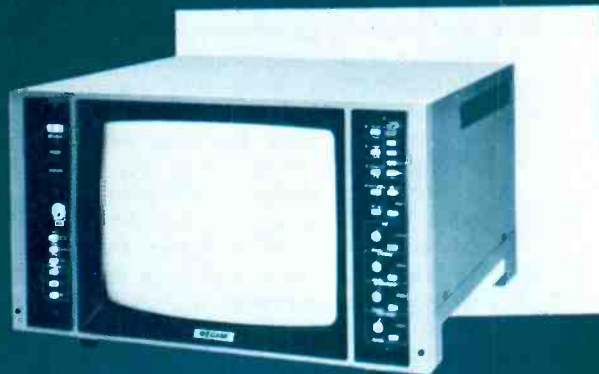

The new Series 9 High Resolution Color Monitors confirm Ikegami's position as the leader in both quality and value. Excellent color reproduction is achieved through I/Q decoding, high resolution by close dot pitch color mask and comb filter. Stability is enhanced through a new era in-line gun (convergence adjustments are eliminated).

The new HL-83 initiates a new era in ENG/EFP simplicity and versatility. Smaller, lighter and requiring 30% less power than other broadcast quality ENG cameras, it utilizes proven, dependable 2/3" Plumbicon* and Saticon** tubes. It provides plug-in convertibility for various system configurations. And it's ready to accept the soon-to-be-announced attachable VCR's for self-contained operation.



Best of Show

Ikegami's reputation for equipment excellence and reliability drew quite a crowd at NAB '81. And, those who came were most impressed with our new products. So if you missed them in April, the show still goes on at Ikegami. For more information, contact: Ikegami Electronics (USA) Inc., 37 Brook Avenue, Maywood, NJ 07607; (201) 368-9171. West Coast: 3445 Kashiwa St., Torrance, CA 90505; (213) 323-2814.

Southwest: 330 North Belt East, Houston, TX 77060; (713) 445-0100. Southeast: 522 So. Lee St., Americus, GA 31709; (912) 924-0061.

*PLUMBICON is a reg. T.M. of N.V. Philips. **SATICON is a reg. T.M. of Hitachi Ltd.

Ikegami

Circle (55) on Reply Card

High-end cameras

build custom control panels for clients desiring more capability.

Philips again showed the LDK-5 as their offering to the high-end studio market. This camera operates entirely with analog controls, but according to Alan Keil, product manager, "Computer control will be added later on." Again, Philips claims to be keeping an eye on the international market, tending to limit the value of computer control. Philips also offers the LDK-25 which is to be used with TV 81 cable, and could be described as a high-end studio camera geared primarily to the non-computer controlled middle market stations.

That completes the top tier of cameras from most-to-least computer control. And although both points of view have their value in the present market, it seems that long term stability with diagnostics and more redundancy microprocessors are gradually modifying camera technology worldwide. A second trend, exemplified by several camera products, can be described as a greater value for a high quality studio camera.

Traditional Studio Cameras

Six manufacturers — including Ikegami, Hitachi, RCA, Fernseh, Harris, and CEI— offer studio cameras with no computer control that are moderately priced and produce broadcast quality studio performance. Ikegami's HK-302 is a perfect example of how volume manufacturing can drive the price of high technology down. Using the same housing, viewfinder, and lens, the HK-302 could be a network grade workhorse, and simplified controls allow easy operation. Ikegami also showed a studio housing for the portable 79 series cameras. Another even less expensive offering from Ikegami, the ITC-350, produces a 52 dB signal to noise ratio and can be used in both studio and field situations.

Hitachi's SK-96, described as a multi-purpose camera, offers the nifty advantage of being able to remove a well-balanced portable field camera from within the camera body with a minimum amount of effort. In fact, the SK-96 includes digital technology at a reduced price in addition to triax operation up to 1500m. The FP-60S is a straightforward studio camera that owes its 600 TV lines of registration to

its three 1" Saticon tubes.

RCA continued to show its TK-46 Deluxe Color Camera, but also pushed the TK-761, a more flexible studio field camera that provides a better 54 dB signal to noise ratio, and moreover is available as the TK-781 Triax version.

Harris showed the TC-50B with a claimed resolution better than 600 lines with 1" Plumbicon tubes. Serviceability is a claim Harris makes for this product, and the camera is obvious.

Fernseh continued its KCP 60 without change. The KCP produces a 52 dB signal to noise ratio with $\frac{2}{3}$ " Plumbicon tubes, and only 0.1% registration error in zone 1.

For the previously mentioned manufacturers, these are the middle of their product line, but for CEI the Americam is its main studio camera, but the 310 is also available in a studio configuration. CEI allows its users to choose between four different types of $\frac{3}{4}$ " tubes. Although the Americam has an unusual shape, it was well-balanced, and its prism optics provided a clean picture with 500 plus lines of resolution. The diversity in approach and price in this second tier of cameras reflects the wider interest in production and programming for distribution and cable television.

In addition, CEI showed a micro-processor controlled subsystem for the 310 and Americam cameras. A reference line generator unit, which designates safe areas and center lines for picture and title areas for multiple video sources in a studio environment, was also displayed.

Although the limelight in the portable-camera arena was stolen this year by the recording cameras (they are covered in another article), there were still several other innovations visible in regular ENG and EFP cameras worth discussion.

ENG/EFP

Ten manufacturers showed high-end ENG or EFP portable cameras at NAB '81. Two basic trends were revealed in the new products introduced. First, an even smaller high quality ENG configuration exemplified by three cameras: the HL-83 from Ikegami and the SK-91 from Hitachi and the PK-40AH from Toshiba. The second trend was the specialization of portable cameras. Existing cameras, such as the 79 series from Ikegami, were offered in several different versions for specific purposes.

Also, innovative cameras shown by CEI and Ikegami were built for electronic cinematography on productions formerly shot on film that would inevitably end up on tape for

playback.

For ENG/EFP work, CEI was on hand with its 300 series cameras. As an added attraction, CEI assembled a group of model train hobbyists that created an 8'x8' model train/city for trying out the cameras. The 310 camera is available in both the field and studio configurations; the 340 is a single-piece production camera; and the 330 is an EFP camera with a digital transmission control. All feature $\frac{3}{4}$ " 3-tube design for broadcast quality performance.

Ikegami provided the largest array of portable cameras at NAB '81 and continued their claim to leadership in camera technology. The HL-83 produces a 57 dB signal and consumes only 15W of power. Optional adaptors allow the attachment of multi-core, triax, gen-lock adaptor, and VTR (note, this camera was shown outside the convention center with a $\frac{1}{4}$ " tape recorder attached.) The HL-83, including viewfinder, weighs only 10 lbs. The TA-79 or triax cable adaptor was available for the HL-79, as well as the MA-79 or multi-core adaptor. The HL-79D replaced the HL-79A, offering available accessories for EFP and the previously mentioned studio adaptor the HL-790A.

For several years Hitachi has been working to create a top flight high-end ENG camera, and the SK-91 is the result. Similar in appearance to the HL-83, Hitachi's SK-91 is also one of the new generation of ultra-small (only 9 lbs) ENG cameras. It is slightly less flexible in that at present it does not offer triax or multi-core capability. However, it produces a 57 dB signal-to-noise ratio, and has finally shaken the awkward feeling of past Hitachi portables. The FP-21, another Hitachi camera, produces a 55 dB S/N picture with $\frac{3}{4}$ " Saticon tubes at over 550 lines of resolution at a fine price. It is slightly heavier than the SK-91, at 11 lbs, but has all the automatic features of the premium camera. Hitachi introduced two new products, the SK-81 modeled upon the small SK-91 with slightly less picture quality, but retaining the compact size at 9.5 lbs. Also, Hitachi upgraded the FP-21 with the FP-22, and included a new digital "Auto-Set-Up" allowing complete computer control of auto-centering, pedestal, and pulse cancellation.

At the NEC booth, NEC introduced its all-new MNC-80A series new-generation, full-broadcast quality camera for ENG/EFP. It is designed for high fidelity color reproduction, superior handling and reliability and has a wide range of optional remote control capabilities, including optical-fiber video transmission, for flexibility and versatility. It is extremely compact and ultra-lightweight: camera

*The big news for Philips this year was that the Philips Broadcast Equipment Corp. has been purchased and merged into the Central Dynamics Corp., the US subsidiary of CDL (Central Dynamics, Ltd.). Details of this merger are carried in the business news section.

BARCO's new series Master Control Monitors: tailored to your needs

CTVM 3 Colour monitors.

In order to satisfy the variety of monitor applications the CTVM 3 series allows you to choose your colour monitor corresponding exactly to your specific wishes regarding screen size, CRT type, resolution, special facilities, decoders and mechanical construction.

- Screen sizes: 37 cm (15") or 51 cm (20") screen.
- Cathode ray tubes: delta gun shadow mask CRT or slot mask CRT.
- Resolution (for delta gun): Standard, semi high or high resolution.
- Versions:
The A version incorporates special facilities such as pulse cross mode, notch filter, split screen, RGB switches, RGBS output, R-Y and B-Y output.
B version: without special facilities.
- Decoders: with an optional set of decoder printed circuit boards plugged in, the CTVM 3 accepts composite NTSC; PAL or SECAM signals (Comb-filter or aperture correction optional on NTSC version).

- Mechanical construction: conversion from cabinet to rack, VTR bridge, in-wall or ceiling mounting is easily accomplished without dismantling the monitor through the optional special mounting kit.

TVM 3 monochrome monitors.

The BARCO professional monochrome monitors are measuring instruments for use in broadcasting, industrial and educational applications where quality and reliability are most required. Facilities to be essential including colour subcarrier filter, pulse cross, size switch, remote control, internal/external sync. offer broadcast-oriented operating features and controls.

As regards to the CRT a choice is offered between WA (6500°K illuminant D) and W (9.300°K) phosphors. Screen size and mechanical construction can be chosen as with the colour monitors.

ROHDE & SCHWARZ SALES CO. (U.S.A.) INC.

14, Gloria Lane, Fairfield, NJ 07006
Phone: (201) 575-0750
Telex: 133310

Sole representative for Barco Professional Video Systems Dep. in the United States.



BARCO

Circle (56) on Reply Card

High-end cameras

head w/o lens and 1.5" viewfinder weighs less than 4.5kg and measures 100mmx260mmx293mm. Features include: 54dB S/N; use of 2/3" Saticon, Plumbicon or Diode Gun Plumbicon tubes; high-transmission prism optics; four-position gain control with noise reducer; auto beam control for handling highlights; and automatic white balance, black level, iris, beam and optional centering control.

Bud Schneider of Toshiba caught attention with his demonstration of their new PK-40AH, again one of three ultra-small new cameras. It is only 8.5 lbs, and has an unusual shape. The PK-40AH is easy to hold and has the balance of a larger camera on the shoulder. Also, this portable camera works with the identical computer-controlled CCU Toshiba developed for the PK-40A studio camera. We felt that production people may develop a special feeling about this unique camera. Toshiba showed their competitive PK-60 with its multi-core, triax, and digital memory adaptors. These two offerings improve



RCA

Toshiba's market position with broadcasters.

RCA introduced its new portable, the TK-86 with a lower optical axis than the old TK-76. Although the TK-86 lacks the ultra-high performance of a 57 dB picture (it is only 54 dB), it is a vast improvement over the outdated TK-76. The TK-86 is lighter, at 14.2 lbs, and feels well-built and rugged. RCA also continued to offer the TKP-46 multi-purpose field production camera.

Sony showed its high-end duo, the BVP-330 and an updated BVP-300A, both weighing about 12 lbs. In addition, the BVP-250, a lower-cost sister with industrial Saticon tubes, was brought to market. In the ultra-miniature area, Sony created the BVP-110, but priced well into the low-end at \$14,000 so that is covered in another article. All three BVP editions achieved high-quality pictures at their respective price levels.

Fernseh debuted an unusual camera, the KCK/R designed for the reporter. This portable weighs only 14 lbs, but has 1-inch Plumbicon tubes creating a beautiful picture for a portable camera. However, the KCK/R feels awkward in the hand and on the shoulder. Fernseh also showed its typical ENG camera, the KCA-100 offering gen-lock, multi-core and fiber optic adaptors.

Thomson-CSF demonstrated its TTV-1603, a joint product with Sony and basically identical to the BVP-300A, excluding their own triax adaptor. Thomson-CSF also showed the MC 701, the equivalent of the

BVP-330, and the Microcam 501, again identical to the new BVP-250.

Philips debuted an improved version called the LDK-14S with 2/3-inch tubes that, according to Alan Keil, product manager, is cost-effective. It should be noted that Philips also showed a truck they had built for the first time with three portable cameras on board.

Marconi showed its Mark IX, a camera complete with extensive accessories and adaptors, and designed for studio/field use, but introduced no new cameras.

All in all, it was a fine convention for cameras...fantastic developments for the wealthy, and consistent progress for the budget-conscious. Ikegami and Sony retain their unique innovative traditions, but Hitachi and Toshiba especially made great strides on all fronts to serve the market.

High-end cameras at NAB '81

Ampex	685
CEI	686
Fernseh	687
Harris/Broadcast Products	688
Hitachi	689
Ikegami	690
Marconi	691
NEC	732
Philips	692
RCA	693
Thomson-CSF	694
Toshiba	695

Circle the appropriate numbers on the reader service card for NAB '81 exhibitor data. Check listing in other articles for additional data leads and the wrap-up of other products/exhibitors elsewhere in this issue.

Low-Cost Broadcast Cameras

By B. F. McClain, president, B. F. McClain Productions, Ashville, NC

"Today you can put an image recorded by a new low-cost broadcast camera beside an image from a studio camera and you can start taking bets," quipped Ed Cook, a video sales consultant for Southeastern Sight & Sound, as he stood behind one of the new low-cost broadcast cameras.

Never was this so well shown as at the 1981 NAB Convention. All one had to do was walk into any booth displaying both high and low end cameras and watch the monitors. In many cases, if the screens weren't tagged, it would have been difficult to tell the \$12,000 from the \$50,000 camera.

One network engineer remarked, "It appears they can make the low-cost ones look as good as the expensive ones."

Broadcasters searching for a good

low-cost (\$10,000-\$15,000) camera hit pay dirt this year at NAB. Hitachi, Panasonic, Ikegami, Sharp, Sony and JVC all had excellent offerings.

Verne Pointer, vice president of engineering for ABC, explained the multifaceted role those cameras would play. Not only could they be a mainstay camera for ENG and studio work at local stations, cable stations, etc., but the networks are now purchasing them to send into troubled areas around the world for network news gathering. They make very acceptable pictures and can be considered "throw away" cameras. As Pointer said, "It makes the difference between getting a picture and not getting it. It's tough to risk sending a \$40,000 camera with an inexperienced cameraman into an area—where no set up and

maintenance can be done, and where there's a good possibility the camera will be confiscated or destroyed. These new cameras make getting the story more feasible."

Many of the offerings in this low-cost line are unique. Hitachi's new FP-21, coming in at \$13,000 becomes the FP-22 at \$18,000 by adding auto setup with computer readout of diagnosis faults and other features.

The Hitachi FP-21 has much the same appearance and well-balanced body as the FP-20 and FP-40 but weighs only 11.2 lbs. (without lens). Its built-in cushioned shoulder-mount is designed to balance the camera when a lens is put on the front and a battery on the back. It is a three-Saticon tube camera with a signal-to-noise ratio of 55dB and 550 lines of resolution. It performs well in low light, especially when the +9dB or +18dB high gain switch is employed. The only offering with a +18dB, it should be effective in low light situations.

The Hitachi-developed ABO (Automatic Beam Optimization) Circuit has

Eliminate insulators and "white noise" with tough, non-conductive guys of Kevlar®.

Steel guy lines can create transmission problems with arcing at insulators.

Non-conductive guys with KEVLAR offer a simple solution.

Antenna guys of non-conductive KEVLAR® aramid fiber need no insulators. This eliminates the arcing that creates "white noise" signal interference in conventional steel guys.

Also, because KEVLAR will not corrode, it resists electromechanical oxidation, chemicals and salt attack, so guys stay in service much longer.



Lightweight, corrosion-free KEVLAR also cuts rigging and maintenance costs.

KEVLAR can match the strength of steel at only *one-fifth* the weight, so riggers can coil two or three guys over their shoulder at once, greatly speeding installation.

For more information and a list of manufacturers of guy lines of KEVLAR, write: DuPont, Room 38811, Wilmington, DE 19898.

® DuPont registered trademark for its aramid fiber. DuPont makes KEVLAR, not antenna guys.



Circle (57) on Reply Card

Low-cost cameras

eliminated much of the comet tail effect where bright lights leave a smeared image when the camera is panned across them. The improved high speed f1.4 prism beam splitter optics and the low noise pre-amplifiers are the main reasons the camera has such excellent S/N and high resolution.

All those controls needed for fast setup are on the camera, including auto iris, auto black & auto white, RS-170A sync, adjustable H & V blanking width, gen-lock, and split field color bars that make it easy to set up 100% modulation level in VTR recording.

The FP-21 uses a wide variety of lenses, bayonet mount, including all the lenses offered for the SK-91. When you add the optional 5" viewfinder and the remote operation unit, you really have a full blown studio camera. There is an optional two line contour corrector. Needless to say, this camera meets all the requirements for an ENG camera and has most of the features and most of the specifications formerly found only in the high cost broadcast cameras. It should be available by October.

Winning the low weight award is Sony's contribution to the low cost broadcast camera market, the BVP-110. Tipping in at a mere 6 lbs., without lens, it should be renamed "Son of BVP" except that its specs are grown up. Although this camera won't

be available until late 1981, the pricing has been announced to be in the \$12,000 to \$15,000 range depending on the lens used.

The BVP-110 has one High Band Saticon Trinicon (HBST) pick-up tube yet provides broadcast standard video signals with 400 lines of resolution and a S/N ratio of 53dB. The camera incorporates a +6dB and +12dB gain, 4 filters, 2 line image enhancement, color bars, and gen-lock. Its magnesium castings make it lighter, and according to Sony, almost indestructible. An inspection of this camera reveals a unique feature: no cables from the lens to the camera. A cableless camera, all the connections are internal...even the mic is built in.

Another unique feature is the use of a circuit breaker instead of a fuse. In addition, the viewfinder folds up for packing, and the module on the side of the camera has a 50 pin internal connection that provides for future growth with a CCU.

The BVP-110 is an energy efficient camera. When used with the Sony recorder (BVU-50 or 110) both will operate continuously for over two hours on the recorder's batteries. It is also ready for use in 4 seconds from power on.

A retractable foot has been placed on the bottom of the camera so it can be set down on the ground. In place of a contoured shoulder mount there is a suede-type pad that allows you to just rest the camera on your shoulder. Since the entire camera, with lens,

weighs only about 9 lbs. you soon begin to wonder just how small can a video camera become.

This camera is the only one-tube broadcast camera shown in the \$12,000 range. If the one tube camera can perform as well as those three tube cameras shown, it will have the advantage of perfect geometry and little setup since there are no multiple tubes to be kept in registration.

Both Canon and Fujinon will supply 10:1 lenses for the BVP-110. A 14:1 lens should be available by the time the camera is deliverable.

Panasonic featured its well known AK-710 broadcast camera that has been on the market for some months and already been purchased by network television as a throw away ENG camera for use in rugged foreign assignments. It offers a maneuverable eyepiece that allows the camera-person to raise the entire viewfinder, thus permitting a look over the camera body.

The AK-710 camera has a price tag of around \$11,000, excluding the lens. It is normally used with either a 13:1 Canon lens or a 12:1 Fujinon lens, both with 2X extenders. The camera utilizes three Saticon tubes, has a resolution of 500 lines, and S/N ratio of 52dB. It also has all those features usually found on the higher priced models—including prism optics, adjustable blanking, vertical enhancer, low light performance (200 foot candles at f3.5), color bars, 3 filters (including one with N.D.), gen-lock, and

Camera	Price	Weight	Tubes	S/N	Resolution	Gain	Lens	Studio kit	Availability
Hitachi FP-21	\$13,000 no lens	12 lbs.	3 Saticons	55 dB	550 lines	+9, +18	Same variety as for SK-91 Bayonet	Yes 5" Viewfinder	October 1981
Ikegami ITC-350	\$12,000 with lens	11 lbs	3 Saticons (Plumbicons available)	52 dB	500 lines	+6, +12	10:1 Canon or Fujinon (plus variety)	Yes 5" Viewfinder	Now
JVC KY-2700U	\$12,000 with lens	11.5 lbs.	3 Saticons	54 dB	500 lines	+6, +12	14:1 Fujinon Special Mount and C Mount	Yes 5" Viewfinder	May 1981
Panasonic AK-710	\$11,000 no lens	12 lbs.	3 Saticons	52 dB	500 lines	+6, +12	13:1 Canon 12:1 Fujinon (both with 2x extenders) Bayonet	Yes 4.5" Viewfinder	Now
Sharp SC-700	\$12,600 no lens	15 lbs.	3 Saticons	52 dB	500 lines	*6, +12	variety of Fujinon 10:1 – 22:1 w/2x extenders bayonet	Yes 7" Viewfinder	Now
Sony BVP-110	\$12,000 to \$15,000 with lens	6 lbs.	1 High-Band Saticon Trinicon	53 dB	400 lines	+6, +12	10:1 f 1.6 plus variety		Winter 1981



The Sachtler 7+7 fluid head: Internally adjustable for neutral counterbalance with long and short lenses and with various cameras. Seven distinct and repeatable fluid drag settings for pans and tilts.

Part of a system of *modern* claw-ball fluid heads and tripods, and intelligent accessories.

The 7+7 fluid head as seen here weighs 5 lb. 14½ oz.

That's with the No. 1 camera platform, *without* the quick-release plate, pan-handle or claw-ball tie-down knob. *With* those, it weighs 6 lb. 14 oz., including the standard-equipment Sachtler claw-ball base.

More 7 + 7 specs.:

Capacity: up to 33 lbs.
Height (including claw-ball tie-down shaft at bottom): 8¾ ins.
Height (less shaft): 7½ ins.
Width (as shown here): 4¾ ins.
Length (as shown here): 47⁄8 ins.

Choice of 3 camera platforms;

1. Single handle (right/left side).
2. Dual handles for television use.
3. Accepts long lens support rods.

All camera platforms use the same Quick-Release/Quick-Attach Plate.



At left: 16SR with 10-150mm zoom lens. At right: with 8mm prime lens.

Different centers of gravity — same position on head

Changing to a heavier lens shifts the center of gravity toward the front. So does adding a zoom motor or production mattebox.

position, release the knob. Camera balance restored.

Simple

No sliding platform. No figuring out which socket to use. And when you tilt, the camera stays where you set it, locked off or not. (That's provided your camera's weight/CG-height ratio is within the 7+7's range, of course.)

There are independent tilt and pan locks. And there are seven *numbered* settings of fluid drag for tilts, and seven settings for pans.

With the Sachtler, here's all you do: Slide the counterbalance knob to one side, select another pre-set balance

Tilt range:

As you can see, it's around 150°. By tilting the head (on its claw ball) 15° to the front or back, you get 180°.

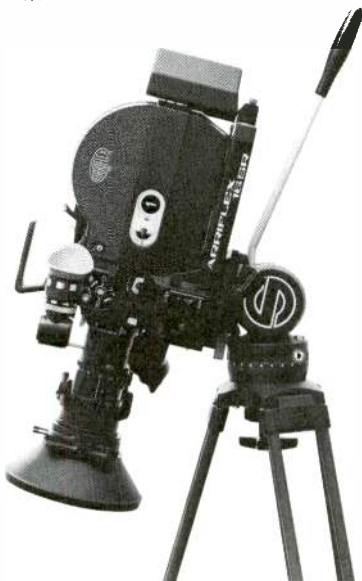

sachtler
SUPPORT SYSTEMS

DISTRIBUTED
IN THE U.S.A.
EXCLUSIVELY
BY ARRIFLEX
CORPORATION

ARRI
ARRIFLEX CORPORATION

500 Route 303, Blauvelt, New York 10913.
(914) 353-1400. And 600 No. Victory Blvd.,
Burbank, California 91502. (213) 841-7070.

Circle (58) on Reply Card

Low-cost cameras

full studio conversion kit with 4.5" viewfinder. The weight is a low 11.6 lbs., including the viewfinder and the shoulder pad, but no lens.

Panasonic has front mounted some of the controls for the more convenient operation. The gain (+6 and +12), color bar, camera signal select switch, and the white set are now on the bottom portion of the front plate, directly below the lens. This should prove to be not only easier to operate but also should cut down on accidental switching of these controls.

The AK-710 incorporates a Feedback Beam Control (FBC) feature that limits the chances of *comet tailing*. The most unique feature of this camera is the wafer type electrical components that are designed to better withstand temperature changes. This should make the AK-710 a more rugged and more versatile camera where extreme temperatures are a major concern.

Even if you weren't looking for a low-cost broadcast camera it would have been hard to miss Sharp's entry. Not only did they almost exclusively feature their XC-700 camera in their booth at NAB, but they advertised the camera on the local Las Vegas stations

during the entire run of the NAB show. Sharp explains that of the 600 cameras that have been sold since June 1980, 500 have been to broadcasters.

The XC-700 is a three-Saticon tube camera that sells for \$12,600 without lens. Fujinon lenses are available from 10:1 to 22:1 with 2X extenders (bayonet mount). In addition, the camera will accommodate a 30:1 Schneider lens for large scale applications.

Closely resembling the Hitachi camera in appearance, the Sharp XC-700 has a built-in contoured shoulder pad that allows the camera to rest securely on the cameraperson's shoulder.

Sharp has attempted to allay the fears of many broadcasters concerning downtime and parts replacement by offering a complete parts kit for \$1,995 that includes all the boards in the camera head. The whole idea of a complete parts kit has been well received by the end users of this camera.

Other features of this camera are prism beam splitter, adjustable blanking, gen-lock & Dynamic Beam Optimization. There is an optional two line enhancer. Comments from end users, which are published in a series of *Field Reports* by Sharp, indicate that the camera performs well in low



Hitachi's FP-21 seems especially designed for low light with its +9 and +18 dB gain and Automatic Beam Optimization Circuitry.



Sony's one tube BVP-110 wins the light-weight award at only 9 lbs. with lens.

The machine of the 80's.

THE GARNER 1100

It's no secret that one-inch will be the videotape of the 80's. If you're planning to convert to one-inch, invest in the Garner 1100 degausser to get the maximum use of your one inch tape. With Garner's one-pass, endless belt operation, you get complete erasures at the rate of 13 reels per minute.

Put the Garner 1100 to the test yourself. Use the 1100 for 30 days. If it doesn't live up to your standards, just return it to us.

We're convinced that you'll agree that the Garner 1100 is the machine to handle one-inch degaussing. It's the machine of the 80's.



Dependability... Guaranteed

GARNER INDUSTRIES 4200 North 48th Street, Lincoln, NE 68504 Phone (402) 464-5911

Circle (59) on Reply Card



1710A



1700B

1701A

THREE GREAT WAYS TO CLEAN UP YOUR ACT.

The Sound Technology 1700 Series

Introducing three fast, accurate and easy-to-use Distortion Measurement Test Systems. All three deliver precise information for the audio professional. All three offer a multitude of features that make them indispensable tools for the engineer/technician.

Every system in the 1700 Series combines a flexible, ultra-low distortion sine-wave signal generator, a high resolution automatic-measuring THD analyzer, optional IMD analyzer and an accurate A.C. level meter in one instrument. Not only will a 1700 analyzer clean up your act, it'll clean up your bench too.

THE FEATURES

- Fully automatic nulling circuitry that measures distortion as low as .0009%. In less than five seconds.
- A simultaneously tuned, balanced and floating oscillator that's capable of 10Hz to 110kHz. With three digit pushbutton frequency selection that's both repeatable and fast. And, adjustable from -90 to +26dBm with three precision attenuators in 10dB, 1dB and .1dB steps (with ± 1 dB vernier).
- You can measure signal-to-noise ratios with a 100dB dynamic range; floating sources from 30 μ V to 300 V; power in

either dBm or watts; push a button and reject hum and high frequency noise with built-in 18dB/octave filters (30kHz, 80kHz and 400Hz).

WHICH ONE IS BEST FOR ME?

For most applications, the 1700B will do a big job for very few dollars. With the 1701A you get ultra-low residual distortion spec's, higher output level and integral, selectable meter detection circuits. Both models are great for R and D, engineering maintenance or Q.C. The 1710A was specifically designed for the broadcast and recording industry. It's the only distortion analyzer available with balanced and floating outputs and RFI shielding.

The 1700 Series Distortion Measurement Test Systems. Fully guaranteed for two years, parts and labor.

They're designed to be three great ways to clean up anyone's act.

SOUND TECHNOLOGY

1400 Dell Avenue, Campbell, CA 95008
(408) 378-6540 Telex: 357445

Please send me more information on how the Sound Technology 1700 Series can help me clean up my act.

NAME _____
 COMPANY _____
 ADDRESS _____
 CITY _____ STATE _____
 ZIP _____ PHONE _____

SOUND
TECHNOLOGY Department 3004104

Low-cost cameras

light and has controls that are well laid out and convenient to use.

Sharp also is offering a studio system, the XC-700SS, that includes a remote operations panel, 7" studio viewfinder and AC power adaptor along with the camera head (no lens) for \$14,000.

Somewhat breaking with tradition, Ikegami, long known for its high end broadcast cameras, showed its ITC-350. Although many saw it first at that October 1980 SMPTE Conference, others were surprised by this offering.

Touted by Ikegami as an industrial camera, it boasts of specifications as good as, if not better than, many of the other cameras billed by various manufacturers as low cost broadcast cameras. Its S/N ratio of 52dB, resolution of 500 lines, and three Saticon tubes certainly qualify it for the broadcast market. It has prism optics, is offered with a 10:1 bayonet mount lens (but can use any lens from the higher end cameras) and sells for \$12,000 complete with lens and tubes. (The camera is also available with Plum-bicon tubes.)

As far as weight is concerned, it is comparable to the other offerings

since it weighs only 11 lbs. without lens. Many features similar to its big brothers including color bars, gen-lock, +6 and +12dB gain, 3 filters plus N.D., and optical CCU for studio conversion are offered.

The ITC-350 offers Dynamic Beam Stretcher that prevents comet tailing, and an auto iris closure circuit protects the camera tubes after the camera is turned off. Also, the battery, tally, white balance, VTR ON, and video level indicators are all superimposed on the camera viewfinder.

The camera has been in use since late 1980 and is currently being used in broadcast applications by Westinghouse. According to Ikegami it "has most all the features of the big guys, plus it's easily serviced." The ITC-350 and the new JVC camera are definitely priced the lowest of those cameras reviewed here.

After delivering two thousand KY-2000 cameras, JVC has come up with a second-generation, low-end broadcast camera which includes a few improvements at a slightly higher price tag, approximately \$12,000 including lens. The new JVC KY-2700U is a three-Saticon tube camera offering quick start, eliminating warm up time.

The new camera has an improved

S/N of 54dB (as compared to 52dB for the KY-2000) and has a resolution of 500 lines. Unlike its competitors, it does not utilize prism optics but rather dichroic mirrors. JVC has also chosen to use a special lens mount (also C mount) and provides a Fujinon 14:1, f1.7 servo zoom in the standard package.

Although the camera was not available until after NAB '81, many who were well pleased with the KY-2000 were placing orders for the new improved model. JVC spokesmen said they estimated 20% of the sales of the KY-2700Us to be to broadcasters. (The bulk of these cameras is aimed at the high end industrial market and production houses.)

Like the other cameras in this price range, the KY-2700U has gen-lock, +6 and +12dB gain, filters and automatic beam control to reduce blooming and comet tailing. In addition, the camera comes with a two line vertical contour correction and, to make servicing easier, the electronic components are installed on plug-in modules.

The KY-2700U can be used as a studio camera by adding the 5" Viewfinder and remote control unit.

It has become obvious that many manufacturers are targeting the low end broadcast market—be it for sales

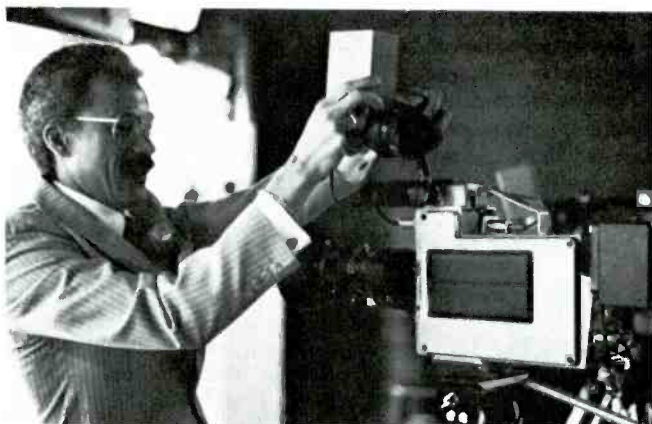

Morris Washington, manager of Panasonic Broadcast, demonstrates the unique maneuverable eyepiece on the new AK-710.



Sharp devoted most of their entire NAB booth to display their new XC-700 shown here in the ENG and studio configuration.



Herman Schkolnick and Don Skulte show Ikegami's new ITC-350 that has "most of the features of our big guys."

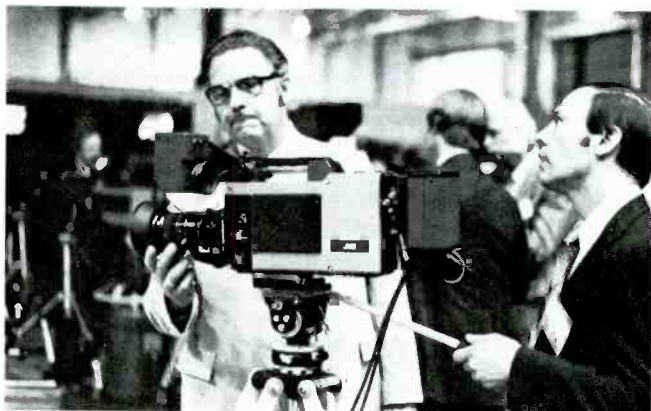

JVC's KY-2700U is the apparent heir to the successful KY-2000 that sold more than 2000 units.

THERE'S MORE THAN ONE WAY TO GO MICROCAM.

Microcam. More than a portable color camera. A family of cameras. For every need. Every locale. Every budget.

FIRST CLASS.

MC701. Three cameras in one. From full studio setup. To EFP with 1800 feet of cable. To its simplest form. To capture the moment with the drama of photo-journalism. And the look of studio broadcast. MC701 weighs a mere 11.2 pounds without lens. Automatic color balance and automatic registration centering make it simple to use. Guaranteed picture quality. In the studio, or in the field, the MC701 offers incomparable versatility. Uncompromising quality. Triax and Coax configurations also available.



ECONOMY CLASS.

MC501. The Microcam for the modest budget. A self-contained, one-piece, three-tube color camera. Lightweight. Compact. Easy to use. With big budget features. Like $\frac{2}{3}$ " Saticon tubes, 2-line image enhancement, excellent resolution, digital white/black balance, low power consumption. And more.

MC701 and MC501 fit all existing Thomson-CSF accessories. Lenses. Cables. Remote controls. 5' viewfinder. Battery systems. And other add-ons.

Microcam. The name that means high quality broadcast. Lightweight portability. Versatility. And a model to fit every budget.

For more information, contact Thomson-CSF Broadcast, Inc.
37 Brownhouse Road, Stamford, CT, (203) 327-7700.

 **THOMSON-CSF BROADCAST, INC.**

Low-cost cameras

to industries that want broadcast quality, independent studios that sell programs and commercials to TV, cable stations, local stations (especially TV news departments), or to the major networks for throw away applications and as back up ENG gear. The market is as large as it is varied, and the entries are many.

Those manufacturers known for mass producing small industrial cameras are raising their sights and entering the broadcast scene, while those manufacturers known for high end broadcast gear are lowering theirs

to capture a larger market. Others, already producing cameras on both ends of the spectrum, are adding a whole new middle line.

The specifications of all these cameras are similar and surprisingly good, but not yet good enough for network use except in extreme situations where high priced cameras can't be risked. What is becoming obvious is that the technology is there. These cameras are challenging their high priced brothers. Many dealers and broadcasters agree with Ed Cook's statement that side-by-side comparisons are startling.

Dan Mulhern, vice president of Cramer, a professional video and

audio sales firm, went on to add, "A few years ago no one would have believed it possible to have broadcast quality in a \$12,000 camera. And even more exciting is the knowledge that the industry, as we know it today, will bear little resemblance to the NAB shows to come."

Hitachi	761
Ikegami	762
Panasonic	763
Sharp	764
Sony	765
US JVC	766

Circle the appropriate numbers on the reader service card for NAB '81 exhibitor data. Check listing in other articles for additional data leads and the wrap-up of other products/exhibitors elsewhere in this issue.

The VRC (Video Recorder/Camera)

By Patrick McEntee, ISO Communications, New York

NAB '81 was an exciting show for broadcasters, but some of the hottest news focused on the new VRCs (video recorder/cameras) being introduced.

Soon after the introduction of home video recorders in 1977, American and Japanese broadcasters realized that the video recording camera was possible, and not far off. The film camera operator for decades has had the total mobility and flexibility of solo recording, but when ENG came it was obvious that the recorder would require a second person to operate and carry it.

A sound person in film usually does not restrict the movement of the camera operator, but in ENG, the umbilical cord ties the camera operator and the videotape operator together. Many a cable torn entirely out of a VTR or camerahead attests to what Julius Barnathan, president of Broadcast Operations and Engineering at ABC, calls "the weakest link in newsgathering."

At NAB '81, four manufacturers, two as a team, offered three original versions of the recording camera. RCA and Matsushita (Panasonic)

demonstrated a production model of a 22-pound recording camera that uses standard 1/2-inch VHS videotape. This joint introduction happened with a great deal of fanfare, but behind the scenes, two other prototypes were being previewed by smaller, select audiences in obscure places.

In the parking lot outside the Convention Center, John Shearer, director of engineering for TCS (Total Communications Systems), had been selected to demonstrate privately the Ikegami CV-One. This recording camera used 1/4-inch videotape on a headdrum assembly that looked similar to the consumer Technicolor product. Ikegami had constructed this prototype for the Nippon Television Network Corporation. The CV-One was used in a documentary about Mount Everest in May 1980.

Almost no technical information was available about the CV-One and Nick Nishi, president of Ikegami, wouldn't comment specifically about the prototype. He did say that Ikegami is still unsure about which tape format standard would be best for the recording camera. My impression is that Ikegami would hope to deliver a version of its HL-83 camera

body that could be compatible with either 1/4- or 1/2-inch VTR components.

Sony Corporation showed a prototype of a recording camera that has been in the developmental stage for just over two years. The BVW-1 recording camera weighs only 15 pounds, including lens and battery. Because the BVW-1 records on the Beta cassette at three times normal speed, playback of the recording can only be achieved with a modified 3x speed Beta I playback machine. Sony demonstrated that this modified playback machine could be interfaced with the BVE-500 3/4-inch editor in their suite. However, this configuration was clearly a prototype, too. In contrast, RCA and Matsushita (Panasonic) introduced full production editing systems with both recorders and playback machines in their 6x VHS format on the convention floor.

The largest difference between Ikegami and Sony prototypes and the RCA-Panasonic VHS system is that the equipment outfit including recording camera and editing module is in production phase and ready for sale. Both Ikegami and Sony have their prototypes about one year from the sale of production model.

The primary reason for RCA-Panasonic's being somewhat ahead is that the basic product research began four years ago at RCA's Princeton



The Ikegami/NTV VRC system was displayed in this van in the parking lot.



Vern Pointer (left), vice president, engineering, ABC, inspects the Ikegami/NTV combination VRC system.



The Panasonic VRC is supported by an editing system consisting of two editing VTR machines and an editing controller.

Now film editors can enjoy editing video tape.



Thrilling Editing vs. Tedious Editing

As an editor, you know the thrill of creating a mood or changing the meaning of a scene. But, if you're used to film, the thrill can be gone when you're editing video tape.

That's why we had editors who know film design the Z-6 Video Tape Editing System. It gives you frame-accurate editing, plus all the useful functions of the SMPTE time code *without* all the problems.

In addition, the Z-6 tracks SMPTE Drop Frame or Non-Drop Frame, 24-frame film rate, or any other time base. And, it "translates" codes for you — adding or subtracting real, decimal or mixed numbers for precise scene and program length computation.

Easy to Operate

With the Z-6, you edit pictures, not numbers, because edit point locations are loaded automatically. Microprocessor-based controls allow you to pick in or out points on-the-fly, maintain lip sync throughout the entire tape during all editing, and do A, B, C external rolls on one pass.

What's more, the Z-6 features auto edit, full lock-ahead/behind logic, and random location of single frames on any tape in the system.

The Z-6 system is also simple to use and understand, because each key on the Z-6 system has a definite, single function. In no time at all, you're doing split edits and text editing, using animation and effects, and performing dissolves or wipes with ease. When you're finished editing, the Z-6 can even edit an exact duplicate tape. Automatically.

Easy to Own

Best of all, every Z-6 editing system is fully upgradable. There are several different Z-6 models available. You can start with a basic Mini-Z. Then, when you want more features (like multiple source, effects, or multi-event memory), you can order the Z-6 system that has them. All you'll pay is the *difference* between the price of the system you own and the price of the system you want.

For complete details on the entire Z-6 line, call or write today:

Videomedia
Professional Television Systems

250 North Wolfe Road
Sunnyvale, CA 94086
Telephone: 408-733-6500

Circle (63) on Reply Card

VRC

Laboratories.

John Clarke, manager of Camera Development for RCA, said, "Princeton did much to examine the alternate strategies for recording the signal onto the tape, the signal processing and the basic studies on tape heads."

Three years ago, much of the basic research had been done by Princeton, and the integrated product had been developed and was the responsibility of Stu Basara, now vice president and general manager, Broadcast Systems Division RCA.

According to Robert Thomson, manager of VTR Development, RCA then began looking for a partner to execute the VTR manufacturing. Thomson said, "Because of VHS, a relationship existed between senior managements and they (RCA and Matsushita) shared common goals in the development process. At the end of the first year, the full specifications were sent with working prototypes to Central Lab in Osaka, and the joint development process with Matsushita began. In the next two years John Clarke and his camera development team made more than 12 trips to Central Lab.

T. Yamamoto, VTR product manager for Matsushita, coordinated the development of the 6x speed head drum, record and playback technology. John Clarke's camera team had the exclusive responsibility for perfecting RCA's 1/2-inch Saticon and Plumbicon tube technology. This patented 1/2-inch tube promises the quality of a 3/8-inch tube. However, partner Matsushita was still demonstrating their unit in the booth with 3/8-inch tubes included. The pictures available in the RCA booth from "Hawkeye" were high quality. Several astute observers commented that the recording on 1/2-inch was better than

the normal speed quality achieved by a standard 3/4-inch recorder.

Hawkeye's being 22 lbs. may be the major disadvantage of the RCA-Matsushita system because the 20 lb. mark has assumed a target value similar to the 1000 mark on the Dow Jones Industrial Average. However, the added production features including a modular gen-lock adaptor and a composite adaptor create flexibility, and allow the VTR to be used with any camera that supplies a composite output video source. Also, the HE-1 editing system can be purchased for 'cuts only' work, or can be upgraded with a modular TBC for multiple machine switcher effects and sophisticated editing in post-production.

With no editing system shown or projected for CV-One from Ikegami, the prototype remains an impressively small camera. But naturally, the largest question looming over the CV-One is: Exactly what is the special advantage of miniature size? The feel was small and light, similar to the original Thomson Micro-Cam. For ENG work, other factors such as service and durability were found to be crucial. Sure, the 8.9kg package of the CV-One would allow great maneuverability, but how much greater than a 15-20 pound camera? If all the weight loss buys is a lower quality recording, it's likely broadcasters will carry the weight.

M. Morizono, managing director, Sony Video Products Group, addressed the press at Sony's press luncheon before NAB '81 opened and was on hand at the suite during the demonstration of the Sony recording camera. The debut of the BVW-1 was clearly at its prototype stage. Production models may change significantly, and could well include features such as circuitry to by-pass the recorder for microwaving ENG coverage. Morizono was particularly interested

in response of broadcasters to the feel of the BVW-1 and features they liked and needed.

Although technical details of the BVW-1 were limited in the suite, it appears that Sony will make production models look and feel much as a film camera. At 15 lbs., the system was well-balanced on the shoulder, and produced a clear picture with more than 400 lines of resolution. Again, Sony will stick with single-tube technology, meaning a Tricon with a Saticon target.

With only half the amount of videotape being used in the VHS-based system, Sony said that its production model will deliver a recording comparable to RCA's Hawkeye.

Let's remember that whatever standard evolves (if indeed only **one** standard emerges), TV news will be changed substantially by the recording cameras. "We expected to see these cameras this year or next year," said Verne Pointer, vice president of engineering, ABC, "but all the manufacturers should be congratulated on the fact that they are responding to the needs of the broadcast market and to the program producers."

With the recording cameras priced over \$50,000 per recording unit, excluding editing support, it seems unlikely that the industry will be swamped with volume unit sales this year. □

VRCs at NAB '81 (video recorder/cameras)

Firm	Model	Circle for data
Ikegami	CV-One	(836)
Panasonic (Matsushita)	---	(837)
RCA	Hawkeye	(838)
Sony	BVW-1	(839)

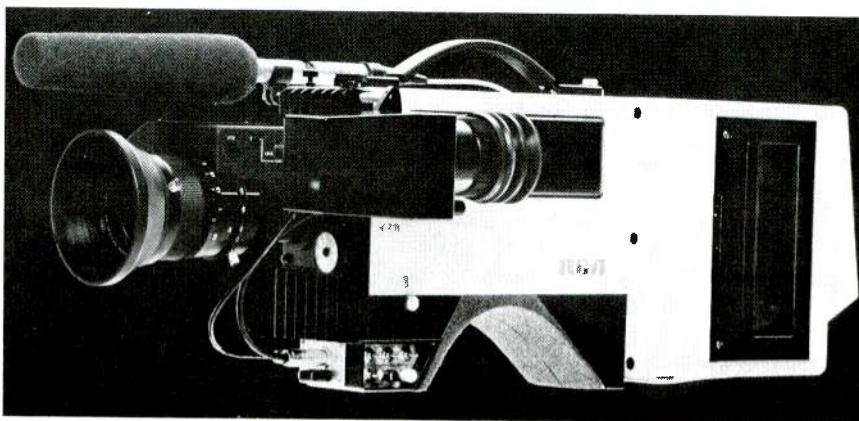

The heart of the RCA Hawkeye HCR-1 system is the VRC itself, but it's supported by the studio portion consisting of the HR-2 videotape recorder and HE-1 edit controller.

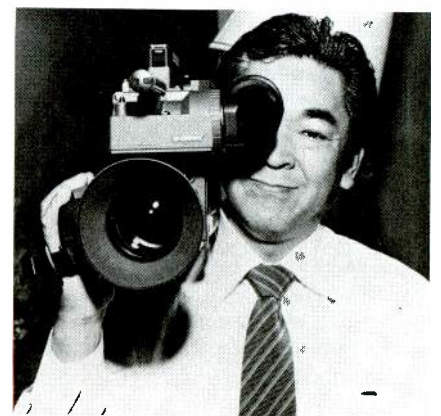

M. Morizono, managing director, Sony's Video Products Group, demonstrated the ease in using the Sony BVW-1 VRC system.



the trendsetters

Unquestionably the industry's standard of excellence in broadcast equipment

Most manufacturers meet industry standards; we exceed them. Our TOMCAT cartridge recorders/reproducers and BMX series of broadcast consoles deliver trendsetting on-line performance in broadcasting systems worldwide, from Boston to L.A., Australia to Great Britain.

TOMCAT: simply the world's finest. Innovative design assures superb sound quality, reliability, and low noise operation. Our Maxtrax™ wide-track fixed azimuth heads yield more signal, lowest phase error.

BMX, Series II: the ultimate in high performance mixing consoles. These compact units feature proven RF immunity and CMOS remote control flexibility, plus a choice of 10, 14, 22,

and 26 input mainframe configurations. A new mix module is now available to offer two mix-minus busses for telephone talk shows. All this in a no-nonsense panel layout! See why TOMCAT and BMX series have made us the industry trademark. Call or write today for free information on our complete line of equipment.



pacific recorders & engineering corporation

11100 roselle street
san diego, california 92121
telephone 714 453-3255

Circle (64) on Reply Card

**Zoom lenses for $\frac{1}{2}$ "
format cameras...**

**The ultimate
field zoom for $\frac{2}{3}$ "
cameras...**

**High resolution
lenses for electronic
cinematography...**

**A full-featured,
economical studio
lens for 1" cameras...**

**Some of the new reasons
why Fujinon is first.**



New

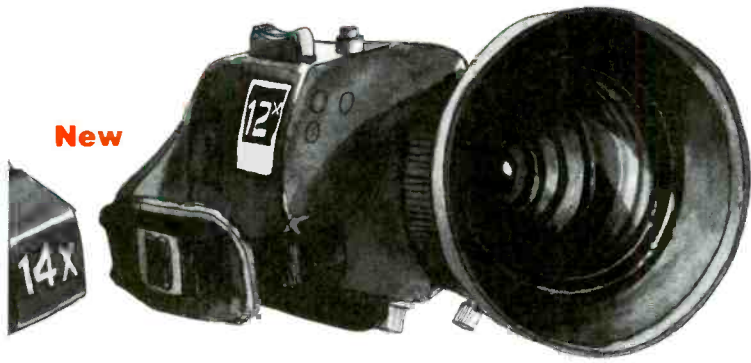

You'll see two new very lightweight zoom lenses for 1/2" format cameras. There's a 12x7 (7mm to 84mm) and 14x7 with built-in 2X extender (7mm to 196mm). Each offers F/1.4 speed, auto/manual iris, servo/manual zoom and focus. MOD is 0.8mm, weight 1.3kg.

Fujinon's first two lenses for electronic cinematography are fast, high resolution 14mm and 40mm fixed focal length models. Speed is F/1.4.

(You can be sure Fujinon will be doing for EC what it has done for ENG/EFP . . . and that's a big commitment.)

A new full-featured studio lens for 1" camera format is Fujinon's 14x14 with built-in 2X extender. Its F/1.6 aperture can be maintained out to 140mm. And at 200mm, it offers a very respectable F/2.0.

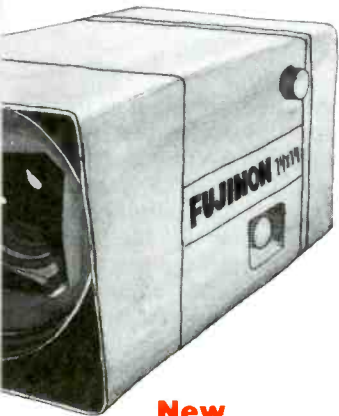

New

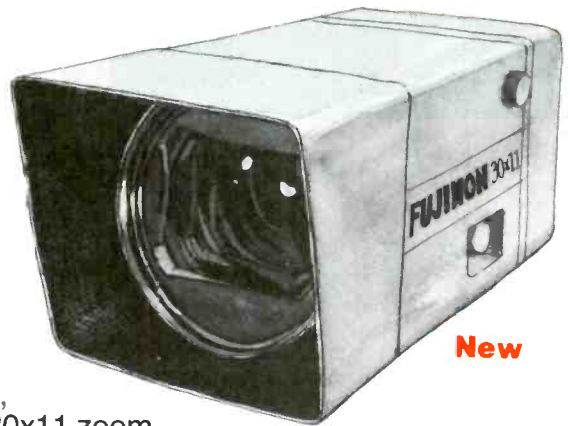

New

For field events, Fujinon's new 30x11 zoom with built-in 2X extender gives new range and flexibility to 2/3" format cameras. At maximum focal length of 660mm, it's the equivalent of 1,000mm on 1 1/4" format. Its F/1.6 aperture stays flat out to a 20X zoom. And at 30X, it gives you F/2.4. There isn't anything else in production that even comes close.

New

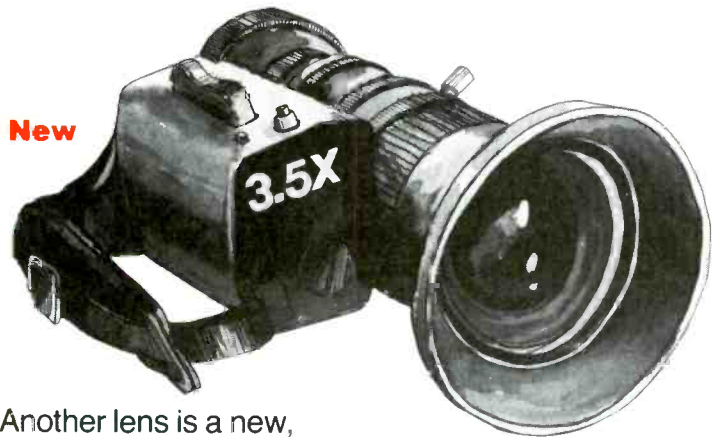

Another lens is a new, faster version of Fujinon's exclusive 3.5x6.5 wide angle ENG/EFP zoom. Now it gives you F/1.7 speed along with performance that is difficult to believe . . . even when you see it.

Discover the difference for yourself. Ask for more information or a free side-by-side demonstration. It'll prove the point: the world sees itself more clearly through the eyes of Fujinon.

FUJINON

Fujinon Optical Inc. 
672 White Plains Road
Scarsdale, New York 10583
(914) 472-9800 Telex: 131-642

Circle (65) on Reply Card

Fuji Optical Systems Inc., 4855 Atherton Avenue, San Jose, California 95130 (408) 866-5466

Fuji Optical Systems Inc., 118 Savarona Way, Carson, California 90746 (213) 532-2861



Teletext and viewdata

By Harmon Shragge, Center for Information and Communications Studies, California State University, Chico, CA

NAB '81/Las Vegas rallied the largest assortment of videotext systems to date and displayed the latest technical innovations. Never before assembled under one roof have so many exhibitors demonstrated such impressive innovations and advancements in videotext technology.

The Canadian Telidon Videotext System made its NAB debut with the announcement of two major projects: one by the Times Mirror Company and another by Time Incorporated.

Also, this year the French Antiope Videotext System announced the Los Angeles Teletext Project. This is a joint venture of KNXT-TV (CBS Broadcast Group, Los Angeles), KCET-TV (PBS Los Angeles), the West Coast office of the caption center of WGBH-TV Boston and Telediffusion de France.

At the British videotext booth, a late



Kenneth Baker, MP, Minister of State for Industry and Information Technology, formally opened the British teletext exhibits.

entry to NAB '81, several new technological advancements as well as the sale of a teletext system to Field Communications in Chicago were announced.

Telidon

NAB '81 was the NAB premier of the Telidon Videotext System developed by the Canadian Department of Communications. Telidon Videotext Systems Inc. markets Telidon systems throughout the United States and is a wholly owned US subsidiary of Infomart (Canada).

As of February 12, 1981, the Times Mirror Company has ordered a complete turnkey Telidon System valued at more than \$1 million and will begin tests in the fourth quarter of 1981. Two hundred terminals will be installed in private homes in Los Angeles and Orange counties. The system will operate simultaneously over both telephone and 2-way cable networks. The trial phase will offer data retrieval as well as transaction services using a Digital Equipment Corporation VAX 11/780 host computer.

Time Inc. has also announced that the Telidon teletext system will be used in the first nationwide satellite operated teletext service scheduled to begin toward the end of this year. The service will use the American Television and Communications satellite and cable system for transmission. An entire satellite transponder will be committed for the duration of the engagement.

The Telidon system's alpha-geometric approach is based on computer graphics techniques. By devising a simple shorthand for graphics description, each frame transmitted is represented by a variety of geometric descriptors, including a point, rectangle, arc, polygon and a line. Also, text signals are used for standard text transmissions, and other control signals are transmitted for adjusting colors and text sizes. Where high quality pictures are needed, "bit" commands allow rapid transmission of picture elements to form actual on-

screen photographic images.

The Telidon System, similar to Antiope, will be using lines 15 and 16 of the vertical blanking interval for broadcast of the teletext signal. The use of more lines could create a stability problem for older TV sets. The data bit rate for Telidon in the US will be restricted to 4.6 megabits/second which will provide for a faster acquisition rate and for more accurate retransmissions. At 100 pages per line, Telidon boasts an average access time of 5.8 seconds with a maximum of approximately 11.6 seconds.

Ordinary TV receivers can be converted to Telidon terminals by adding a microprocessor-equipped adaptor. Ideally, the Telidon decoder will connect to the red, green and blue guns of the receiver, and special RF adapters are being developed to eliminate the need to connect the RGB guns. By the end of 1981, the cost of a Telidon decoder will add \$550 to the purchase price of a TV set. John Smirle of the Canadian Department of Communications said at the teletext workshop at NAB '81 that to bring the cost of teletext decoders down, volume sales is the issue, not timing.

A major advantage of the Telidon system lies in the microprocessor-equipped decoder, which can provide up to 32 kilobits of internal memory. This produces high quality graphics as well as downloading capabilities which make it possible to program the home decoder from the host computer.

Antiope

The first NAB demonstration of the French Antiope teletext system was made in 1979 by SOFRATEV, an Antiope Videotext System (AVS) parent company. This year, AVS announced the successful launch of the Los Angeles Teletext project from which they received live teletext transmission to their booth and hospitality suite via satellite and telephone lines.

The Los Angeles Teletext project is a joint venture of KNXT-TV Los Angeles (CBS/Broadcast Group),



wpbt2
100% LOCAL

“Our Auditronics 720 combines recording studio quality with live broadcast flexibility,”

says Graham Simmons, Chief Engineer at Miami's WPBT — Channel 2. “Auditronics developed this 36 in — 16 out audio mixing console to give us all the EQ, reverb and signal processing we need for studio quality multi-track recording of our productions.”

“When you're a national production facility like we are, you've got to have an audio signal path that's strictly state-of-the-art. For example, our Auditronics 720 preamp design is the latest generation and gives us the best signal-to-noise performance available. It allows us to do multiple generation dubbing and mixing without noise build up.”

“In addition to its multi-track recording advantages, our 720 has the flexibility to do all the necessary mixing and signal processing in real time for a mono mix for TV, a stereo mix for FM simulcast, including network satellite feeds, as well as a scratch mix on videotape for later synchronization in post-production editing.”

“Whether it's multi-track recording, live broadcast or post-production, our Auditronics 720 does everything we want it to do, and does it very nicely.”

If you'd like to know what WPBT-Miami and over 300 other satisfied users know about Auditronics broadcast consoles, circle reader service number or contact:



auditronics, inc.

3750 Old Getwell Road
Memphis, Tennessee 38118
(901) 362-1350

Circle (66) on Reply Card

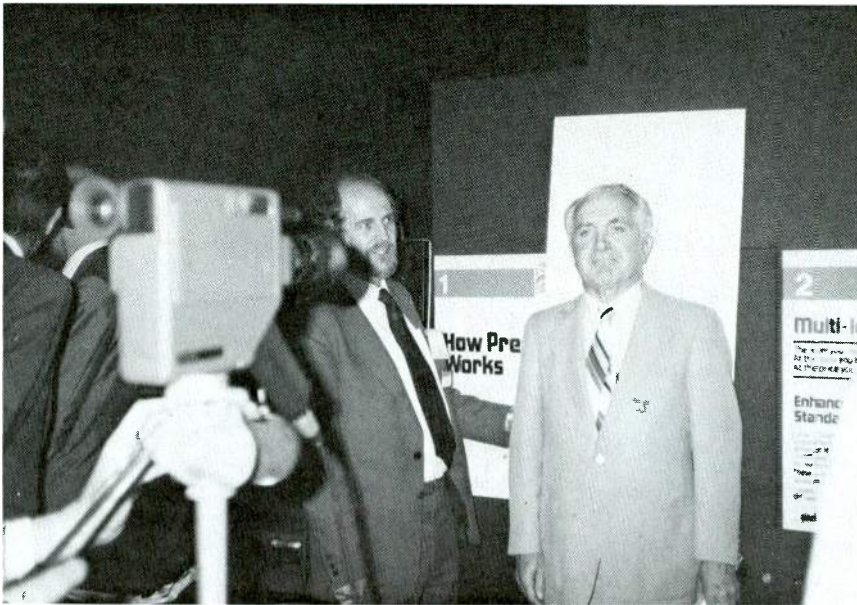

Commissioner James Quello poses to put picture into teletext.



The British Teletext Exhibit took up the entire wall at one end of the exhibit hall.

British Teletext and Videotext

In a unique, nationally coordinated exhibit a group of British organizations combined their technologies to display and demonstrate UK Videotext and Teletext systems designed for the 525 line NTSC TV system. The message from his group was that the British systems are thoroughly designed and engineered and are available worldwide *now*. Even the numerous TV sets on display from US and overseas manufacturers came to NAB '81 with built-in decoders, establishing that the British technology is consumer-based on a large scale, not just prototyped.

Live (interactive) videotext and teletext (broadcast) demonstrations were available at NAB '81 with information fed directly from London, locations in the US and from systems

on the exhibit floor. Specialists from the various British manufacturers were on hand to explain every facet of the British-developed technology. They explained the Teletext test equipment, signal enhancement devices, the semiconductor decoder circuits and every aspect of the system and component performance. Firms represented were British Telecom, Jasmine Electronics Ltd., Logica Ltd., Mullard Ltd., and V. G. Electronics Ltd.

The highlight of the British exhibition was the appearance of Kenneth Baker, Britain's Minister of State for Industry and Information Technology, who formally opened the British Teletext industry display. On hand for opening ceremony were John Summers of NAB and Robert E. Lee and James Quello of the FCC.

Teletext

KCET-TV Los Angeles (Public Broadcasting Service), the West Coast office of the caption center of WGBH-TV Boston, and Telediffusion de France, developer of the teletext system and supplier of the estimated \$1 million turnkey system. Both KNXT and KCET started an air broadcasting of the Antiope teletext system April 8, 1981. One hundred and thirty decoder-implanted TV sets have been placed in homes, business locations and public gathering establishments.

At the teletext workshop, David Percelay of the CBS Broadcast Group in Los Angeles said that he sees the CBS teletext service as being supported by advertising. He also said he sees the use of couponing through the use of a peripheral hard copy printer.

There are five major elements of the Antiope broadcast teletext system. They include DIDON, the data transmission system, and Antiope, the coding system (also referred to as "Antiope language"). Other elements include a TV transmission facility, a decoder terminal using the TV screen as display medium, and data bases.

DIDON is asynchronous and assures the transmission of digital data on a TV signal in complete compatibility with any TV standard in the world. Information to be transmitted is arranged in data packets, to which DIDON adds "control blocks." The DIDON control carries information that gives the system several important attributes, such as correction capability, identification of data and the synchronization of instruction.

The Antiope language features an 8-color capability, special effects such as flashing and animation and special alphabets to be used with four languages simultaneously. The characters may be graphic or alphanumeric. Antiope encryption techniques can limit reception of teletext pages to authorized subscribers.

The Los Angeles Teletext Project is using the Antiope system in the NTSC 525 line/60 field structure. The FCC has authorized the use of lines 15 and 16 on the vertical blanking interval for transmission of the teletext signal. The data rate for the digital information is 5.72 megabits/second, providing an average waiting time of eight or nine seconds in an 80-page magazine. The Antiope character generator produces up to 20 rows of 40 characters per row, which comes out to 160 to 180 words per page.

isi means...

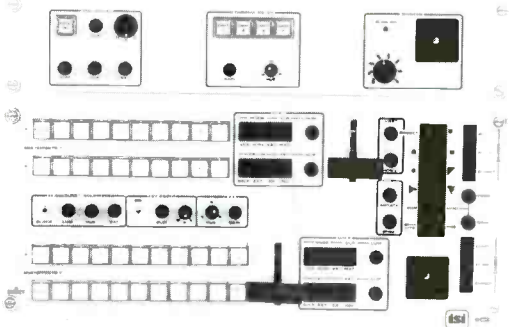

ISI Model 902-S — Video Production Switcher

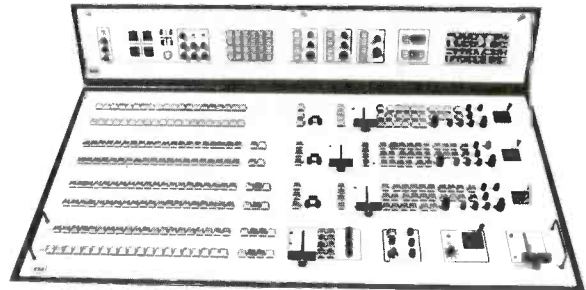

ISI Model 1208 — Video Production Switcher

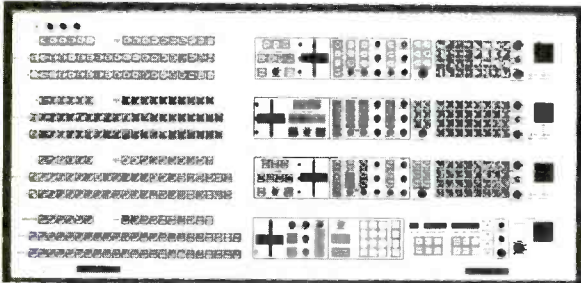

ISI Model 200-3 — Video Production Switcher with **PolyKey**®

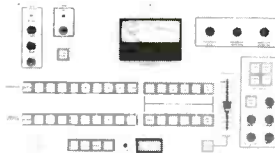

ISI Model 931 — Master Control Switcher

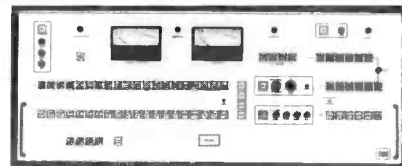

ISI Model 821 — Master Control Switcher

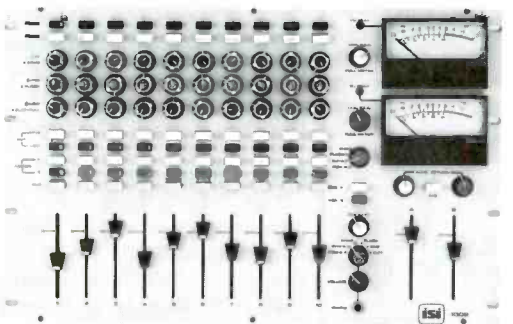

ISI Model 1002 — Audio Console

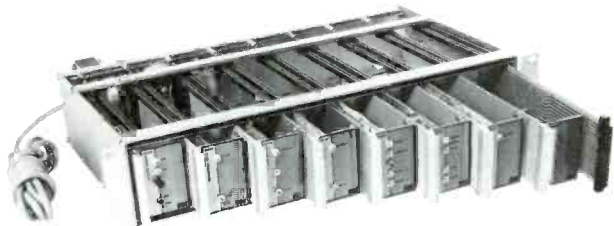

ISI 500 Series — Plug-in Terminal/DA System

innovative Switching Ideas



INDUSTRIAL SCIENCES INC
 P.O. Box 1495 / Gainesville, Florida 32602
 Florida Only: (904) 373-6783

Available in NTSC
 and PAL formats

Teletext

The present memory capability of the Antiope decoder is from one to two kilobits. The system can work equally well from serial to fully parallel attribute memory. At the serial attribute level, the system has an 8-bit memory. At the partial parallel attribute level, the system has a 16 bit memory, and at the fully parallel attribute level, the system has a 24 bit memory.

According to Pierre Gaujard, vice chairman of the board of Antiope Videotex Systems Inc., other new developments at the Antiope booth included teletext TV sets manufactured by RCA and Magnavox with built-in decoders that contained complete VLSI circuits. The use of VLSI circuits greatly reduces the size of the decoder. (Antiope claims to be the only system with a total VLSI software-based system.) Antiope also announced its use of geometric primitives that produces extremely high resolution graphics.

British teletext

New at the British videotext booth at NAB '81 was the announcement of the sale to WFLD-TV Chicago (Field Communications) of 100 decoder implanted TV sets, the majority of which were manufactured by Zenith. The TV sets are to be placed in households, businesses and shopping malls in the Chicago area. One hundred additional sets are on order.

The British videotext display at NAB '81 demonstrated the latest ad-

vancements of UK teletext systems, Ceefax (BEC 1, BBC 2) and Oracle (IBA) by bringing in live pages via satellite from the Field Communication tests in Chicago.

Live data via telephone lines from the United Kingdom Prestel terminals which demonstrated the complete range of viewdata facilities using both 625 line/50 field and 525 line/60 field transmissions. A multilevel standard has been defined by technical authorities that breaks down the British Videotext system into five levels.

Level One is the standard videotext and teletext service presently used in the United Kingdom. Contained within are 94 alpha-numeric characters and mosaic graphics.

Level Two is compatible with Level One, but provides smoothed mosaic graphic characters, multilanguage texts (Roman), non-spacing graphics and limited memory.

Level Three provides dynamically redefinable character sets, high definition graphics using a 12 x 10 dot matrix display, an extended color range and non-Roman character sets including cyrillic, Greek, Japanese and Chinese.

Level Four uses alpha-geometric coding methods employing Picture Description Instructions for high definition graphics.

Level Five offers picture Prestel, color pictures of photographic quality referred to an alpha-photographic display.

United Kingdom Teletext, similar to the French and Canadian systems, is transmitted on the field-blanking interval of the TV signal. The system provides for up to 16 such lines to be used per field; at present only two are in use. Each line of data begins after the line sync pulse and comprises a string of shaped binary pulses representing NR2 coded data at a bit rate of 6.937 Mbits/second (625 line 50 field) or 5.727 Mbits/second (525 line 60 field).

The high bit rate keeps the access time short (10 second average access time for 100 pages). Exhaustive field tests in 1974 using increasingly high bit rates showed the present signal to be rugged enough both for the United Kingdom where video bandwidth is 5.5MHz and other European countries where the bandwidth is 5MHz and US band width of 4.2MHz (with the modified bit rate).

These data represent synchronizing waveforms for bit and byte recovery, address to identify the character row, control words and encoded teletext characters. The pulses are shaped by a suitable filter to minimize inter-

symbol interference introduced in the transmission path and to improve error performance in the presence of noise.

At the heart of the Ceefax system are three Digital Equipment Corporation PDP 11/34 computers.

The Prestel and Prestel International section of the British videotext display claim to be the first operational public viewdata service allowing transactional processes and are currently offering more than 200,000 pages of information provided by over 400 organizations. In fact, both systems will be capable of providing more than one million separate pages of information in the near future.

Prestel data, which are accessed over normal public dial-up telephone lines, make possible the addition of peripheral devices such as hard copy printers, computer software transmission for business applications, video games, programmed learning and page recording on audiocassettes.

Wold feeds live CBS Teletext demo to NAB '81

Wold Communications of Los Angeles, on behalf of CBS/Broadcast Group, provided satellite facilities and services to enable a live demonstration of the new CBS teletext service, EXTRAVISION, at the NAB '81 convention.

The CBS teletext project, a joint developmental effort of CBS/Broadcast Group, Los Angeles public television station KCET, the West Coast office of The Caption Center of WGBH-TV Boston, and Telediffusion de France, developer of the teletext system and supplier of the Antiope teletext equipment, began on-air testing over CBS-owned KNXT-TV Los Angeles April 8.

For the NAB '81 teletext demonstrations, Wold Communications uplinked the KNXT broadcast signal from Wold's Hollywood earth station to Westar III transponder 6 (leased from Western Union by CBS), and downlinked it outside the Las Vegas Convention Center. A seven-meter Microdyne satellite antenna—the same kind of dish Wold will install at TV stations nationwide for satellite distribution of "Entertainment Tonight" and "The Merv Griffin Show"—was used to receive the KNXT signal.

The live demonstration, which was conducted for 21 hours over the five-day period, was available for viewing at both the Telediffusion de France and Wold Communications exhibit booths. □



Antiope/Teletext

BROADCAST ENGINEERING

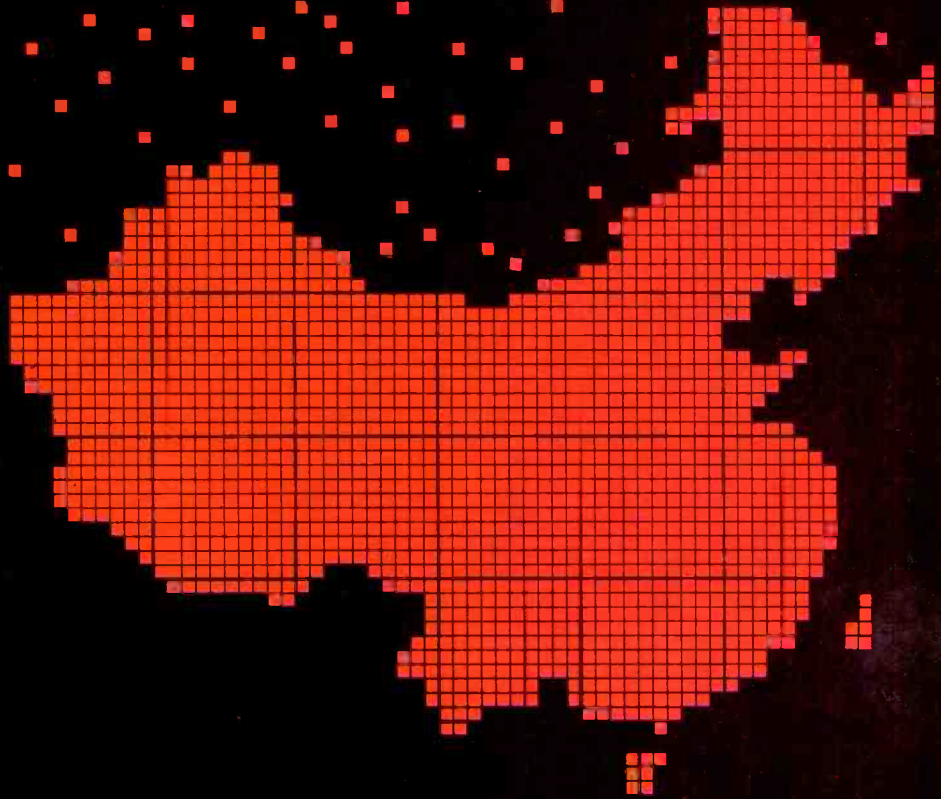

BREAKING INTO CHINA

Our invitation

Broadcast Engineering is proud to be the first Western magazine invited by the PRC Central Broadcasting Administration and Radio Peking to print a special edition specifically for television and radio professionals throughout the People's Republic of China.

Special benefits

The PRC Central Broadcasting Administration and Radio Peking have personally invited Broadcast Engineering into China and have arranged to circulate this issue to 8,500 of their top television and radio buying influences. Circulation will be BPA audited. And additionally, the Chinese have told us pass-along readership will be extremely high.

Besides the comprehensive circulation package, they've offered to translate the special issue—so that experts across China will be able to understand every page. That means your ad will receive the best Chinese translation available.

The invitation to publish Broadcast Engineering's Chinese Language Edition was the result of meetings by our publishing liaison in Beijing (Peking) with

Chinese television and radio officials at all levels.

The Chinese response to Broadcast Engineering was tremendous—certainly better than expected. In fact, the invitation to publish a BE Chinese Language Edition took us by surprise. We had initially only hoped to circulate copies of the English Language Edition of BE to top English speaking Chinese officials.

Their offer was accepted, with the understanding that the special edition would circulate throughout China—reaching all geographic regions of the country. They agreed, and Broadcast Engineering's Chinese Language Edition becomes a reality in August 1981.

A special request for advertising

As part of the invitation, the Chinese specifically asked that advertising be included in the edition. That provides your company a unique opportunity. Now you can introduce your products to broadcast professionals throughout the People's Republic of China. And you can do it in a very cost efficient manner.

This special Chinese Language Edition of Broadcast Engineering is a first and your company will gain special recognition in this market by being part of it.

Reserve your space now

Call: Cameron Bishop 913/888-4664

or the sales office nearest you

BROADCAST
ENGINEERING

BPA

GRAY ENGINEERING LABORATORIES
 504-P W. CHAPMAN AVE.
 ORANGE, CA 92668
 714-997-4151

STOP

**GUESSING FILM FRAMES
 WHEN EDITING ON
 VIDEOTAPES
 NOW YOU CAN BE
 ACCURATE**

Circle (69) on Reply Card

Teletext

A new development in the Prestel system is the addition of software developed by the German Post Office permitting data to be routed directly to and from a third party computer. Now instead of simply accessing information from the Prestel computer about certain airline reservations, for example, one can be interfaced directly with that airline's computer system, enabling a much broader data base.

FCC

It is only natural to wonder at what point the FCC will launch its inquiry into a US teletext policy. Dick Shibben, Chief of the FCC Broadcast Bureau, at an FCC question-and-answer session during NAB '81 said that the FCC will address the question in late May or early June.

The FCC will not concern itself on the adoption of a specific format of a US Teletext system, but will deal with the technical standards of such a system and how the Fairness Doctrine and the equal time provision will come into play.

Editor/publisher Gary Arlen reports in his "International Videotex Teletext News" (April '81) that at least three staff offices at the FCC are involved so far in the teletext issue: The Broadcast Bureau (which is coordinating the effort), the office of Plans and Policy and the office of Science and Technology. It could take the FCC two years or longer to work its way through an inquiry and subsequent rulemaking proceeding on teletext.

Arlen, a leading expert on teletext, said that broadcasters are being confused by the companies involved in the issue due to the "front-stabbing" nature of the competitive statements being distributed. "The teletext companies must sell the concepts involved, something not being done. Broadcasters have far more questions than answers and are not helped by the attacks these companies are making on each other," he said.

Teletext at NAB '81

Antiope	725
British Telecom	726
Jasmin Electronics	727
Logica	728
Mullard	729
Teledon	730
V.G. Electronics	731

Circle the appropriate numbers on the reader service card for NAB '81 exhibitor data. Check listing in other articles for additional data leads and the wrap-up of other products/exhibitors elsewhere in this issue.

**MODULAR ELECTRONIC
 CABINETS - DESKS
 and
 CUSTOM INSTRUMENT
 PANELS**

EQUIPTO ENCLOSURE SYSTEMS — first in choice for excellence! Hundreds of standard sizes available in both our top-of-the-line Heavy Duty Modular Cabinets and the value-engineered Challenger/Solid System line. We also offer a totally new Electronic Desk System in a variety of styles. And since every electronic equipment company is unique and has different enclosure needs, we'll modify our cabinets to meet those requirements.

You can depend on us, just as many leading corporations do, for dependable products and service. The reputation we've earned is our proof! Choice of colors at no extra charge. Also, ask about our Engineering Evaluation program.

WRITE FOR FREE CATALOG

Equipto For Quality
**EQUIPTO ELECTRONICS
 CORPORATION**
 417 Woodlawn Ave.
 Aurora, Illinois 60507
 Phone 312/897-4691

Circle (70) on Reply Card



Beaveronics, Inc.

STUDIO PRODUCTION VIDEO SWITCHING SYSTEMS

8 Haven Avenue
Port Washington, New York 11050
Tel: (516) 883-4414

(Also available in PAL and PAL-M versions)

FOR REMOTE & SMALL PRODUCTION FACILITIES

MODEL J & D 712

\$7,400.00

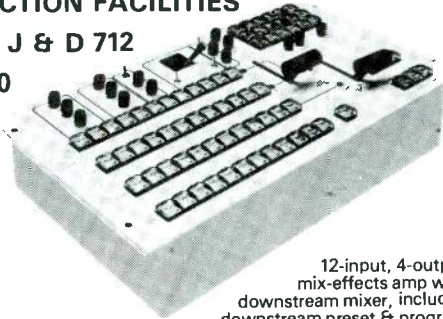

12-input, 4-output mix-effects amp with downstream mixer, includes downstream preset & program busses with cut bar, RGB chroma key

Standard Features

- 12 inputs including Black-burst and Color Background
- Built-in Black Burst Generator
- Built-in Colorizer
- Built-in RGB Chroma keyer
- Four Switching busses
- Downstream Preset and Program Busses with cut bar
- Rack-mounted electronics
- Adjustable Soft Wipe
- Adjustable Border edges
- Color Matte
- Vertical Interval switching thru-out
- Illuminated Momentary Contact push buttons
- Internal, external, Chroma-key, and matte inputs to keyer

- Built-in pattern modulator with frequency and amplitude controls
- Full Tally
- Pattern symmetry control
- Illuminated Momentary contact push buttons for effects selection
- Normal/Reverse/Normal-reverse wipe transitions
- Pattern limit controls for presetting size of patterns or varying vertical and horizontal aspect ratio
- Loop-through inputs
- Input amplifiers with clamping
- Synchronous/Non-synchronous inhibit
- Modular construction with front access plug-in modules

Options:

Downstream Keyer

FOR MODERATE SIZE FACILITIES

MODEL B1-154

\$12,990.00

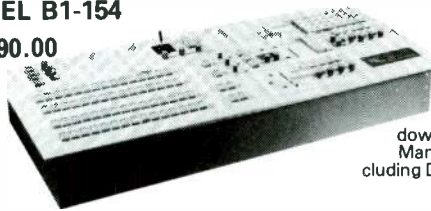

15-input, 4-bus mix/eff/key amp with downstream mix/key amp. Many optional features including DSK & quad-split, etc.

FOR SOPHISTICATED FACILITIES

MODEL B1-156

\$21,795.00

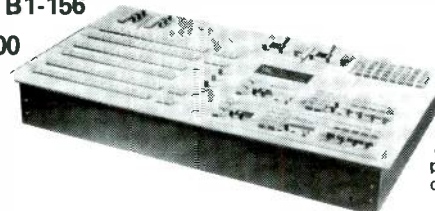

15-input, 6-bus with two full mix/eff/key systems and dir. pgm and pre busses: many options available, DSK, quad, etc.

MODELS 154 & 156

STANDARD FEATURES

1. **Switcher Models 154 and 156** are of the same basic design and utilize the same electronic sub assemblies. These switchers have the same standard basic features, differing only in the number of busses and in the number of mix/effects units. The basic standard features include 32-pattern mix/effects, color black and color matte background generator, and a mix/key unit in the case of the Model 154.
 2. **Input Amplifiers**
 - loop through high impedance input • gain equalization for 1000' cable • 22° sub carrier phase control • clamped inputs (10% to 90% APL) • sync addition on non composite signals if desired.
 3. **Tallies**
 - isolated dry contact relay closure on all inputs (2 amps at 50 v.)
 4. **Mix-Effects Units (Includes Keying Function)**
 - One (1) used in Model B1-154
 - Two (2) used in Model B1-156.
- Fades (or Supers), Wipes, Keys may be produced.**
Positioner Joystick for each M/E positions patterns.
 • **Pattern Modulation** may be accomplished by an internal waveform generator. Modulating sources may be either (1) sine wave, (2) square wave, (3) saw tooth, or (4) an external customer generated source.
 • **Mix Key and Wipe Key** available.
 • **Soft Wipe and Soft Key** available with adjustable variations.
 • **Push to Preview** obtained by depressing knob on clip potentiometers (provides for M/E monitor output).
 • **Wipe Mode**—3 interlocked buttons select "NOR", "REV" or "N/R".
 • **Hard Wipe, Soft Wipe or Border** can be selected with degree of softness made by "Edge" control adjustment.
 • **Border** may be **Colorized** by adjustment of "Hue" and "Luminance" control.
 • **Symmetry of Pattern** may be adjusted by "SYM" knob.
 • **Preset Wipe Limits** are set by potentiometers. "H" and "V" vertical preset limits activated by Pattern Limit button.
 • **Spotlight** alternate action push button produces a 6 db. level difference between "A" and "B" input channels in the "Wipe" mode. (Operates on all patterns.)
 • **Pattern Assignment** is made by depressing "ASSIGN" button. Pattern select

feature may be "locked" to pattern matrix by depressing the "ASSIGN" button a second time on the same pattern. Patterns assigned appear on LED display on M/E control panel.

- **Non-Synchronous Inputs.** An "NS" indicator is provided. Tearing is prevented by not allowing a non-synchronous signal to be switched except at extreme position of fader handle where a "cut" transition occurs.
- **Key Input Sources** may be either (1) "A" bus video for self keying, (2) preview Key bus, (3) chroma key, or (4) an external key source.
- **Key Invert** selector provided to accommodate either positive or negative video as a keying source.
- **Key Fill** may be either "A" video for self keying or a colorized matte.
- **Mix/Key** provided a lieu of second Mix/Effects system for Model B1-154 switching system. Provides for all mix and keying functions of mix/effects system (as previously described) except for the pattern effects.

OPTIONAL FEATURES

- May be added at any time (required control panel wiring already installed) except those indicated with an asterisk. (*)
- Chroma Keyer (C.K.)** \$950.00
 - **Hue**—selects hue of keying color • **Gain**—adjusts the amplitude • **Clip**—adjusts the clip level for keying • **Camera (4 x 1) input switcher**—selects RGB output of any one of 4 cameras to feed C.K.
 - Down Stream Keyer (DSK)** \$1,975.00
 - Keys in titles, inserts, or fades to black with or without insert • Color matte background
 - Key sources: (1) Mix/Effect, (2) Chroma Key, (3) External • Push to Preview (Monitor)
 - DSK Border** \$1,950.00
 - **Border**—black edge around insert • **Shadow**—black edge on right side and bottom of insert
 - Quad Split** \$1,900.00
 - Provides four (4) variable size quadrants from eight possible sources with variable width border.
 - Aux Busses—(Model 156 only)** \$2,100.00
 - Two remote outputs are available—remote control panel and amps required.
 - 2nd Mix/Effects Unit** in lieu of Mix/Key amp in 154 \$2,650.00*
 - Mix/Key amp** fed by preview and program busses in 156 \$3,500.00*
 - PAL/PAL-M version, per switcher** \$1,000.00*

All Beaveronics Switching Equipment Carries a Two Year Warranty

ENG Switcher Model J & D 705

\$7,990.00

FEATURES:

- BUILT IN COLOR BLK AND BKG
- SELF CONTAINED SYNC GEN
- INDEPENDENT COLOR BLK OUTPUTS TO CAMS
- SELF CONTAINED CASE
- 5 INPUTS INCLUDING BLK AND BKG
- 32 PATTERN MIX/EFF/KEY WITH POSITIONER
- ADDITIONAL SEPARATE MIX BUSES
- PREVIEW FEATURES
- FRONT PANEL ANGLE ADJUSTABLE



CHECK BEAVERONICS FOR:

- Master control switchers AFV with audio breakaway
- Specialized custom switchers
- Routing switchers with AFV
- Selected terminal equipment

OTHER ITEMS AVAILABLE FROM BEAVERONICS

FAYAG MASTER CLOCK SYSTEMS

Available with accuracy better than 1 second/yr.

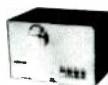

Beaveronics, Inc.

8 Haven Avenue • Port Washington, New York, 11050 • Tel: (516) 883-4414

Prices and Specifications Subject to Change Without Notice.

Circle (71) on Reply Card



Other new products for broadcasters at NAB '81

By Bill Rhodes, editorial director; Rhonda Wickham, managing editor and Carl Bentz, engineer, KCPT, Kansas City, Missouri

As expected, exhibitors unveiled a great many new products for broadcasters at NAB'81 in Las Vegas. Some of these products have been covered in the previous articles, but the bulk of them is described briefly below. Details on these products may be obtained by using the reader service card and the appropriate numbers below each firm's new products.

Exhibitors also displayed some or all of their standard products. Data on these products may be obtained (until July 1) by using the service card in the March pre-NAB issue of *BE*. Also included here are product listings for firms exhibiting at NAB that did not get listed in the March issue because of late registration.

If you missed some products at NAB, or if you didn't make it to this year's great show, use both the June and March issues to shop for new equipment. And, plan to attend next year's show in Dallas to see prototypes displayed this year emerge into production models.

ADC Pro Audio

Female Contact Printed Circuit Board Receptacles—These units withstand 5000 insertions and withdrawals and are interchangeable and compatible with other low impedance receptacles.

Right Angle Low Impedance Receptacles—These units eliminate the need for discrete wiring or mother-daughter board arrangements, match other mounted components and 3-pin connectors separate shield circuit grounds mated plug.

Right Angle Phone Jacks—The ADC jacks match other mounted components, include 2- or 3-conductor option, and the black thermoplastic case resists rough handling and high temperatures.

Circle (251) on Reply Card

ACI/Filmways

Rental service for all audio requirements.

Circle (901) on Reply Card

ADM Technology

ST series—These stereo broadcast consoles are available in 10-, 16- and 20-input configurations with up to three stereo and one monaural outputs.

Circle (253) on Reply Card

AEG Telefunken, Bayly Engineering Division

Model BRT500—This repeater/telephone interface for private 2-way mobile radio stations provides an automatic interface for voice transmission and control signaling between unattended mobile radio base station and a conventional private telephone network.

Circle (254) on Reply Card

A. F. Associates

The company specializes in designing and fabricating total videotape systems, and rebuilds and refurbishes VTR machines.

Circle (255) on Reply Card

Shooting in a Tight Spot?

THE NEW
ELEMACK CRICKET
FITS IN
NARROWER SPACES,
TIGHTER CORNERS
AND BRINGS YOU
CLOSER TO THE ACTION.



The new Cricket lets you go where no dolly has ever been before. And work in areas that are inaccessible for more conventional equipment. Cricket smoothly elevates any size camera—without bumps or vibrations. A new triangular design prevents twisting.

Precision roller bearings and an electric hydro-drive system glide you up or down while you shoot, reaching elevation and stopping softly.

Ruggedly built, yet lightweight (only 300 lbs.) Cricket has the same wheel configuration as the Spider and can be used with or without dolly track.

The Elemack Cricket. One of the lightest, most compact hydraulic dollies available.

Elemack Cricket Accessories:
Jonathan Jib Arm, Mini Job Arm, Low Boy for Angle Shots, LS/6B, Track Wheels for Curved Track Operation.

Write for free brochure for all the details.

The CAMERA MART, Inc.
456 W. 55 St.
New York, N.Y. 10019
(212) 757-6977
Exclusive East Coast Distributor

ALAN GORDON ENTERPRISES, Inc.
1430 N. Cahuenga Blvd
Hollywood, Calif. 90028
(213) 466-3561
Exclusive West Coast Distributor

Circle (72) on Reply Card

Other equipment

Accurate Sound Corporation

AS-100 High Speed Duplicator allows 100% servo controlled speeds of 30, 60, and 120 inches per second on 10 slaved recorders with ¼- and ½-inch tape formats.

Circle (256) on Reply Card

Achro-Video International

Color bar generators, source identifiers, lens service and ENG Lite Mike adapters.

Circle (257) on Reply Card

Acrodyne

Model TT-3500VH—This unit has a single tetrode, wideband solid-state driver, IF modulated and is low-level diplexed.

Series T-2300, T-2320 Translators and TT-3300 transmitters in the 100W and 200W power category employ solid-state amplifier modules; power being determined by the number of modules.

A1480-U Aural Transmitter/Amplifier, replaces klystron amplifier usually found with 50kW visual UHF transmitters. Decreases tube costs and uses forced air cooling. The amplifier uses a single tetrode.

Also see the transmitter article.

Circle (333) on Reply Card

ADDA Corporation

ESP R—This portable digital store system is driven by a 14-inch fixed disc and is designed for mobile broadcast, teleproduction and industrial TV applications.

The Multiple Access System (MAC) permits a standard ESP C digital still storage system to be expanded to permit a total of 9000 images to be on-line and accessible in less than half a second.

The Multipix, a new multiple picture option, provides users of the ESP C the opportunity to preview up to 25 digitally stored graphic stills simultaneously.

A new version of the Library Control System, an interactive information storage and retrieval option, is designed for rapid access to the ESP digital still store system.

Circle (252) on Reply Card

ACI/Filmways

Rental service for all audio requirements.

Circle (901) on Reply Card

Advance Industries

The Generator-Set Buildings are pre-assembled, portable and environmentally protected.

Model S4A—This tower is square self-supporting and is fabricated of structural shapes, angles and H-Beams.

Also microwave towers and accessories, guyed towers and CATV towers are available.

Circle (259) on Reply Card

Adwar Video Corporation

Apple Mod ARS-170A—The unit rectifies the Apple computer signals for NTSC standard equipment, adapts the Apple to use as a video color graphics generator and is compatible with time base correctors.

HIP Switcher III—This unit is a completely mobile ENG/EFP 2-camera switcher and fader useful in studio applications as well.

SEK-2—This special effects keyer works with all standard non-broadcast VTRs and requires only black-and-white video camera for graphic images.

Circle (260) on Reply Card

Agfa-Gevaert Inc.

The company features PEM 368 ¼-inch Studio Tape, PEM 428 Master Tape for SMPTE lock-up and PEM 468 ¼-inch and ½-inch Mastering Tape.

Circle (902) on Reply Card

Allen Avionics

Switch Variable Delay Line—These units consist of individual delay lines, each having their own switch.

T05 series—This series of Lumped Constant, completely passive delay lines, which are housed in the commercial T05 package, are designed for complete compatibility with semiconductor and logic assemblies

Circle (261) on Reply Card

Allied Broadcast Equipment

Telemix 2—This unit provides high-quality beepers for 1-way recording or 2-way interviews. It can also be used to feed actualities and voicers to the network.

Circle (262) on Reply Card

Allsop Inc.

Allsop 3 VCR Cleaner—This cleaning cassette thoroughly removes oxides and other pollutants from the VCR audio and video heads, capstan and pinch roller.

Circle (263) on Reply Card

Amber Electro Design Ltd.

The Model 3500 Distortion Measurement System has an optional IMD measurement capability covering broad frequency range to 100kHz and including SMPTE, DIN and CCIF standard formats.

Circle (265) on Reply Card

Amco Engineering Company

The Modular Enclosure Systems are conventional or styled cabinets.

Circle (266) on Reply Card

American Data Corporation

The 3200 Series microprocessor control system, with the 900, 1900, 3100 series systems, permits versatility of system control in large multilevel video switching matrices. The system is suited for control of A-V applications, machine control systems or master control installations.

Circle (267) on Reply Card

American Telephone & Telegraph

See satellites on page 70.

Circle (268) on Reply Card

Amperex Electronic Corporation

The 80X0, a ½-inch (8mm scan diagonal) hybrid Plumbicon for new EFP/ENG camera systems, has evaporated wall electrodes for low deflection power, front-end mesh connection for reduced line pickup, and low output capacity.

Circle (269) on Reply Card

Ampex

The AVC-33 Digital Video Production Switcher eliminates knobs and places controls with up/down push-buttons. All adjustments except quad split and color background are made with the 3-speed up/down button concept. New effects and capabilities are included in this series switcher, plus a key memory system for instant recall of one of four separate key setups.

The AVA (Ampex Video Art) with the ESS-2 digital video production system gives broadcasters graphics sequence capabilities previously available only in film.

The BCC-21 convertible camera for studio and field production use has all the automatic advantages of the earlier BCC-20 and can be controlled by a computerized setup system.

The ACE Ampex Modular Editing System has three human interfaces: ASCII keyboard, dedicated keyboard and TouchScreen. TouchScreen lets the fingers (on the CRT face) initiate editing decisions.



COMMUNICATIONS INC.

proudly presents . . .

. . . WILK ENGINEERING

AUDIO and VIDEO ROUTING EQUIPMENT

**For Demanding Broadcast, CATV
and Industrial Systems Applications**

AR (Audio Only)

VR (Video Only)

VAR (Audio follow Video)

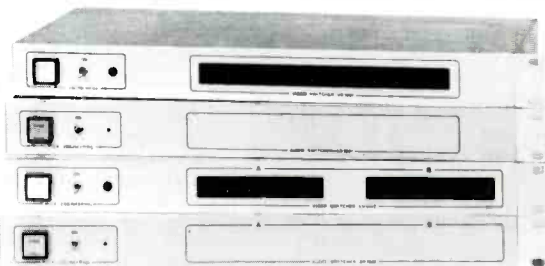

SWITCHERS ● VR & AR0602 ● VR & AR1201

0602 Series:

2 x 6-IN/1-OUT
expandable 6-IN
to multiple outputs

1201 Series:

12-IN/1-OUT
expandable to 24
or 36 IN to single
or multiple outputs

- FEATURES:**
- * LOOPING VIDEO INPUTS
 - * VERTICAL INTERVAL SWITCHING
 - * TWO VIDEO OUTPUTS PER BUS
 - * BRIDGING AUDIO INPUTS
 - * SUPERB FOR STEREO SWITCHING
 - * PARALLEL REMOTE CONTROL

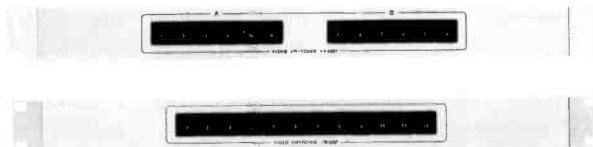

REMOTE CONTROL PANELS
Other Configurations upon request

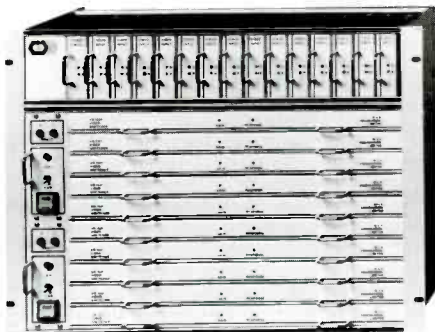

VR 1510 VIDEO MATRIX

1510 Series:
Basic 15-IN/10-OUT,
expandable for
125-IN to 120-OUT
Routing requirements

- FEATURES:**
- * LOOPING VIDEO INPUTS, 2-OUTPUTS PER BUS
 - * VERTICAL INTERVAL SWITCHING
 - * BRIDGING AUDIO INPUTS
 - * BCD SERIAL CONTROL
 - * VARIOUS CONTROL SYSTEM EXECUTIONS
 - * DUAL REDUNDANT POWER SUPPLIES IN EACH FRAME

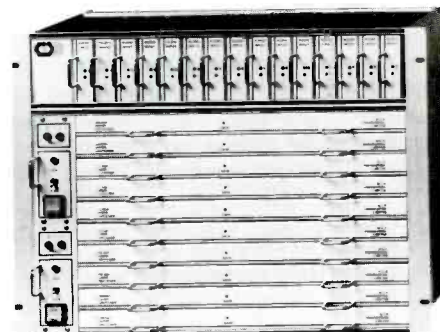

VR 1510 AUDIO MATRIX

DEALER INQUIRIES INVITED



COMMUNICATIONS INC.

2431 Forest Ave., San Jose, CA 95128
7171 Torbram Road, Unit 4, Mississauga, Ontario L4T 3W4
3445-12th Street N.E., Calgary, Alberta T2E 6S6

(408) 247-6152
(416) 677-2232 (TWX) 610 492-4356
(403) 230-2118 (TWX) 610 821-6400

Other equipment

Merlyn, the digital effects system, is designed to alter the geometry, size and perspective of video images in real time. The system can also generate picture rotation about all three axes and execute flips, spins and tumbles with 100% digital transparent video processing in up to four separate channels.
See camera articles.

Circle (270) on Reply Card

Ampro Scully

The 2500, 3500 and 4500 Series Recorder-Reproducers include 34 different modes available in various mono and stereo configurations. All modes include 1kHz stop cue and audio switcher as standard features.

Circle (271) on Reply Card

Amtel Systems Inc.

The Model 3700 Edit Code Master is capable of generating and reading SMPTE edit code as well as serving as a user bit encoder and video character generator.

The Model 3800 Edit Code Master incorporates a generator, a reader, a user bit encoder and a video character generator in a 19-inch rack-mount package.

Also showed the 1238 Production Timer, 1930 Programmable Controller, 3500 Portable Time Code Generator/Reader.

Circle (272) on Reply Card

Amtron

A superimposed Safe Action and Safe Title dotted-line display, conforming to SMPTE specifications for safe area transmission, has been included.

All Amtron monitors equipped with switchable horizontal and vertical delay (pulse cross display), can be supplied with an additional test marker called Micro-Rule, which aids in test and setup of picture information.

Circle (273) on Reply Card

Andrew Corporation

The UHF-TV Transmitting Antennas are completely enclosed in radome, have Traveling-Wave slotted array computerized antenna design, shaped pattern capability for better coverage and have optional mounting for side-of-tower mount or top-of-tower mount.

Circle (274) on Reply Card

Angenieux Corporation of America

The 15 X 9 ENG/IEFP All Weather

Lens provides high illumination because of the extremely high aperture of f/1.5 combined with the photometric factor of 1.1.

The 25X System for 3/8-inch broadcast TV cameras has continuous 25x zoom range.

The 42X Lens has a wide horizontal angle of view, tight narrow horizontal angle of view, high aperture and the same servo and manual controls.

Circle (275) on Reply Card

Animation Video

The Anvid System, a full-color broadcast-quality frame-at-a-time animation direct to videotape, provides a higher quality image than film transferred to tape, is faster than film animation and is less expensive than film.

Circle (276) on Reply Card

Antiope Videotex Systems

See teletext article.

Circle (277) on Reply Card

Anton Bauer

Designed to compliment the LB-30 30V lighting belt, the new LG-30 lighting head is also directly compatible with a 12V 100W FAV type bulb.

The LG-30 can be operated with one hand including focus and on/off control. The spring-loaded, snap-action, swing-away dichroic filter locks in place.

Circle (278) on Reply Card

Anvil Cases

Three types of custom-designed rack-mount cases are being offered. The Shock Mount design is a true shock-isolation travel case with double plywood walls separated by a 2-inch layer of high density polyfoam.

Circle (279) on Reply Card

Aphex Systems Ltd.

Model APHEX II Aural Exciter creates a signal of frequency dependent phase shift with amplitude dependent harmonics and adds to the original signal for enhanced stereo image and improved presence even in complete mono compatible signal.

Circle (903) on Reply Card

Arbitron

Provides complete demographics to broadcasters with ratings services.

Circle (904) on Reply Card

Arrakis Systems

The 500R Professional Console Series feature control of all level and switching functions.

The 500SC Console Series is available in eight or 12 channels, mono or stereo.

The 1000 series is available as an 8-channel console, mono or stereo. It features four balanced inputs per channel for a total of 32 inputs.

Circle (280) on Reply Card

Arriflex

The ARRI 2500 Fresnel is an all-purpose location and studio light for illuminating large areas.

The ARRI 4000 Fresnel with its 20-inch diameter lens is a strong light, but has excellent control for large areas.

The HMI 200 was designed primarily for "Mains Independent" operation.

Circle (281) on Reply Card

Artel

SL-2000 Fiber-Optic Transmission system for up to 2-mile distances interconnections, uses baseband intensity modulation of LED with PIN detection circuitry for signal-to-noise ratios of 70dB.

EN-1000 field portable video/audio transmission link is designed for interconnection of minicams to a news van providing an STL quality signal via fiber-optic cable.

Roadrunner cases are constructed of 3/4-inch A-C plywood laminated to polyester reinforced fiberglass, with a superior moisture barrier along closure seams.

Circle (905) on Reply Card

Arvin/Echo Science

The Sat-Weather is a weather satellite signal processor that converts NOAA satellite weather pictures into color video.

The Image Maker is a disc recorder featuring variable speed operations. It is capable of storing still frames for news, commercials and sports events, can be used for animation and can generate backgrounds and superimposed effects.

Circle (282) on Reply Card

Asaca/Shibasoku Company

The ADC-810 Magnetic Tape Cleaner/Evaluator is a device designed for cleaning and winding magnetic tape.

The 680-1 Digital Video Memory has a high-speed A/D converter that digitally encodes NTSC color video signals and writes the data with a



Take a close look at what Tape Transports are going to be like in the '80s

The all new Telex 3000 is here NOW!

No industry has witnessed more technological improvements over the past few decades than our own. So, if you're looking for a tape transport for broadcast, studio or industry, it's important to choose a product with all the latest industry innovations in one unit, the NEW Telex 3000. Write for exciting details about these features.

- Interchangeable head blocks
 - A.Q.R. (Auto Cue Release)
- Differential electro-mechanical braking
 - Spill-proof logic
 - Motion sensing
 - Tape counter
- 4 head capability
 - Hyperbolic tape path
- Remote control capability
- Play only or record/play combinations
 - Auto cue/rewind/cycle
 - Dual speed
- Hysteresis drive motor
- Two torque spooling motors
 - Quiet operation
- 120/240 volt operation
- Urethane pressure roller

Quality products for the audio professional



TELEX[®]

TELEX COMMUNICATIONS, INC.

9600 Aldrich Ave. So., Minneapolis, MN 55420 U.S.A.
Europe: 22, rue de la Légion-d'Honneur, 93200 St. Denis, France

Circle (74) on Reply Card

Other equipment

4-field sequence into a digital memory having the memory capacity for four fields.

The 898B White Balance Checker is capable of adjusting in a short period of time the uniformity of color picture of a multiple number of monitors and TV receivers.

The 201 Envelope Delay Measuring Set has a large picture tube display, built-in sweep generator that enables envelope delays to be measured up to 200kHz-10 MHz and a sweep rate that can be varied by means of a Sweep Speed control on the front panel.

The ASW-100 is a video switcher for field production where mobility is required.

Circle (283) on Reply Card

Athans Communications

Athans Towers uses only top-grade structural steel and material in building the towers.

Circle (284) on Reply Card

Audico

The Model 751 VTL loads 3/4-inch, VHS or Betamax tape directly into cassettes which eliminates any assembly or disassembly.

Circle (285) on Reply Card

Audicord

The A series cartridge tape machines were featured.

Circle (286) on Reply Card

Audio & Design Recording

See audio processors on page 64.

Circle (287) on Reply Card

Audiomedia Inc.

Model ADC-100 audio display compensator is a digital audio processor for correction of audio-to-video delays (lip sync) when video is involved with frame synchronizers as well as other causes.

Circle (906) on Reply Card

Audio-Technica

The Model AT803R Lapel Microphone has a remote power range of 9 to 52 Vdc, sound level input of 133 dB SPL at 1% THD and a frequency response of 30-20,000 Hz (music) or 100-20,000 Hz (voice).

The Model AT813R Mic has a smooth flat response of from 30 to

20,000 Hz and a uniform off-axis rejection.

Circle (288) on Reply Card

Auditronics

The Model 1000 audio distribution amplifier features quick, solderless installation through the use of quick-connect screw terminals on the rear of the mainframe.

The Model 110A Grandson is an expandable, completely modular professional recording/remixing/on-air audio control console.

The Model 110-8 Grandson II is a fully professional complete 8-track recording console system that may be easily expanded to 16-track capability with plug-in modules.

Circle (289) on Reply Card

Aurora Imaging Systems

The Digital Videographics System may be accessed from a design station or from a display station. A design station includes two color monitors and a digitizing tablet and stylus. Using the stylus on the tablet, the artist paints and draws directly into the video picture on the monitor.

A display station consists of a keyboard and color monitor. The operator may call up a sequence of stored graphics or animation by name. Animation can be cued, paused for narration or started over instantly without waiting for tape pre-roll.

Circle (291) on Reply Card

Autogram

The Autogram T-8 Test Set is designed for measuring audio frequency response of complete broadcast audio systems. Eight preset switchable sine wave audio frequencies are available at three different switchable preset signal levels.

Circle (290) on Reply Card

AVAB America

The FM 800 Mixer features pre-fade listening, line/mic switch, monitor switch and level control, reference oscillator, stereo panpots, input switches and mixer to boom man talkback.

Circle (292) on Reply Card

Avantek

The ACA-4220 is a completely self-contained assembly of low noise GaAs FET preamplifier, block downconverter, local oscillator, filter and IF amplifier. Converting the entire 3.7-4.2 GHz downlink band to a convenient 1440-940 MHz intermediate frequency range, one ACA-4220 provides

the critical front-end performance for virtually any number of tunable or fixed frequency receiver/demodulators.

The Model AR1000 simulchannel earth station video receiving system combines the ACA-4200 antenna-mounted LNA/Downconverter with a modular IF receiver/demodulator assembly.

Circle (293) on Reply Card

BGW Systems

The BGW 320 and 620 2-channel Audio power amplifiers are specifically designed for commercial sound applications.

The 750 Series Professional Amplifiers feature 225W per channel, 720 W monaural.

Circle (294) on Reply Card

The BTX Corporation

The Shadow System is a fully intelligent controller and synchronizer of audio and videotape machines. The Shadow synchronizes to within 1/100 frame in play modes, and to 10 frames (maximum) in wind modes.

Circle (295) on Reply Card

Beaveronics Inc.

The company markets three standard video production switching systems: the J & D 712, the BI-154 and the BI-156. All three incorporate synchronous/nonsynchronous detection allowing only cuts for non-synchronous sources.

Circle (297) on Reply Card

Belar Electronics Inc.

The FMM-1 Frequency and Modulation Monitor is a wideband all solid-state FM Monitor designed specifically for new requirements for monaural monitoring as well as to provide a distortionless demodulated signal to drive the companion FMS-1 Stereo Frequency and Modulation Monitor for multiplex monitoring.

The FMM-2 features ultra-linear discriminator to ensure low intermodulation distortion, sample hold peak modulation meter circuit, and a digitally set peak indicator.

Circle (298) on Reply Card

Belden Communications Inc.

The Lee 200 Strobe Free HMI Unit requires 48Vdc but the supply to the lamphead is at 2000 Hz AC.

The detachable NiCad battery Pack will give 30 minute light life with constant light transmission and color temp. The NiCad cells are protected

by an auto cut out when the charge has expired.

Circle (299) on Reply Card

Bell Helicopter

The 5-place *Bell JetRanger III* and the 7-place *Bell JetRanger II* for ENG operations.

Circle (300) on Reply Card

Berkey Colortran

The *Channel Track System* allows for storage of cues, fades, submastering and manual overrides. It features memory control, masters function, timed faders, manual faders, channel control function, manual controls and a display function.

The *Mini-Ellipse* is a new multi-spread ellipsoid for short-throw applications.

The *Colortrack Lighting Control System* provides instantaneous storage and instantaneous random and sequential access of dimmer channel intensities using solid-state memory. The stored intensity information shall be accessible at all times for modification in either the active or blind modes.

The company also offers lighting fixtures, portable kits, dimmers, accessories for TV and motion picture studios and remote lighting.

Circle (301) on Reply Card

Best Audio

The *Console* has a main console frame containing 48 full VCA input modules. They have been mounted in a modified 40-input frame, the monitor and return modules have been redesigned and moved to provide space for 10 additional eight inputs.

Circle (302) on Reply Card

BEI Beston Electronics Inc.

The *Data Prompter* is an all electronics system designed to perform text editing, assembly and material handling tasks as well as automatically controlling the speed of presentation to talent.

The unit also has line 21 for close captioning for the hearing impaired.

Circle (303) on Reply Card

Beyer Dynamic (USA) Inc.

The *DT 48 Headphone* has a wide frequency response, high sensitivity and low distortion. Maximum output is rated at 125 dB SPL.

The *DT 102 Headphone* is a single muff design with high acoustic isolation, together with rugged construction necessary for professional use.

The *DT 108/9 Earphones* provide a frequency response from 30-20,000 Hz

D.C. Servo Drive Runs Smooth Steady Cool

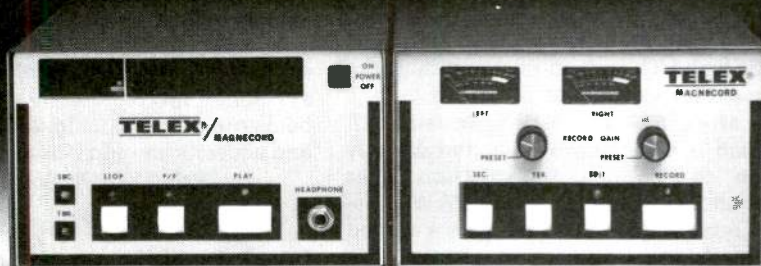

Of course, it's Telex/Magnecord

Telex Magnecord broadcast cart machines run cool and steady. So cool no ventilation is required, so steady not even voltage or frequency fluctuations will alter their speed. Thanks to our dc servo flutter-filter drive. Completely immune to RFI and EMI, it meets or exceeds all NAB standards and is suited for local or remote/automated operation.

Standard features at no extra cost.

- An edit pushbutton to add stop cues in playback and omit stop cues in record
- LED indicators show end of tape, status and secondary/tertiary cue tones
- Front panel headphone jack
- VU meters for each channel

Convenient, Flexible

MC-Series is field convertible from mono to stereo, or play to record. Optional remote controls simply plug in.

Four broadcast cart machines to choose from in the Telex/Magnecord MC-Series - all made in U.S.A. and affordable. Write for detailed information.

Quality products for the audio professional



TELEX

9600 ALDRICH AVE. SO., MINNEAPOLIS, MN 55420 U.S.A.

Telephone: 612-884-4051, telex: 29-7053

EUROPE: 22, rue de la Légion-d'Honneur, 93200 St. Denis, France, Téléphone: 820-98-46, telex: 63-0013

CANADA: Telak Electronics, Ltd., 100 Midwest Road, Scarborough, Ontario M1P3B1, Telephone: 416-752-8575

Circle (75) on Reply Card

Other equipment

with a nominal 400 ohm impedance.

The M 260 Ribbon Microphone provides a flat frequency response from 50Hz-18kHz and uses a special high energy transducer.

The MCE-5 is less than 1 inch in length and weighs only 6.5 grams. The non-reflective black surface passes virtually unnoticed in camera applications

Circle (304) on Reply Card

Bird Electronics

Moduload self cooling RF terminating systems for CW, AM, FM, SSB and TV transmitters eliminate the need for external cooling water.

Model 8790 80,000W Thermaline RF load is designed to be bolted directly on to 6 $\frac{1}{8}$ -inch transmission lines without adapters. This 80kW line-mounted Econoload features a rugged resistor that withstands shocks, it is field replaceable and has a lower pressure drop.

Circle (305) on Reply Card

Blonder Tongue Laboratories Inc.

The MUB-57 is a 75 ohm UHF distribution amplifier with automatic level control to amplify and stabilize output signal levels while allowing large input changes and providing automatic overload protection.

The SCMA series offers a full range of single-channel 3x5x2 inch weather-proof housings completely lightning and surge protected.

The BSF-U is a tunable UHF trap for coaxial cable. The unit has a bandpass from dc to 1 GHz with two isolated traps that are tunable over the entire UHF and translator bands.

Circle (306) on Reply Card

Bogner Broadcast Equipment Corp.

Bogner broadcast quality broadband slot antennas designed for translator and low/medium power TV broadcasters

Still in the prototype form is the omnidirectional low power broadcast antenna featuring horizontal polarization, 1 kW maximum input power and a frequency range of any one channel from 2-6 or FM.

Circle (307) on Reply Card

Boston Insulated Wire and Cable Company

The XV/RV-1100 System consists of the XV-1100 transmitter and RV-1100 receiver. Both units use linear amplitude modulation and dc coupl-

ing throughout to assure transmission of composite video signals of all sorts.

The TK 47 Series In-line Connectors are environmentally sealed for durability. High density contact and pin arrangement create the sleek size.

The TK 47 Panel Mount Series is designed to enable a cable system to be interconnected without the need for additional adapter assemblies.

The BQ Right Angles Series provides an alternative to typical in-line cable connection when space and practicality require a durable, quality connector with the capacity of being installed at right angles to its mate.

Circle (309) on Reply Card

Walter S. Brewer Company

A complete source for lamps, distribution equipment, control systems, meters, cyclorama and background curtains including tracks and accessories, and studio ladders.

Circle (310) on Reply Card

Broadcast Audio

The System 20 Stereo Broadcast Mixer consists of a mainframe, output amplifiers and power supply only.

System 16 is an expandable, completely modular broadcast mixer that uses a motherboard construction with only two types of amplifier modules and a plug-in interconnecting harness.

Circle (311) on Reply Card

Broadcast Cartridge Service Inc.

The company features Fidelipac broadcast cartridges, Capitol audiopaks cartridge storage systems and cartridge reloading services.

Circle (909) on Reply Card

Broadcast Controls

The 1601S Microprocessor Sequencer has full EOM tone controlled audio overlap and switching, almost instantaneous switching, and up to 1000 feet direct connection

The System 80 provides total automation control for any format. The 2800 APM Automatic Program Control System enables the operator to program an entire schedule of broadcast events for automatic sequencing and error-free control.

The 2400R Kartel is a multiple cartridge playback system that is compatible with any automations system or can be manually and remotely controlled.

Circle (313) on Reply Card

Broadcast Electronics Inc.

The 1-tube FM-1.5 incorporates a folded $\frac{1}{2}$ -wave cavity power amplifier

design, digitally programmed FX-30 ultra linear exciter and a microprocessor-based control system. The entire transmitter is contained in a single low profile cabinet with easy access to all components.

The S model FC-30 SCA Generator features a low FM noise, highly stable, ultra-linear 67 kHz modulated oscillator that ensures minimum distortion.

Circle (314) on Reply Card

Broadcast Systems Inc.

BSI specializes in supplying vendor systems products such as waveform and vectorscope monitors, color and b&w monitors, pulse generation and distribution systems, video distribution systems, routing systems, master clock systems; audio origination and control and frame synchronizers and TBCs.

Circle (318) on Reply Card

Broadcast Video Systems Ltd

SA-100 Safe Area Generator ensures correct positioning of picture information regardless of the monitor scan setup. No guesswork remains on positioning of graphics.

The PW-200 Pulse Width measuring set makes possible the continuous monitoring and accurate measurement of any pulse duration occurring in the vertical or horizontal intervals of a TV waveform.

The LS-300 Line Selector expands the versatility of the EV4040 waveform monitor and provides displays of VITS, VIRS and Teletex code.

Circle (319) on Reply Card

CCA Electronics

See Singer Broadcast Products.
Circle (910) on Reply Card

CMC Technology Corporation

The AE 2000 and AE 1200 Auto Equalizers reduce saturation banding, facilitate reproduction of material recorded with non-standard chroma level and non-standard female guide position and improved head life by eliminating the need for readjusting the female guide penetration when recording with a low tip projection head.

The DG 1200 Channel Amplifier features front panel control of DG for each channel.

XPL Heads feature increased head life, improved interchangeability, reduction of chroma noise and chroma saturation banding.

Circle (320) on Reply Card

CMX Orrox

Four new features have been added

WE'VE MOVED...

With a Trainload of Electron Tubes



**NOW...
We Can Serve You Better!**

JSH ELECTRONICS, INC.

WORLD'S LARGEST DISTRIBUTOR
OF ELECTRON TUBES

AMPEREX	RCA
EIMAC	RAYTHEON
GE	SYLVANIA
NATIONAL	VARIAN

**And All Other Major
Tube Manufacturers**

"THE TUBE SPECIALISTS Serving the Broadcast Industry!"



JSH ELECTRONICS, INC.

A Member Company of VSI Electronics International
15682 PRODUCER LANE
HUNTINGTON BEACH, CA 92649
Telephone: (714) 895-2298

Order Desk Numbers:

Toll-Free (Outside California) (800) 854-7651
Toll-Free (Within Calif., except 213/714) .. (800) 472-8441
Toll-Free (213 Area, Los Angeles) (213) 598-9633
714 Area (Orange/San Diego Counties) ... (714) 898-1171

Circle (76) on Reply Card

Other equipment

to The Edge. They are an audio-video dissolver, effects switcher control, list sweep and a 340X edit decision list.

The *FLM-1 Film Editor Controller* is a dual microprocessor-based machine control system tailored specifically for film-style operation.

Circle (321) on Reply Card

CSI Electronics

The *Model T-50-A AM Broadcast Transmitter* allows for all tuning and loading adjustments from front panel, has a hinged exciter panel for accessibility and has low voltage control circuitry for safety.

Circle (322) on Reply Card

Cablewave Systems

Wellflex Transmission Lines are available with air or foam dielectric with copper corrugated outer conductor, solid and corrugated inner conductor and a durable corrosion resistance polyethylene jacket suitable for burial and prolonged life.

Types *WE190* and *WEP190 Wellflex Elliptical Waveguide* operate in the 17.7 to 20.3 GHz frequency range and are designed to provide low attenuation characteristics for short haul 18 GHz industrial and common carrier microwave radio systems.

Circle (323) on Reply Card

Cal Datacom

The *CD/300 Teleterminal* can directly access TLX, TWX and Direct Distance Dialing. The unit also functions as a computer terminal.

Circle (911) on Reply Card

California Microwave

See satellites on page 70.

Circle (324) on Reply Card

Cambridge Products Corporation

The company features type N crimp style coaxial connectors and UHF-RF coaxial connectors.

Circle (912) on Reply Card

The Camera Mart Inc.

Their products include those manufactured by Hitachi, Ikegami, Microtime, Panasonic, Sony, Sharp, Cinema Products, Ultimatte, Videotek and many more.

Circle (325) on Reply Card

Canadian General Electric Co. Ltd.

See TV transmitters on page 78.

Circle (326) on Reply Card

Candex Pacific Inc.

The company features SAMS, their Source and Message System, VISE, the Vertical Interval Source Encoder and VIPS, the Vertical Interval Picture Source.

Circle (913) on Reply Card

Canon U.S.A. Inc.

The *Two Assignment* concept for using ENG cameras for field and studio production has been established with the use of the J series of lenses. Because ENG cameras must be lightweight and rugged, Canon has offered the J13x9B and the J13x9B IE with built-in extenders, for use with the 2/3-inch image tube ENG cameras. The P18x16B AF, an 18x zoom lens for 1 1/4-inch format cameras, employs an infrared active-type auto focus system.

The *U-1B2* is a computerized remote control motorized camera support system that after programming will automatically reposition camera orientation, focus and zoom at the touch of a button.

Circle (327) on Reply Card

Capitol Magnetic Products

AudioPak A-2 broadcast cartridge. *AudioPak AA-3* audio cartridge. Uses Capitol's Q17 HOLN high output, low noise lubricated tape.

Circle (914) on Reply Card

Cases Inc.

The *Gem Tool Case* has solid metal-to-metal construction, lid pocket for printed material, compartmentalized base, removable multi-tool pallets. The unit measures 18x13x6.

The *Endura Carrying Case* is built tough to resist the elements

Circle (915) on Reply Card

CaVox Stereo Productions

The *Tape-Athon Model 750 Dual Cassette System* consists of two TR 100 transports and the "Round Robin Sequencer," capable of program intermix, housed in a compact, rugged, all steel cabinet.

Circle (330) on Reply Card

Central Dynamics

The *CD-480-4 Switcher* includes the CD-480 SFX amplifier that permits control of four video signals in any combination, with one fader handle, plus a wide range of CD-480 modular options.

Circle (331) on Reply Card

Cetec Broadcast Group

The *MAPS Radio Station Business*

LIMITED
TIME OFFER

Trade Up To Eventide's BD955 Save Up To \$640.

If your station still uses tape delay, here's a money-saving opportunity to trade up to the Eventide BD955 Broadcast Delay. For a limited time, trade-in any tape machine and Eventide will give you an allowance of up to \$640 towards the purchase of the BD955—the broadcast delay that breaks Murphy's Law with no-moving-parts digital reliability.

Here's how it works: Send us any tape machine (reel-to-reel, cartridge, even cassette) in any condition, working or not. The tape machine need not be set up for delay operation.

We'll give you a trade-in allowance of up to \$640 depending on which BD955 model you select:

Trade-in Allowance	BD955 Model Max. Delay / Bandwidth
\$640	6.4 second / 15kHz.
\$320	3.2 second / 15kHz.
\$160	1.6 second / 15kHz.

Prefer the extra economy of our 7.5kHz. models? We'll still give you a trade-in allowance:

\$320	6.4 second / 7.5kHz.
\$160	3.2 second / 7.5kHz.
\$ 80	1.6 second / 7.5kHz.

This offer ends September 30, 1981, so see your Eventide dealer soon, or call Eventide at (212) 581-9290 for further information. Say goodbye to that old tape troublemaker and save on an Eventide BD955. You've been living with Murphy's Law long enough.

Eventide's BD955 Broadcast Delay Breaks the Law...

Murphy's Law.

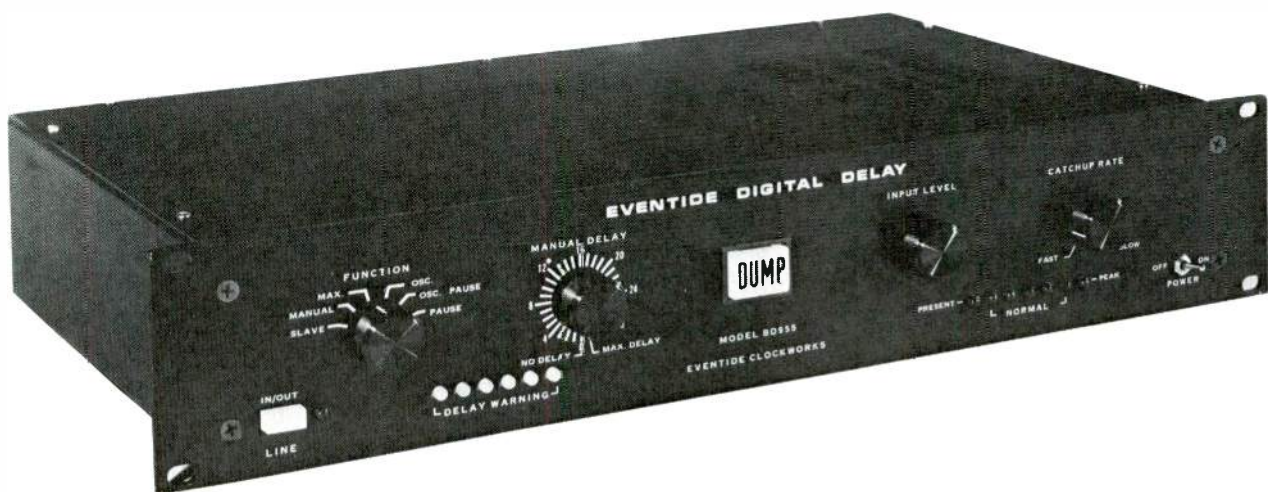

No Tape Loops That Snap • No Moving Parts That Fail • No Dead Air.

If something can go wrong, it will. That's the reason tape delays became common in the first place—to give the broadcaster time to delete the unexpected expletive or libelous statement.

But all too often it's the tape loop delay itself that "goes wrong." Tape loops snap while they're on the air. Or the fill cartridge that many stations use to "cover" the deleted airtime, malfunctions. And errors are frequently made by harried station personnel executing the complex process to get in or out of delay. The net result of all these is dead air...it's unfortunate, but Murphy's Law says it's inevitable.

The Eventide BD955 Broadcast Audio Delay breaks Murphy's Law. Its digital memory replaces unreliable tape loops, so tape loop snaps are banished forever. The BD955's auto catch-up feature eliminates the need to fill the delay period. Instead, as the DUMP button is pressed, the delay instantly goes to zero and the objectionable material is deleted. Then the BD955 automatically rebuilds the delay as the program continues. This action is virtually unnoticeable to the listener. You have to hear it to believe it.

With the auto catch-up feature, getting in and out of (and back into) delay is no problem. In fact, the BD955 is so reliable, many stations simply leave it in-line around the clock.

And there's even more value built into the BD955. When not being used as an obscenity delay, the unit does double duty as a valuable production tool. Any delay from 6.5 milliseconds to the unit's maximum can be set from the front panel, so you can get a wide variety of reverb, "doubling" and other vocal and musical production effects.

The Eventide BD955 is available with maximum delays of 1.6, 3.2 or 6.4 seconds and with full 15 kHz or telephone-compatible 7.5 kHz response. So you need pay only for the capabilities you need.

Before your tape loop delay fails again, get an Eventide BD955. You've been living with Murphy's Law long enough.

Eventide
the next step

Eventide Clockworks Inc. 265 West 54th Street New York, N.Y. 10019 (212) 581-9290

Other equipment

Automation System is dedicated to programs for radio station management accounting, programming and sales.

The 8000 Console is modular throughout for flexibility and easy maintenance. Eight channels and 24 inputs are standard and can be expanded to 16 channels and 48 inputs.

Circle (334) on Reply Card

Cetec Vega

The Model 58 and Model 63 Receivers are extremely sensitive, selective and inherently stable. From mic input to receiver output, the overall audio response is flat from 40Hz to 15kHz at average modulation levels.

Dynex (*Dynamic Expansion*) is an audio signal processing technique used by Cetec Vega to increase the dynamic range of wireless mics and to reduce residual noise.

The Model 80 and Model 81 Hand-Held Wireless Mics use a standard 9V alkaline battery, offering from seven to nine hours continuous use and a range up to 1000 feet.

Circle (335) on Reply Card

Cezar International Ltd.

The Controller is a microprocessor-based, low-cost editing system for use primarily with 3/4-inch and 1/2-inch format VCRs.

The Editing Centre is an expanded version of the microprocessor-based EA-3x. The unit will control any combination of two 3/4-inch or 1/2-inch VTRs including Sony 2260, 2860, BVU-200 series, Beta series, JVC 5500, 6600, 8200, Panasonic 9240, 9600, AU-700, NV 8200 1/2-inch and others using a set of multipin remote control cables that do not require VTR modifications.

Circle (336) on Reply Card

Chase Media Inc.

The CADO System handles music format control, traffic and billing, accounts receivable, payroll, general ledger, management reports and spot sales.

Circle (916) on Reply Card

Christie Electric

The Sequencer Model RS1 when used with ReFLEX-20 charges up to eight different batteries automatically in less than four hours.

ReFLEX-20 System employs a revolutionary patented charging con-

cept—interjection of controlled negative/discharge pulses during the charging process.

Circle (337) on Reply Card

Chyron Corporation

The Chyron Cassette Cleaner and Evaluator Model U-1A is a compact, completely self-contained, easy-to-operate system for rapid cleaning and evaluation of 3/4-inch type U format video magnetic tape in both standard and small size videocassettes.

The Chyron IV features 27-nanosecond resolution, multifont library, proportionally spaced characters and a 64-color palette.

Circle (338) on Reply Card

Cine 60

The ENG-1 Charger is designed to charge any make or brand of 6V to 14.4V NiCad battery of any capacity from 1.2 AH to 7AH, standard or fast charge types.

Circle (339) on Reply Card

Cinema Products

The EFP Matte Box is a swing-away-type matte box that maintains constant orientation. It features two clip-on rotatable filter stage.

The Newsmaker Edit Controller is designed to interface with a variety of VTR models used throughout the video industry. The separate Digital Select Vari-Glide (DSVG) controls for both source and record side VTRs, simplifies tape shuttle and edit point location.

For information: Cinema Products, 2037 Granville Ave., Los Angeles, CA 90025.

Circuit Research Laboratories

See audio processors on page 64.

Circle (340) on Reply Card

Clear-Com

System II features increased station capability, higher output levels and stable side tone.

New products that have been added to the line include the SB-412 4-Channel Matrix/Switchboard, MS-400 4-Channel Main Station and RM-400 4-Channel Remote Station.

Circle (341) on Reply Card

Cohu Inc. Electronics Division

The 1550B Telecine System is a professional quality broadcast color camera featuring the 8500 Color Encoder with image enhancer, automatic balance, automatic differential gamma balance and an optical color comp variable masking system.

Circle (342) on Reply Card

Colorado Video Inc.

The Model 260B Video Compressor converts standard TV signals to narrow bandwidths for transmission over voice grade communications circuits.

The Model 262A Video Compressor is a completely solid-state sampling scan converter that accepts standard composite TV signals and reduces video bandwidth to the audio range.

The Model 275 Video Expander is a solid-state video memory capable of storing one frame of video information.

The Model 285 Digital Slow Scan Transceiver provides the capability to transmit and receive pictorial information over narrow band communication channels using standard or special digital modems.

Circle (343) on Reply Card

Colorgraphics Weather Systems

The Colorgraphics System will permit a blend of weather data handling, without teletype machine or teletype paper cost.

Circle (917) on Reply Card

Columbine Systems

The company offers a total broadcast information system featuring the convenience, control and reliability of on-site equipment.

Circle (344) on Reply Card

Comark Communications

The CI-5080 Remote Control provides control and monitoring of multiple customized functions over any 2-way audio frequency communications channel, such as a leased line, STL link or other dedicated service.

Also see cameras and TV transmitter articles.

Circle (345) on Reply Card

Comex Communications

The company distributes the products of US manufacturers of professional communications equipment.

Circle (346) on Reply Card

CEI Commercial Electronics Inc.

See camera articles.

Circle (347) on Reply Card

Compact Video Sales

The Compact 20-B is designed for network operations, commercial production and local origination cable TV. It offers stand-up room and can be fitted with two cameras, VTRs for both 1-inch and 3/4-inch tape, production switchers, character generator

PERFORMANCE INFLATION

Our SERIES II broadcast mixers now offer even better specifications, but at no increase in price. We call that PERFORMANCE INFLATION!

For instance, the maximum output level has been increased to +26 dBm; THD is lower (less than 0.05% at 1 KHz) and equivalent input noise is only -125 dBm. SERIES II features a spectacular new output amplifier, which will also retrofit previous models, for improved performance.

In addition to SERIES II 8/12/16 mixer consoles, we're now delivering SYSTEM 20 — an exciting new product with optional pan pots and 7-frequency graphic equalizer at each mixing position. Our new Monitor Amplifier has up to four 35 watt channels and we've just introduced a remarkable Passive Equalized Phono Preamp for better record reproduction. Try Broadcast Audio's approach to equipment cost and quality.

PERFORMANCE INFLATION!

**BROADCAST
AUDIO CORPORATION**

11355 PYRITES WAY
RANCHO CORDOVA, CA 95670
(916) 635-1048

Circle (79) on Reply Card

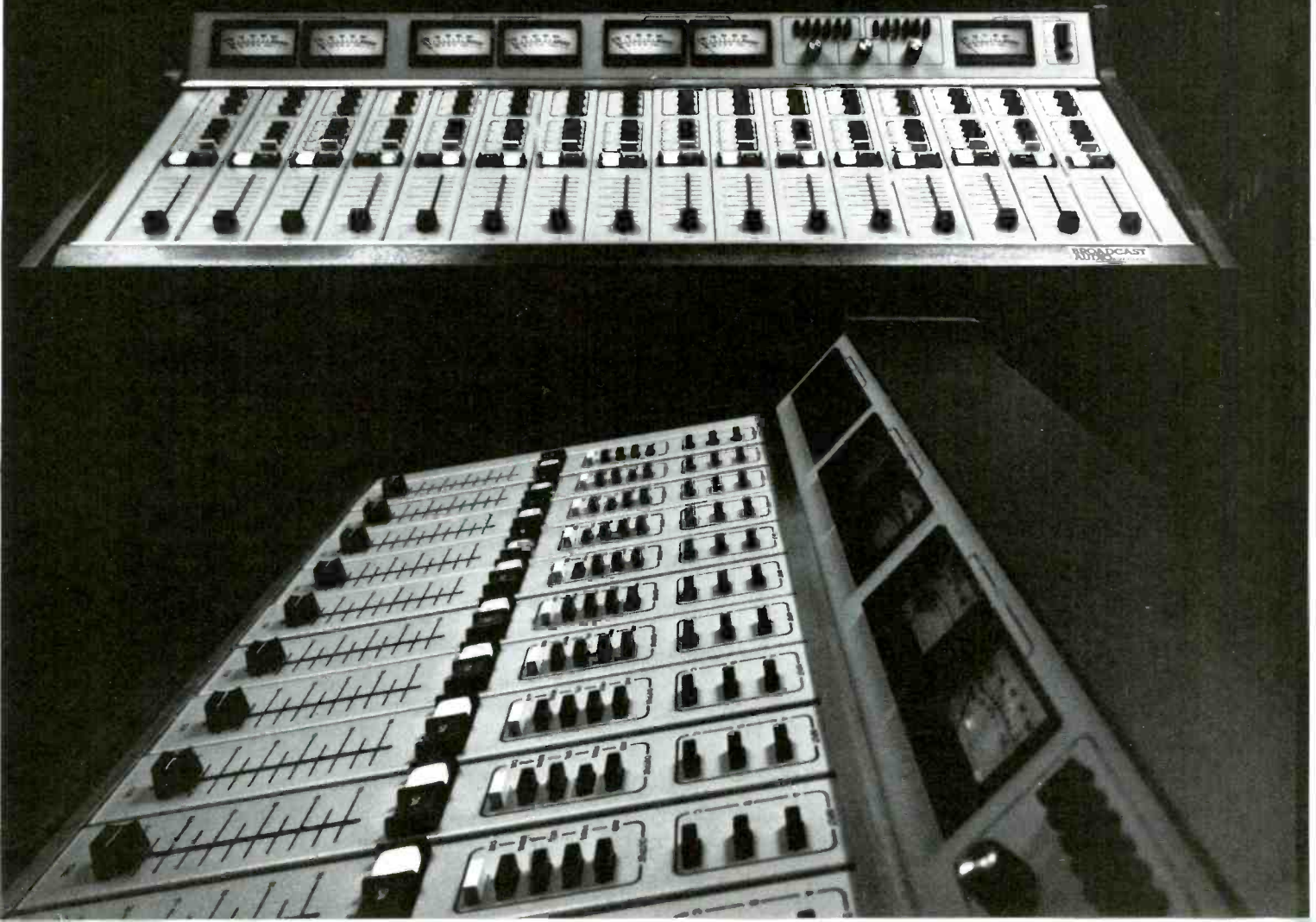

Other equipment

and audio mixing.

The *Compact 22* is designed for the producer-director. There is room for four cameras, two VTRs and a separate soundproof audio booth.

The *Compact 27* is a complete mobile production control room designed to contain up to six broadcast-quality cameras with up to three 1-inch VTRs and other basic state-of-the-art equipment.

Circle (348) on Reply Card

Comprehensive Video Systems

The *Comprehensive Powerbelts* are a new line of high quality battery belts for the industrial and educational video users.

Circle (349) on Reply Card

Compucon Inc.

Also see *satellite article*.

Circle (350) on Reply Card

Computer Concepts

The *Broadcast System* automatically schedules logs with complete horizontal, vertical and random spreading. The AM and FM logs can be printed for any one of the 21 future days as often as necessary. The system will also automatically calculate and print invoices for each customer in the billing cycle. Up to 255 billing formats are available.

Circle (351) on Reply Card

Computer Graphics Labs

The *Image Manipulation and Generation Electronic System (IMAGES)* is an integrated system of computer and video hardware, software and firmware designed to allow creative artistic talent to generate graphics on a color video display.

Circle (352) on Reply Card

Computer Management Systems Inc.

The *BMIS System* features open item accounts receivable for instant resolution, automatic end of scheduling billing, comprehensive analytical reports for management and self-auditing features.

Circle (353) on Reply Card

Computer Video Systems Inc.

The *Compuvid* is a new generation microprocessor data display system that contains only two printed circuit modules that are interchangeable. A

third circuit module is available for memory expansion.

Circle (354) on Reply Card

Comrex Corporation

The *450 RA/TA Wireless Microphone System* consists of a 150 mW pocket transmitter, model 450 TA and a camera mount receiver, model 450 RA. The system is designed to provide interference free broadcast-quality audio transmission.

The model *CRA TV Monitor Receiver* is a pocket-size monitor receiver designed to monitor TV aural channels during live programming.

The model *TLX* is a rack-mounted transmitting encoder designed to encode the output of a console for transmission over dial telephone, microwave, satellite and cable circuits to a Comrex *RLX* receiving encoder.

Circle (355) on Reply Card

Comsearch

The company provides earth station coordination, terrestrial point-to-point coordination, field services and protection and data base maintenance.

Circle (356) on Reply Card

Concept Productions

The company provides various formats of music formats customized to individual needs.

Circle (357) on Reply Card

Conrac Corporation

The *Multi-Standard Color TV Projector Gretag 5170* can be used with color TV cameras, VTRs telecines, professional TV receivers and graphical data and character generators with TV compatibility.

Circle (358) on Reply Card

Continental Electronics Mfg. Co.

The *Model 317C-2* is a 50kW broadcast transmitter built to meet programming demands.

The company also manufactures 5, 10 and 50kW AM transmitters, antenna phasing and coupling equipment, diplexers, filters, combiners and all special requirements related to AM transmitting systems.

Circle (919) on Reply Card

Control Video Corporation

The *CVC synchronizer* is a compact, self-contained, microprocessor-based system capable of controlling the capstan motors of magnetic tape recorders to synchronize them to any available capstan pulse or SMPTE time code. The synchronizer is designed to work with any of the *CVC*

machine interfaces. A basic two machine synchronizer can control ATR to VTR, VTR to VTR or ATR to ATR.

Circle (359) on Reply Card

Convergence Corporation

The *ECS-104 Controller* offers full auto assembly list management capability. The unit includes the *ECS-104 Edit Controller*, one *DD-100 Dual Disc Drive* two *TCR-90/100 Time Code Readers* and three 3/4-inch interfaces.

The *SM-90*, a low-cost single VTR controller features joystick scene search, programmable cue-back for on-air program rolls, high speed search, single monitor operation, switchable status display and source material monitoring.

Circle (360) on Reply Card

Cool Light Company

The *Heat Free Mini Cool light* is a hand-held model on a standard 3/4-inch stand or camera. It is also available with daylight conversions.

Circle (361) on Reply Card

Corporate Communications Consultants

The *System 60XL* is a state-of-the-art film-to-tape transfer with optional pre-recorded videotape color correction in a switchable basis.

Circle (363) on Reply Card

Crosspoint Latch Corporation

Auto Drive is a versatile programmable controller for the 6112 and 6124 series switchers.

As a production tool, it enables artistic combinations of effects that could not be achieved manually to be generated with precision and ease.

As an editing tool, the system can be programmed to perform effects and switching for multiple tool edits.

Circle (364) on Reply Card

Crown International Inc.

The *Crown PS-400 Power Amp* is designed for professional systems.

Circle (365) on Reply Card

Custom Business Systems

The *Wang 2200 SVP* handles information processing such as accounting, inventory and sales analysis; computerizing a specific function such as order entry or payroll; or can serve as a small computer to talk to a larger computer.

Circle (366) on Reply Card

D-B Electronics

The *DB-TEL Equipped Cartridge*

Other equipment

Machine provides high quality messages delivered to the telephone without operator assistance.

The Model DB-2000 2-Deck Cartridge machine has simultaneous record and playback, individual electronics for each deck, manual fast forward, standard, and the plug-in board provides for field installation of Cue I, Cue II options.

Circle (375) on Reply Card

dbx Inc.

The Model 140 Simultaneous Encode/Decode Broadcast Noise Reduction System is a 2-channel compressor/expander providing a minimum of 30 dB broadband audio noise reduction with a 10dB increase in system headroom.

The Models 941 and 942 Broadcast Tape Noise Reduction Units provide broadcasters with Type II noise reduction in the 900 series modular format.

Also see audio processor article.

Circle (376) on Reply Card

Data Communications Corporation

The Master Control Automation Module automates on-air switching and machine assignments, verifies machine delegation and provides stations with up to five alternate schedule logs to support the main program log.

Circle (377) on Reply Card

Datametrics

The Model 716 Code Generator syncs to the RS-170A color frame standard and the 710 has video insertion capabilities for low cost burn into workprints.

The Model 722A Code Reader/Generator reads, generates and displays time and user data in a single chassis design.

The Model 760 Reader and the companion 766 Generator allows for automatic calculation of segment duration video titling functions.

Circle (378) on Reply Card

Datatek

The Datatek Identification of Source System is made up of a family of plug-in module units designed to insert alphanumeric identification codes into a line in the vertical interval of a TV signal; to read this information and key it into the active portion of the signal for display on picture monitors; and to delete this vertical interval

We have the best 2/3" tube for your EJ camera... now.

tube talk



P-8160 Leddicons®

The newest addition to the successful family of EEV Leddicon tubes.

The P-8160 is directly interchangeable with all existing lead oxide tubes.

Lowest lag and no blooming.

EEV Leddicons are rated the best for these image tube characteristics.

EEV 2/3" Leddicons meet the same high performance standards as the 1" and 30mm Leddicons, and are the newest extension to EEV's hallmark of high quality and reliability.

The P-8160 is the best 2/3" lead oxide tube available TODAY.

Call or write today for complete details.

* Registered Trademark of
EEV Lead Oxide Camera Tubes

At EEV... *your image is our business.*



EEV, INC.

7 Westchester Plaza, Elmsford, NY 10523, 914-592-6050
EEV CANADA, LTD., Rexdale, Ontario, 416-745-9494
English Electric Valve Co. Ltd., Chelmsford, England
Telex 851-99103

Members of the GEC Group of Companies

Circle (80) on Reply Card

Other equipment

code where its presence is not desired.

Circle (379) on Reply Card

Datatron Inc.

The *Tempo 76 System* provides A/B roll editing capability with up to three decks and switcher, in either SMPTE or control track operation. Additional capabilities of the unit include split edits, auto assembly from two program sources and up to 320 events of edit list memory.

The *Vanguard* is a microprocessor-based 5-VTR SMPTE control track editor that interfaces to a variety of quads, cassette decks, 1-inch type C VTRs, audio decks and telecines.

The *Smart Scan* is a new option for the *Vanguard* system that allows the operator to make use of variable speed recording capabilities.

Circle (380) on Reply Card

Datatronix

The *Automated Processes Model 525 Compressor Limiter* is designed for reducing distortion because of overload or overmodulation of program peaks in recording or broadcast applications.

The *Automated Processes Model 553* is a low-cost modular equalizer suitable for a wide variety of applications in broadcasting, recording, film mixing and sound reinforcement installations.

Circle (381) on Reply Card

Davis & Sanford

The company features dollies, tripods and heads.

Circle (923) on Reply Card

Delcom

The *AE-3 Auto Effects Interface* combines the editing capabilities of the *Convergence Corporation ECS-103* with the special effects of the *ISI 902* production switcher resulting in expanded post-production techniques.

Circle (382) on Reply Card

Delta Electronics

The *RCS-1 Remote Control/ATS System* is designed for unattended monitoring and control of standard broadcast, FM and TV stations.

Circle (383) on Reply Card

Dictaphone Corporation

The *Series 5600* is a 3-motor deck with a dual capstan hysteresis synchronous drive system that ensures stability when minimizing tape tension and stress.

Circle (384) on Reply Card

Dielectric Communications

The *Model 3150-A* is a field rugged RF wattmeter and 50 ohm dry load unit. Full scale power ranges of 5, 15, 50 and 150 watts are easily selected with the front panel switches. The *1000 Series* of directional wattmeters consists of *Model 1000-A* and *1001-A*.

The *Model 1000-A Wattmeter* measures RF power in 50 ohm coaxial cables and transmission lines.

The *Model 1001-A* is a rugged model 1000-A with the added feature of an auxiliary dc input.

Circle (385) on Reply Card

Digital Video Systems

The *DPS-1 Time Base Corrector* consists of a mainframe, input control modules and a 32-line memory and digital Velcomp. The unit, with advanced sync may be used with a format C 1-inch VTR or using derived subcarrier or the optional Heterodyne Processor, may be used with any cassette VTR.

The *DPS-1 Frame Store* uses a combined framestore, TBC and synchronizer to lock any incoming signal to station sync.

The *Phaser* will synchronize any remote feed from ENG, satellite network or any heterodyne VTR to station sync.

Circle (386) on Reply Card

Di-Tech Inc.

The *Model 404 Video Presence Detector* employs four separate sync detectors each with associated relay alarm circuitry.

The *Model 403* has been designed to use at remote unattended areas where automatic video and audio switching is required when a failure occurs in the transmission system.

Circle (387) on Reply Card

Dolby Laboratories

The *Dolby A-type Noise Reduction Units* can be used with any audio recording or transmission channel in which the signal is available before and after the noisy segment of the channel, and where the signal at both points of access is the same, within normal operating tolerances.

Circle (388) on Reply Card

Victor Duncan Incorporated

Suppliers of everything for video production.

Circle (924) on Reply Card

Dynacom International

The company provides English language TV programming to English

speaking individuals living in foreign countries.

The *Digicode Encoding/Decoding System* is designed to provide reliable, secure and economical service in STV operations abroad.

Circle (391) on Reply Card

Dynair Electronics

The *Series 10* family of solid-state switching products is designed to fill small routing switcher requirements.

The *System 23 Data Switcher* features high performance digital data switching for communications, telemetry, modem and machine controls.

The *System 21 Switcher* features high performance switching for video, audio, SMPTE time code, tally, intercom-PL and data.

Circle (390) on Reply Card

EEV

The company offers electron tubes for Electro-Optical, transmitting/receiving display including Led-dicons, Vidicons, Klystron amplifiers, character display tubes, cathode ray tubes, triodes and tetrodes and special purpose detector tubes.

Circle (395) on Reply Card

EG&G Inc.

The *Strobguard SS-123* is a single enclosure obstruction light designed to meet or exceed the requirements of Advisory Circulars and FAA specifications.

SS-121 and *SS-122* Controllers contain the flash interval and timing circuits, intensity selection controls and monitoring receivers with status indicators required to operate.

Circle (396) on Reply Card

ESE

The *Model ES 142* (12-hour) and *ES 144* (24-hour) Digital Clocks are MOS, solid-state digital clocks/thermometers. They display simultaneously six digits of time: (hours, minutes, seconds) and three digits of temperature in planar gas discharge displays.

The company also features master clock systems, programmable timers, time code generators and readers, audio level indicators and the *ES 790* programmable timer.

Circle (397) on Reply Card

Eastman Kodak Company

The company introduces the *Kodak Filmagic* system for film-to-tape transfer; the *Kodak* and *Eastman Motion Picture Films Reference Chart*; and the *Videofilm Notes* series of technical notes for television.

Circle (398) on Reply Card

tube talk

30 mm

**P8400
Leddicon®**
The new tube
for a
new image.

Here's why . . .

Lag is significantly improved for all channels with the P8400's exclusive variable integral light bias. . . and it's easy to set with the pot and calibrated scale on the base.

Sharper, crisper pictures at all light levels are assured with our new P8400HG tubes (high resolution green) that have 15-20% more depth of modulation.

The best "red" reproduction. The P8400 precision infrared filter cuts off false reds.

Anti microphony double damped mesh. . . only in EEV Leddicons.

Find out how the P8400 Leddicon can improve your image. . . call or write for our Tube Talk brochures.

® Registered Trademark of
EEV Lead Oxide Camera Tubes

**At EEV . . . your image
is our business.**



EEV, INC.

7 Westchester Plaza, Elmsford, NY 10523, 914-592-6050
EEV CANADA, LTD., Rexdale, Ontario, 416-745-9494
English Electric Valve Co. Ltd., Chelmsford, England
Telex 851-99103

Members of the GEC Group of Companies

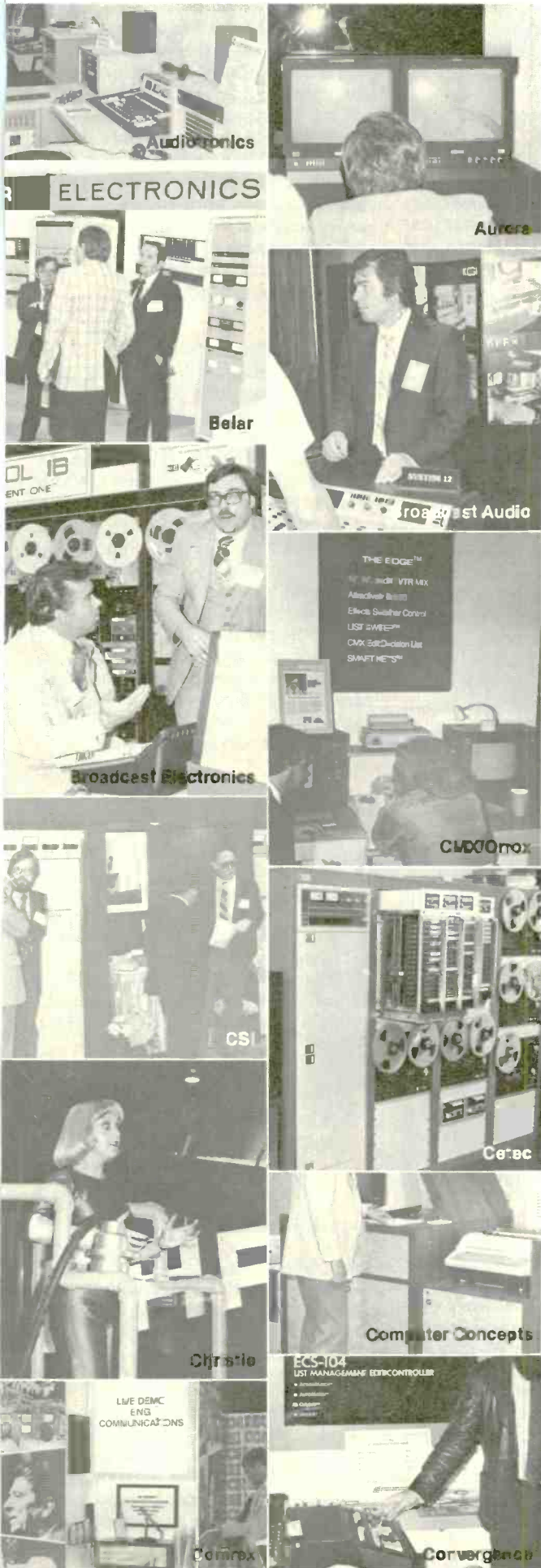

Circle (81) on Reply Card

June 1981 **Broadcast Engineering** 131

Other equipment

Echolab Inc.

SE/4 Special Effects Generator is a compact, inexpensive desk-top console unit that provides versatility in the control of both color and black-and-white cameras. Six effects are provided, including four corner inserts, a non-positionable circle wipe and keying. An internal RS-170 sync generator with gen-lock capability is provided.

Circle (399) on Reply Card

Eddor

The Multiplex Snake is a proven method of transmitting up to eight audio signals over a single microphone-type cable. The device uses digital and analog circuitry to create a timesharing encoded/decoded transmission system. Transmission lengths of 500 feet are easily accomplished, and as much as 1500 feet if proper cabling is used.

The PM 700 Modular Input Preamp Mixer is designed to provide monaural mix for any six of Eddor's input modules.

Circle (400) on Reply Card

Edutron

ccd-1h Video Time Base Corrector has a correction window of one horizontal line with a floating window that tracks the recorder. The unit features automatic color and monochrome selection, and automatic bypass relay. Video Gain Control has a range of ± 40 percent. Set-Up Control has a range of ± 15 IRE. The Chroma Gain Control has a range of ± 40 percent. Hue Control range is $\pm 30^\circ$.

ccd-2h Series Time Base Correctors feature full broadcast standard performance, wide 2H input window, horizontal enhancement, full proc amp controls, and super transparency for all heterodyne, non-segmented VTRs. Available in NTSC and PAL standards.

Y-688³² Total Error Corrector features 32-line super-wide instantaneous window Phase Comp one and two-line digital look ahead velocity compensator and phase error corrector, complete image processing, luminance noise reduction and chroma noise reduction to 10dB.

Circle (401) on Reply Card

Eigen Video

Electronic Slide Package contains the model 16-10 chassis, model 8133 I/H delay module, model 8123 chroma processor/TBC interface, model 8144 slide control with TTL, model 8162 audio dub and model 8003 discs. The

package also includes a model 8049 J Control slo-mo controller.

Circle (402) on Reply Card

Elcom Specialty Products Inc.

FM Composite Level Control WBL is a wide band overshoot processor that will allow the FM broadcaster to achieve full modulation without compromise because of the overshoot produced within stereo generators and composite STLs.

AM Modulation Processor MP-12 is a simple means of increasing the positive modulation from an AM transmitter by use of asymmetrical modulation. The use of controlled negative feedback produces asymmetrical modulation with low distortion.

Circle (403) on Reply Card

Electro and Optical Systems Ltd.

The Elector TCS Mk I Time Code Synchronizer is a versatile synchronizer suitable for use with all makes of audio and videotape recorders that can be remote capstan controlled with a resolution of ± 50 microseconds. It is designed for simple operation with a minimum number of push-button controls.

Circle (404) on Reply Card

Electro Controls

The Plexus 1000 is an economical and sophisticated memory system for lighting control, designed with a modular concept. The original unit may be furnished as a 2-scene manual control unit with no memory system, a memory system with no manual control, or both. Plexus 1000's options include: timed fade modules, submaster module, CRT display, dual floppy disc drive, remote control function, mimic module and line printer.

The Quick Connect is a patented cordless patching system that will allow any load circuit to be connected to any dimmer or non-dim source. It is designed to permit "hotpatching" under full load.

Circle (405) on Reply Card

Electrohome

The Educator 25R is a high performance color TV receiver designed especially for instructional applications. Its companion, the Educator 25RM with VP-7 Video Panel accessory added, permits full use of VTR equipment and highlights the versatility of this design.

Circle (408) on Reply Card

Electro Impulse Inc.

RF Attenuators are for use in the

design and production of communications systems. The variety of applications includes isolation from other components in test set-ups, power attenuation, signal analysis and comparison standards.

The AX Series Attenuators are a wide band RF resistive network, which can be used to reduce voltage, current and power of generators by a known amount in order to measure and analyze high RF power with a low power measuring device.

Circle (406) on Reply Card

Electronic Visuals Limited

Vector Monitor EVL4020 is a half-rack-width package simplified low-cost vector monitor. The monitor is comparable to far more expensive equipment and contains chrominance amplifier, internal reference generator with I and Q decoders on a single printed circuit board. Both NTSC and PAL versions available.

Waveform Monitor EV4040 is a half-rack-width waveform monitor for NTSC or PAL systems.

Color Signal Monitor EV4060 is a combination waveform monitor and vectorscope. A and B channels can be selected from the front panel as well as waveform or vector display.

Circle (409) on Reply Card

Electro Voice

The Model C094 Miniature Electret Condenser Omnidirectional Microphone provides a -45dB output level, with a signal-to-noise ratio of 72dB. An EIA sensitivity rating of -136dB and a dynamic range of 117dB covers a frequency response of 80 to 15,000Hz. The belt clipped power supply/buffer module allows powering from a 9V battery as well as phantom power.

Circle (407) on Reply Card

EMCEE Broadcast Products

See TV transmitters on page 78.

Circle (410) on Reply Card

English Electronics Corporation

STTV Lamps available include mogul bi-post base, medium prefocus base, double-ended tungsten halogen, medium 2-pin tungsten halogen, twin filament and projector lamps.

Circle (412) on Reply Card

Enterprise Electronics Corporation

Model 7900A is a stand-alone cabinet-style radar data remoting receiver that offers a 5-color level depiction of precipitation and background color. It also has independent level selection for severe storm isolation.

tube talk

1"

Leddicons® are in every type 1" camera that uses lead oxide tubes.

Here's why...

Anti microphony.
A double damped mesh...
only in EEV Leddicons.

High Resolution Greens for sharper, crisper pictures at all light levels...and less aperture correction.

Leddicon's light bias technique significantly improves lag in individual channels.

Extended Reds with close tolerance infrared cut-off filters for the best "red" reproduction.

Find out how 1" Leddicons can improve your image. Call or write.

* Registered Trademark of EEV Lead Oxide Camera Tubes

At EEV...your image is our business.

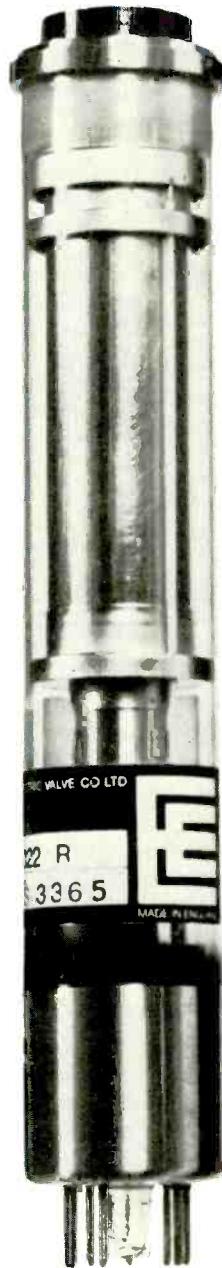

EEV, INC.

7 Westchester Plaza, Elmsford, NY 10523, 914-592-6050
EEV CANADA, LTD., Rexdale, Ontario, 416-745-9494
English Electric Valve Co. Ltd., Chelmsford, England
Telex 851-99103

Members of the GEC Group of Companies

Circle (82) on Reply Card

Other equipment

The *Digital Video Integrator and Processor* processes the radar data to provide, either in digital or analog format, six preset rainfall rate ranges over a dynamic range of 63dB received signal strength.

Circle (413) on Reply Card

Environmental Container Systems Inc.

ECS Transportable Cabinets provide instant portability for delicate instrumentation. Equipment is secured within this shock-mounted case which protects it from rough handling and environmental hazards. Instrumentation may be used in the case by removing the front and rear covers.

Circle (415) on Reply Card

Eumig (USA) Inc.

The *FL-1000 Cassette Tape Deck* is a computer interfaceable cassette recorder. Up to 16 FL-1000 decks can be controlled by an 8-bit computer. Some of the decks can be used for commercials; others for news and weather; and others for music and station IDs.

Circle (925) on Reply Card

Eventide Clockworks Inc.

TIMESQUEEZE System uses a desktop computer (Hewlett-Packard HP-85) suggested with the H949 Harmonizer and PTC945 Precision Tape Controller to expand or compress audio and visual materials into the available format time slot. Normal pitch is maintained even with increased or decreased speeds of the original materials.

Circle (418) on Reply Card

Evershed Power-Optics Ltd.

Scene-Sync solves the "floating" appearance of an actor chroma keyed over a background. Miniature sets cut production costs yet allow the actor to "be" in an otherwise inaccessible "location."

EPO Ganged Zoom allows a master/slave zoom lens control over two cameras, primarily for use along with *Scene-Sync*.

Circle (417) on Reply Card

Excalibur Industries

Featured its custom cases for protecting valuable equipment, especially designed to be rugged, dependable, strong and attractive.

Circle (641) on Reply Card

Fairchild Camera & Instrument Corporation

The company features *CCD221 Area Imaging Array Semiconductor Sensor* and the *CCD2000C Camera System*.

Also the *488 x 380 Matrix Array CCD221* meets all NTSC resolution requirements for television without lag or geometric distortion.

Circle (926) on Reply Card

Faroudja Laboratories

The *Image System* corrects predictable deficiencies in color under videotape formats automatically. The unit consists of a pre-processor called *Record 1* and a post-processor called *Playback 1*. *Record 1* boosts small details that will be predictably degraded or lost in all color under VTR formats.

Circle (927) on Reply Card

Farrtronics

M70 Series DC Controlled Audio Consoles are rack-mounted with separate control panels, interfacing with plug-in cables. The consoles, available in mono and stereo versions, are field convertible and feature dc control for all levels and switching.

M75 Audio Distribution Amplifier package is a wired and tested package designed to eliminate as much on-site wiring as possible. Stereo or mono versions are available.

M750 Series Audio Patchfields feature covered pan construction and shielded cable for all audio applications.

Circle (418) on Reply Card

Fernseh Inc.

The *TCS-1* is a microprocessor/software based machine control system designed to operate up to 100 videotape recorders and/or telecine film chains. It eliminates patch panels or complex relay switching systems where it is desirable to delegate control of machines to various points. Connection between the control panels and the VTRs/film chains is accomplished with dual twisted pair audio-type wiring, rather than the multiple-conductor cabling normally used with remote controls.

The *TeleMation TCF-3000 Broadcast Telecine Camera* provides high quality color film reproduction. As a prism optical system, it offers ghost free, precision color separation, as well as high sensitivity.

Circle (419) on Reply Card

Fiberbilt

Adapt-A-Case is a uniquely versatile and secure carrying and shipping system for the equipment of the pro-

fessional photographer. The interior space can be partitioned and repartitioned to give safe, protective storage to any configuration for cameras, backs, lenses, meters, film projectors, strobe lights, tripods and film packs.

Circle (420) on Reply Card

Fidelipac

The *Model 350 Broadcast Audio Cartridge* is designed primarily for use in stereo cartridge tape machines that have inadequate tape guidance at the tape input side of the record corner post which is factory adjusted to the NAB Standard height of .562 inch. The corner post can be adjusted by station engineers to precisely match the cartridge machine to improve stereo performance.

Model 457 Cue Logging Calibration Cartridge contains tones necessary for the complete electrical alignment and calibration of the cueing system in NAB automatic tape cartridge recorder/reproducers.

Circle (421) on Reply Card

Film/Video Equipment

The company provides service, sales and rental of film and video equipment.

Circle (422) on Reply Card

Flash Technology Corporation of America

The company offers *FTB-205A ElectroFlash Beacon Systems*, the *OL 205 Optical Link*, *AB-2154 Beam Elevation Adjustment Brackets*, *SM-3954 Swing Mounts* and the *FTB-319 Aviation Obstruction Beacons*.

Circle (423) on Reply Card

For-A Company Limited

The *VTW-600 Video Typewriter* is a character generator with optional *WU-300 wipe unit*, *EU-300 edge function*, *MU-600 floppy disc memory*, *MU-300 card memory*, *CU-600 color control unit* and a *DU-600 character design unit*. The *ENC-100 encoder* is required for an encoded video signal.

Circle (424) on Reply Card

Fort Worth Tower Company

See satellites on page 70.

Circle (425) on Reply Card

Frezzolini Electronics

The *Multiple Battery Chargers* are specifically designed to charge eight VTR battery packs in 12 hours with the capability to fast charge an additional five 12-14.4Vdc with 2, 4, or 6AH battery packs simultaneously in less than one hour.

The Frezzi On-Board Battery Packs feature instant hook-on firm electrical and mechanical connection without power cables to the backs of specified portable video cameras. The unit is fully compatible with most camera manufacturers' factory-supplied battery pack brackets.

The Frezzi In-Board Battery Packs are plug-in models that are fully compatible with specified JVC, Panasonic, RCA and Sony VTRs.

The Frezzi Multiple Battery Charger will simultaneously in one hour fully recharge any group of five intermixed or same Ni-cad battery powered On-Board Battery Packs or other specified portable video camera manufacturers' factory supplied battery packs.

Circle (426) on Reply Card

Fuji Photo Film U.S.A. Inc.

The Model E-240 videocassette is designed for the European market where demand for tapes capable of longer recording time has been increasing.

The company has also developed two metal tapes: a metal videotape (MV) and a vacuum videotape (VV).

Circle (427) on Reply Card

Fujinon Optical Inc.

Model R14X14ESM zoom lens for 1-inch format features f1.6 aperture throughout the zoom range, built-in extender provides 40mm to 400mm lens use, with an MOD of 1 m. Servo/manual zoom and focus with auto iris standard.

Model A30X11 TV lens, including integral 2X extender, provides a zoom range from 11mm to 660mm for the 2/3-inch format. F1.6 aperture (to 220mm) is increased to f2.4 at 330mm length. Servo/manual zoom and focus, auto iris.

Model S14X7BERM-1 TV zoom lens, for the 7 to 98mm and 14 to 196mm ranges, implements the 1/2-inch format of the RCA Hawkeye. MOD-0.8m servo/manual zoom, manual focus, auto/manual iris standard. Includes 2X extender.

S12X7BRM-1 Zoom Lens provides a 7 to 84mm zoom lens range with maximum aperture of f1.4 to 72mm and f1.6 to 84mm, MOD 0.8m for 1/2-inch format cameras. Servo/manual zoom, auto/manual iris, manual focus.

Circle (428) on Reply Card

Gardiner Communications Corporation

See satellites on page 70.

Circle (429) on Reply Card

Garner Industries

The Model 270 Video Eraser Unit handles up to 8 1/2-inch reels and

cassettes. Tapes are passed on continuous belt over high flux coils and ejected at the end of the machine. Overheating is protected by an automatic cut-off switch.

The Models 3056 and 4056 have a 60ips duplicating speed, common capstan that eliminates speed variance between master and slave and a 2-minute tape loading feature.

The Model 1100 Video Eraser can do 13 reels per minute. The erasure level is 70dB nominal.

Circle (430) on Reply Card

General Electric

The company features tungsten-

halogen and incandescent lamps for TV production.

Circle (431) on Reply Card

Gerstenlager Company

The company features mobile TV studio vans as well as vans for major market news and sports coverage.

Circle (432) on Reply Card

Cliff Gill Enterprises

The Jock-Mate Controller cues up music or commercials within 1/3 second. It accesses program material from six Eumig decks and starts and

Football Special

The Classic

Shure M-67 Mixer
Telex Sportscaster Headset - CS91
Electrovoice 635A Mike

All Three Only \$379⁰⁰

The Deluxe

Astrolite 2636B
Microtrak Sport IV with Dial*
Electrovoice 635A

All Three Only \$819⁰⁰

*The Microtrak Sport 4-Dial features 4 microphone and one h-gh-level input, spotter mic, input, three headphone outputs, hybrid/talkback capability, and telephone dial for connection to any phone line.

OFFER EXPIRES 8/15/81

Prices are payment with order. UPS prepaid. Write for our complete price list to fill all your equipment needs.

David Green

P.O. Box 590/Leesburg, Virginia 22075. Phone 703-777-8660

broadcast consultants corporation

Circle (83) on Reply Card

Other equipment

stops five auxiliary sources.

The Eumig FL-1000 Cassette Tape Deck is capable of rewinding one deck while another is playing, and still another is moving in fast forward to locate the selection.

Circle (433) on Reply Card

Glentronix Inc.

The TO-9 Message Generator is designed as a convenient source of video messages without requiring the use of telecine slides or production titlers. The unit contains up to 10 fixed messages that are defined by the user when it is ordered.

The Model CLK-5 features full battery back-up, drives up to 25 pulse clocks, uses NTSC color subcarrier or internal crystal and has a daylight savings/standard time switch.

The QSI VSID-8 Video Source Identifier features a highly compact package for minimum space requirements, rapid character changes for mobile unit applications and eight characters for microwave and station identification.

The CLK-7 Digital Clock is an all-digital "Slave" clock that is designed for use with the 12V alternating polarity pulses such as are used in precision systems.

Circle (434) on Reply Card

Alan Gordon Enterprises

Distributors of video animation equipment, battery packs, and chargers, camera equipment, film editors and filters.

Circle (435) on Reply Card

Gorman Redlich Manufacturing Company

The Model CMR Digital Monitor is fully remoteable via land line or telemetry, using standard remote control equipment. An optional repeater controller is available for hardware remote control and readout via multiconductor cable at distances up to 1500 feet.

The Model CRW is a sensitive, highly selective receiver for NWS transmission on 162.40, 162.475 and 162.55MHz. It is equipped with tone decoders that process 1050 and 1650Hz signalling tones transmitted by NWS for automatic audible and visible alarm signals.

Circle (436) on Reply Card

The Grass Valley Group

3430V Video Delay Distribution Amplifier features adjustable delay from 65-550 nanoseconds, 12 nanosecond front card delay trim, six out-

puts, gain adjustment, and ac or dc coupled. Optional variable cable equalization and a 350 nanosecond version are available.

3230 Fiber-Optic Video Link features one channel per fiber, LED transmitter, APD receiver, FM modulation, AGC and squelch, gain adjustment, cable equalization, five outputs, two monitor outputs, and ac or dc coupled.

Circle (437) on Reply Card

The Great American Market

The Scene Machine is a modular projection system designed for professional use. With interchangeable parts, still and moving effects can be projected from one basic unit. The unit can be hung in any position and throws from 10 to 200 feet.

Lighthesizer 212 operates with either 12 dimmers, relays, solenoids or contactors, or any combination thereof. Features include on-the-scene programming, adjustable clock for instant speed variation, eight programmable sequences, 32 steps per sequence and 12 individually controlled channels.

Circle (438) on Reply Card

David Green Broadcast Consultants

WCBC IBM 5120 radio broadcast computing system features single-entry storage for scheduling and billing information, single-entry commands for computer printout of day logs, and 99 product codes for complete product protection.

Circle (439) on Reply Card

Gregg Laboratories

See audio processor article

Circle (440) on Reply Card

HM Electronics

HMI Lights provide an efficient daylight source that is compatible with film and tape. The lights produce 80-102 lumens per watt of light. The lamps are available in a range from 200-4000W.

Circle (442) on Reply Card

Hallikainen & Friends

The Program Logging System automatically keeps program logs. It features full English printout, is FCC acceptable when signed, and logs are printed as the program runs.

The TVA Series Audio Systems are expandable audio mixing systems with AFV. The TVA 142 is the mixing stage of the audio system. Each TVA 142 mixer module has six mic or line

inputs with individual gain controls. Audio routing to the program and audition channels is controlled either manually or by remote control switching (AFV).

Circle (443) on Reply Card

Harris

Autotron Star Single-Entry System integrates all business functions with a single in-house minicomputer.

MW-50B 50kW AM Transmitter uses high-speed op-amp input circuitry for improved transient response for "effectively dc coupled" operation from input through the RF power amplifier, with Modulation Tracking Circuit to keep desired modulation level over +/- 20% change in power.

MICROMAC Modular Audio Console, a microprocessor-based system, uses linear attenuators, keyboard entry of source machine operation, speaker muting, momentary and latching source start/stop commands, VCA level controls.

Also see cameras and TV transmitter articles.

Circle (444) on Reply Card

Harrison Systems

The MR-3 Input Module has an electrically balanced line return that eliminates the small cumulative effects of transformer nonlinearities. The line return is used as a multi-track machine return.

Circle (445) on Reply Card

Karl Heitz

The Gitzo Video Combi features two log sections and adjustable spring balanced video/cine heads, comes in six models to match any video or cine camera up to 25 lbs. or more, and is made of stressproof, hard-tempered light metals.

Also new are the Gitzo Fluid Heads and fluid base for cameras up to 25 lbs., leveling balls with center column for height adjustments for fluid, video/cine heads, the Gitzo Black Light Stands with braces for studio flash, lights, screens and backgrounds and the Gitzo Mini Monopod with swivel head, chest and shoulder support.

Circle (446) on Reply Card

Hitachi Denshi America Ltd.

HR-300 Long Play Format "C" 1-inch Record/Playback VTR allows up to three hours using 14-inch reels of tape. It is compatible with the HR-200 Production Unit and the HR-100 Portable Recorder. Air support allows gentle tape handling. Instant head replacement is possible without

special tools. Microprocessor controls make the machine capable of all producing and editing requirements.

See cameras beginning on page 84.

Circle (447) on Reply Card

Howe Audio

The Model 7000 Stereo Console features indirectly controlled volume through optically coupled integrated circuitry. Because no audio signal passes through the main faders or program audition keys, there are no hot spots or dead spots.

The Howe 702P-B and 702P are stereo phonograph preamps conforming to standard NAB/RIAA disc equalization.

Circle (448) on Reply Card

HEDCO (Hughes Electronic Devices Corporation)

The Model VDA-100 Video Distribution Amplifiers feature a differential input with greater than 60 dB of common mode rejection at low frequencies and greater than 40 dB at 5 MHz with low differential gain and phase.

The Model ADA-200 Audio Distribution Amplifier is a modular, high performance amplifier designed to meet the requirements of the industry. Inputs/outputs can be configured as balanced or unbalanced.

Circle (449) on Reply Card

Hughes Helicopter

The 300C Helicopter and Mobile Van work together as a team in electronic newsgathering capabilities. Hughes has introduced a turn-key airborne ENG package designed exclusively for the piston engine powered 300C.

Circle (642) on Reply Card

IGM Communications

From a prominent position near the main entrance, IGM displayed its line of automation equipment for broadcasters: the Basic A program controller; Instacarts; Go-Carts; Base 16 sequential programmer; CBSI billing, accounting and traffic system; and 2-way communications interface between program automation and billing, accounting and traffic system.

Circle (874) on Reply Card

Ikegami

The new Series 9 Monitors, furnished in 14- and 20-inch sizes, feature advanced circuitry and in-line gun shadow-mask picture tubes. Frequent magnetic convergence adjustments are reduced, and routine maintenance

is simplified.

See cameras beginning on page 84.

Circle (450) on Reply Card

Illinois Cable

Suppliers of wire and cable for the communication and alarm industries, ICC carries thousands of types and sizes in stock; they also will stock special items on request.

Circle (451) on Reply Card

Image Video

The Model 8100 Automated Master Control System may be used manual-

ly, then switched to automation when warranted by increased volume.

The VMP-1 Voltage Monitor Panel is designed with digital circuitry throughout, and provides continuous, automatic monitoring capabilities to 128Vdc.

Audio and visual alarms are issued by the Model 7105 Video Audio Silence Monitor whenever audio input falls below a preset level.

The 6200 Series Switchers are intended for medium to large routing systems and are designed in any combination of video, audio and time

CHALLENGE: To build TV towers soaring nearly 2,000 ft. above the earth.

We've done it...many times.

CHALLENGE: To build a rugged, reliable, multi-tower array for AM transmission.

We've done it...many times.

CHALLENGE: To build microwave towers to virtually zero deflection requirements; towers that withstand fierce winds and severe icing...successfully.

We've done it...many times.

**GIVE US
A TOWERING
CHALLENGE!**

Stainless. Meeting challenges in tower design for over thirty years...successfully.

See us at the NAB Show.
Booth 1009.

The Tower People.

Stainless, inc.

North Wales, PA 19454
Phone (215) 699-4871 • TWX: 510-651-8097

CO181

Circle (84) on Reply Card

Other equipment

code/control (SMPTE/EBU, 1²) matrices.

The Model 4100 Machine Assignment System has a standard configuration of three VTRs with seven levels of control and two telecines with 21 levels of control each.

Video models AJR-S24 and AJF-S48 are prewired (shielded) single audio jackfield assemblies containing, respectively, 24 and 48, PJ339-type jacks.

Circle (452) on Reply Card

Imero Fiorentino

For years in seminars and workshops, Imero Fiorentino Associates has been teaching TV lighting and staging techniques. Now, IFA videocassette tapes bring professional training on a set of four tapes covering three key subjects: *Basic Lighting and Staging Techniques for Television*; *Lighting Techniques for News Sets*; *Basic Make-up Techniques for Television*.

Circle (453) on Reply Card

Industrial Sciences Incorporated

Multiple options keynote the com-

plete line of switching, terminal and processing equipment offered by ISI—initials which this company also uses to signify Innovative Switching Ideas.

Circle (454) on Reply Card

Information Processing System

Offering professional color computer graphics, IPS has incorporated 88K bytes of memory in model CGSL-100 and 280K bytes in model CGS-4000.

IPS also features as unique their model WP-3312 weather satellite recorder, now with graphics.

Circle (455) on Reply Card

Innovative Television Equipment

H10 Hydro Head is a totally new concept in viscosity drag control for pan and tilt operation. Adjustable center of gravity control permits perfect counterbalance load control and constant camera balance.

T-13 Tripod is designed for EFP camera with a studio viewfinder option. The tripod will support up to 70 pounds. Design of the unit eliminates radial torquing to the top assembly and legs. The elevator column gives an additional 18 inches travel.

Circle (456) on Reply Card

Inovonics Inc.

The Model 201 Average and Peak Responding Limiter is a general purpose radio production and recording studio compressor limiter.

The Model 215 Broadcast Audio Processor is a multifunction audio processing system including a slow gain riding gated AGC, a smooth average level compressor and either a phase following, asymmetrical peak controller for AM or a 75/25 microseconds FM peak limiter.

Circle (643) on Reply Card

Integrated Sound Systems

The TDM-8000 Audio Time Compressor analyzes the audio signal in digital form while the program signal remains, throughout, in the analog domain. The TDM-8000 allows recorded audio material to be played back at faster rates than when recorded. Distortion and listening fatigue may be considered minimal.

Circle (457) on Reply Card

International Tapetronics

The 770 Series offers a myriad of professional features in addition to the functional concept of having been designed to critical specifications.

Circle (458) on Reply Card

Controlling high blood pressure on the job is good business.



Illnesses from uncontrolled high blood pressure cost about 26 million lost workdays and billions in lost earnings each year.

About 20% of your workforce has it, and many don't even know it. Proper treatment, every day, can prevent heart failure, stroke, or kidney disease caused by high blood pressure.

High blood pressure can be easily detected and controlled so a person can lead a normal, healthy and active life. On the job, and off. To learn how your company can start a high blood pressure control program, write:

Ms. Judie LaRosa
Worksetting Programs Coordinator
National High Blood Pressure Education
Program
Bethesda, MD 20205

High blood pressure. Treat it and live.

National High Blood Pressure Education Program.
National Heart, Lung, and Blood Institute.
U.S. Department of Health and Human Services

Jatex Inc.

AG-20R Color Bar/Black Burst Generator provides RS-170 NTSC Synchronization on four blackburst outputs, two color bar outputs, with composite sync, blanking, and 3.58 MHz subcarrier outputs. Color bars are full field or split.

VSEC 62TMX A/B Roll Editing Controller provides a full complement of automated editing functions and controls, SCENE-DEX time code readers and generators, for total editing with no modifications required on the three VTRs.

Circle (460) on Reply Card

Jefferson Data Systems

ENP (Electronic News Processing) includes News Watch—receiving and storing all High Speed Wire Services; News Pro—Assignment Editor and Producer functions; News Edit—sophisticated Text Editor; News File—complete Archival function.

Circle (461) on Reply Card

Jenel Consultants Corporation

For communications-related industries. Provides a complete service of engineering, design and consulting services.

Circle (462) on Reply Card

Jensen Tools Inc.

Tools and tool kits for repair or adjustment tasks.

Circle (463) on Reply Card

Kaman Sciences Corporation

FiLMS (Film Library Management System) film contract maintenance, amortization, accounts payable, programming, forecasting. Adaptable to the needs of any station, FiLMS monitors and maintains existing budgets and provides optimum use of the film inventory.

Circle (477) on Reply Card

Kappa Systems (Neve)

COMMUNICATOR is a family of microprocessor-controlled broadcast intercom and audio routing systems featuring IFB, selective privacy or lockout, privacy override functions with complete user control of all calling patterns.

Circle (478) on Reply Card

Keith Monks Audio Ltd.

CR501 Domestic Record Cleaning Machine joins the RCM Mark 2 and Mark 3 professional machines to "deep clean" phonograph records with an alcohol water mixture and nylon brush.

Circle (479) on Reply Card

Kings Electronics Company Inc.

Suppliers of video jackfields, patch cords and a line of coaxial connectors and crimping tools.

Circle (480) on Reply Card

Kliegl Brothers

Lighting control systems in modular design.

Circle (481) on Reply Card

Knox Video Products

K50/K60 Character Generators provide two sizes of 63 alphanumeric or symbols for use in TV titling or any message-type visual display with four full pages of memory. KS version includes internal sync generation; KX adds titling window, crawl and page sequencer.

K128 Video Character Generator features an extensive character set of some accented letters, some Greek letters and a wide selection of symbols in two sizes with full 4-page internal memory formatted to eight lines of 24 characters. Options provide multiple fonts, multiple speed roll/crawl, an independent edit channel and expanded page memory.

Circle (482) on Reply Card

Ross switchers are now more exciting than ever with 16 new spin, rotary and matrix wipes.

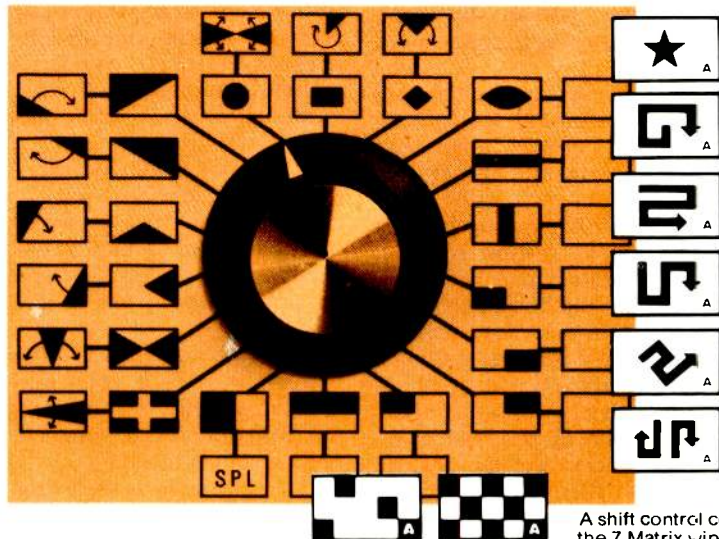

The Ross RVS-514 switcher pattern selector is shown. Other Ross 500 switchers have illuminated pushbutton pattern selectors.

A shift control converts the 7 Matrix wipes into an additional 7, and the Star converts to the Pointer.

Ross 500 Series Switchers now give you a wider selection of special effects patterns with the addition of...

- A 5 pointed Star Spin wipe.
- A Pointer that can be positioned and continuously rotated anywhere on the screen.
- And 14 Matrix wipes (more than any other switcher) that include Checkerboard and Random patterns.

Plus you can create hundreds more of your own special patterns with the 'SPL' selector.

And like the Ross 500's other 9 Rotary and basic wipes, all have soft and color border controls.

Call 613-652-4889 or write ROSS VIDEO LTD., 9 Iroquois Plaza Iroquois, Ontario, Canada K0E 1K0



Circle (85) on Reply Card

Other equipment

LPB Inc.

Signature II Audio Console Series features rotary step attenuators, all circuitry on plug-in modules, telephone-type program bus switches with additional contacts for machine starts. LED peak level indicators located in the illuminated VU meters.

S-2 Audio Compressor/Limiter provides separate gain/output level controls, asymmetric modulation capability, stereo/quad provisions, signal-to-noise ratio of 84 dB below +19 dBm output. FM model available.

AM-5 (5W) AM Broadcast transmitter transmits low power from 360kHz to 2MHz and can be used with the TCU-30 transmitter coupling unit for carrier current broadcasting through an electrical power wiring system.

AM-50/250 Series of AM broadcast transmitters provide 50, 100, 150, and 250W power levels for use in 360 to 2000kHz spectrum for low power AM and carrier current operation.

FM-10SS, FM-150SS, and FM-300SS FM Transmitters meet FCC requirements and are type accepted for mono, stereo and SCA operations with PLL frequency programming in 88 to 108MHz spectrum for 180F3 or 300F9 emission.

DA-1-8 Audio Distribution Amplifier provides one in/eight out while the DA-1-16 unit allows dual one in/eight out or one in/sixteen out. Inputs 600 Ω balanced, 6000 Ω balanced bridging, outputs are 250 resistive balanced with response from 20 to 20,000Hz.

Citation Series Audio Consoles include 6-, 8-, and 10-mixer dual stereo systems, transformer balanced inputs and outputs, three inputs per mixer. Metering includes LED peak indicators.

Circle (483) on Reply Card

LTM Corporation of America

Stellavox Sp8 Professional Self-Contained Tape Recorder uses plug-in head blocks for mono or stereo; three speed; two mic/two line inputs; two mixers; servo motor drives capstan directly, response 20 to 16,000Hz mono, 30 to 18,000Hz stereo.

301 Series Microphone Poles are telescopic design with black anodized finish and friction lock system, standard threaded stud, extendable from 15½ to 46½ inches, 22 to 67 inches, and 4 to 13 feet, with attachable threaded microphone support.

97 LTM 3-Channel Sound Mixer provides two microphone and one mic/line input, phantom power 12V on each input, high pass and presence filter, VU meter and peak indicating

LED. The unit is battery operated with response of 40Hz to 20,000Hz.

200 LUXARC high efficiency compact fresnel fixture is equivalent to a 2K open face fixture, with 200W HMI lamp.

200 AMBIARC KIT uses 200W HMI lamp with high efficiency output equivalent to a 2K open face fixture.

MINETTE/12V Camera Light weighs 10 ounces, provides medium spot lighting with barndoor, filter ring and dichroic filters as accessories.

KIT 504M/12 includes four Minette lights with 'gator' grip clamps, using 12V for high light output. Operable in motor vehicles.

KIT 503M includes 30V battery with charger and hand-held minilight with 150 to 350W lamp, switch and focusing operable with one hand.

Minilux 800 non-focusing floodlight has integral 4-leaf barndoor. Operates from 120-240 Vac or Vdc.

Circle (484) on Reply Card

L-W International

Model 6000 16mm Telecine Film Transport features auto-phase lock to NTSC, PAL or SECAM field rates, slow motion, unlimited time still frame, reel tension sensing for gentle film handling of any reel size.

Model 4000 16mm Telecine Film Transport is designed for cable, industrial medicine, production and training applications, not intended for broadcast application.

Circle (928) on Reply Card

Laird Telemedia Inc.

5300 Optical Multiplexer features three optical inputs, true instant transfer, simple optical alignment, first-surface mirrors and push-button control.

5340 and 5400/Optical Multiplexers offer four optical inputs, true instant transfer, simple optical alignment, front surface mirrors and push-button controls.

5100 Series Optical Diplexer permits two optical inputs, instant transfer, first-surface mirrors with push-button control for a desk-top film island.

4210 TV Slide Projector features dual drum storage, lap-dissolve transitions, quartz halogen lamps with 3-point adjustment mounting.

4220 TV Dissolve Slide Projector includes dual drum storage, quartz halogen lamps, dissolve transitions, 3-point mounting and audio programmable.

5050 Automatic Light Control provides automatic servo controlled compensation for variances in light levels to maintain a constant video signal output, with circuit to remove all burst and chroma information.

3600A TV Character Generator

features 10-line, 25-character format with adjustable width font and horizontal edging, format positioning, crawl, roll, non-additive mix, 4-page memory. Expandable to 24.

3622A TV Disc Memory features random-access operation for 1 Megabyte addressable memory, 1000 pages/309 files per disc, holds two discs, for operation with 3600A character generator.

3220 TV Time/Date Generator contains 100 year calendar, 7-segment character font, data positioning, additive mixing, driven by composite video.

3201 TV Time/Date Generator with 100-year calendar outputs, black or white characters. Offers choice of format with non-additive video mixing.

1200 TV Titling Generator provides assorted character sizes, adjustable character width and horizontal edging, expandable memory, with non-additive mixing.

Circle (485) on Reply Card

Landy Associates Inc.

The Dubner CBG is a full-functioned character generator with diagonal typing, color edging, third dimension, and 2-color drop shadows. Background generation includes control of "every dot on every line." More than 500 colors available for animated pictures. Sequencing up to 30 frames per second.

Circle (929) on Reply Card

JBL James B. Lansing

Series 7510 Automatic Microphone Mixer features program-actuated inputs, automatic control of output level and automatic background noise discrimination, expandable to 24-input channels. 0.2% THD figure, with -130 dBv equivalent input noise figure.

4300 Series Studio Monitors provide a wide bandwidth flat frequency response with high power handling capability, high sound pressure level capability, and wide dispersion angle, for power levels from 15 to 75W, 8 Ω load.

JBL Professional Series Loudspeaker Systems provide a wide selection of speaker systems for studio monitoring, instrument use, sound reinforcement and theatre sound.

Circle (486) on Reply Card

Le Blanc & Royle Communications Towers Limited

Complete tower services, design, manufacturer, erection and services, including emergency services for any tower requirements.

Circle (487) on Reply Card

Lee-Ray Industries Inc.

The Model 1000 is a lightweight video equipment carrier and backpack of all aluminum construction. Weighs 7½ pounds, 9-inch wheels standard. 16-inch air cushion tire and wheel may be used. Adjustable straps.

Model 5200 Videoplay Cart is designed of tubular steel and moves on 16-inch air tires with locking casters. Spacious shelves for the TV, VTR and tape.

The company includes in their line several models of folding carriers and non-folding carriers for ease in transporting portable video equipment.

Circle (488) on Reply Card

Leitch

VPA-330N Video Processing Amplifier provides RS-170A pulse parameters as it regenerates the blanking intervals, deletes or retains VITS data on lines 10 through 21 of either field and includes chroma AGC, linear fade to black, clipping levels.

VPA-300N Video Processing Amplifier locks to input video or external drive at the output of a program switcher or for stabilizing remote inputs, Slow-Lock stabilizes helical scan VTR applications.

SPG-120N NTSC Source Synchronizing Pulse Generator as a "slave" at picture source locations. Provides 10 nanosecond H phase resolution.

SCH-730N Sync/Subcarrier Phase Monitor develops an LED display to show relationship between phase of subcarrier represented by burst in a video signal and the sync of that signal.

DTG-1000 Digital Test Generator produces 35 different test signals, programmed and developed digitally with a microprocessor controlled selector system. Selection made from front panel "menu" listing.

Leitch provides sync generation, calibration and testing and distribution equipment as well as clock systems. PAL sync generation, PAL sync/subcarrier monitoring and processing equipment as well as SECAM video processing equipment completes the line.

Circle (489) on Reply Card

Lemo USA

High Density Patch Panels use self-locking connectors for easy disconnection of coaxial, triaxial and multiple conductor cables.

Triax connector for TV camera cable is self-locking, with a second lock. The unit is compatible with King's Connectors.

Circle (490) on Reply Card

Lenco Inc.

Lenco supplies a complete line of

**LIGHTNING FAST
YET PAMPERED**

That unique combination of
20-minute Burp Charger and
camera mounted, slide-lock,
super ni-cad battery.

REFLEX 20
CHRISTIE

SINCE 1929
CHRISTIE
ELECTRIC CORP.
20665 Manhattan Place, Torrance, CA 90501
(213) 320-0808, TWX 910-349-6260, (800) 421-2955

Circle (86) on Reply Card

**ONE REASON
WE'RE HOT.**

COMPUTER EDITING

- CMX 600
light-pen video-disc assembly
- CMX 50
¾ inch videocassette off-line editing
- CMX 340
1 inch on-line editing with Digital Video Effects

Contact Larry Kingen 415/777-5777

One Pass Inc.
The San Francisco Production Center
900 Third Street, San Francisco, California 94107

Circle (87) on Reply Card

Two intelligently designed products from Coherent Communications

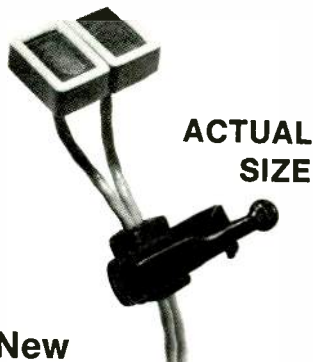

New MINI-MIC 2 double lavalier.

Two separable, hand-picked, music-quality electret mics in one unit for breakdown protection. Capsules are suspended in rubber for isolation from clothing rustle and knocks. Wiring is clamped and epoxied and molded to the head! Send for our free, detailed brochure.



New PS3 mic Power Supply.

A practical in-line mic power supply in a die-cast box with switch guard. Runs on two inexpensive, readily available 9 volt batteries. Battery test jacks; switches for phase/polarity, 20dB pad, high-pass filter. 4 3/4 x 2 1/2 x 1 1/2 ins., 13 oz. Send for our free, detailed brochure.

COHERENT COMMUNICATIONS INC.

13733 GLENOAKS BLVD., SYLMAR, CALIFORNIA 91342. (213) 362-2566.

Circle (88) on Reply Card

Other equipment

sync generators, test/signal and pulse generators, distribution equipment, signal delay and processing equipment as well as a wide selection of monochrome and color monitors.

Circle (491) on Reply Card

Lexicon Inc.

Model 1200 Audio Time Compressor/Expander permits recorded audio data to be reproduced at rates faster or slower than the recording speed without change in the original pitch, for fitting the 36- or 25-second commercial into the 30-second slot. Allows video compression/expansion on 1-inch C-type VTRs fitted with dynamic-track option.

Model 92 Digital Audio Delay provides two independent outputs with 0 to 120 millisecond delay time. Noise and distortion less than .08%. Dynamic range greater than 90 dB. Frequency response 20 to 12,000Hz.

Model 93 Digital Delay Processor/Mixer includes two delay outputs independently adjustable from 0 to 256 milliseconds with complete mixing of delay and reverb processing, doppler pitch shift, flanging and delay up to 2 seconds.

Model 224 Digital Reverberation System allows adjustable reverb from 0.6 to 70 seconds in two bands, adjustable pre-delay. Dynamic range 84 dB typical. Total noise and distortion 0.05% typical from 20Hz to 10,000Hz.

Circle (493) on Reply Card

Libin and Associates

Sanyo electrical products and Tri-Flex indoor equipment.

Circle (494) on Reply Card

Lightning Elimination Associates Inc.

Coaxial Surge Eliminators insert in series with a coax or open-wire transmission line to intercept EMP, lightning-related or induced transients to eliminate overvoltages and surge currents (models to 25kW RF power levels).

ISTE (Intrinsically Safe Transient Eliminator) is a protective barrier providing protection against incoming high voltage transients of any form, limiting energy of the sensor to a level below that required for ignition of hazardous materials.

Transient Eliminator for RS232 Interface protects lines used in data transfer from transients. Clamping voltages to +/-20 volts peak with maximum surge currents of 25,000 amperes, and surges of 500 joules.

CDC-1 Guy Charge Dissipation Choke eliminates static charge

buildup on guy lines either with a replacement strain insulator model or an insulator bypass model. Exhibits high impedance to operational frequency with low impedance to charging mechanism.

High Energy Surge Generator (SG Series) offers energy levels in excess of 1000 Joules for qualification or acceptance testing of surge and transient protectors. Consists of power supply, trigger, 200-joule pulse, high energy (10 Kjoule), and EMP modules.

Circle (495) on Reply Card

Listec Television Equipment Corporation

P-25 TV Camera Pedestal accepts all standard pan heads and handles camera equipment up to 275 lbs. Dual 8-inch wheels at each corner with wheel guards operate in crabbing and tracking steering modes, with steering ring 24-inch diameter.

Vinten Plover Transportable Pedestal, Model 3179, offers 50 to 230 lb. handling without changing gas pressure on a new multi-ram system.

Raven Studio Pedestal, Model 3088, for 200 lbs. maximum capacity. Offers 24.5 to 59-inch elevation range.

Digivision Monitor Prompting Systems, D12/D17SH and ESH, for full-size studio and ENG camera, uses video keyer enhancement with reverse polarity. Completely independent of camera and lens.

Circle (496) on Reply Card

Logica Inc.

See teletext article on page 98.

Circle (930) on Reply Card

Logitek Electronic Systems Inc.

Bright-VU LED Audio Level Displays use 16 bar-type LEDs to display a dynamic range of -22 dB to +18 dB. Sensitivity adjustable with -20 to +20 for a 0 dB reading, +28 dB maximum. Input impedance is 200 Kohms. Available in average response or fast peak response.

ADA-8 Audio Distribution Amp features one in/eight out for input levels to +22 dBm, IM distortion at +23 dBm 0.01% signal-to-noise rating 74 dBm below 0 dBm with 1/4 dB variation between 20 and 20,000Hz.

Custom Audio Series Consoles feature from five to 12 mixing modules with options of headphone amplifiers, built-in distribution amplifiers, clocks, timers, reverb units, intercoms, equalization, sub-mastering and panning.

"Frezzi" Multiple Battery Charger (MBC-2) fully recharges up to five "Frezzi" battery packs simultaneously in one hour or less plus trickle

charge up to eight VTR battery packs, for operation anywhere in the world.

Circle (498) on Reply Card

Lowel-Light Manufacturing Inc.

Innovative solutions to portable, efficient, durable location lighting problems with "tota-light," "omni-light," "d light," "soft light," and "lowel-light" series as well as the "variflector" reflector series, "link" support devices and assorted stands and poles.

Circle (499) on Reply Card

Lyon Lamb

VAS IV Video Animation System interfaces with Ampex 1-inch C-format or JVC/Sony 3/4-inch broadcast VTRs for field accurate, 24 to 30 frame per second operation. Handles automatic search and cue of VTR. Consists of animation controller, broadcast quality camera, color monitor and professional animation stand.

Circle (500) on Reply Card

MCI (Professional Studio Equipment) Ltd.

JH-110B Audiotape Recorder operates at 7.5, 15, or 30ips for mono, stereo, 4-track and 8-track formats with 1/4-, 1/2-, and 1-inch tape. The units exhibit a wide audio response, high signal-to-noise ratio and low distortion figures.

JH-110C-8 features transformerless electronics for a full function, 1-inch 8-track recorder. Three speeds are available with AutoLocator III (10 programmable memories, TVI Tape Velocity Indicator, and yo-yo tape shuttle function). Quiet Initiation Of Record (QUIOR) circuitry eliminates popping during record start.

Circle (501) on Reply Card

MCI/Quantel

The DPE 5000/SP: a low-cost special performance digital production effects systems only 8-3/4-inch high. Donald Prather, MCI/Quantel national sales manager, said that the system can compress to infinity, expand to twice normal picture size, freeze with updating, and squeeze on both axes. Scheduled for fall delivery at less than \$65,000.

The Shot Box: a new control panel for the by-the-number instant access to as many as 700 effects with the DPE 5000/PLUS. Comes factory programmed with 70 effects and can be easily reprogrammed with any 70 of 700 standard effects. Available now at about \$10,000.

DLS 6000: Digital Library System for disc storage of a virtually unlimited number of still pictures, together with

New Coherent MX80 Mixer:

More functions in less space — best electronics, cleanest sound.

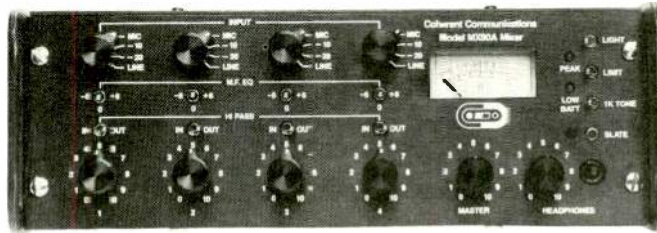

The MX80 uses Jensen transformers, the best in the world. It has a mid-range equalizer, built in slate mic, internal batteries.

Plus a VU meter light, 4 position mic/line select switches, phase reverse switches, internal mic powering, high-pass filters that work.

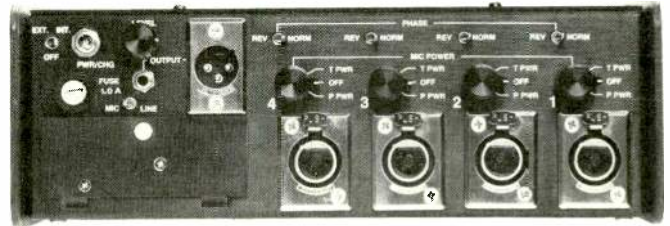

With all these features and more, the new MX80 weighs only 5 lbs. 3 oz., is 3 1/2" high, 9 1/4" wide and is 7 3/4" deep. Send for our brochure.

COHERENT
COMMUNICATIONS INC.

13733 GLENOAKS BLVD., SYLMAR, CALIF. 91342. (213) 362-2566

Circle (89) on Reply Card

CLEAN UP YOUR ACT. \$590.* Get rid of unwanted noise from carts and transmission systems. With dbx Type II Noise Reduction, you get a full 40 dB increase in dynamic range. The new dbx Model 140 provides two channels of encoding and two channels of decoding—usable separately or simultaneously. Provision for Jensen output transformers. Active balanced inputs and other good stuff. See your dbx Pro dealer, or write for complete technical information.

*Manufacturer's suggested retail price.



Model 140 Type II Noise Reduction System

dbx, Incorporated, Professional Products Division, 71 Chapel St., Newton, Mass. 02195 U.S.A. Tel. (617) 964-3210, Telex: 92-2522. Distributed in Canada by BSR (Canada) Ltd., Rexdale, Ontario.



Circle (90) on Reply Card

Other equipment

production effects. The series includes three NTSC broadcast still-store systems: the DLS 6010 basic system; the DLS 6020 on-air transition system; and the DLS 6030 production effects system. Delivery is 90 days ARO at \$49,000 to \$88,000.

DFS 1750: an extremely small digital framestore synchronizer at 1-3/4-inch high.

Also shown were the new changeover/assignment switch for the DPE 5000; the DFS 1550 digital synchronizer, and the DSC 4000 digital standards converter.

In its suite, MCI/Quantel demonstrated its *Telegraphics 7000* system that lets an artist create smooth lines in electronic-generated graphics using a stylus that has pressure sensitivity for line intensity.

Circle (644) on Reply Card

Magnasync/Moviola

Videola V-2000 Deluxe Film-To-Tape Transfer System uses the "flickerless prism" optical system for transfer of 16 or 35mm motion picture film to videotape. Continuous film motion produces a video image consisting of picture frames dissolved one into the next. The transfer is independent of TV synchronization and scanning rate, allowing film to be transported at any speed. Resolution is high for broadcast quality result. Negative or positive film may be used.

Videola V-1000 Film-To-Tape Transfer System provides a high resolution transfer of 16 or 35mm film, negative or positive image to videotape.

Circle (503) on Reply Card

Magnum Towers Inc.

Manufacturers of self-supporting and guyed towers for service as support structures of AM, FM, VHF and UHF TV antennas as well as microwave installations. Their service includes installation and maintenance.

Circle (504) on Reply Card

Marconi Electronics Inc. (Ltd.)

TF2914A Insertion Signal Analyser measures a variety of video parameters in the TV system, using waveforms inserted into the vertical interval of the program signal.

TF2915 Data Monitor compares measured data parameters in the TV signal with predetermined limits and takes corrective action. The TF2914 provides automatic control of the signal.

TK2917 Data Selector interfaces a TV Automatic Monitoring System (TAME) with data storage or transmission systems to supply required signals for an automated logging system.

2920 TV Interval Timer automatically measures horizontal and vertical blanking intervals with .1 line or 10 nanosecond resolution shown on digital display. Measurements produce output on parallel printer.

S1100 Broadcast Audio Transmission Test System automatically performs 17 parameter measurements on mono and stereo sound broadcast chains in 3.6 seconds, compares measured values with programmed limits and prints violations.

Circle (505) on Reply Card

Marti Electronics Inc.

STL-8F with R-200/950 Studio Transmitter Link features direct FM modulation, plug-in modular design, all solid-state circuitry, varactor final. Power output is 81W in the 942 to 960MHz range.

TSL-25/450 Transmitter Studio Link operates in the 450MHz range.

RMC-15 Digital Remote Control system is totally digital command and FSK telemetry capable. Single push-button channel selection gives accuracy of 0.1% for directional antenna monitoring with 15 channels normal. Expandable to 30. Operable via radio link or hard wired line.

CLA-40A Compressor/Limiter Amplifier provides switchable symmetrical or asymmetrical peak limiting, pre-emphasized or flat audio response, compression or compression plus limiting, with a 40dB dynamic range and less than 1% distortion. Usable for both AM and FM systems.

Circle (506) on Reply Card

Matrix Information Systems

Provides automation systems for business and logging. Also serves the broadcaster with a computerized music research and scheduling plan.

Circle (508) on Reply Card

Matthews Studio Equipment Inc.

The **Tulip Crane** is a collapsible crane unit, designed for safety, portability and versatility. Pickup bed mounting is possible.

Matthews Studio Equipment also supplies a large line of support, extension support, and clamping accessories for cameras, lighting, etc.

Circle (507) on Reply Card

Maxell Corporation of America

L-750 1/2-inch Beta Format

Videotape Cassette has been added to the 1/2-inch materials provided by Maxell. The Beta line includes L-250, L-500 and L-750 for up to 4 1/2 hours. The VHS line includes T-30, T-60, T-90, and T-120 for four hours duration. The tape stock is formed with Epitaxial oxide.

KCA-20 3/4-inch tape is now available from Maxell along with a 30- and 60-minute 3/4-inch U-Matic videocassette, featuring Epitaxial magnetic oxide.

Communicator and Duplicator Series of audiocassettes provide 30-, 45-, 60-, 90-, and 120-minute length formats in each series.

UD 18-180 and UD 25-120 Open Reel Tapes are formulated for higher fidelity in slow speed monitoring operations. The Epitaxial oxide material is used.

Circle (509) on Reply Card

McCurdy Radio Industries

SS8900 Mixing Console uses modular design for 32-input channels with a choice of eight submaster/two master or six submaster/four master output configurations. Full range pan-pots for each input, two types of equalizers and dc programmable control boards for remote functions.

Circle (510) on Reply Card

McMartin Industries Inc.

BA-50K 50,000W Am Transmitter employs highly efficient, high level plate modulation, solid-state audio and RF driver circuitry with only four vacuum tubes in the final EIMAC 4CX20000B. A nearly 90% efficient power amplifier delivers 12% positive peak modulation capacity.

SMR1 IF Modulator and SDR1 IF Demodulator provide narrow band FM services with maximum 5kHz bandwidth in the 52 to 88MHz carrier range, applicable to satellite communications as well as terrestrial microwave.

SPR-3 IF Demodulator is designed for satellite and microwave program channel usage and is capable of tracking transponder frequency errors up to 40kHz from the design carrier. Operates in the 52 to 88MHz IF range.

Circle (522) on Reply Card

Media Service Concepts Inc.

RECALL (Research to Explore and Chart Audience Listening Levels) is an analysis package, allowing use of the Apple II computer system to find information according to the Arbitron reports.

Electric Log Program solves the daily program log hassle with the use of the Radio Shack TRS-80 small business computer system. Storing up to 500

spot orders, automatic daily program log generation takes a minimum of operator assistance.

Electric Bill works with the Electric Log Program to handle billing statements for up to 500 accounts, with direct access to current status of all accounts. Only Payroll is not listed among its accounting functions.

Circle (512) on Reply Card

Merlin Engineering Works

Model ME-88 High Band Color Quadraplex VTR is based on a totally refurbished Ampex transport and frame. Modifications to the Ampex involve tape canoe, torque motor assemblies and air system. ME-38 high-band color video system and ME-28 digital time base correction with velocity error correction and ME-188 analog dropout compensator provide a complete machine monitored by 528 waveform monitor and Barco CM33 color video monitor.

ME-158 Audio Monitor is self-contained, including power supply for studio quality audio from a 4-inch woofer and high frequency acoustic suspension soft dome tweeter.

ME-148 Video Record Drive Switcher eliminates the distortion caused in audio and cue channels when insert editing of video-only is done, keeping audio quality and SMPTE time code on the cue track intact.

ME-68 Slave VTR Duplicating System operates in high-band format. Up to 10 ME-68 slaves may be interconnected to a custom-built master control panel for single-point operation.

ME-228 Digital TBC synchronizer adapts the ADDA VW-2 TBC Frame synchronizer. Full frame, "infinite window" time base correction and exceptional transparency results in TBC or synchronizer mode. Capable of delaying non-synchronous video feeds as much as a full frame for synchronization with the system reference.

Circle (513) on Reply Card

Micmix Audio Products Inc.

XL500 Master-Room Reverberation System can synthesize reverb characteristics of a plate, a live chamber or a concert hall. Decay time is variable and a 4-band equalizer peak/dip type allows adjustment for the room. Remote controls are available.

XL210 Master Room Reverberation System operates in monaural as well as true stereo with versatile equalizer for plate, live chamber or concert hall effects.

Circle (514) on Reply Card

Micro Communications Inc.

Series 61000 Coaxial Transfer Switch for 6 $\frac{1}{8}$ -, 3 $\frac{1}{8}$ - and 1 $\frac{1}{8}$ -inch EIA waveguide usage. There are four port transfer switches that will switch two signal sources between two loads.

Series 56000 Remotely Controlled Switching Combiner System can combine the outputs of two parallel transmitters, yet automatically bypass the combiner with failure of one transmitter. Manual override yet compatible with computer control.

Series 41000 Super-High Power TV Diplexer for circular polarized applications is designed for Dual High Power transmitters. The Series 91935

Model operates with 100kW visual and 20kW aural, incorporating "Long Stubb" concept with High Q cavities; Group Delay measured as low as 10 nanoseconds.

Low Power Dual Cavity TV Diplexers are constant impedance for combining visual and aural transmitter outputs into a single antenna. The design allows any two transmitters at different frequencies, or a transmitter and receiver at the same frequency to be connected to a single antenna. Operable for VHF and UHF TV bands.

Circle (521) on Reply Card

WORLD'S BEST VALUE IN CART MACHINES BE Series 2100



Playback
Mono \$950
Stereo \$1050

Record/Play
Mono \$1450
Stereo \$1750

Prices USA only.
115V, 60Hz, FOB factory
exclusive of sales or use tax

Broadcast Electronics Series 2100
direct drive cart machines are loaded with features,
yet economically priced.

Two cue tones (1 kHz and 150Hz) are standard in the Series 2100 machines. A new head assembly, the Phase Lok IV, is incorporated for extremely tight control of stereo phasing. Modular construction assures ease of maintenance. Wear-resistant front panel graphics extend that "new machine" look for years. And, the performance specifications are equal to those of much more expensive machines!

Compare prices ... compare features ... you'll agree the new 2100 gives you more value per dollar than any cart machine in this world ... or any other!

For more information, call or write your local Broadcast Distributor, or call:



BROADCAST ELECTRONICS INC.

4100 N. 24th St., Quincy, IL 62301 217-224-9600

Circle (138) on Reply Card

Other equipment

Micro Control Associates Inc.

The Model *ULX 2001 Uniphase Link Exciter* is designed to enhance the performance of conventional STL systems. The unit modulates and multiplies a radio carrier to the 950MHz STL frequency for transmission to the FM broadcast transmitter site.

Circle (848) on Reply Card

Microdyne Corporation

Model *SATRO 11* is an 11-meter satellite earth station antenna that operates at 4 or 6GHz. The design allows survival of 80 mph winds with stow position protection to 125 mph. Antenna gains of 52 to 55dB possible with Rantec cassegrain dual pole receive-only feed and subreflector system.

Circle (515) on Reply Card

Microprobe Electronics Inc.

Model *100 MP* (microprocessor-controlled) *Programmer* provides easy-to-use automation control with live assist, or manual operation. Lazy-

Time clock makes certain commercial breaks occur at proper times. Silence sense circuit guards against dead air.

Control 3 is a random select controller/programmer, selecting the proper machine and tray as well as the audio to the common output line. More than 900 events can be programmed with "go live" operation hold button.

LOG 4 Automation System and *LOG 2 Automation System* with the 100MP programmer outputs can feed the transmitter of stereo generator directly.

Circle (516) on Reply Card

Microtime, Inc.

T-120 Digital Time Base Corrector uses 8-bit 4X subcarrier heterodyne processor with 16-line memory (15 line window) and 3.58MHz feedback for full bandwidth processing. *Auto-Trac 3* automatically assures vertical blanking.

Model *2525 Video Signal Synchronizer Time Base* corrects any VTR and synchronizes any source. With the *2525SP* special processor, up to eight inputs can be preset for Field 1/Field 2/, full-frame freeze, auto freeze on last video, or blackburst.

Circle (517) on Reply Card

Micro-Trak Corporation

SPORT IV Portable Console includes a telephone dial option for use with regular telephone lines, lowering costs of remote sports programming. It operates from low-cost batteries or a built-in ac supply. The unit allows three headphone outputs and four microphone inputs.

Model *6509 Audio Console* includes five mixing channels for nine inputs, built-in "on air" relays, voltage-controlled attenuators, plug-in boards, for stereo output with rotary or linear controls.

The *D System* and the *Ditty Desk* are audio control locations designed for a more finished look. They are portable, complete with turntables and console.

Model *6618 Broadcast 6-Channel Audio Console* contains six stereo and mono channels with three inputs, 10W monitor amplifier, latch logic switching and clean VCA mixing controls.

6445/6455 Consoles are 5-channel, stereo or mono where space, portability and ease of operation are important. They can travel in the *D* system to do production and news or stay at home "on air."

Circle (518) on Reply Card

STOP GROUND-LOOP HUM!

VIDEO HUM STOP COIL...HSC 1

Will ELIMINATE HUM and other INTERFERENCE in Video Lines caused by differences in Ground Potential.

- For Color and Black and White.
- FLAT-DC to 6.5 MHz.
- No Low-Freq. or Hi-Freq. Roll-off.
- No Differential Phase Distortion.
- No Differential Gain Distortion.
- No Envelope Delay.
- Passive Device - Failure Free-Low Price.
- Small Compact Package 4" x 4" x 2-1/4".

ELIMINATES HUM AND INTERFERENCE:

IN STUDIO

- Between Buildings
- On long runs in Buildings
- Between Studio and Transmitter
- On Incoming Telco circuits
- On Outgoing Telco circuits

IN FIELD

- Betw. Remote Truck and Telco
- Betw. Remote Truck and Microwave
- For Intertruck Hookup
- For VTR Units
- For Monitoring Lines

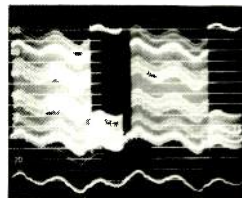

NEW!

\$170
F.O.B.
N.Y.

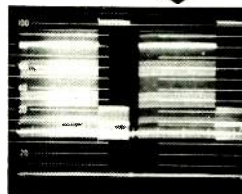

Available on
10 day free trial

AUDIO-VIDEO ENGINEERING COMPANY
65 Nancy Blvd., Merrick, N.Y. 11566
Tel. (516) 546-4239

Circle (91) on Reply Card

VERSATILE

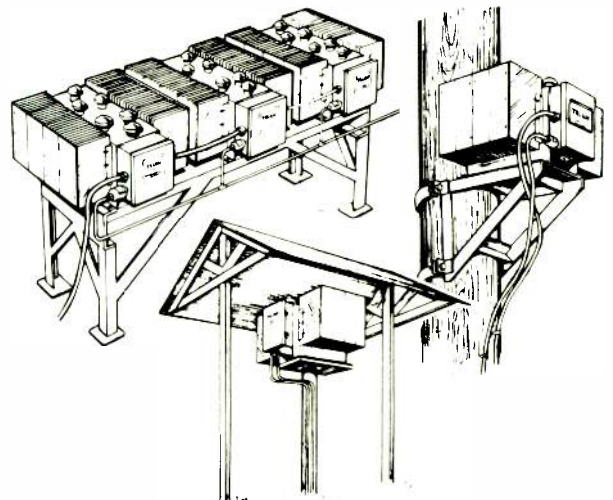

mount it anywhere

Continuous, unattended power 10 to 90 watts. That's TELAN Thermoelectric Gas Fueled Generators. Totally weatherproof and reliable, you can install them in an hour or two, light a match and forget it.

TELEDYNE ENERGY SYSTEMS

110 W. Timonium Rd., Timonium, Md. 21093 U.S.A.
Phone: 301-252-8220 Telex: 8-7780 (TEDYNER TIMO)
Cable: TELISES

Circle (92) on Reply Card

Microwave Associates Communication

7GHz Pyramidal Horn Antenna is portable for tripod-mounted ENG operation. It provides a gain of 17dBi, linearly polarized with vertical or horizontal polarization selectable by means of the mount.

7GHz Parabolic Reflector is two or four feet in diameter, providing 30 to 37dB gain. Metalized fiberglass construction includes a choice of linear or multipolarized feedhorn operation and can be tripod-mounted.

7GHz Phased Array Antenna provides 24dBi gain with circular or linear polarization. Includes a built-in mounting for the PA-700 amplifier and heatsink, with dimensions of 8.2 x 35 x 8 inches.

OMNEX Aircraft ENG/EJ Antennas are omnidirectional antennas for aircraft repeater or any receive/transmit operation in 2, 2.5, 7, or 13GHz auxiliary service microwave bands.

Eagle-Eye Gyro-Stabilized Optical Systems for the helicopter-mounted system. A 3-axis gyro-stabilized camera can achieve an effective zoom lens range of 44:1. Motorized aiming system, spherical enclosure and power conditioner with a remote control panel complete the system for pan, tilt, zoom, focus and iris func-

tions.

Eagle-Eye Gyro-Stabilized Optical System for camera mounting allows close-up images from 3-times farther away than an unaided held-held camera.

Circle (519) on Reply Card

Midwest Corporation

Midwest Corporation can supply remote mobile units from semi-based vehicles to Bronco systems, with audio and video equipment to meet the buyer's needs.

Circle (520) on Reply Card

Mole-Richardson Company

Type 2821 Tweenie 600W Mole-quartz Mole Solarspot unit joins the wide line of lighting equipment for film and television.

Circle (921) on Reply Card

Moseley Associates Inc.

TCS-1 Telecontrol System provides fully independent command and status reporting for use with broadcast transmitters, ENG systems, microwave transmit/receive systems, remotely-located cameras or industrial applications.

TCS-2A Telecontrol System offers fully independent command, status report and telemetry functions for remote control applications. The 8-channel system is based upon the 6802 microprocessor with customized Moseley software.

MRC-1 Microprocessor Remote Control System operates with up to nine remote terminals for remote indications of analog telemetry and status information and provides reliable remote control of equipment. Each remote terminal may access up to 64 command outputs, 32 status inputs or telemetry inputs.

MRC-2 Microprocessor Remote Control System allows multiple control terminals with pre-established control hierarchy, a maximum of 99 remote sites and 255 command lines, status inputs and analog telemetry inputs per site.

Circle (523) on Reply Card

Motorola Inc.

Compatible Quadrature Modulation AM Stereo Exciter and Monitor with relatively simple and inexpensive modification to the existing AM transmitter creates a compatible stereophonic AM broadcast signal.

Mitrek Super Console Base Station

AKG

The design objective of our new D300 series was to put the world's most advanced microphone technology right into the palm of your hand.

The patented suspension system shown here, allows for the first time ever, a combination of the famous AKG studio quality sound with the ruggedness and dependability expected from an "on-the-road" vocal microphone. And, this is just one of the many unique design features you'll find exclusively in our

D-330BT, D-320B and D-310 microphones. Once your AKG dealer puts all the advanced features which distinguish the D300 series into the palm of your hand...we're confident you'll decide to go on-tour with AKG.



AKG ACOUSTICS INC.
A NORTH AMERICAN PHILIPS COMPANY
77 Selleck Street, Stamford, CT 06902
(203) 348-2121

AKG Akustische und Kino/Geräte GmbH, Austria

©AKG 1981

Other equipment

develops 110W VHF low or high band or 50W UHF from 100% solid-state circuitry. Options include private line/digital private line, priority channel scan and QUICK CALL II selective signalling.

Flexar Base Station with 100% solid-state circuits, features 2, 15, 25, and 30W output power. Variable to meet the power level needed for coverage of the area for high VHF and UHF applications.

Pulsar II Mobile Telephone allows "on hook" dialing, last number recall, number memory and Motorola Automatic Channel Scan (MACS) for busy high traffic areas — convenience for the people in the field who must keep in touch from their car.

Syntor XX 800MHz FM 2-Way Radio features TRAC-MODE Microprocessor Control for operating parameters stored in a plug-in memory module, MODE SELECT operator control for private-line or channel scan monitoring and broad-band operation over the 800MHz dispatch spectrum.

RDX 1000 Portable Data Terminal is the hand-held, 2-way, wireless terminal with self-contained FM transmitter and receiver, and batteries for total freedom. Up to 32 data terminals, a duplex FM radio base station, and the RDX1100 Control Unit provide real-time communications to the data processing center.

Communications System Analyzer R2001A uses the 6800 microprocessor to combine 10 separate instruments into a single unit for signal generation, monitoring, trouble shooting. A CRT functions as an oscilloscope as well as alphanumeric readout of test and results.

Circle (524) on Reply Card

Mullard Ltd.

See teletext article on page 99.

Circle (940) on Reply Card

N-Pro

The *K2 Series Hydraulic Masts* extends 22 feet, 2 inches, with a lifting capacity of more than 150 pounds in 105 seconds. The masts retract to 7 feet, 6 inches, which allows for vertical mounting. The series features all-aluminum construction, 4-section telescoping capability and anti-friction devices to allow for sloping locations.

The *ENG Camera Pedestal* rotates about the mast and allows for full control of the camera while aloft. The unit is available with either cable control or remote control by radio. The unit

operates from self-contained batteries or from a power source below.

Circle(775) on Reply Card

NADY Systems

VHF Hand-Held Mic. Available with Shure SM-58 or Electrovoice PL76 elements. Other mic heads available for additional charge.)

VHF 800. Body-Pac transmitter with Hi-Z input for musical instruments.

VHF 900. Body-Pac transmitter with Lo-Z input for lavalier microphone. Also featured were the VHF 600 Receiver, VHF 700 True Diversity Receiver, VHF 610A Receiver (for use where external DC is always available), VHF 610B Receiver, VHF 610C Receiver.

Circle (529) on Reply Card

NEC (Nippon Electric Company Ltd.)

NTC-5000 Time Base Corrector for use with Quadruplex to the smallest helical formats, applicable to direct or indirect recording systems. Heterodyne adaptor for 3/4-inch format.

DME Digital Mix Effects System provides the production center with frame synchronization and a wide range of digital video effects including splits, horizontal and vertical flips and a mosaic effect.

DPC Digital Programmable Controller operates with DME or DVE systems for complete digital control of all system functions, sequences up to 999 frames auto pan tilt.

FS-15 Frame Synchronizer is capable of instantaneous synchronization of remote or local signals. Freeze Frame, TBC and VELCOMP are options.

DVE Digital Video Effects combines the FS-15 and the DVP-15. Digital Video Processor allows computer manipulation of the FS-15 memory for limitless video zoom and digital video feedback effects, tracking chroma-key, continuous compression, positioning, magnifying glass, etc.

FS-16 Frame Synchronizer offers true frame synchronization with studio transparent quality, 4 X subcarrier sampling, 9-bit quantization, full proc amplifier functions.

TKA-105 Routing Switcher uses 8-input by 1-output wideband cross-point chips and single chip 1 by 6 video distribution amplifier chips with full microprocessor logic of each controller. Audio signals are digitized, with provisions of four audio channels, modular in 15 x 15 segments.

TAKS-1000 Series Production Switchers A, B, and C are LSI based 20-input switchers with 1, 2, and 3-Mix/Key buses, respectively. All include preview/key and program

buses (C has eight-output buses) with modulated position, color matte generator and digital wipes. Options include RGB chroma key, shadow key, encoded chroma-key, quad split, borderline generator, digital rotary pattern, downstream keying.

Also see cameras and TV transmitter articles.

Circle (526) on Reply Card

NTI America Inc.

Model 535 Color Digital Monoscope Signal Generator is available for use with NTSC, PAL B, G, H, I, PAL M, and SECAM color standards. Allows measurement of color resolution as well as standard monochrome measurements.

Circle (528) on Reply Card

Nagra Magnetic Products

The *Model E Non-Synchronous Recorder* operates at 7.5ips, internal universal preamplifier, battery operated.

The *Model SN Portable Tape Recorder* for locations needing broadcast quality and synchronous operation.

The *Model IS-LT Synchronous Recorder* has 2 speeds with universal preamplifier for two 200Ω dynamic or two capacitor microphones.

Circle (530) on Reply Card

Neal Ferrograph Inc.

312 Stereo Cassette Recorder incorporates Dolby HX and has metal tape capability. HX (Headroom Extension) eliminates the "cassette sound."

302 Cassette Recorder is a 3-motor, logic-controlled unit that uses ferric or chrome tape.

330 Audio-Visual Recorder uses two identical channels for audio and a third for the sync track used with a slide projector.

340 Cassette Recorder is a 4-channel recorder with four identical audio tracks. Each pair can be recorded independently or simultaneously, allowing quadrasonic or stereo use.

SP 7S Reel-to-Reel Recorder uses 3-head, 3-motor format for 15, 7.5 and 3.75 speeds. Capstan is closed loop servo. Variable speed in record and play possible.

SP74R Broadcast Logging System is a 4-channel, 24-hour system for uninterrupted accurate logging on three audio tracks and one time track. The system consists of two SP74 decks.

Circle (531) on Reply Card

Rupert Neve

Highlighted for the convention was

the Neve line of audio consoles with parameters especially designed to meet the needs of TV broadcasters.

The 542 series spans 6 to 16 inches and is suited to video production facilities and TV sweetening.

The 5315 and 5316 consoles are available in sizes from 12 to 36 inches with four or eight submasters for TV sound production and on-air use.

Also promoted: the COMMUNICATOR, a family of microprocessor-controlled broadcast intercom and audio routing systems, and the NECAM-II, a computer-controlled mixdown system enabling fast and creative post-production editing and mixing for audio.

Circle (389) on Reply Card

NEWSCAN McInnis-Skinner and Associates

NEWSCAN Graphics provides a directly broadcastable color graphics format with 640 horizontal by 480 vertical pixtel resolution and 256 of a possible 4,096 discrete color pallettes on any image. The output can be used full screen, mixed with other video, or key inserted or chroma-keyed over or under other video. Addition of a videodisc allows animation from drawings created on the graphics tablet.

Weathergraphics uses the NEWSCAN system to generate map displays of weather information by means of a dial-up telephone link to the data base in Oklahoma City.

Votescan Module allows the NEWSCAN system to take the latest election returns and present them in alphanumeric and/or chart format.

Circle (533) on Reply Card

Nidus Broadcast Systems

System 100 and System 130 are complete broadcast-oriented business systems to handle automated scheduling, billing, general ledger, payroll, etc. The systems differ only in speed and ease of use and data storage capacity.

Circle (534) on Reply Card

Nippon Television Network Corporation (with FOR-A)

See cameras beginning on page 84.

Circle (527) on Reply Card

Northeast Automation Systems (NEAS) Division of NEP Communications Inc.

Automation system for the broad-

caster to handle all business needs of the station: traffic, sales, technical materials and logs.

Circle (535) on Reply Card

Nortronics

PF-311, PF-312, PF-313 Splicing Blocks are high-grade anodized aluminum, with 90° and 45° slots.

PF-524, PF-526, PF-527, PF-553 Splicing Tabs are polyester film material with rubber/resin adhesive. Available in opaque white or metal-sensing. Tensile strength of 35 pounds per inch to reduce stretching.

AT-120 Alignment Tape for ¼-inch

reel-to-reel use at 7.5ips. Employs NAB Standard Reference Level and equalization. Sweep tone included for check of stereo phase of a head.

AT-200B Cassette Alignment Tape provides a full track 1.875ips master recording at the IEC/DIN Standard Reference Level.

AT320E Alignment Tape is intended for use in full-track cartridge equipment. Each tape is a master recording using the NAB Standard Reference Level and equalization. Mono and stereo machines may be checked. Six tones included for response checks, sweep tone for stereo phasing.

Circle (536) on Reply Card

the OPTEK 8000 Bulk Tape Degausser... kiss the noise goodbye!



Signal and noise are gone. Wiped Clean. Even today's high density tape is no match for the new OPTEK 8000...the most powerful bulk tape recovery system available today. Fully automatic, hands-off operation provides fast—reliable signal erasure.

High performance "E" core coils virtually strip recorded material; with minimum heat, in less than 32 seconds. The 8000 does all the work...you load the tape, reels up to 16" diameter—¼" to 2" widths, set the coils and push the start button. That's it.

Design features include: high quality Bodine drive motor, total solid-state control logic (C-MOS), resonant coil technology, sturdy cast aluminum chassis and hi-tech style fiberglass cabinet.

If you're in the market for a quality conscious, cost efficient degaussing system that delivers recording tape that doesn't talk back...there's not another machine available today that can match the 8000's performance.

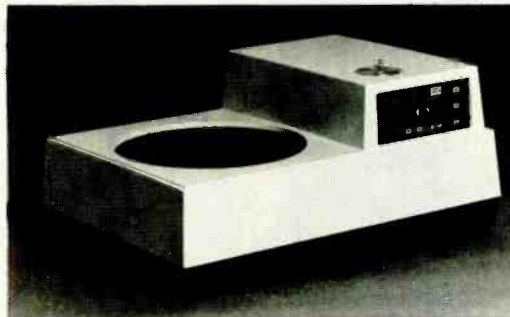

NOW IN STOCK

For complete technical information call or write: Mr. John Baumann
OPTEK INCORPORATED
1360 North McCan Street, Anaheim, California 92806,
(714) 630-8280.

OPTEK

Circle (93) on Reply Card

Other equipment

Fred A. Nudd Corporation

Fabrication, construction and servicing of towers for the broadcast industry.

Circle (537) on Reply Card

Nurad Inc.

QP Series QUAD Receive Antenna Systems operate in 2, 2.5, and 7GHz bands. Use four individually selectable quad-polarized antennas for ENG/EJ signal reception.

LA-Series Low Noise Preamplifiers, for use with the QP Series antennas, reduce system noise figure and compensate for RF transmission line insertion losses, maximizing range of coverage.

Superquad II Antennas combine the best of quad polarization, high gain, directivity and consecant-squared beam shaping for ENG/EJ receive antenna systems. Reception is possible from "under the tower" to the limits of the range without elevation tilting.

MC3 Digital Remote Control units allow operation control of the Superquad II, Supertrack and Quad Receive Antenna Systems. Two units, con-

nected by telephone line or a microwave radio link, make up a usual MC3 system. Single antenna aiming, as well as one of four selection, is possible with the controlling units.

Circle (538) on Reply Card

Nytone Electronics Corporation

TSC-1, TSC-2, TSC-3 Flying Spot Scanners realize broadcast-quality color slide reproduction with a capacity of 80 individual slides. 450 lines horizontal resolution provided with R-Y, B-Y encoding. TSC-1 allows sequential slide access; TSC-2 gives random access.

Circle (539) on Reply Card

OKI Electric Industry Company Ltd.

LT1200 Portable Digital TV Standards Converter incorporates portability with OKI's LT1100 Standards Converter unit. Standby encoder and decoder modules allow conversion between NTSC, PAL, and SECAM by plugging in the appropriate module. Can be used as a frame synchronizer allowing mixing and editing of signals with other standards than the produc-

tion studio.

Circle (545) on Reply Card

Oak Communications

ON-TV provides a pay-TV service of diverse entertainment programming.

SIGMA is an over-the-air subscription TV system for scrambling of signals and descrambling at the paying subscriber's TV set. Audio and video signals are time-varying digitally and analog encoded.

Also see satellite articles.

Circle (546) on Reply Card

O'Connor Engineering Limited

Model 100-C Fluid Camera Head, for cameras up to 100 lbs., is constructed of magnesium and aluminum alloy castings, weighing only 16 lbs.

Model 150-XR Fluid Camera Head is designed for cameras up to 150 lbs.

Hydro-Ped Model 102-B Tripod levels and locks hydraulically on any terrain up to 40 degrees. Rigidity up to four times that of a conventional tripod. Center column adjustable from 30 to 60 inches. Intended to handle up to 100 lbs., weighs only 29 lbs.

Other models of fluid camera heads: Model C; Model 30; Model 50-B. Line includes claw ball and super claw ball

Hydraulic MASTS !

by
N-PRO



SEE our demonstration
at the
nab
CONVENTION

- DUAL SPLINE RAILS
- Lifting power to 300 lbs.(single mast)!
- STAYS PUT at any level w/pump off !
- INSIDE or OUTSIDE MOUNT for
- SMALL or LARGE VANS !
- ALL ALUMINUM construction
- EXCLUSIVE N-PRO MATERIAL
(extruded by REYNOLDS)
- MANY OPTIONS & CUSTOM DESIGN

AVAILABLE
FREE BROCHURES WRITE or CALL

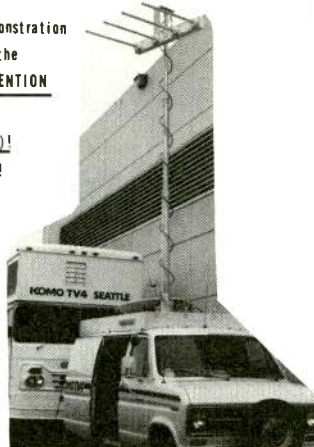

N-PRO Co.

(503) 656 - 5500
657 - 5800

1022 Hazelwood Dr., OREGON CITY, OR. 97045

Circle (94) on Reply Card

cam-lok "J" Series Connectors





MOISTUREPROOF

- Totally shielded contacts • Waterproof • 600 volt plus power conn. • XQJ 220 male & female: #2 to 2/0 cable • XQJ 204 male & female 2/0 to 4/0 cable. (colors available: black, red, white, blue or green). Contacts and insulators can be assembled anywhere. Assembled connectors withstand pulling force of 1,000 lbs. Contacts available for cable attachments by solder, crimp or mechanical method. Similar connectors are available that can be vulcanized for submerged waterproof use.

CABLE AVAILABLE

Fesco can also furnish 600 volt + cable from sizes #4 thru 4/0 in 25, 50 & 100' lengths and also in 500, 1,000 or 10,000' reels.

MADE UP UNITS

Fesco has in stock or will make to order any quantity of cable with any Cam-lok connector, vulcanized or mechanically connected.

These connectors meet OSHA requirements and are approved by Madison Square Garden.



WEST COAST STOCKING WAREHOUSE
1634 COLORADO BL. LOS ANGELES CA 90041
(213) 254-9131 • TELEX: 69-6239

Circle (95) on Reply Card

tripods.

Circle (547) on Reply Card

Oktel Corporation

The company features direct color broadcast, slow motion and slide file disc recorders.

Circle (475) on Reply Card

Olesen

Compulite, a state-of-the-art lighting control system, combines microprocessor technology with lighting design. Features group and preset control; timed cross fades; auto fades.

Altman Zoom-Focus Ellipsoidal Spotlight produces high intensity sharp or soft-edged beams with a spread from 20 to 40 degrees. Accessories include an iris, pattern holder, color frame, patterns and mounting adaptors. It uses a triple 6-inch variable lens system.

Circle (548) on Reply Card

Optek Incorporated

Model 800 Bulk Tape Degausser is adjustable for the size of the reel of tape to be degaussed and uses high power resonant "E" core coils for an erase level of -80dB typical.

Circle (549) on Reply Card

Orban Associates Inc.

111B Reverberation System offers dual channel spring reverb. Six springs per channel create smooth, more natural sound. Transformer-balanced main output in addition to unbalanced "mixed" output yields in-line use without external mixers.

Also see audio processor article.

Circle (550) on Reply Card

Allen Osborne Associates

Pneumatic Telescoping Hilomasts now include the NX series (6-inch) diameter along with the 3-, 4- and 5-inch diameter mast units. The NX series achieves a maximum height of 93 feet with thumb screw locking devices. Keyways prevent these aluminum alloy units from relative rotation, allowing use with directional antennas. They are trailer mountable.

WTM Series Telescoping Hilomasts require a winch for raising and lowering, to a maximum height of 70 feet.

Circle (551) on Reply Card

Osram Sales Corporation

Metallogen Lamps (MMI) metal-halide, high intensity discharge lamps in 575, 1200, 2500, and 4000W sizes use mercury and argon to achieve an arc discharge. Rare earth metals are

added for full spectrum light energy.

OSRAM carries a wide line of incandescent lamps for television, film, and stage lighting needs.

Circle (552) on Reply Card

Otari

MTR-10 Series Mastering Audio Tape Recorders. The MTR-10-2 two channel 1/4-inch and 10-4 four channel 1/2-inch recorders use DC and phase lock loop transport operation. Three speeds (3.75/7.5/15) or (7.5/15/30) take tape past three heads in line. Controls are microprocessor based.

5050BQ-Series II 4-channel 1/4-inch Audio Recorder improves earlier models with microprocessor transport logic, electronic timer, automatic monitor switching, peak reading indicators for each channel, and separate mic/line mixing on each channel. 3.75/7.5 or 7.5/15 IPS models available with variable speed DC capstan servo, reel motors are induction torque.

Circle (553) on Reply Card

Otis Connor Productions

The Modular Music System includes copyrighted material, allowing a radio station to purchase only the elements

Howe Audio History Is Made . . . See us at NAB Booth 438S

Howe 7000 Stereo Console

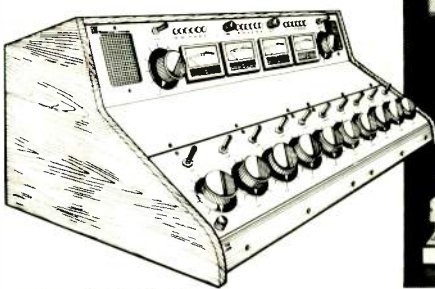

Simply Reliable.

Those words introduced the Howe 7000 in 1979. Since then the Howe 7000 consoles have rapidly grown in popularity. Engineers are impressed with Total Harmonic Distortion of .09% or lower, noise floor of -74 dBm, equivalent input noise of -124 dBm or lower, channel separation of better than 60 dB, frequency response of 20 Hz to 20 kHz \pm 1 dB, and maximum output of +24 dBm.



"Since the installation of our first Howe Series 7000 console last summer, we have enjoyed consistently high quality and no down-time. The operators are delighted with the clean, straight-forward layout of the controls and the useful special features of the Howe Series 7000. The second Howe Series 7000 console is being installed in the KIMN newsroom, a high-volume, 24-hour mobile news operation. Again, the Howe Series 7000 console offers the reliability, special features, and error-free operation that we demand." Chuck Waltman, Engineering Director, KIMN-KYGO, Jefferson-Pilot Broadcasting, Denver, Colorado.

Introducing the Howe 8000.

The 8000 has all the same performance specifications and high reliability of the 7000, but with many new features, including slide attenuators, push-button logic systems for on/off/cue and remote start/stop, simultaneous audition/program bussing, fluorescent VU meters and a built-in real-time clock. As in the 7000 there is a full width option panel and D.C. audio control.

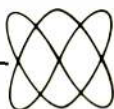

howe audio productions, inc.

Call Howe Audio Marketing

P.O. Box 383 Boulder, Colorado 80306

(303) 424-3231

Mail the Howe Audio reply card on page 185

Circle (96) on Reply Card

Other equipment

of a radio ID and promotional package needed. Additional elements are available for future purchase.

Circle (554) on Reply Card

Pace Incorporated

Dual Path Solder Extractor is 500 percent faster on heat-up time, 70 percent energy efficient, will not clog, and stays cooler longer for extended use.

Pace Micro operates on 110 ac or external 12Vdc with precision variable temperature control, fast warm-up time, fast-rise vacuum system, lightweight handpiece with vacuum control, and interchangeable tips for solder/desolder.

Circle (555) on Reply Card

Pacific Recorders and Engineering Corporation

Tomcat Audio Cartridge Recording and Reproduction Units are designed for NAB AA size cartridges. Operating at 7.5 or 15 ips with MAX-TRAX's wide track tape heads, Left/Right or Sum/Difference matrix audio formats will handle monaural or Stereo playback. DC servo capstan motor runs only while pulling tape. CMOS microprocessor logic controlled.

Circle (556) on Reply Card

Panasonic

AU-700 Master Editor Videocassette Recorder. Dc motors are used for all transport operation, relieving belt problems in tape drive. A separate SMPTE time code track allows dual audio channels. The operation is microprocessor based. The digital counter displays real time fully advising when this full function editing VCR should switch.

AU-A70 Microprocessor-based Editing Controller, can be programmed with up to 20 automatic entry-exit edit positions. The SMPTE reader/generator control pulses are displayed on a digital readout. The controller accepts two separate tape sources plus live camera. Parallel A/B rolls permitted in all modes. Sequential search speed available for all machines.

NVA970 Editing Controller. A microprocessor-based logic control for assemble/insert editing with the Panasonic B2 and G2 series 3/4-inch and Panasonic VHS 1/2-inch machines, uses LED indicators showing time in hours/minutes/seconds/frames. Sequential speed dials permit search from 1/20 to 5-times normal speed for-

ward and reverse.

AV-800 Digital Video Production Switcher. A microprogrammed computer and preprogrammed cartridges hold up to 64 wipe patterns. All signal processing is done via microcomputer, allowing control instruction data transfer from console to electronics rack on an audio pair. See cameras beginning on page 84.

Circle (557) on Reply Card

Panasonic, Audio Division

Model WM-8100 RAMSA Unidirectional Back Electret Condenser Microphone for use in pickup of dynamic instrumental sound, the microphone push-pull type back design with sound pressures up to 154dB SPL with 1 per cent THD.

WR8210 RAMSA Recording Console offers 10 input capability in four group outputs for 4- and 8-track recording applications. 14 point, 3-color LED bar graph meters indicate group output levels.

WR-8715 Sound Reinforcement Mixing Console provides four outputs plus stereo left and right buses and includes plastic conductive straight line faders, 3-band variable frequency equalization, solo function and group pan pots.

Circle (558) on Reply Card

Panasonic Video Systems

VTR/Camera Combination combines 1/2-inch videotape with a three tube color camera for a 22-pound package, including lens and batteries, recording up to 20 minutes on a VHS-like videocassette. The camera uses 3/8-inch pickup tubes. (Note: Not VHS compatible.)

1/2-inch Editing System for use with the VTR/Camera system consists of two full-featured editing videocassette recorders and a controller, for two audio tracks, a separate time code track; insert and assemble editing on either machine, with search at 8X normal speed.

NV-A970 Editing Controller with SMPTE Time Code Accuracy uses microprocessor based logic for insert/assemble editing on Panasonic B2 and G2 3/4-inch equipment as well as on the 1/2-inch VHS models NV-8170 and NV-8200 machines.

Model NV-8050 1/2-inch Videocassette Time Lapse Recorder can store 240 hours of program material. Six time lapse modes as well as real time color or b/w operation is suited for broadcast logging, security, animal behavior, and film time-lapse applications.

Model NV-9920 VTP Master Recorder and NV-9910 VTP Printer form the VTP high speed VHS duplication sys-

tem. Copies of 2- and 4-hour videocassettes can be made in approximately four minutes.

Circle (559) on Reply Card

Parsons Manufacturing Corporation

A variety of cases of high density polyethylene and ABS materials, with and without wheels, with or without anti-electrostatic padding materials, for every "in-transit" need.

Circle (560) on Reply Card

PEP Inc.

SLA 1250 Snap Pack offers snap-on power with the advantage of sealed lead-acid batteries, avoids "memory" effect of some rechargeables, low self-discharge rate and high cycle life.

Charger features two-step constant current, overcharging prevented to maximize battery life; output short-circuit protected; overnight recharging normal.

Circle (567) on Reply Card

Perrott Engineering Labs, Inc.

Model 8100 Series Fast Chargers are microprocessor controlled, portable, lightweight, durable, for 12 or 14V rechargeable packs.

Ni-Cd Evaluator Diagnostic/Charging System shows condition of individual cells, charging of individual cells up to 32, extended battery life with elimination of memory effect. Complete charge without overcharge.

Circle (561) on Reply Card

Phelps Dodge Communications Company

Rigid Coaxial Transmission Line from 7/8-inch to 6 1/8-inches is fabricated from hand-drawn copper tubing. EIA bolt flanges with inner connectors compatible with EIA standards and all necessary components for the complete installation are available.

FM Broadcast Antennas both horizontally and circularly polarized for the high-power super station and the low-power educational station.

Vehicular Antennas for VHF and UHF frequencies, from disguised automotive antennas, quarter wave and base loaded quarter wave, rooftop, coaxial, low profile, and antenna aircraft, with all necessary mounting accessories.

Circle (563) on Reply Card

Philips Broadcast Equipment Corporation

A-10, B-14, C-16, and D-22 Mobile TV Production Systems are self-contained,

self-powered, functionally designed with complete production, engineering and recording areas. Ample storage space, dc lighting, air conditioning and roof-top camera production platforms are standard.

See cameras beginning on page 84.

Circle (564) on Reply Card

Phoebus Manufacturing Company

ULTRA ARC follow spots use the GE MARC 350/16T lamp for a light output comparable to carbon arc fixtures. Wide movement as well as high spotlight capability, automatic color boomerang, dowsers, iris and clippers.

Circle (565) on Reply Card

Porta-Pattern

Test Charts for television and cinematography, transparencies in 2"x2", 3 1/4"x4", and 8"x10" formats with transparency illuminator.

Full Field Color Bar Image provides subjective reference of defined areas of color information closely approximating that of a color bar generator, including three primary colors, three secondary colors, as well as black and white.

Circle (568) on Reply Card

Potomac Instruments

SMR-11(AM) is an AM broadcast band radio receiver for station monitoring with wide-bandwidth, low distortion, and low noise as well as alarm functions required for ATS operation.

Circle (878) on Reply Card

Power-Optics

The company features Grafikon color monitoring instruments, remote color camera control systems and scene-sync device.

Circle (317) on Reply Card

Pro Cart

NAB Type AA audio cartridge, superior phase and phase flutter stability, high impact plastic of XT polymer, bridging design for optimum tape guidance, precision input for automatic height and azimuth alignment, no moving parts except turntable.

Circle (569) on Reply Card

Protech Audio Corporation

SAM 82 and SAM 42 audio mixers, eight inputs and four inputs, respectively. Imported from Sweden from SATT Electronics. SAM 82 operates from ac or dc. SAM 42 is dc operated, with stereo line out, talk-back line out,

built-in talk-back mic, two ppm instruments for level measurements, phantom powering 48V.

Also see audio processor article.

Circle (570) on Reply Card

QEI Corporation

Model 571 AM Modulation Monitor features peak flashers that can be individually set; one for positive peak (50% to 130%), one for negative peaks (50% to 100%).

Model 675 FM Excitor provides direct FM on carrier, phase locked, frequency synthesized, programmable to any 100kHz increment in FM band.

Model 811 SCA Generator, low distortion, crosstalk and noise, auto-mute with adjustable level and delay, sub-audible telemetry input, carrier frequency 41 or 67kHz (20 or 75kHz special order), carrier stability +/-500Hz.

Model 7775 Automatic Transmitter System has failsafe design with internal once-per-minute automatic system verification, operable with station's remote control system, operation via STL or single voice grade phone line.

Model 691 Tunable Stereo Modulation Monitor and FM Test Set has FCC type approval

Circle (571) on Reply Card

Our coaxial switch prices are lower because our deliveries are faster.

STANDARD DELIVERY QTY. 1-25

Positions	Delivery
SP2T	↑ 6 weeks ↓
SP3T	
SP4T	
SP5T	7 weeks
SP6T	
SP7T	8 weeks
SP8T	9 weeks
SP9T	10 weeks
SP10T	10 weeks
Transfer	10 weeks

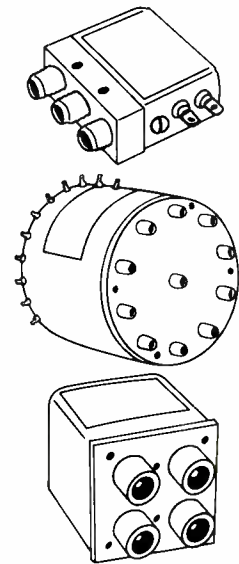

Million cycle reliability per position . . . best warranty in the industry. And, our Sales Administrators will quickly answer any questions on prices or available options. Just call.

Dynatech/U-Z Inc.

9522 West Jefferson Blvd., Culver City, CA 90230
Telephone (213) 839-7503 • TWX. 910-340-7058

Circle (97) on Reply Card

Other equipment

QSI Systems Inc.

QUI VALID (Video Affiliated Line Identifier) System to transport digital data in the vertical blanking period, identifying the active video fields which follow, also for source identification using eight alphanumeric characters.

NVS-8 Eight Digit Numeric Video Slate for identifying tapes within the picture or may be added within the vertical blanking interval as a continuous record of source.

VT-10 Seven Segment Leader Countdown Generator provides video and audiotape cueing information at the headend of each program segment, 1-second interval numerical countdown for 10 seconds (8 seconds of numbers, 2 seconds of black), and audio cueing is 0.5-second 400Hz bursts.

DEMOD 400 Broadcast Television Demodulator covers UHF and VHF bands, LSI signal processing, front panel VU metering, ceramic filtering for separation and rejection of adjacent channel interference and for maximum video and audio response.

CLK-81 Master Clock System is based on NTSC subcarrier or internal

data recording and a 2MHz microing up to 25 pulse clocks.

Circle (572) on Reply Card

Q-TV Telesync

VPS-100 Videocassette Console Transport eliminates large-size typewriters, special paper and ribbons by using 8½x11 single sheets of paper in any typewriter.

Mini-Q-Prompter is lightweight, easy-to-mount on the screen, easy to operate and uses standard paper. Copy may be printed by typewriter or hand for the cartridge loaded unit, belt powered at 12V.

VIV Virtual Image Videoprompter uses optical beamsplitter to magnify the script equal to that of a 15-inch monitor, placed over the camera lens for good talent eye contact.

Circle (573) on Reply Card

Quad-Eight Electronics

Coronado Console is configured with 40 inputs to 24 mixing buses, quad mix-down and monitoring facilities. Active operation is VCA with six subgroup masters that can be assigned independently from each input.

CORONADO Disk Editor System (COMPUMIX III) with floppy disc

crystal, has battery backup, for drivprocessor system takes control of the Coronado console.

2-4-8 Component Series/Audio Consoles are modular from either input to four outputs up to 24 inputs and eight output buses.

Pacifica Console is available as 16, 24, or 36 inputs with eight mixing buses, stereo mix down and monitoring capability.

Also see audio processor article.

Circle (574) on Reply Card

Quantum Audio Labs

Featured its broadcast production audio consoles with: 8 or 12 stereo outputs; up to 24 inputs; balanced inputs and outputs; four independent monitors, and much more.

Circle (645) on Reply Card

Quickset Inc.

Provides "support products" for broadcasters: tripods, pedestals, fluid heads, pan/tilt heads, and remote controlled positioners.

Circle (575) on Reply Card

Quintek Inc.

The microprocessor-based Intelocator XT24 interfaces with the 3M

Winsted

THE MATCHMAKERS
for the customized approach
to videoproduction centers.

Portable PRODUCTION CONSOLE

For in-house or on location — a complete production facility in one compact portable unit. Ample 47¼" of rack space puts all your equipment within easy reach. Large selection of modular components offer many variations.

For full-line catalog of editing, production and dubbing consoles, tape and film trucks, film and videotape storage systems, call or write:

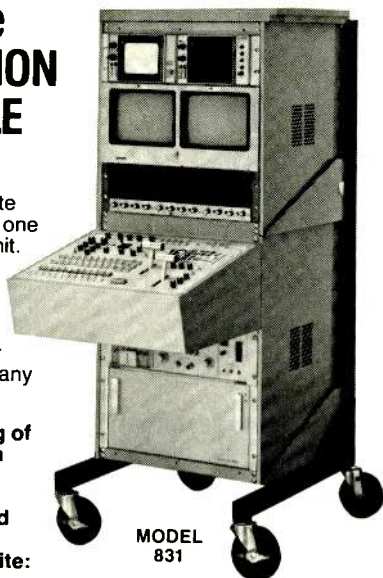

MODEL
831

THE WINSTED CORPORATION

8127 Pleasant Ave. So. • Minneapolis, MN 55420 • 612/888-1957

Phone Toll-Free
1-800-328-2962

Winsted

Circle (98) on Reply Card

Cut lamp costs up to 50%

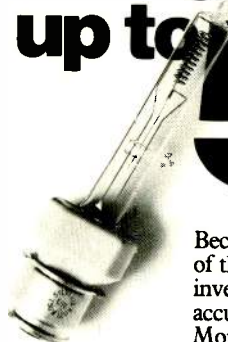

Because Sitler's Supplies maintains one of the industry's largest lamp inventories, you can count on prompt, accurate delivery and low, low prices!

More than 400 types of projector, stage and studio lamps are available in G.E. and Sylvania models.

Lamp	List	You Pay
BTL	\$35.25	\$17.63
EGG	55.50	27.75
FEL	46.00	23.00

Call us today and check our money-saving prices. You'll enjoy FREE transportation on orders of more than \$200.

Sitler's Supplies, Inc.

702 E. Washington St. P.O. Box 10-A • Washington, Iowa 52353
(319) 653-2123 • In Iowa call 800-272-6459

Circle (99) on Reply Card

M79, Studer A80 and the Ampex MM1200. It uses two separate counters, both operating in minutes and seconds. The company also represents Advanced Music Systems, Audio Kinetics, Court Acoustics and Link House Publishers.

See audio processors on page 64.

Circle (918) on Reply Card

RCA

HE-1 Edit Controller operates with HR-2 recorders for 10 selectable search speeds with viewable picture at all times, split audio-video edits from different time cues.

TTG-12H Single-Tube 12kW VHF Transmitter for channels 7 to 13, is solid-state except for final power amplifier, uses combined amplification with aural and visual diplexing at intermediate frequency. Available for NTSC, SECAM and PAL.

TFU-CP Directional Circular Polarized Pylon Antenna for UHF operation can be obtained with skull, peanut and trilobe patterns and uses low wind-load design.

BTA-5SS Solid-State 5kW AM Transmitter uses a new modulation technique for passage of frequencies to 12kHz with minimum signal degra-

ation.

BC4398 Series Saticon camera tube measures 1/2-inch in diameter, uses high resolution Saticon photoconductors with low capacitance and low lag gun for better low-light-level performance. At 400 TV lines, response is 40%.

See TV transmitter article.

See cameras beginning on page 84.

Circle (791) on Reply Card

RCA American Communications Inc.

See satellites on page 70.

Circle (792) on Reply Card

R-Columbia Products Company Inc.

TR4 Self-Powered Intercom Headphones for 2-way intercommunications on a single wire. Can operate up to 10 headphones on a party line connection. Self-contained battery.

TR-50/2B Transmit Base Station is the transmit side only of a TR-50 headphone.

Circle (794) on Reply Card

R.E. Technology Inc.

RF-204C ENGE/EJ Microwave Radio

Central Receiver offers 21 synthesized channels, with a dynamic range of at least 85dB, for operation in the 2GHz band.

RF-700 Series Broadcast Microwave Terminals and Repeaters. For 7GHz intercity and STL/TSL transmission.

RF-704C ENGE/EJ Microwave Radio Central Receiver for reception of remote signals in the 7GHz band, features 30 digital synthesized frequencies with local or remote selection without retuning.

RF-212 Microwave Transmitter provides 3 to 12 RFW power in the 2GHz band with 21 frequencies selectable from thumbwheel controls.

RF-700 Series Portable Broadcast Microwave Systems operate in the 7GHz band with frequency agility over 30 synthesized channels (no retuning required).

RE1300 Series Broadcast Microwave Terminals and Repeaters operate on 250mW at 13GHz with frequency stability of 0.005% or better.

RF-215 is a solid-state microwave amplifier designed for helicopter use with output power to 12W in 2GHz region.

RF-217 and RF-216 are solid-state microwave amplifiers designed to increase power output of the RF-200 Series transmitters to 12W to increase

"We evaluated all carts and have standardized on the Audiopak® AA-3" for music"

—Bob Kanner
Chief Engineer
KRTH, FM 101
KHJ, AM 93
Los Angeles

"Our test results show that the Audiopak® AA-3 holds stereo phasing better than any other cart on the market."

"The excellent phase stability of the AA-3 will be of major importance as AM stations convert to stereo."

"The High Output, Low Noise (HOLN) tape on the AA-3 gives us excellent frequency response combined with 6db more headroom."

"The AA-3 maintains excellent tape motion with low wow and flutter."

"The AA-3 is the 'state of the art' in cartridges — it meets or exceeds the specifications of the current NAB standards."

Capitol

Capitol Magnetic Products
A Division of Capitol Records, Inc.
6902 Sunset Boulevard
Los Angeles, California 90028

(213) 461-2701

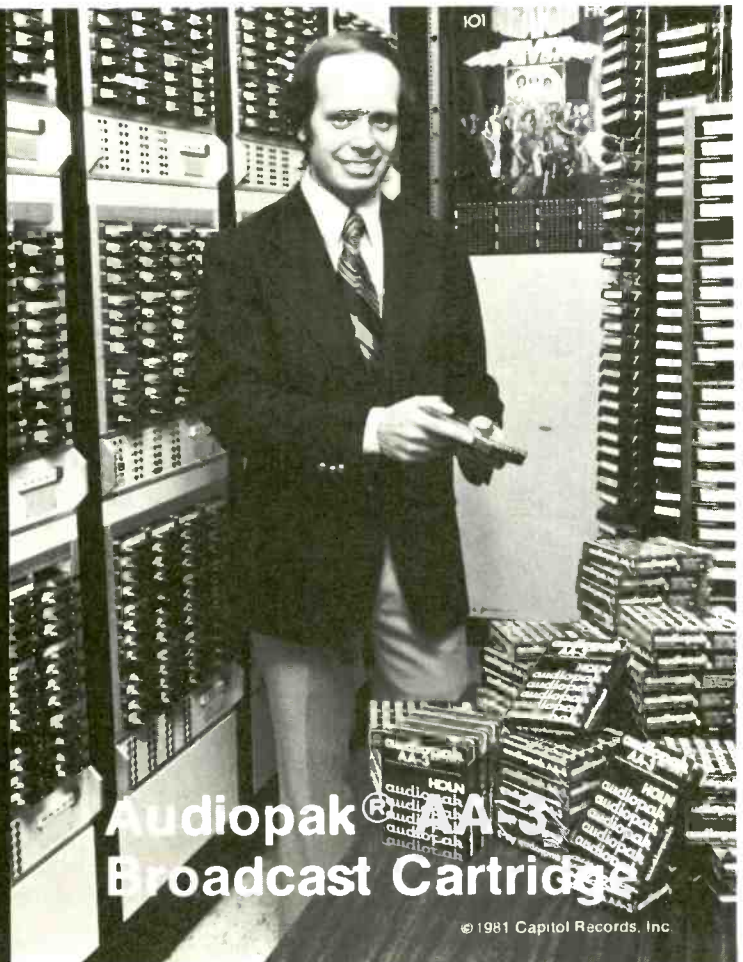

Circle (100) on Reply Card



lightweight and comfortable

headsets

- Independently wired phones
- Intercom and Sportscaster Applications

Literature on request from

Television Equipment Associates, Inc.



Box 260, South Salem, N.Y. 10590

Tel: 914-763-8893

TWX: 710-575-2600

Circle (101) on Reply Card

Audio Connectors

Jacks, Plugs
Patch Cords

SWITCHCRAFT BRAND

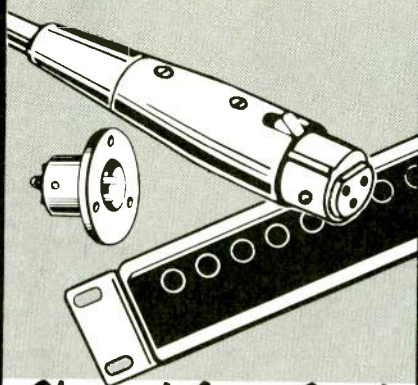

Shipped from Stock

ASK FOR OUR CATALOG
OF PRO-AUDIO SPECIALTIES

Polyline
Corp. 312/298-5300

1233 Rand Rd. • Des Plaines, IL 60016

18

Circle (102) on Reply Card

Other equipment

range of ENG and special events coverage.

RF-2000 Series Pathfinder ENG Antenna System is available in manual, remote steering versions or in tracking version, senses airborne or ground mobile signals and selects wide beam, 11dB gain or reflected 24.5dB parabolic antenna for narrow beam.

RF-1000 Series portable microwave antennas (Pathfinder series) are easily portable, lightweight for mobile unit applications.

RM-101 950MHz diversity RF Mic System uses automatic optimum signal selection, wide AGC range, high dynamic range, 1-, 2- or 5-channel systems operate up to 500 feet (extendable with high gain antennas), are lightweight and small.

Circle (793) on Reply Card

ROH Corporation

Series 300 Intercoms (308) (316) (324) (332) are master stations that interconnect with all other system stations through a single cable containing up to fifty 600 Ω balanced audio channels, with front panel buttons for station selection.

Series 302 Interphone is designed for use with other interphones on a common party line. Portable, with two channels provided, an additional program channel for use with dual muff headsets.

Interphone 304 is a rack-mount, 4-channel station. Channel selection made from front panel switches. Stations interconnect with 25 pair cable.

Series 200 Modular Audio Distribution Amplifiers accept the 211B (six 600 Ω differential outputs) or 212B (six 600 Ω transformer outputs) modules. Model 201B requires external power (contains 10 modules) while 202B contains nine amplifier modules and one power supply.

Series 120 Audio Distribution Amplifier offers eight 600 Ω outputs (differential) with 30dB gain adjustable to an output level of +20 dB. Series 130 uses transformer-coupled outputs.

Series 180 Audio Routing Switchers have unity gain with + or -10 dB adjustment with 100K inputs, balanced bridging, for levels to +30 dBm maximum. Crosstalk attenuation is 80 dB at 10kHz. Several models give 8-, 16-, or 24-inputs.

Model 190 Bridging Switcher/Line monitor expands the inputs for existing equipment or may be used to determine level and quality of critical circuits.

Circle (805) on Reply Card

RTS Systems

Displayed its line of Intercom systems, including the TW, series 800 and 400 IFB, and the HPM-41 microphone mixer, 405 professional phono preamp and its complete line of monitoring amps, distribution amps, and microphone preamps. The new improved TW intercom power supply and product line featured advanced performance and new cosmetics.

Circle (646) on Reply Card

Radiation Systems Inc. — SATCOM Technologies Inc.

Model 300C 3 Meter Satellite Earth Station Antenna for 4GHz receive only terminals feature AccuShape reflectors for exact parabolic dimensions. The LNA is mounted at focal point behind unique breathing radome window.

Model 500C 5 Meter Satellite Earth Station Antenna is constructed of AccuShape panels for exact dimensions, providing 44dBi gain in receive, 47dBi gain in transmit on 4 and 6GHz bands, Cassegrain system.

Model 450TC Torus 4.5 Meter Multiple Beam Satellite Earth Station Antenna is designed for reception of more than one signal simultaneously.

Circle (795) on Reply Card

Radio Computing Services

SELECTOR from RCS music selection system runs on a small disc/memory office-size minicomputer to handle three functions: library control, music selection, and management analysis.

SAMPLER call out survey system operates on the E.D.C. 1104 minicomputer to provide trend analysis, correlation cross tabulation, histograms, top and bottom tested titles from telephone surveys.

TRAFFIC 2000 is a computerized traffic system for radio, handling everything from available time slots and sales order entry to billing and accounts.

Circle (796) on Reply Card

Ramko Research

Phase Master cart system.

Circle (797) on Reply Card

Ramtek

Videograph is a complete illustration system for television. A 64-color palette with selection of line weights, dots, squares and other segments. Image scaling and animation from the electronic drawing board can be stored digitally and recalled via remote keyboard cueing. Computer uses PASCAL language.

Circle (798) on Reply Card

Rangertone Research Inc.

A2 Triple Reproducer is a complete dubbing system for music, voice and effects using a 600 Series playback amplifier and C8 Sync-Selsyn interlock control.

Series D2R Multi-Channel Recorders consist of a D2 Film Transport, the 500 Series Record/Reproduce amplifier and a digital motor drive unit. Selsyn motors are eliminated by full interlock with any compatible motion picture projector or editing device by electronic means.

TC-210 35mm Telecine Projector, designed for 35mm motion picture projection, is available in NTSC or PAL formats.

Series D2 Film Transport uses electronic control for full push-button and/or remote control with Selsyn motors eliminated by electronic interlocks. A crystal-controlled clock controls motor speed.

Circle (799) on Reply Card

Rank Cintel

TOPSY is an option for the MARK III Flying Spot Telecine. This feature can pre-program the telecine's transport controls.

Also the TOPSY pre-programming equipment has added a VDC and a new software package, enabling the user to have enhanced dialogue with the unit and giving greater operational versatility.

Circle (647) on Reply Card

Recortec

LPA (Long Play Attachment) may be attached to the 3/4-inch format VCR to increase the playing time. 14-inch reels allow nine hours with 3/4-inch VTRs, three hours for the Recortec HBU-2860 VTR.

Circle (800) on Reply Card

Research Technology Inc.

CINESCAN high speed previewer has servoed film transport for easy handling, variable speeds to 350 feet per minute.

TV-120 Film Inspection/Cleaning Machine allows previewing and editing at speeds to 400 frames per second.

PHOTOGARD process by 3M coats film, sealing it against scratches, static electricity, dirt and smudges.

OMEGA ECL with liquid cleaning/conditioning module with built-in previewer has computer-type logic for control of machine functions.

Circle (802) on Reply Card

Ritime-CX

Model 211/10 Library system is a

computerized electronic system for rapid and automatic location and presentation of musical items from a library appropriately catalogued.

Circle (803) on Reply Card

Rohde & Schwarz

EKF2/D Precision TV Demodulator conforms with RS-462 EIA standards. Crystal or phase-lock synthesis over entire broadcast range. Two position input level switch, envelope/synchronous demodulation, auto/manual gain, zero reference pulse, and sound notch in/out from 54 to 890MHz.

Circle (871) on Reply Card

Rosco Laboratories

Roscolene Prism Filters diffract light into colors for startling effects. Cinegel diffusion media softens lighting. Roscolux, Roscolene and Roscogel offer greater color selection than any other light coloring manufacturer for stage, screen and television.

Circle (806) on Reply Card

Ross Video Limited

RVS-514 MLE Switcher is designed for the small studio, edit suite or van. Introduces Transition Preview System, allowing a transition from on-air to effects to be previewed without

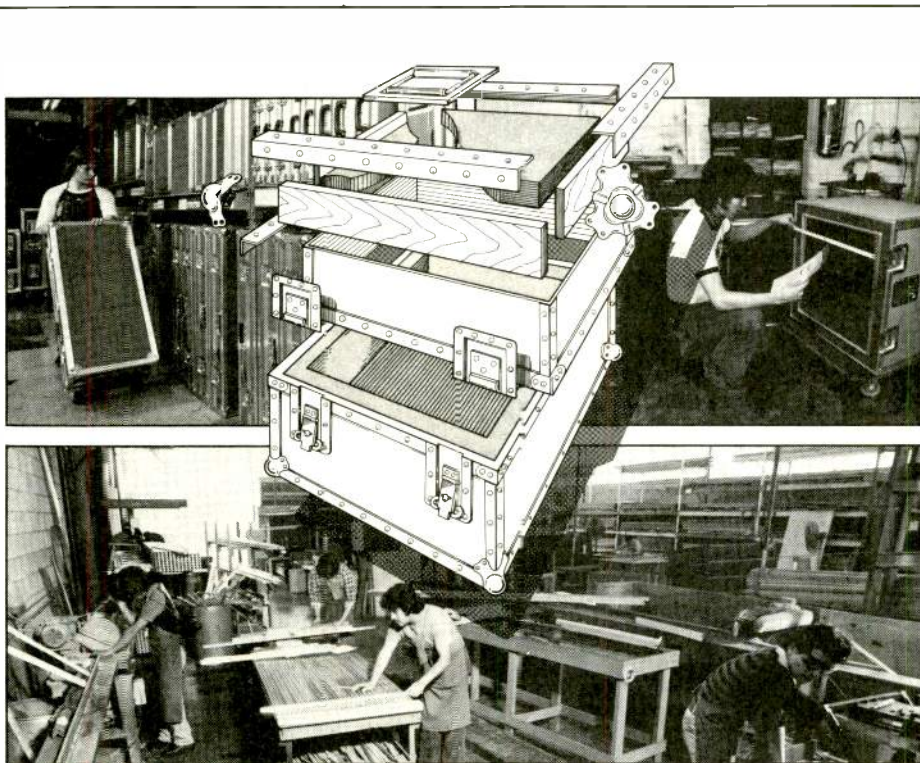

IF IT DOESN'T HAVE AN ANVIL®... you don't have a Case.

It takes a lot to build a top quality Case worthy of the ANVIL® brand name. ANVIL® utilizes only the finest raw materials which must conform to exacting specifications. ANVIL® stocks these materials in huge quantities, so even the largest orders can be produced without delay.

The machinery used to manufacture ANVIL® Cases is the finest in the Travel Case industry. The result is a Case that stands up to the bumps and grinds of life on the road—so your delicate equipment doesn't have to.

But Cases don't build themselves. People do. And ANVIL® has the most highly-skilled and dedicated designers, assemblers and Customer Service people you'll find anywhere.

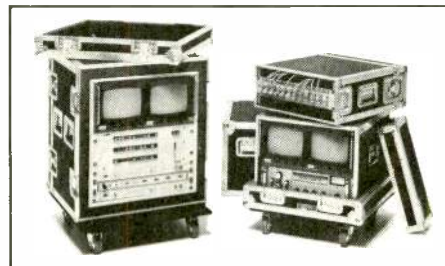

So if your delicate equipment has to get there and back in one piece, every time, just take our word for it—ANVIL®:—The # 1 name in Travel Cases for almost three decades.

ANVIL® CASES, INC., 4128 Temple City Blvd.
Rosemead, CA 91770 • (213) 575-8614

Circle (103) on Reply Card

NOW! CONTINENTAL'S 25 KW FM

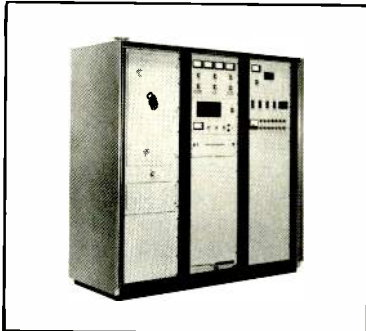

High performance. Offers you high fidelity, dynamic balance, good stereo separation, extremely low noise and distortion; excellent frequency stability. Compact size. Simple installation. Low Power consumption. Proven exciter. Combine with duplicate Type 816R-3 and get 50 kW output.

Write for brochure on 816R-3
Continental Electronics Mfg. Co.
Box 270879
Dallas, Texas 75227

Continental Electronics

Circle (104) on Reply Card

INSTALLING T.V. EQUIPMENT ?

YOU NEED

SERIES 5.25 VIDEO or PULSE DELAY UNITS

from

Matthey



•75Ω

•10 to 2460ns (VIDEO)

•5 to 4965ns (PULSE)

•To fit 19" racks

•Plug straight into on air video

•Used Nationwide

•MORE STABLE
•THAN CABLE

±4ns
TRIM

Television Equipment Associates, Inc.

BILL PEGLER, Director
BOX 260 SOUTH SALEM, N.Y. 10590
Tel. 914-763-8893 Twx: 710-575-2600



Circle (105) on Reply Card

Other equipment

involving an effect that is already in use. Based on MLE Multi-Level Effects system. Can be editor controlled.

Circle (807) on Reply Card

Russco Electronics Inc.

MARK V Variable Speed Turntables use brushless dc servo driven motors.

RTA-12 Tone Arm is 13-inches long with 5 grams max (1 gram min) tracking force and less than 2° tracking error.

Phonomate Phono Pre-amps have 1dB RIAA response from 30 to 15,000Hz with -68dB noise below NAB standard reference level using Shure M44-7 cartridge.

Disco 421 Professional Audio Mixer provides four channels, one mic, two phonographs and one high level tape, with cue position on mixers, 3-band equalizer, right and left LED overload indicators at 3½-inch VU meter switchable from right to left.

Studio/Master 505 Audio Mixer provides five monaural channel mixing for mic phono or high level sources. Cue function on each channel with internal cue amp and speaker. 3½-inch true VU meter indicates output level.

Fidelity-Master and Fidelity-Pro Series of phono preamps have 20 to 15,000Hz response, equivalent noise input to -103 dBm at 1kHz, 0.1% distortion THD at +18 dBm output into 600Ω.

225 MONITOR is an all-purpose dual-channel amplifier with 25W RMS each channel.

Studio/Master 505S stereo audio mixer is a 5-channel stereo unit with four channels having plug in preamps quickly modified for mic, phono or high level inputs; fifth channel accepts one of five push-button selected source.

Addition 32322 Speaker System (3-way) handles 50W RMS, 90W integrated program materials at 8Ω.

Circle (808) on Reply Card

S.W.R. Inc. (Systems With Reliability)

K-Line Transmission Line shows improved caloric conductivity. A thermo-probe within the watchband connector allows heat transfer from one section to another to avoid hot spots and breakdown.

Circle (809) on Reply Card

Sachtler

The company features motion picture and video camera support systems.

Circle (648) on Reply Card

Saki Magnetics

Inspired by the industry's demand for audio posts that last longer: Sakalloy heads for RCA and Ampex 2" video machines.

Circle (849) on Reply Card

Joseph Schneider

The 15 X ENG/EPF Lens, the 15X TV wide angle lens with x2 flip-in RE and diascope are just a few of the items featured.

Circle (649) on Reply Card

Scientific Atlanta

Model 416 TV Modulator for CATV, MATV and ETV systems for channels 2 through 13 and A through W, using SAW technology to generate a vestigial sideband signal. Video modulation limited to 95% to prevent carrier cutoff. Output level +50 to +60 dBmV, variable.

Model 6250 TV Demodulator uses envelope detection (optional synchronous detector) for video. Audio may be baseband or 4.5MHz subcarrier.

Series 7500 Broadcast Video Receiver tunes the 4GHz band via front panel keyboard. Frequency control accomplished with phase-locked frequency synthesizer.

Model 7610 2:N Message Protection Switch provides automatic protection for up to eight Series 411 Message Receivers.

Model 7620 2/N Video Protection Switch where video downlink systems are remotely controlled or when 2:N protection is needed, for 6600, 414, or 7500 Series receivers, up to eight different receivers.

Also see satellite articles.

Circle (811) on Reply Card

Sennheiser Electronic Corporation

Electret Condenser Microphone Series uses K3U powering module (5.6V battery remote powering from recorder, or phantom supply of console) works with omnidirectional head ME20, Super Cardioid head ME40, shotgun head ME80, spot microphone head ME88.

Sennheiser also provides a wide selection of dynamic electret condenser, and RF condenser microphones, headphones and headphone/microphone units, wireless sound systems, wireless FM communications systems, sound studio equipment, audio test equipment, and accessories.

Circle (812) on Reply Card

Sescom Inc.

Wide selection of modular plug-in transformers and amplifiers for distribution amplifiers, monitor

The measure of success.

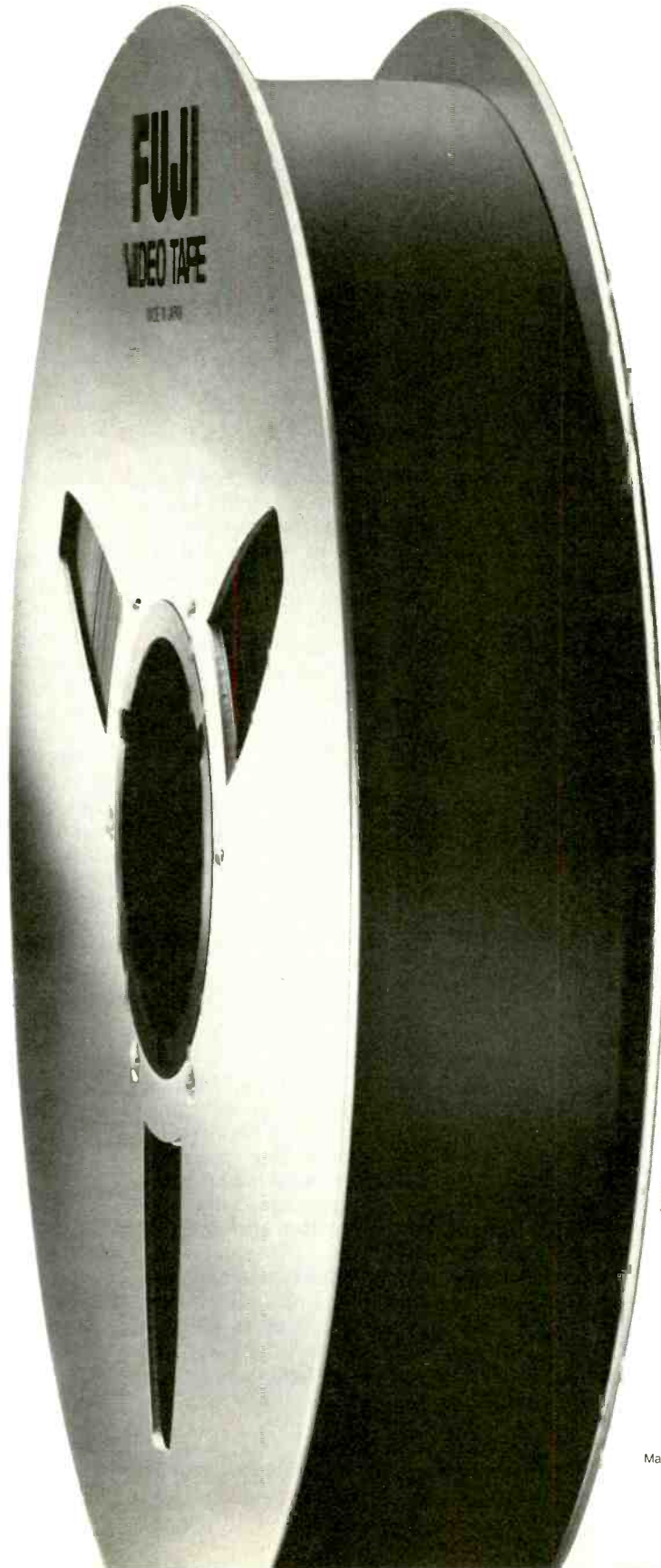

In 2," 1" and 3/4."
1/2" Beta and VHS Video
and Head Cleaning
Cassettes.



FUJI



© 1980 Fuji Photo Film U.S.A., Inc.
Magnetic Tape Division, 350 Fifth Avenue, NY, NY 10118

Circle (106) on Reply Card

NOW! CONTINENTAL'S 40 KW FM

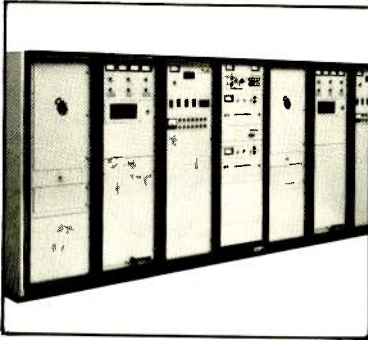

High performance. Offers you high fidelity, dynamic balance, good stereo separation, extremely low noise and distortion; excellent frequency stability. Easy installation. Low power consumption. Proven exciter. Available with fully automatic exciter and combiner control.

Write for brochure on 817R-2
Continental Electronics Mfg. Co.
Box 270879
Dallas, Texas 75227

**Continental
Electronics**

Circle (107) on Reply Card

Other equipment

amplifiers and other audio needs.
Circle (813) on Reply Card

Sharp Electronics

XC-700KIT-0001 complete spare parts kit for the XC-700 ENG/EFP camera contains all printed circuit boards, power modules as complete assemblies and the mother board.

XC-702HE 2 Line Vertical Enhancer for the XC-700 ENG camera allows full detail correction, horizontally as well as vertically, with noise coring, comb filtering and level dependent correction.

XA-600PA Portable Videocassette Recorder System with auto program search (APSS) features insert editing and soft touch microprocessor control; using VHS format allows variable slow motion and still frame.

See cameras beginning on page 84.

Circle (814) on Reply Card

Shintron

Model 372 Compact Switcher designed for broadcast mobile van operation uses SuperBus concept, A, B and C buses as well as Preview/Preset and Program for eight inputs, synchronous or non-synchronous.

Model 575 ISEC Intelligent Switcher/Editor Control drives the Model 375 Super Switcher from Convergence and United Media editing controllers. All switcher operations controlled from the editor.

Model 645 Time Code Reader/Video Character Generator detects either SMPTE or EBU time code and provides display on LCD panel as well as numerical character displays on CRT. Portable with 150-hour battery.

Model 909 Color Monitor is 9-inch PAL and PAL-M standard in line slot mask CRT with pulse cross display, A/B inputs, blue gun only and allows external sync. Provides R-Y/B-Y outputs for vector display.

Model 650 VITC Vertical Interval Time Code Generator is portable. Receiving video from a color camera, the VITC generates time code for placement on a line selected by internal switch. Piggybacked with 641 TCG, the combination also outputs SMPTE/EBU codes.

Model 505-L Videotypewriter (improved 505) contains non-volatile memory to retain text up to 30 days after power is removed.

Circle (815) on Reply Card

Shively Laboratories

Products include antenna systems



HAVE YOU EVER BEEN FRUSTRATED WITH FEEDBACK HOWL EVEN AFTER USING EQUALIZERS? FIND OUT ABOUT OUR FEEDBACK STABILIZERS MOD. NO. 741XR AND 742 XR.

BODE SOUND CO.
1344 ABINGTON PL.
NO. TONAWANDA, N. Y. 14120
716-692-1670

Circle (109) on Reply Card

FREE CATALOG & AUDIO APPLICATIONS

CONSOLES
KITS & WIRED
AMPLIFIERS
MIC, EQ, ACN, LINE,
TAPE, DISC, POWER
OSCILLATORS
AUDIO, TAPE BIAS
POWER SUPPLIES

**OPAMP
LABS INC.**

1033 N. SYCAMORE AVE.
LOS ANGELES, CA. 90038
(213) 934-3566

Circle (110) on Reply Card

and components with radomes or deicers, transmission line, harmonic filters, patching systems, coax components and power combiners.

Circle (850) on Reply Card

Shure Brothers Inc.

Broadcast recording audio mixer includes fast attack limiter, built-in battery pack in case of ac power failure, LED peak indicator, headphone level control, headphone amp/line control, with four mixers each for mic or line level. Available Summer, 1981.

SM85 ProTech Sound hand-held Condenser Microphone has low-end controlled rolloff, midrange tailored response for vocal reproduction with enhanced high-end performance, low distortion with true cardioid polar pattern. Operates on power from 11 to 52Vdc.

SM77-SM78 Cardioid Dynamic Microphones cover 50 to 15,000Hz.

SM81 Cardioid Condenser Microphone for all uses exhibits 20 to 20,000Hz response with 78 dB signal-to-noise ratio.

SC39 Series Phono Cartridges resist stylus damage. Tracking between 3/4 and 1 1/2 grams for improved record wear or 1 1/2 to 3 grams for greater trackability when increased wear is acceptable.

Circle (816) on Reply Card

Sigma Electronics Inc.

System 500 Modular Distribution System includes a main frame with VDA-510/511 video DA module, ADA-520 audio DA, PDA-530 pulse DA, PDA-535 pulse delay, and SDA-540 subcarrier DA modules all powered by PS-501 power supply. Ten

AUDIO TRANSFORMERS

WOW!!

114 Different Types!
In Stock!
And Priced Right Too!

World Famous Sescom™ MI-Series™
Transformers
for Professional Audio Applications

Send for your FREE 1980 Catalog

SESCOM, INC. (702)394-0993
Professional Sound Division (800) 634-3457
1111 Las Vegas Blvd, North TXW 910-397-6996
Las Vegas, NV 89101 U.S.A.

Circle (108) on Reply Card

Other equipment

modules plus power supply in one rack frame.

BBG-140 Black Burst Generator forms sync distribution for TV with four black burst outputs, three independently adjustable horizontal and burst phases from front panel with three sync, blanking and subcarrier outputs.

Circle (817) on Reply Card

Singer Broadcast Products

A newly formed company from the assets of CCA Electronics and Sintronic. The company features the complete line of CCA, AM and FM broadcast transmitters and VHF and UHF transmitters, and the Sintronic line of AM and FM transmitters.

Circle (841) on Reply Card

Sintronic (Singer Broadcast Products Inc.)

S1-A-10 10kW AM Broadcast Transmitter with 125% peak positive capability, to 12,000W output power. Uses three tubes in high level plate modulation format with plug-in solid-state low level stages. Operating frequency determined by phase-locked loop technology, sets 9 or 10kHz increments.

S1-10-E 10W FM exciter design has direct FM "on frequency" master oscillator. When mated with an RF harmonic filter becomes the **S1-10-T 10W FM transmitter** and includes varactor controlled center frequency and ultralinear deviation with automatic loss-of-lock P.A. protection.

S1-A-1 1kW AM broadcast transmitter uses solid-state low power with four single-type tubes in the power amplifier in high level plate modulation. Exciter is phase-locked at 9 or 10kHz increments. LED overload status indicators.

S1-F-3 3.5kW FM broadcast transmitter features direct FM solid-state exciter with excellent stereo/SCA performance and grounded grid power amplifier. Fully remote control capable.

CCA FM2000E has a single 3CX15000A7 triode in ground grid operation in the P.A. for 22kW output power level. Solid-state 40W exciter is synthesized. Audio inputs compatible with various external audio processors and stereo generators.

Circle (819) on Reply Card

Skirpan

Displayed lighting systems and accessories, including Astral dimmers, "K" dimmers, Autocue/80, Cuelog and MCP modular control panels.

Circle (650) on Reply Card

Skotel Corporation

PTC-100 Portable Time Code Generator/Reader includes jam sync capability, for synchronizing several units, can identify color field sequence in code, operates on 4AA cells for five days normal use.

TCG-80N Edit Time Code Production Generator measures sync to sub-carrier phase relationship for determining color field per RS-170A. Identifies color field and makes code correspond using odd-even sequence.

TCR-80 Time Code Wide Band Reader—captures and reads time code from any source from hand turn speed to greater than 40 times play speed.

Intelligent Interface is designed for captioning use. Encodes real language test messages into the time code.

VITC (Vertical Interval Time Code) is designed to use 1-inch C format VTR to approximate film-style editing.

Circle (820) on Reply Card

Warren R. Smith Company

Model 1623 High Speed Periscope (snorkel) for ENG or film cameras has an F4 optical system for inaccessible places, miniature sets and around corners.

Circle (961) on Reply Card

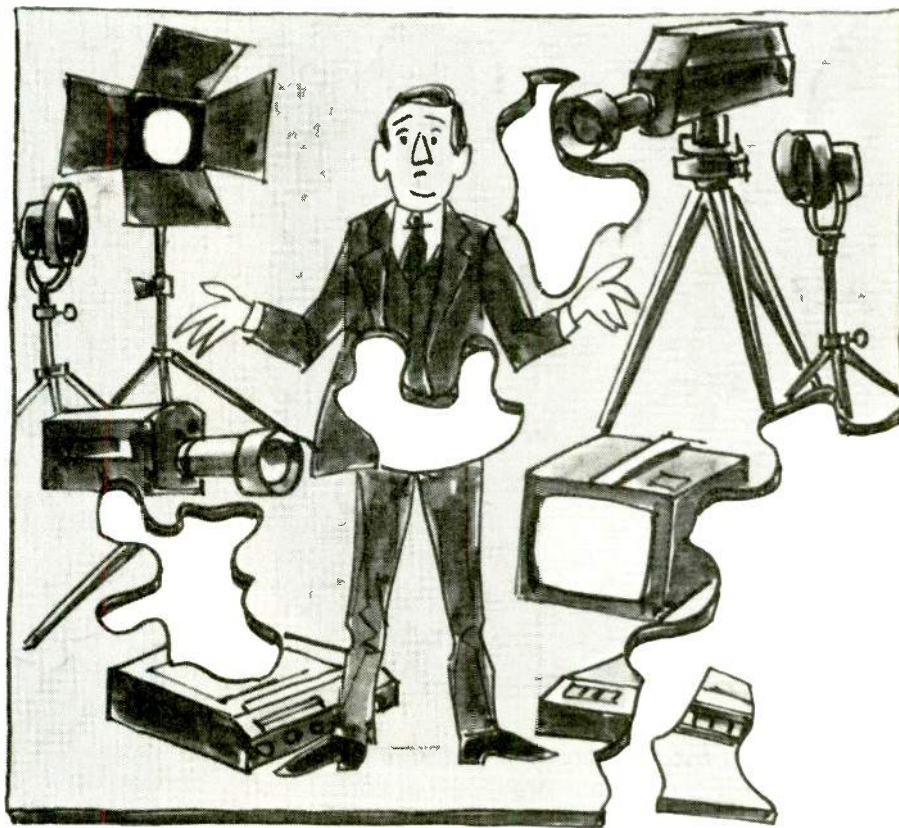

If your present video rental house is missing some pieces...try MPCS.

Renting video equipment can be puzzling enough without the disappointment of missing pieces. At MPCS we give you the whole picture.

Our fifteen years of experience, combined with the largest and most complete rental inventory of its kind, including Sony, JVC, Tektronix, Adda, ISI, and Panasonic, assures you of getting what you need with special rental and lease packages that make it easier to afford.

So if you need 35 monitors or large screen projection for a last minute special presentation, a 3-camera system for a remote shoot, or five odd pieces that you couldn't find anywhere else...MPCS has it all, including skilled person-

nel to select, install and operate the equipment. Our superior in-house service facilities and quality control engineers assure you of maximum equipment performance each and every time.

MPCS solves the puzzle of renting video and helps you fill in the missing pieces.

Find out more by calling, in New York State, 212-586-3690. Out of state, call Toll Free 800-223-0622. Ask for Rentals.

MPCS is also: Broadcast Video, Industrial Video, Repair, IFC, our video production facility, and videomart, the largest home video and TV showroom in N.Y.



MPC'S VIDEO INDUSTRIES, INC.
MPC'S Video Center Building 514 West 57 Street New York, NY 10019

Circle (111) on Reply Card

JOIN THE CSI NETWORK



Now you too can become a member of one of the fastest growing networks in radio broadcasting. CSI's more than 500 satisfied transmitter owners.

You can share the advantage of superb quality craftsmanship and dependable service others expect from CSI.

CSI...the network you'll be glad to be affiliated with.

CSI ELECTRONICS INC.

18248 E. Rogers Cr., Boca Raton, FL 33431
Phone 305-994-6511

This equipment is distributed in Latin America by Electrex Company, 18680 N.E. 2nd Ave., Miami, FL 33179. Contact Ben Ostrovsky, 305/651-5752.

Circle (112) on Reply Card





Perfect Timing

MASTER CLOCK SYSTEMS

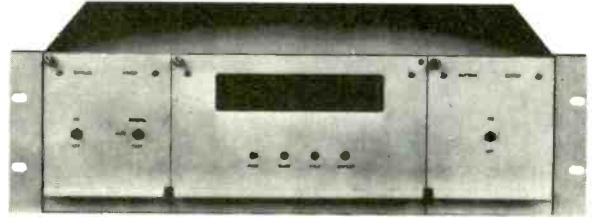

If seeing the same time on all your clocks is important, select **ES 192** - Line Frequency timebase, for only \$312.

If a guaranteed accuracy of three seconds per month is what you want, choose **ES 160**-\$1,005.

How about one second per month? **ES 160/1**-\$1,179.

Or National Bureau of Standards accuracy! **ES 190** is synchronized to Radio Station WWV to provide a Master with unquestioned accuracy. \$1,179 with receiver and antenna.

For a Time/Temperature Master, ask for **ES 196**-\$737.

ESE Master Clock Systems are simple to install. All Masters have a Serial Time Code output, able to drive twenty slave displays without buffering. Slaves range in size from .3" LED to 2" gas discharge displays, priced from \$152 to \$432.

IF YOU ALREADY HAVE A SYSTEM AND WANT TO EXPAND IT, get the **ES 167** Serial Time Code Generator (\$141), then add any number of our low cost slaves.

Many, many options and accessories are available. Ask us about them. Our brochure tells the whole story, but not for long. We keep adding new products.



Write, Wire or Call: (213) 322-2136
142 SIERRA STREET • EL SEGUNDO, CALIFORNIA 90245

NOW! CONTINENTAL'S 2.5 KW FM

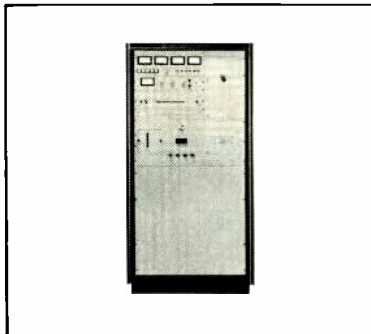

High Performance 2.5 kW transmitter uses field-proven exciter; delivers clean crisp signal; has automatic filament voltage regulation, power control; is suitable for unattended operation; is solid-state except for one tube in final amplifier; provides efficient, cost-effective operation.

Write for brochure on 814R-1
Continental Electronics Mfg. Co.
Box 270879 Dallas, TX 75227
(214) 381-7161

Continental Electronics

Circle (114) on Reply Card

REPLACEMENT TRANSFORMERS GATES, COLLINS, RCA, CCA



PLATE TRANSFORMERS

COLLINS 20V	\$650
COLLINS 20V-1, 20V-2, 20V-3	\$450
CCA FM-400E	\$650
GATES BC1E, BC1F	\$450
GATES BC1G, BC1H	\$400
GATES BC1J	\$400
GATES BC1T	\$400
GATES BC5P 3 Phase	\$1050
GATES BC500T	\$375
GATES FM-250	\$200
GATES FM-1B	\$450
RCA BTA1G, BTA1H	\$450
RCA BTA1R, BTA1S	\$400
RCA BTA5G, BTA5H (Main or Teaser)	\$750
RCA BTA10H (Main or Teaser)	\$1500

MODULATION TRANSFORMERS

BAUER 707 Series	\$550
COLLINS 20V Series	\$550
COLLINS 21E Series	\$1000
GATES BC1 Series	\$550
GATES BC5 Series	\$1000
RCA BTA1 Series	\$550

MODULATION REACTORS

GATES BC1 Series, 40 Hy @ 800 MA DC	\$400
GATES BC5 Series 35 Hy @ 1.4 AMP DC	\$550
10 KW Universal, 20 Hy @ 2.5 AMP DC	\$850

FILTER REACTORS

3 Hy @ 2.5 AMP DC, 10 KV INS	\$200
5 Hy @ 1.0 AMP DC, 10 KV INS	\$175
10 Hy @ 1.0 AMP DC, 10 KV INS	\$200
10 Hy @ 2.5 AMP DC, 10 KV INS	\$350
15 Hy @ 1.0 AMP DC, 10 KV INS	\$225

Many other transformers also available. Call us for free quotations. Large stock and fast delivery. 12 Month Guarantee on all items.

PETER W. DAHL CO., INC.

4007 Fort Blvd., El Paso, Texas 79930
Telephone: (915) 566-5365

Circle (115) on Reply Card

Other equipment

Sono Mag Corporation

ESP-1 Automation Programmer offers a 4000-event memory including subroutine and programmable digital clock. Custom-built for every station specification. Handles up to 20 sources without interfaces, up to 7 external time functions (net-delay recording) and up to 256 individual programmable real-time updates.

Mini Pro I Automation Programmer is capable of switching 10 stereo channels, programmable for 100 events and 50 timed program events, designed as a "live-assist" device.

RSC-100 Programmable Random Selector for Carousels with the Mini-Pro I adds random selection of up to 100 cart selections for each of two Carousels.

Automation Logging System consists of Model 790/792 Logi-Cart recorder, encoding terminal DT-4 and CRT monitor screen for silent studio operation in encoding of messages on cue track of broadcast cartridges.

DS-20 20 channel audio switcher includes stereo line amplifiers and fade down facilities. Unlimited overlap of any number of channels standard.

RAC-30 Remote Control operates with the DS-20/A digital audio switcher for manual operation of the 19 normal audio channels on the switcher and random select arming of up to 99 multi-cartridge playback machines.

PDC-5 Program Clock is 24-hour based programmable clock with control of up to 250 time instructions for use with DP-2 automation programmer.

Model 132S Audi-Cord Delay Record/Reproduce Cartridge Machine includes switch selected erase function, allowing recording of network programs for later play.

TM-4 Tape Meter measures tape-head signals and monitors with built-in head amplifier, signal-to-noise ratio, ac ripple in power supplies and dc used in powering IC circuitry.

Circle (821) on Reply Card

Sony Broadcast

BVX-30 Digital Video Multi-Processor accepts direct or heterodyne video inputs for TBC, frame store, noise reduction or enhancement modes. Fully remoteable including optional color correction system. TBC features infinite window time base correction.

BVU-50 Portable VCR uses 3/4-inch format on 20-minute cassettes. Resolution of 260 lines for color with signal-to-noise rating of 46dB for color.

BVU-200A Broadcast Editing U-matic Videotape Recorder uses

standard 3/4-inch U-matic format for up to 1 hour per cassette. Includes two audio tracks plus SMPTE time code track with optional time code generator for later upgrade to computerized editing.

BVE-500A Editing Console allows total flexibility of editing in assemble or insert modes with individual control over both audio channels and video.

BVH-500 Portable Video Recorder operates on 1-inch SMPTE "C" format and has Time Code Generator standard along with record current optimizer and digital servo control to minimize gyroscopic errors.

C-35P and C-36P Condenser Microphones exhibit cardioid pattern with a response of 30 to 16,000Hz, signal-to-noise of 72 dB, dynamic range of 116 dB and input level maximum of 138 dB SPL.

WRR-37 UHF Diversity Tuner complements WRT027 belt-pack transmitter and lavalier microphone or WRT-57 hand-held wireless microphone for ENG as well as studio use.

MX-P42 Portable Mixer features panning for precise stereo imaging and automatic level control with solo functions on all four inputs.

BVU-800 U-matic VCR is designed for ENG usage. Uses microprocessor and 6 dc motors with tape threaded around drum in all modes. Split edits possible, audio mixing possible, compatible with BVE-500 editor. Available summer '81.

BVH-1180 Console version of the 1100A handles up to three-hour recordings and playback with 14-inch reels.

BVE-3000 3-machine editor incorporates built-in SMPTE time code with optional module for VITC read capability.

BVP-300A improved version of the BVP-300 with improved signal-to-noise ratio of 56 dB and automatic control functions.

BVM-1900 is a 19-inch broadcast evaluation color monitor with 900 line resolution.

DRE-2000 Digital Reverberator unit provides intimate acoustics or instant "Carnegie Hall" sound quality to interface with analog and digital facilities.

Also see camera articles.

Circle (822) on Reply Card

Sound Technology

Model 1020A FM Alignment Generator exhibits system distortion in mono and stereo at less than 0.01%.

Model 1500A Tape Recorder Test System automatically measures and displays frequency response, wow and flutter, noise, speed accuracy, channel separation vs. frequency, and

head azimuth accuracy.

Model 1700 Series distortion measurement systems feature push-button frequency selection, automatic nulling circuits for measurements to 0.0009% in 5 seconds. RMS, peak and average responding meter, internal oscillator from 10 to 110,000Hz measurement of signal-to-noise ratios with 100 dB dynamic range.

Option for 1500A test system is 007 One Third Octave Spectrum Analyzer for analysis of noise components.

Circle (823) on Reply Card

Sphere Electronics

Type C TV Production Console is capable of simultaneous mono and stereo mixes with nine VCA groups available for each input as well as eight audio submaster groups. Can be fitted with DATALOG automation for retrieval of settings, from equalizers to all bus mixes.

EQ1014 Parametric Equalizer features four overlapping equalizer bandwidths, continuously variable frequency and amplitude equalizer controls, variable Q shape on midbands, shelving switch on HI and LO equalization sections.

Circle (825) on Reply Card

Spin Physics Inc.

Quadruplex videotape head refurbishing services.

Circle (825) on Reply Card

Stainless Inc.

Provides towers for 2-way communications, AM, FM, Microwave, CATV translators and Television.

Circle (827) on Reply Card

Standard Tape Laboratory Inc. (with Sound Technology booth)

Test tapes for Sound Technology tape recorder test system. Available in cassette, 1/4-inch reel, 1/2-inch broadcast cartridge, 1/4-inch cartridge, 1/4-inch reel, 1-inch reel, and 2-inch reel formats, for all tape reproduction tests.

EX850 Video Printer (AXIOM) prints graphics, alphanumeric and all character fonts.

Circle (824) on Reply Card

Stanton Magnetics Inc.

PERMOSTAT Anti-Static Record Preservative Kit. One time application "permanently" eliminates static for the normal considered life of the record.

Model 681 EEE Cartridge is equivalent to the S type with a stylus tip 0.2x0.7 mil elliptical diamond.

Model 681 EE response is from 10Hz to 20kHz. Output .82mV/cm/sec with other parameters as 681 EEE.

Model 681A uses 0.7 mil spherical

diamond stylus tip.

Model 681 SE for medium stylus force. Uses 0.4x0.7 mil elliptical stylus diamond.

Stanton also has 680 Series cartridges, 600 Series cartridges, 500 series cartridges, as well as 790/4DQ and 790/Q 4-channel cartridges. Also in the line is the 8005 Series turntable, stereo/wafers headset, Dynaphase 35 headset, 210B stereo turntable preamplifier/equalizer and other audio products.

Circle (828) on Reply Card

Stantron

Division of WYCO Metals

A complete line of enclosures, racks and bench/tables.

Circle (829) on Reply Card

Station Business Systems

Business systems for the CATV or Broadcast operator for all station business from the newsroom, to inventory, to paychecks and accounts receivable.

Circle (830) on Reply Card

Storeel Corporation

A variety of film and tape storage shelving for the tape library room.

Circle (831) on Reply Card

100 watts

FCC says it . . . Bayly has it!

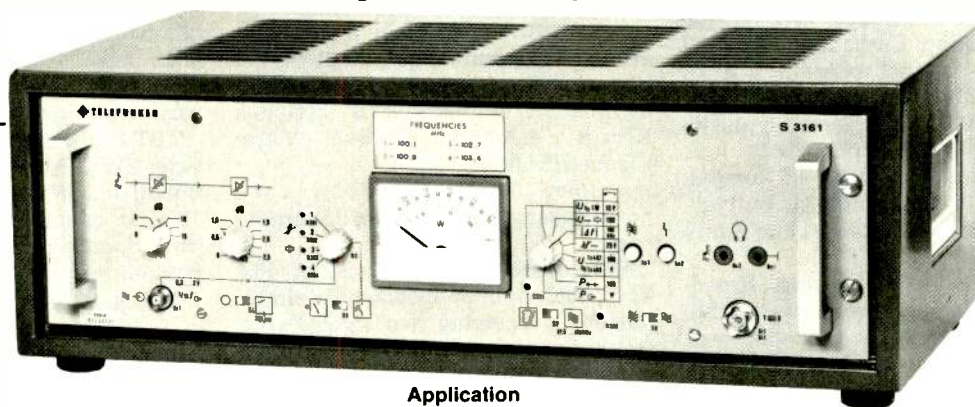

**SOLID STATE
100 WATT VHF
BROADCASTING TRANSMITTER**

Frequency Range 87.5 to 108 MHz

Application

The 100-W VHF Broadcasting Transmitter S 3161 is intended for frequency-modulated transmission — Mono or Stereo — over the VHF broadcasting range. It is fully solid state.

Use as:

Self-contained 100-W broadcasting transmitter
On-the-spot transmitter
Drive unit for transmitters of higher power.

BAYLY ENGINEERING LIMITED

A member of the AEG-TELEFUNKEN group
167 HUNT STREET, AJAX, ONTARIO CANADA L1S 1P6 TELEPHONE (416) 683-8200 TELEX 06-981293

Circle (116) on Reply Card



Other equipment

Strand Century Inc.

CD80 PACK contains 12 CD80 2.4kW dimmers in a portable package for incorporation into a MANTRIX control system. MANTRIX is a 4-scene preset with capability to control up to 288 individual dimmers via an 8 wire control cable.

Ianro POLE-OP allows adjustments (pan, tilt, focus, rotate and adjust barndoors) all from the floor with a pole tip and hook.

The MiniPALETTE Lighting Control System uses CRT for display of cue information, disc memory provides permanent record, 10 playback submasters and three faders (one for split fades).

Circle (832) on Reply Card

Studer Revox

The A800 Multichannel Tape Recorder includes central microprocessor control for drive and editing for 24- or 16-track on 2-inch, 8-track on 1-inch tape on 14-inch reels.

The A80Vu-MkIII Multichannel Tape Recorder converts easily from 1/2-inch to 2-inch, 24-, 16-, 8-, and 4-track versions are readily adaptable to synchronization systems.

The A80 VU-Mk II Master Tape Machine for mixdown recordings is available with 7.5/15 or 15/30ips. Full track, stereo, 2-track, and 4-track heads.

The A80 RC-MK II Studio Tape Machine is controlled by a process control computer.

The B67 MK II Studio Tape Machine (1/4-inch) is compact for studio or vehicle use.

The 089 MK II, 189 MK II, 189 Quadro Mixing Desks are designed for 4- to 16-channel recordings, to 24 inputs with four summations.

The 289/389 Mixing Desks typically handle 10 to 50 inputs with four reverb channels, four to 16 summations, two to four foldback outputs, with peak or VU indicators and remix switching.

The Model 069 Outside Broadcasting Portable Console is suitable for 1-man operation by the reporter or sound engineer on the spot, for transmission on telephone or audio lines.

The Model 369 Mixing Desk allows multi-track recording or mix-down, configured for up to 32 inputs, one to four summations, with six auxiliary outputs.

Circle (833) on Reply Card

Swintek Telecommunications Division

MK200 Wireless Headset System is

designed for continuous closed-circuit intercommunications for video teams, private-line reinforcement or production producer to floorman. No transmit button, operates in 150 to 230MHz region.

Circle (834) on Reply Card

Sylvania/GTE Industrial/Commercial Lighting Products

Wide variety of lighting equipment including Brite-Arc lamps to improve lighting with energy and heat reduction. For stage, theater, and television.

Circle (835) on Reply Card

Systems Associates Inc.

Distributor of used equipment for radio and television.

Circle (836) on Reply Card

System Concepts

QUANTAFONT QVII Teleproduction Graphic Titler includes multiple resident fonts, 20-character size selections per font, borderline and drop shadow enhancements, 20 nano-second resolution, 12 16-row pages.

QUANTAFONT Q-7A Teleproduction Graphic Titler offers true proportional characters and spacing, 16 resident fonts, 10 16-row pages, roll, crawl, flash, automatic font change, random/sequential page access.

QUANTAFONT QST Subtitling System combines the Q-7A/R with dual flexible disc memory and subtitling software program for regular studio titling or up to 500 3-row subtitles and 50 inserts per disc.

Circle (837) on Reply Card

TV Equipment Associates Inc.

Distributors of Matthey delay lines, Philip Drake audio equipment, Avitel Electronics video/pulse distribution equipment, wireless IFB systems, Elcon EA750 Video Tape Cleaner/Profiler.

Matthey Triple Filters for components sampling in Digital TV Equipment.

SEIWA Model MR-220 is an FM VHF dual monitor receiver for simultaneously receiving two signals with selection of one channel or both mixed for effective monitoring.

AVITEL 300 Series video distribution amplifiers, cable equalizers and pulse distribution or delay amplifiers may operate in the same rack frame with Philip Drake Audio Distribution, Power Amplifier, Microphone Amplifiers.

Circle (842) on Reply Card

Taber Manufacturing and Engineering Company

Provides new replacement audio

heads for all professional series Ampex and Scully tape recorders, as well as audio head reconditioning for audio and video recorders, tape recorder overhaul services. Distributor for professional audio equipment.

Circle (843) on Reply Card

Tayburn Electronics

TBR 1K Frequency Agile Video Receiver, remote tuneable receiver for 21 channels of 2 GHz, 30 Channels in 7 GHz, and 22 channels in 13 GHz bands. 60 dB dynamic range, noise figure 3, 4.5 and 6.5 on 2, 7, and 13 GHz.

TBR-50-A Frequency Agile Video Receiver provides 21 channels in 2 GHz or 9 channels in 2.45-2.5 GHz band with 7 dB noise figure in 5.5 x 4.0 x 2 inches, 30 oz, 12 to 32 V dc package.

TBT-50-A Frequency Agile Video Transmitter offers 12 to 15 W on 21 channels of 2 GHz band, designed for ENG van mast or helicopter skid mounting, operates on 12 Vdc or 28 Vdc.

TBA-600 Automatic Tracking Antenna System in 2GHz band gives -36 to +21 degree elevation coverage, 360 degree azimuth coverage with tracking accuracy of 1 degree.

TBA-500 Automatic Tracking Antenna System for the 2 GHz band allows 360 degree azimuth with horizon to 40 degree elevation coverages.

TBA-500 RF Power Amplifier provides 12 W output for 1, 2, or 4 W input, operating in 2 GHz band uses +26 Vdc.

TBT-200 Series Portable ENG Transmitter is crystal controlled (2 channel) with 2W (12 W optional) in 2 GHz band, 1 W (5 W optional) in 7 GHz band. Operates on 28 Vdc with various audio subcarrier frequencies.

TBT-202 Series Transmitters provides 2W (20W optional), 1 W (5W optional) or .2 W (1 W optional) in 2, 7, or 13 GHz bands, using crystal control (two channels possible) with assorted possible audio subcarrier frequencies.

TBR 200/STL ENG Receiver operates in 2, 7, or 13 GHz band with remote frequency selection, sensitivity on all three bands approximately -80 dBm. Has multi-function meter display for adjustment and maintenance.

TBM-100 ENG Master Station Remote Antenna Telecontroller provides simultaneous control and display of all parameters associated with operation of up to 4 ENG Remote Receive Systems.

TBM-100 Electronic ENG Remote Station accepts command information from TBM-100 Master Station and simultaneously returns telemetry on all parameters associated with opera-

tion the ENG receive system. One station may operate two ENG receive dishes.

Circle (845) on Reply Card

TEAC Corporation of America

Model V-1000AB-F (Type IV) Airborne Videocassette Tape Recorder (AVTR) is built for environmental stress, yet compact when space is critical. The unit operates on standard 28V aircraft power (unregulated). 3/4-inch format.

Circle (846) on Reply Card

TEAC/Tascam

The Tascam 32-2B Recorder/Reproducer has switchable 1/4-track playback head built in which provides for greater flexibility. The unit also features a 3-motor transport system and full IC logic control transport controls.

Circle (249) on Reply Card

Teatronics Inc.

Lighting control equipment for rock, disco, theater.

Circle (847) on Reply Card

Tech Theatre

The company features TV and film makeup, bubbleboard rear projection material, set construction supplies and safety devices for lighting equipment.

Circle (943) on Reply Card

Technicolor Audio Visual

Technicolor videocassette recorder/Model 212 weighs 7 lbs., with micro-helical system uses 1/4-inch tape. Battery or ac operated, provides 30 minutes of program on a single cassette. Model 5112 Tuner allows taping off-air programs.

Model 4312 Videocassette Duplicator consists of four slave operation. Single Start/Stop control for source and slaves, built-in image enhancement, built-in audio-video distribution amplifier.

Circle (952) on Reply Card

Tektronix

690SR Color Picture Monitor—a reference standard for TV picture evaluation, high resolution delta gun dot shadow mask picture tubes, stabilized color balance, accurate color decoding, excellent color convergence.

Model 1450-2 TV Demodulator with tunable down converters TDC-1 and TEC-2 for the international users in System B and G locations.

468 Digital Storage Oscilloscope for troubleshooting digital equipment,



“But we can only pay you 200 dollars”

For 200 dollars, ChronTrol is never late. For 200 dollars, you'll be certain not to blow your multi-million dollar research project or forget to turn on the burglar alarm that protects your irreplaceable art collection. For 200 dollars, you've brought on board the most reliable, non-complaining, menial task accomplisher you'll ever need, and once you've purchased your ChronTrol it'll never ask for a raise. ChronTrol. For 200 dollars, you might want two.

Lindburg Enterprises, Inc., 4878 Ronson Court, San Diego, CA, 92111 (714) 292-9292, TLX/TWX 910-335-2057. Time was. ChronTrol is.

Model shown: Table Top.

CHRONTROL

Circle (117) on Reply Card

The Gordon Headroom Meter:

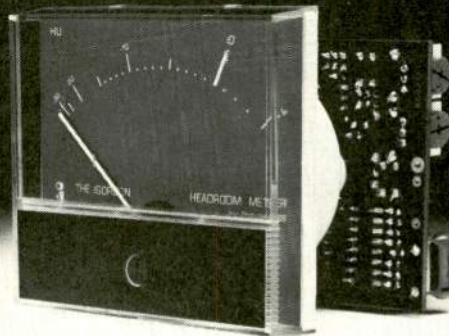

a better idea in program monitoring.

We've combined the best aspects of the traditional VU meter and the precision of the European Programme meter. The result is a meter that meets the UK/EBU standard for

response to program peaks while maintaining a more conventional and artistically desirable "syllabic" response to music and speech.

Get the complete package for \$122.00, or our VU-conversion option for \$69.00. Quantity discounts are available. For further information, contact:

Inovonics, Inc.
503-E Vandell Way
Campbell, CA 95008
Telephone
(408) 374-8300

Send for copy of AES preprint.



Circle (118) on Reply Card

Other equipment

catching glitches and monitoring changing signals.

AA501 Audio Distortion Analyzer (with SG505) permits harmonic distortion, intermodulation distortion, frequency response, gain/loss, and signal-to-noise ratio measurements.

492P Spectrum Analyzer delivers full programmability through GPIB compatibility and the 7L14 which gives digital storage capability.

Circle (411) on Reply Card

Tele-Cine

Exclusive agent, US and Canada, for Schneider TV zoom lenses for all format TV cameras.

Circle (944) on Reply Card

Telcom Research

The *Remote Monitoring and Reporting System* consists of a central station and one or more remote stations.

Also featured were the *6010 High Speed Time Code Reader* and *TCG 550 Time Code Generator*.

Circle (651) on Reply Card

Telemet

Model 4706-A1 NTSC Chroma-Keyer Decoder puts an existing RGB chroma-keyer in-line with zero horizontal delay.

Model 3538 Modular Test Set outputs stairstep; multiburst; 1/2T/T/2T with window, 20T pulse, sweeper; encoded color bars, dot-grate.

7934 AV Routing Switcher is remote controllable, 20-in x 10-out standard, 400 x 400 possible. Color timing is accurate, board removal/insertion possible with power on for NTSC, PAL and SECAM.

3711 RF Synthesizer allows keyboard tuning for all UHF and VHF TV channels with digital display of channel.

5210 Thermal Equalizer compensates for large changes in temperature in 16 PEVL cable.

4210-B2 Fiber Optics Video-Audio Transmission System is linked by optical fiber cables for transmission of video and/or wideband data signals.

Circle (414) on Reply Card

Telescript Inc.

MPS is a 15-inch, 1000-line lightweight monitor/prompter, and it provides the talent with prompting while looking at the camera lens. **Telecue** and **Telescriptor** provide two different means of sourcing the prompting materials.

Circle (851) on Reply Card

Telesource Communications Services Inc.

Election Reporting Service incorporated with Chyron Telesystems.

Circle (852) on Reply Card

Telestrator Div., Interand

Specializing in electronic graphics and animation systems with their **Telestrator**; and in stylus-controlled imagery with **Telestrator Auto Probe II**. Other items: *Electrart* and *Tapas*.

Circle (942) on Reply Card

Television Engineering Corporation

Distributors for the "Parts" or the "Package," video, audio, monitoring.

Circle (853) on Reply Card

Television Equipment Associates

The company features video delays to replace lengths of cable. Other products: pulse delays; video filters; tape evaluators for 1- and 2-inch tape, and evaluators for cassettes; intercom and sportcaster headsets; interphone and intercom systems; and video and audio distribution equipment.

Circle (946) on Reply Card

Television Products Company

P-25 Television Camera Pedestal allows 30 5/8-inch to 50 5/8-inch height (to top of pan head mount); 8-inch dual wheels use polyurethane, with crabbing or tracking steering modes selectable by the touch of a toe.

Model P-80 Television Camera Pedestal is an air-counterbalanced pedestal for studio production where wide-range camera mobility and extreme reliability are needed.

Circle (854) on Reply Card

Television Technology Corporation

See TV transmitters on page 78.

Circle (947) on Reply Card

Telex Communications Inc.

Audiocom closed circuit headset intercom system provides components for single or multiple line intercom systems

FMR-1 FM Wireless Microphone Receiver with one antenna is conventional, but with second antenna becomes a dual diversity receiver.

ST-100 belt pack transmitter, a battery-powered, cigarette-size package, easily concealed beneath clothing,

TMM-150 Music Machine is a monaural tape playback system for NAB-type cartridge programmed music (AA, BB, CC cartridges all com-

patible.)

Model TMS-1000 music machine uses standard 8-track cartridges to allow the programmed playback of whatever music is desired.

Copyette 1&1 and 1&3 and Copier I, II, IV, and V make cassette tape copies at 30 ips, one to three copies made simultaneously in the various models.

Circle (856) on Reply Card

Tennaplex Systems Ltd.

The company features dipole panel antennas for TV and FM frequencies and broadbeamed FM panels for omni 3 panel arrays.

Circle (948) on Reply Card

Tentel

Manufacturers of **Tentelometer**, **Tental U-Matic Spindle Height Gage (TUSH Gage)** and **Tental Timer**. For use with 3/4-inch and other format videotape recorders.

Circle (857) on Reply Card

Terracom

TCM-6 Series of Microwave Radio Systems provide up to 1800 FDM voice channels.

Circle (858) on Reply Card

Theatre Techniques

Compulite Lighting Control System combines microprocessing with common sense for preset control and grouping control, timed cross-fades, auto fades and loops.

Circle (949) on Reply Card

Thermodyne International

SHOK-STOP Cases for the shipping of delicate equipment is manufactured from ABS materials (acrylic butyrdane styrene).

Circle (859) on Reply Card

Thomson CSF Broadcast Inc.

Vidifont IVA, changeable fonts and flexible disc storage, makes a complete electronic character-graphic display system with 45 nanosecond resolution, custom fonts and special logos, proportionally structured and spaced characters.

VIDIVOTE—Election Reporting Package uses the TV data reporting system computer with the Vidifont character generator, capable of handling display of 200 or more election races.

VIDITEXT makes the VIDIFONT IV more functional and adaptable with multiple input keyboards, RAM and disc storage and three visual outputs, Edit/Prompt, Channels 1 and 2.

1602 Dual Audio Distribution Amplifier makes available two separate 1 in/8 out amplifiers with differential, balanced bridging input and capable gain of 40 dB.

5500A/5550/5555 Color Correction System incorporates the corrector, the sensor and remote control units, specifically for use in film transfer work.

7011 NTSC Chroma Insert Keyer designed for existing color installations, contains an insert keyer and makes system retiming minimal with a through delay of less than 25 nanoseconds.

8010/8310/8410 Mark IV Image Enhancer uses combed H and variable coring to add greater detail and remove noise from the video signal, in NTSC, PAL and PAL-M standard production facilities.

9100 Digital Video Processor is capable of selectable synchronization, noise reduction and time base correction without the use of conventional gen-lock.

VIDIPLX 9010/9020 uses digital electronics for simultaneously transmitting and receiving two live color or monochromatic TV pictures over a single video channel.

See cameras beginning on page 84.

Also see audio processor article.

Circle (860) on Reply Card

3M

Model ASM-24 Slow Motion Controller is a companion to the TT-7000 "C" format VTR that allows continuously variable speed from 1/4 X reverse to 2X forward.

TTC Television Titler Controller is an interface system among the computer, the D-8800 graphics generator and an operator to provide time-sharing via telephone line, resulting in broadcastable, immediate election news, with sports and weather news to follow.

3M Digital Mastering System brings new quality of sound into recordings.

The Digital System Editor is a compact control module to determine tape movement on two 3M digital recorders.

D-3016 Character Generator is a multi-page character generator of high resolution characters and two video channel outputs.

D-8800 Graphics System is a graphics production system and titler for television, internally holding four complete fonts, additional possible with disc drive. In addition to the titler function, the Animation Mode uses high speed playback from the floppy disc for 10 animation rates. In-

Model 20X and 40X Routing Switchers supply 20 output channels from 20 to 40 input sources.

TT-7000-3 1-inch "C" format VTR, manufactured by NEC and marketed by 3M includes automatic operation at a pre-set slo-mo or shuttle speed immediately from any mode. Both forward and reverse speeds may be programmed before the actual deck motion.

ASM-24 Slo-Mo Controller keeps up to 10 cue points in memory, allows selectable pre-roll times to 10 seconds, contains a 90-minute clock as well as pre- and post-cue timing to the second for greater operator accuracy and convenience.

RM-7000RC Remote Controller for all functions of the TT-700 series VTRs. Complete control, including cue-up for replay of a tape segment, is possible from up to 100 feet from the VTR.

Circle (950) on Reply Card

Tiffen

Hi-Impact Stackable Filter Case provides compact carrying and filing of seven Series 9 or seven 3x3 inch filters.

86mm Series 9 universal rubber lens shade is collapsible for easy storage.

Tiffen provides a wide selection of filtering, effect filtering, and color cor-



AUDI-CORD: A GOOD SOUND INVESTMENT!!

"A" SERIES

An intermediate priced cartridge tape machine series with most of the quality and features found in units costing much more.

3 TRANSPORT REPRODUCER:



TWO TRANSPORT RECORD-REPRODUCER

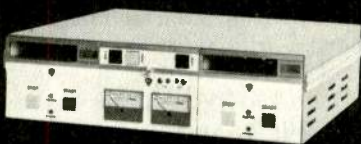

THREE SELECTABLE RECORDING MODES

— STANDARD DUAL REPLAY MODES:

- Dual Recordings
- Dubs — Copies
- Mixed Composites

AT AUDI-CORD WE DON'T TRY TO FOOL YOU ABOUT TAPE CARTRIDGE MACHINES. — WE KNOW THEIR APPLICATIONS AND THE LIMITATIONS. WE OFFER NO MIRACLE CURES — AND NO EXPENSIVE TO OWN COMPLEXITIES.

WE DO OFFER STURDY QUALITY, GOOD USEFUL FEATURES, FINE CUSTOMER SERVICE AND — TOP DOLLAR VALUE.

HERE ARE A FEW OF OUR MAJOR PRODUCT FEATURES:

- 28 Model variations
- Modular constructed for easy service.
- Interchangeable transports and other assemblies.
- 1 or 3 tone — mono or stereo.
- Replay reminder system.
- Full remote control — automation compatible.
- Meets the needs of the 1976 NAB standards.
- Latching connectors — slip/lift cover.

RAK CABINETS OPTIONAL FOR ALL MACHINES.

Modu-Cart 100 Series

RECORD-REPRODUCER

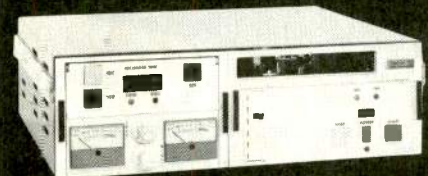

REPRODUCER



AT AUDI-CORD
VALUE IS NOT EXPENSIVE



AUDI-CORD CORPORATION

1845 W. Hawey Ave., P.O. Box 611 Normal, Ill. 61761
(309) 452-9461

GIVE US A CALL AND TALK CARTRIDGE NEEDS

Circle (119) on Reply Card

Other equipment

rection filtering items for use with photographic and TV cameras.

Circle (861) on Reply Card

Time and Frequency Technology

Model 7600 Series Digital Remote Control System is modular, field expandable, fully digital, PCM FSK models, for link by telephone line, STL or SCA.

7601 Digital Telemetry/Control System is fully digital PCM FSK based, for link by phone line, STL, TSL, SCA, with 10 channels of raise/lower and telemetry, 200 millisecond reaction time.

7700 Series Studio Transmitter Link provides high quality sound with 12W power output for 950 MHz STL operation, full redundancy in receiver and transmitter, with frequency synthesized transmitter.

7815 Independent Remote Control and Status Monitoring System handles 15 control/status channels, expandable to 45 or 79 Status channels only. With 7616 Manual Site Selector, it selects one of 16 sites for command and status function monitoring.

7900 Remote Control/Data Acquisition System, microprocessor-based, expandable, for AM, FM, TV, Satellite Communications, Industrial Control,

Energy Management, and Security Monitoring interfaces with CRT or Teletype, yet has total control via front panel, for intelligent control from control or remote locations.

763 FM Modulation Monitor offers everything necessary for the proof of performance except distortion measurements from front panel control.

730A SCA Monitor, with the 763 Modulation Monitor provides complete measurement of SCA transmission characteristics.

724A Stereo Monitor can be used with 763 (and 730A) to meet or exceed all stereo monitoring and proof of performance measurement requirements except distortion.

Circle (841) on Reply Card

Toshiba America Inc. Broadcast Electronic Systems Division

See *camera articles*.

Circle (862) on Reply Card

Townsend Associates Inc.

TMP-4-12 Klystron Mod Anode Pulsar improves operating efficiency, using all solid-state and fiber-optic circuitry, for use in UHF transmitters.

Also see the *transmitter article*.

Circle (863) on Reply Card

Trompeter Electronics

Supplies a wide line of patch panels, patch cables, connectors for coax, triax and electro-optical materials.

Circle (864) on Reply Card

Tweed Audio USA

Custom design service for radio, TV and film dubbing, Tweed engineers and manufactures 12-input 4-group and stereo output studio consoles; portable mixers (in flight case) and portable mixers with 10 inputs and stereo output. They will not modify standard equipment; all modules/consoles are developed to exact customer requirements.

Circle (951) on Reply Card

UMC Electronics

Products: featured the Beaucart 100 audio cartridge tape recorder/reproducer machines with modular design, dual redundant phase lock loop circuitry and advanced amplifier circuitry. Also shown: Beaucart II and Beaucart 300 cartridge tape machines; Beaucart System 8 automatic news recording system; Beau-Master stereo consoles; and automatic tape splice finder.

Circle (852) on Reply Card

UREI (United Recording Electronics Industries)

6150 Dual Channel Power Amplifier offers 75W RMS per channel into 8Ω with less than 0.05% THD at a bandwidth of 20 to 20,000 Hz.

6250 Dual Channel Power Amplifier is capable of 150W RMS per channel into 8Ω with less than 0.05% THD between 20 and 20,000 Hz.

6400 Dual Channel Power Amplifiers provide 255W RMS per channel into 8Ω with less than 0.05% THD between 20 and 20,000 Hz.

Time-Align Studio Monitors 811A, 813A and 815A demonstrate low-loss cross-over for maximum power transfer to transducers for improved sensitivity and more acoustical power.

1122 Stereo Transcription preamplifier includes precise RIAA/NAB equalization with high impedance inputs properly matched for almost all magnetic disc reproducers and has individual high and low frequency equalization trimmers on each channel with separate level controls for each channel.

Model 200 XY Recorder Mainframe for 2000 series modules is cooperatively designed with Hewlett Packard Company.

546 Dual Parametric Equalizer has controls for frequency tuning, filter bandwidth and boost or cut level on each filter section. Gain of the input amplifier is adjustable over a 30 dB range for input levels from -20 to +26

Move Up — to Logitek's Custom Audio Series!

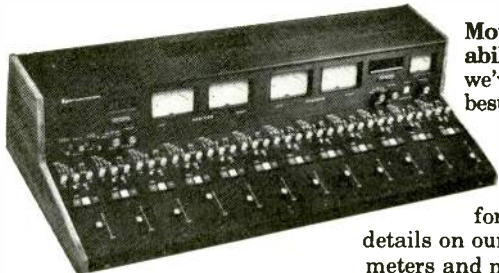

Move up to the great sound, solid reliability and unbeatable versatility that we've built our reputation on! Plus the best selection of features and options of any consoles in our price range!

CALL COLLECT
713-782-4592

for our unbeatable console specs, plus details on our phono amps, monitors, timers, led meters and more.

Logitek

Electronic Systems, Inc. 3320 BERING DRIVE, HOUSTON, TEXAS 77057

In the Mountain states, call **Media West** at 801-295-3308.

Circle (120) on Reply Card

Be a

Broadcaster for a Day (or a week or a month) Rent a Hitachi SK-91

Compact new Color TV Camera carries off its broadcast standards oh, so lightly.

One of the world's smallest, lightest ENG/EFP cameras. Ultra-light (only 9.7 lbs.) with shock-mounted optical

system to deliver excellent picture quality, even under field conditions 57 dB S/N ratio 600-line resolution, auto digital white and black balance, true ABO, 2 ft. candle intensity. Call Justina or Barbara for low daily/weekly rental rates.



L. MATTHEW MILLER Associates Ltd.

Suite 1316, 205 East 42nd Street, New York, NY 10017 (212) 687-1168 • (800) 223-0620, Cable VIDEOUSA Telex 238917
VIDEO EQUIPMENT • RENTALS • SERVICE/REPAIRS • VIDEOTAPE • EDITING

Circle (121) on Reply Card

dB. LED indicator for each channel warns of excessive level anywhere in the circuitry.

Also see audio processor article.

Circle (865) on Reply Card

US JVC Corporation

VHS Professional "TapeHandler" Recorder and Player, BP-5300 and BR-6400 are total direct-drive and are interfaceable with RM88U Automatic Editing Control System, featuring Dolby noise reduction, zero to five X variable with 10 times fixed playback search speed, and dual audio channels.

VM-1200LU Magnetic Video Disc Recorder accepts any NTSC-type signal for variable speed, still-frame or frame-shift playback. Applications include slow-motion analysis of high speed functions, sports or special effects production, animation.

Circle (866) on Reply Card

Ultra Audio Pixtec

VS310C NTSC Vectorscope/WFM/ Serviscope presents a true NTSC vector display on an industry standard graticule with full bandwidth or chroma only video waveform display and 4 MHz bandwidth oscilloscope.

WM310B Waveform Monitor provides single-line or single-field display, H and V blanking intervals on 4 MHz bandwidth oscilloscope.

MS-105 MixMaster consolette gives capability to air one audio source, mix a live program, audition another program and meter a fourth source simultaneously.

Mister 5 X 5 Multiple Channel Audio Distribution uses 10K ohm bridging input transformers, gain control and five transformer coupled 600Ω outputs, 65dB isolation between channels, internal ac supply or external 20-24Vdc operated.

VA Series Audio-Follow-Video passive switchers include 4, 6, 8, and 12 inputs; capable of balanced stereo audio, with tally system and time code switching.

APA52 Dual Channel Audio Power Amplifier delivers 50 W per channel on each 8Ω output. Fused output speaker driver with brute-force heat-sinks.

AMA41 Broadcast Audio Mixer operates on AA batteries (75 hours continuous use) or external 12 Vdc with 4-mic or 3-mic/1 line inputs. Less than .2% THD over 30 to 20,000HZ response range, output noise 83 dB below + 18 dB output.

AM3 Audio Monitor gives 3W output from 4 VU program line with 10K ohm bridging input, headphone jack automatically disconnects internal



IT'S A SNAP

Portable Energy Products announces the PEP Snap Pack — the only snap-on power source available offering the advantages of sealed lead-acid batteries:

- No "memory effect."
- The battery maintains excellent voltage regulation even in extreme temperatures.
- Plus low self discharge
- Increased reliability with fewer cells required for the power supply

The PEP Snap Pack only weighs five pounds. It attaches to standard keyhole mounting brackets via three quick release studs. And PEP's high

performance, two-step constant current maximizes battery life by preventing over charging.

These features plus Portable Energy Product's reputation for quality, reliability and service add up to make the PEP Snap Pack the most dependable snap-on power source available.

PEP

PORTABLE ENERGY PRODUCTS, INC.

1875 South Pearl Street
Denver, Colorado
303-778-8618

Circle (122) on Reply Card

TV Studios with inadequate lighting may have a dim future.

Thanks to our experience in dealing with studio lighting, we have designed six standard TV lighting packages that meet normal needs for standard-sized studios. And since these are complete systems already engineered and in stock, ready to ship, they afford substantial savings.

At Kliegl, we have a team of seasoned engineers who can also design custom studio lighting systems to meet more exacting requirements.

So, if you don't want your viewers to change channels, turn to Kliegl. For complete information on our TV packages, please write or call.

Kliegl

Kliegl Bros.
32-32 48th Ave.
Long Island City
New York 11101
212/786-7474

Circle (123) on Reply Card

Other equipment

speaker.

Circle (867) on Reply Card

UNARCO-Rohn, Division of Unarco Industries Inc.

Suppliers of towers and accessories for all uses, safety equipment for tower workers, and tools.

Circle (868) on Reply Card

Uniset

Modular Staging System for the studio, economical, versatile, durable, yet mobile.

Circle (869) on Reply Card

United Media

Commander II is a fully integrated, computer-assisted electronic editing system based on SMPTE/EBU time code with user bits that is capable of expansion to eight VTRs plus a switcher, internal memory holds 500 edit decisions, interfaces to floppy disc for 10,000 decisions per disc.

Commander I contains memory for 25 edit decisions with interface to paper-tape facilities, with two time code readers, can do split edits—in or out from video, audio 1 or audio 2, portable.

Model 205 Time Code Generator and Character Generator for SMPTE/EBU

Time Code with user bits for NTSC, PAL, and SECAM or film compatible rates in drop or non-drop frame modes, provides stability within one horizontal line, position control of characters over synchronized video.

Model 210 Time Code Generator for SMPTE/EBU code with user bits outputs NTSC, PAL, SECAM and drop or non-drop frame modes, stable within one horizontal line, automatic sync loss detection, synchronized to composite sync or video.

Model 215 Character Generator for SMPTE/EBU time code with user bits provides video mixing of SMPTE time code and user bit characters for display on video monitors.

Model 305 Time Code Reader and Character Generator for SMPTE/EBU time code with user bits displays the time code data on a front panel display as well as mixing it on the video signal.

Model 310 Time Code Reader for SMPTE/EBU Time Code with user bits detects the recorded time code data and displays it in time format in a front panel display.

Circle (870) on Reply Card

United Research Laboratory Corporation

Motion Sensing Modification Kit for use on most Ampex audiotape decks

uses a permanent magnet and reed switch as sensor for Auto-Sense adapter.

Model C5 Solid-State Conversion Record/Reproduce Amplifier for use with Ampex 300, 350, 351, and 354 audiotape machines allows use of original heads, equalization automatically changed by capstan speed switch, FET switched, "Failsafe" bias indication.

Circle (872) on Reply Card

US Instrument Rental Inc.

Portable microwave radios available for shipment anywhere in the United States or Canada within hours.

Circle (873) on Reply Card

Ursa Major

Model 8x32 Digital Reverberation System is compact with comprehensive LED and numerical displays for confirmation of all parameter settings and dynamic properties of input and output reverberated signal levels. Memory retains 32 complete reverb set-ups.

Also see audio processor article.

Circle (875) on Reply Card

Utah Scientific

AVS-1 Switching Matrices are distortion-free routing switchers for

**Some things
you can't get from the Biggest.
Only from the Best.**

capstan idler assemblies

AMPEX

with

Scully

AUTO-TEC® ML 6

ELECTRO-SOUND

FOR MOST PROFESSIONAL RECORDERS
THE ALMOST INDESTRUCTIBLE COATING
THAT TAKES THE LOAD OFF THE DRIVE
MOTOR BEARINGS

NOW with

Self aligning ball bearing

proven dependability from



United Research Laboratory Corp.

681 FIFTH AVENUE • NEW YORK, N.Y. 10022

(212) 751-4663 • TWX 710-581-3622

SERVICE AND SHOWROOM - 16 EAST 52nd STREET
N.Y.C. 10022

Circle (124) on Reply Card



audio, video, tally, time code or machine control signals. Standard configurations are 10 x 10 to 150 x 160 for video only, audio only, or audio-follow-video.

CSP Series Part Line Control Panels allow separate audio and video switching of AVS-1 system, provide continuous audio and video status readout, looping BNC coax connectors allow multiple control panels for one switching matrix.

CSP-1600 Series Alphanumeric Party Line Controls for the AVS-1 routing switchers allow switching and statusing by source name rather than just Card mounts in a card slot and, with DI-232 card, produces RS-232 interfacing to line printer directly or via telephone modem with switchable baud rates for a hard record of all switch commands entered.

UPLIC-A Universal Party Line Interface Card allows interfacing of customer supplied control devices with the switching matrix, not an AVS-1 compatible card.

UPLIC-1 Universal Party Line Interface Card fits in the AVS-1 for customer supplied control device interfacing.

CAV-7 Switching System meets needs of AM, FM, TV, CATV and in-

structional TV users with six basic configurations.

Circle (876) on Reply Card

Utility Tower Company

Towers constructed according to each broadcaster's specifications, including lighting and grounding systems, with only experienced erectors employed for dependable safe installation.

Circle (953) on Reply Card

V & B Tower Construction Inc. (Atlas Tower Manufacturing)

Towers to 1350 feet for TV broadcasters are the result of the company's design, fabrication and erection services.

Circle (877) on Reply Card

Valtec Communication Fiberoptic Company. The company is a joint venture owned by M/A-COM and N.V. Philips for development, manufacture and marketing of optical fibers, optical fiber cable, associated hardware and related systems.

Circle (879) on Reply Card

Varian Associates/Eimac Division

5CX2500A ceramic/metal power pentode for use as Class AB1 linear amplifier in audio or radio frequency

applications, single sideband service. Also operable in CW, FM, and AM services.

4CX40000G VHF radial beam power pentode is recommended for FM broadcast, rf linear power amplifiers and VHF TV linear amplifier service.

8962/3CX1500U7 is a UHF high mu transmitting triode of metal/ceramic construction for 680W of useful CW rf power with 34% efficiency, 10 dB gain at 850 MHz.

8873, 8874, 8875 High-mu triodes, external anode ceramic/metal tubes for Class A, B and C amplifiers allow power gain of 20 times in grounded grid configuration.

EIMAC CV-2200 Power Amplifier cavity assembly for use as final amplifier in 88 to 108 MHz FM broadcast services using 4CX12000A or 4CX20000A for VHF applications.

EIMAC CV-2225 Power Amplifier cavity assembly for FM Broadcast with 4CX3500A produces useful output of 5.5 KW.

EIMAC CV-2240 Power Amplifier cavity assembly for lowband TV service channels two to six uses 3CX10000U7 for 10 KW peak of sync power.

EIMAC CV-2250 Cavity Assembly for final amplifier in high band TV

INTRODUCING THE MODEL 7200 COMMUNICATOR

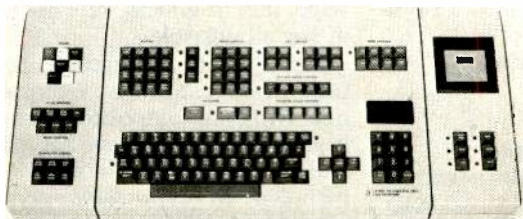

- HIGH RESOLUTION FONT (35 n sec.)
- BASIC SINGLE STROKE CONTROL
- GRAPHICS AND 3 CHARACTER SIZES
- 8 COLORS—CHARACTERS & BACKGROUND
- MIXED CHARACTER SIZES—BY LINE
- AUTO CENTERING BY PAGE OR LINE
- DISC AND/OR TAPE STORAGE
- MULTIPLE KEYBOARD CAPABILITY
- BUILT-IN VIDEO KEYS
- FULL BORDER OR DROP SHADOW

LAIRD TELEMEDIA INC.
2424 SOUTH 2570 WEST • 801 972-5900
SALT LAKE CITY, UTAH 84119

Circle (125) on Reply Card



Script writing and prompting have finally gone electronic.

The fact that the BEI Data-Prompter is an excellent script writing and prompting device is reason enough to check it out. But the BEI Data-Prompter offers other benefits. Like live "real time" Closed Captioning for the hearing impaired, electronic text editing, assembly and material handling, automatic pacing, a director's line for cuing, "on air" story sort and skip/re-insert.

The BEI Data-Prompter also has a clear, easy-to-read display. In addition, the BEI Data-Prompter can generate either a hard copy printout or a log printout.

The BEI Data-Prompter. Not only designed to fit your script writing and prompting needs, but to work for you, not against you.



P.O. Box 106A - Olathe, Kansas 66061
Toll Free 1-800-255-6226
In Kansas 913-764-1900
TWX 910-749-6401

Circle (126) on Reply Card

Other equipment

service uses 3cx10000U7 for 10 KW peak of sync power.

EIMAC 8974 is a high-frequency, very-high power tetrode for medium and shortwave broadcast service and VLF communication in the megawatt power range, as Class C amplifier, capable of plate power output of 2158 KW.

Also see the transmitter article.

Also see satellite articles.

Circle (880) on Reply Card

Video Associates Labs Inc.

VB-1 Computer Board is designed for use with the Apple II computer to allow a key over any standard NTSC signal and features downstream keyer, chroma on/off, adjustable hue and chroma saturation, preview and automatic color framing.

ProPak updates 3/4-inch tach lock to a full broadcast-quality control and synchronization system, allows full frame V and H lock from pause in one second, reduces window needed in time base correction.

Dc Drum Servo for Sony 2850, 2850A and 2860 machines improves tracking of input video, reduces horizontal errors and provides operation from 115V, 50 cycle power lines. Eliminates apparent tension errors inherent in Sony's servo system.

Reference Field Framer for the Sony 2850A and 2860 tach-lock servo machines to allow the machines a unique point in field 2 to which the tach may lock to ensure correct field editing.

Circle (881) on Reply Card

Video Data Systems

TPT-2500 TV Production Title includes 32 pages of internal memory with optional digital cassette memory, downstream keying, three character heights per line. 12-font enhancement/edging choices. 16x20 matrix of upper and lower characters.

Vertical Interval Transmission Link Encoder/Decoder uses a standard TV signal with input data synchronized to the horizontal repetition rate of the TV signal and encoded within a horizontal line in vertical blanking.

V-TEC/IH Video Time and Error Corrector uses CCD memory technology for full bandwidth video and 60 dB signal-to-noise ratio, includes automatic gain control to maintain proper levels and eliminate "tension" errors of helical scan videotape playbacks.

T-1024, T-1024S PAL Low Cost Titler is microprocessor-based character generator, including 8-page memory, expandable to 16, with full

cursor control.

T-1000A, T-1000 PAL TV Studio Titling System is designed for downstream keying and ease of operation with special font and edging enhancement.

Circle (882) on Reply Card

Videomagnetics Inc.

Uses hot pressed high density MN/ZN ferrite to provide performance optimized for quad videotape recorders.

Circle (883) on Reply Card

Videomedia

Z-6000A Editing Controller permits A/B rolls, split edits, in and out points selected on the fly, functionally defined keys, dual shuttle arm controls and full VTR status verification, random search and go to functions.

Z6 Series of Editing Systems incorporate MICRO-LOC instead of time code control for tracking to any standard (even 24 frame film rate) and converts from one standard to another if necessary, no separate audio track required, no cross talk, readable at any speed.

Mini-Z System is a single-event editing system, allows random access to a frame on either VTR with full VTR remote control edit trim + or -, dual bi-directional shuttle arm controls, Rehearse, Perform and Review, fully upgradeable to any Z system.

KR-6000 35 nanosecond resolution character generator will allow fading of characters on and off or downstream character key with full composite face to and from black, proportional spacing, independent character colorizer, four resident fonts, 16 programmable colors, animation.

Circle (884) on Reply Card

Video Production Services

Complete studio, post-production, location and sound services with 27-foot Compact Video constructed mobile van.

Circle (955) on Reply Card

Video Tape Systems Inc.

IG470 Automatic Cue and VTR Controller operates with six playback VTRs and six local or remote program source inputs for insertion of local access spots during breaks. Compatible with 1-inch C format, 3/4-inch and 1/2-inch VHS or Beta-max equipment.

Circle (956) on Reply Card

Videotek Inc.

APM-2R Audio Program Monitor has dual channel monitoring capability,

with a wide dynamic range as low as 70 mV p-p to 3 V p-p.

VSM-5 Video Vectorscope uses a 5-inch CRT for display of phase and amplitude of chroma in video signals. Based on the NTSC standard, two inputs are selectable. Subcarrier reference may be from A, B, and external sources.

TSM-5 Video Waveform Monitor presents NTSC or PAL standard displays on a 5-inch CRT. A and B inputs may be ac or dc coupled. Output feeds a video monitor or other equipment. Internal and external sync selectable.

Circle (957) on Reply Card

VIF International

The VIF 1005 Capstan Idler has a unique self-aligning feature that enables it to remain parallel to the capstan at all times, therefore completely eliminating alignment problems regardless of capstan diameter.

The VIF 1006 JFET tube has lower noise and higher amplification.

The VIF 1000 Lock-Down Reel Retainer is a quick-loading method of securing either NAB or RETMA tape reels in place.

The VIF 450 Background Music Reproducer is designed for radio automation and background music applications.

Circle (958) on Reply Card

Viscount Industries Limited

1107 and 1107 ac/dc Video Production Switcher allows three inputs for two output buses operating in NTSC or PAL provides vertical interval switching. Has full color delay compensation through all paths. Mix, wipe, mix of effects, key, matte, wipe of key all possible.

1127 Video Production Switcher uses five synchronous composite inputs with one composite synchronous keying input to provide two program and two preview outputs, tally system included. Microprocessor-controlled, operates in NTSC or PAL standards with full color delay compensation on all paths.

Circle (886) on Reply Card

Vital Industries

SqueezeZoom Multichannel Digital Effects/Frame Synchronizer is available for NTSC and PAL for video expansion/compression, programmable patterns or with more than 100 standard effects, mirror images, freeze, flip, tumble, with computer graphics. Add PSASII computer control for 2000-event storage.

PSAS-2 Production Switcher Automation System is a microprocessor-based system to operate with VIX-114 Series Switchers

or SqueezeZoom for operations exceeding manual dexterity of the human operator.

VIX-114-10A1 (10 inputs) or VIX-114-16A1 (16 inputs) Production Switchers for small studios, remote, ENG, or post-production work with editor package available to allow computer control access and audio system with mixer. Four output buses, M/E 1 A and B, Program and Preset, two keyer systems, four-input chroma-keyer.

Micromax-32 Series is a Preset 3Z System for TV Automation, which permits up to 32 events to be preset and displayed in English statements on CRT monitor, events than manually placed on air with automatic prerolls. Next event preset automatically.

VIMAX-200 upgrades the Micromax-32 to handle 32,000 events and takes charge of the on-air operation, controls the time and switching of audio, video and machine control functions with printed as-run log for billing and FCC functions.

VIX-114-1A1 Production Switching System is digitally controlled where NTSC, PAL, or PAL-M video standard switching is required.

VIX-115-5 On-Air Switching System combines video, audio and complete machine control functions into preset and take operation. Once next preset is assigned, digital logic rolls machines, changes mirrors, switches audio and video, etc, for flawless station breaks.

VIX-115-3 On-Air Switching System combines audio, video and machine control into preset and take operation with digital logic to do starts, mirror flips, audio, video, and mix/effects switching.

VIX-115-2 On-Air Switcher is a preset-take system with two switching buses.

VRS-304 Video and Audio Routing Switcher will accommodate up to 30 inputs and 4 to 200 outputs, applicable to computer control, multiple audio channels and vertical interval switching with two audio and two video outputs per bus.

Vital Industries offers video distribution amplifiers, pulse distribution amplifiers, video equalizing amplifiers all compatible with the same main frame.

Model 250 P/N Production Switching System accepts 10 inputs including black and color background for five levels of video; program, preview, and three keyers.

VIX-114-4A1 Production Switching System is digitally controlled for NTSC or PAL and PAL-M standards situations. Up to 24 inputs including black and color background may be fed to 10 output buses: Three mix/effects systems, program, preset, monitor, and key.

NEW FM AND TV FIELD STRENGTH METER FIM-71

- Accurate — Direct Reading — Volts or dB
- 45 MHz to 225 MHz — Continuous Tuning
- Peak or Averaging Detector (switch selectable)
- Wide or Narrow IF Bandwidth (switch selectable)
- 20 dB or 60 dB Meter Range (switch selectable)
- AM or FM Demodulator (switch selectable)
- Calibrated Dipole Antenna, Mounted on Case for Near-Ground Measurements or Removable for TASSO Measurements
- 140 dB Measurement Range (1 μ V to 10 V)
- 4½-Inch, Mirrored Scale, Taut-Band Meter
- Front Panel Speaker
- Recorder Output
- Rugged, Portable Package
- Calibrated Signal Generator, 45 MHz to 225 MHz
- Battery or External Power
- Use as Signal Source/Selective Voltmeter for Insertion Loss Measurements of Filters, etc.
- Measures FM Harmonics to -80 dB

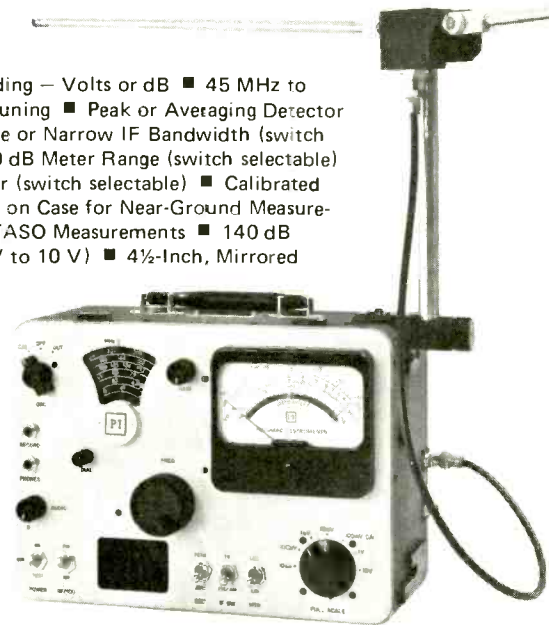

CONTACT US FOR DETAILS.

POTOMAC INSTRUMENTS

932 PHILADELPHIA AVE.
SILVER SPRING, MD. 20910
(301) 589-2662

Circle (127) on Reply Card

The AUDIO • FOLLOW • VIDEO PASSIVE SWITCHER

You've always needed . . . but couldn't find anywhere.

WITH BALANCED, STEREO AUDIO • TALLY • TIME-CODE SWITCHING, TOO 4, 6, 8 & 12 input-stations requiring but 1 RackUnit space. BNConnectors for video & time-code (or balanced video or 2 standard, isolated video sources per station). Screw-terminal audio strips. 3-24 v.d.c. external tally power (inexpensive accessory UAPower Supply, UL-approved). Changeable designation strips. VA-series Switchers for rackmount or tabletop. Video sources internally terminated 75 Ω except the pushbutton pressed.

See them at NABooth 1819 & L.A. VideoShow booth 605.

Ultra Audio Pixtec P.O. BOX 921 • BEVERLY HILLS
CA 90213 • 213/276-2726

A DIVISION OF AUDIO INTERNATIONAL, INC.



Circle (128) on Reply Card

When accuracy Counts... Count on Belar for AM/FM/TV MONITORS



BELAR
AM MODULATION MONITOR



BELAR CALL ARNO MEYER (215) 687-5550
ELECTRONICS LABORATORY, INC.
LANCASTER AVENUE AT DORSET, DEVON, PA. 19333 • BOX 826 • (215) 687-5550

Circle (129) on Reply Card

Other equipment

VIX-114-2A1 Video Production Switching System is digitally controlled with 12 to 24 inputs to feed eight output buses: two mix/effects systems, program, preset, monitor, and key

Saturn Series production switcher may include up to four mix/effects systems, each with three video keyers, two RGB and two composite chroma-keyers, two matte colorizers and two color background generators.

Circle (887) on Reply Card

Ward Beck Systems Ltd.

"microCOM" intercommunications systems use the technology of the microprocessor to provide ease of intercom usage in the often complex needs of the radio, television, or production environment.

The R1200 radio console, a standard WBS console, installed in a mockup of the radio studio for "combo" operation included Series M 40 equipment as well as sequencing devices for cartridge players, all installed in furniture setting as designed for existing radio stations, allowing a better picture of how the equipment might be used in a complete operating system.

Current equipment at the Ward Beck Systems display included a com-

plete line of radio consoles (a custom design for use in CBC control rooms for radio and television production facilities with the M460 series modular electronics offering unsurpassed control of audio requirements) as well as the T1202 and L3242 television consoles. The portable T1202 model includes series M480 modular construction for a compact 12 input channel/2 master output channel capability. The 32 input (four sub-master, two master) standard L3242 TV production/on-air console included series M470 modular construction for an efficient, easily operable facility. WBS continues to offer the 7000 Series intercom/IFB system which uses a standard matrix and as assortment of intercom panels.

Circle (888) on Reply Card

Weathercaster

Model CT-1000 Dual-Processor Computer System provides local real-time weather forecasts as well as for 12, 24, 36 and 48 hours, predicting sky cover, temperature, wind speeds and percent chance for precipitation and type, with color graphics capabilities from graphics tablet as well as graphic weather maps animated for satellite, radar, national, regional and state. Unique Weather Characters Library in a high resolution 512x512 pixel col-

or NTSC or RGB video output.

Model R-300 Weather Data Acquisition and Forecasting System is a stand-alone computer to gather weather information and compute weather predictions, for use in radio stations. An optional voice synthesizer allows the unit to speak sky cover, precipitation probability and type, temperature and wind characteristics for up to 48 hours from the time of observation.

Circle (889) on Reply Card

Weathermation Environmental Satellite Data Inc. (ESD)

Meteorological Satellite Imagery derived from the NOAA Geostationary Operational Environmental Satellite System (GOES) for images each half-hour of North America, including zoom-in views of local areas, color enhancements and animation of sequenced images.

Circle (959) on Reply Card

Western Union Broadcast Services

See satellites on page 70.

Circle (890) on Reply Card

Wilkinson Electronics Inc.

The company provides a variety of power levels of FM transmitters and



PICLEAR®

The worldwide solution to instant image rejuvenation.

The PICLEAR Film Enhancement System makes it possible. Scratches disappear from the projected image. Dirt is removed. Image brightness is increased by 10%, and useful film life is greatly extended.

PICLEAR. 180 E. Prospect Ave. Mamaroneck, NY 10543
914/698-0258

Circle (130) on Reply Card

MODEL C5 MONO \$845.00

AUTO-TEC
RECORDERS

STEREO \$1640.00

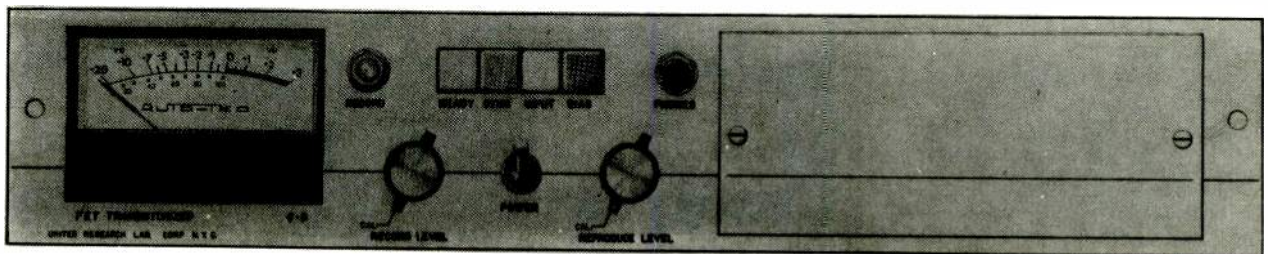

SOLID STATE CONVERSION AMPLIFIER

For AMPEX 300, 350, 351 and 354 Recorders



United Research Laboratory Corp.

681 FIFTH AVENUE • NEW YORK, N. Y. 10022 • (212) 751-4663

Circle (131) on Reply Card

AM transmitters with dummy load, surge protection and stereo generation equipment also available.

Circle (891) on Reply Card

Winsted Corporation

The company handles a wide line of mobile carts, racks, pull-out storage cabinets and shelving for any need for the broadcaster.

Circle (892) on Reply Card

Wireworks Corporation

Wireworks products include multicable components groupings, cable marking materials, professional microphone cables, microphone cable tester TE-2, and multicable microphone systems. Specializes in multiple audio cable systems.

Circle (893) on Reply Card

Robert Wold Company Inc.

See satellites on page 70.

Circle (894) on Reply Card

Wolf Coach

Custom manufacturers of mobile units for broadcast, cable and production company needs. Vehicle selection, structural modification, design, engineering, consoles, custom-built racks, erectable masts, air conditioning systems, shooting platforms, painting, graphics, etc.

Quick-release camera saddle sup-

plies added protection during transportation of ENG cameras and enables quick changeover from baseplates installed in the mobile unit.

Circle (895) on Reply Card

Frank Wooley and Company Inc.

Motionmaster Video Animation System permits preparation of camera ready animated art in studio through the use of polarized light, not a cell or computerized operation.

Circle (896) on Reply Card

World Tower Company Inc.

Ice Kracker attaches to each guy line just ahead of the anchor to prevent ice from damaging preform grips, u-bolts and other mounting hardware, in the form of a cast-iron split cone shaped device.

World Tower offers fabrication, installation and maintenance of AM, FM, TV, CATV and microwave towers.

Circle (897) on Reply Card

Xedit Corporation

Model 20-P Drift and Flutter Meter is a peak and RMS reading instrument.

EDIT/ALL Professional Editing/Splicing System includes splicing blocks and kits for 1/4-, 1/2-, 3/4-, 1-, 2-, and 3-inch tape, with various angles of cut available on each.

Circle (898) on Reply Card

ZEI-MARK Corporation

Model 750 optical multiplexer accepts three film inputs with switching between inputs at less than 100 milliseconds, occurring as a vertical wipe, braked for instant stopping without bounce, using only two mirrors.

Model 4305 Optical Multiplexer is a 3-input, 2-output system with bi-directional dc motor drives to permit "on-air" changes appearing as a vertical switch. Second (preview) output could be used as a four input.

Model ND-4 Universal Automatic Light Control uses a rim-driven circular Inconel ND wedge for light attenuation rated for 100:1 (NDO to 2.0) compensation.

Model ZM-ND-1 Automatic Light Control for film chain use senses video output from the camera with a circular ND wedge to provide nearly constant video output level from the film chain.

Circle (899) on Reply Card

Zenith Radio Corporation

SSAVI-1 for American Television and Communications Corporation is the Sync Suppression and Active Video Inversion unit for dual mode random video scrambling used in the home. Each unit is addressable from the transmitter allowing security for the subscription TV industry.

Circle (900) on Reply Card

WORLD TOWER COMPANY INC.



Offering the Communications Industry
Total Tower Systems and Services
Fabrication, Installation and Maintenance
of AM-FM-TV-CATV Microwave Towers

Call or Write:

M. N. "NATE" SHOLAR, Owner
WORLD TOWER CO. INC.
P.O. BOX 405
Mayfield, Ky. 42066
Phone 502-247-3649

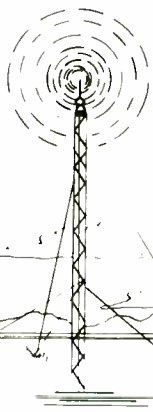

Circle (132) on Reply Card



It's all in our CM-33 B HIR Color-Critical Monitor

- High resolution
- .31 mm. dot screen
- Shadow mask in-line gun picture tube
- Seven mHz video amplifiers standard

ELECTOR

Exclusive North American distributor
for Barco A/V products

5128 Calle Del Sol
Santa Clara, California 95050
(408) 727-1506

31 Progress Court, Scarborough
Ontario, Canada, M1G 3V5
(416) 439-9333, Telex: 065-25431

Circle (133) on Reply Card

Convention

continued from page 16

Amateur and Citizens Division and head of NAB's Engineering Department.

Walker took the FCC to task, accusing the commission of "running scared" in the face of the 9kHz discussion to be held in Rio de Janeiro in November of 1981. Labeling the US negotiating position as both "insidious and creeping," he indicated that the United States has a model broadcasting system for the world, yet the nation is heading into a conference blackmailed by the Soviet Union. "Why," he asked, "should some South American country dictate to us?"

He found praise for the Canadian government and its stand in opposition to the 9kHz concept and said "It is a travesty that the United States does not get behind the Canadians and say it too." Areas of the world using the 9kHz bandwidth were already experiencing a real mess in communications and interference.

Walker also said the next several years will be crucial for broadcasting in spectrum management and noted that it is imperative that the United States coordinate use of the spectrum with other countries—especially Canada, Mexico and the Latin American countries.

He stated that system

characteristics are not necessarily the same as others might propose. "In particular," he said, "the proposed satellite transmitter power and characteristics of the home receiving installation, as well as other system aspects probably would make efficient spectrum utilization less than optimum."

Walker concluded his address with a humorous, but poignant thought. "If one had the acumen to evaluate the present with the hindsight of future generations, we probably would conclude that telecommunications is still in its infancy."

Goldwater: 9kHz won't work

Senator Barry Goldwater (R-AZ), chairman of the Senate Communications Subcommittee, told radio broadcasters at NAB '81 that the proposed change in AM channel spacing from 10kHz to 9kHz "won't work. It hasn't got a chance in Congress."

"When the members of Congress realize that the change means the abolition of most AM radio receivers," Goldwater continued, "that alone is going to defeat it. Canada's decision to back away from the change offers us the indication that the United States should too."

Other Action at NAB '81

The NAB conventions serve as a

hub for a great deal of action that does not occur either on the convention floor or during regular hours. This activity covers private showings (especially for the press and selected customers); sales meetings of networks and manufacturers; hospitality suites; special awards and ceremonies; special showings combined with the traditional dinners; and record-making events that deserve special note.

Even with the large staff BE had at the convention, it was not possible for us to cover all these miscellaneous activities that are vital to the convention success. However, those that we were able to cover are briefly reported.

Acrodyne Industries

In its hospitality suite, Acrodyne reported to the press an overwhelming success for its LPTV seminars with total attendance of about 400 for the two sessions.

Ampex

Because this year marks the 25th anniversary of the introduction of the first VTR, Ampex scheduled its NAB '81 ceremonies around this historical landmark in broadcasting. It is probably coincidental, rather than planned, that Ampex's new products at this year's event may establish a new benchmark in excellent equipment for broadcasters.

Ampex began its celebration at the Convention Center with a special conference and Continental breakfast for the working press. Top executives from Ampex sketched important industry trends and described Ampex's response to broadcasters' needs. The reports were supplemented by a taped presentation (from still stores and ancient tape segments) that outlined the development of videotape technology. Then the press was taken to the convention floor for a private showing of Ampex's new products.

Ampex continued its celebrations of the VTR development with an evening party at the Sahara's Space Center Ballroom, and about 2000 guests were invited. The first VTR was on display for this celebration. It is shown here in the ballroom along with some pioneers involved in its development and use. The same unit is featured in BE's May issue (cover and on page 22) at its first installation: CBS Television City, Hollywood, CA. Following the convention, this VTR was scheduled to be installed in a California-based museum.

Fujinon Optical

As it did last year, Fujinon sprung for a press breakfast and introduced its new camera lenses. On display for

Acrodyne Sponsors LPTV Seminars

In a bold move just before NAB'81, Acrodyne Industries decided to hold information seminars on Low-Power TV (LPTV) during the world's biggest broadcaster's convention. The results were a resounding success, but that was not surprising in view of the recent surge in LPTV technology.

"We were delighted with the turn-out and the high level of interest by the attendees," said John Parke, Acrodyne's vice president of marketing.

The LPTV seminars were held on Monday and Tuesday of the convention week, and the panelists faced a standing-room-only gathering both times. The scheduled program was as follows:

I. Welcome and introduction. By Nat S. Ostroff, vice president engineering, Acrodyne Industries.

II. Current status of FCC regulations and future outlook. By Atty. Grover Cooper of Fisher, Wayland, Cooper & Leader.

III. Transmitting antennas for LPTV stations, including circular polarization. By Dick Bogner of Bogner Broadcast Equipment Corp.

IV. High gain directional antenna applications for LPTV. By Ellis Feinstein, executive vice president/general manager, Scala Electronics.

V. Satellite earth station applications in LPTV. By J.M. Hooper, Scientific Atlanta.

VI. Station configuration interface and equipment choices. By Nat S. Ostroff, vice president engineering, Acrodyne Industries.

VII. The role of the consulting engineer in the emerging LPTV industry. By John F.X. Browne, P.E. of John F.X. Brown & Associates, Inc.

VIII. Panel discussion open question and answer.

Acrodyne's LPTV seminars were designed to help prospective station owners answer the questions of who, what, where, when, how, and how much. The lively questions-and-answer session that concluded the meetings brought out a number of concerns of people facing this potential new marketplace.

Highlights from the panelist's presentations are being planned for an upcoming issue of BE.

Convention

this event was also RCA's new Hawkeye VRC (video recorder/camera) which bears one of the new Fujinon lenses. One of the highlights of the press breakfast was the announcement by Fujinon's president, Fred Nakajima, that Jack Dawson has been named vice president and general manager.

Capitol Magnetics

Incentives for personnel having outstanding performances is a characteristic of most company operations. Capitol Magnetics was at least one firm that recognized its dealers' accomplishments with special awards presented during NAB '81.

Christie Electric

The outstanding performance of a mime at the Christie booth has become a convention expectation. This year she set a world's record. On the last day of the convention, Melody A. Schick of Los Angeles, set a new world's record of 8½ hrs as a 'live mannequin' in her performance at the Christie exhibit.

Panasonic

The evening introduction to

Panasonic's new products at a press conference took place in a relaxed atmosphere but with formal presentations by product managers. Clearly the highlight was the new VCR (video recorder/camera) and its supporting editing equipment, but strong interest also was expressed in other products.

RCA Broadcast Products

RCA continued its tradition of a press luncheon followed by short, well-organized presentations on new products supported by exceptional graphics. The luncheon was followed by a private showing of RCA products at the booth. Again, the new Hawkeye VRC (video recorder/camera) was the star of the show. Although this was the Hawkeye's first viewing to the press, it was later to show up at the Fujinon breakfast for a separate display of its lens.

Sony

Sony's greetings for the working press were up to traditional standards of excellence: an informal lunch followed by a well-organized product presentation and a special demonstration in the suite. Last year, the press saw Sony's digital video recorder technology in the Sony suite; this year, we saw the new VRC (video recorder/

camera). Masahiko Morizono, Sony's managing director of Video Products Group, addressed the press and was on hand to demonstrate the new products.

Final Note

One of the factors that made NAB '81 an overall success was the high level of sales taking place. One firm reported selling more products on the first day than they had during all of last year's convention. Another reported sales of more than \$2 million on Monday alone. On hearing this figure, one of the new VRC manufacturer's representatives thought he could have booked more than that if he could have just delivered the product.

And so it went. Concrete sales figures are not practical to obtain from such convention activity, but the informal reports of sales at NAB '81 were impressive...and speak well for the economy for broadcasters and equipment suppliers.

New products introduced at the show are being covered in the balance of this issue. If you missed something, or if you didn't make it to the show this year, read the following coverage and use the reader service card to obtain more information. □

PROTECT CARRY SHIP PACKAGE

If you're constantly on the move, with no time for repairs, a Fiberbilt case or shipping trunk will protect your equipment and get it there safely...ready to set up and use. Cases and trunks in stock for most A/V equipment. Send for our "Going Places Cases" Catalog G.

Fiberbilt

Ikelheimer-Ernst, Inc.
601 West 26th St. New York, N.Y. 10001
(212) 675-5820

Circle (134) on Reply Card

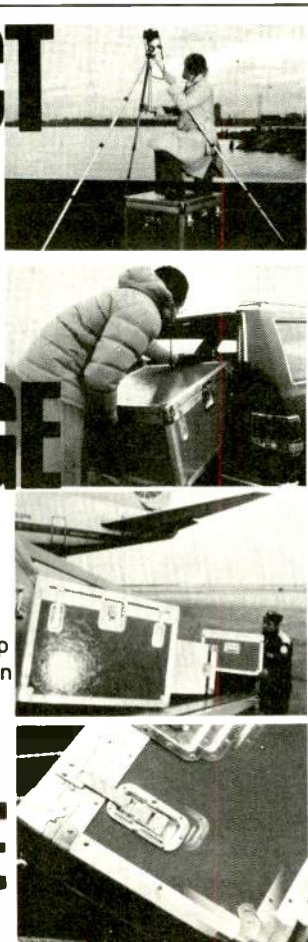

STL

PRECISION



MAGNETIC TEST TAPES

STANDARD TAPE LABORATORY, INC.

26120 EDEN LANDING ROAD #5, HAYWARD, CALIFORNIA 94545 • (415) 786-3546

Circle (135) on Reply Card

professional services

VIR JAMES P.C.
CONSULTING RADIO ENGINEERS
Applications and Field Engineering
Computerized Frequency Surveys
4940 E. 39th Ave.
Phone: (Area Code 303) 393-0468
DENVER, COLORADO 80207
Member AFCCE & NAB

STEIGER, HURRAY & ASSOCIATES INC.
Broadcast Technical Consultants
**ANTENNA SYSTEM
SPECIALISTS**
6816 Westview Drive
Cleveland, OH 44141
(216) 526-7187

RALPH E. EVANS ASSOCIATES
CONSULTING COMMUNICATIONS ENGINEERS
216 N. Green Bay Road
Suite 208
Thiensville, WI 53082
Phone: (414) 242-6000 Member AFCCE

R. L. HOOVER
Consulting Telecommunications
Engineer
11704 Seven Locks Road
Potomac, Maryland 20854
301-983-0054
Member AFCCE

MIDWEST ENGINEERING ASSOCIATES
Consulting Engineers
150 Wesley Rd.,
Creve Coeur, IL 61611,
309-698-3160.
Member AFCCE

Radiotechniques

STATION DESIGN & CONSTRUCTION
TECHNICAL SERVICE • APPRAISALS
EQUIPMENT DESIGN & MANUFACTURING
402 Tenth Avenue, Haddon Heights, NJ 08035
(609) 546-1841

SMITH and POWSTENKO
Broadcasting and Telecommunications
Consultants
2000 N. Street, N.W.
Washington, D. C. 20036
(202) 293-7742

**G.A. GILBREATH ASSOCIATES
INCORPORATED**
AUDIO/VIDEO BROADCAST
CONSULTANTS
6357 LAWTON AVENUE
LAS VEGAS, NV 89107
(702) 878-8313

Lechman, Colligan & Associates
Telecommunications Consultants
Applications—Field Engineering
General Radio Science
Domestic and International
Suite 205
2033 "M" St. N.W.
Washington, D.C. 20036
(202) 775-0057 or (301) 229-5577

LAWRENCE L. MORTON, E.E.
And Associates
Consulting Telecommunications Engineers
AM, FM, TV and Low-Power TV
Applications and Field Engineering
Computerized Frequency Searches
1747 South Douglass Road, Suite D
Anaheim, California 92806
(714) 634-1662

**D. L. MARKLEY
& Associates, Inc.**
CONSULTING ENGINEERS
206 North Bergan
Peoria, Illinois 61604
(309) 673-7511
Member AFCCE

McCLANATHAN & ASSOCIATES, INC.
Consulting Engineers
APPLICATIONS & FIELD ENGINEERING
TURNKEY INSTALLATIONS—RADIO & TV
DIRECTIONAL ANTENNA DESIGN
P.O. Box 750
PORTLAND, OREGON 97207
Phone 503/246-8080 Member AFCCE
TWX 910-464-8112/Frontier

dataworld inc
AM • FM • TV
Translators/Low-Power TV
Directories
Allocation Studies/Antenna Design
1302 18th St., N.W., Suite 502
Washington, D.C. 20036
(202) 296-4790

CHARLES F. KOCHER, P.E.
Consulting Radio and TV Engineer
Allocation Engineering
Antenna Systems
27235 Berkshire Drive
Southfield, Michigan 48076
(313) 357-2304
Member AFCCE

**Put your
money where
your Heart is.**



HOW TO GET BETTER MILEAGE FROM YOUR CAR...

Obey the 55 mph speed limit.



Keep your engine tuned.

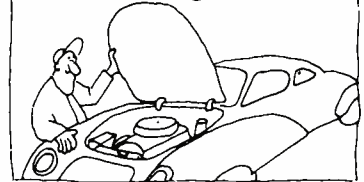

Avoid hot rod starts.

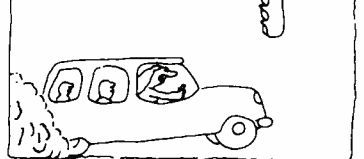

Drive at a steady pace.

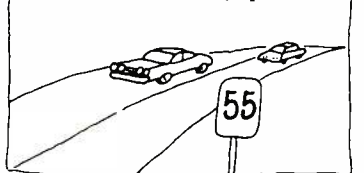

Don't let the engine idle more than 30 seconds.

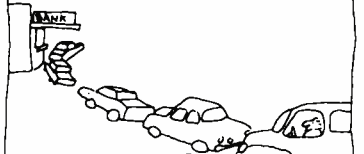

And when buying, don't forget the fuel economy label is part of the price tag, too.



For a free booklet with more easy energy-saving tips, write "Energy," Box 62, Oak Ridge, TN 37830.

ENERGY.
**We can't afford
to waste it.**

U.S. Department of Energy

ad index

ADM Technology Inc.	IFC	Industrial Sciences Inc.	109	US JVC Corp.	67
AKG Acoustics Inc.	147	Inovonics Inc.	167	United Research Lab	
Ampex Corp.	15, 40-41	International Tapetronics	43	Corp.	172, 176
Anvil Cases Inc.	157	JSH Electronics Inc.	123	Utah Scientific	77
Arriflex Corp.	95	Kelcee Communications Inc.	117	Video Data Systems	56
Arvin/Echo	81	Kliegl Brothers	171	Videomedia	101
Audi-Cord Corp.	169	Knox Video Products	28	Videotek Inc.	60
Audio and Design Recording	IBC	Laird Telemedia	173	Ward-Beck Systems Ltd.	BC
Audio Technica US Inc.	61	Leitch Video Ltd.	71	Wilk Engineering	117
Audio Video Engineering	146	Lerro Electrical Corp.	65	Winsted Corp.	154
Auditronics	107	Lyon Lamb Video Animation		World Tower	177
BTX Corp.	37	Systems Inc.	85		
Bayly Engineering	165	Logitek Electronic Systems			
Beaveronics Inc.	113	Inc.	170		
Belar Electronics	175	MPCS Industries Inc.	161		
Beston Electronics Inc.	173	McMartin Industries	80		
Bode Sound Co.	160	Micro Control Assoc.	22		
Broadcast Audio Associates	127	Midwest Corp.	1		
Broadcast Communication		L. Matthew Miller Assoc.			
Devices	149	Ltd.	170		
Broadcast Electronics Inc.	145	N-Pro Co.	150		
CSI Electronics	162	Rupert Neve Inc.	11		
California Microwave Inc.	79	O'Connor Engineering Labs	33		
Canon USA Inc.	75	One Pass Inc.	141		
Capitol Magnetics	155	Alan Osborne Associates	30		
Central Dynamics Corp.	72-73	Opamp Labs	160		
Christie Electric Corp.	141	Optek Inc.	149		
Chrontrol/Lindburg		Orban Associates Inc.	44		
Enterprises	167	Alan Osborne Assoc.	30		
Chyron Telesystems	45	Otari Corp.	27		
Cinema Products Corp.	13	Pacific Recorders & Engineering			
Circuit Research Labs	29	Corp.	103		
Coherent Communications	142, 143	Panasonic	18-19		
Colorgraphics Weather		Philips Test & Measuring			
Systems	9	Instruments	59		
Conrac Corp.	39	Piclear Inc.	176		
Continental Electronics Mfg.		Pierce Phelps Inc.	52-53		
Co.	158, 160, 164	Polorad Electronics	57		
Convergence Corp.	23	Polyline Corp.	156		
Crosspoint Latch Corp.	48	Portable Energy Products	171		
dbx, Inc.	143	Potomac Instruments	175		
Peter W. Dahl, Inc.	164	Quantum Audio Labs Inc.	60		
Datatron Inc.	69	Ramko Research	49		
Dolby Labs Inc.	21	Rohde-Schwarz Sales Co. Inc.	91		
DuPont Kevlar aramid	93	Ross Video Ltd.	139		
Dynatech U-Z Inc.	153	Sescom Inc.	160		
EECO Inc.	47	Sitler's Supplies	154		
EEV Inc.	129, 131, 133	Sony Corp. of America	82-83		
ESE	163	Sound Technology	97		
Elector	177	Stainless Inc.	137		
Electro-Voice Inc.	14, 87	Standard Tape Lab, Inc.	179		
Equipto Electronics Corp.	112	Studer ReVox America Inc.	31		
Eventide Clockworks	124, 125	3M Magnetic Tape	55		
Fesco, Inc.	150	3M Mincom	7		
Fiberbilt	179	Teac Corp. of America	17		
Film Video Equipment	171	Teac Video	12		
Fuji Photo Film USA Inc.	159	Tektronix Inc.	4-5		
Fujinon Optical Inc.	104-105	Teledyne Energy Systems	146		
Garner Industry	96	Television Equipment			
Alan Gordon Enterprises	115	Assoc.	156, 158		
Gray Engineering Labs Inc.	112	Television Products Co.	16		
David Green Broadcast		Telex Communications Inc.	119, 121		
Consultants	135	Tentel	8		
Hitachi Denshi America		Thermodyne International Ltd.	63		
Ltd.	3	Thomson-CSF Broadcast	24-25, 111		
Howe Audio Productions	151, 185	Tiffen Mfg. Corp.	26		
Ikegami Electronics Inc.	35, 51, 89	Ultra Audio Pixtec	175		

BROADCAST engineering

Advertising Sales Offices

NEW YORK, NEW YORK

Joe Concert,
Phone: (212) 888-1977
Tom Palmisano,
Phone: (212) 888-7896
4 West 58th St.
New York, NY 10019

KANSAS CITY, MISSOURI

Jan Winters,
P.O. Box 12901,
Overland Park, KS 66212
Phone: (913) 888-4664

LOS ANGELES, CALIFORNIA

Herb Schiff,
3055 Wilshire Blvd., Suite 630
Los Angeles, CA 90010
Phone: (213) 387-0639

LONDON, ENGLAND

John Ashcraft & Co., John Ashcraft,
12 Bear St.
Leicester Square, London, WC2H 7AS
England
Phone: 930-0525
Telex: 895-2387

AMSTERDAM, HOLLAND

John Ashcraft & Co., John J. Lucassen,
Akerdijk 150A, 1171 PV-Badhoevedorp,
Holland
Phone 0-2968-6226
Telex: 11640

TOKYO, JAPAN

International Media Representatives, Ltd.
2-29, Toranomon 1-ghome, Minato-ku
Tokyo 105, Japan
Phone: 502-0656

NORWOOD, AUSTRALIA

Williamson & Associates, John Williamson,
No. 2 Edmund St., Norwood, S.A. 5067
Australia
Phone: 42-7074

MOVING?

Please complete the
change of address
information on the
subscription form.

To ensure uninterrupted
delivery to new address,
answer all questions on
the form completely.

BROADCAST engineering

classified

Advertising rates in Classified Section are 50 cents per word, each insertion, and must be accompanied by cash to insure publication.

Each initial or abbreviation counts a full word. Minimum classified charge, \$4.00.

For ads on which replies are sent to us for forwarding (blind ads), there is an additional charge of \$5.00 per insertion, to cover department number, processing of replies, and mailing costs.

Classified columns are not open to advertising of any products regularly produced by manufacturers unless used and no longer owned by the manufacturer or distributor.

TRAINING

ELECTRONICS DEGREE by correspondence. Earn A.S.E.T., then B.S.E.T. Free brochure. Grantham College, 2550 South La Cienega, Los Angeles, California 90034. 2-79-tfn

FIRST PHONE through cassette recorded lessons at home plus one week seminar in Boston, Philadelphia, Detroit, Atlanta or Seattle. Our twentieth year teaching FCC license courses. Bob Johnson Radio License Preparation, 1201 Ninth, Manhattan Beach, Calif. 90266. Telephone 213-379-4461. 8-78-tf

SERVICES

ONE STOP FOR ALL YOUR PROFESSIONAL AUDIO REQUIREMENTS. Bottom line oriented. F.T.C. Brewer Company, P.O. Box 8057, Pensacola, Florida 32506. 7-71-tf

HELIX-STYROFLEX. Large stock—bargain prices—tested and certified. Write for price and stock lists. Sierra Western Electric, Box 23872, Oakland, Calif. 94623. Telephone (415) 832-3527. 1-73-tf

TRANSMITTER TUBES REPROCESSED—Save 40 to 50%. 3CX2500, 4CX5000, 4CX15000 and many others. Write for details. FREELAND PRODUCTS CO., 3233 Conti St. N.O., La. 70119. (504) 822-9222. 6-79-tfn

BROADCAST CRYSTALS: for AM, FM or TV transmitters, frequency change, repair or replacement of oven types. Also vacuum types for RCA, Gates, Collins, CCA, etc. transmitters. High quality products, reasonable prices and better delivery! Don't be without a spare crystal. Frequency change for FM and AM monitors. Over 30 years in this business. Eidson Electronic Co., Box 3751, Temple, Texas 76501. Phone (817) 773-3901. 4-81-tfn

EQUIPMENT FOR SALE

GLITCH AWARD! Give this humorous, framable award to fellow video workers for errors, production goofs, missed shots, etc. \$2.95 + 1.00 handling. Also, funny Color Camera Registration Charts. Specify: FUZZY or CURVED lines. \$2.00 + 1.00 handling. Send check to: AARLO Enterprises, 109 Minna St., Suite 254, San Francisco, CA 94105. 3-81-tfn

SMALL STATION EQUIPMENT. 2 studio cameras with spare. Switcher, sync generator and DA's. 2 High band quads. All \$25.00. Call (812) 852-4036. 5-81-2t

FOR SALE: (Contact Lee Brady, WFMY-TV, Greensboro, N.C.): 1. 2—TK 27 film chains. Good set of tubes. Complete cables, connectors, one new 84801V, lazy susan monitor, complete set of books. 1. 2—TP 6 film projectors, excellent condition. N.D. filter and control. 3. Complete DuMont Series 900 transmitters for Channel 2, in place and presently will operate. 6-81-1t

RCA-TK-76 camera with lense. Excellent condition, low hours. \$24,000.00. 206-392-3011. 6-81-6t

IKEGAMI HL 77A broadcast camera w/Canon 10-100 lens, 6 batteries w/fast charger, AC adaptor, excellent condition, one owner, \$25,000.00. Call Mirek Snopce, (201) 891-3372. 6-81-1t

TWO AMPLEX 800 TBC's, one with heterodyne—\$3500.00; one with velcomp—\$3000.00. USCB Television, Santa Barbara, Ca. 93106, (805) 961-4344. 6-81-1t

EQUIPMENT FOR SALE (CONT.)

HITACHI SK-80, 12:1 servo zoom, AC adapter, quick charge belt pack, genlock. \$12,000.00. USCB Television, Santa Barbara, Ca. 93106, (805) 961-4344. 6-81-1t

REMOTE PRODUCTION VEHICLE. 27 foot of production length on roadworthy Ford chassis and cab. Entire unit custom built by Ampex for Transmedia. Aluminum body by Montibello with welded steel drop-frame storage compartments. Originally configured for 6 cameras. All original cabling in place and excellent. Three phase/single phase, all voltage patchable with Stabiline regulators. Air conditioning and heating functional. Four Hannay electric cable reels and dual voltage power cable reel. The unit is panelled and carpeted with all racks in place. Present equipment includes two TKP 45 cameras complete with Plumbicon tubes, lenses and O'Connor Hydropeds. The switcher is a CDL VS10. Audio console is Collins 212T-2 sixteen input with 4 Ward Beck AA601 distribution amps. Monitoring includes 2 Tek 527 WFMS and a Conrac RHA19. Intercom all operating stations and two 5 line phones each position. Telephone bay. Extensive external connector panel. 400 feet of TV81 camera cables, air compressors and other items. CONTACT DIRECTOR OF ENGINEERING, WYES-TV, (504) 486-5511. NO COLLECT CALLS. SERIOUS INQUIRIES ONLY. 6-81-2t

RCA TK 76C CAMERA. In service 6 months. Angenieux 15 to 1 zoom lens, pistol brace, range extender. Large and small viewfinders. Plumbicon tubes. Carrying case. \$33,500. WYES-TV, (504) 486-5511. No collect calls. 6-81-2t

FOR SALE: TEKTRONIX 465 (opt 5,7), 1470, TM-501, TM-506, FG-502, DC-504, DM-502, 200C, P6401, Lambda LMF-12, HICKOK 220, SONY U-matic jigs, parts. Tom O'Brien 803-762-0824. 6-81-1t

SIX (6) INTERNATIONAL TAPETRONICS cartridge record and playback machines—mode RP—with one (1) bulk eraser—all very good condition. Joe Mitchell, 212-628-9700. 6-81-1t

BROADCAST TELEVISION STUDIO CLOSEOUT—must sell two 2" Ampex VR1200B's with Mk III editor; Marconi 16mm telecine with broadcast camera; two IVC 500A cameras; 3-M front projection system; scopes; lighting; dollies; cranes and much, much more. F. Didik, (212) 843-6839. 6-81-1t

40' REMOTE BROADCAST TV PRODUCTION TRUCK. 20 input switcher and audio, VTR. Late equipment. Excellent condition. Reasonable. 213/397-5922. Any hour. 6-81-1t

HELP WANTED

TELEVISION HELP WANTED—TECHNICAL: \$40,000 + FIRST YEAR GUARANTEED. Our company has grown so quickly in the past 5 years, we are in desperate need of a very special person who knows broadcast equipment intimately and has aggressive sales ability. We are diversifying into other areas and need someone to take over the equipment sales division. Responsibilities include sales of new and used broadcast equipment and further development of equipment sales division as business demands. We are a first rate company and believe in paying top dollar for the right person. Call Bill Kitchen, Quality Media Corp., (800) 241-7878. 9-80-TFN

ENGINEERS, TV Systems Engineers, Electronic Technicians, Technical Supervisors, Maintenance. Immediate openings. Experienced. Full time. Full benefits, plus Pension. Excellent salary plus commissions. Send resume to Technical Operations, Inc., P.O. Box 840, New Hyde Park, N.Y. 11040, or call Personnel Mgr. (516) 352-2238. 9-80-tfn

WE'RE IN THE MARKET for a qualified maintenance engineer with aspirations to become assistant chief. Needs background in studio and transmitter. Offering good salary and benefits package and the Monterey Peninsula to live. Send resume to Ken Warren, Chief Engineer, KMST-TV, 46 Garden Court, P.O. Box 1938, Monterey, California 39340. A Retlaw Broadcasting station. EOE. 3-81-4t

LIGHTING EQUIPMENT SALES: Bardwell & McAlister needs sales engineers, sales reps., dealers, and agents for full line of TV and motion picture lighting and grip equipments. Many U.S. Territories and overseas open. Please write to Arthur Florman, President, Bardwell & McAlister, 7051 Santa Monica Blvd., Hollywood, California 90038. 5-81-3t

HELP WANTED (CONT.)

FILM TRANSFER OPERATOR: Applicant must possess a solid background in commercial and feature film transfer work. Contact: Lori Weiss, CFA Video, Los Angeles, California 90028. 5-81-2t

CHIEF ENGINEER: Automation, FM, AM with DA, must be a worker and know FCC rules with 1st Class. Believe in maintenance. Call Manager, 813-639-1188. Equal Opportunity Employer. 4-81-3t

CHIEF ENGINEER for top ranked UHF independent in central California. Experienced in administration, maintenance and some design background. A.S. degree in electrical engineering and a minimum of five years experience as chief or assistant. Submit resume, references and salary history to: Dept. 539, Broadcast Engineering, P.O. Box 12901, Overland Park, KS 66212. An EOE/M-F Employer. 5-81-2t

Field Service Engineers

The Grass Valley Group, Inc., a leading manufacturer of television broadcast equipment, is looking for people who want challenging professional positions. Openings exist in California, Indiana, New Jersey, and Georgia.

These challenging positions combine chances for U.S. travel plus marketing and engineering career opportunities. Individuals with experience designing and/or maintaining television broadcast systems are required to provide after-sales support for our wide variety of complex systems.

Interested and qualified candidates are invited to send a resume in confidence to Sylvia Smith, The Grass Valley Group, Inc., P.O. Box 1114, Grass Valley, CA 95945. An Equal Opportunity Employer M/F/H.

The Grass Valley Group, Inc.
A Tektronix Company

AUDIO-VISUAL TECHNICIAN—Tenure track position beginning September, 1981. Duties involve the installation, repair and maintenance of both fixed and portable audio-visual equipment. Typical equipment includes all types of projectors, audio tape recorders, sound systems, color and b/w television receivers and specialized educational electronic equipment. Minimum requirements are an Associate Degree in Electrical Technology with 3-5 years experience preferred. Salary commensurate with qualifications. The college provides excellent fringe benefits. Send letter of application, resume and the names of three references by June 1 to Colin Plaister, Instructional Resources Center, State University College at Fredonia, New York 14063. An Affirmative Action Employer. 6-81-1t

TECHNICAL SUPERVISOR-PRODUCTION: Responsible for all technical aspects of studio production from pre to post. Knowledgeable and capable in all areas including camera, 1" and 2" VTR, SMPTE editing and audio. Consult on lighting. Must be capable of delivering consistent high quality product. Limited field work, maintenance. Supervisory experience required. Salary commensurate. Contact Director of Finance, WYES-TV, P.O. Box 24026, New Orleans, LA 70184. An equal opportunity employer. 6-81-2t

HELP WANTED (CONT.)

PROFESSIONAL PRODUCT CAMERA SPECIALIST

Excellent opportunity for hands-on technician to join Northern New Jersey company for repair of complex video cameras, and to provide diagnostic aid via telephone to a dealer network. Three years experience in T.V. camera repair a must, preferably with a major broadcasting company.

For immediate consideration please send resume or call: Ms. Jane Kleinhans (201) 778-1101

REED, ROBERTS

HUMAN RESOURCE SERVICES
925 Clifton Ave., Clifton, NJ 07013

\$20,000/PART TIME. Several engineers needed for unusual field project. South, east, mid-west. Keep your present job. Flexible hours; many benefits. Requires degree or equivalent work experience plus ability to deal with people. Resume to Mr. Melear, 3615 Saxon Way, Marietta, Georgia 30062. 6-81-2t

ASSISTANT CHIEF ENGINEER for a top ranked VHF, CBS affiliate in the Midwest. Supervisory experience preferred. Staff of 23. Ampex 2000's, VPR-2B's, ACR 25's, Sony 3/4's, RCA 45's and 76's, vital SWT. and RCA Transmitter. Submit resume, references and salary history to: Bill Huey, Chief Engineer, KCCI-TV, P.O. Box 7111, Grand Station, Des Moines, IA 50309. EOE. 6-81-1t

RADIO—HELP WANTED: TECHNICAL. Chief for Chicago area FM/AM. Requires 1st phone, strong background in studio and transmitter maintenance. Digital knowledge needed. Experience in radio a must. Should be self-starter, able to work without direct supervision. Contact James Maddox, General Manager, WBMX, 312-626-1030 or 408 South Oak Park Avenue, Oak Park, Illinois 60302. 4-81-3t

VTR MAINTENANCE TECHNICIAN

Major Southern California television/production facility has an immediate opportunity for an experienced VTR Maintenance Technician. Selected applicant will maintain and repair Ampex one-inch and two-inch VTR's, Ampex ACR 25 B video cassette recorder/reproducers, VTR terminal equipment and all technical devices for video tape for broadcast or production. Additional responsibilities include new construction, modification and redesign efforts, and performing all function, operations and services for troubleshooting.

An AA degree in Electronics coupled with 3-5 years applicable television/production facility experience is preferred. Technical trade school background, strong mechanical aptitude and First Class Radio-Television License essential.

An attractive salary and benefits package is offered. For confidential consideration, please submit resume to:

Personnel Department
P.O. Box 38906
Los Angeles, CA 90038

An Equal Opportunity Employer M/F

HELP WANTED (CONT.)

MAINTENANCE WIZARD WANTED—Maintenance Engineers imagine this: a sleek modern videotape production facility that produces national spots for major agencies as well as non-broadcast projects for large corporations. Staffed with young, energetic, dedicated personnel. If you qualify in the maintenance of RCA and Norelco cameras, Ampex 2" and 1" type C videotape, CVS EPIC computer tape editing, Vital Squeezoom, and would like to work in the Chicago market, call or write: John Gebhard, Chief Engineer, Telemation Productions, 3204 W. Westlake Avenue, Glenview, Illinois 60025, (312) 729-5215. 6-81-2t

REMOTE ENGINEERING SUPERVISOR—New 32' Truck, Ikegami Cameras, Ampex & Sony 1" Type C, Ross Switching, and much more, needs qualified engineer to maintain and operate. Salary open. For more information call: John Gebhard, Chief Engineer, Telemation Productions, Inc., (312) 729-5215. 6-81-2t

MAINTENANCE AND ENG ENGINEER: Requires experience in operation and maintenance of studio equipment, microwave, mini cams and video tape machines. Transmitter and microprocessor experience helpful. Must be graduate of college technical school or equivalent and have a First Class License. Call or write Larry Curtis, WTNH-TV, 135 College Street, New Haven, Conn. 06510. An Equal Opportunity Employer. 6-81-1t

TV TRANSMITTERS SUPERVISOR: Louisiana Public Broadcasting seeks 1 qualified individual for Supervisor of UHF Television Transmitter near Kaplan, LA. Must have FCC 1st class license and 5 years television experience, including 3 years transmitter experience. UHF experience preferred. Starting salary \$1539 per month. Applications should be submitted to Director of Engineering, Louisiana Public Broadcasting, 2618 Wooddale Blvd., Baton Rouge, LA 70805. For additional information, contact Coy Simmons, Director of Engineering, (504) 342-5822. Louisiana Educational Television Authority is an EQUAL OPPORTUNITY EMPLOYER. 6-81-1t

HELP WANTED (CONT.)

ENGINEERING AND TECHNICAL SALES POSITIONS

We specialize in the placement of Technical Engineers with Television Stations, Cable TV, Satellite Programmers & Networks, Pay TV, Manufacturers, Industrial TV, CCTV, Production Houses & Dealers. Also, technical sales with Manufacturers & Dealers. All levels, positions & locations nationwide. Employers pay all fees - confidential, professional. Over \$3,000,000.00 in Salaried Positions Placed. Employee & Employer inquiries invited.

PHONE/RESUME - Alan Kornish (717)287-9635

KEY SYSTEMS

106 new bridge center, kingston, pa. 18704

FIRST CLASS BROADCAST ENGINEER for WQUE/WGSO, New Orleans. Take charge of FM studio and transmitter operation. Able to assist AM directional operation. Contact Herb Korté, Insilco Broadcasting, P.O. Box 85, New Haven, Connecticut 06501. Phone 203/281-9600. Affirmative Action/Equal Opportunity Employer. 6-81-2t

TELEVISION MAINTENANCE ENGINEERS: First-Class FCC License. Strong Background in all phases of TV maintenance required. Famous year around Colorado recreational area. Contact A. L. Ladage, DOE, XYZ Television, Inc., P.O. Box 789, Grand Junction, CO 81502. 303/242-5000. 5-81-4t

For
Better
Results
Use
Reader
Service
Card

Broadcast Engineers

• Camera • Videotape • Transmitter

Bored With Your Job Or Career?

If you feel confined in your present job, sitting behind a desk or trapped in a day-to-day routine with no future in sight, then a career with RCA Service Company may be your ticket out.

RCA Service Company's Broadcast Engineers travel all over the world to install, maintain and service television cameras, television tape recording equipment, and/or transmitting systems. A digital background, and experience in the maintenance of television broadcast and related equipment are necessary. RCA equipment experience is a real plus.

We are looking for a few of the best Broadcast Specialists, who are able to work without close supervision and who would enjoy working from home to travel throughout the U.S. and occasionally to many foreign countries.

Naturally we provide excellent salaries and Company paid benefits including medical and life insurance, vacations, holidays, and income savings, dental and retirement plans.

For immediate consideration, call collect, or send a letter or resume to: John Thayer, (609) 778-0770, RCA Service Company, 102 Galther Drive, Mt. Laurel, NJ 08054. An Equal Opportunity Employer.

RCA

A Tradition On The Move!

HELP WANTED (CONT.)

CHIEF ENGINEER: We are looking for a certain person who would like to work in immaculate surroundings as Chief Engineer for a long established 5 million watt plant. Must be thoroughly experienced with UHF Klystron transmitter and be able to maintain VTR's and other Control Room equipment. Good pay and fringe benefits in Central California. E. O. E. Telephone (213) 527-3060. 5-81-2t

HELP WANTED—TECHNICAL: SOUTHERN CALIFORNIA OPPORTUNITY. Experienced videotape maintenance engineer for rapidly expanding successful post-production facility. Knowledge of 2" Quad, 1" VTR's and CMX editing systems required. ALSO SEEKING qualified CMX editors and 1" videotape operators. Salary negotiable. Send resume or call Dick Wellman or Rich Thorne, The Post Group, 6335 Homewood Avenue, Hollywood, California 90028, (213) 462-2300. 6-81-2t

MAINTENANCE ENGINEERS: Due to recent Facility expansions, Video Tape Associates, a leader in State of the Art Television Production, has maintenance positions open at both its Hollywood, Florida & Atlanta locations. Applicants should be capable of performing maintenance on quads, Color camera & Switcher, 1 inch Computer editing & Digital effects systems. Light design capabilities helpful in some positions. Salary negotiable. Call: Michael Orsburn, Director of Engineering, (305) 920-0800 or send resume and salary requirements to: Video Tape Associates, 2040 Sherman Street, Hollywood, Florida 33020. 6-81-1t

TPC COMMUNICATIONS, INC. has the following openings in its Pittsburgh-based remote division: 1. **MAINTENANCE TECHNICIAN:** Must be familiar with microprocessors. Will maintain TK47's, VPR-2, Leitch and Grass Valley terminal, PC70's, Audiotronics HS100C. Job requires travel—approximately 80 days/year. 2. **REMOTE OPERATIONS TECHNICIAN:** Must be able to do some maintenance as well as operate video on PC70's, VPR-2's, Audio skills desired. Job requires travel about 95 days/year (mostly in Fall and Winter). Successful applicants must have client-oriented attitude and be willing to work flexible schedules. TPC operates two state-of-the-art mobile units nationwide for major producers. Equal opportunity employer. Send resume, references, and salary requirements to: John Luff, Manager Remote Technical Services, TPC Communications Inc., Production Plaza, Sewickley, PA 15143, 412-771-4700. 6-81-1t

REMOTE VEHICLE SUPERVISOR experienced in remote operations to oversee construction in 43 ft. state-of-the-art vehicle and take charge of same upon completion. Heavy field experience, ability to maintain and control operations of vehicle and certain public contact required. Ability to meet uncompromising technical standards under difficult conditions. Salary commensurate. Position available immediately. CONTACT: Director of Finance, WYES-TV, Box 24026, New Orleans, LA 70184. WYES-TV IS AN EQUAL OPPORTUNITY EMPLOYER. 5-81-3t

BROADCAST CHIEF ENGINEER/RADIO needed immediately for group owned WPOC FM, Baltimore. Complete charge of technical department. Position is Chief Operator of station in charge of all maintenance, construction, hiring of technical people and insurance of station's complete technical compliance to FCC rules. Candidates must have management experience, FCC First Class License, own automobile, plus experience in both studio and transmitter construction and maintenance. Salary commensurate with experience. Great benefits package. For interview call General Manager at 301-366-3693, or send resume with references to General Manager, WPOC, 711 W. 40th St., Baltimore, Md. 21211. No beginners please. A Nationwide Communications, Inc. Station, An Equal Opportunity Employer. 6-81-1t

CHIEF ENGINEER: 50KW, 5 tower directional. WZZD, Philadelphia. Minimum 5 years experience. Resume to Stu Engelke, Box 970, Hackensack, NJ 07602 or call (201) 343-5097. An equal opportunity employer. 6-81-1t

CHRONICLE PRODUCTIONS, a San Francisco based video production house is looking for an experienced maintenance engineer. The successful applicant must have maintenance experience with VPR 2's and 2B's and VPR 20. Experience with Quantel DPE 5000, Grass Valley 1600, Telemation Compositor 1 Character Generator, and/or Epic Editing system would be an advantage. Send resume to Stephen F. Smith, Director of Chronicle Productions, 1001 Van Ness Ave., San Francisco, Ca. 94109. 6-81-1t

HELP WANTED (CONT.)

CHIEF TELEVISION ENGINEER

An administrative position responsible for the area of television operation to include: installation, modification, inspection and maintenance of ¾" video, ENG and editing equipment; CCTV, CATV microwave, and color studio. Two years college or technical school and demonstrated experience in the set-up, operation and maintenance of the above systems. At least 2 years electronic television experience in an educational TV system and the possession of a first-class FCC license.

Starting salary range is \$20,000—\$25,000, contingent upon relevant experience and training. The salary is enhanced by a competitive fringe benefits package. Send letter of interest, resume and the names of three professional references to:

Gordon L. Fox, Coordinator
Audiovisual/Television Services
Lorain County Community College
1005 N. Abbe Road
Elyria, Ohio 44035

Deadline for receipt of application materials is June 30, 1981.

An Affirmative Action/Equal Opportunity Employer 6-81-1t

KUHT-TV HOUSTON/TEXAS: 1. **TV BROADCAST ENGINEER:** BS degree in Electronics Tech, or equivalent experience. Some experience in radio or TV broadcasting engineering or electronics. Applicant will be given 1 year to acquire FCC 1st Class radiotelephone license if not presently licensed. 2. **SENIOR ENGINEER:** BS degree in Electronics Tech. or equivalent in TV Broadcast engineering. FCC 1st Class radiotelephone license required. Minimum 3 years broadcast experience. Some maintenance ability required. 3. **JUNIOR ENGINEER:** Two years or more college level work, some experience in radio or TV broadcast engineering or related electronics. Applicant will be given one year to acquire FCC 1st class radiotelephone license. ALL OF THE ABOVE SHOULD CONTACT: AL LEVERICK or AL HAUBOLD (713) 748-5934. 6-81-1t

FOR LEASE

COMPLETE AIR PAC SYSTEM: 2 Hitachi SK 90's, Ross Switcher, RTS, Sony BVH 500, Full Monitoring, All Accessories. Lease to Own. O.W.C. Call (213) 541-9488. 5-81-6t

WANTED TO BUY

WANTED; Pre-1928 radio equipment and tubes. August J. Link, Surcom Associates, 305 Wisconsin Ave., Oceanside, CA 92054, (714) 722-6162. 3-76-1t

HIGHEST PRICES PAID for 112 Phase Monitors and for clean, 12 year old or less, 1 KW and 10 KW AM Transmitters. All duty and transportation paid. Surplus Equipment Sales, 2 Thorncliffe Park Dr., Unit 28, Toronto, Ontario, Canada. M4H 1H2, 416-421-5631. 2-79-1t

INSTANT CASH FOR TV EQUIPMENT: Urgently need transmitters, antennas, towers, cameras, vtrs, color studio equipment. Call toll free 800-241-7878. Bill Kit-chen, Quality Media Corporation (in Georgia call 404-324-1271). 6-79-1t

WANTED: Radio Transcriptions 16" E.T.'s, any Eddy Arnold, or other Country 15" or 12" Transcriptions. Will consider others. Interested in Radio Station Libraries to purchase, all speeds of records. Boyd Robeson, 2425 W. Maple, Wichita, Kansas 67213, (316) 942-3673, 722-7765 Eve. 9-80-1t

WE WILL PURCHASE FOR CASH any of your excess broadcast components & equipment—especially needed: camera tubes, transmitting tubes, lamps, tape, video recorders, cameras, T.B.C., etc. Write to: S & M Associates, 105 Cedar Ave., Hewlett, NY 11557. Tele: (516) 599-6434. All replies answered. 6-81-1t

WISH TO PURCHASE Thompson CSF Micro Camera MC 602, NTSC. May be second hand/good condition. Please contact Zane Bair, 10100 Santa Monica Blvd., Suite 1075, Los Angeles, CA. 90067. Telephone 212-553-3345. 6-81-1t

WANTED: USED RECORDING EQUIPMENT OF ALL AGES AND VARIETIES. MICS, OUTBOARD, ETC. DAN ALEXANDER, (415) 441-8936. 6-81-12t

If you're worried about cancer, remember this.
Wherever you are, if you want to talk to us about cancer,
call us. We're here to help you.

American Cancer Society
2,000,000 people fighting cancer.

LIMIT TO THE LIMIT.



HERE ARE THE INDUSTRY'S MOST DYNAMIC PERFORMERS.

OF COURSE, THEY ALSO COMPRESS, EXPAND, GATE AND DUCK. THAT'S WHY RECORDING AND BROADCAST ENGINEERS ALIKE APPRECIATE THE EXTREME DEPENDABILITY AND MAXIMUM FLEXIBILITY OF AUDIO & DESIGN'S COMPLETE LINE OF COMPRESSOR /LIMITERS. NO OTHER MANUFACTURER IN THE WORLD CAN MATCH THIS SELECTION OF LOW DISTORTION LEVEL CONTROLLERS.

1. THE GEMINI EASY RIDER OFFERS TWO FULL FUNCTION CHANNELS AT A MODEST PRICE.

2. THE EXPRESS LIMITER IS IDEAL FOR CONTROLLING STEREO MIXES, PLUS IT CAN BE CONFIGURED FOR FM BROADCAST OPERATIONS.

3. KNOWN THE WORLD OVER, THE VOCAL STRESSER COMBINES A COMPLEX LIMITER

WITH FOUR BANDS OF SWEEP EQ. 4. THE ORIGINAL COMPLEX LIMITER FEATURES SEPARATE COMPRESSION, LIMITING AND EXPANSION FACILITIES.

5. FOR SPECIAL APPLICATIONS, THE VOICE-OVER LIMITER AUTOMATICALLY MAINTAINS A PRE-ESTABLISHED MUSIC TO VOICE RATIO.

6. AND, THE UNIQUE SELECTIVE LIMITER CONTROLS LEVEL IN ONE FREQUENCY REGION WITHOUT MODULATING THE REST OF THE PROGRAM.

WITH FEATURES LIKE ADJUSTABLE ATTACK, RELEASE AND RATIO AS WELL AS STEREO COUPLING, "SIDE CHAIN" ACCESS AND "SOFT KNEE" SLOPES AT THE THRESHOLD OF COMPRESSION, THESE EXCEPTIONAL LIMITERS ARE THE MOST PROFESSIONAL CHOICE FOR EFFICIENT, LOW DISTORTION LEVEL CONTROL. CALL TOLL FREE, 800-426-6170 FOR DETAILS ON THESE AND OTHER FINE AUDIO PROCESSORS FROM AUDIO & DESIGN.

AUDIO & DESIGN RECORDING, INC. · P. O. BOX 786 · BREMERTON, WASHINGTON 98310
TELEPHONE (206) 275-5009 · TELEX 15-2426

AUDIO & DESIGN RECORDING, LTD. · NORTH STREET · READING RG1 4DA · BERKSHIRE, ENGLAND
TELEPHONE (0734) 53411 · UK TELEX 848722

Copyright 1981 by Audio & Design Recording, Inc.



Audio + Design

THE HIT SOUND IN AUDIO SCIENCE

Circle (2) on Reply Card

Ward-Beck ♥ NY!

Morning and evening major personal ties and events cover the nation from ABC Television in New York.

"Good Morning America" and "20/20 News Magazine" now originate from ABC's new Studio TV2 featuring this highly sophisticated Ward-Beck console system

Ward-Beck loves New York!

WBS

First by Design.

Ward-Beck Systems Ltd., 841 Progress Avenue, Scarborough, Ontario, Canada M1H 2X4.
Tel: (416) 438-6550.

Ward-Beck Systems Inc., 6900 East Camelback Road, Suite 1010, Scottsdale, Arizona 85261.