

### Overview

### HP ProLiant ML350 Generation9 (Gen9)

The ML350 Gen9 is the 2P premium server which delivers a class-leading combination of performance, availability, expandability, manageability, reliability and serviceability making it the choice for remote offices, growing businesses and data centers.

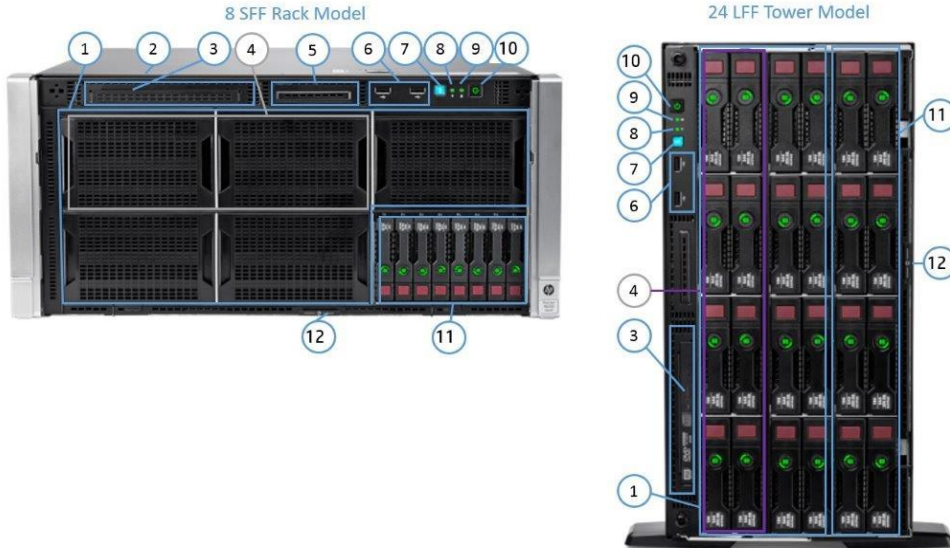

#### Front view details for Rack (SFF) and Tower (LFF)

1. Optional HDD cage Drive Cage Bays (Rack shown with blanks. Tower shown with 16 LFF Optional drives)
2. Quick removal access panel (shown on Rack)
3. Slim Height Drive Bay for Optional Slim Height SATA DVD-ROM or DVD RW Optical Drive (shown on Tower)
4. Media Drive Cage Bays – (SFF Rack supports two half height or one full height device; LFF Tower supports one half height device)
5. Systems Insight Display Bay for Optional SID (Rack models only)
6. Two (2) USB 2.0 connectors
7. Unit ID LED button
8. Health LED
9. NIC Activity LED
10. Power On /Standby button & system power LED button
11. Eight (8) SFF (Rack)/LFF (Tower) SAS/SATA HDD cage
12. Serial label pull tab

### Overview

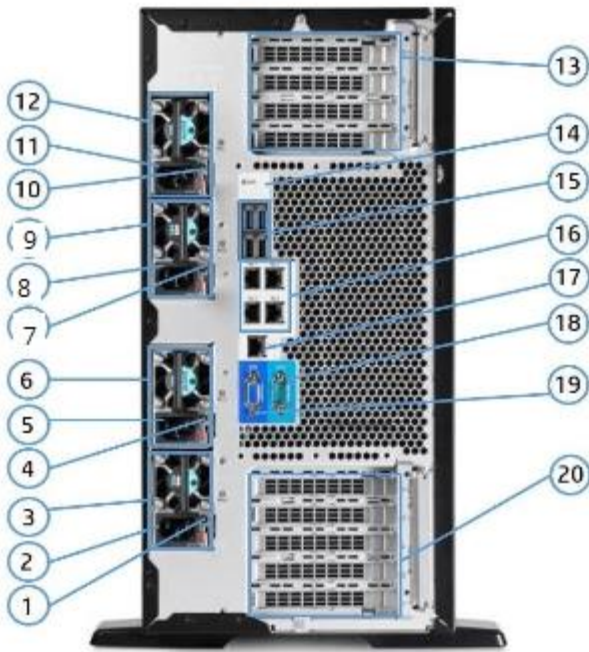

#### Rear View (Tower Model)

1. Power supply Power LED
2. Power supply Power connection
3. HP Flexible Slot 4 Power Supply (Optional - 500w Power Supply shown)
4. Power supply Power LED
5. Power supply Power connection
6. HP Flexible Slot 3 Power Supply (Optional - 500w Power Supply shown)
7. Power supply Power LED
8. Power supply Power connection
9. HP Flexible Slot 2 Power Supply (Optional - 500w Power Supply shown)
10. Power supply Power LED
11. Power supply Power connection
12. HP Flexible Slot 1 Power Supply (Standard Entry Model - 500w Power Supply shown)
13. PCI Slots (Slots 1-4) Slot 1 and 3 can support Optional GPU
14. Unit ID LED
15. USB 3.0 Connectors (2) top & USB 2.0 Connectors (2) bottom
16. Embedded 4 x 1GbE Network Adapter
17. Dedicated iLO Connector
18. Serial Connector
19. Video Connector
20. PCI Slots (Slots 5-9) requires Optional second processor—Slot 6 and 8 can support Optional GPU

### Overview

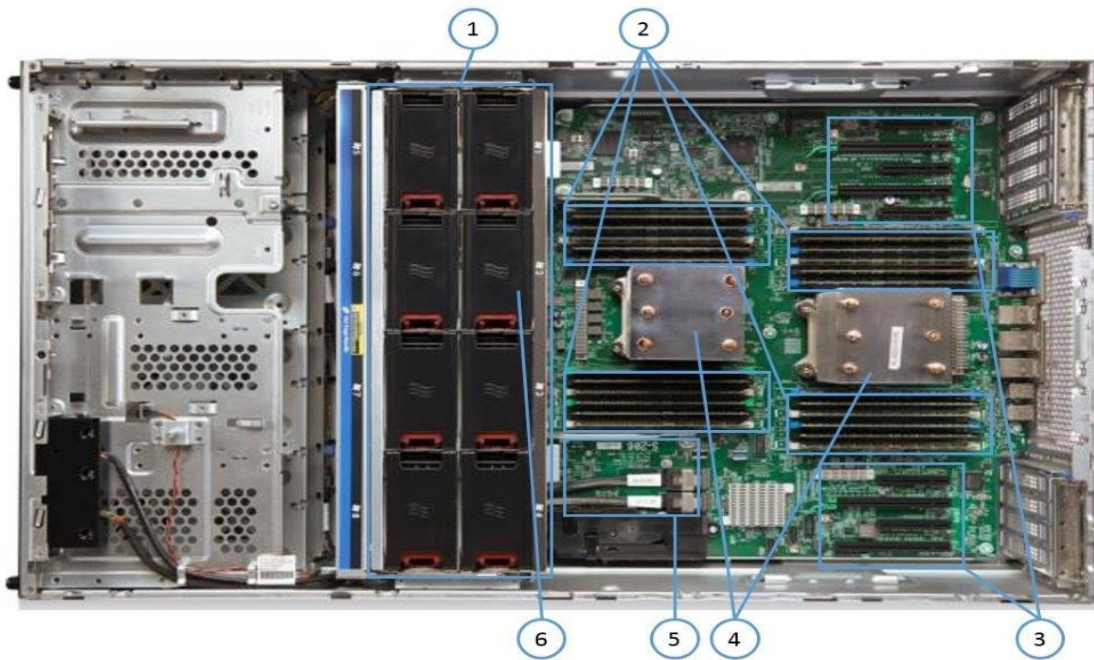

#### Interior View (Rack Model)

1. System fans: Three (3) fans are standard Optional Five (5) systems fans are shown.
2. Twenty four DIMM slots: DDR4 Registered (RDIMM) or Load Reduced Registered (LRDIMM) memory
3. Nine (9) PCIe expansion slots (8 PCIe Gen3 and 1 PCIe Gen2)
4. Two (2) processors and heatsinks (Second Processor is Optional)
5. Optional HP Flexible Smart Array or Smart HBA (not shown here)
6. Optional HP Smart Storage Battery is under the system fans

### Standard Features

**NOTE:** For more information regarding Intel Xeon processors, please see the following <http://www.intel.com/xeon>.

Intel® Xeon® processor E5-2600 v3 product family is designed to deliver the best combination of performance, built-in capabilities, and cost-effectiveness. One (or two) of the following Intel® Xeon® E5-2600 v3 processors based on the model.

Processor	Model	CPU frequency	Cores	L3 Cache	Power	QPI	DDR4 Hz
One of the following depending on model	E5-2699v3	2.3GHz	18	45MB	145W	9.6GT/s	2133
	E5-2698v3	2.3GHz	16	40MB	135W	9.6GT/s	2133
	E5-2697v3	2.6GHz	14	35MB	145W	9.6GT/s	2133
	E5-2695v3	2.3GHz	14	35MB	120W	9.6GT/s	2133
	E5-2690v3	2.6GHz	12	30MB	135W	9.6GT/s	2133
	E5-2683v3	2.0GHz	14	35MB	120W	9.6GT/s	2133
	E5-2680v3	2.5GHz	12	30MB	120W	9.6GT/s	2133
	E5-2670v3	2.3GHz	12	30MB	120W	9.6GT/s	2133
	E5-2667v3	3.2GHz	8	20MB	135W	9.6GT/s	2133
	E5-2660v3	2.6GHz	10	25MB	105W	9.6GT/s	2133
	E5-2650v3	2.3GHz	10	25MB	105W	9.6GT/s	2133
	E5-2650Lv3	1.8GHz	12	30MB	65W	9.6GT/s	2133
	E5-2643v3	3.4GHz	6	20MB	135W	9.6GT/s	2133
	E5-2640v3	2.6GHz	8	20MB	90W	8.0GT/s	1866
	E5-2637v3	3.5GHz	4	15MB	135W	9.6GT/s	2133
	E5-2630v3	2.4Ghz	8	20MB	85W	8.0GT/s	1866
	E5-2630Lv3	1.8GHz	8	20MB	55W	8.0GT/s	1866
	E5-2623v3	3.0GHz	4	10MB	105W	8.0GT/s	1866
	E5-2620v3	2.4GHz	6	15MB	85W	8.0GT/s	1866
	E5-2609v3	1.9GHz	6	15MB	85W	6.4GT/s	1600
E5-2603v3	1.6GHz	6	15MB	85W	6.4GT/s	1600	

**Chipset** Intel® C610 Series Chipset  
Intel® E5-2600v3 Processor Family  
**NOTE:** For more information regarding Intel® chipsets, please see the following URL:  
<http://www.intel.com/products/server/chipsets/>.

**On System Management Chipset** HP iLO (Firmware HP iLO4 2.0) 4GB NAND  
**NOTE:** 1GB USB user space configurable via UEFI and accessible via iLO. Read and learn more in the [iLO QuickSpecs](#).

**Memory** Type:  
HP SmartMemory  
DDR4 Registered (RDIMM) or Load Reduced (LRDIMM)  
DIMM Slots Available 24 (12 DIMM slots per processor, 4 channels per processor, 3 DIMMs per channel)  
Maximum Capacity (LRDIMM) 768GB (24 x 32GB LRDIMM @2133MHz)  
Maximum Capacity (RDIMM) 384GB (24 x 16GB RDIMM @2133MHz)  
**NOTE:** 64GB LRDIMMs, feature support to be available on March 2015.

**Memory Protection** Advanced ECC Advanced ECC uses single device data correction to detect and correct single and all multibit error that occurs within a single DRAM chip.  
Online spare Memory online spare mode detects a rank that is degrading and switches operation to the spare rank.

### Expansion Slots

### Standard Features

Expansion Slots #	Technology	Bus Width	Connector Width	Bus Number	Form Factor	Notes
9	PCIe 3.0	x4	x8		Full length, full height slot	For processor 2 slot
8	PCIe 3.0	x16	x16		Full length, full height slot	For processor 2 slot
7	PCIe 3.0	x4	x8		Full length, full height slot	For processor 2 slot
6	PCIe 3.0	x16	x16		Full length, full height slot	For processor 2 slot
5	PCIe 2.0	x4	x8		Half length, full height slot	For processor 2 slot
4	PCIe 3.0	x4	x8	0	Full length, full height slot	For processor 1 slot
3	PCIe 3.0	x16	x16	0	Full length, full height slot	For processor 1 slot
2	PCIe 3.0	x4	x8	0	Full length, full height slot	For processor 1 slot
1	PCIe 3.0	x8	x16	0	Full length, full height slot	For processor 1 slot

**NOTE:** Bus number - Default bus assignment (in decimal). Inserting cards with PCI bridges may alter the actual bus assignment number.

**NOTE:** Nine total expansion slots. Three PCIe 3.0 x16 (x16 speed); One PCIe 3.0 x16 (x8 speed); Four PCIe 3.0 x8 (x4 speed); One PCIe 2.0 x8 (x4 speed).

Storage Controller	Entry Models	HP Dynamic Smart Array B140i
One of the following depending on model	Base Models	HP Flexible Smart Array P440ar/2GB
	Performance Models	HP Flexible Smart Array P440ar/2GB

Internal Storage Devices	Optical Drive	Optional SATA 9.5mm DVD-ROM Optical Drive Optional SATA 9.5mm DVD RW Optical Drive <b>NOTE:</b> Optical is optional in entry, base and performance BTO models.
One of the following depending on model	Hard Drives	None ship standard
	Hard Drive Bays	(8) Hot plug SFF SAS/SATA HDD bays; upgradable to (48) (8) Hot Plug LFF SAS/SATA HDD Bays; upgradable to (24) <b>NOTE:</b> All Pre-configured Models come populated with some hard drive blanks installed. Should the customer need additional hard drive blanks, they can order more using either P/N 666987-B21: HP SFF HDD Blank Kit or P/N 666986-B21: HP LFF HDD Blank Kit. These part numbers for single HDD blanks below are also provided should the customer require replacement HDD blanks for their server.

Maximum Internal Storage	CAPACITY	CONFIGURATION
One of the following depending on model	Hot Plug LFF SAS	24 x 6TB
	Hot Plug LFF SATA	24 x 6TB
	Hot Plug SFF SAS	48 x 1.2TB
	Hot Plug SFF SATA	48 x 1TB
	Hot Plug SFF SATA SSD	48 x 1.6TB
	Hot Plug SFF SAS SSD	48 x 1.6TB
	Hot Plug LFF SATA SSD	24 x 1.6TB

Power Supply	HP 500W Flex Slot Platinum Hot Plug Power Supply
One of the following depending on model	HP 800W Flex Slot Platinum Hot Plug Power Supply
	HP 1400W Flex Slot Platinum Plus Hot Plug Power Supply
	<b>HP Flexible Slot (Flex Slot) Power Supplies share a common electrical and physical design that allows for hot plug, tool-less installation into HP ProLiant Gen9 Performance Servers. Flex Slot power supplies are certified for high-efficiency operation and offer multiple power output options, allowing users to "right-size" a power supply for</b>

### Standard Features

specific server configurations. This flexibility helps to reduce power waste, lower overall energy costs, and avoid "trapped" power capacity in the data center.

All pre-configured servers ship with a standard 6-foot IEC C-13/C-14 jumper cord (A0K02A). This jumper cord is also included with each standard AC power supply option kit. If a different power cord is required, please check the [ProLiant Power Cables](#) web page.

To review the power requirements for your selected system, please use the HP Power Advisor Tool located at <http://www.hp.com/go/hppoweradvisor>.

Power specifications and technical content for all HP Server power supplies can be found at <http://www.hp.com/go/proliant/powersupply>.

System Fans		Non-redundant	Redundant
One of the following depending on model	1P model	3 fans	6 fans
	<b>NOTE:</b> Fan Redundancy is standard in performance model. Option (725878-B21 includes four fans and PCIe baffles are required for fan redundant kit.		
	2P model	4 fans	8 fans

Interfaces		
	Serial	1
	Video	1 (rear)
	Network RJ-45 (Ethernet)	4
	HP iLO Remote Management Network Port	1 Gb Dedicated
	SD Slot	1 (internal)
	<b>NOTE:</b> The Micro-SD slot is not a hot-pluggable device. Customers should not attempt to plug a Micro-SD card into the Micro-SD slot while the server is powered.	
	USB 2.0 Ports	5 (2 front, 2 rear, 1 internal)
	USB 3.0	3 (2 rear, 1 internal)

Operating Systems and Virtualization Software Support for ProLiant Servers	
	<a href="#">Microsoft Windows Server</a> <a href="#">Canonical Ubuntu</a> <a href="#">Red Hat Enterprise Linux (RHEL)</a> <a href="#">SUSE Linux Enterprise Server (SLES)</a> <a href="#">VMware</a> <a href="#">Citrix XenServer</a>
	<b>NOTE:</b> For more information on HP's Certified and Supported ProLiant Servers for OS and Virtualization Software and latest listing of software drivers available for your server, please visit our <a href="#">Support Matrix</a> at: <a href="http://www.hp.com/go/ossupport">http://www.hp.com/go/ossupport</a> and our driver download page <a href="http://www.hp.com/support/ML350Gen9">http://www.hp.com/support/ML350Gen9</a> .

Upgradeability	
	Upgradable for two processors (Up to 18 Cores) <b>NOTE:</b> Total 4, 6, 8, 10, 12, 14, 16, 18 cores. Up to 24 DIMM slots available for higher Memory capacity Up to 48 SFF Hard Drive Bays; Or 24 LFF Hard Drive Bays 8 PCIe 3.0 and 1 PCIe 2.0 I/O slots for additional communications and storage expansion Redundant Power Supply and Redundant Fans Optional optical drive (up to 1) Optional System Insight Display <b>NOTE:</b> Rack model only.

Industry Standard Compliance	
	ACPI 2.0b Compliant PCIe 3.0 Compliant PXE Support WOL Support Novell Certified IPMI 2.0, SMASH CLP, DCMI 1.0 compliant

### Standard Features

Microsoft® Logo certifications  
 USB 3.0 Support  
 SMBIOS 2.7.1  
 ASHRAE A3/A4  
 Energy Star

**Graphics**

16 bit color: maximum resolution of 1600 x 1200  
 Integrated Matrox G200 video standard  
 32 bit color: maximum resolution of 1280 x 1024

- 16 MB Flash
- 256 MB DDR3

**HP Server  
 UEFI/Legacy ROM**

**HP Server UEFI /Legacy ROM**

Unified Extensible Firmware Interface (UEFI) is an industry standard that provides better manageability and more secured configuration while interacting with your server at boot time. HP ProLiant Gen9 platform defaults to UEFI and can be factory or field configured for Legacy BIOS Boot Mode.

**NOTE:** The UEFI System Utilities function is analogous to the HP ROM-Based Setup Utility (RBSU) of legacy BIOS. For more information, please visit <http://www.hp.com/go/proliantuefi/docs>.

UEFI enables numerous new capabilities specific to HP ProLiant servers such as:

- Secure Boot
- Operating system specific functionality
- Support for > 2.2 TB (using GPT) boot drives
- USB 3.0 Stack
- Embedded UEFI Shell
- Mass Configuration Deployment Tool using HP RESTful API.
- PXE boot support for IPv6 networks
- Boot support for option cards that only support a UEFI option ROM

**For more information please visit** <http://www.hp.com/go/proliant/uefi>.

**NOTE:** For UEFI Boot Mode, boot environment and OS image installations should be configured properly to support UEFI.

**NOTE:** HP UEFI FIO Setting (758959-B22) can be selected to configure the system in Legacy mode in the factory.

**Form Factor** Tower or Rack (5U)

**Embedded  
 Management**

**HP Integrated Lights-Out (HP iLO)** Monitor your servers for ongoing management, service alerting, reporting and remote management with iLO. Learn more at <http://www.hp.com/go/ilo>.

**UEFI** Configure and boot your servers securely with industry standard Unified Extensible Firmware Interface (UEFI). Learn more at <http://www.hp.com/go/ProLiant/uefi>.

**HP RESTful API** RESTful API is an application programming interface. RESTful Web Service API served by iLO's web server. Learn more at <http://www.hp.com/go/restfulapi>.

**Intelligent Provisioning** Provision servers by discovering and deploying 1 to few servers with Intelligent Provisioning. Learn more at <http://www.hp.com/go/intelligentprovisioning>.

**Embedded Remote Support** HP's embedded remote support, used with Insight Online direct connect or HP Insight Remote Support, allows HP ProLiant servers to transmit hardware events directly to HP or an HP Authorized Partner for automated phone home support. Learn more at <http://www.hp.com/go/insightonline/info>.

### Standard Features

<b>Server utilities</b>	<b>HP Smart Update</b>	Optimize firmware and driver updates with HP Smart Update solutions. Learn more at <a href="http://www.hp.com/go/smartupdate">http://www.hp.com/go/smartupdate</a> .
	<b>HP Systems Insight Manager (HP SIM)</b>	HP SIM allows you to monitor the health of your HP ProLiant Servers and HP Integrity Servers, and also provides you with basic support for non-HP servers. HP SIM also integrates with HP SUM to provide quick and seamless firmware updates. Learn more at <a href="http://www.hp.com/go/sim">http://www.hp.com/go/sim</a> .
	<b>HP OneView Standard</b>	HP OneView Standard can inventory, monitor, alert, and report on your G6, G7, Gen8, and Gen9 servers, while using the HP OneView user interface. Annual support is optionally available. Learn more at <a href="http://www.hp.com/go/oneview">http://www.hp.com/go/oneview</a> .
	<b>Scripting Tool Kit and Windows PowerShell</b>	Provision 1 to many servers using your own scripts to discover and deploy them with HP Scripting Tool Kit for Windows and Linux or HP Scripting Tools for Windows PowerShell. Learn more at <a href="http://www.hp.com/go/ProLiantSTK">http://www.hp.com/go/ProLiantSTK</a> or <a href="http://www.hp.com/go/powershell">http://www.hp.com/go/powershell</a> .
	<b>HP RESTful Interface Tool</b>	HP RESTful Interface tool is a scripting tool to provision servers using RESTful API Interface to discover and deploy servers at scale. Learn more at <a href="http://www.hp.com/go/restfulapi">http://www.hp.com/go/restfulapi</a> .
	<b>HP iLO Mobile Application</b>	Enables the ability to access, deploy, and manage your server anytime from anywhere from select smartphones and mobile devices. For additional information please visit: <a href="http://www.hp.com/go/ilo/mobileapp">http://www.hp.com/go/ilo/mobileapp</a> .
	<b>HP Insight Online</b>	HP Insight Online, available at no additional cost as part of your HP warranty, Care Pack or contractual support agreement with HP, is a personalized dashboard for simplified tracking of IT operations and support information from anywhere, anytime. Learn more at <a href="http://www.hp.com/go/insightonline/info">http://www.hp.com/go/insightonline/info</a> . <b>NOTE:</b> The Service Pack for ProLiant (which includes HP SUM) can be downloaded from <a href="http://www.hp.com/go/spp/download">http://www.hp.com/go/spp/download</a> . More information can be found: <a href="http://www.hp.com/go/SmartUpdate">http://www.hp.com/go/SmartUpdate</a> , <a href="http://www.hp.com/go/spp">http://www.hp.com/go/spp</a> and <a href="http://www.hp.com/go/hpsum">http://www.hp.com/go/hpsum</a> .

<b>Security</b>	<ul style="list-style-type: none"> <li>Power-on password</li> <li>Setup password</li> <li>Serial interface control</li> <li>Power switch security</li> <li>Administrator's password</li> <li>TPM 1.2</li> <li>UEFI</li> </ul>
-----------------	---

<b>Warranty</b>	<p>This product is covered by a global limited warranty and supported by HP Services and a worldwide network of HP Authorized Channel Partners resellers. Hardware diagnostic support and repair is available for three years from date of purchase. Support for software and initial setup is available for 90 days from date of purchase. Enhancements to warranty services are available through HP Care Pack services or customized service agreements. Hard drives have either a one year or three year warranty; refer to the specific hard drive QuickSpecs for details.</p> <p><b>NOTE:</b> Server Warranty includes 3-Year Parts, 3-Year Labor, 3-Year Onsite support with next business day response. Warranty repairs may be accomplished through the use of Customer Self Repair (CSR) parts. These parts fall into two categories: 1) Mandatory CSR parts are designed for easy replacement. A travel and labor charge will result when customers decline to replace a Mandatory CSR part; 2) Optional CSR parts are also designed for easy replacement but may involve added complexity. Customers may choose to have HP replace Optional CSR parts at no charge. Additional information regarding worldwide limited warranty and technical support is available at: <a href="http://h18004.www1.hp.com/products/servers/platforms/warranty/index.html">http://h18004.www1.hp.com/products/servers/platforms/warranty/index.html</a>.</p>
-----------------	---



### Optional Features

<b>Embedded Management</b>	<b>iLO Advanced</b>	HP iLO Advanced licenses offer smart remote functionality without compromise, for all HP ProLiant servers. The license includes the full integrated remote console, virtual keyboard, video, and mouse (KVM), multi-user collaboration, console record and replay, and GUI-based and scripted virtual media and virtual folders. You can also activate the enhanced security and power management functionality. Learn more about HP iLO Advanced at <a href="http://www.hp.com/go/iloadvanced">http://www.hp.com/go/iloadvanced</a> .
<b>Server Management</b>	<b>HP Insight Control</b>	HP Insight Control, lets you deploy, migrate, monitor, remote control, and optimize your IT infrastructure through a single, simple management console. For more information, see <a href="http://www.hp.com/go/insightcontrol">http://www.hp.com/go/insightcontrol</a> .
	<b>HP OneView Advanced</b>	HP OneView Advanced is converged management that eliminates infrastructure complexity with automation simplicity. This modern architecture is designed to accelerate your IT operations across servers, storage, and network resources using software-defined approaches and automation, see <a href="http://www.hp.com/go/oneview">http://www.hp.com/go/oneview</a> .
	<b>HP Insight Cluster Management Utility (CMU)</b>	HP Insight Cluster Management Utility is a hyperscale-optimized management framework that includes software for the provisioning, control, performance management and monitoring of groups of nodes and infrastructure. Learn more at <a href="http://www.hp.com/go/cmu">http://www.hp.com/go/cmu</a> .
<b>Rack and Power Infrastructure</b>	HP Rack and Power Infrastructure products and services create highly efficient and intelligent solutions for existing or new IT data centers. HP Rack and Power infrastructure solutions – rack infrastructure, power protection and management, performance optimized data centers (PODs) – are the foundation you are looking for to help secure your long-term IT success. These products are designed to help you react to changes in the industry. They deliver efficient, easy-to-use capabilities to manage, monitor, deploy and provision infrastructure from entry to enterprise. As an industry leader, HP is uniquely positioned to address the key concerns of power, cooling, cable management and system access. Learn more at <a href="#">HP Rack and Power Infrastructure</a> .	
<b>High Performance Clusters</b>	HP Cluster Platforms are specifically engineered, factory-integrated large-scale ProLiant clusters optimized for High Performance Computing, with a choice of servers, networks and software. Operating system options include specially priced offerings for Red Hat Enterprise Linux and SUSE Linux Enterprise Server, as well as Microsoft Windows HPC Server. A Cluster Platform Configurator simplifies ordering. <a href="http://www.hp.com/go/clusters">http://www.hp.com/go/clusters</a> .  HP Insight Cluster Management Utility (CMU) is an HP-licensed and HP-supported suite of tools that are used for lifecycle management of hyperscale clusters of Linux ProLiant systems. CMU includes software for the centralized provisioning, management and monitoring of nodes. CMU makes the administration of clusters user friendly, efficient, and effective. <a href="http://www.hp.com/go/cmu">http://www.hp.com/go/cmu</a> . <b>NOTE:</b> High Performance Computing (HPC) interconnect technologies are available for this server as part of the HP Cluster Platform portfolio. These high-speed InfiniBand and Gigabit interconnects are fully supported by HP when integrated within an HP cluster. Flexible, validated solutions can be defined with the help of configuration tools. <a href="http://www.hp.com/techservers/clusters/ucp/index.html">http://www.hp.com/techservers/clusters/ucp/index.html</a> .	
<b>HPC Interconnects</b>	<b>NOTE:</b> High Performance Computing (HPC) interconnect technologies are available for this server under the HP Cluster Platform product portfolio. These high-speed interconnects are fully supported by HP when they are part of these configure to order clusters. Solutions can be defined with a lot of flexibility with the help of configuration tools. Please visit the following URL to configure HPC Clusters with InfiniBand Interconnects: <a href="http://www.hp.com/techservers/clusters/ucp/index.html">http://www.hp.com/techservers/clusters/ucp/index.html</a> .	
<b>Storage Software</b>	Whether you need to solve a specific data protection, archiving, or storage command and control challenge, or deliver on strategic consolidation, compliance, or continuity initiatives, look no further than HP storage software. Our storage software helps you reduce costs, simplify storage infrastructure, protect vital assets and respond faster to business opportunities. Storage software that gets the job done: <ul style="list-style-type: none"><li>• <b>Data Protection and Recovery Software</b> Whether you're a large enterprise or a smaller business, HP data protection and recovery software will cost-effectively protect you against disaster and ensure business continuity.</li></ul>	

### Optional Features

- **Data Archive and Migration Software**  
HP's storage software enables you to comply with data retention and retrieval requirements, improve application performance, and reduce costs by efficiently migrating infrequently accessed or less valuable data to lower cost storage.
- **Storage Resource Management Software (SRM)**  
HP's storage resource management software reduces operational costs and provides the command and control foundation you need to efficiently manage and visualize your physical and virtual environments.
- **Data Replication Software**  
HP offers array-based and host-based replication software for use in disaster recovery, testing, application development and reporting.
- **Storage Device Management Software**  
Maximize your investment in HP storage and networking with software that enables hardware-specific configuration, performance tuning and connectivity management.
- **HP StoreVirtual VSA**  
With HP StoreVirtual VSA you can use the power of virtualization to create a virtual array within your host server. Manage it as a single pool of shared storage capacity, and scale it to match your evolving needs. HP ProLiant Gen9 servers include a 3-year limited license for HP StoreVirtual VSA software with 1TB of capacity at no extra cost. Simply select to install HP StoreVirtual VSA software during server setup within Intelligent Provisioning. More information, instructional videos, and free console management software are available at <http://www.hp.com/go/vsa1TB>.

**NOTE:** For more information about Storage Software including QuickSpecs, please see: <http://www.hp.com/go/storage/software>.

---

#### **One Config Simple (SCE)**

SCE is a guided self service tool to help sales and non technical people provide customers with initial configurations in 3 to 5 minutes. You may then send the configuration on for configuration help, or use in your existing ordering processes. If you require "custom" rack configuration or configuration for products not available in SCE, please contact HP's Customer Business Center or an Authorized Partner for assistance. <http://www.hp.com/products/configurator>.

---

### Service and Support

---

**Service and Support** **HP Technology Services for Industry Standard Servers**

HP Technology Services delivers confidence, reduces risk and helps customers realize agility and stability. Connect to HP to help prevent problems and solve issues faster. Our support technology lets you tap into the knowledge of millions of devices and thousands of experts to stay informed and in control, anywhere, any time.

**Protect your business beyond warranty with HP Care Pack Services**

HP Care Pack Services enable you to order the right service level, length of coverage and response time as you purchase your new server, giving you full entitlement for the term you select.

---

**Optimized Care** **Supports maintaining servers at optimum performance availability****HP Proactive Care with 24x7 coverage, three year Care Pack Service**

HP Proactive Care helps prevent problems and stabilize IT by utilizing secure, real-time, predictive analytics and proactive consultations when your products are connected to HP. This Care Pack Service combines three years' proactive reporting and advice with our 24x7 coverage and enhanced escalation management, four hour hardware response time and two hour call back for software questions on leading industry standard software running on your HP ProLiant server. <http://h20195.www2.hp.com/v2/GetPDF.aspx/4AA3-8855ENW.pdf>

---

**Standard Care Package** **Supports maintaining high level of server availability****Foundation Care 24x7, three-year Care Pack Service**

HP Foundation Care 24x7 connects you to HP 24 hours a day, seven days a week for assistance on resolving issues. Hardware onsite response within four hours if needed; collaborative software included in this Care Pack service provides troubleshooting assistance on industry leading software running on your HP server. Simplify your support experience and make HP your first call for hardware or software questions.

<http://h20195.www2.hp.com/V2/GetDocument.aspx?docname=4AA4-8876ENW&cc=us&lc=en>

---

**Related Services** **HP ProLiant Server Hardware Installation**

Provides for the basic hardware installation of HP branded servers, storage devices and networking options to assist you in bringing your new hardware into operation in a timely and professional manner.

<http://h20195.www2.hp.com/V2/GetPDF.aspx/5981-9356EN.pdf>

**Factory Express for Servers and storage**

HP Factory Express offers configuration, customization, integration and deployment services for HP servers and storage products. Customers can choose how their factory solutions are built, tested, integrated, shipped and deployed. For more information on Factory Express services for your specific server model please contact your sales representative or go to: <http://www.hp.com/go/factory-express>.

**Data Privacy Services**

Protect your data through better media management. HP Data privacy services help manage and protect sensitive data to reduce the risk of unauthorized access to private information and help meet compliance requirements. Our retention services allow you to keep drives and other devices upon failure, our removal services provide convenient data sanitization and our recovery services allow you to safely retire IT assets and capture any remaining value from the hardware. [www.hp.com/services/dataprivacy](http://www.hp.com/services/dataprivacy)

Additional HP Care Pack services can be found at: <http://www.hp.com/go/cpc>

---

**Get connected to HP to improve your support experience** Prevent problems with innovative, automated monitoring tools and proactive services. Combining Proactive Care Services with our remote support technology such as Insight Online provides you with expert advice and personalized, cloud-based automated IT support, helping to prevent unplanned down time and solve problems quickly. For more information, visit: <http://www.hp.com/go/proactiveinsightexperience>

---

**HP Support Center** Personalized online support portal with access to information, tools and experts to support HP business products. Submit support cases online, chat with HP experts, access support resources or collaborate with peers. Learn more <http://www.hp.com/go/hpsc>

HP's Support Center Mobile App\*\* allows you to resolve issues yourself or quickly connect to an agent for live support. Now, you can get access to personalized IT support anywhere, anytime. HP Insight Remote Support and HP Support Center are available at no additional cost with a HP warranty, HP Care Pack or HP contractual support agreement.

### Service and Support

---

\*\* HP Support Center Mobile App is subject to local availability.

---

**Parts and Materials** HP will provide HP-supported replacement parts and materials necessary to maintain the covered hardware product in operating condition, including parts and materials for available and recommended engineering improvements.

Parts and components that have reached their maximum supported lifetime and/or the maximum usage limitations as set forth in the manufacturer's operating manual, product quick-specs, or the technical product data sheet will not be provided, repaired, or replaced as part of these services.

The defective media retention service feature option applies only to Disk or eligible SSD/Flash Drives replaced by HP due to malfunction.

---

**For more information** To learn more on HP ProLiant servers, please contact your HP sales representative or HP Authorized Channel Partner or visit: <http://www.hp.com/services/proliant>

### Pre-configured Models

For the Standard Features shipped in the "Factory Integrated Models", please see the "Configuration Information - Factory Integrated Models" section.

1. Pre-configured models ship with the configurations below. Options can be selected from the Core or Additional options section of this QuickSpecs.
2. HP does not allow factory integration of options into pre-configured models. Any additional options purchased will be shipped separately.
3. If you desire a custom configuration please see "Configuration Information - Factory Integrated Models" section of this QuickSpecs.
4. Not all models are available in all regions. Check with your local country HP offices for availability.

**NOTE:** All Pre-configured Models come populated with some hard drive blanks installed. Should the customer need additional hard drive blanks, they can order more using either P/N 666987-B21: HP SFF Hard Drive Blank Kit or P/N 666986-B21: HP LFF Hard Drive Blank Kit.

**NOTE:** All pre-configured servers ship with a standard 6-foot IEC C-13/C-14 jumper cord (A0K02A). This jumper cord is also included with each standard AC power supply option kit. If a different power cord is required, please check the [ProLiant Power Cables](#) web page.

**Caution:** HP recommends that a minimum of two people are required for all Rack Server installations. Please refer to your installation instructions for proper tools and number of people to use for any installation.

	Entry Models	Base Models
<b>[SKU Number]</b>	765819-xx1	765820-xx1
<b>Model Name</b>	HP ProLiant ML350 Gen9 E5-2609v3 8GB-R B140i 8LFF 500W PS Entry Tower Server	HP ProLiant ML350 Gen9 E5-2620v3 16GB-R P440ar 8SFF 500W PS Base Tower Server
<b>Processor</b>	Intel® Xeon® E5-2609v3	Intel® Xeon® E5-2620v3
<b>Number of Processors</b>	One	
<b>Memory</b>	8GB (1x8GB Registered DIMMs, 2133 MHz)	16GB (1x16GB Registered DIMMs, 2133 MHz)
<b>Network Controller</b>	HP Embedded 1Gb Ethernet 4-port 331i Adapter	
<b>Storage Controller</b>	HP Dynamic Smart Array B140i	HP Smart Array P440ar/2G Controller
<b>Hard Drive</b>	None ship standard; includes 6 LFF hard drive blanks	None ship standard; includes 6 SFF hard drive blanks
<b>Internal Storage</b>	8 LFF HDD Bays (upgradable to 24)	(8) Hot plug SFF SAS/SATA HDD bays; upgradable to (48)
<b>Optical Drive Bay</b>	1; (Optional: DVD-ROM, DVD-RW)	
<b>Optical Drive</b>	Optional Slim Optical Bay (SATA DVD-RW/ROM Optical Drive)	
<b>PCI-Express Slots</b>	9 PCIe slots	
<b>Power Supply</b>	(1) HP 500W Flex Slot Platinum Power Supply	
<b>Fans</b>	3 hot plug fans, non redundant	
<b>Management</b>	iLO Management (standard), Intelligent Provisioning (standard), iLO Advanced (optional), Insight Control (optional)	
<b>Form Factor</b>	Tower (5U)	
<b>Warranty</b>	Server Warranty includes 3-Year Parts, 3-Year Labor, 3-Year Onsite support with next business day response	

	Energy Star Models	Performance Models
<b>[SKU Number]</b>	765821-xx1	765822-xx1
<b>Model Name</b>	HP ProLiant ML350 Gen9 2xE5-2630v3 2P 32GB-R P440ar 8SFF 2x800W PS ES Rack Server	HP ProLiant ML350 Gen9 2xE5-2650v3 2P 32GB-R P440ar 8SFF 2x800W PS ES Tower Server
<b>Processor</b>	Intel® Xeon® E5-2630v3	Intel® Xeon® E5-2650v3
<b>Number of Processors</b>	Two	
<b>Memory</b>	32GB (2x16GB Registered DIMMs, 2133 MHz)	
<b>Network Controller</b>	HP Embedded 1Gb Ethernet 4-port 331i Adapter	
<b>Storage Controller</b>	HP Smart Array P440ar/2G Controller	
<b>Hard Drive</b>	None ship standard; includes 6 SFF hard drive blanks	
<b>Internal Storage</b>	(8) Hot plug SFF SAS/SATA HDD bays; upgradable to (48)	
<b>Optical Drive Bay</b>	1; (Optional: DVD-ROM, DVD-RW)	Optional Slim Optical Bay (SATA DVD-RW/ROM Optical Drive)
<b>Optical Drive</b>	Optional Slim Optical Bay (SATA DVD-RW/ROM Optical Drive)	
<b>PCI-Express Slots</b>	9 PCIe slots	
<b>Power Supply</b>	(2) HP 800W Flex Slot Platinum Power Supply	

### Pre-configured Models

<b>Fans</b>	4 hot plug fans, redundant	
<b>Management</b>	iLO Management (standard), Intelligent Provisioning (standard), iLO Advanced (optional), Insight Control (optional)	
<b>Energy Star</b>	Meets Energy Star requirements	
<b>Accessories</b>	Rack Kit included	
<b>Form Factor</b>	Rack (5U), HP Easy Install Rails	Tower (5U)
<b>Warranty</b>	Server Warranty includes 3-Year Parts, 3-Year Labor, 3-Year Onsite support with next business day response	

<b>Country Code Key</b>	xx1 = 001	US
	xx1 = 011	AU
	xx1 = 031	UK
	xx1 = 291	Japan
	xx1 = 371	AP
	xx1 = 421	EU
	xx1 = AA1	PRC
	xx1 = B21	Worldwide

**NOTE:** Not all models are available in all regions. Check with your local country HP offices for availability.

### Configuration Information - Factory Integrated Models

This section lists some of the steps required to configure a Factory Integrated Model. To ensure only valid configurations are ordered, HP recommends the use of an HP approved configurator. Contact your local sales representative for information on configurable product offerings and requirements.

1. Factory Integrated Models must start with a CTO Server.
2. FIO indicates that this option is only available as a factory installable option.
3. All Factory Integrated Models will be populated with sufficient hard drive blanks based on the number of initial hard drives ordered with the server.
4. Some options may not be integrated at the factory. Contact your local sales representative for additional information.

### Step 1: Base Configuration (choose one of the following configurable models)

[Chassis]	HP ProLiant ML350 Gen9 Hot Plug 8SFF Configure-to-order Rack Server	HP ProLiant ML350 Gen9 Hot Plug 8SFF Configure-to-order Tower Server	HP ProLiant ML350 Gen9 Hot Plug 8LFF Configure-to-order Tower Server
SKU Number	754534-B21	754536-B21	754537-B21
Processor	2 (optional) x HP Smart Socket Guides		
DIMMSlots	24 DIMM slots for RDIMM, LRDIMM DDR4 Memory		
Storage Controller	HP Dynamic Smart Array B140i		
PCIe	9 Standard (8 FH/FL, 1 FH/HL)		
Drive Cage	8SFF Hot Plug	8LFF Hot Plug	
Network Controller	HP Embedded 1Gb Ethernet 4-port 331i Adapter		
Fans	3 hot plug fans, non redundant		
Management	iLO Management (standard), Intelligent Provisioning (standard), iLO Advanced (optional), Insight Control (optional)		
USB	2 front, 2 internal, 4 rear		

### Step 2: Choose Required Options (only one of the following from each list unless otherwise noted)

#### HP Processors

Select one or two processors from Core options-Processor section below,

- If one processor is desired, select one xxxxxx-L21
- If two processors are desired, select one xxxxxx-L21 and one xxxxxx-B21.
- Up to 2 processors supported. Mixing different processor models is not supported.
- DDR4 speed is the maximum memory speed of the processor. Actual memory speed may depend on the quantity and type of DIMMs installed.

For the Intel® C600 Chipset E5-2600 Series, the letter preceding the model number indicates the Product Line (E3, E5, E7); 2600x v#, 2 = number of CPUs in a Node, 6 is socket/segment designation, 00 = Processor SKU, x = L for low power SKUs and v# (not yet designated) = version number.

#### HP Memory

Select one or more memory from Core options-Memory section below,

- LRDIMM, RDIMM are all distinct memory technologies and cannot be mixed within a server. The majority of ProLiant Gen9 servers support LRDIMM and RDIMM.
- HP memory from previous generation servers are not qualified or warranted with this HP ProLiant Server. HP SmartMemory is required to realize the memory performance improvements and enhanced functionality listed in this document for Gen9.
- If only one processor is installed, only half of the total DIMM slots are available. When populating with two processors all DIMM slots are available.
- Kits described as LP include Low Power DIMMs. For more information on ProLiant Energy Efficient Features, see: <http://www.hp.com/go/proliant-energy-efficient>.
- Depending on the memory configuration and processor model, the memory speed may run at 2133MHz, 1866MHz, 1600MHz or 1333MHz. Please see Memory Population Table or the Online Memory Configuration Tool at: <http://www.hp.com/go/ddr4config>.

#### HP Power Supplies

Select one or more power supplies from Core Options-Power Supplies section below:

### Configuration Information - Factory Integrated Models

- Prior to selecting a power supply option, it is highly recommended that you review your server configuration in the HP Power Advisor tool to determine the right size power supply for your server configuration. The HP Power Advisor is located at: <http://www.hp.com/go/hppoweradvisor>.
- Mixing of power supplies in the same server is not supported. All power supplies must be of the same input voltage, output rating, and efficiency rating. If non-matching power supplies are installed, you may receive an error message and/or experience operational issues with your server.

### Step 3: Choose Additional Factory Integratable Options

#### HP Networking

Select a standup NIC adapter from Core options-Networking section below,

- Please see the QuickSpecs for Technical Specifications and additional information: <http://www.hp.com/go/ProLiantNICs>.
- These options are upgradeable and can be changed from the original configuration after the server is shipped.
- For 10Gb adapters, a minimum of two Gigabytes (2 GB) of server memory is required per each adapter.

#### HP Drives

Select one or more drives from Core options-HP Drives section below:

- The components of a storage subsystem (e.g. the drive, the HBA/controller, firmware, and the server backplane) should operate at the same data transfer rate or the system bandwidth will be negotiated down to an acceptable level for all components.
- Hard drives have either a one year or three year warranty; refer to the specific hard drive QuickSpecs for details.
- The HP ProLiant Gen9 Smart Storage solutions are equipped with re-designed Small Form Factor (SFF 2.5 in) and Large Form Factor (LFF 3.5 in) hot plug carriers for HP Qualified Hard Drives and Solid State Drives. These new carriers provide status and activity indicators as well as caution indicators for "Do Not Remove".

#### HP Graphics Options

Select one or more graphics adapter from Additional options section below.

- Please see the HP Power Advisor for estimated power consumption of your individual system configuration prior to installing GPUs. The HP Power Advisor is located at: <http://www.hp.com/go/hppoweradvisor>.
- This section may contain FIO options, please see HP Computation & Graphics Accelerators section below.

#### HP Unique Options

Select one or more Unique options from Core options section below.

- This section may contain FIO options, please see the Unique options section below.
- FIO indicates that this option is only available as a factory installable option.

#### HP Cooling Options

Select one or more Fan Kits from Core options section below.

- This section may contain FIO options, please see HP Cooling Options section below.
- FIO indicates that this option is only available as a factory installable option.

#### HP Storage Controllers

Select one or more Storage options from Additional options section below.

- The embedded B140i controller will operate in UEFI only mode. For legacy support an additional controller will be needed, and for CTO orders please also select the Legacy mode settings part, 758959-B22
- This section may contain FIO options, please see HP Storage Controllers section below.
- FIO indicates that this option is only available as a factory installable option.

#### HP Rail Kits

Select one type of rail kit from Additional options section below.



## Configuration Information - Factory Integrated Models

---

- Please take a moment to review the installation documentation that comes with the server to help you with the installation of your Gen9 server.
- To assist in the installation of the server into the rack, an optional installation tool is available by contacting your local services representative (p/n 695539-001).
- See HP Rack Options in Additional Options section of this QuickSpecs for more rack kit choices.

**Caution:** HP recommends that a minimum of two people are required for all Rack Server installations. Please refer to your installation instructions for proper tools and number of people to use for any installation.

### Core Options

**NOTE:** Some options may not be integrated at the factory. To ensure only valid configurations are ordered, HP recommends the use of an HP approved configurator. Contact your local sales representative for additional information.

<b>HP Unique Options</b>	<p>HP ML350 Gen9 8SFF Hard Drive Cage Kit <span style="float: right;">778157-B21</span>  <b>NOTE:</b> Add'l 8SFF Hard Drive Cage, allowing for up 48SFF Drive Bays.</p> <p>HP ML350 Gen9 8LFF Hot Plug Drive Cage Kit <span style="float: right;">726547-B21</span>  <b>NOTE:</b> Add'l 8LFF Hard Drive backplane allowing for up 24FF Drive Bays.</p> <p>HP ML350 Gen9 Redundant Fan Kit <span style="float: right;">725878-B21</span>  <b>NOTE:</b> Add'l 4 fans for redundancy.</p> <p>HP ML350 Gen9 Flexible Smart Array Controller Mini-SAS Cable Kit <span style="float: right;">765652-B21</span>  <b>NOTE:</b> Mini-SAS Cable Kit for FlexibleSmart Array Controller.</p> <p>HP ML350 Gen9 Smart Array Cable Kit <span style="float: right;">765650-B21</span>  <b>NOTE:</b> Mini-SAS Cable Kit for stand up P series Smart Array Card.</p> <p>HP ML350 Gen9 LFF Media Cage Kit <span style="float: right;">726561-B21</span>  <b>NOTE:</b> Cage for converting LFF drive bays to a media device. Supports 1*Half-Height tape storage/ Disk-Based Backup device. (RDX)</p> <p>HP ML350 Gen9 SFF Media Cage Kit <span style="float: right;">726545-B21</span>  <b>NOTE:</b> Cage for converting SFF drive bays to a media device. Supports 2*Half-Height/ 1*Full-Height tape storage/ Disk-Based Backup device (RDX).</p> <p>HP ML350 Gen9 Host Bus Adapter Mini-SAS Cable Kit <span style="float: right;">765648-B21</span>  <b>NOTE:</b> Mini-SAS Cable kit for Host Bus Adapter.</p> <p>HP ML350 Gen9 Graphic Card Support Kit <span style="float: right;">726565-B21</span>  <b>NOTE:</b> Cables and brackets for supporting graphic cards.</p> <p>HP ML350 Gen9 Tower to Rack Conversion Kit <span style="float: right;">726567-B21</span>  <b>NOTE:</b> For converting a tower model to a rack model.</p> <p>HP ML350 Gen9 System Insight Display Kit <span style="float: right;">726563-B21</span>  <b>NOTE:</b> For rack model only.</p> <p>HP 12Gb SAS Expander Card for ML350 Gen9 <span style="float: right;">769635-B21</span>  <b>NOTE:</b> The SAS Expander Card Kit supports for 1-24 HDDs, can't support embedded controller and H240ar or P440ar AROC cards. It contains three cables from expander card to HDD backplanes, and one cable from SA or HBA to expander card. Can't support tape storage/ Disk-Based Backup device. (RDX)</p> <p>HP ML350 Gen9 2nd Expander FIO Kit <span style="float: right;">769637-B21</span>  <b>NOTE:</b> 2nd Expander FIO Kit (769637-B21) is for factory integrated only and support for 25-48 HDDs, cannot be selected when 1st Expander Kit (769635-B21) is not in order. When 769637-B21 (2nd Expander FIO Kit) is selected, then 2nd CPU (-B21 processor) and (725870-B21) X4 RPS Enablement FIO Kit and P840 controller must be ordered. Can't support tape storage/ Disk-Based Backup device. (RDX)</p> <p>HP ML350 Gen9 Mini SAS Cable FIO Kit <span style="float: right;">765654-B21</span>  <b>NOTE:</b> Support with embedded controller</p>
--------------------------	---

### HP Processors

#### Entry Processors - E5-2600v3 series Processors

HP ML350 Gen9 Intel® Xeon® E5-2609v3 (1.9GHz/6-core/15MB/85W) Processor Kit	726661-B21
HP ML350 Gen9 Intel® Xeon® E5-2609v3 (1.9GHz/6-core/15MB/85W) FIO Processor Kit	726661-L21
HP ML350 Gen9 Intel® Xeon® E5-2603v3 (1.6GHz/6-core/15MB/85W) Processor Kit	726664-B21
HP ML350 Gen9 Intel® Xeon® E5-2603v3 (1.6GHz/6-core/15MB/85W) FIO Processor Kit	726664-L21

#### Base Processors - E5-2600v3 series Processors

HP ML350 Gen9 Intel® Xeon® E5-2640v3 (2.6GHz/8-core/20MB/90W) Processor Kit	726651-B21
HP ML350 Gen9 Intel® Xeon® E5-2640v3 (2.6GHz/8-core/20MB/90W) FIO Processor Kit	726651-L21
HP ML350 Gen9 Intel® Xeon® E5-2630v3 (2.4GHz/8-core/20MB/85W) Processor Kit	726654-B21
HP ML350 Gen9 Intel® Xeon® E5-2630v3 (2.4GHz/8-core/20MB/85W) FIO Processor Kit	726654-L21
HP ML350 Gen9 Intel® Xeon® E5-2620v3 (2.4GHz/6-core/15MB/85W) Processor Kit	726658-B21
HP ML350 Gen9 Intel® Xeon® E5-2620v3 (2.4GHz/6-core/15MB/85W) FIO Processor Kit	726658-L21
HP ML350 Gen9 Intel® Xeon® E5-2630Lv3 (1.8GHz/8-core/20MB/55W) Processor Kit	726671-B21
HP ML350 Gen9 Intel® Xeon® E5-2630Lv3 (1.8GHz/8-core/20MB/55W) FIO Processor Kit	726671-L21

### Core Options

HP ML350 Gen9 Intel® Xeon® E5-2623v3 (3GHz/4-core/10MB/105W) Processor Kit	779834-B21
HP ML350 Gen9 Intel® Xeon® E5-2623v3 (3GHz/4-core/10MB/105W) FIO Processor Kit	779834-L21
HP ML350 Gen9 Intel® Xeon® E5-2637v3 (3.5GHz/4-core/15MB/135W) Processor Kit	726686-B21
HP ML350 Gen9 Intel® Xeon® E5-2637v3 (3.5GHz/4-core/15MB/135W) FIO Processor Kit	726686-L21
<b>Performance Processors - E5-2600v3 series Processors</b>	
HP ML350 Gen9 Intel® Xeon® E5-2690v3 (2.6GHz/12-core/30MB/135W) Processor Kit	726636-B21
HP ML350 Gen9 Intel® Xeon® E5-2690v3 (2.6GHz/12-core/30MB/135W) FIO Processor Kit	726636-L21
HP ML350 Gen9 Intel® Xeon® E5-2680v3 (2.5GHz/12-core/30MB/120W) Processor Kit	726639-B21
HP ML350 Gen9 Intel® Xeon® E5-2680v3 (2.5GHz/12-core/30MB/120W) FIO Processor Kit	726639-L21
HP ML350 Gen9 Intel® Xeon® E5-2670v3 (2.3GHz/12-core/30MB/120W) Processor Kit	726642-B21
HP ML350 Gen9 Intel® Xeon® E5-2670v3 (2.3GHz/12-core/30MB/120W) FIO Processor Kit	726642-L21
HP ML350 Gen9 Intel® Xeon® E5-2660v3 (2.6GHz/10-core/25MB/105W) Processor Kit	726645-B21
HP ML350 Gen9 Intel® Xeon® E5-2660v3 (2.6GHz/10-core/25MB/105W) FIO Processor Kit	726645-L21
HP ML350 Gen9 Intel® Xeon® E5-2650v3 (2.3GHz/10-core/25MB/105W) Processor Kit	726648-B21
HP ML350 Gen9 Intel® Xeon® E5-2650v3 (2.3GHz/10-core/25MB/105W) FIO Processor Kit	726648-L21
HP ML350 Gen9 Intel® Xeon® E5-2650Lv3 (1.8GHz/12-core/30MB/65W) Processor Kit	726668-B21
HP ML350 Gen9 Intel® Xeon® E5-2650Lv3 (1.8GHz/12-core/30MB/65W) FIO Processor Kit	726668-L21
HP ML350 Gen9 Intel® Xeon® E5-2697v3 (2.6GHz/14-core/35MB/145W) Processor Kit	726674-B21
HP ML350 Gen9 Intel® Xeon® E5-2697v3 (2.6GHz/14-core/35MB/145W) FIO Processor Kit	726674-L21
HP ML350 Gen9 Intel® Xeon® E5-2695v3 (2.3GHz/14-core/35MB/120W) Processor Kit	726677-B21
HP ML350 Gen9 Intel® Xeon® E5-2695v3 (2.3GHz/14-core/35MB/120W) FIO Processor Kit	726677-L21
HP ML350 Gen9 Intel® Xeon® E5-2667v3 (3.2GHz/8-core/20MB/135W) Processor Kit	726680-B21
HP ML350 Gen9 Intel® Xeon® E5-2667v3 (3.2GHz/8-core/20MB/135W) FIO Processor Kit	726680-L21
HP ML350 Gen9 Intel® Xeon® E5-2643v3 (3.4GHz/6-core/20MB/135W) Processor Kit	726683-B21
HP ML350 Gen9 Intel® Xeon® E5-2643v3 (3.4GHz/6-core/20MB/135W) FIO Processor Kit	726683-L21
HP ML350 Gen9 Intel® Xeon® E5-2683v3 (2GHz/14-core/35MB/120W) Processor Kit	765794-B21
HP ML350 Gen9 Intel® Xeon® E5-2683v3 (2GHz/14-core/35MB/120W) FIO Processor Kit	765794-L21
HP ML350 Gen9 Intel® Xeon® E5-2699v3 (2.3GHz/18-core/45MB/145W) Processor Kit	781828-B21
HP ML350 Gen9 Intel® Xeon® E5-2699v3 (2.3GHz/18-core/45MB/145W) FIO Processor Kit	781828-L21
HP ML350 Gen9 Intel® Xeon® E5-2698v3 (2.3GHz/16-core/40MB/135W) Processor Kit	781830-B21
HP ML350 Gen9 Intel® Xeon® E5-2698v3 (2.3GHz/16-core/40MB/135W) FIO Processor Kit	781830-L21

### HP Memory

#### Registered DIMMs (RDIMMs) for E5-2600v3 Series

HP 8GB (1x8GB) Single Rank x4 DDR4-2133 CAS-15-15-15 Registered Memory Kit	726718-B21
HP 4GB (1x4GB) Single Rank x8 DDR4-2133 CAS-15-15-15 Registered Memory Kit	726717-B21
HP 16GB (1x16GB) Dual Rank x4 DDR4-2133 CAS-15-15-15 Registered Memory Kit	726719-B21
HP 8GB (1x8GB) Dual Rank x8 DDR4-2133 CAS-15-15-15 Registered Memory Kit	759934-B21

#### Load Reduced DIMMs (LRDIMMs) for E5-2600v3 Series

HP 32GB (1x32GB) Quad Rank x4 DDR4-2133 CAS-15-15-15 Load Reduced Memory Kit	726722-B21
HP 16GB (1x16GB) Dual Rank x4 DDR4-2133 CAS-15-15-15 Load Reduced Memory Kit	726720-B21

### HP Optical Drives

HP 9.5mm SATA DVD-ROM JackBlack Gen9 Optical Drive	726536-B21
HP 9.5mm SATA DVD-RW JackBlack G9 Optical Drive	726537-B21

### HP Drives

#### SAS Hot Plug SFF (2.5-inch) Enterprise (ENT) Drives

HP 1.2TB 6G SAS 10K rpm SFF (2.5-inch) SC Dual Port Enterprise 3yr Warranty Hard Drive	718162-B21
HP 900GB 6G SAS 10K rpm SFF (2.5-inch) SC Enterprise 3yr Warranty Hard Drive	652589-B21
HP 600GB 12G SAS 15K rpm SFF (2.5-inch) SC Enterprise 3yr Warranty Hard Drive	759212-B21
HP 600GB 6G SAS 10K rpm SFF (2.5-inch) SC Enterprise 3yr Warranty Hard Drive	652583-B21

### Core Options

HP 450GB 12G SAS 15K rpm SFF (2.5-inch) SC Enterprise 3yr Warranty Hard Drive	759210-B21
HP 450GB 6G SAS 10K rpm SFF (2.5-inch) SC Enterprise 3yr Warranty Hard Drive	652572-B21
HP 300GB 12G SAS 15K rpm SFF (2.5-inch) SC Enterprise 3yr Warranty Hard Drive	759208-B21
HP 300GB 6G SAS 10K rpm SFF (2.5-inch) SC Enterprise 3yr Warranty Hard Drive	652564-B21
HP 146GB 6G SAS 15K rpm SFF (2.5-inch) SC Enterprise 3yr Warranty Hard Drive	652605-B21
<b>SAS Hot Plug SFF (2.5-inch) Midline (MDL) Drives</b>	
HP 1TB 6G SAS 7.2K rpm SFF (2.5-inch) SC Midline 1yr Warranty Hard Drive	652749-B21
HP 500GB 6G SAS 7.2K rpm SFF (2.5-inch) SC Midline 1yr Warranty Hard Drive	652745-B21
<b>SAS Hot Plug LFF (3.5-inch) Enterprise (ENT) Drives</b>	
HP 450GB 12G SAS 15K rpm LFF (3.5-inch) SC Converter Enterprise 3yr Warranty Hard Drive	737394-B21
HP 300GB 12G SAS 15K rpm LFF (3.5-inch) SC Converter Enterprise 3yr Warranty Hard Drive	737261-B21
HP 600GB 12G SAS 15K rpm LFF (3.5-inch) SC Converter Enterprise 3yr Warranty Hard Drive	765424-B21
<b>SAS Hot Plug LFF (3.5-inch) Midline (MDL) Drives</b>	
HP 6TB 6G SAS 7.2K rpm LFF (3.5-inch) SC Midline 1yr Warranty Hard Drive	761477-B21
HP 4TB 6G SAS 7.2K rpm LFF (3.5-inch) SC Midline 1yr Warranty Hard Drive	695510-B21
HP 3TB 6G SAS 7.2K rpm LFF (3.5-inch) SC Midline 1yr Warranty Hard Drive	652766-B21
HP 2TB 6G SAS 7.2K rpm LFF (3.5-inch) SC Midline 1yr Warranty Hard Drive	652757-B21
HP 1TB 6G SAS 7.2K rpm LFF (3.5-inch) SC Midline 1yr Warranty Hard Drive	652753-B21
<b>SATA Hot Plug SFF (2.5-inch) Midline (MDL) Drives</b>	
HP 1TB 6G SATA 7.2K rpm SFF (2.5-inch) SC Midline 1yr Warranty Hard Drive	655710-B21
HP 500GB 6G SATA 7.2K rpm SFF (2.5-inch) SC Midline 1yr Warranty Hard Drive	655708-B21
<b>SATA Hot Plug LFF (3.5-inch) Midline (MDL) Drives</b>	
HP 6TB 6G SATA 7.2K rpm LFF (3.5-inch) SC Midline 1yr Warranty Hard Drive	753874-B21
HP 4TB 6G SATA 7.2K rpm LFF (3.5-inch) SC Midline 1yr Warranty Hard Drive	693687-B21
HP 3TB 6G SATA 7.2K rpm LFF (3.5-inch) SC Midline 1yr Warranty Hard Drive	628061-B21
HP 2TB 6G SATA 7.2K rpm LFF (3.5-inch) SC Midline 1yr Warranty Hard Drive	658079-B21
HP 1TB 6G SATA 7.2K rpm LFF (3.5-inch) SC Midline 1yr Warranty Hard Drive	657750-B21
HP 500GB 6G SATA 7.2K rpm LFF (3.5-inch) SC Midline 1yr Warranty Hard Drive	658071-B21
<b>SATA Non-Hot Plug LFF (3.5-inch) Midline (MDL) Drives</b>	
HP ML350 Gen9 8SFF Hard Drive Cage Kit	778157-B21
<b>12G SAS Hot Plug SFF (2.5-inch) Enterprise Performance Solid State Drives</b>	
HP 800GB 12G SAS High Endurance SFF 2.5-in SC Enterprise Performance 3yr Wty Solid State Drive	741159-B21
HP 400GB 12G SAS High Endurance SFF 2.5-in SC Enterprise Performance 3yr Wty Solid State Drive	741155-B21
HP 200GB 12G SAS High Endurance SFF 2.5-in SC Enterprise Performance 3yr Wty Solid State Drive	741151-B21
<b>12G SAS Hot Plug SFF (2.5-inch) Enterprise Mainstream Solid State Drives</b>	
HP 800GB 12G SAS Mainstream Endurance SFF 2.5-in SC Enterprise Mainstream 3yr Wty Solid State Drive	741146-B21
HP 400GB 12G SAS Mainstream Endurance SFF 2.5-in SC Enterprise Mainstream 3yr Wty Solid State Drive	741142-B21
HP 200GB 12G SAS Mainstream Endurance SFF 2.5-in SC Enterprise Mainstream 3yr Wty Solid State Drive	741138-B21
<b>12G SAS Hot Plug SFF (2.5-inch) Enterprise Value Solid State Drives</b>	
HP 1.6TB 12G SAS Value Endurance SFF 2.5-in SC Enterprise Value 3yr Wty Solid State Drive	762263-B21
HP 800GB 12G SAS Value Endurance SFF 2.5-in SC Enterprise Value 3yr Wty Solid State Drive	762261-B21
<b>12G SAS Hot Plug LFF (3.5-inch) Enterprise Value Solid State Drives</b>	

### Core Options

HP 800GB 12G SAS Value Endurance LFF 3.5-in SC Enterprise Value 3yr Wty Solid State Drive	762270-B21
HP 1.6TB 12G SAS Value Endurance LFF 3.5-in SC Enterprise Value 3yr Wty Solid State Drive	762272-B21
<b>6G SATA Hot Plug SFF (2.5-inch) Enterprise Mainstream Solid State Drives</b>	
HP 800GB 6G SATA Mainstream Endurance SFF 2.5-in SC Enterprise Mainstream 3yr Wty Solid State Drive	691868-B21
HP 400GB 6G SATA Mainstream Endurance SFF 2.5-in SC Enterprise Mainstream 3yr Wty Solid State Drive	691866-B21
HP 200GB 6G SATA Mainstream Endurance SFF 2.5-in SC Enterprise Mainstream 3yr Wty Solid State Drive	691864-B21
HP 100GB 6G SATA Mainstream Endurance SFF 2.5-in SC Enterprise Mainstream 3yr Wty Solid State Drive	691862-B21
<b>6G SATA Hot Plug SFF (2.5-inch) Enterprise Value Solid State Drives</b>	
HP 800GB 6G SATA Value Endurance SFF 2.5-in SC Enterprise Value 3yr Wty Solid State Drive	717973-B21
HP 600GB 6G SATA Value Endurance SFF 2.5-in SC Enterprise Value 3yr Wty Solid State Drive	739898-B21
HP 480GB 6G SATA Value Endurance SFF 2.5-in SC Enterprise Value 3yr Wty Solid State Drive	717971-B21
HP 300GB 6G SATA Value Endurance SFF 2.5-in SC Enterprise Value 3yr Wty Solid State Drive	739888-B21
HP 240GB 6G SATA Value Endurance SFF 2.5-in SC Enterprise Value 3yr Wty Solid State Drive	717969-B21
HP 1.6TB 6G SATA Value Endurance SFF 2.5-in SC Enterprise Value 3yr Wty Solid State Drive	757339-B21
<b>6G SATA Hot Plug SFF Value Endurance (2.5-inch) Enterprise Value G1 Solid State Drives</b>	
HP 480GB 6G SATA Value Endurance SFF 2.5-in SC Enterprise Value 3yr Wty G1 Solid State Drive	756657-B21
HP 240GB 6G SATA Value Endurance SFF 2.5-in SC Enterprise Value 3yr Wty G1 Solid State Drive	756636-B21
HP 120GB 6G SATA Value Endurance SFF 2.5-in SC Enterprise Value 3yr Wty G1 Solid State Drive	756621-B21
<b>6G SATA Hot Plug SFF (2.5-inch) Enterprise Light G1 Solid State Drives</b>	
HP 960GB 6G SATA Light Endurance SFF 2.5-in SC Enterprise Light 3yr Wty G1 Solid State Drive	756601-B21
<b>6G SATA Hot Plug SFF (2.5-inch) Enterprise Boot Solid State Drives</b>	
HP 120GB 6G SATA Value Endurance SFF 2.5-in SC Enterprise Boot 3yr Wty Solid State Drive	717965-B21
HP 80GB 6G SATA Value Endurance SFF 2.5-in SC Enterprise Boot 3yr Wty Solid State Drive	734360-B21
<b>6G SATA Hot Plug LFF (3.5-inch) Enterprise Mainstream Solid State Drives</b>	
HP 800GB 6G SATA Mainstream Endurance LFF 3.5-in SC Enterprise Mainstream 3yr Wty Solid State Drive	691860-B21
HP 400GB 6G SATA Mainstream Endurance LFF 3.5-in SC Enterprise Mainstream 3yr Wty Solid State Drive	691856-B21
HP 200GB 6G SATA Mainstream Endurance LFF 3.5-in SC Enterprise Mainstream 3yr Wty Solid State Drive	691854-B21
HP 100GB 6G SATA Mainstream Endurance LFF 3.5-in SC Enterprise Mainstream 3yr Wty Solid State Drive	691852-B21
<b>6G SATA Hot Plug LFF Value Endurance (3.5-inch) Converter Enterprise Value G1 Solid State Drives</b>	
HP 480GB 6G SATA Value Endurance LFF 3.5-in SC Converter ENT Value 3yr Wty G1 Solid State Drive	756660-B21
HP 240GB 6G SATA Value Endurance LFF 3.5-in SC Converter ENT Value 3yr Wty G1 Solid State Drive	756639-B21

### Core Options

HP 120GB 6G SATA Value Endurance LFF 3.5-in SC Converter ENT Value 3yr Wty G1 Solid State Drive 756624-B21

**6G SATA Hot Plug LFF (3.5-inch) Enterprise Value Solid State Drives**

HP 800GB 6G SATA Value Endurance LFF 3.5-in SC Enterprise Value 3yr Wty Solid State Drive 718189-B21

HP 600GB 6G SATA Value Endurance LFF 3.5-in SC Converter Enterprise Value 3yr Wty Solid State Drive 739900-B21

HP 480GB 6G SATA Value Endurance LFF 3.5-in SC Enterprise Value 3yr Wty Solid State Drive 718183-B21

HP 300GB 6G SATA Value Endurance LFF 3.5-in SC Converter Enterprise Value 3yr Wty Solid State Drive 739890-B21

HP 240GB 6G SATA Value Endurance LFF 3.5-in SC Enterprise Value 3yr Wty Solid State Drive 718177-B21

HP 1.6TB 6G SATA Value Endurance LFF 3.5-in SC Converter Enterprise Value 3yr Wty Solid State Drive 757342-B21

**6G SATA Hot Plug LFF (3.5-inch) Enterprise Light G1 Solid State Drives**

HP 960GB 6G SATA Light Endurance LFF 3.5-in SC Converter ENT Light 3yr Wty G1 Solid State Drive 756604-B21

**6G SATA Hot Plug LFF (3.5-inch) Enterprise Boot Solid State Drives**

HP 120GB 6G SATA Value Endurance LFF 3.5-in SC Enterprise Boot 3yr Wty Solid State Drive 718171-B21

HP 80GB 6G SATA Value Endurance LFF 3.5-in SC Enterprise Boot 3yr Wty Solid State Drive 734362-B21

**Hard Drive Blank Kits**

HP Large Form Factor Hard Drive Blank Kit 666986-B21

HP Small Form Factor Hard Drive Blank Kit 666987-B21

**Hard Drive Kits**

HP ML350 Gen9 SFF Media Cage Kit 726545-B21

HP ML350 Gen9 8LFF Hot Plug Drive Cage Kit 726547-B21

HP ML350 Gen9 LFF Media Cage Kit 726561-B21

HP ML350 Gen9 8SFF Hard Drive Cage Kit 778157-B21

**Disk Enclosures**

HP D2600 w/12 4TB 6G SAS 7.2K LFF Dual Port MDL HDD 48TB Bundle E7W32A

**HP Networking**

**1 Gigabit Ethernet adapters**

HP Ethernet 1Gb 4-port 331T Adapter 647594-B21

HP Ethernet 1Gb 2-port 361T Adapter 652497-B21

HP Ethernet 1Gb 2-port 332T Adapter 615732-B21

**10 Gigabit Ethernet adapters**

HP Ethernet 10Gb 2-port 560SFP+ Adapter 665249-B21

HP Ethernet 10Gb 2-port 530T Adapter 656596-B21

HP Ethernet 10Gb 2-port 530SFP Adapter 652503-B21

HP Ethernet 10Gb 2-port 561T Adapter 716591-B21

**HP InfiniBand**

HP InfiniBand FDR 2-port 545QSFP Adapter 702211-B21

**HP Power Supplies**

**HP Flex Slot Platinum Hot-plug Power supplies**

HP 500W Flex Slot Platinum Hot Plug Power Supply Kit 720478-B21

HP 800W Flex Slot Platinum Hot Plug Power Supply Kit 720479-B21

HP 1400W Flex Slot Platinum Plus Hot Plug Power Supply Kit 720620-B21

HP ML350 Gen9 X4 Redundant Power Supply Enablement FIO Kit 725870-B21

**NOTE:** The x4 Redundant Power Supply Enablement (RPS) Kit only supports the HP 800 W and HP 1400 W Flex Slot Platinum hot-plug power supplies. When the x4 RPS kit is

### Core Options

installed, at least three power supply modules must be installed in the server. (for factory integrated only)

HP ML350 Gen9 X4 RPS Enablement Kit

802988-B21

**NOTE:** The x4 Redundant Power Supply Enablement (RPS) Kit only supports the HP 800 W and HP 1400 W Flex Slot Platinum hot-plug power supplies. When the x4 RPS kit is installed, at least three power supply modules must be installed in the server. (for BTO option only)

### HP Computation and Graphics Accelerators

HP ML350 Gen9 Graphic Card Support Kit

726565-B21

**NOTE:** One Graphic Card Support Kit is required for each computation or graphics accelerator.

NVIDIA Quadro K6000 PCI-E Graphics Adapter

730874-B21

**NOTE:** A maximum of four of these cards can be selected. Each requires one Graphic Card Support Kit (726565-B21).

Note: If this SKU is selected then minimum quantity = 2 of 800W Power Supply Kit (725870-B21) must be selected.

HP NVIDIA Quadro K5200 GPU Graphics Accelerator

J0G91A

**NOTE:** A maximum of four of these cards can be selected. Each requires one Graphic Card Support Kit (726565-B21).

HP NVIDIA Quadro K4200 Graphics Accelerator

J0G90A

**NOTE:** A maximum of four of these cards can be selected. Each requires one Graphic Card Support Kit (726565-B21).

NVIDIA Tesla K40C 12GB Computational Accelerator

753960-B21

**NOTE:** A maximum of four of these cards can be selected. Each requires one Graphic Card Support Kit (726565-B21).

Note: If this SKU is selected then minimum quantity = 2 of 800W Power Supply Kit (725870-B21) must be selected.

HP NVIDIA Quadro K2200 Graphics Accelerator

J0G89A

**NOTE:** If more than two Double Wide Graphics options are selected, then HP ML350 Gen9 X4 RPS Enablement Kit must be selected.

**NOTE:** Only the above listed Graphics cards are HP standard supported options in this server.

**NOTE:** The NVIDIA Quadro modules are supported only on 64-bit versions of Linux and Windows operating systems as well as on Virtual Machine client operating systems. The supported bare metal operating systems are RHEL6, SLES 11 and Windows Server 2012 R2.

**NOTE:** Please see the HP Power Advisor for estimated power consumption of your individual system configuration prior to installing GPUs. The HP Power Advisor is located at: [www.hp.com/go/hppoweradvisor](http://www.hp.com/go/hppoweradvisor).

### HP Cooling Options

HP ML350 Gen9 Redundant Fan Kit

725878-B21

**NOTE:** 4 fans are included.

### Additional Options

**NOTE:** Some options may not be integrated at the factory. To ensure only valid configurations are ordered, HP recommends the use of an HP approved configurator. Contact your local sales representative for additional information.

<b>HP Insight Software</b>	<b>HP Insight Control</b>	
	HP Insight Control including 1yr 24x7 Technical Support and Updates Single Server License	C6N27A
	HP Insight Control including 1yr 24x7 Technical Support and Updates Electronic License	C6N28ABE
	<b>NOTE:</b> The Electronic software license is available in EMEA only.	
	HP Insight Control Server Provisioning Media Kit	BD883A
	HP Insight Management Media Kit	C6N31A

<b>Embedded Management</b>	<b>HP iLO Advanced</b>	
	HP iLO Advanced 1 Server License with 3yr 24x7 Tech Support and Updates	BD505A
	HP iLO Advanced including 1yr 24x7 Technical Support and Updates E-LTU	E6U59ABE
	HP iLO Advanced including 1yr 24x7 Technical Support and Updates Single Server License	512485-B21
	HP iLO Advanced including 3yr 24x7 Technical Support and Updates E-LTU	E6U64ABE
	HP Insight Control including 1yr 24x7 Support ProLiant ML/DL/BL-bundle FIO Electronic License	C6N36ABE

<b>High Performance Clusters</b>	<b>HP Cluster Management Utility</b>	
	HP Insight Cluster Management Utility 1yr 24x7 Flexible License	QL803B
	HP Insight Cluster Management Utility 3yr 24x7 Flexible License	BD476A
	<b>NOTE:</b> These part numbers can be used to purchase one certificate for multiple licenses and support with a single activation key. Each license is for one node (server). Customer will receive a printed end user license agreement and license entitlement certificate via physical shipment. The license entitlement certificate must be redeemed online in order to obtain a license key. Customer also will receive a support agreement.	
	HP Insight Cluster Management Utility Media	BD477A

<b>HP PCIe Workload Accelerator Options</b>	<b>Value Endurance (VE) PCIe Workload Accelerators</b>	
	HP 6.4TB FH/HL Value Endurance (VE) PCIe Workload Accelerator	763840-B21
	HP 3.2TB HH/HL Value Endurance (VE) PCIe Workload Accelerator	763838-B21
	HP 1.6TB HH/HL Value Endurance (VE) PCIe Workload Accelerator	763836-B21
	HP 1.3TB HH/HL Value Endurance (VE) PCIe Workload Accelerator	763834-B21
	<b>Light Endurance (LE) PCIe Workload Accelerators</b>	
	HP 5.2TB FH/HL Light Endurance (LE) PCIe Workload Accelerator	775672-B21
	HP 2.6TB HH/HL Light Endurance (LE) PCIe Workload Accelerator	775670-B21
	HP 1.3TB HH/HL Light Endurance (LE) PCIe Workload Accelerator	775668-B21
	HP 1.0TB HH/HL Light Endurance (LE) PCIe Workload Accelerator	775666-B21

<b>HP Security</b>	HP Trusted Platform Module Option	488069-B21
	HP Security Bezel Kit	660584-B21
	<b>NOTE:</b> Rack model only.	
	<b>NOTE:</b> The TPM (Trusted Platform Module) is a microcontroller chip that can securely store artifacts used to authenticate the server platform. These artifacts can include passwords, certificates and encryption keys. Windows® BitLocker™ Drive Encryption (BitLocker) is a data protection feature available in Windows Server® 2008. BitLocker leverages the enhanced security capabilities of a Trusted Platform Module (TPM) version 1.2. The TPM works with BitLocker to help protect user data and to ensure that a server running Windows Server 2008 has not been tampered with while the system was offline. For more information about TPM, including a white paper, go to: <a href="http://www.hp.com/go/TPM">http://www.hp.com/go/TPM</a> .	
	<b>NOTE:</b> ProLiant OS pre-installed units will come with the partition required for TPM deployment.	
	<b>NOTE:</b> The TPM key is unique to every TPM deployed server and must be retained. Misplacing or losing the key could result in data loss.	



### Additional Options

#### HP Storage Controllers

#### SAS Controllers

##### HP Smart Array Controllers

HP Smart Array P440ar/2GB FBWC 12Gb 2-ports Int SAS Controller 726736-B21

**NOTE:** Provides support for up to 8 internal SAS/SATA drives without using a PCIe slot.

**NOTE:** Includes the HP Smart Storage Battery.

HP Smart Array P440ar/2GB FBWC 12Gb 2-ports Int FIO SAS Controller 749974-B21

**NOTE:** Provides support for up to 8 internal SAS/SATA drives without using a PCIe slot.

**NOTE:** Includes the HP Smart Storage Battery.

HP Smart Array P440/4GB FBWC 12Gb 1-port Int SAS Controller 726821-B21

**NOTE:** Provides support for up to 8 internal SAS/SATA drives, consumes 1 PCIe slot.

HP Smart Array P441/4GB FBWC 12Gb 2-ports Ext SAS Controller 726825-B21

HP Smart Array P440/4GB FBWC 12Gb 1-port Int FIO SAS Controller 761872-B21

**NOTE:** Includes the HP Smart Storage Battery.

HP Smart Array P840/4GB FBWC 12Gb 2-ports Int SAS Controller 726897-B21

HP Smart Array P840/4GB FBWC 12Gb 2-ports Int FIO SAS Controller 761874-B21

**NOTE:** Includes the HP Smart Storage Battery.

HP H240ar 12Gb 2-ports Int Smart Host Bus Adapter 726757-B21

**NOTE:** Provides support for up to 8 internal SAS/SATA drives without using a PCIe slot.

HP H240ar 12Gb 2-ports Int FIO Smart Host Bus Adapter 749976-B21

**NOTE:** Provides support for up to 8 internal SAS/SATA drives without using a PCIe slot.

**NOTE:** FIO indicates factory integrated option via CTO.

HP H240 12Gb 2-ports Int Smart Host Bus Adapter 726907-B21

HP H240 12Gb 2-ports Int FIO Smart Host Bus Adapter 761873-B21

HP H241 12Gb 2-ports Ext Smart Host Bus Adapter 726911-B21

HP 12Gb SAS Expander Card for ML350 Gen9 769635-B21

**NOTE:** The SAS Expander Card Kit cannot support H240ar or P440ar AROC cards. It contains three cables from expander card to HDD backplanes, and one cable from SA or HBA to expander card.

HP ML350 Gen9 2nd Expander FIO Kit 769637-B21

**NOTE:** 2nd Expander FIO Kit (769637-B21) cannot be selected when 1st Expander Kit (769635-B21) is not in order. When 769637-B21 (2nd Expander FIO Kit) is selected, then 2nd CPU (-B21 processor) and (725870-B21) X4 RPS Enablement FIO Kit and P840 controller must be ordered.

##### SAS Controller Options

HP 96W Smart Storage Battery with 145mm Cable for DL/ML/SL Servers 727258-B21

##### HP Cable Options

HP ML350 Gen9 Host Bus Adapter Mini-SAS Cable Kit 765648-B21

HP ML350 Gen9 Smart Array Cable Kit 765650-B21

HP ML350 Gen9 Flexible Smart Array Controller Mini-SAS Cable Kit 765652-B21

HP ML350 Gen9 Mini SAS Cable FIO Kit 765654-B21

#### HP Tape Backup

**NOTE:** For the complete range of tape drives, autoloaders, libraries and media see: <http://www.hp.com/go/tape>. For hardware and software compatibility of HP tape backup products see: <http://www.hp.com/storage/SPOCK> and <http://www.hp.com/go/ebs>.

##### Tape Drives

HP StoreEver LTO-6 Ultrium 6650 SAS Internal Tape Drive EH963A

HP StoreEver LTO-6 Ultrium 6650 SAS External Tape Drive EH964A

HP StoreEver LTO-6 Ultrium 6250 Internal Tape Drive EH969A

HP StoreEver 1/8 G2 LTO-6 Ultrium 6250 FC Tape Autoloader COH19A

HP StoreEver LTO-6 Ultrium 6250 Tape Drive in 1U Rack-mount Kit COL99A

HP StoreEver LTO-3 Ultrium 920 SAS Internal Tape Drive EH847B

HP StoreEver LTO-3 Ultrium 920 SAS External Tape Drive EH848B

### Additional Options

HP StoreEver LTO-4 Ultrium 1760 SAS Internal WW Tape Drive	EH919B
HP StoreEver LTO-4 Ultrium 1760 SAS External Tape Drive	EH920B
HP StoreEver LTO-4 Ultrium 1760 SAS (1) in 1U Rack-mount Kit	EH946C
HP StoreEver LTO-5 Ultrium 3000 SAS Internal Tape Drive	EH957B
HP StoreEver LTO-5 Ultrium 3000 SAS External Tape Drive	EH958B
HP StoreEver LTO-5 Ultrium 3000 SAS Tape Drive in 1U Rack-mount	EJ014B
HP StoreEver LTO-5 Ultrium 3280 SAS Internal Tape Drive	EH899B
HP StoreEver LTO-5 Ultrium 3280 SAS External Tape Drive	EH900B
HP StoreEver LTO-5 Ultrium 3280 SAS Tape Drive in 3U Rack-mount	EJ013B
HP StoreEver LTO-6 Ultrium 6250 External Tape Drive	EH970A
HP StoreEver 1U SAS Rack-mount Kit	AE459B
<b>HP StoreEver MSL6480</b>	
HP StoreEver MSL6480 Scaleable Expansion Module	QU626A
<b>NOTE:</b> Please see the QuickSpecs for Technical Specifications and additional information: <a href="http://h18000.www1.hp.com/products/quickspecs/14604_div/14604_div.html">http://h18000.www1.hp.com/products/quickspecs/14604_div/14604_div.html</a> (Worldwide).	
HP StoreEver MSL6480 Scalable Base Module	QU625A
HP MSL2024 0-Drive Tape Library	AK379A
HP MSL4048 0-Drive Tape Library	AK381A
HP MSL Library Extender Kit	AQ746A

#### HP Disk Backup

##### HP RDX Removable Disk Backup Systems USB

HP RDX 2TB USB3.0 Internal Disk Backup System	E7X52A
<b>NOTE:</b> For the complete range of RDX drives and media see: <a href="http://www.hp.com/go/rdx">http://www.hp.com/go/rdx</a> . For hardware and software compatibility of HP disk backup products see: <a href="http://www.hp.com/storage/SPOCK">http://www.hp.com/storage/SPOCK</a> .	

#### HP Storage Options

**NOTE:** The following is a list of all Fibre Channel Host Bus Adapters for Windows and Linux. For detailed compatibility information please see: <http://h18006.www1.hp.com/storage/saninfrastructure/hba.html>.

##### Emulex Fibre Channel HBAs

HP 81E 8Gb 1-port PCIe Fibre Channel Host Bus Adapter	AJ762B
HP 82E 8Gb 2-port PCIe Fibre Channel Host Bus Adapter	AJ763B
HP StoreFabric SN1100E 16Gb Single Port Fibre Channel Host Bus Adapter	C8R38A
HP StoreFabric SN1100E 16Gb Dual Port Fibre Channel Host Bus Adapter	C8R39A

##### QLogic Fibre Channel HBAs

HP 81Q 8Gb 1-port PCIe Fibre Channel Host Bus Adapter	AK344A
HP 82Q 8Gb 2-port PCIe Fibre Channel Host Bus Adapter	AJ764A
HP StoreFabric SN1000Q 16GB 1-port PCIe Fibre Channel Host Bus Adapter	QW971A
HP StoreFabric SN1000Q 16GB 2-port PCIe Fibre Channel Host Bus Adapter	QW972A

##### Converged Network Adapter

HP StoreFabric CN1100R Dual Port Converged Network Adapter	QW990A
HP StoreFabric CN1200E 10Gb Converged Network Adapter	E7Y06A

#### HP Disk Storage Systems

##### Disk Enclosures

HP D6000 Dual I/O Module Disk Enclosure	QQ695A
<b>NOTE:</b> See the D6000 Disk Enclosure QuickSpecs for additional information including configuration steps and additional options needed for a complete solution at: <a href="http://h18000.www1.hp.com/products/quickspecs/14419_div/14419_div.html">http://h18000.www1.hp.com/products/quickspecs/14419_div/14419_div.html</a> (Worldwide).	
HP D6000 w/35 4TB 6G SAS 7.2K LFF Dual Port MDL HDD 140TB Bundle	E7W30A
HP D6000 w/70 4TB 6G SAS 7.2K LFF Dual Port MDL HDD 280TB Bundle	E7W31A

### Additional Options

HP D6000 w/35 2TB 6G SAS 7.2K LFF Dual port MDL HDD 70TB Bundle	QQ697A
HP D6000 w/70 2TB 6G SAS 7.2K LFF Dual port MDL HDD 140TB Bundle	QQ698A
HP D6000 w/35 3TB 6G SAS 7.2K LFF Dual port MDL HDD 105TB Bundle	QQ699A
HP D6000 w/70 3TB 6G SAS 7.2K LFF Dual port MDL HDD 210TB Bundle	QQ700A

#### HP Data Center Racks **Rack 10000 G2 series**

HP 11648 1075mm Pallet Universal Rack	H6J87A
HP 11648 1075mm Shock Universal Rack	H6J88A
HP 11642 1075mm Pallet Universal Rack	H6J65A
HP 11642 1075mm Shock Universal Rack	H6J66A
HP 11642 1200mm Pallet Universal Rack	H6J67A
HP 11642 1200mm Shock Universal Rack	H6J68A
HP 11636 1075mm Pallet Universal Rack	H6J77A
HP 11636 1075mm Shock Universal Rack	H6J78A
HP 11622 G2 1075mm Pallet Universal Rack	H6J83A
HP 11622 G2 1075mm Shock Universal Rack	H6J84A
HP 11614 1075mm Shock Universal Rack	H6J82A

**NOTE:** Please see the [HP 11000 G2 Series Racks QuickSpecs](#) for information on additional racks options and rack specifications.

#### **HP Intelligent Series Rack**

HP 647 1075mm Pallet Intelligent Series Rack	BW911A
HP 647 1075mm Shock Intelligent Series Rack	BW912A
HP 647 1200mm Pallet Intelligent Series Rack	BW913A
HP 647 1200mm Shock Intelligent Series Rack	BW914A
HP 642 1075mm Pallet Intelligent Series Rack	BW903A
HP 642 1075mm Shock Intelligent Series Rack	BW904A
HP 642 1200mm Pallet Intelligent Series Rack	BW907A
HP 642 1200mm Shock Intelligent Series Rack	BW908A
HP 636 1075mm Pallet Intelligent Series Rack	BW895A
HP 636 1075mm Shock Intelligent Series Rack	BW896A
HP 842 1075mm Pallet Intelligent Series Rack	BW917A
HP 842 1075mm Shock Intelligent Series Rack	BW918A

**NOTE:** Please see the [HP Intelligent Series Racks QuickSpecs](#) for information on additional racks options and rack specifications.

#### **HP Value Series Rack**

HP V142 1075mm deep Pallet 100 series Rack	AF046A
--	--------

**NOTE:** Please see the [HP Value Series Rack QuickSpecs](#) for information on additional racks options and rack specifications.

#### **HP Power Distribution Units (PDUs)**

##### **HP Basic Power Distribution Unit (bPDU)**

HP 4.9kVA 24A High Voltage NA/JP Core Modular Power Distribution Unit	252663-D74
HP 8.3kVA 40A High Voltage NA/JP Core Modular Power Distribution Unit	252663-D75
HP 7.3kVA 32A High Voltage INTL Core Modular Power Distribution Unit	252663-B33
HP 17.3kVA 48A Three Phase NA/JP Modular Power Distribution Unit	AF511A
HP 22kVA 32A Three Phase INTL Core Modular Power Distribution Unit	AF518A
HP 3.6kVA 200-240 Volt Detachable C20 Input ( 12xC13) WW Basic PDU	H5M56A
HP 4.9kVA 208 Volt L6-30 Input (20xC13) NA/JP Basic PDU	H5M58A
HP 7.3kVA 230 Volt IEC309 32A Input (20xC13) INTL Basic PDU	H5M68A
HP 7.3kVA 230 Volt IEC309 32A Input (24xC13/6xC19) INTL Basic PDU	H5M70A

### Additional Options

**NOTE:** To learn more about HP Basic Power Distribution Units (bPDU), please visit the HP website at <http://www.hp.com/go/pdu>.

#### HP Monitored Power Distribution Units (mPDU)

HP 2.8kVA 120 Volt L5-30 Input (12xNEMA 5-20R)NA/JP Monitored PDU	D9N43A
HP 3.6kVA 200-240 Volt Detachable C20 Input (16xC13) WW Monitored PDU	D9N45A
HP 4.9kVA 208 Volt L6-30 Input (20xC13/4xC19) NA/JP Monitored PDU	D9N47A
HP 7.3kVA 230 Volt IEC309 32A Input (20xC13/4xC19) INTL Monitored PDU	D9N48A
HP 7.3kVA 230 Volt IEC309 32A Input (32xC13/4xC19) INTL Monitored PDU	D9N50A
HP 11kVA 400 Volt IEC309 16A 3-Phase Input (18xC13/3xC19) INTL Monitored PDU	D9N55A
HP 11kVA 400 Volt IEC309 16A 3-Phase Input (30xC13/3xC19) INTL Monitored PDU	D9N57A
HP 17.3kVA 208 Volt IEC309 60A 3-Phase Input (12xC13/12xC19) NA/JP Monitored PDU	D9N59A
HP 22kVA 400 Volt IEC309 32A 3-Phase Input (30xC13/3xC19) INTL Monitored PDU	D9N56A
HP 22kVA 400 Volt IEC309 32A 3-Phase Input (12xC13/12xC19) INTL Monitored PDU	D9N60A

**NOTE:** Please see the [HP Monitored Power Distribution Units QuickSpecs](#) for information on additional options and product specifications.

#### HP Intelligent Power Distribution Units (iPDU)

HP 4.9kVA 24A Single Phase NA/JP Core Intelligent Modular Power Distribution Unit	AF520A
HP 8.3kVA 40A Single Phase NA/JP Core Intelligent Modular Power Distribution Unit	AF521A
HP 8.6kVA 24A Three Phase NA/JP Core Intelligent Modular Power Distribution Unit	AF522A
HP 17.3kVA 48A Three Phase NA/JP Core Intelligent Modular Power Distribution Unit	AF523A
HP 17.3kVA 48A 208V Three Phase 12 Outlet Core NA/JP Intelligent Power Distribution Unit	AF535A
HP 4.9kVA 24A Single Phase NA/JP Intelligent Modular Power Distribution Kit	AF531A
HP 8.6kVA 24A Three Phase NA/JP Intelligent Modular Power Distribution Kit	AF532A
HP 7.3kVA 32A Single Phase INTL Core Intelligent Modular Power Distribution Unit	AF525A
HP 7.3kVA 32A Single Phase INTL Intelligent Modular Power Distribution Kit	AF534A

**NOTE:** Please see the [HP Intelligent Power Distribution Units QuickSpecs](#) for information on additional options and product specifications.

#### HP Rack Mount Consoles, KVM Switches, and Keyboards

#### HP Location Discovery Services

HP ML350 Gen9 Discover Service FIO Kit	726549-B21
<b>NOTE:</b> Rack CTO server only.	
HP 36U Location Discovery Kit	BW945A
HP 42U Location Discovery Kit	BW946A
HP 47U Location Discovery Kit	BW947A

#### Rail Kits

HP ML350 Gen9 5U FIO Rail Kit	790357-B21
<b>NOTE:</b> Rack CTO server only.	
HP ML350 Gen9 Tower to Rack Conversion Kit	726567-B21

#### HP Rack Mount Consoles

HP TFT7600 G2 KVM Console Rackmount Keyboard US Monitor	AZ870A
HP TFT7600 G2 KVM Console Rackmount Keyboard Intl Monitor	AZ884A
HP TFT7600 G2 KVM Console Rackmount Keyboard DE Monitor	AZ872A
HP TFT7600 G2 KVM Console Rackmount Keyboard UK Monitor	AZ871A

**NOTE:** Please see the [HP Rack Console QuickSpecs](#) for information on additional options and product specifications.

#### HP KVM Switches

HP 1x1Ex8 KVM IP Console Switch G2 with Virtual Media CAC Software	AF620A
HP 2x1Ex16 KVM IP Console Switch G2 with Virtual Media CAC Software	AF621A
HP Server Console 0x2x8 Port Analog Switch	AF616A
HP Server Console 0x2x16 Port Analog Switch	AF617A
HP 0x2x16 KVM Server Console Switch G2 with Virtual Media CAC Software	AF618A

### Additional Options

HP 1x4 USB/PS2 KVM Console Switch AF611A

**NOTE:** To learn more, please visit the [HP KVM Switches web page](#).

#### HP USB Keyboard and Mouse

HP USB BFR with PVC Free US Keyboard/Mouse Kit 631341-B21

HP USB BFR with PVC Free Intl Keyboard/Mouse Kit 672097-B33

HP USB BFR with PVC Free UK Keyboard/Mouse Kit 631344-B21

HP USB BFR with PVC Free FR Keyboard/Mouse Kit 631346-B21

HP USB BFR with PVC Free ES Keyboard/Mouse Kit 631348-B21

HP USB BFR with PVC Free DE Keyboard/Mouse Kit 631358-B21

HP USB BFR with PVC Free JP Keyboard/Mouse Kit 631360-B21

HP USB BFR with PVC Free IT Keyboard/Mouse Kit 631362-B21

HP USB BFR with PVC Free CN Keyboard/Mouse Kit 631364-B21

HP USB BFR with PVC Free AE Keyboard/Mouse Kit 638212-B21

HP USB BFR with PVC Free RU Keyboard/Mouse Kit 638214-B21

HP USB BFR with PVC Free SE Keyboard/Mouse Kit 672097-103

HP USB BFR with PVC Free CH Keyboard/Mouse Kit 672097-113

HP USB BFR with PVC Free PT Keyboard/Mouse Kit 672097-133

HP USB BFR with PVC Free TR Keyboard/Mouse Kit 672097-143

HP USB BFR with PVC Free CZ Keyboard/Mouse Kit 672097-223

HP USB BFR with PVC Free FI Keyboard/Mouse Kit 672097-353

HP USB BFR with PVC Free AP-Intl Keyboard/Mouse Kit 672097-373

HP USB BFR with PVC Free IN Keyboard/Mouse Kit 672097-D63

HP USB BFR with PVC Free KR Keyboard/Mouse Kit 672097-KD3

**NOTE:** Please see the [HP USB Keyboard and Mouse QuickSpecs](#) for information on additional options and product specifications.

#### Micro SD Options

HP 32GB microSD Enterprise Mainstream Flash Media Kit 700139-B21

HP 8GB microSD Enterprise Mainstream Flash Media Kit 726116-B21

HP 8GB USB Enterprise Mainstream Flash Media Drive Key Kit 737953-B21

#### HP Uninterruptible Power Systems (UPS)

##### HP Tower UPS

HP T750J JP Uninterruptible Power System AF456A

HP T1000 G3 1000VA INTL Tower Uninterruptible Power System AF449A

HP T1500 G3 1400VA NA Tower Uninterruptible Power System AF450A

HP T1500 G3 1400VA INTL Tower Uninterruptible Power System AF451A

HP T1000 G3 1000VA NA Tower Uninterruptible Power System AF448A

HP T1000J JP Uninterruptible Power System AF457A

HP T1500J JP Uninterruptible Power System AF458A

##### HP Rack-mountable UPS

HP R1.5kVA G3 1U INTL Uninterruptible Power System AF471A

HP R1.5kVA G3 1U JP/TW Uninterruptible Power System AF470A

HP R/T3000 G2 2U L530 Low Voltage NA/JP Uninterruptible Power System AF466A

HP R/T3000 G2 2U Detachable Cord High Voltage INTL Uninterruptible Power System AF468A

HP R5KVA 3U IEC309-32A High Voltage INTL Uninterruptible Power System AF461A

HP R7KVA 4U IEC-32A High Voltage INTL Uninterruptible Power System AF463A

**NOTE:** To learn more, please visit the [HP Uninterruptible Power Systems \(UPS\) web page](#).

#### HP Care Pack Services

##### Installation & Start-up Services

HP Install ProLiant ML350(p) Service U4522E

### Additional Options

---

HP Startup ProLiant ML350(p) Service	U4523E
<b>Proactive Care</b>	
HP 3 year 24x7 ML350 Gen9 Proactive Care Service	U7BG4E
HP 3 year Call to Repair ML350 Gen9 Proactive Care Service	U7BH0E
HP 3 year 24x7 with Defective Media Retention ML350 Gen9 Proactive Care Service	U7BG5E
HP 3 year 24x7 with Comprehensive Defective Material Retention ML350 Gen9 Proactive Care Service	U7BG6E
HP 3 year Call to Repair with Defective Media Retention ML350 Gen9 Proactive Care Service	U7BH1E
HP 3 year CTR with Comprehensive Defective Material Retention ML350 Gen9 Proactive Care Service	U7BH2E

---

### Memory

**Memory Subsystem Architecture** Each Intel® Xeon® E5-2600v3 family processor socket contains four memory channels per installed processor with three DIMMs per channel for a total of twelve (12) DIMMs or a grand total of twenty-four (24) DIMMs for the server.

### Memory Population guidelines

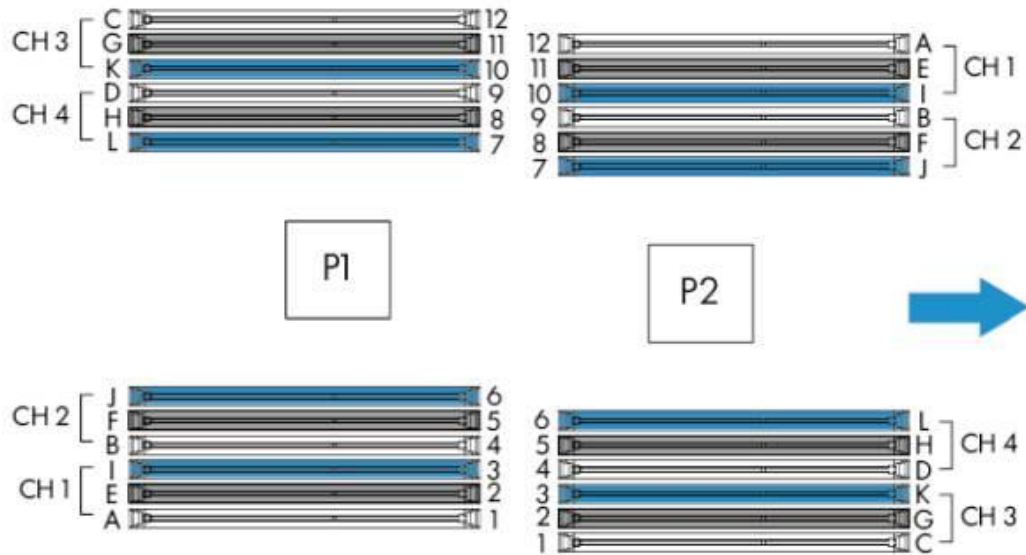

DIMM population order												
	1st slot of channel			2nd slot of channel			3rd slot of channel					
	A	B	C	D	E	F	G	H	I	J	K	L
Number of DIMMs to install	4											
	8											
	12											

### General Memory Population Rules and Guidelines:

- Install DIMMs only if the corresponding processor is installed.
- If only one processor is installed in a two processor system, only half of the DIMM slots are available. To maximize performance, it is recommended to balance the total memory capacity between all installed processors and load the channels similarly whenever possible.
- When two processors are installed, balance the DIMMs across the two processors.
- White DIMM slots denote the first slot to be populated in a channel. Place the DIMMs with the highest number of ranks in the white slot when mixing DIMMs of different ranks on the same channel.
- Do not mix RDIMMs or LRDIMMs.
- Quad rank RDIMMs are not supported in HP ProLiant ML350 Gen9 servers.
- Quad rank LRDIMMs are capable of up to three DIMMs per channel.
- RDIMMs operating at 1.2V.
- DIMMs of different speeds may be mixed in any order; the server will select a common optimal speed.
- The maximum memory speed is a function of the memory type, memory configuration, and processor model.
- The maximum memory capacity is a function of the memory type and number of installed processors.
- To realize the performance memory capabilities listed in this document, HP SmartMemory is required.
- There are four (4) channels per processor; eight (8) channels per server.
- There are three (3) DIMM slots for each memory channel; twenty-four (24) total slots.

### Memory

Memory channels 1 and 3 consists of the three (3) DIMMs that are furthest from the processor.  
Memory channel 2 and 4 consists of the three (3) DIMMs that are closest to the processor.

Intel Gen9 Supported Memory Bandwidth for HP ProLiant Gen9 Intel® Xeon® E5-2600v3 Series Processor Family

Memory Bandwidth and Capacity					
[DIMM Type]	Registered Dimms (RDIMMs)			Load Reduced (LRDIMMs)	Load Reduced (LRDIMMs)
DIMM Rank	Single Rank		Dual Rank		Quad Rank
DIMM Capacity	4GB	8GB	16GB		32GB
Voltage	Std Voltage 1.2V				
SLOTS THAT CAN BE POPULATED					
24 slot servers	24				
MAXIMUM CAPACITY (GB)					
	96	192	384	768	
1 DIMM Per Channel	2133				
2 DIMM Per Channel	2133				
3 DIMM Per Channel	1600	1600	1600	1600	

### DIMM slot and configuration diagram

DIMM slot and configuration diagrams

- Population order; start with "A" first, "B" second, "C" third, etc.
- When one processor is installed, install DIMMs in sequential alphabetic order: A, B, C, D, E, F ...
- When two processors are installed, install DIMMs in sequential alphabetic order: CPU1-A, CPU2-A, CPU1-B, CPU2-B, CPU1-C, CPU2-C

		CPU 1		CPU 2				
		Slot #	population order	Slot #	population order			
Chnl 1	1	A		1	C	Chnl 4		
	2	E		2	G			
	3	I		3	K			
		CPU 1		CPU 2				
		Slot #	population order	Slot #	population order			
Chnl 2	4	B		4	D	Chnl 3		
	5	F		5	H			
	6	J		6	L			
		CPU 1		CPU 2				
		Slot #	population order	Slot #	population order			
Chnl 3	7	L		7	J	Chnl 2		
	8	H		8	F			
	9	D		9	B			
		CPU 1		CPU 2				
		Slot #	population order	Slot #	population order			



### Memory

Chnl 4	10	K	10	I	Chnl 1
	11	G	11	E	
	12	C	12	A	

#### Memory Speed by Processor Model

Processor Models	Supported Memory Speeds
E5-2609v3, E5-2603v3,	1600MHz
E5-2640v3, E5-2630v3, E5-2620v3, E5-2630Lv3, E5-2623v3,	1866MHz
E5-2637v3, E5-2690v3, E5-2680v3, E5-2670v3, E5-2660v3, E5-2650v3, E5-2650Lv3, E5-2697v3, E5-2695v3, E5-2667v3, E5-2643v3, E5-2683v3, E5-2699v3, E5-2698v3,	2133MHz

#### Standard and Maximum Memory Capacity (Pre-configured Models)

Pre-Configured Models	Standard Memory	Maximum Memory Plus Optional Memory	Standard Memory Replaced with Optional Memory
E5-2609v3,	8GB (1x8GB)	376GB (23x16GB, 1x8GB)	768GB (24x32GB)
E5-2620v3,	16GB (1x16GB)	384GB (23x16GB, 1x16GB)	768GB (24x32GB)
E5-2630v3, E5-2650v3,	32GB (2x16GB)	384GB (22x16GB, 2x16GB)	768GB (24x32GB)

DDR4 memory options part number decoder

**NOTE:** Capacity references are rounded to the common gigabyte (GB) values.

- 2GB = 2,048MB
- 4GB = 4,096MB
- 8GB = 8,192MB
- 16GB = 16,384MB
- 32GB = 32,768MB
- 64GB = 65,536MB

### HP gggggg eRxff DDR4 wwwwm a bb-ccd Kit

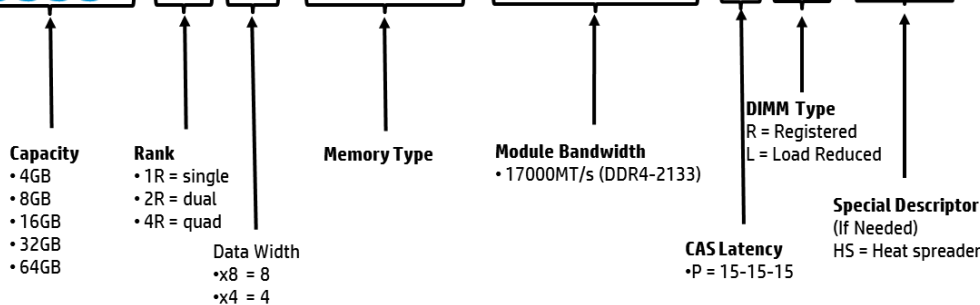

### Storage

#### 48 SFF hot-plug drive model

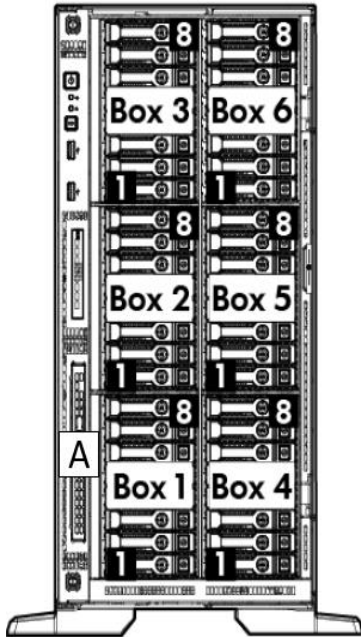

- A Optional Slim DVD-ROM/DVD-RW
- 1-8 8 x SFF SATA/SAS/SSD Hot Pluggable Hard Drive Bays

#### 24 LFF hot-plug drive model

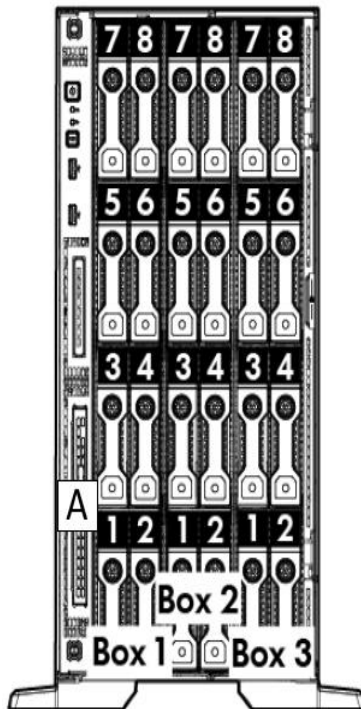

- A Optional Slim DVD-ROM/DVD-RW
- 1-8 8 x LFF SATA/SAS/SSD Hot Pluggable Hard Drive Bays

### Technical Specifications

<b>System Unit</b>	<b>Tower Dimensions</b>	18.27(H) x 8.62(W) x 30.28(D) in (46.4 x 21.9 x 76.9 cm)	
	<b>Rack Dimensions</b>	8.58(H) x 17.51(W) x 29.37(D) in (21.8 x 44.5 x 74.6 cm)	
	<b>Tower Weight</b>	Minimum:	66.14lb(30kg)
		Maximum:	121.30lb (55kg)
	<b>Rack Weight</b>	Minimum:	57.3lb(26kg)
		Maximum:	112.4lb(51kg)
	<b>Input Requirements</b>	Range Line Voltage	100 to 120 VAC 200 to 240 VAC
	<b>BTU Rating</b>	Maximum	For 1400W Power Supply: 5459 BTU/hr (at 200 VAC), 5459 BTU/hr (at 240 VAC), 5459 BTU/hr (at 240 VAC) for China Only For 800W Power Supply: 3207 BTU/hr (at 100 VAC), 3071 BTU/hr (at 200 VAC), 3112 BTU/hr (at 240 VAC) for China Only For 500W Power Supply: 1979 BTU/hr (at 100 VAC), 1911 BTU/hr (at 200 VAC), 1965 BTU/hr (at 240 VAC) for China Only
	<b>Power Supply Output</b>	Rated Steady-State Power	For 1400W Power Supply: 1400W (at 100 VAC), 1400W (at 240 VAC), 1400W (at 240 VAC) For 800W Power Supply: 800W (at 100 VAC), 800W (at 240 VAC), 800W (at 240 VAC) input for China only For 500W Power Supply: 500W (at 100 VAC), 500W (at 240 VAC), 500W (at 240 VAC) input for China only
		Maximum Peak Power	For 1400W Power Supply: 1400W (at 100 to 127 VAC), 1400W (at 200 to 240 1VAC), 1400W (at 240 VAC) input for China only For 800W Power Supply: 800W (at 100 to 127 VAC), 800W (at 200 to 240 1VAC), 800W (at 240 VAC) input for China only For 500W Power Supply: 500W (at 100 to 127 VAC), 500W (at 200 to 240 VAC), 500W (at 240 VAC) input for China only
	<b>System Inlet Temperature</b>	Standard Operating Support	10° to 35°C (50° to 95°F) at sea level with an altitude derating of 1.0°C per every 305 m (1.8°F per every 1000 ft) above sea level to a maximum of 3050 m (10,000 ft), no direct sustained sunlight. Maximum rate of change is 20°C/hr (36°F/hr). The upper limit and rate of change may be limited by the type and number of options installed. For approved hardware configurations, the supported system inlet range is extended to be: 5° to 40°C (41° to 104°F) at sea level with an altitude derating of 1.0°C per every 175 m (1.8°F per every 574 ft) above 900 m (2953 ft) to a maximum of 3050 m (10,000 ft). The approved hardware configurations for this system are listed at the URL: <a href="http://www.hp.com/servers/ashrae">http://www.hp.com/servers/ashrae</a> .
		Extended Ambient Operating Support Non-operating	-30° to 60°C (-22° to 140°F). Maximum rate of change is 20°C/hr (36°F/hr).
	<b>Relative Humidity</b>	Operating	Minimum to be the higher (more moisture) of -12°C (10.4°F) dew point or 8% relative humidity. Maximum to be the lower (less moisture) of 24°C (75.2°F) dew point or 90% relative humidity.
		Non-operating	5 to 95% relative humidity (Rh), 38.7°C (101.7°F) maximum wet bulb temperature, non-condensing.
<b>Altitude</b>	Operating	3050 m (10,000 ft). This value may be limited by the type and number of options installed. Maximum allowable altitude change rate is 457 m/min (1500 ft/min).	

### Technical Specifications

	Non-operating	9144 m (30,000 ft). Maximum allowable altitude change rate is 457 m/min (1500 ft/min).
<b>Acoustic Noise</b>		Listed are the declared A-Weighted sound power levels (LWAd) and declared average bystander position A-Weighted sound pressure levels (LpAm) when the product is operating in a 23°C ambient environment. Noise emissions were measured in accordance with ISO 7779 (ECMA 74) and declared in accordance with ISO 9296 (ECMA 109).
		<b>Idle</b>
	L WAd	3.6 Bels (1P LFF Entry) 3.5 Bels (1P SFF Base) 3.6 Bels (2P SFF E-star Rack) 3.4 Bels (2P SFF E-star Tower)
	L pAm	21 dBA (1P LFF Entry) 21 dBA (1P SFF Base) 20 dBA (2P SFF E-star Rack) 19 dBA (2P SFF E-star Tower)
		<b>Operating</b>
	L WAd	3.7 Bels (1P LFF Entry) 3.6 Bels (1P SFF Base) 4.5 Bels (2P SFF E-star Rack) 4.5 Bels (2P SFF E-star Rack)
	L pAm	21 dBA (1P LFF Entry) 22 dBA (1P SFF Entry) 28 dBA (2P SFF E-star Rack) 28 dBA (2P SFF E-star Tower)
		<b>NOTE:</b> Configurations tested for 1P LFF Entry models included two (2) 500GB LFF SATA Midline HDD and Windows 2012 Enterprise 64-bit.
		<b>NOTE:</b> Configurations tested for 1P and 2P SFF models included two (2) 500GB SFF SATA Midline HDD and Windows 2012 Enterprise 64-bit.
		<b>NOTE:</b> The Listed sound levels apply to standard shipping configurations. Additional options may result in increased sound levels.
<b>Emissions Classification</b>	FCC Rating	Class A
	Normative Standards	CISPR 22; EN55022; EN55024; FCC CFR 47, Pt 15; ICES-003; CNS13438; GB9254; K22;K24; EN 61000-3-2; EN 61000-3-3; EN 60950-1; IEC 60950-1
		<b>NOTE:</b> Product conformance to cited product specifications is based on sample (type) testing, evaluation, or assessment. This product or family of products is eligible to bear the appropriate compliance logos and statements.

<b>HP Dynamic Smart Array B140i Controller</b>	<b>Number of PCI links</b>	Four
	<b>PCI link rate</b>	4 Gb/s
	<b>Storage protocol support</b>	SATA
	<b>SAS/SATA peak data transfer rate</b>	6 Gb/s
	<b>Number of SAS/SATA links</b>	10 links
	<b>SAS/SATA connectivity</b>	2x4 connectors; 2x1 connectors
	<b>Expander support</b>	No
	<b>Drives supported (max)</b>	Up to 10 Internal Drives
	<b>RAID support</b>	0, 1, 10, 5 SATA
	<b>Software management</b>	HP SSA, SMH, SIM
	<b>Warranty</b>	Server warranty

### Technical Specifications

<b>HP Secure Encryption license</b>	Not Supported
<b>HP SmartCache License</b>	Not Supported
<b>HP Smart Storage Administrator</b>	Supported

---

<b>HP Ethernet 1Gb 4-port 331i Adapter</b>	<b>Network Interface</b>	10Base-T/100Base-TX/1000Base-TX	
	<b>Compatibility</b>	IEEE 802.3 10Base-T IEEE 802.3ab 1000Base-T IEEE 802.3u 100Base-TX	
	<b>Data Transfer Method</b>	PCI Express, two lanes (x2)	
	<b>Controller</b>	BCM5719	
	<b>Network Transfer Rate</b>	10Base-T (Half-Duplex)	10 Mb/s per port, 40 Mb/s combined
		10Base-T (Full-Duplex)	20 Mb/s per port, 80 Mb/s combined
		100Base-TX (Half-Duplex)	100 Mb/s per port, 400 Mb/s combined
		100Base-TX (Full-Duplex)	200 Mb/s per port, 800 Mb/s combined
		100Base-TX (Half-Duplex)	1000Mb/s per port, 4000 Mb/s combined
		100Base-TX (Full-Duplex)	2000Mb/s per port, 8000 Mb/s combined
<b>Connector</b>	RJ-45		
<b>Cable Support</b>	10 Base-T	Categories 3, 4 or 5 UTP; up to 328 ft (100 m)	
	10/100/1000 Base-TX	Category 5 or higher UTP; up to 328 ft (100 m)	

---

### Environment-friendly Products and Approach

### End-of-life Management and Recycling

Hewlett-Packard offers end-of-life HP product return, trade-in, and recycling programs in many geographic areas. For trade-in information, please go to: <http://www.hp.com/go/green>. To recycle your product, please go to: <http://www.hp.com/go/green> or contact your nearest HP sales office. Products returned to HP will be recycled, recovered or disposed of in a responsible manner.

The EU WEEE directive (2002/95/EC) requires manufacturers to provide treatment information for each product type for use by treatment facilities. This information (product disassembly instructions) is posted on the Hewlett Packard web site at: <http://www.hp.com/go/green>. These instructions may be used by recyclers and other WEEE treatment facilities as well as HP OEM customers who integrate and re-sell HP equipment.



[hp.com/qref/ml350gen9](http://hp.com/qref/ml350gen9)

### Summary of Changes

Date	Version History	Action	Description of Change
12/01/2014	From Version 3 to 4	Changed	Changes made throughout the entire QuickSpecs.
10/13/2014	From Version 2 to 3	Added	6G SATA Enterprise Value G1 Solid State Drives were added to Core Option section.  High Performance Clusters, HP PCIe Workload Accelerator Options, HP USB and SD options, and HP Care Pack Services were added to the Additional Options section.
		Changed	Standard Features, Optional Features, Core Options, Additional Options, and Memory sections were revised.
9/19/2014	From Version 1 to 2	Changed	Changes made throughout the entire QuickSpecs.

© Copyright 2014 Hewlett-Packard Development Company, L.P.

The information contained herein is subject to change without notice. The only warranties for HP products and services are set forth in the express warranty statements accompanying such products and services. Nothing herein should be construed as constituting an additional warranty. HP shall not be liable for technical or editorial errors or omissions contained herein.

Intel® and Xeon® are registered trademarks of Intel Corporation in the U.S. and other countries.

Microsoft®, Windows®, and Windows Server® are U.S. registered trademarks of the Microsoft group of companies.

For hard drives, 1GB = 1 billion bytes. Actual formatted capacity is less