

WIBE CABLE LADDERS CATALOGUE 2022

The spine of an exceptional infrastructure

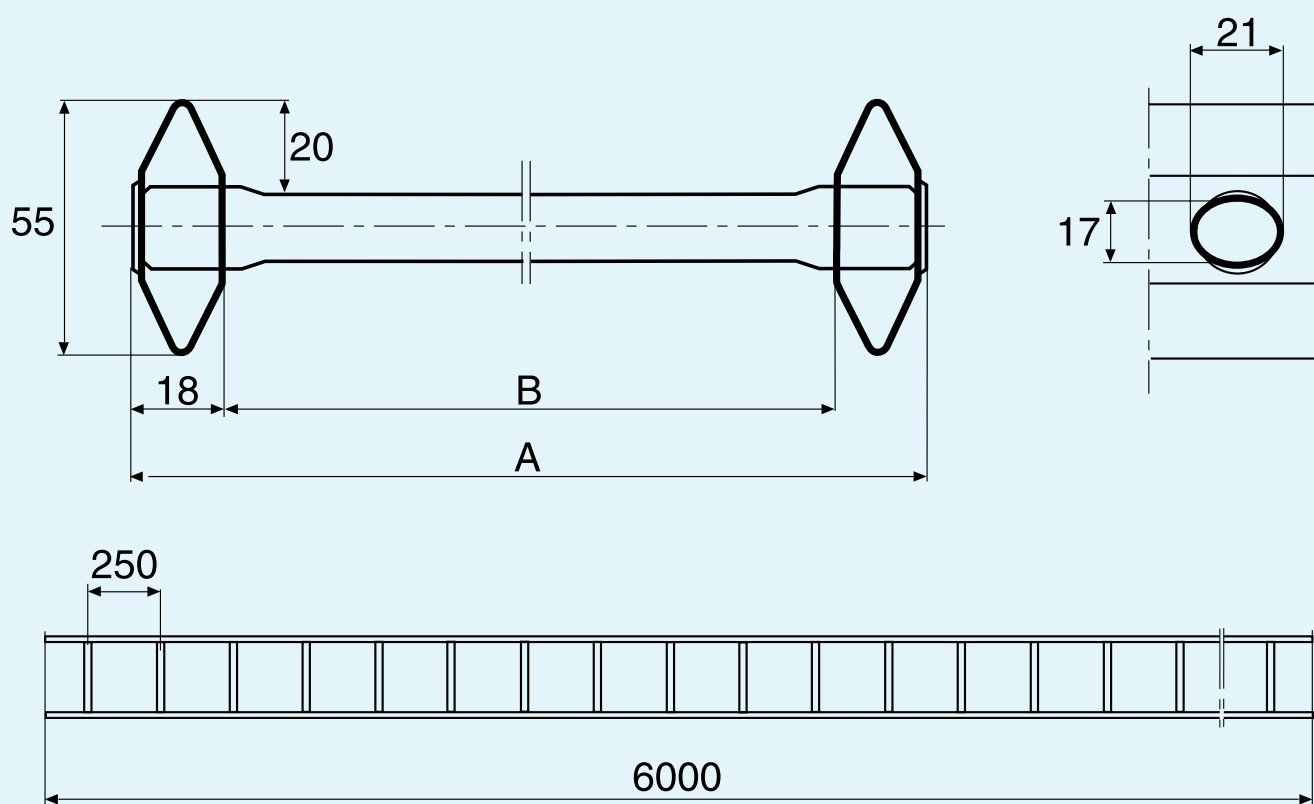

Creating clever, uplifting solutions, together with our clients for almost 100 years. Reimagined in June 2021 – for the coming century.

Looking ahead to the next century, we are reinventing ourselves – as Wibe Group – bringing together four of the world's leading cable management brands as a new independent company to offer a complete, innovative range of cable ladders, cable trays and mesh trays – for applications ranging from commercial buildings to extreme demanding industrial environments.



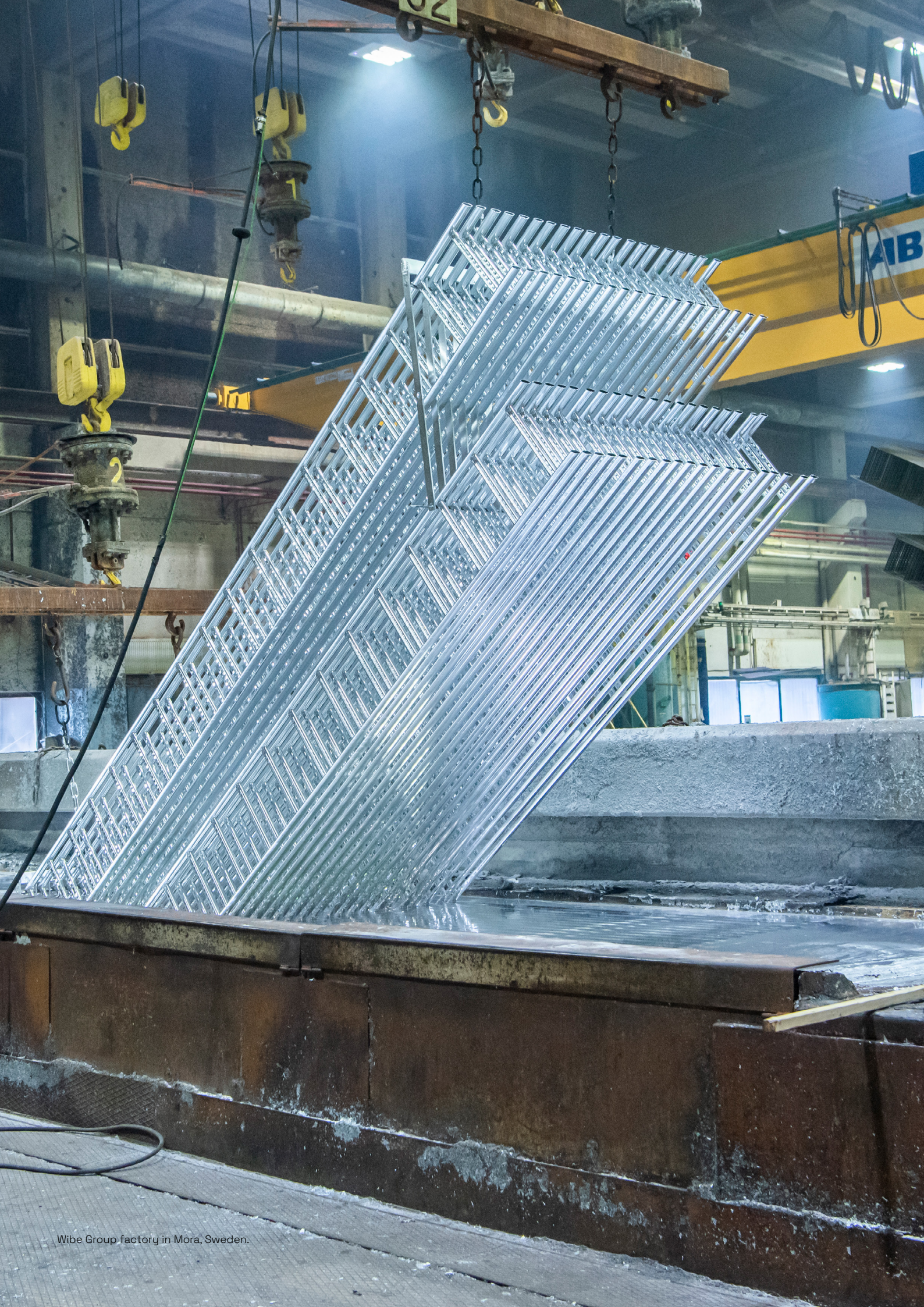

Wibe Group factory in Mora, Sweden.

Content

Presentation	7
Installation summary	32
KHZSP, KHZSPZ+, KHZPS, KHZ, KHZP	32
KHZV, KHZPV	34
Suspension components	36
KHZSP, KHZSPZ+, KHZPS, KHZ, KHZP,	36
KHZV, KHZPV	36
Steel cable ladders	38
Pre-galvanized	38
CLX ³ Click suspension	48
Zink+	51
Hot Dip-galvanized	52
Zinkpox	75
Stainless steel AISI 304L	89
Technical information	104
Corrosion classes	106
Surface treatments	107
Installation regulations	108
Electro-magnetic compatibility EMC	109
Potential balancing	110
E-30 and E-90 fire test	112
Standards and Quality	114
Use and installation	115
Index	207
Reference number overview	207

WIBE CABLE LADDERS

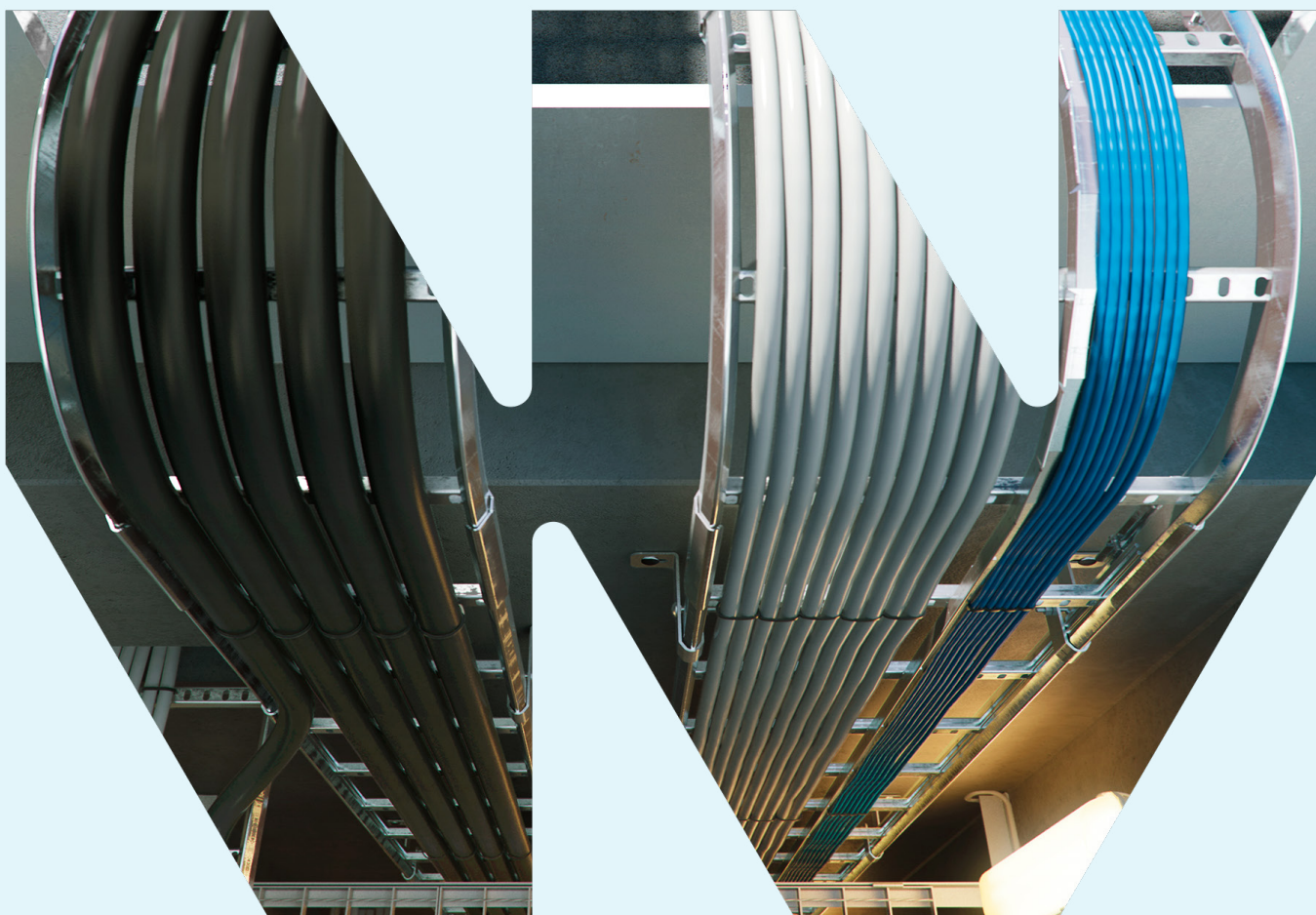

The spine of an exceptional infrastructure

The cable support system is as essential for the building's infrastructure as the bone structure for the body. The Wibe Cable Ladders are robust and functional, enabling the same ladder to be used both horizontally and vertically. Add to that the extensive range of accessories as well as the wide variety of surface treatments – and you will have a safe and easily maintained solution that can be mounted in any direction or angle to fit round bends and curves in any environment.

Wibe Cable ladders	8
A quick over-view of the Wibe cable ladder range and information about corrosion classes.	
Ready for constant change	10
The Wibe Cable Ladder system, agile enough to be completely reconfigured in a matter of days.	
Various applications	12
Accessories and benefits	18
New long span Nema 20C range	20
CLX³ products	24
Fire resistance	26
Configuration tool	27
Some references	28
Product range and technical part	33

Light, strong and endurable

A product with the right properties fit for purpose will meet the high demands on performance, reliability and cost-efficiency. That is why a thorough analysis of the environment in terms of corrosion, pollution, humidity and salt is crucial before deciding on material and surface treatment. Whether you need a ladder for sheltered, dry indoor applications or the harshest offshore environments, we will find the solution for you. Just take a look at our offer.



Wibe KHZ

Cable ladder with round rungs

Length: 6 m.
 Width: 150 - 600 mm
 Corrosion class: C3 to C5-I
 Surface treatment: Hot-dip galvanized, Zinkpox®



Wibe KHZV

Reinforced cable ladder with round rungs

Length: 6 m.
 Width: 200-600 mm
 Corrosion class: C3 to C5-I
 Surface treatment: Hot-dip galvanized, Zinkpox®

Wibe covers all corrosion classes

C1

Electro-galvanized

For heated facilities with low exposure to corrosion, such as hotels and offices.



C2

Pre-galvanized

For partly outdoor environments with low exposure to corrosion, for example warehouses and parking garages.



C3

Hot-dip galvanized

For urban and light industrial areas with average environmental corrosion, such as breweries and dairies.



C4

Hot-dip galvanized

For areas with high levels of environmental corrosion, humidity and airborne pollution such as industrial and coastal areas, chemical plants, dockyards.



C5-I

Stainless steel AISI 304, Zinkpox®, For areas with almost permanent high levels of humidity and airborne pollution, such as chemical and heavy industries, tunnels and dockyards.



C5-M

Stainless steel AISI 316L, For areas with almost permanent high levels of humidity, airborne pollution and salt, such as purifying plants and offshore.

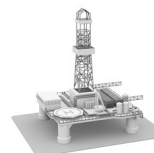

For more information regarding surface treatments and corrosion classes, please see from page 104

Wibe KHZSP / KHZSPZ+

Cable ladder with open profile and perforated rungs

KHZSP

Length: 3, 4 and 6 m. Width: 200-600 mm
Corrosion class: C2 to C5-M
Surface treatment: Pre-galvanized, Stainless steel
AISI 316L

KHZSPZ+

Length: 4 and 6 m. Width: 200-600 mm
Corrosion class: C3 to C4
Surface treatment: Zink+

P135698

P135700

Wibe KHZP / KHZPS

Cable ladder with perforated rungs

KHZPS

Length: 6 m. Width: 150-1000 mm
Corrosion class: C2
Surface treatment: Pre-galvanized

KHZP

Length: 3 and 6 m. Width: 150-1000 mm
Corrosion class: C3 to C5-M
Surface treatment: Hot-dip galvanized, Zinkpox®,
Stainless steel AISI 316L

P135702

Wibe KHZPV

Reinforced cable ladder with perforated rungs

Length: 6 m.
Width: 200-1000 mm
Corrosion class: C3 to C5-M
Surface treatment: Hot-dip galvanized, Zinkpox®,
Stainless steel AISI 316L

Wibe KHZP 20C

High-sided reinforced cable ladder with perforated rungs

Length: 6 m.
Width: 200-1000 mm
Corrosion class: C3 to C4, C5-I Zinkpox® on special
order
Surface treatment: Hot-dip galvanized, Zinkpox®
on special order

P135273

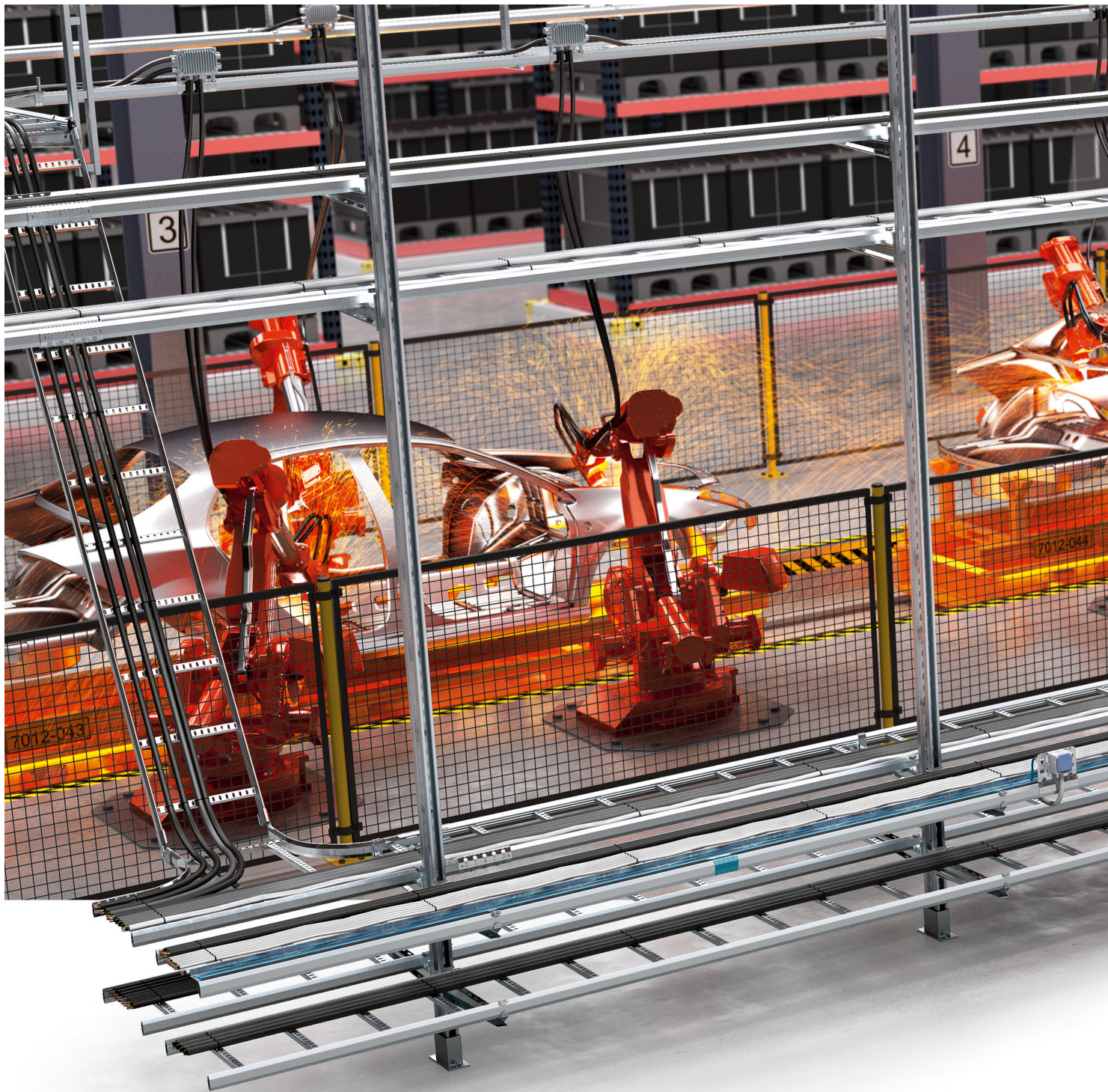

PI35711



PI33788

Support bracket

Sturdy support bracket for centre support of cable ladders on pendant/fixing rails and vertical pieces.



PI35711

Installation plate

Mounted on vertical cable ladders and used for terminal boxes, contact breakers etc.



PI33787

Coupling 22

Versatile joint for horizontal or vertical branches in any angle. Suitable for 90 bend, T- or X-junctions, or as a riser.



PI35711

Vertical piece

Multipurpose support, either used from the ceiling or from the floor. Ready for either cantilever arms or support brackets.

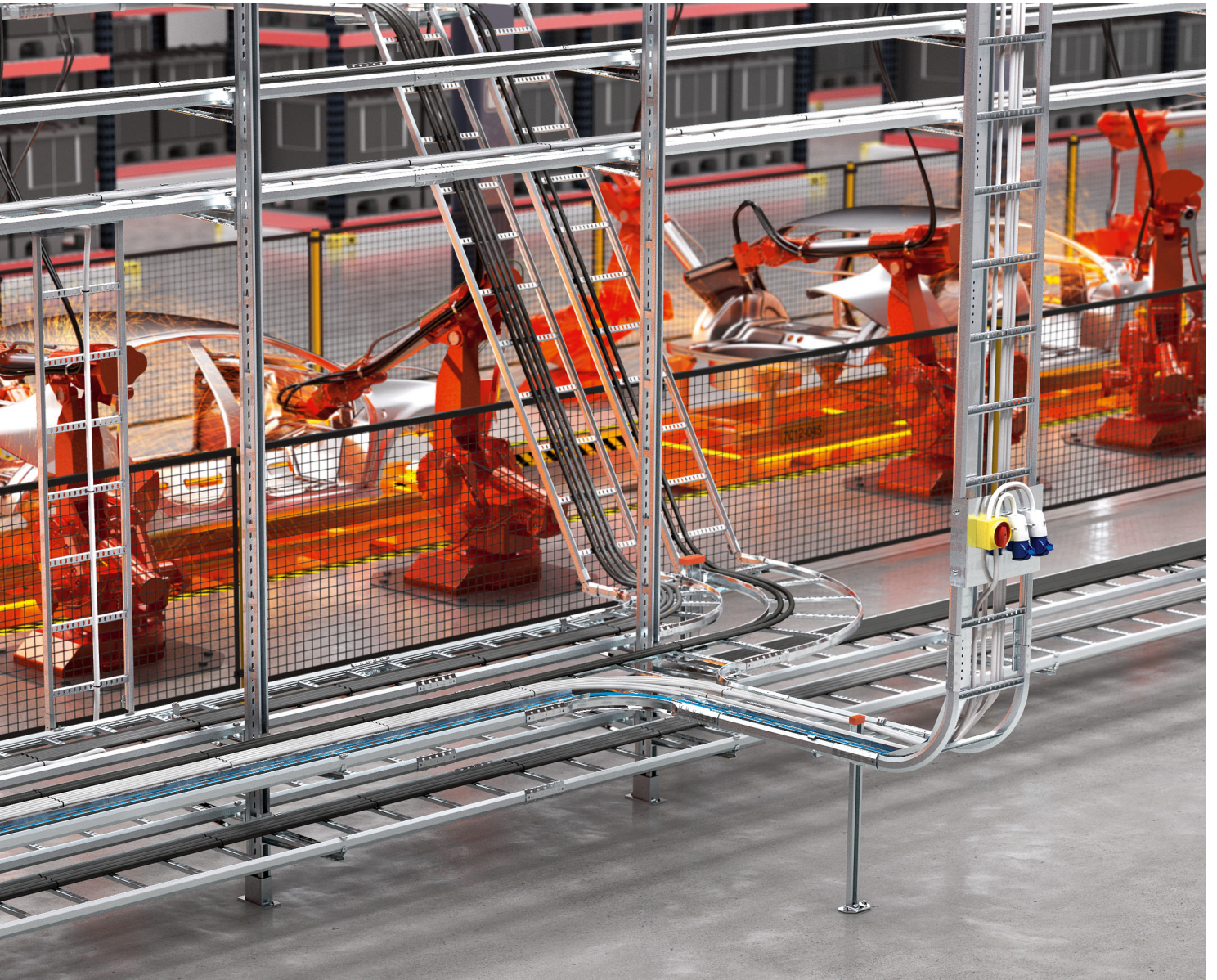

Organised and ready for constant change

In a high-tech industry the infrastructure needs to be modular and flexible, minimizing the risk of costly downtime when shifting to a new design or model. This is why the Wibe Cable Ladder system must be agile enough to be completely reconfigured in a matter of days.

An advanced industrial environment can really put a strain on the power and network infrastructure. For Wibe cable ladders, there is no application too complicated. Our cable ladder offer includes a wide range

of dimensions and accessories like bends, raisers, cantilever arms, brackets, joints, couplings and much more, making the entire solution flexible and adjustable enough to take on any challenging task.



P135725

The challenge

A typical urban environment. Thousands of people commuting every day. It is busy and crowded. Departures and arrivals on time are vital and what everybody expects. And there is no room for an inadequate infrastructure.

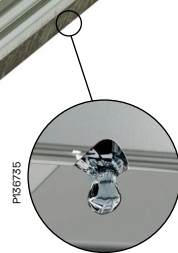

P135725

A smart feature is the drainage holes placed at the top and bottom of the open profiles of the KHZSP stainless steel ladder, preventing moisture from filling up.



P135758

The solution

This installation includes only a few parts:

1. KHZSP Cable ladder in stainless steel
2. Round bar fixing for ceiling
3. Support bracket 3
4. Coupling 22
5. Angle plate 33
6. Joint 21



On track with the future

Today we constantly meet increasing expectations on performance, flexibility and sustainability. Advanced constructions require top quality in every detail and keeping up with technical development is a challenging task. Our goal is to prosper business performance while conserving environmental resources.

The monorail train illustrates a modern, technological city infrastructure, but the idea of an elevated train on a single track actually dates back to the beginning of the 20th century.

Today the monorail trains are often used as fast intercity connections, running through tunnels and open landscapes, exposed to rain, ice and snow – at a speed often

exceeding 300 km/h.

Yet the journey is smooth, comfortable and quiet. Accentuating demands on capacity and comfort have spurred the development of advanced technique and sophisticated design. With the comprehensive offer that is constantly refined and improved, Wibe Cable Ladders match all the requirements by far.

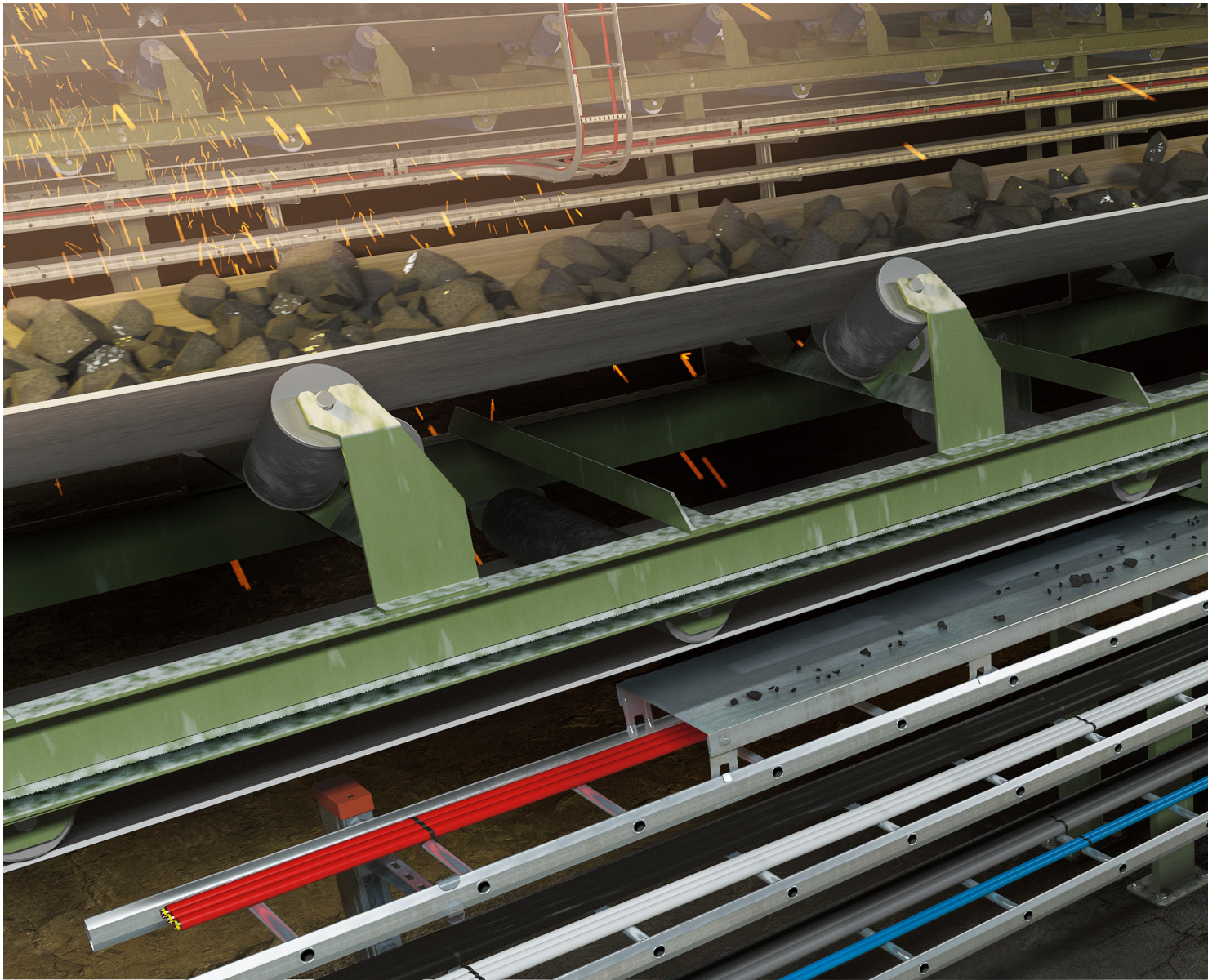

P1357/03

The challenge

Heavy industrial environment with a lot of pollution. Uptime is crucial, no room for costly production shutdowns.

The solution

These are the only parts needed:

1. KHZ Cable ladder in hot-dip galv
2. Riser 18
3. Joint 21
4. Cover plate
5. T-junction 16
6. Vertical piece 20FS, Cantilever arm 50, End cap

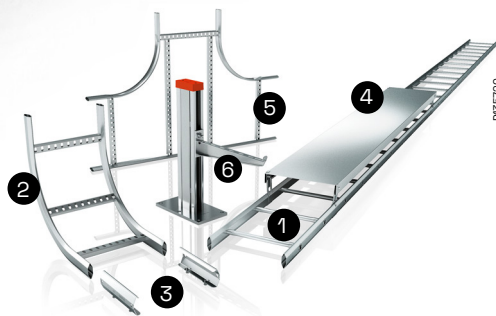

P1357/20



Breaking ground for heavy-duty applications

No environment is too tough or too dirty. With the appropriate material and ideal surface treatment of the cable support solutions, reliable power and network supply is secured.

It is noisy, busy and very harsh conditions. Maintaining continuous production is top priority, and any malfunctions will jeopardize both safety of the staff and the all important profitability. Here the cable support solution is really put to the test. The standing vertical

pieces can carry several layers of ladders on top of each other, securing easy maintenance and service. Details like round rungs and cover plates protect the installation from dirt and damage.

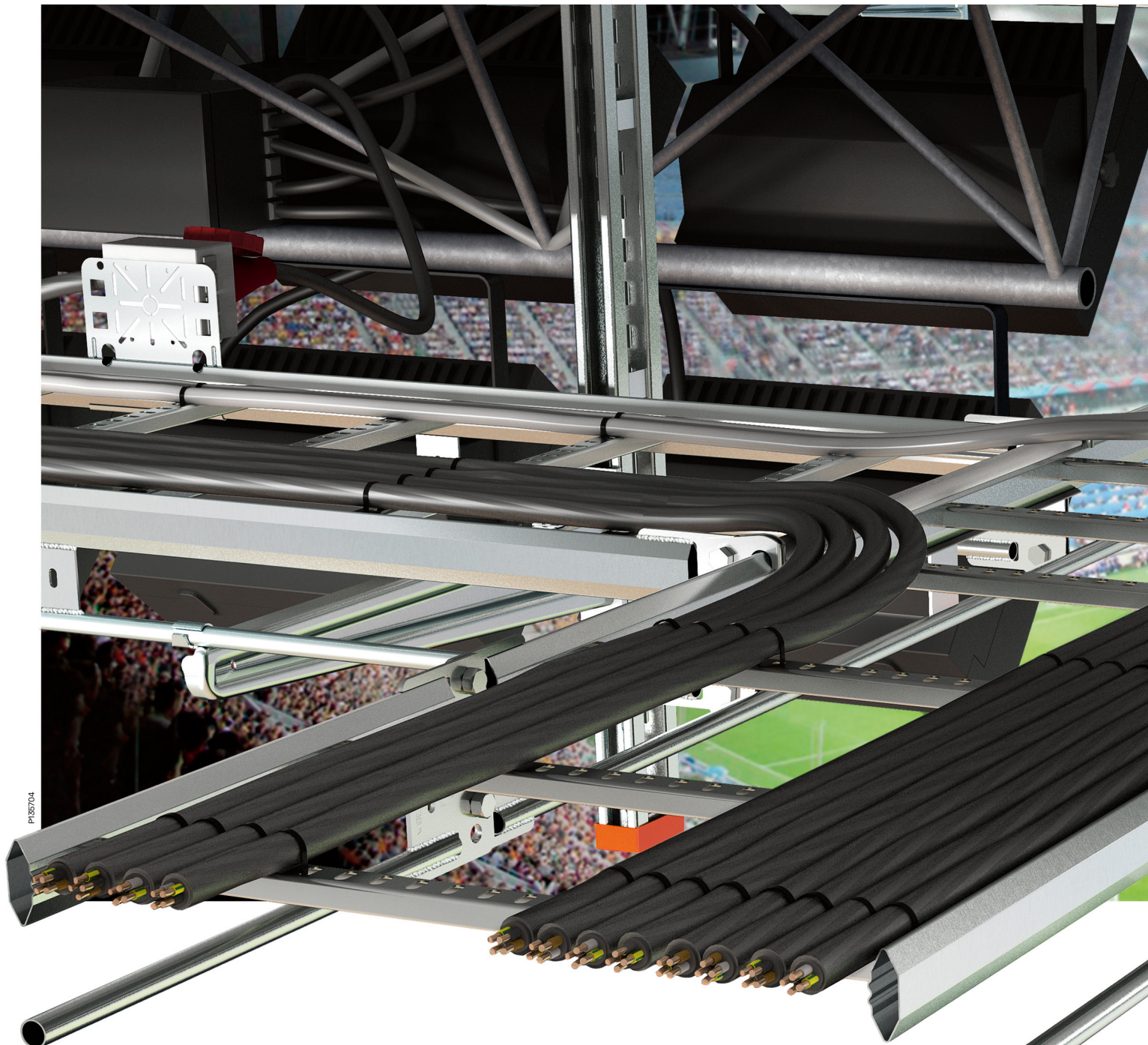

The challenge

An environment like a huge sports arena calls for extra strong solutions – both in terms of safety and easy maintenance in odd spaces.

Few but strong

The installation above is assembled with a limited number of parts:

1. KHZPV Cable ladder in hot-dip galv
2. T-junction 56
3. Take-off hook 47
4. Vertical piece 20F
5. Cantilever arm 50F
- End cap
- Profile protection

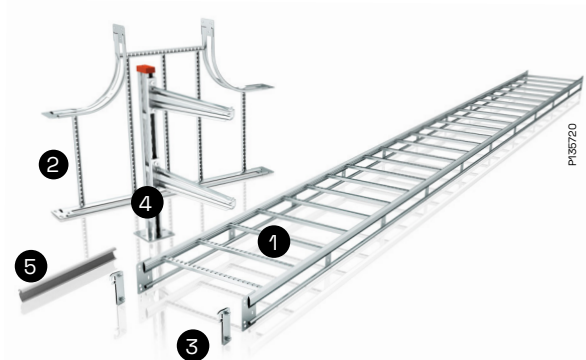



Safety and dependable operation in focus

Tens of thousands of people, roaring, cheering, all eyes on the game. High above is the headlight system, sustained by an extensive infrastructure of cable support solutions. Downright performance is what everybody expects. And what they can count on.

If the task is to support error-free, reliable lighting for the field and the audience, along with power and network supply for broadcasting, only the strongest is good enough. Wibe reinforced ladder KHZPV has an impressive distribution load of 150 kg/m (at 4 m support distance), backed up

by sturdy vertical pieces, cantilever arms, junctions etc. Another good feature is the profile protection, allowing safe tap-offs with secured maximum bend radius anywhere on the ladder. Equipped with a label, the profile protection can also be used for clear marking and identification.

Accessories and benefits

Screwless joint

When joining two ladders the screwless joint is very handy. Just snap it in place. The joint is suitable for fitting of 90° bends, T- and X-junctions and vertical mounting. No extra earthing is necessary.



Coupling 22

This ingenious coupling allows mounting of horizontal or vertical branches at any desired angle. It can be used for 90° bends, T-junctions, X-junctions, or as a riser. In the section Use and installation in this catalogue you will find a lot of installation examples.



Take-off hooks

Convenient hooks for use on ladders to make 90° branches. Just hook on and take off at any place on the ladder. Equipped with an extra hole for earthing or when vertical locking of the ladder is needed.



T-bolt 26U

This clever bolt has a metal spring which allows it to remain anywhere in the fixing rail before it is even fixed. Just apply the T-bolt in the desired position, adjust it if necessary and then fix it in place by tightening the nut.

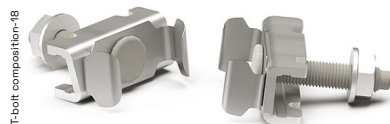



Junction box plates

The multi-purpose junction box plate 35S can be mounted in standing or hanging positions on the side sections of the cable ladder. The pre-defined hole pattern fits both LexCom and Actassi connectors. The junction box plate 35P is intended to be mounted between the rungs of the cable ladder.



Tele-conduit

Keep the entire installation tidy and well organized – the tele-conduit enables the ladder to carry both power cables and network cables.

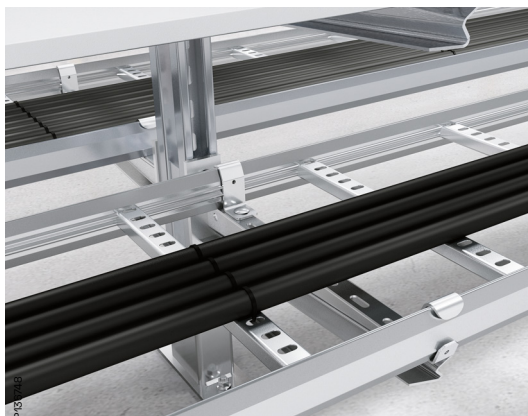

Support

The different supports like vertical pieces, fixing rails, cantilever arms and brackets are delivered in numerous sizes, offering swift flexibility as well as strength and organizational qualities to any complex installation.



Cable roller

The cable rollers simplify pulling of cables. The rollers are adjustable in height to allow cables to pass underneath. Suitable for 90° bends, T- and X-junctions as well as risers.

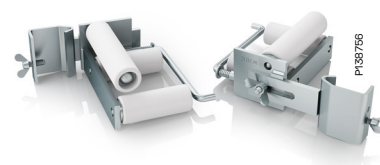



The challenge:

To meet the toughest requirements of extra heavy load and wide support distances in the most critical industrial environments.

Few but strong

The installation above is assembled with a limited number of parts:

1. KHZP 20C Cable ladder in hot-dip galv
2. T-junction 20C
3. Riser coupling 20C
4. 90° Bend 20C
5. Vertical coupling 20C

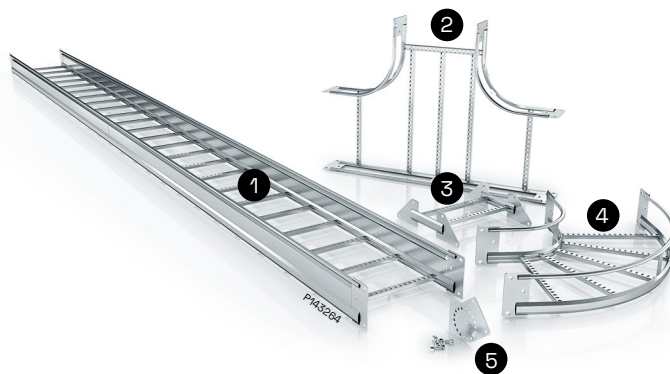



When conditions call for extreme loads and the widest support spans

Over the years, the Wibe Cable Ladder system from Wibe Group has been developed to tackle all kinds of harsh environments, such as Oil & Gas and chemical industries. Now the range has been further reinforced.

The latest and most powerful addition to our cable ladder portfolio is KHZP 20C – a strong, high-sided ladder with excellent properties. Meeting the NEMA 20C SWL standard, 149 kg/m at 6-metre span/safety, this new range offers long spans with heavy-load qualities. Nevertheless, the KHZP 20C range enables fast and easy installation. For example, the

couplers are integrated into the ladder sides, providing much faster mounting time than conventional systems requiring splice plates and multiple nuts and bolts. All in all, the KHZP 20C is a solution that contributes heavily to a safe, easily maintained and long lasting installation.

Based on proven expertise and continuous refinement

The KHZP 20C has evolved from many years of renowned development. With impressive dimensions and easy-to-apply accessories, such as bends, risers, T-junctions, couplings and reducers, the KHZP 20C is the ultimate durable solution for demanding installations.

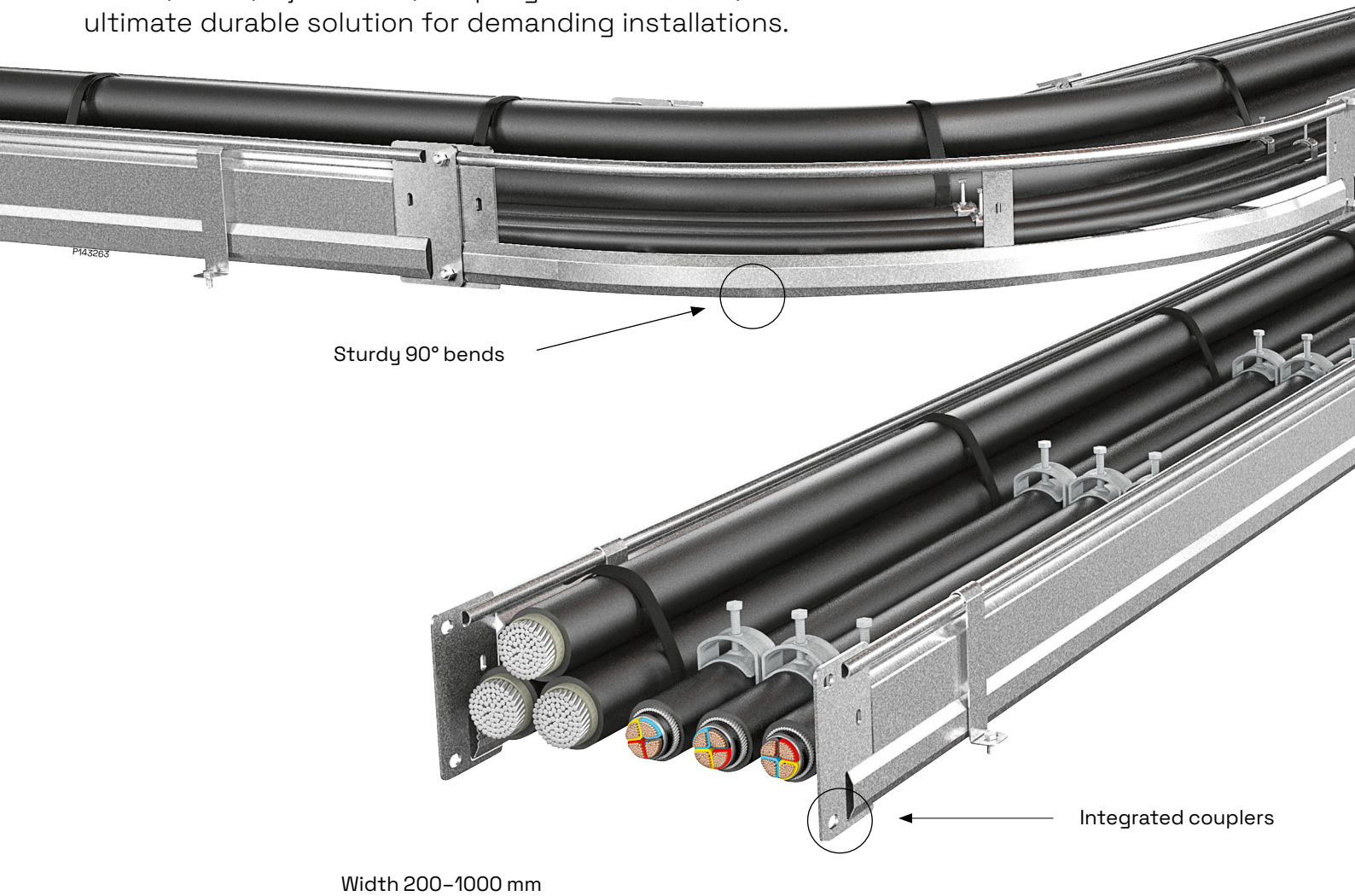

Adjustable vertical coupling

Robust T-junctions

6 m support distance

Riser 20C for internal or external bends

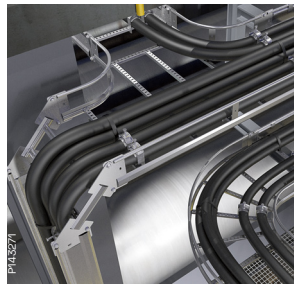

Wibe KHZP 20C is reinforced all the way. All the accessories are dedicated and tested to meet the high load requirements.

Install anywhere at any angle. Fixed angle couplings or couplings that can be adjusted to any angle on the horizontal or vertical plane.

Easy to reduce and expand. Increase or decrease the routing of cables from a wide to a narrow cable ladder.

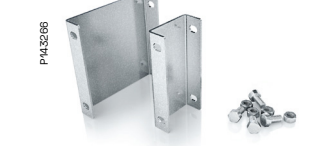
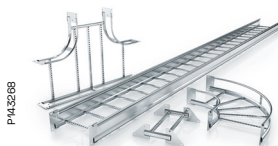

Engineered to set the standard in commercial building installations.

Modern commercial buildings feature cable routing installations that demand flexibility and efficiency. The revolutionary CLX3 support system is ideal regardless of the cable support required, because it is specifically developed to be smoothly and effectively integrated to the same support system.

CLX3 incorporates a set of unique benefits to deliver the most smart, lean and simple cable routing management.

Single bolt ceiling plate:
Fixes the pendant to the construction ceiling for optimal installation speed.

Pre-determined fixation: Square hole pattern adapted for coach bolt fixation of additional accessories.

Large-size cantilever arms:
Feature modular fixation patterns suitable for narrow ladders.

Time saving: Unique click system takes away the need for fixation clamps, bolts and nuts.

Click to lock: Hear the click and be reassured the component is securely locked.

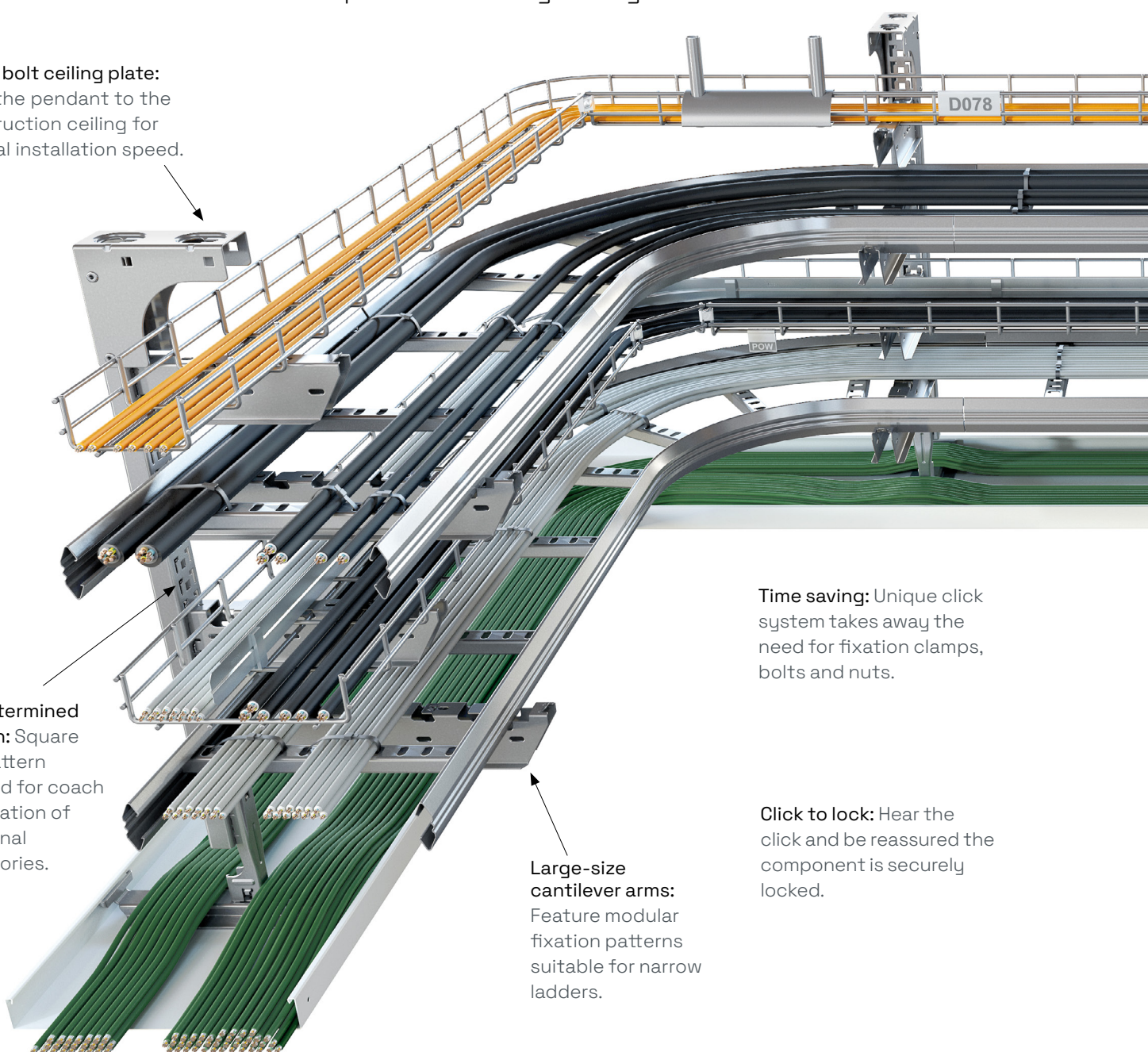

Robust design: Capable of bearing distances up to 4m, requiring less supports to be installed.

Lean: Fewer components needed, leading to more efficiency all along the process from BIM design through ordering, storage and installation.

Key hole fixation: Smart design to facilitate easy fixation of the pendant to the structural ceiling surface.

Flexible: The pendant accommodates installations close to the wall, corners and any other space.

Performance: Supports adjustments of up to 25 degrees with a single adaptor.

Sleek: Minimum space occupancy inside and below the length of the pendant for central suspension.

Multi-functional: Rail back is identical to the Wibe existing rail 24/48, enabling use of legacy system components.

Convenience: The system is designed for single-handed installation.

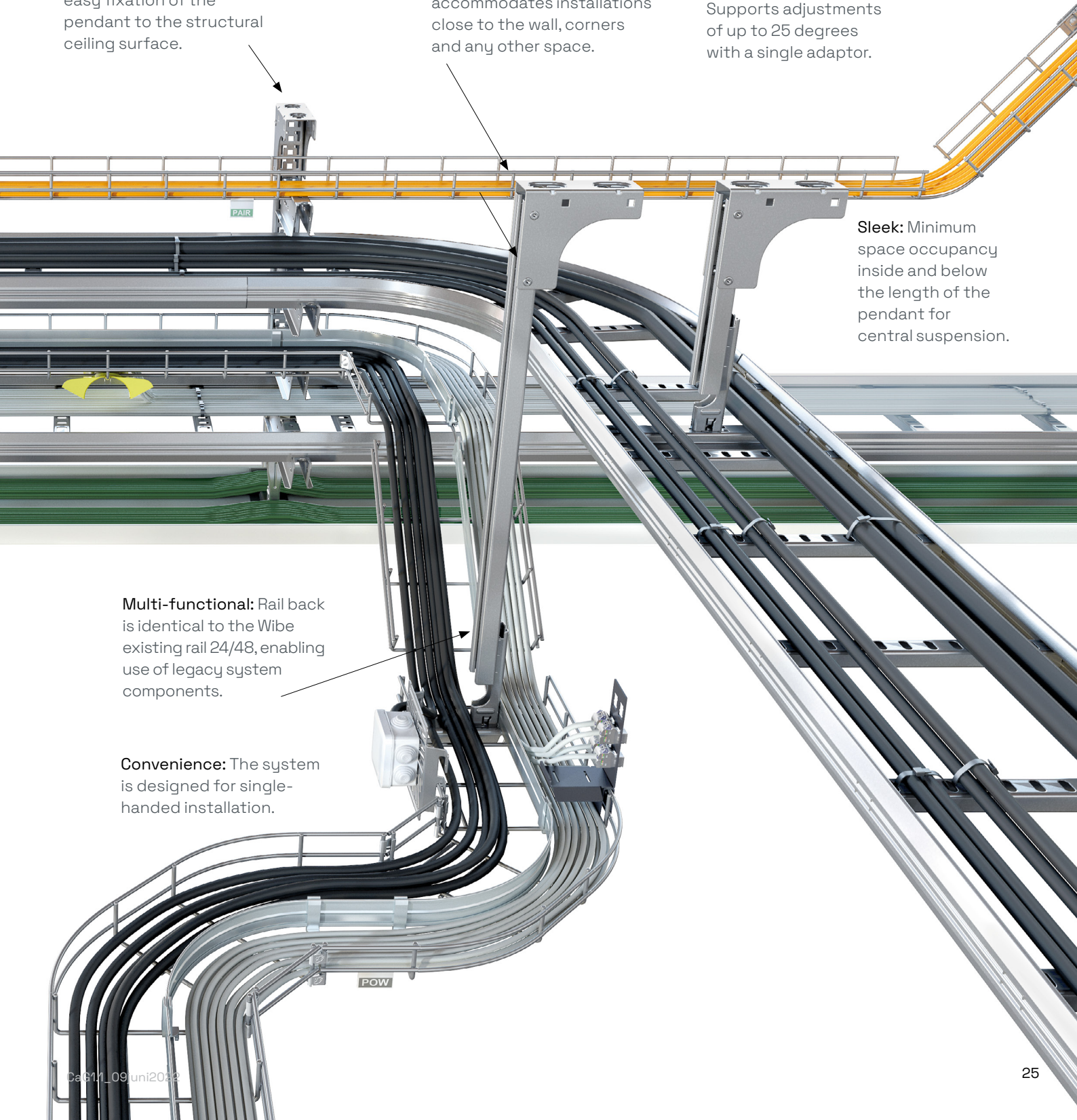

Certified according to DIN4102-12 for fire resistance E30, E60 and E90

The longer the installation is resistant to fire, the longer the electric system will be able to operate normally. Wibe products with E30, E60 and E90 certification help to protect life and property in the event of a fire. The well-proven, reliable system will prolong the access to critical emergency services, such as fire suppression systems, emergency lighting, ventilation and other basic installations.



The Wibe cable ladders meet the toughest product standards:
IEC 61537
DIN 4102-12 for fire resistance classes E30, E60 and E90



The Wibe cable ladder system is also approved by Det Norske Veritas (DNV) for offshore and shipyard use.



The Wibe cable ladder system is also approved according to UL E212854 for use in the US and Canada.



About the test

A selection of the Wibe products have proven excellent fire resistance properties. You can feel confident when installing Wibe cable ladders in environments requiring either E30, E60 or E90 certification.

The cable ladders with supporting system and Dätwyler Pyrofil KERAM E30, E60 and

E90 cables were tested for 90 minutes in a temperature of up to 1000°C without collapsing, with the electrical performance still remaining intact.

For installation specification please see the Technical part in this catalogue.

Our Configuration tool – the right choice

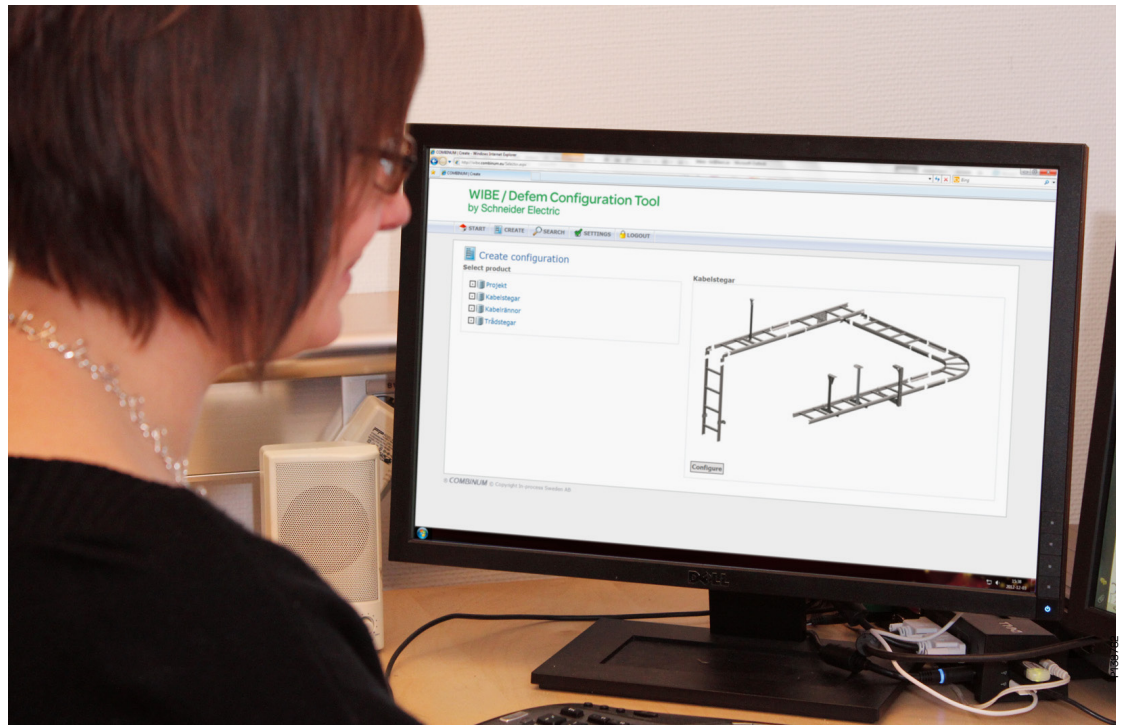

The smartest way to be efficient and profitable, is to cut down on costs. Material that is either insufficient or oversized, means actually money down the drain. Our configuration tool helps you calculate the dimensions you need, eliminating waste of your time, money and effort.

Make your specification accurate, flexible and up-to-date

The Wibe/Defem configuration tool is a unique and user-friendly assistant to specifiers, wholesalers and installers. The tool is free of charge and perfect for optimizing the amount of material for any given installation. No previous experience is necessary – all you need is a standard web browser and a personal login (provided from Wibe Group), and you are ready to go.

Make the right choice

It is all about making the right choice. Just specify your requirements regarding environment/corrosion class, load and

support distances etc and you will have a customized selection for your installation. Your calculations are saved, so you can adjust them at any time. The configuration tool is automatically updated as products are launched or replaced, enabling accurate and exact configurations. You can also easily have the BOM (Bill of Material) transferred to Excel, to be used as your shopping list.

Today the configuration tool is available in English, Russian and Swedish, but more versions are under development.

3.2 million metres
manufactured
each year.

Wibe Cable Ladders form the backbone
of the modern infrastructure.

Experience and knowledge take you higher

Creating shared value

Throughout the years we have stacked up an outstanding amount of knowledge and skills as part of our resources for continuous product development.

Another essential contribution to this is the experience of our customers. Together we investigate the needs of today and tomorrow in our common goal towards finding even more effective, sustainable and future-proof solutions. Our close cooperation brings increased knowledge and stronger competitiveness to both parties, resulting in successful projects that draw attention all over the world.



The Wibe cable ladder system handles routing of power, data and control cables. All with outstanding conditions for high performance and problem-free maintenance.



Burj Khalifa, Dubai. The world's tallest building stretches close to 830 m into the air. As a comparison, the Sears Tower in Chicago reaches 442 m and the Empire State Building in New York comes in at 381 m. Increasing demands on longer, taller and wider constructions call for kilometres of cables – and an infrastructure backbone of comprehensive cable support solutions. As the only approved supplier of cable support to the Hyder Consultant with Emaar, Wibe Group Electric delivered 1,500 pcs of KHZP Cable Ladders (9,000 metres).





Wibe Cable Ladders KHZ and KHZP installed at Borealis Stenungsund. Borealis in Sweden supports customers with speciality plastics for some of the largest energy supply, oil and water pipeline projects in the world.



P1281887

Wibe Cable Ladder KHZV installed at Outo-kumpu Stainless steel, Avesta Sweden.



P1280200

Wibe Cable Ladder KHZP installed at a Nuclear power station in Russia.



P1261821

Wibe Cable Ladder KHZP installed at Lukoil sleetproof mooring line Varandei, Barents Sea Russia.



P1281887

Wibe Cable Ladders KHZ installed at SSAB Borlänge Steel plant, Sweden.



P128702

Wibe Cable Ladder KHZP installed at BP/ARCO/Technip – Al Rayyan Development, Qatar.



P128098

Wibe Cable Ladder KHZP installed at Kista Science Center, Sweden.



P123760

Wibe Cable Ladder KHZV installed at Gärdstaverken, Sweden.

Installation summary - KHZSP, KHZSPZ+, KHZPS, KHZ, KHZP

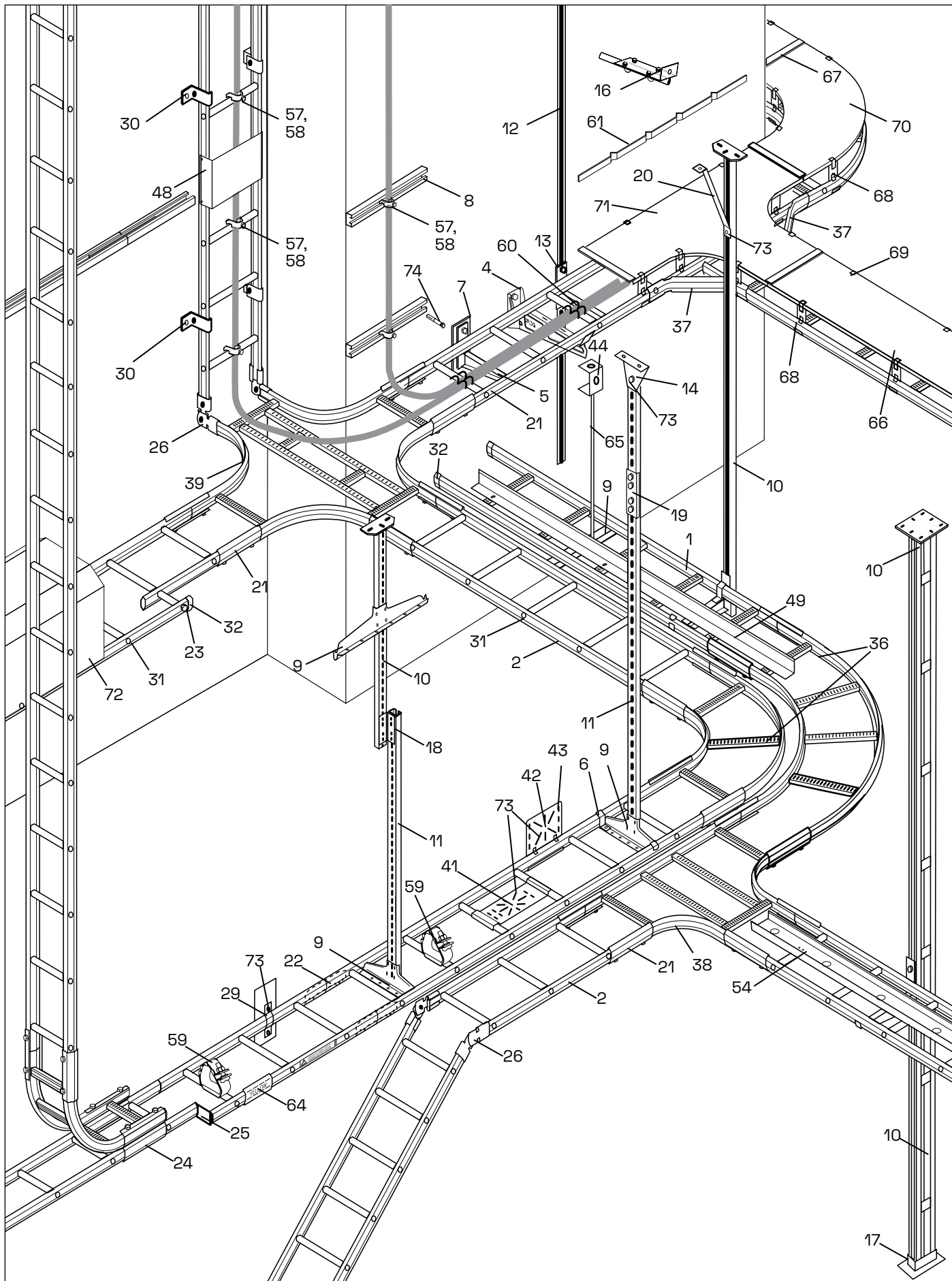

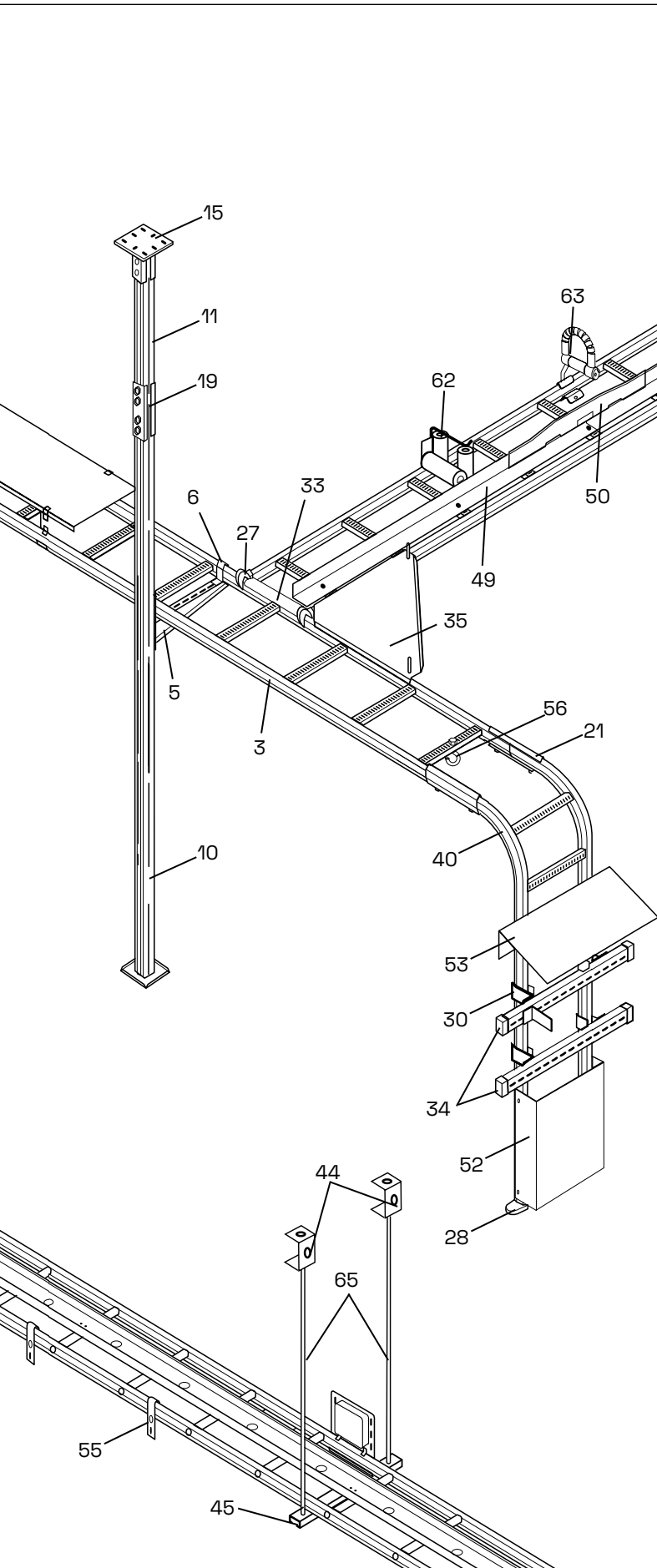

Components

- 1 Cable ladder KHZSP, KHZSPZ+
- 2 Cable ladder KHZ
- 3 Cable ladder KHZPS, KHZP
- 4 Cantilever arm 50i
- 5 Cantilever arm 50, 50F
- 6 Profile clamp 42
- 7 Back plate 40
- 8 Mounting rail 40
- 9 Support bracket 3, Support bracket 6
- 10 Vertical pieces
- 11 Pendant/Fixing rails
- 12 Fixing rail 24/26x53 for casting-in
- 13 T-bolt 26U
- 14 Ceiling bracket 5
- 15 Pendant base plate 520
- 16 Round bar fixings(ceiling,wall,floor)
- 17 Rail fixing support 24/20F, 24/20FS
- 18 End bracket HT-11
- 19 Pendant joint 2J, 2FJ, 20J
- 20 Pendant bar 1
- 21 Joint 21
- 22 Joint 9
- 23 Intermediate connection bolt 29
- 24 Dropper joint 32
- 25 Reducer 31
- 26 Coupling 22
- 27 Fixed take-off hook 4
- 28 End connection 10
- 29 Profile clamp 41
- 30 Wall bracket 11/25, 11/75
- 31 Cross member plug 27
- 32 End plug 28, 28i
- 33 Profile protection 28P
- 34 End plug 28E, 28D, 28C, 28F
- 35 Angle plate 33/1, 33/2
- 36 90° bend 15
- 37 Junction coupling 14
- 38 T-junction 16
- 39 X-junction 17
- 40 Riser 18
- 41 Junction box plate 35P
- 42 Junction box plate 35S
- 43 Earth clamp W79
- 44 Ceiling bracket TF10 and TF16
- 45 Support bracket HSO
- 48 Installation plate 61
- 49 Dividing strip 39
- 50 Distance piece W39
- 52 Cover plate 65
- 53 Junction box cover
- 54 Tele-conduit 36
- 55 Clamp 12
- 56 Hook 8
- 57 Cable clamp ARX
- 58 Insert piece EM
- 59 Cable clamp ER
- 60 Lashing wire
- 61 Mounting rail, WMS25L
- 62 Cable roller S
- 63 Cable roller 38 Rig'n roll/Cable roller set 66
- 64 Marking plate 93
- 65 Threaded rod W76 M10
- 66 Cover W5
- 67 Cover joint
- 68 Profile support piece 37
- 69 Cover clamp
- 70 Cover 90° bend
- 71 Cover T-junction
- 72 Protecting cover
- 73 Screw sets
- 74 Expansion bolts

Installation summary / KHZV, KHZPV

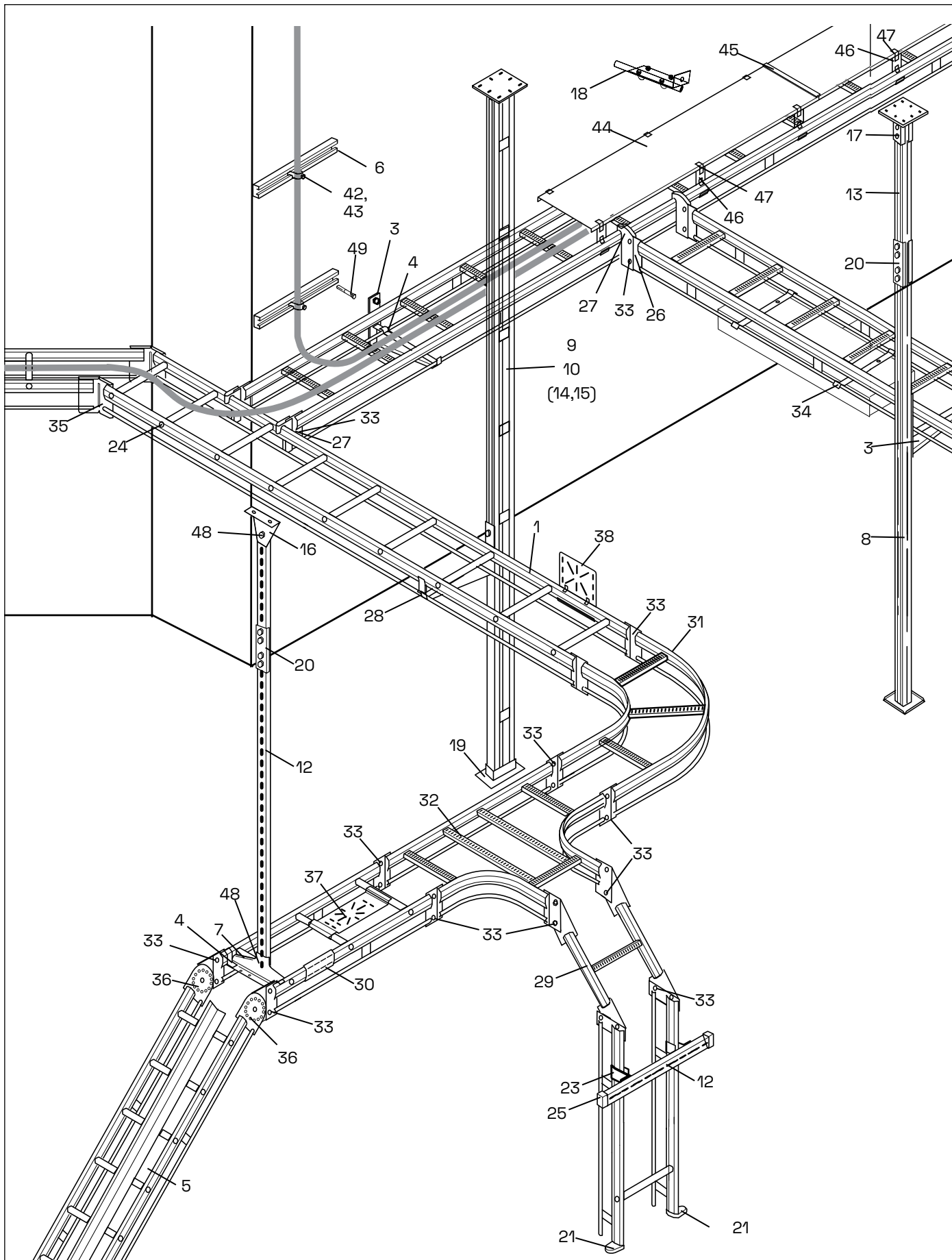

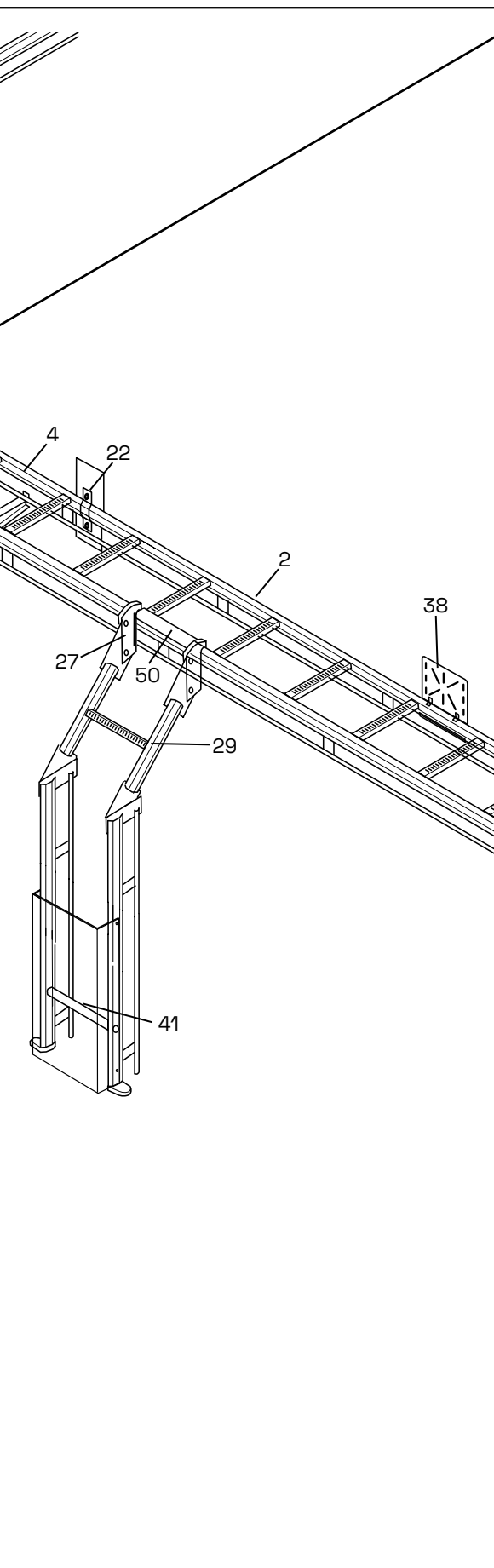

Components

- 1 Cable ladder KHZV
- 2 Cable ladder KHZPV
- 3 Cantilever arm 50F
- 4 Profile clamp 42,43
- 5 Dividing strip 39
- 6 Mounting rail 40
- 7 Support bracket 3
- 8 Vertical piece 20
- 9 Vertical piece 20F
- 10 Vertical piece 20FS
- 12 Pendant/Fixing rail 24/48
- 13 Pendant/Fixing rail 24/20
- 14 Pendant/Fixing rail 24/20F
- 15 Pendant/Fixing rail 24/20FS
- 16 Ceiling bracket 5
- 17 Pendant base plate 520
- 18 Round bar fixings (ceiling, wall, floor)
- 19 Rail fixing support 24/20F, 24/20FS
- 20 Pendant joint 2J, 2FJ, 20J
- 21 End connection 10
- 22 Profile clamp 41
- 23 Wall bracket 11/25, 11/75
- 24 Cross member plug 27
- 25 End plug 28E, 28D, 28C, 28F
- 26 Joint 45
- 27 Take-off hook 47
- 28 Profile support piece 46
- 29 Riser coupling 49
- 30 Marking plate 93
- 31 90° bend 55
- 32 T-junction 56
- 33 Screw set M12
- 34 Lighting bracket 200
- 35 Coupling 44
- 36 Coupling 51
- 37 Junction box plate 35P
- 38 Junction box plate 35S
- 41 Cover plate 65
- 42 Cable clamp ARX
- 43 Insert piece EM
- 44 Cover W5
- 45 Cover joint
- 46 Profile support piece 37
- 47 Cover clamp
- 48 Screw sets
- 49 Expansion bolts
- 50 Profile protection 28P

Suspension components / KHZSP, KHZSPZ+, KHZPS, KHZ, KHZP, KHZV, KHZPV

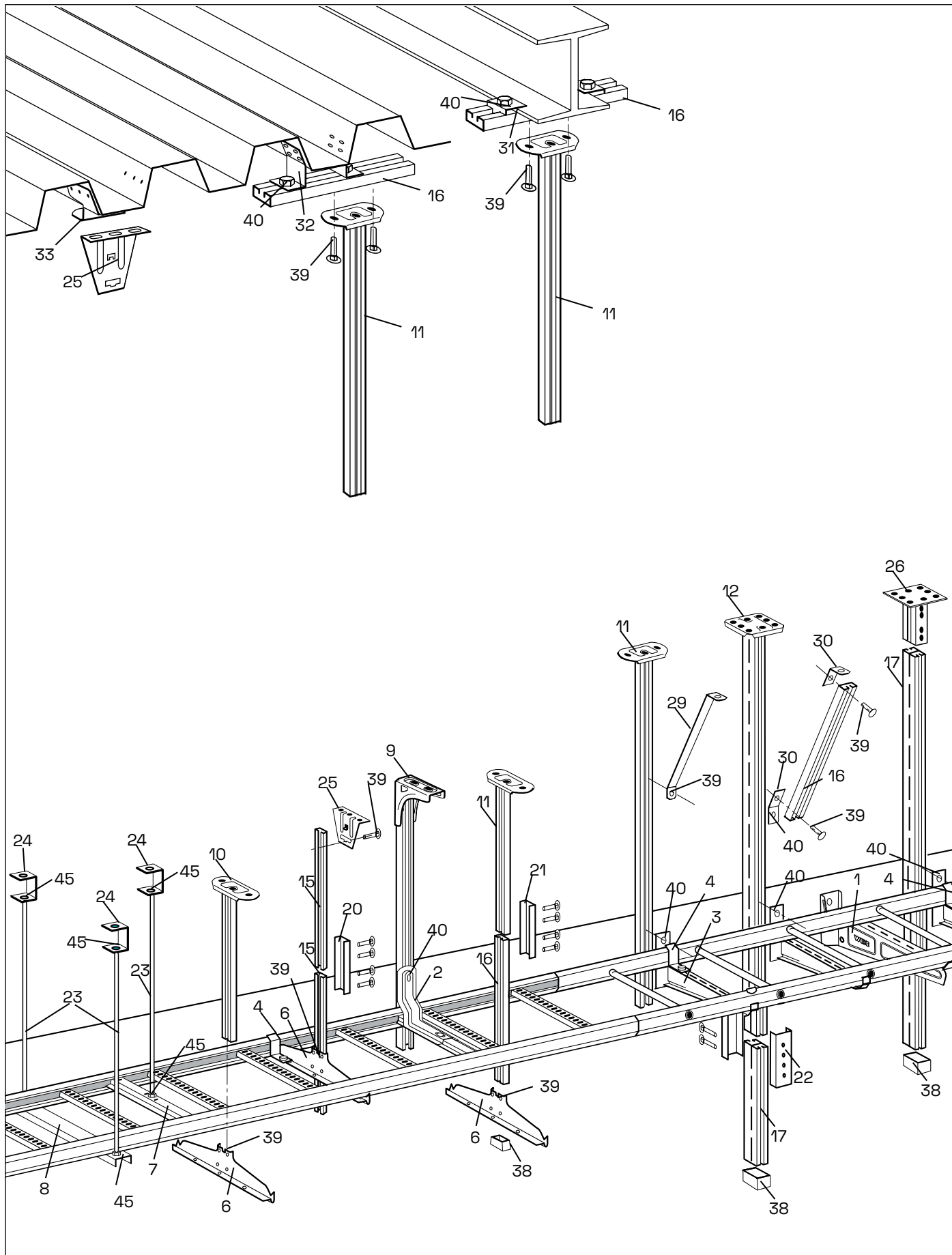

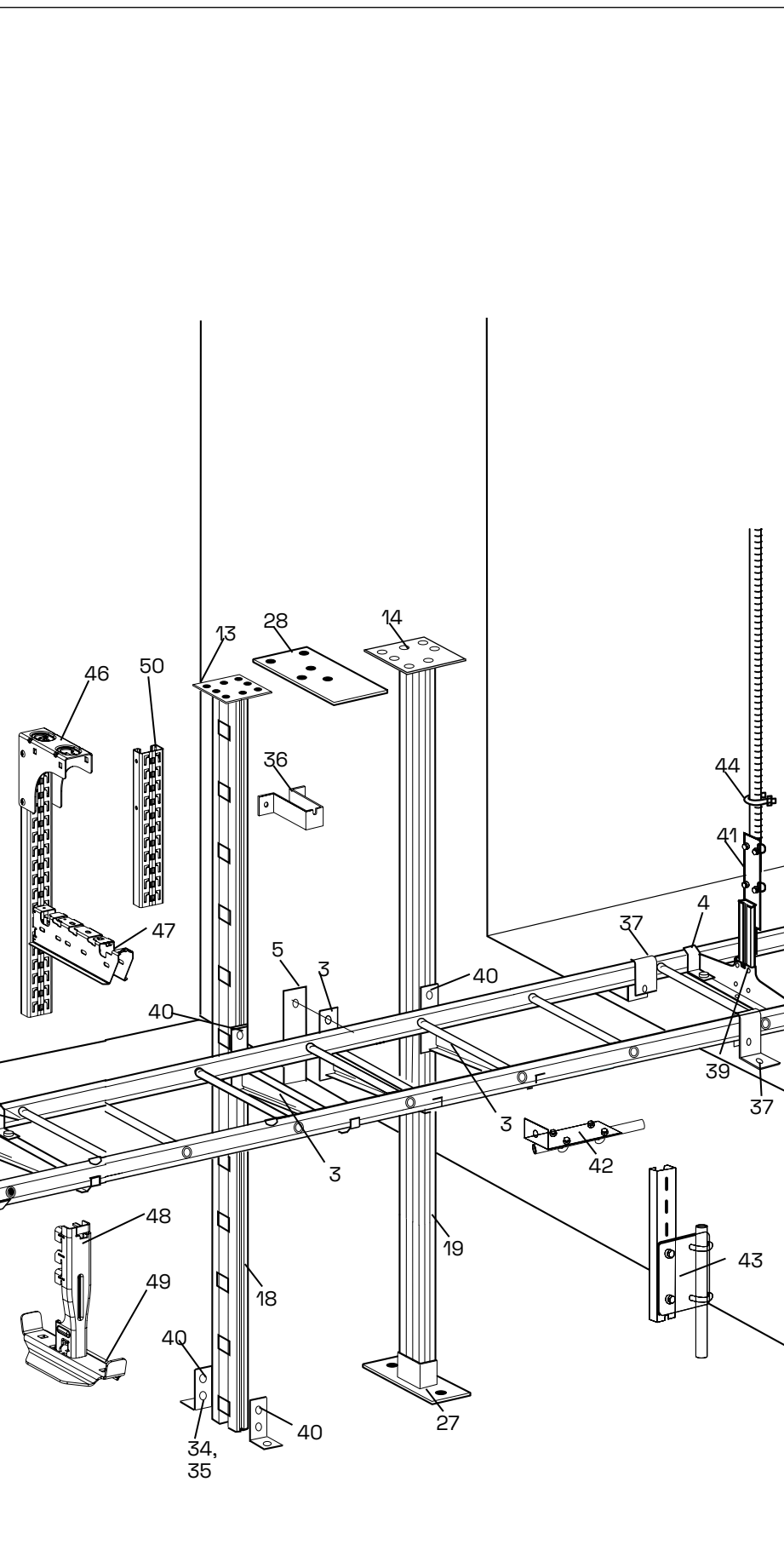

Suspension

- 1 Cantilever arm 50i
- 2 Cantilever arm 30
- 3 Cantilever arm 50, 50F
- 4 Profile clamp 42
- 5 Back plate 40
- 6 Support bracket 3
- 7 Support bracket 6
- 8 Support bracket HSO
- 9 Vertical piece 2Fi
- 10 Vertical piece 2
- 11 Vertical piece 2F
- 12 Vertical piece 20
- 13 Vertical piece 20F
- 14 Vertical piece 20FS
- 15 Pendant/Fixing rail 24/34
- 16 Pendant/Fixing rail 24/48
- 17 Pendant/Fixing rail 24/20
- 18 Pendant/Fixing rail 24/20F
- 19 Pendant/Fixing rail 24/20FS
- 20 Pendant joint 2J
- 21 Pendant joint 2FJ
- 22 Pendant joint 20J
- 23 Threaded rod W76 M10
- 24 Ceiling bracket TF-10, TF-16
- 25 Ceiling bracket 5
- 26 Pendant base plate 520
- 27 Rail fixing support 24/20F, 24/20FS
- 28 Ceiling plate 20F, 20FS
- 29 Pendant bar 1
- 30 Bracket 60/40
- 31 Beam clamp 5BK
- 32 Ceiling bracket 5TP
- 33 Ceiling bracket 5TPA
- 34 Angle bracket 5L
- 35 Angle bracket 5LS
- 36 Wall bracket 20, 20F
- 37 Wall bracket 11/25, 11/75
- 38 End plug 28E, 28D, 28C, 28F, 28J
- 39 Screw set 2S, 22S
- 40 T-bolts
- 41 Round bar fixing for ceilings
- 42 Round bar fixing for walls
- 43 Round bar fixing for floors
- 44 Clamp set M6
- 45 Nut M10
- 46 CLX3 Pendant 24/48
- 47 CLX3 Cantilever arm
- 48 CLX3 Central suspension adapter
- 49 CLX3 Central suspension bracket, Ladder KHZSP
- 50 CLX3 rail 24/48

Pre-galvanized - Corrosion class C2

Cable ladders

PH40324



Type	Dimensions A/B/C mm 	Weight kg/100 m	EAN code	Ref. No.
------	---	-----------------	----------	----------

Cable ladders KHZSP

Cable ladder for indoor applications in dry environments. With open side profiles and profile-shaped rungs. Must not be used as walkway.
Material: Steel, pre-galvanized.

KHZSP-200	55/198/3000	198	7321677831555	783155
	55/198/4000		7321677185726	718572
	55/198/6000		7321677344888	734488
KHZSP-300	55/298/3000	217	7321677831562	783156
	55/298/4000		7321677185733	718573
	55/298/6000		7321677344895	734489
KHZSP-400	55/398/3000	237	7321677831579	783157
	55/398/4000		7321677185740	718574
	55/398/6000		7321677344901	734490
KHZSP-500	55/498/3000	257	7321677831586	783158
	55/498/4000		7321677185757	718575
	55/498/6000		7321677344918	734491
KHZSP-600	55/598/3000	277	7321677831593	783159
	55/598/4000		7321677185764	718576
	55/598/6000		7321677344925	734492

Cable ladders KHZPS

Cable ladder for indoor applications in dry environments. With closed side profiles and profile-shaped rungs. Must not be used as walkway.
Material: Steel, pre-galvanized.

PH40330



KHZPS-150	55/147/6000	225	7321677253500	725350
KHZPS-200	55/197/6000	235	7321677253517	725351
KHZPS-300	55/297/6000	255	7321677253524	725352
KHZPS-400	55/397/6000	275	7321677253531	725353
KHZPS-500	55/497/6000	300	7321677253548	725354
KHZPS-600	55/597/6000	315	7321677253555	725355
KHZPS-800	55/797/6000	410	7321677810994	781099
KHZPS-1000	55/997/6000	490	7321677253562	725356

Dimension table

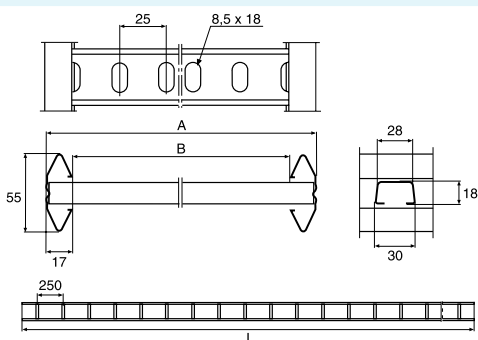

B2294/75

Type	A mm	B mm	L mm	Ref. No.
KHZSP-200	198	164	3000	783155
			4000	718572
			6000	734488
KHZSP-300	298	264	3000	783156
			4000	718573
			6000	734489
KHZSP-400	398	364	3000	783157
			4000	718574
			6000	734490
KHZSP-500	498	464	3000	783158
			4000	718575
			6000	734491
KHZSP-600	598	564	3000	783159
			4000	718576
			6000	734492
KHZPS-150	147	111	6000	725350
KHZPS-200	197	161	6000	725351
KHZPS-300	297	261	6000	725352
KHZPS-400	397	361	6000	725353
KHZPS-500	497	461	6000	725354
KHZPS-600	597	561	6000	725355
KHZPS-800	797	761	6000	781099
KHZPS-1000	997	961	6000	725356

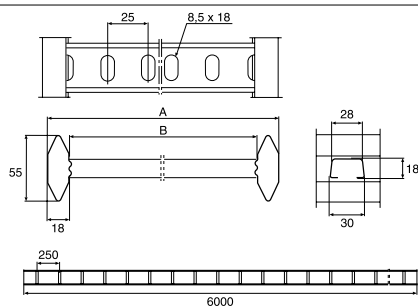

B2296/75

Pre-galvanized - Corrosion class C2

Joins

	Type	Dimensions A/B/C mm	Weight kg/100 pcs	EAN code	Ref. No.
P140020	Joint 21				
	Joint to be used for rigid joining of cable ladders, bends, junctions and risers. Snap-on and fixed by two screws. It also reduces the transition resistance and prevents the ladders from slipping apart. M6 screws included. Material: Steel, Zinc+.				
	21	64/22/300	46	3606480574856	CSU795051
P139854					
	Joint to be used for rigid joining of cable ladders, bends, junctions and risers. Snap-on and fixed by bending the hooks with a screw driver. It also reduces the transition resistance and prevents the ladders from slipping apart. Material: Steel, Zinc+.				
	21	64/32/200	33	3606480574849	CSU795050
P140336	Joint 9				
	Joint to be used for straight joining of cable ladders KHZ, KHZP and KHZPS. The teeth of the joint should face downwards. Under load, the ladders are prevented from slipping apart. If the joint is above a bracket, the teeth should face upwards. Material: Steel, pre-galvanized.				
	9	52/4/200	16	7321677211159	721115

Couplings

P140337	Coupling 22				
	Coupling to be used for horizontal or vertical branches at any desired angle. M6 screws included. Material: Steel, pre-galvanized.				
	22	60/24/150	21	7321677211227	721122
P140338	Junction coupling 14				
	Junction coupling to be used for T- and X-junctions. Suitable for cable ladders KHZ, KHZP, KHZSP and KHZPS, all cable widths. M6 screws included. Material: Steel, pre-galvanized.				
	14	65/73/350	49	7321677232123	723212

Clamps

P151014	Profile clamp 42				
	Profile clamp to be used for installations where the cable ladder is to be fixed to cantilever arms, support brackets, etc. Screw M8 and nut included. Material: Steel, pre-galvanized.				
	42	55/55/30	50	3606485410326	CSU795240
P140339	Profile clamp 42 for fire resistance installations E30 - E90				
	Profile clamp fire resistant certified according to DIN 4102-12. Classification E30 - E90. Specifically to be used to fix the cable ladder KHZPS to cantilever arm 50 or support bracket H50 in fire resistant certified installation configurations. Screw M8 and nut included. Material: Steel, pre-galvanized.				
	42	55/55/30	50	3606485410319	CSU795239
P140340	Profile clamp 41				
	Profile clamp to be used to install a pendant/fixing rail or mounting plate, etc., on the cable ladder profile. Material: Steel, pre-galvanized.				
	41	125/16/30	10	7321677253630	725363

Cantilever arms

P140088	Cantilever arm 30				
	Cantilever arm for installation inside cable ladder KHZSP. Material: Steel, pre-galvanized.				
	30-200	185/184/80	90	7321677277773	727777
	30-300	185/284/80	110	7321677277780	727778
	30-400	185/384/80	120	7321677277797	727779
	30-500	185/484/80	140	7321677277803	727780
	30-600	185/584/80	160	7321677277810	727781

Pre-galvanized - Corrosion class C2

Cantilever arms

P135932



Type	Dimensions A/B/C mm	Weight kg/100 pcs	EAN code	Ref. No.
Cantilever arm 50i				
Cantilever arm to be used for mountings on walls, vertical pieces or pendant/fixing rails. Material: Steel, pre-galvanized.				
50i-200	85/250/43	29	7321677914135	791413
50i-300	110/350/43	46	7321677914142	791414
50i-400	115/450/44	83	7321677914159	791415
50i/500	130/580/50	160	3606480911354	CSU795322
50i/600	130/680/50	186	3606480911361	CSU795323

Wall and support brackets

P140341
P140342



Wall bracket 11/25 and 11/75				
Wall bracket to be used for vertical or horizontal installations of cable ladders against a wall. Maximum loads for vertical mounting: 300 kg (3 kN). For mounting against a rung the max. load is 500 kg (5 kN) for 11/25. Maximum loads for horizontal mounting: 11/25 250 kg (2.5 kN), 11/75 100 kg (1 kN). Material: Steel, pre-galvanized.				
11/25	85/71/40	24	7321677211050	721105
11/75	135/71/40	30	7321677211067	721106

P140343



Support bracket 3				
Support bracket to be used for centre installation of cable ladders on pendant/fixing rails and vertical pieces. Material: Steel, pre-galvanized.				
3-200	92/57/200	33	7321677218691	721869
3-300	92/57/300	58	7321677218707	721870
3-400	92/57/400	78	7321677218714	721871
3-500	92/57/500	120	7321677218721	721872
3-600	92/57/600	145	7321677218738	721873

P140091



Support bracket 6				
Support bracket to be used for centre installation of cable ladders KHZSP. Material: Steel, pre-galvanized.				
6-200	37/80/184	27	7321677275823	727582
6-300	37/80/284	45	7321677275830	727583
6-400	37/80/384	63	7321677275847	727584
6-500	37/80/484	81	7321677275854	727585
6-600	37/80/584	99	7321677275861	727586

Vertical pieces

P140092



Vertical piece 2Fi				
Vertical piece to be used for lighter mountings with Cantilever arm 50i and Cable ladder KHZSP. Material: Steel, pre-galvanized.				
2Fi-300	272/134/54	97	7321677927234	792723
2Fi-500	497/134/54	137	7321677927241	792724
2Fi-750	722/134/54	177	7321677927258	792725
2Fi-1000	922/134/54	225	7321677927265	792726

Pendant/Fixing rails

P140344



Pendant/Fixing rail 24/34				
Pendant/Fixing rail for mounting of support brackets, cantilever arms, etc. Material: Steel, pre-galvanized.				
24/34	293/16/42	23	7321677253579	725357
24/34	383/16/42	31	7321677253586	725358
24/34	495/16/42	40	7321677253593	725359
24/34	698/16/42	56	7321677253609	725360
24/34	990/16/42	80	7321677253616	725361
24/34	2970/16/42	240	7321677211029	721102

Pre-galvanized - Corrosion class C2

Pendant/Fixing rails

P140345



Type	Dimensions A/B/C mm 	Weight kg/100 pcs	EAN code	Ref. No.
Pendant/Fixing rail 24/48				
Pendant/Fixing rail for mounting of support brackets, cantilever arms, etc. Material: Steel, pre-galvanized.				
24/48	1000/26/48	175	3606481317858	CSU795564
24/48	2970/26/48	520	7321677317172	731717
24/48	5940/26/48	1120	7321677317219	731721

Pendant bars

P140348



Pendant bar 1				
Pendant bar to be installed in order to reduce the deflection of heavily loaded vertical pieces. Installed with T-bolt and Expansion bolt. Material: Steel, pre-galvanized.				
1-300	362/-/40	35	7321677927272	792727
1-500	568/-/40	53	7321677927289	792728
1-800	880/-/40	82	7321677927296	792729

Pendant joint

P140347
P13890

Pendant joint 2J and 2FJ				
Pendant joint to be used for joining pendant/fixing rails and vertical pieces. Screw M8x16 and nuts included. Material: Steel, pre-galvanized.				
2J	200/48/18	43	7321677211197	721119
2FJ	200/18/55	46	3606480911385	CSU795325

Ceiling brackets

P140348



Ceiling bracket 5				
Ceiling bracket to be used for installations with Pendant/Fixing rails 24/34 and 24/48. Screw not included. Material: Steel, pre-galvanized.				
5	100/135/40	35	7321677211012	721101

P140349



Ceiling bracket 5TPA				
Ceiling bracket with telescopic function, to be used for mounting of various sizes of trapezoid plates. Including screw MVBF 8x16 and nut M6MF8. Breaking load: 150 kg without deformation. Material: Steel, pre-galvanized.				
5TPA	50/76/79-118	14	7321677321773	732177

P140350



Ceiling bracket 5TP				
Ceiling bracket to be used in trapezoidal sheeting for installations of Pendant/Fixing rail 24/48. Material: Steel, pre-galvanized.				
5TP	71/35/50	12	7321677253623	725362

P140353



Ceiling bracket 2Fi				
Ceiling bracket to be used on Pendant/fixing rail 24/48 to achieve the desired length of vertical pieces. Material: Steel, pre-galvanized.				
2Fi	131/134/54	50	7321677925544	792554

Wall support

P143289
P143290

Wall support 550				
Wall support for mounting of cantilever arm on porous walls or sandwich wall blocks, with six keyholes for easy fixation. When mounting cantilever arm on support, use screw set 25S (M8). Material: Steel, pre-galvanized.				
Wall support 550 mm	20/100/550	105	3606485405476	CSU795220
Wall support 550 mm white	20/100/550	107	3606485405469	CSU795221

Pre-galvanized - Corrosion class C2

Threaded rod

Type	Dimensions A/B/C mm	Weight kg/100 pcs	EAN code	Ref. No.
Threaded rod W76				
Threaded rod to be used for installations of cable ladders and lighting trunking. Joint nuts are used for the joining of Threaded rods W76. Material: Steel, electro-galvanized.				
W76 M8-1000	M8/1000	32	7321677250790	725079
W76 M10-2000	M10/2000	100	7321677167920	716792
W76 M10-3000	M10/3000	150	7321677167937	716793
Joint nut M8	40/15/13	5.6	7321677250837	725083
Joint nut M10	40/18.5/16	7.2	7321677248063	724806
Flange nut B43				
Flange nut to be mounted onto Threaded rod W76 in order to lock it to the Support hook and the Ceiling fittings. Package of 50 pcs. Material: Steel, electro-galvanized.				
B43/M8	17/17/8	0.68	7321677888474	1149405
B43/M10	20/20/15	1.12	7332227014649	1149464
Thread lock B50				
Thread lock to be used when joining Threaded rods. Material: Steel, electro-galvanized.				
B50/M8	10/20/35	1	7332227014564	1149456
B50/M10	12/24/35	2	7332227014663	1149466

Take-off hook, end connection

Fixed take-off hook 4				
Fixed take-off hook to be used for 90° horizontal branches. Material: Aluminium.				
4	71/19/86	8	7321677090174	709017
End connection 10				
End connection to be used for the connection of a ladder vertically to a floor, or horizontally to a wall. Material: Aluminium.				
10	60/55/60	8	7321677090181	709018

Fittings for mesh trays

Combi-fittings B21				
Combi-fitting to be used when mounting mesh trays onto cable ladders. Material: Steel, electro-galvanized.				
B21	250/50/20	44	7332227011594	1149159
B21 90 degrees	120/50/135	44	7332227011914	1149191

Installation and box plates

Installation plate 61				
Installation plate to be used on vertical cable ladder installations for mounting of terminal boxes, contact breakers, etc. Material: Steel, pre-galvanized.				
61-200	310/70/200	100	7321677324866	732486
61-300	310/70/300	140	7321677324873	732487
61-400	310/70/400	170	7321677324880	732488
61-500	310/70/500	240	7321677324897	732489
61-600	310/70/600	270	7321677324903	732490
Junction box plate 35S				
Junction box plate, holed or unholed, to be installed upright or hanging from the profile. Locked with locking tabs. For junction boxes, electric light fittings, etc. Material: Steel, pre-galvanized.				
35S holed	164/20/170	22	7321677112050	711205
35S unholed	164/20/170	23	7321677302451	730245

Pre-galvanized - Corrosion class C2

Installation and box plates

Type	Dimensions A/B/C mm 	Weight kg/100 pcs	EAN code	Ref. No.
Junction box plate 35P				
Junction box plate with holes, to be installed between rungs. Locked with appropriate locking tabs for each ladder. For junction boxes, electric light fittings, etc. Material: Steel, pre-galvanized.				
35P	21/106/250	28	7321677186181	718618
Junction box plate 12xRJ45 Actassi S-One				
Junction box plate suitable for direct mounting of 12 RJ45 LexCom DPM & S-One RJ45 connectors. Delivered flat, to be bended on site. Additional optional fixation to the cable ladder beam with self-drilling screws. Material: Steel, pre-galvanized.				
12xRJ45 DPM	300/1/168	30	3606480916762	CSU795353
Box plate 62				
Box plate to be used for mounting of outlets and junction boxes on walls, ceilings or floors. Material: Steel, pre-galvanized.				
62-100	100/15/130	12	7321677834600	783460
62-200	200/15/130	24	7321677834617	783461

Outlet and junction box sets

Outlet				
Outlet, 2-way, enclosed IP44, mounted on a Junction box plate 35S. Material: Steel, pre-galvanized.				
35S	164/64/170	35	7321677342259	734225
Outlet, 2-way, unenclosed IP21, mounted on a Junction box plate 35S. Material: Steel, pre-galvanized.				
35S	164/58/170	33	7321677342266	734226
Junction box				
Junction box, IP65, mounted on a Junction box plate 35S. Material: Steel, pre-galvanized.				
35S With junction box MP	164/56/170	34	7321677319626	731962
35S With junction box UP	164/56/170	32	7321677319619	731961
Earth clamp W79				
Earth clamp to be used when protective earthing of the junction box plate is required. Material: Steel, pre-galvanized.				
W79	Screw M4/-/4.5	0.2	7321677166404	716640

Bends

90° bend 15, interior				
Interior bend piece to be fitted to the cable ladders by using Joint 21, creating a 90° bend. Inner radius 268 mm. Material: Steel, pre-galvanized.				
15-200	55/597/597	240	7321677230617	723061
15-300	55/697/697	290	7321677230624	723062
15-400	55/797/797	340	7321677230631	723063
15-500	55/897/897	390	7321677230648	723064
15-600	55/997/997	440	7321677230655	723065

Tele-conduits

Tele-conduit 36				
Tele-conduit to be used where a separate tray is required for low-tension cables. Knock-out holes in the bottom of the channel permit the cables to pass through. Material: Steel, pre-galvanized.				
36-50	24/50/2000	94	7321677250653	725065
36-100	24/100/2000	142	7321677250660	725066
36-200	24/200/2000	238	7321677250677	725067

Pre-galvanized - Corrosion class C2

Dividers

	Type	Dimensions A/B/C mm	Weight kg/100 pcs	EAN code	Ref. No.
P140356	Dividing strip 39				
	Dividing strip to be used to separate low-tension and high-tension cables. Material: Steel, pre-galvanized.				
	39/24	24/24/1750	46	7321677188352	718835
	39/55	55/24/1750	73	7321677257850	725785
P140044	Distance piece W39				
	Distance piece to be used for the joining of Dividing strips 39. Material: Plastic, natural coloured.				
	W39	37/-/330	3	7321677168248	716824

Covers/Cover plates

P140357	Cover W5				
	Cover to be used to protect the cable runs from dust, dirt, liquids, etc. Outdoors, it protects against rain and sun. Suitable for all cable ladders. Material: Steel, pre-galvanized.				
	W5-70	11/73/2000	100	7321677322145	732214
	W5-100	11/103/2000	140	7321677322152	732215
	W5-150	11/153/2000	190	7321677322169	732216
	W5-200	11/203/2000	250	7321677322176	732217
	W5-300	11/303/2000	360	7321677322183	732218
	W5-400	11/403/2000	680	7321677322190	732219
	W5-500	11/503/2000	840	7321677322206	732220
	W5-600	11/603/2000	700	7321677322213	732221
P140359	Cover 90° interior bend				
	Cover to be used for 90° interior bends. To be installed with a Profile support piece 37, Cover clamp and Cover joint. Material: Steel, pre-galvanized.				
	150	10/420/420	65	7321677323227	732322
	200	10/470/470	91	7321677323234	732323
	300	10/570/570	143	7321677323241	732324
	400	10/670/670	221	7321677323258	732325
	500	10/770/770	299	7321677323265	732326
	600	10/870/870	390	7321677323272	732327
	800	10/1070/1070	460	7321677818020	781802
1000	10/1270/1270	871	7321677323289	732328	
P140359	Cover T-junction				
	Cover to be used for T-junctions. To be installed with a Profile support piece 37, Cover clamp and Cover joint. Material: Steel, pre-galvanized.				
	150	11/400/651	182	7321677323456	732345
	200	11/450/701	221	7321677323463	732346
	300	11/550/801	312	7321677323470	732347
	400	11/650/901	416	7321677323487	732348
	500	11/750/1001	533	7321677323494	732349
	600	11/850/1101	676	7321677323500	732350
	800	11/1050/1301	710	7321677818037	781803
1000	11/1240/1501	1352	7321677323517	732351	
P140360	Profile support piece 37				
	Profile support piece to be used when installing covers. To be mounted on approximately every 0.5 m along both sides of the cable ladder. Used together with cover clamp for locking covers. Material: Steel, pre-galvanized.				
	37	136/20/50	6	7321677292172	729217
P140361	Cover clamp				
	Cover clamps to be used when installing a cover on a Profile support piece 37. Material: Steel, Zink+.				
	Cover clamp	32/10.5/20	1.5	3606489699413	CSU795598

Pre-galvanized - Corrosion class C2

Covers/Cover plates

Type	Dimensions A/B/C mm		Weight kg/100 pcs	EAN code	Ref. No.
Cover joint					
Cover joint to be inserted between covers. Material: Steel, pre-galvanized.					
150	4/100/125		10	7321677126392	712639
200	4/100/175		20	7321677126408	712640
300	4/100/275		30	7321677126422	712642
400	4/100/375		40	7321677126439	712643
500	4/100/475		50	7321677126446	712644
600	4/100/575		60	7321677126453	712645
Protecting cover					
Cover to be used to protect the cable runs against ice and snow. Suitable for all cable ladder widths 300 and 400 respectively. Material: Steel, pre-galvanized.					
300	280/300/1000		880	7321677867387	786738
400	280/400/1000		990	7321677867394	786739
Cover plate 65					
Cover plate to be used on vertical cable ladder installations as protection of cables near the floor. To be mounted in the side profile with self-tapping screw ST4.2. B223191 Material: Steel, pre-galvanized.					
65-200	1000/120/200		930	7321677324750	732475
65-300	1000/120/300		1140	7321677324767	732476
65-400	1000/120/400		1350	7321677324774	732477
65-500	1000/120/500		1560	7321677324781	732478
65-600	1000/120/600		1780	7321677324798	732479

Angle plates





Angle plate 33					
Angle plate to be used together with 90° horizontal T-junctions. Recommended for all cable ladders. Material: Steel, pre-galvanized.					
33/1	28/150/290		50	7321677687336	768733
33/2	25/195/490		90	7321677211142	721114

Clamps ARX with accessories



Cable clamp type ARX1					
Cable clamp for fastening of one cable on Pendant/Fixing rail 24/48 and on cable ladders KHZ, KHZV, KHZSP, KHZSPZ+, KHZSP85, KHZPS, KHZP and KHZPV, in combination with Insert piece EM. Material: Steel, Zink+.					
CABLE CLAMP ARX1-12 Z+	45/17/30		5.5	3606489726966	CSU795600
CABLE CLAMP ARX1-16 Z+	49/21/30		6.3	3606489726973	CSU795601
CABLE CLAMP ARX1-22 Z+	55/27/30		7.4	3606489726980	CSU795602
CABLE CLAMP ARX1-28 Z+	61/33/30		8.5	3606489726997	CSU795603
CABLE CLAMP ARX1-36 Z+	69/41/30		11.1	3606489727000	CSU795604
CABLE CLAMP ARX1-44 Z+	77/49/30		12.7	3606489727017	CSU795605
CABLE CLAMP ARX1-52 Z+	85/57/30		14.2	3606489727024	CSU795606
CABLE CLAMP ARX1-60 Z+	93/65/30		15.5	3606489727031	CSU795607
CABLE CLAMP ARX1-70 Z+	105/75/30		18.4	3606489727048	CSU795608
Cable clamp type ARX2					
Cable clamp for fastening of two cables on Pendant/Fixing rail 24/48 and on cable ladders KHZ, KHZV, KHZSP, KHZSPZ+, KHZSP85, KHZPS, KHZP and KHZPV, in combination with Insert piece EM. Material: Steel, Zink+.					
CABLE CLAMP ARX2-12 Z+	58/17/30		6.8	3606489727055	CSU795609
CABLE CLAMP ARX2-16 Z+	66/21/30		7.9	3606489727062	CSU795610
CABLE CLAMP ARX2-22 Z+	78/27/30		9.6	3606489727079	CSU795611
CABLE CLAMP ARX2-28 Z+	90/33/30		11.3	3606489727086	CSU795612
CABLE CLAMP ARX2-36 Z+	106/41/30		14.5	3606489727093	CSU795613
CABLE CLAMP ARX2-44 Z+	122/49/30		17.0	3606489727109	CSU795614
CABLE CLAMP ARX2-52 Z+	138/57/30		19.2	3606489727116	CSU795615
CABLE CLAMP ARX2-60 Z+	154/65/30		21.4	3606489727123	CSU795616

Pre-galvanized - Corrosion class C2

Clamps ARX accessories

Type	Dimensions A/B/C mm 	Weight kg/100 pcs	EAN code	Ref. No.	
Insert piece EM					
Insert piece to be used in order to prevent pressure on the cable. The insert piece is placed between the cable and the rung from the same side where the clamp has been fastened to the rung. Material: PE.					
	EM-12 for cable -12	5/15/39	0.2	7321677090501	709050
	EM-16 for cable 13-16	5/19/39	0.2	7321677090518	709051
	EM-22 for cable 17-22	5/25/39	0.3	7321677090525	709052
	EM-28 for cable 23-28	5/31/39	0,3	7321677090532	709053
	EM-36 for cable 29-36	5/39/39	0.5	7321677090549	709054
	EM-44 for cable 37-44	5/46/39	0.7	7321677090556	709055
	EM-52 for cable 45-52	5/55/39	0.8	7321677090563	709056
	EM-60 for cable 53-60	5/62/39	0.9	7321677090570	709057
	EM-70 for cable 61-70	5/72/39	1.0	7321677090587	709058
Lashing wire					
Lashing wire to be used for lashing of wires on cable ladders. Material: Stainless steel, PVC.					
	HTR-2303, white PVC	Ø1.25	1.3/100 m	7321677136865	713686
	HTR-2313, black PVC	Ø1.25	1.3/100 m	7321677136872	713687
Lashing wire to be used for lashing of wires on cable ladders. Material: PVC.					
	HT-2304, white	Ø1.5	1.8/100 m	7321677136841	713684
	HT-2314, black	Ø1.5	1.8/100 m	7321677136858	713685

Installation system HT

Carrying sling HT-51					
Carrying sling for cables, to be used in combination with steel wires. Material: Steel, pre-galvanized.					
	HT-51	65/15/49	6	7321677136766	713676
Carrying bracket HT-33/34					
Carrying bracket to be used for ceiling installations. To be installed with Expansion bolt or concrete screw. Material: Steel, pre-galvanized.					
	HT-33	19.5/15/25	1	7321677136742	713674
	HT-34	43.5/15/25	2	7321677136759	713675
Steel wire					
Steel wire to be installed as carrier of one or more cables. Breaking loads, see below. Material: Available in several qualities.					
	HT-2309, galvanized, soft, breaking load 700 kg	Ø5.0	15.5/100 m	7321677136797	713679
	HT-2311, 7x diam. 1.71=16 mm ² coated, grey, breaking load 970 kg	Ø6.15	13.5/100 m	7321677136889	713688
	HTR-2322 stainless, hard, breaking load 450 kg	Ø2.5	3.9/100 m	7321677136810	713681
	HTR-2323 stainless, hard, breaking load 700 kg	Ø3.0	5.6/100 m	7321677136827	713682
	HTR-2324 stainless, hard, breaking load 1200 kg	Ø4.0	10.0/100 m	7321677136834	713683

Profile protection

Profile protection 28P					
Profile protection to be used to increase the contact surface of the cables, when pulled over the side profile of the ladder. Material: PVC, grey.					
	28P	60/28/2000	80	7321677321513	732151

Pre-galvanized - Corrosion class C2

End plugs

		End plug 28/28i				
		End plug to be mounted on ladder ends for sealing or protection. Material: PP/TPE.				
P140064		28, red	59/25/22	0.8	7321677090198	709019
P140065 P140066		28i, white 28i, red	54/14/19	0.4	7321677354467 7321677319947	735446 731994
		End plug 28C, D, E, F and J				
		End plug to be mounted on pendant ends to provide protection against personal injury and to make the ends of the profiles more conspicuous. Material: PP/TPE, orange.				
P140067		28C for Vertical piece 2 and Pendant/fixing rail 24/34	25/19/46	0.5	7321677898756	789875
P140068		28D for Vertical piece 20 and Pendant/fixing rail 24/20	25/52/58	1	7321677090204	709020
P140069		28E for Vertical piece 2F and pendant/fixing rail 24/48 and CLX ³ pendant fixing rail 24/48	24/30/52	0.5	7321677090211	709021
P140070		28F for Vertical piece 20FS and Pendant/fixing rail 24/20FS	30/53/110	4	7321677898763	789876
P138768		28J for Vertical piece 20F and Pendant/Fixing rail 24/20F	27/53/95	2.1	3606480457531	CSU794520
		Cross member plug 27				
		Cross member plug to be installed at the ends of the rungs of KHZ and KHZV. Used in premises with a high corrosion risk. Material: PE, grey.				
P140071		27	Ø20/10	0.15	7321677266685	726668

Screws and bolts

		Type	Dimensions A/B/C mm	Weight kg/100 pcs	EAN code	Ref. No.
		T-bolt 26U				
		T-bolt to be used for mounting with all vertical pieces except Vertical piece 2 and with Pendant/fixing rail 24/48. Material: Steel, hot-dip galvanized.				
P140156		26U M8 x30	44/50/18	6.8	3606489579777	CSU795595
		26U M10 x30	44/50/18	6.8	3606489579715	CSU795589
		Screw set W34				
		Screw set to be used for fastening of dividing strips on cable ladders KHZSP, KHZSP+, KHZPS, KHZP and KHZPV. Set including screw MSCS 6x12 and nut M6MF 6. Package of 100 pcs. Material: Steel, electro-galvanized.				
P140156		W34	10/10/16	0.8	7321677184736	718473

Marking plate

		Marking plate 93				
		Marking plates are part of a colour marking system that is easy to use when you want to mark out the type of cable that is placed on the cable ladder. Five different colours are available. Material: Sheet steel.				
B223240		93, yellow	103/0.7/100	5	7321677377046	737704
		93, orange	103/0.7/100	5	7321677377053	737705
		93, blue	103/0.7/100	5	7321677377060	737706
		93, green	103/0.7/100	5	7321677377077	737707
		93, black	103/0.7/100	5	7321677377084	737708
		Marking label, equipotential				
		Label to be used to show that a construction is equipotentially bonded. Available in Swedish (other languages on request). Printed on self-adhesive yellow vinyl, 250 labels per roll. Material: Self-adhesive vinyl.				
P135944		Marking label	25/-/86	-	7321677868605	786860

Reliable, functional and flexible. CLX3 is optimized to deliver for a range of applications.



Central cable ladder support

- Occupies minimum space below the ladder. This is beneficial especially when space beneath the cable routing track is limited.
- Developed on the well established Central Suspension Bracket 6 platform.
- The smooth and rounded design helps prevent damage to cables.



Cantilever arm support

- Slim design to minimize occupied space.
- Integrated click for both Cable ladder and Defem mesh tray in the same product.
- Boltless fixation to the rail



CLX³ Suspension system - Corrosion class C2

Vertical piece

Type	Dimensions A/B/C mm 	Weight kg/100 pcs	EAN code	Ref. No.
CLX³ pendant 24/48				
Vertical piece/pendant to be used for ceiling suspended mounting. Perforated pattern to be used with CLX ³ cantilever arm or CLX ³ central suspension adapter. Open side can be used with T-bolt. Material: Steel, pre-galvanized.				
CLX ³ pendant-300	295/145/53	90.6	3606489904937	CSU795632
CLX ³ pendant-400	395/145/53	107.5	3606489904944	CSU795633
CLX ³ pendant-500	495/145/53	124.4	3606489904951	CSU795634
CLX ³ pendant-700	695/145/53	158.1	3606489904968	CSU795635
CLX ³ pendant-1000	995/145/53	208.7	3606489904975	CSU795636
CLX ³ pendant-1500	1495/145/53	294.2	3606481828323	CSU795638
CLX³ pendant rail 24/48				
Pendant rail to be used for direct wall mounting or for vertical piece/pendants extensions. To be connected to the vertical piece/pendant together with the pendant joint CSU795325. Perforated pattern to be used with CLX ³ cantilever arm. Open side can be used with T-bolt. Material: Steel, pre-galvanized.				
CLX ³ rail 24/48 300	280/48/26	47.2	3606481828330	CSU795640
CLX ³ rail 24/48 1000	980/48/26	165.1	3606481828347	CSU795641
CLX ³ rail 24/48 3000	2980/48/26	502	3606489904982	CSU795637

Adjustable ceiling plate

Type	Dimensions A/B/C mm	Weight kg/100 pcs	EAN code	Ref. No.
CLX³ adjustable ceiling plate				
Adjustable ceiling plate. To be used for angular adjustment of pendant vs ceiling. Adjustment between 0-25°. Adjustable ceiling plate is to be mounted to the CLX ³ pendant. To be assembled with 4 screw set 22S (713694), need to be ordered separately. Tightening force of the screw set minimum torque 20 N.m. Material: Steel, pre-galvanized.				
CLX ³ adjustable ceiling plate	150/100/59	49.8	3606489904999	CSU795639

Cantilever arms

Type	Dimensions A/B/C mm	Weight kg/100 pcs	EAN code	Ref. No.
CLX³ Cantilever arm				
Cantilever arm to be used for mounting on vertical pieces or pendant/fixing rails. The cantilever arm is designed for fast click fixation of ladder type KHZSP, Defem mesh tray height 60/110 and Stago tray KG281/KB184/KB284 height 60. Stago trays need to be fastened with the fast fixing clamp (CSU08490100). Material: Steel, pre-galvanized.				
CLX ³ cantilever arm 200	62/280/49	42.8	3606489905026	CSU795647
CLX ³ cantilever arm 300	62/380/49	60.5	3606489905033	CSU795648
CLX ³ cantilever arm 400	92/480/49	90.9	3606489905040	CSU795649
CLX ³ cantilever arm 500	92/580/49	106.6	3606489905057	CSU795650
CLX ³ cantilever arm 600	92/680/49	119.7	3606489905064	CSU795651

Central suspensions

Type	Dimensions A/B/C mm	Weight kg/100 pcs	EAN code	Ref. No.
CLX³ central suspension bracket, ladder KHZSP				
Central suspension bracket be used for mounting Wibe cable ladders type KHZSP on vertical pieces. The central suspension bracket shall first be assembled together with the CLX ³ central suspension adapter (CSU795700) to be able to click in the perforation pattern on the vertical piece. Material: Steel, pre-galvanized.				
200	37/78/185	33.4	3606489905101	CSU795655
300	37/78/285	53.1	3606489905118	CSU795656
400	37/78/385	72	3606489905125	CSU795657
500	37/78/485	90.1	3606489905132	CSU795658
600	37/78/585	109	3606489905149	CSU795659

Type	Dimensions A/B/C mm	Weight kg/100 pcs	EAN code	Ref. No.
CLX³ central suspension adapter				
Central suspension adapter to be first clicked to a CLX ³ central suspension bracket of choice. The adaptor fits to all types of CLX ³ central suspension brackets; ladder, tray and mesh. In a second step the adaptor with the central suspension bracket mounted is clicked in the perforation pattern in the rail or the pendant. Material: Steel, pre-galvanized.				
CLX ³ CSB adapter	166/31/39	17.7	3606489905248	CSU795700

Wall bracket

Type	Dimensions A/B/C mm	Weight kg/100 pcs	EAN code	Ref. No.
Wall bracket for CLX³ cantilevers.				
To be used for direct fixation to wall. Single bolt fixation in keyhole, alternatively multi-bolt fixation in lateral holes for softer walls. Bolts are not included. Material: Steel, pre-galvanized.				
Wall bracket for CLX ³ cantilevers	163/101/26	34	7321677958047	CSU795804

Pre-galvanized - Corrosion class C2

Tools

PI28977



Cable roller S

Cable roller used to facilitate the pulling of cables and lines. Easily installed on all Wibe cable ladders except the high-sided WHS ladders (outer mounting hole). Also suitable for external/internal profiles of all 90° bends, T-junctions, X-junctions and risers (inner mounting hole). With a height adjustment of 45 mm to leave room for cables to pass under the roller.
Material: Steel, electro-galvanized.

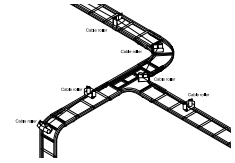

S	230/80/204	230	7321677186600	718660
---	------------	-----	---------------	---------------

PI43449



Cable roller 38 Rig'n roll

Cable roller used for mounting on Wibe cable ladders with belonging junctions and branches.
Material: Stainless steel AISI316L (cable roller).

38 Rig'n roll	220/50/130	48	7321677359981	735998
---------------	------------	----	---------------	---------------

PI48452



Bag	375/160/460	230	7321677801862	780186
-----	-------------	-----	---------------	---------------

Set 66 (1 bag + 10 Cable rollers roll)	375/160/460	710	7321677801879	780187
--	-------------	-----	---------------	---------------

Demo kit

Wibe ladder demo kit consisting of: KHZ 150 HDG L=0,35m, KHZP 150 HDG L=0,35m, KHZSP 200 pre-galv L=0,35m, cantilever arm 50 150 HDG, cantilever arm 50i 200, joint 21 click, coupler 22 HDG, VP 2F /280, end plug 28E, end plug 28, end plug 28i, T-bolt M10-30 HDG, profile clamp 42 HDG, wall bracket 11/25, angle bracket 5L, take off hook 4.
Material: Steel

Wibe Ladder Demo Kit	290/375/580	640	3606480738401	CSU795180
----------------------	-------------	-----	---------------	------------------

Demo kit, length material

Wibe ladder length material demo kit consisting of: KHZ 150 HDG, KHZP 150 HDG, KHZSP 200 pre-galv, KHZSP 200 thermoplastic, KHZ 150 zinkpox, KHZSP 200 316L, KHZP 150 316L. Lengths = 0,35 m each.
Material: Steel

Wibe Ladder Demo kit Length Material	290/375/580	640	3606480738418	CSU795181
--------------------------------------	-------------	-----	---------------	------------------

Zink+ - Corrosion class C3, C4

Cable ladders

P1390619



Type	Dimensions A/B/C mm	Weight kg/100 m	EAN code	Ref. No.
Cable ladders KHZSPZ+				
Cable ladder for indoor or outdoor industrial applications. With open side profiles and profile-shaped rungs. Must not be used as walkway. Material: Steel, Zink+				
KHZSPZ+-200	55/198/4000	198	3606480692802	CSU795122
	55/198/6000		3606480692819	CSU795127
KHZSPZ+-300	55/298/4000	217	3606480692826	CSU795123
	55/298/6000		3606480692833	CSU795128
KHZSPZ+-400	55/398/4000	237	3606480692840	CSU795124
	55/398/6000		3606480692857	CSU795129
KHZSPZ+-500	55/498/4000	257	3606480692864	CSU795125
	55/498/6000		3606480692871	CSU795130
KHZSPZ+-600	55/598/4000	277	3606480692888	CSU795126
	55/598/6000		3606480692895	CSU795131

Dimension table

B223678

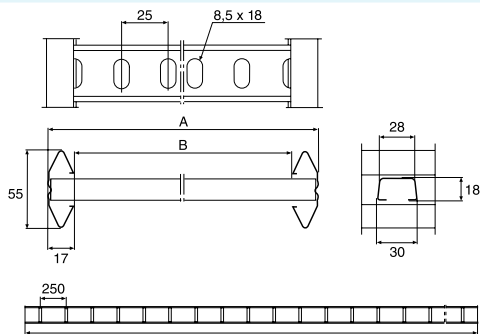

Type	A mm	B mm	L mm	Ref. No.
KHZSPZ+-200	198	164	4000	CSU795122
			6000	CSU795127
KHZSPZ+-300	298	264	4000	CSU795123
			6000	CSU795128
KHZSPZ+-400	398	364	4000	CSU795124
			6000	CSU795129
KHZSPZ+-500	498	464	4000	CSU795125
			6000	CSU795130
KHZSPZ+-600	598	564	4000	CSU795126
			6000	CSU795131

L

Hot Dip-galvanized - Corrosion class C3, C4

Cable ladders

P139826



Type	Dimensions A/B/C mm	Weight kg/100 m	EAN code	Ref. No.
Cable ladders KHZP				
Cable ladder for indoor or outdoor industrial applications. With closed side profiles and profile-shaped rungs. Must not be used as walkway. Material: Steel, hot-dip galvanized.				
KHZP-150	55/147/3000 55/147/6000	260	7321677835164 7321677185627	783516 718562
KHZP-200	55/197/3000 55/197/6000	270	7321677835171 7321677185634	783517 718563
KHZP-300	55/297/3000 55/297/6000	290	7321677835188 7321677185641	783518 718564
KHZP-400	55/397/3000 55/397/6000	315	7321677835195 7321677185658	783519 718565
KHZP-500	55/497/3000 55/497/6000	340	7321677835201 7321677185665	783520 718566
KHZP-600	55/597/3000 55/597/6000	360	7321677835218 7321677185672	783521 718567
KHZP-800	55/797/3000 55/797/6000	490	7321677835225 7321677219605	783522 721960
KHZP-1000	55/997/3000 55/997/6000	560	3606480535598 7321677185689	783523 718568

Dimension table

B22677

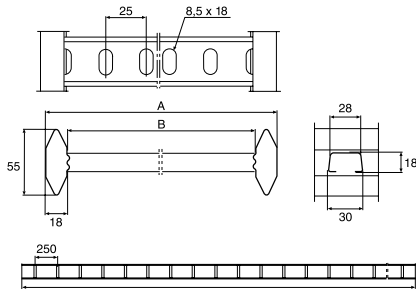

Type	A mm	B mm	L mm	Ref. No.
KHZP-150	147	111	3000 6000	783516 718562
KHZP-200	197	161	3000 6000	783517 718563
KHZP-300	297	261	3000 6000	783518 718564
KHZP-400	397	361	3000 6000	783519 718565
KHZP-500	497	461	3000 6000	783520 718566
KHZP-600	597	561	3000 6000	783521 718567
KHZP-800	797	761	3000 6000	783522 721960
KHZP-1000	997	961	3000 6000	783523 718568

Hot Dip-galvanized - Corrosion class C3, C4

Cable ladders

Type	Dimensions A/B/C mm	Weight kg/100 m	EAN code	Ref. No.
Cable ladders KHZ				
Cable ladder for indoor or outdoor industrial applications. With closed side profiles and round rungs. Must not be used as walkway. Material: Steel, hot-dip galvanized.				
KHZ-150	55/147/6000	270	7321677680016	768001
KHZ-200	55/197/6000	280	7321677680023	768002
KHZ-300	55/297/6000	300	7321677680047	768004
KHZ-400	55/397/6000	320	7321677680054	768005
KHZ-500	55/497/6000	340	7321677680061	768006
KHZ-600	55/597/6000	360	7321677680078	768007
Cable ladder for indoor or outdoor industrial applications. With closed side profiles and round rungs that do not penetrate the outer side of the side profile. Must not be used as walkway. Material: Steel, hot-dip galvanized.				
KHZ-150	55/147/6000	270	7321677264162	726416
KHZ-200	55/197/6000	280	7321677264179	726417
KHZ-300	55/297/6000	300	7321677264193	726419
KHZ-400	55/397/6000	320	7321677264209	726420
KHZ-500	55/497/6000	340	7321677264216	726421
KHZ-600	44/597/6000	360	7321677264223	726422



Dimension table	Type	A mm	B mm	L mm	Ref. No.
	KHZ-150	147	111	6000	768001 726416
	KHZ-200	197	161	6000	768002 726416
	KHZ-300	297	261	6000	768004 726419
	KHZ-400	397	361	6000	768005 726420
	KHZ-500	497	461	6000	768006 726421
	KHZ-600	597	561	6000	768007 726422

L

Hot Dip-galvanized - Corrosion class C3, C4

Cable ladders

P139645

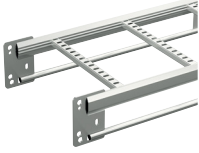

Type	Dimensions A/B/C mm	Weight kg/100 m	EAN code	Ref. No.
------	---------------------	-----------------	----------	----------

Cable ladders KHZPV

Reinforced cable ladder for indoor or outdoor industrial applications. Designed for extreme support distances and loadings. With closed side profiles and profile-shaped rungs. Must not be used as walkway. Material: Steel, hot-dip galvanized.

KHZPV-200	134/197/6000	426	7321677179824	717982
KHZPV-300	134/297/6000	448	7321677179831	717983
KHZPV-400	134/397/6000	470	7321677179848	717984
KHZPV-500	134/497/6000	493	7321677179855	717985
KHZPV-600	134/597/6000	515	7321677179862	717986
KHZPV-1000	134/997/6000	703	7321677164004	716400

P139651



Cable ladders KHZV

Reinforced cable ladder for indoor or outdoor industrial applications. Designed for extreme support distances and loadings. With closed side profiles and round rungs. Must not be used as walkway. Material: Steel, hot-dip galvanized.

KHZV-200	134/197/6000	440	7321677120154	712015
KHZV-300	134/297/6000	460	7321677120178	712017
KHZV-400	134/397/6000	480	7321677120192	712019
KHZV-500	134/497/6000	500	7321677120185	712018
KHZV-600	134/597/6000	530	7321677120208	712020

Dimension table

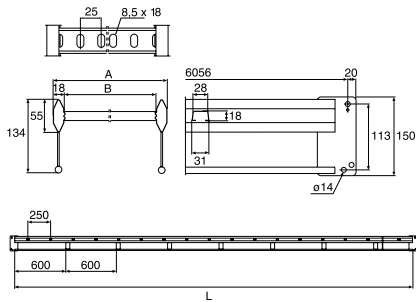

Type	A mm	B mm	L mm	Ref. No.
KHZPV-200	197	161	6000	717982
KHZPV-300	297	261	6000	717983
KHZPV-400	397	361	6000	717984
KHZPV-500	497	461	6000	717985
KHZPV-600	597	561	6000	717986
KHZPV-1000	997	961	6000	716400

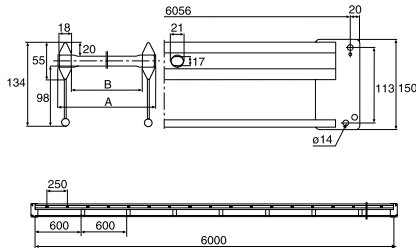

KHZV-200	197	161	6000	712015
KHZV-300	297	261	6000	712017
KHZV-400	397	361	6000	712019
KHZV-500	497	461	6000	712018
KHZV-600	597	561	6000	712020

Hot Dip-galvanized - Corrosion class C3, C4

Cable ladders

P-143717



Type	Dimensions A/B/C mm	Weight kg/100 m	EAN code	Ref. No.
Cable ladders KHZP 20C				
Reinforced cable ladder for indoor or outdoor industrial applications. Designed for extreme support distances and loadings. Fullfills NEMA 20C classification. With closed side profiles and profile-shaped rungs. Must not be used as a connection walkway. Material: Steel, hot-dip galvanized.				
KHZP 20C-200	190/200/6100	867	3606480739224	CSU795138
KHZP 20C-300	190/300/6100	900	3606480739231	CSU795139
KHZP 20C-400	190/400/6100	933	3606480739248	CSU795140
KHZP 20C-500	190/500/6100	967	3606480739255	CSU795141
KHZP 20C-600	190/600/6100	1000	3606480739262	CSU795142
KHZP 20C-800	190/600/6100	1033	3606480739279	CSU795143
KHZP 20C-1000	190/1000/6100	1067	3606480739286	CSU795144



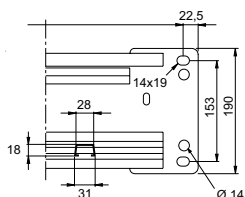
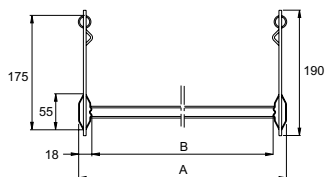
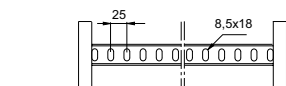

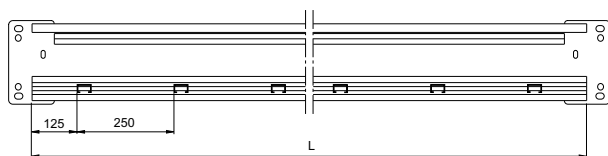

Dimension table



Type	A mm	B mm	L mm	Ref. No.
KHZP 20C-200	197	161	6000	CSU795138
KHZP 20C-300	297	261	6000	CSU795139
KHZP 20C-400	397	361	6000	CSU795140
KHZP 20C-500	497	461	6000	CSU795141
KHZP 20C-600	597	561	6000	CSU795142
KHZP 20C-800	797	761	6000	CSU795143
KHZP 20C-1000	997	961	6000	CSU795144



Hot Dip-galvanized - Corrosion class C3, C4

Joints					
Type	Dimensions A/B/C mm		Weight kg/100 pcs	EAN code	Ref. No.
Joint 21					
P140020 	Joint to be used for straight, rigid joining of cable ladders, bends, junctions and risers. It also reduces the transition resistance and prevents the ladders from slipping apart. M6 screws included. Material: Steel, hot-dip galvanized.				
21	64/22/300		46	7321677911998	791199
P140020 	Joint to be used for rigid joining of cable ladders, bends, junctions and risers. Snap-on and fixed by two screws. It also reduces the transition resistance and prevents the ladders from slipping apart. M6 screws included. Material: Steel, Zinc+.				
21Zinc+	64/22/300		46	3606480574856	CSU795051
P139954 	Joint to be used for rigid joining of cable ladders, bends, junctions and risers. Snap-on and fixed by bending the hooks with a screw driver. It also reduces the transition resistance and prevents the ladders from slipping apart. Material: Steel, Zinc+.				
21Zinc+	64/32/200		33	3606480574849	CSU795050
Joint 9					
P139917 	Joint to be used for straight joining of cable ladders KHZ, KHZP and KHZPS. The teeth of the joint should face downwards. Under load, the ladders are prevented from slipping apart. If the joint is above a bracket, the teeth should face upwards. Material: Steel, hot-dip galvanized.				
9	52/4/200		16	7321677053049	705304
Dropper joint 32					
P139918 	Dropper joint used to form vertical branches in centre position under/on top of cable ladders. Screw M6 included. Material: Steel, hot-dip galvanized.				
32	130/22/200		75	7321677347131	734713
Joint 45					
P139919 	Joint to be fitted as a joining plate in a cut KHZV/KHZPV ladder. Screws M8 and M12 + nuts are included. Material: Steel, hot-dip galvanized.				
45	150/4/95		50	7321677076093	707609

Hot Dip-galvanized - Corrosion class C3, C4

Couplings

Type	Dimensions A/B/C mm		Weight kg/100 pcs	EAN code	Ref. No.
Coupling 22					
Coupling to be used for horizontal or vertical branches at any desired angle. M6 screws included. Material: Steel, hot-dip galvanized.					
22	60/24/150		21	7321677184095	718409
Junction coupling 14					
Junction coupling to be used for T- and X-junctions. Suitable for cable ladders KHZ, KHZP, KHZSP and KHZPS, all cable widths. M6 screws included. Material: Steel, hot-dip galvanized.					
14	65/73/350		49	7321677250967	725096
Coupling 44					
Coupling to be used for horizontal coupling of cable ladders KHZV/KHZPV. Also to be used for branches and as an end connection against a wall. Four screws M8x30 and nuts are included. Material: Steel, hot-dip galvanized.					
44	135/-/120		50	7321677208159	720815
Horizontal coupling for bending 20C					
Coupling to be used for horizontal connection of cable ladders KHZP 20C range. Also to be used for branches and as an end connection against a wall. Four screws M8x30 and nuts are included. Material: Steel, hot-dip galvanized.					
For Bending 20C	180/15/120		55	3606480739583	CSU795210
Horizontal coupling 20C					
Coupling to be used for horizontal connection of cable ladders KHZP 20C range. Four screws M8x30 and nuts are included. Material: Steel, hot-dip galvanized.					
20C	180/15/120		94	3606480739590	CSU795211
Coupling 51					
Coupling to be used as a self-supporting vertical coupling of cable ladders KHZV/KHZPV. Two screws M12 and nuts are included. Material: Steel, hot-dip galvanized.					
51	150/-/193+138		150	7321677318377	731837
Vertical coupling					
Coupling to be used as a self-supporting vertical coupling of cable ladders KHZP 20C range. Adjustable from 10° to 90° gradually in steps of 20°. Two screws M12 and nuts are included. Material: Steel, hot-dip galvanized.					
20C	190/4/250		221	3606480739538	CSU795205

Clamps, support piece

Profile clamp 42					
Profile clamp to be used for installations where the cable ladder is to be fixed to cantilever arms, support brackets, etc. Screw M8 and nut included. Material: Steel, hot-dip galvanized.					
42	55/55/30		56	3606485410340	CSU795242
Profile clamp 42 Zinc+					
Profile clamp to be used for installations where the cable ladder is to be fixed to cantilever arms, support brackets, etc. Screw M8 and nut included. Material: Steel, Zinc+.					
42 Zinc+	55/55/30		56	3606485410333	CSU795241
Profile clamp 43					
Profile clamp to be used for installations where the cable ladders KHZV and KHZPV are to be fixed to cantilever arms, support brackets, etc. Screw M8 and nut included. Material: Steel, hot-dip galvanized.					
43	21/43/30		5	7321677075119	707511

Hot Dip-galvanized - Corrosion class C3, C4

Clamps, support piece

Type	Dimensions A/B/C mm 	Weight kg/100 pcs	EAN code	Ref. No.
Clamp 12				
Clamp to be used on the side profile of the cable ladder for installation of accessories. Bolt and nut included. Material: Steel, hot-dip galvanized.				
12/70	125/25/40	19	7321677286539	728653
12/120	175/25/40	24	7321677286546	728654
Profile clamp 20C				
Profile clamp for KHZP 20 range to be used for installations where the cable ladder is to be fixed to cantilever arms, I-beams, etc. Material: Steel, hot-dip galvanized.				
20C	190/57/40	26	3606480739521	CSU795168
Profile clamp 41				
Profile clamp to be used to install a pendant/fixing rail or mounting plate, etc., on the cable ladder profile. Material: Steel, hot-dip galvanized.				
41	125/16/30	10	7321677208241	720824
Profile support piece 46				
Profile support piece to be fitted between the ladder and the vault pipe when a support bracket is positioned between existing profile support pieces. For cable ladders KHZV and KHZPV. Material: Steel, hot-dip galvanized.				
46	72/18/30	15	7321677080014	708001

Cantilever arms

Cantilever arm 50i				
Cantilever arm to be used for lighter mountings on walls, vertical pieces or pendant/fixing rails. Material: Steel, hot dip galvanized..				
50i/100	120/180/40	42	3606480911293	CSU795316
50i/200	120/280/40	55	3606480911309	CSU795317
50i/300	120/380/40	68	3606480911316	CSU795318
50i/400	142/480/40	86	3606480911323	CSU795319
50i/500	130/580/50	160	3606480911330	CSU795320
50i/600	130/680/50	186	3606480911347	CSU795321
Cantilever arm 50 and 50F				
Cantilever arm for mounting on walls, pendant/fixing rails or vertical pieces. Material: Steel, hot-dip galvanized.				
50-100	85/150/40	24	7321677234325	723432
50-150	85/200/40	28	7321677234332	723433
50-200	85/250/40	34	7321677234349	723434
50-250	105/300/40	52	7321677234356	723435
50-300	105/350/40	60	7321677234363	723436
50-400	120/450/50	228	7321677234370	723437
50-500	140/550/50	172	7321677234387	723438
50-600	150/650/50	215	7321677234394	723439
50-700	150/750/50	270	7321677271252	727125
50-800	160/850/50	310	7321677271269	727126
50-900	160/950/50	350	7321677271276	727127
50-1000	170/1050/50	390	7321677271283	727128
50F-200	148/245/50	95	7321677186242	718624
50F-300	175/345/50	125	7321677186259	718625
50F-400	175/445/50	170	7321677186266	718626
50F-500	180/547/50	220	7321677186273	718627
50F-600	180/647/50	250	7321677186280	718628
50F-1000	240/1052/60	770	7321677124657	712465

Hot Dip-galvanized - Corrosion class C3, C4

Wall and support brackets

Type	Dimensions A/B/C mm		Weight kg/100 pcs	EAN code	Ref. No.
Support bracket 3					
Support bracket to be used for centre installation of cable ladders on pendant/fixing rails and vertical pieces. Material: Steel, hot-dip galvanized.					
3-150	92/57/150		26	7321677207619	720761
3-200	92/57/200		33	7321677207626	720762
3-300	92/57/300		58	7321677207633	720763
3-400	92/57/400		78	7321677207640	720764
3-500	92/57/500		120	7321677207657	720765
3-600	92/57/600		145	7321677207664	720766
Support bracket HSO					
Support bracket to be mounted together with Threaded rod M10 or M16 for the installation of cable ladders. Material: Steel, hot-dip galvanized.					
HSO-150 M10	26/48/210		39	7321677910632	791063
HSO-200 M10	26/48/260		48	7321677910649	791064
HSO-300 M10	26/48/360		66	7321677910656	791065
HSO-400 M16	26/48/460		84	7321677910663	791066
HSO-500 M16	26/48/560		103	7321677910670	791067
HSO-600 M16	26/48/660		121	7321677910687	791068
Washer HSO M16					
Washer to be used for centered mounting with Support bracket HSO M16 and Threaded rod M16. Package of 10. Material: Steel, hot-dip galvanized.					
HSO M16	5/50/50		8.7	7321677910922	791092
Wall bracket 11/25 and 11/75					
Wall bracket to be used for vertical or horizontal installations of cable ladders against a wall. Maximum loads for vertical mounting: 300 kg (3 kN). For mounting against a rung the max. load is 500 kg (5 kN) for 11/25. Maximum loads for horizontal mounting: 11/25 250 kg (2.5 kN), 11/75 100 kg (1 kN). Material: Steel, hot-dip galvanized.					
11/25	85/71/40		24	7321677132041	713204
11/75	135/71/40		30	7321677132034	713203
Wall bracket 20					
Wall bracket to be used at installation of Pendant/fixing rail 24/20 to ceiling beam or wall. Material: Steel, hot-dip galvanized.					
20	50/59/154		47	7321677234509	723450
Wall bracket 20F					
Wall bracket to be used at installation of Pendant/fixing rail 20F to ceiling beam or wall. Material: Steel, hot-dip galvanized.					
20F	50/93/150		69	7321677234516	723451
Wall support 550					
Wall support for mounting of cantilever arm on porous walls or sandwich wall blocks, with six keyholes for easy fixation. When mounting cantilever arm on support, use screw set 25S (M8). Material: Steel, hot-dip galvanized.					
Wall support 550 mm	20/100/550		105	3606480985287	CSU795365

Hot Dip-galvanized - Corrosion class C3, C4

Vertical pieces

Type	Dimensions A/B/C mm 	Weight kg/100 pcs	EAN code	Ref. No.
------	--	----------------------	----------	----------

Vertical piece 2
Vertical piece to be used for installation of Support bracket 3, symmetrical loading. Not suitable for cable ladders KHZV and KHZPV. Can be joined to Pendant/fixing rail 24/34 with Pendant joint 2J.
Material: Steel, hot-dip galvanized.

2-300	279/80/135	52	7321677171910	717191
2-400	392/80/135	62	7321677171927	717192
2-500	504/80/135	72	7321677171934	717193
2-700	729/80/135	93	7321677171941	717194
2-1000	1022/80/135	120	7321677171958	717195

Vertical piece 2F
Vertical piece to be used for installation of Support bracket 3 or Cantilever arm 50. Can be joined to Pendant/fixing rail 24/48 with Pendant joint 2FJ.
Material: Steel, hot-dip galvanized.

2F-280	280/80/135	80	7321677171965	717196
2F-370	370/80/135	100	7321677171972	717197
2F-505	505/80/135	130	7321677171989	717198
2F-640	640/80/135	150	3606480410000	CSU794202
2F-730	730/80/135	170	7321677171996	717199
2F-865	865/80/135	200	3606480410017	CSU794203
2F-1000	1000/80/135	220	7321677172009	717200
2F-1500	1495/80/135	290	7321677872763	787276

Vertical piece 20
Vertical piece, two-sided, to be used for vertical installation together with Cantilever arm 50, from a ceiling or on a floor. Can also be installed as a cantilever arm on a wall.
Material: Steel, hot-dip galvanized.

20-280	280/155/150	165	3606480409967	CSU794204
20-370	370/155/150	198	3606480409974	CSU794205
20-500	505/155/150	243	7321677157235	715723
20-640	640/155/150	293	3606480409981	CSU794206
20-700	730/155/150	324	7321677157242	715724
20-865	865/155/150	372	3606480409998	CSU794207
20-1000	1000/155/150	458	7321677157259	715725
20-1500	1495/155/150	652	7321677157266	715726
20-2000	1990/155/150	799	7321677157273	715727
20-3000	2980/155/150	1177	7321677157280	715728

Vertical piece 20F
Vertical piece, two-sided, to be used for mounting from the ceiling or on the floor. Suitable for rather heavy loads.
Material: Steel, hot-dip galvanized.

20F-1000	995/160/160	590	7321677182497	718249
20F-1500	1490/160/160	790	7321677182503	718250
20F-2000	1985/160/160	990	7321677182510	718251
20F-3000	2980/160/160	1240	7321677097999	709799

Vertical piece 20FS
Vertical piece, two-sided, to be used for mounting from the ceiling or on the floor. Suitable for very heavy loads.
Material: Steel, hot-dip galvanized.

20FS-1500	1495/270/150	1460	7321677187188	718718
20FS-2000	1990/270/150	1810	7321677187195	718719
20FS-2500	2485/270/150	2160	7321677187201	718720
20FS-3000	2980/270/150	2520	7321677187218	718721

P135937



P135938



P135942



P135943



P135944



Hot Dip-galvanized - Corrosion class C3, C4

Pendant/Fixing rails

Type	Dimensions A/B/C mm	Weight kg/100 pcs	EAN code	Ref. No.
Pendant/Fixing rail 24/34				
Pendant/Fixing rail for mounting of support brackets, cantilever arms, etc. Material: Steel, hot-dip galvanized.				
24/34	2970/16/42	240	7321677158799	715879
Pendant/Fixing rail 24/48				
Pendant/Fixing rail for mounting of support brackets, cantilever arms, etc. Material: Steel, hot-dip galvanized.				
24/48	1000/26/48	175	3606481317865	CSU795565
24/48	2970/26/48	520	7321677050932	705093
24/48	5940/26/48	1120	7321677317196	731719
Pendant/Fixing rail 24/20				
Pendant/Fixing rail for mounting of support brackets, cantilever arms, etc. Material: Steel, hot-dip galvanized.				
24/20	2970/55/48	1130	7321677097951	709795
Pendant/Fixing rail 24/20F				
Pendant/Fixing rail for mounting of support brackets, cantilever arms, etc. Material: Steel, hot-dip galvanized.				
24/20F-3000	2970/89/48	1160	7321677097982	709798
24/20F-6000	5940/89/48	2370	7321677188086	718808
Pendant/Fixing rail 24/20FS				
Pendant/Fixing rail for mounting of support brackets, cantilever arms, etc. Material: Steel, hot-dip galvanized.				
24/20FS	5940/106/48	4200	7321677090310	709031
Fixing rail 24/26x53 for casting-in				
Fixing rail for casting-in in wall and ceilings. Material: Steel, hot-dip galvanized.				
24/26x53	4000/26/48	970	7321677680634	768063

Hot Dip-galvanized - Corrosion class C3, C4

Ceiling and base plates

Type	Dimensions A/B/C mm 	Weight kg/100 pcs	EAN code	Ref. No.
Ceiling plate 20F				
Ceiling plate to be used as a pre-drilled attachment for Vertical piece 20F to a steel member. The ceiling plate is welded in position. Material: Steel, hot-dip galvanized.				
20F	-/160/160	200	7321677188499	718849
Ceiling plate 20FS				
Ceiling plate to be used as a pre-drilled attachment for Vertical piece 20FS to a steel member. The ceiling plate is welded in position. Material: Steel, hot-dip galvanized.				
20FS	-/270/150	310	7321677205363	720536
Pendant base plate 520				
Pendant base plate to be used as a ceiling or floor base plate for Pendant/Fixing rail 24/20 in any desired length. Four screws MVBF 8x80 and nuts included. Material: Steel, hot-dip galvanized.				
520	278/160/160	400	7321677182534	718253

Pendant bar, rail fixing

Pendant bar 1				
Pendant bar to be installed in order to reduce the deflection of heavily loaded vertical pieces. Installed with T-bolt and Expansion bolt. Material: Steel, hot-dip galvanized.				
1-300	362/-/40	35	7321677176403	717640
1-500	568/-/40	53	7321677176410	717641
1-800	880/-/40	82	7321677176427	717642
1-1500	1296/35/50	560	7321677189038	718903
Rail fixing support 24/20F, 24/20FS				
Rail fixing support to be used with Pendant/fixing rails 24/20F and 24/20FS respectively, for mounting between floor and ceiling. Material: Steel, hot-dip galvanized.				
24/20F	106/165/80	167	7321677188505	718850
24/20FS	106/185/80	190	7321677188512	718851

Brackets

Angle bracket 5L				
Angle bracket to be used for steel wire installation in ceilings. Also used when assembling pendant/fixing rails to frames for switching cabinets and electrical control centres and for fixing an upright between floor and ceiling. Assembled with a T-bolt. Material: Steel, hot-dip galvanized.				
5L	70/45/49	15	7321677317912	731791
Angle bracket 5LS				
Angle bracket to be used when assembling pendant/fixing rails to frames for switching cabinets and electrical control centres and for fixing an upright between floor and ceiling. Assembled with a T-bolt. Material: Steel, hot-dip galvanized.				
5LS	111/71/60	50	7321677098019	709801
Combi bracket 53				
Combi bracket to be used for the mounting of cable ladders and trays on seamed roofing sheets, etc. To be combined with plastic insulating plate 54. Material: Steel, hot-dip galvanized.				
53 (bracket)	58/52/60	26	7321677823536	782353
54 (plate)	2/70/120	2	7321677872237	787223
Bracket 60/40				
Bracket to be used together with Pendant/fixing rail 24/48 to reduce the deflection of long vertical pieces. Material: Steel, hot-dip galvanized.				
60/40	95/23/40	10	7321677189045	718904

Hot Dip-galvanized - Corrosion class C3, C4

Brackets

Type	Dimensions A/B/C mm 	Weight kg/100 pcs	EAN code	Ref. No.
Rod bracket 82				
Rod bracket to be used together with Cantilever arm 50, in combination with threaded rod support. Material: Steel, hot-dip galvanized.				
82	60/158/43	360	7321677867684	786768



Pendant joint

Pendant joint 2J, 2FJ and 20J				
Pendant joint to be used for joining pendant/fixing rails and vertical pieces. Screws M8x16 (2J and 2FJ) or M8x70 (20J) and nuts included. Material: Steel, hot-dip galvanized.				
2J	200/48/18	43	7321677131778	713177
2FJ	200/55/18	46	7321677131785	713178
20J	200/55/36	94	7321677131730	713173



Ceiling brackets

Ceiling bracket 5				
Ceiling bracket to be used for installations with Pendant/Fixing rails 24/34 and 24/48. Screw not included. Material: Steel, hot-dip galvanized.				
5	100/135/40	35	7321677186402	718640
Ceiling bracket 5TPA				
Ceiling bracket with telescopic function, to be used for mounting of various sizes of trapezoid plates. Including screw MVBF 8x16 and nut M6MF8. Breaking load: 150 kg without deformation. Material: Steel, hot-dip galvanized.				
5TPA	50/76/79-118	14	7321677334872	733487
Ceiling bracket 5TP				
Ceiling bracket to be used for installations of Vertical pieces 2, 2F and 20 in ceilings with a trapezoidal sheet profile. Material: Steel, hot-dip galvanized.				
5TP	75/35/50	12	7321677131532	713153
Ceiling brackets TF-10 and TF-16				
Ceiling bracket to be used for installation with Threaded rods. Nut included. Material: Steel, hot-dip galvanized.				
TF-10 (with nut M10)	55/40/45	15	7321677881642	788164
TF-16 (with nut M16)	75/50/50	30	7321677881659	788165



Take-off hook, end connection

Fixed take-off hook 4				
Fixed take-off hook to be used for 90° horizontal branches. Material: Aluminium.				
4	71/19/86	8	7321677090174	709017
Take-off hook 47				
Take-off hook to be used on cable ladders KHZV and KHZPV to make 90° branches. Screw M12 and nuts are included. Material: Steel, hot-dip galvanized.				
47	155/10/73	27	7321677913503	791350
Take-off hook 20C				
Take-off hook to be used on cable ladders KHZP 20C range to make 90° branches. Screw M12 and nuts are included. Material: Steel, hot-dip galvanized.				
20C	205/10/78	40	3606480739576	CSU795209
End connection 10				
End connection to be used for the connection of a ladder vertically to a floor, or horizontally to a wall. Material: Aluminium.				
10	60/55/60	8	7321677090181	709018



Hot Dip-galvanized - Corrosion class C3, C4

Fittings for mesh tray

P140021



P140022



Type	Dimensions A/B/C mm	Weight kg/100 pcs	EAN code	Ref. No.
Combi-fittings B21				
Combi-fitting to be used when mounting mesh trays onto cable ladders. Material: Steel, hot-dip galvanized.				
B21	250/50/20	48	7332227012591	1149259
B21 90 degrees	120/50/135	46	7332227012911	1149291

Beam clamp, hook

P140026



P140027



Beam clamp 5BK				
Beam clamp to be used for the installation of Vertical pieces 2, 2F or 20 on I-beams. For flange thickness max. 13 mm and 14-30 mm respectively. Material: Steel, hot-dip galvanized.				
5BK-10 (max. 13 mm)	30/50/45	15	7321677156757	715675
5BK-30 (14-30 mm)	50/50/45	18	7321677182435	718243
Hook 8				
Hook to be used for the installation of cables beneath Support bracket 3. Can also be installed in perforated rungs. Material: Steel, hot-dip galvanized.				
8	67/15/40	5	7321677286423	728642

Back, installation and box plates

P140028



P140030



P132524



P140031



Back plate 40				
Back plate to be used for installation behind Cantilever arm 50 to reduce the surface pressure on porous walls. Material: Steel, hot-dip galvanized.				
40	150/-/60	55	7321677687381	768738
Installation plate 61				
Installation plate to be used on vertical cable ladder installations for mounting of terminal boxes, contact breakers, etc. Material: Steel, hot-dip galvanized.				
61-200	310/70/200	100	7321677324910	732491
61-300	310/70/300	140	7321677324927	732492
61-400	310/70/400	170	7321677324934	732493
61-500	310/70/500	240	7321677324941	732494
61-600	310/70/600	270	7321677324958	732495
Junction box plate 35S				
Junction box plate, holed or unholed, to be installed upright or hanging from the profile. Locked with locking tabs. For junction boxes, electric light fittings, etc. Material: Steel, hot-dip galvanized.				
35S holed	164/20/170	22	7321677317462	731746
Junction box plate 35P				
Junction box plate with holes, to be installed between rungs. Locked with appropriate locking tabs for each ladder. For junction boxes, electric light fittings, etc. Material: Steel, hot-dip galvanized.				
35P	-/106/250	28	7321677317455	731745

Bends

P140032



Riser 18				
Riser piece to be fitted to the cable ladders by using Joint 21. Material: Steel, hot-dip galvanized.				
18-150	452/147/452	180	7321677181766	718176
18-200	452/197/452	190	7321677181773	718177
18-300	452/297/452	210	7321677181797	718179
18-400	452/397/452	230	7321677181803	718180
18-500	452/497/452	250	7321677181810	718181
18-600	452/597/452	270	7321677181827	718182
18-800	452/897/452	310	7321677219643	721964
18-1000	452/1097/452	350	7321677181834	718183

Hot Dip-galvanized - Corrosion class C3, C4

Bends

P1410033



Type	Dimensions A/B/C mm	Weight kg/100 pcs	EAN code	Ref. No.
Riser coupling 49				
Coupling to be used as a self-supporting vertical coupling of cable ladders KHZV/KHZPV. Two screw sets M12 are needed. Material: Steel, hot-dip galvanized.				
49-200	120/197/483	220	7321677163892	716389
49-300	120/297/483	230	7321677163908	716390
49-400	120/397/483	240	7321677163915	716391
49-500	120/497/483	245	7321677205172	720517
49-600	120/597/483	250	7321677163922	716392
49-1000	120/997/483	280	7321677163939	716393

P143338



Riser coupling 20C				
Coupling to be used as a self-supporting vertical coupling of cable ladders KHZP 20C range. Two screw sets M12 are needed. Material: Steel, hot-dip galvanized.				
20C-200	170/200/550	249	3606480739439	CSU795159
20C-300	170/330/550	260	3606480739446	CSU795160
20C-400	170/400/550	271	3606480739453	CSU795161
20C-500	170/500/550	282	3606480739460	CSU795162
20C-600	170/600/550	293	3606480739477	CSU795163
20C-800	170/800/550	315	3606480739484	CSU795164
20C-1000	170/1000/550	386	3606480739491	CSU795165

PTCSU-405



Coupling plate 48				
Angled coupling to be used for cable ladders KHZV/KHZPV range. Material: Steel, hot-dip galvanized.				
48 30°	148/-/156	61	7321677189014	718901
48 45°	148/-/190	75	7321677184118	718411
48 60°	148/-/223	80	7321677189021	718902

P143280



Angle plates 20C				
Angled coupling to be used for cable ladders KHZP 20C range. Four screws M12x30 and nuts are included. Material: Steel, hot-dip galvanized.				
20C 60°	180/5/265	111	3606480739545	CSU795206
20C 45°	190/5/220	99	3606480739552	CSU795207
20C 30°	195/5/180	85	3606480739569	CSU795208

P140034



90° bend 15, interior				
Interior bend piece to be fitted to the cable ladders by using Joint 21, creating a 90° bend. Inner radius 268 mm. Material: Steel, hot-dip galvanized.				
15-150	55/547/547	220	7321677160662	716066
15-200	55/597/597	240	7321677160679	716067
15-300	55/697/697	290	7321677160693	716069
15-400	55/797/797	340	7321677160709	716070
15-500	55/897/897	390	7321677160716	716071
15-600	55/997/997	440	7321677160723	716072
15-800	55/1197/1197	640	7321677219612	721961
15-1000	55/1397/1397	760	7321677160730	716073

P140035



90° bend 15, exterior				
Exterior bend piece to be fitted to the cable ladders by using Joint 21, creating a 90° bend. Material: Steel, hot-dip galvanized.				
15-150	55/703/703	320	7321677161799	716179
15-200	55/933/933	370	7321677161805	716180
15-300	55/1133/1133	460	7321677161829	716182
15-400	55/1333/1333	550	7321677161836	716183
15-500	55/1533/1533	640	7321677161843	716184
15-600	55/1733/1733	760	7321677161850	716185
15-800	55/2133/2133	1060	7321677230570	723057
15-1000	55/2533/2533	1280	7321677232604	723260

Hot Dip-galvanized - Corrosion class C3, C4

Bends

Type	Dimensions A/B/C mm		Weight kg/100 pcs	EAN code	Ref. No.
90° bend 55, interior					
Interior bend piece to be fitted to cable ladders KHZV and KHZPV, creating a 90° horizontal bend. Material: Steel, hot-dip galvanized.					
55-200	150/625/625		510	7321677162413	716241
55-300	150/725/725		560	7321677162437	716243
55-400	150/825/825		620	7321677162444	716244
55-500	150/925/925		680	7321677162451	716245
55-600	150/1025/1025		750	7321677162468	716246
55-1000	150/1425/1425		1110	7321677162475	716247
90° bend 20C, interior					
Interior bend piece to be fitted to cable ladders KHZP 20C range, creating a 90° horizontal bend. Material: Steel, hot-dip galvanized.					
20C-200	190/625/625		517	3606480739293	CSU795145
20C-300	190/725/725		568	3606480739309	CSU795146
20C-400	190/825/825		619	3606480739316	CSU795147
20C-500	190/925/925		671	3606480739323	CSU795148
20C-600	190/1025/1025		722	3606480739330	CSU795149
20C-800	190/1225/1225		824	3606480739347	CSU795150
20C-1000	190/1425/1425		1048	3606480739347	CSU795151
T-junction 16					
T-junction piece to be fitted to the cable ladders by using Joint 21. Material: Steel, hot-dip galvanized.					
16-150	55/944/547		300	7321677161935	716193
16-200	55/997/597		320	7321677161942	716194
16-300	55/1097/697		390	7321677161966	716196
16-400	55/1197/797		440	7321677161973	716197
16-500	55/1297/897		530	7321677161980	716198
16-600	55/1397/997		600	7321677161997	716199
16-800	55/1597/1197		750	7321677219629	721962
16-1000	55/1797/1397		860	7321677162000	716200
T-junction 56					
T-junction piece to be fitted to the cable ladder KHZV or KHZPV by using screw set M12. Material: Steel, hot-dip galvanized.					
56-200	150/1050/625		710	7321677162550	716255
56-300	150/1150/725		790	7321677162574	716257
56-400	150/1250/825		840	7321677162581	716258
56-500	150/1350/925		940	7321677162598	716259
56-600	150/1450/1025		1010	7321677162604	716260
56-1000	150/1850/1425		1300	7321677162611	716261
T-junction 20C					
T-junction piece to be fitted to the cable ladder KHZP 20C range by using screw set M12. Material: Steel, hot-dip galvanized.					
20C-200	190/265/1050		783	3606480739361	CSU795152
20C-300	190/725/1150		853	3606480739378	CSU795153
20C-400	190/825/1250		900	3606480739385	CSU795154
20C-500	190/925/1350		987	3606480739392	CSU795155
20C-600	190/1025/1450		1039	3606480739408	CSU795156
20C-800	190/1225/1650		1306	3606480739415	CSU795157
20C-1000	190/1425/1850		1518	3606480739422	CSU795158

Hot Dip-galvanized - Corrosion class C3, C4

Bends

Type	Dimensions A/B/C mm	Weight kg/100 pcs	EAN code	Ref. No.
X-junction 17				
X-junction piece to be fitted to the cable ladders by using Joint 21. Material: Steel, hot-dip galvanized.				
17-150	55/547/547	380	7321677162093	716209
17-200	55/997/997	400	7321677162109	716210
17-300	55/1097/1097	500	7321677162123	716212
17-400	55/1197/1197	550	7321677162130	716213
17-500	55/1297/1297	600	7321677162147	716214
17-600	55/1397/1397	860	7321677162154	716215
17-800	55/1597/1597	1070	7321677219636	721963
17-1000	55/1797/1797	1220	7321677162161	716216
S-bend 67				
S-bend piece to be used as a transition between cable ladders mounted on different levels. Can be mounted both vertically and horizontally. Material: Steel, hot-dip galvanized.				
67	250/-/893	90	7321677886388	788638

Tele-conduits

Tele-conduit 36				
Tele-conduit to be used where a separate tray is required for low-tension cables. Knock-out holes in the bottom of the channel permit the cables to pass through. Material: Steel, hot-dip galvanized.				
36-50	24/50/2000	94	7321677317486	731748
36-100	24/100/2000	142	7321677317493	731749
36-200	24/200/2000	238	7321677317509	731750

Dividers

Dividing strip 39				
Dividing strip to be used to separate low-tension and high-tension cables. Material: Steel, hot-dip galvanized.				
39/24	24/24/1750	46	7321677317479	731747
39/55	55/24/1750	73	7321677329830	732983
Distance piece W39				
Distance piece to be used for the joining of Dividing strips 39. Material: Plastic, natural coloured.				
W39	37/-/330	3	7321677168248	716824

Covers/Cover plates

Cover 64				
Cover to be used for vertically mounted cable ladders. Material: Steel, hot-dip galvanized.				
64-150	10/151/2000	290	7321677825615	WBE782561
64-200	10/201/2000	370	7321677825622	WBE782562
64-300	10/301/2000	540	7321677825639	WBE782563
64-400	10/401/2000	710	7321677825646	WBE782564
64-500	10/501/2000	1020	7321677825653	WBE782565
64-600	10/601/2000	1210	7321677825660	WBE782566
64-800	10/801/2000	1660	7321677825677	WBE782567
64-1000	10/1001/2000	2000	7321677825684	WBE782568

Hot Dip-galvanized - Corrosion class C3, C4

Covers/Cover plates

Type	Dimensions A/B/C mm 	Weight kg/100 pcs	EAN code	Ref. No.
Cover				
Cover to be used to protect the cable runs from dust, dirt, liquids, etc. Outdoors, it protects against rain and sun. Suitable for all cable ladders. Material: Steel, hot-dip galvanized.				
W5-150	10/151/2000	190	7321677322640	732264
W5-200	10/201/2000	250	7321677322657	732265
W5-300	10/301/2000	360	3606480535734	732266
W5-400	10/401/2000	680	7321677322671	732267
W5-500	10/501/2000	880	7321677322688	732268
W5-600	10/601/2000	1050	7321677322695	732269
W5-800	10/801/2000	1420	7321677822133	782213
W5-1000	10/1001/2000	1730	7321677322701	732270
Cover 90° bend				
Cover to be used for 90° interior bends. To be installed with a Profile support piece 37, Cover clamp and Cover joint. Material: Steel, hot-dip galvanized.				
150	10/420/420	65	7321677814336	781433
200	10/470/470	91	7321677814343	781434
300	10/570/570	143	7321677814350	781435
400	10/670/670	221	7321677814367	781436
500	10/770/770	299	7321677814374	781437
600	10/870/870	390	7321677814381	781438
800	10/1070/1070	460	7321677817931	781793
1000	10/1270/1270	871	7321677814398	781439
Cover T-junction				
Cover to be used for T-junctions. To be installed with a Profile support piece 37, Cover clamp and Cover joint. Material: Steel, hot-dip galvanized.				
150	10/400/651	182	7321677814404	781440
200	10/450/701	221	7321677814411	781441
300	10/550/801	312	7321677814428	781442
400	10/650/901	416	7321677814435	781443
500	10/750/1001	533	7321677814442	781444
600	10/850/1101	676	7321677814459	781445
800	10/1050/1301	710	7321677817962	781796
1000	10/1240/1501	1352	7321677814466	781446
Profile support piece 37				
Profile support piece to be used when installing covers. To be mounted on approximately every 0.5 m along both sides of the cable ladder. Used together with cover clamp for locking covers. Material: Steel, hot-dip galvanized.				
37	136/20/50	6	7321677301881	730188
Cover clamp				
Cover clamps to be used when installing a cover on a Profile support piece 37. Material: Steel, Zink+.				
Cover clamp	32/10.5/20	1.5	3606489699413	CSU795598
Cover joint				
Cover joint to be inserted between covers. Material: Steel, hot-dip galvanized.				
150	4/100/125	10	7321677804528	780452
200	4/100/175	20	7321677804535	780453
300	4/100/275	30	7321677804542	780454
400	4/100/375	40	7321677804559	780455
500	4/100/475	50	7321677804566	780456
600	4/100/575	60	7321677804573	780457

Hot Dip-galvanized - Corrosion class C3, C4

Covers/Cover plates

Type	Dimensions A/B/C mm	Weight kg/100 pcs	EAN code	Ref. No.
Protecting cover				
Cover to be used to protect the cable runs against ice and snow. Suitable for all cable ladder widths 300 and 400 respectively. Material: Steel, hot-dip galvanized.				
300	280/300/1000	880	7321677867462	786746
400	280/400/1000	990	7321677867479	786747
Cover plate 65				
Cover plate to be used on vertical cable ladder installations as protection of cables near the floor. To be mounted in the side profile with self-tapping screw ST4.2. Material: Steel, hot-dip galvanized.				
65-200	1000/120/200	930	7321677301928	730192
65-300	1000/120/300	1140	7321677301935	730193
65-400	1000/120/400	1350	7321677301942	730194
65-500	1000/120/500	1560	7321677301959	730195
65-600	1000/120/600	1780	7321677301966	730196

Lighting bracket

Type	Dimensions A/B/C mm	Weight kg/100 pcs	EAN code	Ref. No.
Lighting bracket 200				
Lighting bracket to be used for the installation of lighting fittings beneath cable ladders KHZV and KHZPV 200. Material: Steel, hot-dip galvanized.				
200	24/25/215	16	7321677186433	718643

Angle plate

Type	Dimensions A/B/C mm	Weight kg/100 pcs	EAN code	Ref. No.
Angle plate 33				
Angle plate to be used together with 90° horizontal T-junctions. Recommended for all cable ladders. Material: Steel, hot-dip galvanized.				
33/2	25/195/490	90	7321677077489	707748

Installation system HT

Wall bracket HT-14				
Bracket to be used for wall installations. To be installed with Expansion bolt or concrete screw. Material: Steel, hot-dip galvanized.				
HT-14	30/30/104	18	7321677136711	713671
Carrying bracket HT-31				
Carrying bracket to be used for ceiling installations. To be installed with Expansion bolt or concrete screw. Material: Steel, hot-dip galvanized.				
HT-31	115/4.5/23	2	7321677136728	713672
Carrying bracket HT-152				
Carrying bracket to be used for easy I-beam installations. Material: Steel, hot-dip galvanized.				
HT-152	49/15/65	38	7321677176366	717636
End bracket HT-11				
End bracket to be used for ceiling beam installations. To be installed with Expansion bolt or concrete screw. Material: Steel, hot-dip galvanized.				
HT-11	155/40/40	41	7321677176182	717618
Tightening loop HT				
Tightening loop to be installed at the ends of steel wires. Material: Steel, hot-dip galvanized.				
HT-611	22/22/125	10	7321677136896	713689
HT-621	50/50/270	18	7321677136902	713690
HT-631	50/50/400	29	7321677136919	713691
Pipe HT-68				
Pipe for easy locking of wires. Material: Steel, hot-dip galvanized.				
HT-68	Ø15/25	1.3	7321677136773	713677

Hot Dip-galvanized - Corrosion class C3, C4

Installation system HT

Type	Dimensions A/B/C mm	Weight kg/100 pcs	EAN code	Ref. No.	
Steel wire HT					
Steel wire to be installed as carrier of one or more cables. Breaking loads, see below. Material: Available in several qualities.					
	HT-2309, galvanized, soft, breaking load 700 kg	Ø5.0	15.5/100 m	7321677136797	713679
	HT-2311, 7x diam. 1.71=16 mm ² coated, grey, breaking load 970 kg	Ø6.15	13.5/100 m	7321677136889	713688
	HTR-2322 stainless, hard, breaking load 450 kg	Ø2.5	3.9/100 m	7321677136810	713681
	HTR-2323 stainless, hard, breaking load 700 kg	Ø3.0	5.6/100 m	7321677136827	713682
	HTR-2324 stainless, hard, breaking load 1200 kg	Ø4.0	10.0/100 m	7321677136834	713683

Mounting rail

Mounting rail 40				
Mounting rail to be used for wall installation of cantilever arms on porous walls to reduce the surface pressure or to enable height adjustment of cantilever arms. Material: Steel, hot-dip galvanized.				
40	270/26/48	56	7321677170012	717001

Reducers

Reducer 31				
Reducer to be used for transition joining from a wide to a narrower cable ladder. Material: Steel, hot-dip galvanized.				
31-100	48/100/200	43	7321677341719	734171
31-200	48/200/200	59	7321677341726	734172
31-300	48/300/200	74	7321677341733	734173
31-400	48/400/200	89	7321677341740	734174



Reducer 20C				
Reducer/Expander for transition joining from a wide to a narrower cable ladder of KHZP 20C range. May also be used at centred transition joining. Material: Steel, hot-dip galvanized.				
20C-100	40/200/100	109	3606480739507	CSU795166
20C-200	40/200/200	176	3606480739514	CSU795167

Bar fixings

Round bar fixing				
Round bar fixing to be used for mounting in underground cavities and tunnels. Material: Steel, hot-dip galvanized.				
For ceilings	6/60/325	90	7321677928637	792863
For floors	6/140/130	91	7321677928651	792865
For walls	6/60/161	68	7321677928675	792867

Hot Dip-galvanized - Corrosion class C3, C4







Lashing wire

Type	Dimensions A/B/C mm	Weight kg/100 pcs	EAN code	Ref. No.	
Lashing wire					
Lashing wire to be used for lashing of wires on cable ladders. Material: Stainless steel, PVC.					
	HTR-2303, white PVC	Ø1.25	1.3/100 m	7321677136865	713686
	HTR-2313, black PVC	Ø1.25	1.3/100 m	7321677136872	713687
Lashing wire to be used for lashing of wires on cable ladders. Material: PVC.					
	HT-2304, white	Ø1.5	1.8/100 m	7321677136841	713684
	HT-2314, black	Ø1.5	1.8/100 m	7321677136858	713685

Profile protection

Profile protection 28P					
Profile protection to be used to increase the contact surface of the cables, when pulled over the side profile of the ladder. Material: PVC, grey.					
	28P	60/28/2000	80	7321677321513	732151

End plugs

End plug 28/28i					
End plug to be mounted on ladder ends for sealing or protection. Material: PP/TPE.					
	28, red	59/25/22	0.8	7321677090198	709019
	28i, white 28i, red	54/14/19	0.4	7321677354467 7321677319947	735446 731994
End plug 28C, D, E, F and J					
End plug to be mounted on pendant ends to provide protection against personal injury and to make the ends of the profiles more conspicuous. Material: PP/TPE, orange.					
	28C for Vertical piece 2 and Pendant/fixing rail 24/34	25/19/46	0.5	7321677898756	789875
		28D for Vertical piece 20 and Pendant/fixing rail 24/20	25/52/58	1	7321677090204
		28E for Vertical piece 2F and Pendant/fixing rail 24/48	24/30/52	0.5	7321677090211
		28F for Vertical piece 20FS and Pendant/fixing rail 24/20FS	30/53/110	4	7321677898763
		28J for Vertical piece 20F and Pendant/Fixing rail 24/20F	27/53/95	2.1	3606480457531
	Cross member plug 27				
Cross member plug to be installed at the ends of the rungs of KHZ and KHZV. Used in premises with a high corrosion risk. Material: PE, grey.					
	27	Ø20/10	0.15	7321677266685	726668

Hot Dip-galvanized - Corrosion class C3, C4

Screws, bolts and nuts

Type	Dimensions A/B/C mm	Weight kg/100 pcs	EAN code	Ref. No.
T-bolt 26U				
T-bolt to be used for mounting with all vertical pieces except Vertical piece 2 and with Pendant/fixing rail 24/48. Material: Steel, hot-dip galvanized.				
26U M8	M8x30	5	3606489579777	CSU795595
26U M10	M10x30	5	3606489579715	CSU795589
26U M10	M10x40	6	3606489579722	CSU795590
26U M10	M10x50	7	3606489579739	CSU795591
Screw set M12				
Screw set to be used for all joints with cable ladders KHZV and KHZPV. Set including four bolts M6S 12x25 and four nuts M6M 12. Material: Steel, hot-dip galvanized.				
M12	—	20	7321677064151	706415
Screw set 2S				
Screw set to be used for fastening of Support bracket 3 on Pendant/fixing rail 24/20F and Angle bracket 5L to the opening on Pendant rail 24/34 and 24/48. Set including screw MVBF 8x40 and nut M6MF8. Material: Steel, hot-dip galvanized.				
2S	—	2.9	7321677157358	715735
Screw set 20S				
Screw set to be used for installation of Support bracket 3 on Pendant/fixing rail 24/20 and Vertical piece 20, Angle bracket 5L to the opening on Pendant rail 24/48 and 24/20. Set including screw MVBF 8x60 and nut M6MF8. Material: Steel, hot-dip galvanized.				
20S	—	3,7	7321677157365	715736
Screw set 22S				
Screw set to be used for installation of Support bracket 3 on Vertical piece 2 and 2F, Support bracket 3 and Ceiling bracket 5 on Pendant/fixing rails 24/34 and 24/48, Angle bracket 5L against the back of Pendant/fixing rails, Pendant/fixing rails back to back. Set including screw MVBF 8x16 and nut M6MF8. Material: Steel, hot-dip galvanized.				
22S	—	1.9	7321677136940	713694
Screw set 25S				
Screw set to be used for installation of Cantiliver arm 30, 50i and 50 on Wall support plate. Set including screw MVBF 8x25 and nut M6MF8. Material: Steel, hot-dip galvanized.				
25S	—	2,2	3606485440897	CSU795277
Screw set W34				
Screw set to be used for the fastening of dividing strips on cable ladders KHZSP, KHZSPZ+, KHZPS and KHZPV. Set including screw MSCS 6x12 and nut M6MF 6. Material: Steel, hot-dip galvanized.				
W34	—	0.8	7321677346462	734646
Spring nut M8/M10				
Spring nut to be used for fastening of accessories (control panels, etc.) on Pendant/fixing rail 24/48. Material: Steel, hot-dip galvanized.				
M8	—	2.7	7321677164073	716407
Back nut M8				
Back nut to be used for fastening of vertical pieces, etc., in the rungs of cable ladders KHZSP, KHZSPZ+, KHZP, KHZPS and KHZPV. Material: Steel, hot-dip galvanized.				
M8	—	2.5	7321677186327	718632
Intermediate connection bolt 29				
Intermediate connection bolt to be used at the transition from a broad to a narrower cable ladder KHZ. Material: Steel, hot-dip galvanized.				
29-200	M10x235 (length)	14	7321677053926	705392
29-300	M10x335 (length)	19	7321677053940	705394
29-400	M10x435 (length)	24	7321677053957	705395
29-500	M10x535 (length)	29	7321677053964	705396
29-600	M10x635 (length)	34	7321677053971	705397

P40148



PTCLC-274



P40161



PTCLC-271



PTCLC-272



P40156



P40152



P40153



P40073



Hot Dip-galvanized - Corrosion class C3, C4

Marking plate

Type	Dimensions A/B/C mm		Weight kg/100 pcs	EAN code	Ref. No.
Marking plate 93					
Marking plates are part of a colour marking system that is easy to use when you want to mark out the type of cable that is placed on the cable ladder. Five different colours are available.					
93, yellow	103/0.7/100		5	7321677377046	737704
93, orange	103/0.7/100		5	7321677377053	737705
93, blue	103/0.7/100		5	7321677377060	737706
93, green	103/0.7/100		5	7321677377077	737707
93, black	103/0.7/100		5	7321677377084	737708

B223240



Marking label

Marking label, equipotential					
Label to be used to show that a construction is equipotentially bonded. Available in Swedish (other languages on request). Printed on self-adhesive yellow vinyl, 250 labels per roll. Material: Self-adhesive vinyl.					
Marking label	25/-/86		-	7321677868605	786860

P138944



Mounting accessories

Mounting rail WMS25L					
Mounting rail to be used for installation directly on wall for lashing of cables. Material: Steel, Zink+.					
WMS25L	27/6/2000		35	3606489584955	CSU795597
Threaded rod W76					
Threaded rod for M8 ceiling mounting of cable support. For fixing, use Flange Nut M8 and for extension, Distance nut M8. Material: Steel, hot-dip galvanized.					
W76/M8	8/8/1000		32	3606480483783	CSU794697
	8/8/2000		64	3606480483776	CSU734698
Flange nut					
Flange Nut M8 to be mounted on Threaded rod W76. Intended for ceiling mounting of cable support. Material: Steel, hot-dip galvanized.					
Flange nut M8	17/17/8		1	3606480483806	CSU794715
Distance nut					
Distance nut M8 to be used as an extension and a coupler of Threaded rod W76. Intended for ceiling mounting of cable support. Material: Steel, hot-dip galvanized.					
Distance nut M8	15/15/30		4	3606480483790	CSU794699

PTCSU-104



P140075



P140154



P140155



Hot Dip-galvanized - Corrosion class C3, C4

Paint

P143450



Anti-corrosive repair paint

Anti-corrosive repair paint Galvafruid for the repair of damages on pre-galvanized or hot-dip galvanized ladders and accessories.

Galvafruid, 0,4 litre tin	—	104	7321677176373	717637
---------------------------	---	-----	---------------	---------------

Tools

P123877



Cable roller S

Cable roller used to facilitate the pulling of cables and lines. Easily installed on all Wibe cable ladders except the high-sided WHS ladders (outer mounting hole). Also suitable for external/internal profiles of all 90° bends, T-junctions, X-junctions and risers (inner mounting hole). With a height adjustment of 45 mm to leave room for cables to pass under the roller.
Material: Steel, electro-galvanized.

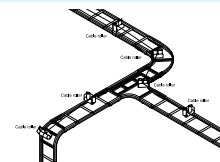

S	230/80/204	230	7321677186600	718660
---	------------	-----	---------------	---------------

P143449



Cable roller 38 Rig'n roll

Cable roller used for mounting on Wibe cable ladders with belonging junctions and branches.
Material: Stainless steel AISI316L (cable roller).

38 Rig'n roll	220/50/130	48	7321677359981	735998
---------------	------------	----	---------------	---------------

P143452



Bag	375/160/460	230	7321677801862	780186
-----	-------------	-----	---------------	---------------

Set 66 (1 bag + 10 Cable rollers 38 Rig'n roll)	375/160/460	710	7321677801879	780187
---	-------------	-----	---------------	---------------

Zinkpox - Corrosion class C5-I

Cable ladders

P410376

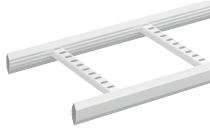

Type	Dimensions A/B/C mm	Weight kg/100 m	EAN code	Ref. No.
Cable ladders KHZP				
Cable ladder for indoor or outdoor industrial applications. With closed side profiles and profile-shaped rungs. Must not be used as walkway. Material: Steel, Zinkpox coated white.				
KHZP-150	55/147/3000 55/147/6000	260	7321677835249 7321677185917	783524 718591
KHZP-200	55/197/3000 55/197/6000	270	7321677835256 7321677185924	783525 718592
KHZP-300	55/297/3000 55/297/6000	290	7321677835263 7321677185931	783526 718593
KHZP-400	55/397/3000 55/397/6000	315	7321677835270 7321677185948	783527 718594
KHZP-500	55/497/3000 55/497/6000	340	7321677835287 7321677185955	783528 718595
KHZP-600	55/597/3000 55/597/6000	360	7321677835294 7321677185962	783529 718596
KHZP-800	55/797/3000 55/797/6000	490	7321677835300 7321677280339	783530 728033
KHZP-1000	55/997/3000 55/997/6000	560	7321677835317 7321677185979	783531 718597

Dimension table		Type	A mm	B mm	L mm	Ref. No.
		KHZP-150	147	111	3000 6000	783524 718591
		KHZP-200	197	161	3000 6000	783525 718592
		KHZP-300	297	261	3000 6000	783526 718593
		KHZP-400	397	361	3000 6000	783527 718594
		KHZP-500	497	461	3000 6000	783528 718595
		KHZP-600	597	561	3000 6000	783529 718596
		KHZP-800	797	761	3000 6000	783530 728033
		KHZP-1000	997	961	3000 6000	783531 718597

B228677

Zinkpox - Corrosion class C5-I

Cable ladders

PH10384



Type	Dimensions A/B/C mm	Weight kg/100 m	EAN code	Ref. No.
Cable ladders KHZ				
Cable ladder for indoor or outdoor industrial applications. With closed side profiles and round rungs. Must not be used as walkway. Material: Steel, Zinkpox coated white.				
KHZ-150	55/147/6000	270	7321677140589	714058
KHZ-200	55/197/6000	280	7321677140596	714059
KHZ-300	55/297/6000	300	7321677140619	714061
KHZ-400	55/397/6000	320	7321677140626	714062
KHZ-500	55/497/6000	340	7321677140633	714063
KHZ-600	55/597/6000	360	7321677140640	714064

Dimension table

B223589

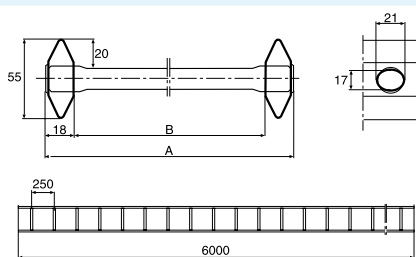

Type	A mm	B mm	L mm	Ref. No.
KHZ-150	147	111	6000	714058
KHZ-200	197	161	6000	714059
KHZ-300	297	261	6000	714061
KHZ-400	397	361	6000	714062
KHZ-500	497	461	6000	714063
KHZ-600	597	561	6000	714064

Zinkpox - Corrosion class C5-I

Cable ladders

PI40390

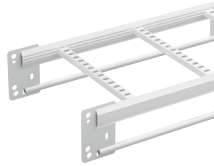

Type	Dimensions A/B/C mm	Weight kg/100 m	EAN code	Ref. No.
------	---------------------	-----------------	----------	----------

Cable ladders KHZPV

Reinforced cable ladder for indoor or outdoor industrial applications. Designed for extreme support distances and loadings. With closed side profiles and profile-shaped rungs. Must not be used as walkway. Material: Steel, Zinkpox coated white.

KHZPV-200	150/197/6000	426	7321677233908	723390
KHZPV-300	150/297/6000	448	7321677233915	723391
KHZPV-400	150/397/6000	470	7321677233922	723392
KHZPV-500	150/497/6000	493	7321677233939	723393
KHZPV-600	150/597/6000	515	7321677233946	723394
KHZPV-1000	150/997/6000	703	7321677164011	716401

PI40397

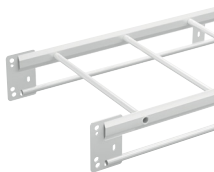

Cable ladders KHZV

Reinforced cable ladder for indoor or outdoor industrial applications. Designed for extreme support distances and loadings. With closed side profiles and round rungs. Must not be used as walkway. Material: Steel, Zinkpox coated white.

KHZV-200	150/197/6000	440	7321677141982	714198
KHZV-300	150/297/6000	460	7321677142002	714200
KHZV-400	150/397/6000	480	7321677142026	714202
KHZV-500	150/497/6000	500	7321677142019	714201
KHZV-600	150/597/6000	530	7321677142033	714203

Dimension table

BE23876

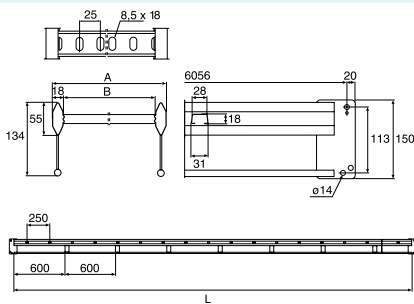

Type	A mm	B mm	L mm	Ref. No.
KHZPV-200	197	161	6000	723390
KHZPV-300	297	261	6000	723391
KHZPV-400	397	361	6000	723392
KHZPV-500	497	461	6000	723393
KHZPV-600	597	561	6000	723394
KHZPV-1000	997	961	6000	716401



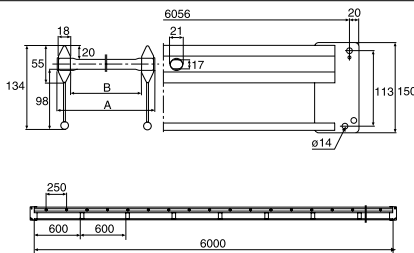

BE23853





KHZV-200	197	161	6000	714198
KHZV-300	297	261	6000	714200
KHZV-400	397	361	6000	714202
KHZV-500	497	461	6000	714201
KHZV-600	597	561	6000	714203

Zinkpox - Corrosion class C5-I



Joins

	Type	Dimensions A/B/C mm 	Weight kg/100 pcs	EAN code	Ref. No.
P140401 	Joint 21				
	Joint to be used for straight, rigid joining of cable ladders, bends, junctions and risers. It also reduced the transition resistance and prevents the ladders from slipping apart. M6 screws included. Material: Steel, Zinkpox coated white.				
	21	64/22/300	46	7321677912001	791200
P140402 	Joint 9				
	Joint to be used for straight joining of cable ladders KHZ, KHZP and KHZPS. The teeth of the joint should face downwards. Under load, the ladders are prevented from slipping apart. If the joint is above a bracket, the teeth should face upwards. Material: Steel, Zinkpox coated white.				
	9	52/4/200	16	7321677140664	714066
P140403 	Dropper joint 32				
	Dropper joint used to form vertical branches in centre position under/on top of cable ladders. Screw M6 included. Material: Steel, Zinkpox coated white.				
	32	130/22/200	75	7321677808748	780874
P140404 	Joint 45				
	Joint to be fitted as a joining plate in a cut KHZV/KHZPV ladder. Screws M8 and M12 + nuts are included. Material: Steel, Zinkpox coated white.				
	45	150/4/95	50	7321677142279	714227

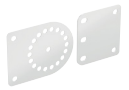
Couplings

P140405 	Coupling 22				
	Coupling to be used for horizontal or vertical branches at any desired angle. M6 screws included. Material: Steel, Zinkpox coated white.				
	22	60/24/150	21	7321677184101	718410
P140406 	Junction coupling 14				
	Junction coupling to be used for T- and X-junctions. Suitable for cable ladders KHZ, KHZP, KHZSP and KHZPS, all cable widths. M6 screws included. Material: Steel, Zinkpox coated white.				
	14	65/73/350	49	7321677909063	790906
P140407 	Coupling 44				
	Coupling to be used for horizontal coupling of cable ladders KHZV/KHZPV. Also to be used for branches and as an end connection against a wall. Four screws M8x30 and nuts are included. Material: Steel, Zinkpox coated white.				
	44	135/-/120	50	7321677208166	720816
P140408 	Coupling 51				
	Coupling to be used as a self-supporting vertical coupling of cable ladders KHZV/KHZPV. Two screws M12 and nuts are included. Material: Steel, Zinkpox coated white.				
	51	150/-/193+138	150	7321677319114	731911

Clamps

P161016 	Profile clamp 42				
	Profile clamp to be used for installations where the cable ladder is to be fixed to cantilever arms, support brackets, etc. Screw M8 and nut included. Material: Steel, Zinkpox coated white.				
	42	55/55/30	56	3606485410357	CSU795243
P140410 	Profile clamp 43				
	Profile clamp to be used for installations where the cable ladders KHZV and KHZPV are to be fixed to cantilever arms, support brackets, etc. Screw M8 and nut included. Material: Steel, Zinkpox coated white.				
	43	21/43/30	5	7321677141654	714165
P140411 	Clamp 12				
	Clamp to be used on the side profile of the cable ladder for installation of accessories. Bolt and nut included. Material: Steel, Zinkpox coated white.				
	12/70	125/25/40	19	7321677329779	732977
	12/120	175/25/40	24	7321677329786	732978

Zinkpox - Corrosion class C5-I

Clamps

Type	Dimensions A/B/C mm	Weight kg/100 pcs	EAN code	Ref. No.
Profile clamp 41				
Profile clamp to be used to install a pendant/fixing rail or mounting plate, etc., on the cable ladder profile. Material: Steel, Zinkpox coated white.				
41	125/16/30	10	7321677219452	721945
Profile support piece 46				
Profile support piece to be fitted between the ladder and the vault pipe when a support bracket is positioned between existing profile support pieces. For cable ladders KHZV and KHZPV. Material: Steel, Zinkpox coated white.				
46	72/18/30	15	7321677141791	714179

Cantilever arms

Cantilever arm 50 and 50F				
Cantilever arm for mounting on walls, pendant/fixing rails or vertical pieces. Material: Steel, Zinkpox coated white.				
50-100	85/150/40	24	7321677234400	723440
50-150	85/200/40	28	7321677234417	723441
50-200	85/250/40	34	7321677234424	723442
50-250	105/300/40	52	7321677234431	723443
50-300	105/350/40	60	7321677234448	723444
50-400	120/450/50	228	7321677234455	723445
50-500	140/550/50	172	7321677234462	723446
50-600	150/650/50	215	7321677234479	723447
50-700	150/750/50	270	7321677277827	727782
50-800	160/850/50	310	7321677277834	727783
50-900	160/950/50	350	7321677277841	727784
50-1000	170/1050/50	390	7321677277858	727785
50F-200	148/245/50	95	7321677140213	714021
50F-300	175/345/50	125	7321677147007	714700
50F-400	175/445/50	170	7321677140220	714022
50F-500	180/547/50	220	7321677187935	718793
50F-600	180/647/50	250	7321677140237	714023
50F-1000	240/1052/60	770	7321677140244	714024

Wall and support brackets

Support bracket 3				
Support bracket to be used for centre installation of cable ladders on pendant/fixing rails and vertical pieces. Material: Steel, Zinkpox coated white.				
3-150	92/57/150	26	7321677218622	721862
3-200	92/57/200	33	7321677218639	721863
3-300	92/57/300	58	7321677218646	721864
3-400	92/57/400	78	7321677218653	721865
3-500	92/57/500	120	7321677218660	721866
3-600	92/57/600	145	7321677218677	721867
Wall bracket 11/25 and 11/75				
Wall bracket to be used for vertical or horizontal installations of cable ladders against a wall. Maximum loads for vertical mounting: 300 kg (3 kN). For mounting against a rung the max. load is 500 kg (5 kN) for 11/25. Maximum loads for horizontal mounting: 11/25 250 kg (2.5 kN), 11/75 100 kg (1 kN). Material: Steel, Zinkpox coated white.				
11/25	85/71/40	24	7321677132089	713208
11/75	135/71/40	30	7321677132072	713207
Wall support 550				
Wall support for mounting of cantilever arm on porous walls or sandwich wall blocks, with six keyholes for easy fixation. When mounting cantilever arm on support, use screw set 25S (M8). Material: Steel, Zinkpox coated white.				
Wall support 550 mm	20/100/550	1047	3606480985294	CSU795366







Zinkpox - Corrosion class C5-I

Vertical pieces

Type	Dimensions A/B/C mm 	Weight kg/100 pcs	EAN code	Ref. No.
Vertical piece 2				
Vertical piece to be used for installation of Support bracket 3, symmetrical loading. Not suitable for cable ladders KHZV and KHZPV. Can be joined to Pendant/fixing rail 24/34 with Pendant joint 2J. Material: Steel, Zinkpox coated white.				
2-300	279/80/135	52	7321677162833	716283
2-400	392/80/135	62	7321677162840	716284
2-500	504/80/135	72	7321677162857	716285
2-700	729/80/135	93	7321677162864	716286
2-1000	1022/80/135	120	7321677162871	716287
Vertical piece 2F				
Vertical piece to be used for installation of Support bracket 3 or Cantilever arm 50. Can be joined to Pendant/fixing rail 24/48 with Pendant joint 2FJ. Material: Steel, Zinkpox coated white.				
2F-280	280/80/135	80	7321677172016	717201
2F-370	370/80/135	100	7321677172023	717202
2F-505	505/80/135	130	7321677172030	717203
2F-730	730/80/135	170	7321677172047	717204
2F-1000	1000/80/135	220	7321677172054	717205
2F-1500	1495/80/135	290	7321677872770	787277
Vertical piece 20				
Vertical piece, two-sided, to be used for vertical installation together with Cantilever arm 50, from a ceiling or on a floor. Can also be installed as a cantilever arm on a wall. Material: Steel, Zinkpox coated white.				
20-500	505/155/150	243	7321677162765	716276
20-700	730/155/150	324	7321677162772	716277
20-1000	1000/155/150	458	7321677162789	716278
20-1500	1495/155/150	652	7321677162796	716279
20-2000	1990/155/150	799	7321677162802	716280
20-3000	2980/155/150	1177	7321677162819	716281
Vertical piece 20F				
Vertical piece, two-sided, to be used for mounting from the ceiling or on the floor. Suitable for rather heavy loads. Material: Steel, Zinkpox coated white.				
20F-1000	995/160/160	590	7321677184842	718484
20F-1500	1490/160/160	790	7321677184859	718485
20F-2000	1985/160/160	990	7321677184866	718486
20F-3000	2980/160/160	1240	7321677162826	716282
Vertical piece 20FS				
Vertical piece, two-sided, to be used for mounting from the ceiling or on the floor. Suitable for very heavy loads. Material: Steel, Zinkpox coated white.				
20FS-1500	1495/270/150	1460	7321677205219	720521
20FS-2000	1990/270/150	1810	7321677205226	720522
20FS-2500	2485/270/150	2160	7321677205233	720523
20FS-3000	2980/270/150	2520	7321677205240	720524

Zinkpox - Corrosion class C5-I

Pendant/Fixing rails

Type	Dimensions A/B/C mm	 Weight kg/100 pcs	EAN code	Ref. No.
Pendant/Fixing rail 24/34				
Pendant/Fixing rail for mounting of support brackets, cantilever arms, etc. Material: Steel, Zinkpox coated white.				
P140427 	24/34	2970/16/42	240	7321677163090 716309
Pendant/Fixing rail 24/48				
Pendant/Fixing rail for mounting of support brackets, cantilever arms, etc. Material: Steel, Zinkpox coated white.				
P140428 	24/48	1000/26/48	175	3606481317896 CSU795568
	24/48	2970/26/48	520	7321677163069 716306
	24/48	5940/26/48	1120	7321677317240 731724
Pendant/Fixing rail 24/20				
Pendant/Fixing rail for mounting of support brackets, cantilever arms, etc. Material: Steel, Zinkpox coated white.				
P140429 	24/20	2970/55/48	1130	7321677163076 716307
Pendant/Fixing rail 24/20F				
Pendant/Fixing rail for mounting of support brackets, cantilever arms, etc. Material: Steel, Zinkpox coated white.				
P140430 	24/20F-3000	2970/89/48	1160	7321677163083 716308
	24/20F-6000	5940/89/48	2370	7321677205257 720525
Pendant/Fixing rail 24/20FS				
Pendant/Fixing rail for mounting of support brackets, cantilever arms, etc. Material: Steel, Zinkpox coated white.				
P140431 	24/20FS	5940/106/48	4200	7321677205264 720526

Base plate

Pendant base plate 520				
Pendant base plate to be used as a ceiling or floor base plate for Pendant/Fixing rail 24/20 in any desired length. Four screws MVBF 8x80 and nuts included. Material: Steel, Zinkpox coated white.				
P140432 	520	278/160/160	400	7321677184880 718488

Zinkpox - Corrosion class C5-I

Pendant bar, rail fixing

Type	Dimensions A/B/C mm	Weight kg/100 pcs	EAN code	Ref. No.
Pendant bar 1				
Pendant bar to be installed in order to reduce the deflection of heavily loaded vertical pieces. Installed with T-bolt and Expansion bolt. Material: Steel, Zinkpox coated white.				
1-300	362/-/40	35	7321677176434	717643
1-500	568/-/40	53	7321677176441	717644
1-800	880/-/40	82	7321677176458	717645
1-1500	1296/35/50	560	7321677205301	720530
Rail fixing support 24/20F, 24/20FS				
Rail fixing support to be used with Pendant/fixing rails 24/20F and 24/20FS respectively, for mounting between floor and ceiling. Material: Steel, Zinkpox coated white.				
24/20F	106/165/80	167	7321677205271	720527
24/20FS	106/185/80	190	7321677205288	720528

Brackets, pendant joint

Angle bracket 5L				
Angle bracket to be used for steel wire installation in ceilings. Also used when assembling pendant/fixing rails to frames for switching cabinets and electrical control centres and for fixing an upright between floor and ceiling. Assembled with a T-bolt. Material: Steel, Zinkpox coated white.				
5L	70/45/49	15	7321677317929	731792
Angle bracket 5LS				
Angle bracket to be used when assembling pendant/fixing rails to frames for switching cabinets and electrical control centres and for fixing an upright between floor and ceiling. Assembled with a T-bolt. Material: Steel, Zinkpox coated white.				
5LS	111/71/60	50	7321677205295	720529
Bracket 60/40				
Bracket to be used together with Pendant/fixing rail 24/48 to reduce the deflection of long vertical pieces. Material: Steel, Zinkpox coated white.				
60/40	95/23/40	10	7321677205318	720531
Pendant joint 2J, 2FJ and 20J				
Pendant joint to be used for joining pendant/fixing rails and vertical pieces. Screws M8x16 (2J and 2FJ) or M8x70 (20J) and nuts included. Material: Steel, Zinkpox coated white.				
2J	200/48/18	43	7321677163038	716303
2FJ	200/55/18	46	7321677163045	716304
20J	200/55/36	94	7321677163021	716302

Zinkpox - Corrosion class C5-I

Ceiling brackets

Type	Dimensions A/B/C mm 	Weight kg/100 pcs	EAN code	Ref. No.
Ceiling bracket 5				
Ceiling bracket to be used for installations with Pendant/Fixing rails 24/34 and 24/48. Screw not included. Material: Steel, Zinkpox coated white.				
5	100/135/40	35	7321677162932	716293
Ceiling bracket 5TP				
Ceiling bracket to be used for installations of Vertical pieces 2, 2F and 20 in ceilings with a trapezoidal sheet profile. Material: Steel, Zinkpox coated white.				
5TP	75/35/50	12	7321677162956	716295

Take-off hook

Fixed take-off hook 4				
Fixed take-off hook to be used for 90° horizontal branches. Material: Aluminium.				
4	71/19/86	8	7321677140671	714067
Take-off hook 47				
Take-off hook to be used on cable ladders KHZV and KHZPV to make 90° branches. Screw M12 and nuts are included. Material: Steel, Zinkpox coated white.				
47	155/10/73	27	7321677914012	791401

End connection

End connection 10				
End connection to be used for the connection of a ladder vertically to a floor, or horizontally to a wall. Material: Aluminium.				
10	60/55/60	8	7321677140855	714085

Lighting bracket

Lighting bracket 200				
Lighting bracket to be used for the installation of lighting fittings beneath cable ladders KHZV and KHZPV 200. Material: Steel, Zinkpox coated white.				
200	24/25/215	16	7321677186440	718644

Beam clamp

Beam clamp 5BK				
Beam clamp to be used for the installation of Vertical pieces 2, 2F or 20 on I-beams. For flange thickness max. 13 mm and 14-30 mm respectively. Material: Steel, Zinkpox coated white.				
5BK-10 (max. 13 mm)	30/50/45	15	7321677162949	716294
5BK-30 (14-30 mm)	50/50/45	18	7321677184873	718487

Back plate

Back plate 40				
Back plate to be used for installation behind Cantilever arm 50 to reduce the surface pressure on porous walls. Material: Steel, Zinkpox coated white.				
40	150/-/60	55	7321677140299	714029

Zinkpox - Corrosion class C5-I

Bends

P1400448



Riser 18

Riser piece to be fitted to the cable ladders by using Joint 21.
Material: Steel, Zinkpox coated white.

18-150	452/147/452	180	7321677181841	718184
18-200	452/197/452	190	7321677181858	718185
18-300	452/297/452	210	7321677181872	718187
18-400	452/397/452	230	7321677181889	718188
18-500	452/497/452	250	7321677181896	718189
18-600	452/597/452	270	7321677181902	718190
18-800	452/897/452	310	7321677280346	728034
18-1000	452/1097/452	350	7321677181919	718191

P1400449



Riser coupling 49

Coupling to be used as a self-supporting vertical coupling of cable ladders KHZV/KHZPV. Two screw sets M12 are needed.
Material: Steel, Zinkpox coated white.

49-200	120/197/483	220	7321677163953	716395
49-300	120/297/483	230	7321677163960	716396
49-400	120/397/483	240	7321677163977	716397
49-500	120/497/483	245	7321677205189	720518
49-600	120/597/483	250	7321677163984	716398
49-1000	120/997/483	280	7321677163991	716399

P1400450









90° bend 15, interior

Interior bend piece to be fitted to the cable ladders by using Joint 21, creating a 90° bend. Inner radius 268 mm.
Material: Steel, Zinkpox coated white.

15-150	55/547/547	220	7321677160747	716074
15-200	55/597/597	240	7321677160754	716075
15-300	55/697/697	290	7321677160778	716077
15-400	55/797/797	340	7321677160785	716078
15-500	55/897/897	390	7321677160792	716079
15-600	55/997/997	440	7321677160808	716080
15-800	55/1197/1197	640	7321677280438	728043
15-1000	55/1397/1397	760	7321677160815	716081

Zinkpox - Corrosion class C5-I

Bends

Type	Dimensions A/B/C mm 	Weight kg/100 pcs	EAN code	Ref. No.	
90° bend 15, exterior					
Exterior bend piece to be fitted to the cable ladders by using Joint 21, creating a 90° bend. Material: Steel, Zinkpox coated white.					
	15-150	55/703/703	320	7321677161867	716186
	15-200	55/933/933	370	7321677161874	716187
	15-300	55/1133/1133	460	7321677161898	716189
	15-400	55/1333/1333	550	7321677161904	716190
	15-500	55/1533/1533	640	7321677161911	716191
	15-600	55/1733/1733	760	7321677161928	716192
	15-800	55/2133/2133	1060	7321677280520	728052
	15-1000	55/2533/2533	1280	7321677280537	728053
90° bend 55, interior					
Interior bend piece to be fitted to cable ladders KHZV and KHZPV, creating a 90° horizontal bend. Material: Steel, Zinkpox coated white.					
	55-200	150/625/625	510	7321677162482	716248
	55-300	150/725/725	560	7321677162505	716250
	55-400	150/825/825	620	7321677162512	716251
	55-500	150/925/925	680	7321677162529	716252
	55-600	150/1025/1025	750	7321677162536	716253
	55-1000	150/1425/1425	1110	7321677162543	716254
T-junction 16					
T-junction piece to be fitted to the cable ladders by using Joint 21. Material: Steel, Zinkpox coated white.					
	16-150	55/944/547	300	7321677162017	716201
	16-200	55/997/597	320	7321677162024	716202
	16-300	55/1097/697	390	7321677162048	716204
	16-400	55/1197/797	440	7321677162055	716205
	16-500	55/1297/897	530	7321677162062	716206
	16-600	55/1397/997	600	7321677162079	716207
	16-1000	55/1797/1397	860	7321677162086	716208
T-junction 56					
T-junction piece to be fitted to the cable ladder KHZV or KHZPV by using screw set M12. Material: Steel, Zinkpox coated white.					
	56-200	150/1050/625	710	7321677162628	716262
	56-300	150/1150/725	790	7321677162642	716264
	56-400	150/1250/825	840	7321677162659	716265
	56-500	150/1350/925	940	7321677162666	716266
	56-600	150/1450/1025	1010	7321677162673	716267
	56-1000	150/1850/1425	1300	7321677162680	716268
X-junction 17					
X-junction piece to be fitted to the cable ladders by using Joint 21. Material: Steel, Zinkpox coated white.					
	17-150	55/547/547	380	7321677162178	716217
	17-200	55/997/997	400	7321677162185	716218
	17-300	55/1097/1097	500	7321677162208	716220
	17-400	55/1197/1197	550	7321677162215	716221
	17-500	55/1297/1297	600	7321677162222	716222
	17-600	55/1397/1397	860	7321677162239	716223
	17-1000	55/1797/1797	1220	7321677162246	716224

Zinkpox - Corrosion class C5-I

Covers/Cover plates

Type	Dimensions A/B/C mm 	Weight kg/100 pcs	EAN code	Ref. No.
Cover 64				
Cover to be used for vertically mounted cable ladders. Material: Steel, Zinkpox coated white.				
64-150	10/2000/151	290	7321677825691	782569
64-200	10/2000/201	370	7321677825707	782570
64-300	10/2000/301	540	7321677825714	782571
64-400	10/2000/401	710	7321677825721	782572
64-500	10/2000/501	1020	7321677825738	782573
64-600	10/2000/601	1210	7321677825745	782574
64-800	10/2000/801	1660	7321677825752	782575
64-1000	10/2000/1001	2000	7321677825769	782576
Cover W5				
Cover to be used to protect the cable runs from dust, dirt, liquids, etc. Outdoors, it protects against rain and sun. Suitable for all cable ladders. Material: Steel, Zinkpox coated white.				
W5-150	10/2000/151	190	7321677823659	782365
W5-200	10/2000/201	250	7321677823666	782366
W5-300	10/2000/301	360	7321677823673	782367
W5-400	10/2000/401	680	7321677823680	782368
W5-500	10/2000/501	880	7321677823697	782369
W5-600	10/2000/601	1050	7321677823703	782370
W5-800	10/2000/801	1420	7321677822140	782214
W5-1000	10/2000/1001	1730	7321677823710	782371
Cover 90° interior bend				
Cover to be used for 90° interior bends. To be installed with a Profile support piece 37, Cover clamp and Cover joint. Material: Steel, Zinkpox coated white.				
150	10/420/420	65	7321677817511	781751
200	10/470/470	91	7321677817528	781752
300	10/570/570	143	7321677817535	781753
400	10/670/670	221	7321677817542	781754
500	10/770/770	299	7321677817559	781755
600	10/870/870	390	7321677817566	781756
800	10/1070/1070	460	7321677817948	781794
1000	10/1270/1270	871	7321677817573	781757
Cover T-junction				
Cover to be used for T-junctions. To be installed with a Profile support piece 37, Cover clamp and Cover joint. Material: Steel, Zinkpox coated white.				
150	10/400/651	182	7321677817658	781765
200	10/450/701	221	7321677817665	781766
300	10/550/801	312	7321677817672	781767
400	10/650/901	416	7321677817689	781768
500	10/750/1001	533	7321677817696	781769
600	10/850/1101	676	7321677817702	781770
800	10/1050/1301	710	7321677817979	781797
1000	10/1240/1501	1352	7321677817719	781771
Profile support piece 37				
Profile support piece to be used when installing covers. To be mounted on approximately every 0.5 m along both sides of the cable ladder. Used together with cover clamp for locking covers. Material: Steel, Zinkpox coated white.				
37	136/20/50	6	7321677823826	782382
Cover clamp				
Cover clamps to be used when installing a cover on a Profile support piece 37. Material: Steel, Zinkpox coated white.				
Cover clamp	32/10.5/20	1.5	3606489699420	CSU795599

P140466



P140467



P140468



P140469



P140480



P140481



Zinkpox - Corrosion class C5-I

Angle plate

Type	Dimensions A/B/C mm	Weight kg/100 pcs	EAN code	Ref. No.
Angle plate 33				
Angle plate to be used together with 90° horizontal T-junctions. Recommended for all cable ladders. Material: Steel, Zinkpox coated white.				
33/2	25/195/490	90	7321677141685	714168

P140462



Mounting rail

Type	Dimensions A/B/C mm	Weight kg/100 pcs	EAN code	Ref. No.
Mounting rail 40				
Mounting rail to be used for wall installation of cantilever arms on porous walls to reduce the surface pressure or to enable height adjustment of cantilever arms. Material: Steel, Zinkpox coated white.				
40	270/26/48	56	7321677290451	729045

P140463



Reducers

Type	Dimensions A/B/C mm	Weight kg/100 pcs	EAN code	Ref. No.
Reducer 31				
Reducer to be used for transition joining from a wide to a narrower cable ladder. Material: Steel, Zinkpox coated white.				
31-100	48/100/200	43	7321677354337	735433
31-200	48/200/200	59	7321677354344	735434
31-300	48/300/200	74	7321677354351	735435
31-400	48/400/200	89	7321677354368	735436

P140464



Lashing wire

Type	Dimensions A/B/C mm	Weight kg/100 m	EAN code	Ref. No.
Lashing wire				
Lashing wire to be used for lashing of wires on cable ladders. Material: Stainless steel, PVC.				
HTR-2303, white PVC	Ø1.25	1.3/100 m	7321677136865	713686
HTR-2313, black PVC	Ø1.25	1.3/100 m	7321677136872	713687
Lashing wire to be used for lashing of wires on cable ladders. Material: PVC.				
HT-2304, white	Ø1.5	1.8/100 m	7321677136841	713684
HT-2314, black	Ø1.5	1.8/100 m	7321677136858	713685

P140226
P140225P140226
P140225

Profile protection

Type	Dimensions A/B/C mm	Weight kg/100 m	EAN code	Ref. No.
Profile protection 28P				
Profile protection to be used to increase the contact surface of the cables, when pulled over the side profile of the ladder. Material: PVC, grey.				
28P	60/28/2000	80	7321677321513	732151

P140063



End plugs

Type	Dimensions A/B/C mm	Weight kg/100 pcs	EAN code	Ref. No.
End plug 28/28i				
End plug to be mounted on ladder ends for sealing or protection. Material: PP/TPE.				
28, red	59/25/22	0.8	7321677090198	709019
28i, white	54/14/19	0.4	7321677354467	735446
28i, red			7321677319947	731994
End plug 28C, D and E				
End plug to be mounted on pendant ends to provide protection against personal injury and to make the ends of the profiles more conspicuous. Material: PP/TPE, orange.				
28C for Vertical piece 2 and Pendant/fixing rail 24/34	25/19/46	0.5	7321677898756	789875
28D for Vertical piece 20 and Pendant/fixing rail 24/20	25/52/58	1	7321677090204	709020
28E for Vertical piece 2F and Pendant/fixing rail 24/48	24/30/52	0.5	7321677090211	709021

P140064

P140065
P140066

P140067



P140068







P140069





Zinkpox - Corrosion class C5-I

End plugs

Type	Dimensions A/B/C mm		Weight kg/100 pcs	EAN code	Ref. No.
End plug 28F and J					
End plug to be mounted on pendant ends to provide protection against personal injury and to make the ends of the profiles more conspicuous. Material: PP/TPE, orange.					
P140070 	28F for Vertical piece 20FS and Pendant/fixing rail 24/20FS	30/53/110	4	7321677898763	789876
P135758 	28J for Vertical piece 20F and Pendant/Fixing rail 24/20F	27/53/95	2.1	3606480457531	CSU794520
Cross member plug 27					
Cross member plug to be installed at the ends of the rungs of KHZ and KHZV. Used in premises with a high corrosion risk. Material: PE, grey.					
P140071 	27	Ø20/10	0.15	7321677266685	726668



Marking plates

Marking plate 93					
Marking plates are part of a colour marking system that is easy to use when you want to mark out the type of cable that is placed on the cable ladder. Five different colours are available.					
B223240 	93, yellow	103/0.7/100	5	7321677377046	737704
	93, orange	103/0.7/100	5	7321677377053	737705
	93, blue	103/0.7/100	5	7321677377060	737706
	93, green	103/0.7/100	5	7321677377077	737707
	93, black	103/0.7/100	5	7321677377084	737708
Marking label, equipotential					
Label to be used to show that a construction is equipotentially bonded. Available in Swedish (other languages on request). Printed on self-adhesive yellow vinyl, 250 labels per roll. Material: Self-adhesive vinyl.					
P135944 	Marking label	25/-/86	-	7321677868605	786860

Paint

Repair paint					
Repair paint for the repair of minor damages of powder-coated products. Colour white RAL 9003, gloss 30.					
B224226 	Spray bottle, 0.4 litres	—	60	7321677397136	739713

Tools

Cable roller S					
Cable roller used to facilitate the pulling of cables and lines. Easily installed on all Wibe cable ladders except the high-sided WHS ladders (outer mounting hole). Also suitable for external/internal profiles of all 90° bends, T-junctions, X-junctions and risers (inner mounting hole). With a height adjustment of 45 mm to leave room for cables to pass under the roller. Material: Steel, electro-galvanized.					
P123977 	S	230/80/204	230	7321677186600	718660
Cable roller 38 Rig'n roll					
Cable roller used for mounting on Wibe cable ladders with belonging junctions and branches. Material: Stainless steel AISI316L (cable roller).					
P149249 	38 Rig'n roll	220/50/130	48	7321677359981	735998
P145452 	Bag	375/160/460	230	7321677801862	780186
	Set 66 (1 bag + 10 Cable rollers 38 Rig'n roll)	375/160/460	710	7321677801879	780187

Stainless Steel AISI 304L - Corrosion class C5-M

Cable ladders

P1396F20



Type	Dimensions A/B/C mm	Weight kg/100 m	EAN code	Ref. No.
Cable ladder KHZSP				
Cable ladder for both indoor and outdoor applications having high demands on corrosion resistance. With open side profiles provided with draining holes and profile-shaped rungs. Material: Stainless steel, AISI304L.				
KHZSP-200	198/164/2995 198/164/5995	198	3606481202512 3606481202567	CSU795543 CSU795548
KHZSP-300	298/264/2995 298/264/5995	217	3606481202529 3606481202574	CSU795544 CSU795549
KHZSP-400	398/364/2995 398/364/5995	237	3606481202536 3606481202581	CSU795545 CSU795550
KHZSP-500	498/464/2995 498/464/5995	257	3606481202543 3606481202598	CSU795546 CSU795551
KHZSP-600	598/564/2995 598/564/5995	277	3606481202550 3606481202604	CSU795547 CSU795552

Dimension table

B224475

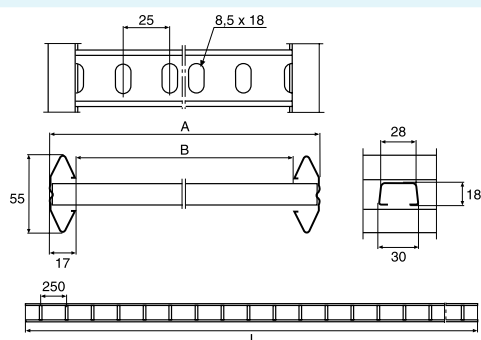

Type	A mm	B mm	L mm	Ref. No.
KHZSP-200	198	164	2995 5995	CSU795543 CSU795548
KHZSP-300	298	264	2995 5995	CSU795544 CSU795549
KHZSP-400	398	364	2995 5995	CSU795545 CSU795550
KHZSP-500	498	464	2995 5995	CSU795546 CSU795551
KHZSP-600	598	564	2995 5995	CSU795547 CSU795552

Stainless Steel AISI 316L - Corrosion class C5-M

Cable ladders AISI 316L C5-M

P139699



Type	Dimensions A/B/C mm	Weight kg/100 m	EAN code	Ref. No.
Cable ladder KHZSP				
Cable ladder for both indoor and outdoor applications having high demands on corrosion resistance. With open side profiles provided with draining holes and profile-shaped rungs. Material: Stainless steel, AISI316L.				
KHZSP-200	198/164/2995 198/164/5995	198	3606480446795 3606480446856	CSU794439 CSU794445
KHZSP-300	298/264/2995 298/264/5995	217	3606480446801 3606480446863	CSU794440 CSU794446
KHZSP-400	398/364/2995 398/364/5995	237	3606480446818 3606480446870	CSU794441 CSU794447
KHZSP-500	498/464/2995 498/464/5995	257	3606480446825 3606480446887	CSU794442 CSU794448
KHZSP-600	598/564/2995 598/564/5995	277	3606480446832 3606480446894	CSU794443 CSU794449

Dimension table

B224475

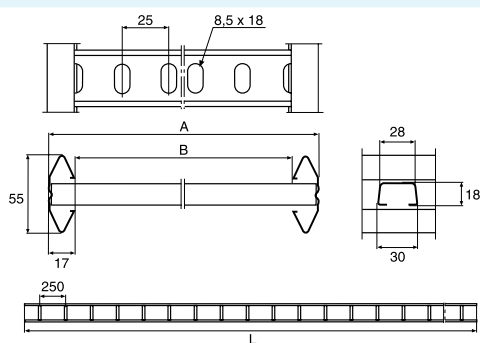

Type	A mm	B mm	L mm	Ref. No.
KHZSP-200	198	164	2995 5995	CSU794439 CSU794445
KHZSP-300	298	264	2995 5995	CSU794440 CSU794446
KHZSP-400	398	364	2995 5995	CSU794441 CSU794447
KHZSP-500	498	464	2995 5995	CSU794442 CSU794448
KHZSP-600	598	564	2995 5995	CSU794443 CSU794449

Stainless Steel AISI 316L - Corrosion class C5-M

Cable ladders

P139595



Type	Dimensions A/B/C mm	Weight kg/100 m	EAN code	Ref. No.
------	------------------------	--------------------	----------	----------

Cable ladders KHZP

Cable ladder for indoor or outdoor industrial applications. With closed side profiles and profile-shaped rungs. Must not be used as walkway.

Material: Stainless steel AISI316L.

KHZP-150	55/147/6000	260	7321677273829	727382
KHZP-200	55/197/6000	270	7321677273836	727383
KHZP-300	55/297/6000	290	7321677273843	727384
KHZP-400	55/397/6000	315	7321677273850	727385
KHZP-500	55/497/6000	340	7321677273867	727386
KHZP-600	55/597/6000	360	7321677273874	727387
KHZP-800	55/797/6000	490	7321677821280	782128
KHZP-1000	55/997/6000	560	7321677821297	782129

Dimension table

B223877

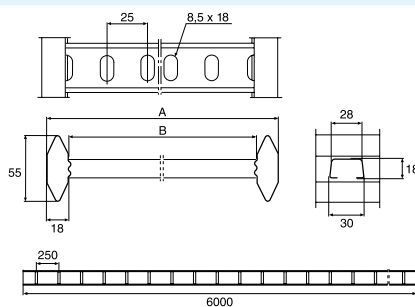

Type	A mm	B mm	L mm	Ref. No.
KHZP-150	147	111	6000	727382
KHZP-200	197	161	6000	727383
KHZP-300	297	261	6000	727384
KHZP-400	397	361	6000	727385
KHZP-500	497	461	6000	727386
KHZP-600	597	561	6000	727387
KHZP-800	797	761	6000	782128
KHZP-1000	997	961	6000	782129

Stainless Steel AISI 316L - Corrosion class C5-M

Cable ladders

P1390589



Type	Dimensions A/B/C mm	Weight kg/100 m	EAN code	Ref. No.
------	------------------------	--------------------	----------	----------

Cable ladder KHZ

Cable ladder for indoor or outdoor industrial applications. With closed side profiles and round rungs that do not penetrate the outer side of the side profile. Must not be used as walkway.
Material: Stainless steel AISI316L.

KHZ-150	55/147/6000	270	7321677273768	727376
KHZ-200	55/197/6000	280	7321677273775	727377
KHZ-300	55/297/6000	300	7321677273782	727378
KHZ-400	55/397/6000	320	7321677273799	727379
KHZ-500	55/497/6000	340	7321677273805	727380
KHZ-600	44/597/6000	360	7321677273812	727381

Dimension table

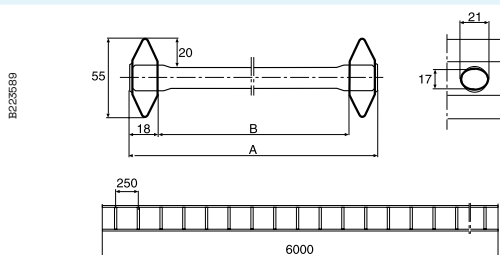

Type	A mm	B mm	L mm	Ref. No.
KHZ-150	147	111	6000	727376
KHZ-200	197	161	6000	727377
KHZ-300	297	261	6000	727378
KHZ-400	397	361	6000	727379
KHZ-500	497	461	6000	727380
KHZ-600	597	561	6000	727381

Stainless Steel AISI 316L - Corrosion class C5-M

Cable ladders

P130645

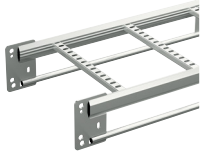

Type	Dimensions A/B/C mm	Weight kg/100 m	EAN code	Ref. No.
------	------------------------	--------------------	----------	----------

Cable ladders KHZPV

Reinforced cable ladder for indoor or outdoor industrial applications. Designed for extreme support distances and loadings. With closed side profiles and profile-shaped rungs. Must not be used as walkway.
Material: Stainless steel AISI316L.

KHZPV-200	150/197/6000	426	7321677840663	784066
KHZPV-300	150/297/6000	448	7321677840670	784067
KHZPV-400	150/397/6000	470	7321677840687	784068
KHZPV-500	150/497/6000	493	7321677840694	784069
KHZPV-600	150/597/6000	515	7321677840700	784070
KHZPV-800	150/797/6000	587	7321677840717	784071
KHZPV-1000	150/997/6000	703	7321677840724	784072

Dimension table

B223676

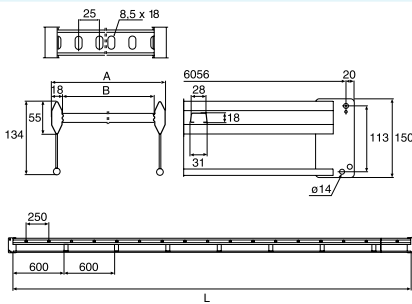

Type	A mm	B mm	L mm	Ref. No.
KHZPV-200	197	161	6000	784066
KHZPV-300	297	261	6000	784067
KHZPV-400	397	361	6000	784068
KHZPV-500	497	461	6000	784069
KHZPV-600	597	561	6000	784070
KHZPV-800	797	761	6000	784071
KHZPV-1000	997	961	6000	784072

Stainless Steel AISI 316L - Corrosion class C5-M

Joins

	Type	Dimensions A/B/C mm 	Weight kg/100 pcs	EAN code	Ref. No.
P139855	Joint 21				
	Joint to be used for straight, rigid joining of cable ladders, bends, junctions and risers. It also reduces the transition resistance and prevents the ladders from slipping apart. M6 screws included. Material: Stainless steel AISI316L.				
	21	64/22/200	37	7321677257515	725751
P13919	Joint 45				
	Joint to be fitted as a joining plate in a cut KHZPV ladder. Screws M8 and M12 + nuts are included. Material: Stainless steel AISI316L.				
	45	150/4/95	50	7321677928736	792873

Couplings

P139856	Coupling 22				
	Coupling to be used for horizontal or vertical branches at any desired angle. M6 screws included. Material: Stainless steel AISI316L.				
	22	60//24/150	21	7321677257607	725760
P139820	Junction coupling 14				
	Junction coupling to be used for T- and X-junctions. Suitable for cable ladders KHZ, KHZP, KHZSP and KHZPS, all cable widths. M6 screws included. Material: Stainless steel AISI316L.				
	14	65/73/350	49	7321677271955	727195
P139821	Coupling 44				
	Coupling to be used for horizontal coupling of cable ladders KHZV/KHZPV. Also to be used for branches and as an end connection against a wall. Four screws M8x30 and nuts are included. Material: Stainless steel AISI316L.				
	44	135/-/120	50	7321677928880	792888
P139822	Coupling 51				
	Coupling to be used as a self-supporting vertical coupling of cable ladders KHZV/KHZPV. Two screws M12 and nuts are included. Material: Stainless steel AISI316L.				
	51	150/-/193+138	150	7321677319145	731914

Clamps, support piece

P139823	Profile clamp 42				
	Profile clamp to be used for installations where the cable ladder is to be fixed to cantilever arms, support brackets, etc. Screw M8 and nut included. Material: Stainless steel AISI316L.				
	42	54/57/30	11	7321677257638	725763
P139824	Profile clamp 43				
	Profile clamp to be used for installations where the cable ladders KHZV and KHZPV are to be fixed to cantilever arms, support brackets, etc. Screw M8 and nut included. Material: Stainless steel AISI316L.				
	43	21/43/30	5	7321677928934	792893
P139825 P139826	Clamp 12				
	Clamp to be used on the side profile of the cable ladder for installation of accessories. Bolt and nut included. Material: Stainless steel AISI316L.				
	12/70	125/25/40	19	7321677286515	728651
	12/120	175/25/40	24	7321677286522	728652
P139827	Profile clamp 41				
	Profile clamp to be used to install a pendant/fixing rail or mounting plate, etc., on the cable ladder profile. Material: Stainless steel AISI316L.				
	41	125/16/30	10	7321677833740	783374
P139828	Profile support piece 46				
	Profile support piece to be fitted between the ladder and the vault pipe when a support bracket is positioned between existing profile support pieces. For cable ladders KHZV and KHZPV. Material: Stainless steel AISI316L.				
	46	72/18/30	15	7321677928774	792877

Stainless Steel AISI 316L - Corrosion class C5-M

Cantilever arms

Type	Dimensions A/B/C mm 	Weight kg/100 pcs	EAN code	Ref. No.
Cantilever arm 50				
Cantilever arm for mounting on walls, pendant/fixing rails or vertical pieces. Material: Stainless steel AISI316L.				
50-100	85/150/40	24	7321677256181	725618
50-150	85/200/40	28	7321677256198	725619
50-200	85/250/40	34	7321677256204	725620
50-250	105/300/40	52	7321677256211	725621
50-300	105/350/40	60	7321677256228	725622
50-400	120/450/50	228	7321677256235	725623
50-500	140/550/50	172	7321677256242	725624
50-600	150/650/50	215	7321677256259	725625

P140016



Wall and support brackets

Type	Dimensions A/B/C mm	Weight kg/100 pcs	EAN code	Ref. No.
Support bracket 3				
Support bracket to be used for centre installation of cable ladders on pendant/fixing rails and vertical pieces. Material: Stainless steel AISI316L.				
3-150	70/39/154	15	7321677264339	726433
3-200	70/39/204	20	7321677264346	726434
3-300	70/40/306	47	7321677264353	726435
3-400	70/40/406	62	7321677264360	726436
3-500	70/40/506	103	7321677264377	726437
3-600	70/40/606	123	7321677264384	726438

P140022



Type	Dimensions A/B/C mm	Weight kg/100 pcs	EAN code	Ref. No.
Wall bracket 11/25 and 11/75				
Wall bracket to be used for vertical or horizontal installations of cable ladders against a wall. Maximum loads for vertical mounting: 300 kg (3 kN). For mounting against a rung the max. load is 500 kg (5 kN) for 11/25. Maximum loads for horizontal mounting: 11/25 250 kg (2.5 kN), 11/75 100 kg (1 kN). Material: Stainless steel AISI316L.				
11/25	85/71/40	24	7321677257744	725774
11/75	135/71/40	30	7321677257751	725775

P139934
P139935

Type	Dimensions A/B/C mm	Weight kg/100 pcs	EAN code	Ref. No.
Wall support 550				
Wall support for mounting of cantilever arm on porous walls or sandwich wall blocks, with six keyholes for easy fixation. When mounting cantilever arm on support, use screw set 25S (M8). Material: Stainless steel AISI316L.				
Wall support 550 mm	20/100/550	105	3606480985300	CSU795367

P143289



Brackets

Type	Dimensions A/B/C mm	Weight kg/100 pcs	EAN code	Ref. No.
Angle bracket 5L				
Angle bracket to be used for steel wire installation in ceilings. Also used when assembling pendant/fixing rails to frames for switching cabinets and electrical control centres and for fixing an upright between floor and ceiling. Assembled with a T-bolt. Material: Stainless steel AISI316L.				
5L	70/45/49	15	7321677317936	731793

P139953



Type	Dimensions A/B/C mm	Weight kg/100 pcs	EAN code	Ref. No.
Angle bracket 5LS				
Angle bracket to be used when assembling pendant/fixing rails to frames for switching cabinets and electrical control centres and for fixing an upright between floor and ceiling. Assembled with a T-bolt. Material: Stainless steel AISI316L.				
5LS	111/71/60	50	7321677256365	725636

P139954



Type	Dimensions A/B/C mm	Weight kg/100 pcs	EAN code	Ref. No.
Pendant joint 2J and 2FJ				
Pendant joint to be used for joining pendant/fixing rails and vertical pieces. Screws M8x16 and nuts included. Material: Stainless steel AISI316L.				
2J	200/48/18	43	7321677264841	726484
2FJ	200/55/18	46	7321677264858	726485

P139959
P139960

Ceiling bracket

Type	Dimensions A/B/C mm	Weight kg/100 pcs	EAN code	Ref. No.
Ceiling bracket 5				
Ceiling bracket to be used for installations with Pendant/Fixing rails 24/34 and 24/48. Screw not included. Material: Stainless steel AISI316L.				
5	100/135/40	35	7321677255733	725573

P139901



Take-off hook

Type	Dimensions A/B/C mm	Weight kg/100 pcs	EAN code	Ref. No.
Take-off hook 47				
Take-off hook to be used on cable ladders KHZV and KHZPV to make 90° branches. Screw M12 and nuts are included. Material: Stainless steel AISI316L.				
47	155/10/73	27	7321677928750	792875

P139958



Stainless Steel AISI 316L - Corrosion class C5-M

Vertical pieces

P133937



Vertical piece 2

Vertical piece to be used for installation of Support bracket 3, symmetrical loading. Not suitable for cable ladders KHZV and KHZPV. Can be joined to Pendant/fixing rail 24/34 with Pendant joint 2J.
Material: Stainless steel AISI316L.

Length	Dimensions	Weight	EAN code	Ref. No.
2-300	279/80/135	52	7321677255573	725557
2-400	392/80/135	62	7321677255580	725558
2-500	504/80/135	72	7321677255597	725559
2-700	729/80/135	93	7321677255603	725560
2-1000	1022/80/135	120	7321677255610	725561

P133938



Vertical piece 2F

Vertical piece to be used for installation of Support bracket 3 or Cantilever arm 50. Can be joined to Pendant/fixing rail 24/48 with Pendant joint 2FJ.
Material: Stainless steel AISI316L.

Length	Dimensions	Weight	EAN code	Ref. No.
2F-280	280/80/135	80	7321677255627	725562
2F-370	370/80/135	100	7321677255634	725563
2F-505	505/80/135	130	7321677255641	725564
2F-730	730/80/135	170	7321677255658	725565
2F-1000	1000/80/135	220	7321677255665	725566
2F-1500	1495/80/135	290	7321677872787	787278

P133942



Vertical piece 20

Vertical piece, two-sided, to be used for vertical installation together with Cantilever arm 50, from a ceiling or on a floor. Can also be installed as a cantilever arm on a wall.
Material: Stainless steel AISI316L.

Length	Dimensions	Weight	EAN code	Ref. No.
20-500	505/155/150	243	7321677255672	725567
20-700	730/155/150	324	7321677255689	725568
20-1000	1000/155/150	458	7321677255696	725569
20-1500	1495/155/150	652	7321677255702	725570
20-2000	1990/155/150	799	7321677255719	725571
20-3000	2980/155/150	1177	7321677255726	725572

Pendant/Fixing rails

P133945



Type **Dimensions A/B/C mm**  **Weight kg/100 pcs** **EAN code** **Ref. No.**

Pendant/Fixing rail 24/34

Pendant/Fixing rail for mounting of support brackets, cantilever arms, etc.
Material: Stainless steel AISI316L.

24/34	293/16/42	23	7321677255740	725574
24/34	383/16/42	31	7321677255757	725575
24/34	495/16/42	40	7321677255764	725576
24/34	698/16/42	56	7321677255771	725577
24/34	990/16/42	80	7321677255788	725578
24/34	2970/16/42	240	7321677255795	725579

P133946



Pendant/Fixing rail 24/48

Pendant/Fixing rail for mounting of support brackets, cantilever arms, etc.
Material: Stainless steel AISI316L.

24/48	1000/26/48	175	3606481317872	CSU795566
24/48	2970/26/48	520	7321677285952	728595
24/48	5940/26/48	1120	7321677317271	731727

P140023



Pendant bar 1

Pendant bar to be installed in order to reduce the deflection of heavily loaded vertical pieces. Installed with T-bolt and Expansion bolt.
Material: Stainless steel AISI316L.

1-500	515/166/40	53	3606480911415	CSU795328
-------	------------	----	---------------	-----------

Stainless Steel AISI 316L - Corrosion class C5-M

Threaded rod

Type	Dimensions A/B/C mm	Weight kg/100 pcs	EAN code	Ref. No.
Threaded rod B41				
Threaded rod according to metric standard 6G. Material: Stainless steel AISI316L.				
B41/M8	8/8/1000	63	7332227015516	1149551
	8/8/2000		7332227015523	1149552
B41/M10	10/10/1000	99	7332227015615	1149561
	10/10/2000		7332227015622	1149562
Flange nut B43				
Flange nut to be mounted onto Threaded rod B41 in order to lock it to the Support hook and the Ceiling fittings. Package of 50 pcs. Material: Stainless steel AISI316L.				
B43/M8	17/17/8	0.68	7332227015547	1149554
B43/M10	20/20/15	1.12	7332227015646	1149564
Distance nut B42				
Distance nut to be used when joining Threaded rods. Material: Stainless steel AISI316L.				
B42/M8	15/15/30	1	7332227015554	1149555
B42/M10	20/20/40	2	7332227015653	1149565

Clamps

Cable clamp ER				
Cable clamp for the installation of cables on cable ladders with round or perforated rungs. Material: Stainless steel AISI316.				
ER for cable 23-28 mm	74/50/80	44	7321677364404	736440
ER for cable 27-32 mm	81/50/82	45	7321677364411	736441
ER for cable 39-35 mm	88/50/82	46	7321677364428	736442
ER for cable 33-38 mm	94/50/85	47	3303432467883	736443
ER for cable 36-42 mm	101/50/113	60	3303432467586	736444
ER for cable 40-46 mm	108/50/115	62	3303437364453	736445
ER for cable 44-50 mm	115/50/117	63	3303437364460	736446
ER for cable 48-55 mm	129/50/120	64	7321677364473	736447
ER for cable 51-58 mm	130/50/121	66	7321677364480	736448
ER for cable 55-62 mm	138/50/156	78	7321677364497	736449
ER for cable 59-66 mm	146/50/158	79	7321677364503	736450
ER for cable 63-70 mm	150/50/160	80	7321677364510	736451
ER for cable 67-74 mm	161/50/163	81	7321677364527	736452
ER for cable 71-78 mm	168/50/165	85	7321677364534	736453
ER for cable 74-82 mm	176/50/167	86	7321677364541	736454
ER for cable 77-85 mm	181/50/169	87	7321677364558	736455
Oval rung adaptor, screw set included, to be used when mounting Cable clamp ER on oval rungs on the KHZ range. Material: PP.				
Adaptor	29.5/48/47	12	7321677364565	736456
Screw set 74S to be used for the installation of cable clamp ER on perforated rungs. Two screws screw sets are required. Material: Stainless steel AISI316.				
74S	20/19/8	2	7321677371983	737198
Clamp set M6				
Clamp set to be used for the installation of Support bracket 3 directly on a roof bolt. The set includes two clamps and four locking nuts. M6-25 must be used for Support bracket 3 in hot-dip and pre-galvanized surface finish, whereas M6-20 must be used for Support bracket 3 in stainless steel and Installation plate 60 in all surface treatments. Material: Stainless steel AISI316L.				
M6-25	Ø29/M8	5	7321677207862	720786
M6-20	Ø24/M6	4	7321677255870	725587

Stainless Steel AISI 316L - Corrosion class C5-M

Box plates





Type	Dimensions A/B/C mm 	Weight kg/100 pcs	EAN code	Ref. No.
Junction box plate 35S				
Junction box plate, holed, to be installed upright or hanging from the profile. Locked with locking tabs. For junction boxes, electric light fittings, etc. Material: Stainless steel AISI316L.				
35S holed	164/20/170	22	7321677257768	725776
Junction box plate 35P				
Junction box plate, unholed, to be installed between rungs. Locked with appropriate locking tabs for each ladder. For junction boxes, electric light fittings, etc. Material: Stainless steel AISI316L.				
35P unholed	21/106/250	28	7321677257775	725777

Bends

Riser 18				
Riser piece to be fitted to the cable ladders by using Joint 21. Material: Stainless steel AISI316L.				
18-150	452/147/452	180	7321677273706	727370
18-200	452/197/452	190	7321677273713	727371
18-300	452/297/452	210	7321677273720	727372
18-400	452/397/452	230	7321677273737	727373
18-500	452/497/452	250	7321677273744	727374
18-600	452/597/452	270	7321677273751	727375
Riser coupling 49				
Coupling to be used as a self-supporting vertical coupling of cable ladders KHZV/KHZPV. Two screw sets M12 are needed. Material: Stainless steel AISI316L.				
49-200	120/197/483	220	7321677928804	792880
49-300	120/297/483	230	7321677928811	792881
49-400	120/397/483	240	7321677928828	792882
49-500	120/497/483	245	7321677928835	792883
49-600	120/597/483	250	7321677928842	792884
49-800	120/797/483	265	7321677928859	792885
49-1000	120/997/483	280	7321677928866	792886
90° bend 15, interior				
Interior bend piece to be fitted to the cable ladders by using Joint 21, creating a 90° bend. Material: Stainless steel AISI316L.				
15-150	55/547/547	220	7321677273461	727346
15-200	55/597/597	240	7321677273478	727347
15-300	55/697/697	290	7321677273485	727348
15-400	55/797/797	340	7321677273492	727349
15-500	55/897/897	390	7321677273508	727350
15-600	55/997/997	440	7321677273515	727351
90° bend 15, exterior				
Exterior bend piece to be fitted to the cable ladders by using Joint 21, creating a 90° bend. Material: Stainless steel AISI316L.				
15-150	55/703/703	320	7321677273522	727352
15-200	55/933/933	370	7321677273539	727353
15-300	55/1133/1133	460	7321677273546	727354
15-400	55/1333/1333	550	7321677273553	727355
15-500	55/1533/1533	640	7321677273560	727356
15-600	55/1733/1733	760	7321677273577	727357

Stainless Steel AISI 316L - Corrosion class C5-M

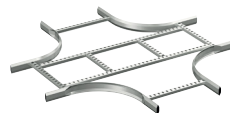

Bends

	Type	Dimensions A/B/C mm 	Weight kg/100 pcs	EAN code	Ref. No.
	90° bend 55, interior				
	Interior bend piece to be fitted to cable ladders KHZV and KHZPV, creating a 90° horizontal bend. Material: Stainless steel AISI316L.				
P140036 	55-200	150/625/625	510	7321677929030	792903
	55-300	150/725/725	560	7321677929047	792904
	55-400	150/825/825	620	7321677929054	792905
	55-500	150/925/925	680	7321677929061	792906
	55-600	150/1025/1025	750	7321677929078	792907
	55-800	150/1225/1225	830	7321677929081	792908
	55-1000	150/1425/1425	1110	7321677929092	792909
	T-junction 16				
	T-junction piece to be fitted to the cable ladders by using Joint 21. Material: Stainless steel AISI316L.				
P140037 	16-150	55/944/547	300	7321677273584	727358
	16-200	55/997/597	320	7321677273591	727359
	16-300	55/1097/697	390	7321677273607	727360
	16-400	55/1197/797	440	7321677273614	727361
	16-500	55/1297/897	530	7321677273621	727362
	16-600	55/1397/997	600	7321677273638	727363
		T-junction 56			
	T-junction piece to be fitted to the cable ladder KHZV or KHZPV by using screw set M12. Material: Stainless steel AISI316L.				
P140038 	56-200	150/1050/625	640	7321677929207	792920
	56-300	150/1150/725	710	7321677929214	792921
	56-400	150/1250/825	760	7321677929221	792922
	56-500	150/1350/925	850	7321677929238	792923
	56-600	150/1450/1025	910	7321677929245	792924
	56-800	150/1650/1225	1050	7321677929252	792925
	56-1000	150/1850/1425	1170	7321677834846	783484
	X-junction 17				
	X-junction piece to be fitted to the cable ladders by using Joint 21. Material: Stainless steel AISI316L.				
P140039 	17-150	55/547/547	380	7321677273645	727364
	17-200	55/997/997	400	7321677273652	727365
	17-300	55/1097/1097	500	7321677273669	727366
	17-400	55/1197/1197	550	7321677273676	727367
	17-500	55/1297/1297	600	7321677273683	727368
	17-600	55/1397/1397	860	7321677273690	727369

Tele-conduits

	Tele-conduit 36				
	Tele-conduit to be used where a separate tray is required for low-tension cables. Knock-out holes in the bottom of the channel permit the cables to pass through. Material: Stainless steel AISI316L.				
P140041 	36-50	24/50/2000	94	7321677255900	725590
	36-100	24/100/2000	142	7321677255917	725591
	36-200	24/200/2000	238	7321677255924	725592

Dividers

	Dividing strip 39				
	Dividing strip to be used to separate low-tension and high-tension cables. Material: Stainless steel AISI316L.				
P140042  P140043 	39/24	24/24/1750	46	7321677255931	725593
	39/55	55/24/1750	73	7321677255948	725594

Stainless Steel AISI 316L - Corrosion class C5-M

Dividers

Type	Dimensions A/B/C mm 	Weight kg/100 pcs	EAN code	Ref. No.
Distance piece W39				
Distance piece to be used for the joining of Dividing strips 39. Material: Plastic, natural coloured.				
W39	37/-/330	3	7321677168248	716824

Covers/Cover plates

Cover 64				
Cover to be used for vertically mounted cable ladders. Material: Stainless steel AISI316L.				
64-150	10/151/2000	290	7321677825851	782585
64-200	10/201/2000	370	7321677825868	782586
64-300	10/301/2000	540	7321677825875	782587
64-400	10/401/2000	710	7321677825882	782588
64-500	10/501/2000	1020	7321677825899	782589
64-600	10/601/2000	1210	7321677825905	782590
64-800	10/801/2000	1660	7321677825912	782591
64-1000	10/1001/2000	2000	7321677825929	782592

Cover W5				
Cover to be used to protect the cable runs from dust, dirt, liquids, etc. Outdoors, it protects against rain and sun. Suitable for all cable ladders. Material: Stainless steel AISI316L.				
W5-150	10/151/2000	190	7321677322916	732291
W5-200	10/201/2000	250	7321677322923	732292
W5-300	10/301/2000	360	7321677322930	732293
W5-400	10/401/2000	680	7321677322947	732294
W5-500	10/501/2000	840	7321677322954	732295
W5-600	10/601/2000	700	7321677322961	732296
W5-800	10/801/2000	1420	7321677833757	783375
W5-1000	10/1001/2000	1730	7321677322978	732297

Cover 90° interior bend				
Cover to be used for 90° interior bends. To be installed with a Profile support piece 37, Cover clamp and Cover joint. Material: Stainless steel AISI316L.				
150	10/420/420	44	7321677886395	788639
200	10/470/470	62	7321677886401	788640
300	10/570/570	105	7321677886418	788641
400	10/670/670	223	7321677886425	788642
500	10/770/770	310	7321677886432	788643
600	10/870/870	408	7321677886449	788644
800	10/1070/1070	643	7321677886456	788645
1000	10/1270/1270	926	7321677886463	788646

Cover T-junction				
Cover to be used for T-junctions. To be installed with a Profile support piece 37, Cover clamp and Cover joint. Material: Stainless steel AISI316L.				
150	10/400/651	95	7321677886470	788647
200	10/450/701	126	7321677886487	788648
300	10/550/801	196	7321677886494	788649
400	10/650/901	394	7321677886500	788650
500	10/750/1001	525	7321677886517	788651
600	10/850/1101	672	7321677886524	788652
800	10/1050/1301	1011	7321677886531	788653
1000	10/1240/1501	1414	7321677886548	788654

Profile support piece 37				
Profile support piece to be used when installing covers. To be mounted on approximately every 0.5 m along both sides of the cable ladder. Used together with cover clamp for locking covers. Material: Stainless steel AISI316L.				
37	136/20/50	6	7321677301904	730190

Stainless Steel AISI 316L - Corrosion class C5-M

Covers/Cover plates

Type	Dimensions A/B/C mm	Weight kg/100 pcs	EAN code	Ref. No.
Cover clamp				
Cover clamps to be used when installing a cover on a Profile support piece 37. Material: Stainless steel AISI316L.				
Cover clamp	32/10.5/20	1.5	7321677285860	728586
Cover plate 65				
Cover plate to be used on vertical cable ladder installations as protection of cables near the floor. To be mounted in the side profile with self-tapping screw ST4.2. Material: Stainless steel AISI316L.				
65-200	1000/120/200	930	7321677324811	732481
65-300	1000/120/300	1140	7321677324828	732482
65-400	1000/120/400	1350	7321677324835	732483
65-500	1000/120/500	1560	7321677324842	732484
65-600	1000/120/600	1780	7321677324859	732485

Angle plates

Angle plate 33				
Angle plate to be used together with 90° horizontal T-junctions. Recommended for all cable ladders. Material: Stainless steel AISI316L.				
33/1	28/150/290	50	7321677273409	727340
33/2	25/195/490	90	7321677271979	727197

Fittings for mesh trays

Combi-fittings B21				
Combi-fitting to be used when mounting mesh trays onto cable ladders. Material: Stainless steel AISI316L.				
B21	250/50/20	45	7332227013598	1149359
B21 90 degrees	120/50/135	45	7332227013918	1149391

Installation system HT



Pipe HTR-68				
Pipe for easy locking of wires. Material: Stainless steel AISI316L.				
HTR-68	Ø15/25	1.3	7321677136780	713678
Steel wire HT-2309				
Hard steel wire to be installed as carrier of one or more cables. Breaking loads, see below. Material: Stainless steel.				
HT-2322 Breaking load 450 kg	Dim. 2.5	3.9/100 m	7321677136810	713681
HT-2323 Breaking load 700 kg	Dim. 3.0	5.6/100 m	7321677136827	713682
HT-2324 Breaking load 1200 kg	Dim. 4.0	10.0/100 m	7321677136834	713683

Bar fixings

Round bar fixing				
Round bar fixing to be used for mounting in underground cavities and tunnels. Material: Stainless steel AISI316L.				
For ceilings	6/60/325	90	7321677928644	792864
For floors	6/140/130	91	7321677928668	792866
For walls	61/60/161	68	7321677928682	792868

Stainless Steel AISI 316L - Corrosion class C5-M







Lashing wire

Type	Dimensions A/B/C mm 	Weight kg/100 pcs	EAN code	Ref. No.
Lashing wire				
Lashing wire to be used for lashing of wires on cable ladders. Material: Stainless steel, PVC.				
	HTR-2303, white PVC	Ø1.25	1.3/100 m	7321677136865 713686
	HTR-2313, black PVC	Ø1.25	1.3/100 m	7321677136872 713687
Lashing wire to be used for lashing of wires on cable ladders. Material: PVC.				
	HT-2304, white	Ø1.5	1.8/100 m	7321677136841 713684
	HT-2314, black	Ø1.5	1.8/100 m	7321677136858 713685



Profile protection

Profile protection 28P				
Profile protection to be used to increase the contact surface of the cables, when pulled over the side profile of the ladder. Material: PVC, grey.				
	28P	60/28/2000	80	7321677321513 732151

End plugs

End plug 28/28i				
End plug to be mounted on ladder ends for sealing or protection. Material: PP/TPE.				
	28, red	59/25/22	0.8	7321677090198 709019
	28i, white 28i, red	54/14/19	0.4	7321677354467 735446 7321677319947 731994
End plug 28C, D, E, F and J				
End plug to be mounted on pendant ends to provide protection against personal injury and to make the ends of the profiles more conspicuous. Material: PP/TPE, orange.				
	28C for Vertical piece 2 and Pendant/fixing rail 24/34	25/19/46	0.5	7321677898756 789875
	28D for Vertical piece 20 and Pendant/fixing rail 24/20	25/52/58	1	7321677090204 709020
	28E for Vertical piece 2F and Pendant/fixing rail 24/48	24/30/52	0.5	7321677090211 709021
	28F for Vertical piece 20FS and Pendant/fixing rail 24/20FS	30/53/110	4	7321677898763 789876
	28J for Vertical piece 20F and Pendant/Fixing rail 24/20F	27/53/95	2.1	3606480457531 CSU794520
Cross member plug 27				
Cross member plug to be installed at the ends of the rungs of KHZ and KHZV. Used in premises with a high corrosion risk. Material: PE, grey.				
	27	Ø20/10	0.15	7321677266685 726668

Screws, bolts and nuts

T-bolt 26U				
T-bolt to be used for the mounting of Cantilever arm 50 on Pendant/Fixing rail 24/48 and all vertical pieces except Vertical piece 2. Material: Stainless steel AISI316.				
	26U M8	M8x30	5	3606489579784 CSU795596
	26U M10	M10x30	5	3606489579746 CSU795592
	26U M10	M10x50	7	3606489579753 CSU795593
Screw set W34				
Screw set to be used for the fastening of dividing strips on cable ladders KHZSP, KHZP and KHZPV. Set including screw MSCS 6x12 and nut M6MF 6. Material: Stainless steel AISI316.				
	W34	—	0.8	7321677255894 725589

Stainless Steel AISI 316L - Corrosion class C5-M

Screws, bolts and nuts

Type	Dimensions A/B/C mm	Weight kg/100 pcs	EAN code	Ref. No.
Screw set M12				
Screw set to be used for all joints with cable ladders KHZPV. Set including four bolts M6S 12x25 and four nuts M6M 12. Material: Stainless steel AISI316.				
M12	—	20	7321677287673	728767
Screw set 22S				
Screw set to be used for installation of Support bracket 3 on Vertical piece 2, Support bracket 3 and Ceiling bracket 5 on Pendant/fixing rails 24/34 and 24/48, Angle bracket 5L against the back of Pendant/fixing rails, Pendant/fixing rails back to back. Set including screw MVBF 8x16 and nut M6MF8. Material: Stainless steel AISI316.				
22S	—	1.9	7321677255825	725582
Screw set 25S				
Screw set to be used for installation of Cantilever arm 30, 50i and 50 on Wall support plate. Set including screw MVBF 8x25 and nut M6MF8. Material: Stainless steel AISI316.				
25S	—	2,2	3606489567057	CSU795587
Spring nut M8/M10				
Spring nut to be used for fastening of accessories (control panels, etc.) on Pendant/fixing rail 24/48. Material: Stainless steel AISI316.				
M10	—	3.9	7321677286225	728622
Screw M10x20				
Screw to be used with Spring nut M10 for the installation of Cantilever arm 50 on Pendant/fixing rail 24/48. Material: Stainless steel AISI316.				
M6S	—	2,2	7321677286492	728649

Marking plate

Marking plate 93				
Marking plates are part of a colour marking system that is easy to use when you want to mark out the type of cable that is placed on the cable ladder. Five different colours are available.				
93, yellow	103/0.7/100	5	7321677377046	737704
93, orange	103/0.7/100	5	7321677377053	737705
93, blue	103/0.7/100	5	7321677377060	737706
93, green	103/0.7/100	5	7321677377077	737707
93, black	103/0.7/100	5	7321677377084	737708
Marking label, equipotential				
Label to be used to show that a construction is equipotentially bonded. Available in Swedish (other languages on request). Printed on self-adhesive yellow vinyl, 250 labels per roll. Material: Self-adhesive vinyl.				
Marking label	25/-/86	-	7321677868605	786860

Tools

Cable roller S				
Cable roller used to facilitate the pulling of cables and lines. Easily installed on all Wibe cable ladders except the high-sided WHS ladders (outer mounting hole). Also suitable for external/internal profiles of all 90° bends, T-junctions, X-junctions and risers (inner mounting hole). With a height adjustment of 45 mm to leave room for cables to pass under the roller. Material: Steel, electro-galvanized.				
S	230/80/204	230	7321677186600	718660
Cable roller 38 Rig'n roll				
Cable roller used for mounting on Wibe cable ladders with belonging junctions and branches. Material: Stainless steel AISI316L (cable roller).				
38 Rig'n roll	220/50/130	48	7321677359981	735998
Bag	375/160/460	230	7321677801862	780186
Set 66 (1 bag + 10 Cable rollers 38 Rig'n roll)	375/160/460	710	7321677801879+	780187

The right surface treatment – crucial for a successful outcome

A cable support installation is considered to be a long-lasting solution and the life expectancy is dependent on the environment in which it is placed. A thorough investigation of the setting in terms of corrosion, pollution, humidity, salt, sanitary regulations etc will help you make the best choice. Our range of cable ladders and accessories covers all types of surface treatments, enabling a reliable, cost-efficient and long-lasting cable support solution.

C1 Electro-galvanized

Indoor environments: Schools, shops, hotels, offices, sports halls etc.

- Very low environmental corrosion.
- Heated areas.
- Arid atmosphere.
- Insignificant quantities of pollutant.
- ISO 2081.

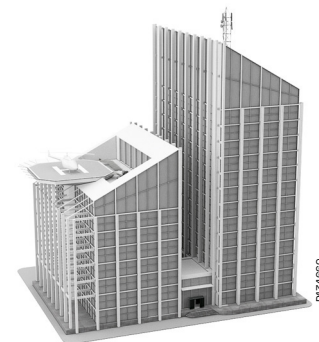

C2 Pre-galvanized

Partly outdoor environments: Industries, sports halls, warehouses, shops, rural outdoor areas etc.

- Low environmental corrosion.
- Non-heated areas with fluctuating levels of temperature and humidity.
- Few instances of condensation and low levels of airborne pollution.
- SS-EN 10346

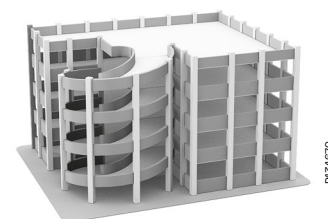

C3 Hot-dip galvanized

Indoor- and outdoor environments: Urban and light industrial areas, breweries, dairies, laundries etc.

- Average environmental corrosion.
- Areas with average levels of humidity and some airborne pollution caused by production processes.
- Atmospheres containing some salt or average levels of airborne pollution.
- EN-ISO1461/EN 10346 (Z+)

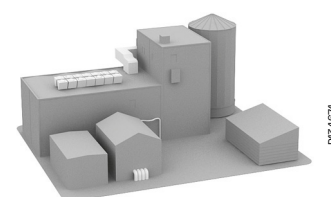

C4 Hot-dip galvanized

Indoor- and outdoor environments: Chemical plants, industrial and coastal areas, swimming pools, farms, dockyards etc.

- High environmental corrosion.
- Areas with high levels of humidity and considerable airborne pollution.
- Atmospheres with average salt content or discernible levels of airborne pollution.
- EN-ISO1461

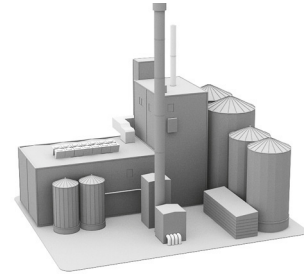

P134672

C5-I Zinkpox[®] (Hot dip galv. + powder coated) Stainless steel AISI 304

Indoor- and outdoor environments: Chemical and heavy industries, tunnels, swimming pools, dockyards etc.

- Very high (industrial) environmental corrosion.
- Areas with almost permanent condensation, large quantities of airborne pollution, high levels of humidity and aggressive atmospheres
- EN 1.4301 acc. to EN 10088/AISI 304

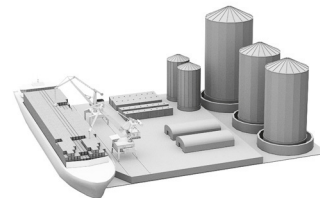

P134675

C5-M Stainless steel AISI 316L

Indoor- and outdoor environments: Heavy industries, coastal and offshore areas, purifying plants etc.

- Very high (marine) environmental corrosion.
- Areas with almost permanent condensation and large quantities of airborne pollution. Atmospheres with high salt content.
- EN 1.4404 acc. to EN 10088/AISI 316L

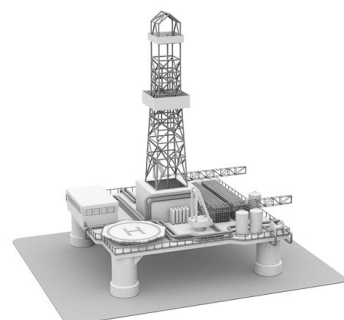

Corrosion Classes

The life expectancy of a cable support system is dependent on the environment in which it is placed. Therefore, it is important to establish the corrosive properties of an environment to ensure that the right treatment and the right material are chosen. Do not use components finish above of the corrosion class targeted. The table below shows various corrosion classes. As a guide, we have included the surface treatment recommended by Wibe Group for the different classes.

On the next page, we briefly outline the various surface treatments and materials. As regards environmental corrosion, a steel design component can usually be assigned to one of the corrosion classes (C1 to C5-M) as shown in table A. Reference values for the average level of corrosion in steel and zinc are given in table B. The corrosion classes comply with those stipulated in SS-EN ISO 12944-2.

Table A

Corrosion classes as stipulated by SS-EN ISO 12944-2 with atmospheric corrosion levels and examples of the environment in which they are most suitable for use.

Corrosion class	Environmental corrosion	Examples of typical environments in temperate climates (informative)		Wibe Group designation
		Outdoors	Indoors	
C1	Very low	–	Heated areas with arid atmosphere and insignificant quantities of pollutant, e.g. offices, shops, schools and hotels.	Electro-galvanized DIN 50961/ISO 2081
C2	Low	Atmospheres with low levels of airborne pollution. Rural areas.	Non-heated areas with fluctuating levels of temperature and humidity. Few instances of condensation and low levels of airborne pollution, e.g. sports halls and warehouses.	Pre-galvanized Z 275 in accordance with EN 10346
C3	Average	Atmospheres containing some salt or average levels of airborne pollution. Urban and light industrial areas. Areas affected by coastal conditions.	Areas with average levels of humidity and some airborne pollution resulting from production processes, e.g. breweries, dairies, laundries.	Hot-dip galvanized after manufacture in accordance with EN-ISO 1461
C4	High	Atmospheres with average salt content or discernible levels of airborne pollution. Industrial and coastal areas.	Areas of high humidity and considerable airborne pollution as the result of production processes, e.g. chemical plants, swimming pools and dockyards.	Zinc+ coating
C5-I	Very high (industrial)	Industrial areas with high levels of humidity and aggressive atmospheres.	Areas with almost permanent condensation and large quantities of airborne pollution.	Zinkpox® HDG+powder coating
C5-M	Very high (marine)	Coastal and offshore areas with high salt content.	Areas with almost permanent condensation and large quantities of airborne pollution.	Stainless steel EN 1.4301/AISI 304
				Stainless steel EN 1.4404/AISI 316L

Table B

Mass losses for steel and zinc in various corrosion classes

Corrosion class	Mass loss per surface unit and thickness reduction (1 year of exposure) ¹			
	Steel		Zinc	
	Mass loss (g/m ²)	Thickness reduction (µm)	Mass loss (g/m ²)	Thickness reduction (µm)
C1	≤ 10	≤ 1.3	≤ 0.7	≤ 0.1
C2	> 10 to 200	> 1.3 to 25	> 0.7 to 5	> 0.1 to 0.7
C3	> 200 to 400	> 25 to 50	> 5 to 15	> 0.7 to 2.1
C4	> 400 to 650	> 50 to 80	> 15 to 30	> 2.1 to 4.2
C5-I	> 650 to 1500	> 80 to 200	> 30 to 60	> 4.2 to 8.4
C5-M	> 650 to 1500	> 80 to 200	> 30 to 60	> 4.2 to 8.4

¹ Corrosion speed is generally higher when the material is first exposed

Surface treatments

Wibe Cable Ladders - Technical and material data

Specification

Cold formed steel:	DX5xD acc. to EN 10346, DC0x acc. to EN 10130, DD1x acc. to EN 10111
Structural steels:	S235 and S355 acc. to EN 10025-2 AISI 316L acc. to EN ISO10088-2
Density:	7.7-7.85 kg/m ³
Surface treatment:	<ul style="list-style-type: none"> • Pre galvanized (>20 µm): EN 10346 • Hot-dip galvanized (55-70 µm): EN ISO 1461 • Zinc+ (>25 µm): EN 10346 • Zinkpox, hot-dip galvanized (55-70 µm) + polyester coating, white RAL9010 <ul style="list-style-type: none"> • Pickled (Stainless steel), except KHZSP ladder range
Resistance to impact:	20 J (IEC 61537)
Temperature range:	From -40°C to +120°C.

Electro-galvanized

Products are manufactured in accordance with ISO 2081. Such products are intended for use only in warm, dry areas with negligible pollutant levels.

Pre-galvanized

Products are manufactured from Z 275 pre-galvanized sheet steel in accordance with SS-EN 10346. Under normal conditions, surface sections created during cutting and drilling will repair themselves, providing superb anti-corrosion protection.

Hot-dip galvanized

Wibe Group has one of the most modern hot-dip galvanization plants in the Nordic countries. The hot-dip process is continuous, guaranteeing a high and even quality. The manufactured products are hot-dip galvanized in accordance with EN-ISO 1461:2009 whilst nuts and bolts are hot-dip galvanized in accordance with SS-EN ISO 10684. This form of galvanization affords very good value-for-money anti-corrosion protection in atmospheres with a pH value of between 6 and 13. However, in acidic environments where pH levels fall below 6 and in alkaline environments where the pH value exceeds 13, the protective zinc layer breaks down relatively quickly. When cuts/perforations or other kind of operation that damage or remove coating in HDG items suitable to be installed in aggressive corrosion class, must be repaired with a zinc rich paint.

Zinc+

Zinc+ surface treatment for some accessories (EN 10346) with a metallic Zinc-based coating containing aluminium and magnesium that offers ultimate corrosion resistance in aggressive environments (e.g. chloride & highly alkaline). In many cases a good alternative to hot-dip galvanization. Excellent surface finish with self-repairing protection of cut edges (galvanic protection).

Zinkpox®

The Zinkpox® method involves applying a homogenous polyester coating to the zinc layer. Besides resisting light-initiated degeneration and weathering, this powder coating has excellent mechanical properties as regards impact resistance and adhesion. It is also resistant to most chemicals. Compared to hot-dip galvanizing, applying a polyester coating to the zinc layer more than doubles the service life of treated components. The zinc layer prevents the development of filiform corrosion. This might otherwise degrade the coating. Consequently, the polyester coating is subject only to atmospheric attack and thus protects the zinc layer. The certified coating plant that treats our components uses a modern and environment-friendly process. Before powder coating, the galvanized components undergo meticulous pre-treatment. This ensures superb adhesion. In addition to extremely good corrosion protection, the Zinkpox® method also offers a choice of colours. Powder coating is a very environment-friendly way of achieving a coloured surface. Because the coating contains no solvents, it has largely replaced solventbased liquid coatings. Where installations are visible, cable ladders and fittings can be finished in a coating that matches the surrounding décor.

Stainless steel

Products manufactured in accordance with AISI 304 acc. to ASTM / 1.4301 acc. to EN 10088-3 or /AISI 316L acc. to ASTM / 1.4404 acc. to EN 10088-3 are designed for use in highly aggressive environments, either indoors or outdoors, on industrial sites where there are high levels of potent airborne pollution such as in certain chemical industries, cellulose-related industries, refineries or artificial fertilizer factories, high humidity tunnels, etc. Stainless steel products are also ideal for use in environments where special hygiene requirements are in force, such as dairies, abattoirs, other food industries and pharmaceutical factories.

Stainless steel AISI 304 or AISI 316L

The deciding factor in choosing between stainless steel AISI 304 or AISI 316L is the aggressiveness of the environment in which it is to be used, and for this atmospheric chlorine content plays a significant role. Environments with a high chlorine content, coastal areas being a prime example, are aggressive and usually require the use of AISI 316L materials. When assessing the needs of factories, consideration should be given to the materials previously used to suspend equipment such as pipe tubing, and from this determine whether stainless steel AISI 304 or AISI 316L material is required.

To consider when installing Stainless Steel Cable Ladders

- 1. Transport/handling:** Make sure that no iron objects come into contact with the stainless steel products.
- 2. Storing:** Never store stainless steel products close to where iron products are machined, for example close to cutting and grinding operations
- 3. Welding:** Welding during installation should be avoided where possible. If welding must be performed, make sure that only methods suitable for stainless steel are used.
- 4. Tools:** When cutting or grinding, always use cutting wheels and grinding tools which are free from iron. Do not use tools that have been previously used for cutting or grinding products containing iron. When drilling, use an HSS-drill. To maximize the useful life of the drill, employ a cooling fluid during drilling. When installing, conventional assembly tools can be used. However, when using a nut tightener, ensure that the thread is first lubricated to prevent jamming.

Never mix untreated or galvanized products with stainless steel.

- 5. Measures:** If a blue annealing appears when cutting, grinding or drilling, re-move it with pickling paste, making sure that the paste is then carefully washed away with water. If selective corrosion appears it can be removed by:
 - a) Washing away with water (high-pressure if possible).
 - b) Polishing with a cleaning cloth or a fine emery paper (wet or dry) and washing with water.
 - c) Grinding with a fine-grained wheel and washing with water.
 - d) Pickling with pickling paste, making sure that the pickling paste is then carefully washed away with water.
- 6. When using pickling paste or similar products, always study the safety code for the product prior to use.**

Installation regulations

Installation of cables on a cable ladder

The installation of cables on cable ladders lies within the IEC 60364-5-52 standard for power cable installation only. Because Wibe cable ladders have rungs which occupy less than 10% of the plan area under the cables, the installation is defined as cables in "free air". Cable spaces do not require any de-rating factor for installation.

Method of installation	Correction Factor C _g Number of circuits of multicore cables							
	2	3	4	5	6	7	8	9
Single layer multicore touching on ladder supports	0,87	0,82	0,80	0,80	0,79	0,79	0,78	0,78

Cables touching must be de-rated in accordance with the table below.

For installation of a combination of power and communication cables on a cable ladder the separating distances should be according to EN 50174-2, see table below.

Communication cable type	Number of power circuits (1-phase 20A, 230V)									
	1-3	4-6	7-9	10-12	13-15	16-30	31-45	46-60	61-75	>75
	Minimum separation distance (mm), see figure A below this table									
Category 5e/6 unshielded	20	40	60	80	100	200	300	400	500	600
Category 5e/6/6 _A shielded	10	20	30	40	50	100	150	200	250	300
Category 7 _A shielded	2	4	6	8	10	20	30	40	50	60

Minimum separation distance (mm), figure A

Recommended cable management

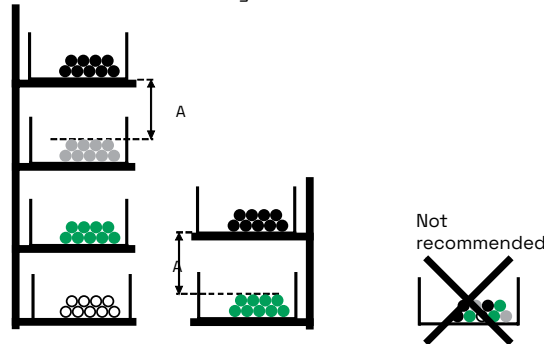

Recommended cable management on common cable ladder

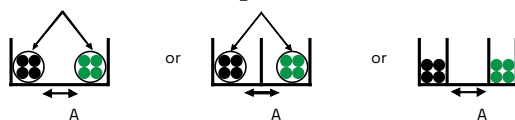

The cables need to be fixed to the ladder or bundled

- Power cables
- Data cables
- Control cables
- Sensitive cables like instrumentation cables

A Separation distance

Installation of cable ladder

Full design data is given according to EN 61537 in the Range part in this catalogue showing all maximum and recommended loadings. Graphs are given in this catalogue to show the deflection against loading for various support distances. Any support system which is supported at intervals and loaded will deflect between the support intervals. Test model II is used for all ladder ranges.

Installation recommendations for cable ladders

The cable ladders should be installed in such a way that, as often as possible, the cables can be laid directly in place rather than being pulled through. Ladders for current carrying cables along the ceiling should be installed in such a way that the distance from the top of the ladder to the ceiling is not less than 300 mm. The free vertical distance between parallel ladders shall be at least 200 mm. Ladders near walls should be installed with a minimum free distance of 50 mm to the wall, so that cables can pass between the ladders and the wall. Ladders along partition walls should be installed with a minimum free distance of 100 mm to the wall. Sharp edges and screw ends on ladders should be removed before the cables can be installed. Expansion bolts for the installation of brackets/fixings should be installed with such a distance between them, that the designated load for ladders will not be exceeded. When selecting the distance between cantilever arms or brackets/fixings, the bearing strength and designated load of the ladders must be taken into consideration.

Electro-magnetic compatibility EMC

Electromagnetic Compatibility

Wibe Group has performed measurements at EMC Services in Gothenburg regarding EMC requirements, report RE-10273-17181. The results show that the shielding performance of both incoming and emitted fields is good concerning Wibe cable ladders.

When correctly installed Wibe cable ladders products work as a protective earth structure. This means that Wibe Group products can be used to achieve good engineering practice in accordance with the EMC directive 2004/108/EG.

Recommended installation examples

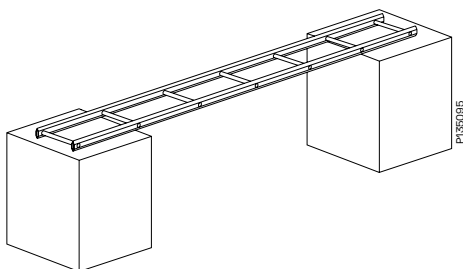

Metal against metal connection
- the ultimate installation

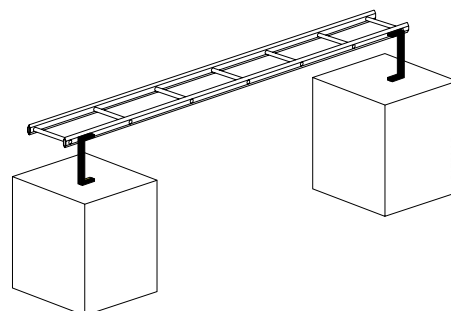

Short double connection
- realistic installation

Not recommended installation examples

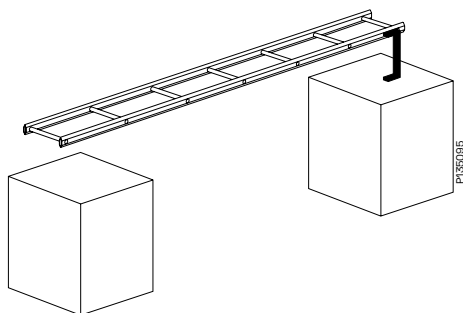

Single connection
- poor installation

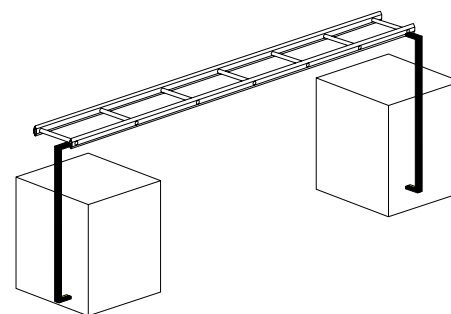

Long double connection
- in best case EMC neutral

Potential balancing

Electrical continuity and earthing

The standard EN 61537 establishes that for cable ladders with electrical continuity characteristics (metal), this continuity should be guaranteed by means of an equipotential connection and one or several connections to earth in accordance with the use of the ladder system.

The impedance must not exceed:

- 50 mΩ through the joint.
- 5 mΩ x metre of cable ladders.(*)











(*) Currently this value is studied through document IEC/SC23A/WG12, CLC/TC213/WG-5 - 765. It will be changed to 50 mΩ x metre.

The metre length and joining systems for the different sections that Wibe Group has, as well as the joints of the different accessories supplied, comply with the electrical continuity test established in the aforementioned standard, guaranteeing the impedance

established. To guarantee these impedance values tightening torque values of no less than 5 Nm are recommended, always using the joints recommended for each ladder type, and taking sizes into account.

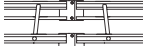
To guarantee a safe installation, Wibe Group recommends a proper earthing of all the elements that make up the system (sections and accessories), using the accessories designed specifically for this purpose. Ensure that all connections are well fixed and proper values are matching according to local legislation

WIBE GROUP RECOMMENDS NOT TO USE THE LADDER AS EARTH OR NEUTRAL CONDUCTORS. Wibe Group IS NOT RESPONSIBLE OF ANY DAMAGE IF YOU USE ACCESSORIES FROM OTHER MANUFACTURERS.

Product		Ohm/m
Cable Ladder KHZSP without joint, pre-galvanized		0.00089
Cable Ladder KHZSP with Joint 21, pre-galvanized		0.00100
Cable Ladder KHZSP with Coupling 22, pre-galvanized		0.00160
Cable Ladder KHZ/KHZP without joint, hot-dip galvanized		0.00050
Cable Ladder KHZ/KHZP with Joint 21, hot-dip galvanized		0.00040
Cable Ladder KHZ/KHZP with Coupling 22, hot-dip galvanized		0.00073
Cable Ladder KHZV without joint, hot-dip galvanized		0.00038
Cable Ladder KHZV joined with Screw set M12, hot-dip galvanized		0.00039
Cable Ladder KHZV with Joint 45, against welded joint, hot-dip galvanized		0.00057
Cable Ladder KHZV with Joint 45, (without welded joint), hot-dip galvanized		0.00083
Cable Ladder KHZV with Coupling 44, hot-dip galvanized		0.00043

Potential balancing

For pre-galv, hot-dip galv and stainless steel AISI 316L

Resistance testing of Wibe Cable Ladders has been performed and approved according to norm IEC61537 for cable ladders in pre-galv, Hot-dip galv and Stainless steel AISI 316L.

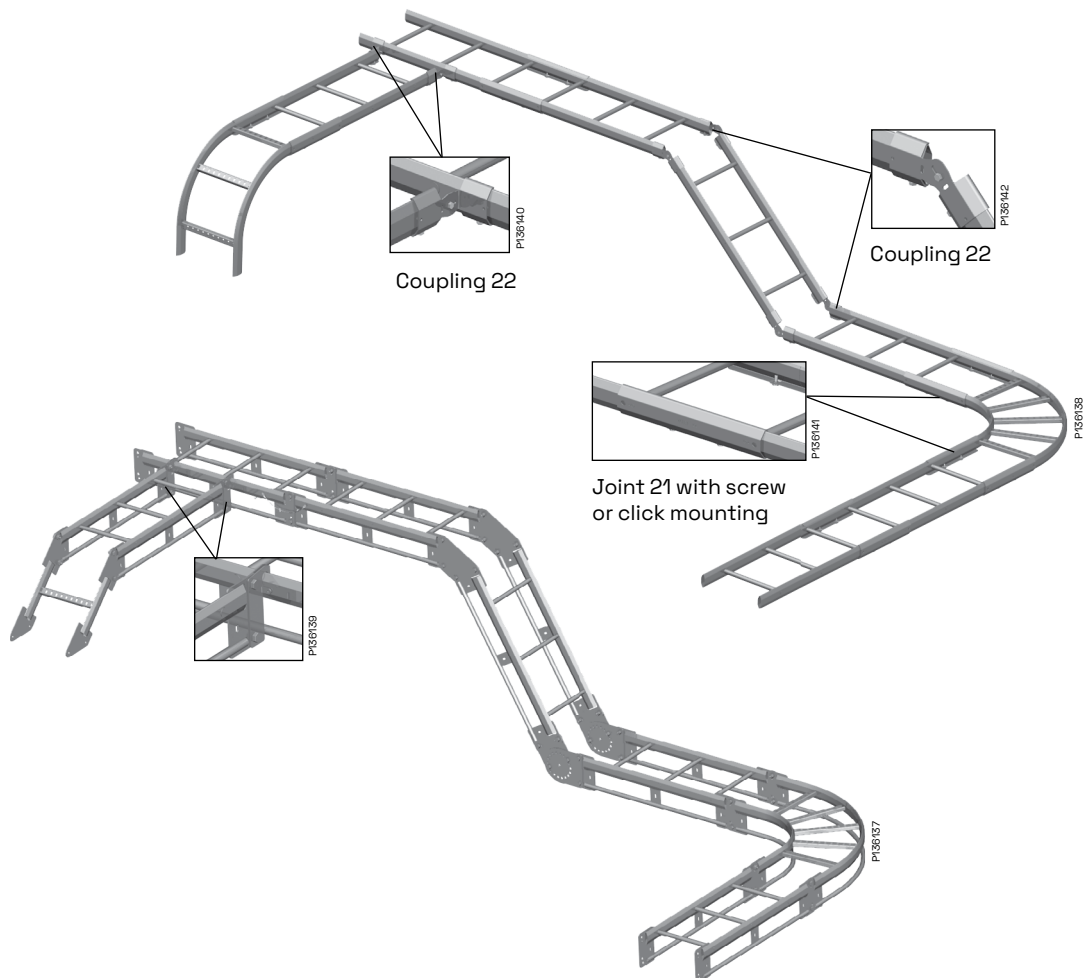

For zinkpox coating

Installation of cable ladders with Zinkpox coating

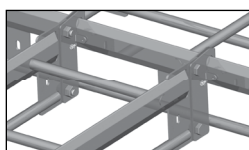

Take-off hook 47 is mounted with self-drilling screw 4.8x13

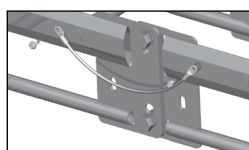

For installation of joints, couplings, junctions and bends self-drilling screw 4.8x13 and ground wire, cable area $\geq 10 \text{ mm}^2$, must be used.

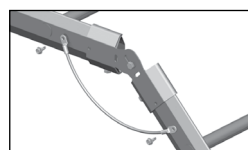

Self-drilling screw 4.8x13 and ground wire, cable area $\geq 10 \text{ mm}^2$, are used for installation of Coupling 22.

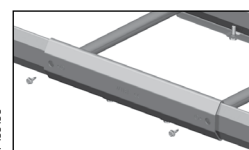

Joint 21 is mounted with self-drilling screw 4.8x13 in the grounding holes. When joining KHZ ladders Joint 21 must be moved approx. 20 mm from centre.

E-30 and E-90 fire test

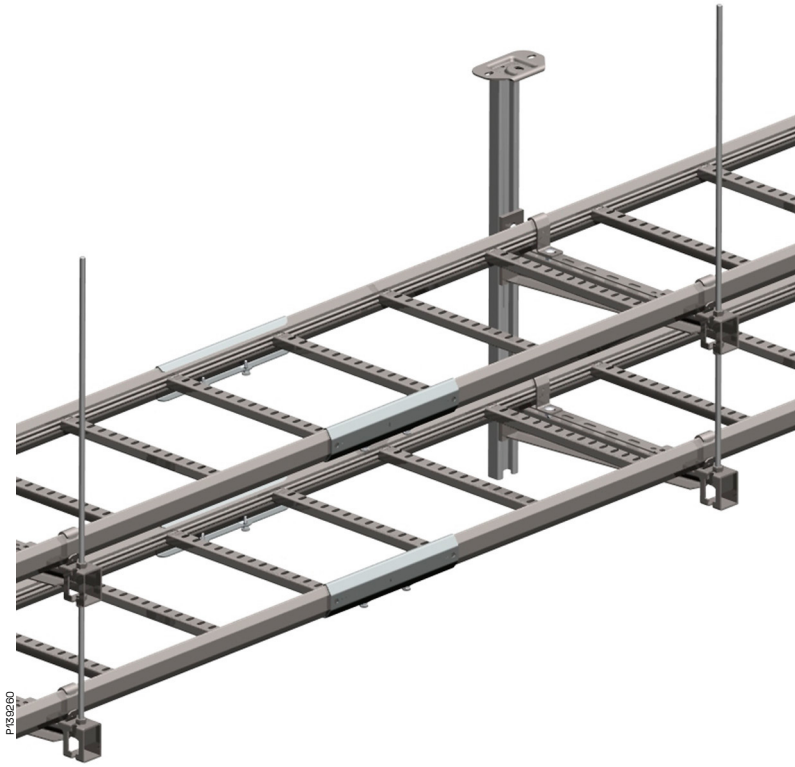

Ceiling suspended, vertical piece, cantilver arm

Cable ladder KHZPS-150, 6 m	725350
Cable ladder KHZPS-200, 6 m	725351
Cable ladder KHZPS-300, 6 m	725352
Cable ladder KHZPS-400, 6 m	725353
Joint 21	791196
Joint 21 ZM	CSU795051
Cantilever arm 50-150	723433
Cantilever arm 50-200	723434
Cantilever arm 50-300	723436
Cantilever arm 50-400	723437
Profile clamp 42	CSU795240
Vertical piece 2F-280	717196
Vertical piece 2F-370	717197
Vertical piece 2F-505	717198
Vertical piece 2F-640	CSU794202
Vertical piece 2F-730	717199
Rod bracket 82	786768
Threded rod W76-1000	725079
Threded rod W76-2000	716792
Nut M10	723938
Nut M10	1149464
Screw set 22S	713694
Bolt MVBF M8-50	CSU795132
Nut M6MF M8	CSU794715

E-30 and E-90 fire test

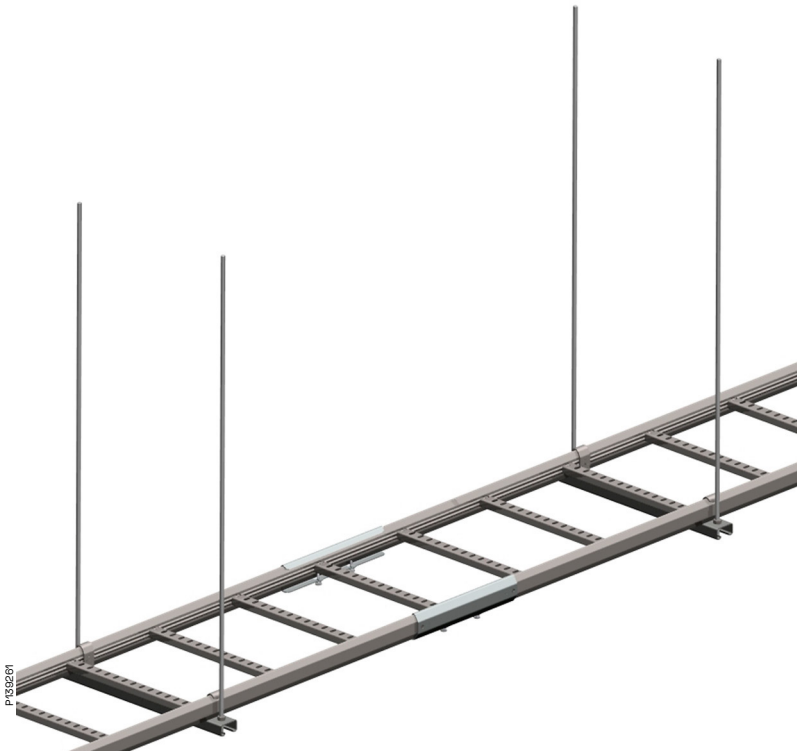

Ceiling suspended, support bracket, threaded rod

Cable ladder KHZPS-150, 6 m	725350
Cable ladder KHZPS-200, 6 m	725351
Cable ladder KHZPS-300, 6 m	725352
Cable ladder KHZPS-400, 6 m	725353
Joint 21	791196
Joint 21 ZM	CSU795051
Support bracket HSO-150	791063
Support bracket HSO-200	791064
Support bracket HSO-300	791065
Support bracket HSO-400	791066
Profile clamp 42	CSU795240
Threaded rod W76-1000	725079
Threaded rod W76-2000	716792
Nut M10	723938
Nut M10	1149464

iBMB MPA
TU BRAUNSCHWEIG
Institut für Bautechnik
Manufaktur und Brandschutz

Allgemeines bauaufsichtliches Prüfzeugnis

Prüfzeugnis Nummer: P-3233/499/11-MPA BS

Gegenstand: Kabelanlage mit integriertem Funktionserhalt der Funktionserhaltsklasse „E 30“ bzw. „E 60“ bzw. „E 90“ nach DIN 4102-12: 1998-11 entsprechend Bauregelliste (BRL) A, Teil 3, Hf. Nr. 2.9 - Ausgabe 2011/1

Antragsteller: Schneider Electric Sverige AB
CMS Product department
Tilverkarvägen 2
61129 Nyköping, SCHWEDEN

Ausstellungsdatum: 30. Oktober 2011

Geltungsdauer bis: 30. Oktober 2016

Dieses allgemeine bauaufsichtliche Prüfzeugnis umfasst 11 Seiten und 13 Anlagen.

Mitteilungsanstalt (MPA)
für das Braunschweig
Berlinerstraße 12
D-38108 Braunschweig

Fon +49 (0)531-991-5400
Fax +49 (0)531-991-5900
info@mpa-tu-bs.de
www.mpa-tu-bs.de

Hausbüchische LB Hannover
106 520-9900 B/L 205 540-00
Bau-Code: MPA_LB_ZS_20
USt-Id-Nr.: DE 153200054
Gew.-Nr.: 1429222089
BANK: DE36250000000000000000

Hebel body (HfB-CPE)
Das MPA Braunschweig ist für Prüfung, Überwachung, Inspektion und Zertifizierung bautechnischer Erzeugnisse und Verfahren. Die MPA Braunschweig ist die MPA und Kabelanlassensystem nach ISO/IEC 17025 und ist in spezialisierte nach ISO/IEC 17025 akkreditiert.

Test conditions

- E30 and E90 according to DIN 4102-12
- IBMB test institute
- Dätwyler Pyrofil KERAM cables
- Load 20 kg/m
- Support distance 1,5 m

Standards and Quality



Wibe Cable ladder system meets the following standards:

IEC 61537
 NEMA VE 1/CSA 22.2
 DIN 4102-12 for fire resistance E30-E90

Tests and Certificates	Test made by
Test concerning fire resistance according to E30-E90. Certificate n°: ABP P-3233/499/11-MPA BS. Certificate n°: ABP-2400/702/18-MPA BS.	IBMB, Germany
EMC performance- Shielding test. Report n° RE-10273-17181.	EMC Services Elmiljöteknik AB, Sweden
Seismic load test. Report n° P603276.	SP, Sweden
Short circuit test. - 1268 Report n° 992531-4 & 20001215-7.	British short circuit testing station BS/F 1265
Wibe cable ladder is tested according to Underwriters Laboratories, UL E-212854 Sec.1.	UL, USA & Canada
Wibe cable ladder is approved by Det Norske Veritas (DNV) for offshore and ship-yard use. Certificate n° TAE00000MM.	DNV, Norway

Management system - Quality and Environment

Wibe Group has a third-party certified management system for quality and environment in accordance with OHSASISO 50001:2011, ISO 45001:2018, ISO 9001:2015 and ISO 14001:2015.

CE-marking of products

The CE-marking of products is placed on the product or on the packing according to "Declaration of Conformity" (DOC), applicable to Wibe Group Cable Support System.

Low voltage directive 2014/35/EU

Wibe Group fulfills the demands according to harmonized standard EN 61537.

Technical Information

Use and Installation

Use and installation

90° bend 15, interior and exterior	229	Flange nut B43 M8, M10	205	Screw set 22S	250
90° bend 20C, interior	230	Flange nut B43 M8, M10	250	Screw set M10 x 20	250
90° bend 55 interior	229	Hook 8	252	Screw set M12	249
Angle bracket 5L and 5LS	221	Horizontal coupling 20C/ Horizontal coupling bending 20C	190	Screw set W34	250
Angle plate 20C	191	Insert piece EM	245	Screw set W37	250
Angle plate 33/1 and 33/2	238	Installation plate 61	227	Spring nut M8/M10	250
Back nut M8	250	Intermediate connection bolt 29	251	Steel wire	241
Back plate 40	199	Joint 9	186	Support bracket 3	201
Beam clamp 5BK	252	Joint 21, with screws		Support bracket 6	203
Bracket 60/40	222	or screwless	186	Support bracket HSO	204
Cable clamp ARX	244	Joint 45	187	Take-off hook 20C	225
Cable clamp ER	246	Joint nut M8, M10	205	Take-off hook 47	225
Cable roller 38 Rig'n roll	254	Junction box plate 12xRJ45 Actassi S-one	228	T-bolt 26U	249
Cable roller S	253	Junction box plate 35P	227	Tele-conduit 36 with knock-out holes	233
Cantilever arm 30	194	Junction box plate 35S	226	Threaded rod B41 and W76 M8, M10	205
Cantilever arm 50 and 50F	197	Junction coupling 14	189	Thread lock B50 M8, M10	205
Cantilever arm 50i	195	KHZ	168	Thread lock B50 M8, M10	250
Carrying bracket HT-31	239	KHZP-20C	170	Tightening loop HT	240
Carrying bracket HT-33/34	239	KHZP / KHZPS	166	T-junction 16	230
Carrying bracket HT-152	239	KHZPV	167	T-junction 20C	231
Carrying sling HT-51	239	KHZSP/ KHZSP+	165	T-junction 56	231
Ceiling bracket 2Fi	219	KHZV	169	Vertical coupling 20C	191
Ceiling bracket 5	223	Lashing wire	245	Vertical piece 2	207
Ceiling bracket 5TP	224	Lighting bracket 200	238	Vertical piece 2F	209
Ceiling bracket 5TPA	224	Marking plate 93	248	Vertical piece 2Fi	208
Ceiling bracket TF-10 and TF-16	205	Mounting rail 40	199	Vertical piece 20	211
Ceiling plate 20F	218	Mounting rail WMS25L	247	Vertical piece 20F	213
Ceiling plate 20FS	218	Pendant bar 1	220	Vertical piece 20FS	214
Clamp 12	193	Pendant base plate 520	219	Wall bracket for CLX ³ cantilevers	133
Clamp set M6	243	Pendant/Fixing rail 24/20	216	Wall bracket 11/25 and 11/75	206
CLX ³ Adjustable ceiling plate	176	Pendant/Fixing rail 24/20F	217	Wall bracket 20	206
CLX ³ Cantilever arm	177	Pendant/Fixing rail 24/20FS	217	Wall bracket 20F	206
CLX ³ Central suspension adapter	181	Pendant/Fixing rail 24/34	215	Wall bracket HT-14	238
CLX ³ General information	171	Pendant/Fixing rail 24/48	215	Wall support	200
CLX ³ KHZSP ladder central suspension bracket	182	Pendant joint 2J, 2FJ and 20J	220	Washer HSO M16	204
CLX ³ Pendant 24/48	173	Pendant limits, torque and deflection	174	X-junction 17	232
Combi bracket 53	222	Pendant load calculation	172		
Combi Fitting B21	226	Pipe HT-68 and HTR-68	240		
Combi Fitting B21 90 degree	226	Profile clamp 20C	192		
Coupling 22	188	Profile clamp 41	193		
Coupling 44	189	Profile clamp 42	192		
Coupling 51	190	Profile clamp 43	192		
Coupling plate 48	189	Profile protection 28P	247		
Cover 64	237	Profile support piece 37	236		
Cover 90° bend	235	Profile support piece 46	193		
Cover clamp	236	Protecting cover	237		
Cover joint	236	Rail fixing support 24/20F, 24/20FS	219		
Cover plate 65	237	Reducer 20C	241		
Cover T-junction	235	Reducer 31	241		
Cover W5	234	Riser 18	228		
Cross member plug 27	248	Riser coupling 20C	228		
Distance piece W39	234	Riser coupling 49	228		
Dividing strip 39	233	Rod bracket 82	223		
Dropper joint 32	187	Round bar fixing for ceilings	242		
Earth clamp W79	227	Round bar fixing for floors	243		
End bracket HT-11	240	Round bar fixing for walls	243		
End connection 10	225	S-bend 67	232		
End plug 28 and 28i	248	Screw set 2S	250		
End plug 28C, D, E, F and J	248	Screw set 20S	250		
Fixed take-off hook 4	225				
Fixing rail 24/26x53 for casting-in	218				

Use and installation



KHZSP/ KHZSPZ+

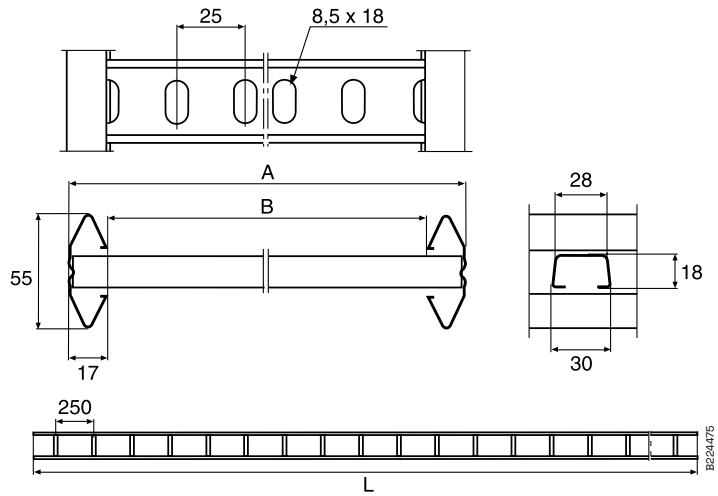

Test model II

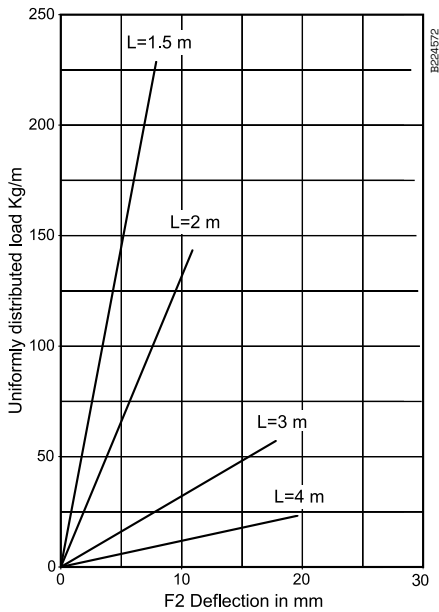
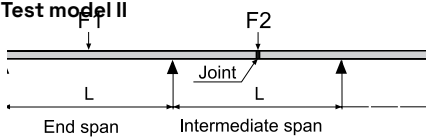

Type	L m	A mm	B mm
KHZSP 200	3, 4, 6	198	164
KHZSP 300	3, 4, 6	298	264
KHZSP 400	3, 4, 6	398	364
KHZSP 500	3, 4, 6	498	464
KHZSP 600	3, 4, 6	598	564
KHZSPZ+ 200	6	198	164
KHZSPZ+ 300	6	298	264
KHZSPZ+ 400	6	398	364
KHZSPZ+ 500	6	498	464
KHZSPZ+ 600	6	598	564

Loadings

The ladders are tested according to IEC 61537, test model II - a joint in the intermediate span (F2).

Guaranteed load

Guaranteed uniformly distributed load includes a minimum safety factor of 1.7 towards rupture. The diagram shows the deflection with Joint 21 for all ladder widths.

The cable ladders must not be used as walkways.

Use and installation

KHZP / KHZPS

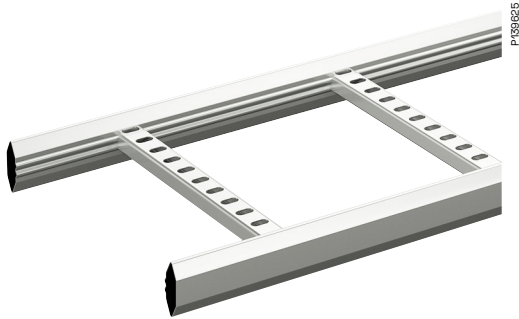

KHZP Test model II

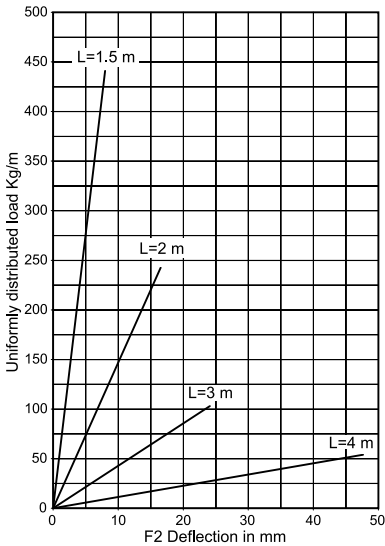
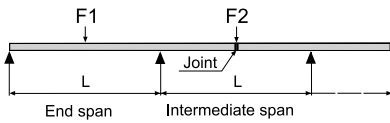

KHZPS Test model II

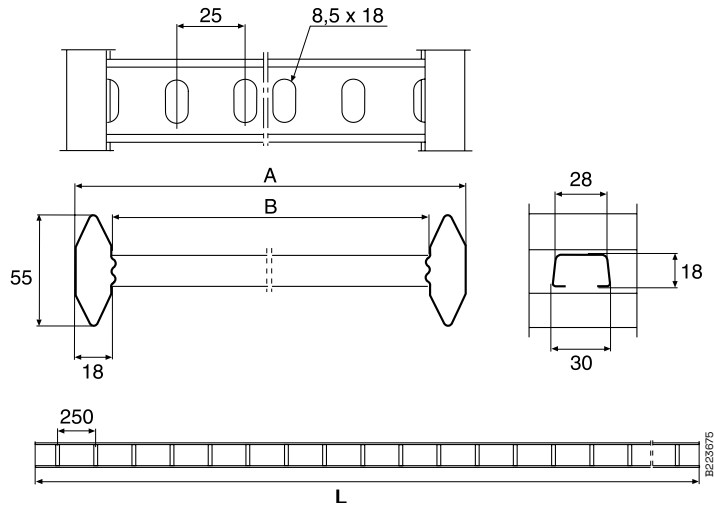
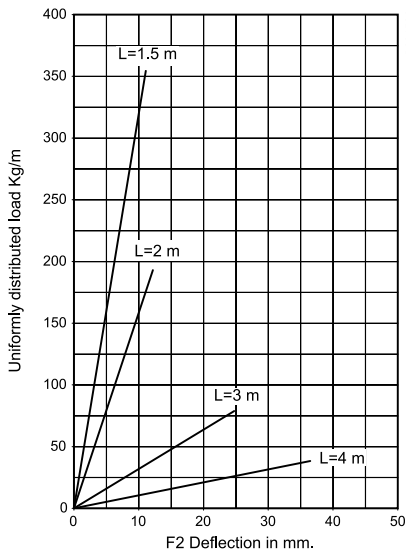
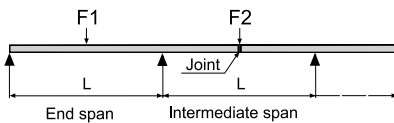

Type	L m	A mm	B mm
KHZP/KHZPS 150	6	147	111
KHZP/KHZPS 200	6	197	161
KHZP/KHZPS 300	6	297	261
KHZP/KHZPS 400	6	397	361
KHZP/KHZPS 500	6	497	461
KHZP/KHZPS 600	6	597	561
KHZP/KHZPS 800	6	797	761
KHZP/KHZPS 1000	6	997	961
KHZP 150	3	147	111
KHZP 200	3	197	161
KHZP 300	3	297	261
KHZP 400	3	397	361
KHZP 500	3	497	461
KHZP 600	3	597	561
KHZP 800	3	797	761
KHZP 1000	3	997	961

Loadings

The ladders are tested according to IEC 61537, test model II - a joint in the intermediate span (F2).

Guaranteed load

Guaranteed uniformly distributed load includes a minimum safety factor of 1.7 towards rupture. The diagrams shows the deflection with Joint 21 for all ladder widths.

The cable ladders must not be used as walkways.

Use and installation

KHZPV

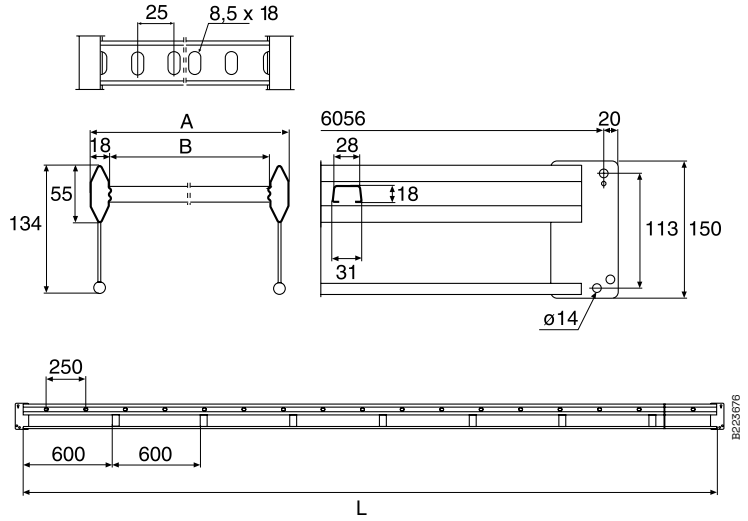
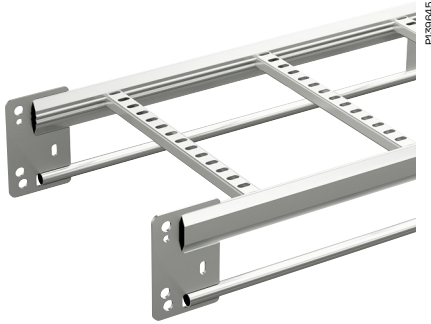

Type	L m	A mm	B mm
KHZPV 200	6	197	161
KHZPV 300	6	297	261
KHZPV 400	6	397	361
KHZPV 500	6	497	461
KHZPV 600	6	597	561
KHZPV 1000	6	997	961

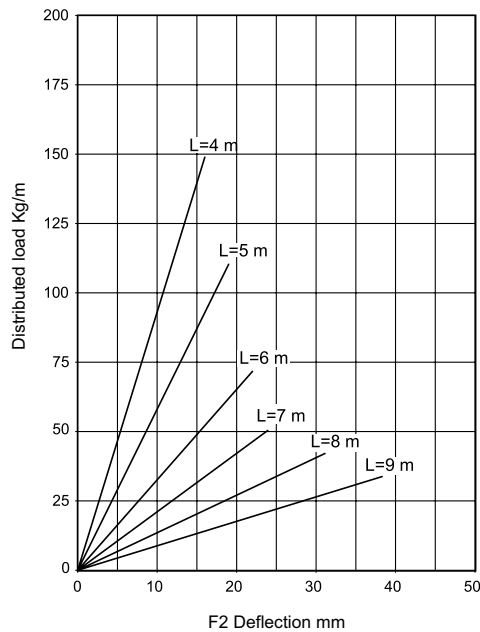
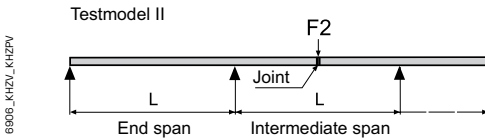

Loadings

The ladders are tested according to IEC 61537, test model II - a joint in the intermediate span (F2).

Guaranteed load

Guaranteed uniformly distributed load includes a minimum safety factor of 1.7 towards rupture. The diagrams shows the deflection for cable ladder widths up to 600 mm.

For widths greater than 600 mm contact Wibe Group or distributor.

The cable ladders must not be used as walkways.

Use and installation

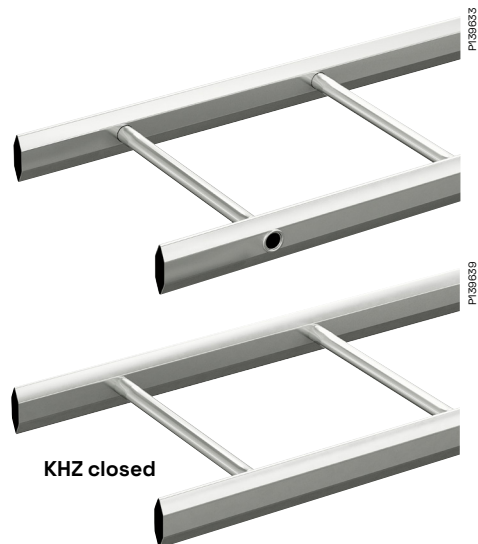

KHZ

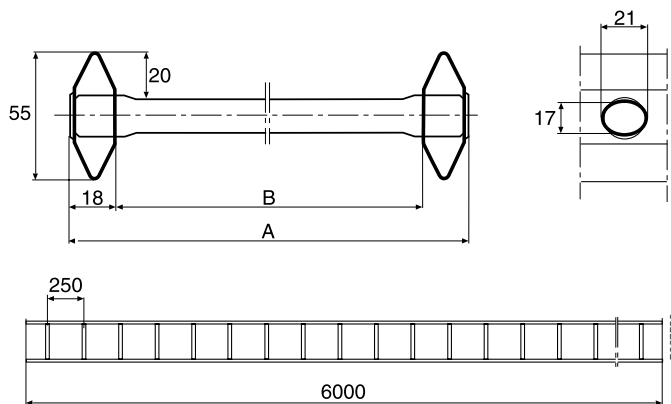

Type	L m	A mm	B mm
KHZ 150	6	147	111
KHZ 200	6	197	161
KHZ 300	6	297	261
KHZ 400	6	397	361
KHZ 500	6	497	461
KHZ 600	6	597	561

Test model II

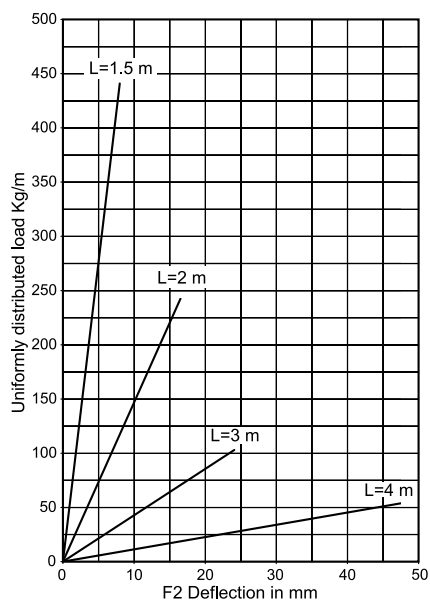
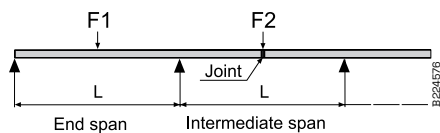

Loadings

The ladders are tested according to IEC 61537, test model II - a joint in the intermediate span (F2).

Guaranteed load

Guaranteed uniformly distributed load includes a minimum safety factor of 1.7 towards rupture. The diagrams shows the deflection with Joint 21 for cable ladder widths up to 600 mm. For widths greater than 600 mm contact Wibe Group or distributor.

The cable ladders must not be used as walkways.

Use and installation

KHZV

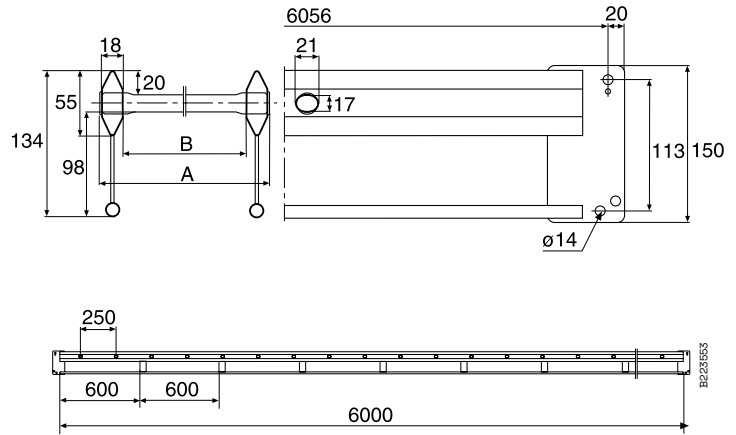
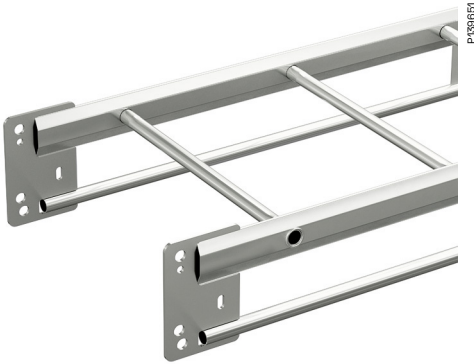

Type	L m	A mm	B mm
KHZV 200	6	197	161
KHZV 300	6	297	261
KHZV 400	6	397	361
KHZV 500	6	497	461
KHZV 600	6	597	561

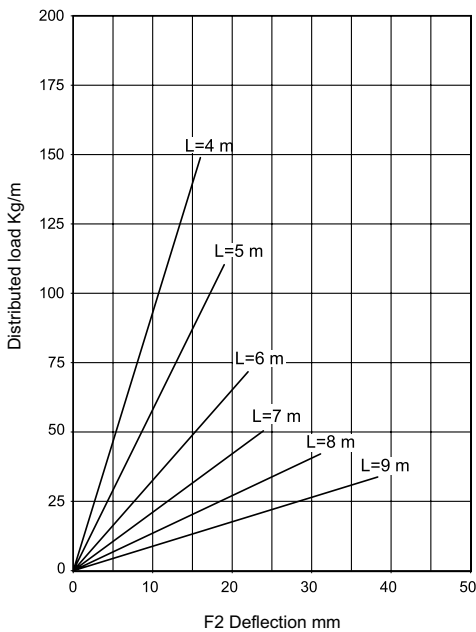
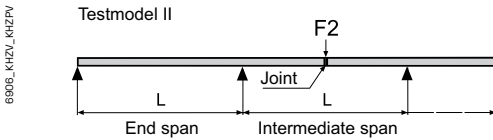

Loadings

The ladders are tested according to IEC 61537, test model II - a joint in the intermediate span (F2).

Guaranteed load

Guaranteed uniformly distributed load includes a minimum safety factor of 1.7 towards rupture. The diagrams shows the deflection for cable ladder widths up to 600 mm.

The cable ladders must not be used as walkways.

Use and installation



PI43717

KHZP-20C

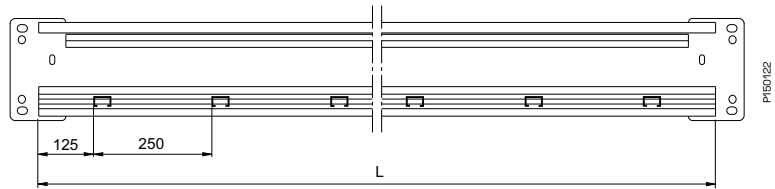
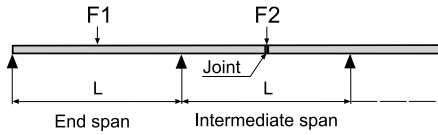
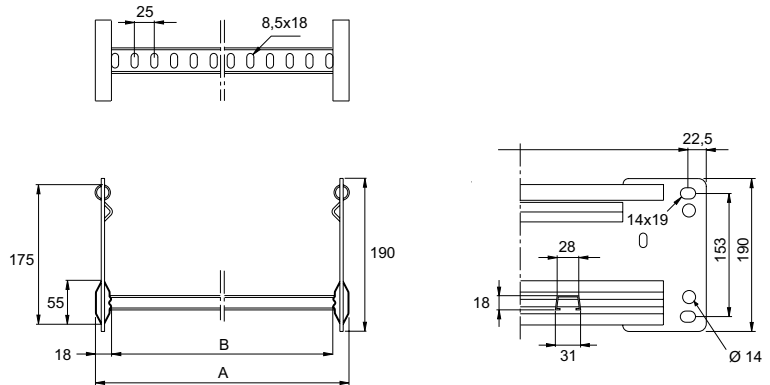

Test model II

SWL (Safe working load) KHZP 20C-200-1000

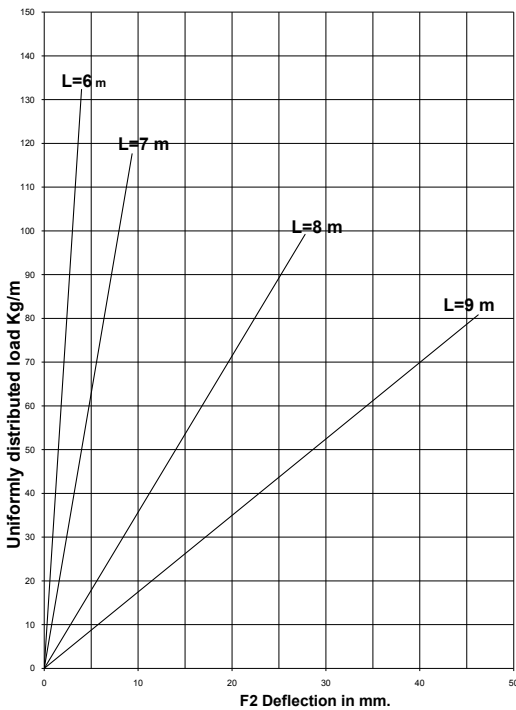

Type	L m	A mm	B mm
KHZP 20C-200	6	197	161
KHZP 20C-300	6	297	261
KHZP 20C-400	6	397	361
KHZP 20C-500	6	497	461
KHZP 20C-600	6	597	561
KHZP 20C-800	6	797	761
KHZP 20C-1000	6	997	961

To be able to take the load requirements the system shall be supported close to all transition points like Bends, T-junctions, Risers, Take-off hooks, Angle plates and Couplers.

Loadings IEC 61537

The ladders are tested according to IEC 61537, test model II.

Guaranteed load

Guaranteed uniformly distributed load supported includes a minimum safety factor of 1.7 towards rupture. The diagram shows the deflection for ladder widths.

Loadings according NEMA V1 20C

Test result at 6 meter support distance 173 kg/m (safety factor of 1.5).

The cable ladders must not be used as walkways.

Use and installation CLX³ Click suspension

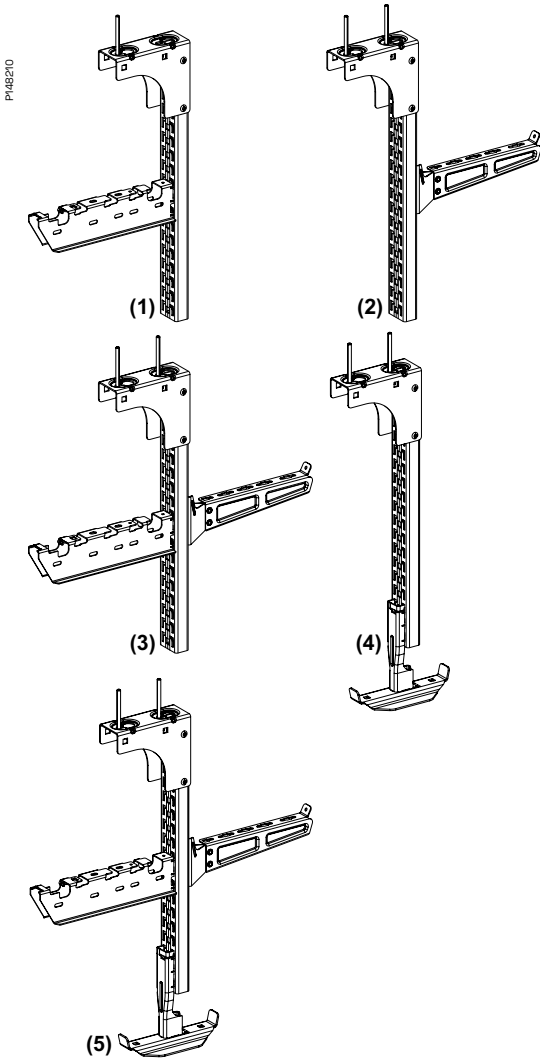

CLX³ General information

Standards

CLX³ installation system is tested and following the classification according to the IEC 61537.



Usage of gloves

According to IEC 61537 it is always recommended to use protective gloves when handling and manipulating cable support systems.

Handling and storage

- Store in dry and covered places.
- Avoid moisture and pollutants.
- Do not remove the packing until installation.
- Take care when storing and handling so that the CLX³ components are well protected from damage.

CLX³ Pendant loading configurations

CLX³ pendant is primarily designed for installation of the CLX³ support system, but can also be used for T-bolt installation.

The system can be installed in different configurations:

- b Click direction **(1)**: the cantilever and the ceiling plate are in the same direction
- b T-bolt direction **(2)**: a cantilever is fixed with a T-bolt to the rail, in the opposite direction of the ceiling plate
- b T installation **(3)**: combination of the first 2 installations
- b Central suspension **(4)**: the pendant is completed by a central suspension bracket
- b T and central suspension **(5)**.

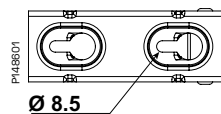

Fixation to the ceiling

Keyhole design

Keyhole design is facilitating easy mounting of the pendant to the ceiling by allowing the bolts to be pre-fixed before finally placing the pendant and tightening the bolts.

For concrete ceiling, use bolts type IMT38051.

For other bolts where bolthead is < 16 mm use washer u 16 mm.

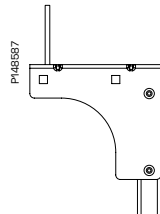

One bolt fixation

For click direction installation of CLX³ Cantilever arm **(1)**, use a single bolt, in the outer hole position on the ceiling plate.

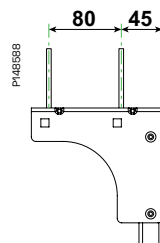

Two bolt fixation

For T-bolt suspension, central suspension, T installation and T and central suspension installation **(2)**, **(3)**, **(4)**, **(5)**, always fix the ceiling plate to the ceiling using 2 bolts.

Use the angle adaptor when the ceiling is not horizontal to level out the suspended pendant.

Use and installation CLX³ Click suspension

Pendant load calculation

To verify that the load applied to each pendant is within performance, it is necessary to calculate and consolidate the total **tensile load force** and the total **moment-force** on each pendant and for each cantilever and after that compare the calculated values with the defined loading limitations to ensure a safe installation.

Total tensile force Ft calculation method

This is calculated as the sum of all forces applied to the pendant from the weight of cables on the length material.

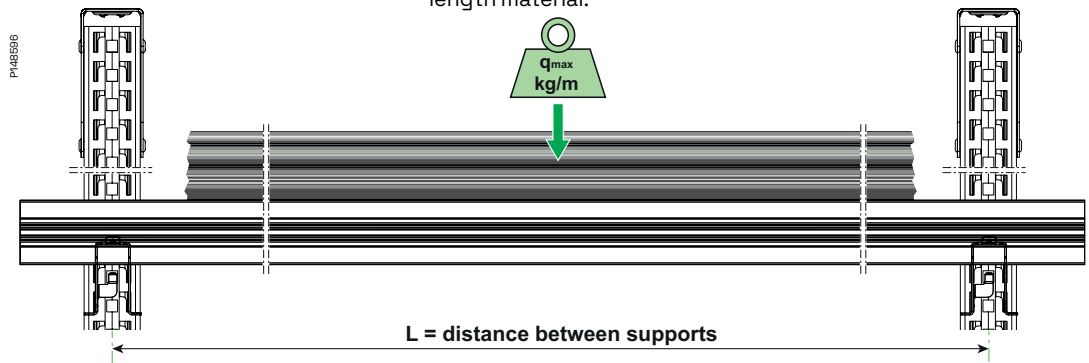

$$F_t \text{ (total load in N)} = L \text{ (span or supports distance in meters)} \times q_{max} \text{ (load in kg/m)} \times 10.$$

In case of several layers are installed on the pendant then the sum of the Ft tensile load from all layers shall be calculated.

Total momentum force Mt calculation method

This is calculated as the sum of all the torsion forces applied to the pendant from the weight of cables on the length material and the offset distance created by the cantilever arm.

$$M_t \text{ (momentum in N.m)} = F_t \text{ (N)} \times d \text{ (distance between axis center and point load in meters)}$$

“d” depends of the position of the length material on the cantilever arm.

The distance **d** can be different depending on installation method. When the length material is installed on the full width of the cantilever, use **d1**.

For length material that are installed at the outer end of the arm, use **d2**.

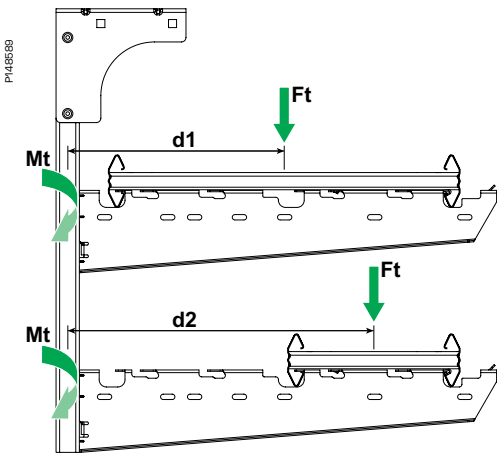

Model	PG	d1 (m)	d2 (m)
CLX ³ cantilever arm 200	CSU795647	0.140	NA
CLX ³ cantilever arm 300	CSU795648	0.190	NA
CLX ³ cantilever arm 400	CSU795649	0.240	0.340
CLX ³ cantilever arm 500	CSU795650	0.290	0.440
CLX ³ cantilever arm 600	CSU795651	0.340	0.490

In case of several layers are installed on the pendant then the sum of the Mt momentum force from all layers shall be calculated.



Ensure that the installation is designed so that Mt and F_t are under the limits.

Use and installation CLX³ Click suspension

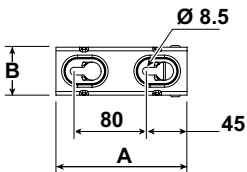
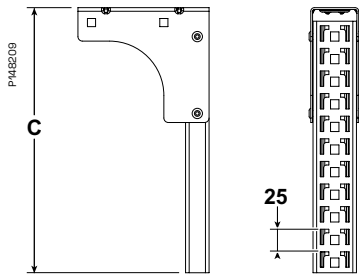
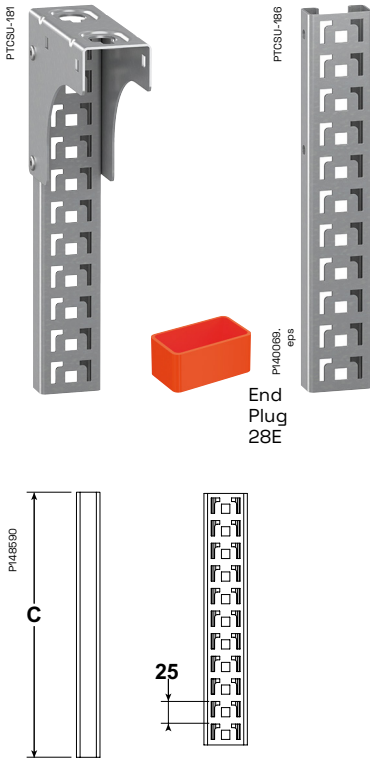

CLX³ Pendant 24/48

Vertical piece with a perforated pattern to be used for installation of CLX³ cantilever arms or CLX³ central suspension adapter. The open side of the rail can be used for installation of cantilever arms and brackets together with T-bolt.

Can be joined to CLX³ Rail 24/48 with pendant joint 2FJ.

Model	PG	High (mm) A	Width (mm) B	Length (mm) C
CLX³ pendant				
CLX ³ pendant 24/48 300 mm PG	CSU795632	145	53	295
CLX ³ pendant 24/48 400 mm PG	CSU795633			395
CLX ³ pendant 24/48 500 mm PG	CSU795634			495
CLX ³ pendant 24/48 700 mm PG	CSU795635			695
CLX ³ pendant 24/48 1000 mm PG	CSU795636			995
CLX ³ pendant 24/48 1500 mm PG	CSU795638			1495
CLX³ rail				
CLX ³ rail 24/48 300 mm PG	CSU795640	26	48	280
CLX ³ rail 24/48 1000 mm PG	CSU795641			980
CLX ³ rail 24/48 3000 mm PG	CSU795637			2980

Pendants Safe Working Load (SWL)

SWL for bending moment of the pendant **Mt**.

Model	PG	Moment (N.m) Click side	Deflection (mm)
CLX ³ pendant 24/48 300 mm PG	CSU795632	235	2
CLX ³ pendant 24/48 400 mm PG	CSU795633		4
CLX ³ pendant 24/48 500 mm PG	CSU795634		7
CLX ³ pendant 24/48 700 mm PG	CSU795635		15
CLX ³ pendant 24/48 1000 mm PG	CSU795636		30
CLX ³ pendant 24/48 1500 mm PG	CSU795638	200	30

Tested according to IEC 61537 standard.

SWL bending moment for Adjustable ceiling plate **Mt**.

Model	PG	Moment (N.m) Click side
CLX ³ adjustable ceiling plate	CSU795639	235

SWL pendant tensile strength **Ft**.

Model	PG	Tensile load SWL (N) 1 bolt CLX ³	Tensile load SWL (N) 2 bolts CLX ³
CLX ³ pendant 24/48 300 mm PG	CSU795632	2000	5000
CLX ³ pendant 24/48 400 mm PG	CSU795633		
CLX ³ pendant 24/48 500 mm PG	CSU795634		
CLX ³ pendant 24/48 700 mm PG	CSU795635		
CLX ³ pendant 24/48 1000 mm PG	CSU795636		
CLX ³ pendant 24/48 1500 mm PG	CSU795638		

Use and installation CLX³ Click suspension

Pendant limits, torque and deflection

In the diagram below it is possible to check if \varnothingMt is below the momentum limitation of the pendant (end of line). It is also possible to see the deflection on the pendant at max \varnothingMt and all values below.

Calculation example

For a cantilever size 600, full size ladder installation, 3 m span, load of 23 kg/m on a 1000 mm pendant.

1) \varnothingF : 3 m (span) x 23 kg/m (load) x 10 = 690 N will be the load for each pendant system.

2) \varnothingMt : 690 (N) x 0.34 (m) = 234 N.m.

$\varnothingF = 690 \text{ N} \leq 2000 \text{ N}$ and $\varnothingMt = 234 \text{ Nm} \leq 235 \text{ N.m.}$

3) Drawing of the lines on the graph: for 234 N.m, the deflexion on the pendant is **30 mm**.

P14E666

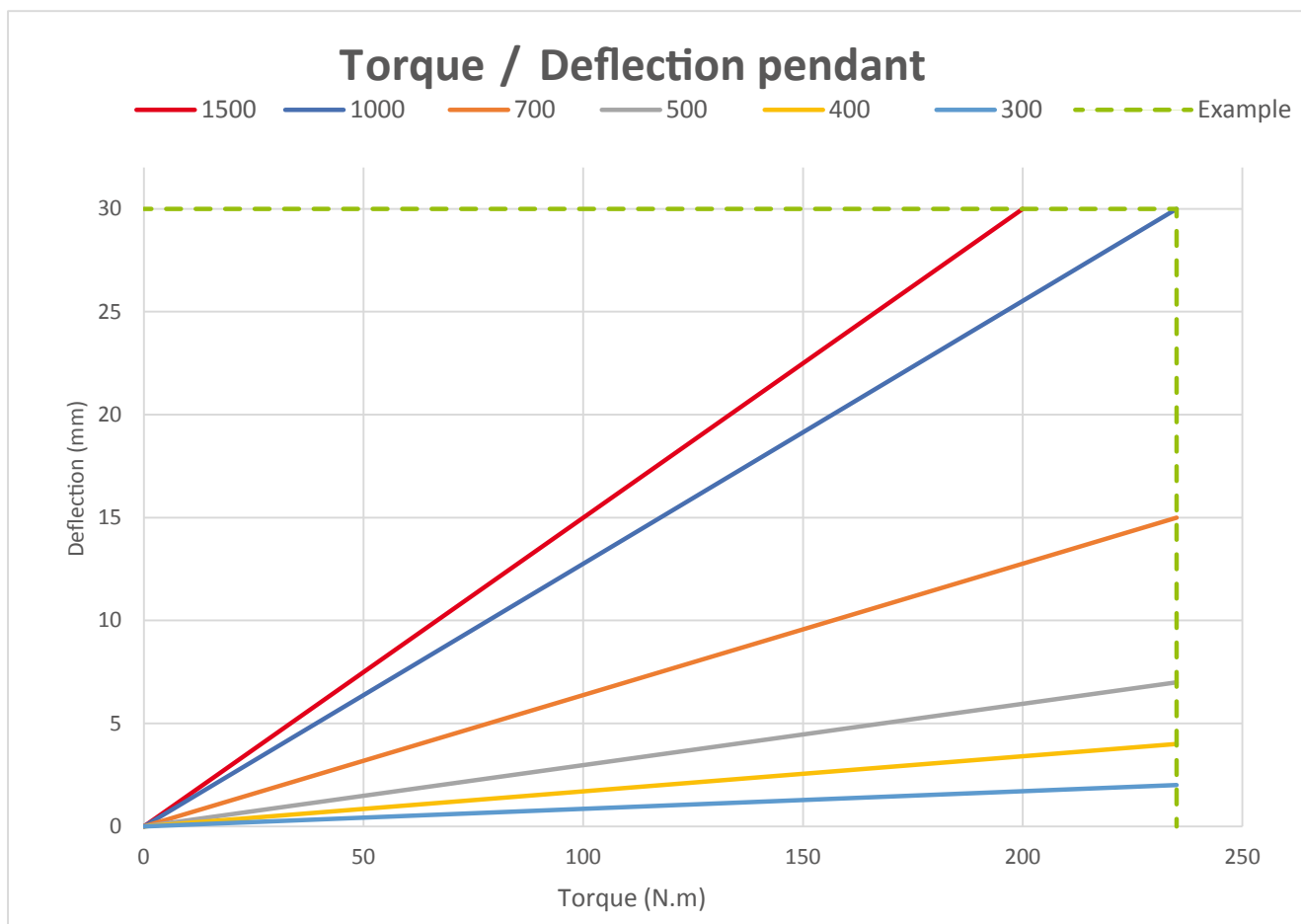

Use and installation CLX³ Click suspension

Distance between rails and offset

CLX³ rail have a pitch between the patterns of 25 mm.
 The support distance between the pendants should be at least than 1.5 m. If the length material can't be installed on the exact same level, the length material should be installed on the closest offset- pitch and never at more than 12.5 mm vertically from the previous pattern.

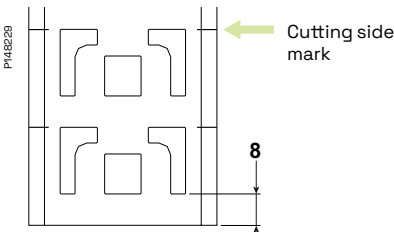
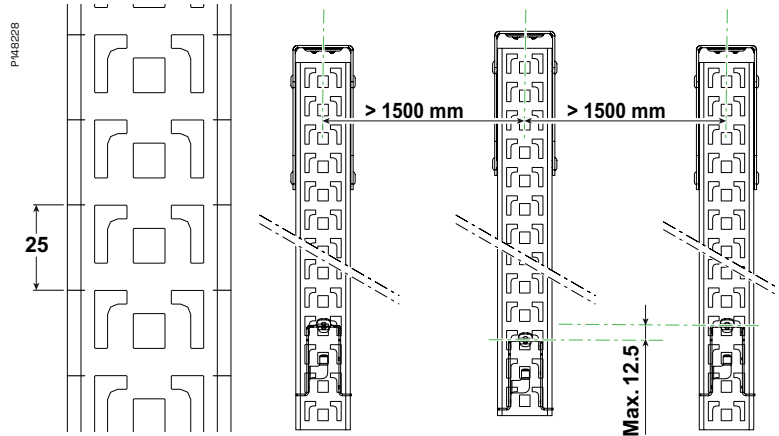

Cutting of the pendant or rail

Cutting of the rail or the pendant should be made at 8 mm under the last pattern needed, as the side marks are showing. This to assure that there is enough material below the bottom pattern to secure proper fixation of the cantilever arm.

Installation of the rail joint

CLX³ rails can be joined together with pendant joint 2FJ.

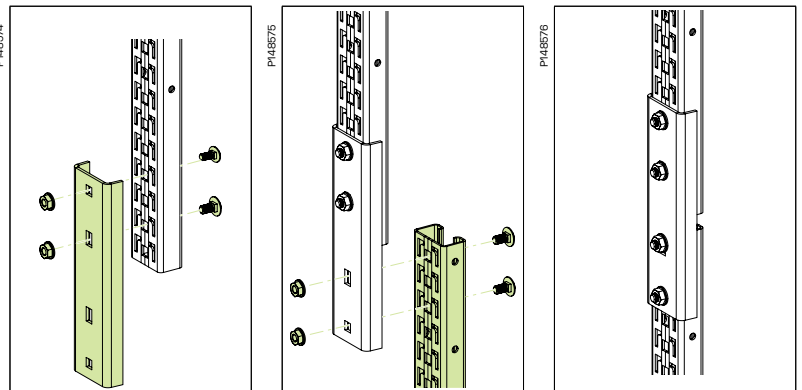

Place the joint on the rail in place, make sure the 2 top holes are in front of slots to install the included bolts and nuts.

Install the second rail as high as possible and install the other bolts and nuts.

Torque of the nuts **11 N.m.**

Note: extending the pendant with the rail joint will decrease the load capacity of the pendant. For SWL information when extending the pendants, contact Technical support.

Use and installation CLX³ Click suspension

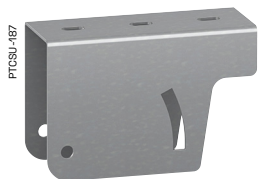

CLX³ Adjustable ceiling plate

Adjustable ceiling plate is used together with CLX³ pendant to allow for angle correction up to 25°. The adjustable ceiling plate is fixed to the CLX³ pendant with

4 screw set 22S to be ordered separately. The pendant can be fixed to the adjustable ceiling plate in both possible directions (1) and (2).

Model	PG	High (mm) A	Width (mm) B	Length (mm) C
CLX ³ adjustable ceiling plate PG	CSU795639	100	59	150

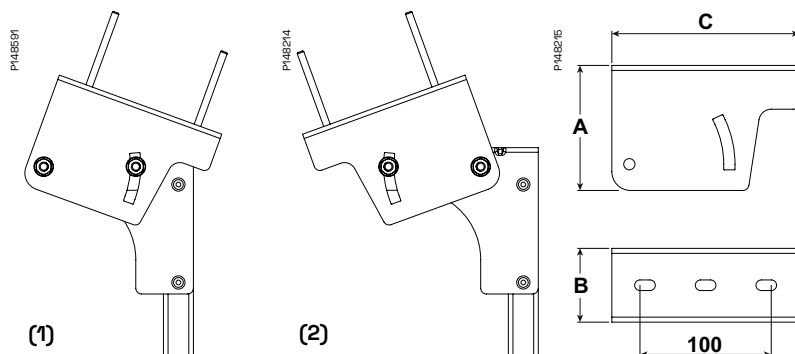

Installation of the adjustable ceiling plate

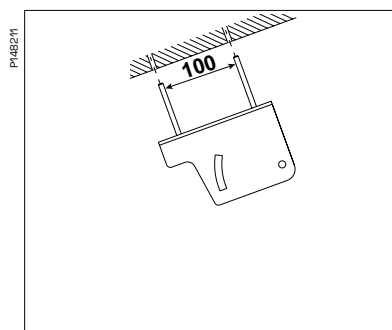

Fix the adjustable ceiling plate to the ceiling with 2 bolts.
(c-c: 100 mm).

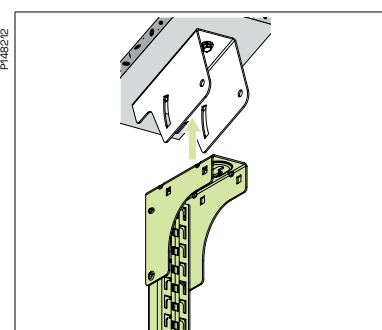

Insert the pendant into the adjustable ceiling plate.

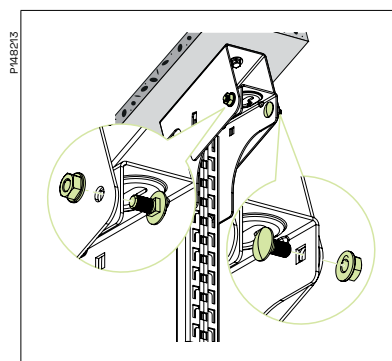

Fix the pendant to the adjustable ceiling plate with 4 bolt sets 22S and align the pendant to the vertical plane before tightening the bolts.

Recommended torque 20 N.m.

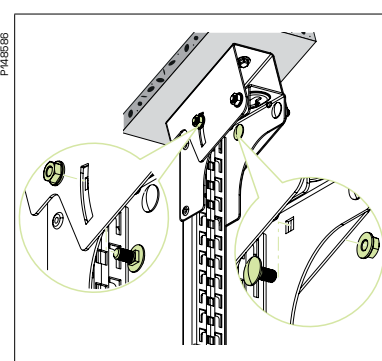

Use and installation CLX³ Click suspension

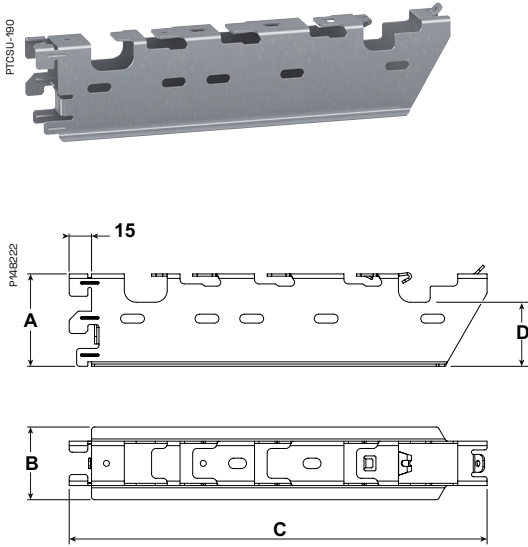

CLX³ Cantilever arm

The CLX³ cantilever arm is a screw-less cantilever that clicks into the pattern in the CLX³ pendant and rail. The cantilever arm is used to fix either the KHZSP ladder, the Defem mesh tray or the Stago height 60 trays. It can also be used for the Performa mesh trays together with fixation bolts.

Model	PG	High (mm) A	Width (mm) B	Length (mm) C	Height below ladder (mm) D
CLX ³ cantilever arm 200 PG	CSU795647	62	49	280	43
CLX ³ cantilever arm 300 PG	CSU795648	62	49	380	43
CLX ³ cantilever arm 400 PG	CSU795649	92	49	480	73
CLX ³ cantilever arm 500 PG	CSU795650	92	49	580	73
CLX ³ cantilever arm 600 PG	CSU795651	92	49	680	73

Cantilever arm size compatibility

The click pattern on the cantilever arm is in some cases fitting more than one ladder width to make it possible to avoid pillars or obstacles on the wall. See the table and illustration below.

The table also clarifies which cantilever arm to use for each with of Defem mesh tray.

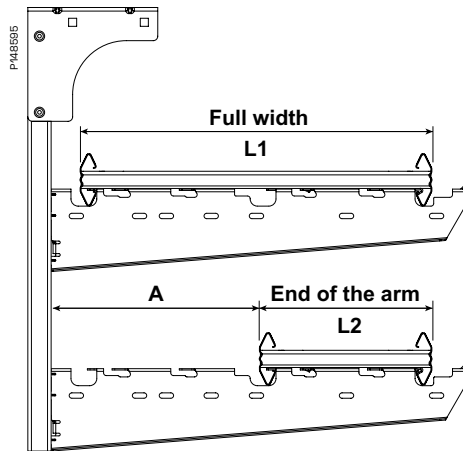

Model	PG	Compatible ladder		Space to the offset ladder (mm) A	Defem size compatibility
		(offset)			
		L1	L2	A	
CLX ³ cantilever arm 200 PG	CSU795647	200	NA	NA	220
CLX ³ cantilever arm 300 PG	CSU795648	300	NA	NA	320
CLX ³ cantilever arm 400 PG	CSU795649	400	200	232	420
CLX ³ cantilever arm 500 PG	CSU795650	500	200	332	520
CLX ³ cantilever arm 600 PG	CSU795651	600	300	332	620

Cantilever arms Safe Working Load (SWL)

SWL of the cantilever bracket

Model	PG	Safety working load as wall bracket (full width) (N)	Safety working load as wall bracket (end of the arm) (N)
CLX ³ cantilever arm 200 PG	CSU795647	1800	NA
CLX ³ cantilever arm 300 PG	CSU795648	1250	NA
CLX ³ cantilever arm 400 PG	CSU795649	1250	1000
CLX ³ cantilever arm 500 PG	CSU795650	1250	750
CLX ³ cantilever arm 600 PG	CSU795651	1000	700

Tested according to IEC 61537 standard.

Use and installation CLX³ Click suspension

Installation of cantilever arms

CLX³ cantilever arms are clicked to the CLX³ pendants and rails. Make sure to select a pattern allowing all hooks to grip and the full cantilever back to be supported by the rail. The horizontal wing must touch the rail.

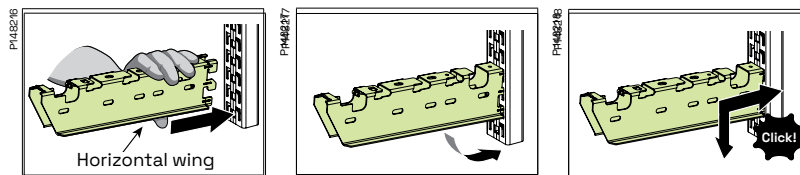

Hold the cantilever close to the hooks and insert the hooks in the rail.

Press the cantilever until the horizontal/top surface touch the rail.

Press against the rail and pull it down until the locking lip go inside the slot in the rail.

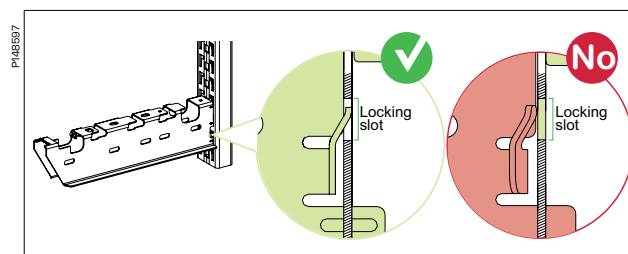

Visually check that the cantilever arm is properly positioned and the locking lip is positioned inside of the slot of the CLX³ rail.



Apply caution with unintended upward movements as it can cause the cantilever arm to unlock and therefore be released from the rail.

Uninstallation of CLX³ cantilever arm using screwdriver

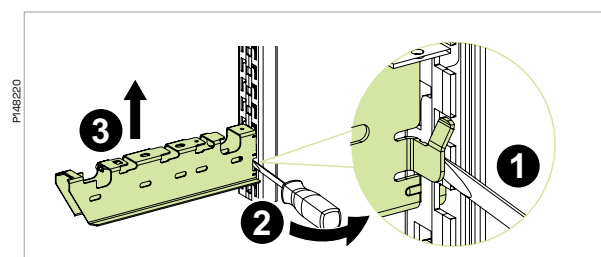

1 Fit the head of the screwdriver between the rail and the locking lip of the cantilever.

Use the screwdriver as a lever to **2** push the lip out of the rail. Deform the lip as little as possible and **3** push the cantilever up to be able to unhook the cantilever arm.

Before reinstalling a cantilever that has been removed after installation, make sure the lip is locking properly. If not, correct the lip to the initial position.

Use and installation CLX³ Click suspension

Installation of KHSZP ladders on cantilever arms

CLX³ cantilever arms are designed to fix KHZSP ladders without need of tools or bolts.

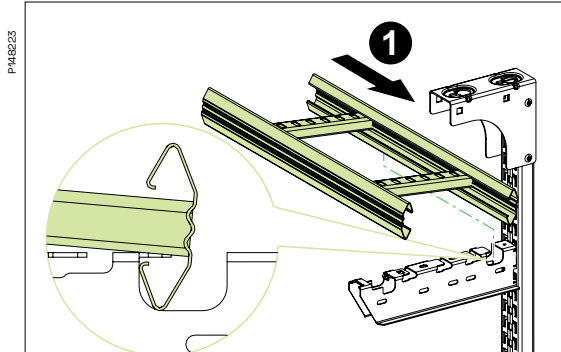

1 Insert the ladder on the rail side. Pull it on the outside direction to lock this side in the lip.

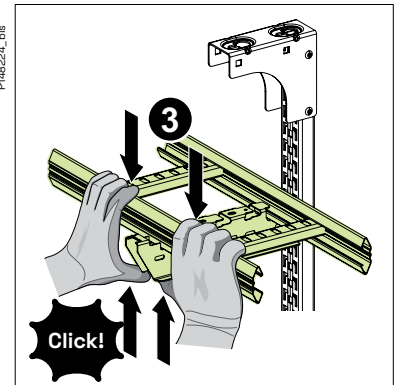
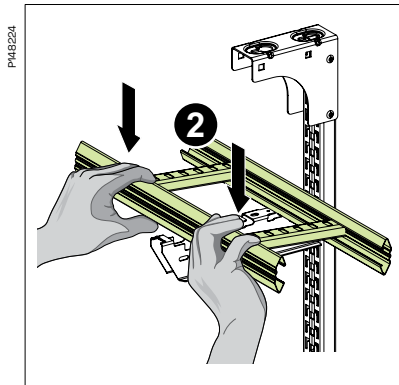

2 Squeeze the free side of the ladder strongly down on the outer end of the cantilever until **3** the ladder overpasses the locking lip.

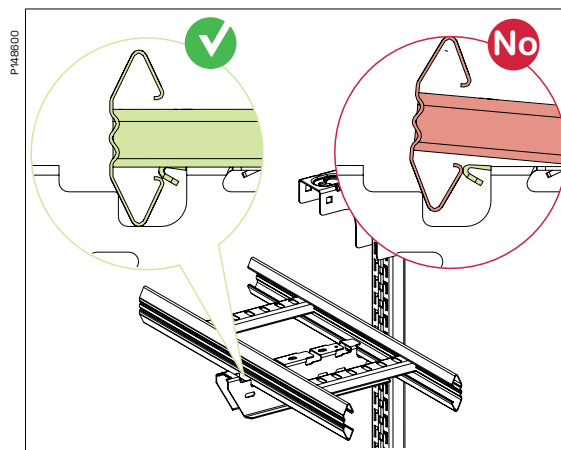

Visually check that the ladder is properly positioned, and the locking lip is positioned inside of the ladder profile.

Use and installation CLX³ Click suspension

Uninstallation of KHSZP ladder of cantilever arms

Remove the ladder from the cantilever arm, by using a flat screwdriver.

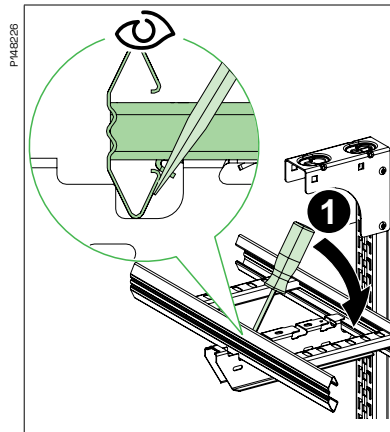

1 Fit the head of the screwdriver between the ladder and the top surface of the cantilever as in the picture. Use the screwdriver as a lever to pull out the ladder of the locking lip until the ladder snaps out.

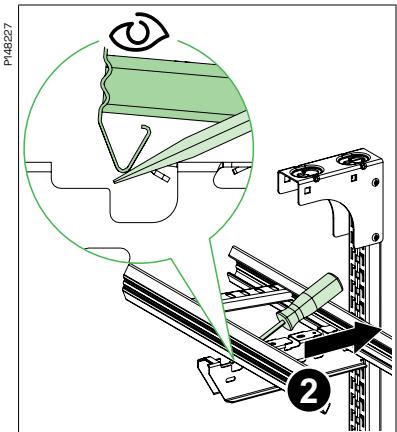

After releasing the outer side of the ladder, **2** push the ladder in the direction of the rail to unlock the other side.

Use and installation CLX³ Click suspension

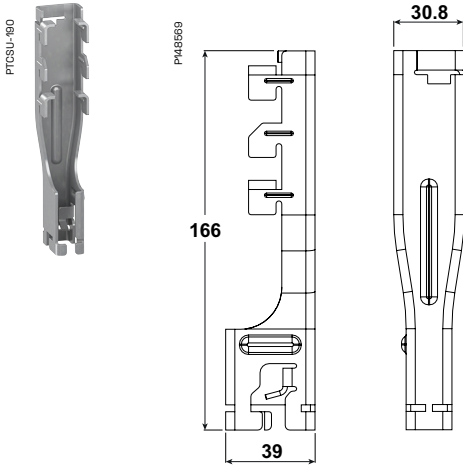

CLX³ Central suspension adapter

The CLX³ central suspension adapter is clicked together with the central suspension brackets to create a central suspension piece that can be clicked to the rail or pendant.

Model	PG	High (mm) A	Width (mm) B	Length (mm) C
CLX ³ Central suspension adapter PG	CSU795700	166	31	39



Installation of the Wall bracket

The Wall bracket is made to directly fix a Cantilever arm to a wall, without using a full-size rail. The Wall bracket doesn't reduce the SWL of the cantilever arm and the distance between the back of the cantilever and the wall is the same as with a rail.

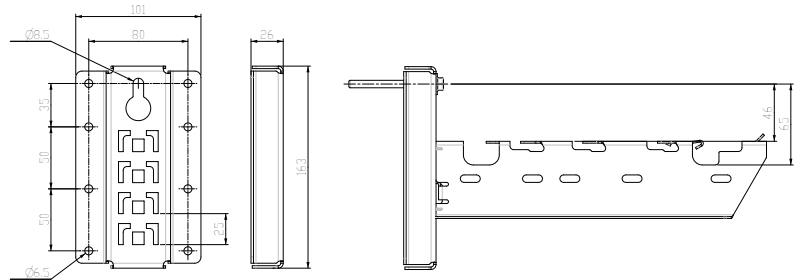

The wall bracket can be fixed in two different ways: With the keyhole (A) or with the lateral holes (B).

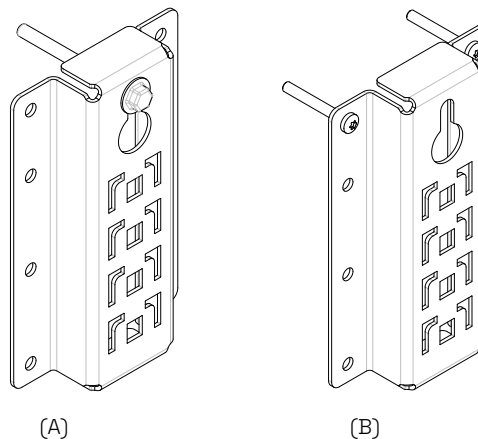

The keyhole design allows to pre-fix the bolt in the wall, before installing the bracket.

For concrete wall, use bolts IMT38051.

For non-concrete wall, M8 bolts with washer >Ø16 should be used.

For the lateral holes, the bracket should always be fixed with at least the two top Ø6mm holes (same height as the keyhole). The left and right bolts should be horizontally separated by 80mm (axis to axis).

Use and installation CLX³ Click suspension



PTCSU-202

CLX³ KHZSP ladder central suspension bracket

Bracket to be used for central suspension of KHZSP ladders. The bracket shall be used together with the CLX³ central suspension adapter.

Model	PG	High mm A	Width mm B	Length mm C
CLX ³ KHZSP central suspension bracket 200 PG	CSU795655	37	78	185
CLX ³ KHZSP central suspension bracket 300 PG	CSU795656	37	78	285
CLX ³ KHZSP central suspension bracket 400 PG	CSU795657	37	78	385
CLX ³ KHZSP central suspension bracket 500 PG	CSU795658	37	78	485
CLX ³ KHZSP central suspension bracket 600 PG	CSU795659	37	78	585

Central suspension bracket	SWL symmetric load (N)
200	1500
300	1500
400	1500
500	1250
600	1200

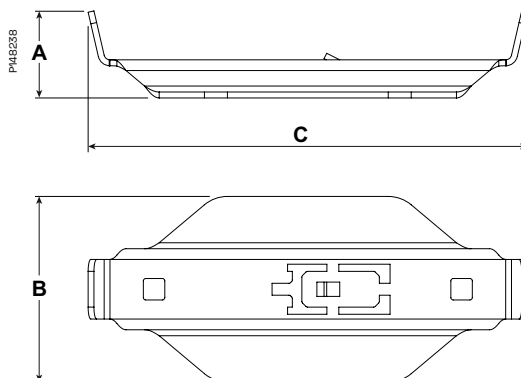

PM48298

Use and installation CLX³ Click suspension

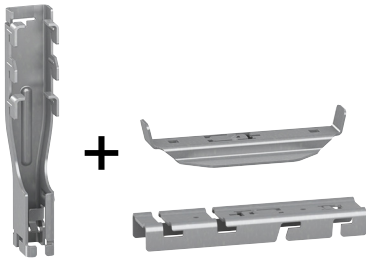

Installation of adaptor to central suspension brackets

The CLX³ central suspension bracket is installed without tools by clicking it to the central suspension. The method is the same for Central suspension bracket ladder -mesh or -tray. In the illustration below, the CSB for ladder is used.

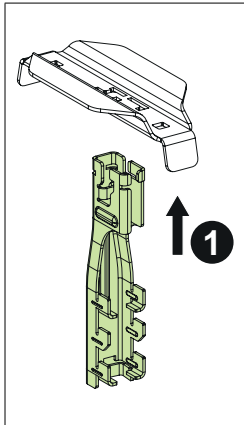

1 Insert the adaptor in the pattern on the central suspension bracket.

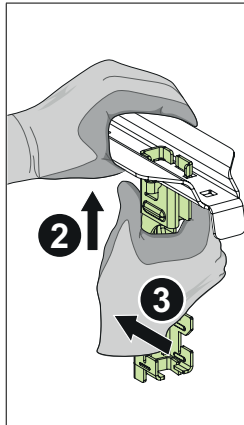

2 Press the pieces together and **3** slide the adaptor until the click lip of the adaptor pass over the locking lip of the central suspension bracket with a **4** click.

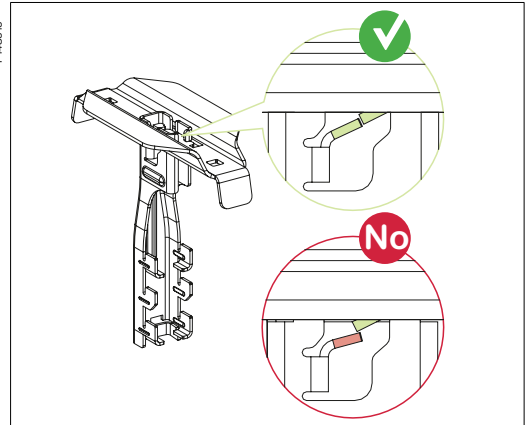
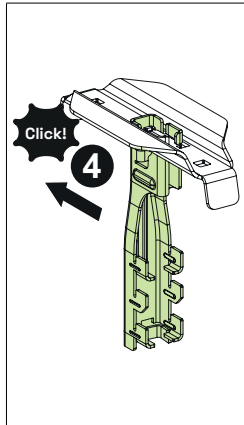

Visually check and secure that the adaptor is properly positioned, and the click lip has overpassed the locking lip.

Installation of central suspension adaptors to the CLX³ rail

The CLX³ central suspension adaptors is installed to the rail without tools, by clicking. To ensure proper installation a hooks must be inserted in the rail:

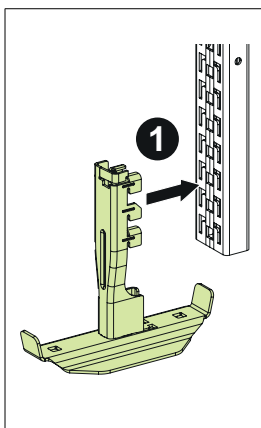

1 Push the central suspension piece until the hooks are fully inserted in the pattern and the surface touches the rail.

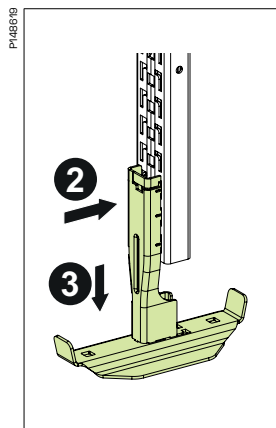

2 Press towards the rail and **3** pull down until the click lip.

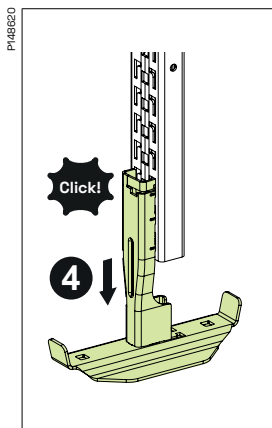

4 Pass inside the slot in the rail.

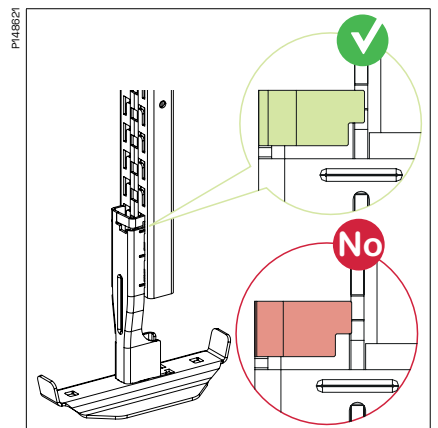

Visually check and secure that the adaptor is properly positioned, and the click lip is properly positioned inside of the slot of the CLX³ rail.



Apply caution with unintended upward movements as it can cause the adaptor to unlock and therefore be released from the rail

Use and installation CLX³ Click suspension

Uninstallation of adaptor from the CLX³ rail

CLX³ central suspension adaptors can be removed, by using a flat screwdriver.

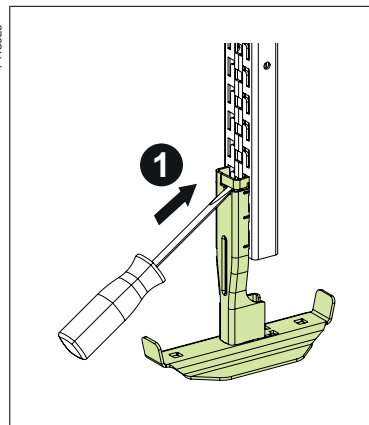

1 Fit the screwdriver's head in the slot of the adaptor.

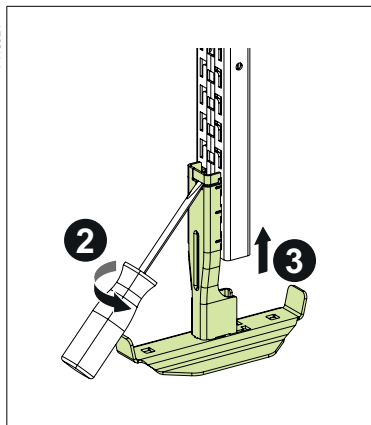

Use the screwdriver as a lever to **2** gently release the click lip from the rail. Then **3** push the adaptor up to release the L hooks from the rail.

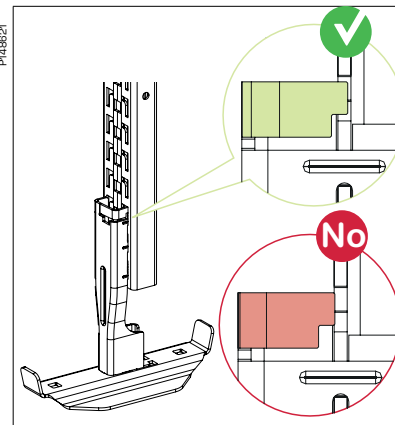

If the adaptor needs to be reinstalled, correct the click lip to the initial position and make sure the click lip is locking properly.

Uninstallation of adaptor from central suspension brackets

CLX³ central suspension brackets can be removed, by using a flat screwdriver.

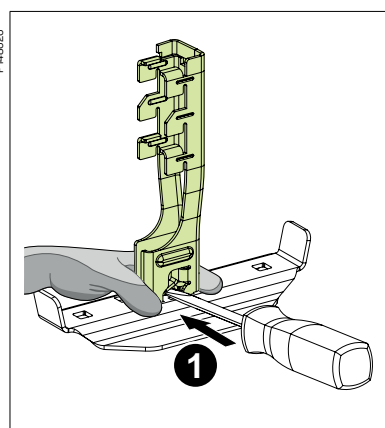

1 Hold the bracket, fit the screwdriver's head between the adaptor lip and the bracket.

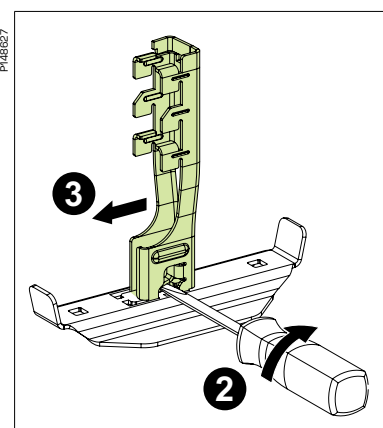

2 Twist the screwdriver to use it as a lever on the click lip until it passes over the bracket's locking lip and **3** pull the adaptor sideways to release it.

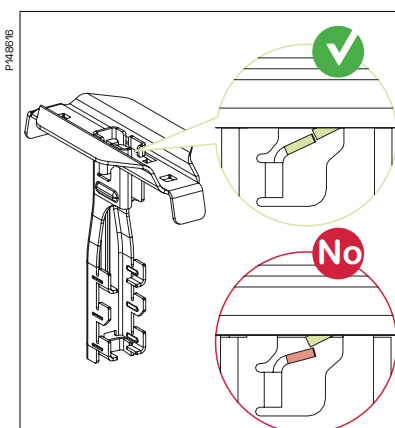

When the bracket needs to be reinstalled, correct the click lip to the initial position and make sure the click lip is locking properly.

Use and installation CLX³ Click suspension

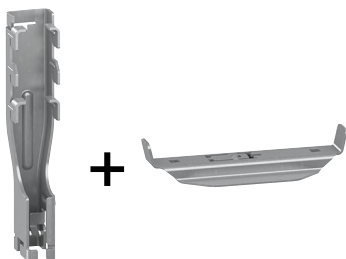

Installation of KHZSP ladders on central suspension brackets

CLX³ brackets are made to fix ladders KHZSP without tool.

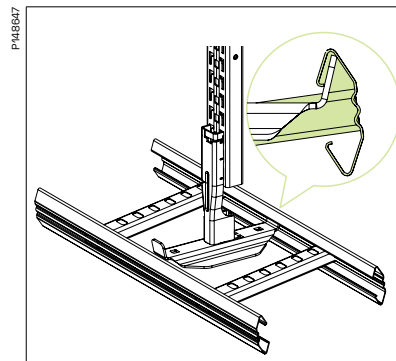
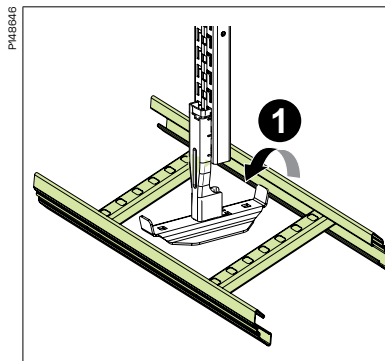

1 Insert one inside side of the ladder on one lips of the bracket.

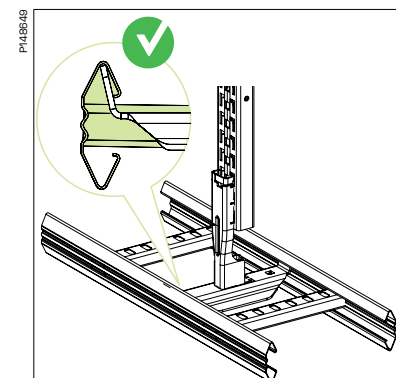
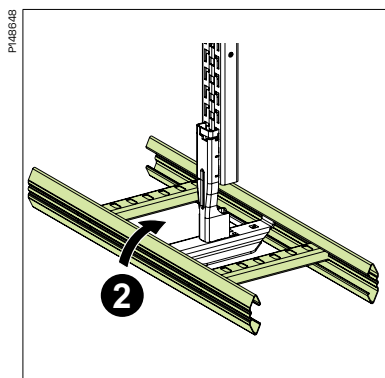

2 Pull up the other side and snap the ladder on the other lip.

Visually check if the bracket lip is inside the ladder profile. Profile clamp 43 can be used to fix the cable ladder to the support bracket.



Apply caution with unintended upward movements as it can cause the bracket to unlock and therefore be released from the rail

Uninstallation of KHZSP ladder from the central suspension bracket

KHZSP ladder can be removed from the bracket.

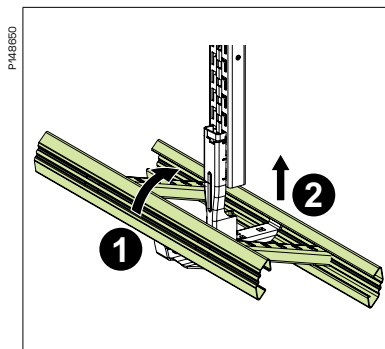

1 Push one side of the ladder up until the ladder leave the lip of the bracket.

2 Release the other side of the ladder from the lip.

Use and installation

Joint 21, with screws or screwless

Joint to be used for straight, rigid joining of cable ladders, bends, junctions and risers. No extra earthing needed.

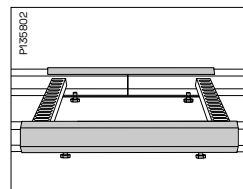
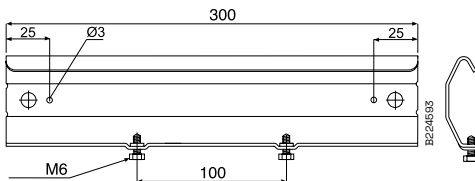

Joint 21 in stainless steel

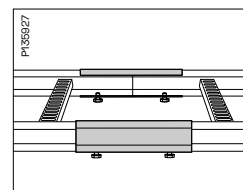
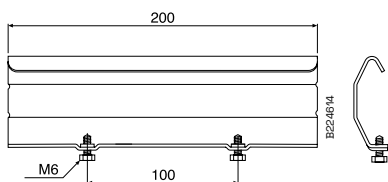

Joint 21 screwless joint

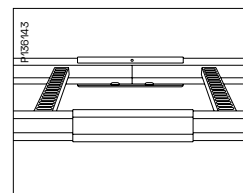
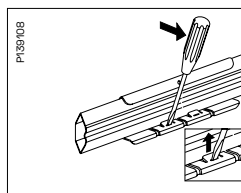
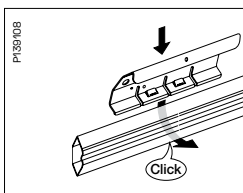
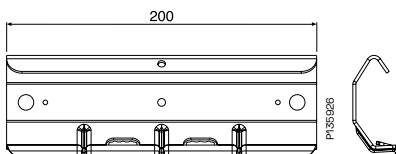

Joint 9

Joint to be used for straight joining of cable ladders KHZ, KHZP and KHZPS. The teeth of the joint should face downwards. Under load, the ladders are prevented from slipping apart. If the joint is above a bracket, the teeth should face upwards.

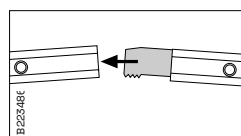
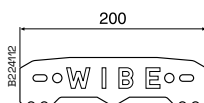

Joint 9 is used in straight joints of KHZ, KHZP and KHZPS.

NOTE! The teeth shall face downwards as shown in the figure. Under load, the ladders are prevented from slipping apart. If the joint is above a bracket, the teeth should face upwards.

Use and installation

Dropper joint 32

Dropper joint used to form vertical branches in centre position under/on top of cable ladders.

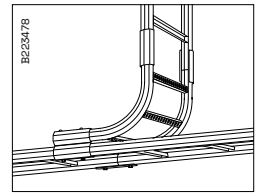
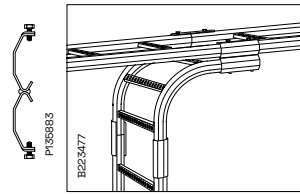
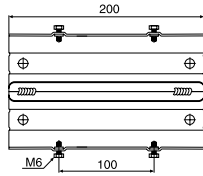

To be used together with Riser 18 to form vertical branches under Cable ladder KHZ, KHZP, KHZSP, KHZSPZ+ and KHZPS.

May also be used together with Riser 18 to form vertical branches on top of Cable ladder KHZ, KHZP, KHZSP, KHZSPZ+ and KHZPS.

Joint 45

Joint to be fitted as a joining plate in a cut KHZV/KHZPV ladder.

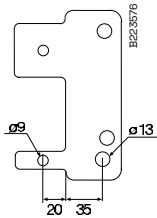
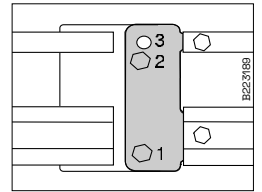
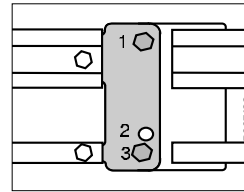
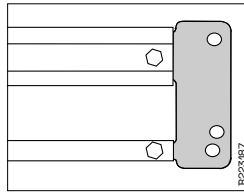
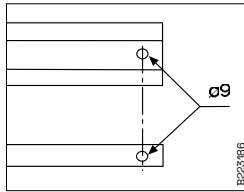

Cable ladders can be joined using separate joints.
 - Cut the ends clean.
 - Place the joints outside the ladders and mark where the holes shall be drilled.
 - Drill 9 mm dia. holes.

- Insert the joint plates into the ladders and bolt them fast.

The holes are laterally displaced to avoid play in joints. If the ladders are mounted with arch pipes facing downwards, use holes 1 and 3.

If the ladders are mounted with arch pipes facing upwards, use holes 1 and 2.

Use and installation

Coupling 22

Coupling to be used for horizontal or vertical branches at any desired angle.

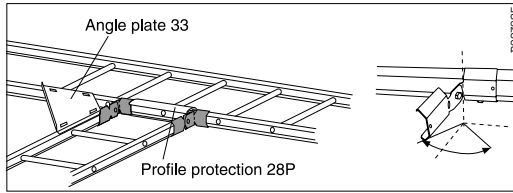
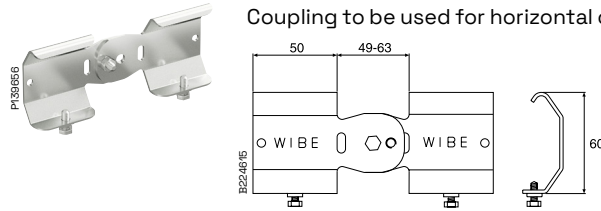

Coupling 22 is used for horizontal branching to the required angle. The cut length of the ladder ends determines the angle. Angle plate 33 is always recommended for horizontal branches. Use Profile protection 28P.

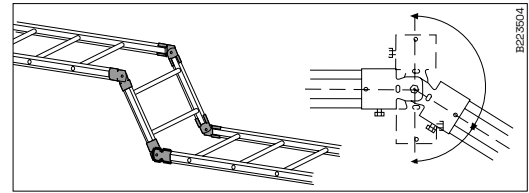

Coupling 22 is used to form vertical angles of the ladder of the required size.

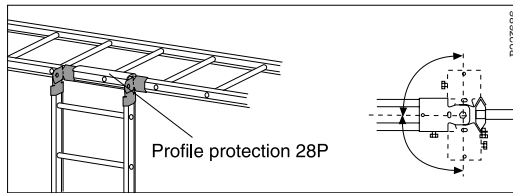

Coupling 22 is used to form vertical branches of the ladder of the required angle. Mount Profile protection 28P. To be cut when required.

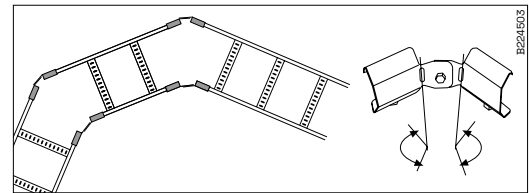

Use 4 Couplings 22 to form a horizontal bend in the ladder at different angles. The cut lengths of the ladder ends determine the angle.

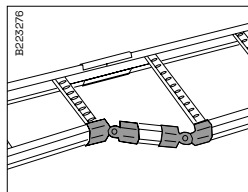

As an alternative at transition joining of KHZSP, KHZPS, KHZ and KHZP use 1 Joint 21 and 2 Couplings 22.

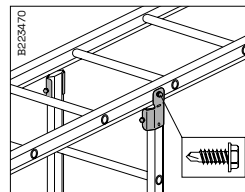

Vertical branching under the cable ladder with one part of Coupling 22 and plate screw.

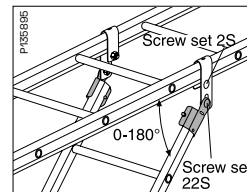

Clamp 12 and one part of Coupling 22 can be used for branching under the cable ladder – allowing angles from 0 – 180°.

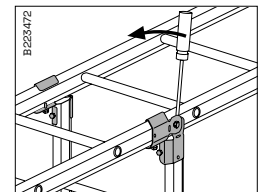

Use 2 Coupling 22 for vertical branching under the cable ladder. **Note!** The screw of Coupling 22 must be turned so that its head will be placed against the side profile of the cable ladder. Bend the coupling with a screwdriver.

Use and installation

Junction coupling 14



Junction coupling to be used for T- and X-junctions. Suitable for cable ladders KHZ, KHZP, KHZSP and KHZPS, all cable widths.

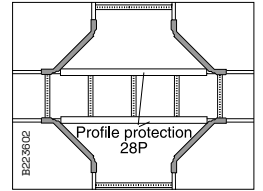
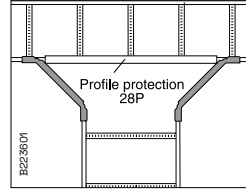
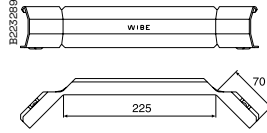

For T-junctions, use 2 Junction couplings 14.
For X-junctions, use 4 Junction couplings 14.
A bracket should be placed under the connecting ladder close to the connection. Profile protection 28P is recommended. To be cut to required length.

Coupling 44

Coupling to be used for horizontal coupling of cable ladders KHZV/KHZPV. Also to be used for branches and as an end connection against a wall.

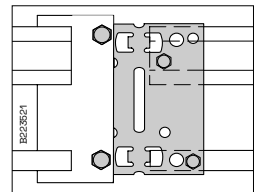
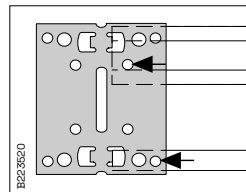
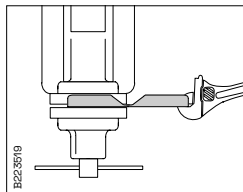
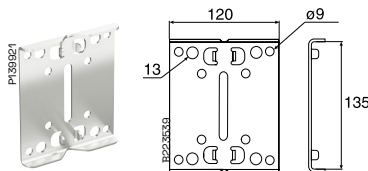

Coupling 44 may be bent to the required angle in a vice, using an adjustable spanner or similar.

Use Coupling 44 as a drilling pattern on the cut ladder. Drill 9 mm dia. holes.

Assemble the cut and drilled ladders using M8x30 mm bolts. If the angle unit is mounted against a fixed joint plate use Screw set M12.

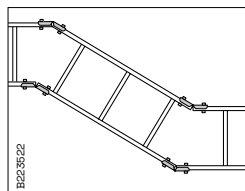

Angled cutting of the ladder ends determines the angle.

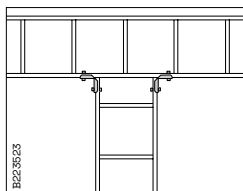

Straight branch.

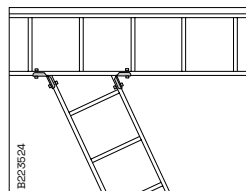

Angled branch.

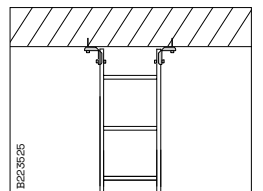

Use Coupling 44 as an end attachment for mounting ladders against walls or floors.

Coupling plate 48

Coupling plate to be used as a self-supporting vertical angle coupling of cable ladders KHZV/KHZPV. Assembled with 2 Screw set M12.

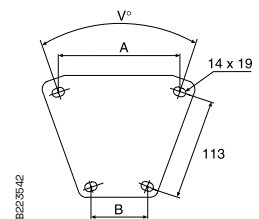
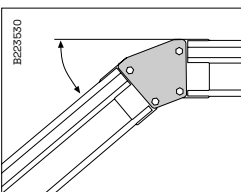

For self-supporting vertical angle adjustment use 2 Coupling plate 48 och 2 Screw set M12
Coupling plate 48/30°=25°-35°
Coupling plate 48/45°=35°-55°
Coupling plate 48/60°=55°-65°

V°	A mm	B mm
30	115	55
45	145	55
60	180	65

Use and installation

Horizontal coupling 20C/ Horizontal coupling bending 20C



Coupling to be used for horizontal connection of cable ladders KHZP 20C range. Four screws M8x30 and nuts are included.

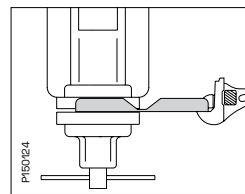
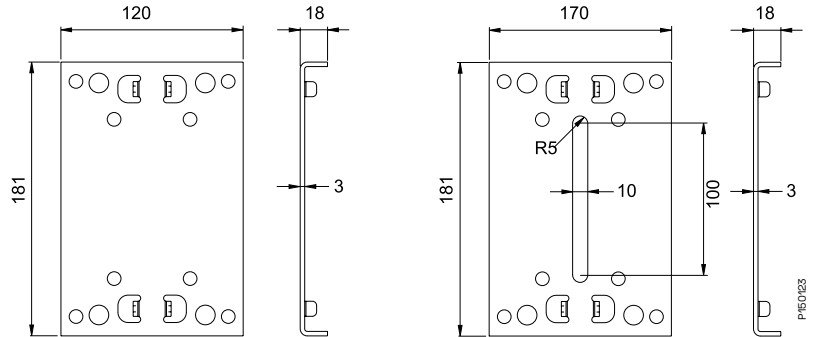

Coupling for Bending 20C may be bent to the required angle in a vice, using an adjustable spanner or similar.

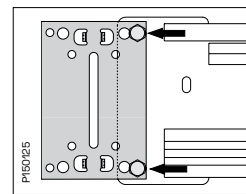

Use Coupling 44 as a drilling pattern on the cut ladder. Drill 9 mm dia. holes.

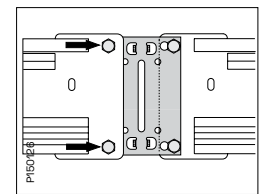

Assemble the cut and drilled ladders using M8x30 mm bolts. If the angle unit is mounted against a fixed joint plate use Screw set M12.

Coupling 51

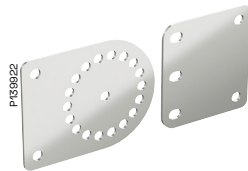

Coupling to be used as a self-supporting vertical coupling of cable ladders KHZV/KHZPV.

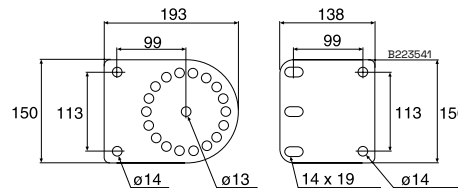

Screw set M12 for installation on the cable ladder is to be ordered separately.

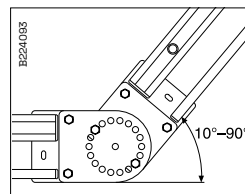

Rising. Adjustable from 10° to 90° gradually in steps of 20°.

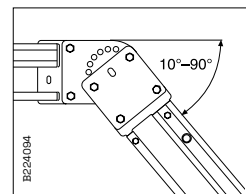

Sloping. Adjustable from 10° to 90° gradually in steps of 20°.

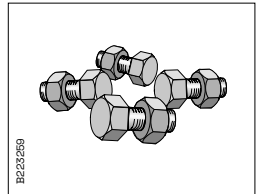

Screw set to be used for all joints with cable ladders KHZV and KHZPV.

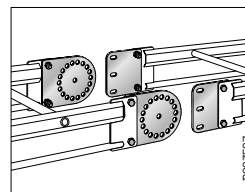

1. Install the plates on the ladder with Screw set M12.

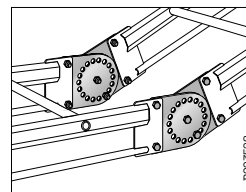

2. Assemble the ladders in the centre hole with one of the included screws/nuts. Adjust to desired angle and fix the installation in one of the outer holes with screw/nut.

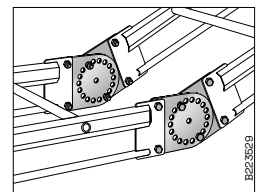

3. Move the nut in the centre hole to the opposite outer hole and tighten.

Use and installation

Vertical coupling 20C



Coupling to be used as a self-supporting vertical coupling of cable ladders KHZP 20C range. Adjustable from 10° to 90° gradually in steps of 20°. Two screws M12 and nuts are included.

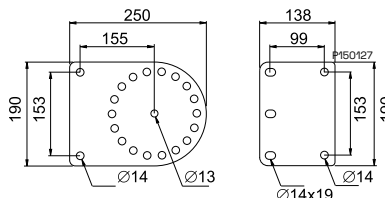

Rising and sloping adjustable from 10° to 90° gradually in steps of 20°. Screw set M12 for installation on the cable ladder is to be ordered separately..

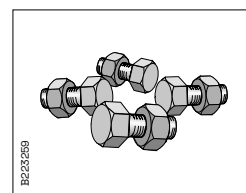

Screw set to be used for all joints with cable ladders KHZP 20C.

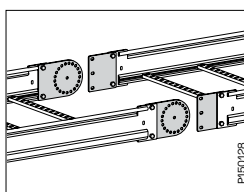

1. Install the plates on the ladder with Screw set M12.

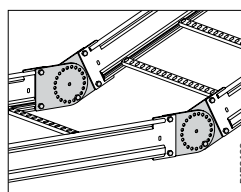

2. Assemble the ladders in the centre hole with one of the included screws/nuts. Adjust to desired angle and fix the installation in one of the outer holes with screw/nut.

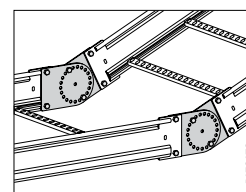

3. Move the nut in the centre hole to the opposite outer hole and tighten.

Angle plate 20C



Angled coupling to be used for cable ladders KHZP 20C range. Four screws M12x30 and nuts are included.

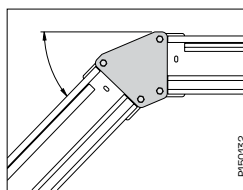
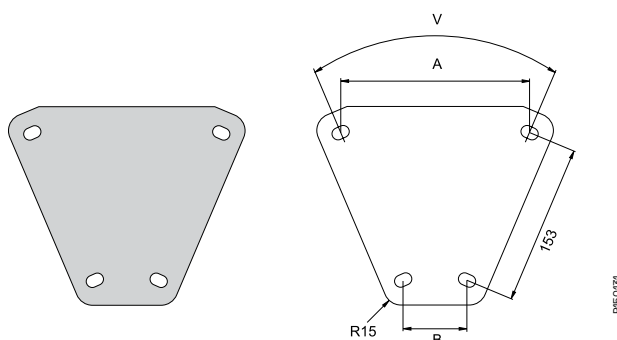

V	A mm	B mm
30	135	56
45	180	62
60	222	69

Use and installation

Profile clamp 42

Profile clamp to be used for installations where the cable ladder is to be fixed to cantilever arms, support brackets, etc. For mounting against wall use wall bracket 11.

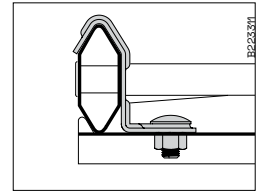
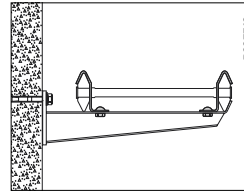
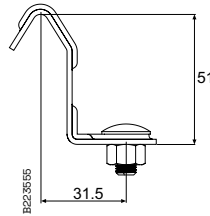

Use Profile clamp 42 for attaching KHZSP, KHZPS, KHZ and KHZP to Cantilever arm 50 and Support bracket 3.

For installation of KHZSP, KHZPS, KHZ and KHZP on Support bracket 3, Profile clamp 42 is used.

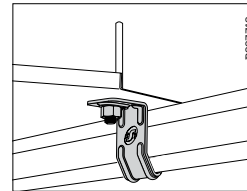

To lock Angle plate 33/2, fit 2 Profile clamp 42.

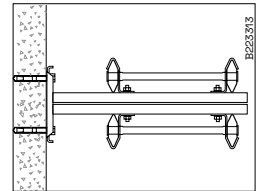

Cable ladders can be mounted directly on Vertical piece 20 or 20F with Profile clamp 42. Use T-bolt for mounting. Convenient at vertical installations in shafts.

Profile clamp 43

Profile clamp to be used for installations where the cable ladders KHZV and KHZPV are to be fixed to cantilever arms, support brackets, etc.

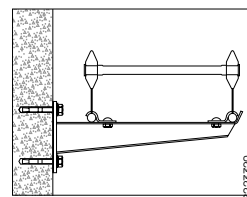
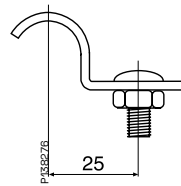

Use Profile clamp 43 to attach KHZV/KHZPV to Cantilever arm 50.

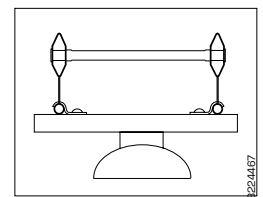

Pendant/Fixing rail 24/48, mounted under Cable ladder KHZV with Profile clamp 43, here used as carrier of lighting fittings.

Profile clamp 20C

Profile clamp for KHZP 20 range to be used for installations where the cable ladder is to be fixed to cantilever arms, I-beams, etc. Slot for screw locking 9 x24 mm.

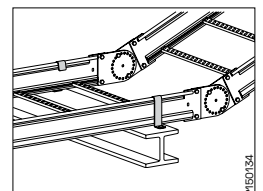
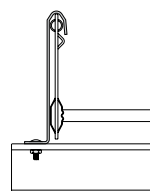
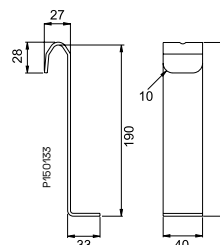

Use and installation

Clamp 12

Clamp to be used on the side profile of the cable ladder for installation of accessories.

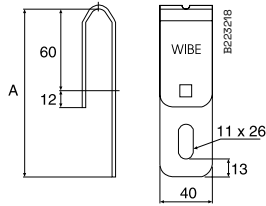
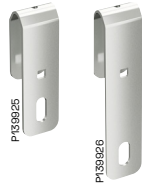

Type	A mm
Clamp12/70	125
Clamp 12/120	175

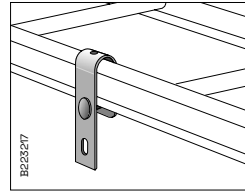

Clamp 12 can be used for installation of antenna brackets, junction boxes and so on. Bolt and nut included.

Profile clamp 41

Profile clamp to be used to install a pendant/fixing rail or mounting plate, etc., on the cable ladder profile.

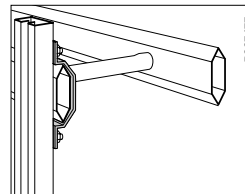
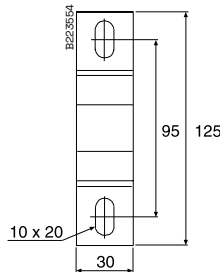

Mounting of pendant/fixing rail on ladder profile Use Screw set 22S.

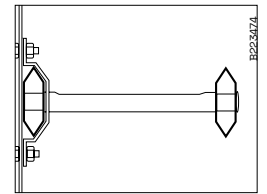

Installation of mounting plate for apparatuses. Use Screw set 22S.

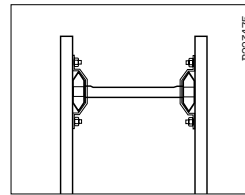
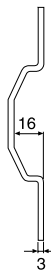

Mounting of cable ladder on floor pendants. Use T-bolts against the opening of the fixing rail.

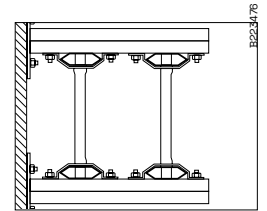

Mounting of cable ladders on wall pendants, such as in shafts. Use T-bolts against the opening of the fixing rail.

Profile support piece 46

To be fitted between the ladder and the vault pipe when a support bracket is positioned between existing profile support pieces. For cable ladders KHZV and KHZPV.

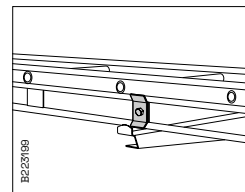
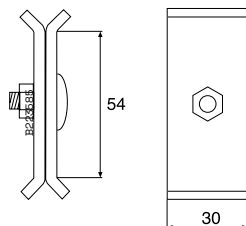

If a support bracket is placed between two profile support pieces, a Profile support piece 46 must be mounted between the arch pipes and the ladder. If the load is half the permitted load, exclude the Profile support piece 46.

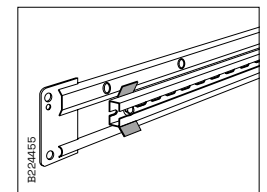

Profile support piece 46 can be installed as a fixing for different applications.

Use and installation

Cantilever arm 30

Cantilever arm for installation inside cable ladder KHZSP.

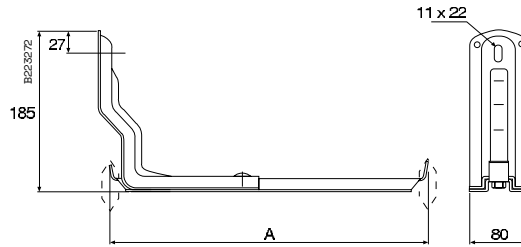

Cantilever arm type	A mm
30/200	184
30/300	284
30/400	384
30/500	484
30/600	584

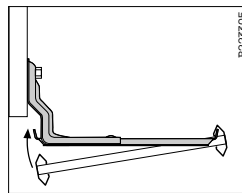

Installation of cable ladder KHZSP. Place the ladder on the outer tab and press it over the inner tab. When necessary, the ladder can be locked with a Profile clamp 43.

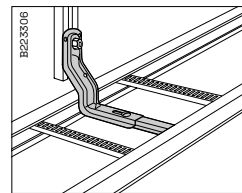

Installation on Vertical piece 2F. Cable ladder KHZSP can be adjusted max 40 mm.

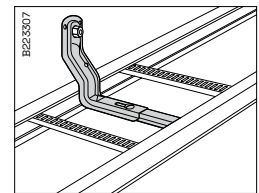

Installation direct on wall. Cable ladder KHZSP is adjustable from 0-15 mm to the wall.

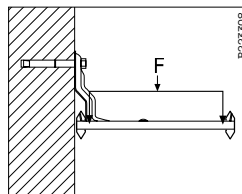

Breaking load for cantilever arm on wall, see table below.

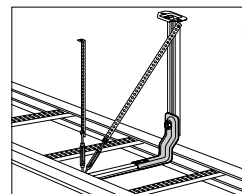

When you mount cable ladders that are 500-600 mm wide it might be necessary with a reinforcement of the outer edge of the cantilever arm. Installation band and stretching screw can be used for mounting in the ceiling or on a vertical piece.

Cantilever arm type	Max. load F on cantilever arm at a deflection of 3°		Deflection at 3° deflection of cantilever arm mm	Breaking load	
	kN	kg		kN	kg
30/200	2.0	200	10	2.3	230
30/300	1.9	190	15	3.5	350
30/400	1.2	120	20	3.0	300
30/500	0.8	80	26	2.4	240
30/600	0.6	60	31	2.0	200

3° is equivalent to 1/20xcantilever width, according to IEC 61537.

Use and installation

Cantilever arm 50i

Cantilever arm to be used for lighter mountings on walls, vertical pieces or pendant/fixing rails.

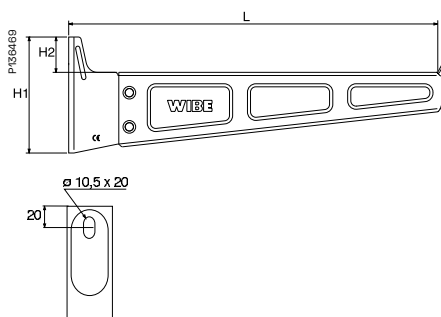

Cantilever arm type	Size		
	L mm	H1 mm	H2 mm
50i-200	250	85	28.5
50i-300	350	110	33.5
50i-400	450	115	31.0
50i-500	550	150	31.0
50i-600	650	150	31.0

Widths = 100

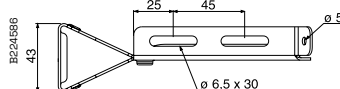

Widths = 200

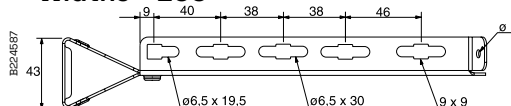

Widths = 300

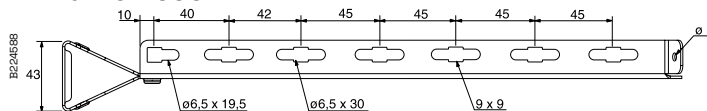

Widths = 400

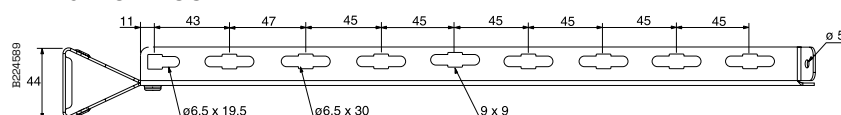

Widths = 500

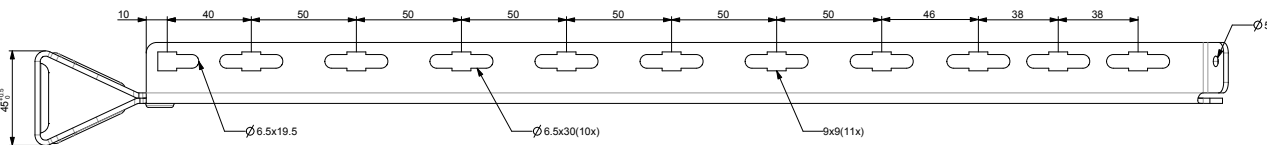

Widths = 600

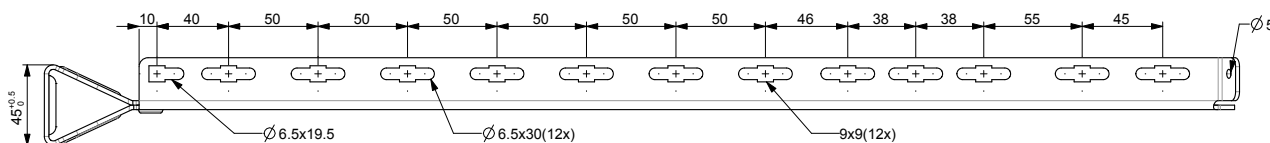

Use and installation

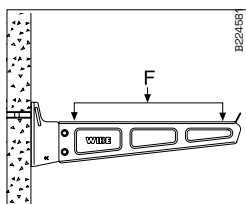

Installation of cantilever arm mounted to wall using Expansion bolt M8. Breaking load - See table below.

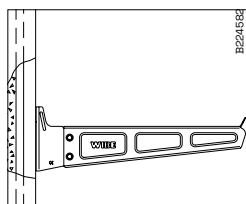

Installation of cantilever arm using T-bolt M8 on Fixing rail 24/26 x 53 for casting-in or Pendant/ Fixing rail wall mounted.

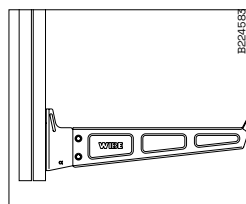

Installation of cantilever arm using T-bolt M8 on vertical piece. Check breaking load of the vertical piece.

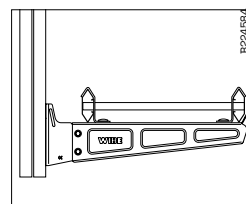

Cable ladder KHZSP mounted on Cantilever arm 50i, Profile clamp 42 is used.

Breaking load F - Mounted on wall		
Type of cantilever arm	kN	kg
50i-100	2.3	230
50i-200	2.15	215
50i-300	2.2	220
50i-400	2.35	235
50i-500	3.0	300
50i-600	3.0	300

Safe working load according to IEC 61537 is breaking load divided by 1,7.

Use and installation

Cantilever arm 50 and 50F

Cantilever arm for mounting on walls, pendant/fixing rails or vertical pieces.

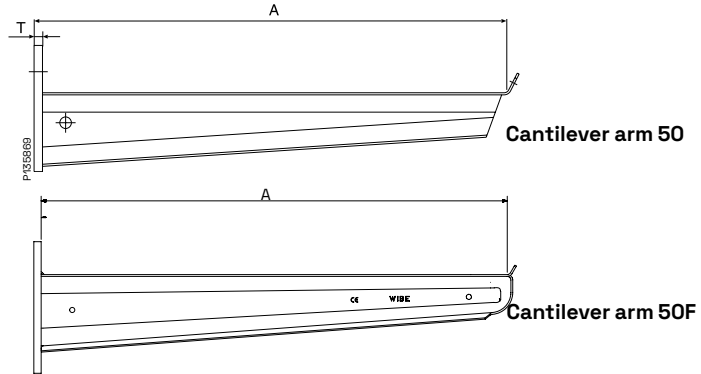

Cantilever arm 50

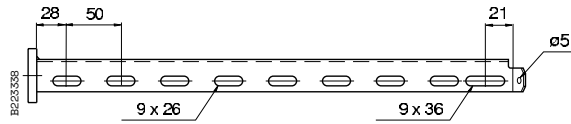

50/100-300

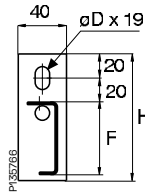

50/400-600

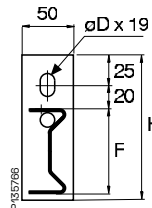

50/700-1000

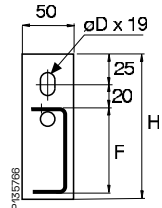

Cantilever arm 50F

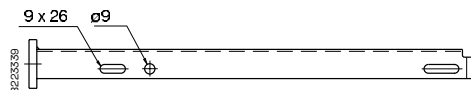

50F/200-600

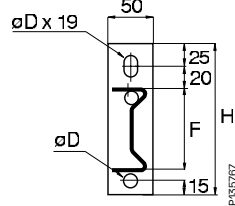

50F/1000

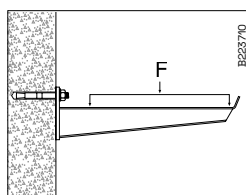
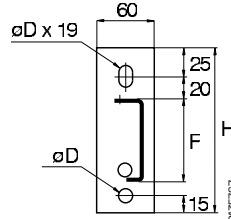

Installation of a cantilever arm to a wall using an Expansion bolt. Breaking load – see on next page.

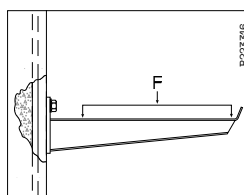

Installation of a cantilever arm using a T-bolt on a Fixing rail 24/26 x 53 rail for casting-in or Pendant/ Fixing rails mounted on the wall. Breaking load – see on next page.

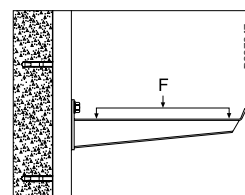

Mounting a cantilever arm using a T-bolt on a Pendant/ Fixing rail mounted on a wall.

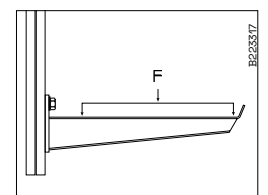

Installation of cantilever arm using T-bolt with vertical pieces. Breaking load – see on next page. Also check breaking load of the vertical piece.

Use and installation

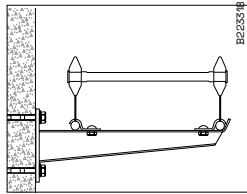

Profile clamp 43 is used for attaching a KHZV onto a Cantilever arm 50F.

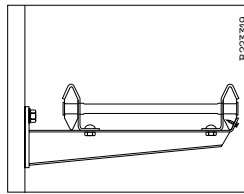

For attaching a KHZSP, KHZ, KHZPS or KHZP cable ladder, mount Profile clamp 42. If it is only necessary to fix the cable ladder at the outer end of the bracket, use self-tapping sheet screws or suchlike with 5 mm dia. holes in the bracket and in the side section.

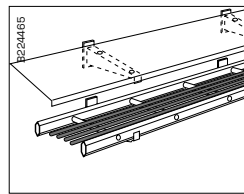

Cantilever arm 50F mounted upside down can be used for installation of tilted protective roofs.

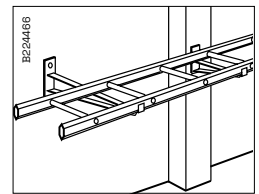

Use Cantilever arm 50/700-1000 as support when cable ladders have to pass columns etc.

Size and Breaking load F

Type	A mm	D mm	F mm	H mm	T mm	Mounted on wall		Mounted on P/F rail 24/48 with T-bolt 26U	
						kN	kg	kN	kg
50/100	150	12	34	85	4	3.0	300	3.0	300
50/150	200	12	36	85	4	3.0	300	3.0	300
50/200	250	12	39	85	4	2.5	250	2.5	250
50/250	300	12	56	105	6(1)	4.0	400	4.0	400
50/300	350	12	60	105	6(1)	4.0	400	4.0	400
50/400	450	12	70	120	8(1)	6.5	650	6.5	650
50/500	550	12	77	140	8(1)	7.0	700	7.0	700
50/600	650	12	84	150	10(1)	7.0	700	7.0	700
50/700	750	12	90	150	10	6.0	600	5.5	550
50/800	850	12	95	160	10	5.5	550	5.2	520
50/900	950	12	100	160	10	5.3	530	4.8	480
50/1000	1050	12	105	170	10	5.0	500	4.2	420
50F/200	245	12	72	148	8	10.0	1000	10.0	1000
50F/300	345	12	79	175	8	10.0	1000	10.0	1000
50F/400	445	12	86	175	8	11.0	1100	9.0	900
50F/500	547	14	93	180	10	10.0	1000	8.0	800
50F/600	647	14	100	180	10	10.0	1000	8.0	800
50F/1000	1052	14	160	240	12	11.0	1100	8.0	800 (2)

Safe working load according to IEC 61537 is breaking load divided by 1.7.

(1) Stainless steel: 50/250-300 T = 4 mm, 50/400-600 T = 5 mm.

(2) Need to fix the cantilever 50F/1000 with two T-bolts, both upper and lower holes in the backplate.

Use and installation

Back plate 40

Back plate to be used for installation behind Cantilever arm 50 to reduce the surface pressure on porous walls.

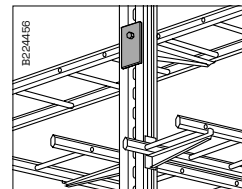
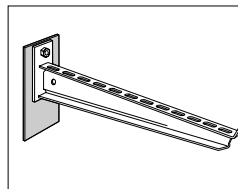
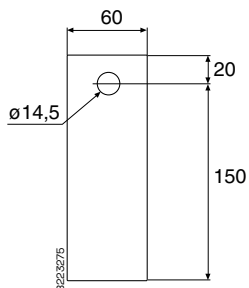

Mount Back plate 40 as shown in the illustration to reduce the surface stress on porous walls.

By using Back plate 40, a cantilever arm can be mounted on the side of Vertical piece 20F.

Mounting rail 40

Mounting rail to be used for wall installation of cantilever arms on porous walls to reduce the surface pressure or to enable height adjustment of cantilever arms.

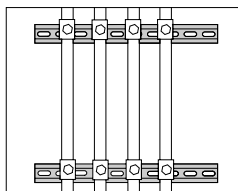
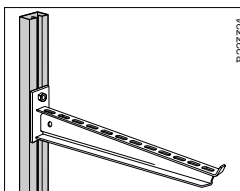
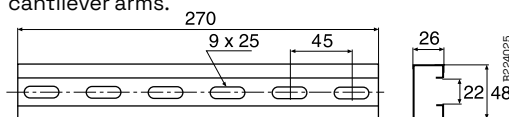

Mounting rails reduce the surface stress on porous walls. Mount the cantilever arm using T-bolt, which permits height adjustment.

Cables may be mounted on walls using Mounting rail 40 and a suitable Cable clamp ARX.

Use and installation

Wall support

Wall support for mounting of cantilever arm on porous walls or sandwich wall blocks, with six keyholes for easy fixation. When mounting cantilever arm on support, use screw set 22S (M8).

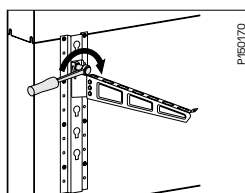
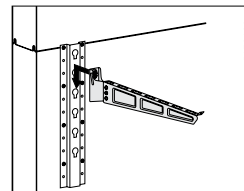
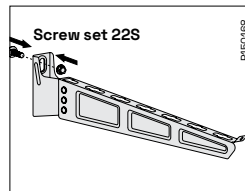
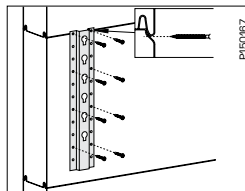

Two wall support plates can be combined with pendent rail 24/48 for extended mounting. for monting of pendent rail use screw set 22S.

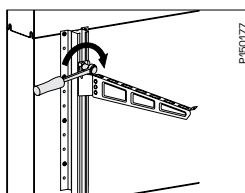
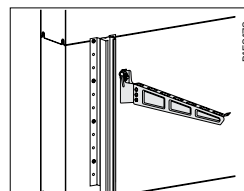
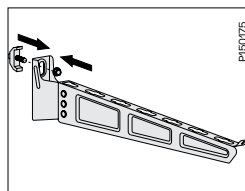
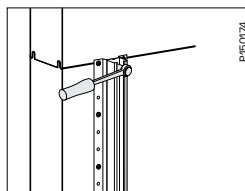
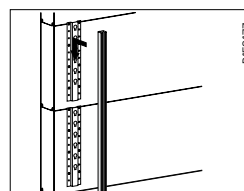
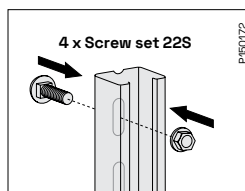
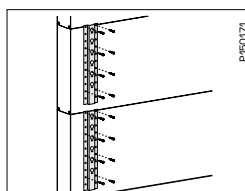

Use and installation

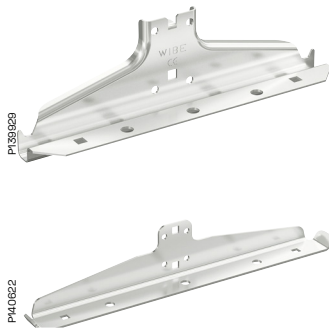

Stainless steel AISI 316L

Support bracket 3

Support bracket to be used for centre installation of cable ladders on pendant/fixing rails and vertical pieces.

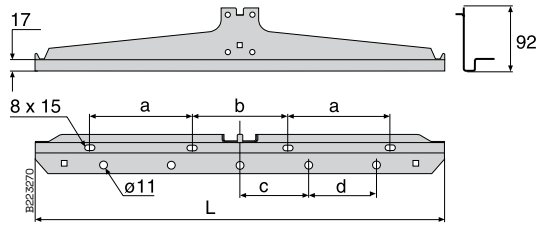

Stainless steel AISI 316L

3/150-200

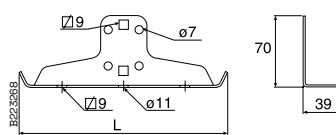

3/300-600

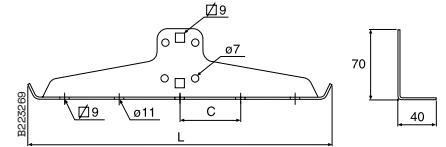

Size

Type	L mm	Stainless steel L mm	a mm	b mm	c mm	d mm
Support bracket 3/150	150	154	-	100	-	-
Support bracket 3/200	200	204	-	100	-	-
Support bracket 3/300	300	306	70	100	-	-
Support bracket 3/400	400	406	70	100	100	-
Support bracket 3/500	500	506	100	140	100	-
Support bracket 3/600	600	606	150	140	100	100

Breaking load for support bracket with symmetrical loading

Type	Breaking load F	
	kN	kg
Support bracket 3/150	16	1600
Support bracket 3/200	16	1600
Support bracket 3/300	16	1600
Support bracket 3/400	12	1200
Support bracket 3/500	12	1200
Support bracket 3/600	10	1000

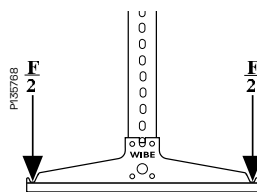

Use and installation

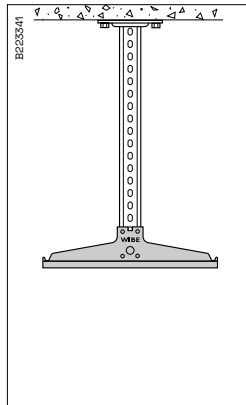

Mount Support bracket 3 on Vertical piece 2 with Screw set 22S.

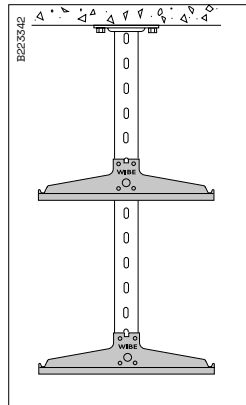

Mount Support bracket 3 on Vertical piece 2F with Screw set 22S.

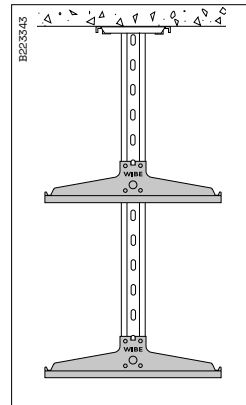

Mount Support bracket 3 on Vertical piece 20 with Screw set 20S.

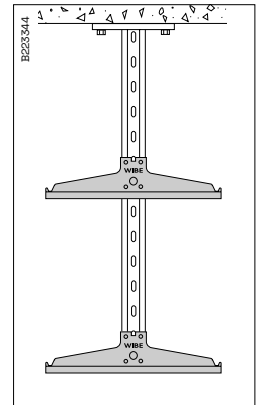

Mount Support bracket 3 on Vertical piece 20F with Screw set 2S.

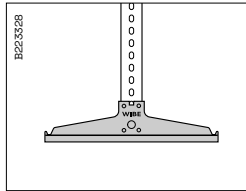

Mount Support bracket 3 on Pendant/Fixing rail 24/34 with Screw set 22S.

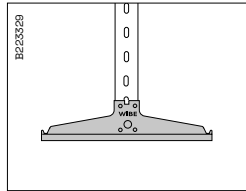

Mount Support bracket 3 on Pendant/Fixing rail 24/20 or 24/48 with Screw set 22S.

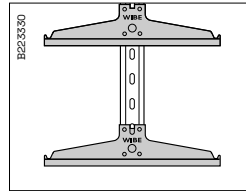

Support bracket 3 installed on Pendant/Fixing rail 24/20F with Screw set 2S.

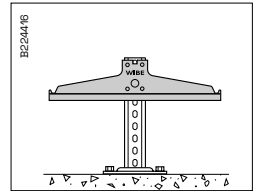

Support bracket 3 can be mounted on floor or under data floor with a suitable vertical piece.

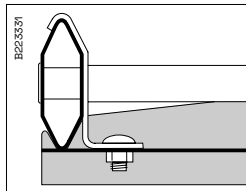

For installation of KHZSP, KHZ, KHZP and KHZPS on Support bracket 3 Profile clamp 42 is used.

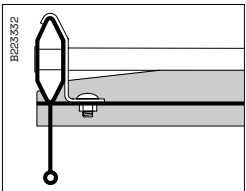

When attaching KHZV/ KHZPV to Support bracket 3, use Profile clamp 42.

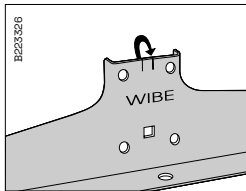

When attaching Support bracket 3 using clamp set M6 the tab must be bent up using a hammer or pair of pliers.

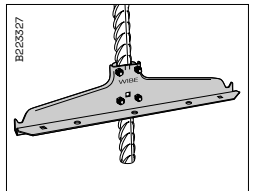

Support bracket 3 mounted on a rock bolt with Clamp set M6.

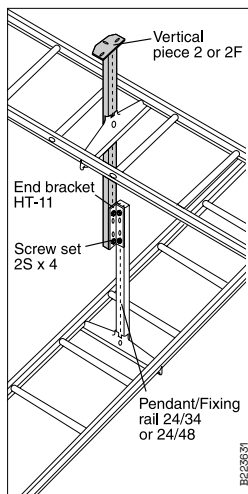

End bracket HT-11 permits the mounting of crossing cable ladders at different levels on the same pendant/fixing rail.

Use and installation

Support bracket 6

Support bracket to be used for centre installation of cable ladders KHZSP.

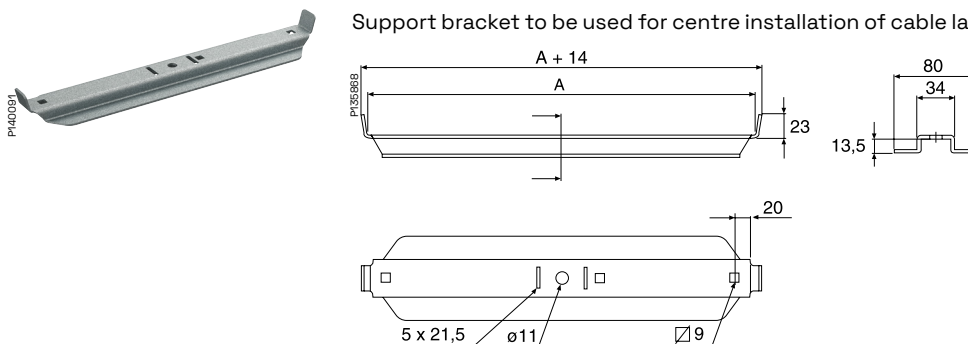

Size

Type	A mm
Support bracket 6/200	170
Support bracket 6/300	270
Support bracket 6/400	370
Support bracket 6/500	470
Support bracket 6/600	570

Breaking load for Support bracket 6 – symmetrical loading

Support bracket	Breaking load with Threaded rod W76 M10		Breaking load with Pendant attachment W21	
	kN	kg	kN	kg
6/200	5.0	500	3.4	340
6/300	4.8	480	3.4	340
6/400	3.0	300	3.0	300
6/500	2.2	220	2.2	220
6/600	1.7	170	1.7	170

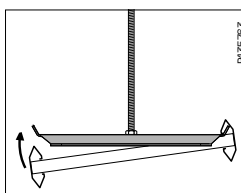

Support bracket 6 must be mounted inside cable ladder KHZSP.

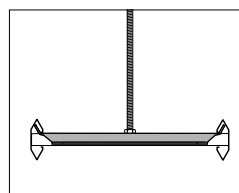

Support bracket 6 mounted with Threaded rod W76 M10. Nut M10 must be used.

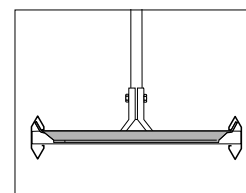

Support bracket 6 mounted with Pendant rail W32, Pendant attachment W21 and Screw set W37 from the Wibe Cable Tray range.

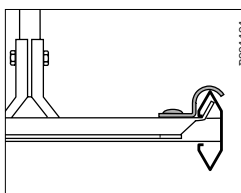

Profile clamp 43 can be used to fix the cable ladder to the support bracket.

Use and installation

Support bracket HSO

Support bracket to be mounted together with Threaded rod M10 or M16 for the installation of cable ladders.

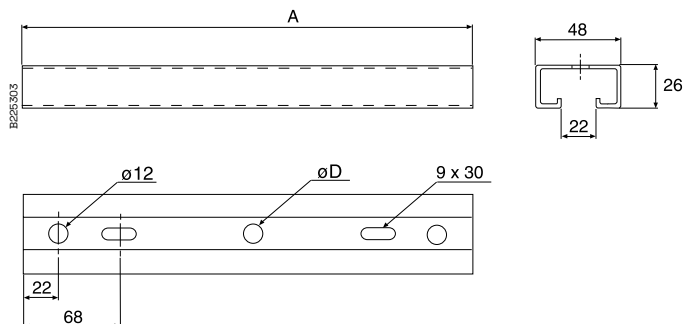

Size

Type	A mm	D mm
Support bracket HSO/150 M10	210	12
Support bracket HSO/200 M10	260	12
Support bracket HSO/300 M10	360	12
Support bracket HSO/400 M16	460	18
Support bracket HSO/500 M16	560	18
Support bracket HSO/600 M16	660	18

Washer HSO M16

Washer to be used for centered mounting with Support bracket HSO M16 and Threaded rod M16.

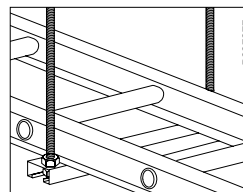
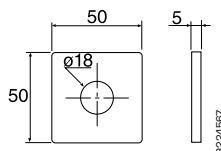
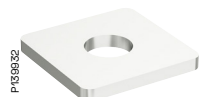

Support bracket HSO M10 installed with Threaded rod W76 M10.

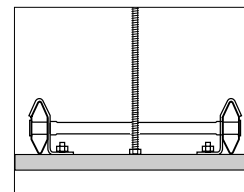

Centered installation with Support bracket HSO M10, widths 150-300, Threaded rod W76 M10 and 2 Nuts M10.

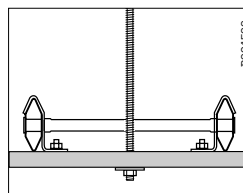

Centered installation with Support bracket HSO M16, widths 400-600, Threaded rod M16, 2 Nuts M16 and Washer HSO M16.

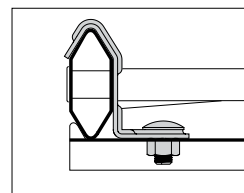

Profile clamp 42 is used to attach the cable ladder to the support bracket.

Use and installation

Threaded rod B41 and W76 M8, M10

Used for installation of light cable ladders.

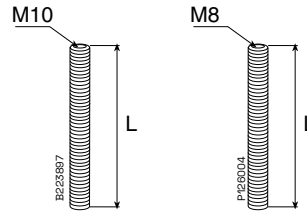

Diametre and Surface treatment	L= 1000mm	L= 2000mm	L= 3000mm
M8 EZ	W76	-	-
M10 EZ	-	W76	W76
M8 HDG	W76	W76	-
M8 AISI	B41	B41	-
M10 AISI	B41	B41	-

Joint nut M8, M10

Used for joining of Threaded rod.



Flange nut B43 M8, M10

Flange nut is mounted onto Threaded rods in order to lock support brackets and ceiling brackets.



Thread lock B50 M8, M10

Used for joining of Threaded rod.

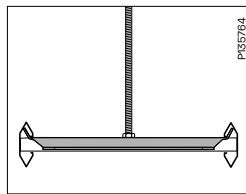

Support bracket 6 mounted with Threaded rod. Flange Nut B43 must be used.

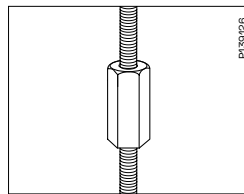

Use Joint nut when joining 2 pieces of Threaded rod.

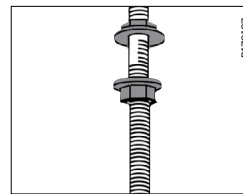

Flange nut B43 is mounted onto Threaded rod in order to lock support brackets and ceiling brackets.

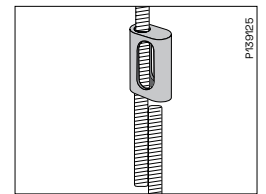

Thread lock B50 is used for the joining of Threaded rod. Max. permitted load=80kg.

Ceiling bracket TF-10 and TF-16

Ceiling bracket to be used for installation with Threaded rods.

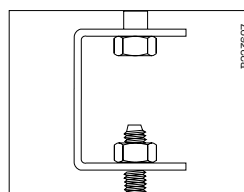
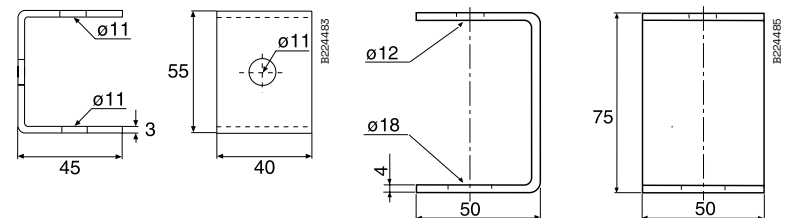
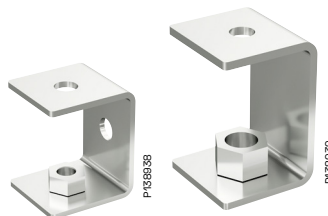

Ceiling bracket TF-10 or TF-16 installed with Threaded rod M10 or M16.

Use and installation

Wall bracket 11/25 and 11/75

To be used for vertical or horizontal installations of cable ladders against a wall.

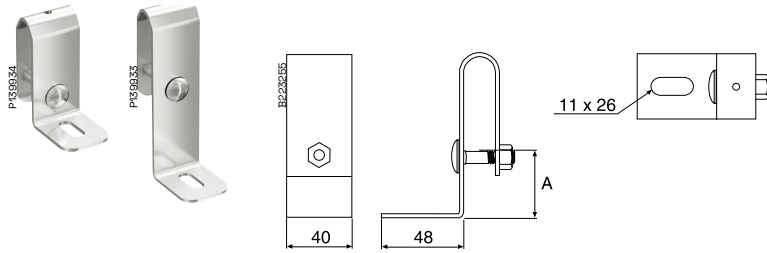

Type	A mm
Wall bracket 11/25	25
Wall bracket 11/75	75

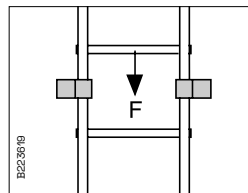

Vertical mounting
(max. load - F)
Wall bracket 11/25:
300 kg (3 kN)
Wall bracket 11/75:
300 kg (3 kN)
When mounting against a rung the max load is 500 kg (5 kN) for wall bracket 11/25.

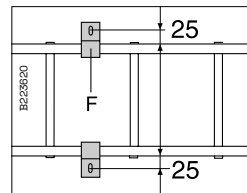

Horizontal mounting
(max. load - F)
Wall bracket 11/25:
250 kg (2.5 kN)
Wall bracket 11/75:
100 kg (1.0 kN)

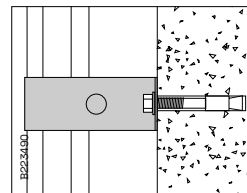

Mount wall brackets against walls using Expansion bolts.

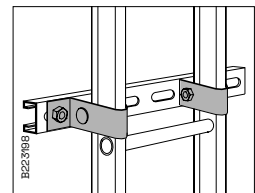

Pendant/fixing rails can be mounted on cable ladders using wall brackets for mounting equipment cubicles etc.
Mount wall brackets on Pendant/fixing rails using Screw set 22S.

Wall bracket 20

To be used at installation of Pendant/fixing rail 24/20 to ceiling beam or wall.

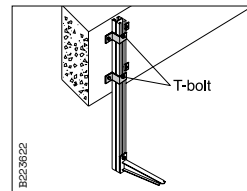
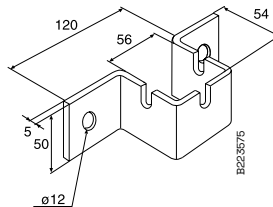
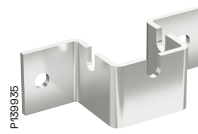

For cable ladder installations along a beam. Pendant/Fixing rail 24/20 must be mounted with 2 Wall brackets 20 and 2 T-bolts 26U-30 placed in the centre outlet. This installation is also used for fixing to wall. Max vertical load 700 kg (7 kN).

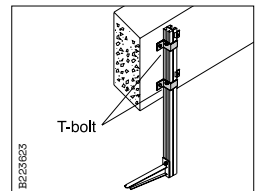

For cable ladder installations across a beam. Pendant/Fixing rail 24/20 shall be mounted with 2 Wall brackets 20 and 2 T-bolts 26U-30 in the side-outlets.

Wall bracket 20F

To be used at installation of Pendant/Fixing rail 20F to ceiling beam or wall.

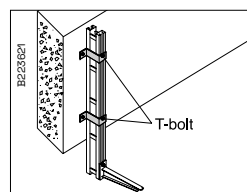
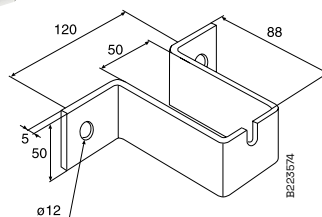
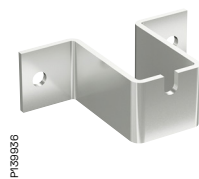

Pendant/Fixing rail 24/20F must be mounted with 2 Wall brackets 20F and 2 T-bolts 26U-30 for cable ladders along beams. This installation is also used for fixing to wall. Max. vertical load 700 kg (7 kN).

Use and installation

Vertical piece 2

Vertical piece to be used for installation of Support bracket 3, symmetrical loading. Not suitable for cable ladders KHZV and KHZPV. Can be joined to Pendant/fixing rail 24/34 with Pendant joint 2J.

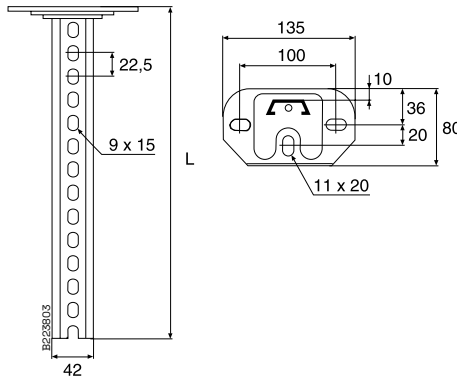
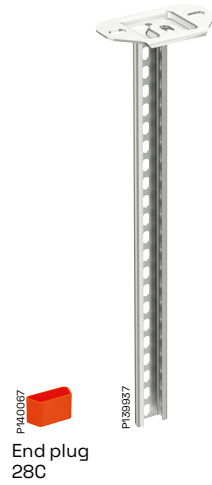

Type	L mm
Vertical piece 2/300	279
Vertical piece 2/400	392
Vertical piece 2/500	504
Vertical piece 2/700	729
Vertical piece 2/1000	1022

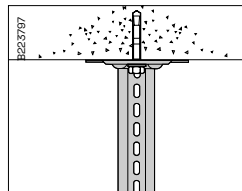

Mount Vertical piece 2 using an Expansion bolt or a concrete screw.

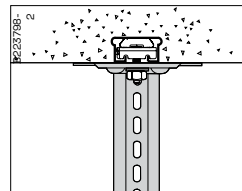

Mount Vertical piece 2 on a Fixing rail 24/26x53 for casting-in using T-bolt 26U.

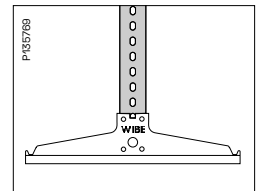

On Vertical piece 2, mount Support bracket 3 using Screw set 22S.

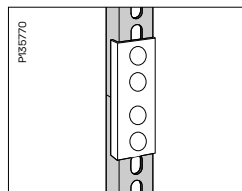

Vertical piece 2 can be joined to achieve the required length using Pendant/fixing rail 24/34 and Pendant joint 2J.

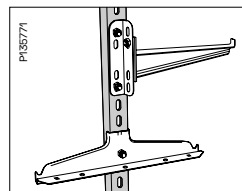

Cantilever arm 50 can, using End bracket HT-11, be mounted at 90° to the pendant/fixing rail. Only for lightweight mounting, such as data cables.

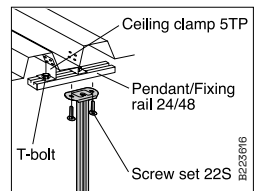

In ceilings with trapezoidal profile sheeting, mount Vertical piece 2 as shown above.

Breaking load

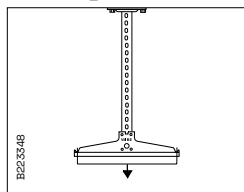

Breaking load for Vertical piece 2 with a symmetrical loading = 1400 kg (14 kN). See also breaking load for support bracket 3.

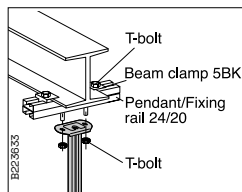

On beams in ceilings. When the beam flange thickness does not exceed 13 mm, use Beam clamp 5BK-10 and T-bolt 26U/40. For flange thicknesses not exceeding 30 mm use Beam clamp 5BK-30 and T-bolt 26U/50.

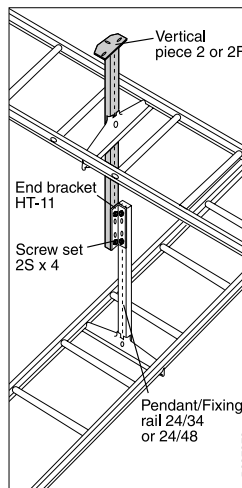

End bracket HT-11 permits the mounting of crossing cable ladders at different levels on the same pendant/fixing rail.

Use and installation

Vertical piece 2Fi

Vertical piece to be used for lighter mountings with Cantilever arm 50i and Cable ladder KHZSP.

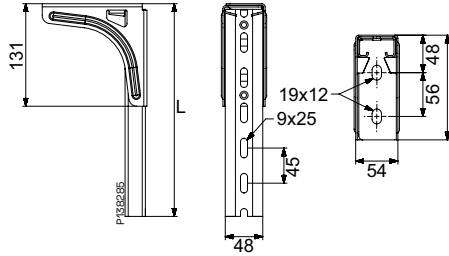
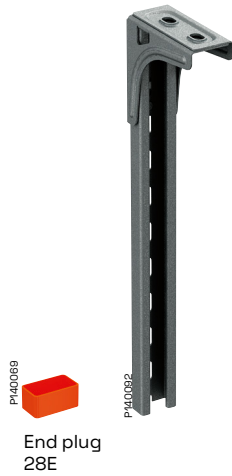

Type	L mm
Vertical piece 2Fi-300	272
Vertical piece 2Fi-500	497
Vertical piece 2Fi-750	722
Vertical piece 2Fi-1000	992

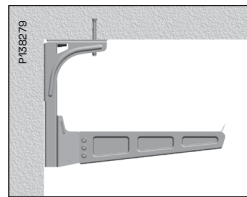

Vertical piece 2Fi can be mounted in ceiling close to wall.

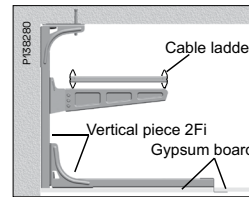

Vertical piece 2Fi can be mounted horizontally on wall and on vertical piece as carrier of gypsum board, cable ladder passages.

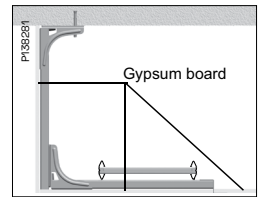

Vertical piece 2Fi can be used as carrier of gypsum boards in order to build in as carrier of gypsum board, cable ladder passages.

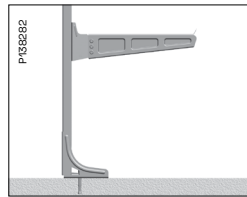

Vertical piece 2Fi is suitable for floor mounting.

Breaking load

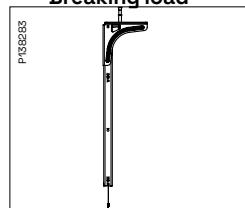

Vertical piece 2Fi mounted in the inner hole. Breaking load=500 kg (5 kN) at symmetrical loading.

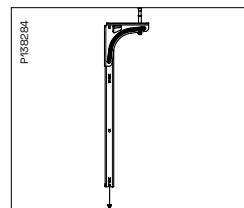

Vertical piece 2Fi mounted in the outer hole. Breaking load=100 kg (1 kN) at symmetrical loading

Use and installation

Vertical piece 2F

Vertical piece to be used for installation of Support bracket 3 or Cantilever arm 50. Can be joined to Pendant/fixing rail 24/48 with Pendant joint 2FJ. Can be mounted from the ceiling or on the floor. Can also be installed as a cantilever arm on a wall.

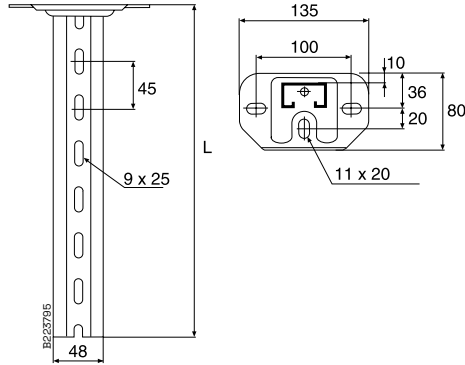

Type	L mm
Vertical piece 2F/280	280
Vertical piece 2F/370	370
Vertical piece 2F/505	505
Vertical piece 2F/640	640
Vertical piece 2F/730	730
Vertical piece 2F/865	865
Vertical piece 2F/1000	1000
Vertical piece 2F/1500	1495

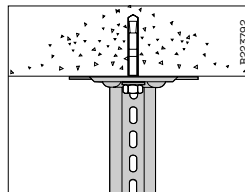

Mount Vertical piece 2F using Expansion bolt alt. Concrete screw.

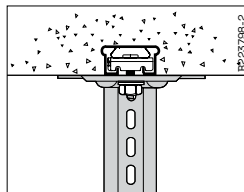

On Fixing rail forecasting-in, mount Vertical piece 2F using T-bolt.

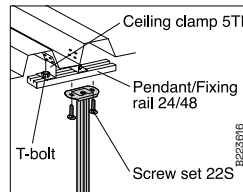

In ceilings with trapezoidal sheeting, mount Vertical piece 2F as shown above.

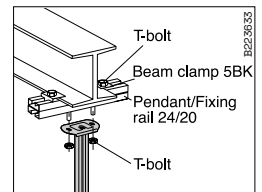

On beams in ceilings, mount Vertical piece 2F as shown in the figure above. When the beam flange thickness does not exceed 13 mm, use Beam clamp 5BK-10 and T-bolt 26U/40. For flange thicknesses not exceeding 30 mm use Beam clamp 5BK-30 and T-bolt 26U/50.

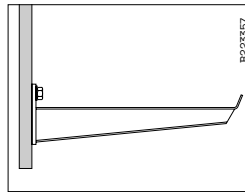

On Vertical piece 2F, mount Cantilever arm 50 using T-bolt.

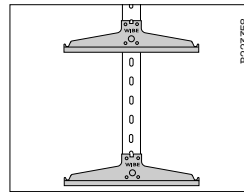

On Vertical piece 2F, mount Support bracket 3 using Screw set 22S.

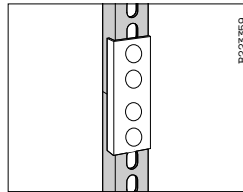

Vertical piece 2F can be joined to achieve the required length using Pendant/fixing rail 24/48 and Pendant joint 2FJ.

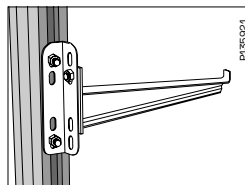

Cantilever arm 50 can, using End bracket HT-11, be mounted at 90° to the pendant/fixing rail. Only for lightweight installation of data cable type and suchlike.

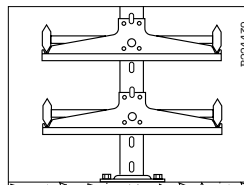

Cable ladders mounted on Vertical piece 2F and Support bracket 3 can be used for cable installations in raised access floors.

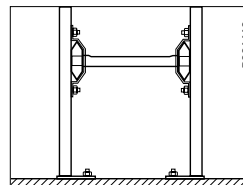

For installation on floor the cable ladders can be mounted with Vertical piece 2F, Profile clamp 41 and T-bolt.

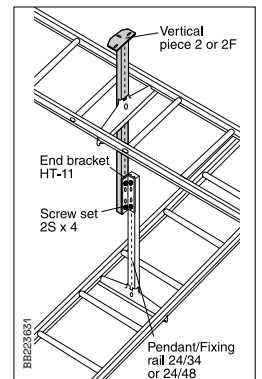

End bracket HT-11 permits mounting of crossing cable ladders on different levels on the same pendant/fixing rail.

Use and installation

Breaking load symmetrical loading*

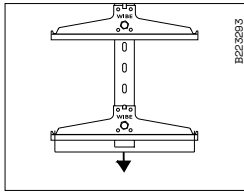

Breaking load for Vertical piece 2F (VP) = 2300 kg (23 kN) at symmetrical loading.

VP + Pendant bar for reduction of deflection

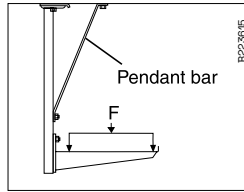

Deflection of Vertical piece 2F is reduced by installing Pendant bar 1. Loadings in accordance with chart below.

Breaking load asymmetrical loading

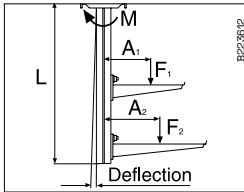

$M = \sum F \times A$
See also max loading for Cantilever arm 50 installed on pendant/fixing rail, page Cantilever arm 50L, 50 and 50F.

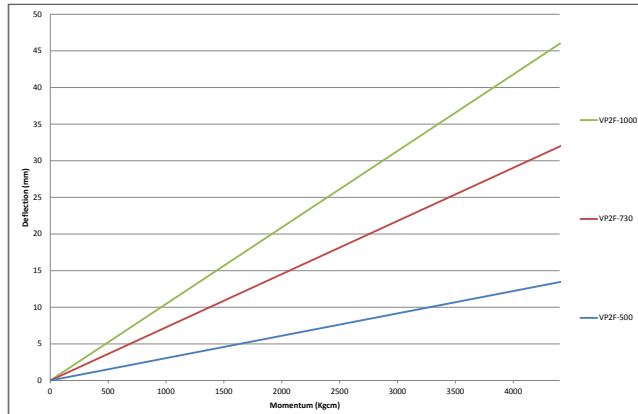

For values outside diagram please contact Wibe Group.

Example

- Conditions:
- 2 m support distance.
 - 10 kg/m ladder
 - Two ladders, 200 and 300 mm
 - One-side loading
 - VP 2F/730
 - Bending?

$$M = \sum F \times A \text{ (kgcm)}$$

$$M = 10 \times 2 \times \frac{(20 + 6.5)}{2} + 10 \times 2 \times \frac{(30 + 6.5)}{2}$$

$$(F_1) (A_1) (F_2) (A_2)$$

M = 760 kgcm - bending as per diagram, about 5.5 mm.

- Bending torque M is total sum of $F \times A$ (kgcm).
 F = Cantilever arm loading (kg)
 F = Loading (kg/m) x support distance (m).
 A = Distance between loading and VP centre line (cm)
 A = $\frac{\text{Ladder width} + 6.5}{2}$
 L = VP length
 Break load torque 6 000 (kgcm)

Loading table for Vertical piece 2F installed as a cantilever arm

Pendant type	Vertical piece 2F with Pendant bar 1/300	
	2F/700	2F/1000
Ladder width	Breaking load	Breaking load
150	120	75
200	125	80
300	135	90
400	140	100
600	—	120

*Safe working load according to IEC 61537 is breaking load divided by 1.7.

Use and installation

Vertical piece 20

Vertical piece, two-sided, to be used for vertical installation together with Cantilever arm 50, from a ceiling or on a floor. Can also be installed as a cantilever arm on a wall.

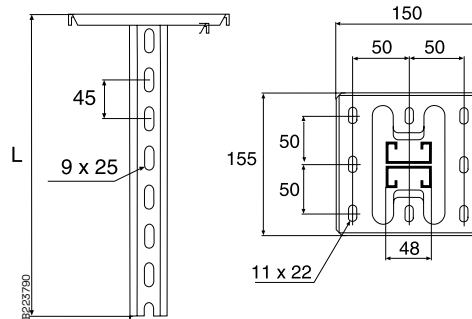
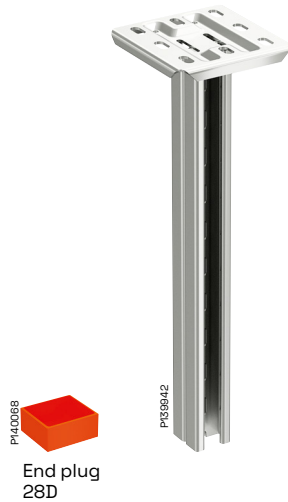

Type	L mm
Vertical piece 20/280	280
Vertical piece 20/370	370
Vertical piece 20/500	505
Vertical piece 20/640	640
Vertical piece 20/700	730
Vertical piece 20/865	865
Vertical piece 20/1000	1000
Vertical piece 20/1500	1495
Vertical piece 20/2000	1990
Vertical piece 20/3000	2980

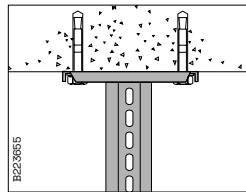

Mount Vertical piece 20 using Expansion bolt.

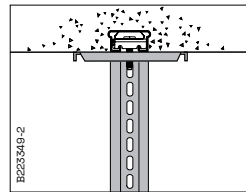

On fixing rail for casting-in, mount Vertical piece 20 using T-bolts.

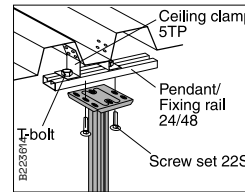

In ceilings with trapezoidal profile sheeting, mount Vertical piece 20 as shown above

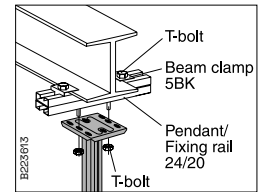

On beams in ceilings, mount Vertical piece 20 as shown in the figure above. When the beam flange thickness does not exceed 13 mm, use Beam clamp 5BK-10 and T-bolt 26U/40. For flange thicknesses not exceeding 30 mm use Beam clamp 5BK-30 and T-bolt 26U/50.

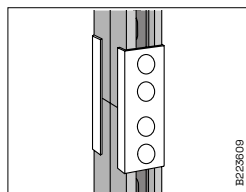

Vertical piece 20 can be joined to achieve the required length using Pendant/Fixing rail 24/20 and Pendant joint 20J.

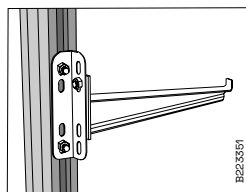

Using End bracket HT-11, Cantilever arm 50 can be mounted at 90° to the pendant/fixing rail. Only for lightweight mounting of data cable type and suchlike

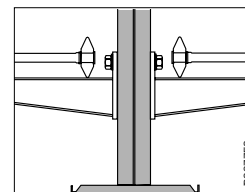

Vertical piece 20 is also suitable for floor mounting

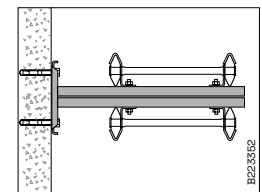

Vertical piece 20 may be used for vertical mounting in a shaft, for example. Mount Wall bracket 11 or Profile clamp 42 using T-bolts. The vertical piece may also be mounted horizontally as a cantilever arm, such as when passing columns.

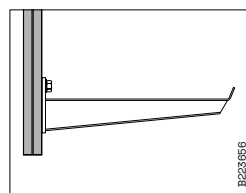

On vertical piece, mount Cantilever arm 50 using T-bolt. For loadings see Cantilever arm 50

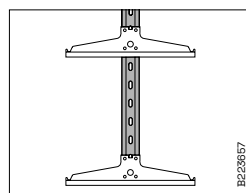

On Vertical piece 20, mount Support bracket 3 using Screw set 20S.

Use and installation

Breaking load symmetrical loading*

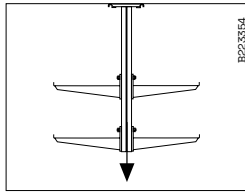

Breaking load for vertical piece (VP) = 3000 kg (30 kN).

Breaking load asymmetrical loading

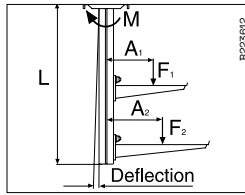

$M = \sum F \times A$
See also max loading for Cantilever arm 50 installed on pendant/fixing rail, page Cantilever arm 50L, 50 and 50F.

Example

- Conditions:
- 2 m support distance.
 - 30 kg/m ladder
 - Two ladders, 400 and 600 mm
 - One-side loading
 - VP 20/1000
 - Bending?

$$M = \sum F \times A \text{ (kgcm)}$$

$$M = 30 \times 2 \times \frac{(40 + 7.7)}{2} + 30 \times 2 \times \frac{(60 + 7.7)}{2}$$

(F₁) (A₁) (F₂) (A₂)

M = 3924 kgcm - bending as per diagram, about 6 mm.

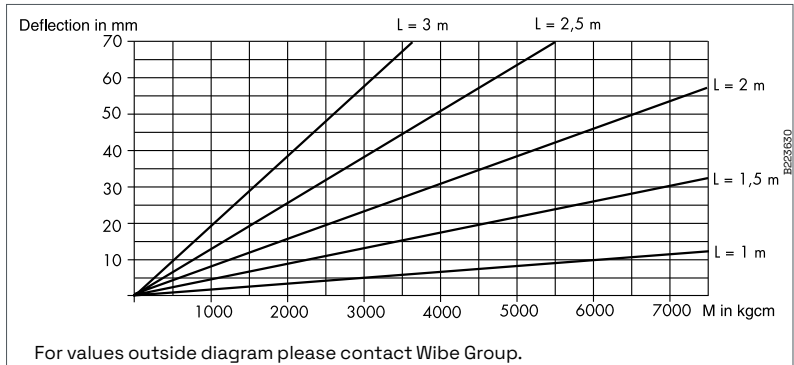

- Bending torque M is total sum of $F \times A$ (kgcm).
 F = Cantilever arm loading (kg)
 F = Loading (kg/m) x support distance (m).
 A = Distance between loading and VP centre line (cm)
 $A = \frac{\text{Ladder width} + 7.7}{2}$
 L = VP length
 Break load torque 19 000 (kgcm)

Loading table for Vertical piece 20 installed as a cantilever arm

Pendant type	Vertical piece 20 with Pendant bar 1/300			Vertical piece 20 without pendant bar		
	20/700	20/1000	20/1500	20/700	20/1000	20/1500
Width Ladder type	Breaking load	Breaking load	Breaking load	Breaking load	Breaking load	Breaking load
150	380	210	155	230	165	115
200	400	240	160	250	170	115
300	425	270	165	280	175	120
400	450	300	170	310	180	125
600	-	320	180	370	190	130

*Safe working load according to IEC 61537 is breaking load divided by 1.7.

Use and installation

Vertical piece 20F

Vertical piece, two-sided, to be used for mounting from the ceiling or on the floor. Suitable for rather heavy loads.

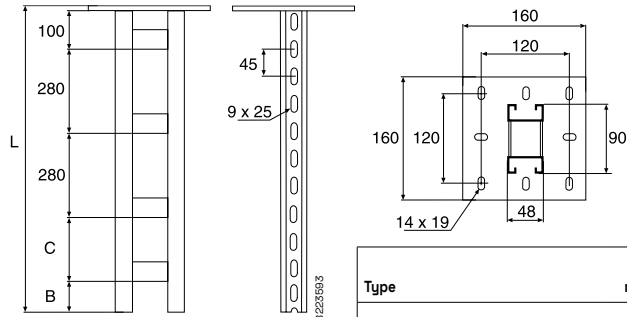
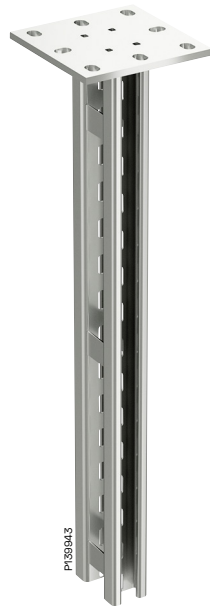

Type	B mm	C mm	L mm
Vertical piece 20F/1000	50	280	995
Vertical piece 20F/1500	70	195	1490
Vertical piece 20F/2000	5	195	1985
Vertical piece 20F/3000	70	280	2980

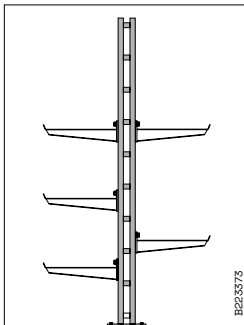

Floor mounting example.

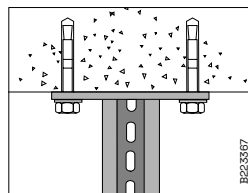

Mount Vertical piece 20F using Expansion bolt alt. Concrete screw.



End plug 28J

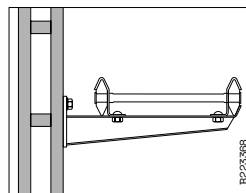

Cantilever arm 50 can be mounted using T-bolt. For loads on Cantilever arm 50, see Cantilever arm 50L, 50 and 50F.

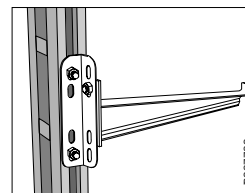

Using End bracket HT-11, Cantilever arm 50 can be mounted at 90° to the vertical piece. Only for lightweight mounting of data cable type or similar.

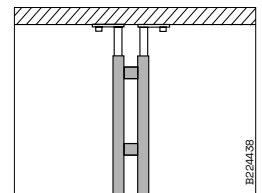

Vertical piece 20F mounted on floor can be fixed using Vertical piece 2 as ceiling bracket, adjustable in the pendant.

Breaking load Symmetrical loading*

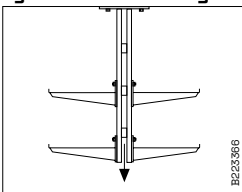

Breaking load for Vertical piece (VP) 20F = 5000 kg (50kN)

Breaking load asymmetrical loading

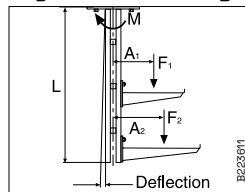

$M = \sum F \times A$
Vertical piece 20F mounted in ceiling, see diagram.

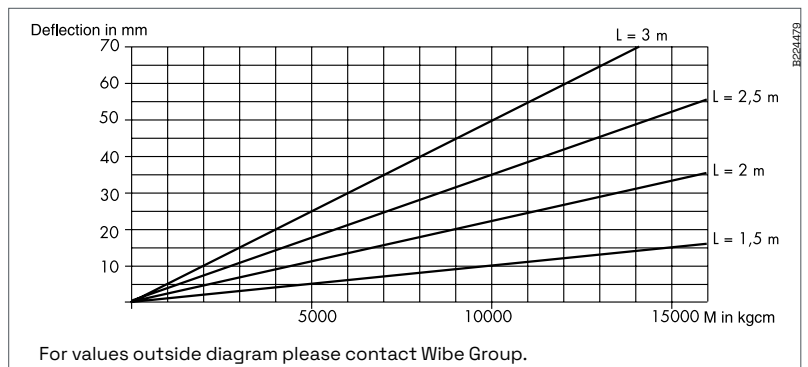

Example

Conditions:

- 2 m support distance 50 kg/m ladder
- Two ladders, 400 and 600 mm
- One-side loading
- VP 20F/1500
- Bending?

$$M = \sum F \times A \text{ (kgcm)}$$

$$M = 50 \times 2 \times \frac{(40 + 9.4)}{2} + 50 \times 2 \times \frac{(60 + 9.4)}{2}$$

$$M = 6880 \text{ kgcm - bending as per diagram, about 6 mm.}$$

Bending torque M is total sum of $F \times A$ (kgcm).

F = Cantilever arm loading (kg)

F = Loading (kg/m) x support distance (m).

A = Distance between loading and VP centre line (cm)

$$A = \frac{\text{Ladder width} + 9.4}{2}$$

L = VP length

Break load torque 30 000 (kgcm)

*Safe working load according to IEC 61537 is breaking load divided by 1.7.

Use and installation

Vertical piece 20FS

Vertical piece, two-sided, to be used for mounting from the ceiling or on the floor. Suitable for very heavy loads.

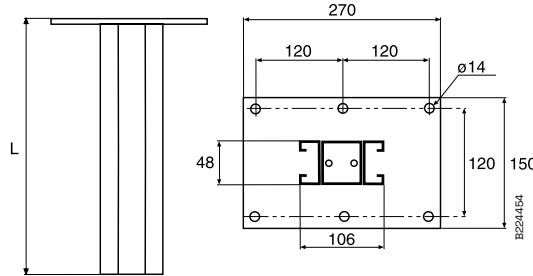

Type	L mm
VP 20FS/1500	1495
VP 20FS/2000	1990
VP 20FS/2500	2485
VP 20FS/3000	2980

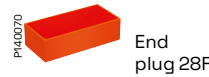

End plug 28F

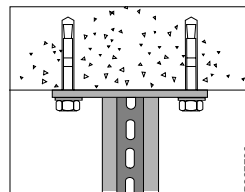
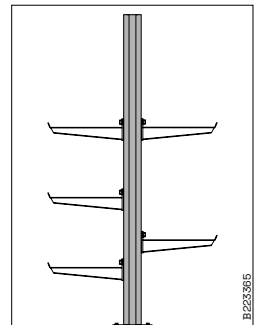

Mount Vertical piece 20FS using Expansion bolt alt Concrete screw.

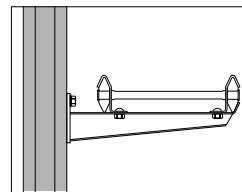

Mount Cantilever arm 50 using T-bolt. For loads on Cantilever arm 50L, 50 and 50F.

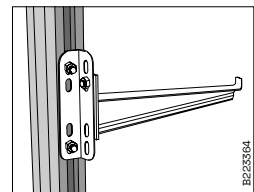

Using End bracket HT-11, Cantilever arm 50 can be mounted at 90° to the vertical piece. Only for lightweight mounting of data cable type or similar.

Breaking load Symmetrical loading

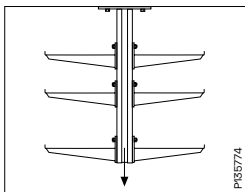

Symmetrical loading
Breaking load for Vertical piece (VP) 20FS = 5000 kg (50 kN)

Breaking load asymmetrical loading

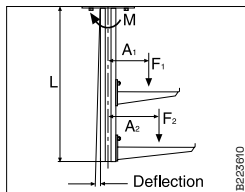

Asymmetrical loading
 $M = \sum F \times A$ Vertical piece 20FS mounted in ceiling, see diagram.

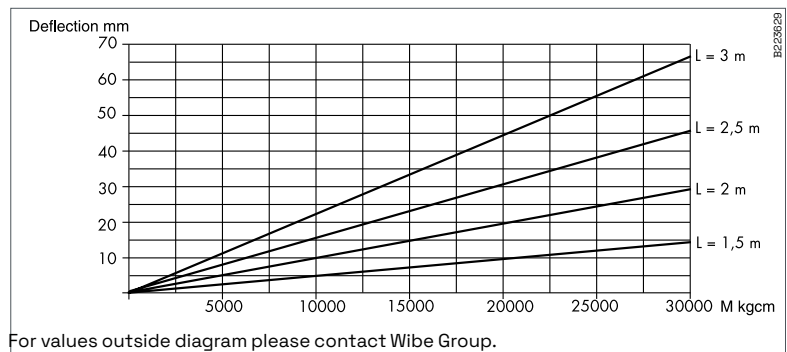

For values outside diagram please contact Wibe Group.

Example

- Conditions:
- 2 m support distance 75 kg/m ladder
 - Two ladders, 400 and 600 mm
 - One-side loading
 - VP 20FS/1500
 - Bending?

$$M = \sum F \times A \text{ (kgcm)}$$

$$M = 75 \times 2 \times \frac{(40 + 10.4)}{2} + 75 \times 2 \times \frac{(60 + 10.4)}{2}$$

$$(F_1) \quad (A_1) \quad (F_2) \quad (A_2)$$

Bending torque M is total sum of $F \times A$ (kgcm).
 F = Cantilever arm loading (kg)
 F = Loading (kg/m) x support distance (m).
 A = Distance between loading and VP centre line (cm)
 $A = \frac{\text{Ladder width} + 10.4}{2}$
 L = VP length
 Break load torque 60 000 (kgcm)

*Safe working load according to IEC 61537 is breaking load divided by 1.7.

$M = 10620 \text{ kgcm}$ - bending as per diagram, about 5 mm.

Use and installation

Pendant/Fixing rail 24/34

Pendant/Fixing rail for mounting of support brackets, cantilever arms, etc.

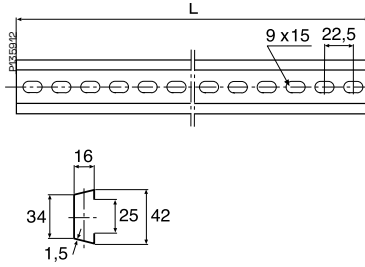
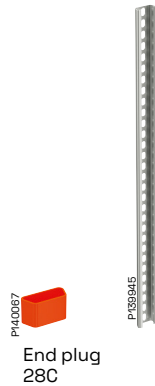

Type	L mm
Pendant/Fixing rail 24/34	292.5
Pendant/Fixing rail 24/34	382.5
Pendant/Fixing rail 24/34	495.0
Pendant/Fixing rail 24/34	697.5
Pendant/Fixing rail 24/34	990.0
Pendant/Fixing rail 24/34	2970.0

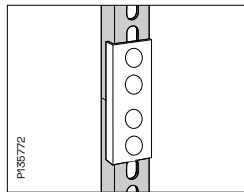

Vertical piece 2 may be joined to Pendant/Fixing rail 24/34 and Pendant joint 2J to achieve a suitable length.

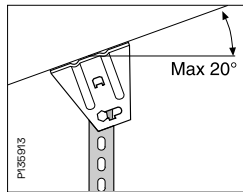

Ceiling bracket 5 and 1 Screw set 22S together provide a vertical piece that can be mounted with up to 20° slope.

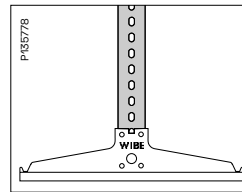

Mount Support bracket 3 using Screw set 22S.

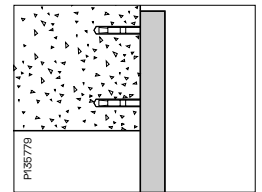

Side mounting of pendant/fixing rails may be done using 2 Expansion bolts alt. 2 Concrete screws.

Pendant/Fixing rail 24/48

Pendant/Fixing rail for mounting of support brackets, cantilever arms, etc.

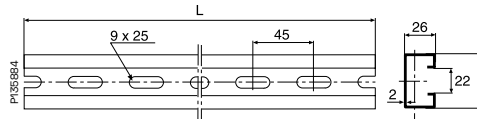

Type	L mm
Pendant/Fix. rail 24/48	1000
Pendant/Fix. rail 24/48	2970
Pendant/Fix. rail 24/48	5940

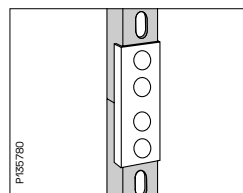

Vertical piece 2F may be joined using Pendant/Fixing rail 24/48 and Pendant joint 2FJ to achieve the required length.

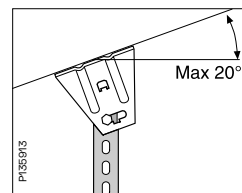

Ceiling bracket 5 and 1 Screw set 22S together provide a vertical piece that can be mounted with up to 20° slope. Only for mounting support brackets.

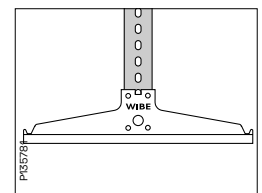

Mount Support bracket 3 using Screw set 22S.

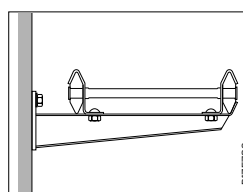

Mount Cantilever arm 50 using T-bolt.

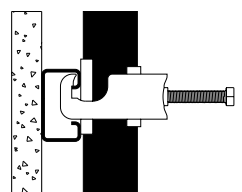

Cables are mounted on a Pendant/Fixing rail 24/48 using cable clamp ARX.

Use and installation

Pendant/Fixing rail 24/20

Pendant/Fixing rail for mounting of support brackets, cantilever arms, etc.

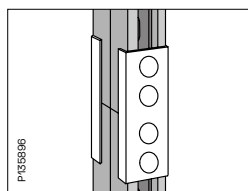
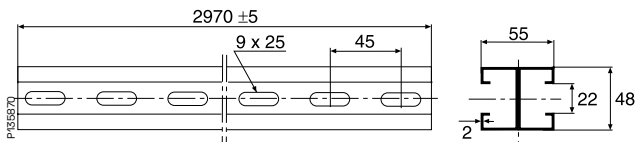

Vertical piece 20 may be joined using Pendant/Fixing rail 24/20 and Pendant joint 20J. Only for symmetrical loading.

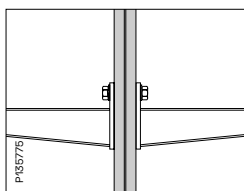

Mount Cantilever arm 50 using T-bolts.

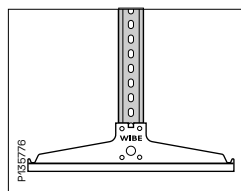

Mount Support bracket 3 using Screw set 20S.

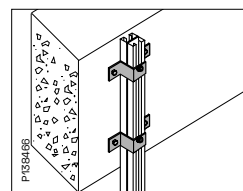

Pendant/Fixing rail can be mounted on beam or wall with Wall bracket 20.

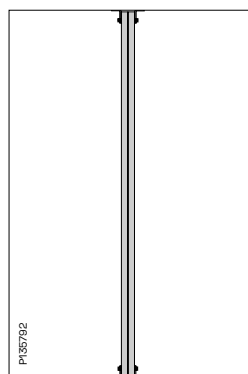

Pendant/Fixing rail 24/20 may be mounted as a riser between the floor and ceiling using 4 Angle brackets 5L and 4 T-bolts.

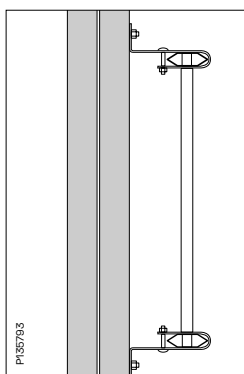

Cable ladder may be mounted vertically or horizontally on Pendant/Fixing rail 24/20 using Wall bracket 11/25 or 11/75 and T-bolt.

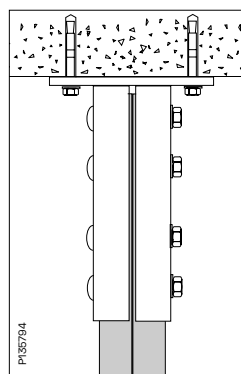

Pendant base plate 520 can be mounted as a ceiling or floor attachment.

Use and installation

Pendant/Fixing rail 24/20F

Pendant/Fixing rail for mounting of support brackets, cantilever arms, etc.

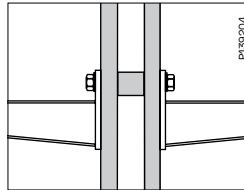
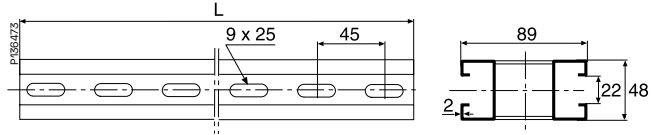
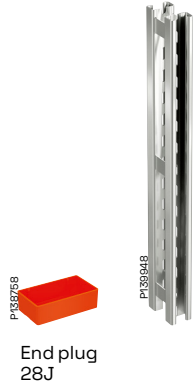

Mount Cantilever arm 50 using T-bolts.

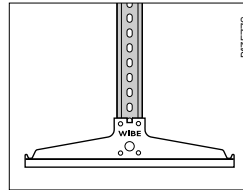

Mount Support bracket 3 using Screw set 2S.

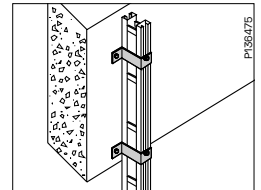

Pendant/Fixing rail 24/20F can be mounted on beam or wall with Wall bracket 20F

Type	L mm
Pendant/Fixing rail 24/20F-3000	2970
Pendant/Fixing rail 24/20F-6000	5940

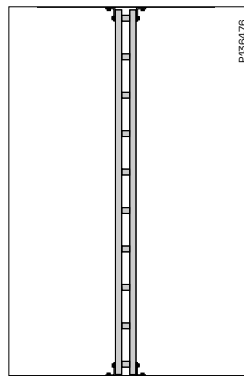

Pendant/Fixing rail 24/20F can be mounted as a riser between the ceiling and floor using 4 Angle brackets 5L and 4 T-bolts.

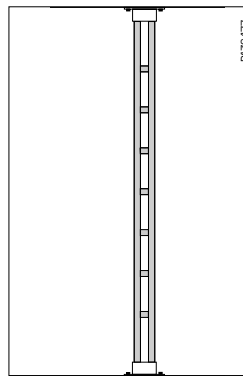

Mount Pendant/Fixing rail 24/20F between a floor and ceiling using 2 Rail fixing supports.

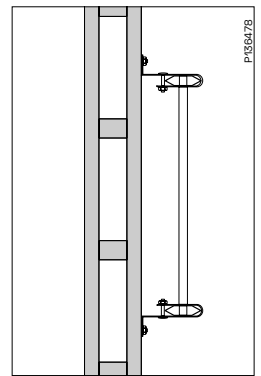

Cable ladder can be mounted vertically or horizontally on Pendant/Fixing rail 24/20F using Wall bracket 11/25 or 11/75.

Pendant/Fixing rail 24/20FS

Pendant/Fixing rail for mounting of support brackets, cantilever arms, etc.

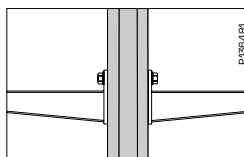
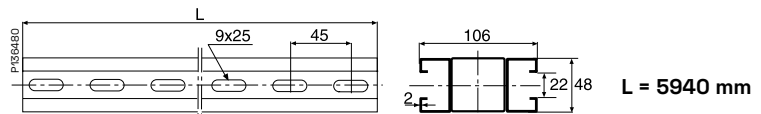
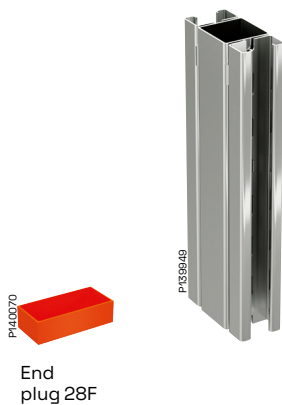

Mount Cantilever arm 50 using T-bolts.

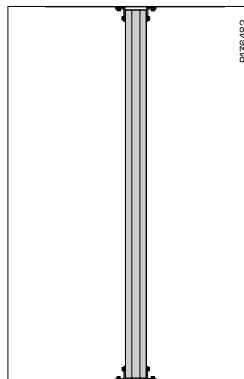

Pendant/Fixing rail 24/20FS can be mounted as a riser between the ceiling and floor using 4 Angle brackets 5L and 4 T-bolts.

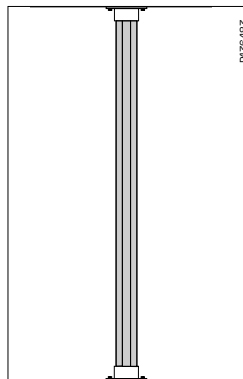

Mount Pendant/Fixing rail 24/20FS between floor and ceiling using 2 Rail fixing supports.

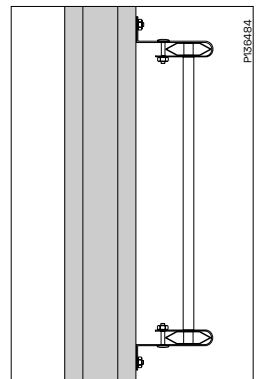

Cable ladders can be mounted vertically or horizontally on Pendant/Fixing rail 24/20FS using Wall bracket 11/25 or 11/75 and T-bolt.

Use and installation

Fixing rail 24/26x53 for casting-in

Fixing rail for casting-in in wall and ceilings.

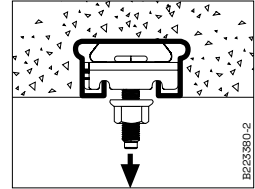
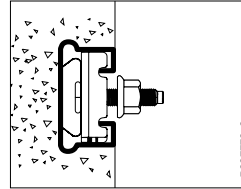
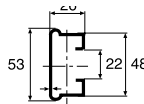
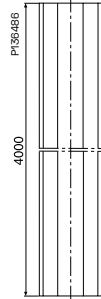

Fixing rail 24/26 x 53 for casting-in in walls and ceilings. Mount cantilever arms with T-bolt 26U.

Max. pull-out load: 1000 kg/0.5 m of casting-in fixing rail (Concrete class K200).

Ceiling plate 20F

Ceiling plate to be used as a pre-drilled attachment for Vertical piece 20F to a steel member. The ceiling plate is welded in position.

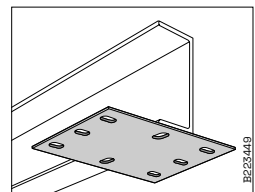
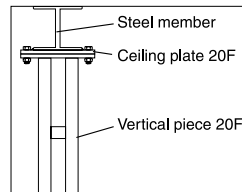
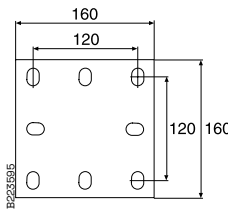
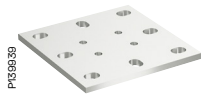

The ceiling plate is welded to the steel member. Permission to weld on the steel member is required. Remove all zinc at the weld. Post-treat using Galvafruid.

Use Ceiling plate 20F as a fully drilled attachment for Vertical piece 20F against a steel member. Secure the ceiling plate by welding. Remove all zinc at the weld. Post-treat using Galvafruid.

Ceiling plate 20FS

Ceiling plate 20F is used as a pre-drilled attachment for Vertical piece 20FS to a steel member. The ceiling plate is welded in position.

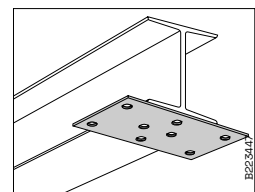
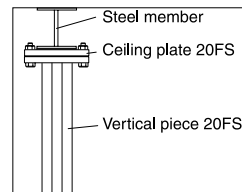
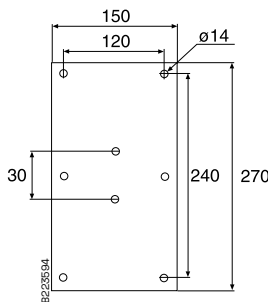

The ceiling plate is welded to the steel member. Permission to weld on the steel member is required. Remove all zinc at the weld. Post-treat using Galvafruid.

Use Ceiling plate 20FS as a fully drilled attachment for Vertical piece 20FS against a steel member. Secure the ceiling plate by welding. Remove all zinc at the weld. Post-treat using Galvafruid.

Use and installation

Pendant base plate 520

Pendant base plate to be used as a ceiling or floor base plate for Pendant/Fixing rail 24/20 in any desired length.

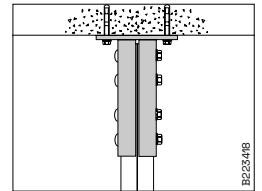
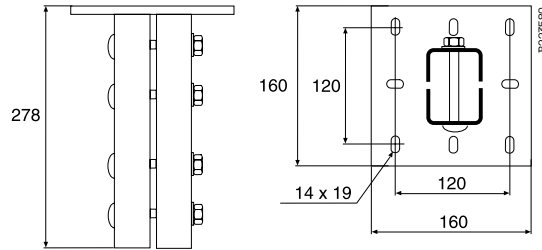

Vertical pieces of the required length can be mounted using Pendant base plate 520 and Pendant/Fixing rail 24/20.

Rail fixing support 24/20F, 24/20FS

Rail fixing support to be used with Pendant/fixing rails 24/20F and 24/20FS respectively, for mounting between floor and ceiling.

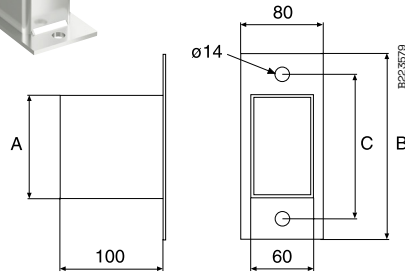

Type	A mm	B mm	C mm
Rail fix. support 24/20F	100	165	135
Rail fix. support 24/20FS	120	185	155

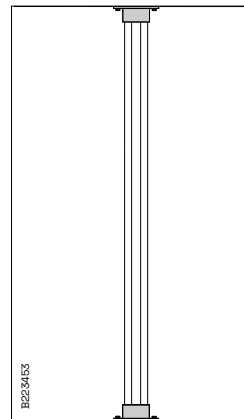

1. Mount one of the rail fixing supports in the ceiling.
2. Adjust the pendant length.
3. Mount the rail fixing support for floor mounting on the pendant.
4. Insert the pendant in the rail fixing support in the ceiling.
5. Attach the bottom rail fixing support securely to the floor.

Ceiling bracket 2Fi

Ceiling bracket to be used on Pendant/fixing rail 24/48 to achieve the desired length of vertical pieces.

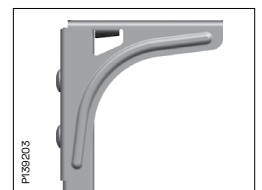
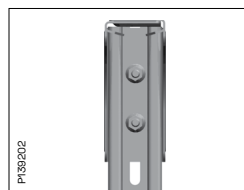
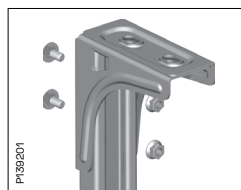
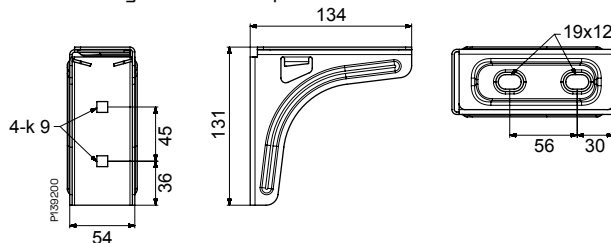

Ceiling bracket 2Fi and Pendant/Fixing rail 24/48, mounted together with 2 Screw sets 22S, are used when other lengths are required than those available for Vertical piece 2Fi.

Use and installation

Pendant bar 1

Pendant bar to be installed in order to reduce the deflection of heavily loaded vertical pieces. Installed with T-bolt and Expansion bolt.

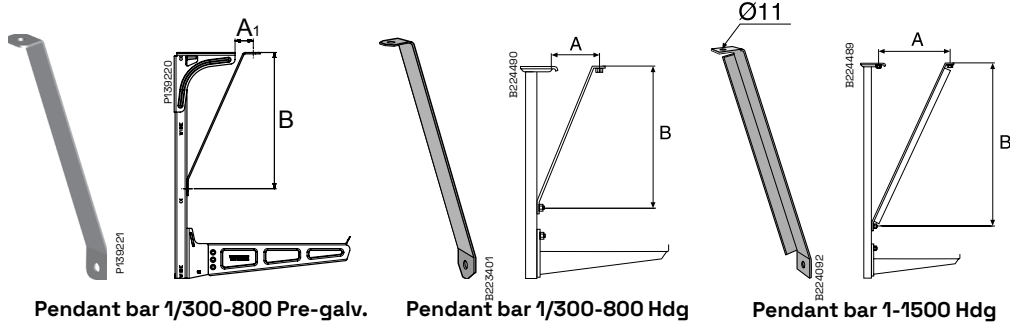

Type	A		B
	A mm'	mm	
1/300	40	80	300
1/500	40	130	500
1/800	125	215	800
1/1500	Varies	Varies	Varies

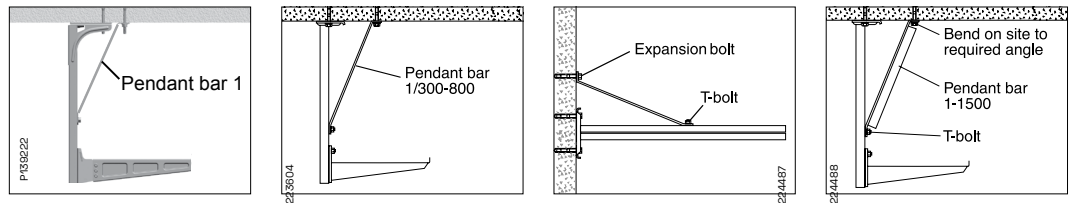

To reduce deflection of Vertical piece 2Fi at heavy loads on Cantilever arm 50i the Pendant bar 1 can be used. Install with T-bolt and Expansion bolt.

To reduce deflection of Vertical piece 2F at heavy loads on Cantilever arm 50 the Pendant bar 1 can be used. Install with T-bolt and Expansion bolt.

To be mounted to strengthen Vertical piece 20 when mounted horizontally. Use T-bolt and Expansion bolt.

Mount this stay to reduce deflection of long Vertical pieces 2F, 20 and 20F.

Pendant joint 2J, 2FJ and 20J

Pendant joint to be used for joining pendant/fixing rails and vertical pieces.

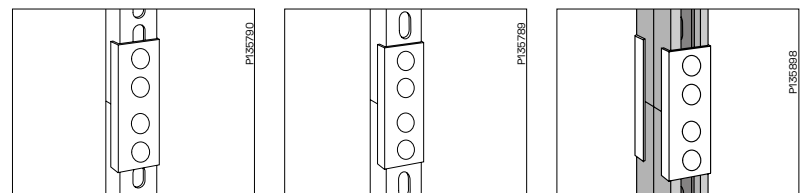
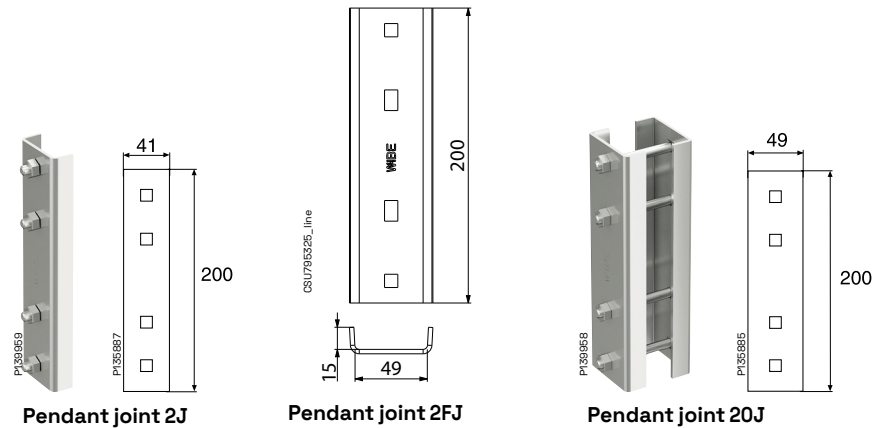

Pendant joint 2J, used for joining of Vertical piece 2 and Pendant/ Fixing rail 24/34.

Pendant joint 2FJ, used for joining of vertical piece 2F.

Pendant joint 20J, used for joining of Vertical piece 20 and Pendant/ Fixing rail 24/20. Only for symmetrical loading.

Use and installation

Angle bracket 5L and 5LS

Angle brackets used when assembling pendant/fixing rails to frames for switching cabinets and electrical control centres and for fixing an upright between floor and ceiling. Assembled with a T-bolt. Angle bracket 5L is also used for steel wire installation in ceilings.



Angle bracket 5L



Angle bracket 5LS

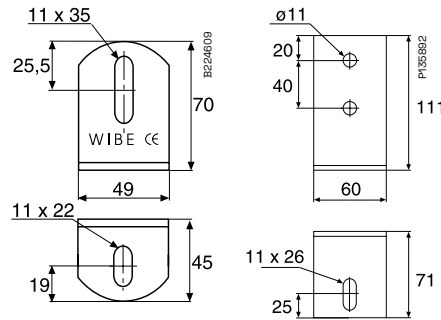

Adjustability 5L

Angle bracket 5L

Angle bracket 5LS

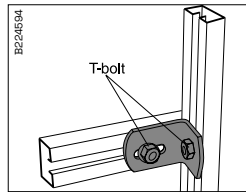

Installation examples for installation of pendant/fixing rails to different frameworks for installation of control panels, electric distribution boards, etc. Angle bracket 5L is used.

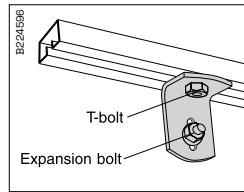
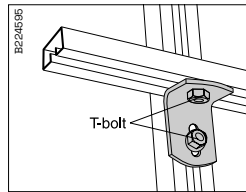

Mounting of a pendant/fixing rail on a wall. Use Angle bracket 5L or 5LS.

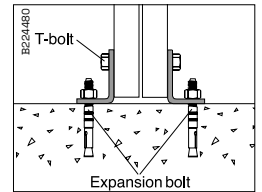

Mounting of a pendant/fixing rail against floor with Angle bracket 5L or 5LS.

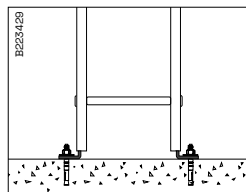

Angle bracket 5L can be mounted inside the ladder profile and thus be used as an end connection against wall or floor.

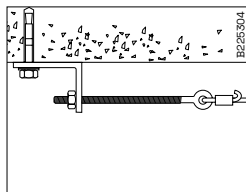

Angle bracket 5L is installed in ceiling with Expansion bolt or concrete screw. Max. permitted loading 600 kg (6 kN).

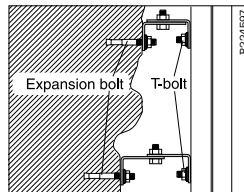

5LS can also be mounted as support behind pendant/fixing rails to compensate for irregularities in, for example, concrete or mountain walls.

Use and installation

Combi bracket 53

Combi bracket to be used for the mounting of cable ladders and trays on seamed roofing sheets, etc. To be combined with plastic insulating plate 54.

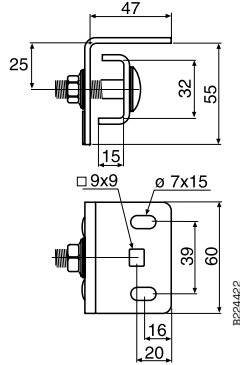

Breaking load*

	Type of roofing sheet	Insulating plate	Permitted load
	Bandsheet Prelac	No	F1=100 kg
	Copper sheeting	Yes	F2=50 kg
	Bandsheet Prelac	No	F3=100 kg
	Copper sheeting	Yes	F4=50 kg

* Loading values and fixing of roof sheet - follow the supplier's recommendations

Test have been made of:

Bandsheet Prelac BLX t=0.6 SSAB tunnplåt Copper sheeting annealed SS 5015-80 t=0.6 Tightening torque at test=60Nm

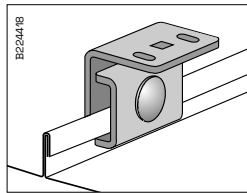

Combi bracket 53 mounted on seamed roofing sheet.

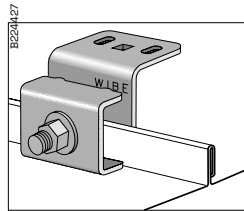

Alternative mounting of Combi bracket 53.

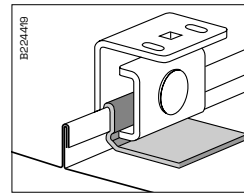

In order to avoid contact between Combi bracket 53 and copper sheeting, Insulating plate 54 must be used.

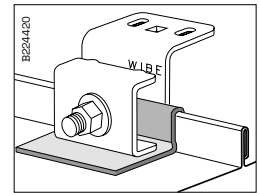

Alternative mounting of Combi bracket 53 and Insulating plate 54.

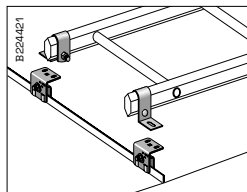

Cable ladder mounted across the seams of the roofing sheets with Combi bracket 53, Wall bracket 11/25 and Screw set 22S.

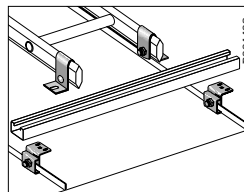

Cable ladder mounted along the seams of the roofing sheets with Combi bracket 53, Wall bracket 11/25, Screw set 22S, Pendant/Fixing rail 24/48 and T-bolt 26U.

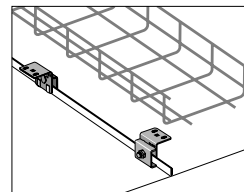

Mesh tray mounted along the seams of the roofing sheets with Combi bracket 53 and accessories from the Mesh tray programme.

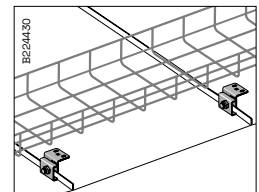

Mesh tray mounted across the seams of the roofing sheets with Combi bracket 53 and accessories from the Mesh tray programme.

Bracket 60/40

Bracket to be used together with Pendant/fixing rail 24/48 to reduce the deflection of long vertical pieces.

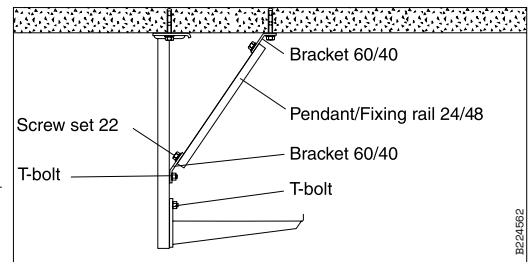
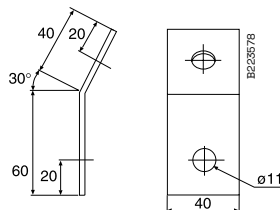

Use Bracket 60/40 together with Pendant/Fixing rail 24/48 to reduce the deflection of long Vertical pieces 2F, 20, 20F or 20FS. Cut the pendant/fixing rail to a suitable length on site.

Use and installation

Rod bracket 82

Rod bracket to be used together with Cantilever arm 50, in combination with threaded rod support.

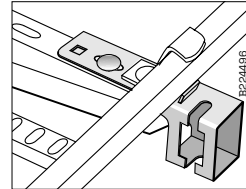
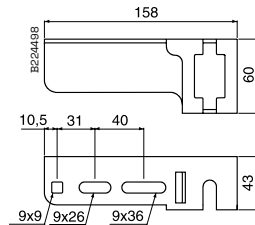

Rod bracket 82 mounted on Cantilever arm 50. Screw set 22S and Profile clamp 42 are to be used.

Ceiling bracket 5

Ceiling bracket to be used for installations with Pendant/Fixing rails 24/34 and 24/48.

P135961

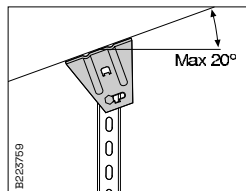
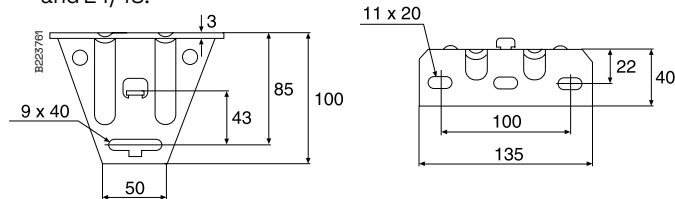

Using Pendant/Fixing rail 24/34 or 24/48, 1 Ceiling bracket 5 and 1 Screw set 22S it is possible to make a vertical piece that can be installed at an angle of up to 20°. Breaking load for rail 34 = 1000 kg (10 kN). Breaking load for rail 48 = 1200 kg (12 kN).

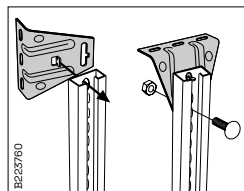

Mount Ceiling bracket 5 to the back of the pendant/fixing rail by turning the ceiling bracket 90° and inserting the tab into the hole in the rail. Then turn the ceiling bracket back and lock it in the required position using 1 Screw set 22S. When mounting it at a horizontal ceiling, lock the screw in the slot recess for better lateral stability. Ceiling bracket 5 can be tilted max. 20°.

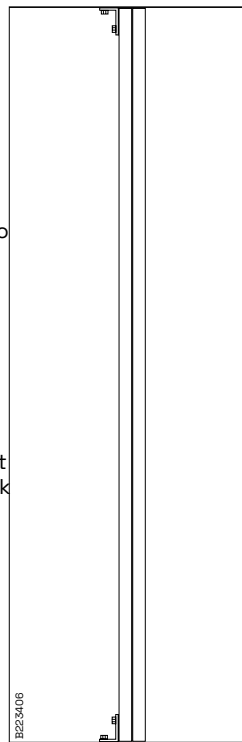

Pendant/Fixing rail 24/20 can, using 2 Ceiling brackets 5 and 2 T-bolts, be mounted between floor and ceiling (see also Angle bracket 5L).

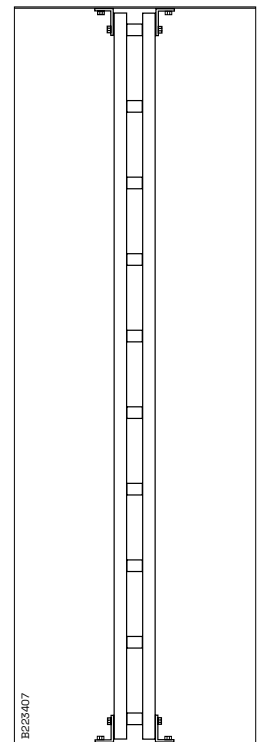

Pendant/Fixing rail 24/20F can, using 4 Ceiling brackets 5 and 4 T-bolts, be mounted between floor and ceiling (see also Angle bracket 5L).

Use and installation

Ceiling bracket 5TPA

Ceiling bracket with telescopic function, to be used for mounting of various sizes of trapezoid plates.

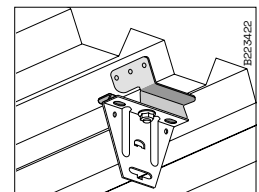
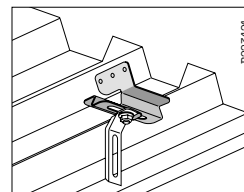
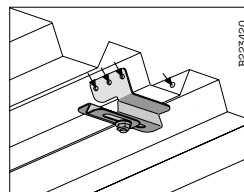
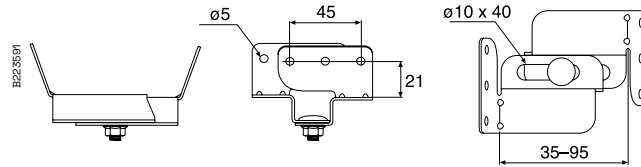

Ceiling bracket 5TPA can be mounted in trapezoid plate with blind rivets or suitable screws. The bracket is adjustable from 35 to 95 mm.

Pendant attachment W21 or Tube pendant attachment W73 (Wibe Cable Tray) can be mounted in Ceiling bracket 5TPA with the existing screw.

Ceiling bracket 5 or Ceiling attachment W31 can be mounted with the existing screw.

Breaking load

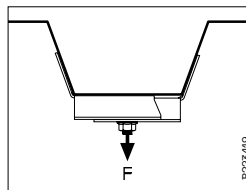

Ceiling bracket 5TPA can be loaded with F=150 kg without deformation. For loading figures for thin plate or fixing elements, follow suppliers recommendations.

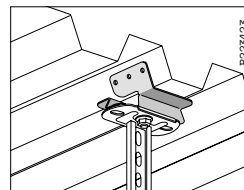

Vertical piece 2 or 2F can be mounted with the existing screw.

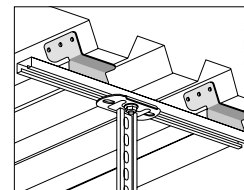

Install Mounting rail 40 between 2 Ceiling brackets 5TPA if the vertical piece must be adjusted sideways.

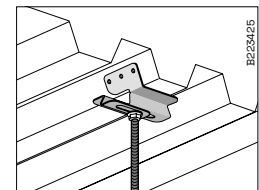

Pendant W76 M8 or M10 installed in Ceiling bracket 5TPA.

Ceiling bracket 5TP

Ceiling bracket to be used in trapezoidal sheeting for installations of Pendant/Fixing rail 24/48.

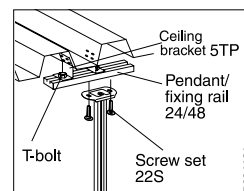
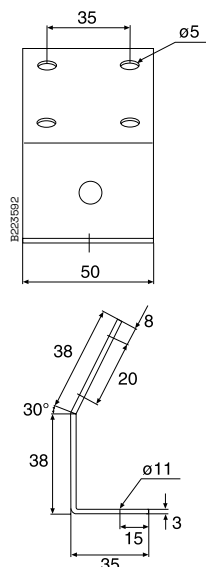

In ceilings with trapezoidal sheeting, mount Vertical piece 2, 2F or 20 using 2 Ceiling brackets 5TP, Pendant/Fixing rail 24/48, 2 T-bolts and Screw set 22S.

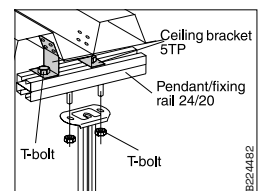

Alternatively Pendant/Fixing rail 24/20 may be used. This will require the use of 4 T-bolts.

Use and installation

Fixed take-off hook 4

Fixed take-off hook to be used for 90° horizontal branches.



5 mm dia. hole for any locking against the ladder profile using sheet screws or blind rivets

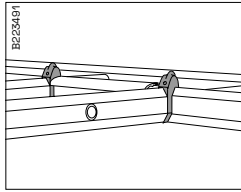
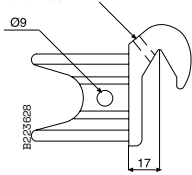

Fixed take-off hook 4 is used at 90° horizontal branches. Coupling 22 can also be used for straight angle formation.

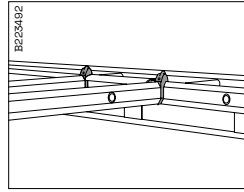

KHZSP, KHZSP+, KHZPS, KHZ and KHZP can also be used to form 90° angles from KHZV/KHZPV using Fixed take-off hook 4. Mount Profile protection 28P.

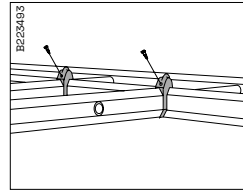

5 mm dia. hole for any locking against the section using sheet screws or blind rivets.

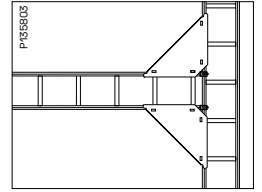

Angle plate 33 is always recommended at horizontal branches.

Take-off hook 47

Take-off hook to be used on cable ladders KHZV and KHZPV to make 90° branches.

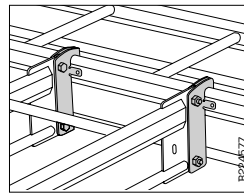
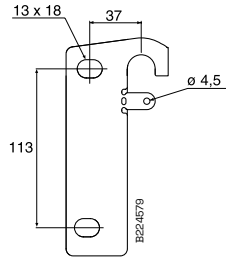

Use Take-off hook 47 to make 90° branches.

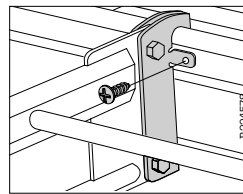

The extra hole, Ø 4.5, is to be used when earthing is demanded or if vertical locking of the ladder is needed. A self-drilling screw must be used.

Take-off hook 20C

Take-off hook to be used on cable ladders KHZP 20C range to make 90° branches. Screw M12 and nuts are included.

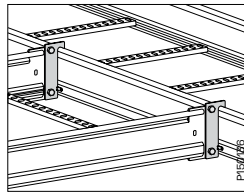
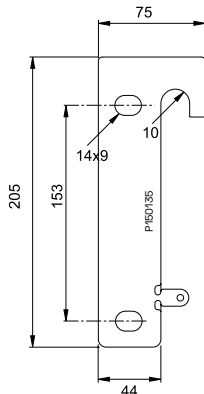

Use Take-off hook 20C to make 90° branches.

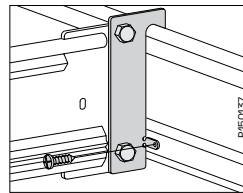

The extra hole, Ø 4.5, is to be used when earthing is demanded or if vertical locking of the ladder is needed. A self-drilling screw must be used.

End connection 10

End connection to be used for the connection of a ladder vertically to a floor, or horizontally to a wall.

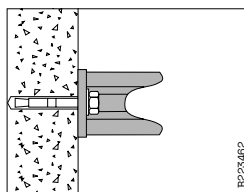
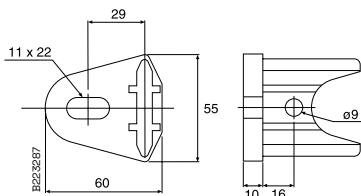

The End connection 10 is mounted at the ladder end vertically against floors or horizontally against walls.

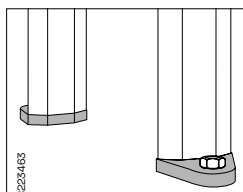

Mount the End connection 10 using Expansion bolts.

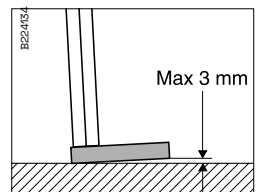

Max. tilt permitted = 3 mm before tightening the screw.

Use and installation

Combi Fitting B21

Combi-fitting to be used when mounting mesh trays onto cable ladders.

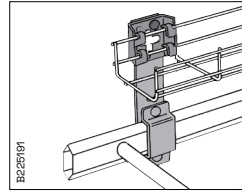
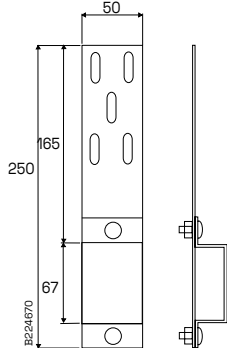

Defem Mesh tray 53 and 75 is mounted onto Combi Fitting B21 with Bracket B4 mini Bolt and Nut B13.

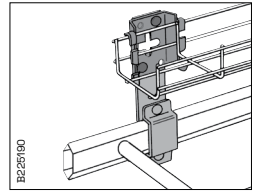

Defem Mesh tray 120 is mounted onto Combi Fitting B21 with Bracket B4 Bolt and Nut B13.

Combi Fitting B21 90 degree

Combi-fitting to be used when mounting mesh trays onto cable ladders.

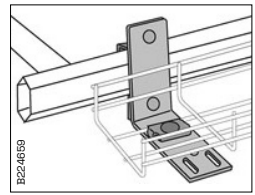
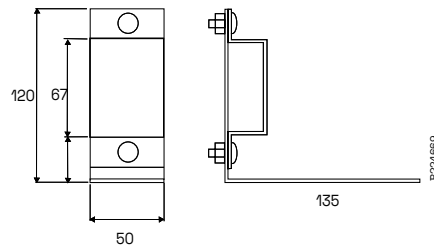

Defem Mesh tray 53, 75 and 120 is mounted onto Combi Fitting B21 90° with 1 Fitting B2.1 Bolt and Nut B13.

Junction box plate 35S

Installed upright or hanging from the profile. Locked with locking tabs.

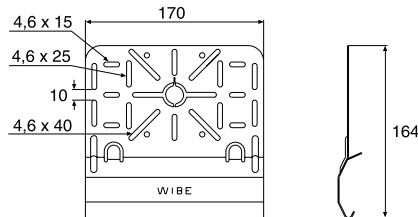
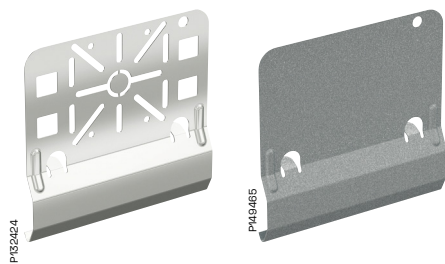

B223560

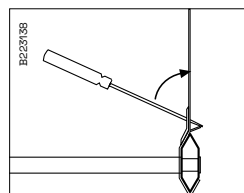

Bend the tab towards the ladder section by using a screwdriver as a lever for mounting junction box plates.

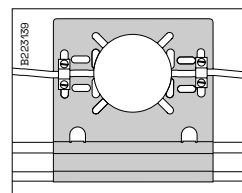

Junction box plates can be mounted in standing or hanging positions on the side sections Strain-relief may be provided using the outermost holes and clamps or strips.

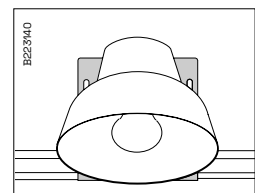

Light fittings can also be mounted on junction box plates.

Use and installation

Installation plate 61

Installation plate to be used on vertical cable ladder installations for mounting of terminal boxes, contact breakers, etc.

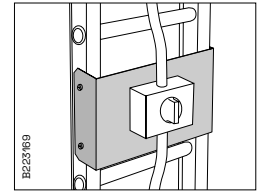
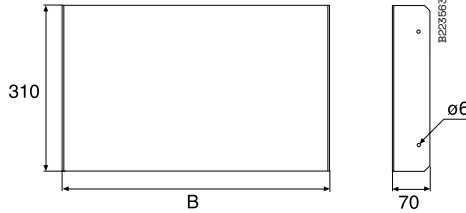

Used on vertical cable ladder installations for mounting of terminal boxes, contact breakers etc. Mount with selftapping screw ST4.2 in the side profile.

Type	B mm
Installation plate 61-200	200
Installation plate 61-300	300
Installation plate 61-400	400
Installation plate 61-500	500
Installation plate 61-600	600

Earth clamp W79

The earth clamp is used when protective earthing of the junction box plate is required.

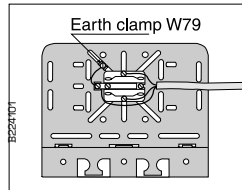
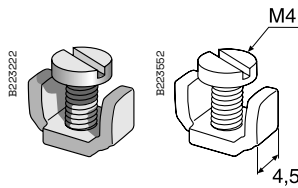

Earth clamps are designed for use when protective earthing of the mounting plate is required for mounting apparatuses as per relevant heavy current directives. The oblong holes in the junction box plate (mounting plate) permit movement of the earth clamp so that it always comes under the casing of the apparatus. If the apparatus's earth clamp is not approved for joining protective earth conductors, it must pass unbroken through the apparatus's earth clamp to the junction box earth clamp (see the fig.).

Junction box plate 35P

Junction box plate with holes, to be installed between rungs. Locked with appropriate locking tabs for each ladder. For junction boxes, electric light fittings, etc.

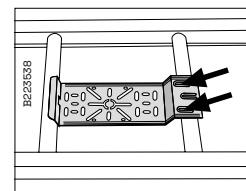
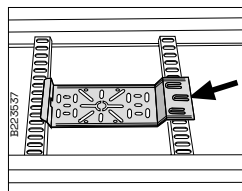
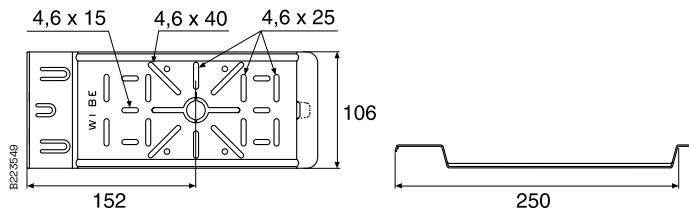

Mount junction box plates between the ladder rungs. On KHZSP, KHZSP+, KHZPS, KHZP and KHZPV attach junction box plates by bending the central tab into the rung perforation using a screwdriver or suchlike.

Mount junction box plates on KHZ and KHZV by bending the two outer tabs towards the round rung using a screwdriver or suchlike

Use and installation

Junction box plate 12xRJ45 Actassi S-one

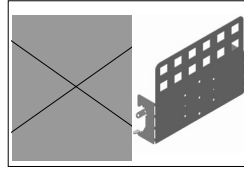
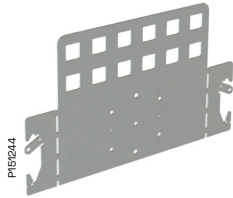

Junction box plate delivered flat, to be bended on site.

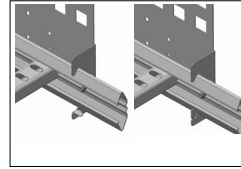

Bend the ladder beam interface part 90° to the inside. Bend the optional fixation lips to the outside to easily position the junction box plate on the ladder beam.

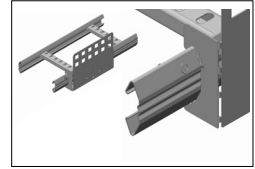

Optional the junction box plate can be fixed to the ladder beam by using self drilling screws.

Riser 18

Riser piece to be fitted to the cable ladders by using Joint 21.

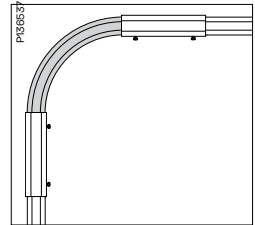
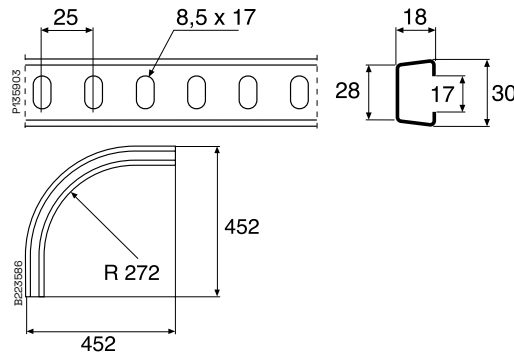
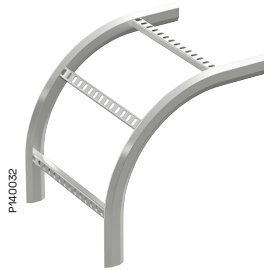

Join the cable ladders to Riser 18 using Joint 21.

Riser coupling 49

Coupling to be used as a self-supporting vertical coupling of cable ladders KHZV/KHZPV. Two screws M12 and nuts are needed.

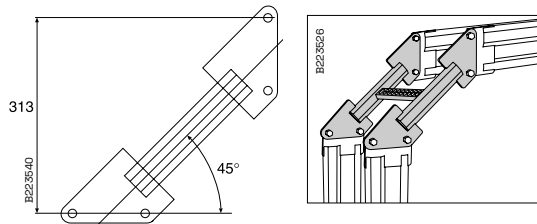
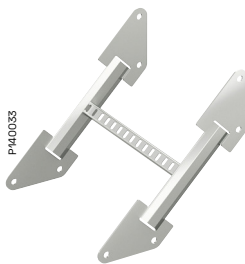

Mount Riser coupling 49 to form a 90° branch on KHZV/KHZPV using 2 Screw sets M12. This provides a large radius for cables.

Riser coupling 20C

Coupling to be used as a self-supporting vertical coupling of cable ladders KHZP 20C range. Two screw sets M12 are needed.

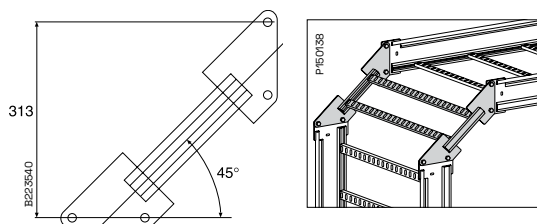
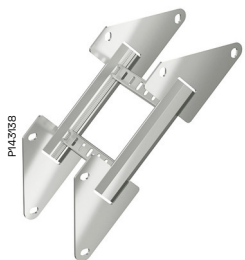

Mount Riser coupling 20C to form a 90° branch on KHZP 20C using 2 Screw sets M12. This provides a large radius for cables.

Use and installation

90° bend 15, interior and exterior

Interior bend piece to be fitted to the cable ladders by using Joint 21, creating a 90° bend. Inner radius 268 mm.

Exterior bend piece to be fitted to the cable ladders by using Joint 21, creating a 90° bend.

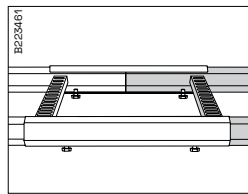
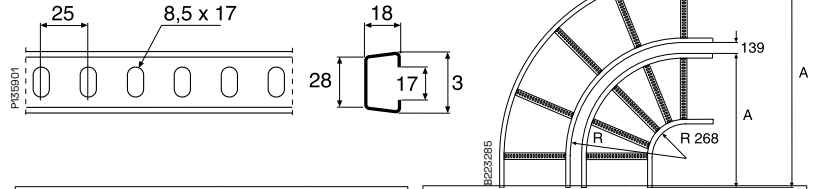
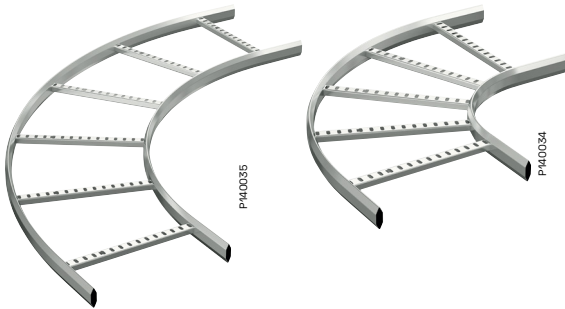

Join cable ladders to 90° bend using Joint 21.

Type	R mm	A mm
Interior		
90° bend 15/150	268	547
90° bend 15/200	268	597
90° bend 15/300	268	697
90° bend 15/400	268	797
90° bend 15/500	268	897
90° bend 15/600	268	997
90° bend 15/800	268	1197
90° bend 15/1000	268	1397

Type	R mm	A mm
Exterior		
90° bend 15/150	554	703
90° bend 15/200	604	933
90° bend 15/300	704	1133
90° bend 15/400	804	1333
90° bend 15/500	904	1533
90° bend 15/600	1004	1733
90° bend 15/800	1204	2133
90° bend 15/1000	1404	2533

90° bend 55 interior

Interior bend piece to be fitted to cable ladders KHZV and KHZPV, creating a 90° horizontal bend.

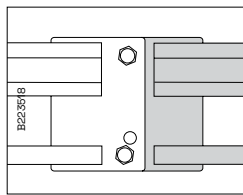
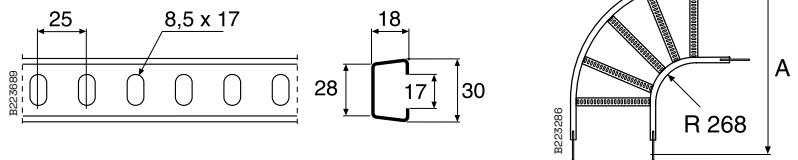
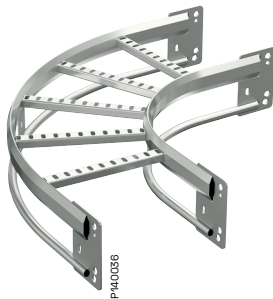

For joining to KHZV and KHZPV, use Screw set M12

Type	A mm
90° bend 55/200	625
90° bend 55/300	725
90° bend 55/400	825
90° bend 55/500	925
90° bend 55/600	1025
90° bend 55/800	1225
90° bend 55/1000	1425

Use and installation

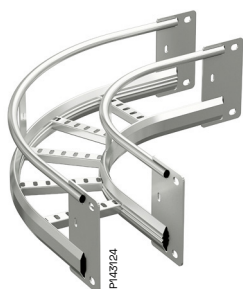

90° bend 20C, interior

Interior bend piece to be fitted to cable ladders KHZP 20C range, creating a 90° horizontal bend.

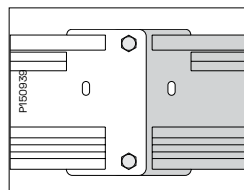
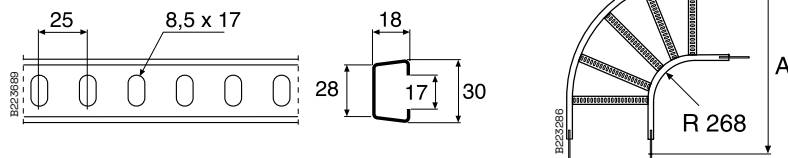

For joining to KHCP 20C/KHZV and KHZPV, use Screw set M12

Type	A mm
90° bend 20C/200	625
90° bend 20C/300	725
90° bend 20C/400	825
90° bend 20C/500	925
90° bend 20C/600	1025
90° bend 20C/800	1025
90° bend 20C/1000	1425

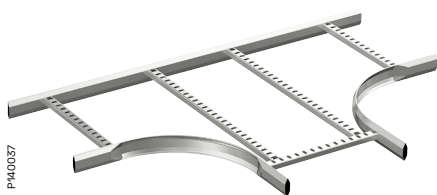

T-junction 16

T-junction piece to be fitted to the cable ladders by using Joint 21.

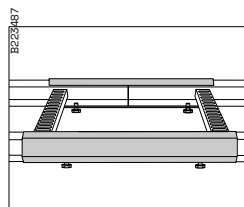
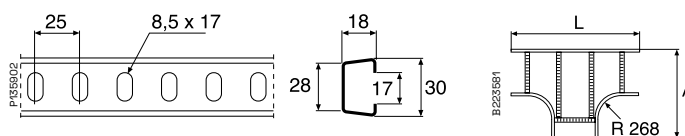

Join the cable ladders to T-junction 16 using Joint 21.

Type	A mm	L mm
T-junction 16/150	547	944
T-junction 16/200	597	997
T-junction 16/300	697	1097
T-junction 16/400	797	1197
T-junction 16/500	897	1297
T-junction 16/600	997	1397
T-junction 16/800	1197	1597
T-junction 16/1000	1397	1797

Use and installation

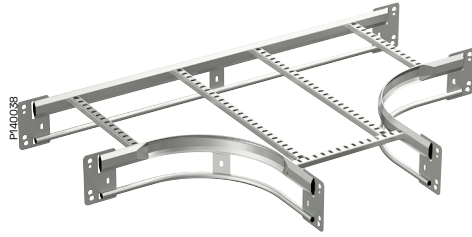

T-junction 56

T-junction piece to be fitted to the cable ladder KHZV or KHZPV by using screw set M12.

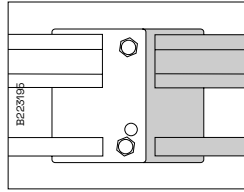
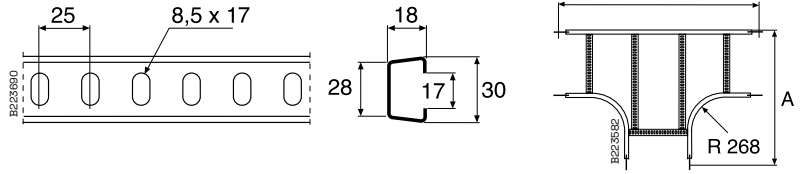

For joining to KHZV and KHZPV, use Screw set M12.

Type	A mm	L mm
T-junction 56/200	625	1050
T-junction 56/300	725	1150
T-junction 56/400	825	1250
T-junction 56/500	925	1350
T-junction 56/600	1025	1450
T-junction 55/800	1225	1650
T-junction 56/1000	1425	1850

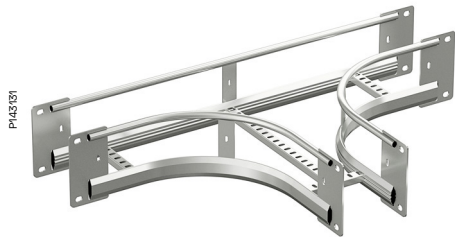

T-junction 20C

T-junction piece to be fitted to the cable ladder KHZP 20C range by using screw set M12.

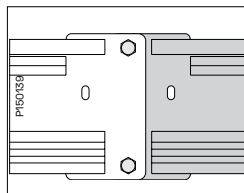
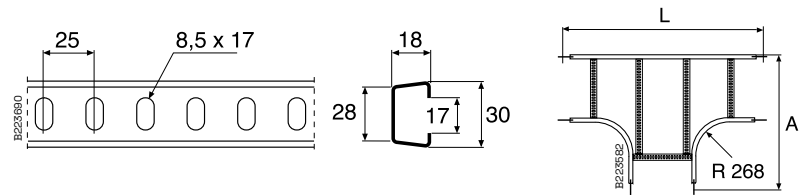

For joining to KHCP 20C/KHZV and KHZPV, use Screw set M12.

Type	A mm	L mm
T-junction 20C/200	625	1050
T-junction 20C/300	725	1150
T-junction 20C/400	825	1250
T-junction 20C/500	925	1350
T-junction 20C/600	1025	1450
T-junction 20C/800	1225	1650
T-junction 56/1000	1425	1850

Use and installation

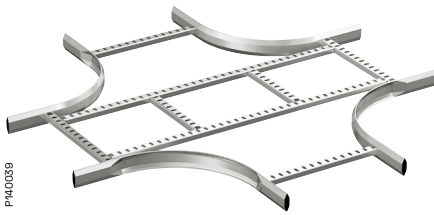

P1400359

X-junction 17

X-junction piece to be fitted to the cable ladders by using Joint 21.

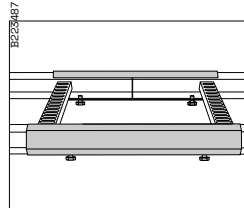
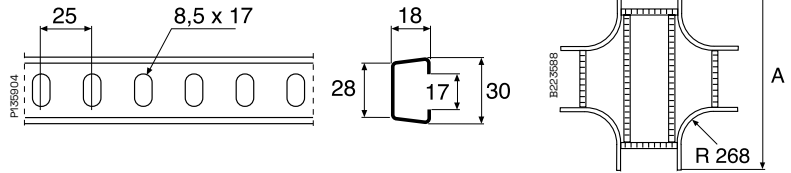

Join the cable ladders to X-junction 17 using Joint 21.

Type	A mm
X-junction 17/150	547
X-junction 17/200	997
X-junction 17/300	1097
X-junction 17/400	1197
X-junction 17/500	1297
X-junction 17/600	1397
X-junction 17/800	1597
X-junction 17/1000	1797



P1400460

S-bend 67

S-bend piece to be used as a transition between cable ladders mounted on different levels. Can be mounted both vertically and horizontally.

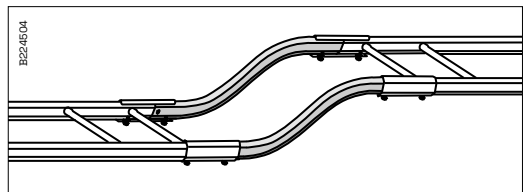
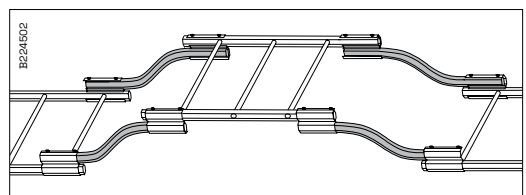
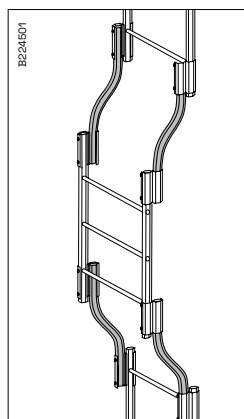
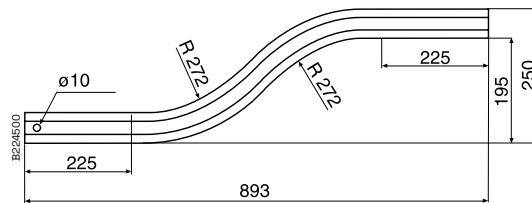

S-bend 67 can be mounted vertically or horizontally between cable ladders by using Dropper joint 32 or Joint 21.

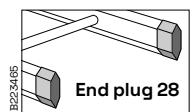

Use and installation

Tele-conduit 36 with knock-out holes

Tele-conduit to be used where a separate tray is required for low-tension cables. Knock-out holes in the bottom of the channel permit the cables to pass through.

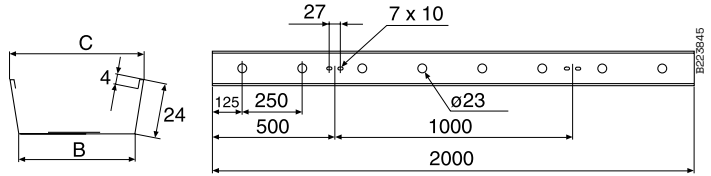

Type	B mm	C mm
Tele-conduit 36/50	42	50
Tele-conduit 36/100	92	100
Tele-conduit 36/200	192	200

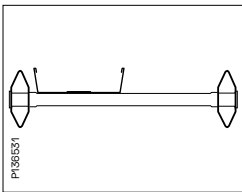

Mount Tele-conduit 36 whenever a special channel is required for low tension lines.

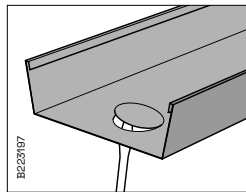

Whenever you wish to make a hole to let a cable through, press the knock-out piece from below using a screwdriver or suchlike

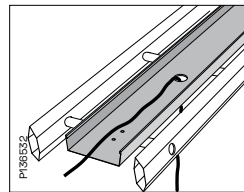

In the event of special needs, a sealing sleeve 22.5 or corresponding may be mounted in the hole.

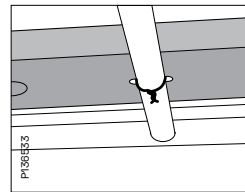

Attach Tele-conduit 36 onto KHZ and KHZV by tying with wire round rungs.

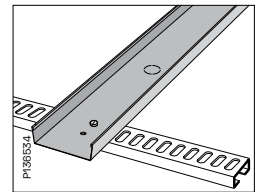

Attach Tele-conduit 36 to KHZSP, KHZSPZ+, KHZPS, KHZP and KHZPV using Screw set W34 through the rung perforations.

Dividing strip 39

Dividing strip to be used to separate low-voltage and high-voltage cables.

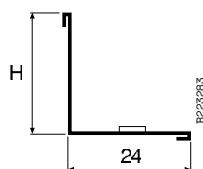
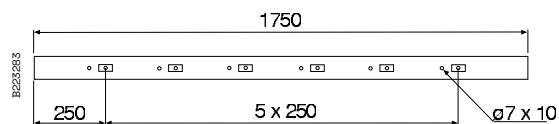

Type	H mm
Dividing strip 39/24	24
Dividing strip 39/55	55

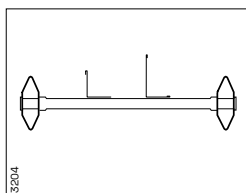

Mount one or more Dividing strips 39 to separate low and high tension cables.

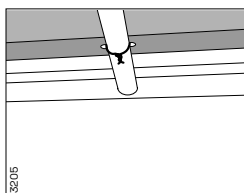

Attach Dividing strip 39 to KHZ and KHZV by lashing around the rungs.

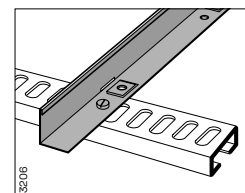

Attach Dividing strip 39 to KHZSP, KHZSPZ+, KHZPS, KHZP and KHZPV using Screw set W34 through the rung perforations.

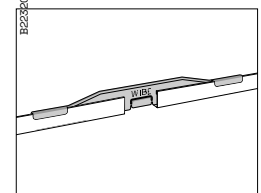

It is advisable to join dividing strips using Distance piece W39.

Use and installation

Distance piece W39

Distance piece to be used for the joining of Dividing strips 39.

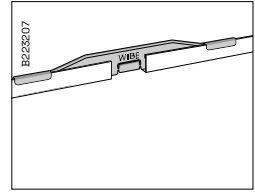
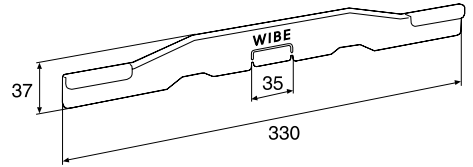

Mount one or more Dividing strips 39 to separate low and high tension cables.

Cover W5

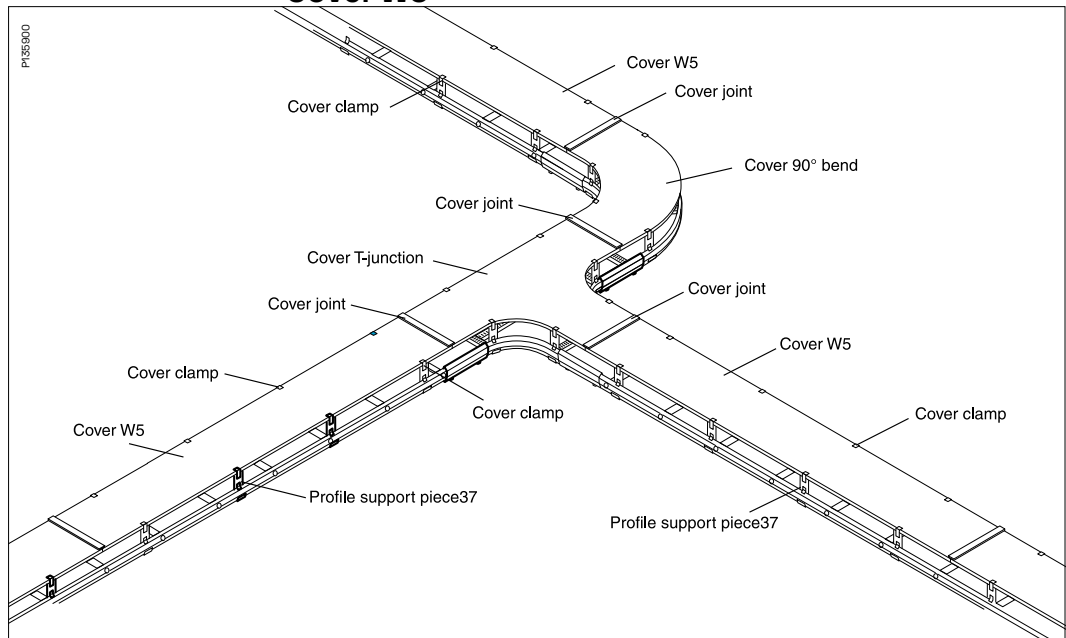

Cover to be used to protect the cable runs from dust, dirt, liquids, etc. Outdoors, it protects against rain and sun. Suitable for all cable ladders.

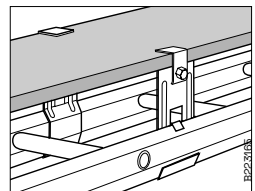
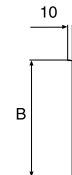
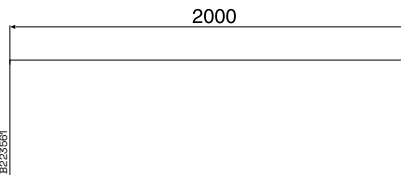

Type	Ladder width mm	B mm
Cover W5 - 150	150	151
Cover W5 - 200	200	201
Cover W5 - 300	300	301
Cover W5 - 400	400	401
Cover W5 - 500	500	501
Cover W5 - 600	600	601
Cover W5 - 800	800	801
Cover W5 - 1000	1000	1001

Mount covers to protect the cable routes from dust, waste, liquids, etc. Outdoors, covers protect against rain and sun. All Wibe cable ladders can be fitted with covers. Mount covers using Profile support piece 37 and Cover clamp.

Use and installation

Cover 90° bend

Cover to be used for 90° interior bends. To be installed with a Profile support piece 37, Cover clamp and Cover joint.

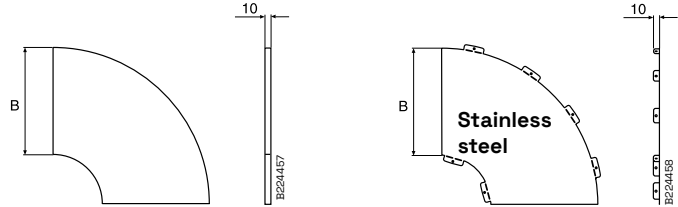

Type	Ladder width mm	B mm
90° bend - 150	150	151
90° bend - 200	200	201
90° bend - 300	300	301
90° bend - 400	400	401
90° bend - 500	500	501
90° bend - 600	600	601
90° bend - 800	800	801
90° bend - 1000	1000	1001

Stainless steel Type	Ladder width mm	B mm
90° bend - 150	150	147
90° bend - 200	200	197
90° bend - 300	300	297
90° bend - 400	400	397
90° bend - 500	500	497
90° bend - 600	600	597
90° bend - 800	800	797
90° bend - 1000	1000	997

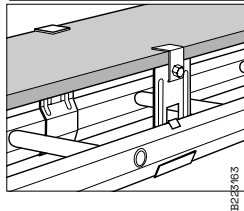

Fasten cover to Profile support piece 37 using Cover clamp.

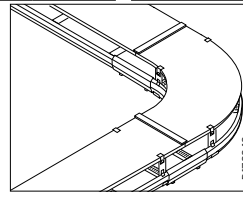

Mount with Profile support pieces 37, Cover clamps and Cover joints.

Cover T-junction

Cover to be used for T-junctions. To be installed with a Profile support piece 37, Cover clamp and Cover joint.

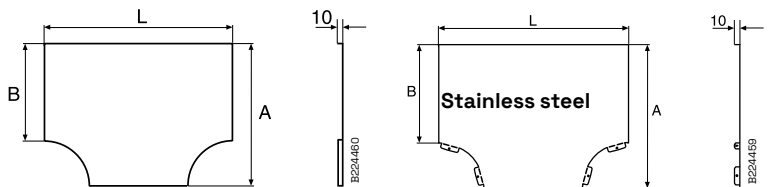

Type + ladder width	A mm	B mm	L mm	Type + ladder width Stainless steel	A mm	B mm	L mm
T-junction - 150	400	151	651	T-junction - 150	402	147	657
T-junction - 200	450	201	701	T-junction - 200	452	197	707
T-junction - 300	550	301	801	T-junction - 300	552	297	807
T-junction - 400	650	401	901	T-junction - 400	652	397	907
T-junction - 500	750	501	1001	T-junction - 500	752	497	1007
T-junction - 600	850	601	1101	T-junction - 600	852	597	1107
T-junction - 800	1050	801	1301	T-junction - 800	1052	797	1307
T-junction - 1000	1240	1001	1501	T-junction - 1000	1242	997	1507

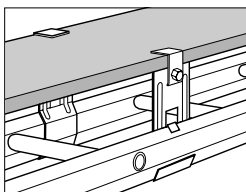

Fasten cover to Profile support piece 37 using Cover clamp.

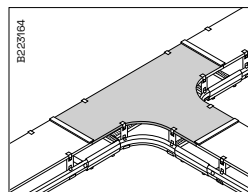

Mount with Profile support pieces 37, Cover clamps and Cover joints.

Use and installation

Profile support piece 37

Profile support piece to be used when installing covers. To be mounted on approximately every 0.5 m along both sides of the cable ladder. Used together with cover clamp for locking covers.

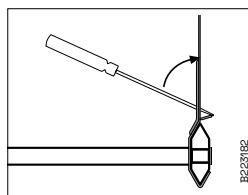
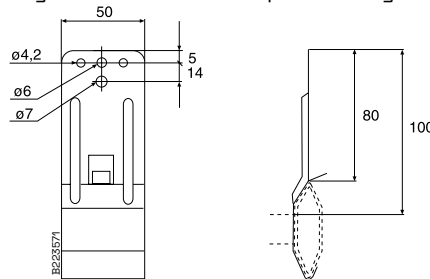

Mount Profile support piece 37 on the inside of the hexagonal section. Bend the tab towards the ladder section using a screwdriver as a lever.

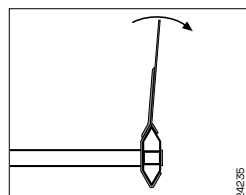

Profile support piece 37 can be bent to fit the cover width.

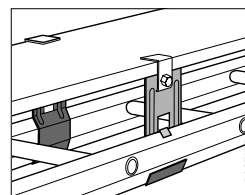

Lock the cover on the Profile support piece 37 using Cover clamps.

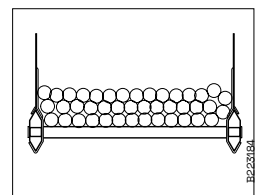

Profile support pieces 37 can be mounted as cable supports. Mount the attachments at about 0.5 m centres on both sides of the ladder.

Cover joint

Cover joint to be inserted between covers.

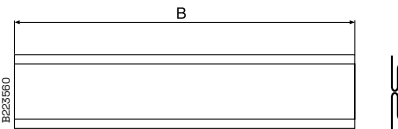

Type	Ladder width mm	B mm
Cover joint 150	10	125
Cover joint 200	200	175
Cover joint 300	300	275
Cover joint 400	400	375
Cover joint 500	500	475
Cover joint 600	600	575

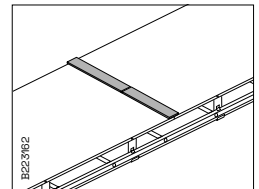

For width 800 or 1000 mm, use a combination of two smaller joints (e.g. 400+600 mm). Insert joints between covers.

Cover clamp

Cover clamps to be used when installing a cover on a Profile support piece 37.

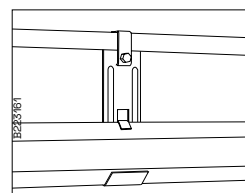
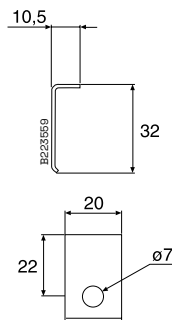

Cover clamps are required for mounting covers on Profile support piece 37.

Use and installation

Protecting cover

Cover to be used to protect the cable runs against ice and snow. Suitable for all cable ladder widths 300 and 400 respectively.

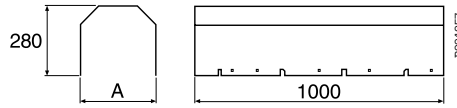

Type	A mm
Protecting cover 300	300
Protecting cover 400	400

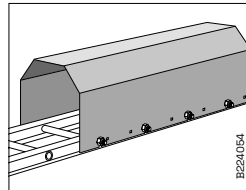

To be mounted on ladder KHZ with Intermediate connection bolt 29. When mounted on other ladders or when needed, drilling screw $\text{Æ} 4.2$ is used.

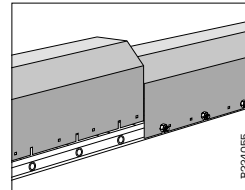

The covers can be mounted with overlap edge.

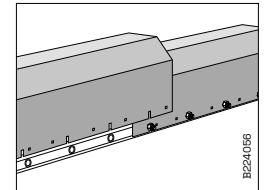

The covers can be mounted with overlap. The asymmetric hole pattern can be used to achieve a good fit.

Cover 64

Cover to be used for vertically mounted cable ladders.

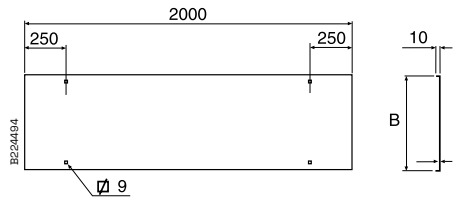

Type	B mm
Cover 64-150	151
Cover 64-200	201
Cover 64-300	301
Cover 64-400	401
Cover 64-500	501
Cover 64- 600	601
Cover 64- 800	801
Cover 64- 1000	1001

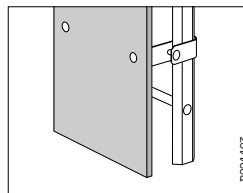

Cover 64 is to be mounted on the cable ladder with Wall bracket 11/25 or Wall bracket 11/75 and Screw set 22S. The covers are to be joined with Cover joints.

Cover plate 65

Cover plate to be used on vertical cable ladder installations as protection of cables near the floor. To be mounted in the side profile with self-tapping screw ST4.2.

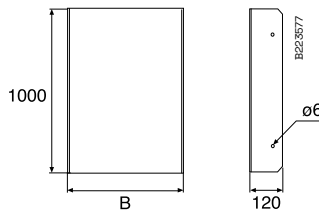

Type	B mm
Cover 65-200	200
Cover 65-300	300
Cover 65-400	400
Cover 65-500	500
Cover 65- 600	600

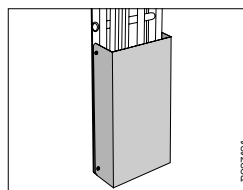

Used on vertical cable ladder installations as protection of cables near the floor. Mounted in the side profile with self-tapping screw ST4.2.

Use and installation



Lighting bracket 200

Lighting bracket to be used for the installation of lighting fittings beneath cable ladders KHZV and KHZPV 200.

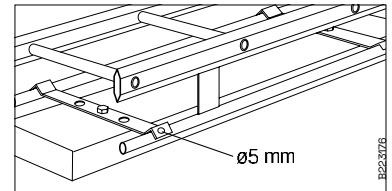
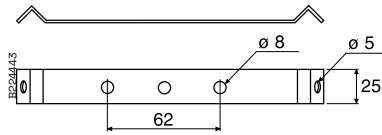

Mount Lighting bracket 200 for KHZV/KHZPV between the two lower tubes. If necessary, 5 mm dia. holes can be used for locking against the arch tube by means of blind rivets or sheet screws.

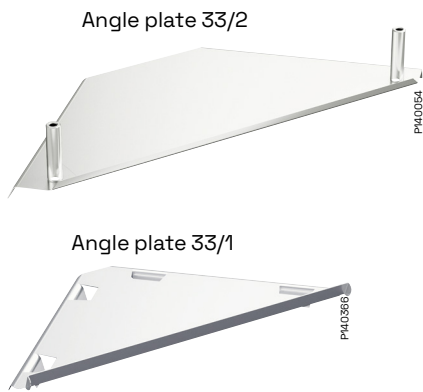

Angle plate 33/1 and 33/2

Angle plate to be used together with 90° horizontal T-junctions. Recommended for all cable ladders.

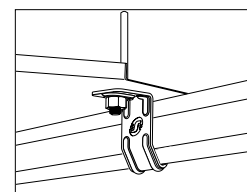
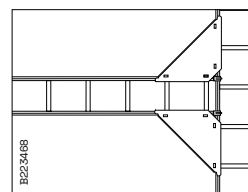
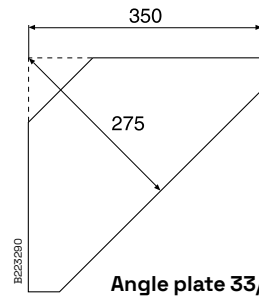
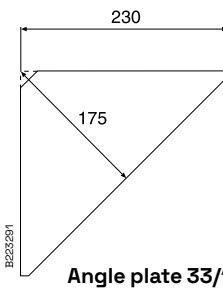

Angle plates are always recommended at 90° horizontal junctions.

To lock Angle plate 33/2, fit Profile clamp 42.



Wall bracket HT-14

Bracket for wall installation

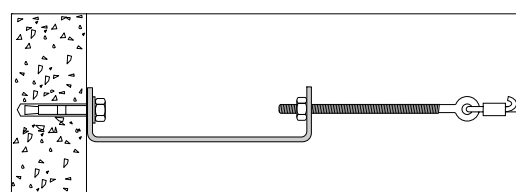
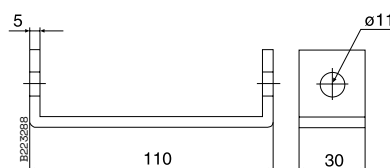

Wall bracket HT-14 is installed on wall with Expansion bolt or concrete screw.

Use and installation

Carrying bracket HT-31

Carrying bracket to be used for ceiling installations. To be installed with Expansion bolt or concrete screw.

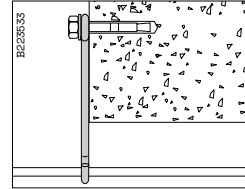
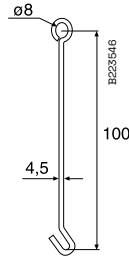

Carrying bracket HT-31 is installed on ceiling beam with Expansion bolt or concrete screw .

Carrying bracket HT-152

Carrying bracket to be used for easy I-beam installations.

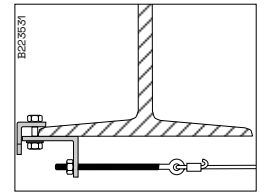
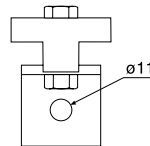
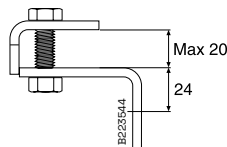
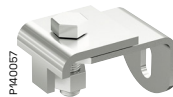

Carrying bracket is easily installed on I-beam.

Carrying bracket HT-33/34

Carrying bracket to be used for ceiling installations. To be installed with Expansion bolt or concrete screw.

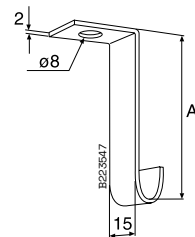
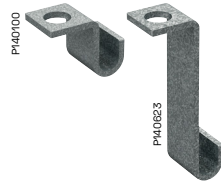

Type	A mm
HT-33	14
HT-34	38

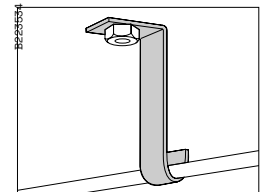

Carrying bracket is installed in ceiling with Expansion bolt or concrete screw.

Carrying sling HT-51

Carrying slings for cables.

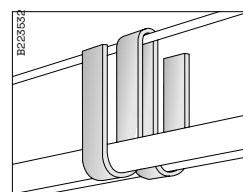
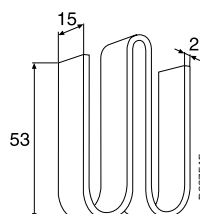
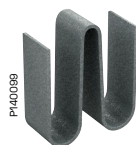

Carrying sling with space for 6 cables max. diam. 16 mm.

Use and installation

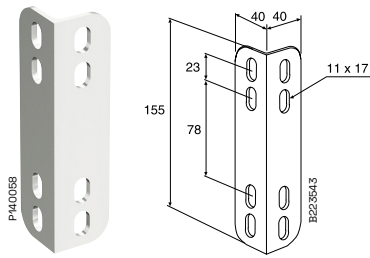

End bracket HT-11

Used for assembling pendant/fixing rails to frames for switching cabinets and electrical control centres. Also suitable for assembling pendant rails for crossing cable runs. Also used as End Bracket for ceiling beam installation.

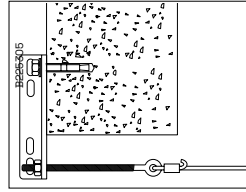

End bracket HT-11 is installed on ceiling beam with Expansion bolt or concrete screw.

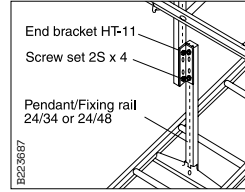

End bracket HT-11 permits mounting of crossing cable ladders in various planes on the same vertical piece.

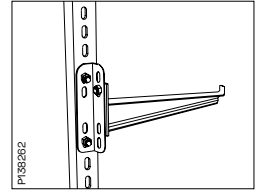

Cantilever arm 50 may, using End bracket HT-11, be mounted at 90° to the vertical piece. Only for lightweight mounting of data cable type or suchlike.

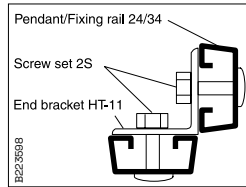

The HT-11 can be used when mounting together 2 Pendant/Fixing rail 24/34, for example when assembling a stand.

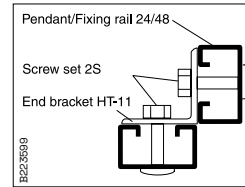

The HT-11 can be used when mounting together 2 Pendant/Fixing rail 24/48 with the opening towards the attachment, for example when assembling a stand.

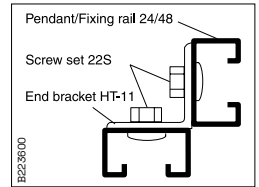

The HT-11 can be used when mounting together 2 Pendant/Fixing rail 24/48, with the rear towards the attachment.

Tightening loop HT

Tightening loop to be installed at the ends of steel wires.

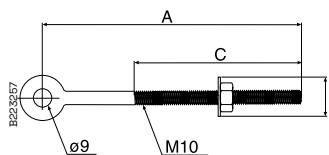

Type	A mm	C mm	D mm
Tightening loop HT-611	125	100	22
Tightening loop HT-621	270	100	50
Tightening loop HT-631	400	150	50

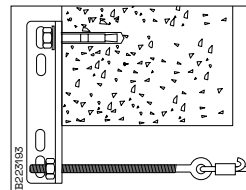

Tightening loop is installed in End bracket HT-11 for installation on ceiling beam.

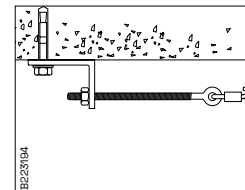

Tightening loop is installed in Angle bracket 5L for installation in ceiling.

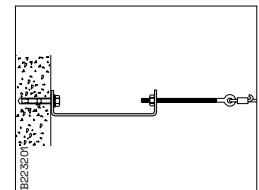

Tightening loop is installed in Wall bracket HT-14 for installation on wall.

Pipe HT-68 and HTR-68

Pipe for easy locking of wires. Ø 15 mm Length 25 mm.

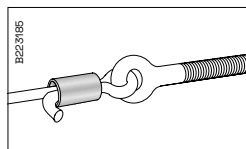

The steel cable is easily locked with the pipe.

Use and installation



Type	Diam. mm	Breaking load kg
HT-2309	5.00	700
HT-2311	6.15	970
HTR-2322	2.50	450
HTR-2323	3.00	700
HTR-2324	4.00	1200

Steel wire

Steel wire to be installed as carrier of one or more cables.

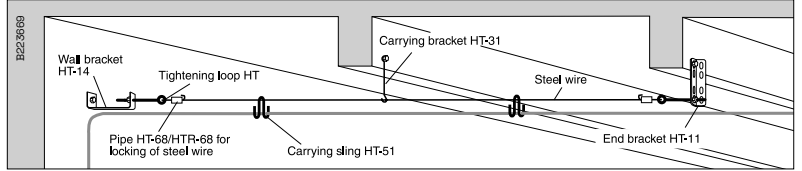

Steel wire installed in ceiling with beams.

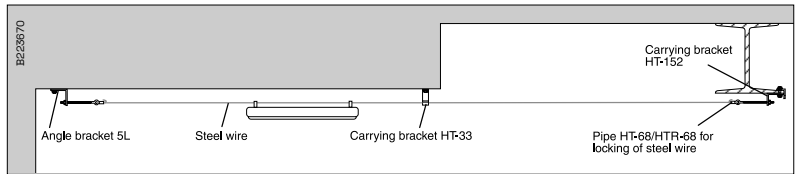

Steel wire installed in ceiling.



Reducer 31

Reducer to be used for transition joining from a wide to a narrower cable ladder.

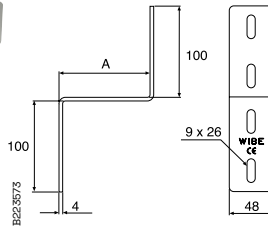

Type	A mm
Reducer 31/100	100
Reducer 31/200	200
Reducer 31/300	300
Reducer 31/400	400

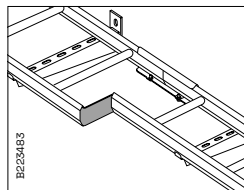

Reducer to be used for transition joining from a wide to a narrower cable ladder.

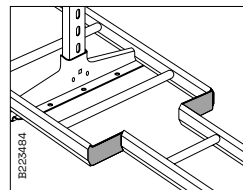

May also be used at centred transition joining



Reducer 20C

Reducer to be used for transition joining from a wide to a narrower cable ladder.

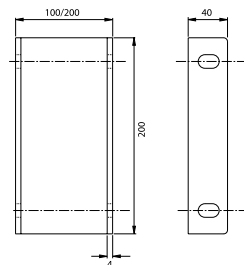

Type	A mm
Reducer 20C/100	100
Reducer 20C/200	200

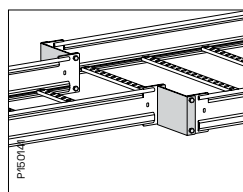

May also be used at centred transition joining

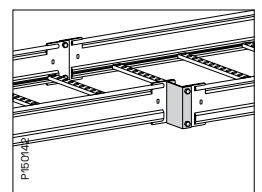

Reducer to be used for transition joining from a wide to a narrower cable ladder.

Use and installation

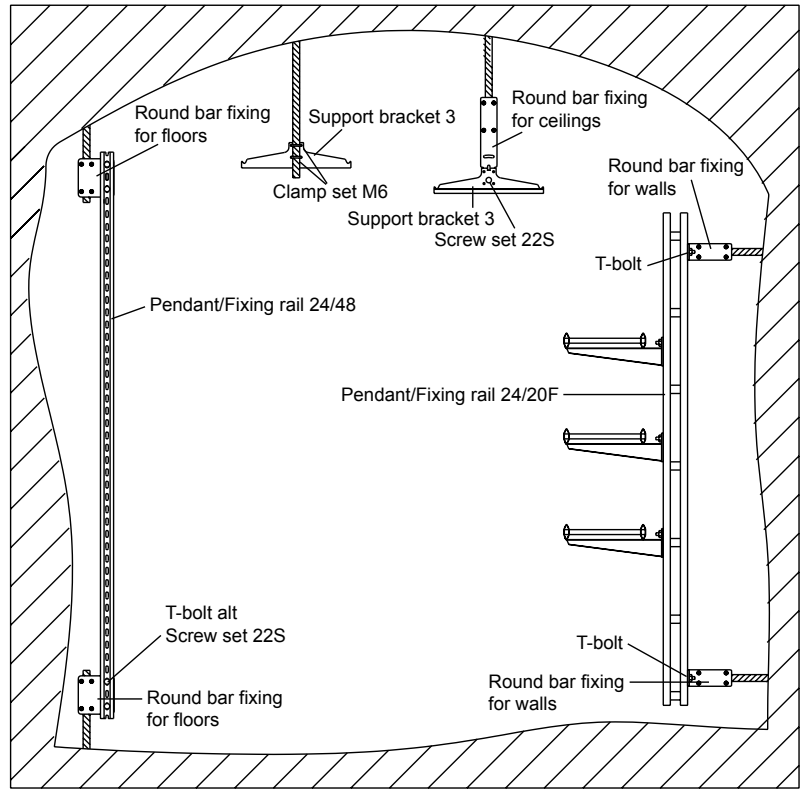

Round bar fixing for ceilings

Round bar fixing to be used for mounting in underground cavities and tunnels.

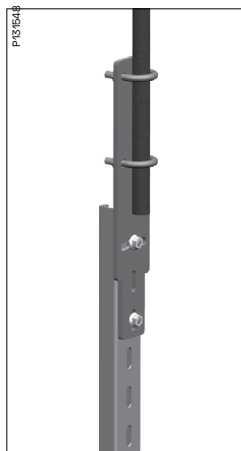
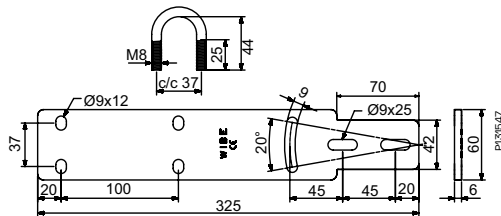

Round bar fixing for ceilings is mounted on pendant/fixing rail 24/48 with screw set 22S. Support bracket 3 is mounted directly on the fixing with Screw set 22S.



Using round bar fixing for ceilings, pendant/fixing rail 24/48 and screw set 22S it is possible to make a vertical piece that can be installed at an angle of up to 10°.

Use and installation



Round bar fixing for walls

Round bar fixing to be used for mounting in underground cavities and tunnels.

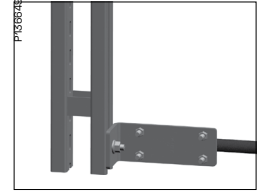
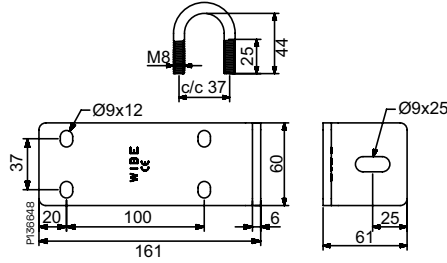

Round bar fixing for walls mounted on Pendant/fixing rail 24/20F with T-bolt 26U.



Round bar fixing for floors

Round bar fixing to be used for mounting in underground cavities and tunnels.

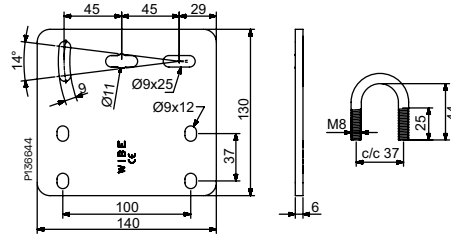

Round bar fixing for floors mounted on Pendant/fixing rail 24/48 with Screw set 22S.



Round bar fixing for floors mounted on Pendant/fixing rail 24/48 with T-bolt 26U.



Clamp set M6

Clamp set to be used for the installation of Support bracket 3 directly on a roof bolt. The set includes two clamps and four locking nuts. M6-25 must be used for Support bracket 3 in hot-dip and pre-galvanized surface finish, whereas M6-20 must be used for Support bracket 3 in stainless steel and Installation plate 60 in all surface treatments.

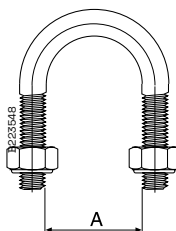

Type	Ø
M6-25	29
M6-20	24

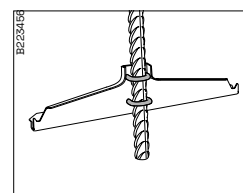

For installation of Support bracket 3 directly on ribbed bar 16-25 or fully threaded bar M16-M27.

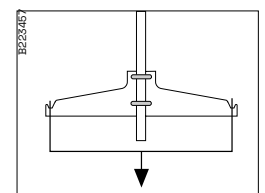

Max. symmetrical loading 300 kg. Make sure the clamps grip the bar in a correct manner.

Use and installation

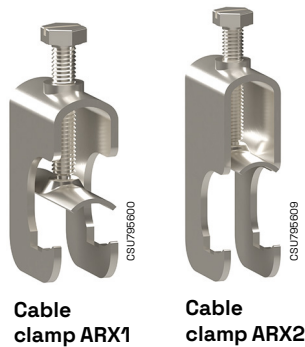

Cable clamp ARX

Cable clamp for fastening of cable on Pendant/Fixing rail 24/48 and on cable ladders KHZ, KHZV, KHZSP, KHZSPZ+, KHZSP85, KHZPS, KHZP and KHZPV, in combination with Insert piece EM.

Cable clamp ARX1

Type	For cable mm
CABLE CLAMP ARX1-12 Z+	- 12
CABLE CLAMP ARX1-16 Z+	13 - 16
CABLE CLAMP ARX1-22 Z+	17 - 22
CABLE CLAMP ARX1-28 Z+	23 - 28
CABLE CLAMP ARX1-36 Z+	29 - 36
CABLE CLAMP ARX1-44 Z+	37 - 44
CABLE CLAMP ARX1-52 Z+	45 - 52
CABLE CLAMP ARX1-60 Z+	53 - 60
CABLE CLAMP ARX1-70 Z+	61 - 70

Cable clamp ARX2

Type	For cable mm
CABLE CLAMP ARX2-12 Z+	- 12
CABLE CLAMP ARX2-16 Z+	13 - 16
CABLE CLAMP ARX2-22 Z+	17 - 22
CABLE CLAMP ARX2-28 Z+	23 - 28
CABLE CLAMP ARX2-36 Z+	29 - 36
CABLE CLAMP ARX2-44 Z+	37 - 44
CABLE CLAMP ARX2-52 Z+	45 - 52
CABLE CLAMP ARX2-60 Z+	53 - 60

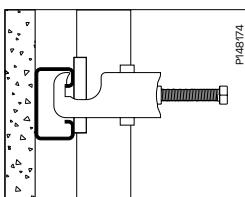

Use Cable clamp ARX to attach cables to Pendant/Fixing rail 24/48. Use Insert piece EM.

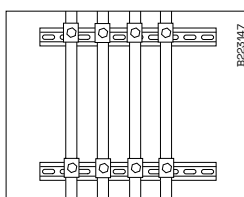

Mounting rail 40 with Cable clamp ARX.

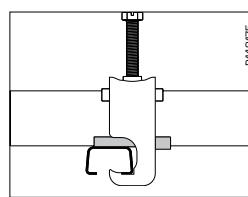

Use Cable clamp ARX to attach cables to cable ladders KHZSP, KHZSPZ+, KHZPS, KHZPV and KHZP. Use Insert piece EM.

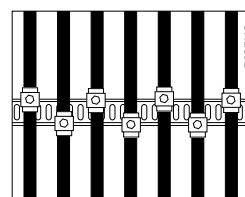

In order to avoid torsion of the rung, cable clamps can be mounted opposite each other on the rung.

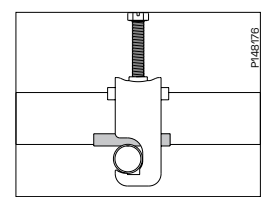

Cable clamp ARX is used for fastening cables on the cable ladders KHZ and KHZV. Insert piece EM must be installed.

Use and installation

Insert piece EM



Insert piece to be used in order to prevent pressure on the cable. The insert piece is placed between the cable and the rung from the same side where the clamp has been fastened to the rung.

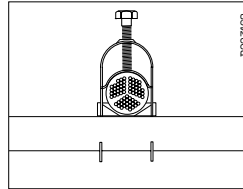
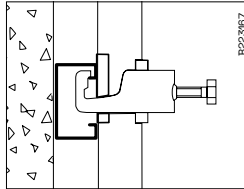

Insert pieces increase the contact area of the cables.

Type	For cable mm
EM - 12	- 12
EM - 16	13 - 16
EM - 22	17 - 22
EM - 28	23 - 28
EM - 36	29 - 36
EM - 44	37 - 44
EM - 52	45 - 52
EM - 60	53 - 60
EM - 70	61 - 70

Lashing wire

Lashing wire to be used for lashing of wires on cable ladders.



Type		Diam mm	Breaking load kg
HTR - 2303	Lashing wire, stainless steel, white PVC	1.25	92
HTR - 2313	Lashing wire, stainless steel, black PVC	1.25	92
HT - 2304	Lashing wire, white PVC	1.5	25
HT - 2314	Lashing wire, black PVC	1.5	25

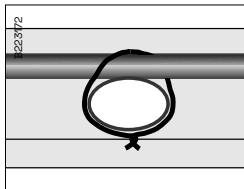

Cables are easily installed by lashing around the rungs of KHZ and KHZV.

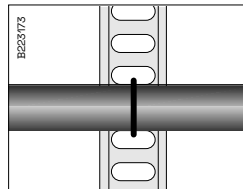

Cables are easily installed by lashing through the perforations of the rungs or around the rungs of KHZSP, KHZSPZ+, KHZPS, KHZP and KHZPV.

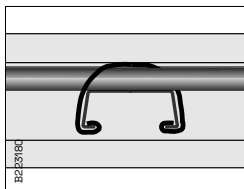

Cables are easily installed on KHZSP, KHZSPZ+, KHZPS, KHZP and KHZPV by lashing in such a way that the lashing wire is pinched around the rung as shown.

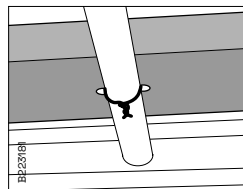

Dividing strips and tele- conduits are attached to the ladder by lashing around the rungs of KHZ and KHZV

Use and installation

Cable clamp ER

Cable clamp for the installation of cables on cable ladders with round or perforated rungs.



Cable clamp ER



Oval rung adaptor

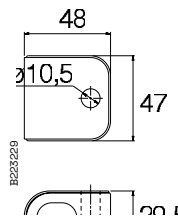
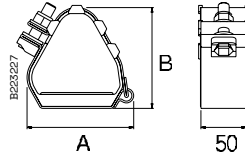

Type	For cable mm	A mm	B mm
Cable clamp ER	23 - 28	80	74
Cable clamp ER	27 - 32	82	81
Cable clamp ER	30 - 35	82	88
Cable clamp ER	33 - 38	85	94
Cable clamp ER	36 - 42	113	101
Cable clamp ER	40 - 46	115	108
Cable clamp ER	44 - 50	117	115
Cable clamp ER	48 - 55	120	129
Cable clamp ER	51 - 58	121	130
Cable clamp ER	55 - 62	156	138
Cable clamp ER	59 - 66	158	146
Cable clamp ER	63 - 70	160	150
Cable clamp ER	67 - 74	163	161
Cable clamp ER	71 - 78	165	168
Cable clamp ER	74 - 82	167	176
Cable clamp ER	77 - 85	169	181

Tested at British short-circuit testing station. Test report no. BS/F 1265

- Wibe cable ladder KHZ-600, KHZP-300 and KHZP-600. Cable clamp ER mounted on every rung.
- Wibe cable ladder KHZ-300. Cable clamp ER mounted on every other rung.

Condition after test

400 volt 58 kA symmetrical current (Peak 140 kA) during 0.1 second:

- All clamps remained secure
- Some slight distortion of the ladder rungs
- The cables were splayed out between the clamps but otherwise in good order.

Test report no. BS/F 1268

- Wibe cable ladder KHZ-600 and KHZP-600. Cable clamp ER mounted on every other rung

Condition after test

352 volt 64 kA symmetrical current (Peak 140 kA) during 0.1 second:

- All clamps remained secure
- There was distortion of a number of the ladder rungs
- The cables were splayed out between the clamps but otherwise in good order.

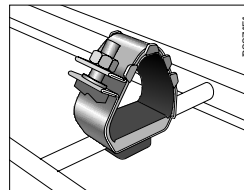

Remove the bottom plate of the clamp and mount it with Oval rung adaptor on cable ladders with round rungs - KHZ and KHZV.

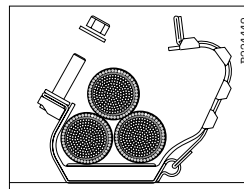

Mount the cables.

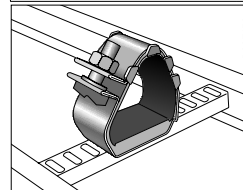

Remove the bottom plate of the clamp and mount it with 2 screw sets 74S on cable ladders with perforated rungs - KHZP, KHZPS, KHZSP, KHZSPZ+ and KHZPV.

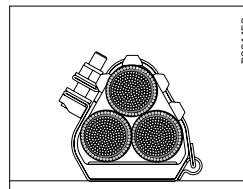

Lock the clamp with the locking nut. Turn the nut to max. 4-5 Nm. The rubber lining must touch the cables but not so tight that the cables will be deformed

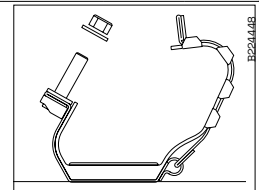

Remove the locking nut. Open the clamp.

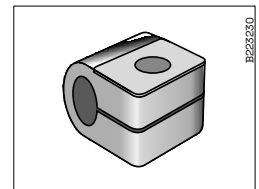

Oval rung adaptor, screw set included, to be used when mounting Cable clamp ER on oval rungs on the KHZ range.

Use and installation



PTCSU-04

Mounting rail WMS25L

Mounting rail to be used for installation directly on wall for lashing of cables.

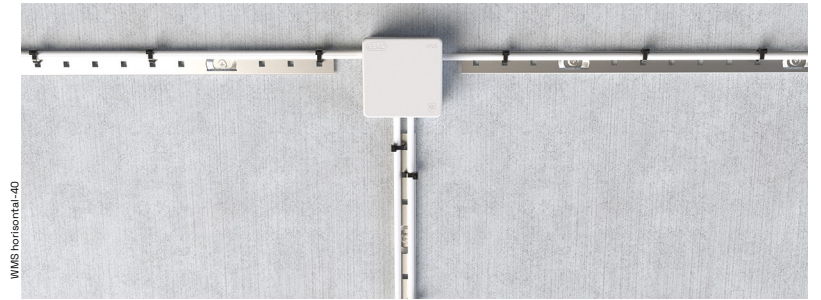
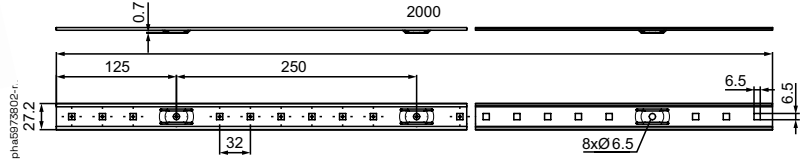

WMS horizontal-40

Mounting of cables with lashing wire, strips etc. The mounting rail installed directly onto wall.



P1440E3

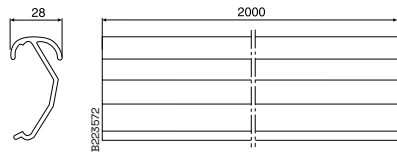

Profile protection 28P

Profile protection to be used to increase the contact surface of the cables, when pulled over the side profile of the ladder.

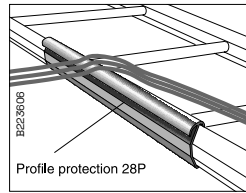

Profile protection 28P

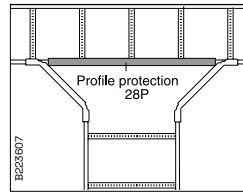

Profile protection 28P

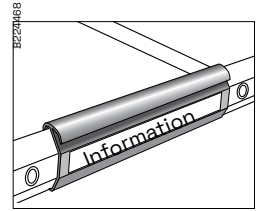

B2220468

Mount Profile protection 28P in order to increase the contact surface of the cable, when pulled over the side profile of the ladder. Cut when required.

Can be cut in suitable lengths and equipped with an information label. Easy to mount on the ladder side profile.

Use and installation

Marking plate 93

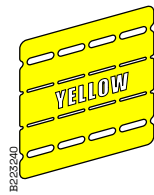

Marking plates are part of a colour marking system that is easy to use when you want to mark out the type of cable that is placed on the cable ladder

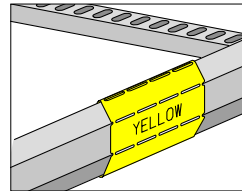
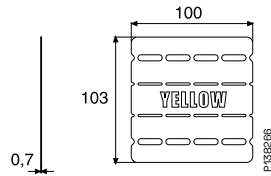

The Marking plate can be bent around the side profile on all Wibe cable ladders.

End plug 28 and 28i

End plug to be mounted on ladder ends for sealing or protection.



End plug 28



End plug 28i

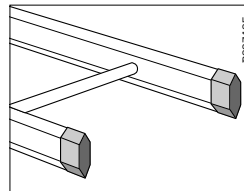

Mount End plug 28 in ladder ends as protection.

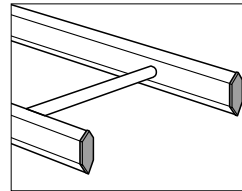

Mount End plug 28i inside the ladder ends for se- aling. Joining with Joint 19 or 21 can be made with End plug 28i left in the ladders ends.

End plug 28C, D, E, F and J

End plug to be mounted on pendant ends to provide protection against personal injury and to make the ends of the profiles more conspicuous.

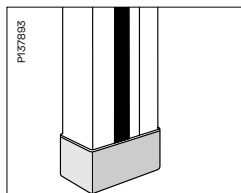
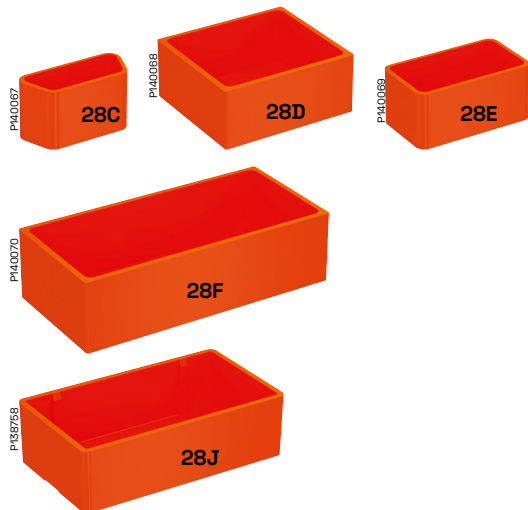

End plug **28C** fits Vertical piece 2 and Pendant/ Fixing rail 24/34.
End plug **28E** fits Vertical piece 2F and Pendant/ Fixing rail 24/48.

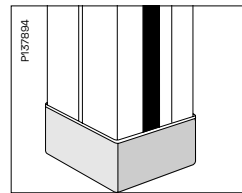

End plug **28D** fits Vertical piece 20 and Pendant/ Fixing rail 24/20.
End plug **28F** fits Vertical piece 20FS and Pendant/ Fixing rail 24/20FS.
End plug **28J** for Vertical piece 20F and Pendant/ Fixing rail 24/20F

Cross member plug 27

Cross member plug to be installed at the ends of the rungs of KHZ and KHZV. Used in premises with a high corrosion risk.

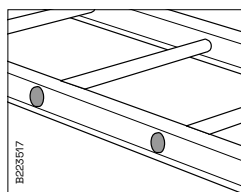
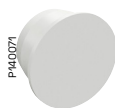

Mount Cross member plug 27 in KHZ and KHZV rung tube ends in pre- mises with high relative humidity where the risk of corrosion is high

Use and installation



T-bolt 26U

Easy to fit into the fixing rail. It is made to stick which makes it easier to mount and attach compared to a spring nut. It stays in place by itself even before it is fixed with the nut. To be used for the mounting of Cantilever arm 50 on Pendant/Fixing rail 24/48 and all vertical pieces except Vertical piece 2.

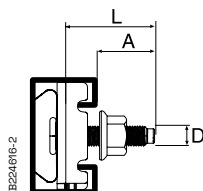

Type	L mm	A mm
M8	34	23
M10	34	23
M10	44	33
M10	54	43

Max permitted extraction force

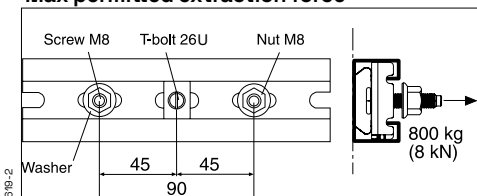

T-bolt 26U M8/M10 + P/F-rail 24/48 + Washer 8.4x19x1.5

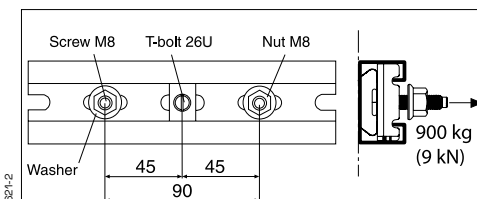

T-bolt 26U M8 + P/F-rail 24/48 + Washer 9x35x2

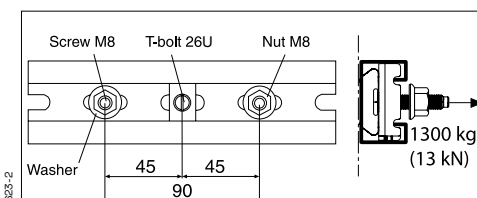

T-bolt 26U M10 + P/F-rail 24/48 + Washer 9x35x2

Screw set M12

Screw set to be used for all joints with cable ladders KHZV and KHZPV.

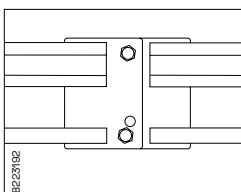

For joining ladders.

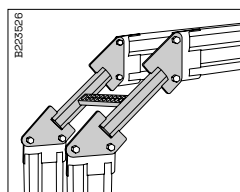

For joints with Riser coupling 49.

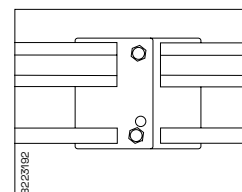

For joints with 90° bend 55 and T-junctions 56.

Use and installation



Screw set 2S

Screw set to be used for fastening of Support bracket 3 on Pendant/fixing rail 24/20F and Angle bracket 5L to the opening on Pendant rail 24/34 and 24/48. Set including screw MVBF 8x40 and nut M6MF8.



Screw set 20S

Screw set to be used for installation of Support bracket 3 on Pendant/fixing rail 24/20 and Vertical piece 20, Angle bracket 5L to the opening on Pendant rail 24/48 and 24/20. Set including screw MVBF 8x60 and nut M6MF8.



Screw set 22S

Screw set to be used for installation of Support bracket 3 on Vertical piece 2 and 2F, Support bracket 3 and Ceiling bracket 5 on Pendant/fixing rails 24/34 and 24/48, Angle bracket 5L against the back of Pendant/fixing rails, Pendant/fixing rails back to back. Set including screw MVBF 8x16 and nut M6MF8.



Screw set W34

Screw set to be used for the fastening of dividing strips on cable ladders KHZSP, KHZSPZ+, KHZPS and KHZPV. Set including screw MSCS 6x12 and nut M6MF 6.



Screw set W37

Screw set including bolt MVBF 8x35 and nut M6MF 8, to be used for the installation of Support bracket 3 on Vertical piece 20F.



Screw set M10 x 20

Screw to be used with Spring nut M10 for the installation of Cantilever arm 50 on Pendant/fixing rail 24/48.



Spring nut M8/M10

Spring nut to be used for fastening of accessories (control panels, etc.) on Pendant/fixing rail 24/48.

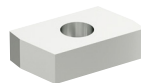

Back nut M8

Back nut to be used for fastening of vertical pieces, etc., in the rungs of cable ladders KHZSP, KHZSPZ+, KHZP, KHZPS and KHZPV.

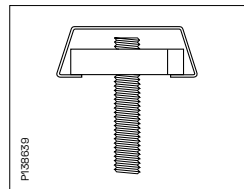

Mounting with Threaded rod M8 and Backnut M8 in the cable ladder rungs.

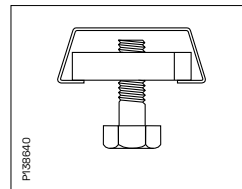

Pendants etc. are mounted with Bolt M8 and Back nut M8 in the rungs.



Flange nut B43 M8, M10

Used for joining of Threaded rod W76 M8 and M10.



Thread lock B50 M8, M10

Used for joining of Threaded rod W76 M8 and M10.

Use and installation



Intermediate connection bolt 29

Intermediate connection bolt to be used at the transition from a broad to a narrower cable ladder KHZ.

Type	Bolt diam x length mm
Intermediate connection bolt 29/200	M10 x 235
Intermediate connection bolt 29/300	M10 x 335
Intermediate connection bolt 29/400	M10 x 435
Intermediate connection bolt 29/500	M10 x 535
Intermediate connection bolt 29/600	M10 x 635

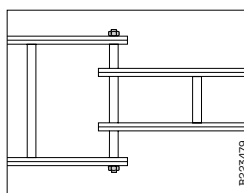

Intermediate connection bolts are used for channing from a broad to a narrower ladder. The broader ladder's last rung is cut to permit the narrower ladder to fit in. The intermediate connection bolt is mounted through the rungs of the KHZ ladder.

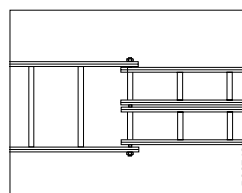

Intermediate connection bolts can also be used for transition from one wide ladder to two narrower ones.

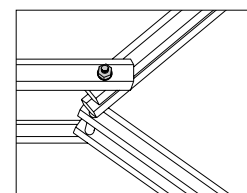

Intermediate connection bolt also permits formation of angles.

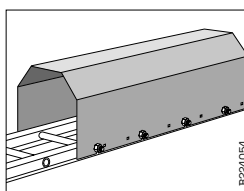

To be mounted on ladder KHZ with Intermediate connection bolt 29.

Use and installation

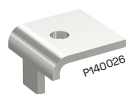

Beam clamp 5BK

Beam clamp to be used for the installation of Vertical pieces 2, 2F or 20 on I-beams.

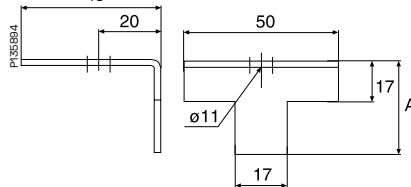

Type	A mm
Beam clamp 5BK-10, for flange thickness max 13 mm	30
Beam clamp 5BK-30, for flange thickness max 14-30 mm	50

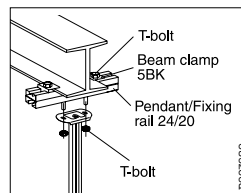
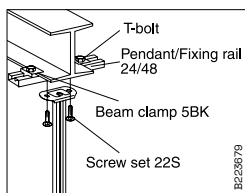

On ceiling beams, mount Vertical piece 2, 2F or 20 using 2 Beam clamps 5BK, Pendant/Fixing rail 24/48 and Screw set 22S. For Beam clamp 5BK-10, use T-bolt 26U/40. For Beam clamp 5BK-30, use T-bolt 26U/50.

Alternatively, a Pendant/Fixing rail 24/20 may be used. This will require 4 T-bolts.



Hot dip galv.

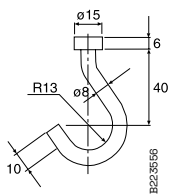

AISI 316L

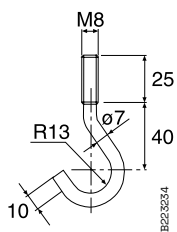

Hook 8

Hook to be used for the installation of cables beneath Support bracket 3. Can also be installed in perforated rungs.

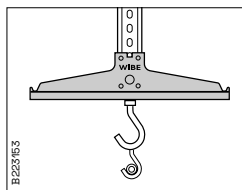

Hook 8 mounted beneath Support bracket 3 for installation of cables.

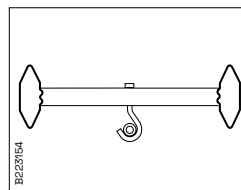

Hook 8 installed in a perforated rung.

Use and installation

Cable roller S

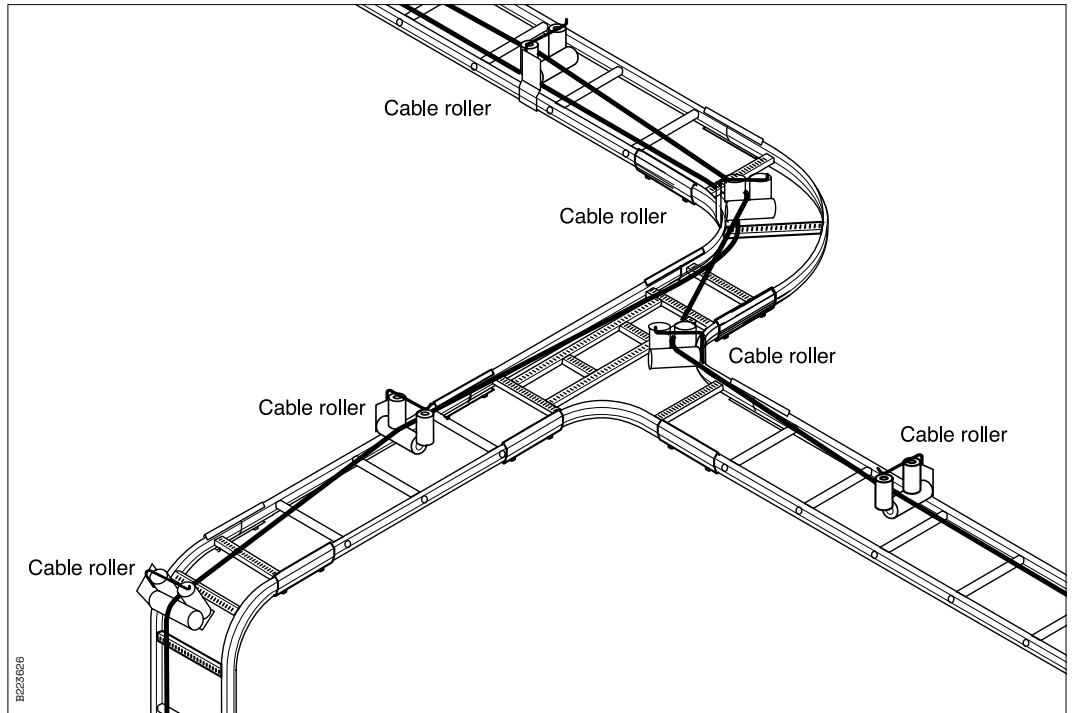

Cable roller used to facilitate the pulling of cables and lines. Easily installed on all Wibe cable ladders except the high-sided WHS ladders (outer mounting hole). Also suitable for external/internal profiles of all 90° bends, T-junctions, X-junctions and risers (inner mounting hole). With a height adjustment of 45 mm to leave room for cables to pass under the roller.

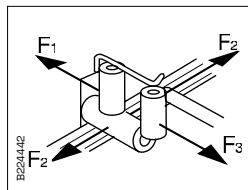
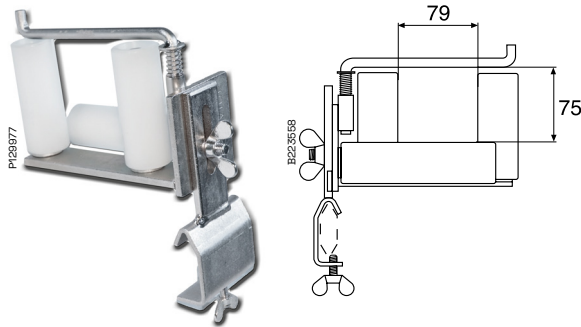

Load

Permitted loading $F_1 = 100$ kg (KHZ, KHZP, KHZV) 35 kg (KHZSP)
 Permitted loading $F_2 = 125$ kg (KHZ, KHZP, KHZV) 35 kg (KHZSP)
 Permitted loading $F_3 = 100$ kg (KHZ, KHZP, KHZV) 35 kg (KHZSP)

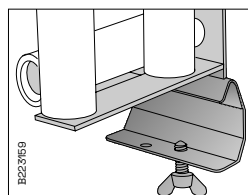

For fitting on 90°, T- and Xjunctions, use the inner mounting hole.

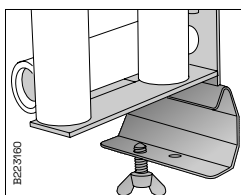

For mounting on ladders, use the outer mounting hole.

Use and installation

Cable roller 38 Rig'n roll

Cable roller used for mounting on Wibe cable ladders with belonging junctions and branches.

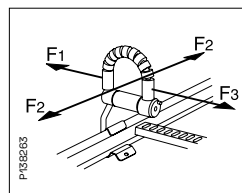
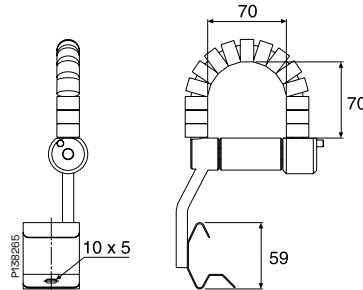

Load

Permitted loading $F_1 = 20$ kg (KHZ, KHZP, KHZV, KHZSP)
 Permitted loading $F_2 = 50$ kg (KHZ, KHZP, KHZV, KHZSP)
 Permitted loading $F_3 = 50$ kg (KHZ, KHZP, KHZV)
 25 kg (KHZSP)

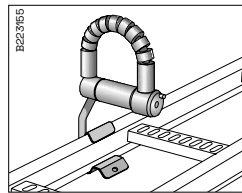

Cable roller 38 is to be mounted on the cable ladder profile.

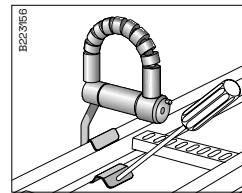

Use a screw driver when dismantling the cable roller.

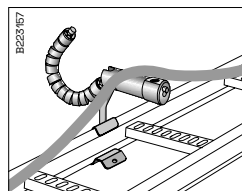

Open the cable roller by pressing the locking button and turn the loop aside.

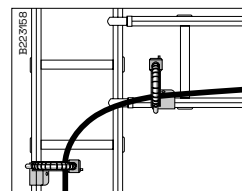

The loop has rollers which make cable pulling over bends and junctions very easy.

Appropriate tightening torque

Part	Application	Tightening torque (Nm)
T-Bolt 26U+2F+Ca50i	Support system	M8: 15/M10: 25
Screw set 2S+Pendant bar1+2F	Support system, front side of 2F	M8: 15/M10: 25
Screw set 2S+Pendant bar1+2F	Support system, back side of 2F	M8: 15/M10: 25
Screw set 20S+2F+(2)Ca50i	Balance application	M8: 15/M10: 25
Screw set 22S+2F+Ca50i	Support system, back side of 2F	M8: 15/M10: 25
2FJ+24/48	Extension application	M8: 15/M10: 25

Reference number overview

7									
705093.....	61	714066.....	78	716252.....	85	718179.....	64	720762.....	59
705304.....	56	714067.....	83	716253.....	85	718180.....	64	720763.....	59
705392.....	72	714085.....	83	716254.....	85	718181.....	64	720764.....	59
705394.....	72	714165.....	78	716255.....	66	718182.....	64	720765.....	59
705395.....	72	714168.....	87	716257.....	66	718183.....	64	720766.....	59
705396.....	72	714179.....	79	716258.....	66	718184.....	84	720786.....	97
705397.....	72	714198.....	77	716259.....	66	718185.....	84	720815.....	57
706415.....	72	714200.....	77	716260.....	66	718187.....	84	720816.....	78
707511.....	57	714201.....	77	716261.....	66	718188.....	84	720824.....	58
707609.....	56	714202.....	77	716262.....	85	718189.....	84	721101.....	41
707748.....	69	714203.....	77	716264.....	85	718190.....	84	721102.....	40
708001.....	58	714227.....	78	716265.....	85	718191.....	84	721105.....	40
709017.....	42, 63	714700.....	79	716266.....	85	718243.....	64	721106.....	40
709018.....	42, 63	715675.....	64	716267.....	85	718249.....	60	721114.....	45
709019.....	47, 71, 87, 102	715723.....	60	716268.....	85	718250.....	60	721115.....	39
709020.....	47, 71, 87, 102	715724.....	60	716276.....	80	718251.....	60	721119.....	41
709021.....	47, 71, 87, 102	715725.....	60	716277.....	80	718253.....	62	721122.....	39
709031.....	61	715726.....	60	716278.....	80	718409.....	57	721862.....	79
709050.....	46	715727.....	60	716279.....	80	718410.....	78	721863.....	79
709051.....	46	715728.....	60	716280.....	80	718411.....	65	721864.....	79
709052.....	46	715735.....	72	716281.....	80	718473.....	47	721865.....	79
709053.....	46	715736.....	72	716282.....	80	718484.....	80	721866.....	79
709054.....	46	715879.....	61	716283.....	80	718485.....	80	721867.....	79
709055.....	46	716066.....	65	716284.....	80	718486.....	80	721869.....	40
709056.....	46	716067.....	65	716285.....	80	718487.....	83	721870.....	40
709057.....	46	716069.....	65	716286.....	80	718488.....	81	721871.....	40
709058.....	46	716070.....	65	716287.....	80	718562.....	52	721872.....	40
709795.....	61	716071.....	65	716293.....	83	718563.....	52	721873.....	40
709798.....	61	716072.....	65	716294.....	83	718564.....	52	721945.....	79
709799.....	60	716073.....	65	716295.....	83	718565.....	52	721960.....	52
709801.....	62	716074.....	84	716302.....	82	718566.....	52	721961.....	65
711205.....	42	716075.....	84	716303.....	82	718567.....	52	721962.....	66
712015.....	54	716077.....	84	716304.....	81	718568.....	52	721963.....	67
712017.....	54	716078.....	84	716306.....	81	718572.....	38	721964.....	64
712018.....	54	716079.....	84	716307.....	81	718573.....	38	723057.....	65
712019.....	54	716080.....	84	716308.....	81	718574.....	38	723061.....	43
712020.....	54	716081.....	84	716309.....	81	718575.....	38	723062.....	43
712465.....	58	716179.....	65	716389.....	65	718576.....	38	723063.....	43
712639.....	45	716180.....	65	716390.....	65	718591.....	75	723064.....	43
712640.....	45	716182.....	65	716391.....	65	718592.....	75	723065.....	43
712642.....	45	716183.....	65	716392.....	65	718593.....	75	723212.....	39
712643.....	45	716184.....	65	716393.....	65	718594.....	75	723260.....	65
712644.....	45	716185.....	65	716395.....	84	718595.....	75	723390.....	77
712645.....	45	716186.....	85	716396.....	84	718596.....	75	723391.....	77
713153.....	63	716187.....	85	716397.....	84	718597.....	75	723392.....	77
713173.....	63	716189.....	85	716398.....	84	718618.....	43	723393.....	77
713177.....	63	716190.....	85	716399.....	84	718624.....	58	723394.....	77
713178.....	63	716191.....	85	716400.....	54	718625.....	58	723432.....	58
713203.....	59	716192.....	85	716401.....	77	718626.....	58	723433.....	58
713204.....	59	716193.....	66	716407.....	72	718627.....	58	723434.....	58
713207.....	79	716194.....	66	716640.....	43	718628.....	58	723435.....	58
713208.....	79	716196.....	66	716792.....	42	718632.....	72	723436.....	58
713671.....	69	716197.....	66	716793.....	42	718640.....	63	723437.....	58
713672.....	69	716198.....	66	716824.....	44, 67, 100	718643.....	69	723438.....	58
713674.....	46	716199.....	66	717001.....	70	718644.....	83	723439.....	58
713675.....	46	716200.....	66	717191.....	60	718660.....	50, 74, 88	723440.....	79
713676.....	46	716201.....	85	717192.....	60	718660.....	103	723441.....	79
713677.....	69	716202.....	85	717193.....	60	718718.....	60	723442.....	79
713678.....	101	716204.....	85	717194.....	60	718719.....	60	723443.....	79
713679.....	46, 70	716205.....	85	717195.....	60	718720.....	60	723444.....	79
713681.....	46, 70, 101	716206.....	85	717196.....	60	718721.....	60	723445.....	79
713682.....	46, 70, 101	716207.....	85	717197.....	60	718793.....	79	723446.....	79
713683.....	46, 70, 101	716208.....	85	717198.....	60	718808.....	61	723447.....	79
713684.....	46, 71, 87, 102	716209.....	67	717199.....	60	718835.....	44	723450.....	59
713685.....	46, 71, 87, 102	716210.....	67	717200.....	60	718849.....	62	723451.....	59
713686.....	46, 71, 87, 102	716212.....	67	717201.....	80	718850.....	62	723904.....	51
713687.....	46, 71, 87, 102	716213.....	67	717202.....	80	718851.....	62	724806.....	42
713688.....	46, 70	716214.....	67	717203.....	80	718901.....	65	725065.....	43
713689.....	69	716215.....	67	717204.....	80	718902.....	65	725066.....	43
713690.....	69	716216.....	67	717205.....	80	718903.....	62	725067.....	43
713691.....	69	716217.....	85	717618.....	69	718904.....	62	725079.....	42
713694.....	72	716218.....	85	717636.....	69	720517.....	65	725083.....	42
714021.....	79	716220.....	85	717637.....	74	720518.....	84	725096.....	57
714022.....	79	716221.....	85	717640.....	62	720521.....	80	725350.....	38
714023.....	79	716222.....	85	717641.....	62	720522.....	80	725351.....	38
714024.....	79	716223.....	85	717642.....	62	720523.....	80	725352.....	38
714029.....	83	716224.....	85	717643.....	82	720524.....	80	725353.....	38
714058.....	76	716241.....	66	717644.....	82	720525.....	81	725354.....	38
714059.....	76	716243.....	66	717645.....	82	720526.....	81	725355.....	38
714061.....	76	716244.....	66	717982.....	54	720527.....	82	725356.....	38
714062.....	76	716245.....	66	717983.....	54	720528.....	82	725357.....	40
714063.....	76	716246.....	66	717984.....	54	720529.....	82	725358.....	40
714064.....	76	716247.....	66	717985.....	54	720530.....	82	725359.....	40
		716248.....	85	717986.....	54	720531.....	82	725360.....	40
		716250.....	85	718176.....	64	720536.....	62	725361.....	40
		716251.....	85	718177.....	64	720761.....	59	725362.....	41

Reference number overview

725363.....	39	727359.....	99	731914.....	94	735446.....	47, 71, 87, 102	782365.....	86
725557.....	96	727360.....	99	731961.....	43	735998.....	50, 74, 88, 103	782366.....	86
725558.....	96	727361.....	99	731962.....	43	736440.....	97	782367.....	86
725559.....	96	727362.....	99	731994.....	47, 71, 87, 102	736441.....	97	782368.....	86
725560.....	96	727363.....	99	732151.....	46, 71, 87, 102	736442.....	97	782369.....	86
725561.....	96	727364.....	99	732177.....	41	736443.....	97	782370.....	86
725562.....	96	727365.....	99	732214.....	44	736444.....	97	782371.....	86
725563.....	96	727366.....	99	732215.....	44	736445.....	97	782382.....	86
725564.....	96	727367.....	99	732216.....	44	736446.....	97	782569.....	86
725565.....	96	727368.....	99	732217.....	44	736447.....	97	782570.....	86
725566.....	96	727369.....	99	732218.....	44	736448.....	97	782571.....	86
725567.....	96	727370.....	98	732219.....	44	736449.....	97	782572.....	86
725568.....	96	727371.....	98	732220.....	44	736450.....	97	782573.....	86
725569.....	96	727372.....	98	732221.....	44	736451.....	97	782574.....	86
725570.....	96	727373.....	98	732222.....	44	736452.....	97	782575.....	86
725571.....	96	727374.....	98	732264.....	68	736453.....	97	782576.....	86
725572.....	96	727375.....	98	732265.....	68	736454.....	97	782585.....	100
725573.....	95	727376.....	92	732266.....	68	736455.....	97	782586.....	100
725574.....	96	727377.....	92	732267.....	68	736456.....	97	782587.....	100
725575.....	96	727378.....	92	732268.....	68	737198.....	97	782588.....	100
725576.....	96	727379.....	92	732269.....	68	737704.....	47, 73, 88, 103	782589.....	100
725577.....	96	727380.....	92	732270.....	68	737705.....	47, 73, 88, 103	782590.....	100
725578.....	96	727381.....	92	732291.....	100	737706.....	47, 73, 88, 103	782591.....	100
725579.....	96	727382.....	91	732292.....	100	737707.....	47, 73, 88, 103	782592.....	100
725582.....	103	727383.....	91	732293.....	100	737708.....	47, 73, 88, 103	783155.....	38
725587.....	97	727384.....	91	732294.....	100	739713.....	88	783156.....	38
725589.....	102	727385.....	91	732295.....	100	768001.....	53	783157.....	38
725590.....	99	727386.....	91	732296.....	100	768002.....	53	783158.....	38
725591.....	99	727387.....	91	732297.....	100	768004.....	53	783159.....	38
725592.....	99	727582.....	40	732322.....	44	768005.....	53	783374.....	94
725593.....	99	727583.....	40	732323.....	44	768006.....	53	783375.....	100
725594.....	99	727584.....	40	732324.....	44	768007.....	53	783460.....	43
725618.....	95	727585.....	40	732325.....	44	768063.....	61	783461.....	43
725619.....	95	727586.....	40	732326.....	44	768733.....	45	783484.....	99
725620.....	95	727777.....	39	732327.....	44	768738.....	64	783516.....	52
725621.....	95	727778.....	39	732328.....	44	780186.....	50, 74, 88, 103	783517.....	52
725622.....	95	727779.....	39	732345.....	44	780187.....	50, 74, 88, 103	783518.....	52
725623.....	95	727780.....	39	732346.....	44	780452.....	68	783519.....	52
725624.....	95	727781.....	39	732347.....	44	780453.....	68	783520.....	52
725625.....	95	727782.....	79	732348.....	44	780454.....	68	783521.....	52
725636.....	95	727783.....	79	732349.....	44	780455.....	68	783522.....	52
725751.....	94	727784.....	79	732350.....	44	780456.....	68	783523.....	52
725760.....	94	727785.....	79	732351.....	44	780457.....	68	783524.....	75
725763.....	94	728033.....	75	732475.....	45	780874.....	78	783525.....	75
725774.....	95	728034.....	84	732476.....	45	781099.....	38	783526.....	75
725775.....	95	728043.....	84	732477.....	45	781433.....	68	783527.....	75
725776.....	98	728052.....	85	732478.....	45	781434.....	68	783528.....	75
725777.....	98	728053.....	85	732479.....	45	781435.....	68	783529.....	75
725785.....	44	728586.....	101	732481.....	101	781436.....	68	783530.....	75
726416.....	53	728595.....	96	732482.....	101	781437.....	68	783531.....	75
726417.....	53	728622.....	103	732483.....	101	781438.....	68	784066.....	93
726419.....	53	728642.....	64	732484.....	101	781439.....	68	784067.....	93
726420.....	53	728649.....	103	732485.....	101	781440.....	68	784068.....	93
726421.....	53	728651.....	94	732486.....	42	781441.....	68	784069.....	93
726422.....	53	728652.....	94	732487.....	42	781442.....	68	784070.....	93
726433.....	95	728653.....	58	732488.....	42	781443.....	68	784071.....	93
726434.....	95	728654.....	58	732489.....	42	781444.....	68	784072.....	93
726435.....	95	728767.....	103	732490.....	42	781445.....	68	786738.....	45
726436.....	95	729045.....	87	732491.....	64	781446.....	68	786739.....	45
726437.....	95	729217.....	44	732492.....	64	781751.....	86	786746.....	69
726438.....	95	730188.....	68	732493.....	64	781752.....	86	786747.....	69
726484.....	95	730190.....	100	732494.....	64	781753.....	86	786768.....	63
726485.....	95	730192.....	69	732495.....	64	781754.....	86	786860.....	47, 73, 88, 103
726668.....	47, 71, 88, 102	730193.....	69	732977.....	78	781755.....	86	787223.....	62
727125.....	58	730194.....	69	732978.....	78	781756.....	86	787276.....	60
727126.....	58	730195.....	69	732983.....	67	781757.....	86	787277.....	80
727127.....	58	730196.....	69	733487.....	63	781765.....	86	787278.....	96
727128.....	58	730245.....	42	734171.....	70	781766.....	86	788164.....	63
727195.....	94	731717.....	41	734172.....	70	781767.....	86	788165.....	63
727197.....	101	731719.....	61	734173.....	70	781768.....	86	788638.....	67
727340.....	101	731721.....	41	734174.....	70	781769.....	86	788639.....	100
727346.....	98	731724.....	81	734225.....	43	781770.....	86	788640.....	100
727347.....	98	731727.....	96	734226.....	43	781771.....	86	788641.....	100
727348.....	98	731745.....	64	734488.....	38	781793.....	68	788642.....	100
727349.....	98	731746.....	64	734489.....	38	781794.....	86	788643.....	100
727350.....	98	731747.....	67	734490.....	38	781796.....	68	788644.....	100
727351.....	98	731748.....	67	734491.....	38	781797.....	86	788645.....	100
727352.....	98	731749.....	67	734492.....	38	781802.....	44	788646.....	100
727353.....	98	731750.....	67	734646.....	72	781803.....	44	788647.....	100
727354.....	98	731791.....	62	734713.....	56	782128.....	91	788648.....	100
727355.....	98	731792.....	82	735433.....	87	782129.....	91	788649.....	100
727356.....	98	731793.....	95	735434.....	87	782213.....	68	788650.....	100
727357.....	98	731837.....	57	735435.....	87	782214.....	86	788651.....	100
727358.....	99	731911.....	78	735436.....	87	782353.....	62	788652.....	100

Reference number overview

788653.....	100	CSU794204.....	60	CSU795545.....	89
788654.....	100	CSU794205.....	60	CSU795546.....	89
789875.....	47, 71, 87, 102	CSU794206.....	60	CSU795547.....	89
789876.....	47, 71, 88, 102	CSU794207.....	60	CSU795548.....	89
790906.....	78	CSU794439.....	90	CSU795549.....	89
791063.....	59	CSU794440.....	90	CSU795550.....	89
791064.....	59	CSU794441.....	90	CSU795551.....	89
791065.....	59	CSU794442.....	90	CSU795552.....	89
791066.....	59	CSU794443.....	90	CSU795564.....	41
791067.....	59	CSU794445.....	90	CSU795565.....	61
791068.....	59	CSU794446.....	90	CSU795566.....	96
791092.....	59	CSU794447.....	90	CSU795568.....	81
791199.....	56	CSU794448.....	90	CSU795587.....	103
791200.....	78	CSU794449.....	90	CSU795588.....	47
791350.....	63	CSU794520.....	47, 71, 88, 102	CSU795589.....	72
791401.....	83	CSU794697.....	73	CSU795590.....	72
791413.....	40	CSU794699.....	73	CSU795591.....	72
791414.....	40	CSU794715.....	73	CSU795592.....	102
791415.....	40	CSU795050.....	39, 56	CSU795593.....	102
792554.....	41	CSU795051.....	39, 56	CSU795594.....	47
792723.....	40	CSU795138.....	55	CSU795595.....	72
792724.....	40	CSU795139.....	55	CSU795596.....	102
792725.....	40	CSU795140.....	55	CSU795597.....	73
792726.....	40	CSU795141.....	55	CSU795598.....	44, 68
792727.....	41	CSU795142.....	55	CSU795599.....	86
792728.....	41	CSU795143.....	55	CSU795600.....	45
792729.....	41	CSU795144.....	55	CSU795601.....	45
792863.....	70	CSU795145.....	66	CSU795602.....	45
792864.....	101	CSU795146.....	66	CSU795603.....	45
792865.....	70	CSU795147.....	66	CSU795604.....	45
792866.....	101	CSU795148.....	66	CSU795605.....	45
792867.....	70	CSU795149.....	66	CSU795606.....	45
792868.....	101	CSU795150.....	66	CSU795607.....	45
792873.....	94	CSU795151.....	66	CSU795608.....	45
792875.....	95	CSU795152.....	66	CSU795609.....	45
792877.....	94	CSU795153.....	66	CSU795610.....	45
792880.....	98	CSU795154.....	66	CSU795611.....	45
792881.....	98	CSU795155.....	66	CSU795612.....	45
792882.....	98	CSU795156.....	66	CSU795613.....	45
792883.....	98	CSU795157.....	66	CSU795614.....	45
792884.....	98	CSU795158.....	66	CSU795615.....	45
792885.....	98	CSU795159.....	65	CSU795616.....	45
792886.....	98	CSU795160.....	65	CSU795632.....	49
792888.....	94	CSU795161.....	65	CSU795633.....	49
792893.....	94	CSU795162.....	65	CSU795634.....	49
792903.....	99	CSU795163.....	65	CSU795635.....	49
792904.....	99	CSU795164.....	65	CSU795636.....	49
792905.....	99	CSU795165.....	65	CSU795637.....	49
792906.....	99	CSU795166.....	70	CSU795638.....	49
792907.....	99	CSU795167.....	70	CSU795639.....	49
792908.....	99	CSU795168.....	58	CSU795640.....	49
792909.....	99	CSU795180.....	50	CSU795641.....	49
792920.....	99	CSU795181.....	50	CSU795647.....	49
792921.....	99	CSU795205.....	57	CSU795648.....	49
792922.....	99	CSU795206.....	65	CSU795649.....	49
792923.....	99	CSU795207.....	65	CSU795650.....	49
792924.....	99	CSU795208.....	65	CSU795651.....	49
792925.....	99	CSU795209.....	63	CSU795655.....	49
		CSU795210.....	57	CSU795656.....	49
		CSU795211.....	57	CSU795657.....	49
		CSU795220.....	41	CSU795658.....	49
		CSU795221.....	41	CSU795659.....	49
		CSU795239.....	39	CSU795700.....	49
		CSU795240.....	39	CSU795804.....	49
		CSU795241.....	57		
		CSU795242.....	57		
		CSU795243.....	78		
		CSU795277.....	72		
		CSU795316.....	58		
		CSU795317.....	58		
		CSU795318.....	58		
		CSU795319.....	58		
		CSU795320.....	58		
		CSU795321.....	58		
		CSU795322.....	40		
		CSU795323.....	40		
		CSU795325.....	41		
		CSU795328.....	96		
		CSU795353.....	43		
		CSU795365.....	59		
		CSU795366.....	79		
		CSU795367.....	95		
		CSU795543.....	89		
		CSU795544.....	89		
1149				WBE	
1149159.....	42			WBE782561.....	67
1149191.....	42			WBE782562.....	67
1149259.....	64			WBE782563.....	67
1149291.....	64			WBE782564.....	67
1149359.....	101			WBE782565.....	67
1149391.....	101			WBE782566.....	67
1149405.....	42			WBE782567.....	67
1149456.....	42			WBE782568.....	67
1149464.....	42				
1149466.....	42				
1149551.....	97				
1149552.....	97				
1149554.....	97				
1149555.....	97				
1149561.....	97				
1149562.....	97				
1149564.....	97				
1149565.....	97				
CSU					
CSU734698.....	73				
CSU794202.....	60				
CSU794203.....	60				

