

– weishaupt –

product

Information on oil, gas and dual-fuel burners

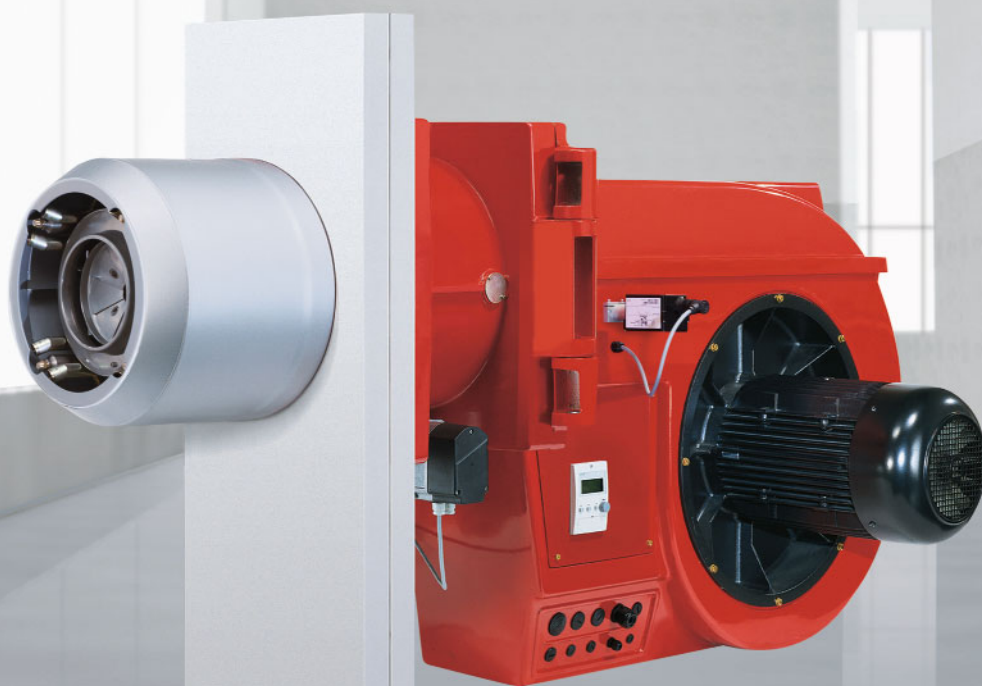

Industrial burners

Industrial burners (1000–11 700 kW) • versatile and reliable

Weishaupt industrial burners: Versatile and reliable



Worldwide, for more than 60 years, Weishaupt industrial burners have been a benchmark for reliability, energy efficiency, noise emissions, and ease of use.

With ratings between 1000 and 11 700 kW, the spectrum of possible applications ranges from heating and steam boilers to air heaters and the latest heavy-duty boilers.

Weishaupt's broad range of industrial burners can be used with almost any gaseous or liquid fuel, ensuring there is the right burner for virtually every job.

Contents

Standard version oil burners		1LN version dual-fuel burners	
Burner selection	10	Burner selection	46
Scope of delivery / special equipment	14	Gas valve train sizing	48
Technical data	15	Scope of delivery / special equipment	50
		Technical data	51
NR version gas burners		3LN version multiflam® oil burners	
Burner selection	20	Burner selection	55
Gas valve train sizing	21	Gas valve train sizing	56
Scope of delivery / special equipment	23	Scope of delivery / special equipment	58
Technical data	24	Technical data	59
1LN version gas burners		3LN version multiflam® gas burners	
Burner selection	25	Burner selection	60
Gas valve train sizing	26	Gas valve train sizing	61
Scope of delivery / special equipment	27	Scope of delivery / special equipment	63
Technical data	28	Technical data	64
LN version gas burners		3LN version multiflam® dual-fuel burners	
Burner selection	29	Burner selection	75
Gas valve train sizing	30	Gas valve train sizing	78
Scope of delivery / special equipment	31	Scope of delivery / special equipment	82
Technical data		Technical data	83
NR version dual-fuel burners		Dimensions	65
Burner selection	34		
Gas valve train sizing	38	Fuel systems	68
Scope of delivery / special equipment	41		
Technical data	43	Pump and preheater stations	70

Weishaupt industrial burners: Powerful and versatile

Weishaupt industrial-series burners have been designed especially for industrial applications. The monobloc burners are noteworthy for their large capacity and their versatility, as well as numerous other interesting details:

Versatility

The burners can be used on heat exchangers such as hot water boilers, steam boilers, or air heaters, and for certain process applications. As the burners are capable of overcoming high combustion chamber resistances, they are primarily used on heavy-duty boilers.

Digital combustion management

Digital combustion management ensures the simple and safe operation of combustion plant. All important functions, such as fuel and air supply or flame monitoring, are controlled with digital precision. Operational functions are optimised, economy is maximised and emissions are minimised. The integral bus interface enables all necessary data and functions to be relayed to a master control system

Energy saving with VSD and O₂ trim

Electrical consumption is definitely a cost factor for large combustion plant. Variable speed drive (VSD) uses a frequency convertor to match the speed of the fan to the actual air requirement, allowing for sizeable electrical savings, particularly at partial load.

With O₂ trim, flue gases are continuously monitored to ensure the best possible degree of combustion efficiency and thus lower fuel consumption and increased reliability.

Fuels

- Light oil (<6 mm²/s at 20 °C) in accordance with DIN 51 603
- MFO/HFO (<50 mm²/s at 100 °C) in accordance with DIN 51 603
- Natural gas
- LPG

Permissible ambient conditions

- Ambient temperature during operation
-10 to +40 °C (oil/dual-fuel burners)
-15 to +40 °C (gas burners)
- Humidity: max. 80 % relative humidity, no condensation
- Suitable for operation indoors only
- For plant in unheated areas, certain further measures may be required (please enquire)

Use of the burner for other applications or in ambient conditions not detailed above is not permitted without the prior written agreement of Max Weishaupt GmbH. Service intervals will be reduced in accordance with the more extreme operational conditions.

Certification

The burners are tested by an independent body and conform to the following standards and EU directives:

- EN 267 and EN 676
- Machinery Directive, 2006/42/EC
- Electromagnetic Compatibility Directive, 2004/108/EC
- Low Voltage Directive, 2006/95/EC
- Gas Appliance Directive 90/396/EEC
- Pressure Equipment Directive, 97/23/EC
- The burners carry CE and CE-PIN marks in accordance with 90/396/EEC

Outstanding service

Weishaupt maintains an extensive global sales and service network. Customer service is available every day around the clock. In-house training by Weishaupt ensures the high standard of their service engineers.

The most important advantages:

- Large capacity and range of applications
- Stable fan characteristics
- Good combustion behaviour
- Burner housing can be hinged open
- Easy to install, commission and service
- Increased safety provided by nozzle-head shut-off device with solenoid
- Nozzle recirculation and precise oil temperature regulation on heavy-oil burners
- Compliance with all current emission standards worldwide
- Higher turndown (RL, RGL)

Characteristics

Standard version

Oil, gas, and dual-fuel burners for installations with no particular NO_x emission limits. Suitable for natural gas, LPG, and light and heavy oils, as well as special oils and gases upon application. Type-tested, standard-version, natural-gas and light-oil burners meet NO_x Class 1 requirements.

NR version

Gas and dual-fuel burners with a more advanced version of the standard mixing assembly for installations with gas-side NO_x emission limits. Compared to standard-version burners, NR-version burners have lower NO_x emissions when firing on gas. Oil-side emissions remain the same. Suitable for natural gas, LPG, and light and heavy oils. Type-tested, NR-version, natural-gas, LPG, and light-oil burners meet NO_x Class 2 (or Class 3) requirements when firing on gas and NO_x Class 1 requirements when firing on oil.

1LN version

Low-NO_x gas and dual-fuel burners with a special mixing assembly for installations with gas and oil-side NO_x emission limits. 1LN-version burners have lower NO_x emissions than NR-version burners. Suitable for natural gas, LPG, and light oil. Type-tested, 1LN-version, natural-gas, LPG, and light-oil burners meet NO_x Class 3 requirements when firing on gas and NO_x Class 2 requirements when firing on oil.

LN version

Low-NO_x gas burners with a special mixing assembly for installations with gas-side NO_x emission limits. LN-version burners have lower NO_x emissions than 1LN-version burners. Suitable for natural gas and LPG. Type-tested, LN-version, natural-gas burners meet NO_x Class 3 requirements.

3LN version

Ultra-Low-NO_x oil, gas, and dual-fuel burners with multiflam[®] mixing assemblies for installations with extremely low NO_x emission limits (suitable for three-pass and through-pass boilers only). The burners' extremely low NO_x emissions are achieved using a special fuel distribution system. Type-tested, 3LN-version, natural-gas and light-oil burners meet NO_x Class 3 requirements.

Notes

Gas-firing standard, NR, 1LN, and 3LN-version burners are equipped with a gas pilot line.

Project-specific NO_x emission figures can be found in our list of guaranteed NO_x figures (Print No. 83097202).

Combustion figures will vary, depending on combustion chamber geometry, volumetric loading and boiler design. The basic conditions listed in relation to

measurement tolerances, temperature, pressure, humidity, etc. should be taken into consideration.

Digital combustion management General system overview	W-FM 100	W-FM 200
Single-fuel operation	●	●
Dual-fuel operation	●	●
Controller for intermittent operation	●	●
Controller for continuous operation	●	●
Flame sensor for intermittent operation	ION/QRI/ORB/QRA	ION/QRI/ORB/QRA
Flame sensor for continuous operation	ION/QRI	ION/QRI
Actuators in electronic compound (max.)	x 4	x 6
Actuators with stepping motors	●	●
Variable speed drive available		●
O ₂ trim available		●
Gas valve proving	●	●
4-20 mA input signal	Optional	●
Integrated, self-checking PID controller for temperature or pressure	Optional	●
Removable operating unit (max. distance)	100 m	100 m
Fuel consumption meter (switchable)		●
Combustion efficiency display		●
eBUS / Modbus interface	●	●
PC-supported commissioning	●	●

Please enquire regarding connections available for additional functions, e.g. flue gas dampers, oil shut-off assemblies etc.

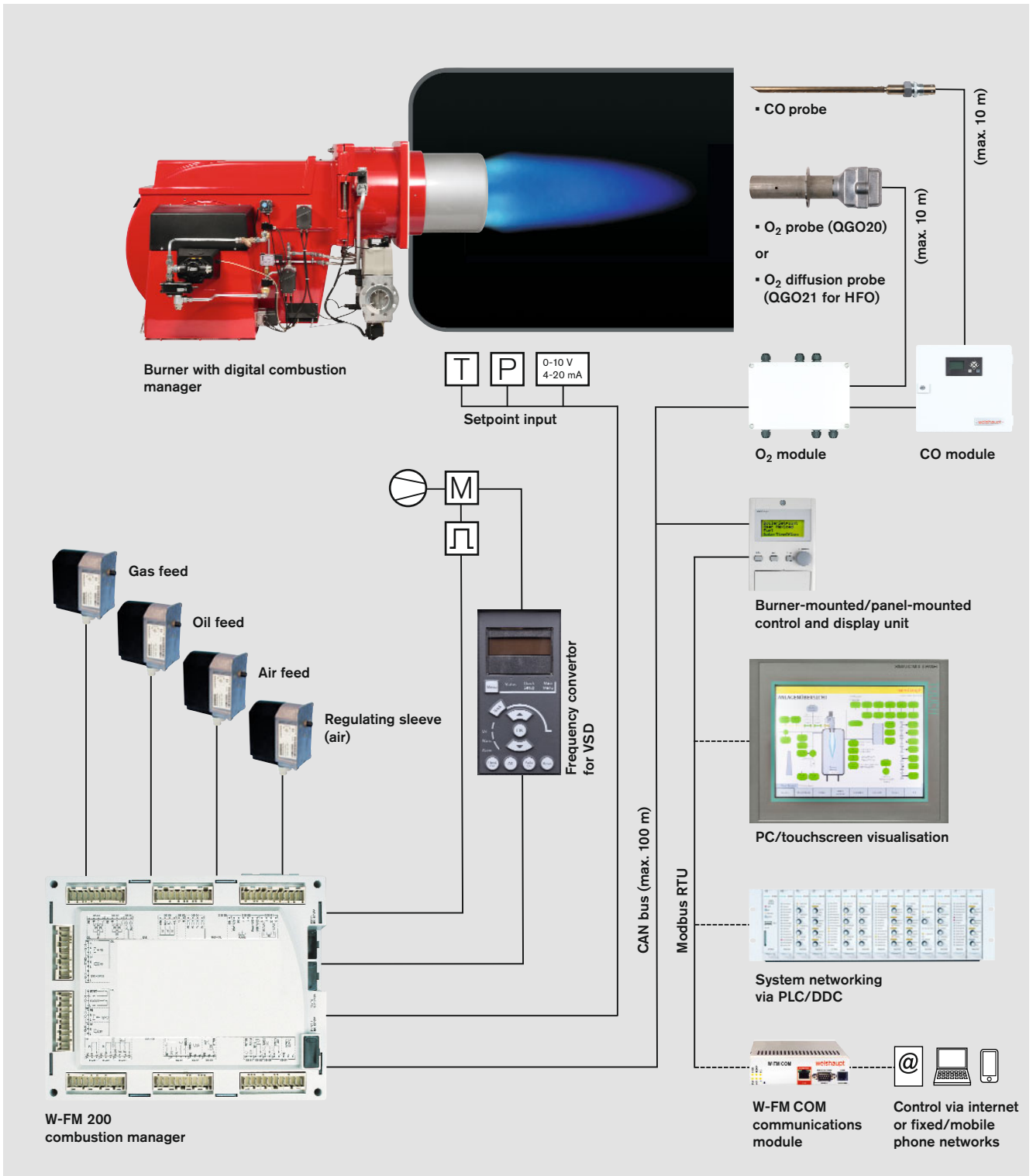

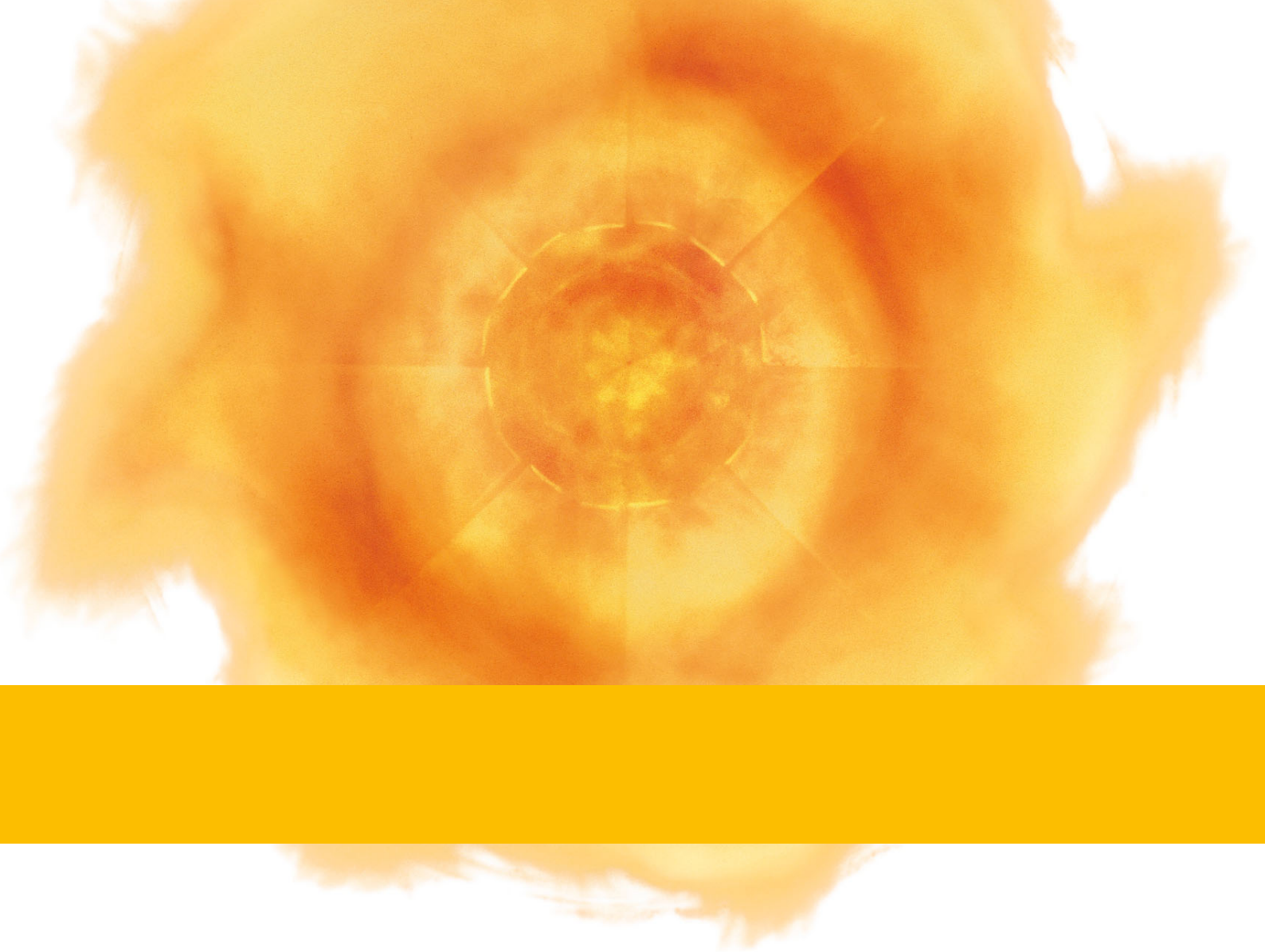

Oil burners

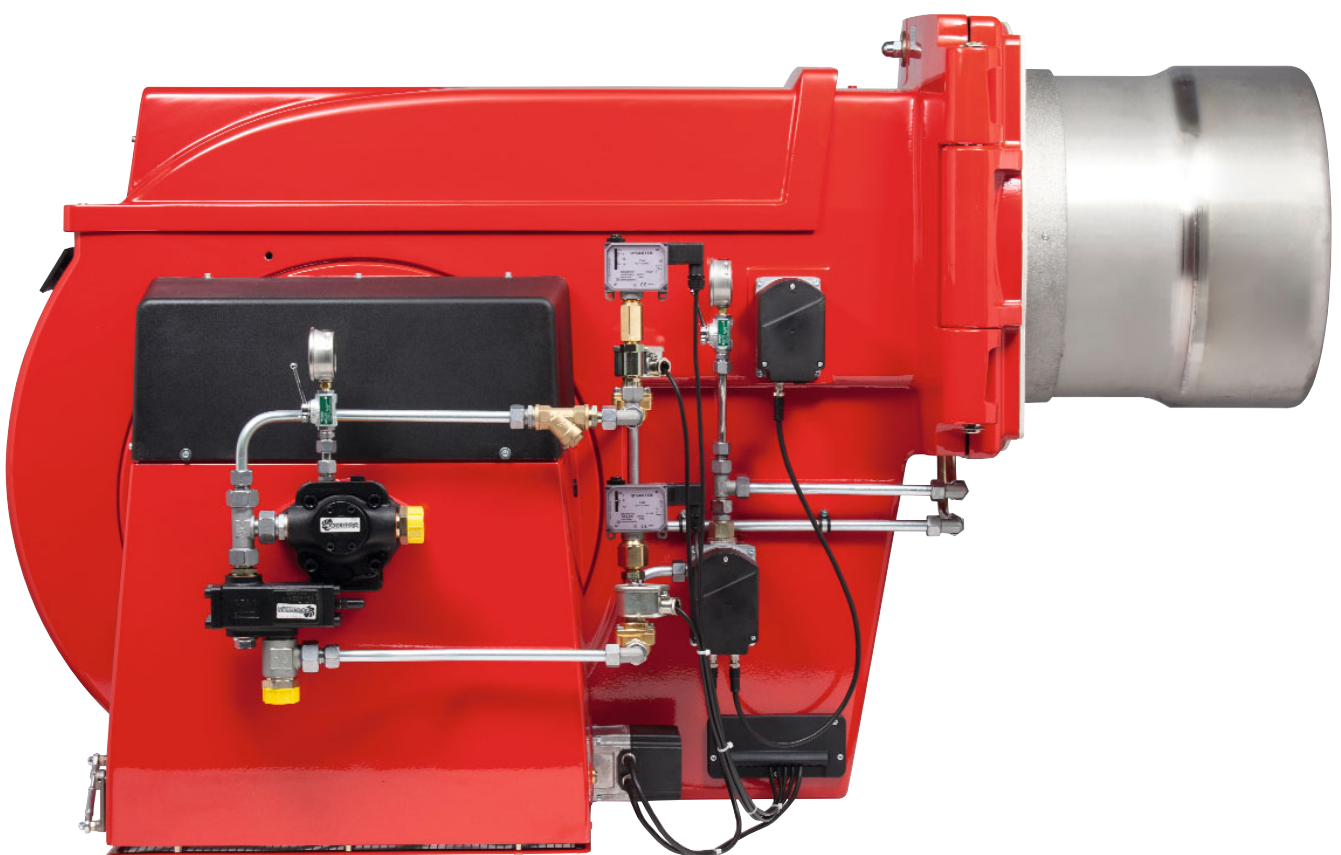

Burner selection

Size 30, standard version

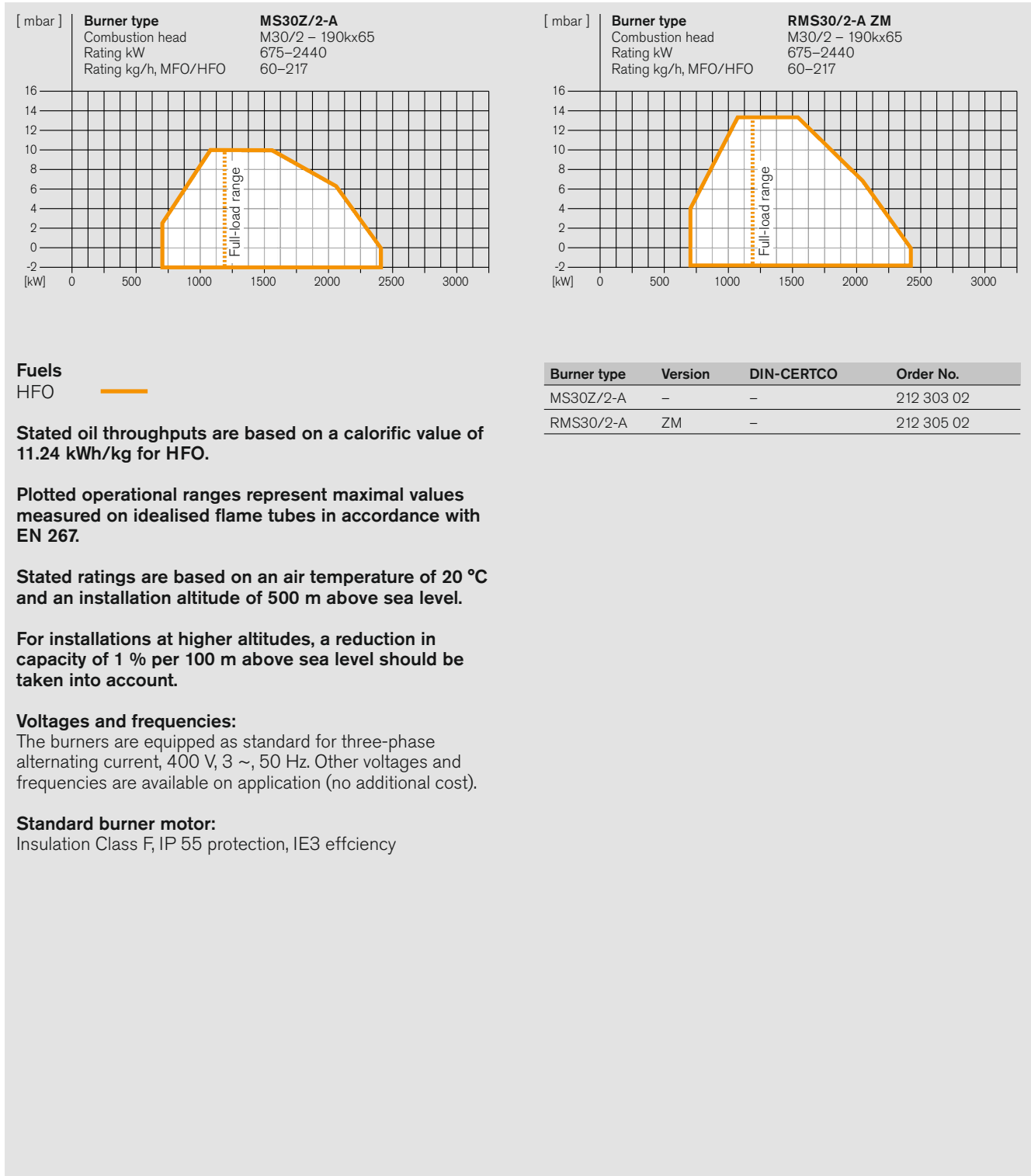

Burner selection

Size 40, standard version

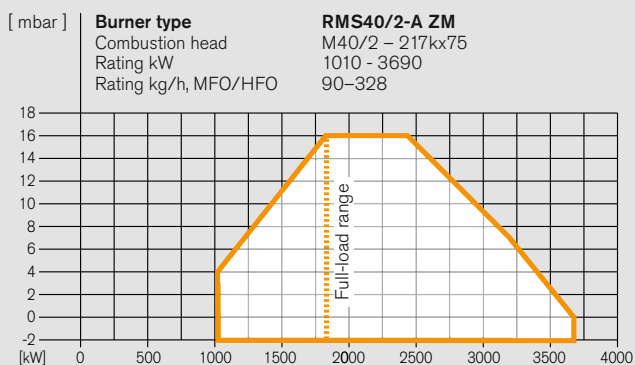
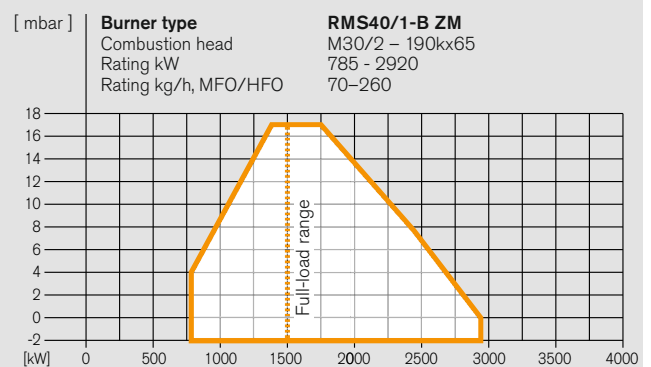
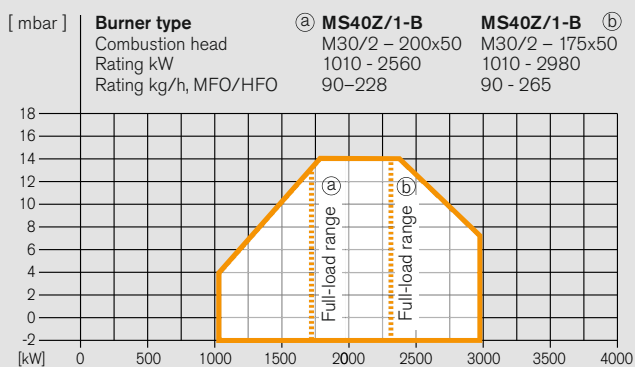

Burner type	Version	DIN-CERTCO	Order No.
MS40Z/1-B	–	–	212 402 00
RMS40/1-B	ZM	–	212 404 00
RMS40/2-A	ZM	–	212 405 02

Fuels

HFO

Stated oil throughputs are based on a calorific value of 11.24 kWh/kg for HFO.

Plotted operational ranges represent maximal values measured on idealised flame tubes in accordance with EN 267.

Stated ratings are based on an air temperature of 20 °C and an installation altitude of 500 m above sea level.

For installations at higher altitudes, a reduction in capacity of 1 % per 100 m above sea level should be taken into account.

Voltages and frequencies:

The burners are equipped as standard for three-phase alternating current, 400 V, 3 ~, 50 Hz. Other voltages and frequencies are available on application (no additional cost).

Standard burner motor:

Insulation Class F, IP 55 protection, IE3 efficiency

Burner selection

Size 50, standard version

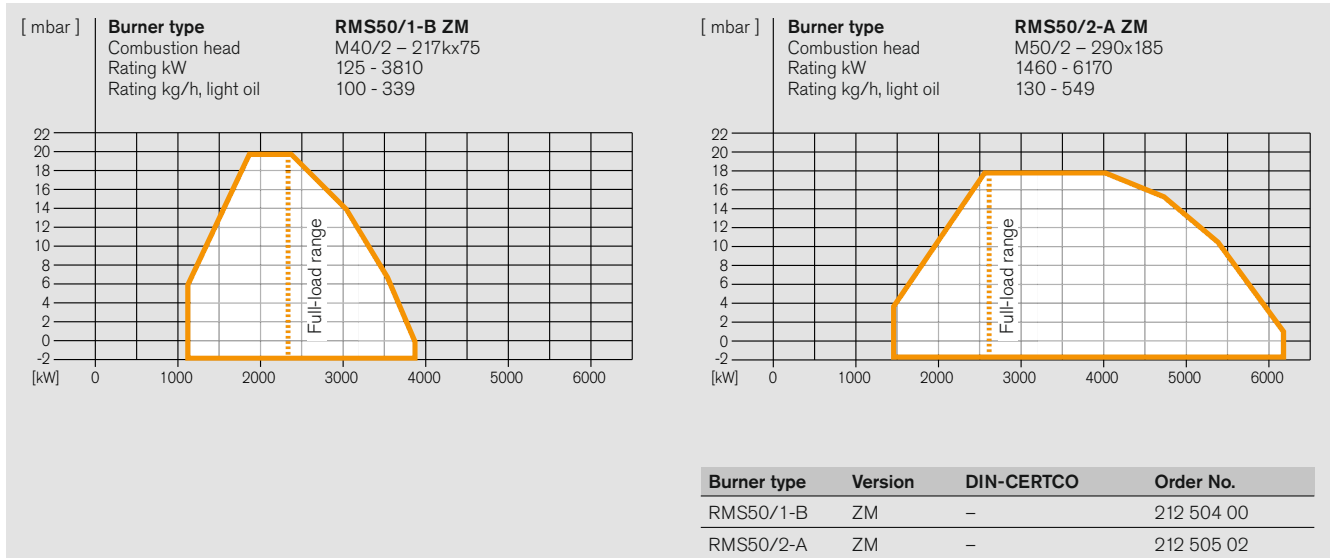

Fuels

HFO —

Stated oil throughputs are based on a calorific value of 11.24 kWh/kg for HFO.

Plotted operational ranges represent maximal values measured on idealised flame tubes in accordance with EN 267.

Stated ratings are based on an air temperature of 20 °C and an installation altitude of 500 m above sea level.

For installations at higher altitudes, a reduction in capacity of 1 % per 100 m above sea level should be taken into account.

Voltagages and frequencies:

The burners are equipped as standard for three-phase alternating current, 400 V, 3 ~, 50 Hz. Other voltages and frequencies are available on application (no additional cost).

Standard burner motor:

Insulation Class F, IP 55 protection, IE3 efficiency

Burner selection

Sizes 60 and 70, standard version

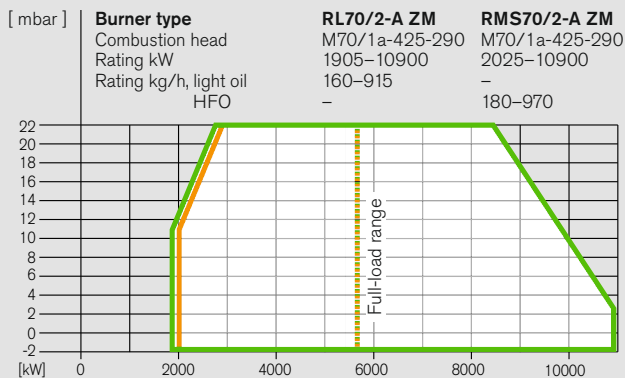
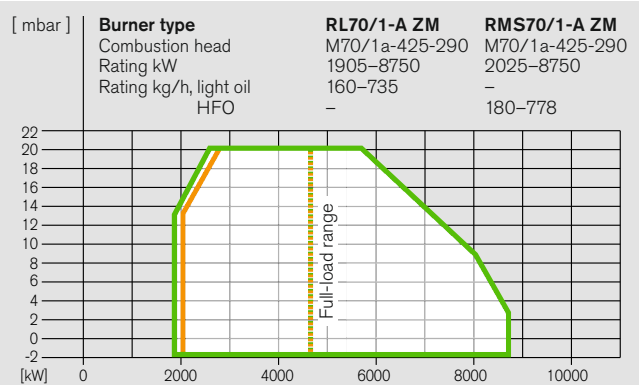
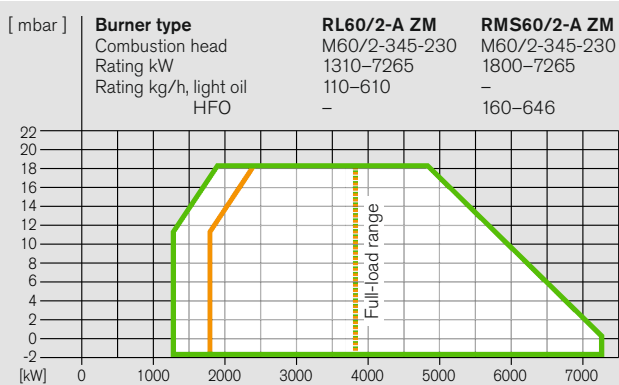

Burner type	Version	DIN-CERTCO	Order No.
RL60/2-A	ZM	5G587/10	211 605 02
RMS60/2-A	ZM	–	212 605 02
RL70/1-A	ZM	5G588/10	211 704 02
RMS70/1-A	ZM	–	212 704 02
RL70/2-A	ZM	5G589/10	211 705 02
RMS70/2-A	ZM	–	212 705 02

Fuels

Light oil —
HFO —

Stated oil throughputs are based on a calorific value of 11.91 kWh/kg for light oil and 11.24 kWh/kg for HFO.

Plotted operational ranges represent maximal values measured on idealised flame tubes in accordance with EN 267.

Stated ratings are based on an air temperature of 20 °C and an installation altitude of 500 m above sea level.

For installations at higher altitudes, a reduction in capacity of 1 % per 100 m above sea level should be taken into account.

Voltages and frequencies:

The burners are equipped as standard for three-phase alternating current, 400 V, 3 ~, 50 Hz. Other voltages and frequencies are available on application (no additional cost).

Standard burner motor:

Insulation Class F, IP 55 protection, IE3 efficiency

Scope of delivery, special equipment

Sizes 30 to 70, standard version

Scope of delivery	MS30	MS40	RMS30	RMS40	RMS50	RMS60	RMS70	RL60	RL70
Burner housing, hinged flange, housing cover, Weishaupt burner motor, air-inlet housing, fan wheel, combustion head, ignition unit, ignition cable, ignition electrodes, nozzle assembly with oil nozzle(s), combustion manager with control unit, flame sensor, stepping motors, flange gasket, limit switch on hinged flange, fixing screws	●	●	●	●	●	●	●	●	●
W-FM 100 combustion manager	-	-	●	●	●	●	●	●	●
Air-pressure switch	-	-	-	-	-	●	●	-	-
Oil-pressure switch in return	●	●	●	●	●	●	●	●	●
Oil-pressure switch in supply	-	-	-	-	-	●	●	-	-
Mixing assembly with adjustable regulating sleeve	●	-	-	-	-	-	-	-	-
Mixing assembly with modulating regulating sleeve	-	-	●	●	●	●	●	●	●
Oil pump, fitted	●	●	●	●	●	-	-	●	●
Oil preheater, fitted	●	●	●	●	●	-	-	-	-
Oil hoses	●	●	●	●	●	●	●	●	●
3 oil solenoid valves, 1 safety valve, three-stage nozzle head without shut-off device	-	-	-	-	-	-	-	-	-
Solenoid valve in supply and return, nozzle assembly with shut-off device (solenoid for RL and RMS burners, hydraulically controlled ball valve for MS burners)	●	●	●	●	●	-	-	●	●
Solenoid valve in supply and return, bypass solenoid valve, nozzle assembly with shut-off device (solenoid)	-	-	-	-	-	●	●	-	-
Downward-firing version	●	●	●	●	●	●	●	●	●
Heated oil-side components	●	●	●	●	●	●	●	-	-
Special equipment	MS30	MS40	RMS30	RMS40	RMS50	RMS60	RMS70	RL60	RL70
Air-inlet flange for duct connection	○	○	○	○	○	○	○	○	○
Heated, stainless-steel oil hoses	○	○	○	○	○	○	○	-	-
Electromagnetic clutch	-	-	○	○	○	-	-	○	○
Combustion-head extension	○	○	○	○	○	○	○	○	○
Medium preheater with fittings	○	○	○	○	○	○	○	-	-
Variable speed drive	-	-	○	○	○	○	○	○	○
O ₂ trim	-	-	○	○	○	○	○	○	○
W-FM supplied loose for mounting in a control panel	-	-	○	○	○	○	○	○	○
Bus interface	-	-	○	○	○	○	○	○	○
PED execution	○	○	○	○	○	○	○	○	○
Multi-language ABE	○	○	○	○	○	○	○	○	○

- Standard
- Optional

Please enquire or see the price list for additional special equipment.

Technical data

Sizes 30 and 40, standard version

Technical data			MS30Z/2-A	RMS30/2-A
400 V, 3 ~ burner motor ¹⁾	Type		W-D112/170-2/4K5	W-D112/170-2/4K5
Nominal rating	kW		4.5	4.5
Current draw at 400 V	A		9.5	9.5
Motor prefusing (YΔ motor start)	A		16	16
Speed (50 Hz)	rpm		2900	2900
Fan wheel	Colour / ø		blue / 268 x 104	blue / 268 x 104
Combustion manager	Type		LAL 2.25	W-FM 100
Ignition unit	Type		W-ZG02	W-ZG02
Actuator	Air	Type	1055/80	SQM45
	Fuel	Type	–	SQM45
	Mixing assembly	Type	–	SQM45
Integral pump	Type		E7	TA3
Oil preheater	Type		EV2D	EV2D
	Oil throughput Heating capacity	kg/h kW	270 13.2	270 13.2
Oil solenoid valves	230 V, 1/8"	19 W	Type 121 K 2423	–
	230 V, 1/8"	19 W	Type 122 K 9321	–
	115 V, 3/8" (supply)	20 W	Type 321 H 2322	321 H 2322
	115 V, 3/8" (return)	20 W	Type 121 G 2320	121 G 2320
Oil pressure switch	1–10 bar (return, light oil - 5 bar)	Type	–	–
	1–10 bar (return, HFO - 7 bar)	Type	DSA 46 F001	DSA 46 F001
Oil hoses (metal, high-pressure hoses on MS, RMS and RGMS burners)	DN / length		20/1000 20/1300	20/1000 20/1300
Burner weight	kg (approx.)		135	140

Technical data			MS40Z/1-B	RMS40/1-B	RMS40/2-A
400 V, 3 ~ burner motor ¹⁾	Type		W-D112/170-2/5K5	W-D112/170-2/5K5	W-D112/170-2/7K0
Nominal rating	kW		5.5	5.5	7
Current draw at 400 V	A		14	14	15
Motor prefusing (YΔ motor start)	A		20	20	25
Speed (50 Hz)	rpm		2940	2940	2940
Fan wheel	Colour / ø		blue / 295 x 104	blue / 295 x 104	blue / 295 x 104
Combustion manager	Type		LAL2.25	W-FM100	W-FM100
Ignition unit	Type		W-ZG02	W-ZG02	W-ZG02
Actuator	Air	Type	SQM10	SQM45	SQM45
	Fuel	Type	–	SQM45	SQM45
	Mixing assembly	Type	–	SQM45	SQM45
Integral pump	Type		E7	TA3	TA3
Oil preheater	Type		EV2D	EV2D	EV2D ^{2) 3)}
	Oil throughput Heating capacity	kg/h kW	270 13.2	270 13.2	270 13.2
Oil solenoid valves	230 V, 1/8"	19 W	Type 121 K 2423	–	–
	230 V, 1/4" (safety valve)	20 W	Type –	–	–
	230 V, 1/8"	19 W	Type 122K9321	–	–
	115 V, 3/8" (supply)	20 W	Type 321 H 2322	321 H 2322	321 H 2322
	115 V, 3/8" (return)	20 W	Type 121 G 2320	121 G 2320	121 G 2320
Oil pressure switch	1–10 bar (return, light oil - 5 bar)	Type	–	–	–
	1–10 bar (return, HFO - 7 bar)	Type	DSA 46 F001	DSA 46 F001	DSA 46 F001
Oil hoses (metal, high-pressure hoses on MS, RMS and RGMS burners)	DN / length		20/1000 20/1300	20/1000 20/1300	20/1000 20/1300
Burner weight	kg (approx.)		159	166	172

¹⁾ The electrical motors are premium-efficiency IE3 motors in accordance with Commission Regulation (EC) No. 640/2009.

²⁾ Burners > 270 kg/h: WEV2.2 oil preheater in lieu of EV2D, see special equipment for additional price.

³⁾ Burners > 300 kg/h: WEV3 oil preheater in lieu of WEV2.2, see special equipment for additional price.

Technical data

Size 50, standard version

Technical data			RMS50/1-B	RMS50/2-A	
400 V, 3 ~ burner motor ¹⁾			Type	W-D132/170-2/9K0	W-D132/210-2/14K0
Nominal rating			kW	9	14
Current draw at 400 V			A	18	28
Motor pre-fusing (YΔ motor start)			A	35	50
Speed (50 Hz)			rpm	2930	2920
Fan wheel			Colour / ø	blue / 345 x 104.5	blue / 345 x 104.5
Combustion manager			Type	W-FM100	W-FM100
Ignition unit			Type	W-ZG02	W-ZG02
Actuator	Air		Type	SQM45	SQM45
	Fuel		Type	SQM45	SQM45
	Mixing assembly		Type	SQM45	SQM45
Integral pump			Type	TA4C	T2C
Oil preheater			Type	WEV2.2/01 ²⁾	WEV3/01
	Oil throughput		kg/h	300	500
	Heating capacity		kW	13.8	22.4
Oil solenoid valves	115 V, 3/8" (supply)	20 W	Type	321 H 2322	321 H 2322
	115 V, 3/8" (return)	20 W	Type	121 G 2320	121 G 2320
Oil pressure switch	1–10 bar (return, light oil - 5 bar)		Type	–	–
	1–10 bar (return, HFO - 7 bar)		Type	DSA 46 F001	DSA 46 F001
Oil hoses (metal, high-pressure hoses on MS, RMS and RGMS burners)			DN / length	25 / 1150	25 / 1150
				25 / 1500	25 / 1500
Burner weight			kg (approx.)	248	250

¹⁾ The electrical motors are premium-efficiency IE3 motors in accordance with Commission Regulation (EC) No. 640/2009.

²⁾ Burners > 300 kg/h: WEV3 oil preheater in lieu of WEV2.2, see special equipment for additional price.

Technical data

Sizes 60 and 70, standard version

Technical data			RL60/2-A	RMS60/2-A
400 V, 3 ~ burner motor ¹⁾	Type		W-D132/210-2/14K0	W-D132/210-2/14K0
Nominal rating	kW		14	14
Current draw at 400 V	A		28	28
Motor pre-fusing (ΥΔ motor start)	A		50	50
Speed (50 Hz)	rpm		2920	2920
Fan wheel	Colour / ø		blue / 515 x 120	blue / 515 x 120
Combustion manager	Type		W-FM100	W-FM100
Ignition unit	Type		W-ZG02	W-ZG02
Actuator	Air	Type	SQM48	SQM48
	Fuel	Type	SQM45	SQM45
	Mixing head	Type	SQM45	SQM45
Integral pump	Type		T2C	–
Oil solenoid valves	115 V, 3/8" (supply)	20 W	Type 321 H 2322	321 H 2322
	115 V, 3/8" (return)	20 W	Type 121 G 2320	121 G 2320
	230 V, 3/8" (bypass)	19 W	Type –	322 H 7306
Oil pressure switch	3–25 bar (supply - 18 bar)	Type	–	DSA 58 F 001
	1–10 bar (return, light oil - 5 bar)	Type	DSA 46 F 001	–
	1–10 bar (return, HFO - 7 bar)	Type	–	DSA 46 F 001
Oil hoses (metal, high-pressure hoses on RMS and RGMS burners)	DN / length		25 / 1300 (x 2)	16 / 1150
			–	16 / 1500
Burner weight	kg (approx.)		250	210 ²⁾

Technical data			RL70/1-A	RL70/2-A	RMS70/1-A	RMS70/2-A
400 V, 3 ~ burner motor ¹⁾	Type		W-D160/240-2/18K0	W-D160/240-2/22K0	W-D160/240-2/18K0	W-D160/240-2/22K0
Nominal rating	kW		18	22	18	22
Current draw at 400 V	A		35	43	35	43
Motor pre-fusing (ΥΔ motor start)	A		50	63	50	63
Speed (50 Hz)	rpm		2950	2940	2950	2940
Fan wheel	Colour / ø		green / 530 x 120	blue / 590 x 160	green / 530 x 120	blue / 590 x 160
Combustion manager	Type		W-FM100	W-FM100	W-FM100	W-FM100
Ignition unit	Type		W-ZG02	W-ZG02	W-ZG02	W-ZG02
Actuator	Air	Type	SQM48	SQM48	SQM48	SQM48
	Fuel	Type	SQM45	SQM45	SQM45	SQM45
	Mixing head	Type	SQM45	SQM45	SQM45	SQM45
Integral pump	Type		T2C (up to 600 kg/h)	T2C (up to 600 kg/h)	–	–
			T3C (from 600 kg/h)	T3C (from 600 kg/h)	–	–
Oil solenoid valves	115 V, 1/2" (supply)	20 W	Type 321 H 2522	321 H 2522	321 H 2522	321 H 2522
	15 V, 1/2" (return)	20 W	Type 121 G 2520	121 G 2520	121 G 2520	121 G 2520
	230 V, 3/8" (bypass)	19 W	Type –	–	322 H 7306	322 H 7306
Oil pressure switch	3–25 bar (supply - 18 bar)	Type	–	–	DSA 58 F 001	DSA 58 F 001
	1–10 bar (return, light oil - 5 bar)	Type	DSA 46 F 001	DSA 46 F 001	–	–
	1–10 bar (return, HFO - 7 bar)	Type	–	–	DSA 46 F 001	DSA 46 F 001
Oil hoses (metal, high-pressure hoses on RMS and RGMS burners)	DN / length		25 / 1300 (x 2)	25 / 1300 (x 2)	20/1150	20/1150
			–	–	20/1500	20/1500
Burner weight	kg (approx.)		350	350	310 ²⁾	310 ²⁾

¹⁾ The electrical motors are premium-efficiency IE3 motors in accordance with Commission Regulation (EC) No. 640/2009.

²⁾ Weight excluding pump and preheater stations.

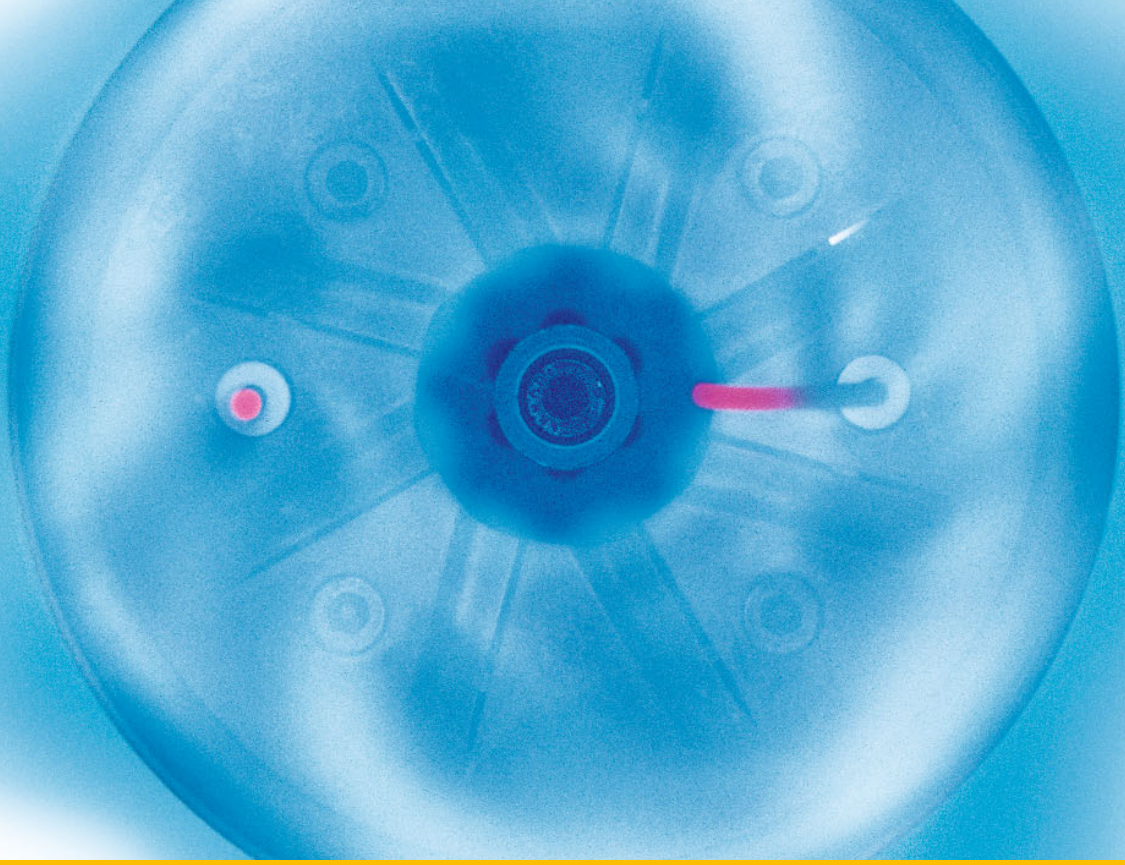

Gas burners

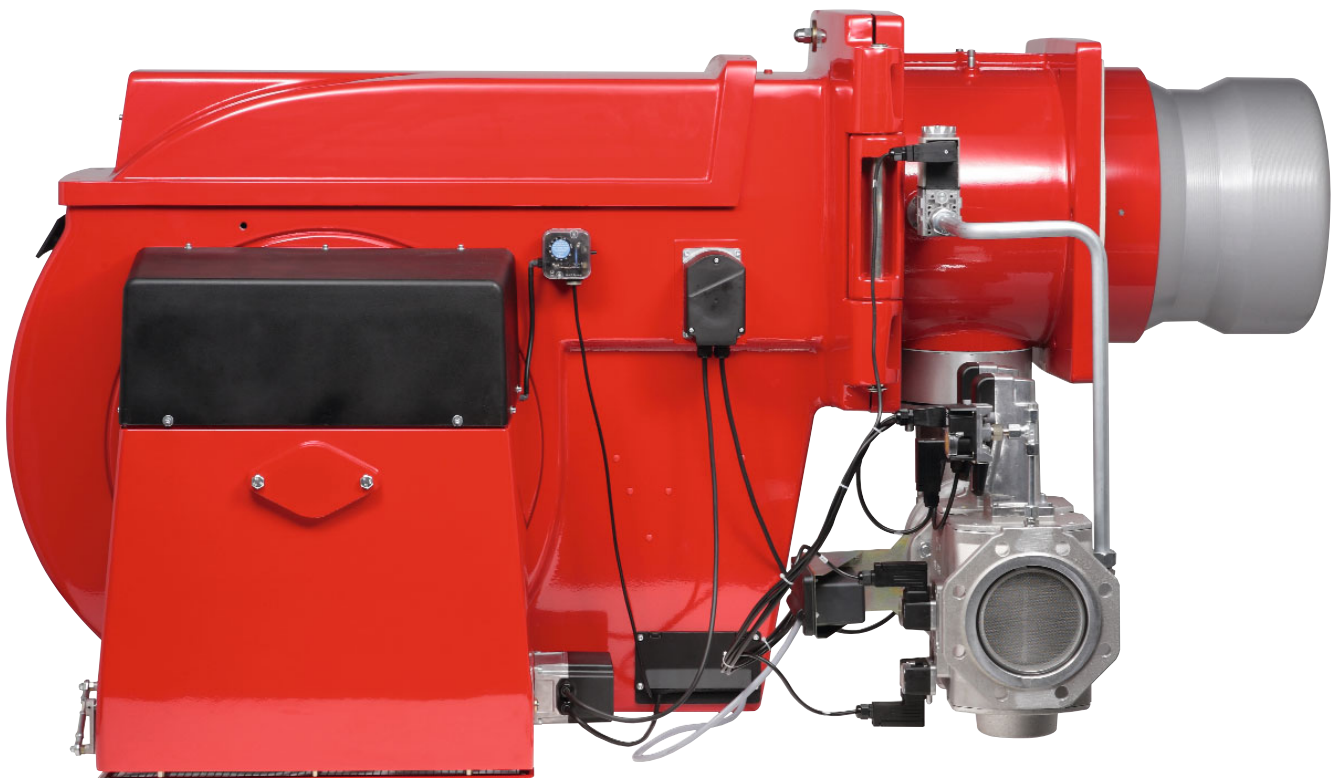

Burner selection

Sizes 60 and 70, version NR

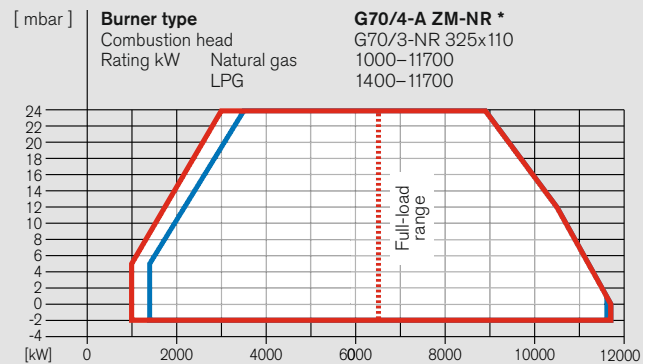
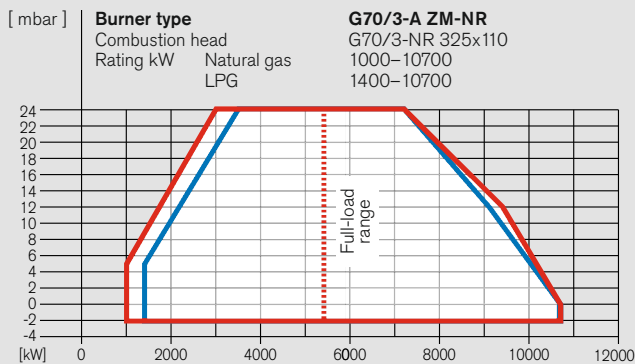
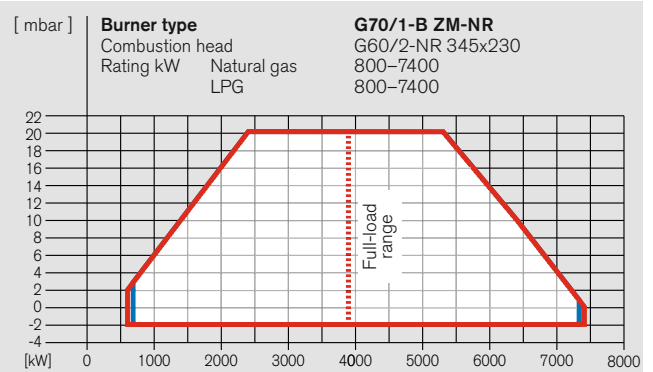
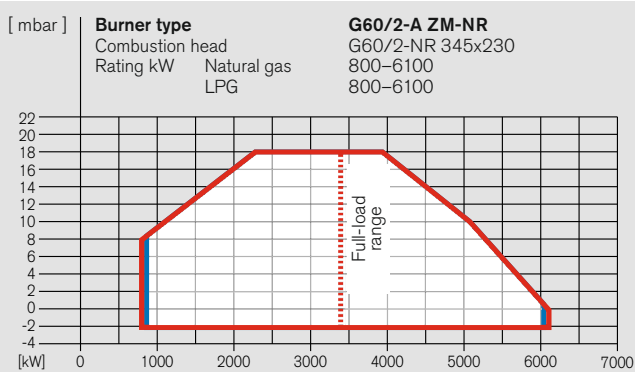

Fuels

Natural gas —
 LPG —

Plotted operational ranges represent maximal values measured on idealised flame tubes in accordance with EN 676.

Stated ratings are based on an air temperature of 20 °C and an installation altitude of 500 m above sea level.

For installations at higher altitudes, a reduction in capacity of 1 % per 100 m above sea level should be taken into account.

Voltages and frequencies:

The burners are equipped as standard for three-phase alternating current, 400 V, 3 ~, 50 Hz. Other voltages and frequencies are available on application (no additional cost).

Standard burner motor:

Insulation Class F, IP 55 protection, IE3 efficiency at 50/60 Hz (no IE classification at 55 Hz).

Burner type	Version	CE-PIN	Valve train	Order No.
G60/2-A	ZM-NR	CE-0085-AQ 0722	DN 65	217 605 42
			DN 80	217 605 52
			DN 100	217 605 62
			DN 125	217 605 72
			DN 150	217 605 82
G70/1-B	ZM-NR	CE-0085-AQ 0723	DN 65	217 704 42
			DN 80	217 704 52
			DN 100	217 704 62
			DN 125	217 704 72
			DN 150	217 704 82
G70/3-A	ZM-NR	CE-0085-AQ 0723	DN 65	217 714 14
			DN 80	217 714 15
			DN 100	217 714 16
			DN 125	217 714 17
			DN 150	217 714 18
G70/4-A *	ZM-NR	CE-0085-AQ 0723	DN 65	217 734 14
			DN 80	217 734 15
			DN 100	217 734 16
			DN 125	217 734 17
			DN 150	217 734 18

* Equipped with W-FM 200 and VSD as standard (55 Hz)

Gas valve train sizing

Size 60, version NR

Type 60/2-A, version NR

Burner rating kW	Low-pressure supply (with FRS) (flow pressure in mbar into shut-off valve, pe, max = 300 mbar)	High-pressure supply (with HP regulator), (flow pressure in mbar into gas valve assembly)
	Nominal valve-train diameter 2" 65 80 100 125 150 Nom. diameter of gas butterfly 100 100 100 100 100	Nominal valve-train diameter 2" 65 80 100 125 150 Nom. diameter of gas butterfly 100 100 100 100 100

Natural Gas E LHV = 10.35 kWh/Nm ³ ; d = 0.606; W _i = 13.295 kWh/Nm ³	
3400	142 72 44 30 25 23
3700	169 86 54 36 31 28
4100	207 106 66 45 38 35
4500	250 127 80 54 46 42
4900	295 150 94 63 54 49
5300	- 174 109 73 62 56
5700	- 200 124 83 70 64
6100	- 227 140 93 78 71

Natural Gas LL LHV = 8.83 kWh/Nm ³ ; d = 0.641; W _i = 11.029 kWh/Nm ³	
3400	199 98 58 37 30 27
3700	238 117 71 45 37 34
4100	293 145 88 57 47 42
4500	- 175 106 68 57 51
4900	- 207 125 81 67 60
5300	- 241 145 93 77 69
5700	- 277 166 106 87 78
6100	- 188 119 98 87

LPG B/P LHV = 25.89 kWh/Nm ³ ; d = 1.555; W _i = 20.762 kWh/Nm ³	
3400	68 39 28 22 20 20
3700	81 47 34 27 24 23
4100	99 58 41 33 30 29
4500	119 69 49 39 36 34
4900	141 81 58 45 41 40
5300	164 94 67 52 48 45
5700	188 107 76 59 54 51
6100	214 122 86 67 60 58

Stated pressures for LPG are based on propane, but may also be used for butane.

The combustion chamber pressure in mbar must be added to the minimum gas pressure determined from the above chart.

For low-pressure supplies, EN 88-compliant governors with safety diaphragms are used. The maximum permissible supply pressure into the shut-off valve for low pressure installations is 300 mbar.

For high-pressure supplies, EN 334-compliant high-pressure regulators should be selected from the brochure *"Pressure regulators with safety devices for Weishaupt gas and dual-fuel burners"*. This brochure details high-gas-pressure sets suitable for supply pressures of up to 4 bar.

Refer to the burner's rating plate for the maximum connection pressure.

Gas valve train sizing

Size 70, version NR

Type 70/1-B, version NR

Burner rating kW	Low-pressure supply (with FRS) (flow pressure in mbar into shut-off valve, pe, max = 300 mbar)	High-pressure supply (with HP regulator), (flow pressure in mbar into gas valve assembly)
	Nominal valve-train diameter 2" 65 80 100 125 150 Nom. diameter of gas butterfly 100 100 100 100 100	Nominal valve-train diameter 2" 65 80 100 125 150 Nom. diameter of gas butterfly 100 100 100 100 100

Natural Gas E LHV = 10.35 kWh/Nm ³ ; d = 0.606; W _i = 13.295 kWh/Nm ³		
3900	189 97 62 42 36 33	93 53 41 32 30 29
4400	239 122 77 52 44 41	118 66 50 40 37 36
4900	295 150 93 63 53 49	145 81 61 48 44 43
5400	- 180 112 75 63 57	175 97 73 57 53 51
5900	- 213 132 87 73 67	- 115 86 67 62 60
6400	- 249 153 101 85 77	- 134 101 78 72 70
6900	- 288 177 116 97 88	- 154 116 90 82 80
7400	- - 202 132 110 100	- 177 132 102 94 91

Natural Gas LL LHV = 8.83 kWh/Nm ³ ; d = 0.641; W _i = 11.029 kWh/Nm ³		
3900	268 134 82 54 46 41	130 71 53 41 37 36
4400	- 170 104 68 57 52	164 90 67 51 47 46
4900	- 209 127 83 69 63	- 110 82 63 58 56
5400	- 253 153 100 83 75	- 133 99 76 69 67
5900	- - 182 117 97 88	- 158 117 89 82 79
6400	- - 212 137 113 102	- 185 137 104 95 92
6900	- - 245 157 129 116	- - 158 119 109 105
7400	- - 280 179 147 132	- - 180 136 124 120

LPG B/P LHV = 25.89 kWh/Nm ³ ; d = 1.555; W _i = 20.762 kWh/Nm ³		
3900	82 45 30 22 20 18	41 25 20 16 15 15
4400	105 57 39 29 25 24	54 33 26 22 21 20
4900	130 71 48 35 31 30	67 41 33 28 26 26
5400	158 86 58 42 38 35	82 50 40 34 32 31
5900	188 101 68 50 44 41	97 60 48 40 38 37
6400	220 118 79 58 51 48	114 69 56 47 44 43
6900	254 136 90 66 58 54	132 80 64 53 50 49
7400	291 155 103 74 65 61	150 91 73 60 57 56

Type 70/4-A, version NR

Burner rating kW	Low-pressure supply (with FRS) (flow pressure in mbar into shut-off valve, pe, max = 300 mbar)	High-pressure supply (with HP regulator), (flow pressure in mbar into gas valve assembly)
	Nominal valve-train diameter 65 80 100 125 150 Nom. diameter of gas butterfly 100 100 100 100	Nominal valve-train diameter 65 80 100 125 150 Nom. diameter of gas butterfly 100 100 100 100

Natural Gas E LHV = 10.35 kWh/Nm ³ ; d = 0.606; W _i = 13.295 kWh/Nm ³		
6500	219 119 66 49 41	99 65 42 35 33
7000	253 138 76 56 47	115 75 48 41 38
7500	290 158 87 64 53	132 86 55 47 44
8000	- 179 98 72 60	150 98 63 53 50
9000	- 226 123 90 75	190 124 79 67 63
10000	- 278 151 111 92	- 153 97 82 77
11000	- - 182 133 110	- 184 117 99 93
11700	- - 205 150 124	- - 133 112 105

Natural Gas LL LHV = 8.83 kWh/Nm ³ ; d = 0.641; W _i = 11.029 kWh/Nm ³		
6500	- 170 93 68 56	142 93 59 50 46
7000	- 197 107 78 65	165 107 68 57 53
7500	- 226 122 89 74	189 123 78 66 61
8000	- 256 138 101 83	- 140 88 74 69
9000	- - 174 127 104	- 176 111 94 87
10000	- - 214 155 128	- - 137 115 107
11000	- - 258 187 154	- - 165 139 130
11700	- - 291 211 173	- - 187 157 146

LPG B/P LHV = 25.89 kWh/Nm ³ ; d = 1.555; W _i = 20.762 kWh/Nm ³		
6500	96 56 34 27 24	46 32 23 20 19
7000	110 63 37 29 26	52 36 25 22 21
7500	125 71 42 32 28	59 40 27 24 23
8000	141 80 46 36 31	66 45 30 26 25
9000	177 99 57 44 37	83 56 38 33 31
10000	218 122 70 53 46	102 69 46 40 38
11000	264 148 85 65 55	124 84 57 49 47
11700	299 167 96 74 63	142 96 65 57 54

Type 70/3-A, version NR

Burner rating kW	Low-pressure supply (with FRS) (flow pressure in mbar into shut-off valve, pe, max = 300 mbar)	High-pressure supply (with HP regulator), (flow pressure in mbar into gas valve assembly)
	Nominal valve-train diameter 65 80 100 125 150 Nom. diameter of gas butterfly 100 100 100 100	Nominal valve-train diameter 65 80 100 125 150 Nom. diameter of gas butterfly 100 100 100 100

Natural Gas E LHV = 10.35 kWh/Nm ³ ; d = 0.606; W _i = 13.295 kWh/Nm ³		
5300	146 80 45 33 28	66 43 28 24 22
6000	187 102 57 42 35	85 56 36 30 28
7000	253 138 76 56 47	115 75 48 41 38
8000	- 179 98 72 60	150 98 63 53 50
9000	- 226 123 90 75	190 124 79 67 63
10000	- 278 151 111 92	- 153 97 82 77
10700	- - 172 126 105	- 175 111 94 88

Natural Gas LL LHV = 8.83 kWh/Nm ³ ; d = 0.641; W _i = 11.029 kWh/Nm ³		
5300	210 115 63 46 39	95 62 40 33 31
6000	269 146 79 58 49	122 79 50 42 40
7000	- 197 107 78 65	165 107 68 57 53
8000	- 256 138 101 83	- 140 88 74 69
9000	- - 174 127 104	- 176 111 94 87
10000	- - 214 155 128	- - 137 115 107
10700	- - 244 177 146	- - 156 132 123

LPG B/P LHV = 25.89 kWh/Nm ³ ; d = 1.555; W _i = 20.762 kWh/Nm ³		
5300	69 42 27 23 20	35 25 19 17 16
6000	84 49 31 25 22	41 29 21 18 18
7000	110 63 37 29 26	52 36 25 22 21
8000	141 80 46 36 31	66 45 30 26 25
9000	177 99 57 44 37	83 56 38 33 31
10000	218 122 70 53 46	102 69 46 40 38
10700	250 140 80 61 52	117 80 54 46 44

Stated pressures for LPG are based on propane, but may also be used for butane.

The combustion chamber pressure in mbar must be added to the minimum gas pressure determined from the above chart.

For low-pressure supplies, EN 88-compliant governors with safety diaphragms are used. The maximum permissible supply pressure into the shut-off valve for low pressure installations is 300 mbar.

For high-pressure supplies, EN 334-compliant high-pressure regulators should be selected from the brochure "Pressure regulators with safety devices for Weishaupt gas and dual-fuel burners". This brochure details high-gas-pressure sets suitable for supply pressures of up to 4 bar.

Refer to the burner's rating plate for the maximum connection pressure.

Scope of delivery, special equipment

Sizes 60 and 70, version NR

Scope of delivery	G60	G70 / 70/4	
Burner housing, hinged flange, housing cover, Weishaupt burner motor, air-inlet housing, fan wheel, combustion head, ignition unit, ignition cable, ignition electrodes, combustion manager with control unit, flame sensor, stepping motors, flange gasket, limit switch on hinged flange, fixing screws	●	●	●
W-FM 100 combustion manager	●	●	–
W-FM 200 combustion manager	–	–	●
Double gas valve assembly (Class A)	●	●	●
Gas butterfly valve	●	●	●
Pilot line solenoid valve (Class A)	●	●	●
Air pressure switch	●	●	●
Low gas pressure switch	●	●	●
Mixing assembly with modulating regulating sleeve	●	●	●
Actuators for compound regulation of gas and air via W-FM:			
Air damper stepping motor	●	●	●
Gas butterfly valve stepping motor	●	●	●
Regulating sleeve stepping motor	●	●	●
Special equipment	G60	G70 / 70/4	
Downward-firing version	○	○	○
Air inlet flange for duct connection	○	○	○
Solenoid valve for air pressure switch test with continuously running fan or post-purge	○	○	○
Combustion head extension	○	○	○
Integral capacity controller for W-FM 100	○	○	–
VSD	○	○	●
O ₂ trim	○	○	○
W-FM supplied loose for mounting in a control panel	○	○	○
Bus interface	○	○	○
High gas pressure switch	○	○	○
Multi-language ABE	○	○	○
Offset gas butterfly valve and DMV	○	○	○

- Standard
- Optional

Please enquire or see the price list for additional special equipment.

Technical data

Sizes 60 and 70, version NR

Technical data		G60/2-A		G70/1-B		G70/3-A		G70/4-A		
400 V, 3 ~ burner motor ¹⁾	Type	W-D132/210-2/14K0		W-D160/240-2/18K0		W-D160/240-2/22K0		W-D160/240-2/28K0		
Nominal rating	kW	14		18		22		28		
Current draw at 400 V	A	28		35		43		53		
Motor prefusing (ΥΔ motor start)	A	50		63		63		*		
Speed (50 Hz)	rpm	2920		2950		2940		3220		
Fan wheel	colour / ø	blue / 515 x 120		blue / 590 x 160		blue / 590 x 160		blue / 590 x 160		
Combustion manager	Type	W-FM100		W-FM100		W-FM100		W-FM200		
Ignition unit	Type	W-ZG02		W-ZG02		W-ZG02		W-ZG02		
Actuator	Air	Type	SQM48		SQM48		SQM48		SQM48	
	Mixing assembly	Type	SQM45		SQM45		SQM48		SQM48	
	Fuel	Type	SQM45		SQM45		SQM45		SQM45	
Burner weight	kg (approx.)	275		390		420		420		
Weight (gas valve assembly and fittings)	R / DN	1½	2	65	80	100	125	150		
	kg (approx.)	13	24	23	31	39	37	48		

¹⁾ The electrical motors are premium-efficiency IE3 motors in accordance with Commission Regulation (EC) No. 640/2009.

* 55 Hz operation with frequency convertor only (no IE classification).

Burner selection

Size 70, version 1LN

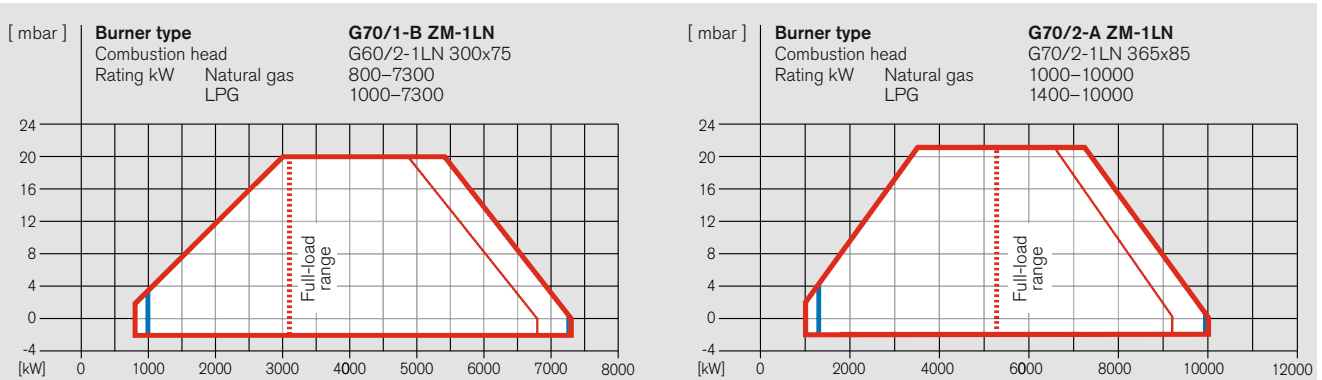

Fuels – Rating with combustion head:

	Open	Closed
Natural gas		
LPG		

Plotted operational ranges represent maximal values measured on idealised flame tubes in accordance with EN 676.

Stated ratings are based on an air temperature of 20 °C and an installation at sea level.

For installations at higher altitudes, a reduction in capacity of 1 % per 100 m above sea level should be taken into account.

Voltages and frequencies:

The burners are equipped as standard for three-phase alternating current, 400 V, 3 ~, 50 Hz. Other voltages and frequencies are available on application (no additional cost).

Standard burner motor:

Insulation Class F, IP 55 protection, IE3 efficiency

Burner type	Version	CE-PIN	Valve train	Order No.
G70/1-B	ZM-1LN	CE-0085AQ 0723	DN 65	217 704 45
			DN 80	217 704 55
			DN 100	217 704 65
			DN 125	217 704 75
			DN 150	217 704 85
G70/2-A	ZM-1LN	CE-0085AQ 0723	DN 65	217 705 45
			DN 80	217 705 55
			DN 100	217 705 65
			DN 125	217 705 75
			DN 150	217 705 85

Gas valve train sizing

Size 70, version 1LN

Type 70/1-B, version 1LN

Burner rating kW	Low-pressure supply (with FRS) (flow pressure in mbar into shut-off valve, pe, max = 300 mbar)	High-pressure supply (with HP regulator), (flow pressure in mbar into gas valve assembly)
	Nominal valve-train diameter 65 80 100 125 150 Nom. diameter of gas butterfly 100 100 100 100 100	Nominal valve-train diameter 65 80 100 125 150 Nom. diameter of gas butterfly 100 100 100 100 100

Natural Gas E LHV = 10.35 kWh/Nm³; d = 0.606; W_i = 13.295 kWh/Nm³

3100	74	52	40	36	34	45	38	32	31	30
3700	95	63	45	40	37	54	43	36	34	33
4300	120	77	53	46	42	66	52	41	38	38
4900	151	94	64	54	50	82	62	49	45	44
5500	186	115	77	65	59	100	76	59	54	53
6100	227	140	92	78	70	122	92	71	65	63
6700	273	168	111	93	84	146	110	85	78	76
7300	-	199	131	110	100	174	131	102	94	91

Natural Gas LL LHV = 8.83 kWh/Nm³; d = 0.641; W_i = 11.029 kWh/Nm³

3100	101	68	51	45	43	60	49	41	39	38
3700	131	84	59	51	47	73	57	46	43	42
4300	167	104	70	59	54	90	69	54	50	48
4900	211	129	85	71	64	112	84	64	59	57
5500	262	159	103	85	77	138	102	78	71	69
6100	-	193	125	103	93	168	124	94	86	83
6700	-	232	150	123	111	-	150	114	104	101
7300	-	276	178	147	132	-	179	136	124	120

LPG B/P LHV = 25.89 kWh/Nm³; d = 1.555; W_i = 20.762 kWh/Nm³

3100	51	42	37	35	34	38	34	32	32	31
3700	62	49	42	39	38	44	39	36	35	35
4300	76	59	49	46	44	53	47	43	41	41
4900	94	71	58	54	53	64	56	51	49	49
5500	115	86	70	65	63	78	68	61	59	59
6100	139	103	84	78	75	95	82	74	71	71
6700	167	124	100	93	89	113	99	88	86	85
7300	198	146	119	110	106	135	117	105	102	101

Type 70/2-A, version 1LN

Burner rating kW	Low-pressure supply (with FRS) (flow pressure in mbar into shut-off valve, pe, max = 300 mbar)	High-pressure supply (with HP regulator), (flow pressure in mbar into gas valve assembly)
	Nominal valve-train diameter 65 80 100 125 150 Nom. diameter of gas butterfly 100 100 100 100 100	Nominal valve-train diameter 65 80 100 125 150 Nom. diameter of gas butterfly 100 100 100 100 100

Natural Gas E LHV = 10.35 kWh/Nm³; d = 0.606; W_i = 13.295 kWh/Nm³

5300	153	87	51	40	34	72	50	34	30	28
5900	188	106	62	48	41	89	61	42	36	35
6500	227	128	74	57	49	107	73	50	44	41
7100	269	151	87	67	58	128	87	59	52	49
7700	-	177	102	78	67	150	102	69	60	57
8300	-	205	118	90	77	174	118	80	70	66
8900	-	235	135	103	88	200	135	92	80	76
9500	-	267	153	116	99	-	154	104	91	86
10000	-	296	169	129	110	-	171	115	100	95

Natural Gas LL LHV = 8.83 kWh/Nm³; d = 0.641; W_i = 11.029 kWh/Nm³

5300	215	119	67	51	43	100	67	44	38	36
5900	266	148	84	63	54	124	83	55	48	45
6500	-	179	101	77	65	151	101	67	58	55
7100	-	213	120	91	77	180	121	80	70	66
7700	-	250	141	106	90	-	142	94	82	77
8300	-	290	163	123	104	-	165	109	94	89
8900	-	-	186	140	119	-	189	125	108	102
9500	-	-	211	159	134	-	-	142	122	115
10000	-	-	233	175	147	-	-	157	135	127

LPG B/P LHV = 25.89 kWh/Nm³; d = 1.555; W_i = 20.762 kWh/Nm³

5300	75	48	33	29	27	41	31	25	23	23
5900	92	59	41	35	32	50	39	31	29	28
6500	111	71	49	42	39	61	47	37	35	34
7100	132	84	58	49	45	73	56	44	41	40
7700	155	98	67	57	53	85	66	52	48	47
8300	179	113	77	66	60	99	76	60	56	54
8900	205	129	88	75	69	113	87	69	64	62
9500	233	146	99	84	77	128	98	78	72	70
10000	257	161	109	93	85	142	109	86	80	78

Stated pressures for LPG are based on propane, but may also be used for butane.

The combustion chamber pressure in mbar must be added to the minimum gas pressure determined from the above chart.

For low-pressure supplies, EN 88-compliant governors with safety diaphragms are used. The maximum permissible supply pressure into the shut-off valve for low pressure installations is 300 mbar.

For high-pressure supplies, EN 334-compliant high-pressure regulators should be selected from the brochure "Pressure regulators with safety devices for Weishaupt gas and dual-fuel burners". This brochure details high-gas-pressure sets suitable for supply pressures of up to 4 bar.

Refer to the burner's rating plate for the maximum connection pressure.

Scope of delivery, special equipment

Size 70, version 1LN

Scope of delivery	G70
Burner housing, hinged flange, housing cover, Weishaupt burner motor, air-inlet housing, fan wheel, combustion head, ignition unit, ignition cable, ignition electrodes, combustion manager with control unit, flame sensor, stepping motors, flange gasket, limit switch on hinged flange, fixing screws	●
W-FM 100 combustion manager	●
Double gas valve assembly (Class A)	●
Gas butterfly valve	●
Pilot line	●
Air pressure switch	●
Low gas pressure switch	●
Mixing assembly with adjustable regulating sleeve	●
Actuators for compound regulation of gas and air via W-FM	
Air damper stepping motor	●
Gas butterfly valve stepping motor	●
Special equipment	G70
Downward-firing version	○
Air inlet flange for duct connection	○
Solenoid valve for air pressure switch test with continuously running fan or post purge	○
Combustion head extension	○
Integral capacity controller for W-FM 100	○
Variable speed drive	○
O ₂ trim	○
W-FM supplied loose for mounting in a control panel	○
Bus interface	○
High gas pressure switch	○

- Standard
- Optional

Please enquire or see the price list for additional special equipment.

Technical data

Size 70, version 1LN

Technical data		G70/1-B				G70/2-A				
400 V, 3 ~ burner motor ¹⁾		Type	W-D160/240-2/18K0				W-D160/240-2/22K0			
Nominal rating		kW	18				22			
Current draw at 400 V		A	35				43			
Motor prefusing (YΔ motor start)		A	63				63			
Speed (50 Hz)		rpm	2950				2940			
Fan wheel		Colour / ø	blue / 590 x 160				blue / 590 x 160			
Combustion manager		Type	W-FM100				W-FM100			
Ignition unit		Type	W-ZG02				W-ZG02			
Actuator	Air	Type	SQM48				SQM48			
	Fuel	Type	SQM45				SQM45			
Burner weight		kg (approx.)	185				390			
Weight (gas valve assembly and fittings)		R / DN	1½	2	65	80	100	125	150	
		kg (approx.)	13	24	23	31	39	37	48	

¹⁾ The electrical motors are premium-efficiency IE3 motors in accordance with Commission Regulation (EC) No. 640/2009.

Burner selection

Sizes 60 and 70, version LN

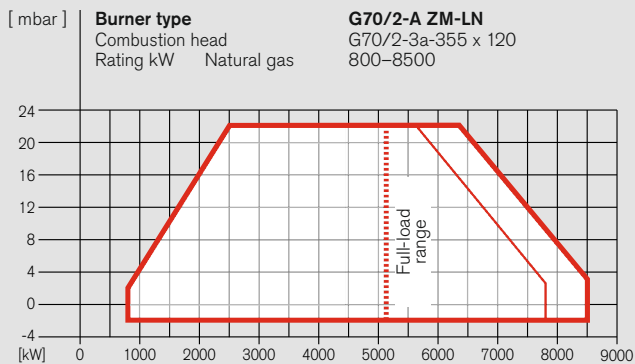
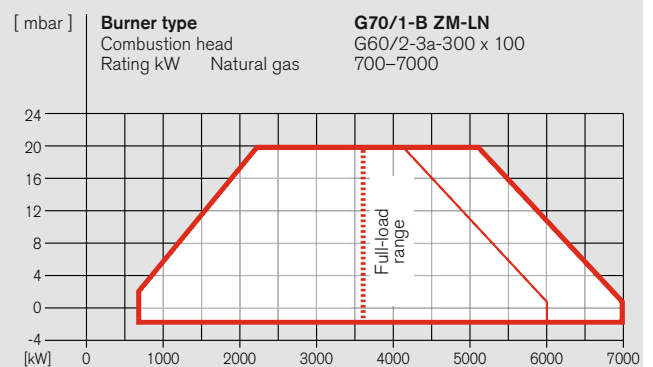
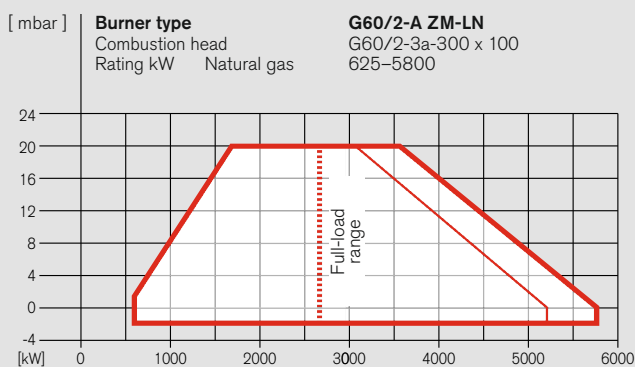

Burner type	Version	CE-PIN	Valve train	Order No.
G60/2-A	ZM-LN	CE-0085AQ 0722	R 2	217 605 13
			DN 65	217 605 43
			DN 80	217 605 53
			DN 100	217 605 63
			DN 125	217 605 73
G70/1-B	ZM-LN	CE-0085AQ 0723	DN 150	217 605 83
			DN 65	217 704 43
			DN 80	217 704 53
G70/2-A	ZM-LN	CE-0085AQ 0723	DN 100	217 704 63
			DN 125	217 704 73
			DN 150	217 704 83
			DN 65	217 705 43
			DN 80	217 705 53

Fuels – Rating with combustion head:

open closed
 Natural gas — —

Plotted operational ranges represent maximal values measured on idealised flame tubes in accordance with EN 676.

Stated ratings are based on an air temperature of 20 °C and an installation at sea level.

For installations at higher altitudes, a reduction in capacity of 1 % per 100 m above sea level should be taken into account.

Voltages and frequencies:

The burners are equipped as standard for three-phase alternating current, 400 V, 3 ~, 50 Hz. Other voltages and frequencies are available on application (no additional cost).

Standard burner motor:

Insulation Class F, IP 55 protection, IE3 efficiency

Gas valve train sizing

Sizes 60 and 70, version LN

Type 60/2-A, version LN

Burner rating kW	Low-pressure supply (with FRS) (flow pressure in mbar into shut-off valve, pe, max = 300 mbar)	High-pressure supply (with HP regulator), (flow pressure in mbar into gas valve assembly)
	Nominal valve-train diameter 2" 65 80 100 125 150 Nom. diameter of gas butterfly 100 100 100 100 100	Nominal valve-train diameter 2" 65 80 100 125 150 Nom. diameter of gas butterfly 100 100 100 100 100

Natural Gas E LHV = 10.35 kWh/Nm ³ ; d = 0.606; W _i = 13.295 kWh/Nm ³	
2700	92 48 31 22 19 17
3000	114 59 38 27 23 22
3300	138 72 46 32 28 26
3600	163 85 54 38 33 30
3900	191 99 63 44 38 35
4200	220 113 72 50 43 39
4500	251 129 81 56 48 44
4800	285 145 91 62 53 48
5200	- 168 104 70 59 54

Natural Gas LL LHV = 8.83 kWh/Nm ³ ; d = 0.641; W _i = 11.029 kWh/Nm ³	
2700	126 62 37 24 19 17
3000	158 79 48 31 26 24
3300	192 96 59 39 33 30
3600	229 115 71 47 40 36
3900	269 135 84 55 47 42
4200	- 157 96 64 54 49
4500	- 179 110 73 61 55
4800	- 203 124 82 68 62
5200	- 235 142 93 77 69

The combustion chamber pressure in mbar must be added to the minimum gas pressure determined from the above chart.

For low-pressure supplies, EN 88-compliant governors with safety diaphragms are used. The maximum permissible supply pressure into the shut-off valve for low pressure installations is 300 mbar.

For high-pressure supplies, EN 334-compliant high-pressure regulators should be selected from the brochure *"Pressure regulators with safety devices for Weishaupt gas and dual-fuel burners"*. This brochure details high-gas-pressure sets suitable for supply pressures of up to 4 bar.

Refer to the burner's rating plate for the maximum connection pressure.

Type 70/1-B, version LN

Burner rating kW	Low-pressure supply (with FRS) (flow pressure in mbar into shut-off valve, pe, max = 300 mbar)	High-pressure supply (with HP regulator), (flow pressure in mbar into gas valve assembly)
	Nominal valve-train diameter 65 80 100 125 150 Nom. diameter of gas butterfly 100 100 100 100 100	Nominal valve-train diameter 65 80 100 125 150 Nom. diameter of gas butterfly 100 100 100 100 100

Natural Gas E LHV = 10.35 kWh/Nm ³ ; d = 0.606; W _i = 13.295 kWh/Nm ³	
3600	82 52 36 30 28
4000	102 64 44 37 34
4400	122 77 52 44 41
4800	144 90 61 52 47
5200	167 104 70 59 54
5600	192 119 79 66 60
6000	218 134 88 74 67
6400	246 150 98 82 74
7000	290 175 113 94 84

Natural Gas LL LHV = 8.83 kWh/Nm ³ ; d = 0.641; W _i = 11.029 kWh/Nm ³	
3600	113 69 45 38 34
4000	141 86 57 47 43
4400	170 105 69 58 52
4800	202 124 81 68 61
5200	236 144 94 78 71
5600	272 165 107 89 80
6000	- 187 121 100 90
6400	- 209 133 109 98
7000	- 243 153 124 111

Type 70/2-A, version LN

Burner rating kW	Low-pressure supply (with FRS) (flow pressure in mbar into shut-off valve, pe, max = 300 mbar)	High-pressure supply (with HP regulator), (flow pressure in mbar into gas valve assembly)
	Nominal valve-train diameter 65 80 10 125 150 Nom. diameter of gas butterfly 100 100 100 100 100	Nominal valve-train diameter 65 80 100 125 150 Nom. diameter of gas butterfly 100 100 100 100 100

Natural Gas E LHV = 10.35 kWh/Nm ³ ; d = 0.606; W _i = 13.295 kWh/Nm ³	
5100	143 82 49 39 34
5600	172 98 59 46 40
6100	203 116 68 53 46
6600	236 134 79 61 53
7100	271 153 89 69 59
7600	- 173 100 77 66
8100	- 193 109 83 71
8500	- 208 117 88 74

Natural Gas LL LHV = 8.83 kWh/Nm ³ ; d = 0.641; W _i = 11.029 kWh/Nm ³	
5100	201 113 65 50 43
5600	242 135 78 59 51
6100	287 160 91 69 59
6600	- 185 105 80 68
7100	- 213 120 90 77
7600	- 241 135 101 85
8100	- 271 150 112 94
8500	- 293 160 118 98

Scope of delivery, special equipment, tech. data

Sizes 60 and 70, version LN

Scope of delivery		G60	G70
Burner housing, hinged flange, housing cover, Weishaupt burner motor, air-inlet housing, fan wheel, combustion head, ignition unit, ignition cable, ignition electrodes, combustion manager with control unit, flame sensor, stepping motors, flange gasket, limit switch on hinged flange, fixing screws		●	●
W-FM 100 combustion manager		●	●
Double gas valve assembly (Class A)		●	●
Gas butterfly valve		●	●
Air pressure switch		●	●
Low gas pressure switch		●	●
Mixing assembly with adjustable flame tube		●	●
Actuators for compound regulation of gas and air via W-FM			
Stepping motor for air damper		●	●
Stepping motor for gas butterfly valve		●	●

Special equipment		G60	G70
Downward-firing version		○	○
Air inlet flange for duct connection		○	○
Combustion-head extension		○	○
Integral capacity controller for W-FM 100		○	○
Variable speed drive		○	○
O ₂ trim		○	○
W-FM supplied loose for mounting in a control panel		○	○
Bus interface		○	○
High gas pressure switch		○	○

● Standard
○ Optional

Please enquire or see the price list for additional special equipment.

Technical data		G60/2-A		G70/1-B		G70/2-A		
400 V, 3 ~ burner motor ¹⁾	Type	W-D132/210-2/14K0		W-D160/240-2/16K0		W-D160/240-2/22K0		
Nominal rating	kW	14		16		22		
Current draw at 380 V (400 V)	A	28		33		43		
Motor prefusing (ΥΔ motor start)	A	50		50		63		
Speed (50 Hz)	rpm	2920		2960		2940		
Fan wheel	Colour / ø	blue / 515 x 120		blue / 590 x 160		blue / 590 x 160		
Combustion manager	Type	W-FM100		W-FM100		W-FM100		
Ignition unit	Type	W-ZG02		W-ZG02		W-ZG02		
Actuator	Air	Type SQM48		SQM48		SQM48		
	Fuel	Type SQM45		SQM45		SQM45		
Burner weight	kg (approx.)	275		390		390		
Weight (gas-valve assembly and fittings)	R / DN	1½	2	65	80	100	125	150
	kg (approx.)	11	22	21	29	37	35	46

¹⁾ The electrical motors are premium-efficiency IE3 motors in accordance with Commission Regulation (EC) No. 640/2009.



Dual-fuel burners

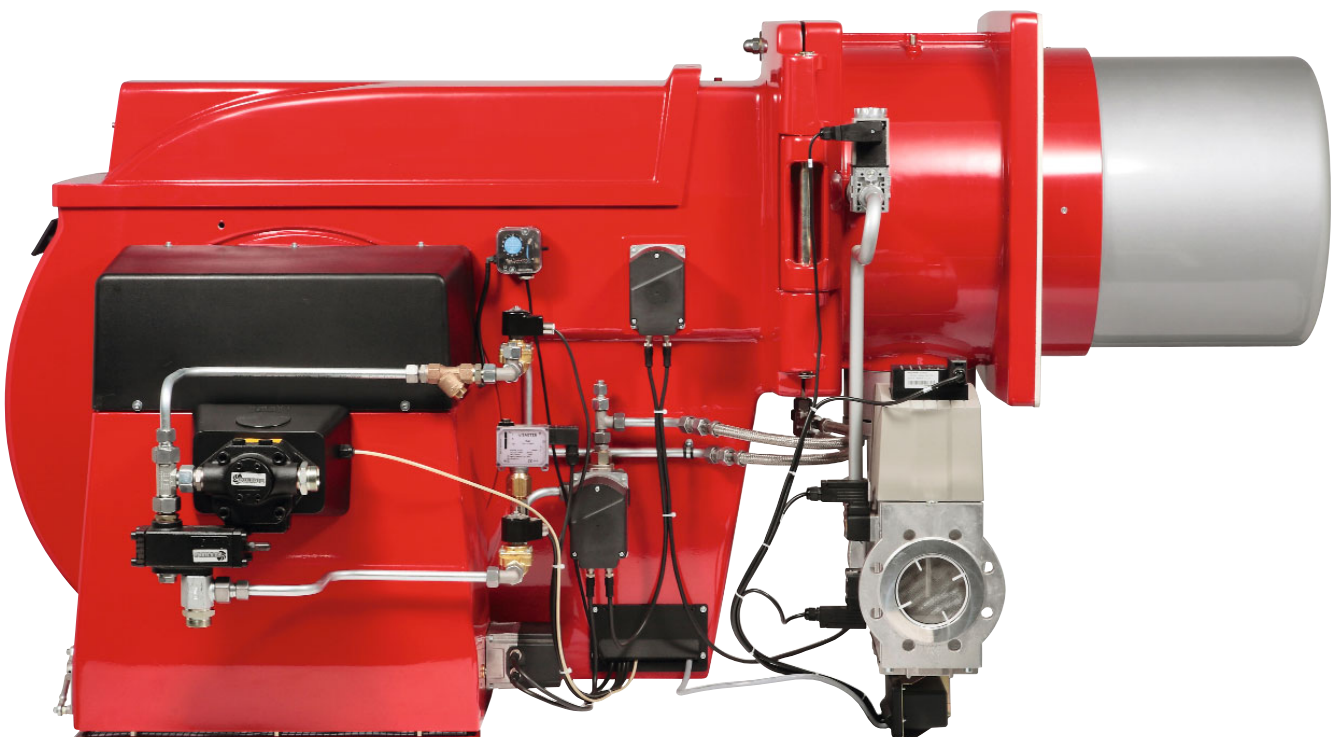

Burner selection

Sizes 30 and 40, version NR

RGMS30/2-A ZM-NR

Combustion head: G30/2-NR 190x65

Rating kW: Natural gas 300–2300, LPG 300–2300

Rating kg/h: HFO 60–205

RGMS40/1-B ZM-NR

Combustion head: G30/2-NR 190x58

Rating kW: Natural gas 450–2700, LPG 450–2700

Rating kg/h: HFO 70–240

Fuels

HFO —

Natural gas —

LPG —

Stated oil throughputs are based on a calorific value of 11.24 kWh/kg for HFO.

Plotted operational ranges represent maximal values measured on idealised flame tubes in accordance with EN 676 and EN 267.

Stated ratings are based on an air temperature of 20 °C and an installation altitude of 500 m above sea level.

For installations at higher altitudes, a reduction in capacity of 1 % per 100 m above sea level should be taken into account.

Voltages and frequencies:

The burners are equipped as standard for three-phase alternating current, 400 V, 3 ~, 50 Hz. Other voltages and frequencies are available on application (no additional cost).

Standard burner motor:

Insulation Class F, IP 55 protection, IE3 efficiency

RGMS40/2-A ZM-NR

Combustion head: G40/2-NR 217x75

Rating kW: Natural gas 500–3450, LPG 500–3450

Rating kg/h: HFO 90–307

Burner type	Version	CE-PIN	Valve train	Order No.
RGMS30/2-A*	ZM-NR	CE-0085-AP 0528	R 1 1/2"	219 305 13
			R 2"	219 305 15
			DN 65	219 305 42
			DN 80	219 305 52
			DN 100	219 305 62
RGMS40/1-B*	ZM-NR	CE-0085-AQ 0720	R 1 1/2"	219 404 13
			R 2"	219 404 15
			DN 65	219 404 42
			DN 80	219 404 52
			DN 100	219 404 62
DN 125	219 404 72			
RGMS40/2-A*	ZM-NR	CE-0085-AQ 0720	R 1 1/2"	219 405 13
			R 2"	219 405 15
			DN 65	219 405 42
			DN 80	219 405 52
			DN 100	219 405 62
DN 125	219 405 72			

* LPG-fired burners do not have a Product ID No. (CE-PIN)

Burner selection

Size 50, version NR

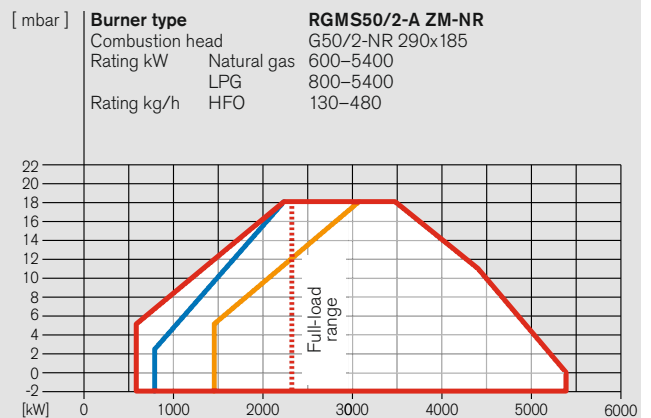
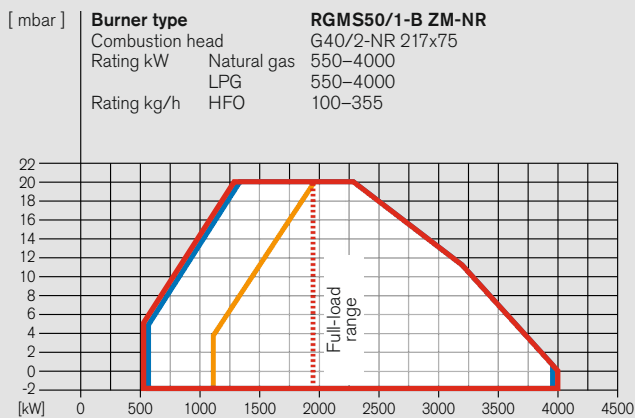

Fuels

- HFO —
- Natural gas —
- LPG —

Stated oil throughputs are based on a calorific value of 11.24 kWh/kg for HFO.

Plotted operational ranges represent maximal values measured on idealised flame tubes in accordance with EN 267.

Stated ratings are based on an air temperature of 20 °C and an installation altitude of 500 m above sea level.

For installations at higher altitudes, a reduction in capacity of 1 % per 100 m above sea level should be taken into account.

Voltages and frequencies:

The burners are equipped as standard for three-phase alternating current, 400 V, 3 ~, 50 Hz. Other voltages and frequencies are available on application (no additional cost).

Standard burner motor:

Insulation Class F, IP 55 protection, IE3 efficiency

Burner type	Version	CE-PIN DIN CERTCO	Valve train	Order No.
RGMS50/1-B* ZM-NR	ZM-NR	CE-0085-AQ 0721	R 1½	219 504 13
			R 2	219 504 15
			DN 65	219 504 42
			DN 80	219 504 52
			DN 100	219 504 62
DN 125	219 504 72			
RGMS50/2-A* ZM-NR	ZM-NR	CE-0085-AQ 0721	R 1½	219 505 13
			R 2	219 505 15
			DN 65	219 505 42
			DN 80	219 505 52
			DN 100	219 505 62
			DN 125	219 505 72
			DN 150	219 505 82

* LPG-fired burners do not have a Product ID No. (CE-PIN)

Burner selection

Sizes 60 and 70, version NR

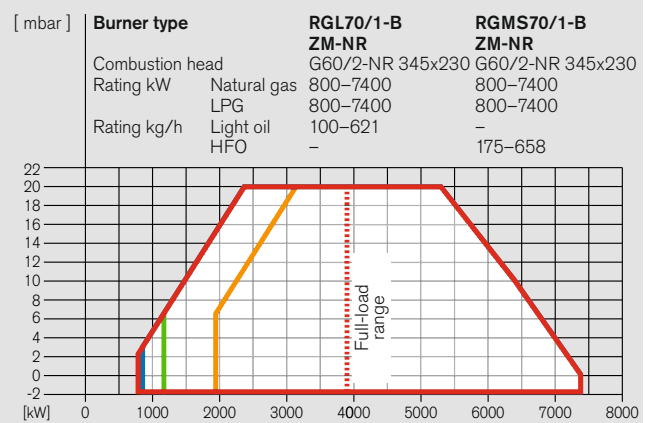
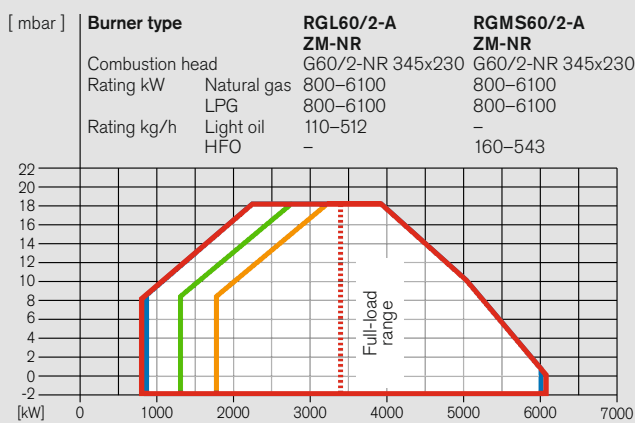

Fuels

Light oil	
HFO	
Natural gas	
LPG	

Stated oil throughputs are based on a calorific value of 11.91 kWh/kg for light oil and 11.24 kWh/kg for HFO.

Plotted operational ranges represent maximal values measured on idealised flame tubes in accordance with EN 267.

Stated ratings are based on an air temperature of 20 °C and an installation altitude of 500 m above sea level.

For installations at higher altitudes, a reduction in capacity of 1 % per 100 m above sea level should be taken into account.

Voltages and frequencies:

The burners are equipped as standard for three-phase alternating current, 400 V, 3 ~, 50 Hz. Other voltages and frequencies are available on application (no additional cost).

Standard burner motor:

Insulation Class F, IP 55 protection, IE3 efficiency

Burner type	Version	CE-PIN DIN CERTCO	Valve train	Order No.
RGL60/2-A	ZM-NR	CE-0085-AQ 0722 5G518/05M	DN 65	218 605 42
			DN 80	218 605 52
			DN 100	218 605 62
			DN 125	218 605 72
			DN 150 *	218 605 82
RGMS60/2-A*	ZM-NR	CE-0085-AQ 0722 –	DN 65	219 605 42
			DN 80	219 605 52
			DN 100	219 605 62
			DN 125	219 605 72
			DN 150 *	219 605 82
RGL70/1-B	ZM-NR	CE-0085-AQ 0723 5G519/05M	DN 65	218 704 42
			DN 80	218 704 52
			DN 100	218 704 62
			DN 125	218 704 72
			DN 150	218 704 82
RGMS70/1-B*	ZM-NR	CE-0085-AQ 0723 –	DN 65	219 704 42
			DN 80	219 704 52
			DN 100	219 704 62
			DN 125	219 704 72
			DN 150	219 704 82

* LPG-fired burners do not have a Product ID No. (CE-PIN)

Burner selection

Size 70, version NR

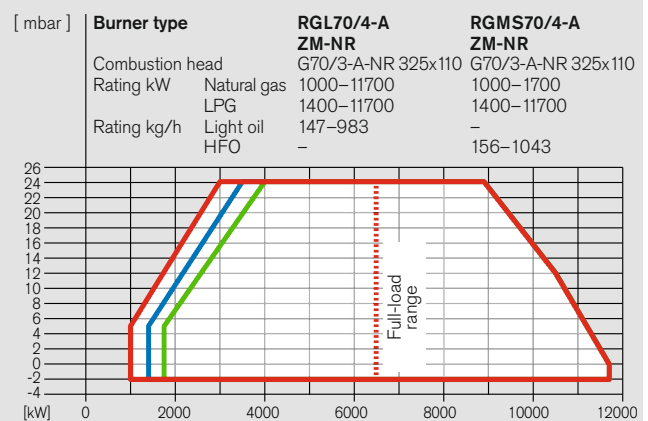
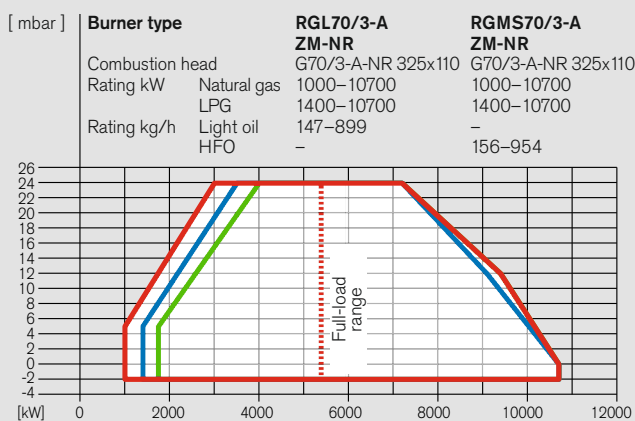

Fuels

- Light oil —
- HFO —
- Natural gas —
- LPG —

Stated oil throughputs are based on a calorific value of 11.91 kWh/kg for light oil and 11.24 kWh/kg for HFO.

Plotted operational ranges represent maximal values measured on idealised flame tubes in accordance with EN 267.

Stated ratings are based on an air temperature of 20 °C and an installation at sea level.

For installations at higher altitudes, a reduction in capacity of 1 % per 100 m above sea level should be taken into account.

Voltages and frequencies:

The burners are equipped as standard for three-phase alternating current, 400 V, 3 ~, 50 Hz. Other voltages and frequencies are available on application (no additional cost).

Standard burner motor:

Insulation Class F, IP 55 protection, IE3 efficiency at 50/60 Hz (no IE classification at 55 Hz).

Burner type	Version	CE-PIN DIN CERTCO	Valve train	Order No.
RGL70/3-A	ZM-NR	CE-0085-AQ 0723 5G519/05M	DN 65	218 714 14
			DN 80	218 714 15
			DN 100	218 714 16
			DN 125	218 714 17
			DN 150	218 714 18
RGMS70/3-A	ZM-NR	CE-0085-AQ 0723 –	DN 65	219 714 14
			DN 80	219 714 15
			DN 100	219 714 16
			DN 125	219 714 17
			DN 150	219 714 18
RGL70/4-A *	ZM-NR	CE-0085-AQ 0723 5G519/05M	DN 65	218 734 14
			DN 80	218 734 15
			DN 100	218 734 16
			DN 125	218 734 17
			DN 150	218 734 18
RGMS70/4-A *	ZM-NR	CE-0085-AQ 0723 –	DN 65	219 734 14
			DN 80	219 734 15
			DN 100	219 734 16
			DN 125	219 734 17
			DN 150	219 734 18

* Equipped with W-FM 200 and VSD as standard (55 Hz)

Gas valve train sizing

Sizes 30 and 40, version NR

Type 30/2-A, version NR

Burner rating kW	Low-pressure supply (with FRS) (flow pressure in mbar into shut-off valve, pe, max = 300 mbar)	High-pressure supply (with HP regulator), (flow pressure in mbar into gas valve assembly)
	Nominal valve-train diameter	Nominal valve-train diameter
	1½" 2" 65 80 100 125	1½" 2" 65 80 100 125
	Nom. diameter of gas butterfly 50 50 50 50 50 50	Nom. diameter of gas butterfly 50 50 50 50 50 50

Natural Gas E LHV = 10.35 kWh/Nm ³ ; d = 0.606; W _i = 13.295 kWh/Nm ³		
1500	89 35 21 16 13 12	48 19 13 11 10 9
1600	100 39 24 18 15 14	54 21 14 12 11 10
1700	113 44 27 20 16 15	61 24 16 14 12 12
1800	127 49 30 22 18 17	69 27 18 16 14 13
1900	141 55 33 24 20 18	77 30 20 18 16 15
2000	156 60 36 27 22 20	85 33 23 19 17 17
2100	171 66 39 29 24 22	94 37 25 21 19 18
2300	205 79 47 34 28 25	112 44 30 25 22 22

Natural Gas LL LHV = 8.83 kWh/Nm ³ ; d = 0.641; W _i = 11.029 kWh/Nm ³		
1500	126 48 28 21 17 15	68 26 17 14 12 12
1600	143 54 32 23 18 17	77 29 19 16 14 13
1700	161 61 36 26 21 19	87 33 22 18 16 15
1800	181 68 40 29 23 21	98 37 24 21 18 17
1900	201 76 44 32 25 23	109 41 27 23 20 19
2000	222 84 49 35 28 25	121 46 30 25 22 21
2100	245 92 53 38 30 28	133 50 33 28 24 23
2300	- 110 63 45 35 32	- 60 40 33 29 28

LPG B/P LHV = 25.89 kWh/Nm ³ ; d = 1.555; W _i = 20.762 kWh/Nm ³		
1500	41 19 13 11 10 9	22 10 8 7 7 7
1600	46 21 14 12 11 10	25 12 9 8 8 7
1700	51 23 16 13 12 11	29 13 10 9 9 8
1800	57 26 18 15 13 12	32 15 12 11 10 10
1900	64 28 20 16 14 14	36 17 13 12 11 11
2000	70 31 21 17 15 15	40 19 14 13 12 12
2100	77 34 23 19 17 16	44 20 16 14 13 13
2300	92 40 27 22 19 19	53 25 19 17 16 16

Type 40/1-B, version NR

Burner rating kW	Low-pressure supply (with FRS) (flow pressure in mbar into shut-off valve, pe, max = 300 mbar)	High-pressure supply (with HP regulator), (flow pressure in mbar into gas valve assembly)
	Nominal valve-train diameter	Nominal valve-train diameter
	1½" 2" 65 80 100 125	1½" 2" 65 80 100 125
	Nom. diameter of gas butterfly 50 50 50 50 50 50	Nom. diameter of gas butterfly 50 50 50 50 50 50

Natural Gas E LHV = 10.35 kWh/Nm ³ ; d = 0.606; W _i = 13.295 kWh/Nm ³		
1750	120 47 28 21 17 16	65 25 17 15 13 13
1900	141 55 33 24 20 18	77 30 20 18 16 15
2050	163 63 38 28 23 21	89 35 24 20 18 17
2200	187 72 43 32 25 23	102 40 27 23 20 20
2350	214 82 49 36 29 26	117 46 31 26 23 23
2500	241 92 55 40 32 30	132 52 35 30 26 25
2700	- 107 63 46 37 34	- 60 40 35 30 29

Natural Gas LL LHV = 8.83 kWh/Nm ³ ; d = 0.641; W _i = 11.029 kWh/Nm ³		
1750	171 65 38 27 22 20	92 35 23 19 17 16
1900	201 76 44 32 25 23	109 41 27 23 20 19
2050	233 88 51 37 29 26	127 48 32 27 23 22
2200	- 101 58 42 33 30	- 55 36 30 26 25
2350	- 115 66 47 37 34	- 63 41 35 30 29
2500	- 129 74 53 41 38	- 71 47 39 34 33
2700	- 150 86 61 48 43	- 82 54 45 40 38

LPG B/P LHV = 25.89 kWh/Nm ³ ; d = 1.555; W _i = 20.762 kWh/Nm ³		
1750	54 25 17 14 12 12	30 14 11 10 9 9
1900	64 28 20 16 14 14	36 17 13 12 11 11
2050	74 33 22 18 16 15	42 20 15 14 13 12
2200	84 37 25 20 18 17	48 22 17 15 14 14
2350	96 42 28 23 20 19	55 26 20 18 17 16
2500	108 47 32 26 23 21	62 29 22 20 19 18
2700	126 54 36 29 26 24	72 34 26 23 22 21

Type 40/2-A, version NR

Burner rating kW	Low-pressure supply (with FRS) (flow pressure in mbar into shut-off valve, pe, max = 300 mbar)	High-pressure supply (with HP regulator), (flow pressure in mbar into gas valve assembly)
	Nominal valve-train diameter	Nominal valve-train diameter
	1½" 2" 65 80 100 125	1½" 2" 65 80 100 125
	Nom. diameter of gas butterfly 65 65 65 65 65 65	Nom. diameter of gas butterfly 65 65 65 65 65 65

Natural Gas E LHV = 10.35 kWh/Nm ³ ; d = 0.606; W _i = 13.295 kWh/Nm ³		
1800	121 44 25 17 13 12	64 22 13 11 9 8
2000	149 54 30 20 15 14	78 27 16 13 11 10
2200	180 65 36 24 18 16	95 33 20 16 13 13
2400	214 77 42 29 21 19	113 39 24 19 16 15
2600	251 90 49 33 24 22	133 46 28 22 18 17
2800	- 103 56 38 28 24	- 53 32 25 21 20
3125	- 128 69 46 34 30	- 66 40 32 27 25
3450	- 156 84 56 41 36	- 80 48 39 32 30

Natural Gas LL LHV = 8.83 kWh/Nm ³ ; d = 0.641; W _i = 11.029 kWh/Nm ³		
1800	174 62 34 23 17 15	92 31 18 14 12 11
2000	215 76 41 27 20 18	113 38 22 18 14 14
2200	259 92 49 33 24 21	137 46 27 22 18 17
2400	- 109 58 39 28 25	- 55 33 26 21 20
2600	- 127 68 45 32 28	- 64 38 30 25 23
2800	- 147 78 51 37 32	- 74 44 35 28 27
3125	- 183 97 63 45 40	- 93 55 44 36 34
3450	- 222 117 77 55 48	- 113 67 53 43 41

LPG B/P LHV = 25.89 kWh/Nm ³ ; d = 1.555; W _i = 20.762 kWh/Nm ³		
1800	53 21 13 10 8 -	28 11 7 6 5 -
2000	65 26 16 12 10 9	34 13 9 7 6 6
2200	78 30 18 14 11 10	41 16 10 9 8 7
2400	92 36 21 16 13 12	49 19 12 11 9 9
2600	107 41 25 18 15 14	58 22 15 12 11 10
2800	124 47 28 20 16 15	67 25 17 14 12 12
3125	154 59 35 25 20 19	84 32 21 18 16 15
3450	187 71 42 30 24 22	102 39 26 22 19 18

Stated pressures for LPG are based on propane, but may also be used for butane.

The combustion chamber pressure in mbar must be added to the minimum gas pressure determined from the above chart.

For low-pressure supplies, EN 88-compliant governors with safety diaphragms are used. The maximum permissible supply pressure into the shut-off valve for low pressure installations is 300 mbar.

For high-pressure supplies, EN 334-compliant high-pressure regulators should be selected from the brochure "Pressure regulators with safety devices for Weishaupt gas and dual-fuel burners". This brochure details high-gas-pressure sets suitable for supply pressures of up to 4 bar.

Refer to the burner's rating plate for the maximum connection pressure.

Gas valve train sizing

Sizes 50 and 60, version NR

Type 50/1-B, version NR														
Burner rating kW	Low-pressure supply (with FRS) (flow pressure in mbar into shut-off valve, pe, max = 300 mbar)						High-pressure supply (with HP regulator), (flow pressure in mbar into gas valve assembly)							
	Nominal valve-train diameter 1½" 2" 65 80 100 125 Nom. diameter of gas butterfly 65 65 65 65 65 65						Nominal valve-train diameter 1½" 2" 65 80 100 125 Nom. diameter of gas butterfly 65 65 65 65 65 65							
Natural Gas E LHV = 10.35 kWh/Nm ³ ; d = 0.606; Wi = 13.295 kWh/Nm ³														
2100	164	59	33	22	17	15	87	30	18	14	12	11		
2400	214	77	42	29	21	19	113	39	24	19	16	15		
2700	270	96	52	35	26	23	-	49	30	24	20	19		
3000	-	118	64	43	32	28	-	61	37	29	24	23		
3300	-	143	77	51	38	33	-	73	44	36	30	28		
3600	-	169	91	60	44	39	-	87	52	42	35	33		
4000	-	208	111	74	53	47	-	107	65	52	43	40		
Natural Gas LL LHV = 8.83 kWh/Nm ³ ; d = 0.641; Wi = 11.029 kWh/Nm ³														
2100	236	84	45	30	22	19	125	42	25	20	16	15		
2400	-	109	58	39	28	25	-	55	33	26	21	20		
2700	-	137	73	48	34	30	-	69	41	32	26	25		
3000	-	168	89	59	42	37	-	85	51	40	33	31		
3300	-	203	107	70	50	44	-	103	61	48	40	37		
3600	-	241	127	83	59	51	-	123	72	57	47	44		
4000	-	297	156	102	72	63	-	-	89	71	58	54		
LPG B/P LHV = 25.89 kWh/Nm ³ ; d = 1.555; Wi = 20.762 kWh/Nm ³														
2100	71	28	17	13	10	10	38	14	9	8	7	7		
2400	92	36	21	16	13	12	49	19	12	11	9	9		
2700	116	44	26	19	16	14	62	24	16	13	11	11		
3000	142	55	32	24	19	17	77	29	20	17	14	14		
3300	172	65	38	28	22	21	93	35	24	20	18	17		
3600	204	77	45	33	26	24	111	42	28	24	21	20		
4000	251	94	55	39	31	28	136	52	34	29	25	24		
Type 50/2-A, version NR														
Burner rating kW	Low-pressure supply (with FRS) (flow pressure in mbar into shut-off valve, pe, max = 300 mbar)						High-pressure supply (with HP regulator), (flow pressure in mbar into gas valve assembly)							
	Nominal valve-train diameter 1½" 2" 65 80 100 125 150 Nom. diameter of gas butterfly 80 80 80 80 80 80 80						Nominal valve-train diameter 1½" 2" 65 80 100 125 150 Nom. diameter of gas butterfly 80 80 80 80 80 80 80							
Natural Gas E LHV = 10.35 kWh/Nm ³ ; d = 0.606; Wi = 13.295 kWh/Nm ³														
2300	210	84	52	40	33	31	30	118	49	35	31	28	27	27
2800	-	113	66	47	38	34	33	-	63	42	35	31	30	29
3300	-	147	82	56	42	38	36	-	78	49	40	34	33	32
3800	-	193	105	71	53	47	44	-	101	63	51	43	41	40
4300	-	247	135	92	68	61	57	-	130	81	66	56	53	52
4800	-	-	167	113	84	74	70	-	-	101	82	69	66	65
5400	-	-	208	140	103	91	85	-	-	125	101	85	81	79
Natural Gas LL LHV = 8.83 kWh/Nm ³ ; d = 0.641; Wi = 11.029 kWh/Nm ³														
2300	-	120	74	56	46	43	41	-	71	50	44	40	38	38
2800	-	162	93	67	52	48	46	-	90	59	50	44	42	42
3300	-	212	116	79	59	53	50	-	112	70	57	49	46	45
3800	-	275	148	99	72	64	60	-	148	88	71	59	56	55
4300	-	-	187	124	90	79	74	-	-	110	89	74	70	68
4800	-	-	229	151	108	95	89	-	-	134	107	89	84	82
5400	-	-	284	185	131	114	106	-	-	130	107	101	98	
LPG B/P LHV = 25.89 kWh/Nm ³ ; d = 1.555; Wi = 20.762 kWh/Nm ³														
2300	86	35	22	17	14	13	13	47	19	13	11	10	10	10
2800	129	52	33	25	21	20	19	71	30	21	19	17	16	16
3300	179	72	45	35	29	27	27	100	42	31	27	24	24	24
3800	237	96	60	46	38	36	35	133	57	41	36	33	32	32
4300	-	121	76	58	48	45	44	-	72	52	46	42	41	40
4800	-	150	93	71	59	55	53	-	90	64	57	52	50	50
5400	-	188	116	88	73	68	66	-	112	81	71	64	63	62
Type 60/2-A, version NR														
Burner rating kW	Low-pressure supply (with FRS) (flow pressure in mbar into shut-off valve, pe, max = 300 mbar)						High-pressure supply (with HP regulator), (flow pressure in mbar into gas valve assembly)							
	Nominal valve-train diameter 2" 65 80 100 125 150 Nom. diameter of gas butterfly 100 100 100 100 100						Nominal valve-train diameter 2" 65 80 100 125 150 Nom. diameter of gas butterfly 100 100 100 100 100							
Natural Gas E LHV = 10.35 kWh/Nm ³ ; d = 0.606; Wi = 13.295 kWh/Nm ³														
4000	197	101	63	43	36	33	96	54	41	32	30	29		
4300	228	116	73	49	42	39	112	63	48	38	35	34		
4500	250	127	80	54	46	42	123	69	52	41	38	37		
4800	284	144	90	61	52	47	139	78	59	47	43	42		
5000	-	156	97	66	56	51	151	85	64	50	47	45		
5300	-	174	109	73	62	56	169	94	72	56	52	50		
5600	-	194	120	80	68	62	188	105	79	62	57	55		
6100	-	227	140	93	78	71	-	122	92	71	66	64		
Natural Gas LL LHV = 8.83 kWh/Nm ³ ; d = 0.641; Wi = 11.029 kWh/Nm ³														
4000	278	138	83	54	44	40	133	71	52	39	36	35		
4300	-	160	97	62	52	47	154	83	61	46	42	41		
4500	-	175	106	68	57	51	169	91	67	51	46	45		
4800	-	198	120	77	64	58	193	103	76	58	53	51		
5000	-	215	130	84	69	62	-	112	83	63	57	55		
5300	-	241	145	93	77	69	-	125	92	70	64	61		
5600	-	267	160	103	84	76	-	139	102	77	70	68		
6100	-	-	188	119	98	87	-	163	119	89	81	78		
LPG B/P LHV = 25.89 kWh/Nm ³ ; d = 1.555; Wi = 20.762 kWh/Nm ³														
4000	95	55	39	31	28	27	52	34	29	25	24	24		
4300	109	63	45	36	33	31	60	40	34	29	28	28		
4500	119	69	49	39	36	34	66	43	37	32	31	30		
4800	135	78	56	44	40	38	74	49	42	36	35	35		
5000	146	84	60	47	43	41	81	53	45	39	38	37		
5300	164	94	67	52	48	45	90	60	50	44	42	41		
5600	182	104	74	57	52	50	100	66	56	48	46	46		
6100	214	122	86	67	60	58	118	77	65	56	54	53		

Stated pressures for LPG are based on propane, but may also be used for butane.

The combustion chamber pressure in mbar must be added to the minimum gas pressure determined from the above chart.

For low-pressure supplies, EN 88-compliant governors with safety diaphragms are used. The maximum permissible supply pressure into the shut-off valve for low pressure installations is 300 mbar.

For high-pressure supplies, EN 334-compliant high-pressure regulators should be selected from the brochure "Pressure regulators with safety devices for Weishaupt gas and dual-fuel burners". This brochure details high-gas-pressure sets suitable for supply pressures of up to 4 bar.

Refer to the burner's rating plate for the maximum connection pressure.

Gas valve train sizing

Size 70, version NR

Type 70/1-B, version NR

Burner rating kW	Low-pressure supply (with FRS) (flow pressure in mbar into shut-off valve, pe, max = 300 mbar)	High-pressure supply (with HP regulator), (flow pressure in mbar into gas valve assembly)
	Nominal valve-train diameter 2" 65 80 100 125 150 Nom. diameter of gas butterfly 100 100 100 100 100	Nominal valve-train diameter 2" 65 80 100 125 150 Nom. diameter of gas butterfly 100 100 100 100 100

Natural Gas E LHV = 10.35 kWh/Nm ³ ; d = 0.606; W _i = 13.295 kWh/Nm ³		
3900	189 97 62 42 36 33	93 53 41 32 30 29
4400	239 122 77 52 44 41	118 66 50 40 37 36
4900	295 150 93 63 53 49	145 81 61 48 44 43
5400	- 180 112 75 63 57	175 97 73 57 53 51
5900	- 213 132 87 73 67	- 115 86 67 62 60
6400	- 249 153 101 85 77	- 134 101 78 72 70
6900	- 288 177 116 97 88	- 154 116 90 82 80
7400	- - 202 132 110 100	- 177 132 102 94 91

Natural Gas LL LHV = 8.83 kWh/Nm ³ ; d = 0.641; W _i = 11.029 kWh/Nm ³		
3900	268 134 82 54 46 41	130 71 53 41 37 36
4400	- 170 104 68 57 52	164 90 67 51 47 46
4900	- 209 127 83 69 63	- 110 82 63 58 56
5400	- 253 153 100 83 75	- 133 99 76 69 67
5900	- - 182 117 97 88	- 158 117 89 82 79
6400	- - 212 137 113 102	- 185 137 104 95 92
6900	- - 245 157 129 116	- - 158 119 109 105
7400	- - 280 179 147 132	- - 180 136 124 120

LPG B/P LHV = 25.89 kWh/Nm ³ ; d = 1.555; W _i = 20.762 kWh/Nm ³		
3900	82 45 30 22 20 18	41 25 20 16 15 15
4400	105 57 39 29 25 24	54 33 26 22 21 20
4900	130 71 48 35 31 30	67 41 33 28 26 26
5400	158 86 58 42 38 35	82 50 40 34 32 31
5900	188 101 68 50 44 41	97 60 48 40 38 37
6400	220 118 79 58 51 48	114 69 56 47 44 43
6900	254 136 90 66 58 54	132 80 64 53 50 49
7400	291 155 103 74 65 61	150 91 73 60 57 56

Type 70/3-A, version NR

Burner rating kW	Low-pressure supply (with FRS) (flow pressure in mbar into shut-off valve, pe, max = 300 mbar)	High-pressure supply (with HP regulator), (flow pressure in mbar into gas valve assembly)
	Nominal valve-train diameter 65 80 100 125 150 Nom. diameter of gas butterfly 100 100 100 100 100	Nominal valve-train diameter 65 80 100 125 150 Nom. diameter of gas butterfly 100 100 100 100 100

Natural Gas E LHV = 10.35 kWh/Nm ³ ; d = 0.606; W _i = 13.295 kWh/Nm ³		
5300	146 80 45 33 28	66 43 28 24 22
6000	187 102 57 42 35	85 56 36 30 28
7000	253 138 76 56 47	115 75 48 41 38
8000	- 179 98 72 60	150 98 63 53 50
9000	- 226 123 90 75	190 124 79 67 63
10000	- 278 151 111 92	- 153 97 82 77
10700	- - 172 126 105	- 175 111 94 88

Natural Gas LL LHV = 8.83 kWh/Nm ³ ; d = 0.641; W _i = 11.029 kWh/Nm ³		
5300	210 115 63 46 39	95 62 40 33 31
6000	269 146 79 58 49	122 79 50 42 40
7000	- 197 107 78 65	165 107 68 57 53
8000	- 256 138 101 83	- 140 88 74 69
9000	- - 174 127 104	- 176 111 94 87
10000	- - 214 155 128	- - 137 115 107
10700	- - 244 177 146	- - 156 132 123

LPG B/P LHV = 25.89 kWh/Nm ³ ; d = 1.555; W _i = 20.762 kWh/Nm ³		
5300	69 42 27 23 20	35 25 19 17 16
6000	84 49 31 25 22	41 29 21 18 18
7000	110 63 37 29 26	52 36 25 22 21
8000	141 80 46 36 31	66 45 30 26 25
9000	177 99 57 44 37	83 56 38 33 31
10000	218 122 70 53 46	102 69 46 40 38
10700	250 140 80 61 52	117 80 54 46 44

Type 70/4-A, version NR

Burner rating kW	Low-pressure supply (with FRS) (flow pressure in mbar into shut-off valve, pe, max = 300 mbar)	High-pressure supply (with HP regulator), (flow pressure in mbar into gas valve assembly)
	Nominal valve-train diameter 65 80 100 125 150 Nom. diameter of gas butterfly 100 100 100 100 100	Nominal valve-train diameter 65 80 100 125 150 Nom. diameter of gas butterfly 100 100 100 100 100

Natural Gas E LHV = 10.35 kWh/mn ³ ; d = 0.606; W _i = 13.295 kWh/mn ³		
6500	219 119 66 49 41	99 65 42 35 33
7000	253 138 76 56 47	115 75 48 41 38
7500	290 158 87 64 53	132 86 55 47 44
8000	- 179 98 72 60	150 98 63 53 50
9000	- 226 123 90 75	190 124 79 67 63
10000	- 278 151 111 92	- 153 97 82 77
11000	- - 182 133 110	- 184 117 99 93
11700	- - 205 150 124	- - 133 112 105

Natural Gas LL LHV = 8.83 kWh/mn ³ ; d = 0.641; W _i = 11.029 kWh/mn ³		
6500	- 170 93 68 56	142 93 59 50 46
7000	- 197 107 78 65	165 107 68 57 53
7500	- 226 122 89 74	189 123 78 66 61
8000	- 256 138 101 83	- 140 88 74 69
9000	- - 174 127 104	- 176 111 94 87
10000	- - 214 155 128	- - 137 115 107
11000	- - 258 187 154	- - 165 139 130
11700	- - 291 211 173	- - 187 157 146

LPG B/P LHV = 25.89 kWh/mn ³ ; d = 1.555; W _i = 20.762 kWh/mn ³		
6500	96 56 34 27 24	46 32 23 20 19
7000	110 63 37 29 26	52 36 25 22 21
7500	125 71 42 32 28	59 40 27 24 23
8000	141 80 46 36 31	66 45 30 26 25
9000	177 99 57 44 37	83 56 38 33 31
10000	218 122 70 53 46	102 69 46 40 38
11000	264 148 85 65 55	124 84 57 49 47
11700	299 167 96 74 63	142 96 65 57 54

Stated pressures for LPG are based on propane, but may also be used for butane.

The combustion chamber pressure in mbar must be added to the minimum gas pressure determined from the above chart.

For low-pressure supplies, EN 88-compliant governors with safety diaphragms are used. The maximum permissible supply pressure into the shut-off valve for low pressure installations is 300 mbar.

For high-pressure supplies, EN 334-compliant high-pressure regulators should be selected from the brochure "Pressure regulators with safety devices for Weishaupt gas and dual-fuel burners". This brochure details high-gas-pressure sets suitable for supply pressures of up to 4 bar.

Refer to the burner's rating plate for the maximum connection pressure.

Scope of delivery, special equipment Sizes 30 to 50, version NR

Scope of delivery	RGMS30	RGMS40	RGMS50
Burner housing, hinged flange, housing cover, Weishaupt burner motor, air-inlet housing, fan wheel, combustion head, ignition unit, ignition cable, ignition electrodes, nozzle assembly with oil nozzle(s), combustion manager with control unit, flame sensor stepping motors, flange gasket, limit switch on hinged flange, fixing screws	●	●	●
W-FM 100 combustion manager	●	●	●
Double gas valve assembly (Class A)	●	●	●
Gas butterfly valve	●	●	●
Pilot line	●	●	●
Air pressure switch	●	●	●
Oil pressure switch in return	●	●	●
Low gas pressure switch	●	●	●
Mixing assembly with modulating regulating sleeve	●	●	●
Actuators for compound regulation of gas and air via W-FM			
Air damper stepping motor	●	●	●
Gas butterfly valve stepping motor	●	●	●
Regulating sleeve stepping motor	●	●	●
Oil pump, fitted	●	●	●
Oil preheater, fitted	●	●	●
Oil hoses	●	●	●
2 solenoid valves in supply and return	–	–	–
Solenoid valve in supply and return, nozzle assembly with shut-off device (solenoid)	●	●	●
Electromagnetic clutch	●	●	●
Special equipment			
Downward-firing version	○	○	○
Air inlet flange for duct connection	○	○	○
Solenoid valve for air pressure switch test with continuously running fan or post-purge	○	○	○
Combustion head extension	○	○	○
Integral capacity controller for W-FM 100	○	○	○
Variable speed drive	○	○	○
O ₂ trim	○	○	○
W-FM supplied loose for mounting in a control panel	○	○	○
Bus interface	○	○	○
PED execution	○	○	○
High gas pressure switch	○	○	○
Separate pump station	○	○	○
Separate preheater station (electric/medium)	○	○	○
Multi-language ABE	○	○	○
Offset gas butterfly valve and DMV	○	○	○
<p>● Standard ○ Optional</p> <p>Please enquire or see the price list for additional special equipment.</p>			

Scope of delivery, special equipment

Sizes 60 and 70, version NR

Scope of delivery	RGMS60	RGMS70	RGL60	RGL70 / 70/4
Burner housing, hinged flange, housing cover, Weishaupt burner motor, air-inlet housing, fan wheel, combustion head, ignition unit, ignition cable, ignition electrodes, nozzle assembly with oil nozzle(s), combustion manager with control unit, flame sensor stepping motors, flange gasket, limit switch on hinged flange, fixing screws	●	●	●	●
W-FM 100 combustion manager	●	●	●	–
W-FM 200 combustion manager	–	–	–	●
Double gas valve assembly (Class A)	●	●	●	●
Gas butterfly valve	●	●	●	●
Pilot line	●	●	●	●
Air pressure switch	●	●	●	●
Oil pressure switch in return	●	●	●	●
Low gas pressure switch	●	●	●	●
Mixing assembly with modulating regulating sleeve	●	●	●	●
Actuators for compound regulation of gas and air via W-FM				
Air damper stepping motor	●	●	●	●
Gas butterfly valve stepping motor	●	●	●	●
Regulating sleeve stepping motor	●	●	●	●
Oil pump, fitted	–	–	●	●
Oil hoses	●	●	●	●
Solenoid valve in supply and return, nozzle assembly with shut-off device (solenoid)	●	●	●	●
Electromagnetic clutch	●	●	●	●
Special equipment				
Downward-firing version	○	○	○	○
Air inlet flange for duct connection	○	○	○	○
Solenoid valve for air pressure switch test with continuously running fan or post-purge	○	○	○	○
Combustion head extension	○	○	○	○
Integral capacity controller for W-FM 100	○	○	○	–
Variable speed drive	○	○	○	●
O ₂ trim	○	○	○	○
W-FM supplied loose for mounting in a control panel	○	○	○	○
Bus interface	○	○	○	○
PED execution	○	○	○	○
High gas pressure switch	○	○	○	○
Separate pump station	○	○	○	○
Separate preheater station (electric/medium)	○	○	–	–
Multi-language ABE	○	○	○	○
Offset gas butterfly valve and DMV	○	○	○	○

- Standard
- Optional

Please enquire or see the price list for additional special equipment.

Technical data

Sizes 30 and 40, version NR

Technical data		RGMS30/2-A							
400 V, 3 ~ burner motor ¹⁾		Type	W-D112/170-2/4K5						
Nominal rating		kW	5.5						
Current draw at 400 V		A	13						
Motor prefusing (YΔ motor start)		A	16						
Speed (50 Hz)		rpm	2900						
Fan wheel		Colour / ø	blue / 268 x 100						
Combustion manager		Type	W-FM100						
Ignition unit		Type	W-ZG02						
Actuator	Air	Type	SQM45						
	Mixing assembly	Type	SQM45						
	Fuel	Type	SQM45						
Integral pump		Type	TA3						
Oil preheater		Type	EV2D						
	Oil throughput	kg/h	270						
	Heating capacity	kW	13.2						
Oil solenoid valves	115 V, 3/8" (supply)	20 W	Type	321 H 2322					
	115 V, 3/8" (return)	20 W	Type	121 G 2320					
Oil pressure switch	1–10 bar (return, HFO - 7 bar)	Type	DSA 46 F001						
Oil hoses (metal, high-pressure hoses on RGMS burners)		DN / length	20 / 1300						
Burner weight		kg (approx.)	175						
Weight (gas valve assembly and fittings)		R / DN	1½	2	65	80	100	125	150
		kg (approx.)	23	25	65	80	130	220	240

Technical data		RGMS40/1-B RGMS40/2-A							
400 V, 3 ~ burner motor ¹⁾	40/1	Type	W-D112/170-2/5K5						
Nominal rating		kW	5.5						
Current draw at 400 V		A	14						
Motor prefusing (YΔ motor start)		A	20						
400 V, 3 ~ burner motor ¹⁾	40/2	Type	W-D112/170-2/7K0						
Nominal rating		kW	7						
Current draw at 400 V		A	15						
Motor prefusing (YΔ motor start)		A	25						
Speed (50 Hz)		rpm	2940						
Fan wheel		Colour / ø	blue / 295 x 100						
Combustion manager		Type	W-FM100						
Ignition unit		Type	W-ZG02						
Actuator	Air	Type	SQM45						
	Mixing assembly	Type	SQM45						
	Fuel	Type	SQM45						
Integral pump		Type	TA3						
Oil preheater		Type	EV2D						
	Oil throughput	kg/h	270						
	Heating capacity	kW	13.2						
Oil solenoid valves	115 V, 1/4" (supply)	20 W	Type	321 H 2322					
	115 V, 1/8" (return)	20 W	Type	121 G 2320					
Oil pressure switch	1–10 bar (return, HFO - 7 bar)	Type	DSA 46 F001						
Oil hoses (metal, high-pressure hoses on RGMS burners)		DN / length	20 / 1300						
Burner weight		kg (approx.)	190						
Weight (gas valve assembly and fittings)		R / DN	1½	2	65	80	100	125	150
		kg (approx.)	23	25	65	80	130	220	240

¹⁾ The electrical motors are premium-efficiency IE3 motors in accordance with Commission Regulation (EC) No. 640/2009.

Technical data

Sizes 50 and 60, version NR

Technical data				RGMS50/1-B		RGMS50/2-A					
400 V, 3 ~ burner motor ¹⁾				Type	W-D132/170-2/9K0	W-D132/210-2/14K0					
Nominal rating				kW	9	14					
Current draw at 400 V				A	18	28					
Motor prefusing (YΔ motor start)				A	35	50					
Speed (50 Hz)				rpm	2930	2920					
Fan wheel		Colour / ø		blue / 345 x 100		blue / 345 x 100					
Combustion manager				Type	W-FM100	W-FM100					
Ignition unit				Type	W-ZG02	W-ZG02					
Actuator	Air			Type	SQM45	SQM45					
	Mixing assembly			Type	SQM45	SQM45					
	Fuel			Type	SQM45	SQM45					
Oil preheater				Type	WEV2.2/01 ²⁾	WEV3/01					
		Oil throughput		kg/h	300	500					
		Heating capacity		kW	13,8	22,4					
Integral pump				Type	TA4C	T2C					
Oil solenoid valves	115 V, 3/8" (supply)	20 W	Type	321 H 2322	321 H 2322						
	115 V, 3/8" (return)	20 W	Type	121 G 2320	121 G 2320						
Oil pressure switch	1–10 bar (return, HFO - 7 bar)		Type	DSA 46 F001	DSA 46 F001						
Oil hoses				DN / length	25 / 1500		25 / 1500				
Burner weight				kg (approx.)	305		305				
Weight (gas valve assembly and fittings)				R / DN	1½	2	65	80	100	125	150
				kg (approx.)	23	25	65	80	130	220	240

¹⁾ The electrical motors are premium-efficiency IE3 motors in accordance with Commission Regulation (EC) No. 640/2009.

²⁾ Burners above 300 kg/h: WEV3 oil preheater in lieu of WEV2.2, see special equipment for additional price.

Technical data				RGMS60/2-A							
400 V, 3 ~ burner motor ¹⁾				Type	W-D132/210-2/14K0						
Nominal rating				kW	14						
Current draw at 400 V				A	28						
Motor prefusing (YΔ motor start)				A	50						
Speed (50 Hz)				rpm	2920						
Fan wheel		Colour / ø		blue / 515 x 120							
Combustion manager				Type	W-FM100						
Ignition unit				Type	W-ZG02						
Actuator	Air			Type	SQM48						
	Mixing assembly			Type	SQM45						
	Fuel			Type	SQM45						
Integral pump				Type	-						
Oil solenoid valves	115 V, 3/8" (supply)	20W	Type	321 H 2322							
	115 V, 3/8" (return)	20W	Type	121 G 2320							
	230 V, 3/8" (bypass)	19W	Type	322 H 7306							
Oil pressure switch	3–25 bar (supply - 18 bar)		Type	DSA 58 F001							
	1–10 bar (return, light oil - 5 bar)		Type	-							
	1–10 bar (return, HFO - 7 bar)		Type	DSA 46 F001							
Oil hoses				DN / length	-						
(metal, high-pressure hoses on RGMS burners)				DN / length	16 / 1500						
Burner weight				kg (approx.)	290 ²⁾						
Weight (gas valve assembly and fittings)				R / DN	2	65	80	100	125	150	
				kg (approx.)	25	65	80	130	220	240	

¹⁾ The electrical motors are premium-efficiency IE3 motors in accordance with Commission Regulation (EC) No. 640/2009.

²⁾ Weight excluding pump and preheater stations.

Technical data

Size 70, version NR

Technical data				RGMS70/1-B		RGMS70/3-A	
400 V, 3 ~ burner motor ¹⁾	Type	W-D160/240-2/18K0	W-D160/240-2/22K0				
Nominal rating	kW	18	22				
Current draw at 400 V	A	35	43				
Motor prefusing (ΥΔ motor start)	A	63	63				
Speed (50 Hz)	rpm	2950	2940				
Fan wheel	Colour / ø	blue / 590 x 160	blue / 590 x 160				
Frequency convertor with braking resistor	Type	W-FM100	W-FM100				
Ignition unit	Type	W-ZG02	W-ZG02				
Actuator	Air	Type	SQM48	SQM48			
	Mixing assembly	Type	SQM45	SQM48			
	Fuel	Type	SQM45	SQM45			
Integral pump	Type	–	–				
	Type	–	–				
Oil solenoid valves	115 V, 1/2" (supply)	20W	Type	321 H 2522	321 H 2522		
	115 V, 1/2" (return)	20W	Type	121 G 2520	121 G 2520		
	230 V, 3/8" (bypass)	19W	Type	322 H 7306	322 H 7306		
Oil pressure switch	3–25 bar (supply - 18 bar)		Type	DSA 58 F001	DSA 58 F001		
	1–10 bar (return, light oil - 5 bar)		Type	–	–		
	1–10 bar (return, HFO - 7 bar)		Type	DSA 46 F001	DSA 46 F001		
Oil hoses (metal, high-pressure hoses on RGMS burners)	DN / length		–	–			
	DN / length		20 / 1150	20 / 1150			
	DN / length		20 / 1500	20 / 1500			
Burner weight	kg (approx.)	385 ²⁾	385 ²⁾				
Weight (gas valve assembly and fittings)	R / DN	2	65	80	100	125	150
	kg (approx.)	25	65	80	130	220	240

Technical data				RGL70/4-A*		RGMS70/4-A*	
400 V, 3 ~ burner motor ¹⁾	Type	W-D160/240-2/28K0	W-D160/240-2/28K0				
Nominal rating	kW	28	28				
Current draw at 400 V	A	53	53				
Motor prefusing (ΥΔ motor start)	A	*	*				
Speed (50 Hz)	rpm	3220	3220				
Frequency convertor with braking resistor	Type	FC301 P22K IP20	FC301 P22K IP20				
Fan wheel	Colour / ø	blue / 590 x 160	blue / 590 x 160				
Frequency convertor with braking resistor	Type	W-FM200	W-FM200				
Ignition unit	Type	W-ZG02	W-ZG02				
Actuator	Air	Type	SQM48	SQM48			
	Mixing assembly	Type	SQM48	SQM48			
	Fuel	Type	SQM45	SQM45			
Integral pump	Type	T4C	–				
Oil solenoid valves	115 V, 1/2" (supply)	20W	Type	321 H 2522	321 H 2522		
	115 V, 1/2" (return)	20W	Type	121 G 2520	121 G 2520		
	230 V, 3/8" (bypass)	19W	Type	–	322 H 7306		
Oil pressure switch	3–25 bar (supply - 18 bar)		Type	–	DSA 58 F001		
	1–10 bar (return, light oil - 5 bar)		Type	DSA 46 F001	–		
	1–10 bar (return, HFO - 7 bar)		Type	–	DSA 46 F001		
Oil hoses (metal, high-pressure hoses on RGMS burners)	DN / length		25 / 1300	–			
	DN / length		–	20 / 1150			
	DN / length		–	20 / 1500			
Burner weight	kg (approx.)	430	385 ²⁾				
Weight (gas valve assembly and fittings)	R / DN	2	65	80	100	125	150
	kg (approx.)	25	65	80	130	220	240

¹⁾ The electrical motors are premium-efficiency IE3 motors in accordance with Commission Regulation (EC) No. 640/2009.

²⁾ Weight excluding pump and preheater stations.

* 55 Hz operation with frequency convertor only (no IE classification).

Burner selection

Size 50, version 1LN

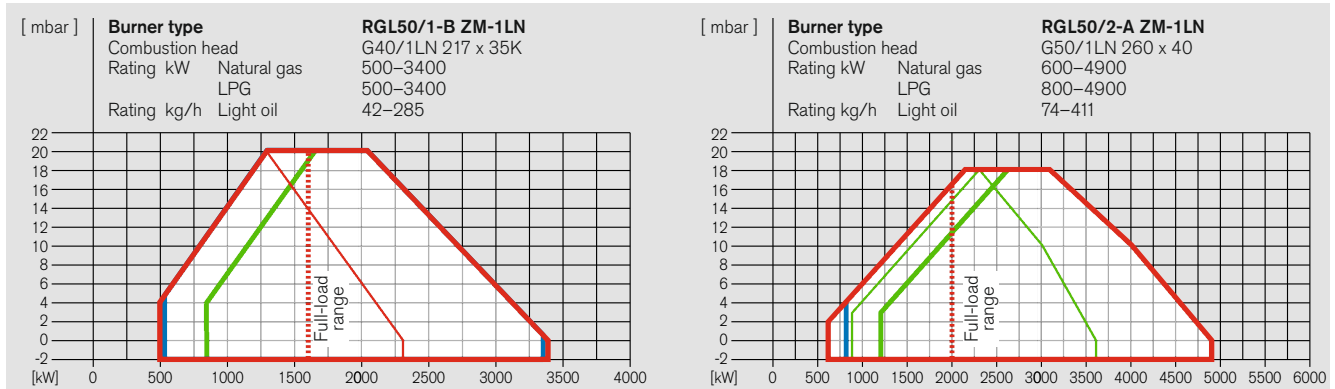

Fuels – Rating with combustion head

	open	closed
Light oil		
Natural gas		
LPG		

Stated oil throughputs are based on a calorific value of 11.91 kWh/kg for light oil.

Plotted operational ranges represent maximal values measured on idealised flame tubes in accordance with EN 676 and EN 267.

Stated ratings are based on an air temperature of 20 °C and an installation at sea level.

For installations at higher altitudes, a reduction in capacity of 1 % per 100 m above sea level should be taken into account.

Voltages and frequencies:

The burners are equipped as standard for three-phase alternating current, 400 V, 3 ~, 50 Hz. Other voltages and frequencies are available on application (no additional cost).

Standard burner motor:

Insulation Class F, IP 55 protection, IE3 efficiency

Burner type	Version	CE-PIN DIN-CERTCO	Valve train	Order No.
RGL50/1-B	ZM-1LN	CE-0085AQ0721 5G535/05M	R 1½	218 504 16
			R 2	218 504 17
			DN 65	218 404 43
			DN 80	218 504 53
			DN 100	218 504 63
DN 125	218 504 73			
RGL50/2-A	ZM-1LN	CE-0085AQ0721	R 1½	218 505 16
			DN 65	218 505 43
			DN 80	218 505 53
			DN 100	218 505 63
			DN 125	218 505 73
DN 150	218 505 83			

Burner selection

Size 70, version 1LN

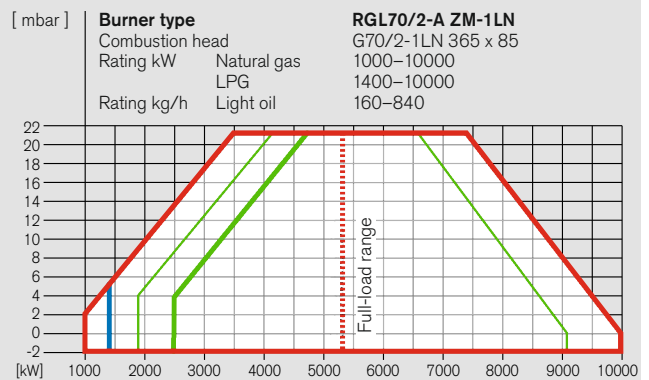
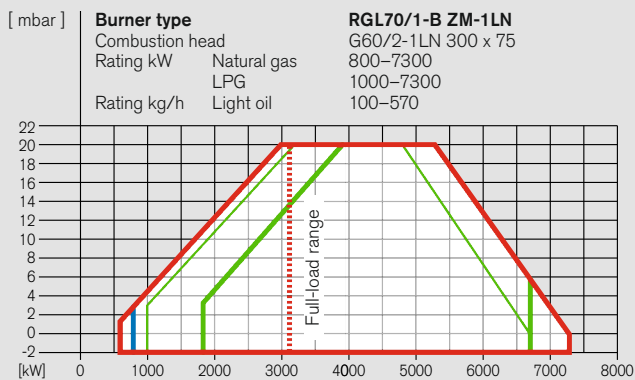

Fuels – Rating with combustion head

	open	closed
Light oil		
Natural gas		
LPG		

Stated oil throughputs are based on a calorific value of 11.91 kWh/kg for light oil.

Plotted operational ranges represent maximal values measured on idealised flame tubes in accordance with EN 676 and EN 267.

Stated ratings are based on an air temperature of 20 °C and an installation at sea level.

For installations at higher altitudes, a reduction in capacity of 1 % per 100 m above sea level should be taken into account.

Voltages and frequencies:

The burners are equipped as standard for three-phase alternating current, 400 V, 3 ~, 50 Hz. Other voltages and frequencies are available on application (no additional cost).

Standard burner motor:

Insulation Class F, IP 55 protection, IE3 efficiency

Burner type	Version	CE-PIN DIN-CERTCO	Valve train	Order No.
RGL70/1-B	ZM-1LN	CE-0085AQ0723 5G519/05M	DN 65	218 704 43
			DN 80	218 704 53
			DN 100	218 704 63
			DN 125	218 704 73
			DN 150	218 704 83
RGL70/2-A	ZM-1LN	CE-0085AQ0723 5G519/05M	DN 65	218 705 43
			DN 80	218 705 53
			DN 100	218 705 63
			DN 125	218 705 73
			DN 150	218 705 83

Gas valve train sizing

Size 50, version 1LN

Type 50/1-B, version 1LN

Burner rating kW	Low-pressure supply (with FRS) (flow pressure in mbar into shut-off valve, pe, max = 300 mbar)						High-pressure supply (with HP regulator), (flow pressure in mbar into gas valve assembly)					
	Nominal valve-train diameter						Nominal valve-train diameter					
	1½"	2"	65	80	100	125	1½"	2"	65	80	100	125
	Nom. diameter of gas butterfly						Nom. diameter of gas butterfly					
	65	65	65	65	65	65	65	65	65	65	65	65
Natural Gas E LHV = 10.35 kWh/Nm ³ ; d = 0.606; W _i = 13.295 kWh/Nm ³												
2100	172	67	40	30	24	23	94	37	26	22	20	19
2300	205	79	47	34	28	26	112	44	30	25	22	22
2500	241	92	54	39	31	29	132	51	34	29	26	25
2700	280	106	62	45	36	33	-	59	40	34	30	29
2900	-	122	71	51	41	37	-	68	45	39	34	33
3100	-	139	81	58	46	42	-	77	52	44	39	37
3400	-	167	97	70	55	50	-	93	62	53	47	45
Natural Gas LL LHV = 8.83 kWh/Nm ³ ; d = 0.641; W _i = 11.029 kWh/Nm ³												
2100	246	93	54	39	31	29	134	51	34	29	25	24
2300	293	110	63	45	35	32	-	60	39	33	29	28
2500	-	128	73	52	40	36	-	69	45	38	33	32
2700	-	148	83	59	45	41	-	80	52	43	37	36
2900	-	169	95	66	51	46	-	91	59	49	42	40
3100	-	192	107	74	57	51	-	103	66	55	47	45
3400	-	229	127	88	67	60	-	123	78	65	56	53
LPG B/P LHV = 25.89 kWh/Nm ³ ; d = 1.555; W _i = 20.762 kWh/Nm ³												
2100	82	39	28	24	22	21	49	26	21	19	18	18
2300	97	46	32	27	25	24	58	30	24	22	21	21
2500	114	53	37	31	28	27	67	34	28	25	24	24
2700	132	60	42	35	32	30	78	40	32	29	28	27
2900	151	69	48	40	36	34	90	45	36	33	32	31
3100	172	79	55	45	40	39	103	52	41	38	36	35
3400	207	94	66	54	48	46	124	63	50	46	43	43

Type 50/2-A, version 1LN

Burner rating kW	Low-pressure supply (with FRS) (flow pressure in mbar into shut-off valve, pe, max = 300 mbar)						High-pressure supply (with HP regulator), (flow pressure in mbar into gas valve assembly)						
	Nominal valve-train diameter						Nominal valve-train diameter						
	1½"	2"	65	80	100	125	1½"	2"	65	80	100	125	150
	Nom. diameter of gas butterfly						Nom. diameter of gas butterfly						
	65	65	65	65	65	65	65	65	65	65	65	65	65
Natural Gas E LHV = 10.35 kWh/Nm ³ ; d = 0.606; W _i = 13.295 kWh/Nm ³													
2500	239	90	52	37	30	27	26	130	49	32	27	24	23
2800	-	113	66	48	38	34	33	-	63	42	35	31	30
3100	-	138	80	57	45	41	40	-	77	51	43	38	36
3400	-	164	94	67	53	48	46	-	91	60	51	44	42
3800	-	201	114	80	62	56	53	-	110	71	60	52	50
4200	-	240	134	92	70	63	59	-	129	82	68	58	56
4600	-	282	154	104	77	69	65	-	153	93	76	64	61
4900	-	-	169	113	83	73	68	-	180	100	81	68	64
Natural Gas LL LHV = 8.83 kWh/Nm ³ ; d = 0.641; W _i = 11.029 kWh/Nm ³													
2500	-	125	70	49	37	34	32	-	67	43	35	30	29
2800	-	157	88	62	47	43	40	-	85	54	45	39	37
3100	-	192	107	74	57	51	48	-	103	66	55	47	45
3400	-	229	127	87	66	59	56	-	123	78	64	55	53
3800	-	281	154	105	79	70	66	-	153	94	77	65	62
4200	-	-	183	123	91	81	76	-	180	110	89	75	71
4600	-	-	214	142	103	90	85	-	210	127	102	85	80
4900	-	-	238	156	112	98	91	-	238	139	111	91	86
LPG B/P LHV = 25.89 kWh/Nm ³ ; d = 1.555; W _i = 20.762 kWh/Nm ³													
2500	109	48	33	27	24	23	22	63	30	23	21	20	19
2800	143	66	47	39	35	34	33	86	44	36	33	31	31
3100	178	84	60	51	46	44	44	108	57	47	44	41	41
3400	214	101	73	61	55	54	53	131	70	57	53	51	50
3800	265	124	88	74	66	64	63	-	85	69	64	61	60
4200	-	145	101	84	75	72	71	-	98	79	73	69	68
4600	-	166	113	93	82	78	77	-	110	87	80	75	73
4900	-	181	121	98	85	81	80	-	117	91	83	78	76

Stated pressures for LPG are based on propane, but may also be used for butane.

The combustion chamber pressure in mbar must be added to the minimum gas pressure determined from the above chart.

For low-pressure supplies, EN 88-compliant governors with safety diaphragms are used. The maximum permissible supply pressure into the shut-off valve for low pressure installations is 300 mbar.

For high-pressure supplies, EN 334-compliant high-pressure regulators should be selected from the brochure "Pressure regulators with safety devices for Weishaupt gas and dual-fuel burners". This brochure details high-gas-pressure sets suitable for supply pressures of up to 4 bar.

Refer to the burner's rating plate for the maximum connection pressure.

Gas valve train sizing

Size 70, version 1LN

Type 70/1-B, version 1LN

Burner rating kW	Low-pressure supply (with FRS) (flow pressure in mbar into shut-off valve, pe, max = 300 mbar)	High-pressure supply (with HP regulator), (flow pressure in mbar into gas valve assembly)
	Nominal valve-train diameter 65 80 100 125 150 Nom. diameter of gas butterfly 100 100 100 100 100	Nominal valve-train diameter 65 80 100 125 150 Nom. diameter of gas butterfly 100 100 100 100 100

Natural Gas E LHV = 10.35 kWh/Nm³; d = 0.606; W_i = 13.295 kWh/Nm³

4600	135	85	58	50	46	74	57	45	42	41
5000	156	97	66	56	51	85	64	51	47	45
5400	180	111	75	63	57	97	73	57	53	51
5800	206	127	84	71	64	111	83	65	60	58
6200	234	144	95	80	73	126	94	73	67	65
6600	265	163	107	90	82	142	107	83	76	74
7000	298	183	121	101	92	160	120	93	86	83
7300	-	199	131	110	100	174	131	102	94	91

Natural Gas LL LHV = 8.83 kWh/Nm³; d = 0.641; W_i = 11.029 kWh/Nm³

4600	188	116	77	65	59	101	76	59	54	53
5000	219	134	88	73	66	116	87	66	61	59
5400	253	153	100	83	75	133	99	76	69	67
5800	290	175	113	94	84	152	113	86	79	76
6200	-	199	128	106	96	174	128	97	89	86
6600	-	225	145	120	108	197	145	110	101	98
7000	-	254	163	135	121	-	164	125	114	110
7300	-	276	178	147	132	-	179	136	124	120

LPG B/P LHV = 25.89 kWh/Nm³; d = 1.555; W_i = 20.762 kWh/Nm³

4600	85	64	53	50	48	58	51	46	45	45
5000	97	73	60	56	54	66	58	52	51	50
5400	111	83	68	63	61	76	66	59	58	57
5800	127	94	77	71	69	86	75	67	65	64
6200	144	107	87	80	77	98	85	76	74	73
6600	162	120	97	90	87	110	96	86	83	82
7000	182	135	109	101	97	124	108	96	93	92
7300	198	146	119	110	106	135	117	105	102	101

Type 70/2-A, version 1LN

Burner rating kW	Low-pressure supply (with FRS) (flow pressure in mbar into shut-off valve, pe, max = 300 mbar)	High-pressure supply (with HP regulator), (flow pressure in mbar into gas valve assembly)
	Nominal valve-train diameter 65 80 100 125 150 Nom. diameter of gas butterfly 100 100 100 100 100	Nominal valve-train diameter 65 80 100 125 150 Nom. diameter of gas butterfly 100 100 100 100 100

Natural Gas E LHV = 10.35 kWh/Nm³; d = 0.606; W_i = 13.295 kWh/mNm³

5300	153	87	51	40	34	72	50	34	30	28
5900	188	106	62	48	41	89	61	42	36	35
6500	227	128	74	57	49	107	73	50	44	41
7100	269	151	87	67	58	128	87	59	52	49
7700	-	177	102	78	67	150	102	69	60	57
8300	-	205	118	90	77	174	118	80	70	66
8900	-	235	135	103	88	200	135	92	80	76
9500	-	267	153	116	99	-	154	104	91	86
10000	-	296	169	129	110	-	171	115	100	95

Natural Gas LL LHV = 8.83 kWh/Nm³; d = 0.641; W_i = 11.029 kWh/Nm³

5300	215	119	67	51	43	100	67	44	38	36
5900	266	148	84	63	54	124	83	55	48	45
6500	-	179	101	77	65	151	101	67	58	55
7100	-	213	120	91	77	180	121	80	70	66
7700	-	250	141	106	90	-	142	94	82	77
8300	-	290	163	123	104	-	165	109	94	89
8900	-	-	186	140	119	-	189	125	108	102
9500	-	-	211	159	134	-	-	142	122	115
10000	-	-	233	175	147	-	-	157	135	127

LPG B/P LHV = 25.89 kWh/Nm³; d = 1.555; W_i = 20.762 kWh/Nm³

5300	75	48	33	29	27	41	31	25	23	23
5900	92	59	41	35	32	50	39	31	29	28
6500	111	71	49	42	39	61	47	37	35	34
7100	132	84	58	49	45	73	56	44	41	40
7700	155	98	67	57	53	85	66	52	48	47
8300	179	113	77	66	60	99	76	60	56	54
8900	205	129	88	75	69	113	87	69	64	62
9500	233	146	99	84	77	128	98	78	72	70
10000	257	161	109	93	85	142	109	86	80	78

Stated pressures for LPG are based on propane, but may also be used for butane.

The combustion chamber pressure in mbar must be added to the minimum gas pressure determined from the above chart.

For low-pressure supplies, EN 88-compliant governors with safety diaphragms are used. The maximum permissible supply pressure into the shut-off valve for low pressure installations is 300 mbar.

For high-pressure supplies, EN 334-compliant high-pressure regulators should be selected from the brochure "Pressure regulators with safety devices for Weishaupt gas and dual-fuel burners". This brochure details high-gas-pressure sets suitable for supply pressures of up to 4 bar.

Refer to the burner's rating plate for the maximum connection pressure.

Scope of delivery

Sizes 50 and 70, version 1LN

Scope of delivery	RGL50	RGL70
Burner housing, hinged flange, housing cover, Weishaupt burner motor, air-inlet housing, fan wheel, combustion head, ignition unit, ignition cable, ignition electrodes, nozzle assembly with oil nozzle(s), combustion manager with control unit, flame sensor stepping motors, flange gasket, limit switch on hinged flange, fixing screws	●	●
W-FM 100 combustion manager	●	●
Double gas valve assembly (Class A)	●	●
Gas butterfly valve	●	●
Pilot line	●	●
Air pressure switch	●	●
Oil pressure switch in return	●	●
Low gas pressure switch	●	●
Mixing assembly with adjustable regulating sleeve	●	-
Mixing assembly with adjustable flame tube	-	●
Actuators for compound regulation of gas and air via W-FM		
Air damper stepping motor	●	●
Gas butterfly valve stepping motor	●	●
Oil regulator stepping motor	●	●
Oil pump, fitted	●	●
Oil hoses	●	●
2 oil solenoid valves, 1 safety valve, two-stage nozzle assembly with shut-off device (solenoid)	●	●
Electromagnetic clutch	●	●
Special equipment	G50	G70
Downward-firing version	○	○
Air inlet flange for duct connection	○	○
Solenoid valve for air pressure switch test with continuously running fan or post-purge	○	○
Combustion head extension	○	○
Integral capacity controller for W-FM 100	○	○
Variable speed drive	○	○
O ₂ trim	○	○
W-FM supplied loose for mounting in a control panel	○	○
Bus interface	○	○
PED execution	○	○
High-gas-pressure switch	○	○
<p>● Standard ○ Optional</p> <p>Please enquire or see the price list for additional special equipment.</p>		

Technical data

Sizes 50 and 70, version 1LN

Technical data				RGL50/1-B			RGL50/2-A				
400 V, 3 ~ burner motor ¹⁾				Type	W-D132/170-2/9K0			W-D132/210-2/14K0			
Nominal rating				kW	9			14			
Current draw at 400 V				A	18			28			
Motor prefusing (YΔ motor start)				A (slow)	35			50			
Speed (50 Hz)				rpm	2930			2920			
Fan wheel				Colour / ø	blue / 345 x 100			blue / 268 x 100			
Combustion manager				Type	W-FM100			W-FM100			
Ignition unit				Type	W-ZG02			W-ZG02			
Actuator	Air			Type	SQM45			SQM45			
	Fuel			Type	SQM45			SQM45			
Integral pump				Type	TA4C			T2C			
Oil solenoid valves	115 V, 3/8" (supply)	20 W		Type	321 H 2322			321 H 2322			
	115 V, 3/8" (return)	20 W		Type	121 G 2320			121 G 2320			
Oil pressure switch				1–10 bar (return - 5 bar)	Type	DSA 46 F001			DSA 46 F001		
Oil hoses				DN / length	25 / 1300			25 / 1300			
Burner weight				kg (approx.)	230			230			
Weight (gas valve assembly and fittings)				R/DN	1½	2	65	80	100	125	150
				kg (approx.)	23	25	65	80	130	220	240

Technical data				RGL70/1-B			RGL70/2-A				
400 V, 3 ~ burner motor ¹⁾				Type	W-D160/240-2/18K0			W-D160/240-2/22K0			
Nominal rating				kW	18			22			
Current draw at 400 V				A	35			43			
Motor prefusing (YΔ motor start)				A (slow)	63			63			
Speed (50 Hz)				rpm	2950			2940			
Fan wheel				Colour / ø	blue / 590 x 160			blue / 590 x 160			
Combustion manager				Type	W-FM100			W-FM 100			
Ignition unit				Type	W-ZG02			W-ZG02			
Actuator	Air			Type	SQM48			SQM48			
	Fuel			Type	SQM45			SQM45			
Integral pump				Type	T2C (< 600 kg/h) T3C (> 600 kg/h)			T2C (< 600 kg/h) T3C (> 600 kg/h)			
Oil solenoid valves	115 V, 3/8" (supply)	20 W		Type	321 H 2522			321 H 2522			
	115 V, 3/8" (return)	20 W		Type	121 G 2520			121 G 2520			
Oil pressure switch				2–40 bar (supply - 18 bar) 1–10 bar (return - 5 bar)	Type	–			–		
				Type	DSA 46 F 001			DSA 46 F 001			
Oil hoses				DN / length	25 / 1300			25 / 1300			
Burner weight				kg (approx.)	430			430			
Weight (gas valve assembly and fittings)				DN	65	80	100	125	150		
				kg (approx.)	65	80	130	220	240		

¹⁾ The electrical motors are premium-efficiency IE3 motors in accordance with Commission Regulation (EC) No. 640/2009.

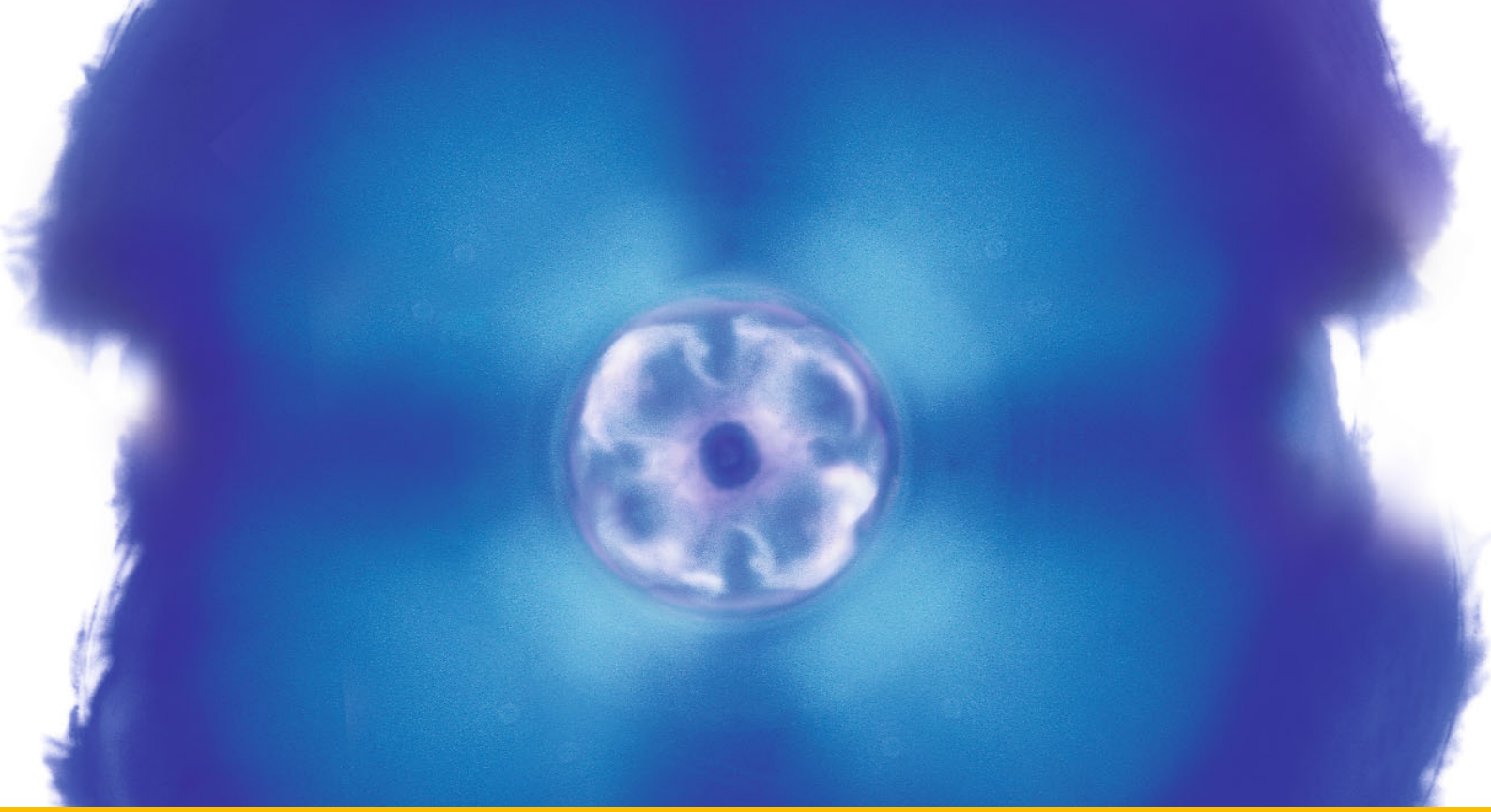

– weishaupt –

multiflam[®] burners

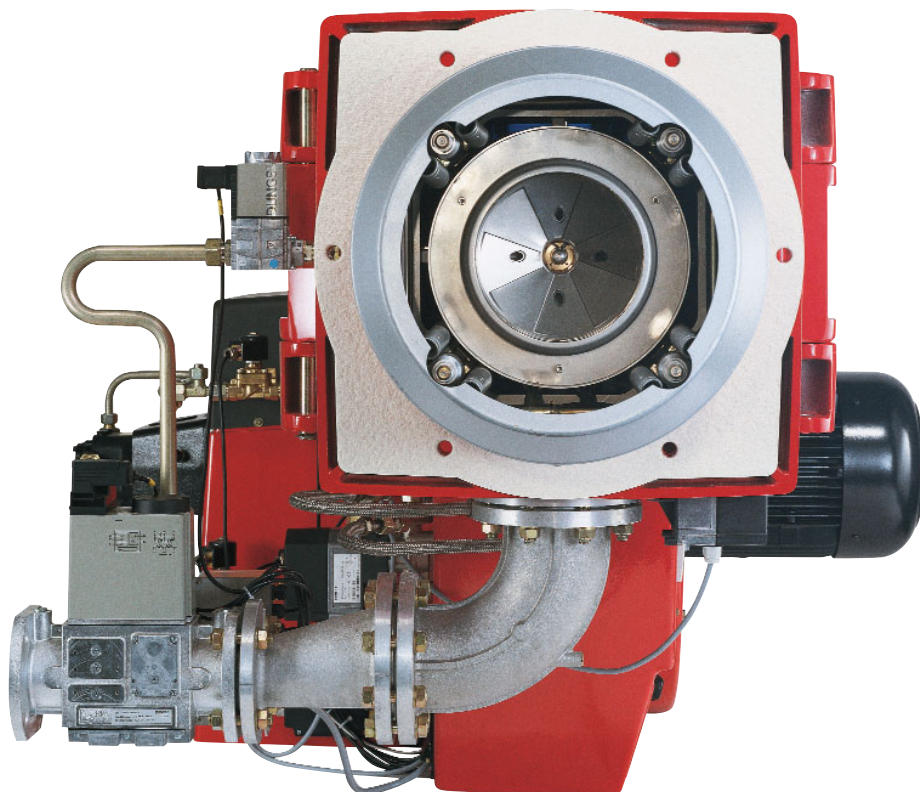

The multiflam® principle: Reduced emissions as standard

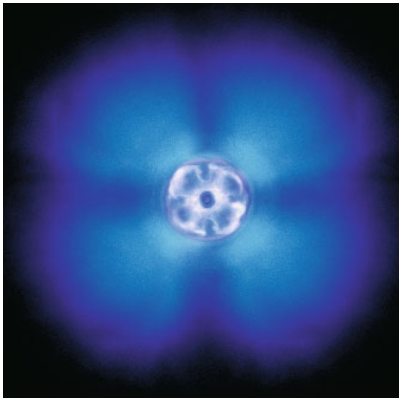

A multiflam® flame showing efficient combustion

When Weishaupt introduced its multiflam® technology in 1998 it made history, astounding the industry with its unprecedentedly low emissions. Using a patented mixing assembly design, Weishaupt was able to reduce the NO_x emissions from large and medium-sized burners to levels that hitherto had only ever been associated with compact burners. Weishaupt set an all-new benchmark, achieving levels below 80 mg/kWh on gas and 120 mg/kWh on oil, subject to the combustion-chamber geometry.

Weishaupt's multiflam® burners meet the world's toughest standards. In those countries with particularly stringent environmental legislation, such as Switzerland, multiflam® industrial burners are market-sector leaders.

At the heart of Weishaupt's multiflam® technology is a special mixing-assembly design which distributes the fuel among primary and secondary nozzles. This results in extremely efficient combustion thanks to recirculation of the flue gases directly at the mixing assembly.

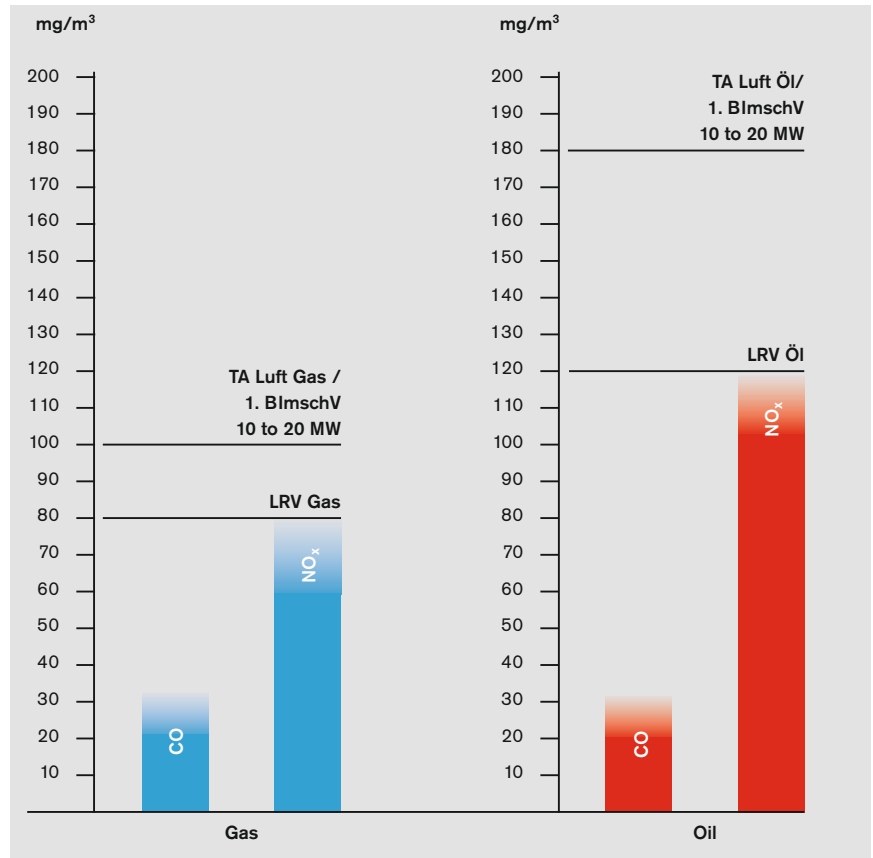

Typical emission levels for hot-water plant (subject to combustion chamber design)

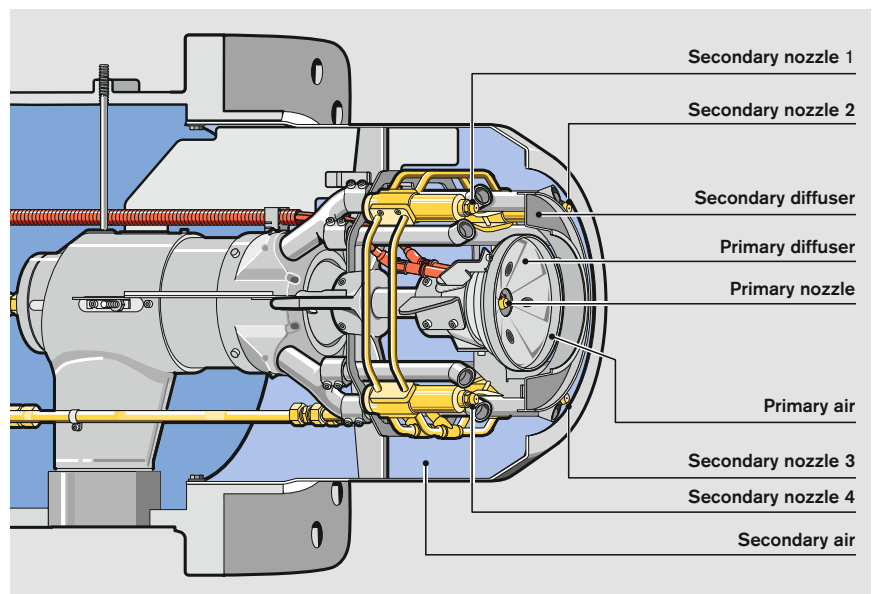

Cut-away illustration of the mixing assembly

Gas burner selection

Sizes 60 and 70, version 3LN – multiflam[®]

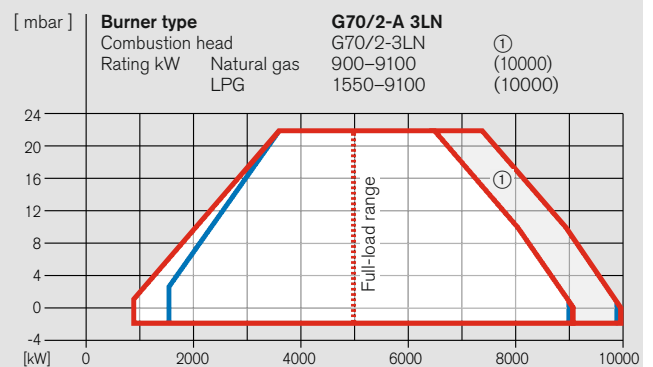
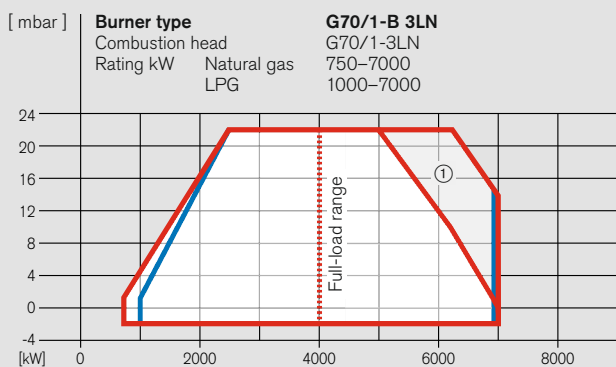
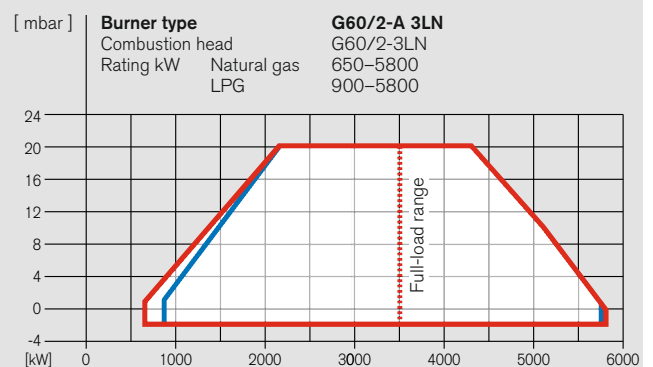
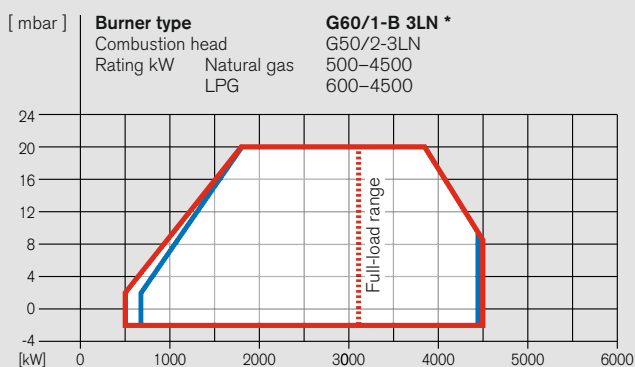

① 55 Hz version with VSD (additional cost)

Fuels
 Natural gas — (red line)
 LPG — (blue line)

Plotted operational ranges represent maximal values measured on idealised flame tubes in accordance with EN 676.

Stated ratings are based on an air temperature of 20 °C and an installation at sea level.

For installations at higher altitudes, a reduction in capacity of 1 % per 100 m above sea level should be taken into account.

Voltages and frequencies:

The burners are equipped as standard for three-phase alternating current, 400 V, 3 ~, 50 Hz. Other voltages and frequencies are available on application (no additional cost).

Standard burner motor:

Insulation Class F, IP 55 protection, IE3 efficiency at 50/60 Hz (no IE classification at 55 Hz).

*** Note regarding G60/1-B 3LN**

The burner is equipped with VSD as standard. Its high-capacity fan wheel is driven by an IP 55 Weishaupt motor operating at 55 Hz when at full speed.

The burner is supplied with a W-FM 200 combustion manager as standard, and the burner price includes an FC301 P11K frequency convertor (IP 20 protection), and a braking resistor suitable for 55 Hz operation (supplied loose for mounting in a control panel).

Burner type	Version	CE-PIN	Valve train	Order No.
G60/1-B	3LN *	CE 0085 AQ 0722	R 2	217 604 14
			DN 65	217 604 44
			DN 80	217 604 54
			DN 100	217 604 64
			DN 125	217 604 74
DN 150	217 604 84			
G60/2-A	3LN	CE 0085 AQ 0722	DN 65	217 605 44
			DN 80	217 605 54
			DN 100	217 605 64
			DN 125	217 605 74
			DN 150	217 605 84
G70/1-B	3LN	CE 0085 AQ 0723	DN 65	217 704 44
			DN 80	217 704 54
			DN 100	217 704 64
			DN 125	217 704 74
			DN 150	217 704 84
G70/2-A	3LN	CE 0085 AQ 0723	DN 65	217 705 44
			DN 80	217 705 54
			DN 100	217 705 64
			DN 125	217 705 74
			DN 150	217 705 84

Gas valve train sizing

Size 60, version 3LN

Type G60/1-B 3LN

Burner rating kW	Low-pressure supply (with FRS) (flow pressure in mbar into shut-off valve, pe, max = 300 mbar)	High-pressure supply (with HP regulator), (flow pressure in mbar into gas valve assembly)
	Nominal valve-train diameter 2" 65 80 100 125 150 Nom. diameter of gas butterfly 100 100 100 100 100	Nominal valve-train diameter 2" 65 80 100 125 150 Nom. diameter of gas butterfly 100 100 100 100 100
	Natural Gas E LHV = 10.35 kWh/Nm ³ ; d = 0.606; W _i = 13.295 kWh/Nm ³	
3100	145 86 64 52 48 46	83 57 50 44 43 42
3300	161 95 70 56 52 49	92 63 54 48 46 46
3600	188 110 79 63 58 55	106 71 61 54 52 51
3900	217 125 90 70 64 61	121 81 69 60 58 57
4200	249 142 101 79 72 68	138 91 77 67 64 64
4500	283 161 113 87 79 75	156 102 86 75 72 70
	Natural Gas LL LHV = 8.83 kWh/Nm ³ ; d = 0.641; W _i = 11.029 kWh/Nm ³	
3100	199 114 81 64 58 55	110 73 62 54 52 51
3300	222 126 89 69 63 60	122 80 67 59 56 55
3600	260 146 102 78 71 67	142 92 77 66 64 62
3900	- 168 116 88 79 75	163 105 87 75 71 70
4200	- 192 132 99 89 84	187 118 98 83 80 78
4500	- 217 148 111 99 93	- 133 109 93 89 87
	LPG B/P LHV = 25.89 kWh/Nm ³ ; d = 1.555; W _i = 20.762 kWh/Nm ³	
3100	85 61 52 47 45 45	58 48 45 42 42 42
3300	94 67 56 51 49 48	64 52 48 46 45 45
3600	108 76 63 56 54 53	73 59 54 51 50 50
3900	123 85 71 63 60 59	82 66 61 57 56 56
4200	140 96 79 70 67 66	93 74 68 64 63 62
4500	158 108 88 78 74 73	104 82 75 71 70 69

Type G60/2-A 3LN

Burner rating kW	Low-pressure supply (with FRS) (flow pressure in mbar into shut-off valve, pe, max = 300 mbar)	High-pressure supply (with HP regulator), (flow pressure in mbar into gas valve assembly)
	Nominal valve-train diameter 2" 65 80 100 125 150 Nom. diameter of gas butterfly 100 100 100 100 100	Nominal valve-train diameter 2" 65 80 100 125 150 Nom. diameter of gas butterfly 100 100 100 100 100
	Natural Gas E LHV = 10.35 kWh/Nm ³ ; d = 0.606; W _i = 13.295 kWh/Nm ³	
3500	160 85 57 41 36 34	82 49 39 32 31 30
3700	177 94 62 44 39 36	90 53 42 35 33 32
3900	194 102 67 47 41 39	98 58 46 37 35 34
4100	213 112 72 51 44 41	108 63 49 40 37 36
4300	233 121 78 55 47 44	117 68 53 43 40 39
4600	265 137 87 61 52 48	132 76 59 47 44 43
4900	299 154 97 67 57 53	149 85 66 52 49 47
5200	- 172 108 74 63 58	166 94 73 58 54 52
5500	- 191 120 81 69 63	185 105 80 63 59 57
5800	- 211 132 89 76 69	- 115 88 69 64 63
	Natural Gas LL LHV = 8.83 kWh/Nm ³ ; d = 0.641; W _i = 11.029 kWh/Nm ³	
3500	222 115 73 50 43 40	110 63 49 39 36 35
3700	247 127 80 55 47 43	122 69 53 42 39 38
3900	273 139 88 60 51 47	135 76 58 46 42 41
4100	- 153 96 65 55 50	148 83 63 50 46 45
4300	- 167 104 70 59 54	162 90 69 54 50 48
4600	- 190 118 79 66 60	184 102 77 60 56 54
4900	- 214 132 88 74 67	- 115 87 68 62 61
5200	- 240 148 98 82 75	- 129 97 75 70 67
5500	- 268 164 109 91 83	- 144 108 84 77 75
5800	- 297 182 120 101 91	- 159 120 93 85 83
	LPG B/P LHV = 25.89 kWh/Nm ³ ; d = 1.555; W _i = 20.762 kWh/Nm ³	
3500	84 53 42 35 33 32	50 37 33 30 29 29
3700	92 58 45 38 35 34	55 40 35 32 31 31
3900	100 63 48 40 38 36	59 43 38 34 33 33
4100	109 68 51 43 40 39	64 46 41 37 36 35
4300	119 73 55 46 43 41	70 50 43 39 38 38
4600	134 82 61 50 47 45	78 55 48 43 42 42
4900	150 91 68 55 51 49	87 61 53 48 46 46
5200	168 101 75 61 56 54	97 68 59 53 51 50
5500	186 111 82 66 62 59	108 75 65 58 56 55
5800	206 123 90 73 67 65	119 82 71 63 61 60

The combustion chamber pressure in mbar must be added to the minimum gas pressure determined from the above chart.

For low-pressure supplies, EN 88-compliant governors with safety diaphragms are used. The maximum permissible supply pressure into the shut-off valve for low pressure installations is 300 mbar.

For high-pressure supplies, EN 334-compliant high-pressure regulators should be selected from the brochure "*Pressure regulators with safety devices for Weishaupt gas and dual-fuel burners*". This brochure details high-gas-pressure sets suitable for supply pressures of up to 4 bar.

Refer to the burner's rating plate for the maximum connection pressure.

Gas valve train sizing

Size 70, version 3LN

Type G70/1-B 3LN

Burner rating kW	Low-pressure supply (with FRS) (flow pressure in mbar into shut-off valve, pe, max = 300 mbar)	High-pressure supply (with HP regulator), (flow pressure in mbar into gas valve assembly)
	Nominal valve-train diameter 65 80 100 125 150 Nom. diameter of gas butterfly 100 100 100 100 100	Nominal valve-train diameter 65 80 100 125 150 Nom. diameter of gas butterfly 100 100 100 100 100

Natural Gas E LHV = 10.35 kWh/Nm ³ ; d = 0.606; W _i = 13.295 kWh/Nm ³		
4000	111 73 53 46 43	64 51 42 40 39
4500	137 90 64 56 52	79 63 51 48 47
5000	167 108 76 66 62	95 75 61 57 56
5500	199 128 89 77 72	113 88 72 67 65
6000	233 149 103 89 82	131 102 82 77 75
6500	270 171 117 100 92	151 117 93 87 85
7000	- 194 131 112 103	171 131 104 97 94

Natural Gas LL LHV = 8.83 kWh/Nm ³ ; d = 0.641; W _i = 11.029 kWh/Nm ³		
4000	152 98 68 59 54	85 67 54 50 49
4500	191 122 85 73 67	107 83 67 63 61
5000	234 148 102 88 81	131 101 81 76 74
5500	280 177 121 103 95	156 120 96 89 87
6000	- 206 140 119 109	182 140 111 103 100
6500	- 236 159 134 122	- 159 125 115 112
7000	- 267 177 148 135	- 177 138 127 123

LPG B/P LHV = 25.89 kWh/Nm ³ ; d = 1.555; W _i = 20.762 kWh/Nm ³		
4000	60 45 37 34 33	40 35 31 30 30
4500	76 56 46 43 41	51 44 39 38 38
5000	93 69 56 52 50	62 54 48 47 46
5500	111 82 66 61 59	74 64 58 56 55
6000	131 96 77 71 69	87 75 67 65 64
6500	151 110 88 81 78	101 87 77 74 73
7000	172 125 99 91 87	114 98 86 83 82

Type G70/2-A 3LN

Burner rating kW	Low-pressure supply (with FRS) (flow pressure in mbar into shut-off valve, pe, max = 300 mbar)	High-pressure supply (with HP regulator), (flow pressure in mbar into gas valve assembly)
	Nominal valve-train diameter 65 80 100 125 150 Nom. diameter of gas butterfly 100 100 100 100 100	Nominal valve-train diameter 65 80 100 125 150 Nom. diameter of gas butterfly 100 100 100 100 100

Natural Gas E LHV = 10.35 kWh/Nm ³ ; d = 0.606; W _i = 13.295 kWh/Nm ³		
5000	143 85 53 43 38	72 52 38 34 33
5500	172 101 63 51 45	86 62 45 41 39
6000	204 120 74 60 53	102 73 53 48 46
6500	239 140 86 69 61	120 85 62 56 53
7000	276 161 99 79 70	138 99 71 64 61
8000	- 209 128 102 90	180 128 93 83 80
9000	- 263 160 128 113	- 161 117 105 100
10000	- - 197 157 138	- 199 144 129 123

Natural Gas LL LHV = 8.83 kWh/Nm ³ ; d = 0.641; W _i = 11.029 kWh/Nm ³		
5000	203 118 72 57 50	100 71 50 45 43
5500	244 141 85 68 59	120 85 60 54 51
6000	289 167 100 79 70	142 100 71 63 61
6500	- 195 117 92 81	167 117 83 74 71
7000	- 225 135 106 93	193 135 96 85 81
8000	- 293 175 137 120	- 176 125 111 106
9000	- - 200 173 151	- - 158 140 134
10000	- - 271 213 185	- - 194 173 165

LPG B/P* LHV = 25.89 kWh/Nm ³ ; d = 1.555; W _i = 20.762 kWh/Nm ³		
5000	75 51 38 34 32	44 36 30 29 28
5500	90 61 46 41 38	54 44 37 35 34
6000	107 72 54 48 45	64 52 44 41 41
6500	125 84 62 55 52	75 61 51 48 47
7000	144 97 72 64 60	86 70 59 56 55
8000	187 126 92 82 77	112 91 77 73 71
9000	236 158 116 103 96	142 115 96 91 90
10000	290 194 142 126 118	174 141 119 112 110

The combustion chamber pressure in mbar must be added to the minimum gas pressure determined from the above chart.

For low-pressure supplies, EN 88-compliant governors with safety diaphragms are used. The maximum permissible supply pressure into the shut-off valve for low pressure installations is 300 mbar.

For high-pressure supplies, EN 334-compliant high-pressure regulators should be selected from the brochure "Pressure regulators with safety devices for Weishaupt gas and dual-fuel burners". This brochure details high-gas-pressure sets suitable for supply pressures of up to 4 bar.

Refer to the burner's rating plate for the maximum connection pressure.

Scope of delivery, special equipment

Sizes 60 and 70, version 3LN – multiflam[®]

Scope of delivery	G60	G70
Burner housing, hinged flange, housing cover, Weishaupt burner motor, air-inlet housing, fan wheel, combustion head, ignition unit, ignition cable, ignition electrodes, combustion manager with control unit, UV flame sensor, stepping motors, flange gasket limit switch on hinged flange, fixing screws	●	●
W-FM 100 combustion manager	●	●
Double gas-valve assembly (Class A)	●	●
Pilot line solenoid valve	●	●
Air pressure switch	●	●
Low gas pressure switch	●	●
Mixing assembly with modulating diffuser	●	●
Actuators for compound regulation of gas and air via W-FM		
Air damper stepping motor	●	●
Gas butterfly valve stepping motor	●	●
Mixing assembly stepping motor	●	●
Special equipment	G60	G70
Air inlet flange for duct connection	○	○
Combustion head extension	○	○
Integral capacity controller for W-FM 100	○	○
Variable speed drive	○	○
O ₂ trim	○	○
W-FM supplied loose for mounting in a control panel	○	○
Bus interface	○	○
High gas pressure switch	○	○

EN 676 stipulates that gas filters and gas-pressure switches form part of the burner supply (see Weishaupt accessories list)

- Standard
- Optional

Please enquire or see the price list for additional special equipment.

Technical data

Sizes 60 and 70, version 3LN – multiflam®

Technical data		G60/1-B 3LN			G60/2-A 3LN			G70/1-B 3LN			G70/2-A 3LN			
400 V, 3 ~ burner motor ¹⁾	Type	W-D132/210-2/14K0			W-D132/210-2/14K0			W-D160/240-2/18K0			W-D160/240-2/22K0			
Nominal rating	kW	14			14			18			22			
Current draw at 400 V	A	28			28			35			43			
Motor prefusing (YΔ motor start) speed (50 Hz)	A (slow) rpm	50 2920			50 2920			63 2950			63 2940			
Frequency convertor with braking resistor	Type	FC301 P11K IP20			–			–			–			
Fan wheel	Colour / ø	blue / 515 x 127.5			blue / 515 x 127.5			blue / 590 x 160			blue / 590 x 160			
Combustion manager	Type	W-FM 200			W-FM 100			W-FM 100			W-FM 100			
Ignition unit	Type	W-ZG02			W-ZG02			W-ZG02			W-ZG02			
Actuator	Air	Type	SQM48			SQM48			SQM48			SQM48		
	Fuel	Type	SQM45			SQM45			SQM45			SQM45		
	Mixing assembly	Type	SQM48			SQM48			SQM48			SQM48		
Burner weight	kg (approx.)	345			330			435			435			
Weight (gas valve assembly and fittings)	R / DN	1½	2	65	80	100	125	150						
	kg (approx.)	13	24	23	31	39	37	48						

¹⁾ The electrical motors are premium-efficiency IE3 motors in accordance with Commission Regulation (EC) No. 640/2009.

Dual-fuel burner selection

Sizes 60 and 70, version 3LN – multiflam[®]

[mbar] **Burner type** **RGL60/1-B 3LN ***

Combustion head G50/2-3LN

Rating kW Natural gas 500–4500

Rating kW LPG 600–4500

Rating kW Light oil 595–4500

Rating kg/h Light oil 50–378

[kW] 0 1000 2000 3000 4000 5000

[mbar] **Burner type** **RGL60/2-A 3LN**

Combustion head G60/2-3LN

Rating kW Natural gas 650–5500

Rating kW LPG 900–5500

Rating kW Light oil 1071–5500

Rating kg/h Light oil 90–462

[kW] 0 1000 2000 3000 4000 5000 6000

[mbar] **Burner type** **RGL70/1-B 3LN**

Combustion head G70/1-3LN

Rating kW Natural gas 750–7000

Rating kW LPG 1000–7000

Rating kW Light oil 1190–7000

Rating kg/h Light oil 100–588

[kW] 0 2000 4000 6000 8000

[mbar] **Burner type** **RGL70/2-A 3LN**

Combustion head G70/2-3LN ①

Rating kW Natural gas 900–9100 (10000)

Rating kW LPG 1550–9100 (10000)

Rating kW Light oil 1550–9100 (10000)

Rating kg/h Light oil 130–763 (839)

[kW] 0 2000 4000 6000 8000 10000

① 55 Hz version with VSD (additional cost)

Fuels

Light oil — Natural gas — LPG —

Stated oil throughputs are based on a calorific value of 11.91 kWh/kg for light oil.

Plotted operational ranges represent maximal values measured on idealised flame tubes in accordance with EN 676 and EN 267.

Stated ratings are based on an air temperature of 20 °C and an installation at sea level.

For installations at higher altitudes, a reduction in capacity of 1 % per 100 m above sea level should be taken into account.

Voltages and frequencies:
The burners are equipped as standard for three-phase alternating current, 400 V, 3 ~, 50 Hz. Other voltages and frequencies are available on application (no additional cost)

Standard burner motor:
Insulation Class F, IP 55 protection, IE3 efficiency at 50/60 Hz (no IE classification at 55 Hz).

*** Note regarding RGL60/1-B 3LN**
The burner is equipped with VSD as standard. Its high-capacity fan wheel is driven by an IP 55 Weishaupt motor operating at 55 Hz when at full speed.

The burner is supplied with a W-FM 200 combustion manager as standard, and the burner price includes an FC301 P11K frequency converter (IP 20 protection), and a braking resistor suitable for 55 Hz operation (supplied loose for mounting in a control panel).

Burner type	Version	CE-PIN	Valve train	Order No.
RGL60/1-B	3LN *	CE 0085 AQ 0722 5G518/05M	R 2	218 604 14
			DN 65	218 604 44
			DN 80	218 604 54
			DN 100	218 604 64
			DN 125	218 604 74
DN 150	218 604 84			
RGL60/2-A	3LN	CE 0085 AQ 0722 5G518/05M	R 2	218 605 14
			DN 65	218 605 44
			DN 80	218 605 54
			DN 100	218 605 64
			DN 125	218 605 74
DN 150	218 605 84			
RGL70/1-B	3LN	CE 0085 AQ 0723 5G519/05M	DN 65	218 704 44
			DN 80	218 704 54
			DN 100	218 704 64
			DN 125	218 704 74
			DN 150	218 704 84
RGL70/2-A	3LN	CE 0085 AQ 0723 5G519/05M	DN 65	218 705 44
			DN 80	218 705 54
			DN 100	218 705 64
			DN 125	218 705 74
			DN 150	218 705 84

Gas valve train sizing

Size 60, version 3LN – multiflam[®]

Type RGL60/1-B 3LN			Type RGL60/2-A 3LN									
Burner rating kW Low-pressure supply (with FRS) (flow pressure in mbar into shut-off valve, pe, max = 300 mbar) Nominal valve-train diameter 2" 65 80 100 125 150 Nom. diameter of gas butterfly 100 100 100 100 100	High-pressure supply (with HP regulator), (flow pressure in mbar into gas valve assembly) Nominal valve-train diameter 2" 65 80 100 125 150 Nom. diameter of gas butterfly 100 100 100 100 100	Burner rating kW Low-pressure supply (with FRS) (flow pressure in mbar into shut-off valve, pe, max = 300 mbar) Nominal valve-train diameter 2" 65 80 100 125 150 Nom. diameter of gas butterfly 100 100 100 100 100	High-pressure supply (with HP regulator), (flow pressure in mbar into gas valve assembly) Nominal valve-train diameter 2" 65 80 100 125 150 Nom. diameter of gas butterfly 100 100 100 100 100									
Natural Gas E LHV = 10.35 kWh/Nm ³ ; d = 0.606; W _i = 13.295 kWh/Nm ³			Natural Gas E LHV = 10.35 kWh/Nm ³ ; d = 0.606; W _i = 13.295 kWh/Nm ³									
3100	145	86	64	52	48	46	83	57	50	44	43	42
3300	161	95	70	56	52	49	92	63	54	48	46	46
3600	188	110	79	63	58	55	106	71	61	54	52	51
3900	217	125	90	70	64	61	121	81	69	60	58	57
4200	249	142	101	79	72	68	138	91	77	67	64	64
4500	283	161	113	87	79	75	156	102	86	75	72	70
Natural Gas LL LHV = 8.83 kWh/Nm ³ ; d = 0.641; W _i = 11.029 kWh/Nm ³			Natural Gas LL LHV = 8.83 kWh/Nm ³ ; d = 0.641; W _i = 11.029 kWh/Nm ³									
3100	199	114	81	64	58	55	110	73	62	54	52	51
3300	222	126	89	69	63	60	122	80	67	59	56	55
3600	260	146	102	78	71	67	142	92	77	66	64	62
3900	-	168	116	88	79	75	163	105	87	75	71	70
4200	-	192	132	99	89	84	187	118	98	83	80	78
4500	-	217	148	111	99	93	-	133	109	93	89	87
LPG B/P LHV = 25.89 kWh/Nm ³ ; d = 1.555; W _i = 20.762 kWh/Nm ³			LPG B/P LHV = 25.89 kWh/Nm ³ ; d = 1.555; W _i = 20.762 kWh/Nm ³									
3100	85	61	52	47	45	45	58	48	45	42	42	42
3300	94	67	56	51	49	48	64	52	48	46	45	45
3600	108	76	63	56	54	53	73	59	54	51	50	50
3900	123	85	71	63	60	59	82	66	61	57	56	56
4200	140	96	79	70	67	66	93	74	68	64	63	62
4500	158	108	88	78	74	73	104	82	75	71	70	69
Natural Gas E LHV = 10.35 kWh/Nm ³ ; d = 0.606; W _i = 13.295 kWh/Nm ³			Natural Gas E LHV = 10.35 kWh/Nm ³ ; d = 0.606; W _i = 13.295 kWh/Nm ³									
3100	129	70	48	36	32	30	67	41	34	28	27	26
3500	160	85	57	41	36	34	82	49	39	32	31	30
4000	204	107	70	49	43	40	103	60	47	39	36	35
4300	233	121	78	55	47	44	117	68	53	43	40	39
4500	254	132	84	59	50	47	127	73	57	46	43	42
4800	287	148	94	65	56	51	143	82	63	51	47	46
5000	-	160	101	69	59	55	155	88	68	54	50	49
5300	-	178	112	76	65	60	172	98	75	59	55	54
5500	-	191	120	81	69	63	185	105	80	63	59	57
Natural Gas LL LHV = 8.83 kWh/Nm ³ ; d = 0.641; W _i = 11.029 kWh/Nm ³			Natural Gas LL LHV = 8.83 kWh/Nm ³ ; d = 0.641; W _i = 11.029 kWh/Nm ³									
3100	178	93	60	43	37	34	89	52	41	33	31	30
3500	222	115	73	50	43	40	110	63	49	39	36	35
4000	287	146	92	62	53	48	141	79	61	48	44	43
4300	-	167	104	70	59	54	162	90	69	54	50	48
4500	-	182	113	76	64	58	176	98	74	58	54	52
4800	-	206	127	85	71	65	200	111	84	65	60	58
5000	-	222	137	91	77	70	-	120	90	70	65	63
5300	-	249	153	101	85	77	-	134	101	78	72	70
5500	-	268	164	109	91	83	-	144	108	84	77	75
LPG B/P LHV = 25.89 kWh/Nm ³ ; d = 1.555; W _i = 20.762 kWh/Nm ³			LPG B/P LHV = 25.89 kWh/Nm ³ ; d = 1.555; W _i = 20.762 kWh/Nm ³									
3100	69	45	36	31	29	29	42	32	29	26	26	26
3500	84	53	42	35	33	32	50	37	33	30	29	29
4000	105	65	50	41	39	38	62	44	39	36	35	34
4300	119	73	55	46	43	41	70	50	43	39	38	38
4500	129	79	59	49	45	44	75	53	47	42	41	40
4800	145	88	66	54	50	48	84	59	51	46	45	44
5000	156	94	70	57	53	51	91	63	55	49	48	47
5300	174	104	77	63	58	56	101	70	61	54	52	52
5500	186	111	82	66	62	59	108	75	65	58	56	55

The combustion chamber pressure in mbar must be added to the minimum gas pressure determined from the above chart.

For low-pressure supplies, EN 88-compliant governors with safety diaphragms are used. The maximum permissible supply pressure into the shut-off valve for low pressure installations is 300 mbar.

For high-pressure supplies, EN 334-compliant high-pressure regulators should be selected from the brochure "Pressure regulators with safety devices for Weishaupt gas and dual-fuel burners". This brochure details high-gas-pressure sets suitable for supply pressures of up to 4 bar.

Refer to the burner's rating plate for the maximum connection pressure.

Gas valve train sizing

Size 70, version 3LN – multiflam[®]

Type RGL70/1-B 3LN

Burner rating kW	Low-pressure supply (with FRS) (flow pressure in mbar into shut-off valve, pe, max = 300 mbar)	High-pressure supply (with HP regulator), (flow pressure in mbar into gas valve assembly)
	Nominal valve-train diameter 65 80 100 125 150 Nom. diameter of gas butterfly 100 100 100 100 100	Nominal valve-train diameter 65 80 100 125 150 Nom. diameter of gas butterfly 100 100 100 100 100
	Natural Gas E LHV = 10.35 kWh/Nm ³ ; d = 0.606; W _i = 13.295 kWh/Nm ³	
4000	111 73 53 46 43	64 51 42 40 39
4500	137 90 64 56 52	79 63 51 48 47
5000	167 108 76 66 62	95 75 61 57 56
5500	199 128 89 77 72	113 88 72 67 65
6000	233 149 103 89 82	131 102 82 77 75
6500	270 171 117 100 92	151 117 93 87 85
7000	- 194 131 112 103	171 131 104 97 94
	Natural Gas LL LHV = 8.83 kWh/Nm ³ ; d = 0.641; W _i = 11.029 kWh/Nm ³	
4000	152 98 68 59 54	85 67 54 50 49
4500	191 122 85 73 67	107 83 67 63 61
5000	234 148 102 88 81	131 101 81 76 74
5500	280 177 121 103 95	156 120 96 89 87
6000	- 206 140 119 109	182 140 111 103 100
6500	- 236 159 134 122	- 159 125 115 112
7000	- 267 177 148 135	- 177 138 127 123
	LPG B/P LHV = 25.89 kWh/Nm ³ ; d = 1.555; W _i = 20.762 kWh/Nm ³	
4000	60 45 37 34 33	40 35 31 30 30
4500	76 56 46 43 41	51 44 39 38 38
5000	93 69 56 52 50	62 54 48 47 46
5500	111 82 66 61 59	74 64 58 56 55
6000	131 96 77 71 69	87 75 67 65 64
6500	151 110 88 81 78	101 87 77 74 73
7000	172 125 99 91 87	114 98 86 83 82

Type RGL70/2-A 3LN

Burner rating kW	Low-pressure supply (with FRS) (flow pressure in mbar into shut-off valve, pe, max = 300 mbar)	High-pressure supply (with HP regulator), (flow pressure in mbar into gas valve assembly)
	Nominal valve-train diameter 65 80 100 125 150 Nom. diameter of gas butterfly 100 100 100 100 100	Nominal valve-train diameter 65 80 100 125 150 Nom. diameter of gas butterfly 100 100 100 100 100
	Natural Gas E LHV = 10.35 kWh/Nm ³ ; d = 0.606; W _i = 13.295 kWh/Nm ³	
5000	143 85 53 43 38	72 52 38 34 33
5500	172 101 63 51 45	86 62 45 41 39
6000	204 120 74 60 53	102 73 53 48 46
6500	239 140 86 69 61	120 85 62 56 53
7000	276 161 99 79 70	138 99 71 64 61
8000	- 209 128 102 90	180 128 93 83 80
9000	- 263 160 128 113	- 161 117 105 100
10000	- - 197 157 138	- 199 144 129 123
	Natural Gas LL LHV = 8.83 kWh/Nm ³ ; d = 0.641; W _i = 11.029 kWh/Nm ³	
5000	203 118 72 57 50	100 71 50 45 43
5500	244 141 85 68 59	120 85 60 54 51
6000	289 167 100 79 70	142 100 71 63 61
6500	- 195 117 92 81	167 117 83 74 71
7000	- 225 135 106 93	193 135 96 85 81
8000	- 293 175 137 120	- 176 125 111 106
9000	- - 200 173 151	- - 158 140 134
10000	- - 271 213 185	- - 194 173 165
	LPG B/P* LHV = 25.89 kWh/Nm ³ ; d = 1.555; W _i = 20.762 kWh/Nm ³	
5000	75 51 38 34 32	44 36 30 29 28
5500	90 61 46 41 38	54 44 37 35 34
6000	107 72 54 48 45	64 52 44 41 41
6500	125 84 62 55 52	75 61 51 48 47
7000	144 97 72 64 60	86 70 59 56 55
8000	187 126 92 82 77	112 91 77 73 71
9000	236 158 116 103 96	142 115 96 91 90
10000	290 194 142 126 118	174 141 119 112 110

The combustion chamber pressure in mbar must be added to the minimum gas pressure determined from the above chart.

For low-pressure supplies, EN 88-compliant governors with safety diaphragms are used. The maximum permissible supply pressure into the shut-off valve for low pressure installations is 300 mbar.

For high-pressure supplies, EN 334-compliant high-pressure regulators should be selected from the brochure *"Pressure regulators with safety devices for Weishaupt gas and dual-fuel burners"*. This brochure details high-gas-pressure sets suitable for supply pressures of up to 4 bar.

Refer to the burner's rating plate for the maximum connection pressure.

Scope of delivery, special equipment Sizes 60 and 70, version 3LN – multiflam[®]

Scope of delivery	RGL60	RGL70
Burner housing, hinged flange, housing cover, Weishaupt burner motor, air-inlet housing, fan wheel, combustion head, ignition unit, ignition cable, ignition electrodes, atomisation system with oil nozzle(s), combustion manager with control unit, flame sensor, stepping motors, flange gasket, limit switch on hinged flange, fixing screws	●	●
W-FM 100 combustion manager	●	●
Double gas valve assembly (Class A)	●	●
Pilot line solenoid valve	●	●
Gas butterfly valve	●	●
Air pressure switch	●	●
Low gas pressure switch	●	●
Mixing assembly with modulating diffuser	●	●
Actuators for compound regulation of gas and air via W-FM		
Air damper stepping motor	●	●
Gas butterfly valve stepping motor	●	●
Mixing assembly stepping motor	●	●
<hr/>		
Special equipment	RGL60	RGL70
Air inlet flange for duct connection	○	○
Solenoid valve for air pressure switch test with continuously running fan or post-purge	○	○
Combustion head extension	○	○
Integral capacity controller for W-FM 100	○	○
Variable speed drive	○	○
O ₂ trim	○	○
W-FM supplied loose for mounting in a control panel	○	○
Bus interface	○	○
PED execution	○	○
High gas pressure switch	○	○
<p>EN 676 stipulates that gas filters and gas-pressure switches form part of the burner supply (see Weishaupt accessories list)</p> <p>● Standard ○ Optional</p> <p>Please enquire or see the price list for additional special equipment.</p>		

Technical data

Sizes 60 and 70, version 3LN – multiflam®

Technical data		RGL60/1-B 3LN			RGL60/2-A 3LN				
400 V, 3 ~ burner motor ¹⁾	Type	W-D132/210-2/14K0			W-D132/210-2/14K0				
Nominal rating	kW	14			14				
Current draw at 400 V	A	28			28				
Motor prefusing (YΔ motor start)	A	50			50				
Speed (50 Hz)	rpm	2920			2920				
Frequency convertor with braking resistor	Type	FC301 P11K IP20			-				
Fan wheel	Colour / ø	- / 515 x 127.5			- / 515 x 127.5				
Combustion manager	Type	W-FM 200			W-FM 100				
Ignition unit	Type	W-ZG02			W-ZG02				
Actuator	Air	Type	SQM48			SQM48			
	Fuel	Type	SQM45			SQM45			
	Mixing assembly	Type	SQM48			SQM48			
Integral pump	Type	T2C			T2C				
Oil solenoid valves	115 V (supply)	Type	321 H 2322 (x 2)			321 H 2322 (x 2)			
	115 V (return)	Type	121 G 2320 (x 2)			121 G 2320 (x 2)			
Oil pressure switch (return, light oil - 5 bar)	1-10 bar	Type	DSA 46 F001			DSA 46 F001			
Oil hoses	DN / length	25 / 1300			25 / 1300				
Burner weight	kg (approx.)	345			330				
Weight (gas valve assembly and fittings)	R / DN	1½	2	65	80	100	125	150	
	kg (approx.)	13	24	23	31	39	37	48	

Technical data		RGL70/1-B 3LN			RGL70/2-A 3LN				
400 V, 3 ~ burner motor ¹⁾	Type	W-D160/240-2/18K0			W-D160/240-2/22K0				
Nominal rating	kW	18			22				
Current draw at 400 V	A	35			43				
Motor prefusing (YΔ motor start)	A	63			63				
Speed (50 Hz)	rpm	2950			2940				
Fan wheel	Colour / ø	blue / 590 x 160			blue / 590 x 160				
Combustion manager	Type	W-FM 100			W-FM 100				
Ignition unit	Type	W-ZG02			W-ZG02				
Actuator	Air	Type	SQM48			SQM48			
	Fuel	Type	SQM45			SQM45			
	Mixing assembly	Type	SQM48			SQM48			
Integral pump	Type	T2C (< 450 kg/h) T3C (> 450 kg/h)			T3C				
Oil solenoid valves	115 V (supply)	Type	321 H 2522 (x 2)			321 H 2522 (x 2)			
	115 V (return)	Type	121 G 2520 (x 2)			121 G 2520 (x 2)			
Oil pressure switch (return, light oil - 5 bar)	1-10 bar	Type	DSA 46 F001			DSA 46 F001			
Oil hoses	DN / length	25 / 1300			25 / 1300				
Burner weight	kg (approx.)	435			435				
Weight (gas valve assembly and fittings)	R / DN	1½	2	65	80	100	125	150	
	kg (approx.)	13	24	23	31	39	37	48	

¹⁾ The electrical motors are premium-efficiency IE3 motors in accordance with Commission Regulation (EC) No. 640/2009

Oil burner dimensions

Sizes 30 to 70

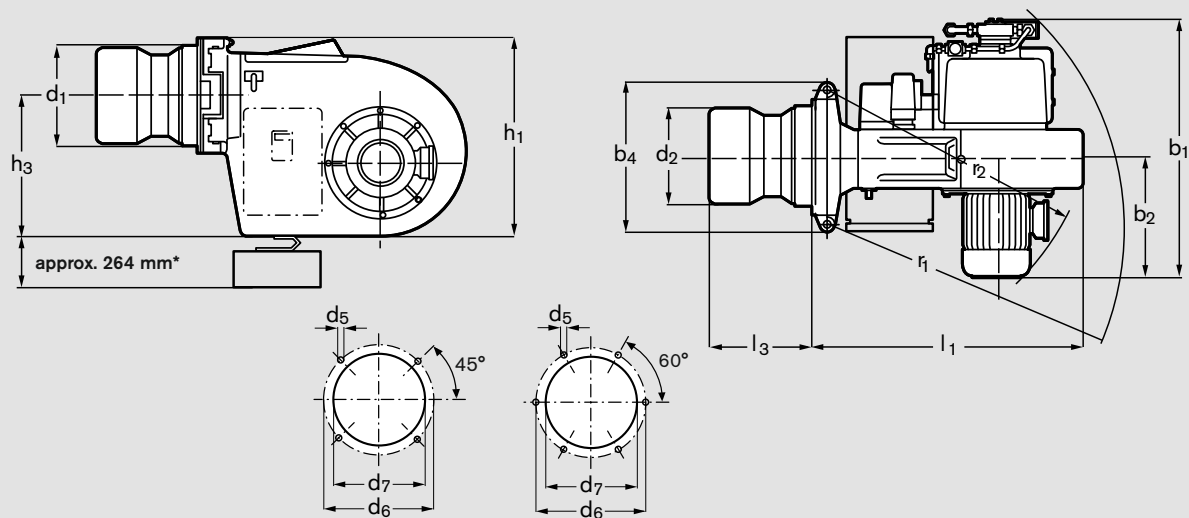

* varies according to oil preheater

Sizes 30-50

Sizes 60-70

Burner type	Dimensions in mm													
	b ₁	b ₂	b ₄	d ₁	d ₂	d ₅	d ₆	d ₇	h ₁	h ₃	l ₁	l ₃	r ₁	r ₂
MS30Z/2-A	843	430	418	280	250	M12	360	285	572	407	892	303	963	929
RMS30/2-A	843	430	418	280	250	M12	360	285	572	407	892	303	963	929
MS40Z/1-B	877	431	462	280	250	M12	360	285	607	422	937	303	1009	958
RMS40/1-B	877	431	462	280	250	M12	360	285	607	422	937	303	1009	958
RMS40/2-A	877	431	462	320	290	M12	400	325	607	422	937	361	1009	958
RMS50/1-B	968	462	550	320	290	M12	400	330	728	513	985	361	1077	1025
RMS50/2-A	1002	502	550	380	350	M16	480	390	728	513	990	386	1083	1050
RL60/2-A	1110	527	670	429	400	M16	470	435	930	670	1189	407	1247	1178
RMS60/2-A	1006	527	670	429	400	M16	470	435	930	670	1189	407	1250	1178
RL70/1-A	1279	603	760	470	480	M16	550	500	1075	775	1368	417	1428	1338
RMS70/1-A	1168	603	760	470	480	M16	550	500	1075	775	1368	417	1428	1338
RL70/2-A	1279	603	760	470	480	M16	550	500	1075	775	1368	417	1428	1338
RMS70/2-A	1168	603	760	470	480	M16	550	500	1075	775	1368	417	1428	1338

See manual for further dimensions

Gas burner dimensions

Sizes 30 to 70

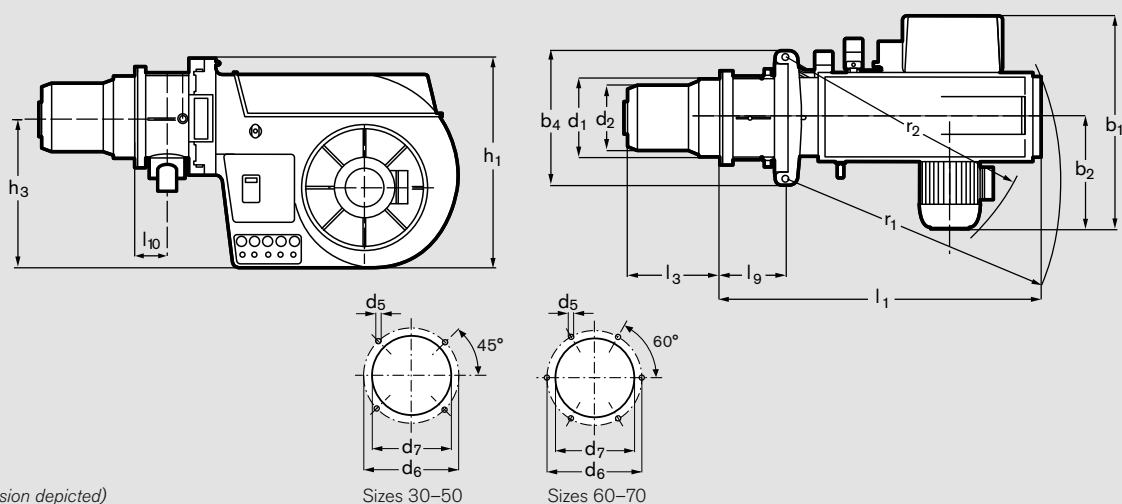

(3LN-version depicted)

Sizes 30-50

Sizes 60-70

Burner type	Dimensions in mm															
	b_1	b_2	b_4	d_1	d_2	d_5	d_6	d_7	h_1	h_3	l_1	l_3	l_9	l_{10}	r_1	r_2
G60/2-A ZM-NR	1006	527	670	432	400	M16	470	435	930	670	1478	357	348	178	1250	1178
G70/1-B ZM-NR	1168	603	760	432	400	M16	470	435	1075	775	1648	357	348	178	1428	1338
G70/3-A ZM-NR	1168	603	760	510	480	M16	580	530	1075	775 *	1660	467	368	186	1428	1338
G70/4-A ZM-NR	1168	603	760	510	480	M16	580	530	1075	775 *	1660	467	368	186	1428	1338
G70/1-B ZM-1LN	1168	603	760	432	406	M16	470	435	1075	775	1648	419	348	178	1428	1338
G70/2-A ZM-1LN	1168	603	760	470	480	M16	550	500	1075	775	1668	447	368	188	1428	1338
G60/2-A ZM-LN	1006	527	670	432	406	M16	470	435	930	670	1478	432	348	178	1250	1178
G70/1-B ZM-LN	1168	603	760	432	406	M16	470	435	1075	775	1648	432	348	178	1428	1338
G70/2-A ZM-LN	1168	603	760	470	480	M16	550	500	1075	775	1668	437	368	188	1428	1338
G60/1-B 3LN	1006	527	670	432	334	M16	470	435	930	670	1478	431	348	178	1250	1178
G60/2-A 3LN	1006	527	670	432	376	M16	470	435	930	670	1478	480	348	178	1250	1178
G70/1-B 3LN	1168	603	760	432	376	M16	470	435	1075	775	1648	480	348	178	1428	1338
G70/2-A 3LN	1168	603	760	470	444	M16	550	500	1075	775	1668	475	368	188	1428	1338

See burner manual for additional dimensions

* Pilot line connection 805 mm

Dual-fuel burner dimensions

Sizes 30 to 70

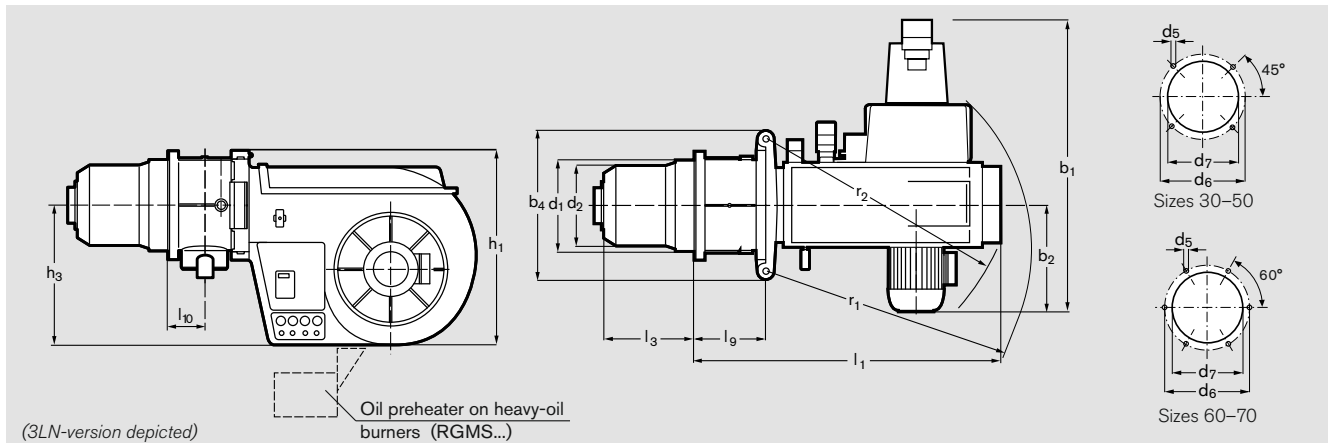

Burner type	Dimensions in mm															
	b ₁	b ₂	b ₄	d ₁	d ₂	d ₅	d ₆	d ₇	h ₁	h ₃	l ₁	l ₃	l ₉	l ₁₀	r ₁	r ₂
RGL60/2-A ZM-NR	1235	527	670	432	400	M16	470	435	930	670	1478	357	348	178	1337	1178
RGL70/1-B ZM-NR	1402	603	760	432	400	M16	470	435	1075	775	1646	357	348	178	1490	1338
RGL70/3-A ZM-NR	1402	603	760	510	480	M16	580	530	1075	775 *	1660	467	368	186	1490	1338
RGL70/4-A ZM-NR	1402	603	760	510	480	M16	580	530	1075	775 *	1660	467	368	186	1490	1338
RGMS30/2-A NR	950	430	330	280	250	M12	360	285	572	407	1083	272	338	123	1003	929
RGMS40/1-B NR	984	431	330	280	250	M12	360	285	608	422	1129	272	338	123	1081	958
RGMS40/2-A NR	984	431	370	320	290	M12	400	325	608	422	1148	330	358	133	1081	958
RGMS50/1-B ZM-NR	1092	462	550	320	290	M12	400	325	730	513	1195	332	258	133	1166	1025
RGMS50/2-A ZM-NR	1125	502	550	382	350	M16	480	390	730	513	1249	332	308	158	1167	1050
RGMS60/2-A ZM-NR	1006	527	670	432	400	M16	470	435	930	670	1478	357	348	178	1250	1178
RGMS70/1-B ZM-NR	1168	603	760	432	400	M16	470	435	1075	775	1646	357	348	178	1490	1338
RGMS70/3-A ZM-NR	1168	603	760	510	480	M16	580	530	1075	775 *	1660	467	368	186	1490	1338
RGMS70/4-A ZM-NR	1168	603	760	510	480	M16	580	530	1075	775 *	1660	467	368	186	1490	1338
RGL50/1-B ZM-1LN	1092	462	550	320	290	M12	400	325	730	513	1195	332	258	133	1166	1025
RGL50/2-A ZM-1LN	1125	502	550	382	350	M16	480	390	730	513	1249	447	308	158	1167	1050
RGL70/1-B ZM-1LN	1402	603	760	432	406	M16	470	435	1075	775	1648	419	348	178	1490	1338
RGL70/2-A ZM-1LN	1402	603	760	470	480	M16	550	500	1075	775	1668	447	368	188	1490	1338
RGML60/1-B 3LN	1235	527	670	432	334	M16	470	435	930	670	1478	431	348	178	1337	1178
RGML60/2-A 3LN	1235	527	670	432	376	M16	470	435	930	670	1478	480	348	178	1337	1178
RGL70/1-B 3LN	1402	603	760	432	376	M16	470	435	1075	775	1648	480	348	178	1490	1338
RGL70/2-A 3LN	1402	603	760	470	444	M16	550	500	1075	775	1668	475	368	188	1490	1338

See manual for further dimensions

* Pilot line connection 805 mm

Fuel systems

**RL60 to RL70
RGL50 to RGL70 (oil side)**

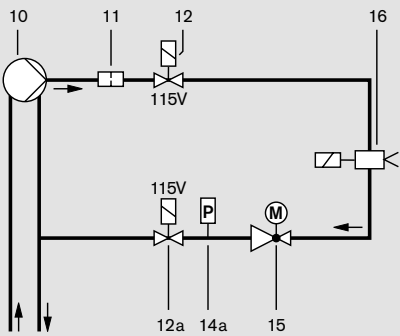

MS30Z/2-A, MS40Z/1-B

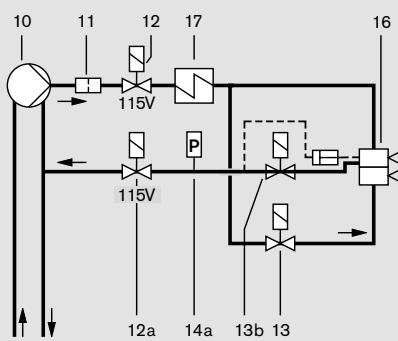

**RMS30 to RMS50
RGMS30 to RGMS50 (oil side)
Integral oil pump and preheater**

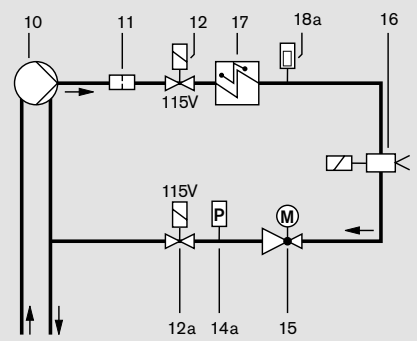

**RMS60 to RMS70
RGMS60 to RGMS70 (oil side)
Separate oil pump and preheater stations**

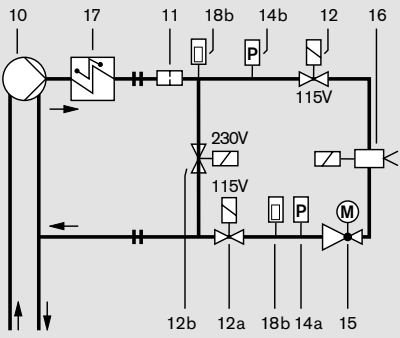

RGL60 to RGL70, version 3LN (oil side)

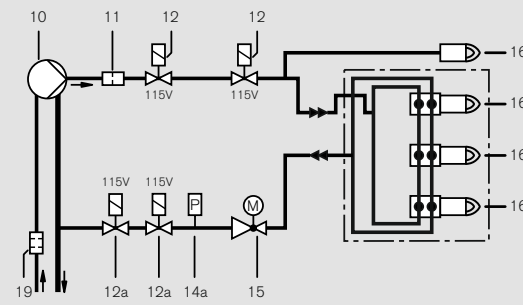

**G60 to G70, versions NR, 1LN & 3LN
RGL50 to RGL70 (gas side)
with gas valve assembly**

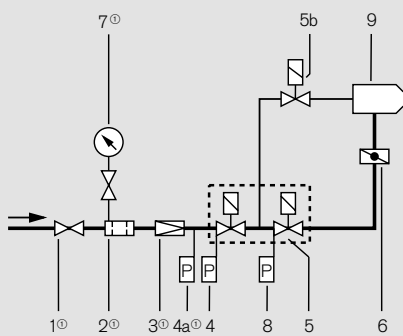

**G60 to G70, version LN
with gas valve assembly**

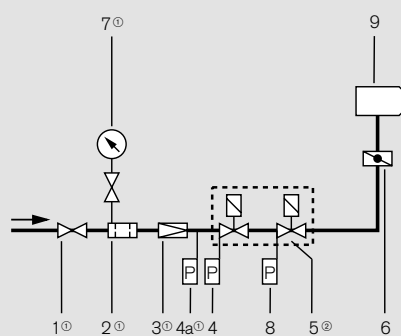

Legend

- 1 Ball valve ①
- 2 Gas filter ①
- 3 Pressure regulator (LP) ①
- 4 Low-gas-pressure switch
- 4a High-gas-pressure switch (for TRD) ①
- 5 Double solenoid valve (DMV) ②
- 5a Pilot line solenoid valve
- 6 Gas butterfly valve
- 7 Pressure gauge with push-button valve ①
- 8 Valve-proving pressure switch ①
- 9 Burner
- 10 Oil pump

- 11 Strainer
- 12 Normally closed solenoid valve (115 V, switched in series with 12a)
- 12a Normally closed solenoid valve (115 V, switched in series with 12, fitted against the direction of flow)
- 12b Normally open bypass solenoid valve
- 13 Normally closed solenoid valve
- 13a Normally closed solenoid valve for stages 1, 2, and 3
- 13b Normally open solenoid valve
- 14a Oil-pressure switch in return

- 14b Oil-pressure switch in supply
- 15 Oil regulator
- 16 Nozzle assembly with shut-off device
- 16a Nozzle assembly without shut-off device
- 17 Oil preheater
- 18a Temperature switch
- 18b PT 100 temperature sensor (to monitor the minimum oil temperature)
- 19 External oil filter ①

① Not included in burner price.

Pump and preheater stations

Scope of supply: pump stations

Pump unit (screw pump with motor), pressure gauge, vacuum gauge, pressure regulating valve, ball valves, inlet flange, outlet flange including counter-flanges, screws and washers, inlet filter. All parts are supplied piped-up and fully assembled on an oil drip tray.

Pump stations are available as simplex units with one pump, or as duplex units with two pumps. The latter operate as duty/standby sets, enabling a prompt change-over to the second pump in the event the first pump fails.

Only tried-and-tested pump types are used. The pumps stations are carefully matched to the capacity of the burner.

Scope of supply: preheater stations

Preheater stations are supplied piped-up on an oil drip tray. The preheater station continuously regulates the preheat temperature, and thus the viscosity, of the oil which is to be atomised.

Two basic types of oil preheater station are available, WEV and MV:

1. Electric preheating (WEV)
2. Medium preheating (MV)

MV-series medium preheaters

Medium preheaters are high-capacity, forced-circulation heat exchangers that utilise hot water, steam or thermal fluid as their heat-supplying medium. A high-capacity is achieved with a uniform, space-saving construction. The oil preheaters guarantee an extremely stable oil temperature and thus good combustion figures. The oil temperature that can be achieved depends on the heating medium used.

When selecting and sizing the preheater, close attention must be paid to the oil temperature charts in section 5.3 of the manual "*Weishaupt Electric & Media Oil Preheaters*" (Print No. 18).

Weishaupt medium oil preheaters are universally employable. They can be operated on a stand-alone basis or in conjunction with an electric preheater, and the medium used can be changed at any time.

If there is a continual supply of process steam at more than 7.5 bar, or hot water at 180 to 200 °C, then an electric preheater is not needed. This is also the case if the plant can be operated on gas or light oil until this minimum pressure or temperature is reached.

If the medium temperature is not sufficient to adequately preheat the fuel oil, then an electric preheater provides the additional heating required. The electric preheater heats the fuel oil during the start-up of the plant, which can then be switched over to the medium preheater once the required medium temperature is reached, thus saving on expensive electrical energy.

Medium preheater connection fittings should be selected to suit the medium being used. If the medium oil preheater is to be used without an electric preheater, then a mechanical temperature regulator must be used with the medium connection fittings.

Medium preheater connection fittings are not included in preheater prices.

General notes

When starting a heavy-oil-fired boiler from a cold condition, the capacity of the electric preheater must be sufficient to cover at least 30 % of the boiler's rated output.

Installation notes

The oil filter, air/gas separator, circulation tank, pump station, and oil preheater must be installed near the burner.

For burners with separate oil preheaters, the time required for oil circulation during start-up depends upon the distance between the burner and the air/gas separator or circulation tank. The shorter the pipeline, the shorter the time between the call for heat and oil release or burner restart after a controlled shut-down.

Pump and preheater stations

Simplex pump stations (not for burner version 3LN)

Burner Rating, kg/h (approx.)	Technical data - Pump			Station with 1 pump	
	Flow rate, l/h	Speed, rpm	Motor, kW	Pump type	Part No.
Light oil, 6 mm²s, ℓ = 0.84 kg/l, frequency 50 Hz*					
504 – 600	1428	2900	2,20	LFW-15-EL	270 008 01
600 – 789	1878	2900	3,00	LFW-20-EL	270 008 02
789 – 1011	2406	2900	3,00	LFW-26-EL	270 008 03
Light oil, 6 mm²s, ℓ = 0.84 kg/l, frequency 60 Hz*					
474 – 748	1782	3450	2,64	LFW-15-EL	270 008 07
748 – 983	2340	3450	3,60	LFW-20-EL	270 008 08
983 – 1260	3000	3450	3,60	LFW-26-EL	270 008 09
HFO, 12 mm²s, ℓ = 0.98 kg/l, frequency 50 Hz*					
349 – 479	977	2900	1,50	LFW-10-S	270 008 24
479 – 749	1529	2900	2,20	LFW-15-S	270 008 25
749 – 985	2011	2900	3,00	LFW-20-S	270 008 26
HFO, 12 mm²s, ℓ = 0.98 kg/l, frequency 60 Hz*					
282 – 438	894	3450	1,80	LFW-7-S	270 008 30
438 – 594	1212	3450	1,80	LFW-10-S	on application
594 – 923	1884	3450	2,60	LFW-15-S	on application

* Design data for operation

Duplex pump stations (not for burner version 3LN)

Burner Rating, kg/h (approx.)	Technical data - Pump			Station with 2 pumps	
	Flow rate, l/h	Speed, rpm	Motor, kW	Pump type	Part No.
Light oil, 6 mm²s, ℓ = 0.84 kg/l, frequency 50 Hz*					
up to 600	1428	2900	2,20	DLC-1800-EL	270 008 12
600 – 789	1878	2900	3,00	DLC-2400-EL	270 008 13
789 – 1011	2406	2900	3,00	DLC-2600-EL	270 008 14
Light oil, 6 mm²s, ℓ = 0.84 kg/l, frequency 60 Hz*					
bis 474	1128	3450	1,80	DLC-1200-EL	270 008 18
474 – 748	1782	3450	2,64	DLC-1800-EL	270 008 19
748 – 983	2340	3450	3,60	DLC-2400-EL	270 008 20
HFO, 12 mm²s, ℓ = 0.98 kg/l, frequency 50 Hz*					
349 – 479	977	2900	1,50	DLC-1200-S	270 008 36
479 – 749	1529	2900	2,20	DLC-1800-S	270 008 37
749 – 985	2011	2900	3,00	DLC-2400-S	270 008 38
HFO, 12 mm²s, ℓ = 0.98 kg/l, frequency 60 Hz*					
282 – 438	894	3450	1,80	DLC-900-S	on application
438 – 594	1212	3450	1,80	DLC-1200-S	on application
594 – 923	1884	3450	2,60	DLC-1800S	on application

* Design data for operation

Preheater stations

Type	Quantity	Medium preheater kg/h	Electric preheater kg/h at $\Delta t = 75^\circ\text{C}$	Part No.
WEV3.1/01	1	–	375	170 003 55
WEV3.1/01	2	–	750	170 003 52
WEV3/01	1	–	500	170 002 23
WEV3/01	2	–	1000	170 002 24
MV9C with temperature regulator	1	500	–	170 001 03
MV9C without temperature regulator	1	500	–	170 001 04
MV10A with temperature regulator	1	1000	–	170 000 94
MV10A without temperature regulator	1	1000	–	170 002 30

Details for connection fittings and for other pump stations and preheaters are available upon request.

- weishaupt -

Max Weishaupt GmbH
88475 Schwendi
Tel +49 7353 830, Fax +49 7353 83358
www.weishaupt.de

Print No. 83211102, December 2014
Printed in Germany. All rights reserved.

Neachells Lane, Willenhall, WV13 3RG
Tel (01902) 609841, Fax (01902) 633343

We're right where you need us

The security of a comprehensive service network

Weishaupt equipment is available from good HVAC specialists, with whom Weishaupt works in close partnership. To support the specialists, Weishaupt maintains a large sales and service network, ensuring equipment, spares

and service are always available.

Weishaupt are there when you need them. The service department is available to Weishaupt customers around the clock, 365 days a year. A Weishaupt office near you is standing by to answer all your heating questions.

