





TABLE OF CONTENTS

Concentrate Control Valves and Trim R-1
Foam Concentrate, Accessories..... R-2
Accessories..... R-3
Proportioning Devices, Discharge Devices..... R-4
Bladder Tanks..... R-5
Double Wall (SAFE) Atmospheric Storage Tanks..... R-6
Single Wall Atmospheric Storage Tanks R-7
Atmospheric Storage Tank Optional Equipment..... R-8
FoamPak Foam Pump Skid, 60 Hz, Single and Dual R-9
FoamPak Foam Pump Skid, 50 Hz, Single and DualR-10
FoamPak AccessoriesR-11
High Expansion Foam Systems.....R-12

Notes

1. Refer to Viking technical data pages for complete product specifications. You may print or download technical data by visiting www.vikinggroupinc.com.
2. List prices effective July 9, 2022. Supersedes February 2022 list price book.
3. All sales by Viking are subject to the Terms & Conditions found on the last page of this book.

DESCRIPTION	NOMINAL SIZE	PART NUMBER	LIST PRICE (each)
<p>FOAM CONCENTRATE CONTROL VALVE Model F-2 Deluge Valve This valve is HALAR® coated for protection in corrosive environments.</p> <p>Straight Through Deluge Valve</p> <p>Groove/Groove</p> 			
	<p>HALAR® Pipe O.D.</p> <p>48mm 60mm 73mm 89mm</p>	<p>Model F-2</p> <p>1½" / DN40 2" / DN50 2½" / DN65 3" / DN80</p>	<p>12127Q/B \$6,380.79 12058Q/B \$6,398.15 12404Q/B \$8,612.28 12023Q/B \$8,612.28</p>
V233			
<p>FOAM CONCENTRATE CONTROL VALVE Model J-2 Flow Control Valve This valve is HALAR® coated for protection in corrosive environments.</p> <p>Straight Through Flow Control Valve This valve is used in Pressure Regulating Foam Systems</p> <p>Groove/Groove</p> 			
	<p>HALAR® Pipe O.D.</p> <p>48mm 60mm 73mm 89mm</p>	<p>Model J-2</p> <p>1½" / DN40 2" / DN50 2½" / DN65 3" / DN80</p>	<p>12131Q/B \$8,237.62 12062Q/B \$8,259.95 12408Q/B \$10,504.32 12025Q/B \$10,504.32</p>
V244			
<p>FOAM CONCENTRATE CONTROL VALVE TRIM</p>	<p>Use with Model F-2 Deluge Valve or Model J-2 Flow Control Valve when used as HALAR® coated Concentrate Control Valves (CCV).</p>		
	<p>Use with Straight Through Valves</p>		
	Galvanized		
	1½" / DN40	12848-1	\$452.83
	2" / DN50	12848-1	\$452.83
	2½" / DN65	12929-1	\$1,039.19
Brass			
1½" / DN40	12848-2	\$628.23	
2" / DN50	12848-2	\$628.23	
2½" / DN65	12929-2	\$1,133.68	
V244			

DESCRIPTION	NOMINAL SIZE	PART NUMBER	LIST PRICE (each)
VALVE TRIM FOR PREMIXED FOAM SYSTEMS			
<p>Model J-1 Alarm Valve Trim Variable Pressure V227</p>			
Vertical	Brass		
	3" / DN80	11428	\$2,775.39
	4" / DN100	11429	\$3,238.64
	6" / DN150	11430	\$3,398.54
	8" / DN200	11431	\$3,398.54
Horizontal	Brass		
	3" / DN80	11432	\$2,873.78
	4" / DN100	11433	\$3,402.65
	6" / DN150	11434	\$3,472.38
	8" / DN200	11435	\$3,472.38
<p>Circuit Closer Vent Trim</p> 	Brass	08220	\$220.58

RELEASE TRIM PACKAGES			
<p>Use with Conventional Trim</p>			
Electric	Brass	10832	\$416.45
Electric/Pneumatic	Brass	12661-2	\$308.95
Pneumatic	Brass	10811	\$370.11
Domestic ¹ Electric	Brass	10832USA	\$555.26
V239			

(1) Meets sourcing requirements of the Buy American Act, American Reinvestment and Recovery Act, and the Buy American Law.

Foam Concentrates

ARK SFFF Fluorine Free Foam Concentrate IPG V300.1



Part Number	Description	Gallons/Container	Shipping Weight*	List Price*
F24175-6.5	ARK SFFF Foam Concentrate	6.5 gal can	62 lbs.	\$ 957.58
F24175-55	ARK SFFF Foam Concentrate	55 gal drum	488 lbs.	\$ 8,102.59
F24175-265	ARK SFFF Foam Concentrate	265 gal IBC tote	2393 lbs.	\$ 39,039.76

*Per container





USP SFFF Fluorine Free Foam Concentrate IPG V300.1



Part Number	Description	Gallons/Container	Shipping Weight*	List Price*
F21720-6.5	USP SFFF Foam Concentrate	6.5 gal can	62 lbs.	\$ 665.07
F21720-55	USP SFFF Foam Concentrate	55 gal drum	487 lbs.	\$ 5,391.80
F21720-265	USP SFFF Foam Concentrate	265 gal IBC tote	2389 lbs.	\$ 26,000.53

*Per container

ACCESSORIES - Foam Systems

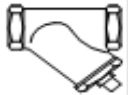
<p>Pressure Operated Relief Valve (PORV) - Model D-3</p>  <p><u>1/2" / DN15</u> <u>Brass</u> 16970 \$ 2,024.12 IPG V242</p>	<p>Pressure Operated Relief Valve (PORV) - Model D-4</p>  <p><u>1/2" / DN15</u> <u>Corrosion Resistant</u> 16971 \$ 3,114.04 IPG V242</p>
<p>1/8" / 3mm Restricted Orifice</p>  <p><u>1/2" / DN15</u> 06555A \$ 45.22 IPG V226</p>	<p>Ball Valve</p>  <p><u>1/2" / DN15</u> 10355USA \$ 46.60 IPG V226</p>
<p>Y Strainer</p>  <p><u>1/2" / DN15</u> 01054A \$ 172.47 IPG V226</p>	<p>CCV - Priming Connection Package</p> <p>Includes:</p> <ul style="list-style-type: none"> - 1/8" Restricted Orifice 10985 - Model D-3 PORV \$ 1,252.02 - Soft Seat Check Valve - Ball Valve - Y Strainer
<p>1/2" Swing Check Valve</p> <p>KT403W-50 \$ 137.74</p>	

ACCESSORIES - Foam Systems (continued)

Description	Size	Part Number	List Price
<u>Bladder Tank Water Supply Control Valve</u>			
Thd Butterball® Valve w/ Switches	2" / DN50	BBSCS02-0200	\$ 1,176.18
Ball Valve	1½" / DN40	FBV3C-0150	\$ 468.79
Ball Valve	2" / DN50	FBV3C-0200	\$ 711.32
OS & Y	2½" / DN65	8068A-0250	\$ 1,314.70
OS & Y	3" / DN80	8068A-0300	\$ 1,446.17
* Butterball® is a registered trademark of Milwaukee Valve Co.			
<u>Foam Concentrate Swing Check Valve</u>			
Swing Check Valve	1½" / DN40	99S-0150	\$ 165.22
Swing Check Valve	2" / DN50	99S-0200	\$ 200.76
Swing Check Valve	2½" / DN65	05497C	\$ 792.35
<u>Foam Solution Test Valve</u>			
Grooved Butterfly Valve	2½" / DN65	01G-0250	\$ 2,146.10
Grooved Butterfly Valve	3" / DN80	01G-0300	\$ 2,180.42
Grooved Butterfly Valve	4" / DN100	01G-0400	\$ 2,280.65
Grooved Butterfly Valve	6" / DN150	01G-0600	\$ 3,018.87
Grooved Butterfly Valve	8" / DN200	01G-0800	\$ 3,985.49
<u>System Isolation Valve</u>			
Grooved Butterfly Valve	2½" / DN65	01G-0250	\$ 1,147.43
Grooved Butterfly Valve	3" / DN80	01G-0300	\$ 1,245.28
Grooved Butterfly Valve	4" / DN100	01G-0400	\$ 1,307.58
Grooved Butterfly Valve	6" / DN150	01G-0600	\$ 1,796.82
Grooved Butterfly Valve	8" / DN200	01G-0800	\$ 2,677.38
<u>Water Supply Control Valve</u>			
OS & Y Valve	2½" / DN65	8068A-0250	\$ 1,314.70
OS & Y Valve	3" / DN80	8068A-0300	\$ 1,446.17
OS & Y Valve	4" / DN100	8068A-0400	\$ 1,688.39
OS & Y Valve	6" / DN150	8068A-0600	\$ 2,401.06
OS & Y Valve	8" / DN200	8068A-0800	\$ 3,944.10
<u>Foam Concentrate Shut-Off Valve</u>			
Ball Valve	1½" / DN40	T595Y66-0150	\$ 810.08
Ball Valve	2" / DN50	T595Y66-0200	\$ 1,322.03
Ball Valve	2½" / DN65	T595Y66-0250	\$ 2,775.77
<u>Foam Test Header</u>			
Angle Hose Valve	2½" / DN65	212AHV	\$ 242.65
Angle Hose Valve Cap	2½" / DN65	212HC	\$ 35.00

Proportioning Devices

BFZ Between Flange Inductor

IPG V304



Part Number	Description	List Price
F15922	4" BFZ Inductor, (145 GPM - 872 GPM)	\$17,028.32
F15923	6" BFZ Inductor, (291 GPM - 1744 GPM)	\$31,818.38
F15924	8" BFZ Inductor, (436 GPM - 2615 GPM)	\$46,115.50
F15925	8"S BFZ Inductor, (436 GPM - 4359 GPM)	\$52,290.84

FomTec Inductor requirements prior to order:

- 1) Required flow rate
- 2) Required pressure at the inlet of the inductor
- 3) Required pressure at the outlet of the inductor
- 4) Centerline of foam inlet above the bottom of atmospheric storage tank
- 5) Type of foam concentrate

Model VNR Wide Range Proportioner

IPG V304



Part Number	Description	List Price
VNR063P	ARK, 6" Wide Range Proportioner, 2.5" Inlet	\$18,285.14
VNR083P	ARK, 8" Wide Range Proportioner, 2.5" Inlet	\$23,936.93
VNR063L	USP, 6" Wide Range Proportioner, 2.5" Inlet	\$18,285.14
VNR083L	USP, 8" Wide Range Proportioner, 2.5" Inlet	\$23,936.93

Discharge Devices

Viking GN202 Grate Nozzles®

IPG V307

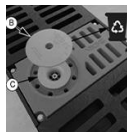
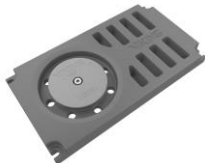

Part Number	Description	List Price
F24811	20" Grate Nozzle Assembly 360°, USP	\$9,688.96
F24812	26" Grate Nozzle Assembly 360°, USP	\$9,688.96
F24808	20" Grate Nozzle Assembly 180°, USP	\$9,688.96
F24809	26" Grate Nozzle Assembly 180°, USP	\$9,688.96
F24805	20" Grate Nozzle Assembly 90°, USP	\$9,688.96
F24806	26" Grate Nozzle Assembly 90°, USP	\$9,688.96

Part Number	Description	List Price
F24829	20" Grate Nozzle 360°, USP	\$8,764.93
F24830	26" Grate Nozzle 360°, USP	\$8,764.93
F24826	20" Grate Nozzle 180°, USP	\$8,764.93
F24827	26" Grate Nozzle 180°, USP	\$8,764.93
F24823	20" Grate Nozzle 90°, USP	\$8,764.93
F24824	26" Grate Nozzle 90°, USP	\$8,764.93

Part Number	Description	List Price
17525	X-Frame Kit, includes two supports & hardware	\$924.03

Part Number	Description	List Price
F25222	GN202 Upgrade Deflector Kit 360°	\$2,496.22
F25223	GN202 Upgrade Deflector Kit 180°	\$2,496.22
F25224	GN202 Upgrade Deflector Kit 90°	\$2,496.22

Approved Sprinklers for use with Foam Concentrates



Viking Pendent and Upright Foam-Water Sprinklers are non-aspirated foam discharge outlets for use in Wet, Deluge and Preaction Systems

Refer to Page F_102221 for listing of sprinklers that are UL Listed and FM Approved.
https://www.vikinggroupinc.com/sites/default/files/documents/F_102221.pdf

Foam Bladder Tanks

Vertical Bladder Tanks		IPG V301
Capacity	Part Number	List Price
25 Gallon	VFTV0025U	\$ 30,626.92
36 Gallon	VFTV0036U	\$ 31,884.15
50 Gallon	VFTV0050U	\$ 36,913.70
75 Gallon	VFTV0075U	\$ 39,687.88
100 Gallon	VFTV0100U	\$ 40,617.40
150 Gallon	VFTV0150U	\$ 45,626.41
200 Gallon	VFTV0200U	\$ 49,992.81
250 Gallon	VFTV0250U	\$ 51,516.23
300 Gallon	VFTV0300U	\$ 54,790.78
350 Gallon	VFTV0350U	\$ 60,497.85
400 Gallon	VFTV0400U	\$ 64,154.06
450 Gallon	VFTV0450U	\$ 65,814.19
500 Gallon	VFTV0500U	\$ 69,039.05
600 Gallon	VFTV0600U	\$ 74,721.31
700 Gallon	VFTV0700U	\$ 80,538.60
800 Gallon	VFTV0800U	\$ 89,988.89
900 Gallon	VFTV0900U	\$ 94,330.88
1000 Gallon	VFTV1000U	\$ 108,399.70
1100 Gallon	VFTV1100U	\$ 115,508.03
1200 Gallon	VFTV1200U	\$ 116,475.85
1300 Gallon	VFTV1300U	\$ 124,884.57
1400 Gallon	VFTV1400U	\$ 131,818.98
1500 Gallon	VFTV1500U	\$ 135,429.78
1600 Gallon	VFTV1600U	\$ 143,204.78
1700 Gallon	VFTV1700U	\$ 145,525.18
1800 Gallon	VFTV1800U	\$ 149,587.64
1900 Gallon	VFTV1900U	\$ 152,368.68
2000 Gallon	VFTV2000U	\$ 155,149.80
2200 Gallon	VFTV2200U	\$ 185,287.67
2400 Gallon	VFTV2400U	\$ 193,985.04
2600 Gallon	VFTV2600U	\$ 203,012.76
2800 Gallon	VFTV2800U	\$ 211,611.27
3000 Gallon	VFTV3000U	\$ 218,712.68
3200 Gallon	VFTV3200U	\$ 228,416.53
3400 Gallon	VFTV3400U	\$ 237,002.80
3600 Gallon	VFTV3600U	\$ 241,459.74
3800 Gallon	VFTV3800U	\$ 246,897.03
4000 Gallon	VFTV4000U	\$ 254,954.22

Horizontal Bladder Tanks		IPG V301
Capacity	Part Number	List Price
50 Gallon	VFTH0050U	\$ 42,346.84
75 Gallon	VFTH0075U	\$ 43,147.33
100 Gallon	VFTH0100U	\$ 44,884.15
150 Gallon	VFTH0150U	\$ 49,861.82
200 Gallon	VFTH0200U	\$ 53,114.44
250 Gallon	VFTH0250U	\$ 58,283.92
300 Gallon	VFTH0300U	\$ 59,719.40
350 Gallon	VFTH0350U	\$ 63,774.13
400 Gallon	VFTH0400U	\$ 67,398.03
450 Gallon	VFTH0450U	\$ 70,732.65
500 Gallon	VFTH0500U	\$ 73,183.23
600 Gallon	VFTH0600U	\$ 76,839.80
700 Gallon	VFTH0700U	\$ 88,266.44
800 Gallon	VFTH0800U	\$ 95,214.06
900 Gallon	VFTH0900U	\$ 100,503.69
1000 Gallon	VFTH1000U	\$ 108,131.94
1100 Gallon	VFTH1100U	\$ 112,320.83
1200 Gallon	VFTH1200U	\$ 119,390.22
1300 Gallon	VFTH1300U	\$ 131,786.32
1400 Gallon	VFTH1400U	\$ 134,983.66
1500 Gallon	VFTH1500U	\$ 139,470.66
1600 Gallon	VFTH1600U	\$ 141,247.24
1700 Gallon	VFTH1700U	\$ 146,447.77
1800 Gallon	VFTH1800U	\$ 152,596.27
1900 Gallon	VFTH1900U	\$ 162,133.66
2000 Gallon	VFTH2000U	\$ 185,091.47
2200 Gallon	VFTH2200U	\$ 194,798.62
2400 Gallon	VFTH2400U	\$ 203,977.12
2600 Gallon	VFTH2600U	\$ 210,926.31
2800 Gallon	VFTH2800U	\$ 220,196.68
3000 Gallon	VFTH3000U	\$ 231,849.26
3200 Gallon	VFTH3200U	\$ 242,531.86
3400 Gallon	VFTH3400U	\$ 250,674.79
3600 Gallon	VFTH3600U	\$ 255,520.53
3800 Gallon	VFTH3800U	\$ 262,057.35
4000 Gallon	VFTH4000U	\$ 269,680.87
4250 Gallon	VFTH4250U	\$ 279,965.42
4500 Gallon	VFTH4500U	\$ 286,702.01
4750 Gallon	VFTH4750U	\$ 293,435.95
5000 Gallon	VFTH5000U	\$ 300,175.24
5250 Gallon	VFTH5250U	\$ 306,907.91



* Bladder tank assemblies include water drain/fill valve, fill line master shut-off valve, concentrate drain/fill valve, fill cup, sight gauge shut-off valve, sight gauge assembly, tank water vent valve, and diaphragm concentrate vent valve.

Double Wall (SAFE) Atmospheric Storage Tanks

Top Discharge Double Wall (SAFE) Atmospheric Storage Tanks IPG V311



These SAFE Atmospheric Storage Tanks are for use with the BFZ Inductor type foam systems or Foam Pump Systems

Part Number	Description	List Price
F20396A1123	105 Gallon SAFE Atmospheric Storage Tank w/1-1/2" fittings & level indicator	\$15,864.43
F20396B23	105 Gallon SAFE Atmospheric Storage Tank w/2" fittings & level indicator	\$15,791.04
F20396C2123	105 Gallon SAFE Atmospheric Storage Tank w/2-1/2" fittings & level indicator	\$18,111.07
F20396D33	105 Gallon SAFE Atmospheric Storage Tank w/3" fittings & level indicator	\$17,976.08
F20003A1123	160 Gallon SAFE Atmospheric Storage Tank w/1-1/2" fittings & level indicator	\$17,052.85
F20003B23	160 Gallon SAFE Atmospheric Storage Tank w/2" fittings & level indicator	\$16,979.46
F20003C2123	160 Gallon SAFE Atmospheric Storage Tank w/2-1/2" fittings & level indicator	\$19,299.51
F20003D33	160 Gallon SAFE Atmospheric Storage Tank w/3" fittings & level indicator	\$19,164.51
F22240A1123	250 Gallon SAFE Atmospheric Storage Tank w/1-1/2" fittings & level indicator	\$16,837.55
F22240B23	250 Gallon SAFE Atmospheric Storage Tank w/2" fittings & level indicator	\$16,864.81
F22240C2123	250 Gallon SAFE Atmospheric Storage Tank w/2-1/2" fittings & level indicator	\$18,750.29
F22240D33	250 Gallon SAFE Atmospheric Storage Tank w/3" fittings & level indicator	\$18,832.07
F20004A1123	405 Gallon SAFE Atmospheric Storage Tank w/1-1/2" fittings & level indicator	\$18,011.95
F20004B23	405 Gallon SAFE Atmospheric Storage Tank w/2" fittings & level indicator	\$17,938.55
F20004C2123	405 Gallon SAFE Atmospheric Storage Tank w/2-1/2" fittings & level indicator	\$20,258.59
F20004D33	405 Gallon SAFE Atmospheric Storage Tank w/3" fittings & level indicator	\$20,123.61
F20005A1123	540 Gallon SAFE Atmospheric Storage Tank w/1-1/2" fittings & level indicator	\$24,096.43
F20005B23	540 Gallon SAFE Atmospheric Storage Tank w/2" fittings & level indicator	\$24,023.04
F20005C2123	540 Gallon SAFE Atmospheric Storage Tank w/2-1/2" fittings & level indicator	\$26,301.38
F20005D33	540 Gallon SAFE Atmospheric Storage Tank w/3" fittings & level indicator	\$26,166.38
F20014A1123	750 Gallon SAFE Atmospheric Storage Tank w/1-1/2" fittings & level indicator	\$29,305.86
F20014B23	750 Gallon SAFE Atmospheric Storage Tank w/2" fittings & level indicator	\$29,232.45
F20014C2123	750 Gallon SAFE Atmospheric Storage Tank w/2-1/2" fittings & level indicator	\$31,878.21
F20014D33	750 Gallon SAFE Atmospheric Storage Tank w/3" fittings & level indicator	\$31,743.21
F20006A1123	1000 Gallon SAFE Atmospheric Storage Tank w/1-1/2" fittings & level indicator	\$31,218.68
F20006B23	1000 Gallon SAFE Atmospheric Storage Tank w/2" fittings & level indicator	\$31,145.29
F20006C2123	1000 Gallon SAFE Atmospheric Storage Tank w/2-1/2" fittings & level indicator	\$33,423.64
F20006D33	1000 Gallon SAFE Atmospheric Storage Tank w/3" fittings & level indicator	\$33,288.65
F20007A1123	1550 Gallon SAFE Atmospheric Storage Tank w/1-1/2" fittings & level indicator	\$34,825.69
F20007B23	1550 Gallon SAFE Atmospheric Storage Tank w/2" fittings & level indicator	\$34,752.30
F20007C2123	1550 Gallon SAFE Atmospheric Storage Tank w/2-1/2" fittings & level indicator	\$37,030.63
F20007D33	1550 Gallon SAFE Atmospheric Storage Tank w/3" fittings & level indicator	\$36,895.64
F20008A1123	2500 Gallon SAFE Atmospheric Storage Tank w/1-1/2" fittings & level indicator	\$51,330.31
F20008B23	2500 Gallon SAFE Atmospheric Storage Tank w/2" fittings & level indicator	\$51,256.92
F20008C2123	2500 Gallon SAFE Atmospheric Storage Tank w/2-1/2" fittings & level indicator	\$53,168.30
F20008D33	2500 Gallon SAFE Atmospheric Storage Tank w/3" fittings & level indicator	\$53,033.32
F20009A1123	3150 Gallon SAFE Atmospheric Storage Tank w/1-1/2" fittings & level indicator	\$58,273.27
F20009B23	3150 Gallon SAFE Atmospheric Storage Tank w/2" fittings & level indicator	\$58,199.88
F20009C2123	3150 Gallon SAFE Atmospheric Storage Tank w/2-1/2" fittings & level indicator	\$60,111.26
F20009D33	3150 Gallon SAFE Atmospheric Storage Tank w/3" fittings & level indicator	\$59,976.27
F20010A1123	4400 Gallon SAFE Atmospheric Storage Tank w/1-1/2" fittings & level indicator	\$78,218.10
F20010B23	4400 Gallon SAFE Atmospheric Storage Tank w/2" fittings & level indicator	\$78,144.71
F20010C2123	4400 Gallon SAFE Atmospheric Storage Tank w/2-1/2" fittings & level indicator	\$80,056.09
F20010D33	4400 Gallon SAFE Atmospheric Storage Tank w/3" fittings & level indicator	\$79,921.10
F20011A1123	5400 Gallon SAFE Atmospheric Storage Tank w/1-1/2" fittings & level indicator	\$85,472.61
F20011B23	5400 Gallon SAFE Atmospheric Storage Tank w/2" fittings & level indicator	\$84,918.50
F20011C2123	5400 Gallon SAFE Atmospheric Storage Tank w/2-1/2" fittings & level indicator	\$87,311.79
F20011D33	5400 Gallon SAFE Atmospheric Storage Tank w/3" fittings & level indicator	\$87,176.80
F20397A1123	6550 Gallon SAFE Atmospheric Storage Tank w/1-1/2" fittings & level indicator	\$94,910.76
F20397B23	6550 Gallon SAFE Atmospheric Storage Tank w/2" fittings & level indicator	\$94,837.30
F20397C2123	6550 Gallon SAFE Atmospheric Storage Tank w/2-1/2" fittings & level indicator	\$96,750.61
F20397D33	6550 Gallon SAFE Atmospheric Storage Tank w/3" fittings & level indicator	\$96,615.50
F20013A1123	8700 Gallon SAFE Atmospheric Storage Tank w/1-1/2" fittings & level indicator	\$130,613.41
F20013B23	8700 Gallon SAFE Atmospheric Storage Tank w/2" fittings & level indicator	\$130,540.02
F20013C2123	8700 Gallon SAFE Atmospheric Storage Tank w/2-1/2" fittings & level indicator	\$132,451.41
F20013D33	8700 Gallon SAFE Atmospheric Storage Tank w/3" fittings & level indicator	\$132,316.42

Above tanks include Primary Tank, Containment Tank, Lid/Manway, Drop Tube Suction Connection, Drop Tube Fill Connection, Pressure Vacuum Vent and Reverse Level Float Gauge

Single Wall Atmospheric Storage Tanks

Single Wall Vertical Atmospheric Storage Tanks (Top Discharge Connections)			IPG V312
Part Number	Description	List Price	
100GVERT2TC	100 Gallon Single Wall Atmospheric Storage Tank w/2" fittings & level indicator	\$	10,743.07
100GVERT212TC	100 Gallon Single Wall Atmospheric Storage Tank w/2-1/2" fittings & level indicator	\$	14,473.53
155GVERT2TC	155 Gallon Single Wall Atmospheric Storage Tank w/2" fittings & level indicator	\$	10,798.41
155GVERT212TC	155 Gallon Single Wall Atmospheric Storage Tank w/2-1/2" fittings & level indicator	\$	14,528.88
205GVERT2TC	205 Gallon Single Wall Atmospheric Storage Tank w/2" fittings & level indicator	\$	12,348.16
205GVERT212TC	205 Gallon Single Wall Atmospheric Storage Tank w/2-1/2" fittings & level indicator	\$	16,078.63
300GVERT2TC	300 Gallon Single Wall Atmospheric Storage Tank w/2" fittings & level indicator	\$	12,541.88
300GVERT212TC	300 Gallon Single Wall Atmospheric Storage Tank w/2-1/2" fittings & level indicator	\$	16,272.35
400GVERT2TC	400 Gallon Single Wall Atmospheric Storage Tank w/2" fittings & level indicator	\$	14,921.85
400GVERT212TC	400 Gallon Single Wall Atmospheric Storage Tank w/2-1/2" fittings & level indicator	\$	18,652.32
540GVERT2TC	540 Gallon Single Wall Atmospheric Storage Tank w/2" fittings & level indicator	\$	14,335.16
540GVERT212TC	540 Gallon Single Wall Atmospheric Storage Tank w/2-1/2" fittings & level indicator	\$	18,065.62
615GVERT2TC	615 Gallon Single Wall Atmospheric Storage Tank w/2" fittings & level indicator	\$	18,846.04
615GVERT212TC	615 Gallon Single Wall Atmospheric Storage Tank w/2-1/2" fittings & level indicator	\$	22,576.49
755GVERT2TC	755 Gallon Single Wall Atmospheric Storage Tank w/2" fittings & level indicator	\$	19,399.52
755GVERT212TC	755 Gallon Single Wall Atmospheric Storage Tank w/2-1/2" fittings & level indicator	\$	23,129.97
805GVERT2TC	805 Gallon Single Wall Atmospheric Storage Tank w/2" fittings & level indicator	\$	18,569.30
805GVERT212TC	805 Gallon Single Wall Atmospheric Storage Tank w/2-1/2" fittings & level indicator	\$	22,299.75
905GVERT2TC	905 Gallon Single Wall Atmospheric Storage Tank w/2" fittings & level indicator	\$	18,818.36
905GVERT212TC	905 Gallon Single Wall Atmospheric Storage Tank w/2-1/2" fittings & level indicator	\$	22,548.81
1000GVERT2TC	1000 Gallon Single Wall Atmospheric Storage Tank w/2" fittings & level indicator	\$	20,318.28
1000GVERT212TC	1000 Gallon Single Wall Atmospheric Storage Tank w/2-1/2" fittings & level indicator	\$	23,583.83
1150GVERT2TC	1150 Gallon Single Wall Atmospheric Storage Tank w/2" fittings & level indicator	\$	19,322.02
1150GVERT212TC	1150 Gallon Single Wall Atmospheric Storage Tank w/2-1/2" fittings & level indicator	\$	22,587.57



These Atmospheric Storage Tanks are for use with the BFZ Inductor type foam systems or Foam Pump Systems

Above tanks include Tank, Lid/Manway, Drop Tube Suction Connection, Drop Tube Fill Connection, Vent and Ultrasonic Level Indicator

Single Wall Vertical Atmospheric Storage Tanks (Side Connections)			IPG V312
Part Number	Description	List Price	
100GVERT2SC	100 Gallon Single Wall Atmospheric Storage Tank w/2" fittings & level indicator	\$	19,200.26
100GVERT212SC	100 Gallon Single Wall Atmospheric Storage Tank w/2-1/2" fittings & level indicator	\$	25,067.16
155GVERT2SC	155 Gallon Single Wall Atmospheric Storage Tank w/2" fittings & level indicator	\$	19,255.60
155GVERT212SC	155 Gallon Single Wall Atmospheric Storage Tank w/2-1/2" fittings & level indicator	\$	25,122.50
205GVERT2SC	205 Gallon Single Wall Atmospheric Storage Tank w/2" fittings & level indicator	\$	20,805.35
205GVERT212SC	205 Gallon Single Wall Atmospheric Storage Tank w/2-1/2" fittings & level indicator	\$	26,672.26
300GVERT2SC	300 Gallon Single Wall Atmospheric Storage Tank w/2" fittings & level indicator	\$	20,999.07
300GVERT212SC	300 Gallon Single Wall Atmospheric Storage Tank w/2-1/2" fittings & level indicator	\$	26,865.97
400GVERT2SC	400 Gallon Single Wall Atmospheric Storage Tank w/2" fittings & level indicator	\$	23,379.03
400GVERT212SC	400 Gallon Single Wall Atmospheric Storage Tank w/2-1/2" fittings & level indicator	\$	29,245.95
540GVERT2SC	540 Gallon Single Wall Atmospheric Storage Tank w/2" fittings & level indicator	\$	22,792.35
540GVERT212SC	540 Gallon Single Wall Atmospheric Storage Tank w/2-1/2" fittings & level indicator	\$	28,659.25
615GVERT2SC	615 Gallon Single Wall Atmospheric Storage Tank w/2" fittings & level indicator	\$	27,303.22
615GVERT212SC	615 Gallon Single Wall Atmospheric Storage Tank w/2-1/2" fittings & level indicator	\$	33,170.12
755GVERT2SC	755 Gallon Single Wall Atmospheric Storage Tank w/2" fittings & level indicator	\$	27,856.71
755GVERT212SC	755 Gallon Single Wall Atmospheric Storage Tank w/2-1/2" fittings & level indicator	\$	33,723.60
805GVERT2SC	805 Gallon Single Wall Atmospheric Storage Tank w/2" fittings & level indicator	\$	27,026.48
805GVERT212SC	805 Gallon Single Wall Atmospheric Storage Tank w/2-1/2" fittings & level indicator	\$	32,893.38
905GVERT2SC	905 Gallon Single Wall Atmospheric Storage Tank w/2" fittings & level indicator	\$	27,275.55
905GVERT212SC	905 Gallon Single Wall Atmospheric Storage Tank w/2-1/2" fittings & level indicator	\$	33,142.44
1000GVERT2SC	1000 Gallon Single Wall Atmospheric Storage Tank w/2" fittings & level indicator	\$	28,775.49
1000GVERT212SC	1000 Gallon Single Wall Atmospheric Storage Tank w/2-1/2" fittings & level indicator	\$	34,177.46
1150GVERT2SC	1150 Gallon Single Wall Atmospheric Storage Tank w/2" fittings & level indicator	\$	27,779.22
1150GVERT212SC	1150 Gallon Single Wall Atmospheric Storage Tank w/2-1/2" fittings & level indicator	\$	33,181.18



These Atmospheric Storage Tanks are for use with the BFZ Inductor type foam systems or Foam Pump Systems

Above tanks include Tank, Lid/Manway, Side Drain Connection, Side Suction Flexible Connection, Side Return Flexible Connection, Top Fill Connection, Pressure Vacuum Vent and Reverse Float Level Gauge

Atmospheric Storage Tank Options

Double Wall (SAFE) Atmospheric Storage Tank Options IPG V311

Options		
F20015	105 Gallon SAFE Tank, Seismic Restraint	\$ 2,640.77
F20016	160 Gallon SAFE Tank, Seismic Restraint	\$ 2,661.04
F20017	405 Gallon SAFE Tank, Seismic Restraint	\$ 2,671.18
F20018	540 Gallon SAFE Tank, Seismic Restraint	\$ 3,385.85
F20019	1000 Gallon SAFE Tank, Seismic Restraint	\$ 4,232.31
F20020	1550 Gallon SAFE Tank, Seismic Restraint	\$ 4,379.31
F20021	2500 Gallon SAFE Tank, Seismic Restraint	\$ 5,251.12
F20022	3150 Gallon SAFE Tank, Seismic Restraint	\$ 5,240.97
F20023	4400 Gallon SAFE Tank, Seismic Restraint	\$ 5,261.25
F20024	5400 Gallon SAFE Tank, Seismic Restraint	\$ 7,030.21
F20398	6550 Gallon SAFE Tank, Seismic Restraint	\$ 7,896.95
F20026	8700 Gallon SAFE Tank, Seismic Restraint	\$ 10,147.43
F20027	6' Ladder for 1000 Gallon Tank	\$ 4,186.70
F20028	7' Ladder for 1550 Gallon & 3150 Gallon Tank	\$ 4,499.77
F20029	10' Ladder for 2500 Gallon, 4400 Gallon, & 5400 Gallon Tank	\$ 4,257.66
F20399	14' Ladder for 6650 Gallon Tank	\$ 6,319.70
F20031	15' Ladder for 8700 Gallon Tank	\$ 6,636.94
F20032	Export Skid Packaging w/Heat Treated Skid	\$ 596.32

Single Wall Atmospheric Storage Tank Options IPG V312

Options		
105GVERTSEISMIC	105 Gallon Single Wall Tank, Seismic Restraint	\$ 3,515.00
155GVERTSEISMIC	155 Gallon Single Wall Tank, Seismic Restraint	\$ 2,889.96
205GVERTSEISMIC	205 Gallon Single Wall Tank, Seismic Restraint	\$ 2,688.34
300GVERTSEISMIC	300 Gallon Single Wall Tank, Seismic Restraint	\$ 2,889.96
400GVERTSEISMIC	400 Gallon Single Wall Tank, Seismic Restraint	\$ 2,896.68
540GVERTSEISMIC	540 Gallon Single Wall Tank, Seismic Restraint	\$ 3,057.99
615GVERTSEISMIC	615 Gallon Single Wall Tank, Seismic Restraint	\$ 2,916.85
755GVERTSEISMIC	755 Gallon Single Wall Tank, Seismic Restraint	\$ 4,066.12
805GVERTSEISMIC	805 Gallon Single Wall Tank, Seismic Restraint	\$ 5,020.48
905GVERTSEISMIC	905 Gallon Single Wall Tank, Seismic Restraint	\$ 4,086.27
1000GVERTSEISMIC	1000 Gallon Single Wall Tank, Seismic Restraint	\$ 4,066.12
1150GVERTSEISMIC	1150 Gallon Single Wall Tank, Seismic Restraint	\$ 4,113.16
905GVERTLAD	6' Ladder for 905 Gallon Tank	\$ 6,485.61
1150/3150GVERTLAD	8' Ladder for 1150 Gallon & 3150 Gallon Tank	\$ 7,500.47
F20399	14' Ladder for 6650 Gallon Tank	\$ 6,319.70
F20031	15' Ladder for 8700 Gallon Tank	\$ 6,636.94
F20032	Export Skid Packaging w/Heat Treated Skid	\$ 596.32

FOAMPAK2 - 60 Hz - SINGLE PUMP

MODEL	FOAM GPM	FOAM PSI	HP	PART NUMBER	LIST PRICE (IPG V310)
FP-15	45	100	7.5	F21950A	\$ 232,432.57
	40	150	10	F21951A	\$ 181,788.53
	35	200	15	F21952A	\$ 183,988.82
	30	261	20	F21953A	\$ 185,985.67
FP-30	55	100	10	F21954A	\$ 181,949.14
	50	150	15	F21955A	\$ 184,149.42
	45	200	15	F21956A	\$ 184,149.42
	40	261	20	F21957A	\$ 186,146.27
FP-50	70	100	15	F21958A	\$ 192,131.48
	65	150	20	F21959A	\$ 194,904.59
	60	200	20	F21960A	\$ 194,904.59
	55	261	25	F21961A	\$ 197,201.24
FP-75	110	100	20	F21962A	\$ 195,841.45
	105	150	25	F21963A	\$ 198,138.10
	100	200	40	F21964A	\$ 202,918.77
	90	261	40	F21965A	\$ 202,918.77
FP-100	150	100	25	F21966A	\$ 222,956.89
	140	150	30	F21967A	\$ 226,008.38
	130	200	40	F21968A	\$ 229,075.93
	120	261	40	F21969A	\$ 229,075.93
FP-150	180	100	25	F21970A	\$ 225,189.29
	170	150	30	F21971A	\$ 228,240.78
	160	200	40	F21972A	\$ 231,308.33
	150	261	50	F21973A	\$ 233,701.35
FP-175	235	100	40	F21974A	\$ 294,570.55
	220	150	50	F21975A	\$ 298,746.27
	200	200	60	F21976A	\$ 304,260.37
	185	261	75	F21977A	\$ 308,409.33
FP-200	250	100	40	F21978A	\$ 303,093.31
	240	150	60	F21979A	\$ 304,260.37
	220	200	75	F21980A	\$ 308,409.33
	200	261	75	F21981A	\$ 308,409.33
FP-225	300	100	40	F21982A	\$ 307,991.76
	280	150	60	F21983A	\$ 309,158.82
	260	200	75	F21984A	\$ 313,307.77
	240	261	75	F21985A	\$ 313,307.77
FP-250	315	100	50	F21986A	\$ 342,179.16
	290	150	60	F21987A	\$ 348,587.29
	270	200	75	F21988A	\$ 353,624.92
	250	261	100	F21989A	\$ 360,434.56
FP-350	420	100	60	F21990A	\$ 358,159.33
	400	150	75	F21991A	\$ 363,196.97
	390	200	100	F21992A	\$ 370,006.61
	380	250	125	F21993A	\$ 378,117.15

FOAMPAK2 - 60 Hz - DUAL PUMP

MODEL	FOAM GPM	FOAM PSI	HP	PART NUMBER	LIST PRICE (IPG V310)
FP-15	45	100	7.5	F21950AA	\$ 299,172.67
	40	150	10	F21951AA	\$ 299,172.67
	35	200	15	F21952AA	\$ 301,729.12
	30	261	20	F21953AA	\$ 303,951.12
FP-30	55	100	10	F21954AA	\$ 299,172.67
	50	150	15	F21955AA	\$ 301,729.12
	45	200	15	F21956AA	\$ 301,729.12
	40	261	20	F21957AA	\$ 303,951.12
FP-50	70	100	15	F21958AA	\$ 324,561.45
	65	150	20	F21959AA	\$ 326,760.79
	60	200	20	F21960AA	\$ 326,760.79
	55	261	25	F21961AA	\$ 329,470.28
FP-75	110	100	20	F21962AA	\$ 326,760.79
	105	150	25	F21963AA	\$ 329,470.28
	100	200	40	F21964AA	\$ 335,977.61
	90	261	40	F21965AA	\$ 335,977.61
FP-100	150	100	25	F21966AA	\$ 391,176.52
	140	150	30	F21967AA	\$ 393,670.61
	130	200	40	F21968AA	\$ 397,683.84
	120	261	40	F21969AA	\$ 397,683.84
FP-150	180	100	25	F21970AA	\$ 391,176.52
	170	150	30	F21971AA	\$ 393,670.61
	160	200	40	F21972AA	\$ 397,683.84
	150	261	50	F21973AA	\$ 400,194.96
FP-175	235	100	40	F21974AA	\$ 520,835.58
	220	150	50	F21975AA	\$ 523,409.04
	200	200	60	F21976AA	\$ 529,598.93
	185	261	75	F21977AA	\$ 535,051.94
FP-200	250	100	40	F21978AA	\$ 520,835.58
	240	150	60	F21979AA	\$ 529,598.93
	220	200	75	F21980AA	\$ 535,051.94
	200	261	75	F21981AA	\$ 535,051.94
FP-225	300	100	40	F21982AA	\$ 520,835.58
	280	150	60	F21983AA	\$ 529,598.93
	260	200	75	F21984AA	\$ 535,051.94
	240	261	75	F21985AA	\$ 535,051.94
FP-250	315	100	50	F21986AA	\$ 601,139.85
	290	150	60	F21987AA	\$ 607,392.10
	270	200	75	F21988AA	\$ 612,850.77
	250	261	100	F21989AA	\$ 629,742.61
FP-350	420	100	60	F21990AA	\$ 626,398.26
	400	150	75	F21991AA	\$ 631,856.93
	390	200	100	F21992AA	\$ 648,748.78
	380	250	125	F21993AA	\$ 653,102.11

60 Hz Foam Pump

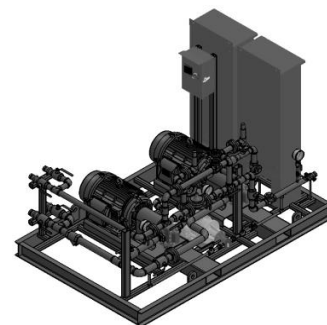
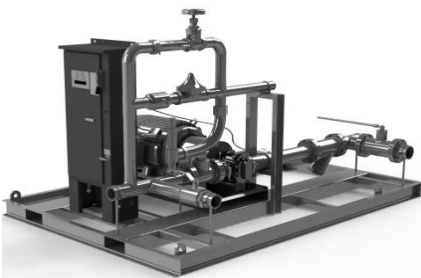

Fully Assembled Foam Pump Skid includes:

- Pump
- Pump Driver
- Pump Controller
- Casing Relief Valve
- Vacuum Gauge
- Pressure Gauge
- Duplex Gauge
- Pump Skid with Coupling Guard
- Panel Support Frame
- Suction Strainer
- UL/FM NamePlates
- Suction & Discharge Control Valve
- All Piping
- Assembled Piping Connections

FOAMPAK2 - 50 Hz - SINGLE PUMP

MODEL	FOAM LPM	FOAM PSI	KW	PART NUMBER	LIST PRICE (IPG V310)
FP-15	130	100	5	F21950B	\$ 179,802.39
	110	150	7	F21951B	\$ 181,579.75
	90	200	8	F21952B	\$ 185,889.31
	75	261	10.5	F21953B	\$ 187,993.23
FP-30	135	100	5	F21954B	\$ 181,740.35
	110	150	7.5	F21955B	\$ 190,236.34
	95	200	10	F21956B	\$ 190,236.34
	90	261	12	F21957B	\$ 194,337.12
FP-50	208	100	7.5	F21958B	\$ 193,924.90
	189	150	10	F21959B	\$ 196,922.85
	170	200	15	F21960B	\$ 196,922.85
	150	261	20	F21961B	\$ 199,776.27
FP-75	340	100	15	F21962B	\$ 200,632.82
	310	150	15	F21963B	\$ 205,782.88
	280	200	20	F21964B	\$ 216,741.48
	225	261	25	F21965B	\$ 216,741.48
FP-100	435	100	15	F21966B	\$ 233,074.99
	395	150	20	F21967B	\$ 232,095.30
	355	200	23	F21968B	\$ 239,167.26
	320	261	28	F21969B	\$ 239,167.26
FP-150	510	100	15	F21970B	\$ 233,878.01
	470	150	20	F21971B	\$ 234,327.70
	435	200	27	F21972B	\$ 241,399.67
	395	261	34	F21973B	\$ 248,353.85
FP-175	680	100	22.5	F21974B	\$ 298,542.84
	625	150	30	F21975B	\$ 303,762.50
	565	200	37.5	F21976B	\$ 313,805.65
	510	261	45	F21977B	\$ 319,507.12
FP-200	750	100	22.5	F21978B	\$ 307,065.60
	715	150	33.5	F21979B	\$ 322,328.41
	640	200	41	F21980B	\$ 328,029.88
	565	261	45	F21981B	\$ 328,029.88
FP-225	900	100	22.5	F21982B	\$ 311,964.05
	830	150	33.5	F21983B	\$ 327,226.85
	755	200	40	F21984B	\$ 332,928.32
	680	261	50	F21985B	\$ 332,928.32
FP-250	925	100	30	F21986B	\$ 347,393.46
	850	150	37.5	F21987B	\$ 359,915.28
	755	200	45	F21988B	\$ 366,869.46
	680	261	56	F21989B	\$ 379,455.52
FP-350	1230	100	37.5	F21990B	\$ 369,487.32
	1130	150	45	F21991B	\$ 376,441.51
	1095	200	56	F21992B	\$ 389,027.57
	1055	250	75	F21993B	\$ 390,365.94

FOAMPAK2 - 50 Hz - DUAL PUMP

MODEL	FOAM LPM	FOAM PSI	KW	PART NUMBER	LIST PRICE (IPG V310)
FP-15	130	100	5	F21950BB	\$ 299,172.67
	110	150	7	F21951BB	\$ 299,172.67
	90	200	8	F21952BB	\$ 301,729.12
	75	261	10.5	F21953BB	\$ 303,951.12
FP-30	135	100	5	F21954BB	\$ 299,172.67
	110	150	7.5	F21955BB	\$ 301,729.12
	95	200	10	F21956BB	\$ 301,729.12
	90	261	12	F21957BB	\$ 303,951.12
FP-50	208	100	7.5	F21958BB	\$ 324,561.45
	189	150	10	F21959BB	\$ 326,760.79
	170	200	15	F21960BB	\$ 326,760.79
	150	261	20	F21961BB	\$ 329,470.28
FP-75	340	100	15	F21962BB	\$ 326,760.79
	310	150	15	F21963BB	\$ 329,470.28
	280	200	20	F21964BB	\$ 335,977.61
	225	261	25	F21965BB	\$ 335,977.61
FP-100	435	100	15	F21966BB	\$ 391,176.52
	395	150	20	F21967BB	\$ 393,670.61
	355	200	23	F21968BB	\$ 397,683.84
	320	261	28	F21969BB	\$ 397,683.84
FP-150	510	100	15	F21970BB	\$ 391,176.52
	470	150	20	F21971BB	\$ 393,670.61
	435	200	27	F21972BB	\$ 397,683.84
	395	261	34	F21973BB	\$ 400,194.96
FP-175	680	100	22.5	F21974BB	\$ 520,835.58
	625	150	30	F21975BB	\$ 523,409.04
	565	200	37.5	F21976BB	\$ 529,598.93
	510	261	45	F21977BB	\$ 535,051.94
FP-200	750	100	22.5	F21978BB	\$ 520,835.58
	715	150	33.5	F21979BB	\$ 529,598.93
	640	200	41	F21980BB	\$ 535,051.94
	565	261	45	F21981BB	\$ 535,051.94
FP-225	900	100	22.5	F21982BB	\$ 520,835.58
	830	150	33.5	F21983BB	\$ 529,598.93
	755	200	40	F21984BB	\$ 535,051.94
	680	261	50	F21985BB	\$ 535,051.94
FP-250	925	100	30	F21986BB	\$ 601,139.85
	850	150	37.5	F21987BB	\$ 607,392.10
	755	200	45	F21988BB	\$ 612,850.77
	680	261	56	F21989BB	\$ 629,742.61
FP-350	1230	100	37.5	F21990BB	\$ 626,398.26
	1130	150	45	F21991BB	\$ 631,856.93
	1095	200	56	F21992BB	\$ 648,748.78
	1055	250	75	F21993BB	\$ 653,102.11

50 Hz Foam Pump

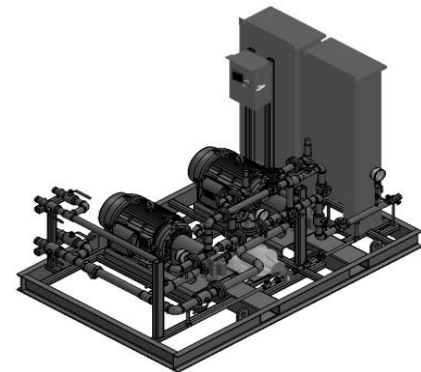
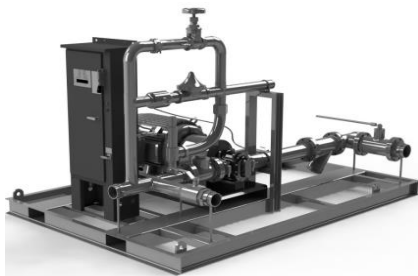

Fully Assembled Foam Pump Skid includes:

- Pump
- Pump Driver
- Pump Controller
- Casing Relief Valve
- Vacuum Gauge
- Pressure Gauge
- Duplex Gauge
- Pump Skid with Coupling Guard
- Panel Support Frame
- Suction Strainer
- UL/FM NamePlates
- Suction & Discharge Control Valve
- All Piping
- Assembled Piping Connections

FOAMPAK FOAM PUMP SYSTEM Optional Equipment	ADD TO LIST PRICE (each)
When Ordering Non-Standard FoamPak, Specify the following suffixes:	
PUMP MOTORS M = IEEE841, ATEX (IP65) Certified for Zone 2	POR
PUMP VOLTAGE V1 = 200/208V V2 = 220/230V V3 = 380/415V V4 = 575V V5 = Diesel Engine	N/C N/C N/C POR POR
NEMA RATING NEMA Rating N = NEMA 4X	\$ 18,559.83
CONTROLLER TRANSFER SWITCH S = Transfer Switch	POR
CONTROLLER STARTING METHOD F = Mercoid Switch Pressure Drop	\$ 1,918.90

FOAMPAK FOAM PUMP SYSTEM Optional Equipment	ADD TO LIST PRICE (each)
When Ordering Non-Standard FoamPak, Specify the following suffixes:	
EXTRA CONTACTS E1 = 1 Contact E2 = 2 Contacts E3 = 3 Contacts	\$ 283.12 \$ 566.23 \$ 849.35
ANTI-CONDENSATION SPACE HEATER FOR CONTROLLER H1 = 120V 1 Phase H2 = 240V 1 Phase	\$ 1,006.64 \$ 1,006.64
TESTING Standard Testing, Water Complete FoamPak Piping Hydro Test w/Report T1 = Witnessed Pump Test, Water only	\$ 2,336.83
Special Testing/Documentation T2 = Pump Only Testing w/Foam Concentrate T3 = Witnessed Pump Testing w/Foam Concentrate T4 = Material Certificates T5 = Witnessed Hydro Testing	POR POR POR POR

PART NUMBER DESCRIPTION AND OPTIONS

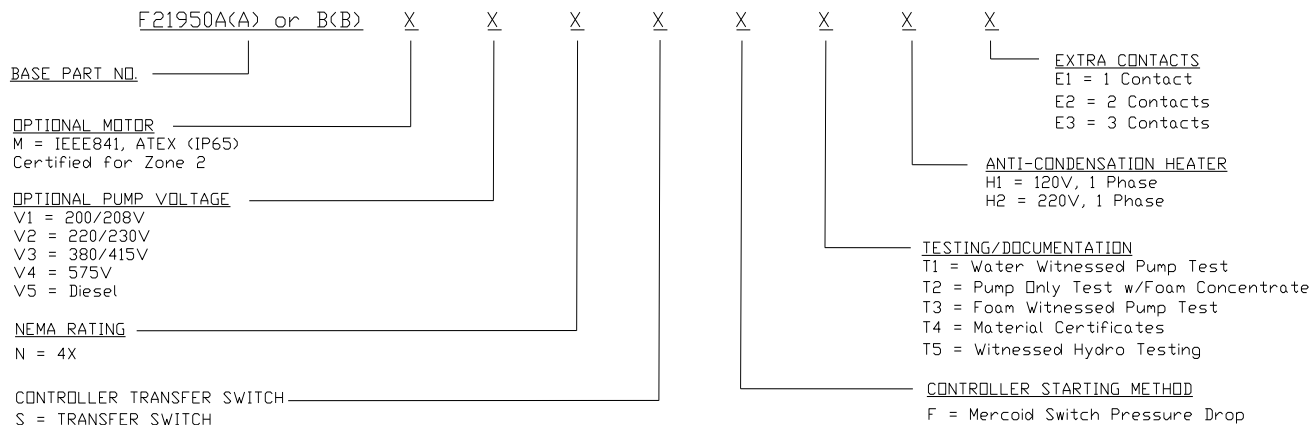

EXAMPLE: F21950AANST1T4

45 GPM @ 100 PSI 7.5HP 60 Hz Dual Pump Skid
with NEMA 4X Enclosure, Transfer Switch and Material Certificates

Base part number indicates flow, pressure, single or dual pump skid.
460/480V Controller and NEMA 2 Enclosure are standard equipment.
60 Hz Pump Motors are in IP-45/DDP and 50 Hz Pump Motors are in IP-55/TEFC as standard

High Expansion Foam Systems

3% XMAX High Expansion Foam Concentrate IPG V300



Part Number	Description	Gallons/Container	Shipping Weight*	List Price*
F23508-6.5	XMAX 3% Foam Concentrate	6.5 gal can	62 lbs.	\$ 427.21
F23508-55	XMAX 3% Foam Concentrate	55 gal drum	488 lbs.	\$ 3,614.86
F23508-265	XMAX 3% Foam Concentrate	265 gal IBC tote	2393 lbs.	\$ 17,417.08

*Per container

Model VGH10000 High Expansion Foam Generator IPG V313



Part Number	Description	List Price
F23772	VGH10000 High Expansion Foam Generator	\$ 19,220.05
F23777	VGH10000 Pairing Bracket Kit	\$ 2,855.55

High Expansion Foam Ratio Controllers IPG V302



Part Number	Description	List Price
F20152N	3" Ratio Controller - XMAX	\$ 3,004.64
F20217N	4" Ratio Controller - XMAX	\$ 3,483.22
F20214N	6" Ratio Controller - XMAX	\$ 5,018.44
F20137N	8" Ratio Controller - XMAX	\$ 8,268.30

High Expansion Foam ILBP IPG V303



Part Number	Description	List Price
F20316N	3" ILBP - XMAX	\$ 17,223.06
F20317N	4" ILBP - XMAX	\$ 18,410.85
F20184N	6" ILBP - XMAX	\$ 21,083.39
F20185N	8" ILBP - XMAX	\$ 23,162.03