

# ViewSonic®



---

## **Pro9510L/Pro9520WL/ Pro9530HDL/Pro9800WUL DLP Projector User Guide**

---

**IMPORTANT:** Please read this User Guide to obtain important information on installing and using your product in a safe manner, as well as registering your product for future service. Warranty information contained in this User Guide will describe your limited coverage from ViewSonic Corporation, which is also found on our web site at <http://www.viewsonic.com> in English, or in specific languages using the Regional selection box in the upper right corner of our website. “Antes de operar su equipo lea cuidadosamente las instrucciones en este manual”

---

**Model No. VS16505/VS16506/VS16507/VS16508**

# Compliance Information

## FCC Statement

This device complies with part 15 of FCC Rules. Operation is subject to the following two conditions: (1) this device may not cause harmful interference, and (2) this device must accept any interference received, including interference that may cause undesired operation.

This equipment has been tested and found to comply with the limits for a Class B digital device, pursuant to part 15 of the FCC Rules. These limits are designed to provide reasonable protection against harmful interference in a residential installation. This equipment generates, uses, and can radiate radio frequency energy, and if not installed and used in accordance with the instructions, may cause harmful interference to radio communications. However, there is no guarantee that interference will not occur in a particular installation. If this equipment does cause harmful interference to radio or television reception, which can be determined by turning the equipment off and on, the user is encouraged to try to correct the interference by one or more of the following measures:

- Reorient or relocate the receiving antenna.
- Increase the separation between the equipment and receiver.
- Connect the equipment into an outlet on a circuit different from that to which the receiver is connected.
- Consult the dealer or an experienced radio/TV technician for help.

**Warning:** You are cautioned that changes or modifications not expressly approved by the party responsible for compliance could void your authority to operate the equipment.

## For Canada

CAN ICES-3 (B)/NMB-3(B)

## CE Conformity for European Countries

 The device complies with the EMC Directive 2014/30/EU and Low Voltage Directive 2014/35/EU.

## Following information is only for EU-member states:

The mark is in compliance with the Waste Electrical and Electronic Equipment Directive 2012/19/EU (WEEE).

The mark indicates the requirement NOT to dispose the equipment including any spent or discarded batteries or accumulators as unsorted municipal waste, but use the return and collection systems available.

If the batteries, accumulators and button cells included with this equipment, display the chemical symbol Hg, Cd, or Pb, then it means that the battery has a heavy metal content of more than 0.0005% Mercury or more than, 0.002% Cadmium, or more than 0.004% Lead.



## Important Safety Instructions

1. Read these instructions.
2. Keep these instructions.
3. Heed all warnings.
4. Follow all instructions.
5. Do not use this unit near water.
6. Clean with a soft, dry cloth.
7. Do not block any ventilation openings. Install the unit in accordance with the manufacturer's instructions.
8. Do not install near any heat sources such as radiators, heat registers, stoves, or other devices (including amplifiers) that produce heat.
9. Do not defeat the safety purpose of the polarized or grounding-type plug. A polarized plug has two blades with one wider than the other. A grounding type plug has two blades and a third grounding prong. The wide blade and the third prong are provided for your safety. If the provided plug does not fit into your outlet, consult an electrician for replacement of the obsolete outlet.
10. Protect the power cord from being walked on or pinched particularly at plugs. Convenience receptacles and the point where they exit from the unit. Be sure that the power outlet is located near the unit so that it is easily accessible.
11. Only use attachments/accessories specified by the manufacturer.
12. Use only with the cart, stand, tripod, bracket, or table specified by the manufacturer, or sold with the unit. When a cart is used, use caution when moving the cart/unit combination to avoid injury from tipping over.
13. Unplug this unit when unused for long periods of time.
14. Refer all servicing to qualified service personnel. Servicing is required when the unit has been damaged in any way, such as: if the power-supply cord or plug is damaged, if liquid is spilled onto or objects fall into the unit, if the unit is exposed to rain or moisture, or if the unit does not operate normally or has been dropped.



# Declaration of RoHS2 Compliance

This product has been designed and manufactured in compliance with Directive 2011/65/EU of the European Parliament and the Council on restriction of the use of certain hazardous substances in electrical and electronic equipment (RoHS2 Directive) and is deemed to comply with the maximum concentration values issued by the European Technical Adaptation Committee (TAC) as shown below:

Substance	Proposed Maximum Concentration	Actual Concentration
Lead (Pb)	0.1%	< 0.1%
Mercury (Hg)	0.1%	< 0.1%
Cadmium (Cd)	0.01%	< 0.01%
Hexavalent Chromium (Cr <sup>6+</sup> )	0.1%	< 0.1%
Polybrominated biphenyls (PBB)	0.1%	< 0.1%
Polybrominated diphenyl ethers (PBDE)	0.1%	< 0.1%

Certain components of products as stated above are exempted under the Annex III of the RoHS2 Directives as noted below:

Examples of exempted components are:

1. Mercury in cold cathode fluorescent lamps and external electrode fluorescent lamps (CCFL and EEFL) for special purposes not exceeding (per lamp):
  - (1) Short length ( $\leq 500$  mm): maximum 3.5 mg per lamp.
  - (2) Medium length ( $> 500$  mm and  $\leq 1,500$  mm): maximum 5 mg per lamp.
  - (3) Long length ( $> 1,500$  mm): maximum 13 mg per lamp.
2. Lead in glass of cathode ray tubes.
3. Lead in glass of fluorescent tubes not exceeding 0.2% by weight.
4. Lead as an alloying element in aluminium containing up to 0.4% lead by weight.
5. Copper alloy containing up to 4% lead by weight.
6. Lead in high melting temperature type solders (i.e. lead-based alloys containing 85% by weight or more lead).
7. Electrical and electronic components containing lead in a glass or ceramic other than dielectric ceramic in capacitors, e.g. piezoelectronic devices, or in a glass or ceramic matrix compound.

## Copyright Information

Copyright © ViewSonic® Corporation, 2016. All rights reserved.

Macintosh and Power Macintosh are registered trademarks of Apple Inc.

Microsoft, Windows, Windows NT, and the Windows logo are registered trademarks of Microsoft Corporation in the United States and other countries.

ViewSonic, the three birds logo, OnView, ViewMatch, and ViewMeter are registered trademarks of ViewSonic Corporation.

VESA is a registered trademark of the Video Electronics Standards Association.

DPMS and DDC are trademarks of VESA.

PS/2, VGA and XGA are registered trademarks of International Business Machines Corporation.

Disclaimer: ViewSonic Corporation shall not be liable for technical or editorial errors or omissions contained herein; nor for incidental or consequential damages resulting from furnishing this material, or the performance or use of this product.

In the interest of continuing product improvement, ViewSonic Corporation reserves the right to change product specifications without notice. Information in this document may change without notice.

No part of this document may be copied, reproduced, or transmitted by any means, for any purpose without prior written permission from ViewSonic Corporation.

## Product Registration

To fulfill possible future product needs, and to receive additional product information as it becomes available, please visit your region section on ViewSonic's website to register your product online.

The ViewSonic CD also provides an opportunity for you to print the product registration form. Upon completion, please mail or fax to a respective ViewSonic office. To find your registration form, use the directory “:\CD\Registration”.

Registering your product will best prepare you for future customer service needs.

Please print this user guide and fill the information in the “For Your Records” section. For additional information, please see the “Customer Support” section in this guide.

### For Your Records

<b>Product Name:</b>	Pro9510L/Pro9520WL/Pro9530HDL/Pro9800WUL ViewSonic DLP Projector
<b>Model Number:</b>	VS16505_VS16506/VS16507_VS16508
<b>Document Number:</b>	Pro9510L/Pro9520WL/Pro9530HDL/Pro9800WUL_UG_ ENG Rev. 1A 07-29-16
<b>Serial Number:</b>	_____
<b>Purchase Date:</b>	_____

### Product disposal at end of product life

The lamp in this product contains mercury which can be dangerous to you and the environment. Please use care and dispose of in accordance with local, state or federal laws.

ViewSonic respects the environment and is committed to working and living green. Thank you for being part of Smarter, Greener Computing. Please visit ViewSonic website to learn more.

USA & Canada: <http://www.viewsonic.com/company/green/recycle-program/>

Europe: <http://www.viewsoniceurope.com/uk/support/recycling-information/>

Taiwan: <http://recycle.epa.gov.tw/recycle/index2.aspx>

## Copyright

This publication, including all photographs, illustrations and software, is protected under international copyright laws, with all rights reserved. Neither this manual, nor any of the material contained herein, may be reproduced without written consent of the author.

© Copyright 2016

## Disclaimer

The information in this document is subject to change without notice. The manufacturer makes no representations or warranties with respect to the contents hereof and specifically disclaims any implied warranties of merchantability or fitness for any particular purpose. The manufacturer reserves the right to revise this publication and to make changes from time to time in the content hereof without obligation of the manufacturer to notify any person of such revision or changes.

## Trademark Recognition



Kensington is a U.S. registered trademark of ACCO Brand Corporation with issued registrations and pending applications in other countries throughout the world.



HDMI, the HDMI Logo, and High-Definition Multimedia Interface are trademarks or registered trademarks of HDMI Licensing LLC in the United States and other countries.



MHL, the MHL logo, and Mobile High-Definition Link are trademarks or registered trademarks of MHL licensing, LCC.

All other product names used in this manual are the properties of their respective owners and are acknowledged.

## Important Safety Information



### **Important:**

It is strongly recommended that you read this section carefully before using the projector. These safety and usage instructions will ensure that you enjoy many years of safe use of the projector. **Keep this manual for future reference.**

## Symbols Used

Warning symbols are used on the unit and in this manual to alert you of hazardous situations.

The following styles are used in this manual to alert you to important information.

### **Note:**

Provides additional information on the topic at hand.



### **Important:**

Provides additional information that should not be overlooked.



### **Caution:**

Alerts you to situations that may damage the unit.



### **Warning:**

Alerts you to situations that may damage the unit, create a hazardous environment, or cause personal injury.

Throughout this manual, component parts and items in the OSD menus are denoted in bold font as in this example:

“Push the **Menu** button on the remote control to open the **Main** menu.”

## General Safety Information

- Do not open the unit case. Aside from the projection lamp, there are no user-serviceable parts in the unit. For servicing, contact qualified service personnel.
- Follow all warnings and cautions in this manual and on the unit case.
- The projection lamp is extremely bright by design. To avoid damage to eyes, do not look into the lens when the lamp is on.
- Do not place the unit on an unstable surface, cart, or stand.
- Avoid using the system near water, in direct sunlight, or near a heating device.
- Do not place heavy objects such as books or bags on the unit.

## Projector Installation Notice

- **Do not tilt the projector to the left or right**, otherwise lamp life could decrease dramatically, and may lead to other **unpredictable damages**.

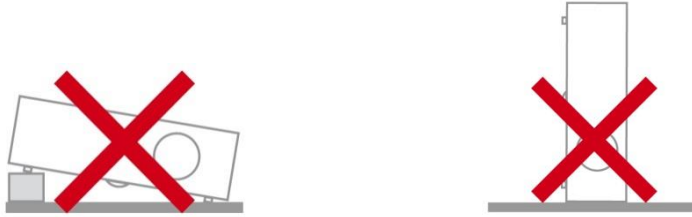

- **There is no limit on the tilt angle upward or downward.**

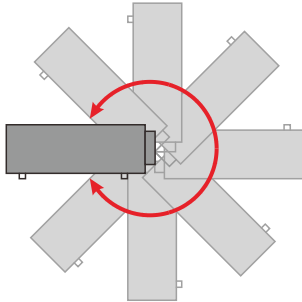

- Allow at least 50 cm clearance around the exhaust vent.

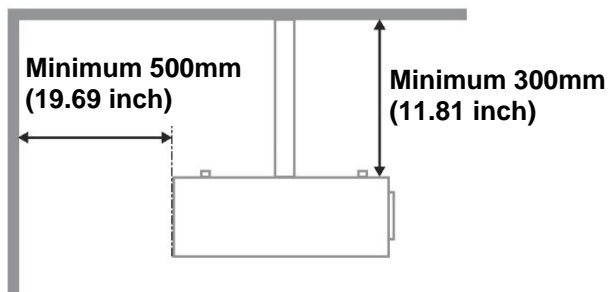
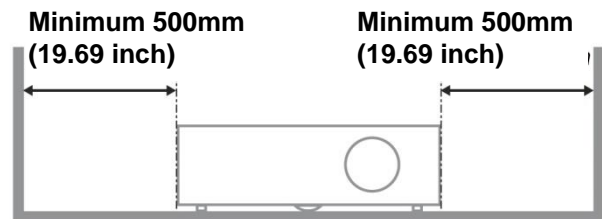
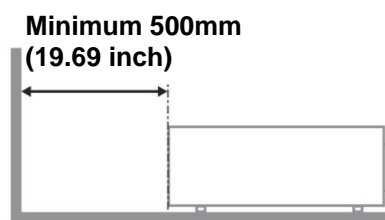

- Ensure that the intake vents do not recycle hot air from the exhaust vent.
- When operating the projector in an enclosed space, ensure that the surrounding air temperature within the enclosure does not exceed operation temperature while the projector is running, and the air intake and exhaust vents are unobstructed.
- All enclosures should pass a certified thermal evaluation to ensure that the projector does not recycle exhaust air, as this may cause the device to shutdown even if the enclosure temperature is within the acceptable operation temperature range.



## Verify Installation Location

- To supply power, the 3-blade (with earthing lead) socket should be used to ensure proper grounding and equalized ground potential for all of the equipment in the Projector System.

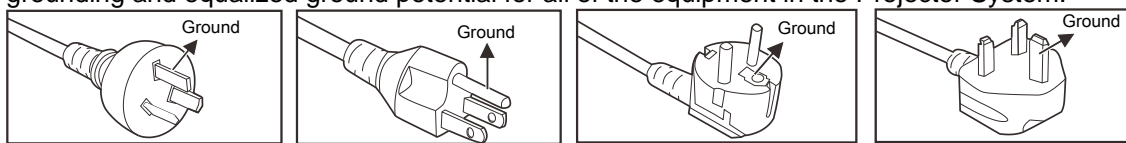

- For Australia and Mainland China
  - For the U.S.A. and Canada
  - For Continental Europe
  - For the U.K.
- The power code provided with the Projector should be used. In case of any missing item, other qualified 3-blade (with earthing lead) power cord can be used as substitution; however, do not use 2-blade power cord.
  - Verify if the voltage is stable, grounded properly and there is no electricity leakage.
  - Measure total power consumption which should not higher the safety capacity and avoid safety issue and short circuit.
  - Turn on Altitude Mode when located in high altitude areas
  - The projector can only be installed upright or inverted.
  - When installation the bracket, make sure the weight limit is not exceed and firmly secured.
  - Avoid installing near air conditioner duct or subwoofer.
  - Avoid installing at high temperature, insufficient cooling and heavy dust locations.
  - Keep your product away from fluorescent lamps (>1 Meter) to avoid malfunction caused by IR interference
  - The VGA IN connector should be connected to the VGA IN port. Note that it should be inserted tightly, with the screws on both sides securely fastened to ensure proper connection of the signal wire for achieving optimal display effect.
  - The AUDIO IN connector should be connected to the AUDIO IN port and CANNOT be connected to AUDIO OUT or other ports like BNC, RCA; otherwise, it will lead to mute output and even DAMAGE the port.
  - Install the projector above 200cm to avoid damage.
  - The power cord and signal cable should be connected before power on the projector. During the projector starting and operating process, DO NOT insert or remove the signal cable or the power cord to avoid damaging the projector.

## Cooling notes

### Air outlet

- Make sure the air outlet is 50cm clear of any obstruction to ensure proper cooling.
- Air outlet location should not be in front of the lens of other projector to avoid causing illusions.
- Keep the outlet at least 100cm away from the inlets of other projectors
- The projector generates a massive amount of heat during use. The internal fan dissipates the heat of the projector when shutting down, and such process may continue for a certain period. After the project enters STANDBY MODE status, press the AC power button to turn off the projector and remove the power cord. DO NOT remove the power cord during the shutdown process, as it may cause damage to the projector. In the meantime, the delayed heat radiating will also affect the service life of the projector. The shutdown process may vary depending on the model used. Whatever the case may be, be sure to disconnect the power cord till after the projector enters the STANDBY status.

### Air inlet

- Make sure there is no object blocking air input within 30 cm.
- Keep the inlet away from other heat sources
- Avoided heavy dust area

## Power Safety

- Only use the supplied power cord.
- Do not place anything on the power cord. Place the power cord where it will not be in the way of foot traffic.
- Remove the batteries from the remote control when storing or not in use for a prolonged period.

## Replacing the Lamp

Replacing the lamp can be hazardous if done incorrectly. See Replacing the Projection Lamp on page 55 for clear and safe instructions for this procedure. Before replacing the lamp:

- Unplug the power cord.
- Allow the lamp to cool for about one hour.

## Cleaning the Projector

- Unplug the power cord before cleaning. See Resetting the Lamp Time page 58.
- Allow the lamp to cool for about one hour.

## Regulatory Warnings

Before installing and using the projector, read the regulatory notices in the Regulatory Compliance on page 75.

### Important Recycle Instructions:



Lamp(s) inside this product contain mercury. This product may contain other electronic waste that can be hazardous if not disposed of properly. Recycle or dispose in accordance with local, state, or federal Laws. For more information, contact the Electronic Industries Alliance at [WWW.EIAE.ORG](http://WWW.EIAE.ORG). For lamp specific disposal information check [WWW.LAMPRECYCLE.ORG](http://WWW.LAMPRECYCLE.ORG).

## Symbol Explanations



DISPOSAL: Do not use household or municipal waste collection services for disposal of electrical and electronic equipment. EU countries require the use of separate recycling collection services.

## Main Features

- Compatible with all major video standards including NTSC, PAL, and SECAM.
- A high brightness rating allows for presentations in daylight or in lit rooms.
- Flexible setup allows for front, rear projections.
- Line-of-vision projections remain square, with advanced keystone correction for angled projections.
- Input source automatically detected.
- High brightness for projection in just about any environment.
- Supports resolutions up to WUXGA for clear and crisp images.
- DLP® and BrilliantColor™ technologies from Texas Instruments.
- Centered lens for easy installation.
- Horizontal and vertical lens shift.
- MHL device compatibility for streaming of video and audio content from a compatible mobile device.
- Built-in speaker with multiple audio-in and audio-out ports.
- Network ready for integration and system administration via RJ45.
- Sealed engine to minimizing the impact of dust and smoke.
- Top sided lamp cover for simple lamp removal and insertion.
- Anti-theft security features include: Kensington security slot, security bar.

## About this Manual

This manual is intended for end users and describes how to install and operate the DLP projector. Wherever possible, relevant information—such as an illustration and its description—has been kept on one page. This printer-friendly format is both for your convenience and to help save paper, thereby protecting the environment. It is suggested that you only print sections that are relevant to your needs.

## Table of Contents

<b>GETTING STARTED</b> .....	<b>1</b>
PACKING CHECKLIST .....	1
VIEWS OF PROJECTOR PARTS.....	2
Front-right View .....	2
Top view—On-Screen Display (OSD) buttons and LEDs .....	3
Rear view.....	4
Bottom view .....	6
REMOTE CONTROL PARTS .....	7
Remote control code .....	9
Using the remote mouse control .....	10
REMOTE CONTROL OPERATING RANGE .....	10
PROJECTOR AND REMOTE CONTROL BUTTONS.....	10
<b>SETUP AND OPERATION</b> .....	<b>11</b>
INSERTING THE REMOTE CONTROL BATTERIES .....	11
STARTING AND SHUTTING DOWN THE PROJECTOR .....	12
SETTING AN ACCESS PASSWORD (SECURITY LOCK).....	14
ADJUSTING THE PROJECTOR LEVEL .....	16
ADJUSTING PROJECTED IMAGE POSITION USING LENS SHIFT .....	17
Adjusting the vertical image position .....	18
Adjusting the horizontal image position.....	20
ADJUSTING THE ZOOM, FOCUS AND KEYSTONE.....	21
ADJUSTING THE VOLUME .....	22
<b>ON-SCREEN DISPLAY (OSD) MENU SETTINGS</b> .....	<b>23</b>
OSD MENU CONTROLS .....	23
Navigating the OSD .....	23
SETTING THE OSD LANGUAGE.....	24
OSD MENU OVERVIEW.....	25
IMAGE MENU .....	28
Advanced Feature .....	29
DISPLAY MENU.....	32
VIDEO/AUDIO MENU .....	33
Audio.....	34
BASIC MENU .....	35
Splash screen.....	36
HV Keystone.....	36
Advanced Feature .....	37
ADVANCED MENU.....	40
Advanced Feature .....	41
OSD Menu Setting.....	42
Lamp Hour Reset .....	42
3D .....	43
Network Setting .....	43
Status.....	54
<b>MAINTENANCE AND SECURITY</b> .....	<b>55</b>
REPLACING THE PROJECTION LAMP .....	55
Resetting the Lamp Time .....	58
CLEANING THE PROJECTOR .....	59
Cleaning the Lens.....	59
Cleaning the Case.....	59
Cleaning the Air Filter .....	60
USING THE PHYSICAL LOCK .....	62
Using the Kensington Security Slot.....	62
Using the Security Bar Lock .....	62
<b>TROUBLESHOOTING</b> .....	<b>63</b>
COMMON PROBLEMS AND SOLUTIONS .....	63
TIPS FOR TROUBLESHOOTING .....	63

LED ERROR MESSAGES .....	64
IMAGE PROBLEMS .....	65
LAMP PROBLEMS.....	65
REMOTE CONTROL PROBLEMS.....	66
AUDIO PROBLEMS .....	66
HAVING THE PROJECTOR SERVICED .....	66
HDMI Q & A .....	67
<b>SPECIFICATIONS.....</b>	<b>68</b>
SPECIFICATIONS.....	68
PROJECTION DISTANCE VS. PROJECTION SIZE .....	70
PRO9510L / PRO9520WL / PRO9530HDL / PRO9800WUL .....	70
TIMING MODE TABLE .....	72
PROJECTOR DIMENSIONS .....	74
<b>REGULATORY COMPLIANCE .....</b>	<b>75</b>
FCC WARNING .....	75
CANADA.....	75
SAFETY CERTIFICATIONS .....	75
<b>APPENDIX I .....</b>	<b>76</b>
IR CODE TABLE.....	76
<b>APPENDIX II .....</b>	<b>77</b>
RS-232C PROTOCOL.....	77

## Packing Checklist

Carefully unpack the projector and check that the following items are included:

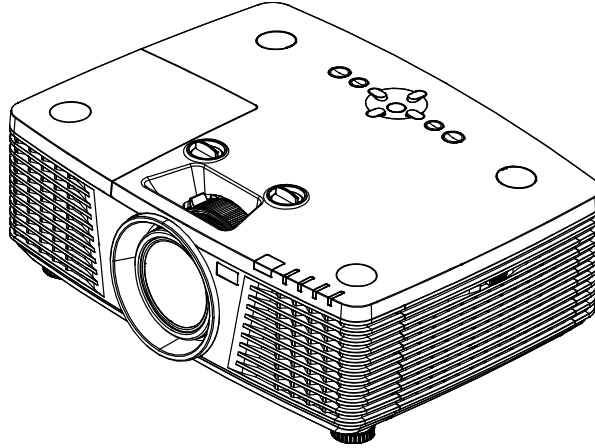

Projector



Remote Control  
(Batteries Included)

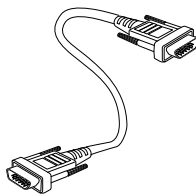

VGA Cable

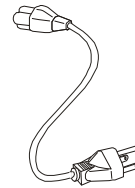

Power Cord



CD-ROM  
(This User's Manual)



Quick Start Guide

Contact your dealer immediately if any items are missing, appear damaged, or if the unit does not work. It is recommended that you keep the original packing material should you ever need to return the equipment for warranty service.



**Caution:**

Avoid using the projector in dusty environments.

## Views of Projector Parts

### Front-right View

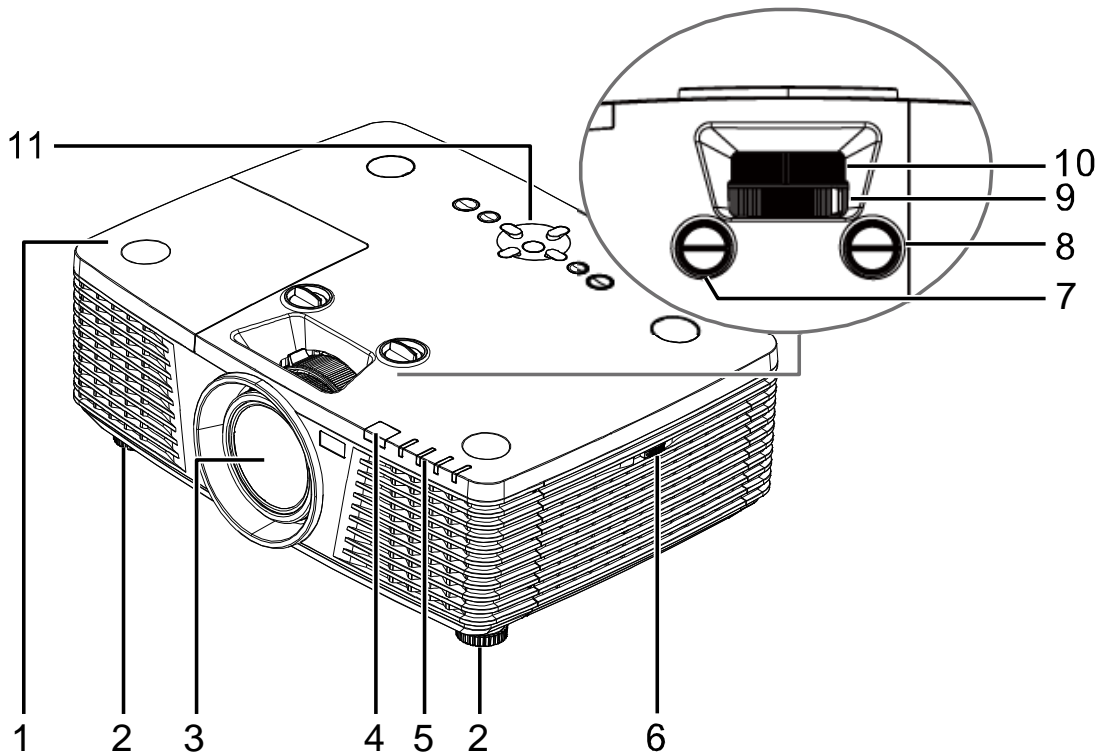

ITEM	LABEL	DESCRIPTION	SEE PAGE
1.	Lamp Cover	Remove cover to replace lamp.	55
2.	Tilt Adjuster	Rotate adjuster lever to adjust angle position.	14
3.	Lens	Projection Lens.	
4.	IR Receiver	Receives IR signal from remote control.	7
5.	LEDs	Displays the projector status.	3
6.	Vent	Cool air intake.	60
7.	Vertical Lens Shift	Adjusts the image position vertically.	18
8.	Horizontal Lens Shift	Adjusts the image position horizontally.	20
9.	Zoom Ring	Enlarges the projected image.	21
10.	Focus Ring	Focuses the projected image.	21
11.	Function Keys	On-Screen Display (OSD) buttons.	3







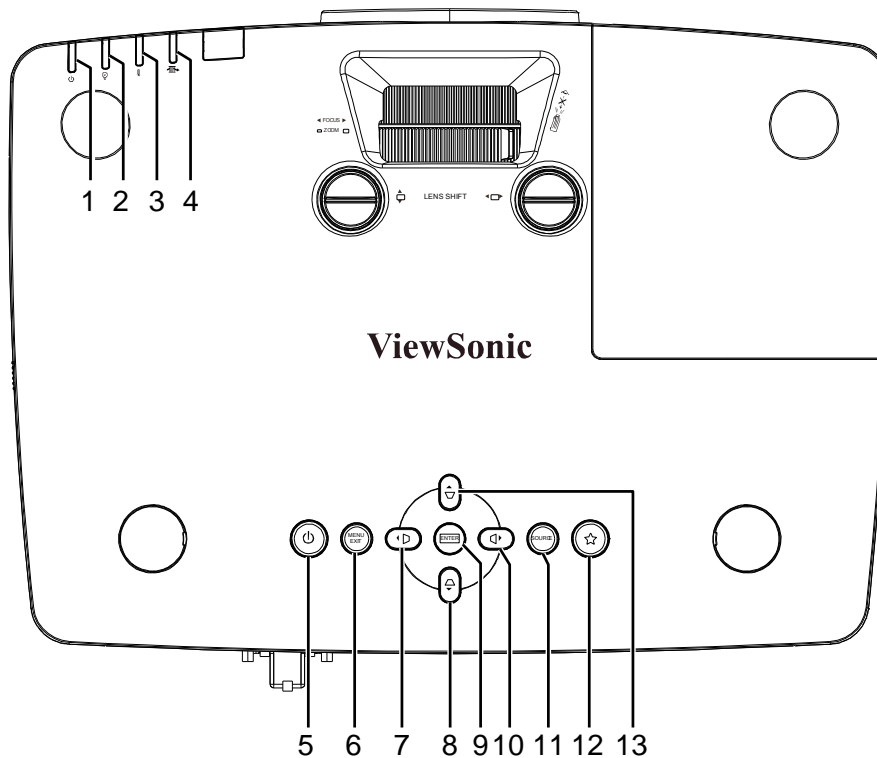

#### Important:

Ventilation openings on the projector allow for good air circulation, which keeps the projector lamp cool. Do not obstruct any of the ventilation openings.

## Top view—On-Screen Display (OSD) buttons and LEDs



ITEM	LABEL	DESCRIPTION	SEE PAGE
1.	Power LED	Display the power on/off sequence status.	64
2.	Lamp LED	Display the lamp status.	64
3.	Temp LED	Display the thermal status.	64
4.	Filter LED	Display the filter replacing warning message.	64
5.		Turn the projector on or off.	12
6.	MENU / EXIT	Opens and exits OSD menus.	23
7.		Navigates and changes settings in the OSD. Quick Menu – For Horizontal Keystone.	23
8.		Navigates and changes settings in the OSD. Quick Menu – For Vertical Keystone.	23
9.	ENTER	Enter or confirm highlighted OSD menu item. Displays the Corner Adj. page.	23
10.		Navigates and changes settings in the OSD. Quick Menu – For Horizontal Keystone.	23
11.	SOURCE	Enter the Source menu.	23
12.	 (My Button)	Allows user to define a short cut key on this button, and the function item is selected in OSD menu.	23
13.		Navigates and changes settings in the OSD. Quick Menu – For Vertical Keystone.	23



## Rear view

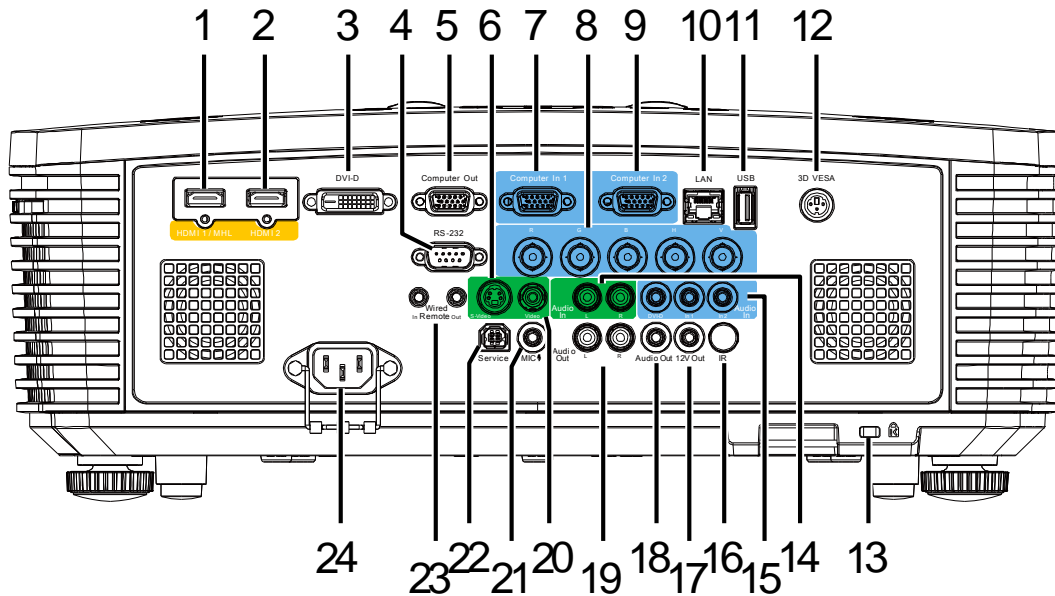

ITEM	LABEL	DESCRIPTION	SEE PAGE
1.	HDMI 1 /MHL	Connect the HDMI/MHL cable from an HDMI/MHL device. <b>Note:</b> Set the Source to HDMI 1/MHL also can be charging connected MHL compatible smart device as long as the projector Power On.	
2.	HDMI 2	Connect the HDMI cable from an HDMI device.	
3.	DVI-D	Connect the DVI CABLE to a display.	
4.	RS-232	Connects RS-232 serial port cable for remote control.	
5.	Computer Out	Connect an RGB cable to a display (Pass through by VGA1 only).	
6.	S-VIDEO	Connect a S-VIDEO cable from a video device.	
7.	Computer In 1	Connect an RGB cable from a computer or a video enabled device.	
8.	BNC	Connect a BNC cable from a computer.	
9.	Computer In 2	Connect an RGB cable from a computer or a video enabled device.	
10.	RJ45 (LAN)	Connect a LAN cable from Ethernet.	
11.	USB	Connect a USB cable for USB host. <b>Note:</b> Support 5V/1.0A for each port output as long as the projector Power On.	
12.	3D-VESA	Connect 3D IR glasses receiver unit.	
13.	Kensington Security Slot	Secures to permanent object with a Kensington Lock system.	62
14.	AUDIO IN L/R	Connect the audio cables from an audio device for VIDEO or S-VIDEO audio input.	
15.	AUDIO IN	Connect an AUDIO cable from the input device.	
16.	IR	Receive IR signal from remote control.	
17.	12V OUT	When connected to the screen through a commercially available cable, the screen deploys automatically on start up of the projector. The screen retracts when the projector is powered off (see notes below).	
18.	AUDIO OUT	Connect an AUDIO cable for audio loop through.	
19.	AUDIO OUT L/R	Connect an AUDIO cable for audio loop through.	
20.	VIDEO	Connect the composite cable from a video device.	

ITEM	LABEL	DESCRIPTION	SEE PAGE
21.	MICROPHONE	Connect the microphone input device.	
22.	SERVICE	For service personnel only.	
23.	WIRE REMOTE In / Out	Connect the wire remote from remote control to the projector for wire remote control. Connect "WIRE REMOTE OUT" to another projector (same model) "WIRE REMOTE IN" for serial control.	
24.	AC IN	Connect the POWER cable.	

**Note:**

- To use this feature, you must plug in the connector before turn on/off the projector.
- Screen controllers are supplied and supported by screen manufacturers.
- Do not use this jack for anything other than intended use.



**Warning:**

As a safety precaution, disconnect all power to the projector and connecting devices before making connections.

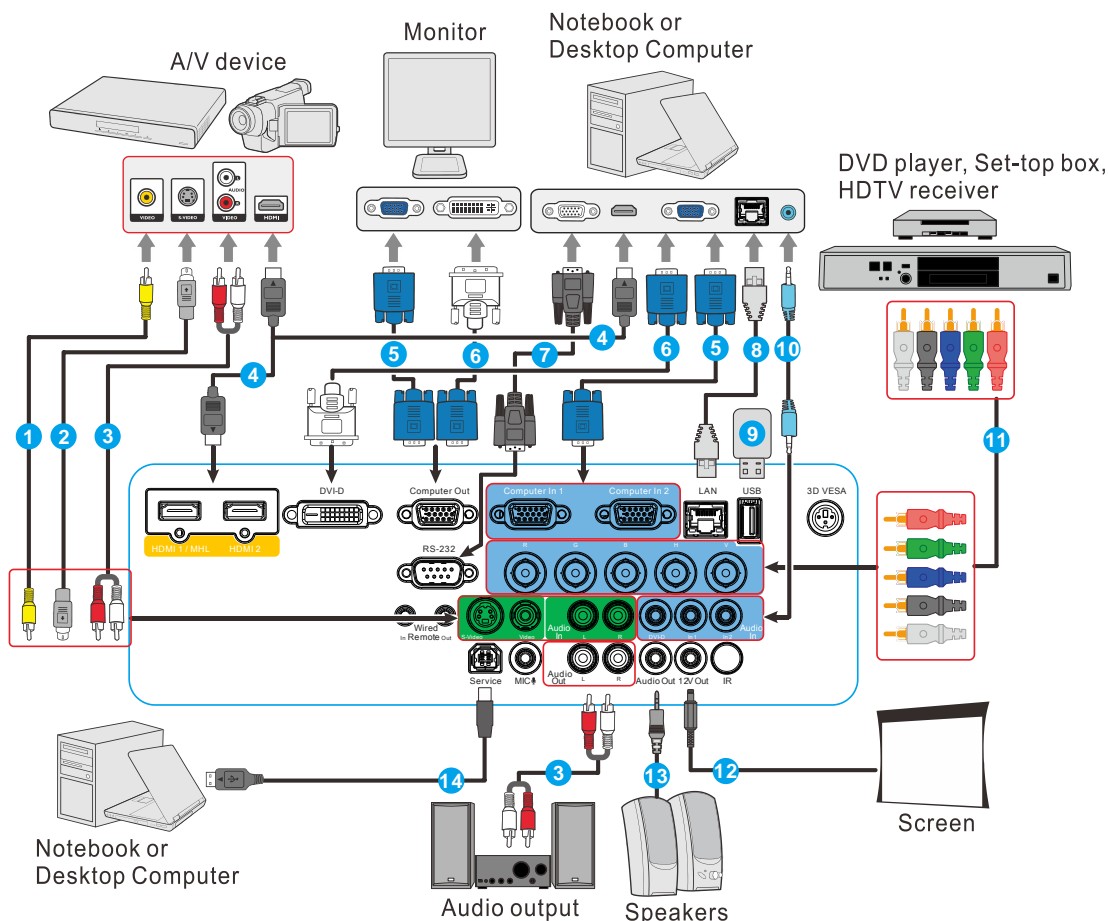

1. Composite Video Cable
2. S-Video Cable
3. Audio L/R Cable
4. HDMI Cable
5. VGA Cable
6. VGA to DVI-D Cable
7. RS-232 Cable

8. RJ45 Cable
9. Type-A port power 1A
10. Audio Cable
11. BNC Cable
12. 12V DC jack
13. Audio Cable
14. USB Cable

Bottom view

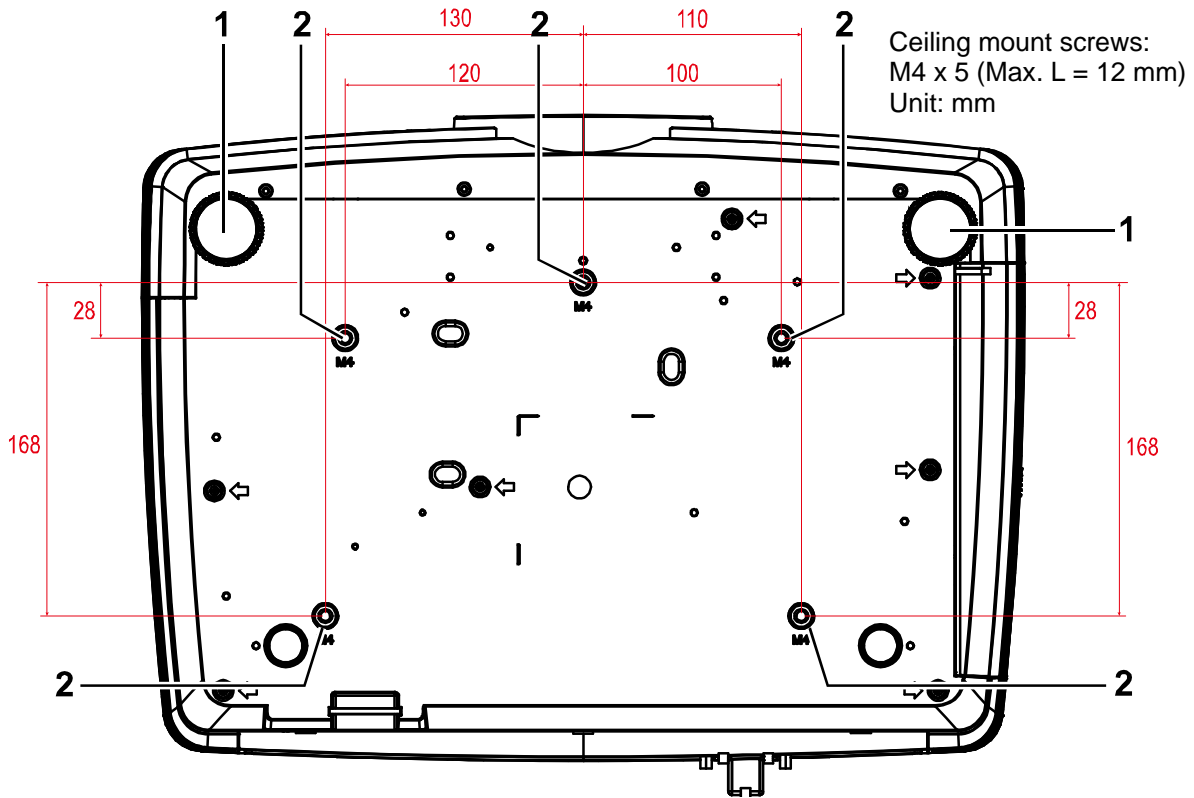

ITEM	LABEL	DESCRIPTION	SEE PAGE
1.	Tilt Adjustor	Rotate adjuster lever to adjust angle position.	16
2.	Ceiling Mount Holes	Contact your dealer for information on mounting the projector on a ceiling.	

**Note:**

When installing, ensure that you use only UL Listed ceiling mounts.

For ceiling installations, use approved mounting hardware and M4 screws with a maximum screw depth of 12 mm (0.47 inch).

The construction of the ceiling mount must be of a suitable shape and strength. The ceiling mount load capacity must exceed the weight of the installed equipment, and as an additional precaution be capable of withstanding three times the weight of the equipment over a period of 60 seconds.

## Remote Control Parts

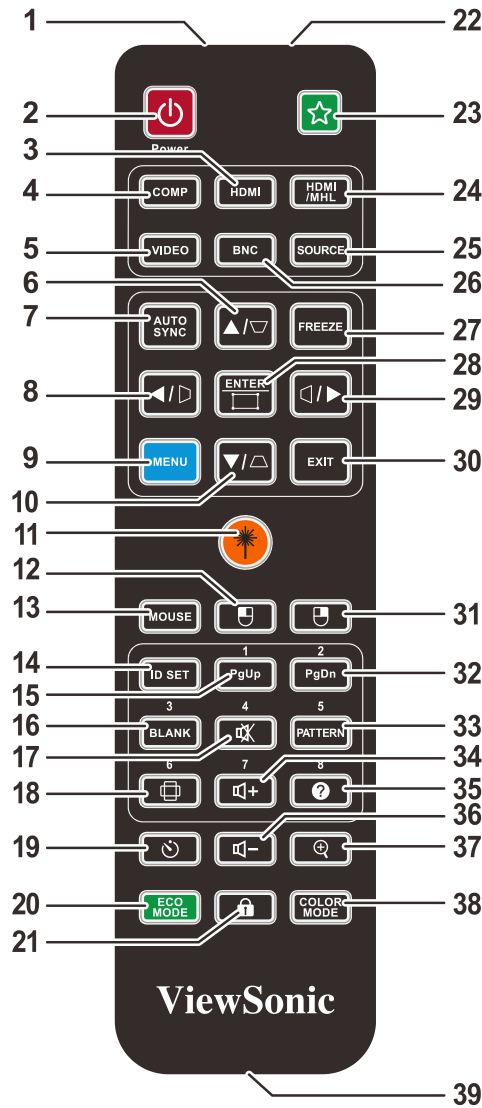

### Important:

1. Avoid using the projector with bright fluorescent lighting turned on. Certain high-frequency fluorescent lights can disrupt remote control operation.
2. Be sure nothing obstructs the path between the remote control and the projector. If the path between the remote control and the projector is obstructed, you can bounce the signal off certain reflective surfaces such as projector screens.
3. The buttons and keys on the projector have the same functions as the corresponding buttons on the remote control. This user's manual describes the functions based on the remote control.













### Note:







Complies with FDA performance standards for laser products except for deviations pursuant to Laser Notice No. 50, dated June 24, 2007



### Caution:

Use of controls, adjustments or performance of procedures other than those specified herein may result in hazardous laser light exposure.

ITEM	LABEL	DESCRIPTION	SEE PAGE
1.	IR Transmitter	Transmits signals to projector.	
2.	Power On	Turns the projector on.	12
3.	HDMI	Displays the HDMI 2 source.	
4.	COMP	Displays the VGA1/VGA2 source selection (toggle).	
5.	Video	Displays the VIDEO/S-VIDEO source selection.	
6.		Navigates and changes settings in the OSD. Quick Menu – For Vertical Keystone.	23
7.	Auto SYNC	Auto adjustment for frequency, phase, and position.	
8.		Navigates and changes settings in the OSD. Quick Menu – For Horizontal Keystone.	23
9.	MENU	Opens the OSD.	23
10.		Navigates and changes settings in the OSD. Quick Menu – For Vertical Keystone.	23
11.	Laser	Press to operate the on-screen pointer. <b>DO NOT POINT IN EYES.</b>	
12.		Performs the same function as the left mouse button when the mouse mode is activated.	
13.	MOUSE	Switches between the normal and mouse modes. PgUp, PgDn,  ,  , ▲, ▼, ◀, ▶,  : active after pressing Mouse. An icon appears on the screen to indicate the activation of the mouse mode. <b>Note:</b> Only available when a PC input signal is selected.	
14.	ID SET	Sets remote control code	
15.	PgUp / 1	Perform page up function when mouse mode is activated. Number for Remote ID setting used.	
16.	Blank / 3	Makes the screen blank. Number for Remote ID setting used.	
17.	 / 4	Mutes the built-in speaker. Number for Remote ID setting used.	22
18.	 / 6	Selects the display aspect ratio.	
19.		Displays the presentation timer settings menu.	
20.	ECO MODE	Selects a lamp mode.	
21.		Activates panel key lock.	
22.	Laser	Use as on-screen pointer. <b>DO NOT POINT IN EYES.</b>	
23.		Allows user to define a short cut key on the remote control, and the function item is selected in OSD menu.	23
24.	HDMI / MHL	Displays the HDMI1 source. Enable the Mobile High-Definition Link technology feature for smart devices.	
25.	Source	Alternate input source.	23
26.	BNC	Displays the BNC source.	
27.	Freeze	Freezes/unfreezes the on-screen picture.	

ITEM	LABEL	DESCRIPTION	SEE PAGE
28.		Enters and confirms settings in the OSD. Displays the Corner Adj. page.	23
29.		Navigates and changes settings in the OSD. Quick Menu – For Horizontal Keystone.	23
30.	EXIT	Return to last OSD page.	23
31.		Performs the same function as the right mouse button when the mouse mode is activated.	
32.	PgDn / 2	Perform page down function when mouse mode is activated. Number for Remote ID setting used.	
33.	PATTERN / 5	Displays embedded test pattern. Number for Remote ID setting used.	
34.	 / 7	Increase the volume level.. Number for Remote ID setting used.	22
35.	 / 8	Displays the HELP menu. Number for Remote ID setting used.	
36.		Decreases the volume level.	22
37.		Displays the digital zoom settings bar.	21
38.	COLOR MODE	Selects an available picture setup mode.	
39.	Wired Jack	Connect wire remote to the projector.	

## Remote control code

The projector can be assigned to 8 different remote control codes, 1 to 8. When several adjacent projectors are in operation at the same time, switching the remote control codes can prevent interference from other remote controls. Set the remote control code for the projector first before changing that for the remote control.

To switch the code for the projector, select from among 1 to 8 in the Basic > Advanced > Remote Control Code menu.



To switch the code for the remote control, press ID set and the corresponding button from 1 to 8 buttons on the remote control together for 5 seconds or more. The initial code is set to 1. When the code is switched to 8, the remote control can control every projector.

**Note:**

If different codes are set on the projector and remote control, there will be no response from the remote control. When that happens, switch the code for the remote control again.

## Using the remote mouse control

The capability of operating your computer with the remote control gives you more flexibility when delivering presentations.

1. Connect the projector to your PC or notebook with a USB cable prior to using the remote control in place of your computer's mouse.
2. Set the input signal to COMPUTER.
3. Press Mouse on the remote control to switch from the normal mode to the mouse mode. An icon appears on the screen to indicate the activation of the mouse mode.
4. Perform the desired mouse controls on your remote control.
  - To move the cursor on the screen, press ▲ / ▼ / ◀ / ▶ /  .
  - To left-click, press  .
  - To right-click, press  .
  - To operate your display software program (on a connected PC) which responds to page up/down commands (like Microsoft PowerPoint), press Page Up/Page Down.
  - To return to the normal mode, press Mouse again or other keys except for the mouse related multi-function keys.

## Remote Control Operating Range

The remote control uses infrared transmission to control the projector. It is not necessary to point the remote directly at the projector. Provided you are not holding the remote perpendicular to the sides or the rear of the projector, the remote will function well within a radius of about 7 meters (23 feet) and 15 degrees above or below the projector level. If the projector does not respond to the remote control, move a little closer.

## Projector and Remote Control Buttons

The projector can be operated using the remote control or the buttons on the top of the projector. All operations can be carried out with the remote control; however, the buttons on the projector are limited in use.

### Inserting the Remote Control Batteries

1. Remove the battery compartment cover by sliding the cover in the direction of the arrow.

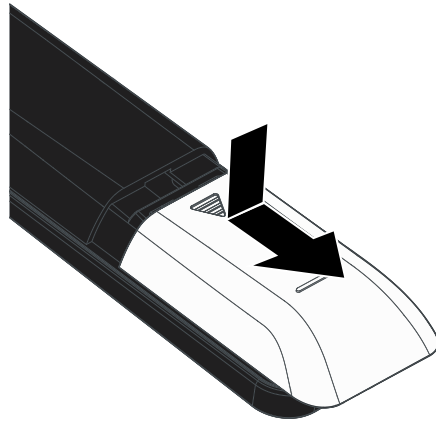

2. Insert the battery with the positive side facing up.

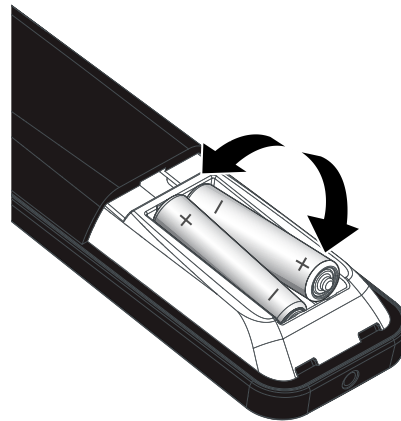

3. Replace the cover.

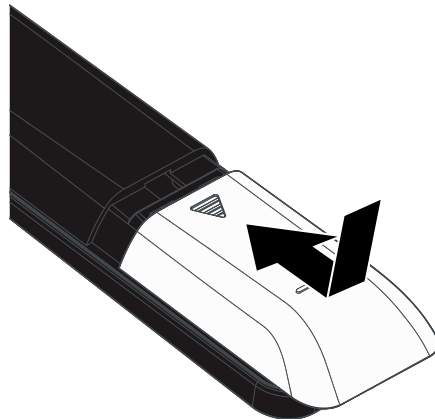

**Caution:**



1. Only use AAA batteries (Alkaline batteries are recommended).
2. Dispose of used batteries according to local ordinance regulations.
3. Remove the batteries when not using the projector for prolonged periods.

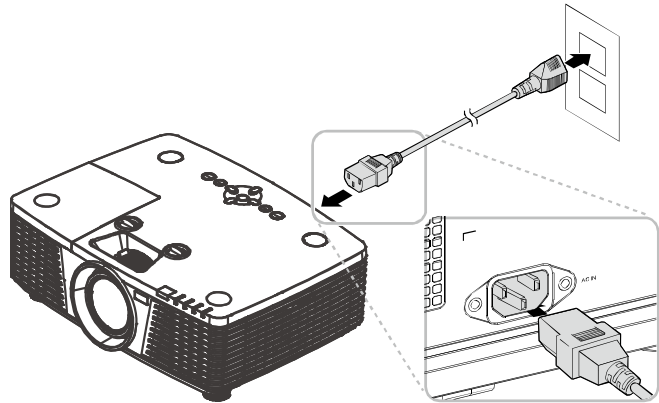

## Starting and Shutting down the Projector

1. Securely connect the power cord and signal cable. When connected, the power led will flash green to solid green.



2. Turn on the lamp by pressing “” button on the top of the projector or “” on the remote control. The PWR LED will now flash green. The startup screen will display in approximately 30 seconds. The first time you use the projector, you can select your preferred language from quick menu after the startup screen display. (See Setting the OSD Language on page 24)

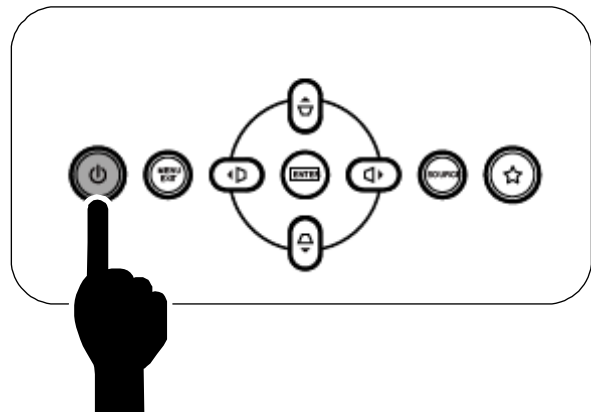

See Setting an Access Password (Security Lock) on page 14 if security lock is enabled.

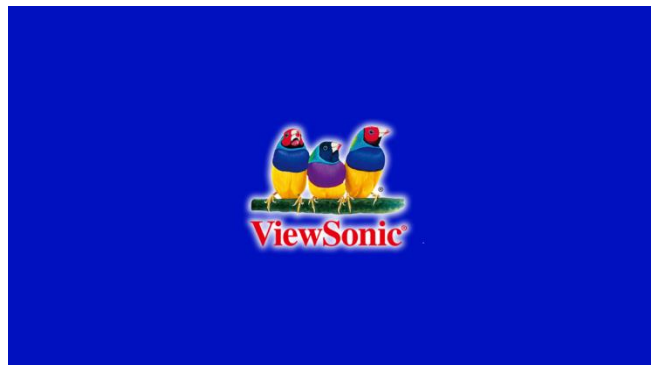

3. If more than one input device is connected, press the **SOURCE** button and use ▲▼ to scroll among devices.

(Component is supported through the RGB to Component adapter.)

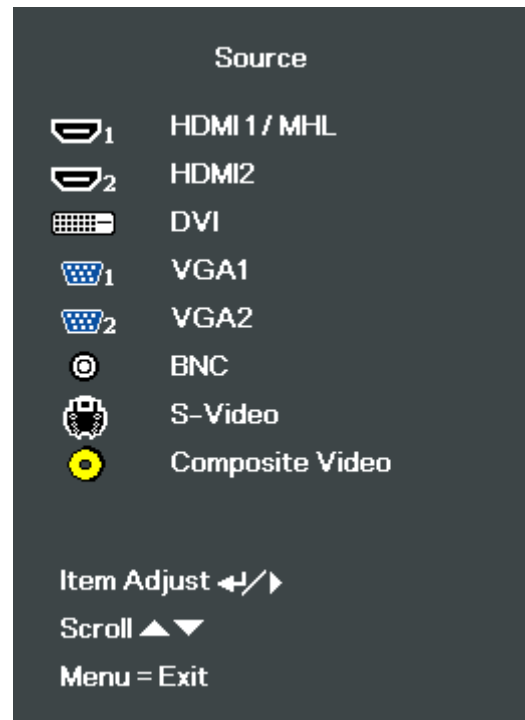

- HDMI 1 / MHL: High-Definition Multimedia Interface and Mobile High-Definition Link compatible
- HDMI 2: High-Definition Multimedia Interface compatible
- DVI: DVI
- VGA 1 / 2: Analog RGB  
DVD input YCbCr/ YPbPr, or HDTV input YPbPr via D-sub connector
- BNC: Analog RGB
- S-Video: Super video (Y/C separated)
- Composite Video: Traditional composite video

4. When the “Power Off? /Press **Power** again” message appears, press the **POWER** button. The projector turns off.

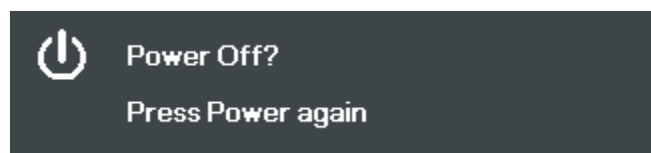

**Caution:**

Do not unplug the power cord until the POWER LED stops flashing – indicating the projector has cooled down.

## Setting an Access Password (Security Lock)

You can use the four (arrow) buttons to set a password and prevent unauthorized use of the projector. When enabled, the password must be entered after you power on the projector. (See Navigating the OSD on page 23 and Setting the OSD Language on page 24 for help on using OSD menus.)

### Important:

Keep the password in a safe place. Without the password, you will not be able to use the projector. If you lose the password, contact your reseller for information on clearing the password.

1. Press the **MENU** button to open the OSD menu.

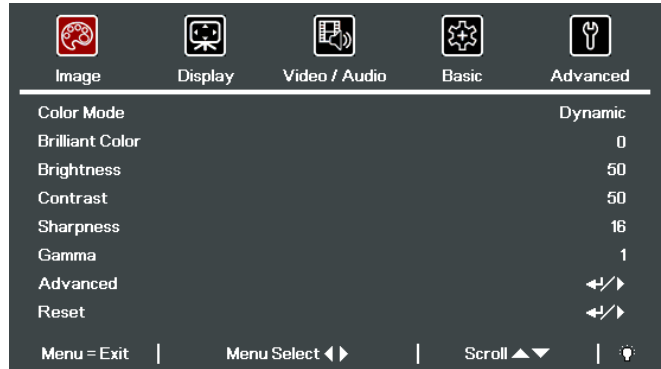

2. Press the cursor **◀▶** button to move to the **Basic** menu.

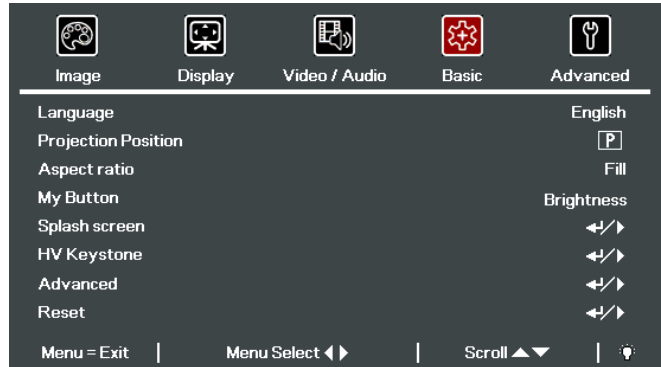

3. Press the cursor **▲▼** button to select **Advanced**.

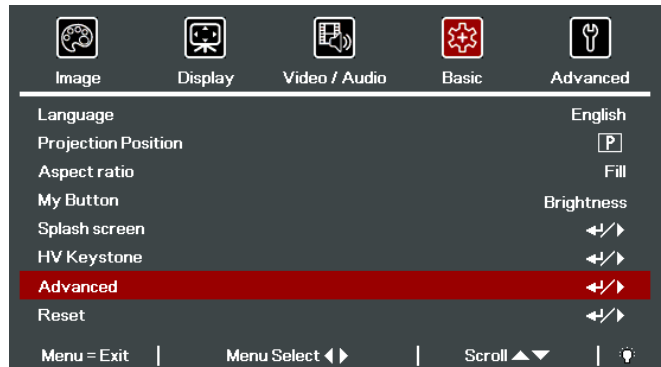

4. Press the cursor ▲▼ button to select **Security Lock**.

5. Press the cursor ◀▶ button to enable or disable security lock function.

A password dialog box automatically appears.

6. You can use the cursor buttons ▲▼◀▶

on IR remote control for password entry. You can use any combination including the same arrow five times, but not less than five.

Press the cursor buttons in any order to set the password. Push the **MENU** button to exit the dialog box.

7. The password confirm menu appears when user presses the power-on key in case the **Security Lock** is enabled. Enter the password in the order you set it at step 6. In case you forget the password, please contact the service center. Service center will validate the owner and help reset the password.

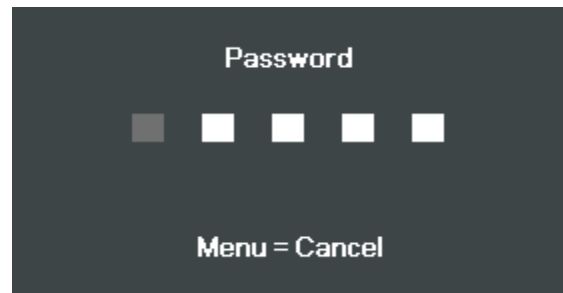
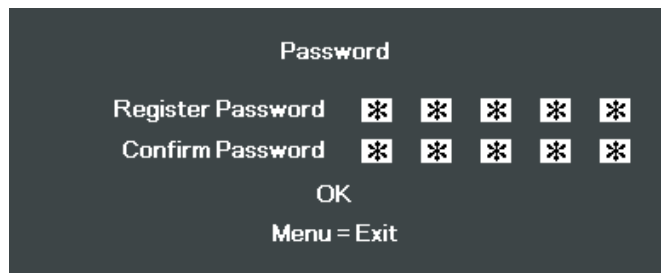
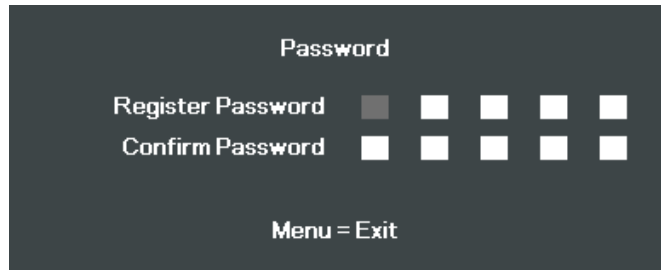
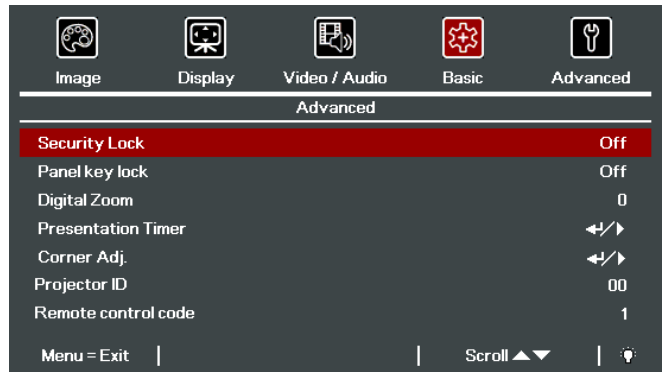

## Adjusting the Projector Level

Take note of the following when setting up the projector:

- The projector table or stand should be level and sturdy.
- Position the projector so that it is perpendicular to the screen.
- Ensure the cables are in a safe location. You could trip over them.

- 1.** To raise the level of the projector, twist the adjusters counter clockwise.

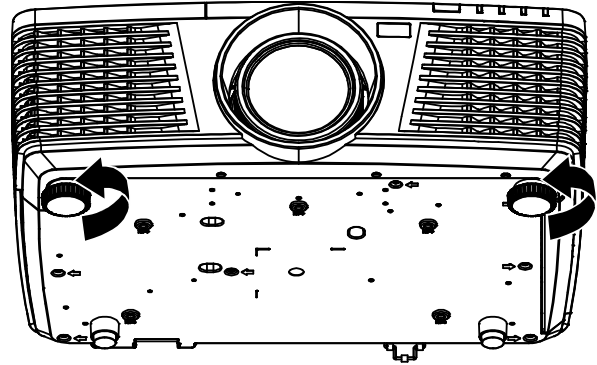

- 2.** To lower the level of the projector, lift the projector and twist the adjusters clockwise.

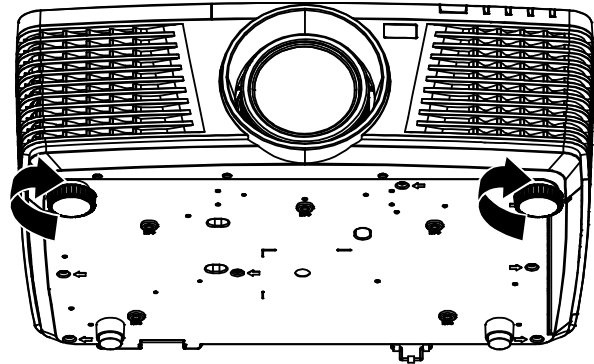

## Adjusting Projected Image Position Using Lens Shift

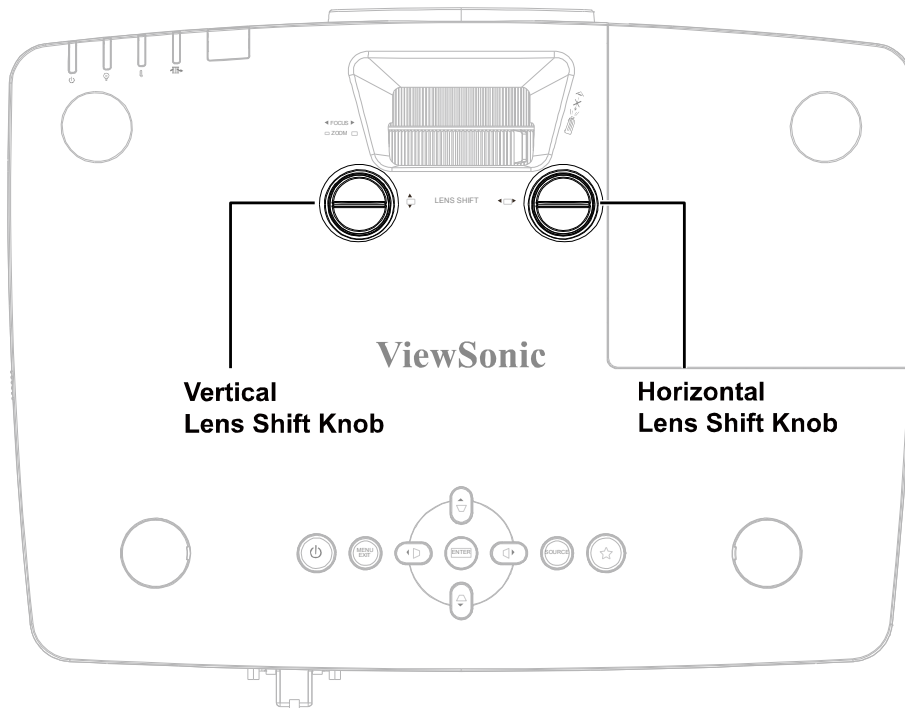

The Lens Shift feature provides a lens shift function that can be used to adjust the position of the projected image either horizontally or vertically within the range detailed below.

**Note:**

Do not rotate lens shift knob further under click sound and lightly press the knob to rotate back.

## Adjusting the vertical image position

The vertical image height can be adjusted between 141.2% and 104.65% for WXGA, 115.35% and 101.85% for XGA, 146.7% and 104.5% for 1080P, 132% and 99.1% for WUXGA of image height. Note that the maximum vertical image height adjustment can be limited by the horizontal image position. For example it is not possible to achieve the maximum vertical image position height detailed above if the horizontal image position is at maximum.

### PRO9520WL

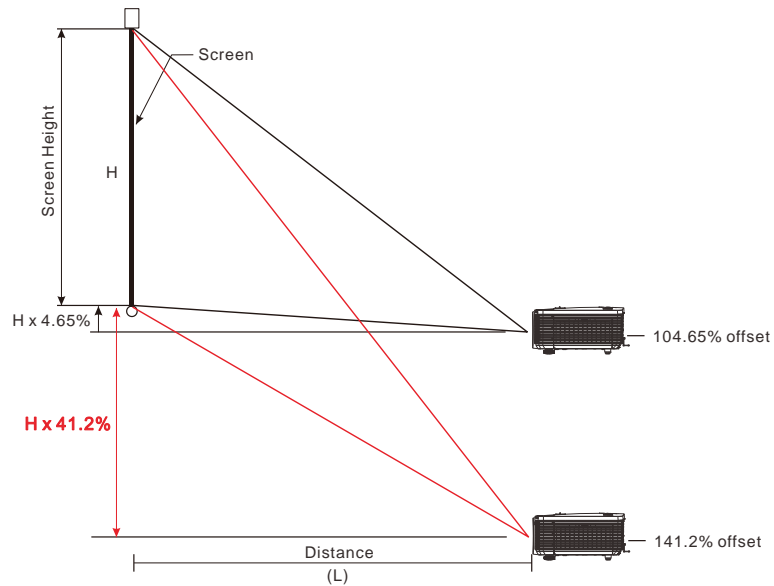

### PRO9510L

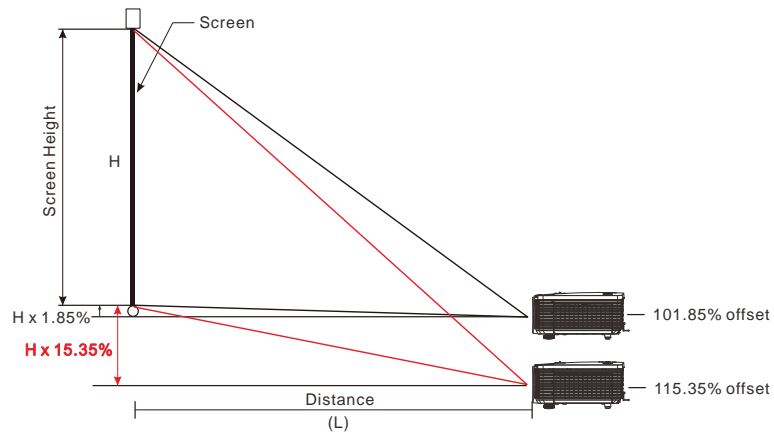

# PRO9530HDL

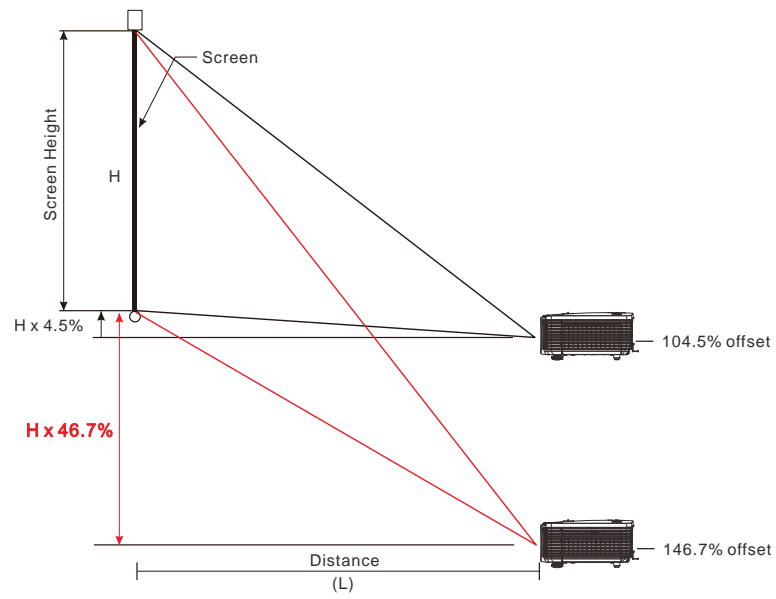

# PRO9800WUL

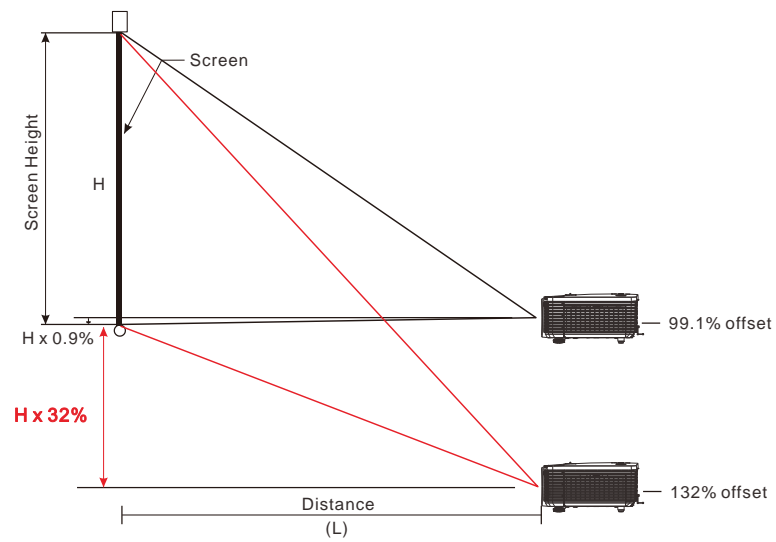



## Adjusting the horizontal image position

With the lens in the center position the horizontal image position can be adjusted to the left or right by up to a maximum of 10.9% for WXGA, 3.8% for XGA, 10.3% for 1080P, 10.3% for WUXGA of the image width. Note that the maximum horizontal image height adjustment can be limited by the vertical image position. For example it is not possible to achieve the maximum horizontal image position if the vertical image position is at maximum.

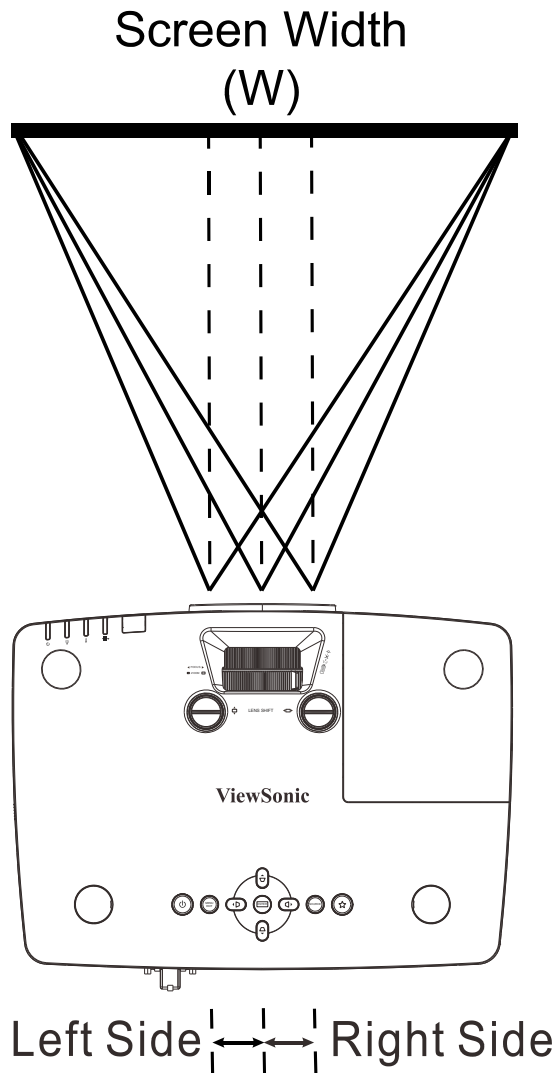

PRO9520WL	Wx10.9%	Wx10.9%
PRO9510L	Wx3.8%	Wx3.8%
PRO9530HDL	Wx10.3%	Wx10.3%
PRO9800WUL	Wx10.3%	Wx10.3%

## Adjusting the Zoom, Focus and Keystone

1. Use the **Image-zoom** control (on the projector only) to resize the projected image and screen size.

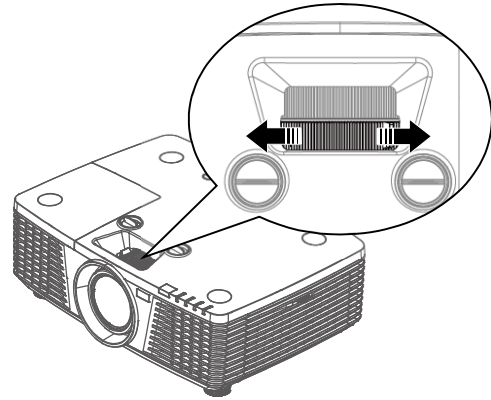

2. Use the **Image-focus** control (on the projector only) to sharpen the projected image.

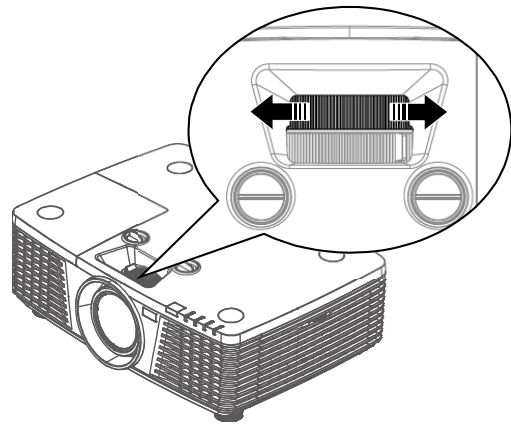

3. Press the **▲ / ▼ / ◀ / ▶** buttons (on the projector or the remote control) to correct vertical or horizontal image-trapezoid .

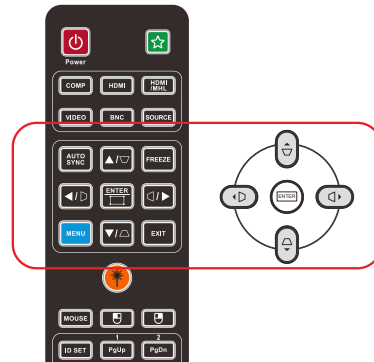

Remote control and OSD panel

4. The keystone control appears on the display.  
 Press **▲ / ▼** for V Keystone correcting image.  
 Press **◀ / ▶** for H Keystone correcting image.

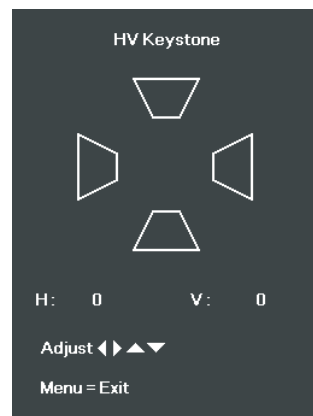





## Adjusting the Volume

8. Press the  /  buttons on the remote control.

The volume control appears on the display.



9. Press the  /  buttons on the remote control or  /  buttons on the keypad to adjust **Volume +/-**.



10. Press the  button to turn off the volume (This feature is available only on the remote).

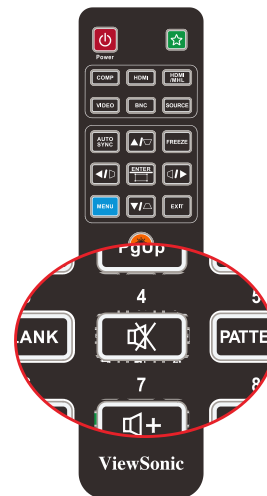

# ON-SCREEN DISPLAY (OSD) MENU SETTINGS

## OSD Menu Controls

The projector has an OSD that lets you make image adjustments and change various settings.

## Navigating the OSD

You can use the remote control cursor buttons or the buttons on the top of the projector to navigate and make changes to the OSD. The following illustration shows the corresponding buttons on the projector.

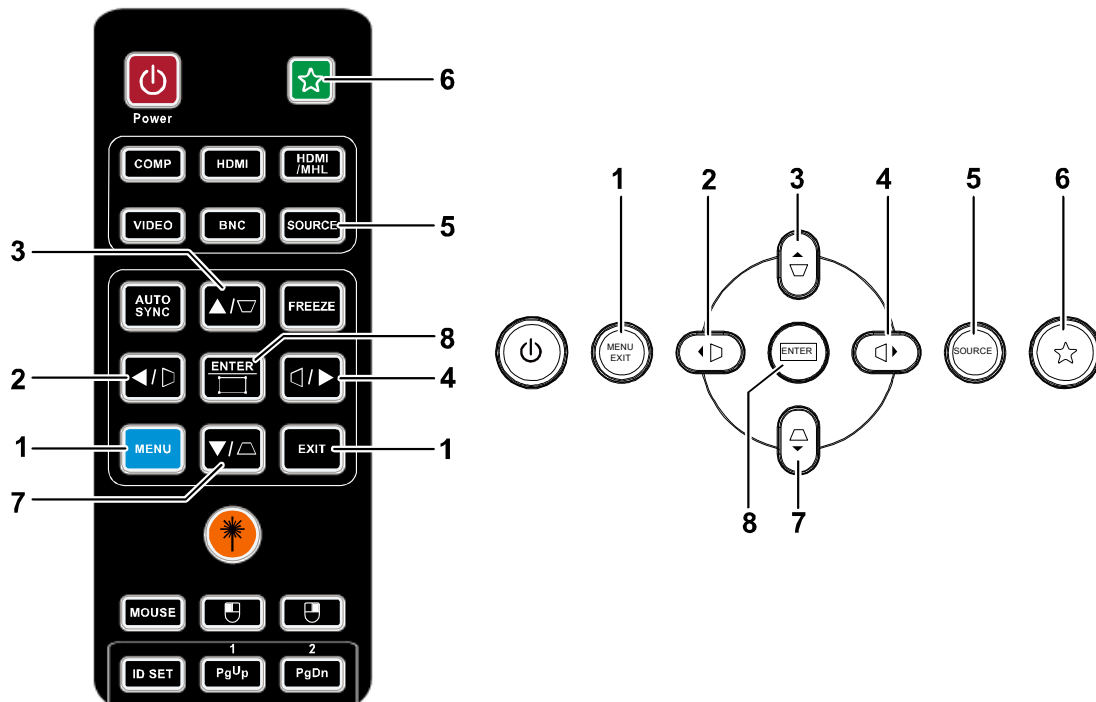

1. To enter the OSD, press the **MENU** button.
2. There are five menus. Press the cursor ◀ / ▶ buttons to move through the menus.
3. Press the cursor ▲ / ▼ buttons to move up and down in a menu.
4. Press the cursor ◀ / ▶ buttons to change values for settings.
5. Press the **MENU** button to close the OSD or leave a submenu. Press the **EXIT** button to return to the previous menu.

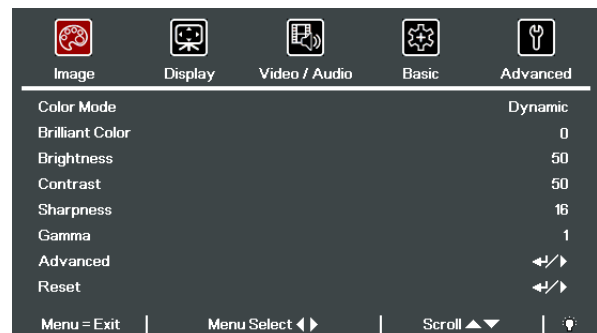

### Note:

Depending on the video source, not all items in the OSD are available. For example, the **Horizontal/Vertical Position** items in the **Display** menu can only be modified when connected to a PC. Items that are not available cannot be accessed and are grayed out.

## Setting the OSD Language

Set the OSD language to your preference before continuing.

1. Press the **MENU** button. Press the cursor ◀▶ button to navigate to **Basic**.

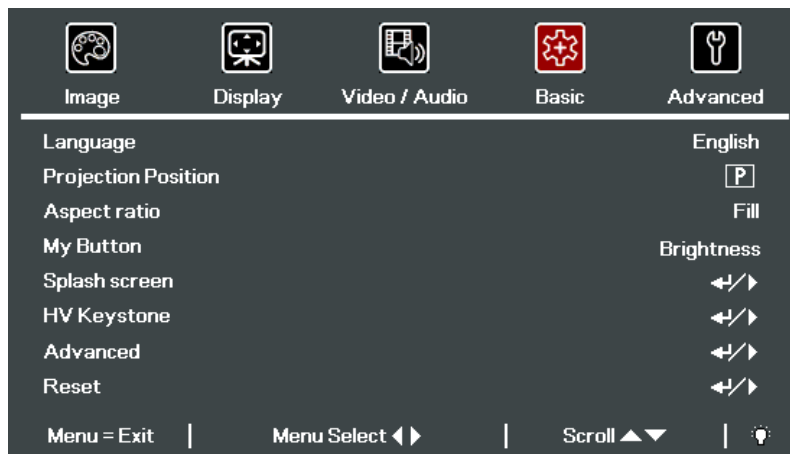

2. Press the cursor ▲▼ button until **Language** is highlighted.

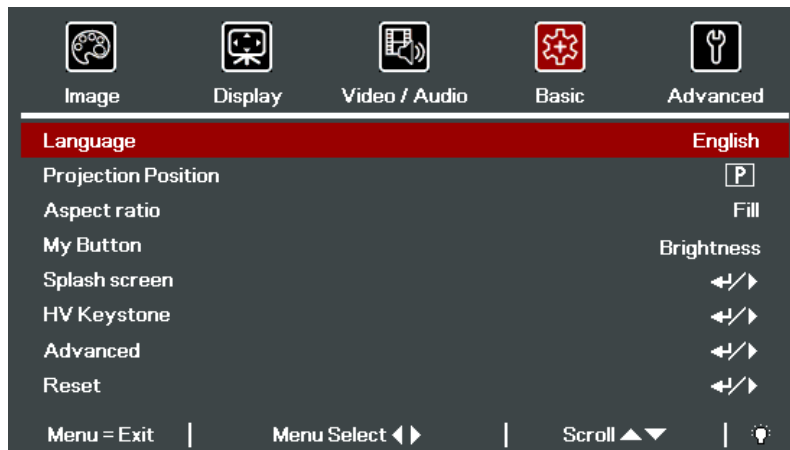

3. Press the cursor ◀▶ button until the language you want is highlighted.
4. Press the **MENU** button twice to close the OSD.

## OSD Menu Overview

Use the following illustration to quickly find a setting or determine the range for a setting.

MAIN MENU	SUB MENU	SETTINGS		
Image	Color Mode	Brightest, Dynamic, Standard, ViewMatch sRGB, Movie, DICOM SIM, User		
	Brilliant Color	0~10		
	Brightness	0~100		
	Contrast	0~100		
	Sharpness	0~31		
	Gamma	1 ~ 13 , DICOM SIM & sRGB		
	Advanced	Color Temperature	Warm, Normal, Cool	
		Color Management	Red	Hue, Saturation, Gain
			Green	Hue, Saturation, Gain
			Blue	Hue, Saturation, Gain
			Cyan	Hue, Saturation, Gain
			Magenta	Hue, Saturation, Gain
			Yellow	Hue, Saturation, Gain
			White	Red, Green, Blue
		White Balance	R Gain	0 ~ 200
G Gain			0 ~ 200	
B Gain	0 ~ 200			
R Offset	-100 ~ 100			
G Offset	-100 ~ 100			
B Offset	-100 ~ 100			
Reset				
Display	Horizontal Position	-5~5		
	Vertical Position	-5~5		
	Frequency	0~31		
	Tracking	-5~5		
	Auto			
Video / Audio	AGC	Off, On		
	Saturation	0~100		
	Tint	0~100		
	Overscan	Off, 1, 2, 3, 4, 5		
	Closed Caption	Off, On		
	Audio	Volume	0~10	
		Mute	Off, On	
		Active audio Out	Off, Mini, RCA	
Reset				

MAIN MENU	SUB MENU	SETTINGS		
Basic	Language	English, Français, Español, Português, 简体中文, 繁體中文, Italiano, Svenska, Nederlands, Русский, Suomi, 한국어, العربية, Türkçe, 日本語, Polski, Português do Brasil, Ағылшын, Việt, Dansk, Deutsch, Norsk, Ελληνικά, Magyar, Čeština, ភាសាខ្មែរ		
	Projection Position	Front, Rear, Ceiling, Rear+ Ceiling		
	Aspect Ratio	Fill, 4:3, 16:9, Letter Box, Native		
	My Button	Brightness, Contrast, Color Mode, Color Temperature, High Altitude, Closed Caption, Low Power Mode, Quick Auto Search, Panel key lock, Splash screen, Screen Capture, Auto, 3D, Status, OSD Message, Projection Position.		
	Splash Screen	Pattern	Off, Test Card, Note Pad, World map, Stave, Trellis chart	
		Splash screen	ViewSonic, Off, Red, Green, Blue, User	
		Screen Capture		
	HV Keystone		H: -25 ~ +25 V: -30 ~ +30	
	Advanced	Security Lock	Off ,On	
		Panel key lock	Off ,On	
		Digital Zoom	-10~10	
		Presentation Timer	Timer	Off ,On
			Preset Time	1-60
			Timer Reset	
		Corner Adj.		H: 0~60 V:0~60
		Projector ID		0~98
	Remote Control Code		1~8	
Reset				

MAIN MENU	SUB MENU	SETTINGS		
Advanced	Quick Auto Search	Off, On		
	Auto Power Off (min.)	0~180		
	Direct Power On	Off, On		
	High Altitude	Normal, High Altitude		
	Lamp Mode	ECO., Normal, Dynamic Eco		
	Advanced	OSD Menu Setting	Menu Position	Center, Down, Up, Left, Right
			Translucent Menu	0%, 25%, 50%, 75%, 100%
			Menu Display	10~20
		Air Filter Timer Reset		
		Lamp Hour Reset		
		Low Power Mode	Off, On, On By Lan	
		Sleep Timer (min)	0~120	
		3D	3D	Off, DLP-Link, IR
			3D Sync Invert	On, Off
			3D Format	Frame Sequential, Top/Bottom, Side-By-Side, Frame Packing (3D Frame Packing HDMI source only)
		Network Setting	Network State	Disconnect, Connect
			DHCP	Off, On
			IP Address	0~255, 0~255, 0~255, 0~255
	Subnet Mask		0~255, 0~255, 0~255, 0~255	
Gateway	0~255, 0~255, 0~255, 0~255			
DNS	0~255, 0~255, 0~255, 0~255			
Apply	Cancel, OK			
Reset All				
Status	Active Source			
	Video Information			
	Lamp Time (Eco, Normal, Dynamic Eco)			
	Software Version			
	Serial Number			
	Air Filter Hour			



## Image Menu

Press the **MENU** button to open the **OSD** menu. Press the cursor ◀▶ button to move to the **Image Menu**. Press the cursor ▲▼ button to move up and down in the **Image** menu. Press ◀▶ to change values for settings.

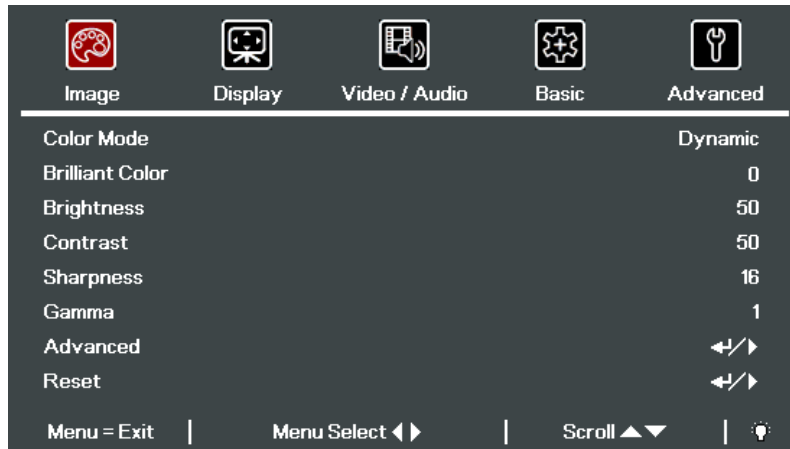

ITEM	DESCRIPTION
Color Mode	Press the cursor ◀▶ button to set the Color Mode.
Brilliant Color	Press the cursor ◀▶ button to adjust the Brilliant Color value.
Brightness	Press the cursor ◀▶ button to adjust the display brightness.
Contrast	Press the cursor ◀▶ button to adjust the display contrast.
Sharpness	Press the cursor ◀▶ button to adjust the display sharpness level.
Gamma	Press the cursor ◀▶ button to adjust the gamma correction of the display.
Advanced	Press ◀ (Enter) / ▶ to enter the Advanced menu. See Advanced Feature on page 29.
Reset	Press ◀ (Enter) / ▶ to reset all settings to default values.

## Advanced Feature

Press the **Menu** button to open the **OSD** menu. Press ◀▶ to move to the **Image** menu. Press ▼▲ to move to the **Advanced** menu and then press ⏏ (Enter) or ▶. Press ▼▲ to move up and down in the **Advanced** menu.

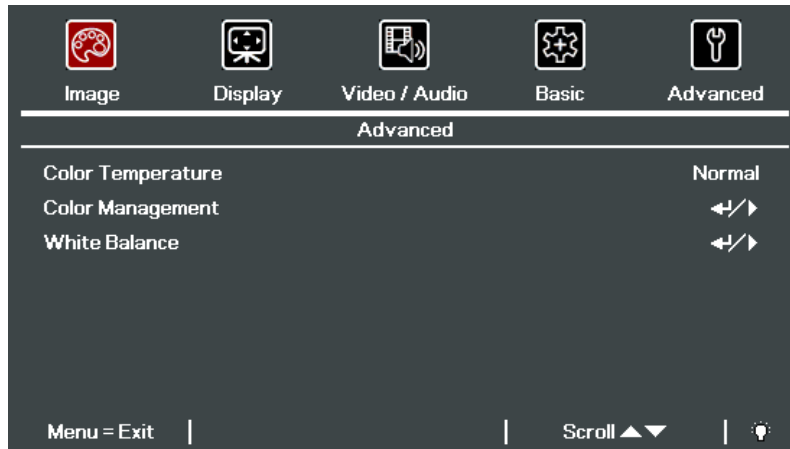

ITEM	DESCRIPTION
Color Temperature	Press the cursor ◀▶ button to adjust the color temperature.
Color Management	Press ⏏ (Enter) / ▶ to enter the color manager menu. See page 30 for more information on Color Management.
White Balance	Press ⏏ (Enter) / ▶ button to enter the <b>White Balance</b> sub menu. See White Balance on page 31.

## Color Management

Press **↵** (Enter) / **▶** to enter the **Color Manager** sub menu.

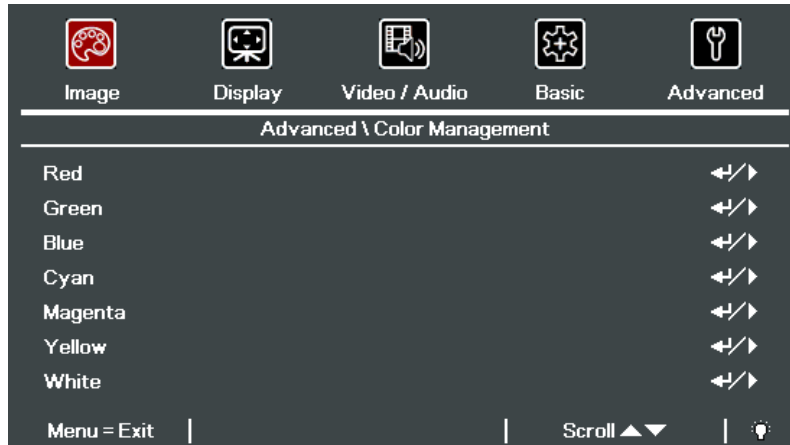

ITEM	DESCRIPTION
Red	Select to enter the Red Color Manager. Press the ◀▶ buttons to adjust the Hue, Saturation, and Gain.
Green	Select to enter the Green Color Manager. Press the ◀▶ buttons to adjust the Hue, Saturation, and Gain.
Blue	Select to enter the Blue Color Manager. Press the ◀▶ buttons to adjust the Hue, Saturation, and Gain.
Cyan	Select to enter the Cyan Color Manager. Press the ◀▶ buttons to adjust the Hue, Saturation, and Gain.
Magenta	Select to enter the Magenta Color Manager. Press the ◀▶ buttons to adjust the Hue, Saturation, and Gain.
Yellow	Select to enter the Yellow Color Manager. Press the ◀▶ buttons to adjust the Hue, Saturation, and Gain.
White	Select to enter the White Color Manager. Press the ◀▶ buttons to adjust the Red, Green, and Blue.

## White Balance

Press the ◀ (Enter) / ▶ button to enter the **White Balance** sub menu.

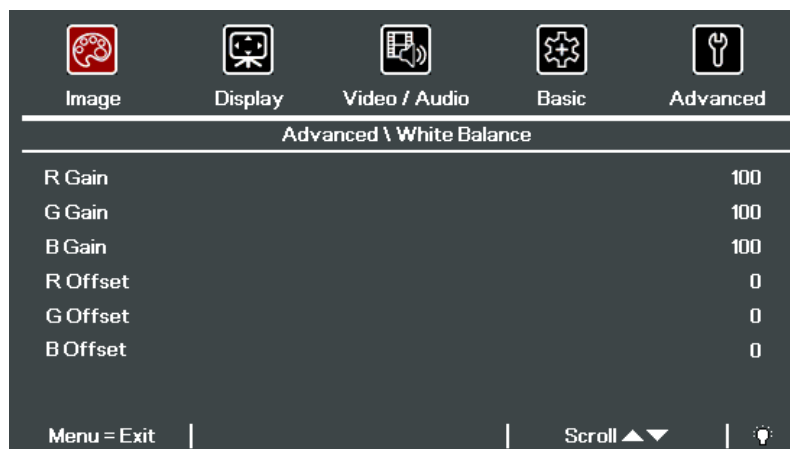

ITEM	DESCRIPTION
R Gain	Press the ◀▶ buttons to adjust the Red Gain.
G Gain	Press the ◀▶ buttons to adjust the Green Gain.
B Gain	Press the ◀▶ buttons to adjust the Blue Gain.
R Offset	Press the ◀▶ buttons to adjust the Red Offset.
G Offset	Press the ◀▶ buttons to adjust the Green Offset.
B Offset	Press the ◀▶ buttons to adjust the Blue Offset.

## Display Menu

Press the **MENU** button to open the **OSD** menu. Press the cursor ◀▶ button to move to the **Display** menu. Press the cursor ▲▼ button to move up and down in the **Display** menu. Press ◀▶ to change values for settings.

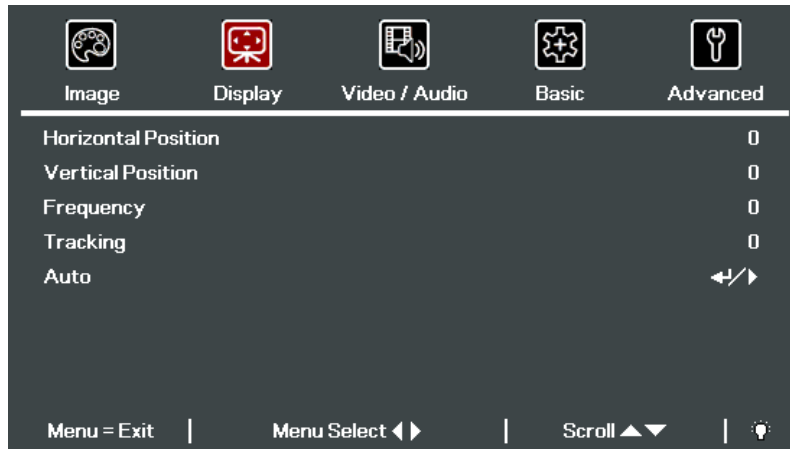

ITEM	DESCRIPTION
Horizontal Position	Press the cursor ◀▶ button to adjust the display position to left or right.
Vertical Position	Press the cursor ◀▶ button to adjust the display position to up or down.
Frequency	Press the cursor ◀▶ button to adjust the A/D sampling clock.
Tracking	Press the cursor ◀▶ button to adjust the A/D sampling dot.
Auto	Press ◀ (Enter) / ▶ to automatically adjustment for frequency, tracking and position.

## Video/Audio Menu

Press the **MENU** button to open the **OSD** menu. Press the cursor **◀▶** button to move to the **Video/Audio** menu. Press the cursor **▲▼** button to move up and down in the **Video/Audio** menu. Press **◀▶** to change values for settings.

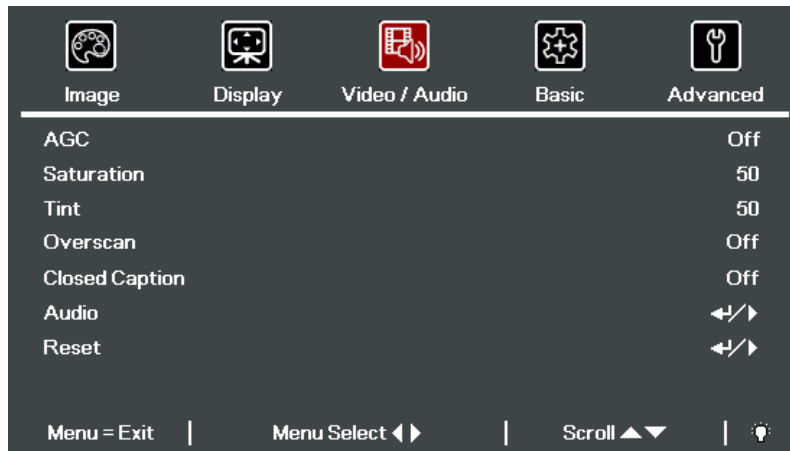

ITEM	DESCRIPTION
AGC	Press the <b>◀▶</b> buttons to enable or disable the Automatic Gain Control for video source.
Saturation	Press the <b>◀▶</b> buttons to adjust the video saturation.
Tint	Press the <b>◀▶</b> buttons to adjust the video tint/hue.
Overscan	Press the <b>◀▶</b> buttons to enable or disable video over scan.
Closed Caption	Press the <b>◀▶</b> buttons to enable or disable closed caption.
Audio	Press <b>↵</b> (Enter) / <b>▶</b> to enter the Audio menu. See Audio on page 34.
Reset	Press <b>↵</b> (Enter) / <b>▶</b> to reset all settings to default values.

## Audio

Press **↵** (Enter) / **▶** to enter the **Audio** sub menu.

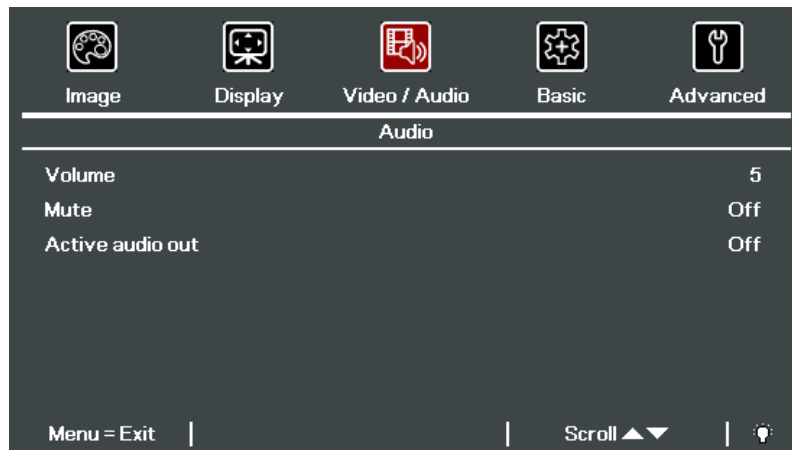

ITEM	DESCRIPTION
Volume	Press the ◀▶ buttons to enter and adjust the audio volume.
Mute	Press the ◀▶ buttons to enter and turn on or off the speaker.
Active audio out	Press the ◀▶ buttons to select audio output connector. <b>Note:</b> When select Off, the default sound is output from speakers.

## Basic Menu

Press the **MENU** button to open the **OSD** menu. Press the cursor ◀▶ button to move to the **Basic** menu. Press the cursor ▲▼ button to move up and down in the **Basic** menu. Press ◀▶ to change values for settings.

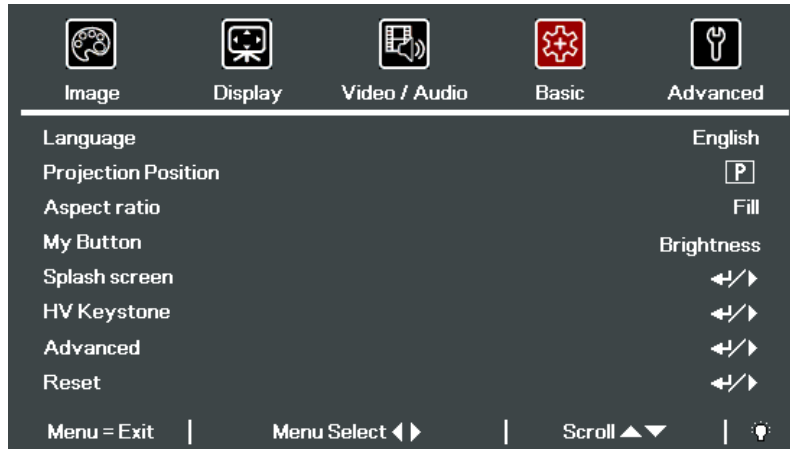

ITEM	DESCRIPTION
Language	Press the cursor ◀▶ button to select a different localization Menu.
Projection Position	Press the cursor ◀▶ button to select different projection.
Aspect ratio	Press the cursor ◀▶ button to adjust the video aspect ratio.
My Button	Press the cursor ◀▶ button to select hot key function.
Splash screen	Press ◀ (Enter) / ▶ to enter the Splash screen menu.
HV Keystone	Press the cursor ◀▶ button to adjust the display keystone.
Advanced	Press ◀ (Enter) / ▶ to the Advanced menu. See Advanced Feature on page 37.
Reset	Press ◀ (Enter) / ▶ to reset all settings to default values (except Language).



## Splash screen

Press **↵** (Enter) / **▶** to enter the **Logo** sub menu.

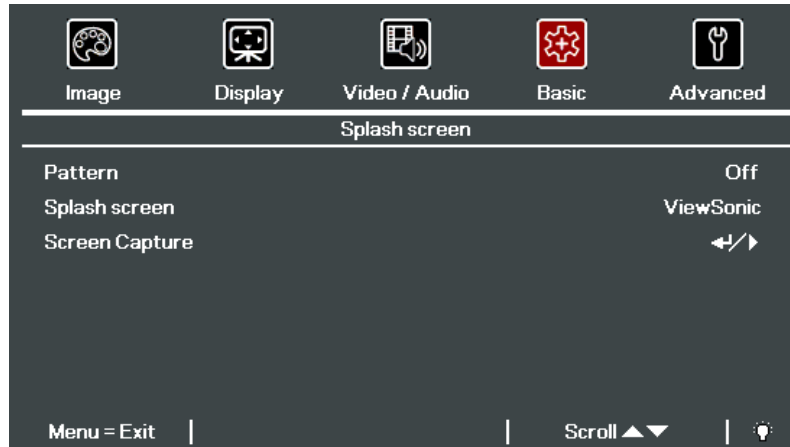

ITEM	DESCRIPTION
Pattern	Press the <b>◀▶</b> buttons to select different Pattern
Splash screen	Press the <b>◀▶</b> buttons to choose start up Logo.
Screen Capture	Press <b>↵</b> (Enter) / <b>▶</b> to capture screen on current display immediately.

## HV Keystone

Press the **Menu** button to open the **OSD** menu. Press **◀▶** to move to the **Basic** menu. Press **▼▲** to move to the **HV Keystone** menu and then press **↵** (Enter) / **▶**. Press **▼▲** to adjust vertical values from -30 to 30. Press **◀▶** to adjust horizontal values from -25 to 25.

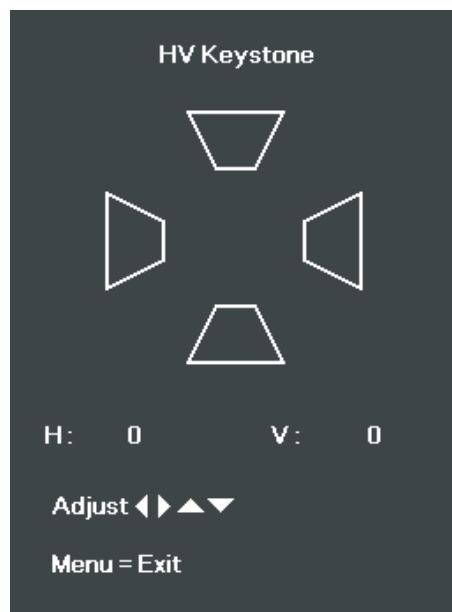

## Advanced Feature

Press the **Menu** button to open the **OSD** menu. Press ◀▶ to move to the **Basic** menu. Press ▲▼ to move to the **Advanced** menu and then press ◀ (Enter) or ▶. Press ▲▼ to move up and down in the **Advanced** menu. Press ◀▶ to change values for setting.

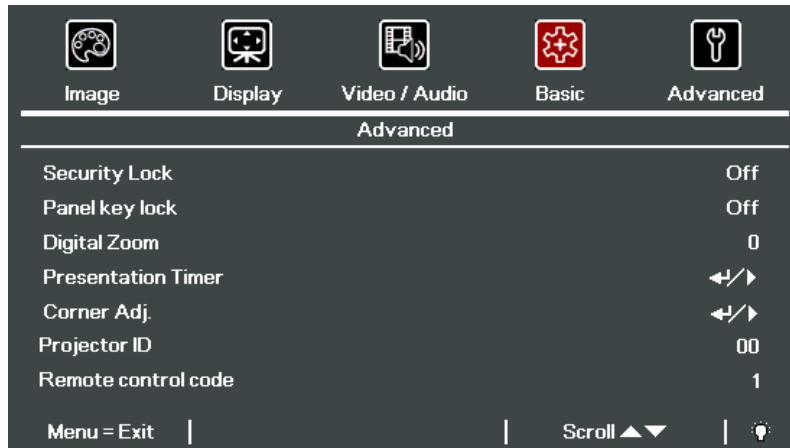

ITEM	DESCRIPTION
Security Lock	Press the cursor ◀▶ button to enable or disable security lock function.
Panel key lock	Press the cursor ◀▶ button to lock or unlock panel key.
Digital Zoom	Press the cursor ◀▶ button to adjust the Digital Zoom menu.
Presentation Timer	Press ◀ (Enter) / ▶ to go to the Presentation Timer Menu. See Presentation Timer on page 38.
Corner Adj.	Press ◀ (Enter) / ▶ to go to the Corner Adj. Menu. See Corner Adj. on page 39.
Projector ID	Press the cursor ◀▶ button to enter and adjust a two digit projector ID from 00 through 98.
Remote control code	Press the ◀▶ buttons to set the Remote control code. See Remote control code on page 9.

## Presentation Timer

The Presentation Timer function can indicate the presentation time on the screen to help you achieve better time management when giving presentations.



ITEM	DESCRIPTION
Timer	Press the cursor ◀▶ button to enable or disable presentation timer.
Preset Time	Press the cursor ◀▶ button to select Preset Time (1 ~ 60 minutes)
Timer Reset	Press ◀ (Enter) / ▶ to reset the timer settings.

## Corner Adj.

Press **↵** (Enter) / **▶** to enter the **Corner Adj.** sub menu.

1. Press the cursor **▲** / **▼** buttons to select a corner and press **ENTER**.

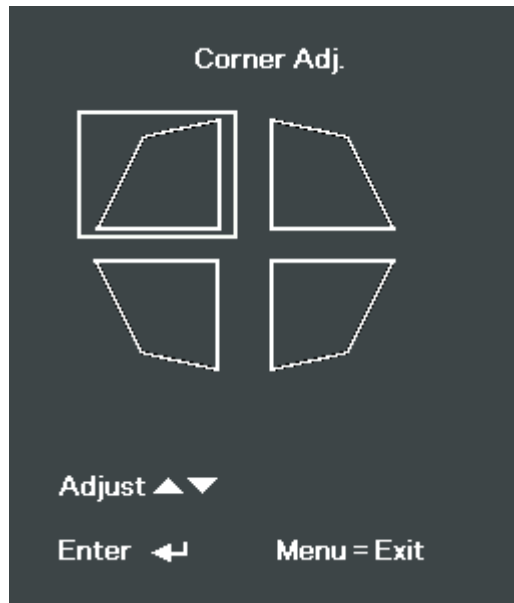

2. Press the cursor **▲** / **▼** buttons to adjust vertical and press the cursor **◀** / **▶** buttons to adjust horizontal.
3. Press **MENU** to save and Exit the settings.

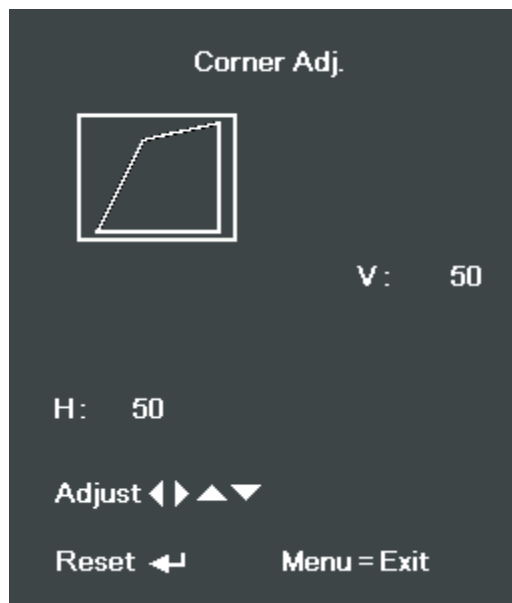

## Advanced Menu

Press the **MENU** button to open the **OSD** menu. Press the cursor ◀▶ button to move to the **Advanced** menu. Press the cursor ▲▼ button to move up and down in the **Advanced** menu.

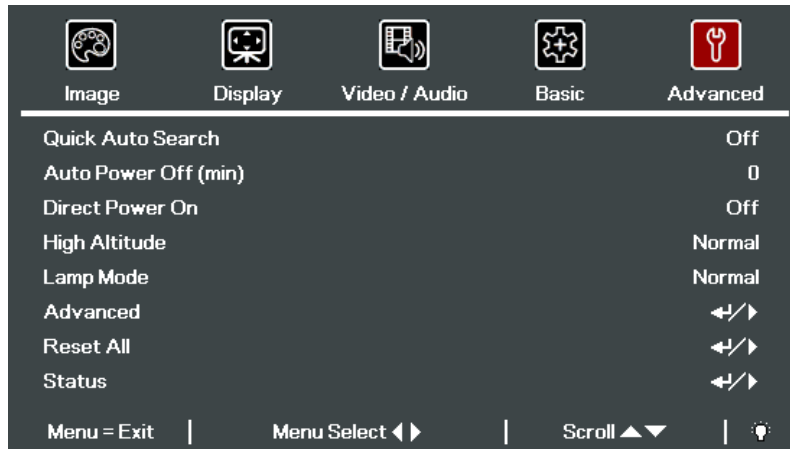

ITEM	DESCRIPTION
Quick Auto Search	Press the cursor ◀▶ button to enable or disable automatic source detection.
Auto Power Off (min.)	Press the cursor ◀▶ button to enable or disable automatic shutdown of lamp when no signal.
Direct Power On	Press the cursor ◀▶ button to enable or disable automatic power On when AC power is supplied.
High Altitude	Press the cursor ◀▶ button to toggle between Normal and High fan speeds. <b>Note:</b> Recommend selecting high speed when the altitude of the environment is higher than 1500m ( 4921ft )
Lamp Mode	Press the cursor ◀▶ button to select the lamp mode for higher brightness or lower brightness to save lamp life.
Advanced	Press ◀ (Enter) / ▶ to enter the Advanced menu. See Advanced Feature on page 41.
Reset All	Press ◀ (Enter) / ▶ to reset all items to factory preset values.
Status	Press ◀ (Enter) / ▶ to enter the Status menu. See page 54 for more information on Status.

**Note :**

**Dynamic ECO:** Auto power consumption saving according to your dynamic content (30% Max saving on blank screen).

**Extreme Dimming:** Saving 50% lamp power consumption by blank screen (press BLANK button)

## Advanced Feature

Press the **Menu** button to open the **OSD** menu. Press ◀▶ to move to the **Advanced** menu. Press ▲▼ to move to the **Advanced** menu and then press ◀ (Enter) or ▶. Press ▲▼ to move up and down in the **Advanced** menu. Press ◀▶ to change values for setting.

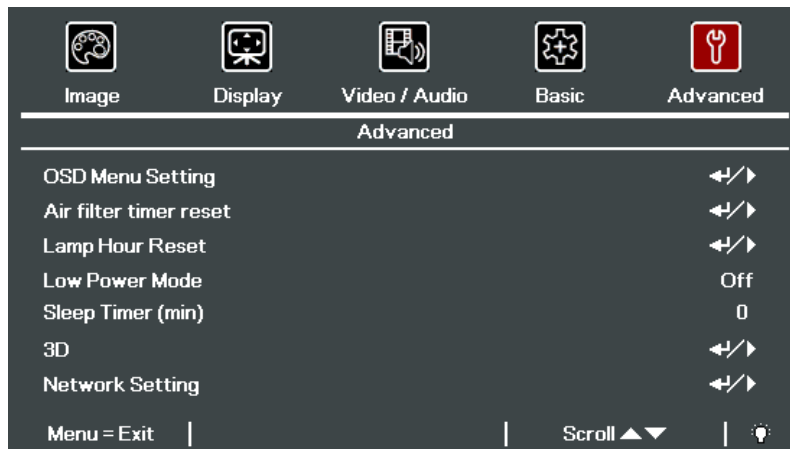

ITEM	DESCRIPTION
OSD Menu Setting	Press ◀ (Enter) / ▶ to enter the OSD setting menu. See page 42 for more information on OSD Menu Setting.
Air filter timer reset	Press ◀ (Enter) / ▶ to reset Air filter timer.
Lamp Hour Reset	After replacing the lamp, this item should be reset. See page 42 for more information on Lamp Hour Reset.
Low Power Mode	Press ◀▶ to turn Low Power Mode Off, On or On by Lan.
Sleep Timer (min)	Press the cursor ◀▶ button to select the Sleep Timer.
3D	Press ◀ (Enter) / ▶ to enter the 3D menu. See page 43 for more information on 3D settings.
Network setting	Press ◀ (Enter) / ▶ to enter the Network menu. See page 43 for more information on Network Setting.

**Note:**

About “**On By Lan**”, RJ45 will support to be waked up in this mode(Under 6W) but scalar won't.

**Note:**

To enjoy the 3D function, first enable the Play Movie in 3D setting found in your DVD device under the 3D Disc Menu.

To enjoy Network function on Low Power Stand-By, Please let Low Power Mode set On, and RS232 set Network.

## OSD Menu Setting

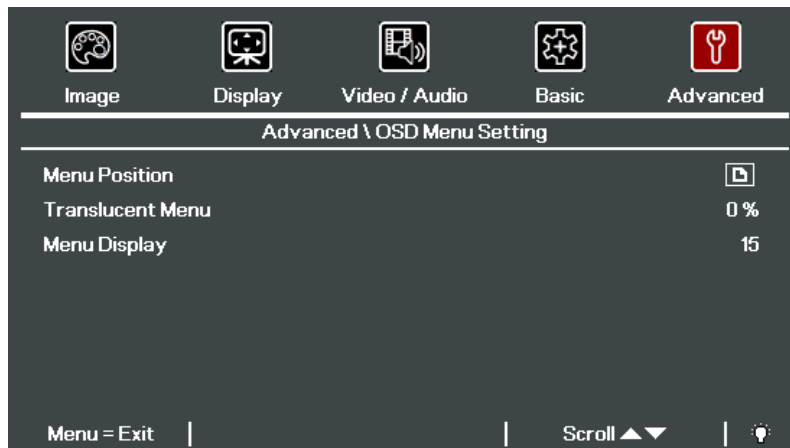

ITEM	DESCRIPTION
Menu Position	Press ◀▶ button to select different OSD location.
Translucent Menu	Press ◀▶ button to select OSD background translucent level.
Menu Display	Press ◀▶ button to select OSD timeout delay.

## Lamp Hour Reset

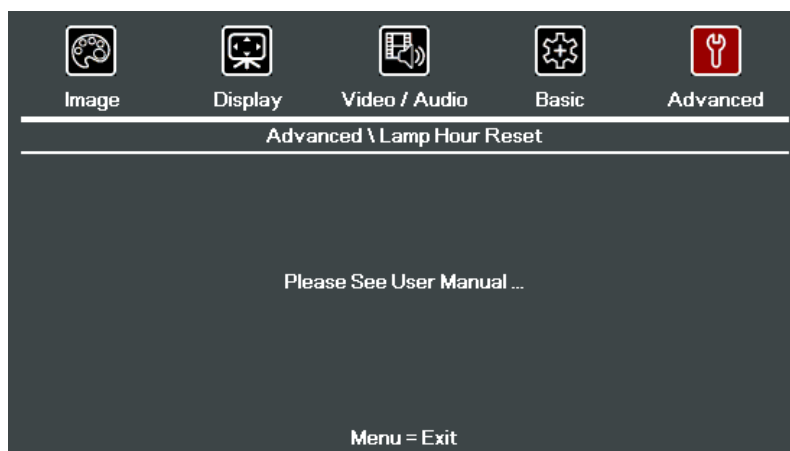

Please refer to Resetting the Lamp Time on page 58 to reset the lamp hour counter.

## 3D

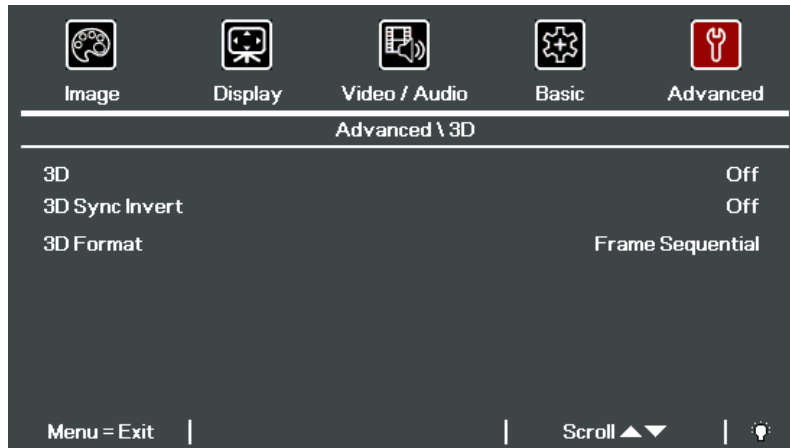

ITEM	DESCRIPTION
3D	Press ◀▶ to select Off, DLP-Link or IR.
3D Sync Invert	Press ◀▶ to turn 3D Sync Invert On or Off.
3D Format	Press ◀▶ to enable or disable 3D Format.

## Network Setting

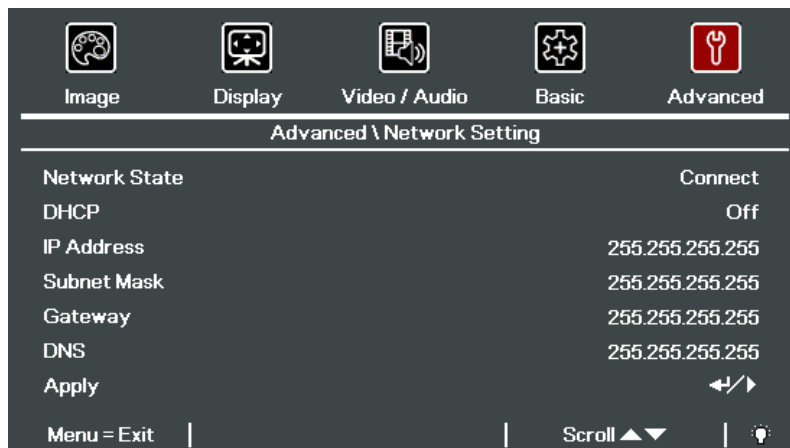

ITEM	DESCRIPTION
Network State	Displays the network connection status.
DHCP	Press ◀▶ to turn DHCP On or Off. <b>Note:</b> If you select DHCP Off, complete the IP Address, Subnet Mask, Gateway, and DNS fields.
IP Address	Enter a valid IP address if DHCP is turned off.
Subnet Mask	Enter a valid Subnet Mask if DHCP is turned off.
Gateway	Enter a valid Gateway address if DHCP is turned off.
DNS	Enter a valid DNS name if DHCP is turned off.
Apply	Press ◀ (Enter) / ▶ to confirm settings.



## LAN\_RJ45

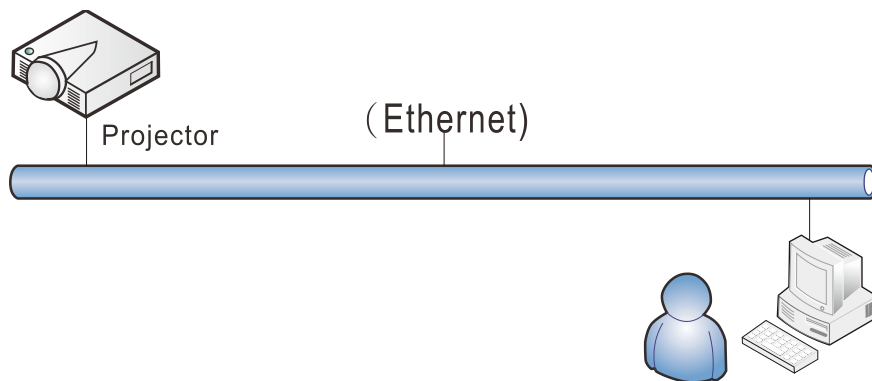

### Wired LAN Terminal functionalities

Remote control and monitoring of a projector from a PC (or Laptop) via wired LAN is also possible. Compatibility with Crestron / AMX (Device Discovery) / Extron control boxes enables not only collective projector management on a network but also management from a control panel on a PC (or Laptop) browser screen.

- ★ Crestron is a registered trademark of Crestron Electronics, Inc. of the United States.
- ★ Extron is a registered trademark of Extron Electronics, Inc. of the United States.
- ★ AMX is a registered trademark of AMX LLC of the United States.
- ★ PJLink applied for trademark and logo registration in Japan, the United States of America, and other countries by JBMIA.

### Supported External Devices

This projector is supported by the specified commands of the Crestron Electronics controller and related software (ex, RoomView ®).

<http://www.crestron.com/>

This projector is supported by AMX ( Device Discovery ).

<http://www.amx.com/>

This projector is compliant to support Extron device(s) for reference.

<http://www.extron.com/>

For more detail of information about the diverse types of external devices which can be connected to the LAN/RJ45 port and remote/control the projector, as well as the related control commands supporting for each external device, kindly please get contact with the Support-Service team directly.

## LAN RJ45

1. Connect an RJ45 cable to RJ45 ports on the projector and the PC (Laptop).

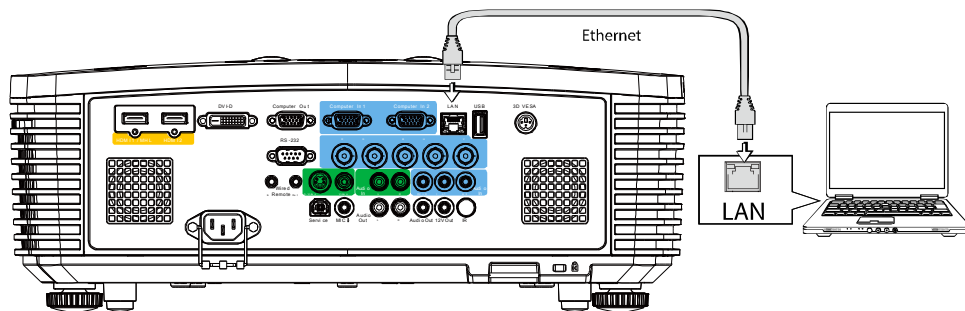

2. On the PC (Laptop), select **Start** → **Control Panel** → **Network and Internet**.

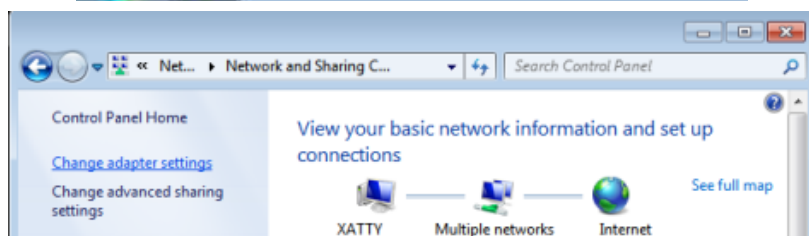
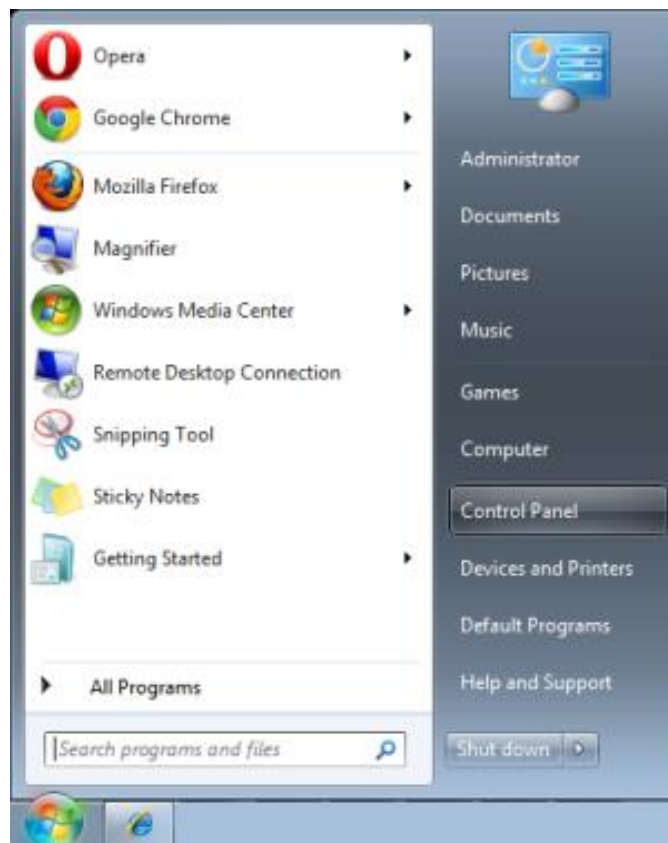

3. Right-click on **Local Area Connection**, and select **Properties**.

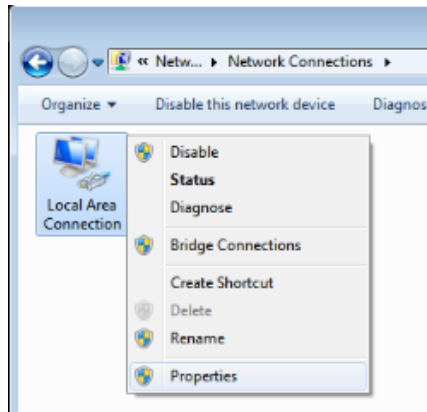

4. In the **Properties** window, select the **Networking** tab, and select **Internet Protocol (TCP/IP)**.
5. Click **Properties**.

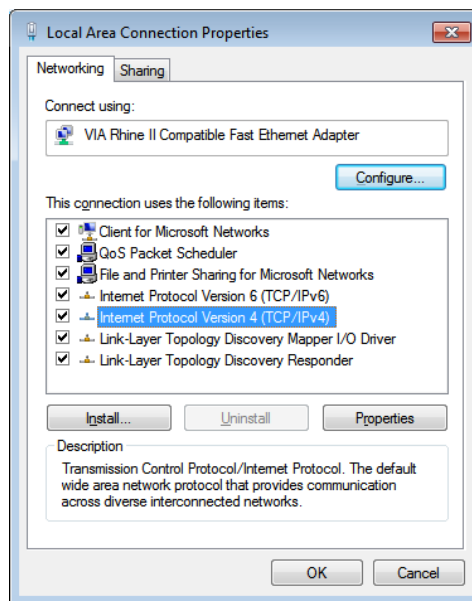

6. Click **Use the following IP address** and fill in the IP address and Subnet mask, then click **OK**.

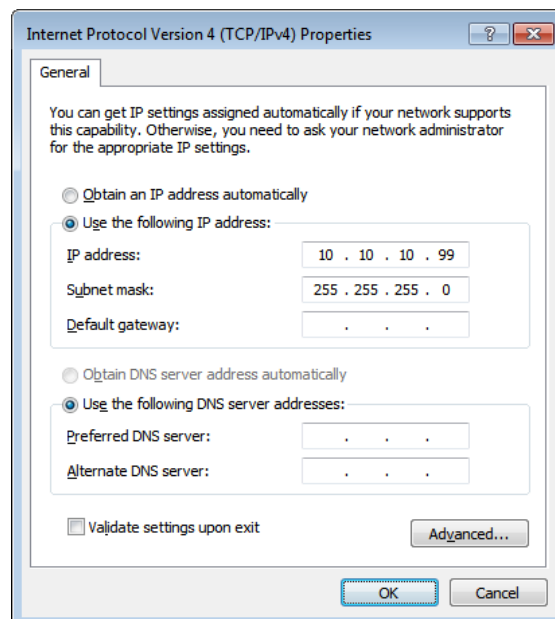

7. Press the **Menu** button on the projector.
8. Select **Advanced** → **Advanced** → **Network Setting**
9. After getting into **Network Setting**, input the following:
  - ▶ DHCP: Off
  - ▶ IP Address: 10.10.10.10
  - ▶ Subnet Mask: 255.255.255.0
  - ▶ Gateway: 0.0.0.0
  - ▶ DNS Server: 0.0.0.0
10. Press **↵** (Enter) / **▶** to confirm settings.

Open a web browser

(for example, Microsoft Internet Explorer with Adobe Flash Player 9.0 or higher).

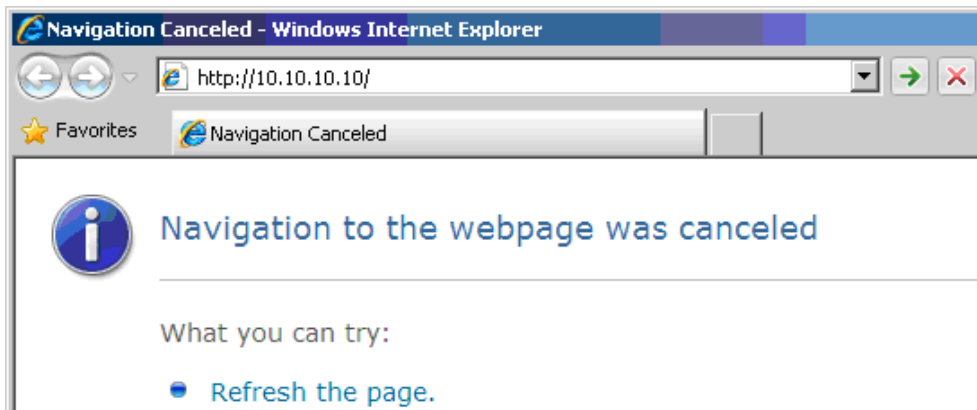

11. In the Address bar, input the IP address: 10.10.10.10.
12. Press **↵** (Enter) / **▶**.

The projector is setup for remote management. The LAN/RJ45 function displays as follows.

**ViewSonic Network Control**

<b>Projector Info</b>	<b>Model Name</b> Pro9510L
<b>Alert Mail Settings</b>	<b>System</b>
<b>Crestron</b>	System Status Power Off
	Display Source No Source
	Lamp Hours 3
	Display Mode N/A
	Error Status No Error
	<b>LAN Status</b>
	IP address 10 10.10.10
	Subnet mask 255.255.255.0
	Default gateway 0.0.0.0
	DNS Server 0.0.0.0
	MAC address 00:18:23:01:07:07
	<b>Version</b>
	LAN Version MHD06_UL
	F/W Version D03



Expansion Options

<b>Crestron Control</b> IP Address <input type="text"/> IP ID <input type="text"/> Control Port <input type="text"/> <input type="button" value="Control Set"/>		<b>Projector</b> Projector Name <input type="text" value="PJ01"/> Location <input type="text" value="RM01"/> Assigned To <input type="text" value="Sir"/> <input type="button" value="Set"/> Network Config <input type="checkbox"/> DHCP Enabled IP Address <input type="text" value="10.10.10.10"/> Subnet Mask <input type="text" value="255.255.255.0"/> Default Gateway <input type="text" value="0.0.0.0"/> DNS Server <input type="text" value="0.0.0.0"/> <input type="button" value="Net Set"/>		<b>User Password</b> <input type="checkbox"/> Usr Enabled Password <input type="text"/> Confirmed <input type="text"/> <input type="button" value="Usr Set"/> <b>Admin Password</b> <input type="checkbox"/> Adm Enabled Password <input type="text"/> Confirmed <input type="text"/> <input type="button" value="Adm Set"/>	
<input type="button" value="Tools Exit"/>					

CATEGORY	ITEM	INPUT-LENGTH
Crestron Control	IP Address	15
	IP ID	3
	Port	5
Projector	Projector Name	10
	Location	10
	Assigned To	10
Network Configuration	DHCP (Enabled)	(N/A)
	IP Address	15
	Subnet Mask	15
	Default Gateway	15
	DNS Server	15
User Password	Enabled	(N/A)
	New Password	10
	Confirm	10
Admin Password	Enabled	(N/A)
	New Password	10
	Confirm	10

For more information, please visit <http://www.crestron.com>.

## Preparing Email Alerts

1. Make sure that user can access the homepage of LAN RJ45 function by web browser (for ex-ample, Microsoft Internet Explorer v6.01/v8.0).
2. From the Homepage of LAN/RJ45, click **Alert Settings**.

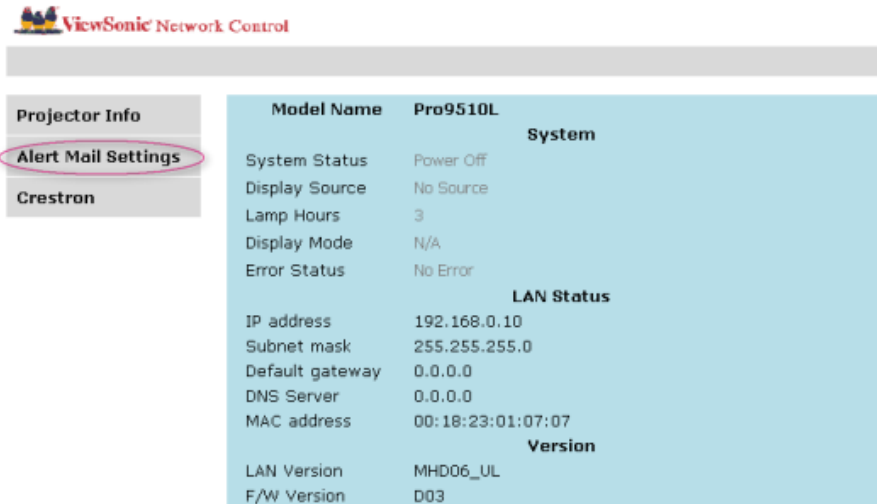

The screenshot shows the ViewSonic Network Control interface. On the left, a sidebar contains 'Projector Info', 'Alert Mail Settings' (highlighted with a red circle), and 'Crestron'. The main content area displays the following information:

Model Name		Pro9510L
<b>System</b>		
System Status	Power Off	
Display Source	No Source	
Lamp Hours	3	
Display Mode	N/A	
Error Status	No Error	
<b>LAN Status</b>		
IP address	192.168.0.10	
Subnet mask	255.255.255.0	
Default gateway	0.0.0.0	
DNS Server	0.0.0.0	
MAC address	00:18:23:01:07:07	
<b>Version</b>		
LAN Version	MHD06_UL	
F/W Version	D03	

3. By default, these input boxes in **Alert Settings** are blank.

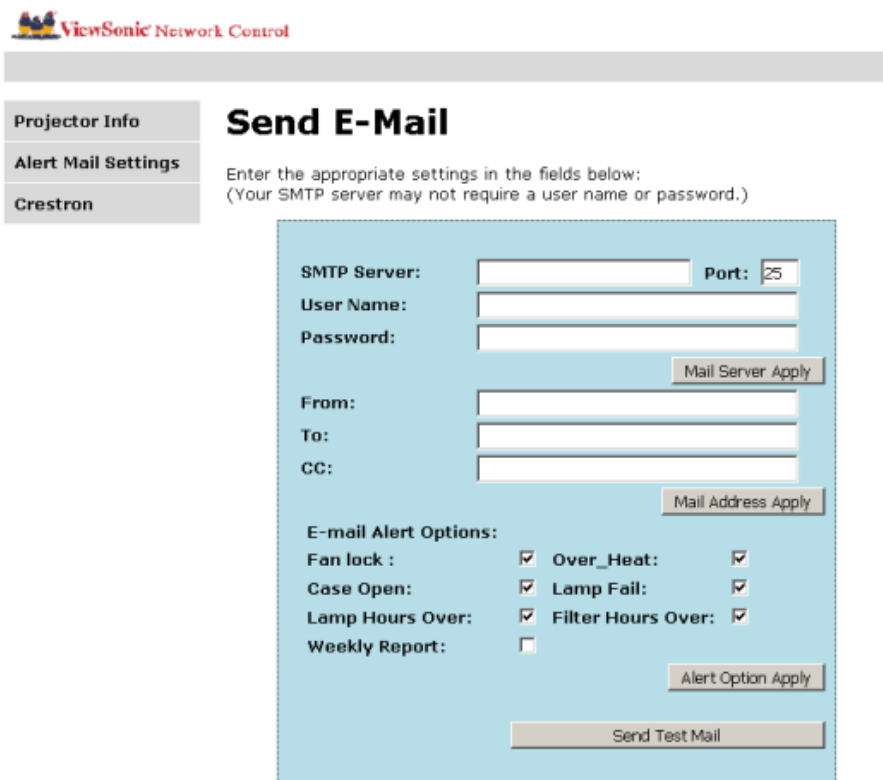

The screenshot shows the 'Send E-Mail' configuration page in the ViewSonic Network Control interface. The sidebar on the left includes 'Projector Info', 'Alert Mail Settings', and 'Crestron'. The main content area is titled 'Send E-Mail' and contains the following fields and options:

Enter the appropriate settings in the fields below:  
(Your SMTP server may not require a user name or password.)

SMTP Server:  Port:

User Name:

Password:

From:

To:

CC:

**E-mail Alert Options:**

Fan lock :	<input checked="" type="checkbox"/>	Over_Heat:	<input checked="" type="checkbox"/>
Case Open:	<input checked="" type="checkbox"/>	Lamp Fail:	<input checked="" type="checkbox"/>
Lamp Hours Over:	<input checked="" type="checkbox"/>	Filter Hours Over:	<input checked="" type="checkbox"/>
Weekly Report:	<input type="checkbox"/>		

4. For Sending alert mail, input the following:

The **SMTP** field is the mail server for sending out email (SMTP protocol). This is a required field.  
The **To** field is the recipient's email address (for example, the projector administrator). This is a required field.

The **Cc** field sends a carbon copy of the alert to the specified email address. This is an optional field (for example, the projector administrator's assistant).

The **From** field is the sender's email address (for example, the projector administrator). This is a required field.

Select the alert conditions by checking the desired boxes.

**ViewSonic Network Control**

**Projector Info**  
**Alert Mail Settings**  
**Crestron**

## Send E-Mail

Enter the appropriate settings in the fields below:  
(Your SMTP server may not require a user name or password.)

**SMTP Server:**  **Port:**

**User Name:**

**Password:**

**From:**

**To:**

**CC:**

**E-mail Alert Options:**

**Fan lock :**  **Over\_Heat:**

**Case Open:**  **Lamp Fail:**

**Lamp Hours Over:**  **Filter Hours Over:**

**Weekly Report:**

**Note:** Fill in all fields as specified. User can click **Send Test Mail** to test what setting is correct. For successful sending an e-mail alert, you must select alert conditions and enter a correct e-mail address.

## RS232 by Telnet Function

Besides projector connected to RS232 interface with “Hyper-Terminal” communication by dedicated RS232 command control, there is alternative RS232 command control way, so called “RS232 by TELNET” for LAN/RJ45 interface.

### Quick Start-Guide for “RS232 by TELNET”

Check and get the IP-Address on OSD of the projector.

Make sure that laptop/PC can access the web-page of the projector.

Make sure that “Windows Firewall” setting to be disabled in case of “TELNET” function filtering out by laptop/PC.

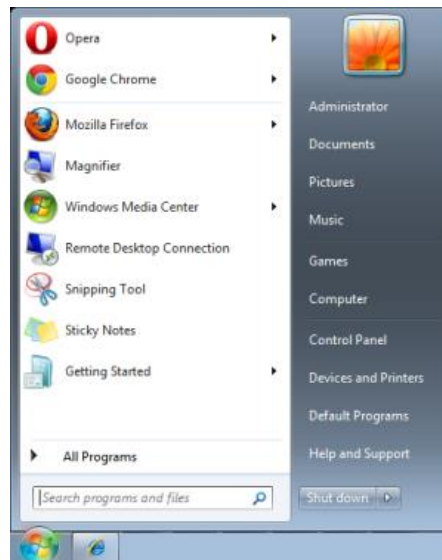

Start => All Programs => Accessories => Command Prompt

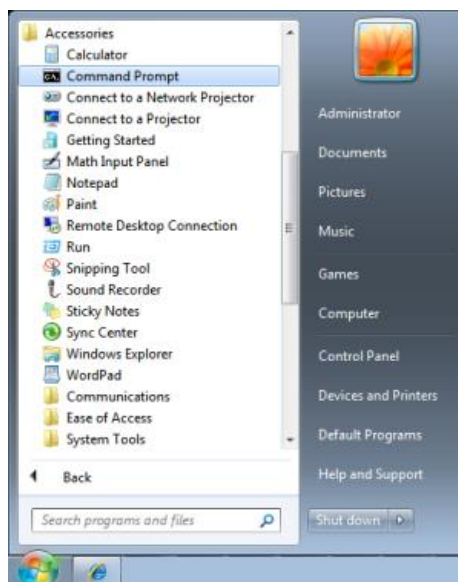



Input the command format like the below:

**telnet ttt.xxx.yyy.zzz 23** (“Enter” key pressed)

(**ttt.xxx.yyy.zzz**: IP-Address of the projector)

If Telnet-Connection ready, and user can have RS232 command input, then “Enter” key pressed, the RS232 command will be workable.

## How to have TELNET enabled in Windows VISTA / 7 / 8

By default installation for Windows VISTA / 7 / 8, “TELNET” function is not included. But end-user can have it by way of “Turn Windows features On or Off” to be enabled.

Open “Control Panel” in Windows VISTA / 7 / 8

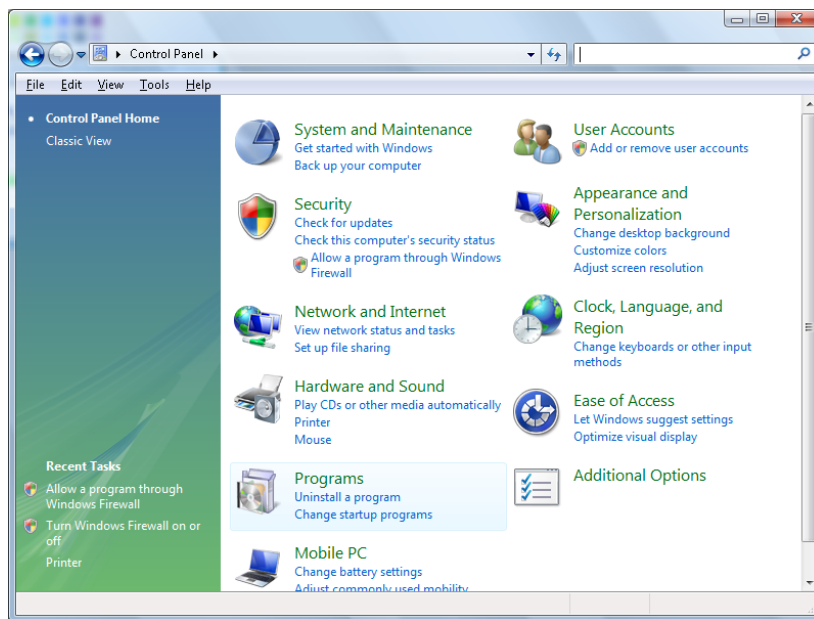

Open “Programs”

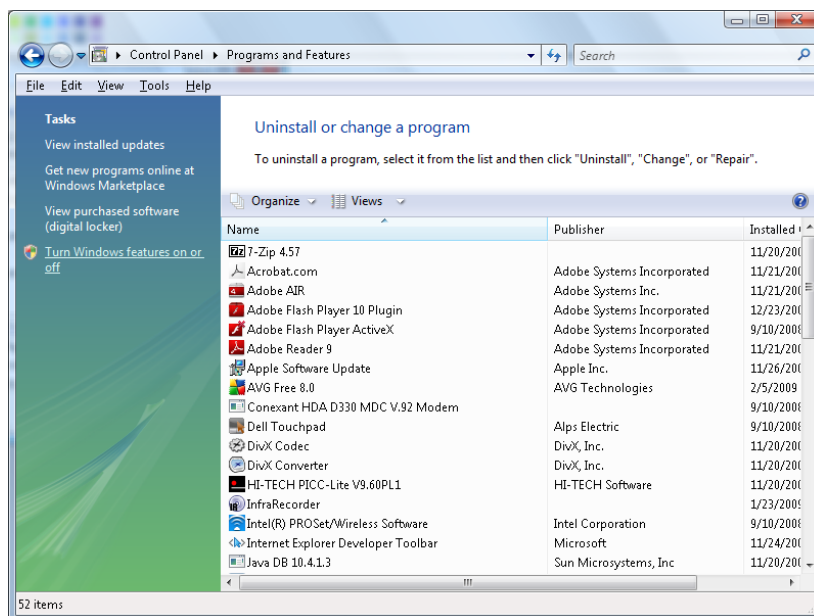

Select “Turn Windows features on or off” to open

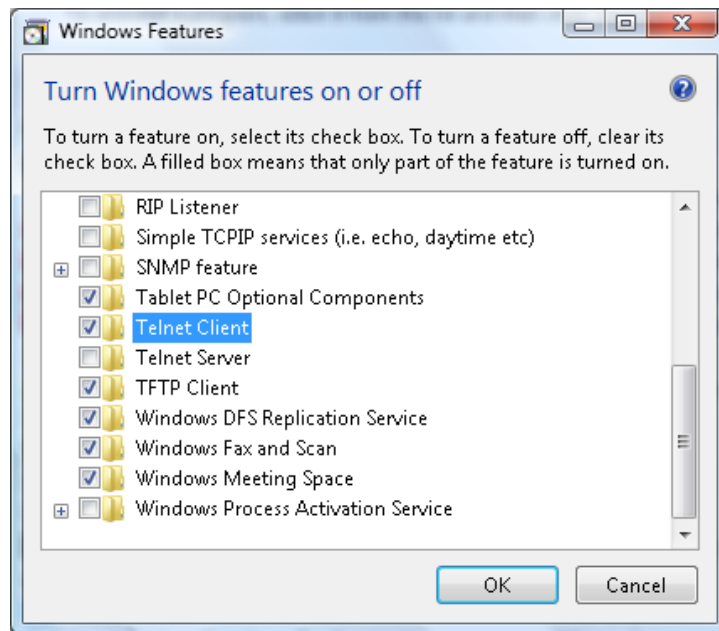

Have “Telnet Client” option checked, then press “OK” button.

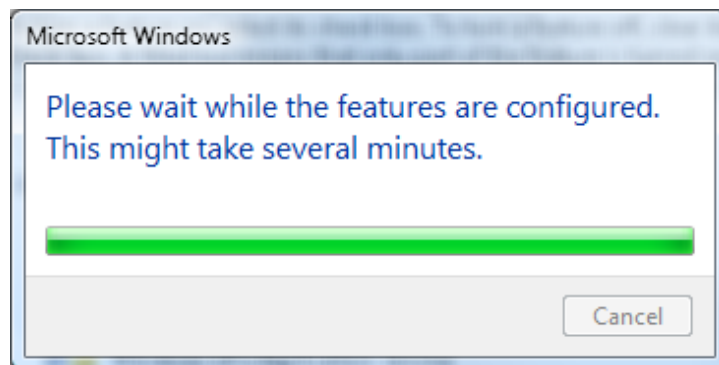

### Specsheet for “RS232 by TELNET” :

1. Telnet: TCP
2. Telnet port: 23  
(for more detail, kindly please get contact with the service agent or team)
3. Telnet utility: Windows “TELNET.exe” (console mode)
4. Disconnection for RS232-by-Telnet control normally: Close Windows Telnet utility directly after TELNET connection ready
5. Limitation 1 for Telnet-Control: there is less than 50 bytes for successive network payload for Telnet-Control application.  
Limitation 2 for Telnet-Control: there is less than 26 bytes for one complete RS232 command for Telnet-Control.  
Limitation 3 for Telnet-Control: Minimum delay for next RS232 command must be more than 200 (ms).  
(\* , In Windows built-in “TELNET.exe” utility, “Enter” key pressed will have “Carriage-Return” and “New-Line” code.)

## Status

Press the cursor ▲▼ button to move up and down in the **Advanced** menu. Select the **Status** sub menu and press ◀ (Enter) / ▶ to enter the **Status** sub menu.

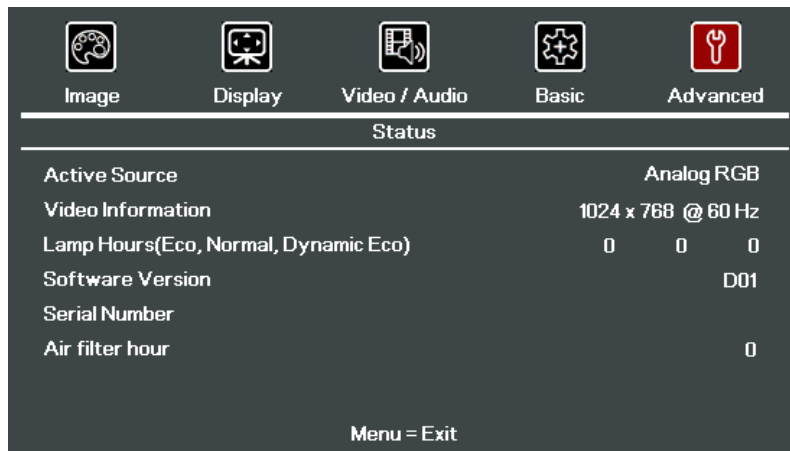

ITEM	DESCRIPTION
Active Source	Display the activated source.
Video Information	Displays resolution/video information for RGB source and color standard for Video source.
Lamp Hours (Eco, Normal, Dynamic Eco)	Lamp Time used information is displayed.
Software Version	Showing system software version.
Serial Number	Showing serial number of product.
Air filter hour	Displays the number of hours the air filter has been in use.

## Replacing the Projection Lamp

The projection lamp should be replaced when it burns out. It should only be replaced with a certified replacement part, which you can order from your local dealer.



### Important:

- a. The projection lamp used in this product contains a small amount of mercury.
- b. Do not dispose this product with general household waste.
- c. Disposal of this product must be carried out in accordance with the regulations of your local authority.



### Warning:

Be sure to turn off and unplug the projector at least 30 minutes before replacing the lamp. Failure to do so could result in a severe burn.



### Caution:

In rare cases the lamp bulb may burn out during normal operation and cause glass dust or shards to be discharged outward from the rear exhaust vent.

Do not inhale or do not touch glass dust or shards. Doing so could result in injury.

Always keep your face away from the exhaust vent so that you do not suffer from the gas and broken shards of the lamp.

When removing the lamp from a ceiling-mounted projector, make sure that no one is under the projector. Glass fragments could fall if the lamp has been burned out.



### IF A LAMP EXPLODES

If a lamp explodes, the gas and broken shards may scatter inside the projector and they may come out of the exhaust vent. The gas contains toxic mercury.

Open windows and doors for ventilation.

If you inhale the gas or the shards of the broken lamp enter your eyes or mouth, consult the doctor immediately.

1. Switch off the power to the projector by pressing the **POWER** button.
2. Allow the projector to cool down at least 30 minutes.
3. Disconnect the power cord.

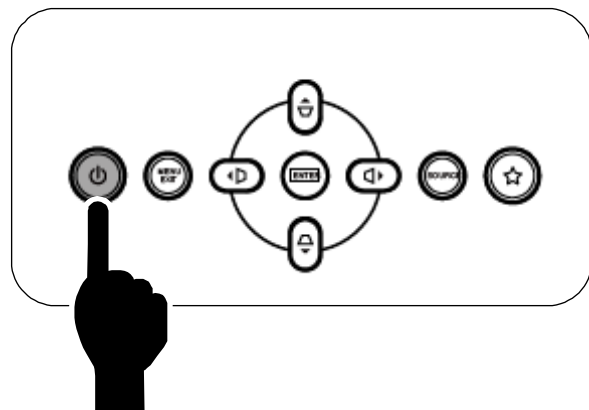

**4.** Unlock the lamp cover.

**5.** Pull up and remove the cover.

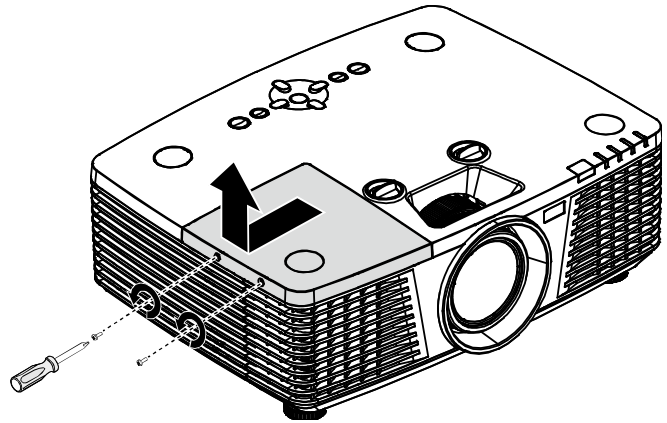

**6.** Use a screwdriver to remove the screws from the lamp module.

**7.** Pull out the lamp module.

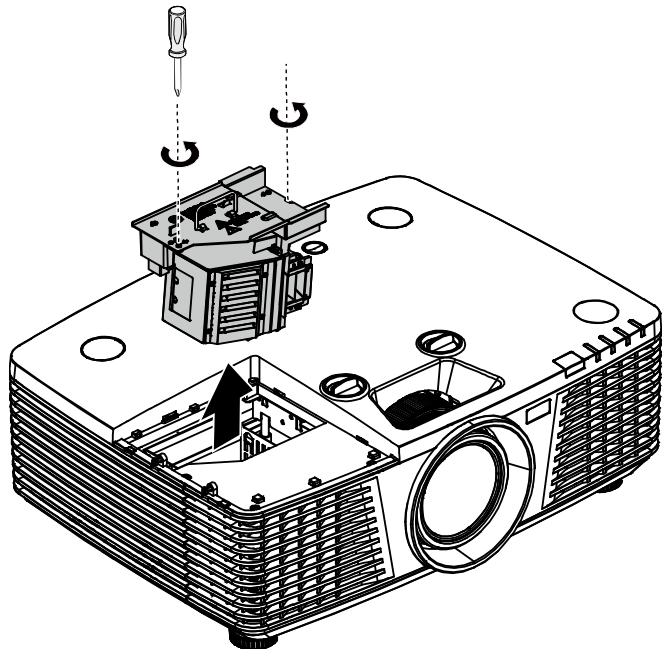

- 8.** Reverse steps 1 to 7 to install the new lamp module.  
While installing, align the lamp module with the connector and ensure it is level to avoid damage.

**Note:**

The lamp module must sit securely in place and the lamp connector must be connected properly before tightening the screws.

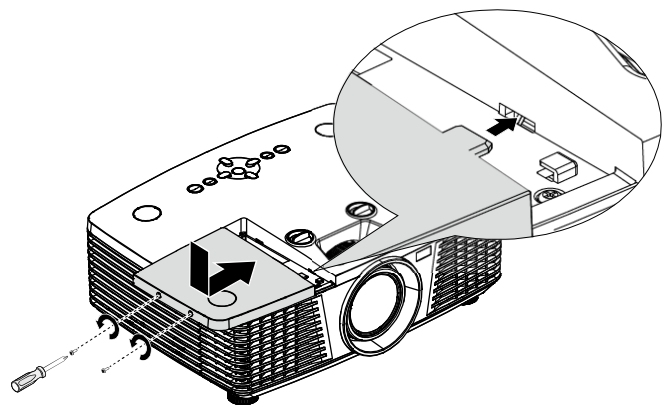
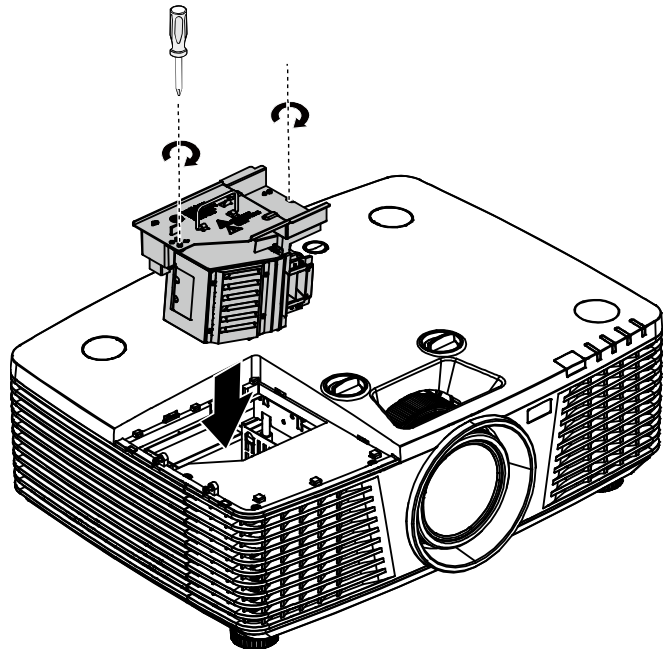

## Resetting the Lamp Time

After replacing the lamp, you should reset the lamp hour counter to zero. Refer to the following:

2. Press the **MENU** button to open the OSD menu.

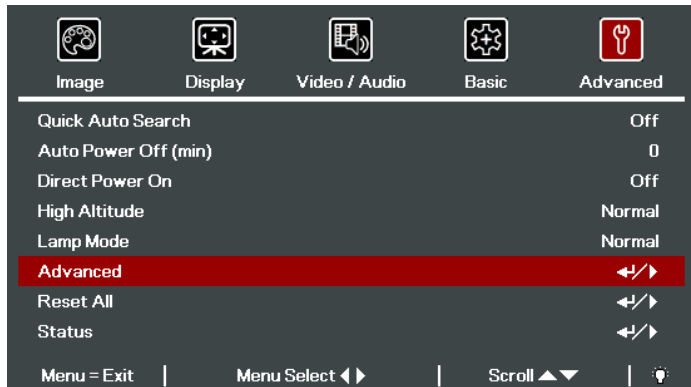

3. Press the cursor ◀▶ button to move to the **Advanced** menu. Press the cursor button to move down to **Advanced**.

4. Press the cursor ▼▲ button to move down to **Lamp Hour Reset**.

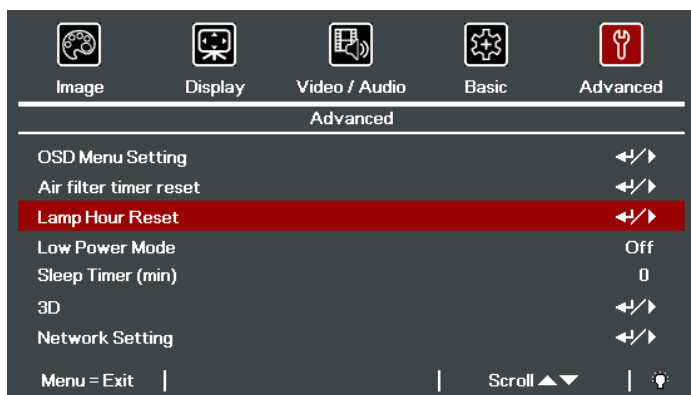

5. Press the cursor ← (Enter) / ▶ button.

A message screen appears.

6. Press ▼▲◀▶ buttons to reset the lamp hour.

7. Press the **MENU** button to get back to **Advanced**.

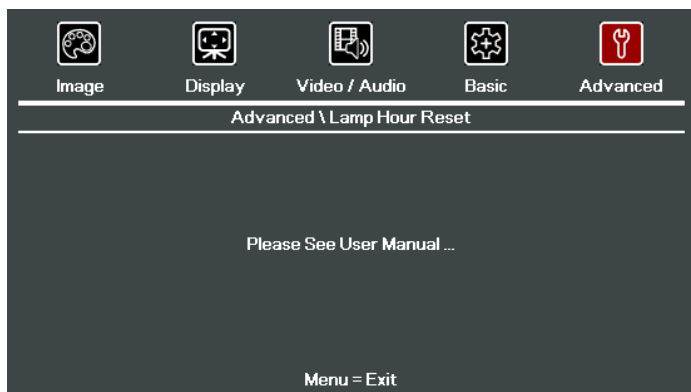

## Cleaning the Projector

Cleaning the projector to remove dust and grime will help ensure trouble-free operation.



### **Warning:**

1. Be sure to turn off and unplug the projector at least 30 minutes before cleaning. Failure to do so could result in a severe burn.
2. Use only a dampened cloth when cleaning. Do not allow water to enter the ventilation openings on the projector.
3. If a little water gets into the projector interior while cleaning, leave unplugged in a well-ventilated room for several hours before using.
4. If a lot of water gets into the projector interior when cleaning, have the projector serviced.

## Cleaning the Lens

You can purchase optic lens cleaner from most camera stores. Refer to the following to clean the projector lens.

1. Apply a little optic lens cleaner to a clean soft cloth. (Do not apply the cleaner directly to the lens.)
2. Lightly wipe the lens in a circular motion.



### **Caution:**

1. Do not use abrasive cleaners or solvents.
2. To prevent discoloration or fading, avoid getting cleaner on the projector case.

## Cleaning the Case

Refer to the following to clean the projector case.

1. Wipe off dust with a clean dampened cloth.
2. Moisten the cloth with warm water and mild detergent (such as used to wash dishes), and then wipe the case.
3. Rinse all detergent from the cloth and wipe the projector again.



### **Caution:**

To prevent discoloration or fading of the case, do not use abrasive alcohol-based cleaners.



## Cleaning the Air Filter

Refer to the following to clean the air filter.

1. Open the latch to open the filter door.

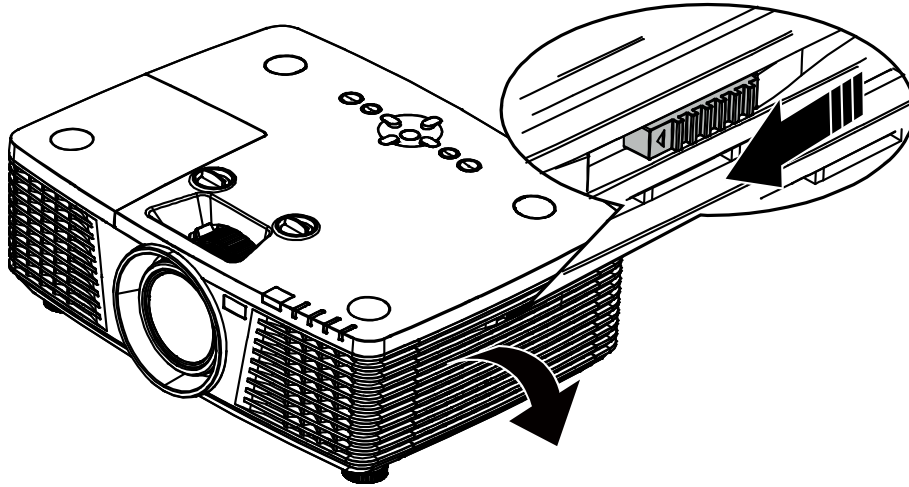

2. Remove the filter.

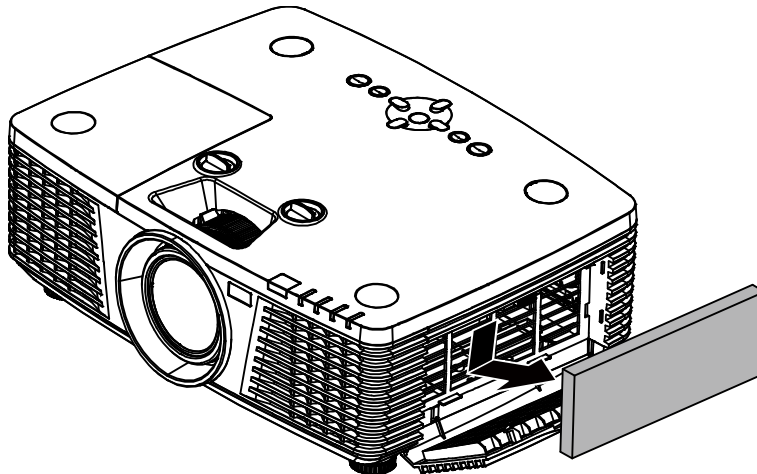

3. Use a vacuum cleaner to vacuum the dust inside.

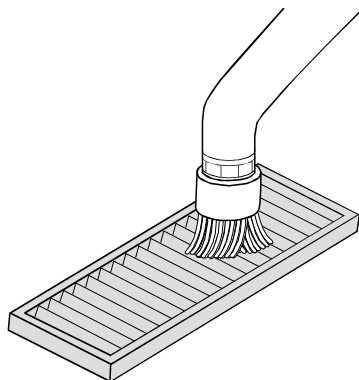

**Note:**

1. Use the soft brush attachment when you vacuum the filter to avoid damage it.
2. Do not wash the filter with water. Doing so can result in filter clogging.

- Put the filter back.

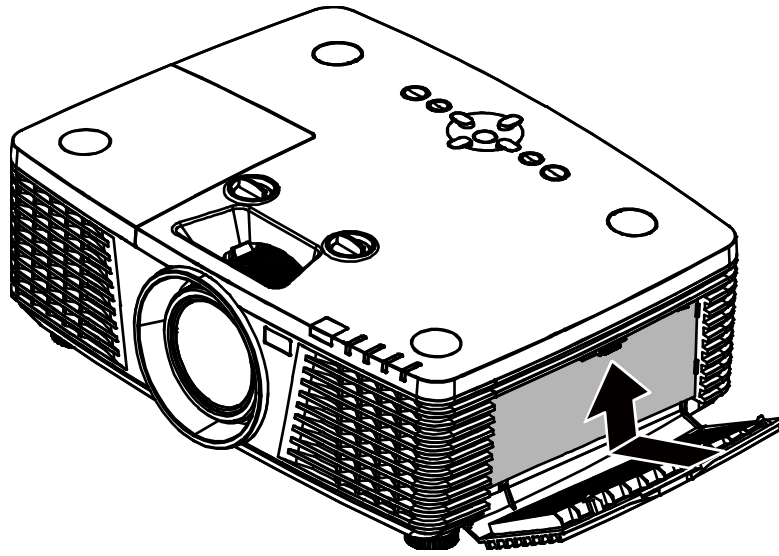

- Close the filter door and lock the latch.

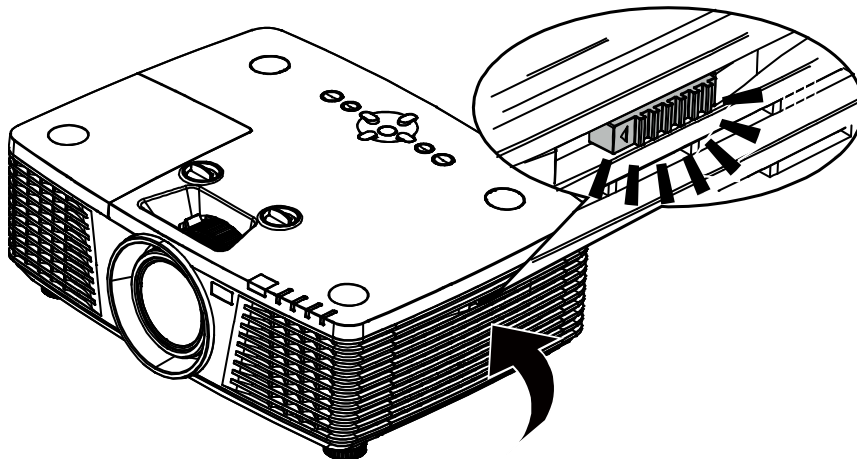

- Turn on the projector and reset the Air Filter Timer after the Air Filter is replaced.  
Air Filter Timer Reset:  
Press **MENU** > Select **Advanced** >> **Advanced** and select **Air Filter Timer Reset**. Press **↵** (Enter) / **▶** to reset timer.



**Important:**

The Filter LED lights when the filter service time is on (1000 hours).  
If the filter is broken, please use a new one.

## Using the Physical Lock

### Using the Kensington Security Slot

If you are concerned about security, attach the projector to a permanent object with the Kensington slot and a security cable.

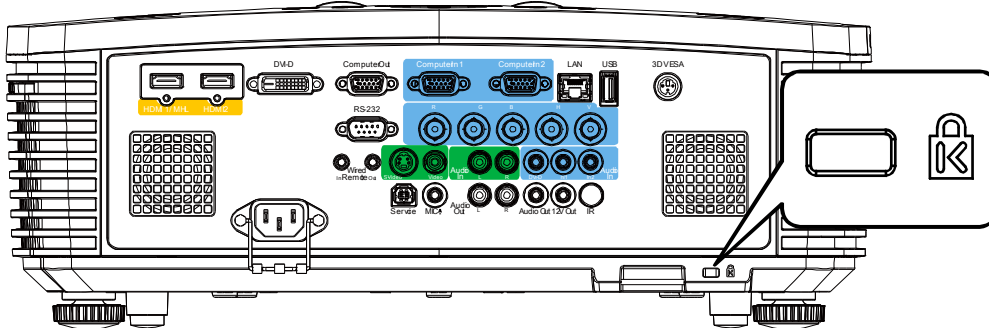

**Note:**

Contact your vendor for details on purchasing a suitable Kensington security cable.

The security lock corresponds to Kensington's MicroSaver Security System. If you have any comment, contact: Kensington, 2853 Campus Drive, San Mateo, CA 94403, U.S.A. Tel: 800-535-4242, <http://www.Kensington.com>.

### Using the Security Bar Lock

In addition to the password protection function and the Kensington lock, the Security Bar Opening helps protect the projector from unauthorized use.

See the following picture.

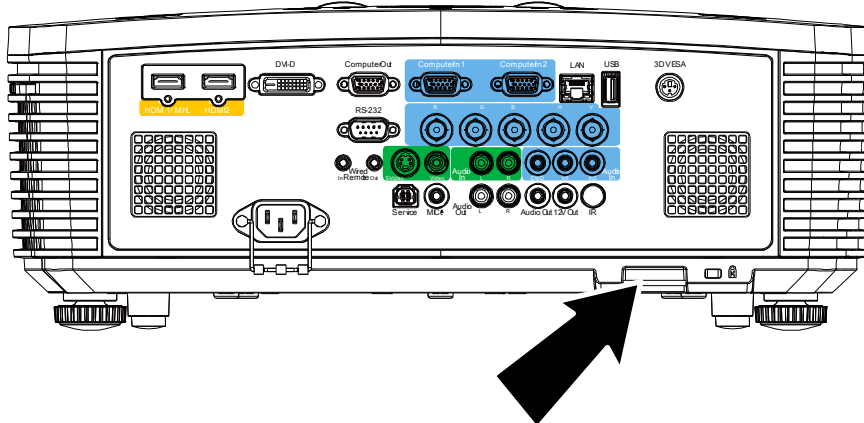

## Common Problems and Solutions

These guidelines provide tips to deal with problems you may encounter while using the projector. If the problem remains unsolved, contact your dealer for assistance.

Often after time spent troubleshooting, the problem is traced to something as simple as a loose connection. Check the following before proceeding to the problem-specific solutions.

- Use some other electrical device to confirm that the electrical outlet is working.
- Ensure the projector is turned on.
- Ensure all connections are securely attached.
- Ensure the attached device is turned on.
- Ensure a connected PC is not in suspending mode.
- Ensure a connected notebook Display is configured for an external display. (This is usually done by pressing an Fn-key combination on the notebook.)

## Tips for Troubleshooting

In each problem-specific section, try the steps in the order suggested. This may help you to solve the problem more quickly.

Try to pin point the problem and thus avoid replacing non-defective parts.

For example, if you replace batteries and the problem remains, put the original batteries back and go to the next step.

Keep a record of the steps you take when troubleshooting: The information may be useful when calling for technical support or for passing on to service personnel.

## LED Error Messages

ERROR CODE MESSAGES	POWER LED	LAMP LED	TEMP LED	FILTER LED
Lamp Ready	Blue	OFF	OFF	OFF
Start	Flashing (Amber)	OFF	OFF	OFF
Cooling	Flashing (Amber)	OFF	OFF	OFF
Over Temperature	OFF	OFF	ON	OFF
Air Filter Timer warning (over or equal 1000hrs)	ON	OFF	OFF	ON
T1 error	3 blinks	1 blinks	OFF	OFF
Thermal Break Sensor error	4 blinks	OFF	OFF	OFF
G794 error	4 blinks	4 blinks	OFF	OFF
Lamp fail	5 blinks	OFF	OFF	OFF
Ballast temp over	5 blinks	1 blinks	OFF	OFF
Ballast circuit short	5 blinks	2 blinks	OFF	OFF
Lamp End of lamp life detected	5 blinks	3 blinks	OFF	OFF
Lamp did not ignite	5 blinks	4 blinks	OFF	OFF
Lamp extinguished during normal operation	5 blinks	5 blinks	OFF	OFF
Lamp extinguished during run-up phase	5 blinks	6 blinks	OFF	OFF
Lamp voltage too low	5 blinks	7 blinks	OFF	OFF
Ballast fail	5 blinks	8 blinks	OFF	OFF
Ballast communication fail	5 blinks	10 blinks	OFF	OFF
Ballast over temp	5 blinks	11 blinks	OFF	OFF
Restrike lamp fail 1	5 blinks	12 blinks	OFF	OFF
Restrike lamp fail 2	5 blinks	13 blinks	OFF	OFF
Lamp fail 1	5 blinks	14 blinks	OFF	OFF
Lamp fail 2	5 blinks	15 blinks	OFF	OFF
Fan 1 error	6 blinks	1 blinks	OFF	OFF
Fan 2 error	6 blinks	2 blinks	OFF	OFF
Fan 3 error	6 blinks	3 blinks	OFF	OFF
Fan 4 error	6 blinks	4 blinks	OFF	OFF
Fan 5 error	6 blinks	5 blinks	OFF	OFF
Case Open	7 blinks	OFF	OFF	OFF
DMD error	8 blinks	OFF	OFF	OFF
Color wheel error	9 blinks	OFF	OFF	OFF

In the event of an error, please disconnect the AC power cord and wait for one (1) minute before restarting the projector. If the Power or Lamp LEDs are still blinking or the Over Temp LED is lit, contact your service center.

## Image Problems

### **Problem: No image appears on the screen**

1. Verify the settings on your notebook or desktop PC.
2. Turn off all equipment and power up again in the correct order.

### **Problem: The image is blurred**

1. Adjust the Focus on the projector.
2. Press the **AUTO SYNC** button on the remote control.
3. Ensure the projector-to-screen distance is within the specified range.
4. Check that the projector lens is clean.

### **Problem: The image is wider at the top or bottom (trapezoid effect)**

1. Position the projector so it is as perpendicular to the screen as possible.
2. Use the **Keystone** button on the remote control or projector to correct the problem.

### **Problem: The image is reversed**

Check the **Projection** setting on the **Basic** menu of the OSD.

### **Problem: The image is streaked**

1. Set the Frequency and Tracking settings on the Display menu of the OSD to the default settings.
2. To ensure the problem is not caused by a connected PC's video card, connect to another computer.

### **Problem: The image is flat with no contrast**

Adjust the **Contrast** setting on the **Image** menu of the OSD.

### **Problem: The color of the projected image does not match the source image.**

1. Adjust the **Gamma** settings on the **Image** menu of the OSD.
2. Adjust the **Color Temperature** settings on the **Image->Advanced** menu of the OSD.

## Lamp Problems

### **Problem: There is no light from the projector**

1. Check that the power cable is securely connected.
2. Ensure the power source is good by testing with another electrical device.
3. Restart the projector in the correct order and check that the Power LED is on.
4. If you have replaced the lamp recently, try resetting the lamp connections.
5. Replace the lamp module.
6. Put the old lamp back in the projector and have the projector serviced.

### **Problem: The lamp goes off**

1. Power surges can cause the lamp to turn off. Re-plug power cord. When the Power LED is on, press the power button.
2. Replace the lamp module.
3. Put the old lamp back in the projector and have the projector serviced.

## Remote Control Problems

### **Problem: The projector does not respond to the remote control**

1. Direct the remote control towards remote sensor on the projector.
2. Ensure the path between remote and sensor is not obstructed.
3. Turn off any fluorescent lights in the room.
4. Check the battery polarity.
5. Replace the batteries.
6. Turn off other Infrared-enabled devices in the vicinity.
7. Have the remote control serviced.

## Audio Problems

### **Problem: There is no sound**

1. Adjust the volume on the remote control.
2. Adjust the volume of the audio source.
3. Check the audio cable connection.
4. Test the source audio output with other speakers.
5. Have the projector serviced.

### **Problem: The sound is distorted**

1. Check the audio cable connection.
2. Test the source audio output with other speakers.
3. Have the projector serviced.

## Having the Projector Serviced

If you are unable to solve the problem, you should have the projector serviced. Pack the projector in the original carton. Include a description of the problem and a checklist of the steps you took when trying to fix the problem: The information may be useful to service personnel. For servicing, return the projector to the place you purchased it.

## HDMI Q & A

### **Q. What is the difference between a “Standard” HDMI cable and a “High-Speed” HDMI cable?**

Recently, HDMI Licensing, LLC announced that cables would be tested as Standard or High-Speed cables.

Standard (or “category 1”) HDMI cables have been tested to perform at speeds of 75Mhz or up to 2.25Gbps, which is the equivalent of a 720p/1080i signal.

High Speed (or “category 2”) HDMI cables have been tested to perform at speeds of 340Mhz or up to 10.2Gbps, which is the highest bandwidth currently available over an HDMI cable and can successfully handle 1080p signals including those at increased color depths and/or increased refresh rates from the Source. High-Speed cables are also able to accommodate higher resolution displays, such as WQXGA cinema monitors (resolution of 2560 x 1600).

### **Q. How do I run HDMI cables longer than 10 meters?**

There are many HDMI Adopters working on HDMI solutions that extend a cable’s effective distance from the typical 10 meter range to much longer lengths. These companies manufacture a variety of solutions that include active cables (active electronics built into cables that boost and extend the cable’s signal), repeaters, amplifiers as well as CAT5/6 and fiber solutions.

### **Q. How can I tell if a cable is an HDMI certified cable?**

All HDMI products are required to be certified by the manufacturer as part of the HDMI Compliance Test Specification. However, there may be instances where cables bearing the HDMI logo are available but have not been properly tested. HDMI Licensing, LLC actively investigates these instances to ensure that the HDMI trademark is properly used in the market. We recommend that consumers buy their cables from a reputable source and a company that is trusted.

For more detail information check <http://www.hdmi.org/learningcenter/faq.aspx#49>



# SPECIFICATIONS

## Specifications

Model Name		PRO9510L	PRO9520WL	PRO9530HDL	PRO9800WUL
Display Type		0.7" XGA, S600HB	0.65" WXGA, S450	0.65" 1080P, S600	0.67" WUXGA, S600HB
Resolution		1024x768	1280x800	1920x1080p	1920x1200
Projection Distance		1 meters ~ 10 meters			
Projection Screen Size		22.3"~378.6"	20.7" ~ 351.7"	21.2" ~ 361.4"	21.8" ~ 371.4"
Projection Lens		Manual Focus/Manual Zoom			
Throw Ratio		1.3-2.21	1.32 ~ 2.24	1.25~2.13	1.25~2.13
Keystone Correction	Vertical	±30° for ±30 steps			
	Horizontal	±25° for ±25 steps			
Projection Methods		Front, Rear, Desktop/Ceiling (Rear, Front)			
Data Compatibility		VGA, SVGA, XGA, SXGA, SXGA+, UXGA, WUXGA@60hz, Mac			
SDTV/EDTV/ HDTV		480i, 480p, 720p, 1080i, 1080p			
Video Compatibility		NTSC/ NTSC 4.43, PAL (B,G,H,I), SECAM			
H-Sync		15, 31 - 91.4kHz			
V-Sync		24 - 30Hz, 47 - 120Hz			
Safety Certification		FCC-B, cUL, UL, CB, CE, CCC, KC, NOM, C-tick, TUV, PSB			
Operation Temperature		5° ~ 40°C			
Operating Relative Humidity		10% to 85% (No condensation)			
Operating Altitude		Sea level to 10,000 feet @ 23degree C			
Environmental Storage Condition		-10° ~ 60°C, 5% to 95% (No condensation)			
Dimensions		445mm (W) x 325.5mm (D) x 167mm (H)			
Weight		8.29KG ( 18.28 lbs)			
Power Supply		AC Universal 100 - 240, Typical @ 110VAC (100 - 240)/+-10%			
Power Consumption		480W (Normal), 380W (Eco) , <0.5W (Standby), <3W (on by Lan)			
Lamp		370W (Normal) / 280W (Eco)			
Audio Speaker		7W RMS x 2			
Input Terminals		VGA x 2			
		DVI-D x 1			
		S-Video x 1			
		5 BNC (RGBHV) x 1			
		Mini-jack Stereo x 3			
		Composite video x 1			
		HDMI (MHL) x 1, HDMI x 1			
		Audio RCA (R/L) x 1			
		Microphone mini jack x 1			
		USB type A x 1			

Output Terminals	VGA x 1
	Audio RCA (R/L) x 1
	PC audio x 1
	3D-Sync x 1
Control Terminals	RS-232C x 1
	RJ45 x 1
	Screen Trigger : DC Jack x 1 (DC12V 200mA output function)
	Wired Remote In x 1
	Wired Remote Out x 1
	USB Type B for service x 1
Security	Kensington Security Slot
	Security Bar

**Note:** For questions regarding product specifications, please contact your local distributor.

## Projection Distance vs. Projection Size

PRO9510L / PRO9520WL / PRO9530HDL / PRO9800WUL

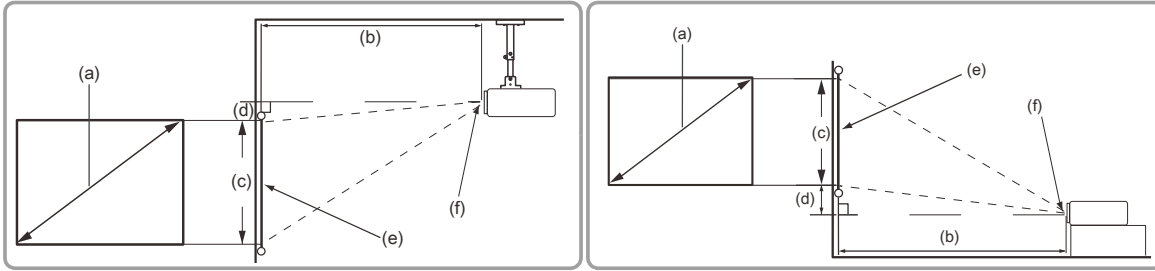

### PRO9510L (XGA)

(a) Screen Size [inch (m)]	4:3 image on a 4:3 Screen			
	(b) Projection distance [m (inch)]		(c) Image height [cm (inch)]	(d) Vertical offset [cm (inch)]
	min.	max.		
26.7 (0.7)	---	1.2 (30.5)	40.7 (16)	5.1 (2)
30 (0.8)	---	1.3 (34.2)	45.7 (18)	5.7 (2.3)
40 (1.0)	1.1 (26.8)	1.8 (45.6)	61 (24)	7.6 (3)
50 (1.3)	1.3 (33.5)	2.2 (57)	76.2 (30)	9.5 (3.8)
60 (1.5)	1.6 (40.3)	2.7 (68.4)	91.4 (36)	11.4 (4.5)
70 (1.8)	1.8 (47)	3.1 (79.8)	106.7 (42)	13.3 (5.3)
80 (2.0)	2.1 (53.7)	3.6 (91.3)	121.9 (48)	15.2 (6)
90 (2.3)	2.4 (60.4)	4 (102.7)	137.2 (54)	17.1 (6.8)
100 (2.5)	2.6 (67.1)	4.5 (114.1)	152.4 (60)	19.1 (7.5)
120 (3.0)	3.2 (80.5)	5.4 (136.9)	182.9 (72)	22.9 (9)
150 (3.8)	4 (100.6)	6.7 (171.1)	228.6 (90)	28.6 (11.3)
200 (5.1)	5.3 (134.2)	9 (228.1)	304.8 (120)	38.1 (15)
250 (6.4)	6.6 (167.7)	11.2 (285.2)	381 (150)	47.6 (18.8)
300 (7.6)	7.9 (201.3)	13.5 (342.2)	457.2 (180)	57.2 (22.5)
378.6 (9.6)	10 (254)	17 (431.8)	577 (227.2)	72.1 (28.4)

### PRO9520WL (WXGA)

(a) Screen Size [inch (m)]	16:10 image on a 16:10 Screen			
	(b) Projection distance [m (inch)]		(c) Image height [cm (inch)]	(d) Vertical offset [cm (inch)]
	min.	max.		
24.9 (0.6)	---	1.2 (30.5)	33.5 (13.2)	5.7 (2.2)
30 (0.8)	---	1.4 (36.8)	40.4 (15.9)	6.9 (2.7)
40 (1.0)	1.1 (28.9)	1.9 (49)	53.8 (21.2)	9.2 (3.6)
50 (1.3)	1.4 (36.1)	2.4 (61.3)	67.3 (26.5)	11.4 (4.5)
60 (1.5)	1.7 (43.3)	2.9 (73.5)	80.8 (31.8)	13.7 (5.4)
70 (1.8)	2 (50.6)	3.4 (85.8)	94.2 (37.1)	16 (6.3)
80 (2.0)	2.3 (57.8)	3.9 (98)	107.7 (42.4)	18.3 (7.2)
90 (2.3)	2.6 (65)	4.3 (110.3)	121.2 (47.7)	20.6 (8.1)
100 (2.5)	2.8 (72.2)	4.8 (122.5)	134.6 (53)	22.9 (9)
120 (3.0)	3.4 (86.7)	5.8 (147.1)	161.5 (63.6)	27.5 (10.8)
150 (3.8)	4.3 (108.3)	7.2 (183.8)	201.9 (79.5)	34.3 (13.5)
200 (5.1)	5.7 (144.4)	9.6 (245.1)	269.2 (106)	45.8 (18)
250 (6.4)	7.1 (180.5)	12.1 (306.4)	336.5 (132.5)	57.2 (22.5)
300 (7.6)	8.5 (216.6)	14.5 (367.6)	403.9 (159)	68.7 (27)
351.7 (8.9)	10 (254)	17 (431)	473.5 (186.4)	80.5 (31.7)

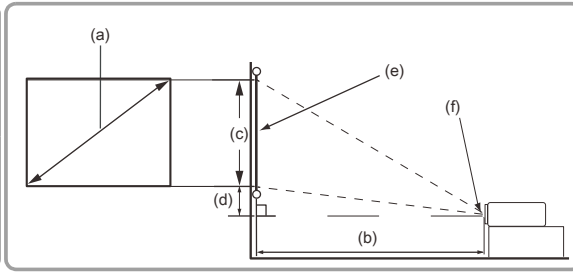
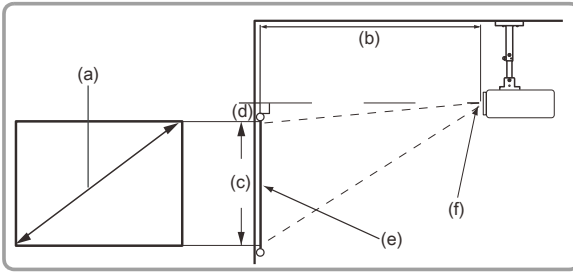

### PRO9530HDL (1080P)

(a) Screen Size [inch (m)]	16:9 image on a 16:9 Screen					
	(b) Projection distance [m (inch)]		(c) Image height [cm (inch)]	(d) Vertical offset [cm (inch)]		
	min.	max.				
25.4 (0.6)	---	1.2 (30.4)	31.6 (12.5)	5.7 (2.2)		
30 (0.8)	---	1.4 (35.9)	37.4 (14.7)	6.7 (2.6)		
40 (1.0)	1.1 (28.1)	1.9 (47.9)	49.8 (19.6)	9 (3.5)		
50 (1.3)	1.4 (35.1)	2.4 (59.9)	62.3 (24.5)	11.2 (4.4)		
60 (1.5)	1.7 (42.2)	2.8 (71.9)	74.7 (29.4)	13.4 (5.3)		
70 (1.8)	1.9 (49.2)	3.3 (83.8)	87.2 (34.3)	15.7 (6.2)		
80 (2.0)	2.2 (56.2)	3.8 (95.8)	99.6 (39.2)	17.9 (7.1)		
90 (2.3)	2.5 (63.3)	4.2 (107.8)	112.1 (44.1)	20.2 (7.9)		
100 (2.5)	2.8 (70.3)	4.7 (119.8)	124.5 (49)	22.4 (8.8)		
120 (3.0)	3.3 (84.3)	5.7 (143.7)	149.4 (58.8)	26.9 (10.6)		
150 (3.8)	4.2 (105.4)	7.1 (179.7)	186.8 (73.5)	33.6 (13.2)		
200 (5.1)	5.5 (140.6)	9.4 (239.5)	249.1 (98.1)	44.8 (17.6)		
250 (6.4)	6.9 (175.7)	11.8 (299.4)	311.3 (122.6)	56 (22.1)		
300 (7.6)	8.3 (210.9)	14.1 (359.3)	373.6 (147.1)	67.2 (26.5)		
361.4 (9.2)	10 (254)	17 (432.9)	450 (177.2)	81 (31.9)		

### PRO9800WUL (WUXGA)

(a) Screen Size [inch (m)]	16:10 image on a 16:10 Screen					
	(b) Projection distance [m (inch)]		(c) Image height [cm (inch)]	(d) Vertical offset [cm (inch)]		
	min.	max.				
26.2 (0.7)	---	1.2 (30.5)	35.3 (13.9)	3.9 (1.5)		
30 (0.8)	---	1.4 (35)	40.4 (15.9)	4.4 (1.7)		
40 (1.0)	1.1 (27.4)	1.8 (46.6)	53.8 (21.2)	5.9 (2.3)		
50 (1.3)	1.3 (34.2)	2.3 (58.3)	67.3 (26.5)	7.4 (2.9)		
60 (1.5)	1.6 (41)	2.8 (69.9)	80.8 (31.8)	8.9 (3.5)		
70 (1.8)	1.9 (47.9)	3.2 (81.6)	94.2 (37.1)	10.4 (4.1)		
80 (2.0)	2.2 (54.7)	3.7 (93.2)	107.7 (42.4)	11.8 (4.7)		
90 (2.3)	2.4 (61.5)	4.1 (104.9)	121.2 (47.7)	13.3 (5.2)		
100 (2.5)	2.7 (68.4)	4.6 (116.5)	134.6 (53)	14.8 (5.8)		
120 (3.0)	3.2 (82.1)	5.5 (139.8)	161.5 (63.6)	17.8 (7)		
150 (3.8)	4 (102.6)	6.9 (174.8)	201.9 (79.5)	22.2 (8.7)		
200 (5.1)	5.4 (136.8)	9.2 (233.1)	269.2 (106)	29.6 (11.7)		
250 (6.4)	6.7 (171)	11.5 (291.3)	336.5 (132.5)	37 (14.6)		
300 (7.6)	8.1 (205.2)	13.8 (349.6)	403.9 (159)	44.4 (17.5)		
371.4 (9.4)	10 (254)	17 (432.8)	500 (196.8)	55 (21.7)		

## Timing Mode Table

The projector can display several resolutions. The following table outlines the resolutions that can be displayed by the projector.

SIGNAL	RESOLUTION	H-SYNC (KHz)	V-SYNC (Hz)	COMPOSITE S_VIDEO	COMPONENT	RGB (ANALOG)	HDMI (DIGITAL)
NTSC	—	15.7	60.0	○	—	—	—
PAL/SECAM	—	15.6	50.0	○	—	—	—
VESA	720 x 400	31.5	70.1	—	—	○	○
	720 x 400	37.9	85.0	—	—	○	○
	640 x 480	31.5	60.0	—	—	○	○
	640 x 480	37.9	72.8	—	—	○	○
	640 x 480	37.5	75.0	—	—	○	○
	640 x 480	43.3	85.0	—	—	○	○
	800 x 600	35.2	56.3	—	—	○	○
	* 800 x 600	37.9	60.3	—	—	○	○
	800 x 600	46.9	75.0	—	—	○	○
	800 x 600	48.1	72.2	—	—	○	○
	800 x 600	53.7	85.1	—	—	○	○
	** 800 x 600	76.3	120.0	—	—	○	○
	* 1024 x 768	48.4	60.0	—	—	○	○
	1024 x 768	56.5	70.1	—	—	○	○
	1024 x 768	60.0	75.0	—	—	○	○
	1024 x 768	68.7	85.0	—	—	○	○
	** 1024 x 768	97.6	120.0	—	—	○	○
	1024 x 768	99.0	120.0	—	—	○	○
	1152 x 864	67.5	75.0	—	—	○	○
	* 1280 x 720	45.0	60.0	—	—	○	○
	* 1280 x 720	90.0	120.0	—	—	○	○
	1280 x 768	47.4	60.0	—	—	○	○
	* 1280 x 768	47.8	59.9	—	—	○	○
	* 1280 x 800	49.7	59.8	—	—	○	○
	1280 x 800	62.8	74.9	—	—	○	○
	1280 x 800	71.6	84.9	—	—	○	○
	** 1280 x 800	101.6	119.9	—	—	○	○
	*** 1280 x 1024	64.0	60.0	—	—	○	○
	1280 x 1024	80.0	75.0	—	—	○	○
	1280 x 1024	91.1	85.0	—	—	○	○
	*** 1280 x 960	60.0	60.0	—	—	○	○
	1280 x 960	85.9	85.0	—	—	○	○
	*** 1366 x 768	47.7	60.0	—	—	○	○
	*** 1400 x 1050	65.3	60.0	—	—	○	○
1440 x 900	55.5	59.9	—	—	○	○	
*** 1440 x 900	55.9	59.9	—	—	○	○	
1440 x 900	70.6	75.0	—	—	○	○	
1600 x 1200	75.0	60.0	—	—	○	○	
1680 x 1050	64.7	59.9	—	—	○	○	
1680 x 1050	65.3	60.0	—	—	○	○	
1920 x 1200	74.0	60.0	—	—	○	○	
1920 x 1080	67.5	60.0	—	—	○	○	

SIGNAL	RESOLUTION	H-SYNC (KHz)	V-SYNC (Hz)	COMPOSITE S_VIDEO	COMPONENT	RGB (ANALOG)	HDMI (DIGITAL)
Apple Macintosh	640 x 480	35.0	66.7	—	—	○	○
	832 x 624	49.7	74.5	—	—	○	○
	1024 x 768	60.2	74.9	—	—	○	○
	1152 x 870	68.7	75.1	—	—	○	○
SDTV	480i	15.7	60.0	—	○	—	○
	576i	15.6	50.0	—	○	—	○
EDTV	576p	31.3	50.0	—	○	—	○
	480p	31.5	60.0	—	○	—	○
HDTV	720p	37.5	50.0	—	○	—	○
	720p	45.0	60.0	—	○	—	○
	1080i	33.8	60.0	—	○	—	○
	1080i	28.1	50.0	—	○	—	○
	1080p	27.0	24.0	—	○	—	○
	1080p	28.0	25.0	—	○	—	○
	1080p	33.7	30.0	—	○	—	○
	1080p	56.3	50.0	—	○	—	○
	1080p	67.5	60.0	—	○	—	○

○: Frequency supported

—: Frequency not supported

★3D note :

“★” It means the timing can support non-3D and 3D signal with Frame Sequential and Top-Bottom format.

“★★”It means the timing can support non-3D and 3D signal with Frame Sequential format.

“★★★”It means the timing can support non-3D and 3D signal with Top-Bottom format.

There 3D timing showing depend the EDID file and display card. It is possible that user cannot choose the above 3D timings on display card.

★The resolution of the panel is 1280 x 800. Resolution other than native resolution may display with uneven size of text or lines.

★The color of      mean Displayable only. (4:3 only)

★The color of      mean may have a little noise is acceptable, Because video mode sync don't auto adjustment.

★HDTV timing main check tool is DVD player, VG828 is secondary

## Projector Dimensions

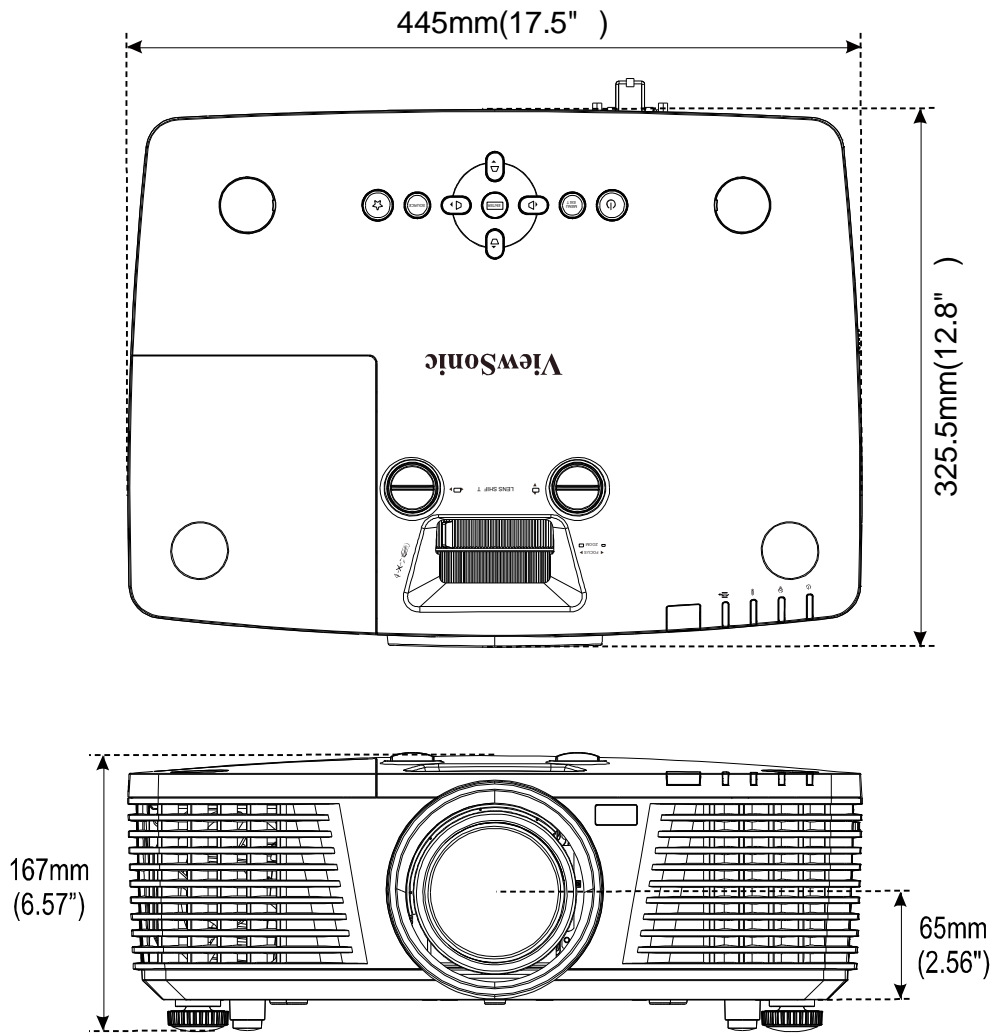

### FCC Warning

This equipment has been tested and found to comply with the limits for a Class B digital device pursuant to Part 15 of the FCC Rules. These limits are designed to provide reasonable protection against harmful interference when the equipment is operated in a commercial environment.

This equipment generates, uses, and can radiate radio frequency energy and, if not installed and used in accordance with the instruction manual, may cause harmful interference to radio communications. Operation of this equipment in a residential area is likely to cause harmful interference in which case the user will be required to correct the interference at his/her own expense.

Changes or modifications not expressly approved by the parties responsible for compliance could void the user's authority to operate the equipment.

### Canada

This class B digital apparatus complies with Canadian ICES-003.

### Safety Certifications

FCC-B, cUL, UL, CB, CE, CCC, KC, , NOM, , C-tick, TUV, PSB



## IR code table

Key No.	Key	format	Byte1	Byte2	Byte3	Byte4
1	Power ON	NEC	X3	F4	17	E8
2	My Button	NEC	X3	F4	56	A9
3	COMP	NEC	X3	F4	41	BE
4	HDMI	NEC	X3	F4	A1	5E
5	HDMI/MHL	NEC	X3	F4	58	A7
6	VIDEO	NEC	X3	F4	9F	60
7	BNC	NEC	X3	F4	57	A8
8	Source	NEC	X3	F4	40	BF
9	Auto SYNC	NEC	X3	F4	8	F7
10	Up /V keystone +	NEC	X3	F4	0B	F4
11	Freeze	NEC	X3	F4	3	FC
12	Left /H keystone -	NEC	X3	F4	0E	F1
13	Enter	NEC	X3	F4	15	EA
14	Right H keystone +	NEC	X3	F4	0F	F0
15	MENU	NEC	X3	F4	30	CF
16	Down/V keystone -	NEC	X3	F4	0C	F3
17	EXIT	NEC	X3	F4	28	D7
18	MOUSE	NEC	X3	F4	31	CE
19	Mouse Left	NEC	X3	F4	36	C9
20	Mouse Right	NEC	X3	F4	37	C8
21	ID SET	NEC	X3	F4	96	69
22	PgUp/ 1	NEC	X3	F4	6	F9
23	PgDn / 2	NEC	X3	F4	5	FA
24	Blank/ 3	NEC	X3	F4	7	F8
25	Mute/ 4	NEC	X3	F4	14	EB
26	PATTERN/ 5	NEC	X3	F4	55	AA
27	Aspect/ 6	NEC	X3	F4	13	EC
28	Volume+/ 7	NEC	X3	F4	82	7D
29	Help/ 8	NEC	X3	F4	21	DE
30	Presentation Timer	NEC	X3	F4	27	D8
31	Volume-	NEC	X3	F4	83	7C
32	Magnify	NEC	X3	F4	32	CD
33	ECO MODE	NEC	X3	F4	2B	D4
34	Key pad lock	NEC	X3	F4	8E	71
35	COLOR MODE	NEC	X3	F4	10	EF

## RS-232C Protocol

### RS232 Setting

Baud Rate	9600
Data Bits	8
Parity Check	None
Stop Bits	1
Flow Control	None
UART16550 FIFO	Disable

Minimum delay for next command: **1ms**

### Control Command Structure

The command is structured by the Header code, command code, data code and end code. Most of the commands are structured except some for the compatibility issue with other projectors.

	Header code	Command code	Data code	End code
<b>HEX</b>		<b>Command</b>	<b>Data</b>	<b>0Dh</b>
<b>ASCII</b>	'V'	<b>Command</b>	<b>Data</b>	<b>CR</b>

### Operation Command

<p>Note:</p> <p>"CR" mean Carriage Return</p> <p>XX=99</p> <p>Ex: S99S001 + enter , To power on.</p> <p>Return Result P=Pass / F=Fail</p> <p>n: 0:Disable/1: Enable/Value(0~9999)</p>
---

Command Group 00				
ASCII	HEX	Function	Description	Return Result
SXXS0001	53h Xh Xh 53h 30h 30h 30h 31h 0Dh	Power On		P/F
SXXS0002	53h Xh Xh 53h 30h 30h 30h 32h 0Dh	Power Off		P/F
SXXS0003	53h Xh Xh 53h 30h 30h 30h 33h 0Dh	Resync		P/F
SXXG0004	53h Xh Xh 47h 30h 30h 30h 34h 0Dh	Get Lamp Hours		Pn/F
SXXG0005	53h Xh Xh 47h 30h 30h 30h 35h 0Dh	Get Air filter timer	n=0~999999	Pn/F
SXXS0006	53h Xh Xh 53h 30h 30h 30h 36h 0Dh	System Reset		P/F
SXXG0007	53h Xh Xh 47h 30h 30h 30h 37h 0Dh	Get System Status	0: Reset 1:Standby 2:Operation 3:Cooling	Pn/F
SXXG0008	53h Xh Xh 47h 30h 30h 30h 38h 0Dh	Get F/W Version		Pn/F
SXXG0009	53h Xh Xh 47h 30h 30h 30h 39h 0Dh	Get Alter EMail		Pn/F
SXXS0009n	53h Xh Xh 53h 30h 30h 30h 39h nh 0Dh	Set Alter Email	n=xxxxxx@xxxx. xxx.xx	P/F
SXXS0010	53h Xh Xh 53h 30h 30h 31h 30h 0Dh	Lamp Hours Reset		Pn/F

Command Group 01				
ASCII	HEX	Function	Description	Return Value
SXXG0101	53h Xh Xh 47h 30h 31h 30h 31h 0Dh	Get Brightness	n=0~100	Pn/F
SXXS0101n	53h Xh Xh 53h 30h 31h 30h 31h nh 0Dh	Set Brightness	n=0~100	P/F
SXXG0102	53h Xh Xh 47h 30h 31h 30h 32h 0Dh	Get Contrast	n=0~100	Pn/F
SXXS0102n	53h Xh Xh 53h 30h 31h 30h 32h nh 0Dh	Set Contrast	n=0~100	P/F
SXXG0103	53h Xh Xh 47h 30h 31h 30h 33h 0Dh	Get Color	n=0~100	Pn/F
SXXS0103n	53h Xh Xh 53h 30h 31h 30h 33h nh 0Dh	Set Color	n=0~100	P/F
SXXG0104	53h Xh Xh 47h 30h 31h 30h 34h 0Dh	Get Tint	n=0~100	Pn/F
SXXS0104n	53h Xh Xh 53h 30h 31h 30h 34h nh 0Dh	Set Tint	n=0~100	P/F
SXXG0105	53h Xh Xh 47h 30h 31h 30h 35h 0Dh	Get Sharpness	0~31	Pn/F
SXXS0105n	53h Xh Xh 53h 30h 31h 30h 35h nh 0Dh	Set Sharpness	0~31	P/F
SXXG0106	53h Xh Xh 47h 30h 31h 30h 36h 0Dh	Get Color Temperature	0=Warm 1=Normal 2=Cool	Pn/F
SXXS0106n	53h Xh Xh 53h 30h 31h 30h 36h nh 0Dh	Set Color Temperature	0=Warm 1=Normal 2=Cool	P/F
SXXG0107	53h Xh Xh 47h 30h 31h 30h 37h 0Dh	Get Gamma	0 to 12 13:DICOM SIM 14:sRGB	Pn/F
SXXS0107n	53h Xh Xh 53h 30h 31h 30h 37h nh 0Dh	Set Gamma	0 to 12 13:DICOM SIM 14:sRGB	P/F
SXXG0108	53h 39h 39h 47h 30h 31h 30h 38h 0Dh	Get Display Mode	0:Brightest 1:Dynamic 2:Standard 3:ViewMatch sRGB 4:Movie 5.DICOM SIM 6: User	Pn/F
SXXS0108n	53h 39h 39h 53h 30h 31h 30h 38h nh 0Dh	Set Display Mode	0:Brightest 1:Dynamic 2:Standard 3:ViewMatch sRGB 4:Movie 5.DICOM SIM 6: User	P/F

Command Group 02				
ASCII	HEX	Function	Description	Return Value
SXXS0201	53h Xh Xh 53h 30h 32h 30h 31h 0Dh	Select RGB		P/F
SXXS0202	53h Xh Xh 53h 30h 32h 30h 32h 0Dh	Select RGB2		P/F
SXXS0203	53h Xh Xh 53h 30h 32h 30h 33h 0Dh	Select DVI		P/F
SXXS0204	53h Xh Xh 53h 30h 32h 30h 34h 0Dh	Select Video		P/F
SXXS0205	53h Xh Xh 53h 30h 32h 30h 35h 0Dh	Select S-Video		P/F
SXXS0206	53h Xh Xh 53h 30h 32h 30h 36h 0Dh	Select HDMI		P/F
SXXS0207	53h Xh Xh 53h 30h 32h 30h 37h 0Dh	Select BNC		P/F
SXXS0208	53h Xh Xh 53h 30h 32h 30h 38h 0Dh	Select Component		P/F
SXXS0209	53h Xh Xh 53h 30h 32h 30h 39h 0Dh	Select HDMI 2		P/F
SXXS0210	53h Xh Xh 53h 30h 32h 31h 30h 0Dh	Select DP		P/F
SXXS0215	53h Xh Xh 53h 30h 32h 31h 33h 0Dh	Select HDBASET		P/F
SXXG0220	53h Xh Xh 47h 30h 32h 32h 30h 0Dh	Get Current Source	Return 1:RGB 2:RGB2 3:DVI 4:Video 5:S-Video 6:HDMI 7:BNC 8:Component 9:HDMI2 10:Display Port 15:HDBASET	Pn/F

Command Group 03				
ASCII	HEX	Function	Description	Return Value
SXXG0301	53h Xh Xh 47h 30h 33h 30h 31h 0Dh	Get Scaling	0: Fill 1: 4:3 2: 16:9 3 :Letter Box 4 :Native	Pn/F
SXXS0301n	53h Xh Xh 53h 30h 33h 30h 31h nh 0Dh	Set Scaling	0: Fill 1: 4:3 2: 16:9 3 :Letter Box 4 :Native	P/F
SXXG0302	53h Xh Xh 47h 30h 33h 30h 32h 0Dh	Blank		Pn/F
SXXS0302n	53h Xh Xh 53h 30h 33h 30h 32h nh 0Dh	Blank		P/F
SXXG0303	53h Xh Xh 47h 30h 33h 30h 33h 0Dh	Auto Keystone On		Pn/F
SXXS0303n	53h Xh Xh 53h 30h 33h 30h 33h nh 0Dh	Auto Keystone On		P/F
SXXG0304	53h Xh Xh 47h 30h 33h 30h 34h 0Dh	Freeze On		Pn/F
SXXS0304n	53h Xh Xh 53h 30h 33h 30h 34h nh 0Dh	Freeze On		P/F
SXXG0305	53h Xh Xh 47h 30h 33h 30h 35h 0Dh	Volume	n=0~10	Pn/F
SXXS0305n	53h Xh Xh 53h 30h 33h 30h 35h nh 0Dh	Volume	n=0~10	P/F
SXXG0306	53h Xh Xh 47h 30h 33h 30h 36h 0Dh	Treble	n=0~16	Pn/F
SXXS0306n	53h Xh Xh 53h 30h 33h 30h 36h nh 0Dh	Treble	n=0~16	P/F

Command Group 03				
ASCII	HEX	Function	Description	Return Value
SXXG0307	53h Xh Xh 47h 30h 33h 30h 37h 0Dh	Bass	n=0~16	Pn/F
SXXS0307n	53h Xh Xh 53h 30h 33h 30h 37h nh 0Dh	Bass	n=0~16	P/F
SXXG0308	53h Xh Xh 47h 30h 33h 30h 38h 0Dh	Projection Mode	0:Front 1:Rear 2: Ceiling 3: Rear+Ceiling	Pn/F
SXXS0308n	53h Xh Xh 53h 30h 33h 30h 38h nh 0Dh	Projection Mode	0:Front 1:Rear 2: Ceiling 3: Rear+Ceiling	P/F
SXXG0309	53h Xh Xh 47h 30h 33h 30h 39h 0Dh	Set vertical keystone value	n=-30~+30	Pn/F
SXXS0309n	53h Xh Xh 53h 30h 33h 30h 39h nh 0Dh	Set vertical keystone value	n=-30~+30	P/F
SXXG0310	53h Xh Xh 47h 30h 33h 31h 30h 0Dh	Set horizontal keystone value	n=-25~+25	Pn/F
SXXS0310n	53h Xh Xh 53h 30h 33h 31h 30h nh 0Dh	Set horizontal keystone value	n=-25~+25	P/F
SXXG0311	53h Xh Xh 47h 30h 33h 31h 31h 0Dh	Adjust the zoom	n=-10~+10	Pn/F
SXXS0311n	53h Xh Xh 53h 30h 33h 31h 31h nh 0Dh	Adjust the zoom	n=-10~+10	P/F
SXXG0312	53h Xh Xh 47h 30h 33h 31h 32h 0Dh	Adjust the focus	n=-20~+20	Pn/F
SXXS0312n	53h Xh Xh 53h 30h 33h 31h 32h nh 0Dh	Adjust the focus	n=-20~+20	P/F
SXXG0313	53h Xh Xh 47h 30h 33h 31h 33h 0Dh	Adjust the vertical lens shift	n=-20~+20	Pn/F
SXXS0313n	53h Xh Xh 53h 30h 33h 31h 33h nh 0Dh	Adjust the vertical lens shift	n=-20~+20	P/F
SXXG0314	53h Xh Xh 47h 30h 33h 31h 34h 0Dh	Adjust the horizontal lens shift	n=-20~+20	Pn/F
SXXS0314n	53h Xh Xh 53h 30h 33h 31h 34h nh 0Dh	Adjust the horizontal lens shift	n=-20~+20	P/F
SXXG0315	53h Xh Xh 47h 30h 33h 31h 35h 0Dh	3D	0:Off 1:DLP-Link 2:IR	Pn/F
SXXS0315n	53h Xh Xh 53h 30h 33h 31h 35h nh 0Dh	3D	0:Off 1:DLP-Link 2:IR	P/F
SXXG0316	53h Xh Xh 47h 30h 33h 31h 36h 0Dh	3D Sync Invert	0:Off 1:On	Pn/F
SXXS0316n	53h Xh Xh 53h 30h 33h 31h 36h nh 0Dh	3D Sync Invert	0:Off 1:On	P/F
SXXG0317	53h Xh Xh 47h 30h 33h 31h 37h 0Dh	3D Format	0:Frame Sequential 1:Top/Bottom 2:Side-By-Side 3:Frame Packing	Pn/F
SXXS0317n	53h Xh Xh 53h 30h 33h 31h 36h nh 0Dh	3D Format	0: Frame Sequential 1:Top/Bottom 2:Side-By-Side 3: Frame Packing	P/F

Command Group 03				
ASCII	HEX	Function	Description	Return Value
SXXG0319	53h Xh Xh 47h 30h 33h 31h 39h 0Dh	Lamp Mode	0:Eco 1:Normal 2:Dynamic Eco	Pn/F
SXXS0319n	53h Xh Xh 53h 30h 33h 31h 39h 0Dh	Lamp Mode	0:Eco 1:Normal 2:Dynamic Eco	P/F
SXXS0320	53h 39h 39h 53h 30h 33h 32h 30h 0Dh	Logo Capture		P/F
SXXG0321	53h 39h 39h 47h 30h 33h 32h 31h 0Dh	Logo Select	0:ViewSonic 1:Off 2: Red 3:Green 4:Blue 5:User	Pn/F
SXXS0321n	53h 39h 39h 53h 30h 33h 32h 31h n 0Dh	Logo Select	0:ViewSonic 1:Off 2: Red 3:Green 4:Blue 5:User	P/F
SXXG0322	53h 39h 39h 47h 30h 33h 32h 32h 0Dh	Fan Speed	0:Normal 1:High	Pn/F
SXXS0322n	53h 39h 39h 53h 30h 33h 32h 32h n 0Dh	Fan Speed	0:Normal 1:High	P/F
SXXG0330	53h 39h 39h 47h 30h 33h 33h 30h 0Dh	Sleep Timer	0~120	Pn/F
SXXS0330n	53h 39h 39h 53h 30h 33h 33h 30h n 0Dh	Sleep Timer	0~120	P/F

# Customer Support

For technical support or product service, see the table below or contact your reseller.

**Note :** You will need the product serial number.

Country/Region	Website	T= Telephone C = CHAT ONLINE	Email
Australia New Zealand	www.viewsonic.com.au	AUS= 1800 880 818 NZ= 0800 008 822	service@au.viewsonic.com
Canada	www.viewsonic.com	T (Toll-Free)= 1-866-463-4775 T (Toll)= 1-424-233-2533	service.ca@viewsonic.com
Europe	www.viewsoniceurope.com	www.viewsoniceurope.com/uk/support/call-desk/	
Hong Kong	www.hk.viewsonic.com	T= 852 3102 2900	service@hk.viewsonic.com
India	www.in.viewsonic.com	T= 1800 419 0959	service@in.viewsonic.com
Korea	ap.viewsonic.com/kr/	T= 080 333 2131	service@kr.viewsonic.com
Latin America (Argentina)	www.viewsonic.com/la/	C= <a href="http://www.viewsonic.com/la/soporte/servicio-tecnico">http://www.viewsonic.com/la/soporte/servicio-tecnico</a>	soporte@viewsonic.com
Latin America (Chile)	www.viewsonic.com/la/	C= <a href="http://www.viewsonic.com/la/soporte/servicio-tecnico">http://www.viewsonic.com/la/soporte/servicio-tecnico</a>	soporte@viewsonic.com
Latin America (Columbia)	www.viewsonic.com/la/	C= <a href="http://www.viewsonic.com/la/soporte/servicio-tecnico">http://www.viewsonic.com/la/soporte/servicio-tecnico</a>	soporte@viewsonic.com
Latin America (Mexico)	www.viewsonic.com/la/	C= <a href="http://www.viewsonic.com/la/soporte/servicio-tecnico">http://www.viewsonic.com/la/soporte/servicio-tecnico</a>	soporte@viewsonic.com
Nexus Hightech Solutions, Cincinnati #40 Desp. 1 Col. De los Deportes Mexico D.F. Tel: 55) 6547-6454 55)6547-6484 Other places please refer to <a href="http://www.viewsonic.com/la/soporte/servicio-tecnico#mexico">http://www.viewsonic.com/la/soporte/servicio-tecnico#mexico</a>			
Latin America (Peru)	www.viewsonic.com/la/	C= <a href="http://www.viewsonic.com/la/soporte/servicio-tecnico">http://www.viewsonic.com/la/soporte/servicio-tecnico</a>	soporte@viewsonic.com
Macau	www.hk.viewsonic.com	T= 853 2870 0303	service@hk.viewsonic.com
Middle East	ap.viewsonic.com/me/	Contact your reseller	service@ap.viewsonic.com
Puerto Rico & Virgin Islands	www.viewsonic.com	T= 1-800-688-6688 (English) C= <a href="http://www.viewsonic.com/la/soporte/servicio-tecnico">http://www.viewsonic.com/la/soporte/servicio-tecnico</a>	service.us@viewsonic.com soporte@viewsonic.com
Singapore/ Malaysia/Thailand	www.ap.viewsonic.com	T= 65 6461 6044	service@sg.viewsonic.com
South Africa	ap.viewsonic.com/za/	Contact your reseller	service@ap.viewsonic.com
United States	www.viewsonic.com	T (Toll-Free)= 1-800-688-6688 T (Toll)= 1-424-233-2530	service.us@viewsonic.com

# Limited Warranty

## ViewSonic® Projector

### What the warranty covers:

ViewSonic warrants its products to be free from defects in material and workmanship, under normal use, during the warranty period. If a product proves to be defective in material or workmanship during the warranty period, ViewSonic will, at its sole option, repair or replace the product with a like product. Replacement product or parts may include remanufactured or refurbished parts or components.

### Limited Three (3) year General Warranty

Subject to the more limited one (1) year warranty set out below, North and South America: Three (3) years warranty for all parts excluding the lamp, three (3) years for labor, and one (1) year for the original lamp from the date of the first consumer purchase.

Other regions or countries: Please check with your local dealer or local ViewSonic office for the warranty information.

### Limited One (1) year Heavy Usage Warranty:

Under heavy usage settings, where a projector's use includes more than fourteen (14) hours average daily usage, North and South America: One (1) year warranty for all parts excluding the lamp, one (1) year for labor, and ninety (90) days for the original lamp from the date of the first consumer purchase; Europe: One (1) year warranty for all parts excluding the lamp, one (1) year for labor, and ninety (90) days for the original lamp from the date of the first consumer purchase.

Other regions or countries: Please check with your local dealer or local ViewSonic office for the warranty information.

Lamp warranty subject to terms and conditions, verification and approval. Applies to manufacturer's installed lamp only. All accessory lamps purchased separately are warranted for 90 days.

### Who the warranty protects:

This warranty is valid only for the first consumer purchaser.

### What the warranty does not cover:

1. Any product on which the serial number has been defaced, modified or removed.
2. Damage, deterioration, failure, or malfunction resulting from:
  - a. Accident, abuse, misuse, neglect, fire, water, lightning, or other acts of nature, improper maintenance, unauthorized product modification, or failure to follow instructions supplied with the product.
  - b. Operation outside of product specifications.
  - c. Operation of the product for other than the normal intended use or not under normal conditions.
  - d. Repair or attempted repair by anyone not authorized by ViewSonic.
  - e. Any damage of the product due to shipment.
  - f. Removal or installation of the product.
  - g. Causes external to the product, such as electric power fluctuations or failure.
  - h. Use of supplies or parts not meeting ViewSonic's specifications.
  - i. Normal wear and tear.
  - j. Any other cause which does not relate to a product defect.
3. Removal, installation, and set-up service charges.



**How to get service:**

1. For information about receiving service under warranty, contact ViewSonic Customer Support (please refer to “Customer Support” page). You will need to provide your product’s serial number.
2. To obtain warranted service, you will be required to provide (a) the original dated sales slip, (b) your name, (c) your address, (d) a description of the problem, and (e) the serial number of the product.
3. Take or ship the product freight prepaid in the original container to an authorized ViewSonic service center or ViewSonic.
4. For additional information or the name of the nearest ViewSonic service center, contact ViewSonic.

**Limitation of implied warranties:**

There are no warranties, express or implied, which extend beyond the description contained herein including the implied warranty of merchantability and fitness for a particular purpose.

**Exclusion of damages:**

ViewSonic’s liability is limited to the cost of repair or replacement of the product.

ViewSonic shall not be liable for:

1. Damage to other property caused by any defects in the product, damages based upon inconvenience, loss of use of the product, loss of time, loss of profits, loss of business opportunity, loss of goodwill, interference with business relationships, or other commercial loss, even if advised of the possibility of such damages.
2. Any other damages, whether incidental, consequential or otherwise.
3. Any claim against the customer by any other party.

**Effect of local law:**

This warranty gives you specific legal rights, and you may also have other rights which vary from local authority. Some local governances do not allow limitations on implied warranties and/or do not allow the exclusion of incidental or consequential damages, so the above limitations and exclusions may not apply to you.

**Sales outside the U.S.A. and Canada:**

For warranty information and service on ViewSonic products sold outside of the U.S.A. and Canada, contact ViewSonic or your local ViewSonic dealer.

The warranty period for this product in mainland China (Hong Kong, Macao and Taiwan Excluded) is subject to the terms and conditions of the Maintenance Guarantee Card.

For users in Europe and Russia, full details of warranty provided can be found in [www.viewsoniceurope.com](http://www.viewsoniceurope.com) under Support/Warranty Information.

# Mexico Limited Warranty

## ViewSonic® Projector

### What the warranty covers:

ViewSonic warrants its products to be free from defects in material and workmanship, under normal use, during the warranty period. If a product proves to be defective in material or workmanship during the warranty period, ViewSonic will, at its sole option, repair or replace the product with a like product. Replacement product or parts may include remanufactured or refurbished parts or components & accessories.

### How long the warranty is effective:

3 years for all parts excluding the lamp, 3 years for labor, 1 year for the original lamp from the date of the first consumer purchase.

Lamp warranty subject to terms and conditions, verification and approval. Applies to manufacturer's installed lamp only.

All accessory lamps purchased separately are warranted for 90 days.

### Who the warranty protects:

This warranty is valid only for the first consumer purchaser.

### What the warranty does not cover:

1. Any product on which the serial number has been defaced, modified or removed.
2. Damage, deterioration or malfunction resulting from:
  - a. Accident, misuse, neglect, fire, water, lightning, or other acts of nature, unauthorized product modification, unauthorized attempted repair, or failure to follow instructions supplied with the product.
  - b. Any damage of the product due to shipment.
  - c. Causes external to the product, such as electrical power fluctuations or failure.
  - d. Use of supplies or parts not meeting ViewSonic's specifications.
  - e. Normal wear and tear.
  - f. Any other cause which does not relate to a product defect.
3. Any product exhibiting a condition commonly known as "image burn-in" which results when a static image is displayed on the product for an extended period of time.
4. Removal, installation, insurance, and set-up service charges.

### How to get service:

For information about receiving service under warranty, contact ViewSonic Customer Support (Please refer to the attached Customer Support page). You will need to provide your product's serial number, so please record the product information in the space provided below on your purchase for your future use. Please retain your receipt of proof of purchase to support your warranty claim.

For Your Records

Product Name: \_\_\_\_\_ Model Number: \_\_\_\_\_  
Document Number: \_\_\_\_\_ Serial Number: \_\_\_\_\_  
Purchase Date: \_\_\_\_\_ Extended Warranty Purchase? \_\_\_\_\_ (Y/N)  
If so, what date does warranty expire? \_\_\_\_\_

1. To obtain warranty service, you will be required to provide (a) the original dated sales slip, (b) your name, (c) your address, (d) a description of the problem, and (e) the serial number of the product.
2. Take or ship the product in the original container packaging to an authorized ViewSonic service center.
3. Round trip transportation costs for in-warranty products will be paid by ViewSonic.

### Limitation of implied warranties:

There are no warranties, express or implied, which extend beyond the description contained herein including the implied warranty of merchantability and fitness for a particular purpose.

### Exclusion of damages:

ViewSonic's liability is limited to the cost of repair or replacement of the product. ViewSonic shall not be liable for:

1. Damage to other property caused by any defects in the product, damages based upon inconvenience, loss of use of the product, loss of time, loss of profits, loss of business opportunity, loss of goodwill, interference with business relationships, or other commercial loss, even if advised of the possibility of such damages.
2. Any other damages, whether incidental, consequential or otherwise.
3. Any claim against the customer by any other party.
4. Repair or attempted repair by anyone not authorized by ViewSonic.

<b>Contact Information for Sales &amp; Authorized Service (Centro Autorizado de Servicio) within Mexico:</b>	
<b>Name, address, of manufacturer and importers:</b> México, Av. de la Palma #8 Piso 2 Despacho 203, Corporativo Interpalmas, Col. San Fernando Huixquilucan, Estado de México Tel: (55) 3605-1099 <a href="http://www.viewsonic.com/la/soporte/index.htm">http://www.viewsonic.com/la/soporte/index.htm</a>	
<b>NÚMERO GRATIS DE ASISTENCIA TÉCNICA PARA TODO MÉXICO: 001.866.823.2004</b>	
<b>Hermosillo:</b> Distribuciones y Servicios Computacionales SA de CV. Calle Juarez 284 local 2 Col. Bugambillas C.P: 83140 Tel: 01-66-22-14-9005 E-Mail: <a href="mailto:disc2@hmo.megared.net.mx">disc2@hmo.megared.net.mx</a>	<b>Villahermosa:</b> Compumantenimientos Garantizados, S.A. de C.V. AV. GREGORIO MENDEZ #1504 COL, FLORIDA C.P. 86040 Tel: 01 (993) 3 52 00 47 / 3522074 / 3 52 20 09 E-Mail: <a href="mailto:compumantenimientos@prodigy.net.mx">compumantenimientos@prodigy.net.mx</a>
<b>Puebla, Pue. (Matriz):</b> RENTA Y DATOS, S.A. DE C.V. Domicilio: 29 SUR 721 COL. LA PAZ 72160 PUEBLA, PUE. Tel: 01(52).222.891.55.77 CON 10 LINEAS E-Mail: <a href="mailto:datos@puebla.megared.net.mx">datos@puebla.megared.net.mx</a>	<b>Veracruz, Ver.:</b> CONEXION Y DESARROLLO, S.A DE C.V. Av. Americas # 419 ENTRE PINZÓN Y ALVARADO Fracc. Reforma C.P. 91919 Tel: 01-22-91-00-31-67 E-Mail: <a href="mailto:gacosta@qplus.com.mx">gacosta@qplus.com.mx</a>
<b>Chihuahua</b> Soluciones Globales en Computación C. Magisterio # 3321 Col. Magisterial Chihuahua, Chih. Tel: 4136954 E-Mail: <a href="mailto:Cefeo@soluglobales.com">Cefeo@soluglobales.com</a>	<b>Cuernavaca</b> Compusupport de Cuernavaca SA de CV Francisco Leyva # 178 Col. Miguel Hidalgo C.P. 62040, Cuernavaca Morelos Tel: 01 777 3180579 / 01 777 3124014 E-Mail: <a href="mailto:aquevedo@compusupportcva.com">aquevedo@compusupportcva.com</a>
<b>Distrito Federal:</b> QPLUS, S.A. de C.V. Av. Coyoacán 931 Col. Del Valle 03100, México, D.F. Tel: 01(52)55-50-00-27-35 E-Mail : <a href="mailto:gacosta@qplus.com.mx">gacosta@qplus.com.mx</a>	<b>Guadalajara, Jal.:</b> SERVICRECE, S.A. de C.V. Av. Niños Héroes # 2281 Col. Arcos Sur, Sector Juárez 44170, Guadalajara, Jalisco Tel: 01(52)33-36-15-15-43 E-Mail: <a href="mailto:mmiranda@servicrece.com">mmiranda@servicrece.com</a>
<b>Guerrero Acapulco</b> GS Computación (Grupo Sesicomp) Progreso #6-A, Colo Centro 39300 Acapulco, Guerrero Tel: 744-48-32627	<b>Monterrey:</b> Global Product Services Mar Caribe # 1987, Esquina con Golfo Pérsico Fracc. Bernardo Reyes, CP 64280 Monterrey N.L. México Tel: 8129-5103 E-Mail: <a href="mailto:aydeem@gps1.com.mx">aydeem@gps1.com.mx</a>
<b>MERIDA:</b> ELECTROSER Av Reforma No. 403Gx39 y 41 Mérida, Yucatán, México CP97000 Tel: (52) 999-925-1916 E-Mail: <a href="mailto:rrrb@sureste.com">rrrb@sureste.com</a>	<b>Oaxaca, Oax.:</b> CENTRO DE DISTRIBUCION Y SERVICIO, S.A. de C.V. Murguía # 708 P.A., Col. Centro, 68000, Oaxaca Tel: 01(52)95-15-15-22-22 Fax: 01(52)95-15-13-67-00 E-Mail: <a href="mailto:gpotai2001@hotmail.com">gpotai2001@hotmail.com</a>
<b>Tijuana:</b> STD Av Ferrocarril Sonora #3780 L-C Col 20 de Noviembre Tijuana, Mexico	<b>FOR USA SUPPORT:</b> ViewSonic Corporation 14035 Pipeline Ave. Chino, CA 91710, USA Tel: 800-688-6688 (English); 866-323-8056 (Spanish); E-Mail: <a href="http://www.viewsonic.com">http://www.viewsonic.com</a>



**ViewSonic®**