

**Radiograph provided by Joshua Jackson, DVM, DACVS Veterinary Specialty Hospital San Diego, CA*

ORTHOPEDIC Trauma

External

Linear ESF System	172
Introduction.....	173
Implants	
ESF Pins.....	174
Instruments.....	176
Instruments for ESF.....	176
Pin Placement Devices.....	176
Drill Sleeves.....	176
Drill Bits.....	177
Clamps.....	178
Unilateral Augmentation System.....	180
Dynamization Bolts.....	181
Wrenches & Nut Drivers.....	181
Rods.....	182
FastFix.....	183
Sterilization Containers.....	184
Reference Materials.....	185

Internal

Introduction.....	186
Pin & Wire Management	188
Introduction.....	188
Implants.....	189
Kirshner Wires (K-wires).....	189
Steinmann/Intramedullary Pins.....	190
Cerclage Wire.....	191
Instruments.....	192
Dual Chucks.....	192
Wire Passers.....	192
Wire Twisters.....	193
Wire Benders.....	197
Pin/Wire Cutters.....	197
Pin Punches.....	200
Sterilization Containers.....	201
Organizer Bags.....	201
Reference Materials.....	201
Conventional Plate Osteosynthesis	202
Introduction.....	202
Implants.....	203
Straight Plates.....	203
Round Hole Plates.....	203
Dynamic Compression Plates.....	203
Limited Contact Dynamic Compression Plates.....	205

Internal

Specialty Plates.....	216
T-Plates.....	216
L-Plates.....	219
Acetabular Plates.....	220
Distal Femur Osteotomy Plates.....	221
Screws.....	222
Washers.....	234
Instruments.....	235
Instruments for Conventional Plating System..	235
Bending Instruments.....	236
Drill Bits.....	239
Taps & Countersinks.....	240
Drill Guides, Sleeves, & Inserts.....	241
Depth Gauges.....	243
Screwdrivers, Handles & Shafts.....	243
Screw Extraction Set.....	246
Sterilization Containers.....	248
Screw Racks & Cases.....	248
Plate Stringers.....	251
Reference Materials.....	251

Polyaxial Locking Plate Osteosynthesis	252
Introduction.....	252
Implants.....	254
Straight Plates.....	254
RP Plates.....	254
SP Plates.....	254
Specialty Plates.....	258
T-Plates.....	258
Butterfly Plates.....	258
Screws.....	259
Instruments.....	261
Instruments for PAX Locked Plating System	261
Plate Holding Forceps.....	261
Bending Instruments.....	261
Drill Bits.....	261
Drill Guides.....	262
Depth Gauges.....	262
Screwdrivers, Handles & Shafts.....	263
Sterilization Containers.....	264
Trays and Covers.....	264
Reference Materials.....	269

External Fixation

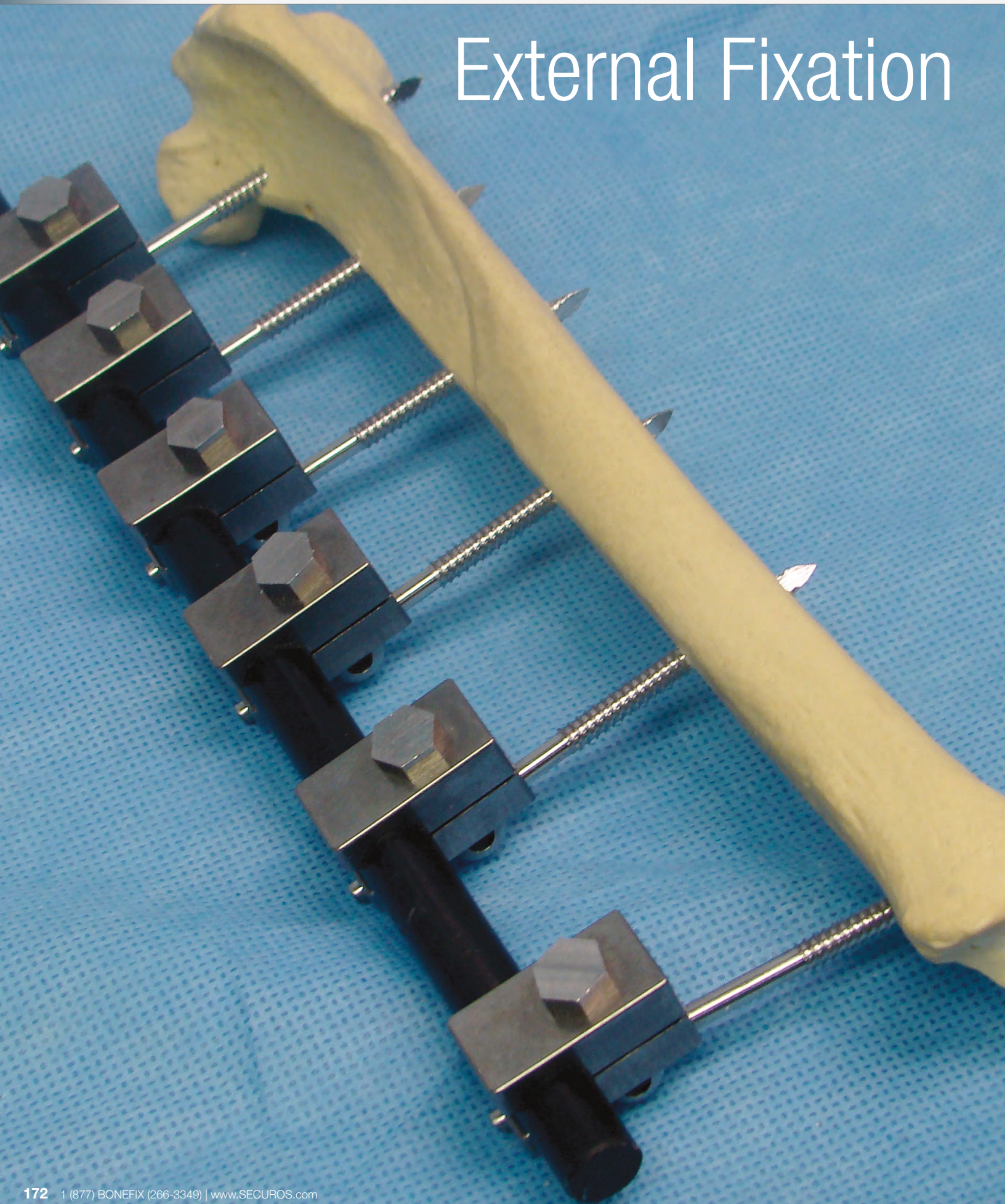

External Skeletal Fixation



TITAN Clamp

External Skeletal Fixation was first introduced in the 1840s. This type of fracture fixation relies on a variety of pins, clamps, and connecting bars to provide the stability that the bone needs to initiate the bone remodeling process. SECUROS has a complete range of external fixation products, available in two different styles to suit the needs of the surgeon; the TITAN system and the U Clamp system. Both systems have the ability to add or remove pins without disrupting the existing construct. The TITAN system is used with Carbon Fiber or Aluminum connecting rods, providing a lighter weight construct. The U clamp system is used with Stainless Steel connecting rods.



U Clamp

ESF Case Study



*Radiographs provided by Karl H. Kraus, DVM, MS, DACVS

IMPLANTS

End-Threaded Positive Profile ESF Pins

Micro ESF Pins - Stainless Steel

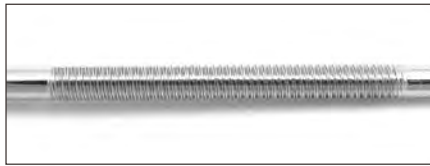

005089



End - Threads



005089



001396



001801



001398



001803

Micro ESF Pins - Stainless Steel

MWI#	SECUROS#	SHANK DIAMETER (")	THREAD DIAMETER (")	THREAD LENGTH (")	ACRYLIC THREAD LENGTH (")	OVERALL LENGTH (")
049503	005089	.045	.055	.6	1.0	3
049504	005090	.062	.071	.6	1.0	3
049505	005091	5/64	.091	.6	1.0	3
049506	005092	3/32	.114	.8	1.0	3

Mini ESF Pins - Stainless Steel

MWI#	SECUROS#	SHANK DIAMETER (")	THREAD DIAMETER (")	THREAD LENGTH (")	OVERALL LENGTH (")	RECOMMENDED DRILL BIT (mm)
028970	001396	1/16	5/64	.5	3.5	1.5

Small ESF Pins - Stainless Steel

MWI#	SECUROS#	SHANK DIAMETER (")	THREAD DIAMETER (")	THREAD LENGTH (")	OVERALL LENGTH (")	RECOMMENDED DRILL BIT (mm)
028974	001801	3/32	.132	1.0	3.5	2.4

Medium ESF Pins - Stainless Steel

MWI#	SECUROS#	SHANK DIAMETER (")	THREAD DIAMETER (")	THREAD LENGTH (")	OVERALL LENGTH (")	RECOMMENDED DRILL BIT (mm)
028972	001398	1/8	.157	1.5	5.0	3.2

Large ESF Pins - Stainless Steel

MWI#	SECUROS#	SHANK DIAMETER (")	THREAD DIAMETER (")	THREAD LENGTH (")	OVERALL LENGTH (")	RECOMMENDED DRILL BIT (mm)
028976	001803	5/32	3/16	2.3	7.0	4.0

Center-Threaded Positive Profile ESF Pins



001397



001802



001399



001804



Center - Threads

Mini ESF Pins - Stainless Steel

MWI#	SECUROS#	SHANK DIAMETER (")	THREAD DIAMETER (")	THREAD LENGTH (")	OVERALL LENGTH (")	RECOMMENDED DRILL BIT (mm)
028971	001397	1/16	5/64	1.0	5.0	1.5

Small ESF Pins - Stainless Steel

MWI#	SECUROS#	SHANK DIAMETER (")	THREAD DIAMETER (")	THREAD LENGTH (")	OVERALL LENGTH (")	RECOMMENDED DRILL BIT (mm)
028975	001802	3/32	.132	1.0	5.0	2.4

Medium ESF Pins - Stainless Steel

MWI#	SECUROS#	SHANK DIAMETER (")	THREAD DIAMETER (")	THREAD LENGTH (")	OVERALL LENGTH (")	RECOMMENDED DRILL BIT (mm)
028973	001399	1/8	.157	1.5	7.0	3.2

Large ESF Pins - Stainless Steel

MWI#	SECUROS#	SHANK DIAMETER (")	THREAD DIAMETER (")	THREAD LENGTH (")	OVERALL LENGTH (")	RECOMMENDED DRILL BIT (mm)
028977	001804	5/32	3/16	2.3	8.0	4.0

INSTRUMENTS

Pin Placement Devices

Pin Placement Devices for TITAN System



MWI#	SECUROS#	SIZE	FOR USE WITH PIN SIZE	INCLUDES DRILL SLEEVES (mm)	COLOR
056025	002360	Small	Mini, Small, Medium	1.5, 2.4, 3.2	Green
044056	001365	Large	Medium, Large	3.2, 4.0	Gold

Pin Placement Devices for U System

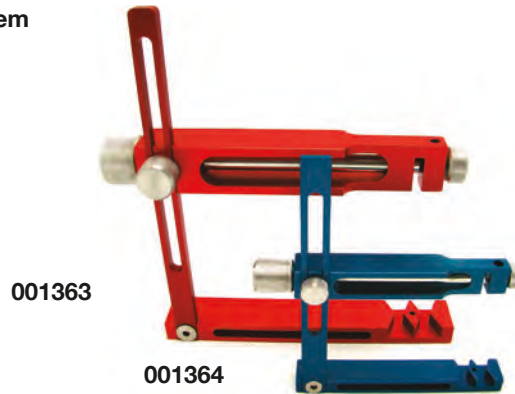

MWI#	SECUROS#	SIZE	FOR USE WITH PIN SIZE	INCLUDES DRILL SLEEVES (mm)	COLOR
031185	001364	Small	Mini, Small, Medium	1.5, 2.4	Blue
031184	001363	Large	Medium, Large	2.4, 3.2	Red

Drill Sleeves



MWI#	SECUROS#	FOR USE WITH DRILL BIT (mm)
055026	002359	1.5
029021	001230	2.4
■ 372181	001231	2.4 Extended
029022	001232	3.2
■ 370238	001233	3.2 Extended
048534	001234	4.0

■ special order item

Drill Bits

Jacobs Chuck Coupling (BITE Bit, Titanium Nitride Coated)



MWI#	SECUROS#	DIAMETER (mm)	TOTAL LENGTH (mm)	FLUTE LENGTH (mm)	RECOMMENDED PINS
031128	001359	1.5	140	32	Mini
031129	001358	2.4	140	32	Small
028992	001357	3.2	165	32	Medium
031130	001360	4.0	165	32	Large

Quick Coupling (BITE Bit, Titanium Nitride Coated)



MWI#	SECUROS#	DIAMETER (mm)	TOTAL LENGTH (mm)	FLUTE LENGTH (mm)	RECOMMENDED PINS
042056	000643	1.5	140	32	Mini
042090	001361	2.4	140	32	Small
045544	001362	3.2	165	32	Medium
045559	000644	4.0	165	32	Large

ESF Clamps

TITAN Clamps

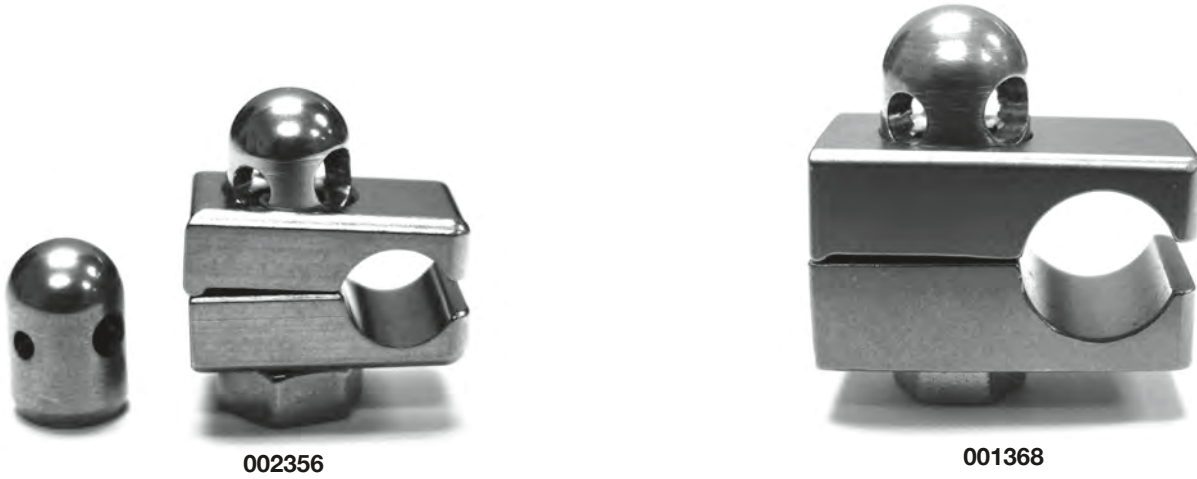

MWI#	SECUROS#	PRODUCT DESCRIPTION	RECOMMENDED PINS
031020	002356	TITAN Small Single Clamp	Mini, Small, Medium
031019	001368	TITAN Large Single Clamp	Medium, Large

U Clamps

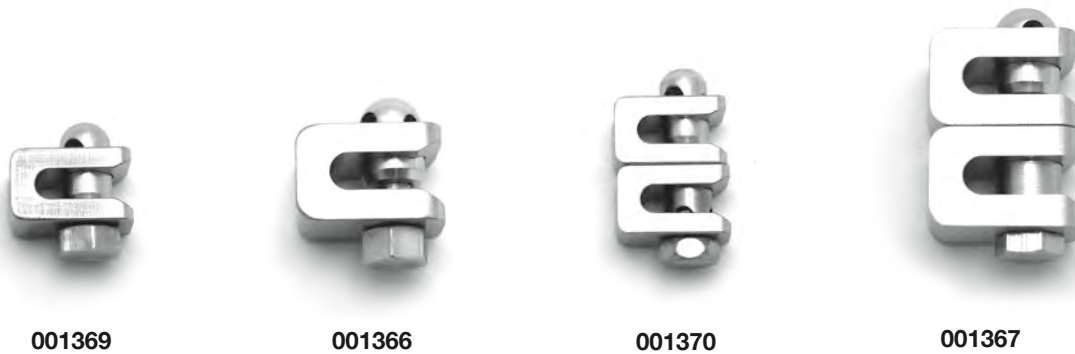

MWI#	SECUROS#	PRODUCT DESCRIPTION	RECOMMENDED PINS
031018	001369	Small Single Clamp	Mini, Small
031016	001366	Large Single Clamp	Medium, Large
031132	001370	Small Double Clamp	Mini, Small
031131	001367	Large Double Clamp	Medium, Large

ESF Clamp Individual Replacement Components

TITAN Clamp Replacement Components

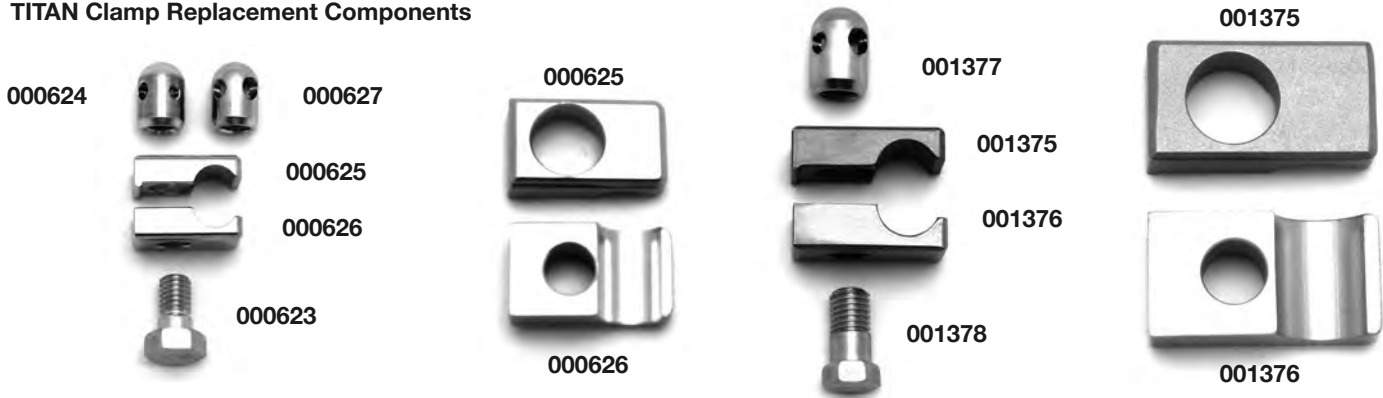

MWI#	SECUROS#	PRODUCT DESCRIPTION
048504	000624	TITAN Small Clamp Mini/Small Head Component
■ 370239	000627	TITAN Small Clamp Small/Medium Head Component
■ 276664	000625	TITAN Small Clamp Top Piece
■ 276665	000626	TITAN Small Clamp Bottom Piece
045533	000623	TITAN Small Clamp Bolt
042092	001377	TITAN Large Clamp Head Component
■ 372096	001375	TITAN Large Clamp Top Piece
■ 372097	001376	TITAN Large Clamp Bottom Piece
042093	001378	TITAN Large Clamp Bolt

U Clamp Replacement Components



MWI#	SECUROS#	PRODUCT DESCRIPTION
049885	001379	Small Pin Head Component
045522	001380	Small Connecting Rod U Component
042094	001381	Small Clamp Bolt
042091	001371	Large Pin Head Component
056011	001372	Large Connecting Rod U Component
056010	001373	Large Clamp Bolt
■ 372098	001382	Small Double Clamp Component
■ 372099	001374	Large Double Clamp Component

■ special order item

Unilateral Augmentation System

Unilateral Augmentation Clamps



MWI#	SECUROS#	PRODUCT DESCRIPTION
056018	001209	Small Unilateral Augmentation Clamp
045554	001203	Unilateral Augmentation Clamp

Unilateral Augmentation Clamp Replacement Components

MWI#	SECUROS#	PRODUCT DESCRIPTION	HEAD SIZE (")
■ 372100	003887	Small Top Screw	1/4
048146	002963	Large Top Screw	5/16

Augmentation Plates - Stainless Steel



MWI#	SECUROS#	PRODUCT DESCRIPTION	CLAMP SPAN (")
■ 370242	011205	Small	1-2
045432	001206	Small	2-3
048531	001207	Small	3-4
048532	001208	Small	4-5
048529	001201	Small	5-6
048530	001202	Small	6-7
045126	002088	Large	1-2
048548	002089	Large	2-3
045127	002090	Large	3-4
048549	002091	Large	4-5

■ special order item

Dynamization Bolts



001383



MWI#	SECUROS#	PRODUCT DESCRIPTION	HEAD SIZE (")
045576	001384	Small	1/4
036064	001383	Large	5/16

Wrenches & Nut Drivers

For Use With All ESF Systems



001222



001221

MWI#	SECUROS#	PRODUCT DESCRIPTION
031187	001222	Precision Torque Wrench with Socket
■ 372101	000836	Precision Torque Wrench without Socket
■ 276468	001223	Socket for Precision Torque Wrench
029020	001221	1/4" x 5/16" Double Open Ended Wrench

Nut Drivers



001224



001225

MWI#	SECUROS#	PRODUCT DESCRIPTION	SOCKET SIZE (")
■ 372102	001224	Small	1/4
■ 372103	001225	Large	5/16

■ special order item

Connecting Rods

Stainless Steel Connecting Rods



MWI#	SECUROS#	DIAMETER	LENGTH (")
028978	001806	1/8" (3.2mm)	2
028979	001807	1/8" (3.2mm)	3
028980	002178	1/8" (3.2mm)	4
028981	002097	1/8" (3.2mm)	5
028982	002098	1/8" (3.2mm)	6
028983	002099	1/8" (3.2mm)	8
028984	002100	1/8" (3.2mm)	10
028985	002201	3/16" (4.8mm)	4
028986	002202	3/16" (4.8mm)	6
028987	002203	3/16" (4.8mm)	8
028988	002204	3/16" (4.8mm)	10
028989	002205	3/16" (4.8mm)	12
028990	002206	3/16" (4.8mm)	14

Carbon Fiber Connecting Rods



MWI#	SECUROS#	DIAMETER	LENGTH (")
031175	002347	3/16" (4.8mm)	4
031176	002348	3/16" (4.8mm)	6
031177	002349	3/16" (4.8mm)	8
031178	002350	3/16" (4.8mm)	10
031179	002351	1/4" (6.3mm)	2
031180	002352	1/4" (6.3mm)	4
031181	002353	1/4" (6.3mm)	6
031182	002354	1/4" (6.3mm)	8
031183	002355	1/4" (6.3mm)	10
044612	002212	3/8" (9.5mm)	2
030966	002213	3/8" (9.5mm)	4
031125	002214	3/8" (9.5mm)	6
031126	002215	3/8" (9.5mm)	8
030967	002216	3/8" (9.5mm)	10
030968	002217	3/8" (9.5mm)	12
045470	002218	3/8" (9.5mm)	14

■ special order item

Connecting Rods

Aluminum Connecting Rods



MWI#	SECUROS#	DIAMETER	LENGTH (")
044925	002207	3/8" (9.5mm)	4
090012	022208	3/8" (9.5mm)	6
044926	002209	3/8" (9.5mm)	8
044928	002346	3/8" (9.5mm)	10
055093	002210	3/8" (9.5mm)	12
044927	002211	3/8" (9.5mm)	14

FastFix Putty



CUT



KNEAD



APPLY

FastFix is a fast-setting, high-strength polymer compound that enables fast, simple, inexpensive external fixation repairs. The polymer can replace both the connecting bar and the external fixation clamp or solely the external fixation clamp.

Each unit contains pre-measured portions of the activator and base throughout—no measuring or mixing tools are necessary. As the polymer is mixed, the two contrasting colors blend into one color and indicate complete mixing. The consistency (like modeling clay) eliminates drips and runs and allows the material to be shaped and formed as needed before curing begins.

FastFix polymer contains no solvents or VOCs. It is non-flammable and does not release noxious fumes. The unused portion stays fresh for future use when saved in its original package.

- Easy to use and very inexpensive
- Bonds instantly with superior strength
- No mixing tools required
- No odor
- Allows ESF pins to be placed at various angles and locations
- Ideal for mandible fractures
- Gas sterilize only

MWI#	SECUROS#	VOLUME PER TUBE
030031	002219	0.25oz



STERILIZATION CONTAINERS

Sterilization Trays

Plastic Cases (Includes Silicone Mat)

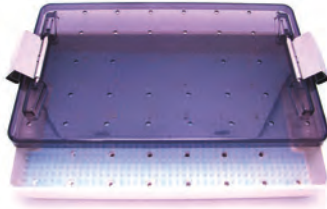

001330



001332



001331

MWI#	SECUROS#	LENGTH (")	WIDTH (")	HEIGHT (")
■ 276469	004176	7	2	.75
043918	001330	11.25	6.75	2
045114	001332	15	10	2.5
045434	001331	20.75	10	2.5

Organizer Bags



MWI#	SECUROS#	PRODUCT DESCRIPTION
031191	002932	Small ESF Organizer Bag
ACCOMMODATES		
Small Pin Placement Device for U System, Connecting Rods 2 ea.: 1/8" x 4", 1/8" x 5", 1/8" x 6", 2.4mm Drill Bit, Center Threaded & End Threaded ESF Pins: 6 ea., Small U Clamps: 20, Double Ended Wrench, 2.4mm Drill Sleeve		

MWI#	SECUROS#	PRODUCT DESCRIPTION
031189	001394	Large ESF Organizer Bag
ACCOMMODATES		
Large Pin Placement Device for U System, Connecting Rods 2 ea.: 3/16" x 6", 3/16" x 8", 3/16" x 10", 3.2mm Drill Bit, Center Threaded & End Threaded ESF Pins: 6 ea., Large U Clamps: 20, Double Ended Wrench, 2.4mm Drill Sleeve, 3.2mm Drill Sleeve		

REFERENCE MATERIALS

External Skeletal Fixation



Clamps				Connecting Rods			
001366- M/LG ESF Clamp	001369- Small ESF Clamp	001368- TITAN Large ESF Clamp	002356- TITAN Small ESF Clamp	1/8" (3.2mm)	3/16" (4.8mm)	248" (6.3mm)	374" (9.5mm)
Pins							
Part Number	Description	Shank Diameter	Thread Diameter	Thread Length	Overall Length	Recommended Drill Bit	
001396	Mini End-Threaded ESF Pin	1/16" (1.6mm)	5/64" (2.0mm)	5/8" (12.7mm)	5.5" (88.9mm)	1.5mm	
001397	Mini Center-Threaded ESF Pin	1/16" (1.6mm)	5/64" (2.0mm)	1.0" (25.4mm)	5.0" (127mm)	1.5mm	
001801	Small End-Threaded ESF Pin	3/32" (2.4mm)	1/32" (3.4mm)	3.0" (76.2mm)	3.5" (88.9mm)	2.4mm	
001802	Small Center-Threaded ESF Pin	3/32" (2.4mm)	1/32" (3.4mm)	1.0" (25.4mm)	5.0" (127mm)	2.4mm	

External Skeletal Fixation



Clamps				Connecting Rods			
001366- M/LG ESF Clamp	001369- Small ESF Clamp	001368- TITAN Large ESF Clamp	002356- TITAN Small ESF Clamp	1/8" (3.2mm)	3/16" (4.8mm)	248" (6.3mm)	374" (9.5mm)
Pins							
Part Number	Description	Shank Diameter	Thread Diameter	Thread Length	Overall Length	Recommended Drill Bit	
001398	Medium End-Threaded ESF Pin	3/8" (9.5mm)	1/2" (12.7mm)	1.50" (38.1mm)	5.0" (127mm)	3.2mm	
001399	Medium Center-Threaded ESF Pin	3/8" (9.5mm)	1/2" (12.7mm)	1.50" (38.1mm)	7.0" (177.8mm)	3.2mm	
001803	Large End-Threaded ESF Pin	5/16" (7.9mm)	3/16" (4.8mm)	2.25" (57.2mm)	7.0" (177.8mm)	4.0mm	
001804	Large Center-Threaded ESF Pin	5/16" (7.9mm)	3/16" (4.8mm)	2.25" (57.2mm)	8.0" (203.2mm)	4.0mm	

MWI#	SECUIROS#	PRODUCT DESCRIPTION
042095	001386	External Skeletal Fixation Instructional CD-ROM
■ 388998	005494	External Skeletal Fixation Order Reference Guide

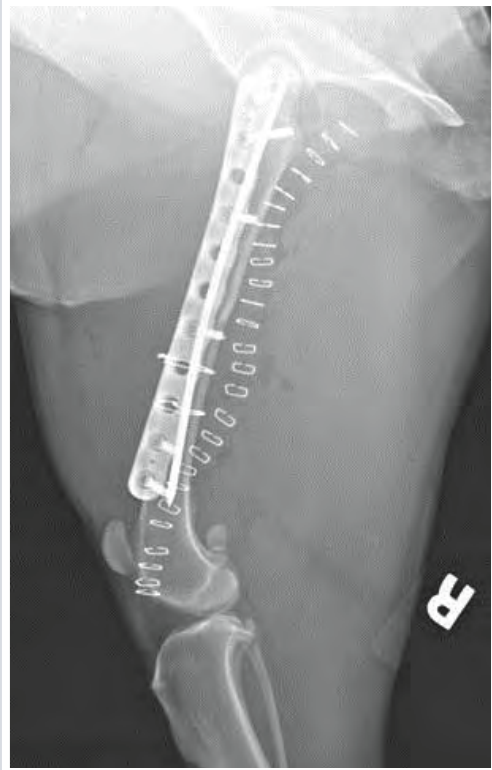
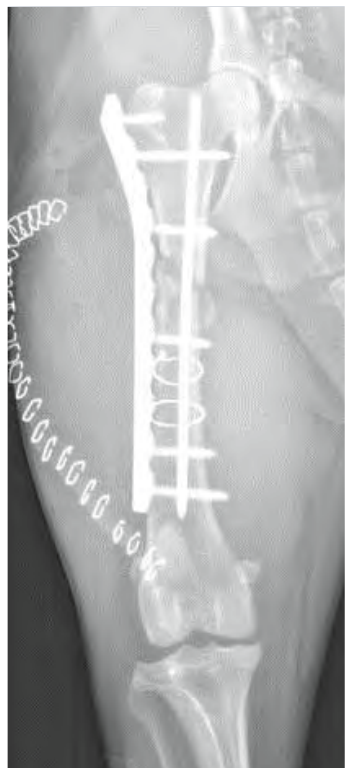
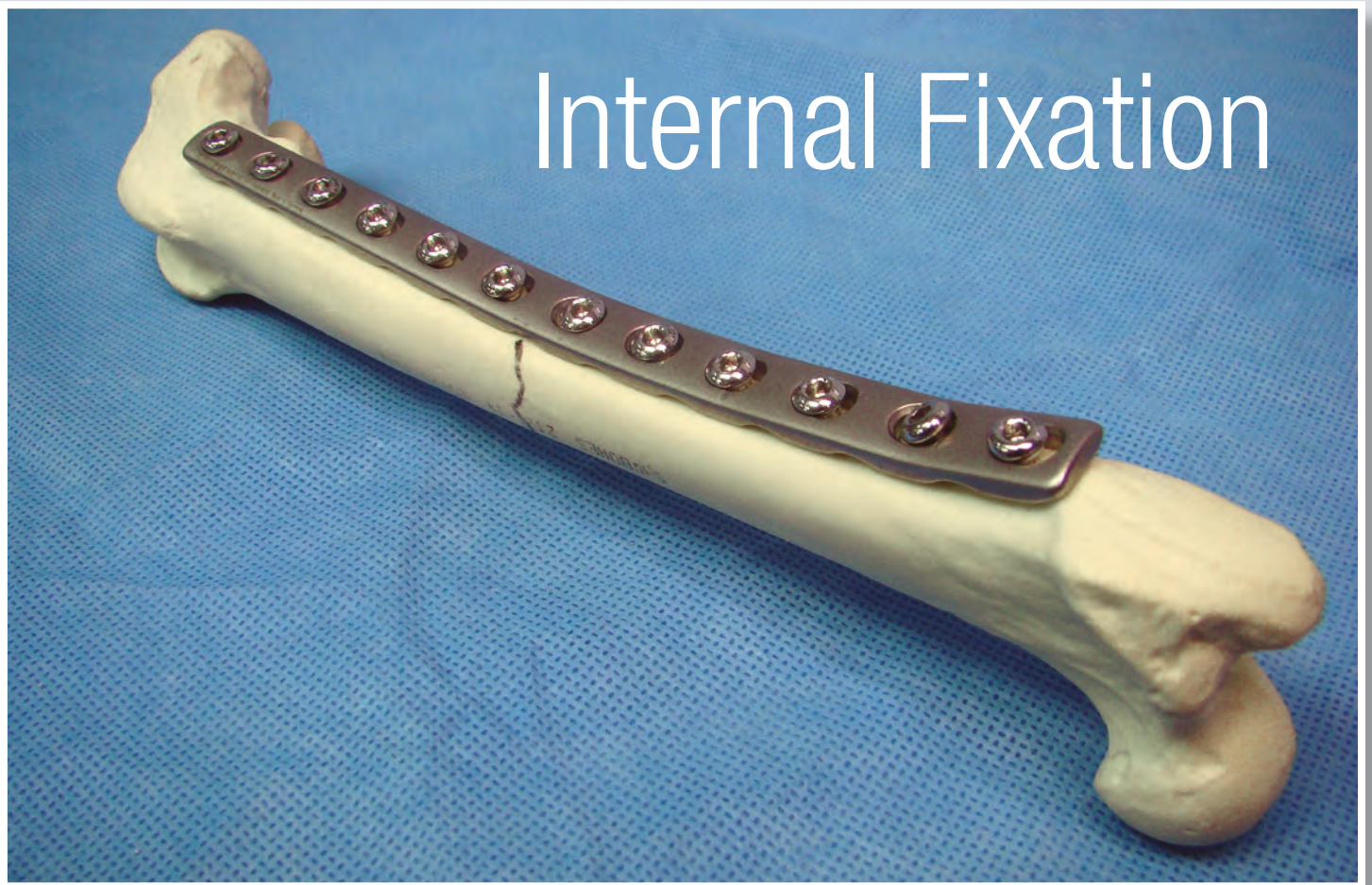

Pin & Wire Management

Pins and wires were some of the earliest forms of internal fixation. Today, pins and wires are often used in conjunction with other forms of internal fixation, however, they can be used alone to treat specific fractures.

SECUROS pins are made using a unique manufacturing process that render the trocar tips concave instead of flat. This creates a sharper cutting edge and 30% reduction in heat generation as compared to traditional pins.



Conventional Plate Osteosynthesis

Conventional plates for internal fixation were first introduced in the 1960s. They act like internal splints that hold broken pieces of bone together. Plates are attached to the bone with screws and rely on friction between the screw and bone for stability. Alternatively, screws alone can be used to hold together specific fractures.

SECUROS is proud to offer conventional plating implants and instrumentation that follow AO/ASIF/ASTM/ISO standards. Our conventional plating offering is manufactured in FDA approved facilities that also serve the human orthopedic industry.

*Radiographs provided by Joshua Jackson, DVM, DACVS Veterinary Specialty Hospital, San Diego, CA.

Polyaxial Locking Plate Osteosynthesis

Locking plates are a newer technology to veterinary medicine, having only been commercially available since the 2000's. Unlike conventional plates and screws, locking plates and screws create fixed angles that do not rely on screw purchase in bone. The threads of the head of the locking screws mate with the holes in the plate to form a rigid, fixed-angle construct.

SECUROS is the first and only veterinary company to offer patented polyaxial locking plate osteosynthesis with the PAX system. Features of the PAX system over traditional locking plate systems include polyaxial locking up to 10 degrees, titanium alloy implants, interchangeable screws between 2.0/2.4mm and 2.7/3.5mm systems, and the ability to remove screws and adjust angulation. Newly introduced in 2014 was our complete SP (Straight Plate) line of PAX implants, instruments, and trays.



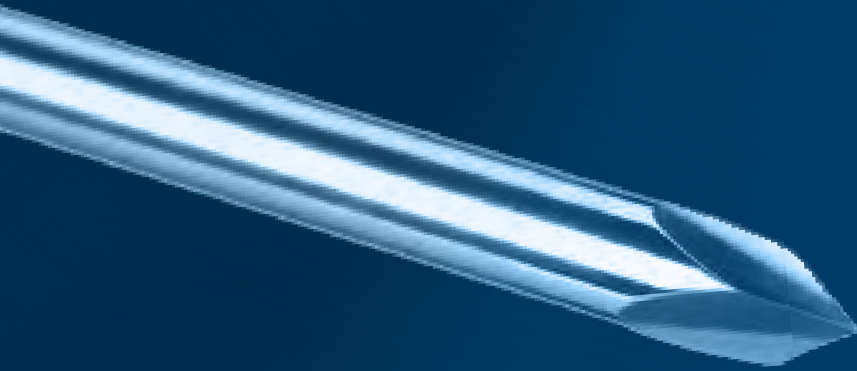

SECUROS Pin & Wire Options

Wide **variety** of pin and wire sizes available for any **application**

- **Proprietary** manufacturing process yields more symmetrical trocar cutting edges for **accurate placement**
- Concave trocar tips result in a **sharper** cutting edge
- 30% **reduction** in **heat** generation as compared to traditional pins and wire

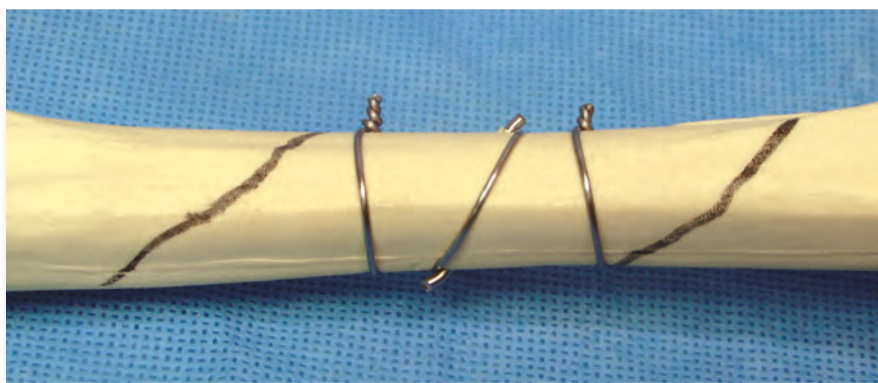

IMPLANTS

Kirschner Wire (K-wire) (Smooth, Trocar/Trocar) - Stainless Steel

**.028"**

MWI#	SECUROS#	UNIT	LENGTH (")
049153	005330	Pack of 10	5
055078	005331	Pack of 6	9

.035"

MWI#	SECUROS#	UNIT	LENGTH (")
055110	004853	Pack of 10	5
029089	001277	Pack of 6	9

.045"

MWI#	SECUROS#	UNIT	LENGTH (")
055111	004854	Pack of 10	5
029090	001278	Pack of 6	9

.054"

MWI#	SECUROS#	UNIT	LENGTH (")
052747	004855	Pack of 10	5
029091	001279	Pack of 6	9

.062"

MWI#	SECUROS#	UNIT	LENGTH (")
055112	004856	Pack of 10	5
029092	001280	Pack of 6	9

.075"

MWI#	SECUROS#	UNIT	LENGTH (")
055113	004857	Pack of 6	9

Steinmann/Intramedullary Pins - Stainless Steel



1/16"

MWI#	SECUROS#	STYLE	LENGTH (")	TROCAR
044962	004270	Smooth	4.5	Single End
029057	001235	Smooth	9	Double End
042426	004271	Partially Threaded	4.5	Single End
029068	001257	Partially Threaded	9	Double End

5/64"

MWI#	SECUROS#	STYLE	LENGTH (")	TROCAR
031011	002986	Smooth	4.5	Single End
029058	001236	Smooth	9	Double End
■ 372086	005485	Partially Threaded	4.5	Single End
029069	001258	Partially Threaded	9	Double End

3/32"

MWI#	SECUROS#	STYLE	LENGTH (")	TROCAR
048256	003587	Smooth	4.5	Single End
029059	001237	Smooth	9	Double End
029066	001244	Smooth	12	Double End
031008	001251	Smooth	14	Double End
035918	003586	Partially Threaded	4.5	Single End
029070	001259	Partially Threaded	9	Double End

7/64"

MWI#	SECUROS#	STYLE	LENGTH (")	TROCAR
■ 372087	005487	Smooth	4.5	Single End
029060	001238	Smooth	9	Double End
031012	001245	Smooth	12	Double End
031013	001252	Smooth	14	Double End
■ 372088	005486	Partially Threaded	4.5	Single End
029071	001260	Partially Threaded	9	Double End

1/8"

MWI#	SECUROS#	STYLE	LENGTH (")	TROCAR
031003	003099	Smooth	4.5	Single End
029061	001239	Smooth	9	Double End
031001	001246	Smooth	12	Double End
031002	001253	Smooth	14	Double End
031005	002985	Partially Threaded	4.5	Single End
029072	002956	Partially Threaded	9	Double End
042412	003963	Partially Threaded	12	Double End

9/64"

MWI#	SECUROS#	STYLE	LENGTH (")	TROCAR
029062	001240	Smooth	9	Double End
031014	001247	Smooth	12	Double End
031015	001254	Smooth	14	Double End
029073	002957	Partially Threaded	9	Double End
044613	003964	Partially Threaded	12	Double End

5/32"

MWI#	SECUROS#	STYLE	LENGTH (")	TROCAR
029063	001241	Smooth	9	Double End
031009	001248	Smooth	12	Double End
031010	001255	Smooth	14	Double End
029074	001261	Partially Threaded	9	Double End
042413	003965	Partially Threaded	12	Double End

3/16"

MWI#	SECUROS#	STYLE	LENGTH (")	TROCAR
029064	001242	Smooth	9	Double End
029067	001249	Smooth	12	Double End
031007	001256	Smooth	14	Double End
029075	001262	Partially Threaded	9	Double End
039177	003966	Partially Threaded	12	Double End

1/4"

MWI#	SECUROS#	STYLE	LENGTH (")	TROCAR
029065	001243	Smooth	12	Double End
029076	001263	Partially Threaded	12	Double End

■ special order item

Orthopedic Wire - Stainless Steel

Orthopedic Wire (1 oz Spool, Autoclavable)



MWI#	SECUROS#	DIAMETER
048241	003720	36 Gauge
048240	003719	34 Gauge
045175	003718	32 Gauge
045493	003717	30 Gauge
045051	003716	28 Gauge
029082	001269	26 Gauge
029081	001268	24 Gauge
029080	001267	22 Gauge
029079	001266	20 Gauge
029078	001265	18 Gauge
029077	001264	16 Gauge

Orthopedic Wire (4 oz Spool, Autoclavable)

MWI#	SECUROS#	DIAMETER
029088	001276	26 Gauge
029087	001275	24 Gauge
029086	001274	22 Gauge
029085	001273	20 Gauge
029084	001272	18 Gauge
029083	001271	16 Gauge

Orthopedic Wire with Loop (Pack of 10)



MWI#	SECUROS#	DIAMETER
031000	002917	22 Gauge
030999	002982	20 Gauge
030998	002981	18 Gauge
030997	002980	16 Gauge

INSTRUMENTS

Dual Chuck Hand Chucks



001480



001479



005015

MWI#	SECUROS#	PRODUCT DESCRIPTION	LENGTH (")
029519	001480	Mini Dual Chuck Hand Chuck	5.75
029517	001479	Dual Chuck Hand Chuck	6.5
049103	004818	Replacement Screwdriver for Hand Chucks	8
029521	001482	Replacement Key for Dual Chuck Hand Chuck	2
■ 370236	002988	Replacement Key for Mini Dual Chuck Hand Chuck	1.75
047958	005015	Jacobs Chuck Key Extension Handle	5.5

Wire Passers



MWI#	SECUROS#	FEATURE	LENGTH (")
045515	840413	Cannulated Double Ended	6



MWI#	SECUROS#	FEATURE	LENGTH (")
049222	840414	Cannulated Single Ended	7



MWI#	SECUROS#	FEATURE	LENGTH (")
045567	000399	Cannulated Single Ended, Phenolic Handle	9.5



MWI#	SECUROS#	FEATURE	LENGTH (")
■ 372104	840416	Hole in tip, Solid Handle	8.75

■ special order item

Wire Twisters



MWI#	SECUROS#	FEATURE	LENGTH (")
045081	840390	Holes in Tip	6.5



MWI#	SECUROS#	FEATURE	LENGTH (")
056034	001461	Blunt, Tungsten Carbide Inserts	7



MWI#	SECUROS#	FEATURE	LENGTH (")
045437	840393	Lateral Jaw, Tungsten Carbide Inserts	6.75



MWI#	SECUROS#	PRODUCT DESCRIPTION	FEATURE	LENGTH (")
049217	840394	Corwin Blunt	Tungsten Carbide Inserts	6

Wire Twisters

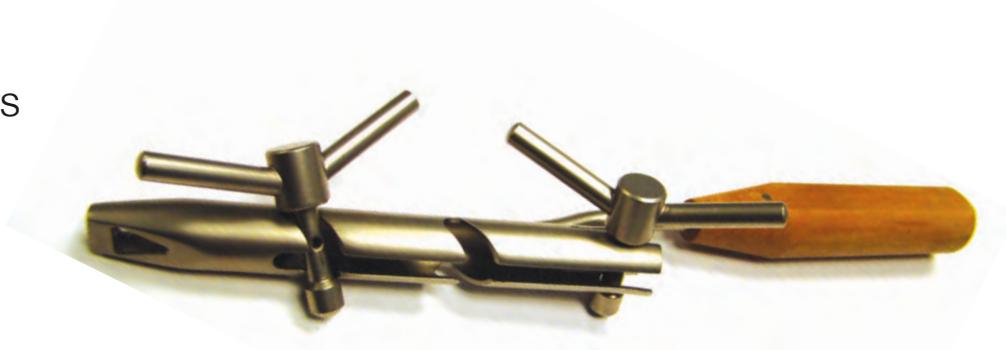

MWI#	SECUROS#	FEATURE	LENGTH (")
043938	003542	Double Wire Twister, Wooden Handle	10

Wire Tightener



MWI#	SECUROS#	PRODUCT DESCRIPTION	LENGTH (")
043913	001704	Cerclage Wire Tightener	4.75"

Parallel Pliers



840370



840371

MWI#	SECUROS#	FEATURE	LENGTH (")
090034	840370	—	7
045348	840371	Wire Cutters	7

Wire Twisters

Vise Grip Locking Pliers



MWI#	SECUROS#	LENGTH (")
045287	840372	7
049212	840373	8
049213	840374	9.5

Vise Grip Locking Needle Nose Pliers



MWI#	SECUROS#	LENGTH (")
090071	840367	8.5
049210	840368	10
049211	840369	12

Wire Twisters

Needle Nose Pliers



Delicate



Tapped



Wide Jaw

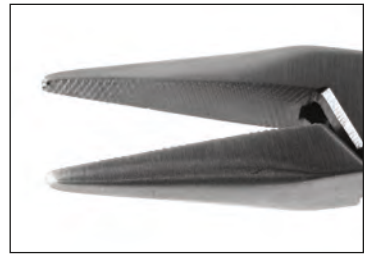

Serrated

MWI#	SECUROS#	FEATURE	LENGTH (")
090036	840377	Delicate	5.5
049214	840378	Tapped	5.5
■ 372105	840379	Wide Jaw	5.5
045023	840380	Serrated	5.5

Flat Nose Pliers



840381



840382



MWI#	SECUROS#	FEATURE	LENGTH (")
049215	840381	2mm Tip	6
■ 372106	840382	2mm Tip, Smooth Jaw	6

■ special order item

Wire Benders



MWI#	SECUROS#	PRODUCT DESCRIPTION	FOR USE WITH
055140	840929	Universal K-wire Bender	.035"/.015"/.054"/.062" K-wires



MWI#	SECUROS#	PRODUCT DESCRIPTION	FOR USE WITH
390152	002062	Double K-wire Bender	0.054"/0.062" K-wires

Pin/Wire Cutters

Side Pin/Wire Cutters



MWI#	SECUROS#	FEATURE	MAXIMUM PIN SIZE (")	LENGTH(")
045293	840403	Single Action	5/64	5.75

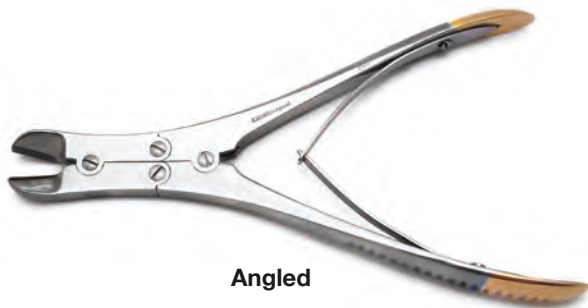

Angled



Straight

MWI#	SECUROS#	FEATURE	MAXIMUM PIN SIZE (")	LENGTH(")
042096	840406	Angled	5/64	7
045027	840404	Angled	7/64	8.75
035820	840405	Straight	7/64	9.25

Pin/Wire Cutters

Side Pin/Wire Cutters



MWI#	SECUROS#	PRODUCT DESCRIPTION	MAXIMUM PIN DIAMETER (")	LENGTH (")
048648	840843	"Hercules", Tungsten Carbide Inserts	7/64	9.25



MWI#	SECUROS#	MAXIMUM PIN DIAMETER (")	LENGTH (")
045561	003890	1/8	15



MWI#	SECUROS#	MAXIMUM PIN DIAMETER (")	LENGTH (")
045028	840407	1/4	18.5



MWI#	SECUROS#	PRODUCT DESCRIPTION	MAXIMUM PIN DIAMETER (")	LENGTH (")
036209	001458	Detachable Handles	1/4	18.5

Pin/Wire Cutters

Front/Side Pin/Wire Cutters

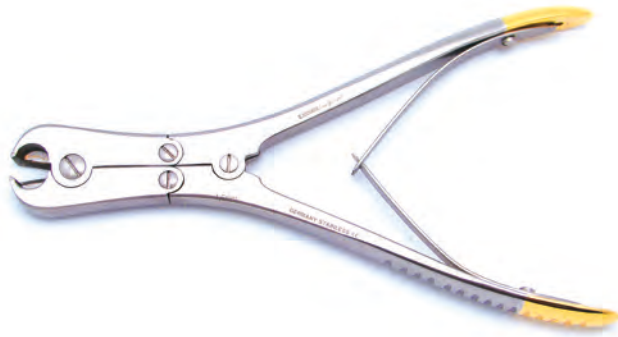

MWI#	SECUROS#	FEATURE	MAXIMUM PIN DIAMETER (")	LENGTH (")
045292	840402	Tungsten Carbide Inserts	1/16	7.5

Front Pin/Wire Cutters



MWI#	SECUROS#	FEATURE	MAXIMUM PIN DIAMETER (")	LENGTH (")
048374	840927	Cannulated	1/16	7.5



MWI#	SECUROS#	FEATURE	MAXIMUM PIN DIAMETER (")	LENGTH (")
045538	001555	Tungsten Carbide Inserts	7/64	8.75



MWI#	SECUROS#	MAXIMUM PIN DIAMETER (")	LENGTH (")
■ 276424	003759	1/8	10

Pin Punches

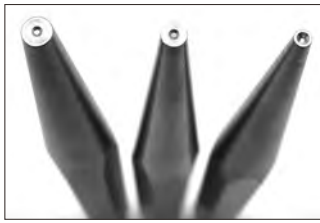

001469 001468 001470



MWI#	SECUROS#	FOR USE WITH PIN SIZE (")	LENGTH (")
043910	001469	3/32	7
044007	001468	1/8	7
044609	001470	5/32	7

IM Pin Starter Kits (Steinmann/Intramedullary)

MWI# 031137, SECUROS# 004021, Smooth IM Pin Starter Kit

MWI#	SECUROS#	PRODUCT DESCRIPTION	QTY
029089	001277	0.035" x 9" K-Wire, Pack of 6	1
029090	001278	0.045" x 9" K-Wire, Pack of 6	1
029092	001280	0.062" x 9" K-Wire, Pack of 6	1
029058	001236	5/64" x 9" Smooth IM Pin, Trocar/Trocar	2
029059	001237	3/32" x 9" Smooth IM Pin, Trocar/Trocar	2
029060	001238	7/64" x 9" Smooth IM Pin, Trocar/Trocar	2
029061	001239	1/8" x 9" Smooth IM Pin, Trocar/Trocar	2
029062	001240	9/64" x 9" Smooth IM Pin, Trocar/Trocar	2
029063	001241	5/32" x 9" Smooth IM Pin, Trocar/Trocar	2
029064	001242	3/16" x 9" Smooth IM Pin, Trocar/Trocar	2
029065	001243	1/4" x 12" Smooth IM Pin, Trocar/Trocar	2
029080	001267	22 Gauge/0.025" Orthopedic Wire, 1 oz. Spool	1
029079	001266	20 Gauge/0.032" Orthopedic Wire, 1 oz. Spool	1
029078	001265	18 Gauge/0.040" Orthopedic Wire, 1 oz. Spool	1
029077	001264	16 Gauge/0.048" Orthopedic Wire, 1 oz. Spool	1
029522	001488	IM Pin Organizer Bag	1

MWI# 031136, SECUROS# 003175, Partially Threaded IM Pin Starter Kit

MWI#	SECUROS#	PRODUCT DESCRIPTION	QTY
029089	001277	0.035" x 9" K-Wire, Pack of 6	1
029090	001278	0.045" x 9" K-Wire, Pack of 6	1
029092	001280	0.062" x 9" K-Wire, Pack of 6	1
029057	001257	1/16" x 9" Partially Threaded IM Pin, Trocar/Trocar	2
029069	001258	5/64" x 9" Partially Threaded IM Pin, Trocar/Trocar	2
029070	001259	3/32" x 9" Partially Threaded IM Pin, Trocar/Trocar	2
029071	001260	7/64" x 9" Partially Threaded IM Pin, Trocar/Trocar	2
029072	002956	1/8" x 9" Partially Threaded IM Pin, Trocar/Trocar	2
029073	002957	9/64" x 9" Partially Threaded IM Pin, Trocar/Trocar	2
029074	001261	5/32" x 9" Partially Threaded IM Pin, Trocar/Trocar	2
029075	001262	3/16" x 9" Partially Threaded IM Pin, Trocar/Trocar	2
029076	001263	1/4" x 12" Partially Threaded IM Pin, Trocar/Trocar	2
029080	001267	22 Gauge/0.025" Orthopedic Wire, 1 oz. Spool	1
029079	001266	20 Gauge/0.032" Orthopedic Wire, 1 oz. Spool	1
029078	001265	18 Gauge/0.040" Orthopedic Wire, 1 oz. Spool	1
029077	001264	16 Gauge/0.048" Orthopedic Wire, 1 oz. Spool	1
029522	001488	IM Pin Organizer Bag	1

STERILIZATION CONTAINERS

Organizer Bags



MWI#	SECUROS#	PRODUCT DESCRIPTION
031190	001487	Pin Punch Organizer Bag
ACCOMODATES		
3/32" Pin Punch, 1/8" Pin Punch, 5/32" Pin Punch, Mallet		

MWI#	SECUROS#	PRODUCT DESCRIPTION
043926	001492	Bone Wire Organizer Bag
ACCOMODATES		
Needle Nose Pliers, Cerclage Wire Passer, Vice Grip Pliers, Parallel Pliers, Large Needle Drivers, Front Pin Cutter, (4) K-wire packs of 6, (4) Spools of 1oz wire.		

MWI#	SECUROS#	PRODUCT DESCRIPTION
029522	001488	IM Pin Organizer Bag
ACCOMODATES		
(18) Smooth or Partially Threaded IM Pins, (4) K-wire Packs of 6, (4) Spools of 1oz wire.		

REFERENCE MATERIALS

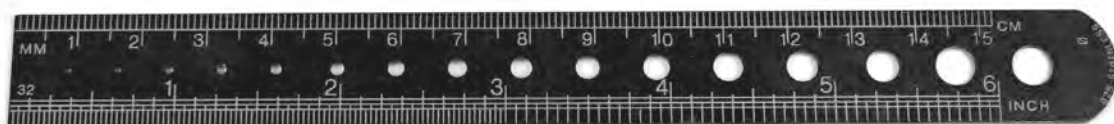

MWI#	SECUROS#	PRODUCT DESCRIPTION
031135	840415	Pin & K-Wire Gauge/Ruler



SECUROS

Anything but Conventional

Complete offering of straight & specialty plates, screws, washers, instruments and sterilization containers

- **Manufactured** according to ASTM, ISO and FDA **standards**
- **Available** in sizes as small as 1.5mm and as large as 6.5mm
- Fully **compatible with AO** implants and instruments



IMPLANTS

1.5mm Conventional Straight Plates

1.5mm Round Hole Cut-to-Length Plate - Stainless Steel



Width: 3.8mm

Thickness: 0.8mm

Distance Between Center of Holes: 5.0mm

MWI#	SECUROS#	# OF HOLES	LENGTH (mm)
042231	001852	20	100

1.5mm Dynamic Compression Plates - Stainless Steel



Width: 3.8mm

Distance Between Center of Holes: 5.0mm

Distance Between Central Holes: 7.0mm

MWI#	SECUROS#	# OF HOLES	LENGTH (mm)	THICKNESS (mm)
042228	001849	4	23	1.0
042229	001850	5	28	1.0
029133	001851	6	33	1.0
042406	003804	7	38	1.5
042407	003805	8	43	1.5
044005	003806	9	48	1.5
044004	003807	10	53	1.5

2.0mm Conventional Straight Plates

2.0mm Round Hole Cut-to-Length Plate - Stainless Steel



Width: 5.0mm

Thickness: 1.2mm

Distance Between Center of Holes: 5.0mm

MWI#	SECUROS#	# OF HOLES	LENGTH (mm)
029206	002480	20	100

2.0/2.4/2.7mm Round Hole Semi-Tubular Cut-to-Length Plate - Stainless Steel



Width: 7.0mm

Thickness: 1.5mm

Distance Between Center of Holes: 6.0mm

MWI#	SECUROS#	# OF HOLES	LENGTH (mm)
042331	003475	50	300

2.0mm Round Hole Reconstruction Plate - Stainless Steel



Width: 5.4mm

Thickness: 1.0mm

Distance Between Center of Holes: 5.0mm

MWI#	SECUROS#	# OF HOLES	LENGTH (mm)
042316	003103	20	100

2.0mm Conventional Straight Plates

2.0mm Round Hole Lengthening Plates - Stainless Steel



Width: 5.0mm

Thickness: 1.0mm

Distance Between Center of Holes: 5.0mm

Distance Between Central Holes: 10.0mm

MWI#	SECUROS#	# OF HOLES	LENGTH (mm)
044936	004078	5	31
044016	004079	6	36

2.0mm Dynamic Compression Plate - Stainless Steel



Width: 5.0mm

Distance Between Center of Holes: 5.0mm

Distance Between Central Holes: 7.0mm

MWI#	SECUROS#	# OF HOLES	LENGTH (mm)	THICKNESS (mm)
042321	003407	4	22	1.0
042322	003408	5	27	1.0
042323	003409	6	32	1.5
042326	003461	7	37	1.5
036202	003462	8	42	1.5

2.0mm Limited Contact Dynamic Compression Plate - Stainless Steel



Width: 6.5mm

Distance Between Center of Holes: 6.0mm

MWI#	SECUROS#	# OF HOLES	LENGTH (mm)	THICKNESS (mm)
046850	003951	4	28	1.5
046870	003952	5	34	1.5
044015	003953	6	40	1.5
044017	003954	7	46	2.0
044018	003955	8	52	2.0
045052	003956	9	58	2.0
044013	003957	10	64	2.0

2.4mm Conventional Straight Plates

2.0/2.4/2.7mm Round Hole Semi-Tubular Cut-to-Length Plate - Stainless Steel



Width: 7.0mm

Thickness: 1.5mm

Distance Between Center of Holes: 6.0mm

MWI#	SECUROS#	# OF HOLES	LENGTH (mm)
042331	003475	50	300

2.4mm Dynamic Compression Plate - Stainless Steel



Width: 6.5mm

Thickness: 2.0mm

Distance Between Center of Holes: 7.0mm

Distance Between Central Holes: 10.0mm

MWI#	SECUROS#	# OF HOLES	LENGTH (mm)
049088	004978	4	31
049089	004979	5	38
049090	004980	6	45
049091	004981	7	52
049092	004982	8	59
049093	004983	9	66
049094	004984	10	73
049095	004985	11	80
049096	004986	12	87
049097	004987	13	94
049098	004988	14	101

2.4mm Limited Contact Dynamic Compression Plate - Stainless Steel



Width: 6.5mm

Thickness: 1.5mm

Distance Between Center of Holes: 8.0mm

MWI#	SECUROS#	# OF HOLES	LENGTH (mm)
044021	003627	4	36
042334	003628	5	44
042335	003629	6	52
044022	003630	7	60
044023	003631	8	68
044024	003819	9	76

Implants: 2.7mm Conventional Straight Plates

2.0/2.4/2.7mm Round Hole Semi-Tubular Cut-to-Length Plate - Stainless Steel



Width: 7.0mm

Thickness: 1.5mm

Distance Between Center of Holes: 6.0mm

MWl#	SECUROS#	# OF HOLES	LENGTH (mm)
042331	003475	50	300

2.7mm Round Hole Reconstruction Plates - Stainless Steel



Width: 8.0mm

Thickness: 2.5mm

Distance Between Center of Holes: 8.0mm

MWl#	SECUROS#	# OF HOLES	LENGTH (mm)
055042	003470	6	48
055043	003471	8	64
390150	003472	10	80
044025	003473	12	96
042317	003104	20	160

2.7mm Conventional Straight Plates

2.7mm Short Round Hole Lengthening Plates - Stainless Steel



Width: 8.0mm

Thickness: 2.0mm

Distance Between Center of Holes: 8.0mm

Distance Between Central Holes: 16.0mm

MWI#	SECUROS#	# OF HOLES	LENGTH (mm)
045170	003632	4	41
045171	003634	5	49
044932	003636	6	57
■ 372107	003638	7	65
■ 372108	003640	8	73

2.7mm Long Round Hole Lengthening Plates - Stainless Steel



Width: 8.0mm

Thickness: 2.0mm

Distance Between Center of Holes: 8.0mm

Distance Between Central Holes: 20.0mm

MWI#	SECUROS#	# OF HOLES	LENGTH (mm)
048197	003633	4	45
048198	003635	5	53
044933	003637	6	61
048216	003639	7	69
■ 276574	003641	8	77

■ special order item

2.7mm Conventional Straight Plates

2.7mm Dynamic Compression Plates - Stainless Steel



Width: 8.0mm

Distance Between Center of Holes: 8.0mm

Distance Between Central Holes: 12.0mm

MWl#	SECUROS#	# OF HOLES	LENGTH (mm)	THICKNESS (mm)
029190	001648	4	36	2.0
029191	001649	5	44	2.0
029192	001650	6	52	2.0
029193	001651	7	60	2.5
029194	001652	8	68	2.5
042218	001653	9	76	2.5
042219	001654	10	84	2.5
042276	002450	11	92	2.5
042220	001655	12	100	2.5

2.7mm Limited Contact Dynamic Compression Plates - Stainless Steel



Width: 8.0mm

Thickness: 2.5mm

Distance Between Center of Holes: 9.0mm

MWl#	SECUROS#	# OF HOLES	LENGTH (mm)
042212	001639	4	42
042213	001640	5	51
029183	001641	6	60
029184	001642	7	69
029185	001643	8	78
042214	001644	9	87
042215	001645	10	96
042216	001646	11	105
042217	001647	12	114
042410	003906	14	132

3.5mm Conventional Straight Plates

3.5mm Round Hole Reconstruction Plates - Stainless Steel



Width: 10.0mm

Thickness: 2.8mm

Distance Between Center of Holes: 12.0mm

MWI#	SECUROS#	# OF HOLES	LENGTH (mm)
048190	003477	4	46
048158	003105	5	58
048159	003106	6	70
045623	003107	7	82
045157	003108	8	94
048160	003109	9	106
048161	003110	10	118
■ 372109	003478	11	130
045158	003111	12	142
048191	003479	13	154
045624	003112	14	166
048192	003485	15	178
055032	002701	16	190
055033	002702	18	214
044038	002703	20	238
045141	002704	22	262

3.5mm Curved Round Hole Reconstruction Plates - Stainless Steel



Width: 10.0mm

Thickness: 3.6mm

Distance Between Center of Holes: 12.0mm

MWI#	SECUROS#	# OF HOLES	OVERALL SPAN (mm)
048569	002696	6	70
048570	002697	8	94
048571	002698	10	118
046260	002699	12	142
048156	003100	14	166
048157	003101	16	190
■ 372111	003102	18	214

■ special order item

3.5mm Conventional Straight Plates

3.5mm Narrow Short Round Hole Lengthening Plates - Stainless Steel



Width: 10.0mm

Thickness: 3.2mm

Distance Between Center of Holes: 12.0mm

Distance Between Central Holes: 40.0mm

MWI#	SECUROS#	# OF HOLES	LENGTH (mm)
048103	000378	4	73
048104	000379	5	85
045400	000380	6	97
045401	000381	7	109
045548	000382	8	121
045565	000383	9	133
045086	000384	10	145

3.5mm Narrow Long Round Hole Lengthening Plates - Stainless Steel



Width: 10.0mm

Thickness: 3.2mm

Distance Between Center of Holes: 12.0mm

Distance Between Central Holes: 52.0mm

MWI#	SECUROS#	# OF HOLES	LENGTH (mm)
048228	004082	4	85
045187	004083	5	97
048229	004084	6	109
044937	004085	7	121
045166	003588	8	133
048230	004087	9	145
■ 372112	004088	10	157

3.5mm Conventional Straight Plates

3.5mm Broad Short Round Hole Lengthening Plates - Stainless Steel



Width: 12.0mm

Thickness: 4.0mm

Distance Between Center of Holes: 12.0mm

Distance Between Central Holes: 52.0mm

MWI#	SECUROS#	# OF HOLES	LENGTH (mm)
045481	003493	4	86
048195	003494	5	98
048196	003495	6	110
045490	003496	7	122
045632	003497	8	134
044931	003498	9	146
■ 372113	003499	10	158

3.5mm Broad Long Round Hole Lengthening Plates - Stainless Steel



Width: 12.0mm

Thickness: 4.0mm

Distance Between Center of Holes: 12.0mm

Distance Between Central Holes: 64.0mm

MWI#	SECUROS#	# OF HOLES	LENGTH (mm)
■ 372114	003486	4	98
048193	003487	5	110
045164	003488	6	122
045479	003489	7	134
045631	003490	8	146
045480	003491	9	158
048194	003492	10	170

■ special order item

3.5mm Conventional Straight Plates

3.5mm Narrow Dynamic Compression Plates - Stainless Steel



Width: 10.0mm

Thickness: 3.2mm

Distance Between Center of Holes: 12.0mm

Distance Between Central Holes: 16.0mm

MWI#	SECUROS#	# OF HOLES	LENGTH (mm)
042260	002111	4	49
042261	002112	5	61
029228	002113	6	73
029229	002114	7	85
029230	002115	8	97
029231	002119	9	109
029232	002117	10	121
042263	002118	11	133
042262	002116	12	145
042446	004413	13	157
042277	002452	14	169
044036	003555	16	193
044037	003556	18	217

3.5mm Broad Dynamic Compression Plates - Stainless Steel



Width: 12.0mm

Thickness: 4.0mm

Distance Between Center of Holes: 12.0mm

Distance Between Central Holes: 16.0mm

MWI#	SECUROS#	# OF HOLES	LENGTH (mm)
029235	002120	7	85
029236	002121	8	97
029237	002122	9	109
029238	002123	10	121
029239	002124	11	133
042264	002125	12	145
029241	002126	13	157
042265	002127	14	169
029243	002128	16	193
029244	002129	18	217
029245	002130	20	241
029246	002131	22	265

3.5mm Conventional Straight Plates

3.5mm Narrow Limited Contact Dynamic Compression Plates - Stainless Steel



Width: 10.0mm

Thickness: 3.2mm

Distance Between Center of Holes: 13.0mm

MWI#	SECUROS#	# OF HOLES	LENGTH (mm)
042254	002102	4	51
042255	002103	5	64
029219	002104	6	77
029220	002105	7	90
029221	002106	8	103
042256	002107	9	116
042257	002108	10	129
042258	002109	11	142
042259	002110	12	155
052745	005503	13	168
045545	003782	14	181
044035	003781	16	207
049479	003780	18	233
055132	005316	20	259

3.5mm Broad Limited Contact Dynamic Compression Plates - Stainless Steel



Width: 14.5mm

Thickness: 4.5mm

Distance Between Center of Holes: 13.0mm

MWI#	SECUROS#	# OF HOLES	LENGTH (mm)
045172	003643	7	90
046920	003644	8	103
044302	003645	9	116
046790	003646	10	129
048495	003647	11	142
044030	003648	12	155
044032	003649	13	168
044033	003650	14	181
045173	003652	16	207
052746	005504	18	233

4.5mm Conventional Straight Plates

4.5mm Narrow Dynamic Compression Plates - Stainless Steel



Width: 12.0mm

Thickness: 4.0mm

Distance Between Center of Holes: 16.0mm

Distance Between Central Holes: 25.0mm

MWI#	SECUIROS#	# OF HOLES	LENGTH (mm)
029247	002132	2	39
029248	002133	3	55
029249	002134	4	71
029250	002135	5	87
029251	002136	6	103
042266	002137	7	119
029253	002138	8	135
029254	002139	9	151
029255	002140	10	167
029256	002141	11	183
029257	002142	12	199
029258	002143	13	215
029259	002144	14	231
029260	002145	15	247
048551	002146	16	263
048552	002147	18	295
048553	002148	20	327
029265	002150	24	391

4.5mm Broad Dynamic Compression Plates - Stainless Steel



Width: 16.5mm

Thickness: 4.5mm

Distance Between Center of Holes: 16.0mm

Distance Between Central Holes: 25.0mm

MWI#	SECUIROS#	# OF HOLES	LENGTH (mm)
029266	002151	6	103
048554	002152	7	119
029268	002153	8	135
029269	002154	9	151
029270	002155	10	167
029271	002156	12	199
029272	002157	14	231
029273	002158	16	263
029274	002159	18	295
048555	002160	20	327
029277	001522	22	359
029278	001523	24	391
029279	001524	26	423

Conventional T-Plates

1.5/2.0mm T-Plates - Stainless Steel



MWI#	SECUROS#	# HOLES HEAD	# HOLES SHAFT	OVERALL LENGTH (mm)	HEAD WIDTH (mm)	SHAFT WIDTH (mm)	THICKNESS (mm)
036066	002508	2	4	34.5	9	5	1.5
042415	003969	2	5	41.5	9	5	1.5
042414	003968	2	6	48.5	9	5	1.5
044003	003967	2	7	55.5	9	5	1.5
042408	003826	2	8	62.5	9	5	1.5

2.0mm T-Plates - Stainless Steel



001823



002311



006082

MWI#	SECUROS#	# HOLES HEAD	# HOLES SHAFT	OVERALL LENGTH (mm)	HEAD WIDTH (mm)	SHAFT WIDTH (mm)	THICKNESS (mm)
044019	001823	2	2	18	10.5	5	1.0
045129	002311	3	3	26	10	5	1.5
042054	000640	3	8	45	15	5	1.2
045528	006081	3	9	50	15	5	1.2
044900	006082	4	9	50	20	5	1.2

2.7mm T-Plates - Stainless Steel



006083



002312

MWI#	SECUROS#	# HOLES HEAD	# HOLES SHAFT	OVERALL LENGTH (mm)	HEAD WIDTH (mm)	SHAFT WIDTH (mm)	THICKNESS (mm)
044960	006083	2	3	32	13	7	1.2
045615	002312	3	3	39	16	8	2.0

Conventional T-Plates

2.7/3.5mm T-Plates - Stainless Steel



MWI#	SECUROS#	# HOLES HEAD	# HOLES SHAFT	OVERALL LENGTH (mm)	HEAD WIDTH (mm)	SHAFT WIDTH (mm)	THICKNESS (mm)
042297	002612	2	5	65	18	9.5	2.0
045532	000641	2	7	85	18	9.5	2.0
044306	000642	2	9	105	18	9.5	2.0

3.5mm T-Plates - Stainless Steel



MWI#	SECUROS#	# HOLES HEAD	# HOLES SHAFT	OVERALL LENGTH (mm)	HEAD WIDTH (mm)	SHAFT WIDTH (mm)	THICKNESS (mm)
055094	002313	3	3	55	22	10	3.0
055095	002314	3	4	80	24	12	3.0

3.5mm Right Angle T-Plates - Stainless Steel



001813

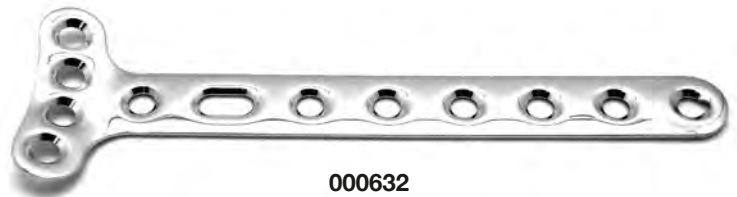

000632

MWI#	SECUROS#	# HOLES HEAD	# HOLES SHAFT	OVERALL LENGTH (mm)	HEAD WIDTH (mm)	SHAFT WIDTH (mm)	THICKNESS (mm)
044303	001813	3	3	50	24	10	1.2
044304	001815	3	5	67	24	10	1.2
■ 372176	001814	4	4	57	31	10	1.2
■ 372177	001816	4	6	79	31	11	1.2
045571	000632	4	8	100	31	11	1.2

■ special order item

Conventional T-Plates

4.5mm T-Plates - Stainless Steel



MWI#	SECUROS#	# HOLES HEAD	# HOLES SHAFT	OVERALL LENGTH (mm)	HEAD WIDTH (mm)	SHAFT WIDTH (mm)	THICKNESS (mm)
045124	001811	2	5	100	33	17	2.0
■ 372178	001812	2	6	115	33	17	2.0



■ special order item

Conventional L-Plates

2.0mm L-Plates - Stainless Steel



000636, 000637

MWI#	SECUROS#	DIRECTION	# HOLES HEAD	# HOLES SHAFT	OVERALL LENGTH (mm)	HEAD WIDTH (mm)	SHAFT WIDTH (mm)	THICKNESS (mm)
045012	000636	Left	2	2	18	11	5	1.0
045568	000637	Right	2	2	18	11	5	1.0

2.7mm L-Plates - Stainless Steel



002476, 002477

002478, 002479

MWI#	SECUROS#	DIRECTION	# HOLES HEAD	# HOLES SHAFT	OVERALL LENGTH (mm)	HEAD WIDTH (mm)	SHAFT WIDTH (mm)	THICKNESS (mm)
055096	002476	Left	2	3	32	13	7	1.2
048567	002477	Right	2	3	32	13	7	1.2
048568	002478	Left Oblique	2	3	34	13	7	1.2
045134	002479	Right Oblique	2	3	34	13	7	1.2

Conventional Acetabular Plates

2.0mm Acetabular Plates - Stainless Steel



MWI#	SECUROS#	# OF HOLES	OVERALL SPAN (mm)	WIDTH (mm)	THICKNESS (mm)
045535	002515	4	20	4	1.2
045534	002514	4	24	5	1.2

2.7mm Acetabular Plates - Stainless Steel



MWI#	SECUROS#	# OF HOLES	OVERALL SPAN (mm)	WIDTH (mm)	THICKNESS (mm)
031202	002516	6	32	6	1.5
044616	002520	6	36	6.5	1.2

3.5mm Acetabular Plates - Stainless Steel



MWI#	SECUROS#	# OF HOLES	OVERALL SPAN (mm)	WIDTH (mm)	THICKNESS (mm)
045586	002518	6	42	7	2.2
■ 276479	002519	6	48	8	2.6

■ special order item

Conventional Distal Femur Osteotomy Plates

2.0mm Distal Femur Osteotomy Plates - Stainless Steel

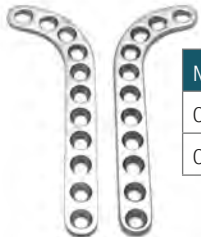

MWI#	SECUROS#	DIRECTION	OVERALL SPAN (mm)	HEAD WIDTH (mm)	SHAFT WIDTH (mm)	THICKNESS (mm)
036192	004071	Left	50	17	5.5	1.5
036203	004070	Right	50	17	5.5	1.5

2.7mm Distal Femur Osteotomy Plates - Stainless Steel

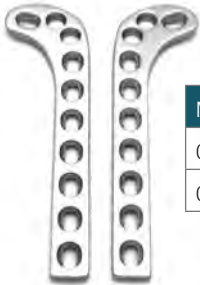

MWI#	SECUROS#	DIRECTION	OVERALL SPAN (mm)	HEAD WIDTH (mm)	SHAFT WIDTH (mm)	THICKNESS (mm)
042302	002694	Left	70	20.5	8	2.5
042303	002695	Right	70	20.5	8	2.5

3.5mm Distal Femur Osteotomy Plates - Stainless Steel



MWI#	SECUROS#	DIRECTION	OVERALL SPAN (mm)	HEAD WIDTH (mm)	SHAFT WIDTH (mm)	THICKNESS (mm)
045536	002692	Left	84	24	10.5	4.0
045555	002693	Right	84	24	10.5	4.0

3.5mm Broad Distal Femur Osteotomy Plates - Stainless Steel



MWI#	SECUROS#	DIRECTION	OVERALL SPAN (mm)	HEAD WIDTH (mm)	SHAFT WIDTH (mm)	THICKNESS (mm)
045562	004073	Left	171.5	30.5	12	4.5
045185	004072	Right	171.5	30.5	12	4.5

1.5mm Cortical Screws

1.5mm Cortical Screw, Self-Tapping, Cruciform Recess - Stainless Steel



Diameter of Thread: 1.5mm

Diameter of Head: 3.0mm

Drill Bit for Threaded Hole: 1.1mm

Drill Bit for Gliding Hole: 1.5mm

For Use With:

1.5/2.0mm Cruciform Screwdriver

Smooth Washer for 1.5mm, 2.0mm Screws

MWI#	SECUROS#	LENGTH (mm)
042141	100026	6
042125	100000	7
042126	100001	8
042127	100002	9
042128	100003	10
042142	100027	11
042129	100004	12
049131	100028	13
042130	100005	14
042131	100006	16
044000	100007	18
044001	100008	20
048127	100029	22
048128	100030	24

1.5mm Cortical Screw, Non Self-Tapping, Cruciform Recess - Stainless Steel



Diameter of Thread: 1.5mm

Diameter of Head: 3.0mm

Drill Bit for Threaded Hole: 1.1mm

Drill Bit for Gliding Hole: 1.5mm

For Use With:

1.5/2.0mm Cruciform Screwdriver

1.5mm Cortical Tap

Smooth Washer for 1.5mm, 2.0mm Screws

MWI#	SECUROS#	LENGTH (mm)
390100	005109	6
390101	005110	7
390102	005111	8
390103	005112	9
390104	005113	10
390105	005114	11
390106	005115	12
390107	005116	13
390108	005117	14
390109	005118	16
390110	005119	18
■ 372115	005120	20
■ 372116	005121	22
■ 372117	005122	24

■ special order item

1.5mm Cortical Screws

1.5mm Cortical Screw, Self-Tapping, Hexagonal Recess - Stainless Steel



Diameter of Thread: 1.5mm

Diameter of Head: 3.0mm

Drill Bit for Threaded Hole: 1.1mm

Drill Bit for Gliding Hole: 1.5mm

For Use With:

1.5mm Hexagonal Screwdriver

Smooth Washer for 1.5mm, 2.0mm Screws

MWI#	SECUROS#	LENGTH (mm)
029121	001835	6
029122	001836	7
029123	001837	8
029124	001839	9
029125	001840	10
031110	002529	11
029126	001841	12
031111	002530	13
029127	001842	14
029128	001843	16
031112	001844	18
031113	001845	20
031114	001846	22
031115	001847	24

1.5mm Cortical Screw, Non Self-Tapping, Hexagonal Recess - Stainless Steel



Diameter of Thread: 1.5mm

Diameter of Head: 3.0mm

Drill Bit for Threaded Hole: 1.1mm

Drill Bit for Gliding Hole: 1.5mm

For Use With:

1.5mm Hexagonal Screwdriver

1.5mm Cortical Tap

Smooth Washer for 1.5mm, 2.0mm Screws



MWI#	SECUROS#	LENGTH (mm)
049359	400040	6
049473	400042	7
■ 372185	400044	8
■ 372186	400046	9
■ 372187	400048	10
049380	400050	11
■ 372191	400052	12
049471	400237	13
■ 372188	400054	14
049383	400056	16
049384	400058	18
049385	400060	20

■ special order item

2.0mm Cortical Screws

2.0mm Cortical Screw, Self-Tapping, Cruciform Recess - Stainless Steel



Diameter of Thread: 2.0mm

Diameter of Head: 4.0mm

Drill Bit for Threaded Hole: 1.5mm

Drill Bit for Gliding Hole: 2.0mm

For Use With:

1.5/2.0mm Cruciform Screwdriver

Smooth Washer for 1.5mm, 2.0mm Screws

Spiked Washer for 2.0mm, 2.4mm Screws

MWI#	SECUROS#	LENGTH (mm)
042132	100009	6
042133	100010	8
042134	100011	10
042140	100022	12
■ 370036	100048	13
042135	100012	14
042136	100013	16
042137	100014	18
042138	100016	20
044009	100017	22
042139	100018	24
055060	100019	26
044010	100020	28
049129	100021	30
045211	100023	32
045214	100024	34
049130	100025	36
■ 370037	100049	38
■ 370038	100050	40

2.0mm Cortical Screw, Non Self-Tapping, Cruciform Recess - Stainless Steel



Diameter of Thread: 2.0mm

Diameter of Head: 4.0mm

Drill Bit for Threaded Hole: 1.5mm

Drill Bit for Gliding Hole: 2.0mm

For Use With:

1.5/2.0mm Cruciform Screwdriver

2.0mm Cortical Tap

Smooth Washer for 1.5mm, 2.0mm Screws

Spiked Washer for 2.0mm, 2.4mm Screws

MWI#	SECUROS#	LENGTH (mm)
390111	100052	8
390112	100053	10
390113	100054	12
390114	100055	13
390115	100056	14
390116	100057	16
390117	100058	18
■ 372118	100059	20
■ 372119	100060	22
■ 372120	100061	24
■ 372121	100062	26
■ 372122	100063	28
■ 372123	100064	30
■ 372124	100065	32
■ 372125	100066	34
■ 372126	100067	36
■ 372127	100068	38
■ 372129	100069	40

■ special order item

2.0mm Cortical Screws

2.0mm Cortical Screw, Self-Tapping, Hexagonal Recess - Stainless Steel



Diameter of Thread: 2.0mm

Diameter of Head: 4.0mm

Drill Bit for Threaded Hole: 1.5mm

Drill Bit for Gliding Hole: 2.0mm

For Use With:

1.5/2.0mm Hexagonal Screwdriver

Smooth Washer for 1.5mm, 2.0mm Screws

Spiked Washer for 2.0mm, 2.4mm Screws

MWI#	SECUROS#	LENGTH (mm)
029135	001853	6
029136	001854	8
029137	001855	10
029138	001856	12
■ 370039	005123	13
029139	001857	14
029140	001858	16
029141	001859	18
029142	001860	20
029143	001861	22
029144	001862	24
029145	001863	26
029146	001864	28
029147	001865	30
029148	001866	32
■ 370040	005124	34
■ 370041	005125	36
■ 370042	005126	38
■ 370043	005127	40

2.0mm Cortical Screw, Non Self-Tapping, Hexagonal Recess - Stainless Steel



Diameter of Thread: 2.0mm

Diameter of Head: 4.0mm

Drill Bit for Threaded Hole: 1.5mm

Drill Bit for Gliding Hole: 2.0mm

For Use With:

1.5/2.0mm Hexagonal Screwdriver

2.0mm Cortical Tap

Smooth Washer for 1.5mm, 2.0mm Screws

Spiked Washer for 2.0mm, 2.4mm Screws

MWI#	SECUROS#	LENGTH (mm)
■ 372189	400062	6
■ 372190	400064	8
049472	400066	10
049388	400068	12
049365	400070	14
049366	400072	16
049367	400074	18
049393	400076	20
049394	400078	22
049395	400080	24
049396	400264	26
049398	400265	28
049400	400266	30
049406	400267	32



■ special order item

2.4mm Cortical Screws

2.4mm Cortical Screw, Self-Tapping, Cruciform Recess - Stainless Steel



Diameter of Thread: 2.4mm

Diameter of Head: 4.0mm

Drill Bit for Threaded Hole: 1.8mm

Drill Bit for Gliding Hole: 2.4mm

For Use With:

1.5/2.0/2.4mm Cruciform Screwdriver

Smooth Washer for 2.4mm, 2.7mm Screws

Spiked Washer for 2.4mm, 2.7mm Screws

MWI#	SECUROS#	LENGTH (mm)
047227	100095	6
047228	100096	7
047229	100097	8
047230	100098	9
047231	100099	10
047232	100100	11
047233	100101	12
047234	100102	13
047235	100103	14
047236	100104	16
047237	100105	18
047238	100106	20
047239	100107	22
047240	100108	24
047241	100109	26
047242	100110	28
047243	100111	30
047244	100112	32
047245	100113	34
047246	100114	36
047247	100115	38
047248	100116	40

2.4mm Cortical Screw, Self-Tapping, Hexagonal Recess - Stainless Steel



Diameter of Thread: 2.4mm

Diameter of Head: 4.0mm

Drill Bit for Threaded Hole: 1.8mm

Drill Bit for Gliding Hole: 2.4mm

For Use With:

2.4mm Hexagonal Screwdriver

Smooth Washer for 2.4mm, 2.7mm Screws

Spiked Washer for 2.4mm, 2.7mm Screws

MWI#	SECUROS#	LENGTH (mm)
■ 370020	005133	7
042299	002614	8
■ 370021	005134	9
030982	001027	10
■ 370022	005135	11
030983	001028	12
■ 370023	005136	13
030984	001029	14
030985	001030	16
030986	001031	18
030987	001032	20
030988	001033	22
030988	001034	24
030989	001035	26
030981	001036	28
030990	001037	30
030991	001038	32
030992	001039	34
030993	001040	36
030994	001041	38
030995	001042	40

■ special order item

2.7mm Cortical Screws

2.7mm Cortical Screw, Self-Tapping, Hexagonal Recess - Stainless Steel



Diameter of Thread: 2.7mm

Diameter of Head: 5.0mm

Drill Bit for Threaded Hole: 2.0mm

Drill Bit for Gliding Hole: 2.7mm

For Use With:

2.7/3.5/4.0mm Hexagonal Screwdriver

Smooth Washer for 2.4mm, 2.7mm Screws

Smooth Washer for 2.7mm, 3.5mm Screws

Spiked Washer for 2.4mm, 2.7mm Screws

Spiked Washer for 2.7mm, 3.5mm Screws

MWI#	SECUROS#	LENGTH (mm)
031116	002540	6
029166	001878	8
029167	001879	10
029168	001880	12
029169	001881	14
029170	001882	16
029171	001883	18
029172	001630	20
029173	001631	22
029174	001632	24
029175	001633	26
029176	001634	28
029177	001635	30

MWI#	SECUROS#	LENGTH (mm)
029178	001636	32
031117	002549	34
031152	002550	36
035974	003554	38
042294	002551	40
048237	004450	42
048238	004451	44
042295	002552	45
048239	004452	46
■ 370044	004453	48
042296	002553	50
■ 370045	005143	55

2.7mm Cortical Screw, Non Self-Tapping, Hexagonal Recess - Stainless Steel



Diameter of Thread: 2.7mm

Diameter of Head: 5.0mm

Drill Bit for Threaded Hole: 2.0mm

Drill Bit for Gliding Hole: 2.7mm

For Use With:

2.7/3.5/4.0mm Hexagonal Screwdriver

2.7mm Cortical Tap

Smooth Washer for 2.4mm, 2.7mm Screws

Smooth Washer for 2.7mm, 3.5mm Screws

Spiked Washer for 2.4mm, 2.7mm Screws

Spiked Washer for 2.7mm, 3.5mm Screws

MWI#	SECUROS#	LENGTH (mm)
046145	004940	6
046146	004941	8
046147	004942	10
046148	004943	12
046149	004944	14
046150	004945	16
046151	004946	18
046152	004947	20
046153	004948	22
046154	004949	24
046155	004950	26
046156	004951	28
046157	004952	30

MWI#	SECUROS#	LENGTH (mm)
046158	004953	32
046159	004954	34
046160	004955	36
046161	004956	38
046162	004957	40
■ 372129	005144	42
■ 372134	005145	44
■ 372135	005150	45
■ 372136	005146	46
■ 372137	005147	48
■ 372138	005148	50
■ 372139	005149	55

■ special order item

3.5mm Cortical Screws

3.5mm Cortical Screw, Self-Tapping, Hexagonal Recess - Stainless Steel



Diameter of Thread: 3.5mm

Diameter of Head: 6.0mm

Drill Bit for Threaded Hole: 2.5mm

Drill Bit for Gliding Hole: 3.5mm

For Use With:

2.7/3.5/4.0mm Hexagonal Screwdriver

Smooth Washer for 2.7mm, 3.5mm Screws

Spiked Washer for 2.7mm, 3.5mm Screws

Spiked Washer for 3.5mm, 4.0mm Screws

MWI#	SECUROS#	LENGTH (mm)
029200	001885	10
029201	001886	12
029202	001887	14
029203	001888	16
029204	001889	18
029205	001890	20
029207	001891	22
029208	001892	24
029209	001893	26
029210	001894	28
029211	001895	30
029212	001896	32
029213	001897	34

MWI#	SECUROS#	LENGTH (mm)
029214	001898	36
029215	001899	38
029216	002101	40
042451	004470	42
042452	004471	44
031119	002593	45
036060	004472	46
042453	004473	48
031120	002592	50
031121	002594	55
036197	002595	60
042382	006068	65
042384	006069	70

3.5mm Cortical Screw, Non Self-Tapping, Hexagonal Recess - Stainless Steel



Diameter of Thread: 3.5mm

Diameter of Head: 6.0mm

Drill Bit for Threaded Hole: 2.5mm

Drill Bit for Gliding Hole: 3.5mm

For Use With:

2.7/3.5/4.0mm Hexagonal Screwdriver

3.5mm Cortical Tap

Smooth Washer for 2.7mm, 3.5mm Screws

Spiked Washer for 2.7mm, 3.5mm Screws

Spiked Washer for 3.5mm, 4.0mm Screws

MWI#	SECUROS#	LENGTH (mm)
046163	004958	10
046164	004959	12
046165	004960	14
046166	004961	16
046167	004962	18
046168	004963	20
046169	004964	22
046170	004965	24
046171	004966	26
046172	004967	28
046173	004968	30
046174	004969	32
046175	004970	34

MWI#	SECUROS#	LENGTH (mm)
046176	004971	36
046177	004972	38
046178	004973	40
046184	004989	42
055124	005163	44
046179	004974	45
055125	005164	46
■ 372141	005165	48
046180	004975	50
046181	004976	55
046182	004977	60
■ 372142	005166	65
■ 372143	005167	70

■ special order item

4.0mm Cancellous Screws

4.0mm Cancellous Screw, Fully Threaded, Hexagonal Recess - Stainless Steel



Diameter of Thread: 4.0mm

Diameter of Head: 6.0mm

Drill Bit for Threaded Hole: 2.0mm

For Use With:

2.7/3.5/4.0mm Hexagonal Screwdriver

4.0mm Cancellous Tap

Smooth Washer for 4.0mm, 4.5mm Screws

Spiked Washer for 3.5mm, 4.0mm Screws

MWI#	SECUROS#	LENGTH (mm)
042043	000441	10
048114	000442	12
048500	000443	14
■ 372046	000444	16
■ 372047	000445	18
048501	000446	20
■ 372048	000447	22
046112	000448	24
■ 372049	000449	26
■ 372172	000450	28
■ 372173	000451	30
042045	000452	32
■ 372050	000453	34

MWI#	SECUROS#	LENGTH (mm)
■ 372051	000454	36
■ 372052	000455	38
■ 372174	000456	40
■ 372053	000413	42
■ 372054	000414	44
046113	000474	45
042041	000439	46
■ 372055	000440	48
■ 372056	000458	50
■ 372057	000459	55
048502	000460	60
■ 372059	005171	65
■ 372059	005172	70

4.0mm Cancellous Screw, Fully Threaded, "Fat Neck", Hexagonal Recess - Stainless Steel



Diameter of Thread: 4.0mm

Diameter of Head: 6.0mm

Drill Bit for Threaded Hole: 2.0mm

For Use With:

2.7/3.5/4.0mm Hexagonal Screwdriver

4.0mm Cancellous Tap

Smooth Washer for 4.0mm, 4.5mm Screws

Spiked Washer for 3.5mm, 4.0mm Screws

MWI#	SECUROS#	LENGTH (mm)
029415	001579	10
029416	001580	12
029417	001581	14
029418	001582	16
029419	001583	18
029420	001584	20
029421	001585	22
029422	001586	24
029423	001587	26
029424	001588	28
029425	001589	30
029426	001590	32
029427	001591	34

MWI#	SECUROS#	LENGTH (mm)
029428	001592	36
029429	001593	38
029430	001594	40
035931	004006	42
035975	004007	44
029431	001595	45
045196	004428	46
045197	004429	48
029432	001596	50
029433	001597	55
029434	001598	60

■ special order item

4.0mm Cancellous Screws

4.0mm Cancellous Screw, Partially Threaded, Hexagonal Recess - Stainless Steel



Diameter of Thread: 4.0mm

Diameter of Head: 6.0mm

Drill Bit for Threaded Hole: 2.0mm

For Use with:

2.7/3.5/4.0mm Hexagonal Screwdriver

4.0mm Cancellous Tap

Smooth Washer for 4.0mm, 4.5mm Screws

Spiked Washer for 3.5mm, 4.0mm Screws

MWI#	SECUROS#	LENGTH (mm)	MWI#	SECUROS#	LENGTH (mm)
029398	001562	10	■ 372146	005175	36
029399	001563	12	■ 372147	005176	38
029400	001564	14	029410	001574	40
029401	001565	16	■ 372148	005177	42
029402	001566	18	■ 372149	005178	44
042206	001567	20	029411	001575	45
029404	001568	22	■ 372150	005179	46
029405	001569	24	■ 372151	005180	48
042207	001570	26	029412	001576	50
042208	001571	28	029413	001577	55
042209	001572	30	029414	001578	60
■ 372144	005173	32	■ 372152	005181	65
■ 372145	005174	34	■ 372153	005182	70



■ special order item

4.5mm Cortical Screws

4.5mm Cortical Screw, Self-Tapping, Hexagonal Recess - Stainless Steel



Diameter of Thread: 4.5mm

Diameter of Head: 8.0mm

Drill Bit for Threaded Hole: 3.2mm

Drill Bit for Gliding Hole: 4.5mm

For Use With:

4.5/5.5/6.5mm Hexagonal Screwdriver

Smooth Washer for 4.0mm, 4.5mm Screws

Smooth Washer for 4.5mm, 5.5mm, 6.5mm Screws

Spiked Washer for 4.5mm, 5.5mm, 6.5mm Screws

MWI#	SECUROS#	LENGTH (mm)
042099	001526	14
042200	001527	16
029283	001528	18
029284	001529	20
029285	001530	22
029286	001531	24
029287	001532	26
029288	001533	28
029289	001534	30
029290	001535	32
029291	001536	34
029292	001537	36
029293	001538	38
029294	001539	40
029295	001540	42
042202	001541	44
029297	001542	46
042203	001543	48
042204	001544	50

MWI#	SECUROS#	LENGTH (mm)
042205	001545	52
029384	001546	54
044901	000874	55
029385	001547	56
029386	001548	58
029387	001549	60
055049	003808	62
044934	004001	64
048178	003809	66
048232	004002	68
029389	001551	70
029390	001552	75
029391	001553	80
029392	001556	85
029393	001557	90
029394	001558	95
029395	001559	100

4.5mm Cortical Screw, Non Self-Tapping, Hexagonal Recess - Stainless Steel



Diameter of Thread: 4.5mm

Diameter of Head: 8.0mm

Drill Bit for Threaded Hole: 3.2mm

Drill Bit for Gliding Hole: 4.5mm

For Use With:

4.5/5.5/6.5mm Hexagonal Screwdriver

4.5mm Cortical Tap

Smooth Washer for 4.0mm, 4.5mm Screws

Smooth Washer for 4.5mm, 5.5mm, 6.5mm Screws

Spiked Washer for 4.5mm, 5.5mm, 6.5mm Screws

MWI#	SECUROS#	LENGTH (mm)
049433	005220	14
049434	005221	16
049436	005222	18
049437	005223	20
049438	005224	22
049439	005225	24
049442	005226	26
049443	005227	28
049444	005228	30
049445	005229	32
049446	005230	34
049447	005231	36
049448	005232	38
049449	005233	40
049450	005234	42
049451	005235	44
049452	005236	45
■ 372154	005237	46
049453	005238	48

MWI#	SECUROS#	LENGTH (mm)
049454	005239	50
■ 372155	005240	52
■ 372156	005241	54
■ 372157	005242	55
■ 372158	005243	56
■ 372159	005244	58
■ 372160	005245	60
■ 372161	005246	62
■ 372162	005247	64
■ 372164	005248	66
■ 370052	005249	68
■ 370053	005250	70
■ 370054	005251	75
■ 370055	005252	80
■ 370056	005253	85
■ 370057	005254	90
■ 370058	005255	95
■ 370059	005256	100

■ special order item

5.5mm Cortical Screws

5.5mm Cortical Screw, Hexagonal Recess - Stainless Steel



Diameter of Thread: 5.5mm

Diameter of Head: 8.0mm

Drill Bit for Threaded Hole: 4.0mm

Drill Bit for Gliding Hole: 5.5mm

For Use With:

4.5/5.5/6.5mm Hexagonal Screwdriver

5.5mm Cortical Tap

Smooth Washer for 4.5mm, 5.5mm, 6.5mm Screws

Spiked Washer for 4.5mm, 5.5mm, 6.5mm Screws

MWI#	SECUROS#	LENGTH (mm)	MWI#	SECUROS#	LENGTH (mm)
■ 370060	005257	24	■ 370071	005269	48
■ 370061	005258	26	■ 370072	005270	50
■ 370062	005259	28	049456	005271	52
■ 370063	005260	30	■ 370073	005272	54
049455	005261	32	■ 370074	005273	56
■ 370064	005262	34	■ 370075	005274	58
■ 370065	005263	36	■ 370076	005275	60
■ 370066	005264	38	■ 370077	005276	65
■ 370067	005265	40	■ 370078	005277	70
■ 370068	005266	42	■ 370079	005278	80
■ 370069	005267	44	049457	005279	90
■ 370070	005268	46	048394	005280	100

6.5mm Cancellous Screws

6.5mm Cancellous Screw, Fully Threaded, Hexagonal Recess - Stainless Steel



Diameter of Thread: 6.5mm

Diameter of Head: 8.0mm

Drill Bit for Threaded Hole: 3.2mm

Drill Bit for Gliding Hole: 4.5mm

For Use With:

4.5/5.5/6.5mm Hexagonal Screwdriver

6.5mm Cancellous Tap

Smooth Washer for 4.5mm, 5.5mm, 6.5mm Screws

Spiked Washer for 4.5mm, 5.5mm, 6.5mm Screws

MWI#	SECUROS#	LENGTH (mm)
■ 370080	004144	25
045149	002904	30
045526	002905	35
044610	002906	40
■ 370081	004145	45
045015	000864	50
044611	000865	55
045296	000866	60
■ 370082	004146	65
■ 370541	000867	70
048509	000868	75
■ 370083	004147	80
■ 370084	004148	85
■ 370085	004149	90
■ 370086	004150	95
■ 370087	004151	100

■ special order item

6.5mm Cancellous Screws

6.5mm Cancellous Screw, 16mm Thread Length, Hexagonal Recess - Stainless Steel



Diameter of Thread: 6.5mm

Diameter of Head: 8.0mm

Drill Bit for Threaded Hole: 3.2mm

Drill Bit for Gliding Hole: 4.5mm

For Use With:

4.5/5.5/6.5mm Hexagonal Screwdriver

6.5mm Cancellous Tap

Smooth Washer for 4.5mm, 5.5mm, 6.5mm Screws

Spiked Washer for 4.5mm, 5.5mm, 6.5mm Screws

MWI#	SECUROS#	LENGTH (mm)
■ 370088	005282	35
■ 370089	005283	40
■ 370090	005284	45
■ 370091	005285	50
■ 370092	005286	55
■ 370093	005287	60
■ 370094	005288	65
■ 370095	005289	70
■ 370096	005290	75
■ 370097	005291	80
■ 370098	005292	85
■ 370099	005293	90
■ 370100	005294	95
■ 370101	005295	100

6.5mm Cancellous Screw, 32mm Thread Length, Hexagonal Recess - Stainless Steel



Diameter of Thread: 6.5mm

Diameter of Head: 8.0mm

Drill Bit for Threaded Hole: 3.2mm

Drill Bit for Gliding Hole: 4.5mm

For Use With:

4.5/5.5/6.5mm Hexagonal Screwdriver

6.5mm Cancellous Tap

Smooth Washer for 4.5mm, 5.5mm, 6.5mm Screws

Spiked Washer for 4.5mm, 5.5mm, 6.5mm Screws

MWI#	SECUROS#	LENGTH (mm)
055105	004154	50
■ 370102	004155	55
■ 370103	004156	60
■ 370105	004157	65
■ 370106	004158	70
■ 370170	004159	75
■ 370171	004160	80
■ 370172	004161	85
■ 370173	004162	90
■ 370174	004163	95
■ 370175	004164	100



■ special order item

Washers

Smooth Washers



MWI#	SECUROS#	RECOMMENDED SCREWS (mm)	OUTER DIAMETER (mm)	INNER DIAMETER (mm)	THICKNESS (mm)
036055	002446	1.5/2.0	4.5	2.2	0.5
042271	002444	2.4/2.7	6.5	2.8	1.0
042272	002445	2.7/3.5	7	4	1.0
042336	003655	4.0/4.5	10	5.2	1.0
042338	003656	4.5/5.5/6.5	13	6.8	1.0

Spiked Washers



MWI#	SECUROS#	RECOMMENDED SCREWS (mm)	OUTER DIAMETER (mm)	INNER DIAMETER (mm)	THICKNESS (mm)
042237	001884	2.0/2.4	8	3.2	4.0
045589	002607	2.4/2.7	8	3.8	4.0
042270	002441	2.7/3.5	13	4	4.0
042221	001656	3.5/4.0	11	4.8	3.5
035921	002442	4.5/5.5/6.5	13	6.8	3.5

INSTRUMENTS

Instruments for Conventional Plate Osteosynthesis

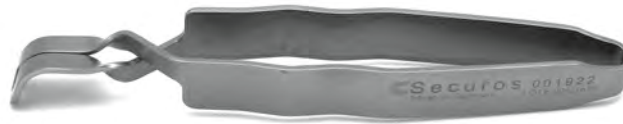

MWI#	SECUROS#	PRODUCT DESCRIPTION	LENGTH (")
042243	001922	Self-Holding Screw Forceps	3.5



MWI#	SECUROS#	PRODUCT DESCRIPTION	LENGTH (")
043946	001923	Plate Holding Forceps	4.5



MWI#	SECUROS#	PRODUCT DESCRIPTION	SPAN (mm)	LENGTH (")
■ 370112	001933	Articulated Tensioning Device	20	3.5



MWI#	SECUROS#	PRODUCT DESCRIPTION	FOR USE WITH	LENGTH (")
■ 370113	001934	Combination Wrench	Articulated Tensioning Device	6



MWI #	SECUROS #	PRODUCT DESCRIPTION	LENGTH (")
■ 370114	001935	Sharp Hook	6

■ special order item

Bending Instruments

Bending Templates



MWI#	SECUROS#	PLATE SIZE (mm)	# OF HOLES
045448	002051	3.5	7
045125	002052	3.5	9
045610	002053	4.5	7
045611	002055	4.5	12

Bending Irons



MWI#	SECUROS#	PRODUCT DESCRIPTION
042253	002056	1.5/2.0mm Bending Iron



002057



002058

MWI#	SECUROS#	PRODUCT DESCRIPTION
029100	002057	2.4/2.7/3.5mm Bending Iron Left
029101	002058	2.4/2.7/3.5mm Bending Iron Right



MWI#	SECUROS#	PRODUCT DESCRIPTION
042314	002948	3.5/4.5mm plate Bending Iron



MWI#	SECUROS#	PRODUCT DESCRIPTION
055011	004326	2.7/3.5mm Reconstruction Plate Bending Iron

Bending Instruments

Bending Pliers



MWI#	SECUROS#	PRODUCT DESCRIPTION
055169	002059	2.0/2.4/2.7mm Small Bending Pliers



MWI#	SECUROS#	PRODUCT DESCRIPTION
045449	002063	2.4/2.7/3.5mm Medium Bending Pliers

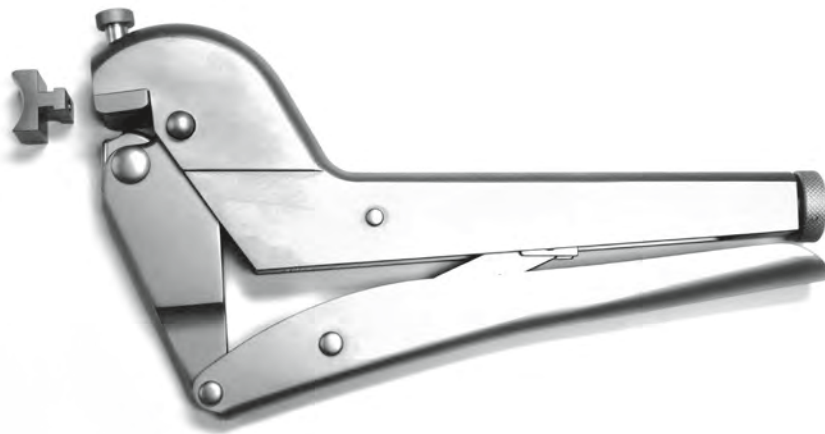

MWI#	SECUROS#	PRODUCT DESCRIPTION
044054	002064	3.5/4.5mm Large Bending Pliers

Bending Instruments

Bending Presses



002065



MWI#	SECUROS#	PRODUCT DESCRIPTION
055117	003891	Small Table Top Bending Press for use with Plates up to 3.5mm Broad
■ 276663	002065	Table Top Bending Press for use with Plates up to 4.5mm Broad

■ special order item

Drill Bits

Jacobs Chuck Coupling (BITE Bit, Titanium Nitride Coated)



MWI#	SECUROS#	DIAMETER (mm)	TOTAL LENGTH (mm)	FLUTE LENGTH (mm)	RECOMMENDED SCREWS (mm)	
					THREADED HOLE	GLIDING HOLE
028993	002034	1.1	45	22	1.5	-
028994	002035	1.5	70	23	2.0	1.5
031139	001017	1.8	131	26	2.4	-
028995	002036	2.0	85	50	2.7/4.0	2.0
031129	001358	2.4	143	32	-	2.4
028996	002037	2.5	95	50	3.5	-
028997	002038	2.7	85	50	-	2.7
028998	002039	3.2	130	40	4.5/6.5	-
029005	002040	3.5	100	43	-	3.5
029006	002041	4.0	130	50	-	4.0
042251	002042	4.5	130	50	-	4.5/6.5

Quick Coupling (BITE Bit, Titanium Nitride Coated)



MWI#	SECUROS#	DIAMETER (mm)	TOTAL LENGTH (mm)	FLUTE LENGTH (mm)	RECOMMENDED SCREWS (mm)	
					THREADED HOLE	GLIDING HOLE
029008	002043	1.1	60	15	1.5	-
029009	002044	1.5	85	18	2.0	1.5
036059	000395	1.8	140	32	2.4	-
029010	001018	2.0	100	22	2.7/4.0	2.0
042090	001361	2.4	140	32	-	2.4
029011	001019	2.5	110	32	3.5	-
029012	002045	2.7	100	29	-	2.7
042252	002046	3.2	145	43	4.5/6.5	-
029014	002047	3.5	100	43	-	3.5
042034	000366	4.0	160	50	-	4.0
029015	002048	4.5	145	50	-	4.5/6.5
048102	000367	5.5	195	50	-	5.5

Taps & Countersinks

Quick Coupling Taps



MWI#	SECUROS#	DIAMETER (mm)	SCREW TYPE	TOTAL LENGTH (mm)	THREAD LENGTH (mm)
042239	001906	1.5	Cortical	50	20
042240	001907	2.0	Cortical	53	24
029104	001908	2.7	Cortical	100	33
029105	001909	3.5	Cortical	110	51
029106	001910	4.5	Cortical	125	70
045135	002500	5.5	Cortical	135	60
042241	001911	4.0	Cancellous	110	45
■ 372182	002503	6.5	Cancellous	200	25

Countersinks



MWI#	SECUROS#	DIAMETER (mm)	FEATURE	LENGTH (")
043934	001912	1.5/2.0	Quick Coupling	2.25
043906	001913	2.7	Quick Coupling	2.25
043909	001914	3.5	Quick Coupling	2.75



MWI#	SECUROS#	DIAMETER (mm)	FEATURE	LENGTH (")
045212	001915	4.5	Handle	7

■ special order item

Drill Guides & Sleeves

Double Drill Guides



MWI#	SECUROS#	PRODUCT DESCRIPTION
030971	002066	1.1/1.5mm Double Drill Guide
030970	002067	1.5/2.0mm Double Drill Guide
055050	003824	1.8/2.4mm Double Drill Guide
031195	001022	2.0/2.7mm Double Drill Guide
030996	001023	2.5/3.5mm Double Drill Guide
031201	002278	3.2/4.5mm Double Drill Guide

Compressional Drill Guides



MWI#	SECUROS#	PRODUCT DESCRIPTION
029016	001902	2.0mm Compressional Drill Guide
042238	001903	2.7mm Compressional Drill Guide
029018	001904	3.5mm Compressional Drill Guide
048538	001905	4.5mm Compressional Drill Guide
048376	004095	3.5mm LC Compressional Drill Guide

Universal Drill Guides



MWI#	SECUROS#	PRODUCT DESCRIPTION
042267	002279	3.5mm Universal Drill Guide
055086	000905	5.5mm Universal Drill Guide

Drill Guides & Sleeves

Drill Sleeves



MWI#	SECUROS#	PRODUCT DESCRIPTION
045109	001901	2.5/3.5mm Insert Drill Sleeve
045099	000904	4.0/5.5mm Insert Drill Sleeve



MWI#	SECUROS#	PRODUCT DESCRIPTION
045392	000368	5.5mm Tap Sleeve



MWI#	SECUROS#	PRODUCT DESCRIPTION
■ 372175	001900	2.0mm Parallel Drill Guide & Drill Sleeve

■ special order item

Depth Gauges

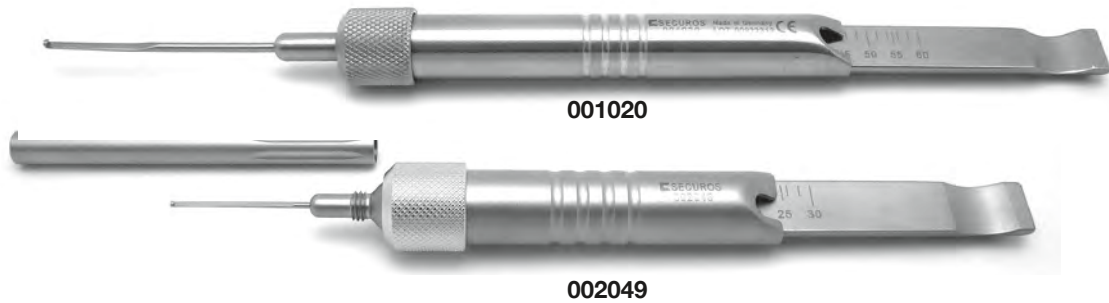

MWI#	SECUROS#	PRODUCT DESCRIPTION	MEASURES UP TO (mm)	MEASUREMENT INCREMENTS (mm)
029097	002049	1.5/2.0/2.4mm Depth Gauge	30	2 & 5
029098	001020	2.7/3.5/4.0mm Depth Gauge	60	2 & 5
090001	005329	2.7/3.5/4.0mm Depth Gauge	60	1
029099	002050	4.5/5.5/6.5mm Depth Gauge	110	2 & 5

Screwdrivers, Handles, & Shafts

Screwdrivers (Includes holding sleeve)



Cruciform



Hexagonal

MWI#	SECUROS#	PRODUCT DESCRIPTION	LENGTH (")
042292	002504	1.5/2.0mm Hexagonal Screwdriver	6.75
042073	001026	1.5/2.0/2.4mm Cruciform Screwdriver	7
035880	003237	2.4mm Hexagonal Screwdriver	7
029524	001024	2.7/3.5/4.0mm Hexagonal Screwdriver	7.75
029526	001920	4.5/5.5/6.5mm Hexagonal Screwdriver	9.5

Screwdrivers, Handles, & Shafts

Screwdriver Shafts (Quick Coupling, Includes Holding Sleeve)



004660



003827



001025

MWI#	SECUROS#	PRODUCT DESCRIPTION	FOR USE WITH	LENGTH (")
055058	004660	1.5/2.0mm Hexagonal Screwdriver Shaft	Mini QC Handle	2
056007	003827	1.5/2.0/2.4mm Cruciform Screwdriver Shaft	Mini QC Handle	2
055102	003904	2.4mm Hexagonal Screwdriver Shaft	Small, Large, Silicone QC Handles	4
029525	001025	2.7/3.5/4.0mm Hexagonal Screwdriver Shaft	Small, Large, Silicone QC Handles	4
029527	001921	4.5/5.5/6.5mm Hexagonal Screwdriver Shaft	Small, Large, Silicone QC Handles	4

Screwdriver Handles (Quick Coupling)



MWI#	SECUROS#	PRODUCT DESCRIPTION	ACCOMMODATES	LENGTH (")
042033	000123	Mini Handle	1.5/2.0mm Hexagonal & 1.5/2.0/2.4mm Cruciform Screwdriver Shafts	4.25



MWI#	SECUROS#	PRODUCT DESCRIPTION	ACCOMMODATES	LENGTH (")
029529	007003	Small Handle	2.7/3.5/4.0mm & 4.5/5.5/6.5mm Hexagonal Screwdriver Shafts	4.5



MWI#	SECUROS#	PRODUCT DESCRIPTION	ACCOMMODATES	LENGTH (")
029528	001916	Large Handle	2.7/3.5/4.0mm & 4.5/5.5/6.5mm Hexagonal Screwdriver Shafts	6

Screwdrivers, Handles, & Shafts

Screwdriver Handles (Quick Coupling)

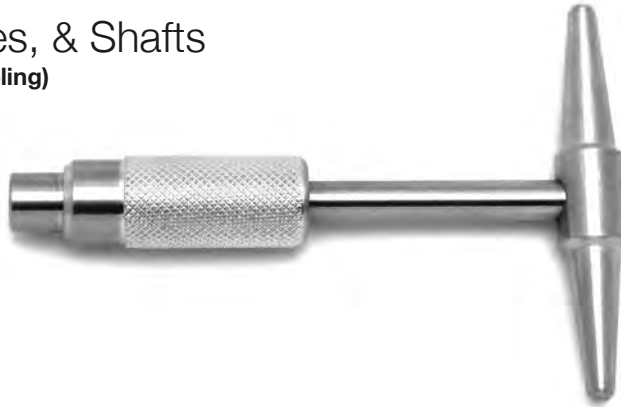

MWI#	SECUROS#	PRODUCT DESCRIPTION	ACCOMMODATES	LENGTH (")
029530	001918	T-Handle	2.7mm - 6.5mm Taps	3.25



MWI#	SECUROS#	PRODUCT DESCRIPTION	ACCOMMODATES	LENGTH (")
052748	007180	Silicone Handle	2.7/3.5/4.0mm & 4.5/5.5/6.5mm Hexagonal Screwdriver Shafts	5.5

Screwdriver Holding Sleeves



005502



003661



005505

MWI#	SECUROS#	PRODUCT DESCRIPTION
052741	005502	1.5/2.0mm Standard Hexagonal Screwdriver Holding Sleeve
036057	003661	2.4mm Standard Hexagonal Screwdriver Holding Sleeve
043904	002190	2.7/3.5/4.0mm Standard Hexagonal Screwdriver Holding Sleeve
055170	005505	4.5/5.5/6.5mm Spring Loaded Hexagonal Screwdriver Holding sleeve

Screw Extraction



Set

MWI#	SECUROS#	PRODUCT DESCRIPTION
■ 370115	000829	Screw Extraction Set (SOS Set)

Instruments

MWI#	SECUROS#	PRODUCT DESCRIPTION
■ 370116	004491	Large Forceps for Broken Screw Removal
390153	004492	Hollow Gouge 4mm
390154	004493	Hollow Gouge 6mm
390155	004494	Hollow Gouge 10mm
■ 370117	004495	6" QC T-Handle



Extraction Bolts

MWI#	SECUROS#	PRODUCT DESCRIPTION
390156	003899	Extraction Bolt for 1.5mm Screws
048315	003900	Extraction Bolt for 2.0mm Screws
390157	003901	Extraction Bolt for 2.7/3.0mm Screws
390158	003902	Extraction Bolt for 3.5/4.0mm Screws
045165	003548	Extraction Bolt for 4.5/5.0mm Screws
■ 370118	004489	Extraction Bolt for 6.5/7.0mm Screws

Instruments



Reamers

MWI#	SECUROS#	PRODUCT DESCRIPTION
390159	004467	Hollow Reamer for 2.7mm Screws
390160	004468	Hollow Reamer for 3.5/4.0mm Screws
■ 370119	004469	Hollow Reamer for 4.5mm Screws
■ 370510	004478	Hollow Reamer for 6.5mm/7.0mm Screws

Extractors and Handle

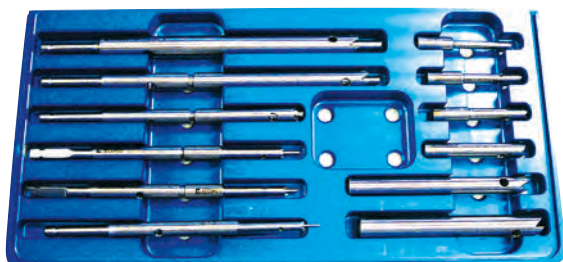

Reamers and Centering Pins

■ special order item

Spare Reamer Tubes

MWI#	SECUROS#	PRODUCT DESCRIPTION
390161	004485	2.7mm Spare Reamer Tube
390162	004486	3.5/4.0mm Spare Reamer Tube
■ 370513	004487	4.5mm Spare Reamer Tube
■ 370514	004488	6.5/7.0mm Spare Reamer Tube

Conical Extraction Screws

MWI#	SECUROS#	PRODUCT DESCRIPTION
390163	003549	Conical Extraction Screws for 2.7mm & 3.5mm Screws
048255	003561	Conical Extraction Screws for Large Screws and 4.9mm Bolts



STERILIZATION CONTAINERS

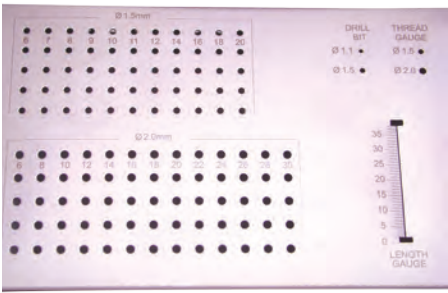

000882

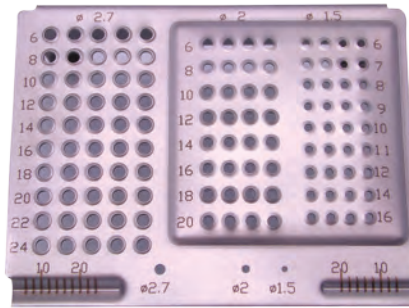

002320

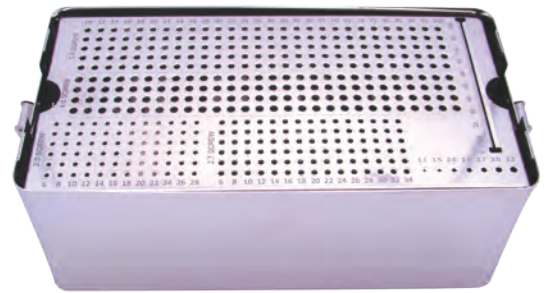

003750

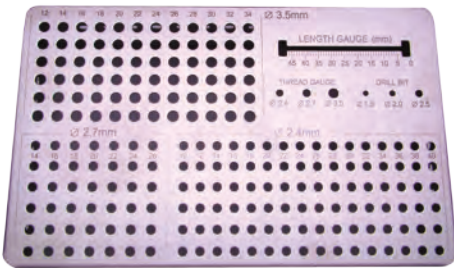

000883

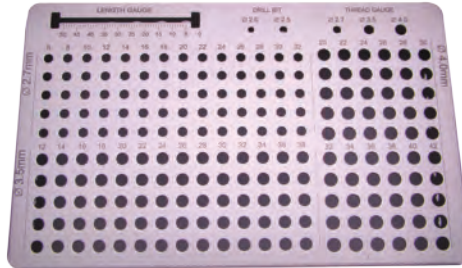

000881



002997

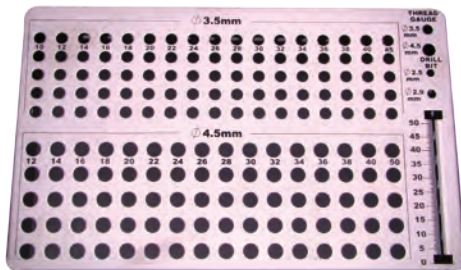

003289

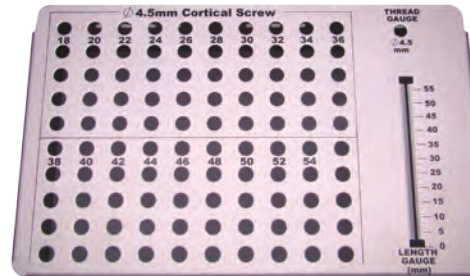

000885

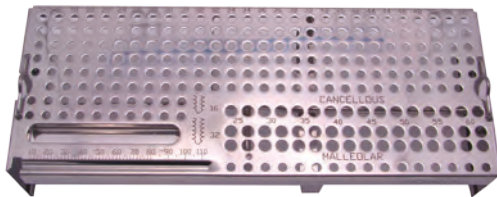

002315

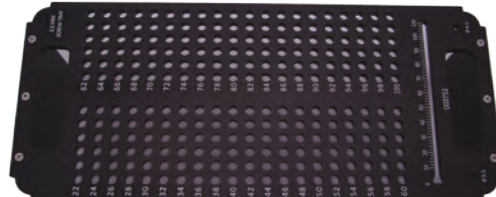

003752

MWI#	SECUROS#	PRODUCT DESCRIPTION	LENGTH (")	WIDTH (")	HEIGHT (")
045549	000882	Screw Rack for 1.5/2.0mm Cortical Screws	6.5	4.25	2.25
ACCOMMODATES					
1.5mm Screws 5 ea.: 6mm-12mm (Increments of 1mm), 14mm-20mm (Increments of 2mm), 2.0mm Screws 5 ea.: 6mm-30mm (Increments of 2mm)					

MWI#	SECUROS#	PRODUCT DESCRIPTION	LENGTH (")	WIDTH (")	HEIGHT (")
044068	002320	Screw Rack for 1.5/2.0/2.7mm Cortical Screws	4.5	3.25	2.25
ACCOMMODATES					
1.5mm Screws 4 ea.: 6-12mm (Increments of 1mm), 14-16mm (Increments of 2mm), 2.0mm Screws 4 ea.: 6-20mm (Increments of 2mm), 2.7mm Screws 5 ea.: 6-24mm (Increments of 2mm)					

MWI#	SECUROS#	PRODUCT DESCRIPTION	LENGTH (")	WIDTH (")	HEIGHT (")
056009	003750	Screw Rack for 2.0/2.7/3.5/4.0mm Cortical Screws	11	5.75	4.25
ACCOMMODATES					
2.0mm Screws 6 ea.: 6mm-28mm (Increments of 2mm), 2.7mm Screws 6 ea.: 6mm-34mm (Increments of 2mm), 3.5mm Screws 5 ea.: 10mm-40mm (Increments of 2mm), 45mm-100mm (Increments of 5mm), 4.0mm Screws 4 ea.: 10mm-40mm (Increments of 2mm), 45mm-100mm (Increments of 5mm)					

MWI#	SECUROS#	PRODUCT DESCRIPTION	LENGTH (")	WIDTH (")	HEIGHT (")
042069	000883	Screw Rack for 2.4/2.7/3.5mm Cortical Screws	6.5	4.25	2.25
ACCOMMODATES					
2.4mm Screws 6 ea.: 10mm-40mm (Increments of 2mm), 2.7mm Screws 6 ea.: 14mm-26mm (Increments of 2mm), 3.5mm Screws 6 ea.: 12mm-34mm (Increments of 2mm)					

MWI#	SECUROS#	PRODUCT DESCRIPTION	LENGTH (")	WIDTH (")	HEIGHT (")
045560	000881	Screw Rack for 2.7/3.5mm Cortical & 4.0mm Cancellous Screws	6.5	4.25	2.25
ACCOMMODATES					
2.7mm Screws 5 ea.: 6mm-32mm (Increments of 2mm), 3.5mm Screws 5 ea.: 12mm-38mm (Increments of 2mm), 4.0mm Screws 5 ea.: 20mm-42mm (Increments of 2mm)					

MWI#	SECUROS#	PRODUCT DESCRIPTION	LENGTH (")	WIDTH (")	HEIGHT (")
045476	002997	Screw Rack for 3.5mm Cortical & 4.0mm Cancellous Screws	6.5	4.25	2.25
ACCOMMODATES					
3.5mm Screws 5 ea.: 10mm-44mm (Increments of 2mm), 45mm, 50mm, 4.0mm Screws 5 ea.: 12mm-44mm (Increments of 2mm), 45mm, 46mm, 50mm					

MWI#	SECUROS #	PRODUCT DESCRIPTION	LENGTH (")	WIDTH (")	HEIGHT (")
045628	003289	Screw Rack for 3.5/4.5mm Cortical Screws	6.5	4.25	2.25
ACCOMMODATES					
3.5mm Screws 5 ea.: 10mm-40mm (Increments of 2mm), 45mm, 4.5mm Screws 5 ea.: 12mm-40mm (Increments of 2mm), 50mm					

MWI#	SECUROS#	PRODUCT DESCRIPTION	LENGTH (")	WIDTH (")	HEIGHT (")
055085	000885	Screw Rack for 4.5mm Cortical Screws	6.5	4.25	2.25
ACCOMMODATES					
4.5mm Screws 5 ea.: 18mm-54mm (Increments of 2mm)					

MWI#	SECUROS#	PRODUCT DESCRIPTION	LENGTH (")	WIDTH (")	HEIGHT (")
048564	002315	Screw Rack for 4.5/6.5mm Cortical Screws	11.5	4.5	2.25
ACCOMMODATES					
4.5mm Screws 7 ea.: 14mm, 8 ea.: 16mm-28mm (Increments of 2mm), 16 ea.: 30mm, 12 ea.: 32mm-40mm (Increments of 2mm), 44mm, 6 ea.: 42mm, 46mm, 48mm, 52mm, 56mm, 60mm, 6.5mm Screws 6 ea.: 25mm-60mm (Increments of 5mm)					

MWI#	SECUROS#	PRODUCT DESCRIPTION	LENGTH (")	WIDTH (")	HEIGHT (")
055101	003752	Screw Rack for 5.5mm Cortical Screws	12.5	5.25	3.75
ACCOMMODATES					
5.5mm Screws 6 ea.: 22mm-100mm (Increments of 2mm)					



MWI#	SECUROS#	PRODUCT DESCRIPTION	LENGTH (")	WIDTH (")	HEIGHT (")
042039	000418	Internal Fixation Organizer Case - Blue Cover w/ Logo	13	6	4.5



MWI#	SECUROS#	PRODUCT DESCRIPTION	LENGTH (")	WIDTH (")	HEIGHT (")
056017	002872	Small Fragment Instrument Case - Aluminum (red)	12	4.75	3

Plate Stringers

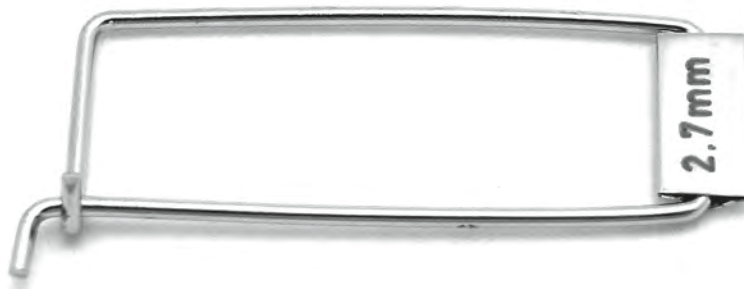

MWI#	SECUROS#	RECOMMENDED PLATES
043901	000402	2.0
043903	000401	2.7
043908	000400	3.5

REFERENCE MATERIALS

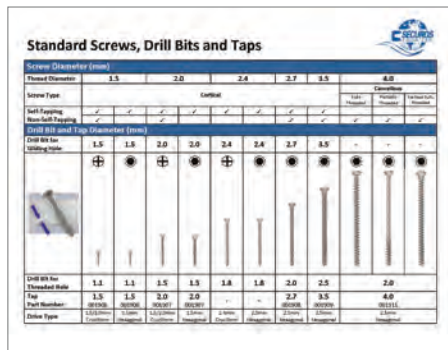

005094

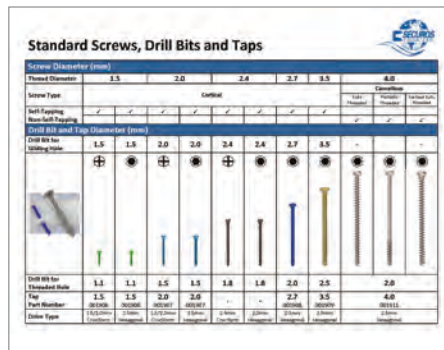

005095

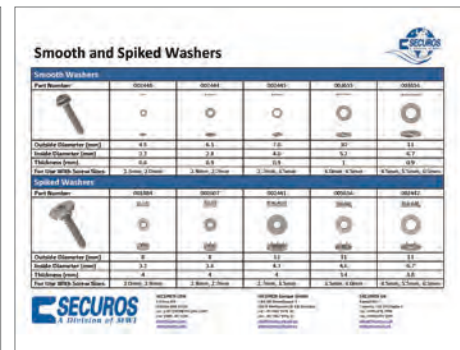

004939

MWI#	SECUROS#	PRODUCT DESCRIPTION
■ 388988	005094	Standard Screw Reference - Stainless Steel
■ 388989	005095	Standard Screw Reference - Titanium
■ 388990	004939	Washer Reference



Top



Bottom

MWI#	SECUROS#	PRODUCT DESCRIPTION
048584	840920	Screw & Drill Bit Gauge

■ special order item



SECUROS

Locking Plate Freedom

- **Polyaxial** locking up to 10°
- **Titanium** implants
- **Interchangeable** screws between 2.0/2.4mm & 2.7/3.5mm systems
- Ability to remove screws & adjust **angulation**



Radiograph provided by: Fred Pike, DVM, DACVS
Veterinary Specialty Hospital



Radiograph provided by: David Mason, DVM, MRCVS,
DACVS, DECVS Las Vegas Veterinary Specialty Center



PAX RP



PAX SP

PAX Polyaxial Advanced Locking Veterinary Osteosynthesis System

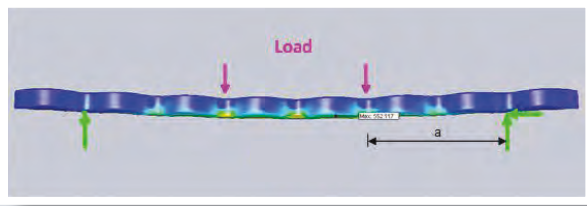

In 2009, SECUROS introduced the PAX System in an effort to combine the advantages of conventional plate systems and locking plate systems to provide the veterinary surgeon the **best of both worlds**. The PAX system is designed for operative fracture treatment, anatomical reconstruction, and re-establishment of lost functionality. The **modern plate geometries** offer the veterinary surgeon a wide range of application from extremities to the spine. The plates and screws present a stable locking system to provide the fundamental conditions for **bone osteosynthesis**. Because it is possible to lock the plates without pressing them onto the bone it reduces damage to the blood supply. The angularly-stable screw-plate locking system offers a **polyaxial insertion** of the screws into the plate at an angle of **+/- 10 degrees**. The stability of the fracture treatment is the result of the **high construct stiffness** and is almost independent of the bone quality, contact pressure, and whether the plate is precisely formed to the bone or not. The loading is transferred directly from the screw to the plate. The **locking mechanism** utilizes plastic deformation of the plate on the screw head thread while inserting the screw and is reliable for repeated insertion of the screw. **Benefits** of the PAX Advanced Locking System include:

- Titanium and titanium alloy for **supreme biocompatibility**
- **Polyaxial** locking up to 10 degrees
- Available in both **contourable RP** (Reconstruction Plate) or **rigid SP** (Straight Plate) styles
- SP plates feature **comparable stiffness** compared to conventional plates ¹
- SP plates are approximately **40% stiffer** than RP plates¹
- **Angle stable** locking without significant screw pushout loss up to 5 degrees and great results up to 10 degrees ²
- Plates **accept both** PAX locking and conventional screws
- **Interchangeable** locking screws between 2.0/2.4mm and 2.7/3.5mm systems
- Biological **internal fixation** design rationale with good **clinical outcomes** ³
- **Patented** locking technology

1. Internal mechanical testing data results available upon request.

2. Bufkin BW, Barnhart MD, Kazanovicz AJ et al. The effect of screw angulation and insertion torque on the push-out strength of polyaxial locking screws and the single cycle to failure in bending of polyaxial locking plates. *Vet Comp Orthop Traumatol* 2013; 26: 186-191.

3. Barnhart MD, Rides CF, Kennedy SC et al. Fracture repair using a polyaxial locking plate system (PAX). *Vet Surg* 2012; 42: 60-66.

*Radiograph provided by Cristóbal Frias Rides, DVM.

IMPLANTS

2.0mm PAX Locking Straight Plates

2.0mm Locking Reconstruction Plates (RP) - Titanium (Light Blue)



Width: 6.0mm

Thickness: 1.5mm

Distance Between Center of Holes: 6.0mm

MWI#	SECUROS#	# OF HOLES	LENGTH (mm)
045529	007010	3	18
042171	007011	4	24
042173	007012	5	30
042174	007013	6	36
042175	007014	7	42
042176	007015	8	48
042178	007016	9	54
044622	007017	10	60

2.0mm Locking Limited Contact Straight Plates (SP) - Titanium (Light Blue)



Width: 6.0mm

Thickness: 1.5mm

Distance Between Center of Holes: 6.0mm

MWI#	SECUROS#	# OF HOLES	LENGTH (mm)
049587	007150	5	34
049588	007151	6	40
049589	007152	7	46
049590	007153	8	52
049591	007154	9	58
049592	007155	10	64
049593	007156	20	124

2.4mm PAX Locking Straight Plates

2.4mm Locking Reconstruction Plates (RP) - Titanium (Copper)



Width: 8.0mm

Thickness: 2.0mm

Distance Between Center of Holes: 7.5mm

MWl#	SECUROS#	# OF HOLES	LENGTH (mm)
044626	007018	4	30
042179	007019	5	37.5
042181	007020	6	45
044627	007021	7	52.5
042182	007022	8	60
042183	007023	9	67.5
044623	007024	10	75
044624	007025	12	90
044625	007026	14	105

2.4mm Locking Limited Contact Straight Plates (SP) - Titanium (Copper)



Width: 8.0mm

Thickness: 2.0mm

Distance Between Center of Holes: 7.5mm

MWl#	SECUROS#	# OF HOLES	LENGTH (mm)
049596	007160	5	42
049597	007161	6	49
049598	007162	7	57
049599	007163	8	64
049600	007164	9	72
049601	007165	10	79
049602	007166	12	94
049603	007167	14	109
049604	007168	20	154

2.7mm PAX Locking Straight Plates

2.7mm Locking Reconstruction Plates (RP) - Titanium (Blue)



Width: 9.5mm

Thickness: 2.5mm

Distance Between Center of Holes: 9.0mm

MWI#	SECUROS#	# OF HOLES	LENGTH (mm)
044638	002804	4	36
044639	002805	5	45
044641	002806	6	54
044642	002807	7	63
042306	002808	8	72
044643	002809	9	81
044634	002810	10	90
044635	002812	12	108
044636	007067	14	126
044637	007068	16	144

2.7mm Locking Limited Contact Straight Plates (SP) - Titanium (Blue)



Width: 8.5mm

Thickness: 2.5mm

Distance Between Center of Holes: 9.0mm

MWI#	SECUROS#	# OF HOLES	LENGTH (mm)
045204	004522	4	39
044944	004523	5	48
044945	004524	6	57
044946	004525	7	66
044947	004526	8	75
044948	004527	9	84
044949	004528	10	93
044899	004529	12	111
044950	004530	14	129
044951	004531	16	147

3.5mm PAX Locking Straight Plates

3.5mm Locking Reconstruction Plates (RP) - Titanium (Gold)



Width: 12.0mm

Thickness: 3.2mm

Distance Between Center of Holes: 11.0mm

MWI#	SECUROS#	# OF HOLES	LENGTH (mm)
042244	001941	4	44
044656	001942	5	55
042245	001943	6	66
044657	001944	7	77
042246	001945	8	88
044658	001946	9	99
042247	001947	10	110
044650	001948	11	121
044651	001949	12	132
044652	007071	14	154
044653	007072	15	165
044654	007073	16	176
044952	007074	18	198
044655	007075	20	220

3.5mm Locking Limited Contact Straight Plates (SP) - Titanium (Gold)



Width: 11.0mm

Thickness: 3.2mm

Distance Between Center of Holes: 12.0mm

MWI#	SECUROS#	# OF HOLES	LENGTH (mm)
045530	004507	4	50
044955	004508	5	62
045531	004509	6	74
044942	004510	7	86
045556	004511	8	98
045199	004512	9	110
045060	004513	10	122
045200	004514	11	134
055056	004515	12	146
048381	004516	13	158
045201	004517	14	170
044943	004518	15	182
048179	004519	16	194
045202	004520	18	218
045203	004521	20	242

PAX Locking T-Plates

2.0mm Locking T-Plates - Titanium (Light Blue)



Head Width: 12.0mm

Shaft Width: 6.0mm

Thickness: 1.5mm

MWI#	SECUROS#	# HOLES HEAD	# HOLES SHAFT	OVERALL LENGTH (mm)
042184	007027	2	2	18
042185	007028	2	3	24
042186	007029	2	4	30
042187	007030	2	5	36
042188	007031	2	6	42
042189	007032	2	7	48

2.4mm Locking T-Plates - Titanium (Copper)



Head Width: 15.0mm

Shaft Width: 8.0mm

Thickness: 2.0mm

MWI#	SECUROS#	# HOLES HEAD	# HOLES SHAFT	OVERALL LENGTH (mm)
044628	007033	2	2	22.5
044629	007034	2	3	30
044630	007035	2	4	37.5
044631	007036	2	5	45
044632	007037	2	6	52.5
044633	007038	2	7	60

2.0mm PAX Locking Butterfly Plates - Titanium (Light Blue)



4 Holes

Width: 11.5mm

Thickness: 2.0mm

MWI#	SECUROS#	LENGTH (mm)
090008	007145	12
090006	007143	14
090007	007144	16

PAX Locking Screws

2.0mm PAX Locking Screw, Self-Tapping, Star Recess - Titanium (Light Blue)



Diameter of Thread: 2.0mm

Diameter of Head: 3.0mm

Drill Bit For Threaded Hole: 1.3mm

For Use With T6 Stardrive Screwdriver

MWI#	SECUROS#	LENGTH (mm)
042190	007039	6
042191	007040	8
042192	007041	10
042193	007042	12
042194	007043	14
042195	007044	16
042196	007045	18
042197	007046	20

2.4mm PAX Locking Screw, Self-Tapping, Star Recess - Titanium (Copper)



Diameter of Thread: 2.4mm

Diameter of Head: 3.0mm

Drill Bit For Threaded Hole: 1.7mm

For Use With T6 Stardrive Screwdriver

MWI#	SECUROS#	LENGTH (mm)
042198	007047	6
042199	007048	8
042337	007049	10
042342	007050	12
042343	007051	14
042344	007052	16
042346	007053	18
042348	007054	20
042349	007055	22
042350	007056	24

PAX Locking Screws

2.7mm PAX Locking Screw, Self-Tapping, Star Recess - Titanium (Blue)



Diameter of Thread: 2.7mm

Diameter of Head: 5.0mm

Drill Bit For Threaded Hole: 2.0mm

For Use With T15 Stardrive Screwdriver

MWI#	SECUROS#	LENGTH (mm)
042279	002485	8
042280	002486	10
042281	002487	12
042282	002488	14
042283	002489	16
042284	002490	18
042285	002491	20
042286	002492	22
042287	002493	24
042288	002494	26

MWI#	SECUROS#	LENGTH (mm)
042289	002495	28
042290	002496	30
042291	002497	32
044644	002498	34
044645	002499	36
044646	007077	38
044647	007078	40
044648	007079	45
044649	007080	50

3.5mm PAX Locking Screw, Self-Tapping, Star Recess - Titanium (Gold)



Diameter of Thread: 3.5mm

Diameter of Head: 5.0mm

Drill Bit For Threaded Hole: 2.5mm

For Use With T15 Stardrive Screwdriver

MWI#	SECUROS#	LENGTH (mm)
042356	007081	8
042357	007082	10
042359	007083	12
042361	007084	14
042364	007085	16
042366	007086	18
042368	007087	20
042369	007088	22
044659	007089	24
042100	007090	26
042105	007091	28
042106	007092	30
042107	007093	32

MWI#	SECUROS#	LENGTH (mm)
042108	007094	34
042109	007095	36
042111	007096	38
042112	007097	40
042113	007098	42
042114	007099	44
042115	007100	46
042116	007101	48
042117	007102	50
042118	007103	52
042119	007104	54
042120	007105	56

INSTRUMENTS

Instruments for PAX Locked Plating System



MWI#	SECUROS#	PRODUCT DESCRIPTION	LENGTH (")
042389	007006	PAX Plate Holding Forceps	5.5

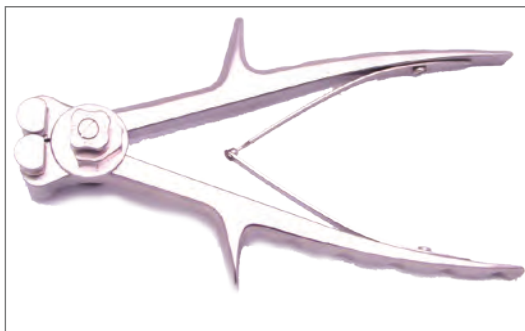

PAX Reconstruction Plate Blending Pliers



Front



Back

MWI#	SECUROS#	PRODUCT DESCRIPTION	ACCOMMODATES	LENGTH (")
■	007185	PAX Reconstruction Plate Bending Pliers	2.0/2.4/2.7/3.5mm RP Plates	7.5

Drill Bits (Quick Coupling, BITE Bit, Titanium Nitride Coated)



MWI#	SECUROS#	DIAMETER (mm)	TOTAL LENGTH (mm)	FLUTE LENGTH (mm)	RECOMMENDED SCREWS (mm)
042390	007007	1.3	80	16	2.0
042391	007008	1.7	90	19	2.4
029010	001018	2.0	100	23	2.7
029011	001019	2.5	110	32	3.5

■ special order item

Drill Guides



MWI#	SECUIROS#	PRODUCT DESCRIPTION
042388	007005	2.0/2.4mm PAX Double Drill Guide
042354	007062	2.7/3.5mm PAX Double Drill Guide



MWI#	SECUIROS#	PRODUCT DESCRIPTION
051986	007175	2.0mm PAX Neutral/Load (Compressional) Drill Guide
051987	007176	2.4mm PAX Neutral/Load (Compressional) Drill Guide
051988	007177	2.7mm PAX Neutral/Load (Compressional) Drill Guide
051989	007178	3.5mm PAX Neutral/Load (Compressional) Drill Guide

Depth Gauges



MWI	SECUIROS#	PRODUCT DESCRIPTION	MEASURES UP TO (mm)	MEASUREMENT INCREMENTS
042392	007009	2.0/2.4mm PAX Locking System Depth Gauge	30	1
042355	007066	2.7/3.5mm PAX Locking System Depth Gauge	60	1

Screwdriver Shafts & Handles

Screwdriver Shafts (Quick Coupling)



MWI#	SECUROS#	PRODUCT DESCRIPTION	LENGTH (")
042387	007004	2.0/2.4mm PAX Stardrive Screwdriver Shaft (T6)	2.2
042353	007061	2.7/3.5mm PAX Stardrive Screwdriver Shaft (T15)	2.2

Screwdriver Handle (Quick Coupling)



MWI#	SECUROS#	PRODUCT DESCRIPTION	ACCOMMODATES	LENGTH (")
029529	007003	Small Handle	2.7/3.5/4.0mm & 4.5/5.5/6.5mm Hexagonal Screwdriver Shafts	4.5



MWI#	SECUROS#	PRODUCT DESCRIPTION	ACCOMMODATES	LENGTH (")
029528	001916	Large Handle	2.7/3.5/4.0mm & 4.5/5.5/6.5mm Hexagonal Screwdriver Shafts	6



MWI#	SECUROS#	PRODUCT DESCRIPTION	ACCOMMODATES	LENGTH (")
052748	007361	Silicone Handle	2.7/3.5/4.0mm & 4.5/5.5/6.5mm Hexagonal Screwdriver Shafts	5.5

STERILIZATION CONTAINERS

PAX 2.0/2.4mm Trays & Covers

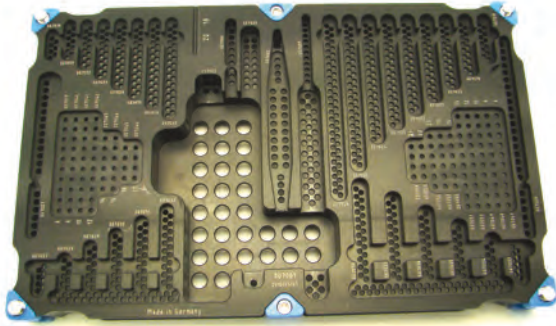

007001

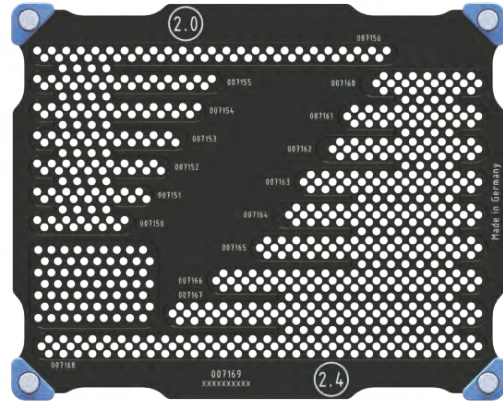

007169

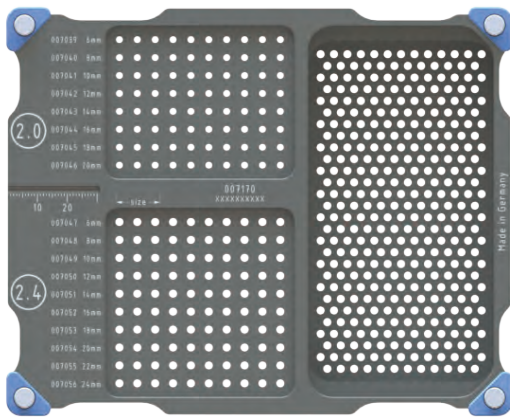

007170

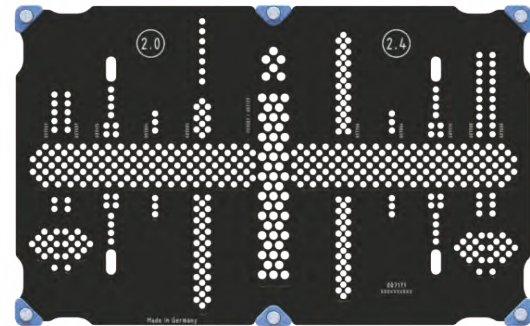

007171

* Order Quantity 2

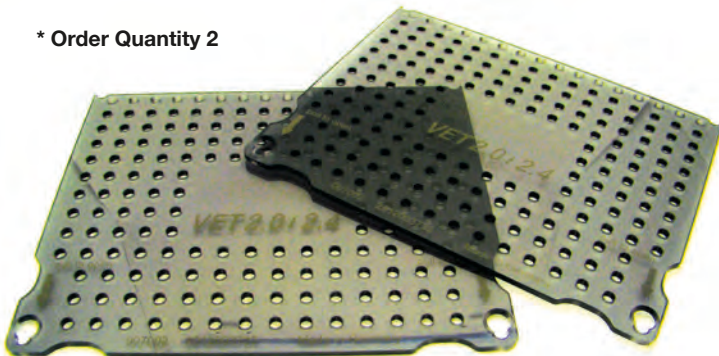

007002



007183

MWI#	SECUROS#	PRODUCT DESCRIPTION	LENGTH (")	WIDTH (")	HEIGHT (")
042385	007001	2.0/2.4mm PAX RP Tray	10.75	6.75	1.5
ACCOMMODATES					
2.0mm Plates 2 ea.: 3-10 hole (Increments of 1), 2.4mm Plates 2 ea.: 4-10 hole (Increments of 1), 12 hole, 14 hole, 2.0mm T-Plates 2 ea.: 2 hole head x 2-7 hole shaft (Increments of 1), 2.4mm T-Plates 2 ea.: 2 hole head x 2-7 hole shaft (Increments of 1), 2.0mm Screws 10 ea.: 6-12mm (Increments of 2mm), 6 ea.: 14-16mm (Increments of 2mm), 4 ea.: 18-20mm (Increments of 2mm), 2.4mm Screws 10 ea.: 6-14mm (Increments of 2mm), 6 ea.: 16-20mm (Increments of 2mm), 4 ea.: 22-24mm (Increments of 2mm), 1.3mm Drill Bit, 1.7mm Drill Bit, 1.3mm/1.7mm Double Drill Guide, T6 Stardrive Screwdriver Shaft: 2, 2.0/2.4mm PAX Depth Gauge, Small Handle, PAX Plate Holding Forceps					

MWI#	SECUROS#	PRODUCT DESCRIPTION	LENGTH (")	WIDTH (")	HEIGHT (")
051703	007169	2.0/2.4mm PAX SP Tray	6.75	5.5	1.5
ACCOMMODATES					
2.0mm Plates 2 ea.: 5-10 Hole (Increments of 1), 20 Hole, 2.4mm Plates 2 ea.: 5-12 Hole (Increments of 1), 20 Hole					

MWI#	SECUROS#	PRODUCT DESCRIPTION	LENGTH (")	WIDTH (")	HEIGHT (")
041701	007170	2.0/2.4mm PAX Screw Rack	6.75	5.5	1.5
ACCOMMODATES					
2.0mm Screws 10 ea.: 6-20mm (Increments of 2mm), 2.4mm Screws 10 ea.: 6-24mm (Increments of 2mm)					

MWI#	SECUROS#	PRODUCT DESCRIPTION	LENGTH (")	WIDTH (")	HEIGHT (")
051706	007171	2.0/2.4mm PAX Instrument Tray	10.75	6.75	1.5
ACCOMMODATES					
1.3mm Drill Bit: 2, 1.7mm Drill Bit: 2, 1.3mm Compressional Drill Guide, 1.7mm Compressional Drill Guide, T6 Stardrive Screwdriver Shaft: 2, 2.0/2.4mm Depth Gauge, Small Handle, PAX Plate Holding Forceps					

MWI#	SECUROS#	PRODUCT DESCRIPTION	LENGTH (")	WIDTH (")	HEIGHT (")
042386	007002	2.0/2.4mm PAX Full Tray Cover * Order QTY 2	6.65	5.35	
FOR USE WITH					
007001, 007171					

MWI#	SECUROS#	PRODUCT DESCRIPTION	LENGTH (")	WIDTH (")	HEIGHT (")
051707	007183	2.0/2.4mm PAX Half Tray Cover	6.65	5.35	
FOR USE WITH					
007169, 007170					

PAX 2.7/3.5mm Trays & Covers

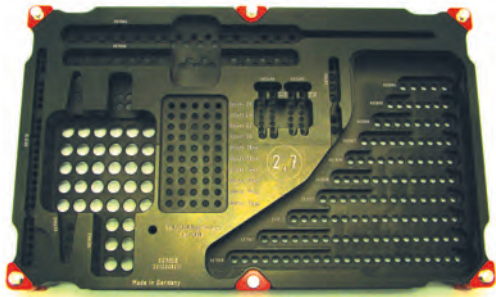

007058

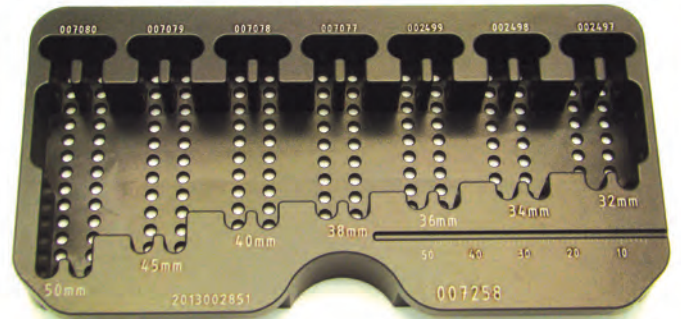

007258

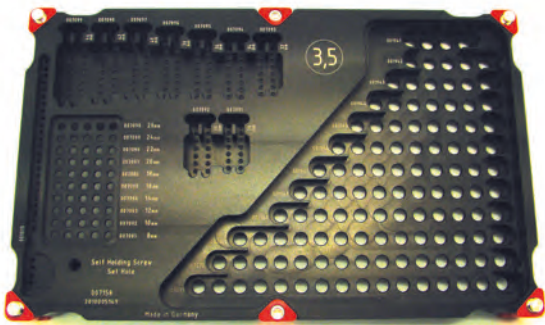

007158

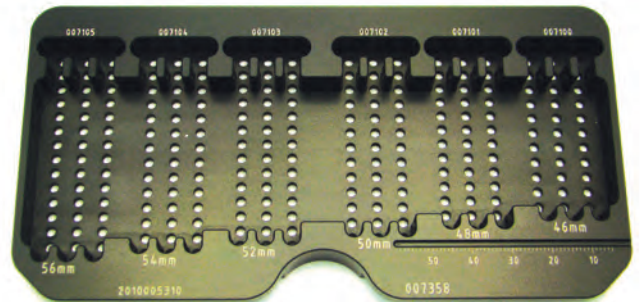

007358

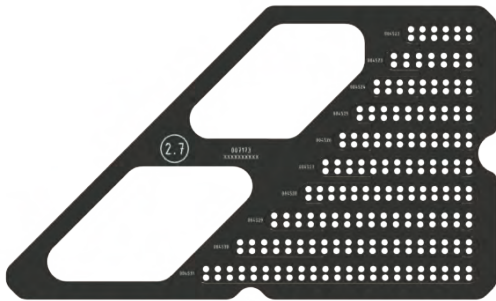

007173

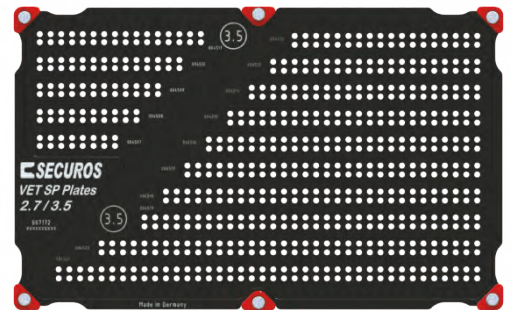

007172

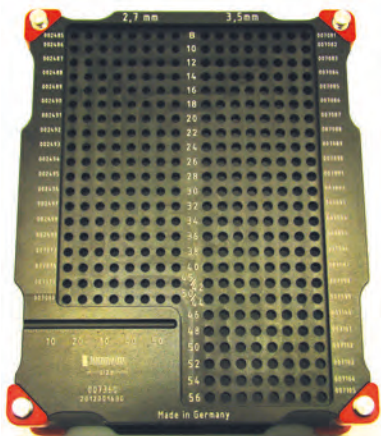

007360

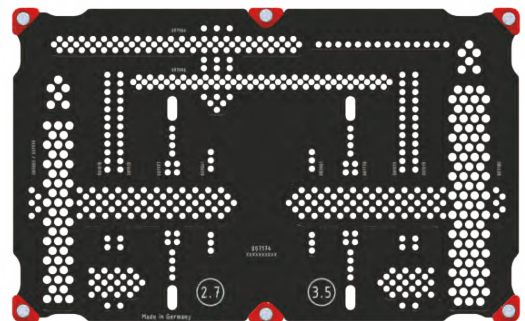

007174

MWI#	SECUROS#	PRODUCT DESCRIPTION	LENGTH (")	WIDTH (")	HEIGHT (")
042351	007058	2.7mm PAX RP Tray	10.75	6.75	1.5
ACCOMMODATES					
2.7mm Plates 2 ea.: 4-10 Hole (Increments of 1), 12-16 Hole (Increments of 2), 2.7mm Screws 5 ea.: 8-26mm (Increments of 2mm), 4 ea.: 28-30mm (Increments of 2mm), 2.0mm Drill Bit, 2.0/2.5mm Double Drill Guide, T15 Stardrive Screwdriver: 2, 2.7/3.5mm PAX Depth Gauge, Small Handle, Silicone Handle, PAX Plate Holding Forceps					

MWI#	SECUROS#	PRODUCT DESCRIPTION	LENGTH (")	WIDTH (")	HEIGHT (")
042122	007258	2.7mm PAX RP Tray Screw Insert *for 007058*	5.25	2.75	0.75
ACCOMMODATES					
2.7mm Screws 4 ea.: 32-40mm (Increments of 2mm), 45mm, 50mm					

MWI#	SECUROS#	PRODUCT DESCRIPTION	LENGTH (")	WIDTH (")	HEIGHT (")
042121	007158	3.5mm PAX RP Tray	10.75	6.75	1.5
ACCOMMODATES					
3.5mm Plates 2 ea.: 4-12 Hole (Increments of 1), 14-20 Hole (Increments of 2), 3.5mm Screws 5 ea.: 8-26mm (Increments of 2mm), 4 ea.: 28-30mm (Increments of 2mm), 2.5mm Drill Bit					

MWI#	SECUROS#	PRODUCT DESCRIPTION	LENGTH (")	WIDTH (")	HEIGHT (")
042123	007358	3.5mm PAX RP Tray Screw Insert *for 007158*	6	3.25	0.5
ACCOMMODATES					
3.5mm Screws 4 ea.: 46-56mm (Increments of 2mm)					

MWI#	SECUROS#	PRODUCT DESCRIPTION	LENGTH (")	WIDTH (")	HEIGHT (")
051704	007173	2.7mm PAX SP Tray Insert *for 007172*	10	6	0.5
ACCOMMODATES					
2.7mm Plates 2 ea.: 4-10 Hole (Increments of 1), 12-16 Hole (Increments of 2)					

MWI #	SECUROS #	PRODUCT DESCRIPTION	LENGTH (")	WIDTH (")	HEIGHT (")
051705	007172	3.5mm PAX SP Tray	10.75	6.75	1.5
ACCOMMODATES					
3.5mm Plates 2 ea.: 4-16 Hole (Increments of 1), 18 Hole, 20 Hole					

MWI#	SECUROS#	PRODUCT DESCRIPTION	LENGTH (")	WIDTH (")	HEIGHT (")
090011	007360	2.7/3.5mm PAX Screw Rack	6.75	5.5	2.75
ACCOMMODATES					
2.7mm Screws 8 ea.: 8-40mm (Increments of 2mm), 45mm, 50mm, 3.5mm Screws 8 ea.: 8-56mm (Increments of 2mm)					

MWI#	SECUROS#	PRODUCT DESCRIPTION	LENGTH (")	WIDTH (")	HEIGHT (")
	007174	2.7/3.5mm PAX Instrument Tray	10.75	6.75	1.5
ACCOMMODATES					
2.0mm Drill Bit: 2, 2.5mm Drill Bit: 2, 2.0mm Compressional Drill Guide, 2.5mm Compressional Drill Guide, T15 Stardrive Screwdriver Shaft: 2, 2.7/3.5mm PAX Depth Gauge, Small Handle, Silicone Handle, PAX Plate Holding Forceps					

PAX 2.7/3.5mm Trays and Covers

* Order Quantity 2

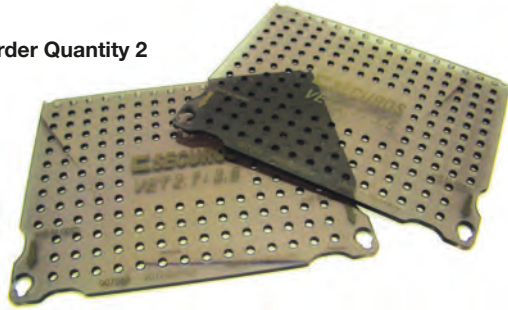

007059



004903

MWI#	SECUROS#	PRODUCT DESCRIPTION	LENGTH (")	WIDTH (")	
042352	007059	2.7/3.5mm PAX Full Tray Cover *Order QTY 2	6.65	5.35	
FOR USE WITH					
007058, 007158, 007172, 007174					

MWI#	SECUROS#	PRODUCT DESCRIPTION	LENGTH (")	WIDTH (")	
051948	004903	2.7/3.5mm PAX Half Tray Cover	6.65	5.35	
FOR USE WITH					
007360					



REFERENCE MATERIALS

PAX Titanium Locking Screws and Drill Bits

Screw Diameter (mm)				
Thread Diameter	2.0 mm	2.4 mm	2.7 mm	3.5 mm
Screw Type	Locking Head, Self Tapping			
Screw Color	Light Blue	Copper	Blue	Gold
Drill Bit Diameter (mm)				
Drill Bit No.	1.1 mm (S07001)	1.7 mm (S07006)	2.0 mm (S02016)	2.6 mm (S01001)
Threaded Hole	T5 Standard (S07004)		T15 Standard (S07001)	
Drill Type	T5 Standard (S07004)		T15 Standard (S07001)	

MWI#	SECUROS#	PRODUCT DESCRIPTION
■ 388991	004934	PAX Locking System Screw Reference



Top



Bottom

MWI#	SECUROS#	PRODUCT DESCRIPTION
048584	840920	Screw & Drill Bit Gauge

■ special order item