

AVENTICS™

G3 Series EtherNet/IP™ DLR Technical Manual



EtherNet/IP™
conformance tested



Conditions for use of this product

(1) Aventics G3 Manifold ("the PRODUCT") shall be used in conditions.

i) Where any problem, fault or failure occurring in the PRODUCT, if any, shall not lead to any major or serious accident.

ii) Where the backup and fail-safe function are systematically or automatically provided outside of the PRODUCT for the case of any problem, fault or failure occurring in the PRODUCT.

(2) The PRODUCT has been designed and manufactured for use in general industries.

Aventics shall have no responsibility or liability including but not limited to any and all responsibility or liability based on contract, warranty, tort, product liability for any injury or death to persons, loss or damage to property caused by the product that are operated or used in application not intended or excluded by instructions, precautions or warnings contained in Aventics. Technical, User, Instruction, Safety manuals or bulletins.

Safety precautions

Before using this product, please read this manual and the relevant manuals carefully and pay attention to safety and product application. The following symbols are used in the manual to identify important safety, installation and application information.



CAUTION

Caution symbol indicates a possible hazard which may cause injury or equipment damage.



Note symbol indicates important information regarding equipment installation and setup



CAUTION

Electrical installation and operational guidelines

- *To be connected to Class 2 power source only*
- *All Aventics communication nodes should be grounded during the installation process. These grounding guidelines can be found in National Electrical code IEC 60204-1 or EN 60204-1.*
- *All Numatics G3 Electronics Products to be installed or wired in accordance with ASCO Aventics published instructions and applicable electrical codes.*
- *MULTIPLE CLASS 2 POWER SOURCES: When interconnects, class 2 sources shall be Listed and rated suitable for parallel interconnection*
- *Sources shall be Listed and rated suitable for parallel interconnection*
- *CLASS 2 WIRING: All field wiring shall be suitable for Class 1, Electric Light and Power, or Class 2, 3 wirings are routed separately and secured to maintain separation between 1) Class 2 wiring and all other class wiring, and 2) Limited energy circuit conductors from unlimited energy circuit conductors*
- *Class 2 Device Wiring Only – Do Not Reclassify and Install as Class 1, 3 or Power and Lighting Wiring*
- *When using molded connector power cables, Do Not rely on wire colors for Pin-Out. Always use pin number references.*
- *Wire connections shall be rated suitable for the wire size (lead and building wiring) employed*
- *MULTIPLE CLASS 2 POWER SOURCES: When interconnects, class 2 sources shall be Listed and rated suitable for parallel interconnection*
- *Sources shall be Listed and rated suitable for parallel interconnection*

Table of Contents

1. About EtherNet/IP™	6
1.1 Overview	6
1.2 G3 EtherNet/IP™ Features	6
1.3 G3 EtherNet/IP™ Performance Data	6
2. G3 Introduction	7
2.1 G3 Electronics Modularity.....	7
2.2 500 Series Pneumatic Valve Manifold	9
2.3 500 Series Manifold Stations	10
2.4 500 Series Standard Z-Board™ Connectors.....	11
2.5 2000 Series Pneumatic Valve Manifold.....	12
2.6 2000 Series Z-Board™ Connectors.....	13
2.7 2000 Series Z-Board™ and Ribbon Cable Example	14
2.8 2000 Series Z-Board™ with Valve Side Sub-D Example	15
3. Zoned Power	16
3.1 503 Series Zoned Power application	16
3.2 503 Series Zoned Power example	17
4. Communication Module	18
4.1 EtherNet/IP DLR Communication Module (Node).....	18
4.2 Communication Module Description.....	19
4.3 Connector Pin-Outs	20
4.4 Electrical Connections.....	21
4.5 Ground Wiring.....	23
4.6 Power Consumption	24
4.7 Diagnostics	26
5. G3 Graphic Display	28
5.1 Main Menu Structure	29
5.2 IP Address	30
5.3 Subnet Mask	31
5.4 Gateway IP	32
5.6 Config. Mode.....	34
5.7 Web-Server	35
5.8 MAC Address.....	36
5.9 Advanced Settings – Comm. Fault	37
5.10 Advanced Settings - Brightness	38
5.11 Advanced Settings – Flip Display	39
5.12 Advanced Settings – Comm. Format	40
5.13 Advanced Settings – Parameters Lock	41
5.14 Advanced Settings – Configuration Lock	42
5.15 Advanced Settings – Quick Connect	43
5.16 Advanced Settings – Compatibility Mode.....	44
5.17 Factory Defaults	45
5.18 Diagnostics	46
5.19 Diagnostics - Self Test Mode	47
5.20 Error Messages.....	48
6. Auto Recovery Module (ARM)	49
6.1 ARM process flowchart	49
6.2 Wireless ARM	51
6.3 Connecting to the Wireless ARM (Computer or Mobil Device).....	52
6.4 Wireless ARM Webserver in “View Only” mode.....	54
6.5 Wireless ARM Webserver in “Configuration & Parameter Changes” mode	54
6.6 Returning Wireless ARM to Factory Defaults	64
7. Distribution	65
7.1 Sub-Bus Distribution Modules.....	66
7.2 Sub-Bus Cables	72
8. Digital I/O Module.....	74
8.1 Digital I/O Module Usage	74

AVENTICS™ G3 Series EtherNet/IP™ DLR Technical Manual

8.2	I/O Module Technical Data	75
8.3	I/O Module Descriptions and Menus	76
8.4	Digital Input Modules	77
8.5	Digital Output Modules	86
8.6	Digital Input/Output Modules	90
9.	Valve Interface Modules.....	91
9.1	2000 Series & 500 Series Valve Driver	91
9.2	Sub-bus Valve Module	93
9.3	Sub-bus Valve Module without Distribution and I/O.....	95
9.4	Valve Side Digital Output Modules.....	97
9.5	500 Series Extended Coil Capability	98
9.6	Extended Coil Configuration	98
9.7	Extended Coil Valve driver IO Mapping	101
9.8	501 Series, up to 64 solenoid coils	102
9.9	501 Series, up to 128 solenoid coils	103
9.10	502 and 503 Series, up to 80 coils	104
10.	Analog I/O Modules.....	105
10.1	Analog I/O Module Rules	105
10.2	Analog Graphic Display.....	112
10.3	Analog Module / Self Test Mode.....	115
10.4	Analog Module / Factory Defaults.....	116
11.	Specialty Modules	117
11.1	RTD Module	117
11.2	Sub-Bus Hub Module	128
12.	I/O Module Wiring Diagrams.....	136
12.1	NPN/PNP Definitions.....	136
13.	EtherNet/IP™ G3 Web Server	138
13.1	Integrated Web Page Configuration.....	138
13.2	Connecting to a G3 Series EtherNet/IP™ Node	138
13.3	EtherNet/IP™ Web Server functionality	142
13.4	IP Address Configuration	151
13.5	User Configurable Device Parameters.....	152
13.6	Communication Fault/Idle Mode Parameter	153
14.	EtherNet/IP™ Commissioning	154
14.1	G3 configuration for RSLogix 5000 (Rockwell Generic Ethernet Module).....	154
14.2	G3 configuration for RSLogix 5000 (Aventics G3 EDS File)	156
15.	EtherNet/IP™ Mapping.....	159
15.1	I/O Sizes	159
15.2	Manifold and I/O Data Sizing Worksheet.....	160
15.3	Bit Mapping Rules	161
15.4	Example No. 1.....	162
15.5	Example No. 2.....	164
15.6	Example No. 3.....	166
15.7	Example No. 4.....	168
15.8	Example No. 5.....	170
15.9	Diagnostic Word	172
16.	IIOT	174
16.1	Rest API introduction	174
16.2	Rest API Examples.....	176
16.3	Rest API – Functions	177
17.	Appendix	199
17.1	System Specifications.....	199
17.2	Factory Default Settings	200
17.3	Troubleshooting.....	201
17.4	Glossary of Terms.....	202
17.5	Technical Support	204

1. About EtherNet/IP™

1.1 Overview

EtherNet/IP™ is a communication protocol that uses the same network technology that can be found in commercial and domestic operations worldwide but has added benefits/features toward manufacturing applications. It is a CIP (common industrial protocol) Network that follows the Open Systems Interconnection (OSI) model.

The ODVA (Open Device Net Vendor Association) is an independent organization that governs the EtherNet/IP™ specification and oversees conformance testing for products.

EtherNet/IP™ uses industrial M12 IP67-rated connectors. The protocol can transfer data at two interface speeds of 10 Mbps and 100 Mbps. Maximum network cabling distance is limited to 100m segments at 20° C.

More information about EtherNet/IP™ and ODVA can be obtained from the ODVA web site www.odva.org

Device level ring or DLR network technology for industrial applications takes advantage of embedded switch functionality within the associated EtherNet/IP™ communication modules. DLR technology adds device-level network resilience to optimize machine operation. When a DLR network detects a break in the ring, it provides alternate routing of the data to help recover the network at extremely fast rates. Enhanced diagnostics built into DLR-enabled products identify the point of failure, helping to speed maintenance and reduce mean time to repair. The DLR module is works equally well in both Linear and Ring configurations.

1.2 G3 EtherNet/IP™ Features

<i>Features</i>	<i>Description</i>
EtherNet/IP™ Spec. Supported	Designed to EtherNet/IP™ and DLR Specification
Bus Topology	Star and Multi-Star and Ring
Baud Rates Supported	10/100 Mbps and Autobaud
CE	CE Compliant
Duplicate Address Detection	If a duplicate address is detected on power up, duplicates will not progress to run mode
Address Setting	Via DHCP/BOOTP, Webserver Configuration or Graphical Display Interface
Duplex	Half and Full supported
Conformance Tested	Tested by ODVA for conformance
Protocols supported	ACD, ARP, DHCP, HTTP, TCP/IP, UDP
IIOT	REST API

1.3 G3 EtherNet/IP™ Performance Data

<i>Features</i>	<i>Description</i>
CIP connections consumed	1
CIP connections available	16
Packets per second (PPS)	10,000
RPI	≥ 5ms
Connection Type	Multicast, Unicast

2. G3 Introduction

The G3 Series is an electronic product platform that features an integrated graphic display for simple commissioning and displaying of diagnostic information. The G3 offers innovative distribution capability which allows the same I/O components that make up a centralized manifold configuration to be used as the distribution components as well, decreasing the need for duplicate components on centralized and distributed applications. The G3 platform interfaces to a variety of valve series and fieldbus interface protocols and can address a total of 1200 I/O points (150 bytes). With proper assembly and termination, the G3 modules will have an IP65 / IP67 rating.

The manifold can be viewed as having two sections to it, the *Valve Side* and the *Discrete I/O Side*. The *Valve Side* supports a maximum of 128 solenoid coils and the *Discrete I/O Side* supports a maximum of 16 modules capable of addressing up to 1200 outputs, 1200 inputs or various combinations.

Various discrete modules with integrated graphic display are available. They include digital I/O, analog I/O, and specialty modules which cover various application needs. Pinouts for all connectors are labeled on the side of the respective modules and are also detailed in the module section of this document.

This manual describes specific information for configuring and commissioning the AVENTICS G3 Series product line. For more information relating to pneumatic valves and valve manifold assemblies, please refer to the AVENTICS "In Control" catalog at www.asco.com.

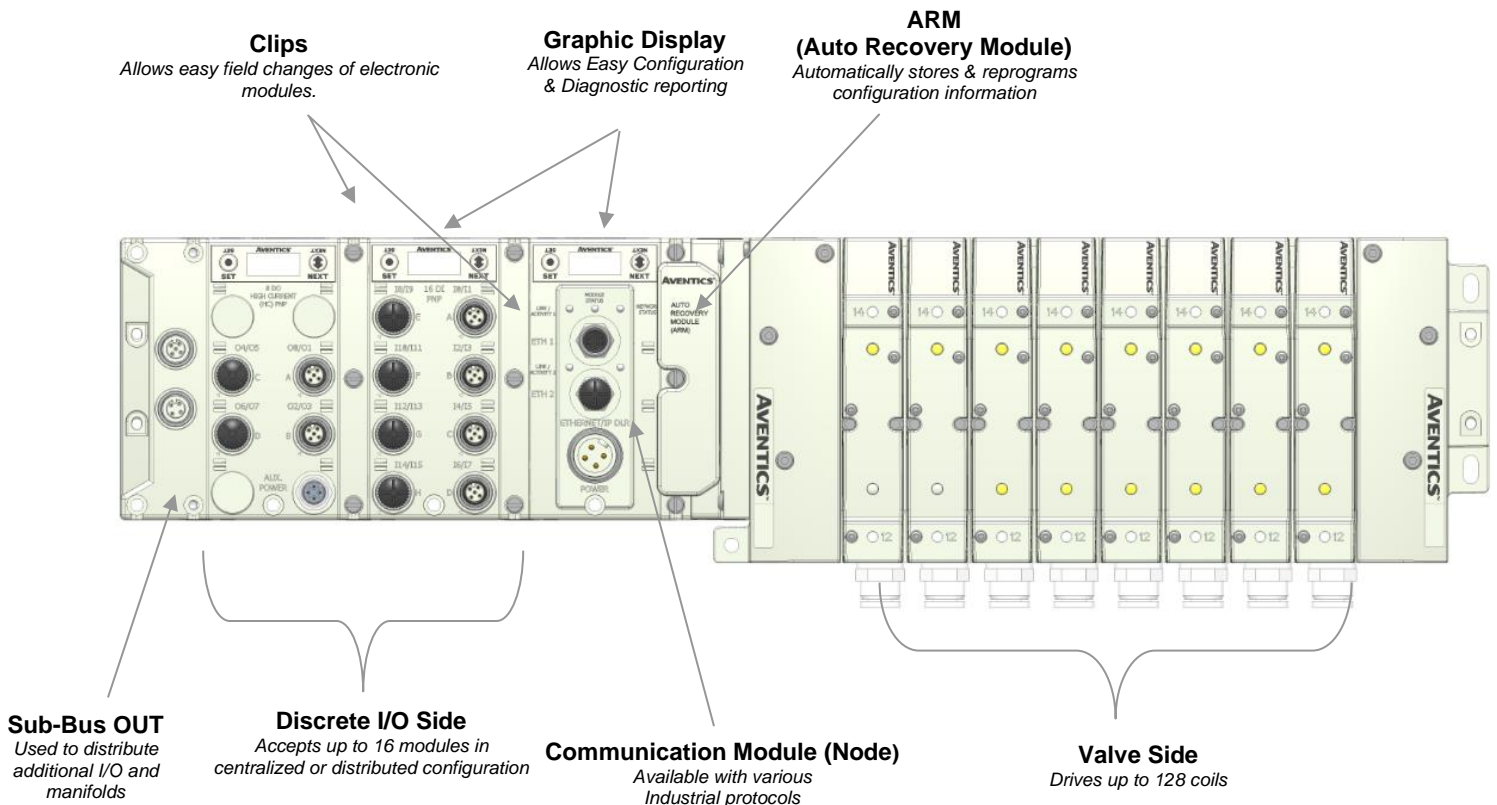

2.1 G3 Electronics Modularity

Discrete I/O

AVENTICS™ G3 Series EtherNet/IP™ DLR Technical Manual

The G3 Series product line is a completely modular and scalable system. As shown below, the G3 electronic modules plug together, via mechanical clips, allowing for easy assembly and field changes.

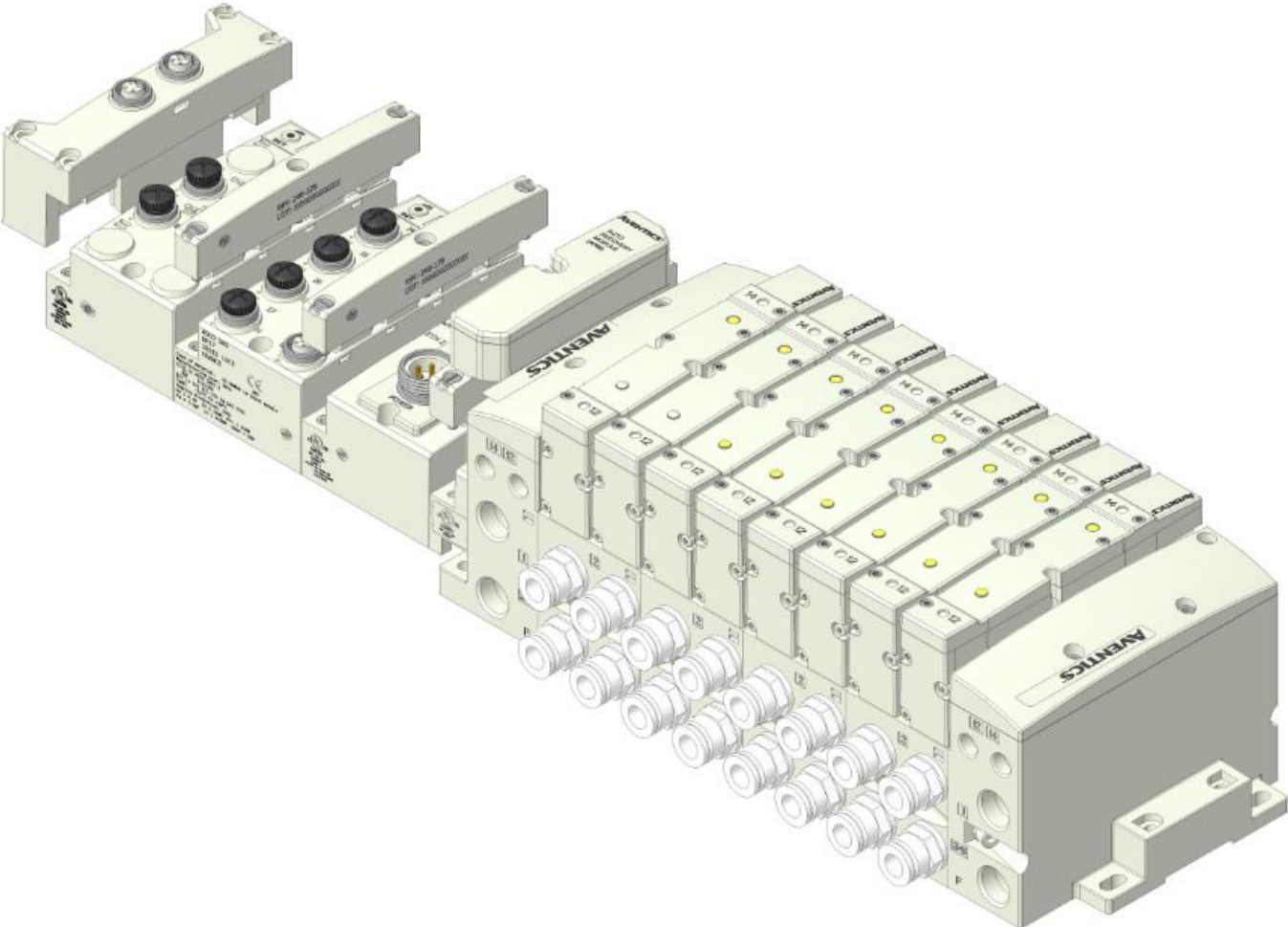

AVENTICS™ G3 Series EtherNet/IP™ DLR Technical Manual

2.2 500 Series Pneumatic Valve Manifold

The pneumatic valve manifold with internal circuit board technology is also modular. The valve solenoid coil connections are automatically made using Z-Board™ technology (plug together PC boards), which allow internal connection from solenoid coils to output drivers without the use of wires. This allows easy assembly and field changes.

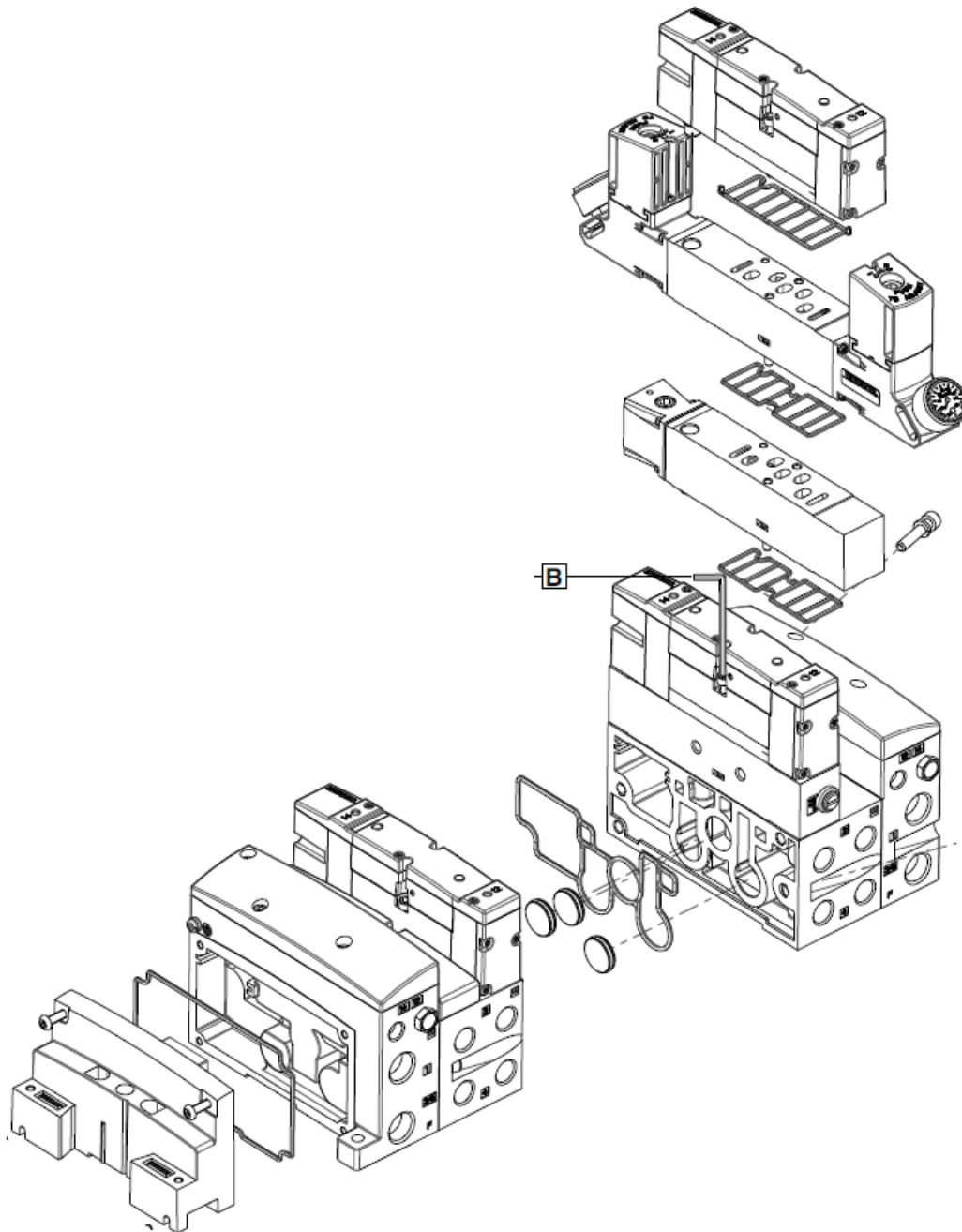

AVENTICS™ G3 Series EtherNet/IP™ DLR Technical Manual

2.3 500 Series Manifold Stations

Solenoid Coil Connections using Z-Board™ Technology for 50x valve series

Z-Board™ plug together technology connects all valve solenoids to the valve coil output driver board, located in the valve adapter. There is a maximum of 128 coil outputs available on the complete manifold assemblies. The 128 available outputs are accessed on the 501 series valves utilizing 4 station manifolds and on the 502 and 503 series utilizing 2 station manifolds.

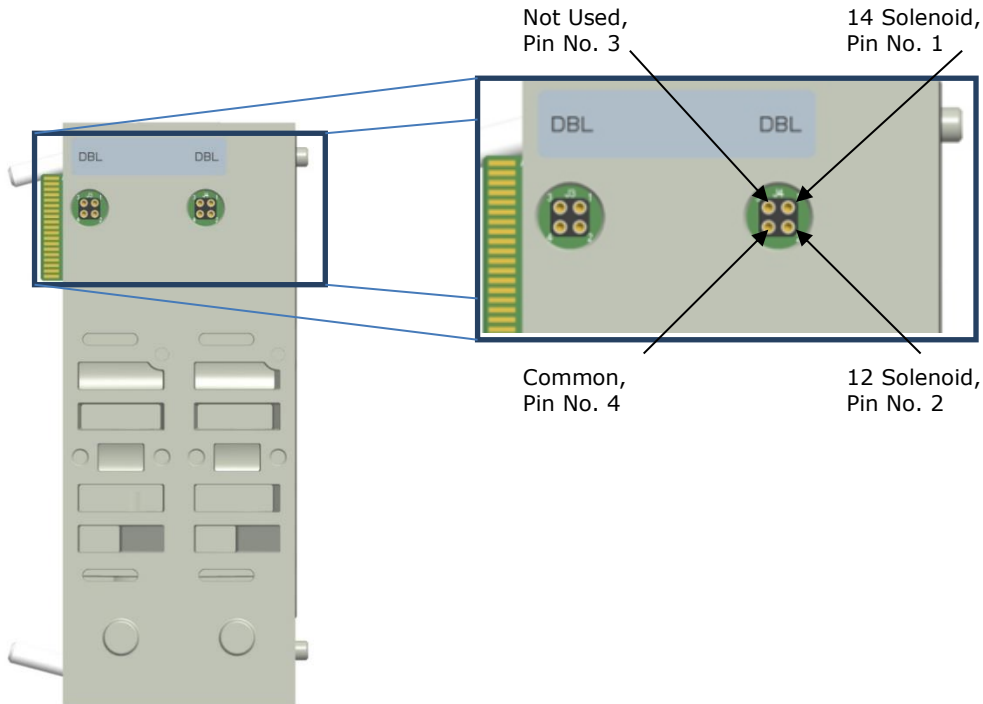
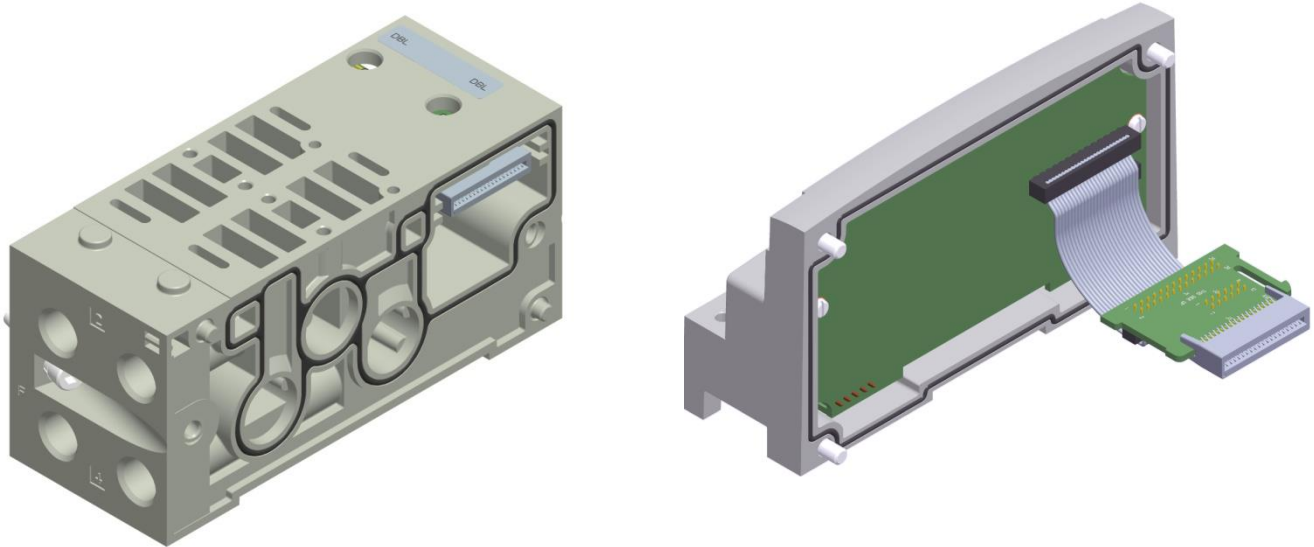

A single solenoid valve's coil is always on the "14" end.

AVENTICS™ G3 Series EtherNet/IP™ DLR Technical Manual

2.4 500 Series Standard Z-Board™ Connectors

The 501, 502 and 503 valve series utilize 2 different Z-Board™ designs to achieve the single and double solenoid output functions.

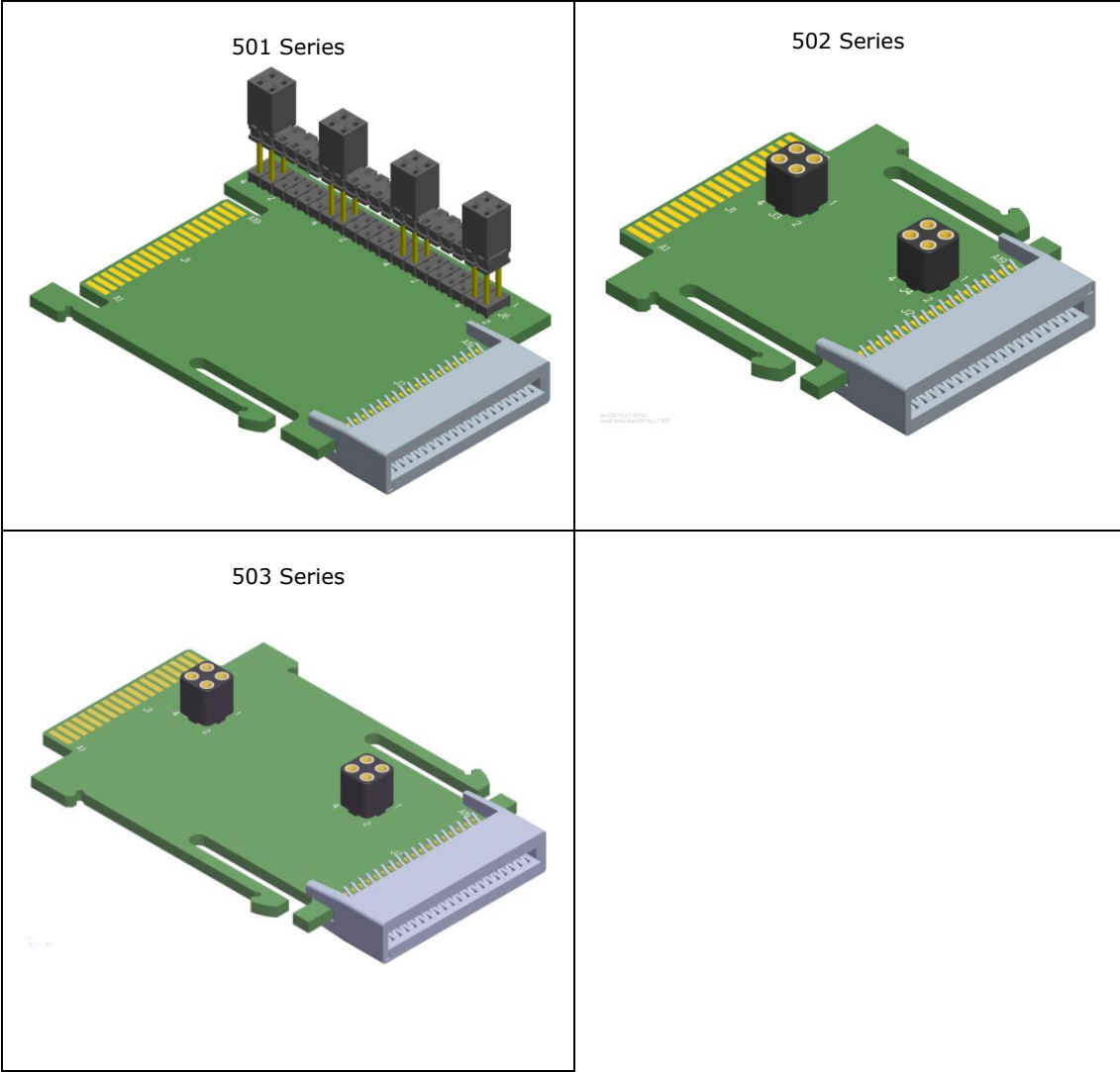

2.5 2000 Series Pneumatic Valve Manifold

The pneumatic valve manifold with internal circuit board technology is also modular. The valve solenoid coil connections are automatically made using Z-Board™ technology (plug together PC boards), which allow internal connection from solenoid coils to output drivers without the use of wires). This allows easy assembly and field changes.

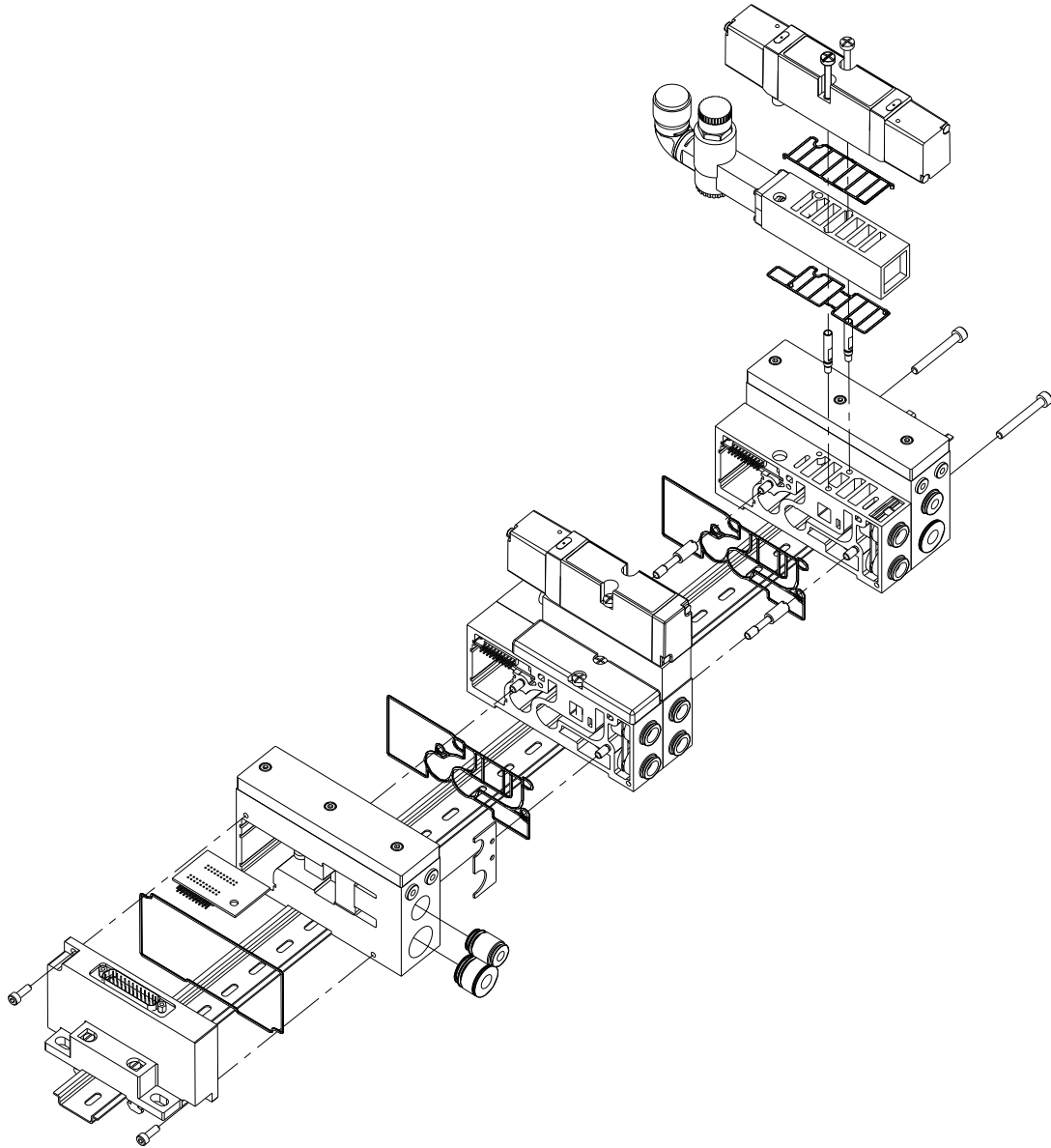

AVENTICS™ G3 Series EtherNet/IP™ DLR Technical Manual

2.6 2000 Series Z-Board™ Connectors

The 2005/2012/2035 valve series utilize 2 different Z-Board™ designs to achieve the single and double solenoid output functions. This yields the possible 32 single, 16 double, or various combinations of valve coil output capabilities.

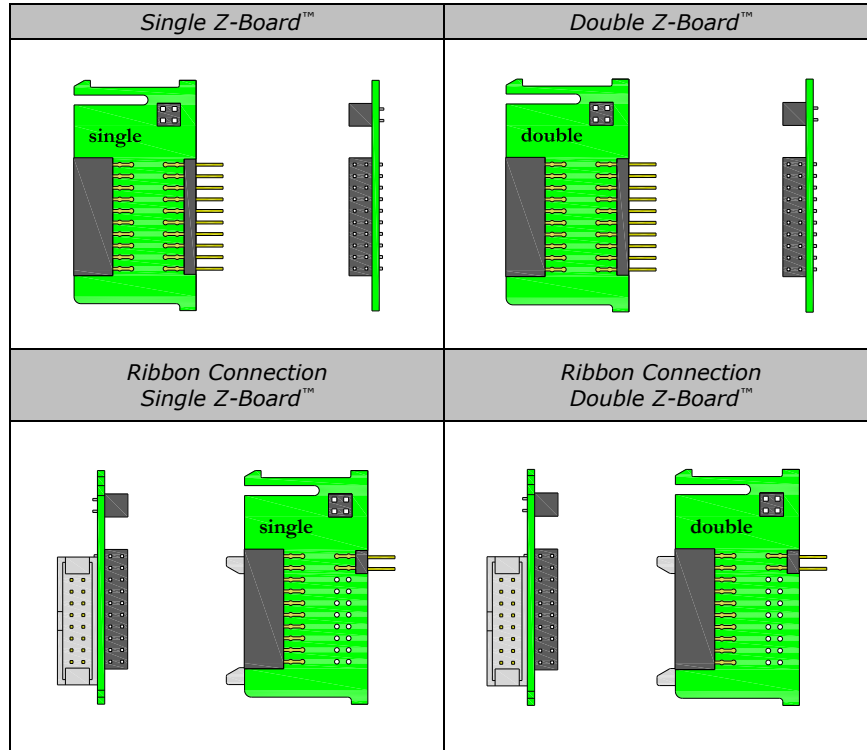

The 17th solenoid (output group No. 2's first bit) must be accessed via either the valve side Sub-D output module or a ribbon connector type Z-board.

AVENTICS™ G3 Series EtherNet/IP™ DLR Technical Manual

2.7 2000 Series Z-Board™ and Ribbon Cable Example

If fourteen (14) single solenoid and one (1) double solenoid valves are connected directly to the communication node through the associated Z-Boards™. one (1) single solenoid and four (4) double solenoid valves are connected to the communication node via the ribbon cable, the following would be the valve side bit map:

S = Single Solenoid with Single Z-Board™
 D = Double Solenoid With Double Z-Board™

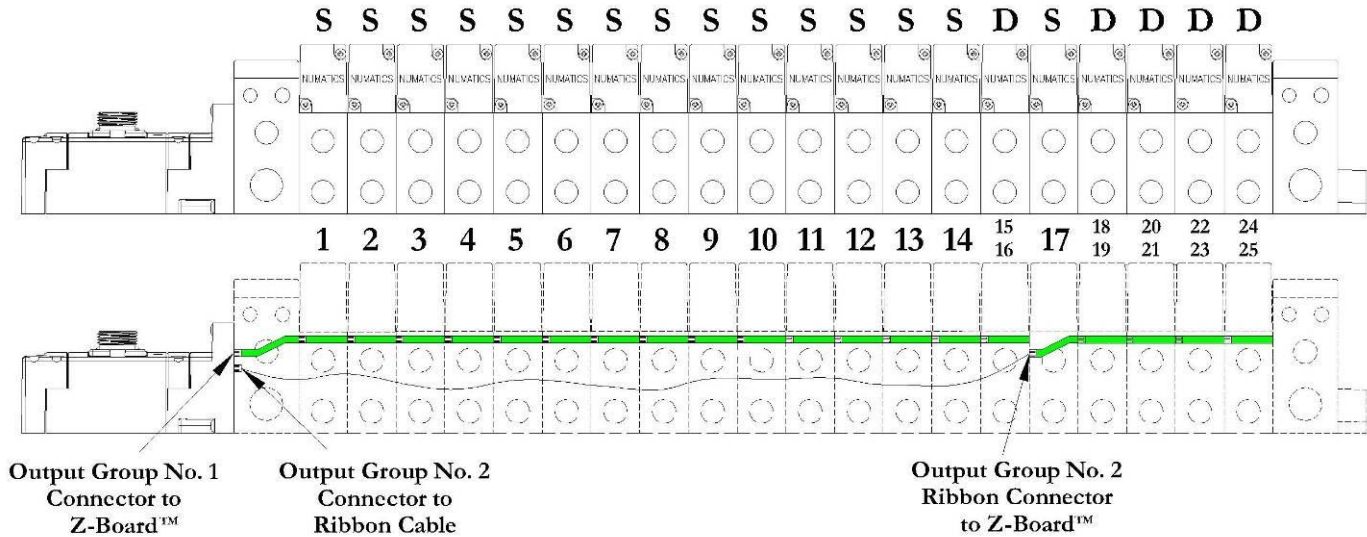

Output Word	0															1																				
Output Byte	0							1								2							3													
Output Bit No.	00	01	02	03	04	05	06	07	08	09	10	11	12	13	14	15	16	17	18	19	20	21	22	23	24	25	26	27	28	29	30	31				
Solenoid Coil Output No.	1	2	3	4	5	6	7	8	9	10	11	12	13	14	15	16	17	18	19	20	21	22	23	24	25	n/a										

AVENTICS™ G3 Series EtherNet/IP™ DLR Technical Manual

2.8 2000 Series Z-Board™ with Valve Side Sub-D Example

If sixteen (16) single solenoid valves are connected directly to the communication node via Z-Boards™ and a valve side Sub-D connector is connected to the communication node via the output Group No. 2 connector then the following would be the valve side bit map:

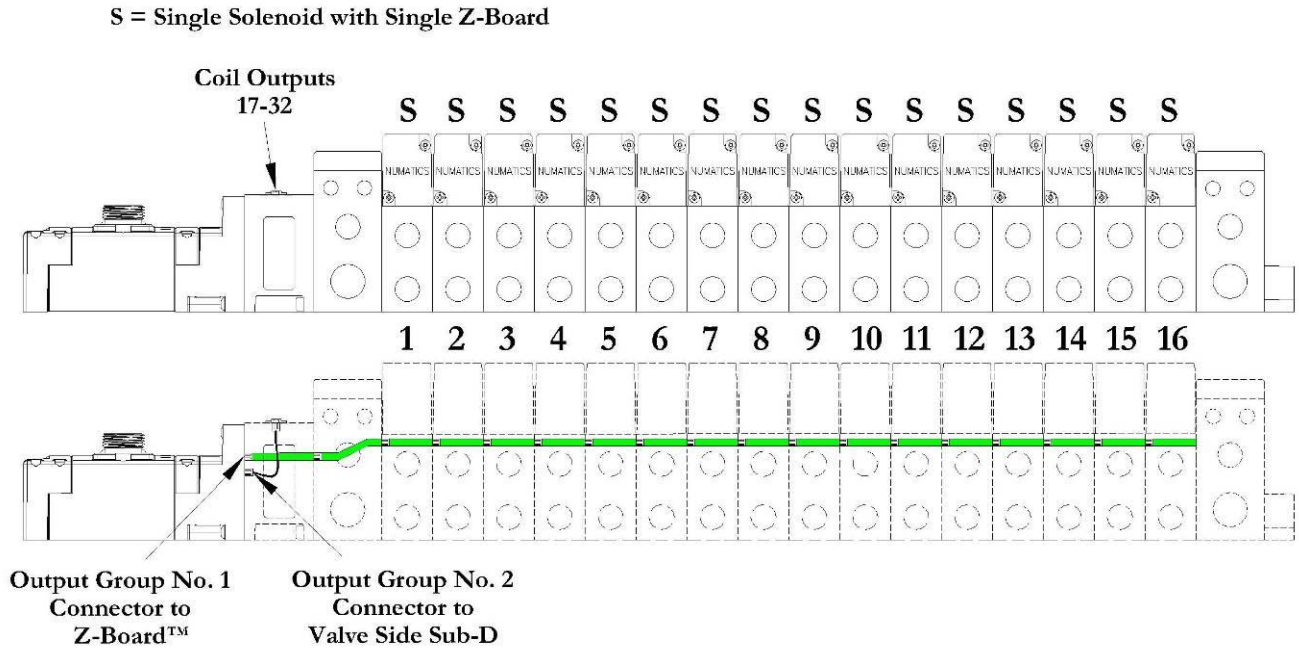

Output Word	0								1																							
Output Byte	0				1				2				3																			
Output Bit No.	00	01	02	03	04	05	06	07	08	09	10	11	12	13	14	15	16	17	18	19	20	21	22	23	24	25	26	27	28	29	30	31
Solenoid Coil Output No.	1	2	3	4	5	6	7	8	9	10	11	12	13	14	15	16	17	18	19	20	21	22	23	24	25	26	27	28	29	30	31	32

3. Zoned Power

3.1 503 Series Zoned Power application

The Zoned Power Manifold blocks can be incorporated into a 503 manifold assembly to isolate Power to a number of valve stations, independent from the main power of the manifold. This is achieved by the integral 4 Pin M12 connector along with the modified manifold board. The total number of Zoned Power Manifold blocks is determined by the maximum solenoid outputs as defined by the type of interface (e.g. G3 Electronics, Terminal Strip, D-Sub). For user flexibility, the Zoned Power Manifold blocks are available in both "proprietary" and "ISO" versions and can be ordered with the M12 connector starting at the first or second station.

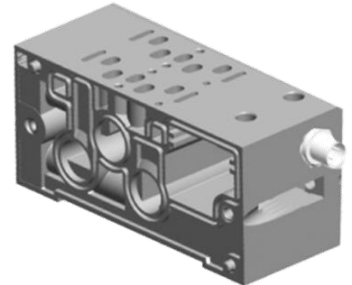
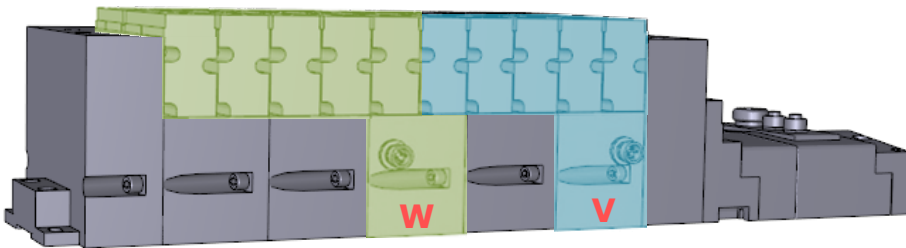

V Wiring Option

W & V Connector Pin Out

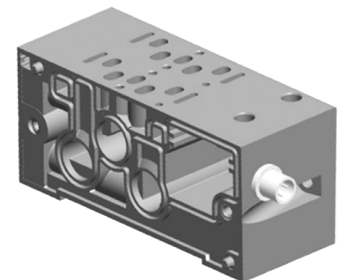
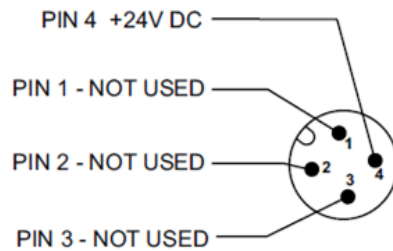

W Wiring Option

Technical Data

Electrical Data:

Voltage:	24 VDC (0 VDC must be common with main power)
Connection:	4 Pin M12 Single Key Male
Environmental:	IP65 (with proper connection)

3.2 503 Series Zoned Power example

In the example shown below there are two Zoned Power Manifold blocks used. One is a "W" wiring option and the other is a "V" wiring option. The first (5) stations of the manifold assembly get their power from the M12 4 Pin connector at station one. The next (5) stations get their power from the M12 4 Pin connector at station six. Each of these "Zones" can be individually switched of if the machine or process requires. This example is considered a manifold with (2) Power Zones. The Main Power (7/8" MINI) cannot be considered or used as a Power Zone; Switched Power (Solenoid/Output Power) **MUST** be present for control to the solenoids.

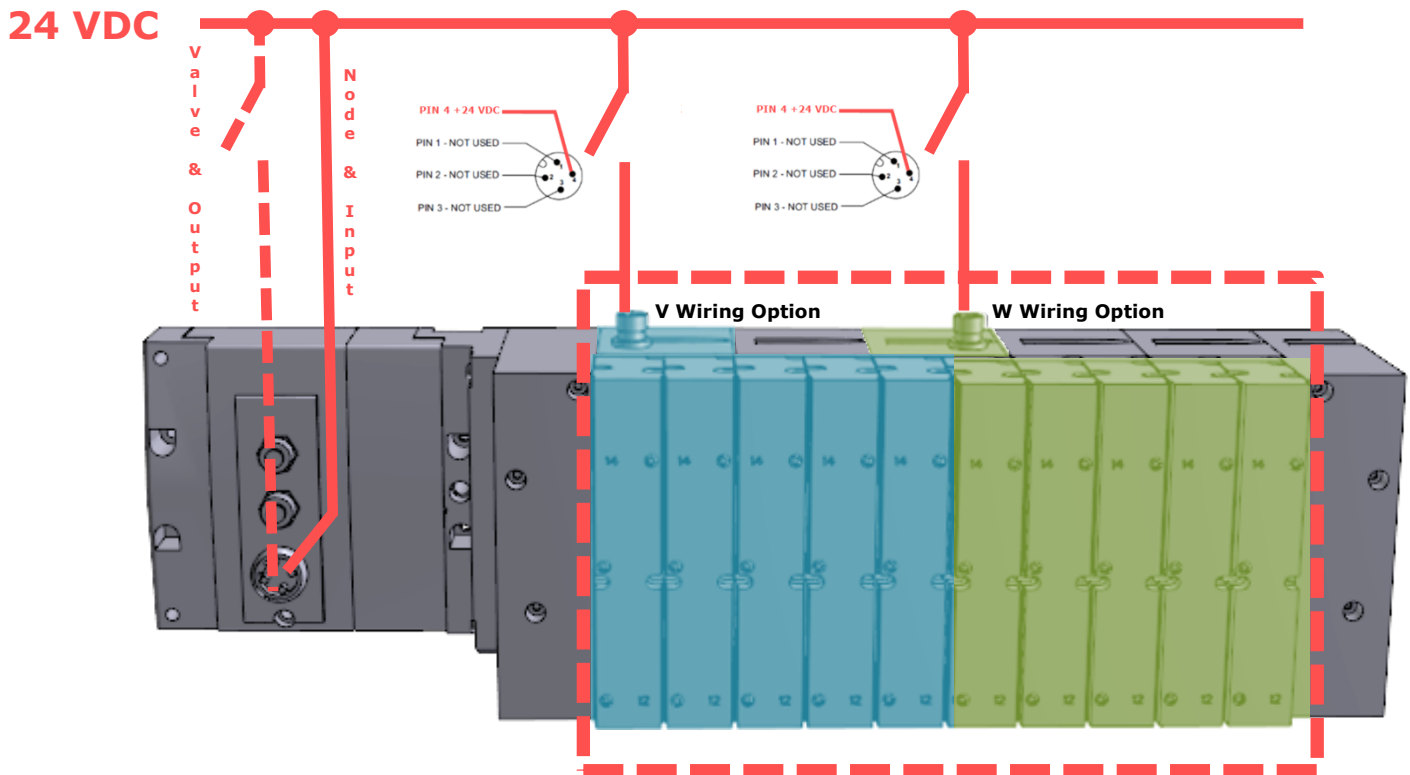

The 0 VDC reference for the +24 VDC applied to Pin 4 of the M12 connector **MUST** be the same as the one used on G3/580/Terminal Strip/25 or 37 Pin Sub-D/19 or 26 Pin Round Connector. If multiple 24 VDC power supplies are used the 0 VDC references of each supply **MUST** be common.

4. Communication Module

4.1 EtherNet/IP DLR Communication Module (Node)

This module is the communication interface to the manifold. It contains communication electronics and internal short circuit protection for power. It can be configured using the module's internal webserver or graphic display interface.

Communication Module Kit Part Number	
EtherNet/IP DLR Communication module	240-325

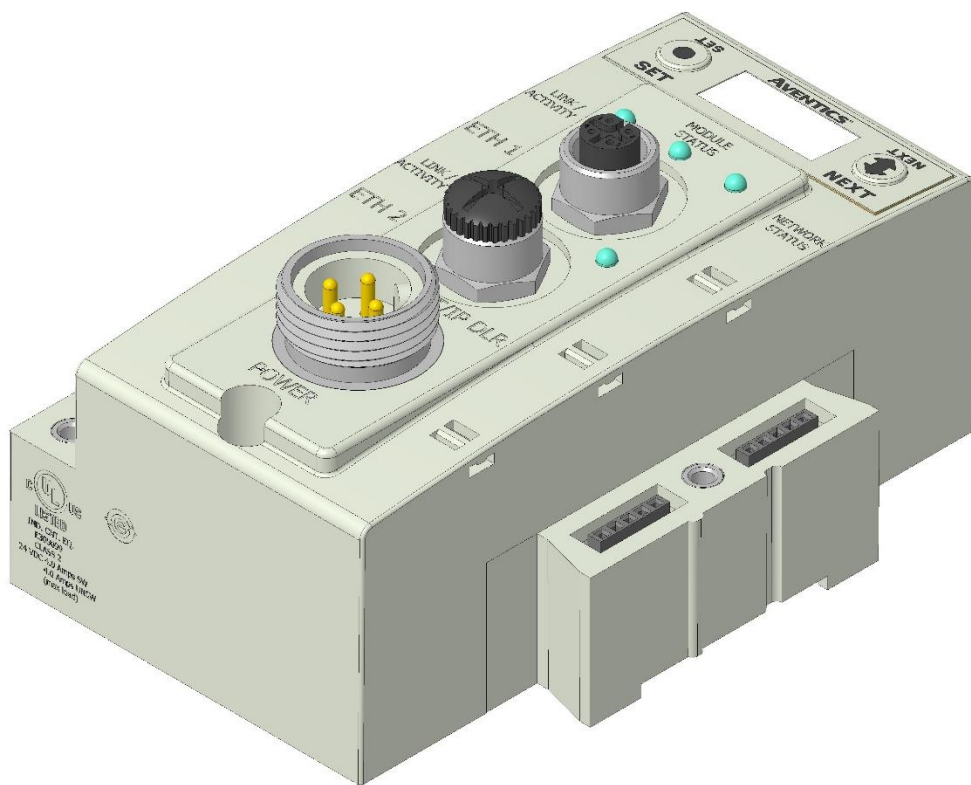

AVENTICS™ G3 Series EtherNet/IP™ DLR Technical Manual

4.2 Communication Module Description

Detail No.	Description
1	"Set" Button – used to navigate through user menus and to set parameters
2	Activity/Link Status LED
3	Two - 4 Pin M12 D-Coded Female Communication Connectors
4	Mounting Hole
5	"Next" Button – used to navigate through user menus and to set parameters
6	Graphic Display – used to display parameter information
7	Network Status LED
8	Slot for text ID tags
9	Keying for preventing I/O module insertion
10	4 Pin MINI Male Power Connector

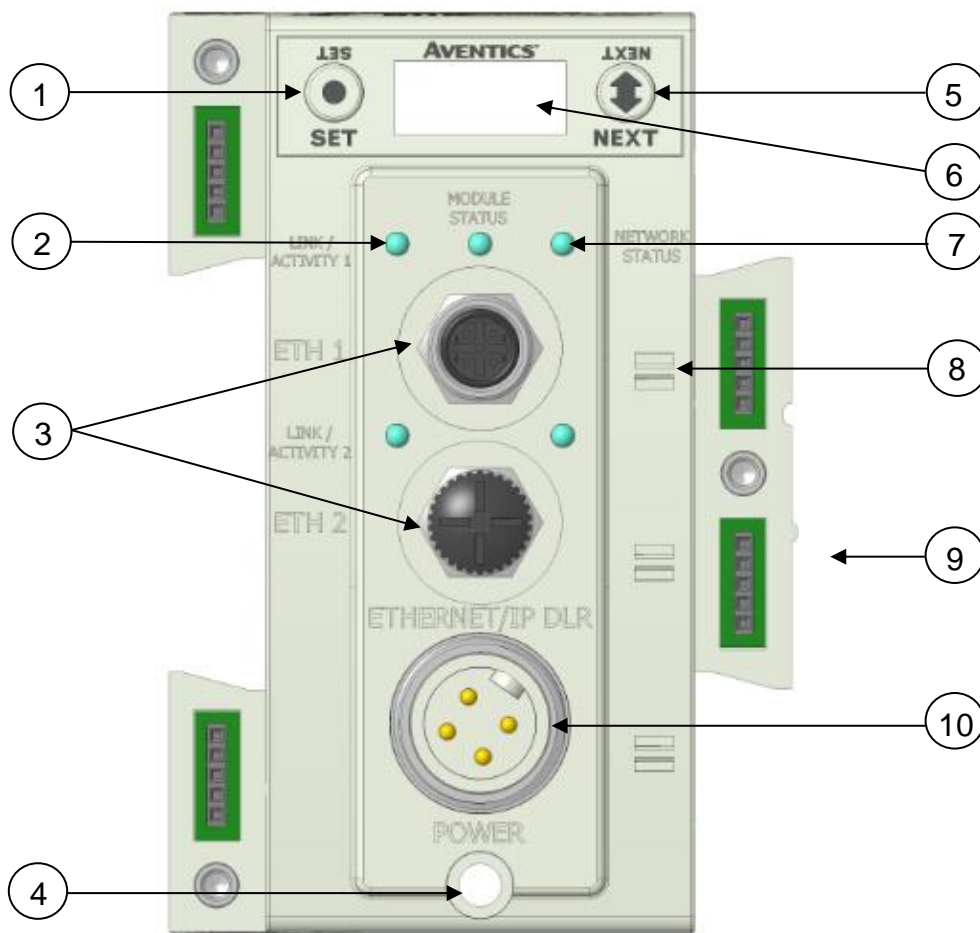

4.3 Connector Pin-Outs

Industry standard connectors are used for communication and auxiliary power. The EtherNet/IP communication connector is a D-coded keyway 4 pin female M12 connector. The Power connector is a single keyway 4 pin male 7/8" MINI connector.

EtherNet/IP Communication Connector Pin-Out

Pin No.	Function	Description
1	TX+	Positive Transmit Line
2	RX+	Positive Receive Line
3	TX-	Negative Transmit Line
4	RX-	Negative Receive Line

Power Connector with Cenelec Pin-Out

Cenelec Pin No.	Function	Description
1	+24 VDC (Valves and Outputs)	Voltage used to power outputs (valve coils and discrete outputs) SW
2	+24 VDC (Node and Inputs)	Voltage used to power discrete inputs and module electronics UNSW
3	0 VDC (Node and Inputs)	0 VDC Voltage used to power discrete inputs and module electronics UNSW
4	0 VDC (Valves and Outputs)	0 VDC Voltage used to power outputs (valve coils and discrete outputs) SW

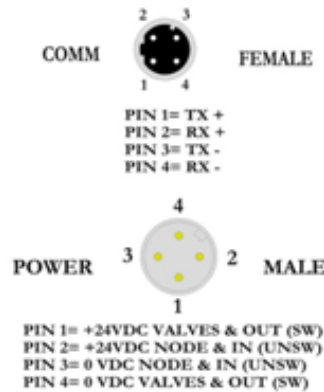

- Power common (0 VDC) pins 3 and 4 are isolated from each other to allow separate (isolated) power supply connection if required. However, they can be tied together if a single common, non-isolated, application is preferred.
- The combined draw of the +24VDC Valves and Outputs and +24VDC Node and Inputs pins cannot exceed 8 Amps, at any given moment in time.
- The Node and Input power pin (2) supplies power to the node electronics. This pin must be powered for the communication module to function.

4.4 Electrical Connections

Power Connector Wiring Diagram

Power Supply Example (Non-isolated commons)

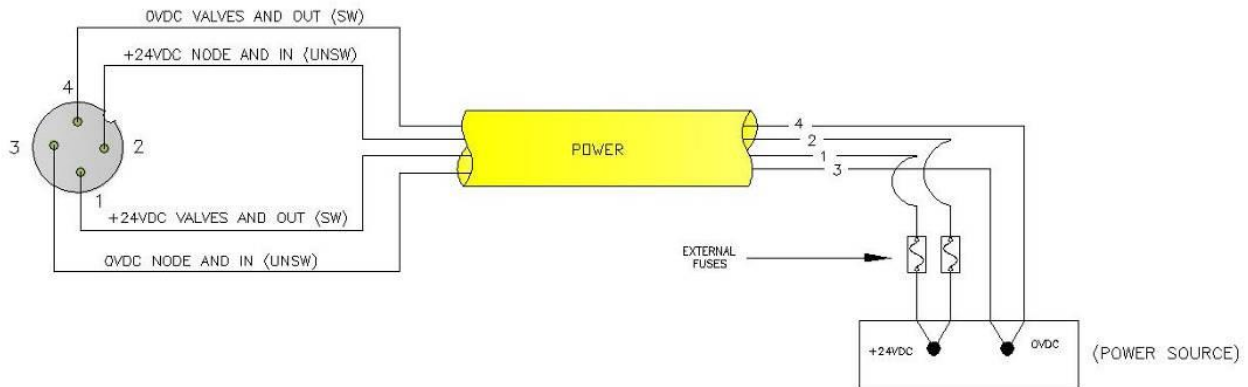

Power Supply Example (Isolated commons)

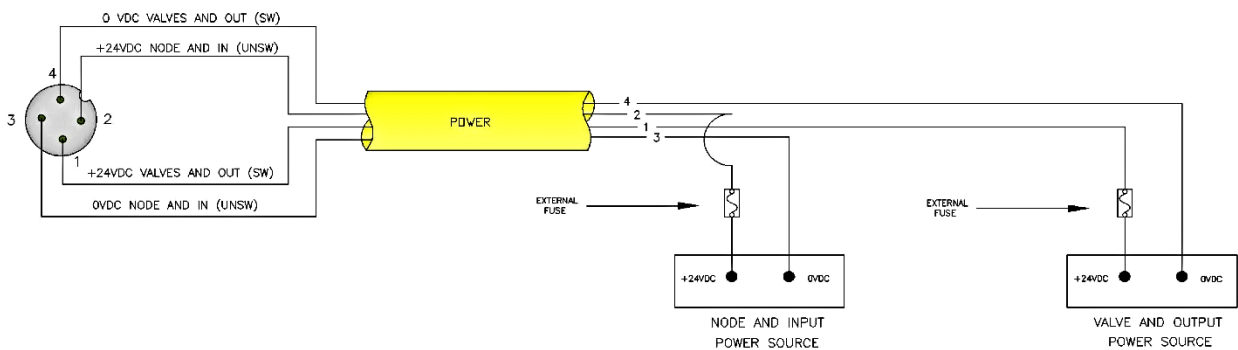

- Please see page 25 for external fuse sizing guide.
- When using molded connector power cables, Do Not rely on wire colors for Pin-Out. Always use pin number references.
- The combined draw of the +24VDC Valves and Outputs and +24VDC Node and Inputs pins cannot exceed 8 Amps, at any given moment in time.

AVENTICS™ G3 Series EtherNet/IP™ DLR Technical Manual

EtherNet/IP™ Cabling Diagram

Here are some basic wiring examples of Straight-Through cabling. Crossover cabling is not required for the G3 Ethernet IP DLR module.

RJ45 to M12 D Coded Cable

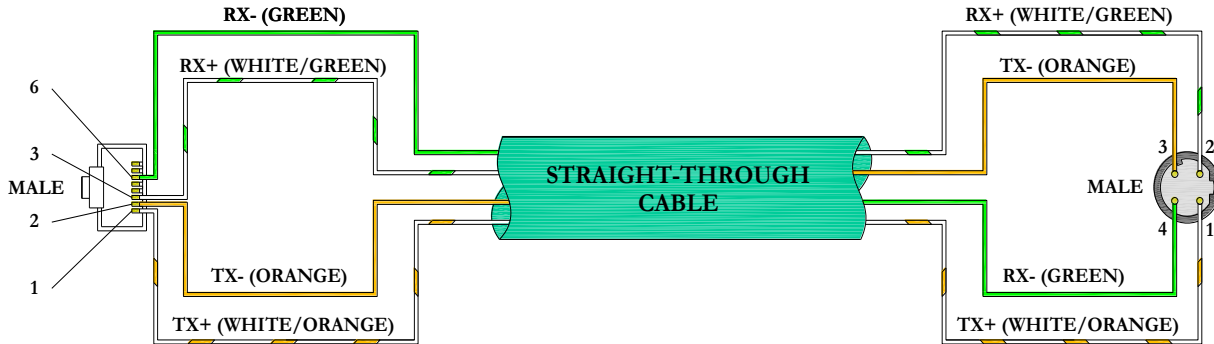

M12 D Coded to M12 D Coded Cable

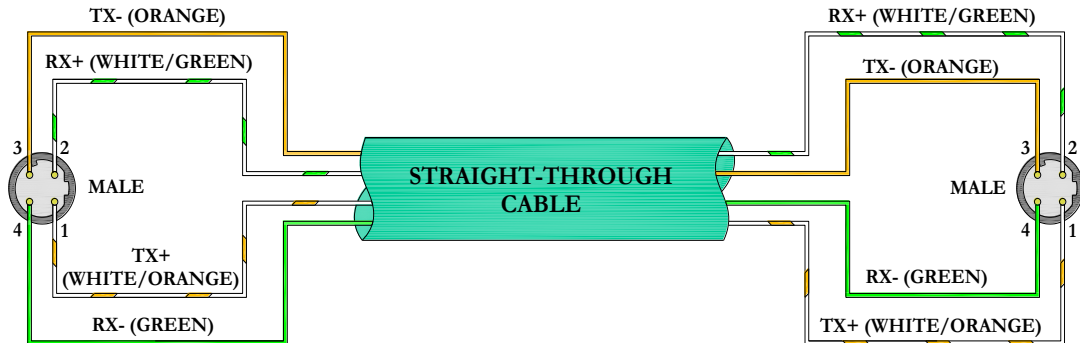

- These are examples only. For appropriate network cabling information, please see the ODVA document titled, "Ethernet/IP™: Media Planning and Installation Manual".
- RJ45 shown as T-568B standard.

AVENTICS™ G3 Series EtherNet/IP™ DLR Technical Manual

4.5 Ground Wiring

All Aventics communication nodes should be grounded during the installation process. These grounding guidelines can be found in National Electrical code IEC 60204-1 or EN 60204-1.

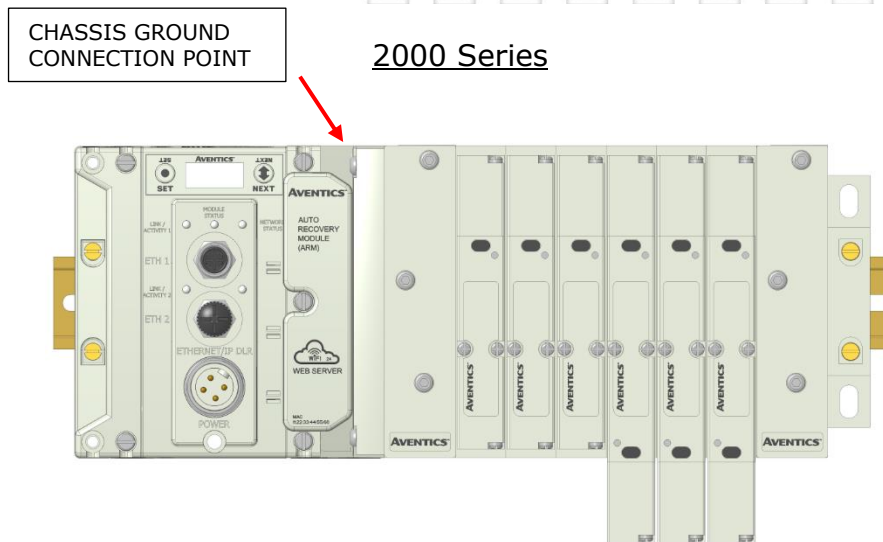
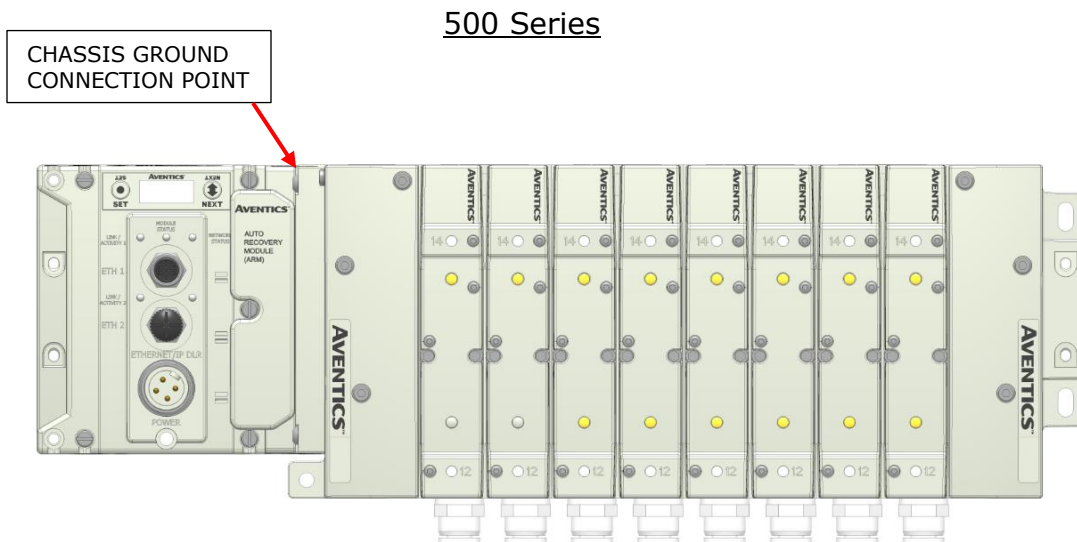

CAUTION

- Proper grounding will prevent many intermittent problems with network communication.
- When grounding to a machine frame, please ensure that the machine frame itself is already properly grounded.
- Better grounding can be achieved when larger diameter (lower gauge) wire is used.

4.6 Power Consumption

Power Connection

CENELEC Pin No.	Function	Description
1	+24 VDC (Valves and Outputs)	Voltage used to power outputs (valve coils and discrete outputs) SW
2	+24 VDC (Node and Inputs)	Voltage used to power discrete inputs and module electronics UNSW
3	0 VDC Common (Node and Inputs)	0 VDC (-V) Voltage used to power discrete inputs and node electronics UNSW
4	0 VDC Common (Valves and Outputs)	0 VDC (-V) Voltage used to power outputs (valve coils and discrete outputs) SW

Power Rating

- For maximum supply current capability please refer to page 75.
- Loads should not draw more than 0.5 Amps of current from any one individual discrete output point (Contact factory for higher current capability requirements).

CHART 1

Component	Voltage	Tolerance	+24VDC (Valves and Outputs) Pins 1 and 4		+24VDC (Node and Inputs) Pins 2 and 3	
			Current	Power	Current	Power
Solenoid Valve Coil 501 (Each)	24 VDC	+10%/-15%	0.03 A	0.80 W	0 A	0 W
Solenoid Valve Coil 502 (Each)	24 VDC	+10%/-15%	0.05 A	1.30 W	0 A	0 W
Solenoid Valve Coil 503 (Each)	24 VDC	+10%/-15%	0.07 A	1.70 W	0 A	0 W
Solenoid Valve Coil 2002 (Each)	24 VDC	+10%/-15%	0.02 A	0.48 W	0 A	0 W
Solenoid Valve Coil 2005 (Each)	24 VDC	+10%/-15%	0.06 A	1.44 W	0 A	0 W
Solenoid Valve Coil 2012 (Each)	24 VDC	+10%/-15%	0.11 A	2.64 W	0 A	0 W
Solenoid Valve Coil 2035 (Each)	24 VDC	+10%/-15%	0.11 A	2.64 W	0 A	0 W
Solenoid Valve Coil ISO 5599/2- SPA	24 VDC	+10%/-15%	0.17 A	4.08 W	0 A	0 W
Valve Adapter (Driver) 2000 series	24 VDC	+/- 10%	0.03A	0.72 W	0.02 A	0.48 W
Valve Adapter (Driver) 500 series	24 VDC	+/- 10%	0.03A	0.72 W	0.02 A	0.48 W
501 Series 32+ valve driver board	24 VDC	+/- 10%	0.03A	0.72 W	0.05 A	1.20 W
502 Series 32+ valve driver board	24 VDC	+/- 10%	0.03A	0.72 W	0.05 A	1.20 W
503 Series 32+ valve driver board	24 VDC	+/- 10%	0.03A	0.72 W	0.05 A	1.20 W
Digital Module (M12 style)	24 VDC	+/- 10%	0.04 A	0.96 W	0.05 A*	1.20 W*
Digital Module (M8 Style)	24 VDC	+/- 10%	0 A	0W	0.19A	4.56 W
Analog Module	24 VDC	+/- 10%	0.01 A	0.24 W	0.08 A*	1.92 W*
Sub-Bus Hub	24 VDC	+/- 10%	0 A	0 W	0.06 A	1.44 W*
RTD Module	24 VDC	+/- 10%	0.01 A	0.24 W	0.06 A	1.44 W*
Communication Module (Node)	24 VDC	+/- 10%	0.04 A	0.9 W	0.10 A*	2.50 W*
Sub-Bus Valve Module	24 VDC	+/- 10%	0.01 A	0.24 W	0.03 A*	0.72 W*
580 Sub-Bus Valve Module	24 VDC	+/- 10%	.034 A	0.8 W	0.04 A*	0.9 W*
Auto Recovery Module (ARM)	24 VDC	+/- 10%	0 A	0 W	0.03 A	0.72 W

* Current depends on graphic display brightness setting. Max. value shown with high brightness. Values decrease by approx. 5% for Medium and 11% for Low brightness settings.



- **Total power consumption for each Discrete I/O point is dependent on the specific current draw of input sensor devices and output loads.**

Recommended External Fuses

External fuses should be chosen based upon the physical manifold configuration. Please refer to the following table for the fuse sizing chart.

External Fuse Sizing Chart

<i>Power Consumption - Power Connector Pin for Valves and Outputs</i>		
<u>Description</u>		<u>Current</u>
Number of Solenoid Valve Coils Energized Simultaneously Number of coils ____ X ____ A (Reference Chart 1 above for specific current draw based on valve series)	=	_____Amps
		+
Total load current drawn by simultaneously energized Discrete Outputs	=	_____Amps
		+
Number of I/O modules installed ____ X 0.04 A	=	_____Amps
		+
Main Valve Driver	=	0.03 Amps
		+
Number of +32 Valve Drivers	=	0.05 Amps
		+
Communication Node Power Consumption	=	0.01 Amps
Total:		_____Amps
Surge Compensation:	X	1.25
Suggested External +24 VDC (Valves and Outputs) Fuse Value:		_____Amps
<i>Power Consumption - Power Connector Pin for Node and Inputs</i>		
<u>Description</u>		<u>Current</u>
Communication Node Power Consumption	=	0.10 Amps
		+
Total load current drawn by Sensor Devices from Discrete Inputs source	=	_____Amps
		+
Number of I/O modules installed ____ X 0.08 A	=	_____Amps
		+
Total:		_____Amps
Surge Compensation:	X	1.25
Suggested External Pin +24 VDC (Node and Inputs) Fuse Value:		_____Amps

*Factory Default Settings



- The Node and Inputs Aux Power pins supply power to the node electronics. These pins must be powered to supply communication node and input power.
- The internal electronic fuses exist to protect against damage due to catastrophic failure of internal components. External fuses are always recommended for protection against power supply failure, over-current conditions, etc.

AVENTICS™ G3 Series EtherNet/IP™ DLR Technical Manual

4.7 Diagnostics

Communication Module LED Functions

Upon power up, the LEDs indicate the status of the unit. There are five LEDs on the G3 EtherNet/IP™ node. The LEDs are described below.

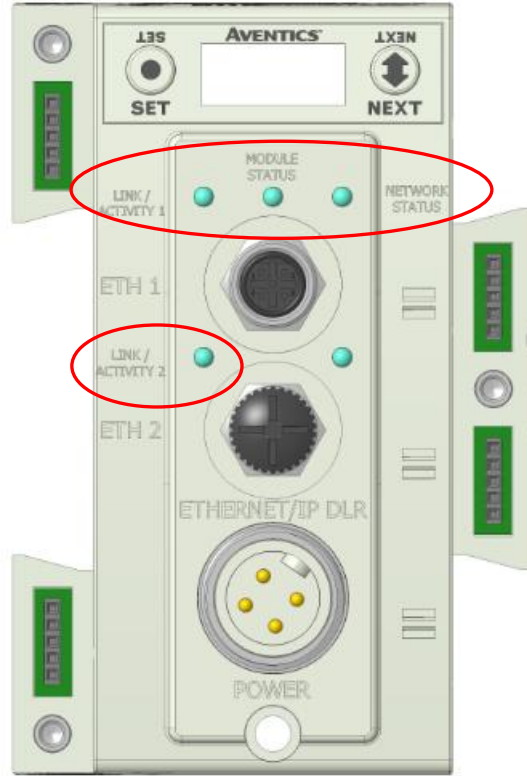

LED Name	Color	Status	Description
MODULE STATUS	Off	OFF	No power applied to +24V <small>NODE/IN.</small>
	Green	ON	Device operational. The module is operating correctly.
	Green	FLASHING	Standby. The module has not been configured.
	Red	ON	Major fault. A major internal error has been detected.
	Green Red	FLASHING	Module initialization and configuration.
NETWORK STATUS	Off	OFF	No EtherNet connection is detected
	Green	ON	EtherNet/IP™ connection established
	Green	FLASHING	EtherNet connection detected
	Red	ON	Duplicate IP address. The module has detected that its IP address is already being used elsewhere on the network
ACTIVITY/LINK 1	Off	OFF	The EtherNet/IP™ connection was lost
	Green	ON	No EtherNet connection is detected
	Green	FLASHING	The module is connected to an EtherNet network Ethernet/IP™ connected and exchanging data
ACTIVITY/LINK 2	Off	OFF	No EtherNet connection is detected
	Green	ON	The module is connected to an EtherNet network
	Green	FLASHING	Ethernet/IP™ connected and exchanging data

AVENTICS™ G3 Series EtherNet/IP™ DLR Technical Manual

Output Short Circuit Protection

G3 Output modules incorporate short circuit protection and diagnostics to identify short circuit, open coils and over temperature conditions. The diagnostics can be accessed within the user PLC program or the G3 Ethernet/IP™ node's integrated webpage. Detailed information regarding these features can be found on page 172.

<i>Output Type</i>	<i>Output State</i>	<i>Fault Condition</i>	<i>Status Bit</i>
Valve Solenoid Coil Driver	ON	No Fault	0
		Fault - Short Circuit, Over Temp/Over Current	1
Valve Solenoid Coil Driver	OFF	No Fault	0
		Fault - Open Load	1
Discrete Outputs	ON	No Fault	0
		Fault - Short Circuit, Over Temp/Over Current	1

5. G3 Graphic Display

The G3 Communication and I/O modules feature an integrated graphic display used to configure parameters and display diagnostic information. The graphic displays on the following page represent the main menu selections of the EtherNet/IP™ communication module (node).

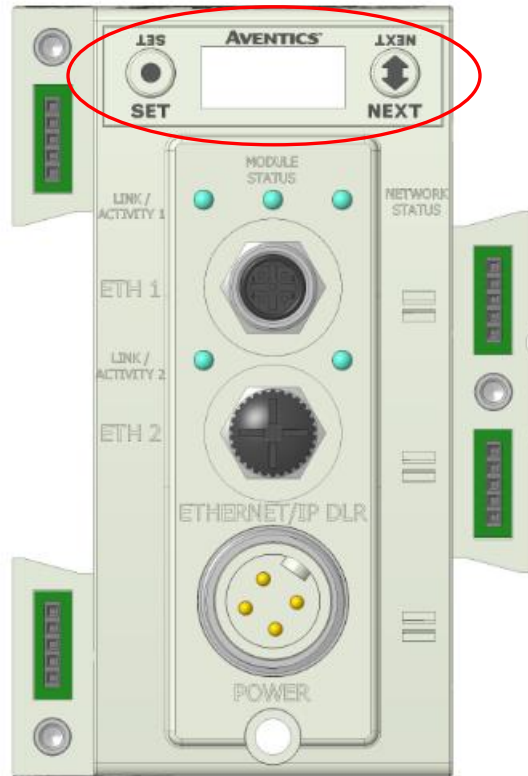

AVENTICS™ G3 Series EtherNet/IP™ DLR Technical Manual

5.1 Main Menu Structure

Use the NEXT button to scroll through the Main menu headings shown below. At this level pressing the SET button allows access the Sub-Menus. Please see the appropriate page referenced below for further details and descriptions of the Sub-Menus. Note that many of these settings can also be adjusted via software with GSD file parameters.

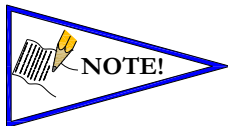
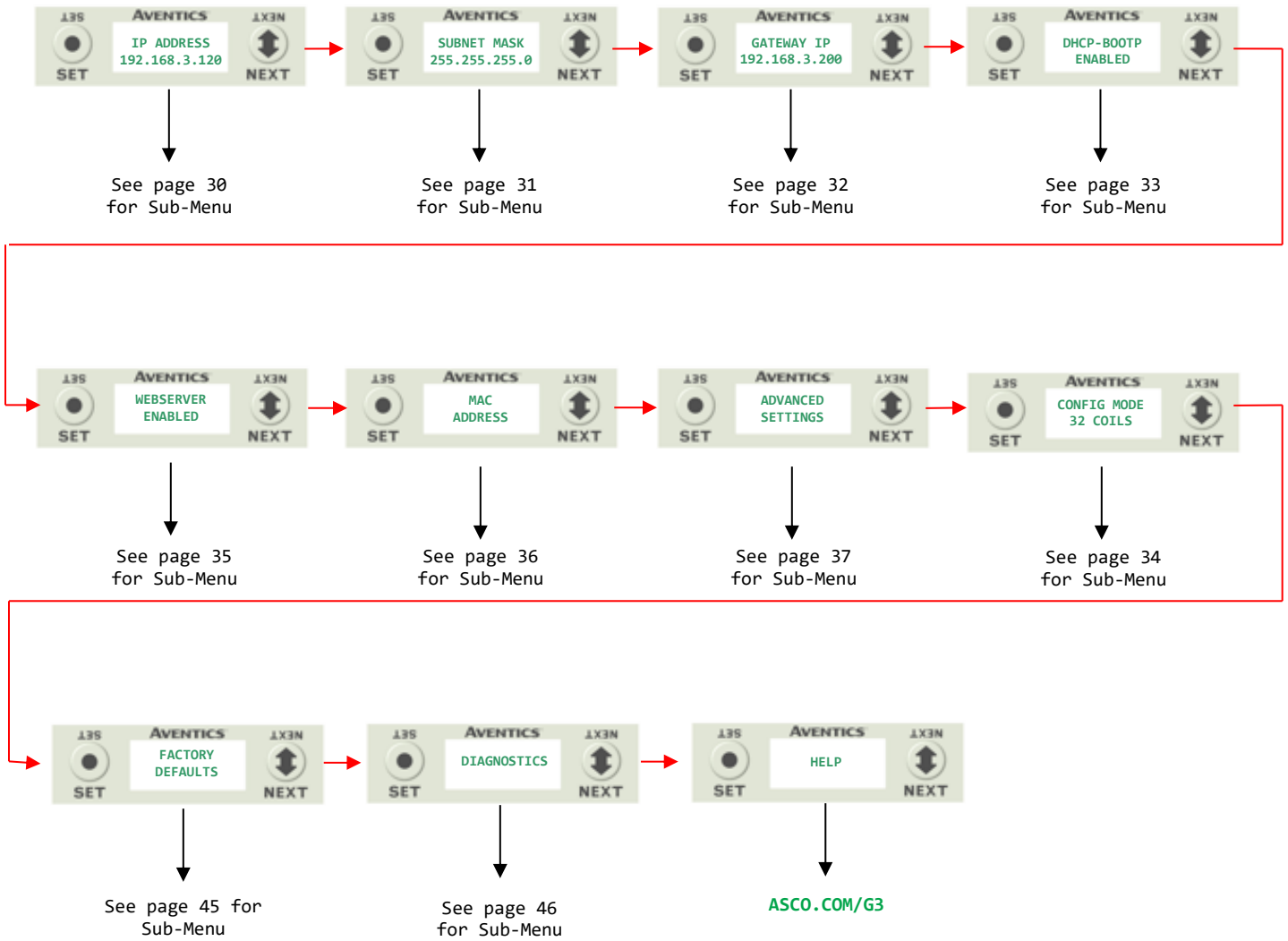

Parameters cannot be modified when a network I/O connection is established.

5.2 IP Address



Steps to Set IP Address

1. Press the SET button to enter the IP ADDRESS sub-menu.
2. Press the NEXT button to select the octet that you would like to change. Press the SET button to change the value.
3. Press the SET button to scroll through the hundred, tens and ones digits of the octet. Press the NEXT button to scroll through the valid digits (0-9). Press the SET button to advance through the octet. Press the NEXT button to advance to the next octet, scroll pass the fourth octet to accept the entire IP Address
4. Press the SET button to input the address shown on the display,
5. Press the NEXT button to select **Yes** or **No** to accept the IP Address shown on the display.
 - a. Selecting **No** will bring you back to the main Address menu.
 - b. Selecting **Yes** will take you to the following SAVE SETTINGS menu
6. Press the NEXT button to select either NOW or LATER.
 - a. Selecting NOW will cause the node to reset and apply the new setting.
 - b. Selecting LATER will cause the new Address to be saved in temporary memory to allow you to make additional parameter changes before the node is reset. However, you must ACCEPT the saved changes before your next power cycle otherwise they will be lost.

Press the SET button to confirm your choice.



- Factory default address is 192.168.3.120
- 0 and 255 are not valid for the fourth octet

5.3 Subnet Mask

Steps to Set Subnet Mask

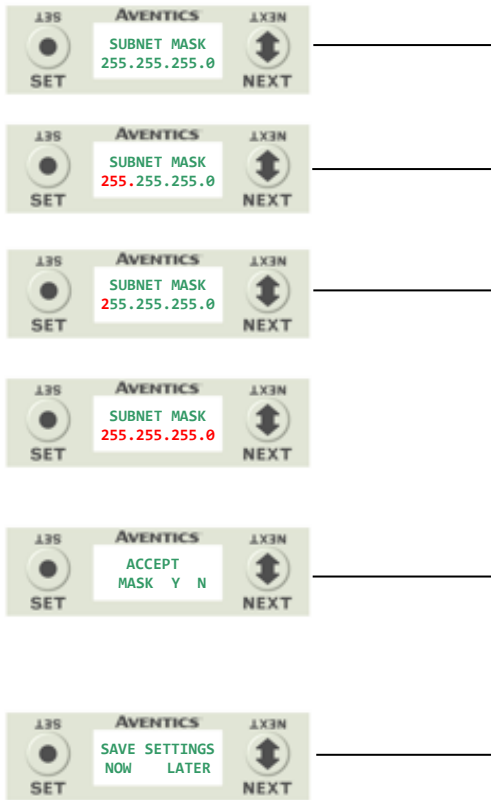
- 
1. Press the SET button to enter the Subnet Mask sub-menu.
 2. Press the NEXT button to select the octet that you would like to change.
Press the SET button to change the value.
 3. Press the SET button to scroll through the hundred, tens and ones digits of the octet.
Press the NEXT button to scroll through the valid digits (0-9).
Press the SET button to advance through the octet.
Press the NEXT button to advance to the next octet, scroll pass the fourth octet to accept the entire Subnet Mask
 4. Press the SET button to input the value shown on the display,
 5. Press the NEXT button to select Yes or No to accept the Subnet Mask shown on the display.
 - c. Selecting No will bring you back to the main Subnet Mask menu.
 - d. Selecting Yes will take you to the following SAVE SETTINGS menu
 6. Press the NEXT button to select either NOW or LATER.
 - c. Selecting NOW will cause the node to reset and apply the new setting.
 - d. Selecting LATER will cause the new Address to be saved in temporary memory to allow you to make additional parameter changes before the node is reset. However, you must ACCEPT the saved changes before your next power cycle otherwise they will be lost.

Press the SET button to confirm your choice.



- Factory default subnet mask is 255.255.255.0

5.4 Gateway IP



Steps to Set Gateway IP

1. Press the SET button to enter the Gateway IP sub-menu.
2. Press the NEXT button to select the octet that you would like to change.
Press the SET button to change the value.
3. Press the SET button to scroll through the octet.
Press the NEXT button to scroll through the valid digits (0-9).
Press the SET button to advance through the octet.
Press the NEXT button to advance to the next octet, scroll pass the fourth octet to accept the entire Subnet Mask
4. Press the SET button to input the value shown on the display,
5. Press the NEXT button to select Yes or No to accept the Subnet Mask shown on the display.
 - e. Selecting No will bring you back to the main Subnet Mask menu.
 - f. Selecting Yes will take you to the following SAVE SETTINGS menu
6. Press the NEXT button to select either NOW or LATER.
 - e. Selecting NOW will cause the node to reset and apply the new setting.
 - f. Selecting LATER will cause the new Address to be saved in temporary memory to allow you to make additional parameter changes before the node is reset. However, you must ACCEPT the saved changes before your next power cycle otherwise they will be lost.

Press the SET button to confirm your choice.



- *Factory default Gateway IP is 0.0.0.0*

This will allow the enabling / disabling of the DHCP (Dynamic Host Control Protocol) and / BOOTP parameters. Enabling this parameter will allow the IP Address to be set via a BOOTP/DHCP server.

DHCP-BOOTP Steps



1. Press the SET button to enter the DHCP-BOOTP sub-menu.



2. Press the NEXT button to scroll through the choices to enable or disable the feature.
 - a. ENABLED (Factory Default)
 - b. DISABLED
 - c. RETURN (this will return you to the main menu)

Press the SET button to confirm your choice.

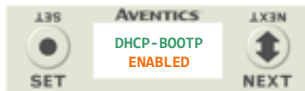

3. Press the NEXT button to select Yes or No to accept the selection.
 - a. Selecting No will bring you back to the main menu.
 - b. Selecting Yes will take you to the following apply changes menu.

Press the SET button to confirm your choice.

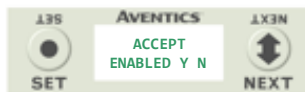

Apply Changes Steps



4. Press the NEXT button to select either NOW or LATER.
 - a. Selecting NOW will cause the node to reset and apply the new setting.
 - b. Selecting LATER will cause the new setting to be saved in memory, you must accept the saved changes before your next power cycle otherwise they will be lost.

Press the SET button to confirm your choice.



- *Factory default setting for DHCP-BOOTP is enabled.*

5.6 Config. Mode

Config Mode Settings



1. Press the SET button to enter the Config Mode sub-menu.



2. Press the SET button to change this parameter to 32, 64, 96 or 128



3. Press the NEXT button to select Yes or No.
 - a. Selecting No will bring you back to the main FACTORY DEFAULTS menu.
 - b. Selecting Yes will cause the node to reset and return all parameters to the factory default conditions.
 - c. Selecting RETURN will bring you back to the main FACTORY DEFAULTS menu

Press the SET button to confirm your choice.

5.7 Web-Server

This will allow the enabling/disabling of the G3 Web Server.

Web-Server Steps



1. Press the SET button to enter the Web-Server sub-menu.



2. Press the NEXT button to scroll through the choices to enable or disable the feature.

d. ENABLED (Factory Default)

e. DISABLED

f. RETURN (this will return you to the main menu)

Press the SET button to confirm your choice.

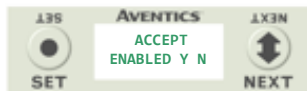

3. Press the NEXT button to select Yes or No to accept the selection.

c. Selecting No will bring you back to the main menu.

d. Selecting Yes will take you to the following apply changes menu.

Press the SET button to confirm your choice.



Apply Changes Steps



4. Press the NEXT button to select either NOW or LATER.

c. Selecting NOW will cause the node to reset and apply the new setting.

d. Selecting LATER will cause the new setting to be saved in memory, you must accept the saved changes before your next power cycle otherwise they will be lost.

Press the SET button to confirm your choice.



- Factory default setting for WEB-SERVER is enabled.

5.8 MAC Address

MAC (Machine Access Control) Address



1. The MAC Address is a fixed unique value that cannot be edited.

The actual MAC ADDR has an extra leading zero. The actual number in the example shown is 00-15-24-00-06-69



- *The MAC address is for reference and cannot be modified.*

5.9 Advanced Settings – Comm. Fault

This will allow the enabling / disabling of the Fault Action parameter. The Fault Action parameter determines the behavior of the outputs during a communication fault. Please see page 153 for more details.

Fault Action Settings

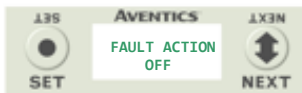

1. Press the SET button to enter the ADVANCED SETTINGS menu.
2. Press the NEXT button to scroll to the ADVANCED MENU / SET FAULT IDLE.
3. Press the SET button to enter the ADVANCED MENU / SET FAULT IDLE.
4. Press the SET button to enter the SET FAULT IDLE / FAULT ACTION menu.
5. The current state of the parameter is shown
6. Press the SET button to change this parameter
Press the NEXT button to scroll the choices for the desired output action during a fault state.
 - a. OFF (Factory Default)
 - b. HOLD LAST STATE
 - c. RETURN (this will return you to the SET FAULT/IDLE menu)

Press the SET button to confirm your choice.
7. Press the NEXT button to select Yes or No to accept the selection
Press the SET button to confirm your choice
 - a. Selecting No will bring you back to the main SET FAULT/IDLE menu.
 - b. Selecting Yes will take you to the following saved settings menu.

Save Settings Steps
8. Press the NEXT button to select either NOW or LATER.
Press the SET button to confirm your choice.
 - a. Selecting NOW will cause the node to reset and apply the new setting
 - b. Selecting LATER will cause the new FAULT ACTION selection to be saved in memory, you must Accept the saved changes before your next power cycle otherwise they will be lost.

Press the SET button to confirm your choice.



- *Factory Default is ALL OFF, See page 153 for more details.*

5.10 Advanced Settings - Brightness

Brightness Settings



1. Press the SET button to enter the ADVANCED SETTINGS menu.



2. Press the NEXT button to scroll to the CONFIG MENU / SET BRIGHTNESS.
Press the SET button to enter the CONFIG MENU / SET BRIGHTNESS.



3. The current state of the parameter is shown



4. Press the SET button to change this parameter
Press the NEXT button to scroll the choices for the desired brightness of the graphic display for all modules on the G3 system.



- a. LOW
- b. MEDIUM
- c. HIGH (Factory Default)



Press the SET button to confirm your choice. The changes will take effect immediately.

5.11 Advanced Settings – Flip Display

Flip Display Settings

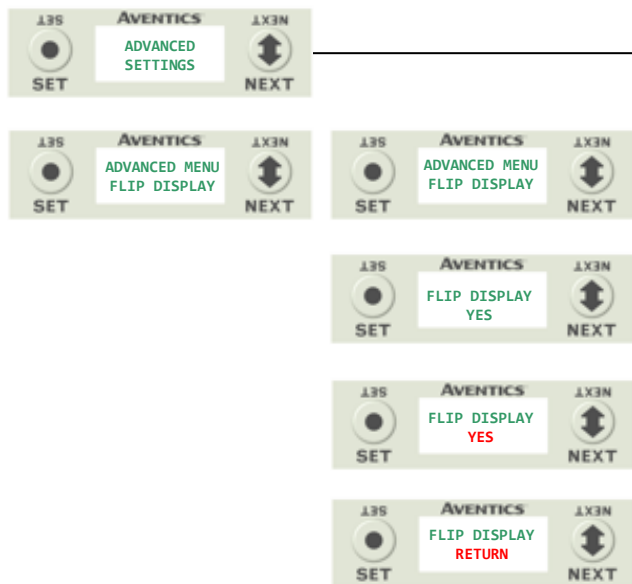

1. Press the SET button to enter the ADVANCED SETTINGS menu.

2. Press the NEXT button to scroll to the CONFIG MENU / FLIP DISPLAY.

Press the SET button to enter the CONFIG MENU / FLIP DISPLAY.

3. The current state of the parameter is shown

4. Press the NEXT button to change this parameter

- a. YES
- b. RETURN

Press the SET button to confirm your choice.



- This a global setting that affects all modules
- Each module, however, has its own setting if different settings are required.

5.12 Advanced Settings – Comm. Format

This allows setting a specific data format for I/O data.

Comm. Format Settings

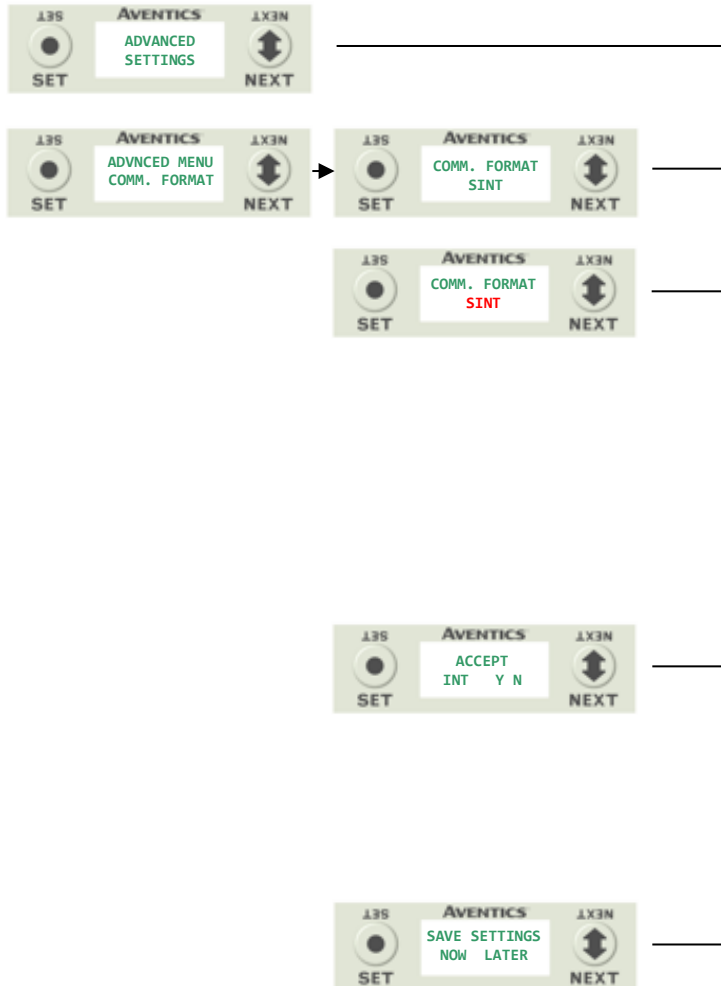

1. Press the SET button to enter the ADVANCED SETTINGS menu.
2. Press the NEXT button to scroll to the ADVANCED MENU / COMM. FORMAT
3. Press the SET button to enter the COMM. FORMAT MENU
4. Press the SET button, the current state of the parameter is highlighted.
5. Press the SET button to change this parameter
Press the NEXT button to scroll the choices for the desired COMM. FORMAT
 - a. SINT (8 Bit)
 - b. INT (16 Bit)
 - c. DINT (32 Bit)
 - d. RETURN (this will return you to the main menu)
6. Press the SET button to confirm your choice
Press the NEXT button to select Yes or No to accept the selection
Press the SET button to confirm your choice
 - a. Selecting No will bring you back to the main COMM. FORMAT menu.
 - b. Selecting Yes will take you to the following save settings menu.

Save Settings Steps

7. Press the NEXT button to select either NOW or LATER.
Press the SET button to confirm your choice.
 - a. Selecting NOW will cause the node to reset and apply the new setting
 - b. Selecting LATER will cause the new COMM. FORMAT selection to be saved in memory, you must Accept the saved changes before your next power cycle otherwise they will be lost.

5.13 Advanced Settings – Parameters Lock

PARAMETER Steps



1. Press the SET button to enter the Parameters sub-menu.



2. Press the NEXT button to scroll through the choices to enable or disable the feature.

- g. UNLOCKED (Factory Default)
- h. LOCKED
- i. RETURN (this will return you to the main menu)

Press the SET button to confirm your choice.



By choosing LOCKED, all settable parameters will be read only via the graphic display. UNLOCKED, the factory default, will allow all parameters to be settable through the graphic display.

Please note that all parameters are read only, regardless of this setting, when an IO connection between the communication module and the controller (PLC) is present



3. Press the NEXT button to select Yes or No to accept the selection.

- e. Selecting No will bring you back to the main menu.
- f. Selecting Yes will take you to the following apply changes menu.

Press the SET button to confirm your choice.



Apply Changes Steps



4. Press the NEXT button to select either NOW or LATER.
 - e. Selecting NOW will cause the node to reset and apply the new setting.
 - f. Selecting LATER will cause the new setting to be saved in memory, you must accept the saved changes before your next power cycle otherwise they will be lost.

Press the SET button to confirm your choice.

5.14 Advanced Settings – Configuration Lock

Configuration Lock Settings



1. Press the SET button to enter the ADVANCED SETTINGS menu.



2. Press the NEXT button to scroll to the CONFIG MENU / CONFIG. LOCK.

Press the SET button to enter the CONFIG MENU / CONFIG. LOCK.

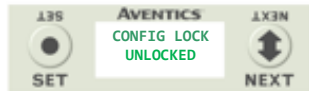

3. The current state of the parameter is shown

4. Press the SET button to change this parameter



5. Press the NEXT button to scroll through the choices to enable or disable the feature.
 - a. UNLOCKED (Factory Default)
 - b. LOCKED
 - c. RETURN (this will return you to the main menu)

Press the SET button to confirm your choice.



6. Press the NEXT button to select Yes or No to accept the selection.
 - g. Selecting No will bring you back to the main menu.
 - h. Selecting Yes will take you to the following apply changes menu.

Press the SET button to confirm your choice.

Apply Changes Steps



7. Press the NEXT button to select either NOW or LATER.
 - g. Selecting NOW will cause the node to reset and apply the new setting.
 - h. Selecting LATER will cause the new setting to be saved in memory, you must accept the saved changes before your next power cycle otherwise they will be lost.

Press the SET button to confirm your choice.

Note;

By choosing LOCKED, the manifold configurations will be stored in memory and the PHYSICAL manifold configuration cannot be changed. UNLOCKED, the manifold configurations can be changed without errors.



5.15 Advanced Settings – Quick Connect

This will allow the enabling / disabling of the “Quick Connect” feature. “Quick Connect” streamlines the startup time of the G3 subbus and is typically utilized in automatic tool change applications.

Quick Connect Settings



8. Press the SET button to enter the ADVANCED SETTINGS menu.



9. Press the NEXT button to scroll to the ADVANCED MENU / QUICK CONNECT
10. Press the SET button to enter the QUICK CONNECT menu



11. Press the SET button, the current state of the parameter is highlighted.



12. Press the SET button to change this parameter
Press the NEXT button;
a. DISABLED menu)
b. ENABLED
c. RETURN (this will return you to the main

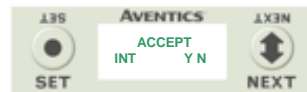

13. Press the SET button to confirm your choice
Press the NEXT button to select Yes or No to accept the selection
Press the SET button to confirm your choice
a. Selecting No will bring you back to the main QUICK CONNECT menu.
b. Selecting Yes will take you to the following save settings menu.



Save Settings Steps

14. Press the NEXT button to select either NOW or LATER.
Press the SET button to confirm your choice.
a. Selecting NOW will cause the node to reset and apply the new setting
b. Selecting LATER will cause the new QUICK CONNECT selection to be saved in memory, you must Accept the saved changes before your next power cycle otherwise they will be lost.

5.16 Advanced Settings – Compatibility Mode

This allows the enabling / disabling of the "Compatibility Mode". Compatibility mode sets the Ethernet IP/DLR module configuration to operate as a standard Ethernet IP (non DLR) node.

Compatibility Mode Settings



15. Press the SET button to enter the ADVANCED SETTINGS menu.



16. Press the NEXT button to scroll to the ADVANCED MENU / COMPAT MODE

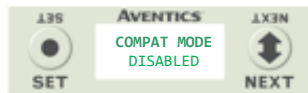

17. Press the SET button to enter the COMPAT MODE menu



18. Press the SET button, the current state of the parameter is highlighted.

19. Press the SET button to change this parameter

- d. DISABLED menu)
- e. ENABLED
- f. RETURN (this will return to the main menu)



20. Press the SET button to confirm your choice
Press the NEXT button to select Yes or No to accept the selection



- Press the SET button to confirm your choice
- c. Selecting No will bring you back to the main COMPAT MODE menu.
- d. Selecting Yes will take you to the following save settings menu.

Save Settings Steps



21. Press the NEXT button to select either NOW or LATER.
Press the SET button to confirm your choice.
- c. Selecting NOW will cause the node to reset and apply the new setting
- d. Selecting LATER will cause the new COMPAT MODE selection to be saved in memory, you must Accept the saved changes before your next power cycle otherwise they will be lost.

5.17 Factory Defaults

Factory Default Settings



4. Press the SET button to enter the FACTORY DEFAULTS sub-menu.



5. Press the SET button to change this parameter



6. Press the NEXT button to select Yes or No.
- d. Selecting No will bring you back to the main FACTORY DEFAULTS menu.
 - e. Selecting Yes will cause the node to reset and return all parameters to the factory default conditions.
 - f. Selecting RETUTN will bring you back to the main FACTORY DEFAULTS menu

Press the SET button to confirm your choice.

FACTORY DEFAULT SETTINGS	
Description	Default
IP Address	192.168.3.120
Sub Net Mask	255.255.255.0
DHCP Boot-P	Enabled
Web Server	Enabled
Diagnostic Word	Enabled
I/O Diagnostic Status	Enabled
Comm Fault – Fault Action	Off
Brightness	High
Comm. Format	SINT
Params Lock	Unlocked
Config Lock	Unlocked
Quick Connect	Disabled
Compatibility Mode	Disabled
Config Mode	32

5.18 Diagnostics

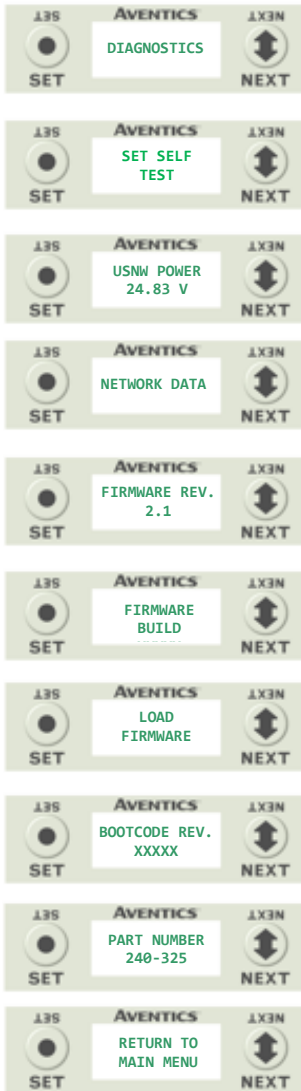

1. Press the SET button to enter Diagnostic sub-menu.
2. Press the NEXT button to scroll through the
 - a. SET SELF TEST
 - i. - Please see following page for description
 - b. UNSW POWER
 - i. - Displays voltage level of un-switched power (Node & Inputs)
 - c. NETWORK DATA
 - i. - Displays the network diagnostics
 - d. FIRMWARE REVISION
 - i. - For service personnel
 - e. FIRMWARE BUILD
 - i. - For service personnel
 - f. LOAD FIRMWARE
 - i. - For service personnel
 - g. BOOTCODE REVISION
 - i. - For service personnel
 - h. BOOTCODE BUILD
 - i. - For service personnel
 - i. PART NUMBER
 - i. - Displays replacement part number of module
 - j. RETURN TO MAIN MENU



- *The UNSW POWER screen indicates the voltage level present on the UNSW (Node & Input) power pins (Pin No. 2 and 3) of the main power connector.*

5.19 Diagnostics - Self Test Mode

An internal diagnostic tool can be enabled on the communication module (node) using the graphic display. This tool allows the user to confirm that all of the inputs and outputs on the manifold and any of the distributed modules are fully functional without needing a network connection or controller. There are two test modes that the user can choose. The "OUTPUTS" test mode tests all the outputs by sequentially turning them ON and OFF for approximately .5 seconds. The "INPUTS" test mode tests the inputs by causing all of the outputs to toggle between even and odd values when any input is made. The Self-Test mode on the communication module (node) is a global setting and will test all devices connected on the main manifold as well as any distributed modules and/or manifolds.

Similar "local" Self-Test mode is available on all output modules types. This "local" Self-Test mode allows any output module to be tested without affecting any other output module.

NOTE: The number of Valve outputs that are tested are affected by the I/O size settings.

To use the Self-Test Mode, the user must first set some initial conditions. Follow these steps to initiate the self-test mode.

- 1) **Disconnect Air and Communication from the manifold!**
- 2) Select the desired test mode using the graphic display. (See example below)
- 3) Starting at the Home Screen, navigate the menus by selecting the NEXT button until the DIAGNOSTICS menu is shown.
- 4) Select the SET button to access the DIAGNOSTICS menu and then again to access the SELF-TEST menu
- 5) Push NEXT to navigate to the desired test mode: OUTPUTS or INPUTS or RETURN
- 6) Push SET to select the desired test mode.
- 7) A message will appear: DISCONNECT AIR HOLD SET BUTTON
- 8) Hold the SET button down for approximately 10 seconds to enable the test. The Display will flash the above message while the button is pushed.
- 9) When the display stops flashing, the self-test mode will run and the Module Status LED will flash Red/Green while the display shows SELF TEST RUNNING.
- 10) The global self-test mode can only be disabled by disconnecting the power to the manifold.

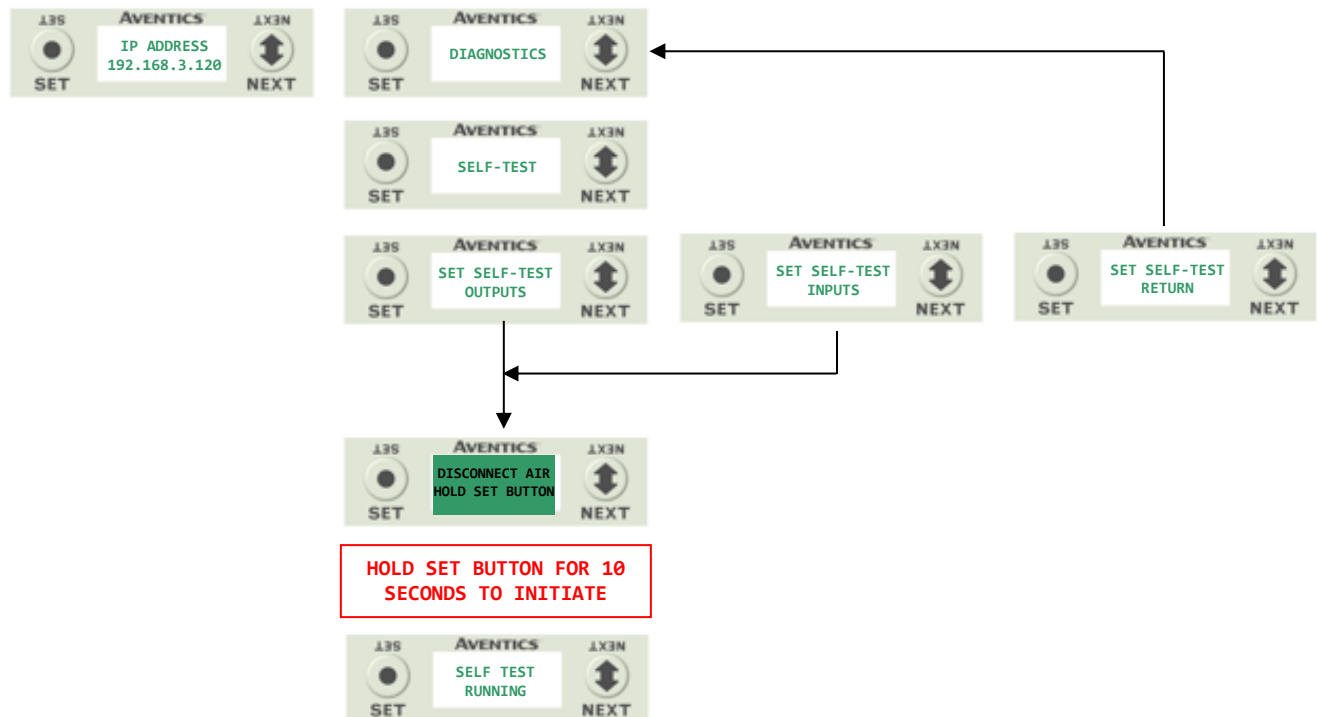

AVENTICS™ G3 Series EtherNet/IP™ DLR Technical Manual

5.20 Error Messages

The following are automatic error messages that are displayed when specific faults occur during operation:

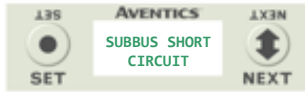

Displayed when a short circuit condition is detected on the Sub-Bus power lines



Displayed when a short circuit condition is detected on a valve coil



Displayed when an open circuit condition is detected on a valve coil



Displayed when a Sub-Bus module that had been previously installed becomes absent from the configuration



Displayed when +24 VDC on Pin No. 1 and No. 4 (Valves and Outputs) is not present or below 22 VDC



Displayed when +24 VDC on Pin No. 2 and No. 3 (Node and Inputs) is below 19 VDC

6. Auto Recovery Module (ARM)

The Auto Recovery Module (ARM) is an optional memory module that is installed between the node and the valve adapter module and is used to backup the manifold system parameters even during catastrophic failure. During the power-up process the communication module reads the configuration of the manifold, including any user settable parameters of I/O modules, and stores the information in its non volatile memory. Once the information is stored, it is disconnected from the power circuits while still mechanically attached to the manifold.

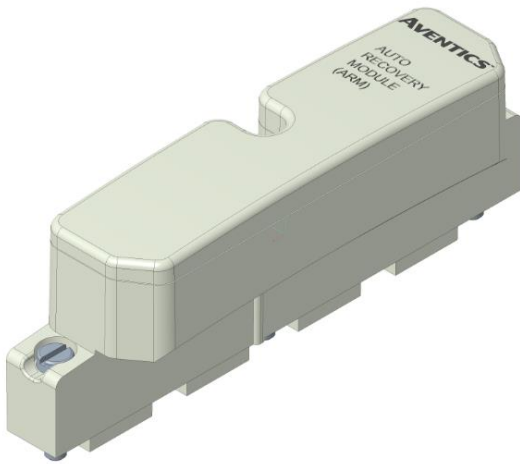

ARM-Clip Module

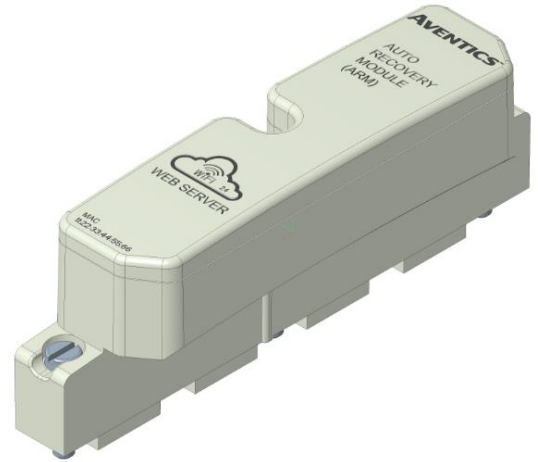

Wireless ARM-Clip Module

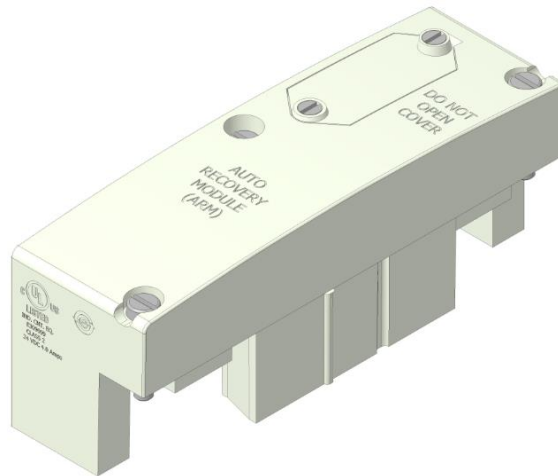

ARM Module (Legacy)

Description	Replacement Part Number
ARM Clip Module	240-383
Wireless ARM Clip Module	240-382
ARM Module (Legacy)	240-182

6.1 ARM process flowchart

ARM function is described in the following flowchart

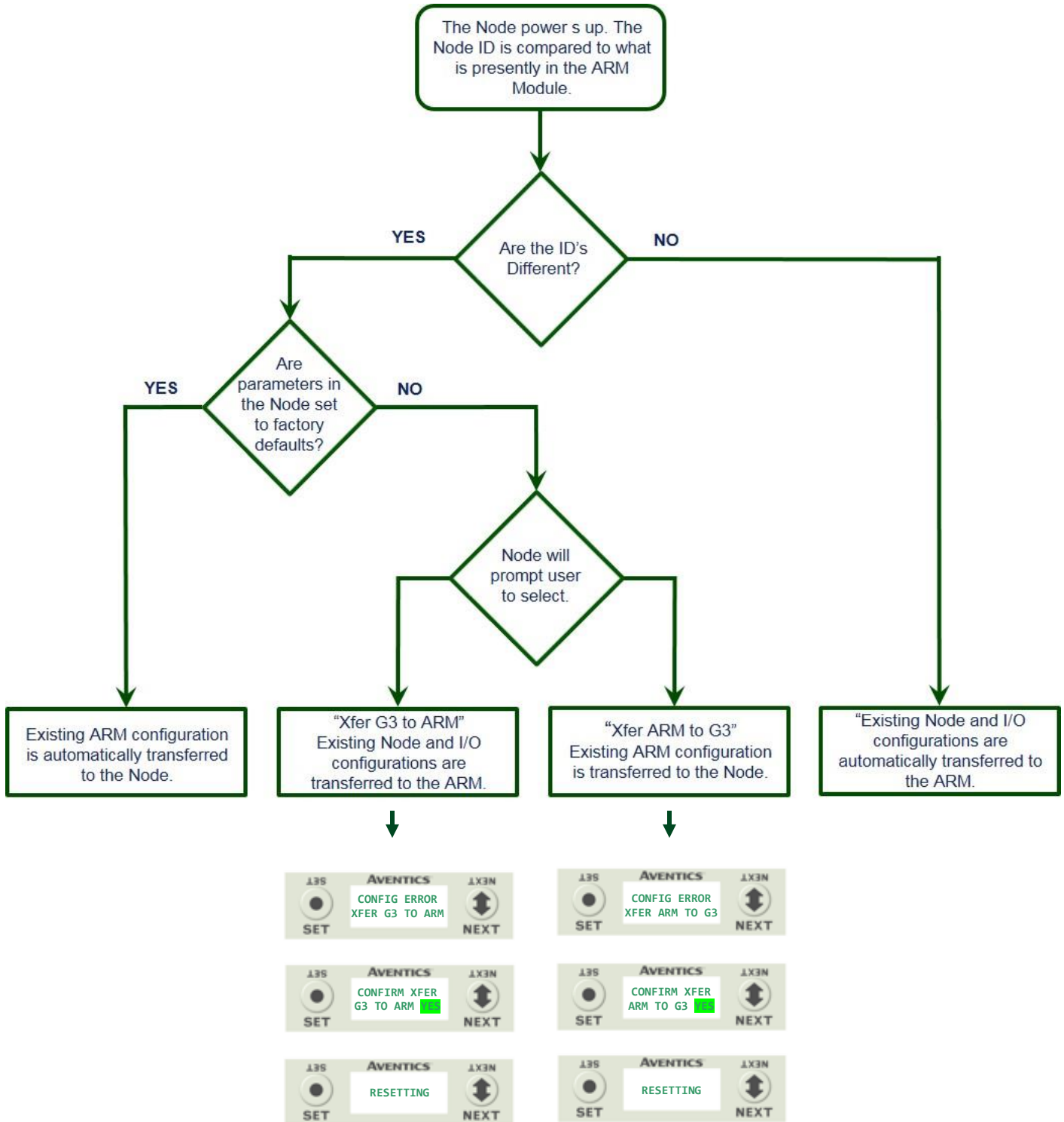

AVENTICS™ G3 Series EtherNet/IP™ DLR Technical Manual

6.2 Wireless ARM

The Wireless ARM supports standard ARM functionality with the addition of a WIFI accessible diagnostic web server. The web server allows the user to connect to the Wireless ARM to access manifold parameters and diagnostics using any WIFI enabled device including computers, tablets and phones.

Description	Replacement Part Number
Wireless ARM Clip Module	240-383

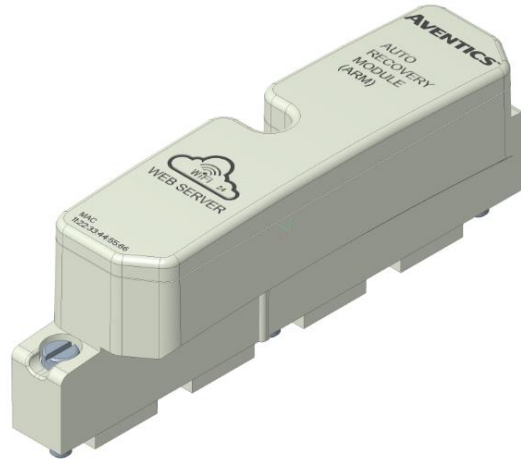

Wireless ARM Minimum Build Firmware Requirements		
Module	Part Number	Firmware
Communication Module	240-325	Rev 1.01 Build 43980

6.3 Connecting to the Wireless ARM (Computer or Mobil Device)

Once a G3 Ethernet DLR manifold equipped with a Wireless ARM is powered on; the Wireless ARM will broadcast it's SSID.

Locate the Wireless ARM broadcast ID

On the computer or mobile device; open available WIFI connections. In this example the SSID is Broadcast as "G3 Numatics 6d3". Each Wireless Arm Module's SSID is unique and comprised of the last 4 digits of the Wireless Arm Module's MAC ID.

Select the connection and enter the network security key.

The default network security key is 12345678

Verify the computer/Mobile device is connected to the Wireless Arm Module

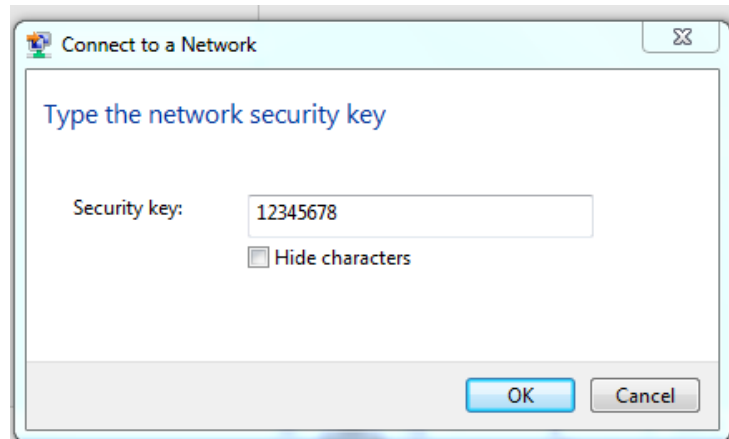
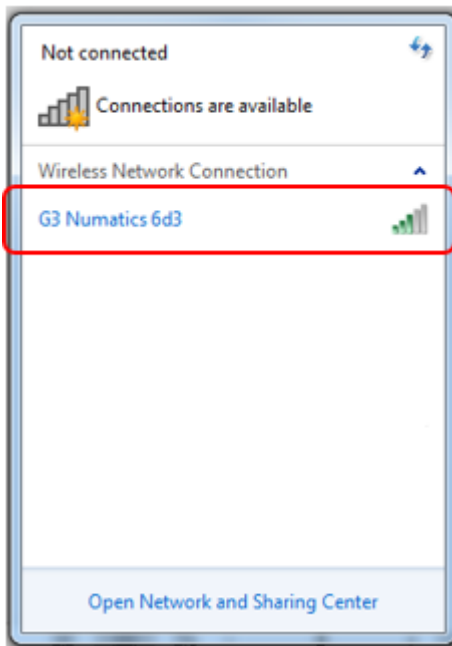

- *Default Security Key is* **12345678**

AVENTICS™ G3 Series EtherNet/IP™ DLR Technical Manual

Open an internet browser and connect to the G3 Wireless ARM webserver by typing the IP address. (default IP address HTTP://192.168.4.1).



CONNECTION TYPE SELECTION



WELCOME TO THE G3 WIRELESS ARM LANDING PAGE.

View only

Status data and configuration can only be viewed.

Configuration & Parameter changes

Status data and configuration can be viewed and manipulated.

G3 VALVE SYSTEM WITH WIRELESS ARM



“View Only” and “Configuration & Parameter changes” buttons are displayed.

- View Only – connects to the G3 Webserver with read only access
- Configuration & Parameter changes) - connects to the G3 Webserver with write access

Select “Configuration & Parameter changes” to open the password protected Configuration & Parameter Webpages with Read and Write Access



Configuration & Parameter changes are password protected

6.4 Wireless ARM Webserver in "View Only" mode

"View Only" mode allows the user read only access. Configuration and parameters are locked and unable to be modified. In this mode you can monitor the condition of all of the modules in the G3 sub-bus network.

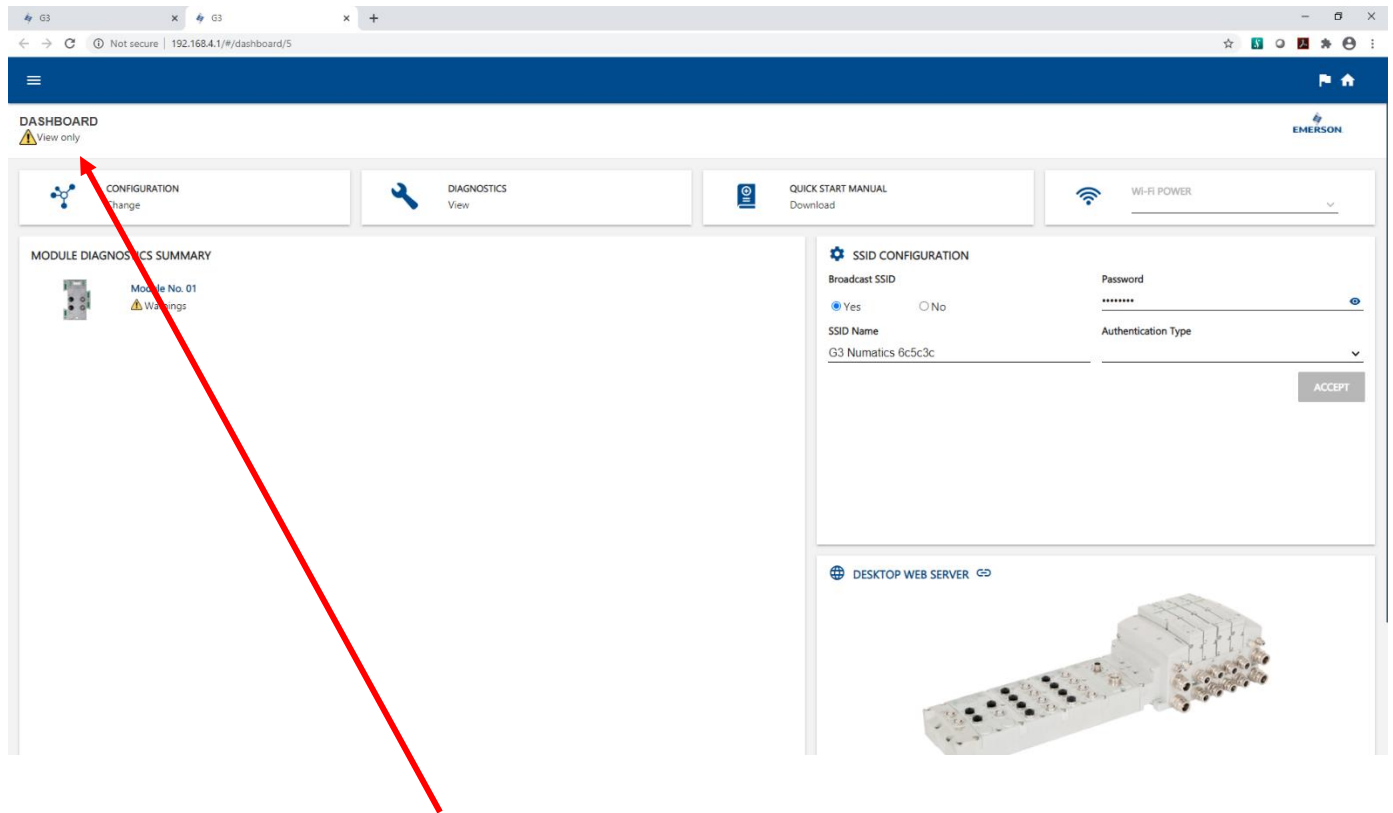

"View Only" mode is identified by the "View only" tag at the top left of the Dashboard page.

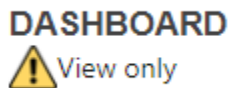

To exit "View Only" mode and change to "Configuration & Parameter Changes" mode, close the **second** open webpage tab from the top of the screen. The first tab is the landing page where you can select which mode you would like to view the webserver in.

NOTE: If using a smartphone or tablet, you will need to open a Tabs view to close the "View Only" page and go back to the landing page.

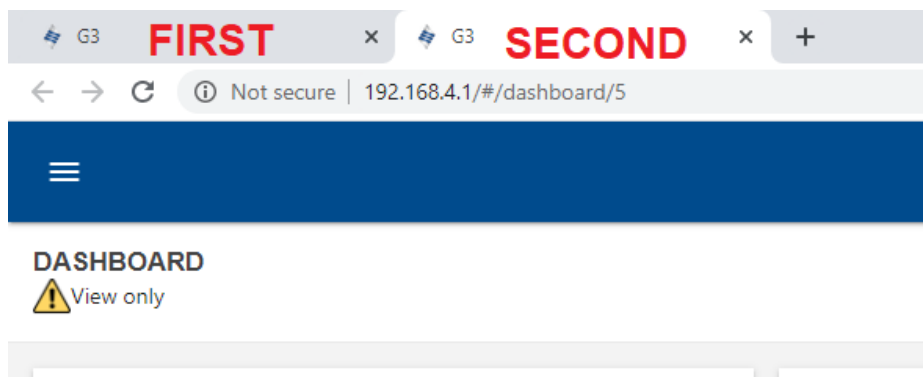

6.5 Wireless ARM Webserver in "Configuration & Parameter Changes" mode

Once a G3 manifold equipped with a Wireless ARM is powered on the Wireless ARM will broadcast it's SSID.

AVENTICS™ G3 Series EtherNet/IP™ DLR Technical Manual

Password Protected Access



PASSWORD REQUIRED

Enter Password



SUBMIT

CHANGE PASSWORD

Enter password to Access the Configuration & Parameter web pages.



- *Default Password is **G3/240-382***

AVENTICS™ G3 Series EtherNet/IP™ DLR Technical Manual

Dashboard

The G3 Wireless ARM Dashboard is displayed.

The screenshot shows the G3 Wireless ARM Dashboard interface. At the top, there is a blue navigation bar with a hamburger menu icon on the left and a 'LOGOUT' button on the right. Below the navigation bar, the word 'DASHBOARD' is displayed on the left, and the 'EMERSON' logo is on the right. The main content area is divided into several sections:

- CONFIGURATION**: A button with a network icon and the text 'Change'.
- DIAGNOSTICS**: A button with a wrench icon and the text 'View'.
- QUICK START MANUAL**: A button with a document icon and the text 'Download'.
- Wi-Fi POWER**: A dropdown menu with a Wi-Fi icon and the text 'High'.

The 'MODULE DIAGNOSTICS SUMMARY' section features a large green square with a white checkmark and the text 'OK'.

The 'SSID CONFIGURATION' section includes the following fields:

- Broadcast SSID**: Radio buttons for 'Yes' (selected) and 'No'.
- Password**: A text field with masked characters and an eye icon to toggle visibility.
- SSID Name**: A text field containing 'G3 Numatics 6c5c3c'.
- Authentication Type**: A dropdown menu showing 'WPA-PSK2'.
- ACCEPT**: A blue button to confirm the configuration.

The 'DESKTOP WEB SERVER' section has a globe icon and a link icon, with an image of a white industrial device below it.

Select the "CONFIGURATION" tab for access to G3 Communication module parameters.

AVENTICS™ G3 Series EtherNet/IP™ DLR Technical Manual

Configuration
G3 Communication Module Parameters

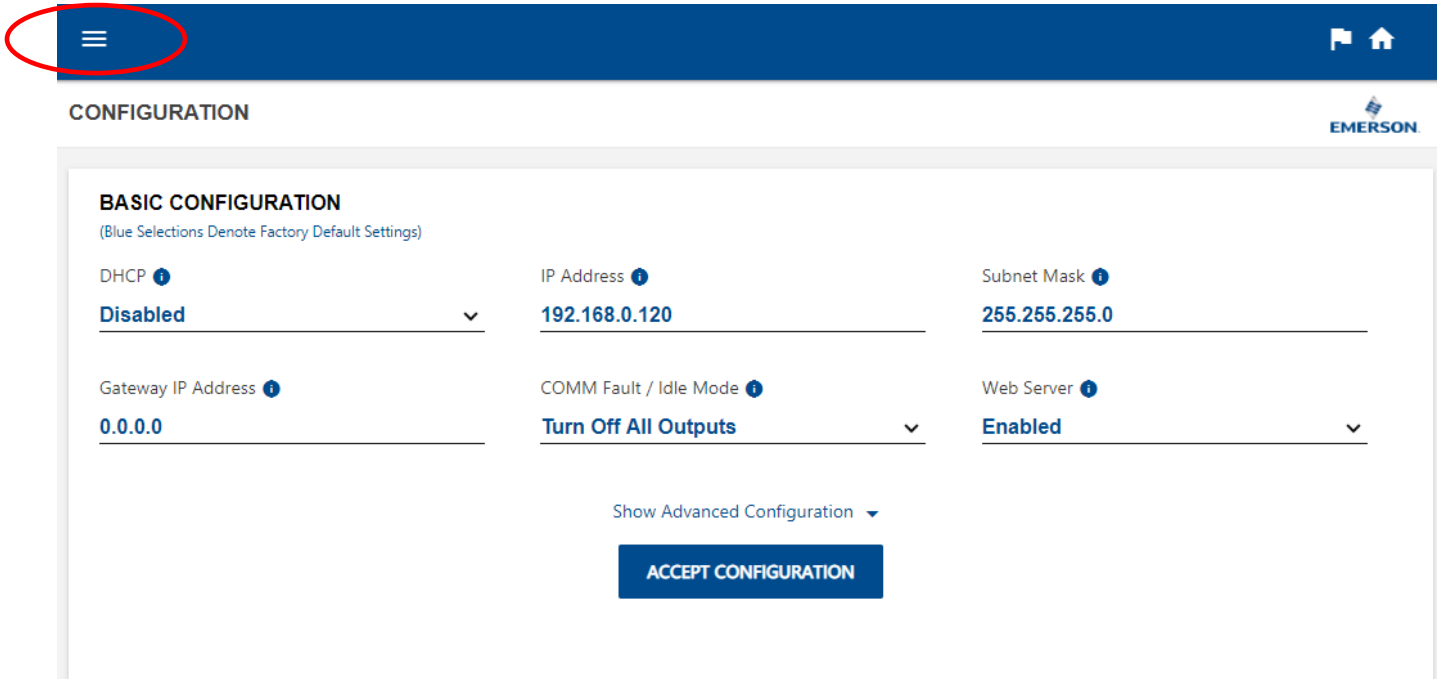

Select the menu options button to access the "DIAGNOSTICS" tab

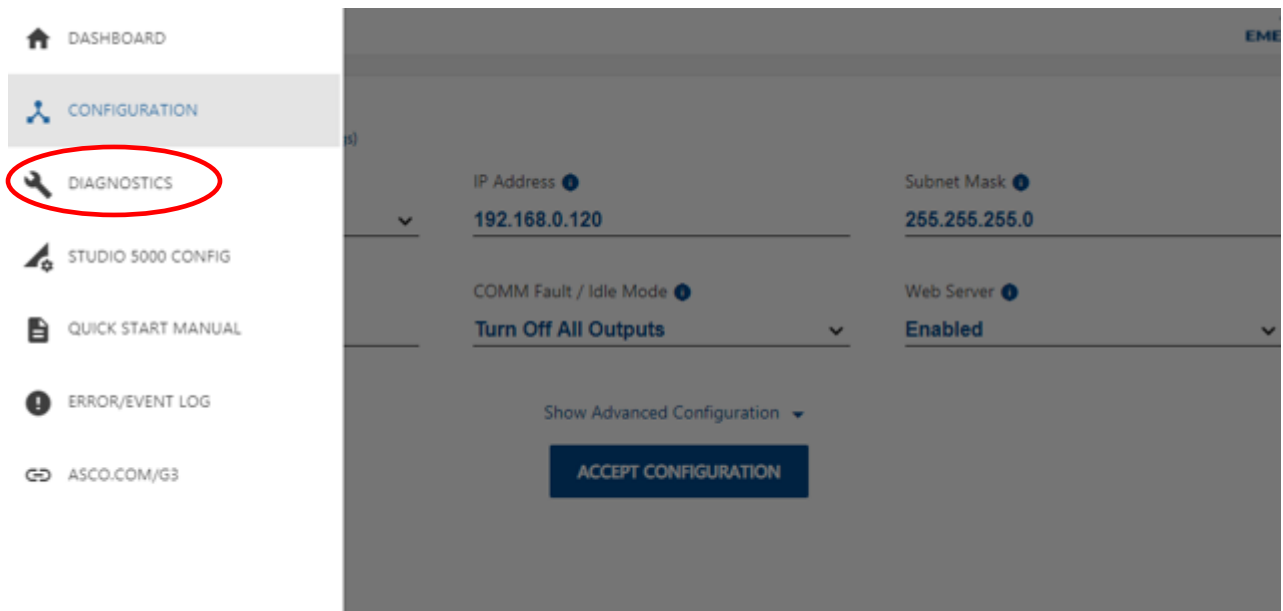

Select the "DIAGNOSTICS" tab for access to G3 manifold diagnostics

AVENTICS™ G3 Series EtherNet/IP™ DLR Technical Manual

Diagnostics

The G3 Diagnostics Webpage is displayed.

The screenshot displays the 'DIAGNOSTICS - CURRENT CONFIGURATION' webpage. The interface includes a navigation menu, a 'LOGOUT' button, and an 'EMERSON' logo. A toggle for 'Output Forcing' is visible. The main content area is divided into a left sidebar and a right main panel. The sidebar lists several modules, each with a small image and a green checkmark: 'Comm. Module', 'Valve Driver Module' (circled in red), 'Wireless ARM Clip', 'Module No. 01', 'HUB 01', and 'Branch 1- Module No. 02'. The main panel shows the configuration for the selected 'Comm. Module'. It includes a 'Comm. Module' header with an image and a green checkmark. Below this, the 'Comm Node' is identified as 'Part Number 240-325'. The configuration details are presented in a table-like format:

IP Address	Subnet Mask	Gateway IP Address
192.168.1.120	255.255.255.0	0.0.0.0

Active COMM Link Type	MAC Address	Node / Input Power
Port 0: 100 Mbps/Full Duplex Port 1: Link Down	00-15-24-00-ea-46	24.47 V

Below the table, there is a 'Show Advanced Information' dropdown menu and an 'ACCEPT' button. At the bottom of the page, a copyright notice reads: 'Copyright © 2019 Emerson Electric Co. All rights reserved. All trademarks, logos, and service marks are the property of their respective owners.'

Select the Valve Driver Module to display the coil diagnostic information

AVENTICS™ G3 Series EtherNet/IP™ DLR Technical Manual

The Valve Driver Module coil diagnostic information is displayed. Here you can turn on Output Forcing to test-fire valve coils and outputs.

DIAGNOSTICS - CURRENT CONFIGURATION

Output Forcing

EMERSON

Comm. Module 

Valve Driver Module 

Wireless ARM Clip 

Module No. 01 

HUB 01 

Branch 1- Module No. 02 

Valve Driver Module

50x Series Valve Driver Output Module

Part Number P599AES08827001

Show Valve Coils 0-31/Status

<input type="checkbox"/> 00	<input type="checkbox"/> 01	<input type="checkbox"/> 02	<input type="checkbox"/> 03	<input checked="" type="checkbox"/> 04	<input checked="" type="checkbox"/> 05	<input checked="" type="checkbox"/> 06	<input checked="" type="checkbox"/> 07
<input checked="" type="checkbox"/> 08	<input checked="" type="checkbox"/> 09	<input checked="" type="checkbox"/> 10	<input checked="" type="checkbox"/> 11	<input checked="" type="checkbox"/> 12	<input checked="" type="checkbox"/> 13	<input checked="" type="checkbox"/> 14	<input checked="" type="checkbox"/> 15
<input checked="" type="checkbox"/> 16	<input checked="" type="checkbox"/> 17	<input checked="" type="checkbox"/> 18	<input checked="" type="checkbox"/> 19	<input checked="" type="checkbox"/> 20	<input checked="" type="checkbox"/> 21	<input checked="" type="checkbox"/> 22	<input checked="" type="checkbox"/> 23
<input checked="" type="checkbox"/> 24	<input checked="" type="checkbox"/> 25	<input checked="" type="checkbox"/> 26	<input checked="" type="checkbox"/> 27	<input checked="" type="checkbox"/> 28	<input checked="" type="checkbox"/> 29	<input checked="" type="checkbox"/> 30	<input checked="" type="checkbox"/> 31

Force / Un-Force

● Shorted Coil

● Open Coil

✘ No Coil Detected

Show Advanced Information ▾

Copyright © 2019 Emerson Electric Co. All rights reserved.
All trademarks, logos, and service marks are the property of their respective owners.



• To force fire valves and/or other outputs you will need to turn on "Output Forcing" from the top of the page. Two Factor Authentication (2FA) will be required for safety.

AVENTICS™ G3 Series EtherNet/IP™ DLR Technical Manual

After selecting "Output Forcing" you will be prompted to authorize this feature via Two-Factor Authentication (2FA). To initiate Output Forcing, first click "SUBMIT REQUEST" to being 2FA.

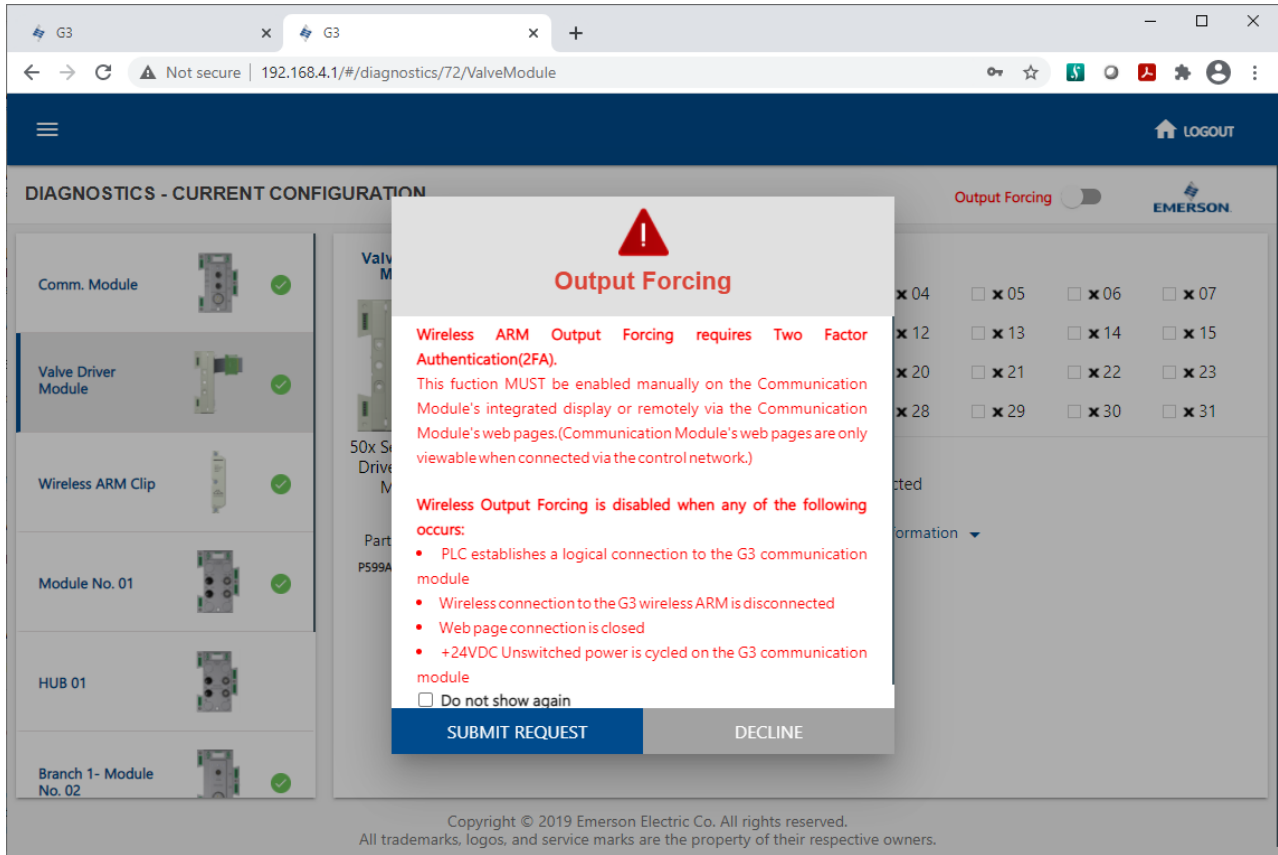

2FA can be completed directly from the Graphic Display on the G3 Communication Module, or through the embedded G3 Webserver. Note that to use the G3 Webserver option you will have to remain connected via WIFI to the ARM module AND be directly connected via Ethernet cable to the G3 Communication Module.

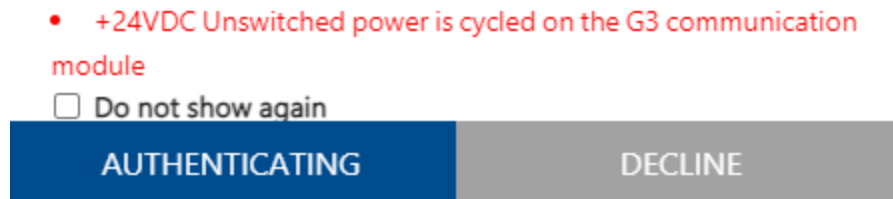

Once you click "Submit Request", the text will change to "AUTHENTICATING" until the second step of the 2FA has been complete either through the G3 Graphic Display or through the embedded G3 Webpage.

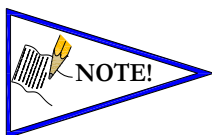

- For safety reasons only one WIFI connection with Output Forcing ON is permitted at a time.

Option 1 – Authentication via the G3 Graphic Display:

Once 2FA has been initiated through the Wireless ARM webpage, the Graphic Display on the G3 Communication Module will read "ENABLE WIFI OUTPUTS". To complete the 2FA process and enable output forcing, click the SET button on the module. The display will then flash the message "WIFI OUTPUTS ARE ENABLED" for several seconds.



Once "WIFI OUTPUTS ARE ENABLED" stops flashing the graphic display will show the option to "DISABLE WIFI OUTPUTS". To exit Output Forcing mode you may either press the SET button on the G3 Communication Module, or turn Output Forcing off using the Wireless ARM webpage.





Output Forcing

Wireless ARM Output Forcing requires Two Factor Authentication(2FA).
This function MUST be enabled manually on the Communication Module's integrated display or remotely via the Communication Module's web pages.(Communication Module's web pages are only viewable when connected via the control network.)

Wireless Output Forcing is disabled when any of the following occurs:

- PLC establishes a logical connection to the G3 communication module
- Wireless connection to the G3 wireless ARM is disconnected
- Web page connection is closed
- +24VDC Unswitched power is cycled on the G3 communication module

Do not show again

ACCEPTDECLINE

On the Wireless ARM webpage, the blue button text will now read "ACCEPT". Click this button to continue with Output Forcing turned on. Output Forcing will remain on until it is turned off via the Wireless ARM webpage or the G3 Graphic Display, or until the WIFI connection with the ARM is terminated.

AVENTICS™ G3 Series EtherNet/IP™ DLR Technical Manual

Option 2 – Authentication via the G3 Comm Module Webpage:

Once 2FA has been initiated through the Wireless ARM webpage, you can authorize the second phase of the authentication process via the G3 Node’s embedded webpage. To do so, first connect to the Comm Module via an Ethernet cable, and by entering the module’s IP Address into a web browser.

Once on the webpage, click the “Diagnostics” tab and locate the Wireless ARM in the module list. Click the box that is marked “Show Details” to see the full list of options.



Module	Part No.	Description	Details	Export Config and Log	Activity
Node	240-325	EtherNet/IP DLR/QC Communications Module	<input type="checkbox"/> Show Details		Close all Details ✓
Valve Driver	P599AE42518800x	50X Series Valve Driver Output Module	<input type="checkbox"/> Show Details		Close all Details ✓
ARM	240-382	Auto Recovery Module + Wireless Clip	<input checked="" type="checkbox"/> Show Details		Close all Details ✓
<div style="display: flex; align-items: flex-start;"> <div style="width: 15%; text-align: center;">  </div> <div style="width: 85%;"> <p>Firmware Revision: 2.014</p> <div style="border: 1px solid #ccc; padding: 5px; margin: 5px 0;"> <input type="button" value="Reset to factory defaults"/> <input checked="" type="button" value="Enable WIFI Outputs"/> </div> <p><input type="checkbox"/> Show I/O Mappings and Sizes</p> </div> </div>					
No. 1	240-311	4 Channel RTD Input	<input type="checkbox"/> Show Details		Close all Details ✓
Hub 1	240-326	Sub-Bus Hub Module	<input type="checkbox"/> Show Details		Close all Details ✓
→ Branch 1, Mod. No. 2	240-241	Sub-Bus Valve Driver	<input type="checkbox"/> Show Details		Close all Details ✓
No. 3	240-215	2 Inputs / 2 Outputs 4-20mA Analog M12 x 4	<input type="checkbox"/> Show Details		Close all Details ✓
No. 4	240-205	16 Inputs PNP Digital M12 x 8	<input type="checkbox"/> Show Details		Close all Details ✓
			<input type="checkbox"/> Show Error/Event Log		

To approve the authentication, click the button labeled “Enable WIFI Outputs”.

Output Forcing

Wireless ARM Output Forcing requires Two Factor Authentication(2FA).
This function **MUST** be enabled manually on the Communication Module's integrated display or remotely via the Communication Module's web pages.(Communication Module's web pages are only viewable when connected via the control network.)

Wireless Output Forcing is disabled when any of the following occurs:

- PLC establishes a logical connection to the G3 communication module
- Wireless connection to the G3 wireless ARM is disconnected
- Web page connection is closed
- +24VDC Unswitched power is cycled on the G3 communication module

Do not show again

ACCEPTDECLINE

On the Wireless ARM webpage the blue button text will now read "ACCEPT". Click this button to continue with Output Forcing turned on. Output Forcing will remain on until it is turned off via the Wireless ARM webpage or the G3 Graphic Display, or until the WIFI connection with the ARM is terminated.

AVENTICS™ G3 Series EtherNet/IP™ DLR Technical Manual

6.6 Returning Wireless ARM to Factory Defaults

To return the Wireless ARM to Factory Default settings, log into the G3 Communication Node embedded webserver (240-325 Ethernet/IP DLR or 240-240 Profinet node). To do this, disconnect the PLC communication from the node and connect a laptop computer via the node directly or through a switch. Set your laptop's IP Address to match the same first 3 octets of the node (i.e. 192.168.003.XXX), and the last octet to an address that is not the same as the node.

To access the webserver, type the IP Address of the node into any internet browser. From the Home page, select the "Diagnostics" tab from the top of the page. Locate the Wireless ARM in the module list and click "Show Details". The window will expand to show you more detail about the ARM. Click the "Reset to factory defaults" button.

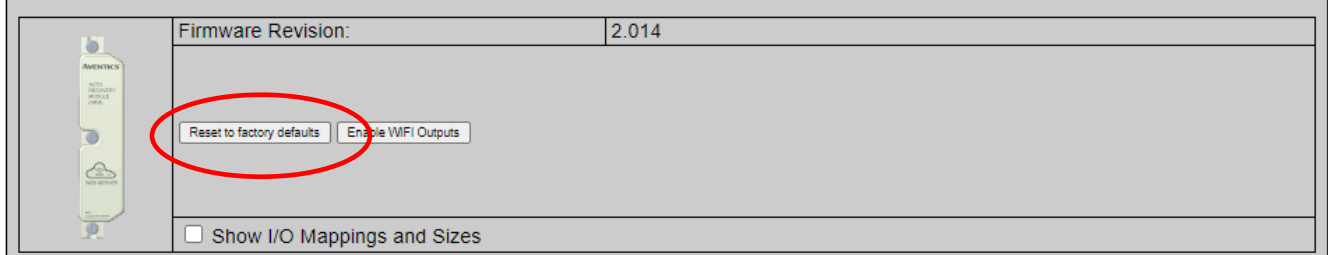

Module	Part No.	Description	Details	Activity
Node	240-325	EtherNet/IP DLR/QC Communications Module	<input type="checkbox"/> Show Details	Close all Details ✓
Valve Driver	P599AE42518800x	50X Series Valve Driver Output Module	<input type="checkbox"/> Show Details	Close all Details ✓
ARM	240-382	Auto Recovery Module + Wireless Clip	<input checked="" type="checkbox"/> Show Details	Close all Details ✓
<div style="border: 1px solid gray; padding: 5px;">  <p>Firmware Revision: 2.014</p> <p><input type="checkbox"/> Show I/O Mappings and Sizes</p> </div>				
No. 1	240-311	4 Channel RTD Input	<input type="checkbox"/> Show Details	Close all Details ✓
Hub 1	240-326	Sub-Bus Hub Module	<input type="checkbox"/> Show Details	Close all Details ✓
→ Branch 1, Mod. No. 2	240-241	Sub-Bus Valve Driver	<input type="checkbox"/> Show Details	Close all Details ✓
No. 3	240-215	2 Inputs / 2 Outputs 4-20mA Analog M12 x 4	<input type="checkbox"/> Show Details	Close all Details ✓
No. 4	240-205	16 Inputs PNP Digital M12 x 8	<input type="checkbox"/> Show Details	Close all Details ✓
			<input type="checkbox"/> Show Error/Event Log	

7. Distribution

Distribution of I/O capability can be easily achieved with the G3 platform by means of Sub-Bus modules. I/O modules, valve manifolds and/or a combination of both can be simply separated from the main manifold and distributed via a sub-bus communication cable. The G3 platform uses the same I/O modules on the main manifold as on the distribution chain. The main communication module can control up to 16 I/O modules either on the main manifold or as part of the sub-bus connections. To utilize the sub-bus distribution capabilities the Sub-Bus OUT module must be located on the end of the main communication manifold and a Terminator Module must be located at the last sub-bus component.

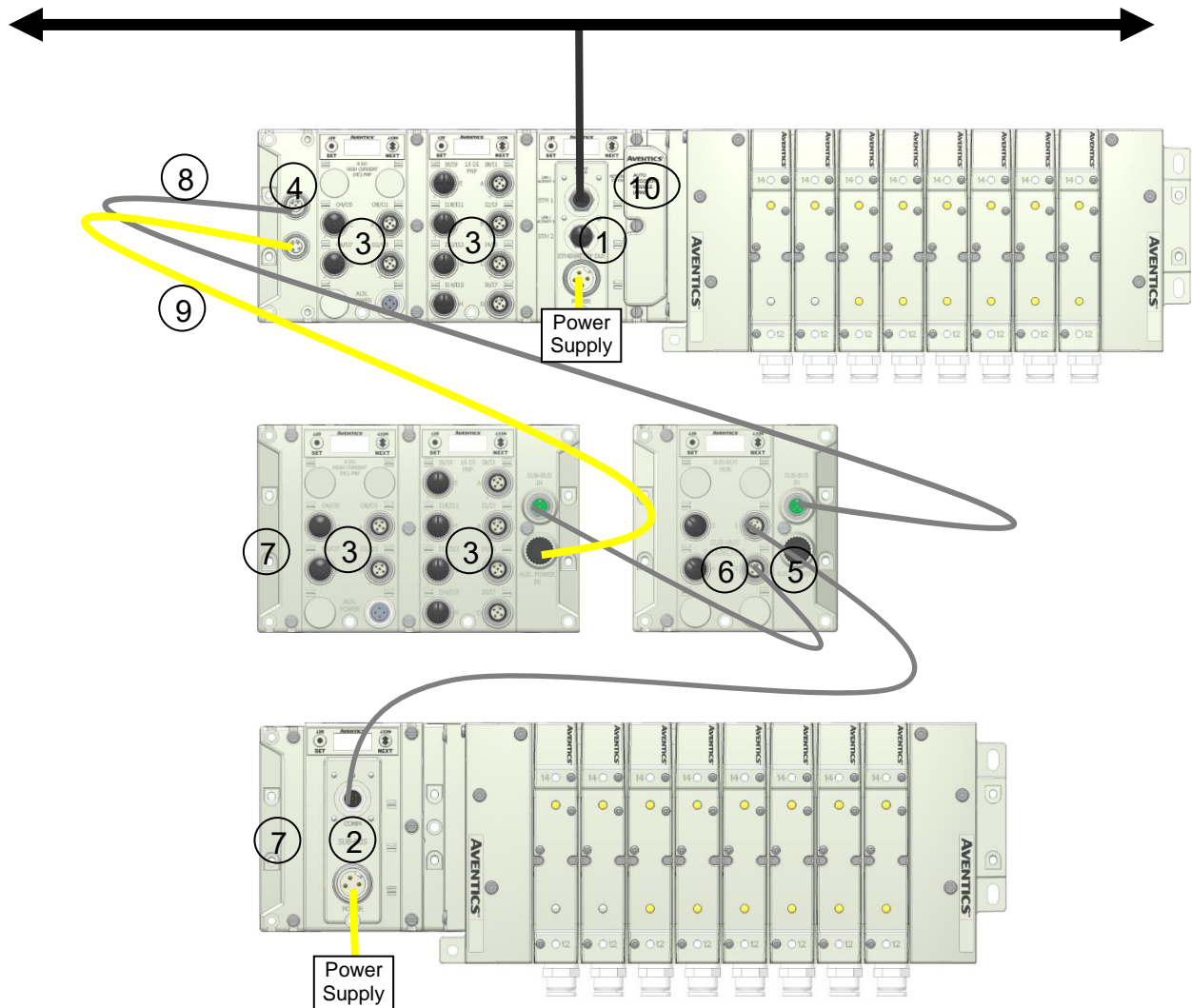

Detail No.	Description
1	Main Communication module (Node)
2	Distributed Sub-Bus Valve module
3	I/O Modules
4	Sub-Bus OUT module
5	Sub-Bus IN module
6	Sub-Bus HUB module
7	Terminator Module (Used to terminate sub-bus)
8	Sub-bus-Cable
9	Power Cable
10	Auto Recovery Module (ARM)

AVENTICS™ G3 Series EtherNet/IP™ DLR Technical Manual

7.1 Sub-Bus Distribution Modules

SUB-BUS OUT Module

- Used only when distributing the Sub-Bus to another assembly is required.
- SUB-BUS OUT - 5 pin M12 female communication connector.
 - Used to distribute the Sub-Bus to the next Sub-Bus assembly.
 - Carries 24 VDC power for electronics of the next module.
- AUX. POWER OUT - 4 pin M12 female aux. power connector.
 - Optional connection.
 - Used as a convenience way to distribute the power connection to the next Sub-Bus assembly.

Description	Replacement Part Number
Sub-Bus OUT module with Din Rail Mounting	240-244
Sub-Bus OUT module without Din Rail Mounting	240-183

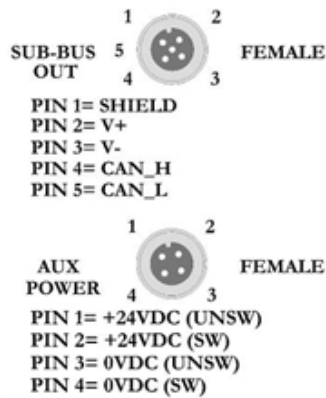
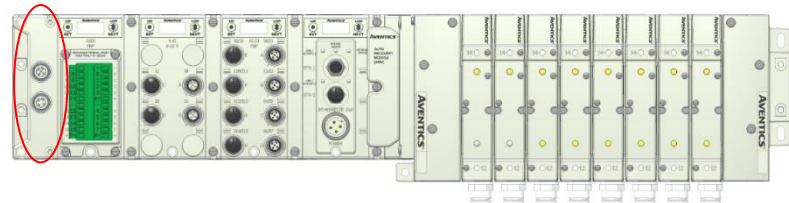
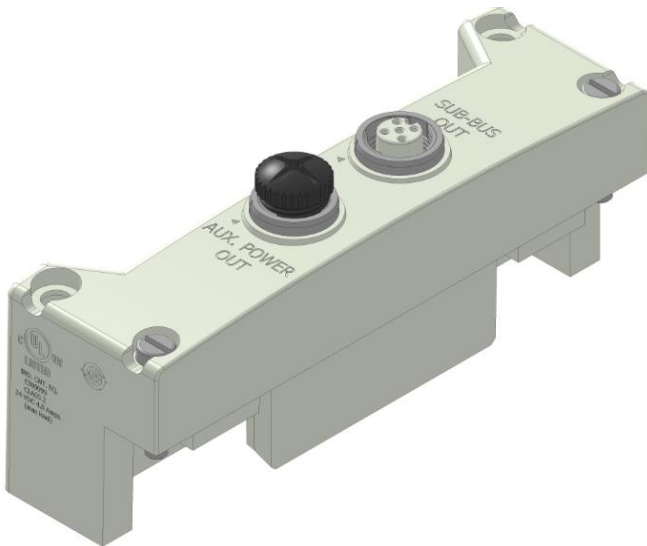

AVENTICS™ G3 Series EtherNet/IP™ DLR Technical Manual

SUB-BUS IN Modules

- Used to distribute I/O assemblies that do not have valves
 - Must be installed to the right of the I/O modules.
- SUB-BUS IN - 5 pin M12 male communication connector.
 - Must be connected to the Sub-Bus Out connector of the previous assembly
 - Carries 24 VDC power for electronics of module
- AUX. POWER IN - 4 pin M12 male connector.
 - Aux power is required for Output modules. This connection also allows Output power to be interrupted to all Output modules connected to this module.
 - Aux. Power is optional for Inputs. Power from the SUN-BUS IN connection is used to power sensors but can be augmented, if necessary, by adding additional power to this connector.

Description	Part Number
Sub-Bus IN module with Din Rail Mounting	240-246
Sub-Bus IN module without Din Rail Mounting	240-185

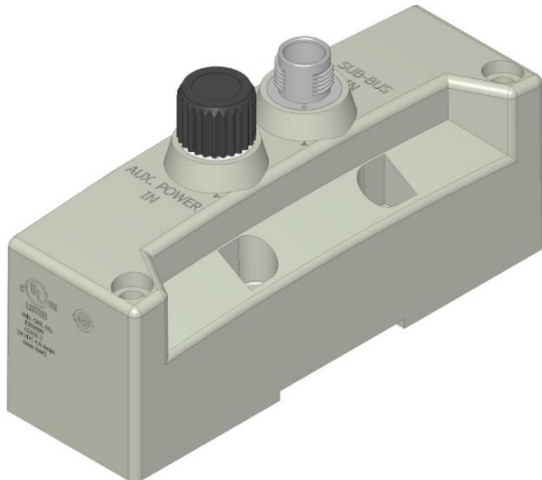

AVENTICS™ G3 Series EtherNet/IP™ DLR Technical Manual

Terminator Module

- Used to terminate SUB-BUS connections.
 - Must be installed on the left side of the last Sub-Bus module.

Description	Part Number
Terminator Module with Din Rail Mounting	240-245
Terminator Module without Din Rail Mounting	240-184

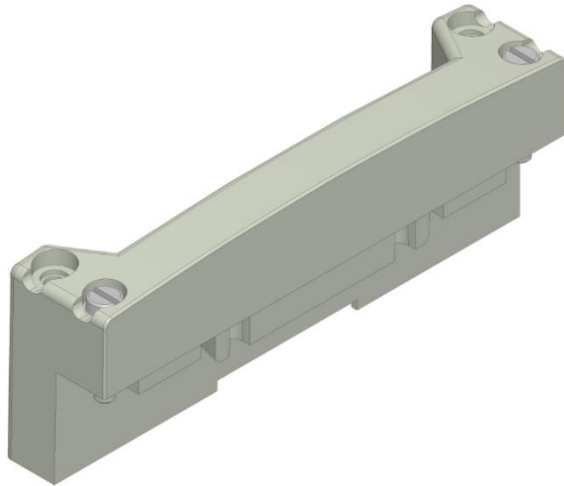

- The terminator must be installed in the G3 system for proper operation.

AVENTICS™ G3 Series EtherNet/IP™ DLR Technical Manual

Sub-Bus Valve Module

- COMM - 5 pin M12 male Sub-Bus input communication connector.
 - Must be connected to the SUB-BUS OUT connector of the previous assembly
 - Carries 24 VDC power for electronics of module
- POWER - 4 pin MINI male power connector.
 - Power is required for Outputs
- Used to distribute Valves on the Sub-Bus.
 - Can accept discrete I/O modules to allow a Sub-Bus Valve manifold with I/O

Description	Part Number
Sub-Bus Valve Module	240-241

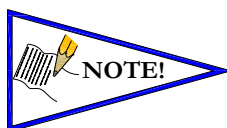
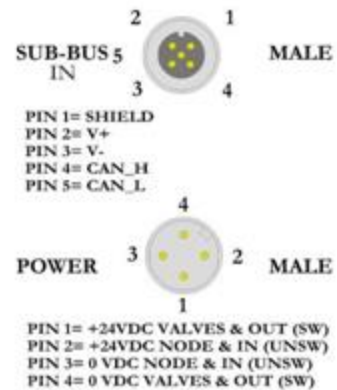
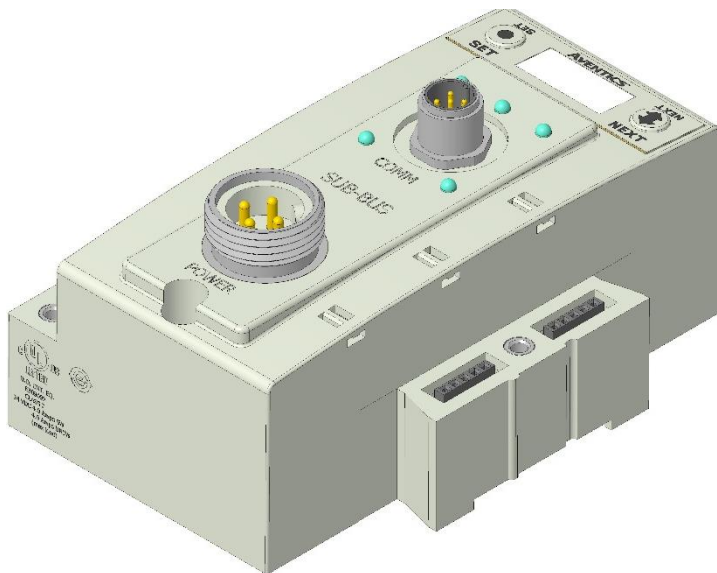

• The Sub-bus Valve Module drops 0.8 VDC across the module

AVENTICS™ G3 Series EtherNet/IP™ DLR Technical Manual

Sub-Bus Valve Module (without distribution and I/O)

- **COMM** - 5 pin M12 male Sub-Bus communication connector.
 - Must be connected to the SUB-BUS OUT connector of the previous assembly
 - Carries 24 VDC power for electronics of module
- **POWER** - 4 pin M12 male power connector.
 - Power is required for Outputs
- Used to distribute Valves on the Sub-Bus.
 - Does not allow connection to G3 I/O modules.

Description	Part Number
Sub-Bus Valve Module without I/O	P580AEDS4010A00

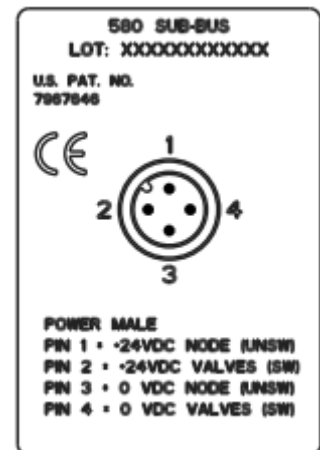
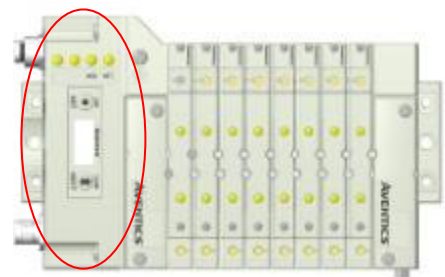
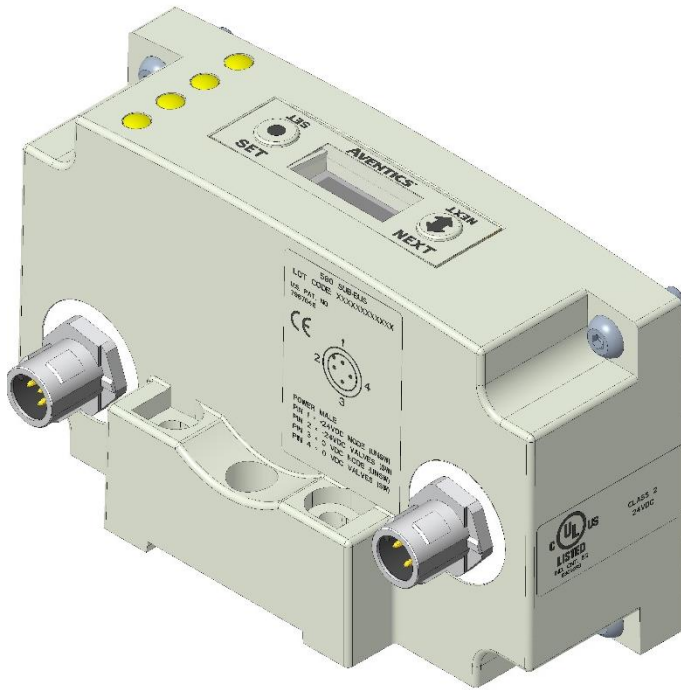

AVENTICS™ G3 Series EtherNet/IP™ DLR Technical Manual

Sub-Bus Hub Module

The G3 HUB module allows for branch distribution from the I/O side of the G3 System and can be integrated into the existing G3 Series Sub-Bus configuration. Auto Addressing allows for trouble free set up and configuration. Input, Output, as well as Valve manifolds can be attached to the available four Branches on a HUB module. Each G3 System can support up to two HUB modules, allowing for maximum flexibility. The HUB module is transparent to the I/O side of the G3 and does not reserve one of the potential sixteen positions.

- Used when distributing the Sub-Bus to another assembly.
- SUB-BUS OUT - 5 pin M12 female communication connector.
 - Used to distribute the Sub-Bus to the next Sub-Bus assembly.
 - Carries 24 VDC power (up to 3A) for electronics of the next module.
- Cannot connect a Hub to a branch of another Hub
- Each branch of the Hub can accommodate a sub-bus cable length of 30 meters.

Description	Part Number
Sub-Bus Hub Module	240-326

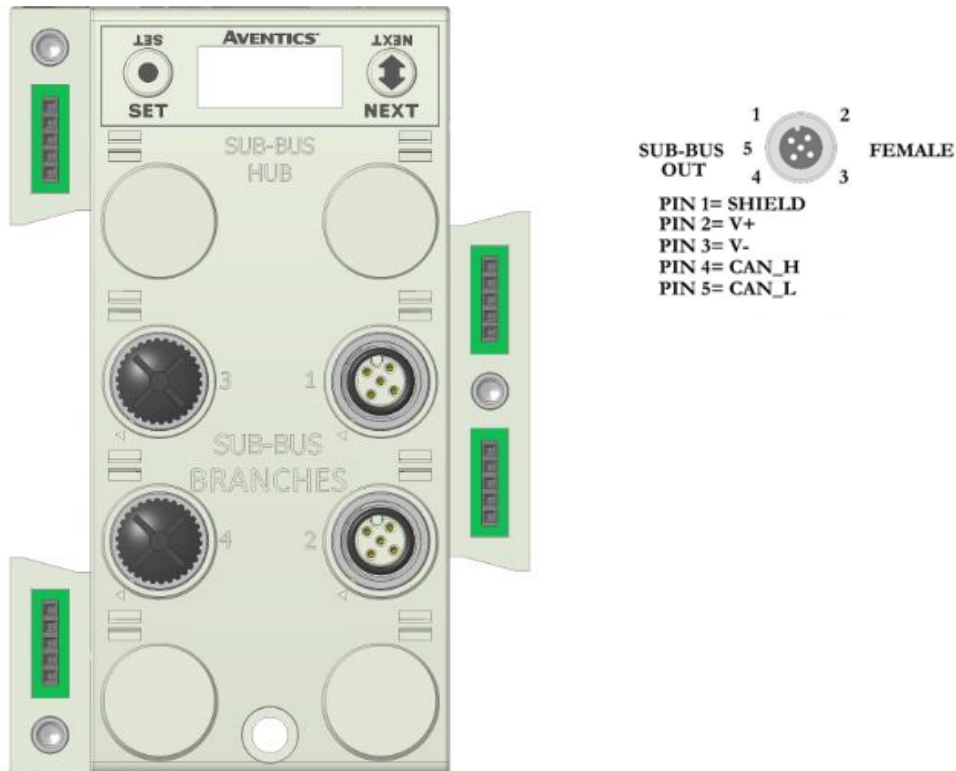

7.2 Sub-Bus Cables



M12 STRAIGHT 5 PIN MALE TO FEMALE SUB-BUS CABLE - SHIELDED

TA0501MGDTC0571P – 1 Meter

TA0505MGDTC0571P – 5 Meter

TA0510MGDTC0571P – 10 Meter



M12 STRAIGHT 5 PIN FEMALE FIELD WIREABLE CONNECTOR, SPRING CAGE

TC05F200000071V – PG9



M12 STRAIGHT 5 PIN MALE FIELD WIREABLE CONNECTOR, SPRING CAGE

TA05F200000071V – PG9



M12 90° 5 PIN FEMALE FIELD WIREABLE CONNECTOR, SPRING CAGE

TD05F200000071V – PG9



M12 90° 5 PIN MALE FIELD WIREABLE CONNECTOR, SPRING CAGE

TB05F200000071V – PG9



BULK SUB-BUS CABLE

*NOTE

000550MGD0005000 – 50 Meter Length

0005A0MGD0005000 – 100 Meter Length

* Note:

Length of field wired cables should not exceed the maximum length of 30 meters for total sub-bus communications link. See appropriate technical manual for sub-bus length requirements. The cable assemblies and Bulk cable are the only approved cables for the G3 Sub-Bus link. See technical document TDG3SBWD1-0EN for proper installation and wiring of field wireable connectors.

Technical Data

TECHNICAL DATA	CABLE	CONNECTORS	BULK CABLE
Molded Body / Insert	TPU	Zinc - Nickel Plated	N/A
Coupling Nut	Zinc - Nickel Plated	Brass - Nickel Plated	N/A
Cable Jacket Material	PUR	N/A	Gray RAL 7001
Cable O.D.	6.70 mm	N/A	6.70 mm
Voltage Rating (Nominal)	60 Volts	60 Volts	60 Volts
Current Rating	4.0 Amps	4.0 Amps	4.0 Amps
Degree of Protection	IP65 (mated)	IP65 (mated)	IP65 (terminated)
Operating Temperature	-40° C - 80° C	-40° C - 80° C	-20° C - 75° C
Conductor Gauge	24 AWG Signal 22 AWG Power	26-20 AWG	24 AWG Signal 22 AWG Power
Bend Radius	67 mm	N/A	67 mm
No. of Bending Cycles	5 Million	N/A	5 Million

G3 Sub-Bus Field Wiring Directions

The purpose of this document is to instruct the end user of the proper wiring techniques required to make a G3 Sub-Bus cable from the available bulk cable and field wireable ends. The effectiveness of the resultant assembly remains on the end user and may have bearing on the proper functionality of the G3 Sub-Bus operation; please follow the manufacturer's Cable Assembly Procedure properly.



Cable Assembly Procedure

- Step #1 Cut cable to desired length.
- Step #2 Run cable through Pressure Nut and Housing.
- Step #3 Strip cable jacket back 28mm (1.10") for straight connectors and 35mm (1.38") for 90° connectors.
- Step #4 Remove shielding from end of wires back approximately 16mm (.630").
- Step #5 Apply shielding foil provided, around the shortened end of the shielding.
- Step #6 Strip individual conductors back approximately 11mm (.433").
- Step #7 Push stranded wires into appropriate colored terminal.
- Step #8 Attach the connector body onto the housing and tighten.
- Step #9 Attach the pressure nut on the back side and tighten
- Step #10 Confirm Continuity between all pins.

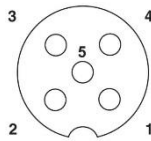

- 1 = Shield Wire (must be connected)
- 2 = Red
- 3 = Black
- 4 = White
- 5 = Blue

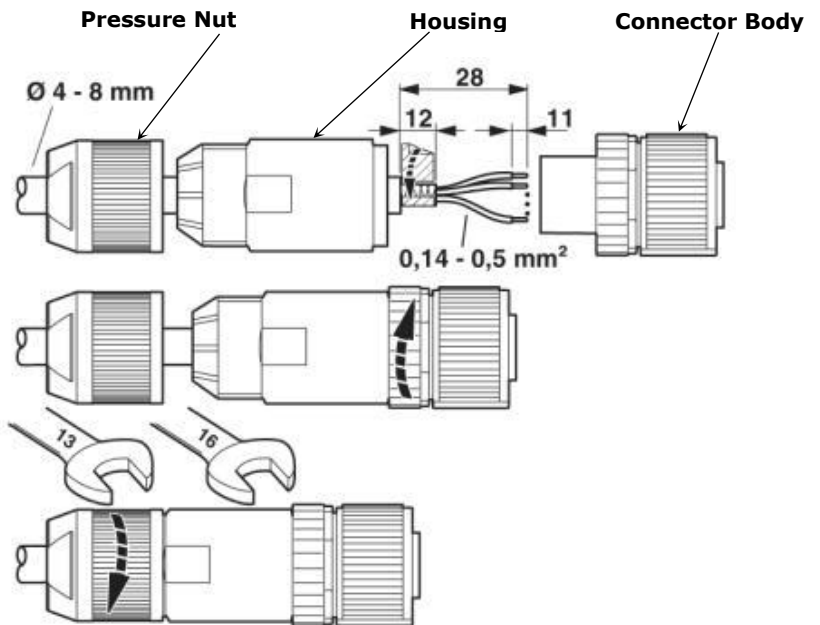
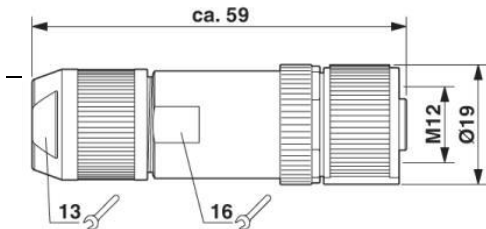

8. Digital I/O Module

8.1 Digital I/O Module Usage

The maximum number of modules that can be used on the Discrete I/O side of the manifold is 16. These modules can be centralized on the main fieldbus manifold, distributed or a combination of both. Modules can be connected in any combination of inputs, outputs and specialty up to the physical limitation of 16 modules.

Input Module Types

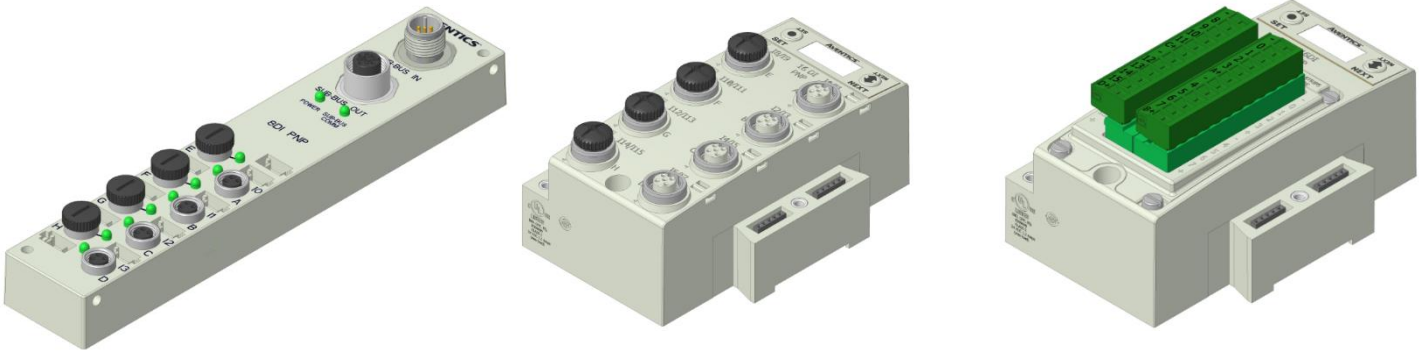

Output Module Types

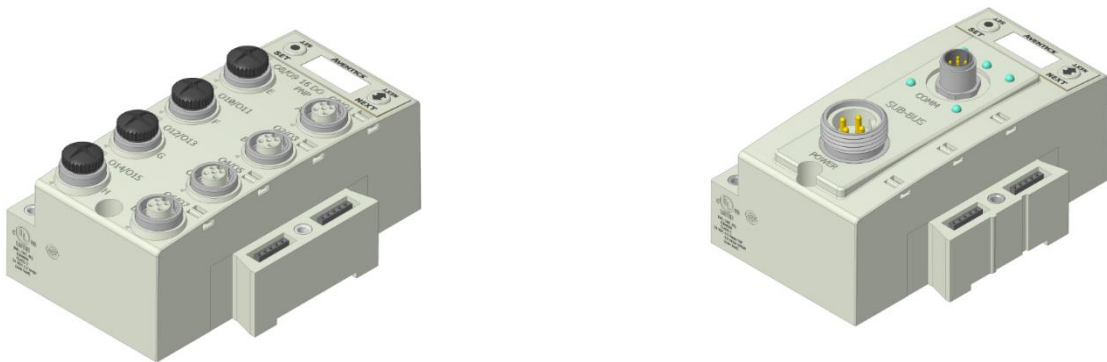

Input/Output Module Types

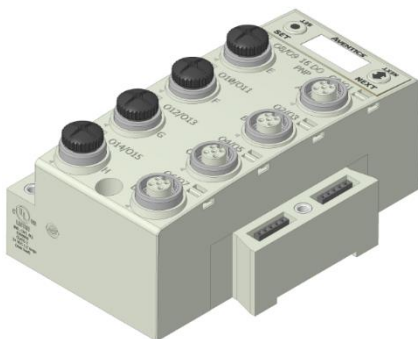

Valve Side Output Module Types



AVENTICS™ G3 Series EtherNet/IP™ DLR Technical Manual

8.2 I/O Module Technical Data

Module No.	Description	Connector Type	Current Limitation for Module	Current Limitation for connector	Current Limitation for manifold assy.
240-203	16 PNP Inputs	Terminal Strip	1.2A	.30A for each +24VDC terminal	4A for +24 Valves and Outputs 4A for +24 Node and Inputs
240-204	16 NPN Inputs				
240-379	8 PNP Inputs	M8		.15A (Pin 1 to Pin 3)	
240-205	16 PNP Inputs	M12		.50A (Pin 3 to Pin 2/4)	
240-206	8 PNP Inputs				
240-207	16 PNP Outputs				
240-208	8 PNP Outputs				
240-209	16 NPN Inputs				
240-210	8 NPN Inputs				
240-211	8 PNP Input and 8 PNP Outputs				
240-212	Analog IO modules	M12	.15A (Pin 1 to Pin 3)		
240-213					
240-214					
240-215					
240-300	8 High Current Outputs	Terminal Strip	8A (From Aux. Power Conn.)	2.0A / output connector (1.0A Pin 3 to Pin 2) (1.0A Pin 3 to Pin 4)	N/A
240-307	2 Analog Inputs and 2 High Current Analog Voltage Outputs		4A (From Aux. Power Conn.)	2.0A (Pin 3 to Pin 4)	N/A
240-311	RTD		N/A	N/A	4A for +24 Valves and Outputs 4A for +24 Node and Inputs
240-316	8 PNP Inputs	Terminal Strip	1.2A	.30A for each +24VDC terminal	4A for +24 Node and Inputs
240-323	16 PNP Inputs				
240-330	16 PNP Outputs				
240-363	4 Analog Inputs and 4 High Current Analog Outputs	M12	8A (From Aux. Power Conn.)	2.0A (Pin 1 to Pin 3)	N/A
240-379	8 PNP Inputs	M8	1.2A	.15A (Pin 1 to Pin 3)	4A for +24 Node and Inputs

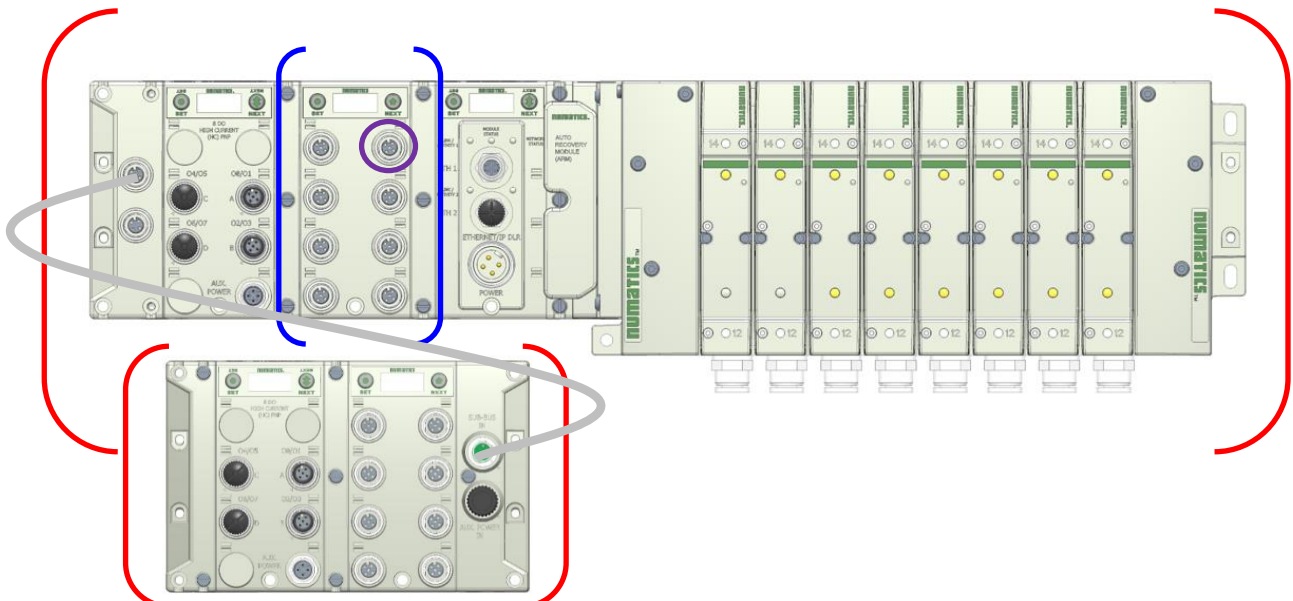

TDG3EDM1-11EN 4/21
Subject to change without notice

AVENTICS™ G3 Series EtherNet/IP™ DLR Technical Manual

8.3 I/O Module Descriptions and Menus

Detail No.	Description
1	"Set" Button – used to navigate through user menus and set parameters
2	Module Function (I/O Type)
3	Alignment arrow for SPEEDCON connector
4	Bit Designation for I/O
5	"Next" Button – used to navigate through user menus and set parameters
6	Graphic Display
7	5 Pin M12 female I/O connector
8	Connector designation
9	Metal threads for SPEEDCON connector
10	Slot for text ID tags
11	Dust Cover
12	Mounting hole

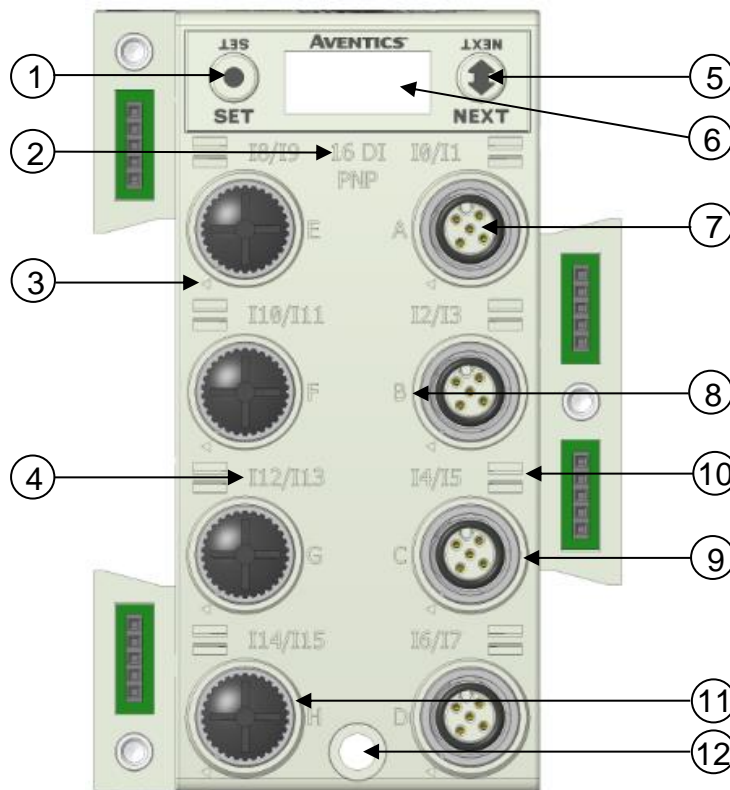

NOTE All dust covers must be tightened to a torque of 4-6 in. lbs. to maintain the IP65 integrity.

AVENTICS™ G3 Series EtherNet/IP™ DLR Technical Manual

8.4 Digital Input Modules

One Digital Input per Connector – M8 Female Modules

Module Part No.	I/O Type	Short Circuit Protection	Short Circuit Protection Status Bits	Input Points
240-379	PNP (Sourcing)	YES – Visual	YES – Optional	8

Input Mapping								
BYTE	Bit 7	Bit 6	Bit 5	Bit 4	Bit 3	Bit 2	Bit 1	Bit 0
X (Required)	Input 7	Input 6	Input 5	Input 4	Input 3	Input 2	Input 1	Input 0
Diagnostics								
X (Selectable)	Conn. H SCP Status	Conn. G SCP Status	Conn. F SCP Status	Conn. E SCP Status	Conn. D SCP Status	Conn. C SCP Status	Conn. B SCP Status	Conn. A SCP Status

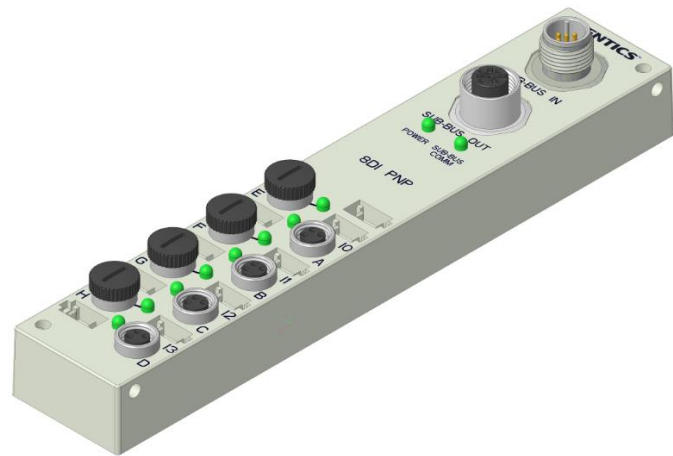

FEMALE

PIN 1= +24VDC (UNSW)
 PIN 3= 0VDC (UNSW)
 PIN 4= INPUT

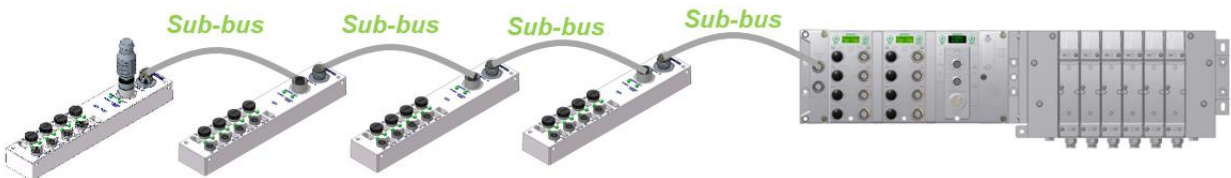

An external terminating resistor, p/n: TA05TR000000000, is required when the 240-379 is the last I/O module on the sub-bus.

AVENTICS™ G3 Series EtherNet/IP™ DLR Technical Manual

One Digital Input per Connector – M12 Female Modules

Module Part No.	I/O Type	Short Circuit Protection	Short Circuit Protection Status Bits	Input Points
240-210	NPN (Sinking)	YES – Visual	YES – Optional	8
240-206	PNP (Sourcing)			

Input Mapping								
BYTE	Bit 7	Bit 6	Bit 5	Bit 4	Bit 3	Bit 2	Bit 1	Bit 0
X (Required)	Input 7	Input 6	Input 5	Input 4	Input 3	Input 2	Input 1	Input 0
Diagnostics								
X (Selectable)	Conn. H SCP Status	Conn. G SCP Status	Conn. F SCP Status	Conn. E SCP Status	Conn. D SCP Status	Conn. C SCP Status	Conn. B SCP Status	Conn. A SCP Status

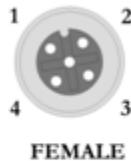
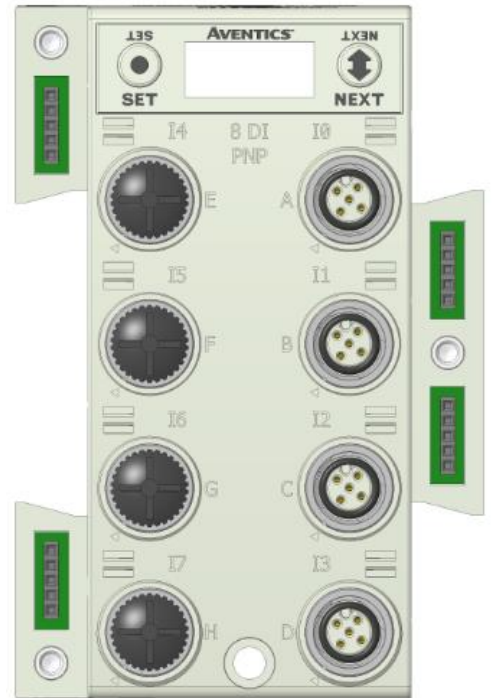
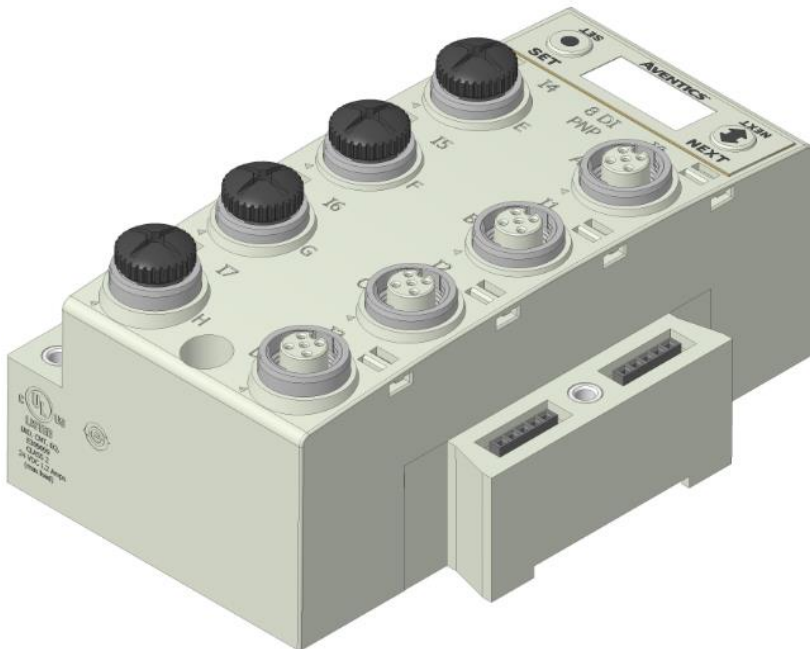

PIN 1= +24VDC (UNSW)
 PIN 2= NOT USED
 PIN 3= 0VDC (UNSW)
 PIN 4= INPUT 1

AVENTICS™ G3 Series EtherNet/IP™ DLR Technical Manual

Two Digital Inputs per Connector – M12 Female Modules

Module Part No.	I/O Type	Short Circuit Protection	Short Circuit Protection Status Bits	Input Points
240-209	NPN (Sinking)	YES – Visual	YES – Optional	16
240-205	PNP (Sourcing)			

Input Mapping								
BYTE	Bit 7	Bit 6	Bit 5	Bit 4	Bit 3	Bit 2	Bit 1	Bit 0
X (Required)	Input 7	Input 6	Input 5	Input 4	Input 3	Input 2	Input 1	Input 0
X+1 (Required)	Input 15	Input 14	Input 13	Input 12	Input 11	Input 10	Input 9	Input 8

Diagnostics								
X (Selectable)	Conn. H SCP Status	Conn. G SCP Status	Conn. F SCP Status	Conn. E SCP Status	Conn. D SCP Status	Conn. C SCP Status	Conn. B SCP Status	Conn. A SCP Status

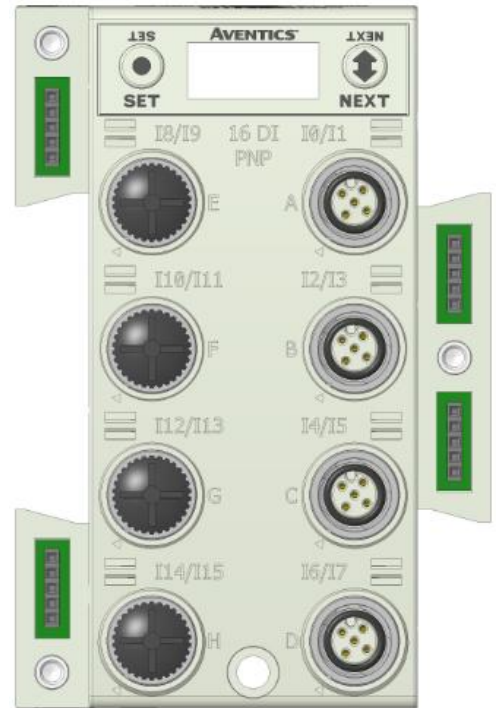
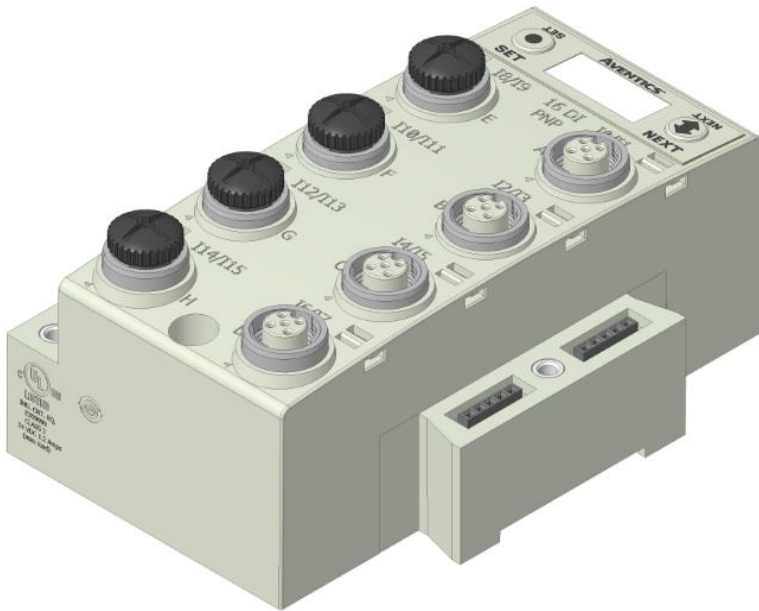

PIN 1= +24VDC (UNSW)
 PIN 2= INPUT 2
 PIN 3= 0VDC (UNSW)
 PIN 4= INPUT 1

AVENTICS™ G3 Series EtherNet/IP™ DLR Technical Manual

Sixteen Digital Inputs – Terminal Strip Modules

Specifications

- Wire Range: 12 to 24 AWG
- Strip Length: 7mm
- Tightening Torque: 0.5 Nm

Module Part No.	I/O Type	Short Circuit Protection	Short Circuit Protection Status Bits	Input Points
240-203	PNP (Sourcing)	YES Visual and Logical Status Bits	4 user enabled bits monitor Short Circuits on the four different + voltage connections of terminal strip	16
240-204	NPN (Sinking)			

Input Mapping								
BYTE	Bit 7	Bit 6	Bit 5	Bit 4	Bit 3	Bit 2	Bit 1	Bit 0
X (Required)	Input 7	Input 6	Input 5	Input 4	Input 3	Input 2	Input 1	Input 0
X+1 (Required)	Input 15	Input 14	Input 13	Input 12	Input 11	Input 10	Input 9	Input 8
Diagnostics								
X	Allocated and Reserved	Allocated and Reserved	Allocated and Reserved	Allocated and Reserved	SCP Status 1 = Fault +D	SCP Status 1 = Fault +C	SCP Status 1 = Fault +B	SCP Status 1 = Fault +A

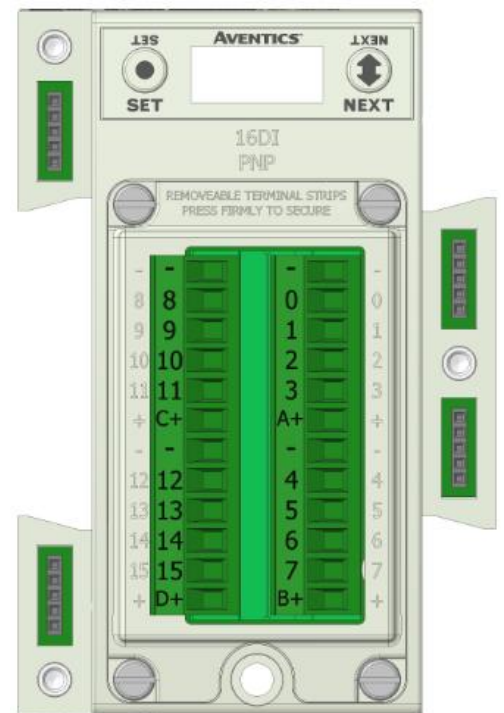
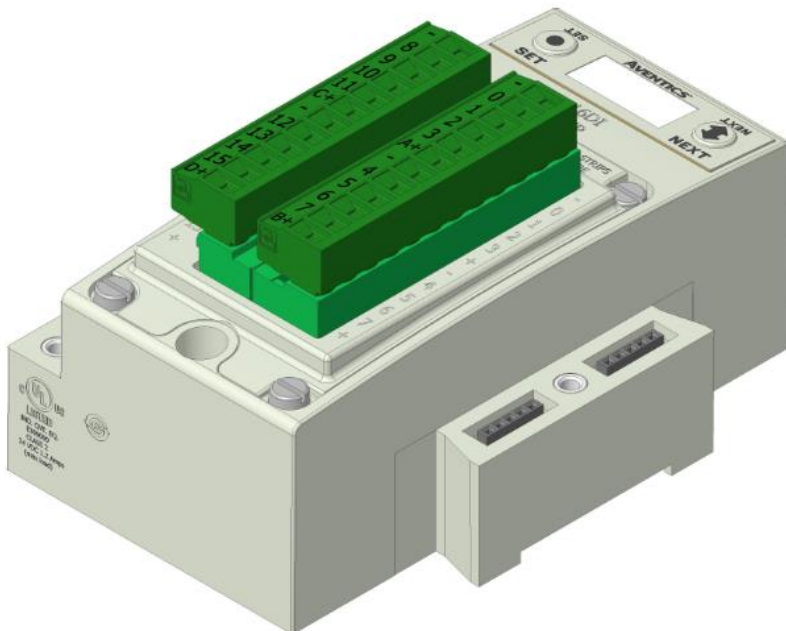

AVENTICS™ G3 Series EtherNet/IP™ DLR Technical Manual

Eight Digital Inputs – Terminal Strip Modules

Specifications

- Wire Range: 12 to 24 AWG
- Strip Length: 7mm
- Tightening Torque: 0.5 Nm

Module Part No.	I/O Type	Short Circuit Protection	Short Circuit Protection Status Bits	Input Points
240-316	PNP (Sourcing)	YES	YES	8

Input Mapping								
BYTE	Bit 7	Bit 6	Bit 5	Bit 4	Bit 3	Bit 2	Bit 1	Bit 0
X	Input 7	Input 6	Input 5	Input 4	Input 3	Input 2	Input 1	Input 0
Diagnostic Telegram								
BYTE	Bit 7	Bit 6	Bit 5	Bit 4	Bit 3	Bit 2	Bit 1	Bit 0
X (Selectable)	Input 7 SCP Status	Input 6 SCP Status	Input 5 SCP Status	Input 4 SCP Status	Input 3 SCP Status	Input 2 SCP Status	Input 1 SCP Status	Input 0 SCP Status

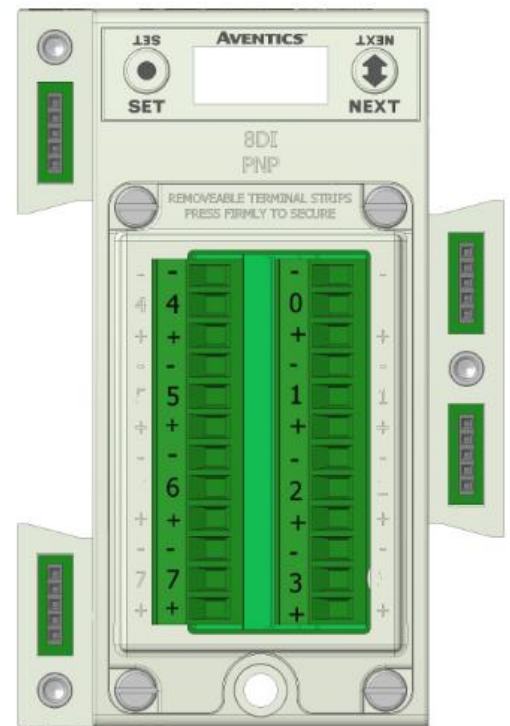
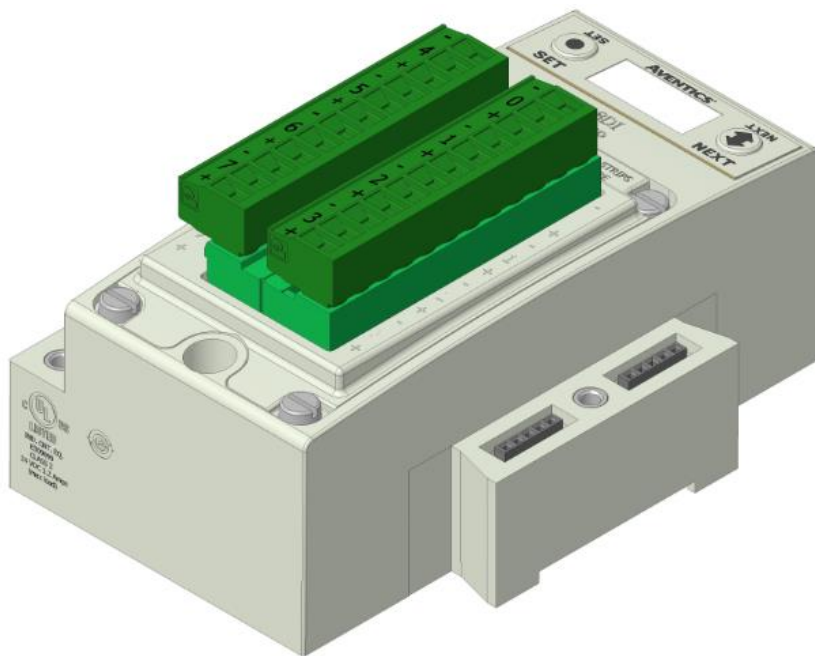

AVENTICS™ G3 Series EtherNet/IP™ DLR Technical Manual

Intrinsically safe [Ex ia] NAMUR Compatible Input Module

One Digital Input per Connector – M12 Female

Input module is for use with NAMUR certified intrinsically safe (IS) sensors. The module can be placed in any G3 I/O position available, but must be used in conjunction with appropriate clips with partition plates (see picture on page 84). This module is for use with (IS) sensors (certified to EN 60947-5-6) where the sensor is placed within the hazardous area, (e.g. ATEX 0-20, 1-21, and 2-22). This [Ex ia] module is part of the G3 electronics platform, which is designed to reside outside of the hazardous environment or in Zone 2-22, inside of a cabinet with appropriate ingress protection. The partition plate clips, used between standard G3 modules and [Ex ia] modules, are required to maintain ATEX approval. The 8.2 V sensor supply for each input connector is short circuit protected.

Part Numbers and Mapping

Module Part No.	I/O Type	Short Circuit /Open Circuit Protection	Short Circuit /Open Circuit Present Status Bits	Input Points
240-320	NAMUR	YES - Visual	YES - Optional	8

Input Mapping								
BYTE	Bit 7	Bit 6	Bit 5	Bit 4	Bit 3	Bit 2	Bit 1	Bit 0
X (Required)	Input 7	Input 6	Input 5	Input 4	Input 3	Input 2	Input 1	Input 0
X	Conn. H SC Status	Conn. G SC Status	Conn. F SC Status	Conn. E SC Status	Conn. D SC Status	Conn. C SC Status	Conn. B SC Status	Conn. A SC Status
X + 1	Conn. H Open Status	Conn. G Open Status	Conn. F Open Status	Conn. E Open Status	Conn. D Open Status	Conn. C Open Status	Conn. B Open Status	Conn. A Open Status

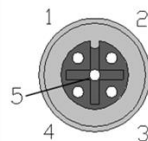
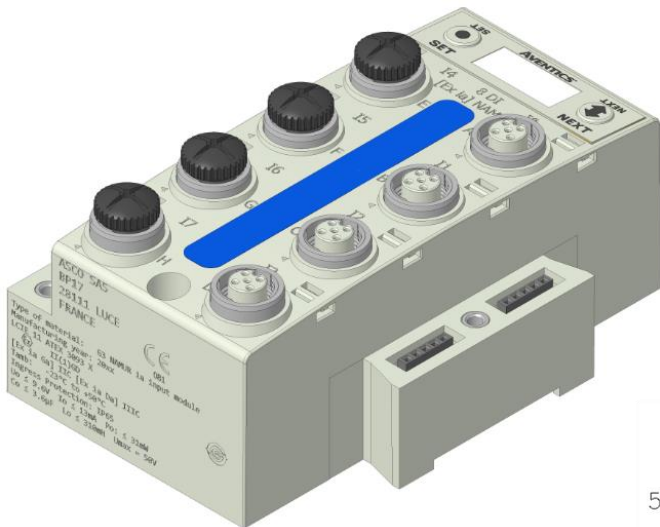

FEMALE
 PIN 1 = SENSOR +
 PIN 2 = SENSOR -
 PIN 3 = Not Connected
 PIN 4 = Not Connected
 PIN 5 = Not Connected

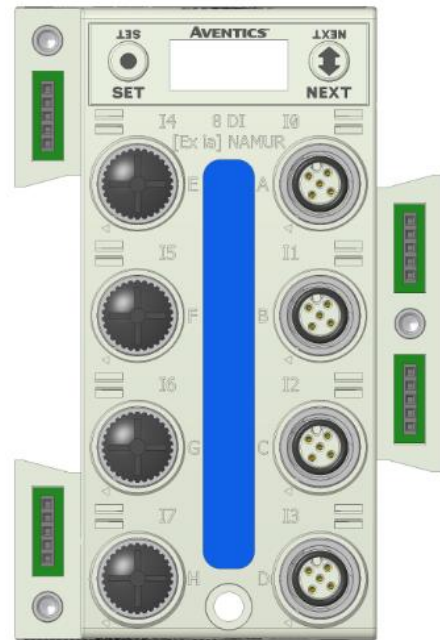

AVENTICS™ G3 Series EtherNet/IP™ DLR Technical Manual

Intrinsically safe [Ex ia] NAMUR Compatible Input terminal strip module

Module Part No.	I/O Type	Short Circuit /Open Circuit Protection	Short Circuit /Open Circuit Present Status Bits	Input Points
240-322	NAMUR	YES - Visual	YES - Optional	8

Input Mapping								
BYTE	Bit 7	Bit 6	Bit 5	Bit 4	Bit 3	Bit 2	Bit 1	Bit 0
X (Required)	Input 7	Input 6	Input 5	Input 4	Input 3	Input 2	Input 1	Input 0
X	Conn. H SC Status	Conn. G SC Status	Conn. F SC Status	Conn. E SC Status	Conn. D SC Status	Conn. C SC Status	Conn. B SC Status	Conn. A SC Status
X + 1	Conn. H Open Status	Conn. G Open Status	Conn. F Open Status	Conn. E Open Status	Conn. D Open Status	Conn. C Open Status	Conn. B Open Status	Conn. A Open Status

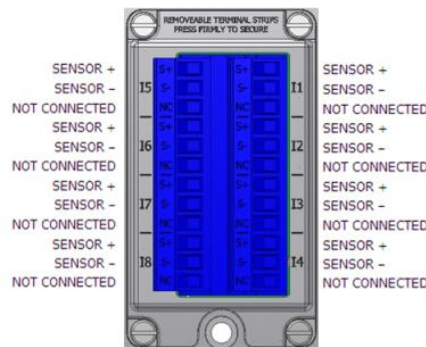
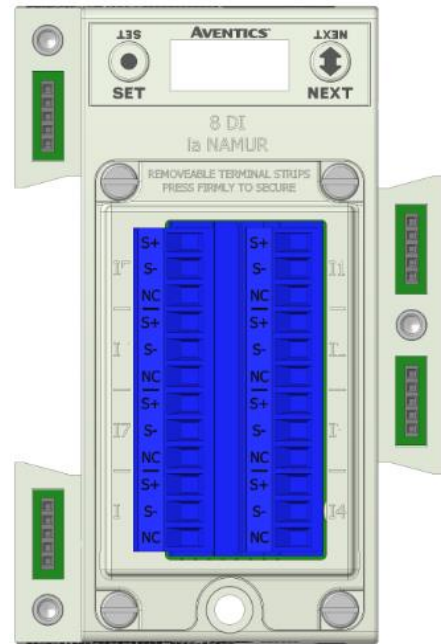
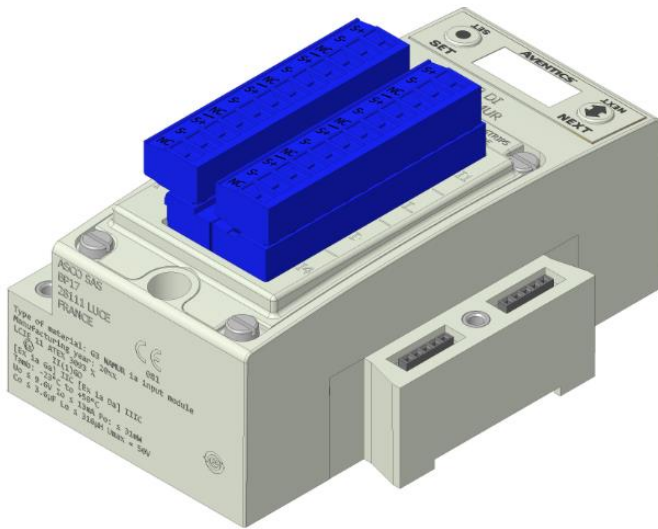

AVENTICS™ G3 Series EtherNet/IP™ DLR Technical Manual

Intrinsically safe [Ex ia] Support Modules

Mechanical isolation between standard and [Ex ia] modules is mandatory to fulfill ATEX certification. Clips with Partition Plates are available to achieve the required isolation.

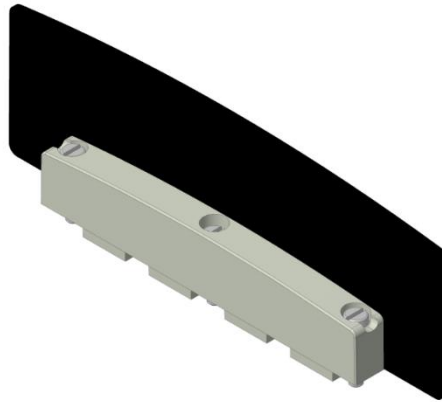

G3 [Ex ia] Clip 240-317

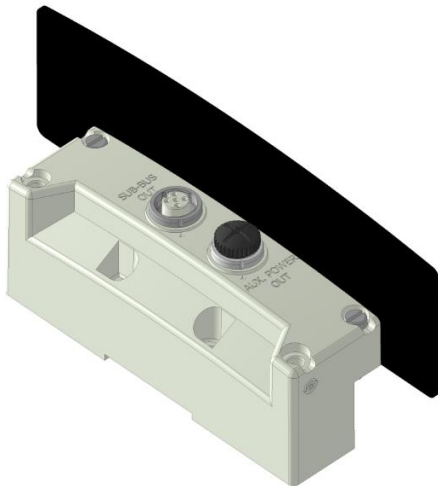

G3 [Ex ia] Sub-Bus Out 240-318

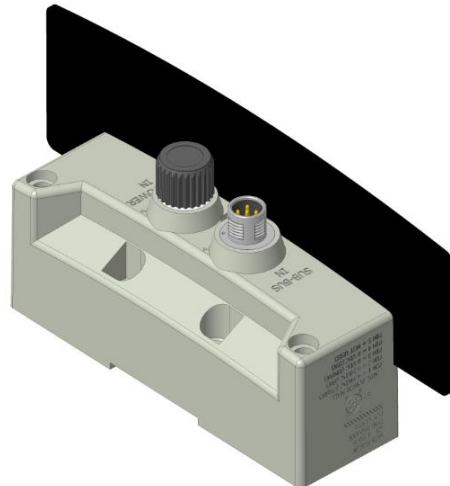

G3 [Ex ia] Sub-Bus In 240-319

AVENTICS™ G3 Series EtherNet/IP™ DLR Technical Manual

19 Pin M23 Input Module

The 19 Pin M23 Input module is for use with any Input block available from Phoenix Contact, Turck, Brad Harrison, etc. It can also be used with a single ended 19 Pin Cable.

Part Numbers and Mapping

Module Part No.	I/O Type	Short Circuit /Open Circuit Protection	Short Circuit /Open Circuit Present Status Bits	Input Points
240-323	Digital	YES - Visual	YES - Optional	16

Input Mapping								
BYTE	Bit 7	Bit 6	Bit 5	Bit 4	Bit 3	Bit 2	Bit 1	Bit 0
X (Required)	Input 7	Input 6	Input 5	Input 4	Input 3	Input 2	Input 1	Input 0
X	Input 15	Input 14	Input 13	Input 12	Input 11	Input 10	Input 9	Input 8
X + 1	Short Circuit	Short Circuit	Short Circuit	Short Circuit	Short Circuit	Short Circuit	Short Circuit	Short Circuit

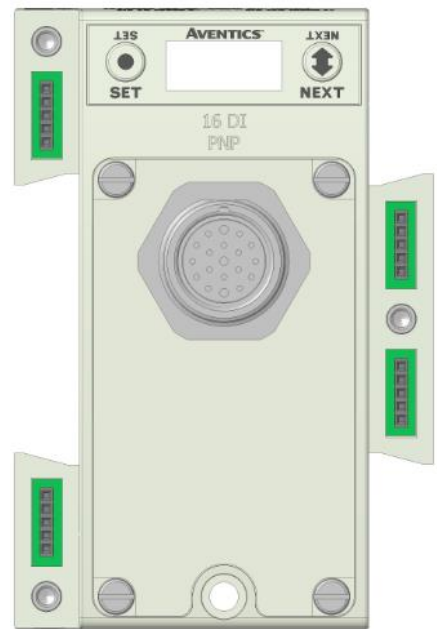
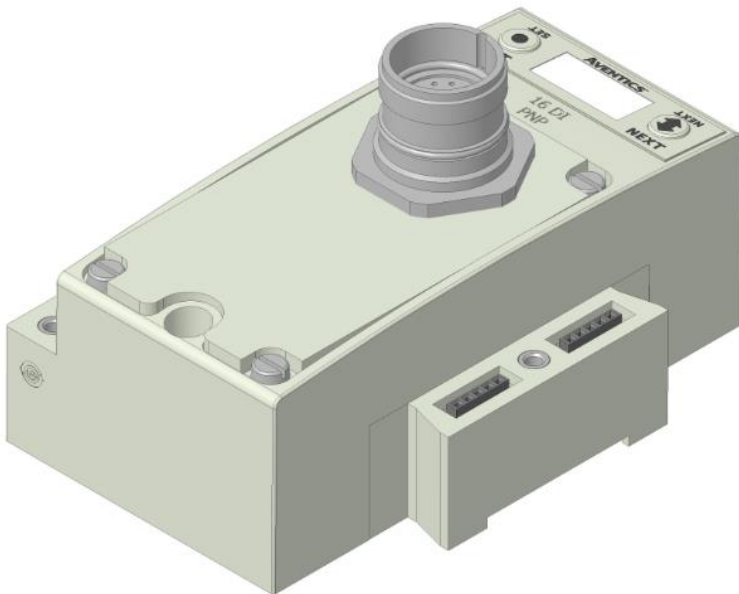

Pin Out Information

- | | |
|-------------------|-------------------|
| Pin 1 = Input 14 | Pin 11 = Input 12 |
| Pin 2 = Input 10 | Pin 12 = P.E. |
| Pin 3 = Input 6 | Pin 13 = Input 11 |
| Pin 4 = Input 3 | Pin 14 = Input 7 |
| Pin 5 = Input 2 | Pin 15 = Input 0 |
| Pin 6 = 0 VDC | Pin 16 = Input 4 |
| Pin 7 = Input 1 | Pin 17 = Input 8 |
| Pin 8 = Input 5 | Pin 18 = Input 15 |
| Pin 9 = Input 9 | Pin 19 = + 24 |
| VDC | |
| Pin 10 = Input 13 | |

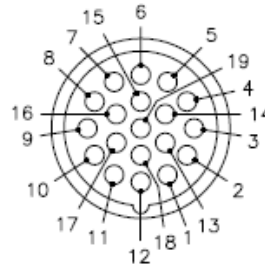

AVENTICS™ G3 Series EtherNet/IP™ DLR Technical Manual

8.5 Digital Output Modules

One Digital Output per Connector - M12 Female Modules

Module Part No.	I/O Type	Short Circuit Protection	Short Circuit Protection Status Bits	Output Points
240-208	PNP (Sourcing)	YES – Visual	YES (8) – Optional	8

Output Mapping								
BYTE	Bit 7	Bit 6	Bit 5	Bit 4	Bit 3	Bit 2	Bit 1	Bit 0
X (Required)	Output 7	Output 6	Output 5	Output 4	Output 3	Output 2	Output 1	Output 0
Input Mapping								
BYTE	Bit 7	Bit 6	Bit 5	Bit 4	Bit 3	Bit 2	Bit 1	Bit 0
X	Output 7 Status	Output 6 Status	Output 5 Status	Output 4 Status	Output 3 Status	Output 2 Status	Output 1 Status	Output 0 Status

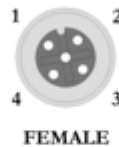
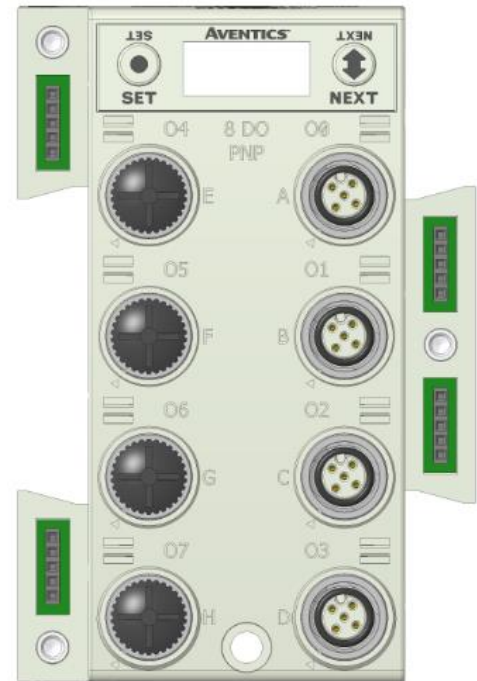
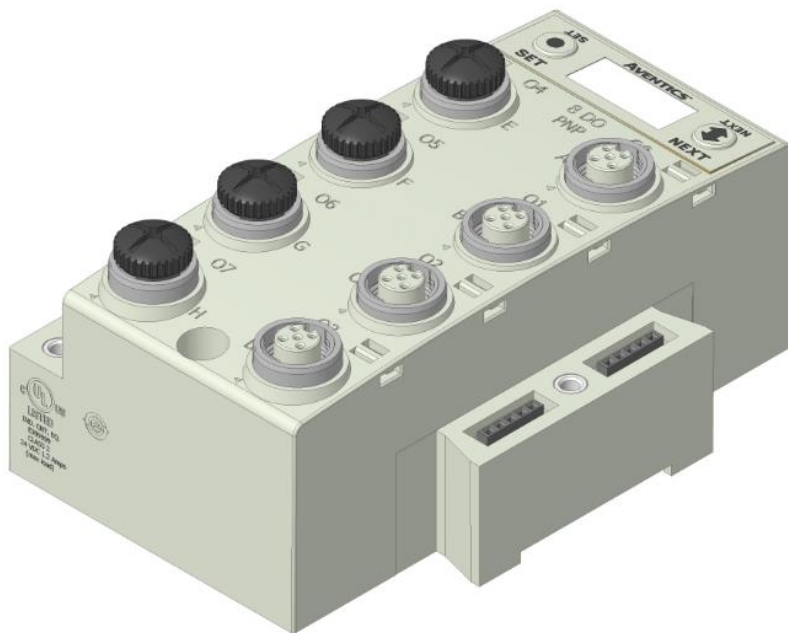

PIN 1= +24VDC (SW)
 PIN 2= NOT USED
 PIN 3= 0VDC (SW)
 PIN 4= OUTPUT 1

AVENTICS™ G3 Series EtherNet/IP™ DLR Technical Manual

Two Digital Outputs per Connector - M12 Female Modules

Module Part No.	I/O Type	Short Circuit Protection	Short Circuit Protection Status Bits	Output Points
240-207	PNP (Sourcing)	YES - Visual	YES (8) - Optional	16

Output Mapping								
BYTE	Bit 7	Bit 6	Bit 5	Bit 4	Bit 3	Bit 2	Bit 1	Bit 0
X (Required)	Output 7	Output 6	Output 5	Output 4	Output 3	Output 2	Output 1	Output 0
X+1 (Required)	Output 15	Output 14	Output 13	Output 12	Output 11	Output 10	Output 9	Output 8

Diagnostics								
BYTE	Bit 7	Bit 6	Bit 5	Bit 4	Bit 3	Bit 2	Bit 1	Bit 0
X	Output 7 Status	Output 6 Status	Output 5 Status	Output 4 Status	Output 3 Status	Output 2 Status	Output 1 Status	Output 0 Status
X+1	Output 15 Status	Output 14 Status	Output 13 Status	Output 12 Status	Output 11 Status	Output 10 Status	Output 9 Status	Output 8 Status

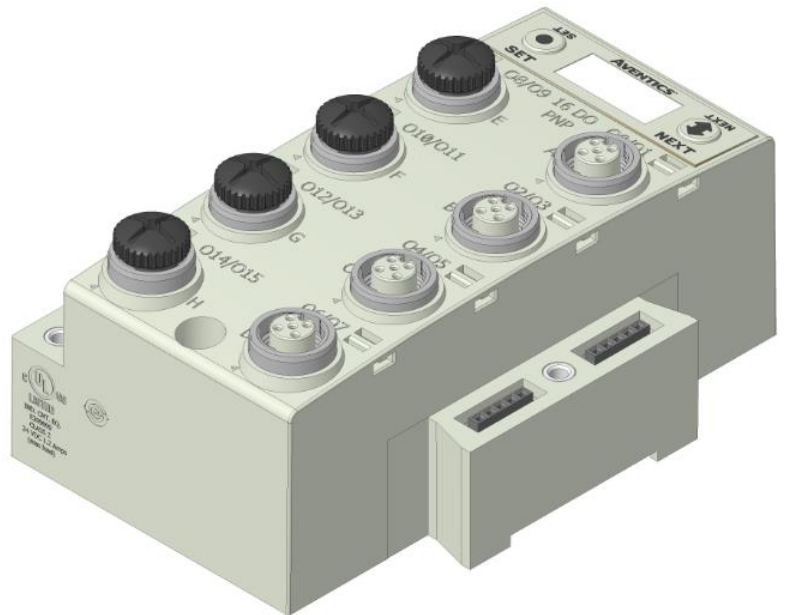
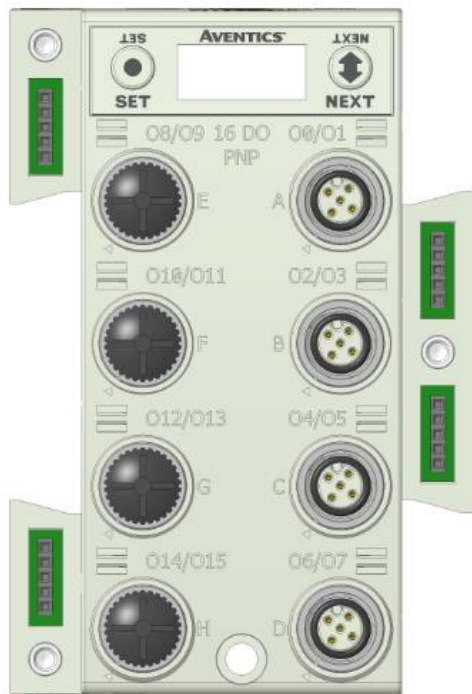

PIN 1= +24VDC (SW)
 PIN 2= OUTPUT 2
 PIN 3= 0VDC (SW)
 PIN 4= OUTPUT 1

AVENTICS™ G3 Series EtherNet/IP™ DLR Technical Manual

Sixteen Digital Outputs – Terminal Strip Modules

Specifications

- Wire Range: 12 to 24 AWG
- Strip Length: 7mm
- Tightening Torque: 0.5 Nm

Module Part No.	I/O Type	Short Circuit Protection	Short Circuit Protection Status Bits	Output Points
240-330	PNP (Sourcing)	YES	YES	16

Output Mapping								
BYTE	Bit 7	Bit 6	Bit 5	Bit 4	Bit 3	Bit 2	Bit 1	Bit 0
X	Output 7	Output 6	Output 5	Output 4	Output 3	Output 2	Output 1	Output 0
X+1	Output 15	Output 14	Output 13	Output 12	Output 11	Output 10	Output 9	Output 8
Diagnostic Telegram								
BYTE	Bit 7	Bit 6	Bit 5	Bit 4	Bit 3	Bit 2	Bit 1	Bit 0
X (Selectable)	Output 7 Status	Output 6 Status	Output 5 Status	Output 4 Status	Output 3 Status	Output 2 Status	Output 1 Status	Output 0 Status
X (Selectable)	Output 15 Status	Output 14 Status	Output 13 Status	Output 12 Status	Output 11 Status	Output 10 Status	Output 9 Status	Output 8 Status

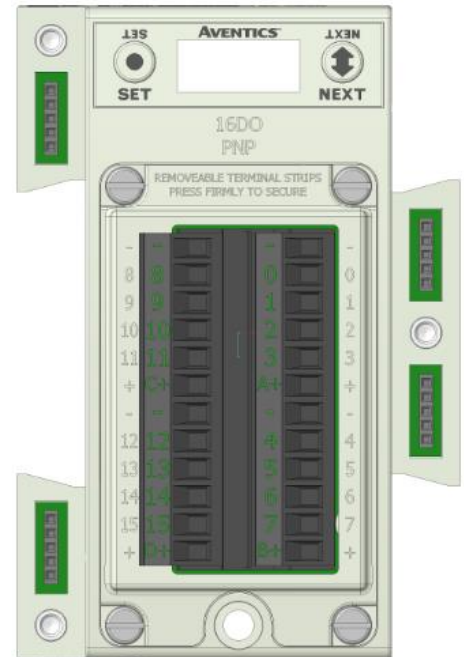
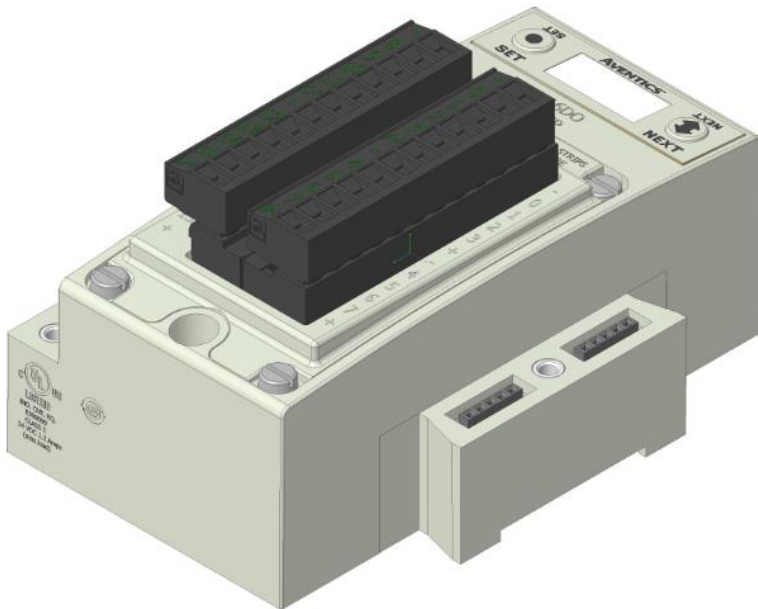

AVENTICS™ G3 Series EtherNet/IP™ DLR Technical Manual

Two Digital High Current Outputs per Connector - M12 Female Modules

The high current output module is to be used with output devices requiring between 0.5 and 1.0 Amps. Each connector incorporates two outputs that are capable of sourcing 1.0 Amp per output.

Module Part No.	I/O Type	Short Circuit Protection	Short Circuit Protection Status Bits	Output Points
240-300	PNP (Sourcing)	YES - Visual	YES (8) - Optional	8

Output Mapping								
BYTE	Bit 7	Bit 6	Bit 5	Bit 4	Bit 3	Bit 2	Bit 1	Bit 0
X (Required)	Output 7	Output 6	Output 5	Output 4	Output 3	Output 2	Output 1	Output 0
Diagnostics								
BYTE	Bit 7	Bit 6	Bit 5	Bit 4	Bit 3	Bit 2	Bit 1	Bit 0
X	Output 7 Status	Output 6 Status	Output 5 Status	Output 4 Status	Output 3 Status	Output 2 Status	Output 1 Status	Output 0 Status

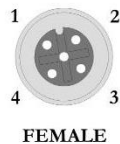
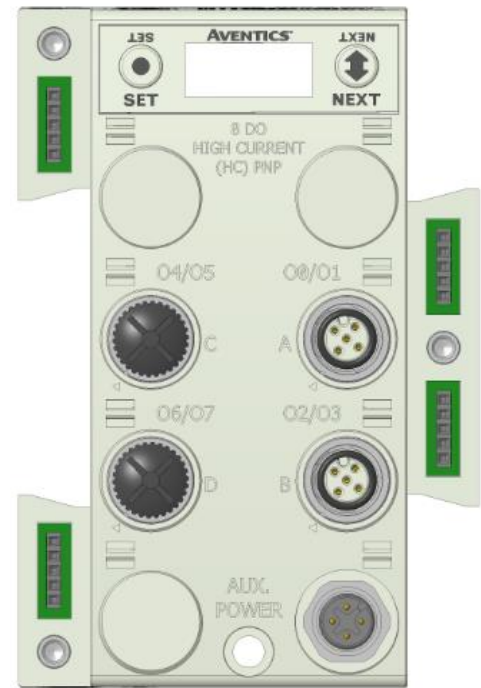

PIN 1= +24VDC (SW)
 PIN 2= OUTPUT 2
 PIN 3= 0VDC (SW)
 PIN 4= OUTPUT 1

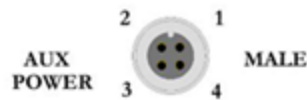

PIN 1 = +24 VDC (For Conn A, B)
 PIN 2 = +24 VDC (For Conn C, D)
 PIN 3 = 0 VDC (For Conn A, B, C, D)
 PIN 4 = 0 VDC (For Conn A, B, C, D)

AVENTICS™ G3 Series EtherNet/IP™ DLR Technical Manual

8.6 Digital Input/Output Modules

Two Digital I/O per Connector - 12mm Female Modules

Module Part No.	I/O Type	Short Circuit Protection	Short Circuit Protection Status Bits	Output Points	Input Points
240-211	PNP (Sourcing)	YES - Visual	YES (8) - Optional	8	8

Output Mapping								
BYTE	Bit 7	Bit 6	Bit 5	Bit 4	Bit 3	Bit 2	Bit 1	Bit 0
X (Required)	Output 7	Output 6	Output 5	Output 4	Output 3	Output 2	Output 1	Output 0
Input Mapping								
BYTE	Bit 7	Bit 6	Bit 5	Bit 4	Bit 3	Bit 2	Bit 1	Bit 0
X (Required)	Input 7	Input 6	Input 5	Input 4	Input 3	Input 2	Input 1	Input 0
Diagnostics								
X	Allocated and Reserved	Allocated and Reserved	Allocated and Reserved	Allocated and Reserved	Conn. D SCP Status	Conn. C SCP Status	Conn. B SCP Status	Conn. A SCP Status
X+1	Output 7 Status Bit	Output 6 Status Bit	Output 5 Status Bit	Output 4 Status Bit	Output 3 Status Bit	Output 2 Status Bit	Output 1 Status Bit	Output 0 Status Bit

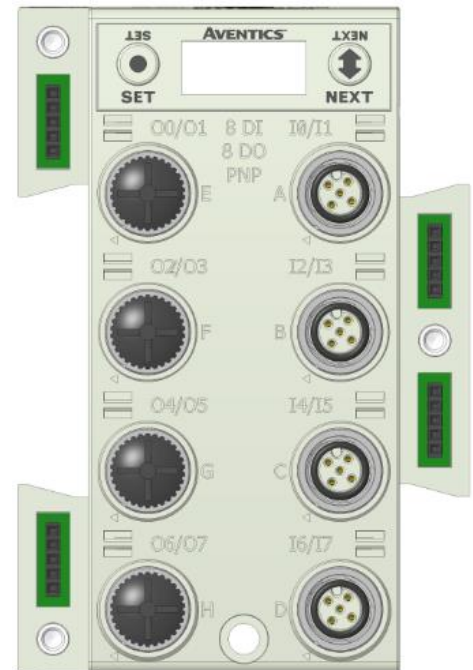
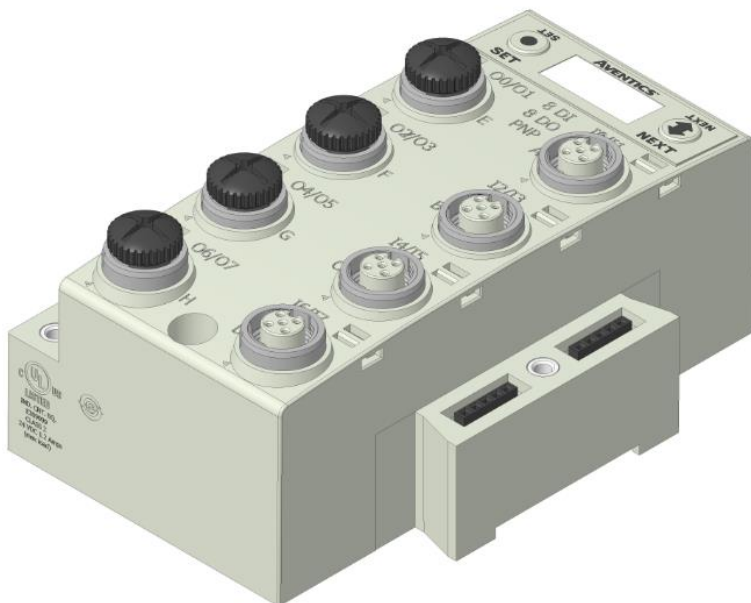

9. Valve Interface Modules

9.1 2000 Series & 500 Series Valve Driver

Output Data Mapping

Interface to control valves from a G3 communication module.

Module Part No.	I/O Type	Short Circuit Protection	Short Circuit Protection Status Bits	Output Points
219-828	NPN (Sinking) 2000 Series	YES – Visual	YES (32) – Optional	32
P599AE425188 01	NPN (Sinking) 500 Series	YES – Visual	YES (128) – Optional	128

<i>Output Mapping</i>								
BYTE	Bit 7	Bit 6	Bit 5	Bit 4	Bit 3	Bit 2	Bit 1	Bit 0
X (Required)	Valve Coil No. 7	Valve Coil No. 6	Valve Coil No. 5	Valve Coil No. 4	Valve Coil No. 3	Valve Coil No. 2	Valve Coil No. 1	Valve Coil No. 0
X+1 (Selectable)	Valve Coil No. 15	Valve Coil No. 14	Valve Coil No. 13	Valve Coil No. 12	Valve Coil No. 11	Valve Coil No. 10	Valve Coil No. 9	Valve Coil No. 8
X+2 (Selectable)	Valve Coil No. 23	Valve Coil No. 22	Valve Coil No. 21	Valve Coil No. 20	Valve Coil No. 19	Valve Coil No. 18	Valve Coil No. 17	Valve Coil No. 16
X+3 (Selectable)	Valve Coil No. 31	Valve Coil No. 30	Valve Coil No. 29	Valve Coil No. 28	Valve Coil No. 27	Valve Coil No. 26	Valve Coil No. 25	Valve Coil No. 24
32 additional coils available per each additional 32+ manifold driver board								
X+4 (Selectable)	Valve Coil No. 39	Valve Coil No. 38	Valve Coil No. 37	Valve Coil No. 36	Valve Coil No. 35	Valve Coil No. 34	Valve Coil No. 33	Valve Coil No. 32
X+5 (Selectable)	Valve Coil No. 47	Valve Coil No. 46	Valve Coil No. 45	Valve Coil No. 44	Valve Coil No. 43	Valve Coil No. 42	Valve Coil No. 41	Valve Coil No. 40
X+6 (Selectable)	Valve Coil No. 55	Valve Coil No. 54	Valve Coil No. 53	Valve Coil No. 52	Valve Coil No. 51	Valve Coil No. 50	Valve Coil No. 49	Valve Coil No. 48
X+7 (Selectable)	Valve Coil No. 63	Valve Coil No. 62	Valve Coil No. 61	Valve Coil No. 60	Valve Coil No. 59	Valve Coil No. 58	Valve Coil No. 57	Valve Coil No. 56
32 additional coils available per each additional 32+ manifold driver board								
X+15 (Selectable)	Valve Coil No. 127	Valve Coil No. 126	Valve Coil No. 125	Valve Coil No. 124	Valve Coil No. 123	Valve Coil No. 122	Valve Coil No. 121	Valve Coil No. 120

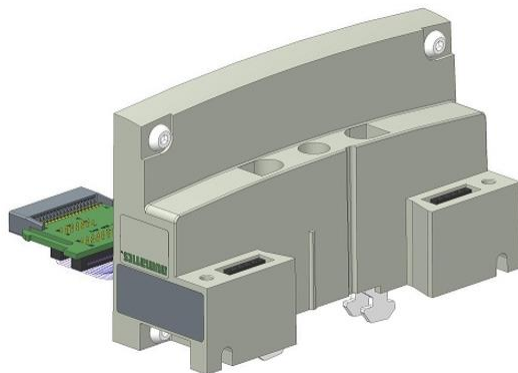

AVENTICS™ G3 Series EtherNet/IP™ DLR Technical Manual

Diagnostic Data Mapping

Module Part No.	I/O Type	Short Circuit Protection	Short Circuit Protection Status Bits	Output Points
219-828	NPN (Sinking) 2000 Series	YES - Visual	YES (32) - Optional	32
P599AE42518801	NPN (Sinking) 500 Series	YES - Visual	YES (128) - Optional	128

BYTE	Bit 7	Bit 6	Bit 5	Bit 4	Bit 3	Bit 2	Bit 1	Bit 0
X (Selectable)	Coil 7 Status	Coil 6 Status	Coil 5 Status	Coil 4 Status	Coil 3 Status	Coil 2 Status	Coil 1 Status	Coil 0 Status
X+1	Coil 15 Status	Coil 14 Status	Coil 13 Status	Coil 12 Status	Coil 11 Status	Coil 10 Status	Coil 9 Status	Coil 8 Status
X+2	Coil 23 Status	Coil 22 Status	Coil 21 Status	Coil 20 Status	Coil 19 Status	Coil 18 Status	Coil 17 Status	Coil 16 Status
X+3	Coil 31 Status	Coil 30 Status	Coil 29 Status	Coil 28 Status	Coil 27 Status	Coil 26 Status	Coil 25 Status	Coil 24 Status
32 additional coil status bits per each additional 32+ manifold driver board								
X+4	Coil 39 Status	Coil 38 Status	Coil 37 Status	Coil 36 Status	Coil 35 Status	Coil 34 Status	Coil 33 Status	Coil 32 Status
X+5	Coil 47 Status	Coil 46 Status	Coil 45 Status	Coil 44 Status	Coil 43 Status	Coil 42 Status	Coil 41 Status	Coil 40 Status
X+6	Coil 55 Status	Coil 54 Status	Coil 53 Status	Coil 52 Status	Coil 51 Status	Coil 50 Status	Coil 49 Status	Coil 48 Status
X+7	Coil 63 Status	Coil 62 Status	Coil 61 Status	Coil 60 Status	Coil 59 Status	Coil 58 Status	Coil 57 Status	Coil 56 Status
128 coil status bits possible								
X+15	Coil 127 Status	Coil 126 Status	Coil 125 Status	Coil 124 Status	Coil 123 Status	Coil 122 Status	Coil 121 Status	Coil 120 Status

9.2 Sub-bus Valve Module

Output Data Mapping

Used to control a distributed valve manifold through the Sub-Bus. See page 69 for more information.

Module Part No.	I/O Type			Short Circuit Protection		Status Bit Data		Output Points	
240-241	NPN (Sinking)			YES – Visual		YES (128) – Optional		128	
Output Mapping									
BYTE	Bit 7	Bit 6	Bit 5	Bit 4	Bit 3	Bit 2	Bit 1	Bit 0	
X (Required)	Valve Coil No. 7	Valve Coil No. 6	Valve Coil No. 5	Valve Coil No. 4	Valve Coil No. 3	Valve Coil No. 2	Valve Coil No. 1	Valve Coil No. 0	
X+1 (Selectable)	Valve Coil No. 15	Valve Coil No. 14	Valve Coil No. 13	Valve Coil No. 12	Valve Coil No. 11	Valve Coil No. 10	Valve Coil No. 9	Valve Coil No. 8	
X+2 (Selectable)	Valve Coil No. 23	Valve Coil No. 22	Valve Coil No. 21	Valve Coil No. 20	Valve Coil No. 19	Valve Coil No. 18	Valve Coil No. 17	Valve Coil No. 16	
X+3 (Selectable)	Valve Coil No. 31	Valve Coil No. 30	Valve Coil No. 29	Valve Coil No. 28	Valve Coil No. 27	Valve Coil No. 26	Valve Coil No. 25	Valve Coil No. 24	
32 additional coils available per each additional 32+ manifold driver board									
X+4 (Selectable)	Valve Coil No. 39	Valve Coil No. 38	Valve Coil No. 37	Valve Coil No. 36	Valve Coil No. 35	Valve Coil No. 34	Valve Coil No. 33	Valve Coil No. 32	
X+5 (Selectable)	Valve Coil No. 47	Valve Coil No. 46	Valve Coil No. 45	Valve Coil No. 44	Valve Coil No. 43	Valve Coil No. 42	Valve Coil No. 41	Valve Coil No. 40	
X+6 (Selectable)	Valve Coil No. 55	Valve Coil No. 54	Valve Coil No. 53	Valve Coil No. 52	Valve Coil No. 51	Valve Coil No. 50	Valve Coil No. 49	Valve Coil No. 48	
X+7 (Selectable)	Valve Coil No. 63	Valve Coil No. 62	Valve Coil No. 61	Valve Coil No. 60	Valve Coil No. 59	Valve Coil No. 58	Valve Coil No. 57	Valve Coil No. 56	
128 coils total possible									
X+15 (Selectable)	Valve Coil No. 127	Valve Coil No. 126	Valve Coil No. 125	Valve Coil No. 124	Valve Coil No. 123	Valve Coil No. 122	Valve Coil No. 121	Valve Coil No. 120	

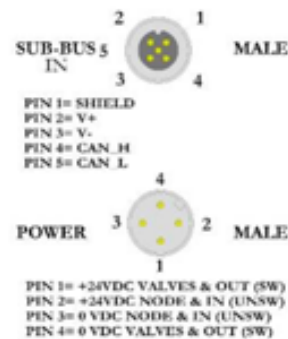
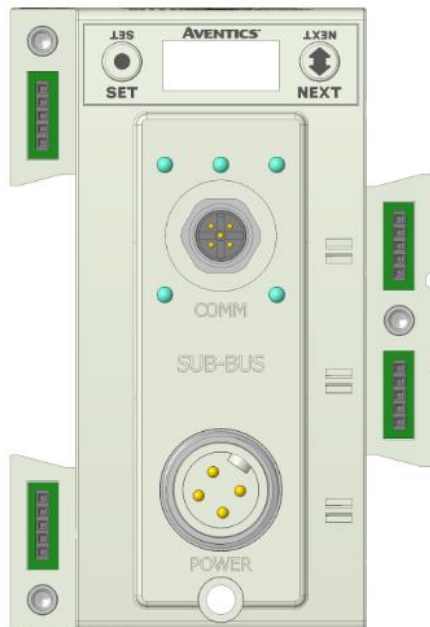

AVENTICS™ G3 Series EtherNet/IP™ DLR Technical Manual

Diagnostic Data Mapping

Module Part No.	I/O Type		Short Circuit Protection		Status Bit Data		Output Points	
240-241	NPN (Sinking)		YES – Visual		YES (128) – Optional		128	
<i>Diagnostics</i>								
BYTE	Bit 7	Bit 6	Bit 5	Bit 4	Bit 3	Bit 2	Bit 1	Bit 0
X (Selectable)	Coil 7 Status	Coil 6 Status	Coil 5 Status	Coil 4 Status	Coil 3 Status	Coil 2 Status	Coil 1 Status	Coil 0 Status
X+1	Coil 15 Status	Coil 14 Status	Coil 13 Status	Coil 12 Status	Coil 11 Status	Coil 10 Status	Coil 9 Status	Coil 8 Status
X+2	Coil 23 Status	Coil 22 Status	Coil 21 Status	Coil 20 Status	Coil 19 Status	Coil 18 Status	Coil 17 Status	Coil 16 Status
X+3	Coil 31 Status	Coil 30 Status	Coil 29 Status	Coil 28 Status	Coil 27 Status	Coil 26 Status	Coil 25 Status	Coil 24 Status
32 additional coil status bits per each additional 32+ manifold driver board								
X+4	Coil 39 Status	Coil 38 Status	Coil 37 Status	Coil 36 Status	Coil 35 Status	Coil 34 Status	Coil 33 Status	Coil 32 Status
X+5	Coil 47 Status	Coil 46 Status	Coil 45 Status	Coil 44 Status	Coil 43 Status	Coil 42 Status	Coil 41 Status	Coil 40 Status
X+6	Coil 55 Status	Coil 54 Status	Coil 53 Status	Coil 52 Status	Coil 51 Status	Coil 50 Status	Coil 49 Status	Coil 48 Status
X+7	Coil 63 Status	Coil 62 Status	Coil 61 Status	Coil 60 Status	Coil 59 Status	Coil 58 Status	Coil 57 Status	Coil 56 Status
128 coil status bits possible								
X+15	Coil 127 Status	Coil 126 Status	Coil 125 Status	Coil 124 Status	Coil 123 Status	Coil 122 Status	Coil 121 Status	Coil 120 Status

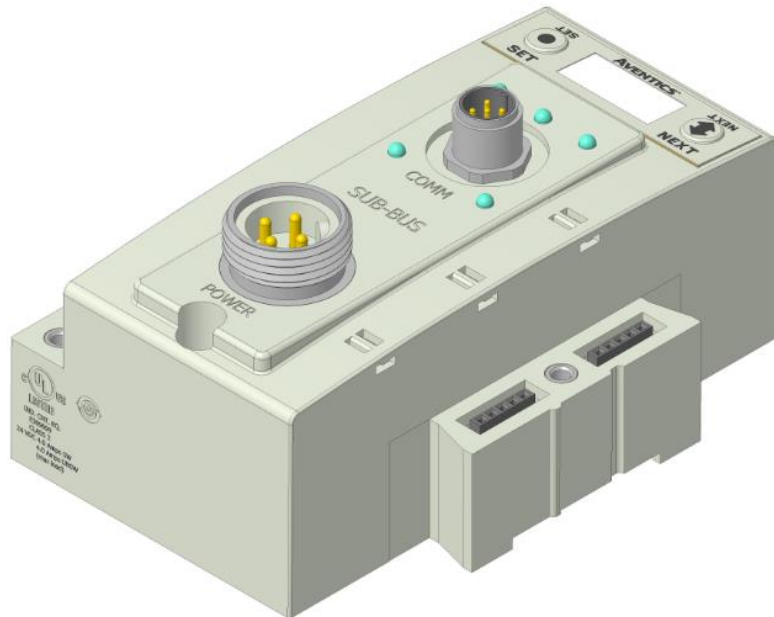

9.3 Sub-bus Valve Module without Distribution and I/O

Used to control a distributed valve manifold through the Sub-Bus. See page 70 for more information.

Module Part No.	I/O Type		Short Circuit Protection			Status Bit Data		Output Points	
P580AEDS4010A00	NPN (Sinking)		YES – Visual			YES (128) – Optional		128	
Output Mapping									
BYTE	Bit 7	Bit 6	Bit 5	Bit 4	Bit 3	Bit 2	Bit 1	Bit 0	
X (Required)	Valve Coil No. 7	Valve Coil No. 6	Valve Coil No. 5	Valve Coil No. 4	Valve Coil No. 3	Valve Coil No. 2	Valve Coil No. 1	Valve Coil No. 0	
X+1 (Selectable)	Valve Coil No. 15	Valve Coil No. 14	Valve Coil No. 13	Valve Coil No. 12	Valve Coil No. 11	Valve Coil No. 10	Valve Coil No. 9	Valve Coil No. 8	
X+2 (Selectable)	Valve Coil No. 23	Valve Coil No. 22	Valve Coil No. 21	Valve Coil No. 20	Valve Coil No. 19	Valve Coil No. 18	Valve Coil No. 17	Valve Coil No. 16	
X+3 (Selectable)	Valve Coil No. 31	Valve Coil No. 30	Valve Coil No. 29	Valve Coil No. 28	Valve Coil No. 27	Valve Coil No. 26	Valve Coil No. 25	Valve Coil No. 24	
32 additional coils available per each additional 32+ manifold driver board									
X+4 (Selectable)	Valve Coil No. 39	Valve Coil No. 38	Valve Coil No. 37	Valve Coil No. 36	Valve Coil No. 35	Valve Coil No. 34	Valve Coil No. 33	Valve Coil No. 32	
X+5 (Selectable)	Valve Coil No. 47	Valve Coil No. 46	Valve Coil No. 45	Valve Coil No. 44	Valve Coil No. 43	Valve Coil No. 42	Valve Coil No. 41	Valve Coil No. 40	
X+6 (Selectable)	Valve Coil No. 55	Valve Coil No. 54	Valve Coil No. 53	Valve Coil No. 52	Valve Coil No. 51	Valve Coil No. 50	Valve Coil No. 49	Valve Coil No. 48	
X+7 (Selectable)	Valve Coil No. 63	Valve Coil No. 62	Valve Coil No. 61	Valve Coil No. 60	Valve Coil No. 59	Valve Coil No. 58	Valve Coil No. 57	Valve Coil No. 56	
128 coils total possible									
X+15 (Selectable)	Valve Coil No. 127	Valve Coil No. 126	Valve Coil No. 125	Valve Coil No. 124	Valve Coil No. 123	Valve Coil No. 122	Valve Coil No. 121	Valve Coil No. 120	

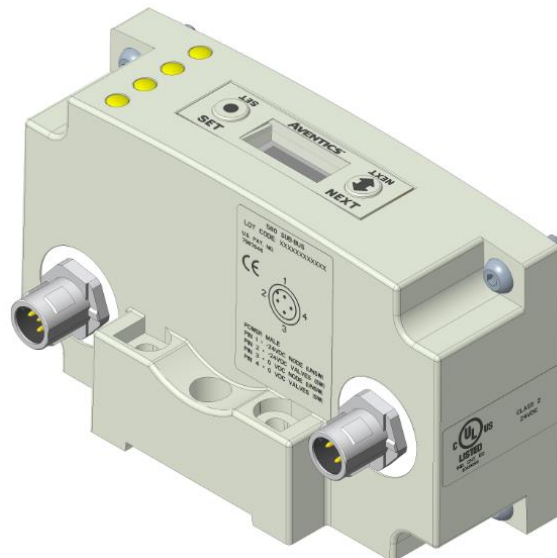

AVENTICS™ G3 Series EtherNet/IP™ DLR Technical Manual

Used to control a distributed valve manifold through the Sub-Bus. See page 70 for more information.

Module Part No.	I/O Type		Short Circuit Protection			Status Bit Data		Output Points
P580AEDS4010A00	NPN (Sinking)		YES – Visual			YES (128) – Optional		128
<i>Diagnostics</i>								
BYTE	Bit 7	Bit 6	Bit 5	Bit 4	Bit 3	Bit 2	Bit 1	Bit 0
X (Selectable)	Coil 7 Status	Coil 6 Status	Coil 5 Status	Coil 4 Status	Coil 3 Status	Coil 2 Status	Coil 1 Status	Coil 0 Status
X+1	Coil 15 Status	Coil 14 Status	Coil 13 Status	Coil 12 Status	Coil 11 Status	Coil 10 Status	Coil 9 Status	Coil 8 Status
X+2	Coil 23 Status	Coil 22 Status	Coil 21 Status	Coil 20 Status	Coil 19 Status	Coil 18 Status	Coil 17 Status	Coil 16 Status
X+3	Coil 31 Status	Coil 30 Status	Coil 29 Status	Coil 28 Status	Coil 27 Status	Coil 26 Status	Coil 25 Status	Coil 24 Status
32 additional coil status bits per each additional 32+ manifold driver board								
X+4	Coil 39 Status	Coil 38 Status	Coil 37 Status	Coil 36 Status	Coil 35 Status	Coil 34 Status	Coil 33 Status	Coil 32 Status
X+5	Coil 47 Status	Coil 46 Status	Coil 45 Status	Coil 44 Status	Coil 43 Status	Coil 42 Status	Coil 41 Status	Coil 40 Status
X+6	Coil 55 Status	Coil 54 Status	Coil 53 Status	Coil 52 Status	Coil 51 Status	Coil 50 Status	Coil 49 Status	Coil 48 Status
X+7	Coil 63 Status	Coil 62 Status	Coil 61 Status	Coil 60 Status	Coil 59 Status	Coil 58 Status	Coil 57 Status	Coil 56 Status
128 coil status bits possible								
X+14	Coil 127 Status	Coil 126 Status	Coil 125 Status	Coil 124 Status	Coil 123 Status	Coil 122 Status	Coil 121 Status	Coil 120 Status

9.4 Valve Side Digital Output Modules

The valve side output module is used to distribute available valve side output points (i.e. when valves are located away from the rest of the electronics). These modules go to the right of the G3 valve adapter. The 16 bit output module utilizes the last 16 output bits on the valve side of the manifold (bits 16-31).

This module is not available with the 501, 502 or 503 series valves.

Sixteen Outputs per Connector - Sub-D 25 Pin Female Module

Module Part No.	I/O Type	Short Circuit Protection	Internal Status Bits	Output Points	Module Size
239-1713	NPN (Sinking)	Yes	16 - Selectable	16	Narrow

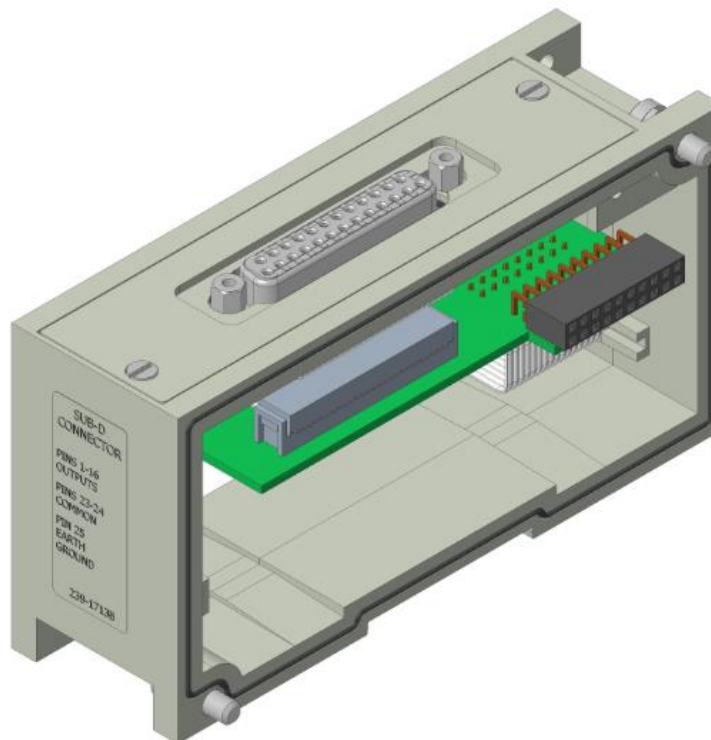

9.5 500 Series Extended Coil Capability

The Extended Coil manifolds must be connected to a G3 Electronics Node to operate. Not all G3 supported protocols will support the Extended Coil Manifolds. Below is a list of the hardware and minimum firmware levels that support the Extended Coil Manifolds.

Extended Solenoid Coil Capability requirements:		
Module	Part Number	Minimum Firmware
Communication Module	240-325	Rev 1.01 Build 42509
Valve Driver Module	P599AE508827001	Rev 4.019

Module firmware revision levels can be confirmed in the integrated graphic display and the built-in web browser. See pg. 46 for more information.

9.6 Extended Coil Configuration

The Extended Coil Manifold can be configured to control three additional extended coil valve driver assemblies; unless already configured from the factory. Modify the configuration with either the graphic display interface as shown on page 34 or using the integrated web server configuration page shown on page 98.

Valve Series	Number of Extended Coil Valve Drivers	Total number of coils	Configuration Selection	Allocated number of I/O Bytes designated for valves
501	0	3-32	32 coils	4
	1	33-64	64 coils	8
	2	65-96	96 coils	12
	3	97-128	128 coils	16
502/503	0	1-32	32 coils	4
	1	33-48	64 coils	8
	2	49-64	64 coils	8
	3	65-80	96 coils	12

AVENTICS™ G3 Series EtherNet/IP™ DLR Technical Manual

The following example of the G3 diagnostic webpage “Node Configuration” identifies the details of a manifold configured for 64 possible coils.



Number of Maximum Coils should only be adjusted if 1 or more additional extended coil valve driver(s) has been physically added.

Node Configuration	
(Green selections denote Factory Default settings)	
DHCP:	Disabled ▼
IP Address:	192.168.10.120
Subnet Mask:	255.255.255.0
Gateway IP Address:	
Web Server:	Enabled ▼
Max Coils on Manifold (32 = Standard):	64 ▼
Safety Zones (Only configurable when Max Coils = 32):	None ▼
COMM Fault / Idle Mode:	Turn OFF All Outputs ▼
Numatics Part No. 240-181 Compatibility Mode:	Disabled ▼
Node Configuration Parameters:	Unlocked ▼
I/O Configuration:	Unlocked ▼
Display Orientation (Global):	Normal ▼
Display Brightness (Global):	Medium ▼
Comm. Format (I/O Data Padding):	SINT ▼

Update Configuration

AVENTICS™ G3 Series EtherNet/IP™ DLR Technical Manual

The following is an example of the G3 diagnostic webpage "Diagnostics" which identifies the details of the valve driver's control of 64 possible coils



Module	Part No.	Description	Details	Export Config and Log	Activity																																																																																																																																																																
Node	240-325	EtherNet/IP DLR/QC Communications Module	<input type="checkbox"/> Show Details		<input checked="" type="checkbox"/> Close all Details																																																																																																																																																																
Valve Driver	P599AE42518800x	50X Series Valve Driver Output Module	<input checked="" type="checkbox"/> Show Details		<input checked="" type="checkbox"/> Close all Details																																																																																																																																																																
 <table border="1"> <tr> <td>Firmware Revision:</td> <td colspan="7">4.16</td> </tr> <tr> <td><input checked="" type="checkbox"/> Show Valve Coils 0-31: Check/Uncheck box to force/un-force valve coil</td> <td>0 <input checked="" type="checkbox"/></td> <td>1 <input type="checkbox"/></td> <td>2 <input checked="" type="checkbox"/></td> <td>3 <input type="checkbox"/></td> <td>4 <input checked="" type="checkbox"/></td> <td>5 <input type="checkbox"/></td> <td>6 <input checked="" type="checkbox"/></td> <td>7 <input type="checkbox"/></td> </tr> <tr> <td></td> <td>8 <input checked="" type="checkbox"/></td> <td>9 <input type="checkbox"/></td> <td>10 <input checked="" type="checkbox"/></td> <td>11 <input type="checkbox"/></td> <td>12 <input checked="" type="checkbox"/></td> <td>13 <input type="checkbox"/></td> <td>14 <input checked="" type="checkbox"/></td> <td>15 <input type="checkbox"/></td> </tr> <tr> <td></td> <td>16 <input checked="" type="checkbox"/></td> <td>17 <input type="checkbox"/></td> <td>18 <input checked="" type="checkbox"/></td> <td>19 <input type="checkbox"/></td> <td>20 <input checked="" type="checkbox"/></td> <td>21 <input type="checkbox"/></td> <td>22 <input checked="" type="checkbox"/></td> <td>23 <input type="checkbox"/></td> </tr> <tr> <td></td> <td>24 <input checked="" type="checkbox"/></td> <td>25 <input type="checkbox"/></td> <td>26 <input checked="" type="checkbox"/></td> <td>27 <input type="checkbox"/></td> <td>28 <input checked="" type="checkbox"/></td> <td>29 <input type="checkbox"/></td> <td>30 <input checked="" type="checkbox"/></td> <td>31 <input type="checkbox"/></td> </tr> <tr> <td>Valve Status: ● = Shorted Coil ● = Open Coil ✘ = No Coil Detected</td> <td>0 <input type="checkbox"/></td> <td>1 <input type="checkbox"/></td> <td>2 <input type="checkbox"/></td> <td>3 <input type="checkbox"/></td> <td>4 <input type="checkbox"/></td> <td>5 <input type="checkbox"/></td> <td>6 <input type="checkbox"/></td> <td>7 <input type="checkbox"/></td> </tr> <tr> <td></td> <td>8 <input type="checkbox"/></td> <td>9 <input type="checkbox"/></td> <td>10 <input type="checkbox"/></td> <td>11 <input type="checkbox"/></td> <td>12 <input type="checkbox"/></td> <td>13 <input type="checkbox"/></td> <td>14 <input type="checkbox"/></td> <td>15 <input type="checkbox"/></td> </tr> <tr> <td></td> <td>16 <input type="checkbox"/></td> <td>17 <input type="checkbox"/></td> <td>18 <input type="checkbox"/></td> <td>19 <input type="checkbox"/></td> <td>20 <input type="checkbox"/></td> <td>21 <input type="checkbox"/></td> <td>22 <input type="checkbox"/></td> <td>23 <input type="checkbox"/></td> </tr> <tr> <td></td> <td>24 <input type="checkbox"/></td> <td>25 <input type="checkbox"/></td> <td>26 <input type="checkbox"/></td> <td>27 <input type="checkbox"/></td> <td>28 <input type="checkbox"/></td> <td>29 <input type="checkbox"/></td> <td>30 <input type="checkbox"/></td> <td>31 <input type="checkbox"/></td> </tr> <tr> <td><input checked="" type="checkbox"/> Show Valve Coils 32-63: Check/Uncheck box to force/un-force valve coil</td> <td>32 <input checked="" type="checkbox"/></td> <td>33 <input type="checkbox"/></td> <td>34 <input checked="" type="checkbox"/></td> <td>35 <input type="checkbox"/></td> <td>36 <input checked="" type="checkbox"/></td> <td>37 <input checked="" type="checkbox"/></td> <td>38 <input checked="" type="checkbox"/></td> <td>39 <input checked="" type="checkbox"/></td> </tr> <tr> <td></td> <td>40 <input checked="" type="checkbox"/></td> <td>41 <input checked="" type="checkbox"/></td> <td>42 <input checked="" type="checkbox"/></td> <td>43 <input checked="" type="checkbox"/></td> <td>44 <input checked="" type="checkbox"/></td> <td>45 <input checked="" type="checkbox"/></td> <td>46 <input checked="" type="checkbox"/></td> <td>47 <input checked="" type="checkbox"/></td> </tr> <tr> <td></td> <td>48 <input checked="" type="checkbox"/></td> <td>49 <input checked="" type="checkbox"/></td> <td>50 <input checked="" type="checkbox"/></td> <td>51 <input checked="" type="checkbox"/></td> <td>52 <input checked="" type="checkbox"/></td> <td>53 <input checked="" type="checkbox"/></td> <td>54 <input type="checkbox"/></td> <td>55 <input type="checkbox"/></td> </tr> <tr> <td></td> <td>56 <input type="checkbox"/></td> <td>57 <input type="checkbox"/></td> <td>58 <input type="checkbox"/></td> <td>59 <input type="checkbox"/></td> <td>60 <input type="checkbox"/></td> <td>61 <input type="checkbox"/></td> <td>62 <input type="checkbox"/></td> <td>63 <input type="checkbox"/></td> </tr> <tr> <td>Valve Status: ● = Shorted Coil ● = Open Coil ✘ = No Coil Detected</td> <td>32 <input type="checkbox"/></td> <td>33 <input type="checkbox"/></td> <td>34 <input type="checkbox"/></td> <td>35 <input type="checkbox"/></td> <td>36 <input type="checkbox"/></td> <td>37 <input type="checkbox"/></td> <td>38 <input type="checkbox"/></td> <td>39 <input type="checkbox"/></td> </tr> <tr> <td></td> <td>40 <input type="checkbox"/></td> <td>41 <input type="checkbox"/></td> <td>42 <input type="checkbox"/></td> <td>43 <input type="checkbox"/></td> <td>44 <input type="checkbox"/></td> <td>45 <input type="checkbox"/></td> <td>46 <input type="checkbox"/></td> <td>47 <input type="checkbox"/></td> </tr> <tr> <td></td> <td>48 <input type="checkbox"/></td> <td>49 <input type="checkbox"/></td> <td>50 <input type="checkbox"/></td> <td>51 <input type="checkbox"/></td> <td>52 <input type="checkbox"/></td> <td>53 <input type="checkbox"/></td> <td>54 <input checked="" type="checkbox"/></td> <td>55 <input checked="" type="checkbox"/></td> </tr> <tr> <td></td> <td>56 <input checked="" type="checkbox"/></td> <td>57 <input checked="" type="checkbox"/></td> <td>58 <input checked="" type="checkbox"/></td> <td>59 <input checked="" type="checkbox"/></td> <td>60 <input checked="" type="checkbox"/></td> <td>61 <input checked="" type="checkbox"/></td> <td>62 <input checked="" type="checkbox"/></td> <td>63 <input checked="" type="checkbox"/></td> </tr> <tr> <td><input type="checkbox"/> Show I/O Mappings and Sizes</td> <td colspan="7"></td> </tr> </table>						Firmware Revision:	4.16							<input checked="" type="checkbox"/> Show Valve Coils 0-31: Check/Uncheck box to force/un-force valve coil	0 <input checked="" type="checkbox"/>	1 <input type="checkbox"/>	2 <input checked="" type="checkbox"/>	3 <input type="checkbox"/>	4 <input checked="" type="checkbox"/>	5 <input type="checkbox"/>	6 <input checked="" type="checkbox"/>	7 <input type="checkbox"/>		8 <input checked="" type="checkbox"/>	9 <input type="checkbox"/>	10 <input checked="" type="checkbox"/>	11 <input type="checkbox"/>	12 <input checked="" type="checkbox"/>	13 <input type="checkbox"/>	14 <input checked="" type="checkbox"/>	15 <input type="checkbox"/>		16 <input checked="" type="checkbox"/>	17 <input type="checkbox"/>	18 <input checked="" type="checkbox"/>	19 <input type="checkbox"/>	20 <input checked="" type="checkbox"/>	21 <input type="checkbox"/>	22 <input checked="" type="checkbox"/>	23 <input type="checkbox"/>		24 <input checked="" type="checkbox"/>	25 <input type="checkbox"/>	26 <input checked="" type="checkbox"/>	27 <input type="checkbox"/>	28 <input checked="" type="checkbox"/>	29 <input type="checkbox"/>	30 <input checked="" type="checkbox"/>	31 <input type="checkbox"/>	Valve Status: ● = Shorted Coil ● = Open Coil ✘ = No Coil Detected	0 <input type="checkbox"/>	1 <input type="checkbox"/>	2 <input type="checkbox"/>	3 <input type="checkbox"/>	4 <input type="checkbox"/>	5 <input type="checkbox"/>	6 <input type="checkbox"/>	7 <input type="checkbox"/>		8 <input type="checkbox"/>	9 <input type="checkbox"/>	10 <input type="checkbox"/>	11 <input type="checkbox"/>	12 <input type="checkbox"/>	13 <input type="checkbox"/>	14 <input type="checkbox"/>	15 <input type="checkbox"/>		16 <input type="checkbox"/>	17 <input type="checkbox"/>	18 <input type="checkbox"/>	19 <input type="checkbox"/>	20 <input type="checkbox"/>	21 <input type="checkbox"/>	22 <input type="checkbox"/>	23 <input type="checkbox"/>		24 <input type="checkbox"/>	25 <input type="checkbox"/>	26 <input type="checkbox"/>	27 <input type="checkbox"/>	28 <input type="checkbox"/>	29 <input type="checkbox"/>	30 <input type="checkbox"/>	31 <input type="checkbox"/>	<input checked="" type="checkbox"/> Show Valve Coils 32-63: Check/Uncheck box to force/un-force valve coil	32 <input checked="" type="checkbox"/>	33 <input type="checkbox"/>	34 <input checked="" type="checkbox"/>	35 <input type="checkbox"/>	36 <input checked="" type="checkbox"/>	37 <input checked="" type="checkbox"/>	38 <input checked="" type="checkbox"/>	39 <input checked="" type="checkbox"/>		40 <input checked="" type="checkbox"/>	41 <input checked="" type="checkbox"/>	42 <input checked="" type="checkbox"/>	43 <input checked="" type="checkbox"/>	44 <input checked="" type="checkbox"/>	45 <input checked="" type="checkbox"/>	46 <input checked="" type="checkbox"/>	47 <input checked="" type="checkbox"/>		48 <input checked="" type="checkbox"/>	49 <input checked="" type="checkbox"/>	50 <input checked="" type="checkbox"/>	51 <input checked="" type="checkbox"/>	52 <input checked="" type="checkbox"/>	53 <input checked="" type="checkbox"/>	54 <input type="checkbox"/>	55 <input type="checkbox"/>		56 <input type="checkbox"/>	57 <input type="checkbox"/>	58 <input type="checkbox"/>	59 <input type="checkbox"/>	60 <input type="checkbox"/>	61 <input type="checkbox"/>	62 <input type="checkbox"/>	63 <input type="checkbox"/>	Valve Status: ● = Shorted Coil ● = Open Coil ✘ = No Coil Detected	32 <input type="checkbox"/>	33 <input type="checkbox"/>	34 <input type="checkbox"/>	35 <input type="checkbox"/>	36 <input type="checkbox"/>	37 <input type="checkbox"/>	38 <input type="checkbox"/>	39 <input type="checkbox"/>		40 <input type="checkbox"/>	41 <input type="checkbox"/>	42 <input type="checkbox"/>	43 <input type="checkbox"/>	44 <input type="checkbox"/>	45 <input type="checkbox"/>	46 <input type="checkbox"/>	47 <input type="checkbox"/>		48 <input type="checkbox"/>	49 <input type="checkbox"/>	50 <input type="checkbox"/>	51 <input type="checkbox"/>	52 <input type="checkbox"/>	53 <input type="checkbox"/>	54 <input checked="" type="checkbox"/>	55 <input checked="" type="checkbox"/>		56 <input checked="" type="checkbox"/>	57 <input checked="" type="checkbox"/>	58 <input checked="" type="checkbox"/>	59 <input checked="" type="checkbox"/>	60 <input checked="" type="checkbox"/>	61 <input checked="" type="checkbox"/>	62 <input checked="" type="checkbox"/>	63 <input checked="" type="checkbox"/>	<input type="checkbox"/> Show I/O Mappings and Sizes							
Firmware Revision:	4.16																																																																																																																																																																				
<input checked="" type="checkbox"/> Show Valve Coils 0-31: Check/Uncheck box to force/un-force valve coil	0 <input checked="" type="checkbox"/>	1 <input type="checkbox"/>	2 <input checked="" type="checkbox"/>	3 <input type="checkbox"/>	4 <input checked="" type="checkbox"/>	5 <input type="checkbox"/>	6 <input checked="" type="checkbox"/>	7 <input type="checkbox"/>																																																																																																																																																													
	8 <input checked="" type="checkbox"/>	9 <input type="checkbox"/>	10 <input checked="" type="checkbox"/>	11 <input type="checkbox"/>	12 <input checked="" type="checkbox"/>	13 <input type="checkbox"/>	14 <input checked="" type="checkbox"/>	15 <input type="checkbox"/>																																																																																																																																																													
	16 <input checked="" type="checkbox"/>	17 <input type="checkbox"/>	18 <input checked="" type="checkbox"/>	19 <input type="checkbox"/>	20 <input checked="" type="checkbox"/>	21 <input type="checkbox"/>	22 <input checked="" type="checkbox"/>	23 <input type="checkbox"/>																																																																																																																																																													
	24 <input checked="" type="checkbox"/>	25 <input type="checkbox"/>	26 <input checked="" type="checkbox"/>	27 <input type="checkbox"/>	28 <input checked="" type="checkbox"/>	29 <input type="checkbox"/>	30 <input checked="" type="checkbox"/>	31 <input type="checkbox"/>																																																																																																																																																													
Valve Status: ● = Shorted Coil ● = Open Coil ✘ = No Coil Detected	0 <input type="checkbox"/>	1 <input type="checkbox"/>	2 <input type="checkbox"/>	3 <input type="checkbox"/>	4 <input type="checkbox"/>	5 <input type="checkbox"/>	6 <input type="checkbox"/>	7 <input type="checkbox"/>																																																																																																																																																													
	8 <input type="checkbox"/>	9 <input type="checkbox"/>	10 <input type="checkbox"/>	11 <input type="checkbox"/>	12 <input type="checkbox"/>	13 <input type="checkbox"/>	14 <input type="checkbox"/>	15 <input type="checkbox"/>																																																																																																																																																													
	16 <input type="checkbox"/>	17 <input type="checkbox"/>	18 <input type="checkbox"/>	19 <input type="checkbox"/>	20 <input type="checkbox"/>	21 <input type="checkbox"/>	22 <input type="checkbox"/>	23 <input type="checkbox"/>																																																																																																																																																													
	24 <input type="checkbox"/>	25 <input type="checkbox"/>	26 <input type="checkbox"/>	27 <input type="checkbox"/>	28 <input type="checkbox"/>	29 <input type="checkbox"/>	30 <input type="checkbox"/>	31 <input type="checkbox"/>																																																																																																																																																													
<input checked="" type="checkbox"/> Show Valve Coils 32-63: Check/Uncheck box to force/un-force valve coil	32 <input checked="" type="checkbox"/>	33 <input type="checkbox"/>	34 <input checked="" type="checkbox"/>	35 <input type="checkbox"/>	36 <input checked="" type="checkbox"/>	37 <input checked="" type="checkbox"/>	38 <input checked="" type="checkbox"/>	39 <input checked="" type="checkbox"/>																																																																																																																																																													
	40 <input checked="" type="checkbox"/>	41 <input checked="" type="checkbox"/>	42 <input checked="" type="checkbox"/>	43 <input checked="" type="checkbox"/>	44 <input checked="" type="checkbox"/>	45 <input checked="" type="checkbox"/>	46 <input checked="" type="checkbox"/>	47 <input checked="" type="checkbox"/>																																																																																																																																																													
	48 <input checked="" type="checkbox"/>	49 <input checked="" type="checkbox"/>	50 <input checked="" type="checkbox"/>	51 <input checked="" type="checkbox"/>	52 <input checked="" type="checkbox"/>	53 <input checked="" type="checkbox"/>	54 <input type="checkbox"/>	55 <input type="checkbox"/>																																																																																																																																																													
	56 <input type="checkbox"/>	57 <input type="checkbox"/>	58 <input type="checkbox"/>	59 <input type="checkbox"/>	60 <input type="checkbox"/>	61 <input type="checkbox"/>	62 <input type="checkbox"/>	63 <input type="checkbox"/>																																																																																																																																																													
Valve Status: ● = Shorted Coil ● = Open Coil ✘ = No Coil Detected	32 <input type="checkbox"/>	33 <input type="checkbox"/>	34 <input type="checkbox"/>	35 <input type="checkbox"/>	36 <input type="checkbox"/>	37 <input type="checkbox"/>	38 <input type="checkbox"/>	39 <input type="checkbox"/>																																																																																																																																																													
	40 <input type="checkbox"/>	41 <input type="checkbox"/>	42 <input type="checkbox"/>	43 <input type="checkbox"/>	44 <input type="checkbox"/>	45 <input type="checkbox"/>	46 <input type="checkbox"/>	47 <input type="checkbox"/>																																																																																																																																																													
	48 <input type="checkbox"/>	49 <input type="checkbox"/>	50 <input type="checkbox"/>	51 <input type="checkbox"/>	52 <input type="checkbox"/>	53 <input type="checkbox"/>	54 <input checked="" type="checkbox"/>	55 <input checked="" type="checkbox"/>																																																																																																																																																													
	56 <input checked="" type="checkbox"/>	57 <input checked="" type="checkbox"/>	58 <input checked="" type="checkbox"/>	59 <input checked="" type="checkbox"/>	60 <input checked="" type="checkbox"/>	61 <input checked="" type="checkbox"/>	62 <input checked="" type="checkbox"/>	63 <input checked="" type="checkbox"/>																																																																																																																																																													
<input type="checkbox"/> Show I/O Mappings and Sizes																																																																																																																																																																					
ARM	240-182	Auto Recovery Module	<input type="checkbox"/> Show Details		<input checked="" type="checkbox"/> Close all Details																																																																																																																																																																
No. 1	240-211	8 Inputs / 8 Outputs PNP Digital M12 x 8	<input type="checkbox"/> Show Details		<input checked="" type="checkbox"/> Close all Details																																																																																																																																																																
No. 2	240-213	2 Inputs / 2 Outputs 0-10V Analog M12 x 4	<input type="checkbox"/> Show Details		<input checked="" type="checkbox"/> Close all Details																																																																																																																																																																
			<input type="checkbox"/> Show Error/Event Log																																																																																																																																																																		

9.7 Extended Coil Valve driver IO Mapping

IO Mapping for each additional 501 series 32 coil valve driver added to the manifold assembly

<i>Input Mapping</i>								
BYTE	Bit 7	Bit 6	Bit 5	Bit 4	Bit 3	Bit 2	Bit 1	Bit 0
X	Coil 7 Status	Coil 6 Status	Coil 5 Status	Coil 4 Status	Coil 3 Status	Coil 2 Status	Coil 1 Status	Coil 0 Status
X+1	Coil 15 Status	Coil 14 Status	Coil 13 Status	Coil 12 Status	Coil 11 Status	Coil 10 Status	Coil 9 Status	Coil 8 Status
X+2	Coil 23 Status	Coil 22 Status	Coil 21 Status	Coil 20 Status	Coil 19 Status	Coil 18 Status	Coil 17 Status	Coil 16 Status
X+3	Coil 31 Status	Coil 30 Status	Coil 29 Status	Coil 28 Status	Coil 27 Status	Coil 26 Status	Coil 25 Status	Coil 24 Status

<i>Output Mapping</i>								
BYTE	Bit 7	Bit 6	Bit 5	Bit 4	Bit 3	Bit 2	Bit 1	Bit 0
X	Valve Coil No. 7	Valve Coil No. 6	Valve Coil No. 5	Valve Coil No. 4	Valve Coil No. 3	Valve Coil No. 2	Valve Coil No. 1	Valve Coil No. 0
X+1	Valve Coil No. 15	Valve Coil No. 14	Valve Coil No. 13	Valve Coil No. 12	Valve Coil No. 11	Valve Coil No. 10	Valve Coil No. 9	Valve Coil No. 8
X+2	Valve Coil No. 23	Valve Coil No. 22	Valve Coil No. 21	Valve Coil No. 20	Valve Coil No. 19	Valve Coil No. 18	Valve Coil No. 17	Valve Coil No. 16
X+3	Valve Coil No. 31	Valve Coil No. 30	Valve Coil No. 29	Valve Coil No. 28	Valve Coil No. 27	Valve Coil No. 26	Valve Coil No. 25	Valve Coil No. 24

IO Mapping for each additional 502/503 series 16 coil valve driver added to the manifold assembly

<i>Input Mapping</i>								
BYTE	Bit 7	Bit 6	Bit 5	Bit 4	Bit 3	Bit 2	Bit 1	Bit 0
X	Coil 7 Status	Coil 6 Status	Coil 5 Status	Coil 4 Status	Coil 3 Status	Coil 2 Status	Coil 1 Status	Coil 0 Status
X+1	Coil 15 Status	Coil 14 Status	Coil 13 Status	Coil 12 Status	Coil 11 Status	Coil 10 Status	Coil 9 Status	Coil 8 Status

<i>Output Mapping</i>								
BYTE	Bit 7	Bit 6	Bit 5	Bit 4	Bit 3	Bit 2	Bit 1	Bit 0
X	Valve Coil No. 7	Valve Coil No. 6	Valve Coil No. 5	Valve Coil No. 4	Valve Coil No. 3	Valve Coil No. 2	Valve Coil No. 1	Valve Coil No. 0
X+1	Valve Coil No. 15	Valve Coil No. 14	Valve Coil No. 13	Valve Coil No. 12	Valve Coil No. 11	Valve Coil No. 10	Valve Coil No. 9	Valve Coil No. 8

AVENTICS™ G3 Series EtherNet/IP™ DLR Technical Manual

9.8 501 Series, up to 64 solenoid coils

501 series, 4 station manifold block with an integrated 32 coil valve driver

- To be used with 501 series valves on valve manifold assemblies with 33-64 coils.
- Only to be used on assemblies where additional power, supply and/or exhaust capacity is not required

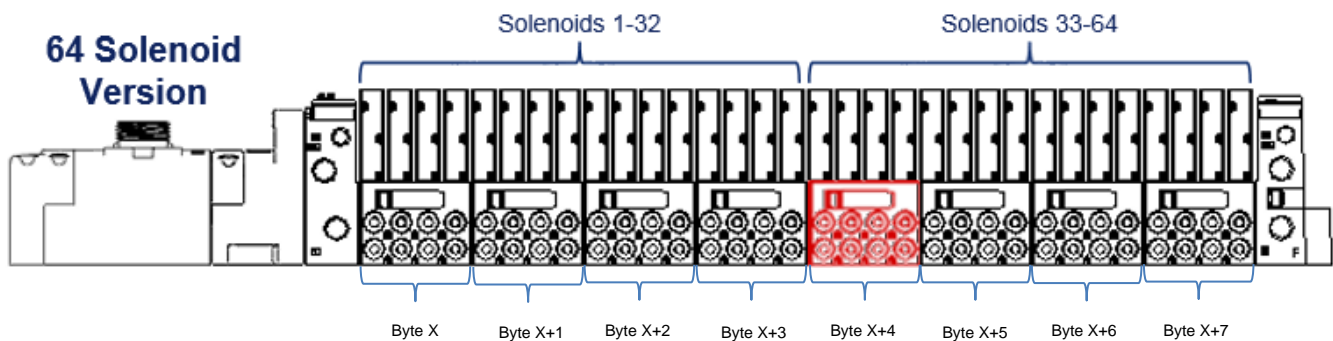
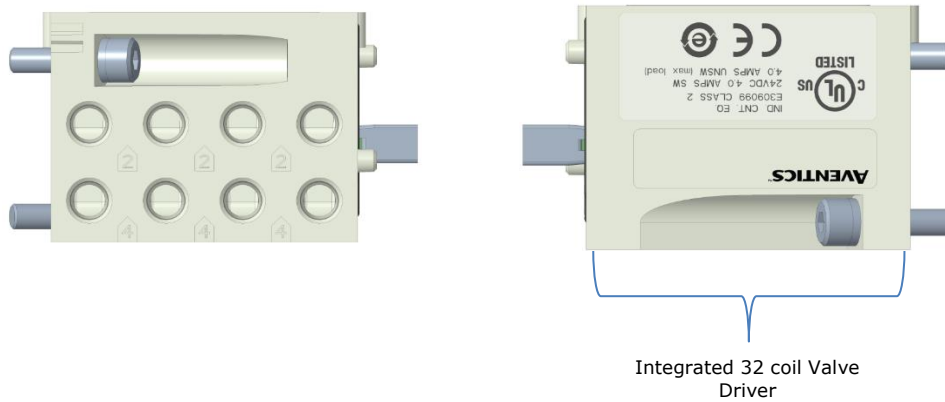

AVENTICS™ G3 Series EtherNet/IP™ DLR Technical Manual

9.9 501 Series, up to 128 solenoid coils

501 series, 8 station manifold with integrated 32 coil valve driver, auxiliary power connector and mid-station supply and exhaust ports

- To be used with 501 series valves on valve manifold assemblies with 33-128 coils.
- Up to 3 of these valve drivers can be used on each assembly
- Required to use on manifold assemblies larger than 64 coils, this manifold block has a M12 power connector to supplement the main power connection on the G3 node and two additional port 1 supply and port 3/5 exhaust ports.
- Aux power is required to be connected to the aux power connector provided on the extended coil valve driver.

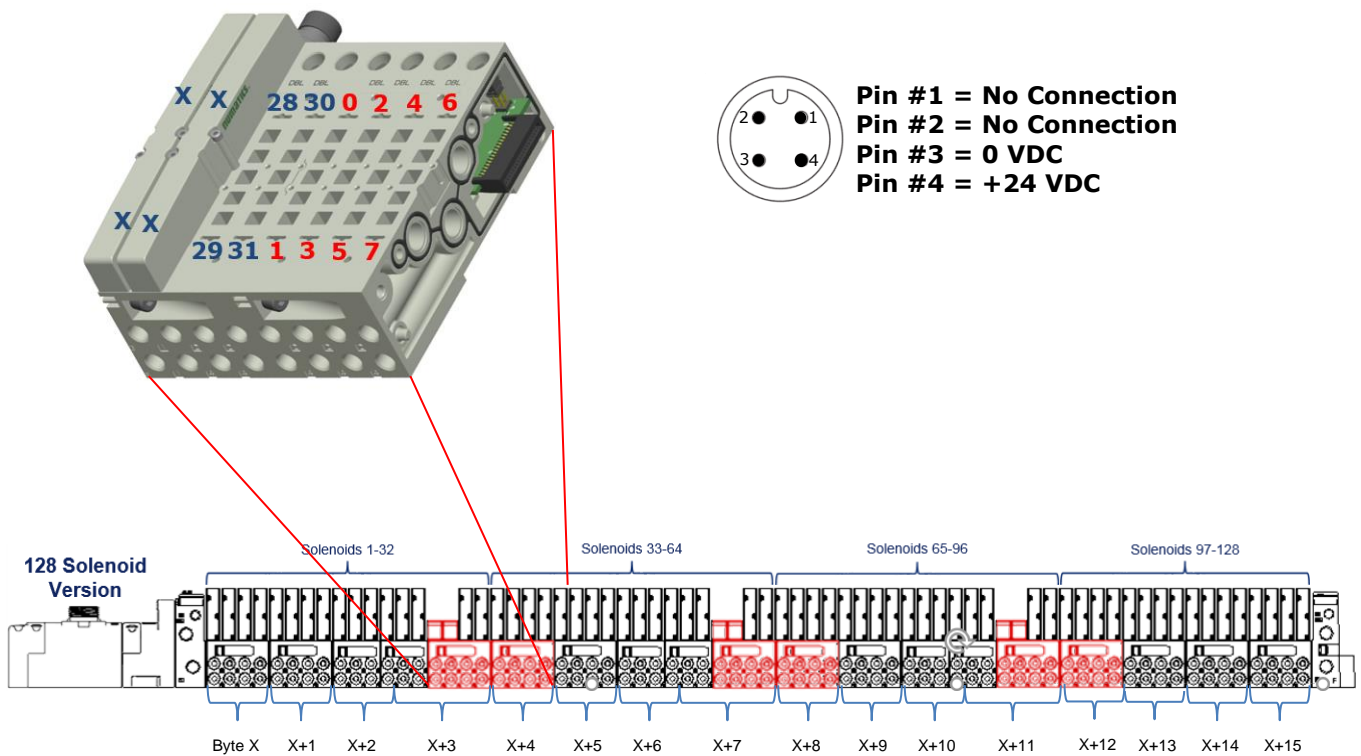
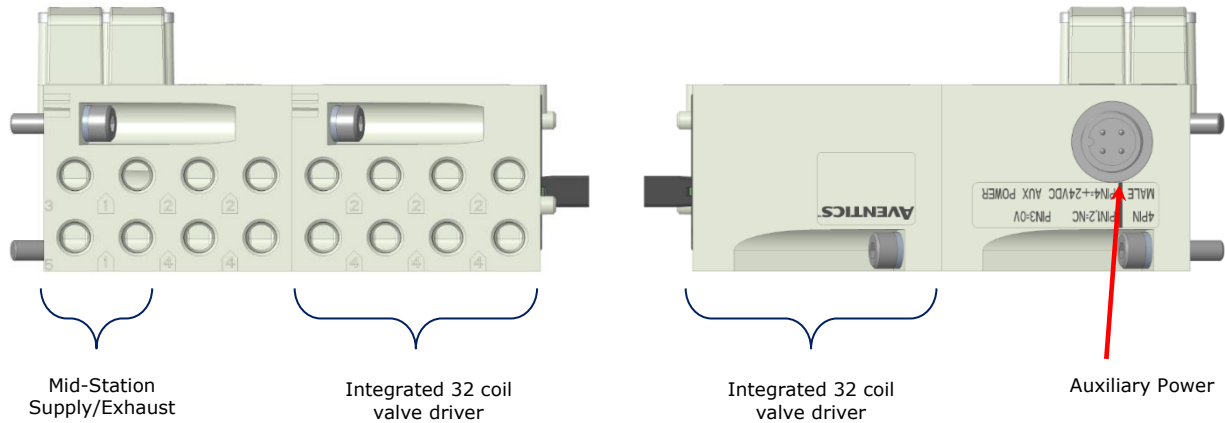

AVENTICS™ G3 Series EtherNet/IP™ DLR Technical Manual

9.10 502 and 503 Series, up to 80 coils

502 and 503 series, 4 station manifold with integrated 16 coil valve driver, power connector and mid-station supply and exhaust ports

- To be used with 502 and 503 series valves on valve manifold assemblies with 33-80 coils.
- Up to 3 of these valve drivers can be used on each assembly
- Required to use on manifold assemblies larger than 32 coils, this manifold block has an M12 power connector and two additional port 1 supply and port 3/5 exhaust ports.
- Aux power is required and will provide power to the 16 coils available via the extended coil valve driver.

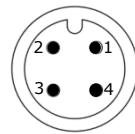
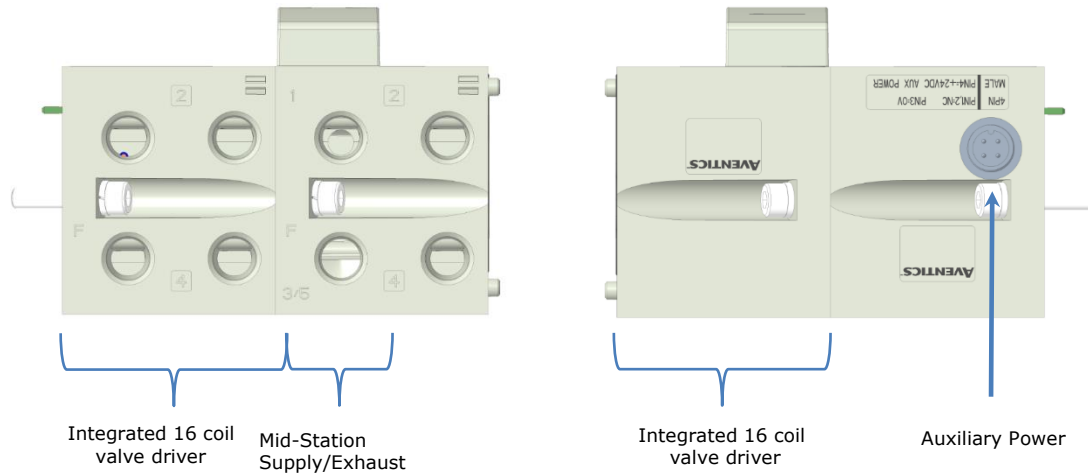

Pin #1 = No Connection
Pin #2 = No Connection
Pin #3 = 0 VDC
Pin #4 = +24 VDC

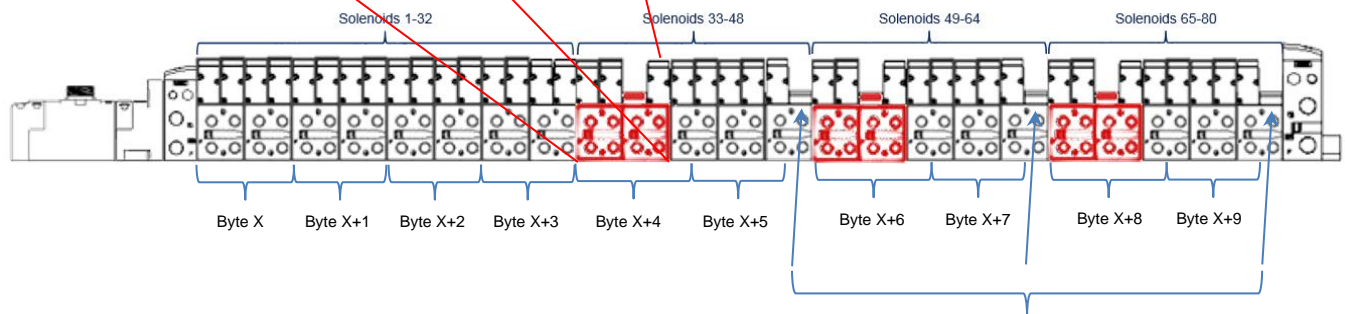

Recommended blank station plates to achieve maximum number of coils with least number of stations

10. Analog I/O Modules

10.1 Analog I/O Module Rules

The analog I/O modules follow the same rules as the digital I/O modules. The maximum total number of modules on the Sub-Bus is 16. The analog boards allow the user to control devices using an analog signal. The analog modules also allow the user to relay analog information from input devices. These modules are available in two analog signal types: 0-10 V and 4-20 mA. These two signal types are offered in two different I/O configurations: 2 analog input channels/ 2 analog outputs channels and 4 analog input channels.

Four I/O - 12mm Female Modules

Specifications

- Input Resolution: 16 bit (65,536 Counts),
- Output Resolution: 16 bit (65,536 Counts)
- Settling Time: 3 ms Max
- Absolute Precision: $\leq 1.0\%$ of Scale
- Voltage Input Impedance: 0-10VDC – 40K Ohms
- Current Input Impedance: 250 Ohms
- Input Cutoff Frequency: 100 Hz

Module Part No.	Signal Type	Input Points	Output Points	Short Circuit Protection
240-212	0 - 10V	4	0	Yes
240-213	0 - 10V	2	2	
240-214	4 - 20mA	4	0	
240-215	4 - 20mA	2	2	
240-307	0 - 10V	2	2	
240-363	4 - 20mA	4	4	

AVENTICS™ G3 Series EtherNet/IP™ DLR Technical Manual

One Analog Input per Connector – M12 Female Modules

Module Part No.	Signal Type	Short Circuit Protection	Short Circuit Protection Status Bits	Input Points
240-212	0-10 VDC	YES – Visual	YES (4) – Selectable	4
240-214	4-20 mA			

Input Mapping								
BYTE	Bit 7	Bit 6	Bit 5	Bit 4	Bit 3	Bit 2	Bit 1	Bit 0
X (Required)	Input No. 1	Input No. 1	Input No. 1	Input No. 1	Input No. 1	Input No. 1	Input No. 1	Input No. 1 (LSB)
X+1 (Required)	Input No. 1 (MSB)	Input No. 1	Input No. 1	Input No. 1	Input No. 1	Input No. 1	Input No. 1	Input No. 1
X+2 (Required)	Input No. 2	Input No. 2	Input No. 2	Input No. 2	Input No. 2	Input No. 2	Input No. 2	Input No. 2 (LSB)
X+3 (Required)	Input No. 2 (MSB)	Input No. 2	Input No. 2	Input No. 2	Input No. 2	Input No. 2	Input No. 2	Input No. 2
X+4 (Required)	Input No. 3	Input No. 3	Input No. 3	Input No. 3	Input No. 3	Input No. 3	Input No. 3	Input No. 3 (LSB)
X+5 (Required)	Input No. 3 (MSB)	Input No. 3	Input No. 3	Input No. 3	Input No. 3	Input No. 3	Input No. 3	Input No. 3
X+6 (Required)	Input No. 4	Input No. 4	Input No. 4	Input No. 4	Input No. 4	Input No. 4	Input No. 4	Input No. 4 (LSB)
X+7 (Required)	Input No. 4 (MSB)	Input No. 4	Input No. 4	Input No. 4	Input No. 4	Input No. 4	Input No. 4	Input No. 4
Diagnostics								
X	Allocated and Reserved	Allocated and Reserved	Allocated and Reserved	Allocated and Reserved	Power Status for Conn. D	Power Status for Conn. C	Power Status for Conn. B	Power Status for Conn. A
X+1	High Alarm for Conn. D	Low Alarm for Conn. D	High Alarm for Conn. C	Low Alarm for Conn. C	High Alarm for Conn. B	Low Alarm for Conn. B	High Alarm for Conn. A	Low Alarm for Conn. A

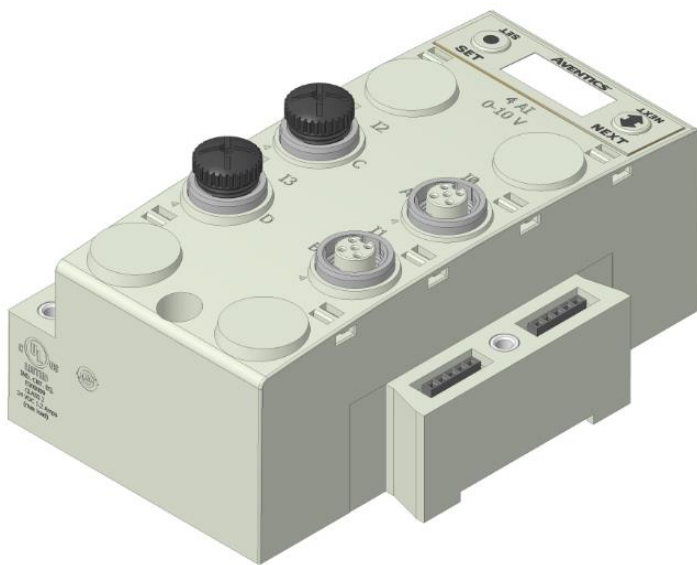

PIN 1= +24VDC (UNSW)
 PIN 2= NOT USED
 PIN 3= 0VDC (UNSW)
 PIN 4= INPUT 1

AVENTICS™ G3 Series EtherNet/IP™ DLR Technical Manual

One Analog I/O per Connector – M12 Female Modules

Module Part No.	Signal Type	Short Circuit Protection	Short Circuit Protection Status Bits	Output Points	Input Points
240-213	0-10 VDC	YES – Visual	YES (4) Selectable	2	2
240-215	4-20 mA				

Output Mapping								
BYTE	Bit 7	Bit 6	Bit 5	Bit 4	Bit 3	Bit 2	Bit 1	Bit 0
X	Output No. 1	Output No. 1	Output No. 1	Output No. 1	Output No. 1	Output No. 1	Output No. 1	Output No. 1 (LSB)
X+1	Output No. 1 (MSB)	Output No. 1	Output No. 1	Output No. 1	Output No. 1	Output No. 1	Output No. 1	Output No. 1
X+2	Output No. 2	Output No. 2	Output No. 2	Output No. 2	Output No. 2	Output No. 2	Output No. 2	Output No. 2 (LSB)
X+3	Output No. 2 (MSB)	Output No. 2	Output No. 2	Output No. 2	Output No. 2	Output No. 2	Output No. 2	Output No. 2
Input Mapping								
BYTE	Bit 7	Bit 6	Bit 5	Bit 4	Bit 3	Bit 2	Bit 1	Bit 0
X	Input No. 1	Input No. 1	Input No. 1	Input No. 1	Input No. 1	Input No. 1	Input No. 1	Input No. 1 (LSB)
X+1	Input No. 1 (MSB)	Input No. 1	Input No. 1	Input No. 1	Input No. 1	Input No. 1	Input No. 1	Input No. 1
X+2	Input No. 2	Input No. 2	Input No. 2	Input No. 2	Input No. 2	Input No. 2	Input No. 2	Input No. 2 (LSB)
X+3	Input No. 2 (MSB)	Input No. 2	Input No. 2	Input No. 2	Input No. 2	Input No. 2	Input No. 2	Input No. 2
Diagnostics								
X	Allocated and Reserved	Allocated and Reserved	Allocated and Reserved	Allocated and Reserved	Power Status for Conn. D	Power Status for Conn. C	Power Status for Conn. B	Power Status for Conn. A
X+1	High Alarm for Conn. D	Low Alarm for Conn. D	High Alarm for Conn. C	Low Alarm for Conn. C	High Alarm for Conn. B	Low Alarm for Conn. B	High Alarm for Conn. A	Low Alarm for Conn. A

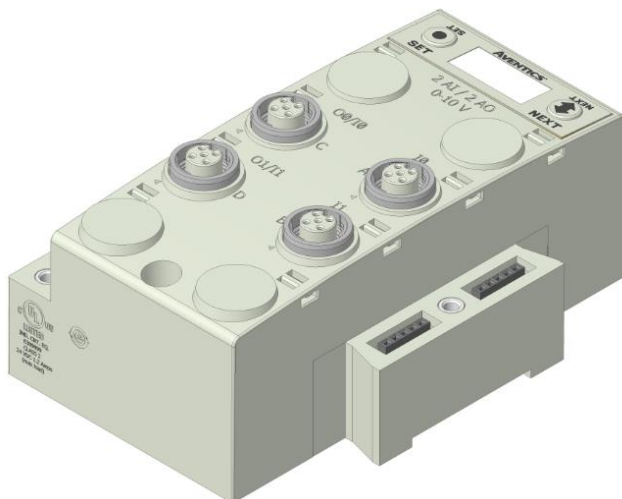

CONNECTORS C & D	CONNECTORS A & B
PIN 1= +24VDC (UNSW)	PIN 1= +24VDC (UNSW)
PIN 2= OUTPUT	PIN 2= NOT USED
PIN 3= 0VDC (UNSW)	PIN 3= 0VDC (UNSW)
PIN 4= INPUT	PIN 4= INPUT

TDG3EDM1-11EN 4/21
Subject to change without notice

AVENTICS™ G3 Series EtherNet/IP™ DLR Technical Manual

One Analog Input per Connector A/B and One Analog Output + Duplicate of Input per Connector C/D – M12 Female Modules

Module Part No.	Signal Type	Short Circuit Protection	Short Circuit Protection Status Bits	Output Points	Input Points
240-307	0-10 VDC	YES	YES	2	2

Output Mapping								
BYTE	Bit 7	Bit 6	Bit 5	Bit 4	Bit 3	Bit 2	Bit 1	Bit 0
X	Output No. 1	Output No. 1	Output No. 1	Output No. 1	Output No. 1	Output No. 1	Output No. 1	Output No. 1 (LSB)
X+1	Output No. 1 (MSB)	Output No. 1	Output No. 1	Output No. 1	Output No. 1	Output No. 1	Output No. 1	Output No. 1
X+2	Output No. 2	Output No. 2	Output No. 2	Output No. 2	Output No. 2	Output No. 2	Output No. 2	Output No. 2 (LSB)
X+3	Output No. 2 (MSB)	Output No. 2	Output No. 2	Output No. 2	Output No. 2	Output No. 2	Output No. 2	Output No. 2
Input Mapping								
BYTE	Bit 7	Bit 6	Bit 5	Bit 4	Bit 3	Bit 2	Bit 1	Bit 0
X	Input No. 1	Input No. 1	Input No. 1	Input No. 1	Input No. 1	Input No. 1	Input No. 1	Input No. 1 (LSB)
X+1	Input No. 1 (MSB)	Input No. 1	Input No. 1	Input No. 1	Input No. 1	Input No. 1	Input No. 1	Input No. 1
X+2	Input No. 2	Input No. 2	Input No. 2	Input No. 2	Input No. 2	Input No. 2	Input No. 2	Input No. 2 (LSB)
X+3	Input No. 2 (MSB)	Input No. 2	Input No. 2	Input No. 2	Input No. 2	Input No. 2	Input No. 2	Input No. 2
Diagnostics								
X	Allocated and Reserved	Allocated and Reserved	Allocated and Reserved	Allocated and Reserved	Power / Short Status for Conn. D	Power / Short Status for Conn. C	Allocated and Reserved	Allocated and Reserved
X+1	High Alarm for Conn. D	Low Alarm for Conn. D	High Alarm for Conn. C	Low Alarm for Conn. C	High Alarm for Conn. B	Low Alarm for Conn. B	High Alarm for Conn. A	Low Alarm for Conn. A

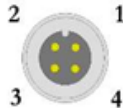
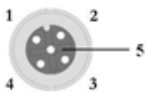

I/O Connectors C & D (Female)

- Pin 1 = +24 VDC
- Pin 2 = OUTPUT
- Pin 3 = 0 VDC
- Pin 4 = INPUT
- Pin 5 = NOT USED

AUXILIARY POWER (Male)

- Pin 1 = +24 VDC (For Conn. C)
- Pin 2 = +24 VDC (For Conn. D)
- Pin 3 = 0 VDC (For Conn. C)
- Pin 4 = 0 VDC (For Conn. D)

Input Connectors A & B (Female)

- Pin 1 = +10 VDC
- Pin 2 = NOT USED
- Pin 3 = 0 VDC
- Pin 4 = INPUT
- Pin 5 = NOT USED

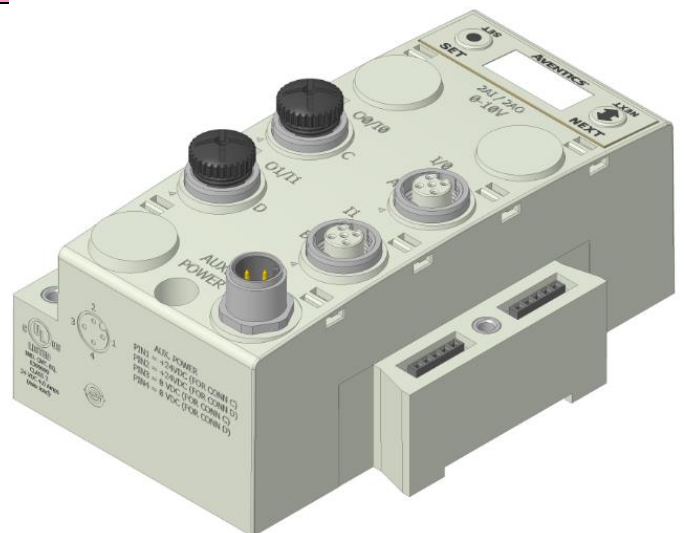

AVENTICS™ G3 Series EtherNet/IP™ DLR Technical Manual

One Analog Input + One Analog Output per Connector – M12 Female Modules

Module Part No.	Signal Type	Short Circuit Protection	Short Circuit / Power Present Status Bits	Input Channels	Output Channels
240-363	4-20 mA	YES	YES (4) – Selectable	4	4

Output Mapping								
BYTE	Bit 7	Bit 6	Bit 5	Bit 4	Bit 3	Bit 2	Bit 1	Bit 0
X (Required)	Output No. 1	Output No. 1	Output No. 1	Output No. 1	Output No. 1	Output No. 1	Output No. 1	Output No. 1 (LSB)
X + 1 (Required)	Output No. 1 (MSB)	Output No. 1	Output No. 1	Output No. 1	Output No. 1	Output No. 1	Output No. 1	Output No. 1
X + 2 (Required)	Output No. 2	Output No. 2	Output No. 2	Output No. 2	Output No. 2	Output No. 2	Output No. 2	Output No. 2 (LSB)
X + 3 (Required)	Output No. 2 (MSB)	Output No. 2	Output No. 2	Output No. 2	Output No. 2	Output No. 2	Output No. 2	Output No. 2
X + 4 (Required)	Output No. 3	Output No. 3	Output No. 3	Output No. 3	Output No. 3	Output No. 3	Output No. 3	Output No. 3 (LSB)
X + 5 (Required)	Output No. 3 (MSB)	Output No. 3	Output No. 3	Output No. 3	Output No. 3	Output No. 3	Output No. 3	Output No. 3
X + 6 (Required)	Output No. 4	Output 4	Output No. 4	Output No. 4	Output No. 4	Output No. 4	Output No. 4	Output No. 4 (LSB)
X + 7 (Required)	Output No. 4 (MSB)	Output 4	Output No. 4	Output No. 4	Output No. 4	Output No. 4	Output No. 4	Output No. 4
Input Mapping								
BYTE	Bit 7	Bit 6	Bit 5	Bit 4	Bit 3	Bit 2	Bit 1	Bit 0
X (Required)	Input No. 1	Input No. 1	Input No. 1	Input No. 1	Input No. 1	Input No. 1	Input No. 1	Input No. 1 (LSB)
X + 1 (Required)	Input No. 1 (MSB)	Input No. 1	Input No. 1	Input No. 1	Input No. 1	Input No. 1	Input No. 1	Input No. 1
X + 2 (Required)	Input No. 2	Input No. 2	Input No. 2	Input No. 2	Input No. 2	Input No. 2	Input No. 2	Input No. 2 (LSB)
X + 3 (Required)	Input No. 2 (MSB)	Input No. 2	Input No. 2	Input No. 2	Input No. 2	Input No. 2	Input No. 2	Input No. 2
X + 4 (Required)	Input No. 3	Input No. 3	Input No. 3	Input No. 1	Input No. 1	Input No. 1	Input No. 1	Input No. 1 (LSB)
X + 5 (Required)	Input No. 3 (MSB)	Input No. 3	Input No. 3	Input No. 1	Input No. 1	Input No. 1	Input No. 1	Input No. 1
X + 6 (Required)	Input No. 4	Input No. 4	Input No. 4	Input No. 2	Input No. 2	Input No. 2	Input No. 2	Input No. 2 (LSB)
X + 7 (Required)	Input No. 4 (MSB)	Input No. 4	Input No. 4	Input No. 2	Input No. 2	Input No. 2	Input No. 2	Input No. 2

AVENTICS™ G3 Series EtherNet/IP™ DLR Technical Manual

One 4-20ma Analog Input + One 4-20 Analog Output per Connector – M12 Female Modules

Module Part No.	Signal Type	Short Circuit Protection	Short Circuit / Power Present Status Bits	Input Channels	Output Channels
240-363	4-20 mA	YES	YES (4) – Selectable	4	4

Diagnostic Mapping								
BYTE	Bit 7	Bit 6	Bit 5	Bit 4	Bit 3	Bit 2	Bit 1	Bit 0
X (Selectable)	Allocated and Reserved	Allocated and Reserved	Allocated and Reserved	Allocated and Reserved	Power/Short Status for Conn. D	Power/Short Status for Conn. C	Power/Short Status for Conn. B	Power/Short Status for Conn. A
X + 1 (Selectable)	High Alarm for Conn. D Input	Low Alarm for Conn. D Input	High Alarm for Conn. C Input	Low Alarm for Conn. C Input	High Alarm for Conn. B Input	Low Alarm for Conn. B Input	High Alarm for Conn. A Input	Low Alarm for Conn. A Input
X + 2 (Selectable)	High Alarm for Conn. D Output	Low Alarm for Conn. D Output	High Alarm for Conn. C Output	Low Alarm for Conn. C Output	High Alarm for Conn. B Output	Low Alarm for Conn. B Output	High Alarm for Conn. A Output	Low Alarm for Conn. A Output

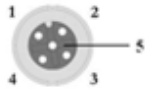

Pin 1 = +24VDC
 Pin 2 = Output
 Pin 3 = 0VDC
 Pin 4 = Input
 Pin 5 = Not Used

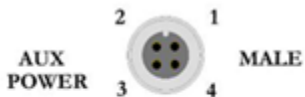

Pin 1 = +24 VDC (For Conn A, B)
 Pin 2 = +24 VDC (For Conn C, D)
 Pin 3 = 0 VDC (For Conn A, B, C, D)
 Pin 4 = 0 VDC (For Conn A, B, C, D)

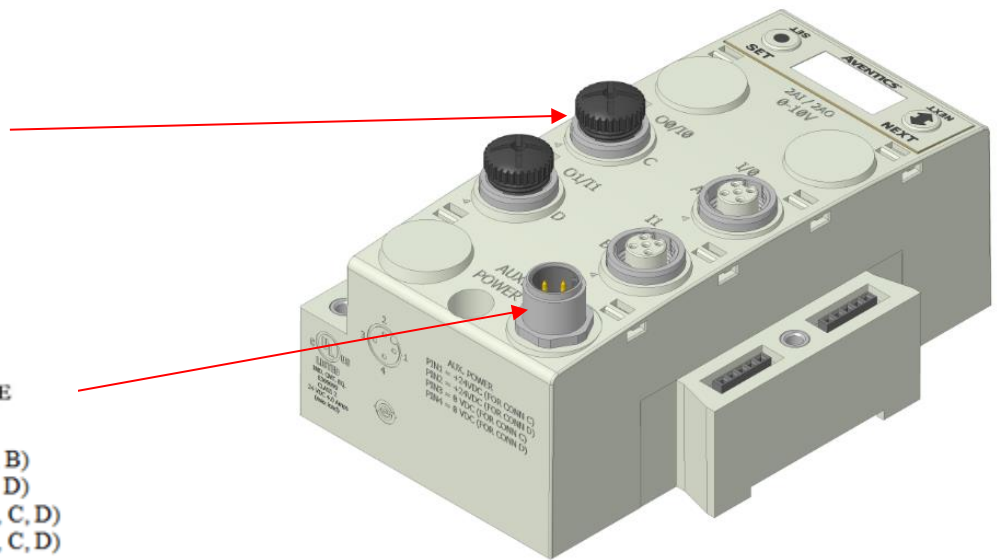

Internal or Aux. Power Select (240-363 Only)

AVENTICS™ G3 Series EtherNet/IP™ DLR Technical Manual

Analog devices connected to the 240-363 can be powered from the Aux. Power supply port (Internal Power Disabled) or from the module backplane (Internal Power Enabled). This is selected through the "Internal Power Menu" as shown. Channels A/B and C/D are controlled independently.

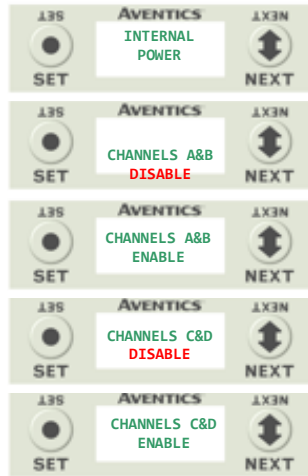

Internal Power Settings

1. Press the SET button to enter the INTERNAL POWER menu
2. CHANNEL A & B DISABLE
3. Press the NEXT button to scroll through the choices to enable or disable the feature.
 - j. ENABLED (Factory Default)
 - k. DISABLED
 - l. RETURN (this will return you to the main menu)
 - m.
- Press the SET button to confirm your choice
4. CHANNEL C & D DISABLE
5. Press the NEXT button to scroll through the choices to enable or disable the feature.
 - n. ENABLED (Factory Default)
 - o. DISABLED
 - p. RETURN (this will return you to the main menu)

Press the SET button to confirm your choice



Power Source	Current Limitation for Module	Current Limitation for connector
Aux Power	8A (From Aux. Power Conn.)	2.0A / output connector (2.0A Pin 1 to Pin 3)
Internal Power	1.2A (from Backplane)	.15A (Pin 1 to Pin 3)

AVENTICS™ G3 Series EtherNet/IP™ DLR Technical Manual

10.2 Analog Graphic Display

The G3 Analog I/O modules have an integrated graphic display that may be used to configure the parameters of the modules as well as show diagnostic information. Please see the following pages for detailed information regarding these displays.

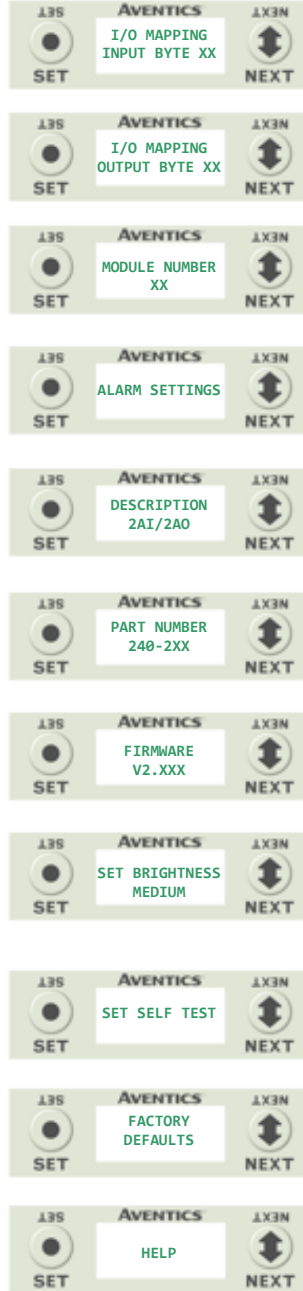

AVENTICS™ G3 Series EtherNet/IP™ DLR Technical Manual

Analog Module / I/O Mapping

Displays the starting Input and Output byte address for the module

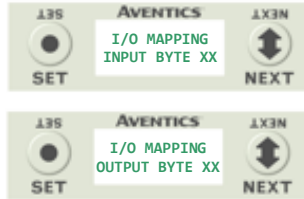

Analog Module / Module Number

Displays the module number; identifying its position in the G3 I/O system.

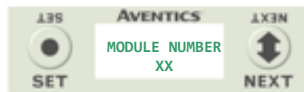

Analog Module / Alarm Settings

Allows the setting of low and high alarms for analog inputs and outputs

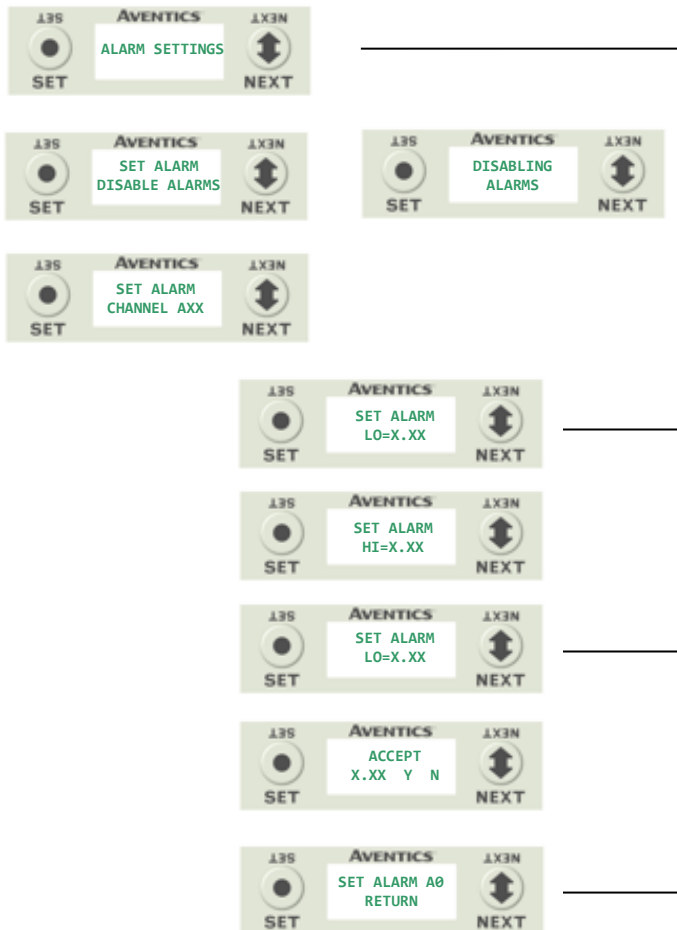

Alarm Settings Steps

1. Press the SET button to enter the Alarm Settings sub-menu.
2. Press the SET button to Disable all alarms (default setting)
*Note- Setting the Minimum value for Low alarm and the Maximum value for High alarm (for a channel) disables the alarm for that channel.
3. Press the NEXT button to scroll to the appropriate analog channel.
4. Press the SET button to set the LO alarm setting
 - a. Push the SET button to access the menu and enter the alarm value
5. Press the NEXT button to SET the HI alarm setting.
 - a. Push the SET button to access the menu and enter the alarm value
 - b. Accept the changes by selecting Y and pushing SET
6. Press the SET button while in the RETURN screen to return to the main menu

AVENTICS™ G3 Series EtherNet/IP™ DLR Technical Manual

Analog Module / Description

Displays the quantity and type of I/O on the module
Ex. 2 analog Inputs and 2 analog outputs



Analog Module / Part number

Displays the replacement part number of the module



Analog Module / Firmware

Displays the firmware revision level for the module



Analog Module / Brightness



Brightness Settings

1. Press the SET button to enter the SET BRIGHTNESS menu.
2. Press the NEXT button to scroll the choices for the desired brightness of the LCD display for the analog module.
 - a. LOW
 - b. MEDIUM (Factory Default)
 - c. HIGH
 - d. RETURN (this will return you to the main menu)



Press the SET button to confirm your choice. The changes will take effect immediately.

10.3 Analog Module / Self Test Mode

Self-test mode is an internal diagnostic tool that can be enabled on the analog module using the graphic display. This tool allows the user to confirm that all of the outputs on the module are fully functional without needing a network connection or controller. The test will cycle the analog outputs. Starting with Output 0 it will increment the analog signal at 10% intervals; once it has reached 100% it will test the next available output. The self-test will continue to run until it is turned off by pressing the SET button.

To use the Self-Test Mode, the user must first set some initial conditions. Follow these steps to initiate the self-test mode.

- 1) **Disconnect Air and Communication from the manifold!**
- 2) Starting at the Home Screen, navigate the menus by selecting the NEXT button until the SELF-TEST menu is shown.
- 3) Select the SET button to access the SELF-TEST menu
- 4) A message will appear: DISCONNECT AIR HOLD SET BUTTON
- 5) Hold the SET button down for approximately 10 seconds to enable the test. The Display will flash the above message while the button is pushed.
- 6) When the display stops flashing, the self-test mode will be running
- 7) Push or hold the NEXT button to cycle through the outputs. Holding the NEXT button will allow the analog outputs to cycle through the 10% intervals automatically. Pushing the NEXT button will allow the outputs to manually step through each 10% interval.
- 8) Releasing the NEXT button will keep the output in its current state.
- 9) The self-test mode can only be disabled by pushing the SET button

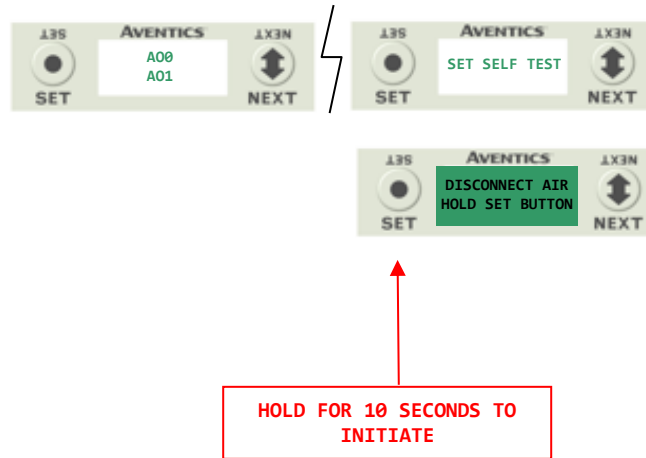

10.4 Analog Module / Factory Defaults

Factory Default Settings



1. Press the SET button to enter the FACTORY DEFAULTS sub-menu.

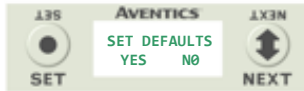

2. Press the NEXT button to select Yes or No.
 - a. Selecting No will bring you back to the main FACTORY DEFAULTS menu.
 - b. Selecting Yes will cause the module to reset and return all parameters to the factory default

<i>FACTORY DEFAULT SETTINGS</i>	
<i>Description</i>	<i>Default</i>
Low Alarm Values	0 V / 4 mA
High Alarm Values	10 V / 20 mA
Brightness	Medium

11. Specialty Modules

11.1 RTD Module

The G3 RTD Temperature module is used with Resistive Temperature Detectors (RTDs) and can support up to 4 RTD devices simultaneously. This module supports various RTD types including: Pt100, Pt200, Pt500, Pt1000, Ni100 and Ni1000. Standard M12 single key connector types are used; each connector/port supports one RTD device, but four different device types can be used simultaneously. User configuration of parameters include: RTD type, temperature scale (Celsius or Fahrenheit), Hi/Low temperature alarms, and filter times, and can be selected individually for each connector port using the integrated display. The G3 RTD module can be incorporated into any G3 electronic system regardless of the protocol or I/O module position.

Module Part No.	I/O Type	Alarms	Diagnostics	Input Points
240-311	RTD	Hi/Low Temp for each Channel	Open/Short, Out of Range	4

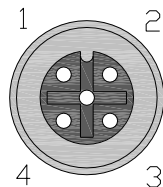
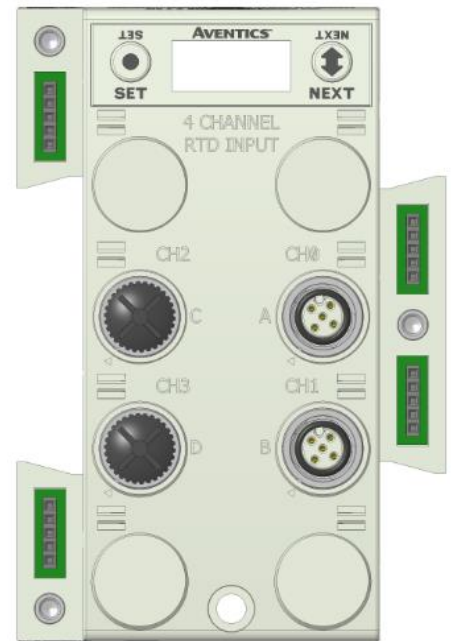
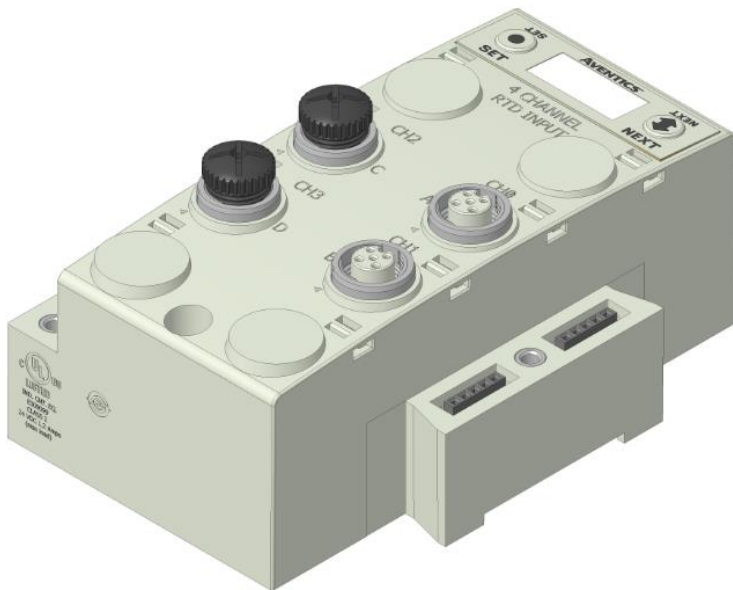

FEMALE
 PIN 1 = Sensor Current Source (I+)
 PIN 2 = Sense Voltage (VIN+)
 PIN 3 = Sensor Current Source (I-)
 PIN 4 = Sense Voltage (VIN-)
 PIN 5 = Not Used

AVENTICS™ G3 Series EtherNet/IP™ DLR Technical Manual

Sensor Wiring Diagrams

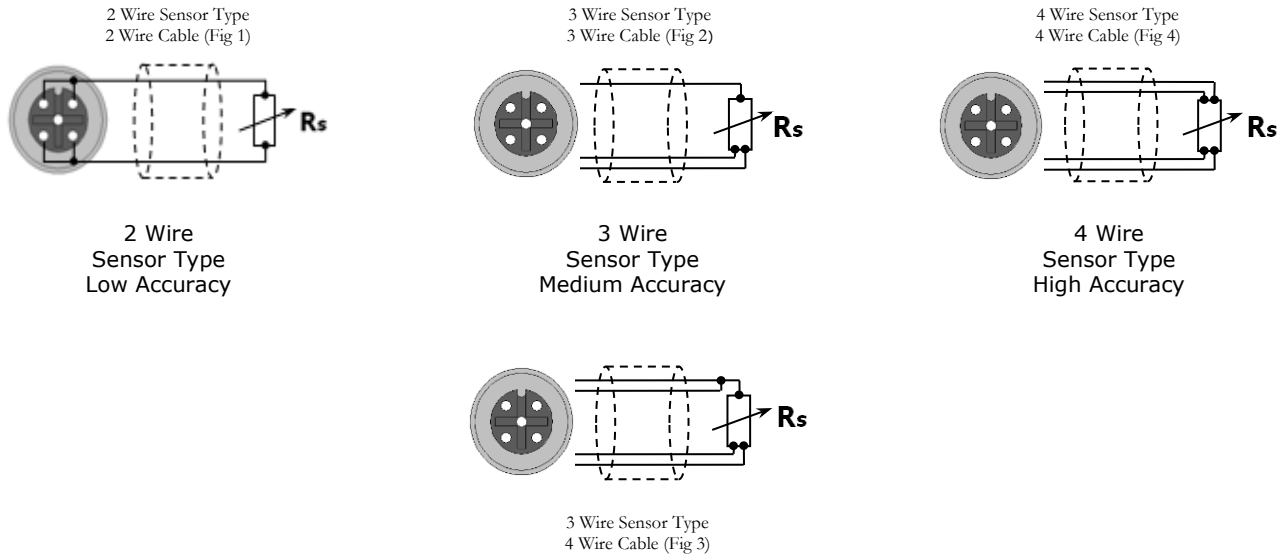

- For maximum accuracy on a 3 wire sensor type make identified jumper connections at the sensor end (see Figure 3). Cable resistance, resulting from cable length, affects measuring error; therefore use cables that are as short as possible.
- For long cable runs and high accuracy use 4 wire sensor types.

Electrical Data	
Voltage	24 VDC Module Supply (Via G3 System Aux. Power Connection)
Input Type	RTD (Resistive Temperature Detector), 4 per Module
Supported Sensor Types	Pt100, Pt200, Pt500, Pt1000, Ni100, Ni1000
Supported Temperature Coefficients	.00385; .00392; ...Ω/Ω/°C
Resolution	15 bits, plus sign.
Data Format	Signed Integer; Two's complement.
Calibration	Factory Calibrated. Field Calibration w/ high tolerance (± 0.005%) 100 ohm and 350 ohm resistor.
Input Update (filter) Rate	Adjustable (5-20mS), factory default: 5mS
Accuracy	0.1% of full scale @ 25° C
Mechanical Data	
I/O Connector	M12 4 Pin Female (Accepts 5 Pin)
Mass	247g / 8.7 oz
Operating Data	
Temperature Range	-10° to 115° F (-23° to 46° C)
Humidity	95% relative humidity: non-condensing
Ingress Protection	IP65 (with appropriate assembly and terminations)

Part Numbers and Mapping



TDG3EDM1-11EN 4/21
Subject to change without notice

www.asco.com/g3

AVENTICS™ G3 Series EtherNet/IP™ DLR Technical Manual

Module Part No.	I/O Type	Alarms	Diagnostics	Input Points
240-311	RTD	Hi/Low Temp for each Channel	Open/Short, Out of Range	4

Input Mapping								
BYTE	Bit 7	Bit 6	Bit 5	Bit 4	Bit 3	Bit 2	Bit 1	Bit 0
X	RTD Channel 0	RTD Channel 0	RTD Channel 0	RTD Channel 0	RTD Channel 0	RTD Channel 0	RTD Channel 0	RTD Channel 0
X + 1	Sign Bit Channel 0	RTD Channel 0	RTD Channel 0	RTD Channel 0	RTD Channel 0	RTD Channel 0	RTD Channel 0	RTD Channel 0
X + 2	RTD Channel 1	RTD Channel 1	RTD Channel 1	RTD Channel 1	RTD Channel 1	RTD Channel 1	RTD Channel 1	RTD Channel 1
X + 3	Sign Bit Channel 1	RTD Channel 1	RTD Channel 1	RTD Channel 1	RTD Channel 1	RTD Channel 1	RTD Channel 1	RTD Channel 1
X + 4	RTD Channel 2	RTD Channel 2	RTD Channel 2	RTD Channel 2	RTD Channel 2	RTD Channel 2	RTD Channel 2	RTD Channel 2
X + 5	Sign Bit Channel 2	RTD Channel 2	RTD Channel 2	RTD Channel 2	RTD Channel 2	RTD Channel 2	RTD Channel 2	RTD Channel 2
X + 6	RTD Channel 3	RTD Channel 3	RTD Channel 3	RTD Channel 3	RTD Channel 3	RTD Channel 3	RTD Channel 3	RTD Channel 3
X + 7	Sign Bit Channel 3	RTD Channel 3	RTD Channel 3	RTD Channel 3	RTD Channel 3	RTD Channel 3	RTD Channel 3	RTD Channel 3
Diagnostic Telegram								
X + 8	Channel 3 Out of Range	Channel 2 Out of Range	Channel 1 Out of Range	Channel 0 Out of Range	Channel 3 Open/Short	Channel 2 Open/Short	Channel 1 Open/Short	Channel 0 Open/Short
X + 9	Channel 3 High Alarm	Channel 3 Low Alarm	Channel 2 High Alarm	Channel 2 Low Alarm	Channel 1 High Alarm	Channel 1 Low Alarm	Channel 0 High Alarm	Channel 0 Low Alarm

RTD Module Graphic display

RTD Module / Temperature Monitoring

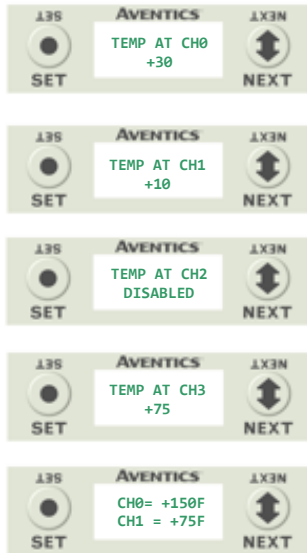

- 1) Press the NEXT button to scroll through the Temperature Monitoring display options.

Pressing the SET button while in one of the Temperature Monitoring displays, will return the display back to the home screen.

If "DISABLED" is the temperature identified at any channel, advance the display to Sensor Type Select, to choose a sensor/Enable the channel, or press the "SET" button to jump directly to the selection display.

Unused channels should be left "DISABLED".



Data is represented by Two's Complement, in tenths of a degree.

AVENTICS™ G3 Series EtherNet/IP™ DLR Technical Manual

RTD Module / Sensor Type Select (Channel Enable)

Allows the sensor type for each channel to be selected, and, enable the channel selected



A) Press the SET button to enter the Sensor Type Select sub menu.



B) Press the NEXT button to scroll through the channels.



C) Press the SET button to select the desired channel. If "DISABLED" is the first selection, the channel is not enabled. Select a sensor type to enable the channel.



D) Press the NEXT button to scroll through the available sensor types.

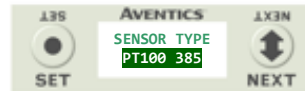

E) Press the SET button to select the desired sensor type.



F) Press the SET button to load the selected sensor type.

AVENTICS™ G3 Series EtherNet/IP™ DLR Technical Manual

RTD Module / Temperature Scale

Allows the temperature scale for each channel to be set to Celsius or Fahrenheit.

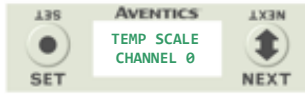

- A) Press the SET button to enter the Temp Scale sub menu.
- B) Press the NEXT button to scroll through the channels.
- C) Press the SET button to choose the desired channel.
- D) Press the NEXT button to choose the desired scale.
- E) Press the SET button to load the selection.

AVENTICS™ G3 Series EtherNet/IP™ DLR Technical Manual

RTD Module / Alarm Settings

Allows the Low and High alarms of each RTD Input channel to be set. This parameter generates a visual and logical (bit) when set value is achieved.



- A) Press the SET button to enter the Alarm Settings sub-menu.
- B) Press the NEXT button to scroll through the RTD Input channels.
- C) Press the SET button to enter the alarm setting for the selected Input channel.
- D) Press the NEXT button to select the Lo or High setting for the selected channel.
- E) Press the SET button to select the change process for the chosen alarm. The first digit/sign will be highlighted.
- F) Press the NEXT button to choose the value, or the SET button to select and move to the next digit.
- G) Press the NEXT button to choose "Y" or "N" Select. Then press the SET Button to Accept.



- When alarm values are set to maximum/minimum values, the alarm function is disabled.
- Factory default settings for all alarms are disabled.

AVENTICS™ G3 Series EtherNet/IP™ DLR Technical Manual

RTD Module / Advanced Setting

Allows the Update Filters for each channel to be set.



A) Press the SET button to enter the Advance Settings sub-menu.

B) Press the NEXT button to choose the option; Update Filters or Calibrate RTD.

Update Filters



C) Press the SET button to choose the Update Filter setting.

D) Press the NEXT button to scroll through the filter times.

E) Press the SET button to select the desired Update Filter time.



RTD Module / I/O Mapping Input Byte

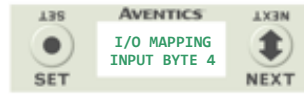

RTD Module / Module Number (Position)



RTD Module / Module Description



RTD Module / Part Number



RTD Module / Firmware Revision



AVENTICS™ G3 Series EtherNet/IP™ DLR Technical Manual

RTD Module / Set Display Brightness

Allows the Brightness of the display to be changed



- A) press the SET button to enter the Set Brightness sub menu.
- B) Press the NEXT button to scroll through the brightness options
- C) Press the SET button to load the selection.

RTD Module / Flip Display

Allows the Display to be flipped 180 degrees.



- A) press the SET button to enter the Flip Display sub menu.
- B) Press the NEXT button to choose the orientation.
- C) Press the SET button to load the selection.

AVENTICS™ G3 Series EtherNet/IP™ DLR Technical Manual

RTD Module / Factory Defaults

Set all parameter settings to default values.

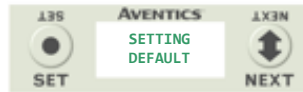

- A) Press the SET button to enter the Factory Defaults sub menu.
- B) Press the NEXT button to choose Yes or No.
- C) Press the SET button to confirm.
- D) Press the SET button again.



Factory Default Settings	
Alarm - High & Low	Disabled (Set to Min/Max for each chosen sensor)
Input Update Filter	5 mS
Sensor Type	Pt 100 385
Temp Scale	Celsius
Display Brightness	Medium
Flip Display	Normal

AVENTICS™ G3 Series EtherNet/IP™ DLR Technical Manual

11.2 Sub-Bus Hub Module

The G3 HUB module allows for branch distribution from the I/O side of the G3 System and can be integrated into the existing G3 Series Sub-Bus configuration. Auto Addressing allows for trouble free set up and configuration. Input, Output, as well as Valve manifolds can be attached to the available four Branches on a HUB module. Each G3 System can support up to two HUB modules, allowing for maximum flexibility. The HUB module is transparent to the I/O side of the G3 and does not reserve one of the potential sixteen positions.

Module Part No.	Module Type	Diagnostics	Input Size / Output Size	Branches
240-326	HUB	Sub-Bus Short Circuit	0 / 0 – See Note	4

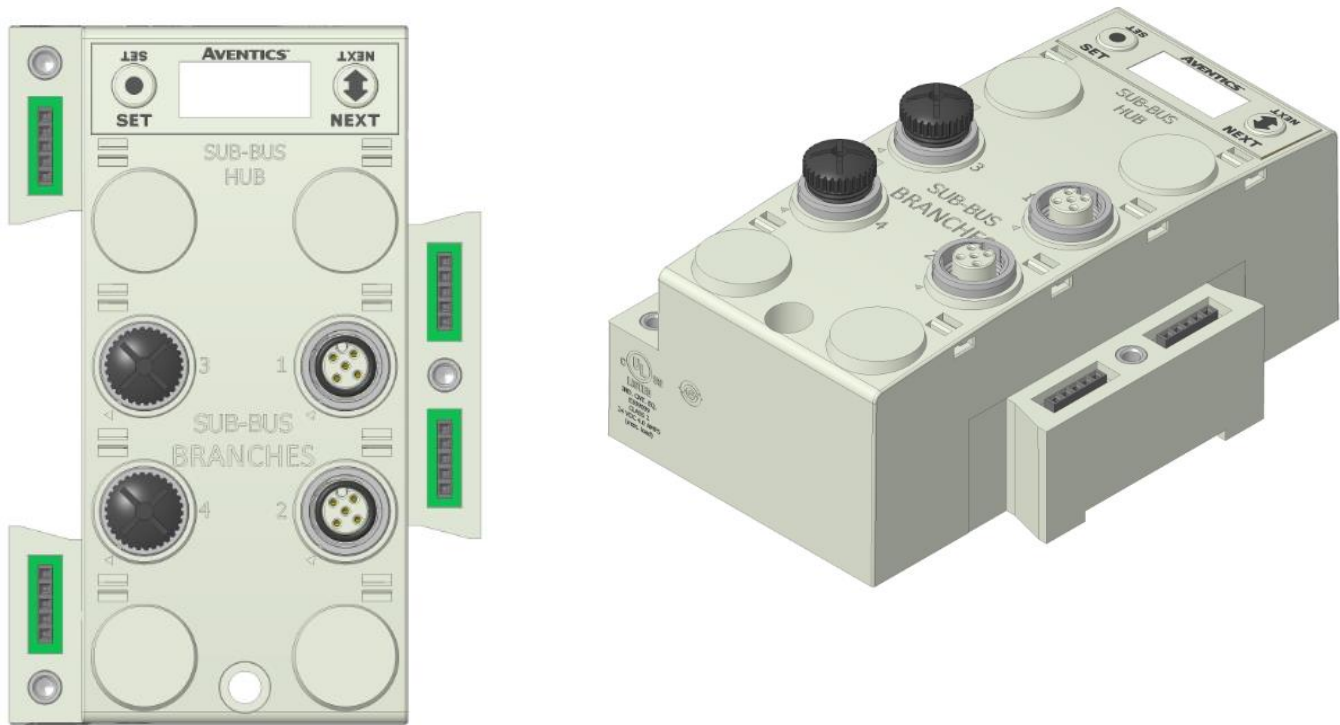

AVENTICS™ G3 Series EtherNet/IP™ DLR Technical Manual

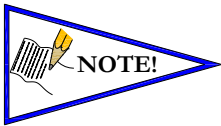
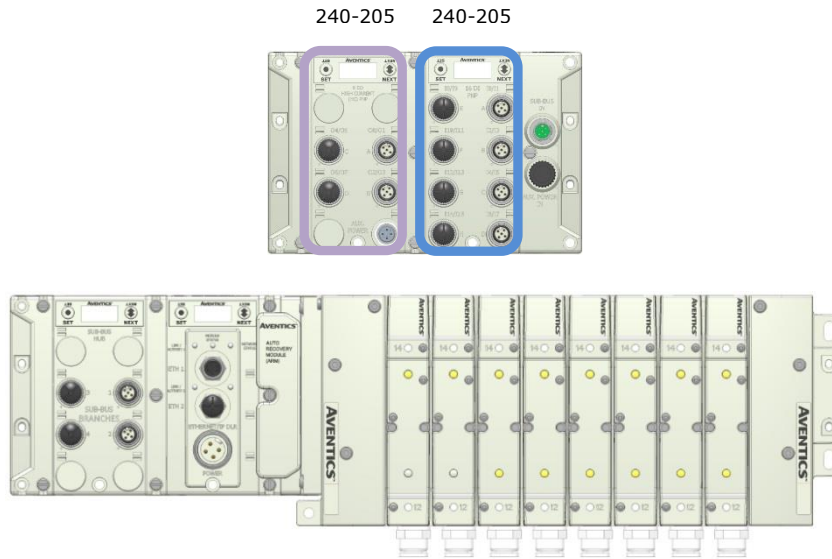

The Sub-bus hub module does not produce mapped diagnostics. The data table in this example represents what is physically attached to the HUB module. This will change as modules are added or removed.

Example I/O Mapping of Attached Modules								
BYTE	Bit 7	Bit 6	Bit 5	Bit 4	Bit 3	Bit 2	Bit 1	Bit 0
X (Required)	Input 7	Input 6	Input 5	Input 4	Input 3	Input 2	Input 1	Input 0
X + 1 (Required)	Input 15	Input 14	Input 13	Input 12	Input 11	Input 10	Input 9	Input 8
X + 2 (Selectable)	Conn. H SCP Status	Conn. G SCP Status	Conn. F SCP Status	Conn. E SCP Status	Conn. D SCP Status	Conn. C SCP Status	Conn. B SCP Status	Conn. A SCP Status
X + 3 (Required)	Input 7	Input 6	Input 5	Input 4	Input 3	Input 2	Input 1	Input 0
X + 4 (Required)	Input 15	Input 14	Input 13	Input 12	Input 11	Input 10	Input 9	Input 8
X + 5 (Selectable)	Conn. H SCP Status	Conn. G SCP Status	Conn. F SCP Status	Conn. E SCP Status	Conn. D SCP Status	Conn. C SCP Status	Conn. B SCP Status	Conn. A SCP Status

Where X = starting byte

Hub Module / Identification



1) Identifies HUB module in G3 System.

Hub Module / Description



2) Identifies Module type.

Hub Module / Advanced Settings



3) Allows the user to set/configure module parameters.

Press the SET button to advance to the first parameter/setting.

Brightness



A) Press the SET button to enter the Set Brightness sub-menu and highlight the selection.

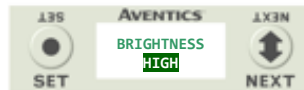

B) Press the NEXT button to select the desired Brightness selection, (Low, Medium, High).



C) Press the SET button to select the desired Brightness level.

Screen Jumps to Next Parameter/Selection

Flip Display



D) Press the SET button to enter the Flip Display sub-menu and highlight the selection.

E) Press the NEXT button to select the desired Flip Display selection, (Normal, Flipped).



F) Press the SET button to select the desired display orientation.

G) Press NEXT to advance to the next parameter selection (Branch Reserve)

Branch Reserve I/O

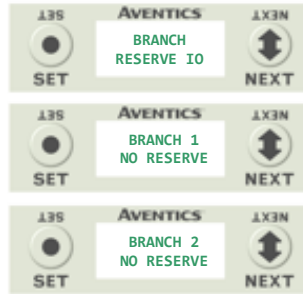

- H) Press the SET button to enter the Branch Reserve IO sub-menu.
- I) Press the NEXT button to select the desired Branch to reserve I/O bytes.

I/O data bytes can be reserved on each branch for future expansion within the G3 system. Space is reserved in Byte levels, and populates Input, Output, and Status depending on the protocol and configuration chosen (e.g. EtherNet/IP™). A maximum of 64 bytes per channel can be reserved.

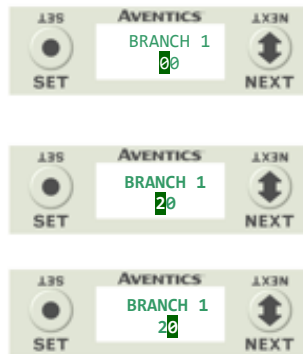

- J) Press the SET button to enter the chosen Branch/Byte Selection screen.
- K) Press the NEXT button to select the desired Tens value of reserved bytes.
- L) Press the SET button to set the desired Tens value.
- M) The screen will advance to the Ones selection
- N) Press the NEXT button to select the desired Ones value for reserved bytes.
- O) Press the SET button to set the desired Ones value.

Once the desired byte size is chosen for the selected branch, the screen will jump to the next branch. The same process is performed for the remaining branches, if desired. Press the NEXT button to skip over branches that do not require reserving I/O.

Factory Defaults



4) Allows all parameter settings to be set back to default values.



- A) Press the SET button to enter the Factory Defaults sub menu.
- B) Press the NEXT button to choose Yes or No.
- C) Press the SET button to confirm.

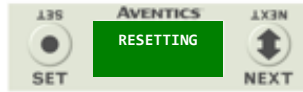

D) Press the SET button again.



<i>Factory Default Settings</i>	
Brightness	Medium
Flip Display	Normal
Reserve I/O	No Reserve (all Branches)

AVENTICS™ G3 Series EtherNet/IP™ DLR Technical Manual

Diagnostics



5) Allows the user to reference Part No., Firmware Rev., and Branch Connections.

Part Number



A) Press the NEXT button to enter the Diagnostics sub-menu.

The Part Number screen is displayed (reference only).

Firmware Rev.



B) Press the NEXT button to advance to the Firmware revision screen (reference only).

Branch Connections



C) Press the NEXT button to advance to the Branch Connections screen.

D) Press the SET button to enter the Branch Connections sub-menu.



E) Press the NEXT button to advance through the Branches.



Each Branch screen indicates identifies the module numbers that are currently connected to that Branch.

Help

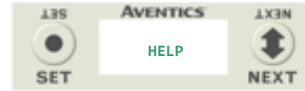

6) Directs the user to the Aventics website.



A) Press the SET button for website address.

AVENTICS™ G3 Series EtherNet/IP™ DLR Technical Manual

Error/Event Messages

The following are error messages that are displayed when specific faults/events occur during operation:

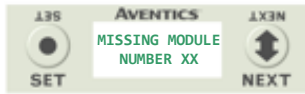

Displayed when a Sub-Bus module that had been previously installed becomes absent from the configuration



Displayed when a Sub-Bus power short circuit condition is detected

Connector Pin Out

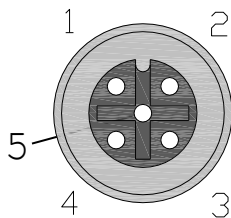

FEMALE

- PIN 1 = Shield
- PIN 2 = V+
- PIN 3 = V-
- PIN 4 = CAN_H
- PIN 5 = CAN_L

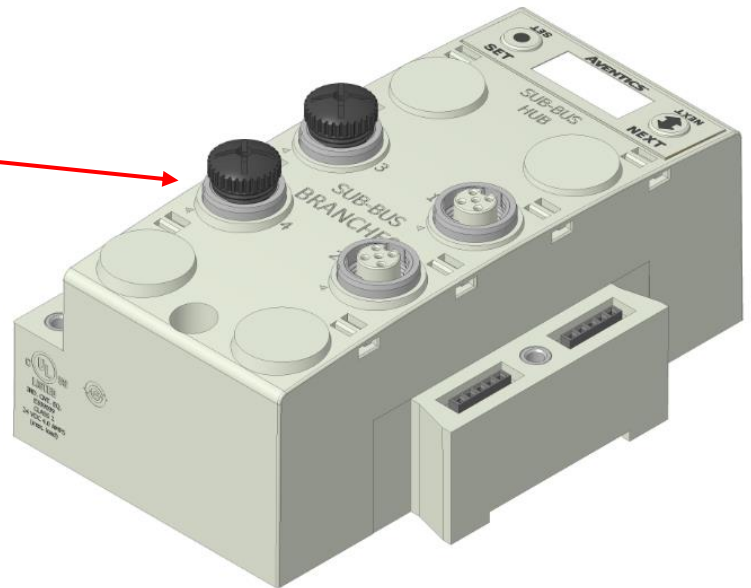

- Length of molded or field wired Sub-Bus Branch cables should not exceed the maximum length of 30 meters per Sub-Bus Branch communication link.
- The molded cable assemblies and bulk cable are the only approved cables for the G3 Sub-Bus and Branch Link. Please refer to the G3 Electronics catalog (LT-G3Catalog), for Sub-Bus cable and connectors options. See Technical Document TDG3SBWD1-0EN for proper installation and wiring of field wire-able connectors.

AVENTICS™ G3 Series EtherNet/IP™ DLR Technical Manual

HUB Integration - Example

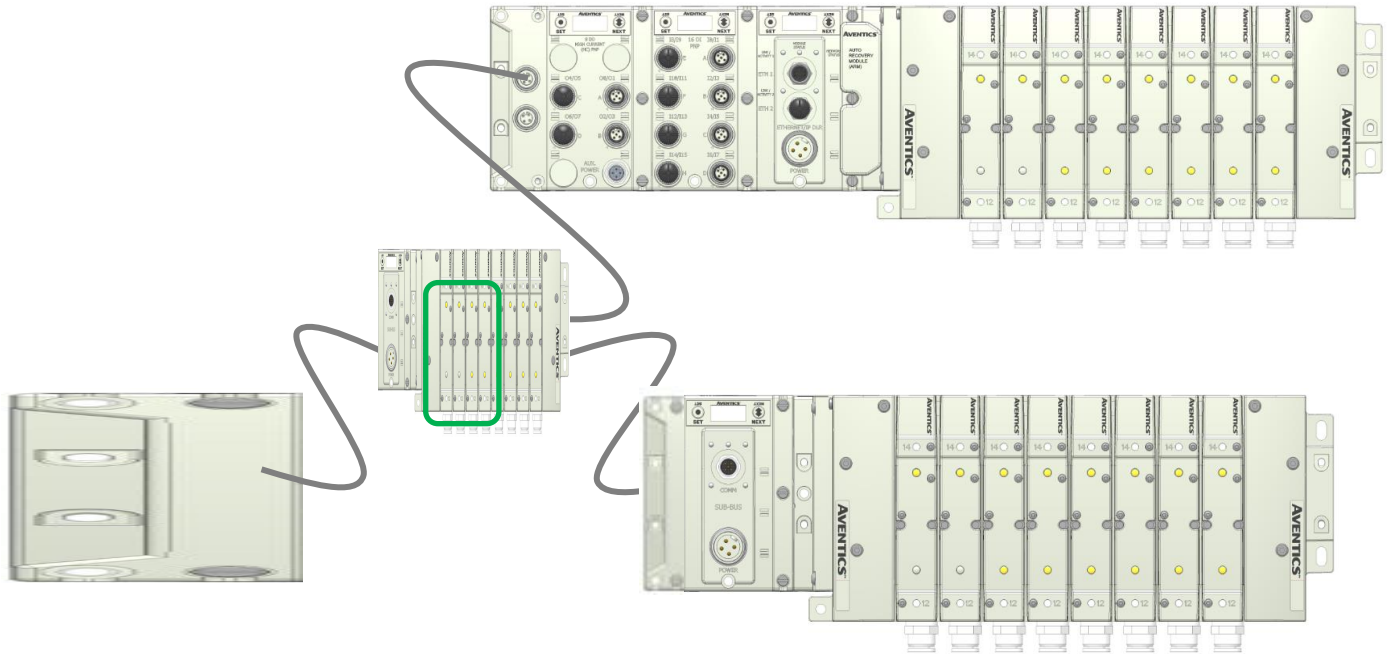

Module	Part No.	Description	Details	Export Config and Log	Activity	
Node	240-325	EtherNet/IP DLR/QC Communications Module	<input type="checkbox"/> Show Details		<input checked="" type="checkbox"/> Close all Details	
ARM	240-182	Auto Recovery Module	<input type="checkbox"/> Show Details		<input checked="" type="checkbox"/> Close all Details	
No. 1	240-205	16 Inputs PNP Digital M12 x 8	<input type="checkbox"/> Show Details		<input checked="" type="checkbox"/> Close all Details	
Hub 1	240-326	Sub-Bus Hub Module	<input checked="" type="checkbox"/> Show Details		<input checked="" type="checkbox"/> Close all Details	
		Firmware Revision:	2 070			
		I/O Reserved (bytes):	Branch 1	Branch 2	Branch 3	Branch 4
		Unused Reserved Input (bytes):	-	-	-	-
		Unused Reserved Diagnostic (Status) Inputs (bytes):	-	-	-	-
		Unused Reserved Output (bytes):	-	-	-	-
		Module No's. on branch:	-	2, 3, 4	-	5, 6
→ Branch 2, Mod. No. 2	240-241	Sub-Bus Valve Driver	<input type="checkbox"/> Show Details		<input checked="" type="checkbox"/> Close all Details	
→ Branch 2, Mod. No. 3	240-205	16 Inputs PNP Digital M12 x 8	<input type="checkbox"/> Show Details		<input checked="" type="checkbox"/> Close all Details	
→ Branch 2, Mod. No. 4	240-205	16 Inputs PNP Digital M12 x 8	<input type="checkbox"/> Show Details		<input checked="" type="checkbox"/> Close all Details	
→ Branch 4, Mod. No. 5	240-205	16 Inputs PNP Digital M12 x 8	<input type="checkbox"/> Show Details		<input checked="" type="checkbox"/> Close all Details	
→ Branch 4, Mod. No. 6	240-205	16 Inputs PNP Digital M12 x 8	<input type="checkbox"/> Show Details		<input checked="" type="checkbox"/> Close all Details	
			<input type="checkbox"/> Show Error/Event Log			

12. I/O Module Wiring Diagrams

12.1 NPN/PNP Definitions

NPN Descriptions

- Sinking
- Switching Negative
- Positive Common

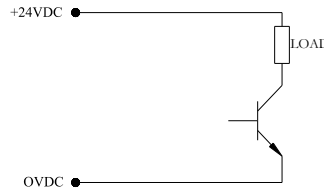

PNP Descriptions

- Sourcing
- Switching Positive
- Negative Common

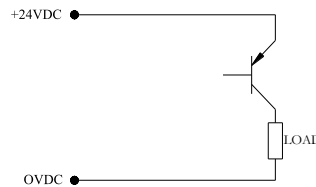

NPN (Sinking) Input Connection

Electric Sensor Type

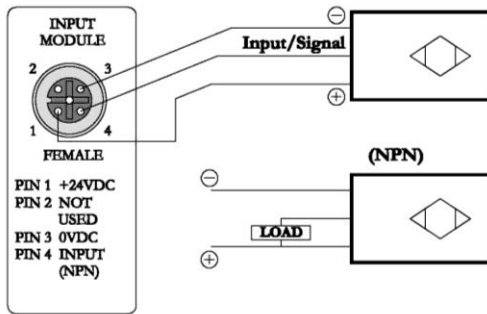

Mechanical Sensor Type

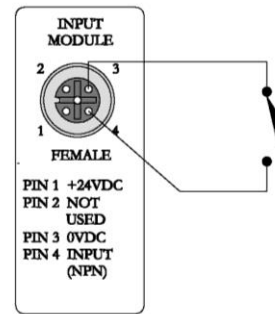

PNP (Sourcing) Input Connection

Electric Sensor Type

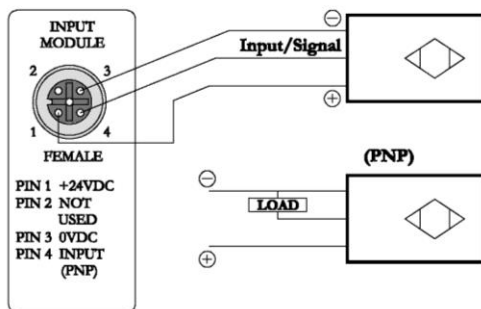

Mechanical Sensor Type

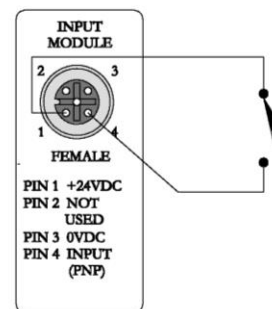

I/O Module Wiring Diagrams Continued

PNP (Sourcing) Output Connection

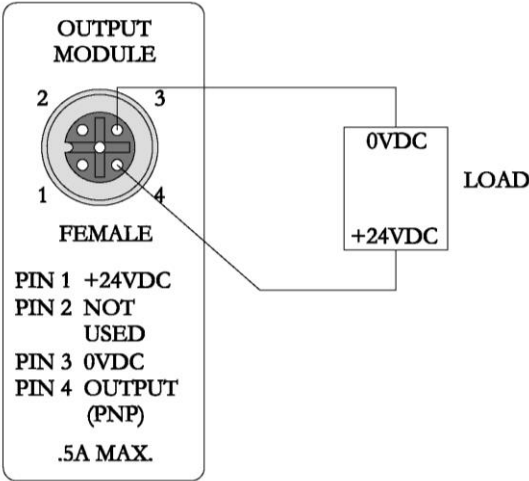

13. EtherNet/IP™ G3 Web Server

13.1 Integrated Web Page Configuration

The Aventics G3-EtherNet/IP™ node utilizes an integrated web server for user access to configuration parameters and diagnostic features. The "G3 Webpage" can be accessed via any standard web browser program. The following steps describe how to connect to a G3 series Ethernet/IP™ to access the integrated webpage using Windows XP (see page 172 for Windows 7 instructions).

13.2 Connecting to a G3 Series EtherNet/IP™ Node

This section will discuss how to connect a computer to a G3 Series EtherNet/IP™ node. There are multiple ways to complete this task, so only two will be discussed. All computer commands are shown in Windows 7.

1. Connect a 24VDC power supply to the valve manifold. The connector pin-out can be found on the side of the EtherNet/IP™ node or on page 20 of this document. (Note: 24VDC only needs to be applied to the "+24VDC (NODE & INPUTS)" pin to power the node.)
2. Connect an Ethernet cable directly from the manifold to the computer -OR- Connect an Ethernet cable from the manifold to a router, hub, or switch. Connect a second Ethernet cable from the computer to the router, hub, or switch. (Network lights should appear on the router, hub, or switch if the correct cables are used).
3. Turn on the computer. Also, make sure the manifold and the switch have power.
4. To communicate with an EtherNet/IP™ manifold the IP address of your computer must be known. To start this process, left click on the "Start" button.
5. Left click on control panel, then left click view network status and tasks

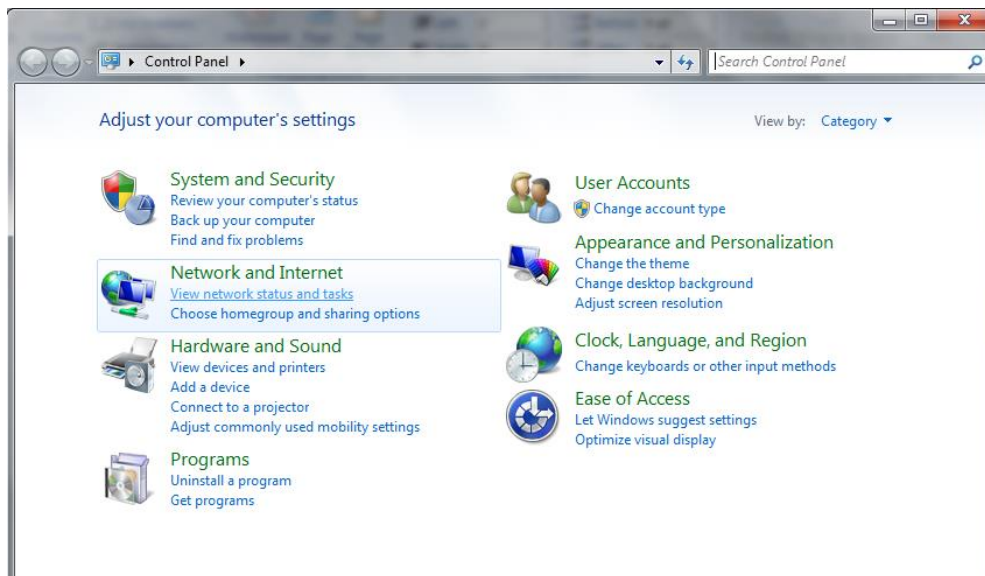

AVENTICS™ G3 Series EtherNet/IP™ DLR Technical Manual

6. The “Network and Sharing Center” window will open. Double click on “Change adapter settings”.

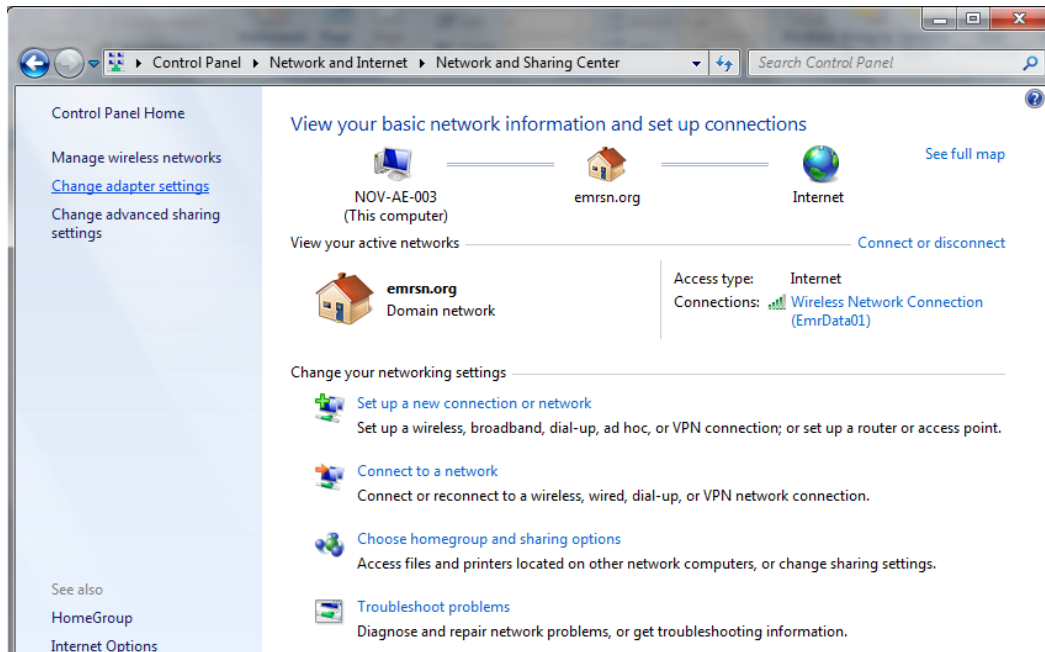

7. The “Network Connections” window opens. Double click the “Local Area Connection Icon”

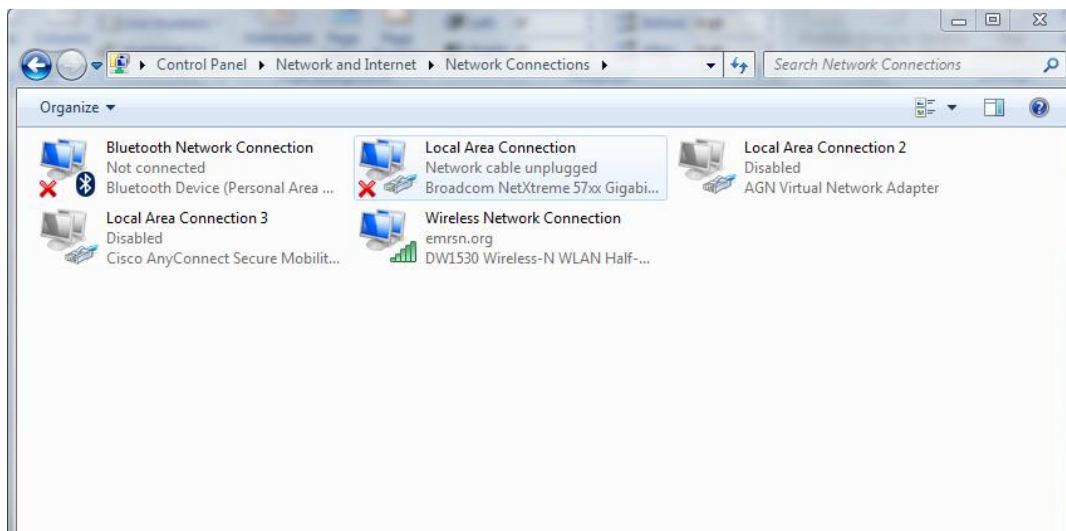

AVENTICS™ G3 Series EtherNet/IP™ DLR Technical Manual

- Click on "Internet Protocol Version 4 (TCP/IPv4)" the properties window will open

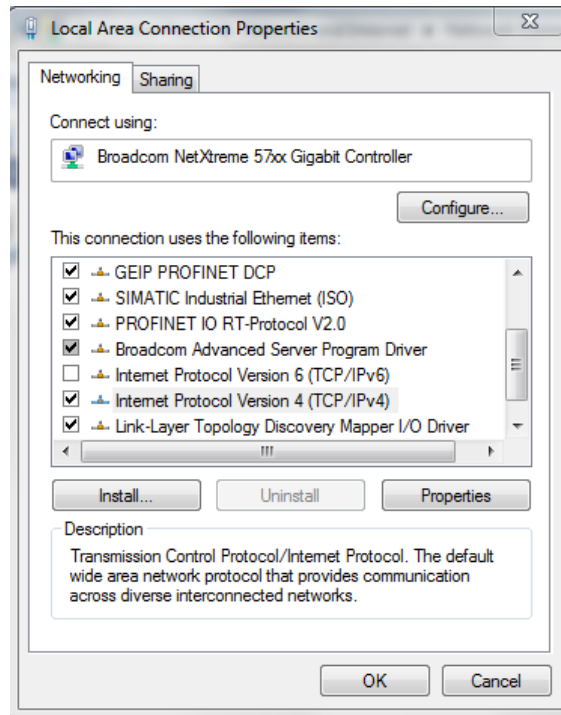

- Choose the option marked "Use the following IP address" and type in an IP address that has the same first three octets as the address that you will set the manifold to. For the last octet you may choose any number from 0-255, just make sure that it is not the same number as the IP address that the manifold will have. Make sure your subnet mask is set to "255.255.255.0" (this value can be changed, but this value will be used for demonstration purposes).

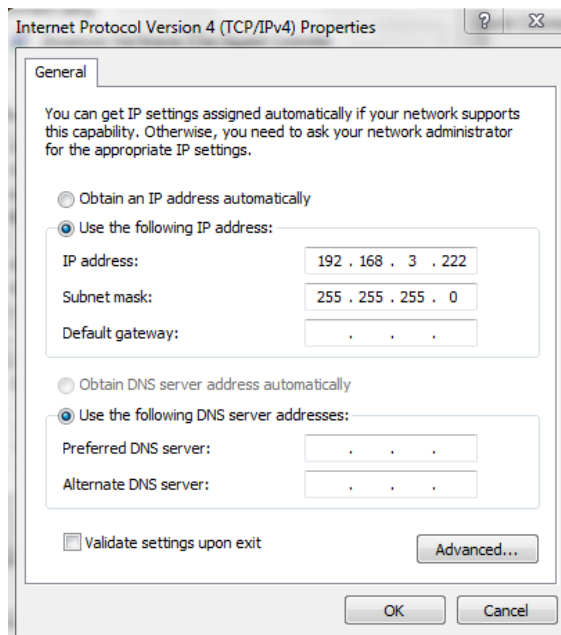

AVENTICS™ G3 Series EtherNet/IP™ DLR Technical Manual

10. Left click "OK" in the "Internet Protocol (TCP/IP) Properties" and "Local Area Connection" windows for the changes to take effect on the computer. Close out of any open windows.
11. Open a web browser on the computer and type the IP address of the manifold.
Ex. <http://192.168.3.120>. The Aventics G3 webpage should load after several seconds.



AVENTICS™ G3 Series EtherNet/IP™ DLR Technical Manual

13.3 EtherNet/IP™ Web Server functionality

This section will discuss the functionality of the built in Ethernet server. Every Aventics EtherNet/IP™ has this feature. Through this server you can configure the node, force I/O, check diagnostics, etc. Each Aventics' webpage will be explained.

Home

To get to the Aventics "Home" page, open a web browser. In the URL line, type in the IP address of the manifold and press "Enter". The Aventics "Home" page will appear. This page shows a picture of the Aventics EtherNet/IP™ manifold. From this page, the user can navigate the entire built-in web server.



AVENTICS™ G3 Series EtherNet/IP™ DLR Technical Manual

Node Configuration

The "Node Configuration" window can be used to control different parameters within the manifold. These parameters include, "IP Address", "Subnet Mask", "Gateway Address", "SMTP Server", "DHCP/BOOTP enabled", "MAC Address", and "COMM Fault/Idle Mode". "DHCP/BOOTP enabled" is controlled by a single check mark box. "COMM Fault/Idle Mode" has two options that can be chosen: "Hold last Output State" and "Turn OFF All Outputs". *IP address, Subnet Mask, and DHCP/BOOTP enabled* selections can all be configured from this page.



[Home](#)
[Node Configuration](#)
[Node Password](#)
[Diagnostics](#)
[Studio 5000 Config](#)
[Quick Start Manual](#)
[Download EDS](#)
[Help](#)

Node Configuration	
(Green selections denote Factory Default settings)	
DHCP:	Disabled
IP Address:	192.168.0.120
Subnet Mask:	255.255.255.0
Gateway IP Address:	
Web Server:	Enabled
Max Coils on Manifold (32 = Standard):	32
Safety Zones (Only configurable when Max Coils = 32):	None
COMM Fault / Idle Mode:	Turn OFF All Outputs
Aventics Part No. 240-181 Compatibility Mode:	Disabled
Node Configuration Parameters:	Unlocked
I/O Configuration:	Unlocked
Display Orientation (Global):	Normal
Display Brightness (Global):	Medium
Comm. Format (I/O Data Padding):	SINT

Update Configuration

AVENTICS™ G3 Series EtherNet/IP™ DLR Technical Manual

Node Password Tab

The "Password" window allows the user to set a password that will prevent access to test outputs in the G3 diagnostic webpage. The password comes disabled from the factory. To set the initial password, leave the "Enter Current Password" field blank and type in the new password in the "Enter New Password" field.



Change Password	
Enter Current Password: (up to 20 characters)	<input type="text"/>
Enter New Password: (up to 20 characters)	<input type="text"/>
Repeat New Password:	<input type="text"/>

This page allows password protection of the [Node Configuration](#) page and the I/O Force & Test features of the [Diagnostics](#) page. To disable password protection, leave the "Enter New password" box empty. If you have forgotten a previously set password please contact Aventics Technical support.



If the password has been lost. Enter the last 6 digits of the MAC Address in the current password field and then enter the desired password in the new password field.

AVENTICS™ G3 Series EtherNet/IP™ DLR Technical Manual

Diagnostics Tab

The "Diagnostics" window allows the user to monitor different values. These values include, "MAC Address", "Serial Number", "Firmware Revision", and "Valve Diagnostic Table". The "Valve Diagnostic Table" enables the user to check the status of the valve side outputs.

Actual Configuration of modules with part numbers and descriptions including distributed modules

The screenshot shows the AVENTICS diagnostics interface. At the top, there is a navigation bar with the following tabs: Home, Node Configuration, Node Password, Diagnostics (highlighted in red), Studio 5000 Config, Quick Start Manual, Download EDS, and Help. Below the navigation bar is a table with the following columns: Module, Part No., Description, Details, and Activity. The table contains the following data:

Module	Part No.	Description	Details	Activity
Node	240-325	EtherNet/IP DLR/QC Communications Module	<input type="checkbox"/> Show Details	✓
Valve Driver	P599AE42518800x	50X Series Valve Driver Output Module	<input type="checkbox"/> Show Details	✓
ARM	240-383	Auto Recovery Module	<input type="checkbox"/> Show Details	✓
No. 1	240-205	16 Inputs PNP Digital M12 x 8	<input type="checkbox"/> Show Details	✓
No. 2	240-215	2 Inputs / 2 Outputs 4-20mA Analog M12 x 4	<input type="checkbox"/> Show Details	✓
			<input type="checkbox"/> Show Error/Event Log	

Reports module status:
 ✓ = OK
 ! = Attention
 X = Lost comm.

Selects which module details will be shown, more than 1 can be selected simultaneously.

AVENTICS™ G3 Series EtherNet/IP™ DLR Technical Manual

Show Details: Communication Module



Module	Part No.	Description	Details	Activity								
Node	240-325	EtherNet/IP DLR/QC Communications Module	<input checked="" type="checkbox"/> Show Details	<input type="checkbox"/> Close all Details <input checked="" type="checkbox"/>								
	Firmware Revision:		1.1 Build 44020 Factory Defaults Firmware Upload									
	IP Address:		192.168.0.120									
	Subnet Mask:		255.255.255.0									
	Gateway IP Address:		0.0.0.0									
	Active COMM Link Type:		Port 0: 100 Mbps/Full Duplex -- Port 1: Link Down									
	MAC Address:		00-15-24-01-4e-31									
	Node / Input Power:		24.4 VDC									
	Diagnostic Word Status:		OK									
	Diagnostic Word Byte 0:		<table border="1"> <tr> <td>0</td><td>1</td><td>2</td><td>3</td><td>4</td><td>5</td><td>6</td><td>7</td> </tr> </table>		0	1	2	3	4	5	6	7
	0	1	2	3	4	5	6	7				
		Bit 0: Switched Power Status Bit 1: Unswitched Power Low (Below 19 VDC) Bit 2: Sub-Bus Module Error Bit 3: Sub-Bus Short Circuit Bits 4-7: Not Used										
Diagnostic Word Byte 1:		<table border="1"> <tr> <td>0</td><td>1</td><td>2</td><td>3</td><td>4</td><td>5</td><td>6</td><td>7</td> </tr> </table>		0	1	2	3	4	5	6	7	
0	1	2	3	4	5	6	7					
		Bits 0-4: Module Number Bits 5-7: Error Code 0: No error 1: Lost communications between I/O module and communications module 2: Valve / Output power is missing 3-7: Not defined / Reserved										
<input type="checkbox"/> Show I/O Mappings and Sizes												

Relevant node information including firmware revision

Diagnostic word information with bit definitions

Mapping position of "Diagnostic" word.

Diagnostic word information mapping with bit definitions

Show Details: 50x Series Valve Driver Output Module

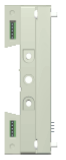
Valve Driver	P599AE42518800x	50X Series Valve Driver Output Module	<input checked="" type="checkbox"/> Show Details	<input type="checkbox"/> Close all Details <input checked="" type="checkbox"/>																																
	Firmware Revision:		4.19																																	
	Valve Coils 0-31: Check/Uncheck box to force/un-force valve coil		<table border="1"> <tr> <td>0</td><td>1</td><td>2</td><td>3</td><td>4</td><td>5</td><td>6</td><td>7</td> </tr> <tr> <td>8</td><td>9</td><td>10</td><td>11</td><td>12</td><td>13</td><td>14</td><td>15</td> </tr> <tr> <td>16</td><td>17</td><td>18</td><td>19</td><td>20</td><td>21</td><td>22</td><td>23</td> </tr> <tr> <td>24</td><td>25</td><td>26</td><td>27</td><td>28</td><td>29</td><td>30</td><td>31</td> </tr> </table>		0	1	2	3	4	5	6	7	8	9	10	11	12	13	14	15	16	17	18	19	20	21	22	23	24	25	26	27	28	29	30	31
	0	1	2	3	4	5	6	7																												
	8	9	10	11	12	13	14	15																												
	16	17	18	19	20	21	22	23																												
	24	25	26	27	28	29	30	31																												
	Valve Status:		<table border="1"> <tr> <td>0</td><td>1</td><td>2</td><td>3</td><td>4</td><td>5</td><td>6</td><td>7</td> </tr> <tr> <td>8</td><td>9</td><td>10</td><td>11</td><td>12</td><td>13</td><td>14</td><td>15</td> </tr> <tr> <td>16</td><td>17</td><td>18</td><td>19</td><td>20</td><td>21</td><td>22</td><td>23</td> </tr> <tr> <td>24</td><td>25</td><td>26</td><td>27</td><td>28</td><td>29</td><td>30</td><td>31</td> </tr> </table>		0	1	2	3	4	5	6	7	8	9	10	11	12	13	14	15	16	17	18	19	20	21	22	23	24	25	26	27	28	29	30	31
	0	1	2	3	4	5	6	7																												
	8	9	10	11	12	13	14	15																												
	16	17	18	19	20	21	22	23																												
24	25	26	27	28	29	30	31																													
		● = Shorted Coil ● = Open Coil ✕ = No Coil Detected																																		
<input checked="" type="checkbox"/> Show I/O Mappings and Sizes																																				
I/O Size, Inputs:		0 bytes																																		
I/O Size, Diagnostic (Status) Inputs:		4 bytes																																		
I/O Size, Outputs:		4 bytes																																		
I/O Mapping, Inputs (Starting Byte):		N/A - No Inputs																																		
I/O Mapping, Diagnostic (Status) Inputs (Starting Byte):		N/A - Diagnostics Not Mapped (I/O Status is Disabled)																																		
I/O Mapping, Outputs (Starting Byte):		4																																		

Valve coil forcing capability. Can be disabled with password

Shows diagnostic status of whether coils are shorted or open.

Show I/O Mapping and sizes

AVENTICS™ G3 Series EtherNet/IP™ DLR Technical Manual

Show Details: 240-383

ARM	240-383	Auto Recovery Module	<input checked="" type="checkbox"/> Show Details	Close all Details
	Firmware Revision:	2.002		
	No user settable parameters			
<input type="checkbox"/> Show I/O Mappings and Sizes				

No user settable parameters

Show Details: 240-205

No. 1	240-205	16 Inputs PNP Digital M12 x 8	<input checked="" type="checkbox"/> Show Details	Close all Details					
	Firmware Revision:	2.032							
	PNP Digital Inputs:	0 <input type="checkbox"/>	1 <input type="checkbox"/>	2 <input type="checkbox"/>	3 <input checked="" type="checkbox"/>	4 <input type="checkbox"/>	5 <input type="checkbox"/>	6 <input type="checkbox"/>	7 <input type="checkbox"/>
		8 <input type="checkbox"/>	9 <input type="checkbox"/>	10 <input type="checkbox"/>	11 <input type="checkbox"/>	12 <input type="checkbox"/>	13 <input type="checkbox"/>	14 <input type="checkbox"/>	15 <input type="checkbox"/>
Connector Status:		A <input type="checkbox"/>	B <input type="checkbox"/>	C <input type="checkbox"/>	D <input type="checkbox"/>	E <input checked="" type="checkbox"/>	F <input type="checkbox"/>	G <input type="checkbox"/>	H <input type="checkbox"/>
<input checked="" type="checkbox"/> = Short on Connector <input type="checkbox"/> Show I/O Mappings and Sizes									

Shows input signal status
Shows diagnostic status of source power to sensor, "Connector E shorted"

Show Details: 240-215

No. 2	240-215	2 Inputs / 2 Outputs 4-20mA Analog M12 x 4	<input checked="" type="checkbox"/> Show Details	Close all Details
	Firmware Revision:	2.051		
	Analog Inputs:	AI0:	4.00 mA	
		AI1:	4.00 mA	
Analog Outputs:		AO0:	<input type="text" value="4.00"/> mA	<input type="button" value="Update"/>
		AO1:	<input type="text" value="4.00"/> mA	<input type="button" value="Update"/>
Input Status:		0 <input checked="" type="checkbox"/>	1 <input checked="" type="checkbox"/>	
<input checked="" type="checkbox"/> = Open Connection <input checked="" type="checkbox"/> = No Input Detected				
Connector Status:		A <input type="checkbox"/>	B <input type="checkbox"/>	C <input type="checkbox"/>
<input checked="" type="checkbox"/> = Short on Connector Connection from 24VDC (Pin no. 1) to 0VDC (pin no. 3)				
Alarms:		AI0 <input type="checkbox"/>	AI1 <input type="checkbox"/>	AO0 <input type="checkbox"/>
<input checked="" type="checkbox"/> = Low Alarm <input checked="" type="checkbox"/> = High Alarm		L: 0.00 H: 20.00	L: 0.00 H: 20.00	L: 4.00 H: 20.00
<input type="checkbox"/> Show I/O Mappings and Sizes				

Analog output forcing capability, can be disabled
Shows input signal status

AVENTICS™ G3 Series EtherNet/IP™ DLR Technical Manual

Error / Event Log:

Keeps a running count of 50 events. First in First out (FIFO)

Event No.	Boot Count	Relative Time (HH:MM:SS.SS)	Description	User Comment	Clear Log
1	1	01:10:56.38	Log cleared		Add Comment
2	1	01:11:02.09	Module 3, input connector E short fixed		Add Comment
3	1	01:11:09.68	Module 16 restored		Add Comment
4	1	01:11:21.39	Module 3, input connector E shorted		Add Comment
5	1	01:11:21.39	Module 3, input connector E short fixed		Add Comment
6	1	01:11:21.43	Module 3, input connector E shorted		Add Comment
7	1	01:11:25.18	Module 3, input connector E short fixed		Add Comment
8	1	01:11:40.27	Ethernet link lost		Add Comment
9	1	01:11:45.16	Ethernet link restored		Add Comment
10	2	00:00:00.82	Reboot - build 40298		Add Comment

Allow user to clear log

Allows user to add comments

Reboot events are shown in red

AVENTICS™ G3 Series EtherNet/IP™ DLR Technical Manual

Studio 5000 Configuration



Configuration with Studio 5000

When commissioning your EtherNet/IP network, specific values must be entered into the "Module Properties" window for the nodes. The "Connection Parameters" section requires user supplied data for "Input Size", "Output Size", and "Configuration". The table below details all pertinent information and is also dynamic, thus the "**Size**" data is based on the current/actual configuration of the manifold. It contains the appropriate values for the module's *Connection Parameters* selections.

The sample screenshot is taken from Rockwell Automation's Studio 5000 programming software. It shows where the appropriate values for the IP Address, Assembly Instance, Size, and Configuration must be entered.

Module Properties Based on Actual Configuration

Connection Parameters				
Description	Assembly Instance Value	Comm Format	Size	Notes
Input	101 (Decimal)	Data-SINT With Status (8 bit)	2	The Size values are determined from the number and type of I/O modules that are installed on the manifold (actual physical configuration). These values are shown in the Size column on the left and are for the specific Comm Format selected. This is a minimum value. Larger values may be specified but may affect overall network throughput.
		Data-INT With Status (16 bit)	1	
		Data-DINT With Status (32 bit)	1	
Output	150 (Decimal)	Data-SINT With Status (8 bit)	4	
		Data-INT With Status (16 bit)	2	
		Data-DINT With Status (32 bit)	1	
Configuration	1 (Decimal)	ALL	0	
		Data-SINT With Status (8 bit)	7	
Status Input	110 (Decimal)	Data-INT With Status (16 bit)	4	
		Data-DINT With Status (32 bit)	2	
		ALL	N/A	
Status Output	193 (Decimal)	ALL	N/A	

AVENTICS™ G3 Series EtherNet/IP™ DLR Technical Manual

Download EDS

The "Download EDS" tab provides a link to download either the embedded EDS file in the node or the EDS file available on the Aventics' website <http://www.asco.com/g3>

Aventics.com

The "Aventics.com" tab is a quick link to Aventics' website. The computer must have internet access for this tab to be functional.



Download embedded EDS & ICON files

Download web based EDS & ICON files

13.4 IP Address Configuration

The IP address of the Aventics G3 EtherNet/IP™ node may be configured via several different methods:

- DHCP/BOOTP
- Integrated Web Page Configuration
- Graphical display

DHCP / BOOTP

The node is shipped from the factory with the DHCP/BOOTP feature enabled. This allows a DHCP server to automatically set the IP address to the node when connected to the network, or a BOOTP server to establish communication to the node and set the IP address. These addressing methods require that the unique MAC ADDRESS of the node is known. The MAC ADDRESS is displayed on the graphical display of the node. It will be different for every node. When DHCP/BOOTP is enabled and a DHCP server is found, the IP address, Subnet mask, and gateway are automatically configured by the DHCP server.

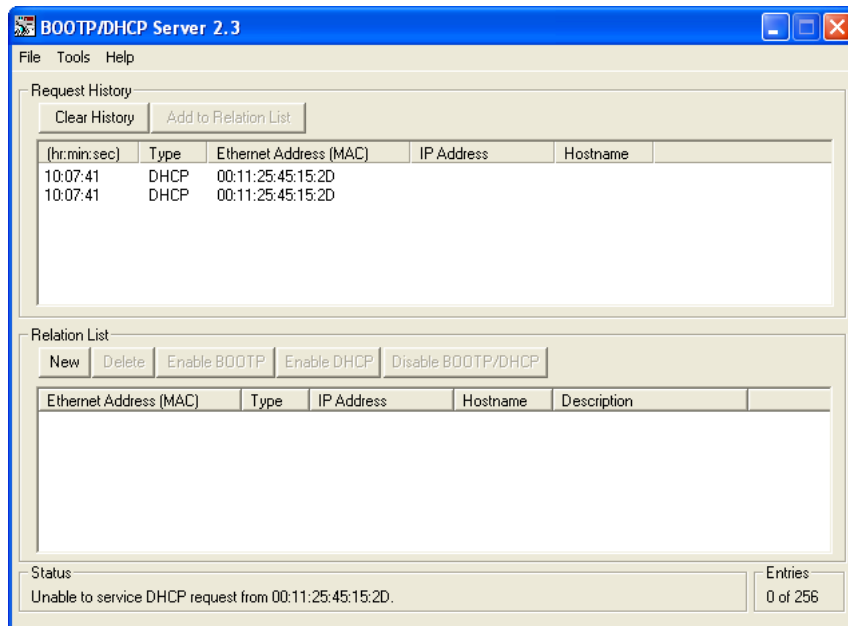

The DHCP/BOOTP setting can be enabled or disabled via the nodes integrated web server or graphical display.

13.5 User Configurable Device Parameters

The Aventics' G3 Ethernet/IP™ node allows the user to set many user options which define how the manifold behaves in certain instances. The following is a description of these device parameters.

<i>Name</i>	<i>Description</i>	<i>Display</i>	<i>Web Server</i>
IP Address	Node address	✓	✓
DHCP Boot-P	Enables / Disables DHCP/Boot-P functionality	✓	✓
Web Server	Web Server Enabled	✓	✓
Comm. Format	Sets Comm. format of I/O data	✓	✓
Quick Connect	Enables fast connection of the Ethernet IP network	✓	✓
Output Idle Action	Determines whether to use idle value attribute or hold last state	✓	✓
Output Fault Action	Determines whether to use idle value attribute or hold last state	✓	✓

13.6 Communication Fault/Idle Mode Parameter

This parameter is used to describe characteristics or behaviors of output points (bits). The parameter shown below is used to determine what state the outputs will have, during an "Idle" event and a "Fault" event. The Communication Fault/Idle Mode parameter will allow control of all output points on the manifold.

The user, through web page or graphic display settings, can determine how the outputs behave when a communication fault or idle actions occurs. These settings are non-volatile and thus will not change upon loss of power.

The two behavior options are:

1. Hold Last State
2. Turn Off All Outputs

Communication Fault / Idle Mode Sequence

The Communication Fault/Idle Mode parameter determines the output state if the device encounters a communication fault and/or idle action. A Communication Fault is defined as an inability for the master node to communicate with a slave node on a network. Idle Mode is a condition when the processor is in program mode.

The process for determining the output state during a Communication Fault/Idle Mode is as follows:

1. The device receives a Communication Fault/Idle Mode event.
2. The device determines what action to take based on the Communication Fault/Idle Mode attribute setting.
3. If the attribute is set to turn off all outputs, all of the outputs will turn off (Factory Default Setting).
4. If the attribute is set to hold last state, all of the outputs will hold their last state.

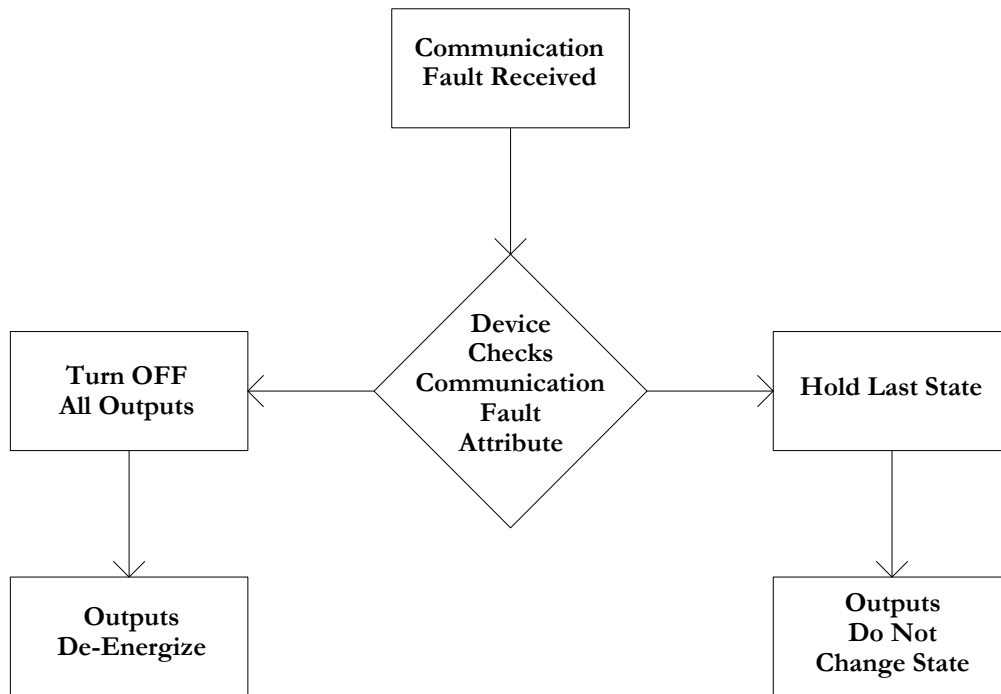

14. EtherNet/IP™ Commissioning

14.1 G3 configuration for RSLogix 5000 (Rockwell Generic Ethernet Module)

When commissioning your EtherNet/IP™ network, specific parameters must be entered into the RS Logix 5000 Generic Ethernet Module configuration. These parameters include: "Comm Format", "Assembly Instance", "Input Size", "Output Size", and "Configuration". The "Size" values are determined from the actual physical configuration of the manifold (i.e. how many and which I/O modules are installed on the manifold). The manifold required data size can easily be determined through the RS Logix 5000 Config. tab of the Ethernet IP webpage (see page 138). The size values are a minimum value; higher values can be used if future manifold I/O expansion is required. An example of the Generic Ethernet module configuration box is shown below.

The screenshot shows the 'New Module' configuration window. The 'Type' is 'ETHERNET-MODULE Generic Ethernet Module'. The 'Vendor' is 'Allen-Bradley' and the 'Parent' is 'Local'. The 'Name' is 'Aventics_G3_Manifold'. The 'Description' is 'Example of Aventics G3 Series 240-325 EtherNet/IP DLR configuration'. The 'Comm Format' is set to 'Data - INT - With Status'. The 'Address / Host Name' section has 'IP Address' selected with the value '192 . 168 . 3 . 120'. The 'Connection Parameters' section includes: Input (Assembly Instance: 101, Size: 5 (16-bit)), Output (Assembly Instance: 150, Size: 2 (16-bit)), Configuration (Assembly Instance: 1, Size: 0 (8-bit)), Status Input (Assembly Instance: 110, Size: 5 (16-bit)), and Status Output (193). There are 'OK', 'Cancel', and 'Help' buttons at the bottom.

Generic Ethernet Module Parameters

Comm. Format

The "Comm Format" determines the format of the data exchanged with the G3 EtherNet/IP™ node. The "Comm Format" parameter "with status"; writes the G3 diagnostic and I/O status and diagnostic data to a separate PLC status table.

Description	Data	Description
Comm Format	Data - DINT	Double Integer - 32 Bit
	Data - DINT (with status)	Double Integer - 32 Bit with separate status table
	Data - INT	Integer - 16 Bit
	Data - INT (with status)	Integer - 16 Bit with separate status table
	Data - SINT	Single Integer - 8 Bit
	Data - SINT (with status)	Single Integer - 8 Bit with separate status table

AVENTICS™ G3 Series EtherNet/IP™ DLR Technical Manual

Assembly Instance Values

The following Assembly Instance parameters must be used with the G3 EtherNet/IP™ DLR module.

Description	Assembly Instance Values	Size (depends on data format)
Input	101 (Decimal)	Total input value from the physical manifold configuration. This is a minimum value. Larger values may be specified for future expansion purposes.
Output	150 (Decimal)	Total output value from the physical manifold configuration. This is a minimum value. Larger values may be specified for future expansion purposes.
Configuration	1 (Decimal)	0
Status Input	110 (Decimal)	Total input value of diagnostic input data. This is a minimum value. Larger values may be specified for future expansion purposes.
Status Output	193 (Decimal)	NA

Generic Ethernet Module (example)

The following example configured as INT-With Status (if diagnostics are enabled in the G3 EtherNet/IP™ node, they are Refer to I/O mapping examples page 162.

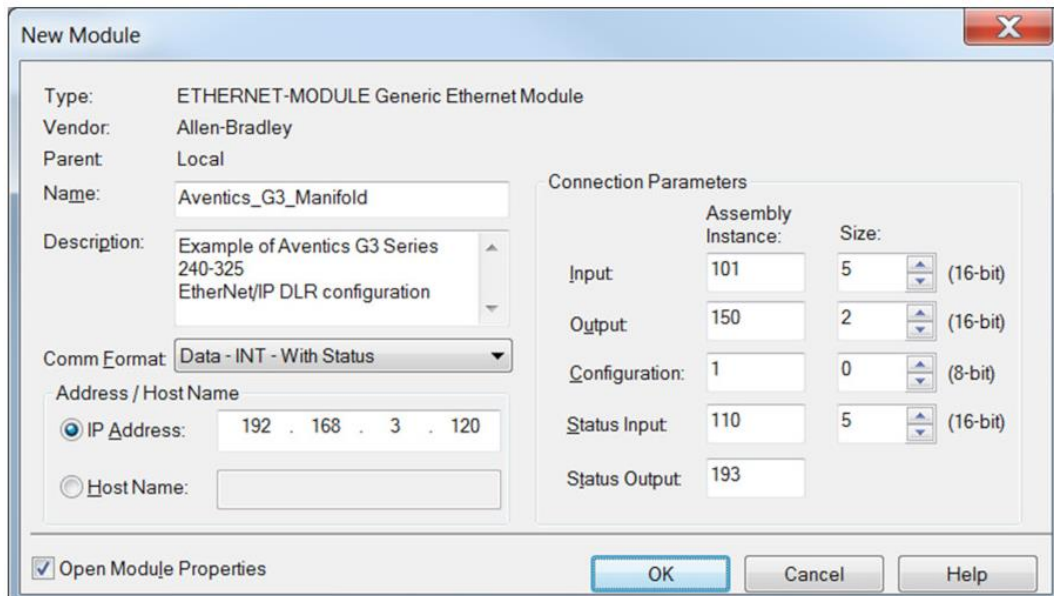

New Module

Type: ETHERNET-MODULE Generic Ethernet Module
 Vendor: Allen-Bradley
 Parent: Local
 Name: Aventics_G3_Manifold
 Description: Example of Aventics G3 Series 240-325 EtherNet/IP DLR configuration
 Comm Format: Data - INT - With Status
 Address / Host Name:
 IP Address: 192 . 168 . 3 . 120
 Host Name:

Connection Parameters

	Assembly Instance:	Size:
Input	101	5 (16-bit)
Output	150	2 (16-bit)
Configuration	1	0 (8-bit)
Status Input	110	5 (16-bit)
Status Output	193	

Open Module Properties

OK Cancel Help

AVENTICS™ G3 Series EtherNet/IP™ DLR Technical Manual

14.2 G3 configuration for RSLogix 5000 (Aventics G3 EDS File)

Download the EDS file for the 240-325 G3 Ethernet DLR module (part no. 240-325) at the link below.

<https://www.asco.com/en-us/Pages/fieldbus-technical-document-search.aspx>

Extract the files from the folder (EDSG3EDSV18_1.zip).

Files

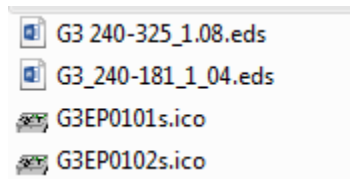

From RS Logix or Studio 5000 run the "EDS Wizard" and install **both version 1.04 and 1.08 EDS files**.

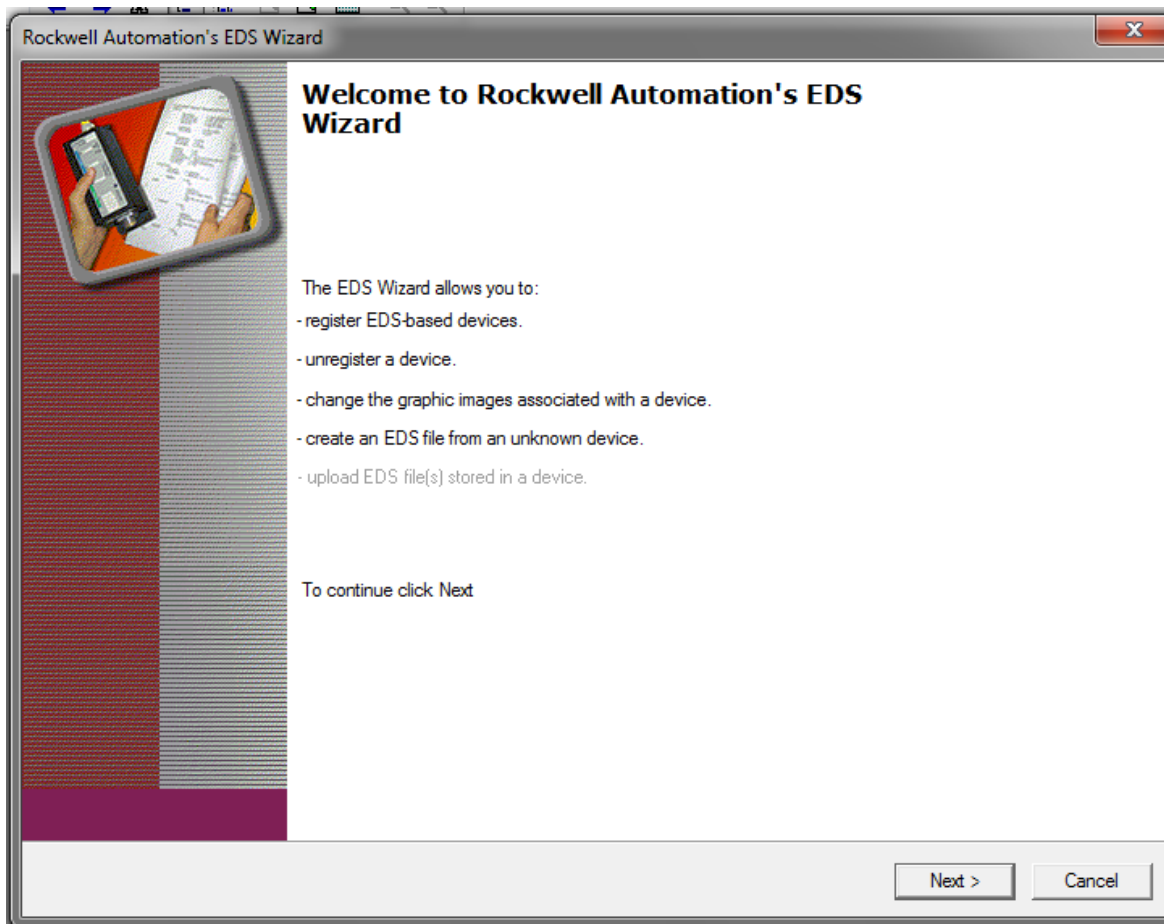

AVENTICS™ G3 Series EtherNet/IP™ DLR Technical Manual

Add the Aventics module to the PLC configuration by selecting; Aventics G3 Ethernet/IP

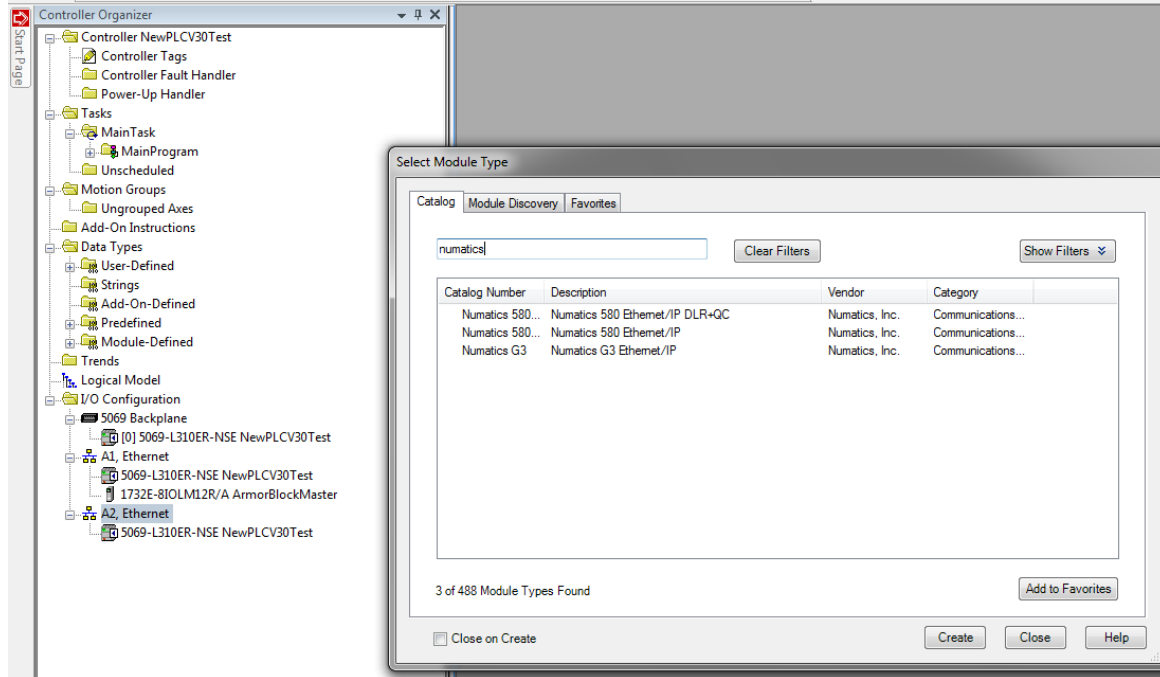

Configure the Aventics G3 Ethernet IP Module parameters including; Name, IP Address and optional description, select "Change"

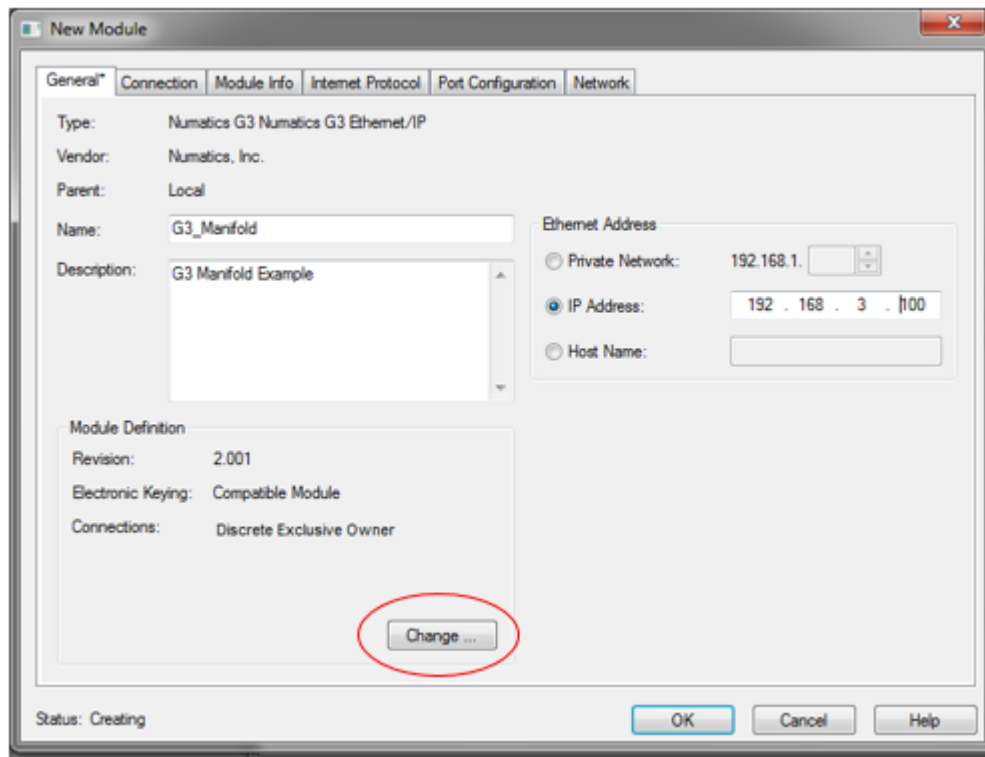

AVENTICS™ G3 Series EtherNet/IP™ DLR Technical Manual

Parameters

Select Revision "2"

Choose data type SINT, INT or DINT

Selected data sizes based on actual manifold configuration

Select Status Only to create a status table for G3 diagnostic data

Save and download the configuration

Select Revision 2

Selected data sizes based on actual manifold configuration

Name	Size	Tag Suffix
Discrete Exclusive Owner	Input: 16	1 · I1 O1
	Output: 16	
Status Only	Input: 16	2 I2 <none>
	Output: 0	

Choose data type SINT, INT or DINT

Select Status Only to create a status table for G3 diagnostic data

15. EtherNet/IP™ Mapping

15.1 I/O Sizes

Manifold

Outputs

Outputs are defined as any valve solenoid coil and/or any discrete output point from any output module. The output size depends upon the physical configuration of the manifold (i.e. module type and how many are used). Please reference the following pages for a detailed explanation for calculating the output size.

Inputs

Inputs are defined as physical input bits from input modules and status bits (i.e. diagnostic word generated by the node, status input bits produced by output drivers and SCP status bits). Thus, the input size will include physical input points, as well as status input bits. Please reference the following pages for a detailed explanation for calculating the input size.

Valve Side

The size for the “valve side” of the manifold consists of an output bit for each valve solenoid coil driver and an input bit for the corresponding diagnostic status input bit. This value for the valve side size is 4 bytes of inputs and 4 bytes of outputs.

Discrete Side

The discrete side of the manifold is defined as all I/O modules connected to the left of the communication node. This includes physically attached modules as well as any distributed sub-bus modules. I/O sizes for the discrete side are automatically configured based on the I/O module type installed. However, the user can affect these sizes manually via settable parameters on the node. The output value consists of physical outputs (i.e. output bit for each output point). The input value consists of physical inputs (i.e. input bit for each input point) and user settable status input bits for corresponding physical outputs and SCP status bits.

Total I/O Size

The overall size of the I/O data for the manifold will consist of the valve size plus the discrete I/O size and all enabled Diagnostic bits. The I/O size can vary greatly, due to the many physical configuration and user settable parameters combinations. The worksheet on page 160 will allow accurate sizing of the I/O data.

AVENTICS™ G3 Series EtherNet/IP™ DLR Technical Manual

15.2 Manifold and I/O Data Sizing Worksheet

Step

- 1** : Choose appropriate value and place the corresponding Input and Output values in the boxes labeled, "Valve Byte Requirements" at the bottom of the page
- 2** : Choose up to sixteen modules to be included on the discrete I/O side of the manifold and place sum of the corresponding input bytes and output bytes in the boxes labeled, "Sub-Bus Byte Requirements" at the bottom of the page.
- 3** : Total the input bytes and output bytes values from the boxes labeled "Sub-Bus Byte Requirements" and "Valve Byte Requirements" in the boxes labeled "Total Input and Output Bytes for Manifold. This is the total input and output byte values required for the configured manifold.

Valve Side					
Step	Valve Side		Input Bytes		Output Bytes
			Status Enabled	Status Disabled	
1	Up to 32 Solenoid Coils		4	0	4

Digital Modules					
Step	Module No.	Description	Input Bytes		Output Bytes
			Status Enabled	Status Disabled	
2	240-203/204	16 Inputs	3	2	0
	240-205/209	16 Inputs	3	2	0
	240-206/210/379	8 Inputs	2	1	0
	240-207	16 Outputs	2	0	2
	240-208	8 Outputs	1	0	1
	240-211	8 Inputs / 8 Outputs	3	1	1
	240-241	Sub – Bus Valve Output	4	0	4
240-300	High Current 8 Outputs	1	0	1	

Analog Modules					
Step	Module No.	Description	Input Bytes		Output Bytes
			Status Enabled	Status Disabled	
2	240-212/214	4 Inputs	10	8	0
	240-213/215/307	2 Inputs/ 2 Outputs	6	4	4

Total Input/Output Size Calculation					
Step	Module Position	Model Number	Input Bytes		Output Bytes
2	1 st				
	2 nd				
	3 rd				
	4 th				
	5 th				
	6 th				
	7 th				
	8 th				
	9 th				
	10 th				
	11 th				
	12 th				
	13 th				
	14 th				
	15 th				
	16 th				
	Sub-Bus Byte Requirements:				
	Optional Diagnostic Word:		2		0
1	Valve Byte Requirements:				
3	Total Input and Output Bytes for Manifold				

15.3 Bit Mapping Rules

The bit mapping for a G3 manifold varies with the physical configuration of the manifold. The following is a breakdown of the bit mapping rules associated with the Aventics valve manifold.

Valve Side

- 1) Solenoid coil outputs are connected to the valve coils using the Z-Boards™.
- 2) The valve solenoid coil output portion of the total output size is fixed at 4 bytes.
- 3) Each solenoid coil output has an associated status input bit (refer to the section labeled, "Output Short Circuit Protection", on page 26 for functional details). The solenoid coil status input size is fixed at 4 bytes.
- 4) Solenoid coil output addressing begins at the 1st manifold station nearest the node using "14" coil 1st and then, if applicable, the "12" coil, and continues in ascending order away from the communication node.
- 5) Each manifold station allocates 1 or 2 output bits. This is dependent on the Z-Board™ type installed. A single Z-Board™ allocates 1 output bit. A double Z-Board™ allocates 2 output bits.
- 6) Z-Boards™ can be used in any arrangement (all singles, all doubles, or any combination) as long as output group No.1 and output group No. 2 bits do not overlap (i.e. combinations of Z-Boards™ could exist where the physical configuration of the manifold could exceed the output capacity).

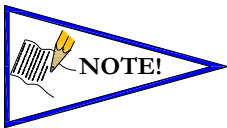

- *Single solenoid valves can be used with double Z-Boards™. However, one of the two available outputs will remain unused.*

Discrete I/O Side

Outputs

- 1) The Sub-Bus output byte size portion is self-configuring in byte increments, after an output module is installed on the Sub-Bus and power is applied.
- 2) Outputs are mapped consecutively by module. The output bits from the 1st module will be mapped directly after the bits from the valve coils. The output bits from the second module will be mapped directly after the output bits from the 1st module and so on.

Inputs

- 1) The Sub-Bus input byte size portion is self-configuring in byte increments, after an input module is plugged into back plane and power is applied.
- 2) Inputs are mapped consecutively by module. The input bits from the 1st module will be mapped directly after the status bits from the valve side. The input bits from the second module will be mapped directly after the input bits from the 1st module and so on.
- 3) All of the modules have associated internal status bits, which will affect the total value of input bytes..
- 4) When a module has discrete and status inputs, the status bits are mapped after the discrete input bits.

AVENTICS™ G3 Series EtherNet/IP™ DLR Technical Manual

I/O Mapping Examples

Assumed Settings

15.4 Example No. 1 (501 Valves with 60 coils)

- Double Z-Boards™ used with all valves
- I/O Modules and mapping schemes are identified by their corresponding color.

Manifold I/O Configuration

Pos. No.	Module Type	Part No.	In	Out	Diag
			Bytes		
		Diagnostic Word	0	0	2
		Local Valve Size:	0	8	8
		Total:	0	8	10

How to Order

Qty	Part Number
1	8501AV37100VA00
6	R501A2B40MA00F1
1	K501AMM42MA0010
	G3ED100R0E44
	ASSEMBLED

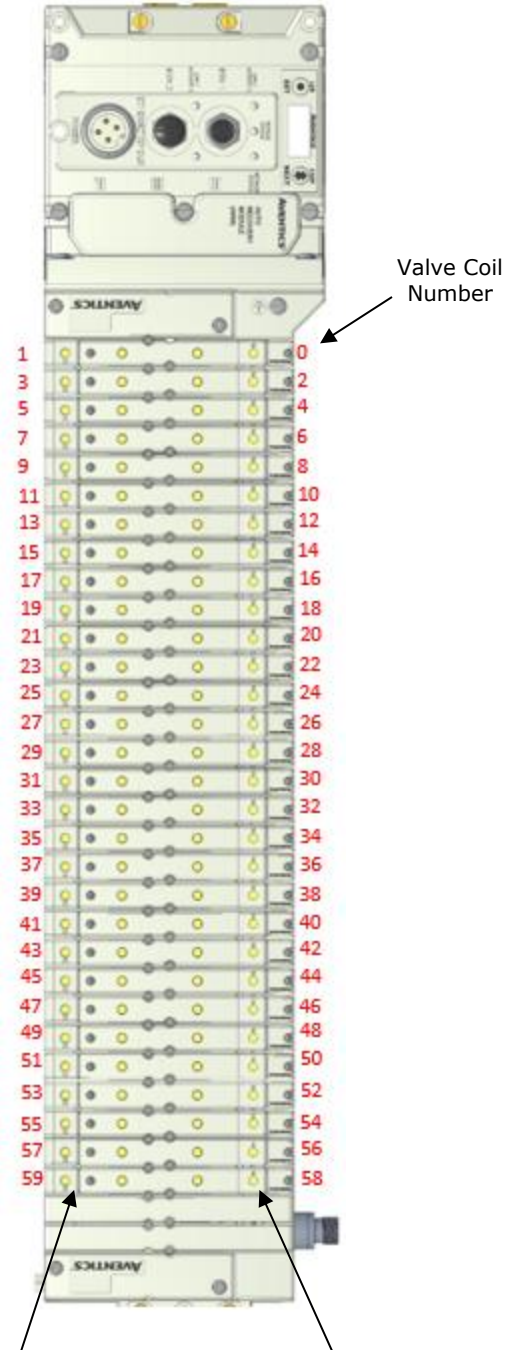

When the 12 End Solenoid is energized, the 2 port is pressurized

When the 14 End Solenoid is energized, the 4 port is pressurized

AVENTICS™ G3 Series EtherNet/IP™ DLR Technical Manual

I/O Table mapping example

This example uses the RS Logix 5000 generic driver selection Data - "SINT - with status". The diagnostic and status data are written to a separate "status" table.

Example No. 1 Table Data "SINT – with status"

<i>Output Table</i>								
BYTE	Bit 7	Bit 6	Bit 5	Bit 4	Bit 3	Bit 2	Bit 1	Bit 0
0	Valve Coil No. 7	Valve Coil No. 6	Valve Coil No. 5	Valve Coil No. 4	Valve Coil No. 3	Valve Coil No. 2	Valve Coil No. 1	Valve Coil No. 0
1	Valve Coil No. 15	Valve Coil No. 14	Valve Coil No. 13	Valve Coil No. 12	Valve Coil No. 11	Valve Coil No. 10	Valve Coil No. 9	Valve Coil No. 8
2	Valve Coil No. 23	Valve Coil No. 22	Valve Coil No. 21	Valve Coil No. 20	Valve Coil No. 19	Valve Coil No. 18	Valve Coil No. 17	Valve Coil No. 16
3	Valve Coil No. 31	Valve Coil No. 30	Valve Coil No. 29	Valve Coil No. 28	Valve Coil No. 27	Valve Coil No. 26	Valve Coil No. 25	Valve Coil No. 24
4	Valve Coil No. 39	Valve Coil No. 38	Valve Coil No. 37	Valve Coil No. 36	Valve Coil No. 35	Valve Coil No. 34	Valve Coil No. 33	Valve Coil No. 32
5	Valve Coil No. 47	Valve Coil No. 46	Valve Coil No. 45	Valve Coil No. 44	Valve Coil No. 43	Valve Coil No. 42	Valve Coil No. 41	Valve Coil No. 40
6	Valve Coil No. 55	Valve Coil No. 54	Valve Coil No. 53	Valve Coil No. 52	Valve Coil No. 51	Valve Coil No. 50	Valve Coil No. 49	Valve Coil No. 48
7	Allocated and Reserved	Allocated and Reserved	Allocated and Reserved	Allocated and Reserved	Valve Coil No. 59	Valve Coil No. 58	Valve Coil No. 57	Valve Coil No. 56

<i>Status Table</i>								
BYTE	Bit 7	Bit 6	Bit 5	Bit 4	Bit 3	Bit 2	Bit 1	Bit 0
0	Comm. Module Diagnostic Bit	Comm. Module Diagnostic Bit	Comm. Module Diagnostic Bit	Comm. Module Diagnostic Bit	Comm. Module Diagnostic Bit	Comm. Module Diagnostic Bit	Comm. Module Diagnostic Bit	Comm. Module Diagnostic Bit
1	Sub-bus Diagnostic Bit	Sub-bus Diagnostic Bit	Sub-bus Diagnostic Bit	Sub-bus Diagnostic Bit	Sub-bus Diagnostic Bit	Sub-bus Diagnostic Bit	Sub-bus Diagnostic Bit	Sub-bus Diagnostic Bit
2	Coil No. 7 Status	Coil No. 6 Status	Coil No. 5 Status	Coil No. 4 Status	Coil No. 3 Status	Coil No. 2 Status	Coil No. 1 Status	Coil No. 0 Status
3	Coil No. 15 Status	Coil No. 14 Status	Coil No. 13 Status	Coil No. 12 Status	Coil No. 11 Status	Coil No. 10 Status	Coil No. 9 Status	Coil No. 8 Status
4	Coil No. 23 Status	Coil No. 22 Status	Coil No. 21 Status	Coil No. 20 Status	Coil No. 19 Status	Coil No. 18 Status	Coil No. 17 Status	Coil No. 16 Status
5	Coil No. 31 Status	Coil No. 30 Status	Coil No. 29 Status	Coil No. 28 Status	Coil No. 27 Status	Coil No. 26 Status	Coil No. 25 Status	Coil No. 24 Status
6	Coil No. 39 Status	Coil No. 38 Status	Coil No. 37 Status	Coil No. 36 Status	Coil No. 35 Status	Coil No. 34 Status	Coil No. 33 Status	Coil No. 32 Status
7	Coil No. 47 Status	Coil No. 46 Status	Coil No. 45 Status	Coil No. 44 Status	Coil No. 43 Status	Coil No. 42 Status	Coil No. 41 Status	Coil No. 40 Status
8	Coil No. 55 Status	Coil No. 54 Status	Coil No. 53 Status	Coil No. 52 Status	Coil No. 51 Status	Coil No. 50 Status	Coil No. 49 Status	Coil No. 48 Status
9	Allocated and Reserved	Allocated and Reserved	Allocated and Reserved	Allocated and Reserved	Coil No. 59 Status	Coil No. 58 Status	Coil No. 57 Status	Coil No. 56 Status

Assumed Settings

15.5 Example No. 2

- Double Z-Boards™ used with all valves
- I/O Modules and mapping schemes are identified by their corresponding color.
- I/O Status bits are enabled
- Diagnostic Word is enabled

Manifold I/O Configuration

Pos. No.	Module Type	Part No.	In	Out	Diag
			Bytes		
		Diagnostic Word	0	0	2
		Local Valve Size:	0	4	4
		Total:	0	4	6

How to Order

Qty	Part Number
1	8503AV3H300VA00
8	R503A1B40MA00F1
4	8503AMM22MA0010
1	G3ED100R0E43
	ASSEMBLED

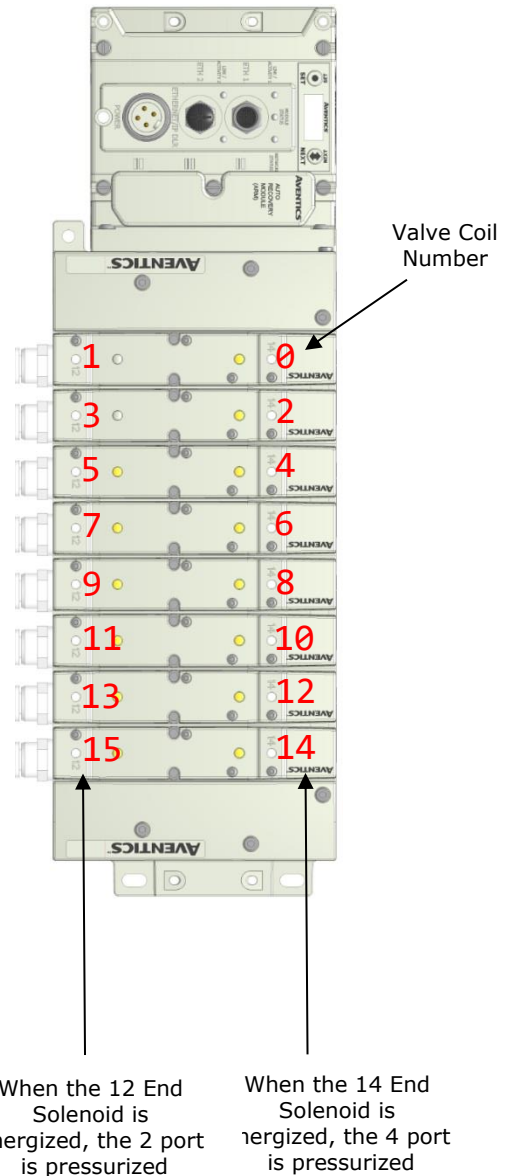

AVENTICS™ G3 Series EtherNet/IP™ DLR Technical Manual

Example No. 2 Table Data "SINT – with status"

<i>Output Table</i>								
BYTE	Bit 7	Bit 6	Bit 5	Bit 4	Bit 3	Bit 2	Bit 1	Bit 0
0	Valve Coil No. 7	Valve Coil No. 6	Valve Coil No. 5	Valve Coil No. 4	Valve Coil No. 3	Valve Coil No. 2	Valve Coil No. 1	Valve Coil No. 0
1	Allocated and Reserved	Allocated and Reserved	Allocated and Reserved	Allocated and Reserved	Valve Coil No. 11	Valve Coil No. 10	Valve Coil No. 9	Valve Coil No. 8
2	Allocated and Reserved	Allocated and Reserved	Allocated and Reserved	Allocated and Reserved	Allocated and Reserved	Allocated and Reserved	Allocated and Reserved	Allocated and Reserved
3	Allocated and Reserved	Allocated and Reserved	Allocated and Reserved	Allocated and Reserved	Allocated and Reserved	Allocated and Reserved	Allocated and Reserved	Allocated and Reserved

<i>Status Table</i>								
BYTE	Bit 7	Bit 6	Bit 5	Bit 4	Bit 3	Bit 2	Bit 1	Bit 0
0	Comm. Module Diagnostic Bit	Comm. Module Diagnostic Bit	Comm. Module Diagnostic Bit	Comm. Module Diagnostic Bit	Comm. Module Diagnostic Bit	Comm. Module Diagnostic Bit	Comm. Module Diagnostic Bit	Comm. Module Diagnostic Bit
1	Sub-bus Diagnostic Bit	Sub-bus Diagnostic Bit	Sub-bus Diagnostic Bit	Sub-bus Diagnostic Bit	Sub-bus Diagnostic Bit	Sub-bus Diagnostic Bit	Sub-bus Diagnostic Bit	Sub-bus Diagnostic Bit
2	Coil No. 7 Status	Coil No. 6 Status	Coil No. 5 Status	Coil No. 4 Status	Coil No. 3 Status	Coil No. 2 Status	Coil No. 1 Status	Coil No. 0 Status
3	Coil No. 15 Status	Coil No. 14 Status	Coil No. 13 Status	Coil No. 12 Status	Coil No. 11 Status	Coil No. 10 Status	Coil No. 9 Status	Coil No. 8 Status
4	Coil No. 23 Status	Coil No. 22 Status	Coil No. 21 Status	Coil No. 20 Status	Coil No. 19 Status	Coil No. 18 Status	Coil No. 17 Status	Coil No. 16 Status
5	Coil No. 31 Status	Coil No. 30 Status	Coil No. 29 Status	Coil No. 28 Status	Coil No. 27 Status	Coil No. 26 Status	Coil No. 25 Status	Coil No. 24 Status

AVENTICS™ G3 Series EtherNet/IP™ DLR Technical Manual

Assumed Settings

15.6 Example No. 3

- Double Z-Boards™ used with all valves
- I/O Modules and mapping schemes are identified by their corresponding color.
- I/O Status bits are enabled
- Diagnostic Word is enabled

Manifold I/O Configuration

Pos No.	Module Type	Part No.	In	Out	Diag
			Bytes		
1	16I PNP	240-205	2	0	1
2	4AI Analog	240-212	8	0	2
3	16I PNP	240-203	2	0	1
Diagnostic Word			0	0	2
Local Valves:			0	4	4
Total:			12	4	10

How to Order

Qty	Part Number
1	8503AV3H300VA00
8	R503A1B40MA00F1
4	8503AMM22MA0010
1	G3ED103R0E44
1	240-205
1	240-212
1	240-203
	ASSEMBLED

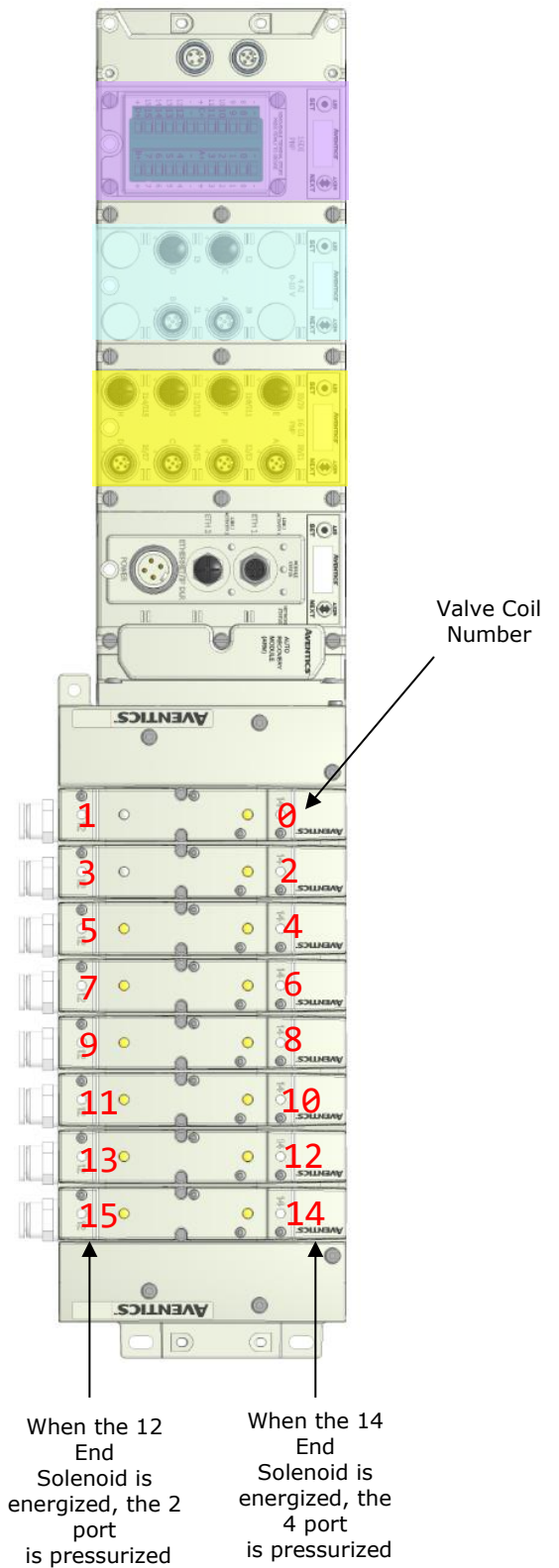

AVENTICS™ G3 Series EtherNet/IP™ DLR Technical Manual

Example No. 3 Table Data –“SINT with Status”

Output Table								
BYTE	Bit 7	Bit 6	Bit 5	Bit 4	Bit 3	Bit 2	Bit 1	Bit 0
0	Valve Coil No. 7	Valve Coil No. 6	Valve Coil No. 5	Valve Coil No. 4	Valve Coil No. 3	Valve Coil No. 2	Valve Coil No. 1	Valve Coil No. 0
1	Allocated and Reserved	Allocated and Reserved	Allocated and Reserved	Allocated and Reserved	Valve Coil No. 11	Valve Coil No. 10	Valve Coil No. 9	Valve Coil No. 8
2	Allocated and Reserved	Allocated and Reserved	Allocated and Reserved	Allocated and Reserved	Allocated and Reserved	Allocated and Reserved	Allocated and Reserved	Allocated and Reserved
3	Allocated and Reserved	Allocated and Reserved	Allocated and Reserved	Allocated and Reserved	Allocated and Reserved	Allocated and Reserved	Allocated and Reserved	Allocated and Reserved

Input Table								
BYTE	Bit 7	Bit 6	Bit 5	Bit 4	Bit 3	Bit 2	Bit 1	Bit 0
0	Discrete Input No. 7	Discrete Input No. 6	Discrete Input No. 5	Discrete Input No. 4	Discrete Input No. 3	Discrete Input No. 2	Discrete Input No. 1	Discrete Input No. 0
1	Discrete Input No. 15	Discrete Input No. 14	Discrete Input No. 13	Discrete Input No. 12	Discrete Input No. 11	Discrete Input No. 10	Discrete Input No. 9	Discrete Input No. 8
2	Analog Input No. 1	Analog Input No. 1	Analog Input No. 1	Analog Input No. 1	Analog Input No. 1	Analog Input No. 1	Analog Input No. 1	Analog Input No. 1 (LSB)
3	Analog Input No. 1 (MSB)	Analog Input No. 1	Analog Input No. 1	Analog Input No. 1	Analog Input No. 1	Analog Input No. 1	Analog Input No. 1	Analog Input No. 1
4	Analog Input No. 2	Analog Input No. 2	Analog Input No. 2	Analog Input No. 2	Analog Input No. 2	Analog Input No. 2	Analog Input No. 2	Analog Input No. 2 (LSB)
5	Analog Input No. 2 (MSB)	Analog Input No. 2	Analog Input No. 2	Analog Input No. 2	Analog Input No. 2	Analog Input No. 2	Analog Input No. 2	Analog Input No. 2
6	Analog Input No. 3	Analog Input No. 3	Analog Input No. 3	Analog Input No. 3	Analog Input No. 3	Analog Input No. 3	Analog Input No. 3	Analog Input No. 3 (LSB)
7	Analog Input No. 3 (MSB)	Analog Input No. 3	Analog Input No. 3	Analog Input No. 3	Analog Input No. 3	Analog Input No. 3	Analog Input No. 3	Analog Input No. 3
8	Analog Input No. 4	Analog Input No. 4	Analog Input No. 4	Analog Input No. 4	Analog Input No. 4	Analog Input No. 4	Analog Input No. 4	Analog Input No. 4 (LSB)
9	Analog Input No. 4 (MSB)	Analog Input No. 4	Analog Input No. 4	Analog Input No. 4	Analog Input No. 4	Analog Input No. 4	Analog Input No. 4	Analog Input No. 4
10	Discrete Input No. 7	Discrete Input No. 6	Discrete Input No. 5	Discrete Input No. 4	Discrete Input No. 3	Discrete Input No. 2	Discrete Input No. 1	Discrete Input No. 0
11	Discrete Input No. 15	Discrete Input No. 14	Discrete Input No. 13	Discrete Input No. 12	Discrete Input No. 11	Discrete Input No. 10	Discrete Input No. 9	Discrete Input No. 8

Status Table								
BYTE	Bit 7	Bit 6	Bit 5	Bit 4	Bit 3	Bit 2	Bit 1	Bit 0
0 (Optional)	Comm. Module Diagnostic Bit	Comm. Module Diagnostic Bit	Comm. Module Diagnostic Bit	Comm. Module Diagnostic Bit	Comm. Module Diagnostic Bit	Comm. Module Diagnostic Bit	Comm. Module Diagnostic Bit	Comm. Module Diagnostic Bit
1 (Optional)	Sub-bus Diagnostic Bit	Sub-bus Diagnostic Bit	Sub-bus Diagnostic Bit	Sub-bus Diagnostic Bit	Sub-bus Diagnostic Bit	Sub-bus Diagnostic Bit	Sub-bus Diagnostic Bit	Sub-bus Diagnostic Bit
2 (Optional)	Coil No. 7 Status	Coil No. 6 Status	Coil No. 5 Status	Coil No. 4 Status	Coil No. 3 Status	Coil No. 2 Status	Coil No. 1 Status	Coil No. 0 Status
3 (Optional)	Coil No. 15 Status	Coil No. 14 Status	Coil No. 13 Status	Coil No. 12 Status	Coil No. 11 Status	Coil No. 10 Status	Coil No. 9 Status	Coil No. 8 Status
4 (Optional)	Coil No. 23 Status	Coil No. 22 Status	Coil No. 21 Status	Coil No. 20 Status	Coil No. 19 Status	Coil No. 18 Status	Coil No. 17 Status	Coil No. 16 Status
5 (Optional)	Coil No. 31 Status	Coil No. 30 Status	Coil No. 29 Status	Coil No. 28 Status	Coil No. 27 Status	Coil No. 26 Status	Coil No. 25 Status	Coil No. 24 Status
6 (Optional)	Allocated and Reserved	Allocated and Reserved	Allocated and Reserved	Allocated and Reserved	Power Status for Conn. D	Power Status for Conn. C	Power Status for Conn. B	Power Status for Conn. A
7 (Optional)	High Alarm for Conn. D	Low Alarm for Conn. D	High Alarm for Conn. C	Low Alarm for Conn. C	High Alarm for Conn. B	Low Alarm for Conn. B	High Alarm for Conn. A	Low Alarm for Conn. A
8 (Optional)	Power Status for Conn. H	Power Status for Conn. G	Power Status for Conn. F	Power Status for Conn. E	Power Status for Conn. D	Power Status for Conn. C	Power Status for Conn. B	Power Status for Conn. A
9 (Optional)	Power Status for Conn. H	Power Status for Conn. G	Power Status for Conn. F	Power Status for Conn. E	Power Status for Conn. D	Power Status for Conn. C	Power Status for Conn. B	Power Status for Conn. A

AVENTICS™ G3 Series EtherNet/IP™ DLR Technical Manual

Assumed Settings

15.7 Example No. 4

- Double Z-Boards™ used with all valves
- I/O Modules and mapping schemes are identified by their corresponding color

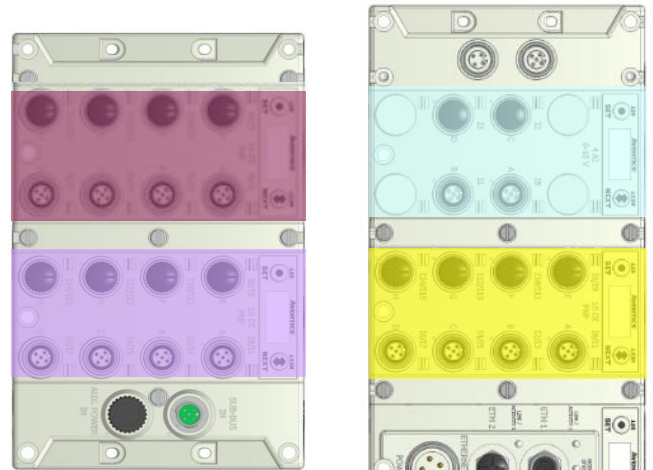

Manifold I/O Configuration

Pos No.	Module Type	Part No.	In	Out	Diag
			Bytes		
1	16I PNP	240-205	2	0	1
2	4I Analog	240-212	8	0	2
3	16I PNP	240-205	2	0	1
4	16I PNP	240-205	2	0	1
Diagnostic Word			0	0	2
Local Valves:			0	4	4
Total:			14	4	11

How to Order

Qty	Part Number
1	K503AV3H300VA00
8	R503A1B40MA00F1
4	8503AMM22MA0010
1	G3ED102D0E44
1	240-205
1	240-212
	ASSEMBLED

1	G3DS302R0STD
1	240-205
1	240-205
	ASSEMBLED

Valve Coil Number

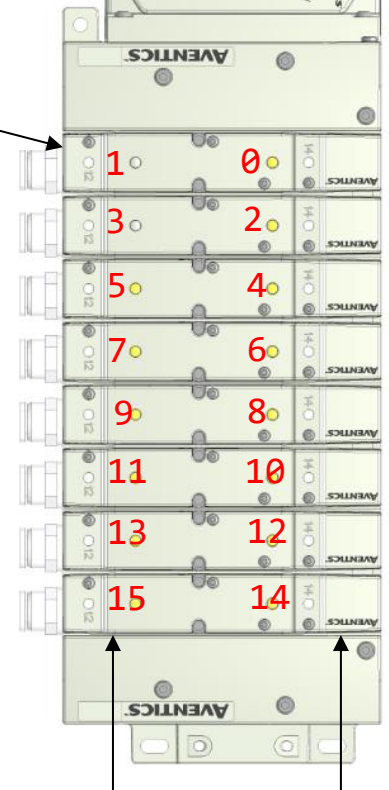

When the 12 End Solenoid is energized, the 2 port is pressurized

When the 14 End Solenoid is energized, the 4 port is pressurized

AVENTICS™ G3 Series EtherNet/IP™ DLR Technical Manual

Example No. 4 Table Data "SINT with Status"

Output Table								
BYTE	Bit 7	Bit 6	Bit 5	Bit 4	Bit 3	Bit 2	Bit 1	Bit 0
0	Valve Coil No. 7	Valve Coil No. 6	Valve Coil No. 5	Valve Coil No. 4	Valve Coil No. 3	Valve Coil No. 2	Valve Coil No. 1	Valve Coil No. 0
1	Allocated and Reserved	Allocated and Reserved	Allocated and Reserved	Allocated and Reserved	Valve Coil No. 11	Valve Coil No. 10	Valve Coil No. 9	Valve Coil No. 8
2	Allocated and Reserved	Allocated and Reserved	Allocated and Reserved	Allocated and Reserved	Allocated and Reserved	Allocated and Reserved	Allocated and Reserved	Allocated and Reserved
3	Allocated and Reserved	Allocated and Reserved	Allocated and Reserved	Allocated and Reserved	Allocated and Reserved	Allocated and Reserved	Allocated and Reserved	Allocated and Reserved

Input Table								
BYTE	Bit 7	Bit 6	Bit 5	Bit 4	Bit 3	Bit 2	Bit 1	Bit 0
0	Discrete Input No. 7	Discrete Input No. 6	Discrete Input No. 5	Discrete Input No. 4	Discrete Input No. 3	Discrete Input No. 2	Discrete Input No. 1	Discrete Input No. 0
1	Discrete Input No. 15	Discrete Input No. 14	Discrete Input No. 13	Discrete Input No. 12	Discrete Input No. 11	Discrete Input No. 10	Discrete Input No. 9	Discrete Input No. 8
2	Analog Input No. 1	Analog Input No. 1	Analog Input No. 1	Analog Input No. 1	Analog Input No. 1	Analog Input No. 1	Analog Input No. 1	Analog Input No. 1 (LSB)
3	Analog Input No. 1 (MSB)	Analog Input No. 1	Analog Input No. 1	Analog Input No. 1	Analog Input No. 1	Analog Input No. 1	Analog Input No. 1	Analog Input No. 1
4	Analog Input No. 2	Analog Input No. 2	Analog Input No. 2	Analog Input No. 2	Analog Input No. 2	Analog Input No. 2	Analog Input No. 2	Analog Input No. 2 (LSB)
5	Analog Input No. 2 (MSB)	Analog Input No. 2	Analog Input No. 2	Analog Input No. 2	Analog Input No. 2	Analog Input No. 2	Analog Input No. 2	Analog Input No. 2
6	Analog Input No. 3	Analog Input No. 3	Analog Input No. 3	Analog Input No. 3	Analog Input No. 3	Analog Input No. 3	Analog Input No. 3	Analog Input No. 3 (LSB)
7	Analog Input No. 3 (MSB)	Analog Input No. 3	Analog Input No. 3	Analog Input No. 3	Analog Input No. 3	Analog Input No. 3	Analog Input No. 3	Analog Input No. 3
8	Analog Input No. 4	Analog Input No. 4	Analog Input No. 4	Analog Input No. 4	Analog Input No. 4	Analog Input No. 4	Analog Input No. 4	Analog Input No. 4 (LSB)
9	Analog Input No. 4 (MSB)	Analog Input No. 4	Analog Input No. 4	Analog Input No. 4	Analog Input No. 4	Analog Input No. 4	Analog Input No. 4	Analog Input No. 4
10	Discrete Input No. 7	Discrete Input No. 6	Discrete Input No. 5	Discrete Input No. 4	Discrete Input No. 3	Discrete Input No. 2	Discrete Input No. 1	Discrete Input No. 0
11	Discrete Input No. 15	Discrete Input No. 14	Discrete Input No. 13	Discrete Input No. 12	Discrete Input No. 11	Discrete Input No. 10	Discrete Input No. 9	Discrete Input No. 8
12	Discrete Input No. 7	Discrete Input No. 6	Discrete Input No. 5	Discrete Input No. 4	Discrete Input No. 3	Discrete Input No. 2	Discrete Input No. 1	Discrete Input No. 0
13	Discrete Input No. 15	Discrete Input No. 14	Discrete Input No. 13	Discrete Input No. 12	Discrete Input No. 11	Discrete Input No. 10	Discrete Input No. 9	Discrete Input No. 8

Status Table								
BYTE	Bit 7	Bit 6	Bit 5	Bit 4	Bit 3	Bit 2	Bit 1	Bit 0
0 (Optional)	Comm. Module Diagnostic Bit	Comm. Module Diagnostic Bit	Comm. Module Diagnostic Bit	Comm. Module Diagnostic Bit	Comm. Module Diagnostic Bit	Comm. Module Diagnostic Bit	Comm. Module Diagnostic Bit	Comm. Module Diagnostic Bit
1 (Optional)	Sub-bus Diagnostic Bit	Sub-bus Diagnostic Bit	Sub-bus Diagnostic Bit	Sub-bus Diagnostic Bit	Sub-bus Diagnostic Bit	Sub-bus Diagnostic Bit	Sub-bus Diagnostic Bit	Sub-bus Diagnostic Bit
2 (Optional)	Coil No. 7 Status	Coil No. 6 Status	Coil No. 5 Status	Coil No. 4 Status	Coil No. 3 Status	Coil No. 2 Status	Coil No. 1 Status	Coil No. 0 Status
3 (Optional)	Coil No. 15 Status	Coil No. 14 Status	Coil No. 13 Status	Coil No. 12 Status	Coil No. 11 Status	Coil No. 10 Status	Coil No. 9 Status	Coil No. 8 Status
4 (Optional)	Coil No. 23 Status	Coil No. 22 Status	Coil No. 21 Status	Coil No. 20 Status	Coil No. 19 Status	Coil No. 18 Status	Coil No. 17 Status	Coil No. 16 Status
5 (Optional)	Coil No. 31 Status	Coil No. 30 Status	Coil No. 29 Status	Coil No. 28 Status	Coil No. 27 Status	Coil No. 26 Status	Coil No. 25 Status	Coil No. 24 Status
8 (Optional)	Power Status for Conn. H	Power Status for Conn. G	Power Status for Conn. F	Power Status for Conn. E	Power Status for Conn. D	Power Status for Conn. C	Power Status for Conn. B	Power Status for Conn. A
7 (Optional)	Allocated and Reserved	Allocated and Reserved	Allocated and Reserved	Allocated and Reserved	Power Status for Conn. D	Power Status for Conn. C	Power Status for Conn. B	Power Status for Conn. A
8 (Optional)	High Alarm for Conn. D	Low Alarm for Conn. D	High Alarm for Conn. C	Low Alarm for Conn. C	High Alarm for Conn. B	Low Alarm for Conn. B	High Alarm for Conn. A	Low Alarm for Conn. A
9 (Optional)	Power Status for Conn. H	Power Status for Conn. G	Power Status for Conn. F	Power Status for Conn. E	Power Status for Conn. D	Power Status for Conn. C	Power Status for Conn. B	Power Status for Conn. A
10 (Optional)	Power Status for Conn. H	Power Status for Conn. G	Power Status for Conn. F	Power Status for Conn. E	Power Status for Conn. D	Power Status for Conn. C	Power Status for Conn. B	Power Status for Conn. A

Assumed Settings

15.8 Example No. 5

- Double Z-Boards™ used with all valves
- I/O Modules and mapping schemes are identified by their corresponding color.
- I/O Status bits are enabled
- Diagnostic Word is enabled

Manifold I/O Configuration

Pos No.	Module Type	Part No.	In	Out	Diag
			Bytes		
1	16I PNP	240-205	2	0	1
2	4I Analog	240-212	8	0	2
Diagnostic Word			0	0	2
Local Valves			0	4	4
Sub-Bus Valves			0	4	4
Total:			10	8	13

How to Order

Qty	Part Number
1	8503AV3H300VA00
8	R503A1B40MA00F1
4	8503AMM22MA0010
1	G3ED102D0E44
1	240-205
1	240-212
	ASSEMBLED

1	8503AV3H300VA00
8	R503A1B40MA00F1
4	8503AMM22MA0010
1	G3DS201R0STD
	ASSEMBLED

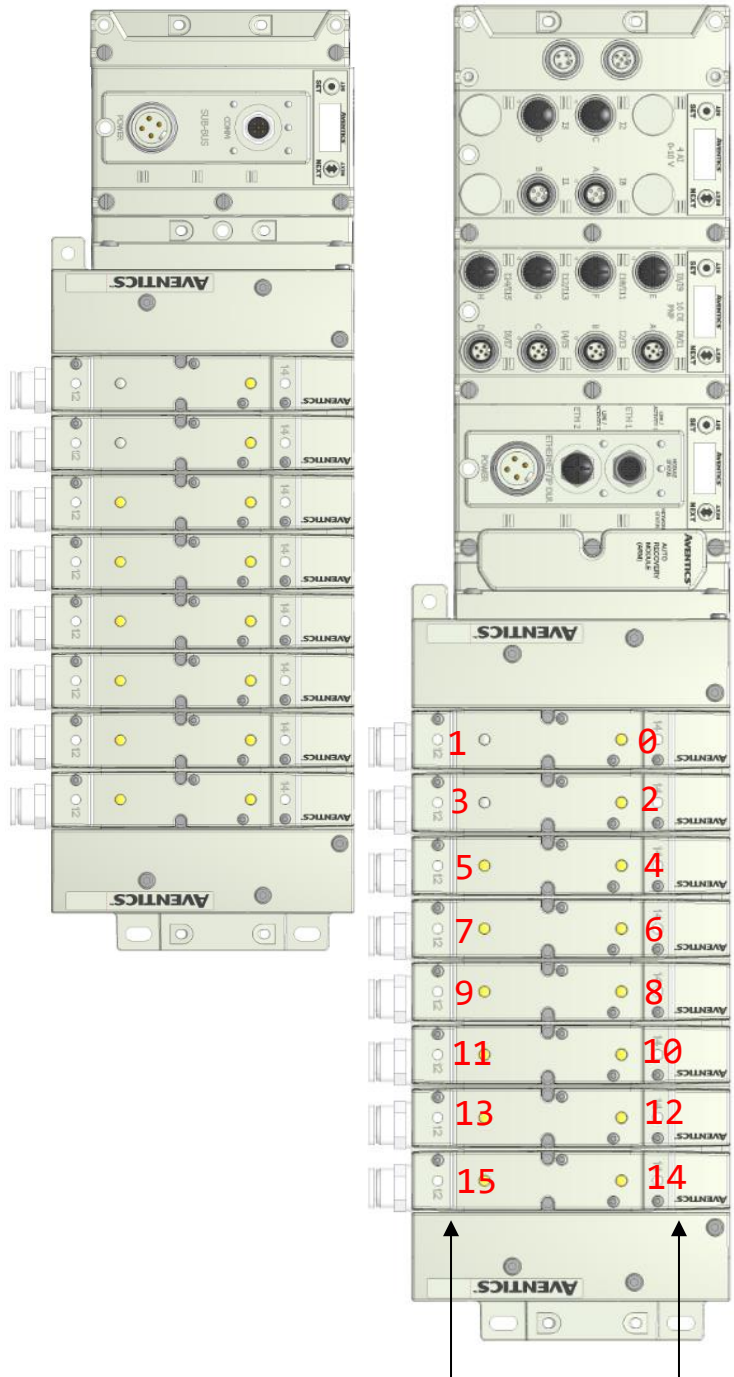

When the 12 End Solenoid is energized, the 2 port is pressurized

When the 14 End Solenoid is energized, the 4 port is pressurized

AVENTICS™ G3 Series EtherNet/IP™ DLR Technical Manual

Example No. 5 Table Data "SINT with status"

Output Table								
BYTE	Bit 7	Bit 6	Bit 5	Bit 4	Bit 3	Bit 2	Bit 1	Bit 0
0	Valve Coil No. 7	Valve Coil No. 6	Valve Coil No. 5	Valve Coil No. 4	Valve Coil No. 3	Valve Coil No. 2	Valve Coil No. 1	Valve Coil No. 0
1	Allocated and Reserved	Allocated and Reserved	Allocated and Reserved	Allocated and Reserved	Valve Coil No. 11	Valve Coil No. 10	Valve Coil No. 9	Valve Coil No. 8
2	Allocated and Reserved	Allocated and Reserved	Allocated and Reserved	Allocated and Reserved	Allocated and Reserved	Allocated and Reserved	Allocated and Reserved	Allocated and Reserved
3	Allocated and Reserved	Allocated and Reserved	Allocated and Reserved	Allocated and Reserved	Allocated and Reserved	Allocated and Reserved	Allocated and Reserved	Allocated and Reserved
4	Valve Coil No. 7	Valve Coil No. 6	Valve Coil No. 5	Valve Coil No. 4	Valve Coil No. 3	Valve Coil No. 2	Valve Coil No. 1	Valve Coil No. 0
5	Allocated and Reserved	Allocated and Reserved	Allocated and Reserved	Allocated and Reserved	Valve Coil No. 11	Valve Coil No. 10	Valve Coil No. 9	Valve Coil No. 8
6 (Optional)	Allocated and Reserved	Allocated and Reserved	Allocated and Reserved	Allocated and Reserved	Allocated and Reserved	Allocated and Reserved	Allocated and Reserved	Allocated and Reserved
7 (Optional)	Allocated and Reserved	Allocated and Reserved	Allocated and Reserved	Allocated and Reserved	Allocated and Reserved	Allocated and Reserved	Allocated and Reserved	Allocated and Reserved

Input Table								
BYTE	Bit 7	Bit 6	Bit 5	Bit 4	Bit 3	Bit 2	Bit 1	Bit 0
6	Discrete Input No. 7	Discrete Input No. 6	Discrete Input No. 5	Discrete Input No. 4	Discrete Input No. 3	Discrete Input No. 2	Discrete Input No. 1	Discrete Input No. 0
7	Discrete Input No. 15	Discrete Input No. 14	Discrete Input No. 13	Discrete Input No. 12	Discrete Input No. 11	Discrete Input No. 10	Discrete Input No. 9	Discrete Input No. 8
9	Analog Input No. 1	Analog Input No. 1	Analog Input No. 1	Analog Input No. 1	Analog Input No. 1	Analog Input No. 1	Analog Input No. 1	Analog Input No. 1 (LSB)
10	Analog Input No. 1 (MSB)	Analog Input No. 1	Analog Input No. 1	Analog Input No. 1	Analog Input No. 1	Analog Input No. 1	Analog Input No. 1	Analog Input No. 1
11	Analog Input No. 2	Analog Input No. 2	Analog Input No. 2	Analog Input No. 2	Analog Input No. 2	Analog Input No. 2	Analog Input No. 2	Analog Input No. 2 (LSB)
12	Analog Input No. 2 (MSB)	Analog Input No. 2	Analog Input No. 2	Analog Input No. 2	Analog Input No. 2	Analog Input No. 2	Analog Input No. 2	Analog Input No. 2
13	Analog Input No. 3	Analog Input No. 3	Analog Input No. 3	Analog Input No. 3	Analog Input No. 3	Analog Input No. 3	Analog Input No. 3	Analog Input No. 3 (LSB)
14	Analog Input No. 3 (MSB)	Analog Input No. 3	Analog Input No. 3	Analog Input No. 3	Analog Input No. 3	Analog Input No. 3	Analog Input No. 3	Analog Input No. 3
15	Analog Input No. 4	Analog Input No. 4	Analog Input No. 4	Analog Input No. 4	Analog Input No. 4	Analog Input No. 4	Analog Input No. 4	Analog Input No. 4 (LSB)
16	Analog Input No. 4 (MSB)	Analog Input No. 4	Analog Input No. 4	Analog Input No. 4	Analog Input No. 4	Analog Input No. 4	Analog Input No. 4	Analog Input No. 4

Diagnostic Table								
BYTE	Bit 7	Bit 6	Bit 5	Bit 4	Bit 3	Bit 2	Bit 1	Bit 0
0	Comm. Module Diagnostic Bit	Comm. Module Diagnostic Bit	Comm. Module Diagnostic Bit	Comm. Module Diagnostic Bit	Comm. Module Diagnostic Bit	Comm. Module Diagnostic Bit	Comm. Module Diagnostic Bit	Comm. Module Diagnostic Bit
1	Sub-bus Diagnostic Bit	Sub-bus Diagnostic Bit	Sub-bus Diagnostic Bit	Sub-bus Diagnostic Bit	Sub-bus Diagnostic Bit	Sub-bus Diagnostic Bit	Sub-bus Diagnostic Bit	Sub-bus Diagnostic Bit
2	Coil No. 7 Status	Coil No. 6 Status	Coil No. 5 Status	Coil No. 4 Status	Coil No. 3 Status	Coil No. 2 Status	Coil No. 1 Status	Coil No. 0 Status
3	Coil No. 15 Status	Coil No. 14 Status	Coil No. 13 Status	Coil No. 12 Status	Coil No. 11 Status	Coil No. 10 Status	Coil No. 9 Status	Coil No. 8 Status
4	Coil No. 23 Status	Coil No. 22 Status	Coil No. 21 Status	Coil No. 20 Status	Coil No. 19 Status	Coil No. 18 Status	Coil No. 17 Status	Coil No. 16 Status
5	Coil No. 31 Status	Coil No. 30 Status	Coil No. 29 Status	Coil No. 28 Status	Coil No. 27 Status	Coil No. 26 Status	Coil No. 25 Status	Coil No. 24 Status
6	Power Status for Conn. H	Power Status for Conn. G	Power Status for Conn. F	Power Status for Conn. E	Power Status for Conn. D	Power Status for Conn. C	Power Status for Conn. B	Power Status for Conn. A
7	Allocated and Reserved	Allocated and Reserved	Allocated and Reserved	Allocated and Reserved	Power Status for Conn. D	Power Status for Conn. C	Power Status for Conn. B	Power Status for Conn. A
8	High Alarm for Conn. D	Low Alarm for Conn. D	High Alarm for Conn. C	Low Alarm for Conn. C	High Alarm for Conn. B	Low Alarm for Conn. B	High Alarm for Conn. A	Low Alarm for Conn. A
9	Coil No. 7 Status	Coil No. 6 Status	Coil No. 5 Status	Coil No. 4 Status	Coil No. 3 Status	Coil No. 2 Status	Coil No. 1 Status	Coil No. 0 Status
10	Coil No. 15 Status	Coil No. 14 Status	Coil No. 13 Status	Coil No. 12 Status	Coil No. 11 Status	Coil No. 10 Status	Coil No. 9 Status	Coil No. 8 Status
11 (Optional)	Coil No. 23 Status	Coil No. 22 Status	Coil No. 21 Status	Coil No. 20 Status	Coil No. 19 Status	Coil No. 18 Status	Coil No. 17 Status	Coil No. 16 Status
12 (Optional)	Coil No. 31 Status	Coil No. 30 Status	Coil No. 29 Status	Coil No. 28 Status	Coil No. 27 Status	Coil No. 26 Status	Coil No. 25 Status	Coil No. 24 Status

15.9 Diagnostic Word

<i>Diagnostic Word Format</i>								
BYTE	Bit 7	Bit 6	Bit 5	Bit 4	Bit 3	Bit 2	Bit 1	Bit 0
0 (Comm. Status)	Reserved	Reserved	Reserved	Reserved	Sub-Bus Short Circuit (1 = Error)	Sub-Bus Error (1=Error)	Un-Switched Power Status (1=Error)	Switched Power Status (1=Error)
1 (Sub-Bus Status)	Error Code	Error Code	Error Code	Module Address	Module Address	Module Address	Module Address	Module Address

Byte 0 (Communication Status)

Byte 0, Bit 0 Switched Power Status = Bit is high when valve / output power is not present on the comm. module.

Byte 0, Bit 1 Un-switched Power Status = Bit is high when node / input power is below 19VDC

Byte 0, Bit 2 Sub-Bus Error = Bit is high when there is an error on the sub-bus; see "Byte 1" of diagnostic word for description.

Byte 0, Bit 3 Sub-Bus Short Circuit = A short circuit has been detected across the Sub-Bus

AVENTICS™ G3 Series EtherNet/IP™ DLR Technical Manual

Diagnostic Word Continued

Byte 1 (Sub-Bus Status)

Module Address

Bit 4	Bit 3	Bit 2	Bit 1	Bit 0	Description
0	0	0	0	0	No error
0	0	0	0	1	Communication Module
0	0	0	1	0	I/O module No. 1
0	0	0	1	1	I/O module No. 2
0	0	1	0	0	I/O module No. 3
0	0	1	0	1	I/O module No. 4
0	0	1	1	0	I/O module No. 5
0	0	1	1	1	I/O module No. 6
0	1	0	0	0	I/O module No. 7
0	1	0	0	1	I/O module No. 8
0	1	0	1	0	I/O module No. 9
0	1	0	1	1	I/O module No. 10
0	1	1	0	0	I/O module No. 11
0	1	1	0	1	I/O module No. 12
0	1	1	1	0	I/O module No. 13
0	1	1	1	1	I/O module No. 14
1	0	0	0	0	I/O module No. 15
1	0	0	0	1	I/O module No. 16
1	0	0	1	1	Communication Valve driver
1	0	1	0	0	ARM
1	0	1	0	1	MCM (Legacy)
X	X	X	X	X	N/A

Sub-Bus Errors

Error Code	Bit 7	Bit 6	Bit 5
0	0	0	0
1	0	0	1
2	0	1	0
3	0	1	1
4	1	0	0
5	1	0	1
6	1	1	0
7	1	1	1

Error Code 0 = No Errors

Error Code 1 = Lost communications between I/O module and communications module

Error Code 2 = Valve / Output power is below 19VDC

Error Code 3...7 = not defined / reserved

16. IIOT

16.1 Rest API introduction

REST is a scalable architecture which allows for devices to communicate over Hypertext Transfer Protocol (HTTP) and is easily adopted for IIoT applications to provide communication

REST API Minimum Build Firmware Requirements		
Module	Part Number	Firmware
Communication Module	240-325	Rev 1.01 Build 44223

16.1.1 Rest Trigger Signal Description

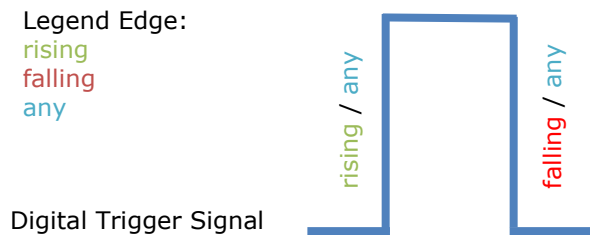

16.1.2 Rest – G3 Module and Addresses

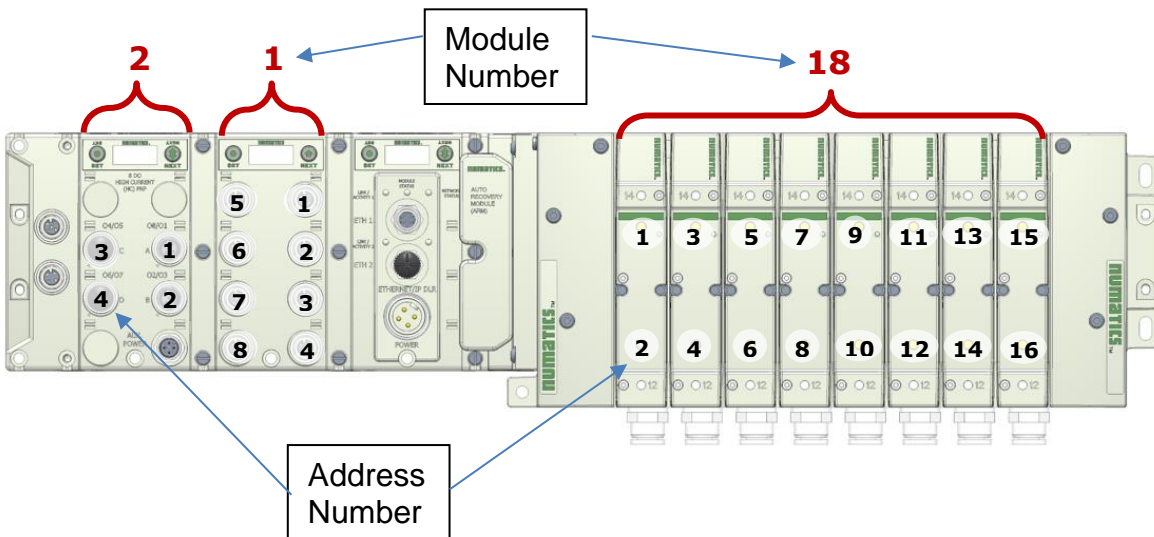

AVENTICS™ G3 Series EtherNet/IP™ DLR Technical Manual

16.1.3 Rest API Terms

Term Description

function	represents the name
mode	String value that represents the mode which is user by the function. Possible values are: INTERVAL TRIGGERS START_TO_PERIOD
from	Key which holds a further object which describes a digital signal like digital output, digital input or valve switch signal
to	
value	Key which holds a further object which describes an analog signal
period	Number that represents the time period in ms. E.g. an end trigger on a function
module	Number of IO module starting with 0 next to the G3 fieldbus node or Number of Valve module starting with 1000 next to the G3 fieldbus node
address	Number of Input or Output on the chosen IO module or Number of trigger of the valve
direction	String value that represents if it's an input or output. E.g. necessary for combined modules. Possible values are: IN OUT
trigger	String value that represents a edge of a digital state change. Possible values are: FALLING RISING ANY
samplerate	Number that represents the sampling rate in ms of an analog signal. E.g. summing up an airflow with a sampling rate of 100ms.
offset	Number that represents the decimal offset of an analog signal. The offset needs to be subtracted from the measured value for all sampled values.
id	Identificator which is created by the G3 starting at zero
v	Value of a function or value array
sr	Number that represents the configured sampling rate
ns	Number that represents the amount of samples
c	Counter is increment every time where the function computes a result
ts	Timestamp in ms since the last power up of the G3

16.2 Rest API Examples

<u>Function</u>	<u>Description</u>	<u>Example / Use case</u>
Get value	Read a value from input or output module.	Read out air flow sensor
Get count of state changes	Returns the count of state changes of an valve, an digital input or digital output since the last power up of the System.	Count the number of valve cycles
Get time of state change	Returns a timestamp of the event relative to the start time of the System in milliseconds.	Detect when the valve has switched
Get time between two state changes	Returns the time difference between two events in milliseconds.	Measurement of shock absorber's damping time or cycle cylinder time
Get summed values (in interval)	Sum up an analog input value in the given interval.	Detect Leakages by sum up the air flow sensor value in a interval
Get summed values (between two state changes)	Sum up an analog input value in between two trigger events for the given interval.	Measure how much air where used for a process step
Get summed values (start with state change for a period of time)	Sum up an analog input value starting with a state change for a period of time.	Compare sensor values to detect anomalies
Get value difference (in interval)	Returns the difference of an analog input value in the given interval.	Get the pressure in a defined interval
Get value difference (between two state changes)	Returns the difference of an analog input between two digital trigger events.	Distance measurement of a cylinder within two events
Get value difference (between state change for a period of time)	Returns the difference of an analog input between a digital trigger start event and a time interval in milliseconds.	Distance measurement of a cylinder triggered by a valve switch within a given time interval, as an indicator for wear out.
Get min/max/average (in interval)	Returns the minimal/maximal/average value of an analog input in the given interval.	Get the maximum pressure every second
Get min/max/average (between two state changes)	Returns the minimal/maximal/average value of an analog input between two digital trigger events.	Get minimum air flow between two events
Get min/max/average (between state change for a period of time)	Returns the minimal/maximal/average value of an analog input between a digital trigger start event and a time interval in milliseconds.	Get average pressure starting on the cylinder movement and stopping after 500ms

16.3 Rest API – Functions

16.3.1 Get Manifold Description

Get manifold type

SPM → G3

```
GET http://<G3_IP>/api/v1/  
{ }
```

G3 → SPM

```
Response  
(HTTP-Status 200, Content-Type: application/json)  
{  
  name: "EMERSON-G3-ETHERNET-IP"  
  version: "1.0"  
}  
name: String that represents the name of the manifold  
version: String that represents the version of the manifold
```

Get list of all modules

SPM → G3

```
GET http://<G3_IP>/api/v1/modules/  
{ }
```

G3 → SPM

```
Response  
(HTTP-Status 200, Content-Type: application/json)  
{  
  ids: [  
    "240-325",  
    "425186-001",  
    "240-205",  
    ...]  
}  
ids: Array of all connected modules (IOs and Valves).
```

16.3.2 Get Value

Read Value

SPM → G3

GET http://<G3_IP>/api/v1/values/

```
{ }
```

G3 → SPM

Response

(HTTP-Status 200, Content-Type: application/json)

```
{  
  vin: [255, 0, 1, ...],  
  vout: [1, 0, 254, ...],  
  vdiag: [1, 0, 254, ...],  
  ts: 710  
}
```

vin/vout are arrays of values, for valves and digital modules each value in the array is 8 inputs or outputs. For analog modules, each value is analog value for the IO point.

vin represents the input signals.

vout represents the output signals or valves.

vdiag is an array of the diagnostic bytes for all the modules.

16.3.3 Get Count of State Changes

Configure after startup

SPM → G3

```
POST http://<G3_IP>/api/v1/functions/  
{  
  function: "GET_COUNT_OF_STATE_CHANGES",  
  from: {  
    module: 2,  
    address: 1,  
    direction: "OUT"  
  }  
}
```

G3 → SPM

```
Response  
(HTTP-Status 201, Content-Type: application/json)  
{  
  id: 3  
}
```

Read value

SPM → G3

```
GET http://<G3_IP>/api/v1/functions/3  
{ }
```

G3 → SPM

```
Response  
(HTTP-Status 200, Content-Type: application/json)  
{  
  id: 3,  
  v: 456,  
  ts: 843  
}  
v: Number of high states since the last power up
```

16.3.4 Get Time of State Changes

Configure after startup

SPM → G3

```
POST http://<G3_IP>/api/v1/functions/  
{  
  function: "GET_TIME_OF_STATE_CHANGE",  
  from: {  
    module: 2,  
    address: 1,  
    direction: "OUT",  
    trigger: "FALLING"  
  }  
}
```

G3 → SPM

```
Response  
(HTTP-Status 201, Content-Type: application/json)  
{  
  id: 3
```

Read value

SPM → G3

```
GET http://<G3_IP>/api/v1/functions/3  
{ }
```

G3 → SPM

```
Response  
(HTTP-Status 200, Content-Type: application/json)  
{  
  id: 3,  
  v: 456,  
  ts: 843  
}  
v: Timestamp of trigger event since the last power up
```

16.3.5 Get time between two state changes

Configure after startup

SPM → G3

```
POST http://<G3_IP>/api/v1/functions/
{
  function: "GET_TIME_BETWEEN_TWO_STATE_CHANGES",
  from: {
    module: 2,
    address: 1,
    direction: "OUT",
    trigger: "FALLING"
  },
  to: {
    module: 2,
    address: 2,
    direction: "IN",
    trigger: "RISING"
  }
}
```

G3 → SPM

```
Response (HTTP-Status 201, Content-Type: application/json)
{
  id: 3
}
```

Read value

SPM → G3

```
GET http://<G3_IP>/api/v1/functions/3
{ }
```

G3 → SPM

```
Response
(HTTP-Status 200, Content-Type: application/json)
{
  id: 3,
  v: 258,
  c: 12,
  ts: 541
}
v: Measured time in ms, between the from and to trigger signals
```

16.3.6 Get summed values (in interval)

SPM → G3

Configure after startup

```
POST http://<G3_IP>/api/v1/functions/  
{  
  function: "GET_SUMMED_VALUES",  
  mode: "INTERVAL",  
  interval: 500,  
  value: {  
    module: 5,  
    address: 1,  
    direction: "IN",  
    samplerate: 100,  
    offset: 0  
  }  
}
```

G3 → SPM

```
Response (HTTP-Status 201, Content-Type: application/json)  
{  
  id: 3  
}
```

Read value

SPM → G3

```
GET http://<G3_IP>/api/v1/functions/3  
{ }
```

G3 → SPM

```
Response  
(HTTP-Status 200, Content-Type: application/json)  
{  
  id: 3,  
  ns: 5,  
  v: 258887,  
  sr: 100,  
  c: 12,  
  ts: 541  
}
```

v: Summed up analog value in the given sample rate and offset, between the beginning and the end of the interval

sr: Sample rate in ms that was configured

ns: Number of samples

16.3.7 Get summed values (between two state changes)

Configure after startup

SPM → G3

```
POST http://<G3_IP>/api/v1/functions/
{
  function: "GET_SUMMED_VALUES",
  mode: "TRIGGERS",
  from: {
    module: 2,
    address: 1,
    direction: "OUT",
    trigger: "FALLING"
  },
  to: {
    module: 2,
    address: 2,
    direction: "IN",
    trigger: "RISING"
  },
  value: {
    module: 5,
    address: 1,
    direction: "IN",
    samplerate: 100,
    offset: 0
  }
}
```

G3 → SPM

Response (HTTP-Status 201, Content-Type: application/json)

```
{
  id: 3
}
```

Read value

SPM → G3

```
GET http://<G3_IP>/api/v1/functions/3
{}
G3 → SPM
Response
(HTTP-Status 200, Content-Type: application/json)
{
  id: 3,
  ns: 5,
  v: 258887,
  sr: 100,
  c: 12,
  ts: 541
}
```

v: Summed up analog value in the given sample rate and offset, between the from and to trigger signals

sr: Sample rate in ms that was configured

ns: Number of samples

16.3.8 Get summed values (start with state change for a period of time)

Configure after startup

SPM → G3

```
POST http://<G3_IP>/api/v1/functions/
{
  function: "GET_SUMMED_VALUES",
  mode: "START_TO_PERIOD",
  from: {
    module: 2,
    address: 1,
    direction: "OUT",
    trigger: "FALLING"
  },
  period: 100,
  value: {
    module: 5,
    address: 1,
    direction: "IN",
    samplerate: 100,
    offset: 0
  }
}
```

G3 → SPM

Response (HTTP-Status 201, Content-Type: application/json)

```
{
  id: 3
}
```

Read value

SPM → G3

GET http://<G3_IP>/api/v1/functions/3

```
{ }
```

G3 → SPM

Response

(HTTP-Status 200, Content-Type: application/json)

```
{
  id: 3,
  ns: 5,
  v: 258887,
  sr: 100,
  c: 12,
  ts: 541
}
```

v: Summed up analog value in the given sample rate and offset, between a start trigger for a period of time

sr: Sample rate in ms that was configured

ns: Number of samples

16.3.9 Get value difference (in interval)

Configure after startup

SPM → G3

```
POST http://<G3_IP>/api/v1/functions/  
{  
  function: "GET_VALUE_DIFFERENCE",  
  mode: "INTERVAL",  
  interval: 500,  
  value: {  
    module: 5,  
    address: 1,  
    direction: "IN"  
  }  
}
```

G3 → SPM

```
Response (HTTP-Status 201, Content-Type: application/json)  
{  
  id: 3  
}
```

Read value

SPM → G3

```
GET http://<G3_IP>/api/v1/functions/3  
{ }
```

G3 → SPM

```
Response  
(HTTP-Status 200, Content-Type: application/json)  
{  
  id: 3,  
  ns: 5,  
  v: -649,  
  c: 12,  
  ts: 541  
}
```

v: Analog value difference, between the beginning and the end of the interval

16.3.10 Get value difference (between two state changes)

Configure after startup

SPM → G3

```
POST http://<G3_IP>/api/v1/functions/
{
  function: "GET_VALUE_DIFFERENCE",
  mode: "TRIGGERS",
  from: {
    module: 2,
    address: 1,
    direction: "OUT",
    trigger: "FALLING"
  },
  to: {
    module: 2,
    address: 2,
    direction: "IN",
    trigger: "RISING"
  },
  value: {
    module: 5,
    address: 1,
    direction: "IN"
  }
}
```

G3 → SPM

Response (HTTP-Status 201, Content-Type: application/json)

```
{
  id: 3
}
```

Read value

SPM → G3

```
GET http://<G3_IP>/api/v1/functions/3
{ }
```

G3 → SPM

Response
(HTTP-Status 200, Content-Type: application/json)

```
{
  id: 3,
  ns: 5,
  v: -649,
  c: 12,
  ts: 541
}
```

v: Analog value difference, between the from and to trigger signals. The calculation is To – From.

16.3.11 Get value difference (between state change for a period of time)

Configure after startup

SPM → G3

```
POST http://<G3_IP>/api/v1/functions/
{
  function: "GET_VALUE_DIFFERENCE",
  mode: "START_TO_PERIOD",
  from: {
    module: 2,
    address: 1,
    direction: "OUT",
    trigger: "FALLING"
  },
  period: 100,
  value: {
    module: 5,
    address: 1,
    direction: "IN"
  }
}
```

G3 → SPM

Response (HTTP-Status 201, Content-Type: application/json)

```
{
  id: 3
}
```

Read value

SPM → G3

```
GET http://<G3_IP>/api/v1/functions/3
{ }
```

G3 → SPM

Response
(HTTP-Status 200, Content-Type: application/json)

```
{
  id: 3,
  ns: 5,
  v: -649,
  c: 12,
  ts: 541
}
```

v: Analog value difference, between a start trigger for a period of time

16.3.12 Get minimal value (in interval)

Configure after startup

SPM → G3

```
POST http://<G3_IP>/api/v1/functions/  
{  
  function: "GET_MIN_VALUE",  
  mode: "INTERVAL",  
  interval: 500,  
  value: {  
    module: 5,  
    address: 1,  
    direction: "IN",  
  }  
}
```

G3 → SPM

```
Response (HTTP-Status 201, Content-Type: application/json)  
{  
  id: 3  
}
```

Read value

SPM → G3

```
GET http://<G3_IP>/api/v1/functions/3  
{ }
```

G3 → SPM

```
Response  
(HTTP-Status 200, Content-Type: application/json)  
{  
  id: 3,  
  ns: 5,  
  v: 649,  
  c: 12,  
  ts: 541  
}
```

v: Minimum analog value, between the beginning and the end of the interval

16.3.13 Get minimal value (between two state changes)

Configure after startup

SPM → G3

```
POST http://<G3_IP>/api/v1/functions/
{
  function: "GET_MIN_VALUE",
  mode: "TRIGGERS",
  from: {
    module: 2,
    address: 1,
    direction: "OUT",
    trigger: "FALLING"
  },
  to: {
    module: 2,
    address: 2,
    direction: "IN",
    trigger: "RISING"
  },
  value: {
    module: 5,
    address: 1,
    direction: "IN"
  }
}
```

G3 → SPM

```
Response (HTTP-Status 201, Content-Type: application/json)
{
  id: 3
}
```

Read value

SPM → G3

```
GET http://<G3_IP>/api/v1/functions/3
{ }
```

G3 → SPM

```
Response
(HTTP-Status 200, Content-Type: application/json)
{
  id: 3,
  ns: 5,
  v: 649,
  c: 12,
  ts: 541
}
```

v: Minimum analog value, between the from and to trigger signals

16.3.14 Get minimal value (between state change for a period of time)

Configure after startup

SPM → G3

```
POST http://<G3_IP>/api/v1/functions/
{
  function: "GET_MIN_VALUE",
  mode: "START_TO_PERIOD",
  from: {
    module: 2,
    address: 1,
    direction: "OUT",
    trigger: "FALLING"
  },
  period: 100,
  value: {
    module: 5,
    address: 1,
    direction: "IN"
  }
}
```

G3 → SPM

Response (HTTP-Status 201, Content-Type: application/json)

```
{
  id: 3
}
```

Read value

SPM → G3

```
GET http://<G3_IP>/api/v1/functions/3
{ }
```

G3 → SPM

Response
(HTTP-Status 200, Content-Type: application/json)

```
{
  id: 3,
  ns: 5,
  v: 649,
  c: 12,
  ts: 541
}
```

v: Minimum analog value, between a start trigger for a period of time

16.3.15 Get maximal value (in interval)

Configure after startup

SPM → G3

```
POST http://<G3_IP>/api/v1/functions/  
{  
  function: "GET_MAX_VALUE",  
  mode: "INTERVAL",  
  interval: 500,  
  value: {  
    module: 5,  
    address: 1,  
    direction: "IN",  
  }  
}
```

G3 → SPM

```
Response (HTTP-Status 201, Content-Type: application/json)  
{  
  id: 3  
}
```

Read value

SPM → G3

```
GET http://<G3_IP>/api/v1/functions/3  
{ }
```

G3 → SPM

```
Response  
(HTTP-Status 200, Content-Type: application/json)  
{  
  id: 3,  
  ns: 5,  
  v: 649,  
  c: 12,  
  ts: 541  
}
```

v: Maximum analog value, between the beginning and the end of the interval

16.3.16 Get maximal value (between two state changes)

Configure after startup

SPM → G3

```
POST http://<G3_IP>/api/v1/functions/
{
  function: "GET_MAX_VALUE",
  mode: "TRIGGERS",
  from: {
    module: 2,
    address: 1,
    direction: "OUT",
    trigger: "FALLING"
  },
  to: {
    module: 2,
    address: 2,
    direction: "IN",
    trigger: "RISING"
  },
  value: {
    module: 5,
    address: 1,
    direction: "IN"
  }
}
```

G3 → SPM

Response (HTTP-Status 201, Content-Type: application/json)

```
{
  id: 3
}
```

Read value

SPM → G3

```
GET http://<G3_IP>/api/v1/functions/3
{ }
```

G3 → SPM

Response
(HTTP-Status 200, Content-Type: application/json)

```
{
  id: 3,
  ns: 5,
  v: 649,
  c: 12,
  ts: 541
}
```

v: Maximum analog value, between the from and to trigger signals

16.3.17 Get maximal value (between state change for a period of time)

Configure after startup

SPM → G3

```
POST http://<G3_IP>/api/v1/functions/
{
  function: "GET_MAX_VALUE",
  mode: "START_TO_PERIOD",
  from: {
    module: 2,
    address: 1,
    direction: "OUT",
    trigger: "FALLING"
  },
  period: 100,
  value: {
    module: 5,
    address: 1,
    direction: "IN"
  }
}
```

G3 → SPM

Response (HTTP-Status 201, Content-Type: application/json)

```
{
  id: 3
}
```

Read value

SPM → G3

```
GET http://<G3_IP>/api/v1/functions/3
{ }
```

G3 → SPM

Response
(HTTP-Status 200, Content-Type: application/json)

```
{
  id: 3,
  ns: 5,
  v: 649,
  c: 12,
  ts: 541
}
```

v: Maximum analog value, between a start trigger for a period of time

16.3.18 Get average value (in interval)

Configure after startup

SPM → G3

```
POST http://<G3_IP>/api/v1/functions/
{
  function: "GET_AVG_VALUE",
  mode: "INTERVAL",
  interval: 500,
  value: {
    module: 5,
    address: 1,
    direction: "IN",
  }
}
```

G3 → SPM

Response (HTTP-Status 201, Content-Type: application/json)

```
{
  id: 3
}
```

Read value

SPM → G3

```
GET http://<G3_IP>/api/v1/functions/3
{ }
```

G3 → SPM

Response
(HTTP-Status 200, Content-Type: application/json)

```
{
  id: 3,
  ns: 5,
  v: 649,
  c: 12,
  ts: 541
}
```

v: Average analog value, between the beginning and the end of the interval

16.3.19 Get average value (between two state changes)

Configure after startup

SPM → G3

```
POST http://<G3_IP>/api/v1/functions/
{
  function: "GET_AVG_VALUE",
  mode: "TRIGGERS",
  from: {
    module: 2,
    address: 1,
    direction: "OUT",
    trigger: "FALLING"
  },
  to: {
    module: 2,
    address: 2,
    direction: "IN",
    trigger: "RISING"
  },
  value: {
    module: 5,
    address: 1,
    direction: "IN"
  }
}
```

G3 → SPM

Response (HTTP-Status 201, Content-Type: application/json)

```
{
  id: 3
}
```

Read value

SPM → G3

```
GET http://<G3_IP>/api/v1/functions/3
{ }
```

G3 → SPM

Response
(HTTP-Status 200, Content-Type: application/json)

```
{
  id: 3,
  ns: 5,
  v: 649,
  c: 12,
  ts: 541
}
```

v: Average analog value, between the from and to trigger signals

16.3.20 Get average value (between state change for a period of time)

Configure after startup

SPM → G3

```
POST http://<G3_IP>/api/v1/functions/
{
  function: "GET_AVG_VALUE",
  mode: "START_TO_PERIOD",
  from: {
    module: 2,
    address: 1,
    direction: "OUT",
    trigger: "FALLING"
  },
  period: 100,
  value: {
    module: 5,
    address: 1,
    direction: "IN"
  }
}
```

G3 → SPM

Response (HTTP-Status 201, Content-Type: application/json)

```
{
  id: 3
}
```

Read value

SPM → G3

```
GET http://<G3_IP>/api/v1/functions/3
{ }
```

G3 → SPM

Response
(HTTP-Status 200, Content-Type: application/json)

```
{
  id: 3,
  ns: 5,
  v: 649,
  c: 12,
  ts: 541
}
```

v: Average analog value, between a start trigger for a period of time

16.3.21 Get All Functions

Read values

SPM → G3

```
GET http://<G3_IP>/api/v1/functions/  
{ }
```

G3 → SPM

```
Response  
(HTTP-Status 200, Content-Type: application/json)  
{  
  Results: [  
    {  
      id: 3,  
      ns: 5,  
      v: 649,  
      c: 12,  
      ts: 541  
    }, ...  
  ]  
}
```

v is Byte Array which contains every configured function result value ordered by id. Every function result value consists of 4 Bytes result value (INT32) + 1 Byte counter (UINT8). Counter is increment every time where the function computes a result.

Example:

[251,	154,	-110,	65,	...]
Value	Counter	Value	Counter	
Value 1 = 251		Counter 1 = 154		
Value 2 = -110		Counter 2 = 65		

16.3.22 Delete function config

Delete one function config

SPM → G3

```
DELETE http://<G3_IP>/api/v1/functions/<ID>  
{ }
```

G3 → SPM

Response
(HTTP-Status 200, Content-Type: application/json)
{ }

When getting all function results filling the missing IDs up with zeros.
Reusing empty IDs will be possible.

Delete all function configs

SPM → G3

```
DELETE http://<G3_IP>/api/v1/functions/  
{ }
```

G3 → SPM

Response
(HTTP-Status 200, Content-Type: application/json)
{ }

17. Appendix

17.1 System Specifications

<i>Electrical</i>	
Supply Voltage	Valves (2005, 2012, 2035): 24 VDC + 10%, -15% Node and Discrete I/O: 24 VDC ± 10%
Current	Total current on the Auxiliary Power Connector ("Valves and Outputs" and "Node and Inputs" Pins) must not exceed 8 Amps.
Internal Electronic Resettable Fuses	The Auxiliary Power Connector pins are each internally fused with an electronically resettable fuse. These fuses are set to the maximum current allowable through the G3 electronics.
Recommended External Fuse	External fuses should be chosen depending upon manifold configuration. Please refer to power consumption chart on page 25 for additional fuse sizing information.
Spike Suppression	Output spike suppression is internally provided for both discrete and valve outputs.
Discrete Outputs	Maximum 0.5 Amps per output. All outputs are short circuit protected and have internal spike suppression. Contact factory for higher current requirements.
Valve Solenoid Coil Output Drivers	Maximum 0.5 Amps per output. All output points are short circuit protected and have internal spike suppression.
Operating Temperature for Electronic Components	23 to 114°F (-5 to 50°C)

AVENTICS™ G3 Series EtherNet/IP™ DLR Technical Manual

17.2 Factory Default Settings

<i>FACTORY DEFAULT SETTINGS</i>	
<i>Description</i>	<i>Default</i>
IP Address	192.168.3.120
Sub Net Mask	255.255.255.0
DHCP Boot-P	Enabled
Web Server	Enabled
Diagnostic Word	Enabled
I/O Diagnostic Status	Enabled
Comm Fault – Fault Action	Off
Brightness	High
Comm. Format	SINT
Params Lock	Unlocked
Config Lock	Unlocked
Quick Connect	Disabled
Compat. Mode	Disabled
Config Mode	32

17.3 Troubleshooting

Communication Node

<i>Symptom</i>	<i>Possible Cause</i>	<i>Solution</i>
The wrong valve solenoid coils are being energized.	Z-Board™ type mismatch. Single Z-Board™ present where double Z-Board™ expected or vice versa.	Check that correct Z-Board™ types are installed. Check that ribbon cable (Output group No. 2) is connected to appropriate valve station. See page 162 for bit mapping rules
Valve outputs do not energize.	Output power not present or connected improperly on Auxiliary Power connector.	Check for 24VDC on the +24 VDC (Valves and Outputs) pin of the MINI Auxiliary Power connector of the Comm. module.
Unable to go to the manifold's web page.	Bad cabling, incorrect computer settings, etc.	Please see page 138
No Activity/Link LED	No network connection	Verify the type of cable (straight-thru or crossover) that is being used. Also, verify the wiring of the cable.

I/O Modules

<i>Symptom</i>	<i>Possible Cause</i>	<i>Solution</i>
Outputs remain on when communication is lost and/or PLC is in "Program" mode.	Communication Fault parameters are set incorrectly. See page 153.	Check the communication fault/idle mode parameter setting to ensure that it is not set to "Hold Last Output State".

AVENTICS™ G3 Series EtherNet/IP™ DLR Technical Manual

17.4 Glossary of Terms

The following is a list and description of common terms and symbols used throughout this document:

<i>Term</i>	<i>Description</i>
Address Resolution Protocol (ARP)	A protocol used to set an IP address using a MAC Address hardware address. This can be done in the command prompt window.
Bit	Smallest unit of digital information either a "0" or "1"
Bit Mapping	Chart showing which bit is connected to which physical input or output point.
Bootstrap Protocol (BOOTP)	A protocol used to set an IP Address, Subnet Mask, and Gateway using a server.
Broadcast	A transmission method that sends packets to multiple unspecified devices.
Byte	8 bits (1/2 word)
Comm. Fault	One or more of the I/O connections have timed out.
DLR	Device Level Ring
Discrete I / O	The inputs / outputs that are available via the "Discrete I/O" side of manifold.
Dynamic Host Configuration Protocol (DHCP)	A protocol used by a node to obtain an IP Address, Subnet Mask, and Gateway Address from a server.
EDS File	<u>E</u> lectronic <u>D</u> ata <u>S</u> heet. A text file, which contains specific product information, definitions of product capabilities and configurable parameters necessary for operation on an EtherNet/IP™ network.
Explicit Messaging	Messaging that sends data to perform request/response functions.
Ground	This term is used to indicate an earth or chassis ground.
I/O	Any combination of inputs and outputs
Idle	A zero (0) length poll message (i.e.: scanner in program mode)
IGMP Snooping	See Implicit Messaging
Implicit Messaging	A function that that can control I/O messaging to another I/O device.
Internet Group Management Protocol (IGMP)	A protocol used to keep local switches informed in a multicast group. Nodes that leave the group will no longer be sent packets of information from switches and routers.
Layer 2 (data link layer or level)	The data layer that physically refers to the frame format and addressing. A layer 2 address is an Ethernet address.
Layer 3 (network layer or level)	The data layer that refers to IP and the IP packet format. A layer 3 address is an IP address.
Link	A group of nodes with different MAC addresses. Segments connected by repeaters make a link. Links that are connected by routers make up a network.
MAC Address	Media Access Connection Address
Multicast	A transmission where a packet is sent to all possible nodes of a certain subset.

AVENTICS™ G3 Series EtherNet/IP™ DLR Technical Manual

Glossary of Terms Continued

<i>Term</i>	<i>Description</i>
NEMA	National Electrical Manufacturers Association
Network	A group of nodes connected by a communication medium through repeaters, router, and gateways.
Node	A device on the network that contains a single MAC Address, which can communicate over a subnet.
Octet	8 bits of information. An IP address is made up of four octets.
ODVA	Open DeviceNet Vendor Association (www.odva.org)
Ping	A group of messages sent between a master and a slave that coordinates time.
Ping Request	A request to see if a device has received a message.
Ping Response	Response to a ping request.
Requested Packet Interval (RPI)	The frequency measure of the required transmission of data from the originating device to the target device.
RSNetWorx	Rockwell Automation's configuration software
Segment	Nodes connected to a continuous section of communication media.
Simple Network Management Protocol (SNMP)	A protocol used to monitor EtherNet devices, switches, routers, and networks connected by communication media.
Sinking (NPN)	Method of connecting electrical circuits in which the zero (0) volt DC side is switched and the common is positive
Sourcing (PNP)	Method of connecting electrical circuits in which the positive side is switched and the common is zero (0) volts DC.
Status Input bit	A bit in the input table that reports the health of a corresponding output. Indicates short circuit or open coil (load) diagnostics
Subnet	Nodes using the same protocol and shared media access arbitration.
System	Contains one or more domains.
Time to Live (TTL)	A method used in best-effort delivery systems to negate endlessly looping packets.
Unicast	A transmission where a packet is sent to a single node.
Word	2 Bytes (16 bits)
Z-Board™	Circuit board installed in the valve manifold which electrically connects the valve solenoid to the electrical /electronic interface. Available in single or double solenoid versions.

AVENTICS™ G3 Series EtherNet/IP™ DLR Technical Manual

17.5 Technical Support

For technical support, contact your local Aventics distributor. If further information is required, please call Aventics. Technical Support Department at (248) 596-3337.

Issues relating to network setup, PLC programming, sequencing, software related functions, etc. should be handled with the appropriate product vendor.

Information on device files, technical manuals, local distributors, and other Aventics products and support issues can be found on the Aventics web site at www.asco.com

EtherNet√IP™
conformance tested