



**CERTIFIED • OEM QUALITY • RELIABILITY**

**2020**

PN: 79-701 v19.2



## **FUEL PUMPS**

**MODULES / KITS / UNIVERSAL / MECHANICAL**



US Motor Works has combined the strength of a technologically orientated manufacturer, superior sales and service organization and a sophisticated global distribution network to keep the company on the forefront of the automotive marketplace.

With the focus of providing Automotive and Heavy-Duty engine parts and components, US Motor Works is constantly looking for ways to support its customers by increasing the availability of quality parts and components. Currently, US Motor Works manufactures a complete line of water pumps, fuel pumps and fan clutches. In addition to our traditional Automotive and Heavy-Duty market, US Motor Works has merged with Derale Performance and Pacer Performance to expand our manufacturing and quality assurance to the High Performance industry.

Precision Engineering and manufacturing are essential in creating products that you can depend on. At US Motor Works, quality begins with skilled technicians utilizing materials that meet or exceed OEM specifications to manufacture premium water pumps, fuel pumps and fan clutches. Our specially trained technicians apply stringent quality control standards utilizing sophisticated technology to make sure that all US Motor Works products meet the rigorous demands of our customers. When you buy US Motor Works manufactured items, you are investing in technology that has been meticulously engineered, manufactured from the highest quality materials and thoroughly tested to assure accuracy, reliability and workmanship.

With more than 50 years of combined experience, we are committed to providing an extensive line of high quality products, the finest customer service and the best support program available in the automotive, high performance and heavy-duty market. Our 99.05% fill rate is proof we're on the right track.



Fan Clutches  
Water Pumps  
Fuel Pumps  
Max Cooling Kits  
Timing Kit w/ Water  
Pumps

Heavy-Duty  
Water Pumps  
Oil Pumps  
Universal Fuel Pumps  
Fuel Lift Pumps & Solenoids  
Viscous Fan Clutches

H.O. Electric Fans  
Belt Driven Fans  
Fluid Coolers  
Transmission Cooling Pans  
Fluid Filtration  
HP Fuel Pumps

Jeep Bumpers & Nerfbars  
Hi-Five Cab Roof Lights  
Flexy Flare®  
Rubber Fender Extenders  
Custom L.E.D. Lights



## A Certified ISO 9001:2015 Company



US Motor works, LLC and its employees are committed to providing an extensive line of consistent High Quality Products, the finest Customer Service and Satisfaction, through our commitment to the continual improvement of our Quality Management System of ISO 9001:2015.

## OPEX: Operational Excellence

US Motor Works adoption of OPEX is a business philosophy aimed to achieve a sustainable competitive advantage. Operational Excellence focuses on the customer's needs. By leadership, teamwork and problem solving principles, US Motor Works achieves continuous improvement, empowered employees, optimized activities and processes.

Implementation of this philosophy is built on 'Lean Manufacturing' principles designed to achieve:

- World-class quality
- Maximum productivity
- Reliable delivery to the customer
- Competitive pricing

Lean Manufacturing is the foundation of the Operational Excellence implementation program to create maximum value for your customers. It builds an integrated product delivery process to meet the changing needs of customers while creating a fundamental and sustainable change in organizational culture.

Lean Manufacturing has helped us achieve:

- Substantial response time and lead time reduction with best in class On Time Delivery rate
- Significant quality improvement, and overall cost reduction
- Constant innovation embedded as part of the day to day work at all organizational levels
- A permanent, on-going cultural change that delivers Continuous Improvement on a daily basis, with collaboration, commitment and partnership among all of the organization's employees



# **WARRANTY POLICY**

## **US Motor Works, LLC**

- USMW Professional Series brand of US Motor Works, LLC products are warranted to be free from defects in material and manufacture, under normal use and service.
- US Motor Works coverage will extend a full 12 months from the date of installation in an engine regardless of mileage or hours.
- US Motor Works will cover (replace free of charge or pay for) all labor and parts needed to repair the warrantable failure, including progressive damage to the engine concerned.

### **Conditions of the warranty are:**

1. US Motor Works must be notified by the customer before filing a warranty claim.
2. All warranty claims must be in writing and US Motor Works reserves the right to examine every single engine or part subject to a claim under this warranty
3. Price of parts will be based on the US Motor Works current price list or other accepted suppliers at US Motor Work's option. Cost of labor will be of reasonable hourly flat rate (overtime or holiday rates are not accepted).

### **The warranty is also subject to the following limitations:**

1. The provisions of this warranty shall not apply to any US Motor Works (USMW) brand part altered from its original specification (including but not limited to alterations in packaging and/or markings) or which has been misused, exposed to weather conditions, negligence or damage by accident.
2. The warranty shall be null and void, if the engine or vehicle is not maintained to the suggested OEM level. All receipts and records should be accounted for in the event it is requested for the warranty analysis.
3. This warranty is provided solely to direct customers of the US Motor Works and not any other party. It is the only agreement or obligation of US Motor Works. All other warranties, expressed or implied, including the warranties of merchantability and/or fitness for a particular purpose, are excluded.

## **US Motor Works, LLC**

14722 Anson Ave.

Santa Fe Springs, CA 90670 USA

Tel (562) 404-0488 Fax (562) 404-8770

[www.usmotorworks.com](http://www.usmotorworks.com)

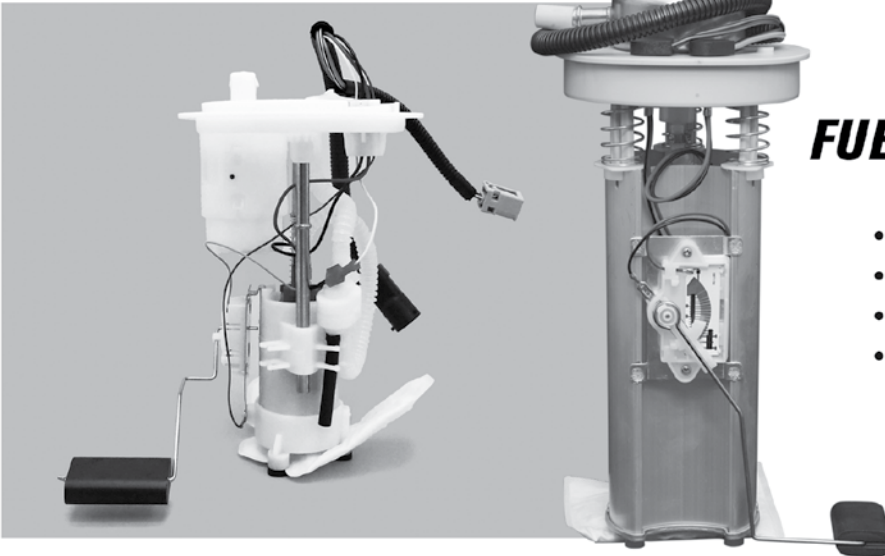

## FUEL PUMP MODULES

- Drop-in replacement
- OE Style internal fuel pumps
- Palladium Silver fuel level sensor
- Made with modern materials that are compatible with today's fuel blends



## FUEL PUMP KITS

USMW uses OE style fuel pumps rather than less expensive turbine units (where applicable). This ensures quality and performance that meets or exceeds OE standards.

**New Wiring**  
**New Strainer**  
**New Fuel Lines**

## MECHANICAL FUEL PUMPS



All mechanical fuel pump kits include gaskets and hardware necessary for installation.



## UNIVERSAL FUEL PUMPS

Our Universal Fuel Pumps are compatible with a range of modern fuels, for carbureted and fuel injection applications



## STRAINERS

Quality made strainers help protect your fuel pump from contamination, this helps ensure longer lasting fuel pump performance.





# TABLE OF CONTENTS



<b>Warranty .....</b>	<b>1</b>
<b>Fuel Pumps Info .....</b>	<b>2</b>
<b>Common Reasons for Fuel Pump Failure .....</b>	<b>4 - 5</b>
<b>Fuel System Diagnostics .....</b>	<b>6 - 9</b>
<b>Instructions .....</b>	<b>10 - 12</b>
<b>Fuel Pump Modules.....</b>	<b>15 - 122</b>
<b>Application Guide.....</b>	<b>17 - 62</b>
<b>Buyers Guide.....</b>	<b>63 - 83</b>
<b>Cross Reference .....</b>	<b>84 - 90</b>
<b>Identification Guide .....</b>	<b>91 - 122</b>
<b>Fuel Pump Kits.....</b>	<b>123 - 213</b>
<b>Application Guide.....</b>	<b>125 - 171</b>
<b>Buyers Guide.....</b>	<b>172 - 190</b>
<b>Cross Reference .....</b>	<b>191 - 197</b>
<b>Identification Guide .....</b>	<b>198 - 213</b>
<b>Mechanical Fuel Pumps .....</b>	<b>214 - 265</b>
<b>Application Guide.....</b>	<b>215 - 239</b>
<b>Buyers Guide.....</b>	<b>240 - 258</b>
<b>Cross Reference .....</b>	<b>259 - 260</b>
<b>Identification Guide .....</b>	<b>261 - 265</b>
<b>Strainers .....</b>	<b>266 - 275</b>
<b>Buyers Guide.....</b>	<b>267 - 271</b>
<b>Identification Guide .....</b>	<b>272 - 275</b>
<b>Universal Fuel Pumps .....</b>	<b>276</b>
<b>Notes .....</b>	<b>277</b>
<b>ISO 9001:2015 Certification.....</b>	<b>280</b>
<b>US Motor Works Timeline.....</b>	<b>281</b>

FUEL PUMP MODULES

FUEL PUMP KITS

MECHANICAL FUEL PUMPS

STRAINERS

All Manufacturers names, numbers, symbols and descriptions are used for reference purposes only, and in no way does it imply that any parts listed in this catalog are the products of these manufacturers.

# COMMON REASONS FOR PUMP FAILURE

- A.** Low quality fuel
- B.** Fuel system contamination
- C.** Clogged strainers/filters
- D.** Low fuel levels
- E.** Overheating



## **A** **LOW QUALITY FUEL**

**Fuel quality** is important for proper function and longevity of your fuel pump. High quality fuels from top tier suppliers include additive packages that help lubricate and cool the internal components of the fuel pump and fuel system.

Low quality fuels do not lubricate the fuel pump properly and if excessive moisture is present, it will also cause premature failure of many fuel system components such as the fuel pump, fuel level sensor, fuel pressure regulator, fuel injectors, etc.

Low quality fuel can also be contaminated with small particles that will quickly clog and damage an in-tank fuel pump.

## **B** **FUEL SYSTEM CONTAMINATION**

**Fuel system contamination** is usually a problem with older vehicles and vehicles used in rough terrain.

Contaminants can enter the automotive fuel system when filling the tank or from the breakdown of fuel system components such as fuel lines and fuel tank liners.

**Did You Know?** If you do not clean your fuel system when replacing your fuel pump that there is a 90% chance that the fuel pump will fail under 30 days.

*Drain & clean your fuel tank every time you replace a fuel pump!!*

## **C** **CLOGGED FILTER OR STRAINER**

A fuel pump must pull fuel through a strainer attached to its inlet and push it through an external fuel filter. If either of these are clogged and cannot support the flow-rate required by the engine, there will be bogging and vehicle hesitation as well as increased strain on the fuel pump causing it to eventually fail.

### **Did You Know?**

A clogged strainer and filter will decrease flow-rate and require a fuel pump to work harder to make the proper pressure and flow. These conditions overheat the fuel pump causing it to fail. Always install a new strainer and fuel filter when replacing a fuel pump.



**D**

## ***LOW FUEL LEVELS***

Running your vehicles on low levels of fuel for extended periods is extremely bad for the fuel system. Fuel is used to cool and lubricate the internals of the fuel pump and if the tank is allowed to frequently run low, the cooling ability is compromised because the fuel heats up much faster.

### ***Did You Know?***

Frequently running on low fuel levels allows a large amount of air to remain in the fuel tank causing potential for condensation. This will cause the internal tank liners to break down much quicker over time.



**E**

## ***OVER HEATING***

Overheating of fuel pumps occurs when the pump is subjected to severe loads with minimal cooling. This can occur when the pump flow is restricted or if foreign debris gets jammed in the pump mechanisms. Overheating can cause damage to fuel pump connectors and associated wiring and electrical components. In severe cases, the fuel pump armatures can get so hot that the plastic armature material can melt.

### ***Did You Know?***

To prevent connector overheating, it is always recommended to replace the wiring connector when replacing a fuel pump. This is especially important for vehicles over 10 years old. USMW assemblies include improved harnesses and pigtail connectors to replace the OE harness when required.



# BEST PRACTICES

## TROUBLESHOOTING YOUR FUEL SYSTEM & REPLACING YOUR FUEL PUMP

Low fuel pressure and low fuel flow-rate at the engine are the most common characteristics that are found in a faulty fuel system. It is a common misconception that these are caused by a faulty fuel pump or fuel pump module, which is usually not the case. The automotive fuel system is made up of several components that should be checked and tested before expending the time & labor to replace the fuel pump.

- A.** Fuel injectors
- B.** Fuel pressure regulator
- C.** Fuel pump
- D.** Fuel filter

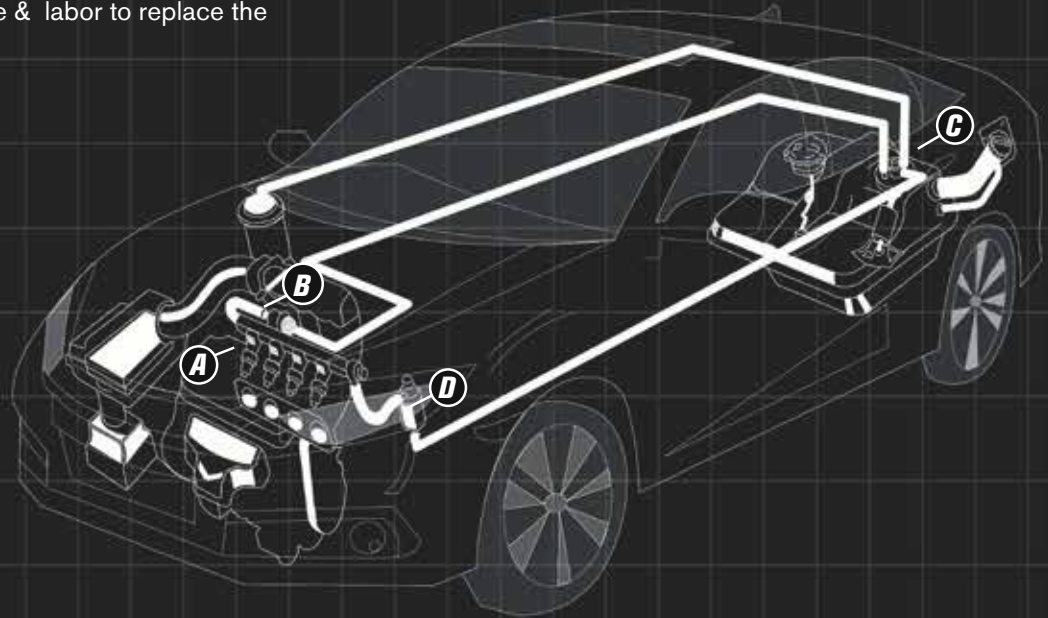

## Fuel System Overview

The fuel system begins with **Voltage**.

Without battery/alternator voltage an electric fuel pump will not operate.

This voltage is normally switched on by a **relay** or controlled directly by the **ECU**.

The **wires** from the relay or ECU carry the power to the fuel pump.

These wires may be connected through several **connectors** before actually reaching the fuel pump.

The **fuel pump** is the heart of the fuel system. Its job is to deliver fuel from the tank to the engine.

The fuel pump sends fuel out of the **fuel tank** at the proper flow-rate and correct pressure for the engine to run at all RPMs and throttles positions.

Depending on the type of fuel system that the vehicle has, (return vs. non-return) there will be differences in configuration at this point.

For return type fuel systems, the fuel will be sent out through **fuel lines** and normally through an **external fuel filter** before reaching the engine.

For non-return type systems the fuel would be sent through a **pressure regulator** and then through the **fuel lines** and **external fuel filter** before reaching the engine.

Once at the engine the fuel is normally fed into the **fuel rails** that supply the fuel to each individual **fuel injector**. At this point we will also see additional differences between a return and non-return type fuel system.

For a return type fuel system, the **fuel pressure regulator** will be found after the fuel rail.

An **additional fuel line** will “return” bypassed fuel from the pressure regulator back to the fuel tank.

On a non-return fuel system, there will only be a **feed line** to the fuel rail.

There is no additional return line back to the tank since the fuel pressure has already been regulated at the fuel pump or fuel tank before reaching the engine.



## ***SAFETY FIRST!***

- A.** Work on a level surface
- B.** Use safety stands for support, not a jack
- C.** Keep an ABC fire extinguisher close by
- D.** Wear approved safety glasses
- E.** Work in a well-ventilated area
- F.** Do not smoke or allow open flames near vehicle
- G.** Disable fuel pump before servicing by removing fuse or battery cables
- H.** Relieve fuel system pressure before servicing pump

## ***WARNING!***

Gasoline is extremely flammable, so take extra precautions when you work on any part of the fuel system. Don't smoke or allow open flames or bare light bulbs near the work area, and don't work in a garage where a natural gas appliance is located. Gasoline is also carcinogenic, take the proper precautions and wear latex gloves when spills are possible. If fuel does come into contact with your skin, rinse it off immediately with soap and water. Mop up all fuel spills and do not store any fuel-soaked rags where they could ignite.

## ***FUEL***

This is the first thing you should check if you are having problems with your fuel delivery system. Make sure that your gas tank is at least ½ full of fuel when diagnosing any fuel delivery problems.

## ***VOLTAGE***

This is the second thing to check when you are having issues with fuel delivery. Without the proper voltage reaching the fuel pump you will immediately have a low or no flow and/or pressure situation. It is important to check the voltage drop directly at the fuel pump connector. There should be less than .5 volt voltage drop from the battery to the positive fuel pump terminal.

### ***Things to check if you find no or low voltage at the pump connector:***

- A.** Check that battery and alternator are in proper working condition
- B.** Verify that ECU is properly functioning
- C.** Check fuel pump fuse
- D.** Check fuel pump and/or ASD relay for proper function
- E.** Check wiring harness for loose or broken connections
- F.** Check fuel pump ground location for good contact

## ***FLOW***

Next thing to check is to see that the fuel pump is actually sending fuel out of the tank. You can verify this by removing the test port cover from the fuel rail or disconnecting the fuel line from the in-line filter. Switch the ignition to the "ON" position and the fuel pump should operate for a few seconds. At this time you can look at the disconnected fuel line or open test port to verify if there is any flow from the fuel pump.

### ***Some common causes of low or no flow other than a faulty fuel pump are:***

- A.** Leak in the fuel line
- B.** Clogged fuel line
- C.** Clogged in-line filter
- D.** Crimped or smashed metal fuel lines

## ***PRESSURE***

After you have confirmed that you have flow in the fuel system then you can move on to checking if there is proper pressure in the system. The best way to check fuel pump output pressure is to connect a pressure gauge to the fuel pump output line before the in-line fuel filter. This will allow you to test the direct output pressure of the fuel pump without additional components in the system such as a fuel pressure regulator.

### ***Some common reasons for low pressure other than a faulty fuel pump are:***

- A.** Low voltage at the pump
- B.** Bad fuel pressure regulator
- C.** Clogged in-line fuel filter
- D.** Leaking injectors
- E.** Leaking fuel line connectors
- F.** Clogged or damaged fuel lines

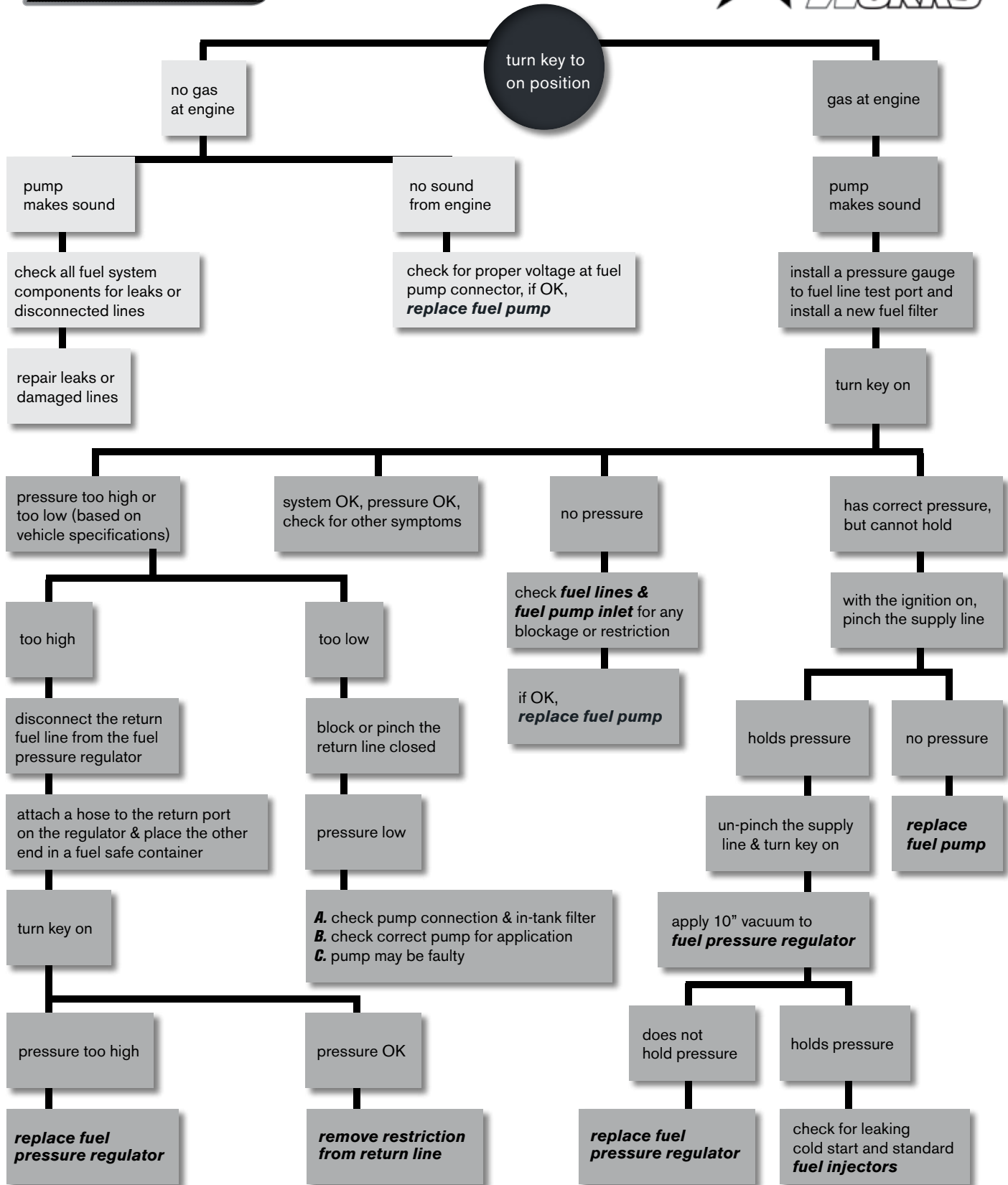

**Keep your work area clean!**

The number 1 cause of fuel pump failures is from fuel pump contaminants such as dirt, rust, & moisture. If the fuel system is not cleaned, then these contaminants will cause the replacement fuel pump to fail prematurely. Make sure to clean your fuel tank & keep your work area clean to prevent this type of contamination.



# BENCHTOP FUEL PUMP TESTER

Part# USEPTEST1



## BENEFITS:

- Compact Bench-top design with Internal fuse-protected Power supply
- Tests Fuel Pumps and Modules
- Large, High Precision, Glycerin Filled pressure Gauge (230psi max)
- Large Heavy Duty Stainless Steel fluid tank with cover
- Removable pump / module holder with integrated splash shield
- Circuit breaker protected front mounted output terminals
- High Precision/ High Volume Flow Meter (250LPH max)
- DIGITAL Volt Meter and Ammeter
- Test harness and adapter leads included
- Drain port in bottom of tank
- Full operating instruction booklet with Pressure and flow specifications



## FUEL PUMP GENERAL INSTALLATION INSTRUCTIONS AND PRECAUTIONS

Please read these instructions completely before starting the installation.

### PRECAUTIONS

- Work on a level surface
- Use safety stands for support, not a jack
- Keep an ABC fire extinguisher close by
- Wear approved safety glasses
- Work in a well-ventilated area
- Do not smoke or allow open flames near vehicle
- Disable fuel pump before servicing by removing fuse or battery cables
- Relieve fuel system pressure before servicing pump

**WARNING:** Gasoline is extremely flammable, so take extra precautions when you work on any part of the fuel system. Don't smoke or allow open flames or bare light bulbs near the work area, and don't work in a garage where a natural gas appliance is located. Gasoline is also carcinogenic, take the proper precautions and wear latex gloves when spills are possible. If fuel does come into contact with your skin, rinse it off immediately with soap and water. Mop up all fuel spills and do not store any fuel-soaked rags where they could ignite.

**NOTE:** Physical configuration of replacement pump may not be identical to the pump being removed, but replacement pump will function the same as the pump being removed.

In some applications the new pump may not mount in the same location as the pump being removed. This kit may service more than one vehicle, so there may be some parts left over after installation. This pump will not remedy malfunctions of the filter, regulator, injectors, or other fuel system components. Diagnose fuel pump using procedures in service manual to confirm pump failure before proceeding with pump replacement.

**CAUTION:** This fuel pump is not approved for aircraft or marine use. Do not run pump dry or damage could result to pump. Do not reuse fuel strainer. Dirt is the major cause of pump failure, keep pump and component parts clean and free of dirt.

### FUEL PUMP REPLACEMENT

Installation of replacement pump may require that some of the mounting or electrical hardware be reused. Do not destroy any hardware that might need to be reused on replacement pump.

- |                                                          |                                                                                                                                                                                                 |
|----------------------------------------------------------|-------------------------------------------------------------------------------------------------------------------------------------------------------------------------------------------------|
| 1. Verify that the pump has failed.                      | *Check all related fuel system components to verify that the fuel pump is the failed component.                                                                                                 |
| 2. Relieve vehicle fuel pressure.                        | *Consult the vehicle specific repair manual for proper procedure.                                                                                                                               |
| 3. Disconnect the negative terminal from the battery     |                                                                                                                                                                                                 |
| 4. Empty fuel from gas tank.                             | *Drain fuel into approved containers and dispose of per local regulations                                                                                                                       |
| 5. Remove fuel tank from vehicle (if required)           | *Consult vehicle specific repair manual for proper procedures.                                                                                                                                  |
| 6. Remove old fuel pump                                  | *Consult vehicle specific repair manual for proper procedures.                                                                                                                                  |
| 7. Clean inside of fuel tank                             | *Fuel contamination is the leading cause for fuel pump failure.<br>*Fuel tank must be clean and a new strainer must be installed with new fuel pump                                             |
| 8. Inspect wiring and hoses on vehicle.                  | *Inspect all original equipment wiring and hoses for damage.<br>*Wiring harness must be replaced if included with fuel pump kit.<br>*Replace all worn or deteriorated hoses and fittings.       |
| 9. Install new fuel pump / Fuel Pump Module and strainer | *Always replace strainer with new parts when replacing fuel pump                                                                                                                                |
| 10. Re-install fuel tank (if required)                   | *Consult vehicle specific repair manual for proper procedures                                                                                                                                   |
| 11. Replace fuel filter                                  | *Clogged fuel filter will reduce fuel pump life and produce low fuel pressures                                                                                                                  |
| 12. Fill tank completely with clean fuel                 | *Complete Fuel pump / Fuel Pump Module must be submerged in order for fuel pump / fuel system to prime.<br>*Wait a minimum of 5 minutes for Fuel Pump Modules to prime before starting vehicle. |
| 13. Start engine and check for leaks                     | *Reconnect battery cable<br>*Key may need to be switched on and off several times before proper fuel system pressure is achieved.<br>*Check for leaks                                           |

**NOTE:** A loss of oil pressure or defective oil pressure switch may cause the fuel pump to be inoperative.





## INSTALACION DE LA BOMBA DE COMBUSTIBLE ELECTRICA HOJA DE INSTRUCCIONES

### PRECAUCIONES DE SEGURIDAD

- Trabaje sobre una superficie nivelada
- Use soportes de seguridad, no use un gato hidráulico
- Mantenga un extinguidor ABC a la mano
- Use gafas de seguridad adecuadas
- Trabaje en un área bien ventilada
- No fume ni permita llamas abiertas cerca del vehículo
- Desconecte la bomba de combustible antes de darle mantenimiento quitando el fusible o los cables de la batería
- Deje escapar la presión del sistema de combustible antes de dar mantenimiento o cambiar la bomba

**ADVERTENCIA:** La gasolina es extremadamente inflamable, así que tome todas las precauciones adicionales cuando usted trabaje en cualquier parte del sistema de combustible. No fume ni permita las llamas abiertas y no use bombillas descubiertas cerca del área de trabajo, no trabaje en un garage donde haya un equipo de gas natural. La gasolina es también carcinógena, tome las precauciones apropiadas y use guantes del látex cuando haya un derrame de gasolina. Si el combustible entra en contacto con su piel, enjuague inmediatamente con jabón y agua. Absorba todos los derrames del combustible y no guarde ningún trapo empapado de gasolina porque podría prenderse.

**NOTA:** Es posible que la apariencia física de la bomba de repuesto no sea idéntica a la de la bomba que sustituye, pero la bomba de repuesto funcionara igual a la bomba que va a cambiar.

En algunas aplicaciones la bomba nueva no quedara instalada en el mismo sitio que la bomba que sustituye. Esta bomba se adapta a mas de un modelo de vehículo. Pueden sobrar algunas piezas al terminar la instalación. Esta bomba no soluciona los problemas en el filtro, regulador, inyectores o de otros componentes del sistema de combustible. Use los procedimientos indicados en el manual de servicio para confirmar la falla de la bomba antes de reemplazarla.

**PRECAUCION:** Esta bomba de combustible no esta autorizada para uso marítimo o en aeronaves. No opere la bomba en seco, puede causarle daños. No utilice el cedazo usado. Las impurezas son la causa principal del mal funcionamiento de la bomba. Mantenga limpia la bomba y demas piezas.

### REEMPLAZO DE LA BOMBA DE COMBUSTIBLE

Es posible que deba volver a utilizar piezas de montaje o eléctricas durante la instalación de la bomba de repuesto. No destruya las piezas que pudiera necesitar en la instalación de la bomba de repuesto nueva.

1. Verifique que la bomba ha fallado. \*Compruebe todos los componentes relacionados del sistema de combustible para verificar que el surtidor de gasolina es el que causo la falla.
2. Deje escapar la presión del combustible del vehículo. \*Consulte el manual de reparaciones específico del vehículo para el procedimiento apropiado
3. Desconecte el cable del poste [terminal] negativo de la batería
4. Vacíe el combustible del tanque [depósito de gasolina]. \* Drene el combustible en envases apropiados y siga todas las regulaciones locales.
5. Quitar el depósito [tanque] de gasolina del vehículo (si se requiere) \* Consulte el manual de reparaciones específico del vehículo para los procedimientos apropiados.
6. Quite la bomba de gasolina vieja \* Consulte el manual de reparaciones específico del vehículo para los procedimientos apropiados.
7. Limpie bien dentro del depósito de gasolina \* La contaminación del combustible es la causa principal que ocasiona la falla de la bomba de gasolina.  
\* El depósito de gasolina debe estar limpio y un nuevo filtro se debe instalar con la nueva bomba de gasolina
8. Examine los cables y las mangueras en el vehículo. \* Examine todo el cableado y mangueras del equipo original para saber si hay daños.  
\* El amés del cableado debe ser substituido si está incluido en el kit de la bomba de gasolina.  
\* Reemplace todas las mangueras gastadas o deterioradas.
9. Instale la nueva bomba y el nuevo módulo con el filtro nuevo de la bomba de gasolina \* Substituya siempre el filtro con las piezas nuevas al cambiar la bomba de gasolina
10. Reinstale el tanque de gasolina (si se requiere) \*Consulte el manual de reparaciones específico del vehículo para los procedimientos apropiados
11. Substituya el filtro de combustible \*El filtro de combustible sucio y viejo reducirá la vida de la bomba de gasolina y producirá presiones de combustible bajas
12. Llene el tanque totalmente con combustible limpio \* La bomba completa de gasolina /el modulo completo se deben sumergir completamente dentro del tanque para que el sistema se prepare a cargar.  
\* Espere un mínimo de 5 minutos para que la bomba de gasolina se prepare a cargar antes de encender el vehículo.
13. Encienda el motor y asegúrese de que no haya fugas \* Vuelva a conectar el cable de la batería  
\* La llave en el switch puede necesitar ser cambiado en on y off por varias veces antes de que se alcance la presión apropiada del sistema de combustible.  
\* Asegúrese nuevamente para saber si hay escapes

**NOTA:** Una perdida de presión de aceite o un interruptor de presión de aceite defectuoso, pueden dejar la bomba fuera de servicio.

## SUPPLEMENTAL “FLAT-4” CONNECTOR WIRING INSTRUCTIONS

The OE wire harness connector should be cut and replaced with the new style connector for improved performance and reliability.

The new connector should be wired to the vehicle harness as noted in the below diagram:

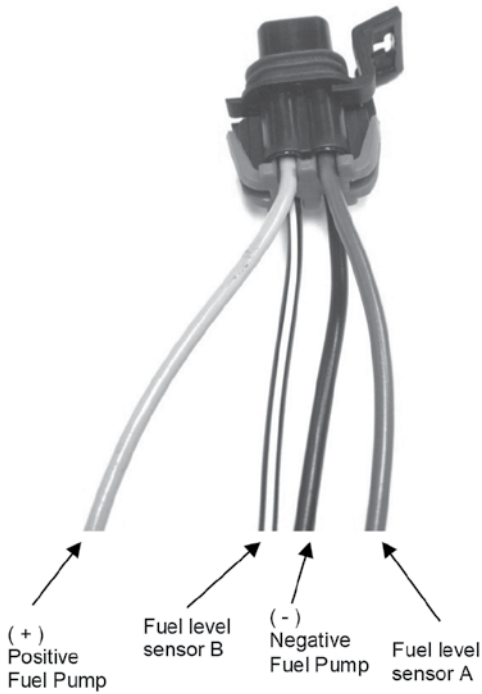

A. E “OLD” HARNESS

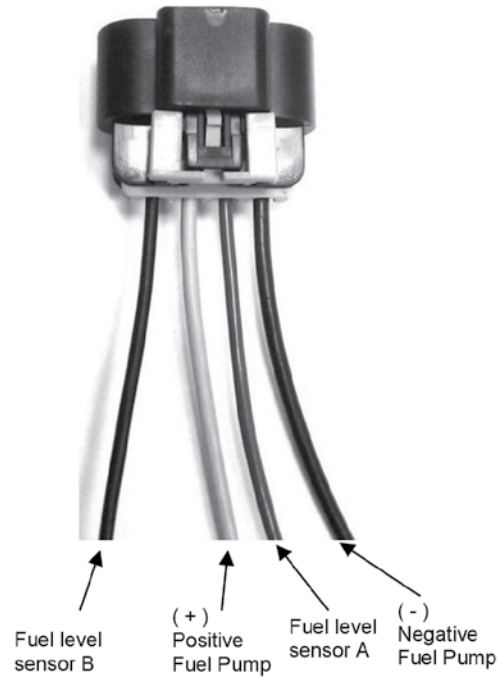

B. NEW “FLAT-4” STYLE HARNESS

1. The (+) positive fuel pump wire should be connected to the positive output wire on the vehicle wire harness.
2. The (-) negative fuel pump wire should be connected to the negative output wire on the vehicle wire harness.
3. The A and B Fuel level sensor wires are non-polarized and can be connected to the vehicle wire harness fuel level sensor wires in either direction.

### Notes:

- A. *The positive and negative fuel pump wires in the included harness are a larger gauge than the fuel level sensor wires. Please take note of the wire sizes when installing the new connector.*
- B. *OE Harness wire colors may not be the same on all vehicles.*



# WARRANTY EXCLUSIONS

USMW Professional Series a brand of US Motor Works, LLC warrants products to be free from defects in material and manufacturing, under normal use and service. The following images are indications of damage caused by improperly maintained systems and modifications.

- A.** Modified parts
- B.** Broken parts
- C.** Dark, clogged, or contaminated strainers
- D.** Units with corrosion, rust, or discoloration from contamination
- E.** Units with burned wiring or connector



**A1**

**A2**



**B1**



**B2**



**C1**



**D1**



**D2**



**E1**



**E2**





# ***INTERNAL PUMP TYPES***



## ***Roller Vane***

This pump uses a steel rotating disk with sliding rollers that move outward and suck fluid through the pump. Roller vane pumps can tolerate fuel contamination much better than other pumps but create more noise.



## ***Gerotor***

This pump has a steel gear type pumping mechanism. Gerotor is quieter than roller vane but cannot tolerate fuel contamination.



## ***Turbine (single and double stage)***

The spinning of the turbine causes fluid to flow through the fins moving the fuel through this pump. The turbine turns at a higher speed than the other pump types and requires tighter tolerances to operate. Because of the tight tolerances required on turbine pumps, they are very susceptible to debris and fuel contamination.





# FUEL PUMP MODULES

*Trusted by professionals around the world*

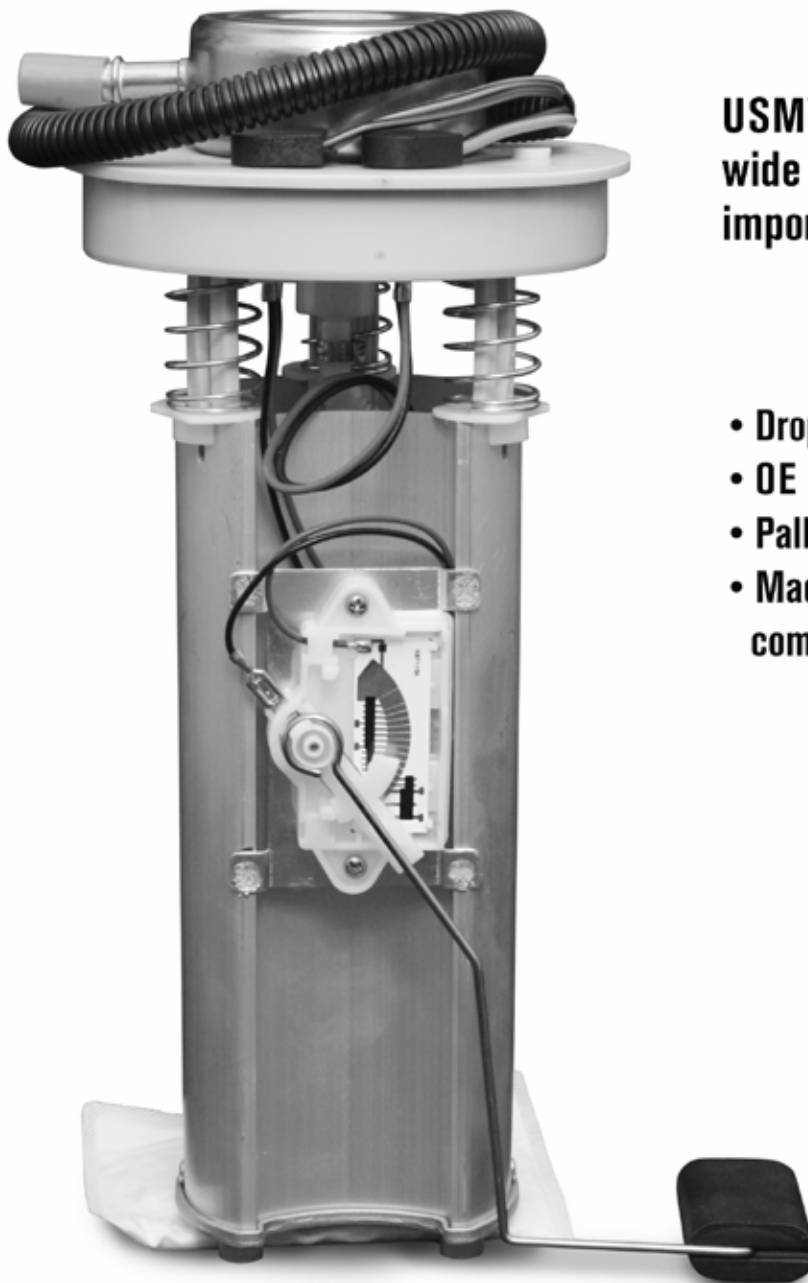

USMW Professional Series offers a wide range of fuel pump modules for import and domestic applications.

- Drop-in replacement
- OE Style internal fuel pumps
- Palladium Silver fuel level sensor
- Made with modern materials that are compatible with today's fuel blends



Designed, tested and inspected in the USA



# FUEL PUMP MODULES



*USMW Professional Series fuel pump modules are manufactured with quality components*

- POM plastic used for strength and durability
- Thicker connector pins for increased reliability
- Teflon insulated wires for superior chemical resistance
- Nitrile or Viton used for rubber components for long life and fuel resistance
- Stainless steel used for all metal components
- Foam fuel float for increased reliability over molded type
- Dual strainers for superior filtration. Mounted internally and externally

## OE Style internal fuel pumps

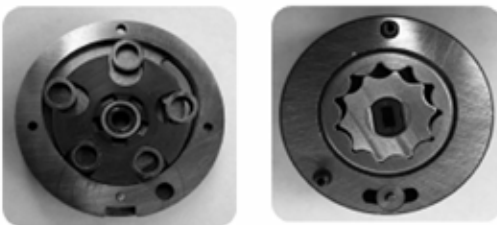

USMW uses OE style fuel pumps rather than less expensive turbine units (where applicable). This ensures quality and performance that meets or exceeds OE standards.



## Palladium Silver fuel level sensor



The Palladium Silver is resistant to corrosion from Ethanol and Ethanol blended fuels.

## Bifurcated Contacts



Level sensors also feature bifurcated contacts for long life and accurate fuel reading.



# FUEL PUMP MODULES APPLICATION GUIDE



FUEL PUMP MODULES

Engine	Years	Application Description	USMW	Engine	Years	Application Description	USMW
<b>ACURA</b>				<b>AUDI (cont'd.)</b>			
<b>CL</b>				<b>A6 QUATTRO (cont'd.)</b>			
2.2L L4 2156cc	1997	(F22B1)	USEP8349H	2.8L V6 2771cc	1998-2001		USEP8384M
2.3L L4 2254cc	1998-1999	(F23A1)	USEP8353H	3.0L V6 2976cc	2002-2004		USEP8384M
3.0L V6 2997cc	1997-1999	(J30A1)	USEP8353H	3.0L V6 2995cc	2009-2011		USEP8765M
<b>INTEGRA</b>				3.0L V6 2995cc 183 CID	2010-2011		USEP8765M
1.7L L4 1678cc	1992-1993	GS-R; (B17A1)	USEP8334H	3.2L V6 3123cc	2008		USEP8765M
1.8L L4 1797cc	1994-1995	GS-R; (B18C1)	USEP8253H	4.2L V8 4163cc	2005-2007		USEP8679M
1.8L L4 1797cc	1996-1997	GS-R; (B18C1)	USEP8345H	4.2L V8 4163cc	2008-2011		USEP8765M
1.8L L4 1797cc	1997	Type R; (B18C5)	USEP8345H	4.2L V8 4172cc	2000-2004		USEP8384M
1.8L L4 1797cc	2000-2001	(B18C1)	USEP8341H	4.2L V8 4172cc	2005		USEP8679M
1.8L L4 1797cc	2000-2001	(B18C5)	USEP8341H	<b>A8</b>			
1.8L L4 1834cc	1990-1991		USEP8334H	3.7L V8 3697cc	1997-1999		USEP8414M
1.8L L4 1834cc	1992-1993	GS, LS, RS; (B18A1)	USEP8334H	<b>A8 QUATTRO</b>			
1.8L L4 1834cc	1994-1995		USEP8338H	4.2L V8 4172cc	1997-2003		USEP8414M
1.8L L4 1834cc	1996-1999	(B18B1)	USEP8341H	<b>ALLROAD QUATTRO</b>			
<b>LEGEND</b>				<b>RS6</b>			
3.2L V6 3206cc	1991-1995		USEP8252H	2.7L V6 2671cc	2001-2005		USEP8384M
<b>MDX</b>				4.2L V8 4172cc	2003-2005		USEP8384M
3.5L V6 3471cc	2001-2002		USEP8720M	<b>S4</b>			
3.5L V6 3471cc	2003-2005		USEP8640M	3.0L V6 2995cc	2010-2012		USEP8880M
3.5L V6 3471cc	2006		USEP8657M	<b>S5</b>			
3.7L V6 3664cc	2007-2013		USEP8792M	3.0L V6 2995cc	2010-2012		USEP8880M
3.7L V6 3664cc 224 CID	2011-2013		USEP8792M	4.2L V8 4163cc	2008-2012		USEP8880M
<b>RSX</b>				<b>S6</b>			
2.0L L4 1998cc 122 CID	2002-2004		USEP8713M	4.2L V8 4172cc	2002-2003		USEP8384M
<b>TL</b>				5.2L V10 5204cc	2007-2011		USEP8765M
2.5L L5 2451cc	1995		USEP8347H	5.2L V10 5204cc 318 CID	2011		USEP8765M
2.5L L5 2451cc	1996-1998	(G25A4)	USEP8347H	<b>S8</b>			
3.2L V6 3206cc	1996-1998	(C32A6)	USEP8347H	4.2L V8 4172cc	2001-2003		USEP8414M
3.2L V6 3210cc	2004-2008		USEP8567M	<b>TT</b>			
3.5L V6 3471cc	2009-2014		USEP8923M	1.8L L4 1781cc	2000-2001		USEP8551M
3.7L V6 3664cc	2011-2013		USEP8923M	1.8L L4 1781cc	2002	To Chassis/VIN 8N-2-030 000	USEP8551M
<b>TSX</b>				2.0L L4 1984cc 121 CID	2008-2009		USEP8831M
2.4L L4 2354cc 144 CID	2009-2014		USEP8922M	<b>TT QUATTRO</b>			
3.5L V6 3471cc	2010-2014		USEP8923M	1.8L L4 1781cc	2000-2002		USEP8551M
<b>VIGOR</b>				<b>BMW</b>			
	1992-1994	GS, LS	USEP8331H	<b>1 SERIES M</b>			
<b>ZDX</b>				3.0L L6 2979cc	2011		USEP8688M
3.7L V6 3664cc	2010-2013		USEP8792M	<b>128i</b>			
3.7L V6 3664cc 224 CID	2011		USEP8792M	3.0L L6 2996cc	2008-2012		USEP8688M
<b>AUDI</b>				3.0L L6 2996cc 183 CID	2013		USEP8688M
<b>A3</b>				<b>135i</b>			
2.0L L4 1968cc 120 CID	2010-2013	DIESEL	USEP8667M	3.0L L6 2979cc	2008-2011		USEP8688M
2.0L L4 1984cc 121 CID	2006-2013		USEP8831M	3.0L L6 2979cc 182 CID	2012-2013		USEP8688M
<b>A4</b>				<b>318i</b>			
1.8L L4 1781cc	1997-2001		USEP8294M	1.8L L4 1766cc 107 CID	1984-1985		USEP8141H
1.8L L4 1781cc	2002-2006		USEP8476M	1.8L L4 1796cc	1992	Convertible	USEP8138H
1.8L L4 1781cc	2008	MEX	USEP12147M	1.8L L4 1796cc	1993-1995		USEP8233M
2.0L L4 1984cc 121 CID	2005-2009		USEP8763M	<b>318TI</b>			
2.0L L4 1984cc 121 CID	2012		USEP8880M	1.9L L4 1895cc	1999		USEP8415M
2.8L V6 2771cc	1996-2001		USEP8294M	<b>320i</b>			
3.0L V6 2976cc	2003-2004		USEP8498M	2.2L L6 2171cc 132 CID	2001-2005	MEX	USEP8416M
3.2L V6 3123cc	2006-2008		USEP8763M	<b>323CI</b>			
<b>A4 QUATTRO</b>				2.5L L6 2494cc 152 CID	2000		USEP8416M
1.8L L4 1781cc	1997-2001		USEP8293M	<b>323I</b>			
1.8L L4 1781cc	2002-2003		USEP8498M	2.5L L6 2494cc 152 CID	1998-1999	Convertible	USEP8233M
1.8L L4 1781cc	2004-2005		USEP8476M	2.5L L6 2494cc 152 CID	1999-2000	Sedan	USEP8416M
2.0L L4 1984cc 121 CID	2009		USEP8763M	<b>325</b>			
2.0L L4 1984cc 121 CID	2010		USEP8880M	2.7L L6 2693cc	1986-1987		USEP8141H
2.0L L4 1984cc 121 CID	2012		USEP8880M	2.7L L6 2693cc	1988		USEP8138H
2.8L V6 2771cc	1996-2001		USEP8293M	<b>325CI</b>			
3.0L V6 2976cc	2003-2005		USEP8498M	2.5L L6 2494cc 152 CID	2001-2006		USEP8416M
<b>A5</b>				<b>325E</b>			
2.0L L4 1984cc 121 CID	2010-2012		USEP8880M	2.7L L6 2693cc	1984-1987		USEP8141H
<b>A5 QUATTRO</b>				<b>325ES</b>			
2.0L L4 1984cc 121 CID	2011-2012		USEP8880M	2.7L L6 2693cc	1986-1987		USEP8141H
3.2L V6 3123cc	2009-2010		USEP8880M	<b>325i</b>			
3.2L V6 3197cc 195 CID	2008		USEP8880M	2.5L L6 2494cc 152 CID	1987		USEP8141H
<b>A6</b>				2.5L L6 2494cc 152 CID	1988-1993		USEP8138H
2.8L V6 2771cc	2000-2001		USEP8368M	2.5L L6 2494cc 152 CID	2001-2005		USEP8416M
3.0L V6 2950cc	2002-2004		USEP8368M	<b>BMW</b>			
3.0L V6 2950cc	2005	MEX	USEP12148M	<b>1 SERIES M</b>			
3.0L V6 2950cc	2006		USEP8765M	3.0L L6 2979cc	2011		USEP8688M
3.2L V6 3123cc	2006-2011		USEP8765M	<b>128i</b>			
<b>A6 QUATTRO</b>				3.0L L6 2996cc	2008-2012		USEP8688M
2.7L V6 2671cc	2000-2004		USEP8384M	3.0L L6 2996cc 183 CID	2013		USEP8688M

Engine	Years	Application Description	USMW	Engine	Years	Application Description	USMW
<b>BMW (cont'd.)</b>				<b>BMW (cont'd.)</b>			
<b>325I (cont'd.)</b>				<b>635CSI</b>			
3.0L L6 2996cc	2006		USEP8688M	3.5L L6 3430cc	1985-1989		USEP8197H
<b>325IS</b>				<b>650I</b>			
2.5L L6 2494cc 152 CID	1987		USEP8141H	4.8L V8 4837cc	2007-2010		USEP8524M
2.5L L6 2494cc 152 CID	1988-1990		USEP8138H	<b>735I</b>			
<b>325IX</b>				3.5L L6 3430cc	1985-1986		USEP8216H
2.5L L6 2494cc 152 CID	1988-1991		USEP8138H	<b>745I</b>			
<b>325XI</b>				4.4L V8 4398cc	2002-2005		USEP8488M
2.5L L6 2494cc 152 CID	2001-2005		USEP8416M	<b>745LI</b>			
3.0L L6 2996cc	2006		USEP8688M	4.4L V8 4398cc	2002-2005		USEP8488M
<b>328CI</b>				<b>750I</b>			
2.8L L6 2793cc	2000		USEP8416M	4.8L V8 4837cc	2006-2008		USEP8488M
<b>328I</b>				<b>750LI</b>			
2.8L L6 2793cc	1999-2000		USEP8416M	4.8L V8 4837cc	2006-2008		USEP8488M
3.0L L6 2979cc 182 CID	2012-2013		USEP8688M	<b>L6</b>			
3.0L L6 2996cc	2007-2013		USEP8688M	3.5L L6 3430cc	1987		USEP8197H
<b>328I XDRIVE</b>				<b>M3</b>			
3.0L L6 2996cc	2009-2013		USEP8688M	2.3L L4 2302cc	1988-1991		USEP8141H
<b>328XI</b>				3.2L L6 3152cc	1996-1999		USEP8233M
3.0L L6 2996cc	2007-2008		USEP8688M	3.2L L6 3246cc	2001-2006		USEP8494M
<b>330CI</b>				<b>M5</b>			
3.0L L6 2979cc	2001-2006		USEP8416M	3.5L L6 3453cc	1988		USEP8197H
<b>330I</b>				3.6L L6 3553cc	1991-1992	(Secondary)	USEP8234M
3.0L L6 2979cc	2001-2005		USEP8416M	3.6L L6 3553cc	1993		USEP8234M
3.0L L6 2996cc	2006		USEP8688M	<b>M6</b>			
<b>330XI</b>				3.5L L6 3453cc	1987-1988		USEP8197H
3.0L L6 2979cc	2001-2005		USEP8416M	<b>X1</b>			
3.0L L6 2996cc	2006		USEP8688M	2.0L L4 1997cc 122 CID	2013-2014		USEP8688M
<b>335I</b>				3.0L L6 2979cc	2013-2014		USEP8688M
3.0L L6 2979cc	2007-2013		USEP8688M	<b>X3</b>			
3.0L L6 2979cc 182 CID	2012-2013		USEP8688M	2.5L L6 2494cc 152 CID	2004-2005	2.5i	USEP8526M
<b>335IS</b>				3.0L L6 2979cc	2004-2006	3.0i	USEP8526M
3.0L L6 2979cc	2011-2013		USEP8688M	<b>X5</b>			
<b>335I XDRIVE</b>				3.0L L6 2979cc	2001-2006	3.0i; (M54)	USEP8412M
3.0L L6 2979cc	2009-2011		USEP8688M	3.0L L6 2996cc	2007-2010		USEP8814M
3.0L L6 2979cc	2013		USEP8688M	4.4L V8 4398cc	2000		USEP8412M
<b>335XI</b>				4.4L V8 4398cc	2001-2003	4.4i; (M62)	USEP8412M
3.0L L6 2979cc	2007-2008		USEP8688M	4.4L V8 4398cc	2004-2006	4.4i; (N62)	USEP8412M
<b>525I</b>				4.6L V8 4598cc	2002-2003	4.6is; (M62)	USEP8412M
2.5L L6 2494cc 152 CID	1991-1995		USEP8234M	<b>Z3</b>			
2.5L L6 2494cc 152 CID	2001-2003		USEP8442H	1.9L L4 1895cc	1996-1998		USEP8320S
3.0L L6 2996cc	2006-2007		USEP8687M	2.5L L6 2494cc 152 CID	1999-2002		USEP8320S
<b>525IT</b>				2.8L L6 2793cc	1997-2000		USEP8320S
2.5L L6 2494cc 152 CID	1993		USEP8234M	3.0L L6 2979cc	2001-2002		USEP8320S
<b>525XI</b>				3.2L L6 3152cc	1998-2000		USEP8320S
3.0L L6 2996cc	2006-2007		USEP8687M	3.2L L6 3246cc	2001-2002		USEP8320S
<b>528E</b>				<b>BUICK</b>			
2.7L L6 2693cc	1985-1988		USEP8197H	<b>ALLURE</b>			
<b>528I</b>				3.6L V6 3564cc 217 CID	2007	with 2 electrical connectors	USEP3792M
2.8L L6 2793cc	1997-2000		USEP8442H	3.8L V6 3800cc 231 CID	2007-2008	with 2 electrical connectors	USEP3792M
3.0L L6 2996cc	2008-2010		USEP8687M	3.8L V6 3800cc 231 CID	2007-2008	with 1 electrical connector	USEP3824M
<b>528I XDRIVE</b>				3.8L V6 3800cc 231 CID	2008-2009	1 ELECTRICAL CONNECTOR, PZEV, WITH 2 PORTS	USEP3749M
3.0L L6 2996cc	2009-2010		USEP8687M	<b>CENTURY</b>			
<b>528XI</b>				2.5L L4 2474cc 151 CID	1990-1992		USEP3639S
3.0L L6 2996cc	2008		USEP8687M	3.1L V6 189 CID	1997	Custom, Limited	USEP3980M
<b>530I</b>				3.1L V6 189 CID	1998-1999		USEP3537M
3.0L L6 2979cc	2001-2003		USEP8442H	3.1L V6 189 CID	2000-2005		USEP3542M
3.0L L6 2996cc	2006-2007		USEP8687M	<b>ENCLAVE</b>			
<b>530XI</b>				3.6L V6 3564cc 217 CID	2008		USEP3748M
3.0L L6 2996cc	2006-2007		USEP8687M	3.6L V6 3564cc 217 CID	2009-2014	WITHOUT FUEL LEVEL SENSOR	USEP3790M
<b>535I</b>				<b>LACROSSE</b>			
3.5L L6 3430cc	1985-1988		USEP8197H	2.4L L4 2384cc 145 CID	2011		USEP4045M
<b>535IS</b>				3.6L V6 3564cc 217 CID	2005-2006	CXS; (7); (Standard)	USEP3679M
3.5L L6 3430cc	1988		USEP8197H	3.6L V6 3564cc 217 CID	2007	with 2 electrical connectors	USEP3792M
<b>540I</b>				3.6L V6 3564cc 217 CID	2012-2016		USEP4021M
4.4L V8 4398cc	1997-2003		USEP8442H	3.6L V6 3564cc 217 CID	2016		USEP4045M
<b>550I</b>				3.8L V6 3800cc 231 CID	2005-2006	CX, CXL; (2)	USEP3679M
4.8L V8 4799cc	2007		USEP8524M	3.8L V6 3800cc 231 CID	2007-2008	with 2 electrical connectors	USEP3792M
4.8L V8 4837cc	2007		USEP8524M	3.8L V6 3800cc 231 CID	2007-2008	with 1 electrical connector	USEP3824M
				3.8L V6 3800cc 231 CID	2008-2009	1 ELECTRICAL CONNECTOR, PZEV, WITH 2 PORTS	USEP3749M
				<b>LESABRE</b>			
				3.8L V6 3800cc 231 CID	1993-1994		USEP3629S



Engine	Years	Application Description	USMW	Engine	Years	Application Description	USMW
<b>BUICK (cont'd.)</b>				<b>CADILLAC (cont'd.)</b>			
<b>LESABRE (cont'd.)</b>				<b>DEVILLE</b>			
3.8L V6 3800cc 231 CID	2000-2005	Naturally Aspirated; 2ND DESIGN, AFTER VIN YU145190	USEP3518M	4.6L V8 281 CID	1994	Fuel Sender Stamped EPV	USEP3913M
3.8L V6 3800cc 231 CID	2000-2005	Naturally Aspirated; 1ST DESIGN, BEFORE VIN YU145189	USEP3533M	4.6L V8 281 CID	1995-1996		USEP3913M
<b>LUCERNE</b>				4.6L V8 281 CID	1997		USEP3935M
3.8L V6 3800cc 231 CID	2006		USEP3709M	4.6L V8 281 CID	1998-1999		USEP3974M
4.6L V8 281 CID	2006		USEP3709M	4.6L V8 281 CID	2000-2005		USEP3518M
<b>PARK AVENUE</b>				4.9L V8 300 CID	1991-1993		USEP3636S
	1997	Base; (K), Naturally Aspirated	USEP3937M	4.9L V8 300 CID	1994	Fuel Sender Stamped EPV	USEP3913M
	1997	Ultra; (1), Supercharged	USEP3938M	4.9L V8 300 CID	1995		USEP3913M
3.8L V6 3800cc 231 CID	1993-1994		USEP3629S	<b>DTS</b>			
3.8L V6 3800cc 231 CID	1998-1999	Supercharged	USEP3536M	4.6L V8 281 CID	2006-2008		USEP3709M
3.8L V6 3800cc 231 CID	1998-2005	Naturally Aspirated; 2ND DESIGN	USEP3518M	<b>ELDORADO</b>			
3.8L V6 3800cc 231 CID	1998-2005	Naturally Aspirated; 1ST DESIGN, BEFORE VIN YU145189	USEP3533M	4.6L V8 281 CID	1994	Fuel Sender Stamped EPV	USEP3913M
3.8L V6 3800cc 231 CID	2001-2005	Supercharged	USEP3536M	4.6L V8 281 CID	1995-1996		USEP3913M
<b>RAINIER</b>				4.6L V8 281 CID	1998-2002		USEP3974M
4.2L L6 256 CID	2004	This Module uses an internal strainer design and may look different from your original Unit	USEP3549M	<b>ESCALADE</b>			
4.2L L6 256 CID	2005-2007		USEP3707M		1999	Radio Frequency Interference Filter	USEP3534M
5.3L V8 5328cc 325 CID	2004		USEP3549M		1999	Exc. Radio Frequency Interference Filter	USEP3972M
5.3L V8 5328cc 325 CID	2005-2007		USEP3707M		2000		USEP3972M
<b>REGAL</b>				5.3L V8 5328cc 325 CID	2002-2003	GAS	USEP3508M
	1998-1999	GS; (1), Supercharged	USEP3973M	5.3L V8 5328cc 325 CID	2004-2005	GAS	USEP3581M
	2000	GSE; (1), Supercharged	USEP3519M	6.0L V8 5967cc 364 CID	2002-2003	Base; (N)	USEP3508M
	2001-2004	GS; (1), Supercharged	USEP3519M	6.0L V8 5967cc 364 CID	2004-2006	GAS	USEP3581M
2.0L L4 1998cc 122 CID	2014-2017		USEP4021M	6.0L V8 5967cc 364 CID	2009-2012		USEP3765M
2.4L L4 2384cc 145 CID	2011-2012		USEP4045M	6.2L V8 6162cc 376 CID	2007	GAS	USEP3581M
3.8L V6 3800cc 231 CID	1997		USEP3543M	6.2L V8 6162cc 376 CID	2008		USEP3765M
3.8L V6 3800cc 231 CID	1998-1999	Naturally Aspirated	USEP3537M	6.2L V8 6162cc 376 CID	2009-2014		USEP3768M
3.8L V6 3800cc 231 CID	2000-2004	Naturally Aspirated	USEP3542M	<b>ESCALADE ESV</b>			
<b>RENDEZVOUS</b>				6.0L V8 5967cc 364 CID	2003		USEP3556M
	2007	CX, CXL	USEP3615M	6.0L V8 5967cc 364 CID	2004-2006	GAS	USEP3610M
3.4L V6 207 CID	2002-2003		USEP3521M	6.2L V8 6162cc 376 CID	2007	GAS	USEP3610M
3.4L V6 207 CID	2004	to VIN 4S558922	USEP3521M	6.2L V8 6162cc 376 CID	2008		USEP3753M
3.4L V6 207 CID	2004	After Vin 4s558922	USEP3701M	6.2L V8 6162cc 376 CID	2009-2014		USEP3797M
3.4L V6 207 CID	2005		USEP3701M	<b>ESCALADE EXT</b>			
3.5L V6 213 CID	2006	CX, CXL; (L)	USEP3615M	6.0L V8 5967cc 364 CID	2002-2003		USEP3556M
3.6L V6 3564cc 217 CID	2004	CXL, Ultra; (7)	USEP3615M	6.0L V8 5967cc 364 CID	2004-2006	GAS	USEP3610M
3.6L V6 3564cc 217 CID	2005	CXL Plus, Ultra; (7)	USEP3615M	6.2L V8 6162cc 376 CID	2007	GAS	USEP3610M
3.6L V6 3564cc 217 CID	2006	CX, CXL; (7)	USEP3615M	6.2L V8 6162cc 376 CID	2008		USEP3753M
<b>RIVIERA</b>				6.2L V8 6162cc 376 CID	2009-2013		USEP3797M
	1996	(1), Supercharged	USEP3922M	<b>FLEETWOOD</b>			
	1997	(K), Naturally Aspirated	USEP3936M	4.9L V8 300 CID	1991-1992		USEP3636S
	1997	(1), Supercharged	USEP3938M	5.7L V8 350 CID	1993		USEP3636S
3.8L V6 3800cc 231 CID	1995-1996	Naturally Aspirated	USEP3912M	<b>SEVILLE</b>			
3.8L V6 3800cc 231 CID	1998-1999	Supercharged	USEP3536M	4.6L V8 281 CID	1994	Fuel Sender Stamped EPV	USEP3913M
<b>SKYLARK</b>				4.6L V8 281 CID	1995-1996		USEP3913M
2.3L L4 138 CID	1992	Custom; (3)	USEP3917M	4.6L V8 281 CID	1997		USEP3935M
2.3L L4 138 CID	1993-1994	Custom, Limited; (3)	USEP3918M	4.6L V8 281 CID	2000-2004		USEP3518M
2.3L L4 138 CID	1995	Custom, Limited; (D)	USEP3918M	<b>SRX</b>			
2.4L L4 2392cc 146 CID	1996	Custom, Olympic Gold Edition; (T)	USEP3919M	2.8L V6 2792cc 170 CID	2010-2011		USEP4024M
2.4L L4 2392cc 146 CID	1997	Custom, Limited; (T)	USEP3919M	3.0L V6 182 CID	2010-2011		USEP4024M
3.1L V6 189 CID	1994-1995	Custom, Gran Sport, Limited; (M)	USEP3918M	3.6L V6 3564cc 217 CID	2004-2005	(7)	USEP3605M
3.1L V6 189 CID	1996	Custom, Gran Sport, Olympic Gold Edition; (M)	USEP3919M	3.6L V6 3564cc 217 CID	2009	(7)	USEP3605M
3.1L V6 189 CID	1997	Custom, Gran Sport, Limited; (M)	USEP3919M	3.6L V6 3564cc 217 CID	2014-2016		USEP4024M
3.1L V6 189 CID	1998	(M)	USEP3919M	4.6L V8 281 CID	2004-2005	(A)	USEP3605M
3.3L V6 204 CID	1992	Custom, Gran Sport; (N)	USEP3917M	4.6L V8 281 CID	2009	(A)	USEP3605M
3.3L V6 204 CID	1993	Custom, Gran Sport, Limited; (N)	USEP3918M	<b>STS</b>			
<b>TERRAZA</b>				3.6L V6 3564cc 217 CID	2005-2007		USEP3691M
	2005	CX, CXL; (Incl. Tank Seal)	USEP3717M	4.6L V8 281 CID	2005-2007		USEP3691M
3.5L V6 213 CID	2006	CX, CXL; (L); (Incl. Tank Seal)	USEP3717M	4.6L V8 4565cc 279 CID	2007		USEP3691M
3.9L V6 3880cc 237 CID	2006	CX, CXL; (1); (Incl. Tank Seal)	USEP3717M	<b>XLR</b>			
3.9L V6 3880cc 237 CID	2007		USEP3718M	4.4L V8 4371cc 267 CID	2006	Left Side Fuel Tank	USEP3579M
<b>VERANO</b>				4.6L V8 281 CID	2004-2006	Left Side Fuel Tank	USEP3579M
2.0L L4 1998cc 122 CID	2013-2015	W/O 13 Gallon Tank	USEP4034M	<b>XTS</b>			
2.4L L4 2384cc 145 CID	2012-2015	W/O 13 Gallon Tank	USEP4034M	3.6L V6 3564cc 217 CID	2013-2017		USEP4021M
<b>CADILLAC</b>				3.6L V6 3564cc 217 CID	2014-2015		USEP4045M
<b>ALLANTE</b>				<b>CHEVROLET</b>			
	1993		USEP3916M	<b>ASTRA</b>			
<b>CTS</b>				1.8L L4 1796cc 110 CID	2006	MEX	USEP12026M
	2003		USEP3606M	2.0L L4 1999cc 122 CID	2004-2005	MEX	USEP12026M
2.8L V6 2792cc 170 CID	2005-2007		USEP3691M	<b>ASTRO</b>			
3.2L V6 197 CID	2004	Base; (N)	USEP3606M		1997-1999		USEP3940M
3.6L V6 3564cc 217 CID	2004-2007		USEP3691M	4.3L V6 262 CID	1992-1994	Base, CL, CS, LT	USEP3650S
6.0L V8 5967cc 364 CID	2007	V; (U)	USEP3692M	4.3L V6 262 CID	1995	Base, CL, LT	USEP3650S
				4.3L V6 262 CID	2000-2005		USEP3506M
				<b>AVALANCHE</b>			
				5.3L V8 5328cc 325 CID	2007	GAS	USEP3610M

Engine	Years	Application Description	USMW	Engine	Years	Application Description	USMW
<b>CHEVROLET (cont'd.)</b>				<b>CHEVROLET (cont'd.)</b>			
<b>AVALANCHE (cont'd.)</b>				<b>C2500</b>			
5.3L V8 5328cc 325 CID	2007	FLEX	USEP3706M	4.3L V6 262 CID	1988-1990	Cheyenne, Scottsdale, Silverado	USEP3621S
5.3L V8 5328cc 325 CID	2008-2013		USEP3797M	4.3L V6 262 CID	1991-1993	Cheyenne, Silverado	USEP3621S
6.0L V8 5967cc 364 CID	2007	GAS	USEP3610M	4.3L V6 262 CID	1994-1995	Base, Cheyenne, Silverado, WT	USEP3621S
<b>AVALANCHE 1500</b>				5.0L V8 305 CID	1988-1990	Cheyenne, Scottsdale, Silverado	USEP3621S
5.3L V8 5328cc 325 CID	2002-2003		USEP3556M	5.0L V8 305 CID	1991-1993	Cheyenne, Silverado	USEP3621S
5.3L V8 5328cc 325 CID	2004-2006	GAS	USEP3610M	5.0L V8 305 CID	1994-1995	Base, Cheyenne, Silverado, WT	USEP3621S
5.3L V8 5328cc 325 CID	2005-2006	FLEX	USEP3706M	5.0L V8 305 CID	1998	Radio Frequency Interference Filter (Module Stamped GDJ,GFK)	USEP3947M
<b>AVALANCHE 2500</b>				5.7L V8 350 CID	1988-1990	Cheyenne, Scottsdale, Silverado	USEP3621S
8.1L V8 496 CID	2002-2003	1 electrical connector, Exc.Evaporative Emissions Control, Secondary Fuel Tank	USEP3553M	5.7L V8 350 CID	1991-1993	Cheyenne, Silverado	USEP3621S
8.1L V8 496 CID	2002-2003	except Export, Primary Fuel Tank	USEP3554M	5.7L V8 350 CID	1994-1995	Base, Cheyenne, Silverado, WT	USEP3621S
8.1L V8 496 CID	2002-2003	Evaporative Emissions Control, Secondary Fuel Tank, with 2 electrical connectors	USEP3555M	5.7L V8 350 CID	1998	Exc.Radio Frequency Interference Filter (Module Stamped GAV)	USEP3947M
8.1L V8 496 CID	2002-2003	export, Robust fuel system unit	USEP3594M	5.7L V8 350 CID	1998-1999	(R), GAS, Naturally Aspirated; Exc.Radio Frequency Interference Filter (Module Stamped GFT)	USEP3962M
8.1L V8 496 CID	2004-2006	Rear tank	USEP3587M	5.7L V8 350 CID	1999	Radio Frequency Interference Filter (Module Stamped GDJ,GFK)	USEP3947M
8.1L V8 496 CID	2004-2006	Front tank	USEP3675M	5.7L V8 350 CID	2000	Calif (Exc.Radio Frequency Interference Filter)	USEP3947M
<b>AVEO</b>				5.7L V8 350 CID	2000	(R), GAS, Naturally Aspirated; Exc.Calif (Exc.Radio Frequency Interference Filter)	USEP3962M
1.6L L4 1598cc 98 CID	2004-2005		USEP3612M	7.4L V8 454 CID	1991-1992	Cheyenne, Silverado	USEP3621S
1.6L L4 1598cc 98 CID	2006-2008		USEP3711M	7.4L V8 454 CID	1994-1995		USEP3623S
1.6L L4 1598cc 98 CID	2009-2017		USEP4003M	7.4L V8 454 CID	1998	Radio Frequency Interference Filter (Module Stamped GDJ,GFK)	USEP3947M
<b>AVEO5</b>				7.4L V8 454 CID	1998-1999	(J), GAS, Naturally Aspirated; Exc.Radio Frequency Interference Filter (Module Stamped GFT)	USEP3962M
1.6L L4 1598cc 98 CID	2006-2008		USEP3711M	7.4L V8 454 CID	1999	Exc.Radio Frequency Interference Filter (Module Stamped GAV)	USEP3947M
1.6L L4 1598cc 98 CID	2009-2011		USEP4003M	7.4L V8 454 CID	2000	Radio Frequency Interference Filter (J), GAS, Naturally Aspirated; Exc.Calif	USEP3947M
<b>BERETTA</b>				7.4L V8 454 CID	2000	(Exc.Radio Frequency Interference Filter)	USEP3962M
2.2L L4 2190cc 134 CID	1993	Base, GT; (4)	USEP3918M	<b>C2500 SUBURBAN</b>			
2.2L L4 2190cc 134 CID	1994-1995	Base; (4)	USEP3918M	5.7L V8 350 CID	1998-1999	(R), GAS, Naturally Aspirated; Calif	USEP3967M
2.2L L4 2190cc 134 CID	1996	Base; (4)	USEP3921M	5.7L V8 350 CID	1998-1999	(R), GAS, Naturally Aspirated; Exc.Calif	USEP3994M
2.3L L4 140 CID	1990-1991		USEP3743S	7.4L V8 454 CID	1998-1999	(J), GAS, Naturally Aspirated; Calif	USEP3967M
2.3L L4 140 CID	1993	GTZ; (A)	USEP3918M	7.4L V8 454 CID	1998-1999	(J), GAS, Naturally Aspirated; Exc.Calif	USEP3994M
2.3L L4 140 CID	1994	Z26; (A)	USEP3918M	<b>C3500</b>			
3.1L V6 189 CID	1990-1991		USEP3743S	5.7L V8 350 CID	1988-1990	Cheyenne, Scottsdale, Silverado	USEP3621S
3.1L V6 189 CID	1993	Base, GT, GTZ; (T)	USEP3918M	5.7L V8 350 CID	1991-1993	Cheyenne, Silverado	USEP3621S
3.1L V6 189 CID	1994-1995	Base, Z26; (M)	USEP3918M	5.7L V8 350 CID	1994-1995	Base, Cheyenne, Silverado	USEP3621S
3.1L V6 189 CID	1996	Base, Z26; (M)	USEP3921M	5.7L V8 350 CID	1996-1997	Base, Cheyenne, Silverado	USEP3622S
<b>BLAZER</b>				5.7L V8 350 CID	1998	Exc.Radio Frequency Interference Filter (Module Stamped GAV)	USEP3947M
	2003-2004	2 Doors	USEP3569M	5.7L V8 350 CID	1998-1999	(R), GAS, Naturally Aspirated; Exc.Radio Frequency Interference Filter (Module Stamped GFT)	USEP3962M
4.3L V6 262 CID	1996	4 Doors	USEP3925M	5.7L V8 350 CID	1999	Radio Frequency Interference Filter (Module Stamped GDJ,GFK)	USEP3947M
4.3L V6 262 CID	1996	2 Doors	USEP3929M	5.7L V8 350 CID	2000	(Calif)	USEP3947M
4.3L V6 262 CID	1997-1998	4 Doors; STEEL TANK	USEP3953M	5.7L V8 350 CID	2000	(R), Cab & Chassis, GAS, Naturally Aspirated; (Exc.Calif)	USEP3956M
4.3L V6 262 CID	1997-2002	2 Doors	USEP3954M	5.7L V8 350 CID	2000	(R), Cab & Chassis, GAS, Naturally Aspirated; (Calif)	USEP3957M
4.3L V6 262 CID	1998-2005	4 Doors; plastic tank	USEP3992M	5.7L V8 350 CID	2000	(R), Crew Cab Pickup, GAS, Naturally Aspirated; (Exc.Calif)	USEP3962M
5.0L V8 305 CID	1987	auxiliary tank	USEP3630S	5.7L V8 350 CID	2000	(R), Extended Cab Pickup, GAS, Naturally Aspirated; (Exc.Calif)	USEP3962M
5.0L V8 305 CID	1987	with 31 gallon tank	USEP3633S	5.7L V8 350 CID	2000	(R), GAS, Naturally Aspirated, Standard Cab Pickup; (Exc.Calif)	USEP3962M
5.7L V8 350 CID	1987	auxiliary tank	USEP3630S	7.4L V8 454 CID	1988-1990	Cheyenne, Scottsdale, Silverado	USEP3621S
5.7L V8 350 CID	1987-1989	w 40 gallon fuel tank	USEP3634S	7.4L V8 454 CID	1991-1993	Cheyenne, Silverado	USEP3621S
5.7L V8 350 CID	1987-1991	with 31 gallon tank	USEP3633S	7.4L V8 454 CID	1994-1995		USEP3623S
<b>C35</b>				7.4L V8 454 CID	1996-1997	Base, Cheyenne, Silverado	USEP3622S
5.7L V8 350 CID	1995	Base, Cheyenne, Tipico	USEP3621S	7.4L V8 454 CID	1998-1999	Exc.Radio Frequency Interference Filter (Module Stamped GAV)	USEP3947M
5.7L V8 350 CID	1998-2000	MEX	USEP3956M	7.4L V8 454 CID	1999-1999	Exc.Radio Frequency Interference Filter (Module Stamped GAV)	USEP3947M
<b>C1500</b>				7.4L V8 454 CID	1998-1999	(J), GAS, Naturally Aspirated; Exc.Radio Frequency Interference Filter (Module Stamped GFT)	USEP3962M
4.3L V6 262 CID	1988	Cheyenne, Scottsdale, Silverado	USEP3621S	8.1L V8 496 CID	2001	GAS, Naturally Aspirated; Exc.Radio Frequency Interference Filter, Primary Fuel Tank	USEP3956M
4.3L V6 262 CID	1990	Cheyenne, Scottsdale, Silverado, WT	USEP3621S	8.1L V8 496 CID	2001	GAS, Naturally Aspirated; Primary Fuel Tank, Radio Frequency Interference Filter	USEP3957M
4.3L V6 262 CID	1991-1993	Cheyenne, Silverado, WT	USEP3621S	8.1L V8 496 CID	2002	GAS, Naturally Aspirated; Exc.Radio Frequency Interference Filter	USEP3956M
4.3L V6 262 CID	1994-1995	Base, Cheyenne, Silverado, WT	USEP3621S	8.1L V8 496 CID	2002	GAS, Naturally Aspirated; Radio Frequency Interference Filter	USEP3957M
4.3L V6 262 CID	1996	Base, Cheyenne, Silverado, WT	USEP3622S	<b>CAMARO</b>			
4.3L V6 262 CID	1997	Exc.Radio Frequency Interference Filter (Module Stamped GAV)	USEP3947M	3.8L V6 3800cc 231 CID	1997		USEP3983S
4.3L V6 262 CID	1998	Radio Frequency Interference Filter (Module Stamped GDJ,GFK)	USEP3947M	3.8L V6 3800cc 231 CID	1998		USEP3745M
5.0L V8 305 CID	1988	Cheyenne, Scottsdale, Silverado	USEP3621S	3.8L V6 3800cc 231 CID	1999-2002	Base; (K)	USEP3969M
5.0L V8 305 CID	1990	Cheyenne, Scottsdale, Silverado, WT	USEP3621S	5.7L V8 350 CID	1998	Z28, Z28 SS; (G)	USEP3961S
5.0L V8 305 CID	1991-1993	Cheyenne, Silverado, WT	USEP3621S	5.7L V8 350 CID	1999-2002	Z28, Z28 SS; (G)	USEP3968M
5.0L V8 305 CID	1994-1995	Base, Cheyenne, Silverado, WT	USEP3621S				
5.0L V8 305 CID	1996-1997	Base, Cheyenne, Silverado, WT	USEP3622S				
5.0L V8 305 CID	1998-1999	Radio Frequency Interference Filter (Module Stamped GDJ,GFK)	USEP3947M				
5.7L V8 350 CID	1988	Cheyenne, Scottsdale, Silverado	USEP3621S				
5.7L V8 350 CID	1990	Cheyenne, Scottsdale, Silverado, WT	USEP3621S				
5.7L V8 350 CID	1991-1993	Cheyenne, Silverado, WT	USEP3621S				
5.7L V8 350 CID	1994-1995	Base, Cheyenne, Silverado, WT	USEP3621S				
5.7L V8 350 CID	1996-1997	Base, Cheyenne, Silverado, WT	USEP3622S				
5.7L V8 350 CID	1998-1999	Radio Frequency Interference Filter (Module Stamped GDJ,GFK)	USEP3947M				
7.4L V8 454 CID	1990	454 SS, Cheyenne, Scottsdale, Silverado, WT	USEP3621S				
7.4L V8 454 CID	1991-1993	454 SS, Cheyenne, Silverado, WT	USEP3621S				
<b>C1500 SUBURBAN</b>							
5.7L V8 350 CID	1998-1999	(R), GAS, Naturally Aspirated	USEP3967M				



# FUEL PUMP MODULES APPLICATION GUIDE



FUEL PUMP MODULES

Engine	Years	Application Description	USMW
<b>CHEVROLET (cont'd.)</b>			
<b>CAVALIER</b>			
2.2L L4 2190cc 134 CID	1992	RS, VL; (4)	USEP3917M
2.2L L4 2190cc 134 CID	1993-1994	RS, VL; (4)	USEP3918M
2.2L L4 2190cc 134 CID	2000	MEX	USEP3507M
2.2L L4 2190cc 134 CID	2000	Plastic Fuel Tank	USEP3507M
2.2L L4 2190cc 134 CID	2000	(4), GAS; Exc.Plastic Fuel Tank	USEP3950M
2.2L L4 2190cc 134 CID	2000	Base; (4), BI-FUEL; Exc.Plastic Fuel Tank	USEP3950M
2.2L L4 2190cc 134 CID	2001		USEP3507M
2.2L L4 2198cc 134 CID	2002-2005		USEP3507M
2.4L L4 2392cc 146 CID	2000	Plastic Fuel Tank	USEP3507M
2.4L L4 2392cc 146 CID	2000	Z24; (T), GAS; Exc.Plastic Fuel Tank	USEP3950M
2.4L L4 2392cc 146 CID	2001-2002		USEP3507M
3.1L V6 189 CID	1992	RS, Z24; (T)	USEP3917M
3.1L V6 189 CID	1993-1994	RS, Z24; (T)	USEP3918M
<b>CELEBRITY</b>			
2.5L L4 2474cc 151 CID	1989-1990		USEP3639S
<b>CLASSIC</b>			
2.2L L4 2198cc 134 CID	2004		USEP3507M
<b>COBALT</b>			
2.0L L4 122 CID	2005		USEP3680M
2.0L L4 122 CID	2006-2007		USEP3726M
2.0L L4 1998cc 122 CID	2008	SS; (X), Turbocharged	USEP3715M
2.2L L4 2198cc 134 CID	2005		USEP3590M
2.2L L4 2198cc 134 CID	2006-2008		USEP3726M
2.2L L4 2198cc 134 CID	2009-2010		USEP3782M
2.4L L4 2384cc 145 CID	2006-2008		USEP3726M
<b>COLORADO</b>			
2.8L L4 2770cc 169 CID	2004	Z71 LS, Z85, Z85 LS; (8)	USEP3614M
2.8L L4 2770cc 169 CID	2005	Sport, Sport LS, Z71, Z71 LS, Z85, Z85 LS; (8)	USEP3614M
2.8L L4 2770cc 169 CID	2006	LS, LT, WT; (8)	USEP3688M
2.9L L4 2921cc 178 CID	2007-2008	LS, LT, WT; (9)	USEP3688M
3.5L L5 3460cc 211 CID	2004	Z71 LS, Z85, Z85 LS; (6)	USEP3614M
3.5L L5 3460cc 211 CID	2005	Sport, Sport LS, Z71, Z71 LS, Z85, Z85 LS; (6)	USEP3614M
3.5L L5 3460cc 211 CID	2006	LT, WT; (6)	USEP3688M
3.7L L5 3654cc 223 CID	2007	LS, LT; (E)	USEP3688M
3.7L L5 3654cc 223 CID	2008	LS, LT, WT; (E)	USEP3688M
<b>CORSA</b>			
1.4L L4 1389cc 85 CID	2002	MEX	USEP12012M
1.8L L4 1796cc 110 CID	2003-2008	MEX	USEP12026M
<b>CORSICA</b>			
2.2L L4 2190cc 134 CID	1993-1995	(4)	USEP3918M
2.2L L4 2190cc 134 CID	1996	(4)	USEP3921M
3.1L V6 189 CID	1990-1991		USEP3743S
3.1L V6 189 CID	1993	(T)	USEP3918M
3.1L V6 189 CID	1994-1995	(M)	USEP3918M
3.1L V6 189 CID	1996	(M)	USEP3921M
<b>CORVETTE</b>			
5.7L V8 350 CID	1997-1999		USEP3578M
5.7L V8 350 CID	2000		USEP3577M
5.7L V8 350 CID	2001-2002	Base; (G)	USEP3577M
5.7L V8 350 CID	2001-2002	Z06; (S)	USEP3577M
5.7L V8 350 CID	2003	Base; (G); 1st Design	USEP3577M
5.7L V8 350 CID	2003	Z06; (S); 1st Design	USEP3577M
5.7L V8 350 CID	2003	2nd Design	USEP3579M
5.7L V8 350 CID	2004		USEP3579M
6.0L V8 364 CID	2005		USEP3579M
6.0L V8 5967cc 364 CID	2006		USEP3579M
7.0L V8 7011cc 427 CID	2006		USEP3579M
<b>CRUZE</b>			
1.4L L4 1364cc 83 CID	2011-2015	with 13 gallon tank	USEP4033M
1.4L L4 1364cc 83 CID	2011-2015	W/O 13 Gallon Tank	USEP4034M
1.8L L4 1796cc 110 CID	2011-2015	W/O 13 Gallon Tank	USEP4034M
<b>CRUZE LIMITED</b>			
1.4L L4 1364cc 83 CID	2016	with 13 gallon tank	USEP4033M
<b>EQUINOX</b>			
2.4L L4 2384cc 145 CID	2010-2017	RIGHT	USEP3840M
3.4L V6 207 CID	2005-2006		USEP3626M
3.4L V6 207 CID	2007-2009		USEP3757M
3.4L V6 3425cc 209 CID	2007-2008		USEP3757M
3.6L V6 3564cc 217 CID	2008-2009		USEP3757M
<b>EXPRESS 1500</b>			
4.3L V6 262 CID	1996	(W)	USEP3927M
4.3L V6 262 CID	1997	(W); (Exc.Fitting for Fuel Line)	USEP3966M
4.3L V6 262 CID	1998-2001	with Fitting for Auxiliary power unit	USEP3573M
4.3L V6 262 CID	1998-2001	(W); (Exc.Fitting for Fuel Line)	USEP3971M
4.3L V6 262 CID	1999-2001	MEX; VAY	USEP3971M
4.3L V6 262 CID	2004		USEP3588M

Engine	Years	Application Description	USMW
<b>CHEVROLET (cont'd.)</b>			
<b>EXPRESS 1500 (cont'd.)</b>			
4.3L V6 262 CID	2005-2006	Standard Passenger Van	USEP3678M
4.3L V6 262 CID	2009		USEP3820M
4.3L V6 262 CID	2010-2012		USEP4048M
4.3L V6 262 CID	2010-2012	GAS; Exc.Left Side Rear Hinged Door	USEP4049M
4.3L V6 4293cc 262 CID	2013-2014	GAS; Exc.Left Side Rear Hinged Door	USEP4049M
5.0L V8 305 CID	1996	(M)	USEP3927M
5.0L V8 305 CID	1997	(M); (Exc.Fitting for Fuel Line)	USEP3966M
5.0L V8 305 CID	1998-2001	(M); (Exc.Fitting for Fuel Line)	USEP3971M
5.3L V8 5328cc 325 CID	2004-2007	Standard Passenger Van	USEP3678M
5.3L V8 5328cc 325 CID	2007		USEP3725M
5.3L V8 5328cc 325 CID	2008	FLEX	USEP3751M
5.3L V8 5328cc 325 CID	2009	FLEX; except left hand rear hinged door	USEP3788M
5.7L V8 350 CID	1996	(R); 31 Gallon Fuel Tank	USEP3927M
5.7L V8 350 CID	1996	(R); 55 Gallon Fuel Tank	USEP3928M
5.7L V8 350 CID	1997	(R); (Exc.Fitting for Fuel Line)	USEP3966M
5.7L V8 350 CID	1998-2002	(R); (Exc.Fitting for Fuel Line)	USEP3971M
<b>EXPRESS 2500</b>			
4.3L V6 262 CID	1996	(W), GAS, Naturally Aspirated	USEP3927M
4.3L V6 262 CID	1997	(W), GAS, Naturally Aspirated; (Exc.Fitting for Fuel Line)	USEP3966M
4.3L V6 262 CID	2003	(X), GAS	USEP3584M
4.3L V6 262 CID	2004		USEP3588M
4.3L V6 262 CID	2005	Standard Passenger Van	USEP3678M
4.8L V8 294 CID	2003	(V), GAS	USEP3584M
4.8L V8 294 CID	2004-2006	Standard Passenger Van	USEP3678M
4.8L V8 294 CID	2006-2007	(V), GAS, Naturally Aspirated	USEP12006M
4.8L V8 294 CID	2006-2008		USEP3678M
4.8L V8 294 CID	2008	Base; (C), GAS, Naturally Aspirated	USEP12006M
4.8L V8 294 CID	2009		USEP3820M
4.8L V8 294 CID	2010-2015	FLEX; Exc.Left Side Rear Hinged Door	USEP4049M
4.8L V8 294 CID	2016	Exc.Left Side Rear Hinged Door	USEP4049M
5.0L V8 305 CID	1996	(M), GAS, Naturally Aspirated	USEP3927M
5.0L V8 305 CID	1997	(M), GAS, Naturally Aspirated; (Exc.Fitting for Fuel Line)	USEP3966M
5.3L V8 5328cc 325 CID	2004-2005	Standard Passenger Van	USEP3678M
5.7L V8 350 CID	1996	(R), GAS, Naturally Aspirated; 31 Gallon Fuel Tank	USEP3927M
5.7L V8 350 CID	1996	(R), GAS, Naturally Aspirated; 55 Gallon Fuel Tank	USEP3928M
5.7L V8 350 CID	1997	(R), GAS, Naturally Aspirated; (Exc.Fitting for Fuel Line)	USEP3966M
5.7L V8 350 CID	1998-2002	with Fitting for Auxiliary power unit	USEP3573M
5.7L V8 350 CID	1998-2002	(R), GAS, Naturally Aspirated; (Exc.Fitting for Fuel Line), Exc.Calif (Over GVW 8,500 Lbs.)	USEP3966M
5.7L V8 350 CID	1998-2002	(R), GAS, Naturally Aspirated; (Exc.Fitting for Fuel Line), Calif (Under GVW 8,500 Lbs.)	USEP3971M
5.7L V8 350 CID	1998-2002	(R), GAS, Naturally Aspirated; (Exc.Fitting for Fuel Line), Exc.Calif (Under GVW 8,500 Lbs.)	USEP3971M
5.7L V8 350 CID	1999	MEX; VAZ	USEP3966M
5.7L V8 350 CID	2001	(R), CNL, Naturally Aspirated; (Exc.Fitting for Fuel Line), Exc.Calif (Over GVW 8,500 Lbs.)	USEP3966M
5.7L V8 350 CID	2001	(R), CNL, Naturally Aspirated; (Exc.Fitting for Fuel Line), Calif (Under GVW 8,500 Lbs.)	USEP3971M
5.7L V8 350 CID	2001	(R), CNL, Naturally Aspirated; (Exc.Fitting for Fuel Line), Exc.Calif (Under GVW 8,500 Lbs.)	USEP3971M
5.7L V8 350 CID	2002	(R), BI-FUEL, Naturally Aspirated; (Exc.Fitting for Fuel Line), Exc.Calif (Over GVW 8,500 Lbs.)	USEP3966M
5.7L V8 350 CID	2002	(R), BI-FUEL, Naturally Aspirated; (Exc.Fitting for Fuel Line), Calif (Under GVW 8,500 Lbs.)	USEP3971M
5.7L V8 350 CID	2002	(R), BI-FUEL, Naturally Aspirated; (Exc.Fitting for Fuel Line), Exc.Calif (Under GVW 8,500 Lbs.)	USEP3971M
6.0L V8 5967cc 364 CID	2003	(U), GAS	USEP3584M
6.0L V8 5967cc 364 CID	2004-2008	Standard Passenger Van	USEP3678M
6.0L V8 5967cc 364 CID	2006-2007	(U), GAS, Naturally Aspirated	USEP12006M
6.0L V8 5967cc 364 CID	2006-2008		USEP3678M
6.0L V8 5967cc 364 CID	2008	LS; (K), GAS, Naturally Aspirated	USEP12006M
6.0L V8 5967cc 364 CID	2010-2015	FLEX; Exc.Left Side Rear Hinged Door	USEP4049M
6.0L V8 5967cc 364 CID	2016	Exc.Left Side Rear Hinged Door	USEP4049M
<b>EXPRESS 3500</b>			
4.8L V8 294 CID	2003	GAS; Federal (Exc.55 Gallon Fuel Tank)	USEP3574M
4.8L V8 294 CID	2003	GAS; Calif (Exc.55 Gallon Fuel Tank)	USEP3575M
4.8L V8 294 CID	2003	GAS; Calif (55 Gallon Fuel Tank)	USEP3602M
4.8L V8 294 CID	2003	Cutaway Van, GAS; 1electrical connector, Federal (55 Gallon Fuel Tank)	USEP3674M
4.8L V8 294 CID	2004		USEP3678M
4.8L V8 294 CID	2005	with 1 electrical connector	USEP3580M
4.8L V8 294 CID	2005	Standard Passenger Van	USEP3678M
4.8L V8 294 CID	2005	Cutaway Van; 1 CONNECTOR, 55 GALLON TANK	USEP3682M



Engine	Years	Application Description	USMW	Engine	Years	Application Description	USMW
<b>CHEVROLET (cont'd.)</b>				<b>CHEVROLET (cont'd.)</b>			
<b>EXPRESS 3500 (cont'd.)</b>				<b>EXPRESS 3500 (cont'd.)</b>			
4.8L V8 294 CID	2005-2008	with 2 electrical connectors, with 55 gallon fuel tank	<b>USEP3681M</b>	5.7L V8 350 CID	2000-2002	(R), GAS, Naturally Aspirated, Standard Passenger Van; (Exc.Fitting for Fuel Line), (Federal)	<b>USEP3966M</b>
4.8L V8 294 CID	2006	Base; (V), Extended Cargo Van, GAS, Naturally Aspirated	<b>USEP12006M</b>	5.7L V8 350 CID	2001-2002	(R), Cutaway Van, GAS, Naturally Aspirated; (Federal) (35 Gallon Fuel Tank)	<b>USEP3551M</b>
4.8L V8 294 CID	2006-2007	Base; (V), Cutaway Van, GAS, Naturally Aspirated; (Exc.55 Gallon Fuel Tank)	<b>USEP3583M</b>	5.7L V8 350 CID	2001-2002	MEX; (35 Gallon Fuel Tank)	<b>USEP3551M</b>
4.8L V8 294 CID	2007		<b>USEP12006M</b>	5.7L V8 350 CID	2001-2002	(R), Cutaway Van, GAS, Naturally Aspirated; (Calif) (35 Gallon Fuel Tank)	<b>USEP3568M</b>
4.8L V8 294 CID	2008	Base; (C), Cutaway Van, GAS, Naturally Aspirated; (Exc.55 Gallon Fuel Tank)	<b>USEP3583M</b>	5.7L V8 350 CID	2001-2002		<b>USEP3676M</b>
4.8L V8 294 CID	2008	Base; (C), GAS, Naturally Aspirated, Standard Cargo Van	<b>USEP12006M</b>	5.7L V8 350 CID	2002	(R), BI-FUEL, Cutaway Van, Naturally Aspirated; (Federal) (35 Gallon Fuel Tank)	<b>USEP3551M</b>
4.8L V8 294 CID	2009		<b>USEP3820M</b>	5.7L V8 350 CID	2002	(R), BI-FUEL, Cutaway Van, Naturally Aspirated; (55 Gallon Fuel Tank), (Exc.Fitting for Fuel Line)	<b>USEP3966M</b>
4.8L V8 294 CID	2010-2015	FLEX; Exc.Cutaway Chassis, Exc.Left Side Rear Hinged Door	<b>USEP4049M</b>	5.7L V8 350 CID	2002	(R), BI-FUEL, Cutaway Van, Naturally Aspirated; (Calif) (35 Gallon Fuel Tank)	<b>USEP3966M</b>
4.8L V8 294 CID	2013-2015	FLEX; Exc.Left Side Rear Hinged Door	<b>USEP4049M</b>	5.7L V8 350 CID	2002	(R), BI-FUEL, Extended Cargo Van, Naturally Aspirated; (Exc.Fitting for Fuel Line), (Federal)	<b>USEP3966M</b>
4.8L V8 294 CID	2016	Exc.Left Side Rear Hinged Door	<b>USEP4049M</b>	5.7L V8 350 CID	2002	(R), BI-FUEL, Extended Passenger Van, Naturally Aspirated; (Exc.Fitting for Fuel Line), (Federal)	<b>USEP3966M</b>
5.7L V8 350 CID	1996	(R), GAS, Naturally Aspirated; 31 Gallon Fuel Tank	<b>USEP3927M</b>	5.7L V8 350 CID	2002	(R), BI-FUEL, Extended Passenger Van, Naturally Aspirated; (Exc.Fitting for Fuel Line), (Federal)	<b>USEP3966M</b>
5.7L V8 350 CID	1996	(R), GAS, Naturally Aspirated; 55 Gallon Fuel Tank	<b>USEP3928M</b>	5.7L V8 350 CID	2002	(R), BI-FUEL, Naturally Aspirated, Standard Cargo Van; (Exc.Fitting for Fuel Line), (Federal)	<b>USEP3966M</b>
5.7L V8 350 CID	1997	(R), Cutaway Van, GAS, Naturally Aspirated; (55 Gallon Fuel Tank), (Exc.Fitting for Fuel Line)	<b>USEP3966M</b>	5.7L V8 350 CID	2002	(R), BI-FUEL, Naturally Aspirated, Standard Passenger Van; (Exc.Fitting for Fuel Line), (Federal)	<b>USEP3966M</b>
5.7L V8 350 CID	1997	(R), Extended Cargo Van, GAS, Naturally Aspirated; (Exc.Fitting for Fuel Line)	<b>USEP3966M</b>	5.7L V8 350 CID	2002	(R), BI-FUEL, Cutaway Van, Naturally Aspirated; (Calif) (55 Gallon Fuel Tank), (Exc.Fitting for Fuel Line)	<b>USEP3971M</b>
5.7L V8 350 CID	1997	(R), Extended Passenger Van, GAS, Naturally Aspirated; (Exc.Fitting for Fuel Line)	<b>USEP3966M</b>	5.7L V8 350 CID	2002	(R), BI-FUEL, Extended Cargo Van, Naturally Aspirated; (Calif)	<b>USEP3971M</b>
5.7L V8 350 CID	1997	(R), GAS, Naturally Aspirated, Standard Cargo Van; (Exc.Fitting for Fuel Line)	<b>USEP3966M</b>	5.7L V8 350 CID	2002	(R), BI-FUEL, Extended Cargo Van, Naturally Aspirated; (Calif)	<b>USEP3971M</b>
5.7L V8 350 CID	1997	(R), GAS, Naturally Aspirated, Standard Passenger Van; (Exc.Fitting for Fuel Line)	<b>USEP3966M</b>	5.7L V8 350 CID	2002	(R), BI-FUEL, Extended Passenger Van, Naturally Aspirated; (Calif)	<b>USEP3971M</b>
5.7L V8 350 CID	1997	(R), Cutaway Van, GAS, Naturally Aspirated; (35 Gallon Fuel Tank)	<b>USEP3995M</b>	5.7L V8 350 CID	2002	(R), BI-FUEL, Extended Passenger Van, Naturally Aspirated; (Calif), (Exc.Fitting for Fuel Line)	<b>USEP3971M</b>
5.7L V8 350 CID	1997-2002	with 1 electrical connector	<b>USEP3760M</b>	5.7L V8 350 CID	2002	(R), BI-FUEL, Naturally Aspirated, Standard Cargo Van; (Calif)	<b>USEP3971M</b>
5.7L V8 350 CID	1998-1999	(R), Cutaway Van, GAS, Naturally Aspirated; (Calif) (35 Gallon Fuel Tank), (Exc.Fitting for Fuel Line)	<b>USEP3511M</b>	5.7L V8 350 CID	2002	(R), BI-FUEL, Naturally Aspirated, Standard Cargo Van; (Calif), (Exc.Fitting for Fuel Line)	<b>USEP3971M</b>
5.7L V8 350 CID	1998-1999	(R), Cutaway Van, GAS, Naturally Aspirated; (Exc.Calif) (55 Gallon Fuel Tank), (Exc.Fitting for Fuel Line)	<b>USEP3966M</b>	5.7L V8 350 CID	2002	(R), BI-FUEL, Naturally Aspirated, Standard Passenger Van; (Calif)	<b>USEP3971M</b>
5.7L V8 350 CID	1998-1999	(R), Extended Cargo Van, GAS, Naturally Aspirated; (Exc.Calif), (Exc.Fitting for Fuel Line)	<b>USEP3966M</b>	5.7L V8 350 CID	2002	(R), BI-FUEL, Naturally Aspirated, Standard Passenger Van; (Calif), (Exc.Fitting for Fuel Line)	<b>USEP3971M</b>
5.7L V8 350 CID	1998-1999	(R), Extended Passenger Van, GAS, Naturally Aspirated; (Exc.Calif), (Exc.Fitting for Fuel Line)	<b>USEP3966M</b>	5.7L V8 350 CID	2002	(R), Extended Cargo Van, GAS, Naturally Aspirated; (Calif)	<b>USEP3971M</b>
5.7L V8 350 CID	1998-1999	(R), GAS, Naturally Aspirated, Standard Cargo Van; (Exc.Calif), (Exc.Fitting for Fuel Line)	<b>USEP3966M</b>	5.7L V8 350 CID	2002	(R), Extended Passenger Van, GAS, Naturally Aspirated; (Calif)	<b>USEP3971M</b>
5.7L V8 350 CID	1998-1999	(R), GAS, Naturally Aspirated, Standard Passenger Van; (Exc.Calif), (Exc.Fitting for Fuel Line)	<b>USEP3966M</b>	5.7L V8 350 CID	2002	(R), GAS, Naturally Aspirated, Standard Cargo Van; (Calif)	<b>USEP3971M</b>
5.7L V8 350 CID	1998-1999	(R), Cutaway Van, GAS, Naturally Aspirated; (Exc.Calif) (35 Gallon Fuel Tank), (Exc.Fitting for Fuel Line)	<b>USEP3996M</b>	5.7L V8 350 CID	2002	(R), GAS, Naturally Aspirated, Standard Passenger Van; (Calif)	<b>USEP3971M</b>
5.7L V8 350 CID	1998-2002	with Fitting for Auxiliary power unit	<b>USEP3573M</b>	6.0L V8 596cc 364 CID	2004	2 electrical connector, 55 gal tank with 1 electrical connector, with 55 gallon fuel tank	<b>USEP3682M</b>
5.7L V8 350 CID	1998-2002	with 2 electrical connectors	<b>USEP3759M</b>	6.0L V8 596cc 364 CID	2004		<b>USEP3682M</b>
5.7L V8 350 CID	1998-2002	(R), Cutaway Van, GAS, Naturally Aspirated; (Calif) (55 Gallon Fuel Tank), (Exc.Fitting for Fuel Line)	<b>USEP3971M</b>	6.0L V8 596cc 364 CID	2004-2005	with 1 electrical connector	<b>USEP3580M</b>
5.7L V8 350 CID	1998-2002	(R), Extended Cargo Van, GAS, Naturally Aspirated; (Calif), (Exc.Fitting for Fuel Line)	<b>USEP3971M</b>	6.0L V8 596cc 364 CID	2004-2008	Standard Passenger Van	<b>USEP3678M</b>
5.7L V8 350 CID	1998-2002	(R), Extended Passenger Van, GAS, Naturally Aspirated; (Calif), (Exc.Fitting for Fuel Line)	<b>USEP3971M</b>	6.0L V8 596cc 364 CID	2004-2008	with 2 electrical connectors, with 55 gallon fuel tank	<b>USEP3681M</b>
5.7L V8 350 CID	1998-2002	(R), GAS, Naturally Aspirated, Standard Cargo Van; (Calif), (Exc.Fitting for Fuel Line)	<b>USEP3971M</b>	6.0L V8 596cc 364 CID	2005	Cutaway Van; 1 CONNECTOR, 55 GALLON TANK	<b>USEP3682M</b>
5.7L V8 350 CID	1998-2002	(R), Extended Passenger Van, GAS, Naturally Aspirated; (Calif), (Exc.Fitting for Fuel Line)	<b>USEP3971M</b>	6.0L V8 596cc 364 CID	2006	LT; (U), GAS, Naturally Aspirated Base; (U), Cutaway Van, GAS, Naturally Aspirated; (Exc.55 Gallon Fuel Tank)	<b>USEP12006M</b>
5.7L V8 350 CID	1998-2002	(R), GAS, Naturally Aspirated, Standard Cargo Van; (Calif), (Exc.Fitting for Fuel Line)	<b>USEP3971M</b>	6.0L V8 596cc 364 CID	2006-2007		<b>USEP3583M</b>
5.7L V8 350 CID	1998-2002	(R), GAS, Naturally Aspirated, Standard Passenger Van; (Calif), (Exc.Fitting for Fuel Line)	<b>USEP3971M</b>	6.0L V8 596cc 364 CID	2007	Base; (U), Extended Cargo Van, GAS, Naturally Aspirated	<b>USEP12006M</b>
5.7L V8 350 CID	1998-2002	(R), GAS, Naturally Aspirated, Standard Passenger Van; (Calif), (Exc.Fitting for Fuel Line)	<b>USEP3971M</b>	6.0L V8 596cc 364 CID	2008	Base; (K), Cutaway Van, GAS, Naturally Aspirated; (Exc.55 Gallon Fuel Tank)	<b>USEP3583M</b>
5.7L V8 350 CID	1999-2002	MEX; with 1 electrical connector	<b>USEP3966M</b>	6.0L V8 596cc 364 CID	2008	LT; (K), GAS, Naturally Aspirated	<b>USEP12006M</b>
5.7L V8 350 CID	1999-2002	MEX; with 2 electrical connectors	<b>USEP3971M</b>	6.0L V8 596cc 364 CID	2009		<b>USEP3820M</b>
5.7L V8 350 CID	2000	(R), Cutaway Van, GAS, Naturally Aspirated; (Exc.Fitting for Fuel Line), (Federal) (35 Gallon Fuel Tank)	<b>USEP3996M</b>	6.0L V8 596cc 364 CID	2010-2015	FLEX; Exc.Cutaway Chassis, Exc.Left Side Rear Hinged Door	<b>USEP4049M</b>
5.7L V8 350 CID	2000-2002	(R), Cutaway Van, GAS, Naturally Aspirated; (55 Gallon Fuel Tank), (Exc.Fitting for Fuel Line)	<b>USEP3966M</b>	6.0L V8 596cc 364 CID	2010-2015	FLEX; Exc.Left Side Rear Hinged Door	<b>USEP4049M</b>
5.7L V8 350 CID	2000-2002	(R), Extended Cargo Van, GAS, Naturally Aspirated; (Exc.Fitting for Fuel Line), (Federal)	<b>USEP3966M</b>	6.0L V8 596cc 364 CID	2016	Exc.Left Side Rear Hinged Door	<b>USEP4049M</b>
5.7L V8 350 CID	2000-2002	(R), Extended Passenger Van, GAS, Naturally Aspirated; (Exc.Fitting for Fuel Line), (Federal)	<b>USEP3966M</b>	6.6L V8 6599cc 403 CID	2016	Exc.Left Side Rear Hinged Door	<b>USEP4049M</b>
5.7L V8 350 CID	2000-2002	(R), Extended Passenger Van, GAS, Naturally Aspirated; (Exc.Fitting for Fuel Line), (Federal)	<b>USEP3966M</b>	7.4L V8 454 CID	1996		<b>USEP3926M</b>
5.7L V8 350 CID	2000-2002	(R), Extended Passenger Van, GAS, Naturally Aspirated; (Exc.Fitting for Fuel Line), (Federal)	<b>USEP3966M</b>	7.4L V8 454 CID	1996	(J), GAS, Naturally Aspirated; 31 Gallon Fuel Tank	<b>USEP3927M</b>
5.7L V8 350 CID	2000-2002	(R), GAS, Naturally Aspirated, Standard Cargo Van; (Exc.Fitting for Fuel Line), (Federal)	<b>USEP3966M</b>	7.4L V8 454 CID	1996	(J), GAS, Naturally Aspirated; 55 Gallon Fuel Tank	<b>USEP3928M</b>
5.7L V8 350 CID	2000-2002	(R), GAS, Naturally Aspirated, Standard Cargo Van; (Exc.Fitting for Fuel Line), (Federal)	<b>USEP3966M</b>	7.4L V8 454 CID	1997	(J), Cutaway Van, GAS, Naturally Aspirated; (55 Gallon Fuel Tank), (Exc.Fitting for Fuel Line)	<b>USEP3966M</b>





# FUEL PUMP MODULES APPLICATION GUIDE



FUEL PUMP MODULES

Engine	Years	Application Description	USMW
<b>CHEVROLET (cont'd.)</b>			
<b>EXPRESS 3500 (cont'd.)</b>			
7.4L V8 454 CID	1997	(J), Extended Cargo Van, GAS, Naturally Aspirated; (Exc.Fitting for Fuel Line)	USEP3966M
7.4L V8 454 CID	1997	(J), Extended Passenger Van, GAS, Naturally Aspirated; (Exc.Fitting for Fuel Line)	USEP3966M
7.4L V8 454 CID	1997	(J), GAS, Naturally Aspirated, Standard Cargo Van; (Exc.Fitting for Fuel Line)	USEP3966M
7.4L V8 454 CID	1997	(J), GAS, Naturally Aspirated, Standard Passenger Van; (Exc.Fitting for Fuel Line)	USEP3966M
7.4L V8 454 CID	1997	(J), Cutaway Van, GAS, Naturally Aspirated; (35 Gallon Fuel Tank)	USEP3995M
7.4L V8 454 CID	1997-1998	with 1 electrical connector	USEP3760M
7.4L V8 454 CID	1998	(J), Cutaway Van, GAS, Naturally Aspirated; (Calif) (35 Gallon Fuel Tank), (Exc.Fitting for Fuel Line)	USEP3511M
7.4L V8 454 CID	1998	with Fitting for Auxiliary power unit	USEP3573M
7.4L V8 454 CID	1998	with 2 electrical connectors	USEP3759M
7.4L V8 454 CID	1998	(J), Cutaway Van, GAS, Naturally Aspirated; (Exc.Calif) (55 Gallon Fuel Tank), (Exc.Fitting for Fuel Line)	USEP3966M
7.4L V8 454 CID	1998	(J), Extended Cargo Van, GAS, Naturally Aspirated; (Exc.Calif), (Exc.Fitting for Fuel Line)	USEP3966M
7.4L V8 454 CID	1998	(J), Extended Passenger Van, GAS, Naturally Aspirated; (Exc.Calif), (Exc.Fitting for Fuel Line)	USEP3966M
7.4L V8 454 CID	1998	(J), GAS, Naturally Aspirated, Standard Cargo Van; (Exc.Calif), (Exc.Fitting for Fuel Line)	USEP3966M
7.4L V8 454 CID	1998	(J), GAS, Naturally Aspirated, Standard Passenger Van; (Exc.Calif), (Exc.Fitting for Fuel Line)	USEP3966M
7.4L V8 454 CID	1998	(J), Cutaway Van, GAS, Naturally Aspirated; (Calif) (55 Gallon Fuel Tank), (Exc.Fitting for Fuel Line)	USEP3971M
7.4L V8 454 CID	1998	(J), Extended Cargo Van, GAS, Naturally Aspirated; (Calif), (Exc.Fitting for Fuel Line)	USEP3971M
7.4L V8 454 CID	1998	(J), Extended Passenger Van, GAS, Naturally Aspirated; (Calif), (Exc.Fitting for Fuel Line)	USEP3971M
7.4L V8 454 CID	1998	(J), GAS, Naturally Aspirated, Standard Cargo Van; (Calif), (Exc.Fitting for Fuel Line)	USEP3971M
7.4L V8 454 CID	1998	(J), GAS, Naturally Aspirated, Standard Passenger Van; (Calif), (Exc.Fitting for Fuel Line)	USEP3971M
7.4L V8 454 CID	1998	(J), Cutaway Van, GAS, Naturally Aspirated; (Exc.Calif) (35 Gallon Fuel Tank), (Exc.Fitting for Fuel Line)	USEP3996M
<b>HHR</b>			
2.0L L4 1998cc 122 CID	2008	SS; (X), Turbocharged	USEP3715M
2.2L L4 2198cc 134 CID	2006-2007	LS, LT; (D)	USEP3715M
2.2L L4 2198cc 134 CID	2008	LS, LS Panel, LT, LT Panel; (D), Naturally Aspirated	USEP3715M
2.2L L4 2198cc 134 CID	2010-2011		USEP3806M
2.4L L4 2384cc 145 CID	2006-2007	LT; (P)	USEP3715M
2.4L L4 2384cc 145 CID	2008	LT, LT Panel; (P), Naturally Aspirated	USEP3715M
2.4L L4 2384cc 145 CID	2010-2011		USEP3806M
<b>IMPALA</b>			
3.4L V6 207 CID	2000-2003		USEP3542M
3.4L V6 207 CID	2004-2005	Naturally Aspirated	USEP3542M
3.5L V6 3490cc 213 CID	2006		USEP3712M
3.5L V6 3490cc 213 CID	2007-2008	GAS; with 2 electrical connectors	USEP3792M
3.5L V6 3490cc 213 CID	2007-2008	GAS; with 1 electrical connector	USEP3824M
3.5L V6 3490cc 213 CID	2007-2008	FLEX	USEP3830M
3.5L V6 3490cc 213 CID	2008-2010	1 ELECTRICAL CONNECTOR, PZEV, WITH 2 PORTS	USEP3749M
3.8L V6 3791cc 231 CID	2000-2003	MEX	USEP3542M
3.8L V6 3800cc 231 CID	2000-2003		USEP3542M
3.8L V6 3800cc 231 CID	2004-2005	Naturally Aspirated	USEP3542M
3.8L V6 3800cc 231 CID	2004-2005	SS; (1), Supercharged	USEP3601M
3.9L V6 3880cc 237 CID	2007	with 2 electrical connectors	USEP3792M
5.3L V8 5328cc 325 CID	2006		USEP3700M
<b>K1500</b>			
4.3L V6 262 CID	1988-1989	Cheyenne, Scottsdale, Silverado	USEP3621S
4.3L V6 262 CID	1990	Cheyenne, Scottsdale, Silverado, WT	USEP3621S
4.3L V6 262 CID	1991	Cheyenne, Silverado, Sport, WT	USEP3621S
4.3L V6 262 CID	1992-1993	Cheyenne, Silverado, WT	USEP3621S
4.3L V6 262 CID	1994-1995	Base, Cheyenne, Silverado, WT	USEP3621S
4.3L V6 262 CID	1996	Base, Cheyenne, Silverado, WT	USEP3622S
4.3L V6 262 CID	1997-1998	Radio Frequency Interference Filter (Module Stamped GDJ,GFK)	USEP3947M
5.0L V8 305 CID	1988-1989	Cheyenne, Scottsdale, Silverado	USEP3621S
5.0L V8 305 CID	1990	Cheyenne, Scottsdale, Silverado, WT	USEP3621S
5.0L V8 305 CID	1991	Cheyenne, Silverado, Sport, WT	USEP3621S
5.0L V8 305 CID	1992-1993	Cheyenne, Silverado, WT	USEP3621S
5.0L V8 305 CID	1994-1995	Base, Cheyenne, Silverado, WT	USEP3621S
5.0L V8 305 CID	1996-1997	Base, Cheyenne, Silverado, WT	USEP3622S

Engine	Years	Application Description	USMW
<b>CHEVROLET (cont'd.)</b>			
<b>K1500 (cont'd.)</b>			
5.0L V8 305 CID	1998-1999	Radio Frequency Interference Filter (Module Stamped GDJ,GFK)	USEP3947M
5.7L V8 350 CID	1988-1989	Cheyenne, Scottsdale, Silverado	USEP3621S
5.7L V8 350 CID	1990	Cheyenne, Scottsdale, Silverado, WT	USEP3621S
5.7L V8 350 CID	1991	Cheyenne, Silverado, Sport, WT	USEP3621S
5.7L V8 350 CID	1992-1993	Cheyenne, Silverado, WT	USEP3621S
5.7L V8 350 CID	1994-1995	Base, Cheyenne, Silverado, WT	USEP3621S
5.7L V8 350 CID	1996-1997	Base, Cheyenne, Silverado, WT	USEP3622S
5.7L V8 350 CID	1998	Exc.Radio Frequency Interference Filter (Module Stamped GAV)	USEP3947M
5.7L V8 350 CID	1999	Radio Frequency Interference Filter (Module Stamped GDJ,GFK)	USEP3947M
<b>K1500 SUBURBAN</b>			
5.7L V8 350 CID	1998-1999	(R), GAS, Naturally Aspirated	USEP3967M
<b>K2500</b>			
4.3L V6 262 CID	1988-1990	Cheyenne, Scottsdale, Silverado	USEP3621S
4.3L V6 262 CID	1991-1993	Cheyenne, Silverado	USEP3621S
4.3L V6 262 CID	1994-1995	Base, Cheyenne, Silverado, WT	USEP3621S
5.0L V8 305 CID	1988-1990	Cheyenne, Scottsdale, Silverado	USEP3621S
5.0L V8 305 CID	1991-1993	Cheyenne, Silverado	USEP3621S
5.0L V8 305 CID	1994-1995	Base, Cheyenne, Silverado, WT	USEP3621S
5.0L V8 305 CID	1998	Exc.Radio Frequency Interference Filter (Module Stamped GAV)	USEP3947M
5.7L V8 350 CID	1988-1990	Cheyenne, Scottsdale, Silverado	USEP3621S
5.7L V8 350 CID	1991-1993	Cheyenne, Silverado	USEP3621S
5.7L V8 350 CID	1994-1995	Base, Cheyenne, Silverado, WT	USEP3621S
5.7L V8 350 CID	1998	Exc.Radio Frequency Interference Filter (Module Stamped GAV)	USEP3947M
5.7L V8 350 CID	1998-1999	(R), GAS, Naturally Aspirated; Exc.Radio Frequency Interference Filter (Module Stamped GFT)	USEP3962M
5.7L V8 350 CID	1999	Radio Frequency Interference Filter (Module Stamped GDJ,GFK)	USEP3947M
5.7L V8 350 CID	2000	Radio Frequency Interference Filter (R), GAS, Naturally Aspirated; Exc.Calif (Exc.Radio Frequency Interference Filter)	USEP3947M
5.7L V8 350 CID	2000	Cheyenne, Silverado	USEP3621S
7.4L V8 454 CID	1991-1993		USEP3621S
7.4L V8 454 CID	1994-1995		USEP3623S
7.4L V8 454 CID	1998-1999	Radio Frequency Interference Filter (Module Stamped GDJ,GFK)	USEP3947M
7.4L V8 454 CID	1998-1999	Exc.Radio Frequency Interference Filter (Module Stamped GFT)	USEP3962M
7.4L V8 454 CID	2000	Calif (Exc.Radio Frequency Interference Filter)	USEP3947M
7.4L V8 454 CID	2000	(J), GAS, Naturally Aspirated; Exc.Calif (Exc.Radio Frequency Interference Filter)	USEP3962M
<b>K2500 SUBURBAN</b>			
5.7L V8 350 CID	1998-1999	(R), GAS, Naturally Aspirated; Calif	USEP3967M
5.7L V8 350 CID	1998-1999	(R), GAS, Naturally Aspirated; Exc.Calif	USEP3994M
7.4L V8 454 CID	1998-1999	(J), GAS, Naturally Aspirated; Calif	USEP3967M
7.4L V8 454 CID	1998-1999	(J), GAS, Naturally Aspirated; Exc.Calif	USEP3994M
<b>K3500</b>			
5.7L V8 350 CID	1988-1990	Cheyenne, Scottsdale, Silverado	USEP3621S
5.7L V8 350 CID	1991-1993	Cheyenne, Silverado	USEP3621S
5.7L V8 350 CID	1994-1995	Base, Cheyenne, Silverado	USEP3621S
5.7L V8 350 CID	1996-1997	Base, Cheyenne, Silverado	USEP3622S
5.7L V8 350 CID	1998	Radio Frequency Interference Filter (Module Stamped GDJ,GFK)	USEP3947M
5.7L V8 350 CID	1998-1999	(R), GAS, Naturally Aspirated; Exc.Radio Frequency Interference Filter (Module Stamped GFR)	USEP3957M
5.7L V8 350 CID	1998-1999	(R), GAS, Naturally Aspirated; Radio Frequency Interference Filter (Module Stamped GFS)	USEP3957M
5.7L V8 350 CID	1998-1999	(R), GAS, Naturally Aspirated; Exc.Radio Frequency Interference Filter (Module Stamped GFT)	USEP3962M
5.7L V8 350 CID	1999	Exc.Radio Frequency Interference Filter (Module Stamped GAV)	USEP3947M
5.7L V8 350 CID	2000	(Calif)	USEP3947M
5.7L V8 350 CID	2000	(R), Cab & Chassis, GAS, Naturally Aspirated; (Exc.Calif)	USEP3956M
5.7L V8 350 CID	2000	(R), Cab & Chassis, GAS, Naturally Aspirated; (Calif)	USEP3957M
5.7L V8 350 CID	2000	(R), Crew Cab Pickup, GAS, Naturally Aspirated; (Exc.Calif)	USEP3962M
5.7L V8 350 CID	2000	(R), Extended Cab Pickup, GAS, Naturally Aspirated; (Exc.Calif)	USEP3962M
5.7L V8 350 CID	2000	(R), GAS, Naturally Aspirated, Standard Cab Pickup; (Exc.Calif)	USEP3962M
7.4L V8 454 CID	1988-1990	Cheyenne, Scottsdale, Silverado	USEP3621S
7.4L V8 454 CID	1991-1993	Cheyenne, Silverado	USEP3621S
7.4L V8 454 CID	1994-1995		USEP3623S
7.4L V8 454 CID	1996-1997	Base, Cheyenne, Silverado	USEP3622S

Engine	Years	Application Description	USMW	Engine	Years	Application Description	USMW
<b>CHEVROLET (cont'd.)</b>				<b>CHEVROLET (cont'd.)</b>			
<b>K3500 (cont'd.)</b>				<b>R10</b>			
7.4L V8 454 CID	1998-1999	(J), GAS, Naturally Aspirated; Radio Frequency Interference Filter (Module Stamped GFP)	USEP3956M	5.7L V8 350 CID	1987	auxiliary tank	USEP3630S
<b>LUMINA</b>				5.7L V8 350 CID	1987	harness code VEE or VEV	USEP3631S
3.1L V6 189 CID	1997	Base, LS, LTZ; (M)	USEP3514M	5.7L V8 350 CID	1987	with 31 gallon tank	USEP3633S
3.1L V6 189 CID	1998	LS, LTZ; (M)	USEP3941M	<b>R10 SUBURBAN</b>			
3.1L V6 189 CID	1999	(M); Refuel Vapor Recovery	USEP3529M	5.7L V8 350 CID	1987-1988	with 31 gallon tank	USEP3633S
3.1L V6 189 CID	1999	(M); Exc.Refuel Vapor Recovery	USEP3941M	5.7L V8 350 CID	1987-1988	with 40 gallon tank	USEP3634S
3.4L V6 207 CID	1997	LTZ; (X)	USEP3942M	<b>R20</b>			
3.8L V6 3800cc 231 CID	1998	LTZ; (K)	USEP3948M	4.3L V6 262 CID	1987	harness code VEE or VEV	USEP3631S
3.8L V6 3800cc 231 CID	1999	(K)	USEP3941M	5.7L V8 350 CID	1987-1988	with 31 gallon tank	USEP3633S
<b>LUMINA APV</b>				<b>R20 SUBURBAN</b>			
3.8L V6 3800cc 231 CID	1992-1994		USEP3649S	5.7L V8 350 CID	1987-1988	with 31 gallon tank	USEP3633S
<b>LUV</b>				5.7L V8 350 CID	1988	harness code VEE or VEV	USEP3631S
2.2L L4 2198cc 134 CID	1998-2005	MEX	USEP3943M	<b>R1500 SUBURBAN</b>			
<b>MALIBU</b>				5.7L V8 350 CID	1989	harness code VEE or VEV	USEP3631S
2.2L L4 2198cc 134 CID	2004-2006		USEP3592M	7.4L V8 454 CID	1989	with 31 gallon tank	USEP3633S
2.2L L4 2198cc 134 CID	2007-2008		USEP3755M	<b>R2500 SUBURBAN</b>			
2.4L L4 2384cc 145 CID	2008	ELECTRIC/GAS	USEP3591M	5.7L V8 350 CID	1989	harness code VEE or VEV	USEP3631S
2.4L L4 2384cc 145 CID	2008	LS, LT, LTZ; GAS	USEP3591M	5.7L V8 350 CID	1989-1991	with 31 gallon tank	USEP3633S
2.4L L4 2384cc 145 CID	2009		USEP3812M	<b>S10</b>			
2.4L L4 2384cc 145 CID	2010		USEP3801M		2004		USEP3566M
2.4L L4 2384cc 145 CID	2011-2012		USEP4050M	2.2L L4 2190cc 134 CID	1994-1995		USEP3641S
2.4L L4 2392cc 146 CID	1999	(T)	USEP3950M	2.2L L4 2190cc 134 CID	1996		USEP3923M
2.5L L4 2457cc 153 CID	2013		USEP4045M	2.2L L4 2190cc 134 CID	1997-2000	(4), FI, GAS, Naturally Aspirated	USEP3943M
2.5L L4 2457cc 153 CID	2015		USEP4045M	2.000	2000	(5), FI, FLEX, Naturally Aspirated	USEP3527M
3.1L V6 189 CID	1999	(J)	USEP3950M	2.2L L4 2190cc 134 CID	2001-2002	(5), FLEX	USEP3527M
3.1L V6 189 CID	1999	(M)	USEP3950M	2.2L L4 2190cc 134 CID	2003	(H)	USEP3703M
3.1L V6 189 CID	2000-2003		USEP3507M	2.5L L4 2474cc 151 CID	1985-1986	Base, Durango, Sport, Tahoe	USEP3637S
3.1L V6 3136cc 191 CID	1999	MEX	USEP3507M	2.5L L4 2474cc 151 CID	1987	Base, Sport, Tahoe	USEP3637S
3.5L V6 213 CID	2004	Maxx, Maxx LS, Maxx LT	USEP3591M	2.5L L4 2474cc 151 CID	1988-1989	Base, Durango, Sport, Tahoe	USEP3637S
3.5L V6 213 CID	2004-2006	LS, LT	USEP3592M	2.5L L4 2474cc 151 CID	1990	Base, Durango, Tahoe	USEP3637S
3.5L V6 213 CID	2005	Maxx LS, Maxx LT	USEP3591M	2.5L L4 2474cc 151 CID	1991	Baja, Base, Tahoe	USEP3637S
3.5L V6 213 CID	2006	Maxx LS, Maxx LT, Maxx LTZ	USEP3591M	2.5L L4 2474cc 151 CID	1992-1993	20 gallon fuel tank	USEP3642S
3.5L V6 3490cc 213 CID	2007	Maxx LS, Maxx LT, Maxx LTZ	USEP3591M	2.5L L4 2474cc 151 CID	1992-1993	13 Gallon Fuel Tank	USEP3648S
3.5L V6 3490cc 213 CID	2007	LS, LT, LTZ	USEP3755M	2.8L V6 173 CID	1986	Base, Durango, Sport, Tahoe	USEP3637S
3.5L V6 3490cc 213 CID	2008	LS	USEP3591M	2.8L V6 173 CID	1987	Base, Sport, Tahoe	USEP3637S
3.5L V6 3490cc 213 CID	2008	Classic LS, Classic LT	USEP3755M	2.8L V6 173 CID	1988	Base, Durango, Sport, Tahoe	USEP3637S
3.5L V6 3490cc 213 CID	2009		USEP3812M	2.8L V6 173 CID	1990	Base, Durango, Tahoe	USEP3637S
3.5L V6 3490cc 213 CID	2010		USEP3801M	2.8L V6 173 CID	1991	Baja, Base, Tahoe	USEP3637S
3.6L V6 3564cc 217 CID	2008		USEP3591M	2.8L V6 173 CID	1992-1993	20 gallon fuel tank	USEP3642S
3.6L V6 3564cc 217 CID	2009		USEP3812M	2.8L V6 173 CID	1992-1993	13 Gallon Fuel Tank	USEP3648S
3.9L V6 3880cc 237 CID	2006	SS	USEP3592M	4.3L V6 262 CID	1989	Base, Durango, Sport, Tahoe	USEP3637S
3.9L V6 3880cc 237 CID	2006-2007	Maxx SS	USEP3591M	4.3L V6 262 CID	1990	Base, Durango, Tahoe	USEP3637S
3.9L V6 3880cc 237 CID	2007	SS	USEP3755M	4.3L V6 262 CID	1991	Baja, Base, Tahoe	USEP3637S
<b>MONTE CARLO</b>				4.3L V6 262 CID	1992-1993	20 gallon fuel tank	USEP3642S
3.1L V6 189 CID	1997-1998	LS; (M)	USEP3941M	4.3L V6 262 CID	1995	MFI	USEP3643S
3.1L V6 189 CID	1999	LS; (M); Refuel Vapor Recovery	USEP3529M	4.3L V6 262 CID	1996	ZR2; (W)	USEP3920M
3.1L V6 189 CID	1999	LS; (M); Exc.Refuel Vapor Recovery	USEP3941M	4.3L V6 262 CID	1996	ZR2; (X)	USEP3920M
3.4L V6 207 CID	1997	Z34; (X)	USEP3942M	4.3L V6 262 CID	1997-1999	(X), FI, GAS, Naturally Aspirated	USEP3952M
3.4L V6 207 CID	2000-2003		USEP3542M	4.3L V6 262 CID	1997-2000	(W), FI, GAS, Naturally Aspirated	USEP3952M
3.4L V6 207 CID	2004-2005	Naturally Aspirated	USEP3542M	4.3L V6 262 CID	2001	(W), GAS	USEP3952M
3.5L V6 3490cc 213 CID	2006		USEP3712M	4.3L V6 262 CID	2002	(W), 108.3 / 275.1 Wheel Base, GAS, Standard Cab Pickup	USEP3563M
3.5L V6 3490cc 213 CID	2007	GAS; with 2 electrical connectors	USEP3792M	4.3L V6 262 CID	2002	(W), Extended Cab Pickup, GAS	USEP3563M
3.5L V6 3490cc 213 CID	2007	GAS; with 1 electrical connector	USEP3824M	4.3L V6 262 CID	2002	(W), 117.9 / 299.5 Wheel Base, GAS, Standard Cab Pickup	USEP3952M
3.5L V6 3490cc 213 CID	2007	FLEX	USEP3830M	4.3L V6 262 CID	2002	(W), 122.9 / 312.2 Wheel Base, GAS, Standard Cab Pickup	USEP3952M
3.8L V6 3800cc 231 CID	1998	Z34; (K)	USEP3948M	4.3L V6 262 CID	2002	(W), Crew Cab Pickup, GAS	USEP3952M
3.8L V6 3800cc 231 CID	1999	(K)	USEP3941M	4.3L V6 262 CID	2003	(X), Extended Cab Pickup	USEP3563M
3.8L V6 3800cc 231 CID	2000-2003		USEP3542M	4.3L V6 262 CID	2003	(X), Standard Cab Pickup	USEP3563M
3.8L V6 3800cc 231 CID	2004-2005	Naturally Aspirated	USEP3542M	4.3L V6 262 CID	2003	(X), Crew Cab Pickup	USEP3566M
3.8L V6 3800cc 231 CID	2004-2005	SS; (1), Supercharged	USEP3601M	<b>S10 BLAZER</b>			
5.3L V8 5328cc 325 CID	2006		USEP3700M	2.5L L4 2474cc 151 CID	1985-1986	Base, Sport, Tahoe	USEP3632S
<b>OPTRA</b>				2.5L L4 2474cc 151 CID	1987-1988	Base, High Country, Sport, Tahoe	USEP3632S
2.0L L4 1999cc 122 CID	2006	FI, MEX	USEP12040M	2.8L V6 173 CID	1986-1987	Sport, Tahoe	USEP3632S
<b>P30</b>				4.3L V6 262 CID	1988	Base, High Country, Sport, Tahoe	USEP3632S
4.3L V6 262 CID	1998-1999	exc school bus, with 1 electrical connector	USEP3968M	4.3L V6 262 CID	1989	Base, High Country, Sport	USEP3632S
4.3L V6 4300cc 262 CID	2001	MEX	USEP3966M	4.3L V6 262 CID	1990	Base, Sport, Tahoe	USEP3632S
5.7L V8 350 CID	1998	exc school bus, with 2 electrical connectors	USEP3965M	4.3L V6 262 CID	1991	Base, Tahoe, Tahoe LT	USEP3632S
5.7L V8 350 CID	1998-1999	Exc.School Bus (Exc.Calif), with 1 electrical connector	USEP3968M	4.3L V6 262 CID	1992	Base, Sport, Tahoe, Tahoe LT; Electronic Fuel Control, FI, GAS	USEP3624S
5.7L V8 350 CID	1998-1999	School Bus	USEP3969M	4.3L V6 262 CID	1992	Base, Sport, Tahoe, Tahoe LT; Electronic Fuel Control, FI, GAS	USEP3625S
5.7L V8 350 CID	1999	with 2 electrical connectors	USEP3965M	4.3L V6 262 CID	1992	Base, Tahoe, Tahoe LT; Electronic Fuel Control, FI, GAS	USEP3624S
7.4L V8 454 CID	1998-1999	Exc.80 Gallon Fuel Tank, exc school bus, with 1 electrical connector	USEP3968M	4.3L V6 262 CID	1993	Base, Tahoe, Tahoe LT; Electronic Fuel Control, FI, GAS	USEP3624S
7.4L V8 454 CID	1998-1999	(B), GAS, Naturally Aspirated; 80 Gallon Fuel Tank	USEP3982M	4.3L V6 262 CID	1993	Base, Tahoe, Tahoe LT; Electronic Fuel Control, FI, GAS	USEP3625S
7.4L V8 454 CID	1998-1999	(J), GAS, Naturally Aspirated; 80 Gallon Fuel Tank	USEP3982M	4.3L V6 262 CID	1994	Base, LT, Tahoe, Tahoe LT; Electronic Fuel Control, FI, GAS	USEP3624S
7.4L V8 454 CID	1998-1999		USEP3997M				





# FUEL PUMP MODULES APPLICATION GUIDE



FUEL PUMP MODULES

Engine	Years	Application Description	USMW
<b>CHEVROLET (cont'd.)</b>			
<b>S10 BLAZER (cont'd.)</b>			
4.3L V6 262 CID	1994	Base, LT, Tahoe, Tahoe LT; Electronic Fuel Control, FI, GAS	USEP3625S
<b>SILVERADO</b>			
5.7L V8 350 CID	1995	SLE, SLX	USEP3621S
5.7L V8 350 CID	1996	SLE, SLX	USEP3622S
5.7L V8 350 CID	1997	SLE, SLT, SLX	USEP3622S
<b>SILVERADO 1500</b>			
4.3L V6 262 CID	1999-2003	electrical connections: 2, Evaporative Emissions Control	USEP3500M
4.3L V6 262 CID	1999-2003	electrical connections: 1, Exc.Evaporative Emissions Control	USEP3501M
4.3L V6 262 CID	2002-2003	MEX; electrical connections: 2, TCF	USEP3500M
4.3L V6 262 CID	2002-2003	MEX; electrical connections: 1	USEP3501M
4.3L V6 262 CID	2004		USEP3500M
4.3L V6 262 CID	2005-2006	78.0 / 198.1 Bed, GAS; Bed Length 78.0", In Tank Assy.(Incl.Fuel Tank Sending Unit)	USEP3609M
4.3L V6 262 CID	2005-2006	96.0 / 243.8 Bed	USEP3831M
4.3L V6 262 CID	2005-2006	96.0 / 243.8 Bed, GAS	USEP3831M
4.3L V6 262 CID	2007-2008		USEP3750M
4.3L V6 262 CID	2007-2008	78.7 / 199.9 Bed, GAS, Standard Cab Pickup	USEP3843M
4.3L V6 262 CID	2009-2010	119.0 / 302.3 Wheel Base, Standard Cab Pickup	USEP3777M
4.3L V6 262 CID	2009-2012		USEP3794M
4.3L V6 262 CID	2014-2017	97.8 / 248.4 Bed	usep12357m
4.3L V6 4293cc 262 CID	2013		USEP3794M
4.3L V6 4300cc 262 CID	2010-2013	119.0 / 302.3 Wheel Base, Standard Cab Pickup	USEP3777M
4.3L V6 4300cc 262 CID	2010-2013		USEP3794M
4.8L V8 294 CID	1999-2003	electrical connections: 2, Evaporative Emissions Control	USEP3500M
4.8L V8 294 CID	1999-2003	electrical connections: 1, Exc.Evaporative Emissions Control	USEP3501M
4.8L V8 294 CID	2004	78.0 / 198.1 Bed, Extended Cab Pickup, GAS	USEP3609M
4.8L V8 294 CID	2004-2006	Crew Cab Pickup	USEP3684M
4.8L V8 294 CID	2004-2006	96.0 / 243.8 Bed, GAS	USEP3831M
4.8L V8 294 CID	2005-2006	78.0 / 198.1 Bed, GAS; Bed Length 78.0", In Tank Assy.(Incl.Fuel Tank Sending Unit)	USEP3609M
4.8L V8 294 CID	2005-2006	Crew Cab Pickup; 69.2 bed length	USEP3684M
4.8L V8 294 CID	2007-2008	GAS	USEP3747M
4.8L V8 294 CID	2007-2008	78.7 / 199.9 Bed, Standard Cab Pickup	USEP3752M
4.8L V8 294 CID	2007-2008		USEP3834M
4.8L V8 294 CID	2009	97.6 / 247.9 Bed, Standard Cab Pickup	USEP3815M
4.8L V8 294 CID	2009	Extended Cab Pickup	USEP3817M
4.8L V8 294 CID	2010	78.9 / 200.4 Bed, Extended Cab Pickup	USEP4005M
4.8L V8 294 CID	2010-2011	69.3 / 176.0 Bed, Crew Cab Pickup	USEP4005M
4.8L V8 294 CID	2010-2013	97.8 / 248.4 Bed, Extended Cab Pickup	USEP4008M
4.8L V8 294 CID	2010-2013	97.8 / 248.4 Bed, Standard Cab Pickup	USEP4008M
4.8L V8 294 CID	2010-2013	78.9 / 200.4 Bed, Standard Cab Pickup	USEP4009M
4.8L V8 294 CID	2012-2013	69.3 / 176.0 Bed	USEP4005M
5.3L V8 5328cc 325 CID	1999-2001	2 electrical connectors	USEP3500M
5.3L V8 5328cc 325 CID	1999-2003	with 1 electrical connector	USEP3501M
5.3L V8 5328cc 325 CID	2002-2003	GAS; 2 electrical connectors	USEP3500M
5.3L V8 5328cc 325 CID	2002-2004	FLEX	USEP3572M
5.3L V8 5328cc 325 CID	2004	78.0 / 198.1 Bed, Extended Cab Pickup, GAS	USEP3609M
5.3L V8 5328cc 325 CID	2004-2006	Crew Cab Pickup, GAS	USEP3684M
5.3L V8 5328cc 325 CID	2004-2006	96.0 / 243.8 Bed, GAS	USEP3831M
5.3L V8 5328cc 325 CID	2005-2006	78.0 / 198.1 Bed, GAS; Bed Length 78.0", In Tank Assy.(Incl.Fuel Tank Sending Unit)	USEP3609M
5.3L V8 5328cc 325 CID	2005-2006	ELECTRIC/GAS; In Tank Assy.(Incl.Fuel Tank Sending Unit)	USEP3609M
5.3L V8 5328cc 325 CID	2005-2006	Crew Cab Pickup, GAS; 69.2 bed length	USEP3684M
5.3L V8 5328cc 325 CID	2005-2006	96.0 / 243.8 Bed, Extended Cab Pickup, FLEX	USEP3702M
5.3L V8 5328cc 325 CID	2005-2006	96.0 / 243.8 Bed, FLEX, Standard Cab Pickup	USEP3702M
5.3L V8 5328cc 325 CID	2006	GAS; In Tank Assy.(Exc.Fuel Tank Sending Unit)	USEP3609M
5.3L V8 5328cc 325 CID	2007	97.6 / 247.9 Bed	USEP3834M
5.3L V8 5328cc 325 CID	2007-2008	FLEX	USEP3732M
5.3L V8 5328cc 325 CID	2007-2008	GAS	USEP3747M
5.3L V8 5328cc 325 CID	2007-2008	78.7 / 199.9 Bed, Standard Cab Pickup	USEP3752M
5.3L V8 5328cc 325 CID	2007-2008		USEP3834M
5.3L V8 5328cc 325 CID	2009	69.3 / 176.0 Bed, Crew Cab Pickup	USEP3809M
5.3L V8 5328cc 325 CID	2009	97.6 / 247.9 Bed, Extended Cab Pickup	USEP3815M
5.3L V8 5328cc 325 CID	2009		USEP3817M
5.3L V8 5328cc 325 CID	2010	78.8 / 200.2 Bed, Extended Cab Pickup	USEP4005M
5.3L V8 5328cc 325 CID	2010-2013	69.3 / 176.0 Bed, Crew Cab Pickup	USEP4005M

Engine	Years	Application Description	USMW
<b>CHEVROLET (cont'd.)</b>			
<b>SILVERADO 1500 (cont'd.)</b>			
5.3L V8 5328cc 325 CID	2010-2013	97.8 / 248.4 Bed, Extended Cab Pickup	USEP4008M
5.3L V8 5328cc 325 CID	2010-2013	97.8 / 248.4 Bed, Standard Cab Pickup	USEP4008M
5.3L V8 5328cc 325 CID	2010-2013	78.9 / 200.4 Bed, Standard Cab Pickup	USEP4009M
5.3L V8 5328cc 325 CID	2011-2013	78.9 / 200.4 Bed, Extended Cab Pickup	USEP4005M
5.3L V8 5328cc 325 CID	2014-2017	97.8 / 248.4 Bed	usep12357m
6.0L V8 5967cc 364 CID	2003	electrical connections: 2, Evaporative Emissions Control	USEP3500M
6.0L V8 5967cc 364 CID	2003	electrical connections: 1, Exc.Evaporative Emissions Control	USEP3501M
6.0L V8 5967cc 364 CID	2004	78.0 / 198.1 Bed, GAS, Standard Cab Pickup	USEP3609M
6.0L V8 5967cc 364 CID	2004	96.0 / 243.8 Bed	USEP3831M
6.0L V8 5967cc 364 CID	2004	96.0 / 243.8 Bed, GAS	USEP3831M
6.0L V8 5967cc 364 CID	2005-2006	78.0 / 198.1 Bed, GAS; Bed Length 78.0", In Tank Assy.(Incl.Fuel Tank Sending Unit)	USEP3609M
6.0L V8 5967cc 364 CID	2005-2006	78.0 / 198.1 Bed, GAS; EVAP Emissions, In Tank Assy.(Incl.Fuel Tank Sending Unit)	USEP3609M
6.0L V8 5967cc 364 CID	2005-2006	GAS; In Tank Assy.(Incl.Fuel Tank Sending Unit)	USEP3609M
6.0L V8 5967cc 364 CID	2006	Crew Cab Pickup	USEP3684M
6.0L V8 5967cc 364 CID	2006	Crew Cab Pickup; 69.2 bed length	USEP3684M
6.0L V8 5967cc 364 CID	2007-2008	GAS	USEP3747M
6.0L V8 5967cc 364 CID	2009	78.7 / 199.9 Bed, Extended Cab Pickup	USEP3817M
6.0L V8 5967cc 364 CID	2009-2013		USEP3816M
6.2L V8 6162cc 376 CID	2009		USEP3809M
6.2L V8 6162cc 376 CID	2010-2013		USEP4005M
<b>SILVERADO 1500 CLASSIC</b>			
4.3L V6 262 CID	2007	78.0 / 198.1 Bed, GAS; Bed Length 78.0", In Tank Assy.(Incl.Fuel Tank Sending Unit)	USEP3609M
4.3L V6 262 CID	2007	96.0 / 243.8 Bed	USEP3831M
4.3L V6 262 CID	2007	96.0 / 243.8 Bed, GAS	USEP3831M
4.8L V8 294 CID	2007	78.0 / 198.1 Bed, GAS; Bed Length 78.0", In Tank Assy.(Incl.Fuel Tank Sending Unit)	USEP3609M
4.8L V8 294 CID	2007	GAS	USEP3747M
4.8L V8 294 CID	2007	96.0 / 243.8 Bed	USEP3831M
4.8L V8 294 CID	2007	96.0 / 243.8 Bed, GAS	USEP3831M
5.3L V8 5328cc 325 CID	2007	78.0 / 198.1 Bed, GAS; Bed Length 78.0", In Tank Assy.(Incl.Fuel Tank Sending Unit)	USEP3609M
5.3L V8 5328cc 325 CID	2007	ELECTRIC/GAS; In Tank Assy.(Incl.Fuel Tank Sending Unit)	USEP3609M
5.3L V8 5328cc 325 CID	2007	GAS; In Tank Assy.(Incl.Fuel Tank Sending Unit)	USEP3609M
5.3L V8 5328cc 325 CID	2007	96.0 / 243.8 Bed, GAS	USEP3831M
6.0L V8 5967cc 364 CID	2007	78.0 / 198.1 Bed, GAS; Bed Length 78.0", In Tank Assy.(Incl.Fuel Tank Sending Unit)	USEP3609M
6.0L V8 5967cc 364 CID	2007	78.0 / 198.1 Bed, GAS; EVAP Emissions, In Tank Assy.(Incl.Fuel Tank Sending Unit)	USEP3609M
6.0L V8 5967cc 364 CID	2007	GAS; In Tank Assy.(Incl.Fuel Tank Sending Unit)	USEP3609M
6.0L V8 5967cc 364 CID	2007	GAS	USEP3747M
<b>SILVERADO 1500 HD</b>			
6.0L V8 5967cc 364 CID	2005-2006	Exc.EVAP Emissions	USEP3604M
6.0L V8 5967cc 364 CID	2001		USEP3500M
6.0L V8 5967cc 364 CID	2002-2003	electrical connections: 2, Evaporative Emissions Control	USEP3500M
6.0L V8 5967cc 364 CID	2005-2006	GAS; EVAP Emissions, In Tank Assy.(Incl.Fuel Tank Sending Unit)(Electrical Connector Qty.2)	USEP3609M
6.0L V8 5967cc 364 CID	2005-2006	GAS; In Tank Assy.(Incl.Fuel Tank Sending Unit)(Electrical Connector Qty.2)	USEP3609M
6.0L V8 5967cc 364 CID	2005-2006	GAS; In Tank Assy.(Incl.Fuel Tank Sending Unit)(Electrical Connector Qty.2)	USEP3609M
6.0L V8 5967cc 364 CID	2005-2006		USEP3832M
<b>SILVERADO 1500 HD CLASSIC</b>			
6.0L V8 5967cc 364 CID	2007	GAS; EVAP Emissions, In Tank Assy.(Incl.Fuel Tank Sending Unit)(Electrical Connector Qty.2)	USEP3609M
6.0L V8 5967cc 364 CID	2007	GAS; In Tank Assy.(Incl.Fuel Tank Sending Unit)(Electrical Connector Qty.2)	USEP3609M
<b>SILVERADO 2500</b>			
5.3L V8 5328cc 325 CID	1999-2000		USEP3500M
5.3L V8 5328cc 325 CID	2001		USEP3501M
5.3L V8 5328cc 325 CID	2003	MEX; electrical connections: 2	USEP3500M
5.3L V8 5328cc 325 CID	2003	MEX; electrical connections: 1	USEP3501M
5.3L V8 5328cc 325 CID	2005-2006	MEX; electrical connections: 2	USEP3500M
5.7L V8 350 CID	2001	MEX	USEP3962M
5.7L V8 350 CID	2001-2002	MEX; electrical connections: 2	USEP3500M
5.7L V8 350 CID	2001-2002	MEX; electrical connections: 1	USEP3501M
6.0L V8 5967cc 364 CID	1999-2000		USEP3500M
6.0L V8 5967cc 364 CID	2001	electrical connections: 2	USEP3500M

Engine	Years	Application Description	USMW	Engine	Years	Application Description	USMW
<b>CHEVROLET (cont'd.)</b>				<b>CHEVROLET (cont'd.)</b>			
<b>SILVERADO 2500 (cont'd.)</b>				<b>SILVERADO 2500 HD CLASSIC (cont'd.)</b>			
6.0L V8 5967cc 364 CID	2001-2003	electrical connections: 1, Exc.Evaporative Emissions Control	USEP3501M	8.1L V8 496 CID	2007	153.0 / 388.6 Wheel Base, GAS; In Tank Assy.(Exc.Fuel Tank Sending Unit), Wheelbase 153" (EVAP Emissions)	USEP3609M
6.0L V8 5967cc 364 CID	2002-2003	electrical connections: 2, Evaporative Emissions Control	USEP3500M	8.1L V8 496 CID	2007	96.0 / 243.8 Bed, GAS	USEP3831M
6.0L V8 5967cc 364 CID	2004	78.0 / 198.1 Bed, GAS; Bed Length 78", In Tank Assy.(Incl.Fuel Tank Sending Unit)(Electrical Connector Qty.2)	USEP3609M	8.1L V8 496 CID	2007	133.0 / 337.8 Wheel Base, GAS; Evaporative Emissions Control	USEP3831M
6.0L V8 5967cc 364 CID	2004	GAS; EVAP Emissions, In Tank Assy.(Incl.Fuel Tank Sending Unit)	USEP3609M	8.1L V8 496 CID	2007	157.5 / 400.1 Wheel Base, GAS; Evaporative Emissions Control	USEP3831M
6.0L V8 5967cc 364 CID	2004	GAS	USEP3831M	8.1L V8 496 CID	2007	167.0 / 424.2 Wheel Base, GAS; Evaporative Emissions Control	USEP3831M
<b>SILVERADO 2500 HD</b>				<b>SILVERADO 3500</b>			
6.0L V8 5967cc 364 CID	2001-2003	electrical connections: 2, Evaporative Emissions Control	USEP3500M	6.0L V8 5967cc 364 CID	2001	electrical connections: 2, Exc.Commercial Chassis (Evaporative Emissions Control)	USEP3500M
6.0L V8 5967cc 364 CID	2001-2003	electrical connections: 1, Exc.Evaporative Emissions Control	USEP3501M	6.0L V8 5967cc 364 CID	2001	electrical connections: 1, Exc.Commercial Chassis (Exc.Evaporative Emissions Control)	USEP3501M
6.0L V8 5967cc 364 CID	2004-2005	GAS	USEP3831M	6.0L V8 5967cc 364 CID	2001-2003	(U), GAS, Naturally Aspirated; Commercial Chassis (Calif), Primary Fuel Tank	USEP3522M
6.0L V8 5967cc 364 CID	2004-2006	78.0 / 198.1 Bed, GAS; Bed Length 78", In Tank Assy.(Incl.Fuel Tank Sending Unit)(Electrical Connector Qty.2)	USEP3609M	6.0L V8 5967cc 364 CID	2001-2003	(U), GAS, Naturally Aspirated; Commercial chassis, Secondary Fuel Tank	USEP3530M
6.0L V8 5967cc 364 CID	2004-2006	153.0 / 388.6 Wheel Base, GAS; In Tank Assy.(Incl.Fuel Tank Sending Unit), Wheelbase 153" (EVAP Emissions)	USEP3609M	6.0L V8 5967cc 364 CID	2001-2003	(U), GAS, Naturally Aspirated; Commercial Chassis (Federal), Primary Fuel Tank	USEP3599M
6.0L V8 5967cc 364 CID	2004-2006	157.5 / 400.1 Wheel Base, GAS; Evaporative Emissions Control	USEP3831M	6.0L V8 5967cc 364 CID	2002-2003	electrical connections: 2, Exc.Commercial Chassis (Calif)	USEP3500M
6.0L V8 5967cc 364 CID	2004-2006	167.0 / 424.2 Wheel Base, GAS; Evaporative Emissions Control	USEP3831M	6.0L V8 5967cc 364 CID	2002-2003	electrical connections: 1, Exc.Commercial Chassis (Federal)	USEP3501M
6.0L V8 5967cc 364 CID	2006	143.5 / 364.5 Wheel Base, GAS; In Tank Assy.(Exc.Fuel Tank Sending Unit), Wheelbase 143.5" (EVAP Emissions)	USEP3609M	6.0L V8 5967cc 364 CID	2004	(U), GAS, Naturally Aspirated; Exc.Commercial Chassis (Exc.Evaporative Emissions Control)	USEP3604M
6.0L V8 5967cc 364 CID	2006	133.0 / 337.8 Wheel Base, GAS	USEP3831M	6.0L V8 5967cc 364 CID	2004-2006	GAS; Evaporative Emissions Control, Exc.Commercial Chassis	USEP3831M
6.0L V8 5967cc 364 CID	2006	GAS; Evaporative Emissions Control	USEP3831M	6.0L V8 5967cc 364 CID	2004-2006	GAS; Exc.Cab & Chassis	USEP3831M
6.0L V8 5967cc 364 CID	2007-2008		USEP3750M	6.0L V8 5967cc 364 CID	2005	(U), GAS, Naturally Aspirated; Exc.Commercial Chassis (Exc.EVAP Emissions)	USEP3604M
6.0L V8 5967cc 364 CID	2009-2010		USEP3818M	6.0L V8 5967cc 364 CID	2005	(U), GAS, Naturally Aspirated; Commercial Chassis (EVAP Emissions)	USEP3616M
8.1L V8 496 CID	2001-2003	electrical connections: 2, Evaporative Emissions Control	USEP3500M	6.0L V8 5967cc 364 CID	2005	(U), GAS, Naturally Aspirated; Commercial Chassis (Exc.EVAP Emissions)	USEP3616M
8.1L V8 496 CID	2001-2003	electrical connections: 1, Exc.Evaporative Emissions Control	USEP3501M	6.0L V8 5967cc 364 CID	2005	(U), GAS, Naturally Aspirated; Commercial Chassis (Exc.EVAP Emissions)	USEP3616M
8.1L V8 496 CID	2004	153.0 / 388.6 Wheel Base, GAS; In Tank Assy.(Incl.Fuel Tank Sending Unit), Wheelbase 153" (EVAP Emissions)	USEP3609M	6.0L V8 5967cc 364 CID	2005	(U), GAS, Naturally Aspirated; Commercial Chassis (EVAP Emissions), Secondary Fuel Tank(Incl.Sender)	USEP3617M
8.1L V8 496 CID	2004-2005	133.0 / 337.8 Wheel Base, GAS; Evaporative Emissions Control	USEP3831M	6.0L V8 5967cc 364 CID	2006	LS, LT, WT; (U), GAS, Naturally Aspirated; Exc.Commercial Chassis (Exc.EVAP Emissions)	USEP3604M
8.1L V8 496 CID	2004-2005	GAS	USEP3831M	6.0L V8 5967cc 364 CID	2006	LS, LT, WT; (U), GAS, Naturally Aspirated; Commercial Chassis (EVAP Emissions)	USEP3616M
8.1L V8 496 CID	2004-2006	78.0 / 198.1 Bed, GAS; Bed Length 78", In Tank Assy.(Incl.Fuel Tank Sending Unit)(Electrical Connector Qty.2)	USEP3609M	6.0L V8 5967cc 364 CID	2006	LS, LT, WT; (U), GAS, Naturally Aspirated; Commercial Chassis (Exc.EVAP Emissions)	USEP3616M
8.1L V8 496 CID	2004-2006	157.5 / 400.1 Wheel Base, GAS; Evaporative Emissions Control	USEP3831M	6.0L V8 5967cc 364 CID	2006	LS, LT, WT; (U), GAS, Naturally Aspirated; Commercial Chassis (EVAP Emissions), Secondary Fuel Tank(Incl.Sender)	USEP3617M
8.1L V8 496 CID	2004-2006	167.0 / 424.2 Wheel Base, GAS; Evaporative Emissions Control	USEP3831M	6.0L V8 5967cc 364 CID	2006	LS, LT, WT; (U), GAS, Naturally Aspirated; Commercial Chassis (EVAP Emissions)	USEP3616M
8.1L V8 496 CID	2005-2006	153.0 / 388.6 Wheel Base, GAS; In Tank Assy.(Exc.Fuel Tank Sending Unit), Wheelbase 153" (EVAP Emissions)	USEP3609M	6.0L V8 5967cc 364 CID	2006	LS, LT, WT; (U), GAS, Naturally Aspirated; Commercial Chassis (EVAP Emissions), Secondary Fuel Tank(Incl.Sender)	USEP3617M
8.1L V8 496 CID	2006	143.5 / 364.5 Wheel Base, GAS; In Tank Assy.(Exc.Fuel Tank Sending Unit), Wheelbase 143.5" (EVAP Emissions)	USEP3609M	6.6L V8 6599cc 403 CID	2005	(2), DIESEL, Turbocharged; Exc.Commercial Chassis	USEP3599M
8.1L V8 496 CID	2006	133.0 / 337.8 Wheel Base, GAS	USEP3831M	8.1L V8 496 CID	2001	electrical connections: 2, Exc.Commercial Chassis (Evaporative Emissions Control)	USEP3500M
8.1L V8 496 CID	2006	GAS; Evaporative Emissions Control	USEP3831M	8.1L V8 496 CID	2001	electrical connections: 1, Exc.Commercial Chassis (Exc.Evaporative Emissions Control)	USEP3501M
<b>SILVERADO 2500 HD CLASSIC</b>				8.1L V8 496 CID	2001-2003	(G), GAS, Naturally Aspirated; Commercial Chassis (Calif), Primary Fuel Tank	USEP3522M
6.0L V8 5967cc 364 CID	2007	78.0 / 198.1 Bed, GAS; Bed Length 78", In Tank Assy.(Incl.Fuel Tank Sending Unit)(Electrical Connector Qty.2)	USEP3609M	8.1L V8 496 CID	2001-2003	(G), GAS, Naturally Aspirated; Commercial chassis, Secondary Fuel Tank	USEP3530M
6.0L V8 5967cc 364 CID	2007	143.5 / 364.5 Wheel Base, GAS; In Tank Assy.(Exc.Fuel Tank Sending Unit), Wheelbase 143.5" (EVAP Emissions)	USEP3609M	8.1L V8 496 CID	2001-2003	(G), GAS, Naturally Aspirated; Commercial Chassis (Federal), Primary Fuel Tank	USEP3599M
6.0L V8 5967cc 364 CID	2007	153.0 / 388.6 Wheel Base, GAS; In Tank Assy.(Incl.Fuel Tank Sending Unit), Wheelbase 153" (EVAP Emissions)	USEP3609M	8.1L V8 496 CID	2002-2003	electrical connections: 2, Exc.Commercial Chassis (Calif)	USEP3500M
6.0L V8 5967cc 364 CID	2007	96.0 / 243.8 Bed, GAS	USEP3831M	8.1L V8 496 CID	2002-2003	electrical connections: 1, Exc.Commercial Chassis (Federal)	USEP3501M
6.0L V8 5967cc 364 CID	2007	133.0 / 337.8 Wheel Base, GAS; Evaporative Emissions Control	USEP3831M	8.1L V8 496 CID	2004-2005	(G), GAS, Naturally Aspirated; Exc.Commercial Chassis (Exc.EVAP Emissions)	USEP3604M
6.0L V8 5967cc 364 CID	2007	157.5 / 400.1 Wheel Base, GAS; Evaporative Emissions Control	USEP3831M	8.1L V8 496 CID	2004-2005	(G), GAS, Naturally Aspirated; Commercial chassis, Secondary Fuel Tank(Incl.Sender)	USEP3617M
6.0L V8 5967cc 364 CID	2007	167.0 / 424.2 Wheel Base, GAS; Evaporative Emissions Control	USEP3831M	8.1L V8 496 CID	2004-2006	GAS; Evaporative Emissions Control, Exc.Commercial Chassis	USEP3831M
6.0L V8 5967cc 364 CID	2007	GAS	USEP3831M	8.1L V8 496 CID	2004-2006	GAS; Exc.Cab & Chassis	USEP3831M
8.1L V8 496 CID	2007	78.0 / 198.1 Bed, GAS; Bed Length 78", In Tank Assy.(Incl.Fuel Tank Sending Unit)(Electrical Connector Qty.2)	USEP3609M	8.1L V8 496 CID	2005	(G), GAS, Naturally Aspirated; Commercial Chassis (EVAP Emissions)	USEP3616M
8.1L V8 496 CID	2007	143.5 / 364.5 Wheel Base, GAS; In Tank Assy.(Exc.Fuel Tank Sending Unit), Wheelbase 143.5" (EVAP Emissions)	USEP3609M				





# FUEL PUMP MODULES APPLICATION GUIDE



FUEL PUMP MODULES

Engine	Years	Application Description	USMW
<b>CHEVROLET (cont'd.)</b>			
<b>SILVERADO 3500 (cont'd.)</b>			
8.1L V8 496 CID	2005	(G), GAS, Naturally Aspirated; Commercial Chassis (Exc.EVAP Emissions)	USEP3616M
8.1L V8 496 CID	2006	LS, LT, WT; (G), GAS, Naturally Aspirated; Exc.Commercial Chassis (Exc.EVAP Emissions)	USEP3604M
8.1L V8 496 CID	2006	LS, LT, WT; (G), GAS, Naturally Aspirated; Commercial Chassis (EVAP Emissions)	USEP3616M
8.1L V8 496 CID	2006	LS, LT, WT; (G), GAS, Naturally Aspirated; Commercial Chassis (Exc.EVAP Emissions)	USEP3616M
8.1L V8 496 CID	2006	LS, LT, WT; (G), GAS, Naturally Aspirated; Commercial chassis, Secondary Fuel Tank(Incl.Sender)	USEP3617M
<b>SILVERADO 3500 CLASSIC</b>			
6.0L V8 5967cc 364 CID	2007	GAS; Evaporative Emissions Control, Exc.Commercial Chassis	USEP3831M
6.0L V8 5967cc 364 CID	2007	GAS; Exc.Cab & Chassis	USEP3831M
8.1L V8 496 CID	2007	GAS; Evaporative Emissions Control, Exc.Commercial Chassis	USEP3831M
8.1L V8 496 CID	2007	GAS; Exc.Cab & Chassis	USEP3831M
<b>SILVERADO 3500 HD</b>			
6.0L V8 5967cc 364 CID	2007-2008		USEP3750M
6.0L V8 5967cc 364 CID	2009-2010		USEP3818M
<b>SONIC</b>			
1.4L L4 1364cc 83 CID	2012-2015		USEP4056M
1.8L L4 1796cc 110 CID	2012-2015		USEP4056M
<b>SONORA</b>			
5.3L V8 5328cc 325 CID	2003		USEP3508M
5.3L V8 5328cc 325 CID	2004	MEX	USEP3508M
5.3L V8 5328cc 325 CID	2005-2006	MEX	USEP3581M
5.7L V8 350 CID	2000	MEX	USEP3972M
<b>SSR</b>			
	2005-2006		USEP3707M
5.3L V8 5328cc 325 CID	2003-2004	This Module uses an internal strainer design and may look different from your original Unit	USEP3549M
<b>SUBURBAN 1500</b>			
5.3L V8 5328cc 325 CID	2000-2001		USEP3509M
5.3L V8 5328cc 325 CID	2002-2003		USEP3556M
5.3L V8 5328cc 325 CID	2002-2003		USEP3586M
5.3L V8 5328cc 325 CID	2002-2004	FLEX	USEP3560M
5.3L V8 5328cc 325 CID	2005-2007	GAS	USEP3610M
5.3L V8 5328cc 325 CID	2005-2007	FLEX	USEP3706M
5.3L V8 5328cc 325 CID	2008-2014		USEP3797M
6.0L V8 5967cc 364 CID	2006-2007	GAS	USEP3610M
<b>SUBURBAN 2500</b>			
	2000	Primary Fuel Tank	USEP3510M
	2000	Evaporative Emissions Control, Secondary Fuel Tank	USEP3512M
	2000	Exc.Evaporative Emissions Control, Secondary Fuel Tank	USEP3513M
6.0L V8 5967cc 364 CID	2001	(U); Primary Fuel Tank	USEP3510M
6.0L V8 5967cc 364 CID	2001	(U); Evaporative Emissions Control, Secondary Fuel Tank	USEP3512M
6.0L V8 5967cc 364 CID	2001	(U); Exc.Evaporative Emissions Control, Secondary Fuel Tank	USEP3513M
6.0L V8 5967cc 364 CID	2002-2003	1 electrical connector, Exc.Evaporative Emissions Control, Secondary Fuel Tank	USEP3553M
6.0L V8 5967cc 364 CID	2002-2003	except Export, Primary Fuel Tank	USEP3554M
6.0L V8 5967cc 364 CID	2002-2003	Evaporative Emissions Control, Secondary Fuel Tank, with 2 electrical connectors	USEP3555M
6.0L V8 5967cc 364 CID	2002-2003	export, Robust fuel system unit	USEP3594M
6.0L V8 5967cc 364 CID	2004-2007	Rear tank	USEP3587M
6.0L V8 5967cc 364 CID	2004-2007	Front tank	USEP3675M
6.0L V8 5967cc 364 CID	2008-2013		USEP3814M
8.1L V8 496 CID	2001	(G); Primary Fuel Tank	USEP3510M
8.1L V8 496 CID	2001	(G); Evaporative Emissions Control, Secondary Fuel Tank	USEP3512M
8.1L V8 496 CID	2001	(G); Exc.Evaporative Emissions Control, Secondary Fuel Tank	USEP3513M
8.1L V8 496 CID	2002	except Export, except Export, Primary Fuel Tank	USEP3554M
8.1L V8 496 CID	2002-2003	1 electrical connector, Exc.Evaporative Emissions Control, Secondary Fuel Tank	USEP3553M
8.1L V8 496 CID	2002-2003	Evaporative Emissions Control, Secondary Fuel Tank, with 2 electrical connectors	USEP3555M
8.1L V8 496 CID	2002-2003	export, Robust fuel system unit	USEP3594M
8.1L V8 496 CID	2003	except Export, Primary Fuel Tank	USEP3554M
8.1L V8 496 CID	2004-2005	Front tank	USEP3675M
8.1L V8 496 CID	2004-2006	Rear tank	USEP3587M

Engine	Years	Application Description	USMW
<b>CHEVROLET (cont'd.)</b>			
<b>SUBURBAN 3500 HD</b>			
6.0L V8 5967cc 364 CID	2016		USEP3814M
<b>TAHOE</b>			
4.8L V8 294 CID	2000	LT; (V)	USEP3508M
4.8L V8 294 CID	2001	(V)	USEP3508M
4.8L V8 294 CID	2002-2003	(V), GAS	USEP3508M
4.8L V8 294 CID	2004		USEP3581M
4.8L V8 294 CID	2004-2007	GAS	USEP3581M
4.8L V8 294 CID	2006-2007		USEP3581M
5.3L V8 5328cc 325 CID	2000-2003	GAS	USEP3508M
5.3L V8 5328cc 325 CID	2002-2004	FLEX	USEP3559M
5.3L V8 5328cc 325 CID	2004		USEP3581M
5.3L V8 5328cc 325 CID	2004-2007	GAS	USEP3581M
5.3L V8 5328cc 325 CID	2005-2007	FLEX	USEP3705M
5.3L V8 5328cc 325 CID	2006	Base, LS, LT, Z71; (L59), (Z), FLEX	USEP3705M
5.3L V8 5328cc 325 CID	2006-2007		USEP3581M
5.3L V8 5328cc 325 CID	2007	LS, LT, LTZ; (0), (LMG), FLEX	USEP3705M
5.3L V8 5328cc 325 CID	2010-2014		USEP3768M
5.7L V8 350 CID	1995	Base, LS, LT	USEP3930M
5.7L V8 350 CID	1997	(R), 4 Doors, GAS, Naturally Aspirated	USEP3932M
5.7L V8 350 CID	1998-1999	(R), 4 Doors, GAS, Naturally Aspirated; (Radio Frequency Interference Filter)	USEP3534M
5.7L V8 350 CID	1998-1999	(R), 2 Doors, GAS, Naturally Aspirated	USEP3963M
5.7L V8 350 CID	1998-1999	(R), 4 Doors, GAS, Naturally Aspirated; (Exc.Radio Frequency Interference Filter)	USEP3972M
6.0L V8 5967cc 364 CID	2010-2011		USEP3765M
<b>TRACKER</b>			
1.6L L4 1588cc 98 CID	1999-2000		USEP3520S
2.0L L4 122 CID	1999-2003		USEP3520S
2.0L L4 1995cc 122 CID	1999-2003		USEP3520S
2.5L V6 2500cc	2001-2004		USEP3520S
<b>TRAILBLAZER</b>			
4.2L L6 256 CID	2002-2004	This Module uses an internal strainer design and may look different from your original Unit	USEP3549M
4.2L L6 256 CID	2005-2007		USEP3707M
4.2L L6 256 CID	2008-2009		USEP3769M
5.3L V8 5328cc 325 CID	2008		USEP3769M
6.0L V8 5967cc 364 CID	2006-2007		USEP3707M
6.0L V8 5967cc 364 CID	2008-2009		USEP3769M
<b>TRAILBLAZER EXT</b>			
4.2L L6 256 CID	2002-2004		USEP3549M
4.2L L6 256 CID	2005-2006		USEP3746M
5.3L V8 5328cc 325 CID	2003-2004		USEP3549M
5.3L V8 5328cc 325 CID	2005-2006		USEP3746M
<b>TRAVERSE</b>			
3.6L V6 3564cc 217 CID	2009-2014	WITHOUT FUEL LEVEL SENSOR	USEP3790M
<b>UPLANDER</b>			
	2005	(Incl.Tank Seal)	USEP3717M
	2008	(1), 121.1 / 307.6 Wheel Base, GAS	USEP3717M
3.5L V6 213 CID	2006		USEP3710M
3.5L V6 213 CID	2006	Base, LS, LT; (L); (Incl.Tank Seal)	USEP3717M
3.5L V6 3500cc 214 CID	2006		USEP3710M
3.9L V6 3880cc 237 CID	2006	LT; (1); (Incl.Tank Seal)	USEP3717M
3.9L V6 3880cc 237 CID	2007		USEP3718M
<b>V10</b>			
4.3L V6 262 CID	1987	harness code VEE or VEV	USEP3631S
5.7L V8 350 CID	1987	harness code VEE or VEV	USEP3631S
<b>V10 SUBURBAN</b>			
5.7L V8 350 CID	1988	with 31 gallon tank	USEP3633S
<b>V20</b>			
5.7L V8 350 CID	1987	harness code VEE or VEV	USEP3631S
<b>V20 SUBURBAN</b>			
5.7L V8 350 CID	1988	harness code VEE or VEV	USEP3631S
7.4L V8 454 CID	1988	harness code VEE or VEV	USEP3631S
<b>V1500 SUBURBAN</b>			
5.7L V8 350 CID	1989-1991	with 31 gallon tank	USEP3633S
<b>V2500 SUBURBAN</b>			
5.7L V8 350 CID	1989	harness code VEE or VEV	USEP3631S
5.7L V8 350 CID	1990-1991	with 31 gallon tank	USEP3633S
<b>VENTURE</b>			
	1997	112.0 / 284.5 Wheel Base	USEP3976M
	1997	120.0 / 304.8 Wheel Base	USEP3976M
	1998-2000	120.0 / 304.8 Wheel Base, USA	USEP3372M
3.4L V6 207 CID	2001	120.0 / 304.8 Wheel Base	USEP3372M
3.4L V6 207 CID	2001-2004	112.0 / 284.5 Wheel Base	USEP3539M
3.4L V6 207 CID	2002-2003	120.0 / 304.8 Wheel Base	USEP3552M
3.4L V6 207 CID	2004	120.0 / 304.8 Wheel Base; conventional chassis	USEP3552M



# FUEL PUMP MODULES APPLICATION GUIDE



Engine	Years	Application Description	USMW	Engine	Years	Application Description	USMW
<b>CHEVROLET (cont'd.)</b>				<b>CHRYSLER (cont'd.)</b>			
<b>VENTURE (cont'd.)</b>				<b>LEBARON</b>			
3.4L V6 207 CID	2005	120.0 / 304.8 Wheel Base	USEP3552M		1994	GTC, Landau, LE	USEP7040M
<b>CHRYSLER</b>					1995		USEP7040M
<b>200</b>				2.2L L4 135 CID	1985	GTS, Mark Cross; (E), FI, Turbocharged; (Double Nipple)	USEP7051S
2.4L L4 2360cc 144 CID	2011-2014		USEP7253M	2.2L L4 135 CID	1986	Base, GTS; (D), Naturally Aspirated	USEP7069H
<b>300</b>				2.2L L4 135 CID	1986	Turbocharged; (1 Tube Type)	USEP7071H
2.7L V6 2736cc 167 CID	2005	FUEL TRANSFER UNIT	USEP7264A	2.2L L4 135 CID	1987	MEX, Turbocharged	USEP7071H
2.7L V6 2736cc 167 CID	2005-2010	GAS; 19 gallon fuel tank	USEP7192M	2.2L L4 135 CID	1987-1988	GTS, Premium; (D), Naturally Aspirated	USEP7069H
2.7L V6 2736cc 167 CID	2005-2010	GAS; 18 gallon fuel tank	USEP7241M	2.2L L4 135 CID	1988	Turbocharged; (Single Nipple)	USEP7071H
2.7L V6 2736cc 167 CID	2006-2010	TRANSFER PUMP	USEP7264A	2.2L L4 135 CID	1989	(D), Naturally Aspirated	USEP7069H
3.5L V6 3497cc 215 CID	2005	FUEL TRANSFER UNIT	USEP7264A	2.2L L4 135 CID	1990	Turbocharged	USEP7071H
3.5L V6 3497cc 215 CID	2005-2010	GAS; 19 gallon fuel tank	USEP7192M	2.5L L4 2507cc 153 CID	1986	GTS, Mark Cross; (K), Naturally Aspirated	USEP7069H
3.5L V6 3497cc 215 CID	2005-2010	GAS; 18 gallon fuel tank	USEP7241M	2.5L L4 2507cc 153 CID	1987-1988	GTS, Premium; (K), Naturally Aspirated	USEP7069H
3.5L V6 3497cc 215 CID	2006-2010	TRANSFER PUMP	USEP7264A	2.5L L4 2507cc 153 CID	1989	(K), Naturally Aspirated	USEP7069H
3.6L V6 3604cc 220 CID	2011-2015	GAS	USEP7192M	2.5L L4 2507cc 153 CID	1989-1990	Turbocharged	USEP7071H
3.6L V6 3604cc 220 CID	2011-2018	TRANSFER PUMP	USEP7264A	2.5L L4 2507cc 153 CID	1990	High Line; (K), Naturally Aspirated	USEP7069H
5.7L V8 345 CID	2005	FUEL TRANSFER UNIT	USEP7264A	2.5L L4 2507cc 153 CID	1991	Base; (K), Naturally Aspirated	USEP7040M
5.7L V8 345 CID	2005-2010	GAS; 18 gallon fuel tank	USEP7241M	2.5L L4 2507cc 153 CID	1991-1992	Base, GTC; (J), Turbocharged	USEP7040M
5.7L V8 345 CID	2006-2010	GAS; 19 gallon fuel tank	USEP7192M	2.5L L4 2507cc 153 CID	1992	Base, Landau; (K), Naturally Aspirated	USEP7040M
5.7L V8 345 CID	2006-2010	TRANSFER PUMP	USEP7264A	2.5L L4 2507cc 153 CID	1993	Base, LE; (K), GAS	USEP7040M
5.7L V8 345 CID	2011-2012	GAS	USEP7192M	2.5L L4 2507cc 153 CID	1993	Base; (V), FLEX	USEP7040M
5.7L V8 345 CID	2014-2015	GAS	USEP7192M	3.0L V6 2972cc 181 CID	1990	Naturally Aspirated	USEP7071H
5.7L V8 345 CID	2016-2017	GAS; 19 gallon fuel tank	USEP7192M	3.0L V6 2972cc 181 CID	1991	Base, GTC, LX; (3), Naturally Aspirated	USEP7040M
5.7L V8 5654cc 345 CID	2013	GAS	USEP7192M	3.0L V6 2972cc 181 CID	1992	Base, GTC, Landau, LX; (3), Naturally Aspirated	USEP7040M
6.1L V8 6059cc 370 CID	2005	GAS; 18 gallon fuel tank	USEP7241M	3.0L V6 2972cc 181 CID	1993	Base, GTC, Landau, LE, LX; (3), GAS	USEP7040M
6.4L V8 6424cc 392 CID	2014	GAS	USEP7192M	<b>LHS</b>			
<b>300M</b>					1994-1995		USEP7054M
3.5L V6 3497cc 215 CID	2002-2004		USEP7152M		1999		USEP7137M
3.5L V6 3518cc 215 CID	1999	MEX	USEP7137M	3.5L V6 3497cc 215 CID	2000-2001		USEP7152M
<b>ASPEN</b>				<b>NEON</b>			
4.7L V8 287 CID	2007		USEP7227M	2.0L L4 1996cc 122 CID	1996-1997	MEX; TQE.PLASTICO	USEP7097M
4.7L V8 287 CID	2008		USEP7234M	<b>NEW YORKER</b>			
5.7L V8 345 CID	2008-2009		USEP7234M		1994-1995		USEP7054M
<b>CIRRUS</b>					1996		USEP7101M
	2001	MEX	USEP7141M	2.2L L4 135 CID	1985	(E), FI, Turbocharged; (Double Nipple)	USEP7051S
2.0L L4 1996cc 122 CID	2000		USEP7113M	2.2L L4 135 CID	1985	Turbocharged; (Single Nipple)	USEP7071H
2.4L L4 2429cc 148 CID	1995-1997		USEP7089M	2.2L L4 135 CID	1986	Turbocharged; (1 Tube Type)	USEP7071H
2.4L L4 2429cc 148 CID	1999-2000		USEP7113M	2.2L L4 135 CID	1987-1988	Turbocharged; (Single Nipple)	USEP7071H
2.4L L4 2429cc 148 CID	2002	MEX	USEP7141M	2.5L L4 2507cc 153 CID	1986-1987	(K), Naturally Aspirated	USEP7069H
2.4L L4 2429cc 148 CID	2003-2004	MEX	USEP7167M	3.0L V6 2972cc 181 CID	1989		USEP7071H
2.5L V6 2497cc 152 CID	1995-1997		USEP7089M	3.3L V6 3301cc 201 CID	1990		USEP7071H
2.5L V6 2497cc 152 CID	1998-2000		USEP7113M	3.3L V6 3301cc 201 CID	1991-1993	Fifth Avenue, Salon; (R)	USEP7040M
2.7L V6 2736cc 167 CID	2002	MEX	USEP7141M	3.8L V6 3778cc 231 CID	1991-1993	Fifth Avenue; (L)	USEP7040M
2.7L V6 2736cc 167 CID	2003-2004	MEX	USEP7167M	<b>PACIFICA</b>			
<b>CONCORDE</b>					2004-2006		USEP7194M
	1997	LX, LXi	USEP7101M	3.8L V6 3778cc 231 CID	2005	(Secondary)	USEP7194M
2.7L V6 2736cc 167 CID	1998-1999	(EER), (R)	USEP7137M	3.8L V6 3778cc 231 CID	2006		USEP7194M
2.7L V6 2736cc 167 CID	2000-2004		USEP7152M	<b>PHANTOM</b>			
3.2L V6 3200cc 197 CID	1998-1999	(EGW), (J)	USEP7137M		1987	MEX	USEP7069H
3.2L V6 3200cc 197 CID	2000-2001		USEP7152M	2.2L L4 135 CID	1988-1989	MEX	USEP7071H
3.3L V6 3301cc 201 CID	1993	(T)	USEP7054M	<b>PT CRUISER</b>			
3.3L V6 3301cc 201 CID	1994-1995	(T), GAS	USEP7054M	2.4L L4 2429cc 148 CID	2001-2003	MEX, Naturally Aspirated	USEP7143M
3.3L V6 3301cc 201 CID	1994-1995	(U), FLEX	USEP7076M	2.4L L4 2429cc 148 CID	2001-2003	Naturally Aspirated, USA	USEP7143M
3.3L V6 3301cc 201 CID	1996	LX; (T)	USEP7101M	2.4L L4 2429cc 148 CID	2003	Turbocharged	USEP7191M
3.5L V6 3497cc 215 CID	1993	(F)	USEP7054M	2.4L L4 2429cc 148 CID	2004	MEX, Naturally Aspirated; to 10/3/03	USEP7143M
3.5L V6 3497cc 215 CID	1994-1995	(F), GAS	USEP7054M	2.4L L4 2429cc 148 CID	2004	Naturally Aspirated, USA; to 10/3/03	USEP7143M
3.5L V6 3497cc 215 CID	1996	LX, LXi; (F)	USEP7101M	2.4L L4 2429cc 148 CID	2004	Naturally Aspirated; from 10-30-03	USEP7189M
3.5L V6 3497cc 215 CID	2002-2004		USEP7152M	2.4L L4 2429cc 148 CID	2004	Turbocharged; FROM 11/10/03	USEP7190M
3.5L V6 3518cc 215 CID	1995	MEX	USEP7054M	2.4L L4 2429cc 148 CID	2004	Turbocharged; to 11/10/03	USEP7191M
3.5L V6 3518cc 215 CID	1996	MEX	USEP7101M	2.4L L4 2429cc 148 CID	2005-2009	Turbocharged	USEP7190M
<b>GRAND VOYAGER</b>				2.4L L4 2429cc 148 CID	2005-2010	Naturally Aspirated	USEP7189M
3.0L V6 2972cc 181 CID	2000		USEP7094M	<b>SEBRING</b>			
3.3L V6 3301cc 201 CID	2000	GAS	USEP7094M		1995-1999		USEP7081H
3.3L V6 3301cc 201 CID	2000	Base, SE; (G), FLEX	USEP7129M	2.4L L4 2351cc	2002-2004	Coupe	USEP7163M
3.8L V6 3778cc 231 CID	1995	MEX	USEP7077M	2.4L L4 2360cc 144 CID	2007		USEP7210M
3.8L V6 3778cc 231 CID	2001	MEX	USEP7144M	2.4L L4 2360cc 144 CID	2008-2010		USEP7253M
<b>IMPERIAL</b>				2.4L L4 2429cc 148 CID	1996-1998		USEP7089M
	1992-1993		USEP7040M	2.4L L4 2429cc 148 CID	2003-2006	GAS	USEP7167M
3.3L V6 3301cc 201 CID	1990		USEP7071H	2.5L V6 2497cc 152 CID	1995		USEP7081H
3.3L V6 3301cc 201 CID	1991	(R)	USEP7040M	2.5L V6 2497cc 152 CID	1996-1998	Convertible	USEP7089M
3.8L V6 3778cc 231 CID	1991	(L)	USEP7040M	2.5L V6 2497cc 152 CID	1996-2000	Coupe	USEP7081H
<b>INTREPID</b>				2.5L V6 2497cc 152 CID	1999-2000	Convertible	USEP7113M
3.5L V6 3518cc 215 CID	1995	MEX	USEP7054M	2.7L V6 2736cc 167 CID	2002	LX; (R)	USEP7141M
3.5L V6 3518cc 215 CID	1996-1997	MEX	USEP7101M	2.7L V6 2736cc 167 CID	2003-2006	GAS	USEP7167M
<b>LASER</b>				2.7L V6 2736cc 167 CID	2003-2006	FLEX	USEP7169M
2.2L L4 135 CID	1985	Base, XE; (E), Turbocharged; (Double Nipple)	USEP7051S	2.7L V6 2736cc 167 CID	2007		USEP7210M
2.2L L4 135 CID	1985-1986	Turbocharged; (1 Tube Type)	USEP7071H	3.0L V6 2972cc 181 CID	2002-2004	Coupe	USEP7163M
2.2L L4 135 CID	1986	Base; (D), Naturally Aspirated	USEP7069H				
2.5L L4 2507cc 153 CID	1986	Base, XE; (K), Naturally Aspirated	USEP7069H				



# FUEL PUMP MODULES APPLICATION GUIDE



FUEL PUMP MODULES

Engine	Years	Application Description	USMW
<b>CHRYSLER (cont'd.)</b>			
<b>SEBRING (cont'd.)</b>			
3.5L V6 3497cc 215 CID	2007		USEP7210M
<b>SHADOW</b>			
2.2L L4 135 CID	1989-1990	MEX	USEP7040M
2.5L L4 2500cc 153 CID	1989-1990	MEX	USEP7069H
<b>SPIRIT</b>			
2.5L L4 2500cc 153 CID	1991	MEX	USEP7040M
<b>TC MASERATI</b>			
2.2L L4 135 CID	1989		USEP7071H
2.2L L4 135 CID	1990	Turbocharged	USEP7071H
3.0L V6 2972cc 181 CID	1990	Naturally Aspirated	USEP7071H
<b>TOWN &amp; COUNTRY</b>			
2.2L L4 135 CID	1985	(E), FI, Turbocharged; (Double Nipple)	USEP7051S
2.2L L4 135 CID	1985-1986	Turbocharged; (1 Tube Type)	USEP7071H
2.2L L4 135 CID	1987-1988	Turbocharged; (Single Nipple)	USEP7071H
2.5L L4 2507cc 153 CID	1986-1988	(K), Naturally Aspirated	USEP7069H
3.3L V6 3301cc 201 CID	1990		USEP7074H
3.3L V6 3301cc 201 CID	1991-1993		USEP7030M
3.3L V6 3301cc 201 CID	1992-1993	AWD; WITH 5 PIN CONNECTOR	USEP7029M
3.3L V6 3301cc 201 CID	1996-1997		USEP7094M
3.3L V6 3301cc 201 CID	1998-2000	GAS	USEP7094M
3.3L V6 3301cc 201 CID	2003	(R), GAS	USEP7144M
3.3L V6 3301cc 201 CID	2003	Limited; (3), FLEX	USEP7146M
3.3L V6 3301cc 201 CID	2004-2007	Exc.Floor Storage (Exc.Fold Away Seats)	USEP7172M
3.3L V6 3301cc 201 CID	2005-2007	With Stow and go seating (Fold Away Seats)	USEP7196M
3.3L V6 3301cc 201 CID	2008		USEP7235M
3.6L V6 3604cc 220 CID	2011-2016		USEP7272M
3.8L V6 3778cc 231 CID	1996-2000		USEP7094M
3.8L V6 3778cc 231 CID	2003	(L), GAS	USEP7144M
3.8L V6 3778cc 231 CID	2004-2006	Exc.Floor Storage (Exc.Fold Away Seats)	USEP7172M
3.8L V6 3778cc 231 CID	2005-2007	With Stow and go seating (Fold Away Seats)	USEP7196M
3.8L V6 3778cc 231 CID	2008-2010		USEP7235M
<b>VOYAGER</b>			
2.4L L4 2429cc 148 CID	2000		USEP7094M
3.0L V6 2972cc 181 CID	2000		USEP7094M
3.3L V6 3301cc 201 CID	1995	SE	USEP7077M
3.3L V6 3301cc 201 CID	1996		USEP7040M
3.3L V6 3301cc 201 CID	1997-1999	MEX	USEP7094M
3.3L V6 3301cc 201 CID	2000	GAS	USEP7094M
<b>DAEWOO</b>			
<b>LANOS</b>			
1.6L L4 1588cc 98 CID	1999-2002		USEP8514M
1.6L L4 1588cc 98 CID	1999-2002	Export only	USEP12001M
<b>LEGANZA</b>			
2.2L L4 2198cc 134 CID	1999-2002		USEP8469M
<b>NUBIRA</b>			
2.0L L4 1998cc	1999-2002		USEP8470M
2.0L L4 1998cc	1999-2002	export market only usa use USEP8470M	USEP12002M
<b>DODGE</b>			
<b>600</b>			
2.2L L4 135 CID	1984		USEP7071H
2.2L L4 135 CID	1985	ES, SE; (E), FI, Turbocharged; (Double Nipple)	USEP7051S
2.2L L4 135 CID	1986	ES, SE; (D), Naturally Aspirated	USEP7069H
2.2L L4 135 CID	1986	Turbocharged; (1 Tube Type)	USEP7071H
2.2L L4 135 CID	1987	Base, SE; (D), Naturally Aspirated	USEP7069H
2.2L L4 135 CID	1987-1988	Turbocharged; (Single Nipple)	USEP7071H
2.2L L4 135 CID	1988	Base; (D), Naturally Aspirated	USEP7069H
2.5L L4 2507cc 153 CID	1986	ES, SE; (K), Naturally Aspirated	USEP7069H
2.5L L4 2507cc 153 CID	1987-1988	Base, SE; (K), Naturally Aspirated	USEP7069H
<b>ARIES</b>			
2.2L L4 135 CID	1986	Base, LE, SE; (D)	USEP7069H
2.2L L4 135 CID	1987	Base, LE; (D)	USEP7069H
2.2L L4 135 CID	1988-1989	(D)	USEP7069H
2.5L L4 2507cc 153 CID	1986	Base, LE, SE; (K)	USEP7069H
2.5L L4 2507cc 153 CID	1987	Base, LE; (K)	USEP7069H
2.5L L4 2507cc 153 CID	1988-1989	(K)	USEP7069H
<b>ATTITUDE</b>			
1.6L L4 1599cc 98 CID	2006-2009	MEX	USEP12026M
<b>AVENGER</b>			
2.0L L4 1996cc 122 CID	1995-1999		USEP7081H
2.4L L4 2360cc 144 CID	2008-2014		USEP7253M
2.5L V6 2497cc 152 CID	1995-2000		USEP7081H

Engine	Years	Application Description	USMW
<b>DODGE (cont'd.)</b>			
<b>B150</b>			
3.9L V6 3906cc 239 CID	1991-1993	(X)	USEP7049M
3.9L V6 3906cc 239 CID	1994	22 Gallon Fuel Tank	USEP7063M
3.9L V6 3906cc 239 CID	1994	35 Gallon Fuel Tank	USEP7063M
5.2L V8 5211cc 318 CID	1991-1993	(Y)	USEP7049M
5.2L V8 5211cc 318 CID	1994	22 Gallon Fuel Tank	USEP7063M
5.2L V8 5211cc 318 CID	1994	35 Gallon Fuel Tank	USEP7063M
<b>B250</b>			
3.9L V6 3906cc 239 CID	1991-1992	(X)	USEP7049M
3.9L V6 3906cc 239 CID	1993	(X), GAS	USEP7049M
3.9L V6 3906cc 239 CID	1994	22 Gallon Fuel Tank	USEP7063M
3.9L V6 3906cc 239 CID	1994	35 Gallon Fuel Tank	USEP7063M
5.2L V8 5211cc 318 CID	1991-1992	(Y)	USEP7049M
5.2L V8 5211cc 318 CID	1993	(Y), GAS	USEP7049M
5.2L V8 5211cc 318 CID	1994	GAS; 22 Gallon Fuel Tank	USEP7063M
5.2L V8 5211cc 318 CID	1994	GAS; 35 Gallon Fuel Tank	USEP7063M
5.9L V8 360 CID	1991	(Z)	USEP7049M
5.9L V8 360 CID	1992	(Z); 22 Gallon Fuel Tank	USEP7049M
5.9L V8 360 CID	1992-1994	35 Gallon Fuel Tank	USEP7063M
5.9L V8 360 CID	1993	(Z), GAS; 22 Gallon Fuel Tank	USEP7049M
5.9L V8 360 CID	1994	22 Gallon Fuel Tank	USEP7063M
<b>B350</b>			
5.2L V8 5211cc 318 CID	1991-1992	(Y)	USEP7049M
5.2L V8 5211cc 318 CID	1993	(Y), GAS	USEP7049M
5.2L V8 5211cc 318 CID	1994	GAS; 22 Gallon Fuel Tank	USEP7063M
5.2L V8 5211cc 318 CID	1994	GAS; 35 Gallon Fuel Tank	USEP7063M
5.9L V8 360 CID	1991	(Z)	USEP7049M
5.9L V8 360 CID	1992	(Z); 22 Gallon Fuel Tank	USEP7049M
5.9L V8 360 CID	1992-1994	35 Gallon Fuel Tank	USEP7063M
5.9L V8 360 CID	1993	(Z), GAS; 22 Gallon Fuel Tank	USEP7049M
5.9L V8 360 CID	1994	22 Gallon Fuel Tank	USEP7063M
<b>B1500</b>			
3.9L V6 3906cc 239 CID	1995	22 Gallon Fuel Tank	USEP7063M
3.9L V6 3906cc 239 CID	1995	35 Gallon Fuel Tank	USEP7063M
3.9L V6 3906cc 239 CID	1996	(X)	USEP7100M
3.9L V6 3906cc 239 CID	1997	(X)	USEP7104M
3.9L V6 3906cc 239 CID	1998	(X); 35 Gallon Fuel Tank	USEP7123M
3.9L V6 3906cc 239 CID	1998	(X); 32 Gallon Fuel Tank	USEP7124M
5.2L V8 5211cc 318 CID	1995	22 Gallon Fuel Tank	USEP7063M
5.2L V8 5211cc 318 CID	1995	35 Gallon Fuel Tank	USEP7063M
5.2L V8 5211cc 318 CID	1996	(Y)	USEP7100M
5.2L V8 5211cc 318 CID	1997	(Y)	USEP7104M
5.2L V8 5211cc 318 CID	1998	(Y); 35 Gallon Fuel Tank	USEP7123M
5.2L V8 5211cc 318 CID	1998	(Y); 32 Gallon Fuel Tank	USEP7124M
5.9L V8 360 CID	1998	(Z); 35 Gallon Fuel Tank	USEP7123M
5.9L V8 360 CID	1998	(Z); 32 Gallon Fuel Tank	USEP7124M
<b>B2500</b>			
3.9L V6 3906cc 239 CID	1995	22 Gallon Fuel Tank	USEP7063M
3.9L V6 3906cc 239 CID	1995	35 Gallon Fuel Tank	USEP7063M
3.9L V6 3906cc 239 CID	1996	(X), GAS	USEP7100M
3.9L V6 3906cc 239 CID	1997	(X)	USEP7104M
5.2L V8 5211cc 318 CID	1995	GAS; 22 Gallon Fuel Tank	USEP7063M
5.2L V8 5211cc 318 CID	1995	GAS; 35 Gallon Fuel Tank	USEP7063M
5.2L V8 5211cc 318 CID	1996	(Y), GAS	USEP7100M
5.2L V8 5211cc 318 CID	1997	(Y)	USEP7104M
5.2L V8 5211cc 318 CID	1998	(Y), GAS; 35 Gallon Fuel Tank	USEP7123M
5.2L V8 5211cc 318 CID	1998	(Y), GAS; 32 Gallon Fuel Tank	USEP7124M
5.9L V8 360 CID	1995	22 Gallon Fuel Tank	USEP7063M
5.9L V8 360 CID	1995	35 Gallon Fuel Tank	USEP7063M
5.9L V8 360 CID	1996	(Z), GAS	USEP7100M
5.9L V8 360 CID	1997	(Z)	USEP7104M
5.9L V8 360 CID	1998	(Z), GAS; 35 Gallon Fuel Tank	USEP7123M
5.9L V8 360 CID	1998	(Z), GAS; 32 Gallon Fuel Tank	USEP7124M
<b>B3500</b>			
5.2L V8 5211cc 318 CID	1995	GAS; 22 Gallon Fuel Tank	USEP7063M
5.2L V8 5211cc 318 CID	1995	GAS; 35 Gallon Fuel Tank	USEP7063M
5.2L V8 5211cc 318 CID	1996	(Y), GAS	USEP7100M
5.2L V8 5211cc 318 CID	1997	(Y), GAS	USEP7104M
5.2L V8 5211cc 318 CID	1998	(Y), GAS; 35 Gallon Fuel Tank	USEP7123M
5.2L V8 5211cc 318 CID	1998	(Y), GAS; 32 Gallon Fuel Tank	USEP7124M
5.9L V8 360 CID	1995	22 Gallon Fuel Tank	USEP7063M
5.9L V8 360 CID	1995	35 Gallon Fuel Tank	USEP7063M
5.9L V8 360 CID	1996	(Z), GAS	USEP7100M
5.9L V8 360 CID	1997	(Z), GAS	USEP7104M
5.9L V8 360 CID	1998	(Z), GAS; 35 Gallon Fuel Tank	USEP7104M
5.9L V8 360 CID	1998	(Z), GAS; 32 Gallon Fuel Tank	USEP7124M
<b>CALIBER</b>			
2.0L L4 1998cc 122 CID	2012		USEP7266M
2.4L L4 2360cc 144 CID	2008-2009		USEP7245M
<b>CARAVAN</b>			
2.4L L4 2429cc 148 CID	1996-2000		USEP7094M
2.4L L4 2429cc 148 CID	2001-2003	SE; (B), GAS	USEP7144M



Engine	Years	Application Description	USMW	Engine	Years	Application Description	USMW
<b>DODGE (cont'd.)</b>				<b>DODGE (cont'd.)</b>			
<b>CARAVAN (cont'd.)</b>				<b>D250 (cont'd.)</b>			
2.4L L4 2429cc 148 CID	2004-2005	Exc.Floor Storage (Exc.Fold Away Seats)	USEP7172M	5.9L V8 360 CID	1993	(5), GAS, Naturally Aspirated; 34 Gallon Fuel Tank	USEP7064M
2.4L L4 2429cc 148 CID	2006-2007	GAS; Exc.Floor Storage (Exc.Fold Away Seats)	USEP7172M	5.9L V8 360 CID	1993	(Z), GAS, Naturally Aspirated; 30 Gallon Fuel Tank	USEP7064M
2.5L L4 2507cc 153 CID	1988	Base, LE, SE; (K)	USEP7068H	5.9L V8 360 CID	1993	(Z), GAS, Naturally Aspirated; 34 Gallon Fuel Tank	USEP7064M
2.5L L4 2507cc 153 CID	1989	Base, C/V, LE, SE; (K), Naturally Aspirated	USEP7068H	<b>D350</b>			
2.5L L4 2507cc 153 CID	1989-1990	Turbocharged	USEP7074H	5.9L V8 360 CID	1991-1992	(5), GAS, Naturally Aspirated	USEP7047M
2.5L L4 2507cc 153 CID	1990	C/V, ES, LE, SE; (K), Naturally Aspirated	USEP7068H	5.9L V8 360 CID	1991-1992	(Z), GAS, Naturally Aspirated	USEP7047M
2.5L L4 2507cc 153 CID	1991-1993	FWD	USEP7030M	5.9L V8 360 CID	1993	(5), GAS, Naturally Aspirated; Exc.30 Gallon Fuel Tank (Exc.34 Gallon Fuel Tank)	USEP7047M
2.5L L4 2507cc 153 CID	1994-1995	Base, C/V	USEP7077M	5.9L V8 360 CID	1993	(Z), GAS, Naturally Aspirated; Exc.30 Gallon Fuel Tank (Exc.34 Gallon Fuel Tank)	USEP7047M
3.0L V6 2972cc 181 CID	1987-1988		USEP7074H	5.9L V8 360 CID	1993	(5), GAS, Naturally Aspirated; 30 Gallon Fuel Tank	USEP7064M
3.0L V6 2972cc 181 CID	1989-1990	Naturally Aspirated	USEP7074H	5.9L V8 360 CID	1993	(5), GAS, Naturally Aspirated; 34 Gallon Fuel Tank	USEP7064M
3.0L V6 2972cc 181 CID	1991-1993	FWD	USEP7030M	5.9L V8 360 CID	1993	(Z), GAS, Naturally Aspirated; 30 Gallon Fuel Tank	USEP7064M
3.0L V6 2972cc 181 CID	1994-1995	Base, C/V, ES, LE, SE	USEP7077M	5.9L V8 360 CID	1993	(Z), GAS, Naturally Aspirated; 34 Gallon Fuel Tank	USEP7064M
3.0L V6 2972cc 181 CID	1996-2000		USEP7094M	5.9L V8 360 CID	1993	(5), GAS, Naturally Aspirated; 30 Gallon Fuel Tank	USEP7064M
3.3L V6 3301cc 201 CID	1990	Naturally Aspirated	USEP7074H	5.9L V8 360 CID	1993	(5), GAS, Naturally Aspirated; 34 Gallon Fuel Tank	USEP7064M
3.3L V6 3301cc 201 CID	1991-1993	AWD; WITH 5 PIN CONNECTOR	USEP7029M	5.9L V8 360 CID	1993	(Z), GAS, Naturally Aspirated; 30 Gallon Fuel Tank	USEP7064M
3.3L V6 3301cc 201 CID	1991-1993	FWD	USEP7030M	5.9L V8 360 CID	1993	(Z), GAS, Naturally Aspirated; 34 Gallon Fuel Tank	USEP7064M
3.3L V6 3301cc 201 CID	1994	ES, LE; (R), AWD, FI, GAS, Naturally Aspirated	USEP7057M	<b>DAKOTA</b>			
3.3L V6 3301cc 201 CID	1994	Base, C/V, SE	USEP7077M		1996		USEP7095M
3.3L V6 3301cc 201 CID	1995	Base, C/V, ES, LE, SE	USEP7077M	2.5L L4 2500cc 153 CID	1996		USEP7050M
3.3L V6 3301cc 201 CID	1996-1997		USEP7094M	2.5L L4 2500cc 153 CID	1996		USEP7096M
3.3L V6 3301cc 201 CID	1998	(G), FI, FLEX, Naturally Aspirated	USEP7129M	2.5L L4 2507cc 153 CID	1991-1993	15 Gallon Fuel Tank	USEP7050M
3.3L V6 3301cc 201 CID	1998-2000	GAS	USEP7094M	2.5L L4 2507cc 153 CID	1994		USEP7050M
3.3L V6 3301cc 201 CID	1999	Sport; (EGM), (G), FI, FLEX, Naturally Aspirated	USEP7129M	2.5L L4 2507cc 153 CID	1995	15 Gallon Fuel Tank	USEP7050M
3.3L V6 3301cc 201 CID	2001	SE, Sport; (EGM), (G), FLEX	USEP7146M	2.5L L4 2507cc 153 CID	1996		USEP7096M
3.3L V6 3301cc 201 CID	2001-2003	SE; (R), GAS	USEP7144M	2.5L L4 2507cc 153 CID	1997	(P); 15 Gallon Fuel Tank	USEP7114M
3.3L V6 3301cc 201 CID	2002-2003	SE, Sport; (3), FLEX	USEP7146M	2.5L L4 2507cc 153 CID	1997	(P); 22 Gallon Fuel Tank	USEP7116M
3.3L V6 3301cc 201 CID	2004	Exc.Floor Storage (Exc.Fold Away Seats)	USEP7172M	2.5L L4 2507cc 153 CID	1998-1999	Sport; (P); 15 Gallon Fuel Tank	USEP7114M
3.3L V6 3301cc 201 CID	2005	GAS; With Stow and go seating (Fold Away Seats)	USEP7196M	2.5L L4 2507cc 153 CID	1998-2001	Sport; (P); 22 Gallon Fuel Tank	USEP7116M
3.3L V6 3301cc 201 CID	2005-2007	GAS; Exc.Floor Storage (Exc.Fold Away Seats)	USEP7172M	2.5L L4 2507cc 153 CID	2000	Sport; (P); 24 Gallon Fuel Tank	USEP7116M
3.3L V6 3301cc 201 CID	2005-2007	FLEX	USEP7223M	2.5L L4 2507cc 153 CID	2001	Sport; (P); 24 Gallon Fuel Tank	USEP7128M
3.8L V6 3778cc 231 CID	1996-1999		USEP7094M	2.5L L4 2507cc 153 CID	2002	(P)	USEP7116M
<b>CHALLENGER</b>				3.7L V6 226 CID	2004	with 20 gallon fuel tank	USEP7171M
3.5L V6 3497cc 215 CID	2009-2010	GAS; 19 gallon fuel tank	USEP7192M	3.7L V6 226 CID	2004	Extended Cab Pickup; with 22 gallon fuel tank	USEP7173M
3.5L V6 3497cc 215 CID	2009-2010	GAS; 18 gallon fuel tank	USEP7241M	3.7L V6 226 CID	2004		USEP7185M
3.6L V6 3604cc 220 CID	2015	GAS	USEP7192M	3.7L V6 226 CID	2005	(K)	USEP7198M
3.6L V6 3604cc 220 CID	2017	GAS	USEP7192M	3.7L V6 226 CID	2006	Laramie, SLT, ST; (K)	USEP7198M
5.7L V8 345 CID	2009-2010	GAS; 18 gallon fuel tank	USEP7241M	3.7L V6 226 CID	2007	Laramie, SLT, ST; (K), GAS	USEP7198M
5.7L V8 345 CID	2009-2014	GAS; 19 gallon fuel tank	USEP7192M	3.7L V6 226 CID	2009	Big Horn, Lone Star, ST, TRX4; (K), GAS	USEP7198M
5.7L V8 345 CID	2015-2017	GAS	USEP7192M	3.7L V6 226 CID	2010-2011	GAS	USEP7216M
6.1L V8 6059cc 370 CID	2008-2010	19 gallon fuel tank	USEP7192M	3.9L V6 3906cc 239 CID	1991	22 Gallon Fuel Tank	USEP7050M
6.4L V8 6424cc 392 CID	2015	GAS	USEP7192M	3.9L V6 3906cc 239 CID	1992-1993	15 Gallon Fuel Tank	USEP7050M
<b>CHARGER</b>				3.9L V6 3906cc 239 CID	1994	(X); 15 Gallon Fuel Tank	USEP7062M
2.7L V6 2736cc 167 CID	2006-2010	GAS; 19 gallon fuel tank	USEP7192M	3.9L V6 3906cc 239 CID	1994	(X); 22 Gallon Fuel Tank	USEP7062M
2.7L V6 2736cc 167 CID	2006-2010	18 gallon fuel tank	USEP7241M	3.9L V6 3906cc 239 CID	1995	(X), GAS; 15 Gallon Fuel Tank	USEP7062M
2.7L V6 2736cc 167 CID	2006-2010	TRANSFER PUMP	USEP7264A	3.9L V6 3906cc 239 CID	1995	(X), GAS; 22 Gallon Fuel Tank	USEP7062M
3.5L V6 3497cc 215 CID	2006	18 gallon fuel tank	USEP7241M	3.9L V6 3906cc 239 CID	1996		USEP7096M
3.5L V6 3518cc 215 CID	2006-2010	GAS; 19 gallon fuel tank	USEP7192M	3.9L V6 3906cc 239 CID	1997	(X); 15 Gallon Fuel Tank	USEP7114M
3.5L V6 3518cc 215 CID	2007-2010	18 gallon fuel tank	USEP7241M	3.9L V6 3906cc 239 CID	1997	(X); 22 Gallon Fuel Tank	USEP7116M
3.6L V6 3604cc 220 CID	2011-2014	GAS	USEP7192M	3.9L V6 3906cc 239 CID	1998-1999	Sport; (X); 15 Gallon Fuel Tank	USEP7114M
5.7L V8 345 CID	2006-2010	18 gallon fuel tank	USEP7241M	3.9L V6 3906cc 239 CID	1998-2001	Sport; (X); 22 Gallon Fuel Tank	USEP7116M
5.7L V8 345 CID	2011-2015	GAS	USEP7192M	3.9L V6 3906cc 239 CID	2000	Sport; (X); 24 Gallon Fuel Tank	USEP7116M
5.7L V8 345 CID	2016	GAS; 19 gallon fuel tank	USEP7192M	3.9L V6 3906cc 239 CID	2001	Sport; (X); 24 Gallon Fuel Tank	USEP7128M
6.1L V8 6059cc 370 CID	2006-2010	GAS; 19 gallon fuel tank	USEP7192M	3.9L V6 3906cc 239 CID	2002	(X), Extended Cab Pickup; Exc.Quad Cab	USEP7116M
6.4L V8 6424cc 392 CID	2015	GAS	USEP7192M	3.9L V6 3906cc 239 CID	2002	(X), Standard Cab Pickup; Exc.Quad Cab	USEP7116M
<b>D150</b>				3.9L V6 3906cc 239 CID	2002	(X), Crew Cab Pickup	USEP7128M
3.9L V6 3906cc 239 CID	1991	Base, S; (X)	USEP7047M	3.9L V6 3906cc 239 CID	2002	(X), Extended Cab Pickup	USEP7128M
3.9L V6 3906cc 239 CID	1992-1993	(X)	USEP7047M	3.9L V6 3906cc 239 CID	2003	Sport; (X), Extended Cab Pickup; (22 Gallon Fuel Tank)	USEP7116M
5.2L V8 5211cc 318 CID	1991	Base, S; (Y)	USEP7047M	3.9L V6 3906cc 239 CID	2003	Sport; (X), Standard Cab Pickup; (22 Gallon Fuel Tank)	USEP7116M
5.2L V8 5211cc 318 CID	1992-1993	(Y)	USEP7047M	3.9L V6 3906cc 239 CID	2003	Sport; (X), Crew Cab Pickup	USEP7128M
5.9L V8 360 CID	1991	Base, (Z)	USEP7047M	3.9L V6 3906cc 239 CID	2003	Sport; (X), Extended Cab Pickup	USEP7128M
5.9L V8 360 CID	1993	(Z); Exc.30 Gallon Fuel Tank (Exc.34 Gallon Fuel Tank)	USEP7047M	3.9L V6 3906cc 239 CID	2003	Sport; (X), Extended Cab Pickup; (20 Gallon Fuel Tank)	USEP7168M
5.9L V8 360 CID	1993	(Z); 30 Gallon Fuel Tank	USEP7064M	3.9L V6 3906cc 239 CID	2003	Sport; (X), Standard Cab Pickup; (20 Gallon Fuel Tank)	USEP7168M
5.9L V8 360 CID	1993	(Z); 34 Gallon Fuel Tank	USEP7064M	4.7L V8 287 CID	2000	Sport; (N); 24 Gallon Fuel Tank	USEP7116M
<b>D250</b>				4.7L V8 287 CID	2000-2001	Sport; (N); 22 Gallon Fuel Tank	USEP7116M
3.9L V6 3906cc 239 CID	1991-1993	(X), GAS, Naturally Aspirated	USEP7047M	4.7L V8 287 CID	2001	Sport; (N); 24 Gallon Fuel Tank	USEP7128M
5.2L V8 5211cc 318 CID	1991-1993	(Y), GAS, Naturally Aspirated	USEP7047M	4.7L V8 287 CID	2002	(N), Extended Cab Pickup; Exc.Quad Cab	USEP7116M
5.9L V8 360 CID	1991	(5), GAS, Naturally Aspirated	USEP7047M	4.7L V8 287 CID	2002	(N), Standard Cab Pickup; Exc.Quad Cab	USEP7116M
5.9L V8 360 CID	1991-1992	(Z), GAS, Naturally Aspirated	USEP7047M	4.7L V8 287 CID	2002	(N), Crew Cab Pickup	USEP7128M
5.9L V8 360 CID	1993	(5), GAS, Naturally Aspirated; Exc.30 Gallon Fuel Tank (Exc.34 Gallon Fuel Tank)	USEP7047M	4.7L V8 287 CID	2002	(N), Extended Cab Pickup	USEP7128M
5.9L V8 360 CID	1993	(Z), GAS, Naturally Aspirated; Exc.30 Gallon Fuel Tank (Exc.34 Gallon Fuel Tank)	USEP7047M	4.7L V8 287 CID	2003	Sport; (N), Extended Cab Pickup; (22 Gallon Fuel Tank)	USEP7116M
5.9L V8 360 CID	1993	(5), GAS, Naturally Aspirated; 30 Gallon Fuel Tank	USEP7064M				





# FUEL PUMP MODULES APPLICATION GUIDE



FUEL PUMP MODULES

Engine	Years	Application Description	USMW
<b>DODGE (cont'd.)</b>			
<b>DAKOTA (cont'd.)</b>			
4.7L V8 287 CID	2003	Sport; (N), Standard Cab Pickup; (22 Gallon Fuel Tank)	USEP7116M
4.7L V8 287 CID	2003	Sport; (N), Crew Cab Pickup	USEP7128M
4.7L V8 287 CID	2003	Sport; (N), Extended Cab Pickup	USEP7128M
4.7L V8 287 CID	2003	Sport; (N), Extended Cab Pickup; (20 Gallon Fuel Tank)	USEP7168M
4.7L V8 287 CID	2003	Sport; (N), Standard Cab Pickup; (20 Gallon Fuel Tank)	USEP7168M
4.7L V8 287 CID	2004	with 20 gallon fuel tank	USEP7171M
4.7L V8 287 CID	2004	Extended Cab Pickup; with 22 gallon fuel tank	USEP7173M
4.7L V8 287 CID	2004		USEP7185M
4.7L V8 287 CID	2005	(J)	USEP7198M
4.7L V8 287 CID	2005	(N)	USEP7198M
4.7L V8 287 CID	2006	Laramie, SLT, ST; (N)	USEP7198M
4.7L V8 287 CID	2006	Laramie, SLT; (J)	USEP7198M
4.7L V8 287 CID	2007	Laramie, SLT, ST; (N), GAS	USEP7198M
4.7L V8 287 CID	2007	Laramie, SLT, ST; (P), FLEX	USEP7198M
4.7L V8 287 CID	2007	Laramie, SLT; (J), GAS	USEP7198M
4.7L V8 287 CID	2007-2010	FLEX	USEP7216M
4.7L V8 287 CID	2009	Big Horn, Laramie, Lone Star, TRX4; (P), FLEX	USEP7198M
5.2L V8 5211cc 318 CID	1991-1993	15 Gallon Fuel Tank	USEP7050M
5.2L V8 5211cc 318 CID	1994	(Y); 15 Gallon Fuel Tank	USEP7062M
5.2L V8 5211cc 318 CID	1994	(Y); 22 Gallon Fuel Tank	USEP7062M
5.2L V8 5211cc 318 CID	1995	(Y), GAS; 15 Gallon Fuel Tank	USEP7062M
5.2L V8 5211cc 318 CID	1995	(Y), GAS; 22 Gallon Fuel Tank	USEP7062M
5.2L V8 5211cc 318 CID	1996		USEP7096M
5.2L V8 5211cc 318 CID	1997	(Y); 15 Gallon Fuel Tank	USEP7114M
5.2L V8 5211cc 318 CID	1997	(Y); 22 Gallon Fuel Tank	USEP7116M
5.2L V8 5211cc 318 CID	1998-1999	Sport; (Y); 15 Gallon Fuel Tank	USEP7114M
5.2L V8 5211cc 318 CID	1998-1999	Sport; (Y); 22 Gallon Fuel Tank	USEP7116M
5.9L V8 360 CID	1998-1999	R/T; (Z); 15 Gallon Fuel Tank	USEP7114M
5.9L V8 360 CID	1998-1999	R/T; (Z); 22 Gallon Fuel Tank	USEP7116M
5.9L V8 360 CID	2000	Sport; (Z); 24 Gallon Fuel Tank	USEP7116M
5.9L V8 360 CID	2000-2001	Sport; (Z); 22 Gallon Fuel Tank	USEP7116M
5.9L V8 360 CID	2001	Sport; (Z); 24 Gallon Fuel Tank	USEP7128M
5.9L V8 360 CID	2002	(Z), Extended Cab Pickup; Exc.Quad Cab	USEP7116M
5.9L V8 360 CID	2002	(Z), Standard Cab Pickup; Exc.Quad Cab	USEP7116M
5.9L V8 360 CID	2002	(Z), Crew Cab Pickup	USEP7128M
5.9L V8 360 CID	2002	(Z), Extended Cab Pickup	USEP7128M
5.9L V8 360 CID	2003	Sport; (Z), Extended Cab Pickup; (22 Gallon Fuel Tank)	USEP7116M
5.9L V8 360 CID	2003	Sport; (Z), Standard Cab Pickup; (22 Gallon Fuel Tank)	USEP7116M
5.9L V8 360 CID	2003	Sport; (Z), Crew Cab Pickup	USEP7128M
5.9L V8 360 CID	2003	Sport; (Z), Extended Cab Pickup	USEP7128M
5.9L V8 360 CID	2003	Sport; (Z), Extended Cab Pickup; (20 Gallon Fuel Tank)	USEP7168M
5.9L V8 360 CID	2003	Sport; (Z), Standard Cab Pickup; (20 Gallon Fuel Tank)	USEP7168M
<b>DAYTONA</b>			
2.2L L4 135 CID	1984		USEP7071H
2.2L L4 135 CID	1985	Turbo; (E), Turbocharged; (Double Nipple)	USEP7051S
2.2L L4 135 CID	1985-1986	Turbocharged; (1 Tube Type)	USEP7071H
2.2L L4 135 CID	1986	Base; (D), Naturally Aspirated	USEP7069H
2.2L L4 135 CID	1987-1988	Turbocharged; (Single Nipple)	USEP7071H
2.2L L4 135 CID	1989-1990	Turbocharged	USEP7071H
2.2L L4 135 CID	1992-1993	Iroc R/T; (A), Turbocharged	USEP7040M
2.5L L4 2507cc 153 CID	1986-1988	Base; (K), Naturally Aspirated	USEP7069H
2.5L L4 2507cc 153 CID	1989-1990	Base, ES; (K), Naturally Aspirated	USEP7069H
2.5L L4 2507cc 153 CID	1989-1990	Turbocharged	USEP7071H
2.5L L4 2507cc 153 CID	1992	Iroc; (J), Turbocharged	USEP7040M
2.5L L4 2507cc 153 CID	1992-1993	Base, ES; (K), Naturally Aspirated	USEP7040M
3.0L V6 2972cc 181 CID	1990	Naturally Aspirated	USEP7071H
3.0L V6 2972cc 181 CID	1992-1993	Base, ES, Iroc; (3), Naturally Aspirated	USEP7040M
<b>DURANGO</b>			
3.6L V6 3604cc 220 CID	2011-2014		USEP7271M
3.7L V6 226 CID	2004-2005	(K)	USEP7184M
3.7L V6 226 CID	2008-2009		USEP7234M
3.9L V6 3906cc 239 CID	1998-1999		USEP7117M
4.7L V8 287 CID	2000-2003		USEP7117M
4.7L V8 287 CID	2004-2005	(N)	USEP7184M
4.7L V8 287 CID	2006-2007		USEP7227M
4.7L V8 287 CID	2008		USEP7234M
5.2L V8 5211cc 318 CID	1998-2000		USEP7117M
5.7L V8 345 CID	2004-2005	(D)	USEP7184M
5.7L V8 345 CID	2008-2009		USEP7234M
5.9L V8 360 CID	1998-2003		USEP7117M
<b>DYNASTY</b>			
2.5L L4 2507cc 153 CID	1989-1990	Base; (K)	USEP7069H
2.5L L4 2507cc 153 CID	1991-1993	Base; (K)	USEP7040M
3.0L V6 2972cc 181 CID	1989-1990		USEP7071H

Engine	Years	Application Description	USMW
<b>DODGE (cont'd.)</b>			
<b>DYNASTY (cont'd.)</b>			
3.0L V6 2972cc 181 CID	1991-1993	Base, LS; (3)	USEP7040M
3.3L V6 3301cc 201 CID	1990		USEP7071H
3.3L V6 3301cc 201 CID	1991-1993	Base, LS; (R)	USEP7040M
<b>GRAND CARAVAN</b>			
2.4L L4 2429cc 148 CID	1996-1997		USEP7094M
2.5L L4 2507cc 153 CID	1988	SE; (K)	USEP7068H
2.5L L4 2507cc 153 CID	1989	Naturally Aspirated	USEP7074H
3.0L V6 2972cc 181 CID	1988		USEP7074H
3.0L V6 2972cc 181 CID	1992-1993	FWD	USEP7030M
3.0L V6 2972cc 181 CID	1994-1995	Base, SE	USEP7077M
3.0L V6 2972cc 181 CID	1996-2000		USEP7094M
3.3L V6 3301cc 201 CID	1990	Naturally Aspirated	USEP7074H
3.3L V6 3301cc 201 CID	1991-1993	AWD; WITH 5 PIN CONNECTOR	USEP7029M
3.3L V6 3301cc 201 CID	1991-1993	FWD	USEP7030M
3.3L V6 3301cc 201 CID	1994	ES, LE, SE; (R), AWD	USEP7057M
3.3L V6 3301cc 201 CID	1995	ES, LE; (R), AWD	USEP7057M
3.3L V6 3301cc 201 CID	1995	SE; (R), 41AE Trans Code, AWD	USEP7057M
3.3L V6 3301cc 201 CID	1995	SE; 41TE Trans Code	USEP7077M
3.3L V6 3301cc 201 CID	1996	GAS	USEP7094M
3.3L V6 3301cc 201 CID	1997		USEP7094M
3.3L V6 3301cc 201 CID	1998	(G), FLEX	USEP7129M
3.3L V6 3301cc 201 CID	1998-2000	GAS	USEP7094M
3.3L V6 3301cc 201 CID	1999-2000	(EGM), (G), FLEX	USEP7129M
3.3L V6 3301cc 201 CID	2001	ES, SE, Sport; (R), GAS	USEP7144M
3.3L V6 3301cc 201 CID	2001	ES, SE, Sport; (3), FLEX	USEP7146M
3.3L V6 3301cc 201 CID	2001	ES; (EGM), (G), FLEX	USEP7146M
3.3L V6 3301cc 201 CID	2002	SE, Sport; (R), GAS	USEP7144M
3.3L V6 3301cc 201 CID	2002	SE, Sport; (3), FLEX	USEP7146M
3.3L V6 3301cc 201 CID	2003	SE; (R), GAS	USEP7144M
3.3L V6 3301cc 201 CID	2003	EL, ES; (3), FLEX	USEP7146M
3.3L V6 3301cc 201 CID	2004	Exc.Floor Storage (Exc.Fold Away Seats)	USEP7172M
3.3L V6 3301cc 201 CID	2005	GAS; Exc.Floor Storage (Exc.Fold Away Seats)	USEP7172M
3.3L V6 3301cc 201 CID	2005	FLEX	USEP7223M
3.3L V6 3301cc 201 CID	2005-2007	GAS; With Stow and go seating (Fold Away Seats)	USEP7196M
3.3L V6 3301cc 201 CID	2006-2007	Base, SE; (E), (EGV), FLEX	USEP7195M
3.6L V6 3604cc 220 CID	2011-2018		USEP7272M
3.8L V6 3778cc 231 CID	1994	LE; (L), AWD	USEP7057M
3.8L V6 3778cc 231 CID	1994	ES	USEP7077M
3.8L V6 3778cc 231 CID	1995	ES; (L), AWD	USEP7057M
3.8L V6 3778cc 231 CID	1995	LE	USEP7077M
3.8L V6 3778cc 231 CID	1996-2000		USEP7094M
3.8L V6 3778cc 231 CID	2001	ES, EX, Sport; (L), GAS	USEP7144M
3.8L V6 3778cc 231 CID	2002	Sport; (L), GAS	USEP7144M
3.8L V6 3778cc 231 CID	2003	EX, Sport; (L), GAS	USEP7144M
3.8L V6 3778cc 231 CID	2004-2005	Exc.Floor Storage (Exc.Fold Away Seats)	USEP7172M
3.8L V6 3778cc 231 CID	2005-2006	With Stow and go seating (Fold Away Seats)	USEP7196M
3.8L V6 3778cc 231 CID	2007	GAS; With Stow and go seating (Fold Away Seats)	USEP7196M
3.8L V6 3778cc 231 CID	2008-2010		USEP7235M
4.0L V6 3952cc 241 CID	2008-2010		USEP7235M
<b>INTREPID</b>			
2.7L V6 2736cc 167 CID	1998-1999	(EER), (R)	USEP7137M
2.7L V6 2736cc 167 CID	2000		USEP7152M
2.7L V6 2736cc 167 CID	2002-2004		USEP7152M
3.2L V6 3200cc 197 CID	1998-1999	(EGW), (J)	USEP7137M
3.2L V6 3200cc 197 CID	2000		USEP7152M
3.3L V6 3301cc 201 CID	1993	Base, ES; (T)	USEP7054M
3.3L V6 3301cc 201 CID	1994-1995	Base, ES; (T), GAS	USEP7054M
3.3L V6 3301cc 201 CID	1994-1995	Base; (U), FLEX	USEP7076M
3.3L V6 3301cc 201 CID	1997	Base; (T)	USEP7101M
3.5L V6 3497cc 215 CID	1993	Base, ES; (F)	USEP7054M
3.5L V6 3497cc 215 CID	1994-1995	Base, ES; (F), GAS	USEP7054M
3.5L V6 3497cc 215 CID	1997	Base, ES; (F)	USEP7101M
3.5L V6 3497cc 215 CID	2000		USEP7152M
3.5L V6 3497cc 215 CID	2002-2004		USEP7152M
<b>JOURNEY</b>			
2.4L L4 2360cc 144 CID	2015-2016		USEP7251M
3.5L V6 3497cc 215 CID	2009-2010		USEP7255M
3.5L V6 3518cc 215 CID	2009-2010		USEP7255M
3.6L V6 3604cc 220 CID	2011-2014		USEP7255M
3.6L V6 3604cc 220 CID	2015		USEP7269M
3.6L V6 3605cc 220 CID	2011-2014		USEP7255M
3.6L V6 3605cc 220 CID	2015		USEP7269M
<b>LANCER</b>			
2.2L L4 135 CID	1985	Base, ES; (E), Turbocharged; (Double Nipple)	USEP7051S
2.2L L4 135 CID	1986	Turbocharged; (1 Tube Type)	USEP7071H
2.2L L4 135 CID	1986-1987	Base, ES; (D), Naturally Aspirated	USEP7069H
2.2L L4 135 CID	1987	Turbocharged; (Single Nipple)	USEP7071H



# FUEL PUMP MODULES APPLICATION GUIDE



Engine	Years	Application Description	USMW	Engine	Years	Application Description	USMW
<b>DODGE (cont'd.)</b>				<b>DODGE (cont'd.)</b>			
<b>LANCER (cont'd.)</b>				<b>RAM 1500 (cont'd.)</b>			
2.2L L4 135 CID	1989	Base; (D), Naturally Aspirated	USEP7069H	4.7L V8 287 CID	2005	SLT; (N), 140.5 / 356.9 Wheel Base, Crew Cab Pickup, GAS; (26 Gallon Fuel Tank)	USEP7186M
2.2L L4 135 CID	1989	Turbocharged	USEP7071H	4.7L V8 287 CID	2006	Laramie, SLT, ST, TRX4; (N), 140.5 / 356.9 Wheel Base, GAS, Standard Cab Pickup	USEP7165M
2.5L L4 2507cc 153 CID	1986-1987	Base, ES; (K), Naturally Aspirated	USEP7069H	4.7L V8 287 CID	2006	Laramie, SLT, ST; (N), 160.5 / 407.7 Wheel Base, Crew Cab Pickup, GAS	USEP7165M
2.5L L4 2507cc 153 CID	1989	Base, ES; (K), Naturally Aspirated	USEP7069H	4.7L V8 287 CID	2006	Laramie, SLT; (N), 160.3 / 407.2 Wheel Base, Crew Cab Pickup, GAS	USEP7165M
2.5L L4 2507cc 153 CID	1989	Turbocharged	USEP7071H	4.7L V8 287 CID	2006	SLT, ST, TRX4; (P), FLEX	USEP7180M
<b>MAGNUM</b>				4.7L V8 287 CID	2006	Laramie, SLT, ST, TRX4; (N), 140.5 / 356.9 Wheel Base, Crew Cab Pickup, GAS; (34 Gallon Fuel Tank)	USEP7182M
2.2L L4 135 CID	1984-1988	MEX	USEP7071H	4.7L V8 287 CID	2006	Laramie, SLT, ST, TRX4; (N), 120.5 / 306.1 Wheel Base, GAS, Standard Cab Pickup	USEP7186M
2.7L V6 2736cc 167 CID	2005-2008	GAS; 19 gallon fuel tank	USEP7192M	4.7L V8 287 CID	2006	Laramie, SLT, ST, TRX4; (N), 140.5 / 356.9 Wheel Base, Crew Cab Pickup, GAS; (26 Gallon Fuel Tank)	USEP7186M
2.7L V6 2736cc 167 CID	2006-2008	18 gallon fuel tank	USEP7241M	4.7L V8 287 CID	2007	SLT, ST, TRX4; (P), 76.3 / 193.8 Bed, FLEX; (26 Gallon Fuel Tank)	USEP7180M
3.5L V6 3497cc 215 CID	2005-2008	GAS; 19 gallon fuel tank	USEP7192M	4.7L V8 287 CID	2007	SLT, ST, TRX4; (P), 76.3 / 193.8 Bed, FLEX; (34 Gallon Fuel Tank)	USEP7180M
3.5L V6 3497cc 215 CID	2006	18 gallon fuel tank	USEP7241M	4.7L V8 287 CID	2007	SLT, ST, TRX4; (P), 98.3 / 249.7 Bed, FLEX	USEP7180M
3.5L V6 3497cc 215 CID	2007-2008	GAS; 18 gallon fuel tank	USEP7241M	4.7L V8 287 CID	2007	SLT, ST, TRX4; (N), 76.3 / 193.8 Bed, GAS; (34 Gallon Fuel Tank)	USEP7182M
5.7L V8 345 CID	2005-2008	GAS; 19 gallon fuel tank	USEP7192M	4.7L V8 287 CID	2007	SLT, ST, TRX4; (N), 98.3 / 249.7 Bed, GAS	USEP7182M
5.7L V8 345 CID	2006	18 gallon fuel tank	USEP7241M	4.7L V8 287 CID	2008		USEP7237M
5.7L V8 345 CID	2007-2008	GAS; 18 gallon fuel tank	USEP7241M	4.7L V8 287 CID	2010		USEP7252M
6.1L V8 6059cc 370 CID	2006-2008	GAS; 19 gallon fuel tank	USEP7192M	5.2L V8 5211cc 318 CID	1994	(Y)	USEP7065M
<b>MINI RAM</b>				5.2L V8 5211cc 318 CID	1995	(Y), GAS	USEP7086M
2.5L L4 2507cc 153 CID	1987	(K), FI	USEP7068H	5.2L V8 5211cc 318 CID	1996-1997	(Y), GAS	USEP7093M
2.5L L4 2507cc 153 CID	1988	(K)	USEP7068H	5.2L V8 5211cc 318 CID	1998	Custom, Laramie, Lujo, Sport, ST; FI, GAS; (35 Gallon Fuel Tank)	USEP7111M
3.0L V6 2972cc 181 CID	1987-1988		USEP7074H	5.2L V8 5211cc 318 CID	1998	(Y)	USEP7138M
<b>MONACO</b>				5.2L V8 5211cc 318 CID	1999	Custom, Laramie, R/T, Sport, ST; FI, GAS; (35 Gallon Fuel Tank)	USEP7111M
	1991	ES, LE; (Z7X-711)	USEP7039M	5.2L V8 5211cc 318 CID	1999	(Y); Exc.35 Gallon Fuel Tank	USEP7138M
	1991	ES, LE; (Z7X-715)	USEP7039M	5.7L V8 345 CID	2003	(D), 140.5 / 356.9 Wheel Base, Standard Cab Pickup; 26 Gallon Fuel Tank	USEP7158M
	1992	ES, LE	USEP7039M	5.7L V8 345 CID	2003	(D), 120.5 / 306.1 Wheel Base, Standard Cab Pickup; 26 Gallon Fuel Tank	USEP7159M
<b>NEON</b>				5.7L V8 345 CID	2003	(D), 140.5 / 356.9 Wheel Base, Crew Cab Pickup; 26 Gallon Fuel Tank	USEP7159M
	2000		USEP7130M	5.7L V8 345 CID	2003	(D); 34 Gallon Fuel Tank	USEP7160M
2.0L L4 1996cc 122 CID	1995		USEP7075M	5.7L V8 345 CID	2004	SLT; (D), 97.9 / 248.7 Bed, GAS	USEP7165M
2.0L L4 1996cc 122 CID	1996	METAL TANK	USEP7075M	5.7L V8 345 CID	2004	SLT; (D), 75.9 / 192.8 Bed, GAS	USEP7186M
2.0L L4 1996cc 122 CID	1996	Plastic Fuel Tank	USEP7097M	5.7L V8 345 CID	2006	Laramie, SLT, Sport, ST, TRX4; (2), (EZB), 140.5 / 356.9 Wheel Base, GAS, Standard Cab Pickup	USEP7165M
2.0L L4 1996cc 122 CID	1997-1999		USEP7097M	5.7L V8 345 CID	2006	Laramie, SLT, ST; (2), (EZB), 160.5 / 407.7 Wheel Base, Crew Cab Pickup, GAS	USEP7165M
2.0L L4 1996cc 122 CID	2001-2005		USEP7142M	5.7L V8 345 CID	2006	Laramie, SLT; (2), (EZB), 160.3 / 407.2 Wheel Base, Crew Cab Pickup, GAS	USEP7165M
2.4L L4 2429cc 148 CID	2003-2005		USEP7142M	5.7L V8 345 CID	2006	Laramie, SLT, ST, TRX4; (2), (EZB), 140.5 / 356.9 Wheel Base, Crew Cab Pickup, GAS; (34 Gallon Fuel Tank)	USEP7182M
<b>NITRO</b>				5.7L V8 345 CID	2006	Laramie, SLT; (D), 160.5 / 407.7 Wheel Base, Crew Cab Pickup, GAS	USEP7165M
3.7L V6 226 CID	2007-2008	SLT, SXT; (K)	USEP7219M	5.7L V8 345 CID	2006	Laramie, SLT, ST, TRX4; (2), (EZB), 140.5 / 356.9 Wheel Base, Crew Cab Pickup, GAS; (34 Gallon Fuel Tank)	USEP7182M
3.7L V6 226 CID	2009	SE, SLT; (K)	USEP7219M	5.7L V8 345 CID	2006	Laramie, SLT; (D), 140.5 / 356.9 Wheel Base, GAS, Standard Cab Pickup	USEP7165M
3.7L V6 226 CID	2010-2011		USEP7219M	5.7L V8 345 CID	2006	Laramie, SLT; (D), 160.3 / 407.2 Wheel Base, Crew Cab Pickup, GAS	USEP7165M
4.0L V6 3952cc 241 CID	2007-2008	R/T; (6)	USEP7219M	5.7L V8 345 CID	2006	Laramie, SLT; (D), 140.5 / 356.9 Wheel Base, Crew Cab Pickup, GAS; (34 Gallon Fuel Tank)	USEP7182M
4.0L V6 3952cc 241 CID	2009	R/T; (X)	USEP7219M	5.7L V8 345 CID	2006	Sport; (2), (EZB), Crew Cab Pickup, GAS; (34 Gallon Fuel Tank)	USEP7182M
<b>OMNI</b>				5.7L V8 345 CID	2006	Laramie, SLT, Sport, ST, TRX4; (2), (EZB), 120.5 / 306.1 Wheel Base, GAS, Standard Cab Pickup	USEP7186M
	1988-1990		USEP7073S	5.7L V8 345 CID	2006	Laramie, SLT, ST, TRX4; (2), (EZB), 140.5 / 356.9 Wheel Base, Crew Cab Pickup, GAS; (26 Gallon Fuel Tank)	USEP7186M
<b>RAM 1500</b>				5.7L V8 345 CID	2006	Laramie, SLT; (D), 120.5 / 306.1 Wheel Base, GAS, Standard Cab Pickup	USEP7186M
3.7L V6 226 CID	2002	(K); 35 Gallon Fuel Tank	USEP7160M	5.7L V8 345 CID	2006	Laramie, SLT; (D), 140.5 / 356.9 Wheel Base, Crew Cab Pickup, GAS; (26 Gallon Fuel Tank)	USEP7186M
3.7L V6 226 CID	2002-2003	(K); 26 Gallon Fuel Tank	USEP7161M	5.7L V8 345 CID	2006	Laramie, SLT; (D), 140.5 / 356.9 Wheel Base, Crew Cab Pickup, GAS; (26 Gallon Fuel Tank)	USEP7186M
3.7L V6 226 CID	2003	(K); 34 Gallon Fuel Tank	USEP7160M	5.7L V8 345 CID	2006	Laramie, SLT; (D), 140.5 / 356.9 Wheel Base, Crew Cab Pickup, GAS; (26 Gallon Fuel Tank)	USEP7186M
3.7L V6 226 CID	2004	ST; (K), 97.9 / 248.7 Bed, GAS	USEP7165M	5.7L V8 345 CID	2006	Laramie, SLT; (D), 140.5 / 356.9 Wheel Base, Crew Cab Pickup, GAS; (34 Gallon Fuel Tank)	USEP7182M
3.7L V6 226 CID	2004	ST; (K), 75.9 / 192.8 Bed, GAS	USEP7186M	5.7L V8 345 CID	2006	Sport; (2), (EZB), Crew Cab Pickup, GAS; (34 Gallon Fuel Tank)	USEP7182M
3.7L V6 226 CID	2005-2006	ST; (K), 140.5 / 356.9 Wheel Base, GAS, Standard Cab Pickup	USEP7165M	5.7L V8 345 CID	2006	Laramie, SLT, Sport, ST, TRX4; (2), (EZB), 120.5 / 306.1 Wheel Base, GAS, Standard Cab Pickup	USEP7186M
3.7L V6 226 CID	2005-2006	ST; (K), 160.5 / 407.7 Wheel Base, Crew Cab Pickup, GAS	USEP7165M	5.7L V8 345 CID	2006	Laramie, SLT, ST, TRX4; (2), (EZB), 140.5 / 356.9 Wheel Base, Crew Cab Pickup, GAS; (26 Gallon Fuel Tank)	USEP7186M
3.7L V6 226 CID	2005-2006	ST; (K), 140.5 / 356.9 Wheel Base, Crew Cab Pickup, GAS; (34 Gallon Fuel Tank)	USEP7182M	5.7L V8 345 CID	2006	Laramie, SLT; (D), 120.5 / 306.1 Wheel Base, GAS, Standard Cab Pickup	USEP7186M
3.7L V6 226 CID	2005-2006	ST; (K), 120.5 / 306.1 Wheel Base, GAS, Standard Cab Pickup	USEP7186M	5.7L V8 345 CID	2006	Laramie, SLT; (D), 140.5 / 356.9 Wheel Base, Crew Cab Pickup, GAS; (26 Gallon Fuel Tank)	USEP7186M
3.7L V6 226 CID	2005-2006	ST; (K), 140.5 / 356.9 Wheel Base, Crew Cab Pickup, GAS; (26 Gallon Fuel Tank)	USEP7186M	5.7L V8 345 CID	2006	Sport; (2), (EZB), Crew Cab Pickup, GAS; (26 Gallon Fuel Tank)	USEP7186M
3.7L V6 226 CID	2007	ST; (K), GAS; 34 Gallon Fuel Tank	USEP7182M	5.7L V8 345 CID	2007	Laramie, SLT; (D), GAS	USEP7165M
3.7L V6 226 CID	2007	ST; (K), GAS; 35 Gallon Fuel Tank	USEP7182M	5.7L V8 345 CID	2007	Laramie, Sport; (2), (EZB), GAS; 34 Gallon Fuel Tank	USEP7182M
3.7L V6 226 CID	2008		USEP7237M	5.7L V8 345 CID	2007	SLT, ST, TRX4; (2), (EZB), 76.3 / 193.8 Bed, GAS; (34 Gallon Fuel Tank)	USEP7182M
3.7L V6 226 CID	2010		USEP7252M				
3.9L V6 3906cc 239 CID	1994	(X)	USEP7065M				
3.9L V6 3906cc 239 CID	1995	(X), GAS	USEP7086M				
3.9L V6 3906cc 239 CID	1996-1997	(X), GAS	USEP7093M				
3.9L V6 3906cc 239 CID	1998	(X)	USEP7138M				
3.9L V6 3906cc 239 CID	1998-1999	Laramie, Sport, ST, WS; FI, GAS; (35 Gallon Fuel Tank)	USEP7111M				
3.9L V6 3906cc 239 CID	1999	(X); Exc.35 Gallon Fuel Tank	USEP7138M				
4.7L V8 287 CID	2002	(N); 35 Gallon Fuel Tank	USEP7160M				
4.7L V8 287 CID	2002-2003	(N); 26 Gallon Fuel Tank	USEP7161M				
4.7L V8 287 CID	2003	(N); 34 Gallon Fuel Tank	USEP7160M				
4.7L V8 287 CID	2004	SLT; (N), 97.9 / 248.7 Bed, GAS	USEP7165M				
4.7L V8 287 CID	2004	SLT; (N), 75.9 / 192.8 Bed, GAS	USEP7186M				
4.7L V8 287 CID	2005	SLT; (N), 140.5 / 356.9 Wheel Base, GAS, Standard Cab Pickup	USEP7165M				
4.7L V8 287 CID	2005	SLT; (N), 160.5 / 407.7 Wheel Base, Crew Cab Pickup, GAS	USEP7165M				
4.7L V8 287 CID	2005	SLT; (N), 140.5 / 356.9 Wheel Base, Crew Cab Pickup, GAS; (34 Gallon Fuel Tank)	USEP7182M				
4.7L V8 287 CID	2005	SLT; (N), 120.5 / 306.1 Wheel Base, GAS, Standard Cab Pickup	USEP7186M				





# FUEL PUMP MODULES APPLICATION GUIDE



FUEL PUMP MODULES

Engine	Years	Application Description	USMW
<b>DODGE (cont'd.)</b>			
<b>RAM 1500 (cont'd.)</b>			
5.7L V8 345 CID	2007	SLT, ST, TRX4; (2), (EZB), 98.3 / 249.7 Bed, GAS	USEP7182M
5.7L V8 345 CID	2008		USEP7237M
5.7L V8 345 CID	2010		USEP7252M
5.9L V8 360 CID	1994	(Z)	USEP7065M
5.9L V8 360 CID	1995	(Z), GAS	USEP7086M
5.9L V8 360 CID	1996-1997	(Z), GAS	USEP7093M
5.9L V8 360 CID	1998	(Z)	USEP7138M
5.9L V8 360 CID	1998-1999	Laramie, Sport, ST; FI, GAS; (35 Gallon Fuel Tank)	USEP7111M
5.9L V8 360 CID	1999	(Z), Extended Cab Pickup; Exc.35 Gallon Fuel Tank	USEP7138M
5.9L V8 360 CID	1999	(Z), Standard Cab Pickup; Exc.35 Gallon Fuel Tank	USEP7138M
5.9L V8 360 CID	2002	SLT, ST; FI, GAS; (35 Gallon Fuel Tank)	USEP7111M
5.9L V8 360 CID	2002	(Z); 35 Gallon Fuel Tank	USEP7160M
5.9L V8 360 CID	2002-2003	(Z); 26 Gallon Fuel Tank	USEP7161M
5.9L V8 360 CID	2003	(Z); 34 Gallon Fuel Tank	USEP7160M
8.3L V10 8275cc 505 CID	2004-2006		USEP7183M
8.3L V10 8277cc 505 CID	2005-2006		USEP7183M
<b>RAM 1500 VAN</b>			
3.9L V6 3906cc 239 CID	1999-2000	(X); 32 Gallon Fuel Tank	USEP7124M
3.9L V6 3906cc 239 CID	1999-2002	(X); 35 Gallon Fuel Tank	USEP7123M
3.9L V6 3906cc 239 CID	2001-2002	(X); 31 Gallon Fuel Tank	USEP7124M
3.9L V6 3906cc 239 CID	2003	(X)	USEP7123M
5.2L V8 5211cc 318 CID	1999-2000	(Y); 32 Gallon Fuel Tank	USEP7124M
5.2L V8 5211cc 318 CID	1999-2002	(Y); 35 Gallon Fuel Tank	USEP7123M
5.2L V8 5211cc 318 CID	2001-2002	(Y); 31 Gallon Fuel Tank	USEP7124M
5.2L V8 5211cc 318 CID	2003	(Y)	USEP7123M
5.9L V8 360 CID	1999-2000	(Z); 32 Gallon Fuel Tank	USEP7124M
5.9L V8 360 CID	1999-2002	(Z); 35 Gallon Fuel Tank	USEP7123M
5.9L V8 360 CID	2001-2002	(Z); 31 Gallon Fuel Tank	USEP7124M
5.9L V8 360 CID	2003	(Z)	USEP7123M
<b>RAM 2500</b>			
5.2L V8 5211cc 318 CID	1994	(Y), GAS, Naturally Aspirated	USEP7065M
5.2L V8 5211cc 318 CID	1996	(Y), GAS, Naturally Aspirated	USEP7093M
5.7L V8 345 CID	2003	(D), 160.5 / 407.7 Wheel Base, Crew Cab Pickup, GAS, Naturally Aspirated	USEP7158M
5.7L V8 345 CID	2003	(D), GAS, Naturally Aspirated, Standard Cab Pickup	USEP7158M
5.7L V8 345 CID	2003	(D), 140.5 / 356.9 Wheel Base, Crew Cab Pickup, GAS, Naturally Aspirated	USEP7160M
5.7L V8 345 CID	2004	(D), GAS, Naturally Aspirated	USEP7170M
5.7L V8 345 CID	2010		USEP7260M
5.9L L6 359 CID	1998-2002	DIESEL; In Tank Module, Only for Vehicles that have been converted to use an IN-Tank Module	USEP7187M
5.9L L6 359 CID	2005-2007		USEP7181M
5.9L V8 360 CID	1994	(Z), GAS, Naturally Aspirated	USEP7065M
5.9L V8 360 CID	1996	(5), GAS, Naturally Aspirated	USEP7093M
5.9L V8 360 CID	1996-1997	(Z), GAS, Naturally Aspirated	USEP7093M
5.9L V8 360 CID	1998	Base, Limited, Lujco; FI, GAS; (35 Gallon Fuel Tank)	USEP7111M
5.9L V8 360 CID	1998-1999	(Z), GAS, Naturally Aspirated	USEP7138M
5.9L V8 360 CID	1999	Base; FI, GAS; (35 Gallon Fuel Tank)	USEP7111M
5.9L V8 360 CID	2000	Base, Custom; FI, GAS; (35 Gallon Fuel Tank)	USEP7111M
5.9L V8 360 CID	2000-2001	(Z), GAS, Naturally Aspirated; 26 Gallon Fuel Tank	USEP7138M
5.9L V8 360 CID	2000-2001	(Z), GAS, Naturally Aspirated; 34 Gallon Fuel Tank	USEP7138M
5.9L V8 360 CID	2001	Base, SLT; FI, GAS; (35 Gallon Fuel Tank)	USEP7111M
5.9L V8 360 CID	2002	Base; FI, GAS; (35 Gallon Fuel Tank)	USEP7111M
6.7L L6 408 CID	2007-2009		USEP7181M
6.7L L6 408 CID	2010		USEP7213M
8.0L V10 7990cc 488 CID	1994	(W), GAS, Naturally Aspirated	USEP7065M
8.0L V10 7990cc 488 CID	1996-1997	(W), GAS, Naturally Aspirated	USEP7093M
8.0L V10 7990cc 488 CID	1998-1999	(W), GAS, Naturally Aspirated	USEP7138M
8.0L V10 7990cc 488 CID	1998-2002	Base; FI, GAS; (35 Gallon Fuel Tank)	USEP7111M
8.0L V10 7990cc 488 CID	2000	(W), GAS, Naturally Aspirated; 26 Gallon Fuel Tank	USEP7138M
8.0L V10 7990cc 488 CID	2000-2001	(W), GAS, Naturally Aspirated; 34 Gallon Fuel Tank	USEP7138M
8.0L V10 7990cc 488 CID	2003	(W), 160.5 / 407.7 Wheel Base, Crew Cab Pickup, GAS, Naturally Aspirated	USEP7158M
8.0L V10 7990cc 488 CID	2003	(W), GAS, Naturally Aspirated, Standard Cab Pickup	USEP7158M
8.0L V10 7990cc 488 CID	2003	(W), 140.5 / 356.9 Wheel Base, Crew Cab Pickup, GAS, Naturally Aspirated	USEP7160M
<b>RAM 2500 VAN</b>			
3.9L V6 3906cc 239 CID	2001	(X), GAS; 35 Gallon Fuel Tank	USEP7123M

Engine	Years	Application Description	USMW
<b>DODGE (cont'd.)</b>			
<b>RAM 2500 VAN (cont'd.)</b>			
3.9L V6 3906cc 239 CID	2001	(X), GAS; 31 Gallon Fuel Tank	USEP7124M
5.2L V8 5211cc 318 CID	1999-2000	(Y), GAS; 32 Gallon Fuel Tank	USEP7124M
5.2L V8 5211cc 318 CID	1999-2002	(Y), GAS; 35 Gallon Fuel Tank	USEP7123M
5.2L V8 5211cc 318 CID	2001-2002	(Y), GAS; 31 Gallon Fuel Tank	USEP7124M
5.2L V8 5211cc 318 CID	2003	(Y), GAS	USEP7123M
5.9L V8 360 CID	1999-2000	(Z), GAS; 32 Gallon Fuel Tank	USEP7124M
5.9L V8 360 CID	1999-2002	(Z), GAS; 35 Gallon Fuel Tank	USEP7123M
5.9L V8 360 CID	2001-2002	(Z), GAS; 31 Gallon Fuel Tank	USEP7124M
5.9L V8 360 CID	2003	(Z), GAS	USEP7123M
<b>RAM 3500</b>			
5.7L V8 345 CID	2003	(D), 160.5 / 407.7 Wheel Base, Crew Cab Pickup, GAS, Naturally Aspirated	USEP7158M
5.7L V8 345 CID	2003	(D), GAS, Naturally Aspirated, Standard Cab Pickup	USEP7158M
5.7L V8 345 CID	2003	(D), 140.5 / 356.9 Wheel Base, Crew Cab Pickup, GAS, Naturally Aspirated	USEP7160M
5.7L V8 345 CID	2004	(D), GAS, Naturally Aspirated	USEP7170M
5.9L L6 359 CID	1998-2002	DIESEL; In Tank Module, Only for Vehicles that have been converted to use an IN-Tank Module	USEP7187M
5.9L L6 359 CID	2005-2007		USEP7181M
5.9L V8 360 CID	1994	(5), GAS, Naturally Aspirated	USEP7065M
5.9L V8 360 CID	1994	(Z), GAS, Naturally Aspirated	USEP7065M
5.9L V8 360 CID	1995	(5), GAS, Naturally Aspirated	USEP7086M
5.9L V8 360 CID	1996-1997	(5), GAS, Naturally Aspirated	USEP7093M
5.9L V8 360 CID	1997	(Z), GAS, Naturally Aspirated	USEP7093M
5.9L V8 360 CID	1998	Base, Custom; FI, GAS; (35 Gallon Fuel Tank)	USEP7111M
5.9L V8 360 CID	1998-1999	(5), GAS, Naturally Aspirated	USEP7138M
5.9L V8 360 CID	1998-1999	(Z), GAS, Naturally Aspirated	USEP7138M
5.9L V8 360 CID	1999	Base; FI, GAS; (35 Gallon Fuel Tank)	USEP7111M
5.9L V8 360 CID	2000-2001	(5), GAS, Naturally Aspirated; 26 Gallon Fuel Tank	USEP7138M
5.9L V8 360 CID	2000-2001	(5), GAS, Naturally Aspirated; 34 Gallon Fuel Tank	USEP7138M
5.9L V8 360 CID	2000-2001	(Z), GAS, Naturally Aspirated; 26 Gallon Fuel Tank	USEP7138M
5.9L V8 360 CID	2000-2001	(Z), GAS, Naturally Aspirated; 34 Gallon Fuel Tank	USEP7138M
5.9L V8 360 CID	2000-2002	Base, Custom; FI, GAS; (35 Gallon Fuel Tank)	USEP7111M
6.7L L6 408 CID	2007-2009		USEP7181M
8.0L V10 7990cc 488 CID	1994	(W), GAS, Naturally Aspirated	USEP7065M
8.0L V10 7990cc 488 CID	1995	(W), GAS, Naturally Aspirated	USEP7086M
8.0L V10 7990cc 488 CID	1996-1997	(W), GAS, Naturally Aspirated	USEP7093M
8.0L V10 7990cc 488 CID	1998-1999	(W), GAS, Naturally Aspirated	USEP7138M
8.0L V10 7990cc 488 CID	1998-2002	Base; FI, GAS; (35 Gallon Fuel Tank)	USEP7111M
8.0L V10 7990cc 488 CID	2000	(W), GAS, Naturally Aspirated; 26 Gallon Fuel Tank	USEP7138M
8.0L V10 7990cc 488 CID	2000-2001	(W), GAS, Naturally Aspirated; 34 Gallon Fuel Tank	USEP7138M
8.0L V10 7990cc 488 CID	2003	(W), 160.5 / 407.7 Wheel Base, Crew Cab Pickup, GAS, Naturally Aspirated	USEP7158M
8.0L V10 7990cc 488 CID	2003	(W), GAS, Naturally Aspirated, Standard Cab Pickup	USEP7158M
8.0L V10 7990cc 488 CID	2003	(W), 140.5 / 356.9 Wheel Base, Crew Cab Pickup, GAS, Naturally Aspirated	USEP7160M
<b>RAM 3500 VAN</b>			
5.2L V8 5211cc 318 CID	1999-2000	(Y), GAS; 32 Gallon Fuel Tank	USEP7124M
5.2L V8 5211cc 318 CID	1999-2002	(Y), GAS; 35 Gallon Fuel Tank	USEP7123M
5.2L V8 5211cc 318 CID	2001-2002	(Y), GAS; 31 Gallon Fuel Tank	USEP7124M
5.2L V8 5211cc 318 CID	2003	(Y), GAS	USEP7123M
5.9L V8 360 CID	1999-2000	(Z), GAS; 32 Gallon Fuel Tank	USEP7124M
5.9L V8 360 CID	1999-2002	(Z), GAS; 35 Gallon Fuel Tank	USEP7123M
5.9L V8 360 CID	2001-2002	(Z), GAS; 31 Gallon Fuel Tank	USEP7124M
5.9L V8 360 CID	2003	(Z), GAS	USEP7123M
<b>RAMCHARGER</b>			
5.2L V8 5211cc 318 CID	1991-1993	(Y)	USEP7048M
5.2L V8 5211cc 318 CID	1999-2000	MEX; 26 Gallon Fuel Tank	USEP7138M
5.2L V8 5211cc 318 CID	1999-2001	MEX	USEP7138M
5.9L V8 360 CID	1991	(Z)	USEP7048M
5.9L V8 360 CID	1992-1993	(Z)	USEP7064M
5.9L V8 360 CID	1994-1995	MEX	USEP7047M
5.9L V8 360 CID	1999-2000	MEX; 35 gal tank	USEP7111M
5.9L V8 5900cc 360 CID	1996	MEX	USEP7047M
<b>SHADOW</b>			
2.2L L4 135 CID	1987	Base; (D), Naturally Aspirated	USEP7069H
2.2L L4 135 CID	1987-1988	Turbocharged; (Single Nipple)	USEP7071H
2.2L L4 135 CID	1988-1990	Base; (D), Naturally Aspirated	USEP7069H
2.2L L4 135 CID	1990	Turbocharged	USEP7071H
2.2L L4 135 CID	1991-1992	America, High Line; (D), Naturally Aspirated	USEP7040M

Engine	Years	Application Description	USMW	Engine	Years	Application Description	USMW
<b>DODGE (cont'd.)</b>				<b>EAGLE (cont'd.)</b>			
<b>SHADOW (cont'd.)</b>				<b>VISION (cont'd.)</b>			
2.2L L4 135 CID	1993	High Line; (D)	USEP7040M	3.5L V6 3497cc 215 CID	1995	ESi, TSi; (F)	USEP7054M
2.2L L4 135 CID	1994	Base; (D)	USEP7040M	3.5L V6 3497cc 215 CID	1996-1997	ESi, TSi; (F)	USEP7101M
2.5L L4 2507cc 153 CID	1988	Base; (K), Naturally Aspirated	USEP7069H	<b>FORD</b>			
2.5L L4 2507cc 153 CID	1989-1990	ES; (K), Naturally Aspirated	USEP7069H	<b>AEROSTAR</b>			
2.5L L4 2507cc 153 CID	1989-1990	Turbocharged	USEP7071H	2.3L L4 140 CID	1986	From 02/86	USEP2080S
2.5L L4 2507cc 153 CID	1991	ES, High Line; (K), Naturally Aspirated	USEP7040M	2.3L L4 140 CID	1987		USEP2080S
2.5L L4 2507cc 153 CID	1991-1992	ES, High Line; (J), Turbocharged	USEP7040M	3.0L V6 2986cc 182 CID	1986-1988		USEP2080S
2.5L L4 2507cc 153 CID	1992	America, ES, High Line; (K), Naturally Aspirated	USEP7040M	3.0L V6 2986cc 182 CID	1989	17 Gallon Fuel Tank	USEP2080S
2.5L L4 2507cc 153 CID	1993	ES, High Line; (K)	USEP7040M	3.0L V6 2986cc 182 CID	1989	with 21 gallon tank	USEP2107S
2.5L L4 2507cc 153 CID	1994	Base, ES; (K)	USEP7040M	3.0L V6 2986cc 182 CID	1990-1997		USEP2107S
3.0L V6 2972cc 181 CID	1992	ES; (3), Naturally Aspirated	USEP7040M	4.0L V6 245 CID	1990-1997		USEP2107S
3.0L V6 2972cc 181 CID	1993	ES, High Line; (3)	USEP7040M	<b>ASPIRE</b>			
3.0L V6 2972cc 181 CID	1994	ES; (3)	USEP7040M	1.3L L4 1295cc	1994-1997	4 Doors	USEP2074H
<b>SPIRIT</b>				1.3L L4 1295cc	1994-1997	2 Doors	USEP2075H
2.2L L4 135 CID	1992	R/T; (A), Turbocharged	USEP7040M	<b>BRONCO</b>			
2.5L L4 2507cc 153 CID	1990	Base, LE; (K), Naturally Aspirated	USEP7069H	4.9L L6 4917cc 300 CID	1991-1992	module and pump, must be used with original FORD module	USEP2059MN
2.5L L4 2507cc 153 CID	1990	Turbocharged	USEP7071H	5.0L V8 302 CID	1985-1986		USEP2090S
2.5L L4 2507cc 153 CID	1991-1992	Base, LE; (K), Naturally Aspirated	USEP7040M	5.0L V8 302 CID	1987	(N), FI	USEP2141S
2.5L L4 2507cc 153 CID	1991-1992	ES, LE; (J), Turbocharged	USEP7040M	5.0L V8 302 CID	1987-1989	External Pump	USEP2090S
2.5L L4 2507cc 153 CID	1993	ES, High Line; (K), GAS	USEP7040M	5.0L V8 302 CID	1988-1989	(N)	USEP2141S
2.5L L4 2507cc 153 CID	1993	High Line; (V), FLEX	USEP7056M	5.0L V8 302 CID	1990-1996	module and pump, must be used with original FORD module	USEP2059MN
2.5L L4 2507cc 153 CID	1994	(K), GAS	USEP7040M	5.8L V8 5753cc 351 CID	1988-1989	(H)	USEP2141S
2.5L L4 2507cc 153 CID	1994	(V), FLEX	USEP7056M	5.8L V8 5753cc 351 CID	1990-1996	module and pump, must be used with original FORD module	USEP2059MN
2.5L L4 2507cc 153 CID	1995	(K)	USEP7040M	<b>BRONCO II</b>			
3.0L V6 2972cc 181 CID	1990	Naturally Aspirated	USEP7071H	2.9L V6 177 CID	1986-1988		USEP2097S
3.0L V6 2972cc 181 CID	1991-1992	Base, ES, LE; (3), Naturally Aspirated	USEP7040M	2.9L V6 177 CID	1989-1990	module and pump, must be used with original FORD module	USEP2059MN
3.0L V6 2972cc 181 CID	1993	ES, High Line; (3), GAS	USEP7040M	<b>CONTOUR</b>			
3.0L V6 2972cc 181 CID	1994	(3), GAS	USEP7040M	2.0L L4 1989cc 121 CID	1995	GL Sport, LX Sport; (3)	USEP2117S
3.0L V6 2972cc 181 CID	1995	(3)	USEP7040M	2.0L L4 1989cc 121 CID	1996	GL, LX, Sport; (3), GAS	USEP2117S
<b>SPRINTER 2500</b>				2.0L L4 1989cc 121 CID	1996	GL, Sport; (Z), BI-FUEL	USEP2117S
2.7L L5 2687cc 165 CID	2003-2005	(w/Heater Booster)	USEP7202M	2.0L L4 1989cc 121 CID	1997	Exc.Fuel Tank Concern	USEP2188S
2.7L L5 2687cc 165 CID	2006	(wo/Heater Booster)	USEP7202M	2.0L L4 1989cc 121 CID	1998	Exc.Fuel Tank Concern (To 02/09/98)	USEP2188S
<b>SPRINTER 3500</b>				2.0L L4 1989cc 121 CID	1998	Base, GL, LX; (3), GAS; Exc.Fuel Tank Concern (From 02/09/98)	USEP2227S
2.7L L5 2687cc 165 CID	2003	(wo/Heater Booster)	USEP7202M	2.0L L4 1989cc 121 CID	1998	GL; (Z), BI-FUEL; Exc.Fuel Tank Concern (From 02/09/98)	USEP2227S
2.7L L5 2687cc 165 CID	2004-2005	(w/Heater Booster)	USEP7202M	2.0L L4 1989cc 121 CID	1998	LX, SE; (Z), BI-FUEL; From 02/09/98	USEP2227S
2.7L L5 2687cc 165 CID	2006	(wo/Heater Booster)	USEP7202M	2.0L L4 1989cc 121 CID	1999	SE; (3), GAS; From 05/03/99	USEP2227S
<b>STRATUS</b>				2.0L L4 1989cc 121 CID	1999	SE; (3), GAS; To 05/03/99	USEP2227S
2.0L L4 1995cc 122 CID	2005	MEX	USEP7167M	2.0L L4 1989cc 121 CID	1999	SE; (Z), BI-FUEL; From 05/03/99	USEP2227S
2.0L L4 1996cc 122 CID	1995-1997		USEP7089M	2.0L L4 1989cc 121 CID	1999	SE; (Z), BI-FUEL; To 05/03/99	USEP2227S
2.0L L4 1996cc 122 CID	1998-2000		USEP7113M	2.0L L4 1989cc 121 CID	1999-2000		USEP2273M
2.4L L4 2351cc	2002-2005	Coupe	USEP7163M	2.5L V6 2450cc 155 CID	1995	GL Sport, LX Sport, SE; (L)	USEP2117S
2.4L L4 2429cc 148 CID	1995-1997		USEP7089M	2.5L V6 2450cc 155 CID	1996	GL, LX, SE, Sport; (L), GAS	USEP2117S
2.4L L4 2429cc 148 CID	1998-2000		USEP7113M	2.5L V6 2450cc 155 CID	1997	Exc.Fuel Tank Concern	USEP2188S
2.4L L4 2429cc 148 CID	2002	SE Plus; (X)	USEP7141M	2.5L V6 2450cc 155 CID	1998	Fuel Tank Concern	USEP2188S
2.4L L4 2429cc 148 CID	2003-2006	GAS	USEP7167M	2.5L V6 2450cc 155 CID	1999	SE; (L), GAS; From 05/03/99	USEP2227S
2.5L V6 2497cc 152 CID	1995-1997		USEP7089M	2.5L V6 2450cc 155 CID	1999	SE; (L), GAS; To 05/03/99	USEP2227S
2.5L V6 2497cc 152 CID	1998-2000		USEP7113M	2.5L V6 2450cc 155 CID	1999	SVT; (G), GAS; From 05/03/99	USEP2227S
2.7L V6 2736cc 167 CID	2002	R/T, SE Plus; (R)	USEP7141M	2.5L V6 2450cc 155 CID	1999	SVT; (G), GAS; To 05/03/99	USEP2273M
2.7L V6 2736cc 167 CID	2003-2006	GAS	USEP7167M	<b>COUNTRY SQUIRE</b>			
2.7L V6 2736cc 167 CID	2003-2006	FLEX	USEP7169M	5.0L V8 302 CID	1987-1991		USEP2087H
3.0L V6 2972cc 181 CID	2002-2004	Coupe	USEP7163M	<b>CROWN VICTORIA</b>			
<b>W150</b>				4.6L V8 281 CID	1992		USEP2121H
3.9L V6 3906cc 239 CID	1991	Base, S; (X)	USEP7047M	4.6L V8 281 CID	1993-1994		USEP2122H
3.9L V6 3906cc 239 CID	1992-1993	(X)	USEP7047M	4.6L V8 281 CID	1995-1996		USEP2113H
5.2L V8 5211cc 318 CID	1991	Base, S; (Y)	USEP7047M	4.6L V8 281 CID	1997	w/o sender	USEP2163H
5.2L V8 5211cc 318 CID	1992-1993	(Y)	USEP7047M	4.6L V8 281 CID	1997	with sender	USEP2222S
5.9L V8 360 CID	1991	Base, S; (Z)	USEP7047M	4.6L V8 281 CID	1998-2000		USEP2227S
5.9L V8 360 CID	1993	(Z)	USEP7047M	4.6L V8 281 CID	2001-2002		USEP2382S
<b>W250</b>				4.6L V8 281 CID	2003-2004		USEP2336S
5.2L V8 5211cc 318 CID	1991-1993	(Y), GAS, Naturally Aspirated	USEP7047M	4.6L V8 281 CID	2005-2008	GAS	USEP2449S
5.9L V8 360 CID	1991	(5), GAS, Naturally Aspirated	USEP7047M	4.6L V8 281 CID	2006-2010	FLEX	USEP2475S
5.9L V8 360 CID	1991-1993	(Z), GAS, Naturally Aspirated	USEP7047M	4.6L V8 281 CID	2010-2011		USEP2542S
5.9L V8 360 CID	1993	(5), GAS, Naturally Aspirated	USEP7047M	<b>E-150</b>			
<b>W350</b>				4.6L V8 281 CID	2004-2008	2 ports, center tank	USEP2365S
5.9L V8 360 CID	1991-1993	(5), GAS, Naturally Aspirated	USEP7047M	4.6L V8 281 CID	2006	Base, Chateau, XL, XLT; (W); (w/Secondary Fuel Ports), Midship Fuel Tank	USEP2364S
5.9L V8 360 CID	1991-1993	(Z), GAS, Naturally Aspirated	USEP7047M	4.6L V8 281 CID	2006	Base, Chateau, XL, XLT; (W); (wo/Secondary Fuel Ports), Midship Fuel Tank	USEP2365S
<b>EAGLE</b>				4.6L V8 281 CID	2006	Base, Chateau, XL, XLT; (W); Aft Axle Fuel Tank	USEP2437S
<b>SUMMIT</b>				4.6L V8 281 CID	2007	Base, Chateau, XL, XLT; (W); (Secondary Fuel Ports)	USEP2364S
1.8L L4 1834cc 112 CID	1992	Base; (D), 4WD	USEP7067S	<b>TALON</b>			
1.8L L4 1834cc 112 CID	1993	Base; (C), Wagon	USEP7067S	2.0L L4 1997cc 122 CID	1995-1998	Naturally Aspirated	USEP7081H
2.4L L4 2351cc	1992	Base; (W), 4WD	USEP7067S	<b>VISION</b>			
2.4L L4 2351cc	1993	Base; (G)	USEP7067S	3.3L V6 3301cc 201 CID	1993-1995	ESi; (T)	USEP7054M
<b>TALON</b>				3.3L V6 3301cc 201 CID	1996-1997	ESi; (T)	USEP7101M
2.0L L4 1997cc 122 CID	1995-1998	Naturally Aspirated	USEP7081H	3.5L V6 3497cc 215 CID	1993-1994	TSi; (F)	USEP7054M
<b>VISION</b>							
3.3L V6 3301cc 201 CID	1993-1995	ESi; (T)	USEP7054M				
3.3L V6 3301cc 201 CID	1996-1997	ESi; (T)	USEP7101M				
3.5L V6 3497cc 215 CID	1993-1994	TSi; (F)	USEP7054M				





# FUEL PUMP MODULES APPLICATION GUIDE



FUEL PUMP MODULES

Engine	Years	Application Description	USMW	Engine	Years	Application Description	USMW
<b>FORD (cont'd.)</b>				<b>FORD (cont'd.)</b>			
<b>E-150 (cont'd.)</b>				<b>E-150 ECONOLINE (cont'd.)</b>			
4.6L V8 281 CID	2007	Base, Chateau, XL, XLT; (W); (Exc.Secondary Fuel Ports)	USEP2365S	5.0L V8 302 CID	1988-1991	(N); External Pump	USEP2133S
4.6L V8 281 CID	2008	Base, XL, XLT; (W); (Secondary Fuel Ports)	USEP2364S	5.0L V8 302 CID	1990	(N), 124.0 / 315.0 Wheel Base; 18 Gallon Midship Fuel Tank	USEP2133S
4.6L V8 281 CID	2008	Base, XL, XLT; (W); (Exc.Secondary Fuel Ports)	USEP2365S	5.0L V8 302 CID	1990	(N); 20 Gallon Aft Axle Fuel Tank (22 Gallon Aft Axle Fuel Tank) (To 05/22/90)	USEP2135S
4.6L V8 281 CID	2009-2010		USEP2540M	5.0L V8 302 CID	1990	(N); 20 Gallon Aft Axle Fuel Tank (22 Gallon Aft Axle Fuel Tank) (From 05/23/90)	USEP2147S
4.6L V8 281 CID	2011-2014	2 tube ports, w/o aux fuel port	USEP2581M	5.0L V8 302 CID	1990-1991	(N), 138.0 / 350.5 Wheel Base; 16 Gallon Midship Fuel Tank	USEP2147S
5.4L V8 330 CID	2003		USEP2276S	5.0L V8 302 CID	1991	(N); 20 Gallon Aft Axle Fuel Tank (22 Gallon Aft Axle Fuel Tank)	USEP2147S
5.4L V8 330 CID	2003		USEP2343S	5.0L V8 302 CID	1992-1996	(N); Midship Fuel Tank	USEP2059MN
5.4L V8 330 CID	2004-2008	2 ports, center tank	USEP2365S	5.0L V8 302 CID	1992-1996	(N); Aft Axle Fuel Tank	USEP2220M
5.4L V8 330 CID	2006	Base, Chateau, XL, XLT; (L); (w/Secondary Fuel Ports), Exc.Extended Range Fuel Tank (Midship Fuel Tank)	USEP2364S	5.0L V8 302 CID	1992-1996	(L); (2 Tube Ports), Midship Fuel Tank	USEP2206S
5.4L V8 330 CID	2006	Base, Chateau, XL, XLT; (L); (w/Secondary Fuel Ports), Exc.Extended Range Fuel Tank (Midship Fuel Tank)	USEP2365S	5.4L V8 330 CID	1997	(L); (3 Tube Ports), Midship Fuel Tank	USEP2223S
5.4L V8 330 CID	2006-2007	Base, Chateau, XL, XLT; (L); Exc.Extended Range Fuel Tank (Aft Axle Fuel Tank)	USEP2437S	5.4L V8 330 CID	1997	(L); (3 Tube Ports), Aft Axle Fuel Tank	USEP2224S
5.4L V8 330 CID	2006-2007	Base, Chateau, XL, XLT; (L); Extended Range Fuel Tank	USEP2437S	5.4L V8 330 CID	1998	(L), GAS; (2 Tube Ports), Midship Fuel Tank	USEP2206S
5.4L V8 330 CID	2007	Base, Chateau, XL, XLT; (L); (Secondary Fuel Ports), Exc.Extended Range Fuel Tank (Midship Fuel Tank)	USEP2364S	5.4L V8 330 CID	1998	(Z), BI-FUEL; (2 Tube Ports), Midship Fuel Tank	USEP2206S
5.4L V8 330 CID	2007	Base, Chateau, XL, XLT; (L); (Exc.Secondary Fuel Ports), Exc.Extended Range Fuel Tank (Midship Fuel Tank)	USEP2365S	5.4L V8 330 CID	1998	(L), GAS; (3 Tube Ports), Midship Fuel Tank	USEP2223S
5.4L V8 330 CID	2008	Base, XL, XLT; (L); (Secondary Fuel Ports), Exc.Extended Range Fuel Tank (Midship Fuel Tank)	USEP2364S	5.4L V8 330 CID	1998	(Z), BI-FUEL; (3 Tube Ports), Midship Fuel Tank	USEP2223S
5.4L V8 330 CID	2008	Base, XL, XLT; (L); (Exc.Secondary Fuel Ports), Exc.Extended Range Fuel Tank (Midship Fuel Tank)	USEP2365S	5.4L V8 330 CID	1998	(L), GAS; (3 Tube Ports), Aft Axle Fuel Tank	USEP2224S
5.4L V8 330 CID	2008	Base, XL, XLT; (L); (Secondary Fuel Ports), Exc.Extended Range Fuel Tank (Midship Fuel Tank)	USEP2364S	5.4L V8 330 CID	1998	(Z), BI-FUEL; (3 Tube Ports), Aft Axle Fuel Tank	USEP2224S
5.4L V8 330 CID	2008	Base, XL, XLT; (L); Exc.Extended Range Fuel Tank (Aft Axle Fuel Tank)	USEP2437S	5.8L V8 5753cc 351 CID	1988	(H), 138.0 / 350.5 Wheel Base; 16 Gallon Fuel Tank	USEP2133S
5.4L V8 330 CID	2008	Base, XL, XLT; (L); Extended Range Fuel Tank	USEP2437S	5.8L V8 5753cc 351 CID	1988-1989	(H), 124.0 / 315.0 Wheel Base; 18 Gallon Fuel Tank	USEP2133S
5.4L V8 330 CID	2009-2010		USEP2540M	5.8L V8 5753cc 351 CID	1988-1989	(H), 138.0 / 350.5 Wheel Base; 20 Gallon Fuel Tank (22 Gallon Fuel Tank)	USEP2135S
5.4L V8 330 CID	2009-2011		USEP2528M	5.8L V8 5753cc 351 CID	1988-1991	(H); External Pump	USEP2133S
5.4L V8 330 CID	2011-2014	2 tube ports, w/o aux fuel port	USEP2581M	5.8L V8 5753cc 351 CID	1990	(H), 124.0 / 315.0 Wheel Base; 18 Gallon Midship Fuel Tank	USEP2133S
<b>E-150 CLUB WAGON</b>				<b>E-150 ECONOLINE CLUB WAGON</b>			
4.2L V6 256 CID	2003	(2); (2 Tube Ports), Midship Fuel Tank	USEP2241S	4.2L V6 256 CID	1997	(2); (2 Tube Ports), Midship Fuel Tank	USEP2209S
4.2L V6 256 CID	2003	(2); (3 Tube Ports), Midship Fuel Tank	USEP2341S	4.2L V6 256 CID	1997	(2); (3 Tube Ports), Aft Axle Fuel Tank	USEP2209S
4.6L V8 281 CID	2003	(W); (2 Tube Ports), Midship Fuel Tank	USEP2241S	4.2L V6 256 CID	1997	(2); (3 Tube Ports), Midship Fuel Tank	USEP2209S
4.6L V8 281 CID	2003	(W); (3 Tube Ports), Midship Fuel Tank	USEP2341S	4.2L V6 256 CID	1997-1998		USEP2201S
4.6L V8 281 CID	2004-2005	(W); (w/Secondary Fuel Ports), Midship Fuel Tank (35 Gallon Fuel Tank)	USEP2364S	4.2L V6 256 CID	1997-1998	3 PORTS, REAR TANK	USEP2210S
4.6L V8 281 CID	2004-2005	2 ports, center tank	USEP2365S	4.2L V6 256 CID	1997-1998	2 PORTS, CENTER TANK	USEP2213S
4.6L V8 281 CID	2004-2005	(W); Aft Axle Fuel Tank	USEP2437S	4.2L V6 256 CID	1997-1998	(2); (2 Tube Ports)	USEP2241S
5.4L V8 330 CID	2003		USEP2343S	4.2L V6 256 CID	1999-2002	(6); (2 Tube Ports), Midship Fuel Tank	USEP2209S
5.4L V8 330 CID	2004	(L); (w/Secondary Fuel Ports), Midship Fuel Tank (35 Gallon Fuel Tank)	USEP2364S	4.6L V8 281 CID	1997	(6); (3 Tube Ports), Aft Axle Fuel Tank	USEP2209S
5.4L V8 330 CID	2004	(L); Aft Axle Fuel Tank	USEP2437S	4.6L V8 281 CID	1997	(6); (3 Tube Ports), Midship Fuel Tank	USEP2209S
5.4L V8 330 CID	2004-2005	2 ports, center tank	USEP2365S	4.6L V8 281 CID	1997-1998		USEP2201S
5.4L V8 330 CID	2005	(L); (w/Secondary Fuel Ports), Exc.Extended Range Fuel Tank (Midship Fuel Tank) (35 Gallon Fuel Tank)	USEP2364S	4.6L V8 281 CID	1997-1998	3 PORTS, REAR TANK	USEP2210S
5.4L V8 330 CID	2005	(L); Exc.Extended Range Fuel Tank (Aft Axle Fuel Tank)	USEP2437S	4.6L V8 281 CID	1997-1998	2 PORTS, CENTER TANK	USEP2213S
5.4L V8 330 CID	2005	(L); Extended Range Fuel Tank	USEP2437S	4.6L V8 281 CID	1999-2002	(W); (2 Tube Ports)	USEP2241S
<b>E-150 ECONOLINE</b>				<b>E-150 ECONOLINE CLUB WAGON</b>			
4.2L V6 256 CID	1997	(2); (2 Tube Ports), Midship Fuel Tank	USEP2209S	4.2L V6 256 CID	1997	(2); (2 Tube Ports), Midship Fuel Tank	USEP2209S
4.2L V6 256 CID	1997	(2); (3 Tube Ports), Aft Axle Fuel Tank	USEP2209S	4.2L V6 256 CID	1997	(2); (3 Tube Ports), Midship Fuel Tank	USEP2209S
4.2L V6 256 CID	1997	(2); (3 Tube Ports), Midship Fuel Tank	USEP2209S	4.2L V6 256 CID	1997-1998		USEP2201S
4.2L V6 256 CID	1997-1998		USEP2201S	4.2L V6 256 CID	1997-1998	3 PORTS, REAR TANK	USEP2210S
4.2L V6 256 CID	1997-1998	3 PORTS, REAR TANK	USEP2210S	4.2L V6 256 CID	1997-1998	2 PORTS, CENTER TANK	USEP2213S
4.2L V6 256 CID	1997-1998	2 PORTS, CENTER TANK	USEP2213S	4.2L V6 256 CID	1999-2002	(2); (2 Tube Ports)	USEP2241S
4.2L V6 256 CID	1997-1998	3 PORTS, REAR TANK	USEP2210S	4.2L V6 256 CID	1999-2002	(6); (2 Tube Ports), Midship Fuel Tank	USEP2209S
4.6L V8 281 CID	1997	(6); (2 Tube Ports), Midship Fuel Tank	USEP2209S	4.6L V8 281 CID	1997	(6); (3 Tube Ports), Aft Axle Fuel Tank	USEP2209S
4.6L V8 281 CID	1997	(6); (3 Tube Ports), Aft Axle Fuel Tank	USEP2209S	4.6L V8 281 CID	1997	(6); (3 Tube Ports), Midship Fuel Tank	USEP2209S
4.6L V8 281 CID	1997	(6); (3 Tube Ports), Midship Fuel Tank	USEP2209S	4.6L V8 281 CID	1997-1998		USEP2201S
4.6L V8 281 CID	1997-1998		USEP2201S	4.6L V8 281 CID	1997-1998	3 PORTS, REAR TANK	USEP2210S
4.6L V8 281 CID	1997-1998	3 PORTS, REAR TANK	USEP2210S	4.6L V8 281 CID	1997-1998	2 PORTS, CENTER TANK	USEP2213S
4.6L V8 281 CID	1997-1998	2 PORTS, CENTER TANK	USEP2213S	4.6L V8 281 CID	1999-2002	(W); (2 Tube Ports)	USEP2241S
4.6L V8 281 CID	1999	Base; (6); (2 Tube Ports)	USEP2241S	4.9L L6 4917cc 300 CID	1992-1996		USEP2059MN
4.9L L6 4917cc 300 CID	1992-1996		USEP2059MN	4.9L L6 4917cc 300 CID	1992-1996		USEP2310M
4.9L L6 4917cc 300 CID	1992-1996		USEP2310M	5.0L V8 302 CID	1986-1987	(N), FI; External Pump	USEP2133S
5.0L V8 302 CID	1986-1987	(N), FI; External Pump	USEP2133S	5.0L V8 302 CID	1986-1987	(N), FI; Midship Fuel Tank	USEP2133S
5.0L V8 302 CID	1986-1987	(N), FI; Midship Fuel Tank	USEP2133S	5.0L V8 302 CID	1986-1987	(N), FI; Aft Axle Fuel Tank	USEP2135S
5.0L V8 302 CID	1986-1987	(N), FI; Aft Axle Fuel Tank	USEP2135S	5.0L V8 302 CID	1989	(N); External Pump	USEP2133S
5.0L V8 302 CID	1988	(N), 138.0 / 350.5 Wheel Base; 16 Gallon Fuel Tank	USEP2133S	5.0L V8 302 CID	1989	(N); 20 Gallon Fuel Tank (22 Gallon Fuel Tank)	USEP2135S
5.0L V8 302 CID	1988-1989	(N), 124.0 / 315.0 Wheel Base; 18 Gallon Fuel Tank	USEP2133S	5.0L V8 302 CID	1989	(N); External Pump	USEP2133S
5.0L V8 302 CID	1988-1989	(N), 138.0 / 350.5 Wheel Base; 20 Gallon Fuel Tank (22 Gallon Fuel Tank)	USEP2135S	5.0L V8 302 CID	1991	(N); External Pump	USEP2133S
				5.0L V8 302 CID	1991	(N), 138.0 / 350.5 Wheel Base; 16 Gallon Midship Fuel Tank	USEP2147S
				5.0L V8 302 CID	1991	(N); 20 Gallon Aft Axle Fuel Tank (22 Gallon Aft Axle Fuel Tank)	USEP2147S
				5.0L V8 302 CID	1992-1996	(N); Midship Fuel Tank	USEP2059MN
				5.0L V8 302 CID	1992-1996	(N); Aft Axle Fuel Tank	USEP2220M
				5.0L V8 302 CID	1992-1996		USEP2310M
				5.4L V8 330 CID	1997	(L); (2 Tube Ports), Midship Fuel Tank	USEP2206S
				5.4L V8 330 CID	1997	(L); (3 Tube Ports), Midship Fuel Tank	USEP2223S

Engine	Years	Application Description	USMW	Engine	Years	Application Description	USMW
<b>FORD (cont'd.)</b>				<b>FORD (cont'd.)</b>			
<b>E-150 ECONOLINE CLUB WAGON (cont'd.)</b>				<b>E-250 ECONOLINE (cont'd.)</b>			
5.4L V8 330 CID	1997	(L); (3 Tube Ports), Aft Axle Fuel Tank	USEP2224S	4.2L V6 256 CID	1999-2002	(2), GAS; (3 Tube Ports), Aft Axle Fuel Tank	USEP2239S
5.4L V8 330 CID	1998	(L), GAS; (2 Tube Ports), Midship Fuel Tank	USEP2206S	4.2L V6 256 CID	1999-2002	(2), GAS; (2 Tube Ports), Midship Fuel Tank	USEP2241S
5.4L V8 330 CID	1998	(Z), BI-FUEL; (2 Tube Ports), Midship Fuel Tank	USEP2206S	4.9L L6 4917cc 300 CID	1992-1996		USEP2059MN
5.4L V8 330 CID	1998	(L), GAS; (3 Tube Ports), Midship Fuel Tank	USEP2223S	4.9L L6 4917cc 300 CID	1992-1996		USEP2310M
5.4L V8 330 CID	1998	(Z), BI-FUEL; (3 Tube Ports), Midship Fuel Tank	USEP2223S	4.9L L6 4917cc 300 CID	1995-1996	GAS; Midship Fuel Tank	USEP2220M
5.4L V8 330 CID	1998	(L), GAS; (3 Tube Ports), Aft Axle Fuel Tank	USEP2224S	4.9L L6 4917cc 300 CID	1995-1996	GAS; Aft Axle Fuel Tank	USEP2282M
5.4L V8 330 CID	1998	(Z), BI-FUEL; (3 Tube Ports), Aft Axle Fuel Tank	USEP2224S	5.0L V8 302 CID	1986-1987	(N), FI; External Pump	USEP2133S
5.4L V8 330 CID	1999	(L); (2 Tube Ports), Midship Fuel Tank	USEP2206S	5.0L V8 302 CID	1986-1987	(N), FI; Midship Fuel Tank	USEP2133S
5.4L V8 330 CID	1999	(L); (3 Tube Ports), Midship Fuel Tank	USEP2223S	5.0L V8 302 CID	1986-1987	(N), FI; Aft Axle Fuel Tank	USEP2135S
5.4L V8 330 CID	2000-2002	(L); (3 Tube Ports), Aft Axle Fuel Tank	USEP2286S	5.0L V8 302 CID	1988	(N); 16 Gallon Fuel Tank	USEP2135S
5.4L V8 330 CID	2000-2002	(L); (3 Tube Ports), Midship Fuel Tank	USEP2286S	5.0L V8 302 CID	1988-1989	(N); 20 Gallon Fuel Tank (22 Gallon Fuel Tank)	USEP2135S
5.4L V8 330 CID	2001-2002	(L); (2 Tube Ports), Midship Fuel Tank	USEP2286S	5.0L V8 302 CID	1991	(N), 138.0 / 350.5 Wheel Base; 16 Gallon Midship Fuel Tank	USEP2147S
5.8L V8 5753cc 351 CID	1988	(H); 16 Gallon Fuel Tank	USEP2133S	5.0L V8 302 CID	1991	(N); 20 Gallon Aft Axle Fuel Tank (22 Gallon Aft Axle Fuel Tank)	USEP2147S
5.8L V8 5753cc 351 CID	1988-1989	(H); 20 Gallon Fuel Tank (22 Gallon Fuel Tank)	USEP2135S	5.4L V8 330 CID	1997-1999	(L), GAS; (2 Tube Ports), Midship Fuel Tank	USEP2206S
5.8L V8 5753cc 351 CID	1988-1991	(H); External Pump	USEP2133S	5.4L V8 330 CID	1997-1999	(L), GAS; (3 Tube Ports), Midship Fuel Tank	USEP2223S
5.8L V8 5753cc 351 CID	1990	(H); 20 Gallon Aft Axle Fuel Tank (22 Gallon Aft Axle Fuel Tank) (To 05/22/90)	USEP2135S	5.4L V8 330 CID	1997-1999	(L), GAS; (3 Tube Ports), Aft Axle Fuel Tank	USEP2224S
5.8L V8 5753cc 351 CID	1990	(H); 16 Gallon Midship Fuel Tank	USEP2147S	5.4L V8 330 CID	1998-1999	(Z), BI-FUEL; (2 Tube Ports), Midship Fuel Tank	USEP2206S
5.8L V8 5753cc 351 CID	1990	(H); 20 Gallon Aft Axle Fuel Tank (22 Gallon Aft Axle Fuel Tank) (From 05/23/90)	USEP2147S	5.4L V8 330 CID	1998-1999	(Z), BI-FUEL; (3 Tube Ports), Midship Fuel Tank	USEP2223S
5.8L V8 5753cc 351 CID	1991	(H), 138.0 / 350.5 Wheel Base; 16 Gallon Midship Fuel Tank	USEP2147S	5.4L V8 330 CID	1998-1999	(Z), BI-FUEL; (3 Tube Ports), Aft Axle Fuel Tank	USEP2224S
5.8L V8 5753cc 351 CID	1991	(H); 20 Gallon Aft Axle Fuel Tank (22 Gallon Aft Axle Fuel Tank)	USEP2147S	5.4L V8 330 CID	2000-2002	(L), GAS; (2 Tube Ports), Midship Fuel Tank	USEP2286S
5.8L V8 5753cc 351 CID	1992-1996		USEP2059MN	5.4L V8 330 CID	2000-2002	(L), GAS; (3 Tube Ports), Aft Axle Fuel Tank	USEP2286S
5.8L V8 5753cc 351 CID	1992-1996	(H); Midship Fuel Tank	USEP2220M	5.4L V8 330 CID	2000-2002	(L), GAS; (3 Tube Ports), Midship Fuel Tank	USEP2286S
5.8L V8 5753cc 351 CID	1992-1996	(H); Aft Axle Fuel Tank	USEP2282M	5.8L V8 5753cc 351 CID	1988	(H); 16 Gallon Fuel Tank	USEP2133S
5.8L V8 5753cc 351 CID	1992-1996		USEP2310M	5.8L V8 5753cc 351 CID	1988-1989	(H); 20 Gallon Fuel Tank (22 Gallon Fuel Tank)	USEP2135S
<b>E-250</b>				5.8L V8 5753cc 351 CID	1990	(H); 20 Gallon Aft Axle Fuel Tank (22 Gallon Aft Axle Fuel Tank) (To 05/22/90)	USEP2135S
4.2L V6 256 CID	2003	(2), GAS; (2 Tube Ports), Midship Fuel Tank	USEP2241S	5.8L V8 5753cc 351 CID	1990	(H); 16 Gallon Midship Fuel Tank	USEP2147S
4.2L V6 256 CID	2003	(2), GAS; (3 Tube Ports), Midship Fuel Tank	USEP2341S	5.8L V8 5753cc 351 CID	1990	(H); 20 Gallon Aft Axle Fuel Tank (22 Gallon Aft Axle Fuel Tank) (From 05/23/90)	USEP2147S
4.6L V8 281 CID	2003	(W), GAS; (2 Tube Ports), Midship Fuel Tank	USEP2241S	5.8L V8 5753cc 351 CID	1991	(H), 138.0 / 350.5 Wheel Base; 16 Gallon Midship Fuel Tank	USEP2147S
4.6L V8 281 CID	2003	(W), GAS; (3 Tube Ports), Midship Fuel Tank	USEP2341S	5.8L V8 5753cc 351 CID	1991	(H); 20 Gallon Aft Axle Fuel Tank (22 Gallon Aft Axle Fuel Tank)	USEP2147S
4.6L V8 281 CID	2004	(W), GAS; (w/Secondary Fuel Ports), Midship Fuel Tank (35 Gallon Fuel Tank)	USEP2364S	5.8L V8 5753cc 351 CID	1992-1994	(H); Midship Fuel Tank	USEP2220M
4.6L V8 281 CID	2004-2005	(W), GAS; Aft Axle Fuel Tank	USEP2437S	5.8L V8 5753cc 351 CID	1992-1994	(H); Aft Axle Fuel Tank	USEP2282M
4.6L V8 281 CID	2004-2008	2 ports, center tank	USEP2365S	5.8L V8 5753cc 351 CID	1992-1996		USEP2059MN
4.6L V8 281 CID	2005	(W), GAS; (w/Secondary Fuel Ports), Midship Fuel Tank (From 01/10/05)	USEP2364S	5.8L V8 5753cc 351 CID	1992-1996		USEP2310M
4.6L V8 281 CID	2005	(W), GAS; (w/Secondary Fuel Ports), Midship Fuel Tank (To 01/10/05)	USEP2364S	5.8L V8 5753cc 351 CID	1995-1996	(H), GAS; Midship Fuel Tank	USEP2220M
4.6L V8 281 CID	2005	(W), GAS; (wo/Secondary Fuel Ports), Midship Fuel Tank (From 01/10/05)	USEP2365S	5.8L V8 5753cc 351 CID	1995-1996	(H), GAS; Aft Axle Fuel Tank	USEP2282M
4.6L V8 281 CID	2006	(W); (w/Secondary Fuel Ports), Midship Fuel Tank	USEP2364S	<b>E-250 ECONOLINE CLUB WAGON</b>			
4.6L V8 281 CID	2006	(W); (wo/Secondary Fuel Ports), Midship Fuel Tank	USEP2365S	5.8L V8 5753cc 351 CID	1988	(H), GAS; 16 Gallon Fuel Tank	USEP2133S
4.6L V8 281 CID	2006	(W); Aft Axle Fuel Tank	USEP2437S	5.8L V8 5753cc 351 CID	1988-1989	(H), GAS; 20 Gallon Fuel Tank (22 Gallon Fuel Tank)	USEP2135S
4.6L V8 281 CID	2007-2008	(W); (Secondary Fuel Ports)	USEP2364S	5.8L V8 5753cc 351 CID	1990	(H), GAS; 20 Gallon Aft Axle Fuel Tank (22 Gallon Aft Axle Fuel Tank) (To 05/22/90)	USEP2135S
4.6L V8 281 CID	2007-2008	(W); (Exc.Secondary Fuel Ports)	USEP2365S	5.8L V8 5753cc 351 CID	1990	(H), GAS; 16 Gallon Midship Fuel Tank	USEP2147S
4.6L V8 281 CID	2009-2010		USEP2540M	5.8L V8 5753cc 351 CID	1990	(H), GAS; 20 Gallon Aft Axle Fuel Tank (22 Gallon Aft Axle Fuel Tank) (From 05/23/90)	USEP2147S
4.6L V8 281 CID	2011-2014	2 tube ports, w/o aux fuel port	USEP2581M	5.8L V8 5753cc 351 CID	1991	(H), 138.0 / 350.5 Wheel Base, GAS; 16 Gallon Midship Fuel Tank	USEP2147S
5.4L V8 330 CID	2003		USEP2276S	5.8L V8 5753cc 351 CID	1991	(H), GAS; 20 Gallon Aft Axle Fuel Tank (22 Gallon Aft Axle Fuel Tank)	USEP2147S
5.4L V8 330 CID	2003		USEP2343S	7.5L V8 460 CID	1985	(L), CARB, GAS; Aft Axle Fuel Tank, External Pump	USEP2133S
5.4L V8 330 CID	2004-2008	2 ports, center tank	USEP2365S	7.5L V8 460 CID	1986-1987	(L), CARB, GAS; Midship Fuel Tank	USEP2133S
5.4L V8 330 CID	2006	(L); (w/Secondary Fuel Ports), Exc.Extended Range Fuel Tank (Midship Fuel Tank)	USEP2364S	7.5L V8 460 CID	1986-1987	(L), CARB, GAS; Aft Axle Fuel Tank	USEP2135S
5.4L V8 330 CID	2006	(L); (wo/Secondary Fuel Ports), Exc.Extended Range Fuel Tank (Midship Fuel Tank)	USEP2365S	7.5L V8 460 CID	1988	(G), GAS; 16 Gallon Fuel Tank	USEP2133S
5.4L V8 330 CID	2006-2008	(L); Exc.Extended Range Fuel Tank (Aft Axle Fuel Tank)	USEP2437S	7.5L V8 460 CID	1988-1989	(G), GAS; 20 Gallon Fuel Tank (22 Gallon Fuel Tank)	USEP2135S
5.4L V8 330 CID	2006-2008	(L); Extended Range Fuel Tank	USEP2437S	7.5L V8 460 CID	1991	(G), 138.0 / 350.5 Wheel Base, GAS; 16 Gallon Midship Fuel Tank	USEP2147S
5.4L V8 330 CID	2007-2008	(L); (Secondary Fuel Ports), Exc.Extended Range Fuel Tank (Midship Fuel Tank)	USEP2364S	7.5L V8 460 CID	1991	(G), GAS; 20 Gallon Aft Axle Fuel Tank (22 Gallon Aft Axle Fuel Tank)	USEP2147S
5.4L V8 330 CID	2007-2008	(L); (Exc.Secondary Fuel Ports), Exc.Extended Range Fuel Tank (Midship Fuel Tank)	USEP2365S	<b>E-350 CLUB WAGON</b>			
5.4L V8 330 CID	2009-2010		USEP2540M	5.4L V8 330 CID	2003		USEP2276S
5.4L V8 330 CID	2009-2014		USEP2528M	5.4L V8 330 CID	2004-2005	2 ports, center tank	USEP2343S
5.4L V8 330 CID	2011-2014	2 tube ports, w/o aux fuel port	USEP2581M	6.8L V10 415 CID	2003		USEP2343S
<b>E-250 ECONOLINE</b>				6.8L V10 415 CID	2005	2 ports, center tank	USEP2365S
4.2L V6 256 CID	1997-1998		USEP2201S	<b>E-350 ECONOLINE</b>			
4.2L V6 256 CID	1997-1998	3 PORTS, REAR TANK	USEP2210S	4.9L L6 4917cc 300 CID	1989-1991	Stripped Chassis; with rear tank	USEP2071S
4.2L V6 256 CID	1997-1998	2 PORTS, CENTER TANK	USEP2213S				





# FUEL PUMP MODULES APPLICATION GUIDE



FUEL PUMP MODULES

Engine	Years	Application Description	USMW
<b>FORD (cont'd.)</b>			
<b>E-350 ECONOLINE (cont'd.)</b>			
4.9L L6 4917cc 300 CID	1992-1996		USEP2059MN
4.9L L6 4917cc 300 CID	1992-1996		USEP2310M
5.4L V8 330 CID	1997-1998	(L), GAS, Naturally Aspirated; (2 Tube Ports), Midship Fuel Tank	USEP2206S
5.4L V8 330 CID	1997-1998	(L), GAS, Naturally Aspirated; (3 Tube Ports), Midship Fuel Tank	USEP2223S
5.4L V8 330 CID	1997-1998	(L), GAS, Naturally Aspirated; (3 Tube Ports), Aft Axle Fuel Tank	USEP2224S
5.4L V8 330 CID	1998	(Z), BI-FUEL, Naturally Aspirated; (2 Tube Ports), Midship Fuel Tank	USEP2206S
5.4L V8 330 CID	1998	(Z), BI-FUEL, Naturally Aspirated; (3 Tube Ports), Midship Fuel Tank	USEP2223S
5.4L V8 330 CID	1998	(Z), BI-FUEL, Naturally Aspirated; (3 Tube Ports), Aft Axle Fuel Tank	USEP2224S
5.8L V8 5753cc 351 CID	1988	(H), GAS; 16 Gallon Fuel Tank	USEP2133S
5.8L V8 5753cc 351 CID	1988	(H), GAS; 20 Gallon Fuel Tank (22 Gallon Fuel Tank)	USEP2135S
5.8L V8 5753cc 351 CID	1989-1991	Stripped Chassis; with rear tank	USEP2071S
5.8L V8 5753cc 351 CID	1990	(H), Cutaway Van, GAS; 40 Gallon Fuel Tank	USEP2060S
5.8L V8 5753cc 351 CID	1990	(H), GAS; 20 Gallon Aft Axle Fuel Tank (22 Gallon Aft Axle Fuel Tank) (To 05/22/90)	USEP2135S
5.8L V8 5753cc 351 CID	1990	(H), GAS; 20 Gallon Aft Axle Fuel Tank (22 Gallon Aft Axle Fuel Tank) (From 05/23/90)	USEP2147S
5.8L V8 5753cc 351 CID	1990-1991	(H), 138.0 / 350.5 Wheel Base, GAS; 16 Gallon Midship Fuel Tank	USEP2147S
5.8L V8 5753cc 351 CID	1991	(H), Cutaway Van, GAS; 40 Gallon Fuel Tank (From 06/91)	USEP2060S
5.8L V8 5753cc 351 CID	1991	(H), GAS; 20 Gallon Aft Axle Fuel Tank (22 Gallon Aft Axle Fuel Tank)	USEP2147S
5.8L V8 5753cc 351 CID	1992-1994	(H), GAS; Midship Fuel Tank	USEP2220M
5.8L V8 5753cc 351 CID	1992-1994	(H), GAS; Aft Axle Fuel Tank	USEP2282M
5.8L V8 5753cc 351 CID	1992-1996		USEP2059MN
5.8L V8 5753cc 351 CID	1992-1996		USEP2310M
5.8L V8 5753cc 351 CID	1995-1996	(H), GAS, Naturally Aspirated; Midship Fuel Tank	USEP2220M
5.8L V8 5753cc 351 CID	1995-1996	(H), GAS, Naturally Aspirated; Aft Axle Fuel Tank	USEP2282M
6.8L V10 415 CID	1997-1998	(S), GAS, Naturally Aspirated; (2 Tube Ports), Midship Fuel Tank	USEP2206S
6.8L V10 415 CID	1997-1998	(S), GAS, Naturally Aspirated; (3 Tube Ports), Midship Fuel Tank	USEP2223S
6.8L V10 415 CID	1997-1998	(S), GAS, Naturally Aspirated; (3 Tube Ports), Aft Axle Fuel Tank	USEP2224S
7.5L V8 460 CID	1986-1987	(L), CARB, GAS; Midship Fuel Tank	USEP2133S
7.5L V8 460 CID	1986-1987	(L), CARB, Cutaway Van, GAS; Aft Axle Fuel Tank	USEP2134S
7.5L V8 460 CID	1986-1987	(L), CARB, Extended Cargo Van, GAS; Aft Axle Fuel Tank	USEP2135S
7.5L V8 460 CID	1986-1987	(L), CARB, Extended Passenger Van, GAS; Aft Axle Fuel Tank	USEP2135S
7.5L V8 460 CID	1986-1987	(L), CARB, GAS, Standard Cargo Van; Aft Axle Fuel Tank	USEP2135S
7.5L V8 460 CID	1986-1987	(L), CARB, GAS, Standard Passenger Van; Aft Axle Fuel Tank	USEP2135S
7.5L V8 460 CID	1986-1987	(L), CARB, GAS, Stripped Chassis; Aft Axle Fuel Tank	USEP2135S
7.5L V8 460 CID	1987	(G), FI, GAS; Midship Fuel Tank	USEP2133S
7.5L V8 460 CID	1987	(G), Cutaway Van, FI, GAS; Aft Axle Fuel Tank	USEP2134S
7.5L V8 460 CID	1987	(G), Extended Cargo Van, FI, GAS; Aft Axle Fuel Tank	USEP2135S
7.5L V8 460 CID	1987	(G), Extended Passenger Van, FI, GAS; Aft Axle Fuel Tank	USEP2135S
7.5L V8 460 CID	1987	(G), FI, GAS, Standard Cargo Van; Aft Axle Fuel Tank	USEP2135S
7.5L V8 460 CID	1987	(G), FI, GAS, Standard Passenger Van; Aft Axle Fuel Tank	USEP2135S
7.5L V8 460 CID	1987	(G), FI, GAS, Stripped Chassis; Aft Axle Fuel Tank	USEP2135S
7.5L V8 460 CID	1988	(G), GAS; 16 Gallon Fuel Tank	USEP2133S
7.5L V8 460 CID	1988	(G), GAS; 20 Gallon Fuel Tank (22 Gallon Fuel Tank)	USEP2135S
7.5L V8 460 CID	1989-1991	Stripped Chassis; with rear tank	USEP2071S
7.5L V8 460 CID	1990	(G), Cutaway Van, GAS; 40 Gallon Fuel Tank	USEP2060S
7.5L V8 460 CID	1990	(G), GAS; 20 Gallon Aft Axle Fuel Tank (22 Gallon Aft Axle Fuel Tank) (To 05/22/90)	USEP2135S
7.5L V8 460 CID	1990	(G), GAS; 20 Gallon Aft Axle Fuel Tank (22 Gallon Aft Axle Fuel Tank) (From 05/22/90)	USEP2147S
7.5L V8 460 CID	1990-1991	(G), 138.0 / 350.5 Wheel Base, GAS; 16 Gallon Midship Fuel Tank	USEP2147S
7.5L V8 460 CID	1991	(G), Cutaway Van, GAS; 40 Gallon Fuel Tank (From 06/91)	USEP2060S
7.5L V8 460 CID	1991	(G), GAS; 20 Gallon Aft Axle Fuel Tank (22 Gallon Aft Axle Fuel Tank)	USEP2147S
7.5L V8 460 CID	1992-1994	(G), GAS; Midship Fuel Tank	USEP2220M
7.5L V8 460 CID	1992-1994	(G), GAS; Aft Axle Fuel Tank	USEP2282M
7.5L V8 460 CID	1992-1996		USEP2059MN
7.5L V8 460 CID	1992-1996		USEP2310M

Engine	Years	Application Description	USMW
<b>FORD (cont'd.)</b>			
<b>E-350 ECONOLINE (cont'd.)</b>			
7.5L V8 460 CID	1995-1996	(G), GAS, Naturally Aspirated; Midship Fuel Tank	USEP2220M
7.5L V8 460 CID	1995-1996	(G), GAS, Naturally Aspirated; Aft Axle Fuel Tank	USEP2282M
<b>E-350 ECONOLINE CLUB WAGON</b>			
4.9L L6 4917cc 300 CID	1992-1996		USEP2059MN
4.9L L6 4917cc 300 CID	1992-1996		USEP2310M
5.4L V8 330 CID	1997	XL HD, XLT; (L), GAS, Naturally Aspirated; (2 Tube Ports), Midship Fuel Tank	USEP2206S
5.4L V8 330 CID	1997	XL HD, XLT; (L), GAS, Naturally Aspirated; (3 Tube Ports), Midship Fuel Tank	USEP2223S
5.4L V8 330 CID	1997	XL HD, XLT; (L), GAS, Naturally Aspirated; (3 Tube Ports), Aft Axle Fuel Tank	USEP2224S
5.4L V8 330 CID	1998	XLT, XLT HD; (L), GAS, Naturally Aspirated; (2 Tube Ports), Midship Fuel Tank	USEP2206S
5.4L V8 330 CID	1998	XLT; (Z), BI-FUEL, Naturally Aspirated; (2 Tube Ports), Midship Fuel Tank	USEP2206S
5.4L V8 330 CID	1998	XLT, XLT HD; (L), GAS, Naturally Aspirated; (3 Tube Ports), Midship Fuel Tank	USEP2223S
5.4L V8 330 CID	1998	XLT; (Z), BI-FUEL, Naturally Aspirated; (3 Tube Ports), Midship Fuel Tank	USEP2223S
5.4L V8 330 CID	1998	XLT, XLT HD; (L), GAS, Naturally Aspirated; (3 Tube Ports), Aft Axle Fuel Tank	USEP2224S
5.4L V8 330 CID	1998	XLT; (Z), BI-FUEL, Naturally Aspirated; (3 Tube Ports), Aft Axle Fuel Tank	USEP2224S
5.4L V8 330 CID	1999	(L), GAS, Naturally Aspirated; (2 Tube Ports), Midship Fuel Tank	USEP2206S
5.4L V8 330 CID	1999	(Z), BI-FUEL, Naturally Aspirated; (2 Tube Ports), Midship Fuel Tank	USEP2206S
5.4L V8 330 CID	1999	(L), GAS, Naturally Aspirated; (3 Tube Ports), Midship Fuel Tank	USEP2223S
5.4L V8 330 CID	1999	(Z), BI-FUEL, Naturally Aspirated; (3 Tube Ports), Midship Fuel Tank	USEP2223S
5.4L V8 330 CID	1999	(L), GAS, Naturally Aspirated; (3 Tube Ports), Aft Axle Fuel Tank	USEP2224S
5.4L V8 330 CID	1999	(Z), BI-FUEL, Naturally Aspirated; (3 Tube Ports), Aft Axle Fuel Tank	USEP2224S
5.4L V8 330 CID	2000-2002	(L), GAS, Naturally Aspirated; (2 Tube Ports), Midship Fuel Tank	USEP2286S
5.4L V8 330 CID	2000-2002	(L), GAS, Naturally Aspirated; (3 Tube Ports), Aft Axle Fuel Tank	USEP2286S
5.4L V8 330 CID	2000-2002	(L), GAS, Naturally Aspirated; (3 Tube Ports), Midship Fuel Tank	USEP2286S
5.8L V8 5753cc 351 CID	1988	(H), GAS; 16 Gallon Fuel Tank	USEP2133S
5.8L V8 5753cc 351 CID	1988	(H), GAS; 20 Gallon Fuel Tank (22 Gallon Fuel Tank)	USEP2135S
5.8L V8 5753cc 351 CID	1990	(H), GAS; 20 Gallon Aft Axle Fuel Tank (22 Gallon Aft Axle Fuel Tank) (To 05/22/90)	USEP2135S
5.8L V8 5753cc 351 CID	1990	(H), GAS; 16 Gallon Midship Fuel Tank	USEP2147S
5.8L V8 5753cc 351 CID	1990	(H), GAS; 20 Gallon Aft Axle Fuel Tank (22 Gallon Aft Axle Fuel Tank) (From 05/23/90)	USEP2147S
5.8L V8 5753cc 351 CID	1991	(H), 138.0 / 350.5 Wheel Base, GAS; 16 Gallon Midship Fuel Tank	USEP2147S
5.8L V8 5753cc 351 CID	1991	(H), GAS; 20 Gallon Aft Axle Fuel Tank (22 Gallon Aft Axle Fuel Tank)	USEP2147S
5.8L V8 5753cc 351 CID	1992-1994	XLT, XLT HD; (H), GAS; Midship Fuel Tank	USEP2220M
5.8L V8 5753cc 351 CID	1992-1994	XLT, XLT HD; (H), GAS; Aft Axle Fuel Tank	USEP2282M
5.8L V8 5753cc 351 CID	1992-1996		USEP2059MN
5.8L V8 5753cc 351 CID	1992-1996		USEP2310M
5.8L V8 5753cc 351 CID	1995-1996	XLT, XLT HD; (H), GAS, Naturally Aspirated; Midship Fuel Tank	USEP2220M
5.8L V8 5753cc 351 CID	1995-1996	XLT, XLT HD; (H), GAS, Naturally Aspirated; Aft Axle Fuel Tank	USEP2282M
6.8L V10 415 CID	1997	XL HD, XLT; (S), GAS, Naturally Aspirated; (2 Tube Ports), Midship Fuel Tank	USEP2206S
6.8L V10 415 CID	1997	XL HD, XLT; (S), GAS, Naturally Aspirated; (3 Tube Ports), Midship Fuel Tank	USEP2223S
6.8L V10 415 CID	1997	XL HD, XLT; (S), GAS, Naturally Aspirated; (3 Tube Ports), Aft Axle Fuel Tank	USEP2224S
6.8L V10 415 CID	1998	XLT, XLT HD; (S), GAS, Naturally Aspirated; (2 Tube Ports), Midship Fuel Tank	USEP2206S
6.8L V10 415 CID	1998	XLT, XLT HD; (S), GAS, Naturally Aspirated; (3 Tube Ports), Midship Fuel Tank	USEP2223S
6.8L V10 415 CID	1998	XLT, XLT HD; (S), GAS, Naturally Aspirated; (3 Tube Ports), Aft Axle Fuel Tank	USEP2224S
6.8L V10 415 CID	1999	(S), GAS, Naturally Aspirated; (2 Tube Ports), Midship Fuel Tank	USEP2206S
6.8L V10 415 CID	1999	(S), GAS, Naturally Aspirated; (3 Tube Ports), Midship Fuel Tank	USEP2223S



Engine	Years	Application Description	USMW	Engine	Years	Application Description	USMW
<b>FORD (cont'd.)</b>				<b>FORD (cont'd.)</b>			
<b>E-350 ECONOLINE CLUB WAGON (cont'd.)</b>				<b>E-350 SUPER DUTY (cont'd.)</b>			
6.8L V10 415 CID	1999	(S), GAS, Naturally Aspirated; (3 Tube Ports), Aft Axle Fuel Tank	USEP2224S	6.8L V10 415 CID	2008	Base; (S), GAS, Naturally Aspirated; (Exc.Secondary Fuel Ports), Midship Fuel Tank	USEP2365S
6.8L V10 415 CID	2000-2002	(S), GAS, Naturally Aspirated; (2 Tube Ports), Midship Fuel Tank	USEP2286S	6.8L V10 415 CID	2008	Base; (S), GAS, Naturally Aspirated; Aft Axle Fuel Tank	USEP2437S
6.8L V10 415 CID	2000-2002	(S), GAS, Naturally Aspirated; (3 Tube Ports), Aft Axle Fuel Tank	USEP2286S	6.8L V10 415 CID	2009-2010		USEP2540M
6.8L V10 415 CID	2000-2002	(S), GAS, Naturally Aspirated; (3 Tube Ports), Midship Fuel Tank	USEP2286S	6.8L V10 415 CID	2009-2016		USEP2528M
7.5L V8 460 CID	1986-1987	(L), CARB, GAS; Midship Fuel Tank	USEP2133S	6.8L V10 415 CID	2011-2016	2 tube ports, w/o aux fuel port	USEP2581M
7.5L V8 460 CID	1986-1987	(L), CARB, GAS; Aft Axle Fuel Tank	USEP2135S	6.8L V10 415 CID	2011-2016		USEP2586M
7.5L V8 460 CID	1988	(G), GAS; 16 Gallon Fuel Tank	USEP2133S	<b>E-450 SUPER DUTY</b>			
7.5L V8 460 CID	1988	(G), GAS; 20 Gallon Fuel Tank (22 Gallon Fuel Tank)	USEP2135S	5.4L V8 330 CID	2003		USEP2343S
7.5L V8 460 CID	1991	(G), 138.0 / 350.5 Wheel Base, GAS; 16 Gallon Midship Fuel Tank	USEP2147S	5.4L V8 330 CID	2004	2 ports, center tank	USEP2365S
7.5L V8 460 CID	1991	(G), GAS; 20 Gallon Aft Axle Fuel Tank (22 Gallon Aft Axle Fuel Tank)	USEP2147S	5.4L V8 330 CID	2006-2008	2 ports, center tank	USEP2365S
7.5L V8 460 CID	1992-1994	XLT, XLT HD; (G), GAS; Midship Fuel Tank	USEP2220M	5.4L V8 330 CID	2009		USEP2540M
7.5L V8 460 CID	1992-1994	XLT, XLT HD; (G), GAS; Aft Axle Fuel Tank	USEP2282M	5.4L V8 330 CID	2009-2016		USEP2528M
7.5L V8 460 CID	1992-1996		USEP2059MN	5.4L V8 330 CID	2010-2016	2 tube ports, w/o aux fuel port	USEP2581M
7.5L V8 460 CID	1992-1996		USEP2310M	6.8L V10 415 CID	2003		USEP2343S
7.5L V8 460 CID	1995-1996	XLT, XLT HD; (G), GAS, Naturally Aspirated; Midship Fuel Tank	USEP2220M	6.8L V10 415 CID	2004-2008	2 ports, center tank	USEP2365S
7.5L V8 460 CID	1995-1996	XLT, XLT HD; (G), GAS, Naturally Aspirated; Aft Axle Fuel Tank	USEP2282M	6.8L V10 415 CID	2009-2010		USEP2540M
<b>E-350 SUPER DUTY</b>				6.8L V10 415 CID	2009-2016		USEP2528M
5.4L V8 330 CID	2003		USEP2343S	6.8L V10 415 CID	2011-2016	2 tube ports, w/o aux fuel port	USEP2581M
5.4L V8 330 CID	2004	(L), GAS, Naturally Aspirated; (w/Secondary Fuel Ports), Midship Fuel Tank (35 Gallon Fuel Tank)	USEP2364S	<b>ECONOLINE SUPER DUTY</b>			
5.4L V8 330 CID	2004	(L), GAS, Naturally Aspirated; Aft Axle Fuel Tank	USEP2437S	5.8L V8 5753cc 351 CID	1996		USEP2059MN
5.4L V8 330 CID	2004-2008	2 ports, center tank	USEP2365S	5.8L V8 5753cc 351 CID	1996		USEP2310M
5.4L V8 330 CID	2005	(L), GAS, Naturally Aspirated; (w/Secondary Fuel Ports), Exc.Extended Range Fuel Tank (Midship Fuel Tank) (35 Gallon Fuel Tank)	USEP2364S	7.5L V8 460 CID	1996		USEP2059MN
5.4L V8 330 CID	2005	(L), GAS, Naturally Aspirated; Exc.Extended Range Fuel Tank (Aft Axle Fuel Tank)	USEP2437S	7.5L V8 460 CID	1996		USEP2310M
5.4L V8 330 CID	2005	(L), GAS, Naturally Aspirated; Extended Range Fuel Tank	USEP2437S	<b>EDGE</b>			
5.4L V8 330 CID	2006	Base, XL, XLT; (L), GAS, Naturally Aspirated; (w/Secondary Fuel Ports), Exc.Extended Range Fuel Tank (Midship Fuel Tank)	USEP2364S	3.5L V6 3496cc 213 CID	2007-2010	AWD	USEP2470M
5.4L V8 330 CID	2006	Base, XL, XLT; (L), GAS, Naturally Aspirated; (w/Secondary Fuel Ports), Exc.Extended Range Fuel Tank (Midship Fuel Tank)	USEP2365S	3.5L V6 3496cc 213 CID	2007-2010	FWD	USEP2479M
5.4L V8 330 CID	2006	Base, XL, XLT; (L), GAS, Naturally Aspirated; (w/Secondary Fuel Ports), Exc.Extended Range Fuel Tank (Midship Fuel Tank)	USEP2365S	3.5L V6 3496cc 213 CID	2011-2015		USEP2578M
5.4L V8 330 CID	2006-2008	Base, XL, XLT; (L), GAS, Naturally Aspirated; Exc.Extended Range Fuel Tank (Aft Axle Fuel Tank)	USEP2437S	3.7L V6 3726cc 227 CID	2011-2014		USEP2578M
5.4L V8 330 CID	2006-2008	Base, XL, XLT; (L), GAS, Naturally Aspirated; Extended Range Fuel Tank	USEP2437S	<b>ESCAPE</b>			
5.4L V8 330 CID	2007-2008	Base, XL, XLT; (L), GAS, Naturally Aspirated; (Secondary Fuel Ports), Exc.Extended Range Fuel Tank (Midship Fuel Tank)	USEP2364S	1.6L L4 1601cc 98 CID	2013-2016		USEP2598M
5.4L V8 330 CID	2007-2008	Base, XL, XLT; (L), GAS, Naturally Aspirated; (Exc.Secondary Fuel Ports), Exc.Extended Range Fuel Tank (Midship Fuel Tank)	USEP2365S	2.0L L4 1989cc 121 CID	2001-2004		USEP2291M
5.4L V8 330 CID	2009-2010		USEP2540M	2.0L L4 1999cc 122 CID	2013-2016		USEP2598M
5.4L V8 330 CID	2009-2016	2 tube ports, w/o aux fuel port	USEP2528M	2.3L L4 140 CID	2005	XLT No Boundaries; (Z), GAS; Onboard Refuel Vapor Recovery	USEP2440M
5.4L V8 330 CID	2011-2016		USEP2581M	2.3L L4 140 CID	2005	XLT No Boundaries; (Z), GAS; Exc.Onboard Refuel Vapor Recovery (From 02/28/05)	USEP2453M
6.8L V10 415 CID	2003		USEP2343S	2.3L L4 140 CID	2005	XLT No Boundaries; (Z), GAS; Exc.Onboard Refuel Vapor Recovery (To 02/28/05)	USEP2453M
6.8L V10 415 CID	2004-2005	(S), GAS, Naturally Aspirated; (w/Secondary Fuel Ports), Midship Fuel Tank	USEP2364S	2.3L L4 140 CID	2005-2007	ELECTRIC/GAS	USEP2473M
6.8L V10 415 CID	2004-2005	(S), GAS, Naturally Aspirated; Aft Axle Fuel Tank	USEP2437S	2.3L L4 140 CID	2006	XLS, XLT; (Z), GAS; Exc.Onboard Refuel Vapor Recovery	USEP2453M
6.8L V10 415 CID	2004-2008	2 ports, center tank	USEP2365S	2.3L L4 140 CID	2007	XLS, XLT; (Z), GAS; Onboard Refuel Vapor Recovery (To 01/02/07)	USEP2440M
6.8L V10 415 CID	2006	Base, XL, XLT; (S), GAS, Naturally Aspirated; (w/Secondary Fuel Ports), Midship Fuel Tank	USEP2364S	2.3L L4 140 CID	2007	XLS, XLT; (Z), GAS; Exc.Onboard Refuel Vapor Recovery (To 01/02/07)	USEP2453M
6.8L V10 415 CID	2006	Base, XL, XLT; (S), GAS, Naturally Aspirated; (w/Secondary Fuel Ports), Midship Fuel Tank	USEP2364S	2.3L L4 140 CID	2007-2008	GAS; WITH ONBOARD VAPOR RECOVERY	USEP2495M
6.8L V10 415 CID	2006	Base, XL, XLT; (S), GAS, Naturally Aspirated; (w/Secondary Fuel Ports), Midship Fuel Tank	USEP2365S	2.3L L4 140 CID	2007-2008		USEP2496M
6.8L V10 415 CID	2006-2007	Base, XL, XLT; (S), GAS, Naturally Aspirated; Aft Axle Fuel Tank	USEP2437S	2.5L L4 2488cc 152 CID	2009-2010		USEP2529M
6.8L V10 415 CID	2007	Base, XL, XLT; (S), GAS, Naturally Aspirated; (Secondary Fuel Ports), Midship Fuel Tank	USEP2364S	2.5L L4 2488cc 152 CID	2013-2018		USEP2606M
6.8L V10 415 CID	2007	Base, XL, XLT; (S), GAS, Naturally Aspirated; (Exc.Secondary Fuel Ports), Midship Fuel Tank	USEP2365S	3.0L V6 2968cc 181 CID	2007-2008	GAS; WITH ONBOARD VAPOR RECOVERY	USEP2495M
6.8L V10 415 CID	2007-2008	Base, XL, XLT; (S), GAS, Naturally Aspirated; Aft Axle Fuel Tank	USEP2365S	3.0L V6 2968cc 181 CID	2009-2010		USEP2529M
6.8L V10 415 CID	2007	Base, XL, XLT; (S), GAS, Naturally Aspirated; (Secondary Fuel Ports), Midship Fuel Tank	USEP2364S	<b>ESCORT</b>			
6.8L V10 415 CID	2007	Base, XL, XLT; (S), GAS, Naturally Aspirated; (Exc.Secondary Fuel Ports), Midship Fuel Tank	USEP2365S	1.8L L4 112 CID	1991-1993		USEP2105S
6.8L V10 415 CID	2008	Base; (S), GAS, Naturally Aspirated; (Secondary Fuel Ports), Midship Fuel Tank	USEP2364S	1.8L L4 112 CID	1994-1996	GT; (8)	USEP2151H
				1.9L L4 116 CID	1987	TBI	USEP2082S
				1.9L L4 116 CID	1987	MFI	USEP2136S
				1.9L L4 116 CID	1988	TBI; 13 Gallon Fuel Tank	USEP2082S
				1.9L L4 116 CID	1988	MFI; From 04/88	USEP2136S
				1.9L L4 116 CID	1989-1990	TBI; 11 Gallon Fuel Tank	USEP2082S
				1.9L L4 116 CID	1989-1990	MFI	USEP2136S
				1.9L L4 116 CID	1991-1993		USEP2105S
				1.9L L4 116 CID	1994	Base; (J)	USEP2151H
				1.9L L4 116 CID	1994	LX, LX Sport	USEP2151H
				1.9L L4 116 CID	1995	Base, LX, LX Sport; (J)	USEP2151H
				1.9L L4 116 CID	1996	Base, Sport; (J)	USEP2151H
				2.0L L4 1989cc 121 CID	1997		USEP2164H
				2.0L L4 1989cc 121 CID	2000		USEP2246M
				2.0L L4 1989cc 121 CID	2002-2003		USEP2246M
				<b>EXCURSION</b>			
				5.4L V8 330 CID	2000-2003	(L), GAS, Naturally Aspirated; Exc.Calif	USEP2287M
				5.4L V8 330 CID	2000-2003	(L), GAS, Naturally Aspirated; Calif	USEP2288M
				5.4L V8 330 CID	2004	(L), GAS, Naturally Aspirated; Exc.Calif (From 02/01/04)	USEP2287M
				5.4L V8 330 CID	2004	(L), GAS, Naturally Aspirated; Exc.Calif (To 02/01/04)	USEP2287M
				5.4L V8 330 CID	2004	(L), GAS, Naturally Aspirated; Calif (From 02/01/04)	USEP2288M



# FUEL PUMP MODULES APPLICATION GUIDE



FUEL PUMP MODULES

Engine	Years	Application Description	USMW	Engine	Years	Application Description	USMW
<b>FORD (cont'd.)</b>				<b>FORD (cont'd.)</b>			
<b>EXCURSION (cont'd.)</b>				<b>EXPLORER (cont'd.)</b>			
5.4L V8 330 CID	2004	(L), GAS, Naturally Aspirated; Calif (To 02/01/04)	USEP2288M	4.6L V8 281 CID	2010		USEP2553M
5.4L V8 330 CID	2005	(L), GAS, Naturally Aspirated; Exc.Calif	USEP2287M	5.0L V8 302 CID	1996	module and pump, must be used with original FORD module	USEP2059MN
5.4L V8 330 CID	2005	(L), GAS, Naturally Aspirated; Calif	USEP2288M	5.0L V8 302 CID	1996		USEP2381S
6.8L V10 415 CID	2000-2003	(S), GAS, Naturally Aspirated; Exc.Calif	USEP2287M	5.0L V8 302 CID	1997-1998	Eddie Bauer, Limited, XLT	USEP2266S
6.8L V10 415 CID	2000-2003	(S), GAS, Naturally Aspirated; Calif	USEP2288M	5.0L V8 302 CID	2000	XLT; (P); To 02/00	USEP2296S
6.8L V10 415 CID	2001-2004	MEX	USEP2287M	5.0L V8 302 CID	2001	XLT; (P), GAS; (1 Port)	USEP2296S
6.8L V10 415 CID	2004	(S), GAS, Naturally Aspirated; Exc.Calif (From 02/01/04)	USEP2287M	<b>EXPLORER SPORT TRAC</b>			
6.8L V10 415 CID	2004	(S), GAS, Naturally Aspirated; Exc.Calif (To 02/01/04)	USEP2287M	4.0L V6 245 CID	2001	To 04/23/01	USEP2332S
6.8L V10 415 CID	2004	(S), GAS, Naturally Aspirated; Calif (To 02/01/04)	USEP2287M	4.0L V6 245 CID	2002	To 03/04/02	USEP2332S
6.8L V10 415 CID	2004	(S), GAS, Naturally Aspirated; Calif (From 02/01/04)	USEP2288M	4.0L V6 245 CID	2002	From 03/04/02	USEP2348M
6.8L V10 415 CID	2004	(S), GAS, Naturally Aspirated; Calif (To 02/01/04)	USEP2288M	4.0L V6 245 CID	2003	XLT; (E), GAS; To 08/04/03	USEP2348M
6.8L V10 415 CID	2004	(S), GAS, Naturally Aspirated; Calif (To 02/01/04)	USEP2288M	4.0L V6 245 CID	2003	From 08/04/03	USEP2358M
6.8L V10 415 CID	2005	(S), GAS, Naturally Aspirated; Exc.Calif	USEP2287M	4.0L V6 245 CID	2004-2005	Limited, XLT; (K); From 08/07/06	USEP2358M
6.8L V10 415 CID	2005	(S), GAS, Naturally Aspirated; Exc.Calif	USEP2287M	4.0L V6 245 CID	2007	Limited, XLT; (K); To 08/07/06	USEP2454M
6.8L V10 415 CID	2005	(S), GAS, Naturally Aspirated; Calif	USEP2288M	4.0L V6 245 CID	2007	Limited, XLT; (K)	USEP2454M
<b>EXP</b>				4.0L V6 245 CID	2010	Limited, XLT; (8); From 08/07/06	USEP2553M
1.9L L4 116 CID	1987-1988		USEP2136S	4.6L V8 281 CID	2007	Limited, XLT; (8); To 08/07/06	USEP2454M
<b>EXPEDITION</b>				4.6L V8 281 CID	2008-2009	Limited, XLT; (8)	USEP2454M
4.6L V8 281 CID	1997-1998	4WD	USEP2201S	4.6L V8 281 CID	2010		USEP2553M
4.6L V8 281 CID	1997-1998	RWD; with Auto suspension	USEP2202S	<b>F53</b>			
4.6L V8 281 CID	1997-1998	RWD; with Standard suspension	USEP2205S	7.5L V8 460 CID	1989-1997		USEP2063M
4.6L V8 281 CID	1999-2002	RWD; adjustable suspension	USEP2252S	<b>F600</b>			
4.6L V8 281 CID	1999-2002	4WD	USEP2297S	7.0L V8 429 CID	1991-1993		USEP2063M
4.6L V8 281 CID	1999-2002	RWD; with standard suspension	USEP2298S	<b>F700</b>			
4.6L V8 281 CID	2003-2004		USEP2361M	7.0L V8 429 CID	1991-1993		USEP2063M
4.6L V8 281 CID	2003-2004	(W)	USEP2361M	7.0L V8 429 CID	1995		USEP2063M
5.4L V8 330 CID	1997-1998	4WD	USEP2201S	7.0L V8 429 CID	1997-1998		USEP2063M
5.4L V8 330 CID	1997-1998	RWD; with Auto suspension	USEP2202S	<b>F-150</b>			
5.4L V8 330 CID	1997-1998	RWD; with Standard suspension	USEP2205S	3.5L V6 3496cc 213 CID	2011-2014	RWD	USEP2588M
5.4L V8 330 CID	1999-2002	RWD; adjustable suspension	USEP2252S	3.5L V6 3496cc 213 CID	2012-2014	4WD	USEP2585M
5.4L V8 330 CID	1999-2002	RWD; with standard suspension	USEP2298S	4.2L V6 256 CID	1997	XLT; (2), 4WD, 120.0 / 304.8 Wheel Base	USEP2221S
5.4L V8 330 CID	2003-2004		USEP2361M	4.2L V6 256 CID	1997	XLT; (2), 120.0 / 304.8 Wheel Base, RWD	USEP2221S
5.4L V8 330 CID	2003-2004	(W)	USEP2361M	4.2L V6 256 CID	1997	XLT; (2), 139.0 / 353.1 Wheel Base, Standard Cab Pickup	USEP2221S
5.4L V8 330 CID	1997-1998	4WD	USEP2201S	4.2L V6 256 CID	1997	XLT; (2), 157.0 / 398.8 Wheel Base	USEP2221S
5.4L V8 330 CID	1997-1998	RWD; with Auto suspension	USEP2202S	4.2L V6 256 CID	1997-1998	4WD, 120.0 / 304.8 Wheel Base	USEP2212S
5.4L V8 330 CID	1997-1998	RWD; with Standard suspension	USEP2205S	4.2L V6 256 CID	1997-1998	120.0 / 304.8 Wheel Base, RWD	USEP2221S
5.4L V8 330 CID	1999-2002	RWD; adjustable suspension	USEP2252S	4.2L V6 256 CID	1997-1998	139.0 / 353.1 Wheel Base	USEP2221S
5.4L V8 330 CID	1999-2002	RWD; with standard suspension	USEP2298S	4.2L V6 256 CID	1997-1998	157.0 / 398.8 Wheel Base	USEP2221S
5.4L V8 330 CID	2001-2002	4WD	USEP2297S	4.2L V6 256 CID	1998	(2), 120.0 / 304.8 Wheel Base, GAS, RWD	USEP2221S
5.4L V8 330 CID	2003-2004	MEX	USEP2360M	4.2L V6 256 CID	1998	(2), 139.0 / 353.1 Wheel Base, Extended Cab Pickup, GAS	USEP2221S
5.4L V8 330 CID	2005-2006		USEP2443M	4.2L V6 256 CID	1998	(2), 139.0 / 353.1 Wheel Base, GAS, Standard Cab Pickup	USEP2221S
5.4L V8 330 CID	2007-2008	119.0 wheelbase	USEP2476M	4.2L V6 256 CID	1998	XLT; (2), 4WD, 120.0 / 304.8 Wheel Base, GAS	USEP2221S
5.4L V8 330 CID	2007-2008		USEP2494M	4.2L V6 256 CID	1998	XLT; (2), 157.0 / 398.8 Wheel Base, GAS	USEP2221S
5.4L V8 330 CID	2009-2014	119.0 / 302.3 Wheel Base, USA	USEP2523M	4.2L V6 256 CID	1999	139.0 / 353.1 Wheel Base, GAS	USEP2237S
5.4L V8 330 CID	2010-2014	131.0 / 332.7 Wheel Base	USEP2572M	4.2L V6 256 CID	1999-2003	120.0 / 304.8 Wheel Base, GAS	USEP2237S
<b>EXPLORER</b>				4.2L V6 256 CID	1999-2003	157.0 / 398.8 Wheel Base, GAS	USEP2237S
4.0L V6 245 CID	1991-1994		USEP2144S	4.2L V6 256 CID	2000-2003	Exc.Extended Cab	USEP2237S
4.0L V6 245 CID	1995		USEP2181S	4.2L V6 256 CID	2000-2003	139.0 / 353.1 Wheel Base, GAS; Extended Cab	USEP2237S
4.0L V6 245 CID	1995-1996	module and pump, must be used with original FORD module	USEP2059MN	4.2L V6 256 CID	2005-2008	with 27 GALLON TANK	USEP2441M
4.0L V6 245 CID	1996		USEP2381S	4.6L V8 281 CID	1997	XLT; (6), 4WD, 120.0 / 304.8 Wheel Base	USEP2221S
4.0L V6 245 CID	1997	(E), 4 Doors; (Mexico Built Vehicle)	USEP2190S	4.6L V8 281 CID	1997	XLT; (6), 120.0 / 304.8 Wheel Base, RWD	USEP2221S
4.0L V6 245 CID	1997	(E); USA Built (Canada Built Vehicle)	USEP2190S	4.6L V8 281 CID	1997	XLT; (6), 139.0 / 353.1 Wheel Base, Standard Cab Pickup	USEP2221S
4.0L V6 245 CID	1997	(X), 4 Doors; (Mexico Built Vehicle)	USEP2190S	4.6L V8 281 CID	1997	XLT; (6), 157.0 / 398.8 Wheel Base	USEP2221S
4.0L V6 245 CID	1997	(X); USA Built (Canada Built Vehicle)	USEP2190S	4.6L V8 281 CID	1997	XLT; (W), 4WD, 120.0 / 304.8 Wheel Base	USEP2221S
4.0L V6 245 CID	1997-1998	Eddie Bauer, Limited, Sport, XL, XLT	USEP2266S	4.6L V8 281 CID	1997	XLT; (W), 120.0 / 304.8 Wheel Base, RWD	USEP2221S
4.0L V6 245 CID	1997-2000	(E), 2 Doors; (Mexico Built Vehicle)	USEP2190S	4.6L V8 281 CID	1997	XLT; (W), 139.0 / 353.1 Wheel Base, Standard Cab Pickup	USEP2221S
4.0L V6 245 CID	1997-2000	(X), 2 Doors; (Mexico Built Vehicle)	USEP2190S	4.6L V8 281 CID	1997-1998	4WD, 120.0 / 304.8 Wheel Base	USEP2221S
4.0L V6 245 CID	1998-2000	(E), 4 Doors; (Exc.Mexico Built Vehicle)	USEP2190S	4.6L V8 281 CID	1997-1998	120.0 / 304.8 Wheel Base, RWD	USEP2221S
4.0L V6 245 CID	1998-2000	(X), 4 Doors; (Exc.Mexico Built Vehicle)	USEP2190S	4.6L V8 281 CID	1997-1998	139.0 / 353.1 Wheel Base	USEP2221S
4.0L V6 245 CID	2000	(E), 0 Doors; (Exc.Mexico Built Vehicle)	USEP2190S	4.6L V8 281 CID	1997-1998	157.0 / 398.8 Wheel Base	USEP2221S
4.0L V6 245 CID	2000	(X), 0 Doors; (Exc.Mexico Built Vehicle)	USEP2190S	4.6L V8 281 CID	1998	(6), 120.0 / 304.8 Wheel Base, GAS, RWD	USEP2221S
4.0L V6 245 CID	2001	XLT; (E), GAS	USEP2296S	4.6L V8 281 CID	1998	(6), 139.0 / 353.1 Wheel Base, Extended Cab Pickup, GAS	USEP2221S
4.0L V6 245 CID	2001	(E), GAS; (1 Port), To 04/23/01	USEP2332S	4.6L V8 281 CID	1998	(6), 139.0 / 353.1 Wheel Base, GAS, Standard Cab Pickup	USEP2221S
4.0L V6 245 CID	2001	(E), GAS; (2 Ports), From 04/23/01	USEP2332S				
4.0L V6 245 CID	2002	(E), GAS; To 03/04/02	USEP2332S				
4.0L V6 245 CID	2002	WITH 7 PIN CONNECTOR	USEP2334M				
4.0L V6 245 CID	2002	WITH 8 PIN CONNECTOR	USEP2338M				
4.0L V6 245 CID	2002	(E), GAS; From 03/04/02 (To 08/19/02)	USEP2348M				
4.0L V6 245 CID	2002	GAS; From 08/19/02	USEP2353M				
4.0L V6 245 CID	2003		USEP2351M				
4.0L V6 245 CID	2003	GAS	USEP2353M				
4.0L V6 245 CID	2004	(K), FLEX; To 03/01/04	USEP2355M				
4.0L V6 245 CID	2004	(K), FLEX; From 03/01/04	USEP2439M				
4.0L V6 245 CID	2004-2005	(E), GAS; To 03/01/04	USEP2355M				
4.0L V6 245 CID	2004-2005	(E), GAS; From 03/01/04	USEP2439M				
4.0L V6 245 CID	2006	Eddie Bauer, Limited, XLS, XLT; (E)	USEP2454M				
4.0L V6 245 CID	2007-2009	Eddie Bauer, Limited, XLT; (E)	USEP2454M				
4.0L V6 245 CID	2010		USEP2553M				
4.0L V6 4015cc 245 CID	2010		USEP2553M				
4.6L V8 281 CID	2002	WITH 7 PIN CONNECTOR	USEP2334M				
4.6L V8 281 CID	2002	WITH 8 PIN CONNECTOR	USEP2338M				
4.6L V8 281 CID	2003		USEP2351M				
4.6L V8 281 CID	2004-2005		USEP2359M				
4.6L V8 281 CID	2006-2009	Eddie Bauer, Limited, XLT; (8)	USEP2454M				









# FUEL PUMP MODULES APPLICATION GUIDE



FUEL PUMP MODULES

Engine	Years	Application Description	USMW	Engine	Years	Application Description	USMW
<b>FORD (cont'd.)</b>				<b>FORD (cont'd.)</b>			
<b>F-150 (cont'd.)</b>				<b>F-250 (cont'd.)</b>			
5.8L V8 5753cc 351 CID	1993-1994	XL(T); (H); 18 Gallon Aft Axle Fuel Tank (Steel Fuel Tank)	USEP2064MN	5.8L V8 5753cc 351 CID	1993-1994	(H), GAS, Naturally Aspirated; (3 Tube Ports), 19 Gallon Midship Fuel Tank (Steel Fuel Tank)	USEP2059MN
5.8L V8 5753cc 351 CID	1995-1996		USEP2059MN				
6.2L V8 6210cc 379 CID	2010		USEP2530M	5.8L V8 5753cc 351 CID	1993-1994	(H), GAS, Naturally Aspirated; 18 Gallon Aft Axle Fuel Tank (Steel Fuel Tank)	USEP2064MN
<b>F-150 HERITAGE</b>				<b>F-250 SUPER DUTY</b>			
4.2L V6 256 CID	2004	119.9 / 304.5 Wheel Base, GAS; RWD	USEP2237S	5.8L V8 5753cc 351 CID	1995-1996		USEP2059MN
4.2L V6 256 CID	2004	138.5 / 351.8 Wheel Base, GAS; Exc.Extended Cab	USEP2237S	6.6L V8 400 CID	1980-1982		USEP2089S
4.2L V6 256 CID	2004	157.1 / 399.0 Wheel Base, GAS	USEP2237S	7.5L V8 460 CID	1983-1984		USEP2089S
4.6L V8 281 CID	2004	119.9 / 304.5 Wheel Base, GAS; RWD	USEP2237S	7.5L V8 460 CID	1985-1986	(L), CARB, GAS; Midship Fuel Tank	USEP2088S
4.6L V8 281 CID	2004	138.5 / 351.8 Wheel Base, GAS; Exc.Extended Cab	USEP2237S	7.5L V8 460 CID	1985-1986	(L), CARB, GAS; 19 Gallon Aft Axle Fuel Tank (Plastic Fuel Tank)	USEP2091S
4.6L V8 281 CID	2004	138.5 / 351.8 Wheel Base, GAS; Extended Cab	USEP2237S	7.5L V8 460 CID	1988	(G), GAS; Rear Fuel Tank (Steel Fuel Tank)	USEP2104S
4.6L V8 281 CID	2004	157.1 / 399.0 Wheel Base, GAS	USEP2237S	7.5L V8 460 CID	1988	(G), GAS; Rear Fuel Tank (Plastic Fuel Tank)	USEP2143S
4.6L V8 281 CID	2004	GAS; Crew Cab	USEP2237S	7.5L V8 460 CID	1988-1989	(G), GAS; 17 Gallon Midship Fuel Tank	USEP2102S
5.4L V8 330 CID	2004	119.9 / 304.5 Wheel Base, BI-FUEL; RWD	USEP2237S	7.5L V8 460 CID	1988-1989	(G), GAS; 19 Gallon Midship Fuel Tank	USEP2103S
5.4L V8 330 CID	2004	138.5 / 351.8 Wheel Base, BI-FUEL; Exc.Extended Cab	USEP2237S	7.5L V8 460 CID	1989	(G), GAS; Aft Axle Fuel Tank (Steel Fuel Tank)	USEP2104S
5.4L V8 330 CID	2004	138.5 / 351.8 Wheel Base, BI-FUEL; Extended Cab	USEP2237S	7.5L V8 460 CID	1989	(G), GAS; Aft Axle Fuel Tank (Plastic Fuel Tank)	USEP2143S
5.4L V8 330 CID	2004	157.1 / 399.0 Wheel Base, BI-FUEL	USEP2237S	7.5L V8 460 CID	1995-1996		USEP2059MN
5.4L V8 330 CID	2004	BI-FUEL; Crew Cab	USEP2237S	<b>F-250 SUPER DUTY</b>			
5.4L V8 330 CID	2004		USEP2265S	5.4L V8 330 CID	1999	With California emissions	USEP2232M
<b>F-250</b>				5.4L V8 330 CID	1999	without California emissions	USEP2233M
4.6L V8 281 CID	1997	(6), GAS, Naturally Aspirated, Standard Cab Pickup	USEP2221S	5.4L V8 330 CID	1999-2004	142 and 156 wheelbase, Center tank, with california Emissions	USEP2230M
4.6L V8 281 CID	1997	(W), GAS, Naturally Aspirated, Standard Cab Pickup	USEP2221S	5.4L V8 330 CID	1999-2004	137,158, 172 wheelbase, Center tank, with california Emissions	USEP2235M
4.6L V8 281 CID	1997-1998	139.0 / 353.1 Wheel Base	USEP2221S	5.4L V8 330 CID	1999-2004	142 and 156 wheelbase, center tank, w/o california emissions	USEP2238M
4.6L V8 281 CID	1999	GAS; Extended Cab	USEP2237S	5.4L V8 330 CID	1999-2004	137,158, 172 wheelbase, center tank, w/o california emissions	USEP2245M
4.6L V8 281 CID	1999	GAS; Standard Cab	USEP2237S	5.4L V8 330 CID	2000-2004	rear tank, with california Emissions	USEP2280M
4.6L V8 281 CID	2000-2002	MEX	USEP2237S	5.4L V8 330 CID	2000-2004	rear tank, w/o california emissions	USEP2281M
4.9L L6 4917cc 300 CID	1995-1996		USEP2059MN	5.4L V8 330 CID	2005	(5), GAS, Naturally Aspirated; Aft Axle Fuel Tank	USEP2442M
5.0L V8 302 CID	1980-1982		USEP2089S	5.4L V8 330 CID	2005-2007	141.8 / 360.2 Wheel Base; CENTER TANK, EXC. CAB AND CHASSIS	usep2461m
5.0L V8 302 CID	1985	(N), FI, GAS; 19 Gallon Midship Fuel Tank	USEP2148S	5.4L V8 330 CID	2005-2007	CENTER TANK, EXC.CAB AND CHASSIS	usep2461m
5.0L V8 302 CID	1985	(N), FI, GAS; 17 Gallon Midship Fuel Tank	USEP2149S	5.4L V8 330 CID	2005-2007	172.4 / 437.9 Wheel Base; center tank King Ranch; (5), 156.2 / 396.7 Wheel Base, GAS, Naturally Aspirated	USEP2344M
5.0L V8 302 CID	1985-1986	(N), FI, GAS; External Pump	USEP2093S	5.4L V8 330 CID	2006	Lariat, XL, XLT; (5), 141.8 / 360.2 Wheel Base, GAS, Naturally Aspirated; Midship Fuel Tank	USEP2364S
5.0L V8 302 CID	1985-1986	(N), FI, GAS; Rear Fuel Tank	USEP2093S	5.4L V8 330 CID	2006	Lariat, XL, XLT; (5), 156.2 / 396.7 Wheel Base, GAS, Naturally Aspirated; Midship Fuel Tank	USEP2364S
5.0L V8 302 CID	1986	with rear steel tank	USEP2093S	5.4L V8 330 CID	2006	Lariat, XL, XLT; (5), 141.8 / 360.2 Wheel Base, GAS, Naturally Aspirated; Aft Axle Fuel Tank	USEP2442M
5.0L V8 302 CID	1986	17 GALLON TANK	USEP2149S	5.4L V8 330 CID	2006-2007	Wheel Base, GAS, Naturally Aspirated; Midship Fuel Tank	USEP2442M
5.0L V8 302 CID	1987	(N), FI, GAS; 17 Gallon Midship Fuel Tank	USEP2102S	5.4L V8 330 CID	2008-2010	98.0 / 248.9 Bed	USEP2509M
5.0L V8 302 CID	1987	(N), FI, GAS; 19 Gallon Midship Fuel Tank	USEP2103S	5.4L V8 330 CID	1999	With California emissions	USEP2232M
5.0L V8 302 CID	1987	(N), FI, GAS; Rear Fuel Tank (Steel Fuel Tank)	USEP2104S	6.8L V10 415 CID	1999	without California emissions	USEP2233M
5.0L V8 302 CID	1988-1989	(N), GAS; 17 Gallon Midship Fuel Tank	USEP2102S	6.8L V10 415 CID	1999-2004	142 and 156 wheelbase, Center tank, with california Emissions	USEP2230M
5.0L V8 302 CID	1988-1989	(N), GAS; 19 Gallon Midship Fuel Tank	USEP2103S	6.8L V10 415 CID	1999-2004	137,158, 172 wheelbase, Center tank, with california Emissions	USEP2235M
5.0L V8 302 CID	1988-1989	(N), GAS; Rear Fuel Tank (Steel Fuel Tank)	USEP2104S	6.8L V10 415 CID	1999-2004	142 and 156 wheelbase, center tank, w/o california emissions	USEP2238M
5.0L V8 302 CID	1988-1989	(N), GAS; Rear Fuel Tank (Plastic Fuel Tank)	USEP2143S	6.8L V10 415 CID	1999-2004	137,158, 172 wheelbase, center tank, w/o california emissions	USEP2245M
5.0L V8 302 CID	1995-1996		USEP2059MN	6.8L V10 415 CID	2000-2004	rear tank, with california Emissions	USEP2280M
5.0L V8 302 CID	1997	MEX	USEP2059MN	6.8L V10 415 CID	2000-2004	rear tank, w/o california emissions	USEP2281M
5.4L V8 330 CID	1997	139.0 / 353.1 Wheel Base	USEP2221S	6.8L V10 415 CID	2005	(Y), GAS, Naturally Aspirated; Aft Axle Fuel Tank	USEP2442M
5.4L V8 330 CID	1999	GAS; Extended Cab	USEP2237S	6.8L V10 415 CID	2005-2007	141.8 / 360.2 Wheel Base; CENTER TANK, EXC. CAB AND CHASSIS	usep2461m
5.4L V8 330 CID	1999	GAS; Standard Cab	USEP2237S	6.8L V10 415 CID	2005-2007	156.2 / 396.7 Wheel Base; CENTER TANK, EXC.CAB AND CHASSIS	usep2461m
5.8L V8 5753cc 351 CID	1980-1982		USEP2089S	6.8L V10 415 CID	2005-2007	172.4 / 437.9 Wheel Base; center tank King Ranch; (Y), 156.2 / 396.7 Wheel Base, GAS, Naturally Aspirated	USEP2364S
5.8L V8 5753cc 351 CID	1988	(H), GAS; Rear Fuel Tank (Steel Fuel Tank)	USEP2104S	6.8L V10 415 CID	2006	Lariat, XL, XLT; (Y), 141.8 / 360.2 Wheel Base, GAS, Naturally Aspirated; Midship Fuel Tank	USEP2364S
5.8L V8 5753cc 351 CID	1988-1989	(H), GAS; 17 Gallon Midship Fuel Tank	USEP2102S	6.8L V10 415 CID	2006	Lariat, XL, XLT; (Y), 156.2 / 396.7 Wheel Base, GAS, Naturally Aspirated; Midship Fuel Tank	USEP2364S
5.8L V8 5753cc 351 CID	1988-1989	(H), GAS; 19 Gallon Midship Fuel Tank	USEP2103S	6.8L V10 415 CID	2006	Lariat, XL, XLT; (Y), 141.8 / 360.2 Wheel Base, GAS, Naturally Aspirated; Midship Fuel Tank	USEP2364S
5.8L V8 5753cc 351 CID	1988-1989	(H), GAS; Rear Fuel Tank (Plastic Fuel Tank)	USEP2143S	6.8L V10 415 CID	2006-2007	Lariat, XL, XLT; (Y), 141.8 / 360.2 Wheel Base, GAS, Naturally Aspirated; Aft Axle Fuel Tank	USEP2442M
5.8L V8 5753cc 351 CID	1990-1991	(H), GAS; 19 Gallon Midship Fuel Tank (Steel Fuel Tank)	USEP2059MN	6.8L V10 415 CID	2008-2010	98.0 / 248.9 Bed	USEP2509M
5.8L V8 5753cc 351 CID	1990-1992	(H), GAS; 17 Gallon Midship Fuel Tank (Steel Fuel Tank)	USEP2059MN	<b>F-350</b>			
5.8L V8 5753cc 351 CID	1990-1992	(H), GAS; 19 Gallon Aft Axle Fuel Tank (Plastic Fuel Tank)	USEP2059MN	4.9L L6 4917cc 300 CID	1996		USEP2059MN
5.8L V8 5753cc 351 CID	1990-1992	(H), GAS; 18 Gallon Aft Axle Fuel Tank (Steel Fuel Tank)	USEP2064MN	5.0L V8 302 CID	1980		USEP2089S
5.8L V8 5753cc 351 CID	1990-1994		USEP2310M	5.0L V8 302 CID	1995	MEX	USEP2063M
5.8L V8 5753cc 351 CID	1992	(H), GAS; (2 Tube Ports), 19 Gallon Midship Fuel Tank (Steel Fuel Tank)	USEP2059MN	5.4L V8 330 CID	2000	MEX	USEP2234M
5.8L V8 5753cc 351 CID	1992	(H), GAS; (3 Tube Ports), 19 Gallon Midship Fuel Tank (Steel Fuel Tank)	USEP2059MN	5.8L V8 5753cc 351 CID	1980-1982		USEP2089S
5.8L V8 5753cc 351 CID	1993-1994	(H), GAS, Naturally Aspirated; 17 Gallon Midship Fuel Tank (Steel Fuel Tank)	USEP2059MN				
5.8L V8 5753cc 351 CID	1993-1994	(H), GAS, Naturally Aspirated; 19 Gallon Aft Axle Fuel Tank (Plastic Fuel Tank)	USEP2059MN				
5.8L V8 5753cc 351 CID	1993-1994	(H), GAS, Naturally Aspirated; (2 Tube Ports), 19 Gallon Midship Fuel Tank (Steel Fuel Tank)	USEP2059MN				

Engine	Years	Application Description	USMW	Engine	Years	Application Description	USMW
<b>FORD (cont'd.)</b>				<b>FORD (cont'd.)</b>			
<b>F-350 (cont'd.)</b>				<b>F-350 SUPER DUTY (cont'd.)</b>			
5.8L V8 5753cc 351 CID	1988-1989	(H), 133.0 / 337.8 Wheel Base, GAS; 19 Gallon Midship Fuel Tank	USEP2103S	5.4L V8 330 CID	2007	Lariat, XL, XLT; (5), 141.8 / 360.2 Wheel Base, GAS, Naturally Aspirated; Aft Axle Fuel Tank	USEP2442M
5.8L V8 5753cc 351 CID	1988-1989	(H), 155.0 / 393.7 Wheel Base, GAS; 19 Gallon Midship Fuel Tank	USEP2103S	5.4L V8 330 CID	2007	XL, XLT; (5), 162.0 / 411.5 Wheel Base, GAS, Naturally Aspirated; Aft Axle Fuel Tank	USEP2442M
5.8L V8 5753cc 351 CID	1988-1989	(H), GAS; Aft Axle Fuel Tank (Steel Fuel Tank)	USEP2104S	5.4L V8 330 CID	2007	XL, XLT; (5), 165.0 / 419.1 Wheel Base, GAS, Naturally Aspirated; Aft Axle Fuel Tank	USEP2442M
5.8L V8 5753cc 351 CID	1988-1989	(H), GAS; Aft Axle Fuel Tank (Plastic Fuel Tank)	USEP2143S	5.4L V8 330 CID	2007	XL, XLT; (5), 176.0 / 447.0 Wheel Base, GAS, Naturally Aspirated; Aft Axle Fuel Tank	USEP2442M
5.8L V8 5753cc 351 CID	1990-1991	(H), GAS; 19 Gallon Midship Fuel Tank (Steel Fuel Tank)	USEP2059MN	5.4L V8 330 CID	2007	98.0 / 248.9 Bed; CENTER TANK	USEP2509M
5.8L V8 5753cc 351 CID	1990-1992	(H), GAS; 17 Gallon Midship Fuel Tank (Steel Fuel Tank)	USEP2059MN	5.4L V8 330 CID	2008-2010	With California emissions	USEP2232M
5.8L V8 5753cc 351 CID	1990-1992	(H), GAS; 19 Gallon Aft Axle Fuel Tank (Plastic Fuel Tank)	USEP2059MN	6.8L V10 415 CID	1999	without California emissions	USEP2233M
5.8L V8 5753cc 351 CID	1990-1992	(H), GAS; 18 Gallon Aft Axle Fuel Tank (Steel Fuel Tank)	USEP2064MN	6.8L V10 415 CID	1999-2004	142 and 156 wheelbase, Center tank, with California Emissions	USEP2230M
5.8L V8 5753cc 351 CID	1990-1995	(H), GAS; (2 Tube Ports), 19 Gallon Midship Fuel Tank (Steel Fuel Tank)	USEP2310M	6.8L V10 415 CID	1999-2004	Cab & Chassis, USA; Center tank, with CA emissions	USEP2231M
5.8L V8 5753cc 351 CID	1992	(H), GAS; (3 Tube Ports), 19 Gallon Midship Fuel Tank (Steel Fuel Tank)	USEP2059MN	6.8L V10 415 CID	1999-2004	Cab & Chassis; Center tank, Without CA emissions	USEP2234M
5.8L V8 5753cc 351 CID	1992	(H), GAS, Naturally Aspirated; 17 Gallon Midship Fuel Tank (Steel Fuel Tank)	USEP2059MN	6.8L V10 415 CID	1999-2004	137,158, 172 wheelbase, Center tank, with California Emissions	USEP2235M
5.8L V8 5753cc 351 CID	1993-1995	(H), GAS, Naturally Aspirated; 19 Gallon Aft Axle Fuel Tank (Plastic Fuel Tank)	USEP2059MN	6.8L V10 415 CID	1999-2004	142 and 156 wheelbase, center tank, w/o California emissions	USEP2238M
5.8L V8 5753cc 351 CID	1993-1995	(H), GAS, Naturally Aspirated; (2 Tube Ports), 19 Gallon Midship Fuel Tank (Steel Fuel Tank)	USEP2059MN	6.8L V10 415 CID	1999-2004	137,158, 172 wheelbase, center tank, w/o California emissions	USEP2245M
5.8L V8 5753cc 351 CID	1993-1995	(H), GAS, Naturally Aspirated; (3 Tube Ports), 19 Gallon Midship Fuel Tank (Steel Fuel Tank)	USEP2059MN	6.8L V10 415 CID	2000-2004	rear tank, with California Emissions	USEP2280M
5.8L V8 5753cc 351 CID	1993-1995	(H), GAS, Naturally Aspirated; 18 Gallon Aft Axle Fuel Tank (Steel Fuel Tank)	USEP2064MN	6.8L V10 415 CID	2000-2004	rear tank, w/o California emissions	USEP2281M
5.8L V8 5753cc 351 CID	1996	(H), GAS, Naturally Aspirated; 17 Gallon Midship Fuel Tank (Steel Fuel Tank)	USEP2059MN	6.8L V10 415 CID	2005	(Y), GAS, Naturally Aspirated; Aft Axle Fuel Tank	USEP2442M
5.8L V8 5753cc 351 CID	1997	(H), GAS, Naturally Aspirated; 19 Gallon Aft Axle Fuel Tank (Plastic Fuel Tank)	USEP2059MN	6.8L V10 415 CID	2005-2007	156.2 / 396.7 Wheel Base; CENTER TANK, EXC. CAB AND CHASSIS	usep2461m
5.8L V8 5753cc 351 CID	1997	(H), GAS, Naturally Aspirated; (2 Tube Ports), 19 Gallon Midship Fuel Tank (Steel Fuel Tank)	USEP2059MN	6.8L V10 415 CID	2005-2007	172.4 / 437.9 Wheel Base; center tank	USEP2344M
5.8L V8 5753cc 351 CID	1997	(H), GAS, Naturally Aspirated; (3 Tube Ports), 19 Gallon Midship Fuel Tank (Steel Fuel Tank)	USEP2059MN	6.8L V10 415 CID	2007	Lariat, XL, XLT; (Y), 141.8 / 360.2 Wheel Base, GAS, Naturally Aspirated; Aft Axle Fuel Tank	USEP2442M
5.8L V8 5753cc 351 CID	1997	(H), GAS, Naturally Aspirated; 18 Gallon Aft Axle Fuel Tank (Steel Fuel Tank)	USEP2064MN	6.8L V10 415 CID	2007	XL, XLT; (Y), 162.0 / 411.5 Wheel Base, GAS, Naturally Aspirated; Aft Axle Fuel Tank	USEP2442M
5.8L V8 5753cc 351 CID	1997	(H), GAS, Naturally Aspirated; (2 Tube Ports), 19 Gallon Midship Fuel Tank (Steel Fuel Tank)	USEP2059MN	6.8L V10 415 CID	2007	XL, XLT; (Y), 165.0 / 419.1 Wheel Base, GAS, Naturally Aspirated; Aft Axle Fuel Tank	USEP2442M
5.8L V8 5753cc 351 CID	1997	(H), GAS, Naturally Aspirated; 18 Gallon Aft Axle Fuel Tank (Steel Fuel Tank)	USEP2064MN	6.8L V10 415 CID	2007	XL, XLT; (Y), 176.0 / 447.0 Wheel Base, GAS, Naturally Aspirated; Aft Axle Fuel Tank	USEP2442M
5.8L V8 5753cc 351 CID	1997	(H), GAS, Naturally Aspirated; 17 Gallon Midship Fuel Tank (Steel Fuel Tank)	USEP2059MN	6.8L V10 415 CID	2008-2010	98.0 / 248.9 Bed; CENTER TANK	USEP2509M
5.8L V8 5753cc 351 CID	1997	(H), GAS, Naturally Aspirated; 19 Gallon Aft Axle Fuel Tank (Plastic Fuel Tank)	USEP2059MN	6.8L V10 415 CID	1999	With California emissions	USEP2232M
6.6L V8 400 CID	1980-1982	(L), CARB, GAS; Midship Fuel Tank	USEP2089S	6.8L V10 415 CID	1999	without California emissions	USEP2233M
7.5L V8 460 CID	1983-1984	(L), CARB, GAS; 19 Gallon Aft Axle Fuel Tank (Plastic Fuel Tank)	USEP2089S	6.8L V10 415 CID	1999-2004	rear tank, with California Emissions	USEP2280M
7.5L V8 460 CID	1985-1986	(L), CARB, GAS; 19 Gallon Aft Axle Fuel Tank (Plastic Fuel Tank)	USEP2088S	6.8L V10 415 CID	1999-2004	rear tank, w/o California emissions	USEP2281M
7.5L V8 460 CID	1985-1986	(L), CARB, GAS; 19 Gallon Aft Axle Fuel Tank (Plastic Fuel Tank)	USEP2091S	6.8L V10 415 CID	2002	142 and 156 wheelbase, Center tank, with California Emissions	USEP2230M
7.5L V8 460 CID	1988-1989	(G), 133.0 / 337.8 Wheel Base, GAS; 19 Gallon Midship Fuel Tank	USEP2103S	6.8L V10 415 CID	2002	142 and 156 wheelbase, center tank, w/o California emissions	USEP2238M
7.5L V8 460 CID	1988-1989	(G), 155.0 / 393.7 Wheel Base, GAS; 19 Gallon Midship Fuel Tank	USEP2103S	6.8L V10 415 CID	2002	137,158, 172 wheelbase, center tank, w/o California emissions	USEP2245M
7.5L V8 460 CID	1988-1989	(G), GAS; Aft Axle Fuel Tank (Steel Fuel Tank)	USEP2104S	6.8L V10 415 CID	2005-2007	center tank	USEP2344M
7.5L V8 460 CID	1988-1989	(G), GAS; Aft Axle Fuel Tank (Plastic Fuel Tank)	USEP2143S	7.3L V8 445 CID	2000	rear tank, with California Emissions	USEP2280M
7.5L V8 460 CID	1996	(G), GAS; Aft Axle Fuel Tank (Plastic Fuel Tank)	USEP2059MN	7.3L V8 445 CID	2000	rear tank, w/o California emissions	USEP2281M
<b>F-350 SUPER DUTY</b>				<b>F-550 SUPER DUTY</b>			
5.4L V8 330 CID	1999	With California emissions	USEP2232M	6.8L V10 415 CID	1999	With California emissions	USEP2232M
5.4L V8 330 CID	1999	without California emissions	USEP2233M	6.8L V10 415 CID	1999	without California emissions	USEP2233M
5.4L V8 330 CID	1999-2004	142 and 156 wheelbase, Center tank, with California Emissions	USEP2230M	6.8L V10 415 CID	1999-2004	rear tank, with California Emissions	USEP2280M
5.4L V8 330 CID	1999-2004	Cab & Chassis, USA; Center tank, with CA emissions	USEP2231M	6.8L V10 415 CID	1999-2004	rear tank, w/o California emissions	USEP2281M
5.4L V8 330 CID	1999-2004	Cab & Chassis; Center tank, Without CA emission	USEP2234M	6.8L V10 415 CID	2002	142 and 156 wheelbase, center tank, with California Emissions	USEP2230M
5.4L V8 330 CID	1999-2004	137,158, 172 wheelbase, Center tank, with California Emissions	USEP2235M	6.8L V10 415 CID	2002	142 and 156 wheelbase, center tank, w/o California emissions	USEP2238M
5.4L V8 330 CID	1999-2004	142 and 156 wheelbase, center tank, w/o California emissions	USEP2238M	6.8L V10 415 CID	2002	137,158, 172 wheelbase, center tank, w/o California emissions	USEP2245M
5.4L V8 330 CID	1999-2004	137,158, 172 wheelbase, center tank, w/o California emissions	USEP2245M	6.8L V10 415 CID	2005-2007	center tank	USEP2344M
5.4L V8 330 CID	2000-2004	rear tank, with California Emissions	USEP2280M	7.3L V8 445 CID	2000	rear tank, with California Emissions	USEP2280M
5.4L V8 330 CID	2000-2004	rear tank, w/o California emissions	USEP2281M	7.3L V8 445 CID	2000	rear tank, w/o California emissions	USEP2281M
5.4L V8 330 CID	2005	(5), GAS, Naturally Aspirated; Aft Axle Fuel Tank	USEP2442M	<b>F-550 SUPER DUTY</b>			
5.4L V8 330 CID	2005-2007	141.8 / 360.2 Wheel Base; CENTER TANK, EXC. CAB AND CHASSIS	usep2461m	6.8L V10 415 CID	1999	With California emissions	USEP2232M
5.4L V8 330 CID	2005-2007	156.2 / 396.7 Wheel Base; CENTER TANK, EXC. CAB AND CHASSIS	usep2461m	6.8L V10 415 CID	1999	without California emissions	USEP2233M
5.4L V8 330 CID	2005-2007	172.4 / 437.9 Wheel Base; center tank	USEP2344M	6.8L V10 415 CID	1999-2004	rear tank, with California Emissions	USEP2280M
5.4L V8 330 CID	2007		USEP2438M	6.8L V10 415 CID	1999-2004	rear tank, w/o California emissions	USEP2281M
				<b>FIESTA</b>			
				1.3L L4 1299cc 79 CID			
				1998-1999			
				MEX			
				USEP12142M			
				<b>FIVE HUNDRED</b>			
				3.0L V6 2968cc 181 CID			
				2005-2007			
				USEP2467M			
				<b>FLEX</b>			
				3.5L V6 3496cc 213 CID			
				2009			
				USEP2505M			
				3.5L V6 3496cc 213 CID			
				2010-2012			
				USEP2558M			
				<b>FOCUS</b>			
				1.0L L3 999cc 61 CID			
				2015-2018			
				USEP2592M			
				2.0L L4 1989cc 121 CID			
				2000-2002			
				USEP2556M			
				2.0L L4 1989cc 121 CID			
				2002			
				USEP2325M			
				2.0L L4 1989cc 121 CID			
				2003			
				USEP2326M			
				2.0L L4 1989cc 121 CID			
				2003-2004			
				USEP2326M			
				2.0L L4 1989cc 121 CID			
				2004			
				USEP2326M			
				2.0L L4 1989cc 121 CID			
				2009-2011			
				USEP2525M			
				2.0L L4 1999cc 122 CID			
				2005-2007			
				USEP2450M			
				2.0L L4 1999cc 122 CID			
				2009-2011			
				USEP2525M			
				2.0L L4 1999cc 122 CID			
				2013-2017			
				USEP2592M			
				2.3L L4 140 CID			
				2003-2004			
				LX, SE, ZTS, ZTW, ZX3, ZX5; (Z)			
				USEP2368M			





# FUEL PUMP MODULES APPLICATION GUIDE



FUEL PUMP MODULES

Engine	Years	Application Description	USMW	Engine	Years	Application Description	USMW
<b>FORD (cont'd.)</b>				<b>FORD (cont'd.)</b>			
<b>FOCUS (cont'd.)</b>				<b>PROBE (cont'd.)</b>			
2.3L L4 140 CID	2005-2007		USEP2450M	2.5L V6 2497cc	1993-1995		USEP2156H
<b>FREESTAR</b>				2.5L V6 2497cc	1995	From 03/01/95	USEP2118H
3.9L V6 238 CID	2004	SE, SES; (6); (Incl. Tank Seal)	USEP2383M	2.5L V6 2497cc	1996-1997		USEP2118H
3.9L V6 238 CID	2005	S; (6); (Incl. Tank Seal)	USEP2383M	<b>RANGER</b>			
3.9L V6 238 CID	2006-2007	Base, SE; (6)	USEP2466M	2.2L L4 2198cc 134 CID	2015-2018	DIESEL, MEX	USEP12375M
4.2L V6 256 CID	2004	Limited; (2); (Incl. Tank Seal)	USEP2383M	2.3L L4 140 CID	1985	(A), FI, GAS, Naturally Aspirated; Midship Fuel Tank	USEP2095S
4.2L V6 256 CID	2004-2005	MEX	USEP2383M	2.3L L4 140 CID	1985	(A), FI, GAS, Naturally Aspirated; Aft Axle Fuel Tank	USEP2096S
4.2L V6 256 CID	2005	SEL; (2); (Incl. Tank Seal)	USEP2383M	2.3L L4 140 CID	1986-1987	XLT; (A), Cab & Chassis, FI, GAS, Naturally Aspirated; Midship Fuel Tank	USEP2095S
4.2L V6 256 CID	2006-2007	Limited, SEL; (2)	USEP2466M	2.3L L4 140 CID	1986-1987	XLT; (A), FI, GAS, Naturally Aspirated, Standard Cab Pickup; Midship Fuel Tank	USEP2095S
<b>FREESTYLE</b>				2.3L L4 140 CID	1986-1987	XLT; (A), FI, GAS, Naturally Aspirated, Stripped Chassis; Midship Fuel Tank	USEP2095S
3.0L V6 2968cc 181 CID	2005-2007		USEP2465M	2.3L L4 140 CID	1986-1988	Center tank	USEP2094S
<b>F SUPER DUTY</b>				2.3L L4 140 CID	1988	XLT; (A), FI, Standard Cab Pickup; Midship Fuel Tank	USEP2095S
7.5L V8 460 CID	1990-1997		USEP2310M	2.3L L4 140 CID	1988	XLT; (A), FI; Rear Fuel Tank	USEP2096S
<b>FUSION</b>				2.3L L4 140 CID	1989-1997	Standard Cab Pickup	USEP2078S
2.3L L4 140 CID	2006-2007	S, SE, SEL; (Z)	USEP2459M	2.3L L4 140 CID	1990-1997	Extended Cab Pickup	USEP2106S
2.5L L4 2488cc 152 CID	2010-2012		USEP2561M	2.3L L4 140 CID	2001-2002	XLT; (D), 112.0 / 284.5 Wheel Base, FI, GAS, Naturally Aspirated	USEP2293M
3.0L V6 2968cc 181 CID	2006-2009	FWD	USEP2472M	2.3L L4 140 CID	2001-2002	XLT; (D), 126.0 / 320.0 Wheel Base, FI, GAS, Naturally Aspirated	USEP2293M
3.0L V6 2968cc 181 CID	2007-2009	AWD	USEP2474M	2.3L L4 140 CID	2001-2002	XLT; (D), 118.0 / 299.7 Wheel Base, FI, GAS, Naturally Aspirated	USEP2295M
<b>GHIA</b>				2.3L L4 140 CID	2003	XLT; (D), 112.0 / 284.5 Wheel Base, GAS	USEP2293M
3.0L V6 2986cc 182 CID	1993	MEX	USEP2098S	2.3L L4 140 CID	2003	XLT; (D), 126.0 / 320.0 Wheel Base, GAS	USEP2293M
<b>GRAND MARQUIS</b>				2.3L L4 140 CID	2003	XLT; (D), 118.0 / 299.7 Wheel Base, GAS	USEP2295M
4.6L V8 281 CID	1991-1997	MEX	USEP2122H	2.3L L4 140 CID	2004	117.4 and 117.6 wheelbase	USEP2356M
4.6L V8 281 CID	2001-2002		USEP2382S	2.3L L4 140 CID	2004	111.4 and 111.6 wheelbase	USEP2357M
4.6L V8 281 CID	2003-2004	MEX	USEP2336S	2.3L L4 140 CID	2004-2006	125.7 / 319.3 Wheel Base	USEP2363M
<b>LOBO</b>				2.3L L4 140 CID	2006	117.4 and 117.6 wheelbase	USEP2356M
5.4L V8 330 CID	2001-2002	MEX	USEP2237S	2.3L L4 140 CID	2006	111.4 and 111.6 wheelbase	USEP2357M
<b>LTD</b>				2.3L L4 140 CID	2007-2011		USEP8808M
3.8L V6 232 CID	1984		USEP2131S	2.5L L4 153 CID	1998	Standard Cab Pickup; STANDARD RANGE FUEL TANK	USEP2207S
3.8L V6 232 CID	1985	TO 5/1985	USEP2131S	2.5L L4 153 CID	1998	Extended Cab Pickup	USEP2208S
3.8L V6 232 CID	1985	FROM 5/1985	USEP2132S	2.5L L4 153 CID	1998	Standard Cab Pickup; extended range fuel tank	USEP2214S
3.8L V6 232 CID	1986		USEP2132S	2.5L L4 153 CID	1999		USEP2261S
3.8L V6 232 CID	1986	Base; (3), FI, Wagon	USEP2146S	2.5L L4 153 CID	1999	XLT; (C), 112.0 / 284.5 Wheel Base, FI, GAS, Naturally Aspirated	USEP2261S
5.0L V8 302 CID	1984-1985		USEP2131S	2.5L L4 153 CID	1999	XLT; (C), 118.0 / 299.7 Wheel Base, FI, GAS, Naturally Aspirated	USEP2261S
<b>LTD CROWN VICTORIA</b>				2.5L L4 153 CID	1999	XLT; (C), 126.0 / 320.0 Wheel Base, FI, GAS, Naturally Aspirated	USEP2261S
5.0L V8 302 CID	1987-1989	Wagon	USEP2087H	2.5L L4 153 CID	1999	118.0 / 299.7 Wheel Base, GAS	USEP2262S
5.0L V8 302 CID	1990-1991		USEP2120S	2.5L L4 153 CID	1999		USEP2263S
<b>MONDEO</b>				2.5L L4 153 CID	2000-2001	XLT; (C), 112.0 / 284.5 Wheel Base, FI, GAS, Naturally Aspirated	USEP2269S
2.0L L4 1999cc 122 CID	2001-2007	MEX	USEP10546M	2.5L L4 153 CID	2000-2001	XLT; (C), 126.0 / 320.0 Wheel Base, FI, GAS, Naturally Aspirated	USEP2270S
2.5L V6 2450cc 155 CID	2001-2007	MEX	USEP10546M	2.5L L4 153 CID	2000-2001	XLT; (C), 118.0 / 299.7 Wheel Base, FI, GAS, Naturally Aspirated	USEP2278S
<b>MUSTANG</b>				2.9L V6 177 CID	1986-1987	XLT; (T), Cab & Chassis, FI, GAS, Naturally Aspirated; Midship Fuel Tank	USEP2095S
2.3L L4 140 CID	1985-1986	LX, SVO	USEP2110H	2.9L V6 177 CID	1986-1987	XLT; (T), FI, GAS, Naturally Aspirated, Standard Cab Pickup; Midship Fuel Tank	USEP2095S
2.3L L4 140 CID	1987-1993	LX	USEP2110H	2.9L V6 177 CID	1986-1987	XLT; (T), FI, GAS, Naturally Aspirated, Stripped Chassis; Midship Fuel Tank	USEP2095S
3.8L V6 232 CID	1985-1986	LX	USEP2110H	2.9L V6 177 CID	1986-1987	XLT; (T), FI, GAS, Naturally Aspirated; Rear Fuel Tank	USEP2096S
3.8L V6 232 CID	1994-1997	Base; (4)	USEP2191H	2.9L V6 177 CID	1986-1988	Center tank	USEP2094S
3.8L V6 232 CID	1998		USEP2218M	2.9L V6 177 CID	1988	XLT; (T), FI, Standard Cab Pickup; Midship Fuel Tank	USEP2095S
3.8L V6 232 CID	1998	Base; (4); Calif	USEP2218M	2.9L V6 177 CID	1988	XLT; (T), FI; Rear Fuel Tank	USEP2096S
3.8L V6 232 CID	1998	Base; (4); Exc. Calif	USEP2218M	2.9L V6 177 CID	1989-1992	Standard Cab Pickup	USEP2078S
3.8L V6 232 CID	1999-2000	Base; (4)	USEP2244M	2.9L V6 177 CID	1990-1992	Extended Cab Pickup	USEP2106S
3.8L V6 232 CID	2001-2002	Base; (4)	USEP2301M	3.0L V6 2986cc 182 CID	1991-1997	Standard Cab Pickup	USEP2078S
3.8L V6 232 CID	2003-2004	Base; (4), Naturally Aspirated	USEP2301M	3.0L V6 2986cc 182 CID	1991-1997	Extended Cab Pickup	USEP2106S
3.9L V6 238 CID	2004	Base; (6), Naturally Aspirated	USEP2301M	3.0L V6 2986cc 182 CID	1998	Standard Cab Pickup; STANDARD RANGE FUEL TANK	USEP2207S
4.0L V6 245 CID	2005	Base; FI, GAS	USEP2457M	3.0L V6 2986cc 182 CID	1998	Extended Cab Pickup	USEP2208S
4.0L V6 245 CID	2006-2009		USEP2469M	3.0L V6 2986cc 182 CID	1998	Standard Cab Pickup; extended range fuel tank	USEP2214S
4.0L V6 4009cc 245 CID	2007-2009		USEP2469M	3.0L V6 2986cc 182 CID	1999	112.0 / 284.5 Wheel Base, FLEX	USEP2257S
4.6L V8 281 CID	1996-1997	GT; (X)	USEP2191H	3.0L V6 2986cc 182 CID	1999	118.0 / 299.7 Wheel Base, FLEX	USEP2259S
4.6L V8 281 CID	1998	CALIFORNIA	USEP2200M	3.0L V6 2986cc 182 CID	1999	Extended Cab Pickup, FLEX	USEP2260S
4.6L V8 281 CID	1998	EXCEPT CALIFORNIA	USEP2203M	3.0L V6 2986cc 182 CID	1999		USEP2261S
4.6L V8 281 CID	1999	SVT Cobra; (V)	USEP2244M	3.0L V6 2986cc 182 CID	1999		USEP2262S
4.6L V8 281 CID	1999-2000	GT; (X)	USEP2244M	3.0L V6 2986cc 182 CID	1999		USEP2263S
4.6L V8 281 CID	2001	GT, GT Bullitt; (X)	USEP2301M	3.0L V6 2986cc 182 CID	1999		USEP2268S
4.6L V8 281 CID	2001	SVT Cobra; (V)	USEP2301M				
4.6L V8 281 CID	2002	GT; (X)	USEP2301M				
4.6L V8 281 CID	2003	SVT Cobra 10th Anniversary; (Y), Supercharged	USEP2301M				
4.6L V8 281 CID	2003-2004	GT; (X), Naturally Aspirated	USEP2301M				
4.6L V8 281 CID	2003-2004	Mach 1; (R), Naturally Aspirated	USEP2301M				
4.6L V8 281 CID	2005	GT, GT Base, GT Equipado; FI, GAS	USEP2457M				
4.6L V8 281 CID	2006-2009		USEP2469M				
5.0L V8 302 CID	1985-1992	GT, LX	USEP2110H				
5.0L V8 302 CID	1993	GT, LX, SVT Cobra, SVT Cobra R	USEP2110H				
<b>P-350</b>							
5.8L V8 5753cc 351 CID	1993	MEX	USEP2059MN				
5.8L V8 5753cc 351 CID	1996-1997	MEX	USEP2059MN				
<b>PROBE</b>							
2.0L L4 1989cc 122 CID	1993-1995		USEP2156H				
2.0L L4 1989cc 122 CID	1995	From 03/01/95	USEP2118H				
2.0L L4 1989cc 122 CID	1996-1997		USEP2118H				



Engine	Years	Application Description	USMW	Engine	Years	Application Description	USMW
<b>FORD (cont'd.)</b>				<b>FORD (cont'd.)</b>			
<b>RANGER (cont'd.)</b>				<b>TAURUS (cont'd.)</b>			
3.0L V6 2986cc 182 CID	2002-2003	FLEX	USEP2349M	3.0L V6 2986cc 182 CID	2001	GAS	USEP2294M
3.0L V6 2986cc 182 CID	2004	117.4 and 117.6 wheelbase	USEP2356M	3.0L V6 2986cc 182 CID	2006-2007	GAS	USEP2435M
3.0L V6 2986cc 182 CID	2004	111.4 and 111.6 wheelbase	USEP2357M	3.2L V6 195 CID	1993-1995	SHO; (P), GAS	USEP2115S
3.0L V6 2986cc 182 CID	2004	125.9 / 319.8 Wheel Base	USEP2363M	3.4L V8 207 CID	1996		USEP2153M
3.0L V6 2986cc 182 CID	2004-2006	125.7 / 319.3 Wheel Base	USEP2363M	3.4L V8 207 CID	1997	SHO; (N), GAS	USEP2165M
3.0L V6 2986cc 182 CID	2006	117.4 and 117.6 wheelbase	USEP2356M	3.4L V8 207 CID	1997		USEP2185M
3.0L V6 2986cc 182 CID	2006	111.4 and 111.6 wheelbase	USEP2357M	3.4L V8 207 CID	1998-1999	SHO; (N), GAS	USEP2264M
3.0L V6 2986cc 182 CID	2006	125.9 / 319.8 Wheel Base	USEP2363M	3.5L V6 3496cc 213 CID	2008-2009		USEP2506M
3.0L V6 2986cc 182 CID	2007-2008		USEP8808M	3.5L V6 3496cc 213 CID	2010-2012		USEP2557M
3.2L L5 195 CID	2017-2019	DIESEL, MEX	USEP12375M	3.5L V6 3496cc 213 CID	2013-2015		USEP2613M
4.0L V6 245 CID	1990-1997	Standard Cab Pickup	USEP2078S	3.8L V6 232 CID	1989	GL, LX; (4); 18.6 Gallon Fuel Tank (Digital Instrument Cluster)	USEP2079S
4.0L V6 245 CID	1990-1997	Extended Cab Pickup	USEP2106S	3.8L V6 232 CID	1989-1990	GL, LX; 16 Gallon Fuel Tank	USEP2076S
4.0L V6 245 CID	1998	Standard Cab Pickup; STANDARD RANGE FUEL TANK	USEP2207S	3.8L V6 232 CID	1989-1991	18.6 Gallon Fuel Tank (Exc.Digital Instrument Cluster)	USEP2077S
4.0L V6 245 CID	1998	Extended Cab Pickup	USEP2208S	3.8L V6 232 CID	1990	GL, LX; (4); 18.6 Gallon Fuel Tank (Digital Instrument Cluster)	USEP2108S
4.0L V6 245 CID	1998	Standard Cab Pickup; extended range fuel tank	USEP2214S	3.8L V6 232 CID	1991	GL, L, LX; 16 Gallon Fuel Tank	USEP2076S
4.0L V6 245 CID	1999		USEP2261S	3.8L V6 232 CID	1991	GL, L, LX; (4); 18.6 Gallon Fuel Tank (Digital Instrument Cluster)	USEP2108S
4.0L V6 245 CID	1999	XL; (X), 112.0 / 284.5 Wheel Base, FI, GAS, Naturally Aspirated	USEP2261S	3.8L V6 232 CID	1993	18.6 Gallon Fuel Tank (Exc.Digital Instrument Cluster)	USEP2077S
4.0L V6 245 CID	1999	XL; (X), 118.0 / 299.7 Wheel Base, FI, GAS, Naturally Aspirated	USEP2261S	3.8L V6 232 CID	1993	GL, LX; (4); GAS; 18.6 Gallon Fuel Tank (Digital Instrument Cluster)	USEP2108S
4.0L V6 245 CID	1999	XL; (X), 126.0 / 320.0 Wheel Base, FI, GAS, Naturally Aspirated	USEP2261S	3.8L V6 232 CID	1993-1994	GL, LX; 16 Gallon Fuel Tank	USEP2076S
4.0L V6 245 CID	1999	118.0 / 299.7 Wheel Base	USEP2262S	3.8L V6 232 CID	1994	18.6 Gallon Fuel Tank (Exc.Digital Instrument Cluster) (To 01/94)	USEP2077S
4.0L V6 245 CID	1999	Extended Cab Pickup	USEP2263S	3.8L V6 232 CID	1994	GL, LX; (4); GAS; 18.6 Gallon Fuel Tank (Digital Instrument Cluster) (From 01/94)	USEP2108S
4.0L V6 245 CID	2000	XL; (X), 112.0 / 284.5 Wheel Base, FI, GAS, Naturally Aspirated	USEP2269S	3.8L V6 232 CID	1994	GL, LX; (4); GAS; 18.6 Gallon Fuel Tank (Digital Instrument Cluster) (To 01/94)	USEP2108S
4.0L V6 245 CID	2000	XL; (X), 126.0 / 320.0 Wheel Base, FI, GAS, Naturally Aspirated	USEP2270S	3.8L V6 232 CID	1995	GL, LX, SE; 16 Gallon Fuel Tank	USEP2076S
4.0L V6 245 CID	2000	XL; (X), 118.0 / 299.7 Wheel Base, FI, GAS, Naturally Aspirated	USEP2278S	3.8L V6 232 CID	1995	18.6 Gallon Fuel Tank (Exc.Digital Instrument Cluster)	USEP2077S
4.0L V6 245 CID	2001-2002	Edge, XL; (E), 112.0 / 284.5 Wheel Base, FI, GAS, Naturally Aspirated	USEP2293M	3.8L V6 232 CID	1995	GL, LX, SE; (4); GAS; 18.6 Gallon Fuel Tank (Digital Instrument Cluster)	USEP2108S
4.0L V6 245 CID	2001-2002	Edge, XL; (E), 126.0 / 320.0 Wheel Base, FI, GAS, Naturally Aspirated	USEP2293M				
4.0L V6 245 CID	2001-2002	Edge, XL; (E), 118.0 / 299.7 Wheel Base, FI, GAS, Naturally Aspirated	USEP2295M				
4.0L V6 245 CID	2003	Edge, XL; (E), 112.0 / 284.5 Wheel Base, GAS	USEP2293M	<b>TAURUS X</b>			
4.0L V6 245 CID	2003	Edge, XL; (E), 126.0 / 320.0 Wheel Base, GAS	USEP2293M	3.5L V6 3496cc 213 CID	2008-2009		USEP2505M
4.0L V6 245 CID	2003	Edge, XL; (E), 118.0 / 299.7 Wheel Base, GAS	USEP2295M	<b>TEMPO</b>			
4.0L V6 245 CID	2004	117.4 and 117.6 wheelbase	USEP2356M	2.3L L4 140 CID	1985-1986		USEP2081S
4.0L V6 245 CID	2004	125.9 / 319.8 Wheel Base	USEP2363M	2.3L L4 140 CID	1988-1989	GL, GLS, LX, Sport	USEP2101S
4.0L V6 245 CID	2004-2006	125.7 / 319.3 Wheel Base	USEP2363M	2.3L L4 140 CID	1990-1991	GL, GLS, L, LX, Sport	USEP2101S
4.0L V6 245 CID	2006	117.4 and 117.6 wheelbase	USEP2356M	2.3L L4 140 CID	1992-1994	GL, LX	USEP2101S
4.0L V6 245 CID	2006	111.4 and 111.6 wheelbase	USEP2357M	<b>THUNDERBIRD</b>			
4.0L V6 245 CID	2006	125.9 / 319.8 Wheel Base	USEP2363M	2.3L L4 140 CID	1984		USEP2131S
4.0L V6 245 CID	2007-2011		USEP8808M	2.3L L4 140 CID	1985-1986		USEP2084H
<b>SABLE</b>				3.8L V6 232 CID	1986		USEP2100H
3.0L V6 2968cc 181 CID	1996	MEX	USEP2159M	3.8L V6 232 CID	1989-1997		USEP2098S
3.0L V6 2968cc 181 CID	1999	MEX	USEP2243M	4.6L V8 281 CID	1994-1997		USEP2098S
3.0L V6 2968cc 181 CID	2001	GAS, MEX	USEP2294M	5.0L V8 302 CID	1986		USEP2100H
3.8L V6 232 CID	1995	MEX; 16 Gallon Fuel Tank	USEP2076S	5.0L V8 302 CID	1991-1993		USEP2098S
3.8L V6 232 CID	1995	MEX; 18.6 Gallon Fuel Tank	USEP2108S	<b>TOPAZ</b>			
<b>TAURUS</b>				2.3L L4 2309cc 140 CID	1994	MEX	USEP2101S
	2003	(S), GAS	USEP2313M	<b>WINDSTAR</b>			
	2003	(U), GAS	USEP2313M	3.0L V6 2986cc 182 CID	1997-1998		USEP2199M
	2004-2005	(2), FLEX	USEP2455M	3.8L V6 232 CID	1996	(4)	USEP2116H
	2006	SE, SEL; (2), FLEX	USEP2455M	3.8L V6 232 CID	1997-1998		USEP2199M
2.5L L4 153 CID	1986	(D); 18.6 Gallon Fuel Tank (Digital Instrument Cluster)	USEP2079S	3.8L V6 232 CID	1999	SEL; (4)	USEP2248M
2.5L L4 153 CID	1986-1987	GL, L, LX, MT5; 16 Gallon Fuel Tank	USEP2076S	3.8L V6 232 CID	2000	(4)	USEP2248M
2.5L L4 153 CID	1986-1987	18.6 Gallon Fuel Tank (Exc.Digital Instrument Cluster)	USEP2077S	3.8L V6 232 CID	2001-2002		USEP2290M
2.5L L4 153 CID	1987	GL, L, LX, MT5; (D); 18.6 Gallon Fuel Tank (Digital Instrument Cluster)	USEP2079S	3.8L V6 232 CID	2003	From 01/02/03	USEP2290M
2.5L L4 153 CID	1989	GL, L; (D); 18.6 Gallon Fuel Tank (Digital Instrument Cluster)	USEP2079S	3.8L V6 232 CID	2003	To 01/02/03	USEP2290M
2.5L L4 153 CID	1989-1990	GL, L; 16 Gallon Fuel Tank	USEP2076S	<b>GEO</b>			
2.5L L4 153 CID	1989-1990	18.6 Gallon Fuel Tank (Exc.Digital Instrument Cluster)	USEP2077S	<b>STORM</b>			
2.5L L4 153 CID	1990	GL, L; (D); 18.6 Gallon Fuel Tank (Digital Instrument Cluster)	USEP2108S	1.6L L4 1588cc 98 CID	1990-1993		USEP8275H
2.5L L4 153 CID	1991	GL; 16 Gallon Fuel Tank	USEP2076S	<b>GMC</b>			
3.0L V6 2968cc 181 CID	1996		USEP2153M	<b>ACADIA</b>			
3.0L V6 2968cc 181 CID	1997		USEP2185M	3.6L V6 3564cc 217 CID	2007-2008		USEP3748M
3.0L V6 2968cc 181 CID	1999		USEP2243M	3.6L V6 3564cc 217 CID	2009-2014	WITHOUT FUEL LEVEL SENSOR	USEP3790M
3.0L V6 2968cc 181 CID	2000	GAS; 16 Gallon Fuel Tank (White Label)	USEP2283M	<b>C1500</b>			
3.0L V6 2968cc 181 CID	2001	GAS	USEP2294M	4.3L V6 262 CID	1988-1993	Sierra, Sierra SLE, Sierra SLX	USEP3621S
3.0L V6 2968cc 181 CID	2004-2005	GAS	USEP2435M	4.3L V6 262 CID	1994-1995	Sierra SL, Sierra SLE, Sierra SLT, Sierra Special	USEP3621S
3.0L V6 2986cc 182 CID	1996		USEP2159M	4.3L V6 262 CID	1996	Sierra SL, Sierra SLE, Sierra SLT, Sierra Special	USEP3622S
3.0L V6 2986cc 182 CID	1997		USEP2184M	4.3L V6 262 CID	1997	Radio Frequency Interference Filter (Module Stamped GDJ, GFK)	USEP3947M
3.0L V6 2986cc 182 CID	1999		USEP2243M	4.3L V6 262 CID	1998	Exc.Radio Frequency Interference Filter (Module Stamped GAV)	USEP3947M
3.0L V6 2986cc 182 CID	2000-2003	FLEX; with extended range fuel tank	USEP2285M	5.0L V8 305 CID	1988-1993	Sierra, Sierra SLE, Sierra SLX	USEP3621S

Engine	Years	Application Description	USMW	Engine	Years	Application Description	USMW
<b>GMC (cont'd.)</b>				<b>GMC (cont'd.)</b>			
<b>C1500 (cont'd.)</b>				<b>C3500 (cont'd.)</b>			
5.0L V8 305 CID	1994-1995	Sierra SL, Sierra SLE, Sierra SLT, Sierra Special	USEP3621S	7.4L V8 454 CID	1998	(J), GAS, Naturally Aspirated; Exc.Radio Frequency Interference Filter (Module Stamped GFT)	USEP3962M
5.0L V8 305 CID	1996	Sierra SL, Sierra SLE, Sierra SLT, Sierra Special	USEP3622S	7.4L V8 454 CID	1999	Calif	USEP3947M
5.0L V8 305 CID	1997	Sierra GT, Sierra SL, Sierra SLE, Sierra SLT, Sierra Special	USEP3622S	7.4L V8 454 CID	1999	(J), GAS, Naturally Aspirated; Exc.Calif (Radio Frequency Interference Filter)	USEP3956M
5.0L V8 305 CID	1998-1999	Radio Frequency Interference Filter (Module Stamped GDJ,GFK)	USEP3947M	7.4L V8 454 CID	1999	(J), GAS, Naturally Aspirated; Exc.Calif (Exc.Radio Frequency Interference Filter)	USEP3957M
5.7L V8 350 CID	1988-1993	Sierra, Sierra SLE, Sierra SLX	USEP3621S	<b>CANYON</b>			
5.7L V8 350 CID	1994-1995	Sierra SL, Sierra SLE, Sierra SLT, Sierra Special	USEP3621S	2.8L L4 2770cc 169 CID	2004	SLE, Z71 Fleet, Z71 SL, Z71 SLE, Z85 SL, Z85 SLE; (8)	USEP3614M
5.7L V8 350 CID	1996	Sierra SL, Sierra SLE, Sierra SLT, Sierra Special	USEP3622S	2.8L L4 2770cc 169 CID	2005	Z71 Fleet, Z71 SL, Z71 SLE, Z85 SL, Z85 SLE; (8)	USEP3614M
5.7L V8 350 CID	1997	Sierra GT, Sierra SL, Sierra SLE, Sierra SLT, Sierra Special	USEP3622S	2.8L L4 2770cc 169 CID	2006	SL, SLE, WT; (8)	USEP3688M
5.7L V8 350 CID	1998	Radio Frequency Interference Filter (Module Stamped GDJ,GFK)	USEP3947M	2.9L L4 2921cc 178 CID	2007	SL, SLE, WT; (9)	USEP3688M
5.7L V8 350 CID	1999	Exc.Radio Frequency Interference Filter (Module Stamped GAV)	USEP3947M	2.9L L4 2921cc 178 CID	2008	SL, SLE, SLT, WT; (9)	USEP3688M
<b>C1500 SUBURBAN</b>				3.5L L5 3460cc 211 CID	2004	SLE, Z71 Fleet, Z71 SL, Z71 SLE, Z85 SL, Z85 SLE; (6)	USEP3614M
5.7L V8 350 CID	1998-1999	(R), GAS, Naturally Aspirated	USEP3967M	3.5L L5 3460cc 211 CID	2005	Z71 Fleet, Z71 SL, Z71 SLE, Z85 SL, Z85 SLE; (6)	USEP3614M
<b>C2500</b>				3.5L L5 3460cc 211 CID	2006	SLE, SLT, WT; (6)	USEP3688M
4.3L V6 262 CID	1988-1993	Sierra, Sierra SLE, Sierra SLX	USEP3621S	3.7L L5 3654cc 223 CID	2007-2008	SLE, SLT, WT; (E)	USEP3688M
4.3L V6 262 CID	1994-1995	Sierra SL, Sierra SLE	USEP3621S	<b>ENVOY</b>			
5.0L V8 305 CID	1988-1993	Sierra, Sierra SLE, Sierra SLX	USEP3621S	4.2L L6 256 CID	2002-2004	This Module uses an internal strainer design and may look different from your original Unit	USEP3549M
5.0L V8 305 CID	1994-1995	Sierra SL, Sierra SLE, Sierra SLT	USEP3621S	4.2L L6 256 CID	2005-2007		USEP3707M
5.0L V8 305 CID	1996-1997	Sierra SL, Sierra SLE, Sierra SLT	USEP3622S	4.2L L6 256 CID	2008-2009		USEP3769M
5.0L V8 305 CID	1998	Radio Frequency Interference Filter (Module Stamped GDJ,GFK)	USEP3947M	5.3L V8 5328cc 325 CID	2005-2006		USEP3746M
5.7L V8 350 CID	1988-1993	Sierra, Sierra SLE, Sierra SLX	USEP3621S	5.3L V8 5328cc 325 CID	2008-2009		USEP3769M
5.7L V8 350 CID	1994-1995	Sierra SL, Sierra SLE, Sierra SLT	USEP3621S	<b>ENVOY XL</b>			
5.7L V8 350 CID	1996-1997	Sierra SL, Sierra SLE, Sierra SLT	USEP3622S	4.2L L6 256 CID	2002-2004		USEP3549M
5.7L V8 350 CID	1998	Radio Frequency Interference Filter (Module Stamped GDJ,GFK)	USEP3947M	4.2L L6 256 CID	2005-2006		USEP3746M
5.7L V8 350 CID	1988-1993	Sierra, Sierra SLE, Sierra SLX	USEP3621S	5.3L V8 5328cc 325 CID	2003-2004		USEP3549M
5.7L V8 350 CID	1994-1995	Sierra SL, Sierra SLE, Sierra SLT	USEP3621S	5.3L V8 5328cc 325 CID	2005-2006		USEP3746M
5.7L V8 350 CID	1996-1997	Sierra SL, Sierra SLE, Sierra SLT	USEP3622S	<b>ENVOY XUV</b>			
5.7L V8 350 CID	1998-1999	Exc.Radio Frequency Interference Filter (Module Stamped GAV)	USEP3947M	4.2L L6 256 CID	2004		USEP3549M
5.7L V8 350 CID	1998-1999	(R), GAS, Naturally Aspirated; Exc.Radio Frequency Interference Filter (Module Stamped GFT)	USEP3962M	4.2L L6 256 CID	2005		USEP3746M
5.7L V8 350 CID	2000	Calif (Exc.Radio Frequency Interference Filter)	USEP3947M	5.3L V8 5328cc 325 CID	2004		USEP3549M
5.7L V8 350 CID	2000	(R), GAS, Naturally Aspirated; Exc.Calif (Exc.Radio Frequency Interference Filter)	USEP3962M	5.3L V8 5328cc 325 CID	2005		USEP3746M
7.4L V8 454 CID	1991-1993	Sierra, Sierra SLE, Sierra SLX	USEP3621S	<b>JIMMY</b>			
7.4L V8 454 CID	1994-1995	Sierra SL, Sierra SLE, Sierra SLT	USEP3623S	4.3L V6 262 CID	1992	Base, SLE, SLT; Electronic Fuel Control, FI, GAS	USEP3625S
7.4L V8 454 CID	1996-1997	Sierra SL, Sierra SLE, Sierra SLT	USEP3622S	4.3L V6 262 CID	1993-1994	Base, SLE, SLS, SLT; Electronic Fuel Control, FI, GAS	USEP3625S
7.4L V8 454 CID	1998-1999	Exc.Radio Frequency Interference Filter (Module Stamped GAV)	USEP3947M	4.3L V6 262 CID	1996	4 Doors	USEP3925M
7.4L V8 454 CID	1998-1999	(J), GAS, Naturally Aspirated; Exc.Radio Frequency Interference Filter (Module Stamped GFT)	USEP3962M	4.3L V6 262 CID	1996	2 Doors	USEP3929M
7.4L V8 454 CID	2000	Calif (Exc.Radio Frequency Interference Filter)	USEP3947M	4.3L V6 262 CID	1997-1998	4 Doors; STEEL TANK	USEP3953M
7.4L V8 454 CID	2000	(J), GAS, Naturally Aspirated; Exc.Calif (Exc.Radio Frequency Interference Filter)	USEP3962M	4.3L V6 262 CID	1997-2002	2 Doors	USEP3954M
<b>C2500 SUBURBAN</b>				4.3L V6 262 CID	1998-2003	4 Doors; plastic tank	USEP3992M
5.7L V8 350 CID	1998-1999	(R), GAS, Naturally Aspirated; Calif	USEP3967M	5.7L V8 350 CID	1988-1991	with 31 gallon tank	USEP3633S
5.7L V8 350 CID	1998-1999	(R), GAS, Naturally Aspirated; Exc.Calif	USEP3994M	<b>K1500</b>			
7.4L V8 454 CID	1998-1999	(J), GAS, Naturally Aspirated; Calif	USEP3967M	4.3L V6 262 CID	1988-1993	Sierra, Sierra SLE, Sierra SLX	USEP3621S
7.4L V8 454 CID	1998-1999	(J), GAS, Naturally Aspirated; Exc.Calif	USEP3994M	4.3L V6 262 CID	1994	Sierra SL, Sierra SLE, Sierra SLT, Sierra Special	USEP3621S
<b>C3500</b>				4.3L V6 262 CID	1995	Sierra SL, Sierra SLE, Sierra SLS, Sierra SLT, Sierra Special	USEP3621S
5.7L V8 350 CID	1988-1993	Sierra, Sierra SLE, Sierra SLX	USEP3621S	4.3L V6 262 CID	1996	Sierra SL, Sierra SLE, Sierra SLT, Sierra Special	USEP3622S
5.7L V8 350 CID	1994-1995	Sierra SL, Sierra SLE, Sierra SLT	USEP3621S	4.3L V6 262 CID	1997	Radio Frequency Interference Filter (Module Stamped GDJ,GFK)	USEP3947M
5.7L V8 350 CID	1996-1997	Sierra SL, Sierra SLE, Sierra SLT	USEP3622S	5.0L V8 305 CID	1988-1993	Sierra, Sierra SLE, Sierra SLX	USEP3621S
5.7L V8 350 CID	1998	Exc.Radio Frequency Interference Filter (Module Stamped GAV)	USEP3947M	5.0L V8 305 CID	1994	Sierra SL, Sierra SLE, Sierra SLT, Sierra Special	USEP3621S
5.7L V8 350 CID	1998-1999	(R), GAS, Naturally Aspirated; Exc.Radio Frequency Interference Filter (Module Stamped GFT)	USEP3962M	5.0L V8 305 CID	1995	Sierra SL, Sierra SLE, Sierra SLS, Sierra SLT, Sierra Special	USEP3621S
5.7L V8 350 CID	1999	Radio Frequency Interference Filter (Module Stamped GDJ,GFK)	USEP3947M	5.0L V8 305 CID	1996-1997	Sierra SL, Sierra SLE, Sierra SLT, Sierra Special	USEP3622S
5.7L V8 350 CID	2000	(Calif)	USEP3947M	5.0L V8 305 CID	1999	Exc.Radio Frequency Interference Filter (Module Stamped GAV)	USEP3947M
5.7L V8 350 CID	2000	(R), Cab & Chassis, GAS, Naturally Aspirated; (Exc.Calif)	USEP3956M	5.7L V8 350 CID	1988-1993	Sierra, Sierra SLE, Sierra SLX	USEP3621S
5.7L V8 350 CID	2000	(R), Cab & Chassis, GAS, Naturally Aspirated; (Calif)	USEP3957M	5.7L V8 350 CID	1994	Sierra SL, Sierra SLE, Sierra SLT, Sierra Special	USEP3621S
5.7L V8 350 CID	2000	(R), Crew Cab Pickup, GAS, Naturally Aspirated; (Exc.Calif)	USEP3962M	5.7L V8 350 CID	1995	Sierra SL, Sierra SLE, Sierra SLS, Sierra SLT, Sierra Special	USEP3621S
5.7L V8 350 CID	2000	(R), Extended Cab Pickup, GAS, Naturally Aspirated; (Exc.Calif)	USEP3962M	5.7L V8 350 CID	1996-1997	Sierra SL, Sierra SLE, Sierra SLT, Sierra Special	USEP3622S
5.7L V8 350 CID	2000	(R), GAS, Naturally Aspirated, Standard Cab Pickup; (Exc.Calif)	USEP3962M	5.7L V8 350 CID	1998	Exc.Radio Frequency Interference Filter (Module Stamped GAV)	USEP3947M
7.4L V8 454 CID	1988-1993	Sierra, Sierra SLE, Sierra SLX	USEP3621S	5.7L V8 350 CID	1998-1999	Radio Frequency Interference Filter (Module Stamped GDJ,GFK)	USEP3947M
7.4L V8 454 CID	1994-1995	Sierra SL, Sierra SLE, Sierra SLT	USEP3623S	<b>K1500 SUBURBAN</b>			
7.4L V8 454 CID	1996-1997	Sierra SL, Sierra SLE, Sierra SLT	USEP3622S	5.7L V8 350 CID	1998-1999	(R), GAS, Naturally Aspirated	USEP3967M
7.4L V8 454 CID	1998	Radio Frequency Interference Filter (Module Stamped GDJ,GFK)	USEP3947M	<b>K2500</b>			
<b>C3500</b>				4.3L V6 262 CID	1988-1993	Sierra, Sierra SLE, Sierra SLX	USEP3621S

Engine	Years	Application Description	USMW	Engine	Years	Application Description	USMW
<b>GMC (cont'd.)</b>				<b>GMC (cont'd.)</b>			
<b>K2500 (cont'd.)</b>				<b>S15</b>			
4.3L V6 262 CID	1994-1995	Sierra SL, Sierra SLE	USEP3621S	2.5L L4 2474cc 151 CID	1985	Base, High Sierra, Sierra Classic	USEP3637S
5.0L V8 305 CID	1988-1993	Sierra, Sierra SLE, Sierra SLX	USEP3621S	2.5L L4 2474cc 151 CID	1986	Base, Gypsy, High Sierra, Sierra Classic	USEP3637S
5.0L V8 305 CID	1994-1995	Sierra SL, Sierra SLE, Sierra SLT	USEP3621S	2.5L L4 2474cc 151 CID	1987	Base, EL, Gypsy, High Sierra, Sierra Classic	USEP3637S
5.0L V8 305 CID	1998	Exc.Radio Frequency Interference Filter (Module Stamped GAV)	USEP3947M	2.5L L4 2474cc 151 CID	1988	Base, Gypsy, High Sierra, Sierra Classic	USEP3637S
5.7L V8 350 CID	1988-1993	Sierra, Sierra SLE, Sierra SLX	USEP3621S	2.5L L4 2474cc 151 CID	1989-1990	Base, High Sierra, Sierra Classic	USEP3637S
5.7L V8 350 CID	1994-1995	Sierra SL, Sierra SLE, Sierra SLT	USEP3621S	2.8L V6 173 CID	1986	Base, Gypsy, High Sierra, Sierra Classic	USEP3637S
5.7L V8 350 CID	1996-1997	Sierra SL, Sierra SLE, Sierra SLT	USEP3622S	2.8L V6 173 CID	1987	Base, EL, Gypsy, High Sierra, Sierra Classic	USEP3637S
5.7L V8 350 CID	1998-1999	Exc.Radio Frequency Interference Filter (Module Stamped GAV) (R), GAS, Naturally Aspirated; Exc.Radio Frequency Interference Filter (Module Stamped GFT)	USEP3947M	2.8L V6 173 CID	1988	Base, Gypsy, High Sierra, Sierra Classic	USEP3637S
5.7L V8 350 CID	2000	Radio Frequency Interference Filter (R), GAS, Naturally Aspirated; Exc.Calif (Exc.Radio Frequency Interference Filter)	USEP3962M	2.8L V6 173 CID	1989-1990	Base, High Sierra, Sierra Classic	USEP3637S
5.7L V8 350 CID	2000	Radio Frequency Interference Filter (R), GAS, Naturally Aspirated; Exc.Calif (Exc.Radio Frequency Interference Filter)	USEP3947M	4.3L V6 262 CID	1988	Base, Gypsy, High Sierra, Sierra Classic	USEP3637S
7.4L V8 454 CID	1991-1993	Sierra, Sierra SLE, Sierra SLX	USEP3621S	4.3L V6 262 CID	1989-1990	Base, High Sierra, Sierra Classic	USEP3637S
7.4L V8 454 CID	1994-1995	Sierra, Sierra SLE, Sierra SLX	USEP3623S	<b>S15 JIMMY</b>			
7.4L V8 454 CID	1996-1997	Sierra SL, Sierra SLE, Sierra SLT	USEP3622S	2.5L L4 2474cc 151 CID	1985	Base, Gypsy, High Sierra, Sierra Classic	USEP3632S
7.4L V8 454 CID	1998	Exc.Radio Frequency Interference Filter (Module Stamped GAV) (J), GAS, Naturally Aspirated; Exc.Radio Frequency Interference Filter (Module Stamped GFT)	USEP3947M	2.5L L4 2474cc 151 CID	1986-1987	Base, Gypsy, Sierra Classic	USEP3632S
7.4L V8 454 CID	1998-1999	Exc.Radio Frequency Interference Filter (Module Stamped GFT)	USEP3962M	2.5L L4 2474cc 151 CID	1988	Base, Gypsy, Sierra Classic, Timberline	USEP3632S
7.4L V8 454 CID	1999	Radio Frequency Interference Filter (Module Stamped GDJ,GFK)	USEP3947M	2.8L V6 173 CID	1986-1987	Base, Gypsy, Sierra Classic	USEP3632S
7.4L V8 454 CID	2000	Radio Frequency Interference Filter (J), GAS, Naturally Aspirated; Exc.Calif (Exc.Radio Frequency Interference Filter)	USEP3947M	2.8L V6 173 CID	1989	Base, Gypsy, Sierra Classic, Timberline	USEP3632S
7.4L V8 454 CID	2000	Radio Frequency Interference Filter (J), GAS, Naturally Aspirated; Exc.Calif (Exc.Radio Frequency Interference Filter)	USEP3962M	4.3L V6 262 CID	1988	Base, Gypsy, Sierra Classic, Timberline	USEP3632S
<b>K2500 SUBURBAN</b>				4.3L V6 262 CID	1990	Base, Gypsy, Sierra Classic	USEP3632S
5.7L V8 350 CID	1998-1999	(R), GAS, Naturally Aspirated; Calif	USEP3967M	4.3L V6 262 CID	1991	Base, SLE, SLS, SLT	USEP3632S
5.7L V8 350 CID	1998-1999	(R), GAS, Naturally Aspirated; Exc.Calif	USEP3994M	<b>SAFARI</b>			
7.4L V8 454 CID	1998-1999	(J), GAS, Naturally Aspirated; Calif	USEP3967M	4.3L V6 262 CID	1997-1999		USEP3940M
7.4L V8 454 CID	1998-1999	(J), GAS, Naturally Aspirated; Exc.Calif	USEP3994M	4.3L V6 262 CID	1992	Base	USEP3650S
<b>K3500</b>				4.3L V6 262 CID	1993	Base, GT	USEP3650S
5.7L V8 350 CID	1988-1993	Sierra, Sierra SLE, Sierra SLX	USEP3621S	4.3L V6 262 CID	1994	Base	USEP3650S
5.7L V8 350 CID	1994-1995	Sierra SL, Sierra SLE, Sierra SLT	USEP3621S	4.3L V6 262 CID	1995	Base, SL	USEP3650S
5.7L V8 350 CID	1996-1997	Sierra SL, Sierra SLE, Sierra SLT	USEP3622S	4.3L V6 262 CID	2000-2005		USEP3506M
5.7L V8 350 CID	1998-1999	Exc.Radio Frequency Interference Filter (Module Stamped GAV) (R), GAS, Naturally Aspirated; Exc.Radio Frequency Interference Filter (Module Stamped GFR)	USEP3947M	<b>SAVANA 1500</b>			
5.7L V8 350 CID	1998-1999	Exc.Radio Frequency Interference Filter (Module Stamped GAV) (R), GAS, Naturally Aspirated; Exc.Radio Frequency Interference Filter (Module Stamped GFR)	USEP3957M	4.3L V6 262 CID	1996	(W)	USEP3927M
5.7L V8 350 CID	1998-1999	Exc.Radio Frequency Interference Filter (Module Stamped GAV) (R), GAS, Naturally Aspirated; Radio Frequency Interference Filter (Module Stamped GFS)	USEP3957M	4.3L V6 262 CID	1997	(W); (Exc.Fitting for Fuel Line)	USEP3966M
5.7L V8 350 CID	1998-1999	Exc.Radio Frequency Interference Filter (Module Stamped GFT) (Calif)	USEP3962M	4.3L V6 262 CID	1998-2001	with Fitting for Auxiliary power unit	USEP3573M
5.7L V8 350 CID	2000	(R), Cab & Chassis, GAS, Naturally Aspirated; (Exc.Calif)	USEP3956M	4.3L V6 262 CID	1998-2002	(W); (Exc.Fitting for Fuel Line)	USEP3971M
5.7L V8 350 CID	2000	(R), Cab & Chassis, GAS, Naturally Aspirated; (Calif)	USEP3957M	4.3L V6 262 CID	2003	(X)	USEP3584M
5.7L V8 350 CID	2000	(R), Crew Cab Pickup, GAS, Naturally Aspirated; (Exc.Calif)	USEP3962M	4.3L V6 262 CID	2004	(X)	USEP3588M
5.7L V8 350 CID	2000	(R), Extended Cab Pickup, GAS, Naturally Aspirated; (Exc.Calif)	USEP3962M	4.3L V6 262 CID	2005	(X)	USEP12006M
5.7L V8 350 CID	2000	(R), GAS, Naturally Aspirated, Standard Cab Pickup; (Exc.Calif)	USEP3962M	4.3L V6 262 CID	2005-2006	Standard Passenger Van	USEP3678M
7.4L V8 454 CID	1988-1993	Sierra, Sierra SLE, Sierra SLX	USEP3621S	4.3L V6 262 CID	2005-2008		USEP3678M
7.4L V8 454 CID	1994-1995	Sierra, Sierra SLE, Sierra SLX	USEP3623S	4.3L V6 262 CID	2006	Base, LS, LT; (X)	USEP12006M
7.4L V8 454 CID	1996-1997	Sierra SL, Sierra SLE, Sierra SLT	USEP3622S	4.3L V6 262 CID	2008	Base; (X), GAS	USEP12006M
7.4L V8 454 CID	1998-1999	Exc.Radio Frequency Interference Filter (Module Stamped GFP) (J), GAS, Naturally Aspirated; Radio Frequency Interference Filter (Module Stamped GFP)	USEP3956M	4.3L V6 262 CID	2009		USEP3820M
<b>P3500</b>				4.3L V6 262 CID	2010-2012	GAS; Exc.Left Side Rear Hinged Door	USEP4048M
4.3L V6 262 CID	1998-1999	exc school bus, with 1 electrical connector	USEP3968M	4.3L V6 262 CID	2010-2012	GAS; Exc.Left Side Rear Hinged Door	USEP4049M
5.7L V8 350 CID	1998-1999	exc school bus, with 2 electrical connectors	USEP3965M	4.3L V6 262 CID	2014		USEP4048M
5.7L V8 350 CID	1998-1999	Exc.School Bus (Exc.Calif), with 1 electrical connector	USEP3968M	4.3L V6 262 CID	2013	GAS; Exc.Left Side Rear Hinged Door	USEP4049M
5.7L V8 350 CID	1998-1999	School Bus	USEP3969M	5.0L V8 305 CID	1996	(M)	USEP3927M
7.4L V8 454 CID	1998-1999	Exc.80 Gallon Fuel Tank, exc school bus, with 1 electrical connector	USEP3968M	5.0L V8 305 CID	1997	(M); (Exc.Fitting for Fuel Line)	USEP3966M
7.4L V8 454 CID	1998-1999	(B), GAS, Naturally Aspirated; 80 Gallon Fuel Tank	USEP3982M	5.0L V8 305 CID	1998-2002	(M); (Exc.Fitting for Fuel Line)	USEP3971M
7.4L V8 454 CID	1998-1999	(J), GAS, Naturally Aspirated; 80 Gallon Fuel Tank	USEP3982M	5.3L V8 5328cc 325 CID	2004-2006	Standard Passenger Van	USEP3678M
7.4L V8 454 CID	1998-1999		USEP3997M	5.3L V8 5328cc 325 CID	2004-2007		USEP3678M
<b>R1500</b>				5.3L V8 5328cc 325 CID	2007	GAS	USEP3678M
4.3L V6 262 CID	1987	harness code VEE or VEV	USEP3631S	5.3L V8 5328cc 325 CID	2007	FLEX	USEP3725M
7.4L V8 350 CID	1987	harness code VEE or VEV	USEP3631S	5.3L V8 5328cc 325 CID	2008	FLEX	USEP3751M
<b>R2500</b>				5.3L V8 5328cc 325 CID	2009	FLEX; except left hand rear hinged door	USEP3788M
4.3L V6 262 CID	1987	harness code VEE or VEV	USEP3631S	5.7L V8 350 CID	1996	(R); 31 Gallon Fuel Tank	USEP3927M
<b>S1500</b>				5.7L V8 350 CID	1996	(R); 55 Gallon Fuel Tank	USEP3928M
4.3L V6 262 CID	1987	harness code VEE or VEV	USEP3631S	5.7L V8 350 CID	1997	(R); (Exc.Fitting for Fuel Line)	USEP3966M
4.3L V6 262 CID	1987	harness code VEE or VEV	USEP3631S	5.7L V8 350 CID	1998-2002	(R); (Exc.Fitting for Fuel Line)	USEP3971M
<b>S2500</b>				<b>SAVANA 2500</b>			
4.3L V6 262 CID	1987	harness code VEE or VEV	USEP3631S	4.3L V6 262 CID	1996	(W), GAS, Naturally Aspirated	USEP3927M
4.3L V6 262 CID	1987	harness code VEE or VEV	USEP3631S	4.3L V6 262 CID	1997	(W), GAS, Naturally Aspirated; (Exc.Fitting for Fuel Line)	USEP3966M
4.3L V6 262 CID	1987	harness code VEE or VEV	USEP3631S	4.3L V6 262 CID	2001-2002	(W), GAS, Naturally Aspirated; (Exc.Fitting for Fuel Line), Exc.Calif (Over GVW 8,500 Lbs.)	USEP3966M
4.3L V6 262 CID	1987	harness code VEE or VEV	USEP3631S	4.3L V6 262 CID	2001-2002	(W), GAS, Naturally Aspirated; (Exc.Fitting for Fuel Line), Calif	USEP3971M
4.3L V6 262 CID	1987	harness code VEE or VEV	USEP3631S	4.3L V6 262 CID	2001-2002	(W), GAS, Naturally Aspirated; (Exc.Fitting for Fuel Line), Exc.Calif (Under GVW 8,500 Lbs.)	USEP3971M
4.3L V6 262 CID	1987	harness code VEE or VEV	USEP3631S	4.3L V6 262 CID	2003	(X), GAS	USEP3584M
4.3L V6 262 CID	1987	harness code VEE or VEV	USEP3631S	4.3L V6 262 CID	2004	(X), GAS	USEP3588M
4.3L V6 262 CID	1987	harness code VEE or VEV	USEP3631S	4.3L V6 262 CID	2005		USEP3678M
4.3L V6 262 CID	1987	harness code VEE or VEV	USEP3631S	4.3L V6 262 CID	2005	Standard Passenger Van	USEP3678M
4.3L V6 262 CID	1987	harness code VEE or VEV	USEP3631S	4.3L V6 262 CID	2005	(X), GAS	USEP12006M





# FUEL PUMP MODULES APPLICATION GUIDE



FUEL PUMP MODULES

Engine	Years	Application Description	USMW	Engine	Years	Application Description	USMW
<b>GMC (cont'd.)</b>				<b>GMC (cont'd.)</b>			
<b>SAVANA 2500 (cont'd.)</b>				<b>SAVANA 3500 (cont'd.)</b>			
4.8L V8 294 CID	2003	(V), GAS	USEP3584M			(R), GAS, Naturally Aspirated, Standard Cargo Van; (Exc.Fitting for Fuel Line)	USEP3966M
4.8L V8 294 CID	2004-2005	(V), GAS	USEP12006M	5.7L V8 350 CID	1997		
4.8L V8 294 CID	2004-2006	Standard Passenger Van	USEP3678M			(R), GAS, Naturally Aspirated, Standard Passenger Van; (Exc.Fitting for Fuel Line)	USEP3966M
4.8L V8 294 CID	2004-2008		USEP3678M	5.7L V8 350 CID	1997		
4.8L V8 294 CID	2006-2007	(V), GAS, Naturally Aspirated	USEP12006M			(R), Cutaway Van, GAS, Naturally Aspirated; (35 Gallon Fuel Tank)	USEP3995M
4.8L V8 294 CID	2008	Base; (C), GAS, Naturally Aspirated	USEP12006M	5.7L V8 350 CID	1997-2002	with 1 electrical connector	USEP3760M
4.8L V8 294 CID	2009		USEP3820M	5.7L V8 350 CID	1998-1999	(R), Cutaway Van, GAS, Naturally Aspirated; (Exc.Calif (55 Gallon Fuel Tank), (Exc.Fitting for Fuel Line)	USEP3511M
4.8L V8 294 CID	2010-2015	FLEX; Exc.Left Side Rear Hinged Door	USEP4049M	5.7L V8 350 CID	1998-1999	(R), Cutaway Van, GAS, Naturally Aspirated; (Exc.Calif (55 Gallon Fuel Tank), (Exc.Fitting for Fuel Line)	USEP3966M
4.8L V8 294 CID	2016	Exc.Left Side Rear Hinged Door	USEP4049M	5.7L V8 350 CID	1998-1999	(R), Extended Cargo Van, GAS, Naturally Aspirated; (Exc.Calif), (Exc.Fitting for Fuel Line)	USEP3966M
5.0L V8 305 CID	1996	(M), GAS, Naturally Aspirated	USEP3927M	5.7L V8 350 CID	1998-1999	(R), Extended Passenger Van, GAS, Naturally Aspirated; (Exc.Calif), (Exc.Fitting for Fuel Line)	USEP3966M
5.0L V8 305 CID	1997	(M), GAS, Naturally Aspirated; (Exc.Fitting for Fuel Line)	USEP3966M	5.7L V8 350 CID	1998-1999	(R), GAS, Naturally Aspirated, Standard Cargo Van; (Exc.Calif), (Exc.Fitting for Fuel Line)	USEP3966M
5.0L V8 305 CID	2001-2002	(M), GAS, Naturally Aspirated; (Exc.Fitting for Fuel Line), Exc.Calif (Over GVW 8,500 Lbs.)	USEP3966M	5.7L V8 350 CID	1998-1999	(R), GAS, Naturally Aspirated, Standard Passenger Van; (Exc.Calif), (Exc.Fitting for Fuel Line)	USEP3966M
5.0L V8 305 CID	2001-2002	(M), GAS, Naturally Aspirated; (Exc.Fitting for Fuel Line), Calif	USEP3971M	5.7L V8 350 CID	1998-1999	(R), Cutaway Van, GAS, Naturally Aspirated; (Exc.Calif (35 Gallon Fuel Tank), (Exc.Fitting for Fuel Line)	USEP3996M
5.0L V8 305 CID	2001-2002	(M), GAS, Naturally Aspirated; (Exc.Fitting for Fuel Line), Exc.Calif (Under GVW 8,500 Lbs.)	USEP3971M	5.7L V8 350 CID	1998-2000	with Fitting for Auxiliary power unit	USEP3573M
5.3L V8 5328cc 325 CID	2004-2005		USEP3678M	5.7L V8 350 CID	1998-2000	(R), Cutaway Van, GAS, Naturally Aspirated; (Exc.Fitting for Fuel Line), Calif	USEP3971M
5.7L V8 350 CID	1996	(R), GAS, Naturally Aspirated; 31 Gallon Fuel Tank	USEP3927M	5.7L V8 350 CID	1998-2000	(R), GAS, Naturally Aspirated; (Exc.Fitting for Fuel Line), Exc.Calif (Under GVW 8,500 Lbs.)	USEP3971M
5.7L V8 350 CID	1996	(R), GAS, Naturally Aspirated; 55 Gallon Fuel Tank	USEP3928M	5.7L V8 350 CID	1998-2000	with Fitting for Auxiliary power unit	USEP3573M
5.7L V8 350 CID	1997	(R), GAS, Naturally Aspirated; (Exc.Fitting for Fuel Line)	USEP3966M	6.0L V8 5967cc 364 CID	2003	(U), GAS	USEP3584M
5.7L V8 350 CID	1998-2000	(R), GAS, Naturally Aspirated; (Exc.Fitting for Fuel Line), Exc.Calif (Over GVW 8,500 Lbs.)	USEP3966M	6.0L V8 5967cc 364 CID	2004-2005	Standard Passenger Van	USEP3678M
5.7L V8 350 CID	1998-2000	(R), GAS, Naturally Aspirated; (Exc.Fitting for Fuel Line), Calif	USEP3971M	6.0L V8 5967cc 364 CID	2004-2005	(U), GAS	USEP12006M
5.7L V8 350 CID	1998-2000	(R), GAS, Naturally Aspirated; (Exc.Fitting for Fuel Line), Exc.Calif (Under GVW 8,500 Lbs.)	USEP3971M	6.0L V8 5967cc 364 CID	2004-2008		USEP3678M
5.7L V8 350 CID	1998-2002	with Fitting for Auxiliary power unit	USEP3573M	6.0L V8 5967cc 364 CID	2006-2007	(U), GAS, Naturally Aspirated	USEP12006M
6.0L V8 5967cc 364 CID	2003	(U), GAS	USEP3584M	6.0L V8 5967cc 364 CID	2008	LT; (K), GAS, Naturally Aspirated	USEP12006M
6.0L V8 5967cc 364 CID	2004-2005	Standard Passenger Van	USEP3678M	6.0L V8 5967cc 364 CID	2009		USEP3820M
6.0L V8 5967cc 364 CID	2004-2005	(U), GAS	USEP12006M	6.0L V8 5967cc 364 CID	2010-2015	FLEX; Exc.Left Side Rear Hinged Door	USEP4049M
6.0L V8 5967cc 364 CID	2004-2008		USEP3678M	6.0L V8 5967cc 364 CID	2016	Exc.Left Side Rear Hinged Door	USEP4049M
6.0L V8 5967cc 364 CID	2006-2007	(U), GAS, Naturally Aspirated	USEP12006M	6.6L V8 6599cc 403 CID	2016	Exc.Left Side Rear Hinged Door	USEP4049M
6.0L V8 5967cc 364 CID	2008	LT; (K), GAS, Naturally Aspirated	USEP12006M				
6.0L V8 5967cc 364 CID	2009		USEP3820M				
6.0L V8 5967cc 364 CID	2010-2015	FLEX; Exc.Left Side Rear Hinged Door	USEP4049M				
6.0L V8 5967cc 364 CID	2016	Exc.Left Side Rear Hinged Door	USEP4049M				
6.6L V8 6599cc 403 CID	2016	Exc.Left Side Rear Hinged Door	USEP4049M				
<b>SAVANA 3500</b>							
	2003	GAS; Federal (Exc.55 Gallon Fuel Tank)	USEP3574M	5.7L V8 350 CID	2000	(R), Extended Cargo Van, GAS, Naturally Aspirated; (Exc.Fitting for Fuel Line), (Federal)	USEP3966M
	2003	GAS; Calif (Exc.55 Gallon Fuel Tank)	USEP3575M	5.7L V8 350 CID	2000	(R), Extended Passenger Van, GAS, Naturally Aspirated; (Exc.Fitting for Fuel Line), (Federal)	USEP3966M
	2003	GAS; Calif (55 Gallon Fuel Tank) Cutaway Van, GAS; 1 electrical connector, Federal (55 Gallon Fuel Tank)	USEP3602M	5.7L V8 350 CID	2000	(R), GAS, Naturally Aspirated, Standard Cargo Van; (Exc.Fitting for Fuel Line), (Federal)	USEP3966M
4.8L V8 294 CID	2004-2005	with 1 electrical connector	USEP3580M	5.7L V8 350 CID	2000	(R), GAS, Naturally Aspirated, Standard Passenger Van; (Exc.Fitting for Fuel Line), (Federal)	USEP3966M
4.8L V8 294 CID	2004-2005	Standard Passenger Van	USEP3678M	5.7L V8 350 CID	2000	(R), Cutaway Van, GAS, Naturally Aspirated; (Exc.Fitting for Fuel Line), (Federal) (35 Gallon Fuel Tank)	USEP3996M
4.8L V8 294 CID	2004-2008		USEP3678M	6.0L V8 5967cc 364 CID	2004-2005	with 1 electrical connector	USEP3580M
4.8L V8 294 CID	2005	Cutaway Van; 1 CONNECTOR, 55 GALLON TANK	USEP3682M	6.0L V8 5967cc 364 CID	2004-2005	Cutaway Van; 1 CONNECTOR, 55 GALLON TANK	USEP3682M
4.8L V8 294 CID	2005-2008	with 2 electrical connectors, with 55 gallon fuel tank	USEP3681M	6.0L V8 5967cc 364 CID	2004-2008		USEP3678M
4.8L V8 294 CID	2006	Base; (V), GAS, Naturally Aspirated, Standard Cargo Van	USEP12006M	6.0L V8 5967cc 364 CID	2004-2008	Standard Passenger Van	USEP3678M
4.8L V8 294 CID	2006-2007	Base; (V), Cutaway Van, GAS, Naturally Aspirated; (Exc.55 Gallon Fuel Tank)	USEP3583M	6.0L V8 5967cc 364 CID	2004-2008	with 2 electrical connectors, with 55 gallon fuel tank	USEP3681M
4.8L V8 294 CID	2006-2007	Base; (V), Extended Cargo Van, GAS, Naturally Aspirated	USEP12006M	6.0L V8 5967cc 364 CID	2006-2007	Base; (U), Cutaway Van, GAS, Naturally Aspirated; (Exc.55 Gallon Fuel Tank)	USEP3583M
4.8L V8 294 CID	2008	Base; (C), Cutaway Van, GAS, Naturally Aspirated; (Exc.55 Gallon Fuel Tank)	USEP3583M	6.0L V8 5967cc 364 CID	2006-2007	LS; (U), GAS, Naturally Aspirated	USEP12006M
4.8L V8 294 CID	2008	Base; (C), GAS, Naturally Aspirated, Standard Cargo Van	USEP12006M	6.0L V8 5967cc 364 CID	2008	Base; (K), Cutaway Van, GAS, Naturally Aspirated; (Exc.55 Gallon Fuel Tank)	USEP3583M
4.8L V8 294 CID	2009		USEP3820M	6.0L V8 5967cc 364 CID	2008	LS; (K), GAS, Naturally Aspirated	USEP12006M
4.8L V8 294 CID	2010-2015	FLEX; Exc.Cutaway Chassis, Exc.Left Side Rear Hinged Door	USEP4049M	6.0L V8 5967cc 364 CID	2009		USEP3820M
4.8L V8 294 CID	2013-2015	FLEX; Exc.Left Side Rear Hinged Door	USEP4049M	6.0L V8 5967cc 364 CID	2010-2015	FLEX; Exc.Cutaway Chassis, Exc.Left Side Rear Hinged Door	USEP4049M
4.8L V8 294 CID	2016	Exc.Left Side Rear Hinged Door	USEP4049M	6.0L V8 5967cc 364 CID	2016	Exc.Left Side Rear Hinged Door	USEP4049M
5.7L V8 350 CID	1996		USEP3926M	6.6L V8 6599cc 403 CID	2016	Exc.Left Side Rear Hinged Door	USEP4049M
5.7L V8 350 CID	1996	(R), GAS, Naturally Aspirated; 31 Gallon Fuel Tank	USEP3927M	7.4L V8 454 CID	1996		USEP3926M
5.7L V8 350 CID	1996	(R), GAS, Naturally Aspirated; 55 Gallon Fuel Tank	USEP3928M	7.4L V8 454 CID	1996	(J), GAS, Naturally Aspirated; 31 Gallon Fuel Tank	USEP3927M
5.7L V8 350 CID	1997	(R), Cutaway Van, GAS, Naturally Aspirated; (55 Gallon Fuel Tank), (Exc.Fitting for Fuel Line)	USEP3966M	7.4L V8 454 CID	1996	(J), GAS, Naturally Aspirated; 55 Gallon Fuel Tank	USEP3928M
5.7L V8 350 CID	1997	(R), Extended Cargo Van, GAS, Naturally Aspirated; (Exc.Fitting for Fuel Line)	USEP3966M	7.4L V8 454 CID	1997	(J), Cutaway Van, GAS, Naturally Aspirated; (55 Gallon Fuel Tank), (Exc.Fitting for Fuel Line)	USEP3966M
5.7L V8 350 CID	1997	(R), Extended Passenger Van, GAS, Naturally Aspirated; (Exc.Fitting for Fuel Line)	USEP3966M				
5.7L V8 350 CID	1997	(R), Extended Passenger Van, GAS, Naturally Aspirated; (Exc.Fitting for Fuel Line)	USEP3966M				

Engine	Years	Application Description	USMW	Engine	Years	Application Description	USMW
<b>GMC (cont'd.)</b>				<b>GMC (cont'd.)</b>			
<b>SAVANA 3500 (cont'd.)</b>				<b>SIERRA 1500 (cont'd.)</b>			
7.4L V8 454 CID	1997	(J), Extended Cargo Van, GAS, Naturally Aspirated; (Exc.Fitting for Fuel Line)	USEP3966M	4.8L V8 294 CID	2010-2013	97.8 / 248.4 Bed, Extended Cab Pickup	USEP4008M
7.4L V8 454 CID	1997	(J), Extended Passenger Van, GAS, Naturally Aspirated; (Exc.Fitting for Fuel Line)	USEP3966M	4.8L V8 294 CID	2010-2013	97.8 / 248.4 Bed, Standard Cab Pickup	USEP4008M
7.4L V8 454 CID	1997	(J), GAS, Naturally Aspirated, Standard Cargo Van; (Exc.Fitting for Fuel Line)	USEP3966M	4.8L V8 294 CID	2010-2013	78.9 / 200.4 Bed, Standard Cab Pickup	USEP4009M
7.4L V8 454 CID	1997	(J), GAS, Naturally Aspirated, Standard Passenger Van; (Exc.Fitting for Fuel Line)	USEP3966M	5.3L V8 5328cc 325 CID	1999-2001	electrical connections: 2	USEP3500M
7.4L V8 454 CID	1997	(J), Cutaway Van, GAS, Naturally Aspirated; (35 Gallon Fuel Tank)	USEP3995M	5.3L V8 5328cc 325 CID	1999-2001	with 1 electrical connector	USEP3501M
7.4L V8 454 CID	1997-1998	with 1 electrical connector	USEP3760M	5.3L V8 5328cc 325 CID	2002-2003	GAS; electrical connections: 2	USEP3500M
7.4L V8 454 CID	1998	(J), Cutaway Van, GAS, Naturally Aspirated; (Calif) (35 Gallon Fuel Tank), (Exc.Fitting for Fuel Line)	USEP3511M	5.3L V8 5328cc 325 CID	2002-2004	FLEX	USEP3572M
7.4L V8 454 CID	1998	with Fitting for Auxiliary power unit with 2 electrical connectors	USEP3573M	5.3L V8 5328cc 325 CID	2004	78.0 / 198.1 Bed; 2 electrical connectors	USEP3609M
7.4L V8 454 CID	1998	(J), Cutaway Van, GAS, Naturally Aspirated; (Exc.Calif) (55 Gallon Fuel Tank), (Exc.Fitting for Fuel Line)	USEP3759M	5.3L V8 5328cc 325 CID	2004	96.0 / 243.8 Bed; 2 electrical connectors	USEP3831M
7.4L V8 454 CID	1998	(J), Extended Cargo Van, GAS, Naturally Aspirated; (Exc.Calif), (Exc.Fitting for Fuel Line)	USEP3966M	5.3L V8 5328cc 325 CID	2004-2006	96.0 / 243.8 Bed, GAS	USEP3684M
7.4L V8 454 CID	1998	(J), Extended Passenger Van, GAS, Naturally Aspirated; (Exc.Calif), (Exc.Fitting for Fuel Line)	USEP3966M	5.3L V8 5328cc 325 CID	2004-2006	96.0 / 243.8 Bed, GAS	USEP3831M
7.4L V8 454 CID	1998	(J), GAS, Naturally Aspirated, Standard Cargo Van; (Exc.Calif), (Exc.Fitting for Fuel Line)	USEP3966M	5.3L V8 5328cc 325 CID	2005	GAS; In Tank Assy.(Exc.Fuel Tank Sending Unit)	USEP3609M
7.4L V8 454 CID	1998	(J), GAS, Naturally Aspirated, Standard Passenger Van; (Exc.Calif), (Exc.Fitting for Fuel Line)	USEP3966M	5.3L V8 5328cc 325 CID	2005-2006	78.0 / 198.1 Bed, GAS; Bed Length 78.0", In Tank Assy.(Incl.Fuel Tank Sending Unit)	USEP3609M
7.4L V8 454 CID	1998	(J), Cutaway Van, GAS, Naturally Aspirated; (Exc.Calif) (55 Gallon Fuel Tank), (Exc.Fitting for Fuel Line)	USEP3971M	5.3L V8 5328cc 325 CID	2005-2006	ELECTRIC/GAS; In Tank Assy.(Incl.Fuel Tank Sending Unit)	USEP3609M
7.4L V8 454 CID	1998	(J), Extended Cargo Van, GAS, Naturally Aspirated; (Exc.Calif), (Exc.Fitting for Fuel Line)	USEP3966M	5.3L V8 5328cc 325 CID	2005-2006	Crew Cab Pickup, GAS; 69.2 bed length	USEP3684M
7.4L V8 454 CID	1998	(J), Extended Passenger Van, GAS, Naturally Aspirated; (Exc.Calif), (Exc.Fitting for Fuel Line)	USEP3966M	5.3L V8 5328cc 325 CID	2005-2006	96.0 / 243.8 Bed, Extended Cab Pickup, FLEX	USEP3702M
7.4L V8 454 CID	1998	(J), GAS, Naturally Aspirated, Standard Cargo Van; (Exc.Calif), (Exc.Fitting for Fuel Line)	USEP3966M	5.3L V8 5328cc 325 CID	2005-2006	96.0 / 243.8 Bed, FLEX, Standard Cab Pickup	USEP3702M
7.4L V8 454 CID	1998	(J), GAS, Naturally Aspirated, Standard Passenger Van; (Exc.Calif), (Exc.Fitting for Fuel Line)	USEP3966M	5.3L V8 5328cc 325 CID	2007-2008	78.7 / 199.9 Bed	USEP3752M
7.4L V8 454 CID	1998	(J), Cutaway Van, GAS, Naturally Aspirated; (Calif) (55 Gallon Fuel Tank), (Exc.Fitting for Fuel Line)	USEP3971M	5.3L V8 5328cc 325 CID	2007-2008	97.6 / 247.9 Bed	USEP3834M
7.4L V8 454 CID	1998	(J), Extended Cargo Van, GAS, Naturally Aspirated; (Calif), (Exc.Fitting for Fuel Line)	USEP3971M	5.3L V8 5328cc 325 CID	2010-2013	69.3 / 176.0 Bed, Crew Cab Pickup	USEP4005M
7.4L V8 454 CID	1998	(J), Extended Passenger Van, GAS, Naturally Aspirated; (Calif), (Exc.Fitting for Fuel Line)	USEP3971M	5.3L V8 5328cc 325 CID	2010-2013	78.9 / 200.4 Bed, Extended Cab Pickup	USEP4005M
7.4L V8 454 CID	1998	(J), GAS, Naturally Aspirated, Standard Cargo Van; (Calif), (Exc.Fitting for Fuel Line)	USEP3971M	5.3L V8 5328cc 325 CID	2010-2013	97.8 / 248.4 Bed, Extended Cab Pickup	USEP4008M
7.4L V8 454 CID	1998	(J), GAS, Naturally Aspirated, Standard Passenger Van; (Calif), (Exc.Fitting for Fuel Line)	USEP3971M	5.3L V8 5328cc 325 CID	2010-2013	97.8 / 248.4 Bed, Standard Cab Pickup	USEP4008M
7.4L V8 454 CID	1998	(J), Cutaway Van, GAS, Naturally Aspirated; (Exc.Calif) (35 Gallon Fuel Tank), (Exc.Fitting for Fuel Line)	USEP3996M	5.3L V8 5328cc 325 CID	2010-2013	78.9 / 200.4 Bed, Standard Cab Pickup	USEP4009M
8.1L V8 496 CID	2001-2002	with 2 electrical connectors	USEP3759M	5.3L V8 5328cc 325 CID	2010-2017	97.8 / 248.4 Bed	usep12357m
8.1L V8 496 CID	2001-2002	with 1 electrical connector	USEP3760M	6.0L V8 5967cc 364 CID	2001	electrical connections: 1, Exc.Evaporative Emissions Control	USEP3501M
<b>SIERRA 1500</b>				<b>SIERRA 1500 CLASSIC</b>			
4.3L V6 262 CID	1999-2001	electrical connections: 2, Evaporative Emissions Control	USEP3500M	4.3L V6 262 CID	2007	96.0 / 243.8 Bed, GAS	USEP3831M
4.3L V6 262 CID	1999-2001	electrical connections: 1, Exc.Evaporative Emissions Control	USEP3501M	4.8L V8 294 CID	2007	Crew Cab Pickup	USEP3684M
4.3L V6 262 CID	2002-2004	electrical connections: 2	USEP3500M	4.8L V8 294 CID	2007	96.0 / 243.8 Bed, GAS	USEP3831M
4.3L V6 262 CID	2005-2006	78.0 / 198.1 Bed, GAS; Bed Length 78.0", In Tank Assy.(Incl.Fuel Tank Sending Unit)	USEP3609M	5.3L V8 5328cc 325 CID	2007	Crew Cab Pickup, GAS	USEP3684M
4.3L V6 262 CID	2005-2006	96.0 / 243.8 Bed, GAS	USEP3831M	5.3L V8 5328cc 325 CID	2007	96.0 / 243.8 Bed, Extended Cab Pickup, FLEX	USEP3702M
4.3L V6 262 CID	2007-2008		USEP3750M	5.3L V8 5328cc 325 CID	2007	96.0 / 243.8 Bed, FLEX, Standard Cab Pickup	USEP3702M
4.3L V6 262 CID	2007-2008	78.7 / 199.9 Bed, GAS, Standard Cab Pickup	USEP3843M	5.3L V8 5328cc 325 CID	2007	96.0 / 243.8 Bed, GAS	USEP3831M
4.3L V6 262 CID	2009	78.7 / 199.9 Bed, 143.5 / 364.5 Wheel Base, Extended Cab Pickup	USEP3794M	6.0L V8 5967cc 364 CID	2007	Crew Cab Pickup	USEP3684M
4.3L V6 262 CID	2009-2013	119.0 / 302.3 Wheel Base, Standard Cab Pickup	USEP3777M	6.0L V8 5967cc 364 CID	2007	96.0 / 243.8 Bed, GAS; Evaporative Emissions Control	USEP3831M
4.3L V6 262 CID	2010-2013		USEP3794M	<b>SIERRA 1500 HD</b>			
4.3L V6 262 CID	2014-2017	97.8 / 248.4 Bed	usep12357m	6.0L V8 5967cc 364 CID	2005-2006	SLE, SLT; Exc.EVAP Emissions	USEP3604M
4.8L V8 294 CID	1999-2001	electrical connections: 2, Evaporative Emissions Control	USEP3500M	6.0L V8 5967cc 364 CID	2001-2003	electrical connections: 2, Evaporative Emissions Control	USEP3500M
4.8L V8 294 CID	1999-2001	electrical connections: 1, Exc.Evaporative Emissions Control	USEP3501M	6.0L V8 5967cc 364 CID	2005-2006	GAS; EVAP Emissions, In Tank Assy.(Incl.Fuel Tank Sending Unit)(Electrical Connector Qty.2)	USEP3609M
4.8L V8 294 CID	2002-2003	electrical connections: 2	USEP3500M	6.0L V8 5967cc 364 CID	2005-2006	GAS; In Tank Assy.(Incl.Fuel Tank Sending Unit)(Electrical Connector Qty.2)	USEP3609M
4.8L V8 294 CID	2004	78.0 / 198.1 Bed, GAS, Standard Cab Pickup	USEP3609M	6.0L V8 5967cc 364 CID	2005-2006		USEP3609M
4.8L V8 294 CID	2004	96.0 / 243.8 Bed; 2 electrical connectors	USEP3831M	6.0L V8 5967cc 364 CID	2005-2006		USEP3832M
4.8L V8 294 CID	2004-2006	Crew Cab Pickup	USEP3684M	<b>SIERRA 1500 HD CLASSIC</b>			
4.8L V8 294 CID	2004-2006	96.0 / 243.8 Bed, GAS	USEP3831M	6.0L V8 5967cc 364 CID	2007	GAS; EVAP Emissions, In Tank Assy.(Incl.Fuel Tank Sending Unit)(Electrical Connector Qty.2)	USEP3609M
4.8L V8 294 CID	2005-2006	78.0 / 198.1 Bed, GAS; Bed Length 78.0", In Tank Assy.(Incl.Fuel Tank Sending Unit)	USEP3609M	6.0L V8 5967cc 364 CID	2007	GAS; In Tank Assy.(Incl.Fuel Tank Sending Unit)(Electrical Connector Qty.2)	USEP3609M
4.8L V8 294 CID	2005-2006	Crew Cab Pickup; 69.2 bed length	USEP3684M	6.0L V8 5967cc 364 CID	2007		USEP3832M
4.8L V8 294 CID	2007-2008	78.7 / 199.9 Bed	USEP3752M	<b>SIERRA 1500</b>			
4.8L V8 294 CID	2007-2008	97.6 / 247.9 Bed	USEP3834M	5.3L V8 5328cc 325 CID	1999-2000	electrical connections: 2	USEP3500M
4.8L V8 294 CID	2010-2013	69.3 / 176.0 Bed, Crew Cab Pickup	USEP4005M	6.0L V8 5967cc 364 CID	1999-2000	electrical connections: 2	USEP3500M
4.8L V8 294 CID	2010-2013	78.9 / 200.4 Bed, Extended Cab Pickup	USEP4005M				





# FUEL PUMP MODULES APPLICATION GUIDE



FUEL PUMP MODULES

Engine	Years	Application Description	USMW	Engine	Years	Application Description	USMW
<b>GMC (cont'd.)</b>				<b>GMC (cont'd.)</b>			
<b>SIERRA 2500 (cont'd.)</b>				<b>SIERRA 2500 HD CLASSIC (cont'd.)</b>			
6.0L V8 5967cc 364 CID	2001-2003	electrical connections: 2, Evaporative Emissions Control	USEP3500M	8.1L V8 496 CID	2007	133.0 / 337.8 Wheel Base, GAS; Evaporative Emissions Control	USEP3831M
6.0L V8 5967cc 364 CID	2001-2003	electrical connections: 1, Exc.Evaporative Emissions Control 78.0 / 198.1 Bed, GAS; Bed Length 78", In Tank Assy.(Incl.Fuel Tank Sending Unit)(Electrical Connector Qty.2)	USEP3501M	8.1L V8 496 CID	2007	157.5 / 400.1 Wheel Base, GAS; Evaporative Emissions Control	USEP3831M
6.0L V8 5967cc 364 CID	2004	96.0 / 243.8 Bed, GAS	USEP3609M	8.1L V8 496 CID	2007	167.0 / 424.2 Wheel Base, GAS; Evaporative Emissions Control	USEP3831M
6.0L V8 5967cc 364 CID	2004	GAS; Evaporative Emissions Control	USEP3831M	<b>SIERRA 3500</b>			
6.0L V8 5967cc 364 CID	2004	GAS; Evaporative Emissions Control	USEP3831M	6.0L V8 5967cc 364 CID	2001	electrical connections: 2, Exc.Commercial Chassis (Evaporative Emissions Control)	USEP3500M
<b>SIERRA 2500 HD</b>				6.0L V8 5967cc 364 CID	2001	electrical connections: 1, Exc.Commercial Chassis (Exc.Evaporative Emissions Control)	USEP3501M
6.0L V8 5967cc 364 CID	2001-2003	electrical connections: 2, Evaporative Emissions Control	USEP3500M	6.0L V8 5967cc 364 CID	2001-2003	(U), GAS, Naturally Aspirated; Commercial Chassis (Calif), Primary Fuel Tank	USEP3522M
6.0L V8 5967cc 364 CID	2001-2003	electrical connections: 1, Exc.Evaporative Emissions Control 153.0 / 388.6 Wheel Base, GAS; In Tank Assy.(Incl.Fuel Tank Sending Unit), Wheelbase 153" (EVAP Emissions)	USEP3501M	6.0L V8 5967cc 364 CID	2001-2003	(U), GAS, Naturally Aspirated; Commercial chassis, Secondary Fuel Tank	USEP3530M
6.0L V8 5967cc 364 CID	2004	78.0 / 198.1 Bed, GAS; Bed Length 78", In Tank Assy.(Incl.Fuel Tank Sending Unit)(Electrical Connector Qty.2)	USEP3609M	6.0L V8 5967cc 364 CID	2001-2003	(U), GAS, Naturally Aspirated; Commercial Chassis (Federal), Primary Fuel Tank	USEP3599M
6.0L V8 5967cc 364 CID	2004-2006	96.0 / 243.8 Bed, GAS	USEP3609M	6.0L V8 5967cc 364 CID	2002-2003	electrical connections: 2, Exc.Commercial Chassis (Calif)	USEP3500M
6.0L V8 5967cc 364 CID	2004-2006	157.5 / 400.1 Wheel Base, GAS; Evaporative Emissions Control	USEP3831M	6.0L V8 5967cc 364 CID	2002-2003	electrical connections: 1, Exc.Commercial Chassis (Federal)	USEP3501M
6.0L V8 5967cc 364 CID	2004-2006	167.0 / 424.2 Wheel Base, GAS; Evaporative Emissions Control	USEP3831M	6.0L V8 5967cc 364 CID	2004	(U), GAS, Naturally Aspirated; Exc.Commercial Chassis (Exc.Evaporative Emissions Control)	USEP3604M
6.0L V8 5967cc 364 CID	2005	143.5 / 364.5 Wheel Base, GAS; In Tank Assy.(Exc.Fuel Tank Sending Unit), Wheelbase 143.5" (EVAP Emissions)	USEP3609M	6.0L V8 5967cc 364 CID	2004	(U), GAS, Naturally Aspirated; Commercial chassis, Secondary Fuel Tank	USEP3616M
6.0L V8 5967cc 364 CID	2006	153.0 / 388.6 Wheel Base, GAS; In Tank Assy.(Incl.Fuel Tank Sending Unit), Wheelbase 153" (EVAP Emissions)	USEP3609M	6.0L V8 5967cc 364 CID	2004-2006	GAS; Evaporative Emissions Control, Exc.Commercial Chassis	USEP3831M
6.0L V8 5967cc 364 CID	2006	133.0 / 337.8 Wheel Base, GAS; Evaporative Emissions Control	USEP3831M	6.0L V8 5967cc 364 CID	2004-2006	GAS; Exc.Cab & Chassis	USEP3831M
6.0L V8 5967cc 364 CID	2007-2008		USEP3750M	6.0L V8 5967cc 364 CID	2005	(U), GAS, Naturally Aspirated; Exc.Commercial Chassis (Exc.EVAP Emissions)	USEP3604M
6.0L V8 5967cc 364 CID	2009-2010		USEP3818M	6.0L V8 5967cc 364 CID	2005	(U), GAS, Naturally Aspirated; Commercial Chassis (EVAP Emissions)	USEP3616M
8.1L V8 496 CID	2001-2003	electrical connections: 2, Evaporative Emissions Control	USEP3500M	6.0L V8 5967cc 364 CID	2005	(U), GAS, Naturally Aspirated; Commercial Chassis (Exc.EVAP Emissions)	USEP3616M
8.1L V8 496 CID	2001-2003	electrical connections: 1, Exc.Evaporative Emissions Control 143.5 / 364.5 Wheel Base, GAS; In Tank Assy.(Incl.Fuel Tank Sending Unit), Wheelbase 143.5" (EVAP Emissions)	USEP3501M	6.0L V8 5967cc 364 CID	2005	(U), GAS, Naturally Aspirated; Commercial Chassis (EVAP Emissions), Secondary Fuel Tank(Incl.Sender)	USEP3617M
8.1L V8 496 CID	2004	78.0 / 198.1 Bed, GAS; Bed Length 78", In Tank Assy.(Incl.Fuel Tank Sending Unit)(Electrical Connector Qty.2)	USEP3609M	6.0L V8 5967cc 364 CID	2006	SL, SLE, SLT, WT; (U), GAS, Naturally Aspirated; Exc.Commercial Chassis (Exc.EVAP Emissions)	USEP3604M
8.1L V8 496 CID	2004-2006	96.0 / 243.8 Bed, GAS	USEP3831M	6.0L V8 5967cc 364 CID	2006	SL, SLE, SLT, WT; (U), GAS, Naturally Aspirated; Commercial Chassis (EVAP Emissions)	USEP3616M
8.1L V8 496 CID	2004-2006	157.5 / 400.1 Wheel Base, GAS; Evaporative Emissions Control	USEP3831M	6.0L V8 5967cc 364 CID	2006	SL, SLE, SLT, WT; (U), GAS, Naturally Aspirated; Commercial Chassis (Exc.EVAP Emissions)	USEP3616M
8.1L V8 496 CID	2004-2006	167.0 / 424.2 Wheel Base, GAS; Evaporative Emissions Control	USEP3831M	6.0L V8 5967cc 364 CID	2006	SL, SLE, SLT, WT; (U), GAS, Naturally Aspirated; Commercial Chassis (EVAP Emissions), Secondary Fuel Tank(Incl.Sender)	USEP3617M
8.1L V8 496 CID	2005	143.5 / 364.5 Wheel Base, GAS; In Tank Assy.(Exc.Fuel Tank Sending Unit), Wheelbase 143.5" (EVAP Emissions)	USEP3609M	6.0L V8 5967cc 364 CID	2006	GAS	USEP3831M
8.1L V8 496 CID	2005-2006	133.0 / 337.8 Wheel Base, GAS; Evaporative Emissions Control	USEP3831M	6.6L V8 6599cc 403 CID	2005	(2), DIESEL, Turbocharged; Exc.Commercial Chassis	USEP3599M
<b>SIERRA 2500 HD CLASSIC</b>				8.1L V8 496 CID	2001	electrical connections: 2, Exc.Commercial Chassis (Evaporative Emissions Control)	USEP3500M
6.0L V8 5967cc 364 CID	2007	78.0 / 198.1 Bed, GAS; Bed Length 78", In Tank Assy.(Incl.Fuel Tank Sending Unit)(Electrical Connector Qty.2)	USEP3609M	8.1L V8 496 CID	2001	electrical connections: 1, Exc.Commercial Chassis (Exc.Evaporative Emissions Control)	USEP3501M
6.0L V8 5967cc 364 CID	2007	143.5 / 364.5 Wheel Base, GAS; In Tank Assy.(Exc.Fuel Tank Sending Unit), Wheelbase 143.5" (EVAP Emissions)	USEP3609M	8.1L V8 496 CID	2001-2003	(G), GAS, Naturally Aspirated; Commercial Chassis (Calif), Primary Fuel Tank	USEP3522M
6.0L V8 5967cc 364 CID	2007	153.0 / 388.6 Wheel Base, GAS; In Tank Assy.(Incl.Fuel Tank Sending Unit), Wheelbase 153" (EVAP Emissions)	USEP3609M	8.1L V8 496 CID	2001-2003	(G), GAS, Naturally Aspirated; Commercial chassis, Secondary Fuel Tank	USEP3530M
6.0L V8 5967cc 364 CID	2007	96.0 / 243.8 Bed, GAS	USEP3831M	8.1L V8 496 CID	2001-2003	(G), GAS, Naturally Aspirated; Commercial Chassis (Federal), Primary Fuel Tank	USEP3599M
6.0L V8 5967cc 364 CID	2007	133.0 / 337.8 Wheel Base, GAS; Evaporative Emissions Control	USEP3831M	8.1L V8 496 CID	2002-2003	electrical connections: 2, Exc.Commercial Chassis (Calif)	USEP3500M
6.0L V8 5967cc 364 CID	2007	157.5 / 400.1 Wheel Base, GAS; Evaporative Emissions Control	USEP3831M	8.1L V8 496 CID	2002-2003	electrical connections: 1, Exc.Commercial Chassis (Federal)	USEP3501M
6.0L V8 5967cc 364 CID	2007	167.0 / 424.2 Wheel Base, GAS; Evaporative Emissions Control	USEP3831M	8.1L V8 496 CID	2004-2005	(G), GAS, Naturally Aspirated; Exc.Commercial Chassis (Exc.EVAP Emissions)	USEP3604M
8.1L V8 496 CID	2007	78.0 / 198.1 Bed, GAS; Bed Length 78", In Tank Assy.(Incl.Fuel Tank Sending Unit)(Electrical Connector Qty.2)	USEP3609M	8.1L V8 496 CID	2004-2005	(G), GAS, Naturally Aspirated; Commercial chassis, Secondary Fuel Tank(Incl.Sender)	USEP3617M
8.1L V8 496 CID	2007	143.5 / 364.5 Wheel Base, GAS; In Tank Assy.(Exc.Fuel Tank Sending Unit), Wheelbase 143.5" (EVAP Emissions)	USEP3609M	8.1L V8 496 CID	2004-2006	GAS; Evaporative Emissions Control, Exc.Commercial Chassis	USEP3831M
8.1L V8 496 CID	2007	153.0 / 388.6 Wheel Base, GAS; In Tank Assy.(Exc.Fuel Tank Sending Unit), Wheelbase 153" (EVAP Emissions)	USEP3609M	8.1L V8 496 CID	2004-2006	GAS; Exc.Cab & Chassis	USEP3831M
8.1L V8 496 CID	2007	96.0 / 243.8 Bed, GAS	USEP3831M	8.1L V8 496 CID	2005	(G), GAS, Naturally Aspirated; Commercial Chassis (EVAP Emissions)	USEP3616M



Engine	Years	Application Description	USMW	Engine	Years	Application Description	USMW
<b>GMC (cont'd.)</b>				<b>GMC (cont'd.)</b>			
<b>SIERRA 3500 (cont'd.)</b>				<b>YUKON (cont'd.)</b>			
8.1L V8 496 CID	2005	(G), GAS, Naturally Aspirated; Commercial Chassis (Exc.EVAP Emissions)	USEP3616M	5.3L V8 5328cc 325 CID	2004-2007		USEP3581M
8.1L V8 496 CID	2006	SL, SLE, SLT, WT; (G), GAS, Naturally Aspirated; Exc.Commercial Chassis (Exc.EVAP Emissions)	USEP3604M	5.3L V8 5328cc 325 CID	2004-2007	GAS	USEP3581M
8.1L V8 496 CID	2006	SL, SLE, SLT, WT; (G), GAS, Naturally Aspirated; Commercial Chassis (EVAP Emissions)	USEP3616M	5.3L V8 5328cc 325 CID	2005	SLE, SLT; (L59), (Z), FLEX	USEP3705M
8.1L V8 496 CID	2006	SL, SLE, SLT, WT; (G), GAS, Naturally Aspirated; Commercial Chassis (Exc.EVAP Emissions)	USEP3616M	5.3L V8 5328cc 325 CID	2005-2007	FLEX	USEP3705M
8.1L V8 496 CID	2006	SL, SLE, SLT, WT; (G), GAS, Naturally Aspirated; Commercial chassis, Secondary Fuel Tank(Incl.Sender)	USEP3617M	5.3L V8 5328cc 325 CID	2006	SL, SLE, SLT; (L59), (Z), FLEX	USEP3705M
8.1L V8 496 CID	2006	GAS	USEP3831M	5.3L V8 5328cc 325 CID	2007	SLE, SLT; (0), (LMG), FLEX	USEP3705M
<b>SIERRA 3500 CLASSIC</b>				<b>YUKON XL 1500</b>			
6.0L V8 5967cc 364 CID	2007	GAS; Evaporative Emissions Control, Exc.Commercial Chassis	USEP3831M	5.3L V8 5328cc 325 CID	2005	SLE, SLT; (Z), FLEX	USEP3705M
6.0L V8 5967cc 364 CID	2007	GAS; Exc.Cab & Chassis	USEP3831M	5.3L V8 5328cc 325 CID	2000-2001		USEP3509M
8.1L V8 496 CID	2007	GAS; Evaporative Emissions Control, Exc.Commercial Chassis	USEP3831M	5.3L V8 5328cc 325 CID	2002-2003		USEP3556M
8.1L V8 496 CID	2007	GAS; Exc.Cab & Chassis	USEP3831M	5.3L V8 5328cc 325 CID	2002-2003		USEP3586M
<b>SIERRA 3500 HD</b>				<b>YUKON XL 2500</b>			
6.0L V8 5967cc 364 CID	2007-2008		USEP3750M	5.3L V8 5328cc 325 CID	2000-2004	FLEX	USEP3560M
6.0L V8 5967cc 364 CID	2009-2010		USEP3818M	5.3L V8 5328cc 325 CID	2005	GAS	USEP3610M
<b>SONOMA</b>				<b>YUKON XL 2500</b>			
2.2L L4 2190cc 134 CID	1994-1995		USEP3566M	5.3L V8 5328cc 325 CID	2005-2007	FLEX	USEP3706M
2.2L L4 2190cc 134 CID	1996		USEP3641S	5.3L V8 5328cc 325 CID	2007	GAS	USEP3610M
2.2L L4 2190cc 134 CID	1997-1999	(4)	USEP3923M	5.3L V8 5328cc 325 CID	2008-2014		USEP3797M
2.2L L4 2190cc 134 CID	2000	(4), GAS	USEP3943M	6.0L V8 5967cc 364 CID	2001		USEP3509M
2.2L L4 2190cc 134 CID	2000-2002	(5), FLEX	USEP3943M	6.0L V8 5967cc 364 CID	2002-2003		USEP3556M
2.2L L4 2190cc 134 CID	2003	(H)	USEP3527M	6.0L V8 5967cc 364 CID	2005-2007	GAS	USEP3610M
2.5L L4 2474cc 151 CID	1991	Base, SLE	USEP3703M	6.2L V8 6162cc 376 CID	2007	GAS	USEP3610M
2.5L L4 2474cc 151 CID	1992-1993	20 gallon fuel tank	USEP3637S	6.2L V8 6162cc 376 CID	2009-2014		USEP3797M
2.5L L4 2474cc 151 CID	1992-1993	13 Gallon Fuel Tank	USEP3642S	<b>YUKON XL 2500</b>			
2.8L V6 173 CID	1991	Base, SLE	USEP3648S		2000	Primary Fuel Tank	USEP3510M
2.8L V6 173 CID	1992-1993	20 gallon fuel tank	USEP3637S		2000	Evaporative Emissions Control, Secondary Fuel Tank	USEP3512M
2.8L V6 173 CID	1992-1993	13 Gallon Fuel Tank	USEP3642S		2000	Exc.Evaporative Emissions Control, Secondary Fuel Tank	USEP3513M
4.3L V6 262 CID	1991	Base, SLE	USEP3648S	6.0L V8 5967cc 364 CID	2001	(U); Primary Fuel Tank	USEP3510M
4.3L V6 262 CID	1992-1993	20 gallon fuel tank	USEP3637S	6.0L V8 5967cc 364 CID	2001	(U); Evaporative Emissions Control, Secondary Fuel Tank	USEP3512M
4.3L V6 262 CID	1995	MF1	USEP3642S	6.0L V8 5967cc 364 CID	2001	(U); Exc.Evaporative Emissions Control, Secondary Fuel Tank	USEP3513M
4.3L V6 262 CID	1996	(W)	USEP3643S	6.0L V8 5967cc 364 CID	2002-2003	1 electrical connector, Exc.Evaporative Emissions Control, Secondary Fuel Tank	USEP3553M
4.3L V6 262 CID	1996	(X)	USEP3920M	6.0L V8 5967cc 364 CID	2002-2003	except Export, Primary Fuel Tank	USEP3554M
4.3L V6 262 CID	1997-1999	(W)	USEP3920M	6.0L V8 5967cc 364 CID	2002-2003	Evaporative Emissions Control, Secondary Fuel Tank, with 2 electrical connectors	USEP3555M
4.3L V6 262 CID	1997-1999	(X)	USEP3952M	6.0L V8 5967cc 364 CID	2002-2003	export, Robust fuel system unit	USEP3594M
4.3L V6 262 CID	2000-2001	(W), GAS	USEP3952M	6.0L V8 5967cc 364 CID	2004-2007	Rear tank	USEP3587M
4.3L V6 262 CID	2002	(W), GAS	USEP3563M	6.0L V8 5967cc 364 CID	2004-2007	Front tank	USEP3675M
4.3L V6 262 CID	2003	(X), Extended Cab Pickup	USEP3563M	6.0L V8 5967cc 364 CID	2008-2013		USEP3814M
4.3L V6 262 CID	2003	(X), Standard Cab Pickup	USEP3563M	8.1L V8 496 CID	2001	(G); Primary Fuel Tank	USEP3510M
4.3L V6 262 CID	2003	(X), Crew Cab Pickup	USEP3566M	8.1L V8 496 CID	2001	(G); Evaporative Emissions Control, Secondary Fuel Tank	USEP3512M
<b>TERRAIN</b>				<b>HONDA</b>			
2.4L L4 2384cc 145 CID	2010-2017	RIGHT	USEP3840M	<b>ACCORD</b>			
<b>TYPHOON</b>					1994	DX; (F22B2)	USEP8351H
4.3L V6 262 CID	1992-1993	Base; Electronic Fuel Control, FI, GAS	USEP3625S		1994	EX; (F22B1); Japan Built	USEP8351H
<b>V1500</b>					1994	EX; (F22B1); USA Built	USEP8351H
4.3L V6 262 CID	1987	harness code VEE or VEV	USEP3631S		1994	LX; (F22B2); Japan Built	USEP8351H
5.7L V8 350 CID	1987	harness code VEE or VEV	USEP3631S		1994	LX; (F22B2); USA Built	USEP8351H
<b>V1500 SUBURBAN</b>					1986-1989	CARB	USEP8269H
5.7L V8 350 CID	1988		USEP3633S		1986-1989	FI	USEP8324H
5.7L V8 350 CID	1989-1991	with 31 gallon tank	USEP3633S		1990-1993		USEP8322H
<b>V2500</b>					1995		USEP8339H
5.7L V8 350 CID	1987	harness code VEE or VEV	USEP3631S		2003-2007	not california	USEP8656M
<b>V2500 SUBURBAN</b>					2008-2012		USEP8922M
5.7L V8 350 CID	1988-1991	with 31 gallon tank	USEP3633S		2003-2007		USEP8693M
<b>YUKON</b>					2008-2012		USEP8923M
	1998	Radio Frequency Interference Filter	USEP3534M		3.5L V6 3471cc		
	1998	Exc.Radio Frequency Interference Filter	USEP3972M	<b>ACCORD CROSSTOUR</b>			
	1999	SLE, SLT; Radio Frequency Interference Filter	USEP3534M	3.5L V6 3471cc	2010-2011		USEP8923M
	1999	SLE, SLT; Exc.Radio Frequency Interference Filter	USEP3972M				
4.8L V8 294 CID	2000	SLE, SLT; (V)	USEP3508M				
4.8L V8 294 CID	2001	(V)	USEP3508M				
4.8L V8 294 CID	2002-2003	(V), GAS	USEP3508M				
4.8L V8 294 CID	2004	(V), GAS	USEP3581M				
4.8L V8 294 CID	2004-2007		USEP3581M				
4.8L V8 294 CID	2004-2007	GAS	USEP3581M				
5.3L V8 5328cc 325 CID	2000-2003	GAS	USEP3508M				
5.3L V8 5328cc 325 CID	2002-2004	FLEX	USEP3559M				



# FUEL PUMP MODULES APPLICATION GUIDE



FUEL PUMP MODULES

Engine	Years	Application Description	USMW
<b>HONDA (cont'd.)</b>			
<b>CIVIC</b>			
1.3L L4 1339cc	2003-2004	Hybrid; (LDA1), ELECTRIC/GAS; Federal	USEP8566M
1.3L L4 1339cc	2005		USEP8566M
1.5L L4 1493cc	1988	Base, Wagon; Wagon	USEP8325H
1.5L L4 1493cc	1988	Base; Hatchback	USEP8325H
1.5L L4 1493cc	1988	DX, LX; (D15B2), Sedan	USEP8325H
1.5L L4 1493cc	1988	DX; (D15B2), Hatchback	USEP8325H
1.5L L4 1493cc	1989	(Canada Built Vehicle)	USEP8321H
1.5L L4 1493cc	1990	Base; Wagon	USEP8325H
1.5L L4 1493cc	1990-1991	Base; Hatchback	USEP8325H
1.5L L4 1493cc	1990-1991	DX, LX; (D15B2), Sedan	USEP8325H
1.5L L4 1493cc	1990-1991	DX; (D15B2), Hatchback	USEP8325H
1.5L L4 1493cc	1991	DX; (D15B2), Wagon	USEP8325H
1.5L L4 1493cc	1992		USEP8338H
1.5L L4 1493cc	1993	(USA Built)	USEP8338H
1.5L L4 1493cc	1994-1995		USEP8338H
1.6L L4 1588cc 98 CID	1989		USEP8321H
1.6L L4 1588cc 98 CID	1990-1991	EX, Si; (D16A6)	USEP8325H
1.6L L4 1588cc 98 CID	1992-1995		USEP8338H
1.6L L4 1588cc 98 CID	1996-1997	(D16Y7)	USEP8341H
1.6L L4 1588cc 98 CID	1996-1997	(D16Y8)	USEP8341H
1.6L L4 1590cc	1996-1997	(D16Y5)	USEP8341H
1.7L L4 1668cc	2005		USEP8566M
1.7L L4 1700cc	2004	DX, LX; (D17A1), 4 Doors, GAS; (Exc.Canada Built Vehicle)	USEP8566M
1.7L L4 1700cc	2004	EX; (D17A2), 4 Doors, GAS; (Exc.Canada Built Vehicle)	USEP8566M
1.8L L4 1799cc	2006-2011		USEP8723M
2.0L L4 1998cc 122 CID	2002		USEP8566M
2.0L L4 1998cc 122 CID	2005		USEP8566M
<b>CROSSTOUR</b>			
2.4L L4 2354cc 144 CID	2012		USEP8922M
3.5L V6 3471cc	2012		USEP8923M
<b>CR-V</b>			
	2000	EX, LX, SE	USEP8461S
2.0L L4 1972cc	1997-1998		USEP8460S
2.4L L4 2354cc 144 CID	2005-2006		USEP8655M
2.4L L4 2354cc 144 CID	2007-2011		USEP8859M
<b>CRX</b>			
1.5L L4 1493cc	1989		USEP8321H
1.5L L4 1493cc	1990-1991	Base; (D15B2)	USEP8325H
1.5L L4 1493cc	1990-1991	HF; (D15B6)	USEP8325H
1.6L L4 1588cc 98 CID	1989	From Chassis/VIN KS021547	USEP8321H
1.6L L4 1588cc 98 CID	1990-1991	Si; (D16A6)	USEP8325H
<b>ELEMENT</b>			
2.4L L4 2354cc 144 CID	2003-2011		USEP8654M
<b>FIT</b>			
1.5L L4 1496cc 91 CID	2010-2013		USEP8943M
1.5L L4 1497cc	2009-2013		USEP8943M
<b>ODYSSEY</b>			
3.5L V6 3471cc	2000		USEP8642M
3.5L V6 3471cc	2005-2010		USEP8692M
3.5L V6 3474cc	1999-2004		USEP8642M
<b>PASSPORT</b>			
	1998-2000	EX, LX	USEP8397M
2.6L L4 2559cc	1994		USEP8078H
2.6L L4 2559cc	1995	From 05/95	USEP8078H
2.6L L4 2559cc	1995	To 04/95	USEP8078H
3.2L V6 3165cc	2001		USEP8721M
3.2L V6 3165cc	2002	EX, LX	USEP8483M
<b>PILOT</b>			
3.5L V6 3471cc	2005-2008		USEP8657M
3.5L V6 3471cc	2009-2011		USEP8792M
3.5L V6 3471cc	2014-2015		USEP8792M
3.5L V6 3475cc	2003-2004		USEP8720M
<b>PRELUDE</b>			
	1988-1989	2.0 Si, 2.0 Si 4WS; (B20A5), FI	USEP8328H
	1997	Base, Type SH; Calif	USEP8365H
	1997	Base, Type SH; Exc.Calif	USEP8365H
	1988-1990	CARB	USEP8269H
2.0L L4 1958cc	1990	2.0 Si; (B20A5), FI	USEP8328H
2.0L L4 1958cc	1991	2.0 Si; (B20A5)	USEP8328H
2.1L L4 2056cc	1990	Si, Si 4WS, Si ALB; (B21A1), FI	USEP8328H
2.1L L4 2056cc	1991	Si, Si 4WS, Si ALB; (B21A1)	USEP8328H
2.2L L4 2156cc	1997-2001		USEP8372H
<b>RIDGELINE</b>			
3.5L V6 3471cc	2006-2014		USEP8717M

Engine	Years	Application Description	USMW
<b>HUMMER</b>			
<b>H2</b>			
6.0L V8 5967cc 364 CID	2003		USEP3558M
6.0L V8 5967cc 364 CID	2004-2007		USEP3689M
<b>H3</b>			
3.5L L5 3460cc 211 CID	2006		USEP3724M
3.7L L5 3654cc 223 CID	2007-2008		USEP3724M
5.3L V8 5328cc 325 CID	2008		USEP3724M
<b>HYUNDAI</b>			
<b>ACCENT</b>			
1.5L L4 1495cc	2000-2002		USEP8994M
1.6L L4 1599cc	2006-2011		USEP8730M
1.6L L4 1600cc	2001-2002		USEP8994M
1.6L L4 1600cc	2006		USEP8730M
<b>ELANTRA</b>			
1.8L L4 1797cc	2011-2014		USEP9073M
2.0L L4 1975cc	2001		USEP8527M
2.0L L4 1975cc	2002		USEP8737M
<b>SANTA FE</b>			
2.4L L4 2351cc	2004	Base	USEP8662M
2.7L V6 2656cc	2004-2005		USEP8663M
2.7L V6 2656cc	2007-2009		USEP8821M
3.3L V6 3342cc	2007-2009		USEP8821M
3.5L V6 3500cc	2003-2005	LX	USEP8662M
<b>SONATA</b>			
2.4L L4 2351cc	2001		USEP8519M
2.4L L4 2351cc	2002-2005		USEP8637M
2.4L L4 2359cc	2006-2007		USEP8903M
2.4L L4 2359cc	2011		USEP9036M
2.4L L4 2359cc	2012-2013	ELECTRIC/GAS; HYBRID	USEP9122M
2.4L L4 2359cc	2012-2014	GAS	USEP9120M
3.3L V6 3342cc	2006-2010		USEP8903M
<b>TIBURON</b>			
2.0L L4 1975cc	2007-2008		USEP8736M
2.7L V6 2656cc	2003-2004	GT	USEP8529M
2.7L V6 2656cc	2005-2008		USEP8736M
<b>TUCSON</b>			
2.0L L4 1975cc	2005-2009		USEP8677M
2.7L V6 2656cc	2005-2009		USEP8677M
<b>INFINITI</b>			
<b>FX35</b>			
	2003-2008		USEP8540M
<b>FX45</b>			
4.5L V8 4494cc	2006-2008		USEP8538M
4.5L V8 4500cc	2003-2005		USEP8538M
<b>G25</b>			
2.5L V6 2496cc 152 CID	2011-2012		USEP8928M
<b>G35</b>			
3.5L V6 3498cc	2004-2006	Coupe	USEP8534M
3.5L V6 3498cc	2007-2008		USEP8976M
<b>G37</b>			
3.7L V6 3696cc	2009-2013		USEP8928M
3.7L V6 3696cc 226 CID	2012-2013		USEP8928M
<b>M35</b>			
3.5L V6 3498cc	2006-2008		USEP8534M
3.5L V6 3498cc	2009-2010		USEP8928M
<b>M45</b>			
4.5L V8 4494cc	2006-2008		USEP8534M
4.5L V8 4494cc	2009-2010		USEP8928M
<b>Q40</b>			
3.7L V6 3696cc	2015		USEP8928M
<b>Q60</b>			
3.7L V6 3696cc	2014-2015		USEP8928M
3.7L V6 3696cc 226 CID	2014-2015		USEP8928M
<b>QX56</b>			
5.6L V8 5552cc	2004		USEP8595M
5.6L V8 5552cc	2005	To 02/05	USEP8595M
5.6L V8 5552cc	2006		USEP8595M
5.6L V8 5552cc	2007-2010		USEP8788M
<b>ISUZU</b>			
<b>AMIGO</b>			
2.2L L4 2180cc	1999-2000		USEP8400M
2.6L L4 2559cc	1989-1994		USEP8078H
3.2L V6 3165cc	1999-2000		USEP8400M



# FUEL PUMP MODULES APPLICATION GUIDE



Engine	Years	Application Description	USMW
<b>ISUZU (cont'd.)</b>			
<b>ASCENDER</b>			
4.2L L6 256 CID	2003-2004	This Module uses an internal strainer design and may look different from your original Unit	<b>USEP3549M</b>
4.2L L6 256 CID	2005-2007		
4.2L L6 256 CID	2008		
5.3L V8 5328cc 325 CID	2003-2004		
5.3L V8 5328cc 325 CID	2005-2006		
<b>AXIOM</b>			
3.5L V6 3475cc	2002	From 11/01	<b>USEP8483M</b>
3.5L V6 3475cc	2002	To 10/01	<b>USEP8721M</b>
3.5L V6 3491cc	2003		<b>USEP8483M</b>
<b>HOMBRE</b>			
2.2L L4 2190cc 134 CID	1996		<b>USEP3923M</b>
2.2L L4 2190cc 134 CID	1997-2000	(4)	<b>USEP3943M</b>
4.3L V6 4294cc	1997-1999	(X)	<b>USEP3952M</b>
<b>IMPULSE</b>			
1.6L L4 1588cc	1990		<b>USEP8275H</b>
1.6L L4 1588cc	1991	Naturally Aspirated	<b>USEP8275H</b>
1.6L L4 1588cc	1991-1992	Turbocharged	<b>USEP8275H</b>
1.8L L4 1809cc 110 CID	1992	Naturally Aspirated	<b>USEP8275H</b>
2.0L L4 1994cc	1985-1989	(F), Turbocharged	<b>USEP8051H</b>
2.3L L4 2254cc	1988-1989	(L), Naturally Aspirated	<b>USEP8051H</b>
<b>NPR</b>			
5.7L V8 350 CID	1998-2002	Except Calif.	<b>USEP8842M</b>
5.7L V8 350 CID	1998-2002	With California emissions	<b>USEP8843M</b>
6.0L V8 5967cc 364 CID	2003-2004	Except Calif.	<b>USEP8842M</b>
6.0L V8 5967cc 364 CID	2003-2004	With California emissions	<b>USEP8843M</b>
<b>NPR-HD</b>			
5.7L V8 350 CID	1999-2002	Except Calif.	<b>USEP8842M</b>
5.7L V8 350 CID	1999-2002	With California emissions	<b>USEP8843M</b>
6.0L V8 5967cc 364 CID	2003-2004	Except Calif.	<b>USEP8842M</b>
6.0L V8 5967cc 364 CID	2003-2004	With California emissions	<b>USEP8843M</b>
<b>PICKUP</b>			
2.3L L4 2254cc	1995		<b>USEP8078H</b>
2.6L L4 2559cc	1988-1989		<b>USEP8078H</b>
2.6L L4 2559cc	1990	From 04/90	<b>USEP8078H</b>
2.6L L4 2559cc	1991-1992		<b>USEP8078H</b>
2.6L L4 2559cc	1993	From 06/93 (Japan Built)	<b>USEP8078H</b>
2.6L L4 2559cc	1994	From 02/94	<b>USEP8078H</b>
2.6L L4 2559cc	1995		<b>USEP8078H</b>
<b>RODEO</b>			
2.2L L4 2180cc	1998	(X22SE); From 04/98	<b>USEP8397M</b>
2.2L L4 2180cc	1998	(X22SE); To 03/98	<b>USEP8397M</b>
2.2L L4 2180cc	2000	(X22SE)	<b>USEP8397M</b>
2.2L L4 2180cc	2001		<b>USEP8721M</b>
2.2L L4 2180cc	2002-2003	S; (D), (X22SE)	<b>USEP8486M</b>
2.6L L4 2559cc	1991-1994		<b>USEP8078H</b>
2.6L L4 2559cc	1995	From 04/95	<b>USEP8078H</b>
3.1L V6 3137cc	1991-1992	(Z)	<b>USEP8205H</b>
3.2L V6 3165cc	1997	(V); From 07/97	<b>USEP8397M</b>
3.2L V6 3165cc	1998	(6VD1); From 04/98 (To 05/98)	<b>USEP8397M</b>
3.2L V6 3165cc	1998	(6VD1); From 05/98	<b>USEP8397M</b>
3.2L V6 3165cc	1998	(6VD1); To 03/98	<b>USEP8397M</b>
3.2L V6 3165cc	1999-2000	(6VD1)	<b>USEP8397M</b>
3.2L V6 3165cc	2001		<b>USEP8721M</b>
3.2L V6 3165cc	2002-2003	S V6; (6VD1), (W)	<b>USEP8483M</b>
3.2L V6 3165cc	2004	(6VD1), (W)	<b>USEP8483M</b>
3.5L V6 3494cc	2004	(6VE1), (Y)	<b>USEP8483M</b>
<b>RODEO SPORT</b>			
2.2L L4 2180cc	2002-2003	S; (D), (X22SE)	<b>USEP8484M</b>
3.2L V6 3165cc	2001		<b>USEP8721M</b>
3.2L V6 3165cc	2002-2003	S V6; (6VD1), (W)	<b>USEP8484M</b>
<b>STYLUS</b>			
1.6L L4 1588cc	1991-1993		<b>USEP8275H</b>
1.8L L4 1809cc 110 CID	1992		<b>USEP8275H</b>
<b>TROOPER</b>			
2.6L L4 2559cc	1988-1991		<b>USEP8078H</b>
2.8L V6 2827cc	1989-1991	(R)	<b>USEP8205H</b>
3.2L V6 3165cc	1992-1993		<b>USEP8078H</b>
<b>JAGUAR</b>			
<b>X-TYPE</b>			
2.5L V6 152 CID	2002-2003		<b>USEP8576M</b>
3.0L V6 2968cc 181 CID	2002-2003		<b>USEP8576M</b>
<b>JEEP</b>			
<b>CHEROKEE</b>			
2.5L L4 150 CID	1991-1993	Base; (P)	<b>USEP7072S</b>
2.5L L4 150 CID	1994-1996		<b>USEP7125S</b>

Engine	Years	Application Description	USMW
<b>JEEP (cont'd.)</b>			
<b>CHEROKEE (cont'd.)</b>			
2.5L L4 150 CID	1997-2000		<b>USEP7121M</b>
4.0L L6 242 CID	1987-1988	Base, Chief, Laredo, Limited, Pioneer; Electronic Fuel Control, FI, GAS	<b>USEP7091S</b>
4.0L L6 242 CID	1989-1990	Base, Laredo, Limited, Pioneer, Sport; Electronic Fuel Control, FI, GAS	<b>USEP7091S</b>
4.0L L6 242 CID	1991-1992	Base, Briarwood, Laredo, Limited, Sport; (S)	<b>USEP7072S</b>
4.0L L6 242 CID	1993	Base, Country, Sport; (S)	<b>USEP7072S</b>
4.0L L6 242 CID	1994-1996		<b>USEP7125S</b>
4.0L L6 242 CID	1997-2001		<b>USEP7121M</b>
<b>COMANCHE</b>			
2.5L L4 150 CID	1991	Base, Pioneer; (P)	<b>USEP7072S</b>
2.5L L4 150 CID	1992	Base; (P)	<b>USEP7072S</b>
4.0L L6 242 CID	1987	Base, Chief, Laredo, Pioneer; (M), GAS, Naturally Aspirated	<b>USEP7072S</b>
4.0L L6 242 CID	1988	Chief, Eliminator, Laredo, Pioneer; (M)	<b>USEP7072S</b>
4.0L L6 242 CID	1989-1990	Base, Eliminator, Pioneer; (L)	<b>USEP7072S</b>
4.0L L6 242 CID	1991-1992	Base, Eliminator, Pioneer; (S)	<b>USEP7072S</b>
<b>COMMANDER</b>			
3.7L V6 226 CID	2006	65th Anniversary Edition; (K)	<b>USEP7197M</b>
3.7L V6 226 CID	2007	Base; (K), GAS	<b>USEP7197M</b>
3.7L V6 226 CID	2008-2009	Sport; (K), GAS	<b>USEP7197M</b>
4.7L V8 287 CID	2006	65th Anniversary Edition, Limited; (N)	<b>USEP7197M</b>
4.7L V8 287 CID	2007	Base, Limited; (N), GAS	<b>USEP7197M</b>
4.7L V8 287 CID	2007	Base, Limited; (P), FLEX	<b>USEP7197M</b>
4.7L V8 287 CID	2008	Limited, Sport; (N), FLEX	<b>USEP7197M</b>
4.7L V8 287 CID	2008-2009	Limited, Sport; (N), GAS	<b>USEP7197M</b>
4.7L V8 287 CID	2009	Limited, Sport; (P), FLEX	<b>USEP7197M</b>
5.7L V8 345 CID	2006	Limited; (2)	<b>USEP7197M</b>
5.7L V8 345 CID	2007-2008	Limited, Overland; (2), GAS	<b>USEP7197M</b>
5.7L V8 345 CID	2009	Limited, Overland; (EZD), (T), GAS	<b>USEP7197M</b>
<b>COMPASS</b>			
2.0L L4 1998cc 122 CID	2007	Base; FWD	<b>USEP7220M</b>
2.0L L4 1998cc 122 CID	2007-2016	4WD	<b>USEP7218M</b>
2.0L L4 1998cc 122 CID	2008	Sport; FWD	<b>USEP7220M</b>
2.0L L4 1998cc 122 CID	2009	Sport; (A), (ECN), FWD	<b>USEP7220M</b>
2.0L L4 1998cc 122 CID	2010-2011	(A), (ECN), FWD	<b>USEP7220M</b>
2.4L L4 2360cc 144 CID	2007	Base, Limited; (W), FWD	<b>USEP7220M</b>
2.4L L4 2360cc 144 CID	2007-2016	4WD	<b>USEP7218M</b>
2.4L L4 2360cc 144 CID	2008	Limited, Sport; (W), FWD	<b>USEP7220M</b>
2.4L L4 2360cc 144 CID	2009	Limited, Sport; (B), (ED3), FWD	<b>USEP7220M</b>
2.4L L4 2360cc 144 CID	2009	Limited, Sport; (B), (EDG), FWD	<b>USEP7220M</b>
2.4L L4 2360cc 144 CID	2010-2016	(B), (ED3), FWD	<b>USEP7220M</b>
<b>GRAND CHEROKEE</b>			
3.6L V6 3604cc 220 CID	2011-2014		<b>USEP7271M</b>
3.7L V6 226 CID	2005	Laredo; (K)	<b>USEP7197M</b>
3.7L V6 226 CID	2006	65th Anniversary Edition, Laredo; (K)	<b>USEP7197M</b>
3.7L V6 226 CID	2007	Laredo; (K), GAS, Naturally Aspirated	<b>USEP7197M</b>
3.7L V6 226 CID	2009	Laredo; (K), GAS, Naturally Aspirated	<b>USEP7197M</b>
4.0L L6 242 CID	1993	Base, Laredo, Limited; (S)	<b>USEP7055M</b>
4.0L L6 242 CID	1994	Laredo, Limited, SE; (S)	<b>USEP7055M</b>
4.0L L6 242 CID	1995	Laredo, Limited, Orvis, SE; (S)	<b>USEP7087M</b>
4.0L L6 242 CID	1996	Laredo, Limited; (S)	<b>USEP7099M</b>
4.0L L6 242 CID	1997	Laredo, Limited, Orvis, TSi; (S)	<b>USEP7103M</b>
4.0L L6 242 CID	1998	Laredo, Limited, TSi; (S)	<b>USEP7103M</b>
4.0L L6 242 CID	1999-2001	Laredo, Limited; (S)	<b>USEP7127M</b>
4.0L L6 242 CID	2002	Laredo, Limited, Sport; (S)	<b>USEP7127M</b>
4.0L L6 242 CID	2003	Laredo, Limited; (S)	<b>USEP7127M</b>
4.0L L6 242 CID	2004	Laredo, Limited, Special Edition; (S)	<b>USEP7127M</b>
4.7L V8 287 CID	1999-2001	Laredo, Limited; (N)	<b>USEP7127M</b>
4.7L V8 287 CID	2002	Laredo, Limited, Sport; (N)	<b>USEP7127M</b>
4.7L V8 287 CID	2002-2003	Limited, Overland; (J)	<b>USEP7127M</b>
4.7L V8 287 CID	2003	Laredo, Limited; (N)	<b>USEP7127M</b>
4.7L V8 287 CID	2004	Laredo, Limited, Overland; (J)	<b>USEP7127M</b>
4.7L V8 287 CID	2004	Laredo, Limited, Special Edition; (N)	<b>USEP7127M</b>
4.7L V8 287 CID	2005	Laredo, Limited; (N)	<b>USEP7197M</b>
4.7L V8 287 CID	2006	65th Anniversary Edition, Laredo, Limited; (N)	<b>USEP7197M</b>
4.7L V8 287 CID	2007	Laredo, Limited; (N), GAS, Naturally Aspirated	<b>USEP7197M</b>
4.7L V8 287 CID	2007	Laredo, Limited; (P), FLEX, Naturally Aspirated	<b>USEP7197M</b>
4.7L V8 287 CID	2009	Laredo, Limited; (P), FLEX, Naturally Aspirated	<b>USEP7197M</b>
5.2L V8 5211cc 318 CID	1993	Base, Laredo, Limited; (Y)	<b>USEP7055M</b>
5.2L V8 5211cc 318 CID	1994	Laredo, Limited, SE; (Y)	<b>USEP7055M</b>
5.2L V8 5211cc 318 CID	1995	Laredo, Limited, Orvis, SE; (Y)	<b>USEP7087M</b>
5.2L V8 5211cc 318 CID	1996	Laredo, Limited; (Y)	<b>USEP7099M</b>
5.2L V8 5211cc 318 CID	1997	Laredo, Limited, Orvis, TSi; (Y)	<b>USEP7103M</b>
5.2L V8 5211cc 318 CID	1998	Laredo, Limited, TSi; (Y)	<b>USEP7103M</b>
5.7L V8 345 CID	2005	Limited; (2)	<b>USEP7197M</b>
5.7L V8 345 CID	2006	Limited, Overland; (2)	<b>USEP7197M</b>
5.7L V8 345 CID	2007	Limited, Overland; (2), GAS, Naturally Aspirated	<b>USEP7197M</b>





# FUEL PUMP MODULES APPLICATION GUIDE



FUEL PUMP MODULES

Engine	Years	Application Description	USMW
<b>JEEP (cont'd.)</b>			
<b>GRAND CHEROKEE (cont'd.)</b>			
5.7L V8 345 CID	2009	Overland; (EZD), (T), GAS, Naturally Aspirated	USEP7197M
5.9L V8 360 CID	1998	5.9 Limited; (Z)	USEP7103M
6.1L V8 6059cc 370 CID	2006	SRT8; (3)	USEP7197M
6.1L V8 6059cc 370 CID	2007	SRT8; (3), GAS, Naturally Aspirated	USEP7197M
6.1L V8 6059cc 370 CID	2009	SRT8; (W), GAS, Naturally Aspirated	USEP7197M
<b>GRAND WAGONEER</b>			
	1993		USEP7055M
<b>LIBERTY</b>			
	2007	Limited, Sport	USEP7199M
2.4L L4 148 CID	2002	Renegade; (1)	USEP7162M
2.4L L4 148 CID	2003		USEP7162M
2.4L L4 148 CID	2004		USEP7244M
2.4L L4 148 CID	2005	Sport; (1), GAS, Naturally Aspirated	USEP7199M
3.7L V6 226 CID	2002	Limited, Sport; (K)	USEP7162M
3.7L V6 226 CID	2003		USEP7162M
3.7L V6 226 CID	2004		USEP7244M
3.7L V6 226 CID	2005	Limited, Renegade, Rocky Mountain Edition, Sport; (K), GAS, Naturally Aspirated	USEP7199M
3.7L V6 226 CID	2006	65th Anniversary Edition, Limited, Renegade, Sport; (K), GAS, Naturally Aspirated	USEP7199M
3.7L V6 226 CID	2008-2009	Limited, Sport	USEP7219M
3.7L V6 226 CID	2010-2012		USEP7219M
<b>PATRIOT</b>			
2.0L L4 1998cc 122 CID	2008	Sport; FWD	USEP7220M
2.0L L4 1998cc 122 CID	2008-2012	4WD	USEP7218M
2.0L L4 1998cc 122 CID	2009	Sport; (A), (ECN), FWD	USEP7220M
2.0L L4 1998cc 122 CID	2010-2016	(A), (ECN), FWD	USEP7220M
2.4L L4 2360cc 144 CID	2008	Limited, Sport; (W), FWD	USEP7220M
2.4L L4 2360cc 144 CID	2008-2014	4WD	USEP7218M
2.4L L4 2360cc 144 CID	2009	Limited, Sport; (B), (ED3), FWD	USEP7220M
2.4L L4 2360cc 144 CID	2009	Limited, Sport; (B), (EDG), FWD	USEP7220M
<b>TJ</b>			
2.4L L4 148 CID	2003		USEP7156MN
4.0L L6 242 CID	2003-2004		USEP7156MN
<b>WAGONEER</b>			
4.0L L6 242 CID	1987	Base, Limited; Electronic Fuel Control, FI, GAS	USEP7091S
4.0L L6 242 CID	1988-1990	Limited; Electronic Fuel Control, FI, GAS	USEP7091S
<b>WRANGLER</b>			
2.4L L4 148 CID	2003-2004		USEP7156MN
2.4L L4 148 CID	2005-2006	SE; (1)	USEP7200M
2.5L L4 150 CID	1994-1995		USEP12028S
2.5L L4 150 CID	1997-1998	SE; (P); 19 Gallon Fuel Tank	USEP7115MN
2.5L L4 150 CID	1997-1998	SE; (P); 15 Gallon Fuel Tank	USEP7122M
2.5L L4 150 CID	1999	SE; (P)	USEP7115MN
2.5L L4 150 CID	2000	(P)	USEP7115MN
2.5L L4 150 CID	2001-2002	SE; (P)	USEP7115MN
3.6L V6 3604cc 220 CID	2012-2017		USEP7265M
3.8L V6 3778cc 231 CID	2007-2008		USEP7243M
3.8L V6 3778cc 231 CID	2009-2011		USEP7265M
4.0L L6 242 CID	1994-1995		USEP12028S
4.0L L6 242 CID	1997	Sahara, Sport; (S); 19 Gallon Fuel Tank	USEP7115MN
4.0L L6 242 CID	1997	Sahara, Sport; (S); 15 Gallon Fuel Tank	USEP7122M
4.0L L6 242 CID	1998-1999	Sport; (S); 19 Gallon Fuel Tank	USEP7115MN
4.0L L6 242 CID	1998-1999	Sport; (S); 15 Gallon Fuel Tank	USEP7122M
4.0L L6 242 CID	2000-2001	Sport; (S)	USEP7115MN
4.0L L6 242 CID	2002	Sahara, Sport, X; (S)	USEP7115MN
4.0L L6 242 CID	2003-2004		USEP7156MN
4.0L L6 242 CID	2005	Rubicon, Sport, Unlimited, Unlimited Rubicon, X; (S)	USEP7200M
4.0L L6 242 CID	2006	65th Anniversary Edition, Rubicon, SE, Sport, Unlimited, Unlimited Rubicon, X; (S)	USEP7200M
4.0L L6 3956cc 241 CID	2003-2004		USEP7156MN
<b>WRANGLER JK</b>			
3.6L V6 3604cc 220 CID	2018		USEP7265M
<b>KIA</b>			
<b>AMANTI</b>			
3.5L V6 3497cc	2004-2006		USEP8674M
<b>OPTIMA</b>			
2.4L L4 2351cc	2001		USEP8519M
2.4L L4 2351cc	2002-2004		USEP8637M
2.4L L4 2351cc	2004	(6); Optional	USEP8673M
2.4L L4 2351cc	2005-2006	EX, LX; (6); Optional	USEP8673M
2.4L L4 2359cc	2006	EX, LX; (3)	USEP8673M
2.4L L4 2359cc	2011-2013	ELECTRIC/GAS; HYBRID	USEP9122M

Engine	Years	Application Description	USMW
<b>KIA (cont'd.)</b>			
<b>OPTIMA (cont'd.)</b>			
2.4L L4 2359cc	2012-2015	GAS	USEP9120M
<b>RIO</b>			
	2005	Base, Cinco	USEP8636M
1.5L L4 1493cc	2001-2002		USEP8420M
1.6L L4 1594cc	2003-2004		USEP8744M
1.6L L4 1599cc	2006-2011		USEP8730M
<b>RIO5</b>			
1.6L L4 1599cc	2006-2011		USEP8730M
<b>SEDONA</b>			
	2002		USEP8661M
	2003	From 03/21/03	USEP8482M
	2003	To 03/21/03	USEP8661M
	2003-2004		USEP8482M
	2005	EX, LX	USEP8482M
<b>SEPHIA</b>			
	2001	From 07/01/00	USEP8421M
	2001	To 07/01/00	USEP8421M
1.8L L4 1793cc	1998-1999	Base, LS	USEP8393M
1.8L L4 1793cc	2000-2001		USEP8408M
1.8L L4 1839cc	1995	Calif (Early)	USEP8401H
<b>SORENTO</b>			
	2003-2004		USEP8520M
3.3L V6 3342cc	2008-2009		USEP8783M
3.5L V6 3497cc	2005-2006		USEP8676M
3.8L V6 3778cc 231 CID	2007-2009		USEP8783M
<b>SPECTRA</b>			
	2000-2003		USEP8421M
1.8L L4 1793cc	2004	LS; (1), (5BP)	USEP8421M
2.0L L4 1975cc	2004-2006		USEP8728M
<b>SPECTRA5</b>			
2.0L L4 1975cc	2005-2006		USEP8728M
<b>SPORTAGE</b>			
2.0L L4 1975cc	2005-2010		USEP8677M
2.0L L4 1998cc 122 CID	1999-2002		USEP8440H
2.0L L4 1998cc 122 CID	2001-2002	FROM 10/1/2000	USEP9053M
2.7L V6 2656cc	2005-2010		USEP8677M
<b>LAND ROVER</b>			
<b>DISCOVERY</b>			
4.0L V8 3950cc	1997-1999		USEP8388M
4.0L V8 3950cc	1999-2002		USEP8478M
4.6L V8 4554cc 278 CID	2003-2004		USEP8478M
<b>FREELANDER</b>			
2.5L V6 2500cc 153 CID	2002		USEP8493M
2.5L V6 2500cc 153 CID	2003-2005		USEP8522M
<b>LR3</b>			
4.0L V6 4009cc 245 CID	2005-2007		USEP8858M
4.4L V8 4394cc	2005-2009		USEP8858M
<b>RANGE ROVER</b>			
4.0L V8 3950cc	1995-1998		USEP8491M
4.6L V8 4554cc 278 CID	1996-1998		USEP8491M
<b>RANGE ROVER SPORT</b>			
4.4L V8 4394cc	2006-2009		USEP8858M
<b>LEXUS</b>			
<b>GX470</b>			
4.7L V8 4663cc 285 CID	2005-2009		USEP8797M
<b>LINCOLN</b>			
<b>AVIATOR</b>			
	2003	FROM 12/10/2002	USEP2354M
	2004-2005		USEP2354M
4.6L V8 281 CID	2003		USEP2347M
<b>BLACKWOOD</b>			
	2002		USEP2316S
<b>CONTINENTAL</b>			
	1995		USEP2186M
	1996	Anniversary	USEP2186M
	1999-2002		USEP2249M
	1988-1993		USEP2077S
3.8L V6 232 CID	1994	From 01/94	USEP2077S
3.8L V6 232 CID	1997		USEP2187M
4.6L V8 281 CID	1998		USEP2193M
5.0L V8 302 CID	1985-1986		USEP2100H

Engine	Years	Application Description	USMW
<b>LINCOLN (cont'd.)</b>			
<b>LS</b>			
3.9L V8 242 CID	2000-2002 (A)		USEP2274M
3.9L V8 242 CID	2003-2004 (A)		USEP2388M
3.9L V8 242 CID	2005	Ultimate; (A)	USEP2388M
<b>MARK LT</b>			
5.4L V8 330 CID	2006-2008	138.5 / 351.8 Wheel Base	USEP2533M
5.4L V8 330 CID	2007-2008	with 27 GALLON TANK	USEP2441M
<b>MARK VII</b>			
5.0L V8 302 CID	1985-1986		USEP2100H
5.0L V8 302 CID	1986-1992		USEP2084H
<b>MARK VIII</b>			
	1997-1998	Base, LSC	USEP2194M
4.6L V8 281 CID	1993-1996		USEP2070H
<b>MKC</b>			
2.0L L4 1999cc 122 CID	2015-2016		USEP2598M
<b>MKS</b>			
3.7L V6 3726cc 227 CID	2011-2012		USEP2557M
<b>MKT</b>			
3.7L V6 3726cc 227 CID	2010-2012		USEP2558M
<b>MKX</b>			
3.5L V6 3496cc 213 CID	2007-2010	AWD	USEP2470M
3.5L V6 3496cc 213 CID	2007-2010	FWD	USEP2479M
3.7L V6 3726cc 227 CID	2011-2014		USEP2578M
<b>MKZ</b>			
2.5L L4 2488cc 152 CID	2011-2012		USEP2561M
3.5L V6 3496cc 213 CID	2007-2009	FWD	USEP2472M
<b>NAVIGATOR</b>			
5.4L V8 330 CID	1998	4WD	USEP2201S
5.4L V8 330 CID	1998	RWD; with Auto suspension	USEP2202S
5.4L V8 330 CID	1999	RWD, SOHC	USEP2252S
5.4L V8 330 CID	1999	4WD	USEP2297S
5.4L V8 330 CID	1999-2002	4WD	USEP2253S
5.4L V8 330 CID	1999-2002	DOHC, RWD	USEP2255S
5.4L V8 330 CID	2003-2004		USEP2362M
5.4L V8 330 CID	2005-2006		USEP2443M
5.4L V8 330 CID	2007-2008	119.0 wheelbase	USEP2476M
5.4L V8 330 CID	2007-2008		USEP2494M
5.4L V8 330 CID	2009-2014	119.0 / 302.3 Wheel Base	USEP2523M
5.4L V8 330 CID	2010-2014	131.0 / 332.7 Wheel Base	USEP2572M
<b>TOWN CAR</b>			
4.6L V8 281 CID	1991		USEP2123S
4.6L V8 281 CID	1991-1992		USEP2121H
4.6L V8 281 CID	1993-1994		USEP2122H
4.6L V8 281 CID	1995-1996		USEP2113H
4.6L V8 281 CID	1997	w/o sender	USEP2163H
4.6L V8 281 CID	1997	with sender	USEP2222S
4.6L V8 281 CID	1998-1999		USEP2272S
4.6L V8 281 CID	2000	Standard	USEP2272S
4.6L V8 281 CID	2001-2002		USEP2382S
4.6L V8 281 CID	2003-2004		USEP2336S
4.6L V8 281 CID	2005-2008	GAS	USEP2449S
4.6L V8 281 CID	2006-2010	FLEX	USEP2475S
4.6L V8 281 CID	2010-2011		USEP2542S
5.0L V8 302 CID	1987-1989	External Pump	USEP2085H
5.0L V8 302 CID	1990	Campaign CP-4697	USEP2123S
<b>ZEPHYR</b>			
	2006		USEP2458M
<b>MAZDA</b>			
<b>3</b>			
2.0L L4 1998cc 122 CID	2012-2013		USEP9049M
2.0L L4 1999cc 122 CID	2009	CALIFORNIA	USEP8589M
2.0L L4 1999cc 122 CID	2009	EXCEPT CA	USEP8591M
2.0L L4 1999cc 122 CID	2010-2013		USEP9049M
2.0L L4 2000cc 122 CID	2004-2009	CALIFORNIA	USEP8589M
2.0L L4 2000cc 122 CID	2004-2009	EXCEPT CA	USEP8591M
2.0L L4 2000cc 122 CID	2010-2013		USEP9049M
2.3L L4 2260cc	2004-2009	CALIFORNIA	USEP8589M
2.3L L4 2260cc	2004-2009	EXCEPT CA	USEP8591M
2.5L L4 2489cc 152 CID	2010-2013		USEP9049M
<b>3 SPORT</b>			
2.0L L4 1998cc 122 CID	2012-2013		USEP9049M
2.0L L4 2000cc 122 CID	2012-2013		USEP9049M
2.5L L4 2488cc 152 CID	2012-2013		USEP9049M
<b>5</b>			
2.3L L4 2260cc	2006-2010		USEP8809M
2.5L L4 2488cc 152 CID	2012-2014		USEP8809M
2.5L L4 2489cc 152 CID	2012-2013		USEP8809M

Engine	Years	Application Description	USMW
<b>MAZDA (cont'd.)</b>			
<b>6</b>			
2.3L L4 2260cc	2003-2004	GLASS MOUNTED ANTENNA	USEP8587M
2.3L L4 2260cc	2003-2008	ROOF MOUNTED ANTENNA	USEP8588M
2.3L L4 2260cc	2005-2008	CALIFORNIA	USEP8719M
3.0L V6 2968cc 181 CID	2003-2004	ROOF MOUNTED ANTENNA	USEP8586M
3.0L V6 2968cc 181 CID	2003-2004	GLASS ANTENNA	USEP8590M
3.0L V6 2968cc 181 CID	2005-2008		USEP8586M
<b>626</b>			
2.0L L4 1991cc	1995		USEP2156H
2.0L L4 1991cc	1996-1997		USEP2118H
2.5L V6 2497cc	1995		USEP2156H
2.5L V6 2497cc	1996-1997		USEP2118H
<b>B2300</b>			
	2001-2003		USEP2293M
2.3L L4 140 CID	1994-1997	Standard Cab Pickup	USEP2078S
2.3L L4 140 CID	1994-1997	Extended Cab Pickup	USEP2106S
2.3L L4 140 CID	2004-2006	111.4 and 111.6 wheelbase	USEP2357M
2.3L L4 140 CID	2006-2009		USEP8808M
<b>B2500</b>			
	1999-2000	Standard Cab Pickup	USEP2207S
	2001		USEP2269S
2.5L L4 2492cc	1998	Standard Cab Pickup	USEP2207S
2.5L L4 2492cc	1998-2000	Extended Cab Pickup	USEP2208S
<b>B3000</b>			
	1998	Standard Cab Pickup	USEP2207S
3.0L V6 2986cc 182 CID	1994-1995	Standard Cab Pickup	USEP2078S
3.0L V6 2986cc 182 CID	1994-1996	Extended Cab Pickup	USEP2106S
3.0L V6 2986cc 182 CID	1997	Standard Cab Pickup	USEP2078S
3.0L V6 2986cc 182 CID	1998	Extended Cab Pickup	USEP2208S
3.0L V6 2986cc 182 CID	1999	Standard Cab Pickup	USEP2257S
3.0L V6 2986cc 182 CID	1999	Extended Cab Pickup, FLEX	USEP2260S
3.0L V6 2986cc 182 CID	2000	FLEX	USEP2268S
3.0L V6 2986cc 182 CID	2004-2006	111.4 and 111.6 wheelbase	USEP2357M
3.0L V6 2986cc 182 CID	2004-2006	Extended Cab Pickup	USEP2363M
3.0L V6 2986cc 182 CID	2006-2007		USEP8808M
<b>B4000</b>			
	2001-2003		USEP2293M
4.0L V6 4016cc	1994-1997	Standard Cab Pickup	USEP2078S
4.0L V6 4016cc	1994-1997	Extended Cab Pickup	USEP2106S
4.0L V6 4016cc	1998	Extended Cab Pickup	USEP2208S
4.0L V6 4016cc	1998-1999	Extended Cab Pickup	USEP2263S
4.0L V6 4016cc	1999		USEP2261S
4.0L V6 4016cc	2004-2005		USEP2363M
4.0L V6 4016cc	2006	From 05/01/2006	USEP2363M
4.0L V6 4016cc	2006-2009		USEP8707M
<b>CX-7</b>			
2.3L L4 2260cc	2007-2012		USEP8750M
<b>MPV</b>			
	2004		USEP8584M
<b>MX-6</b>			
2.0L L4 1991cc	1995		USEP2156H
2.0L L4 1991cc	1996-1997		USEP2118H
2.5L V6 2497cc	1995		USEP2156H
2.5L V6 2497cc	1996-1997		USEP2118H
<b>RX-8</b>			
1.3L R2 1308cc	2004-2008		USEP8592M
<b>TRIBUTE</b>			
2.0L L4 1989cc 121 CID	2001-2004		USEP2291M
2.3L L4 140 CID	2008	GAS; WITH ONBOARD VAPOR RECOVERY	USEP2495M
2.5L L4 2488cc 152 CID	2009		USEP2529M
3.0L V6 2968cc 181 CID	2001-2003		USEP2291M
3.0L V6 2968cc 181 CID	2008	GAS; WITH ONBOARD VAPOR RECOVERY	USEP2495M
3.0L V6 2968cc 181 CID	2009		USEP2529M
<b>MERCEDES-BENZ</b>			
<b>A160</b>			
1.6L L4 1598cc 98 CID	2000-2001	MEX	USEP10281M
1.6L L4 1598cc 98 CID	2003	MEX	USEP10281M
<b>C230</b>			
1.8L L4 1796cc	2003-2005		USEP8475M
2.3L L4 2295cc	2002	To Chassis/VIN A252579	USEP8474M
2.3L L4 2295cc	2002	From Chassis/VIN A252580	USEP8475M
2.5L V6 2496cc	2006		USEP8475M
2.5L V6 2496cc	2007		USEP8531M
<b>C240</b>			
2.6L V6 2597cc	2001		USEP8474M



# FUEL PUMP MODULES APPLICATION GUIDE



FUEL PUMP MODULES

Engine	Years	Application Description	USMW
<b>MERCEDES-BENZ (cont'd.)</b>			
<b>C240 (cont'd.)</b>			
2.6L V6 2597cc	2002	To Chassis/VIN R043190 (To Chassis/VIN A252579) (To Chassis/VIN F182330)	USEP8474M
2.6L V6 2597cc	2002	From Chassis/VIN R043191 (From Chassis/VIN A252580) (From Chassis/VIN F182331)	USEP8475M
2.6L V6 2597cc	2003-2005		USEP8475M
<b>C280</b>			
3.0L V6 2996cc	2006-2007		USEP8475M
<b>C300</b>			
3.0L V6 2996cc	2008-2012		USEP9081M
3.0L V6 2996cc 183 CID	2010-2011		USEP9081M
<b>C320</b>			
3.2L V6 3199cc	2001		USEP8475M
3.2L V6 3199cc	2002	To Chassis/VIN R043190 (To Chassis/VIN A252579) (To Chassis/VIN F182330)	USEP8474M
3.2L V6 3199cc	2002	From Chassis/VIN R043191 (From Chassis/VIN A252580) (From Chassis/VIN F182331)	USEP8475M
3.2L V6 3199cc	2003-2005		USEP8475M
<b>C350</b>			
3.5L V6 3498cc	2006-2007		USEP8531M
3.5L V6 3498cc	2008-2011		USEP9081M
3.5L V6 3498cc 213 CID	2008-2009		USEP9081M
<b>CLK320</b>			
3.2L V6 3199cc	2003-2005		USEP8475M
<b>CLK350</b>			
3.5L V6 3498cc	2006	To 05/19/05	USEP8531M
3.5L V6 3498cc	2007-2009		USEP8531M
<b>CLK500</b>			
5.0L V8 4966cc	2006		USEP8531M
5.0L V8 4973cc	2003-2004		USEP8531M
5.0L V8 4973cc	2005	To 05/19/05	USEP8531M
<b>E55 AMG</b>			
	2003-2005		USEP8572M
<b>E350</b>			
3.5L V6 3498cc	2010-2011		USEP9081M
3.5L V6 3498cc 213 CID	2010-2011		USEP9081M
<b>E500</b>			
	2003		USEP8530M
	2004-2005	Base	USEP8530M
<b>E550</b>			
5.5L V8 5461cc	2010-2011		USEP9081M
<b>GL450</b>			
4.6L V8 4663cc	2007-2010		USEP8924M
<b>GL550</b>			
5.5L V8 5461cc	2008-2010		USEP8924M
<b>GLK350</b>			
3.5L V6 3498cc	2010-2012		USEP9081M
<b>ML55 AMG</b>			
5.5L V8 5439cc 332 CID	2001		USEP8389M
5.5L V8 5439cc 335 CID	2000-2003		USEP8389M
<b>ML320</b>			
3.2L V6 3199cc	1998-2003		USEP8389M
<b>ML350</b>			
3.5L V6 3498cc	2006-2011		USEP8924M
3.5L V6 3498cc 213 CID	2006-2011		USEP8924M
3.7L V6 3699cc	2003-2005		USEP8389M
3.7L V6 3724cc	2003-2005		USEP8389M
<b>ML430</b>			
4.3L V8 4266cc	1999-2001		USEP8389M
<b>ML500</b>			
5.0L V8 4966cc	2002-2005		USEP8389M
5.0L V8 4966cc 303 CID	2003-2005		USEP8389M
5.0L V8 4973cc	2002-2005		USEP8389M
<b>ML550</b>			
5.5L V8 5461cc	2008-2010		USEP8924M

Engine	Years	Application Description	USMW
<b>MERCURY (cont'd.)</b>			
<b>COLONY PARK</b>			
5.0L V8 302 CID	1987-1991		USEP2087H
<b>COUGAR</b>			
2.0L L4 1989cc 121 CID	1999	Base; (3); From 05/25/99	USEP2227S
2.0L L4 1989cc 121 CID	1999	Base; (3); To 05/25/99	USEP2227S
2.0L L4 1989cc 121 CID	1999-2002		USEP2273M
2.3L L4 140 CID	1984		USEP2131S
2.3L L4 140 CID	1985-1986		USEP2084H
2.5L V6 2450cc 155 CID	1999	V6; (L); From 05/25/99	USEP2227S
2.5L V6 2450cc 155 CID	1999	V6; (L); To 05/25/99	USEP2227S
2.5L V6 2450cc 155 CID	1999-2002		USEP2273M
3.8L V6 232 CID	1986		USEP2100H
3.8L V6 232 CID	1989-1997		USEP2098S
4.6L V8 281 CID	1994-1997		USEP2098S
5.0L V8 302 CID	1991-1993		USEP2098S
<b>GRAND MARQUIS</b>			
4.6L V8 281 CID	1992		USEP2121H
4.6L V8 281 CID	1993-1994		USEP2122H
4.6L V8 281 CID	1995-1996		USEP2113H
4.6L V8 281 CID	1997	w/o sender	USEP2163H
4.6L V8 281 CID	1997	with sender	USEP2222S
4.6L V8 281 CID	1998-2000		USEP2272S
4.6L V8 281 CID	2001-2002		USEP2382S
4.6L V8 281 CID	2003-2004		USEP2336S
4.6L V8 281 CID	2005-2007	GAS	USEP2449S
4.6L V8 281 CID	2006-2010	FLEX	USEP2475S
4.6L V8 281 CID	2010-2011		USEP2542S
5.0L V8 302 CID	1990-1991		USEP2120S
<b>LYNX</b>			
1.9L L4 116 CID	1987	TBI	USEP2082S
1.9L L4 116 CID	1987	MFI	USEP2136S
<b>MARAUDER</b>			
4.6L V8 281 CID	2003-2004		USEP2336S
<b>MARINER</b>			
2.3L L4 140 CID	2005	Base; (Z); Onboard Refuel Vapor Recovery (From 10/03/05)	USEP2440M
2.3L L4 140 CID	2005	Base; (Z); Exc.Onboard Refuel Vapor Recovery (From 02/28/05)	USEP2453M
2.3L L4 140 CID	2006	Convenience; (Z); GAS; Exc.Onboard Refuel Vapor Recovery	USEP2453M
2.3L L4 140 CID	2006-2007	ELECTRIC/GAS	USEP2473M
2.3L L4 140 CID	2007	Convenience; (Z); GAS; Onboard Refuel Vapor Recovery (To 01/02/07)	USEP2440M
2.3L L4 140 CID	2007	Convenience; (Z); GAS; Exc.Onboard Refuel Vapor Recovery (To 01/02/07)	USEP2453M
2.3L L4 140 CID	2007-2008	GAS; WITH ONBOARD VAPOR RECOVERY	USEP2495M
2.3L L4 140 CID	2007-2008		USEP2496M
2.5L L4 2488cc 152 CID	2009-2010		USEP2529M
3.0L V6 2968cc 181 CID	2007-2008	GAS; WITH ONBOARD VAPOR RECOVERY	USEP2495M
3.0L V6 2968cc 181 CID	2009-2010		USEP2529M
<b>MARQUIS</b>			
3.8L V6 232 CID	1984		USEP2131S
3.8L V6 232 CID	1985	TO 5/1985	USEP2131S
3.8L V6 232 CID	1985	FROM 5 / 1985	USEP2132S
3.8L V6 232 CID	1985	Base, Brougham; (3), Fl, Wagon; (Exc.Electronic Instrument Cluster)	USEP2146S
3.8L V6 232 CID	1986		USEP2132S
3.8L V6 232 CID	1986	Brougham; (3), Fl, Wagon; (Exc.Electronic Instrument Cluster)	USEP2146S
<b>MILAN</b>			
2.3L L4 140 CID	2006-2007	Base, Premier; (Z)	USEP2459M
2.5L L4 2488cc 152 CID	2010-2011		USEP2561M
3.0L V6 2968cc 181 CID	2008	FWD	USEP2472M
3.0L V6 2968cc 181 CID	2010-2011		USEP2562M
<b>MONTEGO</b>			
3.0L V6 2968cc 181 CID	2005-2007		USEP2467M
<b>MONTEREY</b>			
	2004	Base, Premier; (Incl.Tank Seal)	USEP2383M
	2005	(Incl.Tank Seal)	USEP2383M
	2006-2007		USEP2466M
<b>MOUNTAINEER</b>			
4.0L V6 245 CID	1998	Base	USEP2266S
4.0L V6 245 CID	1999-2000	(E)	USEP2296S
4.0L V6 245 CID	2001	(E); (1 Port)	USEP2296S
4.0L V6 245 CID	2002	(K), FLEX	USEP2352M
4.0L V6 245 CID	2002-2003	WITH 7 PIN CONNECTOR	USEP2334M
4.0L V6 245 CID	2002-2003	WITH 8 PIN CONNECTOR	USEP2338M
4.0L V6 245 CID	2003		USEP2350M
4.0L V6 245 CID	2004	Base, Premier; (E); GAS; To 03/01/04	USEP2355M
4.0L V6 245 CID	2004	Base; (K), FLEX; To 03/01/04	USEP2355M



Engine	Years	Application Description	USMW
<b>MERCURY (cont'd.)</b>			
<b>MOUNTAINEER (cont'd.)</b>			
4.0L V6 245 CID	2004	Base, Premier; (E), GAS; From 03/01/04	USEP2439M
4.0L V6 245 CID	2004	Base; (K), FLEX; From 03/01/04	USEP2439M
4.0L V6 245 CID	2005	(E), GAS; To 03/01/04	USEP2355M
4.0L V6 245 CID	2005	(K), FLEX; To 03/01/04	USEP2355M
4.0L V6 245 CID	2005	(E), GAS; From 03/01/04	USEP2439M
4.0L V6 245 CID	2005	(K), FLEX; From 03/01/04	USEP2439M
4.0L V6 245 CID	2006	Convenience, Luxury; (E)	USEP2454M
4.0L V6 245 CID	2007-2009	Base, Premier; (E)	USEP2454M
4.0L V6 245 CID	2010		USEP2553M
4.6L V8 281 CID	2002-2003	WITH 7 PIN CONNECTOR	USEP2334M
4.6L V8 281 CID	2002-2003	WITH 8 PIN CONNECTOR	USEP2338M
4.6L V8 281 CID	2003		USEP2351M
4.6L V8 281 CID	2004-2005		USEP2359M
4.6L V8 281 CID	2006	Luxury, Premier; (8)	USEP2454M
4.6L V8 281 CID	2007-2009	Premier; (8)	USEP2454M
4.6L V8 281 CID	2010		USEP2553M
5.0L V8 302 CID	1997		USEP2059MN
5.0L V8 302 CID	1998	Base	USEP2266S
5.0L V8 302 CID	1999-2000	(P)	USEP2296S
5.0L V8 302 CID	2001	(P); (1 Port)	USEP2296S
<b>MYSTIQUE</b>			
2.0L L4 1989cc 121 CID	1995	GS Spree, LS; (3)	USEP2117S
2.0L L4 1989cc 121 CID	1996	GS, LS; (3)	USEP2117S
2.0L L4 1989cc 121 CID	1997	Exc.Fuel Tank Concern	USEP2188S
2.0L L4 1989cc 121 CID	1998	Exc.Fuel Tank Concern (To 02/09/98)	USEP2188S
2.0L L4 1989cc 121 CID	1998	GS; (3); Exc.Fuel Tank Concern (From 02/09/98)	USEP2227S
2.0L L4 1989cc 121 CID	1999	(3); From 05/03/99	USEP2227S
2.0L L4 1989cc 121 CID	1999	(3); To 05/03/99	USEP2227S
2.0L L4 1989cc 121 CID	1999-2000		USEP2273M
2.5L V6 2450cc 155 CID	1995	GS Spree, LS Young America; (L)	USEP2117S
2.5L V6 2450cc 155 CID	1996	GS, LS; (L)	USEP2117S
2.5L V6 2450cc 155 CID	1997	Exc.Fuel Tank Concern	USEP2188S
2.5L V6 2450cc 155 CID	1998	Fuel Tank Concern	USEP2188S
2.5L V6 2450cc 155 CID	1999	(L); From 05/03/99	USEP2227S
2.5L V6 2450cc 155 CID	1999	(L); To 05/03/99	USEP2227S
2.5L V6 2450cc 155 CID	1999-2000		USEP2273M
<b>SABLE</b>			
	1997	(S); 16 Gallon Fuel Tank	USEP2185M
	1997	(S); 18 Gallon Fuel Tank	USEP2185M
	1998	(S)	USEP2192M
	1998	(U)	USEP2198M
	2001	LS; (2), FLEX	USEP2329M
	2002	(S)	USEP2313M
	2002	(U)	USEP2313M
	2003	(S), GAS	USEP2313M
	2003	(U), GAS	USEP2313M
	2003	GS; (2), FLEX	USEP2330M
	2004-2005	GS; (2), FLEX	USEP2455M
2.5L L4 153 CID	1986	GS, LS; 16 Gallon Fuel Tank	USEP2076S
2.5L L4 153 CID	1986	(D); 18.6 Gallon Fuel Tank (Digital Instrument Cluster)	USEP2079S
3.0L V6 2968cc 181 CID	1996		USEP2153M
3.0L V6 2968cc 181 CID	1999		USEP2243M
3.0L V6 2968cc 181 CID	2000	GAS; 18 Gallon Fuel Tank (Red Label)	USEP2283M
3.0L V6 2968cc 181 CID	2001	GAS	USEP2294M
3.0L V6 2986cc 182 CID	1987	18.6 Gallon Fuel Tank (Exc.Digital Instrument Cluster)	USEP2077S
3.0L V6 2986cc 182 CID	1987	18.6 Gallon Fuel Tank (Digital Instrument Cluster)	USEP2079S
3.0L V6 2986cc 182 CID	1996		USEP2159M
3.0L V6 2986cc 182 CID	1997		USEP2184M
3.0L V6 2986cc 182 CID	1999		USEP2243M
3.0L V6 2986cc 182 CID	2001	GAS	USEP2294M
3.0L V6 2986cc 182 CID	2004-2005	GAS	USEP2435M
3.5L V6 3496cc 213 CID	2008-2009		USEP2506M
3.8L V6 232 CID	1988-1989	(4); 18.6 Gallon Fuel Tank (Digital Instrument Cluster)	USEP2079S
3.8L V6 232 CID	1988-1994	18.6 Gallon Fuel Tank (Exc.Digital Instrument Cluster)	USEP2077S
3.8L V6 232 CID	1988-1995	GS, LS; 16 Gallon Fuel Tank	USEP2076S
3.8L V6 232 CID	1990-1993	(4); 18.6 Gallon Fuel Tank (Digital Instrument Cluster)	USEP2108S
3.8L V6 232 CID	1994	(4); 18.6 Gallon Fuel Tank (Digital Instrument Cluster) (From 01/94)	USEP2108S
3.8L V6 232 CID	1994	(4); 18.6 Gallon Fuel Tank (Digital Instrument Cluster) (To 01/94)	USEP2108S
3.8L V6 232 CID	1995	(4); 18.6 Gallon Fuel Tank (Digital Instrument Cluster)	USEP2108S
<b>TOPAZ</b>			
2.3L L4 140 CID	1985-1987		USEP2081S
2.3L L4 140 CID	1988-1992	GS, LS, LTS, Sport, XR5	USEP2101S
2.3L L4 140 CID	1993-1994	GS	USEP2101S

Engine	Years	Application Description	USMW
<b>MERCURY (cont'd.)</b>			
<b>TRACER</b>			
1.8L L4 112 CID	1998	LS, Trio	USEP2197M
1.8L L4 112 CID	1991-1993		USEP2105S
1.8L L4 112 CID	1994-1996	LTS; (8)	USEP2151H
1.9L L4 116 CID	1991-1993		USEP2105S
1.9L L4 116 CID	1994-1996	LS; (J)	USEP2151H
2.0L L4 1989cc 121 CID	1997		USEP2164H
2.0L L4 1989cc 121 CID	1999		USEP2246M
<b>VILLAGER</b>			
3.0L V6 182 CID	1993-1997		USEP2493S
<b>MERKUR</b>			
<b>SCORPIO</b>			
2.9L V6 177 CID	1988-1989		USEP2155S
<b>MINI</b>			
<b>COOPER</b>			
1.6L L4 1597cc 98 CID	2005-2008		USEP8747M
1.6L L4 1598cc	2007-2008		USEP8747M
1.6L L4 1600cc	2002-2004		USEP8594M
1.6L L4 1600cc	2005-2008		USEP8747M
<b>MITSUBISHI</b>			
<b>ECLIPSE</b>			
2.0L L4 1997cc 122 CID	1995-1997	Naturally Aspirated	USEP7081H
2.0L L4 1997cc 122 CID	1999	Naturally Aspirated	USEP7081H
2.4L L4 2351cc	1996	Convertible, Naturally Aspirated	USEP7081H
2.4L L4 2351cc	2000-2001		USEP7151M
2.4L L4 2351cc	2002		USEP7163M
2.4L L4 2378cc	2006-2010		USEP8732M
2.4L L4 2378cc	2012		USEP8732M
3.0L V6 2972cc 181 CID	2000-2001		USEP7151M
3.0L V6 2972cc 181 CID	2002-2004		USEP7163M
<b>GALANT</b>			
2.4L L4 2351cc	1994	From 11/93	USEP7081H
2.4L L4 2351cc	1995	(From 03/95) (DSM Plant Built)	USEP7081H
2.4L L4 2351cc	1996	Exc.Calif (USA Built)	USEP7081H
2.4L L4 2351cc	1997-1998	Exc.Calif	USEP7081H
2.4L L4 2351cc	1999-2001		USEP7151M
2.4L L4 2351cc	2002-2003		USEP7163M
2.4L L4 2378cc	2006-2010		USEP8732M
2.4L L4 2378cc	2012		USEP8732M
3.0L V6 2972cc 181 CID	1999-2000		USEP7151M
3.0L V6 2972cc 181 CID	2002-2003		USEP7163M
<b>RAIDER</b>			
3.7L V6 226 CID	2006-2007	DuroCross, LS; (K)	USEP7198M
3.7L V6 226 CID	2008-2009		USEP7198M
4.7L V8 287 CID	2006	DuroCross, XLS; (N)	USEP7198M
4.7L V8 287 CID	2007	LS, SE; (N)	USEP7198M
<b>NISSAN</b>			
<b>350Z</b>			
3.5L V6 3498cc	2003		USEP8534M
3.5L V6 3498cc	2004	From 02/04	USEP8534M
3.5L V6 3498cc	2005-2006		USEP8534M
3.5L V6 3498cc	2007	From 03/07	USEP8534M
3.5L V6 3498cc	2008-2009		USEP8534M
<b>ALTIMA</b>			
2.5L L4 2488cc 152 CID	2002-2003		USEP8496M
2.5L L4 2488cc 152 CID	2004-2006	Except CALIFORNIA	USEP8545M
2.5L L4 2488cc 152 CID	2004-2006	CALIFORNIA	USEP8660M
2.5L L4 2488cc 152 CID	2007-2013		USEP8755M
3.5L V6 3498cc	2002-2003		USEP8496M
3.5L V6 3498cc	2004-2006	Except CALIFORNIA	USEP8545M
3.5L V6 3498cc	2006	CALIFORNIA	USEP8660M
3.5L V6 3498cc	2007-2012		USEP8755M
<b>ARMADA</b>			
5.6L V8 5552cc	2005-2006		USEP8595M
5.6L V8 5552cc	2007-2015	GAS	USEP8788M
5.6L V8 5552cc	2007-2015	FLEX	USEP8862M
<b>CUBE</b>			
1.8L L4 1798cc	2009-2014		USEP8855M
<b>D21</b>			
2.4L L4 2389cc	1988-1989	XE; (N), (Z24); Japan Built	USEP8268S
2.4L L4 2389cc	1990-1991	Base; (KA24E), (S); Japan Built	USEP8268S
3.0L V6 2960cc 181 CID	1990	(H), (VG30E), 104.3 / 264.9 Wheel Base, Standard Cab Pickup; (Japan Built)	USEP8268S
3.0L V6 2960cc 181 CID	1992	SE; (H), (VG30E), Extended Cab Pickup, RWD; To 01/1992 (Japan Built Vehicle)	USEP8268S



# FUEL PUMP MODULES APPLICATION GUIDE



FUEL PUMP MODULES

Engine	Years	Application Description	USMW
<b>NISSAN (cont'd.)</b>			
<b>FRONTIER</b>			
2.4L L4 2389cc	1998-2000	Exc.Low Fuel Warning	USEP8378S
2.4L L4 2389cc	1998-2004		USEP8441S
2.4L L4 2389cc 146 CID	2001-2004		USEP8441S
2.5L L4 2488cc 152 CID	2005-2018		USEP8743M
4.0L V6 3954cc	2005-2018		USEP8743M
<b>MAXIMA</b>			
3.5L V6 3498cc	2004-2008		USEP8545M
3.5L V6 3498cc	2009-2013		USEP8755M
<b>MURANO</b>			
3.5L V6 3498cc	2003-2007		USEP8536M
3.5L V6 3498cc	2009-2014		USEP8536M
<b>NV1500</b>			
4.0L V6 3954cc	2012-2018		USEP8862M
<b>NV2500</b>			
4.0L V6 3954cc	2012-2018		USEP8862M
5.6L V8 5552cc	2012-2017		USEP8862M
<b>NV3500</b>			
4.0L V6 3954cc	2012-2018		USEP8862M
5.6L V8 5552cc	2012-2017		USEP8862M
<b>PATHFINDER</b>			
4.0L V6 3954cc	2005-2009		USEP8743M
4.0L V6 3954cc	2010-2012	USA	USEP8743M
<b>QUEST</b>			
3.5L V6 3498cc	2004-2009		USEP8545M
<b>ROGUE</b>			
2.5L L4 2488cc 152 CID	2008-2013	FWD; FWD	USEP8854M
2.5L L4 2488cc 152 CID	2008-2013	AWD; AWD	USEP8856M
<b>ROGUE SELECT</b>			
2.5L L4 2488cc 152 CID	2014-2015	FWD; FWD	USEP8854M
2.5L L4 2488cc 152 CID	2014-2015	AWD; AWD	USEP8856M
<b>SENTRA</b>			
1.8L L4 1769cc	2000-2001		USEP8427M
1.8L L4 1769cc	2002-2006	with 1 tube port QG18DE	USEP8502M
1.8L L4 1769cc	2002-2006	With 2 tube ports	USEP9184M
2.0L L4 1997cc 122 CID	2007-2009	(2 Ports)	USEP8752M
2.0L L4 1997cc 122 CID	2007-2009	(1 Port)	USEP12096M
2.0L L4 1998cc	2000-2001	With 2 tube ports	USEP9184M
2.0L L4 1998cc	2000-2001	With 2 tube ports	USEP9184M
2.5L L4 2488cc 152 CID	2002-2004	with 1 tube port QR25DE	USEP8502M
2.5L L4 2488cc 152 CID	2002-2006	With 2 tube ports	USEP9184M
2.5L L4 2488cc 152 CID	2005-2006	with 1 tube port	USEP8502M
2.5L L4 2488cc 152 CID	2007-2009	(2 Ports)	USEP8752M
2.5L L4 2488cc 152 CID	2007-2009	(1 Port)	USEP12096M
<b>TIIDA</b>			
1.8L L4 1798cc	2007-2009	MEX	USEP10684M
1.8L L4 1798cc	2010	Comfort, Custom; MEX	USEP10684M
<b>TITAN</b>			
5.6L V8 5552cc	2004	GAS; From 02/05	USEP8595M
5.6L V8 5552cc	2005	GAS; To 02/05	USEP8595M
5.6L V8 5552cc	2005-2015	FLEX	USEP8862M
5.6L V8 5552cc	2006-2007	GAS; TO 8/06	USEP8595M
5.6L V8 5552cc	2007-2015	GAS	USEP8788M
<b>TSURU</b>			
1.6L L4 1597cc 97 CID	2008	GS I; MEX	USEP12038M
<b>URVAN</b>			
2.4L L4 2389cc	2008		USEP12263M
2.5L L4 2488cc 152 CID	2008-2011		USEP12263M
3.0L L4 2953cc 180 CID	2008-2011		USEP12263M
<b>VERSA</b>			
1.6L L4 1598cc	2009-2011		USEP8855M
1.6L L4 1598cc	2012-2018		USEP9100M
1.8L L4 1798cc	2007-2012		USEP8855M
<b>VERSA NOTE</b>			
1.6L L4 1598cc	2014-2018		USEP9100M
<b>XTERRA</b>			
4.0L V6 3954cc	2005-2015		USEP8743M
<b>OLDSMOBILE</b>			
<b>88</b>			
3.8L V6 3800cc 231 CID	1993-1994		USEP3629S
<b>98</b>			
3.8L V6 3800cc 231 CID	1993-1994		USEP3629S

Engine	Years	Application Description	USMW
<b>OLDSMOBILE (cont'd.)</b>			
<b>ACHIEVA</b>			
2.3L L4 138 CID	1992	S, SC, SL; (D)	USEP3917M
2.3L L4 138 CID	1992	S; (3)	USEP3917M
2.3L L4 138 CID	1993	S, SL; (D)	USEP3918M
2.3L L4 138 CID	1993-1994	S; (3)	USEP3918M
2.3L L4 138 CID	1994	S, SC, SL; (D)	USEP3918M
2.3L L4 138 CID	1995	S, SL; (D)	USEP3918M
2.3L L4 140 CID	1992	S, SC, SCX; (A)	USEP3917M
2.3L L4 140 CID	1993	S, SCX; (A)	USEP3918M
2.3L L4 140 CID	1994	SC, SL; (A)	USEP3918M
2.4L L4 2392cc 146 CID	1996	SC, SL; (T)	USEP3919M
2.4L L4 2392cc 146 CID	1997-1998	(T)	USEP3919M
3.1L V6 189 CID	1994	S, SC, SL; (M)	USEP3918M
3.1L V6 189 CID	1995	S, SL; (M)	USEP3918M
3.1L V6 189 CID	1996	SC, SL; (M)	USEP3919M
3.1L V6 189 CID	1997-1998	(M)	USEP3919M
3.3L V6 204 CID	1992	S, SC, SL; (N)	USEP3917M
3.3L V6 204 CID	1993	S, SL; (N)	USEP3918M
<b>ALERO</b>			
2.2L L4 2198cc 134 CID	2002-2004		USEP3507M
2.4L L4 2392cc 146 CID	1999	(T)	USEP3950M
2.4L L4 2392cc 146 CID	2000-2001		USEP3507M
3.4L V6 207 CID	1999	(E)	USEP3950M
3.4L V6 207 CID	2000-2004		USEP3507M
<b>AURORA</b>			
3.5L V6 214 CID	1997		USEP3936M
4.0L V8 244 CID	2001-2002		USEP3518M
4.0L V8 244 CID	1995-1996		USEP3912M
4.0L V8 244 CID	2001-2003		USEP3518M
<b>BRAVADA</b>			
4.2L L6 256 CID	2002-2004	This Module uses an internal strainer design and may look different from your original Unit	USEP3549M
4.3L V6 262 CID	1991	Base	USEP3632S
4.3L V6 262 CID	1992-1994	Base; Electronic Fuel Control, FI, GAS	USEP3624S
4.3L V6 262 CID	1992-1994	Base; Electronic Fuel Control, FI, GAS	USEP3625S
4.3L V6 262 CID	1996		USEP3925M
4.3L V6 262 CID	1997	STEEL TANK	USEP3953M
4.3L V6 262 CID	1998	Exc.18 Gallon Fuel Tank	USEP3953M
4.3L V6 262 CID	1998-2001	4 Doors; plastic tank	USEP3992M
<b>CUTLASS</b>			
	1997	Base, GLS	USEP3945M
	1998		USEP3950M
	1999	(J)	USEP3950M
	1999	(M)	USEP3950M
<b>CUTLASS CIERA</b>			
2.5L L4 2474cc 151 CID	1989-1992		USEP3639S
3.3L V6 204 CID	1989-1992		USEP3640S
3.3L V6 3340cc 204 CID	1989-1990		USEP3640S
<b>CUTLASS CRUISER</b>			
2.8L V6 173 CID	1989		USEP3742S
3.3L V6 204 CID	1989-1992		USEP3742S
<b>INTRIGUE</b>			
3.5L V6 214 CID	1999-2000		USEP3537M
3.5L V6 214 CID	2001-2002		USEP3542M
3.8L V6 3800cc 231 CID	1998-1999		USEP3537M
<b>SILHOUETTE</b>			
	1997	112.0 / 284.5 Wheel Base	USEP3976M
	1997	120.0 / 304.8 Wheel Base	USEP3976M
3.4L V6 207 CID	1998-1999	120.0 / 304.8 Wheel Base	USEP3372M
3.4L V6 207 CID	2000-2001		USEP3372M
3.4L V6 207 CID	2002-2004	120.0 / 304.8 Wheel Base	USEP3552M
3.8L V6 3800cc 231 CID	1992-1994		USEP3649S
<b>PEUGEOT</b>			
<b>307</b>			
2.0L L4 1997cc 122 CID	2006-2009	MEX	USEP10693M
<b>406</b>			
2.0L L4 1998cc 122 CID	2005	MEX	USEP10305M
3.0L V6 2950cc 180 CID	2001	MEX	USEP10305M
<b>PLYMOUTH</b>			
<b>ACCLAIM</b>			
2.5L L4 2507cc 153 CID	1989-1990	Base, LE; (K), Naturally Aspirated	USEP7069H
2.5L L4 2507cc 153 CID	1989-1990	Turbocharged	USEP7071H
2.5L L4 2507cc 153 CID	1991	Base, LE; (K)	USEP7040M
2.5L L4 2507cc 153 CID	1992	(K)	USEP7040M
2.5L L4 2507cc 153 CID	1993-1994	(K), GAS	USEP7040M
2.5L L4 2507cc 153 CID	1993-1994	(V), FLEX	USEP7056M
2.5L L4 2507cc 153 CID	1995	(K)	USEP7040M
3.0L V6 2972cc 181 CID	1989-1990	Naturally Aspirated	USEP7071H

Engine	Years	Application Description	USMW	Engine	Years	Application Description	USMW
<b>PLYMOUTH (cont'd.)</b>				<b>PLYMOUTH (cont'd.)</b>			
<b>ACCLAIM (cont'd.)</b>				<b>VOYAGER (cont'd.)</b>			
3.0L V6 2972cc 181 CID	1991	Base, LE, LX; (3)	USEP7040M	3.0L V6 2972cc 181 CID	1995	Base, LE, SE	USEP7077M
3.0L V6 2972cc 181 CID	1992	(3)	USEP7040M	3.0L V6 2972cc 181 CID	1996-2000		USEP7094M
3.0L V6 2972cc 181 CID	1993-1994	(3), GAS	USEP7040M	3.3L V6 3301cc 201 CID	1991-1993	AWD; WITH 5 PIN CONNECTOR	USEP7029M
3.0L V6 2972cc 181 CID	1995	(3)	USEP7040M	3.3L V6 3301cc 201 CID	1991-1993	FWD	USEP7030M
<b>BREEZE</b>				3.3L V6 3301cc 201 CID	1994	Base, LE, LX, SE	USEP7077M
2.0L L4 1996cc 122 CID	1996-1997		USEP7089M	3.3L V6 3301cc 201 CID	1995	Base, LE, SE	USEP7077M
2.0L L4 1996cc 122 CID	1998-2000		USEP7113M	3.3L V6 3301cc 201 CID	1996-1997		USEP7094M
2.4L L4 2429cc 148 CID	1996-1997		USEP7089M	3.3L V6 3301cc 201 CID	1998-1999	(EGM), (G), FI, FLEX, Naturally Aspirated	USEP7129M
2.4L L4 2429cc 148 CID	1998-2000		USEP7113M	3.3L V6 3301cc 201 CID	1998-2000	GAS	USEP7094M
<b>CARAVELLE</b>				3.3L V6 3301cc 201 CID	2000	(EGM), (G), FLEX	USEP7129M
2.2L L4 135 CID	1985	SE; (E), FI, Turbocharged; (Double Nipple)	USEP7051S	3.8L V6 230 CID	1998		USEP7094M
2.2L L4 135 CID	1986	Base, SE; (D), FI, Naturally Aspirated	USEP7069H	3.8L V6 3778cc 231 CID	1997		USEP7094M
2.2L L4 135 CID	1986	Turbocharged; (1 Tube Type)	USEP7071H	3.8L V6 3778cc 231 CID	1999		USEP7094M
2.5L L4 2507cc 153 CID	1986-1988	Base, SE; (K), FI, Naturally Aspirated	USEP7069H	<b>PONTIAC</b>			
<b>COLT</b>				<b>6000</b>			
1.8L L4 1834cc 112 CID	1992	Vista; (D), AWD	USEP7067S	2.8L V6 173 CID	1989		USEP3640S
1.8L L4 1834cc 112 CID	1993	Vista; (C), AWD	USEP7067S	3.1L V6 189 CID	1990-1991		USEP3640S
2.4L L4 2351cc	1992	Vista; (W), AWD	USEP7067S	<b>AZTEK</b>			
<b>GRAND VOYAGER</b>				3.4L V6 207 CID	2001-2003		USEP3521M
2.4L L4 2429cc 148 CID	1996-1997		USEP7094M	3.4L V6 207 CID	2004	to VIN 4S558922	USEP3521M
2.5L L4 2507cc 153 CID	1988	SE; (K)	USEP7068H	3.4L V6 207 CID	2004	After Vin 4s558922	USEP3701M
3.0L V6 2972cc 181 CID	1988-1989		USEP7074H	3.4L V6 207 CID	2005		USEP3701M
3.0L V6 2972cc 181 CID	1992-1993	FWD	USEP7030M	<b>BONNEVILLE</b>			
3.0L V6 2972cc 181 CID	1996-2000		USEP7094M	3.8L V6 3800cc 231 CID	1993-1994		USEP3629S
3.3L V6 3301cc 201 CID	1990		USEP7074H	3.8L V6 3800cc 231 CID	2000-2005	Naturally Aspirated	USEP3518M
3.3L V6 3301cc 201 CID	1991-1993	AWD; WITH 5 PIN CONNECTOR	USEP7029M	3.8L V6 3800cc 231 CID	2001-2003	Supercharged	USEP3536M
3.3L V6 3301cc 201 CID	1991-1993	FWD	USEP7030M	4.6L V8 281 CID	2004-2005		USEP3518M
3.3L V6 3301cc 201 CID	1994	LE, SE; (R), AWD	USEP7057M	<b>FIREBIRD</b>			
3.3L V6 3301cc 201 CID	1995	LE; (R), AWD	USEP7057M	3.8L V6 3800cc 231 CID	1996-1997		USEP3983S
3.3L V6 3301cc 201 CID	1995	SE; AWD	USEP7057M	3.8L V6 3800cc 231 CID	1998		USEP3745M
3.3L V6 3301cc 201 CID	1996-1997		USEP7094M	3.8L V6 3800cc 231 CID	1999-2002	Base; (K)	USEP3369M
3.3L V6 3301cc 201 CID	1998-2000	GAS	USEP7094M	5.7L V8 350 CID	1996-1997	Formula, Trans Am; (P)	USEP3924M
3.3L V6 3301cc 201 CID	1998-2000	(EGM), (G), FLEX	USEP7129M	5.7L V8 350 CID	1998	Formula, Trans Am; (G)	USEP3961S
3.8L V6 3778cc 231 CID	1994	LE; (L), AWD	USEP7057M	5.7L V8 350 CID	1999-2002	Formula, Trans Am; (G)	USEP3368M
3.8L V6 3778cc 231 CID	1996-1999		USEP7094M	<b>G3</b>			
<b>HORIZON</b>				<b>G3 WAVE</b>			
	1988-1990		USEP7073S	1.6L L4 1598cc 98 CID	2009-2010		USEP4003M
<b>NEON</b>				<b>G5</b>			
	2000		USEP7130M	1.6L L4 1598cc 98 CID	2009		USEP4003M
2.0L L4 1996cc 122 CID	1995		USEP7075M	<b>G6</b>			
2.0L L4 1996cc 122 CID	1996	METAL TANK	USEP7075M	2.4L L4 2198cc 134 CID	2007-2008		USEP3726M
2.0L L4 1996cc 122 CID	1996	Plastic Fuel Tank	USEP7097M	2.2L L4 2198cc 134 CID	2009-2010		USEP3782M
2.0L L4 1996cc 122 CID	1997-1999		USEP7097M	2.4L L4 2384cc 145 CID	2007-2008		USEP3726M
2.0L L4 1996cc 122 CID	2001		USEP7142M	<b>GRAND AM</b>			
<b>RELIANT</b>				2.2L L4 2384cc 145 CID	2006-2008		USEP3591M
2.2L L4 135 CID	1986-1987	Base, LE; (D)	USEP7069H	2.4L L4 2384cc 145 CID	2009		USEP3812M
2.2L L4 135 CID	1988-1989	(D)	USEP7069H	2.4L L4 2384cc 145 CID	2010		USEP3801M
2.5L L4 2507cc 153 CID	1986	LE, SE; (K)	USEP7069H	3.5L V6 214 CID	2006		USEP3591M
2.5L L4 2507cc 153 CID	1987	Base, LE; (K)	USEP7069H	3.5L V6 3490cc 213 CID	2007-2008		USEP3591M
2.5L L4 2507cc 153 CID	1988-1989	(K)	USEP7069H	3.5L V6 3490cc 213 CID	2009		USEP3812M
<b>SUNDANCE</b>				3.5L V6 3490cc 213 CID	2010		USEP3801M
	1987	(D), Naturally Aspirated	USEP7069H	3.5L V6 3498cc 213 CID	2009		USEP3812M
2.2L L4 135 CID	1987-1988	Turbocharged; (Single Nipple)	USEP7071H	3.6L V6 3564cc 217 CID	2007-2008		USEP3591M
2.2L L4 135 CID	1988	Base; (D), Naturally Aspirated	USEP7069H	3.6L V6 3564cc 217 CID	2009		USEP3812M
2.2L L4 135 CID	1989	(D), Naturally Aspirated	USEP7069H	3.9L V6 3880cc 237 CID	2006-2008		USEP3591M
2.2L L4 135 CID	1990	Base; (D), Naturally Aspirated	USEP7069H	3.9L V6 3880cc 237 CID	2009		USEP3812M
2.2L L4 135 CID	1991	America, High Line; (D), Naturally Aspirated	USEP7040M	<b>GRAND PRIX</b>			
2.2L L4 135 CID	1993-1994	Base; (D)	USEP7040M	2.2L L4 2198cc 134 CID	2002-2005		USEP3507M
2.5L L4 2507cc 153 CID	1988	Base; (K), Naturally Aspirated	USEP7069H	2.3L L4 138 CID	1992	GT, SE; (D)	USEP3917M
2.5L L4 2507cc 153 CID	1989	(K), Naturally Aspirated	USEP7069H	2.3L L4 138 CID	1992	SE; (3)	USEP3917M
2.5L L4 2507cc 153 CID	1989-1990	Turbocharged	USEP7071H	2.3L L4 138 CID	1993	GT, SE; (D)	USEP3918M
2.5L L4 2507cc 153 CID	1990	RS; (K), Naturally Aspirated	USEP7069H	2.3L L4 138 CID	1993-1994	SE; (3)	USEP3918M
2.5L L4 2507cc 153 CID	1991	High Line, RS; (K), Naturally Aspirated	USEP7040M	2.3L L4 138 CID	1994	GT; (D)	USEP3918M
2.5L L4 2507cc 153 CID	1991	RS; (J), Turbocharged	USEP7040M	2.3L L4 138 CID	1995	GT, SE; (D)	USEP3918M
2.5L L4 2507cc 153 CID	1993-1994	Base, Duster; (K)	USEP7040M	2.3L L4 140 CID	1992	GT; (A)	USEP3917M
3.0L V6 2972cc 181 CID	1993-1994	Duster; (3)	USEP7040M	2.3L L4 140 CID	1993-1994	GT; (A)	USEP3918M
<b>VOYAGER</b>				2.4L L4 2392cc 146 CID	1996-1998	GT, SE; (T)	USEP3919M
2.4L L4 2429cc 148 CID	1996-2000		USEP7094M	2.4L L4 2392cc 146 CID	1999	(T)	USEP3950M
2.5L L4 2507cc 153 CID	1988	Base, LE, SE; (K)	USEP7068H	2.4L L4 2392cc 146 CID	2000-2001		USEP3507M
2.5L L4 2507cc 153 CID	1989	Base, LE, SE; (K), Naturally Aspirated	USEP7068H	3.1L V6 189 CID	1994-1995	GT, SE; (M)	USEP3918M
2.5L L4 2507cc 153 CID	1989-1990	Turbocharged	USEP7074H	3.1L V6 189 CID	1996-1998	GT, SE; (M)	USEP3919M
2.5L L4 2507cc 153 CID	1990	LE, LX, SE; (K), Naturally Aspirated	USEP7068H	3.3L V6 204 CID	1992	GT, SE; (N)	USEP3917M
2.5L L4 2507cc 153 CID	1991-1993	FWD	USEP7030M	3.3L V6 204 CID	1993	GT, SE; (N)	USEP3918M
2.5L L4 2507cc 153 CID	1994-1995	Base	USEP7077M	3.4L V6 207 CID	1999	(E)	USEP3950M
3.0L V6 2972cc 181 CID	1988		USEP7074H	3.4L V6 207 CID	2000-2005		USEP3507M
3.0L V6 2972cc 181 CID	1989-1990	Naturally Aspirated	USEP7074H	<b>GRAND PRIX</b>			
3.0L V6 2972cc 181 CID	1991-1993	FWD	USEP7030M	3.1L V6 189 CID	1997	SE; (M), Naturally Aspirated; From Chassis/VIN 238198	USEP3978M
3.0L V6 2972cc 181 CID	1994	Base, LE, LX, SE	USEP7077M				





# FUEL PUMP MODULES APPLICATION GUIDE



FUEL PUMP MODULES

Engine	Years	Application Description	USMW
<b>PONTIAC (cont'd.)</b>			
<b>GRAND PRIX (cont'd.)</b>			
3.1L V6 189 CID	1997	SE; (M), Naturally Aspirated; To Chassis/VIN 238198	USEP3978M
3.1L V6 189 CID	1999-2000	Naturally Aspirated	USEP3537M
3.1L V6 189 CID	2001	Naturally Aspirated; Standard	USEP3542M
3.1L V6 189 CID	2002-2003	Naturally Aspirated	USEP3542M
3.1L V6 3136cc 191 CID	1998		USEP3537M
3.8L V6 3800cc 231 CID	1997	GTP; (1), Supercharged; To Chassis/VIN 238198	USEP3939M
3.8L V6 3800cc 231 CID	1997	GT, SE; (K), Naturally Aspirated; From Chassis/VIN 238198	USEP3978M
3.8L V6 3800cc 231 CID	1997	GT, SE; (K), Naturally Aspirated; To Chassis/VIN 238198	USEP3978M
3.8L V6 3800cc 231 CID	1997	GTP; (1), Supercharged; From Chassis/VIN 238198	USEP3979M
3.8L V6 3800cc 231 CID	1998-2000	Naturally Aspirated	USEP3537M
3.8L V6 3800cc 231 CID	1998-2000	GTP; (1), Supercharged	USEP3973M
3.8L V6 3800cc 231 CID	2001	Naturally Aspirated; Standard	USEP3542M
3.8L V6 3800cc 231 CID	2001-2003	GTP; (1), Supercharged	USEP3519M
3.8L V6 3800cc 231 CID	2002-2003	Naturally Aspirated	USEP3542M
3.8L V6 3800cc 231 CID	2004	Naturally Aspirated	USEP3564M
3.8L V6 3800cc 231 CID	2004	Supercharged	USEP3565M
3.8L V6 3800cc 231 CID	2005-2006		USEP3700M
3.8L V6 3800cc 231 CID	2007-2008	with 2 electrical connectors	USEP3792M
3.8L V6 3800cc 231 CID	2007-2008	with 1 electrical connector	USEP3824M
3.8L V6 3800cc 231 CID	2008	1 ELECTRICAL CONNECTOR, PZEV, WITH 2 PORTS	USEP3749M
5.3L V8 5328cc 325 CID	2005-2006		USEP3700M
<b>GTO</b>			
5.7L V8 350 CID	2004		USEP3611M
6.0L V8 5967cc 364 CID	2005-2006		USEP3611M
<b>MONTANA</b>			
3.4L V6 207 CID	1999-2001	120.0 / 304.8 Wheel Base	USEP3372M
3.4L V6 207 CID	2001-2004	112.0 / 284.5 Wheel Base	USEP3539M
3.4L V6 207 CID	2002-2004	120.0 / 304.8 Wheel Base	USEP3552M
3.5L V6 213 CID	2005	SV6; (L); (Incl.Tank Seal)	USEP3717M
3.5L V6 213 CID	2006	(L); (Incl.Tank Seal)	USEP3717M
3.9L V6 3880cc 237 CID	2006	(1); (Incl.Tank Seal)	USEP3717M
3.9L V6 3880cc 237 CID	2007		USEP3710M
3.9L V6 3880cc 237 CID	2007		USEP3717M
<b>PURSUIT</b>			
2.2L L4 2198cc 134 CID	2005		USEP3590M
2.2L L4 2198cc 134 CID	2006		USEP3726M
2.4L L4 2384cc 145 CID	2006		USEP3726M
<b>SUNBIRD</b>			
2.0L L4 122 CID	1992	LE Value Leader, SE; (H)	USEP3917M
2.0L L4 122 CID	1993	LE Value Leader, SE; (H)	USEP3918M
2.0L L4 122 CID	1994	LE; (H)	USEP3918M
3.1L V6 189 CID	1992	GT, SE; (T)	USEP3917M
3.1L V6 189 CID	1993	GT, LE Value Leader, SE; (T)	USEP3918M
3.1L V6 189 CID	1994	LE, SE; (T)	USEP3918M
<b>SUNFIRE</b>			
2.2L L4 2190cc 134 CID	1995	SE; (4)	USEP3914M
2.2L L4 2190cc 134 CID	1996	SE; (4)	USEP3919M
2.2L L4 2190cc 134 CID	1998	(4)	USEP3919M
2.2L L4 2190cc 134 CID	1999	(4)	USEP3950M
2.2L L4 2190cc 134 CID	2000	Plastic Fuel Tank	USEP3507M
2.2L L4 2190cc 134 CID	2000	(4); Exc.Plastic Fuel Tank	USEP3950M
2.2L L4 2190cc 134 CID	2002		USEP3507M
2.2L L4 2198cc 134 CID	2002-2003		USEP3507M
2.2L L4 2198cc 134 CID	2005		USEP3507M
2.2L L4 2200cc 134 CID	2002	MEX	USEP3507M
2.3L L4 138 CID	1995	GT, SE; (D)	USEP3914M
2.4L L4 2392cc 146 CID	1996	GT, SE; (T)	USEP3919M
2.4L L4 2392cc 146 CID	1998	(T)	USEP3919M
2.4L L4 2392cc 146 CID	1999	(T)	USEP3950M
2.4L L4 2392cc 146 CID	2000	MEX	USEP3507M
2.4L L4 2392cc 146 CID	2000	Plastic Fuel Tank	USEP3507M
2.4L L4 2392cc 146 CID	2000	(T); Exc.Plastic Fuel Tank	USEP3950M
2.4L L4 2392cc 146 CID	2002		USEP3507M
<b>TORRENT</b>			
3.4L V6 207 CID	2006		USEP3626M
3.4L V6 207 CID	2007-2009		USEP3757M
3.4L V6 3350cc 204 CID	2007-2008		USEP3757M
3.6L V6 3564cc 217 CID	2008-2009		USEP3757M
<b>TRANS SPORT</b>			
	1997	112.0 / 284.5 Wheel Base	USEP3976M
	1997	120.0 / 304.8 Wheel Base	USEP3976M
3.4L V6 207 CID	1998	120.0 / 304.8 Wheel Base	USEP3372M
3.8L V6 3800cc 231 CID	1992-1994		USEP3649S
<b>VIBE</b>			
1.8L L4 1798cc 110 CID	2009-2010		USEP3781M
2.4L L4 2362cc	2009-2010		USEP3781M

Engine	Years	Application Description	USMW
<b>PONTIAC (cont'd.)</b>			
<b>WAVE</b>			
1.6L L4 1598cc 98 CID	2005		USEP3612M
1.6L L4 1598cc 98 CID	2006-2007		USEP3711M
<b>RAM</b>			
<b>1500</b>			
3.6L V6 3604cc 220 CID	2013		USEP7270M
3.6L V6 3604cc 220 CID	2015-2017		USEP7270M
3.7L V6 226 CID	2011-2012		USEP7270M
4.7L V8 287 CID	2011-2013		USEP7270M
5.7L V8 345 CID	2011		USEP7270M
5.7L V8 345 CID	2012	EZH engine	USEP7270M
5.7L V8 345 CID	2012	EZC engine	USEP7275M
5.7L V8 345 CID	2013-2017		USEP7270M
<b>2500</b>			
5.7L V8 345 CID	2011-2018	EZC engine	USEP7275M
6.4L V8 6424cc 392 CID	2014-2018		USEP7275M
<b>3500</b>			
5.7L V8 345 CID	2013-2017		USEP7275M
6.4L V8 6424cc 392 CID	2014-2017		USEP7275M
<b>C/V</b>			
3.6L V6 3604cc 220 CID	2012-2015		USEP7272M
<b>DAKOTA</b>			
3.7L V6 226 CID	2011	GAS	USEP7216M
4.7L V8 287 CID	2011	FLEX	USEP7216M
<b>RENAULT</b>			
<b>MEGANE</b>			
2.0L L4 1998cc 122 CID	2001-2003		USEP12026M
<b>SCENIC</b>			
2.0L L4 1998cc 122 CID	2001-2004	MEX	USEP12026M
<b>SAAB</b>			
<b>9-3</b>			
	2003	SE; (B205R)	USEP8426M
2.0L L4 1985cc	2000-2001	Base; (B205L), (H)	USEP8426M
2.0L L4 1985cc	2000-2002	SE; (B205R), (K)	USEP8426M
2.3L L4 2290cc 140 CID	1999	Viggen; (B235R), (G)	USEP8426M
2.3L L4 2290cc 140 CID	2000-2002	Viggen; (B235R)	USEP8426M
<b>9-5</b>			
2.3L L4 2290cc 140 CID	1999-2005		USEP8431M
3.0L V6 2961cc 181 CID	1999-2003		USEP8431M
<b>9-7X</b>			
4.2L L6 256 CID	2005-2007		USEP3707M
4.2L L6 256 CID	2008-2009		USEP3769M
5.3L V8 5328cc 325 CID	2005-2007		USEP3707M
5.3L V8 5328cc 325 CID	2008-2009		USEP3769M
6.0L V8 5967cc 364 CID	2008-2009		USEP3769M
<b>9000</b>			
	1991	Base, CD, S; (B234I), (B), Naturally Aspirated	USEP8515M
	1991	CD Turbo, Turbo; (B234L), (M), Turbocharged	USEP8515M
2.0L L4 1985cc	1990	CD, Turbo; (B202L), (L), Turbocharged	USEP8515M
2.0L L4 1985cc	1990	S; (B202I), (D), Naturally Aspirated	USEP8515M
2.3L L4 2290cc 140 CID	1990	CD, S; (B234I), (B), Naturally Aspirated	USEP8515M
<b>SATURN</b>			
<b>AURA</b>			
2.4L L4 2384cc 145 CID	2008		USEP3591M
2.4L L4 2384cc 145 CID	2009		USEP3812M
3.5L V6 3490cc 213 CID	2007-2008		USEP3591M
3.6L V6 3564cc 217 CID	2007-2008		USEP3591M
<b>ION</b>			
2.0L L4 122 CID	2007		USEP3726M
2.2L L4 2198cc 134 CID	2003-2005		USEP3590M
2.2L L4 2198cc 134 CID	2007		USEP3726M
2.4L L4 2384cc 145 CID	2007		USEP3726M
<b>L100</b>			
2.2L L4 2198cc 134 CID	2001-2002		USEP3557M
<b>L200</b>			
2.2L L4 2198cc 134 CID	2001-2003		USEP3557M
<b>L300</b>			
2.2L L4 2198cc 134 CID	2004		USEP3557M
3.0L V6 3000cc 181 CID	2001-2005		USEP3557M
<b>LS</b>			
	2000		USEP3737M
2.2L L4 2198cc 134 CID	2000		USEP3548M



# FUEL PUMP MODULES APPLICATION GUIDE



Engine	Years	Application Description	USMW	Engine	Years	Application Description	USMW
<b>SATURN (cont'd.)</b>				<b>SUBARU (cont'd.)</b>			
<b>LS1</b>				<b>OUTBACK</b>			
	2000		USEP3737M	2.5L H4 2458cc	2000-2003		USEP8596M
2.2L L4 2198cc 134 CID	2000		USEP3548M	2.5L H4 2458cc	2004		USEP8600M
<b>LS2</b>				3.0L H6 3000cc	2001-2003	VDC; (EZ30D)	USEP8518M
	2000		USEP3737M	<b>SUZUKI</b>			
3.0L V6 3000cc 181 CID	2000		USEP3548M	<b>EQUATOR</b>			
<b>LW1</b>				2.5L L4 2488cc 152 CID	2009-2012		USEP8743M
	2000		USEP3737M	4.0L V6 3954cc	2009-2012		USEP8743M
2.2L L4 2198cc 134 CID	2000		USEP3548M	<b>ESTEEM</b>			
<b>LW2</b>				1.6L L4 1590cc 97 CID	1999-2000		USEP8437M
	2000		USEP3737M	1.8L L4 1790cc	1999-2002		USEP8437M
3.0L V6 3000cc 181 CID	2000		USEP3548M	<b>FORENZA</b>			
<b>LW200</b>				2.0L L4 1998cc 122 CID	2004-2008		USEP8703M
2.2L L4 2198cc 134 CID	2001-2003		USEP3557M	<b>GRAND VITARA</b>			
<b>LW300</b>				2.5L V6 2500cc	1999-2005		USEP3520S
3.0L V6 3000cc 181 CID	2001-2003		USEP3557M	<b>RENO</b>			
<b>OUTLOOK</b>				2.0L L4 1998cc	2005-2007		USEP8703M
3.6L V6 3564cc 217 CID	2007-2008		USEP3748M	2.0L L4 1998cc 122 CID	2008		USEP8703M
3.6L V6 3564cc 217 CID	2009-2010	WITHOUT FUEL LEVEL SENSOR	USEP3790M	<b>SIDEKICK</b>			
<b>RELAY</b>				1.6L L4 1590cc 97 CID	1989	JLX; (0), FI	USEP8238H
	2005	2; (Incl. Tank Seal)	USEP3717M	1.6L L4 1590cc 97 CID	1991	JLX, JX; 4 Doors	USEP8238H
3.5L V6 213 CID	2006	3; (L); (Incl. Tank Seal)	USEP3717M	<b>SX4</b>			
3.9L V6 3880cc 237 CID	2006	3; (1); (Incl. Tank Seal)	USEP3717M	2.0L L4 1995cc 122 CID	2007-2012		USEP8773M
3.9L V6 3880cc 237 CID	2007		USEP3718M	<b>VITARA</b>			
<b>SC</b>				1.6L L4 1590cc 97 CID	1999-2002		USEP3520S
1.9L L4 116 CID	1991-1992		USEP3905M	2.0L L4 2000cc	1999-2003		USEP3520S
<b>SC1</b>				2.5L V6 2500cc	2004		USEP3520S
	1997		USEP3944M	<b>XL-7</b>			
	1998-2000		USEP3951M	2.7L V6 2737cc	2005-2006		USEP8601S
1.9L L4 116 CID	1993-1996		USEP3905M	<b>TOYOTA</b>			
1.9L L4 116 CID	2001-2002		USEP3951M	<b>4RUNNER</b>			
<b>SC2</b>				4.7L V8 4663cc 285 CID	2005-2009		USEP8797M
	1997		USEP3944M	<b>CAMRY</b>			
1.9L L4 116 CID	1993-1996		USEP3905M	2.4L L4 2357cc 144 CID	2007		USEP8899M
1.9L L4 116 CID	1998-2002		USEP3951M	2.4L L4 2362cc	2007		USEP8899M
<b>SL1</b>				2.4L L4 2362cc	2010-2011		USEP8899M
	1997		USEP3944M	2.5L L4 2494cc 152 CID	2010-2011		USEP8937M
1.9L L4 116 CID	1991-1996		USEP3905M	<b>COROLLA</b>			
1.9L L4 116 CID	1998-2002		USEP3951M	1.8L L4 1794cc	2005-2008		USEP8874M
<b>SL2</b>				1.8L L4 1794cc	2009		USEP3781M
	1997		USEP3944M	1.8L L4 1795cc	2005-2006		USEP8874M
1.9L L4 116 CID	1991-1996		USEP3905M	1.8L L4 1798cc 110 CID	2009-2018		USEP3781M
1.9L L4 116 CID	1998-2002		USEP3951M	2.4L L4 2362cc	2009-2010		USEP3781M
<b>SW1</b>				2.4L L4 2400cc 146 CID	2010		USEP3781M
	1997		USEP3944M	<b>FJ CRUISER</b>			
1.9L L4 116 CID	1993-1996		USEP3905M	4.0L V6 3956cc 241 CID	2007-2009		USEP8878M
1.9L L4 116 CID	1998-1999		USEP3951M	<b>MATRIX</b>			
<b>SW2</b>				1.8L L4 1794cc	2005-2008		USEP8874M
	1997		USEP3944M	1.8L L4 1795cc	2005-2006		USEP8874M
1.9L L4 116 CID	1993-1996		USEP3905M	1.8L L4 1798cc 110 CID	2009-2013		USEP3781M
1.9L L4 116 CID	1998-2001		USEP3951M	2.4L L4 2362cc	2009-2013		USEP3781M
<b>VUE</b>				2.4L L4 2362cc 144 CID	2010		USEP3781M
2.2L L4 2198cc 134 CID	2002-2003		USEP3585M	<b>SEQUOIA</b>			
2.2L L4 2198cc 134 CID	2004	(Secondary)	USEP3626M	4.6L V8 4608cc	2010-2012		USEP8869M
2.2L L4 2198cc 134 CID	2005-2006		USEP3626M	4.7L V8 4663cc 285 CID	2005-2007		USEP8694M
3.0L V6 3000cc 181 CID	2002-2003	(B)	USEP3585M	4.7L V8 4663cc 285 CID	2008-2009		USEP8806M
3.5L V6 3471cc	2006		USEP3626M	5.7L V8 5663cc 345 CID	2008-2018		USEP8869M
3.5L V6 3474cc	2005		USEP3626M	<b>SIENNA</b>			
3.5L V6 3475cc	2004		USEP3626M	3.5L V6 3456cc	2007-2010		USEP8805M
<b>SEAT</b>				<b>TACOMA</b>			
<b>ALHAMBRA</b>				2.7L L4 2694cc	2005-2016		USEP8756M
1.8L L4 1781cc	2003-2004	MEX	USEP12050M	4.0L V6 3956cc 241 CID	2005-2015		USEP8757M
<b>ALTEA</b>				<b>TUNDRA</b>			
2.0L L4 1984cc 121 CID	2005	MEX	USEP12050M	4.0L V6 3956cc 241 CID	2005-2006		USEP8694M
<b>SUBARU</b>				4.0L V6 3956cc 241 CID	2007-2014		USEP8806M
<b>BAJA</b>				4.6L V8 4608cc	2010-2018		USEP8869M
2.5L H4 2458cc	2003		USEP8596M	4.7L V8 4663cc 285 CID	2005-2006		USEP8694M
2.5L H4 2458cc	2004-2006	Naturally Aspirated	USEP8600M	4.7L V8 4663cc 285 CID	2007-2009		USEP8806M
<b>IMPREZA</b>				5.7L V8 5663cc 345 CID	2007-2018		USEP8869M
2.5L H4 2458cc	2004-2005		USEP8599M	<b>VOLKSWAGEN</b>			
<b>LEGACY</b>				<b>BEEBLE</b>			
2.5L H4 2458cc	2000-2003		USEP8596M	1.8L L4 1781cc	2004-2005	5.4 INCH OD FLANGE, PLASTIC TANK	USEP8705M
2.5L H4 2458cc	2004		USEP8600M				

Engine	Years	Application Description	USMW
<b>VOLKSWAGEN (cont'd.)</b>			
<b>BEETLE (cont'd.)</b>			
1.8L L4 1798cc 110 CID	2014-2017		USEP8831M
1.9L L4 1896cc 116 CID	2004-2006		USEP8668M
2.0L L4 1968cc 120 CID	2013-2014	DIESEL	USEP8667M
2.0L L4 1984cc 121 CID	2004-2005	5.4 INCH OD FLANGE, PLASTIC TANK	USEP8705M
2.0L L4 1984cc 121 CID	2012-2016		USEP8831M
2.0L L4 1984cc 121 CID	2018		USEP8831M
2.5L L5 2480cc 151 CID	2006-2010	5.4 INCH OD FLANGE, PLASTIC TANK	USEP8705M
2.5L L5 2480cc 151 CID	2010		USEP8424M
2.5L L5 2480cc 151 CID	2012-2014		USEP8831M
<b>BORA</b>			
2.0L L4 1984cc 121 CID	2006	MEX	USEP8833M
2.5L L5 2480cc 151 CID	2006-2010	MEX	USEP8833M
<b>CABRIO</b>			
2.0L L4 1984cc 121 CID	1995		USEP8244M
2.0L L4 1984cc 121 CID	1997-2002		USEP8366M
<b>CC</b>			
3.6L V6 3597cc 219 CID	2009-2012		USEP8740M
3.6L V6 3597cc 219 CID	2014		USEP8740M
3.6L V6 3597cc 220 CID	2014		USEP8740M
<b>CLASICO</b>			
2.0L L4 1984cc 121 CID	2011	MEX	USEP12050M
<b>COMBI</b>			
1.8L L4 1780cc	1991-1994	MEX	USEP8244M
1.8L L4 1781cc	1995-1999	MEX	USEP8244M
<b>CORRADO</b>			
1.8L L4 1780cc	1990	From Chassis/VIN 50-L-005733	USEP8394M
1.8L L4 1780cc	1991-1992		USEP8394M
2.8L V6 2771cc	1992		USEP8394M
<b>DERBY</b>			
1.8L L4 1781cc	1995-1999	MEX	USEP8244M
<b>EOS</b>			
2.0L L4 1984cc 121 CID	2007	To Chassis/VIN 1f-7-031 000	USEP8833M
2.0L L4 1984cc 121 CID	2007-2016	from chassis1k-7-108 001	USEP8831M
3.2L V6 3189cc 195 CID	2007	To Chassis/VIN 1f-7-031 000	USEP8833M
3.2L V6 3189cc 195 CID	2007-2008	to chassis1k-7-108 000	USEP8671M
3.2L V6 3197cc 195 CID	2008	to chassis1k-7-108 000	USEP8671M
<b>EUROVAN</b>			
2.5L L5 2459cc 150 CID	1993	To Chassis/VIN 70-P-030000	USEP8245M
2.5L L5 2459cc 150 CID	1995		USEP8244M
2.5L L5 2461cc 150 CID	2004	MEX	USEP12050M
2.8L V6 2771cc	1997		USEP8244M
2.8L V6 2771cc	2002-2003		USEP8244M
<b>GOLF</b>			
1.8L L4 1781cc	1993-1998	MEX	USEP8244M
1.8L L4 1781cc	2003-2006	5.4 INCH OD FLANGE, PLASTIC TANK	USEP8705M
1.9L L4 1896cc 116 CID	2004-2006		USEP8668M
2.0L L4 1968cc 120 CID	2010-2014	DIESEL	USEP8667M
2.0L L4 1984cc 121 CID	1993-1998		USEP8366M
2.0L L4 1984cc 121 CID	1995-1997	MEX; Golf III	USEP12013M
2.0L L4 1984cc 121 CID	2003-2006	5.4 INCH OD FLANGE, PLASTIC TANK	USEP8705M
2.5L L5 2480cc 151 CID	2010-2014		USEP8831M
2.8L V6 2771cc	1995-1998		USEP8366M
2.8L V6 2771cc	2003-2005	5.4 INCH OD FLANGE, PLASTIC TANK	USEP8705M
3.2L V6 3189cc	2004		USEP8551M
<b>GTI</b>			
2.0L L4 1984cc 121 CID	2006-2014		USEP8831M
<b>JETTA</b>			
1.4L L4 1395cc 85 CID	2016-2018		USEP8831M
1.8L L4 1781cc	1993-1994	MEX	USEP8244M
1.8L L4 1781cc	1998	MEX	USEP8244M
1.8L L4 1781cc	2004-2005	5.4 INCH OD FLANGE, PLASTIC TANK	USEP8705M
1.8L L4 1798cc 110 CID	2014-2018		USEP8831M
1.9L L4 1896cc 116 CID	2004-2005		USEP8668M
1.9L L4 1896cc 116 CID	2005-2006	DIESEL	USEP8667M
2.0L L4 1968cc 120 CID	2009-2010	DIESEL	USEP8667M
2.0L L4 1968cc 120 CID	2012-2015	DIESEL	USEP8667M
2.0L L4 1984cc 121 CID	1993-1994		USEP8366M
2.0L L4 1984cc 121 CID	1998		USEP8366M
2.0L L4 1984cc 121 CID	2004-2005	5.4 INCH OD FLANGE, PLASTIC TANK	USEP8705M
2.0L L4 1984cc 121 CID	2006-2018		USEP8831M
2.5L L5 2480cc 151 CID	2008-2014		USEP8831M
2.8L V6 2771cc	1994		USEP8366M

Engine	Years	Application Description	USMW
<b>VOLKSWAGEN (cont'd.)</b>			
<b>JETTA (cont'd.)</b>			
2.8L V6 2771cc	1998		USEP8366M
<b>LUPO</b>			
1.6L L4 1599cc 98 CID	2006	MEX	USEP12050M
1.6L L4 1599cc 98 CID	2008-2009	MEX	USEP12050M
<b>PASSAT</b>			
1.8L L4 1781cc	1998		USEP8368M
1.8L L4 1781cc	2000-2005		USEP8368M
2.0L L4 1967cc 120 CID	2004-2005		USEP8672M
2.0L L4 1984cc 121 CID	1996		USEP8244M
2.8L V6 2771cc	1997	(4.0 Bar)	USEP8394M
2.8L V6 2771cc	1997	MEX	USEP8394M
2.8L V6 2771cc	1998		USEP8368M
2.8L V6 2771cc	2000		USEP8368M
2.8L V6 2771cc	2001-2005	FWD	USEP8368M
2.8L V6 2771cc	2001-2005	AWD	USEP8384M
3.6L V6 3597cc 219 CID	2006-2008		USEP8740M
<b>POINTER</b>			
1.8L L4 1781cc	1998-1999	MEX	USEP12053M
<b>POINTER TRUCK</b>			
1.8L L4 1781cc	1999	MEX	USEP12053M
<b>POLO</b>			
1.6L L4 1596cc 97 CID	2003-2007	MEX	USEP12050M
<b>RABBIT</b>			
2.5L L5 2480cc 151 CID	2007	to chassis1k-7-108 000	USEP8671M
2.5L L5 2480cc 151 CID	2007	To Chassis/VIN 1K-7-108 000	USEP8833M
2.5L L5 2480cc 151 CID	2007-2009	from chassis1k-7-108 001	USEP8831M
<b>ROUTAN</b>			
3.6L V6 3604cc 220 CID	2011-2014		USEP7272M
3.8L V6 3778cc 231 CID	2009-2010		USEP7235M
4.0L V6 3952cc 241 CID	2009-2010		USEP7235M
<b>SEDAN</b>			
1.6L H4 1584cc 97 CID	1993-2004	MEX	USEP12003
<b>TOUAREG</b>			
3.2L V6 3189cc 195 CID	2004-2006		USEP8569M
3.2L V6 3200cc 195 CID	2004		USEP8569M
3.6L V6 3597cc 219 CID	2007		USEP8568M
4.2L V8 4163cc	2007		USEP8568M
4.2L V8 4172cc	2004-2006		USEP8569M
4.2L V8 4172cc	2007		USEP8568M
<b>VOLVO</b>			
<b>850</b>			
2.3L L5 2319cc	1993		USEP8379M
2.3L L5 2319cc	1994	Turbo; (5), (B5234FT), Turbocharged	USEP8379M
2.3L L5 2319cc	1995	T-5R; (58), (B5234T5), Turbocharged	USEP8379M
2.3L L5 2319cc	1996-1997	R; (58), (B5234T5), Turbocharged	USEP8379M
2.3L L5 2319cc	1997	T-5; (57), (B5234T1), Turbocharged	USEP8379M
2.4L L5 2435cc	1997	GLT; (56), (B5254T), Turbocharged	USEP8379M
<b>S40</b>			
1.9L L4 1855cc 113 CID	2000-2002		USEP8607M
1.9L L4 1948cc	2000-2004		USEP8607M
<b>S60</b>			
2.3L L5 2319cc	2001-2002	PLASTIC TANK	USEP8633M
2.3L L5 2319cc	2001-2003	STEEL FUEL TANK	USEP8847M
2.3L L5 2319cc	2004	T5; (B5234T3), Turbocharged; Plastic Fuel Tank	USEP8635M
2.3L L5 2319cc	2004		USEP8847M
2.4L L5 2401cc 147 CID	2006	STEEL FUEL TANK	USEP8847M
2.4L L5 2401cc 147 CID	2008	STEEL FUEL TANK	USEP8847M
2.4L L5 2435cc	2001-2002	PLASTIC TANK	USEP8633M
2.4L L5 2435cc	2001-2002	STEEL TANK	USEP8847M
2.4L L5 2435cc	2003	STEEL FUEL TANK	USEP8847M
2.4L L5 2435cc	2004	2.4; (B5244S), Naturally Aspirated; Plastic Fuel Tank	USEP8635M
2.4L L5 2435cc	2005-2006	STEEL FUEL TANK	USEP8847M
2.4L L5 2435cc	2008-2009	STEEL FUEL TANK	USEP8847M
2.4L L5 2435cc 149 CID	2001-2003	steel tank	USEP8490M
2.4L L5 2435cc 149 CID	2001-2003	STEEL FUEL TANK	USEP8847M
2.5L L5 2500cc 153 CID	2004		USEP8634M
2.5L L5 2521cc	2004		USEP8634M
2.5L L5 2521cc	2008-2009		USEP8807M
2.5L L5 2521cc 154 CID	2004		USEP8634M
<b>S80</b>			
2.8L L6 2783cc 170 CID	1999-2001		USEP8633M
2.8L L6 2798cc	1999-2001		USEP8633M
2.9L L6 2917cc	1999-2002		USEP8633M
2.9L L6 2922cc 178 CID	2000		USEP8633M





# FUEL PUMP MODULES APPLICATION GUIDE



Engine	Years	Application Description	USMW	Engine	Years	Application Description	USMW
<b>VOLVO (cont'd.)</b>							
<b>V40</b>							
1.9L L4 1948cc	2000-2004		USEP8607M				
<b>V70</b>							
2.3L L5 2319cc	2001-2002	PLASTIC TANK	USEP8633M				
2.3L L5 2319cc	2003	STEEL FUEL TANK	USEP8847M				
2.3L L5 2319cc	2004	T5; (B5234T3), Turbocharged; Plastic Fuel Tank	USEP8635M				
2.3L L5 2319cc	2004		USEP8847M				
2.4L L5 2435cc	2001-2002	PLASTIC TANK	USEP8633M				
2.4L L5 2435cc	2003	STEEL FUEL TANK	USEP8847M				
2.4L L5 2435cc	2004	2.4; (B5244S), Naturally Aspirated; Plastic Fuel Tank	USEP8635M				
2.4L L5 2435cc	2005	STEEL FUEL TANK	USEP8847M				
2.4L L5 2435cc	2006		USEP8851M				
2.4L L5 2435cc	2007		USEP8807M				
2.4L L5 2435cc 149 CID	2002-2003	steel tank	USEP8490M				
2.4L L5 2435cc 149 CID	2003	STEEL FUEL TANK	USEP8847M				
2.5L L5 2521cc	2004		USEP8634M				
2.5L L5 2521cc	2005-2006		USEP8851M				
2.5L L5 2521cc	2007		USEP8807M				
<b>XC70</b>							
	2004		USEP8635M				
2.5L L5 2521cc	2005-2006		USEP8851M				
2.5L L5 2521cc	2007		USEP8807M				
2.5L L5 2521cc 154 CID	2007		USEP8807M				
<b>XC90</b>							
2.9L L6 2917cc	2005		USEP8851M				



# FUEL PUMP MODULES BUYERS GUIDE



FUEL PUMP MODULES

USMW	Years	Application	Engine	USMW	Years	Application	Engine	
<b>usep2461m</b>	2005-2007	FORD F-250 SUPER DUTY	5.4L V8 330 CID	<b>USEP2079S</b>	1986-1987	FORD TAURUS	2.5L L4 153 CID	
	2005-2007	FORD F-250 SUPER DUTY	6.8L V10 415 CID		1987	MERCURY SABLE	3.0L V6 2986cc 182 CID	
	2005-2007	FORD F-350 SUPER DUTY	5.4L V8 330 CID		1988-1989	MERCURY SABLE	3.8L V6 232 CID	
	2005-2007	FORD F-350 SUPER DUTY	6.8L V10 415 CID		1989	FORD TAURUS	2.5L L4 153 CID	
<b>usep12357m</b>	2014-2017	CHEVROLET SILVERADO 1500	4.3L V6 262 CID	1989	FORD TAURUS	3.8L V6 232 CID		
	2014-2017	CHEVROLET SILVERADO 1500	5.3L V8 5328cc 325 CID	<b>USEP2080S</b>	1986-1987	FORD AEROSTAR	2.3L L4 140 CID	
	2014-2017	GMC SIERRA 1500	4.3L V6 262 CID		1986-1989	FORD AEROSTAR	3.0L V6 2986cc 182 CID	
<b>USEP2059MN</b>	2014-2017	GMC SIERRA 1500	5.3L V8 5328cc 325 CID	<b>USEP2081S</b>	1985-1986	FORD TEMPO	2.3L L4 140 CID	
	1989-1990	FORD BRONCO II	2.9L V6 177 CID		1985-1987	MERCURY TOPAZ	2.3L L4 140 CID	
	1990-1996	FORD BRONCO	5.0L V8 302 CID	<b>USEP2082S</b>	1987	MERCURY LYNX	1.9L L4 116 CID	
	1990-1996	FORD BRONCO	5.8L V8 5753cc 351 CID		1987-1990	FORD ESCORT	1.9L L4 116 CID	
1990-1996	FORD F-150	5.8L V8 5753cc 351 CID	<b>USEP2084H</b>	1985-1986	FORD THUNDERBIRD	2.3L L4 140 CID		
1990-1996	FORD F-250	5.8L V8 5753cc 351 CID		1985-1986	MERCURY COUGAR	2.3L L4 140 CID		
1990-1997	FORD F-350	5.8L V8 5753cc 351 CID	<b>USEP2085H</b>	1986-1992	LINCOLN MARK VII	5.0L V8 302 CID		
1991-1992	FORD BRONCO	4.9L L6 4917cc 300 CID		1987-1989	LINCOLN TOWN CAR	5.0L V8 302 CID		
1992-1996	FORD E-150 ECONOLINE	4.9L L6 4917cc 300 CID	<b>USEP2087H</b>	1987-1989	FORD LTD CROWN VICTORIA	5.0L V8 302 CID		
1992-1996	FORD E-150 ECONOLINE	5.0L V8 302 CID		1987-1991	FORD COUNTRY SQUIRE	5.0L V8 302 CID		
1992-1996	FORD E-150 ECONOLINE	5.8L V8 5753cc 351 CID	<b>USEP2088S</b>	1987-1991	MERCURY COLONY PARK	5.0L V8 302 CID		
1992-1996	FORD E-150 ECONOLINE CLUB WAGON	4.9L L6 4917cc 300 CID		1985-1986	FORD F-250	7.5L V8 460 CID		
1992-1996	FORD E-150 ECONOLINE CLUB WAGON	5.0L V8 302 CID	1985-1986	FORD F-350	7.5L V8 460 CID			
	FORD E-150 ECONOLINE CLUB WAGON	5.8L V8 5753cc 351 CID	1980	FORD F-350	5.0L V8 302 CID			
1992-1996	FORD E-150 ECONOLINE CLUB WAGON	5.8L V8 5753cc 351 CID	1980-1982	FORD F-250	5.0L V8 302 CID			
1992-1996	FORD E-250 ECONOLINE	4.9L L6 4917cc 300 CID	1980-1982	FORD F-250	5.8L V8 5753cc 351 CID			
1992-1996	FORD E-250 ECONOLINE	5.8L V8 5753cc 351 CID	1980-1982	FORD F-250	6.6L V8 400 CID			
1992-1996	FORD E-350 ECONOLINE	4.9L L6 4917cc 300 CID	1980-1982	FORD F-350	5.8L V8 5753cc 351 CID			
1992-1996	FORD E-350 ECONOLINE	5.8L V8 5753cc 351 CID	1980-1982	FORD F-350	6.6L V8 400 CID			
1992-1996	FORD E-350 ECONOLINE	7.5L V8 460 CID	1983-1984	FORD F-250	7.5L V8 460 CID			
1992-1996	FORD E-350 ECONOLINE CLUB WAGON	4.9L L6 4917cc 300 CID	1983-1984	FORD F-350	7.5L V8 460 CID			
1992-1996	FORD E-350 ECONOLINE CLUB WAGON	5.8L V8 5753cc 351 CID	<b>USEP2090S</b>	1985-1989	FORD BRONCO	5.0L V8 302 CID		
	FORD E-350 ECONOLINE CLUB WAGON	7.5L V8 460 CID		1985-1986	FORD F-250	7.5L V8 460 CID		
1992-1996	FORD E-350 ECONOLINE CLUB WAGON	7.5L V8 460 CID	<b>USEP2091S</b>	1985-1986	FORD F-350	7.5L V8 460 CID		
	FORD P-350	5.8L V8 5753cc 351 CID		1985-1986	FORD F-150	5.0L V8 302 CID		
1995-1996	FORD EXPLORER	4.0L V6 245 CID	1985-1986	FORD F-250	5.0L V8 302 CID			
1995-1996	FORD F-150	4.9L L6 4917cc 300 CID	<b>USEP2093S</b>	1985-1986	FORD F-150	5.0L V8 302 CID		
1995-1996	FORD F-150	5.0L V8 302 CID		1985-1986	FORD F-250	5.0L V8 302 CID		
1995-1996	FORD F-250	4.9L L6 4917cc 300 CID	<b>USEP2094S</b>	1986-1988	FORD RANGER	2.3L L4 140 CID		
1995-1996	FORD F-250	7.5L V8 460 CID		1986-1988	FORD RANGER	2.9L V6 177 CID		
1995-1997	FORD F-250	5.0L V8 302 CID	<b>USEP2095S</b>	1986-1988	FORD RANGER	2.3L L4 140 CID		
1996	FORD ECONOLINE SUPER DUTY	5.8L V8 5753cc 351 CID		1986-1988	FORD RANGER	2.9L V6 177 CID		
1996	FORD ECONOLINE SUPER DUTY	7.5L V8 460 CID	<b>USEP2096S</b>	1986-1988	FORD RANGER	2.3L L4 140 CID		
1996	FORD EXPLORER	5.0L V8 302 CID		1986-1988	FORD RANGER	2.9L V6 177 CID		
1996	FORD F-350	4.9L L6 4917cc 300 CID	<b>USEP2097S</b>	1986-1988	FORD BRONCO II	2.9L V6 177 CID		
1996	FORD F-350	7.5L V8 460 CID		1989-1997	FORD THUNDERBIRD	3.8L V6 232 CID		
1996-1997	FORD P-350	5.8L V8 5753cc 351 CID	1989-1997	MERCURY COUGAR	3.8L V6 232 CID			
1997	MERCURY MOUNTAINEER	5.0L V8 302 CID	1991-1993	FORD THUNDERBIRD	5.0L V8 302 CID			
<b>USEP2060S</b>	1990-1991	FORD E-350 ECONOLINE	5.8L V8 5753cc 351 CID	1991-1993	MERCURY COUGAR	5.0L V8 302 CID		
	1990-1991	FORD E-350 ECONOLINE	7.5L V8 460 CID	1993	FORD GHIA	3.0L V6 2986cc 182 CID		
<b>USEP2063M</b>	1989-1997	FORD F53	7.5L V8 460 CID	1994-1997	FORD THUNDERBIRD	4.6L V8 281 CID		
	1991-1993	FORD F600	7.0L V8 429 CID	1994-1997	MERCURY COUGAR	4.6L V8 281 CID		
	1991-1993	FORD F700	7.0L V8 429 CID	1985-1986	LINCOLN CONTINENTAL	5.0L V8 302 CID		
	1995	FORD F700	7.0L V8 429 CID	1985-1986	LINCOLN MARK VII	5.0L V8 302 CID		
	1995	FORD F-350	5.0L V8 302 CID	1986	FORD THUNDERBIRD	3.8L V6 232 CID		
<b>USEP2064MN</b>	1997-1998	FORD F700	7.0L V8 429 CID	1986	FORD THUNDERBIRD	5.0L V8 302 CID		
	1990-1994	FORD F-150	5.8L V8 5753cc 351 CID	1986	MERCURY COUGAR	3.8L V6 232 CID		
	1990-1994	FORD F-250	5.8L V8 5753cc 351 CID	<b>USEP2100H</b>	1988-1994	FORD TEMPO	2.3L L4 140 CID	
	1990-1995	FORD F-350	5.8L V8 5753cc 351 CID		1988-1994	MERCURY TOPAZ	2.3L L4 140 CID	
1997	FORD F-350	5.8L V8 5753cc 351 CID	1994	FORD TOPAZ	2.3L L4 2309cc 140 CID			
<b>USEP2070H</b>	1993-1996	LINCOLN MARK VIII	4.6L V8 281 CID	<b>USEP2102S</b>	1987-1989	FORD F-150	5.0L V8 302 CID	
	1993-1996	LINCOLN MARK VIII	4.6L V8 281 CID		1987-1989	FORD F-250	5.0L V8 302 CID	
<b>USEP2071S</b>	1989-1991	FORD E-350 ECONOLINE	4.9L L6 4917cc 300 CID	1988-1989	FORD F-150	4.9L L6 4917cc 300 CID		
	1989-1991	FORD E-350 ECONOLINE	5.8L V8 5753cc 351 CID	1988-1989	FORD F-150	5.8L V8 5753cc 351 CID		
	1989-1991	FORD E-350 ECONOLINE	7.5L V8 460 CID	1988-1989	FORD F-250	5.8L V8 5753cc 351 CID		
<b>USEP2074H</b>	1994-1997	FORD ASPIRE	1.3L L4 1295cc	1988-1989	FORD F-250	7.5L V8 460 CID		
	1994-1997	FORD ASPIRE	1.3L L4 1295cc	1988-1989	FORD F-250	5.8L V8 5753cc 351 CID		
<b>USEP2075H</b>	1986	MERCURY SABLE	2.5L L4 153 CID	<b>USEP2103S</b>	1988-1989	FORD F-250	7.5L V8 460 CID	
	1986-1987	FORD TAURUS	2.5L L4 153 CID		1988-1989	FORD F-150	5.0L V8 302 CID	
	1988-1995	MERCURY SABLE	3.8L V6 232 CID		1988-1989	FORD F-150	5.0L V8 302 CID	
	1989-1991	FORD TAURUS	2.5L L4 153 CID		1988-1989	FORD F-150	4.9L L6 4917cc 300 CID	
	1989-1991	FORD TAURUS	3.8L V6 232 CID		1988-1989	FORD F-150	5.8L V8 5753cc 351 CID	
	1993-1995	FORD TAURUS	3.8L V6 232 CID		1988-1989	FORD F-250	7.5L V8 460 CID	
	1995	FORD SABLE	3.8L V6 232 CID		1988-1989	FORD F-250	5.0L V8 302 CID	
	<b>USEP2077S</b>	1986-1987	FORD TAURUS		2.5L L4 153 CID	1988-1989	FORD F-250	5.0L V8 302 CID
		1987	MERCURY SABLE		3.0L V6 2986cc 182 CID	1988-1989	FORD F-250	4.9L L6 4917cc 300 CID
		1988-1994	LINCOLN CONTINENTAL		3.8L V6 232 CID	1988-1989	FORD F-350	5.8L V8 5753cc 351 CID
		1988-1994	MERCURY SABLE		3.8L V6 232 CID	1988-1989	FORD F-350	7.5L V8 460 CID
		1989-1990	FORD TAURUS		2.5L L4 153 CID	1988-1989	FORD F-350	5.0L V8 302 CID
1989-1991		FORD TAURUS	3.8L V6 232 CID	1988-1989	FORD F-350	5.0L V8 302 CID		
<b>USEP2078S</b>	1993-1995	FORD TAURUS	3.8L V6 232 CID	<b>USEP2104S</b>	1987-1989	FORD F-150	5.8L V8 5753cc 351 CID	
	1989-1992	FORD RANGER	2.9L V6 177 CID		1987-1989	FORD F-250	5.0L V8 302 CID	
	1989-1997	FORD RANGER	2.3L L4 140 CID	1988	FORD F-150	5.8L V8 5753cc 351 CID		
	1990-1997	FORD RANGER	4.0L V6 245 CID	1988	FORD F-250	4.9L L6 4917cc 300 CID		
	1991-1997	FORD RANGER	3.0L V6 2986cc 182 CID	1988-1989	FORD F-150	7.5L V8 460 CID		
	1994-1995	MAZDA B3000	3.0L V6 2986cc 182 CID	1988-1989	FORD F-150	5.8L V8 5753cc 351 CID		
	1994-1997	MAZDA B2300	2.3L L4 140 CID	1988-1989	FORD F-250	5.8L V8 5753cc 351 CID		
	1994-1997	MAZDA B4000	4.0L V6 4016cc	1988-1989	FORD F-250	7.5L V8 460 CID		
	1997	MAZDA B3000	3.0L V6 2986cc 182 CID	1988-1989	FORD F-350	7.5L V8 460 CID		
	1986	MERCURY SABLE	2.5L L4 153 CID	1991-1993	FORD ESCORT	1.8L L4 112 CID		
<b>USEP2079S</b>	1986	MERCURY SABLE	2.5L L4 153 CID	1991-1993	FORD ESCORT	1.9L L4 116 CID		
	1986	MERCURY SABLE	2.5L L4 153 CID	1991-1993	MERCURY TRACER	1.8L L4 112 CID		
	1986	MERCURY SABLE	2.5L L4 153 CID	1991-1993	MERCURY TRACER	1.9L L4 116 CID		
	1986	MERCURY SABLE	3.8L V6 232 CID	<b>USEP2106S</b>	1990-1992	FORD RANGER	2.9L V6 177 CID	
	1986	MERCURY SABLE	2.5L L4 153 CID		1990-1997	FORD RANGER	2.3L L4 140 CID	
	1986	MERCURY SABLE	3.8L V6 232 CID	1990-1997	FORD RANGER	4.0L V6 245 CID		
	1986	MERCURY SABLE	3.8L V6 232 CID	1991-1997	FORD RANGER	3.0L V6 2986cc 182 CID		
	1986	MERCURY SABLE	3.8L V6 232 CID	1994-1996	MAZDA B3000	3.0L V6 2986cc 182 CID		
	1986	MERCURY SABLE	3.8L V6 232 CID	1994-1997	MAZDA B2300	2.3L L4 140 CID		
	1986	MERCURY SABLE	3.8L V6 232 CID	1994-1997	MAZDA B4000	4.0L V6 4016cc		
	1986	MERCURY SABLE	3.8L V6 232 CID					
	1986	MERCURY SABLE	3.8L V6 232 CID					

USMW	Years	Application	Engine	USMW	Years	Application	Engine	
<b>USEP2107S</b>	1989-1997	FORD AEROSTAR	3.0L V6 2986cc 182 CID	<b>USEP2136S</b>	1987	MERCURY LYNX	1.9L L4 116 CID	
	1990-1997	FORD AEROSTAR	4.0L V6 245 CID		1987-1988	FORD EXP	1.9L L4 116 CID	
<b>USEP2108S</b>	1990	FORD TAURUS	2.5L L4 153 CID	1987-1990	FORD ESCORT	1.9L L4 116 CID		
	1990-1991	FORD TAURUS	3.8L V6 232 CID	1987-1989	FORD BRONCO	5.0L V8 302 CID		
	1990-1995	MERCURY SABLE	3.8L V6 232 CID	1988-1989	FORD BRONCO	5.8L V8 5753cc 351 CID		
	1993-1995	FORD TAURUS	3.8L V6 232 CID	<b>USEP2143S</b>	1988-1989	FORD F-150	4.9L L6 4917cc 300 CID	
1995	FORD SABLE	3.8L V6 232 CID	1988-1989		FORD F-150	5.0L V8 302 CID		
<b>USEP2110H</b>	1985-1986	FORD MUSTANG	3.8L V6 232 CID		1988-1989	FORD F-150	5.8L V8 5753cc 351 CID	
	1985-1986	MERCURY CAPRI	3.8L V6 232 CID		1988-1989	FORD F-250	5.0L V8 302 CID	
	1985-1986	MERCURY CAPRI	5.0L V8 302 CID		1988-1989	FORD F-250	5.8L V8 5753cc 351 CID	
	1985-1993	FORD MUSTANG	2.3L L4 140 CID		1988-1989	FORD F-250	7.5L V8 460 CID	
	1985-1993	FORD MUSTANG	5.0L V8 302 CID		1988-1989	FORD F-350	5.8L V8 5753cc 351 CID	
<b>USEP2113H</b>	1995-1996	FORD CROWN VICTORIA	4.6L V8 281 CID		1988-1989	FORD F-350	7.5L V8 460 CID	
	1995-1996	LINCOLN TOWN CAR	4.6L V8 281 CID		<b>USEP2144S</b>	1991-1994	FORD EXPLORER	4.0L V6 245 CID
	1995-1996	MERCURY GRAND MARQUIS	4.6L V8 281 CID			<b>USEP2146S</b>	1985-1986	MERCURY MARQUIS
<b>USEP2115S</b>	1993-1995	FORD TAURUS	3.2L V6 195 CID	1986	FORD LTD		3.8L V6 232 CID	
	<b>USEP2116H</b>	1996	FORD WINDSTAR	3.8L V6 232 CID	<b>USEP2147S</b>	1990-1991	FORD E-150 ECONOLINE	5.0L V8 302 CID
<b>USEP2117S</b>	1995-1996	FORD CONTOUR	2.0L L4 1989cc 121 CID	1990-1991		FORD E-150 ECONOLINE	5.8L V8 5753cc 351 CID	
	1995-1996	FORD CONTOUR	2.5L V6 2450cc 155 CID	1990-1991	FORD E-150 ECONOLINE CLUB WAGON	5.8L V8 5753cc 351 CID		
	1995-1996	MERCURY MYSTIQUE	2.0L L4 1989cc 121 CID	1990-1991	FORD E-250 ECONOLINE	5.8L V8 5753cc 351 CID		
	1995-1996	MERCURY MYSTIQUE	2.5L V6 2450cc 155 CID	1990-1991	FORD E-250 ECONOLINE CLUB WAGON	5.8L V8 5753cc 351 CID		
<b>USEP2118H</b>	1995-1997	FORD PROBE	2.0L L4 1989cc 122 CID	1990-1991	FORD E-350 ECONOLINE	5.8L V8 5753cc 351 CID		
	1995-1997	FORD PROBE	2.5L V6 2497cc	1990-1991	FORD E-350 ECONOLINE	7.5L V8 460 CID		
	1996-1997	MAZDA 626	2.0L L4 1991cc	<b>USEP2148S</b>	1991	FORD E-150 ECONOLINE CLUB WAGON	5.0L V8 302 CID	
	1996-1997	MAZDA 626	2.5L V6 2497cc		1985-1986	FORD F-150	5.0L V8 302 CID	
	1996-1997	MAZDA MX-6	2.0L L4 1991cc	<b>USEP2149S</b>	1985-1986	FORD F-150	5.0L V8 302 CID	
	1996-1997	MAZDA MX-6	2.5L V6 2497cc		1985-1986	FORD F-250	5.0L V8 302 CID	
<b>USEP2120S</b>	1990-1991	FORD LTD CROWN VICTORIA	5.0L V8 302 CID	<b>USEP2151H</b>	1994-1996	FORD ESCORT	1.8L L4 112 CID	
	1990-1991	MERCURY GRAND MARQUIS	5.0L V8 302 CID		1994-1996	FORD ESCORT	1.9L L4 116 CID	
<b>USEP2121H</b>	1991-1992	LINCOLN TOWN CAR	4.6L V8 281 CID		1994-1996	MERCURY TRACER	1.8L L4 112 CID	
	1992	FORD CROWN VICTORIA	4.6L V8 281 CID		1994-1996	MERCURY TRACER	1.9L L4 116 CID	
	1992	MERCURY GRAND MARQUIS	4.6L V8 281 CID	<b>USEP2153M</b>	1996	FORD TAURUS	3.0L V6 2968cc 181 CID	
<b>USEP2122H</b>	1991-1997	FORD GRAND MARQUIS	4.6L V8 281 CID		1996	FORD TAURUS	3.4L V8 207 CID	
	1993-1994	FORD CROWN VICTORIA	4.6L V8 281 CID		1996	MERCURY SABLE	3.0L V6 2968cc 181 CID	
	1993-1994	MERCURY GRAND MARQUIS	4.6L V8 281 CID	<b>USEP2155S</b>	1988-1989	MERKUR SCORPIO	2.9L V6 177 CID	
<b>USEP2123S</b>	1990	LINCOLN TOWN CAR	5.0L V8 302 CID		<b>USEP2156H</b>	1993-1995	FORD PROBE	2.0L L4 1989cc 122 CID
	1991	LINCOLN TOWN CAR	4.6L V8 281 CID	1993-1995		FORD PROBE	2.5L V6 2497cc	
	<b>USEP2131S</b>	1984	FORD THUNDERBIRD	2.3L L4 140 CID		1995	MAZDA 626	2.0L L4 1991cc
		1984	MERCURY COUGAR	2.3L L4 140 CID		1995	MAZDA 626	2.5L V6 2497cc
1984-1985		FORD LTD	3.8L V6 232 CID	1995		MAZDA MX-6	2.0L L4 1991cc	
<b>USEP2132S</b>	1984-1985	FORD LTD	5.0L V8 302 CID	1995		MAZDA MX-6	2.5L V6 2497cc	
	1984-1985	MERCURY MARQUIS	3.8L V6 232 CID	<b>USEP2159M</b>		1996	FORD SABLE	3.0L V6 2968cc 181 CID
	1985-1986	FORD LTD	3.8L V6 232 CID		1996	FORD TAURUS	3.0L V6 2986cc 182 CID	
	<b>USEP2133S</b>	1985-1986	MERCURY MARQUIS		3.8L V6 232 CID	1996	MERCURY SABLE	3.0L V6 2986cc 182 CID
1985-1988		FORD E-250 ECONOLINE CLUB WAGON	7.5L V8 460 CID		1997	FORD CROWN VICTORIA	4.6L V8 281 CID	
<b>USEP2134S</b>	1986-1987	FORD E-150 ECONOLINE CLUB WAGON	5.0L V8 302 CID	1997	LINCOLN TOWN CAR	4.6L V8 281 CID		
	1986-1988	FORD E-250 ECONOLINE	5.0L V8 302 CID	<b>USEP2164H</b>	1997	FORD ESCORT	2.0L L4 1989cc 121 CID	
	1986-1988	FORD E-350 ECONOLINE	7.5L V8 460 CID		1997	MERCURY TRACER	2.0L L4 1989cc 121 CID	
	1986-1988	FORD E-350 ECONOLINE CLUB WAGON	7.5L V8 460 CID	<b>USEP2165M</b>	1997	FORD TAURUS	3.4L V8 207 CID	
	1986-1988	FORD E-350 ECONOLINE CLUB WAGON	7.5L V8 460 CID		<b>USEP2181S</b>	1995	FORD EXPLORER	4.0L V6 245 CID
	1986-1991	FORD E-150 ECONOLINE	5.0L V8 302 CID	<b>USEP2184M</b>		1997	FORD TAURUS	3.0L V6 2986cc 182 CID
	1988	FORD E-250 ECONOLINE	5.8L V8 5753cc 351 CID		1997	MERCURY SABLE	3.0L V6 2986cc 182 CID	
	1988	FORD E-250 ECONOLINE CLUB WAGON	5.8L V8 5753cc 351 CID	<b>USEP2185M</b>	1997	FORD TAURUS	3.0L V6 2968cc 181 CID	
	1988	FORD E-350 ECONOLINE	5.8L V8 5753cc 351 CID		1997	FORD TAURUS	3.4L V8 207 CID	
	1988	FORD E-350 ECONOLINE CLUB WAGON	5.8L V8 5753cc 351 CID		1997	MERCURY SABLE		
	1988-1991	FORD E-150 ECONOLINE	5.8L V8 5753cc 351 CID	<b>USEP2186M</b>	1995-1996	LINCOLN CONTINENTAL	4.6L V8 281 CID	
	1988-1991	FORD E-150 ECONOLINE CLUB WAGON	5.8L V8 5753cc 351 CID		1997	LINCOLN CONTINENTAL	4.6L V8 281 CID	
	1989	FORD E-150 ECONOLINE CLUB WAGON	5.0L V8 302 CID	<b>USEP2187M</b>	1997-1998	FORD CONTOUR	2.0L L4 1989cc 121 CID	
	<b>USEP2135S</b>	1991	FORD E-150 ECONOLINE CLUB WAGON		5.0L V8 302 CID	1997-1998	FORD CONTOUR	2.5L V6 2450cc 155 CID
1986-1987		FORD E-350 ECONOLINE	7.5L V8 460 CID		1997-1998	MERCURY MYSTIQUE	2.0L L4 1989cc 121 CID	
<b>USEP2136S</b>	1986-1988	FORD E-350 ECONOLINE CLUB WAGON	7.5L V8 460 CID	1997-1998	MERCURY MYSTIQUE	2.5L V6 2450cc 155 CID		
	1986-1988	FORD E-350 ECONOLINE CLUB WAGON	7.5L V8 460 CID	<b>USEP2190S</b>	1997-2000	FORD EXPLORER	4.0L V6 245 CID	
	1986-1989	FORD E-250 ECONOLINE	5.0L V8 302 CID		<b>USEP2191H</b>	1994-1997	FORD MUSTANG	3.8L V6 232 CID
	1986-1989	FORD E-250 ECONOLINE CLUB WAGON	7.5L V8 460 CID	1996-1997		FORD MUSTANG	4.6L V8 281 CID	
	1986-1990	FORD E-150 ECONOLINE	5.0L V8 302 CID	<b>USEP2192M</b>	1998	MERCURY SABLE		
	1988	FORD E-350 ECONOLINE	5.8L V8 5753cc 351 CID		<b>USEP2193M</b>	1998	LINCOLN CONTINENTAL	4.6L V8 281 CID
	1988	FORD E-350 ECONOLINE CLUB WAGON	5.8L V8 5753cc 351 CID	<b>USEP2194M</b>		1997-1998	LINCOLN MARK VIII	
	1988-1990	FORD E-150 ECONOLINE	5.8L V8 5753cc 351 CID		<b>USEP2197M</b>	1998	MERCURY TRACER	
	1988-1990	FORD E-150 ECONOLINE CLUB WAGON	5.8L V8 5753cc 351 CID	<b>USEP2198M</b>		1998	MERCURY SABLE	
	1988-1990	FORD E-250 ECONOLINE	5.8L V8 5753cc 351 CID		<b>USEP2199M</b>	1997-1998	FORD WINDSTAR	3.0L V6 2986cc 182 CID
	1988-1990	FORD E-250 ECONOLINE CLUB WAGON	5.8L V8 5753cc 351 CID	1997-1998		FORD WINDSTAR	3.8L V6 232 CID	
	<b>USEP2137S</b>	1989	FORD E-150 ECONOLINE CLUB WAGON	5.0L V8 302 CID	<b>USEP2200M</b>	1998	FORD MUSTANG	4.6L V8 281 CID
1990		FORD E-350 ECONOLINE	5.8L V8 5753cc 351 CID	<b>USEP2201S</b>		1997-1998	FORD E-150 ECONOLINE	4.2L V6 256 CID
1990		FORD E-350 ECONOLINE	7.5L V8 460 CID		1997-1998	FORD E-150 ECONOLINE	4.6L V8 281 CID	
1990		FORD E-350 ECONOLINE CLUB WAGON	5.8L V8 5753cc 351 CID		1997-1998	FORD E-150 ECONOLINE CLUB WAGON	4.2L V6 256 CID	
1990		FORD E-350 ECONOLINE CLUB WAGON	5.8L V8 5753cc 351 CID		1997-1998	FORD E-150 ECONOLINE CLUB WAGON	4.6L V8 281 CID	





# FUEL PUMP MODULES BUYERS GUIDE



FUEL PUMP MODULES

USMW	Years	Application	Engine	USMW	Years	Application	Engine
<b>USEP2201S</b>	1997-1998	FORD E-250 ECONOLINE	4.2L V6 256 CID	<b>USEP2224S</b>	1997-1998	FORD E-150 ECONOLINE CLUB WAGON	5.4L V8 330 CID
	1997-1998	FORD EXPEDITION	4.6L V8 281 CID		1997-1998	FORD E-350 ECONOLINE	5.4L V8 330 CID
	1997-1998	FORD EXPEDITION	5.4L V8 330 CID		1997-1998	FORD E-350 ECONOLINE	6.8L V10 415 CID
<b>USEP2202S</b>	1998	LINCOLN NAVIGATOR	5.4L V8 330 CID	1997-1999	FORD E-250 ECONOLINE	5.4L V8 330 CID	
	1997-1998	FORD EXPEDITION	4.6L V8 281 CID	1997-1999	FORD E-350 ECONOLINE CLUB WAGON	5.4L V8 330 CID	
	1997-1998	FORD EXPEDITION	5.4L V8 330 CID	1997-1999	FORD E-350 ECONOLINE CLUB WAGON	6.8L V10 415 CID	
<b>USEP2203M</b>	1998	FORD MUSTANG	4.6L V8 281 CID	<b>USEP2227S</b>	1998-1999	FORD CONTOUR	2.0L L4 1989cc 121 CID
<b>USEP2205S</b>	1997-1998	FORD EXPEDITION	4.6L V8 281 CID		1998-1999	MERCURY MYSTIQUE	2.0L L4 1989cc 121 CID
1997-1998	FORD EXPEDITION	5.4L V8 330 CID	1999		FORD CONTOUR	2.5L V6 2450cc 155 CID	
<b>USEP2206S</b>	1997-1998	FORD E-150 ECONOLINE	5.4L V8 330 CID	1999	MERCURY COUGAR	2.0L L4 1989cc 121 CID	
	1997-1998	FORD E-350 ECONOLINE	5.4L V8 330 CID	1999	MERCURY COUGAR	2.5L V6 2450cc 155 CID	
	1997-1998	FORD E-350 ECONOLINE	6.8L V10 415 CID	1999	MERCURY MYSTIQUE	2.5L V6 2450cc 155 CID	
1997-1999	FORD E-150 ECONOLINE CLUB WAGON	5.4L V8 330 CID	<b>USEP2230M</b>	1999-2004	FORD F-250 SUPER DUTY	5.4L V8 330 CID	
1997-1999	FORD E-250 ECONOLINE	5.4L V8 330 CID		1999-2004	FORD F-250 SUPER DUTY	6.8L V10 415 CID	
1997-1999	FORD E-350 ECONOLINE CLUB WAGON	5.4L V8 330 CID		1999-2004	FORD F-350 SUPER DUTY	5.4L V8 330 CID	
<b>USEP2207S</b>	1997-2004	FORD E-350 ECONOLINE CLUB WAGON	6.8L V10 415 CID	1999-2004	FORD F-350 SUPER DUTY	6.8L V10 415 CID	
	1997-1999	FORD E-250 ECONOLINE	5.4L V8 330 CID	2002	FORD F-450 SUPER DUTY	6.8L V10 415 CID	
	1997-1999	FORD E-350 ECONOLINE CLUB WAGON	5.4L V8 330 CID	<b>USEP2231M</b>	1999-2004	FORD F-350 SUPER DUTY	5.4L V8 330 CID
1998	FORD RANGER	2.5L L4 153 CID	1999-2004		FORD F-350 SUPER DUTY	6.8L V10 415 CID	
1998	FORD RANGER	3.0L V6 2986cc 182 CID	<b>USEP2232M</b>		1999	FORD F-250 SUPER DUTY	5.4L V8 330 CID
1998	FORD RANGER	4.0L V6 245 CID		1999	FORD F-250 SUPER DUTY	6.8L V10 415 CID	
1998	MAZDA B2500	2.5L L4 2492cc		1999	FORD F-350 SUPER DUTY	5.4L V8 330 CID	
<b>USEP2208S</b>	1998	MAZDA B3000	2.5L L4 2492cc	1999	FORD F-350 SUPER DUTY	6.8L V10 415 CID	
	1998	MAZDA B2500	2.5L L4 2492cc	1999	FORD F-450 SUPER DUTY	6.8L V10 415 CID	
	1998	FORD RANGER	2.5L L4 153 CID	1999	FORD F-450 SUPER DUTY	6.8L V10 415 CID	
<b>USEP2209S</b>	1998	FORD RANGER	3.0L V6 2986cc 182 CID	1999	FORD F-550 SUPER DUTY	6.8L V10 415 CID	
	1998	FORD RANGER	4.0L V6 245 CID	<b>USEP2233M</b>	1999	FORD F-250 SUPER DUTY	5.4L V8 330 CID
	1998	MAZDA B3000	3.0L V6 2986cc 182 CID		1999	FORD F-250 SUPER DUTY	6.8L V10 415 CID
1998	MAZDA B4000	4.0L V6 4016cc	1999		FORD F-350 SUPER DUTY	5.4L V8 330 CID	
<b>USEP2210S</b>	1998-2000	MAZDA B2500	2.5L L4 2492cc	1999	FORD F-350 SUPER DUTY	6.8L V10 415 CID	
	1997	FORD E-150 ECONOLINE	4.2L V6 256 CID	1999	FORD F-450 SUPER DUTY	6.8L V10 415 CID	
	1997	FORD E-150 ECONOLINE	4.6L V8 281 CID	1999	FORD F-550 SUPER DUTY	6.8L V10 415 CID	
<b>USEP2211S</b>	1997	FORD E-150 ECONOLINE CLUB WAGON	4.2L V6 256 CID	<b>USEP2234M</b>	1999-2004	FORD F-350 SUPER DUTY	5.4L V8 330 CID
	1997	FORD E-150 ECONOLINE CLUB WAGON	4.2L V6 256 CID		1999-2004	FORD F-350 SUPER DUTY	6.8L V10 415 CID
	1997	FORD E-150 ECONOLINE CLUB WAGON	4.6L V8 281 CID		2000	FORD F-350	5.4L V8 330 CID
<b>USEP2212S</b>	1997-1998	FORD E-150 ECONOLINE	4.2L V6 256 CID	<b>USEP2235M</b>	1999-2004	FORD F-250 SUPER DUTY	5.4L V8 330 CID
	1997-1998	FORD E-150 ECONOLINE	4.6L V8 281 CID		1999-2004	FORD F-250 SUPER DUTY	6.8L V10 415 CID
	1997-1998	FORD E-150 ECONOLINE CLUB WAGON	4.2L V6 256 CID		1999-2004	FORD F-350 SUPER DUTY	5.4L V8 330 CID
<b>USEP2213S</b>	1997-1998	FORD E-150 ECONOLINE	4.2L V6 256 CID	1999-2004	FORD F-350 SUPER DUTY	6.8L V10 415 CID	
	1997-1998	FORD E-150 ECONOLINE	4.6L V8 281 CID	<b>USEP2237S</b>	1999	FORD F-250	5.4L V8 330 CID
	1997-1998	FORD E-150 ECONOLINE CLUB WAGON	4.2L V6 256 CID		1999-2002	FORD F-250	4.6L V8 281 CID
1997-1998	FORD E-150 ECONOLINE CLUB WAGON	4.6L V8 281 CID	1999-2003		FORD F-150	4.2L V6 256 CID	
<b>USEP2214S</b>	1997-1998	FORD E-250 ECONOLINE	4.2L V6 256 CID	1999-2003	FORD F-150	4.6L V8 281 CID	
	1997-1998	FORD F-150	4.2L V6 256 CID	1999-2003	FORD F-150	5.4L V8 330 CID	
	1997-1998	FORD F-150	4.6L V8 281 CID	2001-2002	FORD LOBO	5.4L V8 330 CID	
<b>USEP2218M</b>	1997-1998	FORD E-150 ECONOLINE	4.2L V6 256 CID	2004	FORD F-150 HERITAGE	4.2L V6 256 CID	
	1997-1998	FORD E-150 ECONOLINE	4.6L V8 281 CID	2004	FORD F-150 HERITAGE	4.6L V8 281 CID	
	1997-1998	FORD E-150 ECONOLINE CLUB WAGON	4.2L V6 256 CID	2004	FORD F-150 HERITAGE	5.4L V8 330 CID	
<b>USEP2220M</b>	1997-1998	FORD E-150 ECONOLINE CLUB WAGON	4.6L V8 281 CID	<b>USEP2238M</b>	1999-2004	FORD F-250 SUPER DUTY	5.4L V8 330 CID
	1997-1998	FORD E-250 ECONOLINE	4.2L V6 256 CID		1999-2004	FORD F-250 SUPER DUTY	6.8L V10 415 CID
	1997-1998	FORD E-250 ECONOLINE	4.2L V6 256 CID		1999-2004	FORD F-350 SUPER DUTY	5.4L V8 330 CID
<b>USEP2221S</b>	1997-1998	FORD E-150 ECONOLINE	5.0L V8 302 CID	1999-2004	FORD F-350 SUPER DUTY	6.8L V10 415 CID	
	1997-1998	FORD E-150 ECONOLINE	5.8L V8 5753cc 351 CID	2002	FORD F-450 SUPER DUTY	6.8L V10 415 CID	
	1997-1998	FORD E-150 ECONOLINE CLUB WAGON	5.0L V8 302 CID	<b>USEP2239S</b>	1999-2002	FORD E-250 ECONOLINE	4.2L V6 256 CID
1992-1996	FORD E-150 ECONOLINE CLUB WAGON	5.8L V8 5753cc 351 CID	<b>USEP2241S</b>		1999	FORD E-150 ECONOLINE	4.6L V8 281 CID
1992-1996	FORD E-250 ECONOLINE	5.8L V8 5753cc 351 CID			1999-2002	FORD E-150 ECONOLINE CLUB WAGON	4.2L V6 256 CID
1992-1996	FORD E-350 ECONOLINE	5.8L V8 5753cc 351 CID		1999-2002	FORD E-150 ECONOLINE CLUB WAGON	4.6L V8 281 CID	
<b>USEP2222S</b>	1992-1996	FORD E-350 ECONOLINE	7.5L V8 460 CID	1999-2002	FORD E-250 ECONOLINE	4.2L V6 256 CID	
	1992-1996	FORD E-350 ECONOLINE CLUB WAGON	5.8L V8 5753cc 351 CID	2003	FORD E-150 CLUB WAGON	4.2L V6 256 CID	
	1992-1996	FORD E-350 ECONOLINE	7.5L V8 460 CID	2003	FORD E-150 CLUB WAGON	4.6L V8 281 CID	
<b>USEP2223S</b>	1992-1996	FORD E-350 ECONOLINE CLUB WAGON	5.8L V8 5753cc 351 CID	2003	FORD E-250	4.2L V6 256 CID	
	1995-1996	FORD E-250 ECONOLINE	4.9L L6 4917cc 300 CID	2003	FORD E-250	4.6L V8 281 CID	
	1997	FORD F-250	5.4L V8 330 CID	<b>USEP2243M</b>	1999	FORD SABLE	3.0L V6 2968cc 181 CID
1997-1998	FORD F-150	4.2L V6 256 CID	1999		FORD TAURUS	3.0L V6 2968cc 181 CID	
1997-1998	FORD F-150	4.6L V8 281 CID	1999		FORD TAURUS	3.0L V6 2986cc 182 CID	
<b>USEP2225S</b>	1997-1998	FORD F-150	5.4L V8 330 CID	1999	MERCURY SABLE	3.0L V6 2968cc 181 CID	
	1997-1998	FORD F-150	5.4L V8 330 CID	1999	MERCURY SABLE	3.0L V6 2986cc 182 CID	
	1997-1998	FORD F-250	4.6L V8 281 CID	<b>USEP2244M</b>	1999-2000	FORD MUSTANG	3.8L V6 232 CID
1997-1998	FORD F-250	4.6L V8 281 CID	1999-2000		FORD MUSTANG	4.6L V8 281 CID	
1997-1998	FORD F-250	4.6L V8 281 CID	<b>USEP2245M</b>		1999-2004	FORD F-250 SUPER DUTY	5.4L V8 330 CID
1997-1998	FORD F-250	4.6L V8 281 CID		1999-2004	FORD F-250 SUPER DUTY	6.8L V10 415 CID	
1997-1998	FORD F-250	4.6L V8 281 CID		1999-2004	FORD F-350 SUPER DUTY	5.4L V8 330 CID	
<b>USEP2227S</b>	1997-1998	FORD F-250	4.6L V8 281 CID	1999-2004	FORD F-350 SUPER DUTY	6.8L V10 415 CID	
	1997-1998	FORD F-250	4.6L V8 281 CID	2002	FORD F-450 SUPER DUTY	6.8L V10 415 CID	
	1997-1998	FORD F-250	4.6L V8 281 CID	<b>USEP2246M</b>	1999	MERCURY TRACER	2.0L L4 1989cc 121 CID
1997-1998	FORD F-250	4.6L V8 281 CID	2000		FORD ESCORT	2.0L L4 1989cc 121 CID	
1997-1998	FORD F-250	4.6L V8 281 CID	2002-2003		FORD ESCORT	2.0L L4 1989cc 121 CID	
<b>USEP2228S</b>	1997-1998	FORD F-250	4.6L V8 281 CID	1999-2000	FORD WINDSTAR	3.8L V6 232 CID	
	1997-1998	FORD F-250	4.6L V8 281 CID	<b>USEP2248M</b>	1999-2000	FORD WINDSTAR	3.8L V6 232 CID
	1997-1998	FORD F-250	4.6L V8 281 CID		1999-2002	LINCOLN CONTINENTAL	
1997-1998	FORD F-250	4.6L V8 281 CID	<b>USEP2249M</b>		1999-2002	LINCOLN CONTINENTAL	
1997-1998	FORD F-250	4.6L V8 281 CID		1999	LINCOLN NAVIGATOR	5.4L V8 330 CID	
1997-1998	FORD F-250	4.6L V8 281 CID		1999-2002	FORD EXPEDITION	4.6L V8 281 CID	
<b>USEP2229S</b>	1997-1998	FORD F-250	4.6L V8 281 CID	1999-2002	FORD EXPEDITION	5.4L V8 330 CID	
	1997-1998	FORD F-250	4.6L V8 281 CID	1999-2002	FORD EXPEDITION	5.4L V8 330 CID	
	1997-1998	FORD F-250	4.6L V8 281 CID	<b>USEP2253S</b>	1999-2002	LINCOLN NAVIGATOR	5.4L V8 330 CID
1997-1998	FORD F-250	4.6L V8 281 CID	<b>USEP2255S</b>		1999-2002	LINCOLN NAVIGATOR	5.4L V8 330 CID
1997-1998	FORD F-250	4.6L V8 281 CID			<b>USEP2257S</b>	1999	FORD RANGER
1997-1998	FORD F-250	4.6L V8 281 CID					

USMW	Years	Application	Engine	USMW	Years	Application	Engine
USEP2257S	1999	MAZDA B3000	3.0L V6 2986cc 182 CID	USEP2293M	2001-2003	FORD RANGER	2.3L L4 140 CID
USEP2259S	1999	FORD RANGER	3.0L V6 2986cc 182 CID	2001-2003	FORD RANGER	4.0L V6 245 CID	
USEP2260S	1999	FORD RANGER	3.0L V6 2986cc 182 CID	2001-2003	MAZDA B2300		
	1999	MAZDA B3000	3.0L V6 2986cc 182 CID	2001-2003	MAZDA B4000		
USEP2261S	1999	FORD RANGER	2.5L L4 153 CID	USEP2294M	2001	FORD SABLE	3.0L V6 2968cc 181 CID
	1999	FORD RANGER	3.0L V6 2986cc 182 CID	2001	FORD TAURUS	3.0L V6 2968cc 181 CID	
	1999	FORD RANGER	4.0L V6 245 CID	2001	FORD TAURUS	3.0L V6 2986cc 182 CID	
	1999	MAZDA B4000	4.0L V6 4016cc	2001	MERCURY SABLE	3.0L V6 2968cc 181 CID	
USEP2262S	1999	FORD RANGER	2.5L L4 153 CID	2001	MERCURY SABLE	3.0L V6 2986cc 182 CID	
	1999	FORD RANGER	3.0L V6 2986cc 182 CID	USEP2295M	2001-2003	FORD RANGER	2.3L L4 140 CID
	1999	FORD RANGER	4.0L V6 245 CID	2001-2003	FORD RANGER	4.0L V6 245 CID	
USEP2263S	1998-1999	MAZDA B4000	4.0L V6 4016cc	USEP2296S	1999-2001	MERCURY MOUNTAINEER	4.0L V6 245 CID
	1999	FORD RANGER	2.5L L4 153 CID	1999-2001	MERCURY MOUNTAINEER	5.0L V8 302 CID	
	1999	FORD RANGER	3.0L V6 2986cc 182 CID	2000-2001	FORD EXPLORER	5.0L V8 302 CID	
	1999	FORD RANGER	4.0L V6 245 CID	2001	FORD EXPLORER	4.0L V6 245 CID	
USEP2264M	1998-1999	FORD TAURUS	3.4L V8 207 CID	USEP2297S	1999	LINCOLN NAVIGATOR	5.4L V8 330 CID
USEP2265S	1999-2003	FORD F-150	5.4L V8 330 CID	1999-2002	FORD EXPEDITION	4.6L V8 281 CID	
	2004	FORD F-150 HERITAGE	5.4L V8 330 CID	2001-2002	FORD EXPEDITION	5.4L V8 330 CID	
USEP2266S	1997-1998	FORD EXPLORER	4.0L V6 245 CID	USEP2298S	1999-2002	FORD EXPEDITION	4.6L V8 281 CID
	1997-1998	FORD EXPLORER	5.0L V8 302 CID	1999-2002	FORD EXPEDITION	5.4L V8 330 CID	
	1998	MERCURY MOUNTAINEER	4.0L V6 245 CID	USEP2301M	2001-2004	FORD MUSTANG	3.8L V6 232 CID
	1998	MERCURY MOUNTAINEER	5.0L V8 302 CID	2001-2004	FORD MUSTANG	4.6L V8 281 CID	
USEP2268S	2000	MAZDA B3000	3.0L V6 2986cc 182 CID	2004	FORD MUSTANG	3.9L V6 238 CID	
	2000-2001	FORD RANGER	3.0L V6 2986cc 182 CID	USEP2310M	1990-1994	FORD F-150	5.8L V8 5753cc 351 CID
USEP2269S	2000	FORD RANGER	4.0L V6 245 CID	1990-1994	FORD F-250	5.8L V8 5753cc 351 CID	
	2000-2001	FORD RANGER	2.5L L4 153 CID	1990-1995	FORD F-350	5.8L V8 5753cc 351 CID	
	2001	MAZDA B2500		1990-1997	FORD F SUPER DUTY	7.5L V8 460 CID	
USEP2270S	2000	FORD RANGER	4.0L V6 245 CID	1992-1996	FORD E-150 ECONOLINE	4.9L L6 4917cc 300 CID	
	2000-2001	FORD RANGER	2.5L L4 153 CID	1992-1996	FORD E-150 ECONOLINE	5.0L V8 302 CID	
USEP2272S	1998-2000	FORD CROWN VICTORIA	4.6L V8 281 CID	1992-1996	FORD E-150 ECONOLINE	5.8L V8 5753cc 351 CID	
	1998-2000	LINCOLN TOWN CAR	4.6L V8 281 CID	1992-1996	FORD E-150 ECONOLINE CLUB WAGON	4.9L L6 4917cc 300 CID	
	1998-2000	MERCURY GRAND MARQUIS	4.6L V8 281 CID	1992-1996	FORD E-150 ECONOLINE CLUB WAGON	5.0L V8 302 CID	
USEP2273M	1999-2000	FORD CONTOUR	2.0L L4 1989cc 121 CID	1992-1996	FORD E-150 ECONOLINE CLUB WAGON	5.8L V8 5753cc 351 CID	
	1999-2000	FORD CONTOUR	2.5L V6 2450cc 155 CID	1992-1996	FORD E-250 ECONOLINE	4.9L L6 4917cc 300 CID	
	1999-2000	MERCURY MYSTIQUE	2.0L L4 1989cc 121 CID	1992-1996	FORD E-250 ECONOLINE	5.8L V8 5753cc 351 CID	
	1999-2000	MERCURY MYSTIQUE	2.5L V6 2450cc 155 CID	1992-1996	FORD E-350 ECONOLINE	4.9L L6 4917cc 300 CID	
	1999-2002	MERCURY COUGAR	2.0L L4 1989cc 121 CID	1992-1996	FORD E-350 ECONOLINE	5.8L V8 5753cc 351 CID	
	1999-2002	MERCURY COUGAR	2.5L V6 2450cc 155 CID	1992-1996	FORD E-350 ECONOLINE	7.5L V8 460 CID	
USEP2274M	2000-2002	LINCOLN LS	3.9L V8 242 CID	1992-1996	FORD E-350 ECONOLINE CLUB WAGON	4.9L L6 4917cc 300 CID	
USEP2276S	2003	FORD E-150	5.4L V8 330 CID	1992-1996	FORD E-350 ECONOLINE CLUB WAGON	5.8L V8 5753cc 351 CID	
	2003	FORD E-250	5.4L V8 330 CID	1992-1996	FORD E-350 ECONOLINE CLUB WAGON	7.5L V8 460 CID	
	2003	FORD E-350 CLUB WAGON		1992-1996	FORD E-350 ECONOLINE CLUB WAGON	4.9L L6 4917cc 300 CID	
USEP2278S	2000	FORD RANGER	4.0L V6 245 CID	1992-1996	FORD E-350 ECONOLINE CLUB WAGON	5.8L V8 5753cc 351 CID	
	2000-2001	FORD RANGER	2.5L L4 153 CID	1992-1996	FORD E-350 ECONOLINE CLUB WAGON	7.5L V8 460 CID	
USEP2280M	1999-2004	FORD F-450 SUPER DUTY	6.8L V10 415 CID	1996	FORD ECONOLINE SUPER DUTY	5.8L V8 5753cc 351 CID	
	1999-2004	FORD F-550 SUPER DUTY	6.8L V10 415 CID	1996	FORD ECONOLINE SUPER DUTY	7.5L V8 460 CID	
	2000	FORD F-450 SUPER DUTY	7.3L V8 445 CID	1997	FORD F-350	5.8L V8 5753cc 351 CID	
	2000-2004	FORD F-250 SUPER DUTY	5.4L V8 330 CID	USEP2313M	2002-2003	MERCURY SABLE	
	2000-2004	FORD F-250 SUPER DUTY	6.8L V10 415 CID	2003	FORD TAURUS		
	2000-2004	FORD F-350 SUPER DUTY	5.4L V8 330 CID	USEP2316S	2002	LINCOLN BLACKWOOD	
	2000-2004	FORD F-350 SUPER DUTY	6.8L V10 415 CID	USEP2325M	2002	FORD FOCUS	2.0L L4 1989cc 121 CID
USEP2281M	1999-2004	FORD F-450 SUPER DUTY	6.8L V10 415 CID	2003-2004	FORD FOCUS	2.0L L4 1989cc 121 CID	
	1999-2004	FORD F-550 SUPER DUTY	6.8L V10 415 CID	USEP2326M	2003-2004	FORD FOCUS	
	2000	FORD F-450 SUPER DUTY	7.3L V8 445 CID	USEP2329M	2001	MERCURY SABLE	
	2000-2004	FORD F-250 SUPER DUTY	5.4L V8 330 CID	USEP2330M	2003	MERCURY SABLE	
	2000-2004	FORD F-250 SUPER DUTY	6.8L V10 415 CID	USEP2332S	2001-2002	FORD EXPLORER	4.0L V6 245 CID
	2000-2004	FORD F-350 SUPER DUTY	5.4L V8 330 CID	2001-2002	FORD EXPLORER SPORT TRAC	4.0L V6 245 CID	
	2000-2004	FORD F-350 SUPER DUTY	6.8L V10 415 CID	USEP2334M	2002	FORD EXPLORER	4.0L V6 245 CID
USEP2282M	1992-1996	FORD E-150 ECONOLINE	5.0L V8 302 CID	2002	FORD EXPLORER	4.6L V8 281 CID	
	1992-1996	FORD E-150 ECONOLINE	5.8L V8 5753cc 351 CID	2002	FORD EXPLORER	4.0L V6 245 CID	
	1992-1996	FORD E-150 ECONOLINE CLUB WAGON	5.0L V8 302 CID	2002-2003	MERCURY MOUNTAINEER	4.0L V6 245 CID	
	1992-1996	FORD E-150 ECONOLINE CLUB WAGON	5.8L V8 5753cc 351 CID	2002-2003	MERCURY MOUNTAINEER	4.6L V8 281 CID	
	1992-1996	FORD E-250 ECONOLINE	5.8L V8 5753cc 351 CID	2003-2004	FORD CROWN VICTORIA	4.6L V8 281 CID	
	1992-1996	FORD E-350 ECONOLINE	5.8L V8 5753cc 351 CID	2003-2004	FORD GRAND MARQUIS	4.6L V8 281 CID	
	1992-1996	FORD E-350 ECONOLINE	7.5L V8 460 CID	2003-2004	LINCOLN TOWN CAR	4.6L V8 281 CID	
	1992-1996	FORD E-350 ECONOLINE	7.5L V8 460 CID	2003-2004	MERCURY GRAND MARQUIS	4.6L V8 281 CID	
	1992-1996	FORD E-350 ECONOLINE CLUB WAGON	5.8L V8 5753cc 351 CID	2003-2004	MERCURY MARAUDER	4.6L V8 281 CID	
	1992-1996	FORD E-350 ECONOLINE CLUB WAGON	7.5L V8 460 CID	USEP2338M	2002	FORD EXPLORER	4.0L V6 245 CID
	1995-1996	FORD E-250 ECONOLINE	4.9L L6 4917cc 300 CID	2002	FORD EXPLORER	4.6L V8 281 CID	
USEP2283M	2000	FORD TAURUS	3.0L V6 2968cc 181 CID	2002-2003	MERCURY MOUNTAINEER	4.0L V6 245 CID	
	2000	MERCURY SABLE	3.0L V6 2968cc 181 CID	2002-2003	MERCURY MOUNTAINEER	4.6L V8 281 CID	
USEP2285M	2000-2003	FORD TAURUS	3.0L V6 2986cc 182 CID	USEP2341S	2003	FORD E-150 CLUB WAGON	4.2L V6 256 CID
USEP2286S	2000-2002	FORD E-150 ECONOLINE CLUB WAGON	5.4L V8 330 CID	2003	FORD E-150 CLUB WAGON	4.6L V8 281 CID	
	2000-2002	FORD E-250 ECONOLINE	5.4L V8 330 CID	2003	FORD E-250	4.2L V6 256 CID	
	2000-2002	FORD E-350 ECONOLINE CLUB WAGON	5.4L V8 330 CID	2003	FORD E-250	4.6L V8 281 CID	
	2000-2002	FORD E-350 ECONOLINE CLUB WAGON	6.8L V10 415 CID	USEP2343S	2003	FORD E-150	5.4L V8 330 CID
USEP2287M	2000-2005	FORD EXCURSION	5.4L V8 330 CID	2003	FORD E-150 CLUB WAGON	5.4L V8 330 CID	
	2000-2005	FORD EXCURSION	6.8L V10 415 CID	2003	FORD E-250	5.4L V8 330 CID	
USEP2288M	2000-2005	FORD EXCURSION	5.4L V8 330 CID	2003	FORD E-350 CLUB WAGON	5.4L V8 330 CID	
	2000-2005	FORD EXCURSION	6.8L V10 415 CID	2003	FORD E-350 CLUB WAGON	6.8L V10 415 CID	
USEP2290M	2001-2003	FORD WINDSTAR	3.8L V6 232 CID	2003	FORD E-350 SUPER DUTY	5.4L V8 330 CID	
USEP2291M	2001-2003	MAZDA TRIBUTE	3.0L V6 2968cc 181 CID	2003	FORD E-350 SUPER DUTY	6.8L V10 415 CID	
	2001-2004	FORD ESCAPE	2.0L L4 1989cc 121 CID	2003	FORD E-450 SUPER DUTY	5.4L V8 330 CID	
	2001-2004	MAZDA TRIBUTE	2.0L L4 1989cc 121 CID	USEP2344M	2005-2007	FORD F-250 SUPER DUTY	5.4L V8 330 CID
				2005-2007	FORD F-250 SUPER DUTY	6.8L V10 415 CID	
				2005-2007	FORD F-350 SUPER DUTY	5.4L V8 330 CID	
				2005-2007	FORD F-350 SUPER DUTY	6.8L V10 415 CID	
				2005-2007	FORD F-450 SUPER DUTY	6.8L V10 415 CID	



# FUEL PUMP MODULES BUYERS GUIDE



FUEL PUMP MODULES

USMW	Years	Application	Engine	USMW	Years	Application	Engine
USEP2347M	2003	LINCOLN AVIATOR	4.6L V8 281 CID	USEP2438M	2007	FORD F-350 SUPER DUTY	5.4L V8 330 CID
USEP2348M	2002	FORD EXPLORER	4.0L V6 245 CID	2007	FORD F-350 SUPER DUTY	6.8L V10 415 CID	
	2002-2003	FORD EXPLORER SPORT TRAC	4.0L V6 245 CID	USEP2439M	2004-2005	FORD EXPLORER	4.0L V6 245 CID
USEP2349M	2002-2003	FORD RANGER	3.0L V6 2986cc 182 CID	2004-2005	MERCURY MOUNTAINEER	4.0L V6 245 CID	
USEP2350M	2003	MERCURY MOUNTAINEER	4.0L V6 245 CID	USEP2440M	2005	FORD ESCAPE	2.3L L4 140 CID
USEP2351M	2003	FORD EXPLORER	4.0L V6 245 CID	2005	MERCURY MARINER	2.3L L4 140 CID	
	2003	FORD EXPLORER	4.6L V8 281 CID	2007	FORD ESCAPE	2.3L L4 140 CID	
	2003	MERCURY MOUNTAINEER	4.6L V8 281 CID	2007	MERCURY MARINER	2.3L L4 140 CID	
USEP2352M	2002	MERCURY MOUNTAINEER	4.0L V6 245 CID	USEP2441M	2004-2008	FORD F-150	4.6L V8 281 CID
USEP2353M	2002-2003	FORD EXPLORER	4.0L V6 245 CID	2005-2008	FORD F-150	4.2L V6 256 CID	
USEP2354M	2003-2005	LINCOLN AVIATOR		2005-2008	FORD F-150	5.4L V8 330 CID	
USEP2355M	2004-2005	FORD EXPLORER	4.0L V6 245 CID	2007-2008	LINCOLN MARK LT	5.4L V8 330 CID	
	2004-2005	MERCURY MOUNTAINEER	4.0L V6 245 CID	USEP2442M	2005	FORD F-350 SUPER DUTY	5.4L V8 330 CID
USEP2356M	2004	FORD RANGER	2.3L L4 140 CID	2005	FORD F-350 SUPER DUTY	6.8L V10 415 CID	
	2004	FORD RANGER	3.0L V6 2986cc 182 CID	2005-2007	FORD F-250 SUPER DUTY	5.4L V8 330 CID	
	2004	FORD RANGER	4.0L V6 245 CID	2005-2007	FORD F-250 SUPER DUTY	6.8L V10 415 CID	
	2006	FORD RANGER	2.3L L4 140 CID	2007	FORD F-350 SUPER DUTY	5.4L V8 330 CID	
	2006	FORD RANGER	3.0L V6 2986cc 182 CID	2007	FORD F-350 SUPER DUTY	6.8L V10 415 CID	
	2006	FORD RANGER	4.0L V6 245 CID	USEP2443M	2005-2006	FORD EXPEDITION	5.4L V8 330 CID
USEP2357M	2004	FORD RANGER	2.3L L4 140 CID	2005-2006	LINCOLN NAVIGATOR	5.4L V8 330 CID	
	2004	FORD RANGER	3.0L V6 2986cc 182 CID	USEP2449S	2005-2007	MERCURY GRAND MARQUIS	4.6L V8 281 CID
	2004-2006	MAZDA B2300	2.3L L4 140 CID	2005-2008	FORD CROWN VICTORIA	4.6L V8 281 CID	
	2004-2006	MAZDA B3000	3.0L V6 2986cc 182 CID	2005-2008	LINCOLN TOWN CAR	4.6L V8 281 CID	
	2006	FORD RANGER	3.0L V6 2986cc 182 CID	2005-2007	FORD FOCUS	2.0L L4 1999cc 122 CID	
	2006	FORD RANGER	4.0L V6 2986cc 182 CID	2005-2007	FORD FOCUS	2.3L L4 140 CID	
	2006	FORD RANGER	4.0L V6 245 CID	USEP2450M	2006-2008	FORD F-150	5.4L V8 330 CID
USEP2358M	2003-2005	FORD EXPLORER SPORT TRAC	4.0L V6 245 CID	USEP2452M	2005-2007	FORD ESCAPE	2.3L L4 140 CID
USEP2359M	2004-2005	FORD EXPLORER	4.6L V8 281 CID	USEP2453M	2005-2007	MERCURY MARINER	2.3L L4 140 CID
	2004-2005	MERCURY MOUNTAINEER	4.6L V8 281 CID	USEP2454M	2006-2009	FORD EXPLORER	4.0L V6 245 CID
USEP2360M	2003-2004	FORD EXPEDITION	5.4L V8 330 CID	2006-2009	FORD EXPLORER	4.6L V8 281 CID	
USEP2361M	2003-2004	FORD EXPEDITION	4.6L V8 281 CID	2006-2009	MERCURY MOUNTAINEER	4.0L V6 245 CID	
USEP2362M	2003-2004	LINCOLN NAVIGATOR	5.4L V8 330 CID	2006-2009	MERCURY MOUNTAINEER	4.6L V8 281 CID	
USEP2363M	2004-2006	FORD RANGER	2.3L L4 140 CID	2007-2008	FORD EXPLORER SPORT TRAC	4.0L V6 245 CID	
	2004-2006	FORD RANGER	3.0L V6 2986cc 182 CID	2007-2009	FORD EXPLORER SPORT TRAC	4.6L V8 281 CID	
	2004-2006	FORD RANGER	4.0L V6 245 CID	USEP2455M	2004-2005	MERCURY SABLE	
	2004-2006	MAZDA B3000	3.0L V6 2986cc 182 CID	2004-2006	FORD TAURUS		
	2004-2006	MAZDA B4000	4.0L V6 4016cc	USEP2456M	2006-2008	FORD F-150	5.4L V8 330 CID
USEP2364S	2004-2005	FORD E-150 CLUB WAGON	4.6L V8 281 CID	USEP2457M	2005	FORD MUSTANG	4.0L V6 245 CID
	2004-2005	FORD E-150 CLUB WAGON	5.4L V8 330 CID	2005	FORD MUSTANG	4.6L V8 281 CID	
	2004-2008	FORD E-250	4.6L V8 281 CID	USEP2458M	2006	LINCOLN ZEPHYR	
	2004-2008	FORD E-350 SUPER DUTY	5.4L V8 330 CID	USEP2459M	2006-2007	FORD FUSION	2.3L L4 140 CID
	2004-2008	FORD E-350 SUPER DUTY	6.8L V10 415 CID	2006-2007	MERCURY MILAN	2.3L L4 140 CID	
	2006	FORD F-250 SUPER DUTY	5.4L V8 330 CID	USEP2465M	2005-2007	FORD FREESTYLE	3.0L V6 2968cc 181 CID
	2006	FORD F-250 SUPER DUTY	6.8L V10 415 CID	USEP2466M	2006-2007	FORD FREESTAR	3.9L V6 238 CID
	2006-2008	FORD E-150	4.6L V8 281 CID	2006-2007	FORD FREESTAR	4.2L V6 256 CID	
	2006-2008	FORD E-150	5.4L V8 330 CID	2006-2007	MERCURY MONTEREY		
	2006-2008	FORD E-250	5.4L V8 330 CID	USEP2467M	2005-2007	FORD FIVE HUNDRED	3.0L V6 2968cc 181 CID
USEP2365S	2004	FORD E-450 SUPER DUTY	5.4L V8 330 CID	2005-2007	MERCURY MONTEGO	3.0L V6 2968cc 181 CID	
	2004-2005	FORD E-150 CLUB WAGON	4.6L V8 281 CID	USEP2469M	2006-2009	FORD MUSTANG	4.0L V6 245 CID
	2004-2005	FORD E-150 CLUB WAGON	5.4L V8 330 CID	2006-2009	FORD MUSTANG	4.6L V8 281 CID	
	2004-2005	FORD E-350 CLUB WAGON	5.4L V8 330 CID	2007-2009	FORD MUSTANG	4.0L V6 4009cc 245 CID	
	2004-2008	FORD E-150	4.6L V8 281 CID	USEP2470M	2007-2010	FORD EDGE	3.5L V6 3496cc 213 CID
	2004-2008	FORD E-150	5.4L V8 330 CID	2007-2010	LINCOLN MKX	3.5L V6 3496cc 213 CID	
	2004-2008	FORD E-250	4.6L V8 281 CID	USEP2472M	2006-2009	FORD FUSION	3.0L V6 2968cc 181 CID
	2004-2008	FORD E-250	5.4L V8 330 CID	2007-2009	LINCOLN MKZ	3.5L V6 3496cc 213 CID	
	2004-2008	FORD E-350 SUPER DUTY	5.4L V8 330 CID	2008	MERCURY MILAN	3.0L V6 2968cc 181 CID	
	2004-2008	FORD E-350 SUPER DUTY	6.8L V10 415 CID	USEP2473M	2005-2007	FORD ESCAPE	2.3L L4 140 CID
	2004-2008	FORD E-450 SUPER DUTY	2.3L L4 140 CID	2006-2007	MERCURY MARINER	2.3L L4 140 CID	
	2005	FORD E-350 CLUB WAGON	6.8L V10 415 CID	USEP2474M	2007-2009	FORD FUSION	3.0L V6 2968cc 181 CID
	2006-2008	FORD E-450 SUPER DUTY	5.4L V8 330 CID	USEP2475S	2006-2010	FORD CROWN VICTORIA	4.6L V8 281 CID
USEP2368M	2003-2004	FORD FOCUS	2.3L L4 140 CID	2006-2010	LINCOLN TOWN CAR	4.6L V8 281 CID	
USEP2381S	1996	FORD EXPLORER	4.0L V6 245 CID	2006-2010	MERCURY GRAND MARQUIS	4.6L V8 281 CID	
	1996	FORD EXPLORER	5.0L V8 302 CID	USEP2476M	2007-2008	FORD EXPEDITION	5.4L V8 330 CID
USEP2382S	2001-2002	FORD CROWN VICTORIA	4.6L V8 281 CID	2007-2008	LINCOLN NAVIGATOR	5.4L V8 330 CID	
	2001-2002	FORD GRAND MARQUIS	4.6L V8 281 CID	USEP2479M	2007-2010	FORD EDGE	3.5L V6 3496cc 213 CID
	2001-2002	LINCOLN TOWN CAR	4.6L V8 281 CID	2007-2010	LINCOLN MKX	3.5L V6 3496cc 213 CID	
	2001-2002	MERCURY GRAND MARQUIS	4.6L V8 281 CID	USEP2493S	1993-1997	MERCURY VILLAGER	3.0L V6 182 CID
USEP2383M	2004-2005	FORD FREESTAR	3.9L V6 238 CID	USEP2494M	2007-2008	FORD EXPEDITION	5.4L V8 330 CID
	2004-2005	FORD FREESTAR	4.2L V6 256 CID	2007-2008	LINCOLN NAVIGATOR	5.4L V8 330 CID	
	2004-2005	MERCURY MONTEREY		USEP2495M	2007-2008	FORD ESCAPE	2.3L L4 140 CID
USEP2388M	2003-2005	LINCOLN LS	3.9L V8 242 CID	2007-2008	FORD ESCAPE	3.0L V6 2968cc 181 CID	
USEP2434M	2004	FORD F-150	4.6L V8 281 CID	2007-2008	MERCURY MARINER	2.3L L4 140 CID	
	2004	FORD F-150	5.4L V8 330 CID	2007-2008	MERCURY MARINER	3.0L V6 2968cc 181 CID	
USEP2435M	2004-2005	FORD TAURUS	3.0L V6 2968cc 181 CID	2008	MAZDA TRIBUTE	2.3L L4 140 CID	
	2004-2005	MERCURY SABLE	3.0L V6 2986cc 182 CID	2008	MAZDA TRIBUTE	3.0L V6 2968cc 181 CID	
	2006-2007	FORD TAURUS	3.0L V6 2986cc 182 CID	USEP2496M	2007-2008	FORD ESCAPE	2.3L L4 140 CID
USEP2436M	2004	FORD F-150	4.6L V8 281 CID	2007-2008	MERCURY MARINER	2.3L L4 140 CID	
	2004	FORD F-150	5.4L V8 330 CID	USEP2501M	2006-2008	FORD F-150	5.4L V8 330 CID
USEP2437S	2004-2005	FORD E-150 CLUB WAGON	4.6L V8 281 CID	USEP2505M	2008-2009	FORD TAURUS X	3.5L V6 3496cc 213 CID
	2004-2005	FORD E-150 CLUB WAGON	5.4L V8 330 CID	2009	FORD FLEX	3.5L V6 3496cc 213 CID	
	2004-2006	FORD E-250	4.6L V8 281 CID	USEP2506M	2008-2009	FORD TAURUS	3.5L V6 3496cc 213 CID
	2004-2008	FORD E-350 SUPER DUTY	5.4L V8 330 CID	2008-2009	MERCURY SABLE	3.5L V6 3496cc 213 CID	
	2004-2008	FORD E-350 SUPER DUTY	6.8L V10 415 CID	USEP2509M	2008-2010	FORD F-250 SUPER DUTY	5.4L V8 330 CID
	2006	FORD E-150	4.6L V8 281 CID	2008-2010	FORD F-250 SUPER DUTY	6.8L V10 415 CID	
	2006-2008	FORD E-150	5.4L V8 330 CID	2008-2010	FORD F-350 SUPER DUTY	5.4L V8 330 CID	
	2006-2008	FORD E-250	5.4L V8 330 CID	2008-2010	FORD F-350 SUPER DUTY	6.8L V10 415 CID	
USEP2438M	2005	FORD F-350 SUPER DUTY	5.4L V8 330 CID	USEP2523M	2009-2014	FORD EXPEDITION	5.4L V8 330 CID
	2005	FORD F-350 SUPER DUTY	6.8L V10 415 CID	2009-2014	LINCOLN NAVIGATOR	5.4L V8 330 CID	



USMW	Years	Application	Engine	USMW	Years	Application	Engine
<b>USEP2525M</b>	2009-2011	FORD FOCUS	2.0L L4 1989cc 121 CID	<b>USEP3500M</b>	1999-2003	CHEVROLET SILVERADO 2500	6.0L V8 5967cc 364 CID
	2009-2011	FORD FOCUS	2.0L L4 1999cc 122 CID		1999-2003	GMC SIERRA 1500	4.8L V8 294 CID
<b>USEP2528M</b>	2009-2011	FORD E-150	5.4L V8 330 CID	1999-2003	GMC SIERRA 1500	5.3L V8 5328cc 325 CID	
	2009-2014	FORD E-250	5.4L V8 330 CID	1999-2003	GMC SIERRA 2500	6.0L V8 5967cc 364 CID	
	2009-2016	FORD E-350 SUPER DUTY	5.4L V8 330 CID	1999-2004	CHEVROLET SILVERADO 1500	4.3L V6 262 CID	
	2009-2016	FORD E-350 SUPER DUTY	6.8L V10 415 CID	1999-2004	GMC SIERRA 1500	4.3L V6 262 CID	
	2009-2016	FORD E-450 SUPER DUTY	5.4L V8 330 CID	2001-2002	CHEVROLET SILVERADO 2500	5.7L V8 350 CID	
<b>USEP2529M</b>	2009-2016	FORD E-450 SUPER DUTY	6.8L V10 415 CID	2001-2003	CHEVROLET SILVERADO 1500 HD	6.0L V8 5967cc 364 CID	
	2009	MAZDA TRIBUTE	2.5L L4 2488cc 152 CID	2001-2003	CHEVROLET SILVERADO 2500 HD	6.0L V8 5967cc 364 CID	
	2009	MAZDA TRIBUTE	3.0L V6 2968cc 181 CID	2001-2003	CHEVROLET SILVERADO 2500 HD	8.1L V8 496 CID	
	2009-2010	FORD ESCAPE	2.5L L4 2488cc 152 CID	2001-2003	CHEVROLET SILVERADO 3500	6.0L V8 5967cc 364 CID	
	2009-2010	FORD ESCAPE	3.0L V6 2968cc 181 CID	2001-2003	CHEVROLET SILVERADO 3500	8.1L V8 496 CID	
<b>USEP2530M</b>	2009-2010	MERCURY MARINER	2.5L L4 2488cc 152 CID	2001-2003	GMC SIERRA 1500	6.0L V8 5967cc 364 CID	
	2009-2010	MERCURY MARINER	3.0L V6 2968cc 181 CID	2001-2003	GMC SIERRA 1500 HD	6.0L V8 5967cc 364 CID	
	2009-2010	FORD F-150	4.6L V8 281 CID	2001-2003	GMC SIERRA 2500 HD	6.0L V8 5967cc 364 CID	
	2009-2010	FORD F-150	5.4L V8 330 CID	2001-2003	GMC SIERRA 2500 HD	8.1L V8 496 CID	
	2010	FORD F-150	6.2L V8 6210cc 379 CID	2001-2003	GMC SIERRA 3500	6.0L V8 5967cc 364 CID	
<b>USEP2531M</b>	2006-2008	FORD F-150	5.4L V8 330 CID	2001-2003	GMC SIERRA 3500	8.1L V8 496 CID	
	2006-2008	FORD F-150	4.6L V8 281 CID	2003	CHEVROLET SILVERADO 1500	6.0L V8 5967cc 364 CID	
<b>USEP2533M</b>	2006-2008	FORD F-150	5.4L V8 330 CID	2003	CHEVROLET SILVERADO 2500	5.3L V8 5328cc 325 CID	
	2006-2008	LINCOLN MARK LT	5.4L V8 330 CID	2005-2006	CHEVROLET SILVERADO 2500	5.3L V8 5328cc 325 CID	
<b>USEP2540M</b>	2009	FORD E-450 SUPER DUTY	5.4L V8 330 CID	<b>USEP3501M</b>	1999-2001	GMC SIERRA 1500	4.3L V6 262 CID
	2009-2010	FORD E-150	4.6L V8 281 CID		1999-2001	GMC SIERRA 1500	4.8L V8 294 CID
	2009-2010	FORD E-150	5.4L V8 330 CID		1999-2001	GMC SIERRA 1500	5.3L V8 5328cc 325 CID
	2009-2010	FORD E-250	4.6L V8 281 CID		1999-2003	CHEVROLET SILVERADO 1500	4.3L V6 262 CID
	2009-2010	FORD E-250	5.4L V8 330 CID		1999-2003	CHEVROLET SILVERADO 1500	4.8L V8 294 CID
	2009-2010	FORD E-350 SUPER DUTY	5.4L V8 330 CID		1999-2003	CHEVROLET SILVERADO 1500	5.3L V8 5328cc 325 CID
	2009-2010	FORD E-350 SUPER DUTY	6.8L V10 415 CID		2001	CHEVROLET SILVERADO 2500	5.3L V8 5328cc 325 CID
	2009-2010	FORD E-450 SUPER DUTY	6.8L V10 415 CID		2001	GMC SIERRA 1500	6.0L V8 5967cc 364 CID
	2009-2010	FORD F-150	4.6L V8 281 CID		2001-2002	CHEVROLET SILVERADO 2500	5.7L V8 350 CID
	2009-2010	FORD F-150	5.4L V8 330 CID		2001-2003	CHEVROLET SILVERADO 2500	6.0L V8 5967cc 364 CID
<b>USEP2542S</b>	2010-2011	FORD CROWN VICTORIA	4.6L V8 281 CID	2001-2003	CHEVROLET SILVERADO 2500 HD	6.0L V8 5967cc 364 CID	
	2010-2011	LINCOLN TOWN CAR	4.6L V8 281 CID	2001-2003	CHEVROLET SILVERADO 2500 HD	8.1L V8 496 CID	
<b>USEP2545M</b>	2010-2011	MERCURY GRAND MARQUIS	4.6L V8 281 CID	2001-2003	CHEVROLET SILVERADO 3500	6.0L V8 5967cc 364 CID	
	2009-2010	FORD F-150	4.6L V8 281 CID	2001-2003	CHEVROLET SILVERADO 3500	8.1L V8 496 CID	
	2009-2010	FORD F-150	5.4L V8 330 CID	2001-2003	GMC SIERRA 2500	6.0L V8 5967cc 364 CID	
<b>USEP2553M</b>	2010	FORD EXPLORER	4.0L V6 245 CID	2001-2003	GMC SIERRA 2500 HD	6.0L V8 5967cc 364 CID	
	2010	FORD EXPLORER	4.0L V6 4015cc 245 CID	2001-2003	GMC SIERRA 2500 HD	8.1L V8 496 CID	
	2010	FORD EXPLORER	4.6L V8 281 CID	2001-2003	GMC SIERRA 3500	6.0L V8 5967cc 364 CID	
	2010	FORD EXPLORER SPORT TRAC	4.0L V6 245 CID	2001-2003	GMC SIERRA 3500	8.1L V8 496 CID	
	2010	FORD EXPLORER SPORT TRAC	4.6L V8 281 CID	2003	CHEVROLET SILVERADO 1500	6.0L V8 5967cc 364 CID	
	2010	MERCURY MOUNTAINEER	4.0L V6 245 CID	2003	CHEVROLET SILVERADO 2500	5.3L V8 5328cc 325 CID	
	2010	MERCURY MOUNTAINEER	4.6L V8 281 CID	<b>USEP3506M</b>	2000-2005	CHEVROLET ASTRO	4.3L V6 262 CID
2000-2002	FORD FOCUS	2.0L L4 1989cc 121 CID	2000-2005		GMC SAFARI	4.3L V6 262 CID	
<b>USEP2556M</b>	2010-2012	FORD TAURUS	3.5L V6 3496cc 213 CID	<b>USEP3507M</b>	2000	PONTIAC SUNFIRE	2.2L L4 2190cc 134 CID
<b>USEP2557M</b>	2011-2012	LINCOLN MKS	3.7L V6 3726cc 227 CID		2000	PONTIAC SUNFIRE	2.4L L4 2392cc 146 CID
<b>USEP2558M</b>	2010-2012	FORD FLEX	3.5L V6 3496cc 213 CID	2000-2001	CHEVROLET CAVALIER	2.2L L4 2190cc 134 CID	
	2010-2012	LINCOLN MKT	3.7L V6 3726cc 227 CID	2000-2001	OLDSMOBILE ALERO	2.4L L4 2392cc 146 CID	
<b>USEP2561M</b>	2010-2011	MERCURY MILAN	2.5L L4 2488cc 152 CID	2000-2001	PONTIAC GRAND AM	2.4L L4 2392cc 146 CID	
	2010-2012	FORD FUSION	2.5L L4 2488cc 152 CID	2000-2002	CHEVROLET CAVALIER	2.4L L4 2392cc 146 CID	
	2011-2012	LINCOLN MKZ	2.5L L4 2488cc 152 CID	2000-2003	CHEVROLET MALIBU	3.1L V6 189 CID	
<b>USEP2562M</b>	2010-2011	MERCURY MILAN	3.0L V6 2968cc 181 CID	2000-2004	OLDSMOBILE ALERO	3.4L V6 207 CID	
<b>USEP2572M</b>	2010-2014	FORD EXPEDITION	5.4L V8 330 CID	2000-2005	PONTIAC GRAND AM	3.4L V6 207 CID	
<b>USEP2578M</b>	2010-2014	LINCOLN NAVIGATOR	5.4L V8 330 CID	2002	PONTIAC SUNFIRE	2.2L L4 2190cc 134 CID	
	2011-2014	FORD EDGE	3.7L V6 3726cc 227 CID	2002	PONTIAC SUNFIRE	2.2L L4 2200cc 134 CID	
	2011-2014	LINCOLN MKX	3.7L V6 3726cc 227 CID	2002	PONTIAC SUNFIRE	2.4L L4 2392cc 146 CID	
	2011-2015	FORD EDGE	3.5L V6 3496cc 213 CID	2002-2003	PONTIAC SUNFIRE	2.2L L4 2198cc 134 CID	
<b>USEP2581M</b>	2010-2016	FORD E-450 SUPER DUTY	5.4L V8 330 CID	2002-2004	OLDSMOBILE ALERO	2.2L L4 2198cc 134 CID	
	2011-2014	FORD E-150	4.6L V8 281 CID	2002-2005	CHEVROLET CAVALIER	2.2L L4 2198cc 134 CID	
	2011-2014	FORD E-150	5.4L V8 330 CID	2002-2005	PONTIAC GRAND AM	2.2L L4 2198cc 134 CID	
	2011-2014	FORD E-250	4.6L V8 281 CID	2004	CHEVROLET CLASSIC	2.2L L4 2198cc 134 CID	
	2011-2014	FORD E-250	5.4L V8 330 CID	2005	PONTIAC SUNFIRE	2.2L L4 2198cc 134 CID	
	2011-2016	FORD E-350 SUPER DUTY	5.4L V8 330 CID	<b>USEP3508M</b>	2000-2003	CHEVROLET TAHOE	4.8L V8 294 CID
	2011-2016	FORD E-350 SUPER DUTY	6.8L V10 415 CID		2000-2003	CHEVROLET TAHOE	5.3L V8 5328cc 325 CID
	2011-2016	FORD E-450 SUPER DUTY	6.8L V10 415 CID	2000-2003	GMC YUKON	4.8L V8 294 CID	
	<b>USEP2585M</b>	2012-2014	FORD F-150	3.5L V6 3496cc 213 CID	2000-2003	GMC YUKON	5.3L V8 5328cc 325 CID
	<b>USEP2586M</b>	2011-2016	FORD E-350 SUPER DUTY	5.4L V8 330 CID	2001-2003	GMC YUKON	6.0L V8 5967cc 364 CID
<b>USEP2588M</b>	2011-2016	FORD E-350 SUPER DUTY	6.8L V10 415 CID	2002-2003	CADILLAC ESCALADE	5.3L V8 5328cc 325 CID	
	2011-2014	FORD F-150	3.5L V6 3496cc 213 CID	2002-2003	CADILLAC ESCALADE	6.0L V8 5967cc 364 CID	
<b>USEP2592M</b>	2013-2017	FORD FOCUS	2.0L L4 1999cc 122 CID	2003-2004	CHEVROLET SONORA	5.3L V8 5328cc 325 CID	
<b>USEP2598M</b>	2015-2018	FORD FOCUS	1.0L L3 999cc 61 CID	<b>USEP3509M</b>	2000-2001	CHEVROLET SUBURBAN 1500	5.3L V8 5328cc 325 CID
	2013-2016	FORD ESCAPE	1.6L L4 1601cc 98 CID		2000-2001	GMC YUKON XL 1500	5.3L V8 5328cc 325 CID
	2013-2016	FORD ESCAPE	2.0L L4 1999cc 122 CID	2001	GMC YUKON XL 1500	6.0L V8 5967cc 364 CID	
<b>USEP2606M</b>	2015-2016	LINCOLN MKC	2.0L L4 1999cc 122 CID	<b>USEP3510M</b>	2000	CHEVROLET SUBURBAN 2500	
	2013-2018	FORD ESCAPE	2.5L L4 2488cc 152 CID		2000	GMC YUKON XL 2500	
<b>USEP2613M</b>	2013-2015	FORD TAURUS	3.5L V6 3496cc 213 CID	2001	CHEVROLET SUBURBAN 2500	6.0L V8 5967cc 364 CID	
<b>USEP3368M</b>	1999-2002	CHEVROLET CAMARO	5.7L V8 350 CID	2001	CHEVROLET SUBURBAN 2500	8.1L V8 496 CID	
	1999-2002	PONTIAC FIREBIRD	5.7L V8 350 CID	2001	GMC YUKON XL 2500	6.0L V8 5967cc 364 CID	
<b>USEP3369M</b>	1999-2002	CHEVROLET CAMARO	3.8L V6 3800cc 231 CID	2001	GMC YUKON XL 2500	8.1L V8 496 CID	
	1999-2002	PONTIAC FIREBIRD	3.8L V6 3800cc 231 CID	<b>USEP3511M</b>	1998	CHEVROLET EXPRESS 3500	7.4L V8 454 CID
<b>USEP3372M</b>	1998	PONTIAC TRANS SPORT	3.4L V6 207 CID		1998	GMC SAVANA 3500	7.4L V8 454 CID
	1998-2001	CHEVROLET VENTURE	3.4L V6 207 CID		1998-1999	CHEVROLET EXPRESS 3500	5.7L V8 350 CID
<b>USEP3500M</b>	1998-2001	OLDSMOBILE SILHOUETTE	3.4L V6 207 CID		1998-1999	GMC SAVANA 3500	5.7L V8 350 CID
	1999-2001	PONTIAC MONTANA	3.4L V6 207 CID		<b>USEP3512M</b>	2000	CHEVROLET SUBURBAN 2500
	1999-2000	CHEVROLET SILVERADO 2500	5.3L V8 5328cc 325 CID	2000		GMC YUKON XL 2500	
1999-2000	GMC SIERRA 2500	5.3L V8 5328cc 325 CID	2001	CHEVROLET SUBURBAN 2500		6.0L V8 5967cc 364 CID	
1999-2003	CHEVROLET SILVERADO 1500	4.8L V8 294 CID	2001	CHEVROLET SUBURBAN 2500		8.1L V8 496 CID	
1999-2003	CHEVROLET SILVERADO 1500	5.3L V8 5328cc 325 CID	2001	GMC YUKON XL 2500		6.0L V8 5967cc 364 CID	



# FUEL PUMP MODULES BUYERS GUIDE



FUEL PUMP MODULES

USMW	Years	Application	Engine	USMW	Years	Application	Engine
USEP3512M	2001	GMC YUKON XL 2500	8.1L V8 496 CID	USEP3551M	2001-2002	CHEVROLET EXPRESS 3500	5.7L V8 350 CID
USEP3513M	2000	CHEVROLET SUBURBAN 2500		USEP3552M	2002-2004	OLDSMOBILE SILHOUETTE	3.4L V6 207 CID
	2000	GMC YUKON XL 2500			2002-2004	PONTIAC MONTANA	3.4L V6 207 CID
	2001	CHEVROLET SUBURBAN 2500	6.0L V8 5967cc 364 CID		2002-2005	CHEVROLET VENTURE	3.4L V6 207 CID
	2001	CHEVROLET SUBURBAN 2500	8.1L V8 496 CID	USEP3553M	2002-2003	CHEVROLET AVALANCHE 2500	8.1L V8 496 CID
	2001	GMC YUKON XL 2500	6.0L V8 5967cc 364 CID		2002-2003	CHEVROLET SUBURBAN 2500	6.0L V8 5967cc 364 CID
	2001	GMC YUKON XL 2500	8.1L V8 496 CID		2002-2003	CHEVROLET SUBURBAN 2500	8.1L V8 496 CID
USEP3514M	2000-2001	CHEVROLET LUMINA			2002-2003	GMC YUKON XL 2500	6.0L V8 5967cc 364 CID
USEP3518M	1998-2005	BUICK PARK AVENUE	3.8L V6 3800cc 231 CID		2002-2003	GMC YUKON XL 2500	8.1L V8 496 CID
	2000-2004	CADILLAC SEVILLE	4.6L V8 281 CID	USEP3554M	2002-2003	CHEVROLET AVALANCHE 2500	8.1L V8 496 CID
	2000-2005	BUICK LESABRE	3.8L V6 3800cc 231 CID		2002-2003	CHEVROLET SUBURBAN 2500	6.0L V8 5967cc 364 CID
	2000-2005	CADILLAC DEVILLE	4.6L V8 281 CID		2002-2003	CHEVROLET SUBURBAN 2500	8.1L V8 496 CID
	2000-2005	PONTIAC BONNEVILLE	3.8L V6 3800cc 231 CID		2002-2003	GMC YUKON XL 2500	6.0L V8 5967cc 364 CID
	2001-2002	OLDSMOBILE AURORA	3.5L V6 214 CID		2002-2003	GMC YUKON XL 2500	8.1L V8 496 CID
	2001-2003	OLDSMOBILE AURORA	4.0L V8 244 CID	USEP3555M	2002-2003	CHEVROLET AVALANCHE 2500	8.1L V8 496 CID
	2004-2005	PONTIAC BONNEVILLE	4.6L V8 281 CID		2002-2003	CHEVROLET SUBURBAN 2500	6.0L V8 5967cc 364 CID
USEP3519M	2000-2004	BUICK REGAL			2002-2003	CHEVROLET SUBURBAN 2500	8.1L V8 496 CID
	2001-2003	PONTIAC GRAND PRIX	3.8L V6 3800cc 231 CID		2002-2003	GMC YUKON XL 2500	6.0L V8 5967cc 364 CID
USEP3520S	1999-2000	CHEVROLET TRACKER	1.6L L4 1588cc 98 CID		2002-2003	GMC YUKON XL 2500	8.1L V8 496 CID
	1999-2002	SUZUKI VITARA	1.6L L4 1590cc 97 CID	USEP3556M	2002-2003	CADILLAC ESCALADE EXT	6.0L V8 5967cc 364 CID
	1999-2003	CHEVROLET TRACKER	2.0L L4 122 CID		2002-2003	CHEVROLET AVALANCHE 1500	5.3L V8 5328cc 325 CID
	1999-2003	CHEVROLET TRACKER	2.0L L4 1995cc 122 CID		2002-2003	CHEVROLET SUBURBAN 1500	5.3L V8 5328cc 325 CID
	1999-2003	SUZUKI VITARA	2.0L L4 2000cc		2002-2003	GMC YUKON XL 1500	5.3L V8 5328cc 325 CID
	1999-2005	SUZUKI GRAND VITARA	2.5L V6 2500cc		2002-2003	GMC YUKON XL 1500	6.0L V8 5967cc 364 CID
	2001-2004	CHEVROLET TRACKER	2.5L V6 2500cc		2003	CADILLAC ESCALADE ESV	6.0L V8 5967cc 364 CID
	2004	SUZUKI VITARA	2.5L V6 2500cc	USEP3557M	2001-2002	SATURN L100	2.2L L4 2198cc 134 CID
USEP3521M	2001-2004	PONTIAC AZTEK	3.4L V6 207 CID		2001-2003	SATURN L200	2.2L L4 2198cc 134 CID
	2002-2004	BUICK RENDEZVOUS	3.4L V6 207 CID		2001-2003	SATURN LW200	2.2L L4 2198cc 134 CID
USEP3522M	2001-2003	CHEVROLET SILVERADO 3500	6.0L V8 5967cc 364 CID		2001-2003	SATURN LW300	3.0L V6 3000cc 181 CID
	2001-2003	CHEVROLET SILVERADO 3500	8.1L V8 496 CID		2001-2005	SATURN L300	3.0L V6 3000cc 181 CID
	2001-2003	GMC SIERRA 3500	6.0L V8 5967cc 364 CID		2004	SATURN L300	2.2L L4 2198cc 134 CID
	2001-2003	GMC SIERRA 3500	8.1L V8 496 CID	USEP3558M	2003	HUMMER H2	6.0L V8 5967cc 364 CID
USEP3527M	2000-2002	CHEVROLET S10	2.2L L4 2190cc 134 CID	USEP3559M	2002-2004	CHEVROLET TAHOE	5.3L V8 5328cc 325 CID
	2000-2002	GMC SONOMA	2.2L L4 2190cc 134 CID		2002-2004	GMC YUKON	5.3L V8 5328cc 325 CID
USEP3529M	1999	CHEVROLET LUMINA	3.1L V6 189 CID	USEP3560M	2002-2004	CHEVROLET SUBURBAN 1500	5.3L V8 5328cc 325 CID
	1999	CHEVROLET MONTE CARLO	3.1L V6 189 CID		2002-2004	GMC YUKON XL 1500	5.3L V8 5328cc 325 CID
USEP3530M	2001-2003	CHEVROLET SILVERADO 3500	6.0L V8 5967cc 364 CID	USEP3563M	2002-2003	CHEVROLET S10	4.3L V6 262 CID
	2001-2003	CHEVROLET SILVERADO 3500	8.1L V8 496 CID		2002-2003	GMC SONOMA	4.3L V6 262 CID
	2001-2003	GMC SIERRA 3500	6.0L V8 5967cc 364 CID	USEP3564M	2004	PONTIAC GRAND PRIX	3.8L V6 3800cc 231 CID
	2001-2003	GMC SIERRA 3500	8.1L V8 496 CID	USEP3565M	2004	PONTIAC GRAND PRIX	3.8L V6 3800cc 231 CID
USEP3533M	1998-2005	BUICK PARK AVENUE	3.8L V6 3800cc 231 CID	USEP3566M	2003	CHEVROLET S10	4.3L V6 262 CID
	2000-2005	BUICK LESABRE	3.8L V6 3800cc 231 CID		2003	GMC SONOMA	4.3L V6 262 CID
USEP3534M	1998-1999	CHEVROLET TAHOE	5.7L V8 350 CID		2004	CHEVROLET S10	
	1998-1999	GMC YUKON			2004	GMC SONOMA	
	1999	CADILLAC ESCALADE		USEP3568M	2001-2002	CHEVROLET EXPRESS 3500	5.7L V8 350 CID
USEP3536M	1998-1999	BUICK PARK AVENUE	3.8L V6 3800cc 231 CID	USEP3569M	2003-2004	CHEVROLET BLAZER	
	1998-1999	BUICK RIVIERA	3.8L V6 3800cc 231 CID	USEP3572M	2002-2004	CHEVROLET SILVERADO 1500	5.3L V8 5328cc 325 CID
	2001-2003	PONTIAC BONNEVILLE	3.8L V6 3800cc 231 CID		2002-2004	GMC SIERRA 1500	5.3L V8 5328cc 325 CID
	2001-2005	BUICK PARK AVENUE	3.8L V6 3800cc 231 CID	USEP3573M	1998	CHEVROLET EXPRESS 3500	7.4L V8 454 CID
USEP3537M	1998	PONTIAC GRAND PRIX	3.1L V6 3136cc 191 CID		1998	GMC SAVANA 3500	7.4L V8 454 CID
	1998-1999	BUICK CENTURY	3.1L V6 189 CID		1998-2000	GMC SAVANA 3500	5.7L V8 350 CID
	1998-1999	BUICK REGAL	3.8L V6 3800cc 231 CID		1998-2001	CHEVROLET EXPRESS 1500	4.3L V6 262 CID
	1998-1999	OLDSMOBILE INTRIGUE	3.8L V6 3800cc 231 CID		1998-2001	GMC SAVANA 1500	4.3L V6 262 CID
	1998-2000	PONTIAC GRAND PRIX	3.8L V6 3800cc 231 CID		1998-2002	CHEVROLET EXPRESS 2500	5.7L V8 350 CID
	1999-2000	OLDSMOBILE INTRIGUE	3.5L V6 214 CID		1998-2002	CHEVROLET EXPRESS 3500	5.7L V8 350 CID
	1999-2000	PONTIAC GRAND PRIX	3.1L V6 189 CID		1998-2002	GMC SAVANA 2500	5.7L V8 350 CID
USEP3539M	2001-2004	CHEVROLET VENTURE	3.4L V6 207 CID	USEP3574M	2003	CHEVROLET EXPRESS 3500	
	2001-2004	PONTIAC MONTANA	3.4L V6 207 CID		2003	GMC SAVANA 3500	
USEP3542M	2000-2003	CHEVROLET IMPALA	3.8L V6 3791cc 231 CID	USEP3575M	2003	CHEVROLET EXPRESS 3500	
	2000-2004	BUICK REGAL	3.8L V6 3800cc 231 CID		2003	GMC SAVANA 3500	
	2000-2005	BUICK CENTURY	3.1L V6 189 CID	USEP3577M	2000-2003	CHEVROLET CORVETTE	5.7L V8 350 CID
	2000-2005	CHEVROLET IMPALA	3.4L V6 207 CID	USEP3578M	1997-1999	CHEVROLET CORVETTE	
	2000-2005	CHEVROLET IMPALA	3.8L V6 3800cc 231 CID	USEP3579M	2003-2004	CHEVROLET CORVETTE	5.7L V8 350 CID
	2000-2005	CHEVROLET MONTE CARLO	3.4L V6 207 CID		2004-2006	CADILLAC XLR	4.6L V8 281 CID
	2000-2005	CHEVROLET MONTE CARLO	3.8L V6 3800cc 231 CID		2005	CHEVROLET CORVETTE	6.0L V8 364 CID
	2001-2002	OLDSMOBILE INTRIGUE	3.5L V6 214 CID		2006	CADILLAC XLR	4.4L V8 4371cc 267 CID
	2001-2003	PONTIAC GRAND PRIX	3.1L V6 189 CID		2006	CHEVROLET CORVETTE	6.0L V8 5967cc 364 CID
	2001-2003	PONTIAC GRAND PRIX	3.8L V6 3800cc 231 CID		2006	CHEVROLET CORVETTE	7.0L V8 7011cc 427 CID
USEP3543M	1997	BUICK REGAL	3.8L V6 3800cc 231 CID	USEP3580M	2004-2005	CHEVROLET EXPRESS 3500	6.0L V8 5967cc 364 CID
USEP3548M	2000	SATURN LS	2.2L L4 2198cc 134 CID		2004-2005	GMC SAVANA 3500	4.8L V8 294 CID
	2000	SATURN LS1	2.2L L4 2198cc 134 CID		2004-2005	GMC SAVANA 3500	6.0L V8 5967cc 364 CID
	2000	SATURN LS2	3.0L V6 3000cc 181 CID		2005	CHEVROLET EXPRESS 3500	4.8L V8 294 CID
	2000	SATURN LW1	2.2L L4 2198cc 134 CID	USEP3581M	2004-2005	CADILLAC ESCALADE	5.3L V8 5328cc 325 CID
	2000	SATURN LW2	3.0L V6 3000cc 181 CID		2004-2006	CADILLAC ESCALADE	6.0L V8 5967cc 364 CID
USEP3549M	2002-2004	CHEVROLET TRAILBLAZER	4.2L L6 256 CID		2004-2006	GMC YUKON	6.0L V8 5967cc 364 CID
	2002-2004	CHEVROLET TRAILBLAZER EXT	4.2L L6 256 CID		2004-2007	CHEVROLET TAHOE	4.8L V8 294 CID
	2002-2004	GMC ENVOY	4.2L L6 256 CID		2004-2007	CHEVROLET TAHOE	5.3L V8 5328cc 325 CID
	2002-2004	GMC ENVOY XL	4.2L L6 256 CID		2004-2007	GMC YUKON	4.8L V8 294 CID
	2002-2004	OLDSMOBILE BRAVADA	4.2L L6 256 CID		2004-2007	GMC YUKON	5.3L V8 5328cc 325 CID
	2003-2004	CHEVROLET SSR	5.3L V8 5328cc 325 CID		2005-2006	CHEVROLET SONORA	5.3L V8 5328cc 325 CID
	2003-2004	CHEVROLET TRAILBLAZER EXT	5.3L V8 5328cc 325 CID		2007	CADILLAC ESCALADE	6.2L V8 6162cc 376 CID
	2003-2004	GMC ENVOY XL	5.3L V8 5328cc 325 CID		2007	GMC YUKON	6.2L V8 6162cc 376 CID
	2003-2004	ISUZU ASCENDER	4.2L L6 256 CID	USEP3583M	2006-2008	CHEVROLET EXPRESS 3500	4.8L V8 294 CID
	2003-2004	ISUZU ASCENDER	5.3L V8 5328cc 325 CID		2006-2008	CHEVROLET EXPRESS 3500	6.0L V8 5967cc 364 CID
	2004	BUICK RAINIER	4.2L L6 256 CID		2006-2008	GMC SAVANA 3500	4.8L V8 294 CID
	2004	BUICK RAINIER	5.3L V8 5328cc 325 CID		2006-2008	GMC SAVANA 3500	6.0L V8 5967cc 364 CID
	2004	GMC ENVOY XUV	4.2L L6 256 CID	USEP3584M	2003	CHEVROLET EXPRESS 2500	4.3L V6 262 CID
	2004	GMC ENVOY XUV	5.3L V8 5328cc 325 CID		2003	CHEVROLET EXPRESS 2500	4.8L V8 294 CID





# FUEL PUMP MODULES BUYERS GUIDE



USMW	Years	Application	Engine	USMW	Years	Application	Engine
<b>USEP3584M</b>	2003	CHEVROLET EXPRESS 2500	6.0L V8 5967cc 364 CID	<b>USEP3609M</b>	2007	CHEVROLET SILVERADO 1500 HD CLASSIC	6.0L V8 5967cc 364 CID
	2003	GMC SAVANA 1500	4.3L V6 262 CID		2007	CHEVROLET SILVERADO 2500 HD CLASSIC	6.0L V8 5967cc 364 CID
	2003	GMC SAVANA 2500	4.3L V6 262 CID		2007	CHEVROLET SILVERADO 2500 HD CLASSIC	8.1L V8 496 CID
	2003	GMC SAVANA 2500	4.8L V8 294 CID		2007	GMC SIERRA 1500 HD CLASSIC	6.0L V8 5967cc 364 CID
	2003	GMC SAVANA 2500	6.0L V8 5967cc 364 CID		2007	GMC SIERRA 2500 HD CLASSIC	8.1L V8 496 CID
<b>USEP3585M</b>	2002-2003	SATURN VUE	2.2L L4 2198cc 134 CID	2007	GMC SIERRA 2500 HD CLASSIC	6.0L V8 5967cc 364 CID	
	2002-2003	SATURN VUE	3.0L V6 3000cc 181 CID	2007	GMC SIERRA 2500 HD CLASSIC	8.1L V8 496 CID	
<b>USEP3586M</b>	2002-2003	CHEVROLET SUBURBAN 1500	5.3L V8 5328cc 325 CID	<b>USEP3610M</b>	2004-2006	CADILLAC ESCALADE ESV	6.0L V8 5967cc 364 CID
	2002-2003	GMC YUKON XL 1500	5.3L V8 5328cc 325 CID		2004-2006	CADILLAC ESCALADE EXT	6.0L V8 5967cc 364 CID
<b>USEP3587M</b>	2004-2006	CHEVROLET AVALANCHE 2500	8.1L V8 496 CID	2004-2006	CHEVROLET AVALANCHE 1500	5.3L V8 5328cc 325 CID	
	2004-2006	CHEVROLET SUBURBAN 2500	8.1L V8 496 CID	2005	GMC YUKON XL 1500	5.3L V8 5328cc 325 CID	
	2004-2006	GMC YUKON XL 2500	8.1L V8 496 CID	2005-2007	CHEVROLET SUBURBAN 1500	5.3L V8 5328cc 325 CID	
	2004-2007	CHEVROLET SUBURBAN 2500	6.0L V8 5967cc 364 CID	2005-2007	GMC YUKON XL 1500	6.0L V8 5967cc 364 CID	
	2004-2007	GMC YUKON XL 2500	6.0L V8 5967cc 364 CID	2006-2007	CHEVROLET SUBURBAN 1500	6.0L V8 5967cc 364 CID	
<b>USEP3588M</b>	2004	CHEVROLET EXPRESS 1500	4.3L V6 262 CID	2007	CADILLAC ESCALADE ESV	6.2L V8 6162cc 376 CID	
	2004	CHEVROLET EXPRESS 2500	4.3L V6 262 CID	2007	CADILLAC ESCALADE EXT	6.2L V8 6162cc 376 CID	
	2004	GMC SAVANA 1500	4.3L V6 262 CID	2007	CHEVROLET AVALANCHE	5.3L V8 5328cc 325 CID	
	2004	GMC SAVANA 2500	4.3L V6 262 CID	2007	CHEVROLET AVALANCHE	6.0L V8 5967cc 364 CID	
<b>USEP3590M</b>	2003-2005	SATURN ION	2.2L L4 2198cc 134 CID	2007	GMC YUKON XL 1500	5.3L V8 5328cc 325 CID	
	2005	CHEVROLET COBALT	2.2L L4 2198cc 134 CID	2007	GMC YUKON XL 1500	6.2L V8 6162cc 376 CID	
	2005	PONTIAC PURSUIT	2.2L L4 2198cc 134 CID	2004	PONTIAC GTO	5.7L V8 350 CID	
<b>USEP3591M</b>	2004-2006	CHEVROLET MALIBU	3.5L V6 213 CID	2005-2006	PONTIAC GTO	6.0L V8 5967cc 364 CID	
	2006	PONTIAC G6	3.5L V6 214 CID	2004-2005	CHEVROLET AVEO	1.6L L4 1598cc 98 CID	
	2006-2007	CHEVROLET MALIBU	3.9L V6 3880cc 237 CID	2005	PONTIAC WAVE	1.6L L4 1598cc 98 CID	
	2006-2008	PONTIAC G6	2.4L L4 2384cc 145 CID	2004-2005	CHEVROLET COLORADO	2.8L L4 2770cc 169 CID	
	2007-2008	CHEVROLET MALIBU	3.9L V6 3880cc 237 CID	2004-2005	CHEVROLET COLORADO	3.5L L5 3460cc 211 CID	
	2007-2008	PONTIAC G6	3.5L V6 3490cc 213 CID	2004-2005	GMC CANYON	2.8L L4 2770cc 169 CID	
	2007-2008	PONTIAC G6	3.5L V6 3490cc 213 CID	2004-2005	GMC CANYON	3.5L L5 3460cc 211 CID	
	2007-2008	PONTIAC G6	3.6L V6 3564cc 217 CID	<b>USEP3615M</b>	2004-2006	BUICK RENDEZVOUS	3.6L V6 3564cc 217 CID
	2007-2008	SATURN AURA	3.5L V6 3490cc 213 CID		2006	BUICK RENDEZVOUS	3.5L V6 213 CID
	2007-2008	SATURN AURA	3.6L V6 3564cc 217 CID		2007	BUICK RENDEZVOUS	
	<b>USEP3592M</b>	2008	CHEVROLET MALIBU	2.4L L4 2384cc 145 CID	<b>USEP3616M</b>	2004-2006	GMC SIERRA 3500
2008		CHEVROLET MALIBU	3.6L V6 3564cc 217 CID	2005-2006		CHEVROLET SILVERADO 3500	6.0L V8 5967cc 364 CID
2008		SATURN AURA	2.4L L4 2384cc 145 CID	2005-2006		CHEVROLET SILVERADO 3500	8.1L V8 496 CID
<b>USEP3592M</b>		2004-2006	CHEVROLET MALIBU	2.2L L4 2198cc 134 CID	2005-2006	GMC SIERRA 3500	8.1L V8 496 CID
	2004-2006	CHEVROLET MALIBU	3.5L V6 213 CID	<b>USEP3617M</b>	2004-2006	CHEVROLET SILVERADO 3500	8.1L V8 496 CID
	2006	CHEVROLET MALIBU	3.9L V6 3880cc 237 CID		2004-2006	GMC SIERRA 3500	8.1L V8 496 CID
2006	CHEVROLET MALIBU	8.1L V8 496 CID	2005-2006		CHEVROLET SILVERADO 3500	6.0L V8 5967cc 364 CID	
<b>USEP3594M</b>	2002-2003	CHEVROLET AVALANCHE 2500	8.1L V8 496 CID	2005-2006	GMC SIERRA 3500	6.0L V8 5967cc 364 CID	
	2002-2003	CHEVROLET SUBURBAN 2500	6.0L V8 5967cc 364 CID	<b>USEP3621S</b>	1988	CHEVROLET C1500	4.3L V6 262 CID
	2002-2003	CHEVROLET SUBURBAN 2500	8.1L V8 496 CID		1988	CHEVROLET C1500	5.0L V8 305 CID
	2002-2003	GMC YUKON XL 2500	6.0L V8 5967cc 364 CID		1988	CHEVROLET C1500	5.7L V8 350 CID
	2002-2003	GMC YUKON XL 2500	8.1L V8 496 CID		1988-1993	CHEVROLET C3500	7.4L V8 454 CID
2002-2003	GMC YUKON XL 2500	8.1L V8 496 CID	1988-1993		CHEVROLET K3500	7.4L V8 454 CID	
<b>USEP3599M</b>	2001-2003	CHEVROLET SILVERADO 3500	6.0L V8 5967cc 364 CID	1988-1993	GMC C3500	7.4L V8 454 CID	
	2001-2003	CHEVROLET SILVERADO 3500	8.1L V8 496 CID	1988-1993	GMC K3500	7.4L V8 454 CID	
	2001-2003	GMC SIERRA 3500	6.0L V8 5967cc 364 CID	1988-1995	CHEVROLET C2500	4.3L V6 262 CID	
	2001-2003	GMC SIERRA 3500	8.1L V8 496 CID	1988-1995	CHEVROLET C2500	5.0L V8 305 CID	
	2005	CHEVROLET SILVERADO 3500	6.6L V8 6599cc 403 CID	1988-1995	CHEVROLET C2500	5.7L V8 350 CID	
<b>USEP3601M</b>	2005	GMC SIERRA 3500	6.6L V8 6599cc 403 CID	1988-1995	CHEVROLET C3500	5.7L V8 350 CID	
	2005	GMC SIERRA 3500	6.6L V8 6599cc 403 CID	1988-1995	CHEVROLET K1500	4.3L V6 262 CID	
<b>USEP3601M</b>	2004-2005	CHEVROLET IMPALA	3.8L V6 3800cc 231 CID	1988-1995	CHEVROLET K1500	5.0L V8 305 CID	
	2004-2005	CHEVROLET MONTE CARLO	3.8L V6 3800cc 231 CID	1988-1995	CHEVROLET K1500	5.7L V8 350 CID	
<b>USEP3602M</b>	2003	CHEVROLET EXPRESS 3500		1988-1995	CHEVROLET K2500	4.3L V6 262 CID	
	2003	GMC SAVANA 3500		1988-1995	CHEVROLET K2500	5.0L V8 305 CID	
<b>USEP3604M</b>	2004-2006	CHEVROLET SILVERADO 3500	6.0L V8 5967cc 364 CID	1988-1995	CHEVROLET K2500	5.7L V8 350 CID	
	2004-2006	CHEVROLET SILVERADO 3500	8.1L V8 496 CID	1988-1995	CHEVROLET K3500	5.7L V8 350 CID	
	2004-2006	GMC SIERRA 3500	6.0L V8 5967cc 364 CID	1988-1995	GMC C1500	4.3L V6 262 CID	
	2004-2006	GMC SIERRA 3500	8.1L V8 496 CID	1988-1995	GMC C1500	5.0L V8 305 CID	
	2005-2006	CHEVROLET SILVERADO 1500 HD		1988-1995	GMC C2500	5.7L V8 350 CID	
<b>USEP3605M</b>	2005-2006	GMC SIERRA 1500 HD		1988-1995	GMC C2500	5.0L V8 305 CID	
	2004-2005	CADILLAC SRX	3.6L V6 3564cc 217 CID	1988-1995	GMC C2500	5.7L V8 350 CID	
<b>USEP3606M</b>	2004-2005	CADILLAC SRX	4.6L V8 281 CID	1988-1995	GMC C2500	5.7L V8 350 CID	
	2009	CADILLAC SRX	3.6L V6 3564cc 217 CID	1988-1995	GMC C2500	5.0L V8 305 CID	
	2009	CADILLAC SRX	4.6L V8 281 CID	1988-1995	GMC C2500	5.7L V8 350 CID	
	2009	CADILLAC SRX	4.6L V8 281 CID	1988-1995	GMC C2500	5.7L V8 350 CID	
<b>USEP3606M</b>	2003	CADILLAC CTS		1988-1995	GMC C2500	5.0L V8 305 CID	
	2004	CADILLAC CTS	3.2L V6 197 CID	1988-1995	GMC C2500	5.7L V8 350 CID	
<b>USEP3609M</b>	2004	CHEVROLET SILVERADO 2500	6.0L V8 5967cc 364 CID	1988-1995	GMC C2500	5.7L V8 350 CID	
	2004	GMC SIERRA 2500	6.0L V8 5967cc 364 CID	1988-1995	GMC C3500	5.7L V8 350 CID	
	2004-2006	CHEVROLET SILVERADO 1500	4.8L V8 294 CID	1988-1995	GMC K1500	4.3L V6 262 CID	
	2004-2006	CHEVROLET SILVERADO 1500	5.3L V8 5328cc 325 CID	1988-1995	GMC K1500	5.0L V8 305 CID	
	2004-2006	CHEVROLET SILVERADO 1500	6.0L V8 5967cc 364 CID	1988-1995	GMC K1500	5.7L V8 350 CID	
	2004-2006	CHEVROLET SILVERADO 1500	6.0L V8 5967cc 364 CID	1988-1995	GMC K2500	4.3L V6 262 CID	
	2004-2006	CHEVROLET SILVERADO 2500 HD	6.0L V8 5967cc 364 CID	1988-1995	GMC K2500	5.0L V8 305 CID	
	2004-2006	CHEVROLET SILVERADO 2500 HD	8.1L V8 496 CID	1988-1995	GMC K2500	5.7L V8 350 CID	
	2004-2006	GMC SIERRA 1500	4.8L V8 294 CID	1988-1995	GMC K2500	5.7L V8 350 CID	
	2004-2006	GMC SIERRA 1500	5.3L V8 5328cc 325 CID	1988-1995	GMC K3500	5.7L V8 350 CID	
	2004-2006	GMC SIERRA 2500 HD	6.0L V8 5967cc 364 CID	1990-1993	CHEVROLET C1500	7.4L V8 454 CID	
	2004-2006	GMC SIERRA 2500 HD	8.1L V8 496 CID	1990-1995	CHEVROLET C1500	4.3L V6 262 CID	
	2005-2006	CHEVROLET SILVERADO 1500	4.3L V6 262 CID	1990-1995	CHEVROLET C1500	5.0L V8 305 CID	
	2005-2006	CHEVROLET SILVERADO 1500 HD	6.0L V8 5967cc 364 CID	1990-1995	CHEVROLET C1500	5.7L V8 350 CID	
	2005-2006	GMC SIERRA 1500	4.3L V6 262 CID	1991-1992	CHEVROLET C2500	7.4L V8 454 CID	
	2005-2006	GMC SIERRA 1500	6.0L V8 5967cc 364 CID	1991-1993	CHEVROLET K2500	7.4L V8 454 CID	
	2005-2006	GMC SIERRA 1500 HD	6.0L V8 5967cc 364 CID	1991-1993	GMC C2500	7.4L V8 454 CID	
	2007	CHEVROLET SILVERADO 1500 CLASSIC	4.3L V6 262 CID	1991-1993	GMC K2500	7.4L V8 454 CID	
	2007	CHEVROLET SILVERADO 1500 CLASSIC	4.8L V8 294 CID	1995	CHEVROLET C35	5.7L V8 350 CID	
	2007	CHEVROLET SILVERADO 1500 CLASSIC	4.8L V8 294 CID	1995	CHEVROLET SILVERADO	5.7L V8 350 CID	
	2007	CHEVROLET SILVERADO 1500 CLASSIC	5.3L V8 5328cc 325 CID	1996	CHEVROLET C1500	4.3L V6 262 CID	
	2007	CHEVROLET SILVERADO 1500 CLASSIC	5.3L V8 5328cc 325 CID	1996	CHEVROLET K1500	4.3L V6 262 CID	
	2007	CHEVROLET SILVERADO 1500 CLASSIC	6.0L V8 5967cc 364 CID	1996	GMC C1500	4.3L V6 262 CID	
				1996	GMC K1500	4.3L V6 262 CID	
				1996-1997	CHEVROLET C1500	5.0L V8 305 CID	
				1996-1997	CHEVROLET C1500	5.7L V8 350 CID	



USMW	Years	Application	Engine	USMW	Years	Application	Engine	
<b>USEP3622S</b>	1996-1997	CHEVROLET C3500	5.7L V8 350 CID	<b>USEP3633S</b>	1990-1991	CHEVROLET V2500 SUBURBAN	5.7L V8 350 CID	
	1996-1997	CHEVROLET C3500	7.4L V8 454 CID	<b>USEP3634S</b>	1987-1988	CHEVROLET R10 SUBURBAN	5.7L V8 350 CID	
	1996-1997	CHEVROLET K1500	5.0L V8 305 CID		1987-1989	CHEVROLET BLAZER	5.7L V8 350 CID	
	1996-1997	CHEVROLET K1500	5.7L V8 350 CID	<b>USEP3636S</b>	1991-1992	CADILLAC FLEETWOOD	4.9L V8 300 CID	
	1996-1997	CHEVROLET K3500	5.7L V8 350 CID		1991-1993	CADILLAC DEVILLE	4.9L V8 300 CID	
	1996-1997	CHEVROLET K3500	7.4L V8 454 CID		1993	CADILLAC FLEETWOOD	5.7L V8 350 CID	
	1996-1997	CHEVROLET SILVERADO	5.7L V8 350 CID	<b>USEP3637S</b>	1985-1990	GMC S15	2.5L L4 2474cc 151 CID	
	1996-1997	GMC C1500	5.0L V8 305 CID		1985-1991	CHEVROLET S10	2.5L L4 2474cc 151 CID	
	1996-1997	GMC C1500	5.7L V8 350 CID		1986-1988	CHEVROLET S10	2.8L V6 173 CID	
	1996-1997	GMC C2500	5.0L V8 305 CID		1986-1990	GMC S15	2.8L V6 173 CID	
	1996-1997	GMC C2500	5.7L V8 350 CID		1988-1990	GMC S15	4.3L V6 262 CID	
	1996-1997	GMC C2500	7.4L V8 454 CID		1989-1991	CHEVROLET S10	4.3L V6 262 CID	
	1996-1997	GMC C3500	5.7L V8 350 CID		1990-1991	CHEVROLET S10	2.8L V6 173 CID	
	1996-1997	GMC C3500	7.4L V8 454 CID		1991	GMC SONOMA	2.5L L4 2474cc 151 CID	
	1996-1997	GMC K1500	5.0L V8 305 CID		1991	GMC SONOMA	2.8L V6 173 CID	
	1996-1997	GMC K1500	5.7L V8 350 CID		1991	GMC SONOMA	4.3L V6 262 CID	
	1996-1997	GMC K2500	5.7L V8 350 CID	<b>USEP3639S</b>	1989-1990	CHEVROLET CELEBRITY	2.5L L4 2474cc 151 CID	
	1996-1997	GMC K2500	7.4L V8 454 CID		1989-1992	OLDSMOBILE CUTLASS CIERA	2.5L L4 2474cc 151 CID	
	1996-1997	GMC K3500	5.7L V8 350 CID		1990-1992	BUICK CENTURY	2.5L L4 2474cc 151 CID	
	1996-1997	GMC K3500	7.4L V8 454 CID	<b>USEP3640S</b>	1989	PONTIAC 6000	2.8L V6 173 CID	
<b>USEP3623S</b>	1994-1995	CHEVROLET C2500	7.4L V8 454 CID		1989-1990	OLDSMOBILE CUTLASS CIERA	3.3L V6 3340cc 204 CID	
	1994-1995	CHEVROLET C3500	7.4L V8 454 CID		1989-1992	OLDSMOBILE CUTLASS CIERA	3.3L V6 204 CID	
	1994-1995	CHEVROLET K2500	7.4L V8 454 CID		1990-1991	PONTIAC 6000	3.1L V6 189 CID	
	1994-1995	CHEVROLET K3500	7.4L V8 454 CID	<b>USEP3641S</b>	1994-1995	CHEVROLET S10	2.2L L4 2190cc 134 CID	
	1994-1995	GMC C2500	7.4L V8 454 CID		1994-1995	GMC SONOMA	2.2L L4 2190cc 134 CID	
	1994-1995	GMC C3500	7.4L V8 454 CID	<b>USEP3642S</b>	1992-1993	CHEVROLET S10	2.5L L4 2474cc 151 CID	
	1994-1995	GMC K2500	7.4L V8 454 CID		1992-1993	CHEVROLET S10	2.8L V6 173 CID	
	1994-1995	GMC K3500	7.4L V8 454 CID		1992-1993	CHEVROLET S10	4.3L V6 262 CID	
<b>USEP3624S</b>	1992-1994	CHEVROLET S10 BLAZER	4.3L V6 262 CID		1992-1993	GMC SONOMA	2.5L L4 2474cc 151 CID	
	1992-1994	OLDSMOBILE BRAVADA	4.3L V6 262 CID		1992-1993	GMC SONOMA	2.8L V6 173 CID	
<b>USEP3625S</b>	1992-1993	GMC TYPHOON	4.3L V6 262 CID		1992-1993	GMC SONOMA	4.3L V6 262 CID	
	1992-1994	CHEVROLET S10 BLAZER	4.3L V6 262 CID	<b>USEP3643S</b>	1995	CHEVROLET S10	4.3L V6 262 CID	
	1992-1994	GMC JIMMY	4.3L V6 262 CID		1995	GMC SONOMA	4.3L V6 262 CID	
<b>USEP3626M</b>	1992-1994	OLDSMOBILE BRAVADA	4.3L V6 262 CID	<b>USEP3648S</b>	1992-1993	CHEVROLET S10	2.5L L4 2474cc 151 CID	
	2004	SATURN VUE	3.5L V6 3475cc		1992-1993	CHEVROLET S10	2.8L V6 173 CID	
	2004-2006	SATURN VUE	2.2L L4 2198cc 134 CID		1992-1993	GMC SONOMA	2.5L L4 2474cc 151 CID	
	2005	SATURN VUE	3.5L V6 3474cc		1992-1993	GMC SONOMA	2.8L V6 173 CID	
	2005-2006	CHEVROLET EQUINOX	3.4L V6 207 CID	<b>USEP3649S</b>	1992-1994	CHEVROLET LUMINA APV	3.8L V6 3800cc 231 CID	
	2006	PONTIAC TORRENT	3.4L V6 207 CID		1992-1994	OLDSMOBILE SILHOUETTE	3.8L V6 3800cc 231 CID	
<b>USEP3629S</b>	2006	SATURN VUE	3.5L V6 3471cc		1992-1994	PONTIAC TRANS SPORT	3.8L V6 3800cc 231 CID	
	1993-1994	BUICK LESABRE	3.8L V6 3800cc 231 CID	<b>USEP3650S</b>	1992-1995	CHEVROLET ASTRO	4.3L V6 262 CID	
	1993-1994	BUICK PARK AVENUE	3.8L V6 3800cc 231 CID		1992-1995	GMC SAFARI	4.3L V6 262 CID	
	1993-1994	OLDSMOBILE 88	3.8L V6 3800cc 231 CID	<b>USEP3674M</b>	2003	CHEVROLET EXPRESS 3500		
	1993-1994	OLDSMOBILE 98	3.8L V6 3800cc 231 CID		2003	GMC SAVANA 3500		
<b>USEP3630S</b>	1993-1994	PONTIAC BONNEVILLE	3.8L V6 3800cc 231 CID	<b>USEP3675M</b>	2004-2005	CHEVROLET SUBURBAN 2500	8.1L V8 496 CID	
	1987	CHEVROLET BLAZER	5.0L V8 305 CID		2004-2006	CHEVROLET AVALANCHE 2500	8.1L V8 496 CID	
	1987	CHEVROLET BLAZER	5.7L V8 350 CID		2004-2006	GMC YUKON XL 2500	8.1L V8 496 CID	
	1987	CHEVROLET R10	5.7L V8 350 CID		2004-2007	CHEVROLET SUBURBAN 2500	6.0L V8 5967cc 364 CID	
	1987	CHEVROLET R10	5.7L V8 350 CID		2004-2007	GMC YUKON XL 2500	6.0L V8 5967cc 364 CID	
<b>USEP3631S</b>	1987	CHEVROLET R20	4.3L V6 262 CID	<b>USEP3676M</b>	2001-2002	CHEVROLET EXPRESS 3500	5.7L V8 350 CID	
	1987	CHEVROLET V10	4.3L V6 262 CID	<b>USEP3678M</b>	2004-2005	CHEVROLET EXPRESS 2500	5.3L V8 5328cc 325 CID	
	1987	CHEVROLET V10	5.7L V8 350 CID		2004-2005	CHEVROLET EXPRESS 3500	4.8L V8 294 CID	
	1987	CHEVROLET V20	5.7L V8 350 CID		2004-2005	GMC SAVANA 2500	5.3L V8 5328cc 325 CID	
	1987	GMC R1500	4.3L V6 262 CID		2004-2007	CHEVROLET EXPRESS 1500	5.3L V8 5328cc 325 CID	
	1987	GMC R1500	5.7L V8 350 CID		2004-2007	GMC SAVANA 1500	5.3L V8 5328cc 325 CID	
	1987	GMC R2500	4.3L V6 262 CID		2004-2008	CHEVROLET EXPRESS 2500	4.8L V8 294 CID	
	1987	GMC V1500	4.3L V6 262 CID		2004-2008	CHEVROLET EXPRESS 2500	6.0L V8 5967cc 364 CID	
	1987	GMC V1500	5.7L V8 350 CID		2004-2008	CHEVROLET EXPRESS 3500	6.0L V8 5967cc 364 CID	
	1987	GMC V2500	5.7L V8 350 CID		2004-2008	GMC SAVANA 2500	4.8L V8 294 CID	
	1988	CHEVROLET R20 SUBURBAN	5.7L V8 350 CID		2004-2008	GMC SAVANA 2500	6.0L V8 5967cc 364 CID	
	1988	CHEVROLET V20 SUBURBAN	5.7L V8 350 CID		2004-2008	GMC SAVANA 3500	4.8L V8 294 CID	
	1988	CHEVROLET V20 SUBURBAN	7.4L V8 454 CID		2004-2008	GMC SAVANA 3500	6.0L V8 5967cc 364 CID	
	1989	CHEVROLET R2500	5.7L V8 350 CID		2005	CHEVROLET EXPRESS 2500	4.3L V6 262 CID	
	1989	CHEVROLET R2500 SUBURBAN	5.7L V8 350 CID		2005	GMC SAVANA 2500	4.3L V6 262 CID	
	1989	CHEVROLET V2500 SUBURBAN	5.7L V8 350 CID		2005-2006	CHEVROLET EXPRESS 1500	4.3L V6 262 CID	
					2005-2008	GMC SAVANA 1500	4.3L V6 262 CID	
	<b>USEP3632S</b>	1985-1988	CHEVROLET S10 BLAZER	2.5L L4 2474cc 151 CID	<b>USEP3679M</b>	2005-2006	BUICK LACROSSE	3.6L V6 3564cc 217 CID
		1985-1988	GMC S15 JIMMY	2.5L L4 2474cc 151 CID		2005-2006	BUICK LACROSSE	3.8L V6 3800cc 231 CID
		1986-1987	CHEVROLET S10 BLAZER	2.8L V6 173 CID	<b>USEP3680M</b>	2005	CHEVROLET COBALT	2.0L L4 122 CID
1986-1987		GMC S15 JIMMY	2.8L V6 173 CID	<b>USEP3681M</b>	2004-2008	CHEVROLET EXPRESS 3500	6.0L V8 5967cc 364 CID	
1988		GMC S15 JIMMY	4.3L V6 262 CID		2004-2008	GMC SAVANA 3500	6.0L V8 5967cc 364 CID	
1988-1991		CHEVROLET S10 BLAZER	4.3L V6 262 CID		2005-2008	CHEVROLET EXPRESS 3500	4.8L V8 294 CID	
1989		GMC S15 JIMMY	2.8L V6 173 CID		2005-2008	GMC SAVANA 3500	4.8L V8 294 CID	
1990-1991		GMC S15 JIMMY	4.3L V6 262 CID	<b>USEP3682M</b>	2004-2005	CHEVROLET EXPRESS 3500	6.0L V8 5967cc 364 CID	
1991		OLDSMOBILE BRAVADA	4.3L V6 262 CID		2004-2005	GMC SAVANA 3500	6.0L V8 5967cc 364 CID	
<b>USEP3633S</b>		1987	CHEVROLET BLAZER	5.0L V8 305 CID		2005	CHEVROLET EXPRESS 3500	4.8L V8 294 CID
		1987	CHEVROLET R10	5.7L V8 350 CID		2005	GMC SAVANA 3500	4.8L V8 294 CID
		1987-1988	CHEVROLET R10 SUBURBAN	5.7L V8 350 CID	<b>USEP3684M</b>	2004-2006	CHEVROLET SILVERADO 1500	4.8L V8 294 CID
	1987-1988	CHEVROLET R20	5.7L V8 350 CID		2004-2006	CHEVROLET SILVERADO 1500	5.3L V8 5328cc 325 CID	
	1987-1988	CHEVROLET R20 SUBURBAN	5.7L V8 350 CID		2004-2006	GMC SIERRA 1500	4.8L V8 294 CID	
	1987-1991	CHEVROLET BLAZER	5.7L V8 350 CID		2004-2006	GMC SIERRA 1500	5.3L V8 5328cc 325 CID	
	1988	CHEVROLET V10 SUBURBAN	5.7L V8 350 CID		2004-2006	GMC SIERRA 1500	6.0L V8 5967cc 364 CID	
	1988-1991	GMC JIMMY	5.7L V8 350 CID		2006	CHEVROLET SILVERADO 1500	6.0L V8 5967cc 364 CID	
	1988-1991	GMC V1500 SUBURBAN	5.7L V8 350 CID		2007	GMC SIERRA 1500 CLASSIC	4.8L V8 294 CID	
	1988-1991	GMC V2500 SUBURBAN	5.7L V8 350 CID		2007	GMC SIERRA 1500 CLASSIC	5.3L V8 5328cc 325 CID	
	1989	CHEVROLET R2500	7.4L V8 454 CID		2007	GMC SIERRA 1500 CLASSIC	6.0L V8 5967cc 364 CID	
	1989-1991	CHEVROLET R1500 SUBURBAN	5.7L V8 350 CID	<b>USEP3688M</b>	2006	CHEVROLET COLORADO	2.8L L4 2770cc 169 CID	
	1989-1991	CHEVROLET R2500 SUBURBAN	5.7L V8 350 CID		2006	CHEVROLET COLORADO	3.5L L5 3460cc 211 CID	
	1989-1991	CHEVROLET V1500 SUBURBAN	5.7L V8 350 CID					

USMW	Years	Application	Engine	USMW	Years	Application	Engine
USEP3688M	2006	GMC CANYON	2.8L L4 2770cc 169 CID	USEP3737M	2000	SATURN LS1	
	2006	GMC CANYON	3.5L L5 3460cc 211 CID		2000	SATURN LS2	
	2007-2008	CHEVROLET COLORADO	2.9L L4 2921cc 178 CID		2000	SATURN LW1	
	2007-2008	CHEVROLET COLORADO	3.7L L5 3654cc 223 CID		2000	SATURN LW2	
	2007-2008	GMC CANYON	2.9L L4 2921cc 178 CID		USEP3742S	1989	OLDSMOBILE CUTLASS CRUISER
2007-2008	GMC CANYON	3.7L L5 3654cc 223 CID	1989-1992	OLDSMOBILE CUTLASS CRUISER		3.3L V6 204 CID	
USEP3689M	2004-2007	HUMMER H2	6.0L V8 5967cc 364 CID	USEP3743S	1990-1991	CHEVROLET BERETTA	2.3L L4 140 CID
USEP3691M	2004-2007	CADILLAC CTS	3.6L V6 3564cc 217 CID		1990-1991	CHEVROLET BERETTA	3.1L V6 189 CID
	2005-2007	CADILLAC CTS	2.8L V6 2792cc 170 CID		1990-1991	CHEVROLET CORSICA	3.1L V6 189 CID
	2005-2007	CADILLAC STS	3.6L V6 3564cc 217 CID	USEP3745M	1998	CHEVROLET CAMARO	3.8L V6 3800cc 231 CID
	2005-2007	CADILLAC STS	4.6L V8 281 CID		1998	PONTIAC FIREBIRD	3.8L V6 3800cc 231 CID
	2007	CADILLAC STS	4.6L V8 4565cc 279 CID	USEP3746M	2005	GMC ENVOY XUV	4.2L L6 256 CID
2007	CADILLAC CTS	6.0L V8 5967cc 364 CID	2005		GMC ENVOY XUV	5.3L V8 5328cc 325 CID	
USEP3692M	2005-2006	PONTIAC GRAND PRIX	3.8L V6 3800cc 231 CID	2005-2006	CHEVROLET TRAILBLAZER EXT	4.2L L6 256 CID	
	2005-2006	PONTIAC GRAND PRIX	5.3L V8 5328cc 325 CID	2005-2006	CHEVROLET TRAILBLAZER EXT	5.3L V8 5328cc 325 CID	
USEP3700M	2006	CHEVROLET IMPALA	5.3L V8 5328cc 325 CID	2005-2006	GMC ENVOY	5.3L V8 5328cc 325 CID	
	2006	CHEVROLET MONTE CARLO	5.3L V8 5328cc 325 CID	2005-2006	GMC ENVOY XL	4.2L L6 256 CID	
	2006	CHEVROLET MONTE CARLO	3.4L V6 207 CID	2005-2006	GMC ENVOY XL	5.3L V8 5328cc 325 CID	
USEP3701M	2004-2005	BUICK RENDEZVOUS	3.4L V6 207 CID	USEP3747M	2007	CHEVROLET SILVERADO 1500 CLASSIC	4.8L V8 294 CID
	2004-2005	PONTIAC AZTEK	3.4L V6 207 CID		2007	CHEVROLET SILVERADO 1500 CLASSIC	6.0L V8 5967cc 364 CID
USEP3702M	2005-2006	CHEVROLET SILVERADO 1500	5.3L V8 5328cc 325 CID	2007-2008	CHEVROLET SILVERADO 1500	4.8L V8 294 CID	
	2005-2006	GMC SIERRA 1500	5.3L V8 5328cc 325 CID	2007-2008	CHEVROLET SILVERADO 1500	5.3L V8 5328cc 325 CID	
USEP3703M	2007	GMC SIERRA 1500 CLASSIC	5.3L V8 5328cc 325 CID	2007-2008	CHEVROLET SILVERADO 1500	6.0L V8 5967cc 364 CID	
	2003	CHEVROLET S10	2.2L L4 2190cc 134 CID	2007-2008	CHEVROLET SILVERADO 1500	3.6L V6 3564cc 217 CID	
USEP3703M	2003	GMC SONOMA	2.2L L4 2190cc 134 CID	USEP3748M	2007-2008	GMC ACADIA	3.6L V6 3564cc 217 CID
	2005	GMC YUKON XL 1500			2007-2008	SATURN OUTLOOK	3.6L V6 3564cc 217 CID
USEP3705M	2005-2007	CHEVROLET TAHOE	5.3L V8 5328cc 325 CID	2008	BUICK ENCLAVE	3.6L V6 3564cc 217 CID	
	2005-2007	GMC YUKON	5.3L V8 5328cc 325 CID	USEP3749M	2008	PONTIAC GRAND PRIX	3.8L V6 3800cc 231 CID
USEP3706M	2005-2006	CHEVROLET AVALANCHE 1500	5.3L V8 5328cc 325 CID		2008-2009	BUICK ALLURE	3.8L V6 3800cc 231 CID
	2005-2007	CHEVROLET SUBURBAN 1500	5.3L V8 5328cc 325 CID	2008-2009	BUICK LACROSSE	3.8L V6 3800cc 231 CID	
USEP3706M	2005-2007	GMC YUKON XL 1500	5.3L V8 5328cc 325 CID	2008-2010	CHEVROLET IMPALA	3.5L V6 3490cc 213 CID	
	2007	CHEVROLET AVALANCHE	5.3L V8 5328cc 325 CID	USEP3750M	2007-2008	CHEVROLET SILVERADO 1500	4.3L V6 262 CID
USEP3707M	2005-2006	CHEVROLET SSR			2007-2008	CHEVROLET SILVERADO 2500 HD	6.0L V8 5967cc 364 CID
	2005-2006	ISUZU ASCENDER	5.3L V8 5328cc 325 CID	2007-2008	CHEVROLET SILVERADO 3500 HD	6.0L V8 5967cc 364 CID	
2005-2007	BUICK RAINIER	4.2L L6 256 CID	2007-2008	GMC SIERRA 1500	4.3L V6 262 CID		
2005-2007	BUICK RAINIER	5.3L V8 5328cc 325 CID	2007-2008	GMC SIERRA 2500 HD	6.0L V8 5967cc 364 CID		
2005-2007	CHEVROLET TRAILBLAZER	4.2L L6 256 CID	2007-2008	GMC SIERRA 3500 HD	6.0L V8 5967cc 364 CID		
2005-2007	GMC ENVOY	4.2L L6 256 CID	USEP3751M	2008	CHEVROLET EXPRESS 1500	5.3L V8 5328cc 325 CID	
2005-2007	ISUZU ASCENDER	4.2L L6 256 CID		2008	GMC SAVANA 1500	5.3L V8 5328cc 325 CID	
2005-2007	SAAB 9-7X	4.2L L6 256 CID	USEP3752M	2007-2008	CHEVROLET SILVERADO 1500	4.8L V8 294 CID	
2005-2007	SAAB 9-7X	5.3L V8 5328cc 325 CID		2007-2008	CHEVROLET SILVERADO 1500	5.3L V8 5328cc 325 CID	
2006-2007	CHEVROLET TRAILBLAZER	6.0L V8 5967cc 364 CID	2007-2008	GMC SIERRA 1500	4.8L V8 294 CID		
USEP3709M	2006	BUICK LUCERNE	3.8L V6 3800cc 231 CID	2007-2008	GMC SIERRA 1500	5.3L V8 5328cc 325 CID	
	2006	BUICK LUCERNE	4.6L V8 281 CID	USEP3753M	2008	CADILLAC ESCALADE ESV	6.2L V8 6162cc 376 CID
2006-2008	CADILLAC DTS	4.6L V8 281 CID	2008		CADILLAC ESCALADE EXT	6.2L V8 6162cc 376 CID	
USEP3710M	2006	CHEVROLET UPLANDER	3.5L V6 213 CID	USEP3755M	2007	CHEVROLET MALIBU	3.9L V6 3880cc 237 CID
	2006	CHEVROLET UPLANDER	3.5L V6 3500cc 214 CID		2007-2008	CHEVROLET MALIBU	2.2L L4 2198cc 134 CID
USEP3710M	2007	PONTIAC MONTANA	3.9L V6 3880cc 237 CID	2007-2008	CHEVROLET MALIBU	3.5L V6 3490cc 213 CID	
	2006-2007	PONTIAC WAVE	1.6L L4 1598cc 98 CID	USEP3757M	2007-2008	CHEVROLET EQUINOX	3.4L V6 3425cc 209 CID
2006-2008	CHEVROLET AVEO	1.6L L4 1598cc 98 CID	2007-2008		PONTIAC TORRENT	3.4L V6 3350cc 204 CID	
USEP3711M	2006-2008	CHEVROLET AVEO5	1.6L L4 1598cc 98 CID	2007-2009	CHEVROLET EQUINOX	3.4L V6 207 CID	
	2006	CHEVROLET IMPALA	3.5L V6 3490cc 213 CID	2007-2009	PONTIAC TORRENT	3.4L V6 207 CID	
USEP3712M	2006	CHEVROLET MONTE CARLO	3.5L V6 3490cc 213 CID	2008-2009	CHEVROLET EQUINOX	3.6L V6 3564cc 217 CID	
	2006	CHEVROLET MONTE CARLO	2.2L L4 2198cc 134 CID	2008-2009	PONTIAC TORRENT	3.6L V6 3564cc 217 CID	
USEP3715M	2006-2008	CHEVROLET HHR	2.4L L4 2384cc 145 CID	USEP3759M	1998	CHEVROLET EXPRESS 3500	7.4L V8 454 CID
	2006-2008	CHEVROLET HHR	2.0L L4 1998cc 122 CID		1998	GMC SAVANA 3500	7.4L V8 454 CID
2008	CHEVROLET COBALT	2.0L L4 1998cc 122 CID	USEP3760M	1998-2002	CHEVROLET EXPRESS 3500	5.7L V8 350 CID	
2008	CHEVROLET HHR	2.0L L4 1998cc 122 CID		1998-2002	GMC SAVANA 3500	5.7L V8 350 CID	
USEP3717M	2005	BUICK TERRAZA		2001-2002	GMC SAVANA 3500	8.1L V8 496 CID	
	2005	CHEVROLET UPLANDER		1997-1998	CHEVROLET EXPRESS 3500	7.4L V8 454 CID	
2005	SATURN RELAY		1997-1998	GMC SAVANA 3500	7.4L V8 454 CID		
2005-2006	PONTIAC MONTANA	3.5L V6 213 CID	1997-2002	CHEVROLET EXPRESS 3500	5.7L V8 350 CID		
2006	BUICK TERRAZA	3.5L V6 213 CID	1997-2002	GMC SAVANA 3500	8.1L V8 496 CID		
2006	BUICK TERRAZA	3.9L V6 3880cc 237 CID	USEP3765M	2008	CADILLAC ESCALADE	6.2L V8 6162cc 376 CID	
2006	CHEVROLET UPLANDER	3.5L V6 213 CID		2009-2012	CADILLAC ESCALADE	6.0L V8 5967cc 364 CID	
2006	CHEVROLET UPLANDER	3.9L V6 3880cc 237 CID	2010-2011	CHEVROLET TAHOE	6.0L V8 5967cc 364 CID		
2006	SATURN RELAY	3.5L V6 213 CID	2010-2013	GMC YUKON	6.0L V8 5967cc 364 CID		
2006	SATURN RELAY	3.9L V6 3880cc 237 CID	USEP3768M	2009-2014	CADILLAC ESCALADE	6.2L V8 6162cc 376 CID	
2006	SATURN RELAY	3.9L V6 3880cc 237 CID		2010-2014	CHEVROLET TAHOE	5.3L V8 5328cc 325 CID	
2006-2007	PONTIAC MONTANA	3.9L V6 3880cc 237 CID	2010-2014	GMC YUKON	5.3L V8 5328cc 325 CID		
USEP3718M	2008	CHEVROLET UPLANDER		2010-2014	GMC YUKON	6.2L V8 6162cc 376 CID	
	2007	BUICK TERRAZA	3.9L V6 3880cc 237 CID	USEP3769M	2008	CHEVROLET TRAILBLAZER	5.3L V8 5328cc 325 CID
2007	CHEVROLET UPLANDER	3.9L V6 3880cc 237 CID	2008		ISUZU ASCENDER	4.2L L6 256 CID	
2007	SATURN RELAY	3.9L V6 3880cc 237 CID	2008-2009	CHEVROLET TRAILBLAZER	4.2L L6 256 CID		
USEP3724M	2006	HUMMER H3	3.5L L5 3460cc 211 CID	2008-2009	CHEVROLET TRAILBLAZER	6.0L V8 5967cc 364 CID	
	2007-2008	HUMMER H3	3.7L L5 3654cc 223 CID	2008-2009	GMC ENVOY	4.2L L6 256 CID	
USEP3725M	2008	HUMMER H3	5.3L V8 5328cc 325 CID	2008-2009	GMC ENVOY	5.3L V8 5328cc 325 CID	
	2007	CHEVROLET EXPRESS 1500	5.3L V8 5328cc 325 CID	2008-2009	SAAB 9-7X	4.2L L6 256 CID	
USEP3726M	2007	GMC SAVANA 1500	5.3L V8 5328cc 325 CID	2008-2009	SAAB 9-7X	5.3L V8 5328cc 325 CID	
	2006	PONTIAC PURSUIT	2.2L L4 2198cc 134 CID	2008-2009	SAAB 9-7X	6.0L V8 5967cc 364 CID	
2006	PONTIAC PURSUIT	2.4L L4 2384cc 145 CID	USEP3777M	2009-2010	CHEVROLET SILVERADO 1500	4.3L V6 262 CID	
2006-2007	CHEVROLET COBALT	2.0L L4 122 CID		2009-2013	GMC SIERRA 1500	4.3L V6 262 CID	
2006-2008	CHEVROLET COBALT	2.2L L4 2198cc 134 CID	2010-2013	CHEVROLET SILVERADO 1500	4.3L V6 4300cc 262 CID		
2006-2008	CHEVROLET COBALT	2.4L L4 2384cc 145 CID	USEP3781M	2009	TOYOTA COROLLA	1.8L L4 1794cc	
2006-2008	CHEVROLET COBALT	2.0L L4 122 CID		2009-2010	PONTIAC VIBE	1.8L L4 1798cc 110 CID	
2007	SATURN ION	2.0L L4 122 CID	2009-2010	PONTIAC VIBE	2.4L L4 2362cc		
2007	SATURN ION	2.2L L4 2198cc 134 CID	2009-2010	TOYOTA COROLLA	2.4L L4 2362cc		
2007	SATURN ION	2.4L L4 2384cc 145 CID					
2007-2008	PONTIAC G5	2.2L L4 2198cc 134 CID					
2007-2008	PONTIAC G5	2.4L L4 2384cc 145 CID					
USEP3732M	2007-2008	CHEVROLET SILVERADO 1500	5.3L V8 5328cc 325 CID				
USEP3737M	2000	SATURN LS					





# FUEL PUMP MODULES BUYERS GUIDE



FUEL PUMP MODULES

USMW	Years	Application	Engine	USMW	Years	Application	Engine
USEP3781M	2009-2013	TOYOTA MATRIX	1.8L L4 1798cc 110 CID	USEP3831M	2004-2006	GMC SIERRA 1500	5.3L V8 5328cc 325 CID
	2009-2013	TOYOTA MATRIX	2.4L L4 2362cc		2004-2006	GMC SIERRA 2500 HD	6.0L V8 5967cc 364 CID
	2009-2018	TOYOTA COROLLA	1.8L L4 1798cc 110 CID		2004-2006	GMC SIERRA 2500 HD	8.1L V8 496 CID
	2010	TOYOTA COROLLA	2.4L L4 2400cc 146 CID		2004-2006	GMC SIERRA 3500	6.0L V8 5967cc 364 CID
USEP3782M	2009-2010	CHEVROLET COBALT	2.2L L4 2198cc 134 CID	2004-2006	GMC SIERRA 3500	8.1L V8 496 CID	
	2009-2010	PONTIAC G5	2.2L L4 2198cc 134 CID	2005-2006	CHEVROLET SILVERADO 1500	4.3L V6 262 CID	
USEP3788M	2009	CHEVROLET EXPRESS 1500	5.3L V8 5328cc 325 CID	2005-2006	GMC SIERRA 1500	4.3L V6 262 CID	
	2009	GMC SAVANA 1500	5.3L V8 5328cc 325 CID	2005-2006	GMC SIERRA 1500	6.0L V8 5967cc 364 CID	
USEP3790M	2009-2010	SATURN OUTLOOK	3.6L V6 3564cc 217 CID	2007	CHEVROLET SILVERADO 1500 CLASSIC	4.3L V6 262 CID	
	2009-2014	BUICK ENCLAVE	3.6L V6 3564cc 217 CID	2007	CHEVROLET SILVERADO 1500 CLASSIC	4.8L V8 294 CID	
	2009-2014	CHEVROLET TRAVERSE	3.6L V6 3564cc 217 CID	2007	CHEVROLET SILVERADO 1500 CLASSIC	5.3L V8 5328cc 325 CID	
	2009-2014	GMC ACADIA	3.6L V6 3564cc 217 CID	2007	CHEVROLET SILVERADO 2500 HD CLASSIC	6.0L V8 5967cc 364 CID	
USEP3792M	2007	BUICK ALLURE	3.6L V6 3564cc 217 CID	2007	CHEVROLET SILVERADO 2500 HD CLASSIC	8.1L V8 496 CID	
	2007	BUICK LACROSSE	3.6L V6 3564cc 217 CID	2007	CHEVROLET SILVERADO 2500 HD CLASSIC	8.1L V8 496 CID	
	2007	CHEVROLET IMPALA	3.9L V6 3880cc 237 CID	2007	CHEVROLET SILVERADO 3500 CLASSIC	6.0L V8 5967cc 364 CID	
	2007	CHEVROLET MONTE CARLO	3.5L V6 3490cc 213 CID	2007	CHEVROLET SILVERADO 3500 CLASSIC	8.1L V8 496 CID	
	2007-2008	BUICK ALLURE	3.8L V6 3800cc 231 CID	2007	CHEVROLET SILVERADO 3500 CLASSIC	8.1L V8 496 CID	
	2007-2008	BUICK LACROSSE	3.8L V6 3800cc 231 CID	2007	GMC SIERRA 1500 CLASSIC	4.3L V6 262 CID	
	2007-2008	CHEVROLET IMPALA	3.5L V6 3490cc 213 CID	2007	GMC SIERRA 1500 CLASSIC	4.8L V8 294 CID	
	2007-2008	PONTIAC GRAND PRIX	3.8L V6 3800cc 231 CID	2007	GMC SIERRA 1500 CLASSIC	5.3L V8 5328cc 325 CID	
USEP3794M	2009-2012	CHEVROLET SILVERADO 1500	4.3L V6 262 CID	2007	GMC SIERRA 1500 CLASSIC	6.0L V8 5967cc 364 CID	
	2009-2013	GMC SIERRA 1500	4.3L V6 262 CID	2007	GMC SIERRA 1500 CLASSIC	6.0L V8 5967cc 364 CID	
	2010-2013	CHEVROLET SILVERADO 1500	4.3L V6 4300cc 262 CID	2007	GMC SIERRA 2500 HD CLASSIC	8.1L V8 496 CID	
	2013	CHEVROLET SILVERADO 1500	4.3L V6 4293cc 262 CID	2007	GMC SIERRA 2500 HD CLASSIC	8.1L V8 496 CID	
USEP3797M	2008-2013	CHEVROLET AVALANCHE	5.3L V8 5328cc 325 CID	2007	GMC SIERRA 3500 CLASSIC	6.0L V8 5967cc 364 CID	
	2008-2014	CHEVROLET SUBURBAN 1500	5.3L V8 5328cc 325 CID	2007	GMC SIERRA 3500 CLASSIC	8.1L V8 496 CID	
	2008-2014	GMC YUKON XL 1500	5.3L V8 5328cc 325 CID	2007	GMC SIERRA 3500 CLASSIC	8.1L V8 496 CID	
	2009-2013	CADILLAC ESCALADE EXT	6.2L V8 6162cc 376 CID	2007	GMC SIERRA 3500 CLASSIC	8.1L V8 496 CID	
USEP3801M	2009-2014	CADILLAC ESCALADE ESV	6.2L V8 6162cc 376 CID	2005-2006	CHEVROLET SILVERADO 1500 HD	6.0L V8 5967cc 364 CID	
	2009-2014	GMC YUKON XL 1500	6.2L V8 6162cc 376 CID	2005-2006	GMC SIERRA 1500 HD	6.0L V8 5967cc 364 CID	
	2010	CHEVROLET MALIBU	2.4L L4 2384cc 145 CID	2007	GMC SIERRA 1500 HD CLASSIC	6.0L V8 5967cc 364 CID	
	2010	CHEVROLET MALIBU	3.5L V6 3490cc 213 CID	2007-2008	CHEVROLET SILVERADO 1500	4.8L V8 294 CID	
USEP3806M	2010	PONTIAC G6	2.4L L4 2384cc 145 CID	2007-2008	CHEVROLET SILVERADO 1500	5.3L V8 5328cc 325 CID	
	2010	PONTIAC G6	3.5L V6 3490cc 213 CID	2007-2008	GMC SIERRA 1500	4.8L V8 294 CID	
	2010-2011	CHEVROLET HHR	2.2L L4 2198cc 134 CID	2007-2008	GMC SIERRA 1500	5.3L V8 5328cc 325 CID	
	2010-2011	CHEVROLET HHR	2.4L L4 2384cc 145 CID	2010-2017	CHEVROLET EQUINOX	2.4L L4 2384cc 145 CID	
USEP3809M	2009	CHEVROLET SILVERADO 1500	5.3L V8 5328cc 325 CID	2010-2017	GMC TERRAIN	2.4L L4 2384cc 145 CID	
	2009	CHEVROLET SILVERADO 1500	6.2L V8 6162cc 376 CID	2007-2008	CHEVROLET SILVERADO 1500	4.3L V6 262 CID	
USEP3812M	2009	CHEVROLET MALIBU	2.4L L4 2384cc 145 CID	2007-2008	GMC SIERRA 1500	4.3L V6 262 CID	
	2009	CHEVROLET MALIBU	3.5L V6 3490cc 213 CID	USEP3905M	1991-1992	SATURN SC	1.9L L4 116 CID
	2009	CHEVROLET MALIBU	3.6L V6 3564cc 217 CID	1991-1996	SATURN SL1	1.9L L4 116 CID	
	2009	PONTIAC G6	2.4L L4 2384cc 145 CID	1991-1996	SATURN SL2	1.9L L4 116 CID	
	2009	PONTIAC G6	3.5L V6 3490cc 213 CID	1993-1996	SATURN SC1	1.9L L4 116 CID	
	2009	PONTIAC G6	3.5L V6 3490cc 213 CID	1993-1996	SATURN SC2	1.9L L4 116 CID	
	2009	PONTIAC G6	3.6L V6 3564cc 217 CID	1993-1996	SATURN SW1	1.9L L4 116 CID	
	2009	PONTIAC G6	3.9L V6 3880cc 237 CID	1993-1996	SATURN SW2	1.9L L4 116 CID	
USEP3814M	2008-2013	CHEVROLET SUBURBAN 2500	6.0L V8 5967cc 364 CID	USEP3912M	1995-1996	BUICK RIVIERA	3.8L V6 3800cc 231 CID
	2008-2013	GMC YUKON XL 2500	6.0L V8 5967cc 364 CID	1995-1996	OLDSMOBILE AURORA	4.0L V8 244 CID	
USEP3815M	2009	CHEVROLET SILVERADO 1500	4.8L V8 294 CID	USEP3913M	1994-1995	CADILLAC DEVILLE	4.9L V8 300 CID
	2009	CHEVROLET SILVERADO 1500	5.3L V8 5328cc 325 CID	1994-1996	CADILLAC DEVILLE	4.6L V8 281 CID	
USEP3816M	2009-2013	CHEVROLET SILVERADO 1500	6.0L V8 5967cc 364 CID	1994-1996	CADILLAC ELDOURO	4.6L V8 281 CID	
	2010-2013	GMC SIERRA 1500	6.0L V8 5967cc 364 CID	1994-1996	CADILLAC SEVILLE	2.2L L4 2190cc 134 CID	
USEP3817M	2009	CHEVROLET SILVERADO 1500	4.8L V8 294 CID	USEP3914M	1995	PONTIAC SUNFIRE	2.3L L4 138 CID
	2009	CHEVROLET SILVERADO 1500	5.3L V8 5328cc 325 CID	1995	PONTIAC SUNFIRE	2.3L L4 138 CID	
	2009	CHEVROLET SILVERADO 1500	6.0L V8 5967cc 364 CID	USEP3916M	1993	CADILLAC ALLANTE	
USEP3818M	2009-2010	CHEVROLET SILVERADO 2500 HD	6.0L V8 5967cc 364 CID	USEP3917M	1992	BUICK SKYLARK	2.3L L4 138 CID
	2009-2010	CHEVROLET SILVERADO 3500 HD	6.0L V8 5967cc 364 CID	1992	BUICK SKYLARK	3.3L V6 204 CID	
	2009-2010	GMC SIERRA 2500 HD	6.0L V8 5967cc 364 CID	1992	CHEVROLET CAVALIER	2.2L L4 2190cc 134 CID	
	2009-2010	GMC SIERRA 3500 HD	6.0L V8 5967cc 364 CID	1992	CHEVROLET CAVALIER	3.1L V6 189 CID	
USEP3820M	2009	CHEVROLET EXPRESS 1500	4.3L V6 262 CID	1992	OLDSMOBILE ACHIEVA	2.3L L4 138 CID	
	2009	CHEVROLET EXPRESS 2500	4.8L V8 294 CID	1992	OLDSMOBILE ACHIEVA	2.3L L4 140 CID	
	2009	CHEVROLET EXPRESS 3500	4.8L V8 294 CID	1992	OLDSMOBILE ACHIEVA	3.3L V6 204 CID	
	2009	CHEVROLET EXPRESS 3500	6.0L V8 5967cc 364 CID	1992	PONTIAC GRAND AM	2.3L L4 138 CID	
	2009	GMC SAVANA 1500	4.3L V6 262 CID	1992	PONTIAC GRAND AM	2.3L L4 140 CID	
	2009	GMC SAVANA 2500	4.8L V8 294 CID	1992	PONTIAC GRAND AM	3.3L V6 204 CID	
	2009	GMC SAVANA 2500	6.0L V8 5967cc 364 CID	1992	PONTIAC SUNBIRD	2.0L L4 122 CID	
	2009	GMC SAVANA 3500	4.8L V8 294 CID	1992	PONTIAC SUNBIRD	3.1L V6 189 CID	
USEP3824M	2007	CHEVROLET MONTE CARLO	3.5L V6 3490cc 213 CID	USEP3918M	1993	BUICK SKYLARK	3.3L V6 204 CID
	2007-2008	BUICK ALLURE	3.8L V6 3800cc 231 CID	1993	OLDSMOBILE ACHIEVA	3.3L V6 204 CID	
	2007-2008	BUICK LACROSSE	3.8L V6 3800cc 231 CID	1993-1994	PONTIAC GRAND AM	3.3L V6 204 CID	
	2007-2008	CHEVROLET IMPALA	3.5L V6 3490cc 213 CID	1993-1994	CHEVROLET BERETTA	2.3L L4 140 CID	
	2007-2008	PONTIAC GRAND PRIX	3.8L V6 3800cc 231 CID	1993-1994	CHEVROLET CAVALIER	2.2L L4 2190cc 134 CID	
	2007-2008	PONTIAC GRAND PRIX	3.8L V6 3800cc 231 CID	1993-1994	CHEVROLET CAVALIER	3.1L V6 189 CID	
USEP3830M	2007	CHEVROLET MONTE CARLO	3.5L V6 3490cc 213 CID	1993-1994	OLDSMOBILE ACHIEVA	2.3L L4 140 CID	
	2007-2008	CHEVROLET IMPALA	3.5L V6 3490cc 213 CID	1993-1994	PONTIAC GRAND AM	2.3L L4 140 CID	
USEP3831M	2004	CHEVROLET SILVERADO 1500	6.0L V8 5967cc 364 CID	1993-1994	PONTIAC SUNBIRD	2.0L L4 122 CID	
	2004	CHEVROLET SILVERADO 2500	6.0L V8 5967cc 364 CID	1993-1994	PONTIAC SUNBIRD	3.1L V6 189 CID	
	2004	GMC SIERRA 2500	6.0L V8 5967cc 364 CID	1993-1995	BUICK SKYLARK	2.3L L4 138 CID	
	2004-2006	CHEVROLET SILVERADO 1500	4.8L V8 294 CID	1993-1995	CHEVROLET BERETTA	2.2L L4 2190cc 134 CID	
	2004-2006	CHEVROLET SILVERADO 1500	5.3L V8 5328cc 325 CID	1993-1995	CHEVROLET BERETTA	3.1L V6 189 CID	
	2004-2006	CHEVROLET SILVERADO 2500 HD	6.0L V8 5967cc 364 CID	1993-1995	CHEVROLET CORSICA	2.2L L4 2190cc 134 CID	
	2004-2006	CHEVROLET SILVERADO 2500 HD	8.1L V8 496 CID	1993-1995	CHEVROLET CORSICA	3.1L V6 189 CID	
	2004-2006	CHEVROLET SILVERADO 3500	6.0L V8 5967cc 364 CID	1993-1995	OLDSMOBILE ACHIEVA	2.3L L4 138 CID	
	2004-2006	CHEVROLET SILVERADO 3500	8.1L V8 496 CID	1993-1995	PONTIAC GRAND AM	2.3L L4 138 CID	
	2004-2006	GMC SIERRA 1500	4.8L V8 294 CID	1994-1995	BUICK SKYLARK	3.1L V6 189 CID	
				1994-1995	OLDSMOBILE ACHIEVA	3.1L V6 189 CID	
				1994-1995	PONTIAC GRAND AM	3.1L V6 189 CID	
				1996	PONTIAC SUNFIRE	2.2L L4 2190cc 134 CID	



USMW	Years	Application	Engine	USMW	Years	Application	Engine	
USEP3919M	1996	PONTIAC SUNFIRE	2.4L L4 2392cc 146 CID	USEP3947M	1998	CHEVROLET C2500	5.0L V8 305 CID	
	1996-1997	BUICK SKYLARK	2.4L L4 2392cc 146 CID		1998	CHEVROLET K2500	5.0L V8 305 CID	
	1996-1998	BUICK SKYLARK	3.1L V6 189 CID		1998	GMC C2500	5.0L V8 305 CID	
	1996-1998	OLDSMOBILE ACHIEVA	2.4L L4 2392cc 146 CID		1998	GMC K2500	5.0L V8 305 CID	
	1996-1998	OLDSMOBILE ACHIEVA	3.1L V6 189 CID		1998-1999	CHEVROLET C1500	5.0L V8 305 CID	
	1996-1998	PONTIAC GRAND AM	2.4L L4 2392cc 146 CID		1998-1999	CHEVROLET C1500	5.7L V8 350 CID	
	1996-1998	PONTIAC GRAND AM	3.1L V6 189 CID		1998-1999	CHEVROLET C3500	7.4L V8 454 CID	
	1998	PONTIAC SUNFIRE	2.2L L4 2190cc 134 CID		1998-1999	CHEVROLET K1500	5.0L V8 305 CID	
	1998	PONTIAC SUNFIRE	2.4L L4 2392cc 146 CID		1998-1999	CHEVROLET K1500	5.7L V8 350 CID	
	1996	CHEVROLET S10	4.3L V6 262 CID		1998-1999	GMC C1500	5.0L V8 305 CID	
1996	GMC SONOMA	4.3L V6 262 CID	1998-1999	GMC C1500	5.7L V8 350 CID			
USEP3921M	1996	CHEVROLET BERETTA	2.2L L4 2190cc 134 CID	1998-1999	GMC C3500	7.4L V8 454 CID		
	1996	CHEVROLET BERETTA	3.1L V6 189 CID	1998-1999	GMC K1500	5.7L V8 350 CID		
	1996	CHEVROLET CORSICA	2.2L L4 2190cc 134 CID	1998-2000	CHEVROLET C2500	5.7L V8 350 CID		
1996	CHEVROLET CORSICA	3.1L V6 189 CID	1998-2000	CHEVROLET C2500	7.4L V8 454 CID			
1996	BUICK RIVIERA		1998-2000	CHEVROLET C3500	5.7L V8 350 CID			
USEP3923M	1996	CHEVROLET S10	2.2L L4 2190cc 134 CID	1998-2000	CHEVROLET K2500	5.7L V8 350 CID		
1996	GMC SONOMA	2.2L L4 2190cc 134 CID	1998-2000	CHEVROLET K2500	7.4L V8 454 CID			
1996	ISUZU HOMBRE	2.2L L4 2190cc 134 CID	1998-2000	CHEVROLET K3500	5.7L V8 350 CID			
USEP3924M	1996-1997	PONTIAC FIREBIRD	5.7L V8 350 CID	1998-2000	GMC C2500	5.7L V8 350 CID		
USEP3925M	1996	CHEVROLET BLAZER	4.3L V6 262 CID	1998-2000	GMC C2500	7.4L V8 454 CID		
	1996	GMC JIMMY	4.3L V6 262 CID	1998-2000	GMC C3500	5.7L V8 350 CID		
	1996	OLDSMOBILE BRAVADA	4.3L V6 262 CID	1998-2000	GMC K2500	5.7L V8 350 CID		
USEP3926M	1996	CHEVROLET EXPRESS 3500	5.7L V8 350 CID	1998-2000	GMC K2500	7.4L V8 454 CID		
	1996	CHEVROLET EXPRESS 3500	7.4L V8 454 CID	1998-2000	GMC K3500	5.7L V8 350 CID		
	1996	GMC SAVANA 3500	5.7L V8 350 CID	1999	GMC K1500	5.0L V8 305 CID		
	1996	GMC SAVANA 3500	7.4L V8 454 CID	USEP3948M	1998	CHEVROLET LUMINA	3.8L V6 3800cc 231 CID	
USEP3927M	1996	CHEVROLET EXPRESS 1500	4.3L V6 262 CID		1998	CHEVROLET MONTE CARLO	3.8L V6 3800cc 231 CID	
	1996	CHEVROLET EXPRESS 1500	5.0L V8 305 CID		USEP3950M	1998-1999	OLDSMOBILE CUTLASS	
	1996	CHEVROLET EXPRESS 1500	5.7L V8 350 CID			1999	CHEVROLET MALIBU	2.4L L4 2392cc 146 CID
	1996	CHEVROLET EXPRESS 2500	4.3L V6 262 CID			1999	CHEVROLET MALIBU	3.1L V6 189 CID
	1996	CHEVROLET EXPRESS 2500	5.0L V8 305 CID			1999	CHEVROLET MALIBU	3.1L V6 3136cc 191 CID
	1996	CHEVROLET EXPRESS 2500	5.7L V8 350 CID			1999	OLDSMOBILE ALERO	2.4L L4 2392cc 146 CID
	1996	CHEVROLET EXPRESS 3500	5.7L V8 350 CID			1999	OLDSMOBILE ALERO	3.4L V6 207 CID
	1996	CHEVROLET EXPRESS 3500	7.4L V8 454 CID			1999	PONTIAC GRAND AM	2.4L L4 2392cc 146 CID
	1996	GMC SAVANA 1500	4.3L V6 262 CID			1999	PONTIAC GRAND AM	3.4L V6 207 CID
	1996	GMC SAVANA 1500	5.0L V8 305 CID	1999-2000		PONTIAC SUNFIRE	2.2L L4 2190cc 134 CID	
1996	GMC SAVANA 1500	5.7L V8 350 CID	1999-2000	PONTIAC SUNFIRE		2.4L L4 2392cc 146 CID		
1996	GMC SAVANA 2500	4.3L V6 262 CID	2000	CHEVROLET CAVALIER	2.2L L4 2190cc 134 CID			
1996	GMC SAVANA 2500	5.0L V8 305 CID	2000	CHEVROLET CAVALIER	2.4L L4 2392cc 146 CID			
1996	GMC SAVANA 2500	5.7L V8 350 CID	USEP3951M	1998-1999	SATURN SW1	1.9L L4 116 CID		
1996	GMC SAVANA 3500	5.7L V8 350 CID		1998-2000	SATURN SC1			
1996	GMC SAVANA 3500	7.4L V8 454 CID		1998-2001	SATURN SW2	1.9L L4 116 CID		
USEP3928M	1996	CHEVROLET EXPRESS 1500		5.7L V8 350 CID	1998-2002	SATURN SC2	1.9L L4 116 CID	
	1996	CHEVROLET EXPRESS 2500		5.7L V8 350 CID	1998-2002	SATURN SL1	1.9L L4 116 CID	
	1996	CHEVROLET EXPRESS 3500		5.7L V8 350 CID	1998-2002	SATURN SL2	1.9L L4 116 CID	
	1996	CHEVROLET EXPRESS 3500		7.4L V8 454 CID	2001-2002	SATURN SC1	1.9L L4 116 CID	
	1996	GMC SAVANA 1500		5.7L V8 350 CID	USEP3952M	1997-1999	ISUZU HOMBRE	4.3L V6 4294cc
	1996	GMC SAVANA 2500		5.7L V8 350 CID		1997-2001	GMC SONOMA	4.3L V6 262 CID
	1996	GMC SAVANA 3500		5.7L V8 350 CID		1997-2002	CHEVROLET S10	4.3L V6 262 CID
	1996	GMC SAVANA 3500	7.4L V8 454 CID	USEP3953M	1997-1998	CHEVROLET BLAZER	4.3L V6 262 CID	
	1996	GMC SAVANA 3500	7.4L V8 454 CID		1997-1998	GMC JIMMY	4.3L V6 262 CID	
	1996	GMC SAVANA 3500	7.4L V8 454 CID		1997-1998	OLDSMOBILE BRAVADA	4.3L V6 262 CID	
USEP3929M	1996	CHEVROLET BLAZER	4.3L V6 262 CID	USEP3954M	1997-2002	CHEVROLET BLAZER	4.3L V6 262 CID	
	1996	GMC JIMMY	4.3L V6 262 CID		1997-2002	GMC JIMMY	4.3L V6 262 CID	
USEP3930M	1995	CHEVROLET TAHOE	5.7L V8 350 CID	USEP3956M	1998-1999	CHEVROLET K3500	7.4L V8 454 CID	
	1995	GMC YUKON	5.7L V8 350 CID		1998-1999	GMC K3500	7.4L V8 454 CID	
USEP3932M	1997	CHEVROLET TAHOE	5.7L V8 350 CID	1998-2000	CHEVROLET C35	5.7L V8 350 CID		
	1997	GMC YUKON	5.7L V8 350 CID	1999	GMC C3500	7.4L V8 454 CID		
USEP3935M	1997	CADILLAC DEVILLE	4.6L V8 281 CID	2000	CHEVROLET C3500	5.7L V8 350 CID		
	1997	CADILLAC SEVILLE	4.6L V8 281 CID	2000	CHEVROLET K3500	5.7L V8 350 CID		
USEP3936M	1997	BUICK RIVIERA		2000	GMC C3500	5.7L V8 350 CID		
	1997	OLDSMOBILE AURORA		2000	GMC C3500	5.7L V8 350 CID		
USEP3937M	1997	BUICK PARK AVENUE		2000	GMC C3500	5.7L V8 350 CID		
USEP3938M	1997	BUICK PARK AVENUE		2000	GMC K3500	5.7L V8 350 CID		
1997	BUICK RIVIERA		2001-2002	CHEVROLET C3500	8.1L V8 496 CID			
USEP3939M	1997	PONTIAC GRAND PRIX	3.8L V6 3800cc 231 CID	USEP3957M	1998-2000	CHEVROLET K3500	5.7L V8 350 CID	
USEP3940M	1997-1999	CHEVROLET ASTRO			1998-2000	GMC K3500	5.7L V8 350 CID	
	1997-1999	GMC SAFARI		1999	GMC C3500	7.4L V8 454 CID		
USEP3941M	1997-1999	CHEVROLET LUMINA	3.1L V6 189 CID	2000	CHEVROLET C3500	5.7L V8 350 CID		
	1997-1999	CHEVROLET MONTE CARLO	3.1L V6 189 CID	2000	GMC C3500	5.7L V8 350 CID		
	1999	CHEVROLET LUMINA	3.8L V6 3800cc 231 CID	2001-2002	CHEVROLET C3500	8.1L V8 496 CID		
	1999	CHEVROLET MONTE CARLO	3.8L V6 3800cc 231 CID	USEP3961S	1998	CHEVROLET CAMARO	5.7L V8 350 CID	
USEP3942M	1997	CHEVROLET LUMINA	3.4L V6 207 CID		1998	PONTIAC FIREBIRD	5.7L V8 350 CID	
	1997	CHEVROLET MONTE CARLO	3.4L V6 207 CID	USEP3962M	1998	GMC C3500	7.4L V8 454 CID	
USEP3943M	1997-2000	CHEVROLET S10	2.2L L4 2190cc 134 CID		1998-1999	CHEVROLET C3500	7.4L V8 454 CID	
	1997-2000	GMC SONOMA	2.2L L4 2190cc 134 CID		1998-2000	CHEVROLET C2500	5.7L V8 350 CID	
	1997-2000	ISUZU HOMBRE	2.2L L4 2190cc 134 CID		1998-2000	CHEVROLET C2500	7.4L V8 454 CID	
	1998-2005	CHEVROLET LUV	2.2L L4 2198cc 134 CID		1998-2000	CHEVROLET C3500	5.7L V8 350 CID	
USEP3944M	1997	SATURN SC1			1998-2000	CHEVROLET K2500	5.7L V8 350 CID	
	1997	SATURN SC2			1998-2000	CHEVROLET K2500	7.4L V8 454 CID	
	1997	SATURN SL1			1998-2000	CHEVROLET K3500	5.7L V8 350 CID	
	1997	SATURN SL2			1998-2000	GMC C2500	5.7L V8 350 CID	
	1997	SATURN SW1			1998-2000	GMC C2500	7.4L V8 454 CID	
	1997	SATURN SW2		1998-2000	GMC C3500	5.7L V8 350 CID		
USEP3945M	1997	OLDSMOBILE CUTLASS		1998-2000	GMC K2500	5.7L V8 350 CID		
USEP3947M	1997	GMC K1500	4.3L V6 262 CID	1998-2000	GMC K2500	7.4L V8 454 CID		
	1997-1998	CHEVROLET C1500	4.3L V6 262 CID	1998-2000	GMC K3500	5.7L V8 350 CID		
	1997-1998	CHEVROLET K1500	4.3L V6 262 CID	2001	CHEVROLET SILVERADO 2500	5.7L V8 350 CID		
	1997-1998	GMC C1500	4.3L V6 262 CID	USEP3963M	1998-1999	CHEVROLET TAHOE	5.7L V8 350 CID	



# FUEL PUMP MODULES BUYERS GUIDE



FUEL PUMP MODULES

USMW	Years	Application	Engine	USMW	Years	Application	Engine
<b>USEP3965M</b>	1998-1999	<b>CHEVROLET P30</b>	5.7L V8 350 CID	<b>USEP3995M</b>	1997	<b>GMC SAVANA 3500</b>	7.4L V8 454 CID
	1998-1999	<b>GMC P3500</b>	5.7L V8 350 CID	<b>USEP3996M</b>	1998	<b>CHEVROLET EXPRESS 3500</b>	7.4L V8 454 CID
<b>USEP3966M</b>	1997	<b>CHEVROLET EXPRESS 1500</b>	4.3L V6 262 CID		1998	<b>GMC SAVANA 3500</b>	7.4L V8 454 CID
	1997	<b>CHEVROLET EXPRESS 1500</b>	5.0L V8 305 CID		1998-2000	<b>CHEVROLET EXPRESS 3500</b>	5.7L V8 350 CID
	1997	<b>CHEVROLET EXPRESS 1500</b>	5.7L V8 350 CID		1998-2000	<b>GMC SAVANA 3500</b>	5.7L V8 350 CID
	1997	<b>CHEVROLET EXPRESS 2500</b>	4.3L V6 262 CID	<b>USEP3997M</b>	1998-1999	<b>CHEVROLET P30</b>	7.4L V8 454 CID
	1997	<b>CHEVROLET EXPRESS 2500</b>	5.0L V8 305 CID		1998-1999	<b>GMC P3500</b>	7.4L V8 454 CID
	1997	<b>GMC SAVANA 1500</b>	4.3L V6 262 CID	<b>USEP4003M</b>	2009	<b>PONTIAC G3 WAVE</b>	1.6L L4 1598cc 98 CID
	1997	<b>GMC SAVANA 1500</b>	5.0L V8 305 CID		2009-2010	<b>PONTIAC G3</b>	1.6L L4 1598cc 98 CID
	1997	<b>GMC SAVANA 1500</b>	5.7L V8 350 CID		2009-2011	<b>CHEVROLET AVEO5</b>	1.6L L4 1598cc 98 CID
	1997	<b>GMC SAVANA 2500</b>	4.3L V6 262 CID		2009-2017	<b>CHEVROLET AVEO</b>	1.6L L4 1598cc 98 CID
	1997	<b>GMC SAVANA 2500</b>	5.0L V8 305 CID	<b>USEP4005M</b>	2010-2013	<b>CHEVROLET SILVERADO 1500</b>	4.8L V8 294 CID
	1997-1998	<b>CHEVROLET EXPRESS 3500</b>	7.4L V8 454 CID		2010-2013	<b>CHEVROLET SILVERADO 1500</b>	5.3L V8 5328cc 325 CID
	1997-1998	<b>GMC SAVANA 3500</b>	7.4L V8 454 CID		2010-2013	<b>CHEVROLET SILVERADO 1500</b>	6.2L V8 6162cc 376 CID
	1997-2000	<b>GMC SAVANA 2500</b>	5.7L V8 350 CID		2010-2013	<b>GMC SIERRA 1500</b>	4.8L V8 294 CID
	1997-2000	<b>GMC SAVANA 3500</b>	5.7L V8 350 CID		2010-2013	<b>GMC SIERRA 1500</b>	5.3L V8 5328cc 325 CID
	1997-2002	<b>CHEVROLET EXPRESS 2500</b>	5.7L V8 350 CID	<b>USEP4008M</b>	2010-2013	<b>CHEVROLET SILVERADO 1500</b>	6.2L V8 6162cc 376 CID
	1997-2002	<b>CHEVROLET EXPRESS 3500</b>	5.7L V8 350 CID		2010-2013	<b>CHEVROLET SILVERADO 1500</b>	4.8L V8 294 CID
	2001	<b>CHEVROLET P30</b>	4.3L V6 4300cc 262 CID		2010-2013	<b>CHEVROLET SILVERADO 1500</b>	5.3L V8 5328cc 325 CID
	2001-2002	<b>GMC SAVANA 2500</b>	4.3L V6 262 CID		2010-2013	<b>GMC SIERRA 1500</b>	4.8L V8 294 CID
	2001-2002	<b>GMC SAVANA 2500</b>	5.0L V8 305 CID	<b>USEP4009M</b>	2010-2013	<b>CHEVROLET SILVERADO 1500</b>	5.3L V8 5328cc 325 CID
<b>USEP3967M</b>	1998-1999	<b>CHEVROLET C1500 SUBURBAN</b>	5.7L V8 350 CID		2010-2013	<b>CHEVROLET SILVERADO 1500</b>	4.8L V8 294 CID
	1998-1999	<b>CHEVROLET C2500 SUBURBAN</b>	5.7L V8 350 CID		2010-2013	<b>CHEVROLET SILVERADO 1500</b>	5.3L V8 5328cc 325 CID
	1998-1999	<b>CHEVROLET C2500 SUBURBAN</b>	7.4L V8 454 CID		2010-2013	<b>GMC SIERRA 1500</b>	4.8L V8 294 CID
	1998-1999	<b>CHEVROLET K1500 SUBURBAN</b>	5.7L V8 350 CID		2010-2013	<b>GMC SIERRA 1500</b>	5.3L V8 5328cc 325 CID
	1998-1999	<b>CHEVROLET K2500 SUBURBAN</b>	5.7L V8 350 CID	<b>USEP4021M</b>	2012-2016	<b>BUICK LACROSSE</b>	3.6L V6 3564cc 217 CID
	1998-1999	<b>CHEVROLET K2500 SUBURBAN</b>	7.4L V8 454 CID		2013-2017	<b>CADILLAC XTS</b>	3.6L V6 3564cc 217 CID
	1998-1999	<b>GMC C1500 SUBURBAN</b>	5.7L V8 350 CID		2014-2017	<b>BUICK REGAL</b>	2.0L L4 1998cc 122 CID
	1998-1999	<b>GMC C2500 SUBURBAN</b>	5.7L V8 350 CID	<b>USEP4024M</b>	2010-2011	<b>CADILLAC SRX</b>	2.8L V6 2792cc 170 CID
	1998-1999	<b>GMC C2500 SUBURBAN</b>	7.4L V8 454 CID		2010-2011	<b>CADILLAC SRX</b>	3.0L V6 182 CID
	1998-1999	<b>GMC K1500 SUBURBAN</b>	5.7L V8 350 CID		2014-2016	<b>CADILLAC SRX</b>	3.6L V6 3564cc 217 CID
	1998-1999	<b>GMC K2500 SUBURBAN</b>	5.7L V8 350 CID	<b>USEP4033M</b>	2011-2015	<b>CHEVROLET CRUZE</b>	1.4L L4 1364cc 83 CID
	1998-1999	<b>GMC K2500 SUBURBAN</b>	7.4L V8 454 CID		2016	<b>CHEVROLET CRUZE LIMITED</b>	1.4L L4 1364cc 83 CID
<b>USEP3968M</b>	1998-1999	<b>CHEVROLET P30</b>	4.3L V6 262 CID	<b>USEP4034M</b>	2011-2015	<b>CHEVROLET CRUZE</b>	1.4L L4 1364cc 83 CID
	1998-1999	<b>CHEVROLET P30</b>	5.7L V8 350 CID		2011-2015	<b>CHEVROLET CRUZE</b>	1.8L L4 1796cc 110 CID
	1998-1999	<b>CHEVROLET P30</b>	7.4L V8 454 CID		2012-2015	<b>BUICK VERANO</b>	2.4L L4 2384cc 145 CID
	1998-1999	<b>GMC P3500</b>	4.3L V6 262 CID		2013-2015	<b>BUICK VERANO</b>	2.0L L4 1998cc 122 CID
	1998-1999	<b>GMC P3500</b>	5.7L V8 350 CID	<b>USEP4045M</b>	2011	<b>BUICK LACROSSE</b>	2.4L L4 2384cc 145 CID
	1998-1999	<b>GMC P3500</b>	7.4L V8 454 CID		2011-2012	<b>BUICK REGAL</b>	2.4L L4 2384cc 145 CID
<b>USEP3969M</b>	1998-1999	<b>CHEVROLET P30</b>	5.7L V8 350 CID		2013	<b>CHEVROLET MALIBU</b>	2.5L L4 2457cc 153 CID
	1998-1999	<b>GMC P3500</b>	5.7L V8 350 CID		2014-2015	<b>CADILLAC XTS</b>	3.6L V6 3564cc 217 CID
<b>USEP3971M</b>	1998	<b>CHEVROLET EXPRESS 3500</b>	7.4L V8 454 CID		2015	<b>CHEVROLET MALIBU</b>	2.5L L4 2457cc 153 CID
	1998	<b>GMC SAVANA 3500</b>	7.4L V8 454 CID		2016	<b>BUICK LACROSSE</b>	3.6L V6 3564cc 217 CID
	1998-2000	<b>GMC SAVANA 2500</b>	5.7L V8 350 CID	<b>USEP4048M</b>	2010-2012	<b>CHEVROLET EXPRESS 1500</b>	4.3L V6 262 CID
	1998-2000	<b>GMC SAVANA 3500</b>	5.7L V8 350 CID		2010-2012	<b>GMC SAVANA 1500</b>	4.3L V6 262 CID
	1998-2001	<b>CHEVROLET EXPRESS 1500</b>	4.3L V6 262 CID		2014	<b>GMC SAVANA 1500</b>	4.3L V6 262 CID
	1998-2001	<b>CHEVROLET EXPRESS 1500</b>	5.0L V8 305 CID	<b>USEP4049M</b>	2010-2012	<b>CHEVROLET EXPRESS 1500</b>	4.3L V6 262 CID
	1998-2002	<b>CHEVROLET EXPRESS 1500</b>	5.7L V8 350 CID		2010-2012	<b>GMC SAVANA 1500</b>	4.3L V6 262 CID
	1998-2002	<b>CHEVROLET EXPRESS 2500</b>	5.7L V8 350 CID		2010-2016	<b>CHEVROLET EXPRESS 2500</b>	4.8L V8 294 CID
	1998-2002	<b>CHEVROLET EXPRESS 3500</b>	5.7L V8 350 CID		2010-2016	<b>CHEVROLET EXPRESS 2500</b>	6.0L V8 5967cc 364 CID
	1998-2002	<b>GMC SAVANA 1500</b>	4.3L V6 262 CID		2010-2016	<b>CHEVROLET EXPRESS 3500</b>	4.8L V8 294 CID
	1998-2002	<b>GMC SAVANA 1500</b>	5.0L V8 305 CID		2010-2016	<b>CHEVROLET EXPRESS 3500</b>	6.0L V8 5967cc 364 CID
	1998-2002	<b>GMC SAVANA 1500</b>	5.7L V8 350 CID		2010-2016	<b>GMC SAVANA 2500</b>	4.8L V8 294 CID
	2001-2002	<b>GMC SAVANA 2500</b>	4.3L V6 262 CID		2010-2016	<b>GMC SAVANA 2500</b>	6.0L V8 5967cc 364 CID
	2001-2002	<b>GMC SAVANA 2500</b>	5.0L V8 305 CID		2010-2016	<b>GMC SAVANA 3500</b>	4.8L V8 294 CID
<b>USEP3972M</b>	1998-1999	<b>CHEVROLET TAHOE</b>	5.7L V8 350 CID		2010-2016	<b>GMC SAVANA 3500</b>	6.0L V8 5967cc 364 CID
	1998-1999	<b>GMC YUKON</b>			2013	<b>GMC SAVANA 1500</b>	4.3L V6 4293cc 262 CID
	1999-2000	<b>CADILLAC ESCALADE</b>			2013-2014	<b>CHEVROLET EXPRESS 1500</b>	4.3L V6 4293cc 262 CID
	2000	<b>CHEVROLET SONORA</b>	5.7L V8 350 CID		2016	<b>CHEVROLET EXPRESS 3500</b>	6.6L V8 6599cc 403 CID
<b>USEP3973M</b>	1998-1999	<b>BUICK REGAL</b>			2016	<b>GMC SAVANA 2500</b>	6.6L V8 6599cc 403 CID
	1998-2000	<b>PONTIAC GRAND PRIX</b>	3.8L V6 3800cc 231 CID	<b>USEP4050M</b>	2011-2012	<b>CHEVROLET MALIBU</b>	2.4L L4 2384cc 145 CID
<b>USEP3974M</b>	1998-1999	<b>CADILLAC DEVILLE</b>	4.6L V8 281 CID	<b>USEP4056M</b>	2012-2015	<b>CHEVROLET SONIC</b>	1.4L L4 1364cc 83 CID
	1998-2002	<b>CADILLAC ELDRADO</b>	4.6L V8 281 CID		2012-2015	<b>CHEVROLET SONIC</b>	1.8L L4 1796cc 110 CID
<b>USEP3976M</b>	1997	<b>CHEVROLET VENTURE</b>		<b>USEP7029M</b>	1991-1993	<b>DODGE CARAVAN</b>	3.3L V6 3301cc 201 CID
	1997	<b>OLDSMOBILE SILHOUETTE</b>			1991-1993	<b>DODGE GRAND CARAVAN</b>	3.3L V6 3301cc 201 CID
	1997	<b>PONTIAC TRANS SPORT</b>			1991-1993	<b>PLYMOUTH GRAND VOYAGER</b>	3.3L V6 3301cc 201 CID
<b>USEP3978M</b>	1997	<b>PONTIAC GRAND PRIX</b>	3.1L V6 189 CID		1991-1993	<b>PLYMOUTH VOYAGER</b>	3.3L V6 3301cc 201 CID
	1997	<b>PONTIAC GRAND PRIX</b>	3.8L V6 3800cc 231 CID		1992-1993	<b>CHRYSLER TOWN &amp; COUNTRY</b>	3.3L V6 3301cc 201 CID
<b>USEP3979M</b>	1997	<b>PONTIAC GRAND PRIX</b>	3.8L V6 3800cc 231 CID	<b>USEP7030M</b>	1991-1993	<b>CHRYSLER TOWN &amp; COUNTRY</b>	3.3L V6 3301cc 201 CID
<b>USEP3980M</b>	1997	<b>BUICK CENTURY</b>	3.1L V6 189 CID		1991-1993	<b>DODGE CARAVAN</b>	2.5L L4 2507cc 153 CID
<b>USEP3982M</b>	1998-1999	<b>CHEVROLET P30</b>	7.4L V8 454 CID		1991-1993	<b>DODGE CARAVAN</b>	3.0L V6 2972cc 181 CID
	1998-1999	<b>GMC P3500</b>	7.4L V8 454 CID		1991-1993	<b>DODGE CARAVAN</b>	3.3L V6 3301cc 201 CID
<b>USEP3983S</b>	1996-1997	<b>PONTIAC FIREBIRD</b>	3.8L V6 3800cc 231 CID		1991-1993	<b>DODGE GRAND CARAVAN</b>	3.3L V6 3301cc 201 CID
	1997	<b>CHEVROLET CAMARO</b>	3.8L V6 3800cc 231 CID		1991-1993	<b>PLYMOUTH GRAND VOYAGER</b>	3.3L V6 3301cc 201 CID
<b>USEP3992M</b>	1998-2001	<b>OLDSMOBILE BRAVADA</b>	4.3L V6 262 CID		1991-1993	<b>PLYMOUTH VOYAGER</b>	2.5L L4 2507cc 153 CID
	1998-2003	<b>GMC JIMMY</b>	4.3L V6 262 CID		1991-1993	<b>PLYMOUTH VOYAGER</b>	3.0L V6 2972cc 181 CID
	1998-2005	<b>CHEVROLET BLAZER</b>	4.3L V6 262 CID		1991-1993	<b>PLYMOUTH VOYAGER</b>	3.3L V6 3301cc 201 CID
<b>USEP3994M</b>	1998-1999	<b>CHEVROLET C2500 SUBURBAN</b>	5.7L V8 350 CID		1992-1993	<b>DODGE GRAND CARAVAN</b>	3.0L V6 2972cc 181 CID
	1998-1999	<b>CHEVROLET C2500 SUBURBAN</b>	7.4L V8 454 CID		1992-1993	<b>PLYMOUTH GRAND VOYAGER</b>	3.0L V6 2972cc 181 CID
	1998-1999	<b>CHEVROLET K2500 SUBURBAN</b>	5.7L V8 350 CID	<b>USEP7039M</b>	1991-1992	<b>DODGE MONACO</b>	
	1998-1999	<b>CHEVROLET K2500 SUBURBAN</b>	7.4L V8 454 CID	<b>USEP7040M</b>	1989-1990	<b>CHRYSLER SHADOW</b>	2.2L L4 135 CID
	1998-1999	<b>GMC C2500 SUBURBAN</b>	5.7L V8 350 CID		1991	<b>CHRYSLER IMPERIAL</b>	3.3L V6 3301cc 201 CID
	1998-1999	<b>GMC C2500 SUBURBAN</b>	7.4L V8 454 CID		1991	<b>CHRYSLER IMPERIAL</b>	3.8L V6 3778cc 231 CID
	1998-1999	<b>GMC K2500 SUBURBAN</b>	5.7L V8 350 CID		1991	<b>CHRYSLER SPIRIT</b>	2.5L L4 2500cc 153 CID
	1998-1999	<b>GMC K2500 SUBURBAN</b>	7.4L V8 454 CID		1991	<b>CHRYSLER SPIRIT</b>	2.2L L4 135 CID
<b>USEP3995M</b>	1997	<b>CHEVROLET EXPRESS 3500</b>	5.7L V8 350 CID		1991	<b>PLYMOUTH SUNDANCE</b>	2.2L L4 135 CID
	1997	<b>CHEVROLET EXPRESS 3500</b>	7.4L V8 454 CID		1991	<b>PLYMOUTH SUNDANCE</b>	2.5L L4 2507cc 153 CID
	1997	<b>GMC SAVANA 3500</b>	5.7L V8 350 CID		1991-1993	<b>CHRYSLER LEBARON</b>	2.5L L4 2507cc 153 CID

USMW	Years	Application	Engine	USMW	Years	Application	Engine	
<b>USEP7040M</b>	1991-1993	CHRYSLER LEBARON	3.0L V6 2972cc 181 CID	<b>USEP7063M</b>	1994	DODGE B250	5.2L V8 5211cc 318 CID	
	1991-1993	CHRYSLER NEW YORKER	3.3L V6 3301cc 201 CID		1994	DODGE B350	5.2L V8 5211cc 318 CID	
	1991-1993	CHRYSLER NEW YORKER	3.8L V6 3778cc 231 CID		1995	DODGE B1500	3.9L V6 3906cc 239 CID	
	1991-1993	DODGE DYNASTY	2.5L L4 2507cc 153 CID		1995	DODGE B1500	5.2L V8 5211cc 318 CID	
	1991-1993	DODGE DYNASTY	3.0L V6 2972cc 181 CID		1995	DODGE B2500	3.9L V6 3906cc 239 CID	
	1991-1993	DODGE DYNASTY	3.3L V6 3301cc 201 CID		1995	DODGE B2500	5.2L V8 5211cc 318 CID	
	1991-1994	DODGE SHADOW	2.2L L4 135 CID		1995	DODGE B2500	5.9L V8 360 CID	
	1991-1994	DODGE SHADOW	2.5L L4 2507cc 153 CID		1995	DODGE B3500	5.2L V8 5211cc 318 CID	
	1991-1995	DODGE SPIRIT	2.5L L4 2507cc 153 CID		1995	DODGE B3500	5.9L V8 360 CID	
	1991-1995	DODGE SPIRIT	3.0L V6 2972cc 181 CID		<b>USEP7064M</b>	1992-1993	DODGE RAMCHARGER	5.9L V8 360 CID
	1991-1995	PLYMOUTH ACCLAIM	2.5L L4 2507cc 153 CID	1993		DODGE D150	5.9L V8 360 CID	
	1991-1995	PLYMOUTH ACCLAIM	3.0L V6 2972cc 181 CID	1993		DODGE D250	5.9L V8 360 CID	
	1992	DODGE SPIRIT	2.2L L4 135 CID	1993		DODGE D350	5.9L V8 360 CID	
	1992-1993	CHRYSLER IMPERIAL		<b>USEP7065M</b>	1994	DODGE RAM 1500	3.9L V6 3906cc 239 CID	
	1992-1993	DODGE DAYTONA	2.2L L4 135 CID		1994	DODGE RAM 1500	5.2L V8 5211cc 318 CID	
	1992-1993	DODGE DAYTONA	2.5L L4 2507cc 153 CID		1994	DODGE RAM 1500	5.9L V8 360 CID	
	1992-1993	DODGE DAYTONA	3.0L V6 2972cc 181 CID		1994	DODGE RAM 2500	5.2L V8 5211cc 318 CID	
	1992-1994	DODGE SHADOW	3.0L V6 2972cc 181 CID		1994	DODGE RAM 2500	5.9L V8 360 CID	
	1993-1994	PLYMOUTH SUNDANCE	2.2L L4 135 CID		1994	DODGE RAM 2500	8.0L V10 7990cc 488 CID	
	1993-1994	PLYMOUTH SUNDANCE	2.5L L4 2507cc 153 CID	<b>USEP7067S</b>	1994	DODGE RAM 3500	5.9L V8 360 CID	
	1993-1994	PLYMOUTH SUNDANCE	3.0L V6 2972cc 181 CID		1994	DODGE RAM 3500	8.0L V10 7990cc 488 CID	
	1994-1995	CHRYSLER LEBARON			<b>USEP7067S</b>	1992	PLYMOUTH COLT	2.4L L4 2351cc
	1996	CHRYSLER VOYAGER	3.3L V6 3301cc 201 CID			1992-1993	EAGLE SUMMIT	1.8L L4 1834cc 112 CID
	1991	DODGE D150	5.9L V8 360 CID		1992-1993	EAGLE SUMMIT	2.4L L4 2351cc	
	1991	DODGE W150	5.9L V8 360 CID		1992-1993	PLYMOUTH COLT	1.8L L4 1834cc 112 CID	
	1991-1993	DODGE D150	3.9L V6 3906cc 239 CID		<b>USEP7068H</b>	1987-1988	DODGE MINI RAM	2.5L L4 2507cc 153 CID
1991-1993	DODGE D150	5.2L V8 5211cc 318 CID	1988			DODGE GRAND CARAVAN	2.5L L4 2507cc 153 CID	
1991-1993	DODGE D250	3.9L V6 3906cc 239 CID	1988			PLYMOUTH GRAND VOYAGER	2.5L L4 2507cc 153 CID	
1991-1993	DODGE D250	5.2L V8 5211cc 318 CID	1988-1990			DODGE CARAVAN	2.5L L4 2507cc 153 CID	
1991-1993	DODGE D250	5.9L V8 360 CID	1988-1990	PLYMOUTH VOYAGER	2.5L L4 2507cc 153 CID			
1991-1993	DODGE D350	5.9L V8 360 CID	<b>USEP7069H</b>	1986	CHRYSLER LASER	2.2L L4 135 CID		
1991-1993	DODGE W150	3.9L V6 3906cc 239 CID		1986	CHRYSLER LASER	2.5L L4 2507cc 153 CID		
1991-1993	DODGE W150	5.2L V8 5211cc 318 CID		1986	DODGE DAYTONA	2.2L L4 135 CID		
1991-1993	DODGE W250	5.2L V8 5211cc 318 CID		1986	PLYMOUTH CARAVELLE	2.2L L4 135 CID		
1991-1993	DODGE W250	5.9L V8 360 CID		1986-1987	CHRYSLER NEW YORKER	2.5L L4 2507cc 153 CID		
1991-1993	DODGE W350	5.9L V8 360 CID		1986-1987	DODGE LANCER	2.2L L4 135 CID		
1993	DODGE D150	5.9L V8 360 CID		1986-1987	DODGE LANCER	2.5L L4 2507cc 153 CID		
1993	DODGE W150	5.9L V8 360 CID		1986-1988	CHRYSLER TOWN & COUNTRY	2.5L L4 2507cc 153 CID		
1994-1995	DODGE RAMCHARGER	5.9L V8 360 CID		1986-1988	DODGE 600	2.2L L4 135 CID		
1996	DODGE RAMCHARGER	5.9L V8 5900cc 360 CID		1986-1988	DODGE 600	2.5L L4 2507cc 153 CID		
<b>USEP7048M</b>	1991	DODGE RAMCHARGER	5.9L V8 360 CID	1986-1988	PLYMOUTH CARAVELLE	2.5L L4 2507cc 153 CID		
1991-1993	DODGE RAMCHARGER	5.2L V8 5211cc 318 CID	1986-1989	CHRYSLER LEBARON	2.2L L4 135 CID			
<b>USEP7049M</b>	1991-1993	DODGE B150	3.9L V6 3906cc 239 CID	1986-1989	DODGE ARIES	2.2L L4 135 CID		
1991-1993	DODGE B150	5.2L V8 5211cc 318 CID	1986-1989	DODGE ARIES	2.5L L4 2507cc 153 CID			
1991-1993	DODGE B250	3.9L V6 3906cc 239 CID	1986-1989	PLYMOUTH RELIANT	2.2L L4 135 CID			
1991-1993	DODGE B250	5.2L V8 5211cc 318 CID	1986-1989	PLYMOUTH RELIANT	2.5L L4 2507cc 153 CID			
1991-1993	DODGE B250	5.9L V8 360 CID	1986-1990	CHRYSLER LEBARON	2.5L L4 2507cc 153 CID			
1991-1993	DODGE B350	5.2L V8 5211cc 318 CID	1986-1990	DODGE DAYTONA	2.5L L4 2507cc 153 CID			
1991-1993	DODGE B350	5.9L V8 360 CID	1987	CHRYSLER PHANTOM	2.2L L4 135 CID			
<b>USEP7050M</b>	1991-1993	DODGE DAKOTA	3.9L V6 3906cc 239 CID	1987	DODGE SHADOW			
1991-1993	DODGE DAKOTA	5.2L V8 5211cc 318 CID	1987	PLYMOUTH SUNDANCE				
1991-1995	DODGE DAKOTA	2.5L L4 2507cc 153 CID	1988-1990	DODGE SHADOW	2.2L L4 135 CID			
1996	DODGE DAKOTA	2.5L L4 2500cc 153 CID	1988-1990	DODGE SHADOW	2.5L L4 2507cc 153 CID			
<b>USEP7051S</b>	1985	CHRYSLER LASER	2.2L L4 135 CID	1988-1990	PLYMOUTH SUNDANCE	2.2L L4 135 CID		
	1985	CHRYSLER LEBARON	2.2L L4 135 CID	1988-1990	PLYMOUTH SUNDANCE	2.5L L4 2507cc 153 CID		
	1985	CHRYSLER NEW YORKER	2.2L L4 135 CID	1989	DODGE LANCER	2.2L L4 135 CID		
	1985	CHRYSLER TOWN & COUNTRY	2.2L L4 135 CID	1989	DODGE LANCER	2.5L L4 2507cc 153 CID		
	1985	DODGE 600	2.2L L4 135 CID	1989	DODGE LANCER	2.5L L4 2500cc 153 CID		
	1985	DODGE DAYTONA	2.2L L4 135 CID	1989-1990	CHRYSLER SHADOW	2.5L L4 2507cc 153 CID		
	1985	DODGE LANCER	2.2L L4 135 CID	1989-1990	DODGE DYNASTY	2.5L L4 2507cc 153 CID		
	1985	PLYMOUTH CARAVELLE	2.2L L4 135 CID	1989-1990	PLYMOUTH ACCLAIM	2.5L L4 2507cc 153 CID		
<b>USEP7054M</b>	1993-1995	CHRYSLER CONCORDE	3.3L V6 3301cc 201 CID	<b>USEP7071H</b>	1984	DODGE 600	2.2L L4 135 CID	
	1993-1995	CHRYSLER CONCORDE	3.5L V6 3497cc 215 CID		1984-1988	DODGE MAGNUM	2.2L L4 135 CID	
	1993-1995	DODGE INTREPID	3.3L V6 3301cc 201 CID		1984-1990	DODGE DAYTONA	2.2L L4 135 CID	
	1993-1995	DODGE INTREPID	3.5L V6 3497cc 215 CID		1985-1986	CHRYSLER LASER	2.2L L4 135 CID	
	1993-1995	EAGLE VISION	3.3L V6 3301cc 201 CID		1985-1988	CHRYSLER NEW YORKER	2.2L L4 135 CID	
	1993-1995	EAGLE VISION	3.5L V6 3497cc 215 CID		1985-1988	CHRYSLER TOWN & COUNTRY	2.2L L4 135 CID	
	1994-1995	CHRYSLER LHS			1986	PLYMOUTH CARAVELLE	2.2L L4 135 CID	
	1994-1995	CHRYSLER NEW YORKER			1986-1987	DODGE LANCER	2.2L L4 135 CID	
	1995	CHRYSLER CONCORDE	3.5L V6 3518cc 215 CID		1986-1988	CHRYSLER LEBARON	2.2L L4 135 CID	
	1995	CHRYSLER INTREPID	3.5L V6 3518cc 215 CID		1986-1988	DODGE 600	2.2L L4 135 CID	
	<b>USEP7055M</b>	1993	JEEP GRAND WAGONEER		1987-1988	DODGE SHADOW	2.2L L4 135 CID	
		1993-1994	JEEP GRAND CHEROKEE	4.0L L6 242 CID	1987-1988	PLYMOUTH SUNDANCE	2.2L L4 135 CID	
1993-1994		JEEP GRAND CHEROKEE	5.2L V8 5211cc 318 CID	1988-1989	CHRYSLER PHANTOM	2.2L L4 135 CID		
<b>USEP7056M</b>	1993-1994	DODGE SPIRIT	2.5L L4 2507cc 153 CID	1989	CHRYSLER NEW YORKER	3.0L V6 2972cc 181 CID		
	1993-1994	PLYMOUTH ACCLAIM	2.5L L4 2507cc 153 CID	1989	DODGE LANCER	2.2L L4 135 CID		
<b>USEP7057M</b>	1994	DODGE CARAVAN	3.3L V6 3301cc 201 CID	1989	DODGE LANCER	2.5L L4 2507cc 153 CID		
	1994	PLYMOUTH GRAND VOYAGER	3.8L V6 3778cc 231 CID	1989-1990	CHRYSLER LEBARON	2.5L L4 2507cc 153 CID		
	1994-1995	DODGE GRAND CARAVAN	3.3L V6 3301cc 201 CID	1989-1990	CHRYSLER TC MASERATI	2.2L L4 135 CID		
	1994-1995	DODGE GRAND CARAVAN	3.8L V6 3778cc 231 CID	1989-1990	DODGE DAYTONA	2.5L L4 2507cc 153 CID		
	1994-1995	PLYMOUTH GRAND VOYAGER	3.3L V6 3301cc 201 CID	1989-1990	DODGE DYNASTY	3.0L V6 2972cc 181 CID		
<b>USEP7062M</b>	1994-1995	DODGE DAKOTA	3.9L V6 3906cc 239 CID	1989-1990	DODGE SHADOW	2.5L L4 2507cc 153 CID		
	1994-1995	DODGE DAKOTA	5.2L V8 5211cc 318 CID	1989-1990	PLYMOUTH ACCLAIM	2.5L L4 2507cc 153 CID		
<b>USEP7063M</b>	1992-1994	DODGE B250	5.9L V8 360 CID	1989-1990	PLYMOUTH ACCLAIM	3.0L V6 2972cc 181 CID		
	1992-1994	DODGE B350	5.9L V8 360 CID	1989-1990	PLYMOUTH SUNDANCE	2.5L L4 2507cc 153 CID		
	1994	DODGE B150	3.9L V6 3906cc 239 CID	1990	CHRYSLER IMPERIAL	3.3L V6 3301cc 201 CID		
	1994	DODGE B150	5.2L V8 5211cc 318 CID	1990	CHRYSLER LEBARON	2.2L L4 135 CID		
	1994	DODGE B250	3.9L V6 3906cc 239 CID					
	1994	DODGE B250	5.2L V8 5211cc 318 CID					





# FUEL PUMP MODULES BUYERS GUIDE



FUEL PUMP MODULES

USMW	Years	Application	Engine	USMW	Years	Application	Engine		
USEP7071H	1990	CHRYSLER LEBARON	3.0L V6 2972cc 181 CID	USEP7094M	1996-2000	DODGE GRAND CARAVAN	3.3L V6 3301cc 201 CID		
	1990	CHRYSLER NEW YORKER	3.3L V6 3301cc 201 CID		1996-2000	DODGE GRAND CARAVAN	3.8L V6 3778cc 231 CID		
	1990	CHRYSLER TC MASERATI	3.0L V6 2972cc 181 CID		1996-2000	PLYMOUTH GRAND VOYAGER	3.0L V6 2972cc 181 CID		
	1990	DODGE DAYTONA	3.0L V6 2972cc 181 CID		1996-2000	PLYMOUTH GRAND VOYAGER	3.3L V6 3301cc 201 CID		
	1990	DODGE DYNASTY	3.3L V6 3301cc 201 CID		1996-2000	PLYMOUTH VOYAGER	2.4L L4 2429cc 148 CID		
	1990	DODGE SHADOW	2.2L L4 135 CID		1996-2000	PLYMOUTH VOYAGER	3.0L V6 2972cc 181 CID		
	1990	DODGE SPIRIT	2.5L L4 2507cc 153 CID		1996-2000	PLYMOUTH VOYAGER	3.3L V6 3301cc 201 CID		
	1990	DODGE SPIRIT	3.0L V6 2972cc 181 CID		1997	PLYMOUTH VOYAGER	3.8L V6 3778cc 231 CID		
	1997-1992	JEEP COMANCHE	4.0L L6 242 CID		1997-2000	CHRYSLER VOYAGER	3.3L V6 3301cc 201 CID		
USEP7072S	1991-1992	JEEP COMANCHE	2.5L L4 150 CID	1998	PLYMOUTH VOYAGER	3.8L V6 230 CID			
	1991-1993	JEEP CHEROKEE	2.5L L4 150 CID	1999	PLYMOUTH VOYAGER	3.8L V6 3778cc 231 CID			
	1991-1993	JEEP CHEROKEE	4.0L L6 242 CID	2000	CHRYSLER GRAND VOYAGER	3.0L V6 2972cc 181 CID			
	1991-1993	JEEP CHEROKEE	4.0L L6 242 CID	2000	CHRYSLER GRAND VOYAGER	3.3L V6 3301cc 201 CID			
USEP7073S	1988-1990	DODGE OMNI		2000	CHRYSLER VOYAGER	2.4L L4 2429cc 148 CID			
	1988-1990	PLYMOUTH HORIZON		2000	CHRYSLER VOYAGER	3.0L V6 2972cc 181 CID			
USEP7074H	1987-1988	DODGE MINI RAM	3.0L V6 2972cc 181 CID	USEP7095M	1996	DODGE DAKOTA			
	1987-1990	DODGE CARAVAN	3.0L V6 2972cc 181 CID		USEP7096M	1996	DODGE DAKOTA	2.5L L4 2500cc 153 CID	
	1988	DODGE GRAND CARAVAN	3.0L V6 2972cc 181 CID			1996	DODGE DAKOTA	2.5L L4 2507cc 153 CID	
	1988-1989	PLYMOUTH GRAND VOYAGER	3.0L V6 2972cc 181 CID			1996	DODGE DAKOTA	3.9L V6 3906cc 239 CID	
	1988-1990	PLYMOUTH VOYAGER	3.0L V6 2972cc 181 CID			1996	DODGE DAKOTA	5.2L V8 5211cc 318 CID	
	1989	DODGE GRAND CARAVAN	2.5L L4 2507cc 153 CID			USEP7097M	1996-1997	CHRYSLER NEON	2.0L L4 1996cc 122 CID
	1989-1990	DODGE CARAVAN	2.5L L4 2507cc 153 CID				1996-1999	DODGE NEON	2.0L L4 1996cc 122 CID
	1989-1990	PLYMOUTH VOYAGER	2.5L L4 2507cc 153 CID				1996-1999	PLYMOUTH NEON	2.0L L4 1996cc 122 CID
	1990	CHRYSLER TOWN & COUNTRY	3.3L V6 3301cc 201 CID			USEP7099M	1996	JEEP GRAND CHEROKEE	4.0L L6 242 CID
	1990	DODGE CARAVAN	3.3L V6 3301cc 201 CID				1996	JEEP GRAND CHEROKEE	5.2L V8 5211cc 318 CID
	1990	DODGE GRAND CARAVAN	3.3L V6 3301cc 201 CID			USEP7100M	1996	DODGE B1500	3.9L V6 3906cc 239 CID
	1990	PLYMOUTH GRAND VOYAGER	3.3L V6 3301cc 201 CID				1996	DODGE B1500	5.2L V8 5211cc 318 CID
	1995-1996	DODGE NEON	2.0L L4 1996cc 122 CID				1996	DODGE B2500	3.9L V6 3906cc 239 CID
USEP7075M	1995-1996	PLYMOUTH NEON	2.0L L4 1996cc 122 CID	1996		DODGE B2500	5.2L V8 5211cc 318 CID		
	1995-1996	CHRYSLER NEON	2.0L L4 1996cc 122 CID	1996	DODGE B2500	5.9L V8 360 CID			
USEP7076M	1994-1995	CHRYSLER CONCORDE	3.3L V6 3301cc 201 CID	1996	DODGE B3500	5.2L V8 5211cc 318 CID			
	1994-1995	DODGE INTREPID	3.3L V6 3301cc 201 CID	1996	DODGE B3500	5.9L V8 360 CID			
USEP7077M	1994-1995	DODGE CARAVAN	2.5L L4 2507cc 153 CID	USEP7101M	1996	CHRYSLER CONCORDE	3.3L V6 3301cc 201 CID		
	1994-1995	DODGE CARAVAN	3.0L V6 2972cc 181 CID		1996	CHRYSLER CONCORDE	3.5L V6 3497cc 215 CID		
	1994-1995	DODGE CARAVAN	3.3L V6 3301cc 201 CID		1996	CHRYSLER CONCORDE	3.5L V6 3518cc 215 CID		
	1994-1995	DODGE GRAND CARAVAN	3.0L V6 2972cc 181 CID		1996	CHRYSLER NEW YORKER			
	1994-1995	DODGE GRAND CARAVAN	3.8L V6 3778cc 231 CID		1996-1997	CHRYSLER INTREPID	3.3L V6 3518cc 215 CID		
	1994-1995	PLYMOUTH VOYAGER	2.5L L4 2507cc 153 CID		1996-1997	EAGLE VISION	3.5L V6 3301cc 201 CID		
	1994-1995	PLYMOUTH VOYAGER	3.0L V6 2972cc 181 CID		1996-1997	EAGLE VISION	3.5L V6 3497cc 215 CID		
	1994-1995	PLYMOUTH VOYAGER	3.0L V6 2972cc 181 CID		1997	CHRYSLER CONCORDE			
	1995	CHRYSLER GRAND VOYAGER	3.8L V6 3778cc 231 CID		1997	DODGE INTREPID	3.3L V6 3301cc 201 CID		
	1995	CHRYSLER VOYAGER	3.3L V6 3301cc 201 CID		1997	DODGE INTREPID	3.5L V6 3497cc 215 CID		
	1995	DODGE GRAND CARAVAN	3.3L V6 3301cc 201 CID		USEP7103M	1997-1998	JEEP GRAND CHEROKEE	4.0L L6 242 CID	
	1995	DODGE GRAND CARAVAN	3.3L V6 3301cc 201 CID			1997-1998	JEEP GRAND CHEROKEE	5.2L V8 5211cc 318 CID	
	1995	DODGE GRAND CARAVAN	3.3L V6 3301cc 201 CID			1998	JEEP GRAND CHEROKEE	5.9L V8 360 CID	
USEP7081H	1994-1998	CHRYSLER SEBRING	2.0L L4 1996cc 122 CID	USEP7104M	1997	DODGE B1500	3.9L V6 3906cc 239 CID		
	1995-1997	DODGE AVENGER	2.0L L4 1996cc 122 CID		1997	DODGE B1500	5.2L V8 5211cc 318 CID		
	1995-1998	CHRYSLER SEBRING	2.5L V6 2497cc 152 CID		1997	DODGE B2500	3.9L V6 3906cc 239 CID		
	1995-1999	CHRYSLER SEBRING	2.5L V6 2497cc 152 CID		1997	DODGE B2500	5.2L V8 5211cc 318 CID		
	1995-1999	DODGE AVENGER	2.4L L4 2351cc		1997	DODGE B2500	5.9L V8 360 CID		
	1995-2000	CHRYSLER SEBRING	2.0L L4 1997cc 122 CID		1997	DODGE B2500	5.9L V8 360 CID		
	1995-2000	DODGE AVENGER	2.0L L4 1997cc 122 CID		1997	DODGE B3500	5.2L V8 5211cc 318 CID		
	1996	MITSUBISHI ECLIPSE	2.4L L4 2351cc		1997-1998	DODGE B3500	5.9L V8 360 CID		
	1999	MITSUBISHI ECLIPSE	2.0L L4 1997cc 122 CID		USEP7111M	1998-1999	DODGE RAM 1500	3.9L V6 3906cc 239 CID	
	1999	MITSUBISHI ECLIPSE	2.0L L4 1997cc 122 CID			1998-1999	DODGE RAM 1500	5.2L V8 5211cc 318 CID	
	1995	DODGE RAM 1500	3.9L V6 3906cc 239 CID			1998-1999	DODGE RAM 1500	5.9L V8 360 CID	
	1995	DODGE RAM 1500	5.9L V8 360 CID			1998-2002	DODGE RAM 2500	5.9L V8 360 CID	
	1995	DODGE RAM 1500	5.9L V8 360 CID			1998-2002	DODGE RAM 2500	8.0L V10 7990cc 488 CID	
USEP7087M	1995	DODGE RAM 3500	8.0L V10 7990cc 488 CID	USEP7113M	1998-2002	DODGE RAM 2500	8.0L V10 7990cc 488 CID		
	1995	DODGE RAM 3500	8.0L V10 7990cc 488 CID		1998-2002	DODGE RAM 3500	5.9L V8 360 CID		
USEP7089M	1995	DODGE RAM 3500	8.0L V10 7990cc 488 CID	USEP7114M	1998-2002	DODGE RAM 3500	8.0L V10 7990cc 488 CID		
	1995-1997	DODGE RAM 3500	8.0L V10 7990cc 488 CID		1999-2000	DODGE RAMCHARGER	5.9L V8 360 CID		
	1995-1997	JEEP GRAND CHEROKEE	4.0L L6 242 CID		2002	DODGE RAM 1500	5.9L V8 360 CID		
	1995-1997	JEEP GRAND CHEROKEE	5.2L V8 5211cc 318 CID		USEP7113M	1998-2000	CHRYSLER CIRRUS	2.5L V6 2497cc 152 CID	
	1995-1997	JEEP GRAND CHEROKEE	5.2L V8 5211cc 318 CID			1998-2000	DODGE STRATUS	2.0L L4 1996cc 122 CID	
	1995-1997	JEEP GRAND CHEROKEE	5.2L V8 5211cc 318 CID			1998-2000	DODGE STRATUS	2.4L L4 2429cc 148 CID	
	1995-1997	JEEP GRAND CHEROKEE	5.2L V8 5211cc 318 CID			1998-2000	DODGE STRATUS	2.5L V6 2497cc 152 CID	
	1995-1997	JEEP GRAND CHEROKEE	5.2L V8 5211cc 318 CID			1998-2000	DODGE STRATUS	2.5L V6 2497cc 152 CID	
	USEP7091S	1995-1997	JEEP GRAND CHEROKEE		5.2L V8 5211cc 318 CID	1998-2000	PLYMOUTH BREEZE	2.0L L4 1996cc 122 CID	
		1995-1997	JEEP GRAND CHEROKEE		5.2L V8 5211cc 318 CID	1998-2000	PLYMOUTH BREEZE	2.4L L4 2429cc 148 CID	
		1995-1997	JEEP GRAND CHEROKEE		5.2L V8 5211cc 318 CID	1999-2000	CHRYSLER CIRRUS	2.4L L4 2429cc 148 CID	
		1995-1997	JEEP GRAND CHEROKEE		5.2L V8 5211cc 318 CID	1999-2000	CHRYSLER SEBRING	2.5L V6 2497cc 152 CID	
		1995-1997	JEEP GRAND CHEROKEE		5.2L V8 5211cc 318 CID	2000	CHRYSLER CIRRUS	2.0L L4 1996cc 122 CID	
1996-1997		JEEP GRAND CHEROKEE	5.2L V8 5211cc 318 CID	USEP7114M	1997-1999	DODGE DAKOTA	2.5L L4 2507cc 153 CID		
1996-1997		JEEP GRAND CHEROKEE	5.2L V8 5211cc 318 CID		1997-1999	DODGE DAKOTA	3.9L V6 3906cc 239 CID		
1996-1997		JEEP GRAND CHEROKEE	5.2L V8 5211cc 318 CID		1997-1999	DODGE DAKOTA	5.2L V8 5211cc 318 CID		
1996-1997		JEEP GRAND CHEROKEE	5.2L V8 5211cc 318 CID		1998-1999	DODGE DAKOTA	5.9L V8 360 CID		
1996-1997		JEEP GRAND CHEROKEE	5.2L V8 5211cc 318 CID		USEP7115MN	1997-2002	JEEP WRANGLER	2.5L L4 150 CID	
1996-1997		JEEP GRAND CHEROKEE	5.2L V8 5211cc 318 CID	1997-2002		JEEP WRANGLER	4.0L L6 242 CID		
USEP7093M		1996-1997	JEEP GRAND CHEROKEE	5.2L V8 5211cc 318 CID	USEP7116M	1997-1999	DODGE DAKOTA	5.2L V8 5211cc 318 CID	
		1996-1997	JEEP GRAND CHEROKEE	5.2L V8 5211cc 318 CID		1997-2002	DODGE DAKOTA	2.5L L4 2507cc 153 CID	
	1996-1997	JEEP GRAND CHEROKEE	5.2L V8 5211cc 318 CID	1997-2003		DODGE DAKOTA	3.9L V6 3906cc 239 CID		
	1996-1997	JEEP GRAND CHEROKEE	5.2L V8 5211cc 318 CID	1998-2003	DODGE DAKOTA	5.9L V8 360 CID			
	1996-1997	JEEP GRAND CHEROKEE	5.2L V8 5211cc 318 CID	2000-2003	DODGE DAKOTA	4.7L V8 287 CID			
	1996-1997	JEEP GRAND CHEROKEE	5.2L V8 5211cc 318 CID	USEP7117M	1998-1999	DODGE DURANGO	3.9L V6 3906cc 239 CID		
	1996-1997	JEEP GRAND CHEROKEE	5.2L V8 5211cc 318 CID		1998-2000	DODGE DURANGO	5.2L V8 5211cc 318 CID		
	1996-1997	JEEP GRAND CHEROKEE	5.2L V8 5211cc 318 CID		1998-2003	DODGE DURANGO	5.9L V8 360 CID		
	1996-1997	JEEP GRAND CHEROKEE	5.2L V8 5211cc 318 CID		2000-2003	DODGE DURANGO	4.7L V8 287 CID		
	1996-1997	JEEP GRAND CHEROKEE	5.2L V8 5211cc 318 CID		USEP7121M	1997-2000	JEEP CHEROKEE	2.5L L4 150 CID	
	1996-1997	JEEP GRAND CHEROKEE	5.2L V8 5211cc 318 CID	1997-2001		JEEP CHEROKEE	4.0L L6 242 CID		
	USEP7094M	1996-1997	JEEP GRAND CHEROKEE	5.2L V8 5211cc 318 CID					
		1996-1997	JEEP GRAND CHEROKEE	5.2L V8 5211cc 318 CID					
1996-1997		JEEP GRAND CHEROKEE	5.2L V8 5211cc 318 CID						
1996-1997		JEEP GRAND CHEROKEE	5.2L V8 5211cc 318 CID						
1996-1997		JEEP GRAND CHEROKEE	5.2L V8 5211cc 318 CID						
1996-1997		JEEP GRAND CHEROKEE	5.2L V8 5211cc 318 CID						
1996-1997		JEEP GRAND CHEROKEE	5.2L V8 5211cc 318 CID						
1996-1997		JEEP GRAND CHEROKEE	5.2L V8 5211cc 318 CID						
1996-1997		JEEP GRAND CHEROKEE	5.2L V8 5211cc 318 CID						
1996-1997		JEEP GRAND CHEROKEE	5.2L V8 5211cc 318 CID						
1996-1997		JEEP GRAND CHEROKEE	5.2L V8 5211cc 318 CID						
1996-1997		JEEP GRAND CHEROKEE	5.2L V8 5211cc 318 CID						
1996-1997		JEEP GRAND CHEROKEE	5.2L V8 5211cc 318 CID						

USMW	Years	Application	Engine	USMW	Years	Application	Engine	
<b>USEP7122M</b>	1997-1998	<b>JEEP WRANGLER</b>	2.5L L4 150 CID	<b>USEP7152M</b>	2000-2001	<b>CHRYSLER CONCORDE</b>	3.2L V6 3200cc 197 CID	
	1997-1999	<b>JEEP WRANGLER</b>	4.0L L6 242 CID		2000-2001	<b>CHRYSLER LHS</b>	3.5L V6 3497cc 215 CID	
<b>USEP7123M</b>	1998	<b>DODGE B1500</b>	3.9L V6 3906cc 239 CID	2000-2004	<b>CHRYSLER CONCORDE</b>	2.7L V6 2736cc 167 CID		
	1998	<b>DODGE B1500</b>	5.2L V8 5211cc 318 CID	2002-2004	<b>CHRYSLER 300M</b>	3.5L V6 3497cc 215 CID		
	1998	<b>DODGE B1500</b>	5.9L V8 360 CID	2002-2004	<b>CHRYSLER CONCORDE</b>	3.5L V6 3497cc 215 CID		
	1998	<b>DODGE B2500</b>	5.2L V8 5211cc 318 CID	2002-2004	<b>DODGE INTREPID</b>	2.7L V6 2736cc 167 CID		
	1998	<b>DODGE B2500</b>	5.9L V8 360 CID	2002-2004	<b>DODGE INTREPID</b>	3.5L V6 3497cc 215 CID		
	1998	<b>DODGE B3500</b>	5.2L V8 5211cc 318 CID	<b>USEP7156MN</b>	2003	<b>JEEP TJ</b>	2.4L L4 148 CID	
	1999-2003	<b>DODGE RAM 1500 VAN</b>	3.9L V6 3906cc 239 CID		2003-2004	<b>JEEP TJ</b>	4.0L L6 242 CID	
	1999-2003	<b>DODGE RAM 1500 VAN</b>	5.2L V8 5211cc 318 CID		2003-2004	<b>JEEP WRANGLER</b>	2.4L L4 148 CID	
	1999-2003	<b>DODGE RAM 1500 VAN</b>	5.9L V8 360 CID		2003-2004	<b>JEEP WRANGLER</b>	4.0L L6 242 CID	
	1999-2003	<b>DODGE RAM 2500 VAN</b>	5.2L V8 5211cc 318 CID	2003-2004	<b>JEEP WRANGLER</b>	4.0L L6 3956cc 241 CID		
	1999-2003	<b>DODGE RAM 2500 VAN</b>	5.9L V8 360 CID	<b>USEP7158M</b>	2003	<b>DODGE RAM 1500</b>	5.7L V8 345 CID	
	1999-2003	<b>DODGE RAM 3500 VAN</b>	5.2L V8 5211cc 318 CID		2003	<b>DODGE RAM 2500</b>	5.7L V8 345 CID	
	1999-2003	<b>DODGE RAM 3500 VAN</b>	5.9L V8 360 CID	2003	<b>DODGE RAM 2500</b>	8.0L V10 7990cc 488 CID		
	2001	<b>DODGE RAM 2500 VAN</b>	3.9L V6 3906cc 239 CID	2003	<b>DODGE RAM 3500</b>	5.7L V8 345 CID		
	<b>USEP7124M</b>	1998	<b>DODGE B1500</b>	3.9L V6 3906cc 239 CID	2003	<b>DODGE RAM 3500</b>	8.0L V10 7990cc 488 CID	
1998		<b>DODGE B1500</b>	5.2L V8 5211cc 318 CID	<b>USEP7159M</b>	2003	<b>DODGE RAM 1500</b>	5.7L V8 345 CID	
1998		<b>DODGE B1500</b>	5.9L V8 360 CID		<b>USEP7160M</b>	2002-2003	<b>DODGE RAM 1500</b>	3.7L V6 226 CID
1998		<b>DODGE B2500</b>	5.2L V8 5211cc 318 CID			2002-2003	<b>DODGE RAM 1500</b>	4.7L V8 287 CID
1998		<b>DODGE B2500</b>	5.9L V8 360 CID		2002-2003	<b>DODGE RAM 1500</b>	5.9L V8 360 CID	
1998		<b>DODGE B3500</b>	5.2L V8 5211cc 318 CID		2003	<b>DODGE RAM 1500</b>	5.7L V8 345 CID	
1998		<b>DODGE B3500</b>	5.9L V8 360 CID		2003	<b>DODGE RAM 2500</b>	5.7L V8 345 CID	
1999-2002		<b>DODGE RAM 1500 VAN</b>	3.9L V6 3906cc 239 CID		2003	<b>DODGE RAM 2500</b>	8.0L V10 7990cc 488 CID	
1999-2002		<b>DODGE RAM 1500 VAN</b>	5.2L V8 5211cc 318 CID		2003	<b>DODGE RAM 2500</b>	5.7L V8 345 CID	
1999-2002		<b>DODGE RAM 1500 VAN</b>	5.9L V8 360 CID		2003	<b>DODGE RAM 3500</b>	8.0L V10 7990cc 488 CID	
1999-2002		<b>DODGE RAM 2500 VAN</b>	5.2L V8 5211cc 318 CID		2003	<b>DODGE RAM 3500</b>	5.7L V8 345 CID	
1999-2002		<b>DODGE RAM 2500 VAN</b>	5.9L V8 360 CID		<b>USEP7161M</b>	2002-2003	<b>DODGE RAM 1500</b>	3.7L V6 226 CID
1999-2002		<b>DODGE RAM 3500 VAN</b>	5.2L V8 5211cc 318 CID			2002-2003	<b>DODGE RAM 1500</b>	4.7L V8 287 CID
1999-2002		<b>DODGE RAM 3500 VAN</b>	5.9L V8 360 CID			2002-2003	<b>DODGE RAM 1500</b>	5.9L V8 360 CID
2001		<b>DODGE RAM 2500 VAN</b>	3.9L V6 3906cc 239 CID		<b>USEP7162M</b>	2002-2003	<b>JEEP LIBERTY</b>	2.4L L4 148 CID
<b>USEP7125S</b>	1994-1996	<b>JEEP CHEROKEE</b>	2.5L L4 150 CID			2002-2003	<b>JEEP LIBERTY</b>	3.7L V6 226 CID
	1994-1996	<b>JEEP CHEROKEE</b>	4.0L L6 242 CID	<b>USEP7163M</b>		2002	<b>CHRYSLER SEBRING</b>	2.4L L4 2351cc
	<b>USEP7127M</b>	1999-2004	<b>JEEP GRAND CHEROKEE</b>		4.0L L6 242 CID	2002-2003	<b>MITSUBISHI GALANT</b>	2.4L L4 2351cc
		1999-2004	<b>JEEP GRAND CHEROKEE</b>		4.7L V8 287 CID	2002-2003	<b>MITSUBISHI GALANT</b>	3.0L V6 2972cc 181 CID
	<b>USEP7128M</b>	2001	<b>DODGE DAKOTA</b>	2.5L L4 2507cc 153 CID	2002-2004	<b>CHRYSLER SEBRING</b>	2.4L L4 2351cc	
		2001-2003	<b>DODGE DAKOTA</b>	3.9L V6 3906cc 239 CID	2002-2004	<b>CHRYSLER SEBRING</b>	3.0L V6 2972cc 181 CID	
		2001-2003	<b>DODGE DAKOTA</b>	4.7L V8 287 CID	2002-2004	<b>DODGE STRATUS</b>	3.0L V6 2972cc 181 CID	
		2001-2003	<b>DODGE DAKOTA</b>	5.9L V8 360 CID	2002-2004	<b>MITSUBISHI ECLIPSE</b>	3.0L V6 2972cc 181 CID	
	<b>USEP7129M</b>	1998-1999	<b>DODGE CARAVAN</b>	3.3L V6 3301cc 201 CID	2002-2005	<b>DODGE STRATUS</b>	2.4L L4 2351cc	
		1998-2000	<b>DODGE GRAND CARAVAN</b>	3.3L V6 3301cc 201 CID	<b>USEP7165M</b>	2004	<b>DODGE RAM 1500</b>	5.7L V8 345 CID
		1998-2000	<b>PLYMOUTH GRAND VOYAGER</b>	3.3L V6 3301cc 201 CID		2004-2006	<b>DODGE RAM 1500</b>	3.7L V6 226 CID
		1998-2000	<b>PLYMOUTH VOYAGER</b>	3.3L V6 3301cc 201 CID		2004-2006	<b>DODGE RAM 1500</b>	4.7L V8 287 CID
		2000	<b>CHRYSLER GRAND VOYAGER</b>	3.3L V6 3301cc 201 CID		2006-2007	<b>DODGE RAM 1500</b>	5.7L V8 345 CID
	<b>USEP7130M</b>	2000	<b>DODGE NEON</b>			2003-2004	<b>CHRYSLER CIRRUS</b>	2.4L L4 2429cc 148 CID
		2000	<b>PLYMOUTH NEON</b>		2003-2004	<b>CHRYSLER CIRRUS</b>	2.7L V6 2736cc 167 CID	
<b>USEP7137M</b>	1998-1999	<b>CHRYSLER CONCORDE</b>	2.7L V6 2736cc 167 CID	2003-2006	<b>CHRYSLER SEBRING</b>	2.4L L4 2429cc 148 CID		
	1998-1999	<b>CHRYSLER CONCORDE</b>	3.2L V6 3200cc 197 CID	2003-2006	<b>CHRYSLER SEBRING</b>	2.7L V6 2736cc 167 CID		
	1998-1999	<b>DODGE INTREPID</b>	2.7L V6 2736cc 167 CID	2003-2006	<b>DODGE STRATUS</b>	2.4L L4 2429cc 148 CID		
	1998-1999	<b>DODGE INTREPID</b>	3.2L V6 3200cc 197 CID	2003-2006	<b>DODGE STRATUS</b>	2.7L V6 2736cc 167 CID		
	1999	<b>CHRYSLER 300M</b>	3.5L V6 3518cc 215 CID	2005	<b>DODGE STRATUS</b>	2.0L L4 1995cc 122 CID		
	1999	<b>CHRYSLER LHS</b>		<b>USEP7168M</b>	2003	<b>DODGE DAKOTA</b>	3.9L V6 3906cc 239 CID	
<b>USEP7138M</b>	1998-1999	<b>DODGE RAM 1500</b>	3.9L V6 3906cc 239 CID		2003	<b>DODGE DAKOTA</b>	4.7L V8 287 CID	
	1998-1999	<b>DODGE RAM 1500</b>	5.2L V8 5211cc 318 CID	2003	<b>DODGE DAKOTA</b>	5.9L V8 360 CID		
	1998-1999	<b>DODGE RAM 1500</b>	5.9L V8 360 CID	<b>USEP7169M</b>	2003-2006	<b>CHRYSLER SEBRING</b>	2.7L V6 2736cc 167 CID	
	1998-2001	<b>DODGE RAM 2500</b>	5.9L V8 360 CID		2003-2006	<b>DODGE STRATUS</b>	2.7L V6 2736cc 167 CID	
	1998-2001	<b>DODGE RAM 2500</b>	8.0L V10 7990cc 488 CID	<b>USEP7170M</b>	2004	<b>DODGE RAM 2500</b>	5.7L V8 345 CID	
	1998-2001	<b>DODGE RAM 3500</b>	5.9L V8 360 CID		2004	<b>DODGE RAM 3500</b>	5.7L V8 345 CID	
	1998-2001	<b>DODGE RAM 3500</b>	8.0L V10 7990cc 488 CID	<b>USEP7171M</b>	2004	<b>DODGE DAKOTA</b>	3.7L V6 226 CID	
	1999-2001	<b>DODGE RAMCHARGER</b>	5.2L V8 5211cc 318 CID		2004	<b>DODGE DAKOTA</b>	4.7L V8 287 CID	
	<b>USEP7141M</b>	2001	<b>CHRYSLER CIRRUS</b>		<b>USEP7172M</b>	2004-2005	<b>DODGE GRAND CARAVAN</b>	3.3L V6 3301cc 201 CID
		2002	<b>CHRYSLER CIRRUS</b>	2.4L L4 2429cc 148 CID		2004-2005	<b>DODGE GRAND CARAVAN</b>	3.8L V6 3778cc 231 CID
2002		<b>CHRYSLER CIRRUS</b>	2.7L V6 2736cc 167 CID	2004-2006		<b>CHRYSLER TOWN &amp; COUNTRY</b>	3.8L V6 3778cc 231 CID	
2002		<b>CHRYSLER SEBRING</b>	2.7L V6 2736cc 167 CID	2004-2007		<b>CHRYSLER TOWN &amp; COUNTRY</b>	3.3L V6 3301cc 201 CID	
2002		<b>DODGE STRATUS</b>	2.4L L4 2429cc 148 CID	2004-2007		<b>DODGE CARAVAN</b>	2.4L L4 2429cc 148 CID	
<b>USEP7142M</b>	2002	<b>DODGE STRATUS</b>	2.7L V6 2736cc 167 CID	2004-2007	<b>DODGE CARAVAN</b>	3.3L V6 3301cc 201 CID		
	2001	<b>PLYMOUTH NEON</b>	2.0L L4 1996cc 122 CID	<b>USEP7173M</b>	2004	<b>DODGE DAKOTA</b>	3.7L V6 226 CID	
	2001-2005	<b>DODGE NEON</b>	2.0L L4 1996cc 122 CID		2004	<b>DODGE DAKOTA</b>	4.7L V8 287 CID	
2003-2005	<b>DODGE NEON</b>	2.4L L4 2429cc 148 CID	<b>USEP7180M</b>	2006-2007	<b>DODGE RAM 1500</b>	4.7L V8 287 CID		
<b>USEP7143M</b>	2001-2004	<b>CHRYSLER PT CRUISER</b>		2.4L L4 2429cc 148 CID	<b>USEP7181M</b>	2005-2007	<b>DODGE RAM 2500</b>	5.9L L6 359 CID
	<b>USEP7144M</b>	2001	<b>CHRYSLER GRAND VOYAGER</b>	3.8L V6 3778cc 231 CID		2005-2007	<b>DODGE RAM 3500</b>	5.9L L6 359 CID
2001-2003		<b>DODGE CARAVAN</b>	2.4L L4 2429cc 148 CID	2007-2009	<b>DODGE RAM 2500</b>	6.7L L6 408 CID		
2001-2003		<b>DODGE CARAVAN</b>	3.3L V6 3301cc 201 CID	2007-2009	<b>DODGE RAM 3500</b>	6.7L L6 408 CID		
2001-2003		<b>DODGE GRAND CARAVAN</b>	3.3L V6 3301cc 201 CID	<b>USEP7182M</b>	2005-2007	<b>DODGE RAM 1500</b>	3.7L V6 226 CID	
2001-2003		<b>DODGE GRAND CARAVAN</b>	3.8L V6 3778cc 231 CID		2005-2007	<b>DODGE RAM 1500</b>	4.7L V8 287 CID	
2003		<b>CHRYSLER TOWN &amp; COUNTRY</b>	3.3L V6 3301cc 201 CID		2006-2007	<b>DODGE RAM 1500</b>	5.7L V8 345 CID	
2003		<b>CHRYSLER TOWN &amp; COUNTRY</b>	3.8L V6 3778cc 231 CID	<b>USEP7183M</b>	2004-2006	<b>DODGE RAM 1500</b>	8.3L V10 8275cc 505 CID	
<b>USEP7146M</b>		2001-2003	<b>DODGE CARAVAN</b>		3.3L V6 3301cc 201 CID	2005-2006	<b>DODGE RAM 1500</b>	8.3L V10 8277cc 505 CID
		2001-2003	<b>DODGE GRAND CARAVAN</b>	3.3L V6 3301cc 201 CID	<b>USEP7184M</b>	2004-2005	<b>DODGE DURANGO</b>	3.7L V6 226 CID
		2003	<b>CHRYSLER TOWN &amp; COUNTRY</b>	3.3L V6 3301cc 201 CID		2004-2005	<b>DODGE DURANGO</b>	4.7L V8 287 CID
<b>USEP7151M</b>	1999-2000	<b>MITSUBISHI GALANT</b>	3.0L V6 2972cc 181 CID	2004-2005		<b>DODGE DURANGO</b>	5.7L V8 345 CID	
	1999-2001	<b>MITSUBISHI GALANT</b>	2.4L L4 2351cc	<b>USEP7185M</b>	2004	<b>DODGE DAKOTA</b>	3.7L V6 226 CID	
	2000-2001	<b>MITSUBISHI ECLIPSE</b>	2.4L L4 2351cc		2004	<b>DODGE DAKOTA</b>	4.7L V8 287 CID	
	2000-2001	<b>MITSUBISHI ECLIPSE</b>	3.0L V6 2972cc 181 CID	<b>USEP7186M</b>	2004	<b>DODGE RAM 1500</b>	5.7L V8 345 CID	
<b>USEP7152M</b>	2000	<b>DODGE INTREPID</b>	2.7L V6 2736cc 167 CID		2004-2006	<b>DODGE RAM 1500</b>	3.7L V6 226 CID	
	2000	<b>DODGE INTREPID</b>	3.2L V6 3200cc 197 CID					
	2000	<b>DODGE INTREPID</b>	3.5L V6 3497cc 215 CID					



# FUEL PUMP MODULES BUYERS GUIDE



FUEL PUMP MODULES

USMW	Years	Application	Engine	USMW	Years	Application	Engine
<b>USEP7186M</b>	2004-2006	<b>DODGE RAM 1500</b>	4.7L V8 287 CID	<b>USEP7234M</b>	2008-2009	<b>DODGE DURANGO</b>	3.7L V6 226 CID
	2006	<b>DODGE RAM 1500</b>	5.7L V8 345 CID		2008-2009	<b>DODGE DURANGO</b>	5.7L V8 345 CID
<b>USEP7187M</b>	1998-2002	<b>DODGE RAM 2500</b>	5.9L L6 359 CID	<b>USEP7235M</b>	2008	<b>CHRYSLER TOWN &amp; COUNTRY</b>	3.3L V6 3301cc 201 CID
	1998-2002	<b>DODGE RAM 3500</b>	5.9L L6 359 CID		2008-2010	<b>CHRYSLER TOWN &amp; COUNTRY</b>	3.8L V6 3778cc 231 CID
<b>USEP7189M</b>	2004-2010	<b>CHRYSLER PT CRUISER</b>	2.4L L4 2429cc 148 CID	2008-2010	<b>DODGE GRAND CARAVAN</b>	3.8L V6 3778cc 231 CID	
<b>USEP7190M</b>	2004-2009	<b>CHRYSLER PT CRUISER</b>	2.4L L4 2429cc 148 CID	2008-2010	<b>DODGE GRAND CARAVAN</b>	4.0L V6 3952cc 241 CID	
<b>USEP7191M</b>	2003-2004	<b>CHRYSLER PT CRUISER</b>	2.4L L4 2429cc 148 CID	2009-2010	<b>VOLKSWAGEN ROUTAN</b>	3.8L V6 3778cc 231 CID	
<b>USEP7192M</b>	2005-2008	<b>DODGE MAGNUM</b>	2.7L V6 2736cc 167 CID	2009-2010	<b>VOLKSWAGEN ROUTAN</b>	4.0L V6 3952cc 241 CID	
	2005-2008	<b>DODGE MAGNUM</b>	3.5L V6 3497cc 215 CID	<b>USEP7237M</b>	2008	<b>DODGE RAM 1500</b>	3.7L V6 226 CID
2005-2008	<b>DODGE MAGNUM</b>	5.7L V8 345 CID		2008	<b>DODGE RAM 1500</b>	4.7L V8 287 CID	
2005-2010	<b>CHRYSLER 300</b>	2.7L V6 2736cc 167 CID		2008	<b>DODGE RAM 1500</b>	5.7L V8 345 CID	
2005-2010	<b>CHRYSLER 300</b>	3.5L V6 3497cc 215 CID		<b>USEP7241M</b>	2005	<b>CHRYSLER 300</b>	6.1L V8 6059cc 370 CID
2006-2008	<b>DODGE MAGNUM</b>	6.1L V8 6059cc 370 CID			2005-2010	<b>CHRYSLER 300</b>	2.7L V6 2736cc 167 CID
2006-2010	<b>DODGE CHARGER</b>	2.7L V6 2736cc 167 CID		2005-2010	<b>CHRYSLER 300</b>	3.5L V6 3497cc 215 CID	
2006-2010	<b>DODGE CHARGER</b>	3.5L V6 3518cc 215 CID		2005-2010	<b>CHRYSLER 300</b>	5.7L V8 345 CID	
2006-2010	<b>DODGE CHARGER</b>	6.1L V8 6059cc 370 CID		2006	<b>DODGE CHARGER</b>	3.5L V6 3497cc 215 CID	
2006-2012	<b>CHRYSLER 300</b>	5.7L V8 345 CID		2006-2008	<b>DODGE MAGNUM</b>	2.7L V6 2736cc 167 CID	
2008-2010	<b>DODGE CHALLENGER</b>	6.1L V8 6059cc 370 CID		2006-2008	<b>DODGE MAGNUM</b>	3.5L V6 3497cc 215 CID	
2009-2010	<b>DODGE CHALLENGER</b>	3.5L V6 3497cc 215 CID		2006-2008	<b>DODGE MAGNUM</b>	5.7L V8 345 CID	
2009-2017	<b>DODGE CHALLENGER</b>	5.7L V8 345 CID		2006-2010	<b>DODGE CHARGER</b>	2.7L V6 2736cc 167 CID	
2011-2014	<b>DODGE CHARGER</b>	3.6L V6 3604cc 220 CID		2006-2010	<b>DODGE CHARGER</b>	5.7L V8 345 CID	
2011-2015	<b>CHRYSLER 300</b>	3.6L V6 3604cc 220 CID		2007-2010	<b>DODGE CHARGER</b>	3.5L V6 3518cc 215 CID	
2011-2016	<b>DODGE CHARGER</b>	5.7L V8 345 CID		2009-2010	<b>DODGE CHALLENGER</b>	3.5L V6 3497cc 215 CID	
2013	<b>CHRYSLER 300</b>	5.7L V8 5654cc 345 CID		2009-2010	<b>DODGE CHALLENGER</b>	5.7L V8 345 CID	
2014	<b>CHRYSLER 300</b>	6.4L V8 6424cc 392 CID		<b>USEP7243M</b>	2007-2008	<b>JEEP WRANGLER</b>	3.8L V6 3778cc 231 CID
2014-2017	<b>CHRYSLER 300</b>	5.7L V8 345 CID			<b>USEP7244M</b>	2004	<b>JEEP LIBERTY</b>
2015	<b>DODGE CHALLENGER</b>	3.6L V6 3604cc 220 CID		2004		<b>JEEP LIBERTY</b>	3.7L V6 226 CID
2015	<b>DODGE CHALLENGER</b>	6.4L V8 6424cc 392 CID		<b>USEP7245M</b>	2008-2009	<b>DODGE CALIBER</b>	2.4L L4 2360cc 144 CID
2015	<b>DODGE CHARGER</b>	6.4L V8 6424cc 392 CID			<b>USEP7251M</b>	2015-2016	<b>DODGE JOURNEY</b>
2017	<b>DODGE CHALLENGER</b>	3.6L V6 3604cc 220 CID		<b>USEP7252M</b>		2010	<b>DODGE RAM 1500</b>
<b>USEP7194M</b>	2004-2006	<b>CHRYSLER PACIFICA</b>	3.5L V6 3497cc 215 CID		2010	<b>DODGE RAM 1500</b>	4.7L V8 287 CID
	2005-2006	<b>CHRYSLER PACIFICA</b>	3.8L V6 3778cc 231 CID	2010	<b>DODGE RAM 1500</b>	5.7L V8 345 CID	
<b>USEP7195M</b>	2006-2007	<b>DODGE GRAND CARAVAN</b>	3.3L V6 3301cc 201 CID	<b>USEP7253M</b>	2008-2010	<b>CHRYSLER SEBRING</b>	2.4L L4 2360cc 144 CID
<b>USEP7196M</b>	2005	<b>DODGE CARAVAN</b>	3.3L V6 3301cc 201 CID		2008-2014	<b>DODGE AVENGER</b>	2.4L L4 2360cc 144 CID
	2005-2007	<b>CHRYSLER TOWN &amp; COUNTRY</b>	3.3L V6 3301cc 201 CID	2011-2014	<b>CHRYSLER 200</b>	2.4L L4 2360cc 144 CID	
2005-2007	<b>CHRYSLER TOWN &amp; COUNTRY</b>	3.8L V6 3778cc 231 CID		<b>USEP7255M</b>	2009-2010	<b>DODGE JOURNEY</b>	3.5L V6 3497cc 215 CID
2005-2007	<b>DODGE GRAND CARAVAN</b>	3.3L V6 3301cc 201 CID			2009-2010	<b>DODGE JOURNEY</b>	3.5L V6 3518cc 215 CID
2005-2007	<b>DODGE GRAND CARAVAN</b>	3.8L V6 3778cc 231 CID		2011-2014	<b>DODGE JOURNEY</b>	3.6L V6 3604cc 220 CID	
<b>USEP7197M</b>	2005-2007	<b>JEEP GRAND CHEROKEE</b>	3.7L V6 226 CID	2011-2014	<b>DODGE JOURNEY</b>	3.6L V6 3605cc 220 CID	
	2005-2007	<b>JEEP GRAND CHEROKEE</b>	4.7L V8 287 CID	<b>USEP7260M</b>	2010	<b>DODGE RAM 2500</b>	5.7L V8 345 CID
2005-2007	<b>JEEP GRAND CHEROKEE</b>	5.7L V8 345 CID	<b>USEP7264A</b>		2005-2010	<b>CHRYSLER 300</b>	2.7L V6 2736cc 167 CID
2006-2007	<b>JEEP GRAND CHEROKEE</b>	6.1L V8 6059cc 370 CID		2005-2010	<b>CHRYSLER 300</b>	3.5L V6 3497cc 215 CID	
2006-2009	<b>JEEP COMMANDER</b>	3.7L V6 226 CID		2005-2018	<b>CHRYSLER 300</b>	5.7L V8 345 CID	
2006-2009	<b>JEEP COMMANDER</b>	4.7L V8 287 CID		2006-2010	<b>DODGE CHARGER</b>	2.7L V6 2736cc 167 CID	
2006-2009	<b>JEEP COMMANDER</b>	5.7L V8 345 CID		2011-2018	<b>CHRYSLER 300</b>	3.6L V6 3604cc 220 CID	
2009	<b>JEEP GRAND CHEROKEE</b>	3.7L V6 226 CID		<b>USEP7265M</b>	2009-2011	<b>JEEP WRANGLER</b>	3.8L V6 3778cc 231 CID
2009	<b>JEEP GRAND CHEROKEE</b>	4.7L V8 287 CID			2012-2017	<b>JEEP WRANGLER</b>	3.6L V6 3604cc 220 CID
2009	<b>JEEP GRAND CHEROKEE</b>	5.7L V8 345 CID		2018	<b>JEEP WRANGLER JK</b>	3.6L V6 3604cc 220 CID	
2009	<b>JEEP GRAND CHEROKEE</b>	6.1L V8 6059cc 370 CID		<b>USEP7266M</b>	2012	<b>DODGE CALIBER</b>	2.0L L4 1998cc 122 CID
<b>USEP7198M</b>	2005-2007	<b>DODGE DAKOTA</b>	3.7L V6 226 CID		<b>USEP7269M</b>	2015	<b>DODGE JOURNEY</b>
	2005-2007	<b>DODGE DAKOTA</b>	4.7L V8 287 CID	2015		<b>DODGE JOURNEY</b>	3.6L V6 3605cc 220 CID
2006-2007	<b>MITSUBISHI RAIDER</b>	4.7L V8 287 CID		<b>USEP7270M</b>	2011-2012	<b>RAM 1500</b>	3.7L V6 226 CID
2006-2009	<b>MITSUBISHI RAIDER</b>	3.7L V6 226 CID			2011-2013	<b>RAM 1500</b>	4.7L V8 287 CID
2009	<b>DODGE DAKOTA</b>	3.7L V6 226 CID		2011-2017	<b>RAM 1500</b>	5.7L V8 345 CID	
2009	<b>DODGE DAKOTA</b>	4.7L V8 287 CID		2013	<b>RAM 1500</b>	3.6L V6 3604cc 220 CID	
<b>USEP7199M</b>	2005	<b>JEEP LIBERTY</b>	2.4L L4 148 CID	2015-2017	<b>RAM 1500</b>	3.6L V6 3604cc 220 CID	
	2005-2006	<b>JEEP LIBERTY</b>	3.7L V6 226 CID	<b>USEP7271M</b>	2011-2014	<b>DODGE DURANGO</b>	3.6L V6 3604cc 220 CID
2007	<b>JEEP LIBERTY</b>	3.7L V6 226 CID	<b>USEP7272M</b>		2011-2014	<b>JEEP GRAND CHEROKEE</b>	3.6L V6 3604cc 220 CID
<b>USEP7200M</b>	2005-2006	<b>JEEP WRANGLER</b>		2.4L L4 148 CID	2011-2014	<b>VOLKSWAGEN ROUTAN</b>	3.6L V6 3604cc 220 CID
	2005-2006	<b>JEEP WRANGLER</b>	4.0L L6 242 CID	2011-2016	<b>CHRYSLER TOWN &amp; COUNTRY</b>	3.6L V6 3604cc 220 CID	
<b>USEP7202M</b>	2003-2006	<b>DODGE SPRINTER 2500</b>	2.7L L5 2687cc 165 CID	2011-2018	<b>DODGE GRAND CARAVAN</b>	3.6L V6 3604cc 220 CID	
	2003-2006	<b>DODGE SPRINTER 3500</b>	2.7L L5 2687cc 165 CID	2012-2015	<b>RAM C/V</b>	3.6L V6 3604cc 220 CID	
<b>USEP7210M</b>	2007	<b>CHRYSLER SEBRING</b>	2.4L L4 2360cc 144 CID	<b>USEP7275M</b>	2011-2018	<b>RAM 2500</b>	5.7L V8 345 CID
	2007	<b>CHRYSLER SEBRING</b>	2.7L V6 2736cc 167 CID		2012	<b>RAM 1500</b>	5.7L V8 345 CID
	2007	<b>CHRYSLER SEBRING</b>	3.5L V6 3497cc 215 CID	2013-2017	<b>RAM 3500</b>	5.7L V8 345 CID	
<b>USEP7213M</b>	2010	<b>DODGE RAM 2500</b>	6.7L L6 408 CID	2014-2017	<b>RAM 3500</b>	6.4L V8 6424cc 392 CID	
	2007-2010	<b>DODGE DAKOTA</b>	4.7L V8 287 CID	2014-2018	<b>RAM 2500</b>	6.4L V8 6424cc 392 CID	
<b>USEP7216M</b>	2010-2011	<b>DODGE DAKOTA</b>	3.7L V6 226 CID	<b>USEP8051H</b>	1985-1989	<b>ISUZU IMPULSE</b>	2.0L L4 1994cc
	2011	<b>RAM DAKOTA</b>	3.7L V6 226 CID		1988-1989	<b>ISUZU IMPULSE</b>	2.3L L4 2254cc
2011	<b>RAM DAKOTA</b>	4.7L V8 287 CID		<b>USEP8078H</b>	1988-1991	<b>ISUZU TROOPER</b>	2.6L L4 2559cc
<b>USEP7218M</b>	2007-2016	<b>JEEP COMPASS</b>	2.0L L4 1998cc 122 CID		1988-1995	<b>ISUZU PICKUP</b>	2.6L L4 2559cc
	2007-2016	<b>JEEP COMPASS</b>	2.4L L4 2360cc 144 CID	1989-1994	<b>ISUZU AMIGO</b>	2.6L L4 2559cc	
2008-2012	<b>JEEP PATRIOT</b>	2.0L L4 1998cc 122 CID		1991-1995	<b>ISUZU RODEO</b>	2.6L L4 2559cc	
2008-2014	<b>JEEP PATRIOT</b>	2.4L L4 2360cc 144 CID		1992-1993	<b>ISUZU TROOPER</b>	3.2L V6 3165cc	
<b>USEP7219M</b>	2007-2009	<b>DODGE NITRO</b>	4.0L V6 3952cc 241 CID	1994-1995	<b>HONDA PASSPORT</b>	2.6L L4 2559cc	
	2007-2011	<b>DODGE NITRO</b>	3.7L V6 226 CID	1995	<b>ISUZU PICKUP</b>	2.3L L4 2254cc	
2008-2012	<b>JEEP LIBERTY</b>	3.7L V6 226 CID		<b>USEP8138H</b>	1988	<b>BMW 325</b>	2.7L L6 2693cc
2007-2011	<b>JEEP COMPASS</b>	2.0L L4 1998cc 122 CID			1988-1990	<b>BMW 325IS</b>	2.5L L6 2494cc 152 CID
2007-2016	<b>JEEP COMPASS</b>	2.4L L4 2360cc 144 CID		1988-1991	<b>BMW 325IX</b>	2.5L L6 2494cc 152 CID	
2008-2009	<b>JEEP PATRIOT</b>	2.4L L4 2360cc 144 CID		1988-1993	<b>BMW 325I</b>	2.5L L6 2494cc 152 CID	
2008-2016	<b>JEEP PATRIOT</b>	2.0L L4 1998cc 122 CID		1992	<b>BMW 318I</b>	1.8L L4 1796cc	
<b>USEP7223M</b>	2005	<b>DODGE GRAND CARAVAN</b>	3.3L V6 3301cc 201 CID	<b>USEP8141H</b>	1984-1985	<b>BMW 318I</b>	1.8L L4 1766cc 107 CID
	2005-2007	<b>DODGE CARAVAN</b>	3.3L V6 3301cc 201 CID		1984-1987	<b>BMW 325E</b>	2.7L L6 2693cc
<b>USEP7227M</b>	2006-2007	<b>DODGE DURANGO</b>	4.7L V8 287 CID	1986-1987	<b>BMW 325</b>	2.7L L6 2693cc	
	2007	<b>CHRYSLER ASPEN</b>	4.7L V8 287 CID	1986-1987	<b>BMW 325ES</b>	2.7L L6 2693cc	
<b>USEP7234M</b>	2008	<b>CHRYSLER ASPEN</b>	4.7L V8 287 CID	1987	<b>BMW 325I</b>	2.5L L6 2494cc 152 CID	
	2008	<b>DODGE DURANGO</b>	4.7L V8 287 CID	1987	<b>BMW 325IS</b>	2.5L L6 2494cc 152 CID	
2008-2009	<b>CHRYSLER ASPEN</b>	5.7L V8 345 CID		1988-1991	<b>BMW M3</b>	2.3L L4 2302cc	



USMW	Years	Application	Engine	USMW	Years	Application	Engine	
<b>USEP8197H</b>	1985-1988	<b>BMW 528E</b>	2.7L L6 2693cc	<b>USEP8366M</b>	1995-1998	<b>VOLKSWAGEN GOLF</b>	2.8L V6 2771cc	
	1985-1988	<b>BMW 535I</b>	3.5L L6 3430cc		1997-2002	<b>VOLKSWAGEN CABRIO</b>	2.0L L4 1984cc 121 CID	
	1985-1989	<b>BMW 635CSI</b>	3.5L L6 3430cc	1998	<b>VOLKSWAGEN JETTA</b>	2.0L L4 1984cc 121 CID		
	1987	<b>BMW L6</b>	3.5L L6 3430cc	1998	<b>VOLKSWAGEN JETTA</b>	2.8L V6 2771cc		
	1987-1988	<b>BMW M6</b>	3.5L L6 3453cc	<b>USEP8368M</b>	1998	<b>VOLKSWAGEN PASSAT</b>	1.8L L4 1781cc	
	1988	<b>BMW 535IS</b>	3.5L L6 3430cc		1998	<b>VOLKSWAGEN PASSAT</b>	2.8L V6 2771cc	
	1988	<b>BMW M5</b>	3.5L L6 3453cc		2000-2001	<b>AUDI A6</b>	2.8L V6 2771cc	
<b>USEP8205H</b>	1989-1991	<b>ISUZU TROOPER</b>	2.8L V6 2827cc	2000-2005	<b>VOLKSWAGEN PASSAT</b>	1.8L L4 1781cc		
	1991-1992	<b>ISUZU RODEO</b>	3.1L V6 3137cc	2000-2005	<b>VOLKSWAGEN PASSAT</b>	2.8L V6 2771cc		
<b>USEP8216H</b>	1985-1986	<b>BMW 735I</b>	3.5L L6 3430cc	2002-2004	<b>AUDI A6</b>	3.0L V6 2950cc		
<b>USEP8233M</b>	1993-1995	<b>BMW 318I</b>	1.8L L4 1796cc	<b>USEP8372H</b>	1997-2001	<b>HONDA PRELUDE</b>	2.2L L4 2156cc	
	1996-1999	<b>BMW M3</b>	3.2L L6 3152cc	<b>USEP8378S</b>	1998-2000	<b>NISSAN FRONTIER</b>	2.4L L4 2389cc	
	1998-1999	<b>BMW 323I</b>	2.5L L6 2494cc 152 CID	<b>USEP8379M</b>	1993	<b>VOLVO 850</b>		
<b>USEP8234M</b>	1991-1993	<b>BMW M5</b>	3.6L L6 3553cc	1994-1997	<b>VOLVO 850</b>	2.3L L5 2319cc		
	1991-1995	<b>BMW 525I</b>	2.5L L6 2494cc 152 CID	1997	<b>VOLVO 850</b>	2.4L L5 2435cc		
	1993	<b>BMW 525IT</b>	2.5L L6 2494cc 152 CID	<b>USEP8384M</b>	1998-2001	<b>AUDI A6 QUATTRO</b>	2.8L V6 2771cc	
<b>USEP8238H</b>	1989	<b>SUZUKI SIDEKICK</b>	1.6L L4 1590cc 97 CID		2000-2004	<b>AUDI A6 QUATTRO</b>	2.7L V6 2671cc	
	1991	<b>SUZUKI SIDEKICK</b>	1.6L L4 1590cc 97 CID		2000-2004	<b>AUDI A6 QUATTRO</b>	4.2L V8 4172cc	
<b>USEP8244M</b>	1991-1994	<b>VOLKSWAGEN COMBI</b>	1.8L L4 1780cc		2001-2005	<b>AUDI ALLROAD QUATTRO</b>	2.7L V6 2671cc	
	1993-1994	<b>VOLKSWAGEN JETTA</b>	1.8L L4 1781cc		2001-2005	<b>VOLKSWAGEN PASSAT</b>	2.8L V6 2771cc	
	1993-1998	<b>VOLKSWAGEN GOLF</b>	1.8L L4 1781cc		2002-2003	<b>AUDI S6</b>	4.2L V8 4172cc	
	1995	<b>VOLKSWAGEN CABRIO</b>	2.0L L4 1984cc 121 CID		2002-2004	<b>AUDI A6 QUATTRO</b>	3.0L V6 2976cc	
	1995	<b>VOLKSWAGEN EUROVAN</b>	2.5L L5 2459cc 150 CID		2003-2005	<b>AUDI ALLROAD QUATTRO</b>	4.2L V8 4172cc	
	1995-1999	<b>VOLKSWAGEN COMBI</b>	1.8L L4 1781cc		1997-1999	<b>LAND ROVER DISCOVERY</b>	4.0L V8 3950cc	
	1995-1999	<b>VOLKSWAGEN DERBY</b>	1.8L L4 1781cc		<b>USEP8389M</b>	1998-2003	<b>MERCEDES-BENZ ML320</b>	3.2L V6 3199cc
	1996	<b>VOLKSWAGEN PASSAT</b>	2.0L L4 1984cc 121 CID			1999-2001	<b>MERCEDES-BENZ ML430</b>	4.3L V8 4266cc
	1997	<b>VOLKSWAGEN EUROVAN</b>	2.8L V6 2771cc	2000-2003	<b>MERCEDES-BENZ ML55 AMG</b>	5.5L V8 5439cc 335 CID		
	1998	<b>VOLKSWAGEN JETTA</b>	1.8L L4 1781cc	2001	<b>MERCEDES-BENZ ML55 AMG</b>	5.5L V8 5439cc 332 CID		
	2002-2003	<b>VOLKSWAGEN EUROVAN</b>	2.8L V6 2771cc	2002-2005	<b>MERCEDES-BENZ ML500</b>	5.0L V8 4966cc		
<b>USEP8245M</b>	1993	<b>VOLKSWAGEN EUROVAN</b>	2.5L L5 2459cc 150 CID	2002-2005	<b>MERCEDES-BENZ ML500</b>	5.0L V8 4973cc		
	1991-1995	<b>ACURA LEGEND</b>	3.2L V6 3206cc	2003-2005	<b>MERCEDES-BENZ ML350</b>	3.7L V6 3699cc		
<b>USEP8253H</b>	1994-1995	<b>ACURA INTEGRA</b>	1.8L L4 1797cc	2003-2005	<b>MERCEDES-BENZ ML350</b>	3.7L V6 3724cc		
<b>USEP8268S</b>	1988-1991	<b>NISSAN D21</b>	2.4L L4 2389cc	2003-2005	<b>MERCEDES-BENZ ML500</b>	5.0L V8 4966cc 303 CID		
	1990	<b>NISSAN D21</b>	3.0L V6 2960cc 181 CID	<b>USEP8393M</b>	1998-1999	<b>KIA SEPHIA</b>	1.8L L4 1793cc	
	1992	<b>NISSAN D21</b>	3.0L V6 2960cc 181 CID		<b>USEP8394M</b>	1990-1992	<b>VOLKSWAGEN CORRADO</b>	1.8L L4 1780cc
<b>USEP8269H</b>	1986-1989	<b>HONDA ACCORD</b>	2.0L L4 1955cc	1992		<b>VOLKSWAGEN CORRADO</b>	2.8L V6 2771cc	
	1988-1990	<b>HONDA PRELUDE</b>	2.0L L4 1958cc	1997	<b>VOLKSWAGEN PASSAT</b>	2.8L V6 2771cc		
<b>USEP8275H</b>	1990-1992	<b>ISUZU IMPULSE</b>	1.6L L4 1588cc	<b>USEP8397M</b>	1997-2000	<b>ISUZU RODEO</b>	3.2L V6 3165cc	
	1990-1993	<b>GEO STORM</b>	1.6L L4 1588cc 98 CID		1998	<b>ISUZU RODEO</b>	2.2L L4 2180cc	
	1991-1993	<b>ISUZU STYLUS</b>	1.6L L4 1588cc		1998-2000	<b>HONDA PASSPORT</b>		
	1992	<b>ISUZU IMPULSE</b>	1.8L L4 1809cc 110 CID	2000	<b>ISUZU RODEO</b>	2.2L L4 2180cc		
	1992	<b>ISUZU STYLUS</b>	1.8L L4 1809cc 110 CID	<b>USEP8400M</b>	1999-2000	<b>ISUZU AMIGO</b>	2.2L L4 2180cc	
	1992	<b>ISUZU STYLUS</b>	1.8L L4 1809cc 110 CID		1999-2000	<b>ISUZU AMIGO</b>	3.2L V6 3165cc	
<b>USEP8293M</b>	1996-2001	<b>AUDI A4 QUATTRO</b>	2.8L V6 2771cc	<b>USEP8401H</b>	1995	<b>KIA SEPHIA</b>	1.8L L4 1839cc	
	1997-2001	<b>AUDI A4 QUATTRO</b>	1.8L L4 1781cc		<b>USEP8408M</b>	2000-2001	<b>KIA SEPHIA</b>	1.8L L4 1793cc
<b>USEP8294M</b>	1996-2001	<b>AUDI A4</b>	2.8L V6 2771cc	<b>USEP8412M</b>		2000-2006	<b>BMW X5</b>	4.4L V8 4398cc
	1997-2001	<b>AUDI A4</b>	1.8L L4 1781cc		2001-2006	<b>BMW X5</b>	3.0L L6 2979cc	
<b>USEP8320S</b>	1996-1998	<b>BMW Z3</b>	1.9L L4 1895cc	2002-2003	<b>BMW X5</b>	4.6L V8 4598cc		
	1997-2000	<b>BMW Z3</b>	2.8L L6 2793cc	<b>USEP8414M</b>	1997-1999	<b>AUDI A8</b>	3.7L V8 3697cc	
	1998-2000	<b>BMW Z3</b>	3.2L L6 3152cc		1997-2003	<b>AUDI A8 QUATTRO</b>	4.2L V8 4172cc	
	1999-2002	<b>BMW Z3</b>	2.5L L6 2494cc 152 CID	2001-2003	<b>AUDI S8</b>	4.2L V8 4172cc		
	2001-2002	<b>BMW Z3</b>	3.0L L6 2979cc	<b>USEP8415M</b>	1999	<b>BMW 318TI</b>	1.9L L4 1895cc	
	2001-2002	<b>BMW Z3</b>	3.2L L6 3246cc		<b>USEP8416M</b>	1999-2000	<b>BMW 323I</b>	2.5L L6 2494cc 152 CID
<b>USEP8321H</b>	1989	<b>HONDA CIVIC</b>	1.5L L4 1493cc	1999-2000		<b>BMW 328I</b>	2.8L L6 2793cc	
	1989	<b>HONDA CIVIC</b>	1.6L L4 1588cc 98 CID	2000		<b>BMW 323CI</b>	2.5L L6 2494cc 152 CID	
	1989	<b>HONDA CRX</b>	1.5L L4 1493cc	2000		<b>BMW 328CI</b>	2.8L L6 2793cc	
	1989	<b>HONDA CRX</b>	1.6L L4 1588cc 98 CID	2001-2005		<b>BMW 320I</b>	2.2L L6 2171cc 132 CID	
<b>USEP8322H</b>	1990-1993	<b>HONDA ACCORD</b>	2.2L L4 2156cc	2001-2005		<b>BMW 325I</b>	2.5L L6 2494cc 152 CID	
<b>USEP8324H</b>	1986-1989	<b>HONDA ACCORD</b>	2.0L L4 1955cc	2001-2005		<b>BMW 325XI</b>	2.5L L6 2494cc 152 CID	
<b>USEP8325H</b>	1988	<b>HONDA CIVIC</b>	1.5L L4 1493cc	2001-2005		<b>BMW 330I</b>	3.0L L6 2979cc	
	1990-1991	<b>HONDA CIVIC</b>	1.5L L4 1493cc	2001-2005		<b>BMW 330XI</b>	3.0L L6 2979cc	
	1990-1991	<b>HONDA CIVIC</b>	1.6L L4 1588cc 98 CID	2001-2006		<b>BMW 325CI</b>	2.5L L6 2494cc 152 CID	
	1990-1991	<b>HONDA CRX</b>	1.5L L4 1493cc	2001-2006		<b>BMW 330CI</b>	3.0L L6 2979cc	
	1990-1991	<b>HONDA CRX</b>	1.6L L4 1588cc 98 CID	<b>USEP8420M</b>	2001-2002	<b>KIA RIO</b>	1.5L L4 1493cc	
<b>USEP8328H</b>	1988-1989	<b>HONDA PRELUDE</b>		<b>USEP8421M</b>	2000-2003	<b>KIA SPECTRA</b>		
	1990-1991	<b>HONDA PRELUDE</b>	2.0L L4 1958cc		2001	<b>KIA SEPHIA</b>		
	1990-1991	<b>HONDA PRELUDE</b>	2.1L L4 2056cc		2004	<b>KIA SPECTRA</b>	1.8L L4 1793cc	
<b>USEP8331H</b>	1992-1994	<b>ACURA VIGOR</b>		<b>USEP8424M</b>	2010	<b>VOLKSWAGEN BEETLE</b>	2.5L L5 2480cc 151 CID	
<b>USEP8334H</b>	1990-1993	<b>ACURA INTEGRA</b>	1.8L L4 1834cc		1999-2002	<b>SAAB 9-3</b>	2.3L L4 2290cc 140 CID	
	1992-1993	<b>ACURA INTEGRA</b>	1.7L L4 1678cc	2000-2002	<b>SAAB 9-3</b>	2.0L L4 1985cc		
<b>USEP8338H</b>	1992-1995	<b>HONDA CIVIC</b>	1.5L L4 1493cc	2003	<b>SAAB 9-3</b>			
	1992-1995	<b>HONDA CIVIC</b>	1.6L L4 1588cc 98 CID	<b>USEP8427M</b>	2000-2001	<b>NISSAN SENTRA</b>	1.8L L4 1769cc	
	1994-1995	<b>ACURA INTEGRA</b>	1.8L L4 1834cc		<b>USEP8431M</b>	1999-2003	<b>SAAB 9-5</b>	3.0L V6 2961cc 181 CID
	1995	<b>HONDA ACCORD</b>	2.2L L4 2156cc	1999-2005		<b>SAAB 9-5</b>	2.3L L4 2290cc 140 CID	
<b>USEP8339H</b>	1996-1997	<b>HONDA CIVIC</b>	1.6L L4 1588cc 98 CID	<b>USEP8437M</b>	1999-2000	<b>SUZUKI ESTEEM</b>	1.6L L4 1590cc 97 CID	
<b>USEP8341H</b>	1996-1997	<b>HONDA CIVIC</b>	1.6L L4 1590cc		1999-2002	<b>SUZUKI ESTEEM</b>	1.8L L4 1790cc	
	1996-1999	<b>ACURA INTEGRA</b>	1.8L L4 1834cc	<b>USEP8440H</b>	1999-2002	<b>KIA SPORTAGE</b>	2.0L L4 1998cc 122 CID	
	2000-2001	<b>ACURA INTEGRA</b>	1.8L L4 1797cc		<b>USEP8441S</b>	1998-2004	<b>NISSAN FRONTIER</b>	2.4L L4 2389cc
<b>USEP8345H</b>	1996-1997	<b>ACURA INTEGRA</b>	1.8L L4 1797cc	2001-2004		<b>NISSAN FRONTIER</b>	2.4L L4 2389cc 146 CID	
<b>USEP8347H</b>	1995-1998	<b>ACURA TL</b>	2.5L L5 2451cc	<b>USEP8442H</b>	1997-2000	<b>BMW 528I</b>	2.8L L6 2793cc	
	1996-1998	<b>ACURA TL</b>	3.2L V6 3206cc		1997-2003	<b>BMW 540I</b>	4.4L V8 4398cc	
<b>USEP8349H</b>	1997	<b>ACURA CL</b>	2.2L L4 2156cc		2001-2003	<b>BMW 525I</b>	2.5L L6 2494cc 152 CID	
<b>USEP8351H</b>	1994	<b>HONDA ACCORD</b>		2001-2003	<b>BMW 530I</b>	3.0L L6 2979cc		
<b>USEP8353H</b>	1997-1999	<b>ACURA CL</b>	3.0L V6 2997cc	1997-1998	<b>HONDA CR-V</b>	2.0L L4 1972cc		
	1998-1999	<b>ACURA CL</b>	2.3L L4 2254cc	<b>USEP8460S</b>	2000	<b>HONDA CR-V</b>		
<b>USEP8365H</b>	1997	<b>HONDA PRELUDE</b>			<b>USEP8461S</b>	1999-2002	<b>DAEWOO LEGANZA</b>	2.2L L4 1928cc 134 CID
<b>USEP8366M</b>	1993-1994	<b>VOLKSWAGEN JETTA</b>	2.0L L4 1984cc 121 CID	<b>USEP8469M</b>		1999-2002	<b>DAEWOO NUBIRA</b>	2.0L L4 1998cc
	1993-1998	<b>VOLKSWAGEN GOLF</b>	2.0L L4 1984cc 121 CID	<b>USEP8474M</b>	2001-2002	<b>MERCEDES-BENZ C240</b>	2.6L V6 2597cc	
	1994	<b>VOLKSWAGEN JETTA</b>	2.8L V6 2771cc					



# FUEL PUMP MODULES BUYERS GUIDE



FUEL PUMP MODULES

USMW	Years	Application	Engine	USMW	Years	Application	Engine
USEP8474M	2002	MERCEDES-BENZ C230	2.3L L4 2295cc	USEP8569M	2004-2006	VOLKSWAGEN TOUAREG	3.2L V6 3189cc 195 CID
	2002	MERCEDES-BENZ C320	3.2L V6 3199cc		2004-2006	VOLKSWAGEN TOUAREG	4.2L V8 4172cc
USEP8475M	2001-2005	MERCEDES-BENZ C320	3.2L V6 3199cc	USEP8572M	2003-2005	MERCEDES-BENZ E55 AMG	
	2002	MERCEDES-BENZ C230	2.3L L4 2295cc	USEP8576M	2002-2003	JAGUAR X-TYPE	2.5L V6 152 CID
	2002-2005	MERCEDES-BENZ C240	2.6L V6 2597cc		2002-2003	JAGUAR X-TYPE	3.0L V6 2968cc 181 CID
	2003-2005	MERCEDES-BENZ C230	1.8L L4 1796cc	USEP8584M	2004	MAZDA MPV	
	2003-2005	MERCEDES-BENZ CLK320	3.2L V6 3199cc	USEP8586M	2003-2008	MAZDA 6	3.0L V6 2968cc 181 CID
	2006	MERCEDES-BENZ C230	2.5L V6 2496cc	USEP8587M	2003-2004	MAZDA 6	2.3L L4 2260cc
USEP8476M	2006-2007	MERCEDES-BENZ C280	3.0L V6 2996cc	USEP8588M	2003-2008	MAZDA 6	2.3L L4 2260cc
	2002-2006	AUDI A4	1.8L L4 1781cc	USEP8589M	2004-2009	MAZDA 3	2.0L L4 2000cc 122 CID
USEP8478M	2004-2005	AUDI A4 QUATTRO	1.8L L4 1781cc		2004-2009	MAZDA 3	2.3L L4 2260cc
	1999-2002	LAND ROVER DISCOVERY	4.0L V8 3950cc		2009	MAZDA 3	2.0L L4 1999cc 122 CID
USEP8482M	2003-2004	LAND ROVER DISCOVERY	4.6L V8 4554cc 278 CID	USEP8590M	2003-2004	MAZDA 6	3.0L V6 2968cc 181 CID
USEP8482M	2003-2005	KIA SEDONA		USEP8591M	2004-2009	MAZDA 3	2.0L L4 2000cc 122 CID
USEP8483M	2002	HONDA PASSPORT	3.2L V6 3165cc		2004-2009	MAZDA 3	2.3L L4 2260cc
	2002	ISUZU AXIOM	3.5L V6 3475cc		2009	MAZDA 3	2.0L L4 1999cc 122 CID
USEP8484M	2002-2004	ISUZU RODEO	3.2L V6 3165cc	USEP8592M	2004-2008	MAZDA RX-8	1.3L R2 1308cc
	2003	ISUZU AXIOM	3.5L V6 3491cc	USEP8594M	2002-2004	MINI COOPER	1.6L L4 1600cc
USEP8484M	2004	ISUZU RODEO	3.5L V6 3494cc	USEP8595M	2004-2006	INFINITI QX56	5.6L V8 5552cc
USEP8486M	2002-2003	ISUZU RODEO SPORT	2.2L L4 2180cc		2004-2007	NISSAN TITAN	5.6L V8 5552cc
	2002-2003	ISUZU RODEO SPORT	3.2L V6 3165cc		2005-2006	NISSAN ARMADA	5.6L V8 5552cc
USEP8488M	2002-2003	ISUZU RODEO	2.2L L4 2180cc	USEP8596M	2000-2003	SUBARU LEGACY	2.5L H4 2458cc
	2002-2005	BMW 745i	4.4L V8 4398cc		2000-2003	SUBARU OUTBACK	2.5L H4 2458cc
USEP8490M	2002-2005	BMW 745Li	4.4L V8 4398cc		2003	SUBARU BAJA	2.5L H4 2458cc
	2006-2008	BMW 750i	4.8L V8 4837cc	USEP8599M	2004-2005	SUBARU IMPREZA	2.5L H4 2458cc
	2006-2008	BMW 750Li	4.8L V8 4837cc	USEP8600M	2004	SUBARU LEGACY	2.5L H4 2458cc
	2001-2003	VOLVO S60	2.4L L5 2435cc 149 CID		2004	SUBARU OUTBACK	2.5L H4 2458cc
USEP8491M	2002-2003	VOLVO V70	2.4L L5 2435cc 149 CID		2004-2006	SUBARU BAJA	2.5L H4 2458cc
	1995-1998	LAND ROVER RANGE ROVER	4.0L V8 3950cc	USEP8601S	2005-2006	SUZUKI XL-7	2.7L V6 2737cc
USEP8493M	1996-1998	LAND ROVER RANGE ROVER	4.6L V8 4554cc 278 CID	USEP8607M	2000-2002	VOLVO S40	1.9L L4 1855cc 113 CID
USEP8494M	2002	LAND ROVER FREELANDER	2.5L V6 2500cc 153 CID		2000-2004	VOLVO S40	1.9L L4 1948cc
USEP8494M	2001-2006	BMW M3	3.2L L6 3246cc		2000-2004	VOLVO V40	1.9L L4 1948cc
USEP8496M	2002-2003	NISSAN ALTIMA	2.5L L4 2488cc 152 CID	USEP8633M	1999-2001	VOLVO S80	2.8L L6 2783cc 170 CID
	2002-2003	NISSAN ALTIMA	3.5L V6 3498cc		1999-2001	VOLVO S80	2.8L L6 2798cc
USEP8498M	2002-2003	AUDI A4 QUATTRO	1.8L L4 1781cc		1999-2002	VOLVO S80	2.9L L6 2917cc
	2003-2004	AUDI A4	3.0L V6 2976cc		2000	VOLVO S80	2.9L L6 2922cc 178 CID
	2003-2005	AUDI A4 QUATTRO	3.0L V6 2976cc		2001-2002	VOLVO S60	2.3L L5 2319cc
USEP8502M	2002-2006	NISSAN SENTRA	1.8L L4 1769cc		2001-2002	VOLVO S60	2.4L L5 2435cc
	2002-2006	NISSAN SENTRA	2.5L L4 2488cc 152 CID		2001-2002	VOLVO V70	2.3L L5 2319cc
USEP8514M	1999-2002	DAEWOO LANOS	1.6L L4 1588cc 98 CID		2001-2002	VOLVO V70	2.4L L5 2435cc
USEP8515M	1990	SAAB 9000	2.0L L4 1985cc	USEP8634M	2004	VOLVO S60	2.5L L5 2500cc 153 CID
	1990	SAAB 9000	2.3L L4 2290cc 140 CID		2004	VOLVO S60	2.5L L5 2521cc
USEP8518M	2001-2003	SUBARU OUTBACK	3.0L H6 3000cc		2004	VOLVO S60	2.5L L5 2521cc 154 CID
USEP8519M	2001	HYUNDAI SONATA	2.4L L4 2351cc		2004	VOLVO V70	2.5L L5 2521cc
USEP8520M	2001	KIA OPTIMA	2.4L L4 2351cc	USEP8635M	2004	VOLVO S60	2.3L L5 2319cc
	2003-2004	KIA SORENTO			2004	VOLVO S60	2.4L L5 2435cc
USEP8522M	2003-2005	LAND ROVER FREELANDER	2.5L V6 2500cc 153 CID		2004	VOLVO V70	2.3L L5 2319cc
USEP8524M	2007	BMW 550i	4.8L V8 4799cc		2004	VOLVO V70	2.4L L5 2435cc
	2007	BMW 550i	4.8L V8 4837cc	USEP8636M	2005	KIA RIO	
	2007-2010	BMW 650i	4.8L V8 4837cc	USEP8637M	2002-2004	KIA OPTIMA	2.4L L4 2351cc
	2004-2005	BMW X3	2.5L L6 2494cc 152 CID		2002-2005	HYUNDAI SONATA	2.4L L4 2351cc
USEP8526M	2004-2006	BMW X3	3.0L L6 2979cc	USEP8640M	2003-2005	ACURA MDX	3.5L V6 3471cc
	2001	HYUNDAI ELANTRA	2.0L L4 1975cc	USEP8642M	1999-2004	HONDA ODYSSEY	3.5L V6 3474cc
USEP8527M	2003-2004	HYUNDAI TIBURON	2.7L V6 2656cc		2000	HONDA ODYSSEY	3.5L V6 3471cc
USEP8530M	2003-2005	MERCEDES-BENZ E500		USEP8654M	2003-2011	HONDA ELEMENT	2.4L L4 2354cc 144 CID
USEP8531M	2003-2005	MERCEDES-BENZ CLK500	5.0L V8 4973cc	USEP8655M	2005-2006	HONDA CR-V	2.4L L4 2354cc 144 CID
	2006	MERCEDES-BENZ CLK500	5.0L V8 4966cc	USEP8656M	2003-2007	HONDA ACCORD	2.4L L4 2354cc 144 CID
	2006-2007	MERCEDES-BENZ C350	3.5L V6 3498cc	USEP8657M	2005-2008	HONDA PILOT	3.5L V6 3471cc
	2006-2009	MERCEDES-BENZ CLK350	3.5L V6 3498cc		2006	ACURA MDX	3.5L V6 3471cc
	2007	MERCEDES-BENZ C230	2.5L V6 2496cc	USEP8660M	2004-2006	NISSAN ALTIMA	2.5L L4 2488cc 152 CID
USEP8534M	2003-2009	NISSAN 350Z	3.5L V6 3498cc		2006	NISSAN ALTIMA	3.5L V6 3498cc
	2004-2006	INFINITI G35	3.5L V6 3498cc	USEP8661M	2002-2003	KIA SEDONA	
	2006-2008	INFINITI M35	3.5L V6 3498cc	USEP8662M	2003-2005	HYUNDAI SANTA FE	3.5L V6 3500cc
USEP8536M	2006-2008	INFINITI M45	4.5L V8 4494cc		2004	HYUNDAI SANTA FE	2.4L L4 2351cc
	2003-2007	NISSAN MURANO	3.5L V6 3498cc	USEP8663M	2004-2005	HYUNDAI SANTA FE	2.7L V6 2656cc
USEP8538M	2009-2014	NISSAN MURANO	3.5L V6 3498cc	USEP8667M	2005-2006	VOLKSWAGEN JETTA	1.9L L4 1896cc 116 CID
	2003-2005	INFINITI FX45	4.5L V8 4500cc		2009-2010	VOLKSWAGEN JETTA	2.0L L4 1968cc 120 CID
USEP8540M	2006-2008	INFINITI FX45	4.5L V8 4494cc		2010-2013	AUDI A3	2.0L L4 1968cc 120 CID
	2003-2008	INFINITI FX35			2010-2014	VOLKSWAGEN GOLF	2.0L L4 1968cc 120 CID
USEP8545M	2004-2006	NISSAN ALTIMA	2.5L L4 2488cc 152 CID		2012-2015	VOLKSWAGEN JETTA	2.0L L4 1968cc 120 CID
	2004-2006	NISSAN ALTIMA	3.5L V6 3498cc		2013-2014	VOLKSWAGEN BEETLE	2.0L L4 1968cc 120 CID
	2004-2008	NISSAN MAXIMA	3.5L V6 3498cc	USEP8668M	2004-2005	VOLKSWAGEN JETTA	1.9L L4 1896cc 116 CID
	2004-2009	NISSAN QUEST	3.5L V6 3498cc		2004-2006	VOLKSWAGEN BEETLE	1.9L L4 1896cc 116 CID
USEP8551M	2000-2002	AUDI TT	1.8L L4 1781cc		2004-2006	VOLKSWAGEN GOLF	1.9L L4 1896cc 116 CID
	2000-2002	AUDI TT QUATTRO	1.8L L4 1781cc	USEP8671M	2007	VOLKSWAGEN RABBIT	2.5L L5 2480cc 151 CID
USEP8564M	2004	VOLKSWAGEN GOLF	3.2L V6 3189cc		2007-2008	VOLKSWAGEN EOS	3.2L V6 3189cc 195 CID
	2003-2004	AUDI RS6	4.2L V8 4172cc		2008	VOLKSWAGEN EOS	3.2L V6 3197cc 195 CID
USEP8566M	2002	HONDA CIVIC	2.0L L4 1998cc 122 CID	USEP8672M	2004-2005	VOLKSWAGEN PASSAT	2.0L L4 1967cc 120 CID
	2003-2005	HONDA CIVIC	1.3L L4 1339cc	USEP8673M	2004-2006	KIA OPTIMA	2.4L L4 2351cc
USEP8567M	2004	HONDA CIVIC	1.7L L4 1700cc		2006	KIA OPTIMA	2.4L L4 2359cc
	2005	HONDA CIVIC	1.7L L4 1668cc	USEP8674M	2004-2006	KIA AMANTI	3.5L V6 3497cc
	2005	HONDA CIVIC	2.0L L4 1998cc 122 CID	USEP8676M	2005-2006	KIA SORENTO	3.5L V6 3497cc
	2004-2008	ACURA TL	3.2L V6 3210cc	USEP8677M	2005-2009	HYUNDAI TUCSON	2.0L L4 1975cc
USEP8568M	2007	VOLKSWAGEN TOUAREG	3.6L V6 3597cc 219 CID		2005-2009	HYUNDAI TUCSON	2.7L V6 2656cc
	2007	VOLKSWAGEN TOUAREG	4.2L V8 4163cc		2005-2010	KIA SPORTAGE	2.0L L4 1975cc
USEP8569M	2007	VOLKSWAGEN TOUAREG	4.2L V8 4172cc		2005-2010	KIA SPORTAGE	2.7L V6 2656cc
	2004	VOLKSWAGEN TOUAREG	3.2L V6 3200cc 195 CID	USEP8679M	2005	AUDI A6 QUATTRO	4.2L V8 4172cc

USMW	Years	Application	Engine	USMW	Years	Application	Engine
USEP8679M	2005-2007	AUDI A6 QUATTRO	4.2L V8 4163cc	USEP8755M	2007-2013	NISSAN ALTIMA	2.5L L4 2488cc 152 CID
USEP8687M	2006-2007	BMW 525I	3.0L L6 2996cc	2009-2013	NISSAN MAXIMA	3.5L V6 3498cc	
	2006-2007	BMW 525XI	3.0L L6 2996cc	USEP8756M	2005-2016	TOYOTA TACOMA	2.7L L4 2694cc
	2006-2007	BMW 530I	3.0L L6 2996cc	USEP8757M	2005-2015	TOYOTA TACOMA	4.0L V6 3956cc 241 CID
	2006-2007	BMW 530XI	3.0L L6 2996cc	USEP8763M	2005-2009	AUDI A4	2.0L L4 1984cc 121 CID
	2008	BMW 528XI	3.0L L6 2996cc		2006-2008	AUDI A4	3.2L V6 3123cc
	2008-2010	BMW 528I	3.0L L6 2996cc		2009	AUDI A4 QUATTRO	2.0L L4 1984cc 121 CID
	2009-2010	BMW 528I XDRIVE	3.0L L6 2996cc	USEP8765M	2006	AUDI A6	3.0L V6 2950cc
USEP8688M	2006	BMW 325I	3.0L L6 2996cc		2006-2011	AUDI A6	3.2L V6 3123cc
	2006	BMW 325XI	3.0L L6 2996cc		2007-2011	AUDI S6	5.2L V10 5204cc
	2006	BMW 330I	3.0L L6 2996cc		2008	AUDI A6 QUATTRO	3.2L V6 3123cc
	2006	BMW 330XI	3.0L L6 2996cc		2008-2011	AUDI A6 QUATTRO	4.2L V8 4163cc
	2007-2008	BMW 328XI	3.0L L6 2996cc		2009-2011	AUDI A6 QUATTRO	3.0L V6 2995cc
	2007-2008	BMW 335XI	3.0L L6 2979cc		2010-2011	AUDI A6 QUATTRO	3.0L V6 2995cc 183 CID
	2007-2013	BMW 328I	3.0L L6 2996cc		2011	AUDI S6	5.2L V10 5204cc 318 CID
	2007-2013	BMW 335I	3.0L L6 2979cc	USEP8773M	2007-2012	SUZUKI SX4	2.0L L4 1995cc 122 CID
	2008-2011	BMW 135I	3.0L L6 2979cc	USEP8783M	2007-2009	KIA SORENTO	3.8L V6 3778cc 231 CID
	2008-2012	BMW 128I	3.0L L6 2996cc		2008-2009	KIA SORENTO	3.3L V6 3342cc
	2009-2011	BMW 335I XDRIVE	3.0L L6 2979cc	USEP8788M	2007-2010	INFINITI QX56	5.6L V8 5552cc
	2009-2013	BMW 328I XDRIVE	3.0L L6 2996cc		2007-2015	NISSAN ARMADA	5.6L V8 5552cc
	2011	BMW 1 SERIES M	3.0L L6 2979cc		2007-2015	NISSAN TITAN	5.6L V8 5552cc
	2011-2013	BMW 335IS	3.0L L6 2979cc	USEP8792M	2007-2013	ACURA MDX	3.7L V6 3664cc
	2012-2013	BMW 135I	3.0L L6 2979cc 182 CID		2009-2011	HONDA PILOT	3.5L V6 3471cc
	2012-2013	BMW 328I	3.0L L6 2979cc 182 CID		2010-2013	ACURA ZDX	3.7L V6 3664cc
	2012-2013	BMW 335I	3.0L L6 2979cc 182 CID		2011	ACURA ZDX	3.7L V6 3664cc 224 CID
	2013	BMW 128I	3.0L L6 2996cc 183 CID		2011-2013	ACURA MDX	3.7L V6 3664cc 224 CID
	2013	BMW 335I XDRIVE	3.0L L6 2979cc		2014-2015	HONDA PILOT	3.5L V6 3471cc
	2013-2014	BMW X1	2.0L L4 1997cc 122 CID	USEP8797M	2005-2009	LEXUS GX470	4.7L V8 4663cc 285 CID
	2013-2014	BMW X1	3.0L L6 2979cc		2005-2009	TOYOTA 4RUNNER	4.7L V8 4663cc 285 CID
USEP8692M	2005-2010	HONDA ODYSSEY	3.5L V6 3471cc	USEP8805M	2007-2010	TOYOTA SIENNA	3.5L V6 3456cc
USEP8693M	2003-2007	HONDA ACCORD	3.0L V6 2997cc	USEP8806M	2007-2009	TOYOTA TUNDRA	4.7L V8 4663cc 285 CID
USEP8694M	2005-2006	TOYOTA TUNDRA	4.0L V6 3956cc 241 CID		2007-2014	TOYOTA TUNDRA	4.0L V6 3956cc 241 CID
	2005-2006	TOYOTA TUNDRA	4.7L V8 4663cc 285 CID		2008-2009	TOYOTA SEQUOIA	4.7L V8 4663cc 285 CID
	2005-2007	TOYOTA SEQUOIA	4.7L V8 4663cc 285 CID	USEP8807M	2007	VOLVO V70	2.4L L5 2435cc
USEP8703M	2004-2008	SUZUKI FORENZA	2.0L L4 1998cc 122 CID		2007	VOLVO V70	2.5L L5 2521cc
	2005-2007	SUZUKI RENO	2.0L L4 1998cc		2007	VOLVO XC70	2.5L L5 2521cc
	2008	SUZUKI RENO	2.0L L4 1998cc 122 CID		2007	VOLVO XC70	2.5L L5 2521cc 154 CID
USEP8705M	2003-2005	VOLKSWAGEN GOLF	2.8L V6 2771cc		2008-2009	VOLVO S60	2.5L L5 2521cc
	2003-2006	VOLKSWAGEN GOLF	1.8L L4 1781cc	USEP8808M	2006-2007	MAZDA B3000	3.0L V6 2986cc 182 CID
	2003-2006	VOLKSWAGEN GOLF	2.0L L4 1984cc 121 CID		2006-2009	MAZDA B2300	2.3L L4 140 CID
	2004-2005	VOLKSWAGEN BEETLE	1.8L L4 1781cc		2007-2008	FORD RANGER	3.0L V6 2986cc 182 CID
	2004-2005	VOLKSWAGEN BEETLE	2.0L L4 1984cc 121 CID		2007-2011	FORD RANGER	2.3L L4 140 CID
	2004-2005	VOLKSWAGEN JETTA	1.8L L4 1781cc		2007-2011	FORD RANGER	4.0L V6 245 CID
	2004-2005	VOLKSWAGEN JETTA	2.0L L4 1984cc 121 CID	USEP8809M	2006-2010	MAZDA 5	2.3L L4 2260cc
	2006-2010	VOLKSWAGEN BEETLE	2.5L L5 2480cc 151 CID		2012-2013	MAZDA 5	2.5L L4 2489cc 152 CID
USEP8707M	2006-2009	MAZDA B4000	4.0L V6 4016cc		2012-2014	MAZDA 5	2.5L L4 2488cc 152 CID
USEP8713M	2002-2004	ACURA RSX	2.0L L4 1998cc 122 CID	USEP8814M	2007-2010	BMW X5	3.0L L6 2996cc
USEP8717M	2006-2014	HONDA RIDGELINE	3.5L V6 3471cc	USEP8821M	2007-2009	HYUNDAI SANTA FE	2.7L V6 2656cc
USEP8719M	2005-2008	MAZDA 6	2.3L L4 2260cc		2007-2009	HYUNDAI SANTA FE	3.3L V6 3342cc
USEP8720M	2001-2002	ACURA MDX	3.5L V6 3471cc	USEP8831M	2006-2013	AUDI A3	2.0L L4 1984cc 121 CID
	2003-2004	HONDA PILOT	3.5L V6 3475cc		2006-2014	VOLKSWAGEN GTI	2.0L L4 1984cc 121 CID
USEP8721M	2001	HONDA PASSPORT	3.2L V6 3165cc		2006-2018	VOLKSWAGEN JETTA	2.0L L4 1984cc 121 CID
	2001	ISUZU RODEO	2.2L L4 2180cc		2007-2009	VOLKSWAGEN RABBIT	2.5L L5 2480cc 151 CID
	2001	ISUZU RODEO	3.2L V6 3165cc		2007-2016	VOLKSWAGEN EOS	2.0L L4 1984cc 121 CID
	2001	ISUZU RODEO SPORT	3.2L V6 3165cc		2008-2009	AUDI TT	2.0L L4 1984cc 121 CID
	2002	ISUZU AXIOM	3.5L V6 3475cc		2008-2014	VOLKSWAGEN JETTA	2.5L L5 2480cc 151 CID
USEP8723M	2006-2011	HONDA CIVIC	1.8L L4 1799cc		2010-2014	VOLKSWAGEN GOLF	2.5L L5 2480cc 151 CID
USEP8728M	2004-2006	KIA SPECTRA	2.0L L4 1975cc		2012-2014	VOLKSWAGEN BEETLE	2.5L L5 2480cc 151 CID
	2005-2006	KIA SPECTRA5	2.0L L4 1975cc		2012-2016	VOLKSWAGEN BEETLE	2.0L L4 1984cc 121 CID
USEP8730M	2006	HYUNDAI ACCENT	1.6L L4 1600cc		2014-2017	VOLKSWAGEN BEETLE	1.8L L4 1798cc 110 CID
	2006-2011	HYUNDAI ACCENT	1.6L L4 1599cc		2014-2018	VOLKSWAGEN JETTA	1.8L L4 1798cc 110 CID
	2006-2011	KIA RIO	1.6L L4 1599cc		2016-2018	VOLKSWAGEN JETTA	1.4L L4 1395cc 85 CID
	2006-2011	KIA RIO5	1.6L L4 1599cc		2018	VOLKSWAGEN BEETLE	2.0L L4 1984cc 121 CID
USEP8732M	2006-2010	MITSUBISHI ECLIPSE	2.4L L4 2378cc	USEP8833M	2006	VOLKSWAGEN BORA	2.0L L4 1984cc 121 CID
	2006-2010	MITSUBISHI GALANT	2.4L L4 2378cc		2006-2010	VOLKSWAGEN BORA	2.5L L5 2480cc 151 CID
	2012	MITSUBISHI ECLIPSE	2.4L L4 2378cc		2007	VOLKSWAGEN EOS	2.0L L4 1984cc 121 CID
	2012	MITSUBISHI GALANT	2.4L L4 2378cc		2007	VOLKSWAGEN EOS	3.2L V6 3189cc 195 CID
USEP8736M	2005-2008	HYUNDAI TIBURON	2.7L V6 2656cc		2007	VOLKSWAGEN RABBIT	2.5L L5 2480cc 151 CID
	2007-2008	HYUNDAI TIBURON	2.0L L4 1975cc	USEP8842M	1998-2002	ISUZU NPR	5.7L V8 350 CID
USEP8737M	2002	HYUNDAI ELANTRA	2.0L L4 1975cc		1999-2002	ISUZU NPR-HD	5.7L V8 350 CID
USEP8740M	2006-2008	VOLKSWAGEN PASSAT	3.6L V6 3597cc 219 CID		2003-2004	ISUZU NPR	6.0L V8 5967cc 364 CID
	2009-2012	VOLKSWAGEN CC	3.6L V6 3597cc 219 CID		2003-2004	ISUZU NPR-HD	6.0L V8 5967cc 364 CID
	2014	VOLKSWAGEN CC	3.6L V6 3597cc 219 CID	USEP8843M	1998-2002	ISUZU NPR	5.7L V8 350 CID
	2014	VOLKSWAGEN CC	3.6L V6 3597cc 220 CID		1999-2002	ISUZU NPR-HD	5.7L V8 350 CID
USEP8743M	2005-2012	NISSAN PATHFINDER	4.0L V6 3954cc		2003-2004	ISUZU NPR	6.0L V8 5967cc 364 CID
	2005-2015	NISSAN XTERRA	4.0L V6 3954cc		2003-2004	ISUZU NPR-HD	6.0L V8 5967cc 364 CID
	2005-2018	NISSAN FRONTIER	2.5L L4 2488cc 152 CID	USEP8847M	2001-2003	VOLVO S60	2.4L L5 2435cc
	2005-2018	NISSAN FRONTIER	4.0L V6 3954cc		2001-2003	VOLVO S60	2.4L L5 2435cc 149 CID
	2009-2012	SUZUKI EQUATOR	2.5L L4 2488cc 152 CID		2001-2004	VOLVO S60	2.3L L5 2319cc
	2009-2012	SUZUKI EQUATOR	4.0L V6 3954cc		2003	VOLVO V70	2.4L L5 2435cc
USEP8744M	2003-2004	KIA RIO	1.6L L4 1594cc		2003	VOLVO V70	2.4L L5 2435cc 149 CID
USEP8747M	2005-2008	MINI COOPER	1.6L L4 1597cc 98 CID		2003-2004	VOLVO V70	2.3L L5 2319cc
	2005-2008	MINI COOPER	1.6L L4 1600cc		2005	VOLVO V70	2.4L L5 2435cc
	2007-2008	MINI COOPER	1.6L L4 1598cc		2005-2006	VOLVO S60	2.4L L5 2435cc
USEP8750M	2007-2012	MAZDA CX-7	2.3L L4 2260cc		2006	VOLVO S60	2.4L L5 2401cc 147 CID
USEP8752M	2007-2009	NISSAN SENTRA	2.0L L4 1997cc 122 CID		2008	VOLVO S60	2.4L L5 2401cc 147 CID
	2007-2009	NISSAN SENTRA	2.5L L4 2488cc 152 CID		2008-2009	VOLVO S60	2.4L L5 2435cc
USEP8755M	2007-2012	NISSAN ALTIMA	3.5L V6 3498cc				





# FUEL PUMP MODULES BUYERS GUIDE



FUEL PUMP MODULES

USMW	Years	Application	Engine	USMW	Years	Application	Engine
USEP8851M	2005	VOLVO XC90	2.9L L6 2917cc	USEP9081M	2010-2011	MERCEDES-BENZ C300	3.0L V6 2996cc 183 CID
	2005-2006	VOLVO V70	2.5L L5 2521cc		2010-2011	MERCEDES-BENZ E350	3.5L V6 3498cc
	2005-2006	VOLVO XC70	2.5L L5 2521cc		2010-2011	MERCEDES-BENZ E350	3.5L V6 3498cc 213 CID
	2006	VOLVO V70	2.4L L5 2435cc		2010-2011	MERCEDES-BENZ E550	5.5L V8 5461cc
USEP8854M	2008-2013	NISSAN ROGUE	2.5L L4 2488cc 152 CID	USEP9100M	2010-2012	MERCEDES-BENZ GLK350	3.5L V6 3498cc
	2014-2015	NISSAN ROGUE SELECT	2.5L L4 2488cc 152 CID		2012-2018	NISSAN VERSA	1.6L L4 1598cc
USEP8855M	2007-2012	NISSAN VERSA	1.8L L4 1798cc	USEP9120M	2014-2018	NISSAN VERSA NOTE	1.6L L4 1598cc
	2009-2011	NISSAN VERSA	1.6L L4 1598cc		2012-2014	HYUNDAI SONATA	2.4L L4 2359cc
	2009-2014	NISSAN CUBE	1.8L L4 1798cc	2012-2015	KIA OPTIMA	2.4L L4 2359cc	
USEP8856M	2008-2013	NISSAN ROGUE	2.5L L4 2488cc 152 CID	USEP9122M	2011-2013	KIA OPTIMA	2.4L L4 2359cc
	2014-2015	NISSAN ROGUE SELECT	2.5L L4 2488cc 152 CID		2012-2013	HYUNDAI SONATA	2.4L L4 2359cc
USEP8858M	2005-2007	LAND ROVER LR3	4.0L V6 4009cc 245 CID	USEP9184M	2000-2001	NISSAN SENTRA	2.0L L4 1998cc
	2005-2009	LAND ROVER LR3	4.4L V8 4394cc		2000-2001	NISSAN SENTRA	2.0L L4 1998cc 122 CID
	2006-2009	LAND ROVER RANGE ROVER SPORT	4.4L V8 4394cc		2002-2006	NISSAN SENTRA	1.8L L4 1769cc
2002-2006			NISSAN SENTRA		2.5L L4 2488cc 152 CID		
USEP8859M	2007-2011	HONDA CR-V	2.4L L4 2354cc 144 CID	USEP10281M	2000-2001	MERCEDES-BENZ A160	1.6L L4 1598cc 98 CID
USEP8862M	2005-2015	NISSAN TITAN	5.6L V8 5552cc		2003	MERCEDES-BENZ A160	1.6L L4 1598cc 98 CID
	2007-2015	NISSAN ARMADA	5.6L V8 5552cc	USEP10305M	2001	PEUGEOT 406	3.0L V6 2950cc 180 CID
	2012-2017	NISSAN NV2500	5.6L V8 5552cc		2005	PEUGEOT 406	2.0L L4 1998cc 122 CID
	2012-2017	NISSAN NV3500	5.6L V8 5552cc	USEP10546M	2001-2007	FORD MONDEO	2.0L L4 1999cc 122 CID
	2012-2018	NISSAN NV1500	4.0L V6 3954cc		2001-2007	FORD MONDEO	2.5L V6 2450cc 155 CID
	2012-2018	NISSAN NV2500	4.0L V6 3954cc	USEP10684M	2007-2010	NISSAN TIIDA	1.8L L4 1798cc
	2012-2018	NISSAN NV3500	4.0L V6 3954cc		2006-2009	PEUGEOT 307	2.0L L4 1997cc 122 CID
	USEP8869M	2007-2018	TOYOTA TUNDRA	5.7L V8 5663cc 345 CID	USEP10693M	2006-2009	PEUGEOT 307
2008-2018		TOYOTA SEQUOIA	5.7L V8 5663cc 345 CID	1999-2002		DAEWOO LANOS	1.6L L4 1588cc 98 CID
2010-2012		TOYOTA SEQUOIA	4.6L V8 4608cc	USEP12002M	1999-2002	DAEWOO NUBIRA	2.0L L4 1998cc
2010-2018		TOYOTA TUNDRA	4.6L V8 4608cc		USEP12003	1993-2004	VOLKSWAGEN SEDAN
USEP8874M	2005-2006	TOYOTA COROLLA	1.8L L4 1795cc	USEP12006M	2004-2008	GMC SAVANA 2500	4.8L V8 294 CID
	2005-2006	TOYOTA MATRIX	1.8L L4 1795cc		2004-2008	GMC SAVANA 2500	6.0L V8 5967cc 364 CID
	2005-2008	TOYOTA COROLLA	1.8L L4 1794cc	2005	GMC SAVANA 2500	4.3L V6 262 CID	
	2005-2008	TOYOTA MATRIX	1.8L L4 1794cc	2005-2006	GMC SAVANA 1500	4.3L V6 262 CID	
			2006-2008	CHEVROLET EXPRESS 2500	4.8L V8 294 CID		
USEP8878M	2007-2009	TOYOTA FJ CRUISER	4.0L V6 3956cc 241 CID	2006-2008	CHEVROLET EXPRESS 2500	6.0L V8 5967cc 364 CID	
USEP8880M	2008	AUDI A5 QUATTRO	3.2L V6 3197cc 195 CID	2006-2008	CHEVROLET EXPRESS 3500	4.8L V8 294 CID	
	2008-2012	AUDI S5	4.2L V8 4163cc	2006-2008	CHEVROLET EXPRESS 3500	6.0L V8 5967cc 364 CID	
	2009-2010	AUDI A5 QUATTRO	3.2L V6 3123cc	2006-2008	GMC SAVANA 3500	4.8L V8 294 CID	
	2010	AUDI A4 QUATTRO	2.0L L4 1984cc 121 CID	2006-2008	GMC SAVANA 3500	6.0L V8 5967cc 364 CID	
	2010-2012	AUDI A5	2.0L L4 1984cc 121 CID	2008	GMC SAVANA 1500	4.3L V6 262 CID	
	2010-2012	AUDI S4	3.0L V6 2995cc	USEP12012M	2002	CHEVROLET CORSA	1.4L L4 1389cc 85 CID
	2010-2012	AUDI S5	3.0L V6 2995cc		USEP12013M	1995-1997	VOLKSWAGEN GOLF
	2011-2012	AUDI A5 QUATTRO	2.0L L4 1984cc 121 CID	USEP12026M	2001-2003	RENAULT MEGANE	2.0L L4 1998cc 122 CID
	2012	AUDI A4	2.0L L4 1984cc 121 CID		2001-2004	RENAULT SCENIC	2.0L L4 1998cc 122 CID
	2012	AUDI A4 QUATTRO	2.0L L4 1984cc 121 CID	2003-2008	CHEVROLET CORSA	1.8L L4 1796cc 110 CID	
	USEP8899M	2007	TOYOTA CAMRY	2.4L L4 2357cc 144 CID	2004-2005	CHEVROLET ASTRA	2.0L L4 1999cc 122 CID
		2007	TOYOTA CAMRY	2.4L L4 2362cc	2006	CHEVROLET ASTRA	1.8L L4 1796cc 110 CID
2010-2011		TOYOTA CAMRY	2.4L L4 2362cc	2006-2009	DODGE ATTITUDE	1.6L L4 1599cc 98 CID	
USEP8903M	2006-2007	HYUNDAI SONATA	2.4L L4 2359cc	USEP12028S	1994-1995	JEEP WRANGLER	2.5L L4 150 CID
	2006-2010	HYUNDAI SONATA	3.3L V6 3342cc		1994-1995	JEEP WRANGLER	4.0L L6 242 CID
USEP8922M	2008-2012	HONDA ACCORD	2.4L L4 2354cc 144 CID	USEP12038M	2008	NISSAN TSURU	1.6L L4 1597cc 97 CID
	2009-2014	ACURA TSX	2.4L L4 2354cc 144 CID		USEP12040M	2006	CHEVROLET OPTRA
	2012	HONDA CROSSTOUR	2.4L L4 2354cc 144 CID	USEP12050M	2003-2004	SEAT ALHAMBRA	1.8L L4 1781cc
USEP8923M	2008-2012	HONDA ACCORD	3.5L V6 3471cc		2003-2007	VOLKSWAGEN POLO	1.6L L4 1596cc 97 CID
	2009-2014	ACURA TL	3.5L V6 3471cc		2004	VOLKSWAGEN EUROVAN	2.5L L5 2461cc 150 CID
	2010-2011	HONDA ACCORD CROSSTOUR	3.5L V6 3471cc		2005	SEAT ALTEA	2.0L L4 1984cc 121 CID
	2010-2014	ACURA TSX	3.5L V6 3471cc		2006	VOLKSWAGEN LUPO	1.6L L4 1599cc 98 CID
	2011-2013	ACURA TL	3.7L V6 3664cc		2008-2009	VOLKSWAGEN LUPO	1.6L L4 1599cc 98 CID
2012	HONDA CROSSTOUR	3.5L V6 3471cc	2011	VOLKSWAGEN CLASICO	2.0L L4 1984cc 121 CID		
USEP8924M	2006-2011	MERCEDES-BENZ ML350	3.5L V6 3498cc	USEP12053M	1998-1999	VOLKSWAGEN POINTER	1.8L L4 1781cc
	2006-2011	MERCEDES-BENZ ML350	3.5L V6 3498cc 213 CID		1999	VOLKSWAGEN POINTER TRUCK	1.8L L4 1781cc
	2007-2010	MERCEDES-BENZ GL450	4.6L V8 4663cc	USEP12096M	2007-2009	NISSAN SENTRA	2.0L L4 1997cc 122 CID
	2008-2010	MERCEDES-BENZ GL550	5.5L V8 5461cc		2007-2009	NISSAN SENTRA	2.5L L4 2488cc 152 CID
	2008-2010	MERCEDES-BENZ ML550	5.5L V8 5461cc	USEP12142M	1998-1999	FORD FIESTA	1.3L L4 1299cc 79 CID
USEP8928M	2009-2010	INFINITI M35	3.5L V6 3498cc		USEP12147M	2008	AUDI A4
	2009-2010	INFINITI M45	4.5L V8 4494cc	USEP12148M		2005	AUDI A6
	2009-2013	INFINITI G37	3.7L V6 3696cc		USEP12263M	2008	NISSAN URVAN
	2011-2012	INFINITI G25	2.5L V6 2496cc 152 CID	2008-2011		NISSAN URVAN	2.5L L4 2488cc 152 CID
	2012-2013	INFINITI G37	3.7L V6 3696cc 226 CID	2008-2011		NISSAN URVAN	3.0L L4 2953cc 180 CID
	2014-2015	INFINITI Q60	3.7L V6 3696cc	USEP12300M		1992-1997	FORD F-150
	2014-2015	INFINITI Q60	3.7L V6 3696cc 226 CID		USEP12301M	1990-1991	FORD F-150
	2015	INFINITI Q40	3.7L V6 3696cc	USEP12375M		2015-2018	FORD RANGER
	USEP8937M	2010-2011	TOYOTA CAMRY		2.5L L4 2494cc 152 CID	2017-2019	FORD RANGER
	USEP8943M	2009-2013	HONDA FIT	1.5L L4 1497cc			
2010-2013		HONDA FIT	1.5L L4 1496cc 91 CID				
USEP8976M	2007-2008	INFINITI G35	3.5L V6 3498cc				
USEP8994M	2000-2002	HYUNDAI ACCENT	1.5L L4 1495cc				
	2001-2002	HYUNDAI ACCENT	1.6L L4 1600cc				
USEP9036M	2011	HYUNDAI SONATA	2.4L L4 2359cc				
USEP9049M	2010-2013	MAZDA 3	2.0L L4 1999cc 122 CID				
	2010-2013	MAZDA 3	2.0L L4 2000cc 122 CID				
	2010-2013	MAZDA 3	2.5L L4 2489cc 152 CID				
	2012-2013	MAZDA 3	2.0L L4 1998cc 122 CID				
	2012-2013	MAZDA 3 SPORT	2.0L L4 1998cc 122 CID				
	2012-2013	MAZDA 3 SPORT	2.0L L4 2000cc 122 CID				
	2012-2013	MAZDA 3 SPORT	2.5L L4 2488cc 152 CID				
	2012-2013	MAZDA 3 SPORT	2.5L L4 2488cc 152 CID				
USEP9053M	2001-2002	KIA SPORTAGE	2.0L L4 1998cc 122 CID				
USEP9073M	2011-2014	HYUNDAI ELANTRA	1.8L L4 1797cc				
USEP9081M	2008-2009	MERCEDES-BENZ C350	3.5L V6 3498cc 213 CID				
	2008-2011	MERCEDES-BENZ C350	3.5L V6 3498cc				
	2008-2012	MERCEDES-BENZ C300	3.0L V6 2996cc				



# FUEL PUMP MODULES CROSS REFERENCE



BMW	Chrysler (cont'd.)	Chrysler (cont'd.)
12 14 7 194 207	USEP8688M 4897 426AB	USEP7093M 5018 873AB
16 11 6 752 626	USEP8412M 4897 428AB	USEP7101M 5018 875AA
16 11 6 755 043	USEP8412M 4897 431AA	USEP7129M 5018 875AB
16 11 6 759 830	USEP8488M 4897 431AB	USEP7129M 5019 003AA
16 11 7 159 604	USEP8526M 4897 493AA	USEP7114M 5019 003AB
16 11 7 194 000	USEP8488M 4897 494AA	USEP7116M 5069 054AA
16 14 1 179 415	USEP8141H 4897 495AA	USEP7104M 5069 054AC
16 14 1 179 425	USEP8197H 4897 495AB	USEP7104M 5072 763AB
16 14 1 179 427	USEP8216H 4897 666AA	USEP7138M 5072 764AB
16 14 1 181 354	USEP8234M 4897 666AB	USEP7138M 5083 317AA
16 14 1 183 176	USEP8442H 4897 666AC	USEP7138M 5086 278AA
16 14 6 752 368	USEP8442H 4897 666AF	USEP7138M 5086 280AA
16 14 6 752 499	USEP8416M 4897 667AA	USEP7111M 5086 280AB
16 14 6 758 735	USEP8415M 4897 667AD	USEP7111M 5086 280AC
16 14 6 765 820	USEP8524M 4897 667AD	USEP7138M 5086 286AA
16 14 6 766 942	USEP8416M 4897 667AF	USEP7111M 5086 286AB
16 14 7 161 387	USEP8234M 4897 668AE	USEP7187M 5086 650AA
16 14 7 163 298	USEP8688M 4897 668AF	USEP7187M 5086 650AC
<b>Chrysler</b>		
4075 445	USEP7069H 4897 804AA	USEP7113M 5093 455AA
4203 941	USEP7071H 4897 804AB	USEP7113M 5093 455AB
4279 296	USEP7071H 4897 804AC	USEP7113M 5093 455AC
4279 917	USEP7051S 4897 920AA	USEP7114M 5093 457AA
4419 617	USEP7068H 4897 920AB	USEP7114M 5093 457AB
4419 618	USEP7074H 4897 921AA	USEP7116M 5093 804AA
4495 002	USEP7040M 5003 465AB	USEP7117M 5093 856AA
4495 088	USEP7068H 5003 465AC	USEP7117M 5096 149AA
4495 132	USEP7029M 5003 465AD	USEP7117M 5096 149AB
4495 140	USEP7039M 5003 855AA	USEP7087M 5101 795AA
4495 163	USEP7040M 5003 867AA	USEP7099M 5101 803AA
4495 391	USEP7056M 5003 958AA	USEP7137M 5101 803AB
4637 192	USEP7072S 5003 958AB	USEP7137M 5101 805AB
4728 729	USEP7049M 5003 958AC	USEP7137M 5101 805AC
4740 370	USEP7029M 5010 017AA	USEP7123M 5101 830AA
4742 670	USEP7040M 5010 370AA	USEP7124M 5101 830AB
4742 671	USEP7040M 5010 370AC	USEP7124M 5102 527AA
4761 646	USEP7057M 5010 370AE	USEP7124M 5103 114AB
4762 405	USEP7057M 5010 370AF	USEP7124M 5104 694AA
4762 406	USEP7050M 5012 273AA	USEP7116M 5104 694AB
4762 407	USEP7062M 5012 273AB	USEP7116M 5104 695AD
4762 408	USEP7062M 5012 273AC	USEP7116M 5104 696AA
4762 539	USEP7047M 5012 273AD	USEP7116M 5104 696AB
4762 540	USEP7048M 5012 380AA	USEP7127M 5104 697AA
4762 996	USEP7050M 5012 380AB	USEP7127M 5104 697AB
4773 804	USEP7054M 5012 380AD	USEP7127M 5104 698AB
4778 112	USEP7076M 5012 951AB	USEP7122M 5104 698AC
4778 198	USEP7089M 5012 951AC	USEP7122M 5114 302AA
4778 436	USEP7057M 5012 953AB	USEP7121M 5114 547AB
4797 804	USEP7057M 5012 953AC	USEP7121M 5114 547AD
4797 880	USEP7068H 5014 024AA	USEP7054M 5114 547AE
4797 882	USEP7069H 5014 192AA	USEP7187M 5114 547AF
4797 885	USEP7074H 5014 318AA	USEP7138M 5119 605AA
4797 887	USEP7071H 5014 318AB	USEP7138M 5119 607AA
4798 057	USEP7065M 5014 351AA	USEP7130M 5127 562AC
4798 271	USEP7100M 5014 351AB	USEP7130M 5134 554AC
4798 287	USEP7065M 5014 789AB	USEP7123M 5134 554AD
4798 292	USEP7086M 5014 789AC	USEP7123M 5134 554AF
4798 485	USEP7097M 5014 789AD	USEP7123M 5135 549AA
4798 822	USEP7093M 5014 884AA	USEP7116M 5135 549AB
4856 260	USEP7099M 5014 884AD	USEP7116M 5139 031AE
4856 445	USEP7101M 5014 884AE	USEP7128M 5140 813AC
4863 888	USEP7086M 5014 884AF	USEP7128M 5140 829AB
4863 888AB	USEP7086M 5015 553AA	USEP7128M 5140 829AC
4864 035AB	USEP7075M 5016 221AA	USEP7187M 5143 579AB
4874 173	USEP7121M 5017 204AA	USEP7152M 5143 579AC
4874 173AB	USEP7121M 5017 204AB	USEP7143M 5143 579AD
4882 079	USEP7101M 5017 204AC	USEP7143M 5143 579AE
4883 029	USEP7100M 5017 204AE	USEP7143M 5143 579AF
4897 417AA	USEP7097M 5018 056AB	USEP7143M 5143 579AH
4897 417AC	USEP7097M 5018 056AC	USEP7127M 5143 579AI
4897 420AA	USEP7089M 5018 056AC	USEP7127M 5143 579AJ
4897 420AB	USEP7089M 5018 691AA	USEP7141M 5161 335AB
4897 424AA	USEP7094M 5018 691AB	USEP7141M 5161 335AC
4897 424AB	USEP7094M 5018 697AA	USEP7142M 5161 377AA
	USEP7094M 5018 873AA	USEP7144M 5161 377AB



# FUEL PUMP MODULES CROSS REFERENCE



FUEL PUMP MODULES

Chrysler (cont'd.)		Ford (cont'd.)		Ford (cont'd.)	
5161 377AC	USEP7189M	2L1Z 9H307-BF	USEP2360M	5L3Z 9H307-CB	USEP2441M
5161 377AD	USEP7189M	2L1Z 9H307-BG	USEP2360M	5L3Z 9H307-DB	USEP2436M
5179 396AA	USEP7184M	2L1Z 9H307-CA	USEP2361M	5L8Z 9H307-A	USEP2453M
5183 201AA	USEP7220M	2L1Z 9H307-CG	USEP2361M	5L8Z 9H307-B	USEP2440M
5183 201AB	USEP7220M	2L1Z 9H307-CH	USEP2361M	5L8Z 9H307-BD	USEP2453M
5183 202AA	USEP7220M	2L2Z 9H307-FA	USEP2348M	5R3Z 9275-AC	USEP2457M
5183 202AB	USEP7220M	2L2Z 9H307-GA	USEP2352M	5W1Z 9H307-AA	USEP2449S
5200 4835	USEP7049M	2L2Z 9H307-GB	USEP2352M	5W1Z 9H307-AC	USEP2449S
5200 4837	USEP7048M	2L2Z 9H307-GC	USEP2352M	6C2Z 9H307-AA	USEP2365S
5200 5099	USEP7055M	2L2Z 9H307-HA	USEP2332S	6C2Z 9H307-BA	USEP2364S
5201 7632	USEP7049M	2L2Z 9H307-HC	USEP2332S	6C2Z 9H307-CA	USEP2437S
5201 7634	USEP7047M	2L7Z 9H307-AF	USEP2362M	6C3Z 9H307-BA	USEP2364S
5201 7635	USEP7048M	2M5Z 9H307-AD	USEP2325M	6C3Z 9H307-CA	USEP2442M
5201 7814	USEP7047M	3C2Z 9H307-AA	USEP2341S	6E5Z 9H307-F	USEP2459M
5201 7915	USEP7063M	3C2Z 9H307-AB	USEP2341S	6E5Z 9H307-G	USEP2458M
5201 7916	USEP7064M	3C3Z 9H307-CB	USEP2245M	6F1Z 9H307-A	USEP2435M
5201 8061	USEP7064M	3C3Z 9H307-DB	USEP2245M	6F1Z 9H307-B	USEP2455M
5201 8796	USEP7087M	3C3Z 9H307-EC	USEP2245M	6F2Z 9H307-BA	USEP2466M
5210 2862AB	USEP7117M	3C3Z 9H307-FC	USEP2245M	6F9Z 9H307-A	USEP2465M
5212 7761	USEP7063M	3C3Z 9H307-GD	USEP2245M	6F9Z 9275-A	USEP2465M
5212 7763	USEP7063M	3C3Z 9H307-HB	USEP2245M	6L1Z 9H307-A	USEP2443M
5217 794	USEP7073S	3C3Z 9H307-JB	USEP2245M	6L2Z 9H307-A	USEP2454M
5217 796	USEP7073S	3C3Z 9H307-KB	USEP2245M	6L2Z 9H307-AA	USEP2454M
5217 852	USEP7071H	3C3Z 9H307-LB	USEP2245M	6L3Z 9H307-A	USEP2434M
5217 856	USEP7074H	3C3Z 9H307-MA	USEP2280M	6L3Z 9H307-B	USEP2434M
6800 1958AB	USEP7165M	3C3Z 9H307-MB	USEP2245M	6L3Z 9H307-C	USEP2441M
6800 3766AA	USEP7184M	3C3Z 9H307-CA	USEP2280M	6L3Z 9H307-D	USEP2436M
6800 4095AA	USEP7219M	3C5Z 9H307-CA	USEP2354M	6L3Z 9H307-E	USEP2436M
6800 4095AB	USEP7219M	3C7Z 9H307-NA	USEP2287M	6L5Z 9H307-BA	USEP2356M
6800 4518AA	USEP7182M	3C7Z 9H307-NB	USEP2287M	6L5Z 9H307-CA	USEP2363M
6801 1583AA	USEP7199M	3C7Z 9H307-PA	USEP2288M	6L8Z 9H307-CA	USEP2363M
6801 1609AA	USEP7180M	3C7Z 9H307-PB	USEP2288M	6W1Z 9H307-A	USEP2449S
6802 2583AA	USEP7197M	3F1Z 9H307-AB	USEP2313M	6W1Z 9H307-B	USEP2449S
6802 4002AA	USEP7197M	3F1Z 9H307-BB	USEP2330M	6W1Z 9H307-C	USEP2449S
6802 5169AA	USEP7198M	3F2Z 9H307-AB	USEP2383M	6W1Z 9H307-D	USEP2449S
521798	USEP7030M	3L2Z 9H307-CB	USEP2351M	7E5Z 9H307-S	USEP2459M
4682260	USEP7030M	3L2Z 9H307-CC	USEP2351M	7L2Z 9H307-A	USEP2454M
4682761	USEP7030M	3L2Z 9H307-EB	USEP2348M	7L2Z 9H307-B	USEP2359M
4682761AB	USEP7030M	3L2Z 9H307-EC	USEP2348M	7L2Z 9H307-C	USEP2439M
5003860AA	USEP12028S	3L2Z 9H307-FB	USEP2353M	7L3Z 9H307-A	USEP2434M
5003860AB	USEP12028S	3L2Z 9H307-FC	USEP2348M	7L3Z 9H307-B	USEP2434M
5003861AA	USEP12028S	3L2Z 9H307-FC	USEP2353M	7L3Z 9H307-C	USEP2441M
5003861AB	USEP12028S	3L5Z 9H307-EC	USEP2295M	7L3Z 9H307-D	USEP2436M
5217988	USEP7030M	3L5Z 9H307-FC	USEP2293M	7L3Z 9H307-E	USEP2434M
52018390	USEP12028S	3S4Z 9H307-AB	USEP2368M	7L3Z 9H307-E	USEP2436M
52018391	USEP12028S	3S4Z 9H307-BC	USEP2326M	7L3Z 9H307-F	USEP2434M
MB831561	USEP7067S	3W1Z 9H307-AB	USEP2336S	7L3Z 9H307-G	USEP2436M
MR134804	USEP7081H	3W4Z 9H307-AD	USEP2388M	7L3Z 9H307-H	USEP2501M
MR134868	USEP7081H	3W4Z 9275-AB	USEP2388M	7L8Z 9H307-B	USEP2453M
R4495391	USEP7056M	4C2Z 9H307-BB	USEP2364S	7L8Z 9H307-C	USEP2363M
R4762541	USEP7064M	4C2Z 9H307-CB	USEP2437S	7L8Z 9H307-C	USEP2440M
R4762543	USEP7064M	4F1Z 9H307-AB	USEP2435M	8L3Z 9H307-A	USEP2434M
R4778112	USEP7076M	4L2Z 9H307-AC	USEP2358M	8L3Z 9H307-B	USEP2434M
<b>Ford</b>		4L2Z 9H307-EA	USEP2439M	8L3Z 9H307-C	USEP2441M
1F1Z 9H307-EC	USEP2329M	4L3Z 9H307-AF	USEP2434M	8L3Z 9H307-D	USEP2436M
1F1Z 9H307-GA	USEP2294M	4L3Z 9H307-BF	USEP2434M	8L3Z 9H307-F	USEP2434M
1F1Z 9H307-GB	USEP2294M	4L3Z 9H307-CF	USEP2434M	8L3Z 9H307-G	USEP2436M
1F2Z 9H307-AA	USEP2290M	4L3Z 9H307-DF	USEP2436M	8L3Z 9H307-H	USEP2501M
1L2Z 9H307-MB	USEP2332S	4L5Z 9H307-BF	USEP2356M	E3UZ 9350-A	USEP2133S
1L5Z 9H307-EE	USEP2295M	4L5Z 9H307-CF	USEP2363M	E4DZ 9H307-A	USEP2131S
1L5Z 9H307-EF	USEP2295M	4W4Z 9H307-AA	USEP2388M	E4DZ 9H307-B	USEP2146S
1L5Z 9H307-FE	USEP2293M	5C2Z 9H307-A	USEP2365S	E4DZ 9H307-E	USEP2131S
1L5Z 9H307-FF	USEP2293M	5C2Z 9H307-B	USEP2364S	E5SZ 9A407-B	USEP2084H
1R3Z 9H307-AA	USEP2301M	5C3Z 9H307-A	USEP2364S	E5TZ 9H307-B	USEP2093S
1R3Z 9H307-AB	USEP2301M	5C3Z 9H307-B	USEP2442M	E5TZ 9H307-BA	USEP2093S
2C2Z 9H307-AA	USEP2241S	5C3Z 9H307-CA	USEP2442M	E5TZ 9H307-C	USEP2148S
2C2Z 9H307-AB	USEP2241S	5C5Z 9H307-A	USEP2354M	E5TZ 9H307-CA	USEP2148S
2C2Z 9H307-CB	USEP2239S	5F9Z 9H307-AA	USEP2465M	E5TZ 9H307-D	USEP2149S
2C6Z 9H307-AA	USEP2316S	5F9Z 9275-AE	USEP2465M	E5TZ 9H307-DA	USEP2149S
2C6Z 9H307-AB	USEP2316S	5L2Z 9H307-A	USEP2359M	E5TZ 9H307-E	USEP2091S
2F1Z 9H307-FB	USEP2313M	5L2Z 9H307-C	USEP2358M	E5TZ 9H307-J	USEP2095S
2F2Z 9H307-AB	USEP2290M	5L2Z 9H307-EA	USEP2439M	E5TZ 9H307-L	USEP2088S
2F2Z 9H307-AC	USEP2290M	5L3Z 9H307-AB	USEP2434M	E5TZ 9H307-LA	USEP2088S
2L1Z 9H307-BA	USEP2360M	5L3Z 9H307-BB	USEP2434M	E5ZZ 9A407-A	USEP2110H





# FUEL PUMP MODULES CROSS REFERENCE



Ford (cont'd.)		Ford (cont'd.)		Ford (cont'd.)	
E5ZZ 9A407-B	USEP2110H	F1TZ 9H307-D	USEP2078S	F7RZ 9H307-HB	USEP2188S
E6AZ 9350-A	USEP2087H	F1UZ 9H307-A	USEP2060S	F7UZ 9H307-AC	USEP2213S
E6AZ 9350-AA	USEP2087H	F1UZ 9H307-AA	USEP2060S	F7UZ 9H307-AD	USEP2210S
E6KZ 9H307-B	USEP2132S	F1UZ 9H307-B	USEP2071S	F7UZ 9H307-AD	USEP2213S
E6LZ 9A407-A	USEP2084H	F1UZ 9H307-BA	USEP2071S	F7UZ 9H307-BC	USEP2206S
E6LZ 9A407-AA	USEP2084H	F1ZZ 9A407-C	USEP2110H	F7UZ 9H307-BD	USEP2206S
E6UZ 9H307-A	USEP2133S	F1ZZ 9A407-CA	USEP2110H	F7UZ 9H307-CC	USEP2223S
E6UZ 9H307-AA	USEP2133S	F2TZ 9H307-L	USEP2144S	F7UZ 9H307-CD	USEP2223S
E6UZ 9H307-B	USEP2135S	F2TZ 9H307-LA	USEP2144S	F7UZ 9H307-DB	USEP2224S
E6UZ 9H307-BA	USEP2135S	F2VY 9A407-A	USEP2122H	F7UZ 9H307-DC	USEP2224S
E6UZ 9H307-H	USEP2133S	F2VY 9A407-AA	USEP2122H	F7UZ 9H307-EB	USEP2210S
E6UZ 9H307-J	USEP2135S	F2VZ 9A407-EA	USEP2059MN	F7UZ 9H307-EB	USEP2213S
E6VZ 9350-A	USEP2087H	F2VZ 9A407-EB	USEP2059MN	F7UZ 9H307-EC	USEP2210S
E7FZ 9H307-B	USEP2082S	F3DZ 9H307-D	USEP2115S	F7UZ 9H307-EC	USEP2213S
E7FZ 9H307-BA	USEP2082S	F3DZ 9H307-DA	USEP2115S	F7UZ 9H307-FB	USEP2213S
E7FZ 9H307-D	USEP2136S	F3DZ 9H307-E	USEP2108S	F7UZ 9H307-FC	USEP2210S
E7RY 9H307-A	USEP2155S	F3LY 9A407-A	USEP2070H	F7UZ 9H307-FC	USEP2213S
E7RY 9350-A	USEP2155S	F3LY 9A407-B	USEP2070H	F8CZ 9H307-AJ	USEP2197M
E7TZ 9C407-B	USEP2093S	F3LY 9A407-BA	USEP2070H	F8CZ 9H307-AK	USEP2197M
E7TZ 9C407-BA	USEP2093S	F3TZ 9A407-A	USEP2059MN	F8DZ 9H307-HB	USEP2198M
E7TZ 9H307-A	USEP2102S	F4DZ 9H307-A	USEP2076S	F8DZ 9H307-HC	USEP2198M
E7TZ 9H307-AA	USEP2102S	F4DZ 9H307-AA	USEP2076S	F8PZ 9A407-GB	USEP2191H
E7TZ 9H307-B	USEP2103S	F4DZ 9H307-B	USEP2077S	F8PZ 9A407-HB	USEP2191H
E7TZ 9H307-BA	USEP2103S	F4DZ 9H307-BB	USEP2077S	F8PZ 9350-JA	USEP2194M
E7TZ 9H307-D	USEP2104S	F4DZ 9H307-CA	USEP2108S	F8PZ 9350-JB	USEP2194M
E7UZ 9C407-A	USEP2133S	F4TZ 9A407-D	USEP2059MN	F8RZ 9H307-AB	USEP2188S
E7UZ 9C407-AA	USEP2133S	F4TZ 9A407-N	USEP2059MN	F8RZ 9H307-AC	USEP2188S
E7UZ 9H307-A	USEP2133S	F4TZ 9A407-P	USEP2059MN	F8RZ 9H307-AE	USEP2227S
E8DZ 9H307-C	USEP2076S	F4TZ 9A407-R	USEP2064MN	F8RZ 9H307-BB	USEP2227S
E8FZ 9H307-B	USEP2136S	F4TZ 9A407-S	USEP2059MN	F8RZ 9H307-BC	USEP2188S
E8FZ 9H307-D	USEP2082S	F4ZZ 9350-C	USEP2191H	F8RZ 9H307-BD	USEP2188S
E8TZ 9H307-B	USEP2095S	F4ZZ 9350-D	USEP2191H	F8RZ 9H307-BE	USEP2227S
E8TZ 9H307-BA	USEP2095S	F5CZ 9350-B	USEP2151H	F8RZ 9350-AA	USEP2227S
E8TZ 9H307-C	USEP2096S	F5CZ 9350-BA	USEP2151H	F8ZZ 9H307-AD	USEP2218M
E8TZ 9H307-D	USEP2104S	F5SZ 9H307-B	USEP2098S	F8ZZ 9H307-AE	USEP2218M
E8TZ 9H307-DA	USEP2104S	F5SZ 9H307-BA	USEP2098S	F8ZZ 9H307-BD	USEP2200M
E8TZ 9H307-E	USEP2097S	F6PZ 9H307-BA	USEP2282M	F8ZZ 9H307-BE	USEP2200M
E8TZ 9H307-EA	USEP2097S	F6PZ 9H307-BB	USEP2282M	F8ZZ 9H307-CE	USEP2218M
E8TZ 9H307-G	USEP2141S	F6PZ 9H307-CA	USEP2220M	F8ZZ 9H307-CF	USEP2218M
E8TZ 9H307-GA	USEP2141S	F6PZ 9H307-CB	USEP2220M	F8ZZ 9H307-DE	USEP2200M
E8UZ 9H307-E	USEP2133S	F6PZ 9H307-EB	USEP2059MN	F8ZZ 9H307-DF	USEP2200M
E8UZ 9H307-F	USEP2135S	F6PZ 9H307-EC	USEP2059MN	F32Z 9A407-A	USEP2156H
E8UZ 9H307-FA	USEP2135S	F6RZ 9H307-AB	USEP2117S	F32Z 9A407-CC	USEP2156H
E8UZ 9H307-G	USEP2133S	F6RZ 9350-AA	USEP2117S	F42Z 9350-A	USEP2156H
E8UZ 9H307-GA	USEP2133S	F6SZ 9H307-AB	USEP2098S	F52Z 9350-AA	USEP2118H
E9DZ 9H307-A	USEP2115S	F6SZ 9350-AB	USEP2098S	F52Z 9350-AB	USEP2118H
E9DZ 9H307-C	USEP2115S	F6TZ 9A407-AA	USEP2059MN	F57Z 9H307-B	USEP2059MN
E9DZ 9H307-D	USEP2079S	F6TZ 9A407-AB	USEP2059MN	F57Z 9H307-BA	USEP2059MN
E9FZ 9H307-A	USEP2136S	F6TZ 9A407-BA	USEP2059MN	F57Z 9H307-C	USEP2059MN
E9SZ 9H307-C	USEP2098S	F6TZ 9A407-BB	USEP2059MN	F57Z 9H307-CA	USEP2059MN
E9TZ 9H307-D	USEP2059MN	F6TZ 9A407-CA	USEP2064MN	F57Z 9H307-D	USEP2190S
E9TZ 9H307-DA	USEP2059MN	F6TZ 9A407-CC	USEP2064MN	F57Z 9H307-DA	USEP2190S
E9UZ 9H307-C	USEP2147S	F6TZ 9A407-DA	USEP2059MN	F57Z 9H307-E	USEP2078S
E9UZ 9H307-CA	USEP2147S	F6TZ 9A407-DB	USEP2059MN	F57Z 9H307-EA	USEP2078S
E55Y 9A407-A	USEP2100H	F6TZ 9A407-EA	USEP2059MN	F57Z 9H307-F	USEP2106S
E55Y 9A407-AA	USEP2100H	F6TZ 9A407-EB	USEP2059MN	F57Z 9H307-FA	USEP2106S
E69Z 9H307-G	USEP2080S	F6TZ 9A407-KA	USEP2059MN	F60Z 9A407-AF	USEP2186M
E73Z 9H307-B	USEP2081S	F6TZ 9A407-KB	USEP2059MN	F60Z 9H307-AE	USEP2186M
E73Z 9H307-BA	USEP2081S	F7AZ 9H307-AE	USEP2222S	F60Z 9350-AD	USEP2186M
E83Z 9H307-B	USEP2101S	F7AZ 9350-AB	USEP2222S	F60Z 9350-AE	USEP2186M
E89Z 9H307-B	USEP2080S	F7CZ 9350-AA	USEP2164H	F67Z 9H307-AA	USEP2059MN
E89Z 9H307-BA	USEP2080S	F7CZ 9350-AB	USEP2164H	F67Z 9H307-AC	USEP2059MN
E90Z 9H307-A	USEP2077S	F7DZ 9H307-LB	USEP2185M	F67Z 9H307-BA	USEP2059MN
F0DZ 9H307-A	USEP2108S	F7LZ 9H307-AC	USEP2194M	F67Z 9H307-BB	USEP2059MN
F0TZ 9H307-M	USEP2063M	F7PZ 9A407-CB	USEP2185M	F67Z 9H307-CA	USEP2190S
F0UZ 9H307-A	USEP2147S	F7PZ 9H307-BA	USEP2059MN	F67Z 9H307-CB	USEP2190S
F0UZ 9H307-AA	USEP2147S	F7PZ 9H307-BA	USEP2190S	F68Z 9A407-AA	USEP2116H
F0VY 9H307-D	USEP2123S	F7PZ 9H307-BA	USEP2266S	F70Z 9A407-AB	USEP2187M
F1PY 9A407-A	USEP2121H	F7PZ 9H307-BE	USEP2059MN	F70Z 9H307-BB	USEP2187M
F1PY 9A407-AA	USEP2121H	F7PZ 9H307-BE	USEP2190S	F70Z 9350-AA	USEP2187M
F1SZ 9H307-B	USEP2098S	F7PZ 9H307-BE	USEP2266S	F70Z 9350-BB	USEP2187M
F1SZ 9H307-BA	USEP2098S	F7RZ 9H307-GA	USEP2188S	F75Z 9H307-KC	USEP2201S
F1SZ 9H307-C	USEP2098S	F7RZ 9H307-GB	USEP2188S	F75Z 9H307-KE	USEP2201S
F1SZ 9H307-CA	USEP2098S	F7RZ 9H307-HA	USEP2188S	F75Z 9H307-LC	USEP2201S



# FUEL PUMP MODULES CROSS REFERENCE



FUEL PUMP MODULES

Ford (cont'd.)		Ford (cont'd.)		General Motors (cont'd.)	
F75Z 9H307-LE	USEP2201S	XL3Z 9H307-FB	USEP2237S	19133462	USEP3616M
F75Z 9H307-MC	USEP2201S	XL5Z 9H307-DA	USEP2261S	19133464	USEP3616M
F75Z 9H307-ME	USEP2201S	XL5Z 9H307-DG	USEP2261S	19133465	USEP3616M
F78Z 9H307-BA	USEP2199M	XL5Z 9H307-EA	USEP2261S	19133468	USEP3702M
F78Z 9H307-BB	USEP2116H	XL5Z 9H307-EG	USEP2261S	19133469	USEP3702M
F78Z 9H307-BB	USEP2199M	XL5Z 9H307-FA	USEP2261S	19133472	USEP3702M
F81Z 9H307-AA	USEP2245M	XL5Z 9H307-FG	USEP2261S	19133474	USEP3675M
F81Z 9H307-AG	USEP2245M	XR3Z 9H307-AD	USEP2244M	19133475	USEP3675M
F81Z 9H307-CA	USEP2245M	XR3Z 9H307-AE	USEP2244M	19133480	USEP3684M
F81Z 9H307-DA	USEP2245M	XS2Z 9H307-AA	USEP2227S	19133481	USEP3684M
F81Z 9H307-DD	USEP2245M	XS2Z 9H307-CA	USEP2227S	19133491	USEP3617M
F81Z 9H307-EA	USEP2245M	XS4Z 9H307-AA	USEP2246M	19133502	USEP3681M
F81Z 9H307-EE	USEP2245M	XS4Z 9H307-AB	USEP2246M	19133505	USEP3682M
F81Z 9H307-FA	USEP2245M	XW1Z 9H307-AB	USEP2272S	19133508	USEP3583M
F81Z 9H307-FG	USEP2245M	XW1Z 9H307-AG	USEP2272S	19133531	USEP3688M
F81Z 9H307-HA	USEP2245M	XW4Z 9H307-AA	USEP2274M	19133543	USEP3706M
F81Z 9H307-JA	USEP2245M	YF1Z 9H307-EE	USEP2285M	19133544	USEP3706M
F81Z 9H307-KA	USEP2245M	YF1Z 9H307-EG	USEP2285M	19133546	USEP3705M
F81Z 9H307-KE	USEP2245M	YFTT-13-35X	USEP2291M	19133578	USEP3705M
F85Z 9H307-AA	USEP2221S	YL5Z 9H307-DC	USEP2269S	19133580	USEP3679M
F85Z 9H307-AB	USEP2221S	YL5Z 9H307-DF	USEP2269S	19133582	USEP3679M
F85Z 9H307-BA	USEP2221S	YL5Z 9H307-EC	USEP2278S	19133584	USEP3700M
F85Z 9H307-BB	USEP2221S	YL5Z 9H307-EF	USEP2278S	19133596	USEP3587M
F85Z 9H307-CA	USEP2221S	YL8Z 9H307-AA	USEP2291M	19133598	USEP3587M
F85Z 9H307-CB	USEP2221S	YL8Z 9H307-AE	USEP2291M	19149227	USEP3579M
F87Z 9H307-AA	USEP2207S	YL8Z 9H307-AF	USEP2291M	19149556	USEP3702M
F87Z 9H307-AB	USEP2207S	YL8Z 9H307-AG	USEP2291M	19149559	USEP3702M
F87Z 9H307-BA	USEP2207S	YL8Z 9H307-BA	USEP2291M	19149684	USEP3579M
F87Z 9H307-BB	USEP2207S	YL8Z 9H307-BB	USEP2291M	19149687	USEP3579M
F87Z 9H307-CA	USEP2207S	YW4Z 9H307-BB	USEP2274M	19149689	USEP3579M
F87Z 9H307-CA	USEP2208S			19149713	USEP3679M
F87Z 9H307-CB	USEP2207S	<b>General Motors</b>			
F87Z 9H307-CB	USEP2208S	10337590	USEP3579M	19151141	USEP3692M
XG3Z 9H307-BA	USEP2245M	10339526	USEP3579M	19151143	USEP3605M
XC3Z 9H307-CA	USEP2245M	10374394	USEP3592M	19151144	USEP3692M
XF1Z 9H307-AA	USEP2243M	10376291	USEP3591M	19151519	USEP3701M
XF1Z 9H307-AB	USEP2243M	10378485	USEP3626M	19152153	USEP3674M
XF1Z 9H307-DA	USEP2243M	10388378	USEP3692M	19152155	USEP3574M
XF1Z 9H307-DB	USEP2243M	10388379	USEP3605M	19152157	USEP3584M
XF2Z 9H307-BA	USEP2248M	10388880	USEP3507M	19152213	USEP3684M
XF2Z 9H307-BB	USEP2248M	15049579	USEP3560M	19152214	USEP3684M
XF3Z 9H307-AB	USEP2249M	15050444	USEP3549M	19152995	USEP3679M
XF3Z 9H307-AE	USEP2249M	15073337	USEP3527M	19152997	USEP3700M
XL1Z 9H307-AB	USEP2297S	15077623	USEP3549M	19153005	USEP3615M
XL1Z 9H307-AC	USEP2297S	15127827	USEP3703M	19153045	USEP3583M
XL1Z 9H307-BB	USEP2297S	15129825	USEP3527M	19153049	USEP3717M
XL1Z 9H307-BC	USEP2297S	15146374	USEP3626M	19153052	USEP3709M
XL1Z 9H307-CB	USEP2297S	15205623	USEP3500M	19153056	USEP3681M
XL1Z 9H307-CC	USEP2297S	15245457	USEP3590M	19153374	USEP3707M
XL1Z 9H307-DA	USEP2253S	15263190	USEP3709M	19153716	USEP3509M
XL1Z 9H307-DB	USEP2253S	15295456	USEP3737M	19153718	USEP3510M
XL1Z 9H307-DC	USEP2253S	15850486	USEP3715M	19153719	USEP3522M
XL1Z 9H307-FB	USEP2253S	15867656	USEP3626M	19153724	USEP3918M
XL1Z 9H307-FC	USEP2253S	15867657	USEP3626M	19153724	USEP3921M
XL2Z 9H307-AA	USEP2296S	15947445	USEP3732M	19153725	USEP3936M
XL2Z 9H307-AJ	USEP2296S	19121352	USEP3717M	19153726	USEP3935M
XL2Z 9H307-AJ	USEP2296S	19121626	USEP3500M	19153727	USEP3912M
XL2Z 9H307-AJ	USEP2332S	19121627	USEP3501M	19167115	USEP3688M
XL2Z 9H307-AK	USEP2190S	19121628	USEP3508M	19167467	USEP3609M
XL2Z 9H307-AK	USEP2296S	19121636	USEP3599M	19167468	USEP3609M
XL2Z 9H307-AL	USEP2190S	19122012	USEP3688M	19167470	USEP3604M
XL2Z 9H307-AL	USEP2296S	19122089	USEP3978M	19167471	USEP3604M
XL2Z 9H307-AL	USEP2332S	19122340	USEP3679M	19167474	USEP3609M
XL2Z 9H307-DA	USEP2296S	19133425	USEP3579M	19167480	USEP3702M
XL3Z 9H307-AA	USEP2237S	19133430	USEP3579M	19167483	USEP3702M
XL3Z 9H307-AB	USEP2237S	19133432	USEP3579M	19167488	USEP3675M
XL3Z 9H307-BA	USEP2237S	19133439	USEP3579M	19167489	USEP3675M
XL3Z 9H307-BB	USEP2237S	19133441	USEP3579M	19167492	USEP3616M
XL3Z 9H307-CA	USEP2237S	19133449	USEP3609M	19167494	USEP3616M
XL3Z 9H307-CB	USEP2237S	19133450	USEP3609M	19167495	USEP3616M
XL3Z 9H307-DA	USEP2237S	19133452	USEP3604M	19167497	USEP3587M
XL3Z 9H307-DB	USEP2237S	19133453	USEP3604M	19167498	USEP3587M
XL3Z 9H307-EA	USEP2237S	19133455	USEP3609M	19167710	USEP3706M
XL3Z 9H307-EB	USEP2237S	19133456	USEP3609M	19167711	USEP3706M
XL3Z 9H307-FA	USEP2237S	19133459	USEP3604M	19168097	USEP3747M



# FUEL PUMP MODULES CROSS REFERENCE



General Motors (cont'd.)		General Motors (cont'd.)		General Motors (cont'd.)	
19168127	USEP3581M	19180126	USEP3552M	25314339	USEP3957M
19168418	USEP3705M	19181827	USEP3605M	25314341	USEP3967M
19168419	USEP3705M	19206532	USEP3747M	25314352	USEP3966M
19168521	USEP3715M	19207716	USEP3581M	25314353	USEP3971M
19168775	USEP3610M	19207718	USEP3560M	25314356	USEP3966M
19169381	USEP3521M	19256523	USEP3626M	25314357	USEP3971M
19177220	USEP3992M	21015072	USEP3944M	25314609	USEP3935M
19177221	USEP3542M	21015152	USEP3951M	25314655	USEP3501M
19177222	USEP3519M	21015329	USEP3905M	25315983	USEP3509M
19177226	USEP3947M	21015330	USEP3905M	25316320	USEP3369M
19177227	USEP3963M	22631715	USEP3507M	25317743	USEP3542M
19177228	USEP3994M	22672353	USEP3557M	25317746	USEP3511M
19177231	USEP3967M	22683260	USEP3507M	25317747	USEP3996M
19177232	USEP3966M	22699047	USEP3557M	25317984	USEP3950M
19177234	USEP3966M	22710031	USEP3557M	25318056	USEP3512M
19177236	USEP3996M	22710504	USEP3626M	25318805	USEP3513M
19177237	USEP3369M	22716735	USEP3585M	25319806	USEP3522M
19177238	USEP3952M	22717995	USEP3591M	25319808	USEP3530M
19177240	USEP3962M	22728631	USEP3592M	25320815	USEP3519M
19177242	USEP3956M	22734856	USEP3590M	25322662	USEP3514M
19177256	USEP3954M	25028220	USEP3917M	25322891	USEP3974M
19177259	USEP3943M	25028422	USEP3916M	25322894	USEP3536M
19177264	USEP3971M	25028581	USEP3918M	25323787	USEP3521M
19177272	USEP3500M	25028921	USEP3917M	25323823	USEP3372M
19179477	USEP3512M	25028921	USEP3918M	25323829	USEP3941M
19179478	USEP3513M	25029709	USEP3912M	25323831	USEP3973M
19179480	USEP3553M	25029982	USEP3913M	25323833	USEP3537M
19179492	USEP3971M	25161064	USEP3919M	25323841	USEP3941M
19179493	USEP3563M	25162246	USEP3922M	25323841	USEP3948M
19179494	USEP3566M	25162373	USEP3978M	25323845	USEP3368M
19179495	USEP3566M	25163021	USEP3914M	25325702	USEP3537M
19179528	USEP3924M	25163219	USEP3921M	25325871	USEP3974M
19179591	USEP3992M	25163486	USEP3923M	25326140	USEP3568M
19179593	USEP3971M	25163487	USEP3920M	25326140	USEP3966M
19179595	USEP3551M	25163488	USEP3929M	25326141	USEP3551M
19179596	USEP3530M	25163489	USEP3925M	25326332	USEP3518M
19179597	USEP3534M	25163531	USEP3927M	25326334	USEP3518M
19179597	USEP3972M	25163533	USEP3928M	25326603	USEP3529M
19179615	USEP3925M	25164186	USEP3942M	25326814	USEP3519M
19179616	USEP3920M	25164521	USEP3924M	25329396	USEP3372M
19179617	USEP3938M	25166642	USEP3936M	25329424	USEP3539M
19179618	USEP3922M	25166648	USEP3938M	25329440	USEP3552M
19179619	USEP3927M	25166710	USEP3939M	25330716	USEP3518M
19179620	USEP3995M	25167249	USEP3995M	25330718	USEP3518M
19179622	USEP3928M	25168405	USEP3945M	25330970	USEP3919M
19179627	USEP3950M	25169302	USEP3508M	25331861	USEP3542M
19179818	USEP3591M	25169303	USEP3510M	25335914	USEP3533M
19179819	USEP3591M	25174013	USEP3976M	25335917	USEP3518M
19179979	USEP3916M	25174015	USEP3976M	25335918	USEP3536M
19179982	USEP3913M	25176789	USEP3992M	25335956	USEP3533M
19179984	USEP3923M	25176865	USEP3500M	25338726	USEP3563M
19180091	USEP3940M	25178123	USEP3969M	25338871	USEP3368M
19180094	USEP3939M	25178124	USEP3965M	25338963	USEP3974M
19180094	USEP3979M	25178125	USEP3968M	25344810	USEP3599M
19180098	USEP3941M	25178145	USEP3982M	25344812	USEP3530M
19180099	USEP3556M	25178729	USEP3943M	25344814	USEP3952M
19180101	USEP3554M	25178730	USEP3952M	25344816	USEP3954M
19180103	USEP3974M	25178731	USEP3953M	25344818	USEP3992M
19180104	USEP3974M	25178732	USEP3954M	25344820	USEP3506M
19180105	USEP3978M	25178736	USEP3940M	25344945	USEP3539M
19180106	USEP3980M	25179344	USEP3978M	25344953	USEP3518M
19180107	USEP3537M	25179345	USEP3979M	25344964	USEP3552M
19180109	USEP3542M	25179749	USEP3919M	25344968	USEP3519M
19180110	USEP3601M	25180273	USEP3980M	25345015	USEP3554M
19180114	USEP3536M	25312608	USEP3948M	25345017	USEP3555M
19180115	USEP3518M	25314319	USEP3962M	25345022	USEP3553M
19180115	USEP3533M	25314321	USEP3947M	25345024	USEP3556M
19180117	USEP3518M	25314323	USEP3947M	25345026	USEP3500M
19180118	USEP3372M	25314325	USEP3963M	25345028	USEP3501M
19180119	USEP3372M	25314327	USEP3972M	25347143	USEP3566M
19180120	USEP3976M	25314329	USEP3534M	25347145	USEP3569M
19180121	USEP3976M	25314333	USEP3994M	25347147	USEP3992M
19180124	USEP3539M	25314335	USEP3956M	25348313	USEP3971M
19180125	USEP3552M	25314337	USEP3957M	25348387	USEP3584M





# FUEL PUMP MODULES CROSS REFERENCE















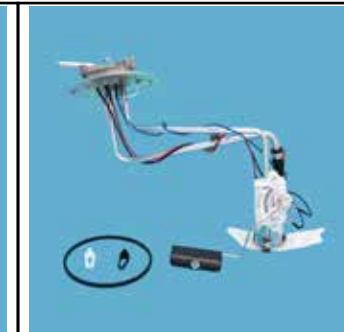





FUEL PUMP MODULES

General Motors (cont'd.)		Honda (cont'd.)		Isuzu (cont'd.)	
25348513	USEP3574M	17040-S04-L00	USEP8341H	8-25326-590-0	USEP8721M
25348517	USEP3674M	17040-S04-L01	USEP8341H	8-25333-229-0	USEP8484M
25348563	USEP3575M	17040-S10-A10	USEP8461S	8-25341-205-0	USEP8484M
25348566	USEP3602M	17040-S30-A30	USEP8365H	8-25341-208-0	USEP8483M
25349620	USEP3518M	17040-S30-A31	USEP8365H	8-25346-755-0	USEP8486M
25349626	USEP3518M	17040-S30-A50	USEP8372H	8-88967-148-0	USEP3707M
25351390	USEP3614M	17040-S30-L00	USEP8365H	8-94384-528-0	USEP8275H
25359055	USEP3566M	17040-S30-L00	USEP8372H	8-94384-528-1	USEP8275H
25360892	USEP3588M	17040-S30-L01	USEP8365H	8-94471-314-0	USEP8051H
25361136	USEP3587M	17040-S30-L01	USEP8372H	8-94471-315-0	USEP8051H
25361361	USEP3675M	17040-SH5-A30	USEP8321H	8-94471-617-1	USEP8078H
25361858	USEP3518M	17040-SH5-A30	USEP8325H	8-94473-950-1	USEP8078H
25361862	USEP3518M	17040-SK7-A70	USEP8334H	8-94479-418-1	USEP8275H
25369309	USEP3602M	17040-SL5-A30	USEP8331H	8-94479-418-2	USEP8275H
25369311	USEP3575M	17040-SR1-A31	USEP8338H	8-97013-922-1	USEP8321H
25679320	USEP3606M	17040-SR3-A31	USEP8338H	8-97016-142-1	USEP8078H
25756353	USEP3606M	17040-SS8-A02	USEP8353H	8-97019-185-0	USEP8078H
25764417	USEP3692M	17040-ST7-A32	USEP8345H	8-97019-185-1	USEP8078H
25764719	USEP3605M	17040-SR7-A33	USEP8345H	8-97019-186-1	USEP8078H
88957239	USEP3507M	17040-ST7-L00	USEP8341H	8-97019-187-0	USEP8051H
88963640	USEP3518M	17040-S77-L31	USEP8341H	8-97019-188-1	USEP8051H
88963641	USEP3518M	17040-SV1-A30	USEP8351H	8-97019-189-0	USEP8205H
88963648	USEP3518M	17040-SV1-A31	USEP8349H	8-97065-370-1	USEP8078H
88963649	USEP3536M	17040-SV1-A32	USEP8349H	8-97065-370-2	USEP8078H
88965371	USEP3609M	17040-SV1-L00	USEP8351H	8-97069-337-2	USEP8321H
88965372	USEP3609M	17040-SV1-L02	USEP8349H	8-97069-338-1	USEP8205H
88965373	USEP3500M	17040-SV4-A30	USEP8351H	8-98032-171-0	USEP8483M
88965391	USEP3609M	17040-SW5-A30	USEP8347H	8-98032-172-0	USEP8484M
88965395	USEP3702M	17040-SW5-A31	USEP8347H	8-98032-173-0	USEP8486M
88965398	USEP3700M	17040-SW5-A32	USEP8347H	89803-217-10	USEP8483M
88965399	USEP3679M	17040-SY8-A01	USEP8353H		
88965416	USEP3583M	17045-S3V-A01	USEP8657M	<b>Kia</b>	
88965437	USEP3604M	17045-S5A-A00	USEP8566M	0K2AA-13-35Z	USEP8393M
88965440	USEP3675M	17045-S9V-A00	USEP8657M	0K2DJ-13-35Z	USEP8421M
88965449	USEP3615M	17045-SCV-A00	USEP8654M	0K2NA-13-35Z	USEP8421M
88965550	USEP3701M	17045-SCV-A30	USEP8654M	0K24T-13-35Z	USEP8401H
88965557	USEP3610M	17045-SJC-A00	USEP8717M	0K24T-13-35ZA	USEP8401H
88965558	USEP3581M	17045-SNA-A00	USEP8723M	0K32A-13-35ZA	USEP8420M
88965564	USEP3717M	17045-SNA-A01	USEP8723M	0K52Y-13-35X	USEP8661M
88965573	USEP3506M	17708-SE0-013	USEP8269H	0K52Y-13-35XA	USEP8482M
88965802	USEP3705M	17708-SE0-020	USEP8269H	0K52Y-13-35Z	USEP8482M
88965808	USEP3692M	17708-SE0-935	USEP8324H	31110-3C500	USEP8673M
88965809	USEP3692M	17708-SE0-S30	USEP8324H	31110-FD500	USEP8636M
88965816	USEP3614M	17708-SF1-A06	USEP8269H	31150-3E200	USEP8520M
88966955	USEP3707M	17708-SF1-A31	USEP8328H	<b>Mazda</b>	
88966963	USEP3560M	17708-SF1-S07	USEP8269H	1F20-13-350D	USEP2293M
88966971	USEP3507M	17708-SF1-S30	USEP8328H	1F21-13-350B	USEP2269S
88967148	USEP3707M	17708-SH3-A30	USEP8325H	1F80-13-350	USEP2293M
88967292	USEP3507M	17708-SH3-A31	USEP8325H	1F80-13-350	USEP2363M
88967315	USEP3579M	17708-SH3-A34	USEP8321H	1F81-13-350	USEP2293M
88983262	USEP3615M	17708-SH3-A36	USEP8325H	1F81-13-350	USEP2363M
89047667	USEP3521M	17708-SH3-A42	USEP8321H	1FAA-13-350	USEP2363M
89047745	USEP3578M	17708-SH3-S02	USEP8321H	1FAC-13-350	USEP2363M
89047747	USEP3577M	17708-SH5-A30	USEP8321H	1FAC-13-350A	USEP2363M
89047748	USEP3577M	17708-SH5-A30	USEP8325H	1FBA-13-350	USEP2357M
89060193	USEP3542M	17708-SH5-A31	USEP8325H	1FBA-13-350	USEP2363M
89060194	USEP3601M	17708-SH5-S00	USEP8321H	AJ03-13-35XB	USEP2291M
92120576	USEP3611M	17708-SK7-A36	USEP8334H	AJ51-13-35Z	USEP8584M
94384528	USEP8275H	17708-SL5-A31	USEP8331H	KL12-13-350G	USEP2156H
		17708-SM4-A32	USEP8322H	KL12-13-350H	USEP2118H
				KL12-13-350H	USEP2156H
<b>Honda</b>		<b>Hyundai</b>		YF09-13-35XC	USEP2291M
8-25326-590-0	USEP8721M	31110-2C631	USEP8529M	ZZM5-13-350	USEP2106S
8-25331-808-0	USEP8397M	31110-26350	USEP8662M	ZZM5-13-350A	USEP2106S
8-25336-451-1	USEP8483M	<b>Isuzu</b>		ZZP0-13-350	USEP2207S
8-97069-336-1	USEP8078H	8-15050-444-0	USEP3549M	ZZP0-13-350A	USEP2207S
8-97118-512-0	USEP8078H	8-19177-238-0	USEP3952M	ZZP1-13-350	USEP2207S
1770A-SR0-A000	USEP8338H	8-19177-259-0	USEP3943M	ZZP1-13-350A	USEP2207S
17040-S01-A30	USEP8341H	8-25166-689-0	USEP8397M	ZZTT-13-35X	USEP2291M
17040-S01-A31	USEP8341H	8-25175-791-0	USEP3943M		
17040-S02-L00	USEP8341H	8-25178-729-0	USEP3943M	<b>Mercedes-Benz</b>	
17040-S02-L01	USEP8341H	8-25178-730-0	USEP3952M	203 470 23 94	USEP8475M
17040-S04-G30	USEP8341H	8-25318-879-0	USEP8397M	203 470 35 94	USEP8474M
17040-S04-G31	USEP8341H	8-25319-098-0	USEP8397M	209 470 01 94	USEP8531M
17040-S04-G40	USEP8341H	8-25326-588-0	USEP8721M	211 470 14 94	USEP8530M
17040-S04-G41	USEP8341H				

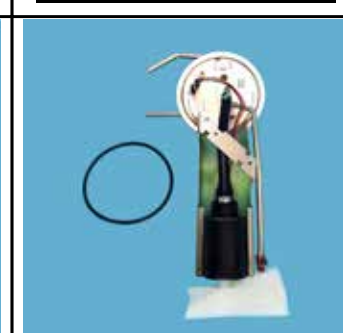
<b>Mercedes-Benz (cont'd.)</b>		<b>Toyota (cont'd.)</b>	
211 470 17 94	USEP8572M	77020-04070	USEP8756M
<b>Mitsubishi</b>		77020-04071	USEP8756M
5142 218AB	USEP7198M	<b>VOLKSWAGEN</b>	
5142 218AC	USEP7198M	1H0 919 651 P	USEP8244M
5142 218AE	USEP7198M	1H0 919 651 Q	USEP8394M
6802 4546AA	USEP7198M	1HM 919 051 J	USEP8366M
6802 4546AB	USEP7198M	1HM 919 051 M	USEP8366M
<b>Nissan</b>		1J0 919 051 J	USEP12050M
17040-3S500	USEP8378S	1J0 919 087 D	USEP12050M
17040-3S505	USEP8378S	1J0 919 087 G	USEP12050M
17040-3S510	USEP8378S	1J0 919 087 H	USEP12050M
17040-5S105	USEP8378S	1J0 919 087 J	USEP12050M
17040-7S000	USEP8595M	1K0 919 051 AP	USEP8833M
17040-7S00A	USEP8595M	1K0 919 051 AR	USEP8833M
17040-7Y000	USEP8545M	1K0 919 051 BH	USEP8833M
17040-8J000	USEP8496M	4B0 906 087 BF	USEP8564M
17040-8J005	USEP8496M	4B0 906 087 P	USEP8384M
17040-8J020	USEP8545M	4B0 906 089 A	USEP8564M
17040-8U000	USEP8502M	4D0 298 087	USEP8414M
17040-AC80A	USEP8534M	4D0 298 087 B	USEP8414M
17040-AC800	USEP8534M	4F0 919 051 AH	USEP8679M
17040-CA000	USEP8536M	4F0 919 051 AK	USEP8765M
17040-CD000	USEP8534M	4F0 919 051 AM	USEP8765M
17040-CD01A	USEP8534M	4F0 919 087 D	USEP8679M
17040-CD010	USEP8534M	4F0 919 087 F	USEP8765M
17040-CG000	USEP8540M	7L0 919 087 E	USEP8568M
17040-CG00B	USEP8540M	7L0 919 087 F	USEP8568M
17040-EA000	USEP8743M	7L6 919 087 F	USEP8568M
17040-EH11A	USEP8534M	7L6 919 087 G	USEP8568M
17040-EH110	USEP8534M	8D0 906 089	USEP8294M
17040-ET00A	USEP8752M	8D0 906 089 A	USEP8293M
17040-EV10A	USEP8534M	8E0 906 087 D	USEP8368M
17040-ZB00A	USEP8545M	8E0 906 087 E	USEP8384M
17040-ZD80B	USEP8545M	8E0 906 087 N	USEP8476M
17040-ZH000	USEP8595M	8E0 919 051 AG	USEP8476M
17040-ZP00A	USEP8743M	8E0 919 051 CJ	USEP8476M
17040-ZQ60A	USEP8595M	8E0 919 051 P	USEP8476M
17040-ZQ60B	USEP8595M	8L0 919 051 J	USEP8551M
17040-ZS00A	USEP8743M	8L0 919 051 N	USEP8551M
17040-ZZ00A	USEP8743M	357 906 091 A	USEP8245M
17041-5M015	USEP8427M	<b>Volvo</b>	
17042-5M010	USEP8427M	3531850-0	USEP8379M
17042-5M011	USEP8427M	9142957-0	USEP8379M
<b>Saab</b>		9480152-0	USEP8379M
12 75 7165	USEP8431M	30761742-0	USEP8635M
30 58 7015	USEP8426M	30794757-0	USEP8490M
30 58 7077	USEP8431M	30794758-0	USEP8490M
51 96 415	USEP8426M	31261127-0	USEP8635M
53 28 653	USEP8515M		
88 96 7148	USEP3707M		
<b>Subaru</b>			
42021 AE02A	USEP8596M		
42021 AE03A	USEP8518M		
42021 AE05A	USEP8600M		
42021 AE06A	USEP8600M		
42021 AE06B	USEP8600M		
42022 AE02B	USEP8600M		
<b>Suzuki</b>			
15100-57B00	USEP8238H		
15100-57B2V	USEP8238H		
15100-57B10	USEP8238H		
15100-58B00	USEP8238H		
15100-58B01	USEP8238H		
15100-61A01	USEP8238H		
15100-61A1V	USEP8238H		
15100-61A02	USEP8238H		
15100-65810	USEP8437M		
15100-65811	USEP8437M		
15100-65842	USEP8437M		
<b>Toyota</b>			
77020-0C061	USEP8694M		
77020-04060	USEP8757M		
77020-04061	USEP8757M		

<p><b>USEP2059MN</b></p>	<p><b>USEP2063M</b></p>	<p><b>USEP2064MN</b></p>	<p><b>USEP2076S</b></p>
<p><b>USEP2077S</b></p>	<p><b>USEP2078S</b></p>	<p><b>USEP2079S</b></p>	<p><b>USEP2080S</b></p>
<p><b>USEP2081S</b></p>	<p><b>USEP2082S</b></p>	<p><b>USEP2084H</b></p>	<p><b>USEP2090S</b></p>
<p><b>USEP2091S</b></p>	<p><b>USEP2093S</b></p>	<p><b>USEP2094S</b></p>	<p><b>USEP2095S</b></p>
<p><b>USEP2096S</b></p>	<p><b>USEP2097S</b></p>	<p><b>USEP2098S</b></p>	<p><b>USEP2100H</b></p>



			
<p>USEP2101S</p>	<p>USEP2102S</p>	<p>USEP2103S</p>	<p>USEP2104S</p>
			
<p>USEP2105S</p>	<p>USEP2106S</p>	<p>USEP2107S</p>	<p>USEP2108S</p>
			
<p>USEP2110H</p>	<p>USEP2115S</p>	<p>USEP2117S</p>	<p>USEP2120S</p>
			
<p>USEP2121H</p>	<p>USEP2122H</p>	<p>USEP2123S</p>	<p>USEP2131S</p>
			
<p>USEP2132S</p>	<p>USEP2133S</p>	<p>USEP2135S</p>	<p>USEP2136S</p>



USEP2141S



USEP2144S



USEP2147S

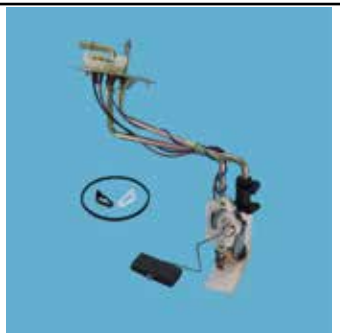

USEP2148S



USEP2149S



USEP2151H



USEP2153M



USEP2159M



USEP2164H



USEP2165M



USEP2181S



USEP2184M



USEP2185M



USEP2191H



USEP2192M



USEP2193M



USEP2197M



USEP2198M













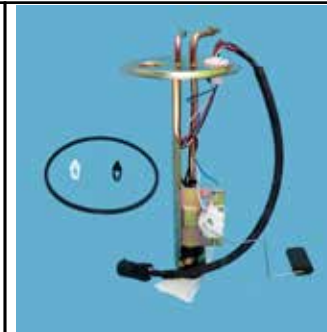







USEP2199M





















USEP2200M



			
<b>USEP2201S</b>	<b>USEP2203M</b>	<b>USEP2205S</b>	<b>USEP2206S</b>
			
<b>USEP2212S</b>	<b>USEP2213S</b>	<b>USEP2218M</b>	<b>USEP2220M</b>
			
<b>USEP2221S</b>	<b>USEP2227S</b>	<b>USEP2230M</b>	<b>USEP2235M</b>
			
<b>USEP2237S</b>	<b>USEP2238M</b>	<b>USEP2241S</b>	<b>USEP2243M</b>
			
<b>USEP2244M</b>	<b>USEP2245M</b>	<b>USEP2246M</b>	<b>USEP2248M</b>

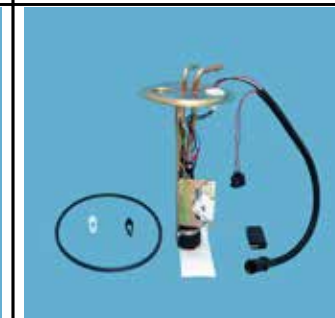

 USEP2249M	 USEP2252S	 USEP2266S	 USEP2272S
 USEP2273M	 USEP2280M	 USEP2281M	 USEP2282M
 USEP2283M	 USEP2285M	 USEP2287M	 USEP2288M
 USEP2290M	 USEP2291M	 USEP2293M	 USEP2294M
 USEP2295M	 USEP2296S	 USEP2297S	 USEP2298S



USEP2301M



USEP2313M

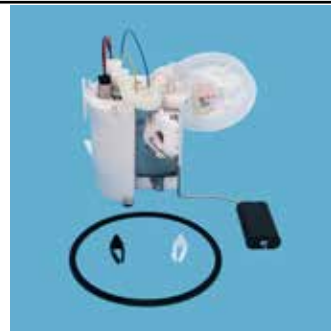

USEP2325M



USEP2326M



USEP2329M



USEP2330M



USEP2334M



USEP2336S



USEP2338M



USEP2344M



USEP2348M



USEP2349M



USEP2351M



USEP2352M



USEP2354M



USEP2356M



USEP2357M



USEP2358M



USEP2359M







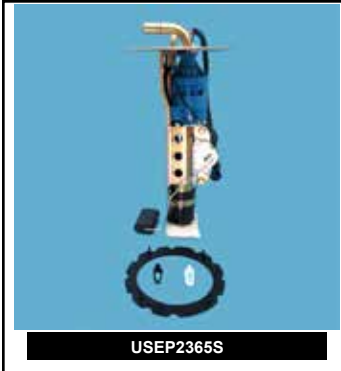

























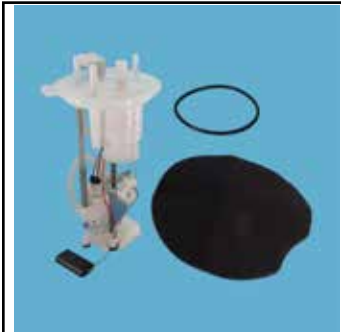









USEP2360M







			
<b>USEP2452M</b>	<b>USEP2453M</b>	<b>USEP2454M</b>	<b>USEP2455M</b>
			
<b>USEP2457M</b>	<b>USEP2459M</b>	<b>USEP2465M</b>	<b>USEP2467M</b>
			
<b>USEP2469M</b>	<b>USEP2470M</b>	<b>USEP2472M</b>	<b>USEP2474M</b>
			
<b>USEP2476M</b>	<b>USEP2493S</b>	<b>USEP2501M</b>	<b>USEP2506M</b>
			
<b>USEP2509M</b>	<b>USEP2525M</b>	<b>USEP2528M</b>	<b>USEP2529M</b>

			
<b>USEP2531M</b>	<b>USEP2533M</b>	<b>USEP2545M</b>	<b>USEP2557M</b>
			
<b>USEP2561M</b>	<b>USEP2562M</b>	<b>USEP2572M</b>	<b>USEP2578M</b>
			
<b>USEP2581M</b>	<b>USEP3368M</b>	<b>USEP3369M</b>	<b>USEP3371M</b>
			
<b>USEP3372M</b>	<b>USEP3500M</b>	<b>USEP3501M</b>	<b>USEP3506M</b>
			
<b>USEP3507M</b>	<b>USEP3508M</b>	<b>USEP3509M</b>	<b>USEP3510M</b>



USEP3511M



USEP3512M



USEP3513M



USEP3514M



USEP3518M



USEP3519M



USEP3520S



USEP3521M



USEP3522M



USEP3527M



USEP3529M



USEP3530M



USEP3533M



USEP3534M



USEP3536M



USEP3537M



USEP3539M



USEP3542M



USEP3543M



USEP3548M





USEP3549M



USEP3551M



USEP3552M



USEP3553M



USEP3554M



USEP3555M



USEP3556M



USEP3557M



USEP3558M



USEP3559M



USEP3560M



USEP3563M



USEP3564M



USEP3565M



USEP3566M



USEP3568M



USEP3569M























USEP3572M



USEP3573M























USEP3574M

			
<b>USEP3575M</b>	<b>USEP3580M</b>	<b>USEP3581M</b>	<b>USEP3583M</b>
			
<b>USEP3584M</b>	<b>USEP3585M</b>	<b>USEP3587M</b>	<b>USEP3588M</b>
			
<b>USEP3591M</b>	<b>USEP3592M</b>	<b>USEP3594M</b>	<b>USEP3598M</b>
			
<b>USEP3599M</b>	<b>USEP3602M</b>	<b>USEP3604M</b>	<b>USEP3605M</b>
			
<b>USEP3606M</b>	<b>USEP3609M</b>	<b>USEP3610M</b>	<b>USEP3611M</b>

<b>USEP3612M</b>	<b>USEP3614M</b>	<b>USEP3615M</b>	<b>USEP3616M</b>
<b>USEP3617M</b>	<b>USEP3621S</b>	<b>USEP3622S</b>	<b>USEP3624S</b>
<b>USEP3625S</b>	<b>USEP3626M</b>	<b>USEP3631S</b>	<b>USEP3632S</b>
<b>USEP3633S</b>	<b>USEP3637S</b>	<b>USEP3641S</b>	<b>USEP3642S</b>
<b>USEP3643S</b>	<b>USEP3650S</b>	<b>USEP3675M</b>	<b>USEP3678M</b>



			
<b>USEP3679M</b>	<b>USEP3681M</b>	<b>USEP3682M</b>	<b>USEP3684M</b>
			
<b>USEP3688M</b>	<b>USEP3691M</b>	<b>USEP3700M</b>	<b>USEP3702M</b>
			
<b>USEP3703M</b>	<b>USEP3705M</b>	<b>USEP3706M</b>	<b>USEP3707M</b>
			
<b>USEP3709M</b>	<b>USEP3711M</b>	<b>USEP3712M</b>	<b>USEP3715M</b>
			
<b>USEP3717M</b>	<b>USEP3718M</b>	<b>USEP3726M</b>	<b>USEP3732M</b>



USEP3737M



USEP3743S



USEP3746M



USEP3747M



USEP3748M



USEP3750M



USEP3752M



USEP3755M



USEP3757M



USEP3759M



USEP3760M



USEP3768M



USEP3769M



USEP3777M



USEP3782M



USEP3788M



USEP3790M











USEP3797M



USEP3801M



USEP3812M

			
<b>USEP3815M</b>	<b>USEP3817M</b>	<b>USEP3818M</b>	<b>USEP3820M</b>
			
<b>USEP3824M</b>	<b>USEP3834M</b>	<b>USEP3843M</b>	<b>USEP3905M</b>
			
<b>USEP3912M</b>	<b>USEP3913M</b>	<b>USEP3914M</b>	<b>USEP3917M</b>
			
<b>USEP3918M</b>	<b>USEP3919M</b>	<b>USEP3920M</b>	<b>USEP3921M</b>
			
<b>USEP3922M</b>	<b>USEP3923M</b>	<b>USEP3924M</b>	<b>USEP3925M</b>





**USEP3927M**



**USEP3929M**



**USEP3930M**



**USEP3932M**



**USEP3935M**



**USEP3937M**



**USEP3938M**



**USEP3939M**



**USEP3940M**



**USEP3941M**



**USEP3942M**



**USEP3943M**



**USEP3944M**



**USEP3945M**



**USEP3947M**



**USEP3948M**



**USEP3950M**

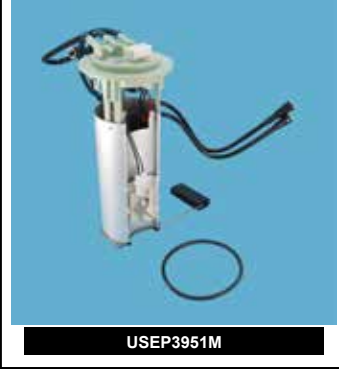

**USEP3951M**



**USEP3952M**



**USEP3953M**



USEP3954M



USEP3956M



USEP3957M



USEP3962M



USEP3963M



USEP3966M



USEP3967M



USEP3968M



USEP3971M



USEP3972M



USEP3973M



USEP3974M



USEP3976M



USEP3978M



USEP3979M



USEP3980M



USEP3994M



USEP3995M



USEP3996M



USEP4003M



USEP4034M



USEP4048M



USEP4056M



USEP7030M



USEP7040M



USEP7047M



USEP7048M



USEP7049M



USEP7050M



USEP7051S



USEP7054M



USEP7055M



USEP7056M



USEP7057M



USEP7062M



USEP7063M



USEP7065M



USEP7068H



USEP7069H



USEP7071H





USEP7073S



USEP7074H



USEP7075M



USEP7076M



USEP7077M



USEP7086M



USEP7087M



USEP7089M



USEP7091S



USEP7093M



USEP7094M



USEP7095M



USEP7096M



USEP7097M



USEP7099M



USEP7100M



USEP7101M



USEP7103M



USEP7104M



USEP7111M



USEP7113M



USEP7114M



USEP7115MN



USEP7116M



USEP7117M



USEP7121M



USEP7122M



USEP7123M



USEP7124M



USEP7125S



USEP7127M



USEP7127M



USEP7128M



USEP7129M



USEP7130M



USEP7137M



USEP7138M



USEP7141M



USEP7142M



USEP7143M

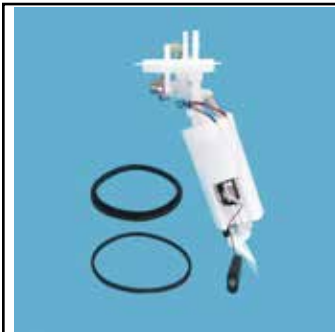

USEP7144M



USEP7146M



USEP7151M



USEP7152M



USEP7156M



USEP7158M



USEP7159M



USEP7160M



USEP7161M



USEP7162M



USEP7165M



USEP7167M



USEP7168M



USEP7169M



USEP7170M



USEP7171M



USEP7172M



USEP7173M



USEP7180M



USEP7181M





USEP7182M



USEP7184M



USEP7185M



USEP7186M



USEP7189M



USEP7191M



USEP7192M



USEP7194M



USEP7195M



USEP7196M



USEP7197M



USEP7198M



USEP7199M



USEP7200M



USEP7210M



USEP7213M



USEP7216M















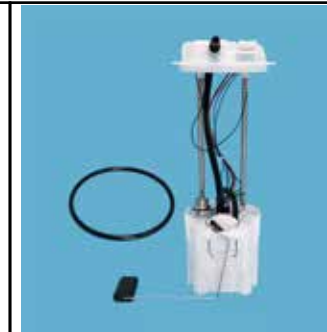



USEP7218M



USEP7219M



USEP7220M

			
<b>USEP7223M</b>	<b>USEP7234M</b>	<b>USEP7235M</b>	<b>USEP7237M</b>
			
<b>USEP7241M</b>	<b>USEP7243M</b>	<b>USEP7244M</b>	<b>USEP7245M</b>
			
<b>USEP7252M</b>	<b>USEP7253M</b>	<b>USEP7255M</b>	<b>USEP7269M</b>
			
<b>USEP7270M</b>	<b>USEP7271M</b>	<b>USEP7275M</b>	<b>USEP8138H</b>
			
<b>USEP8233M</b>	<b>USEP8234M</b>	<b>USEP8238H</b>	<b>USEP8244M</b>

			
<b>USEP8268S</b>	<b>USEP8269H</b>	<b>USEP8293M</b>	<b>USEP8294M</b>
			
<b>USEP8322H</b>	<b>USEP8324H</b>	<b>USEP8325H</b>	<b>USEP8338H</b>
			
<b>USEP8341H</b>	<b>USEP8349H</b>	<b>USEP8351H</b>	<b>USEP8366M</b>
			
<b>USEP8368M</b>	<b>USEP8379M</b>	<b>USEP8384M</b>	<b>USEP8393M</b>
			
<b>USEP8394M</b>	<b>USEP8397M</b>	<b>USEP8400M</b>	<b>USEP8408M</b>





USEP8412M



USEP8416M



USEP8420M



USEP8421M



USEP8427M



USEP8441S



USEP8442H

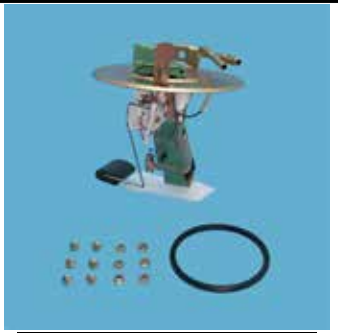

USEP8460S



USEP8461S



USEP8469M



USEP8474M



USEP8475M



USEP8476M



USEP8478M



USEP8482M



USEP8483M



USEP8488M



USEP8493M





















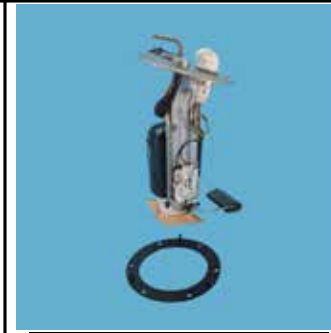

USEP8496M



USEP8498M









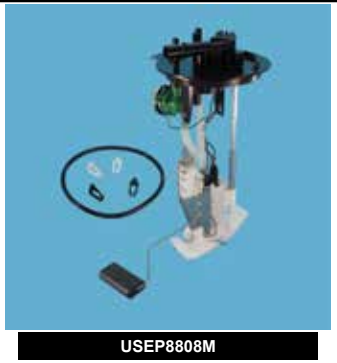













			
<b>USEP8588M</b>	<b>USEP8590M</b>	<b>USEP8591M</b>	<b>USEP8592M</b>
			
<b>USEP8594M</b>	<b>USEP8595M</b>	<b>USEP8596M</b>	<b>USEP8607M</b>
			
<b>USEP8633M</b>	<b>USEP8635M</b>	<b>USEP8637M</b>	<b>USEP8640M</b>
			
<b>USEP8642M</b>	<b>USEP8654M</b>	<b>USEP8655M</b>	<b>USEP8656M</b>
			
<b>USEP8657M</b>	<b>USEP8660M</b>	<b>USEP8661M</b>	<b>USEP8662M</b>



<b>USEP8663M</b>	<b>USEP8667M</b>	<b>USEP8668M</b>	<b>USEP8674M</b>
<b>USEP8677M</b>	<b>USEP8687M</b>	<b>USEP8688M</b>	<b>USEP8692M</b>
<b>USEP8693M</b>	<b>USEP8694M</b>	<b>USEP8707M</b>	<b>USEP8717M</b>
<b>USEP8720M</b>	<b>USEP8721M</b>	<b>USEP8723M</b>	<b>USEP8728M</b>
<b>USEP8730M</b>	<b>USEP8732M</b>	<b>USEP8737M</b>	<b>USEP8743M</b>



			
<b>USEP8869M</b>	<b>USEP8874M</b>	<b>USEP8878M</b>	<b>USEP8903M</b>
			
<b>USEP8922M</b>	<b>USEP8923M</b>	<b>USEP8924M</b>	<b>USEP8937M</b>
			
<b>USEP8943M</b>	<b>USEP8976M</b>	<b>USEP8994M</b>	<b>USEP9049M</b>
			
<b>USEP9073M</b>	<b>USEP9081M</b>	<b>USEP9120M</b>	<b>USEP9122M</b>
			
<b>USEP10546M</b>	<b>USEP10684M</b>	<b>USEP10693M</b>	<b>USEP12001M</b>





USEP12002M



USEP12003



USEP12006M



USEP12012M



USEP12013M



USEP12026M



USEP12028S



USEP12038M



USEP12039M



USEP12040M



USEP12050M



USEP12053M



USEP12096M



USEP12142M



USEP12147M



USEP12148M



USEP12210S



USEP12300M



# FUEL PUMP KITS

*Trusted by professionals around the world*

USMW Professional Series offers a wide range of fuel pump kits for import and domestic applications.



FUEL PUMP KITS



- **Designed to OE dimensions**
- **All items included for proper module rebuild**
- **100% functional tested**



Designed, tested and inspected in the USA



# FUEL PUMP KITS

***Trusted by professionals around the world***

## ***OE Style internal fuel pumps***



USMW uses OE style fuel pumps rather than less expensive turbine units (where applicable). This ensures quality and performance that meets or exceeds OE standards.

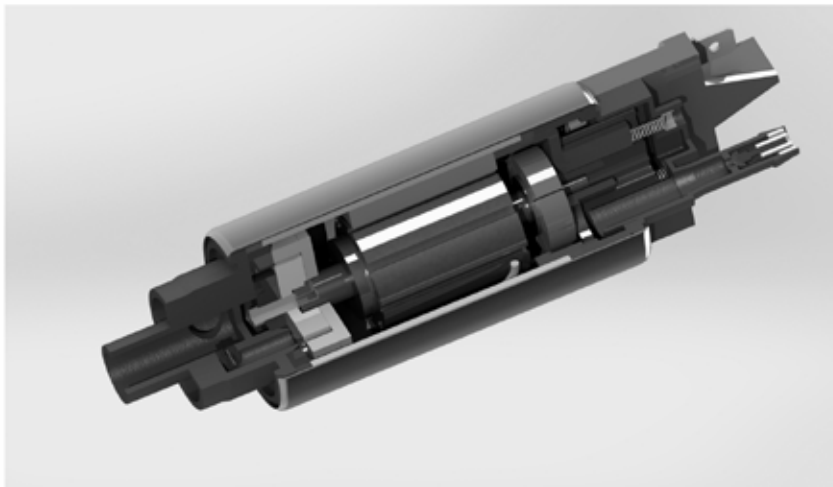

***New Wiring***

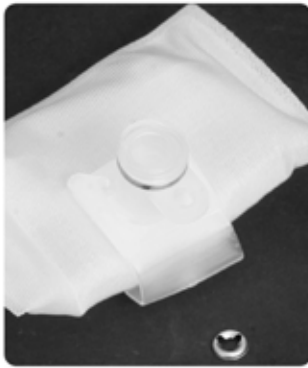

***New Strainer***



***New Fuel Lines***



USMW Professional Series fuel pump kits for Domestic and Import applications include all components required to rebuild your existing fuel pump module or hanger assembly. All fuel pump kits include strainers and are manufactured using quality components, wiring and gaskets. All units are manufactured using the highest quality raw materials that are compatible with today's fuel blends.



**Designed, tested and inspected in the USA**



Engine	Years	Application Description	USMW	Engine	Years	Application Description	USMW
<b>ACURA</b>				<b>AUDI (cont'd.)</b>			
<b>CL</b>				<b>80 QUATTRO</b>			
2.2L L4 2156cc	1997		USEP8229	2.3L L5 2309cc	1988-1989		USEP8146
2.3L L4 2254cc	1998-1999		USEP8229	2.3L L5 2309cc	1990-1992	External Pump	USEP8307
3.0L V6 2997cc	1997-1999		USEP8229	<b>90</b>			
<b>INTEGRA</b>				2.0L L4 1983cc	1988		USEP8146
1.6L L4 1590cc	1986-1989	External Pump	USEP8000	2.3L L5 2309cc	1988-1989		USEP8146
1.8L L4 1797cc	1994-1995	GS-R; (B18C1)	USEP8271	2.3L L5 2309cc	1990-1991	External Pump	USEP8307
1.8L L4 1797cc	1996	(B18C1)	USEP8335	2.8L V6 2771cc	1994	To Chassis 8C-R-030000	USEP8222
1.8L L4 1797cc	1998	(B18C5)	USEP8229	2.8L V6 2771cc	1994	from Chassis code 8c-r-030001	USEP8256
1.8L L4 1834cc	1990-1991	GS, LS, RS	USEP8119	2.8L V6 2771cc	1995		USEP8256
1.8L L4 1834cc	1994-1995	(B18B1)	USEP8335	<b>90 QUATTRO</b>			
1.8L L4 1834cc	1996-1997	(B18B1)	USEP8229	2.3L L5 2309cc	1988-1989		USEP8146
1.8L L4 1834cc	1999-2001	(B18B1)	USEP8229	2.3L L5 2309cc	1990-1991	External Pump	USEP8307
<b>LEGEND</b>				2.8L V6 2771cc	1993		USEP8222
2.5L V6 2494cc	1986-1987		USEP8023	2.8L V6 2771cc	1994	To Chassis/VIN 8C-R-030000	USEP8222
2.7L V6 2675cc	1987-1990		USEP8023	2.8L V6 2771cc	1994-1995		USEP8256
<b>MDX</b>				<b>100</b>			
3.5L V6 3471cc	2001-2002		USEP8335	2.3L L5 2309cc	1989	BOSCH ORIGINAL PUMP	USEP8348
3.5L V6 3471cc	2003-2004		USEP8513	2.8L V6 2771cc	1992-1993		USEP8222
<b>NSX</b>				2.8L V6 2771cc	1994		USEP8256
3.0L V6 2977cc	1991-1994		USEP8119	<b>100 QUATTRO</b>			
3.0L V6 2977cc	1995-1996	Base, T	USEP8119	2.3L L5 2309cc	1989	BOSCH ORIGINAL PUMP	USEP8348
3.0L V6 2977cc	1997-1999	Base, T; (C30A1)	USEP8119	2.8L V6 2771cc	1992		USEP8236
3.0L V6 2977cc	2000-2005	(C30A1)	USEP8119	2.8L V6 2771cc	1993		USEP8222
3.2L V6 3179cc	1997-1998	Base, T; (C32B1)	USEP8119	2.8L V6 2771cc	1994		USEP8256
3.2L V6 3179cc	1999	Alex Zanardi Edition, Base, T; (C32B1)	USEP8119	<b>200</b>			
3.2L V6 3179cc	2000-2005	(C32B1)	USEP8119	2.2L L5 2226cc	1989-1991	BOSCH ORIGINAL PUMP	USEP8348
<b>RL</b>				<b>200 QUATTRO</b>			
3.5L V6 3475cc	1996-1999		USEP8271	2.2L L5 2226cc	1989	BOSCH ORIGINAL PUMP	USEP8348
3.5L V6 3475cc	2000-2004		USEP8335	2.2L L5 2226cc	1991	BOSCH ORIGINAL PUMP	USEP8348
<b>SLX</b>				<b>4000</b>			
3.2L V6 3165cc	1996-1997		USEP8229	1.7L L4 1715cc	1981-1983		USEP8307
<b>TL</b>				1.8L L4 1780cc	1984		USEP8307
2.5L L5 2451cc	1995-1998		USEP8229	1.8L L4 1780cc	1985-1987	External Pump	USEP8307
3.2L V6 3206cc	1996-1998		USEP8229	<b>4000 QUATTRO</b>			
3.2L V6 3210cc	2004-2008		USEP8513	2.2L L5 2226cc	1984		USEP8307
<b>TSX</b>				2.2L L5 2226cc	1985-1987	External Pump	USEP8307
2.4L L4 2354cc 144 CID	2004-2008		USEP8513	<b>5000</b>			
<b>ALFA ROMEO</b>				2.2L L5 2144cc	1978-1983		USEP8307
<b>8C</b>				2.2L L5 2226cc	1985-1988	BOSCH ORIGINAL PUMP	USEP8348
4.7L V8 4691cc	2008		USEP8149	2.2L L5 2226cc	1987	PIERBURG ORIGINAL PUMP	USEP8390
<b>147</b>				2.3L L5 2309cc	1987-1988	BOSCH ORIGINAL PUMP	USEP8348
2.0L L4 1970cc 120 CID	2002	MEX	USEP12144	2.3L L5 2309cc	1987-1988	PIERBURG ORIGINAL PUMP	USEP8390
2.0L L4 1970cc 120 CID	2004-2005	MEX	USEP12144	<b>5000 QUATTRO</b>			
<b>156</b>				2.2L L5 2226cc	1986-1988	PIERBURG ORIGINAL PUMP	USEP8390
2.0L L4 1970cc 120 CID	2002	MEX	USEP12144	2.3L L5 2309cc	1987-1988	PIERBURG ORIGINAL PUMP	USEP8390
2.0L L4 1970cc 120 CID	2004	MEX	USEP12144	<b>A3</b>			
<b>164</b>				1.8L L4 1781cc	1999	MEX	USEP8244
3.0L V6 2959cc	1991		USEP8258	1.8L L4 1781cc	2000-2004	MEX	USEP12024
3.0L V6 2959cc	1993-1995		USEP8258	2.0L L4 1984cc 121 CID	2004-2005	MEX	USEP12024
<b>GTV-6</b>				<b>A4</b>			
2.5L V6 2492cc	1985-1986	External Pump	USEP8149	1.8L L4 1781cc	2007-2008	MEX	USEP12147
<b>MILANO</b>				1.8L L4 1781cc 109 CID	2011	MEX	USEP12147
2.5L V6 2492cc	1987-1989	External Pump	USEP8149	2.0L L4 1984cc 121 CID	2010-2011	MEX	USEP12147
3.0L V6 2959cc	1988-1989	External Pump	USEP8149	<b>A4 QUATTRO</b>			
<b>SPIDER</b>				2.0L L4 1984cc 121 CID	2011	MEX	USEP12147
2.0L L4 1961cc 120 CID	1985-1986	External Pump	USEP8149	<b>A6</b>			
2.0L L4 1961cc 120 CID	1988	External Pump	USEP8149	2.8L V6 2771cc	1995-1997		USEP8256
2.0L L4 1961cc 120 CID	1989-1991		USEP8149	<b>A6 QUATTRO</b>			
2.0L L4 1961cc 120 CID	1992-1994	External Pump	USEP8149	2.8L V6 2771cc	1995-1998		USEP8256
<b>AM GENERAL</b>				<b>CABRIOLET</b>			
<b>HUMMER</b>				2.8L V6 2771cc	1994	External Pump	USEP8307
5.7L V8 350 CID	1995-1996		USEP8149	2.8L V6 2771cc	1995	External Pump, From Chassis/VIN S-002-001	USEP8307
6.2L V8 379 CID	1992-1993	External Pump	USEP8149	2.8L V6 2771cc	1996-1998	External Pump	USEP8307
6.5L V8 395 CID	1994-1995	External Pump	USEP8149	<b>COUPE</b>			
6.5L V8 395 CID	1996-1998	Naturally Aspirated; External Pump	USEP8149	2.2L L5 2144cc	1982-1984		USEP8307
6.5L V8 395 CID	1996-1998	Turbocharged; External Pump	USEP8149	2.2L L5 2226cc	1985-1987	External Pump	USEP8307
6.5L V8 395 CID	1999-2001	External Pump	USEP8149	2.3L L5 2309cc	1987		USEP8146
<b>AUDI</b>				<b>COUPE QUATTRO</b>			
<b>80</b>				2.3L L5 2309cc	1990	BOSCH ORIGINAL PUMP	USEP8348
2.0L L4 1983cc	1988-1989		USEP8146	2.3L L5 2309cc	1991		USEP8222
2.0L L4 1983cc	1990	External Pump	USEP8307	<b>S4</b>			
2.3L L5 2309cc	1991-1992	External Pump	USEP8307	2.2L L5 2226cc	1992		USEP8236
				2.2L L5 2226cc	1992-1993		USEP8222



# FUEL PUMP KITS APPLICATION GUIDE



Engine	Years	Application Description	USMW	Engine	Years	Application Description	USMW
<b>AUDI (cont'd.)</b>				<b>BMW (cont'd.)</b>			
<b>S4 (cont'd.)</b>				<b>535I</b>			
2.2L L5 2226cc	1994		USEP8256		1989-1993		USEP8139
<b>S6</b>				3.5L L6 3430cc	1985-1988	External Pump	USEP7334
2.2L L5 2226cc	1995-1996		USEP8256	<b>535IS</b>			
<b>V8 QUATTRO</b>				3.5L L6 3430cc	1988	External Pump	USEP7334
3.6L V8 3562cc	1990-1991		USEP8256	<b>540I</b>			
4.2L V8 4172cc	1992-1994		USEP8256		1994-1995		USEP8278
<b>BMW</b>				<b>635CSI</b>			
<b>318I</b>				3.5L L6 3430cc	1985-1989	External Pump	USEP7334
1.8L L4 1766cc 107 CID	1985	External Pump	USEP7334	<b>735I</b>			
1.8L L4 1796cc	1992	External Pump	USEP7334		1987-1992		USEP8139
1.8L L4 1796cc	1992-1994	IN-TANK PUMP	USEP8233	3.5L L6 3430cc	1985-1986	External Pump	USEP7334
1.8L L4 1796cc	1995	in-tank pump	USEP8233	<b>735IL</b>			
1.9L L4 1895cc	1996-1998	IN-TANK PUMP	USEP8233		1988-1992		USEP8139
<b>318IS</b>				<b>740I</b>			
1.8L L4 1796cc	1991	1.45 inch pump diameter, Except for Bosch, Carter, and Delphi	USEP3240		1993-1994		USEP8278
1.8L L4 1796cc	1992-1995	IN-TANK PUMP	USEP8233		1995		USEP8287
1.9L L4 1895cc	1996-1997	IN-TANK PUMP	USEP8233		1997		USEP8287
<b>318TI</b>					1998-2001		USEP8385
1.8L L4 1796cc	1995	IN-TANK PUMP	USEP8233	<b>740IL</b>			
1.9L L4 1895cc	1996-1998	IN-TANK PUMP	USEP8233		1993-1994		USEP8278
<b>320I</b>					1995-1997		USEP8287
2.0L L4 1990cc 121 CID	1977-1978	in-line external	USEP8144		1998-2001		USEP8385
2.0L L4 1990cc 121 CID	1977-1978		USEP8185	<b>745I</b>			
2.0L L4 1990cc 121 CID	1978-1979	in-tank	USEP2485		2002-2005		USEP8488
<b>323CI</b>				<b>745LI</b>			
2.5L L6 2494cc 152 CID	2000	IN-TANK PUMP	USEP8233		2002-2005		USEP8488
<b>323I</b>				<b>750I</b>			
2.5L L6 2494cc 152 CID	1997	MEX; IN-TANK PUMP	USEP8233		2006		USEP8488
2.5L L6 2494cc 152 CID	1998-2000	IN-TANK PUMP	USEP8233	4.8L V8 4837cc	2007-2008	Base	USEP8488
2.5L L6 2494cc 152 CID	2001	MEX; IN-TANK PUMP	USEP8233	<b>750IL</b>			
<b>323IS</b>					1988-1994		USEP8132
2.5L L6 2494cc 152 CID	1998-1999	IN-TANK PUMP	USEP8233		1995-1997		USEP8287
<b>325</b>					1998	(M73)	USEP8385
2.7L L6 2693cc	1986-1988	External Pump	USEP7334		1998	(M73N)	USEP8385
<b>325E</b>					1999-2001		USEP8385
2.7L L6 2693cc	1985-1987	External Pump	USEP7334	<b>750LI</b>			
<b>325ES</b>					2006		USEP8488
2.7L L6 2693cc	1986-1987	External Pump	USEP7334	4.8L V8 4837cc	2007-2008	Base	USEP8488
<b>325I</b>				<b>850CI</b>			
2.5L L6 2494cc 152 CID	1987	External Pump	USEP7334		1993-1997		USEP8132
2.5L L6 2494cc 152 CID	1992-1993	External Pump	USEP7334	<b>850CSI</b>			
2.5L L6 2494cc 152 CID	1992-1994	IN-TANK PUMP	USEP8233		1994-1995		USEP8132
2.5L L6 2494cc 152 CID	1995	IN-TANK PUMP, To 01/95	USEP8233	<b>850I</b>			
2.5L L6 2494cc 152 CID	1996-1997	MEX; IN-TANK PUMP	USEP8233		1991-1992		USEP8132
2.5L L6 2494cc 152 CID	2005	IN-TANK PUMP	USEP8233	<b>L6</b>			
<b>325IS</b>				3.5L L6 3430cc	1987	External Pump	USEP7334
2.5L L6 2494cc 152 CID	1987	External Pump	USEP7334	<b>L7</b>			
2.5L L6 2494cc 152 CID	1991-1994	IN-TANK PUMP	USEP8233		1986-1987		USEP8139
2.5L L6 2494cc 152 CID	1995	IN-TANK PUMP, To 01/95	USEP8233	<b>M3</b>			
<b>328CI</b>				2.3L L4 2302cc	1988-1991	External Pump	USEP7334
2.8L L6 2793cc	2000	IN-TANK PUMP	USEP8233	3.0L L6 2990cc	1995	From 01/95, IN-TANK PUMP	USEP8233
<b>328I</b>				3.2L L6 3152cc	1996-1997	IN-TANK PUMP	USEP8233
2.8L L6 2793cc	1996-2000	IN-TANK PUMP	USEP8233	<b>M5</b>			
<b>328IS</b>					1991-1993		USEP8139
2.8L L6 2793cc	1996-1999	IN-TANK PUMP	USEP8233	3.5L L6 3453cc	1988	External Pump	USEP7334
<b>330CI</b>				<b>M6</b>			
3.0L L6 2979cc	2001-2003	IN-TANK PUMP	USEP8233	3.5L L6 3453cc	1987-1988	External Pump	USEP7334
<b>330I</b>				<b>Z3</b>			
3.0L L6 2979cc	2001-2003	IN-TANK PUMP	USEP8233	1.9L L4 1895cc	1996-1997	IN-TANK PUMP	USEP8233
<b>524TD</b>				2.8L L6 2793cc	1997	IN-TANK PUMP	USEP8233
2.4L L6 2443cc	1985-1986		USEP2324	<b>BUICK</b>			
<b>525I</b>				<b>CENTURY</b>			
	1989-1995		USEP8139	2.2L L4 2190cc 134 CID	1993	Single Inlet	USEP3290A
<b>525IT</b>				2.2L L4 2190cc 134 CID	1994-1996	DOUBLE INLET	USEP3290
	1993		USEP8139	2.2L L4 2190cc 134 CID	1994-1996	SINGLE INLET	USEP3290A
<b>528E</b>				2.5L L4 2474cc 151 CID	1985-1987		USEP3902
2.7L L6 2693cc	1985-1988	External Pump	USEP7334	2.5L L4 2474cc 151 CID	1988	Harness Stamped ARA	USEP3212
<b>530I</b>				2.5L L4 2474cc 151 CID	1988	Harness Stamped APH	USEP3902
	1994-1995		USEP8278	2.5L L4 2474cc 151 CID	1989-1990		USEP3212
				2.8L V6 173 CID	1987	Sedan; 1.45 inch pump diameter, Except for Bosch, Carter, and Delphi	USEP3240

Engine	Years	Application Description	USMW	Engine	Years	Application Description	USMW
<b>BUICK (cont'd.)</b>				<b>BUICK (cont'd.)</b>			
<b>CENTURY (cont'd.)</b>				<b>REGAL (cont'd.)</b>			
2.8L V6 173 CID	1987-1989	2 inch pump diameter	USEP3222	3.1L V6 189 CID	1989	1.45 inch pump diameter, Except for Bosch, Carter, and Delphi	USEP3240
2.8L V6 173 CID	1989	Sedan; 1.45 inch pump diameter, Except for Bosch, Carter, and Delphi	USEP3240	3.1L V6 189 CID	1989-1996		USEP3265
3.0L V6 181 CID	1984-1985		USEP3736	3.1L V6 189 CID	1990	1.45 inch pump diameter, Except for Bosch, Carter, and Delphi, Prom Stamped WEL,WER	USEP3240
3.1L V6 189 CID	1994-1996	DOUBLE INLET	USEP3290	3.1L V6 189 CID	1990	Prom Stamped WEJ (Prom Stamped WEM)	USEP3265
3.1L V6 189 CID	1994-1996	SINGLE INLET	USEP3290A	3.1L V6 189 CID	1991-1993	1.45 inch pump diameter	USEP3240
3.1L V6 189 CID	1998-1999		USEP3240R	3.1L V6 189 CID	1995-1996	1.45 inch pump diameter	USEP3240
3.3L V6 204 CID	1989-1990	2 inch pump diameter	USEP3222	3.8L V6 3800cc 231 CID	1985	Grand National, T-Type; (9), FI, GAS, Turbocharged	USEP3211
3.3L V6 204 CID	1989-1990	Sedan; 1.45 inch pump diameter, Except for Bosch, Carter, and Delphi	USEP3240	3.8L V6 3800cc 231 CID	1986	Grand National, T-Type; (7), FI, Turbocharged	USEP3211
3.3L V6 204 CID	1993	Single Inlet	USEP3290A	3.8L V6 3800cc 231 CID	1987	Grand National, Limited; (7), FI, Turbocharged	USEP3211
3.8L V6 3800cc 231 CID	1986-1988	Sedan; 1.45 inch pump diameter, Except for Bosch, Carter, and Delphi	USEP3240	3.8L V6 3800cc 231 CID	1990	1.45 inch pump diameter, Except for Bosch, Carter, and Delphi, Prom Stamped WEH,WEU	USEP3240
3.8L V6 3800cc 231 CID	1987-1988	2 inch pump diameter	USEP3222	3.8L V6 3800cc 231 CID	1990	Prom Stamped WEJ (Prom Stamped WEM)	USEP3265
4.3L V6 260 CID	1982		USEP8012SP	3.8L V6 3800cc 231 CID	1990-1996		USEP3265
<b>COMMERCIAL CHASSIS</b>				3.8L V6 3800cc 231 CID	1991-1993	1.45 inch pump diameter	USEP3240
	1993		USEP3268	3.8L V6 3800cc 231 CID	1995-1996	1.45 inch pump diameter	USEP3240
	1994-1996		USEP3270	3.8L V6 3800cc 231 CID	1996	Gran Sport, Olympic Gold Edition; (K)	USEP3210
<b>ELECTRA</b>				3.8L V6 3800cc 231 CID	1999	Naturally Aspirated	USEP3240R
3.0L V6 181 CID	1985		USEP3736	3.8L V6 3800cc 231 CID	1999	Supercharged	USEP3240R
3.8L V6 3800cc 231 CID	1986-1987	1.45 inch pump diameter, Except for Bosch, Carter, and Delphi	USEP3240	4.3L V6 260 CID	1982-1983		USEP8012SP
3.8L V6 3800cc 231 CID	1988	2 inch pump diameter, Harness Stamped CPB,CPC	USEP3222	4.3L V6 260 CID	1984	Base	USEP8012SP
		1.45 inch pump diameter, Except for Bosch, Carter, and Delphi, Harness Stamped HEL,HEM	USEP3240	4.3L V6 260 CID	1985	Limited	USEP8012SP
3.8L V6 3800cc 231 CID	1989	2 inch pump diameter	USEP3222	5.7L V8 350 CID	1985	Base; (N), DIESEL, FI, Naturally Aspirated; External Pump	USEP3076
<b>LESABRE</b>				5.7L V8 350 CID	1985	Base	USEP8012SP
3.0L V6 181 CID	1986	1.45 inch pump diameter, Except for Bosch, Carter, and Delphi	USEP3240	<b>RIVIERA</b>			
3.8L V6 3800cc 231 CID	1986-1987	1.45 inch pump diameter, Except for Bosch, Carter, and Delphi	USEP3240	3.8L V6 3800cc 231 CID	1984	1.45 inch pump diameter	USEP3240
3.8L V6 3800cc 231 CID	1988	1.45 inch pump diameter, Except for Bosch, Carter, and Delphi, Harness Stamped CPB,CPC	USEP3240	3.8L V6 3800cc 231 CID	1985	Luxury, T-Type; (9), FI, GAS, Turbocharged	USEP3211
3.8L V6 3800cc 231 CID	1988-1989	2 inch pump diameter, Harness Stamped CPB,CPC	USEP3222	3.8L V6 3800cc 231 CID	1986-1988	1.45 inch pump diameter, Except for Bosch, Carter, and Delphi	USEP3240
3.8L V6 3800cc 231 CID	1989	1.45 inch pump diameter, Except for Bosch, Carter, and Delphi, Harness Stamped CPK,CPV	USEP3240	3.8L V6 3800cc 231 CID	1989-1993	1.45 inch pump diameter	USEP3240
3.8L V6 3800cc 231 CID	1990-1992	2 inch pump diameter	USEP3222	3.8L V6 3800cc 231 CID	1990-1993		USEP3265
3.8L V6 3800cc 231 CID	1993-1994	Custom, Limited	USEP3305	3.8L V6 3800cc 231 CID	1996-1997	Supercharged	USEP3240R
3.8L V6 3800cc 231 CID	1994	DOUBLE INLET, Harness Stamped CRC	USEP3290	3.8L V6 3800cc 231 CID	1998-1999		USEP3240R
3.8L V6 3800cc 231 CID	1994	Harness Stamped CRC, SINGLE INLET	USEP3290A	5.7L V8 350 CID	1984	Luxury	USEP8012SP
3.8L V6 3800cc 231 CID	1995-1999	DOUBLE INLET	USEP3290	5.7L V8 350 CID	1985	Luxury; (N), DIESEL, FI, Naturally Aspirated; External Pump	USEP3076
3.8L V6 3800cc 231 CID	1995-1999	SINGLE INLET	USEP3290A	5.7L V8 350 CID	1985	Base	USEP8012SP
5.7L V8 350 CID	1984	Custom, Limited	USEP8012SP	<b>ROADMASTER</b>			
5.7L V8 350 CID	1985	Custom, Estate Wagon, Limited; (N), DIESEL, FI; External Pump	USEP3076		1991		USEP3268
5.7L V8 350 CID	1985	Estate Wagon	USEP8012SP		1993	Estate Wagon, Limited	USEP3268
<b>PARK AVENUE</b>					1994-1995	Estate Wagon, Limited	USEP3270
	2000	Supercharged; To Chassis/VIN Y4120914	USEP3240R		1996	Estate Wagon Collector's Edition, Limited Collector's Edition	USEP3270
	2001	Ultra; Supercharged	USEP3240R	<b>SKYHAWK</b>			
	2003	Ultra; Supercharged	USEP3240R	1.8L L4 112 CID	1985-1986	Turbocharged; 1.45 inch pump diameter, Except for Bosch, Carter, and Delphi	USEP3240
	2005	Ultra; Supercharged	USEP3240R	1.8L L4 112 CID	1985-1986		USEP3902
3.8L V6 3800cc 231 CID	1991-1992	2 inch pump diameter	USEP3222	2.0L L4 122 CID	1985-1986		USEP3902
3.8L V6 3800cc 231 CID	1991-1995	Ultra; (1), Supercharged	USEP3285	2.0L L4 122 CID	1987	Turbocharged; 1.45 inch pump diameter, Except for Bosch, Carter, and Delphi	USEP3240
3.8L V6 3800cc 231 CID	1993-1994	Base; (L), Naturally Aspirated	USEP3305	2.0L L4 122 CID	1987	TBI	USEP3902
3.8L V6 3800cc 231 CID	1994	DOUBLE INLET, Harness Stamped CRC	USEP3290	2.0L L4 122 CID	1987-1989		USEP3212
3.8L V6 3800cc 231 CID	1994	Naturally Aspirated; Harness Stamped CRC, SINGLE INLET	USEP3290A	3.8L V6 3800cc 231 CID	1978-1980		USEP3736
3.8L V6 3800cc 231 CID	1995	DOUBLE INLET	USEP3290	<b>SKYLARK</b>			
3.8L V6 3800cc 231 CID	1995	Naturally Aspirated; SINGLE INLET	USEP3290A	2.3L L4 138 CID	1988	1.45 inch pump diameter, Except for Bosch, Carter, and Delphi	USEP3240
3.8L V6 3800cc 231 CID	1996	Naturally Aspirated	USEP3290A	2.3L L4 138 CID	1990-1992	1.45 inch pump diameter	USEP3240
3.8L V6 3800cc 231 CID	1997-1999		USEP3240R	2.3L L4 138 CID	1994-1995		USEP3313
<b>RAINIER</b>				2.4L L4 2392cc 146 CID	1996	Custom, Olympic Gold Edition	USEP3240R
4.2L L6 256 CID	2005-2007 (S)		USEP3707	2.4L L4 2392cc 146 CID	1997	Custom, Limited	USEP3240R
<b>REATA</b>				2.5L L4 2474cc 151 CID	1984		USEP3901
3.8L V6 3800cc 231 CID	1988-1989	1.45 inch pump diameter, Except for Bosch, Carter, and Delphi	USEP3240	2.5L L4 2474cc 151 CID	1985	Custom, Limited; (R), FI	USEP3901
3.8L V6 3800cc 231 CID	1990-1991	1.45 inch pump diameter	USEP3240	2.5L L4 2474cc 151 CID	1986-1987		USEP3902
3.8L V6 3800cc 231 CID	1990-1991		USEP3265	2.5L L4 2474cc 151 CID	1988-1991		USEP3212
<b>REGAL</b>				2.8L V6 173 CID	1985	FI; 1.45 inch pump diameter, Except for Bosch, Carter, and Delphi	USEP3240
	1997-1998	GS; Supercharged	USEP3240R	3.0L V6 181 CID	1986-1988	1.45 inch pump diameter, Except for Bosch, Carter, and Delphi	USEP3240
	1998	LS; Naturally Aspirated	USEP3240R	3.1L V6 189 CID	1994-1995		USEP3313
2.8L V6 173 CID	1988	1.45 inch pump diameter, Except for Bosch, Carter, and Delphi, Prom Stamped WEC07	USEP3240	3.1L V6 189 CID	1996	Custom, Gran Sport, Olympic Gold Edition	USEP3240R
2.8L V6 173 CID	1989	1.45 inch pump diameter, Except for Bosch, Carter, and Delphi	USEP3240	3.1L V6 189 CID	1997	Custom, Gran Sport, Limited	USEP3240R
				3.1L V6 189 CID	1998		USEP3240R
				3.3L V6 204 CID	1989-1992	1.45 inch pump diameter	USEP3240



Engine	Years	Application Description	USMW	Engine	Years	Application Description	USMW
<b>BUICK (cont'd.)</b>				<b>CADILLAC (cont'd.)</b>			
<b>SOMERSET</b>				<b>ESCALADE (cont'd.)</b>			
2.5L L4 2474cc 151 CID	1986-1987		USEP3902	5.7L V8 350 CID	2000		USEP3240R
3.0L V6 181 CID	1986-1987	1.45 inch pump diameter, Except for Bosch, Carter, and Delphi	USEP3240	<b>FLEETWOOD</b>			
<b>SOMERSET REGAL</b>					1993	Brougham	USEP3268
2.5L L4 2474cc 151 CID	1985		USEP3902	1994	Brougham	USEP3270	
3.0L V6 181 CID	1985	1.45 inch pump diameter, Except for Bosch, Carter, and Delphi	USEP3240	1995	Brougham	USEP3210	
<b>CADILLAC</b>				1996	Brougham	USEP3270	
<b>60 SPECIAL</b>				1986	Harness Stamped CPG	USEP3212	
4.9L V8 300 CID	1993	2 inch pump diameter	USEP3222	1986	75 Formal, Base; (8), FI; Harness Stamped HEF	USEP3902	
<b>ALLANTE</b>				1987		USEP3212	
	1993		USEP3307	1988-1989		USEP3212	
4.1L V8 250 CID	1987	1.45 inch pump diameter, Except for Bosch, Carter, and Delphi	USEP3240	4.9L V8 300 CID	1992	2 inch pump diameter	USEP3222
4.1L V8 250 CID	1988	1.45 inch pump diameter	USEP3240	5.7L V8 350 CID	1984	Brougham	USEP8012SP
4.1L V8 250 CID	1988		USEP3265	<b>SEVILLE</b>			
4.5L V8 273 CID	1989-1992	1.45 inch pump diameter	USEP3240		1994	SLS; (Y); Fuel Sender Stamped EPT,EPW	USEP3307
4.5L V8 273 CID	1989-1992		USEP3265	4.1L V8 250 CID	1985	(8), GAS	USEP3901
<b>BROUGHAM</b>				4.1L V8 250 CID	1986-1987		USEP3212
5.0L V8 305 CID	1991	(E)	USEP3567	4.5L V8 273 CID	1988-1989		USEP3212
5.0L V8 305 CID	1992		USEP3902	4.5L V8 273 CID	1990	1.45 inch pump diameter	USEP3240
5.7L V8 350 CID	1990	(7), FI	USEP3567	4.5L V8 273 CID	1990		USEP3265
5.7L V8 350 CID	1991	(7)	USEP3567	4.6L V8 281 CID	1993	STS; (9)	USEP3307
<b>CATERA</b>				4.9L V8 300 CID	1991-1992	1.45 inch pump diameter	USEP3240
	1997-2001		USEP3964	4.9L V8 300 CID	1991-1992		USEP3265
<b>CIMARRON</b>				4.9L V8 300 CID	1993	Base; (B)	USEP3307
2.0L L4 122 CID	1984		USEP3901	5.7L V8 350 CID	1984	Base, Elegante	USEP8012SP
2.0L L4 122 CID	1985	Digital Instrument Cluster	USEP3902	5.7L V8 350 CID	1985	(N), DIESEL; External Pump	USEP3076
2.0L L4 122 CID	1986		USEP3902	5.7L V8 350 CID	1985	Elegante	USEP8012SP
2.8L V6 173 CID	1985-1988	1.45 inch pump diameter, Except for Bosch, Carter, and Delphi	USEP3240	<b>CHEVROLET</b>			
<b>COMMERCIAL CHASSIS</b>				<b>ASTRA</b>			
4.1L V8 250 CID	1994-1996		USEP3270	1.8L L4 1796cc 110 CID	2000-2003	MEX	USEP12026
4.5L V8 273 CID	1988-1989		USEP3212	1.8L L4 1796cc 110 CID	2007-2008	MEX	USEP12143
4.9L V8 300 CID	1992-1993	2 inch pump diameter	USEP3222	2.0L L4 1999cc 122 CID	2004-2006	MEX	USEP12026
5.7L V8 350 CID	1992		USEP3902	2.0L L4 1999cc 122 CID	2007-2008	MEX	USEP12143
5.7L V8 350 CID	1993	(7)	USEP3268	2.2L L4 2198cc 134 CID	2001-2002	MEX	USEP12026
<b>DEVILLE</b>				<b>ASTRO</b>			
4.1L V8 250 CID	1984		USEP3901		1992-1994	(W)	USEP3270
4.1L V8 250 CID	1985	(8), GAS	USEP3567		1995-1996		USEP3270
4.1L V8 250 CID	1986	Harness Stamped CPG	USEP3212	2.5L L4 2474cc 151 CID	1987-1990	(E)	USEP3902
4.1L V8 250 CID	1986	Harness Stamped HEF	USEP3902	4.3L V6 262 CID	1987-1990	(Z)	USEP3902
4.1L V8 250 CID	1987		USEP3212	4.3L V6 262 CID	1990	(B)	USEP3902
4.3L V6 260 CID	1985	(T), DIESEL; Exc.External EGR Valve, External Pump	USEP3073	4.3L V6 262 CID	1991		USEP3902
4.3L V6 260 CID	1985	(T), DIESEL; External EGR Valve, External Pump	USEP3076	4.3L V6 262 CID	1992-1994	(Z)	USEP3902
4.3L V6 260 CID	1985	Base, Cabriolet	USEP8012SP	4.3L V6 262 CID	1997-1999		USEP3240R
4.5L V8 273 CID	1988-1989		USEP3212	<b>B60</b>			
4.6L V8 281 CID	1994	Concours; (Y); Fuel Sender Stamped EPT,EPW	USEP3307	6.0L V8 366 CID	1988-1989		USEP2486
4.6L V8 4565cc 279 CID	1996	MEX	USEP3222	<b>BERETTA</b>			
4.9L V8 300 CID	1991-1992	2 inch pump diameter	USEP3222	2.0L L4 122 CID	1987		USEP3212
4.9L V8 300 CID	1993	MEX	USEP3222	2.0L L4 122 CID	1988	From Chassis/VIN 500001	USEP3212
4.9L V8 300 CID	1994	Base; (B); Fuel Sender Stamped EPT,EPW	USEP3307	2.0L L4 122 CID	1988	To Chassis/VIN 500000	USEP3212
5.7L V8 350 CID	1984	Base	USEP8012SP	2.0L L4 122 CID	1989		USEP3212
<b>ELDORADO</b>				2.2L L4 2190cc 134 CID	1992	1.45 inch pump diameter	USEP3240
	1994	Base; (Y); Fuel Sender Stamped EPT,EPW	USEP3307	2.2L L4 2190cc 134 CID	1993-1995		USEP3313
	1994	Touring; (9); Fuel Sender Stamped EPT,EPW	USEP3307	2.3L L4 140 CID	1992	1.45 inch pump diameter	USEP3240
4.1L V8 250 CID	1984		USEP3901	2.3L L4 140 CID	1992		USEP3265
4.1L V8 250 CID	1985	Biarritz, Touring; (8), GAS	USEP3901	2.3L L4 140 CID	1993-1994		USEP3313
4.1L V8 250 CID	1986-1987		USEP3212	2.8L V6 173 CID	1987	1.45 inch pump diameter, Except for Bosch, Carter, and Delphi	USEP3240
4.5L V8 273 CID	1988-1989		USEP3212	2.8L V6 173 CID	1988	1.45 inch pump diameter, Except for Bosch, Carter, and Delphi, To Chassis/VIN 500000	USEP3240
4.5L V8 273 CID	1990	1.45 inch pump diameter	USEP3240	2.8L V6 173 CID	1988-1989		USEP3265
4.5L V8 273 CID	1990		USEP3265	2.8L V6 173 CID	1989	1.45 inch pump diameter	USEP3240
4.6L V8 281 CID	1993	Sport; (Y)	USEP3307	3.1L V6 189 CID	1990-1992		USEP3265
4.6L V8 281 CID	1993	Touring; (9)	USEP3307	3.1L V6 189 CID	1992	1.45 inch pump diameter	USEP3240
4.9L V8 300 CID	1991-1992	1.45 inch pump diameter	USEP3240	3.1L V6 189 CID	1993-1995		USEP3313
4.9L V8 300 CID	1991-1992		USEP3265	<b>BLAZER</b>			
4.9L V8 300 CID	1993	Base; (B)	USEP3307	4.3L V6 262 CID	2002	2 Doors	USEP3240R
5.7L V8 350 CID	1984	Cabriolet, Touring	USEP8012SP	4.3L V6 262 CID	2002	4 Doors; (1st Design)	USEP3240R
5.7L V8 350 CID	1985	Touring; (N), DIESEL; External Pump	USEP3076	4.3L V6 262 CID	2002	4 Doors; (2nd Design)	USEP3240R
5.7L V8 350 CID	1985	Touring	USEP8012SP	4.3L V6 262 CID	2003-2004	4 Doors	USEP3240R
<b>ESCALADE</b>				5.0L V8 305 CID	1987	(H), GAS	USEP3902
5.7L V8 350 CID	1999	Exc.Radio Frequency Interference Filter	USEP3240R	5.7L V8 350 CID	1987-1991	(K), GAS	USEP3902
5.7L V8 350 CID	1999	Radio Frequency Interference Filter	USEP3240R	5.7L V8 350 CID	1992-1993		USEP3902
				5.7L V8 350 CID	1994	(K), GAS, Naturally Aspirated	USEP3902
				6.5L V8 395 CID	1994	(S), DIESEL, Turbocharged; External Pump	USEP3309
				<b>C35</b>			
				5.7L V8 350 CID	1998-1999	MEX	USEP3956

Engine	Years	Application Description	USMW	Engine	Years	Application Description	USMW
<b>CHEVROLET (cont'd.)</b>				<b>CHEVROLET (cont'd.)</b>			
<b>C60</b>				<b>CAMARO (cont'd.)</b>			
6.0L V8 366 CID	1988-1989		USEP2486	3.8L V6 3800cc 231 CID	1996-1997		USEP3983
<b>C70</b>				3.8L V6 3800cc 231 CID	1997	MEX	USEP3907
6.0L V8 366 CID	1988-1989		USEP2486	3.8L V6 3800cc 231 CID	1998		USEP3745
7.0L V8 427 CID	1988-1989		USEP2486	3.8L V6 3800cc 231 CID	1999-2002		USEP3240R
<b>C1500</b>				5.0L V8 305 CID	1986	Berlinetta, Iroc-Z, Sport; (H), CAN, CARB	USEP3903
4.3L V6 262 CID	1988-1989	(Z), GAS	USEP3902	5.0L V8 305 CID	1986	Berlinetta, Iroc-Z, Sport; (H), CARB, USA	USEP3903
4.3L V6 262 CID	1990	WT; (Z), GAS	USEP3567	5.0L V8 305 CID	1986	Iroc-Z, Z28; (G), CAN, CARB	USEP3903
4.3L V6 262 CID	1991	(Z), GAS	USEP3567	5.0L V8 305 CID	1986	Iroc-Z, Z28; (G), CARB, USA	USEP3903
5.0L V8 305 CID	1988-1989	(H), GAS	USEP3902	5.0L V8 305 CID	1986-1987	Iroc-Z, Z28; (F), CAN, FI	USEP3210
5.0L V8 305 CID	1990	WT; (H), GAS	USEP3567	5.0L V8 305 CID	1986-1987	Iroc-Z, Z28; (F), FI, USA	USEP3210
5.0L V8 305 CID	1991	(H), GAS	USEP3567	5.0L V8 305 CID	1990	Iroc-Z; (F)	USEP3210
5.7L V8 350 CID	1988-1989	(K), GAS	USEP3902	5.0L V8 305 CID	1990-1991	RS; (E)	USEP3902
5.7L V8 350 CID	1990	WT; (K), GAS	USEP3567	5.0L V8 305 CID	1991	Z28; (F)	USEP3210
5.7L V8 350 CID	1991	(K), GAS	USEP3567	5.0L V8 305 CID	1992	Z28 Heritage Edition; (F)	USEP3210
6.2L V8 379 CID	1988-1989	(C), DIESEL; External Pump	USEP3158	5.0L V8 305 CID	1992	RS Heritage Edition; (E)	USEP3902
6.2L V8 379 CID	1990-1991	WT; (C), DIESEL; External Pump	USEP3158	5.7L V8 350 CID	1987	Iroc-Z; (8), CAN, FI	USEP3210
7.4L V8 454 CID	1990	WT; (N), GAS	USEP3567	5.7L V8 350 CID	1987	Iroc-Z; (8), FI, USA	USEP3210
7.4L V8 454 CID	1991	(N), GAS	USEP3567	5.7L V8 350 CID	1990	Iroc-Z; (8)	USEP3210
<b>C1500 SUBURBAN</b>				5.7L V8 350 CID	1991	Z28; (8)	USEP3210
5.7L V8 350 CID	1992-1994		USEP3902	5.7L V8 350 CID	1992	Z28 Heritage Edition; (8)	USEP3210
5.7L V8 350 CID	1995	(K), GAS, Naturally Aspirated	USEP3902	5.7L V8 350 CID	1993-1994	Z28; (P)	USEP3908
5.7L V8 350 CID	1996-1997	(R), GAS, Naturally Aspirated	USEP3270	5.7L V8 350 CID	1995	MEX	USEP3908
5.7L V8 350 CID	1998-1999	GAS, Naturally Aspirated	USEP3240R	5.7L V8 350 CID	1998	Z28, Z28 SS; (G)	USEP3961
6.5L V8 395 CID	1995-1998	(F), DIESEL, Turbocharged; External Pump	USEP3309	<b>CAPRICE</b>			
6.5L V8 395 CID	1999	(F), DIESEL, Turbocharged; External Pump	USEP3540	4.3L V6 262 CID	1985	Classic; (Z), FI, GAS	USEP3902
<b>C2500</b>				4.3L V6 262 CID	1986	Base, Classic Brougham; (Z), FI; Harness Stamped BEB	USEP3902
4.3L V6 262 CID	1988-1989	(Z), GAS	USEP3902	4.3L V6 262 CID	1986	Base, Classic Brougham; (Z), FI; Harness Stamped BEG	USEP3902
4.3L V6 262 CID	1990-1991	(Z), GAS	USEP3567	4.3L V6 262 CID	1987-1988	Base, Classic, Classic LS Brougham; (Z), FI	USEP3902
4.3L V6 262 CID	1992	(Z), GAS, Naturally Aspirated	USEP3902	4.3L V6 262 CID	1989	Base, Classic; (Z), FI	USEP3902
5.0L V8 305 CID	1988-1989	(H), GAS	USEP3902	4.3L V6 262 CID	1990	Base, Classic; (Z), FI	USEP3901
5.0L V8 305 CID	1990-1991	(H), GAS	USEP3567	4.3L V6 262 CID	1993	Classic; (Z)	USEP3268
5.0L V8 305 CID	1992	(H), GAS, Naturally Aspirated	USEP3902	4.3L V8 265 CID	1996	(W)	USEP3210
5.7L V8 350 CID	1988-1989	(K), GAS	USEP3902	5.0L V8 305 CID	1989-1990	Base, Classic, Classic LS Brougham; (E), FI	USEP3902
5.7L V8 350 CID	1990-1991	(K), GAS	USEP3567	5.0L V8 305 CID	1991-1992	Classic, Classic LTZ; (E)	USEP3268
5.7L V8 350 CID	1992	(K), GAS, Naturally Aspirated	USEP3902	5.0L V8 305 CID	1993	Classic, Classic LS; (E)	USEP3268
6.2L V8 379 CID	1988-1991	(C), DIESEL; External Pump	USEP3158	5.7L V8 350 CID	1985	Classic; (N), DIESEL, FI; External Pump	USEP3076
6.2L V8 379 CID	1989-1991	(J), DIESEL; External Pump	USEP3158	5.7L V8 350 CID	1985	Classic	USEP8012SP
6.2L V8 379 CID	1992	(C), DIESEL, Naturally Aspirated; External Pump	USEP3158	5.7L V8 350 CID	1989-1990	Base; (7), FI	USEP3902
6.2L V8 379 CID	1992	(J), DIESEL, Naturally Aspirated; External Pump	USEP3158	5.7L V8 350 CID	1991-1992	Classic, Classic LTZ; (7)	USEP3268
6.5L V8 395 CID	1992	(F), DIESEL, Turbocharged; External Pump	USEP3158	5.7L V8 350 CID	1993	Classic LTZ; (7)	USEP3268
7.4L V8 454 CID	1991	(N), GAS	USEP3567	5.7L V8 350 CID	1996	(P)	USEP3270
7.4L V8 454 CID	1992	(N), GAS, Naturally Aspirated	USEP3902	<b>CAVALIER</b>			
<b>C2500 SUBURBAN</b>					2005	Except for Bosch, Carter, and Delphi	USEP3507
5.7L V8 350 CID	1992-1993	(K)	USEP3902	2.0L L4 122 CID	1985	CL, CS, Type-10; (P)	USEP3567
5.7L V8 350 CID	1994	(K), GAS, Naturally Aspirated	USEP3902	2.0L L4 122 CID	1986	CL, CS, RS; (P)	USEP3902
5.7L V8 350 CID	1997	(R), GAS, Naturally Aspirated	USEP3270	2.0L L4 122 CID	1987		USEP3212
5.7L V8 350 CID	1998-1999	GAS, Naturally Aspirated; Calif	USEP3240R	2.2L L4 134 CID	1990-1991		USEP3212
6.5L V8 395 CID	1994	(F), DIESEL, Turbocharged; External Pump	USEP3309	2.2L L4 2190cc 134 CID	1992-1994		USEP3313
6.5L V8 395 CID	1997-1999	(F), DIESEL, Turbocharged; External Pump	USEP3309	2.2L L4 2190cc 134 CID	1999-2000	MEX	USEP12011
7.4L V8 454 CID	1992-1993	(N)	USEP3902	2.2L L4 2190cc 134 CID	2000	(4), GAS; Except for Bosch, Carter, and Delphi, Plastic Fuel Tank	USEP3507
7.4L V8 454 CID	1994		USEP3212	2.2L L4 2190cc 134 CID	2000	Base; (4), BI-FUEL; Except for Bosch, Carter, and Delphi, Plastic Fuel Tank	USEP3507
7.4L V8 454 CID	1997	(J), GAS, Naturally Aspirated	USEP3270	2.2L L4 2190cc 134 CID	2000	MEX; Except for Bosch, Carter, and Delphi	USEP3507
7.4L V8 454 CID	1998-1999	GAS, Naturally Aspirated; Calif	USEP3240R	2.2L L4 2190cc 134 CID	2001	(4); Except for Bosch, Carter, and Delphi	USEP3507
<b>C3500</b>				2.4L L4 2392cc 146 CID	2000	Z24; (T), GAS; Except for Bosch, Carter, and Delphi, Plastic Fuel Tank	USEP3507
5.7L V8 350 CID	1988-1991	(K), GAS	USEP3902	2.4L L4 2392cc 146 CID	2001	(T); Except for Bosch, Carter, and Delphi	USEP3507
5.7L V8 350 CID	1997	(R), GAS, Naturally Aspirated	USEP3270	2.8L V6 173 CID	1985-1987	1.45 inch pump diameter, Except for Bosch, Carter, and Delphi	USEP3240
5.7L V8 350 CID	2001		USEP3500	2.8L V6 173 CID	1990-1994	MEX	USEP3240
6.2L V8 379 CID	1988-1991	(J), DIESEL; External Pump	USEP3158	3.1L V6 189 CID	1990-1991		USEP3265
6.5L V8 395 CID	1997	(F), DIESEL, Turbocharged; External Pump	USEP3309	3.1L V6 189 CID	1992-1994		USEP3313
7.4L V8 454 CID	1988	(N), GAS	USEP3902	<b>CELEBRITY</b>			
7.4L V8 454 CID	1989		USEP3902	2.5L L4 2474cc 151 CID	1987	(R)	USEP3902
7.4L V8 454 CID	1990-1991	(N), GAS	USEP3902	2.5L L4 2474cc 151 CID	1988	Harness Stamped ARA	USEP3212
7.4L V8 454 CID	1997	(J), GAS, Naturally Aspirated	USEP3270	2.5L L4 2474cc 151 CID	1988	(R); Harness Stamped APH	USEP3902
8.1L V8 496 CID	2001-2002	GAS, Naturally Aspirated; External Pump(Secondary Fuel Tank)	USEP3540	2.5L L4 2474cc 151 CID	1989		USEP3212
<b>CAMARO</b>				2.8L V6 173 CID	1982-1984	MEX	USEP3240
2.5L L4 2474cc 151 CID	1986	Sport; (2), FI	USEP3902	2.8L V6 173 CID	1985-1986		USEP2486
2.8L V6 173 CID	1986	1.45 inch pump diameter, Exc.Harness Stamped FEM, Except for Bosch, Carter, and Delphi	USEP3240	2.8L V6 173 CID	1987-1989	2 inch pump diameter	USEP3222
2.8L V6 173 CID	1987	1.45 inch pump diameter, Except for Bosch, Carter, and Delphi	USEP3240	2.8L V6 173 CID	1987-1989	1.45 inch pump diameter, Except for Bosch, Carter, and Delphi	USEP3240
3.1L V6 189 CID	1990-1991	1.45 inch pump diameter, Except for Bosch, Carter, and Delphi	USEP3240	4.3L V6 260 CID	1982-1983		USEP8012SP
3.4L V6 207 CID	1993-1995	Base; (S)	USEP3907	4.3L V6 260 CID	1984	Base	USEP8012SP
3.8L V6 3800cc 231 CID	1995	Base; (K)	USEP3907	4.3L V6 260 CID	1985		USEP3127

Engine	Years	Application Description	USMW	Engine	Years	Application Description	USMW
<b>CHEVROLET (cont'd.)</b>				<b>CHEVROLET (cont'd.)</b>			
<b>CHEVY</b>				<b>EXPRESS 2500 (cont'd.)</b>			
1.4L L4 1389cc 85 CID	1994	Joy; GAS, MEX	<b>USEP3902</b>	5.7L V8 350 CID	1997	GAS, Naturally Aspirated; (Exc.Fitting for Fuel Line)	<b>USEP3240R</b>
1.4L L4 1389cc 85 CID	1994	Swing; MEX	<b>USEP3902</b>	5.7L V8 350 CID	1998-2000	(Exc.Fitting for Fuel Line), Calif	<b>USEP3906</b>
1.4L L4 1389cc 85 CID	2001	Pop; MEX	<b>USEP12026</b>	5.7L V8 350 CID	1998-2000	(Exc.Fitting for Fuel Line), Exc.Calif (Under GVW 8,500 Lbs.)	<b>USEP3906</b>
1.6L L4 1588cc 98 CID	1996	Joy; GAS, MEX	<b>USEP3902</b>	5.7L V8 350 CID	1998-2002	GAS, Naturally Aspirated; (Exc.Fitting for Fuel Line), Exc.Calif (Over GVW 8,500 Lbs.)	<b>USEP3240R</b>
1.6L L4 1588cc 98 CID	1996	Swing; MEX	<b>USEP3902</b>	5.7L V8 350 CID	1999	MEX; VAZ	<b>USEP3240R</b>
1.6L L4 1598cc 98 CID	1998	Joy; MEX	<b>USEP3902</b>	5.7L V8 350 CID	2001	CNG, Naturally Aspirated; (Exc.Fitting for Fuel Line), Exc.Calif (Over GVW 8,500 Lbs.)	<b>USEP3240R</b>
1.6L L4 1598cc 98 CID	1998	Monza; MEX	<b>USEP12026</b>	5.7L V8 350 CID	2001	(R), CNG, Naturally Aspirated; (Exc.Fitting for Fuel Line), Calif	<b>USEP3906</b>
1.6L L4 1598cc 98 CID	1999	Joy, Monza; MEX	<b>USEP12026</b>	5.7L V8 350 CID	2001-2002	(R), GAS, Naturally Aspirated; (Exc.Fitting for Fuel Line), Calif	<b>USEP3906</b>
1.6L L4 1598cc 98 CID	2000-2002	Joy, Monza, Swing; MEX	<b>USEP12026</b>	5.7L V8 350 CID	2001-2002	(R), GAS, Naturally Aspirated; (Exc.Fitting for Fuel Line), Exc.Calif (Under GVW 8,500 Lbs.)	<b>USEP3906</b>
1.6L L4 1598cc 98 CID	2004-2010	MEX	<b>USEP12026</b>	5.7L V8 350 CID	2002	BI-FUEL, Naturally Aspirated; (Exc.Fitting for Fuel Line), Exc.Calif (Over GVW 8,500 Lbs.)	<b>USEP3240R</b>
<b>CHEVY PICKUP</b>				5.7L V8 350 CID	2002	(R), BI-FUEL, Naturally Aspirated; (Exc.Fitting for Fuel Line), Calif	<b>USEP3906</b>
1.6L L4 1598cc 98 CID	1999-2003	MEX	<b>USEP12027</b>	5.7L V8 350 CID	2002	(R), BI-FUEL, Naturally Aspirated; (Exc.Fitting for Fuel Line), Exc.Calif (Under GVW 8,500 Lbs.)	<b>USEP3906</b>
<b>CITATION II</b>				5.7L V8 350 CID	2002	(R), BI-FUEL, Naturally Aspirated; (Exc.Fitting for Fuel Line), Exc.Calif (Under GVW 8,500 Lbs.)	<b>USEP3906</b>
2.5L L4 2474cc 151 CID	1985	(R), FI	<b>USEP3901</b>	5.7L V8 350 CID	2002	LS; (F), DIESEL, Turbocharged; External Pump	<b>USEP3309</b>
<b>CLASSIC</b>				5.7L V8 350 CID	1997-1998	(F), DIESEL, Turbocharged; External Pump	<b>USEP3309</b>
	2004	Except for Bosch, Carter, and Delphi	<b>USEP3507</b>	5.7L V8 350 CID	1999-2002	(F), DIESEL, Turbocharged; External Pump	<b>USEP3540</b>
<b>COBALT</b>				<b>EXPRESS 3500</b>			
2.2L L4 2198cc 134 CID	2007-2010		<b>USEP3784</b>	4.8L V8 294 CID	2005	Base	<b>USEP12046</b>
<b>CORSA</b>				5.7L V8 350 CID	1997	Cutaway Van, GAS, Naturally Aspirated; (55 Gallon Fuel Tank), (Exc.Fitting for Fuel Line)	<b>USEP3240R</b>
1.8L L4 1796cc 110 CID	2006-2008	MEX	<b>USEP12026</b>	5.7L V8 350 CID	1997	Extended Cargo Van, GAS, Naturally Aspirated; (Exc.Fitting for Fuel Line)	<b>USEP3240R</b>
<b>CORSICA</b>				5.7L V8 350 CID	1997	Extended Passenger Van, GAS, Naturally Aspirated; (Exc.Fitting for Fuel Line)	<b>USEP3240R</b>
2.0L L4 122 CID	1987		<b>USEP3212</b>	5.7L V8 350 CID	1997	GAS, Naturally Aspirated, Standard Cargo Van; (Exc.Fitting for Fuel Line)	<b>USEP3240R</b>
2.0L L4 122 CID	1988	To Chassis/VIN 500000	<b>USEP3212</b>	5.7L V8 350 CID	1997	GAS, Naturally Aspirated, Standard Passenger Van; (Exc.Fitting for Fuel Line)	<b>USEP3240R</b>
2.0L L4 122 CID	1989		<b>USEP3212</b>	5.7L V8 350 CID	1998-1999	(R), Cutaway Van, GAS, Naturally Aspirated; (Exc.Calif) (55 Gallon Fuel Tank), (Exc.Fitting for Fuel Line)	<b>USEP3240R</b>
2.2L L4 2190cc 134 CID	1992		<b>USEP3265</b>	5.7L V8 350 CID	1998-1999	(R), Extended Cargo Van, GAS, Naturally Aspirated; (Exc.Calif), (Exc.Fitting for Fuel Line)	<b>USEP3240R</b>
2.2L L4 2190cc 134 CID	1993-1995		<b>USEP3313</b>	5.7L V8 350 CID	1998-1999	(R), Extended Passenger Van, GAS, Naturally Aspirated; (Exc.Calif), (Exc.Fitting for Fuel Line)	<b>USEP3240R</b>
2.8L V6 173 CID	1987	1.45 inch pump diameter, Except for Bosch, Carter, and Delphi	<b>USEP3240</b>	5.7L V8 350 CID	1998-1999	(R), GAS, Naturally Aspirated, Standard Cargo Van; (Exc.Calif), (Exc.Fitting for Fuel Line)	<b>USEP3240R</b>
2.8L V6 173 CID	1988	1.45 inch pump diameter, Except for Bosch, Carter, and Delphi, To Chassis/VIN 500000	<b>USEP3240</b>	5.7L V8 350 CID	1998-1999	(R), GAS, Naturally Aspirated, Standard Passenger Van; (Exc.Calif), (Exc.Fitting for Fuel Line)	<b>USEP3240R</b>
2.8L V6 173 CID	1988	From Chassis/VIN 500001	<b>USEP3265</b>	5.7L V8 350 CID	1998-2002	(R), Cutaway Van, GAS, Naturally Aspirated; (Calif) (55 Gallon Fuel Tank), (Exc.Fitting for Fuel Line)	<b>USEP3906</b>
2.8L V6 173 CID	1989		<b>USEP3265</b>	5.7L V8 350 CID	1998-2002	(R), Extended Cargo Van, GAS, Naturally Aspirated; (Calif), (Exc.Fitting for Fuel Line)	<b>USEP3906</b>
3.1L V6 189 CID	1990-1992		<b>USEP3265</b>	5.7L V8 350 CID	1998-2002	(R), GAS, Naturally Aspirated, Standard Cargo Van; (Calif), (Exc.Fitting for Fuel Line)	<b>USEP3906</b>
3.1L V6 189 CID	1993-1995		<b>USEP3313</b>	5.7L V8 350 CID	1998-2002	(R), GAS, Naturally Aspirated, Standard Passenger Van; (Calif), (Exc.Fitting for Fuel Line)	<b>USEP3906</b>
<b>CORVETTE</b>				5.7L V8 350 CID	1999-2002	MEX; with 1 electrical connector	<b>USEP3240R</b>
	1985-1989		<b>USEP3210</b>	5.7L V8 350 CID	1999-2002	MEX; with 2 electrical connectors	<b>USEP3906</b>
	1990-1994	ZR-1; (J)	<b>USEP3904</b>	5.7L V8 350 CID	2000-2002	(R), Cutaway Van, GAS, Naturally Aspirated; (55 Gallon Fuel Tank), (Exc.Fitting for Fuel Line)	<b>USEP3240R</b>
	1992-1994	Base; (P)	<b>USEP3271</b>	5.7L V8 350 CID	2000-2002	(R), Extended Cargo Van, GAS, Naturally Aspirated; (Exc.Fitting for Fuel Line), (Federal)	<b>USEP3240R</b>
	1996	(5)	<b>USEP3271</b>	5.7L V8 350 CID	2000-2002	(R), Extended Passenger Van, GAS, Naturally Aspirated; (Exc.Fitting for Fuel Line), (Federal)	<b>USEP3240R</b>
	1996	(P)	<b>USEP3271</b>	5.7L V8 350 CID	2000-2002	(R), GAS, Naturally Aspirated, Standard Cargo Van; (Exc.Fitting for Fuel Line), (Federal)	<b>USEP3240R</b>
5.7L V8 350 CID	1982	in-tank pump	<b>USEP3070</b>	5.7L V8 350 CID	2000-2002	(R), GAS, Naturally Aspirated, Standard Passenger Van; (Exc.Fitting for Fuel Line), (Federal)	<b>USEP3240R</b>
5.7L V8 350 CID	1984	in-tank pump	<b>USEP3071</b>	5.7L V8 350 CID	2000-2002	(R), GAS, Naturally Aspirated, Standard Cargo Van; (Exc.Fitting for Fuel Line), (Federal)	<b>USEP3240R</b>
5.7L V8 350 CID	1990-1991		<b>USEP3265</b>	5.7L V8 350 CID	2000-2002	(R), GAS, Naturally Aspirated, Standard Passenger Van; (Exc.Fitting for Fuel Line), (Federal)	<b>USEP3240R</b>
<b>EL CAMINO</b>				5.7L V8 350 CID	2000-2002	(R), GAS, Naturally Aspirated, Standard Cargo Van; (Exc.Fitting for Fuel Line), (Federal)	<b>USEP3240R</b>
4.3L V6 262 CID	1985-1987	(Z), FI	<b>USEP3902</b>				
<b>EXPRESS 1500</b>							
4.3L V6 262 CID	1997	(Exc.Fitting for Fuel Line)	<b>USEP3240R</b>				
4.3L V6 262 CID	1998	(Exc.Fitting for Fuel Line)	<b>USEP3906</b>				
4.3L V6 262 CID	1999-2002	VAY	<b>USEP3906</b>				
5.0L V8 305 CID	1997	(Exc.Fitting for Fuel Line)	<b>USEP3240R</b>				
5.0L V8 305 CID	1998-2002	(Exc.Fitting for Fuel Line)	<b>USEP3906</b>				
5.3L V8 5328cc 325 CID	2008	MEX	<b>USEP3240R</b>				
5.7L V8 350 CID	1997	(Exc.Fitting for Fuel Line)	<b>USEP3240R</b>				
5.7L V8 350 CID	1998-2002	(Exc.Fitting for Fuel Line)	<b>USEP3906</b>				
<b>EXPRESS 2500</b>							
4.3L V6 262 CID	1997-1998	GAS, Naturally Aspirated; (Exc.Fitting for Fuel Line)	<b>USEP3240R</b>	5.7L V8 350 CID	1998-2002	(R), Cutaway Van, GAS, Naturally Aspirated; (Calif) (55 Gallon Fuel Tank), (Exc.Fitting for Fuel Line)	<b>USEP3906</b>
4.3L V6 262 CID	1999-2000	(Exc.Fitting for Fuel Line), Calif	<b>USEP3906</b>	5.7L V8 350 CID	1998-2002	(R), Extended Cargo Van, GAS, Naturally Aspirated; (Calif), (Exc.Fitting for Fuel Line)	<b>USEP3906</b>
4.3L V6 262 CID	1999-2000	(Exc.Fitting for Fuel Line), Exc.Calif (Under GVW 8,500 Lbs.)	<b>USEP3906</b>	5.7L V8 350 CID	1998-2002	(R), Extended Passenger Van, GAS, Naturally Aspirated; (Calif), (Exc.Fitting for Fuel Line)	<b>USEP3906</b>
4.3L V6 262 CID	1999-2002	GAS, Naturally Aspirated; (Exc.Fitting for Fuel Line), Exc.Calif (Over GVW 8,500 Lbs.)	<b>USEP3240R</b>	5.7L V8 350 CID	1998-2002	(R), GAS, Naturally Aspirated, Standard Cargo Van; (Calif), (Exc.Fitting for Fuel Line)	<b>USEP3906</b>
4.3L V6 262 CID	2001-2002	(W), GAS, Naturally Aspirated; (Exc.Fitting for Fuel Line), Calif	<b>USEP3906</b>	5.7L V8 350 CID	1998-2002	(R), GAS, Naturally Aspirated, Standard Passenger Van; (Calif), (Exc.Fitting for Fuel Line)	<b>USEP3906</b>
4.3L V6 262 CID	2001-2002	(W), GAS, Naturally Aspirated; (Exc.Fitting for Fuel Line), Exc.Calif (Under GVW 8,500 Lbs.)	<b>USEP3906</b>	5.7L V8 350 CID	1999-2002	MEX; with 1 electrical connector	<b>USEP3240R</b>
5.0L V8 305 CID	1997-1998	GAS, Naturally Aspirated; (Exc.Fitting for Fuel Line)	<b>USEP3240R</b>	5.7L V8 350 CID	1999-2002	MEX; with 2 electrical connectors	<b>USEP3906</b>
5.0L V8 305 CID	1999-2001	(Exc.Fitting for Fuel Line), Calif	<b>USEP3906</b>	5.7L V8 350 CID	2000-2002	(R), Cutaway Van, GAS, Naturally Aspirated; (55 Gallon Fuel Tank), (Exc.Fitting for Fuel Line)	<b>USEP3240R</b>
5.0L V8 305 CID	1999-2001	(Exc.Fitting for Fuel Line), Exc.Calif (Under GVW 8,500 Lbs.)	<b>USEP3906</b>	5.7L V8 350 CID	2000-2002	(R), Extended Cargo Van, GAS, Naturally Aspirated; (Exc.Fitting for Fuel Line), (Federal)	<b>USEP3240R</b>
5.0L V8 305 CID	1999-2002	GAS, Naturally Aspirated; (Exc.Fitting for Fuel Line), Exc.Calif (Over GVW 8,500 Lbs.)	<b>USEP3240R</b>	5.7L V8 350 CID	2000-2002	(R), Extended Passenger Van, GAS, Naturally Aspirated; (Exc.Fitting for Fuel Line), (Federal)	<b>USEP3240R</b>
5.0L V8 305 CID	2002	(M), GAS, Naturally Aspirated; (Exc.Fitting for Fuel Line), Calif	<b>USEP3906</b>	5.7L V8 350 CID	2000-2002	(R), GAS, Naturally Aspirated, Standard Cargo Van; (Exc.Fitting for Fuel Line), (Federal)	<b>USEP3240R</b>
5.0L V8 305 CID	2002	(M), GAS, Naturally Aspirated; (Exc.Fitting for Fuel Line), Exc.Calif (Under GVW 8,500 Lbs.)	<b>USEP3906</b>				





# FUEL PUMP KITS APPLICATION GUIDE



FUEL PUMP KITS

Engine	Years	Application Description	USMW	Engine	Years	Application Description	USMW
<b>CHEVROLET (cont'd.)</b>				<b>CHEVROLET (cont'd.)</b>			
<b>EXPRESS 3500 (cont'd.)</b>				<b>EXPRESS 3500 (cont'd.)</b>			
5.7L V8 350 CID	2000-2002	(R), GAS, Naturally Aspirated, Standard Passenger Van; (Exc.Fitting for Fuel Line), (Federal)	USEP3240R	7.4L V8 454 CID	1998-2000	(J), GAS, Naturally Aspirated, Standard Passenger Van; (Calif), (Exc.Fitting for Fuel Line)	USEP3906
5.7L V8 350 CID	2002	(R), BI-FUEL, Cutaway Van, Naturally Aspirated; (55 Gallon Fuel Tank), (Exc.Fitting for Fuel Line)	USEP3240R	7.4L V8 454 CID	2000	(J), Cutaway Van, GAS, Naturally Aspirated; (55 Gallon Fuel Tank), (Exc.Fitting for Fuel Line)	USEP3240R
5.7L V8 350 CID	2002	(R), BI-FUEL, Cutaway Van, Naturally Aspirated; (Calif) (35 Gallon Fuel Tank)	USEP3240R	7.4L V8 454 CID	2000	(J), Extended Cargo Van, GAS, Naturally Aspirated; (Exc.Fitting for Fuel Line), (Federal)	USEP3240R
5.7L V8 350 CID	2002	(R), BI-FUEL, Extended Cargo Van, Naturally Aspirated; (Exc.Fitting for Fuel Line), (Federal)	USEP3240R	7.4L V8 454 CID	2000	(J), Extended Passenger Van, GAS, Naturally Aspirated; (Exc.Fitting for Fuel Line), (Federal)	USEP3240R
5.7L V8 350 CID	2002	(R), BI-FUEL, Extended Passenger Van, Naturally Aspirated; (Exc.Fitting for Fuel Line), (Federal)	USEP3240R	7.4L V8 454 CID	2000	(J), GAS, Naturally Aspirated, Standard Cargo Van; (Exc.Fitting for Fuel Line), (Federal)	USEP3240R
5.7L V8 350 CID	2002	(R), BI-FUEL, Naturally Aspirated, Standard Cargo Van; (Exc.Fitting for Fuel Line), (Federal)	USEP3240R	7.4L V8 454 CID	2000	(J), GAS, Naturally Aspirated, Standard Passenger Van; (Exc.Fitting for Fuel Line), (Federal)	USEP3240R
5.7L V8 350 CID	2002	(R), BI-FUEL, Naturally Aspirated, Standard Passenger Van; (Exc.Fitting for Fuel Line), (Federal)	USEP3240R	8.1L V8 496 CID	2001	(G), Extended Cargo Van, GAS, Naturally Aspirated; (Exc.Fitting for Fuel Line)	USEP3240R
5.7L V8 350 CID	2002	(R), BI-FUEL, Cutaway Van, Naturally Aspirated; (Calif) (55 Gallon Fuel Tank), (Exc.Fitting for Fuel Line)	USEP3906	8.1L V8 496 CID	2001	(G), Extended Passenger Van, GAS, Naturally Aspirated; (Exc.Fitting for Fuel Line)	USEP3240R
5.7L V8 350 CID	2002	(R), BI-FUEL, Extended Cargo Van, Naturally Aspirated; (Calif)	USEP3906	8.1L V8 496 CID	2001	(G), GAS, Naturally Aspirated, Standard Cargo Van; (Exc.Fitting for Fuel Line)	USEP3240R
5.7L V8 350 CID	2002	(R), BI-FUEL, Extended Cargo Van, Naturally Aspirated; (Calif), (Exc.Fitting for Fuel Line)	USEP3906	8.1L V8 496 CID	2001	(G), GAS, Naturally Aspirated, Standard Passenger Van; (Exc.Fitting for Fuel Line)	USEP3240R
5.7L V8 350 CID	2002	(R), BI-FUEL, Naturally Aspirated, Standard Cargo Van; (Calif)	USEP3906	8.1L V8 496 CID	2002	(G), Extended Cargo Van, GAS, Naturally Aspirated; (Exc.Fitting for Fuel Line), (Federal)	USEP3240R
5.7L V8 350 CID	2002	(R), BI-FUEL, Naturally Aspirated, Standard Cargo Van; (Calif), (Exc.Fitting for Fuel Line)	USEP3906	8.1L V8 496 CID	2002	(G), Extended Passenger Van, GAS, Naturally Aspirated; (Exc.Fitting for Fuel Line), (Federal)	USEP3240R
5.7L V8 350 CID	2002	(R), BI-FUEL, Naturally Aspirated, Standard Passenger Van; (Calif)	USEP3906	8.1L V8 496 CID	2002	(G), GAS, Naturally Aspirated, Standard Cargo Van; (Exc.Fitting for Fuel Line), (Federal)	USEP3240R
5.7L V8 350 CID	2002	(R), BI-FUEL, Naturally Aspirated, Standard Passenger Van; (Calif), (Exc.Fitting for Fuel Line)	USEP3906	8.1L V8 496 CID	2002	(G), GAS, Naturally Aspirated, Standard Passenger Van; (Exc.Fitting for Fuel Line), (Federal)	USEP3240R
5.7L V8 350 CID	2002	(R), Extended Cargo Van, GAS, Naturally Aspirated; (Calif)	USEP3906	8.1L V8 496 CID	2002	(G), Extended Cargo Van, GAS, Naturally Aspirated; (Calif)	USEP3906
5.7L V8 350 CID	2002	(R), Extended Passenger Van, GAS, Naturally Aspirated; (Calif)	USEP3906	8.1L V8 496 CID	2002	(G), Extended Passenger Van, GAS, Naturally Aspirated; (Calif)	USEP3906
5.7L V8 350 CID	2002	(R), GAS, Naturally Aspirated, Standard Cargo Van; (Calif)	USEP3906	8.1L V8 496 CID	2002	(G), GAS, Naturally Aspirated, Standard Cargo Van; (Calif)	USEP3906
5.7L V8 350 CID	2002	(R), GAS, Naturally Aspirated, Standard Passenger Van; (Calif)	USEP3906	8.1L V8 496 CID	2002	(G), GAS, Naturally Aspirated, Standard Passenger Van; (Calif)	USEP3906
6.0L V8 5967cc 364 CID	2004	Base, LS	USEP12046	<b>G10</b>			
6.0L V8 5967cc 364 CID	2006-2008	Base, LS, LT	USEP12046	4.3L V6 262 CID	1987-1993	Chevy Van, Sportvan; (Z)	USEP3902
6.5L V8 395 CID	1996-1998	(F), DIESEL, Turbocharged; External Pump	USEP3309	4.3L V6 262 CID	1994-1995	(Z)	USEP3902
6.5L V8 395 CID	1999-2002	(F), DIESEL, Turbocharged; External Pump	USEP3540	5.0L V8 305 CID	1987-1993	Chevy Van, Sportvan; (H)	USEP3902
7.4L V8 454 CID	1997	Cutaway Van, GAS, Naturally Aspirated; (55 Gallon Fuel Tank), (Exc.Fitting for Fuel Line)	USEP3240R	5.0L V8 305 CID	1994-1995	(H)	USEP3902
7.4L V8 454 CID	1997	Extended Cargo Van, GAS, Naturally Aspirated; (Exc.Fitting for Fuel Line)	USEP3240R	5.7L V8 350 CID	1987-1993	Sportvan; (K)	USEP3902
7.4L V8 454 CID	1997	Extended Passenger Van, GAS, Naturally Aspirated; (Exc.Fitting for Fuel Line)	USEP3240R	<b>G20</b>			
7.4L V8 454 CID	1997	GAS, Naturally Aspirated, Standard Cargo Van; (Exc.Fitting for Fuel Line)	USEP3240R	4.3L V6 262 CID	1987-1995	Chevy Van, Sportvan; (Z), GAS	USEP3902
7.4L V8 454 CID	1997	GAS, Naturally Aspirated, Standard Passenger Van; (Exc.Fitting for Fuel Line)	USEP3240R	5.0L V8 305 CID	1987-1995	Chevy Van, Sportvan; (H), GAS	USEP3902
7.4L V8 454 CID	1998-1999	(J), Cutaway Van, GAS, Naturally Aspirated; (Exc.Calif) (55 Gallon Fuel Tank), (Exc.Fitting for Fuel Line)	USEP3240R	5.7L V8 350 CID	1987-1994	Chevy Van, Sportvan; (K), GAS	USEP3902
7.4L V8 454 CID	1998-1999	(J), Extended Cargo Van, GAS, Naturally Aspirated; (Exc.Calif), (Exc.Fitting for Fuel Line)	USEP3240R	5.7L V8 350 CID	1995	Sportvan; (K), GAS	USEP3902
7.4L V8 454 CID	1998-1999	(J), Extended Passenger Van, GAS, Naturally Aspirated; (Exc.Calif), (Exc.Fitting for Fuel Line)	USEP3240R	<b>G30</b>			
7.4L V8 454 CID	1998-1999	(J), GAS, Naturally Aspirated, Standard Cargo Van; (Exc.Calif), (Exc.Fitting for Fuel Line)	USEP3240R	4.3L V6 262 CID	1987-1988	Hi-Cube; (Z), FI, GAS	USEP3902
7.4L V8 454 CID	1998-1999	(J), GAS, Naturally Aspirated, Standard Passenger Van; (Exc.Calif), (Exc.Fitting for Fuel Line)	USEP3240R	4.3L V6 262 CID	1989-1995	Hi-Cube; (Z), GAS	USEP3902
7.4L V8 454 CID	1998-1999	(J), GAS, Naturally Aspirated, Standard Passenger Van; (Exc.Calif), (Exc.Fitting for Fuel Line)	USEP3240R	5.7L V8 350 CID	1987-1988	Hi-Cube, Sportvan; (K), FI, GAS	USEP3902
7.4L V8 454 CID	1998-2000	(J), Cutaway Van, GAS, Naturally Aspirated; (Calif) (55 Gallon Fuel Tank), (Exc.Fitting for Fuel Line)	USEP3906	5.7L V8 350 CID	1989-1995	Hi-Cube, Sportvan; (K), GAS	USEP3902
7.4L V8 454 CID	1998-2000	(J), Extended Cargo Van, GAS, Naturally Aspirated; (Calif), (Exc.Fitting for Fuel Line)	USEP3906	5.7L V8 350 CID	1996	Hi-Cube, Sportvan; (K), GAS	USEP3268
7.4L V8 454 CID	1998-2000	(J), Extended Passenger Van, GAS, Naturally Aspirated; (Calif), (Exc.Fitting for Fuel Line)	USEP3906	7.4L V8 454 CID	1988	Sportvan; (N), FI, GAS	USEP3567
7.4L V8 454 CID	1998-2000	(J), GAS, Naturally Aspirated, Standard Cargo Van; (Calif), (Exc.Fitting for Fuel Line)	USEP3906	7.4L V8 454 CID	1988	Hi-Cube; (N), FI, GAS	USEP3902
7.4L V8 454 CID	1998-2000	(J), GAS, Naturally Aspirated, Standard Passenger Van; (Calif), (Exc.Fitting for Fuel Line)	USEP3906	7.4L V8 454 CID	1989-1993	Hi-Cube, Sportvan; (N), GAS	USEP3902
7.4L V8 454 CID	1998-2000	(J), GAS, Naturally Aspirated, Standard Passenger Van; (Calif), (Exc.Fitting for Fuel Line)	USEP3906	7.4L V8 454 CID	1994-1996	Hi-Cube, Sportvan; (N), GAS	USEP3212
7.4L V8 454 CID	1998-2000	(J), GAS, Naturally Aspirated, Standard Cargo Van; (Calif), (Exc.Fitting for Fuel Line)	USEP3906	<b>IMPALA</b>			
7.4L V8 454 CID	1998-2000	(J), GAS, Naturally Aspirated, Standard Passenger Van; (Calif), (Exc.Fitting for Fuel Line)	USEP3906	4.3L V6 262 CID	1994-1996		USEP3270
7.4L V8 454 CID	1998-2000	(J), GAS, Naturally Aspirated, Standard Passenger Van; (Calif), (Exc.Fitting for Fuel Line)	USEP3906	5.7L V8 350 CID	1985	(Z), FI, GAS	USEP3902
7.4L V8 454 CID	1998-2000	(J), GAS, Naturally Aspirated, Standard Passenger Van; (Calif), (Exc.Fitting for Fuel Line)	USEP3906	5.7L V8 350 CID	1985	(N), DIESEL, FI; External Pump	USEP3076
7.4L V8 454 CID	1998-2000	(J), GAS, Naturally Aspirated, Standard Passenger Van; (Calif), (Exc.Fitting for Fuel Line)	USEP3906	5.7L V8 350 CID	1985	Base	USEP8012SP
7.4L V8 454 CID	1998-2000	(J), GAS, Naturally Aspirated, Standard Passenger Van; (Calif), (Exc.Fitting for Fuel Line)	USEP3906	<b>K1500</b>			
7.4L V8 454 CID	1998-2000	(J), GAS, Naturally Aspirated, Standard Passenger Van; (Calif), (Exc.Fitting for Fuel Line)	USEP3906	4.3L V6 262 CID	1988-1989	(Z), GAS	USEP3902
7.4L V8 454 CID	1998-2000	(J), GAS, Naturally Aspirated, Standard Passenger Van; (Calif), (Exc.Fitting for Fuel Line)	USEP3906	4.3L V6 262 CID	1990-1991	(Z), GAS	USEP3567
7.4L V8 454 CID	1998-2000	(J), GAS, Naturally Aspirated, Standard Passenger Van; (Calif), (Exc.Fitting for Fuel Line)	USEP3906	5.0L V8 305 CID	1988-1989	(H), GAS	USEP3902
7.4L V8 454 CID	1998-2000	(J), GAS, Naturally Aspirated, Standard Passenger Van; (Calif), (Exc.Fitting for Fuel Line)	USEP3906	5.0L V8 305 CID	1990-1991	(H), GAS	USEP3567
7.4L V8 454 CID	1998-2000	(J), GAS, Naturally Aspirated, Standard Passenger Van; (Calif), (Exc.Fitting for Fuel Line)	USEP3906	5.7L V8 350 CID	1988-1989	(K), GAS	USEP3902
7.4L V8 454 CID	1998-2000	(J), GAS, Naturally Aspirated, Standard Passenger Van; (Calif), (Exc.Fitting for Fuel Line)	USEP3906	5.7L V8 350 CID	1990-1991	(K), GAS	USEP3567
7.4L V8 454 CID	1998-2000	(J), GAS, Naturally Aspirated, Standard Passenger Van; (Calif), (Exc.Fitting for Fuel Line)	USEP3906	6.2L V8 379 CID	1988-1991	(C), DIESEL; External Pump	USEP3158
7.4L V8 454 CID	1998-2000	(J), GAS, Naturally Aspirated, Standard Passenger Van; (Calif), (Exc.Fitting for Fuel Line)	USEP3906	<b>K1500 SUBURBAN</b>			
7.4L V8 454 CID	1998-2000	(J), GAS, Naturally Aspirated, Standard Passenger Van; (Calif), (Exc.Fitting for Fuel Line)	USEP3906	5.7L V8 350 CID	1992-1994		USEP3902
7.4L V8 454 CID	1998-2000	(J), GAS, Naturally Aspirated, Standard Passenger Van; (Calif), (Exc.Fitting for Fuel Line)	USEP3906	5.7L V8 350 CID	1995	(K), GAS, Naturally Aspirated	USEP3902
7.4L V8 454 CID	1998-2000	(J), GAS, Naturally Aspirated, Standard Passenger Van; (Calif), (Exc.Fitting for Fuel Line)	USEP3906	5.7L V8 350 CID	1996-1997	(R), GAS, Naturally Aspirated	USEP3270

Engine	Years	Application Description	USMW	Engine	Years	Application Description	USMW
<b>CHEVROLET (cont'd.)</b>				<b>CHEVROLET (cont'd.)</b>			
<b>K1500 SUBURBAN (cont'd.)</b>				<b>METRO</b>			
5.7L V8 350 CID	1998-1999	(R), GAS, Naturally Aspirated	USEP3240R	1.0L L3 993cc 61 CID	1998-2000		USEP8229
6.5L V8 395 CID	1995-1998	(F), DIESEL, Turbocharged; External Pump	USEP3309	1.3L L4 1295cc 79 CID	1998-2001		USEP8229
6.5L V8 395 CID	1999	(F), DIESEL, Turbocharged; External Pump	USEP3540	<b>MONTE CARLO</b>			
<b>K2500</b>				3.1L V6 189 CID	1995-1996		USEP3265
4.3L V6 262 CID	1988-1989	(Z), GAS	USEP3902	3.4L V6 207 CID	1995-1996	1.45 inch pump diameter	USEP3240
4.3L V6 262 CID	1990-1991	(Z), GAS	USEP3567	3.4L V6 207 CID	1995-1996		USEP3265
4.3L V6 262 CID	1992	(Z), GAS, Naturally Aspirated	USEP3902	3.8L V6 3800cc 231 CID	1998	Z34; (K)	USEP3240R
5.0L V8 305 CID	1988-1989	(H), GAS	USEP3902	4.3L V6 260 CID	1982-1983		USEP8012SP
5.0L V8 305 CID	1990-1991	(H), GAS	USEP3567	4.3L V6 262 CID	1985	Base; (Z), FI	USEP3901
5.0L V8 305 CID	1992	(H), GAS, Naturally Aspirated	USEP3902	4.3L V6 262 CID	1986-1987	LS; (Z), FI	USEP3901
5.7L V8 350 CID	1988-1989	(K), GAS	USEP3902	4.3L V6 262 CID	1988	LS; (Z), FI	USEP3902
5.7L V8 350 CID	1990-1991	(K), GAS	USEP3567	<b>P20</b>			
5.7L V8 350 CID	1992	(K), GAS, Naturally Aspirated	USEP3902	5.7L V8 350 CID	1987-1988	(K), FI, GAS	USEP3902
6.2L V8 379 CID	1988-1991	(C), DIESEL; External Pump	USEP3158	<b>P30</b>			
6.2L V8 379 CID	1989-1991	(J), DIESEL; External Pump	USEP3158	4.3L V6 262 CID	1990-1991	(Z), GAS, Naturally Aspirated	USEP3268
6.2L V8 379 CID	1992	(C), DIESEL, Naturally Aspirated; External Pump	USEP3158	4.3L V6 262 CID	1992-1993	(Z), GAS	USEP3268
6.2L V8 379 CID	1992	(J), DIESEL, Naturally Aspirated; External Pump	USEP3158	4.3L V6 262 CID	1994-1995	(Z), GAS, Naturally Aspirated	USEP3268
6.5L V8 395 CID	1992	(F), DIESEL, Turbocharged; External Pump	USEP3158	4.3L V6 262 CID	1997	(W), GAS, Naturally Aspirated	USEP3270
7.4L V8 454 CID	1991	(N), GAS	USEP3567	4.3L V6 262 CID	1998-1999	(W), GAS, Naturally Aspirated	USEP3240R
7.4L V8 454 CID	1992	(N), GAS, Naturally Aspirated	USEP3902	4.3L V6 4300cc 262 CID	2001	MEX	USEP3240R
<b>K2500 SUBURBAN</b>				5.7L V8 350 CID	1987-1988	(K), FI, GAS	USEP3268
5.7L V8 350 CID	1992-1993	(K)	USEP3902	5.7L V8 350 CID	1989	(K), FI, GAS, Naturally Aspirated	USEP3268
5.7L V8 350 CID	1994	(K), GAS, Naturally Aspirated	USEP3902	5.7L V8 350 CID	1990-1991	(K), GAS, Naturally Aspirated	USEP3268
5.7L V8 350 CID	1997	(R), GAS, Naturally Aspirated	USEP3270	5.7L V8 350 CID	1992-1993	(K), GAS	USEP3268
5.7L V8 350 CID	1998-1999	(R), GAS, Naturally Aspirated; Calif	USEP3240R	5.7L V8 350 CID	1994-1995	(K), GAS, Naturally Aspirated	USEP3268
6.5L V8 395 CID	1994	(F), DIESEL, Turbocharged; External Pump	USEP3309	5.7L V8 350 CID	1997	(R), GAS, Naturally Aspirated	USEP3270
6.5L V8 395 CID	1997-1998	(F), DIESEL, Turbocharged; External Pump	USEP3309	5.7L V8 350 CID	1998-1999	(R), GAS, Naturally Aspirated; Exc.School Bus (Calif)	USEP3240R
6.5L V8 395 CID	1999	(F), DIESEL, Turbocharged; External Pump	USEP3540	5.7L V8 350 CID	1998-1999	(R), GAS, Naturally Aspirated; Exc.School Bus (Exc.Calif)	USEP3240R
7.4L V8 454 CID	1992-1993	(N)	USEP3902	6.5L V8 395 CID	1994-1995	(F), DIESEL, Turbocharged; External Pump	USEP3309
7.4L V8 454 CID	1994		USEP3212	6.5L V8 395 CID	1997-1998	(F), DIESEL, Turbocharged; External Pump	USEP3309
7.4L V8 454 CID	1997	(J), GAS, Naturally Aspirated	USEP3270	6.5L V8 395 CID	1998	(Y), DIESEL, Naturally Aspirated; External Pump	USEP3309
7.4L V8 454 CID	1998-1999	(J), GAS, Naturally Aspirated; Calif	USEP3240R	6.5L V8 395 CID	1999	(F), DIESEL, Turbocharged; External Pump	USEP3540
<b>K3500</b>				6.5L V8 395 CID	1999	(Y), DIESEL, Naturally Aspirated; External Pump	USEP3540
5.7L V8 350 CID	1988-1991	(K), GAS	USEP3902	7.4L V8 454 CID	1990-1991	(N), GAS, Naturally Aspirated	USEP3268
5.7L V8 350 CID	1997	(R), GAS, Naturally Aspirated	USEP3270	7.4L V8 454 CID	1992-1993	(N), GAS	USEP3268
6.2L V8 379 CID	1988-1991	(J), DIESEL; External Pump	USEP3158	7.4L V8 454 CID	1994-1995		USEP3212
6.5L V8 395 CID	1997	(F), DIESEL, Turbocharged; External Pump	USEP3309	7.4L V8 454 CID	1997		USEP3212
7.4L V8 454 CID	1988	(N), GAS	USEP3902	7.4L V8 454 CID	1997	(J), GAS, Naturally Aspirated	USEP3270
7.4L V8 454 CID	1989		USEP3902	7.4L V8 454 CID	1998-1999	(B), GAS, Naturally Aspirated; Exc.80 Gallon Fuel Tank	USEP3240R
7.4L V8 454 CID	1990-1991	(N), GAS	USEP3902	7.4L V8 454 CID	1998-1999	(J), GAS, Naturally Aspirated; Exc.80 Gallon Fuel Tank	USEP3240R
7.4L V8 454 CID	1997	(J), GAS, Naturally Aspirated	USEP3270	<b>PRIZM</b>			
<b>LLV</b>				1.8L L4 1794cc	1998-2002		USEP8213
2.2L L4 2190cc 134 CID	1994-1995	1.45 inch pump diameter, Except for Bosch, Carter, and Delphi	USEP3240	<b>R10</b>			
2.5L L4 2474cc 151 CID	1987-1993		USEP3902	4.3L V6 262 CID	1987	(Z), GAS	USEP3902
<b>LUMINA</b>				5.0L V8 305 CID	1987	(H), GAS	USEP3902
2.2L L4 2190cc 134 CID	1993		USEP3313	5.7L V8 350 CID	1987	(K), GAS	USEP3902
2.5L L4 2474cc 151 CID	1990-1992		USEP3212	<b>R10 SUBURBAN</b>			
3.1L V6 189 CID	1990	1.45 inch pump diameter, Except for Bosch, Carter, and Delphi, Prom Stamped WEL,WER	USEP3240	5.0L V8 305 CID	1987	(H), GAS	USEP3902
3.1L V6 189 CID	1990	Prom Stamped WEM	USEP3265	5.7L V8 350 CID	1987-1988	(K), GAS	USEP3902
3.1L V6 189 CID	1991-1993		USEP3265	<b>R20</b>			
3.1L V6 189 CID	1995-1996		USEP3265	4.3L V6 262 CID	1987	(Z), FI, GAS	USEP3902
3.4L V6 207 CID	1991-1993	1.45 inch pump diameter	USEP3240	5.0L V8 305 CID	1987	(H), FI, GAS	USEP3902
3.4L V6 207 CID	1995-1996	1.45 inch pump diameter	USEP3240	5.7L V8 350 CID	1987-1988	(K), FI, GAS	USEP3902
3.8L V6 3800cc 231 CID	1998	LTZ; (K)	USEP3240R	7.4L V8 454 CID	1987-1988	(N), FI, GAS	USEP3902
<b>LUMINA APV</b>				<b>R20 SUBURBAN</b>			
3.1L V6 189 CID	1990-1991		USEP3902	5.7L V8 350 CID	1987	(K), GAS	USEP3902
3.1L V6 189 CID	1992-1995	(D)	USEP3902	7.4L V8 454 CID	1987	(N), GAS	USEP3902
3.4L V6 207 CID	1996	1.45 inch pump diameter, Except for Bosch, Carter, and Delphi	USEP3240	<b>R30</b>			
3.8L V6 3800cc 231 CID	1992		USEP3265	5.7L V8 350 CID	1987-1988	(K), FI, GAS	USEP3902
3.8L V6 3800cc 231 CID	1994-1995		USEP3265	6.2L V8 379 CID	1988	(J), DIESEL, FI; External Pump	USEP3158
<b>LUV</b>				7.4L V8 454 CID	1987-1988	(N), FI, GAS	USEP3902
1.8L L4 111 CID	1975-1980		USEP3015	<b>R1500 SUBURBAN</b>			
2.2L L4 2198cc 134 CID	1998-2002	MEX	USEP3240R	5.7L V8 350 CID	1989-1991	(K), GAS	USEP3902
<b>MALIBU</b>				<b>R2500</b>			
2.2L L4 2198cc 134 CID	2004	MEX; Except for Bosch, Carter, and Delphi	USEP3507	7.4L V8 454 CID	1989	(N), GAS	USEP3902
4.3L V6 260 CID	1982-1983		USEP8012SP	<b>R2500 SUBURBAN</b>			
<b>MERIVA</b>				5.7L V8 350 CID	1989-1991	(K), GAS	USEP3902
1.8L L4 1796cc 110 CID	2004-2005	MEX	USEP12026	7.4L V8 454 CID	1989-1991	(N), GAS	USEP3902
1.8L L4 1796cc 110 CID	2006-2008	MEX	USEP12143	<b>R3500</b>			
				5.7L V8 350 CID	1989	(K), FI, GAS	USEP3902

Engine	Years	Application Description	USMW	Engine	Years	Application Description	USMW
<b>CHEVROLET (cont'd.)</b>				<b>CHEVROLET (cont'd.)</b>			
<b>R3500 (cont'd.)</b>				<b>SILVERADO 2500 (cont'd.)</b>			
5.7L V8 350 CID	1990-1991	(K), GAS	USEP3902	6.0L V8 5967cc 364 CID	2002	BI-FUEL; Evaporative Emissions Control	USEP3500
7.4L V8 454 CID	1989	(N), FI, GAS	USEP3902	6.0L V8 5967cc 364 CID	2002	GAS; Evaporative Emissions Control	USEP3500
7.4L V8 454 CID	1990-1991	(N), GAS	USEP3902	6.0L V8 5967cc 364 CID	2002	BI-FUEL; Exc.Evaporative Emissions Control	USEP3501
<b>S10</b>				<b>SILVERADO 2500 HD</b>			
2.2L L4 2190cc 134 CID	1994-1995	1.45 inch pump diameter, Except for Bosch, Carter, and Delphi	USEP3240	6.0L V8 5967cc 364 CID	2002	(U), GAS, Naturally Aspirated; Evaporative Emissions Control	USEP3500
2.2L L4 2190cc 134 CID	1996	(4)	USEP3240R	6.0L V8 5967cc 364 CID	2003	(U), GAS, Naturally Aspirated; Exc.Evaporative Emissions Control	USEP3501
2.2L L4 2190cc 134 CID	1997-2000	(4), FI, GAS, Naturally Aspirated	USEP3240R	6.0L V8 5967cc 364 CID	2003	(U), GAS, Naturally Aspirated; Exc.Evaporative Emissions Control	USEP3501
2.2L L4 2190cc 134 CID	2001-2002	MEX	USEP12016	<b>SILVERADO 2500 HD</b>			
4.3L V6 262 CID	1994	(W), MFI	USEP3270	6.0L V8 5967cc 364 CID	2001-2003	(U), GAS, Naturally Aspirated; Evaporative Emissions Control	USEP3500
4.3L V6 262 CID	1994-1995	(Z), TBI	USEP3902	6.0L V8 5967cc 364 CID	2001-2003	(U), GAS, Naturally Aspirated; Exc.Evaporative Emissions Control	USEP3501
4.3L V6 262 CID	1995	(W)	USEP3270	6.0L V8 5967cc 364 CID	2002	(U), BI-FUEL, Naturally Aspirated; Evaporative Emissions Control	USEP3500
4.3L V6 262 CID	1996	ZR2; (W)	USEP3240R	6.0L V8 5967cc 364 CID	2002	(U), BI-FUEL, Naturally Aspirated; Exc.Evaporative Emissions Control	USEP3501
4.3L V6 262 CID	1996	ZR2; (X)	USEP3240R	6.0L V8 5967cc 364 CID	2002	(U), BI-FUEL, Naturally Aspirated; Exc.Evaporative Emissions Control	USEP3501
4.3L V6 262 CID	1997-1999	(X), FI, GAS, Naturally Aspirated	USEP3240R	6.6L V8 6599cc 403 CID	2001-2003	(1), DIESEL, Turbocharged	USEP3526
4.3L V6 262 CID	1997-2000	(W), FI, GAS, Naturally Aspirated	USEP3240R	6.6L V8 6599cc 403 CID	2001-2003	(1), DIESEL, Turbocharged; External Pump(Secondary Fuel Tank)	USEP3526
4.3L V6 262 CID	2001	(W), GAS	USEP3240R	6.6L V8 6599cc 403 CID	2006	LS, LT, WT; (2), DIESEL, Turbocharged	USEP3526
4.3L V6 262 CID	2002	(W), 108.3 / 275.1 Wheel Base, GAS, Standard Cab Pickup	USEP3240R	6.6L V8 6599cc 403 CID	2006	LS, LT, WT; (2), DIESEL, Turbocharged; External Pump(Secondary Fuel Tank)	USEP3526
4.3L V6 262 CID	2002	(W), 117.9 / 299.5 Wheel Base, GAS, Standard Cab Pickup	USEP3240R	6.6L V8 6599cc 403 CID	2006	LS, LT, WT; (D), (LBZ), DIESEL, Turbocharged	USEP3526
4.3L V6 262 CID	2002	(W), 122.9 / 312.2 Wheel Base, GAS, Standard Cab Pickup	USEP3240R	6.6L V8 6599cc 403 CID	2006	LS, LT, WT; (D), (LBZ), DIESEL, Turbocharged; External Pump(Secondary Fuel Tank)	USEP3526
4.3L V6 262 CID	2002	(W), Crew Cab Pickup, GAS	USEP3240R	6.6L V8 6599cc 403 CID	2006	LS, LT, WT; (D), (LBZ), DIESEL, Turbocharged	USEP3526
4.3L V6 262 CID	2002	(W), Extended Cab Pickup, GAS	USEP3240R	6.6L V8 6599cc 403 CID	2006	LS, LT, WT; (D), (LBZ), DIESEL, Turbocharged	USEP3526
4.3L V6 262 CID	2002	(X), Extended Cab Pickup	USEP3240R	6.6L V8 6599cc 403 CID	2006	LS, LT, WT; (D), (LBZ), DIESEL, Turbocharged; External Pump(Secondary Fuel Tank)	USEP3526
4.3L V6 262 CID	2003	(X), Standard Cab Pickup	USEP3240R	6.6L V8 6599cc 403 CID	2007-2008	LT, LTZ, WT; (6), (LMM), DIESEL, Turbocharged	USEP3526
<b>S10 BLAZER</b>				6.6L V8 6599cc 403 CID	2007-2008	LT, LTZ, WT; (6), (LMM), DIESEL, Turbocharged; External Pump	USEP3526
3.1L V6 3137cc 189 CID	1992-1994	(W)	USEP3270	8.1L V8 496 CID	2001-2003	(G), GAS, Naturally Aspirated; Evaporative Emissions Control	USEP3500
4.3L V6 262 CID	1991		USEP3902	8.1L V8 496 CID	2001-2003	(G), GAS, Naturally Aspirated; Exc.Evaporative Emissions Control	USEP3501
4.3L V6 262 CID	1992-1994	(Z)	USEP3902	<b>SILVERADO 3500</b>			
<b>SILVERADO</b>				6.0L V8 5967cc 364 CID	2001	(U), GAS, Naturally Aspirated; Exc.Commercial Chassis (Evaporative Emissions Control)	USEP3500
5.7L V8 350 CID	1995	MEX	USEP3902	6.0L V8 5967cc 364 CID	2001	(U), GAS, Naturally Aspirated; Exc.Commercial Chassis (Exc.Evaporative Emissions Control)	USEP3501
<b>SILVERADO 1500</b>				6.0L V8 5967cc 364 CID	2002-2003	(U), GAS, Naturally Aspirated; Exc.Commercial Chassis (Calif)	USEP3500
4.3L V6 262 CID	1999-2001	(W); Evaporative Emissions Control	USEP3500	6.0L V8 5967cc 364 CID	2002-2003	(U), GAS, Naturally Aspirated; Exc.Commercial Chassis (Federal)	USEP3501
4.3L V6 262 CID	1999-2001	(W); Exc.Evaporative Emissions Control	USEP3501	6.6L V8 6599cc 403 CID	2001-2003	(1), DIESEL, Turbocharged; Commercial chassis, Primary Fuel Tank	USEP3526
4.3L V6 262 CID	2002	(W), GAS; Evaporative Emissions Control	USEP3500	6.6L V8 6599cc 403 CID	2001-2003	(1), DIESEL, Turbocharged; Exc.Commercial Chassis	USEP3526
4.3L V6 262 CID	2002	(X), GAS; Evaporative Emissions Control	USEP3500	6.6L V8 6599cc 403 CID	2001-2004	(1), DIESEL, Turbocharged; Commercial chassis, External Pump(Secondary Fuel Tank)	USEP3526
4.3L V6 262 CID	2002	(W), GAS; Exc.Evaporative Emissions Control	USEP3501	6.6L V8 6599cc 403 CID	2005	(2), DIESEL, Turbocharged; (Primary Fuel Tank), Commercial chassis	USEP3526
4.3L V6 262 CID	2002	(X), GAS; Exc.Evaporative Emissions Control	USEP3501	6.6L V8 6599cc 403 CID	2005	(2), DIESEL, Turbocharged; (Secondary Fuel Tank), Commercial chassis	USEP3526
4.3L V6 262 CID	2002	MEX, Standard Cab Pickup; TCF	USEP3500	6.6L V8 6599cc 403 CID	2005	(2), DIESEL, Turbocharged; Commercial chassis, External Pump(Secondary Fuel Tank)	USEP3526
4.3L V6 262 CID	2002-2003	MEX, Standard Cab Pickup	USEP3501	6.6L V8 6599cc 403 CID	2005	(2), DIESEL, Turbocharged; Commercial chassis, Primary Fuel Tank	USEP3526
4.3L V6 262 CID	2003	WT; (X), GAS; Evaporative Emissions Control	USEP3500	6.6L V8 6599cc 403 CID	2005	(2), DIESEL, Turbocharged; Commercial chassis, Secondary Fuel Tank(Incl.Sender)	USEP3526
4.3L V6 262 CID	2003	WT; (X), GAS; Exc.Evaporative Emissions Control	USEP3501	6.6L V8 6599cc 403 CID	2005	(2), DIESEL, Turbocharged; Exc.Commercial Chassis	USEP3526
4.3L V6 262 CID	2004	Z71; (X), GAS; Evaporative Emissions Control	USEP3500	6.6L V8 6599cc 403 CID	2006	(2), DIESEL, Turbocharged; (Primary Fuel Tank), Commercial Chassis (Auxiliary Fuel Tank)	USEP3526
4.8L V8 294 CID	1999-2001	(V); Evaporative Emissions Control	USEP3500	6.6L V8 6599cc 403 CID	2006	LS, LT, WT; (2), DIESEL, Turbocharged; (Secondary Fuel Tank), Commercial Chassis (Exc.Auxiliary Fuel Tank)	USEP3526
4.8L V8 294 CID	1999-2001	(V); Exc.Evaporative Emissions Control	USEP3501	6.6L V8 6599cc 403 CID	2006	LS, LT, WT; (2), DIESEL, Turbocharged; Commercial chassis, External Pump(Secondary Fuel Tank)	USEP3526
4.8L V8 294 CID	2002	(V), GAS; Evaporative Emissions Control	USEP3500	6.6L V8 6599cc 403 CID	2006	LS, LT, WT; (2), DIESEL, Turbocharged; Commercial chassis, External Pump(Secondary Fuel Tank)	USEP3526
4.8L V8 294 CID	2002	(V), GAS; Exc.Evaporative Emissions Control	USEP3501	6.6L V8 6599cc 403 CID	2006	LS, LT, WT; (2), DIESEL, Turbocharged; Commercial chassis, External Pump(Secondary Fuel Tank)	USEP3526
4.8L V8 294 CID	2003	WT; (V), GAS; Evaporative Emissions Control	USEP3500	6.6L V8 6599cc 403 CID	2006	LS, LT, WT; (2), DIESEL, Turbocharged; Commercial chassis, External Pump(Secondary Fuel Tank)	USEP3526
4.8L V8 294 CID	2003	WT; (V), GAS; Exc.Evaporative Emissions Control	USEP3501	6.6L V8 6599cc 403 CID	2006	LS, LT, WT; (2), DIESEL, Turbocharged; Commercial chassis, External Pump(Secondary Fuel Tank)	USEP3526
4.8L V8 294 CID	2007-2008	LT, WT; (C), 143.5 / 364.5 Wheel Base, GAS; Except for Bosch, Carter, and Delphi	USEP12046	6.6L V8 6599cc 403 CID	2006	LS, LT, WT; (2), DIESEL, Turbocharged; Commercial chassis, External Pump(Secondary Fuel Tank)	USEP3526
4.8L V8 294 CID	2008	LS; (C), GAS; Except for Bosch, Carter, and Delphi	USEP12046	6.6L V8 6599cc 403 CID	2006	LS, LT, WT; (2), DIESEL, Turbocharged; Commercial chassis, External Pump(Secondary Fuel Tank)	USEP3526
4.8L V8 294 CID	2008	LT, WT; (C), 134.0 / 340.4 Wheel Base, GAS; Except for Bosch, Carter, and Delphi	USEP12046	6.6L V8 6599cc 403 CID	2006	LS, LT, WT; (2), DIESEL, Turbocharged; Commercial chassis, External Pump(Secondary Fuel Tank)	USEP3526
4.8L V8 294 CID	2008	Base, LT, LTZ, WT	USEP12046	6.6L V8 6599cc 403 CID	2006	LS, LT, WT; (2), DIESEL, Turbocharged; Commercial chassis, External Pump(Secondary Fuel Tank)	USEP3526
5.3L V8 5328cc 325 CID	2007-2008	SS; (N), GAS; Evaporative Emissions Control	USEP3500	6.6L V8 6599cc 403 CID	2006	LS, LT, WT; (2), DIESEL, Turbocharged; Commercial chassis, External Pump(Secondary Fuel Tank)	USEP3526
6.0L V8 5967cc 364 CID	2003	SS; (N), GAS; Exc.Evaporative Emissions Control	USEP3501	6.6L V8 6599cc 403 CID	2006	LS, LT, WT; (2), DIESEL, Turbocharged; Commercial chassis, External Pump(Secondary Fuel Tank)	USEP3526
6.0L V8 5967cc 364 CID	2003	SS; (N), GAS; Exc.Evaporative Emissions Control	USEP3501	6.6L V8 6599cc 403 CID	2006	LS, LT, WT; (2), DIESEL, Turbocharged; Commercial chassis, External Pump(Secondary Fuel Tank)	USEP3526
6.0L V8 5967cc 364 CID	2007	LT, LTZ	USEP12046	6.6L V8 6599cc 403 CID	2006	LS, LT, WT; (2), DIESEL, Turbocharged; Commercial chassis, External Pump(Secondary Fuel Tank)	USEP3526
6.0L V8 5967cc 364 CID	2008	LT, LTZ; (L76), (Y), GAS; Except for Bosch, Carter, and Delphi	USEP12046	6.6L V8 6599cc 403 CID	2006	LS, LT, WT; (2), DIESEL, Turbocharged; Commercial chassis, External Pump(Secondary Fuel Tank)	USEP3526
<b>SILVERADO 1500 HD</b>				6.6L V8 6599cc 403 CID	2006	LS, LT, WT; (2), DIESEL, Turbocharged; Exc.Commercial Chassis	USEP3526
6.0L V8 5967cc 364 CID	2001-2003	Evaporative Emissions Control	USEP3500	6.6L V8 6599cc 403 CID	2006	LS, LT, WT; (D), (LBZ), DIESEL, Turbocharged; External Pump(Secondary Fuel Tank)	USEP3526
6.0L V8 5967cc 364 CID	2001-2003	Exc.Evaporative Emissions Control	USEP3501	6.6L V8 6599cc 403 CID	2006	WT; (D), (LBZ), DIESEL, Turbocharged	USEP3526
<b>SILVERADO 2500</b>				8.1L V8 496 CID	2001	(G), GAS, Naturally Aspirated; Exc.Commercial Chassis (Evaporative Emissions Control)	USEP3500
6.0L V8 5967cc 364 CID	1999-2000	(U); Evaporative Emissions Control	USEP3500				
6.0L V8 5967cc 364 CID	1999-2000	(U); Exc.Evaporative Emissions Control	USEP3501				



Engine	Years	Application Description	USMW	Engine	Years	Application Description	USMW
<b>CHEVROLET (cont'd.)</b>				<b>CHEVROLET (cont'd.)</b>			
<b>SILVERADO 3500 (cont'd.)</b>				<b>V3500 (cont'd.)</b>			
8.1L V8 496 CID	2001	(G), GAS, Naturally Aspirated; Exc.Commercial Chassis (Exc.Evaporative Emissions Control)	USEP3501	7.4L V8 454 CID	1989	(N), FI, GAS	USEP3902
8.1L V8 496 CID	2002-2003	(G), GAS, Naturally Aspirated; Exc.Commercial Chassis (Calif)	USEP3500	7.4L V8 454 CID	1990-1991	(N), GAS	USEP3902
8.1L V8 496 CID	2002-2003	(G), GAS, Naturally Aspirated; Exc.Commercial Chassis (Federal)	USEP3501	<b>VECTRA</b>			
<b>SILVERADO 3500 HD</b>				2.8L V6 2792cc 170 CID	2006-2008	MEX	USEP8335
6.6L V8 6599cc 403 CID	2007-2008	LT, LTZ, WT; (6), (LMM), DIESEL, Turbocharged	USEP3526	<b>VENTURE</b>			
6.6L V8 6599cc 403 CID	2007-2008	LT, LTZ, WT; (6), (LMM), DIESEL, Turbocharged; External Pump	USEP3526		2001	120.0 / 304.8 Wheel Base	USEP3372
<b>SONORA</b>				<b>ZAFIRA</b>			
5.7L V8 350 CID	2000	FI, MEX	USEP3240R	2.2L L4 2198cc 134 CID	2002	MEX	USEP8335
5.7L V8 350 CID	2001-2002	MEX	USEP3919	2.2L L4 2198cc 134 CID	2004-2006	MEX	USEP8335
<b>SPECTRUM</b>				<b>CHRYSLER</b>			
1.5L L4 1471cc 92 CID	1987-1988	2 inch pump diameter	USEP3222	<b>200</b>			
<b>SPRINT</b>				2.4L L4 2360cc 144 CID	2011-2014		USEP2518
1.0L L3 993cc 61 CID	1987-1988		USEP8023	<b>CIRRUS</b>			
<b>SSR</b>				2.4L L4 2429cc 148 CID	1995		USEP7041
	2005-2006		USEP3707	2.4L L4 2429cc 148 CID	1997		USEP7041
<b>SUBURBAN 1500</b>				2.4L L4 2429cc 148 CID	2001	MEX	USEP8455
5.3L V8 5328cc 325 CID	2003	(T), GAS	USEP3507R	2.5L V6 2497cc 152 CID	1995		USEP7041
5.7L V8 350 CID	2000-2001		USEP3509	2.5L V6 2497cc 152 CID	1997		USEP7041
5.7L V8 350 CID	2001	MEX	USEP3240R	2.5L V6 2497cc 152 CID	1998-2000		USEP7113
<b>TAHOE</b>				<b>CONCORDE</b>			
5.7L V8 350 CID	1995	(K), GAS, Naturally Aspirated	USEP3902	3.3L V6 3301cc 201 CID	1993	(T)	USEP7054
5.7L V8 350 CID	1996	(R), GAS, Naturally Aspirated	USEP3270	3.3L V6 3301cc 201 CID	1994-1995	(T), GAS	USEP7054
5.7L V8 350 CID	1997	(R), 2 Doors, GAS, Naturally Aspirated	USEP3270	3.3L V6 3301cc 201 CID	1994-1995	(U), FLEX	USEP7076
5.7L V8 350 CID	1997	(R), 4 Doors, GAS, Naturally Aspirated	USEP3933	3.5L V6 3497cc 215 CID	1993	(F)	USEP7054
5.7L V8 350 CID	1998-1999	(R), 4 Doors, GAS, Naturally Aspirated; (Exc.Radio Frequency Interference Filter)	USEP3240R	3.5L V6 3497cc 215 CID	1994-1995	(F), GAS	USEP7054
5.7L V8 350 CID	1998-1999	(R), 4 Doors, GAS, Naturally Aspirated; (Radio Frequency Interference Filter)	USEP3240R	3.5L V6 3518cc 215 CID	1995	MEX	USEP7054
6.5L V8 395 CID	1995-1998	(S), DIESEL, Turbocharged; External Pump	USEP3309	<b>CONQUEST</b>			
6.5L V8 395 CID	1999	(S), DIESEL, Turbocharged; External Pump	USEP3540	2.6L L4 2555cc 156 CID	1987-1989	External Pump	USEP8000
<b>TIGRA</b>				<b>CROSSFIRE</b>			
1.6L L4 1598cc 98 CID	1999	MEX	USEP12007	3.2L V6 3199cc	2005-2006	SRT-6; (EGZ), (N), Supercharged; External Pump	USEP8289
<b>TORNADO</b>				3.2L V6 3200cc 195 CID	2004	External Pump	USEP8289
1.8L L4 1796cc 110 CID	2004-2007	MEX, Standard Cab Pickup	USEP12026	3.2L V6 3200cc 195 CID	2005	Limited; (L), Naturally Aspirated; External Pump	USEP8289
1.8L L4 1796cc 110 CID	2009-2010	MEX, Standard Cab Pickup	USEP12026	3.2L V6 3200cc 195 CID	2006	Base, Limited; (L), Naturally Aspirated; External Pump	USEP8289
<b>TRACKER</b>				3.2L V6 3200cc 195 CID	2007	Base, Limited; External Pump	USEP8289
1.6L L4 1588cc 98 CID	1999		USEP8229	3.2L V6 3200cc 195 CID	2008	External Pump	USEP8289
2.0L L4 122 CID	2003		USEP8229	<b>DAYTONA</b>			
2.0L L4 1995cc 122 CID	1999		USEP8229	2.2L L4 135 CID	1985-1988	CAN	USEP7012
2.5L V6 2500cc	2003-2004		USEP8229	2.5L L4 2507cc 153 CID	1987	CAN	USEP7012
<b>TRAILBLAZER</b>				<b>GRAND VOYAGER</b>			
4.2L L6 256 CID	2005-2007	LS, LT; (S)	USEP3707	3.0L V6 2972cc 181 CID	2000		USEP7041
4.2L L6 256 CID	2009	LT; (S)	USEP3707	3.3L V6 3301cc 201 CID	2000		USEP7041
6.0L V8 5967cc 364 CID	2006-2007	SS; (H)	USEP3707	3.8L V6 3778cc 231 CID	1995		USEP7041
6.0L V8 5967cc 364 CID	2009	SS; (H)	USEP3707	3.8L V6 3778cc 231 CID	1998-2000		USEP7041
<b>V10</b>				3.8L V6 3778cc 231 CID	2001		USEP7093
4.3L V6 262 CID	1987	(Z), GAS	USEP3902	<b>IMPERIAL</b>			
5.0L V8 305 CID	1987	(H), GAS	USEP3902	3.3L V6 3301cc 201 CID	1991	(R); Except for Bosch, Carter, and Delphi	USEP7040
5.7L V8 350 CID	1987	(K), GAS	USEP3902	3.3L V6 3301cc 201 CID	1991		USEP7041
<b>V10 SUBURBAN</b>				3.8L V6 3778cc 231 CID	1991	(L); Except for Bosch, Carter, and Delphi	USEP7040
5.7L V8 350 CID	1987-1988	(K), GAS	USEP3902	3.8L V6 3778cc 231 CID	1991-1993		USEP7041
<b>V20</b>				5.2L V8 5211cc 318 CID	1982		USEP8094
5.7L V8 350 CID	1987	(K), FI, GAS	USEP3902	<b>INTREPID</b>			
<b>V20 SUBURBAN</b>				3.5L V6 3518cc 215 CID	1995	MEX	USEP7054
5.7L V8 350 CID	1987	(K), GAS	USEP3902	<b>LASER</b>			
<b>V30</b>				2.2L L4 135 CID	1985	Base, XE; (D), Naturally Aspirated	USEP7031
5.7L V8 350 CID	1987-1988	(K), FI, GAS	USEP3902	2.5L L4 2507cc 153 CID	1986	Base; (D), Naturally Aspirated	USEP7000
6.2L V8 379 CID	1988	(J), DIESEL, FI; External Pump	USEP3158	2.5L L4 2507cc 153 CID	1986	Base, XE; (K), Naturally Aspirated	USEP7000
7.4L V8 454 CID	1987-1988	(N), FI, GAS	USEP3902	<b>LEBARON</b>			
<b>V1500 SUBURBAN</b>				2.2L L4 135 CID	1984	MEX	USEP2486
5.7L V8 350 CID	1989-1991	(K), GAS	USEP3902	2.2L L4 135 CID	1985	GTS, Mark Cross; (D), FI, Naturally Aspirated	USEP7031
<b>V2500 SUBURBAN</b>				2.2L L4 135 CID	1986	Base, GTS; (D), Naturally Aspirated	USEP7000
5.7L V8 350 CID	1990-1991	(K), GAS	USEP3902	2.2L L4 135 CID	1987-1988	GTS, Premium; (D), Naturally Aspirated	USEP7000
7.4L V8 454 CID	1990	(N), GAS	USEP3567	2.5L L4 2500cc 153 CID	1993		USEP7041
<b>V3500</b>				2.5L L4 2500cc 153 CID	1995		USEP7041
5.7L V8 350 CID	1989	(K), FI, GAS	USEP3902	2.5L L4 2507cc 153 CID	1986	GTS, Mark Cross; (K), Naturally Aspirated	USEP7000
5.7L V8 350 CID	1990-1991	(K), GAS	USEP3902	2.5L L4 2507cc 153 CID	1987-1988	GTS, Premium; (K), Naturally Aspirated	USEP7000
				2.5L L4 2507cc 153 CID	1991	Base; (J), Turbocharged; Except for Bosch, Carter, and Delphi	USEP7040
				2.5L L4 2507cc 153 CID	1991	Base; (K), Naturally Aspirated; Except for Bosch, Carter, and Delphi	USEP7040

Engine	Years	Application Description	USMW
<b>CHRYSLER (cont'd.)</b>			
<b>LEBARON (cont'd.)</b>			
2.5L L4 2507cc 153 CID	1991-1992		USEP7041
3.0L V6 2972cc 181 CID	1991	Base, LX; (3), Naturally Aspirated; Except for Bosch, Carter, and Delphi	USEP7040
3.0L V6 2972cc 181 CID	1991-1993		USEP7041
<b>LHS</b>			
	1994-1995		USEP7054
<b>NEON</b>			
2.0L L4 1996cc 122 CID	1995	TQE.PLASTICO	USEP7041
2.0L L4 1996cc 122 CID	1996-1997	MEX; Except for Bosch, Carter, and Delphi, TQE.PLASTICO	USEP7097
<b>NEW YORKER</b>			
2.2L L4 135 CID	1984		USEP7054
2.2L L4 135 CID	1985	MEX	USEP7012
2.2L L4 135 CID	1986-1988	GAS, MEX, Sedan	USEP7012
2.5L L4 2507cc 153 CID	1986-1987	(K), Naturally Aspirated	USEP7000
3.0L V6 2972cc 181 CID	1988	Base, Landau; (3), Naturally Aspirated	USEP7012
3.3L V6 3301cc 201 CID	1991	Fifth Avenue, Salon; (R); Except for Bosch, Carter, and Delphi	USEP7040
3.3L V6 3301cc 201 CID	1991-1993		USEP7041
3.8L V6 3778cc 231 CID	1991	Fifth Avenue; (L); Except for Bosch, Carter, and Delphi	USEP7040
3.8L V6 3778cc 231 CID	1991-1993		USEP7041
<b>PHANTOM</b>			
2.2L L4 135 CID	1987-1989	MEX	USEP7012
<b>PT CRUISER</b>			
	2005	Dream Cruiser; (G), Turbocharged; Except for Bosch, Carter, and Delphi	USEP7206
	2005	Limited; (8), Turbocharged; Except for Bosch, Carter, and Delphi	USEP7206
	2005	Touring; (E), Turbocharged; Except for Bosch, Carter, and Delphi	USEP7206
	2005	Limited; (B), Naturally Aspirated; Except for Bosch, Carter, and Delphi	USEP7207
	2005-2007	GT; (S), Turbocharged; Except for Bosch, Carter, and Delphi	USEP7206
	2006	Limited, Touring; (E), Turbocharged; Except for Bosch, Carter, and Delphi	USEP7206
	2006	Base, Limited, Street Cruiser, Touring; (B), Naturally Aspirated; Except for Bosch, Carter, and Delphi	USEP7207
	2006-2007	GT; (G), Turbocharged; Except for Bosch, Carter, and Delphi	USEP7206
	2006-2007	Base, Touring; (X), Naturally Aspirated; Except for Bosch, Carter, and Delphi	USEP7207
	2007	Limited; (8), Turbocharged; Except for Bosch, Carter, and Delphi	USEP7206
	2007	Touring; (E), Turbocharged; Except for Bosch, Carter, and Delphi	USEP7206
	2007	Base, Limited, Touring; (B), Naturally Aspirated; Except for Bosch, Carter, and Delphi	USEP7207
	2008	Base, Limited, Touring; (E), Turbocharged; Except for Bosch, Carter, and Delphi	USEP7206
	2008	Limited, Touring; (8), Turbocharged; Except for Bosch, Carter, and Delphi	USEP7206
	2008	Base, LX, Touring; (B), Naturally Aspirated; Except for Bosch, Carter, and Delphi	USEP7207
	2008	Base; (EDZ), (X), Naturally Aspirated; Except for Bosch, Carter, and Delphi	USEP7207
	2009	Limited; (8), Turbocharged; Except for Bosch, Carter, and Delphi	USEP7207
	2009	LX, Touring; (9), (EDZ), Naturally Aspirated; Except for Bosch, Carter, and Delphi	USEP7207
<b>SEBRING</b>			
2.0L L4 1996cc 122 CID	1995-1996		USEP8229
2.0L L4 1996cc 122 CID	1997-1999	Coupe	USEP8229
2.4L L4 2351cc	2001-2002	LX; (G)	USEP8455
2.4L L4 2351cc	2003	LX; (G), GAS	USEP8455
2.4L L4 2351cc	2004	Base; (G), GAS	USEP8455
2.4L L4 2351cc	2005		USEP8456
2.4L L4 2360cc 144 CID	2008-2010		USEP2518
2.4L L4 2429cc 148 CID	1996-1998	Convertible	USEP7041
2.5L V6 2497cc 152 CID	1995		USEP8229
2.5L V6 2497cc 152 CID	1996-2000	Convertible	USEP7041
2.5L V6 2497cc 152 CID	1996-2000	Coupe	USEP8229
2.5L V6 2497cc 152 CID	1999-2000		USEP7113
3.0L V6 2972cc 181 CID	2001-2005		USEP8456
3.5L V6 3497cc 215 CID	2008		USEP2518
<b>SHADOW</b>			
2.2L L4 135 CID	1989-1990		USEP7041
2.5L L4 2500cc 153 CID	1989-1990	GAS, MEX	USEP7012

Engine	Years	Application Description	USMW
<b>CHRYSLER (cont'd.)</b>			
<b>SPIRIT</b>			
2.5L L4 2500cc 153 CID	1991		USEP7041
<b>STRATUS</b>			
2.4L L4 2429cc 148 CID	1996-1997		USEP7041
<b>TOWN &amp; COUNTRY</b>			
2.5L L4 2507cc 153 CID	1986-1988	(K), Naturally Aspirated	USEP7012
3.3L V6 3301cc 201 CID	1991-1993		USEP7000
3.3L V6 3301cc 201 CID	1996-1998		USEP7041
3.3L V6 3301cc 201 CID	2004	Base; (R)	USEP7221
3.3L V6 3301cc 201 CID	2005	Base; (R); Exc.Floor Storage (Exc.Fold Away Seats)	USEP7221
3.3L V6 3301cc 201 CID	2005	Base; (R); Floor Storage (Fold Away Seats)	USEP7221
3.3L V6 3301cc 201 CID	2006-2007	Base, LX; (R)	USEP7221
3.8L V6 3778cc 231 CID	1994		USEP7041
3.8L V6 3778cc 231 CID	1996-1998		USEP7041
3.8L V6 3778cc 231 CID	2004	Touring; (L)	USEP7221
3.8L V6 3778cc 231 CID	2005	Limited; (L); Exc.Floor Storage (Exc.Fold Away Seats)	USEP7221
3.8L V6 3778cc 231 CID	2005	Limited; (L); Floor Storage (Fold Away Seats)	USEP7221
3.8L V6 3778cc 231 CID	2006-2007	Limited, Touring; (L)	USEP7221
<b>VOYAGER</b>			
3.3L V6 3301cc 201 CID	1996-1997		USEP7041
3.3L V6 3301cc 201 CID	2001-2002	MEX	USEP7097
3.3L V6 3301cc 201 CID	2005	Mini Passenger Van	USEP7221
3.3L V6 3301cc 201 CID	2007-2008	Mini Passenger Van	USEP7221
<b>DAEWOO</b>			
<b>LEGANZA</b>			
2.2L L4 2198cc 134 CID	1999-2002		USEP12021
<b>DAIHATSU</b>			
<b>CHARADE</b>			
1.0L L3 993cc 61 CID	1988-1992		USEP8023
1.3L L4 1295cc	1989-1992		USEP8023
<b>ROCKY</b>			
1.6L L4 1589cc	1990-1992	External Pump	USEP8000
<b>DELOREAN</b>			
<b>DMC 12</b>			
2.9L V6 2850cc 174 CID	1982		USEP8185
<b>DODGE</b>			
<b>600</b>			
2.2L L4 135 CID	1985	ES, SE; (D), FI, Naturally Aspirated	USEP7031
2.2L L4 135 CID	1986	ES, SE; (D), Naturally Aspirated	USEP7000
2.2L L4 135 CID	1987	Base, SE; (D), Naturally Aspirated	USEP7000
2.2L L4 135 CID	1988	Base; (D), Naturally Aspirated	USEP7000
2.5L L4 2507cc 153 CID	1986	ES, SE; (K), Naturally Aspirated	USEP7000
2.5L L4 2507cc 153 CID	1987-1988	Base, SE; (K), Naturally Aspirated	USEP7000
<b>ARIES</b>			
	1985	Base; (D), FI	USEP7031
2.2L L4 135 CID	1985	LE, SE; (D), FI	USEP7031
2.2L L4 135 CID	1986	Base, LE, SE; (D)	USEP7000
2.2L L4 135 CID	1987	Base, LE; (D)	USEP7000
2.2L L4 135 CID	1988-1989	(D)	USEP7000
2.5L L4 2507cc 153 CID	1986	Base, LE, SE; (K)	USEP7000
2.5L L4 2507cc 153 CID	1987	Base, LE; (K)	USEP7000
2.5L L4 2507cc 153 CID	1988-1989	(K)	USEP7000
<b>ATTITUDE</b>			
1.4L L4 1399cc 85 CID	2006-2010	MEX	USEP8335
1.6L L4 1599cc 98 CID	2006-2009	MEX	USEP12026
<b>AVENGER</b>			
2.0L L4 1996cc 122 CID	1995-1999		USEP8229
2.4L L4 2360cc 144 CID	2008-2014		USEP2518
2.5L V6 2497cc 152 CID	1995-2000		USEP8229
3.5L V6 3497cc 215 CID	2008		USEP2518
3.5L V6 3518cc 215 CID	2008		USEP2518
<b>B150</b>			
3.9L V6 3906cc 239 CID	1988-1990	(X)	USEP7018
3.9L V6 3906cc 239 CID	1991-1993	(X)	USEP7049
5.2L V8 5211cc 318 CID	1988-1990	(Y)	USEP7018
5.2L V8 5211cc 318 CID	1991-1993	(Y)	USEP7049
<b>B250</b>			
3.9L V6 3906cc 239 CID	1988	(X), FI	USEP7018
3.9L V6 3906cc 239 CID	1989-1990	(X)	USEP7018
3.9L V6 3906cc 239 CID	1991-1992	(X)	USEP7049
3.9L V6 3906cc 239 CID	1993	(X), GAS	USEP7049
5.2L V8 5211cc 318 CID	1988	(Y), FI	USEP7018

Engine	Years	Application Description	USMW	Engine	Years	Application Description	USMW
<b>DODGE (cont'd.)</b>				<b>DODGE (cont'd.)</b>			
<b>B250 (cont'd.)</b>				<b>D150</b>			
5.2L V8 5211cc 318 CID	1989-1990	(Y)	USEP7018	3.9L V6 3906cc 239 CID	1988	(X), FI	USEP7018
5.2L V8 5211cc 318 CID	1991-1992	(Y)	USEP7049	3.9L V6 3906cc 239 CID	1989	(X)	USEP7018
5.2L V8 5211cc 318 CID	1993	(Y), GAS	USEP7049	3.9L V6 3906cc 239 CID	1990	Base, S; (X)	USEP7018
5.9L V8 360 CID	1989-1990	(Z)	USEP7018	3.9L V6 3906cc 239 CID	1991-1993		USEP7047
5.9L V8 360 CID	1991	(Z)	USEP7049	5.2L V8 5211cc 318 CID	1988	(Y), FI	USEP7018
5.9L V8 360 CID	1992	(Z); 22 Gallon Fuel Tank	USEP7049	5.2L V8 5211cc 318 CID	1989	(Y)	USEP7018
5.9L V8 360 CID	1993	(Z), GAS; 22 Gallon Fuel Tank	USEP7049	5.2L V8 5211cc 318 CID	1990	Base, S; (Y)	USEP7018
<b>B350</b>				5.2L V8 5211cc 318 CID	1991-1993		USEP7047
5.2L V8 5211cc 318 CID	1988	(Y), FI	USEP7018	5.9L V8 360 CID	1989	(Z)	USEP7018
5.2L V8 5211cc 318 CID	1989-1990	(Y)	USEP7018	5.9L V8 360 CID	1990	Base; (Z)	USEP7018
5.2L V8 5211cc 318 CID	1991-1992	(Y)	USEP7049	5.9L V8 360 CID	1991		USEP7047
5.2L V8 5211cc 318 CID	1993	(Y), GAS	USEP7049	5.9L V8 360 CID	1993	Exc.30 Gallon Fuel Tank (Exc.34 Gallon Fuel Tank)	USEP7047
5.9L V8 360 CID	1989-1990	(Z)	USEP7018	<b>D250</b>			
5.9L V8 360 CID	1991	(Z)	USEP7049	3.9L V6 3906cc 239 CID	1988	(X), FI	USEP7018
5.9L V8 360 CID	1992	(Z); 22 Gallon Fuel Tank	USEP7049	3.9L V6 3906cc 239 CID	1989-1990	(X), GAS, Naturally Aspirated	USEP7018
5.9L V8 360 CID	1993	(Z), GAS; 22 Gallon Fuel Tank	USEP7049	3.9L V6 3906cc 239 CID	1991-1993		USEP7047
<b>B1500</b>				5.2L V8 5211cc 318 CID	1988	(Y), FI	USEP7018
3.9L V6 3906cc 239 CID	1997	(X)	USEP7094	5.2L V8 5211cc 318 CID	1989-1990	(Y), GAS, Naturally Aspirated	USEP7018
3.9L V6 3906cc 239 CID	1998	(X); 35 Gallon Fuel Tank	USEP7094	5.2L V8 5211cc 318 CID	1991-1993		USEP7047
5.2L V8 5211cc 318 CID	1997	(Y)	USEP7094	5.9L V8 360 CID	1989-1990	(5), GAS, Naturally Aspirated	USEP7018
5.2L V8 5211cc 318 CID	1998	(Y); 35 Gallon Fuel Tank	USEP7094	5.9L V8 360 CID	1989-1990	(Z), GAS, Naturally Aspirated	USEP7018
5.9L V8 360 CID	1998	(Z); 35 Gallon Fuel Tank	USEP7094	5.9L V8 360 CID	1991-1992		USEP7047
<b>B2500</b>				5.9L V8 360 CID	1993	Exc.30 Gallon Fuel Tank (Exc.34 Gallon Fuel Tank)	USEP7047
3.9L V6 3906cc 239 CID	1997	(X)	USEP7094	<b>D350</b>			
5.2L V8 5211cc 318 CID	1997	(Y)	USEP7094	3.7L L6 3687cc 225 CID	1982-1987	MEX	USEP8004
5.2L V8 5211cc 318 CID	1998	(Y), GAS; 35 Gallon Fuel Tank	USEP7094	5.9L V8 360 CID	1989-1990	(5), GAS, Naturally Aspirated	USEP7018
5.9L V8 360 CID	1997	(Z)	USEP7094	5.9L V8 360 CID	1989-1990	(Z), GAS, Naturally Aspirated	USEP7018
5.9L V8 360 CID	1998	(Z), GAS; 35 Gallon Fuel Tank	USEP7094	5.9L V8 360 CID	1991-1992		USEP7047
<b>B3500</b>				5.9L V8 360 CID	1993	Exc.30 Gallon Fuel Tank (Exc.34 Gallon Fuel Tank)	USEP7047
5.2L V8 5211cc 318 CID	1997	(Y), GAS	USEP7094	<b>DAKOTA</b>			
5.2L V8 5211cc 318 CID	1998	(Y), GAS; 35 Gallon Fuel Tank	USEP7094	2.5L L4 2507cc 153 CID	1989	Sport; (G)	USEP7018
5.9L V8 360 CID	1997	(Z), GAS	USEP7094	2.5L L4 2507cc 153 CID	1990	SE; (G)	USEP7018
5.9L V8 360 CID	1998	(Z), GAS; 35 Gallon Fuel Tank	USEP7094	2.5L L4 2507cc 153 CID	1991	SE; (G); 15 Gallon Fuel Tank	USEP7050
<b>CALIBER</b>				2.5L L4 2507cc 153 CID	1991	SE; (G); 22 Gallon Fuel Tank	USEP7050
2.0L L4 1998cc 122 CID	2012		USEP2518	2.5L L4 2507cc 153 CID	1992-1993	(G); 15 Gallon Fuel Tank	USEP7050
<b>CARAVAN</b>				2.5L L4 2507cc 153 CID	1992-1993	(G); 22 Gallon Fuel Tank	USEP7050
2.4L L4 2429cc 148 CID	1996-1998		USEP7041	2.5L L4 2507cc 153 CID	1995	(G), GAS; 15 Gallon Fuel Tank	USEP7050
2.4L L4 2429cc 148 CID	2004-2007	SE; (B), GAS	USEP7221	2.5L L4 2507cc 153 CID	1995	(G), GAS; 22 Gallon Fuel Tank	USEP7050
2.5L L4 2507cc 153 CID	1988	Base, LE, SE; (K)	USEP7000	2.5L L4 2507cc 153 CID	1997-2002		USEP7116
2.5L L4 2507cc 153 CID	1989	Base, CV, LE, SE; (K), Naturally Aspirated	USEP7000	3.7L V6 226 CID	2005	(K); Except for Bosch, Carter, and Delphi	USEP7206
2.5L L4 2507cc 153 CID	1989	Base, C/V, LE, SE; (J), Turbocharged	USEP7012	3.7L V6 226 CID	2006	Laramie, SLT, ST; (K); Except for Bosch, Carter, and Delphi	USEP7206
2.5L L4 2507cc 153 CID	1990	C/V, ES, LE, SE; (K), Naturally Aspirated	USEP7000	3.7L V6 226 CID	2007	Laramie, SLT, ST; (K), GAS; Except for Bosch, Carter, and Delphi	USEP7206
2.5L L4 2507cc 153 CID	1990	C/V, ES, LE, SE; (J), Turbocharged	USEP7012	3.7L V6 226 CID	2009	Big Horn, Lone Star, ST, TRX4; (K), GAS; Except for Bosch, Carter, and Delphi	USEP7206
2.5L L4 2507cc 153 CID	1991-1995		USEP7041	3.9L V6 3906cc 239 CID	1988	Sport; (X), FI	USEP7018
3.0L V6 2972cc 181 CID	1987	LE, SE; (3), FI	USEP7012	3.9L V6 3906cc 239 CID	1989-1990	SE, Sport; (X)	USEP7018
3.0L V6 2972cc 181 CID	1988	LE, SE; (3)	USEP7012	3.9L V6 3906cc 239 CID	1991	SE, Sport; (X); 15 Gallon Fuel Tank	USEP7050
3.0L V6 2972cc 181 CID	1989	C/V, LE, SE; (3), Naturally Aspirated	USEP7012	3.9L V6 3906cc 239 CID	1991	SE, Sport; (X); 22 Gallon Fuel Tank	USEP7050
3.0L V6 2972cc 181 CID	1990	C/V, ES, LE, SE; (3), Naturally Aspirated	USEP7012	3.9L V6 3906cc 239 CID	1992-1993	(X); 15 Gallon Fuel Tank	USEP7050
3.0L V6 2972cc 181 CID	1990		USEP7012	3.9L V6 3906cc 239 CID	1992-1993	(X); 22 Gallon Fuel Tank	USEP7050
3.0L V6 2972cc 181 CID	1991-1998		USEP7041	3.9L V6 3906cc 239 CID	1997-2003		USEP7116
3.3L V6 3301cc 201 CID	1990	(R), Naturally Aspirated	USEP7012	4.7L V8 287 CID	2000-2003		USEP7116
3.3L V6 3301cc 201 CID	1991-1998		USEP7041	4.7L V8 287 CID	2004	Crew Cab Pickup	USEP7154
3.3L V6 3301cc 201 CID	2004	SXT; (R), GAS	USEP7221	4.7L V8 287 CID	2004	Extended Cab Pickup	USEP7154
3.3L V6 3301cc 201 CID	2005	C/V; (R), GAS	USEP7221	4.7L V8 287 CID	2005	(J); Except for Bosch, Carter, and Delphi	USEP7206
3.3L V6 3301cc 201 CID	2006	Base, SXT; (R), GAS	USEP7221	4.7L V8 287 CID	2005	(N); Except for Bosch, Carter, and Delphi	USEP7206
3.3L V6 3301cc 201 CID	2007	Base, SE, SXT; (R), GAS	USEP7221	4.7L V8 287 CID	2006	Laramie, SLT, ST; (N); Except for Bosch, Carter, and Delphi	USEP7206
3.8L V6 3778cc 231 CID	1996-1998		USEP7041	4.7L V8 287 CID	2006	Laramie, SLT; (J); Except for Bosch, Carter, and Delphi	USEP7206
<b>CHARGER</b>				4.7L V8 287 CID	2007	Laramie, SLT, ST; (N), GAS; Except for Bosch, Carter, and Delphi	USEP7206
	1985-1987	Shelby; (E), FI, Turbocharged; External Pump	USEP7052	4.7L V8 287 CID	2007	Laramie, SLT, ST; (P), FLEX; Except for Bosch, Carter, and Delphi	USEP7206
	1985-1987	Shelby; (E), FI, Turbocharged; In Tank Pump	USEP7359	4.7L V8 287 CID	2007	Laramie, SLT; (J), GAS; Except for Bosch, Carter, and Delphi	USEP7206
<b>COLT</b>				4.7L V8 287 CID	2009	Big Horn, Laramie, Lone Star, TRX4; (P), FLEX; Except for Bosch, Carter, and Delphi	USEP7206
1.5L L4 1468cc 90 CID	1989		USEP8023	5.2L V8 5211cc 318 CID	1989	Shelby; (Y)	USEP7018
1.5L L4 1468cc 90 CID	1992		USEP8229	5.2L V8 5211cc 318 CID	1990	SE; (Y)	USEP7018
1.6L L4 1597cc 98 CID	1985-1987	2 inch pump diameter	USEP3222	5.2L V8 5211cc 318 CID	1991	SE, Sport; (Y); 15 Gallon Fuel Tank	USEP7050
1.6L L4 1597cc 98 CID	1989		USEP8023	5.2L V8 5211cc 318 CID	1991	SE, Sport; (Y); 22 Gallon Fuel Tank	USEP7050
1.8L L4 1754cc 107 CID	1989	2 inch pump diameter	USEP3222	5.2L V8 5211cc 318 CID	1992-1993	(Y); 15 Gallon Fuel Tank	USEP7050
2.0L L4 1997cc 122 CID	1989	2 inch pump diameter	USEP3222	5.2L V8 5211cc 318 CID	1992-1993	(Y); 22 Gallon Fuel Tank	USEP7050
2.4L L4 2351cc	1993-1994		USEP8229	5.2L V8 5211cc 318 CID	1997-1999		USEP7116
<b>CONQUEST</b>				5.9L V8 360 CID	1998-2003		USEP7116
2.6L L4 2555cc 156 CID	1985-1986	External Pump	USEP8000				
<b>D100</b>							
3.9L V6 3906cc 239 CID	1988	(X), FI	USEP7018				
3.9L V6 3906cc 239 CID	1989	(X)	USEP7018				
5.2L V8 5211cc 318 CID	1988	(Y), FI	USEP7018				
5.2L V8 5211cc 318 CID	1989	(Y)	USEP7018				



Engine	Years	Application Description	USMW
<b>DODGE (cont'd.)</b>			
<b>DART</b>			
2.2L L4 135 CID	1983-1984	MEX	USEP3127
2.2L L4 135 CID	1986-1987	MEX	USEP3127
3.7L L6 3687cc 225 CID	1977	MEX	USEP8004
<b>DAYTONA</b>			
2.2L L4 135 CID	1985	Base; (D), Naturally Aspirated	USEP7031
2.2L L4 135 CID	1984		USEP7012
2.2L L4 135 CID	1986	Base; (D), Naturally Aspirated	USEP7000
2.5L L4 2507cc 153 CID	1986-1988	Base; (K), Naturally Aspirated	USEP7000
2.5L L4 2507cc 153 CID	1992-1993		USEP7041
3.0L V6 2972cc 181 CID	1992-1993		USEP7041
<b>DURANGO</b>			
3.9L V6 3906cc 239 CID	1998-1999		USEP7117
4.7L V8 287 CID	2000		USEP7117
4.7L V8 287 CID	2002-2003		USEP7117
5.2L V8 5211cc 318 CID	1998-2000		USEP7117
5.9L V8 360 CID	1998-2000		USEP7117
5.9L V8 360 CID	2002-2003		USEP7117
<b>DYNASTY</b>			
2.5L L4 2507cc 153 CID	1988	Base, LE; (K)	USEP7012
2.5L L4 2507cc 153 CID	1991	Base; (K); Except for Bosch, Carter, and Delphi	USEP7040
2.5L L4 2507cc 153 CID	1992-1993		USEP7041
3.0L V6 2972cc 181 CID	1988	Base, LE; (3)	USEP7012
3.0L V6 2972cc 181 CID	1991	Base, LS; (3); Except for Bosch, Carter, and Delphi	USEP7040
3.0L V6 2972cc 181 CID	1991-1993		USEP7041
3.3L V6 3301cc 201 CID	1991	Base, LS; (R); Except for Bosch, Carter, and Delphi	USEP7040
3.3L V6 3301cc 201 CID	1991-1993		USEP7041
<b>GRAND CARAVAN</b>			
2.4L L4 2429cc 148 CID	1989-1990	LE, SE	USEP7012
2.4L L4 2429cc 148 CID	1996	Base; (B), GAS	USEP7041
2.4L L4 2429cc 148 CID	1997	Base; (B)	USEP7041
2.5L L4 2507cc 153 CID	1988	SE; (K)	USEP7000
3.0L V6 2972cc 181 CID	1988	LE, SE; (3)	USEP7012
3.0L V6 2972cc 181 CID	1992	Base; (3)	USEP7041
3.0L V6 2972cc 181 CID	1993	ES; (3), FWD	USEP7041
3.0L V6 2972cc 181 CID	1994-1995	Base	USEP7041
3.0L V6 2972cc 181 CID	1996	Base; (3), GAS	USEP7041
3.0L V6 2972cc 181 CID	1997	Base; (3)	USEP7041
3.0L V6 2972cc 181 CID	1998-2000	(3), GAS	USEP7041
3.3L V6 3301cc 201 CID	1991		USEP7041
3.3L V6 3301cc 201 CID	1992	LE; (R), FWD	USEP7041
3.3L V6 3301cc 201 CID	1993	ES; (R), FWD	USEP7041
3.3L V6 3301cc 201 CID	1995	SE; 41TE Trans Code	USEP7041
3.3L V6 3301cc 201 CID	1996	ES; (R), GAS	USEP7041
3.3L V6 3301cc 201 CID	1997	Base; (R)	USEP7041
3.3L V6 3301cc 201 CID	1998-2000	(R), GAS	USEP7041
3.3L V6 3301cc 201 CID	2004	SE; (R)	USEP7221
3.3L V6 3301cc 201 CID	2005	(R), GAS; Exc.Floor Storage (Exc.Fold Away Seats)	USEP7221
3.3L V6 3301cc 201 CID	2005	(R), GAS; Floor Storage (Fold Away Seats)	USEP7221
3.3L V6 3301cc 201 CID	2006-2007	Base, SE; (R), GAS	USEP7221
3.8L V6 3778cc 231 CID	1994	ES	USEP7041
3.8L V6 3778cc 231 CID	1995	LE	USEP7041
3.8L V6 3778cc 231 CID	1996	ES; (L), GAS	USEP7041
3.8L V6 3778cc 231 CID	1997	ES; (L)	USEP7041
3.8L V6 3778cc 231 CID	1998-2000	(L), GAS	USEP7041
3.8L V6 3778cc 231 CID	2004	Anniversary Edition; (L)	USEP7221
3.8L V6 3778cc 231 CID	2005	(L), GAS; Exc.Floor Storage (Exc.Fold Away Seats)	USEP7221
3.8L V6 3778cc 231 CID	2005	(L), GAS; Floor Storage (Fold Away Seats)	USEP7221
3.8L V6 3778cc 231 CID	2006-2007	SXT; (L), GAS	USEP7221
<b>INTREPID</b>			
3.3L V6 3301cc 201 CID	1993	Base, ES; (T)	USEP7054
3.3L V6 3301cc 201 CID	1994-1995	Base, ES; (T), GAS	USEP7054
3.3L V6 3301cc 201 CID	1994-1995	Base; (U), FLEX	USEP7076
3.5L V6 3497cc 215 CID	1993	Base, ES; (F)	USEP7054
3.5L V6 3497cc 215 CID	1994-1995	Base, ES; (F), GAS	USEP7054
<b>JOURNEY</b>			
2.4L L4 2360cc 144 CID	2009-2016		USEP2518
3.5L V6 3497cc 215 CID	2009-2010		USEP2518
3.5L V6 3518cc 215 CID	2009-2010		USEP2518
3.6L V6 3604cc 220 CID	2011-2014		USEP2518
3.6L V6 3605cc 220 CID	2011-2014		USEP2518
<b>LANCER</b>			
2.2L L4 135 CID	1985	Base, ES; (D), Naturally Aspirated	USEP7031
2.5L L4 2507cc 153 CID	1986-1987	Base, ES; (D), Naturally Aspirated	USEP7000
2.5L L4 2507cc 153 CID	1986-1987	Base, ES; (K), Naturally Aspirated	USEP7000

Engine	Years	Application Description	USMW
<b>DODGE (cont'd.)</b>			
<b>MAGNUM</b>			
2.2L L4 135 CID	1983-1988	MEX	USEP2486
<b>MINI RAM</b>			
2.5L L4 2507cc 153 CID	1987	(K), FI	USEP7000
2.5L L4 2507cc 153 CID	1988	(K)	USEP7000
3.0L V6 2972cc 181 CID	1987	(3), FI	USEP7012
3.0L V6 2972cc 181 CID	1988	(3)	USEP7012
<b>MONACO</b>			
	1990	ES, LE	USEP7020
<b>NEON</b>			
2.0L L4 1996cc 122 CID	1996	Exc.Plastic Fuel Tank	USEP7041
2.0L L4 1996cc 122 CID	1996	Base, High Line, Sport; (C), (ECB); Except for Bosch, Carter, and Delphi, Plastic Fuel Tank	USEP7097
2.0L L4 1996cc 122 CID	1996	Base, High Line; (Y); Except for Bosch, Carter, and Delphi, Plastic Fuel Tank	USEP7097
2.0L L4 1996cc 122 CID	1996	Sport; (ECC), (Y); Except for Bosch, Carter, and Delphi, Plastic Fuel Tank	USEP7097
2.0L L4 1996cc 122 CID	1997	Base, High Line, Sport; (ECC), (Y); Except for Bosch, Carter, and Delphi	USEP7097
2.0L L4 1996cc 122 CID	1997	Base, High Line; (C), (ECB); Except for Bosch, Carter, and Delphi	USEP7097
2.0L L4 1996cc 122 CID	1997	Sport; (C); Except for Bosch, Carter, and Delphi	USEP7097
2.0L L4 1996cc 122 CID	1998	(C), (ECB); Except for Bosch, Carter, and Delphi	USEP7097
2.0L L4 1996cc 122 CID	1998	(ECC), (Y); Except for Bosch, Carter, and Delphi	USEP7097
2.0L L4 1996cc 122 CID	1999	(C); Except for Bosch, Carter, and Delphi	USEP7097
2.0L L4 1996cc 122 CID	1999	(Y); Except for Bosch, Carter, and Delphi	USEP7097
2.0L L4 1997cc 122 CID	1995		USEP7041
<b>OMNI</b>			
	1988-1990		USEP7000
<b>RAIDER</b>			
3.0L V6 2972cc 181 CID	1989	2 inch pump diameter	USEP3222
<b>RAM 50</b>			
2.4L L4 2351cc	1990	2 inch pump diameter	USEP3222
2.4L L4 2351cc	1991-1993		USEP8229
3.0L V6 2972cc 181 CID	1990	2 inch pump diameter	USEP3222
<b>RAM 1500</b>			
3.7L V6 226 CID	2004-2007		USEP7182
3.9L V6 3906cc 239 CID	1994	(X)	USEP7065
3.9L V6 3906cc 239 CID	1995	(X), GAS	USEP7094
3.9L V6 3906cc 239 CID	1996-1997		USEP7093
3.9L V6 3906cc 239 CID	1998-1999	Laramie, Sport, ST, WS; FI, GAS; (35 Gallon Fuel Tank)	USEP7094
4.7L V8 287 CID	2004-2008		USEP7182
5.2L V8 5211cc 318 CID	1994	(Y)	USEP7065
5.2L V8 5211cc 318 CID	1995	(Y), GAS	USEP7094
5.2L V8 5211cc 318 CID	1996-1997		USEP7093
5.2L V8 5211cc 318 CID	1998	Custom, Laramie, Lujjo, Sport, ST; FI, GAS; (35 Gallon Fuel Tank)	USEP7094
5.2L V8 5211cc 318 CID	1999	Custom, Laramie, R/T, Sport, ST; FI, GAS; (35 Gallon Fuel Tank)	USEP7094
5.7L V8 345 CID	2004-2008		USEP7182
5.9L V8 360 CID	1994	(Z)	USEP7065
5.9L V8 360 CID	1995	(Z), GAS	USEP7094
5.9L V8 360 CID	1996-1997		USEP7093
5.9L V8 360 CID	1998-1999	Laramie, Sport, ST; FI, GAS; (35 Gallon Fuel Tank)	USEP7094
5.9L V8 360 CID	2002	SLT, ST; FI, GAS; (35 Gallon Fuel Tank)	USEP7094
<b>RAM 1500 VAN</b>			
3.9L V6 3906cc 239 CID	1999-2002	(X); 35 Gallon Fuel Tank	USEP7094
3.9L V6 3906cc 239 CID	2003	(X)	USEP7094
5.2L V8 5211cc 318 CID	1999-2002	(Y); 35 Gallon Fuel Tank	USEP7094
5.2L V8 5211cc 318 CID	2003	(Y)	USEP7094
5.9L V8 360 CID	1999-2002	(Z); 35 Gallon Fuel Tank	USEP7094
5.9L V8 360 CID	2003	(Z)	USEP7094
<b>RAM 2500</b>			
4.7L V8 287 CID	2005		USEP7182
5.2L V8 5211cc 318 CID	1994	(Y), GAS, Naturally Aspirated	USEP7065
5.2L V8 5211cc 318 CID	1996		USEP7093
5.7L V8 345 CID	2005-2009		USEP7182
5.9L L6 359 CID	1998-2002	DIESEL, Turbocharged; External Pump(Transfer Pump)	USEP7153
5.9L L6 359 CID	2003	(6), DIESEL, Turbocharged; External Pump(Transfer Pump)	USEP7230
5.9L L6 359 CID	2003	(C), DIESEL, Turbocharged; External Pump(Transfer Pump)	USEP7230
5.9L V8 360 CID	1994	(Z), GAS, Naturally Aspirated	USEP7065
5.9L V8 360 CID	1996-1997		USEP7093

Engine	Years	Application Description	USMW	Engine	Years	Application Description	USMW
<b>DODGE (cont'd.)</b>				<b>DODGE (cont'd.)</b>			
<b>RAM 2500 (cont'd.)</b>				<b>SPIRIT</b>			
5.9L V8 360 CID	1998	Base, Limited, Lujjo; FI, GAS; (35 Gallon Fuel Tank)	USEP7094	2.2L L4 135 CID	1991	R/T; (A), Turbocharged; Except for Bosch, Carter, and Delphi	USEP7040
5.9L V8 360 CID	1999	Base; FI, GAS; (35 Gallon Fuel Tank)	USEP7094	2.2L L4 135 CID	1992	R/T; (A), Turbocharged	USEP7041
5.9L V8 360 CID	2000	Base, Custom; FI, GAS; (35 Gallon Fuel Tank)	USEP7094	2.5L L4 2507cc 153 CID	1991	Base, LE; (K), Naturally Aspirated; Except for Bosch, Carter, and Delphi	USEP7040
5.9L V8 360 CID	2001	Base, SLT; FI, GAS; (35 Gallon Fuel Tank)	USEP7094	2.5L L4 2507cc 153 CID	1991	ES, LE; (J), Turbocharged; Except for Bosch, Carter, and Delphi	USEP7040
5.9L V8 360 CID	2002	Base; FI, GAS; (35 Gallon Fuel Tank)	USEP7094	2.5L L4 2507cc 153 CID	1991-1992	Base, LE; (K), Naturally Aspirated	USEP7041
8.0L V10 7990cc 488 CID	1994	(W), GAS, Naturally Aspirated	USEP7065	2.5L L4 2507cc 153 CID	1991-1992	ES, LE; (J), Turbocharged	USEP7041
8.0L V10 7990cc 488 CID	1996-1997		USEP7093	2.5L L4 2507cc 153 CID	1993	ES, High Line; (K), GAS	USEP7041
8.0L V10 7990cc 488 CID	1998-2002	Base; FI, GAS; (35 Gallon Fuel Tank)	USEP7094	2.5L L4 2507cc 153 CID	1993	High Line; (V), FLEX	USEP7041
<b>RAM 2500 VAN</b>				2.5L L4 2507cc 153 CID	1994	(K), GAS	USEP7041
3.9L V6 3906cc 239 CID	2001	(X), GAS; 35 Gallon Fuel Tank	USEP7094	2.5L L4 2507cc 153 CID	1994	(V), FLEX	USEP7041
5.2L V8 5211cc 318 CID	1998-2001	MEX	USEP7093	2.5L L4 2507cc 153 CID	1995	(K)	USEP7041
5.2L V8 5211cc 318 CID	1999-2002	(Y), GAS; 35 Gallon Fuel Tank	USEP7094	3.0L V6 2972cc 181 CID	1991	Base, ES, LE; (3), Naturally Aspirated; Except for Bosch, Carter, and Delphi	USEP7040
5.2L V8 5211cc 318 CID	2003	(Y), GAS	USEP7094	3.0L V6 2972cc 181 CID	1991-1992	Base, ES, LE; (3), Naturally Aspirated	USEP7041
5.9L V8 360 CID	1999-2002	(Z), GAS; 35 Gallon Fuel Tank	USEP7094	3.0L V6 2972cc 181 CID	1993	ES, High Line; (3), GAS	USEP7041
5.9L V8 360 CID	2003	(Z), GAS	USEP7094	3.0L V6 2972cc 181 CID	1994	(3), GAS	USEP7041
<b>RAM 3500</b>				3.0L V6 2972cc 181 CID	1995	(3)	USEP7041
5.7L V8 345 CID	2005-2008		USEP7182	<b>STRATUS</b>			
5.9L L6 359 CID	1998-2002	DIESEL, Turbocharged; External Pump(Transfer Pump)	USEP7153	2.0L L4 1995cc 122 CID	2006	MEX	USEP8455
5.9L L6 359 CID	2003	(6), DIESEL, Turbocharged; External Pump(Transfer Pump)	USEP7230	2.0L L4 1996cc 122 CID	1995-1997	Base, ES; (C), (ECB)	USEP7041
5.9L L6 359 CID	2003	(C), DIESEL, Turbocharged; External Pump(Transfer Pump)	USEP7230	2.0L L4 1996cc 122 CID	1998-2000		USEP7113
5.9L V8 360 CID	1994	(5), GAS, Naturally Aspirated	USEP7065	2.0L L4 1996cc 122 CID	2001-2003	MEX	USEP8455
5.9L V8 360 CID	1994	(Z), GAS, Naturally Aspirated	USEP7065	2.0L L4 1999cc 122 CID	1998-2000		USEP7113
5.9L V8 360 CID	1995	(5), GAS, Naturally Aspirated	USEP7094	2.4L L4 2351cc	2001-2002	SE; (G)	USEP8455
5.9L V8 360 CID	1996-1997		USEP7093	2.4L L4 2351cc	2003-2005	SXT; (G), GAS	USEP8455
5.9L V8 360 CID	1998	Base, Custom; FI, GAS; (35 Gallon Fuel Tank)	USEP7094	2.4L L4 2429cc 148 CID	1995	Base; (EDZ), (X)	USEP7041
5.9L V8 360 CID	1999	Base; FI, GAS; (35 Gallon Fuel Tank)	USEP7094	2.4L L4 2429cc 148 CID	1995	ES; (X)	USEP7041
5.9L V8 360 CID	2000-2002	Base, Custom; FI, GAS; (35 Gallon Fuel Tank)	USEP7094	2.4L L4 2429cc 148 CID	1996-1997	Base, ES; (EDZ), (X)	USEP7041
8.0L V10 7990cc 488 CID	1994	(W), GAS, Naturally Aspirated	USEP7065	2.4L L4 2429cc 148 CID	1998-2000		USEP7113
8.0L V10 7990cc 488 CID	1995	(W), GAS, Naturally Aspirated	USEP7094	2.4L L4 2429cc 148 CID	2001-2006	MEX	USEP8455
8.0L V10 7990cc 488 CID	1996-1997		USEP7093	2.5L V6 2497cc 152 CID	1995-1997	ES; (EEB), (H)	USEP7041
8.0L V10 7990cc 488 CID	1998-2002	Base; FI, GAS; (35 Gallon Fuel Tank)	USEP7094	2.5L V6 2497cc 152 CID	1998-2000		USEP7113
<b>RAM 3500 VAN</b>				3.0L V6 2972cc 181 CID	2001-2005		USEP8456
5.2L V8 5211cc 318 CID	1999-2002	(Y), GAS; 35 Gallon Fuel Tank	USEP7094	<b>VIPER</b>			
5.2L V8 5211cc 318 CID	2003	(Y), GAS	USEP7094		1992-1995		USEP8151
5.9L V8 360 CID	1999-2002	(Z), GAS; 35 Gallon Fuel Tank	USEP7094		1996	Base, GTS	USEP8151
5.9L V8 360 CID	2003	(Z), GAS	USEP7094	<b>W100</b>			
<b>RAMCHARGER</b>				3.9L V6 3906cc 239 CID	1989	(X)	USEP7018
5.2L V8 5211cc 318 CID	1988	(Y), FI	USEP7018	5.2L V8 5211cc 318 CID	1988	(Y), FI	USEP7018
5.2L V8 5211cc 318 CID	1989-1990	(Y)	USEP7018	5.2L V8 5211cc 318 CID	1989	(Y)	USEP7018
5.2L V8 5211cc 318 CID	1991-1993	(Y)	USEP7048	5.2L V8 5211cc 318 CID	1990	Base, S; (Y)	USEP7018
5.2L V8 5211cc 318 CID	1999-2001	MEX	USEP7093	5.2L V8 5211cc 318 CID	1991-1993		USEP7047
5.9L V8 360 CID	1989-1990	(Z)	USEP7018	5.9L V8 360 CID	1989	(Z)	USEP7018
5.9L V8 360 CID	1991	(Z)	USEP7048	5.9L V8 360 CID	1990	Base; (Z)	USEP7018
5.9L V8 360 CID	1994-1995	MEX	USEP7047	5.9L V8 360 CID	1991		USEP7047
5.9L V8 360 CID	1999-2000	MEX	USEP7093	5.9L V8 360 CID	1993		USEP7047
5.9L V8 5900cc 360 CID	1996	MEX	USEP7047	<b>W250</b>			
<b>SHADOW</b>				5.2L V8 5211cc 318 CID	1988	(Y), FI	USEP7018
2.2L L4 135 CID	1987	Base; (D), Naturally Aspirated	USEP7000	5.2L V8 5211cc 318 CID	1989-1990	(Y), GAS, Naturally Aspirated	USEP7018
2.2L L4 135 CID	1988	Base; (D), Naturally Aspirated	USEP7000	5.2L V8 5211cc 318 CID	1991-1993		USEP7047
2.2L L4 135 CID	1991	America, High Line; (D), Naturally Aspirated; Except for Bosch, Carter, and Delphi	USEP7040	5.9L V8 360 CID	1989-1990	(5), GAS, Naturally Aspirated	USEP7018
2.2L L4 135 CID	1992	America, High Line; (D), Naturally Aspirated	USEP7041	5.9L V8 360 CID	1989-1990	(Z), GAS, Naturally Aspirated	USEP7018
2.2L L4 135 CID	1993	High Line; (D)	USEP7041	5.9L V8 360 CID	1991-1993		USEP7047
2.2L L4 135 CID	1994	Base; (D)	USEP7041	<b>W350</b>			
2.5L L4 2507cc 153 CID	1988	Base; (K), Naturally Aspirated	USEP7000	5.9L V8 360 CID	1989-1990	(5), GAS, Naturally Aspirated	USEP7018
2.5L L4 2507cc 153 CID	1991	ES, High Line; (J), Turbocharged; Except for Bosch, Carter, and Delphi	USEP7040	5.9L V8 360 CID	1989-1990	(Z), GAS, Naturally Aspirated	USEP7018
2.5L L4 2507cc 153 CID	1991	High Line; (K), Naturally Aspirated; Except for Bosch, Carter, and Delphi	USEP7040	5.9L V8 360 CID	1991-1993		USEP7047
2.5L L4 2507cc 153 CID	1991	ES, High Line; (K), Naturally Aspirated	USEP7041	<b>EAGLE</b>			
2.5L L4 2507cc 153 CID	1991-1992	ES, High Line; (J), Turbocharged	USEP7041	<b>PREMIER</b>			
2.5L L4 2507cc 153 CID	1992	America, ES, High Line; (K), Naturally Aspirated	USEP7041		1990	ES, ES Limited, LX	USEP7020
2.5L L4 2507cc 153 CID	1993	ES, High Line; (K)	USEP7041	2.5L L4 150 CID	1988	LX; (Z)	USEP7020
2.5L L4 2507cc 153 CID	1994	Base, ES; (K)	USEP7041	2.5L L4 150 CID	1989	LX; (H)	USEP7020
3.0L V6 2972cc 181 CID	1992	ES; (3), Naturally Aspirated	USEP7041	3.0L V6 2972cc 182 CID	1988	ES, LX; (J)	USEP7020
3.0L V6 2972cc 181 CID	1993	ES, High Line; (3)	USEP7041	3.0L V6 2972cc 182 CID	1989	ES, LX; (U), (Z7X-711)	USEP7020
3.0L V6 2972cc 181 CID	1994	ES; (3)	USEP7041	<b>SUMMIT</b>			
<b>DODGE (cont'd.)</b>				1.5L L4 1468cc 90 CID	1989-1990		USEP8023
<b>DODGE (cont'd.)</b>				1.5L L4 1468cc 90 CID	1991-1996		USEP8229
<b>DODGE (cont'd.)</b>				1.6L L4 1597cc 98 CID	1989-1990		USEP8023
<b>DODGE (cont'd.)</b>				1.8L L4 1834cc 112 CID	1992-1996		USEP8229
<b>DODGE (cont'd.)</b>				2.4L L4 2351cc	1992-1996		USEP8229

Engine	Years	Application Description	USMW	Engine	Years	Application Description	USMW
<b>EAGLE (cont'd.)</b>				<b>FORD (cont'd.)</b>			
<b>TALON</b>				<b>CONTOUR (cont'd.)</b>			
1.8L L4 1755cc 107 CID	1993-1994		USEP8229	2.0L L4 1989cc 121 CID	1998	Base, GL, LX; (3), GAS; Exc.Fuel Tank Concern (To 02/09/98)	USEP2373
2.0L L4 1997cc 122 CID	1990	Turbocharged	USEP8023	2.0L L4 1989cc 121 CID	1998	GL; (Z), BI-FUEL; Exc.Fuel Tank Concern (To 02/09/98)	USEP2373
2.0L L4 1997cc 122 CID	1990-1991	Naturally Aspirated	USEP8023	2.0L L4 1989cc 121 CID	1998	LX, SE; (Z), BI-FUEL; To 02/09/98	USEP2373
2.0L L4 1997cc 122 CID	1991	AWD, Turbocharged	USEP8023	2.0L L4 1989cc 121 CID	2000	From 05/03/99	USEP2390
2.0L L4 1997cc 122 CID	1992-1994		USEP8229	2.5L V6 2450cc 155 CID	1995-1996		USEP2068
2.0L L4 1997cc 122 CID	1995-1998	Naturally Aspirated	USEP8229	2.5L V6 2450cc 155 CID	1997	GL, LX, SE, Sport; (L), GAS; Exc.Fuel Tank Concern	USEP2373
2.0L L4 1997cc 122 CID	1995-1998	Turbocharged	USEP8271	2.5L V6 2450cc 155 CID	1997	GL, LX, SE, Sport; (L), GAS; Fuel Tank Concern	USEP2373
<b>VISION</b>				2.5L V6 2450cc 155 CID	1997-1998	MEX; Except for Bosch, Carter, and Delphi	USEP2226
3.3L V6 3301cc 201 CID	1993-1995	ESi; (T)	USEP7054	2.5L V6 2450cc 155 CID	1998	GL, LX, SE; (L), GAS; Fuel Tank Concern	USEP2373
3.5L V6 3497cc 215 CID	1993-1994	TSi; (F)	USEP7054	2.5L V6 2450cc 155 CID	1998	SVT; (G), GAS; Fuel Tank Concern	USEP2373
3.5L V6 3497cc 215 CID	1995	ESi, TSi; (F)	USEP7054	2.5L V6 2450cc 155 CID	2000	From 05/03/99	USEP2390
<b>FIAT</b>				<b>COUGAR</b>			
<b>IDEA</b>				3.8L V6 232 CID	1985-1988	GAS, MEX	USEP2001
1.8L L4 1796cc 110 CID	2008	MEX	USEP12027	3.8L V6 3797cc 232 CID	1990-1993		USEP2044
<b>PALIO</b>				<b>COUNTRY SQUIRE</b>			
1.6L L4 1596cc 97 CID	2004	MEX	USEP12067	1987-1991	Base, LX		USEP2182
1.8L L4 1796cc 110 CID	2005-2008	MEX	USEP12067	<b>COURIER</b>			
<b>PANDA</b>				1.6L L4 1588cc 98 CID	2003-2005	MEX	USEP2229
1.2L L4 1242cc 76 CID	2007-2008	MEX	USEP12027	1.6L L4 1588cc 98 CID	2006	MEX	USEP2226
<b>PUNTO</b>				1.8L L4 110 CID	1972-1978		USEP8016SP
1.4L L4 1368cc 83 CID	2007-2008	MEX	USEP12027	1.8L L4 110 CID	1979		USEP2019
<b>STRADA</b>				1.8L L4 1796cc 110 CID	1972-1974		USEP2014
1.8L L4 1796cc 110 CID	2007-2008	MEX	USEP12067	2.0L L4 1989cc 122 CID	1979-1982		USEP2019
<b>FORD</b>				2.3L L4 140 CID	1977-1978		USEP8016SP
<b>AEROSTAR</b>				2.3L L4 140 CID	1979-1982		USEP2019
	1988		USEP2002	<b>CROWN VICTORIA</b>			
	1989	17 Gallon Fuel Tank	USEP2002		1995	Base, LX, Police Interceptor, S	USEP2378
3.0L V6 2986cc 182 CID	1991-1992		USEP2001		1996	Base, LX, Police Interceptor, S; (6), GAS	USEP2378
4.0L V6 245 CID	1990-1992	(X)	USEP2001		1996	Base, LX, Police Interceptor, S; (W), GAS	USEP2378
4.0L V6 245 CID	1993	XLT Sport; (X)	USEP2001		1997	Base, LX, Police Interceptor, S; (W), GAS	USEP2375
4.0L V6 245 CID	1995	(X)	USEP2001		1998	Base, LX, Police Interceptor, S; (W), GAS	USEP2374
4.0L V6 245 CID	1996-1997	XLT Sport; (X)	USEP2001		1999-2000	(W), GAS	USEP2374
<b>ASPIRE</b>					2001-2002	(W), GAS	USEP2375
1.3L L4 1295cc	1994-1997		USEP2111		2003-2004	(W), GAS; Except for Bosch, Carter, and Delphi	USEP2337
<b>BRONCO</b>				4.6L V8 281 CID	1993-1994		USEP2068
4.9L L6 4917cc 300 CID	1987	(Y), CAN, FI; 1.45 inch pump diameter, External Pump	USEP2000A	4.6L V8 281 CID	2005-2008		USEP2576
4.9L L6 4917cc 300 CID	1987	(Y), FI, USA; 1.45 inch pump diameter, External Pump	USEP2000A	<b>E-150</b>			
4.9L L6 4917cc 300 CID	1987-1989		USEP2025	4.6L V8 281 CID	2006	Base, Chateau, XL, XLT; (W); (w/Secondary Fuel Ports), Midship Fuel Tank	USEP2364
4.9L L6 4917cc 300 CID	1989	2 inch pump diameter, External Pump	USEP2000	4.6L V8 281 CID	2006	Base, Chateau, XL, XLT; (W); (w/Secondary Fuel Ports), Except for Bosch, Carter, and Delphi, Midship Fuel Tank	USEP2377
5.0L V8 302 CID	1985-1987	(N), FI; 1.45 inch pump diameter, External Pump	USEP2000A	4.6L V8 281 CID	2006	Base, Chateau, XL, XLT; (W); Aft Axle Fuel Tank, Except for Bosch, Carter, and Delphi	USEP2377
5.0L V8 302 CID	1985-1987	(N), FI	USEP2484	4.6L V8 281 CID	2006	Base, Chateau, XL, XLT; (W); (w/Secondary Fuel Ports), Midship Fuel Tank	USEP2515
5.0L V8 302 CID	1985-1989	2 inch pump diameter, External Pump	USEP2000	4.6L V8 281 CID	2007	Base, Chateau, XL, XLT; (W); (Secondary Fuel Ports)	USEP2364
5.0L V8 302 CID	1985-1989		USEP2025	4.6L V8 281 CID	2007	Base, Chateau, XL, XLT; (W); (Exc.Secondary Fuel Ports)	USEP2377
5.0L V8 302 CID	1988-1989	(N); 1.45 inch pump diameter, External Pump	USEP2000A	4.6L V8 281 CID	2008	Base, XL, XLT; (W); (Secondary Fuel Ports)	USEP2364
5.0L V8 302 CID	1988-1989	(N)	USEP2484	4.6L V8 281 CID	2008	Base, XL, XLT; (W); (Secondary Fuel Ports), Except for Bosch, Carter, and Delphi	USEP2377
5.0L V8 302 CID	1990-1996	(N)	USEP2059	4.6L V8 281 CID	2008	Base, XL, XLT; (W); (Exc.Secondary Fuel Ports)	USEP2515
5.8L V8 5753cc 351 CID	1988-1989	2 inch pump diameter, External Pump	USEP2000	4.6L V8 281 CID	2008	Base, Chateau, XL, XLT; (L); (w/Secondary Fuel Ports), Exc.Extended Range Fuel Tank (Midship Fuel Tank)	USEP2364
5.8L V8 5753cc 351 CID	1988-1989	(H); 1.45 inch pump diameter, External Pump	USEP2000A	4.6L V8 281 CID	2008	Base, Chateau, XL, XLT; (L); (w/Secondary Fuel Ports), Exc.Extended Range Fuel Tank (Midship Fuel Tank), Except for Bosch, Carter, and Delphi	USEP2377
5.8L V8 5753cc 351 CID	1988-1989		USEP2025	4.6L V8 281 CID	2008	Base, Chateau, XL, XLT; (L); (w/Secondary Fuel Ports)	USEP2377
5.8L V8 5753cc 351 CID	1988-1989	(H)	USEP2484	5.4L V8 330 CID	2006	Base, Chateau, XL, XLT; (L); (w/Secondary Fuel Ports), Exc.Extended Range Fuel Tank (Midship Fuel Tank)	USEP2364
5.8L V8 5753cc 351 CID	1990-1994	(H)	USEP2059	5.4L V8 330 CID	2006	Base, Chateau, XL, XLT; (L); (w/Secondary Fuel Ports), Exc.Extended Range Fuel Tank (Midship Fuel Tank), Except for Bosch, Carter, and Delphi	USEP2377
5.8L V8 5753cc 351 CID	1996	(H)	USEP2059	5.4L V8 330 CID	2006	Base, Chateau, XL, XLT; (L); (w/Secondary Fuel Ports), Exc.Extended Range Fuel Tank (Midship Fuel Tank)	USEP2515
<b>BRONCO II</b>				<b>CONTOUR</b>			
2.9L V6 177 CID	1986	GAS; 2 inch pump diameter, External Pump	USEP2000	2.0L L4 1989cc 121 CID	1995-1996		USEP2068
2.9L V6 177 CID	1986-1988		USEP2036	2.0L L4 1989cc 121 CID	1997	Base, GL, LX; (3), GAS; Exc.Fuel Tank Concern	USEP2373
2.9L V6 177 CID	1986-1989	1.45 inch pump diameter, External Pump	USEP2000A	2.0L L4 1989cc 121 CID	1997	GL; (Z), BI-FUEL; Exc.Fuel Tank Concern	USEP2373
2.9L V6 177 CID	1987-1989	2 inch pump diameter, External Pump	USEP2000	2.0L L4 1989cc 121 CID	1997-1998	Base, GL, LX; (3), GAS; Fuel Tank Concern	USEP2373
2.9L V6 177 CID	1989-1990		USEP2059	2.0L L4 1989cc 121 CID	1997-1998	GL; (Z), BI-FUEL; Fuel Tank Concern	USEP2373
<b>CONTOUR</b>				2.0L L4 1989cc 121 CID	1998	Base, GL, LX; (3), GAS; Exc.Fuel Tank Concern (From 02/09/98)	USEP2372
2.0L L4 1989cc 121 CID	1995-1996		USEP2068	2.0L L4 1989cc 121 CID	1998	GL; (Z), BI-FUEL; Exc.Fuel Tank Concern (From 02/09/98)	USEP2372
2.0L L4 1989cc 121 CID	1997	Base, GL, LX; (3), GAS; Exc.Fuel Tank Concern	USEP2373	2.0L L4 1989cc 121 CID	1998	LX, SE; (Z), BI-FUEL; From 02/09/98	USEP2372
2.0L L4 1989cc 121 CID	1997	GL; (Z), BI-FUEL; Exc.Fuel Tank Concern	USEP2373				
2.0L L4 1989cc 121 CID	1997-1998	Base, GL, LX; (3), GAS; Fuel Tank Concern	USEP2373				
2.0L L4 1989cc 121 CID	1997-1998	GL; (Z), BI-FUEL; Fuel Tank Concern	USEP2373				
2.0L L4 1989cc 121 CID	1998	Base, GL, LX; (3), GAS; Exc.Fuel Tank Concern (From 02/09/98)	USEP2372				
2.0L L4 1989cc 121 CID	1998	GL; (Z), BI-FUEL; Exc.Fuel Tank Concern (From 02/09/98)	USEP2372				
2.0L L4 1989cc 121 CID	1998	LX, SE; (Z), BI-FUEL; From 02/09/98	USEP2372				



Engine	Years	Application Description	USMW	Engine	Years	Application Description	USMW
<b>FORD (cont'd.)</b>				<b>FORD (cont'd.)</b>			
<b>E-150 (cont'd.)</b>				<b>E-150 ECONOLINE (cont'd.)</b>			
5.4L V8 330 CID	2006-2007	Base, Chateau, XL, XLT; (L); Exc.Extended Range Fuel Tank (Aft Axle Fuel Tank), Except for Bosch, Carter, and Delphi	USEP2377	4.6L V8 281 CID	1998	(6), GAS; (3 Tube Ports), Aft Axle Fuel Tank	USEP2379
5.4L V8 330 CID	2006-2007	Base, Chateau, XL, XLT; (L); Except for Bosch, Carter, and Delphi, Extended Range Fuel Tank	USEP2377	4.6L V8 281 CID	1998	(6), GAS; (3 Tube Ports), Midship Fuel Tank	USEP2379
5.4L V8 330 CID	2007	Base, Chateau, XL, XLT; (L); (Secondary Fuel Ports), Exc.Extended Range Fuel Tank (Midship Fuel Tank)	USEP2364	4.6L V8 281 CID	1999	(2 Tube Ports)	USEP2068
5.4L V8 330 CID	2007	Base, Chateau, XL, XLT; (L); (Secondary Fuel Ports), Exc.Extended Range Fuel Tank (Midship Fuel Tank), Except for Bosch, Carter, and Delphi	USEP2377	4.6L V8 281 CID	1999	Base; (6); (3 Tube Ports)	USEP2376
5.4L V8 330 CID	2007	Base, Chateau, XL, XLT; (L); (Exc.Secondary Fuel Ports), Exc.Extended Range Fuel Tank (Midship Fuel Tank)	USEP2515	5.0L V8 302 CID	1986-1987	(N), FI; 1.45 inch pump diameter, External Pump	USEP2000A
5.4L V8 330 CID	2008	Base, XL, XLT; (L); (Secondary Fuel Ports), Exc.Extended Range Fuel Tank (Midship Fuel Tank)	USEP2364	5.0L V8 302 CID	1986-1987	(N), FI; Aft Axle Fuel Tank	USEP2008
5.4L V8 330 CID	2008	Base, XL, XLT; (L); (Secondary Fuel Ports), Exc.Extended Range Fuel Tank (Midship Fuel Tank), Except for Bosch, Carter, and Delphi	USEP2377	5.0L V8 302 CID	1986-1987	(N), FI; Midship Fuel Tank	USEP2008
5.4L V8 330 CID	2008	Base, XL, XLT; (L); Exc.Extended Range Fuel Tank (Aft Axle Fuel Tank), Except for Bosch, Carter, and Delphi	USEP2377	5.0L V8 302 CID	1986-1989	2 inch pump diameter, External Pump	USEP2000
5.4L V8 330 CID	2008	Base, XL, XLT; (L); Except for Bosch, Carter, and Delphi, Extended Range Fuel Tank	USEP2377	5.0L V8 302 CID	1988	(N), 138.0 / 350.5 Wheel Base; 16 Gallon Fuel Tank	USEP2008
5.4L V8 330 CID	2008	Base, XL, XLT; (L); (Exc.Secondary Fuel Ports), Exc.Extended Range Fuel Tank (Midship Fuel Tank)	USEP2515	5.0L V8 302 CID	1988-1989	(N); 1.45 inch pump diameter, External Pump	USEP2000A
<b>E-150 CLUB WAGON</b>				5.0L V8 302 CID	1988-1989	(N), 124.0 / 315.0 Wheel Base; 18 Gallon Fuel Tank	USEP2008
4.2L V6 256 CID	2003		USEP2068	5.0L V8 302 CID	1988-1989	(N), 138.0 / 350.5 Wheel Base; 20 Gallon Fuel Tank (22 Gallon Fuel Tank)	USEP2008
4.6L V8 281 CID	2003		USEP2068	5.0L V8 302 CID	1992-1996	Aft Axle Fuel Tank	USEP2284
4.6L V8 281 CID	2004	(W); (wo/Secondary Fuel Ports), Midship Fuel Tank (35 Gallon Fuel Tank)	USEP2515	5.0L V8 302 CID	1992-1996	Midship Fuel Tank	USEP2284
4.6L V8 281 CID	2004-2005	(W); (w/Secondary Fuel Ports), Midship Fuel Tank (35 Gallon Fuel Tank)	USEP2364	5.0L V8 302 CID	1992-1996		USEP2490
4.6L V8 281 CID	2004-2005	(W); (w/Secondary Fuel Ports), Except for Bosch, Carter, and Delphi, Midship Fuel Tank (35 Gallon Fuel Tank)	USEP2377	5.4L V8 330 CID	1997	(L); (2 Tube Ports), Midship Fuel Tank	USEP2380
4.6L V8 281 CID	2004-2005	(W); Aft Axle Fuel Tank, Except for Bosch, Carter, and Delphi	USEP2377	5.4L V8 330 CID	1997	(L); (3 Tube Ports), Midship Fuel Tank	USEP2380
4.6L V8 281 CID	2005	(W); (wo/Secondary Fuel Ports), Midship Fuel Tank (55 Gallon Fuel Tank)	USEP2515	5.4L V8 330 CID	1997-1998	(3 Tube Ports), Aft Axle Fuel Tank	USEP2158
5.4L V8 330 CID	2004	(L); (w/Secondary Fuel Ports), Midship Fuel Tank (35 Gallon Fuel Tank)	USEP2364	5.4L V8 330 CID	1998	(L), GAS; (2 Tube Ports), Midship Fuel Tank	USEP2380
5.4L V8 330 CID	2004	(L); (w/Secondary Fuel Ports), Except for Bosch, Carter, and Delphi, Midship Fuel Tank (35 Gallon Fuel Tank)	USEP2377	5.4L V8 330 CID	1998	(L), GAS; (3 Tube Ports), Midship Fuel Tank	USEP2380
5.4L V8 330 CID	2004	(L); Aft Axle Fuel Tank, Except for Bosch, Carter, and Delphi	USEP2377	5.4L V8 330 CID	1998	(Z), BI-FUEL; (2 Tube Ports), Midship Fuel Tank	USEP2380
5.4L V8 330 CID	2004	(L); (wo/Secondary Fuel Ports), Midship Fuel Tank (35 Gallon Fuel Tank)	USEP2515	5.4L V8 330 CID	1998	(Z), BI-FUEL; (3 Tube Ports), Midship Fuel Tank	USEP2380
5.4L V8 330 CID	2005	(L); (w/Secondary Fuel Ports), Exc.Extended Range Fuel Tank (Midship Fuel Tank) (35 Gallon Fuel Tank)	USEP2364	5.8L V8 5753cc 351 CID	1988	(H), 138.0 / 350.5 Wheel Base; 16 Gallon Fuel Tank	USEP2008
5.4L V8 330 CID	2005	(L); (w/Secondary Fuel Ports), Exc.Extended Range Fuel Tank (Midship Fuel Tank) (35 Gallon Fuel Tank), Except for Bosch, Carter, and Delphi	USEP2377	5.8L V8 5753cc 351 CID	1988-1989	2 inch pump diameter, External Pump	USEP2000
5.4L V8 330 CID	2005	(L); Exc.Extended Range Fuel Tank (Aft Axle Fuel Tank), Except for Bosch, Carter, and Delphi	USEP2377	5.8L V8 5753cc 351 CID	1988-1989	(H); 1.45 inch pump diameter, External Pump	USEP2000A
5.4L V8 330 CID	2005	(L); Except for Bosch, Carter, and Delphi, Extended Range Fuel Tank	USEP2377	5.8L V8 5753cc 351 CID	1988-1989	(H), 124.0 / 315.0 Wheel Base; 18 Gallon Fuel Tank	USEP2008
5.4L V8 330 CID	2005	(L); (wo/Secondary Fuel Ports), Exc.Extended Range Fuel Tank (Midship Fuel Tank) (55 Gallon Fuel Tank)	USEP2515	5.8L V8 5753cc 351 CID	1988-1989	(H), 138.0 / 350.5 Wheel Base; 20 Gallon Fuel Tank (22 Gallon Fuel Tank)	USEP2008
<b>E-150 ECONOLINE</b>				5.8L V8 5753cc 351 CID	1992-1996	Aft Axle Fuel Tank	USEP2284
4.2L V6 256 CID	1992-1996	in-tank	USEP2521	5.8L V8 5753cc 351 CID	1992-1996	Midship Fuel Tank	USEP2284
4.2L V6 256 CID	1997	(2); (2 Tube Ports), Midship Fuel Tank	USEP2379	5.8L V8 5753cc 351 CID	1992-1996		USEP2490
4.2L V6 256 CID	1997	(2); (3 Tube Ports), Aft Axle Fuel Tank	USEP2379	<b>E-150 ECONOLINE CLUB WAGON</b>			
4.2L V6 256 CID	1997	(2); (3 Tube Ports), Midship Fuel Tank	USEP2379	4.2L V6 256 CID	1992-1996	in-tank pump	USEP2521
4.2L V6 256 CID	1998	(2), GAS; (2 Tube Ports), Midship Fuel Tank	USEP2379	4.2L V6 256 CID	1997	(2); (2 Tube Ports), Midship Fuel Tank	USEP2379
4.2L V6 256 CID	1998	(2), GAS; (3 Tube Ports), Aft Axle Fuel Tank	USEP2379	4.2L V6 256 CID	1997	(2); (3 Tube Ports), Aft Axle Fuel Tank	USEP2379
4.2L V6 256 CID	1998	(2), GAS; (3 Tube Ports), Midship Fuel Tank	USEP2379	4.2L V6 256 CID	1997	(2); (3 Tube Ports), Midship Fuel Tank	USEP2379
4.6L V8 281 CID	1997	(6); (2 Tube Ports), Midship Fuel Tank	USEP2379	4.2L V6 256 CID	1998	(2), GAS; (2 Tube Ports), Midship Fuel Tank	USEP2379
4.6L V8 281 CID	1997	(6); (3 Tube Ports), Aft Axle Fuel Tank	USEP2379	4.2L V6 256 CID	1998	(2), GAS; (3 Tube Ports), Aft Axle Fuel Tank	USEP2379
4.6L V8 281 CID	1997	(6); (3 Tube Ports), Midship Fuel Tank	USEP2379	4.2L V6 256 CID	1998	(2), GAS; (3 Tube Ports), Midship Fuel Tank	USEP2379
4.6L V8 281 CID	1998	(6), GAS; (2 Tube Ports), Midship Fuel Tank	USEP2379	4.2L V6 256 CID	1998	(2), GAS; (3 Tube Ports), Aft Axle Fuel Tank	USEP2379
4.6L V8 281 CID	1998	(6), GAS; (3 Tube Ports), Aft Axle Fuel Tank	USEP2379	4.2L V6 256 CID	1998	(2), GAS; (3 Tube Ports), Midship Fuel Tank	USEP2379
4.6L V8 281 CID	1998	(2), GAS; (3 Tube Ports), Midship Fuel Tank	USEP2379	4.2L V6 256 CID	1998	(2), GAS; (3 Tube Ports), Midship Fuel Tank	USEP2379
4.6L V8 281 CID	1997	(6); (2 Tube Ports), Midship Fuel Tank	USEP2379	4.2L V6 256 CID	1999-2002	(2 Tube Ports)	USEP2068
4.6L V8 281 CID	1997	(6); (3 Tube Ports), Aft Axle Fuel Tank	USEP2379	4.6L V8 281 CID	1997	(6); (2 Tube Ports), Midship Fuel Tank	USEP2379
4.6L V8 281 CID	1997	(6); (3 Tube Ports), Midship Fuel Tank	USEP2379	4.6L V8 281 CID	1997	(6); (3 Tube Ports), Aft Axle Fuel Tank	USEP2379
4.6L V8 281 CID	1998	(6), GAS; (2 Tube Ports), Midship Fuel Tank	USEP2379	4.6L V8 281 CID	1997	(6); (3 Tube Ports), Midship Fuel Tank	USEP2379
4.6L V8 281 CID	1998	(2), GAS; (3 Tube Ports), Aft Axle Fuel Tank	USEP2379	4.6L V8 281 CID	1998	(6), GAS; (2 Tube Ports), Midship Fuel Tank	USEP2379
4.6L V8 281 CID	1998	(2), GAS; (3 Tube Ports), Midship Fuel Tank	USEP2379	4.6L V8 281 CID	1998	(6), GAS; (3 Tube Ports), Aft Axle Fuel Tank	USEP2379
4.6L V8 281 CID	1997	(6); (2 Tube Ports), Midship Fuel Tank	USEP2379	4.6L V8 281 CID	1998	(6), GAS; (3 Tube Ports), Midship Fuel Tank	USEP2379
4.6L V8 281 CID	1997	(6); (3 Tube Ports), Aft Axle Fuel Tank	USEP2379	4.6L V8 281 CID	1999-2002	(2 Tube Ports)	USEP2068
4.6L V8 281 CID	1997	(6); (3 Tube Ports), Midship Fuel Tank	USEP2379	4.6L V8 281 CID	1999-2002	(W); (3 Tube Ports)	USEP2376
4.6L V8 281 CID	1998	(6), GAS; (2 Tube Ports), Midship Fuel Tank	USEP2379	5.0L V8 302 CID	1986-1987	(N), FI; 1.45 inch pump diameter, External Pump	USEP2000A
4.6L V8 281 CID	1998	(6), GAS; (3 Tube Ports), Aft Axle Fuel Tank	USEP2379	5.0L V8 302 CID	1986-1987	(N), FI; Aft Axle Fuel Tank	USEP2008
4.6L V8 281 CID	1998	(2), GAS; (3 Tube Ports), Midship Fuel Tank	USEP2379	5.0L V8 302 CID	1986-1987	(N), FI; Midship Fuel Tank	USEP2008
4.6L V8 281 CID	1997	(6); (2 Tube Ports), Midship Fuel Tank	USEP2379	5.0L V8 302 CID	1986-1989	2 inch pump diameter, External Pump	USEP2000
4.6L V8 281 CID	1997	(6); (3 Tube Ports), Aft Axle Fuel Tank	USEP2379	5.0L V8 302 CID	1988	(N); 16 Gallon Fuel Tank	USEP2008
4.6L V8 281 CID	1997	(6); (3 Tube Ports), Midship Fuel Tank	USEP2379	5.0L V8 302 CID	1988-1989	(N); 1.45 inch pump diameter, External Pump	USEP2000A
4.6L V8 281 CID	1998	(6), GAS; (2 Tube Ports), Midship Fuel Tank	USEP2379	5.0L V8 302 CID	1988-1989	(N); 20 Gallon Fuel Tank (22 Gallon Fuel Tank)	USEP2008
4.6L V8 281 CID	1998	(6), GAS; (3 Tube Ports), Aft Axle Fuel Tank	USEP2379	5.0L V8 302 CID	1992	Aft Axle Fuel Tank	USEP2284
4.6L V8 281 CID	1998	(2), GAS; (3 Tube Ports), Midship Fuel Tank	USEP2379	5.0L V8 302 CID	1992-1996	(N); Midship Fuel Tank	USEP2284
4.6L V8 281 CID	1997	(6); (2 Tube Ports), Midship Fuel Tank	USEP2379	5.0L V8 302 CID	1992-1996		USEP2490
4.6L V8 281 CID	1997	(6); (3 Tube Ports), Aft Axle Fuel Tank	USEP2379	5.0L V8 302 CID	1993-1996	(N); Aft Axle Fuel Tank	USEP2284
4.6L V8 281 CID	1997	(6); (3 Tube Ports), Midship Fuel Tank	USEP2379	5.4L V8 330 CID	1997	(L); (2 Tube Ports), Midship Fuel Tank	USEP2380
4.6L V8 281 CID	1997	(6); (3 Tube Ports), Aft Axle Fuel Tank	USEP2379	5.4L V8 330 CID	1997	(L); (3 Tube Ports), Midship Fuel Tank	USEP2380
4.6L V8 281 CID	1997	(6); (3 Tube Ports), Midship Fuel Tank	USEP2379	5.4L V8 330 CID	1997-1998	(3 Tube Ports), Aft Axle Fuel Tank	USEP2158
4.6L V8 281 CID	1998	(6), GAS; (2 Tube Ports), Midship Fuel Tank	USEP2379	5.4L V8 330 CID	1998	(L), GAS; (2 Tube Ports), Midship Fuel Tank	USEP2380



# FUEL PUMP KITS APPLICATION GUIDE



FUEL PUMP KITS

Engine	Years	Application Description	USMW	Engine	Years	Application Description	USMW
<b>FORD (cont'd.)</b>				<b>FORD (cont'd.)</b>			
<b>E-150 ECONOLINE CLUB WAGON (cont'd.)</b>				<b>E-250 ECONOLINE (cont'd.)</b>			
5.4L V8 330 CID	1998	(L), GAS; (3 Tube Ports), Midship Fuel Tank	USEP2380	4.2L V6 256 CID	1997	(2 Tube Ports), Exc.Commercial Chassis	USEP2068
5.4L V8 330 CID	1998	(Z), BI-FUEL; (2 Tube Ports), Midship Fuel Tank	USEP2380	4.2L V6 256 CID	1997	(3 Tube Ports), Exc.Commercial Chassis	USEP2068
5.4L V8 330 CID	1998	(Z), BI-FUEL; (3 Tube Ports), Midship Fuel Tank	USEP2380	4.2L V6 256 CID	1997	Commercial chassis	USEP2068
5.4L V8 330 CID	1999	(L); (2 Tube Ports), Midship Fuel Tank	USEP2380	4.2L V6 256 CID	1998	(2), GAS; (2 Tube Ports), Midship Fuel Tank	USEP2379
5.4L V8 330 CID	1999	(L); (3 Tube Ports), Midship Fuel Tank	USEP2380	4.2L V6 256 CID	1998	(2), GAS; (3 Tube Ports), Aft Axle Fuel Tank	USEP2379
5.4L V8 330 CID	2000-2002	(L); (2 Tube Ports), Except for Bosch, Carter, and Delphi, Midship Fuel Tank	USEP2377	4.2L V6 256 CID	1998	(2), GAS; (3 Tube Ports), Midship Fuel Tank	USEP2379
5.4L V8 330 CID	2000-2002	(L); (3 Tube Ports), Aft Axle Fuel Tank, Except for Bosch, Carter, and Delphi	USEP2377	4.2L V6 256 CID	1999-2002	(2 Tube Ports), Midship Fuel Tank	USEP2068
5.4L V8 330 CID	2000-2002	(L); (3 Tube Ports), Except for Bosch, Carter, and Delphi, Midship Fuel Tank	USEP2377	4.2L V6 256 CID	1999-2002	(3 Tube Ports), Aft Axle Fuel Tank	USEP2068
5.8L V8 5753cc 351 CID	1988	(H); 16 Gallon Fuel Tank	USEP2008	4.9L L6 4917cc 300 CID	1992-1993		USEP2490
5.8L V8 5753cc 351 CID	1988-1989	2 inch pump diameter, External Pump	USEP2000	4.9L L6 4917cc 300 CID	1995	GAS; Aft Axle Fuel Tank	USEP2284
5.8L V8 5753cc 351 CID	1988-1989	(H); 1.45 inch pump diameter, External Pump	USEP2000A	4.9L L6 4917cc 300 CID	1996	GAS; Midship Fuel Tank	USEP2284
5.8L V8 5753cc 351 CID	1988-1989	(H); 20 Gallon Fuel Tank (22 Gallon Fuel Tank)	USEP2008	5.0L V8 302 CID	1980-1982		USEP2025
5.8L V8 5753cc 351 CID	1992	Aft Axle Fuel Tank	USEP2284	5.0L V8 302 CID	1986-1987	(N), FI; 1.45 inch pump diameter, External Pump	USEP2000A
5.8L V8 5753cc 351 CID	1992	Midship Fuel Tank	USEP2284	5.0L V8 302 CID	1986-1987	(N), FI; Aft Axle Fuel Tank	USEP2008
5.8L V8 5753cc 351 CID	1992-1996		USEP2490	5.0L V8 302 CID	1986-1987	(N), FI; Midship Fuel Tank	USEP2008
5.8L V8 5753cc 351 CID	1993-1996	(H); Aft Axle Fuel Tank	USEP2284	5.0L V8 302 CID	1986-1989	2 inch pump diameter, External Pump	USEP2000
5.8L V8 5753cc 351 CID	1993-1996	(H); Midship Fuel Tank	USEP2284	5.0L V8 302 CID	1988	(N); 16 Gallon Fuel Tank	USEP2008
<b>E-250</b>				5.0L V8 302 CID	1988-1989	(N); 20 Gallon Fuel Tank (22 Gallon Fuel Tank)	USEP2008
4.2L V6 256 CID	2003	(3 Tube Ports), Midship Fuel Tank	USEP2068	5.0L V8 302 CID	1988-1991	(N); 1.45 inch pump diameter, External Pump	USEP2000A
4.6L V8 281 CID	2003	(2 Tube Ports), Midship Fuel Tank	USEP2068	5.0L V8 302 CID	1990	(N); 16 Gallon Midship Fuel Tank	USEP2008
4.6L V8 281 CID	2004	(W), GAS; (w/Secondary Fuel Ports), Midship Fuel Tank (35 Gallon Fuel Tank)	USEP2364	5.0L V8 302 CID	1990	(N); 20 Gallon Aft Axle Fuel Tank (22 Gallon Aft Axle Fuel Tank) (From 05/23/90)	USEP2008
4.6L V8 281 CID	2004	(W), GAS; (w/Secondary Fuel Ports), Except for Bosch, Carter, and Delphi, Midship Fuel Tank (35 Gallon Fuel Tank)	USEP2377	5.0L V8 302 CID	1990	(N); 20 Gallon Aft Axle Fuel Tank (22 Gallon Aft Axle Fuel Tank) (To 05/22/90)	USEP2008
4.6L V8 281 CID	2004	(W), GAS; (wo/Secondary Fuel Ports), Midship Fuel Tank (35 Gallon Fuel Tank)	USEP2515	5.0L V8 302 CID	1991	2 inch pump diameter, External Pump	USEP2000
4.6L V8 281 CID	2004-2005	(W), GAS; Aft Axle Fuel Tank, Except for Bosch, Carter, and Delphi	USEP2377	5.0L V8 302 CID	1991	(N), 138.0 / 350.5 Wheel Base; 16 Gallon Midship Fuel Tank	USEP2008
4.6L V8 281 CID	2005	(w/Secondary Fuel Ports), Except for Bosch, Carter, and Delphi, Midship Fuel Tank (From 01/10/05)	USEP2226	5.0L V8 302 CID	1991	(N); 20 Gallon Aft Axle Fuel Tank (22 Gallon Aft Axle Fuel Tank)	USEP2008
4.6L V8 281 CID	2005	(W), GAS; (w/Secondary Fuel Ports), Midship Fuel Tank (From 01/10/05)	USEP2364	5.4L V8 330 CID	1997-1999	(3 Tube Ports), Aft Axle Fuel Tank	USEP2158
4.6L V8 281 CID	2005	(W), GAS; (w/Secondary Fuel Ports), Midship Fuel Tank (To 01/10/05)	USEP2364	5.4L V8 330 CID	1997-1999	(L), GAS; (2 Tube Ports), Midship Fuel Tank	USEP2380
4.6L V8 281 CID	2005	(W), GAS; (w/Secondary Fuel Ports), Except for Bosch, Carter, and Delphi, Midship Fuel Tank (To 01/10/05)	USEP2377	5.4L V8 330 CID	1997-1999	(L), GAS; (3 Tube Ports), Midship Fuel Tank	USEP2380
4.6L V8 281 CID	2005	(W), GAS; (wo/Secondary Fuel Ports), Midship Fuel Tank (From 01/10/05)	USEP2515	5.4L V8 330 CID	1998-1999	(Z), BI-FUEL; (2 Tube Ports), Midship Fuel Tank	USEP2380
4.6L V8 281 CID	2005	(W), GAS; (wo/Secondary Fuel Ports), Midship Fuel Tank (To 01/10/05)	USEP2515	5.4L V8 330 CID	1998-1999	(Z), BI-FUEL; (3 Tube Ports), Midship Fuel Tank	USEP2380
4.6L V8 281 CID	2006	(W); (w/Secondary Fuel Ports), Midship Fuel Tank	USEP2364	5.4L V8 330 CID	2000-2002	(L), GAS; (2 Tube Ports), Except for Bosch, Carter, and Delphi, Midship Fuel Tank	USEP2377
4.6L V8 281 CID	2006	(W); (w/Secondary Fuel Ports), Except for Bosch, Carter, and Delphi, Midship Fuel Tank	USEP2377	5.4L V8 330 CID	2000-2002	(L), GAS; (3 Tube Ports), Aft Axle Fuel Tank, Except for Bosch, Carter, and Delphi	USEP2377
4.6L V8 281 CID	2006	(W); Aft Axle Fuel Tank, Except for Bosch, Carter, and Delphi	USEP2377	5.4L V8 330 CID	2000-2002	(L), GAS; (3 Tube Ports), Except for Bosch, Carter, and Delphi, Midship Fuel Tank	USEP2377
4.6L V8 281 CID	2006	(W); (wo/Secondary Fuel Ports), Midship Fuel Tank	USEP2515	5.8L V8 5753cc 351 CID	1980-1982		USEP2025
4.6L V8 281 CID	2007-2008	(W); (Secondary Fuel Ports)	USEP2364	5.8L V8 5753cc 351 CID	1988	(H); 16 Gallon Fuel Tank	USEP2008
4.6L V8 281 CID	2007-2008	(W); (Secondary Fuel Ports), Except for Bosch, Carter, and Delphi	USEP2377	5.8L V8 5753cc 351 CID	1988-1989	(H); 20 Gallon Fuel Tank (22 Gallon Fuel Tank)	USEP2008
4.6L V8 281 CID	2007-2008	(W); (Exc.Secondary Fuel Ports)	USEP2515	5.8L V8 5753cc 351 CID	1988-1991	2 inch pump diameter, External Pump	USEP2000
5.4L V8 330 CID	2006	(L); (w/Secondary Fuel Ports), Exc.Extended Range Fuel Tank (Midship Fuel Tank)	USEP2364	5.8L V8 5753cc 351 CID	1988-1991	(H); 1.45 inch pump diameter, External Pump	USEP2000A
5.4L V8 330 CID	2006	(L); (w/Secondary Fuel Ports), Exc.Extended Range Fuel Tank (Midship Fuel Tank), Except for Bosch, Carter, and Delphi	USEP2377	5.8L V8 5753cc 351 CID	1990	(H); 16 Gallon Midship Fuel Tank	USEP2008
5.4L V8 330 CID	2006	(L); (wo/Secondary Fuel Ports), Exc.Extended Range Fuel Tank (Midship Fuel Tank)	USEP2515	5.8L V8 5753cc 351 CID	1990	(H); 20 Gallon Aft Axle Fuel Tank (22 Gallon Aft Axle Fuel Tank) (From 05/23/90)	USEP2008
5.4L V8 330 CID	2006-2008	(L); Exc.Extended Range Fuel Tank (Aft Axle Fuel Tank), Except for Bosch, Carter, and Delphi	USEP2377	5.8L V8 5753cc 351 CID	1990	(H); 20 Gallon Aft Axle Fuel Tank (22 Gallon Aft Axle Fuel Tank) (To 05/22/90)	USEP2008
5.4L V8 330 CID	2006-2008	(L); Except for Bosch, Carter, and Delphi, Extended Range Fuel Tank	USEP2377	5.8L V8 5753cc 351 CID	1991	(H), 138.0 / 350.5 Wheel Base; 16 Gallon Midship Fuel Tank	USEP2008
5.4L V8 330 CID	2007-2008	(L); (Secondary Fuel Ports), Exc.Extended Range Fuel Tank (Midship Fuel Tank)	USEP2364	5.8L V8 5753cc 351 CID	1991	(H); 20 Gallon Aft Axle Fuel Tank (22 Gallon Aft Axle Fuel Tank)	USEP2008
5.4L V8 330 CID	2007-2008	(L); (Secondary Fuel Ports), Exc.Extended Range Fuel Tank (Midship Fuel Tank), Except for Bosch, Carter, and Delphi	USEP2377	5.8L V8 5753cc 351 CID	1992-1994	(H); Aft Axle Fuel Tank	USEP2284
5.4L V8 330 CID	2007-2008	(L); (Exc.Secondary Fuel Ports), Exc.Extended Range Fuel Tank (Midship Fuel Tank)	USEP2515	5.8L V8 5753cc 351 CID	1992-1994	(H); Midship Fuel Tank	USEP2284
5.4L V8 330 CID	2007-2008	(L); (Secondary Fuel Ports), Exc.Extended Range Fuel Tank (Midship Fuel Tank)	USEP2364	5.8L V8 5753cc 351 CID	1992-1996		USEP2490
5.4L V8 330 CID	2007-2008	(L); (Secondary Fuel Ports), Exc.Extended Range Fuel Tank (Midship Fuel Tank), Except for Bosch, Carter, and Delphi	USEP2377	5.8L V8 5753cc 351 CID	1995	GAS; Midship Fuel Tank	USEP2284
5.4L V8 330 CID	2007-2008	(L); (Exc.Secondary Fuel Ports), Exc.Extended Range Fuel Tank (Midship Fuel Tank)	USEP2515	5.8L V8 5753cc 351 CID	1995-1996	(H), GAS; Aft Axle Fuel Tank	USEP2284
5.4L V8 330 CID	2007-2008	(L); (Exc.Secondary Fuel Ports), Exc.Extended Range Fuel Tank (Midship Fuel Tank)	USEP2515	5.8L V8 5753cc 351 CID	1995-1996	(H), GAS; Midship Fuel Tank	USEP2284
5.4L V8 330 CID	2007-2008	(L); (Exc.Secondary Fuel Ports), Exc.Extended Range Fuel Tank (Midship Fuel Tank)	USEP2515	5.8L V8 5753cc 351 CID	1996	GAS; Aft Axle Fuel Tank	USEP2284
<b>E-250 ECONOLINE</b>				6.6L V8 400 CID	1980		USEP2025
	1992-1996	in-tank pump	USEP2521	<b>E-250 ECONOLINE CLUB WAGON</b>			
				5.0L V8 302 CID	1980		USEP2025
				5.8L V8 5753cc 351 CID	1980-1982		USEP2025
				5.8L V8 5753cc 351 CID	1988	(H), GAS; 16 Gallon Fuel Tank	USEP2008
				5.8L V8 5753cc 351 CID	1988-1989	(H), GAS; 20 Gallon Fuel Tank (22 Gallon Fuel Tank)	USEP2008
				5.8L V8 5753cc 351 CID	1988-1991	2 inch pump diameter, External Pump	USEP2000
				5.8L V8 5753cc 351 CID	1988-1991	(H), GAS; 1.45 inch pump diameter, External Pump	USEP2000A







Engine	Years	Application Description	USMW	Engine	Years	Application Description	USMW
<b>FORD (cont'd.)</b>				<b>FORD (cont'd.)</b>			
<b>E-350 ECONOLINE CLUB WAGON (cont'd.)</b>				<b>E-350 SUPER DUTY (cont'd.)</b>			
6.8L V10 415 CID	1997-1998	(3 Tube Ports), Aft Axle Fuel Tank	USEP2158	5.4L V8 330 CID	2006	Base, XL, XLT; (L), GAS, Naturally Aspirated; (w/Secondary Fuel Ports), Exc.Extended Range Fuel Tank (Midship Fuel Tank)	USEP2364
6.8L V10 415 CID	1998	XLT, XLT HD; (S), GAS, Naturally Aspirated; (2 Tube Ports), Midship Fuel Tank	USEP2380	5.4L V8 330 CID	2006	Base, XL, XLT; (L), GAS, Naturally Aspirated; (w/Secondary Fuel Ports), Exc.Extended Range Fuel Tank (Midship Fuel Tank), Except for Bosch, Carter, and Delphi	USEP2377
6.8L V10 415 CID	1998	XLT, XLT HD; (S), GAS, Naturally Aspirated; (3 Tube Ports), Midship Fuel Tank	USEP2380	5.4L V8 330 CID	2006	Base, XL, XLT; (L), GAS, Naturally Aspirated; (wo/Secondary Fuel Ports), Exc.Extended Range Fuel Tank (Midship Fuel Tank)	USEP2515
6.8L V10 415 CID	1999	(S), GAS, Naturally Aspirated; (2 Tube Ports), Midship Fuel Tank	USEP2380	5.4L V8 330 CID	2006-2008	Base, XL, XLT; (L), GAS, Naturally Aspirated; Exc.Extended Range Fuel Tank (Aft Axle Fuel Tank), Except for Bosch, Carter, and Delphi	USEP2377
6.8L V10 415 CID	1999	(S), GAS, Naturally Aspirated; (3 Tube Ports), Midship Fuel Tank	USEP2380	5.4L V8 330 CID	2006-2008	Base, XL, XLT; (L), GAS, Naturally Aspirated; Except for Bosch, Carter, and Delphi, Extended Range Fuel Tank	USEP2377
6.8L V10 415 CID	2000-2002	(S), GAS, Naturally Aspirated; (2 Tube Ports), Except for Bosch, Carter, and Delphi, Midship Fuel Tank	USEP2377	5.4L V8 330 CID	2007-2008	Base, XL, XLT; (L), GAS, Naturally Aspirated; (Secondary Fuel Ports), Exc.Extended Range Fuel Tank (Midship Fuel Tank)	USEP2364
6.8L V10 415 CID	2000-2002	(S), GAS, Naturally Aspirated; (3 Tube Ports), Aft Axle Fuel Tank, Except for Bosch, Carter, and Delphi	USEP2377	5.4L V8 330 CID	2007-2008	Base, XL, XLT; (L), GAS, Naturally Aspirated; (Secondary Fuel Ports), Exc.Extended Range Fuel Tank (Midship Fuel Tank), Except for Bosch, Carter, and Delphi	USEP2377
6.8L V10 415 CID	2000-2002	(S), GAS, Naturally Aspirated; (3 Tube Ports), Except for Bosch, Carter, and Delphi, Midship Fuel Tank	USEP2377	6.0L V8 363 CID	2004-2005	(P), DIESEL, Turbocharged; External Pump	USEP2340
7.3L V8 445 CID	1998	XLT, XLT HD; (F), DIESEL, Turbocharged; External Pump	USEP2236	6.0L V8 363 CID	2006-2008	Base, XL, XLT; (P), DIESEL, Turbocharged; External Pump	USEP2340
7.3L V8 445 CID	1999-2002	(F), DIESEL, Turbocharged; External Pump	USEP2236	6.8L V10 415 CID	2004-2005	(S), GAS, Naturally Aspirated; (w/Secondary Fuel Ports), Midship Fuel Tank	USEP2364
7.5L V8 460 CID	1980-1982		USEP2025	6.8L V10 415 CID	2004-2005	(S), GAS, Naturally Aspirated; (w/Secondary Fuel Ports), Except for Bosch, Carter, and Delphi, Midship Fuel Tank	USEP2377
7.5L V8 460 CID	1984-1985		USEP2025	6.8L V10 415 CID	2004-2005	(S), GAS, Naturally Aspirated; Aft Axle Fuel Tank, Except for Bosch, Carter, and Delphi	USEP2377
7.5L V8 460 CID	1985	(L), CARB, GAS; Aft Axle Fuel Tank	USEP2484	6.8L V10 415 CID	2004-2005	(S), GAS, Naturally Aspirated; (wo/Secondary Fuel Ports), Midship Fuel Tank	USEP2515
7.5L V8 460 CID	1986-1987	(L), CARB, GAS; Aft Axle Fuel Tank	USEP2008	6.8L V10 415 CID	2006	Base, XL, XLT; (S), GAS, Naturally Aspirated; (w/Secondary Fuel Ports), Midship Fuel Tank	USEP2364
7.5L V8 460 CID	1986-1987	(L), CARB, GAS; Midship Fuel Tank	USEP2008	6.8L V10 415 CID	2006	Base, XL, XLT; (S), GAS, Naturally Aspirated; (w/Secondary Fuel Ports), Except for Bosch, Carter, and Delphi, Midship Fuel Tank	USEP2377
7.5L V8 460 CID	1988	(G), GAS; 16 Gallon Fuel Tank	USEP2008	6.8L V10 415 CID	2006	Base, XL, XLT; (S), GAS, Naturally Aspirated; (wo/Secondary Fuel Ports), Midship Fuel Tank	USEP2515
7.5L V8 460 CID	1988	(G), GAS; 20 Gallon Fuel Tank (22 Gallon Fuel Tank)	USEP2008	6.8L V10 415 CID	2006-2007	Base, XL, XLT; (S), GAS, Naturally Aspirated; Aft Axle Fuel Tank, Except for Bosch, Carter, and Delphi	USEP2377
7.5L V8 460 CID	1988	(G), GAS; 36 Gallon Fuel Tank (40 Gallon Fuel Tank)	USEP2031	6.8L V10 415 CID	2007	Base, XL, XLT; (S), GAS, Naturally Aspirated; (Secondary Fuel Ports), Midship Fuel Tank	USEP2364
7.5L V8 460 CID	1988-1991	2 inch pump diameter, External Pump	USEP2000	6.8L V10 415 CID	2007	Base, XL, XLT; (S), GAS, Naturally Aspirated; (Secondary Fuel Ports), Except for Bosch, Carter, and Delphi, Midship Fuel Tank	USEP2377
7.5L V8 460 CID	1988-1991	(G), GAS; 1.45 inch pump diameter, External Pump	USEP2000A	6.8L V10 415 CID	2008	Base; (S), GAS, Naturally Aspirated; (Secondary Fuel Ports), Midship Fuel Tank	USEP2364
7.5L V8 460 CID	1990	(G), GAS; 16 Gallon Midship Fuel Tank	USEP2008	6.8L V10 415 CID	2008	Base; (S), GAS, Naturally Aspirated; (Secondary Fuel Ports), Except for Bosch, Carter, and Delphi, Midship Fuel Tank	USEP2377
7.5L V8 460 CID	1990	(G), GAS; 20 Gallon Aft Axle Fuel Tank (22 Gallon Aft Axle Fuel Tank) (From 05/22/90)	USEP2008	6.8L V10 415 CID	2008	Base; (S), GAS, Naturally Aspirated; Aft Axle Fuel Tank, Except for Bosch, Carter, and Delphi	USEP2377
7.5L V8 460 CID	1990	(G), GAS; 20 Gallon Aft Axle Fuel Tank (22 Gallon Aft Axle Fuel Tank) (To 05/22/90)	USEP2008	6.8L V10 415 CID	2008	Base; (S), GAS, Naturally Aspirated; (Exc.Secondary Fuel Ports), Midship Fuel Tank	USEP2515
7.5L V8 460 CID	1991	(G), 138.0 / 350.5 Wheel Base, GAS; 16 Gallon Midship Fuel Tank	USEP2008	<b>ECOSPORT</b>			
7.5L V8 460 CID	1991	(G), GAS; 20 Gallon Aft Axle Fuel Tank (22 Gallon Aft Axle Fuel Tank)	USEP2008	2.0L L4 1999cc 122 CID	2004-2006	MEX	USEP2226
7.5L V8 460 CID	1992-1994	XLT, XLT HD; (G), GAS; Aft Axle Fuel Tank	USEP2284	<b>EDGE</b>			
7.5L V8 460 CID	1992-1994	XLT, XLT HD; (G), GAS; Midship Fuel Tank	USEP2284	3.5L V6 3496cc 213 CID	2007-2015		USEP2518
7.5L V8 460 CID	1992-1996	XLT, XLT HD; (G), GAS, Naturally Aspirated; Aft Axle Fuel Tank	USEP2490	3.7L V6 3726cc 227 CID	2011-2014		USEP2518
7.5L V8 460 CID	1995	XLT, XLT HD; (G), GAS, Naturally Aspirated; Aft Axle Fuel Tank	USEP2284	<b>ESCAPE</b>			
7.5L V8 460 CID	1995	XLT, XLT HD; (G), GAS, Naturally Aspirated; Midship Fuel Tank	USEP2284	2.0L L4 1989cc 121 CID	2001-2004		USEP2291
7.5L V8 460 CID	1995	XLT, XLT HD; (G), GAS, Naturally Aspirated; Midship Fuel Tank	USEP2284				
7.5L V8 460 CID	1996	Aft Axle Fuel Tank	USEP2284				
7.5L V8 460 CID	1996	Midship Fuel Tank	USEP2284				
<b>E-350 SUPER DUTY</b>							
5.4L V8 330 CID	2004	(L), GAS, Naturally Aspirated; (w/Secondary Fuel Ports), Midship Fuel Tank (35 Gallon Fuel Tank)	USEP2364				
5.4L V8 330 CID	2004	(L), GAS, Naturally Aspirated; (w/Secondary Fuel Ports), Except for Bosch, Carter, and Delphi, Midship Fuel Tank (35 Gallon Fuel Tank)	USEP2377				
5.4L V8 330 CID	2004	(L), GAS, Naturally Aspirated; Aft Axle Fuel Tank, Except for Bosch, Carter, and Delphi	USEP2377				
5.4L V8 330 CID	2004	(L), GAS, Naturally Aspirated; (wo/Secondary Fuel Ports), Midship Fuel Tank (35 Gallon Fuel Tank)	USEP2515				
5.4L V8 330 CID	2005	(L), GAS, Naturally Aspirated; (w/Secondary Fuel Ports), Exc.Extended Range Fuel Tank (Midship Fuel Tank) (35 Gallon Fuel Tank)	USEP2364				
5.4L V8 330 CID	2005	(L), GAS, Naturally Aspirated; (w/Secondary Fuel Ports), Exc.Extended Range Fuel Tank (Midship Fuel Tank) (35 Gallon Fuel Tank), Except for Bosch, Carter, and Delphi	USEP2377				
5.4L V8 330 CID	2005	(L), GAS, Naturally Aspirated; Exc.Extended Range Fuel Tank (Aft Axle Fuel Tank), Except for Bosch, Carter, and Delphi	USEP2377				
5.4L V8 330 CID	2005	(L), GAS, Naturally Aspirated; Except for Bosch, Carter, and Delphi, Extended Range Fuel Tank	USEP2377				
5.4L V8 330 CID	2005	(L), GAS, Naturally Aspirated; (wo/Secondary Fuel Ports), Exc.Extended Range Fuel Tank (Midship Fuel Tank) (55 Gallon Fuel Tank)	USEP2515				

Engine	Years	Application Description	USMW	Engine	Years	Application Description	USMW
<b>FORD (cont'd.)</b>				<b>FORD (cont'd.)</b>			
<b>ESCORT</b>				<b>F-150 (cont'd.)</b>			
1.6L L4 1598cc 98 CID	1985	GT, LX; (5), FI, GAS, Naturally Aspirated; External Pump	USEP2315	4.2L V6 256 CID	1997	XL; (2), 139.0 / 353.1 Wheel Base, Standard Cab Pickup	USEP2379
1.6L L4 1598cc 98 CID	1985	GT Turbo; (8), FI, GAS, Turbocharged; External Pump	USEP2315	4.2L V6 256 CID	1997	XL; (2), 157.0 / 398.8 Wheel Base (2), 4WD, 120.0 / 304.8 Wheel Base, GAS	USEP2379
1.8L L4 112 CID	1991	GT; (8)	USEP2065	4.2L V6 256 CID	1998	(2), 120.0 / 304.8 Wheel Base, GAS, RWD	USEP2379
1.8L L4 112 CID	1992-1993	GT, LX-E; (8)	USEP2065	4.2L V6 256 CID	1998	(2), 139.0 / 353.1 Wheel Base, Extended Cab Pickup, GAS	USEP2379
1.9L L4 116 CID	1991-1992	Base, LX Sport; (J)	USEP2065	4.2L V6 256 CID	1998	(2), 139.0 / 353.1 Wheel Base, Standard Cab Pickup	USEP2379
1.9L L4 116 CID	1993	Base, LX Sport, Sport; (J)	USEP2065	4.2L V6 256 CID	1998	(2), 157.0 / 398.8 Wheel Base, GAS	USEP2379
2.0L L4 1989cc 121 CID	1999-2003		USEP2446	4.2L V6 256 CID	1999-2001	XL; (2), 4WD, 120.0 / 304.8 Wheel Base, GAS, Naturally Aspirated; Except for Bosch, Carter, and Delphi	USEP2377
<b>EXCURSION</b>				4.2L V6 256 CID	1999-2001	XL; (2), 120.0 / 304.8 Wheel Base, GAS, Naturally Aspirated, RWD; Except for Bosch, Carter, and Delphi	USEP2377
5.4L V8 330 CID	2000-2005		USEP2318	4.2L V6 256 CID	1999-2001	XL; (2), 139.0 / 353.1 Wheel Base, Extended Cab Pickup, GAS, Naturally Aspirated; Except for Bosch, Carter, and Delphi	USEP2377
6.8L V10 415 CID	2000-2005		USEP2318	4.2L V6 256 CID	1999-2001	XL; (2), 139.0 / 353.1 Wheel Base, Extended Cab Pickup, GAS, Naturally Aspirated; Except for Bosch, Carter, and Delphi	USEP2377
<b>EXP</b>				4.2L V6 256 CID	2000-2001	XL; (2), 157.0 / 398.8 Wheel Base, GAS, Naturally Aspirated; Except for Bosch, Carter, and Delphi	USEP2377
	1985	Turbo; (8), FI, Turbocharged; External Pump	USEP2315	4.2L V6 256 CID	2001	XL; (2), 139.0 / 353.1 Wheel Base, Crew Cab Pickup, GAS, Naturally Aspirated; Except for Bosch, Carter, and Delphi	USEP2377
	1986	(9), CARB; External Pump	USEP2315	4.2L V6 256 CID	2003	XL; (2), 4WD, 120.0 / 304.8 Wheel Base, GAS, Naturally Aspirated; Except for Bosch, Carter, and Delphi	USEP2377
	1986	(J), FI; External Pump	USEP2315	4.2L V6 256 CID	2003	XL; (2), 120.0 / 304.8 Wheel Base, GAS, Naturally Aspirated, RWD; Except for Bosch, Carter, and Delphi	USEP2377
	1987	Luxury; (9)	USEP2002	4.2L V6 256 CID	2003	XL; (2), 139.0 / 353.1 Wheel Base, Crew Cab Pickup, GAS, Naturally Aspirated; Except for Bosch, Carter, and Delphi	USEP2377
	1987	Sport; (J)	USEP2002	4.2L V6 256 CID	2003	XL; (2), 139.0 / 353.1 Wheel Base, Standard Cab Pickup, GAS, Naturally Aspirated; Except for Bosch, Carter, and Delphi	USEP2377
	1988		USEP2002	4.2L V6 256 CID	2003	XL; (2), 157.0 / 398.8 Wheel Base, GAS, Naturally Aspirated; Except for Bosch, Carter, and Delphi	USEP2377
<b>EXPEDITION</b>				4.2L V6 256 CID	2003	XL; (2), 139.0 / 353.1 Wheel Base, Extended Cab Pickup, GAS, Naturally Aspirated; Except for Bosch, Carter, and Delphi	USEP2377
4.6L V8 281 CID	1997-1998		USEP2158	4.2L V6 256 CID	2003	XL; (2), 139.0 / 353.1 Wheel Base, Extended Cab Pickup, GAS, Naturally Aspirated; Except for Bosch, Carter, and Delphi	USEP2377
4.6L V8 281 CID	1999-2000		USEP2226	4.2L V6 256 CID	2003	XL; (2), 157.0 / 398.8 Wheel Base, GAS, Naturally Aspirated; Except for Bosch, Carter, and Delphi	USEP2377
4.6L V8 281 CID	2001	Except for Bosch, Carter, and Delphi (Exc. Automatic Adjustable Suspension), Except for Bosch, Carter, and Delphi	USEP2226	4.2L V6 256 CID	2003	XL; (2), 139.0 / 353.1 Wheel Base, Crew Cab Pickup, GAS, Naturally Aspirated; Except for Bosch, Carter, and Delphi	USEP2377
4.6L V8 281 CID	2002		USEP2226	4.2L V6 256 CID	2003	XL; (2), 139.0 / 353.1 Wheel Base, Standard Cab Pickup, GAS, Naturally Aspirated; Except for Bosch, Carter, and Delphi	USEP2377
5.4L V8 330 CID	1997-1998		USEP2158	4.2L V6 256 CID	2003	XL; (2), 139.0 / 353.1 Wheel Base, Standard Cab Pickup, GAS, Naturally Aspirated; Except for Bosch, Carter, and Delphi	USEP2377
5.4L V8 330 CID	1999-2000		USEP2226	4.2L V6 256 CID	2003	XL; (2), 157.0 / 398.8 Wheel Base, GAS, Naturally Aspirated; Except for Bosch, Carter, and Delphi	USEP2377
5.4L V8 330 CID	2001-2002	Except for Bosch, Carter, and Delphi	USEP2226	4.2L V6 256 CID	2003	XL; (2), 139.0 / 353.1 Wheel Base, Extended Cab Pickup, GAS, Naturally Aspirated; Except for Bosch, Carter, and Delphi	USEP2377
<b>EXPLORER</b>				4.2L V6 256 CID	2003	XL; (2), 139.0 / 353.1 Wheel Base, Extended Cab Pickup, GAS, Naturally Aspirated; Except for Bosch, Carter, and Delphi	USEP2377
3.5L V6 3496cc 213 CID	2011-2012		USEP2518	4.2L V6 256 CID	2003	XL; (2), 139.0 / 353.1 Wheel Base, Crew Cab Pickup, GAS, Naturally Aspirated; Except for Bosch, Carter, and Delphi	USEP2377
4.0L V6 245 CID	1995-1996		USEP2059	4.2L V6 256 CID	2003	XL; (2), 139.0 / 353.1 Wheel Base, Extended Cab Pickup, GAS, Naturally Aspirated; Except for Bosch, Carter, and Delphi	USEP2377
4.0L V6 245 CID	1997	MEX; Except for Bosch, Carter, and Delphi	USEP2226	4.2L V6 256 CID	2003	XL; (2), 139.0 / 353.1 Wheel Base, Standard Cab Pickup, GAS, Naturally Aspirated; Except for Bosch, Carter, and Delphi	USEP2379
4.0L V6 245 CID	1997	(E), 2 Doors; (Mexico Built Vehicle)	USEP2379	4.2L V6 256 CID	2003	XL; (2), 157.0 / 398.8 Wheel Base, GAS, Naturally Aspirated; Except for Bosch, Carter, and Delphi	USEP2379
4.0L V6 245 CID	1997	(E), 4 Doors; (Mexico Built Vehicle)	USEP2379	4.2L V6 256 CID	2003	XL; (2), 139.0 / 353.1 Wheel Base, Extended Cab Pickup, GAS, Naturally Aspirated; Except for Bosch, Carter, and Delphi	USEP2377
4.0L V6 245 CID	1997	(E); USA Built (Canada Built Vehicle)	USEP2379	4.2L V6 256 CID	2003	XL; (2), 139.0 / 353.1 Wheel Base, Standard Cab Pickup, GAS, Naturally Aspirated; Except for Bosch, Carter, and Delphi	USEP2379
4.0L V6 245 CID	1997	(X), 2 Doors; (Mexico Built Vehicle)	USEP2379	4.2L V6 256 CID	2003	XL; (2), 157.0 / 398.8 Wheel Base, GAS, Naturally Aspirated; Except for Bosch, Carter, and Delphi	USEP2379
4.0L V6 245 CID	1997	(X), 4 Doors; (Mexico Built Vehicle)	USEP2379	4.2L V6 256 CID	2003	XL; (2), 139.0 / 353.1 Wheel Base, Standard Cab Pickup, GAS, Naturally Aspirated; Except for Bosch, Carter, and Delphi	USEP2379
4.0L V6 245 CID	1997	(X); USA Built (Canada Built Vehicle)	USEP2379	4.2L V6 256 CID	2003	XL; (2), 139.0 / 353.1 Wheel Base, Extended Cab Pickup, GAS, Naturally Aspirated; Except for Bosch, Carter, and Delphi	USEP2377
4.0L V6 245 CID	1999-2000	MEX; Except for Bosch, Carter, and Delphi	USEP2226	4.2L V6 256 CID	2003	XL; (2), 157.0 / 398.8 Wheel Base, GAS, Naturally Aspirated; Except for Bosch, Carter, and Delphi	USEP2379
4.0L V6 245 CID	1999-2000	(E), 2 Doors; (Mexico Built Vehicle)	USEP2379	4.2L V6 256 CID	2003	XL; (2), 139.0 / 353.1 Wheel Base, Standard Cab Pickup, GAS, Naturally Aspirated; Except for Bosch, Carter, and Delphi	USEP2379
4.0L V6 245 CID	1999-2000	(E), 4 Doors; (Exc. Mexico Built Vehicle)	USEP2379	4.2L V6 256 CID	2003	XL; (2), 139.0 / 353.1 Wheel Base, Extended Cab Pickup, GAS, Naturally Aspirated; Except for Bosch, Carter, and Delphi	USEP2377
4.0L V6 245 CID	1999-2000	(X), 2 Doors; (Mexico Built Vehicle)	USEP2379	4.6L V8 281 CID	1997	XL; (6), 4WD, 120.0 / 304.8 Wheel Base	USEP2379
4.0L V6 245 CID	1999-2000	(X), 4 Doors; (Exc. Mexico Built Vehicle)	USEP2379	4.6L V8 281 CID	1997	XL; (6), 120.0 / 304.8 Wheel Base, RWD	USEP2379
4.0L V6 245 CID	2000	(E), 0 Doors; (Exc. Mexico Built Vehicle)	USEP2379	4.6L V8 281 CID	1997	XL; (6), 139.0 / 353.1 Wheel Base, Standard Cab Pickup	USEP2379
4.0L V6 245 CID	2000	(X), 0 Doors; (Exc. Mexico Built Vehicle)	USEP2379	4.6L V8 281 CID	1997	XL; (6), 157.0 / 398.8 Wheel Base	USEP2379
4.0L V6 245 CID	2002	XL; (E), GAS; From 05/12/02	USEP2339	4.6L V8 281 CID	1997	XL; (W), 4WD, 120.0 / 304.8 Wheel Base	USEP2379
4.0L V6 245 CID	2002	XL; (E), GAS; To 05/12/02	USEP2339	4.6L V8 281 CID	1997	XL; (W), 120.0 / 304.8 Wheel Base, RWD	USEP2379
4.0L V6 245 CID	2002	XL; (W), GAS	USEP2059	4.6L V8 281 CID	1997	XL; (W), 139.0 / 353.1 Wheel Base, Standard Cab Pickup	USEP2379
4.0L V6 245 CID	1996		USEP2059	4.6L V8 281 CID	1997	XL; (W), 157.0 / 398.8 Wheel Base	USEP2379
5.0L V8 302 CID	1997	MEX	USEP2068	4.6L V8 281 CID	1998	(6), 4WD, 120.0 / 304.8 Wheel Base, GAS	USEP2379
5.0L V8 302 CID	1997	XL; (P), 4 Doors; (Mexico Built Vehicle), Except for Bosch, Carter, and Delphi	USEP2377	4.6L V8 281 CID	1998	(6), 120.0 / 304.8 Wheel Base, GAS, RWD	USEP2379
5.0L V8 302 CID	1997	XL; (P); Except for Bosch, Carter, and Delphi, USA Built (Canada Built Vehicle)	USEP2377	4.6L V8 281 CID	1998	(6), 139.0 / 353.1 Wheel Base, Extended Cab Pickup, GAS	USEP2379
5.0L V8 302 CID	1999		USEP2158	4.6L V8 281 CID	1998	(6), 139.0 / 353.1 Wheel Base, Standard Cab Pickup	USEP2379
5.0L V8 302 CID	2000	MEX; Except for Bosch, Carter, and Delphi	USEP2226	4.6L V8 281 CID	1998	(6), 157.0 / 398.8 Wheel Base, GAS	USEP2379
5.0L V8 302 CID	2000	XL; (P); (1 Port), Except for Bosch, Carter, and Delphi, From 02/00	USEP2377	4.6L V8 281 CID	1998	(6), 4WD, 120.0 / 304.8 Wheel Base, GAS	USEP2379
5.0L V8 302 CID	2000	XL; (P); Except for Bosch, Carter, and Delphi, To 02/00	USEP2377	4.6L V8 281 CID	1998	(W), 120.0 / 304.8 Wheel Base, GAS, RWD	USEP2379
<b>EXPLORER SPORT TRAC</b>				4.6L V8 281 CID	1998	(W), 139.0 / 353.1 Wheel Base, Extended Cab Pickup, GAS	USEP2379
	2001	(1 Port), To 04/23/01	USEP2333	4.6L V8 281 CID	1998	(W), 139.0 / 353.1 Wheel Base, Standard Cab Pickup	USEP2379
	2001	(2 Ports), From 04/23/01	USEP2333	4.6L V8 281 CID	1998	(W), 157.0 / 398.8 Wheel Base, GAS	USEP2379
<b>F53</b>				4.6L V8 281 CID	1999	XL; (6), 4WD, 120.0 / 304.8 Wheel Base, GAS, Naturally Aspirated; Except for Bosch, Carter, and Delphi	USEP2377
	1990-1997	in-tank pump	USEP2521	4.6L V8 281 CID	1999	XL; (6), 120.0 / 304.8 Wheel Base, GAS, Naturally Aspirated, RWD; Except for Bosch, Carter, and Delphi	USEP2377
<b>F-150</b>				4.6L V8 281 CID	1999	XL; (6), 139.0 / 353.1 Wheel Base, Extended Cab Pickup, GAS, Naturally Aspirated; Except for Bosch, Carter, and Delphi	USEP2377
	1990-1996		USEP2064	4.6L V8 281 CID	1999	XL; (6), 139.0 / 353.1 Wheel Base, Standard Cab Pickup, GAS, Naturally Aspirated; Except for Bosch, Carter, and Delphi	USEP2377
	1999-2003	4WD	USEP2229	4.6L V8 281 CID	1999	XL; (6), 157.0 / 398.8 Wheel Base, GAS	USEP2379
3.8L V6 3797cc 232 CID	1986-1989		USEP2485	4.6L V8 281 CID	1999	(W), 4WD, 120.0 / 304.8 Wheel Base, GAS	USEP2379
4.2L V6 256 CID	1997	XL; (2), 4WD, 120.0 / 304.8 Wheel Base	USEP2379	4.6L V8 281 CID	1999	(W), 120.0 / 304.8 Wheel Base, GAS, RWD	USEP2379
4.2L V6 256 CID	1997	XL; (2), 120.0 / 304.8 Wheel Base, RWD	USEP2379	4.6L V8 281 CID	1999	(W), 139.0 / 353.1 Wheel Base, Extended Cab Pickup, GAS	USEP2379



# FUEL PUMP KITS APPLICATION GUIDE



FUEL PUMP KITS

Engine	Years	Application Description	USMW	Engine	Years	Application Description	USMW
<b>FORD (cont'd.)</b>				<b>FORD (cont'd.)</b>			
<b>F-150 (cont'd.)</b>				<b>F-150 (cont'd.)</b>			
4.6L V8 281 CID	1999	XLT; (6), 139.0 / 353.1 Wheel Base, GAS, Naturally Aspirated, Standard Cab Pickup; Except for Bosch, Carter, and Delphi	USEP2377	4.9L L6 4917cc 300 CID	1988-1989	(Y), 133.0 / 337.8 Wheel Base; 19 Gallon Midship Fuel Tank	USEP2008
4.6L V8 281 CID	1999	XLT; (6), 157.0 / 398.8 Wheel Base, GAS, Naturally Aspirated; Except for Bosch, Carter, and Delphi	USEP2377	4.9L L6 4917cc 300 CID	1988-1989	(Y), 139.0 / 353.1 Wheel Base; 17 Gallon Midship Fuel Tank	USEP2008
4.6L V8 281 CID	1999	XLT; (W), 157.0 / 398.8 Wheel Base, GAS, Naturally Aspirated; Except for Bosch, Carter, and Delphi	USEP2377	4.9L L6 4917cc 300 CID	1988-1989	(Y), 155.0 / 393.7 Wheel Base; 19 Gallon Midship Fuel Tank	USEP2008
4.6L V8 281 CID	1999-2000	XLT; (W), 4WD, 120.0 / 304.8 Wheel Base, GAS, Naturally Aspirated; Except for Bosch, Carter, and Delphi	USEP2377	4.9L L6 4917cc 300 CID	1988-1989	(Y); Rear Fuel Tank (Steel Fuel Tank)	USEP2035
4.6L V8 281 CID	1999-2000	XLT; (W), 120.0 / 304.8 Wheel Base, GAS, Naturally Aspirated, RWD; Except for Bosch, Carter, and Delphi	USEP2377	4.9L L6 4917cc 300 CID	1988-1989	(Y); Rear Fuel Tank (Plastic Fuel Tank)	USEP2484
4.6L V8 281 CID	1999-2001	XLT; (W), 139.0 / 353.1 Wheel Base, Extended Cab Pickup, GAS, Naturally Aspirated; Except for Bosch, Carter, and Delphi	USEP2377	5.0L V8 302 CID	1985	(N), FI, GAS; 1.45 inch pump diameter, External Pump	USEP2000A
4.6L V8 281 CID	1999-2001	XLT; (W), 139.0 / 353.1 Wheel Base, GAS, Naturally Aspirated, Standard Cab Pickup; Except for Bosch, Carter, and Delphi	USEP2377	5.0L V8 302 CID	1985	(N), 117.0 / 297.2 Wheel Base, FI, GAS; 17 Gallon Midship Fuel Tank	USEP2035
4.6L V8 281 CID	2001	XLT; (W), 4WD, 120.0 / 304.8 Wheel Base, Extended Cab Pickup, GAS, Naturally Aspirated; Except for Bosch, Carter, and Delphi	USEP2377	5.0L V8 302 CID	1985	(N), 117.0 / 297.2 Wheel Base, FI, GAS; 19 Gallon Midship Fuel Tank	USEP2035
4.6L V8 281 CID	2001	XLT; (W), 4WD, 120.0 / 304.8 Wheel Base, GAS, Naturally Aspirated, Standard Cab Pickup; Except for Bosch, Carter, and Delphi	USEP2377	5.0L V8 302 CID	1985	(N), 139.0 / 353.1 Wheel Base, FI, GAS; 17 Gallon Midship Fuel Tank	USEP2035
4.6L V8 281 CID	2001	XLT; (W), 120.0 / 304.8 Wheel Base, Extended Cab Pickup, GAS, Naturally Aspirated, RWD; Except for Bosch, Carter, and Delphi	USEP2377	5.0L V8 302 CID	1985	(N), 139.0 / 353.1 Wheel Base, FI, GAS; 19 Gallon Midship Fuel Tank	USEP2035
4.6L V8 281 CID	2001	XLT; (W), 4WD, 120.0 / 304.8 Wheel Base, GAS, Naturally Aspirated, Standard Cab Pickup; Except for Bosch, Carter, and Delphi	USEP2377	5.0L V8 302 CID	1985-1989	(N), FI, GAS; Rear Fuel Tank 2 inch pump diameter, External Pump	USEP2000
4.6L V8 281 CID	2001	XLT; (W), 157.0 / 398.8 Wheel Base, GAS, Naturally Aspirated, Standard Cab Pickup; Except for Bosch, Carter, and Delphi	USEP2377	5.0L V8 302 CID	1985-1989	(N), FI, GAS; Rear Fuel Tank 2 inch pump diameter, External Pump	USEP2485
4.6L V8 281 CID	2001	XLT; (W), 157.0 / 398.8 Wheel Base, GAS, Naturally Aspirated, Standard Cab Pickup; Except for Bosch, Carter, and Delphi	USEP2377	5.0L V8 302 CID	1986	(N), 117.0 / 297.2 Wheel Base, FI; 17 Gallon Midship Fuel Tank	USEP2035
4.6L V8 281 CID	2001	XLT; (W), Crew Cab Pickup, GAS, Naturally Aspirated; Except for Bosch, Carter, and Delphi	USEP2377	5.0L V8 302 CID	1986	(N), 117.0 / 297.2 Wheel Base, FI; 19 Gallon Midship Fuel Tank	USEP2035
4.6L V8 281 CID	2003	XLT; (6), 4WD, 120.0 / 304.8 Wheel Base, GAS, Naturally Aspirated; Except for Bosch, Carter, and Delphi	USEP2377	5.0L V8 302 CID	1986	(N), 139.0 / 353.1 Wheel Base, FI; 17 Gallon Midship Fuel Tank	USEP2035
4.6L V8 281 CID	2003	XLT; (6), 120.0 / 304.8 Wheel Base, GAS, Naturally Aspirated, RWD; Except for Bosch, Carter, and Delphi	USEP2377	5.0L V8 302 CID	1986	(N), 139.0 / 353.1 Wheel Base, FI; 19 Gallon Midship Fuel Tank	USEP2035
4.6L V8 281 CID	2003	XLT; (6), 139.0 / 353.1 Wheel Base, Crew Cab Pickup, GAS, Naturally Aspirated; Except for Bosch, Carter, and Delphi	USEP2377	5.0L V8 302 CID	1986	(N), FI, Rear Fuel Tank	USEP2035
4.6L V8 281 CID	2003	XLT; (6), 139.0 / 353.1 Wheel Base, Extended Cab Pickup, GAS, Naturally Aspirated; Except for Bosch, Carter, and Delphi	USEP2377	5.0L V8 302 CID	1986-1987	(N), FI, 1.45 inch pump diameter, External Pump	USEP2000A
4.6L V8 281 CID	2003	XLT; (6), 157.0 / 398.8 Wheel Base, GAS, Naturally Aspirated; Except for Bosch, Carter, and Delphi	USEP2377	5.0L V8 302 CID	1987	(N), 117.0 / 297.2 Wheel Base, FI; 17 Gallon Midship Fuel Tank	USEP2008
4.6L V8 281 CID	2003	XLT; (W), 4WD, 120.0 / 304.8 Wheel Base, GAS, Naturally Aspirated; Except for Bosch, Carter, and Delphi	USEP2377	5.0L V8 302 CID	1987	(N), 133.0 / 337.8 Wheel Base, FI; 19 Gallon Midship Fuel Tank	USEP2008
4.6L V8 281 CID	2003	XLT; (W), 120.0 / 304.8 Wheel Base, GAS, Naturally Aspirated, RWD; Except for Bosch, Carter, and Delphi	USEP2377	5.0L V8 302 CID	1987	(N), 139.0 / 353.1 Wheel Base, FI; 17 Gallon Midship Fuel Tank	USEP2008
4.6L V8 281 CID	2003	XLT; (W), 139.0 / 353.1 Wheel Base, Crew Cab Pickup, GAS, Naturally Aspirated; Except for Bosch, Carter, and Delphi	USEP2377	5.0L V8 302 CID	1987	(N), 155.0 / 393.7 Wheel Base, FI; 19 Gallon Midship Fuel Tank	USEP2008
4.6L V8 281 CID	2003	XLT; (W), 139.0 / 353.1 Wheel Base, Extended Cab Pickup, GAS, Naturally Aspirated; Except for Bosch, Carter, and Delphi	USEP2377	5.0L V8 302 CID	1987	(N), FI, Rear Fuel Tank (Steel Fuel Tank)	USEP2035
4.6L V8 281 CID	2003	XLT; (W), 157.0 / 398.8 Wheel Base, GAS, Naturally Aspirated; Except for Bosch, Carter, and Delphi	USEP2377	5.0L V8 302 CID	1988-1989	(N); 1.45 inch pump diameter, External Pump	USEP2000A
4.9L L6 4917cc 300 CID	1985-1989		USEP2485	5.0L V8 302 CID	1988-1989	(N), 117.0 / 297.2 Wheel Base; 17 Gallon Midship Fuel Tank	USEP2008
4.9L L6 4917cc 300 CID	1988-1989	2 inch pump diameter, External Pump	USEP2000	5.0L V8 302 CID	1988-1989	(N), 133.0 / 337.8 Wheel Base; 19 Gallon Midship Fuel Tank	USEP2008
4.9L L6 4917cc 300 CID	1988-1989	(Y); 1.45 inch pump diameter, External Pump	USEP2000A	5.0L V8 302 CID	1988-1989	(N), 139.0 / 353.1 Wheel Base; 17 Gallon Midship Fuel Tank	USEP2008
4.9L L6 4917cc 300 CID	1988-1989	(Y), 117.0 / 297.2 Wheel Base; 17 Gallon Midship Fuel Tank	USEP2008	5.0L V8 302 CID	1988-1989	(N), 155.0 / 393.7 Wheel Base; 19 Gallon Midship Fuel Tank	USEP2008
				5.0L V8 302 CID	1988-1989	(N); Rear Fuel Tank (Steel Fuel Tank)	USEP2035
				5.0L V8 302 CID	1988-1989	(N); Rear Fuel Tank (Plastic Fuel Tank)	USEP2484
				5.4L V8 330 CID	1997-2001	RWD	USEP2158
				5.4L V8 330 CID	1999-2000	XLT; (L), 4WD, 120.0 / 304.8 Wheel Base, GAS, Naturally Aspirated; Except for Bosch, Carter, and Delphi	USEP2377
				5.4L V8 330 CID	1999-2000	XLT; (L), 120.0 / 304.8 Wheel Base, GAS, Naturally Aspirated, RWD; Except for Bosch, Carter, and Delphi	USEP2377
				5.4L V8 330 CID	1999-2001	XLT; (L), 139.0 / 353.1 Wheel Base, Extended Cab Pickup, GAS, Naturally Aspirated; Except for Bosch, Carter, and Delphi	USEP2377
				5.4L V8 330 CID	1999-2001	XLT; (L), 139.0 / 353.1 Wheel Base, GAS, Naturally Aspirated, Standard Cab Pickup; Except for Bosch, Carter, and Delphi	USEP2377
				5.4L V8 330 CID	1999-2001	XLT; (Z), 4WD, 120.0 / 304.8 Wheel Base, BI-FUEL, Naturally Aspirated; Except for Bosch, Carter, and Delphi	USEP2377
				5.4L V8 330 CID	1999-2001	XLT; (Z), 120.0 / 304.8 Wheel Base, BI-FUEL, Naturally Aspirated, RWD; Except for Bosch, Carter, and Delphi	USEP2377
				5.4L V8 330 CID	1999-2001	XLT; (Z), 139.0 / 353.1 Wheel Base, BI-FUEL, Extended Cab Pickup, Naturally Aspirated; Except for Bosch, Carter, and Delphi	USEP2377
				5.4L V8 330 CID	1999-2001	XLT; (Z), 139.0 / 353.1 Wheel Base, BI-FUEL, Naturally Aspirated, Standard Cab Pickup; Except for Bosch, Carter, and Delphi	USEP2377
				5.4L V8 330 CID	2001	Harley-Davidson Edition, XLT; (L), Crew Cab Pickup, GAS, Naturally Aspirated; Except for Bosch, Carter, and Delphi	USEP2377
				5.4L V8 330 CID	2001	XLT; (L), 4WD, 120.0 / 304.8 Wheel Base, Extended Cab Pickup, GAS, Naturally Aspirated; Except for Bosch, Carter, and Delphi	USEP2377
				5.4L V8 330 CID	2001	XLT; (L), 4WD, 120.0 / 304.8 Wheel Base, GAS, Naturally Aspirated, Standard Cab Pickup; Except for Bosch, Carter, and Delphi	USEP2377







# FUEL PUMP KITS APPLICATION GUIDE



FUEL PUMP KITS

Engine	Years	Application Description	USMW	Engine	Years	Application Description	USMW
<b>FORD (cont'd.)</b>				<b>FORD (cont'd.)</b>			
<b>F-150 HERITAGE (cont'd.)</b>				<b>F-350 (cont'd.)</b>			
5.4L V8 330 CID	2004	(Z), 157.4 / 399.8 Wheel Base, BI-FUEL, Extended Cab Pickup; Except for Bosch, Carter, and Delphi	USEP2377	5.8L V8 5753cc 351 CID	1988-1989	(H), 155.0 / 393.7 Wheel Base, GAS; 2 inch pump diameter, External Pump	USEP2000
5.4L V8 330 CID	2004	(Z), 157.4 / 399.8 Wheel Base, BI-FUEL, Standard Cab Pickup; Except for Bosch, Carter, and Delphi	USEP2377	5.8L V8 5753cc 351 CID	1988-1989	(H), 133.0 / 337.8 Wheel Base, GAS; 1.45 inch pump diameter, External Pump	USEP2000A
<b>F-250</b>				5.8L V8 5753cc 351 CID	1988-1989	(H), 137.0 / 348.0 Wheel Base, GAS; 1.45 inch pump diameter, External Pump	USEP2000A
4.6L V8 281 CID	1990-1996	(6), GAS, Naturally Aspirated, Standard Cab Pickup	USEP2064	5.8L V8 5753cc 351 CID	1988-1989	(H), 155.0 / 393.7 Wheel Base, GAS; 1.45 inch pump diameter, External Pump	USEP2000A
4.6L V8 281 CID	1997	(W), GAS, Naturally Aspirated, Standard Cab Pickup	USEP2379	5.8L V8 5753cc 351 CID	1988-1989	(H), 133.0 / 337.8 Wheel Base, GAS; 19 Gallon Midship Fuel Tank	USEP2008
4.6L V8 281 CID	2000	MEX	USEP2157	5.8L V8 5753cc 351 CID	1988-1989	(H), 155.0 / 393.7 Wheel Base, GAS; 19 Gallon Midship Fuel Tank	USEP2008
4.6L V8 281 CID	2004	MEX	USEP2157	5.8L V8 5753cc 351 CID	1988-1989	(H), GAS; Aft Axle Fuel Tank (Steel Fuel Tank)	USEP2035
5.0L V8 302 CID	1986	(N), FI, GAS; 17 Gallon Midship Fuel Tank	USEP2035	5.8L V8 5753cc 351 CID	1988-1989	(H), GAS; Aft Axle Fuel Tank (Plastic Fuel Tank)	USEP2484
5.0L V8 302 CID	1986	(N), FI, GAS; 19 Gallon Midship Fuel Tank	USEP2035	7.5L V8 460 CID	1985-1986	(L), CARB, GAS; 18 Gallon Aft Axle Fuel Tank (Steel Fuel Tank)	USEP2484
5.0L V8 302 CID	1986	(N), FI, GAS; Rear Fuel Tank	USEP2035	7.5L V8 460 CID	1985-1986	(L), CARB, GAS; 19 Gallon Aft Axle Fuel Tank (Plastic Fuel Tank)	USEP2484
5.0L V8 302 CID	1986-1987	(N), FI, GAS; 1.45 inch pump diameter, External Pump	USEP2000A	7.5L V8 460 CID	1985-1986	(L), CARB, GAS; Midship Fuel Tank	USEP2484
5.0L V8 302 CID	1986-1988	2 inch pump diameter, External Pump	USEP2000	7.5L V8 460 CID	1988-1989	(G), 133.0 / 337.8 Wheel Base, GAS; 2 inch pump diameter, External Pump	USEP2000
5.0L V8 302 CID	1987	(N), FI, GAS; 17 Gallon Midship Fuel Tank	USEP2008	7.5L V8 460 CID	1988-1989	(G), 137.0 / 348.0 Wheel Base, GAS; 2 inch pump diameter, External Pump	USEP2000
5.0L V8 302 CID	1987	(N), FI, GAS; 19 Gallon Midship Fuel Tank	USEP2008	7.5L V8 460 CID	1988-1989	(G), 155.0 / 393.7 Wheel Base, GAS; 2 inch pump diameter, External Pump	USEP2000
5.0L V8 302 CID	1987	(N), FI, GAS; Rear Fuel Tank (Steel Fuel Tank)	USEP2035	7.5L V8 460 CID	1988-1989	(G), 133.0 / 337.8 Wheel Base, GAS; 1.45 inch pump diameter, External Pump	USEP2000A
5.0L V8 302 CID	1988-1989	(N), GAS; 1.45 inch pump diameter, External Pump	USEP2000A	7.5L V8 460 CID	1988-1989	(G), 155.0 / 393.7 Wheel Base, GAS; 19 Gallon Midship Fuel Tank	USEP2008
5.0L V8 302 CID	1988-1989	(N), GAS; 17 Gallon Midship Fuel Tank	USEP2008	7.5L V8 460 CID	1988-1989	(G), 155.0 / 393.7 Wheel Base, GAS; 19 Gallon Midship Fuel Tank	USEP2008
5.0L V8 302 CID	1988-1989	(N), GAS; 19 Gallon Midship Fuel Tank	USEP2008	7.5L V8 460 CID	1988-1989	(G), GAS; Aft Axle Fuel Tank (Steel Fuel Tank)	USEP2035
5.0L V8 302 CID	1988-1989	(N), GAS; Rear Fuel Tank (Steel Fuel Tank)	USEP2035	7.5L V8 460 CID	1988-1989	(G), GAS; Aft Axle Fuel Tank (Plastic Fuel Tank)	USEP2484
5.0L V8 302 CID	1988-1989	(N), GAS; Rear Fuel Tank (Plastic Fuel Tank)	USEP2484	<b>F-350 SUPER DUTY</b>			
5.0L V8 302 CID	1989	(N), GAS; 2 inch pump diameter, External Pump	USEP2000	5.4L V8 330 CID	1999-2004	rear tank, W/O CA Emissions	USEP2312
5.8L V8 5753cc 351 CID	1988	(H), GAS; Rear Fuel Tank (Steel Fuel Tank)	USEP2035	5.4L V8 330 CID	1999-2004	center tank	USEP2318
5.8L V8 5753cc 351 CID	1988-1989	2 inch pump diameter, External Pump	USEP2000	5.4L V8 330 CID	2000-2007	rear tank, with ca emissions	USEP2366
5.8L V8 5753cc 351 CID	1988-1989	(H), GAS; 17 Gallon Midship Fuel Tank	USEP2008	6.4L V8 391 CID	2008-2010		USEP2519
5.8L V8 5753cc 351 CID	1988-1989	(H), GAS; 19 Gallon Midship Fuel Tank	USEP2008	6.8L V10 415 CID	1999-2004	rear tank, W/O CA Emissions	USEP2312
5.8L V8 5753cc 351 CID	1988-1989	(H), GAS; Rear Fuel Tank (Plastic Fuel Tank)	USEP2484	6.8L V10 415 CID	1999-2004	center tank	USEP2318
7.5L V8 460 CID	1986	(L), CARB, GAS; 18 Gallon Aft Axle Fuel Tank (Steel Fuel Tank)	USEP2484	6.8L V10 415 CID	2000-2007	rear tank, with ca emissions	USEP2366
7.5L V8 460 CID	1986	(L), CARB, GAS; 19 Gallon Aft Axle Fuel Tank (Plastic Fuel Tank)	USEP2484	<b>F-450 SUPER DUTY</b>			
7.5L V8 460 CID	1986	(L), CARB, GAS; Midship Fuel Tank	USEP2484	6.4L V8 391 CID	2008-2010		USEP2519
7.5L V8 460 CID	1988	2 inch pump diameter, External Pump	USEP2000	6.8L V10 415 CID	1999-2004	rear tank, W/O CA Emissions	USEP2312
7.5L V8 460 CID	1988	(G), GAS; 1.45 inch pump diameter, External Pump	USEP2000A	6.8L V10 415 CID	1999-2007	rear tank, with ca emissions	USEP2366
7.5L V8 460 CID	1988	(G), GAS; Rear Fuel Tank (Steel Fuel Tank)	USEP2035	6.8L V10 415 CID	2002	center tank	USEP2318
7.5L V8 460 CID	1988	(G), GAS; Rear Fuel Tank (Plastic Fuel Tank)	USEP2484	<b>F-550 SUPER DUTY</b>			
7.5L V8 460 CID	1988-1989	(G), GAS; 17 Gallon Midship Fuel Tank	USEP2008	6.4L V8 391 CID	2008-2010		USEP2519
7.5L V8 460 CID	1988-1989	(G), GAS; 19 Gallon Midship Fuel Tank	USEP2008	6.8L V10 415 CID	1999-2004	rear tank, W/O CA Emissions	USEP2312
7.5L V8 460 CID	1989	Extended Cab Pickup; 2 inch pump diameter, External Pump	USEP2000	6.8L V10 415 CID	1999-2007	rear tank, with ca emissions	USEP2366
7.5L V8 460 CID	1989	Standard Cab Pickup; 2 inch pump diameter, External Pump	USEP2000	<b>FESTIVA</b>			
7.5L V8 460 CID	1989	(G), Extended Cab Pickup, GAS; 1.45 inch pump diameter, External Pump	USEP2000A	1.3L L4 1295cc	1989-1993		USEP8023
7.5L V8 460 CID	1989	(G), GAS, Standard Cab Pickup; 1.45 inch pump diameter, External Pump	USEP2000A	<b>FIESTA</b>			
7.5L V8 460 CID	1989	(G), GAS; Aft Axle Fuel Tank (Steel Fuel Tank)	USEP2035	1.3L L4 1299cc 79 CID	1998-2001	MEX	USEP2157
7.5L V8 460 CID	1989	(G), GAS; Aft Axle Fuel Tank (Plastic Fuel Tank)	USEP2484	1.6L L4 1596cc 97 CID	2003-2005	MEX	USEP2226
<b>F-250 SUPER DUTY</b>				1.6L L4 1596cc 97 CID	2006	MEX	USEP2471
5.4L V8 330 CID	1999-2004	center tank	USEP2318	1.6L L4 1596cc 97 CID	2007-2009	MEX	USEP2226
5.4L V8 330 CID	2000-2004	rear tank, W/O CA Emissions	USEP2312	1.6L L4 1596cc 97 CID	2010	MEX	USEP2314
5.4L V8 330 CID	2000-2007	rear tank, with ca emissions	USEP2366	<b>FIESTA IKON</b>			
6.4L V8 391 CID	2008-2010		USEP2519	1.6L L4 1596cc 97 CID	2002	MEX	USEP2157
6.8L V10 415 CID	1999-2004	center tank	USEP2318	1.6L L4 1596cc 97 CID	2003-2004	MEX	USEP2226
6.8L V10 415 CID	2000-2004	rear tank, W/O CA Emissions	USEP2312	<b>FIVE HUNDRED</b>			
6.8L V10 415 CID	2000-2007	rear tank, with ca emissions	USEP2366	3.0L V6 2968cc 181 CID	2005-2007		USEP2522
<b>F-350</b>				<b>FOCUS</b>			
5.0L V8 302 CID	1990-1997		USEP2064	2.0L L4 1989cc 121 CID	2000-2001		USEP2448
5.0L V8 302 CID	1980	MEX	USEP8004	2.3L L4 140 CID	2003-2004		USEP2369
5.0L V8 302 CID	1983-1989	MEX	USEP8004	<b>FREESTAR</b>			
5.8L V8 5753cc 351 CID	1988-1989	(H), 133.0 / 337.8 Wheel Base, GAS; 2 inch pump diameter, External Pump	USEP2000	3.9L V6 238 CID	2004	SE, SES; (6); (Incl. Tank Seal)	USEP2386
5.8L V8 5753cc 351 CID	1988-1989	(H), 137.0 / 348.0 Wheel Base, GAS; 2 inch pump diameter, External Pump	USEP2000	3.9L V6 238 CID	2005	S; (6); (Incl. Tank Seal)	USEP2386
				4.2L V6 256 CID	2004	Limited; (2); (Incl. Tank Seal)	USEP2386
				4.2L V6 256 CID	2005	SEL; (2); (Incl. Tank Seal)	USEP2386

Engine	Years	Application Description	USMW	Engine	Years	Application Description	USMW
<b>FORD (cont'd.)</b>				<b>FORD (cont'd.)</b>			
<b>FUSION</b>				<b>RANGER (cont'd.)</b>			
2.3L L4 140 CID	2006-2009		USEP2518	2.3L L4 140 CID	1986-1987	XL; (A), FI, GAS, Naturally Aspirated, Stripped Chassis; Midship Fuel Tank	USEP2036
3.0L V6 2968cc 181 CID	2006-2009		USEP2518	2.3L L4 140 CID	1986-1987	XL; (A), FI, GAS, Naturally Aspirated; Rear Fuel Tank	USEP2036
3.5L V6 3496cc 213 CID	2010-2012		USEP2518	2.3L L4 140 CID	1987	(A), FI, GAS, Naturally Aspirated; 2 inch pump diameter, External Pump	USEP2000
<b>Ghia</b>				2.3L L4 140 CID	1987	(A), FI, GAS, Naturally Aspirated; 1.45 inch pump diameter, External Pump	USEP2000A
3.0L V6 2986cc 182 CID	1992-1993	MEX	USEP2001	2.3L L4 140 CID	1988	(A), FI; 2 inch pump diameter, External Pump	USEP2000
3.0L V6 2986cc 182 CID	1994	MEX	USEP2068	2.3L L4 140 CID	1988	(A), FI; 1.45 inch pump diameter, External Pump	USEP2000A
<b>GRAND MARQUIS</b>				2.3L L4 140 CID	1988	XL; (A), FI, Standard Cab Pickup; Midship Fuel Tank	USEP2036
4.6L V8 281 CID	1991-1997	MEX	USEP2068	2.3L L4 140 CID	1988-1997	XL; (A), FI; Rear Fuel Tank	USEP2036 USEP2078
4.6L V8 281 CID	1998-2002	MEX	USEP2157	2.3L L4 140 CID	2001-2002	XL; (D), 112.0 / 284.5 Wheel Base, FI, GAS, Naturally Aspirated	USEP2293
4.6L V8 281 CID	2003-2004	MEX	USEP2337	2.3L L4 140 CID	2001-2002	XL; (D), 126.0 / 320.0 Wheel Base, FI, GAS, Naturally Aspirated	USEP2293
<b>KA</b>				2.3L L4 140 CID	2002	125.7 / 319.3 Wheel Base, MEX	USEP2293
1.6L L4 1596cc 97 CID	2001-2008	MEX	USEP2157	2.3L L4 140 CID	2003	XL; (D), 112.0 / 284.5 Wheel Base, GAS	USEP2293
<b>LOBO</b>				2.3L L4 140 CID	2003	XL; (D), 126.0 / 320.0 Wheel Base, GAS	USEP2293
4.6L V8 281 CID	2004-2005	MEX	USEP2284	2.3L L4 140 CID	2004		USEP8914
5.4L V8 330 CID	2001-2002	MEX	USEP2284	2.3L L4 140 CID	2006		USEP8914
5.4L V8 330 CID	2003	MEX	USEP2366	2.5L L4 153 CID	1999	118.0 / 299.7 Wheel Base; Except for Bosch, Carter, and Delphi	USEP2226
5.4L V8 330 CID	2004-2006	MEX	USEP2284	2.5L L4 153 CID	1999	126.0 / 320.0 Wheel Base; Except for Bosch, Carter, and Delphi	USEP2226
<b>LTD</b>				2.5L L4 153 CID	1999-2001	112.0 / 284.5 Wheel Base; Except for Bosch, Carter, and Delphi	USEP2226
3.8L V6 232 CID	1984-1986		USEP2003	2.5L L4 153 CID	2000-2001	118.0 / 299.7 Wheel Base	USEP2068
<b>MONDEO</b>				2.5L L4 153 CID	2000-2001	126.0 / 320.0 Wheel Base	USEP2068
2.0L L4 1999cc 122 CID	2001-2005	MEX	USEP2226	2.9L V6 177 CID	1986	XL; (T), FI, GAS, Naturally Aspirated; 2 inch pump diameter, External Pump	USEP2000
2.5L V6 2450cc 155 CID	2001-2005	MEX	USEP2226	2.9L V6 177 CID	1986	XL; (T), FI, GAS, Naturally Aspirated; 1.45 inch pump diameter, External Pump	USEP2000A
<b>MUSTANG</b>				2.9L V6 177 CID	1986-1987	XL; (T), FI, GAS, Naturally Aspirated; Standard Cab Pickup; Midship Fuel Tank	USEP2036
2.3L L4 140 CID	1983	2 inch pump diameter	USEP2000	2.9L V6 177 CID	1986-1987	XL; (T), FI, GAS, Naturally Aspirated, Stripped Chassis; Midship Fuel Tank	USEP2036
2.3L L4 140 CID	1983	1.45 inch pump diameter	USEP2000A	2.9L V6 177 CID	1986-1987	XL; (T), FI, GAS, Naturally Aspirated; Rear Fuel Tank	USEP2036
2.3L L4 140 CID	1985-1993		USEP2061	2.9L V6 177 CID	1987	(T), FI, GAS, Naturally Aspirated; 2 inch pump diameter, External Pump	USEP2000
3.8L V6 232 CID	1985-1986		USEP2061	2.9L V6 177 CID	1987	(T), FI, GAS, Naturally Aspirated; 1.45 inch pump diameter, External Pump	USEP2000A
3.8L V6 232 CID	1994-1997		USEP2061	2.9L V6 177 CID	1988	2 inch pump diameter, External Pump	USEP2000
3.8L V6 232 CID	1999-2004		USEP2366	2.9L V6 177 CID	1988	(T), FI; 1.45 inch pump diameter, External Pump	USEP2000A
3.9L V6 238 CID	2004		USEP2366	2.9L V6 177 CID	1988	XL; (T), FI, Standard Cab Pickup; Midship Fuel Tank	USEP2036
4.6L V8 281 CID	1996-1997		USEP2061	2.9L V6 177 CID	1988	XL; (T), FI; Rear Fuel Tank	USEP2036 USEP2078
4.6L V8 281 CID	1998-2004		USEP2366	2.9L V6 177 CID	1989-1992		USEP2078
5.0L V8 302 CID	1984	2 inch pump diameter	USEP2000	3.0L V6 2986cc 182 CID	1991-1997		USEP2078
5.0L V8 302 CID	1984	1.45 inch pump diameter	USEP2000A	3.0L V6 2986cc 182 CID	1999-2001		USEP2258
5.0L V8 302 CID	1985-1995	standard replacement	USEP2061	3.0L V6 2986cc 182 CID	2004		USEP8914
5.0L V8 302 CID	1987-1992	high performance replacement	USEP2073	3.0L V6 2986cc 182 CID	2006		USEP8914
5.8L V8 5753cc 351 CID	1995		USEP2061	4.0L V6 245 CID	1991-1997		USEP2078
<b>MUSTANG II</b>				4.0L V6 245 CID	1999	118.0 / 299.7 Wheel Base; Except for Bosch, Carter, and Delphi	USEP2226
5.0L V8 302 CID	1975-1978	MEX	USEP8004	4.0L V6 245 CID	1999	126.0 / 320.0 Wheel Base; Except for Bosch, Carter, and Delphi	USEP2226
<b>MYSTIQUE</b>				4.0L V6 245 CID	1999-2000	112.0 / 284.5 Wheel Base; Except for Bosch, Carter, and Delphi	USEP2226
2.5L V6 2450cc 155 CID	1997	MEX; Except for Bosch, Carter, and Delphi	USEP2226	4.0L V6 245 CID	2000	118.0 / 299.7 Wheel Base	USEP2068
2.5L V6 2450cc 155 CID	1998-1999	MEX	USEP2226	4.0L V6 245 CID	2000	126.0 / 320.0 Wheel Base	USEP2068
2.5L V6 2450cc 155 CID	1999-2000	From 05/03/99	USEP2390	4.0L V6 245 CID	2001-2002	Edge, XL; (E), 112.0 / 284.5 Wheel Base, FI, GAS, Naturally Aspirated	USEP2293
2.5L V6 2450cc 155 CID	2000	MEX	USEP2158	4.0L V6 245 CID	2001-2002	Edge, XL; (E), 126.0 / 320.0 Wheel Base, FI, GAS, Naturally Aspirated	USEP2293
<b>P-350</b>				4.0L V6 245 CID	2003	Edge, XL; (E), 112.0 / 284.5 Wheel Base, GAS	USEP2293
5.8L V8 5753cc 351 CID	1993	MEX	USEP2059	4.0L V6 245 CID	2003	Edge, XL; (E), 126.0 / 320.0 Wheel Base, GAS	USEP2293
<b>PROBE</b>				4.0L V6 245 CID	2004		USEP8914
2.0L L4 1989cc 122 CID	1993		USEP2068	4.0L V6 245 CID	2006		USEP8914
2.0L L4 1989cc 122 CID	1994	From 07/94	USEP2068	<b>SABLE</b>			
2.0L L4 1989cc 122 CID	1995	To 03/01/95	USEP2068	3.0L V6 2968cc 181 CID	1998-1999	MEX	USEP2284
2.0L L4 1989cc 122 CID	1996-1997		USEP2068	3.0L V6 2968cc 181 CID	2000	MEX	USEP2229
2.2L L4 133 CID	1989	Naturally Aspirated	USEP8023	<b>TAURUS</b>			
2.2L L4 133 CID	1989	Turbocharged	USEP8023	2.5L L4 153 CID	1986	(D); 16 Gallon Fuel Tank	USEP2001
2.5L V6 2497cc	1993		USEP2068	2.5L L4 153 CID	1986	(D); 18.6 Gallon Fuel Tank (Digital Instrument Cluster)	USEP2042
2.5L V6 2497cc	1994	To 07/94	USEP2068				
2.5L V6 2497cc	1995	To 03/01/95	USEP2068				
2.5L V6 2497cc	1996-1997		USEP2068				
3.0L V6 2986cc 182 CID	1990-1992		USEP2051				
<b>RANGER</b>							
2.3L L4 140 CID	1985	(A), FI, GAS, Naturally Aspirated; 2 inch pump diameter, External Pump	USEP2000				
2.3L L4 140 CID	1985	(A), FI, GAS, Naturally Aspirated; 1.45 inch pump diameter, External Pump	USEP2000A				
2.3L L4 140 CID	1985	(A), FI, GAS, Naturally Aspirated; Aft Axle Fuel Tank	USEP2036				
2.3L L4 140 CID	1985	(A), FI, GAS, Naturally Aspirated; Midship Fuel Tank	USEP2036				
2.3L L4 140 CID	1985-1987	(E), DIESEL, FI, Turbocharged; External Pump	USEP2054				
2.3L L4 140 CID	1986	XL; (A), FI, GAS, Naturally Aspirated; 2 inch pump diameter, External Pump	USEP2000				
2.3L L4 140 CID	1986	XL; (A), FI, GAS, Naturally Aspirated; 1.45 inch pump diameter, External Pump	USEP2000A				
2.3L L4 140 CID	1986-1987	XL; (A), Cab & Chassis, FI, GAS, Naturally Aspirated; Midship Fuel Tank	USEP2036				
2.3L L4 140 CID	1986-1987	XL; (A), FI, GAS, Naturally Aspirated, Standard Cab Pickup; Midship Fuel Tank	USEP2036				



Engine	Years	Application Description	USMW	Engine	Years	Application Description	USMW
<b>FORD (cont'd.)</b>				<b>FREIGHTLINER (cont'd.)</b>			
<b>TAURUS (cont'd.)</b>				<b>SPRINTER 2500 (cont'd.)</b>			
2.5L L4 153 CID	1986	(D); 18.6 Gallon Fuel Tank (Exc.Digital Instrument Cluster)	USEP2042	3.0L V6 2987cc	2007-2008		USEP8023
2.5L L4 153 CID	1987	GL, L, LX, MT5; (D); 16 Gallon Fuel Tank	USEP2001	3.5L V6 3498cc	2007-2008		USEP8023
2.5L L4 153 CID	1987	GL, L, LX, MT5; (D); 18.6 Gallon Fuel Tank (Digital Instrument Cluster)	USEP2042	<b>SPRINTER 3500</b>			
2.5L L4 153 CID	1987	GL, L, LX, MT5; (D); 18.6 Gallon Fuel Tank (Exc.Digital Instrument Cluster)	USEP2042	2.7L L5 2687cc 165 CID	2002-2006		USEP8023
3.0L V6 2968cc 181 CID	1996		USEP2369	3.0L V6 2987cc	2007-2008		USEP8023
3.0L V6 2968cc 181 CID	1997-1998		USEP2305	3.5L V6 3498cc	2007-2008		USEP8023
3.0L V6 2968cc 181 CID	2000-2001		USEP2305	<b>GEO</b>			
3.0L V6 2968cc 181 CID	2001		USEP2447	<b>METRO</b>			
3.0L V6 2986cc 182 CID	1996-1997	GAS	USEP2303	1.0L L3 993cc 61 CID	1989	To Chassis/VIN KK770415	USEP8076
3.0L V6 2986cc 182 CID	1996-2006	FLEX	USEP2497	1.0L L3 993cc 61 CID	1990	To Chassis/VIN LK705225	USEP8076
3.2L V6 195 CID	1993-1995	SHO; (F), GAS	USEP2001	1.0L L3 993cc 61 CID	1991-1994		USEP8076
3.4L V8 207 CID	1996		USEP2369	1.0L L3 993cc 61 CID	1995-1997		USEP8229
3.4L V8 207 CID	1998-1999		USEP2306	1.3L L4 1295cc 79 CID	1995-1997		USEP8229
3.5L V6 3496cc 213 CID	2008-2009		USEP2518	<b>PRIZM</b>			
3.8L V6 232 CID	1993	GL, LX; (4), GAS; 18.6 Gallon Fuel Tank (Digital Instrument Cluster)	USEP2042	1.6L L4 1588cc 98 CID	1993-1997		USEP8213
3.8L V6 232 CID	1993	GL, LX; (4), GAS; 18.6 Gallon Fuel Tank (Exc.Digital Instrument Cluster)	USEP2042	1.8L L4 1762cc 107 CID	1993-1997		USEP8213
3.8L V6 232 CID	1993-1994	GL, LX; (4), GAS; 16 Gallon Fuel Tank	USEP2042	<b>STORM</b>			
3.8L V6 232 CID	1994	GL, LX; (4), GAS; 18.6 Gallon Fuel Tank (Digital Instrument Cluster) (From 01/94)	USEP2042	1.6L L4 1588cc 98 CID	1990-1991		USEP8229
3.8L V6 232 CID	1994	GL, LX; (4), GAS; 18.6 Gallon Fuel Tank (Digital Instrument Cluster) (To 01/94)	USEP2042	1.8L L4 1809cc 110 CID	1992-1993		USEP8229
3.8L V6 232 CID	1994	GL, LX; (4), GAS; 18.6 Gallon Fuel Tank (Exc.Digital Instrument Cluster) (From 01/94)	USEP2042	<b>TRACKER</b>			
3.8L V6 232 CID	1994	GL, LX; (4), GAS; 18.6 Gallon Fuel Tank (Exc.Digital Instrument Cluster) (To 01/94)	USEP2042	1.6L L4 1588cc 98 CID	1989-1995		USEP8229
3.8L V6 232 CID	1995	GL, LX, SE; (4), GAS; 16 Gallon Fuel Tank	USEP2042	1.6L L4 1588cc 98 CID	1995	MEX; 2 inch pump diameter	USEP3222
3.8L V6 232 CID	1995	GL, LX, SE; (4), GAS; 18.6 Gallon Fuel Tank (Digital Instrument Cluster)	USEP2042	1.6L L4 1588cc 98 CID	1997		USEP8229
3.8L V6 232 CID	1995	GL, LX, SE; (4), GAS; 18.6 Gallon Fuel Tank (Exc.Digital Instrument Cluster)	USEP2042	<b>GMC</b>			
3.8L V6 232 CID	1995	GL, LX, SE; (4), GAS; 18.6 Gallon Fuel Tank (Exc.Digital Instrument Cluster)	USEP2042	<b>C1500</b>			
<b>TAURUS X</b>				4.3L V6 262 CID	1988-1989	(Z), GAS	USEP3902
3.5L V6 3496cc 213 CID	2008-2009		USEP2518	4.3L V6 262 CID	1990-1991	(Z), GAS	USEP3567
<b>TEMPO</b>				5.0L V8 305 CID	1988-1989	(H), GAS	USEP3902
2.3L L4 140 CID	1985	Base, GL, LX; (X), FI, GAS	USEP2015	5.0L V8 305 CID	1990-1991	(H), GAS	USEP3567
2.3L L4 140 CID	1985-1986	GL; (S), FI, GAS	USEP2015	5.7L V8 350 CID	1988-1989	(K), GAS	USEP3902
2.3L L4 140 CID	1986	GL, LX; (X), FI, GAS	USEP2015	5.7L V8 350 CID	1990-1991	(K), GAS	USEP3567
2.3L L4 140 CID	1990	LX AWD; (S), AWD	USEP2052	6.2L V8 379 CID	1988-1991	(C), DIESEL; External Pump	USEP3158
2.3L L4 140 CID	1990		USEP2068	6.2L V8 379 CID	1991	(C), DIESEL; External Pump	USEP3158
<b>THUNDERBIRD</b>				<b>C1500 SUBURBAN</b>			
	1989-1990	Base, LX; (4), Naturally Aspirated	USEP2044	5.7L V8 350 CID	1992-1994		USEP3902
	1989-1990	Super Coupe; (R), Supercharged	USEP2044	5.7L V8 350 CID	1996-1997	(R), GAS, Naturally Aspirated	USEP3270
	2003-2005	Except for Bosch, Carter, and Delphi	USEP2337	5.7L V8 350 CID	1998-1999	(R), GAS, Naturally Aspirated	USEP3240R
2.3L L4 140 CID	1983-1984	2 inch pump diameter	USEP2000	6.5L V8 395 CID	1995-1998	(F), DIESEL, Turbocharged; External Pump	USEP3309
2.3L L4 140 CID	1983-1984	1.45 inch pump diameter	USEP2000A	6.5L V8 395 CID	1999	(F), DIESEL, Turbocharged; External Pump	USEP3540
2.3L L4 140 CID	1985-1987	Turbo; (W), Turbocharged	USEP2044	<b>C2500</b>			
2.3L L4 140 CID	1988	Turbo; (T), Turbocharged	USEP2044	4.3L V6 262 CID	1988-1989	(Z), GAS	USEP3902
3.8L V6 232 CID	1984		USEP2003	4.3L V6 262 CID	1990-1991	(Z), GAS	USEP3567
3.8L V6 232 CID	1986	Sport; (3), Naturally Aspirated	USEP2024	4.3L V6 262 CID	1992	(Z), GAS, Naturally Aspirated	USEP3902
3.8L V6 232 CID	1987	Base, LX; (3), Naturally Aspirated	USEP2024	5.0L V8 305 CID	1988-1989	(H), GAS	USEP3902
3.8L V6 232 CID	1988	Base, LX; (4), Naturally Aspirated	USEP2024	5.0L V8 305 CID	1990-1991	(H), GAS	USEP3567
3.8L V6 232 CID	1991-1992	Base, LX; (4), Naturally Aspirated	USEP2044	5.0L V8 305 CID	1992	(H), GAS, Naturally Aspirated	USEP3902
3.8L V6 232 CID	1991-1995	Super Coupe; (R), Supercharged	USEP2044	5.0L V8 305 CID	1997	(M), GAS, Naturally Aspirated	USEP3270
3.8L V6 232 CID	1993-1995	LX; (4), Naturally Aspirated	USEP2044	5.7L V8 350 CID	1988-1989	(K), GAS	USEP3902
3.8L V6 232 CID	1996-1997	(4)	USEP2044	5.7L V8 350 CID	1990-1991	(K), GAS	USEP3567
4.6L V8 281 CID	1994-1995	LX; (W), Naturally Aspirated	USEP2044	5.7L V8 350 CID	1992	(K), GAS, Naturally Aspirated	USEP3902
4.6L V8 281 CID	1996-1997	(W)	USEP2044	5.7L V8 350 CID	1997	(R), GAS, Naturally Aspirated	USEP3270
5.0L V8 302 CID	1983	2 inch pump diameter	USEP2000	6.2L V8 379 CID	1988-1991	(C), DIESEL; External Pump	USEP3158
5.0L V8 302 CID	1983	1.45 inch pump diameter	USEP2000A	6.2L V8 379 CID	1989-1991	(J), DIESEL; External Pump	USEP3158
5.0L V8 302 CID	1984		USEP2003	6.2L V8 379 CID	1992	(C), DIESEL, Naturally Aspirated; External Pump	USEP3158
5.0L V8 302 CID	1986	Sport; (F), Naturally Aspirated	USEP2024	6.2L V8 379 CID	1992	(J), DIESEL, Naturally Aspirated; External Pump	USEP3158
5.0L V8 302 CID	1987-1988	Base, LX, Sport; (F), Naturally Aspirated	USEP2024	6.5L V8 395 CID	1992	(F), DIESEL, Turbocharged; External Pump	USEP3158
5.0L V8 302 CID	1991-1992	Base, LX; (T), Naturally Aspirated	USEP2044	6.5L V8 395 CID	1997	(F), DIESEL, Turbocharged; External Pump	USEP3309
5.0L V8 302 CID	1993	LX; (T), Naturally Aspirated	USEP2044	6.5L V8 395 CID	1997	(S), DIESEL, Turbocharged; External Pump	USEP3309
<b>TOPAZ</b>				7.4L V8 454 CID	1991	(N), GAS	USEP3567
2.3L L4 2309cc 140 CID	1993	MEX	USEP2001	7.4L V8 454 CID	1992	(N), GAS, Naturally Aspirated	USEP3902
2.3L L4 2309cc 140 CID	1994	MEX	USEP2068	7.4L V8 454 CID	1997	(J), GAS, Naturally Aspirated	USEP3270
<b>WINDSTAR</b>				<b>C2500 SUBURBAN</b>			
3.0L V6 2986cc 182 CID	1997-1998		USEP2199	5.7L V8 350 CID	1992-1993	(K)	USEP3902
3.0L V6 2986cc 182 CID	2000		USEP2305	5.7L V8 350 CID	1996-1997	(R), GAS, Naturally Aspirated	USEP3270
3.8L V6 232 CID	1997-1998		USEP2199	5.7L V8 350 CID	1998-1999	(R), GAS, Naturally Aspirated; Calif	USEP3240R
<b>FREIGHTLINER</b>				6.5L V8 395 CID	1996-1998	(F), DIESEL, Turbocharged; External Pump	USEP3309
<b>SPRINTER 2500</b>				6.5L V8 395 CID	1999	(F), DIESEL, Turbocharged; External Pump	USEP3540
2.7L L5 2687cc 165 CID	2002-2006		USEP8023	7.4L V8 454 CID	1992-1993	(N)	USEP3902
				7.4L V8 454 CID	1996-1997	(J), GAS, Naturally Aspirated	USEP3270
				7.4L V8 454 CID	1998-1999	(J), GAS, Naturally Aspirated; Calif	USEP3240R
				<b>C3500</b>			
				5.7L V8 350 CID	1988-1991	(K), GAS	USEP3902

Engine	Years	Application Description	USMW	Engine	Years	Application Description	USMW
<b>GMC (cont'd.)</b>				<b>GMC (cont'd.)</b>			
<b>C3500 (cont'd.)</b>				<b>K2500 (cont'd.)</b>			
5.7L V8 350 CID	1997	(R), GAS, Naturally Aspirated	USEP3270	4.3L V6 262 CID	1992	(Z), GAS, Naturally Aspirated	USEP3902
6.2L V8 379 CID	1988-1991	(J), DIESEL; External Pump	USEP3158	5.0L V8 305 CID	1988-1989	(H), GAS	USEP3902
6.5L V8 395 CID	1997	(F), DIESEL, Turbocharged; External Pump	USEP3309	5.0L V8 305 CID	1990-1991	(H), GAS	USEP3567
7.4L V8 454 CID	1988-1991	(N), GAS	USEP3902	5.0L V8 305 CID	1992	(H), GAS, Naturally Aspirated	USEP3902
7.4L V8 454 CID	1997	(J), GAS, Naturally Aspirated	USEP3270	5.7L V8 350 CID	1988-1989	(K), GAS	USEP3902
<b>CABALLERO</b>				5.7L V8 350 CID	1990-1991	(K), GAS	USEP3567
4.3L V6 262 CID	1985-1987	(Z), FI	USEP3902	5.7L V8 350 CID	1992	(K), GAS, Naturally Aspirated	USEP3902
<b>ENVOY</b>				5.7L V8 350 CID	1996-1997	(R), GAS, Naturally Aspirated	USEP3270
4.2L L6 256 CID	2005-2007	SLE, SLT; (S)	USEP3707	6.2L V8 379 CID	1988-1991	(C), DIESEL; External Pump	USEP3158
4.2L L6 256 CID	2009	SLE, SLT; (S)	USEP3707	6.2L V8 379 CID	1989-1991	(J), DIESEL; External Pump	USEP3158
<b>G1500</b>				6.2L V8 379 CID	1992	(C), DIESEL, Naturally Aspirated; External Pump	USEP3158
4.3L V6 262 CID	1987-1993	Rally STX, Vandura; (Z)	USEP3902	6.2L V8 379 CID	1992	(J), DIESEL, Naturally Aspirated; External Pump	USEP3158
4.3L V6 262 CID	1994-1995	Vandura; (Z)	USEP3902	6.5L V8 395 CID	1992	(F), DIESEL, Turbocharged; External Pump	USEP3158
5.0L V8 305 CID	1987-1995	Rally STX, Vandura; (H)	USEP3902	6.5L V8 395 CID	1996-1997	(F), DIESEL, Turbocharged; External Pump	USEP3309
5.7L V8 350 CID	1987-1993	Rally STX; (K)	USEP3902	7.4L V8 454 CID	1991	(N), GAS	USEP3902
<b>G2500</b>				7.4L V8 454 CID	1992	(N), GAS, Naturally Aspirated	USEP3902
4.3L V6 262 CID	1987-1995	Rally STX, Vandura; (Z), GAS	USEP3902	7.4L V8 454 CID	1996-1997	(J), GAS, Naturally Aspirated	USEP3270
5.0L V8 305 CID	1987	Vandura; (H), GAS	USEP3902	<b>K2500 SUBURBAN</b>			
5.0L V8 305 CID	1988-1995	Rally STX, Vandura; (H), GAS	USEP3902	5.7L V8 350 CID	1992	(K)	USEP3902
5.7L V8 350 CID	1987-1995	Rally STX, Vandura; (K), GAS	USEP3902	5.7L V8 350 CID	1994	(K), GAS, Naturally Aspirated	USEP3902
6.2L V8 379 CID	1988	Rally STX, Vandura; (C), DIESEL; External Pump	USEP3158	5.7L V8 350 CID	1997	(R), GAS, Naturally Aspirated	USEP3270
<b>G3500</b>				5.7L V8 350 CID	1998-1999	(R), GAS, Naturally Aspirated; Calif	USEP3240R
4.3L V6 262 CID	1987-1988	Vandura Special; (Z), FI, GAS	USEP3902	6.5L V8 395 CID	1994	(F), DIESEL, Turbocharged; External Pump	USEP3309
4.3L V6 262 CID	1989-1991	Vandura Special; (Z), GAS	USEP3902	6.5L V8 395 CID	1997-1998	(F), DIESEL, Turbocharged; External Pump	USEP3309
4.3L V6 262 CID	1992-1995	Vandura; (Z), GAS	USEP3902	6.5L V8 395 CID	1999	(F), DIESEL, Turbocharged; External Pump	USEP3540
5.7L V8 350 CID	1987-1988	Magnavan, Rally STX, Vandura Special; (K), FI, GAS	USEP3902	7.4L V8 454 CID	1992-1993	(N)	USEP3902
5.7L V8 350 CID	1989-1991	Magnavan, Rally STX, Vandura Special; (K), GAS	USEP3902	7.4L V8 454 CID	1994		USEP3212
5.7L V8 350 CID	1992-1993	Magnavan, Rally STX, Vandura; (K), GAS	USEP3902	7.4L V8 454 CID	1997	(J), GAS, Naturally Aspirated	USEP3270
5.7L V8 350 CID	1994	Magnavan, Vandura; (K), GAS	USEP3902	7.4L V8 454 CID	1998-1999	(J), GAS, Naturally Aspirated; Calif	USEP3240R
5.7L V8 350 CID	1995	Magnavan, Rally STX, Vandura; (K), GAS	USEP3902	<b>K3500</b>			
5.7L V8 350 CID	1996	Magnavan, Rally STX, Vandura, Vandura Special; (K), GAS	USEP3268	5.7L V8 350 CID	1988-1991	(K), GAS	USEP3902
6.2L V8 379 CID	1988	Magnavan, Rally STX, Vandura Special; (J), DIESEL, FI; External Pump	USEP3158	5.7L V8 350 CID	1997	(R), GAS, Naturally Aspirated	USEP3270
7.4L V8 454 CID	1988	Magnavan; (N), FI, GAS	USEP3902	6.2L V8 379 CID	1988-1991	(J), DIESEL; External Pump	USEP3158
7.4L V8 454 CID	1989-1990	Magnavan, Rally STX, Vandura Special; (N), GAS	USEP3902	6.5L V8 395 CID	1997	(F), DIESEL, Turbocharged; External Pump	USEP3309
7.4L V8 454 CID	1991	Rally STX, Vandura Special; (N), GAS	USEP3902	7.4L V8 454 CID	1988-1991	(N), GAS	USEP3902
7.4L V8 454 CID	1992-1993	Magnavan, Rally STX, Vandura; (N), GAS	USEP3902	7.4L V8 454 CID	1997	(J), GAS, Naturally Aspirated	USEP3270
7.4L V8 454 CID	1994-1996		USEP3212	<b>P2500</b>			
<b>JIMMY</b>				5.7L V8 350 CID	1988	(K), GAS	USEP3902
4.3L V6 262 CID	1993-1994	(W)	USEP3270	5.7L V8 350 CID	1989	(K), FI, GAS	USEP3902
4.3L V6 262 CID	1993-1994	(Z)	USEP3902	6.2L V8 379 CID	1988	(J), DIESEL; External Pump	USEP3158
4.3L V6 262 CID	1995		USEP3270	<b>P3500</b>			
4.3L V6 262 CID	1996-1997	4 Doors	USEP3240R	4.3L V6 262 CID	1990-1991	(Z), GAS, Naturally Aspirated	USEP3268
4.3L V6 262 CID	1997	2 Doors	USEP3240R	4.3L V6 262 CID	1992-1995	(Z), GAS	USEP3268
4.3L V6 262 CID	1998	Envoy; 18 Gallon Fuel Tank	USEP3240R	4.3L V6 262 CID	1996	(W), GAS	USEP3270
4.3L V6 262 CID	1998	Envoy; Exc. 18 Gallon Fuel Tank	USEP3240R	4.3L V6 262 CID	1997	(W), GAS, Naturally Aspirated	USEP3270
4.3L V6 262 CID	1998	SLT; 4 Doors; (18 Gallon Fuel Tank)	USEP3240R	4.3L V6 262 CID	1998-1999	(W), GAS, Naturally Aspirated	USEP3240R
4.3L V6 262 CID	1998	SLT; 4 Doors; (Exc. 18 Gallon Fuel Tank)	USEP3240R	5.7L V8 350 CID	1987-1988	(K), FI, GAS	USEP3268
4.3L V6 262 CID	1999-2000	Envoy	USEP3240R	5.7L V8 350 CID	1989	(K), FI, GAS, Naturally Aspirated	USEP3268
4.3L V6 262 CID	1999-2001	SLT; 4 Doors	USEP3240R	5.7L V8 350 CID	1990-1991	(K), GAS, Naturally Aspirated	USEP3268
5.0L V8 305 CID	1987	(H), GAS	USEP3902	5.7L V8 350 CID	1992-1995	(K), GAS	USEP3268
5.7L V8 350 CID	1987-1991	(K), GAS	USEP3902	5.7L V8 350 CID	1996	(R), GAS	USEP3270
<b>K1500</b>				5.7L V8 350 CID	1997	(R), GAS, Naturally Aspirated	USEP3270
4.3L V6 262 CID	1988-1989	(Z), GAS	USEP3902	5.7L V8 350 CID	1998-1999	(R), GAS, Naturally Aspirated; Exc. School Bus (Calif)	USEP3240R
4.3L V6 262 CID	1990-1991	(Z), GAS	USEP3567	5.7L V8 350 CID	1998-1999	(R), GAS, Naturally Aspirated; Exc. School Bus (Calif)	USEP3240R
5.0L V8 305 CID	1988-1989	(H), GAS	USEP3902	6.2L V8 379 CID	1988	(J), DIESEL, FI; External Pump	USEP3158
5.0L V8 305 CID	1990-1991	(H), GAS	USEP3567	6.5L V8 395 CID	1994-1996	(Y), DIESEL; External Pump	USEP3309
5.7L V8 350 CID	1988-1989	(K), GAS	USEP3902	6.5L V8 395 CID	1997-1998	(F), DIESEL, Turbocharged; External Pump	USEP3309
5.7L V8 350 CID	1990-1991	(K), GAS	USEP3567	6.5L V8 395 CID	1999	(F), DIESEL, Turbocharged; External Pump	USEP3540
6.2L V8 379 CID	1988-1991	(C), DIESEL; External Pump	USEP3158	6.5L V8 395 CID	1999	(Y), DIESEL, Naturally Aspirated; External Pump	USEP3540
<b>K1500 SUBURBAN</b>				7.4L V8 454 CID	1990-1991	(N), GAS, Naturally Aspirated	USEP3268
5.7L V8 350 CID	1992-1994		USEP3902	7.4L V8 454 CID	1992-1993	(N), GAS	USEP3268
5.7L V8 350 CID	1995	(K), GAS, Naturally Aspirated	USEP3902	7.4L V8 454 CID	1994-1995		USEP3212
5.7L V8 350 CID	1996-1997	(R), GAS, Naturally Aspirated	USEP3270	7.4L V8 454 CID	1996	(J), GAS	USEP3270
5.7L V8 350 CID	1998-1999	(R), GAS, Naturally Aspirated	USEP3240R	7.4L V8 454 CID	1996	(L19), (N), GAS	USEP3270
6.5L V8 395 CID	1995-1998	(F), DIESEL, Turbocharged; External Pump	USEP3309	7.4L V8 454 CID	1997		USEP3212
6.5L V8 395 CID	1999	(F), DIESEL, Turbocharged; External Pump	USEP3540	7.4L V8 454 CID	1997	(J), GAS, Naturally Aspirated	USEP3270
<b>K2500</b>				7.4L V8 454 CID	1998-1999	(B), GAS, Naturally Aspirated; Exc. 80 Gallon Fuel Tank	USEP3240R
4.3L V6 262 CID	1988-1989	(Z), GAS	USEP3902	7.4L V8 454 CID	1998-1999	(J), GAS, Naturally Aspirated; Exc. 80 Gallon Fuel Tank	USEP3240R
4.3L V6 262 CID	1990-1991	(Z), GAS	USEP3567	<b>R1500</b>			
				4.3L V6 262 CID	1987	(Z), GAS	USEP3902





Engine	Years	Application Description	USMW	Engine	Years	Application Description	USMW
<b>GMC (cont'd.)</b>				<b>GMC (cont'd.)</b>			
<b>SAVANA 3500 (cont'd.)</b>				<b>SIERRA 1500 (cont'd.)</b>			
6.5L V8 395 CID	1999-2002	(F), (L65), DIESEL, Turbocharged; External Pump	<b>USEP3540</b>	4.3L V6 262 CID	2002	(W), GAS; Evaporative Emissions Control	<b>USEP3500</b>
7.4L V8 454 CID	1997	(J), Cutaway Van, GAS, Naturally Aspirated; (55 Gallon Fuel Tank), (Exc.Fitting for Fuel Line)	<b>USEP3240R</b>	4.3L V6 262 CID	2002	(W), GAS; Exc.Evaporative Emissions Control	<b>USEP3501</b>
7.4L V8 454 CID	1997	(J), Extended Cargo Van, GAS, Naturally Aspirated; (Exc.Fitting for Fuel Line)	<b>USEP3240R</b>	4.3L V6 262 CID	2002-2003	(X), GAS; Exc.Evaporative Emissions Control	<b>USEP3501</b>
7.4L V8 454 CID	1997	(J), Extended Passenger Van, GAS, Naturally Aspirated; (Exc.Fitting for Fuel Line)	<b>USEP3240R</b>	4.3L V6 262 CID	2002-2004	(X), GAS; Evaporative Emissions Control	<b>USEP3500</b>
7.4L V8 454 CID	1997	(J), GAS, Naturally Aspirated, Standard Cargo Van; (Exc.Fitting for Fuel Line)	<b>USEP3240R</b>	4.8L V8 294 CID	1999-2001	(V); Evaporative Emissions Control	<b>USEP3500</b>
7.4L V8 454 CID	1997	(J), GAS, Naturally Aspirated, Standard Passenger Van; (Exc.Fitting for Fuel Line)	<b>USEP3240R</b>	4.8L V8 294 CID	1999-2001	(V); Exc.Evaporative Emissions Control	<b>USEP3501</b>
7.4L V8 454 CID	1998-1999	(J), Cutaway Van, GAS, Naturally Aspirated; (Exc.Calif) (55 Gallon Fuel Tank), (Exc.Fitting for Fuel Line)	<b>USEP3240R</b>	4.8L V8 294 CID	2002-2003	(V), GAS; Exc.Evaporative Emissions Control	<b>USEP3501</b>
7.4L V8 454 CID	1998-1999	(J), Extended Cargo Van, GAS, Naturally Aspirated; (Exc.Calif), (Exc.Fitting for Fuel Line)	<b>USEP3240R</b>	4.8L V8 294 CID	2007	SLE, WT; (C), 143.5 / 364.5 Wheel Base, GAS; Except for Bosch, Carter, and Delphi	<b>USEP12046</b>
7.4L V8 454 CID	1998-1999	(J), Extended Passenger Van, GAS, Naturally Aspirated; (Exc.Calif), (Exc.Fitting for Fuel Line)	<b>USEP3240R</b>	4.8L V8 294 CID	2008	SL, SLE, WT; (C), 143.5 / 364.5 Wheel Base, GAS; Except for Bosch, Carter, and Delphi	<b>USEP12046</b>
7.4L V8 454 CID	1998-1999	(J), GAS, Naturally Aspirated, Standard Cargo Van; (Exc.Calif), (Exc.Fitting for Fuel Line)	<b>USEP3240R</b>	4.8L V8 294 CID	2008	SLE, WT; (C), 134.0 / 340.4 Wheel Base, GAS; Except for Bosch, Carter, and Delphi	<b>USEP12046</b>
7.4L V8 454 CID	1998-1999	(J), GAS, Naturally Aspirated, Standard Passenger Van; (Exc.Calif), (Exc.Fitting for Fuel Line)	<b>USEP3240R</b>	5.3L V8 5328cc 325 CID	2007-2008	SLE, SLT, WT	<b>USEP12046</b>
7.4L V8 454 CID	1998-2000	(J), Cutaway Van, GAS, Naturally Aspirated; (Calif) (55 Gallon Fuel Tank), (Exc.Fitting for Fuel Line)	<b>USEP3906</b>	6.0L V8 5967cc 364 CID	2007	SLE, SLT	<b>USEP12046</b>
7.4L V8 454 CID	1998-2000	(J), Extended Cargo Van, GAS, Naturally Aspirated; (Calif), (Exc.Fitting for Fuel Line)	<b>USEP3906</b>	6.0L V8 5967cc 364 CID	2008	SLE, SLT; (L76), (Y), GAS; Except for Bosch, Carter, and Delphi	<b>USEP12046</b>
7.4L V8 454 CID	1998-2000	(J), Extended Passenger Van, GAS, Naturally Aspirated; (Calif), (Exc.Fitting for Fuel Line)	<b>USEP3906</b>	<b>SIERRA 1500 HD</b>			
7.4L V8 454 CID	1998-2000	(J), GAS, Naturally Aspirated, Standard Cargo Van; (Calif), (Exc.Fitting for Fuel Line)	<b>USEP3906</b>	6.0L V8 5967cc 364 CID	2001-2003	Evaporative Emissions Control	<b>USEP3500</b>
7.4L V8 454 CID	1998-2000	(J), GAS, Naturally Aspirated, Standard Passenger Van; (Calif), (Exc.Fitting for Fuel Line)	<b>USEP3906</b>	6.0L V8 5967cc 364 CID	2001-2003	Exc.Evaporative Emissions Control	<b>USEP3501</b>
7.4L V8 454 CID	2000	(J), Cutaway Van, GAS, Naturally Aspirated; (55 Gallon Fuel Tank), (Exc.Fitting for Fuel Line)	<b>USEP3240R</b>	<b>SIERRA 2500</b>			
7.4L V8 454 CID	2000	(J), Extended Cargo Van, GAS, Naturally Aspirated; (Exc.Fitting for Fuel Line), (Federal)	<b>USEP3240R</b>	6.0L V8 5967cc 364 CID	1999-2000	(U); Evaporative Emissions Control	<b>USEP3500</b>
7.4L V8 454 CID	2000	(J), Extended Passenger Van, GAS, Naturally Aspirated; (Exc.Fitting for Fuel Line), (Federal)	<b>USEP3240R</b>	6.0L V8 5967cc 364 CID	1999-2000	(U); Exc.Evaporative Emissions Control	<b>USEP3501</b>
7.4L V8 454 CID	2000	(J), GAS, Naturally Aspirated, Standard Cargo Van; (Exc.Fitting for Fuel Line), (Federal)	<b>USEP3240R</b>	6.0L V8 5967cc 364 CID	2001	Evaporative Emissions Control	<b>USEP3500</b>
7.4L V8 454 CID	2000	(J), GAS, Naturally Aspirated, Standard Passenger Van; (Exc.Fitting for Fuel Line), (Federal)	<b>USEP3240R</b>	6.0L V8 5967cc 364 CID	2001	Exc.Evaporative Emissions Control	<b>USEP3501</b>
8.1L V8 496 CID	2001	(G), Extended Cargo Van, GAS, Naturally Aspirated; (Exc.Fitting for Fuel Line)	<b>USEP3240R</b>	6.0L V8 5967cc 364 CID	2002	BI-FUEL; Evaporative Emissions Control	<b>USEP3500</b>
8.1L V8 496 CID	2001	(G), Extended Passenger Van, GAS, Naturally Aspirated; (Exc.Fitting for Fuel Line)	<b>USEP3240R</b>	6.0L V8 5967cc 364 CID	2002	GAS; Evaporative Emissions Control	<b>USEP3500</b>
8.1L V8 496 CID	2001	(G), GAS, Naturally Aspirated, Standard Cargo Van; (Exc.Fitting for Fuel Line)	<b>USEP3240R</b>	6.0L V8 5967cc 364 CID	2002	BI-FUEL; Exc.Evaporative Emissions Control	<b>USEP3501</b>
8.1L V8 496 CID	2001	(G), GAS, Naturally Aspirated, Standard Passenger Van; (Exc.Fitting for Fuel Line)	<b>USEP3240R</b>	6.0L V8 5967cc 364 CID	2002	GAS; Exc.Evaporative Emissions Control	<b>USEP3501</b>
8.1L V8 496 CID	2002	(G), Extended Cargo Van, GAS, Naturally Aspirated; (Exc.Fitting for Fuel Line), (Federal)	<b>USEP3240R</b>	6.0L V8 5967cc 364 CID	2003	Evaporative Emissions Control	<b>USEP3500</b>
8.1L V8 496 CID	2002	(G), Extended Passenger Van, GAS, Naturally Aspirated; (Exc.Fitting for Fuel Line), (Federal)	<b>USEP3240R</b>	6.0L V8 5967cc 364 CID	2003	Exc.Evaporative Emissions Control	<b>USEP3501</b>
8.1L V8 496 CID	2002	(G), GAS, Naturally Aspirated, Standard Cargo Van; (Exc.Fitting for Fuel Line), (Federal)	<b>USEP3240R</b>	<b>SIERRA 2500 HD</b>			
8.1L V8 496 CID	2002	(G), GAS, Naturally Aspirated, Standard Passenger Van; (Exc.Fitting for Fuel Line), (Federal)	<b>USEP3240R</b>	6.0L V8 5967cc 364 CID	2001-2003	(U), GAS, Naturally Aspirated; Evaporative Emissions Control	<b>USEP3500</b>
8.1L V8 496 CID	2002	(G), Extended Cargo Van, GAS, Naturally Aspirated; (Calif)	<b>USEP3906</b>	6.0L V8 5967cc 364 CID	2001-2003	(U), GAS, Naturally Aspirated; Exc.Evaporative Emissions Control	<b>USEP3501</b>
8.1L V8 496 CID	2002	(G), Extended Passenger Van, GAS, Naturally Aspirated; (Calif)	<b>USEP3906</b>	6.0L V8 5967cc 364 CID	2002	(U), BI-FUEL, Naturally Aspirated; Evaporative Emissions Control	<b>USEP3500</b>
8.1L V8 496 CID	2002	(G), GAS, Naturally Aspirated, Standard Cargo Van; (Calif)	<b>USEP3906</b>	6.0L V8 5967cc 364 CID	2002	(U), BI-FUEL, Naturally Aspirated; Exc.Evaporative Emissions Control	<b>USEP3501</b>
8.1L V8 496 CID	2002	(G), GAS, Naturally Aspirated, Standard Passenger Van; (Calif)	<b>USEP3906</b>	6.6L V8 6599cc 403 CID	2001-2004	(1), DIESEL, Turbocharged	<b>USEP3526</b>
<b>SIERRA 1500</b>				6.6L V8 6599cc 403 CID	2001-2004	(1), DIESEL, Turbocharged; External Pump(Secondary Fuel Tank)	<b>USEP3526</b>
4.3L V6 262 CID	1999-2001	(W); Evaporative Emissions Control	<b>USEP3500</b>	6.6L V8 6599cc 403 CID	2006	SL, SLE, SLT, WT; (2), DIESEL, Turbocharged	<b>USEP3526</b>
4.3L V6 262 CID	1999-2001	(W); Exc.Evaporative Emissions Control	<b>USEP3501</b>	6.6L V8 6599cc 403 CID	2006	SL, SLE, SLT, WT; (2), DIESEL, Turbocharged; External Pump(Secondary Fuel Tank)	<b>USEP3526</b>
				6.6L V8 6599cc 403 CID	2006	SL, SLE, SLT, WT; (D), (LBZ), DIESEL, Turbocharged	<b>USEP3526</b>
				6.6L V8 6599cc 403 CID	2006	SL, SLE, SLT, WT; (D), (LBZ), DIESEL, Turbocharged; External Pump(Secondary Fuel Tank)	<b>USEP3526</b>
				6.6L V8 6599cc 403 CID	2007	SLE, SLT, WT; (6), (LMM), DIESEL, Turbocharged	<b>USEP3526</b>
				6.6L V8 6599cc 403 CID	2007-2008	SLE, SLT, WT; (6), (LMM), DIESEL, Turbocharged; External Pump	<b>USEP3526</b>
				8.1L V8 496 CID	2001-2003	(G), GAS, Naturally Aspirated; Evaporative Emissions Control	<b>USEP3500</b>
				8.1L V8 496 CID	2001-2003	(G), GAS, Naturally Aspirated; Exc.Evaporative Emissions Control	<b>USEP3501</b>
				<b>SIERRA 3500</b>			
				6.0L V8 5967cc 364 CID	2001	(U), GAS, Naturally Aspirated; Exc.Commercial Chassis (Evaporative Emissions Control)	<b>USEP3500</b>
				6.0L V8 5967cc 364 CID	2001	(U), GAS, Naturally Aspirated; Exc.Commercial Chassis (Exc.Evaporative Emissions Control)	<b>USEP3501</b>
				6.0L V8 5967cc 364 CID	2002-2003	(U), GAS, Naturally Aspirated; Exc.Commercial Chassis (Calif)	<b>USEP3500</b>
				6.0L V8 5967cc 364 CID	2002-2003	(U), GAS, Naturally Aspirated; Exc.Commercial Chassis (Federal)	<b>USEP3501</b>
				6.6L V8 6599cc 403 CID	2001-2004	(1), DIESEL, Turbocharged; Commercial chassis, External Pump(Secondary Fuel Tank)	<b>USEP3526</b>

Engine	Years	Application Description	USMW
<b>GMC (cont'd.)</b>			
<b>SIERRA 3500 (cont'd.)</b>			
6.6L V8 6599cc 403 CID	2001-2004	(1), DIESEL, Turbocharged; Commercial chassis, Primary Fuel Tank	<b>USEP3526</b>
6.6L V8 6599cc 403 CID	2001-2004	(1), DIESEL, Turbocharged; Exc.Commercial Chassis	<b>USEP3526</b>
6.6L V8 6599cc 403 CID	2005	(2), DIESEL, Turbocharged; (Primary Fuel Tank), Commercial chassis	<b>USEP3526</b>
6.6L V8 6599cc 403 CID	2005	(2), DIESEL, Turbocharged; (Secondary Fuel Tank), Commercial chassis	<b>USEP3526</b>
6.6L V8 6599cc 403 CID	2005	(2), DIESEL, Turbocharged; Commercial chassis, External Pump(Secondary Fuel Tank)	<b>USEP3526</b>
6.6L V8 6599cc 403 CID	2005	(2), DIESEL, Turbocharged; Commercial chassis, Primary Fuel Tank	<b>USEP3526</b>
6.6L V8 6599cc 403 CID	2005	(2), DIESEL, Turbocharged; Commercial chassis, Secondary Fuel Tank(Incl.Sender)	<b>USEP3526</b>
6.6L V8 6599cc 403 CID	2005	(2), DIESEL, Turbocharged; Exc.Commercial Chassis	<b>USEP3526</b>
6.6L V8 6599cc 403 CID	2006	SL, SLE, SLT, WT; (2), DIESEL, Turbocharged; (Primary Fuel Tank), Commercial Chassis (Auxiliary Fuel Tank)	<b>USEP3526</b>
6.6L V8 6599cc 403 CID	2006	SL, SLE, SLT, WT; (2), DIESEL, Turbocharged; (Secondary Fuel Tank), Commercial Chassis (Exc.Auxiliary Fuel Tank)	<b>USEP3526</b>
6.6L V8 6599cc 403 CID	2006	SL, SLE, SLT, WT; (2), DIESEL, Turbocharged; Commercial chassis, External Pump(Secondary Fuel Tank)	<b>USEP3526</b>
6.6L V8 6599cc 403 CID	2006	SL, SLE, SLT, WT; (2), DIESEL, Turbocharged; Exc.Commercial Chassis	<b>USEP3526</b>
6.6L V8 6599cc 403 CID	2006	SL, SLE, SLT, WT; (D); (LBZ), DIESEL, Turbocharged; External Pump(Secondary Fuel Tank)	<b>USEP3526</b>
8.1L V8 496 CID	2001	(G), GAS, Naturally Aspirated; Exc.Commercial Chassis (Evaporative Emissions Control)	<b>USEP3500</b>
8.1L V8 496 CID	2001	(G), GAS, Naturally Aspirated; Exc.Commercial Chassis (Exc.Evaporative Emissions Control)	<b>USEP3501</b>
8.1L V8 496 CID	2002-2003	(G), GAS, Naturally Aspirated; Exc.Commercial Chassis (Calif)	<b>USEP3500</b>
8.1L V8 496 CID	2002-2003	(G), GAS, Naturally Aspirated; Exc.Commercial Chassis (Federal)	<b>USEP3501</b>
<b>SIERRA 3500 HD</b>			
6.6L V8 6599cc 403 CID	2007	SLE, SLT, WT; (6), (LMM), DIESEL, Turbocharged	<b>USEP3526</b>
6.6L V8 6599cc 403 CID	2007-2008	SLE, SLT, WT; (6), (LMM), DIESEL, Turbocharged; External Pump	<b>USEP3526</b>
<b>SONOMA</b>			
2.2L L4 2190cc 134 CID	1994-1995	1.45 inch pump diameter, Except for Bosch, Carter, and Delphi	<b>USEP3240</b>
2.2L L4 2190cc 134 CID	1996-2000		<b>USEP3240R</b>
4.3L V6 262 CID	1994-1995	(W)	<b>USEP3270</b>
4.3L V6 262 CID	1994-1995	(Z)	<b>USEP3902</b>
4.3L V6 262 CID	1996-2003		<b>USEP3240R</b>
<b>SYCLONE</b>			
4.3L V6 262 CID	1991		<b>USEP3270</b>
<b>TYPHOON</b>			
4.3L V6 262 CID	1992-1993		<b>USEP3270</b>
<b>V1500</b>			
4.3L V6 262 CID	1987	(Z), GAS	<b>USEP3902</b>
5.0L V8 305 CID	1987	(H), GAS	<b>USEP3902</b>
5.7L V8 350 CID	1987	(K), GAS	<b>USEP3902</b>
<b>V1500 SUBURBAN</b>			
5.7L V8 350 CID	1987-1991	(K), GAS	<b>USEP3902</b>
<b>V2500</b>			
5.7L V8 350 CID	1987	(K), FI, GAS	<b>USEP3902</b>
<b>V2500 SUBURBAN</b>			
5.7L V8 350 CID	1987-1991	(K), GAS	<b>USEP3902</b>
<b>V3500</b>			
5.7L V8 350 CID	1987-1989	(K), FI, GAS	<b>USEP3902</b>
5.7L V8 350 CID	1990-1991	(K), GAS	<b>USEP3902</b>
6.2L V8 379 CID	1988	(J), DIESEL, FI; External Pump	<b>USEP3158</b>
7.4L V8 454 CID	1987-1989	(N), FI, GAS	<b>USEP3902</b>
7.4L V8 454 CID	1990-1991	(N), GAS	<b>USEP3902</b>
<b>YUKON</b>			
5.7L V8 350 CID	1992-1993		<b>USEP3902</b>
5.7L V8 350 CID	1994-1995	(K), GAS, Naturally Aspirated	<b>USEP3902</b>
5.7L V8 350 CID	1996	(R), GAS, Naturally Aspirated	<b>USEP3270</b>
5.7L V8 350 CID	1997	(R), 2 Doors, GAS, Naturally Aspirated	<b>USEP3270</b>
5.7L V8 350 CID	1997	(R), 4 Doors, GAS, Naturally Aspirated	<b>USEP3933</b>

Engine	Years	Application Description	USMW
<b>GMC (cont'd.)</b>			
<b>YUKON (cont'd.)</b>			
5.7L V8 350 CID	1998-1999	Exc.Radio Frequency Interference Filter	<b>USEP3240R</b>
5.7L V8 350 CID	1998-1999	Radio Frequency Interference Filter	<b>USEP3240R</b>
6.5L V8 395 CID	1994-1997	(S), DIESEL, Turbocharged; External Pump	<b>USEP3309</b>
<b>YUKON XL 1500</b>			
	2002-2003	(T), GAS	<b>USEP3507R</b>
5.3L V8 5328cc 325 CID	2000-2001		<b>USEP3509</b>
6.0L V8 5967cc 364 CID	2001		<b>USEP3509</b>
<b>HONDA</b>			
<b>ACCORD</b>			
	1986	DX, LX; (BS), CARB	<b>USEP8371</b>
	1987-1989	DX, LX; (A20A1), CARB	<b>USEP8371</b>
1.6L L4 1598cc	1985	CARB; External Pump	<b>USEP8316</b>
1.8L L4 1751cc	1979-1981		<b>USEP8303</b>
1.8L L4 1829cc	1985	External Pump	<b>USEP8000</b>
2.0L L4 1955cc	1986-1989	FI	<b>USEP8023</b>
2.2L L4 2156cc	1992-1993		<b>USEP8023</b>
2.2L L4 2156cc	1994		<b>USEP8229</b>
2.2L L4 2156cc	1995	(Calif)	<b>USEP8229</b>
2.2L L4 2156cc	1997	Calif	<b>USEP8229</b>
2.3L L4 2254cc	1998-2002		<b>USEP8229</b>
2.4L L4 2354cc 144 CID	2005	Calif	<b>USEP8456</b>
2.7L V6 2675cc	1995-1997		<b>USEP8229</b>
3.0L V6 2997cc	1998-2002		<b>USEP8229</b>
3.0L V6 2997cc	2005-2007	GAS	<b>USEP8513</b>
<b>CIVIC</b>			
1.3L L4 1335cc	1980-1983		<b>USEP8055</b>
1.3L L4 1339cc	2003-2004	Hybrid; (LDA1), ELECTRIC/GAS; Calif	<b>USEP8508</b>
1.5L L4 1487cc	1980-1983		<b>USEP8055</b>
1.5L L4 1487cc	1985-1987	External Pump	<b>USEP8000</b>
1.5L L4 1493cc	1988		<b>USEP8023</b>
1.5L L4 1493cc	1990-1991		<b>USEP8023</b>
1.5L L4 1493cc	1992	CX; (D15B8)	<b>USEP8335</b>
1.5L L4 1493cc	1993-1995		<b>USEP8229</b>
1.5L L4 1493cc	1993-1995	DX; (D15B7), 4 Doors; (Japan Built)	<b>USEP8335</b>
1.6L L4 1588cc 98 CID	1988		<b>USEP8023</b>
1.6L L4 1588cc 98 CID	1989	From Chassis/VIN KS000138 (Japan Built)	<b>USEP8023</b>
1.6L L4 1588cc 98 CID	1990-1991		<b>USEP8023</b>
1.6L L4 1588cc 98 CID	1992	EX; (D16Z6)	<b>USEP8335</b>
1.6L L4 1588cc 98 CID	1993	EX; (D16Z6), 4 Doors	<b>USEP8335</b>
1.6L L4 1588cc 98 CID	1993-1994		<b>USEP8229</b>
1.6L L4 1588cc 98 CID	1994	EX; (D16Z6)	<b>USEP8335</b>
1.6L L4 1588cc 98 CID	1995	EX; (D16Z6), 4 Doors; (Japan Built)	<b>USEP8335</b>
1.6L L4 1588cc 98 CID	1998		<b>USEP8229</b>
1.6L L4 1590cc	1996-1997		<b>USEP8229</b>
1.6L L4 1590cc	1999-2000		<b>USEP8229</b>
1.7L L4 1668cc	2001		<b>USEP8229</b>
1.7L L4 1668cc	2005		<b>USEP8456</b>
1.7L L4 1700cc	2002-2004		<b>USEP8229</b>
1.7L L4 1700cc	2004	(Canada Built Vehicle)	<b>USEP8456</b>
1.8L L4 1799cc	2006-2011		<b>USEP8513</b>
2.0L L4 1998cc 122 CID	2002-2005		<b>USEP8456</b>
2.0L L4 1998cc 122 CID	2006-2011		<b>USEP8513</b>
<b>CIVIC DEL SOL</b>			
1.5L L4 1493cc	1993-1995	S; (D15B7)	<b>USEP8335</b>
1.6L L4 1588cc 98 CID	1993-1995	Si; (D16Z6)	<b>USEP8335</b>
1.6L L4 1588cc 98 CID	1996-1997		<b>USEP8229</b>
<b>CR-V</b>			
2.0L L4 1972cc	1997-1998		<b>USEP8229</b>
2.0L L4 1972cc	2001		<b>USEP8335</b>
2.4L L4 2354cc 144 CID	2002-2003		<b>USEP8335</b>
2.4L L4 2354cc 144 CID	2004	Japan Built Vehicle	<b>USEP8335</b>
2.4L L4 2354cc 144 CID	2004	United Kingdom Built	<b>USEP8456</b>
2.4L L4 2354cc 144 CID	2005-2006		<b>USEP8335</b>
2.4L L4 2354cc 144 CID	2007		<b>USEP8513</b>
2.4L L4 2354cc 144 CID	2008-2009	Japan Built	<b>USEP8513</b>
<b>CRX</b>			
1.5L L4 1493cc	1988		<b>USEP8023</b>
1.5L L4 1493cc	1989	From Chassis/VIN KS023844	<b>USEP8023</b>
1.5L L4 1493cc	1990-1991		<b>USEP8023</b>
1.6L L4 1588cc 98 CID	1988		<b>USEP8023</b>
1.6L L4 1588cc 98 CID	1989	To Chassis/VIN KS016142	<b>USEP8023</b>
1.6L L4 1588cc 98 CID	1990-1991		<b>USEP8023</b>
<b>INSIGHT</b>			
1.0L L3 995cc 61 CID	2000-2003		<b>USEP8455</b>
<b>ODYSSEY</b>			
2.2L L4 2156cc	1995-1997		<b>USEP8335</b>
2.3L L4 2234cc	1998		<b>USEP8335</b>

Engine	Years	Application Description	USMW	Engine	Years	Application Description	USMW
<b>HONDA (cont'd.)</b>				<b>HYUNDAI (cont'd.)</b>			
<b>ODYSSEY (cont'd.)</b>				<b>SONATA (cont'd.)</b>			
3.5L V6 3474cc	1999-2000		USEP8335	2.0L L4 1997cc	1993-1998		USEP8229
<b>PASSPORT</b>				2.4L L4 2351cc	1989-1991		USEP8198
2.6L L4 2559cc	1994	DX; (4ZE1)	USEP8235	2.4L L4 2351cc	1999-2001		USEP8335
2.6L L4 2559cc	1995	From 05/95	USEP8229	2.4L L4 2351cc	2002-2004		USEP8229
2.6L L4 2559cc	1995	DX; (4ZE1); To 04/95	USEP8235	2.4L L4 2351cc	2005		USEP8335
2.6L L4 2559cc	1996		USEP8229	2.4L L4 2359cc	2006-2009		USEP8335
3.2L V6 3165cc	1994-1995		USEP8229	2.4L L4 2359cc	2011-2015		USEP8818
3.2L V6 3165cc	1996	From 12/95	USEP8229	2.5L V6 2493cc	1999-2001		USEP8335
3.2L V6 3165cc	1997		USEP8229	2.7L V6 2656cc	2002-2005		USEP8229
<b>PRELUDE</b>				3.0L V6 2972cc	1990-1992		USEP8198
	1988-1989	2.0 S; CARB	USEP8371	3.0L V6 2972cc	1993-1998		USEP8229
	1979-1982		USEP8303	3.3L V6 3342cc	2006-2009		USEP8335
1.8L L4 1751cc	1985	Base; (ET2), CARB; External Pump	USEP8310	<b>TIBURON</b>			
1.8L L4 1829cc	1986	Base; (ET2), CARB; External Pump	USEP8158	2.0L L4 1975cc	2003		USEP8335
1.8L L4 1829cc	1987	Base; (A18A1), CARB; External Pump	USEP8158	2.0L L4 1975cc	2004		USEP8804
2.0L L4 1955cc	1985-1987	External Pump	USEP8000	2.0L L4 1975cc	2006		USEP8335
2.0L L4 1958cc	1988-1990	FI	USEP8023	2.0L L4 1975cc	2007	From 5/15/2007	USEP8335
2.0L L4 1958cc	1990	2.0 S; CARB	USEP8371	2.0L L4 1975cc	2008	To 2/04/2008	USEP8335
2.0L L4 1958cc	1991		USEP8023	2.7L V6 2656cc	2003		USEP8335
2.1L L4 2056cc	1990	FI	USEP8023	2.7L V6 2656cc	2004		USEP8804
2.1L L4 2056cc	1991		USEP8023	2.7L V6 2656cc	2006-2008		USEP8804
2.2L L4 2156cc	1993-1996		USEP8023	<b>TUCSON</b>			
2.2L L4 2156cc	1997	Calif	USEP8335	2.0L L4 1975cc	2005-2009		USEP8335
2.2L L4 2156cc	1998-2001		USEP8335	2.7L V6 2656cc	2005-2009		USEP8335
2.3L L4 2259cc	1993-1996		USEP8023	<b>VELOSTER</b>			
<b>RIDGELINE</b>				1.6L L4 1591cc 97 CID	2012-2015		USEP2518
3.5L V6 3471cc	2006-2014		USEP8513	<b>VERACRUZ</b>			
<b>S2000</b>				3.8L V6 3778cc 231 CID	2007-2012		USEP8818
2.0L L4 1997cc	2000-2003		USEP8335	<b>XG300</b>			
2.2L L4 2157cc	2004-2005		USEP8335	3.0L V6 2972cc	2001		USEP8335
<b>HYUNDAI</b>				<b>XG350</b>			
<b>ACCENT</b>				3.5L V6 3500cc	2002		USEP8335
1.5L L4 1495cc	1995-1999		USEP8302	3.5L V6 3500cc	2004-2005		USEP8229
1.5L L4 1495cc	2000		USEP8229	<b>INFINITI</b>			
1.6L L4 1591cc 97 CID	2012-2014		USEP2518	<b>G20</b>			
1.6L L4 1599cc	2006-2009		USEP12019		1991-1992		USEP8235
1.6L L4 1600cc	2001-2002		USEP8229		1994	Base	USEP8235
1.6L L4 1600cc	2003-2005		USEP8335		2000-2001		USEP8454
<b>AZERA</b>					2002	Base	USEP8454
3.3L V6 3342cc	2007-2011		USEP8818	2.0L L4 1998cc	1994	T	USEP8247
3.8L V6 3778cc 231 CID	2006-2011		USEP8818	2.0L L4 1998cc	1995-1996	Base, T	USEP8247
<b>ELANTRA</b>				2.0L L4 2000cc	1999		USEP8229
1.6L L4 1596cc	1992-1993		USEP8229	<b>G35</b>			
1.6L L4 1596cc	1994	From 02/07/94	USEP8229	3.5L V6 3498cc	2003-2006		USEP8335
1.6L L4 1596cc	1995		USEP8229	<b>I30</b>			
1.8L L4 1796cc	1998	USA	USEP8302	3.0L V6 2988cc 182 CID	1996-1997		USEP8229
1.8L L4 1797cc	2013-2014		USEP2518	3.0L V6 2988cc 182 CID	1999		USEP8229
1.8L L4 1836cc	1993		USEP8229	3.0L V6 2988cc 182 CID	2000-2001		USEP8335
1.8L L4 1836cc	1994	From 02/07/94	USEP8229	<b>I35</b>			
1.8L L4 1836cc	1995		USEP8229	3.5L V6 3498cc	2002-2004		USEP8335
2.0L L4 1975cc	2001	To 2/04/2008	USEP8335	<b>J30</b>			
2.0L L4 1975cc	2001	from 2/4/2008	USEP8804		1993-1994		USEP8235
2.0L L4 1975cc	2002		USEP8335	3.0L V6 2960cc 181 CID	1995-1997		USEP8235
2.0L L4 1975cc	2003	Calif	USEP8335	<b>M30</b>			
2.0L L4 1975cc	2003	Exc. Calif	USEP8804		1990-1992		USEP8218
2.0L L4 1975cc	2004-2006		USEP8335	<b>M45</b>			
2.0L L4 1975cc	2007-2009		USEP8804		2003-2004		USEP8450
2.0L L4 1999cc	2014		USEP2518	<b>Q45</b>			
<b>ELANTRA COUPE</b>					1990-1996		USEP8219
1.8L L4 1797cc	2013		USEP8818		1997-2001		USEP8392
<b>ELANTRA GT</b>					2002-2005		USEP8450
1.8L L4 1797cc	2013		USEP8818		2006	To 12/05	USEP8450
<b>EXCEL</b>				<b>QX4</b>			
1.5L L4 1468cc 90 CID	1992-1994		USEP8335		2001-2003		USEP8432
<b>GENESIS</b>				3.3L V6 3275cc	1997-1998		USEP8229
3.8L V6 3778cc 231 CID	2009-2012		USEP8818	<b>ISUZU</b>			
<b>GENESIS COUPE</b>				<b>AMIGO</b>			
2.0L L4 1998cc 122 CID	2010-2012		USEP2518	2.6L L4 2559cc	1989-1993	(E), FI	USEP8235
3.8L V6 3778cc 231 CID	2010-2012		USEP2518	2.6L L4 2559cc	1994		USEP8235
<b>SANTA FE</b>				<b>ASCENDER</b>			
	2007-2009		USEP8821		2007		USEP3707
<b>SCOUPE</b>				4.2L L6 256 CID	2005	LS, S; (S)	USEP3707
1.5L L4 1495cc	1993-1995		USEP8335	4.2L L6 256 CID	2006	Base, LS; (S)	USEP3707
<b>SONATA</b>							
2.0L L4 1997cc	1992		USEP8198				



Engine	Years	Application Description	USMW
<b>ISUZU (cont'd.)</b>			
<b>HOMBRE</b>			
2.2L L4 2190cc 134 CID	1997-2000		USEP3240R
4.3L V6 4294cc	1997-1999		USEP3240R
<b>I-MARK</b>			
1.5L L4 1471cc	1987-1989	2 inch pump diameter	USEP3222
1.6L L4 1588cc	1989	2 inch pump diameter	USEP3222
<b>IMPULSE</b>			
1.6L L4 1588cc	1990-1992		USEP8229
1.8L L4 1809cc 110 CID	1992		USEP8229
1.9L L4 1949cc	1985	(A), Naturally Aspirated; External Pump, From Chassis/VIN F0906660	USEP8235
1.9L L4 1949cc	1985	(A), Naturally Aspirated; External Pump, To Chassis/VIN F0906660	USEP8312
1.9L L4 1949cc	1986-1987	(A), Naturally Aspirated; External Pump	USEP8235
2.0L L4 1994cc	1985-1989		USEP8051
2.3L L4 2254cc	1988-1989		USEP8051
<b>OASIS</b>			
2.3L L4 2234cc	1999		USEP8229
2.3L L4 2254cc	1998		USEP8229
<b>PICKUP</b>			
2.3L L4 2254cc	1995	(L)	USEP8235
2.6L L4 2559cc	1988	1 Ton, S; (E), FI	USEP8235
2.6L L4 2559cc	1989	1 Ton, XS; (E), FI	USEP8235
2.6L L4 2559cc	1990	1 Ton, LS, XS; (E), FI; From 04/90	USEP8235
2.6L L4 2559cc	1990	1 Ton, LS, XS; (E), FI; To 03/90	USEP8235
2.6L L4 2559cc	1991-1992	1 Ton, LS, S; (E), FI	USEP8235
2.6L L4 2559cc	1993	(E), FI; From 06/93 (Japan Built)	USEP8235
2.6L L4 2559cc	1993	(E), FI; From 06/93 (USA Built)	USEP8235
2.6L L4 2559cc	1993	(E), FI; To 05/93	USEP8235
2.6L L4 2559cc	1994	(E), FI; From 02/94	USEP8235
2.6L L4 2559cc	1994	(E), FI; To 01/94 (Japan Built)	USEP8235
2.6L L4 2559cc	1994	(E), FI; To 01/94 (USA Built)	USEP8235
2.6L L4 2559cc	1995	(E)	USEP8235
3.1L V6 3137cc	1991	LS; (Z), FI	USEP8321
3.1L V6 3137cc	1992	S; (Z), FI	USEP8321
3.1L V6 3137cc	1993-1994	(Z), FI	USEP8321
<b>RODEO</b>			
2.6L L4 2559cc	1991-1992	(E)	USEP8235
2.6L L4 2559cc	1995-1997		USEP8229
3.2L V6 3165cc	1993-1995		USEP8229
3.2L V6 3165cc	1996	From 12/95	USEP8229
3.2L V6 3165cc	1996	To 11/95	USEP8229
<b>STYLUS</b>			
1.6L L4 1588cc	1991-1993		USEP8229
1.8L L4 1809cc 110 CID	1992		USEP8229
<b>TROOPER</b>			
2.6L L4 2559cc	1988		USEP8235
2.6L L4 2559cc	1989-1991	(E)	USEP8235
3.2L V6 3165cc	1994	From 07/94	USEP8229
3.2L V6 3165cc	1995-1997		USEP8229
3.5L V6 3475cc	1998-2002		USEP8335
<b>VEHICROSS</b>			
3.5L V6 3475cc	1999-2001		USEP8335
<b>JAGUAR</b>			
<b>VANDEN PLAS</b>			
3.6L L6 3590cc	1988-1989	External Pump	USEP8002
3.6L L6 3590cc	1988-1989	In Tank Pump	USEP8224
4.0L L6 3980cc	1990-1993	External Pump	USEP8002
4.0L L6 3980cc	1990-1993	In Tank Pump	USEP8224
4.0L L6 3980cc	1994	From Chassis/VIN 705894	USEP8249
4.0L L6 3980cc	1995-1997		USEP8285
4.2L L6 4235cc	1985-1987	External Pump	USEP8308
<b>XJ6</b>			
3.6L L6 3590cc	1988-1989	External Pump	USEP8002
3.6L L6 3590cc	1988-1989	In Tank Pump	USEP8224
4.0L L6 3980cc	1990-1992	External Pump	USEP8002
4.0L L6 3980cc	1990-1992	In Tank Pump	USEP8224
4.0L L6 3980cc	1993	From Chassis/VIN 679207 (To Chassis/VIN 705893)	USEP8249
4.0L L6 3980cc	1994	From Chassis/VIN 705894	USEP8249
4.0L L6 3980cc	1995-1997		USEP8285
4.2L L6 4235cc	1985-1987	External Pump	USEP8308
<b>XJ12</b>			
6.0L V12 5994cc	1994	Left Side Fuel Tank	USEP8249
6.0L V12 5994cc	1995-1996		USEP8285
<b>XJR</b>			
4.0L L6 3980cc	1995-1997		USEP8285

Engine	Years	Application Description	USMW
<b>JAGUAR (cont'd.)</b>			
<b>XJRS</b>			
6.0L V12 5994cc	1993		USEP8285
<b>XJS</b>			
4.0L L6 3980cc	1993	From Chassis/VIN 188105	USEP8249
4.0L L6 3980cc	1994		USEP8249
5.3L V12 5343cc	1985-1992	External Pump	USEP8308
6.0L V12 5994cc	1994	Left Side Fuel Tank	USEP8249
<b>XK8</b>			
4.0L V8 3996cc 244 CID	1997-1998		USEP8285
<b>JEEP</b>			
<b>CHEROKEE</b>			
2.5L L4 150 CID	1986	Base, Chief, Laredo, Pioneer; (H), FI, GAS, Naturally Aspirated; Except for Bosch, Carter, and Delphi	USEP7001
2.5L L4 150 CID	1991-1993		USEP7006
2.5L L4 150 CID	1991-1993	Base; (P)	USEP7006A
2.5L L4 150 CID	1994-1995		USEP8229
2.5L L4 150 CID	1996		USEP8335
4.0L L6 242 CID	1991-1992	Base, Briarwood, Laredo, Limited, Sport; (S)	USEP7006A
4.0L L6 242 CID	1993	Base, Country, Sport; (S)	USEP7006A
4.0L L6 242 CID	1994-1995		USEP8229
<b>COMANCHE</b>			
2.5L L4 150 CID	1986	Custom, X, XLS; (H), FI, GAS, Naturally Aspirated; Except for Bosch, Carter, and Delphi	USEP7001
2.5L L4 150 CID	1987	Base, Chief, Laredo, Pioneer; (H), GAS, Naturally Aspirated; Except for Bosch, Carter, and Delphi	USEP7001
2.5L L4 150 CID	1988	Chief, Laredo, Pioneer; (H); Except for Bosch, Carter, and Delphi	USEP7001
2.5L L4 150 CID	1989-1990	Base, Pioneer; (E); Except for Bosch, Carter, and Delphi	USEP7001
2.5L L4 150 CID	1991	Base, Pioneer; (P)	USEP7006A
2.5L L4 150 CID	1991-1992		USEP7006
2.5L L4 150 CID	1992	Base; (P)	USEP7006A
4.0L L6 242 CID	1987	Base, Chief, Laredo, Pioneer; (M), GAS, Naturally Aspirated	USEP7006A
4.0L L6 242 CID	1987-1992		USEP7006
4.0L L6 242 CID	1988	Chief, Eliminator, Laredo, Pioneer; (M)	USEP7006A
4.0L L6 242 CID	1989-1990	Base, Eliminator, Pioneer; (L)	USEP7006A
4.0L L6 242 CID	1991-1992	Base, Eliminator, Pioneer; (S)	USEP7006A
<b>COMMANDER</b>			
3.7L V6 226 CID	2006	65th Anniversary Edition; (K); Except for Bosch, Carter, and Delphi	USEP7206
3.7L V6 226 CID	2007	Base; (K), GAS; Except for Bosch, Carter, and Delphi	USEP7206
3.7L V6 226 CID	2008-2009	Sport; (K), GAS; Except for Bosch, Carter, and Delphi	USEP7206
4.7L V8 287 CID	2006	65th Anniversary Edition, Limited; (N); Except for Bosch, Carter, and Delphi	USEP7206
4.7L V8 287 CID	2007	Base, Limited; (N), GAS; Except for Bosch, Carter, and Delphi	USEP7206
4.7L V8 287 CID	2007	Base, Limited; (P), FLEX; Except for Bosch, Carter, and Delphi	USEP7207
4.7L V8 287 CID	2008	Limited, Sport; (N), FLEX; Except for Bosch, Carter, and Delphi	USEP7207
4.7L V8 287 CID	2008-2009	Limited, Sport; (N), GAS; Except for Bosch, Carter, and Delphi	USEP7206
4.7L V8 287 CID	2009	Limited, Sport; (P), FLEX; Except for Bosch, Carter, and Delphi	USEP7206
5.7L V8 345 CID	2006	Limited; (2); Except for Bosch, Carter, and Delphi	USEP7206
5.7L V8 345 CID	2007-2008	Limited, Overland; (2), GAS; Except for Bosch, Carter, and Delphi	USEP7206
5.7L V8 345 CID	2009	Limited, Overland; (E2D), (T), GAS; Except for Bosch, Carter, and Delphi	USEP7206
<b>COMPASS</b>			
2.4L L4 2360cc 144 CID	2007-2016		USEP2518
<b>GRAND CHEROKEE</b>			
3.7L V6 226 CID	2005	Laredo; (K); Except for Bosch, Carter, and Delphi	USEP7206
3.7L V6 226 CID	2006	65th Anniversary Edition, Laredo; (K); Except for Bosch, Carter, and Delphi	USEP7206
3.7L V6 226 CID	2007-2009	Laredo; (K), GAS, Naturally Aspirated; Except for Bosch, Carter, and Delphi	USEP7206
4.7L V8 287 CID	2005	Laredo, Limited; (N); Except for Bosch, Carter, and Delphi	USEP7206
4.7L V8 287 CID	2006	65th Anniversary Edition, Laredo, Limited; (N); Except for Bosch, Carter, and Delphi	USEP7206
4.7L V8 287 CID	2007	Laredo, Limited; (P), FLEX, Naturally Aspirated; Except for Bosch, Carter, and Delphi	USEP7207
4.7L V8 287 CID	2007-2008	Laredo, Limited; (N), GAS, Naturally Aspirated; Except for Bosch, Carter, and Delphi	USEP7206
4.7L V8 287 CID	2008	MEX	USEP7206

Engine	Years	Application Description	USMW	Engine	Years	Application Description	USMW
<b>JEEP (cont'd.)</b>				<b>KIA (cont'd.)</b>			
<b>GRAND CHEROKEE (cont'd.)</b>				<b>OPTIMA</b>			
4.7L V8 287 CID	2008	Laredo, Limited; (N), FLEX, Naturally Aspirated; Except for Bosch, Carter, and Delphi	USEP7207	2.4L L4 2351cc	2001	From 06/01/01	USEP8229
4.7L V8 287 CID	2009	Laredo, Limited; (P), FLEX, Naturally Aspirated; Except for Bosch, Carter, and Delphi	USEP7206	2.4L L4 2351cc	2001	To 06/01/01	USEP8335
5.7L V8 345 CID	2005	Limited; (2); Except for Bosch, Carter, and Delphi	USEP7206	2.4L L4 2351cc	2002	From 08/13/02	USEP8335
5.7L V8 345 CID	2006	Limited, Overland; (2); Except for Bosch, Carter, and Delphi	USEP7206	2.4L L4 2351cc	2003		USEP8335
5.7L V8 345 CID	2007-2008	Limited, Overland; (2), GAS, Naturally Aspirated; Except for Bosch, Carter, and Delphi	USEP7206	2.4L L4 2351cc	2004-2005		USEP8229
5.7L V8 345 CID	2009	Overland; (E2D), (T), GAS, Naturally Aspirated; Except for Bosch, Carter, and Delphi	USEP7206	2.4L L4 2359cc	2007-2009		USEP8804
6.1L V8 6059cc 370 CID	2006	SRT8; (3); Except for Bosch, Carter, and Delphi	USEP7206	2.4L L4 2359cc	2012-2015		USEP8818
6.1L V8 6059cc 370 CID	2007-2008	SRT8; (3), GAS, Naturally Aspirated; Except for Bosch, Carter, and Delphi	USEP7206	2.5L V6 2500cc	2001	From 06/01/01	USEP8229
6.1L V8 6059cc 370 CID	2009	SRT8; (W), GAS, Naturally Aspirated; Except for Bosch, Carter, and Delphi	USEP7206	2.5L V6 2500cc	2001	To 06/01/01	USEP8335
<b>LIBERTY</b>				<b>RIO</b>			
	2007	Limited, Sport; Except for Bosch, Carter, and Delphi	USEP7207	1.6L L4 1599cc	2006-2009		USEP12019
2.4L L4 148 CID	2005	Sport; (1), GAS, Naturally Aspirated; Except for Bosch, Carter, and Delphi	USEP7207	<b>RIO5</b>			
3.7L V6 226 CID	2005	Limited, Renegade, Rocky Mountain Edition, Sport; (K), GAS, Naturally Aspirated; Except for Bosch, Carter, and Delphi	USEP7207	1.6L L4 1599cc	2006-2007		USEP12019
3.7L V6 226 CID	2006	65th Anniversary Edition, Limited, Renegade, Sport; (K), GAS, Naturally Aspirated; Except for Bosch, Carter, and Delphi	USEP7207	1.6L L4 1599cc	2008		USEP8335
<b>PATRIOT</b>				<b>RONDO</b>			
2.4L L4 2360cc 144 CID	2007-2016		USEP2518	2.4L L4 2359cc	2007-2009		USEP8335
<b>WAGONEER</b>				<b>SEPHIA</b>			
2.5L L4 150 CID	1986	Limited; (H), FI; Except for Bosch, Carter, and Delphi	USEP7001	1.6L L4 1597cc	1995	Late	USEP8229
4.6L L6 4622cc 282 CID	1980	MEX	USEP8004	1.6L L4 1597cc	1996-1997		USEP8229
<b>WRANGLER</b>				<b>SORENTO</b>			
2.4L L4 148 CID	2005-2006	SE; (1); Except for Bosch, Carter, and Delphi	USEP7207	3.3L V6 3342cc	2008-2009		USEP8818
2.5L L4 150 CID	1987	Base, Laredo, Sport; (H), FI; 14.5 Gallon Fuel Tank, Except for Bosch, Carter, and Delphi	USEP7001	3.5L V6 3497cc	2005-2006		USEP8818
2.5L L4 150 CID	1987	Base, Laredo, Sport; (H), FI; 20 Gallon Fuel Tank, Except for Bosch, Carter, and Delphi	USEP7001	3.8L V6 3778cc 231 CID	2007-2009		USEP8818
2.5L L4 150 CID	1988	Base, Laredo, S, Sahara, Sport; (H), FI; 14.5 Gallon Fuel Tank, Except for Bosch, Carter, and Delphi	USEP7001	<b>SOUL</b>			
2.5L L4 150 CID	1988	Base, Laredo, S, Sahara, Sport; (H), FI; 20 Gallon Fuel Tank, Except for Bosch, Carter, and Delphi	USEP7001	1.6L L4 1591cc	2010-2011		USEP8818
2.5L L4 150 CID	1989-1990	Base, Islander, Sahara; (E), FI; 20 Gallon Fuel Tank, Except for Bosch, Carter, and Delphi	USEP7001	1.6L L4 1591cc	2012-2013		USEP2518
2.5L L4 150 CID	1989-1990	Islander, Sahara; (E), FI; 14.5 Gallon Fuel Tank, Except for Bosch, Carter, and Delphi	USEP7001	2.0L L4 1975cc	2010-2011		USEP8818
3.6L V6 3604cc 220 CID	2012-2015		USEP2518	2.0L L4 1999cc 122 CID	2012-2013		USEP8818
3.8L V6 3778cc 231 CID	2007-2008		USEP2518	<b>SPECTRA</b>			
3.8L V6 3778cc 231 CID	2010-2011		USEP2518	2.0L L4 1975cc	2004-2006		USEP8335
4.0L L6 242 CID	2005	Rubicon, Sport, Unlimited, Unlimited Rubicon, X; (S); Except for Bosch, Carter, and Delphi	USEP7207	2.0L L4 1975cc	2007-2008		USEP8804
4.0L L6 242 CID	2006	65th Anniversary Edition, Rubicon, SE, Sport, Unlimited, Unlimited Rubicon, X; (S); Except for Bosch, Carter, and Delphi	USEP7207	2.0L L4 1975cc	2009	To 2/04/2008	USEP8335
<b>KIA</b>				2.0L L4 1975cc	2009	from 2/4/2008	USEP8804
<b>AMANTI</b>				<b>SPECTRA5</b>			
3.5L V6 3497cc	2004-2006		USEP8335	2.0L L4 1975cc	2005-2006		USEP8335
3.8L V6 3778cc 231 CID	2007-2009		USEP8804	2.0L L4 1975cc	2007		USEP8804
<b>BORREGO</b>				2.0L L4 1975cc	2008	To 2/04/2008	USEP8335
3.8L V6 3778cc 231 CID	2009		USEP8804	2.0L L4 1975cc	2008	from 2/4/2008	USEP8335
4.6L V8 4627cc	2009		USEP8335	2.0L L4 1975cc	2009		USEP8804
<b>FORTE</b>				<b>SPORTAGE</b>			
1.8L L4 1797cc	2014-2015		USEP2518	2.0L L4 1975cc	2005-2008		USEP8335
2.0L L4 1999cc 122 CID	2014-2015		USEP2518	2.0L L4 1998cc 122 CID	1995-1996		USEP2068
<b>FORTE5</b>				2.0L L4 1998cc 122 CID	1997-1999		USEP8229
2.0L L4 1999cc 122 CID	2015		USEP2518	2.0L L4 1998cc 122 CID	1999-2002		USEP8734
<b>FORTE KOUP</b>				2.7L V6 2656cc	2005-2009		USEP8335
2.0L L4 1999cc 122 CID	2014-2015		USEP2518	<b>LEXUS</b>			
<b>KIA</b>				<b>ES250</b>			
<b>AMANTI</b>				2.5L V6 2508cc 1990-1991 USEP8023			
<b>BORREGO</b>				<b>ES300</b>			
<b>FORTE</b>				3.0L V6 2959cc 1992-1993 USEP8213			
<b>FORTE5</b>				3.0L V6 2959cc 1996-1998 USEP8213			
<b>FORTE KOUP</b>				3.0L V6 2995cc 1994-1995 USEP8213			
<b>KIA</b>				3.0L V6 2995cc 1999-2003 USEP8213			
<b>AMANTI</b>				<b>ES330</b>			
<b>BORREGO</b>				3.3L V6 3300cc 202 CID 2004-2006 USEP8213			
<b>FORTE</b>				<b>ES350</b>			
<b>FORTE5</b>				3.5L V6 3456cc 2007-2009 USEP8213			
<b>FORTE KOUP</b>				<b>GS300</b>			
<b>KIA</b>				3.0L L6 2997cc 1998-2005 USEP8382			
<b>AMANTI</b>				1993-1997 USEP8240			
<b>BORREGO</b>				<b>GS400</b>			
<b>FORTE</b>				1998-2000 USEP8382			
<b>FORTE5</b>				<b>GS430</b>			
<b>FORTE KOUP</b>				4.3L V8 4293cc 2001-2005 USEP8451			
<b>KIA</b>				<b>GX470</b>			
<b>AMANTI</b>				4.7L V8 4663cc 285 CID 2003-2005 USEP8501			

Engine	Years	Application Description	USMW	Engine	Years	Application Description	USMW
<b>LEXUS (cont'd.)</b>				<b>LINCOLN (cont'd.)</b>			
<b>IS300</b>				<b>TOWN CAR</b>			
	2001		USEP8382	1986	External Pump, From 05/86	USEP2182	
	2002-2005	Base, Sportcross	USEP8382	1986	External Pump, To 05/86	USEP2182	
<b>LS400</b>				1987-1988	Base, Cartier, Signature; External Pump	USEP2182	
4.0L V8 3969cc	1990-2000		USEP8119	1989	Base, Cartier, Signature, Signature SE; External Pump	USEP2182	
<b>LS430</b>				1997	Cartier, Executive, Signature, Touring Edition	USEP2374	
4.3L V8 4293cc	2001-2005		USEP8451	1998	Cartier, Executive, Signature	USEP2374	
<b>LX450</b>				1999		USEP2374	
4.5L L6 4477cc	1996-1997		USEP8240	2000	Cartier, Executive, Signature; Optional	USEP2374	
<b>LX470</b>				2000	Cartier, Executive, Signature; Standard	USEP2374	
4.7L V8 4663cc 285 CID	1998-2007		USEP8240	2001-2002	Cartier L, Executive L, Signature	USEP2375	
<b>NX300H</b>				2003	Cartier L, Executive Protection Series, Signature; Except for Bosch, Carter, and Delphi	USEP2337	
2.5L L4 2494cc 152 CID	2015-2016		USEP9086	4.6L V8 281 CID	1993-1994	USEP2068	
<b>RX300</b>				4.6L V8 281 CID	2004	Executive, Executive L, Signature, Ultimate, Ultimate L	USEP2157
3.0L V6 2995cc	1999-2003		USEP8404	4.6L V8 281 CID	2005-2008	USEP2576	
<b>RX330</b>				5.0L V8 302 CID	1981-1984	USEP2182	
3.3L V6 3300cc 202 CID	2004-2006	Exc. Japan Built Vehicle	USEP8513	5.0L V8 302 CID	1985	USEP2484	
3.3L V6 3300cc 202 CID	2004-2006	Japan Built Vehicle	USEP8516	<b>ZEPHYR</b>			
<b>RX350</b>				3.0L V6 2968cc 181 CID	2006	USEP2518	
3.5L V6 3456cc	2007-2009		USEP8866	<b>MAZDA</b>			
<b>RX400H</b>				<b>5</b>			
3.3L V6 3300cc 202 CID	2006-2007		USEP8404	2.3L L4 2260cc	2006-2010	USEP8818	
<b>SC300</b>				2.5L L4 2489cc 152 CID	2012-2015	USEP8818	
3.0L L6 2997cc	1992	To 01/92	USEP8240	<b>6</b>			
3.0L L6 2997cc	1993-2000		USEP8240	2.3L L4 2260cc	2003-2004	USEP2369	
<b>SC400</b>				2.5L L4 2488cc 152 CID	2009-2013	USEP2518	
4.0L V8 3969cc	1993-2000		USEP8240	2.5L L4 2489cc 152 CID	2010-2013	USEP2518	
<b>SC430</b>				<b>323</b>			
4.3L V8 4293cc	2002-2009		USEP8451	1.6L L4 1597cc	1986-1987	USEP8023	
<b>LINCOLN</b>				1.6L L4 1597cc	1988-1989	Naturally Aspirated	USEP8023
<b>AVIATOR</b>				1.6L L4 1597cc	1988-1989	Turbocharged	USEP8023
4.6L V8 281 CID	2003	To 12/10/2002	USEP2068	1.6L L4 1597cc	1990-1991	USEP8023	
<b>BLACKWOOD</b>				1.6L L4 1597cc	1992-1994	USEP8229	
5.4L V8 330 CID	2002		USEP2068	<b>626</b>			
<b>CONTINENTAL</b>				2.0L L4 1991cc	1993	USEP8229	
	1986		USEP2024	2.0L L4 1991cc	1994	From Chassis/VIN 122924	USEP8229
	1987	Base, Givenchy	USEP2024	2.0L L4 1991cc	1995	Early	USEP2068
	1988-1990	Base, Signature	USEP2042	2.0L L4 1991cc	1996-1997	USEP2068	
	1991-1993	Executive, Signature	USEP2042	2.0L L4 1991cc	1998	DX, LX	USEP2157
	1994	Executive, Signature; From 01/94	USEP2042	2.0L L4 1991cc	1999-2001	USEP2157	
	1994	Executive, Signature; To 01/94	USEP2042	2.0L L4 1991cc	2002	LX	USEP2157
2.4L L6 146 CID	1984		USEP2324	2.0L L4 1998cc 122 CID	1986-1987	Naturally Aspirated	USEP8023
2.4L L6 146 CID	1985		USEP2324	2.0L L4 1998cc 122 CID	1986-1987	Turbocharged	USEP8023
4.6L V8 281 CID	1995-1997	External Pump	USEP2369	2.2L L4 2184cc	1988	Turbocharged; 2-Wheel Steering	USEP8023
4.6L V8 281 CID	1997		USEP2187	2.2L L4 2184cc	1988-1991	Naturally Aspirated	USEP8023
5.0L V8 302 CID	1980		USEP2182	2.2L L4 2184cc	1989-1991	Turbocharged	USEP8023
5.0L V8 302 CID	1985	(F), GAS, Naturally Aspirated	USEP2024	2.2L L4 2184cc	1992		USEP8023
<b>MARK VI</b>				2.5L V6 2497cc	1993		USEP8229
5.0L V8 302 CID	1981-1983		USEP2182	2.5L V6 2497cc	1994	From Chassis/VIN 122924	USEP8229
<b>MARK VII</b>				2.5L V6 2497cc	1995	Early	USEP2068
	1986	Bill Blass; (F)	USEP2024	2.5L V6 2497cc	1996-1997		USEP2068
	1986-1987	LSC; (M)	USEP2044	2.5L V6 2497cc	1998	ES, LX	USEP2157
	1987	Base, Bill Blass; (F)	USEP2024	2.5L V6 2497cc	1999-2001	USEP2157	
	1988-1992	Bill Blass, LSC	USEP2044	2.5L V6 2497cc	2002	ES, LX	USEP2157
2.4L L6 146 CID	1984		USEP2324	<b>929</b>			
2.4L L6 146 CID	1985	External Pump	USEP2324	3.0L V6 2954cc 180 CID	1988-1991	USEP8023	
5.0L V8 302 CID	1985	LSC; (M), GAS, Naturally Aspirated	USEP2024	3.0L V6 2954cc 180 CID	1992-1995	USEP8229	
5.0L V8 302 CID	1985	Versace; (F), GAS, Naturally Aspirated	USEP2024	<b>B2000</b>			
<b>MARK VIII</b>				2.0L L4 1970cc	1979-1980	USEP2019	
4.6L V8 281 CID	1997-1998		USEP2498	2.0L L4 1970cc	1981	USEP8016SP	
<b>MKS</b>				2.0L L4 1970cc	1982	USEP2019	
3.7L V6 3726cc 227 CID	2009-2010		USEP2518	2.0L L4 1970cc	1983-1984	USEP8016SP	
<b>MKX</b>				<b>B2200</b>			
3.5L V6 3496cc 213 CID	2007-2010		USEP2518	1987-1989	Automatic Trans, Extended Cab Pickup	USEP8237	
3.7L V6 3726cc 227 CID	2011-2014		USEP2518	1987-1989	Automatic Trans, Standard Cab Pickup	USEP8237	
<b>MKZ</b>				1992-1993	Automatic Trans, CARB, Extended Cab Pickup	USEP8237	
3.5L V6 3496cc 213 CID	2007-2012		USEP2518	1992-1993	Automatic Trans, CARB, Standard Cab Pickup	USEP8237	
<b>NAVIGATOR</b>				2.2L L4 2184cc	1992-1993	Extended Cab Pickup, FI	USEP8023
	1998		USEP2158	2.2L L4 2184cc	1992-1993	FI, Standard Cab Pickup	USEP8023
	2000	4WD	USEP2254	<b>B2300</b>			
	2000	RWD	USEP2254	2.3L L4 140 CID	1994-1997	USEP2078	
5.4L V8 330 CID	1999		USEP2158	2.3L L4 140 CID	2001-2004	USEP2293	
				2.3L L4 140 CID	2004-2006	USEP8914	



Engine	Years	Application Description	USMW
<b>MAZDA (cont'd.)</b>			
<b>B2500</b>			
2.5L L4 2492cc	1998-2000	Extended Cab Pickup	USEP2068
2.5L L4 2492cc	1998-2000	Standard Cab Pickup	USEP2068
2.5L L4 2492cc	2001	Except for Bosch, Carter, and Delphi	USEP2226
<b>B2600</b>			
	1987-1988	Extended Cab Pickup	USEP8237
	1987-1988	Standard Cab Pickup	USEP8237
2.6L L4 2606cc	1989	Extended Cab Pickup	USEP8023
2.6L L4 2606cc	1989	Standard Cab Pickup	USEP8023
<b>B3000</b>			
	1994	114.0 / 289.6 Wheel Base	USEP2001
	1994	125.0 / 317.5 Wheel Base	USEP2001
	1994	108.0 / 274.3 Wheel Base	USEP2002
	1994	114.0 / 289.6 Wheel Base; (17 Gallon Fuel Tank)	USEP2002
3.0L V6 2986cc 182 CID	1995-1997		USEP2078
3.0L V6 2986cc 182 CID	1998	Extended Cab Pickup	USEP2068
3.0L V6 2986cc 182 CID	1998	Standard Cab Pickup	USEP2068
3.0L V6 2986cc 182 CID	2001-2003	(U), GAS	USEP2293
3.0L V6 2986cc 182 CID	2001-2003	(V), FLEX	USEP2293
3.0L V6 2986cc 182 CID	2004	Extended Cab Pickup	USEP2293
3.0L V6 2986cc 182 CID	2004	Standard Cab Pickup	USEP2293
<b>B4000</b>			
4.0L V6 4016cc	1994-1997		USEP2078
4.0L V6 4016cc	1998		USEP2068
4.0L V6 4016cc	1999	Extended Cab Pickup	USEP2068
4.0L V6 4016cc	1999	Standard Cab Pickup	USEP2068
4.0L V6 4016cc	2001-2003		USEP2293
<b>CX-7</b>			
2.5L L4 2488cc 152 CID	2010-2012		USEP8818
<b>CX-9</b>			
3.5L V6 3496cc 213 CID	2007		USEP2518
3.7L V6 3726cc 227 CID	2008-2010		USEP2518
<b>MIATA</b>			
1.6L L4 1597cc	1990-1993		USEP8229
1.8L L4 1839cc	1994-1997		USEP8229
1.8L L4 1839cc	1999-2004		USEP2111
1.8L L4 1839cc	2005	Naturally Aspirated	USEP2111
<b>MILLENNIA</b>			
2.3L V6 2254cc	1997	S; Supercharged	USEP3285
2.5L V6 2497cc	1997		USEP8229
<b>MPV</b>			
2.6L L4 2606cc	1989-1992		USEP8023
2.6L L4 2606cc	1993	From Chassis/VIN 536368	USEP8023
2.6L L4 2606cc	1993	To Chassis/VIN 536367	USEP8023
3.0L V6 2968cc 181 CID	2004		USEP8335
<b>MX-3</b>			
1.6L L4 1597cc	1992-1995		USEP8229
1.8L V6 1845cc	1992-1994		USEP8229
<b>MX-6</b>			
2.0L L4 1991cc	1993-1994		USEP8229
2.0L L4 1991cc	1995	Early	USEP2068
2.0L L4 1991cc	1995	Late	USEP2068
2.0L L4 1991cc	1996-1997		USEP2068
2.2L L4 2184cc	1988-1992	Naturally Aspirated	USEP8023
2.2L L4 2184cc	1988-1992	Turbocharged; 2-Wheel Steering	USEP8023
2.5L V6 2497cc	1993-1994		USEP8229
2.5L V6 2497cc	1995-1997		USEP2068
<b>PROTEGE</b>			
1.5L L4 1489cc	1995-1998		USEP8229
1.6L L4 1589cc	1999-2001		USEP8229
1.8L L4 1839cc	1990		USEP8023
1.8L L4 1839cc	1992-2000		USEP8229
2.0L L4 1998cc 122 CID	2003	Turbocharged	USEP8229
2.0L L4 2000cc	2001-2002		USEP8229
2.0L L4 2000cc	2003	Naturally Aspirated	USEP8229
<b>PROTEGE5</b>			
2.0L L4 2000cc	2002-2003		USEP8229
<b>RX-7</b>			
1.1L R2 1146cc	1985	S; CARB; External Pump	USEP8124
1.3L R2 1308cc	1985	External Pump	USEP8000
1.3L R2 1308cc	1987	Turbo; Turbocharged	USEP8023
1.3L R2 1308cc	1987-1988	Naturally Aspirated	USEP8023
1.3L R2 1308cc	1988	Turbocharged	USEP8023
1.3L R2 1308cc	1989	GXL 2+2; Naturally Aspirated	USEP8119
1.3L R2 1308cc	1989-1991	Turbo; Turbocharged	USEP8119
1.3L R2 1308cc	1990	GTUs, GXL, GXL 2+2; Naturally Aspirated	USEP8119
1.3L R2 1308cc	1991	Convertible; Naturally Aspirated	USEP8119

Engine	Years	Application Description	USMW
<b>MAZDA (cont'd.)</b>			
<b>RX-7 (cont'd.)</b>			
1.3L R2 1308cc	1993-1995		USEP8119
<b>TRIBUTE</b>			
2.0L L4 1989cc 121 CID	2003-2004		USEP2291
3.0L V6 2968cc 181 CID	2001-2003		USEP2291
<b>MERCEDES-BENZ</b>			
<b>190E</b>			
2.3L L4 2299cc	1985	External Pump, Late	USEP8314
2.3L L4 2299cc	1985-1988	Early, External Pump	USEP8177
2.3L L4 2299cc	1986-1987	2.3, 2.3-16; External Pump, Late	USEP8314
2.3L L4 2299cc	1988	2.3; External Pump, Late	USEP8314
2.3L L4 2299cc	1991-1993	External Pump, Late	USEP8177
2.3L L4 2299cc	1991-1993	2.3; Early, External Pump	USEP8314
2.6L L6 2599cc	1987-1993	External Pump	USEP8177
<b>260E</b>			
2.6L L6 2599cc	1987-1989	External Pump, Late	USEP8177
2.6L L6 2599cc	1987-1989	Early, External Pump	USEP8314
<b>280SE</b>			
2.8L L6 2746cc	1977	in-line external	USEP8144
2.8L L6 2746cc	1977		USEP8185
<b>300CE</b>			
3.0L L6 2962cc	1988-1992	External Pump	USEP8177
3.2L L6 3199cc	1993	External Pump	USEP8177
<b>300E</b>			
2.6L L6 2599cc	1990-1992	External Pump	USEP8177
2.8L L6 2799cc	1993	External Pump	USEP8177
3.0L L6 2962cc	1986-1989	External Pump, Late	USEP8177
3.0L L6 2962cc	1986-1989	Early, External Pump	USEP8314
3.0L L6 2962cc	1990	External Pump	USEP8177
3.0L L6 2962cc	1992-1993	External Pump	USEP8177
3.2L L6 3199cc	1993	External Pump	USEP8177
<b>300SE</b>			
3.0L L6 2962cc	1988-1991	External Pump	USEP8314
3.2L L6 3199cc	1992-1993	External Pump	USEP8177
<b>300SEL</b>			
3.0L L6 2962cc	1988-1991	External Pump	USEP8314
<b>300SL</b>			
3.0L L6 2962cc	1990-1993	External Pump	USEP8177
<b>300TE</b>			
3.0L L6 2962cc	1988-1993	External Pump	USEP8177
3.2L L6 3199cc	1993	External Pump	USEP8177
<b>380SE</b>			
3.8L V8 3839cc	1985	External Pump	USEP8314
<b>380SL</b>			
3.8L V8 3839cc	1985	External Pump	USEP8314
<b>400E</b>			
4.2L V8 4196cc	1992-1993	External Pump	USEP8177
<b>400SE</b>			
4.2L V8 4196cc	1992	External Pump	USEP8177
<b>400SEL</b>			
4.2L V8 4196cc	1993	External Pump	USEP8177
<b>420SEL</b>			
4.2L V8 4196cc	1986-1991	External Pump	USEP8177
<b>450SE</b>			
4.5L V8 4520cc	1976	in-line external	USEP8144
4.5L V8 4520cc	1976		USEP8185
<b>450SEL</b>			
4.5L V8 4520cc	1976-1977	in-line external	USEP8144
4.5L V8 4520cc	1976-1977		USEP8185
<b>450SL</b>			
4.5L V8 4520cc	1976-1977	in-line external	USEP8144
4.5L V8 4520cc	1976-1977		USEP8185
<b>450SLC</b>			
4.5L V8 4520cc	1976-1977	in-line external	USEP8144
4.5L V8 4520cc	1976-1977		USEP8185
<b>500E</b>			
5.0L V8 4973cc	1992-1993	External Pump	USEP8177
<b>500SEC</b>			
5.0L V8 4973cc	1985	External Pump	USEP8314
5.0L V8 4973cc	1993	External Pump	USEP8177
<b>500SEL</b>			
5.0L V8 4973cc	1985	External Pump	USEP8314

Engine	Years	Application Description	USMW	Engine	Years	Application Description	USMW
<b>MERCEDES-BENZ (cont'd.)</b>				<b>MERCEDES-BENZ (cont'd.)</b>			
<b>500SEL (cont'd.)</b>				<b>E420 (cont'd.)</b>			
5.0L V8 4973cc	1992-1993	External Pump	USEP8177	4.2L V8 4196cc	1995	External Pump, From Chassis/VIN 226336	USEP8289
<b>500SL</b>				4.2L V8 4196cc	1995	External Pump, To Chassis/VIN 226335	USEP8289
5.0L V8 4973cc	1990-1993	External Pump	USEP8177	<b>E430</b>			
<b>560SEC</b>				4.3L V8 4266cc	1998-1999	External Pump	USEP8289
5.6L V8 5547cc	1986-1991	External Pump	USEP8177	4.3L V8 4266cc	2000-2002	External Pump	USEP8286
<b>560SEL</b>				<b>E500</b>			
5.6L V8 5547cc	1986-1991	External Pump	USEP8177	5.0L V8 4973cc	1994	External Pump	USEP8177
<b>560SL</b>				<b>G55 AMG</b>			
5.6L V8 5547cc	1986-1989	External Pump	USEP8177	5.5L V8 5439cc 335 CID	2003-2004	External Pump	USEP8286
<b>600SEC</b>				<b>G500</b>			
6.0L V12 5987cc	1993	External Pump	USEP8177	5.0L V8 4966cc	2002-2004	External Pump	USEP8286
<b>600SEL</b>				5.0L V8 4966cc	2006-2008	External Pump	USEP8286
6.0L V12 5987cc	1992-1993	External Pump	USEP8177	5.0L V8 4973cc	2005	External Pump	USEP8286
<b>600SL</b>				<b>G550</b>			
6.0L V12 5987cc	1993	External Pump	USEP8177	5.5L V8 5461cc	2009	External Pump	USEP8286
<b>A160</b>				<b>S55 AMG</b>			
1.6L L4 1598cc 98 CID	2000-2001	MEX	USEP12223	5.5L V8 5439cc 335 CID	2001-2002	External Pump, To Chassis/VIN A272607	USEP8286
1.6L L4 1598cc 98 CID	2003	MEX	USEP12223	5.5L V8 5439cc 335 CID	2001-2002	External Pump, From Chassis/VIN A272608	USEP8480
<b>C36 AMG</b>				<b>S320</b>			
3.6L L6 3606cc	1995	External Pump	USEP8286	3.2L L6 3199cc	1994-1996	External Pump, To Chassis/VIN A220244	USEP8177
3.6L L6 3606cc	1996-1997	External Pump	USEP8289	3.2L L6 3199cc	1994-1996	External Pump, From Chassis/VIN A220245	USEP8289
<b>C43 AMG</b>				3.2L L6 3199cc	1997-1999	External Pump	USEP8289
4.3L V8 4266cc	1998-2000	External Pump	USEP8286	<b>S350</b>			
<b>C220</b>				3.7L V6 3724cc	2006	External Pump	USEP8480
2.2L L4 2199cc	1994	External Pump	USEP8177	<b>S420</b>			
2.2L L4 2199cc 134 CID	1995-1996	External Pump	USEP8177	4.2L V8 4196cc	1994-1995	External Pump, To Chassis/VIN A220244	USEP8177
<b>C230</b>				4.2L V8 4196cc	1994-1995	External Pump, From Chassis/VIN A220245	USEP8289
2.3L L4 2295cc	1997-2000	External Pump	USEP8286	4.2L V8 4196cc	1996-1999	External Pump	USEP8289
<b>C280</b>				<b>S430</b>			
2.8L L6 2799cc	1994	External Pump	USEP8177		2000	External Pump	USEP8289
2.8L L6 2799cc 171 CID	1995-1998	External Pump	USEP8286		2003	Base; (113.941); External Pump	USEP8480
2.8L V6 2799cc	1999-2000	External Pump	USEP8286		2003-2006	4Matic; (113.948); External Pump	USEP8480
<b>CL55 AMG</b>					2004-2005	Base; External Pump	USEP8480
5.5L V8 5439cc 335 CID	2001-2002	External Pump, To Chassis/VIN A016836	USEP8286	4.3L V8 4266cc	2001-2002	External Pump, To Chassis/VIN A272607	USEP8286
5.5L V8 5439cc 335 CID	2001-2002	External Pump, From Chassis/VIN A016837	USEP8480	4.3L V8 4266cc	2001-2002	External Pump, From Chassis/VIN A272608	USEP8480
<b>CL500</b>				4.3L V8 4266cc	2006	Base; External Pump	USEP8480
5.0L V8 4966cc	1998-1999	External Pump	USEP8289	<b>S500</b>			
5.0L V8 4973cc	2000-2002	External Pump, To Chassis/VIN A016836	USEP8480		1996-1997	Coupe; External Pump	USEP8289
5.0L V8 4973cc	2000-2002	External Pump, From Chassis/VIN A016837	USEP8480		1996-1997	Sedan; External Pump	USEP8289
5.0L V8 4973cc	2003-2005	External Pump	USEP8480		1998-1999	External Pump	USEP8289
<b>CL600</b>					2003-2006	4Matic; (113.966); External Pump	USEP8480
5.8L V12 5786cc 353 CID	1998-1999	External Pump	USEP8289		2003-2006	Base; (113.960); External Pump	USEP8480
5.8L V12 5786cc 353 CID	2001	External Pump, To 06/30/01	USEP8286	5.0L V8 4966cc	2000	External Pump	USEP8286
5.8L V12 5786cc 353 CID	2001	External Pump, From 06/30/01	USEP8480	5.0L V8 4966cc	2001	External Pump, To 06/30/2001	USEP8286
5.8L V12 5786cc 353 CID	2002	External Pump	USEP8480	5.0L V8 4966cc	2001	External Pump, From 06/30/2001	USEP8480
5.8L V12 5786cc 353 CID	2002	MEX	USEP8480	5.0L V8 4966cc	2002	External Pump	USEP8480
<b>CLK55 AMG</b>				5.0L V8 4973cc	1994	(To Chassis/VIN A22578), External Pump	USEP8177
5.5L V8 5439cc 335 CID	2001	External Pump, To Chassis/VIN A 018859	USEP8286	5.0L V8 4973cc	1994-1995	Coupe; (From Chassis/VIN A22579), External Pump	USEP8289
<b>CLK320</b>				5.0L V8 4973cc	1994-1995	Sedan; (From Chassis/VIN A22579), External Pump	USEP8289
3.2L V6 3199cc	1998-2003	External Pump	USEP8286	5.0L V8 4973cc	1995	(To Chassis/VIN A22579), External Pump	USEP8177
<b>CLK430</b>				<b>S600</b>			
4.3L V8 4266cc 260 CID	1999-2003	External Pump	USEP8286		1996-1997	Coupe; External Pump	USEP8289
<b>E55 AMG</b>					1996-1997	Sedan; External Pump	USEP8289
5.5L V8 5439cc 335 CID	1999	External Pump	USEP8289	5.8L V12 5786cc	2001	External Pump, To Chassis/VIN A272607	USEP8286
5.5L V8 5439cc 335 CID	2000-2002	External Pump	USEP8286	5.8L V12 5786cc	2001	External Pump, From Chassis/VIN A272608	USEP8480
<b>E320</b>				5.8L V12 5786cc 353 CID	2002	External Pump, To Chassis/VIN A272607	USEP8286
3.2L L6 3199cc	1994-1995	External Pump	USEP8177	5.8L V12 5786cc 353 CID	2002	External Pump, From Chassis/VIN A272608	USEP8480
3.2L L6 3199cc	1996-1997	External Pump	USEP8289	6.0L V12 5987cc	1994	(To Chassis/VIN A22578), External Pump	USEP8177
3.2L V6 3199cc	1998-1999	4Matic, Base; External Pump	USEP8289	6.0L V12 5987cc	1994-1995	Coupe; (From Chassis/VIN A22579), External Pump	USEP8289
3.2L V6 3199cc	2001	External Pump	USEP8286	6.0L V12 5987cc	1994-1995	Sedan; (From Chassis/VIN A22579), External Pump	USEP8289
3.2L V6 3199cc	2003	External Pump	USEP8286	6.0L V12 5987cc	1994-1995	External Pump	USEP8289
3.2L V6 3199cc 195 CID	2002	External Pump	USEP8286				
<b>E420</b>							
	1997	External Pump	USEP8289				

Engine	Years	Application Description	USMW	Engine	Years	Application Description	USMW
<b>MERCEDES-BENZ (cont'd.)</b>				<b>MERCURY (cont'd.)</b>			
<b>S600 (cont'd.)</b>				<b>GRAND MARQUIS (cont'd.)</b>			
6.0L V12 5987cc	1995	(To Chassis/VIN A22579), External Pump	USEP8177	4.6L V8 281 CID	2005-2007		USEP2576
6.0L V12 5987cc	1998-1999	External Pump	USEP8289	5.0L V8 302 CID	1985	Colony Park; (F), FI; External Pump	USEP2182
<b>SL320</b>				5.0L V8 302 CID	1985	LS; (F), FI, Sedan; External Pump	USEP2182
3.2L L6 3199cc	1994	External Pump	USEP8177	5.0L V8 302 CID	1986	(F), FI, Sedan; (From 05/86), External Pump	USEP2182
3.2L L6 3199cc	1995	External Pump, To Chassis/VIN F110984	USEP8177	5.0L V8 302 CID	1986	(F), FI, Wagon	USEP2182
3.2L L6 3199cc	1995	External Pump, From Chassis/VIN F110985	USEP8289	5.0L V8 302 CID	1986	(F), FI, Wagon; External Pump	USEP2182
3.2L L6 3199cc	1996-1997	External Pump	USEP8289	5.0L V8 302 CID	1986	Colony Park; (F), FI; External Pump, From 05/86	USEP2182
<b>SL500</b>				5.0L V8 302 CID	1986	Colony Park; (F), FI; External Pump, To 05/86	USEP2182
	1997-1998	External Pump	USEP8289	5.0L V8 302 CID	1986	(F), FI, Sedan; (To 05/86)	USEP2484
	2003	External Pump	USEP8480	5.0L V8 302 CID	1987-1989	LS; (F), FI, Sedan; External Pump	USEP2182
5.0L V8 4966cc	2006	External Pump	USEP8480	<b>LYNX</b>			
5.0L V8 4973cc	1994-1995	External Pump, To Chassis/VIN F110984	USEP8177	1.9L L4 116 CID	1986	XR3; (J), FI, GAS; External Pump	USEP2315
5.0L V8 4973cc	1994-1995	External Pump, From Chassis/VIN F110985	USEP8289	<b>MARAUDER</b>			
5.0L V8 4973cc	1996	External Pump	USEP8289		2003-2004	Except for Bosch, Carter, and Delphi	USEP2337
5.0L V8 4973cc	1999-2002	External Pump	USEP8286	<b>MARQUIS</b>			
5.0L V8 4973cc	2004-2005	External Pump	USEP8480	3.8L V6 232 CID	1984-1986	Wagon	USEP2003
<b>SL550</b>				<b>MILAN</b>			
5.5L V8 5461cc	2007-2009	External Pump	USEP8480	2.3L L4 140 CID	2006-2009		USEP2518
<b>SL600</b>				3.0L V6 2968cc 181 CID	2006-2009		USEP2518
	1996-1998	External Pump	USEP8289	<b>MONTEGO</b>			
	1995	External Pump, From Chassis/VIN F110985	USEP8289	3.0L V6 2968cc 181 CID	2005-2007		USEP2522
6.0L V12 5987cc	1995	External Pump, To Chassis/VIN F110984	USEP8289	<b>MONTEREY</b>			
6.0L V12 5987cc	1999	External Pump	USEP8286		2004	Base, Premier; (Incl. Tank Seal)	USEP2386
6.0L V12 5987cc 365 CID	2000-2002	External Pump	USEP8286		2005	(Incl. Tank Seal)	USEP2386
<b>SLK32 AMG</b>				<b>MOUNTAINEER</b>			
3.2L V6 3199cc	2002-2004	External Pump	USEP8286	4.0L V6 245 CID	1998-2000	(E); Except for Bosch, Carter, and Delphi	USEP2377
<b>SLK230</b>				4.0L V6 245 CID	2001	(E); (1 Port), Except for Bosch, Carter, and Delphi	USEP2377
2.3L L4 2295cc	1998-2004	External Pump	USEP8286	4.0L V6 245 CID	2002	(E), GAS	USEP2339
<b>SLK320</b>				4.6L V8 281 CID	2002	(W), GAS	USEP2339
3.2L V6 3199cc	2001-2004	External Pump	USEP8286	5.0L V8 302 CID	1997	From 07/29/96	USEP2059
<b>MERCURY</b>				5.0L V8 302 CID	1997	To 07/29/96	USEP2059
<b>CAPRI</b>				5.0L V8 302 CID	1998-2000	(P); Except for Bosch, Carter, and Delphi	USEP2377
1.6L L4 1598cc 98 CID	1991-1994	Naturally Aspirated	USEP8023	5.0L V8 302 CID	2001	(P); (1 Port), Except for Bosch, Carter, and Delphi	USEP2377
1.6L L4 1598cc 98 CID	1991-1994	Turbocharged	USEP8023	<b>MYSTIQUE</b>			
3.8L V6 232 CID	1985-1986		USEP2061	2.0L L4 1989cc 121 CID	1995-1996		USEP2068
5.0L V8 302 CID	1985-1986		USEP2061	2.0L L4 1989cc 121 CID	1997	GS, LS; (3); Exc. Fuel Tank Concern	USEP2373
<b>COLONY PARK</b>				2.0L L4 1989cc 121 CID	1997	GS, LS; (3); Fuel Tank Concern	USEP2373
	1987-1991		USEP2182	2.0L L4 1989cc 121 CID	1998	GS; (3); Exc. Fuel Tank Concern (From 02/09/98)	USEP2372
<b>COUGAR</b>				2.0L L4 1989cc 121 CID	1998	GS; (3); Exc. Fuel Tank Concern (To 02/09/98)	USEP2373
	1989-1990	LS; (4), Naturally Aspirated	USEP2044	2.0L L4 1989cc 121 CID	1998	GS; (3); Fuel Tank Concern	USEP2373
	1989-1990	XR-7; (R), Supercharged	USEP2044	2.0L L4 1989cc 121 CID	2000	From 05/03/99	USEP2390
2.0L L4 1989cc 121 CID	1999	Base; (3); From 05/25/99	USEP2372	2.5L V6 2450cc 155 CID	1995-1996		USEP2068
2.0L L4 1989cc 121 CID	1999	Base; (3); To 05/25/99	USEP2372	2.5L V6 2450cc 155 CID	1997	GS, LS; (L); Exc. Fuel Tank Concern	USEP2373
2.0L L4 1989cc 121 CID	1999-2002	From 05/03/99	USEP2390	2.5L V6 2450cc 155 CID	1997	GS, LS; (L); Fuel Tank Concern	USEP2373
2.3L L4 140 CID	1984	2 inch pump diameter	USEP2000	2.5L V6 2450cc 155 CID	1998	LS; (L); Fuel Tank Concern	USEP2373
2.3L L4 140 CID	1984	1.45 inch pump diameter	USEP2000A	2.5L V6 2450cc 155 CID	2000	From 05/03/99	USEP2390
2.3L L4 140 CID	1985-1986	XR-7; (W), Turbocharged	USEP2044	<b>SABLE</b>			
2.5L V6 2450cc 155 CID	1999	V6; (L); From 05/25/99	USEP2372		1987	16 Gallon Fuel Tank	USEP2001
2.5L V6 2450cc 155 CID	1999	V6; (L); To 05/25/99	USEP2372		1987	18.6 Gallon Fuel Tank (Digital Instrument Cluster)	USEP2042
2.5L V6 2450cc 155 CID	1999-2002	From 05/03/99	USEP2390		1987	18.6 Gallon Fuel Tank (Exc. Digital Instrument Cluster)	USEP2042
3.8L V6 232 CID	1984		USEP2003		2002	(S)	USEP2314
3.8L V6 232 CID	1986	LS; (3), Naturally Aspirated	USEP2024		2002	(U)	USEP2314
3.8L V6 232 CID	1987	LS; (3)	USEP2024	2.5L L4 153 CID	1986	(D); 16 Gallon Fuel Tank	USEP2001
3.8L V6 232 CID	1987-1988	LS; (4)	USEP2024	2.5L L4 153 CID	1986	(D); 18.6 Gallon Fuel Tank (Exc. Digital Instrument Cluster)	USEP2001
3.8L V6 232 CID	1991-1992	LS; (4)	USEP2044	2.5L L4 153 CID	1986	(D); 18.6 Gallon Fuel Tank (Digital Instrument Cluster)	USEP2042
3.8L V6 232 CID	1993-1997	(4)	USEP2044	3.0L V6 2968cc 181 CID	1997-1998		USEP2305
4.6L V8 281 CID	1994-1997	(W)	USEP2044	3.0L V6 2968cc 181 CID	2001		USEP2447
5.0L V8 302 CID	1983	2 inch pump diameter	USEP2000	3.0L V6 2968cc 181 CID	2003-2005		USEP2497
5.0L V8 302 CID	1983	1.45 inch pump diameter	USEP2000A	3.0L V6 2986cc 182 CID	1996-1997		USEP2303
5.0L V8 302 CID	1984		USEP2003	3.0L V6 2986cc 182 CID	2001	FLEX	USEP2497
5.0L V8 302 CID	1986	LS; (F), Naturally Aspirated	USEP2024	3.0L V6 2986cc 182 CID	2003-2005	FLEX	USEP2497
5.0L V8 302 CID	1987-1988	LS, XR-7; (F)	USEP2024	3.5L V6 3496cc 213 CID	2008-2009		USEP2518
5.0L V8 302 CID	1991-1992	LS, XR-7; (T)	USEP2044	3.8L V6 232 CID	1988-1989	(4); 16 Gallon Fuel Tank	USEP2001
5.0L V8 302 CID	1993	(T)	USEP2044	3.8L V6 232 CID	1988-1993	(4); 18.6 Gallon Fuel Tank (Digital Instrument Cluster)	USEP2042
<b>GRAND MARQUIS</b>				3.8L V6 232 CID	1988-1993	(4); 18.6 Gallon Fuel Tank (Exc. Digital Instrument Cluster)	USEP2042
	1995		USEP2378	3.8L V6 232 CID	1990-1995	(4); 16 Gallon Fuel Tank	USEP2042
	1996	(6)	USEP2378	3.8L V6 232 CID	1994	(4); 18.6 Gallon Fuel Tank (Digital Instrument Cluster) (From 01/94)	USEP2042
	1996	(W)	USEP2378				
	1997		USEP2378				
	1998-2000		USEP2374				
	2001-2002		USEP2375				
	2003-2004	Except for Bosch, Carter, and Delphi	USEP2337				



Engine	Years	Application Description	USMW
<b>MERCURY (cont'd.)</b>			
<b>SABLE (cont'd.)</b>			
3.8L V6 232 CID	1994	(4); 18.6 Gallon Fuel Tank (Digital Instrument Cluster) (To 01/94)	USEP2042
3.8L V6 232 CID	1994	(4); 18.6 Gallon Fuel Tank (Exc.Digital Instrument Cluster) (From 01/94)	USEP2042
3.8L V6 232 CID	1994	(4); 18.6 Gallon Fuel Tank (Exc.Digital Instrument Cluster) (To 01/94)	USEP2042
3.8L V6 232 CID	1995	(4); 18.6 Gallon Fuel Tank (Digital Instrument Cluster)	USEP2042
3.8L V6 232 CID	1995	(4); 18.6 Gallon Fuel Tank (Exc.Digital Instrument Cluster)	USEP2042
<b>TOPAZ</b>			
	1987	XR5; (S), FI, FWD	USEP2015
	1987	XR5; (X), FI	USEP2015
2.3L L4 140 CID	1985-1986	(S), FI, GAS	USEP2015
2.3L L4 140 CID	1985-1986	(X), FI, GAS	USEP2015
<b>TRACER</b>			
1.6L L4 1598cc 98 CID	1988-1989		USEP8023
1.8L L4 112 CID	1991-1993	LTS; (8)	USEP2065
1.9L L4 116 CID	1991-1993	LS; (J)	USEP2065
2.0L L4 1989cc 121 CID	1999		USEP2446
<b>VILLAGER</b>			
	1999-2002		USEP2319
3.0L V6 182 CID	1993-1998		USEP2067
<b>MERKUR</b>			
<b>XR4TI</b>			
2.3L L4 140 CID	1985-1989	2 inch pump diameter, External Pump	USEP2000
2.3L L4 140 CID	1985-1989	1.45 inch pump diameter, External Pump	USEP2000A
2.3L L4 140 CID	1985-1989		USEP2484
<b>MG</b>			
<b>MGB</b>			
1.8L L4 1798cc 110 CID	1968-1980		USEP8122
<b>MGC</b>			
2.9L L6 2912cc	1969		USEP8122
2.9L L6 2912cc 178 CID	1968-1969		USEP8122
<b>MIDGET</b>			
1.1L L4 1098cc 67 CID	1964-1966		USEP8016SP
1.3L L4 1275cc 78 CID	1967-1974		USEP8016SP
<b>MITSUBISHI</b>			
<b>3000GT</b>			
3.0L V6 2972cc 181 CID	1999	VR-4; (6G72T), (K), Turbocharged	USEP8119
3.0L V6 2972cc 181 CID	1999		USEP8229
<b>DIAMANTE</b>			
3.0L V6 2972cc 181 CID	1992-1995		USEP8229
3.5L V6 3497cc 215 CID	1997-2004		USEP8229
<b>ECLIPSE</b>			
1.8L L4 1755cc 107 CID	1990	Naturally Aspirated	USEP8023
1.8L L4 1755cc 107 CID	1991-1994		USEP8229
2.0L L4 1997cc 122 CID	1990	Naturally Aspirated	USEP8023
2.0L L4 1997cc 122 CID	1990	Turbocharged	USEP8023
2.0L L4 1997cc 122 CID	1995-1997	Naturally Aspirated	USEP8229
2.0L L4 1997cc 122 CID	1995-1997	Turbocharged	USEP8271
2.4L L4 2351cc	1996-1997		USEP8229
2.4L L4 2351cc	2000	GS; (4G64), (G)	USEP8455
2.4L L4 2351cc	2001	GS, Spyder GS; (4G64), (G)	USEP8455
2.4L L4 2351cc	2002	GS; (4G64), (G)	USEP8455
2.4L L4 2351cc	2002	Spyder GS; (4G64), (G); From 01/02	USEP8455
2.4L L4 2351cc	2002	Spyder GS; (4G64), (G); To 01/02	USEP8229
2.4L L4 2351cc	2002-2005		USEP8456
2.4L L4 2351cc	2004		USEP8456
3.0L V6 2972cc 181 CID	2000-2005		USEP8456
<b>EXPO</b>			
2.4L L4 2351cc	1992-1995		USEP8229
<b>EXPO LRV</b>			
1.8L L4 1834cc 112 CID	1992-1994		USEP8229
2.4L L4 2351cc	1993-1994		USEP8229
<b>GALANT</b>			
2.0L L4 1997cc 122 CID	1989-1990		USEP8023
2.0L L4 1997cc 122 CID	1991-1993		USEP8229
2.4L L4 2351cc	1985-1987		USEP8023
2.4L L4 2351cc	1994	From 11/93	USEP8229
2.4L L4 2351cc	1995	(From 03/95) (DSM Plant Built)	USEP8229
2.4L L4 2351cc	1996	Exc.Calif (USA Built)	USEP8229
2.4L L4 2351cc	1997-1998	Exc.Calif	USEP8229
2.4L L4 2351cc	2000		USEP8229
2.4L L4 2351cc	2001	ES; (4G64), (G)	USEP8455
2.4L L4 2351cc	2002-2003	LS; (4G64), (G)	USEP8455

Engine	Years	Application Description	USMW
<b>MITSUBISHI (cont'd.)</b>			
<b>GALANT (cont'd.)</b>			
2.4L L4 2378cc	2004	MEX	USEP8455
3.0L V6 2972cc 181 CID	1988		USEP8023
3.0L V6 2972cc 181 CID	2000		USEP8456
3.0L V6 2972cc 181 CID	2002-2003		USEP8456
<b>LANCER</b>			
2.0L L4 1997cc 122 CID	2005-2006		USEP8465
2.0L L4 1999cc 122 CID	2004		USEP8548
2.0L L4 1999cc 122 CID	2005-2006		USEP8465
2.0L L4 1999cc 122 CID	2007		USEP8548
2.0L L4 2000cc	2002-2004		USEP8548
2.4L L4 2400cc	2004		USEP8548
<b>MIGHTY MAX</b>			
2.4L L4 2351cc	1990	2 inch pump diameter	USEP3222
2.4L L4 2351cc	1991		USEP8229
2.4L L4 2351cc	1993		USEP8229
2.4L L4 2351cc	1994	(From 01/94)	USEP8229
2.4L L4 2351cc	1995-1996		USEP8229
3.0L V6 2972cc 181 CID	1990	2 inch pump diameter	USEP3222
3.0L V6 2972cc 181 CID	1991		USEP8229
3.0L V6 2972cc 181 CID	1993-1994		USEP8229
<b>MIRAGE</b>			
1.5L L4 1468cc 90 CID	1989	Naturally Aspirated	USEP8023
1.6L L4 1597cc 98 CID	1985-1988	2 inch pump diameter	USEP3222
1.6L L4 1597cc 98 CID	1989	Turbocharged	USEP8023
<b>MONTERO</b>			
3.0L V6 2972cc 181 CID	1989-1990	2 inch pump diameter	USEP3222
3.0L V6 2972cc 181 CID	1992-1996		USEP8229
3.5L V6 3497cc 215 CID	1994-1998		USEP8229
3.5L V6 3497cc 215 CID	1999-2000		USEP2158
<b>MONTERO SPORT</b>			
2.4L L4 2351cc	1997-1998		USEP8229
3.0L V6 2972cc 181 CID	1997-1998		USEP8229
3.5L V6 3497cc 215 CID	2005-2008	MEX	USEP2158
<b>OUTLANDER</b>			
	2003-2004		USEP8503
	2005	Limited, LS, XLS	USEP8503
	2006	Limited, LS, SE	USEP8503
3.0L V6 2998cc 182 CID	2007-2011		USEP8818
<b>PRECIS</b>			
	1990-1991	Base, RS	USEP8211
	1992-1994		USEP8211
<b>RAIDER</b>			
	2008-2009	Except for Bosch, Carter, and Delphi	USEP7206
3.7L V6 226 CID	2007	DuroCross, LS; (K); Except for Bosch, Carter, and Delphi	USEP7206
4.7L V8 287 CID	2007	LS, SE; (N); Except for Bosch, Carter, and Delphi	USEP7206
<b>SIGMA</b>			
3.0L V6 2972cc 181 CID	1989-1990		USEP8023
<b>STARION</b>			
2.6L L4 2555cc 156 CID	1985-1989	External Pump	USEP8000
<b>VAN</b>			
2.4L L4 2351cc	1987-1990	2 inch pump diameter	USEP3222
<b>NISSAN</b>			
<b>200SX</b>			
1.6L L4 1597cc 97 CID	1995-1997		USEP8229
1.8L L4 1809cc	1985-1986	Turbo; (C), (CA18ET), Turbocharged	USEP8375
2.0L L4 1974cc	1985-1986	XE; (CA20E), (P), Naturally Aspirated	USEP8375
2.0L L4 1974cc	1987	XE; (CA20E), (H), Naturally Aspirated	USEP8375
2.0L L4 1974cc	1988	XE; (CA20E), (P)	USEP8375
2.0L L4 1998cc	1995-1997		USEP8229
3.0L V6 2960cc 181 CID	1987	SE; (H), (VG30E), Naturally Aspirated	USEP8375
3.0L V6 2960cc 181 CID	1988	SE; (H), (VG30E)	USEP8375
<b>240SX</b>			
2.4L L4 2389cc	1989-1992		USEP8235
2.4L L4 2389cc	1994-1997		USEP8235
<b>300ZX</b>			
	1985-1989	2+2, Base; (H), (VG30), Naturally Aspirated	USEP8375
	1985-1989	Turbo; (C), (VG30T), Turbocharged	USEP8375
	1990-1996	Base; (R), (VG30DE), Naturally Aspirated; 2 Passenger Seating	USEP8111
	1990-1996	2+2; (R), (VG30DE), Naturally Aspirated	USEP8113
	1990-1996	Turbo; (C), (VG30DETT), Turbocharged	USEP8114

Engine	Years	Application Description	USMW
<b>NISSAN (cont'd.)</b>			
<b>720</b>			
2.0L L4 1952cc	1985	(F), (Z20), CARB, GAS; External Pump	USEP8318
2.0L L4 1952cc	1986	Base; (F), (Z20), CARB, GAS; External Pump	USEP8318
2.4L L4 2389cc	1985	(N), (Z24), CARB, GAS; External Pump	USEP8318
2.4L L4 2389cc	1986	Japan Built	USEP8376
<b>ALTIMA</b>			
2.4L L4 2389cc	1994-1995	GLE, GXE, SE, XE	USEP8247
2.4L L4 2389cc	1996	XE; to 10/95	USEP8247
2.4L L4 2389cc	2000-2001		USEP8229
2.4L L4 2400cc 146 CID	1996	MEX	USEP8229
2.4L L4 2400cc 146 CID	1996	GLE, GXE, SE; to 10/95	USEP8247
<b>AXXESS</b>			
2.4L L4 2389cc	1990	AWD	USEP8235
2.4L L4 2389cc	1991	CAN	USEP8235
<b>D21</b>			
2.4L L4 2389cc	1986-1990	Japan Built	USEP8376
2.4L L4 2389cc	1988-1989	XE; (N), (Z24); USA Built	USEP8032
2.4L L4 2389cc	1990	Base; (KA24E), (S); USA Built (From 02/90)	USEP8032
2.4L L4 2389cc	1990	Base; (KA24E), (S); USA Built (To 02/90)	USEP8032
2.4L L4 2389cc	1992	Base; (KA24E), (S); USA Built	USEP8032
2.4L L4 2389cc	1992	Japan Built (From 07/92)	USEP8229
2.4L L4 2389cc	1992-1994	Japan Built	USEP8376
2.4L L4 2389cc	1993		USEP8032
2.4L L4 2389cc	1994	Base; (KA24E), (S); Exc.Japan Built	USEP8032
2.4L L4 2389cc	1994	XE; (KA24E), (S); Exc.Japan Built Vehicle	USEP8032
3.0L V6 2960cc	1986-1989	Japan Built	USEP8376
3.0L V6 2960cc 181 CID	1990	(H), (VG30E), 104.3 / 264.9 Wheel Base, Standard Cab Pickup; (Exc.Japan Built Vehicle) (From 02/90)	USEP8032
3.0L V6 2960cc 181 CID	1990	(H), (VG30E), 104.3 / 264.9 Wheel Base, Standard Cab Pickup; (Exc.Japan Built Vehicle) (To 02/90)	USEP8032
3.0L V6 2960cc 181 CID	1990	(H), (VG30E), 116.1 / 294.9 Wheel Base, Standard Cab Pickup	USEP8032
3.0L V6 2960cc 181 CID	1990	(H), (VG30E), Standard Cab Pickup; (Heavy Duty) (Dual Rear Wheels)	USEP8032
3.0L V6 2960cc 181 CID	1990	(H), (VG30E), Standard Cab Pickup; (Heavy Duty) (Single Rear Wheels) (Japan Built)	USEP8032
3.0L V6 2960cc 181 CID	1990	(H), (VG30E); Exc.Japan Built Vehicle	USEP8032
3.0L V6 2960cc 181 CID	1990	Japan Built	USEP8376
3.0L V6 2960cc 181 CID	1992	SE; (H), (VG30E); To 01/1992 (Exc.Japan Built Vehicle)	USEP8032
3.0L V6 2960cc 181 CID	1992	From 01/1992 (Exc.Heavy Duty) (Japan Built Vehicle)	USEP8229
3.0L V6 2960cc 181 CID	1992-1994	Japan Built	USEP8376
<b>FRONTIER</b>			
2.4L L4 2389cc	1998	Low Fuel Warning	USEP8537
2.4L L4 2389cc	1998-2000	Exc.Low Fuel Warning	USEP8229
2.4L L4 2389cc	1999	(KA24DE); Low Fuel Warning	USEP8537
2.4L L4 2389cc	2000	XE; (KA24DE); Low Fuel Warning	USEP8537
2.4L L4 2389cc	2001-2004		USEP8229
2.4L L4 2389cc	2007	MEX	USEP8229
3.3L V6 3275cc	1999-2000		USEP8458
3.3L V6 3275cc	2001	SC; (VG33ER), Supercharged	USEP8499
3.3L V6 3275cc	2001-2004	Naturally Aspirated	USEP8458
3.3L V6 3275cc	2002-2003	SVE; (VG33ER), Supercharged	USEP8499
3.3L V6 3275cc	2004	SC; (VG33ER), Supercharged	USEP8499
<b>HIKARI</b>			
1.6L L4 1597cc 97 CID	1988-1992	Turbo; MEX	USEP8097
<b>LUCINO</b>			
1.6L L4 1597cc 97 CID	1996-2000	MEX	USEP8229
2.0L L4 1998cc 122 CID	1996-2000	MEX	USEP8229
<b>MAXIMA</b>			
	1985-1988		USEP8075
	1989-1991		USEP8190
	1992-1993	GXE; (H), (VG30E)	USEP8190
	1994	GXE; (H), (VG30E); From 02/94	USEP8190
	1994	GXE; (H), (VG30E); To 02/94	USEP8190
3.0L V6 2960cc 181 CID	1993-1994	SE	USEP8235
3.0L V6 2988cc 182 CID	1996	MEX	USEP8229
3.0L V6 2988cc 182 CID	1999	MEX	USEP8229
3.0L V6 2988cc 182 CID	2000-2001		USEP8335
3.5L V6 3498cc	2002-2003		USEP8335
<b>MICRA</b>			
1.4L L4 1386cc 85 CID	2005	MEX	USEP8229
<b>NX</b>			
1.6L L4 1597cc 97 CID	1991-1993	(E), (GA16DE)	USEP8272
2.0L L4 1998cc	1991-1993	(G), (SR20DE)	USEP8272

Engine	Years	Application Description	USMW
<b>NISSAN (cont'd.)</b>			
<b>PATHFINDER</b>			
	1989		USEP8116
	1990-1993	SE, XE	USEP8116
	1994-1995	LE, SE, XE	USEP8116
	2001-2003		USEP8432
2.4L L4 2389cc	1987	E; (N), (Z24I)	USEP8116
3.0L V6 2960cc 181 CID	1987-1988	XE; (H), (VG30I)	USEP8116
3.3L V6 3275cc	1996		USEP8229
3.5L V6 3498cc	2004	SE; (VQ35DE)	USEP8432
<b>PICKUP</b>			
2.4L L4 2389cc	1995		USEP8032
2.4L L4 2389cc	1995	Crew Cab Pickup, MEX; To 12/94	USEP8032
2.4L L4 2389cc	1995	Exc.Low Fuel Warning	USEP8229
2.4L L4 2389cc	1998-2004	MEX	USEP8229
3.0L V6 2960cc 181 CID	1995	SE, XE; (H), (VG30E), RWD	USEP8032
3.0L V6 2960cc 181 CID	1995	Japan Built	USEP8376
<b>PLATINA</b>			
1.6L L4 1598cc 98 CID	2002-2005	FI, GAS, MEX, Naturally Aspirated	USEP12027
1.6L L4 1598cc 98 CID	2006-2010	MEX	USEP12027
<b>PULSAR NX</b>			
	1987	XE; (E16I), (P)	USEP8097
	1987	SE; (CA16DE)	USEP8098
	1990	XE	USEP8098
1.6L L4 1597cc 97 CID	1988	XE; (E16I), (P)	USEP8097
1.6L L4 1597cc 97 CID	1989	XE; (G), (GA16I)	USEP8098
1.8L L4 1809cc	1988-1989	SE; (C), (CA18DE)	USEP8098
<b>QUEST</b>			
3.0L V6 2960cc 181 CID	1993-1998		USEP2067
3.3L V6 3275cc	1999-2002		USEP2068
<b>SENTRA</b>			
	1988	FWD; (USA Built)	USEP8097
	1988	4WD	USEP8118
	1989	FWD	USEP8098
	1990	XE	USEP8098
1.6L L4 1597cc 97 CID	1987	(E16I), (P), FI, GAS	USEP8097
1.6L L4 1597cc 97 CID	1991-1992	XE; (E), (GA16DE); Japan Built	USEP8272
1.6L L4 1597cc 97 CID	1991-1992	XE; (E), (GA16DE); USA Built	USEP8272
1.6L L4 1597cc 97 CID	1993	E, GXE, SE, XE; (E), (GA16DE); Japan Built	USEP8272
1.6L L4 1597cc 97 CID	1993	GXE, SE, XE; (E), (GA16DE); USA Built	USEP8272
1.6L L4 1597cc 97 CID	1994	E, GXE, Limited Edition, SE, XE; (E), (GA16DE); Japan Built	USEP8272
1.6L L4 1597cc 97 CID	1994	E, Limited Edition, SE, XE; (E), (GA16DE); USA Built	USEP8272
1.6L L4 1597cc 97 CID	1995	Japan Built	USEP8229
1.6L L4 1597cc 97 CID	1996	Mexico Built Vehicle	USEP8229
1.6L L4 1597cc 97 CID	2000	MEX	USEP8229
1.8L L4 1769cc	2000-2001		USEP2068
1.8L L4 1769cc	2002		USEP8335
2.0L L4 1998cc	1991-1994	SE-R; (G), (SR20DE); Japan Built	USEP8272
2.0L L4 1998cc	1991-1994	SE-R; (G), (SR20DE); USA Built	USEP8272
2.0L L4 1998cc 122 CID	1996	MEX	USEP8235
<b>STANZA</b>			
	1985	GL, XE; External Pump	USEP8312
	1986	External Pump	USEP8312
	1987-1989		USEP8048
2.4L L4 2389cc	1990-1992		USEP8235
<b>TIIDA</b>			
1.8L L4 1798cc	2007-2010	MEX	USEP12019
<b>TSUBAME</b>			
1.6L L4 1597cc 97 CID	1995		USEP8235
1.6L L4 1597cc 97 CID	1998	MEX	USEP8229
1.6L L4 1597cc 97 CID	2000	MEX	USEP8229
1.6L L4 1597cc 97 CID	2001-2004	MEX	USEP8235
<b>TSURU</b>			
1.6L L4 1597cc 97 CID	1993-1994	MEX	USEP8272
1.6L L4 1597cc 97 CID	1995-1997	MEX	USEP8235
1.6L L4 1597cc 97 CID	1998-2001	MEX	USEP8229
1.6L L4 1597cc 97 CID	2008	MEX	USEP8229
2.0L L4 1998cc 122 CID	1994	MEX	USEP8272
2.0L L4 1998cc 122 CID	1995-1996	MEX	USEP8235
<b>URVAN</b>			
2.4L L4 2389cc	2000-2005	MEX	USEP12027
2.4L L4 2389cc	2006-2007	MEX	USEP8229
<b>VAN</b>			
	1987		USEP8118
	1988	From 01/88	USEP8118
	1988	To 01/88	USEP8118

Engine	Years	Application Description	USMW	Engine	Years	Application Description	USMW
<b>NISSAN (cont'd.)</b>				<b>OLDSMOBILE (cont'd.)</b>			
<b>XTERRA</b>				<b>CUTLASS CALAIS</b>			
2.4L L4 2389cc	2000-2001	Naturally Aspirated	USEP8458	2.3L L4 138 CID	1990-1991	1.45 inch pump diameter	USEP3265
2.4L L4 2389cc	2002		USEP8458	2.3L L4 140 CID	1989		USEP3265
2.4L L4 2389cc	2003-2004		USEP8458	2.3L L4 140 CID	1989-1991		USEP3240
3.3L V6 3275cc	2000-2004		USEP8458	2.5L L4 2474cc 151 CID	1988-1991		USEP3212
<b>X-TRAIL</b>				<b>CUTLASS CIERA</b>			
2.5L L4 2488cc 152 CID	2002	MEX	USEP8458	2.2L L4 2190cc 134 CID	1993-1996	DOUBLE INLET	USEP3290
2.5L L4 2488cc 152 CID	2003-2006	MEX	USEP8376	2.2L L4 2190cc 134 CID	1993-1996	SINGLE INLET	USEP3290A
2.5L L4 2488cc 152 CID	2007-2008	MEX	USEP8458	2.5L L4 2474cc 151 CID	1986	Brougham, Holiday; (R), FI	USEP3902
<b>OLDSMOBILE</b>				<b>CUTLASS CRUISER</b>			
<b>88</b>				<b>CUTLASS SALON</b>			
3.8L V6 3791cc 231 CID	1995	DOUBLE INLET	USEP3290	2.5L L4 2474cc 151 CID	1987	Brougham, LS; (R)	USEP3902
3.8L V6 3800cc 231 CID	1992	2 inch pump diameter	USEP3222	2.5L L4 2474cc 151 CID	1988	Harness Stamped ARA	USEP3212
3.8L V6 3800cc 231 CID	1993-1994	Royale, Royale LS	USEP3305	2.5L L4 2474cc 151 CID	1988	LS, SL; (R); Harness Stamped APH	USEP3902
3.8L V6 3800cc 231 CID	1994	DOUBLE INLET, Harness Stamped CRC	USEP3290	2.5L L4 2474cc 151 CID	1989-1992		USEP3212
3.8L V6 3800cc 231 CID	1994	Harness Stamped CRC, SINGLE INLET	USEP3290A	2.8L V6 173 CID	1987-1989	1.45 inch pump diameter, Except for Bosch, Carter, and Delphi	USEP3240
3.8L V6 3800cc 231 CID	1995	Royale LSS; (1), Supercharged	USEP3285	3.1L V6 189 CID	1994-1996	DOUBLE INLET	USEP3290
3.8L V6 3800cc 231 CID	1995-1999	SINGLE INLET	USEP3290A	3.1L V6 189 CID	1994-1996	SINGLE INLET	USEP3290A
3.8L V6 3800cc 231 CID	1996-1999	DOUBLE INLET	USEP3290	3.3L V6 204 CID	1989-1992	1.45 inch pump diameter, Except for Bosch, Carter, and Delphi	USEP3240
<b>98</b>				<b>CUTLASS SUPREME</b>			
3.8L V6 3800cc 231 CID	1986-1987	1.45 inch pump diameter, Except for Bosch, Carter, and Delphi	USEP3240	2.3L L4 138 CID	1991	1.45 inch pump diameter	USEP3240
3.8L V6 3800cc 231 CID	1988	2 inch pump diameter, Harness Stamped CPB,CPC	USEP3222	2.3L L4 138 CID	1991		USEP3265
3.8L V6 3800cc 231 CID	1988	1.45 inch pump diameter, Except for Bosch, Carter, and Delphi, Harness Stamped HEL,HEM	USEP3240	2.3L L4 140 CID	1990	1.45 inch pump diameter, Except for Bosch, Carter, and Delphi, Prom Stamped WEL,WER	USEP3240
3.8L V6 3800cc 231 CID	1989-1992	2 inch pump diameter	USEP3222	2.3L L4 140 CID	1990	Prom Stamped WEM	USEP3265
3.8L V6 3800cc 231 CID	1992-1993	Touring; (1), Supercharged	USEP3285	2.8L V6 173 CID	1988	1.45 inch pump diameter, Except for Bosch, Carter, and Delphi, Prom Stamped WEC	USEP3240
3.8L V6 3800cc 231 CID	1993	Regency, Regency Elite, Touring; (L), Naturally Aspirated	USEP3305	2.8L V6 173 CID	1989	1.45 inch pump diameter, Except for Bosch, Carter, and Delphi, Prom Stamped WEL	USEP3240
3.8L V6 3800cc 231 CID	1994	Regency Elite; (1), Supercharged	USEP3285	3.1L V6 189 CID	1989	1.45 inch pump diameter, Except for Bosch, Carter, and Delphi, Prom Stamped WEL	USEP3240
3.8L V6 3800cc 231 CID	1994	DOUBLE INLET, Harness Stamped CRC	USEP3290	3.1L V6 189 CID	1990	1.45 inch pump diameter, Except for Bosch, Carter, and Delphi, Prom Stamped WEL,WER	USEP3240
3.8L V6 3800cc 231 CID	1994	Naturally Aspirated; Harness Stamped CRC, SINGLE INLET	USEP3290A	3.1L V6 189 CID	1990	Prom Stamped WEM	USEP3265
3.8L V6 3800cc 231 CID	1994	Regency, Regency Elite; (L), Naturally Aspirated	USEP3305	3.1L V6 189 CID	1991-1997		USEP3265
3.8L V6 3800cc 231 CID	1995	(1), Supercharged	USEP3285	3.4L V6 207 CID	1991-1994	1.45 inch pump diameter	USEP3240
3.8L V6 3800cc 231 CID	1995	Naturally Aspirated; SINGLE INLET	USEP3290A	3.4L V6 207 CID	1991-1996		USEP3265
3.8L V6 3800cc 231 CID	1995-1996	DOUBLE INLET	USEP3290	3.4L V6 207 CID	1996	1.45 inch pump diameter	USEP3240
3.8L V6 3800cc 231 CID	1996	SINGLE INLET	USEP3290A	4.3L V6 260 CID	1982-1983		USEP8012SP
5.7L V8 350 CID	1984	Regency Brougham	USEP8012SP	4.3L V6 260 CID	1984	Brougham	USEP8012SP
<b>ACHIEVA</b>				<b>CUTLASS SUPREME</b>			
2.3L L4 138 CID	1992-1995		USEP3313	5.7L V8 350 CID	1985	Base; (N), DIESEL, FI; External Pump Base	USEP3076
2.4L L4 2392cc 146 CID	1996-1998		USEP3240R	5.7L V8 350 CID	1985		USEP8012SP
3.1L V6 189 CID	1994-1995		USEP3313	<b>CUTLASS SUPREME</b>			
3.1L V6 189 CID	1996-1998		USEP3240R	2.3L L4 138 CID	1991	1.45 inch pump diameter	USEP3240
<b>ALERO</b>				2.3L L4 138 CID	1991		USEP3265
2.2L L4 2198cc 134 CID	2002-2003	(F), (L61); Except for Bosch, Carter, and Delphi	USEP3507	2.3L L4 140 CID	1990	1.45 inch pump diameter, Except for Bosch, Carter, and Delphi, Prom Stamped WEL,WER	USEP3240
2.2L L4 2198cc 134 CID	2004	GL; (F), (L61); Except for Bosch, Carter, and Delphi	USEP3507	2.3L L4 140 CID	1990	Prom Stamped WEM	USEP3265
2.4L L4 2392cc 146 CID	2000-2001	(T); Except for Bosch, Carter, and Delphi	USEP3507	2.8L V6 173 CID	1988	1.45 inch pump diameter, Except for Bosch, Carter, and Delphi, Prom Stamped WEC	USEP3240
3.4L V6 207 CID	2000-2003	(E); Except for Bosch, Carter, and Delphi	USEP3507	2.8L V6 173 CID	1989	1.45 inch pump diameter, Except for Bosch, Carter, and Delphi, Prom Stamped WEL	USEP3240
3.4L V6 207 CID	2004	GL; (E); Except for Bosch, Carter, and Delphi	USEP3507	3.1L V6 189 CID	1989	1.45 inch pump diameter, Except for Bosch, Carter, and Delphi, Prom Stamped WEL	USEP3240
<b>BRAVADA</b>				3.1L V6 189 CID	1990	1.45 inch pump diameter, Except for Bosch, Carter, and Delphi, Prom Stamped WEL,WER	USEP3240
4.3L V6 262 CID	1991		USEP3902	3.1L V6 189 CID	1990	Prom Stamped WEM	USEP3265
4.3L V6 262 CID	1992	(W)	USEP3270	3.1L V6 189 CID	1991-1997		USEP3265
4.3L V6 262 CID	1992	(Z)	USEP3902	3.4L V6 207 CID	1991-1994	1.45 inch pump diameter	USEP3240
4.3L V6 262 CID	1993-1994		USEP3270	3.4L V6 207 CID	1991-1996		USEP3265
4.3L V6 262 CID	1996-1997		USEP3240R	3.4L V6 207 CID	1996	1.45 inch pump diameter	USEP3240
4.3L V6 262 CID	1998	18 Gallon Fuel Tank	USEP3240R	4.3L V6 260 CID	1982-1983		USEP8012SP
4.3L V6 262 CID	1999-2001		USEP3240R	4.3L V6 260 CID	1984	Brougham	USEP8012SP
<b>CALAIS</b>				5.7L V8 350 CID	1984	Brougham	USEP8012SP
2.3L L4 138 CID	1987	1.45 inch pump diameter, 1st Design, Except for Bosch, Carter, and Delphi	USEP3240	5.7L V8 350 CID	1984		USEP8012SP
2.5L L4 2474cc 151 CID	1985	Base, Supreme; (U)	USEP3902	5.7L V8 350 CID	1985	Brougham, LS; (N), DIESEL, FI; External Pump	USEP3076
2.5L L4 2474cc 151 CID	1986-1987	GT, Supreme; (U)	USEP3902	5.7L V8 350 CID	1985	LS	USEP8012SP
3.0L V6 181 CID	1985-1987	1.45 inch pump diameter, Except for Bosch, Carter, and Delphi	USEP3240	<b>DELTA 88</b>			
<b>CUSTOM CRUISER</b>				3.0L V6 181 CID	1986	1.45 inch pump diameter, Except for Bosch, Carter, and Delphi	USEP3240
5.0L V8 305 CID	1991		USEP3268	3.8L V6 3800cc 231 CID	1986-1987	1.45 inch pump diameter, Except for Bosch, Carter, and Delphi	USEP3240
5.7L V8 350 CID	1984	(E)	USEP3268	3.8L V6 3800cc 231 CID	1988	2 inch pump diameter, Harness Stamped CPB,CPC	USEP3222
5.7L V8 350 CID	1985	Base	USEP8012SP	3.8L V6 3800cc 231 CID	1988	1.45 inch pump diameter, Except for Bosch, Carter, and Delphi, Harness Stamped HEL	USEP3240
5.7L V8 350 CID	1985	(N), DIESEL, FI; External Pump	USEP3076	3.8L V6 3800cc 231 CID	1989	2 inch pump diameter, Harness Stamped CPL	USEP3222
5.7L V8 350 CID	1992	(7)	USEP3268	<b>CUTLASS</b>			
<b>CUTLASS</b>				3.1L V6 189 CID	1997		USEP3240R



Engine	Years	Application Description	USMW	Engine	Years	Application Description	USMW
<b>OLDSMOBILE (cont'd.)</b>				<b>PEUGEOT (cont'd.)</b>			
<b>DELTA 88 (cont'd.)</b>				<b>GRAND RAID</b>			
3.8L V6 3800cc 231 CID	1989	1.45 inch pump diameter, Except for Bosch, Carter, and Delphi, Harness Stamped CPK, CPV	USEP3240	1.6L L4 1587cc 97 CID	2007	MEX	USEP12027
3.8L V6 3800cc 231 CID	1990-1991	2 inch pump diameter	USEP3222	<b>PARTNER</b>			
5.7L V8 350 CID	1984	Royale Brougham, Royale Brougham LS	USEP8012SP	1.6L L4 1587cc 97 CID	2004-2008	MEX	USEP12027
5.7L V8 350 CID	1985	Royale, Royale Brougham, Royale Brougham LS; (N), DIESEL, FI; External Pump	USEP3076	<b>PLYMOUTH</b>			
5.7L V8 350 CID	1985	Royale	USEP8012SP	<b>ACCLAIM</b>			
<b>FIRENZA</b>				2.5L L4 2507cc 153 CID	1991	Base, LE; (K)	USEP7041
1.8L L4 112 CID	1985	Base, Cruiser LX, Cruiser SX, GT; (0)	USEP3902	2.5L L4 2507cc 153 CID	1992	(K)	USEP7041
1.8L L4 112 CID	1986	Cruiser, LC, LX, S; (0)	USEP3902	2.5L L4 2507cc 153 CID	1993-1994	(K), GAS	USEP7041
2.0L L4 122 CID	1985	Base, Cruiser LX, Cruiser SX, GT; (P)	USEP3902	2.5L L4 2507cc 153 CID	1993-1994	(V), FLEX	USEP7041
2.0L L4 122 CID	1986	Cruiser, LC, LX, S; (P)	USEP3902	2.5L L4 2507cc 153 CID	1995	(K)	USEP7041
2.0L L4 122 CID	1987	Cruiser, LC, LX, S; (K)	USEP3902	3.0L V6 2972cc 181 CID	1991	Base, LE, LX; (3)	USEP7041
2.0L L4 1998cc 122 CID	1987-1988		USEP3212	3.0L V6 2972cc 181 CID	1992	(3)	USEP7041
2.8L V6 173 CID	1985-1987	1.45 inch pump diameter, Except for Bosch, Carter, and Delphi	USEP3240	3.0L V6 2972cc 181 CID	1993-1994	(3), GAS	USEP7041
<b>INTRIGUE</b>				3.0L V6 2972cc 181 CID	1995	(3)	USEP7041
3.5L V6 214 CID	1999-2000		USEP3240R	<b>BREEZE</b>			
3.8L V6 3800cc 231 CID	1998-1999		USEP3240R	2.0L L4 1996cc 122 CID	1996-1998	(C), (ECB)	USEP7041
<b>LSS</b>				2.0L L4 1996cc 122 CID	1998-2000		USEP7113
3.8L V6 3800cc 231 CID	1996	DOUBLE INLET	USEP3290	2.0L L4 1996cc 122 CID	1999-2000	(C)	USEP7041
3.8L V6 3800cc 231 CID	1996	Naturally Aspirated; SINGLE INLET	USEP3290A	2.4L L4 2429cc 148 CID	1997-1998	(EDZ), (X)	USEP7041
3.8L V6 3800cc 231 CID	1996	(1), Supercharged	USEP3367	2.4L L4 2429cc 148 CID	1998-2000		USEP7113
3.8L V6 3800cc 231 CID	1997	Naturally Aspirated; Single Inlet	USEP3290A	2.4L L4 2429cc 148 CID	1999-2000	(X)	USEP7041
3.8L V6 3800cc 231 CID	1998-1999	DOUBLE INLET	USEP3290	<b>CARAVELLE</b>			
3.8L V6 3800cc 231 CID	1998-1999	Naturally Aspirated; SINGLE INLET	USEP3290A	2.2L L4 135 CID	1985	SE; (D), FI, Naturally Aspirated	USEP7031
3.8L V6 3800cc 231 CID	1998-1999	(1), Supercharged	USEP3367	2.2L L4 135 CID	1986	Base, SE; (D), FI, Naturally Aspirated	USEP7000
<b>REGENCY</b>				2.5L L4 2507cc 153 CID	1986-1988	Base, SE; (K), FI, Naturally Aspirated	USEP7000
3.8L V6 3800cc 231 CID	1997-1998	DOUBLE INLET	USEP3290	<b>COLT</b>			
3.8L V6 3800cc 231 CID	1997-1998	SINGLE INLET	USEP3290A	1.5L L4 1468cc 90 CID	1988	2 inch pump diameter	USEP3222
<b>SILHOUETTE</b>				1.5L L4 1468cc 90 CID	1989	Naturally Aspirated	USEP8023
3.1L V6 189 CID	1998-2001		USEP3372	1.5L L4 1468cc 90 CID	1992		USEP8229
3.1L V6 189 CID	1990-1991		USEP3902	1.6L L4 1597cc 98 CID	1985-1988	2 inch pump diameter	USEP3222
3.1L V6 189 CID	1992-1994	(D)	USEP3902	1.6L L4 1597cc 98 CID	1989	Turbocharged	USEP8023
3.4L V6 207 CID	1996	1.45 inch pump diameter, Except for Bosch, Carter, and Delphi	USEP3240	1.8L L4 1754cc 107 CID	1989	2 inch pump diameter	USEP3222
3.4L V6 207 CID	1996		USEP3265	1.8L L4 1834cc 112 CID	1992		USEP8229
3.8L V6 3800cc 231 CID	1992-1995		USEP3265	2.0L L4 1997cc 122 CID	1988-1989	2 inch pump diameter	USEP3222
<b>TORONADO</b>				2.4L L4 2351cc	1992		USEP8229
3.8L V6 3800cc 231 CID	1986-1989	1.45 inch pump diameter, Except for Bosch, Carter, and Delphi	USEP3240	<b>CONQUEST</b>			
3.8L V6 3800cc 231 CID	1990-1992		USEP3265	2.6L L4 2555cc 156 CID	1985-1986	External Pump	USEP8000
5.7L V8 350 CID	1984-1985	Brougham	USEP8012SP	<b>GRAND VOYAGER</b>			
5.7L V8 350 CID	1985	Brougham, Caliente; (N), DIESEL, FI; External Pump	USEP3076		1989-1990	LE, SE	USEP7012
<b>PEUGEOT</b>				2.4L L4 2429cc 148 CID	1996	Base, SE; (B), GAS	USEP7041
<b>206</b>				2.4L L4 2429cc 148 CID	1997	Base, SE; (B)	USEP7041
1.4L L4 1360cc 83 CID	2000-2003	MEX	USEP12027	2.5L L4 2507cc 153 CID	1988	SE; (K)	USEP7000
1.4L L4 1360cc 83 CID	2006-2008	MEX	USEP12027	3.0L V6 2972cc 181 CID	1988	LE; (3)	USEP7012
1.6L L4 1587cc 97 CID	2001-2008	MEX	USEP12027	3.0L V6 2972cc 181 CID	1992	Base, SE; (3)	USEP7041
<b>307</b>				3.0L V6 2972cc 181 CID	1993	Base, LE, SE; (3)	USEP7041
2.0L L4 1997cc 122 CID	2003-2005	MEX	USEP12027	3.0L V6 2972cc 181 CID	1996	Base, SE; (3), GAS	USEP7041
2.0L L4 1997cc 122 CID	2006-2009	MEX	USEP12224	3.0L V6 2972cc 181 CID	1997	Base, SE; (3)	USEP7041
<b>405</b>				3.0L V6 2972cc 181 CID	1998	(3), (EFA), GAS	USEP7041
1.9L L4 1905cc	1989	External Pump	USEP8260	3.0L V6 2972cc 181 CID	1999-2000	(3), GAS	USEP7041
1.9L L4 1905cc	1990-1991		USEP8260	3.3L V6 3301cc 201 CID	1991		USEP7041
<b>406</b>				3.3L V6 3301cc 201 CID	1992	SE; (R), FWD	USEP7041
2.0L L4 1998cc 122 CID	2000-2004	MEX	USEP12027	3.3L V6 3301cc 201 CID	1993	LE, SE; (R), FWD	USEP7041
2.0L L4 1998cc 122 CID	2005	MEX	USEP12224	3.3L V6 3301cc 201 CID	1996	SE; (J), CNG	USEP7041
3.0L V6 2950cc 180 CID	2001	MEX	USEP12224	3.3L V6 3301cc 201 CID	1996	SE; (R), GAS	USEP7041
3.0L V6 2950cc 180 CID	2002	MEX	USEP12027	3.3L V6 3301cc 201 CID	1997	Base, SE; (R)	USEP7041
<b>505</b>				3.3L V6 3301cc 201 CID	1998	(EGA), (R), GAS	USEP7041
2.0L L4 1971cc	1985	GL, S; (1), GAS, Naturally Aspirated; External Pump	USEP8150	3.3L V6 3301cc 201 CID	1999-2000	(R), GAS	USEP7041
2.0L L4 1971cc	1985-1987		USEP8149	3.8L V6 3778cc 231 CID	1994	LE; (L), FWD	USEP7041
2.0L L4 1971cc	1986	GL, S, STI; (1), GAS, Naturally Aspirated; External Pump	USEP8150	3.8L V6 3778cc 231 CID	1999	(L), GAS	USEP7041
2.0L L4 1971cc	1987	Liberte; (1), GAS, Naturally Aspirated; External Pump	USEP8150	<b>HORIZON</b>			
2.2L L4 2155cc	1986-1987	External Pump	USEP8149		1988-1990		USEP7000
2.2L L4 2155cc	1989	External Pump	USEP8149	<b>LASER</b>			
2.2L L4 2165cc	1988	External Pump	USEP8149	1.8L L4 1755cc 107 CID	1990-1991	Naturally Aspirated	USEP8023
2.8L V6 2849cc	1987		USEP8149	2.0L L4 1997cc 122 CID	1990-1991	Naturally Aspirated	USEP8023
2.8L V6 2849cc	1988	External Pump	USEP8149	2.0L L4 1997cc 122 CID	1990-1991	Turbocharged	USEP8023
2.8L V6 2849cc	1989		USEP8149	<b>NEON</b>			
<b>607</b>				2.0L L4 1996cc 122 CID	1996	Exc. Plastic Fuel Tank	USEP7041
2.9L V6 2946cc 180 CID	2002-2006	MEX	USEP12027	2.0L L4 1996cc 122 CID	1996	Base, High Line, Sport; (C), (ECB); Except for Bosch, Carter, and Delphi, Plastic Fuel Tank	USEP7097
				2.0L L4 1996cc 122 CID	1996	Base, High Line, Sport; (ECC), (Y); Except for Bosch, Carter, and Delphi, Plastic Fuel Tank	USEP7097
				2.0L L4 1996cc 122 CID	1997	(C), (ECB); Except for Bosch, Carter, and Delphi	USEP7097
				2.0L L4 1996cc 122 CID	1997	(ECC), (Y); Except for Bosch, Carter, and Delphi	USEP7097
				2.0L L4 1996cc 122 CID	1998	High Line; (ECC), (Y); Except for Bosch, Carter, and Delphi	USEP7097

Engine	Years	Application Description	USMW	Engine	Years	Application Description	USMW
<b>PLYMOUTH (cont'd.)</b>				<b>PONTIAC (cont'd.)</b>			
<b>NEON (cont'd.)</b>				<b>BONNEVILLE (cont'd.)</b>			
2.0L L4 1996cc 122 CID	1998	Style; (C), (ECB); Except for Bosch, Carter, and Delphi	USEP7097	4.3L V6 262 CID	1986	Base, Brougham, LE; (Z), FI	USEP3211
2.0L L4 1996cc 122 CID	1999	High Line; (Y); Except for Bosch, Carter, and Delphi	USEP7097	<b>FIERO</b>			
2.0L L4 1996cc 122 CID	1999	Style; (C); Except for Bosch, Carter, and Delphi	USEP7097	2.5L L4 2474cc 151 CID	1985	Base, SE, Sport; (R)	USEP3902
<b>RELIANT</b>				2.5L L4 2474cc 151 CID	1986-1987	SE, Sport, Value Leader; (R)	USEP3902
2.2L L4 135 CID	1986	Base, LE, SE; (D)	USEP7000	2.5L L4 2474cc 151 CID	1988	Value Leader; (R)	USEP3902
2.2L L4 135 CID	1987	Base, LE; (D)	USEP7000	2.8L V6 173 CID	1985-1988	1.45 inch pump diameter, Except for Bosch, Carter, and Delphi	USEP3240
2.2L L4 135 CID	1988-1989	(D)	USEP7000	<b>FIREBIRD</b>			
2.5L L4 2507cc 153 CID	1986	Base, LE, SE; (K)	USEP7000	2.5L L4 2474cc 151 CID	1985	Base; (2), FI	USEP3901
2.5L L4 2507cc 153 CID	1987	Base, LE; (K)	USEP7000	2.5L L4 2474cc 151 CID	1986	Base; (2), FI	USEP3902
2.5L L4 2507cc 153 CID	1988-1989	(K)	USEP7000	2.8L V6 173 CID	1985	1.45 inch pump diameter, Except for Bosch, Carter, and Delphi	USEP3240
<b>SUNDANCE</b>				2.8L V6 173 CID	1986	1.45 inch pump diameter, Except for Bosch, Carter, and Delphi, Harness Stamped FEM	USEP3240
2.2L L4 135 CID	1987	(D), Naturally Aspirated	USEP7000	2.8L V6 173 CID	1987	1.45 inch pump diameter, Except for Bosch, Carter, and Delphi	USEP3240
2.2L L4 135 CID	1988	Base; (D), Naturally Aspirated	USEP7000	3.1L V6 189 CID	1990-1992	1.45 inch pump diameter, Except for Bosch, Carter, and Delphi	USEP3240
2.2L L4 135 CID	1991	America, High Line; (D), Naturally Aspirated	USEP7041	3.4L V6 207 CID	1993-1994	Base; (S)	USEP3907
2.2L L4 135 CID	1993-1994	Base; (D)	USEP7041	3.8L V6 3800cc 231 CID	1996-1997		USEP3983
2.5L L4 2507cc 153 CID	1988	Base; (K), Naturally Aspirated	USEP7000	3.8L V6 3800cc 231 CID	1998		USEP3745
2.5L L4 2507cc 153 CID	1991	High Line, RS; (K), Naturally Aspirated	USEP7041	3.8L V6 3800cc 231 CID	1999-2002		USEP3240R
2.5L L4 2507cc 153 CID	1991	RS; (J), Turbocharged	USEP7041	5.0L V8 305 CID	1985-1986	Trans Am; (F), FI	USEP3210
2.5L L4 2507cc 153 CID	1993-1994	Base, Duster; (K)	USEP7041	5.0L V8 305 CID	1986	Trans Am; (G), CARB	USEP3903
3.0L V6 2972cc 181 CID	1993-1994	Duster; (3)	USEP7041	5.0L V8 305 CID	1987	Base, Trans Am; (F), FI	USEP3210
<b>VOYAGER</b>				5.0L V8 305 CID	1990-1992	Formula, Trans Am, Trans Am GTA; (F)	USEP3210
2.4L L4 2429cc 148 CID	1996-1997	Base, SE; (B)	USEP7041	5.0L V8 305 CID	1990-1992	Base, Formula; (E)	USEP3902
2.4L L4 2429cc 148 CID	1998-2000		USEP7041	5.7L V8 350 CID	1987	Base, Trans Am; (8), FI	USEP3210
2.5L L4 2507cc 153 CID	1988	Base, LE, SE; (K)	USEP7000	5.7L V8 350 CID	1990-1992	Formula, Trans Am, Trans Am GTA; (8)	USEP3210
2.5L L4 2507cc 153 CID	1989	Base, LE, SE; (K), Naturally Aspirated	USEP7000	5.7L V8 350 CID	1993	Trans Am; (P)	USEP3908
2.5L L4 2507cc 153 CID	1989	Base, LE, SE; (J), Turbocharged	USEP7012	5.7L V8 350 CID	1994	Formula, Trans Am, Trans Am GT; (P)	USEP3908
2.5L L4 2507cc 153 CID	1990	LE, LX, SE; (K), Naturally Aspirated	USEP7000	5.7L V8 350 CID	1996-1997		USEP3240R
2.5L L4 2507cc 153 CID	1990	LE, LX, SE; (J), Turbocharged	USEP7012	5.7L V8 350 CID	1998	Formula, Trans Am; (G)	USEP3961
2.5L L4 2507cc 153 CID	1991	LE, LX, SE; (K)	USEP7041	<b>G5</b>			
2.5L L4 2507cc 153 CID	1994-1995	Base	USEP7041	2.2L L4 2198cc 134 CID	2007-2010		USEP3784
3.0L V6 2972cc 181 CID	1988	LE, SE; (3)	USEP7012	2.4L L4 2384cc 145 CID	2008		USEP3784
3.0L V6 2972cc 181 CID	1989	LE, SE; (3), Naturally Aspirated	USEP7012	<b>GRAND AM</b>			
3.0L V6 2972cc 181 CID	1990	LE, LX, SE; (3), Naturally Aspirated	USEP7012	2.0L L4 122 CID	1987-1988	1.45 inch pump diameter, Except for Bosch, Carter, and Delphi	USEP3240
3.0L V6 2972cc 181 CID	1991	LE, LX, SE; (3)	USEP7041	2.0L L4 122 CID	1989	1.45 inch pump diameter	USEP3240
3.0L V6 2972cc 181 CID	1994	Base, LE, LX, SE	USEP7041	2.2L L4 2198cc 134 CID	2002-2003	(F), (L61); Except for Bosch, Carter, and Delphi	USEP3507
3.0L V6 2972cc 181 CID	1995	Base, LE, SE	USEP7041	2.2L L4 2198cc 134 CID	2004-2005	SE; (F), (L61); Except for Bosch, Carter, and Delphi	USEP3507
3.0L V6 2972cc 181 CID	1995	Base, LE, SE	USEP7041	2.3L L4 138 CID	1988	1.45 inch pump diameter, Except for Bosch, Carter, and Delphi	USEP3240
3.0L V6 2972cc 181 CID	1996-1997	Base, SE; (3)	USEP7041	2.3L L4 138 CID	1990	1.45 inch pump diameter	USEP3240
3.0L V6 2972cc 181 CID	1998-2000		USEP7041	2.3L L4 138 CID	1994-1995		USEP3313
3.3L V6 3301cc 201 CID	1991	LE, SE; (R), FWD	USEP7041	2.3L L4 140 CID	1989	1.45 inch pump diameter, Except for Bosch, Carter, and Delphi	USEP3240
3.3L V6 3301cc 201 CID	1994	Base, LE, LX, SE	USEP7041	2.3L L4 140 CID	1991	1.45 inch pump diameter	USEP3240
3.3L V6 3301cc 201 CID	1995	Base, LE, SE	USEP7041	2.3L L4 140 CID	1992-1993		USEP3313
3.3L V6 3301cc 201 CID	1996	SE; (R)	USEP7041	2.4L L4 2392cc 146 CID	1996-1998		USEP3240R
3.3L V6 3301cc 201 CID	1997	Base, SE; (R)	USEP7041	2.4L L4 2392cc 146 CID	2000-2001	(T); Except for Bosch, Carter, and Delphi	USEP3507
3.3L V6 3301cc 201 CID	1998-2000		USEP7041	2.5L L4 2474cc 151 CID	1985-1986	Base, LE; (U)	USEP3902
3.8L V6 3778cc 231 CID	1999		USEP7041	2.5L L4 2474cc 151 CID	1987	Base, LE, SE; (U), Naturally Aspirated	USEP3902
<b>PONTIAC</b>				2.5L L4 2474cc 151 CID	1988-1991		USEP3212
<b>6000</b>				2.8L V6 173 CID	1986	FI; 1.45 inch pump diameter, Except for Bosch, Carter, and Delphi	USEP3240
2.5L L4 2474cc 151 CID	1986	Base, LE; (R), FI	USEP3902	2.8L V6 173 CID	1987-1989	2 inch pump diameter	USEP3222
2.5L L4 2474cc 151 CID	1987	Base, LE; (R)	USEP3902	2.8L V6 173 CID	1987-1989	1.45 inch pump diameter, Except for Bosch, Carter, and Delphi	USEP3240
2.5L L4 2474cc 151 CID	1988	Harness Stamped ARA	USEP3212	3.1L V6 189 CID	1988	1.45 inch pump diameter, Except for Bosch, Carter, and Delphi	USEP3240
2.5L L4 2474cc 151 CID	1988	Base, LE; (R); Harness Stamped APH	USEP3902	3.1L V6 189 CID	1990	Special Edition; (T), AWD, Sedan	USEP3210
2.5L L4 2474cc 151 CID	1989-1991		USEP3212	3.1L V6 189 CID	1990-1991	2 inch pump diameter	USEP3222
2.8L V6 173 CID	1986	FI; 1.45 inch pump diameter, Except for Bosch, Carter, and Delphi	USEP3240	3.1L V6 189 CID	1990-1991	1.45 inch pump diameter, Except for Bosch, Carter, and Delphi	USEP3240
2.8L V6 173 CID	1987-1989	2 inch pump diameter	USEP3222	4.3L V6 260 CID	1982-1984		USEP8012SP
2.8L V6 173 CID	1987-1989	1.45 inch pump diameter, Except for Bosch, Carter, and Delphi	USEP3240	<b>BONNEVILLE</b>			
3.1L V6 189 CID	1988	1.45 inch pump diameter, Except for Bosch, Carter, and Delphi	USEP3240	3.8L V6 3800cc 231 CID	1987	1.45 inch pump diameter, Except for Bosch, Carter, and Delphi	USEP3240
3.1L V6 189 CID	1990	Special Edition; (T), AWD, Sedan	USEP3210	3.8L V6 3800cc 231 CID	1988	2 inch pump diameter, Harness Stamped CPB,CPC	USEP3222
3.1L V6 189 CID	1990-1991	2 inch pump diameter	USEP3222	3.8L V6 3800cc 231 CID	1988	1.45 inch pump diameter, Except for Bosch, Carter, and Delphi, Harness Stamped CPD,CPE	USEP3240
3.1L V6 189 CID	1990-1991	1.45 inch pump diameter, Except for Bosch, Carter, and Delphi	USEP3240	3.8L V6 3800cc 231 CID	1989	1.45 inch pump diameter, Except for Bosch, Carter, and Delphi, Harness Stamped CPJ	USEP3240
4.3L V6 260 CID	1982-1984		USEP8012SP	3.8L V6 3800cc 231 CID	1990	2 inch pump diameter	USEP3222
<b>BONNEVILLE</b>				3.8L V6 3800cc 231 CID	1994-1999	Naturally Aspirated; Single Inlet To Chassis/VIN Y4120965	USEP3290A
3.8L V6 3800cc 231 CID	1987	1.45 inch pump diameter, Except for Bosch, Carter, and Delphi	USEP3240	3.8L V6 3800cc 231 CID	2000		USEP3240R
3.8L V6 3800cc 231 CID	1988	2 inch pump diameter, Harness Stamped CPB,CPC	USEP3222	3.8L V6 3800cc 231 CID	2001		USEP3240R
3.8L V6 3800cc 231 CID	1988	1.45 inch pump diameter, Except for Bosch, Carter, and Delphi, Harness Stamped CPD,CPE	USEP3240	3.8L V6 3800cc 231 CID	2003		USEP3240R
3.8L V6 3800cc 231 CID	1989	1.45 inch pump diameter, Except for Bosch, Carter, and Delphi, Harness Stamped CPJ	USEP3240	<b>GRAND PRIX</b>			
3.8L V6 3800cc 231 CID	1990	2 inch pump diameter	USEP3222	2.3L L4 138 CID	1990-1991		USEP3265
3.8L V6 3800cc 231 CID	1994-1999	Naturally Aspirated; Single Inlet To Chassis/VIN Y4120965	USEP3290A	2.8L V6 173 CID	1988	1.45 inch pump diameter, Except for Bosch, Carter, and Delphi, Prom Stamped WEC07	USEP3240
3.8L V6 3800cc 231 CID	2000		USEP3240R	2.8L V6 173 CID	1989	1.45 inch pump diameter, Except for Bosch, Carter, and Delphi, Prom Stamped WEL	USEP3240
3.8L V6 3800cc 231 CID	2001		USEP3240R	3.1L V6 189 CID	1989	SE; (V), Turbocharged	USEP3210
3.8L V6 3800cc 231 CID	2003		USEP3240R	3.1L V6 189 CID	1989	1.45 inch pump diameter, Except for Bosch, Carter, and Delphi, Prom Stamped WEL,WER	USEP3240
				3.1L V6 189 CID	1990-1996		USEP3265
				3.1L V6 189 CID	1998-2000		USEP3240R

Engine	Years	Application Description	USMW	Engine	Years	Application Description	USMW
<b>PONTIAC (cont'd.)</b>				<b>PORSCHE</b>			
<b>GRAND PRIX (cont'd.)</b>				<b>911</b>			
3.1L V6 3136cc 191 CID	1998		USEP3240R	2.7L H6 2688cc	1977		USEP8169
3.4L V6 207 CID	1991-1996		USEP3265	3.0L H6 2999cc	1978-1983		USEP8169
3.4L V6 207 CID	1992-1996		USEP3240	3.3L H6 3294cc	1986-1989		USEP8169
3.8L V6 3800cc 231 CID	1997	1.45 inch pump diameter To Chassis/VIN 238198	USEP3240R	3.3L H6 3294cc	1991-1992		USEP8169
3.8L V6 3800cc 231 CID	1998-2000		USEP3240R	3.6L H6 3606cc	1989-1992		USEP8307
4.3L V6 262 CID	1986	Base, Brougham, LE; (Z), FI	USEP3901	3.6L H6 3606cc	1993-1994		USEP8169
4.3L V6 262 CID	1987	Base, Brougham, LE; (Z), FI	USEP3902	3.6L H6 3606cc	1998		USEP8307
<b>J2000 SUNBIRD</b>				<b>924</b>			
1.8L L4 112 CID	1985	1.45 inch pump diameter, Except for Bosch, Carter, and Delphi	USEP3240	2.0L L4 1983cc	1977-1982		USEP8169
1.8L L4 112 CID	1985	Base, LE; (O), Naturally Aspirated	USEP3567	<b>928</b>			
2.0L L4 122 CID	1985	Base, LE; (P), Naturally Aspirated	USEP3567	4.5L V8 4474cc	1978-1979		USEP8169
<b>LEMANS</b>				4.5L V8 4474cc	1980-1982		USEP8171
	1988	Aerocoupe, Aerocoupe YL, SE, Value Leader	USEP3567	4.7L V8 4671cc	1983-1984		USEP8171
	1991-1992	LE, Value Leader	USEP3567	5.0L V8 4950cc	1985-1986		USEP8171
	1993	SE, Value Leader	USEP3567	5.0L V8 4950cc	1987-1991		USEP8307
1.6L L4 1588cc 98 CID	1989-1990	LE, Value Leader; (6)	USEP3567	5.4L V8 5392cc	1993-1995		USEP8307
2.0L L4 122 CID	1989	GSE, LE, SE; (K)	USEP3567	<b>RENAULT</b>			
2.0L L4 122 CID	1990	GSE; (K)	USEP3567	<b>ALLIANCE</b>			
<b>MATIZ</b>				1.4L L4 1397cc	1985	Base; (E)	USEP7010
1.0L L4 995cc 61 CID	2004-2009	MEX	USEP12020	1.4L L4 1397cc	1986	Base; (E); Digital Instrument Cluster, Except for Bosch, Carter, and Delphi	USEP7001
<b>MONTANA</b>				1.4L L4 1397cc	1986	Base; (E); Exc.Digital Instrument Cluster	USEP7010
	1999-2000		USEP3372	1.4L L4 1397cc 85 CID	1983	Base, DL, L, Limited, MT	USEP7006A
	2001	120.0 / 304.8 Wheel Base	USEP3372	1.4L L4 1397cc 85 CID	1984	Base, DL, L, Limited	USEP7006A
<b>PARISIENNE</b>				1.4L L4 1397cc 85 CID	1985	Base, DL, L; (D)	USEP7010
4.3L V6 262 CID	1985	Base, Brougham; (Z), FI, GAS	USEP3902	1.4L L4 1397cc 85 CID	1986	Base, DL, L; (D); Exc.Digital Instrument Cluster	USEP7010
4.3L V6 262 CID	1986	Base, Brougham; (Z), FI; Harness Stamped BEB	USEP3902	1.4L L4 1397cc 85 CID	1986-1987	Base, DL, L; (D); Digital Instrument Cluster, Except for Bosch, Carter, and Delphi	USEP7001
4.3L V6 262 CID	1986	Base, Brougham; (Z), FI; Harness Stamped BEG	USEP3902	1.4L L4 1397cc 85 CID	1987	Base, DL, L; (D); Exc.Digital Instrument Cluster, Except for Bosch, Carter, and Delphi	USEP7001
5.7L V8 350 CID	1984	Base, Brougham	USEP8012SP	1.4L L4 1397cc 85 CID	1987	DL, L, Limited; (A)	USEP7010
5.7L V8 350 CID	1985	Base, Brougham; (N), DIESEL, FI; External Pump	USEP3076	1.7L L4 105 CID	1985	Base, DL, L; (A); Digital Instrument Cluster, Except for Bosch, Carter, and Delphi	USEP7001
<b>SUNBIRD</b>				1.7L L4 105 CID	1986	Base, DL, L; (A); Exc.Digital Instrument Cluster	USEP7010
1.8L L4 112 CID	1986	1.45 inch pump diameter, Except for Bosch, Carter, and Delphi	USEP3240	1.7L L4 105 CID	1986	Base, DL, GS, L; (A); Digital Instrument Cluster, Except for Bosch, Carter, and Delphi	USEP7001
1.8L L4 112 CID	1986	GT, SE; (O), Naturally Aspirated	USEP3902	1.7L L4 105 CID	1987	Base, DL, GS, L; (A); Exc.Digital Instrument Cluster, Except for Bosch, Carter, and Delphi	USEP7001
2.0L L4 122 CID	1986	SE; (P), Naturally Aspirated	USEP3902	1.7L L4 105 CID	1987	GTA; (F3R), (V); Digital Instrument Cluster, Except for Bosch, Carter, and Delphi	USEP7001
2.0L L4 122 CID	1987	1.45 inch pump diameter, Except for Bosch, Carter, and Delphi	USEP3240	2.0L L4 1965cc 120 CID	1987	GTA; (F3R), (V); Exc.Digital Instrument Cluster, Except for Bosch, Carter, and Delphi	USEP7001
2.0L L4 122 CID	1987	Base, GT, SE; (K), Naturally Aspirated	USEP3902	2.0L L4 1965cc 120 CID	1987		USEP7001
2.0L L4 122 CID	1988-1990	1.45 inch pump diameter	USEP3240	<b>CLIO</b>			
2.0L L4 122 CID	1988-1991		USEP3212	1.6L L4 1598cc 98 CID	2002-2009	MEX	USEP12027
2.0L L4 122 CID	1992-1994		USEP3313	2.0L L4 1998cc 122 CID	2004	Sport; MEX	USEP12027
3.1L V6 189 CID	1991		USEP3265	<b>ENCORE</b>			
3.1L V6 189 CID	1992-1994		USEP3313	1.4L L4 1397cc	1985	Base; (E)	USEP7010
3.8L V6 3800cc 231 CID	1977-1980		USEP3736	1.4L L4 1397cc 85 CID	1984	Base, GS, LS, S	USEP7006A
<b>SUNFIRE</b>				1.4L L4 1397cc 85 CID	1985	Base, LS, S; (D)	USEP7010
	2003	Except for Bosch, Carter, and Delphi	USEP3507	1.4L L4 1397cc 85 CID	1986	LS, S; (D)	USEP7010
	2005	Except for Bosch, Carter, and Delphi	USEP3507	1.7L L4 105 CID	1985	GS, LS, S; (A)	USEP7010
2.2L L4 2190cc 134 CID	1995-1996		USEP3240R	1.7L L4 105 CID	1986	Electronic, GS, LS, S; (A)	USEP7010
2.2L L4 2190cc 134 CID	1998		USEP3240R	<b>FUEGO</b>			
2.2L L4 2190cc 134 CID	2000	(4); Except for Bosch, Carter, and Delphi, Plastic Fuel Tank	USEP3507	2.2L L4 2152cc 131 CID	1985	External Pump	USEP7334
2.2L L4 2190cc 134 CID	2002	(4); Except for Bosch, Carter, and Delphi	USEP3507	<b>KANGOO</b>			
2.2L L4 2198cc 134 CID	2002	(F), (L61); Except for Bosch, Carter, and Delphi	USEP3507	1.6L L4 1598cc 98 CID	2007-2009	MEX	USEP12027
2.2L L4 2200cc 134 CID	2002	MEX; Except for Bosch, Carter, and Delphi	USEP3507	<b>MEGANE</b>			
2.3L L4 138 CID	1995		USEP3240R	2.0L L4 1998cc 122 CID	2001-2003		USEP12026
2.4L L4 2392cc 146 CID	1996		USEP3240R	<b>R12</b>			
2.4L L4 2392cc 146 CID	1998		USEP3240R	1.6L L4 1647cc 100 CID	1980	TS; MEX	USEP7333
2.4L L4 2392cc 146 CID	2000	(T); Except for Bosch, Carter, and Delphi, Plastic Fuel Tank	USEP3507	<b>R18</b>			
2.4L L4 2392cc 146 CID	2000	MEX; Except for Bosch, Carter, and Delphi	USEP3507	1.6L L4 1647cc 100 CID	1980-1984	MEX	USEP7333
2.4L L4 2392cc 146 CID	2002	(T); Except for Bosch, Carter, and Delphi	USEP3507	2.0L L4 1995cc 122 CID	1984-1986	MEX	USEP7001
<b>TRANS SPORT</b>				<b>R18i</b>			
3.1L V6 189 CID	1998	Base, Montana	USEP3372	2.2L L4 2152cc 131 CID	1985-1986	External Pump	USEP7334
3.4L V6 207 CID	1990-1995		USEP3902	<b>SCENIC</b>			
3.4L V6 207 CID	1996	1.45 inch pump diameter, Except for Bosch, Carter, and Delphi	USEP3240	2.0L L4 1998cc 122 CID	2001-2004	MEX	USEP12026
3.4L V6 207 CID	1996		USEP3265	<b>SAAB</b>			
3.8L V6 3800cc 231 CID	1992-1995		USEP3265	<b>9-5</b>			
<b>VIBE</b>				2.3L L4 2290cc 140 CID	1999	(B235E)	USEP8077
1.8L L4 1794cc	2003-2006		USEP8213				
1.8L L4 1795cc	2003-2004		USEP8213				
1.8L L4 1795cc	2006		USEP8213				
2.4L L4 2362cc	2009-2010		USEP8801				



Engine	Years	Application Description	USMW
<b>SAAB (cont'd.)</b>			
<b>9-5 (cont'd.)</b>			
2.3L L4 2290cc 140 CID	2000	2.3t; (B235E), (E)	USEP8077
2.3L L4 2290cc 140 CID	2000	Aero; (B235R)	USEP8077
3.0L V6 2961cc 181 CID	1999	(B308E)	USEP8077
3.0L V6 2961cc 181 CID	2000	SE; (B308E), (Z)	USEP8077
<b>9-7X</b>			
4.2L L6 256 CID	2005	Linear	USEP3707
4.2L L6 256 CID	2006-2007	4.2i	USEP3707
<b>900</b>			
	1985	Turbo; (B202L), (L), Turbocharged	USEP8778
	1985-1986	Base, S; (B201), (J), Naturally Aspirated; External Pump	USEP8061
	1985-1986	Base, S; (B201), (J), Naturally Aspirated	USEP8778
	1986-1988	S; (B202), (D), Naturally Aspirated	USEP8778
	1986-1988	SPG; (B202L), (L), Turbocharged	USEP8778
	1987	SPG; (B202L), (L), Turbocharged; External Pump	USEP8096
	1987-1988	Base; (B201), (J), Naturally Aspirated; External Pump	USEP8060
	1987-1988	S; (B202), (D), Naturally Aspirated; External Pump	USEP8096
	1987-1988	Base; (B201), (J), Naturally Aspirated	USEP8778
	1988	SPG; (B202L), (L), Turbocharged; External Pump	USEP8060
2.0L L4 1985cc	1981-1984	Base, S, Turbo; FI, GAS	USEP8061
2.0L L4 1985cc	1990-1993		USEP8077
2.1L L4 2119cc	1991-1993		USEP8077
<b>9000</b>			
	1987	Turbo; (B202L), (L), Turbocharged; External Pump	USEP8096
	1988	Turbo; (B202L), (L), Turbocharged; From Chassis/VIN J1026230	USEP8077
	1988	Turbo; (B202L), (L), Turbocharged; External Pump, To Chassis/VIN J1026229	USEP8096
<b>SATURN</b>			
<b>ION</b>			
2.2L L4 2198cc 134 CID	2007		USEP3784
<b>SC</b>			
	1991-1992		USEP3910
<b>SC1</b>			
	1993-1996		USEP3910
1.9L L4 116 CID	1997-2002		USEP3545
<b>SC2</b>			
	1993-1996		USEP3910
1.9L L4 116 CID	1997-2002		USEP3545
<b>SL</b>			
1.9L L4 116 CID	1997-2002		USEP3545
<b>SL1</b>			
	1991-1996		USEP3910
1.9L L4 116 CID	1997-2002		USEP3545
<b>SL2</b>			
	1991-1996		USEP3910
1.9L L4 116 CID	1997-2002		USEP3545
<b>SW1</b>			
	1993-1996		USEP3910
1.9L L4 116 CID	1997-1999		USEP3545
<b>SW2</b>			
	1993-1996		USEP3910
1.9L L4 116 CID	1997-2001		USEP3545
<b>SCION</b>			
<b>TC</b>			
2.4L L4 2398cc	2005-2009		USEP8404
<b>XA</b>			
1.5L L4 1497cc	2004-2006		USEP8213
<b>XB</b>			
1.5L L4 1497cc	2004-2006		USEP8213
<b>SEAT</b>			
<b>ALHAMBRA</b>			
1.8L L4 1781cc	2002-2005	MEX	USEP12024
2.8L V6 2771cc	2002	MEX	USEP12024
<b>ALTEA</b>			
2.0L L4 1984cc 121 CID	2006	MEX	USEP12024
<b>CORDOBA</b>			
1.6L L4 1595cc 97 CID	2001-2002	MEX	USEP12024

Engine	Years	Application Description	USMW
<b>SEAT (cont'd.)</b>			
<b>CORDOBA (cont'd.)</b>			
1.6L L4 1597cc 98 CID	2004-2008	MEX	USEP12024
2.0L L4 1984cc 121 CID	2003-2008	MEX	USEP12024
<b>IBIZA</b>			
1.6L L4 1597cc 98 CID	2004-2008	MEX	USEP12024
2.0L L4 1984cc 121 CID	2003-2008	MEX	USEP12024
<b>LEON</b>			
1.8L L4 1781cc	2001-2006	MEX	USEP12024
2.0L L4 1984cc 121 CID	2006-2008	MEX	USEP12024
<b>TOLEDO</b>			
1.8L L4 1781cc	2001-2005	MEX	USEP12024
2.0L L4 1984cc 121 CID	2006	MEX	USEP12024
<b>STERLING</b>			
<b>825</b>			
2.5L V6 2494cc	1987-1988	From Chassis/VIN 200605	USEP8023
<b>827</b>			
2.7L V6 2675cc	1989-1991	To Chassis/VIN 200604	USEP8023
<b>SUBARU</b>			
<b>BAJA</b>			
2.5L H4 2458cc	2004-2006	Turbo; (EJ255), Turbocharged	USEP8450
	2003		USEP8229
<b>BRAT</b>			
	1985-1987	External Pump	USEP8095
<b>DL</b>			
	1985-1986	(4); External Pump	USEP8016S
	1985-1986	(5); External Pump	USEP8016S
	1987	(5), CARB; External Pump	USEP8016S
	1987	(4), FI; External Pump	USEP8059
	1988-1989	(4); External Pump	USEP8059
	1988-1989	(5); External Pump	USEP8059
<b>FORESTER</b>			
	2004	XT; (EJ255), Turbocharged	USEP8450
	2005	XT Premium; (EJ255), Turbocharged	USEP8450
	2006-2007	XT Limited; (EJ255), Turbocharged	USEP8450
	2008	Sports 2.5 XT, XT Limited; (EJ255), Turbocharged	USEP8450
2.5L H4 2458cc	1998-2002		USEP8229
2.5L H4 2458cc	2003		USEP8335
2.5L H4 2458cc	2006-2008	Naturally Aspirated	USEP8335
<b>GL</b>			
	1985	Base; (4), CARB, Naturally Aspirated; External Pump	USEP8095
	1985	Base; (5), CARB, Naturally Aspirated; External Pump	USEP8095
	1985	Turbo; (5), FI, Turbocharged; External Pump	USEP8312
	1985	Turbo; (7), FI, Turbocharged; External Pump	USEP8312
	1988-1989	Base; (4), FI, Naturally Aspirated; External Pump	USEP8059
	1988-1989	Base; (4), CARB, Naturally Aspirated; External Pump	USEP8095
	1988-1989	Base; (5), CARB, Naturally Aspirated; External Pump	USEP8095
	1989	Base; (5), FI, Naturally Aspirated; External Pump	USEP8059
1.6L H4 1595cc	1986	Base; (2), CARB, Naturally Aspirated; External Pump	USEP8095
1.6L H4 1595cc	1987	(2), CARB; External Pump	USEP8095
1.8L H4 1781cc	1986	Base; (4), CARB, Naturally Aspirated; External Pump	USEP8095
1.8L H4 1781cc	1986	Base; (4), FI, Naturally Aspirated; External Pump	USEP8095
1.8L H4 1781cc	1986	Base; (5), CARB, Naturally Aspirated; External Pump	USEP8095
1.8L H4 1781cc	1986	Base; (5), FI, Naturally Aspirated; External Pump	USEP8095
1.8L H4 1781cc	1986	Turbo; (5), FI, Turbocharged; External Pump	USEP8312
1.8L H4 1781cc	1987	(4), FI; External Pump	USEP8059
1.8L H4 1781cc	1987	(4), CARB; External Pump	USEP8095
1.8L H4 1781cc	1987	(5), CARB; External Pump	USEP8095
1.8L H4 1781cc	1987	(5), FI; External Pump	USEP8095
1.8L H4 1781cc	1988	Base; (5), FI, Naturally Aspirated; External Pump	USEP8059
<b>GL-10</b>			
	1987-1989	Base; (4), Naturally Aspirated; External Pump	USEP8059
1.8L H4 1781cc	1985	External Pump	USEP8059
1.8L H4 1781cc	1985-1989	Turbo	USEP8312
1.8L H4 1781cc	1986	Base; (4), Naturally Aspirated; External Pump	USEP8059

Engine	Years	Application Description	USMW	Engine	Years	Application Description	USMW
<b>SUBARU (cont'd.)</b>				<b>SUZUKI</b>			
<b>IMPREZA</b>				<b>AERIO</b>			
	2006	WRX STI; (EJ257), Turbocharged	USEP8450	2.0L L4 2000cc	2002-2003		USEP8229
	2006-2007	WRX, WRX Limited, WRX TR; (EJ255), Turbocharged	USEP8450	2.3L L4 2290cc 140 CID	2004-2007		USEP8229
	2007	WRX STI, WRX STI Limited; (EJ257), Turbocharged	USEP8450	<b>ESTEEM</b>			
1.8L H4 1781cc	1993-1994		USEP8229	1.6L L4 1590cc 97 CID	1995-1999		USEP8229
2.0L H4 1994cc	2002-2005	WRX; (EJ205), Turbocharged	USEP8450	1.6L L4 1590cc 97 CID	2000		USEP8335
2.2L H4 2212cc	1995-2001		USEP8229	1.8L L4 1790cc	2000-2001		USEP8335
2.5L H4 2458cc	2000-2001		USEP8229	<b>GRAND VITARA</b>			
2.5L H4 2458cc	2002-2004	Naturally Aspirated	USEP8335	2.5L V6 2500cc	1999-2005		USEP8229
2.5L H4 2458cc	2004-2005	WRX STI; (EJ257), Turbocharged	USEP8450	<b>SAMURAI</b>			
2.5L H4 2458cc	2005		USEP8229	1.3L L4 1298cc 79 CID	1990-1995		USEP2111
2.5L H4 2458cc	2006-2007	Naturally Aspirated	USEP8335	<b>SIDEKICK</b>			
<b>JUSTY</b>				1.6L L4 1590cc 97 CID	1989-1990		USEP8023
	1987	DL, GL; External Pump	USEP8016S	1.6L L4 1590cc 97 CID	1991	2 Doors	USEP8023
	1988	DL, GL; (7); External Pump	USEP8016S	1.6L L4 1590cc 97 CID	1991-1993	4 Doors	USEP2111
	1988	GL; (8); External Pump	USEP8016S	1.6L L4 1590cc 97 CID	1995	4 Doors	USEP2111
1.2L L3 1189cc	1990-1994		USEP8229	1.6L L4 1590cc 97 CID	1996-1998		USEP8229
				1.8L L4 1840cc	1996-1998		USEP8229
<b>LEGACY</b>				<b>SWIFT</b>			
2.2L H4 2212cc	1999		USEP8229	1.3L L4 1298cc 79 CID	1989	From Chassis/VIN KS5107973	USEP8076
2.5L H4 2458cc	1998	GT, GT Limited, Outback; (6)	USEP8235	1.3L L4 1298cc 79 CID	1989-1994	DOHC	USEP8023
2.5L H4 2458cc	1999-2003		USEP8229	1.3L L4 1298cc 79 CID	1990-1994	SOHC	USEP8076
2.5L H4 2458cc	2005-2009		USEP8513	1.3L L4 1298cc 79 CID	1995-2001		USEP8229
3.0L H6 3000cc	2008-2009		USEP8513	<b>VITARA</b>			
<b>LOYALE</b>				1.6L L4 1590cc 97 CID	1999-2001		USEP8229
	1990	Base, RS; (5), Naturally Aspirated; External Pump	USEP8059	2.0L L4 2000cc	1999-2000		USEP8229
	1990	Base; (4), Naturally Aspirated; External Pump	USEP8059	2.5L V6 2500cc	2004		USEP8229
	1990	RS Turbo, Turbo; (5), Turbocharged; External Pump	USEP8312	<b>X-90</b>			
	1990	Turbo; (4), Turbocharged; External Pump	USEP8312	1.6L L4 1590cc 97 CID	1996-1998		USEP8229
	1991-1993	(4); External Pump	USEP8059	<b>TOYOTA</b>			
	1991-1993	(5); External Pump	USEP8059	<b>4RUNNER</b>			
	1994	External Pump	USEP8059	2.4L L4 2366cc	1985-1988	Naturally Aspirated	USEP8023
<b>OUTBACK</b>				2.4L L4 2366cc	1985-1988	Turbocharged	USEP8023
2.5L H4 2458cc	2000-2003		USEP8229	2.4L L4 2366cc	1989-1991		USEP8023
2.5L H4 2458cc	2005-2009		USEP8513	2.4L L4 2366cc	1992-1994		USEP8213
3.0L H6 3000cc	2001-2004		USEP8335	2.7L L4 2694cc	1997-2000		USEP8213
3.0L H6 3000cc	2005-2009		USEP8513	3.0L V6 2959cc	1988	Naturally Aspirated	USEP8023
<b>RX</b>				3.0L V6 2959cc	1989-1991		USEP8023
	1986	External Pump	USEP8059	3.0L V6 2959cc	1992-1994		USEP8213
	1987	External Pump, From 02/87	USEP8312	3.4L V6 3378cc	1997-2002		USEP8213
	1987	External Pump, To 02/87	USEP8312	4.0L V6 3956cc 241 CID	2003-2009		USEP8501
	1988-1989	External Pump	USEP8312	4.7L V8 4663cc 285 CID	2003-2005		USEP8501
<b>STANDARD</b>				<b>AVALON</b>			
1.6L H4 1595cc	1985-1986	External Pump	USEP8095	3.0L V6 2995cc	2001		USEP8418
1.8L H4 1781cc	1987	(2); External Pump	USEP8095	3.0L V6 2995cc	1995-1999		USEP8213
	1987	(5); External Pump	USEP8016S	3.0L V6 2995cc	2000		USEP8404
<b>SVX</b>				3.0L V6 2995cc	2002-2004		USEP8213
3.3L H6 3318cc	1992-1997		USEP8235	3.5L V6 3456cc	2005-2009		USEP8213
<b>XT</b>				<b>CAMRY</b>			
	1985	DL, GL; (4), Naturally Aspirated; External Pump	USEP8312	2.2L L4 2164cc	1992	USA Built	USEP8213
	1985	GL-10 Turbo; (4), Turbocharged; External Pump	USEP8312	2.2L L4 2164cc	1993	Japan Built	USEP8213
	1985	GL-10 Turbo; (7), Turbocharged; External Pump	USEP8312	2.2L L4 2164cc	1997	USA Built	USEP8213
	1986	DL, GL; (4), Naturally Aspirated; External Pump, From 07/86	USEP8312	2.2L L4 2164cc	2000		USEP8213
	1986	DL, GL; (4), Naturally Aspirated; External Pump, To 06/86	USEP8312	2.2L L4 2164cc	2001	Japan Built	USEP8213
	1986	GL-10 Turbo; (4), Turbocharged; External Pump, From 07/86	USEP8312	2.2L L4 2164cc	2001	XLE; (5S-FE), GAS; USA Built	USEP8419
	1986	GL-10 Turbo; (4), Turbocharged; External Pump, To 06/86	USEP8312	2.4L L4 2357cc 144 CID	2002-2005	MEX	USEP8213
	1986	GL-10 Turbo; (7), Turbocharged; External Pump, From 07/86	USEP8312	2.4L L4 2357cc 144 CID	2007-2008		USEP8727
	1986	GL-10 Turbo; (7), Turbocharged; External Pump, To 06/86	USEP8312	2.4L L4 2362cc	2002-2006		USEP8404
	1986	GL-10 Turbo; (4), Turbocharged; External Pump, From 07/86	USEP8312	2.4L L4 2362cc	2007-2009		USEP8727
	1986	GL-10 Turbo; (4), Turbocharged; External Pump, To 06/86	USEP8312	2.4L L4 2362cc 144 CID	2009		USEP8727
	1986	GL-10 Turbo; (7), Turbocharged; External Pump, From 07/86	USEP8312	2.5L L4 2494cc 152 CID	2010-2011		USEP8727
	1986	GL-10 Turbo; (7), Turbocharged; External Pump, To 06/86	USEP8312	3.0L V6 2959cc	1992	USA Built	USEP8213
	1987	DL, GL, GL-10; (4), Naturally Aspirated; External Pump	USEP8312	3.0L V6 2959cc	1993	Japan Built	USEP8213
	1987	GL-10 Turbo; (7), Turbocharged; External Pump	USEP8312	3.0L V6 2995cc	1997-1998	USA Built	USEP8213
	1987	GL, GL-10 Turbo; (4), Turbocharged; External Pump	USEP8312	3.0L V6 2995cc	2000		USEP8213
	1987	GL; (7), Naturally Aspirated; External Pump	USEP8312	3.0L V6 2995cc	2001	Japan Built	USEP8213
1.8L H4 1781cc	1988	DL, GL; (4); External Pump	USEP8312	3.0L V6 2995cc	2001	XLE; (1MZ-FE), GAS; USA Built	USEP8419
1.8L H4 1781cc	1988-1989	GL; (7); External Pump	USEP8312	3.0L V6 2995cc	2002		USEP8404
1.8L H4 1781cc	1989-1991	GL; (4); External Pump	USEP8312	3.0L V6 2995cc	2003-2004	5 Speeds	USEP8213
2.7L H6 2672cc	1988-1991	XT6; (8); External Pump	USEP8312	3.0L V6 2995cc	2003-2004	4 Speeds	USEP8404
2.7L H6 2672cc	1989-1990	XT6; (9); External Pump	USEP8312	3.0L V6 2995cc	2005-2006		USEP8213
				3.3L V6 3300cc	2004		USEP8213
				3.3L V6 3300cc 202 CID	2005-2006		USEP8213
				3.5L V6 3456cc	2007-2009		USEP8213
<b>CELICA</b>				<b>CELICA</b>			
				1.6L L4 1587cc	1990-1993	ST; (4A-FE), (A), Naturally Aspirated	USEP8119
				1.8L L4 1762cc 107 CID	1994-1997		USEP8213
				1.8L L4 1794cc	2000-2005		USEP8213
				2.0L L4 1998cc	1986		USEP8023

Engine	Years	Application Description	USMW
<b>TOYOTA (cont'd.)</b>			
<b>CELICA (cont'd.)</b>			
2.0L L4 1998cc 122 CID	1987-1989		USEP8023
2.0L L4 1998cc 122 CID	1990-1992	All Trac; (3S-GTE), (S), Turbocharged	USEP8119
2.0L L4 1998cc 122 CID	1993	GTS All Trac; (3S-GTE), (S), Turbocharged	USEP8119
2.2L L4 2164cc	1990-1992	GT, GTS; (5S-FE), (S), Naturally Aspirated	USEP8119
2.2L L4 2164cc	1993	GTS; (5S-FE), (S), Naturally Aspirated	USEP8119
2.2L L4 2164cc	1994-1999		USEP8213
2.2L L4 2189cc	1975-1979		USEP8188
2.4L L4 2366cc	1984-1985		USEP8023
2.8L L6 2754cc	1985-1986		USEP8023
<b>COROLLA</b>			
1.6L L4 1587cc	1992	Base, DLX, DLX All Trac, LE; (4A-FE)	USEP8119
1.6L L4 1587cc	1993	(USA Built)	USEP8213
1.6L L4 1587cc	1994-1996	Japan Built	USEP8213
1.6L L4 1587cc	1994-1996	USA Built	USEP8271
1.6L L4 1588cc 97 CID	1975-1976		USEP8188
1.8L L4 1762cc 107 CID	1993	(Japan Built)	USEP8213
1.8L L4 1762cc 107 CID	1993-1995	Manual Trans; (USA Built)	USEP8271
1.8L L4 1762cc 107 CID	1995	(Japan Built)	USEP8213
1.8L L4 1794cc	1998-2002		USEP8213
1.8L L4 1794cc	2005-2006		USEP8404
1.8L L4 1795cc	2005		USEP8404
<b>CORONA</b>			
2.2L L4 2189cc	1975-1979		USEP8188
<b>CRESSIDA</b>			
2.8L L6 2754cc	1985-1988		USEP8023
3.0L L6 2954cc	1989-1992		USEP8023
<b>ECHO</b>			
1.5L L4 1497cc	2000-2005		USEP8213
<b>HIGHLANDER</b>			
2.4L L4 2362cc	2001-2003		USEP8404
2.4L L4 2362cc	2004-2007		USEP8571
3.0L V6 2995cc	2001-2003		USEP8404
3.3L V6 3300cc	2004	(3MZ-FE)	USEP8516
3.3L V6 3300cc 202 CID	2005	(3MZ-FE)	USEP8516
3.3L V6 3300cc 202 CID	2005-2007	GAS, USA	USEP8513
3.3L V6 3300cc 202 CID	2006	Limited, Sport; (3MZ-FE), GAS	USEP8516
3.3L V6 3300cc 202 CID	2006-2007	ELECTRIC/GAS	USEP8404
3.3L V6 3300cc 202 CID	2007	Base, Limited, Sport; (3MZ-FE), GAS	USEP8516
3.5L V6 3456cc	2008-2010		USEP8866
<b>LAND CRUISER</b>			
4.0L L6 3956cc	1988-1992		USEP8023
4.5L L6 4477cc	1993-1997		USEP8240
4.7L V8 4663cc 285 CID	1999-2007		USEP8240
<b>MATRIX</b>			
1.8L L4 1794cc	2005-2007		USEP8404
2.4L L4 2362cc	2009-2013		USEP8801
<b>MR2</b>			
1.6L L4 1587cc	1985-1989		USEP8023
2.0L L4 1998cc 122 CID	1991-1993	Turbo; (3S-GTE), Turbocharged	USEP8119
2.2L L4 2164cc	1991-1993		USEP8023
<b>MR2 SPYDER</b>			
	2000-2005		USEP8419
<b>PASEO</b>			
1.5L L4 1497cc	1992-1998		USEP8213
<b>PICKUP</b>			
2.2L L4 2189cc	1975-1979		USEP8188
2.4L L4 2366cc	1985-1987		USEP8023
2.4L L4 2366cc	1992-1995		USEP8213
3.0L V6 2959cc	1992-1995		USEP8213
<b>PREVIA</b>			
2.4L L4 2438cc	1991-1993		USEP8023
2.4L L4 2438cc	1994	To 01/94	USEP8023
2.4L L4 2438cc	1994	From 01/94	USEP8213
2.4L L4 2438cc	1994-1995	Supercharged	USEP8240
2.4L L4 2438cc	1995	Naturally Aspirated	USEP8213
2.4L L4 2438cc	1996-1997		USEP8240
<b>RAV4</b>			
2.0L L4 1998cc 122 CID	2004-2005		USEP8419
2.0L L4 1998cc 122 CID	1996-2000		USEP8213
2.0L L4 1998cc 122 CID	2001-2003	(1AZ-FE), FI, GAS, Naturally Aspirated	USEP8419
2.4L L4 2362cc	2008		USEP8798
2.4L L4 2400cc 146 CID	2008		USEP8798
2.5L L4 2494cc 152 CID	2009-2016		USEP9086
<b>SEQUOIA</b>			
4.7L V8 4663cc 285 CID	2001-2002		USEP8240

Engine	Years	Application Description	USMW
<b>TOYOTA (cont'd.)</b>			
<b>SEQUOIA (cont'd.)</b>			
4.7L V8 4663cc 285 CID	2003	To 08/02	USEP8240
4.7L V8 4663cc 285 CID	2003	From 08/02	USEP8505
4.7L V8 4663cc 285 CID	2004		USEP8505
<b>SIENNA</b>			
	2001-2003		USEP8418
3.0L V6 2995cc	1998-2000		USEP8213
3.3L V6 3300cc 202 CID	2004-2006		USEP8513
<b>SOLARA</b>			
2.2L L4 2164cc	1999	SE; (5S-FE)	USEP8419
2.2L L4 2164cc	2000-2001	(5S-FE)	USEP8419
2.4L L4 2362cc	2002-2006		USEP8404
2.4L L4 2362cc	2007-2008		USEP8727
3.0L V6 2995cc	1999	SLE; (1MZ-FE)	USEP8419
3.0L V6 2995cc	2000-2003	(1MZ-FE)	USEP8419
3.3L V6 3300cc	2004		USEP8213
3.3L V6 3300cc 202 CID	2005-2008		USEP8213
<b>SUPRA</b>			
	1988	Base; (7M-GE), Naturally Aspirated	USEP8119
	1988-1990	Turbo; (7M-GTE), Turbocharged	USEP8119
	1991	(7M-GTE), Turbocharged	USEP8119
	1992	Base; (7M-GE), Naturally Aspirated	USEP8119
	1992	Turbo; (7M-GTE), Turbocharged	USEP8119
	1993-1995	Twin Turbo; (2JZ-GTE), Turbocharged	USEP8255
	1994-1995	Base; (2JZ-GE), Naturally Aspirated	USEP8254
	1996-1997	Base; (2JZ-GE), (D), Naturally Aspirated	USEP8254
	1996-1998	Twin Turbo; (2JZ-GTE), (E), Turbocharged	USEP8255
3.0L L6 2954cc	1986		USEP8023
3.0L L6 2954cc	1989-1991	Naturally Aspirated	USEP8023
3.0L L6 2997cc	1998	Naturally Aspirated	USEP8240
<b>T100</b>			
2.7L L4 2694cc	1994-1998		USEP8213
3.0L V6 2959cc	1993-1994		USEP8213
3.4L V6 3378cc	1995-1998		USEP8213
<b>TACOMA</b>			
2.4L L4 2438cc	1995-1997		USEP8213
2.4L L4 2438cc	1999-2000		USEP8213
2.4L L4 2438cc	2003-2004		USEP8213
2.7L L4 2694cc	1995-1997		USEP8213
2.7L L4 2694cc	1999-2000		USEP8213
2.7L L4 2694cc	2003-2004		USEP8213
3.4L V6 3378cc	1995-1997		USEP8213
3.4L V6 3378cc	1999-2000		USEP8213
3.4L V6 3378cc	2003-2004		USEP8213
<b>TERCEL</b>			
1.5L L4 1456cc	1990	FI	USEP8213
1.5L L4 1456cc	1991-1994		USEP8213
1.5L L4 1497cc	1995-1998		USEP8213
<b>TUNDRA</b>			
3.4L V6 3378cc	2000-2004		USEP8404
4.7L V8 4663cc 285 CID	2000-2002		USEP8240
4.7L V8 4663cc 285 CID	2003-2004		USEP8505
<b>YARIS</b>			
1.5L L4 1497cc	2007-2009		USEP12083
<b>TRIUMPH</b>			
<b>STAG</b>			
3.0L V8 2997cc	1971-1973		USEP8122
3.0L V8 2997cc 183 CID	1971-1973		USEP8122
<b>VOLKSWAGEN</b>			
<b>BEETLE</b>			
1.8L L4 1781cc	2004-2005		USEP12024
2.0L L4 1984cc 121 CID	1999-2003	MEX	USEP12024
2.0L L4 1984cc 121 CID	2004-2005		USEP12024
2.0L L4 1984cc 121 CID	2009		USEP12024
2.5L L5 2480cc 151 CID	2009		USEP12024
<b>CABRIO</b>			
2.0L L4 1984cc 121 CID	1998-2002		USEP8244
<b>CABRIOLET</b>			
1.8L L4 1780cc	1985-1989	External Pump	USEP8305
1.8L L4 1780cc	1985-1993	IN-TANK	USEP8200
1.8L L4 1780cc	1990-1993	External Pump	USEP8202
<b>CARIBE</b>			
1.8L L4 1780cc	1985	MEX	USEP8016SP
<b>COMBI</b>			
1.8L L4 1780cc	1990-1994	MEX	USEP8016SP



Engine	Years	Application Description	USMW
<b>VOLKSWAGEN (cont'd.)</b>			
<b>COMBI (cont'd.)</b>			
1.8L L4 1781cc	1995-2001	MEX	USEP8244
<b>CORRADO</b>			
1.8L L4 1780cc	1990	External Pump, To Chassis/VIN 50-L-005732	USEP8030
<b>CORSAR</b>			
1.8L L4 1780cc	1984	MEX	USEP8016SP
1.8L L4 1781cc	1985-1988	MEX	USEP8016SP
<b>CROSSFOX</b>			
1.6L L4 1599cc 98 CID	2007	MEX	USEP12024
<b>DERBY</b>			
1.8L L4 1781cc	1995-1999	MEX	USEP8244
1.8L L4 1781cc	2000-2009	MEX	USEP12024
2.0L L4 1984cc 121 CID	2002-2003	MEX	USEP12024
<b>EUROVAN</b>			
2.5L L5 2461cc 150 CID	2002-2004	MEX	USEP8244
2.8L V6 2771cc	1999-2000		USEP12024
<b>FOX</b>			
1.8L L4 1780cc	1987-1990	IN-TANK	USEP8200
1.8L L4 1780cc	1987-1990	External Pump	USEP8307
1.8L L4 1780cc	1991	From 11/90	USEP8200
1.8L L4 1780cc	1991	External Pump, From 11/90	USEP8202
1.8L L4 1780cc	1991	External Pump, To 10/90	USEP8307
1.8L L4 1780cc	1992-1993	IN-TANK	USEP8200
1.8L L4 1780cc	1992-1993	External Pump	USEP8202
<b>GOL</b>			
1.6L L4 1598cc 98 CID	2009-2011	MEX	USEP12024
<b>GOLF</b>			
1.8L L4 1780cc	1985	EXTERNAL PUMP (50mm)	USEP8343
1.8L L4 1780cc	1985	External Pump(60mm)	USEP8428
1.8L L4 1780cc	1985-1986	IN-TANK	USEP8200
1.8L L4 1780cc	1986	EXTERNAL PUMP (50mm), To Chassis/VIN 17-G-001053	USEP8343
1.8L L4 1780cc	1986	External Pump(60mm), To Chassis/VIN 17-G-001053	USEP8428
1.8L L4 1780cc	1989-1990	External Pump	USEP8030
1.8L L4 1780cc	1989-1992	IN-TANK	USEP8200
1.8L L4 1780cc	1992	External Pump	USEP8030
1.8L L4 1781cc	1989-1992	MEX	USEP8030
1.8L L4 1781cc	1993-1999	MEX	USEP8244
2.0L L4 1984cc 121 CID	1990-1992	EXTERNAL PUMP (50mm)	USEP8343
2.0L L4 1984cc 121 CID	1990-1992	External Pump(60mm)	USEP8428
2.0L L4 1984cc 121 CID	1993-1998		USEP8244
2.0L L4 1984cc 121 CID	1999	Mexico Built Vehicle	USEP8244
2.0L L4 1984cc 121 CID	2002-2003	MEX	USEP12024
2.0L L4 1984cc 121 CID	2007	MEX	USEP12024
<b>JETTA</b>			
1.8L L4 1780cc	1985-1986	External Pump(60mm)	USEP8428
1.8L L4 1780cc	1985-1988	EXTERNAL PUMP (50mm)	USEP8343
1.8L L4 1780cc	1985-1989	IN-TANK	USEP8200
1.8L L4 1780cc	1988	External Pump(60mm)	USEP8428
1.8L L4 1780cc	1988-1992	External Pump	USEP8030
1.8L L4 1781cc	1987-1992	MEX; IN-TANK	USEP8200
1.8L L4 1781cc	1994	MEX	USEP8244
1.8L L4 1781cc	1995		USEP8244
1.8L L4 1781cc	1999		USEP8244
1.8L L4 1781cc	2000-2005		USEP12024
2.0L L4 1984cc 121 CID	1990-1992	IN-TANK	USEP8200
2.0L L4 1984cc 121 CID	1990-1992	EXTERNAL PUMP (50mm)	USEP8343
2.0L L4 1984cc 121 CID	1990-1992	External Pump(60mm)	USEP8428
2.0L L4 1984cc 121 CID	1993-1998		USEP8244
2.0L L4 1984cc 121 CID	1999	Old Body Style	USEP8244
2.0L L4 1984cc 121 CID	2000-2005		USEP12024
2.0L L4 1984cc 121 CID	2006-2009	MEX	USEP12024
2.0L L4 1984cc 121 CID	2011	MEX	USEP12024
2.5L L5 2480cc 151 CID	2005		USEP12024
<b>LUPO</b>			
1.6L L4 1599cc 98 CID	2005	MEX	USEP12024
1.6L L4 1599cc 98 CID	2007	MEX	USEP12024
<b>PANEL</b>			
1.8L L4 1780cc	1990	MEX	USEP8016SP
1.8L L4 1780cc	1991-1994	MEX	USEP8244
1.8L L4 1781cc	1995-1999	MEX	USEP8244
<b>PASSAT</b>			
2.0L L4 1984cc 121 CID	1990-1993	IN-TANK	USEP8200
2.0L L4 1984cc 121 CID	1990-1993	External Pump(60mm), EXTERNAL PUMP (50mm)	USEP8343
2.0L L4 1984cc 121 CID	1990-1993	External Pump(60mm)	USEP8428

Engine	Years	Application Description	USMW
<b>VOLKSWAGEN (cont'd.)</b>			
<b>POINTER</b>			
1.8L L4 1781cc	2007	MEX	USEP12067
1.8L L4 1781cc	2000-2006	MEX	USEP12067
1.8L L4 1781cc	2008-2009	MEX	USEP12067
2.0L L4 1985cc 121 CID	2000-2003	MEX	USEP12024
<b>POINTER TRUCK</b>			
1.8L L4 1781cc	1999-2007	MEX	USEP12067
<b>QUANTUM</b>			
	1986	Base, GL; (B), (KX)	USEP8309
	1986	Base, GL; (E), (KX)	USEP8309
	1986	Syncro; (B), (JT)	USEP8309
	1987	GL; (KX)	USEP8309
	1987	Syncro; (JT)	USEP8309
	1988	GL, Syncro	USEP8309
1.8L L4 1780cc	1985	Base, GL; (A), (JN), GAS, Naturally Aspirated	USEP8309
1.8L L4 1780cc	1985	GL; (B), (JN), GAS, Naturally Aspirated	USEP8309
2.2L L5 2226cc	1985	Base, GL; (B), (KX), GAS, Naturally Aspirated	USEP8309
2.2L L5 2226cc	1985	Base, GL; (E), (KX), GAS, Naturally Aspirated	USEP8309
<b>SCIROCCO</b>			
1.8L L4 1780cc	1985-1988	IN-TANK	USEP8200
1.8L L4 1780cc	1985-1988	External Pump	USEP8305
<b>SEDAN</b>			
1.6L H4 1584cc 97 CID	1993-2004	MEX	USEP12004
<b>SHARAN</b>			
1.8L L4 1781cc	2002-2006	MEX	USEP12024
<b>SPORTVAN</b>			
1.6L L4 1599cc 98 CID	2007-2009	MEX	USEP12024
<b>VAN</b>			
1.8L L4 1781cc	2003	MEX	USEP12024
1.8L L4 1781cc	2005-2009	MEX	USEP12024
<b>VANAGON</b>			
1.9L H4 1915cc	1985	External Pump	USEP8308
2.1L H4 2109cc	1986-1991	External Pump	USEP8308
<b>VOLVO</b>			
<b>240</b>			
2.3L L4 2316cc	1990-1993	External Pump	USEP8002
2.3L L4 2316cc	1990-1993	In Tank Pump	USEP8224
<b>242</b>			
2.1L L4 2127cc	1980-1984		USEP8307
2.1L L4 2127cc	1981	Base, DL, GL, GLT, Turbo; FI; In Tank Pump	USEP3044
2.1L L4 2127cc	1981	Base, DL, GL, GLT, Turbo; FI; External Pump	USEP8123
2.1L L4 2127cc	1982-1983	DL, GLT; FI; In Tank Pump	USEP3044
2.1L L4 2127cc	1982-1983	DL, GLT; FI; External Pump	USEP8123
2.1L L4 2127cc	1984	GLT; FI; In Tank Pump	USEP3044
2.1L L4 2127cc	1984	GLT; FI; External Pump	USEP8123
<b>244</b>			
2.1L L4 2127cc	1980-1985		USEP8307
2.1L L4 2127cc	1985	Turbo; (4), (B21FT), Turbocharged	USEP2487
2.1L L4 2127cc	1985	External Pump	USEP8123
2.3L L4 2316cc	1985-1989	External Pump	USEP8002
2.3L L4 2316cc	1985-1989	In Tank Pump	USEP8224
<b>245</b>			
2.1L L4 2127cc	1980-1985		USEP8307
2.1L L4 2127cc	1985	(4), (B21FT), Turbocharged	USEP2487
2.1L L4 2127cc	1985	(4), (B21FT), Turbocharged; In Tank Pump	USEP3044
2.3L L4 2316cc	1985-1989	External Pump	USEP8002
2.3L L4 2316cc	1985-1989	In Tank Pump	USEP8224
<b>262</b>			
2.8L V6 2849cc	1980-1981		USEP8307
2.8L V6 2849cc	1981	GL; FI; In Tank Pump	USEP3044
2.8L V6 2849cc	1981	GL; FI; External Pump	USEP8123
<b>264</b>			
2.1L L4 2127cc	1980		USEP8307
2.1L L4 2127cc	1981	GL, GLE; FI; In Tank Pump	USEP3044
2.1L L4 2127cc	1981	GL, GLE; FI; External Pump	USEP8123
2.8L V6 2849cc	1980		USEP8307
2.8L V6 2849cc	1981-1982	GLE; FI; In Tank Pump	USEP3044
2.8L V6 2849cc	1981-1982	GLE; FI; External Pump	USEP8123
<b>265</b>			
2.8L V6 2849cc	1980-1981		USEP8307
2.8L V6 2849cc	1981	GLE; FI; In Tank Pump	USEP3044
2.8L V6 2849cc	1981	GLE; FI; External Pump	USEP8123

Engine	Years	Application Description	USMW	Engine	Years	Application Description	USMW
<b>VOLVO (cont'd.)</b>							
<b>740</b>							
	1987	(B230F), Naturally Aspirated; External Pump	USEP8147				
	1987	(B230FT), Turbocharged; External Pump	USEP8147				
	1987	(B230F), Naturally Aspirated; In Tank Pump	USEP8381				
	1987	(B230FT), Turbocharged; In Tank Pump	USEP8381				
2.3L L4 2316cc	1986	(8), (B230F), GAS, Naturally Aspirated; External Pump	USEP8147				
2.3L L4 2316cc	1986	(8), (B230FT), GAS, Turbocharged; External Pump	USEP8147				
2.3L L4 2316cc	1986	(8), (B230F), GAS, Naturally Aspirated; In Tank Pump	USEP8381				
2.3L L4 2316cc	1986	(8), (B230FT), GAS, Turbocharged; In Tank Pump	USEP8381				
2.3L L4 2316cc	1988-1989	External Pump	USEP8002				
2.3L L4 2316cc	1988-1989	In Tank Pump	USEP8224				
2.3L L4 2316cc	1990	GLE; (B234F), Naturally Aspirated	USEP2487				
2.3L L4 2316cc	1990	Exc.REX Ignition (Calif), External Pump	USEP8002				
2.3L L4 2316cc	1990	Base; (B230FT), Turbocharged	USEP8186				
<b>760</b>							
2.3L L4 2316cc	1985	Base, GLE; (8), (B230FT), GAS, Turbocharged; External Pump	USEP8147				
2.3L L4 2316cc	1985	Base, GLE; (8), (B230FT), GAS, Turbocharged; External Pump, In Tank Pump	USEP8381				
2.3L L4 2316cc	1985	Base, GLE; (8), (B230FT), GAS, Turbocharged; In Tank Pump	USEP8381				
2.3L L4 2316cc	1986	(8), (B230FT), Turbocharged; In Tank Pump	USEP8381				
2.3L L4 2316cc	1986-1987	(8), (B230FT), Turbocharged; External Pump	USEP8147				
2.3L L4 2316cc	1986-1987	(8), (B230FT), Turbocharged; External Pump, In Tank Pump	USEP8381				
2.3L L4 2316cc	1987	(8), (B230FT), Turbocharged; 1st Design, External Pump	USEP8147				
2.3L L4 2316cc	1987	(8), (B230FT), Turbocharged; 2nd Design, External Pump	USEP8147				
2.3L L4 2316cc	1987	(8), (B230FT), Turbocharged; 1st Design, In Tank Pump	USEP8381				
2.3L L4 2316cc	1987	(8), (B230FT), Turbocharged; 2nd Design, In Tank Pump	USEP8381				
2.3L L4 2316cc	1988	(8), (B230FT), Turbocharged	USEP8186				
2.3L L4 2316cc	1988-1990	External Pump	USEP8002				
2.3L L4 2316cc	1989-1990	In Tank Pump	USEP8224				
2.8L V6 2849cc	1985	GLE; (6), (B28F), GAS, Naturally Aspirated; External Pump	USEP8147				
2.8L V6 2849cc	1985	GLE; (6), (B28F), GAS, Naturally Aspirated; External Pump, In Tank Pump	USEP8381				
2.8L V6 2849cc	1986	(6), (B28F), Naturally Aspirated; External Pump	USEP8147				
2.8L V6 2849cc	1986	(6), (B28F), Naturally Aspirated; External Pump, In Tank Pump	USEP8381				
2.8L V6 2849cc	1986	(6), (B28F), Naturally Aspirated; In Tank Pump	USEP8381				
2.8L V6 2849cc	1988	In Tank Pump	USEP8224				
2.8L V6 2849cc	1988-1990	External Pump	USEP8002				
<b>780</b>							
2.3L L4 2316cc	1989	(8), (B230FT), Turbocharged	USEP8186				
2.3L L4 2316cc	1989-1991	External Pump	USEP8002				
2.3L L4 2316cc	1989-1991	In Tank Pump	USEP8224				
2.8L V6 2849cc	1987-1990	External Pump	USEP8002				
2.8L V6 2849cc	1987-1990	In Tank Pump	USEP8224				
<b>850</b>							
	1993		USEP8643				
2.3L L5 2319cc	1994	Turbo; (5), (B5234FT), Turbocharged	USEP8643				
2.3L L5 2319cc	1995	T-5R; (58), (B5234T5), Turbocharged	USEP8643				
2.3L L5 2319cc	1996-1997	R; (58), (B5234T5), Turbocharged	USEP8643				
2.3L L5 2319cc	1997	T-5; (57), (B5234T1), Turbocharged	USEP8643				
2.4L L5 2435cc	1997	GLT; (56), (B5254T), Turbocharged	USEP8643				
<b>940</b>							
2.3L L4 2316cc	1994	External Pump	USEP8002				
2.3L L4 2316cc	1994-1995	In Tank Pump	USEP8224				
2.3L L4 2316cc	1995	Base; (B230FD), Naturally Aspirated	USEP8250				
<b>960</b>							
2.9L L6 2922cc	1992-1994	External Pump	USEP8002				
2.9L L6 2922cc	1992-1994	In Tank Pump	USEP8224				
2.9L L6 2922cc	1994		USEP8186				

USMW	Years	Application	Engine	USMW	Years	Application	Engine	
<b>USEP2000</b>	1983	FORD MUSTANG	2.3L L4 140 CID	<b>USEP2002</b>	1987-1988	FORD EXP		
	1983	FORD THUNDERBIRD	5.0L V8 302 CID		1988-1989	FORD AEROSTAR		
	1983	MERCURY COUGAR	5.0L V8 302 CID	1994	MAZDA B3000			
	1983-1984	FORD THUNDERBIRD	2.3L L4 140 CID	<b>USEP2003</b>	1984	FORD THUNDERBIRD	3.8L V6 232 CID	
	1984	FORD MUSTANG	5.0L V8 302 CID		1984	FORD THUNDERBIRD	5.0L V8 302 CID	
	1984	MERCURY COUGAR	2.3L L4 140 CID		1984	MERCURY COUGAR	3.8L V6 232 CID	
	1984-1988	FORD RANGER	2.3L L4 140 CID		1984	MERCURY COUGAR	5.0L V8 302 CID	
	1985-1988	FORD RANGER	2.3L L4 140 CID	1984-1986	FORD LTD	3.8L V6 232 CID		
	1985-1989	FORD BRONCO	5.0L V8 302 CID	1984-1986	MERCURY MARQUIS	3.8L V6 232 CID		
	1985-1989	FORD F-150	5.0L V8 302 CID	<b>USEP2008</b>	1986	FORD E-350 ECONOLINE	7.5L V8 460 CID	
	1985-1989	MERKUR XR4TI	2.3L L4 140 CID		1986-1988	FORD E-350 ECONOLINE CLUB WAGON	7.5L V8 460 CID	
	1986-1988	FORD RANGER	2.9L V6 177 CID	1986-1989	FORD E-150 ECONOLINE	5.0L V8 302 CID		
	1986-1989	FORD BRONCO II	2.9L V6 177 CID	1986-1989	FORD E-150 ECONOLINE CLUB WAGON	5.0L V8 302 CID		
	1986-1989	FORD E-150 ECONOLINE	5.0L V8 302 CID	1986-1991	FORD E-250 ECONOLINE	5.0L V8 302 CID		
	1986-1989	FORD E-150 ECONOLINE CLUB WAGON	5.0L V8 302 CID	1986-1991	FORD E-250 ECONOLINE CLUB WAGON	7.5L V8 460 CID		
	1986-1989	FORD E-250 ECONOLINE	5.0L V8 302 CID	1986-1989	FORD F-150	4.9L L6 4917cc 300 CID		
	1986-1989	FORD F-250	5.0L V8 302 CID	1988-1989	FORD F-150	5.8L V8 5753cc 351 CID		
	1988-1989	FORD BRONCO	5.8L V8 5753cc 351 CID	1988-1989	FORD F-150	5.8L V8 5753cc 351 CID		
	1988-1989	FORD E-150 ECONOLINE	5.8L V8 5753cc 351 CID	1988-1989	FORD F-250	5.8L V8 5753cc 351 CID		
	1988-1989	FORD E-150 ECONOLINE CLUB WAGON	5.8L V8 5753cc 351 CID	1988-1989	FORD F-250	7.5L V8 460 CID		
	1988-1989	FORD F-150	4.9L L6 4917cc 300 CID	1988-1989	FORD F-350	5.8L V8 5753cc 351 CID		
	1988-1989	FORD F-150	5.8L V8 5753cc 351 CID	1988-1989	FORD F-350	7.5L V8 460 CID		
	1988-1989	FORD F-250	5.8L V8 5753cc 351 CID	1988-1989	FORD F-350	7.5L V8 460 CID		
	1988-1989	FORD F-250	7.5L V8 460 CID	1988-1991	FORD E-250 ECONOLINE	5.8L V8 5753cc 351 CID		
	1988-1989	FORD F-350	5.8L V8 5753cc 351 CID	1988-1991	FORD E-250 ECONOLINE CLUB WAGON	5.8L V8 5753cc 351 CID		
	1988-1989	FORD F-350	7.5L V8 460 CID	1988-1991	FORD E-250 ECONOLINE CLUB WAGON	5.8L V8 5753cc 351 CID		
	1988-1991	FORD E-250 ECONOLINE	5.8L V8 5753cc 351 CID	1990-1991	FORD E-350 ECONOLINE CLUB WAGON	5.8L V8 5753cc 351 CID		
	1988-1991	FORD E-250 ECONOLINE CLUB WAGON	5.8L V8 5753cc 351 CID	1990-1991	FORD E-350 ECONOLINE CLUB WAGON	7.5L V8 460 CID		
	1988-1991	FORD E-250 ECONOLINE CLUB WAGON	7.5L V8 460 CID	<b>USEP2014</b>	1972-1974	FORD COURIER	1.8L L4 1796cc 110 CID	
	1988-1991	FORD E-350 ECONOLINE CLUB WAGON	7.5L V8 460 CID		<b>USEP2015</b>	1985-1986	FORD TEMPO	2.3L L4 140 CID
	1989	FORD BRONCO	4.9L L6 4917cc 300 CID			1985-1986	MERCURY TOPAZ	2.3L L4 140 CID
	1989	FORD E-350 ECONOLINE	5.8L V8 5753cc 351 CID	1987	MERCURY TOPAZ			
	1989	FORD E-350 ECONOLINE	7.5L V8 460 CID	<b>USEP2019</b>	1979	FORD COURIER	1.8L L4 110 CID	
	1991	FORD E-250 ECONOLINE	5.0L V8 302 CID		1979-1980	MAZDA B2000	2.0L L4 1970cc	
	<b>USEP2000A</b>	1983	FORD MUSTANG		2.3L L4 140 CID	1979-1982	FORD COURIER	2.0L L4 1989cc 122 CID
		1983	FORD THUNDERBIRD		5.0L V8 302 CID	1979-1982	FORD COURIER	2.3L L4 140 CID
		1983	MERCURY COUGAR		5.0L V8 302 CID	1982	MAZDA B2000	2.0L L4 1970cc
		1983-1984	FORD THUNDERBIRD	2.3L L4 140 CID	<b>USEP2024</b>	1985	LINCOLN CONTINENTAL	5.0L V8 302 CID
		1984	FORD MUSTANG	5.0L V8 302 CID		1985	LINCOLN MARK VII	5.0L V8 302 CID
		1984	MERCURY COUGAR	2.3L L4 140 CID		1986-1987	LINCOLN CONTINENTAL	
1984		MERCURY COUGAR	2.3L L4 140 CID	1986-1987		LINCOLN MARK VII		
1985-1988		FORD RANGER	2.3L L4 140 CID	1986-1988		FORD THUNDERBIRD	3.8L V6 232 CID	
1985-1989		FORD BRONCO	5.0L V8 302 CID	1986-1988	FORD THUNDERBIRD	5.0L V8 302 CID		
1985-1989		FORD F-150	5.0L V8 302 CID	1986-1988	MERCURY COUGAR	3.8L V6 232 CID		
1985-1989		MERKUR XR4TI	2.3L L4 140 CID	1986-1988	MERCURY COUGAR	5.0L V8 302 CID		
1986-1988		FORD RANGER	2.9L V6 177 CID	<b>USEP2025</b>	1980	FORD E-250 ECONOLINE	6.6L V8 400 CID	
1986-1988		FORD RANGER	2.9L V6 177 CID		1980	FORD E-250 ECONOLINE CLUB WAGON	5.0L V8 302 CID	
1986-1989		FORD BRONCO II	2.9L V6 177 CID		1980-1982	FORD E-250 ECONOLINE	5.0L V8 302 CID	
1986-1989		FORD E-150 ECONOLINE	5.0L V8 302 CID		1980-1982	FORD E-250 ECONOLINE	5.8L V8 5753cc 351 CID	
1986-1989		FORD E-150 ECONOLINE CLUB WAGON	5.0L V8 302 CID		1980-1982	FORD E-250 ECONOLINE CLUB WAGON	5.8L V8 5753cc 351 CID	
1986-1989		FORD F-250	5.0L V8 302 CID	1980-1982	FORD E-250 ECONOLINE CLUB WAGON	6.6L V8 400 CID		
1986-1989		FORD F-250	5.0L V8 302 CID	1980-1982	FORD E-350 ECONOLINE	5.8L V8 5753cc 351 CID		
1986-1991		FORD E-250 ECONOLINE	5.0L V8 302 CID	1980-1982	FORD E-350 ECONOLINE	6.6L V8 400 CID		
1987		FORD BRONCO	4.9L L6 4917cc 300 CID	1980-1982	FORD E-350 ECONOLINE CLUB WAGON	5.8L V8 5753cc 351 CID		
1988-1989		FORD BRONCO	5.8L V8 5753cc 351 CID	1980-1982	FORD E-350 ECONOLINE CLUB WAGON	6.6L V8 400 CID		
1988-1989		FORD E-150 ECONOLINE	5.8L V8 5753cc 351 CID	1980-1982	FORD E-350 ECONOLINE CLUB WAGON	6.6L V8 400 CID		
1988-1989		FORD E-150 ECONOLINE CLUB WAGON	5.8L V8 5753cc 351 CID	1980-1982	FORD E-350 ECONOLINE CLUB WAGON	6.6L V8 400 CID		
1988-1989		FORD F-150	4.9L L6 4917cc 300 CID	1980-1982	FORD E-350 ECONOLINE CLUB WAGON	6.6L V8 400 CID		
1988-1989		FORD F-150	5.8L V8 5753cc 351 CID	1980-1982	FORD E-350 ECONOLINE CLUB WAGON	6.6L V8 400 CID		
1988-1989		FORD F-250	5.8L V8 5753cc 351 CID	1980-1982	FORD E-350 ECONOLINE CLUB WAGON	6.6L V8 400 CID		
1988-1989		FORD F-250	7.5L V8 460 CID	1980-1982	FORD E-350 ECONOLINE CLUB WAGON	6.6L V8 400 CID		
1988-1989		FORD F-350	5.8L V8 5753cc 351 CID	1980-1982	FORD E-350 ECONOLINE CLUB WAGON	6.6L V8 400 CID		
1988-1989		FORD F-350	7.5L V8 460 CID	1980-1982	FORD E-350 ECONOLINE CLUB WAGON	6.6L V8 400 CID		
1988-1991		FORD E-250 ECONOLINE	5.8L V8 5753cc 351 CID	1980-1982	FORD E-350 ECONOLINE CLUB WAGON	6.6L V8 400 CID		
1988-1991		FORD E-250 ECONOLINE CLUB WAGON	5.8L V8 5753cc 351 CID	1980-1982	FORD E-350 ECONOLINE CLUB WAGON	6.6L V8 400 CID		
1988-1991		FORD E-250 ECONOLINE CLUB WAGON	7.5L V8 460 CID	1980-1985	FORD E-350 ECONOLINE	7.5L V8 460 CID		
1988-1991		FORD E-350 ECONOLINE CLUB WAGON	5.8L V8 5753cc 351 CID	1981-1985	FORD E-250 ECONOLINE CLUB WAGON	7.5L V8 460 CID		
1988-1991		FORD E-350 ECONOLINE CLUB WAGON	7.5L V8 460 CID	1984-1985	FORD E-350 ECONOLINE CLUB WAGON	7.5L V8 460 CID		
1989		FORD E-350 ECONOLINE	5.8L V8 5753cc 351 CID	1985-1989	FORD BRONCO	5.0L V8 302 CID		
1989		FORD E-350 ECONOLINE	7.5L V8 460 CID	1986	FORD E-350 ECONOLINE	5.8L V8 5753cc 351 CID		
<b>USEP2001</b>		1985-1988	FORD COUGAR	3.8L V6 232 CID	1986	FORD E-350 ECONOLINE CLUB WAGON	5.8L V8 5753cc 351 CID	
		1986	MERCURY SABLE	2.5L L4 153 CID	1987-1989	FORD BRONCO	4.9L L6 4917cc 300 CID	
		1986-1987	FORD TAURUS	2.5L L4 153 CID	1988-1989	FORD BRONCO	5.8L V8 5753cc 351 CID	
		1987	MERCURY SABLE		1989	FORD E-350 ECONOLINE	4.9L L6 4917cc 300 CID	
	1988-1989	MERCURY SABLE	3.8L V6 232 CID	1989	FORD E-350 ECONOLINE	5.8L V8 5753cc 351 CID		
	1988-1989	MERCURY SABLE	3.8L V6 232 CID	1989	FORD E-350 ECONOLINE	5.8L V8 5753cc 351 CID		
	1990-1993	FORD AEROSTAR	4.0L V6 245 CID	1989	FORD E-350 ECONOLINE	7.5L V8 460 CID		
	1991-1992	FORD AEROSTAR	3.0L V6 2986cc 182 CID	<b>USEP2031</b>	1988	FORD E-350 ECONOLINE CLUB WAGON	5.8L V8 5753cc 351 CID	
	1992-1993	FORD GHIA	3.0L V6 2986cc 182 CID		1988	FORD E-350 ECONOLINE CLUB WAGON	7.5L V8 460 CID	
	1993	FORD TOPAZ	2.3L L4 2309cc 140 CID		1989	FORD E-350 ECONOLINE	5.8L V8 5753cc 351 CID	
	1993-1995	FORD TAURUS	3.2L V6 195 CID		1989	FORD E-350 ECONOLINE	7.5L V8 460 CID	
	1994	MAZDA B3000						
	1995-1997	FORD AEROSTAR	4.0L V6 245 CID					



USMW	Years	Application	Engine	USMW	Years	Application	Engine	
<b>USEP2035</b>	1985-1989	FORD F-150	5.0L V8 302 CID	<b>USEP2068</b>	2002	LINCOLN BLACKWOOD	5.4L V8 330 CID	
	1986-1989	FORD F-250	5.0L V8 302 CID		2003	FORD E-150 CLUB WAGON	4.2L V6 256 CID	
	1988	FORD F-150	5.8L V8 5753cc 351 CID		2003	FORD E-150 CLUB WAGON	4.6L V8 281 CID	
	1988	FORD F-250	5.8L V8 5753cc 351 CID		2003	FORD E-250	4.2L V6 256 CID	
	1988-1989	FORD F-150	4.9L L6 4917cc 300 CID		2003	FORD E-250	4.6L V8 281 CID	
	1988-1989	FORD F-250	7.5L V8 460 CID		2003	LINCOLN AVIATOR	4.6L V8 281 CID	
	1988-1989	FORD F-350	5.8L V8 5753cc 351 CID		<b>USEP2073</b>	1987-1992	FORD MUSTANG	5.0L V8 302 CID
	1988-1989	FORD F-350	7.5L V8 460 CID			<b>USEP2078</b>	1989-1992	FORD RANGER
<b>USEP2036</b>	1985-1988	FORD RANGER	2.3L L4 140 CID	1989-1997	FORD RANGER		2.3L L4 140 CID	
	1986-1988	FORD BRONCO II	2.9L V6 177 CID	1991-1997	FORD RANGER		3.0L V6 2986cc 182 CID	
	1986-1988	FORD RANGER	2.9L V6 177 CID	1991-1997	FORD RANGER		4.0L V6 245 CID	
	<b>USEP2042</b>	1986	MERCURY SABLE	2.5L L4 153 CID	1994-1997		MAZDA B2300	2.3L L4 140 CID
1986-1987		FORD TAURUS	2.5L L4 153 CID	1994-1997	MAZDA B4000		4.0L V6 4016cc	
1987		MERCURY SABLE		1995-1997	MAZDA B3000		3.0L V6 2986cc 182 CID	
1988-1994		LINCOLN CONTINENTAL		<b>USEP2111</b>	1990-1995		SUZUKI SAMURAI	1.3L L4 1298cc 79 CID
1988-1995		MERCURY SABLE	3.8L V6 232 CID		1991-1993		SUZUKI SIDEKICK	1.6L L4 1590cc 97 CID
1993-1995		FORD TAURUS	3.8L V6 232 CID		1994-1997		FORD ASPIRE	1.3L L4 1295cc
<b>USEP2044</b>		1985-1986	MERCURY COUGAR		2.3L L4 140 CID		1995	SUZUKI SIDEKICK
		1985-1988	FORD THUNDERBIRD	2.3L L4 140 CID	1999-2005		MAZDA MIATA	1.8L L4 1839cc
	1986-1992	LINCOLN MARK VII		<b>USEP2157</b>	1998-2001	FORD FIESTA	1.3L L4 1299cc 79 CID	
	1989-1990	FORD THUNDERBIRD			1998-2002	FORD GRAND MARQUIS	4.6L V8 281 CID	
	1989-1990	MERCURY COUGAR			1998-2002	MAZDA 626	2.0L L4 1991cc	
	1990-1993	FORD COUGAR	3.8L V6 3797cc 232 CID		1998-2002	MAZDA 626	2.5L V6 2497cc	
	1991-1993	FORD THUNDERBIRD	5.0L V8 302 CID		2000	FORD F-250	4.6L V8 281 CID	
	1991-1993	MERCURY COUGAR	5.0L V8 302 CID		2001-2008	FORD KA	1.6L L4 1596cc 97 CID	
	1991-1997	FORD THUNDERBIRD	3.8L V6 232 CID		2002	FORD FIESTA IKON	1.6L L4 1596cc 97 CID	
	1991-1997	MERCURY COUGAR	3.8L V6 232 CID		2004	FORD F-250	4.6L V8 281 CID	
	1994-1997	FORD THUNDERBIRD	4.6L V8 281 CID		2004	LINCOLN TOWN CAR	4.6L V8 281 CID	
	1994-1997	MERCURY COUGAR	4.6L V8 281 CID		<b>USEP2158</b>	1997-1998	FORD E-150 ECONOLINE	5.4L V8 330 CID
<b>USEP2051</b>	1990-1992	FORD PROBE	3.0L V6 2986cc 182 CID	1997-1998		FORD E-150 ECONOLINE CLUB WAGON	5.4L V8 330 CID	
	<b>USEP2052</b>	1990	FORD TEMPO	2.3L L4 140 CID		1997-1998	FORD E-350 ECONOLINE	5.4L V8 330 CID
<b>USEP2054</b>		1985-1987	FORD RANGER	2.3L L4 140 CID		1997-1998	FORD E-350 ECONOLINE	6.8L V10 415 CID
	<b>USEP2059</b>	1989-1990	FORD BRONCO II	2.9L V6 177 CID		1997-1998	FORD E-350 ECONOLINE CLUB WAGON	5.4L V8 330 CID
1990-1994		FORD BRONCO	5.8L V8 5753cc 351 CID	1997-1998		FORD E-350 ECONOLINE CLUB WAGON	6.8L V10 415 CID	
1990-1996		FORD BRONCO	5.0L V8 302 CID			1997-1998	FORD E-350 ECONOLINE CLUB WAGON	6.8L V10 415 CID
1993		FORD P-350	5.8L V8 5753cc 351 CID	1997-1998		FORD EXPEDITION	4.6L V8 281 CID	
1995-1996		FORD EXPLORER	4.0L V6 245 CID	1997-1998		FORD EXPEDITION	5.4L V8 330 CID	
1996		FORD BRONCO	5.8L V8 5753cc 351 CID	1997-1999		FORD E-250 ECONOLINE	5.4L V8 330 CID	
1996		FORD EXPLORER	5.0L V8 302 CID	1997-2001		FORD F-150	5.4L V8 330 CID	
1997		MERCURY MOUNTAINEER	5.0L V8 302 CID	1998		LINCOLN NAVIGATOR		
<b>USEP2061</b>		1985-1986	FORD MUSTANG	3.8L V6 232 CID	1999	FORD EXPLORER	5.0L V8 302 CID	
		1985-1986	MERCURY CAPRI	3.8L V6 232 CID	1999	LINCOLN NAVIGATOR	5.4L V8 330 CID	
		1985-1986	MERCURY CAPRI	5.0L V8 302 CID	1999-2000	MITSUBISHI MONTERO	3.5L V6 3497cc 215 CID	
		1985-1993	FORD MUSTANG	2.3L L4 140 CID	2000	FORD MYSTIQUE	2.5L V6 2450cc 155 CID	
	1985-1995	FORD MUSTANG	5.0L V8 302 CID	2003-2004	FORD F-150	5.4L V8 330 CID		
	1994-1997	FORD MUSTANG	3.8L V6 232 CID	2005-2008	MITSUBISHI MONTERO SPORT	3.5L V6 3497cc 215 CID		
	1995	FORD MUSTANG	5.8L V8 5753cc 351 CID	<b>USEP2182</b>	1980	LINCOLN CONTINENTAL	5.0L V8 302 CID	
	1996-1997	FORD MUSTANG	4.6L V8 281 CID		1981-1983	LINCOLN MARK VI	5.0L V8 302 CID	
<b>USEP2064</b>	1990-1996	FORD F-150			1981-1984	LINCOLN TOWN CAR	5.0L V8 302 CID	
	1990-1996	FORD F-250			1985-1989	MERCURY GRAND MARQUIS	5.0L V8 302 CID	
	1990-1997	FORD F-350			1986-1989	LINCOLN TOWN CAR		
<b>USEP2065</b>	1991-1993	FORD ESCORT	1.8L L4 112 CID		1987-1991	FORD COUNTRY SQUIRE		
	1991-1993	FORD ESCORT	1.9L L4 116 CID		1987-1991	MERCURY COLONY PARK		
	1991-1993	MERCURY TRACER	1.8L L4 112 CID		<b>USEP2187</b>	1997	LINCOLN CONTINENTAL	4.6L V8 281 CID
	1991-1993	MERCURY TRACER	1.9L L4 116 CID			<b>USEP2199</b>	1997-1998	FORD WINDSTAR
<b>USEP2067</b>	1993-1998	MERCURY VILLAGER	3.0L V6 182 CID		1997-1998		FORD WINDSTAR	3.8L V6 232 CID
	1993-1998	NISSAN QUEST	3.0L V6 2960cc 181 CID		<b>USEP2226</b>	1997	FORD EXPLORER	4.0L V6 245 CID
<b>USEP2068</b>	1990	FORD TEMPO	2.3L L4 140 CID			1997-1998	FORD CONTOUR	2.5L V6 2450cc 155 CID
	1991-1997	FORD GRAND MARQUIS	4.6L V8 281 CID	1997-1999		FORD MYSTIQUE	2.5L V6 2450cc 155 CID	
	1993-1994	FORD CROWN VICTORIA	4.6L V8 281 CID	1999-2000		FORD EXPLORER	4.0L V6 245 CID	
	1993-1994	LINCOLN TOWN CAR	4.6L V8 281 CID	1999-2000		FORD RANGER	4.0L V6 245 CID	
	1993-1997	FORD PROBE	2.0L L4 1989cc 122 CID	1999-2001		FORD RANGER	2.5L L4 153 CID	
	1993-1997	FORD PROBE	2.5L V6 2497cc	1999-2002		FORD EXPEDITION	4.6L V8 281 CID	
	1994	FORD GHIA	3.0L V6 2986cc 182 CID	1999-2002		FORD EXPEDITION	5.4L V8 330 CID	
	1994	FORD TOPAZ	2.3L L4 2309cc 140 CID	2000		FORD EXPLORER	5.0L V8 302 CID	
	1995-1996	FORD CONTOUR	2.0L L4 1989cc 121 CID	2001		MAZDA B2500	2.5L L4 2492cc	
	1995-1996	FORD CONTOUR	2.5L V6 2450cc 155 CID	2001-2005		FORD MONDEO	2.0L L4 1999cc 122 CID	
	1995-1996	KIA SPORTAGE	2.0L L4 1998cc 122 CID	2001-2005		FORD MONDEO	2.5L V6 2450cc 155 CID	
	1995-1996	MERCURY MYSTIQUE	2.0L L4 1989cc 121 CID	2003-2004	FORD FIESTA IKON	1.6L L4 1596cc 97 CID		
1995-1996	MERCURY MYSTIQUE	2.5L V6 2450cc 155 CID	2003-2005	FORD FIESTA	1.6L L4 1596cc 97 CID			
1995-1997	MAZDA 626	2.0L L4 1991cc	2004-2006	FORD ECOSPORT	2.0L L4 1999cc 122 CID			
1995-1997	MAZDA 626	2.5L V6 2497cc	2005	FORD E-250	4.6L V8 281 CID			
1995-1997	MAZDA MX-6	2.0L L4 1991cc	2006	FORD COURIER	1.6L L4 1588cc 98 CID			
1995-1997	MAZDA MX-6	2.5L V6 2497cc	2007-2009	FORD FIESTA	1.6L L4 1596cc 97 CID			
1997	FORD E-250 ECONOLINE	4.2L V6 256 CID	<b>USEP2229</b>	1999-2003	FORD F-150			
1997	FORD EXPLORER	5.0L V8 302 CID		2000	FORD SABLE	3.0L V6 2968cc 181 CID		
1998	MAZDA B3000	3.0L V6 2986cc 182 CID		2003-2005	FORD COURIER	1.6L L4 1588cc 98 CID		
1998-1999	MAZDA B4000	4.0L V6 4016cc		2004	FORD F-150 HERITAGE			
1998-2000	MAZDA B2500	2.5L L4 2492cc		<b>USEP2236</b>	1998	FORD E-350 ECONOLINE	7.3L V8 445 CID	
1999	FORD E-150 ECONOLINE	4.6L V8 281 CID			1998-2002	FORD E-350 ECONOLINE CLUB WAGON	7.3L V8 445 CID	
1999-2002	FORD E-150 ECONOLINE CLUB WAGON	4.2L V6 256 CID		2003	FORD E-350 CLUB WAGON	7.3L V8 445 CID		
1999-2002	FORD E-250 ECONOLINE	4.2L V6 256 CID		<b>USEP2254</b>	2000	LINCOLN NAVIGATOR		
1999-2002	NISSAN QUEST	3.3L V6 3275cc			<b>USEP2258</b>	1999-2001	FORD RANGER	3.0L V6 2986cc 182 CID
2000	FORD RANGER	4.0L V6 245 CID		<b>USEP2284</b>		1992-1996	FORD E-150 ECONOLINE	5.0L V8 302 CID
2000-2001	FORD RANGER	2.5L L4 153 CID			1992-1996	FORD E-150 ECONOLINE	5.8L V8 5753cc 351 CID	
2000-2001	NISSAN SENTRA	1.8L L4 1769cc						

USMW	Years	Application	Engine	USMW	Years	Application	Engine		
USEP2284	1992-1996	FORD E-150 ECONOLINE CLUB WAGON	5.0L V8 302 CID	USEP2372	1998	MERCURY MYSTIQUE	2.0L L4 1989cc 121 CID		
	1992-1996	FORD E-150 ECONOLINE CLUB WAGON	5.8L V8 5753cc 351 CID		1999	MERCURY COUGAR	2.0L L4 1989cc 121 CID		
	1992-1996	FORD E-250 ECONOLINE	5.8L V8 5753cc 351 CID	USEP2373	1999	MERCURY COUGAR	2.5L V6 2450cc 155 CID		
	1992-1996	FORD E-350 ECONOLINE	5.8L V8 5753cc 351 CID		1997-1998	FORD CONTOUR	2.0L L4 1989cc 121 CID		
	1992-1996	FORD E-350 ECONOLINE	7.5L V8 460 CID		1997-1998	FORD CONTOUR	2.5L V6 2450cc 155 CID		
	1992-1996	FORD E-350 ECONOLINE CLUB WAGON	5.8L V8 5753cc 351 CID	USEP2374	1997-1998	MERCURY MYSTIQUE	2.0L L4 1989cc 121 CID		
	1992-1996	FORD E-350 ECONOLINE CLUB WAGON	5.8L V8 5753cc 351 CID		1997-1998	MERCURY MYSTIQUE	2.5L V6 2450cc 155 CID		
	1992-1996	FORD E-350 ECONOLINE CLUB WAGON	7.5L V8 460 CID		1997-2000	LINCOLN TOWN CAR			
	1995-1996	FORD E-250 ECONOLINE	4.9L L6 4917cc 300 CID	USEP2375	1998-2000	FORD CROWN VICTORIA			
	1998-1999	FORD SABLE	3.0L V6 2968cc 181 CID		1998-2000	MERCURY GRAND MARQUIS			
	2001-2002	FORD LOBO	5.4L V8 330 CID		1997	FORD CROWN VICTORIA			
2004-2005	FORD LOBO	4.6L V8 281 CID	1997		MERCURY GRAND MARQUIS				
2004-2006	FORD LOBO	5.4L V8 330 CID	2001-2002		FORD CROWN VICTORIA				
USEP2291	2001-2003	MAZDA TRIBUTE	3.0L V6 2968cc 181 CID	USEP2376	2001-2002	LINCOLN TOWN CAR			
	2001-2004	FORD ESCAPE	2.0L L4 1989cc 121 CID		2001-2002	MERCURY GRAND MARQUIS			
	2003-2004	MAZDA TRIBUTE	2.0L L4 1989cc 121 CID	1999	FORD E-150 ECONOLINE	4.6L V8 281 CID			
	USEP2293	2001-2003	FORD RANGER	2.3L L4 140 CID	USEP2377	1999-2002	FORD E-150 ECONOLINE CLUB WAGON	4.6L V8 281 CID	
		2001-2003	FORD RANGER	4.0L V6 245 CID		1997	FORD EXPLORER	5.0L V8 302 CID	
		2001-2003	MAZDA B4000	4.0L V6 4016cc		1998-2001	MERCURY MOUNTAINEER	4.0L V6 245 CID	
2001-2004		MAZDA B2300	2.3L L4 140 CID	1998-2001		MERCURY MOUNTAINEER	5.0L V8 302 CID		
2001-2004		MAZDA B3000	3.0L V6 2986cc 182 CID	1999-2001		FORD F-150	4.2L V6 256 CID		
USEP2303	1996-1997	FORD TAURUS	3.0L V6 2986cc 182 CID	1999-2001		FORD F-150	4.6L V8 281 CID		
	1996-1997	MERCURY SABLE	3.0L V6 2986cc 182 CID	1999-2001		FORD F-150	5.4L V8 330 CID		
USEP2305	1997-1998	FORD TAURUS	3.0L V6 2968cc 181 CID	2000		FORD EXPLORER	5.0L V8 302 CID		
	1997-1998	MERCURY SABLE	3.0L V6 2968cc 181 CID	2000-2002		FORD E-150 ECONOLINE CLUB WAGON	5.4L V8 330 CID		
	2000	FORD WINDSTAR	3.0L V6 2986cc 182 CID	2000-2002		FORD E-250 ECONOLINE	5.4L V8 330 CID		
	2000-2001	FORD TAURUS	3.0L V6 2968cc 181 CID	2000-2002		FORD E-350 ECONOLINE CLUB WAGON	5.4L V8 330 CID		
USEP2306	1998-1999	FORD TAURUS	3.4L V8 207 CID	USEP2378	2000-2002	FORD E-350 ECONOLINE CLUB WAGON	6.8L V10 415 CID		
USEP2312	1999-2004	FORD F-350 SUPER DUTY	5.4L V8 330 CID		2003	FORD F-150	4.2L V6 256 CID		
	1999-2004	FORD F-350 SUPER DUTY	6.8L V10 415 CID		2003	FORD F-150	4.6L V8 281 CID		
	1999-2004	FORD F-450 SUPER DUTY	6.8L V10 415 CID		2003	FORD F-150	5.4L V8 330 CID		
	1999-2004	FORD F-550 SUPER DUTY	6.8L V10 415 CID		2004	FORD F-150 HERITAGE	4.2L V6 256 CID		
	2000-2004	FORD F-250 SUPER DUTY	5.4L V8 330 CID		2004	FORD F-150 HERITAGE	4.6L V8 281 CID		
USEP2314	2002	MERCURY SABLE			2004	FORD F-150 HERITAGE	5.4L V8 330 CID		
	2010	FORD FIESTA	1.6L L4 1596cc 97 CID		2004-2005	FORD E-150 CLUB WAGON	4.6L V8 281 CID		
USEP2315	1985	FORD ESCORT	1.6L L4 1598cc 98 CID		2004-2005	FORD E-150 CLUB WAGON	5.4L V8 330 CID		
	1985-1986	FORD EXP			2004-2008	FORD E-250	4.6L V8 281 CID		
USEP2318	1986	MERCURY LYNX	1.9L L4 116 CID		2004-2008	FORD E-350 SUPER DUTY	5.4L V8 330 CID		
	1999-2004	FORD F-250 SUPER DUTY	5.4L V8 330 CID	2004-2008	FORD E-350 SUPER DUTY	6.8L V10 415 CID			
	1999-2004	FORD F-250 SUPER DUTY	6.8L V10 415 CID	2006-2008	FORD E-150	4.6L V8 281 CID			
	1999-2004	FORD F-350 SUPER DUTY	5.4L V8 330 CID	2006-2008	FORD E-150	5.4L V8 330 CID			
	1999-2004	FORD F-350 SUPER DUTY	6.8L V10 415 CID	2006-2008	FORD E-250	5.4L V8 330 CID			
USEP2319	2000-2005	FORD EXCURSION	5.4L V8 330 CID	USEP2378	1995-1996	FORD CROWN VICTORIA			
	2000-2005	FORD EXCURSION	6.8L V10 415 CID		1995-1996	MERCURY GRAND MARQUIS			
	2002	FORD F-450 SUPER DUTY	6.8L V10 415 CID	USEP2379	1997	FORD EXPLORER	4.0L V6 245 CID		
	1999-2002	MERCURY VILLAGER			1997	FORD F-250	4.6L V8 281 CID		
USEP2324	1984-1985	LINCOLN CONTINENTAL	2.4L L6 146 CID	1997-1998	FORD E-150 ECONOLINE	4.2L V6 256 CID			
	1984-1985	LINCOLN MARK VII	2.4L L6 146 CID	1997-1998	FORD E-150 ECONOLINE	4.6L V8 281 CID			
	1985-1986	BMW 524TD	2.4L L6 2443cc	1997-1998	FORD E-150 ECONOLINE CLUB WAGON	4.2L V6 256 CID			
	USEP2333	2001	FORD EXPLORER SPORT TRAC		USEP2379	1997-1998	FORD E-150 ECONOLINE CLUB WAGON	4.6L V8 281 CID	
2003		LINCOLN TOWN CAR		1997-1998		FORD F-150	4.2L V6 256 CID		
USEP2337	2003-2004	FORD CROWN VICTORIA		1997-1998		FORD F-150	4.6L V8 281 CID		
	2003-2004	FORD GRAND MARQUIS	4.6L V8 281 CID	1998		FORD E-250 ECONOLINE	4.2L V6 256 CID		
	2003-2004	MERCURY GRAND MARQUIS		1999-2000		FORD EXPLORER	4.0L V6 245 CID		
	2003-2004	MERCURY MARAUDER		USEP2380		1997-1998	FORD E-150 ECONOLINE	5.4L V8 330 CID	
	2003-2005	FORD THUNDERBIRD				1997-1998	FORD E-350 ECONOLINE	5.4L V8 330 CID	
USEP2339	2002	FORD EXPLORER	4.0L V6 245 CID			1997-1998	FORD E-350 ECONOLINE	6.8L V10 415 CID	
	2002	FORD EXPLORER	4.6L V8 281 CID			1997-1999	FORD E-150 ECONOLINE CLUB WAGON	5.4L V8 330 CID	
	2002	MERCURY MOUNTAINEER	4.0L V6 245 CID			1997-1999	FORD E-250 ECONOLINE	5.4L V8 330 CID	
	2002	MERCURY MOUNTAINEER	4.6L V8 281 CID	1997-1999		FORD E-350 ECONOLINE CLUB WAGON	5.4L V8 330 CID		
USEP2340	2004-2008	FORD E-350 SUPER DUTY	6.0L V8 363 CID	USEP2380	1997-1999	FORD E-350 ECONOLINE CLUB WAGON	6.8L V10 415 CID		
USEP2364	2004-2005	FORD E-150 CLUB WAGON	4.6L V8 281 CID		1997-1999	FORD E-250 ECONOLINE	5.4L V8 330 CID		
	2004-2005	FORD E-150 CLUB WAGON	5.4L V8 330 CID		1997-1999	FORD E-350 ECONOLINE CLUB WAGON	5.4L V8 330 CID		
	2004-2008	FORD E-250	4.6L V8 281 CID		1997-1999	FORD E-350 ECONOLINE CLUB WAGON	6.8L V10 415 CID		
	2004-2008	FORD E-350 SUPER DUTY	5.4L V8 330 CID		USEP2386	2004-2005	FORD FREESTAR	3.9L V6 238 CID	
	2004-2008	FORD E-350 SUPER DUTY	6.8L V10 415 CID			2004-2005	FORD FREESTAR	4.2L V6 256 CID	
	2006-2008	FORD E-150	4.6L V8 281 CID			2004-2005	MERCURY MONTEREY		
	2006-2008	FORD E-150	5.4L V8 330 CID			USEP2390	1999-2000	FORD MYSTIQUE	2.5L V6 2450cc 155 CID
	2006-2008	FORD E-250	5.4L V8 330 CID				1999-2002	MERCURY COUGAR	2.0L L4 1989cc 121 CID
	USEP2366	1998-2004	FORD MUSTANG		4.6L V8 281 CID		1999-2002	MERCURY COUGAR	2.5L V6 2450cc 155 CID
		1999-2004	FORD MUSTANG		3.8L V6 232 CID		2000	FORD CONTOUR	2.0L L4 1989cc 121 CID
1999-2007		FORD F-450 SUPER DUTY	6.8L V10 415 CID	2000	FORD CONTOUR		2.5L V6 2450cc 155 CID		
1999-2007		FORD F-550 SUPER DUTY	6.8L V10 415 CID	2000	MERCURY MYSTIQUE	2.0L L4 1989cc 121 CID			
2000-2007		FORD F-250 SUPER DUTY	5.4L V8 330 CID	2000	MERCURY MYSTIQUE	2.5L V6 2450cc 155 CID			
2000-2007		FORD F-250 SUPER DUTY	6.8L V10 415 CID	USEP2446	1999	MERCURY TRACER	2.0L L4 1989cc 121 CID		
2000-2007		FORD F-350 SUPER DUTY	5.4L V8 330 CID		1999-2003	FORD ESCORT	2.0L L4 1989cc 121 CID		
2000-2007		FORD F-350 SUPER DUTY	6.8L V10 415 CID	USEP2447	2001	FORD TAURUS	3.0L V6 2968cc 181 CID		
2000-2007		FORD F-350 SUPER DUTY	6.8L V10 415 CID		2001	MERCURY SABLE	3.0L V6 2968cc 181 CID		
2003		FORD LOBO	5.4L V8 330 CID	USEP2448	2000-2001	FORD FOCUS	2.0L L4 1989cc 121 CID		
2004		FORD MUSTANG	3.9L V6 238 CID		USEP2471	2006	FORD FIESTA	1.6L L4 1596cc 97 CID	
USEP2369	1995-1997	LINCOLN CONTINENTAL	4.6L V8 281 CID		USEP2484	1985	FORD E-250 ECONOLINE CLUB WAGON	7.5L V8 460 CID	
	1996	FORD TAURUS	3.0L V6 2968cc 181 CID			1985	FORD E-350 ECONOLINE	7.5L V8 460 CID	
	1996	FORD TAURUS	3.4L V8 207 CID	1985		FORD E-350 ECONOLINE CLUB WAGON	7.5L V8 460 CID		
	2003-2004	FORD FOCUS	2.3L L4 140 CID						
	2003-2004	MAZDA 6	2.3L L4 2260cc						
USEP2372	1998	FORD CONTOUR	2.0L L4 1989cc 121 CID						

USMW	Years	Application	Engine	USMW	Years	Application	Engine		
<b>USEP2484</b>	1985	LINCOLN TOWN CAR	5.0L V8 302 CID	<b>USEP2518</b>	2010-2013	MAZDA 6	2.5L L4 2489cc 152 CID		
	1985-1986	FORD F-350	7.5L V8 460 CID		2011-2012	FORD EXPLORER	3.5L V6 3496cc 213 CID		
	1985-1989	FORD BRONCO	5.0L V8 302 CID		2011-2014	CHRYSLER 200	2.4L L4 2360cc 144 CID		
	1985-1989	MERKUR XR4TI	2.3L L4 140 CID		2011-2014	DODGE JOURNEY	3.6L V6 3604cc 220 CID		
	1986	FORD F-250	7.5L V8 460 CID		2011-2014	DODGE JOURNEY	3.6L V6 3605cc 220 CID		
	1986	MERCURY GRAND MARQUIS	5.0L V8 302 CID		2011-2014	FORD EDGE	3.7L V6 3726cc 227 CID		
	1988-1989	FORD BRONCO	5.8L V8 5753cc 351 CID		2011-2014	LINCOLN MKX	3.7L V6 3726cc 227 CID		
	1988-1989	FORD F-150	4.9L L6 4917cc 300 CID		2012	DODGE CALIBER	2.0L L4 1998cc 122 CID		
	1988-1989	FORD F-150	5.0L V8 302 CID		2012-2013	KIA SOUL	1.6L L4 1591cc		
	1988-1989	FORD F-150	5.8L V8 5753cc 351 CID		2012-2014	HYUNDAI ACCENT	1.6L L4 1591cc 97 CID		
	1988-1989	FORD F-250	5.0L V8 302 CID		2012-2015	HYUNDAI VELOSTER	1.6L L4 1591cc 97 CID		
	1988-1989	FORD F-250	5.8L V8 5753cc 351 CID		2012-2015	JEEP WRANGLER	3.6L V6 3604cc 220 CID		
	1988-1989	FORD F-250	7.5L V8 460 CID		2013-2014	HYUNDAI ELANTRA	1.8L L4 1797cc		
	1988-1989	FORD F-350	5.8L V8 5753cc 351 CID		2014	HYUNDAI ELANTRA	2.0L L4 1999cc		
	1988-1989	FORD F-350	7.5L V8 460 CID		2014-2015	KIA FORTE	1.8L L4 1797cc		
	1989	FORD E-350 ECONOLINE	5.8L V8 5753cc 351 CID		2014-2015	KIA FORTE	2.0L L4 1999cc 122 CID		
	1989	FORD E-350 ECONOLINE	7.5L V8 460 CID		2014-2015	KIA FORTE KOUP	2.0L L4 1999cc 122 CID		
					2015	KIA FORTE5	2.0L L4 1999cc 122 CID		
	<b>USEP2485</b>	1978-1979	BMW 320i		2.0L L4 1990cc 121 CID	<b>USEP2519</b>	2008-2010	FORD F-250 SUPER DUTY	6.4L V8 391 CID
		1985-1989	FORD F-150		4.9L L6 4917cc 300 CID		2008-2010	FORD F-350 SUPER DUTY	6.4L V8 391 CID
1985-1989		FORD F-150	5.0L V8 302 CID	2008-2010	FORD F-450 SUPER DUTY		6.4L V8 391 CID		
1986-1989		FORD F-150	3.8L V6 3797cc 232 CID	2008-2010	FORD F-550 SUPER DUTY		6.4L V8 391 CID		
<b>USEP2486</b>	1983-1988	DODGE MAGNUM	2.2L L4 135 CID	<b>USEP2521</b>	1990-1997	FORD F53			
	1984	CHRYSLER LEBARON	2.2L L4 135 CID		1992-1996	FORD E-150 ECONOLINE			
	1985-1986	CHEVROLET CELEBRITY	2.8L V6 173 CID		1992-1996	FORD E-150 ECONOLINE CLUB WAGON			
	1988-1989	CHEVROLET B60	6.0L V8 366 CID		1992-1996	FORD E-250 ECONOLINE			
	1988-1989	CHEVROLET C60	6.0L V8 366 CID		1992-1996	FORD E-350 ECONOLINE			
	1988-1989	CHEVROLET C70	6.0L V8 366 CID		1992-1996	FORD E-350 ECONOLINE CLUB WAGON			
	1988-1989	CHEVROLET C70	7.0L V8 427 CID						
<b>USEP2487</b>	1985	VOLVO 244	2.1L L4 2127cc	<b>USEP2522</b>	2005-2007	FORD FIVE HUNDRED	3.0L V6 2968cc 181 CID		
	1985	VOLVO 245	2.1L L4 2127cc		2005-2007	MERCURY MONTEGO	3.0L V6 2968cc 181 CID		
	1990	VOLVO 740	2.3L L4 2316cc						
<b>USEP2490</b>	1992-1993	FORD E-250 ECONOLINE	4.9L L6 4917cc 300 CID	<b>USEP2576</b>	2005-2007	MERCURY GRAND MARQUIS	4.6L V8 281 CID		
	1992-1996	FORD E-150 ECONOLINE	5.0L V8 302 CID		2005-2008	FORD CROWN VICTORIA	4.6L V8 281 CID		
	1992-1996	FORD E-150 ECONOLINE CLUB WAGON	5.0L V8 302 CID		2005-2008	LINCOLN TOWN CAR	4.6L V8 281 CID		
	<b>USEP2492</b>	1992-1996	FORD E-150 ECONOLINE CLUB WAGON	5.8L V8 5753cc 351 CID	<b>USEP3015</b>	1975-1980	CHEVROLET LUV	1.8L L4 111 CID	
		1992-1996	FORD E-250 ECONOLINE	5.8L V8 5753cc 351 CID		<b>USEP3044</b>	1981	VOLVO 262	2.8L V6 2849cc
		1992-1996	FORD E-350 ECONOLINE	5.8L V8 5753cc 351 CID			1981	VOLVO 264	2.1L L4 2127cc
		1992-1996	FORD E-350 ECONOLINE	5.8L V8 5753cc 351 CID			1981	VOLVO 265	2.8L V6 2849cc
1992-1996		FORD E-350 ECONOLINE	7.5L V8 460 CID	1981-1982			VOLVO 264	2.8L V6 2849cc	
1992-1996		FORD E-350 ECONOLINE CLUB WAGON	5.8L V8 5753cc 351 CID	1981-1984			VOLVO 242	2.1L L4 2127cc	
1992-1996		FORD E-350 ECONOLINE CLUB WAGON	7.5L V8 460 CID	1985			VOLVO 245	2.1L L4 2127cc	
1992-1996	FORD E-350 ECONOLINE CLUB WAGON	7.5L V8 460 CID	<b>USEP3070</b>	1982	CHEVROLET CORVETTE		5.7L V8 350 CID		
1992-1996	FORD E-350 ECONOLINE CLUB WAGON	7.5L V8 460 CID		<b>USEP3071</b>	1984	CHEVROLET CORVETTE	5.7L V8 350 CID		
<b>USEP2497</b>	1996-2006	FORD TAURUS	3.0L V6 2986cc 182 CID		<b>USEP3073</b>	1985	CADILLAC DEVILLE	4.3L V6 260 CID	
	2001	MERCURY SABLE	3.0L V6 2986cc 182 CID	<b>USEP3076</b>		1985	BUICK LESABRE	5.7L V8 350 CID	
	2003-2005	MERCURY SABLE	3.0L V6 2986cc 181 CID		1985	BUICK REGAL	5.7L V8 350 CID		
	2003-2005	MERCURY SABLE	3.0L V6 2986cc 182 CID	1985	BUICK RIVIERA	5.7L V8 350 CID			
<b>USEP2498</b>	1997-1998	LINCOLN MARK VIII	4.6L V8 281 CID	1985	CADILLAC DEVILLE	4.3L V6 260 CID			
	1997-1998	LINCOLN MARK VIII	4.6L V8 281 CID	1985	CADILLAC ELDERADO	5.7L V8 350 CID			
<b>USEP2515</b>	2004-2005	FORD E-150 CLUB WAGON	4.6L V8 281 CID	1985	CADILLAC SEVILLE	5.7L V8 350 CID			
	2004-2005	FORD E-150 CLUB WAGON	5.4L V8 330 CID	1985	CHEVROLET CAPRICE	5.7L V8 350 CID			
	2004-2008	FORD E-250	4.6L V8 281 CID	1985	CHEVROLET IMPALA	5.7L V8 350 CID			
	2004-2008	FORD E-350 SUPER DUTY	5.4L V8 330 CID	1985	OLDSMOBILE CUSTOM CRUISER	5.7L V8 350 CID			
	2004-2008	FORD E-350 SUPER DUTY	6.8L V10 415 CID	1985	OLDSMOBILE CUTLASS SALON	5.7L V8 350 CID			
	2006-2008	FORD E-150	4.6L V8 281 CID	1985	OLDSMOBILE CUTLASS SUPREME	5.7L V8 350 CID			
	2006-2008	FORD E-150	5.4L V8 330 CID	1985	OLDSMOBILE DELTA 88	5.7L V8 350 CID			
	2006-2008	FORD E-250	5.4L V8 330 CID	1985	OLDSMOBILE TORONADO	5.7L V8 350 CID			
	2006-2008	FORD E-250	5.4L V8 330 CID	1985	PONTIAC PARIISIENNE	5.7L V8 350 CID			
	2006-2009	FORD FUSION	2.3L L4 140 CID	<b>USEP3127</b>	1983-1984	DODGE DART	2.2L L4 135 CID		
2006-2009	FORD FUSION	3.0L V6 2968cc 181 CID	1985		CHEVROLET CELEBRITY	4.3L V6 260 CID			
<b>USEP2518</b>	2006-2009	MERCURY MILAN	2.3L L4 140 CID	1986-1987	DODGE DART	2.2L L4 135 CID			
	2006-2009	MERCURY MILAN	3.0L V6 2968cc 181 CID	<b>USEP3158</b>	1988	CHEVROLET R30	6.2L V8 379 CID		
	2007	MAZDA CX-9	3.5L V6 3496cc 213 CID		1988	CHEVROLET V30	6.2L V8 379 CID		
	2007-2008	JEEP WRANGLER	3.8L V6 3778cc 231 CID		1988	GMC G2500	6.2L V8 379 CID		
	2007-2010	LINCOLN MKX	3.5L V6 3496cc 213 CID		1988	GMC G3500	6.2L V8 379 CID		
	2007-2012	LINCOLN MKZ	3.5L V6 3496cc 213 CID		1988	GMC P2500	6.2L V8 379 CID		
	2007-2015	FORD EDGE	3.5L V6 3496cc 213 CID		1988	GMC P3500	6.2L V8 379 CID		
	2007-2016	JEEP COMPASS	2.4L L4 2360cc 144 CID		1988	GMC R3500	6.2L V8 379 CID		
	2007-2016	JEEP PATRIOT	2.4L L4 2360cc 144 CID		1988	GMC V3500	6.2L V8 379 CID		
	2008	CHRYSLER SEBRING	3.5L V6 3497cc 215 CID		1988-1991	CHEVROLET C1500	6.2L V8 379 CID		
	2008	DODGE AVENGER	3.5L V6 3497cc 215 CID		1988-1991	CHEVROLET C3500	6.2L V8 379 CID		
	2008	DODGE AVENGER	3.5L V6 3518cc 215 CID		1988-1991	CHEVROLET K1500	6.2L V8 379 CID		
	2008-2009	FORD TAURUS	3.5L V6 3496cc 213 CID		1988-1991	CHEVROLET K3500	6.2L V8 379 CID		
	2008-2009	FORD TAURUS X	3.5L V6 3496cc 213 CID		1988-1991	GMC C1500	6.2L V8 379 CID		
	2008-2009	MERCURY SABLE	3.5L V6 3496cc 213 CID		1988-1991	GMC C3500	6.2L V8 379 CID		
	2008-2010	CHRYSLER SEBRING	2.4L L4 2360cc 144 CID		1988-1991	GMC K1500	6.2L V8 379 CID		
	2008-2010	MAZDA CX-9	3.7L V6 3726cc 227 CID		1988-1991	GMC K3500	6.2L V8 379 CID		
	2008-2014	DODGE AVENGER	2.4L L4 2360cc 144 CID		1988-1992	CHEVROLET C2500	6.2L V8 379 CID		
	2009-2010	DODGE JOURNEY	3.5L V6 3497cc 215 CID		1988-1992	CHEVROLET K2500	6.2L V8 379 CID		
	2009-2010	DODGE JOURNEY	3.5L V6 3518cc 215 CID	1988-1992	GMC C2500	6.2L V8 379 CID			
2009-2010	LINCOLN MKS	3.7L V6 3726cc 227 CID	1988-1992	GMC K2500	6.2L V8 379 CID				
2009-2013	MAZDA 6	2.5L L4 2488cc 152 CID	1992	CHEVROLET C2500	6.5L V8 395 CID				
2009-2016	DODGE JOURNEY	2.4L L4 2360cc 144 CID	1992	CHEVROLET K2500	6.5L V8 395 CID				
2010-2011	JEEP WRANGLER	3.8L V6 3778cc 231 CID	1992	GMC C2500	6.5L V8 395 CID				
2010-2012	FORD FUSION	3.5L V6 3496cc 213 CID	1992	GMC K2500	6.5L V8 395 CID				
2010-2012	HYUNDAI GENESIS COUPE	2.0L L4 1998cc 122 CID	<b>USEP3210</b>	1985-1987	PONTIAC FIREBIRD	5.0L V8 305 CID			
2010-2012	HYUNDAI GENESIS COUPE	3.8L V6 3778cc 231 CID		1985-1989	CHEVROLET CORVETTE				
			1986-1987	CHEVROLET CAMARO	5.0L V8 305 CID				



USMW	Years	Application	Engine	USMW	Years	Application	Engine
<b>USEP3210</b>	1987	CHEVROLET CAMARO	5.7L V8 350 CID	<b>USEP3222</b>	1993	CADILLAC 60 SPECIAL	4.9L V8 300 CID
	1987	PONTIAC FIREBIRD	5.7L V8 350 CID		1995	GEO TRACKER	1.6L L4 1588cc 98 CID
	1989	PONTIAC GRAND PRIX	3.1L V6 189 CID		1996	CADILLAC DEVILLE	4.6L V8 4565cc 279 CID
	1990	PONTIAC 6000	3.1L V6 189 CID	<b>USEP3240</b>	1982-1984	CHEVROLET CELEBRITY	2.8L V6 173 CID
	1990-1992	CHEVROLET CAMARO	5.0L V8 305 CID		1984	BUICK RIVIERA	3.8L V6 3800cc 231 CID
	1990-1992	CHEVROLET CAMARO	5.7L V8 350 CID		1985	BUICK SKYLARK	2.8L V6 173 CID
	1990-1992	PONTIAC FIREBIRD	5.0L V8 305 CID		1985	BUICK SOMERSET REGAL	3.0L V6 181 CID
	1990-1992	PONTIAC FIREBIRD	5.7L V8 350 CID		1985	PONTIAC J2000 SUNBIRD	1.8L L4 112 CID
	1995	CADILLAC FLEETWOOD			1985-1986	BUICK SKYHAWK	1.8L L4 112 CID
	1996	BUICK REGAL	3.8L V6 3800cc 231 CID		1985-1987	CHEVROLET CAVALIER	2.8L V6 173 CID
1996	CHEVROLET CAPRICE	4.3L V8 265 CID	1985-1987		OLDSMOBILE CALAIS	3.0L V6 181 CID	
<b>USEP3211</b>	1985	BUICK RIVIERA	3.8L V6 3800cc 231 CID		1985-1987	OLDSMOBILE FIRENZA	2.8L V6 173 CID
	1985-1987	BUICK REGAL	3.8L V6 3800cc 231 CID		1985-1987	PONTIAC FIREBIRD	2.8L V6 173 CID
<b>USEP3212</b>	1986	PONTIAC BONNEVILLE	4.3L V6 262 CID		1985-1987	PONTIAC GRAND AM	3.0L V6 181 CID
	1986-1987	CADILLAC DEVILLE	4.1L V8 250 CID		1985-1988	CADILLAC CIMARRON	2.8L V6 173 CID
	1986-1987	CADILLAC ELDORADO	4.1L V8 250 CID		1985-1988	PONTIAC FIERO	2.8L V6 173 CID
	1986-1987	CADILLAC FLEETWOOD	4.1L V8 250 CID		1986	BUICK LESABRE	3.0L V6 181 CID
	1986-1987	CADILLAC SEVILLE	4.1L V8 250 CID		1986	OLDSMOBILE DELTA 88	3.0L V6 181 CID
	1987	CADILLAC COMMERCIAL CHASSIS	4.1L V8 250 CID		1986	PONTIAC SUNBIRD	1.8L L4 112 CID
	1987	CHEVROLET CAVALIER	2.0L L4 122 CID		1986-1987	BUICK SOMERSET	3.0L V6 181 CID
	1987-1988	OLDSMOBILE FIRENZA	2.0L L4 1998cc 122 CID	1986-1987	CHEVROLET CAMARO	2.8L V6 173 CID	
	1987-1989	BUICK SKYHAWK	2.0L L4 122 CID	1986-1988	BUICK CENTURY	3.8L V6 3800cc 231 CID	
	1987-1989	CHEVROLET BERETTA	2.0L L4 122 CID	1986-1988	BUICK ELECTRA	3.8L V6 3800cc 231 CID	
	1987-1989	CHEVROLET CORSICA	2.0L L4 122 CID	1986-1988	BUICK SKYLARK	3.0L V6 181 CID	
	1988-1989	CADILLAC COMMERCIAL CHASSIS	4.5L V8 273 CID	1986-1988	OLDSMOBILE 98	3.8L V6 3800cc 231 CID	
	1988-1989	CADILLAC DEVILLE	4.5L V8 273 CID	1986-1988	OLDSMOBILE CUTLASS CIERA	3.8L V6 3800cc 231 CID	
	1988-1989	CADILLAC ELDORADO	4.5L V8 273 CID	1986-1989	BUICK LESABRE	3.8L V6 3800cc 231 CID	
	1988-1989	CADILLAC FLEETWOOD	4.5L V8 273 CID	1986-1989	OLDSMOBILE DELTA 88	3.8L V6 3800cc 231 CID	
	1988-1989	CADILLAC SEVILLE	4.5L V8 273 CID	1986-1989	OLDSMOBILE TORONADO	3.8L V6 3800cc 231 CID	
	1988-1989	CHEVROLET CELEBRITY	2.5L L4 2474cc 151 CID	1986-1989	PONTIAC 6000	2.8L V6 173 CID	
	1988-1990	BUICK CENTURY	2.5L L4 2474cc 151 CID	1986-1993	BUICK RIVIERA	3.8L V6 3800cc 231 CID	
	1988-1990	OLDSMOBILE CUTLASS CRUISER	2.5L L4 2474cc 151 CID	1987	BUICK CENTURY	2.8L V6 173 CID	
	1988-1991	BUICK SKYLARK	2.5L L4 2474cc 151 CID	1987	BUICK SKYHAWK	2.0L L4 122 CID	
	1988-1991	OLDSMOBILE CUTLASS CALAIS	2.5L L4 2474cc 151 CID	1987	OLDSMOBILE CALAIS	2.3L L4 138 CID	
	1988-1991	PONTIAC 6000	2.5L L4 2474cc 151 CID	1987-1988	CADILLAC ALLANTE	4.1L V8 250 CID	
	1988-1991	PONTIAC GRAND AM	2.5L L4 2474cc 151 CID	1987-1988	CHEVROLET CORSICA	2.8L V6 173 CID	
	1988-1991	PONTIAC SUNBIRD	2.0L L4 122 CID	1987-1989	CHEVROLET BERETTA	2.8L V6 173 CID	
	1988-1992	OLDSMOBILE CUTLASS CIERA	2.5L L4 2474cc 151 CID	1987-1989	CHEVROLET CELEBRITY	2.8L V6 173 CID	
	1990-1991	CHEVROLET CAVALIER	2.2L L4 134 CID	1987-1989	OLDSMOBILE CUTLASS CIERA	2.8L V6 173 CID	
	1990-1992	CHEVROLET LUMINA	2.5L L4 2474cc 151 CID	1987-1989	PONTIAC BONNEVILLE	3.8L V6 3800cc 231 CID	
	1994	CHEVROLET C2500 SUBURBAN	7.4L V8 454 CID	1987-1989	PONTIAC GRAND AM	2.0L L4 122 CID	
	1994	CHEVROLET K2500 SUBURBAN	7.4L V8 454 CID	1987-1990	PONTIAC SUNBIRD	2.0L L4 122 CID	
	1994	GMC K2500 SUBURBAN	7.4L V8 454 CID	1988	BUICK SKYLARK	2.3L L4 138 CID	
	1994-1995	CHEVROLET P30	7.4L V8 454 CID	1988	OLDSMOBILE CUTLASS CALAIS	3.0L V6 181 CID	
	1994-1995	GMC P3500	7.4L V8 454 CID	1988	PONTIAC 6000	3.1L V6 189 CID	
	1994-1996	CHEVROLET G30	7.4L V8 454 CID	1988	PONTIAC GRAND AM	2.3L L4 138 CID	
	1994-1996	GMC G3500	7.4L V8 454 CID	1988-1989	BUICK REGAL	2.8L V6 173 CID	
	1997	CHEVROLET P30	7.4L V8 454 CID	1988-1989	OLDSMOBILE CUTLASS SUPREME	2.8L V6 173 CID	
	1997	GMC P3500	7.4L V8 454 CID	1988-1989	PONTIAC GRAND PRIX	2.8L V6 173 CID	
	<b>USEP3222</b>	1985-1987	DODGE COLT	1.6L L4 1597cc 98 CID	1988-1991	BUICK REATTA	3.8L V6 3800cc 231 CID
		1985-1988	MITSUBISHI MIRAGE	1.6L L4 1597cc 98 CID	1989	BUICK CENTURY	2.8L V6 173 CID
		1985-1988	PLYMOUTH COLT	1.6L L4 1597cc 98 CID	1989	PONTIAC GRAND AM	2.3L L4 140 CID
		1987-1988	BUICK CENTURY	3.8L V6 3800cc 231 CID	1989	PONTIAC GRAND PRIX	3.1L V6 189 CID
		1987-1988	CHEVROLET SPECTRUM	1.5L L4 1471cc 92 CID	1989-1990	BUICK CENTURY	3.3L V6 204 CID
		1987-1988	OLDSMOBILE CUTLASS CRUISER	3.8L V6 3800cc 231 CID	1989-1990	OLDSMOBILE CUTLASS SUPREME	3.1L V6 189 CID
		1987-1989	BUICK CENTURY	2.8L V6 173 CID	1989-1991	OLDSMOBILE CUTLASS CALAIS	2.3L L4 140 CID
		1987-1989	CHEVROLET CELEBRITY	2.8L V6 173 CID	1989-1992	BUICK SKYLARK	3.3L V6 204 CID
		1987-1989	ISUZU I-MARK	1.5L L4 1471cc	1989-1992	CADILLAC ALLANTE	4.5L V8 273 CID
1987-1989		OLDSMOBILE CUTLASS CRUISER	2.8L V6 173 CID	1989-1992	OLDSMOBILE CUTLASS CIERA	3.3L V6 204 CID	
1987-1989		PONTIAC 6000	2.8L V6 173 CID	1989-1993	BUICK REGAL	3.1L V6 189 CID	
1987-1990		MITSUBISHI VAN	2.4L L4 2351cc	1990	CADILLAC ELDORADO	4.5L V8 273 CID	
1988		PLYMOUTH COLT	1.5L L4 1468cc 90 CID	1990	CADILLAC SEVILLE	4.5L V8 273 CID	
1988		PONTIAC BONNEVILLE	3.8L V6 3800cc 231 CID	1990	CHEVROLET LUMINA	3.1L V6 189 CID	
1988-1989		BUICK ELECTRA	3.8L V6 3800cc 231 CID	1990	OLDSMOBILE CUTLASS SUPREME	2.3L L4 140 CID	
1988-1989		PLYMOUTH COLT	2.0L L4 1997cc 122 CID	1990	PONTIAC GRAND AM	2.3L L4 138 CID	
1988-1991		OLDSMOBILE DELTA 88	3.8L V6 3800cc 231 CID	1990-1991	CHEVROLET CAMARO	3.1L V6 189 CID	
1988-1992		BUICK LESABRE	3.8L V6 3800cc 231 CID	1990-1991	PONTIAC 6000	3.1L V6 189 CID	
1988-1992		OLDSMOBILE 98	3.8L V6 3800cc 231 CID	1990-1992	BUICK SKYLARK	2.3L L4 138 CID	
1989		DODGE COLT	1.8L L4 1754cc 107 CID	1990-1992	PONTIAC FIREBIRD	3.1L V6 189 CID	
1989		DODGE COLT	2.0L L4 1997cc 122 CID	1990-1993	BUICK REGAL	3.8L V6 3800cc 231 CID	
1989		DODGE RAIDER	3.0L V6 2972cc 181 CID	1990-1994	CHEVROLET CAVALIER	2.8L V6 173 CID	
1989		ISUZU I-MARK	1.6L L4 1588cc	1991	BMW 318IS	1.8L L4 1796cc	
1989		PLYMOUTH COLT	1.8L L4 1754cc 107 CID	1991	OLDSMOBILE CUTLASS SUPREME	2.3L L4 138 CID	
1989-1990		BUICK CENTURY	3.3L V6 204 CID	1991	PONTIAC GRAND AM	2.3L L4 140 CID	
1989-1990		MITSUBISHI MONTERO	3.0L V6 2972cc 181 CID	1991-1992	CADILLAC ELDORADO	4.9L V8 300 CID	
1989-1992		OLDSMOBILE CUTLASS CRUISER	3.3L V6 204 CID	1991-1992	CADILLAC SEVILLE	4.9L V8 300 CID	
1990		DODGE RAM 50	2.4L L4 2351cc	1991-1993	CHEVROLET LUMINA	3.4L V6 207 CID	
1990		DODGE RAM 50	3.0L V6 2972cc 181 CID	1991-1994	OLDSMOBILE CUTLASS SUPREME	3.4L V6 207 CID	
1990		MITSUBISHI MIGHTY MAX	2.4L L4 2351cc	1992	CHEVROLET BERETTA	2.2L L4 2190cc 134 CID	
1990		MITSUBISHI MIGHTY MAX	3.0L V6 2972cc 181 CID	1992	CHEVROLET BERETTA	2.3L L4 140 CID	
1990		PONTIAC BONNEVILLE	3.8L V6 3800cc 231 CID	1992	CHEVROLET BERETTA	3.1L V6 189 CID	
1990-1991		PONTIAC 6000	3.1L V6 189 CID	1992-1996	PONTIAC GRAND PRIX	3.4L V6 207 CID	
1991-1992		BUICK PARK AVENUE	3.8L V6 3800cc 231 CID	1994-1995	CHEVROLET LLV	2.2L L4 2190cc 134 CID	
1991-1992		OLDSMOBILE CUTLASS CIERA	3.3L V6 204 CID	1994-1995	CHEVROLET S10	2.2L L4 2190cc 134 CID	
1991-1993		CADILLAC DEVILLE	4.9L V8 300 CID	1994-1995	GMC SONOMA	2.2L L4 2190cc 134 CID	
1992		CADILLAC FLEETWOOD	4.9L V8 300 CID	1995-1996	BUICK REGAL	3.1L V6 189 CID	
1992		OLDSMOBILE 88	3.8L V6 3800cc 231 CID	1995-1996	BUICK REGAL	3.8L V6 3800cc 231 CID	
1992-1993		CADILLAC COMMERCIAL CHASSIS	4.9L V8 300 CID	1995-1996	CHEVROLET LUMINA	3.4L V6 207 CID	

USMW	Years	Application	Engine	USMW	Years	Application	Engine
<b>USEP3240</b>	1995-1996	CHEVROLET MONTE CARLO	3.4L V6 207 CID	<b>USEP3240R</b>	2002-2004	CHEVROLET BLAZER	4.3L V6 262 CID
	1996	CHEVROLET LUMINA APV	3.4L V6 207 CID		2003	BUICK PARK AVENUE	
	1996	OLDSMOBILE CUTLASS SUPREME	3.4L V6 207 CID		2003	PONTIAC BONNEVILLE	3.8L V6 3800cc 231 CID
	1996	OLDSMOBILE SILHOUETTE	3.4L V6 207 CID		2005	BUICK PARK AVENUE	
<b>USEP3240R</b>	1996	PONTIAC TRANS SPORT	3.4L V6 207 CID	2008	CHEVROLET EXPRESS 1500	5.3L V8 5328cc 325 CID	
	1995	PONTIAC SUNFIRE	2.3L L4 138 CID	<b>USEP3265</b>	1988	CADILLAC ALLANTE	4.1L V8 250 CID
	1995-1996	PONTIAC SUNFIRE	2.2L L4 2190cc 134 CID		1988-1989	CHEVROLET BERETTA	2.8L V6 173 CID
	1996	PONTIAC SUNFIRE	2.4L L4 2392cc 146 CID		1988-1989	CHEVROLET CORSICA	2.8L V6 173 CID
1996-1997	BUICK SKYLARK	2.4L L4 2392cc 146 CID	1989		OLDSMOBILE CUTLASS CALAIS	2.3L L4 140 CID	
1996-1997	PONTIAC FIREBIRD	5.7L V8 350 CID	1989-1992	CADILLAC ALLANTE	4.5L V8 273 CID		
1996-1998	BUICK SKYLARK	3.1L V6 189 CID	1989-1996	BUICK REGAL	3.1L V6 189 CID		
1996-1998	OLDSMOBILE ACHIEVA	2.4L L4 2392cc 146 CID	1990	CADILLAC ELDORADO	4.5L V8 273 CID		
1996-1998	OLDSMOBILE ACHIEVA	3.1L V6 189 CID	1990	CADILLAC SEVILLE	4.5L V8 273 CID		
1996-1998	PONTIAC GRAND AM	2.4L L4 2392cc 146 CID	1990	OLDSMOBILE CUTLASS SUPREME	2.3L L4 140 CID		
1996-1998	PONTIAC GRAND AM	3.1L V6 189 CID	1990-1991	BUICK REATTA	3.8L V6 3800cc 231 CID		
1996-1999	BUICK RIVIERA	3.8L V6 3800cc 231 CID	1990-1991	CHEVROLET CAVALIER	3.1L V6 189 CID		
1996-2000	CHEVROLET S10	2.2L L4 2190cc 134 CID	1990-1991	CHEVROLET CORVETTE	5.7L V8 350 CID		
1996-2000	GMC SONOMA	2.2L L4 2190cc 134 CID	1990-1991	OLDSMOBILE CUTLASS CALAIS	2.3L L4 138 CID		
1996-2001	GMC JIMMY	4.3L V6 262 CID	1990-1991	OLDSMOBILE CUTLASS CALAIS	3.3L V6 204 CID		
1996-2001	OLDSMOBILE BRAVADA	4.3L V6 262 CID	1990-1991	PONTIAC GRAND PRIX	2.3L L4 138 CID		
1996-2003	CHEVROLET S10	4.3L V6 262 CID	1990-1992	CHEVROLET BERETTA	3.1L V6 189 CID		
1996-2003	GMC SONOMA	4.3L V6 262 CID	1990-1992	CHEVROLET CORSICA	3.1L V6 189 CID		
1997	CHEVROLET EXPRESS 1500	4.3L V6 262 CID	1990-1992	OLDSMOBILE TORONADO	3.8L V6 3800cc 231 CID		
1997	CHEVROLET EXPRESS 1500	5.0L V8 305 CID	1990-1993	BUICK RIVIERA	3.8L V6 3800cc 231 CID		
1997	CHEVROLET EXPRESS 1500	5.7L V8 350 CID	1990-1993	CHEVROLET LUMINA	3.1L V6 189 CID		
1997	GMC SAVANA 1500	4.3L V6 262 CID	1990-1996	BUICK REGAL	3.8L V6 3800cc 231 CID		
1997	GMC SAVANA 1500	5.0L V8 305 CID	1990-1996	PONTIAC GRAND PRIX	3.1L V6 189 CID		
1997	GMC SAVANA 1500	5.7L V8 350 CID	1990-1997	OLDSMOBILE CUTLASS SUPREME	3.1L V6 189 CID		
1997	OLDSMOBILE CUTLASS	3.1L V6 189 CID	1991	OLDSMOBILE CUTLASS SUPREME	2.3L L4 138 CID		
1997-1998	BUICK REGAL		1991	PONTIAC SUNBIRD	3.1L V6 189 CID		
1997-1999	BUICK PARK AVENUE	3.8L V6 3800cc 231 CID	1991-1992	CADILLAC ELDORADO	4.9L V8 300 CID		
1997-1999	CHEVROLET ASTRO	4.3L V6 262 CID	1991-1992	CADILLAC SEVILLE	4.9L V8 300 CID		
1997-1999	GMC SAFARI	4.3L V6 262 CID	1991-1996	OLDSMOBILE CUTLASS SUPREME	3.4L V6 207 CID		
1997-1999	ISUZU HOMBRE	4.3L V6 4294cc	1991-1996	PONTIAC GRAND PRIX	3.4L V6 207 CID		
1997-2000	CHEVROLET EXPRESS 3500	7.4L V8 454 CID	1992	CHEVROLET BERETTA	2.3L L4 140 CID		
1997-2000	GMC SAVANA 2500	5.7L V8 350 CID	1992	CHEVROLET CORSICA	2.2L L4 2190cc 134 CID		
1997-2000	GMC SAVANA 3500	5.7L V8 350 CID	1992	CHEVROLET LUMINA APV	3.8L V6 3800cc 231 CID		
1997-2000	GMC SAVANA 3500	7.4L V8 454 CID	1992-1995	OLDSMOBILE SILHOUETTE	3.8L V6 3800cc 231 CID		
1997-2000	ISUZU HOMBRE	2.2L L4 2190cc 134 CID	1992-1995	PONTIAC TRANS SPORT	3.8L V6 3800cc 231 CID		
1997-2000	PONTIAC GRAND PRIX	3.8L V6 3800cc 231 CID	1994	OLDSMOBILE CUTLASS CRUISER	3.1L V6 189 CID		
1997-2002	CHEVROLET EXPRESS 2500	4.3L V6 262 CID	1994-1995	CHEVROLET LUMINA APV	3.8L V6 3800cc 231 CID		
1997-2002	CHEVROLET EXPRESS 2500	5.0L V8 305 CID	1995-1996	CHEVROLET LUMINA	3.1L V6 189 CID		
1997-2002	CHEVROLET EXPRESS 2500	5.7L V8 350 CID	1995-1996	CHEVROLET MONTE CARLO	3.1L V6 189 CID		
1997-2002	CHEVROLET EXPRESS 3500	5.7L V8 350 CID	1995-1996	CHEVROLET MONTE CARLO	3.4L V6 207 CID		
1997-2002	GMC SAVANA 2500	4.3L V6 262 CID	1996	OLDSMOBILE SILHOUETTE	3.4L V6 207 CID		
1997-2002	GMC SAVANA 2500	5.0L V8 305 CID	1996	PONTIAC TRANS SPORT	3.4L V6 207 CID		
1998	CHEVROLET LUMINA	3.8L V6 3800cc 231 CID	<b>USEP3268</b>	1987-1995	CHEVROLET P30	5.7L V8 350 CID	
1998	CHEVROLET MONTE CARLO	3.8L V6 3800cc 231 CID		1987-1995	GMC P3500	5.7L V8 350 CID	
1998	PONTIAC GRAND PRIX	3.1L V6 3136cc 191 CID		1990-1993	CHEVROLET P30	7.4L V8 454 CID	
1998	PONTIAC SUNFIRE	2.2L L4 2190cc 134 CID		1990-1993	GMC P3500	7.4L V8 454 CID	
1998	PONTIAC SUNFIRE	2.4L L4 2392cc 146 CID	1990-1995	CHEVROLET P30	4.3L V6 262 CID		
1998-1999	BUICK CENTURY	3.1L V6 189 CID	1990-1995	GMC P3500	4.3L V6 262 CID		
1998-1999	CHEVROLET C1500 SUBURBAN	5.7L V8 350 CID	1991	BUICK ROADMASTER			
1998-1999	CHEVROLET C2500 SUBURBAN	5.7L V8 350 CID	1991	OLDSMOBILE CUSTOM CRUISER			
1998-1999	CHEVROLET C2500 SUBURBAN	7.4L V8 454 CID	1991-1993	CHEVROLET CAPRICE	5.0L V8 305 CID		
1998-1999	CHEVROLET K1500 SUBURBAN	5.7L V8 350 CID	1991-1993	CHEVROLET CAPRICE	5.7L V8 350 CID		
1998-1999	CHEVROLET K2500 SUBURBAN	5.7L V8 350 CID	1992	OLDSMOBILE CUSTOM CRUISER	5.0L V8 305 CID		
1998-1999	CHEVROLET K2500 SUBURBAN	7.4L V8 454 CID	1992	OLDSMOBILE CUSTOM CRUISER	5.7L V8 350 CID		
1998-1999	CHEVROLET P30	4.3L V6 262 CID	1993	BUICK COMMERCIAL CHASSIS			
1998-1999	CHEVROLET P30	5.7L V8 350 CID	1993	BUICK ROADMASTER			
1998-1999	CHEVROLET P30	7.4L V8 454 CID	1993	CADILLAC COMMERCIAL CHASSIS	5.7L V8 350 CID		
1998-1999	CHEVROLET TAHOE	5.7L V8 350 CID	1993	CADILLAC FLEETWOOD			
1998-1999	GMC C1500 SUBURBAN	5.7L V8 350 CID	1993	CHEVROLET CAPRICE	4.3L V6 262 CID		
1998-1999	GMC C2500 SUBURBAN	5.7L V8 350 CID	1996	CHEVROLET G30	5.7L V8 350 CID		
1998-1999	GMC C2500 SUBURBAN	7.4L V8 454 CID	1996	GMC G3500	5.7L V8 350 CID		
1998-1999	GMC K1500 SUBURBAN	5.7L V8 350 CID	<b>USEP3270</b>	1991	GMC SYCLONE	4.3L V6 262 CID	
1998-1999	GMC K2500 SUBURBAN	5.7L V8 350 CID		1992-1993	GMC TYPHOON	4.3L V6 262 CID	
1998-1999	GMC K2500 SUBURBAN	7.4L V8 454 CID		1992-1994	CHEVROLET S10 BLAZER		
1998-1999	GMC P3500	4.3L V6 262 CID		1992-1994	OLDSMOBILE BRAVADA	4.3L V6 262 CID	
1998-1999	GMC P3500	5.7L V8 350 CID	1992-1996	CHEVROLET ASTRO			
1998-1999	GMC P3500	7.4L V8 454 CID	1992-1996	GMC SAFARI	4.3L V6 262 CID		
1998-1999	GMC YUKON	5.7L V8 350 CID	1993-1995	GMC JIMMY	4.3L V6 262 CID		
1998-1999	OLDSMOBILE INTRIGUE	3.8L V6 3800cc 231 CID	1994	CADILLAC FLEETWOOD			
1998-2000	PONTIAC GRAND PRIX	3.1L V6 189 CID	1994-1995	CHEVROLET S10	4.3L V6 262 CID		
1998-2002	CHEVROLET LUV	2.2L L4 2198cc 134 CID	1994-1995	GMC SONOMA	4.3L V6 262 CID		
1999	BUICK REGAL	3.8L V6 3800cc 231 CID	1994-1996	BUICK COMMERCIAL CHASSIS			
1999-2000	CADILLAC ESCALADE	5.7L V8 350 CID	1994-1996	BUICK ROADMASTER			
1999-2000	OLDSMOBILE INTRIGUE	3.5L V6 214 CID	1994-1996	CADILLAC COMMERCIAL CHASSIS			
1999-2002	CHEVROLET CAMARO	3.8L V6 3800cc 231 CID	1994-1996	CHEVROLET IMPALA			
1999-2002	PONTIAC FIREBIRD	3.8L V6 3800cc 231 CID	1996	CADILLAC FLEETWOOD			
2000	CHEVROLET SONORA	5.7L V8 350 CID	1996	CHEVROLET CAPRICE	5.7L V8 350 CID		
2000-2001	BUICK PARK AVENUE		1996-1997	CHEVROLET C1500 SUBURBAN	5.7L V8 350 CID		
2000-2001	PONTIAC BONNEVILLE	3.8L V6 3800cc 231 CID	1996-1997	CHEVROLET K1500 SUBURBAN	5.7L V8 350 CID		
2001	CHEVROLET P30	4.3L V6 4300cc 262 CID	1996-1997	CHEVROLET TAHOE	5.7L V8 350 CID		
2001	CHEVROLET SUBURBAN 1500	5.7L V8 350 CID	1996-1997	GMC C1500 SUBURBAN	5.7L V8 350 CID		
2001-2002	CHEVROLET EXPRESS 3500	8.1L V8 496 CID	1996-1997	GMC C2500 SUBURBAN	5.7L V8 350 CID		
2001-2002	GMC SAVANA 3500	8.1L V8 496 CID	1996-1997	GMC C2500 SUBURBAN	7.4L V8 454 CID		
2002	GMC SAVANA 3500	5.7L V8 350 CID	1996-1997	GMC K1500 SUBURBAN	5.7L V8 350 CID		





USMW	Years	Application	Engine	USMW	Years	Application	Engine		
<b>USEP3507</b>	2002-2005	PONTIAC GRAND AM	2.2L L4 2198cc 134 CID	<b>USEP3707</b>	2006-2007	CHEVROLET TRAILBLAZER	6.0L V8 5967cc 364 CID		
	2003	PONTIAC SUNFIRE			2007	ISUZU ASCENDER			
	2004	CHEVROLET CLASSIC			2009	CHEVROLET TRAILBLAZER	4.2L L6 256 CID		
	2004	CHEVROLET MALIBU	2.2L L4 2198cc 134 CID		2009	CHEVROLET TRAILBLAZER	6.0L V8 5967cc 364 CID		
	2005	CHEVROLET CAVALIER			2009	GMC ENVOY	4.2L L6 256 CID		
<b>USEP3507R</b>	2002-2003	GMC YUKON XL 1500		<b>USEP3736</b>	1977-1980	PONTIAC SUNBIRD	3.8L V6 3800cc 231 CID		
	2003	CHEVROLET SUBURBAN 1500			1978-1980	BUICK SKYHAWK	3.8L V6 3800cc 231 CID		
<b>USEP3509</b>	2000-2001	CHEVROLET SUBURBAN 1500	5.3L V8 5328cc 325 CID		1984-1985	BUICK CENTURY	3.0L V6 181 CID		
	2000-2001	GMC YUKON XL 1500	5.3L V8 5328cc 325 CID		1985	BUICK ELECTRA	3.0L V6 181 CID		
	2001	GMC YUKON XL 1500	6.0L V8 5967cc 364 CID	<b>USEP3745</b>	1998	CHEVROLET CAMARO	3.8L V6 3800cc 231 CID		
<b>USEP3526</b>	2001-2003	CHEVROLET SILVERADO 2500 HD	6.6L V8 6599cc 403 CID		1998	PONTIAC FIREBIRD	3.8L V6 3800cc 231 CID		
	2001-2004	GMC SIERRA 2500 HD	6.6L V8 6599cc 403 CID		<b>USEP3784</b>	2007	SATURN ION	2.2L L4 2198cc 134 CID	
	2001-2006	CHEVROLET SILVERADO 3500	6.6L V8 6599cc 403 CID			2007-2010	CHEVROLET COBALT	2.2L L4 2198cc 134 CID	
	2001-2006	GMC SIERRA 3500	6.6L V8 6599cc 403 CID	2007-2010		PONTIAC G5	2.2L L4 2198cc 134 CID		
	2006-2008	CHEVROLET SILVERADO 2500 HD	6.6L V8 6599cc 403 CID	2008	PONTIAC G5	2.4L L4 2384cc 145 CID			
2006-2008	GMC SIERRA 2500 HD	6.6L V8 6599cc 403 CID	<b>USEP3901</b>	1984	CADILLAC CIMARRON	2.0L L4 122 CID			
2007-2008	CHEVROLET SILVERADO 3500 HD	6.6L V8 6599cc 403 CID		1984	CADILLAC DEVILLE	4.1L V8 250 CID			
2007-2008	GMC SIERRA 3500 HD	6.6L V8 6599cc 403 CID		1984-1985	BUICK SKYLARK	2.5L L4 2474cc 151 CID			
<b>USEP3540</b>	1999	CHEVROLET C1500 SUBURBAN		6.5L V8 395 CID	1984-1985	CADILLAC ELDORADO	4.1L V8 250 CID		
	1999	CHEVROLET K1500 SUBURBAN		6.5L V8 395 CID	1985	CADILLAC SEVILLE	4.1L V8 250 CID		
	1999	CHEVROLET K2500 SUBURBAN	6.5L V8 395 CID	1985	CHEVROLET CITATION II	2.5L L4 2474cc 151 CID			
	1999	CHEVROLET P300	6.5L V8 395 CID	1985	PONTIAC FIREBIRD	2.5L L4 2474cc 151 CID			
	1999	CHEVROLET TAHOE	6.5L V8 395 CID	1985-1987	CHEVROLET MONTE CARLO	4.3L V6 262 CID			
	1999	GMC C1500 SUBURBAN	6.5L V8 395 CID	1986	PONTIAC GRAND PRIX	4.3L V6 262 CID			
	1999	GMC C2500 SUBURBAN	6.5L V8 395 CID	1990	CHEVROLET CAPRICE	4.3L V6 262 CID			
	1999	GMC K1500 SUBURBAN	6.5L V8 395 CID	<b>USEP3902</b>	1985	BUICK SOMERSET REGAL	2.5L L4 2474cc 151 CID		
	1999	GMC K2500 SUBURBAN	6.5L V8 395 CID		1985	CHEVROLET IMPALA	4.3L V6 262 CID		
	1999	GMC P3500	6.5L V8 395 CID		1985-1986	BUICK SKYHAWK	1.8L L4 112 CID		
	1999-2002	CHEVROLET EXPRESS 2500	6.5L V8 395 CID		1985-1986	CADILLAC CIMARRON	2.0L L4 122 CID		
	1999-2002	CHEVROLET EXPRESS 3500	6.5L V8 395 CID		1985-1986	OLDSMOBILE FIRENZA	1.8L L4 112 CID		
	1999-2002	GMC SAVANA 2500	6.5L V8 395 CID		1985-1986	PONTIAC PARISIENNE	4.3L V6 262 CID		
	1999-2002	GMC SAVANA 3500	6.5L V8 395 CID		1985-1987	BUICK SKYHAWK	2.0L L4 122 CID		
	2001-2002	CHEVROLET C3500	8.1L V8 496 CID		1985-1987	CHEVROLET EL CAMINO	4.3L V6 262 CID		
	<b>USEP3545</b>	1997-1999	SATURN SW1		1.9L L4 116 CID	1985-1987	GMC CABALLERO	4.3L V6 262 CID	
		1997-2001	SATURN SW2		1.9L L4 116 CID	1985-1987	OLDSMOBILE CALAIS	2.5L L4 2474cc 151 CID	
		1997-2002	SATURN SC1		1.9L L4 116 CID	1985-1987	OLDSMOBILE FIRENZA	2.0L L4 122 CID	
		1997-2002	SATURN SC2		1.9L L4 116 CID	1985-1987	PONTIAC GRAND AM	2.5L L4 2474cc 151 CID	
1997-2002		SATURN SL	1.9L L4 116 CID		1985-1988	BUICK CENTURY	2.5L L4 2474cc 151 CID		
1997-2002		SATURN SL1	1.9L L4 116 CID		1985-1988	PONTIAC FIERO	2.5L L4 2474cc 151 CID		
1997-2002		SATURN SL2	1.9L L4 116 CID		1985-1989	CHEVROLET CAPRICE	4.3L V6 262 CID		
<b>USEP3567</b>		1985	CADILLAC DEVILLE		4.1L V8 250 CID	1986	CADILLAC DEVILLE	4.1L V8 250 CID	
		1985	CHEVROLET CAVALIER		2.0L L4 122 CID	1986	CADILLAC FLEETWOOD	4.1L V8 250 CID	
		1985	GMC SAFARI		2.5L L4 2474cc 151 CID	1986	CHEVROLET CAMARO	2.5L L4 2474cc 151 CID	
	1985	PONTIAC J2000 SUNBIRD	1.8L L4 112 CID		1986	CHEVROLET CAVALIER	2.0L L4 122 CID		
	1985	PONTIAC J2000 SUNBIRD	2.0L L4 122 CID	1986	PONTIAC FIREBIRD	2.5L L4 2474cc 151 CID			
	1988	CHEVROLET G30	7.4L V8 454 CID	1986	PONTIAC SUNBIRD	1.8L L4 112 CID			
	1988	PONTIAC LEMANS		1986-1987	BUICK SKYLARK	2.5L L4 2474cc 151 CID			
	1989-1990	PONTIAC LEMANS	1.6L L4 1588cc 98 CID	1986-1987	BUICK SOMERSET	2.5L L4 2474cc 151 CID			
	1989-1990	PONTIAC LEMANS	2.0L L4 122 CID	1986-1987	PONTIAC SUNBIRD	2.0L L4 122 CID			
	1990	CHEVROLET V2500 SUBURBAN	7.4L V8 454 CID	1986-1988	OLDSMOBILE CUTLASS CIERA	2.5L L4 2474cc 151 CID			
	1990-1991	CADILLAC BROUGHAM	5.7L V8 350 CID	1986-1988	PONTIAC 6000	2.5L L4 2474cc 151 CID			
	1990-1991	CHEVROLET C1500	4.3L V6 262 CID	1987	CHEVROLET BLAZER	5.0L V8 305 CID			
	1990-1991	CHEVROLET C1500	5.0L V8 305 CID	1987	CHEVROLET R10	4.3L V6 262 CID			
	1990-1991	CHEVROLET C1500	5.7L V8 350 CID	1987	CHEVROLET R10	5.0L V8 305 CID			
	1990-1991	CHEVROLET C1500	7.4L V8 454 CID	1987	CHEVROLET R10 SUBURBAN	5.7L V8 305 CID			
	1990-1991	CHEVROLET C2500	4.3L V6 262 CID	1987	CHEVROLET R20	4.3L V6 262 CID			
	1990-1991	CHEVROLET C2500	5.0L V8 305 CID	1987	CHEVROLET R20	5.0L V8 305 CID			
	1990-1991	CHEVROLET C2500	5.7L V8 350 CID	1987	CHEVROLET R20 SUBURBAN	5.7L V8 350 CID			
	1990-1991	CHEVROLET K1500	4.3L V6 262 CID	1987	CHEVROLET R20 SUBURBAN	7.4L V8 454 CID			
	1990-1991	CHEVROLET K1500	5.0L V8 305 CID	1987	CHEVROLET V10	4.3L V6 262 CID			
	1990-1991	CHEVROLET K1500	5.7L V8 350 CID	1987	CHEVROLET V10	5.0L V8 305 CID			
	1990-1991	CHEVROLET K2500	4.3L V6 262 CID	1987	CHEVROLET V10	5.7L V8 350 CID			
	1990-1991	CHEVROLET K2500	5.0L V8 305 CID	1987	CHEVROLET V20	5.7L V8 350 CID			
	1990-1991	CHEVROLET K2500	5.7L V8 350 CID	1987	CHEVROLET V20 SUBURBAN	5.7L V8 350 CID			
	1990-1991	GMC C1500	4.3L V6 262 CID	1987	GMC JIMMY	5.0L V8 305 CID			
	1990-1991	GMC C1500	5.0L V8 305 CID	1987	GMC R1500	4.3L V6 262 CID			
	1990-1991	GMC C1500	5.7L V8 350 CID	1987	GMC R1500	5.0L V8 305 CID			
	1990-1991	GMC C2500	4.3L V6 262 CID	1987	GMC R1500	5.7L V8 350 CID			
	1990-1991	GMC C2500	5.0L V8 305 CID	1987	GMC R1500 SUBURBAN	5.0L V8 305 CID			
	1990-1991	GMC C2500	5.7L V8 350 CID	1987	GMC R2500	4.3L V6 262 CID			
	1990-1991	GMC K1500	4.3L V6 262 CID	1987	GMC R2500	5.0L V8 305 CID			
	1990-1991	GMC K1500	5.0L V8 305 CID	1987	GMC V1500	4.3L V6 262 CID			
	1990-1991	GMC K1500	5.7L V8 350 CID	1987	GMC V1500	5.0L V8 305 CID			
	1990-1991	GMC K2500	4.3L V6 262 CID	1987	GMC V1500	5.7L V8 350 CID			
	1990-1991	GMC K2500	5.0L V8 305 CID	1987	GMC V2500	5.7L V8 350 CID			
	1990-1991	GMC K2500	5.7L V8 350 CID	1987	PONTIAC GRAND PRIX	4.3L V6 262 CID			
	1991	CADILLAC BROUGHAM	5.0L V8 305 CID	1987-1988	CHEVROLET CELEBRITY	2.5L L4 2474cc 151 CID			
	1991	CHEVROLET C2500	7.4L V8 454 CID	1987-1988	CHEVROLET P20	5.7L V8 350 CID			
	1991	CHEVROLET K2500	7.4L V8 454 CID	1987-1988	CHEVROLET R10 SUBURBAN	5.7L V8 350 CID			
	1991	GMC C2500	7.4L V8 454 CID	1987-1988	CHEVROLET R20	5.7L V8 350 CID			
	<b>USEP3707</b>	1991-1993	PONTIAC LEMANS		1987-1988	CHEVROLET R20	7.4L V8 454 CID		
2005-2006		CHEVROLET SSR		1987-1988	CHEVROLET R30	5.7L V8 350 CID			
2005-2006		ISUZU ASCENDER	4.2L L6 256 CID	1987-1988	CHEVROLET R30	7.4L V8 454 CID			
2005-2007		BUICK RAINIER	4.2L L6 256 CID	1987-1988	CHEVROLET V10 SUBURBAN	5.7L V8 350 CID			
2005-2007		CHEVROLET TRAILBLAZER	4.2L L6 256 CID	1987-1988	CHEVROLET V30	5.7L V8 350 CID			
2005-2007		GMC ENVOY	4.2L L6 256 CID	1987-1988	CHEVROLET V30	7.4L V8 454 CID			
2005-2007		SAAB 9-7X	4.2L L6 256 CID	1987-1988	GMC R1500 SUBURBAN	5.7L V8 350 CID			

USMW	Years	Application	Engine	USMW	Years	Application	Engine	
<b>USEP3902</b>	1987-1988	OLDSMOBILE CUTLASS CRUISER	2.5L L4 2474cc 151 CID	<b>USEP3902</b>	1991	CHEVROLET S10 BLAZER	3.1L V6 3137cc 189 CID	
	1987-1989	GMC R2500	5.7L V8 350 CID		1991	GMC S15 JIMMY	4.3L V6 262 CID	
	1987-1989	GMC R2500	7.4L V8 454 CID		1991-1992	GMC K2500	7.4L V8 454 CID	
	1987-1990	CHEVROLET ASTRO	2.5L L4 2474cc 151 CID		1991-1992	OLDSMOBILE BRAVADA	4.3L V6 262 CID	
	1987-1991	GMC JIMMY	5.7L V8 350 CID		1992	CADILLAC BROUGHAM	5.0L V8 305 CID	
	1987-1991	GMC R2500 SUBURBAN	5.7L V8 350 CID		1992	CADILLAC COMMERCIAL CHASSIS	5.7L V8 350 CID	
	1987-1991	GMC R2500 SUBURBAN	7.4L V8 454 CID		1992	CHEVROLET C2500	4.3L V6 262 CID	
	1987-1991	GMC R3500	5.7L V8 350 CID		1992	CHEVROLET C2500	5.0L V8 305 CID	
	1987-1991	GMC R3500	7.4L V8 454 CID		1992	CHEVROLET C2500	5.7L V8 350 CID	
	1987-1991	GMC V1500 SUBURBAN	5.7L V8 350 CID		1992	CHEVROLET C2500	7.4L V8 454 CID	
	1987-1991	GMC V2500 SUBURBAN	5.7L V8 350 CID		1992	CHEVROLET K2500	4.3L V6 262 CID	
	1987-1991	GMC V3500	5.7L V8 350 CID		1992	CHEVROLET K2500	5.0L V8 305 CID	
	1987-1991	GMC V3500	7.4L V8 454 CID		1992	CHEVROLET K2500	5.7L V8 350 CID	
	1987-1993	CHEVROLET G10	5.7L V8 350 CID		1992	CHEVROLET K2500	7.4L V8 454 CID	
	1987-1993	CHEVROLET LLV	2.5L L4 2474cc 151 CID		1992	GMC C2500	4.3L V6 262 CID	
	1987-1993	GMC G1500	5.7L V8 350 CID		1992	GMC C2500	5.0L V8 305 CID	
	1987-1994	CHEVROLET ASTRO	4.3L V6 262 CID		1992	GMC C2500	5.7L V8 350 CID	
	1987-1994	CHEVROLET BLAZER	5.7L V8 350 CID		1992	GMC C2500	7.4L V8 454 CID	
	1987-1995	CHEVROLET G10	4.3L V6 262 CID		1992	GMC K2500	4.3L V6 262 CID	
	1987-1995	CHEVROLET G10	5.0L V8 305 CID		1992	GMC K2500	5.0L V8 305 CID	
	1987-1995	CHEVROLET G20	4.3L V6 262 CID		1992	GMC K2500	5.7L V8 350 CID	
	1987-1995	CHEVROLET G20	5.0L V8 305 CID		1992	GMC K2500 SUBURBAN	5.7L V8 350 CID	
	1987-1995	CHEVROLET G20	5.7L V8 350 CID		1992-1993	CHEVROLET C2500 SUBURBAN	7.4L V8 454 CID	
	1987-1995	CHEVROLET G30	4.3L V6 262 CID		1992-1993	CHEVROLET K2500 SUBURBAN	7.4L V8 454 CID	
	1987-1995	CHEVROLET G30	5.7L V8 350 CID		1992-1993	GMC C2500 SUBURBAN	5.7L V8 350 CID	
	1987-1995	GMC G1500	4.3L V6 262 CID		1992-1993	GMC C2500 SUBURBAN	7.4L V8 454 CID	
	1987-1995	GMC G1500	5.0L V8 305 CID		1992-1993	GMC K2500 SUBURBAN	7.4L V8 454 CID	
	1987-1995	GMC G2500	4.3L V6 262 CID		1992-1994	CHEVROLET C2500 SUBURBAN	5.7L V8 350 CID	
	1987-1995	GMC G2500	5.0L V8 305 CID		1992-1994	CHEVROLET K2500 SUBURBAN	5.7L V8 350 CID	
	1987-1995	GMC G2500	5.7L V8 350 CID		1992-1994	CHEVROLET S10 BLAZER	4.3L V6 262 CID	
	1987-1995	GMC G3500	4.3L V6 262 CID		1992-1994	GMC C1500 SUBURBAN	5.7L V8 350 CID	
	1987-1995	GMC G3500	5.7L V8 350 CID		1992-1995	CHEVROLET C1500 SUBURBAN	5.7L V8 350 CID	
	1988	CHEVROLET MONTE CARLO	4.3L V6 262 CID		1992-1995	CHEVROLET K1500 SUBURBAN	5.7L V8 350 CID	
	1988-1989	CHEVROLET C1500	4.3L V6 262 CID		1992-1995	GMC K1500 SUBURBAN	5.7L V8 350 CID	
	1988-1989	CHEVROLET C1500	5.0L V8 305 CID		1992-1995	GMC YUKON	5.7L V8 350 CID	
	1988-1989	CHEVROLET C1500	5.7L V8 350 CID		1993-1994	GMC JIMMY	4.3L V6 262 CID	
	1988-1989	CHEVROLET C2500	4.3L V6 262 CID		1994	CHEVROLET CHEVY	1.4L L4 1389cc 85 CID	
	1988-1989	CHEVROLET C2500	5.0L V8 305 CID		1994	GMC K2500 SUBURBAN	5.7L V8 350 CID	
	1988-1989	CHEVROLET C2500	5.7L V8 350 CID		1994-1995	CHEVROLET S10	4.3L V6 262 CID	
	1988-1989	CHEVROLET K1500	4.3L V6 262 CID		1994-1995	GMC SONOMA	4.3L V6 262 CID	
	1988-1989	CHEVROLET K1500	5.0L V8 305 CID		1995	CHEVROLET SILVERADO	5.7L V8 350 CID	
	1988-1989	CHEVROLET K1500	5.7L V8 350 CID		1995	CHEVROLET TAHOE	5.7L V8 350 CID	
	1988-1989	CHEVROLET K2500	4.3L V6 262 CID		1996	CHEVROLET CHEVY	1.6L L4 1588cc 98 CID	
	1988-1989	CHEVROLET K2500	5.0L V8 305 CID		1998	CHEVROLET CHEVY	1.6L L4 1598cc 98 CID	
	1988-1989	CHEVROLET K2500	5.7L V8 350 CID		<b>USEP3903</b>	1986	CHEVROLET CAMARO	5.0L V8 305 CID
	1988-1989	GMC C1500	4.3L V6 262 CID			1986	PONTIAC FIREBIRD	5.0L V8 305 CID
	1988-1989	GMC C1500	5.0L V8 305 CID		<b>USEP3904</b>	1990-1994	CHEVROLET CORVETTE	
	1988-1989	GMC C1500	5.7L V8 350 CID			<b>USEP3906</b>	1998-2000	CHEVROLET EXPRESS 3500
	1988-1989	GMC C2500	4.3L V6 262 CID		1998-2000		GMC SAVANA 2500	5.7L V8 350 CID
	1988-1989	GMC C2500	5.0L V8 305 CID		1998-2000	GMC SAVANA 3500	5.7L V8 350 CID	
	1988-1989	GMC C2500	5.7L V8 350 CID		1998-2000	GMC SAVANA 3500	7.4L V8 454 CID	
	1988-1989	GMC K1500	4.3L V6 262 CID		1998-2002	CHEVROLET EXPRESS 1500	4.3L V6 262 CID	
	1988-1989	GMC K1500	5.0L V8 305 CID		1998-2002	CHEVROLET EXPRESS 1500	5.0L V8 305 CID	
	1988-1989	GMC K1500	5.7L V8 350 CID		1998-2002	CHEVROLET EXPRESS 1500	5.7L V8 350 CID	
1988-1989	GMC K2500	4.3L V6 262 CID	1998-2002	CHEVROLET EXPRESS 2500	5.7L V8 350 CID			
1988-1989	GMC K2500	5.0L V8 305 CID	1998-2002	CHEVROLET EXPRESS 3500	5.7L V8 350 CID			
1988-1989	GMC K2500	5.7L V8 350 CID	1998-2002	GMC SAVANA 1500	4.3L V6 262 CID			
1988-1989	GMC P2500	5.7L V8 350 CID	1998-2002	GMC SAVANA 1500	5.0L V8 305 CID			
1988-1990	GMC SAFARI	2.5L L4 2474cc 151 CID	1998-2002	GMC SAVANA 1500	5.7L V8 350 CID			
1988-1991	CHEVROLET C3500	5.7L V8 350 CID	1999-2002	CHEVROLET EXPRESS 2500	4.3L V6 262 CID			
1988-1991	CHEVROLET C3500	7.4L V8 454 CID	1999-2002	CHEVROLET EXPRESS 2500	5.0L V8 305 CID			
1988-1991	CHEVROLET K3500	5.7L V8 350 CID	1999-2002	GMC SAVANA 2500	4.3L V6 262 CID			
1988-1991	CHEVROLET K3500	7.4L V8 454 CID	1999-2002	GMC SAVANA 2500	5.0L V8 305 CID			
1988-1991	GMC C3500	5.7L V8 350 CID	2002	CHEVROLET EXPRESS 3500	8.1L V8 496 CID			
1988-1991	GMC C3500	7.4L V8 454 CID	2002	GMC SAVANA 3500	5.7L V8 350 CID			
1988-1991	GMC K3500	5.7L V8 350 CID	2002	GMC SAVANA 3500	8.1L V8 496 CID			
1988-1991	GMC K3500	7.4L V8 454 CID	<b>USEP3907</b>	1993-1994	PONTIAC FIREBIRD	3.4L V6 207 CID		
1988-1993	CHEVROLET G30	7.4L V8 454 CID		1993-1995	CHEVROLET CAMARO	3.4L V6 207 CID		
1988-1993	GMC G3500	7.4L V8 454 CID	1995	CHEVROLET CAMARO	3.8L V6 3800cc 231 CID			
1988-1994	GMC SAFARI	4.3L V6 262 CID	1997	CHEVROLET CAMARO	3.8L V6 3800cc 231 CID			
1989	CHEVROLET R2500	7.4L V8 454 CID	<b>USEP3908</b>	1993-1994	PONTIAC FIREBIRD	5.7L V8 350 CID		
1989-1990	CHEVROLET CAPRICE	5.0L V8 305 CID		1993-1995	CHEVROLET CAMARO	5.7L V8 350 CID		
1989-1990	CHEVROLET CAPRICE	5.7L V8 350 CID	<b>USEP3910</b>	1991-1992	SATURN SC			
1989-1991	CHEVROLET R1500 SUBURBAN	5.7L V8 350 CID		1991-1996	SATURN SL1			
1989-1991	CHEVROLET R2500 SUBURBAN	5.7L V8 350 CID		1991-1996	SATURN SL2			
1989-1991	CHEVROLET R2500 SUBURBAN	7.4L V8 454 CID		1993-1996	SATURN SC1			
1989-1991	CHEVROLET R3500	5.7L V8 350 CID		1993-1996	SATURN SC2			
1989-1991	CHEVROLET R3500	7.4L V8 454 CID		1993-1996	SATURN SW1			
1989-1991	CHEVROLET V1500 SUBURBAN	5.7L V8 350 CID		1993-1996	SATURN SW2			
1989-1991	CHEVROLET V3500	5.7L V8 350 CID		<b>USEP3919</b>	2001-2002	CHEVROLET SONORA	5.7L V8 350 CID	
1989-1991	CHEVROLET V3500	7.4L V8 454 CID			<b>USEP3933</b>	1997	CHEVROLET TAHOE	5.7L V8 350 CID
1990-1991	CHEVROLET V2500 SUBURBAN	5.7L V8 350 CID		1997		GMC YUKON	5.7L V8 350 CID	
1990-1991	GMC R1500 SUBURBAN	5.7L V8 350 CID	<b>USEP3956</b>	1998-1999	CHEVROLET C35	5.7L V8 350 CID		
1990-1992	CHEVROLET CAMARO	5.0L V8 305 CID		<b>USEP3961</b>	1998	CHEVROLET CAMARO	5.7L V8 350 CID	
1990-1992	PONTIAC FIREBIRD	5.0L V8 305 CID	1998		PONTIAC FIREBIRD	5.7L V8 350 CID		
1990-1994	OLDSMOBILE SILHOUETTE	3.1L V6 189 CID	<b>USEP3964</b>	1997-2001	CADILLAC CATERA			
1990-1995	CHEVROLET LUMINA APV	3.1L V6 189 CID		<b>USEP3983</b>	1996-1997	CHEVROLET CAMARO	3.8L V6 3800cc 231 CID	
1990-1995	PONTIAC TRANS SPORT	3.1L V6 189 CID	1996-1997		PONTIAC FIREBIRD	3.8L V6 3800cc 231 CID		

USMW	Years	Application	Engine	USMW	Years	Application	Engine		
<b>USEP7000</b>	1986	CHRYSLER LASER	2.2L L4 135 CID	<b>USEP7018</b>	1988-1990	DODGE RAMCHARGER	5.2L V8 5211cc 318 CID		
	1986	CHRYSLER LASER	2.5L L4 2507cc 153 CID		1988-1990	DODGE W150	5.2L V8 5211cc 318 CID		
	1986	DODGE DAYTONA	2.2L L4 135 CID		1988-1990	DODGE W250	5.2L V8 5211cc 318 CID		
	1986	PLYMOUTH CARAVELLE	2.2L L4 135 CID		1989	DODGE W100	3.9L V6 3906cc 239 CID		
	1986-1987	CHRYSLER NEW YORKER	2.5L L4 2507cc 153 CID		1989-1990	DODGE B250	5.9L V8 360 CID		
	1986-1987	DODGE LANCER	2.2L L4 135 CID		1989-1990	DODGE B350	5.9L V8 360 CID		
	1986-1987	DODGE LANCER	2.5L L4 2507cc 153 CID		1989-1990	DODGE D150	5.9L V8 360 CID		
	1986-1988	CHRYSLER LEBARON	2.2L L4 135 CID		1989-1990	DODGE D250	5.9L V8 360 CID		
	1986-1988	CHRYSLER LEBARON	2.5L L4 2507cc 153 CID		1989-1990	DODGE D350	5.9L V8 360 CID		
	1986-1988	CHRYSLER TOWN & COUNTRY	2.5L L4 2507cc 153 CID		1989-1990	DODGE DAKOTA	2.5L L4 2507cc 153 CID		
	1986-1988	DODGE 600	2.2L L4 135 CID		1989-1990	DODGE DAKOTA	5.2L V8 5211cc 318 CID		
	1986-1988	DODGE 600	2.5L L4 2507cc 153 CID		1989-1990	DODGE RAMCHARGER	5.9L V8 360 CID		
	1986-1988	DODGE DAYTONA	2.5L L4 2507cc 153 CID		1989-1990	DODGE W150	3.9L V6 3906cc 239 CID		
	1986-1988	PLYMOUTH CARAVELLE	2.5L L4 2507cc 153 CID		1989-1990	DODGE W150	5.9L V8 360 CID		
	1986-1989	DODGE ARIES	2.2L L4 135 CID		1989-1990	DODGE W250	5.9L V8 360 CID		
	1986-1989	DODGE ARIES	2.5L L4 2507cc 153 CID		1989-1990	DODGE W350	5.9L V8 360 CID		
	1986-1989	PLYMOUTH RELIANT	2.2L L4 135 CID		<b>USEP7020</b>	1988-1989	EAGLE PREMIER	2.5L L4 150 CID	
	1986-1989	PLYMOUTH RELIANT	2.5L L4 2507cc 153 CID			1988-1989	EAGLE PREMIER	3.0L V6 2972cc 182 CID	
	1987	DODGE SHADOW				1990	DODGE MONACO		
	1987	PLYMOUTH SUNDANCE			1990	EAGLE PREMIER			
	1987-1988	DODGE MINI RAM	2.5L L4 2507cc 153 CID		<b>USEP7031</b>	1985	CHRYSLER LASER		
	1988	DODGE GRAND CARAVAN	2.5L L4 2507cc 153 CID			1985	CHRYSLER LEBARON	2.2L L4 135 CID	
	1988	DODGE SHADOW	2.2L L4 135 CID			1985	DODGE 600	2.2L L4 135 CID	
	1988	DODGE SHADOW	2.5L L4 2507cc 153 CID			1985	DODGE ARIES		
	1988	PLYMOUTH GRAND VOYAGER	2.5L L4 2507cc 153 CID			1985	DODGE ARIES	2.2L L4 135 CID	
	1988	PLYMOUTH SUNDANCE	2.2L L4 135 CID			1985	DODGE DAYTONA		
	1988	PLYMOUTH SUNDANCE	2.5L L4 2507cc 153 CID			1985	DODGE LANCER		
	1988-1990	DODGE CARAVAN	2.5L L4 2507cc 153 CID			1985	PLYMOUTH CARAVELLE	2.2L L4 135 CID	
	1988-1990	DODGE OMNI			<b>USEP7040</b>	1991	CHRYSLER IMPERIAL	3.3L V6 3301cc 201 CID	
	1988-1990	PLYMOUTH HORIZON				1991	CHRYSLER IMPERIAL	3.8L V6 3778cc 231 CID	
	1988-1990	PLYMOUTH VOYAGER	2.5L L4 2507cc 153 CID			1991	CHRYSLER LEBARON	2.5L L4 2507cc 153 CID	
	<b>USEP7001</b>	1984-1986	RENAULT R18			2.0L L4 1995cc 122 CID	1991	CHRYSLER LEBARON	3.0L V6 2972cc 181 CID
		1986	JEEP CHEROKEE			2.5L L4 150 CID	1991	CHRYSLER NEW YORKER	3.3L V6 3301cc 201 CID
		1986	JEEP WAGONEER			2.5L L4 150 CID	1991	CHRYSLER NEW YORKER	3.8L V6 3778cc 231 CID
		1986	RENAULT ALLIANCE			1.4L L4 1397cc	1991	DODGE DYNASTY	2.5L L4 2507cc 153 CID
		1986-1987	RENAULT ALLIANCE			1.4L L4 1397cc 85 CID	1991	DODGE DYNASTY	3.0L V6 2972cc 181 CID
		1986-1987	RENAULT ALLIANCE		1.7L L4 105 CID	1991	DODGE DYNASTY	3.3L V6 3301cc 201 CID	
		1986-1990	JEEP COMANCHE		2.5L L4 150 CID	1991	DODGE SHADOW	2.2L L4 135 CID	
1987		RENAULT ALLIANCE	2.0L L4 1965cc 120 CID	1991	DODGE SHADOW	2.5L L4 2507cc 153 CID			
1987-1990		JEEP WRANGLER	2.5L L4 150 CID	1991	DODGE SPIRIT	2.2L L4 135 CID			
1987-1992		JEEP COMANCHE	4.0L L6 242 CID	1991	DODGE SPIRIT	2.5L L4 2507cc 153 CID			
<b>USEP7006</b>	1991-1992	JEEP COMANCHE	2.5L L4 150 CID	1991	DODGE SPIRIT	3.0L V6 2972cc 181 CID			
	1991-1993	JEEP CHEROKEE	2.5L L4 150 CID	<b>USEP7041</b>	1989-1990	CHRYSLER SHADOW	2.2L L4 135 CID		
	<b>USEP7006A</b>	1983-1984	RENAULT ALLIANCE		1.4L L4 1397cc 85 CID	1991	CHRYSLER IMPERIAL	3.3L V6 3301cc 201 CID	
		1984	RENAULT ENCORE		1.4L L4 1397cc 85 CID	1991	CHRYSLER SPIRIT	2.5L L4 2500cc 153 CID	
		1987-1992	JEEP COMANCHE		4.0L L6 242 CID	1991	PLYMOUTH SUNDANCE	2.2L L4 135 CID	
1991-1992		JEEP COMANCHE	2.5L L4 150 CID		1991	PLYMOUTH SUNDANCE	2.5L L4 2507cc 153 CID		
1991-1993	JEEP CHEROKEE	2.5L L4 150 CID	1991		PLYMOUTH VOYAGER	2.5L L4 2507cc 153 CID			
1991-1993	JEEP CHEROKEE	4.0L L6 242 CID	1991		PLYMOUTH VOYAGER	3.0L V6 2972cc 181 CID			
<b>USEP7010</b>	1985	RENAULT ENCORE	1.4L L4 1397cc		1991	PLYMOUTH VOYAGER	3.3L V6 3301cc 201 CID		
	1985-1986	RENAULT ALLIANCE	1.4L L4 1397cc		1991-1992	CHRYSLER LEBARON	2.5L L4 2507cc 153 CID		
	1985-1986	RENAULT ALLIANCE	1.4L L4 1397cc 85 CID		1991-1993	CHRYSLER IMPERIAL	3.8L V6 3778cc 231 CID		
	1985-1986	RENAULT ALLIANCE	1.7L L4 105 CID	1991-1993	CHRYSLER LEBARON	3.0L V6 2972cc 181 CID			
	1985-1986	RENAULT ENCORE	1.4L L4 1397cc 85 CID	1991-1993	CHRYSLER NEW YORKER	3.3L V6 3301cc 201 CID			
	1985-1986	RENAULT ENCORE	1.7L L4 105 CID	1991-1993	CHRYSLER NEW YORKER	3.8L V6 3778cc 231 CID			
	1985-1986	RENAULT ENCORE	1.7L L4 105 CID	1991-1993	CHRYSLER TOWN & COUNTRY	3.3L V6 3301cc 201 CID			
<b>USEP7012</b>	1984	DODGE DAYTONA	2.2L L4 135 CID	1991-1993	CHRYSLER TOWN & COUNTRY	3.3L V6 3301cc 201 CID			
	1984-1988	CHRYSLER NEW YORKER	2.2L L4 135 CID	1991-1993	DODGE DYNASTY	3.0L V6 2972cc 181 CID			
	1985-1988	CHRYSLER DAYTONA	2.2L L4 135 CID	1991-1993	DODGE DYNASTY	3.3L V6 3301cc 201 CID			
	1987	CHRYSLER DAYTONA	2.5L L4 2507cc 153 CID	1991-1993	DODGE GRAND CARAVAN	3.3L V6 3301cc 201 CID			
	1987-1988	DODGE MINI RAM	3.0L V6 2972cc 181 CID	1991-1993	PLYMOUTH GRAND VOYAGER	3.3L V6 3301cc 201 CID			
	1987-1989	CHRYSLER PHANTOM	2.2L L4 135 CID	1991-1994	DODGE SHADOW	2.5L L4 2507cc 153 CID			
	1987-1990	DODGE CARAVAN	3.0L V6 2972cc 181 CID	1991-1995	DODGE CARAVAN	2.5L L4 2507cc 153 CID			
	1988	CHRYSLER NEW YORKER	3.0L V6 2972cc 181 CID	1991-1995	DODGE SPIRIT	2.5L L4 2507cc 153 CID			
	1988	DODGE DYNASTY	2.5L L4 2507cc 153 CID	1991-1995	DODGE SPIRIT	3.0L V6 2972cc 181 CID			
	1988	DODGE DYNASTY	3.0L V6 2972cc 181 CID	1991-1995	PLYMOUTH ACCLAIM	2.5L L4 2507cc 153 CID			
	1988	DODGE GRAND CARAVAN	3.0L V6 2972cc 181 CID	1991-1995	PLYMOUTH ACCLAIM	3.0L V6 2972cc 181 CID			
	1988	PLYMOUTH GRAND VOYAGER	3.0L V6 2972cc 181 CID	1991-1998	DODGE CARAVAN	3.0L V6 2972cc 181 CID			
	1988-1990	PLYMOUTH VOYAGER	3.0L V6 2972cc 181 CID	1991-1998	DODGE CARAVAN	3.3L V6 3301cc 201 CID			
	1989-1990	CHRYSLER SHADOW	2.5L L4 2500cc 153 CID	1992	DODGE SPIRIT	2.2L L4 135 CID			
	1989-1990	DODGE CARAVAN	2.5L L4 2507cc 153 CID	1992-1993	DODGE DAYTONA	2.5L L4 2507cc 153 CID			
	1989-1990	DODGE GRAND CARAVAN		1992-1993	DODGE DAYTONA	3.0L V6 2972cc 181 CID			
	1989-1990	PLYMOUTH GRAND VOYAGER		1992-1993	DODGE DYNASTY	2.5L L4 2507cc 153 CID			
	1989-1990	PLYMOUTH VOYAGER	2.5L L4 2507cc 153 CID	1992-1993	PLYMOUTH GRAND VOYAGER	3.0L V6 2972cc 181 CID			
	1990	CHRYSLER TOWN & COUNTRY		1992-1994	DODGE SHADOW	2.2L L4 135 CID			
	1990	DODGE CARAVAN	3.3L V6 3301cc 201 CID	1992-1994	DODGE SHADOW	3.0L V6 2972cc 181 CID			
	<b>USEP7018</b>	1988-1989	DODGE D100	3.9L V6 3906cc 239 CID	1992-2000	DODGE GRAND CARAVAN	3.0L V6 2972cc 181 CID		
		1988-1989	DODGE D100	5.2L V8 5211cc 318 CID	1993	CHRYSLER LEBARON	2.5L L4 2500cc 153 CID		
		1988-1989	DODGE W100	5.2L V8 5211cc 318 CID	1993-1994	PLYMOUTH SUNDANCE	2.2L L4 135 CID		
1988-1990		DODGE B150	3.9L V6 3906cc 239 CID	1993-1994	PLYMOUTH SUNDANCE	2.5L L4 2507cc 153 CID			
1988-1990		DODGE B150	5.2L V8 5211cc 318 CID	1993-1994	PLYMOUTH SUNDANCE	3.0L V6 2972cc 181 CID			
1988-1990		DODGE B250	3.9L V6 3906cc 239 CID	1994	CHRYSLER TOWN & COUNTRY	3.8L V6 3778cc 231 CID			
1988-1990		DODGE B250	5.2L V8 5211cc 318 CID	1994	PLYMOUTH GRAND VOYAGER	3.8L V6 3778cc 231 CID			
1988-1990		DODGE B350	5.2L V8 5211cc 318 CID	1994-1995	PLYMOUTH VOYAGER	2.5L L4 2507cc 153 CID			
1988-1990		DODGE D150	3.9L V6 3906cc 239 CID	1994-2000	DODGE GRAND CARAVAN	3.8L V6 3778cc 231 CID			
1988-1990		DODGE D150	5.2L V8 5211cc 318 CID	1994-2000	PLYMOUTH VOYAGER	3.0L V6 2972cc 181 CID			
1988-1990		DODGE D250	3.9L V6 3906cc 239 CID	1994-2000	PLYMOUTH VOYAGER	3.3L V6 3301cc 201 CID			
1988-1990		DODGE D250	5.2L V8 5211cc 318 CID	1995	CHRYSLER CIRBUS	2.4L L4 2429cc 148 CID			
1988-1990		DODGE DAKOTA	3.9L V6 3906cc 239 CID	1995	CHRYSLER CIRBUS	2.5L V6 2497cc 152 CID			



USMW	Years	Application	Engine	USMW	Years	Application	Engine				
<b>USEP7041</b>	1995	<b>CHRYSLER GRAND VOYAGER</b>	3.8L V6 3778cc 231 CID	<b>USEP7093</b>	1996-1997	<b>DODGE RAM 2500</b>	5.9L V8 360 CID				
	1995	<b>CHRYSLER LEBARON</b>	2.5L L4 2500cc 153 CID		1996-1997	<b>DODGE RAM 2500</b>	8.0L V10 7990cc 488 CID				
	1995	<b>CHRYSLER NEON</b>	2.0L L4 1996cc 122 CID		1996-1997	<b>DODGE RAM 3500</b>	5.9L V8 360 CID				
	1995	<b>DODGE NEON</b>	2.0L L4 1997cc 122 CID		1996-1997	<b>DODGE RAM 3500</b>	8.0L V10 7990cc 488 CID				
	1995-1997	<b>DODGE STRATUS</b>	2.0L L4 1996cc 122 CID		1998-2001	<b>DODGE RAM 2500 VAN</b>	5.2L V8 5211cc 318 CID				
	1995-1997	<b>DODGE STRATUS</b>	2.4L L4 2429cc 148 CID		1999-2000	<b>DODGE RAMCHARGER</b>	5.9L V8 360 CID				
	1995-1997	<b>DODGE STRATUS</b>	2.5L V6 2497cc 152 CID		1999-2001	<b>DODGE RAMCHARGER</b>	5.2L V8 5211cc 318 CID				
	1995-2000	<b>DODGE GRAND CARAVAN</b>	3.3L V6 3301cc 201 CID		2001	<b>CHRYSLER GRAND VOYAGER</b>	3.8L V6 3778cc 231 CID				
	1996	<b>DODGE NEON</b>	2.0L L4 1996cc 122 CID		<b>USEP7094</b>	1995	<b>DODGE RAM 1500</b>	3.9L V6 3906cc 239 CID			
	1996	<b>PLYMOUTH NEON</b>	2.0L L4 1996cc 122 CID			1995	<b>DODGE RAM 1500</b>	5.2L V8 5211cc 318 CID			
	1996-1997	<b>CHRYSLER STRATUS</b>	2.4L L4 2429cc 148 CID			1995	<b>DODGE RAM 1500</b>	5.9L V8 360 CID			
	1996-1997	<b>CHRYSLER VOYAGER</b>	3.3L V6 3301cc 201 CID			1995	<b>DODGE RAM 3500</b>	5.9L V8 360 CID			
	1996-1997	<b>DODGE GRAND CARAVAN</b>	2.4L L4 2429cc 148 CID			1995	<b>DODGE RAM 3500</b>	8.0L V10 7990cc 488 CID			
	1996-1997	<b>PLYMOUTH GRAND VOYAGER</b>	2.4L L4 2429cc 148 CID			1997	<b>DODGE B2500</b>	3.9L V6 3906cc 239 CID			
	1996-1998	<b>CHRYSLER SEBRING</b>	2.4L L4 2429cc 148 CID			1997-1998	<b>DODGE B1500</b>	3.9L V6 3906cc 239 CID			
	1996-1998	<b>CHRYSLER TOWN &amp; COUNTRY</b>	3.3L V6 3301cc 201 CID			1997-1998	<b>DODGE B1500</b>	5.2L V8 5211cc 318 CID			
	1996-1998	<b>CHRYSLER TOWN &amp; COUNTRY</b>	3.8L V6 3778cc 231 CID			1997-1998	<b>DODGE B2500</b>	5.2L V8 5211cc 318 CID			
	1996-1998	<b>DODGE CARAVAN</b>	2.4L L4 2429cc 148 CID			1997-1998	<b>DODGE B2500</b>	5.9L V8 360 CID			
	1996-1998	<b>DODGE CARAVAN</b>	3.8L V6 3778cc 231 CID			1997-1998	<b>DODGE B3500</b>	5.2L V8 5211cc 318 CID			
	1996-2000	<b>CHRYSLER SEBRING</b>	2.5L V6 2497cc 152 CID			1997-1998	<b>DODGE B3500</b>	5.9L V8 360 CID			
	1996-2000	<b>PLYMOUTH BREEZE</b>	2.0L L4 1996cc 122 CID			1998	<b>DODGE B1500</b>	3.9L V6 3906cc 239 CID			
	1996-2000	<b>PLYMOUTH GRAND VOYAGER</b>	3.0L V6 2972cc 181 CID			1998-1999	<b>DODGE RAM 1500</b>	5.2L V8 5211cc 318 CID			
	1996-2000	<b>PLYMOUTH GRAND VOYAGER</b>	3.3L V6 3301cc 201 CID			1998-1999	<b>DODGE RAM 1500</b>	5.9L V8 360 CID			
	1996-2000	<b>PLYMOUTH VOYAGER</b>	2.4L L4 2429cc 148 CID			1998-2002	<b>DODGE RAM 2500</b>	5.9L V8 360 CID			
	1997	<b>CHRYSLER CIRRUS</b>	2.4L L4 2429cc 148 CID			1998-2002	<b>DODGE RAM 2500</b>	8.0L V10 7990cc 488 CID			
	1997	<b>CHRYSLER CIRRUS</b>	2.5L V6 2497cc 152 CID			1998-2002	<b>DODGE RAM 3500</b>	5.9L V8 360 CID			
	1997-2000	<b>PLYMOUTH BREEZE</b>	2.4L L4 2429cc 148 CID			1998-2002	<b>DODGE RAM 3500</b>	8.0L V10 7990cc 488 CID			
	1998-2000	<b>CHRYSLER GRAND VOYAGER</b>	3.8L V6 3778cc 231 CID			1999-2003	<b>DODGE RAM 1500 VAN</b>	3.9L V6 3906cc 239 CID			
	1999	<b>PLYMOUTH GRAND VOYAGER</b>	3.8L V6 3778cc 231 CID			1999-2003	<b>DODGE RAM 1500 VAN</b>	5.2L V8 5211cc 318 CID			
	1999	<b>PLYMOUTH VOYAGER</b>	3.8L V6 3778cc 231 CID			1999-2003	<b>DODGE RAM 1500 VAN</b>	5.9L V8 360 CID			
	2000	<b>CHRYSLER GRAND VOYAGER</b>	3.0L V6 2972cc 181 CID			1999-2003	<b>DODGE RAM 2500 VAN</b>	5.2L V8 5211cc 318 CID			
	2000	<b>CHRYSLER GRAND VOYAGER</b>	3.3L V6 3301cc 201 CID			1999-2003	<b>DODGE RAM 3500 VAN</b>	5.9L V8 360 CID			
	<b>USEP7047</b>	1991	<b>DODGE D150</b>			5.9L V8 360 CID	2001	<b>DODGE RAM 2500 VAN</b>	3.9L V6 3906cc 239 CID		
		1991	<b>DODGE W150</b>			5.9L V8 360 CID	2002	<b>DODGE RAM 1500</b>	5.9L V8 360 CID		
		1991-1993	<b>DODGE D150</b>			3.9L V6 3906cc 239 CID	<b>USEP7097</b>	1996-1997	<b>CHRYSLER NEON</b>	2.0L L4 1996cc 122 CID	
		1991-1993	<b>DODGE D150</b>			5.2L V8 5211cc 318 CID		1996-1999	<b>DODGE NEON</b>	2.0L L4 1996cc 122 CID	
1991-1993		<b>DODGE D250</b>	3.9L V6 3906cc 239 CID	1996-1999		<b>PLYMOUTH NEON</b>		2.0L L4 1996cc 122 CID			
1991-1993		<b>DODGE D250</b>	5.2L V8 5211cc 318 CID	2001-2002		<b>CHRYSLER VOYAGER</b>		3.3L V6 3301cc 201 CID			
1991-1993		<b>DODGE D250</b>	5.9L V8 360 CID	<b>USEP7113</b>		1998-2000		<b>CHRYSLER CIRRUS</b>	2.5L V6 2497cc 152 CID		
1991-1993		<b>DODGE D350</b>	5.9L V8 360 CID			1998-2000		<b>DODGE STRATUS</b>	2.0L L4 1996cc 122 CID		
1991-1993		<b>DODGE W150</b>	3.9L V6 3906cc 239 CID			1998-2000		<b>DODGE STRATUS</b>	2.0L L4 1999cc 122 CID		
1991-1993		<b>DODGE W150</b>	5.2L V8 5211cc 318 CID			1998-2000		<b>DODGE STRATUS</b>	2.4L L4 2429cc 148 CID		
1991-1993		<b>DODGE W250</b>	5.2L V8 5211cc 318 CID			1998-2000		<b>DODGE STRATUS</b>	2.5L V6 2497cc 152 CID		
1991-1993		<b>DODGE W250</b>	5.9L V8 360 CID			1998-2000		<b>PLYMOUTH BREEZE</b>	2.0L L4 1996cc 122 CID		
1991-1993		<b>DODGE W350</b>	5.9L V8 360 CID		1998-2000	<b>PLYMOUTH BREEZE</b>		2.4L L4 2429cc 148 CID			
1993		<b>DODGE D150</b>	5.9L V8 360 CID		1999-2000	<b>CHRYSLER SEBRING</b>		2.5L V6 2497cc 152 CID			
1993		<b>DODGE W150</b>	5.9L V8 360 CID		<b>USEP7116</b>	1997-1999		<b>DODGE DAKOTA</b>	5.2L V8 5211cc 318 CID		
1994-1995		<b>DODGE RAMCHARGER</b>	5.9L V8 360 CID			1997-2002		<b>DODGE DAKOTA</b>	2.5L L4 2507cc 153 CID		
1996		<b>DODGE RAMCHARGER</b>	5.9L V8 5900cc 360 CID			1997-2003		<b>DODGE DAKOTA</b>	3.9L V6 3906cc 239 CID		
<b>USEP7048</b>		1991	<b>DODGE RAMCHARGER</b>			5.9L V8 360 CID		1998-2003	<b>DODGE DAKOTA</b>	5.9L V8 360 CID	
		1991-1993	<b>DODGE RAMCHARGER</b>			5.2L V8 5211cc 318 CID		2000-2003	<b>DODGE DAKOTA</b>	4.7L V8 287 CID	
		1991-1993	<b>DODGE B150</b>			3.9L V6 3906cc 239 CID		<b>USEP7117</b>	1998-1999	<b>DODGE DURANGO</b>	3.9L V6 3906cc 239 CID
1991-1993		<b>DODGE B150</b>	5.2L V8 5211cc 318 CID			1998-2000			<b>DODGE DURANGO</b>	5.2L V8 5211cc 318 CID	
1991-1993		<b>DODGE B250</b>	3.9L V6 3906cc 239 CID			1998-2000			<b>DODGE DURANGO</b>	5.9L V8 360 CID	
<b>USEP7049</b>		1991-1993	<b>DODGE B250</b>			5.2L V8 5211cc 318 CID		2000	<b>DODGE DURANGO</b>	4.7L V8 287 CID	
		1991-1993	<b>DODGE B250</b>			5.9L V8 360 CID		2002-2003	<b>DODGE DURANGO</b>	4.7L V8 287 CID	
		1991-1993	<b>DODGE B350</b>			5.2L V8 5211cc 318 CID		2002-2003	<b>DODGE DURANGO</b>	5.9L V8 360 CID	
	1991-1993	<b>DODGE B350</b>	5.9L V8 360 CID			<b>USEP7153</b>		1998-2002	<b>DODGE RAM 2500</b>	5.9L L6 359 CID	
	1991-1993	<b>DODGE B350</b>	5.9L V8 360 CID					1998-2002	<b>DODGE RAM 3500</b>	5.9L L6 359 CID	
<b>USEP7050</b>	1991-1993	<b>DODGE DAKOTA</b>	2.5L L4 2507cc 153 CID				<b>USEP7154</b>	2004	<b>DODGE DAKOTA</b>	4.7L V8 287 CID	
	1991-1993	<b>DODGE DAKOTA</b>	3.9L V6 3906cc 239 CID					<b>USEP7182</b>	2004-2007	<b>DODGE RAM 1500</b>	3.7L V6 226 CID
	1991-1993	<b>DODGE DAKOTA</b>	5.2L V8 5211cc 318 CID						2004-2008	<b>DODGE RAM 1500</b>	4.7L V8 287 CID
	1995	<b>DODGE DAKOTA</b>	2.5L L4 2507cc 153 CID			2004-2008			<b>DODGE RAM 1500</b>	5.7L V8 345 CID	
	<b>USEP7052</b>	1985-1987	<b>DODGE CHARGER</b>			2005			<b>DODGE RAM 2500</b>	4.7L V8 287 CID	
<b>USEP7054</b>		1993-1995	<b>CHRYSLER CONCORDE</b>	3.3L V6 3301cc 201 CID		2005-2008	<b>DODGE RAM 3500</b>		5.7L V8 345 CID		
		1993-1995	<b>CHRYSLER CONCORDE</b>	3.5L V6 3497cc 215 CID		2005-2009	<b>DODGE RAM 2500</b>	5.7L V8 345 CID			
		1993-1995	<b>DODGE INTREPID</b>	3.3L V6 3301cc 201 CID		<b>USEP7206</b>	2005-2007	<b>DODGE DAKOTA</b>	3.7L V6 226 CID		
		1993-1995	<b>DODGE INTREPID</b>	3.5L V6 3497cc 215 CID			2005-2007	<b>DODGE DAKOTA</b>	4.7L V8 287 CID		
		1993-1995	<b>EAGLE VISION</b>	3.3L V6 3301cc 201 CID			2005-2008	<b>CHRYSLER PT CRUISER</b>			
		1993-1995	<b>EAGLE VISION</b>	3.5L V6 3497cc 215 CID			2005-2009	<b>JEEP GRAND CHEROKEE</b>	3.7L V6 226 CID		
		1994-1995	<b>CHRYSLER LHS</b>				2005-2009	<b>JEEP GRAND CHEROKEE</b>	4.7L V8 287 CID		
		1994-1995	<b>CHRYSLER NEW YORKER</b>		2005-2009		<b>JEEP GRAND CHEROKEE</b>	5.7L V8 345 CID			
		1995	<b>CHRYSLER CONCORDE</b>	3.5L V6 3518cc 215 CID	2006-2009		<b>JEEP COMMANDER</b>	3.7L V6 226 CID			
	1995	<b>CHRYSLER INTREPID</b>	3.5L V6 3518cc 215 CID	2006-2009	<b>JEEP COMMANDER</b>		4.7L V8 287 CID				
<b>USEP7065</b>	1994	<b>DODGE RAM 1500</b>	3.9L V6 3906cc 239 CID	2006-2009	<b>JEEP COMMANDER</b>		5.7L V8 345 CID				
	1994	<b>DODGE RAM 1500</b>	5.2L V8 5211cc 318 CID	2006-2009	<b>JEEP GRAND CHEROKEE</b>		6.1L V8 6059cc 370 CID				
	1994	<b>DODGE RAM 1500</b>	5.9L V8 360 CID	2007	<b>MITSUBISHI RAIDER</b>	3.7L V6 226 CID					
	1994	<b>DODGE RAM 2500</b>	5.2L V8 5211cc 318 CID	2007	<b>MITSUBISHI RAIDER</b>	4.7L V8 287 CID					
	1994	<b>DODGE RAM 2500</b>	5.9L V8 360 CID	<b>USEP7093</b>	2008-2009	<b>MITSUBISHI RAIDER</b>					
	1994	<b>DODGE RAM 2500</b>	8.0L V10 7990cc 488 CID		2009	<b>DODGE DAKOTA</b>	3.7L V6 226 CID				
1994	<b>DODGE RAM 3500</b>	5.9L V8 360 CID	2009		<b>DODGE DAKOTA</b>	4.7L V8 287 CID					
1994	<b>DODGE RAM 3500</b>	8.0L V10 7990cc 488 CID									
1994	<b>DODGE RAM 3500</b>	8.0L V10 7990cc 488 CID									
<b>USEP7076</b>	1994-1995	<b>CHRYSLER CONCORDE</b>	3.3L V6 3301cc 201 CID								
	1994-1995	<b>DODGE INTREPID</b>	3.3L V6 3301cc 201 CID								
<b>USEP7093</b>	1996	<b>DODGE RAM 2500</b>	5.2L V8 5211cc 318 CID								
	1996-1997	<b>DODGE RAM 1500</b>	3.9L V6 3906cc 239 CID								
	1996-1997	<b>DODGE RAM 1500</b>	5.2L V8 5211cc 318 CID								
	1996-1997	<b>DODGE RAM 1500</b>	5.9L V8 360 CID								

USMW	Years	Application	Engine	USMW	Years	Application	Engine	
<b>USEP7207</b>	2005	JEEP LIBERTY	2.4L L4 148 CID	<b>USEP8012SP</b>	1984-1985	OLDSMOBILE CUTLASS SUPREME	5.7L V8 350 CID	
	2005-2006	JEEP LIBERTY	3.7L V6 226 CID		1984-1985	OLDSMOBILE DELTA 88	5.7L V8 350 CID	
	2005-2006	JEEP WRANGLER	2.4L L4 148 CID		1984-1985	OLDSMOBILE TORONADO	5.7L V8 350 CID	
	2005-2006	JEEP WRANGLER	4.0L L6 242 CID		1985	BUICK REGAL	5.7L V8 350 CID	
	2005-2009	CHRYSLER PT CRUISER			1985	CADILLAC DEVILLE	4.3L V6 260 CID	
	2007	JEEP LIBERTY			1985	CHEVROLET CAPRICE	5.7L V8 350 CID	
	2007-2008	JEEP COMMANDER	4.7L V8 287 CID		1985	CHEVROLET IMPALA	5.7L V8 350 CID	
2007-2008	JEEP GRAND CHEROKEE	4.7L V8 287 CID	1985		OLDSMOBILE CUTLASS SALON	5.7L V8 350 CID		
<b>USEP7221</b>	2004-2007	CHRYSLER TOWN & COUNTRY	3.3L V6 3301cc 201 CID		<b>USEP8016S</b>	1985-1987	SUBARU DL	
	2004-2007	CHRYSLER TOWN & COUNTRY	3.8L V6 3778cc 231 CID			1987	SUBARU STANDARD	1.8L H4 1781cc
	2004-2007	DODGE CARAVAN	2.4L L4 2429cc 148 CID		1987-1988	SUBARU JUSTY		
	2004-2007	DODGE CARAVAN	3.3L V6 3301cc 201 CID		<b>USEP8016SP</b>	1964-1966	MG MIDGET	1.1L L4 1098cc 67 CID
	2004-2007	DODGE GRAND CARAVAN	3.3L V6 3301cc 201 CID			1967-1974	MG MIDGET	1.3L L4 1275cc 78 CID
	2004-2007	DODGE GRAND CARAVAN	3.8L V6 3778cc 231 CID			1972-1978	FORD COURIER	1.8L L4 110 CID
	2005	CHRYSLER VOYAGER	3.3L V6 3301cc 201 CID			1977-1978	FORD COURIER	2.3L L4 140 CID
2007-2008	CHRYSLER VOYAGER	3.3L V6 3301cc 201 CID	1981	MAZDA B2000		2.0L L4 1970cc		
<b>USEP7230</b>	2003	DODGE RAM 2500	5.9L L6 359 CID	1983-1984		MAZDA B2000	2.0L L4 1970cc	
	2003	DODGE RAM 3500	5.9L L6 359 CID	1984	VOLKSWAGEN CORSAR	1.8L L4 1780cc		
<b>USEP7333</b>	1980	RENAULT R12	1.6L L4 1647cc 100 CID	1985	VOLKSWAGEN CARIBE	1.8L L4 1780cc		
	1980-1984	RENAULT R18	1.6L L4 1647cc 100 CID	1985-1988	VOLKSWAGEN CORSAR	1.8L L4 1781cc		
<b>USEP7334</b>	1985	BMW 181I	1.8L L4 1766cc 107 CID	1990	VOLKSWAGEN PANEL	1.8L L4 1780cc		
	1985	RENAULT FUEGO	2.2L L4 2152cc 131 CID	1990-1994	VOLKSWAGEN COMBI	1.8L L4 1780cc		
	1985-1986	BMW 735I	3.5L L6 3430cc	<b>USEP8023</b>	1984-1985	TOYOTA CELICA	2.4L L4 2366cc	
	1985-1986	RENAULT R18I	2.2L L4 2152cc 131 CID		1985-1986	TOYOTA CELICA	2.8L L6 2754cc	
	1985-1987	BMW 325E	2.7L L6 2693cc		1985-1987	MITSUBISHI GALANT	2.4L L4 2351CC	
	1985-1988	BMW 528E	2.7L L6 2693cc		1985-1987	TOYOTA PICKUP	2.4L L4 2366cc	
	1985-1988	BMW 535I	3.5L L6 3430cc		1985-1988	TOYOTA CRESSIDA	2.8L L6 2754cc	
	1985-1989	BMW 635CSI	3.5L L6 3430cc		1985-1989	TOYOTA MR2	1.6L L4 1587cc	
	1986-1987	BMW 325ES	2.7L L6 2693cc		1985-1991	TOYOTA 4RUNNER	2.4L L4 2366cc	
	1986-1988	BMW 325	2.7L L6 2693cc		1986	TOYOTA CELICA	2.0L L4 1998cc	
	1987	BMW 325I	2.5L L6 2494cc 152 CID		1986	TOYOTA SUPRA	3.0L L6 2954cc	
	1987	BMW 325IS	2.5L L6 2494cc 152 CID		1986-1987	ACURA LEGEND	2.5L V6 2494cc	
	1987	BMW L6	3.5L L6 3430cc		1986-1987	MAZDA 626	2.0L L4 1998cc 122 CID	
	1987-1988	BMW M6	3.5L L6 3453cc		1986-1989	HONDA ACCORD	2.0L L4 1955cc	
	1988	BMW 535IS	3.5L L6 3430cc		1986-1991	MAZDA 323	1.6L L4 1597cc	
	1988	BMW M5	3.5L L6 3453cc		1987-1988	CHEVROLET SPRINT	1.0L L3 993cc 61 CID	
	1988-1991	BMW M3	2.3L L4 2302cc		1987-1988	MAZDA RX-7	1.3L R2 1308cc	
	1992	BMW 318I	1.8L L4 1796cc		1987-1988	STERLING 825	2.5L V6 2494cc	
	1992-1993	BMW 325I	2.5L L6 2494cc 152 CID		1987-1989	TOYOTA CELICA	2.0L L4 1998cc 122 CID	
	<b>USEP7359</b>	1985-1987	DODGE CHARGER			1987-1990	ACURA LEGEND	2.7L V6 2675cc
	<b>USEP8000</b>	1985	HONDA ACCORD		1.8L L4 1829cc	1988	HONDA CIVIC	1.5L L4 1493cc
		1985	MAZDA RX-7		1.3L R2 1308cc	1988	MITSUBISHI GALANT	3.0L V6 2972cc 181 CID
1985-1986		DODGE CONQUEST	2.6L L4 2555cc 156 CID		1988-1989	MERCURY TRACER	1.6L L4 1598cc 98 CID	
1985-1986		PLYMOUTH CONQUEST	2.6L L4 2555cc 156 CID		1988-1991	HONDA CIVIC	1.6L L4 1588cc 98 CID	
1985-1987		HONDA CIVIC	1.5L L4 1487cc		1988-1991	HONDA CRX	1.5L L4 1493cc	
1985-1987		HONDA PRELUDE	2.0L L4 1955cc	1988-1991	HONDA CRX	1.6L L4 1588cc 98 CID		
1985-1989		MITSUBISHI STARION	2.6L L4 2555cc 156 CID	1988-1991	HONDA PRELUDE	2.0L L4 1958cc		
1986-1989		ACURA INTEGRA	1.6L L4 1590cc	1988-1991	MAZDA 929	3.0L V6 2954cc 180 CID		
1987-1989		CHRYSLER CONQUEST	2.6L L4 2555cc 156 CID	1988-1991	TOYOTA 4RUNNER	3.0L V6 2959cc		
1990-1992		DAIHATSU ROCKY	1.6L L4 1589cc	1988-1992	DAIHATSU CHARADE	1.0L L3 993cc 61 CID		
<b>USEP8002</b>		1985-1989	VOLVO 244	2.3L L4 2316cc	1988-1992	MAZDA 626	2.2L L4 2184cc	
		1985-1989	VOLVO 245	2.3L L4 2316cc	1988-1992	MAZDA MX-6	2.2L L4 2184cc	
		1987-1990	VOLVO 780	2.8L V6 2849cc	1988-1992	TOYOTA LAND CRUISER	4.0L L6 3956cc	
		1988-1989	JAGUAR VANDEN PLAS	3.6L L6 3590cc	1989	DODGE COLT	1.5L L4 1468cc 90 CID	
		1988-1989	JAGUAR XJ6	3.6L L6 3590cc	1989	DODGE COLT	1.6L L4 1597cc 98 CID	
		1988-1990	VOLVO 740	2.3L L4 2316cc	1989	FORD PROBE	2.2L L4 133 CID	
		1988-1990	VOLVO 760	2.3L L4 2316cc	1989	MAZDA B2600	2.6L L4 2606cc	
		1988-1990	VOLVO 760	2.8L V6 2849cc	1989	MITSUBISHI MIRAGE	1.5L L4 1468cc 90 CID	
	1989-1991	VOLVO 780	2.3L L4 2316cc	1989	MITSUBISHI MIRAGE	1.6L L4 1597cc 98 CID		
	1990-1992	JAGUAR XJ6	4.0L L6 3980cc	1989	PLYMOUTH COLT	1.5L L4 1468cc 90 CID		
	1990-1993	JAGUAR VANDEN PLAS	4.0L L6 3980cc	1989	PLYMOUTH COLT	1.6L L4 1597cc 98 CID		
	1990-1993	VOLVO 240	2.3L L4 2316cc	1989-1990	EAGLE SUMMIT	1.5L L4 1468cc 90 CID		
	1992-1994	VOLVO 960	2.9L L6 2922cc	1989-1990	EAGLE SUMMIT	1.6L L4 1597cc 98 CID		
	1994	VOLVO 940	2.3L L4 2316cc	1989-1990	MITSUBISHI GALANT	2.0L L4 1997cc 122 CID		
	<b>USEP8004</b>	1975-1978	FORD MUSTANG II	5.0L V8 302 CID	1989-1990	MITSUBISHI SIGMA	3.0L V6 2972cc 181 CID	
		1977	DODGE DART	3.7L L6 3687cc 225 CID	1989-1991	STERLING 827	2.7L V6 2675cc	
		1980	FORD F-350	5.0L V8 302 CID	1989-1991	SUZUKI SIDEKICK	1.6L L4 1590cc 97 CID	
1980		JEEP WAGONEER	4.6L L6 4622cc 282 CID	1989-1991	TOYOTA SUPRA	3.0L L6 2954cc		
1982-1987		DODGE D350	3.7L L6 3687cc 225 CID	1989-1992	DAIHATSU CHARADE	1.3L L4 1295cc		
1983-1989		FORD F-350	5.0L V8 302 CID	1989-1992	TOYOTA CRESSIDA	3.0L L6 2954cc		
<b>USEP8012SP</b>		1982	BUICK CENTURY	4.3L V6 260 CID	1989-1993	FORD FESTIVA	1.3L L4 1295cc	
		1982-1983	CHEVROLET MALIBU	4.3L V6 260 CID	1989-1993	MAZDA MPV	2.6L L4 2606cc	
		1982-1983	CHEVROLET MONTE CARLO	4.3L V6 260 CID	1989-1994	SUZUKI SWIFT	1.3L L4 1298cc 79 CID	
		1982-1983	OLDSMOBILE CUTLASS CIERA	4.3L V6 260 CID	1990	MAZDA PROTEGE	1.8L L4 1839cc	
		1982-1984	CHEVROLET CELEBRITY	4.3L V6 260 CID	1990	MITSUBISHI ECLIPSE	1.8L L4 1755cc 107 CID	
	1982-1984	OLDSMOBILE CUTLASS CALAIS	4.3L V6 260 CID	1990	MITSUBISHI ECLIPSE	2.0L L4 1997cc 122 CID		
	1982-1984	OLDSMOBILE CUTLASS SUPREME	4.3L V6 260 CID	1990-1991	EAGLE TALON	2.0L L4 1997cc 122 CID		
	1982-1984	PONTIAC 6000	4.3L V6 260 CID	1990-1991	HONDA CIVIC	1.5L L4 1493cc		
	1982-1985	BUICK REGAL	4.3L V6 260 CID	1990-1991	HONDA PRELUDE	2.1L L4 2056cc		
	1984	CADILLAC DEVILLE	5.7L V8 350 CID	1990-1991	LEXUS ES250	2.5L V6 2508cc		
	1984	CADILLAC FLEETWOOD	5.7L V8 350 CID	1990-1991	PLYMOUTH LASER	1.8L L4 1755cc 107 CID		
	1984	OLDSMOBILE 98	5.7L V8 350 CID	1990-1991	PLYMOUTH LASER	2.0L L4 1997cc 122 CID		
	1984	OLDSMOBILE CUSTOM CRUISER	5.7L V8 350 CID	1991-1993	TOYOTA MR2	2.2L L4 2164cc		
	1984	PONTIAC PARISIENNE	5.7L V8 350 CID	1991-1994	MERCURY CAPRI	1.6L L4 1598cc 98 CID		
	1984-1985	BUICK LESABRE	5.7L V8 350 CID	1991-1994	TOYOTA PREVIA	2.4L L4 2438cc		
	1984-1985	BUICK RIVIERA	5.7L V8 350 CID	1992-1993	HONDA ACCORD	2.2L L4 2156cc		
	1984-1985	CADILLAC EL DorADO	5.7L V8 350 CID	1992-1993	MAZDA B2200	2.2L L4 2184cc		
	1984-1985	CADILLAC SEVILLE	5.7L V8 350 CID	1993-1996	HONDA PRELUDE	2.2L L4 2156cc		

USMW	Years	Application	Engine
<b>USEP8023</b>	1993-1996	HONDA PRELUDE	2.3L L4 2259cc
	2002-2006	FREIGHTLINER SPRINTER 2500	2.7L L5 2687cc 165 CID
	2002-2006	FREIGHTLINER SPRINTER 3500	2.7L L5 2687cc 165 CID
	2007-2008	FREIGHTLINER SPRINTER 2500	3.0L V6 2987cc
	2007-2008	FREIGHTLINER SPRINTER 2500	3.5L V6 3498cc
	2007-2008	FREIGHTLINER SPRINTER 3500	3.0L V6 2987cc
	2007-2008	FREIGHTLINER SPRINTER 3500	3.5L V6 3498cc
<b>USEP8030</b>	1988-1992	VOLKSWAGEN JETTA	1.8L L4 1780cc
	1989-1990	VOLKSWAGEN GOLF	1.8L L4 1780cc
	1989-1992	VOLKSWAGEN GOLF	1.8L L4 1781cc
	1990	VOLKSWAGEN CORRADO	1.8L L4 1780cc
	1992	VOLKSWAGEN GOLF	1.8L L4 1780cc
<b>USEP8032</b>	1988-1990	NISSAN D21	2.4L L4 2389cc
	1990	NISSAN D21	3.0L V6 2960cc 181 CID
	1992	NISSAN D21	3.0L V6 2960cc 181 CID
	1992-1994	NISSAN D21	2.4L L4 2389cc
	1995	NISSAN PICKUP	2.4L L4 2389cc
	1995	NISSAN PICKUP	3.0L V6 2960cc 181 CID
<b>USEP8048</b>	1987-1989	NISSAN STANZA	
<b>USEP8051</b>	1985-1989	ISUZU IMPULSE	2.0L L4 1994cc
	1988-1989	ISUZU IMPULSE	2.3L L4 2254cc
<b>USEP8055</b>	1980-1983	HONDA CIVIC	1.3L L4 1335cc
	1980-1983	HONDA CIVIC	1.5L L4 1487cc
<b>USEP8059</b>	1985-1986	SUBARU GL-10	1.8L H4 1781cc
	1986	SUBARU RX	
	1987-1988	SUBARU GL	1.8L H4 1781cc
	1987-1989	SUBARU DL	
	1987-1989	SUBARU GL-10	
	1988-1989	SUBARU GL	
	1990-1994	SUBARU LOYALE	
<b>USEP8060</b>	1987-1988	SAAB 900	
<b>USEP8061</b>	1981-1984	SAAB 900	2.0L L4 1985cc
	1985-1986	SAAB 900	
<b>USEP8075</b>	1985-1988	NISSAN MAXIMA	
<b>USEP8076</b>	1989-1994	GEO METRO	1.0L L3 993cc 61 CID
	1989-1994	SUZUKI SWIFT	1.3L L4 1298cc 79 CID
<b>USEP8077</b>	1988	SAAB 9000	
	1990-1993	SAAB 900	2.0L L4 1985cc
	1991-1993	SAAB 900	2.1L L4 2119cc
	1999-2000	SAAB 9-5	2.3L L4 2290cc 140 CID
	1999-2000	SAAB 9-5	3.0L V6 2961cc 181 CID
<b>USEP8094</b>	1982	CHRYSLER IMPERIAL	5.2L V8 5211cc 318 CID
<b>USEP8095</b>	1985	SUBARU GL	
	1985-1986	SUBARU STANDARD	
	1985-1987	SUBARU BRAT	
	1986-1987	SUBARU GL	1.6L H4 1595cc
	1986-1987	SUBARU GL	1.8L H4 1781cc
	1987	SUBARU STANDARD	1.6L H4 1595cc
	1988-1989	SUBARU GL	
<b>USEP8096</b>	1987-1988	SAAB 900	
	1987-1988	SAAB 9000	
<b>USEP8097</b>	1987	NISSAN PULSAR NX	
	1987	NISSAN SENTRA	1.6L L4 1597cc 97 CID
	1988	NISSAN PULSAR NX	1.6L L4 1597cc 97 CID
	1988	NISSAN SENTRA	
	1988-1992	NISSAN HIKARI	1.6L L4 1597cc 97 CID
<b>USEP8098</b>	1987	NISSAN PULSAR NX	
	1988-1989	NISSAN PULSAR NX	1.8L L4 1809cc
	1989	NISSAN PULSAR NX	1.6L L4 1597cc 97 CID
	1989-1990	NISSAN SENTRA	
	1990	NISSAN PULSAR NX	
<b>USEP8111</b>	1990-1996	NISSAN 300ZX	
<b>USEP8113</b>	1990-1996	NISSAN 300ZX	
<b>USEP8114</b>	1990-1996	NISSAN 300ZX	
<b>USEP8116</b>	1987	NISSAN PATHFINDER	2.4L L4 2389cc
	1987-1988	NISSAN PATHFINDER	3.0L V6 2960cc 181 CID
	1989-1995	NISSAN PATHFINDER	
<b>USEP8118</b>	1987-1988	NISSAN VAN	
	1988	NISSAN SENTRA	
<b>USEP8119</b>	1988-1992	TOYOTA SUPRA	
	1989-1991	MAZDA RX-7	1.3L R2 1308cc
	1990-1991	ACURA INTEGR	1.8L L4 1834cc
	1990-1993	TOYOTA CELICA	1.6L L4 1587cc
	1990-1993	TOYOTA CELICA	2.0L L4 1998cc 122 CID
	1990-1993	TOYOTA CELICA	2.2L L4 2164cc
	1990-2000	LEXUS LS400	4.0L V8 3969cc
	1991-1993	TOYOTA MR2	2.0L L4 1998cc 122 CID
	1991-2005	ACURA NSX	3.0L V6 2977cc
	1992	TOYOTA COROLLA	1.6L L4 1587cc
	1993-1995	MAZDA RX-7	1.3L R2 1308cc
	1997-2005	ACURA NSX	3.2L V6 3179cc
	1999	MITSUBISHI 3000GT	3.0L V6 2972cc 181 CID
<b>USEP8122</b>	1968-1969	MG MGC	2.9L L6 2912cc 178 CID
	1968-1980	MG MGB	1.8L L4 1798cc 110 CID
	1969	MG MGC	2.9L L6 2912cc
	1971-1973	TRIUMPH STAG	3.0L V8 2997cc
	1971-1973	TRIUMPH STAG	3.0L V8 2997cc 183 CID
<b>USEP8123</b>	1981	VOLVO 262	2.8L V6 2849cc

USMW	Years	Application	Engine
<b>USEP8123</b>	1981	VOLVO 264	2.1L L4 2127cc
	1981	VOLVO 265	2.8L V6 2849cc
	1981-1982	VOLVO 264	2.8L V6 2849cc
	1981-1984	VOLVO 242	2.1L L4 2127cc
	1985	VOLVO 244	2.1L L4 2127cc
	1985	MAZDA RX-7	1.1L R2 1146cc
<b>USEP8124</b>	1988-1994	BMW 750IL	
<b>USEP8132</b>	1991-1992	BMW 850I	
	1993-1997	BMW 850CI	
	1994-1995	BMW 850CSI	
<b>USEP8139</b>	1986-1987	BMW L7	
	1987-1992	BMW 735I	
	1988-1992	BMW 735IL	
	1989-1993	BMW 535I	
	1989-1995	BMW 525I	
	1991-1993	BMW M5	
	1993	BMW 525IT	
<b>USEP8144</b>	1976	MERCEDES-BENZ 450SE	4.5L V8 4520cc
	1976-1977	MERCEDES-BENZ 450SEL	4.5L V8 4520cc
	1976-1977	MERCEDES-BENZ 450SL	4.5L V8 4520cc
	1976-1977	MERCEDES-BENZ 450SLC	4.5L V8 4520cc
	1977	MERCEDES-BENZ 280SE	2.8L L6 2746cc
	1977-1978	BMW 320I	2.0L L4 1990cc 121 CID
<b>USEP8146</b>	1987	AUDI COUPE	2.3L L5 2309cc
	1988	AUDI 90	2.0L L4 1983cc
	1988-1989	AUDI 80	2.0L L4 1983cc
	1988-1989	AUDI 80 QUATTRO	2.3L L5 2309cc
	1988-1989	AUDI 90	2.3L L5 2309cc
	1988-1989	AUDI 90 QUATTRO	2.3L L5 2309cc
<b>USEP8147</b>	1985-1986	VOLVO 760	2.8L V6 2849cc
	1985-1987	VOLVO 760	2.3L L4 2316cc
	1986	VOLVO 740	2.3L L4 2316cc
	1987	VOLVO 740	
<b>USEP8149</b>	1985-1986	ALFA ROMEO GTV-6	2.5L V6 2492cc
	1985-1986	ALFA ROMEO SPIDER	2.0L L4 1961cc 120 CID
	1985-1987	PEUGEOT 505	2.0L L4 1971cc
	1986-1987	PEUGEOT 505	2.2L L4 2155cc
	1987-1989	ALFA ROMEO MILANO	2.5L V6 2492cc
	1987-1989	PEUGEOT 505	2.8L V6 2849cc
	1988	PEUGEOT 505	2.2L L4 2165cc
	1988-1989	ALFA ROMEO MILANO	3.0L V6 2959cc
	1988-1994	ALFA ROMEO SPIDER	2.0L L4 1961cc 120 CID
	1989	PEUGEOT 505	2.2L L4 2155cc
	1992-1993	AM GENERAL HUMMER	6.2L V8 379 CID
	1994-2001	AM GENERAL HUMMER	6.5L V8 395 CID
	1995-1996	AM GENERAL HUMMER	5.7L V8 350 CID
	2008	ALFA ROMEO 8C	4.7L V8 4691cc
<b>USEP8150</b>	1985-1987	PEUGEOT 505	2.0L L4 1971cc
<b>USEP8151</b>	1992-1996	DODGE VIPER	
<b>USEP8158</b>	1986-1987	HONDA PRELUDE	1.8L L4 1829cc
<b>USEP8169</b>	1977	PORSCHE 911	2.7L H6 2688cc
	1977-1982	PORSCHE 924	2.0L L4 1983cc
	1978-1979	PORSCHE 928	4.5L V8 4474cc
	1978-1983	PORSCHE 911	3.0L H6 2999cc
	1986-1989	PORSCHE 911	3.3L H6 3294cc
	1991-1992	PORSCHE 911	3.3L H6 3294cc
	1993-1994	PORSCHE 911	3.6L H6 3606cc
<b>USEP8171</b>	1980-1982	PORSCHE 928	4.5L V8 4474cc
	1983-1984	PORSCHE 928	4.7L V8 4671cc
	1985-1986	PORSCHE 928	5.0L V8 4950cc
<b>USEP8177</b>	1985-1988	MERCEDES-BENZ 190E	2.3L L4 2299cc
	1986-1989	MERCEDES-BENZ 560SL	5.6L V8 5547cc
	1986-1990	MERCEDES-BENZ 300E	3.0L L6 2962cc
	1986-1991	MERCEDES-BENZ 420SEL	4.2L V8 4196cc
	1986-1991	MERCEDES-BENZ 560SEC	5.6L V8 5547cc
	1986-1991	MERCEDES-BENZ 560SEL	5.6L V8 5547cc
	1987-1989	MERCEDES-BENZ 260E	2.6L L6 2599cc
	1987-1993	MERCEDES-BENZ 190E	2.6L L6 2599cc
	1988-1992	MERCEDES-BENZ 300CE	3.0L L6 2962cc
	1988-1993	MERCEDES-BENZ 300TE	3.0L L6 2962cc
	1990-1992	MERCEDES-BENZ 300E	2.6L L6 2599cc
	1990-1993	MERCEDES-BENZ 300SL	3.0L L6 2962cc
	1990-1993	MERCEDES-BENZ 500SL	5.0L V8 4973cc
	1991-1993	MERCEDES-BENZ 190E	2.3L L4 2299cc
	1992	MERCEDES-BENZ 400SE	4.2L V8 4196cc
	1992-1993	MERCEDES-BENZ 300E	3.0L L6 2962cc
	1992-1993	MERCEDES-BENZ 300SE	3.2L L6 3199cc
	1992-1993	MERCEDES-BENZ 400E	4.2L V8 4196cc
	1992-1993	MERCEDES-BENZ 500E	5.0L V8 4973cc
	1992-1993	MERCEDES-BENZ 500SEL	5.0L V8 4973cc
	1992-1993	MERCEDES-BENZ 600SEL	6.0L V12 5987cc
	1993	MERCEDES-BENZ 300CE	3.2L L6 3199cc
	1993	MERCEDES-BENZ 300E	2.8L L6 2799cc
	1993	MERCEDES-BENZ 300E	3.2L L6 3199cc
	1993	MERCEDES-BENZ 300TE	3.2L L6 3199cc
	1993	MERCEDES-BENZ 400SEL	4.2L V8 4196cc
	1993	MERCEDES-BENZ 500SEC	5.0L V8 4973cc
	1993	MERCEDES-BENZ 600SEC	6.0L V12 5987cc



USMW	Years	Application	Engine	USMW	Years	Application	Engine	
<b>USEP8177</b>	1993	<b>MERCEDES-BENZ</b> 600SL	6.0L V12 5987cc	<b>USEP8213</b>	2003-2004	<b>PONTIAC</b> VIBE	1.8L L4 1795cc	
	1994	<b>MERCEDES-BENZ</b> C220	2.2L L4 2199cc		2003-2004	<b>TOYOTA</b> TACOMA	2.4L L4 2438cc	
	1994	<b>MERCEDES-BENZ</b> C280	2.8L L6 2799cc		2003-2004	<b>TOYOTA</b> TACOMA	2.7L L4 2694cc	
	1994	<b>MERCEDES-BENZ</b> E500	5.0L V8 4973cc		2003-2004	<b>TOYOTA</b> TACOMA	3.4L V6 3378cc	
	1994-1995	<b>MERCEDES-BENZ</b> E320	3.2L L6 3199cc		2003-2006	<b>PONTIAC</b> VIBE	1.8L L4 1794cc	
	1994-1995	<b>MERCEDES-BENZ</b> S420	4.2L V8 4196cc		2003-2006	<b>TOYOTA</b> CAMRY	3.0L V6 2995cc	
	1994-1995	<b>MERCEDES-BENZ</b> S500	5.0L V8 4973cc		2004	<b>TOYOTA</b> CAMRY	3.3L V6 3300cc	
	1994-1995	<b>MERCEDES-BENZ</b> S600	6.0L V12 5987cc		2004	<b>TOYOTA</b> SOLARA	3.3L V6 3300cc	
	1994-1995	<b>MERCEDES-BENZ</b> SL320	3.2L L6 3199cc		2004-2006	<b>LEXUS</b> ES330	3.3L V6 3300cc 202 CID	
	1994-1995	<b>MERCEDES-BENZ</b> SL500	5.0L V8 4973cc		2004-2006	<b>SCION</b> XA	1.5L L4 1497cc	
	1994-1996	<b>MERCEDES-BENZ</b> S320	3.2L L6 3199cc		2004-2006	<b>SCION</b> XB	1.5L L4 1497cc	
	1995-1996	<b>MERCEDES-BENZ</b> C220	2.2L L4 2199cc 134 CID		2005-2006	<b>TOYOTA</b> CAMRY	3.3L V6 3300cc 202 CID	
	<b>USEP8185</b>	1976	<b>MERCEDES-BENZ</b> 450SE		4.5L V8 4520cc	2005-2008	<b>TOYOTA</b> SOLARA	3.3L V6 3300cc 202 CID
		1976-1977	<b>MERCEDES-BENZ</b> 450SEL		4.5L V8 4520cc	2005-2009	<b>TOYOTA</b> AVALON	3.5L V6 3456cc
1976-1977		<b>MERCEDES-BENZ</b> 450SL	4.5L V8 4520cc	2006	<b>PONTIAC</b> VIBE	1.8L L4 1795cc		
1976-1977		<b>MERCEDES-BENZ</b> 450SLC	4.5L V8 4520cc	2007-2009	<b>LEXUS</b> ES350	3.5L V6 3456cc		
1977		<b>MERCEDES-BENZ</b> 280SE	2.8L L6 2746cc	2007-2009	<b>TOYOTA</b> CAMRY	3.5L V6 3456cc		
1977-1978		<b>BMW</b> 320i	2.0L L4 1990cc 121 CID	<b>USEP8218</b>	1990-1992	<b>INFINITI</b> M30		
1982		<b>DELOREAN</b> DMC 12	2.9L V6 2850cc 174 CID		<b>USEP8219</b>	1990-1996	<b>INFINITI</b> Q45	
<b>USEP8186</b>	1988	<b>VOLVO</b> 760	2.3L L4 2316cc	<b>USEP8222</b>		1991	<b>AUDI</b> COUPE QUATTRO	2.3L L5 2309cc
	1989	<b>VOLVO</b> 780	2.3L L4 2316cc		1992-1993	<b>AUDI</b> 100	2.8L V6 2771cc	
	1990	<b>VOLVO</b> 740	2.3L L4 2316cc		1992-1993	<b>AUDI</b> S4	2.2L L5 2226cc	
	1994	<b>VOLVO</b> 960	2.9L L6 2922cc		1993	<b>AUDI</b> 100 QUATTRO	2.8L V6 2771cc	
<b>USEP8188</b>	1975-1976	<b>TOYOTA</b> COROLLA	1.6L L4 1588cc 97 CID	1993-1994	<b>AUDI</b> 90 QUATTRO	2.8L V6 2771cc		
	1975-1979	<b>TOYOTA</b> CELICA	2.2L L4 2189cc	1994	<b>AUDI</b> 90	2.8L V6 2771cc		
	1975-1979	<b>TOYOTA</b> CORONA	2.2L L4 2189cc	<b>USEP8224</b>	1985-1989	<b>VOLVO</b> 244	2.3L L4 2316cc	
	1975-1979	<b>TOYOTA</b> PICKUP	2.2L L4 2189cc		1985-1989	<b>VOLVO</b> 245	2.3L L4 2316cc	
<b>USEP8190</b>	1989-1994	<b>NISSAN</b> MAXIMA			1987-1990	<b>VOLVO</b> 780	2.8L V6 2849cc	
	1989-1991	<b>HYUNDAI</b> SONATA	2.4L L4 2351cc		1988	<b>VOLVO</b> 760	2.8L V6 2849cc	
<b>USEP8198</b>	1990-1992	<b>HYUNDAI</b> SONATA	3.0L V6 2972cc		1988-1989	<b>JAGUAR</b> VANDEN PLAS	3.6L L6 3590cc	
	1992	<b>HYUNDAI</b> SONATA	2.0L L4 1997cc		1988-1989	<b>JAGUAR</b> XJ6	3.6L L6 3590cc	
<b>USEP8200</b>	1985-1986	<b>VOLKSWAGEN</b> GOLF	1.8L L4 1780cc		1988-1989	<b>VOLVO</b> 740	2.3L L4 2316cc	
	1985-1988	<b>VOLKSWAGEN</b> SCIROCCO	1.8L L4 1780cc		1989-1990	<b>VOLVO</b> 760	2.3L L4 2316cc	
	1985-1989	<b>VOLKSWAGEN</b> JETTA	1.8L L4 1780cc		1989-1991	<b>VOLVO</b> 780	2.3L L4 2316cc	
	1985-1993	<b>VOLKSWAGEN</b> CABRIOLET	1.8L L4 1780cc		1990-1992	<b>JAGUAR</b> XJ6	4.0L L6 3980cc	
	1987-1992	<b>VOLKSWAGEN</b> JETTA	1.8L L4 1781cc		1990-1993	<b>JAGUAR</b> VANDEN PLAS	4.0L L6 3980cc	
	1987-1993	<b>VOLKSWAGEN</b> FOX	1.8L L4 1780cc		1990-1993	<b>VOLVO</b> 240	2.3L L4 2316cc	
	1989-1992	<b>VOLKSWAGEN</b> GOLF	1.8L L4 1780cc		1992-1994	<b>VOLVO</b> 960	2.9L L6 2922cc	
	1990-1992	<b>VOLKSWAGEN</b> JETTA	2.0L L4 1984cc 121 CID		1994-1995	<b>VOLVO</b> 940	2.3L L4 2316cc	
	1990-1993	<b>VOLKSWAGEN</b> PASSAT	2.0L L4 1984cc 121 CID	<b>USEP8229</b>	1989-1995	<b>GEO</b> TRACKER	1.6L L4 1588cc 98 CID	
	1990-1993	<b>VOLKSWAGEN</b> CABRIOLET	1.8L L4 1780cc		1990-1991	<b>GEO</b> STORM	1.6L L4 1588cc 98 CID	
	1991-1993	<b>VOLKSWAGEN</b> FOX	1.8L L4 1780cc		1990-1992	<b>ISUZU</b> IMPULSE	1.6L L4 1588cc	
<b>USEP8211</b>	1990-1994	<b>MITSUBISHI</b> PRECIS			1990-1993	<b>MAZDA</b> MIATA	1.6L L4 1597cc	
	1990-1994	<b>TOYOTA</b> TERCEL	1.5L L4 1456cc		1990-1994	<b>SUBARU</b> JUSTY	1.2L L3 1189cc	
<b>USEP8213</b>	1992-1993	<b>LEXUS</b> ES300	3.0L V6 2959cc		1991	<b>MITSUBISHI</b> MIGHTY MAX	2.4L L4 2351cc	
	1992-1993	<b>TOYOTA</b> CAMRY	2.2L L4 2164cc		1991	<b>MITSUBISHI</b> MIGHTY MAX	3.0L V6 2972cc 181 CID	
	1992-1993	<b>TOYOTA</b> CAMRY	3.0L V6 2959cc		1991-1993	<b>DODGE</b> RAM 50	2.4L L4 2351cc	
	1992-1994	<b>TOYOTA</b> 4RUNNER	2.4L L4 2366cc		1991-1993	<b>ISUZU</b> STYLUS	1.6L L4 1588cc	
	1992-1994	<b>TOYOTA</b> 4RUNNER	3.0L V6 2959cc		1991-1993	<b>MITSUBISHI</b> GALANT	2.0L L4 1997cc 122 CID	
	1992-1995	<b>TOYOTA</b> PICKUP	2.4L L4 2366cc		1991-1994	<b>MITSUBISHI</b> ECLIPSE	1.8L L4 1755cc 107 CID	
	1992-1995	<b>TOYOTA</b> PICKUP	3.0L V6 2959cc		1991-1996	<b>EAGLE</b> SUMMIT	1.5L L4 1468cc 90 CID	
	1992-1998	<b>TOYOTA</b> PASEO	1.5L L4 1497cc		1992	<b>DODGE</b> COLT	1.5L L4 1468cc 90 CID	
	1993	<b>TOYOTA</b> COROLLA	1.8L L4 1762cc 107 CID		1992	<b>ISUZU</b> IMPULSE	1.8L L4 1809cc 110 CID	
	1993-1994	<b>TOYOTA</b> T100	3.0L V6 2959cc	1992	<b>ISUZU</b> STYLUS	1.8L L4 1809cc 110 CID		
	1993-1996	<b>TOYOTA</b> COROLLA	1.6L L4 1587cc	1992	<b>NISSAN</b> D21	2.4L L4 2389cc		
	1993-1997	<b>GEO</b> PRIZM	1.6L L4 1588cc 98 CID	1992	<b>NISSAN</b> D21	3.0L V6 2960cc 181 CID		
	1993-1997	<b>GEO</b> PRIZM	1.8L L4 1762cc 107 CID	1992	<b>PLYMOUTH</b> COLT	1.5L L4 1468cc 90 CID		
	1994-1995	<b>LEXUS</b> ES300	3.0L V6 2959cc	1992	<b>PLYMOUTH</b> COLT	1.8L L4 1834cc 112 CID		
	1994-1995	<b>TOYOTA</b> PREVIA	2.4L L4 2438cc	1992	<b>PLYMOUTH</b> COLT	2.4L L4 2351cc		
	1994-1997	<b>TOYOTA</b> CELICA	1.8L L4 1762cc 107 CID	1992-1993	<b>GEO</b> STORM	1.8L L4 1809cc 110 CID		
	1994-1998	<b>TOYOTA</b> T100	2.7L L4 2694cc	1992-1994	<b>MAZDA</b> 323	1.6L L4 1597cc		
	1994-1999	<b>TOYOTA</b> CELICA	2.2L L4 2164cc	1992-1994	<b>MAZDA</b> MX-3	1.8L V6 1845cc		
	1995	<b>TOYOTA</b> COROLLA	1.8L L4 1762cc 107 CID	1992-1994	<b>MITSUBISHI</b> EXPO LRV	1.8L L4 1834cc 112 CID		
	1995-1997	<b>TOYOTA</b> TACOMA	2.4L L4 2438cc	1992-1995	<b>HYUNDAI</b> ELANTRA	1.6L L4 1596cc		
	1995-1997	<b>TOYOTA</b> TACOMA	2.7L L4 2694cc	1992-1995	<b>MAZDA</b> 929	3.0L V6 2954cc 180 CID		
	1995-1997	<b>TOYOTA</b> TACOMA	3.4L V6 3378cc	1992-1995	<b>MAZDA</b> MX-3	1.6L L4 1597cc		
	1995-1998	<b>TOYOTA</b> T100	3.4L V6 3378cc	1992-1995	<b>MITSUBISHI</b> DIAMANTE	3.0L V6 2972cc 181 CID		
	1995-1998	<b>TOYOTA</b> TERCEL	1.5L L4 1497cc	1992-1995	<b>MITSUBISHI</b> EXPO	2.4L L4 2351cc		
	1995-1999	<b>TOYOTA</b> AVALON	3.0L V6 2995cc	1992-1996	<b>EAGLE</b> SUMMIT	1.8L L4 1834cc 112 CID		
	1996-1998	<b>LEXUS</b> ES300	3.0L V6 2959cc	1992-1996	<b>EAGLE</b> SUMMIT	2.4L L4 2351cc		
	1996-2000	<b>TOYOTA</b> RAV4	2.0L L4 1998cc 122 CID	1992-1996	<b>MITSUBISHI</b> MONTERO	3.0L V6 2972cc 181 CID		
	1997	<b>TOYOTA</b> CAMRY	2.2L L4 2164cc	1992-1998	<b>EAGLE</b> TALON	2.0L L4 1997cc 122 CID		
	1997-1998	<b>TOYOTA</b> CAMRY	3.0L V6 2995cc	1992-2000	<b>MAZDA</b> PROTEGE	1.8L L4 1839cc		
	1997-2000	<b>TOYOTA</b> 4RUNNER	2.7L L4 2694cc	1993-1994	<b>DODGE</b> COLT	2.4L L4 2351cc		
	1997-2002	<b>TOYOTA</b> 4RUNNER	3.4L V6 3378cc	1993-1994	<b>EAGLE</b> TALON	1.8L L4 1755cc 107 CID		
	1998-2000	<b>TOYOTA</b> SIENNA	3.0L V6 2995cc	1993-1994	<b>HONDA</b> CIVIC	1.6L L4 1588cc 98 CID		
	1998-2002	<b>CHEVROLET</b> PRIZM	1.8L L4 1794cc	1993-1994	<b>MAZDA</b> 626	2.0L L4 1991cc		
	1998-2002	<b>TOYOTA</b> COROLLA	1.8L L4 1794cc	1993-1994	<b>MAZDA</b> 626	2.5L V6 2497cc		
	1999-2000	<b>TOYOTA</b> TACOMA	2.4L L4 2438cc	1993-1994	<b>MAZDA</b> MX-6	2.0L L4 1991cc		
	1999-2000	<b>TOYOTA</b> TACOMA	2.7L L4 2694cc	1993-1994	<b>MAZDA</b> MX-6	2.5L V6 2497cc		
	1999-2000	<b>TOYOTA</b> TACOMA	3.4L V6 3378cc	1993-1994	<b>MITSUBISHI</b> EXPO LRV	2.4L L4 2351cc		
	1999-2003	<b>LEXUS</b> ES300	3.0L V6 2995cc	1993-1994	<b>MITSUBISHI</b> MIGHTY MAX	3.0L V6 2972cc 181 CID		
	2000-2001	<b>TOYOTA</b> CAMRY	2.2L L4 2164cc	1993-1994	<b>SUBARU</b> IMPREZA	1.8L H4 1781cc		
	2000-2001	<b>TOYOTA</b> CAMRY	3.0L V6 2995cc	1993-1995	<b>HONDA</b> CIVIC	1.5L L4 1493cc		
	2000-2005	<b>TOYOTA</b> CELICA	1.8L L4 1794cc	1993-1995	<b>HYUNDAI</b> ELANTRA	1.8L L4 1836cc		
	2000-2005	<b>TOYOTA</b> ECHO	1.5L L4 1497cc	1993-1996	<b>ISUZU</b> RODEO	3.2L V6 3165cc		
	2002-2004	<b>TOYOTA</b> AVALON	3.0L V6 2995cc	1993-1996	<b>MITSUBISHI</b> MIGHTY MAX	2.4L L4 2351cc		
	2002-2005	<b>TOYOTA</b> CAMRY	2.4L L4 2357cc 144 CID	1993-1998	<b>HYUNDAI</b> SONATA	2.0L L4 1997cc		

USMW	Years	Application	Engine	USMW	Years	Application	Engine			
<b>USEP8229</b>	1993-1998	<b>HYUNDAI SONATA</b>	3.0L V6 2972cc	<b>USEP8229</b>	2000	<b>NISSAN TSUBAME</b>	1.6L L4 1597cc 97 CID			
	1994-1995	<b>HONDA ACCORD</b>	2.2L L4 2156cc		2000-2001	<b>NISSAN ALTIMA</b>	2.4L L4 2389cc			
	1994-1995	<b>JEEP CHEROKEE</b>	2.5L L4 150 CID		2000-2001	<b>SUBARU IMPREZA</b>	2.5L H4 2458cc			
	1994-1995	<b>JEEP CHEROKEE</b>	4.0L L6 242 CID		2000-2003	<b>SUBARU OUTBACK</b>	2.5L H4 2458cc			
	1994-1997	<b>HONDA PASSPORT</b>	3.2L V6 3165cc		2001	<b>HONDA CIVIC</b>	1.7L L4 1668cc			
	1994-1997	<b>ISUZU TROOPER</b>	3.2L V6 3165cc		2001	<b>KIA OPTIMA</b>	2.4L L4 2351cc			
	1994-1997	<b>MAZDA MIATA</b>	1.8L L4 1839cc		2001	<b>KIA OPTIMA</b>	2.5L V6 2500cc			
	1994-1998	<b>MITSUBISHI GALANT</b>	2.4L L4 2351cc		2001-2002	<b>HYUNDAI ACCENT</b>	1.6L L4 1600cc			
	1994-1998	<b>MITSUBISHI MONTERO</b>	3.5L V6 3497cc 215 CID		2001-2003	<b>MAZDA PROTEGE</b>	2.0L L4 2000cc			
	1995	<b>KIA SEPHIA</b>	1.8L L4 1839cc		2002-2003	<b>MAZDA PROTEGE5</b>	2.0L L4 2000cc			
	1995	<b>NISSAN PICKUP</b>	2.4L L4 2389cc		2002-2003	<b>SUZUKI AERIO</b>	2.0L L4 2000cc			
	1995-1996	<b>HONDA PASSPORT</b>	2.6L L4 2559cc		2002-2004	<b>HONDA CIVIC</b>	1.7L L4 1700cc			
	1995-1996	<b>NISSAN SENTRA</b>	1.6L L4 1597cc 97 CID		2002-2004	<b>HYUNDAI SONATA</b>	2.4L L4 2351cc			
	1995-1997	<b>GEO METRO</b>	1.0L L3 993cc 61 CID		2002-2005	<b>HYUNDAI SONATA</b>	2.7L V6 2656cc			
	1995-1997	<b>GEO METRO</b>	1.3L L4 1295cc 79 CID		2002-2005	<b>KIA OPTIMA</b>	2.7L V6 2656cc			
	1995-1997	<b>HONDA ACCORD</b>	2.7L V6 2675cc		2002-2005	<b>MITSUBISHI ECLIPSE</b>	2.4L L4 2351cc			
	1995-1997	<b>ISUZU RODEO</b>	2.6L L4 2559cc		2003	<b>CHEVROLET TRACKER</b>	2.0L L4 122 CID			
	1995-1997	<b>KIA SEPHIA</b>	1.6L L4 1597cc		2003	<b>MAZDA PROTEGE</b>	2.0L L4 1998cc 122 CID			
	1995-1997	<b>MITSUBISHI ECLIPSE</b>	2.0L L4 1997cc 122 CID		2003	<b>SUBARU BAJA</b>	2.5L H4 2458cc			
	1995-1997	<b>NISSAN 200SX</b>	1.6L L4 1597cc 97 CID		2003-2004	<b>CHEVROLET TRACKER</b>	2.5L V6 2500cc			
	1995-1997	<b>NISSAN 200SX</b>	2.0L L4 1998cc		2004	<b>SUZUKI VITARA</b>	2.5L V6 2500cc			
	1995-1998	<b>ACURA TL</b>	2.5L L5 2451cc		2004-2005	<b>HYUNDAI XG350</b>	3.5L V6 3500cc			
	1995-1998	<b>MAZDA PROTEGE</b>	1.5L L4 1489cc		2004-2005	<b>KIA OPTIMA</b>	2.4L L4 2351cc			
	1995-1999	<b>CHRYSLER SEBRING</b>	2.0L L4 1996cc 122 CID		2004-2007	<b>SUZUKI AERIO</b>	2.3L L4 2290cc 140 CID			
	1995-1999	<b>DODGE AVENGER</b>	2.0L L4 1996cc 122 CID		2005	<b>NISSAN MICRA</b>	1.4L L4 1386cc 85 CID			
	1995-1999	<b>SUZUKI ESTEEM</b>	1.6L L4 1590cc 97 CID		2005	<b>SUBARU IMPREZA</b>	2.5L H4 2458cc			
	1995-2000	<b>CHRYSLER SEBRING</b>	2.5L V6 2497cc 152 CID		2006-2007	<b>NISSAN URVAN</b>	2.4L L4 2389cc			
	1995-2000	<b>DODGE AVENGER</b>	2.5L V6 2497cc 152 CID		2007	<b>NISSAN FRONTIER</b>	2.4L L4 2389cc			
	1995-2001	<b>SUBARU IMPREZA</b>	2.2L H4 2212cc		2008	<b>NISSAN TSURU</b>	1.6L L4 1597cc 97 CID			
	1995-2001	<b>SUZUKI SWIFT</b>	1.3L L4 1298cc 79 CID		<b>USEP8233</b>	1991-1995	<b>BMW 325IS</b>	2.5L L6 2494cc 152 CID		
	1996	<b>NISSAN ALTIMA</b>	2.4L L4 2400cc 146 CID			1992-1995	<b>BMW 318I</b>	1.8L L4 1796cc		
	1996	<b>NISSAN MAXIMA</b>	3.0L V6 2988cc 182 CID			1992-1995	<b>BMW 318IS</b>	1.8L L4 1796cc		
	1996	<b>NISSAN PATHFINDER</b>	3.3L V6 3275cc			1992-1997	<b>BMW 325I</b>	2.5L L6 2494cc 152 CID		
	1996-1997	<b>ACURA INTEGRA</b>	1.8L L4 1834cc			1995	<b>BMW 318TI</b>	1.8L L4 1796cc		
	1996-1997	<b>ACURA SLX</b>	3.2L V6 3165cc			1995	<b>BMW M3</b>	3.0L L6 2990cc		
	1996-1997	<b>HONDA CIVIC</b>	1.6L L4 1590cc			1996-1997	<b>BMW 318IS</b>	1.9L L4 1895cc		
	1996-1997	<b>HONDA CIVIC DEL SOL</b>	1.6L L4 1588cc 98 CID			1996-1997	<b>BMW M3</b>	3.2L L6 3152cc		
	1996-1997	<b>INFINITI I30</b>	3.0L V6 2988cc 182 CID			1996-1997	<b>BMW Z3</b>	1.9L L4 1895cc		
	1996-1997	<b>MITSUBISHI ECLIPSE</b>	2.4L L4 2351cc			1996-1998	<b>BMW 318I</b>	1.9L L4 1895cc		
	1996-1998	<b>ACURA TL</b>	3.2L V6 3206cc			1996-1998	<b>BMW 318TI</b>	1.9L L4 1895cc		
	1996-1998	<b>SUZUKI SIDEKICK</b>	1.6L L4 1590cc 97 CID			1996-1999	<b>BMW 328IS</b>	2.8L L6 2793cc		
	1996-1998	<b>SUZUKI SIDEKICK</b>	1.8L L4 1840cc			1996-2000	<b>BMW 328I</b>	2.8L L6 2793cc		
	1996-1998	<b>SUZUKI X-90</b>	1.6L L4 1590cc 97 CID			1997	<b>BMW Z3</b>	2.8L L6 2793cc		
	1996-2000	<b>NISSAN LUCINO</b>	1.6L L4 1597cc 97 CID			1997-2001	<b>BMW 323I</b>	2.5L L6 2494cc 152 CID		
	1996-2000	<b>NISSAN LUCINO</b>	2.0L L4 1998cc 122 CID			1998-1999	<b>BMW 323IS</b>	2.5L L6 2494cc 152 CID		
	1997	<b>ACURA CL</b>	2.2L L4 2156cc			2000	<b>BMW 323CI</b>	2.5L L6 2494cc 152 CID		
	1997	<b>GEO TRACKER</b>	1.6L L4 1588cc 98 CID			2000	<b>BMW 328CI</b>	2.8L L6 2793cc		
	1997	<b>HONDA ACCORD</b>	2.2L L4 2156cc			2001-2003	<b>BMW 330CI</b>	3.0L L6 2979cc		
	1997	<b>KIA SEPHIA</b>	1.8L L4 1839cc			2001-2003	<b>BMW 330I</b>	3.0L L6 2979cc		
	1997	<b>MAZDA MILLENIA</b>	2.5L V6 2497cc			2005	<b>BMW 325I</b>	2.5L L6 2494cc 152 CID		
	1997-1998	<b>HONDA CR-V</b>	2.0L L4 1972cc			<b>USEP8235</b>	1985-1987	<b>ISUZU IMPULSE</b>	1.9L L4 1949cc	
	1997-1998	<b>INFINITI QX4</b>	3.3L V6 3275cc				1988-1991	<b>ISUZU TROOPER</b>	2.6L L4 2559cc	
	1997-1998	<b>MITSUBISHI MONTERO SPORT</b>	2.4L L4 2351cc				1988-1995	<b>ISUZU PICKUP</b>	2.6L L4 2559cc	
	1997-1998	<b>MITSUBISHI MONTERO SPORT</b>	3.0L V6 2972cc 181 CID				1989-1992	<b>NISSAN 240SX</b>	2.4L L4 2389cc	
	1997-1999	<b>ACURA CL</b>	3.0L V6 2997cc				1989-1994	<b>ISUZU AMIGO</b>	2.6L L4 2559cc	
1997-1999	<b>KIA SPORTAGE</b>	2.0L L4 1998cc 122 CID	1990-1991	<b>NISSAN AXXESS</b>			2.4L L4 2389cc			
1997-2004	<b>MITSUBISHI DIAMANTE</b>	3.5L V6 3497cc 215 CID	1990-1992	<b>NISSAN STANZA</b>			2.4L L4 2389cc			
1998	<b>ACURA INTEGRA</b>	1.8L L4 1797cc	1991-1992	<b>INFINITI G20</b>						
1998	<b>HONDA CIVIC</b>	1.6L L4 1588cc 98 CID	1991-1992	<b>ISUZU RODEO</b>			2.6L L4 2559cc			
1998	<b>ISUZU OASIS</b>	2.3L L4 2254cc	1992-1997	<b>SUBARU SVX</b>			3.3L H6 3318cc			
1998	<b>NISSAN TSUBAME</b>	1.6L L4 1597cc 97 CID	1993-1994	<b>INFINITI J30</b>						
1998-1999	<b>ACURA CL</b>	2.3L L4 2254cc	1993-1994	<b>NISSAN MAXIMA</b>			3.0L V6 2960cc 181 CID			
1998-2000	<b>CHEVROLET METRO</b>	1.0L L3 993cc 61 CID	1994	<b>INFINITI G20</b>						
1998-2001	<b>CHEVROLET METRO</b>	1.3L L4 1295cc 79 CID	1994-1995	<b>HONDA PASSPORT</b>			2.6L L4 2559cc			
1998-2001	<b>NISSAN TSURU</b>	1.6L L4 1597cc 97 CID	1994-1997	<b>NISSAN 240SX</b>			2.4L L4 2389cc			
1998-2002	<b>HONDA ACCORD</b>	2.3L L4 2254cc	1995	<b>ISUZU PICKUP</b>			2.3L L4 2254cc			
1998-2002	<b>HONDA ACCORD</b>	3.0L V6 2997cc	1995	<b>NISSAN TSUBAME</b>			1.6L L4 1597cc 97 CID			
1998-2002	<b>SUBARU FORESTER</b>	2.5L H4 2458cc	1995-1996	<b>NISSAN TSURU</b>			2.0L L4 1998cc 122 CID			
1998-2004	<b>NISSAN FRONTIER</b>	2.4L L4 2389cc	1995-1997	<b>INFINITI J30</b>			3.0L V6 2960cc 181 CID			
1998-2004	<b>NISSAN PICKUP</b>	2.4L L4 2389cc	1995-1997	<b>NISSAN TSURU</b>			1.6L L4 1597cc 97 CID			
1999	<b>CHEVROLET TRACKER</b>	1.6L L4 1588cc 98 CID	1996	<b>NISSAN SENTRA</b>			2.0L L4 1998cc 122 CID			
1999	<b>CHEVROLET TRACKER</b>	2.0L L4 1995cc 122 CID	1998	<b>SUBARU LEGACY</b>			2.5L H4 2458cc			
1999	<b>INFINITI G20</b>	2.0L L4 2000cc	2001-2004	<b>NISSAN TSUBAME</b>			1.6L L4 1597cc 97 CID			
1999	<b>INFINITI I30</b>	3.0L V6 2988cc 182 CID	<b>USEP8236</b>	1992			<b>AUDI 100 QUATTRO</b>	2.8L V6 2771cc		
1999	<b>ISUZU OASIS</b>	2.3L L4 2234cc		1992			<b>AUDI S4</b>	2.2L L5 2226cc		
1999	<b>MITSUBISHI 3000GT</b>	3.0L V6 2972cc 181 CID		<b>USEP8237</b>			1987-1988	<b>MAZDA B2600</b>		
1999	<b>NISSAN MAXIMA</b>	3.0L V6 2988cc 182 CID					1987-1989	<b>MAZDA B2200</b>		
1999	<b>SUBARU LEGACY</b>	2.2L H4 2212cc					1992-1993	<b>MAZDA B2200</b>		
1999-2000	<b>HONDA CIVIC</b>	1.6L L4 1590cc					<b>USEP8240</b>	1992-2000	<b>LEXUS SC300</b>	3.0L L6 2997cc
1999-2000	<b>SUZUKI VITARA</b>	2.0L L4 2000cc						1993-1997	<b>LEXUS GS300</b>	3.0L L6 2997cc
1999-2001	<b>ACURA INTEGRA</b>	1.8L L4 1834cc						1993-1997	<b>TOYOTA LAND CRUISER</b>	4.5L L6 4477cc
1999-2001	<b>MAZDA PROTEGE</b>	1.6L L4 1589cc						1993-2000	<b>LEXUS SC400</b>	4.0L V8 3969cc
1999-2001	<b>SUZUKI VITARA</b>	1.6L L4 1590cc 97 CID						1994-1997	<b>TOYOTA PREVIA</b>	2.4L L4 2438cc
1999-2003	<b>SUBARU LEGACY</b>	2.5L H4 2458cc						1996-1997	<b>LEXUS LX450</b>	4.5L L6 4477cc
1999-2005	<b>SUZUKI GRAND VITARA</b>	2.5L V6 2500cc			1998			<b>TOYOTA SUPRA</b>	3.0L L6 2997cc	
2000	<b>HYUNDAI ACCENT</b>	1.5L L4 1495cc			1998-2007			<b>LEXUS LX470</b>	4.7L V8 4663cc 285 CID	
2000	<b>MITSUBISHI GALANT</b>	2.4L L4 2351cc			1999-2007			<b>TOYOTA LAND CRUISER</b>	4.7L V8 4663cc 285 CID	
2000	<b>NISSAN SENTRA</b>	1.6L L4 1597cc 97 CID			2000-2002			<b>TOYOTA TUNDRA</b>	4.7L V8 4663cc 285 CID	

USMW	Years	Application	Engine	USMW	Years	Application	Engine
<b>USEP8240</b>	2001-2003	TOYOTA SEQUOIA	4.7L V8 4663cc 285 CID	<b>USEP8286</b>	2003	MERCEDES-BENZ E320	3.2L V6 3199cc
<b>USEP8244</b>	1991-1994	VOLKSWAGEN PANEL	1.8L L4 1780cc	2003-2004	MERCEDES-BENZ G55 AMG	5.5L V8 5439cc 335 CID	
	1993-1999	VOLKSWAGEN GOLF	1.8L L4 1781cc	2005	MERCEDES-BENZ G500	5.0L V8 4973cc	
	1993-1999	VOLKSWAGEN GOLF	2.0L L4 1984cc 121 CID	2006-2008	MERCEDES-BENZ G500	5.0L V8 4966cc	
	1993-1999	VOLKSWAGEN JETTA	2.0L L4 1984cc 121 CID	2009	MERCEDES-BENZ G550	5.5L V8 5461cc	
	1994-1995	VOLKSWAGEN JETTA	1.8L L4 1781cc	<b>USEP8287</b>	1995	BMW 740I	
	1995-1999	VOLKSWAGEN DERBY	1.8L L4 1781cc	1995-1997	BMW 740IL		
	1995-1999	VOLKSWAGEN PANEL	1.8L L4 1781cc	1995-1997	BMW 750IL		
	1995-2001	VOLKSWAGEN COMBI	1.8L L4 1781cc	1997	BMW 740I		
	1998-2002	VOLKSWAGEN CABRIO	2.0L L4 1984cc 121 CID	<b>USEP8289</b>	1994-1995	MERCEDES-BENZ S500	5.0L V8 4973cc
	1999	AUDI A3	1.8L L4 1781cc	1994-1995	MERCEDES-BENZ S600	6.0L V12 5987cc	
	1999	VOLKSWAGEN JETTA	1.8L L4 1781cc	1994-1996	MERCEDES-BENZ SL500	5.0L V8 4973cc	
	2002-2004	VOLKSWAGEN EUROVAN	2.5L L5 2461cc 150 CID	1994-1999	MERCEDES-BENZ S320	3.2L L6 3199cc	
<b>USEP8247</b>	1994-1996	INFINITI G20	2.0L L4 1998cc	1994-1999	MERCEDES-BENZ S420	4.2L V8 4196cc	
	1994-1996	NISSAN ALTIMA	2.4L L4 2389cc	1995	MERCEDES-BENZ E420	4.2L V8 4196cc	
	1996	NISSAN ALTIMA	2.4L L4 2400cc 146 CID	1995	MERCEDES-BENZ SL600	6.0L V12 5987cc	
<b>USEP8249</b>	1993-1994	JAGUAR XJ6	4.0L L6 3980cc	1995-1997	MERCEDES-BENZ SL320	3.2L L6 3199cc	
	1993-1994	JAGUAR XJS	4.0L L6 3980cc	1996-1997	MERCEDES-BENZ C36 AMG	3.6L L6 3606cc	
	1994	JAGUAR VANDEN PLAS	4.0L L6 3980cc	1996-1997	MERCEDES-BENZ E320	3.2L L6 3199cc	
	1994	JAGUAR XJ12	6.0L V12 5994cc	1996-1997	MERCEDES-BENZ S600		
	1994	JAGUAR XJS	6.0L V12 5994cc	1996-1998	MERCEDES-BENZ SL600		
<b>USEP8250</b>	1995	VOLVO 940	2.3L L4 2316cc	1996-1999	MERCEDES-BENZ S500		
<b>USEP8254</b>	1994-1997	TOYOTA SUPRA		1997	MERCEDES-BENZ E420		
<b>USEP8255</b>	1993-1998	TOYOTA SUPRA		1997-1998	MERCEDES-BENZ SL500		
<b>USEP8256</b>	1990-1991	AUDI V8 QUATTRO	3.6L V8 3562cc	1998-1999	MERCEDES-BENZ CL500		
	1992-1994	AUDI V8 QUATTRO	4.2L V8 4172cc	1998-1999	MERCEDES-BENZ CL600		
	1994	AUDI 100	2.8L V6 2771cc	1998-1999	MERCEDES-BENZ E320	3.2L V6 3199cc	
	1994	AUDI 100 QUATTRO	2.8L V6 2771cc	1998-1999	MERCEDES-BENZ E430		
	1994	AUDI S4	2.2L L5 2226cc	1998-1999	MERCEDES-BENZ S600	6.0L V12 5987cc	
	1994-1995	AUDI 90	2.8L V6 2771cc	1999	MERCEDES-BENZ E55 AMG		
	1994-1995	AUDI 90 QUATTRO	2.8L V6 2771cc	2000	MERCEDES-BENZ E430	4.3L V8 4266cc	
	1995-1996	AUDI S6	2.2L L5 2226cc	2000	MERCEDES-BENZ S430		
	1995-1997	AUDI A6	2.8L V6 2771cc	2004-2008	CHRYSLER CROSSFIRE	3.2L V6 3200cc 195 CID	
	1995-1998	AUDI A6 QUATTRO	2.8L V6 2771cc	2005-2006	CHRYSLER CROSSFIRE	3.2L V6 3199cc	
<b>USEP8258</b>	1991	ALFA ROMEO 164	3.0L V6 2959cc	<b>USEP8302</b>	1995-1999	HYUNDAI ACCENT	1.5L L4 1945cc
	1993-1995	ALFA ROMEO 164	3.0L V6 2959cc	1998	HYUNDAI ELANTRA	1.8L L4 1796cc	
<b>USEP8260</b>	1989-1991	PEUGEOT 405	1.9L L4 1905cc	<b>USEP8303</b>	1979-1981	HONDA ACCORD	1.8L L4 1751cc
<b>USEP8271</b>	1993-1995	TOYOTA COROLLA	1.8L L4 1762cc 107 CID	1979-1982	HONDA PRELUDE	1.8L L4 1751cc	
	1994-1995	ACURA INTEGRA	1.8L L4 1797cc	<b>USEP8305</b>	1985-1988	VOLKSWAGEN SCIROCCO	1.8L L4 1780cc
	1994-1996	TOYOTA COROLLA	1.6L L4 1587cc	1985-1989	VOLKSWAGEN CABRIOLET	1.8L L4 1780cc	
	1995-1997	MITSUBISHI ECLIPSE	2.0L L4 1997cc 122 CID	<b>USEP8307</b>	1978-1983	AUDI 5000	2.2L L5 2144cc
	1995-1998	EAGLE TALON	2.0L L4 1997cc 122 CID	1980	VOLVO 264	2.1L L4 2127cc	
	1996-1999	ACURA RL	3.5L V6 3475cc	1980	VOLVO 264	2.8L V6 2849cc	
<b>USEP8272</b>	1991-1993	NISSAN NX	1.6L L4 1597cc 97 CID	1980-1981	VOLVO 262	2.8L V6 2849cc	
	1991-1993	NISSAN NX	2.0L L4 1998cc	1980-1981	VOLVO 265	2.8L V6 2849cc	
	1991-1994	NISSAN SENTRA	1.6L L4 1597cc 97 CID	1980-1984	VOLVO 242	2.1L L4 2127cc	
	1991-1994	NISSAN SENTRA	2.0L L4 1998cc	1980-1985	VOLVO 244	2.1L L4 2127cc	
	1993-1994	NISSAN TSURU	1.6L L4 1597cc 97 CID	1980-1985	VOLVO 245	2.1L L4 2127cc	
	1994	NISSAN TSURU	2.0L L4 1998cc 122 CID	1981-1983	AUDI 4000	1.7L L4 1715cc	
<b>USEP8278</b>	1993-1994	BMW 740I		1982-1984	AUDI COUPE	2.2L L5 2144cc	
	1993-1994	BMW 740IL		1984-1987	AUDI 4000	1.8L L4 1780cc	
	1994-1995	BMW 530I		1984-1987	AUDI 4000 QUATTRO	2.2L L5 2226cc	
	1994-1995	BMW 540I		1985-1987	AUDI COUPE	2.2L L5 2226cc	
<b>USEP8285</b>	1993	JAGUAR XJRS	6.0L V12 5994cc	1987-1991	PORSCHE 928	5.0L V8 4950cc	
	1995-1996	JAGUAR XJ12	6.0L V12 5994cc	1987-1991	VOLKSWAGEN FOX	1.8L L4 1780cc	
	1995-1997	JAGUAR VANDEN PLAS	4.0L L6 3980cc	1989-1992	PORSCHE 911	3.6L H6 3606cc	
	1995-1997	JAGUAR XJ6	4.0L L6 3980cc	1990	AUDI 80	2.0L L4 1983cc	
	1995-1997	JAGUAR XJR	4.0L L6 3980cc	1990-1991	AUDI 90	2.3L L5 2309cc	
	1997-1998	JAGUAR XK8	4.0L V8 3996cc 244 CID	1990-1991	AUDI 90 QUATTRO	2.3L L5 2309cc	
<b>USEP8286</b>	1995	MERCEDES-BENZ C36 AMG	3.6L L6 3606cc	1990-1992	AUDI 80 QUATTRO	2.3L L5 2309cc	
	1995-1998	MERCEDES-BENZ C280	2.8L L6 2799cc 171 CID	1991-1992	AUDI 80	2.3L L5 2309cc	
	1997-2000	MERCEDES-BENZ C230	2.3L L4 2295cc	1993-1995	PORSCHE 928	5.4L V8 5392cc	
	1998-2000	MERCEDES-BENZ C43 AMG	4.3L V8 4266cc	1994-1998	AUDI CABRIOLET	2.8L V6 2771cc	
	1998-2003	MERCEDES-BENZ CLK320	3.2L V6 3199cc	1998	PORSCHE 911	3.6L H6 3606cc	
	1998-2004	MERCEDES-BENZ SLK230	2.3L L4 2295cc	<b>USEP8308</b>	1985	VOLKSWAGEN VANAGON	1.9L H4 1915cc
	1999	MERCEDES-BENZ SL600	6.0L V12 5987cc	1985-1987	JAGUAR VANDEN PLAS	4.2L L6 4235cc	
	1999-2000	MERCEDES-BENZ C280	2.8L V6 2799cc	1985-1987	JAGUAR XJ6	4.2L L6 4235cc	
	1999-2002	MERCEDES-BENZ SL500	5.0L V8 4973cc	1985-1992	JAGUAR XJS	5.3L V12 5343cc	
	1999-2003	MERCEDES-BENZ CLK430	4.3L V8 4266cc 260 CID	1986-1991	VOLKSWAGEN VANAGON	2.1L H4 2109cc	
	2000-2001	MERCEDES-BENZ S500	5.0L V8 4966cc	<b>USEP8309</b>	1985	VOLKSWAGEN QUANTUM	1.8L L4 1780cc
	2000-2002	MERCEDES-BENZ CL500	5.0L V8 4973cc	1985	VOLKSWAGEN QUANTUM	2.2L L5 2226cc	
	2000-2002	MERCEDES-BENZ E55 AMG	5.5L V8 5439cc 335 CID	1986-1988	VOLKSWAGEN QUANTUM		
	2000-2002	MERCEDES-BENZ E430	4.3L V8 4266cc	<b>USEP8310</b>	1985	HONDA PRELUDE	1.8L L4 1829cc
	2000-2002	MERCEDES-BENZ SL600	6.0L V12 5987cc 365 CID	<b>USEP8312</b>	1985	ISUZU IMPULSE	1.9L L4 1949cc
	2001	MERCEDES-BENZ CL600	5.8L V12 5786cc 353 CID	1985	SUBARU GL		
	2001	MERCEDES-BENZ CLK55 AMG	5.5L V8 5439cc 335 CID	1985-1986	NISSAN STANZA		
	2001	MERCEDES-BENZ E320	3.2L V6 3199cc	1985-1987	SUBARU XT		
	2001	MERCEDES-BENZ S600	5.8L V12 5786cc	1985-1989	SUBARU GL-10	1.8L H4 1781cc	
	2001-2002	MERCEDES-BENZ CL55 AMG	5.5L V8 5439cc 335 CID	1986	SUBARU GL	1.8L H4 1781cc	
	2001-2002	MERCEDES-BENZ S55 AMG	5.5L V8 5439cc 335 CID	1987-1989	SUBARU RX		
	2001-2002	MERCEDES-BENZ S430	4.3L V8 4266cc	1988-1991	SUBARU XT	1.8L H4 1781cc	
	2001-2004	MERCEDES-BENZ SLK320	3.2L V6 3199cc	1988-1991	SUBARU XT	2.7L H6 2672cc	
	2002	MERCEDES-BENZ E320	3.2L V6 3199cc 195 CID	1990	SUBARU LOYALE		
	2002	MERCEDES-BENZ S600	5.8L V12 5786cc 353 CID	<b>USEP8314</b>	1985	MERCEDES-BENZ 380SE	3.8L V8 3839cc
	2002-2004	MERCEDES-BENZ C500	5.0L V8 4966cc	1985	MERCEDES-BENZ 380SL	3.8L V8 3839cc	
	2002-2004	MERCEDES-BENZ SLK32 AMG	3.2L V6 3199cc	1985	MERCEDES-BENZ 500SEC	5.0L V8 4973cc	
				1985	MERCEDES-BENZ 500SEL	5.0L V8 4973cc	
				1985-1988	MERCEDES-BENZ 190E	2.3L L4 2299cc	



USMW	Years	Application	Engine	USMW	Years	Application	Engine	
<b>USEP8314</b>	1986-1989	<b>MERCEDES-BENZ</b> 300E	3.0L L6 2962cc	<b>USEP8371</b>	1986-1989	<b>HONDA</b> ACCORD		
	1987-1989	<b>MERCEDES-BENZ</b> 260E	2.6L L6 2599cc		1988-1989	<b>HONDA</b> PRELUDE		
	1988-1991	<b>MERCEDES-BENZ</b> 300SE	3.0L L6 2962cc	1990	<b>HONDA</b> PRELUDE	2.0L L4 1958cc		
	1988-1991	<b>MERCEDES-BENZ</b> 300SEL	3.0L L6 2962cc	<b>USEP8375</b>	1985-1986	<b>NISSAN</b> 200SX	1.8L L4 1809cc	
	1991-1993	<b>MERCEDES-BENZ</b> 190E	2.3L L4 2299cc		1985-1988	<b>NISSAN</b> 200SX	2.0L L4 1974cc	
<b>USEP8316</b>	1985	<b>HONDA</b> ACCORD	1.6L L4 1598cc	1985-1989	<b>NISSAN</b> 300ZX			
<b>USEP8318</b>	1985	<b>NISSAN</b> 720	2.4L L4 2389cc	1987-1988	<b>NISSAN</b> 200SX	3.0L V6 2960cc 181 CID		
	1985-1986	<b>NISSAN</b> 720	2.0L L4 1952cc	<b>USEP8376</b>	1986	<b>NISSAN</b> 720	2.4L L4 2389cc	
<b>USEP8321</b>	1991-1994	<b>ISUZU</b> PICKUP	3.1L V6 3137cc		1986-1989	<b>NISSAN</b> D21	3.0L V6 2960cc	
<b>USEP8335</b>	1992-1994	<b>HYUNDAI</b> EXCEL	1.5L L4 1468cc 90 CID		1986-1990	<b>NISSAN</b> D21	2.4L L4 2389cc	
	1992-1995	<b>HONDA</b> CIVIC	1.5L L4 1493cc		1990	<b>NISSAN</b> D21	3.0L V6 2960cc 181 CID	
	1992-1995	<b>HONDA</b> CIVIC	1.6L L4 1588cc 98 CID		1992-1994	<b>NISSAN</b> D21	2.4L L4 2389cc	
	1993-1995	<b>HONDA</b> CIVIC DEL SOL	1.5L L4 1493cc		1992-1994	<b>NISSAN</b> D21	3.0L V6 2960cc 181 CID	
	1993-1995	<b>HONDA</b> CIVIC DEL SOL	1.6L L4 1588cc 98 CID		1995	<b>NISSAN</b> PICKUP	3.0L V6 2960cc 181 CID	
	1993-1995	<b>HYUNDAI</b> SCOUPE	1.5L L4 1495cc		2003-2006	<b>NISSAN</b> X-TRAIL	2.5L L4 2488cc 152 CID	
	1994-1995	<b>ACURA</b> INTEGRA	1.8L L4 1834cc		<b>USEP8381</b>	1985-1986	<b>VOLVO</b> 760	2.8L V6 2849cc
	1995-1997	<b>HONDA</b> ODYSSEY	2.2L L4 2156cc			1985-1987	<b>VOLVO</b> 760	2.3L L4 2316cc
	1996	<b>ACURA</b> INTEGRA	1.8L L4 1797cc	1986	<b>VOLVO</b> 740	2.3L L4 2316cc		
	1996	<b>JEEP</b> CHEROKEE	2.5L L4 150 CID	1987	<b>VOLVO</b> 740			
	1997-2001	<b>HONDA</b> PRELUDE	2.2L L4 2156cc	<b>USEP8382</b>	1998-2000	<b>LEXUS</b> GS400		
	1998	<b>HONDA</b> ODYSSEY	2.3L L4 2234cc		1998-2005	<b>LEXUS</b> GS300		
	1998-2002	<b>ISUZU</b> TROOPER	3.5L V6 3475cc		2001-2005	<b>LEXUS</b> IS300		
	1999-2000	<b>HONDA</b> ODYSSEY	3.5L V6 3474cc	<b>USEP8385</b>	1998-2001	<b>BMW</b> 740I		
	1999-2001	<b>HYUNDAI</b> SONATA	2.4L L4 2351cc		1998-2001	<b>BMW</b> 740IL		
	1999-2001	<b>HYUNDAI</b> SONATA	2.5L V6 2493cc		1998-2001	<b>BMW</b> 750IL		
	1999-2001	<b>ISUZU</b> VEHICROSS	3.5L V6 3475cc	<b>USEP8390</b>	1986-1988	<b>AUDI</b> 5000 QUATTRO	2.2L L5 2226cc	
	2000	<b>SUZUKI</b> ESTEEM	1.6L L4 1590cc 97 CID		1987	<b>AUDI</b> 5000	2.2L L5 2226cc	
	2000-2001	<b>INFINITI</b> I30	3.0L V6 2988cc 182 CID		1987-1988	<b>AUDI</b> 5000	2.3L L5 2309cc	
	2000-2001	<b>NISSAN</b> MAXIMA	3.0L V6 2988cc 182 CID	1987-1988	<b>AUDI</b> 5000 QUATTRO	2.3L L5 2309cc		
	2000-2001	<b>SUZUKI</b> ESTEEM	1.8L L4 1790cc	<b>USEP8392</b>	1997-2001	<b>INFINITI</b> Q45		
	2000-2003	<b>HONDA</b> S2000	2.0L L4 1997cc		<b>USEP8404</b>	1999-2003	<b>LEXUS</b> RX300	3.0L V6 2995cc
	2000-2004	<b>ACURA</b> RL	3.5L V6 3475cc	2000		<b>TOYOTA</b> AVALON	3.0L V6 2995cc	
	2001	<b>HONDA</b> CR-V	2.0L L4 1972cc	2000-2004		<b>TOYOTA</b> TUNDRA	3.4L V6 3378cc	
	2001	<b>HYUNDAI</b> XG300	3.0L V6 2972cc	2001-2003		<b>TOYOTA</b> HIGHLANDER	2.4L L4 2362cc	
	2001	<b>KIA</b> OPTIMA	2.5L V6 2500cc	2001-2003		<b>TOYOTA</b> HIGHLANDER	3.0L V6 2995cc	
	2001-2002	<b>ACURA</b> MDX	3.5L V6 3471cc	2002-2004		<b>TOYOTA</b> CAMRY	3.0L V6 2995cc	
	2001-2003	<b>KIA</b> OPTIMA	2.4L L4 2351cc	2002-2006		<b>TOYOTA</b> CAMRY	2.4L L4 2362cc	
	2001-2004	<b>SUBARU</b> OUTBACK	3.0L H6 3000cc	2002-2006		<b>TOYOTA</b> SOLARA	2.4L L4 2362cc	
	2001-2006	<b>HYUNDAI</b> ELANTRA	2.0L L4 1975cc	2005		<b>TOYOTA</b> COROLLA	1.8L L4 1795cc	
	2002	<b>CHEVROLET</b> ZAFIRA	2.2L L4 2198cc 134 CID	2005-2006		<b>TOYOTA</b> COROLLA	1.8L L4 1794cc	
	2002	<b>HYUNDAI</b> XG350	3.5L V6 3500cc	2005-2007		<b>TOYOTA</b> MATRIX	1.8L L4 1794cc	
	2002	<b>KIA</b> OPTIMA	2.7L V6 2656cc	2005-2009		<b>SCION</b> TC	2.4L L4 2398cc	
	2002	<b>NISSAN</b> SENTRA	1.8L L4 1769cc	2006-2007		<b>LEXUS</b> RX400H	3.3L V6 3300cc 202 CID	
	2002-2003	<b>NISSAN</b> MAXIMA	3.5L V6 3498cc	2006-2007		<b>TOYOTA</b> HIGHLANDER	3.3L V6 3300cc 202 CID	
	2002-2004	<b>INFINITI</b> I35	3.5L V6 3498cc	<b>USEP8418</b>		2001	<b>TOYOTA</b> AVALON	
	2002-2004	<b>SUBARU</b> IMPREZA	2.5L H4 2458cc			2001-2003	<b>TOYOTA</b> SIENNA	
	2002-2006	<b>HONDA</b> CR-V	2.4L L4 2354cc 144 CID	<b>USEP8419</b>		1999-2001	<b>TOYOTA</b> SOLARA	2.2L L4 2164cc
	2003	<b>HYUNDAI</b> TIBURON	2.0L L4 1975cc			1999-2003	<b>TOYOTA</b> SOLARA	3.0L V6 2995cc
	2003	<b>HYUNDAI</b> TIBURON	2.7L V6 2656cc			2000-2005	<b>TOYOTA</b> MR2 SPYDER	
	2003	<b>SUBARU</b> FORESTER	2.5L H4 2458cc			2001	<b>TOYOTA</b> CAMRY	2.2L L4 2164cc
	2003-2005	<b>HYUNDAI</b> ACCENT	1.6L L4 1600cc		2001	<b>TOYOTA</b> CAMRY	3.0L V6 2995cc	
	2003-2006	<b>INFINITI</b> G35	3.5L V6 3498cc		2001-2003	<b>TOYOTA</b> RAV4	2.0L L4 1998cc 122 CID	
	2004	<b>MAZDA</b> MPV	3.0L V6 2968cc 181 CID		2004-2005	<b>TOYOTA</b> RAV4		
	2004-2005	<b>HONDA</b> S2000	2.2L L4 2157cc		<b>USEP8428</b>	1985-1986	<b>VOLKSWAGEN</b> GOLF	1.8L L4 1780cc
	2004-2006	<b>CHEVROLET</b> ZAFIRA	2.2L L4 2198cc 134 CID			1985-1986	<b>VOLKSWAGEN</b> JETTA	1.8L L4 1780cc
	2004-2006	<b>KIA</b> AMANTI	3.5L V6 3497cc			1988	<b>VOLKSWAGEN</b> JETTA	1.8L L4 1780cc
	2004-2006	<b>KIA</b> SPECTRA	2.0L L4 1975cc	1990-1992		<b>VOLKSWAGEN</b> GOLF	2.0L L4 1984cc 121 CID	
	2005	<b>HYUNDAI</b> SONATA	2.4L L4 2351cc	1990-1992		<b>VOLKSWAGEN</b> JETTA	2.0L L4 1984cc 121 CID	
	2005-2006	<b>KIA</b> SPECTRA5	2.0L L4 1975cc	1990-1993	<b>VOLKSWAGEN</b> PASSAT	2.0L L4 1984cc 121 CID		
	2005-2008	<b>KIA</b> SPORTAGE	2.0L L4 1975cc	<b>USEP8432</b>	2001-2003	<b>INFINITI</b> QX4		
	2005-2009	<b>HYUNDAI</b> TUCSON	2.0L L4 1975cc		2001-2003	<b>NISSAN</b> PATHFINDER		
	2005-2009	<b>HYUNDAI</b> TUCSON	2.7L V6 2656cc		2004	<b>NISSAN</b> PATHFINDER	3.5L V6 3498cc	
	2005-2009	<b>KIA</b> SPORTAGE	2.7L V6 2656cc		<b>USEP8450</b>	2002-2005	<b>SUBARU</b> IMPREZA	2.0L H4 1994cc
	2006-2007	<b>SUBARU</b> IMPREZA	2.5L H4 2458cc	2002-2006		<b>INFINITI</b> Q45		
	2006-2008	<b>CHEVROLET</b> VECTRA	2.8L V6 2792cc 170 CID	2003-2004		<b>INFINITI</b> M45		
	2006-2008	<b>HYUNDAI</b> TIBURON	2.0L L4 1975cc	2004-2005		<b>SUBARU</b> IMPREZA	2.5L H4 2458cc	
	2006-2008	<b>SUBARU</b> FORESTER	2.5L H4 2458cc	2004-2006		<b>SUBARU</b> BAJA		
	2006-2009	<b>HYUNDAI</b> SONATA	2.4L L4 2359cc	2004-2008		<b>SUBARU</b> FORESTER		
	2006-2009	<b>HYUNDAI</b> SONATA	3.3L V6 3342cc	2006-2007		<b>SUBARU</b> IMPREZA		
	2006-2010	<b>DODGE</b> ATTITUDE	1.4L L4 1399cc 85 CID	<b>USEP8451</b>		2001-2005	<b>LEXUS</b> GS430	4.3L V8 4293cc
	2007-2009	<b>KIA</b> RONDO	2.4L L4 2359cc		2001-2005	<b>LEXUS</b> LS430	4.3L V8 4293cc	
	2008	<b>KIA</b> RIO5	1.6L L4 1599cc		2002-2009	<b>LEXUS</b> SC430	4.3L V8 4293cc	
	2008	<b>KIA</b> SPECTRA5	2.0L L4 1975cc	<b>USEP8454</b>	2000-2002	<b>INFINITI</b> G20		
	2009	<b>KIA</b> BORREGO	4.6L V8 4627cc		<b>USEP8455</b>	2000-2002	<b>MITSUBISHI</b> ECLIPSE	2.4L L4 2351cc
	2009	<b>KIA</b> SPECTRA	2.0L L4 1975cc	2000-2003		<b>HONDA</b> INSIGHT	1.0L L3 995cc 61 CID	
<b>USEP8343</b>	1985-1986	<b>VOLKSWAGEN</b> GOLF	1.8L L4 1780cc	2001		<b>CHRYSLER</b> CIRRUS	2.4L L4 2429cc 148 CID	
	1985-1988	<b>VOLKSWAGEN</b> JETTA	1.8L L4 1780cc	2001-2003		<b>DODGE</b> STRATUS	2.0L L4 1996cc 122 CID	
	1990-1992	<b>VOLKSWAGEN</b> GOLF	2.0L L4 1984cc 121 CID	2001-2003		<b>MITSUBISHI</b> GALANT	2.4L L4 2351cc	
	1990-1992	<b>VOLKSWAGEN</b> JETTA	2.0L L4 1984cc 121 CID	2001-2004		<b>CHRYSLER</b> SEBRING	2.4L L4 2351cc	
	1990-1993	<b>VOLKSWAGEN</b> PASSAT	2.0L L4 1984cc 121 CID	2001-2005		<b>DODGE</b> STRATUS	2.4L L4 2351cc	
<b>USEP8348</b>	1985-1988	<b>AUDI</b> 5000	2.2L L5 2226cc	2001-2006		<b>DODGE</b> STRATUS	2.4L L4 2429cc 148 CID	
	1987-1988	<b>AUDI</b> 5000	2.3L L5 2309cc	2004		<b>MITSUBISHI</b> GALANT	2.4L L4 2378cc	
	1989	<b>AUDI</b> 100	2.3L L5 2309cc	2006		<b>DODGE</b> STRATUS	2.0L L4 1995cc 122 CID	
	1989	<b>AUDI</b> 100 QUATTRO	2.3L L5 2309cc	2000		<b>MITSUBISHI</b> GALANT	3.0L V6 2972cc 181 CID	
	1989	<b>AUDI</b> 200 QUATTRO	2.2L L5 2226cc	2000-2005		<b>MITSUBISHI</b> ECLIPSE	3.0L V6 2972cc 181 CID	
	1989-1991	<b>AUDI</b> 200	2.2L L5 2226cc	2001-2005		<b>CHRYSLER</b> SEBRING	3.0L V6 2972cc 181 CID	
	1990	<b>AUDI</b> COUPE QUATTRO	2.3L L5 2309cc	2001-2005		<b>DODGE</b> STRATUS	3.0L V6 2972cc 181 CID	
	1991	<b>AUDI</b> 200 QUATTRO	2.2L L5 2226cc	2002-2003		<b>MITSUBISHI</b> GALANT	3.0L V6 2972cc 181 CID	

USMW	Years	Application	Engine	USMW	Years	Application	Engine	
<b>USEP8456</b>	2002-2005	HONDA CIVIC	2.0L L4 1998cc 122 CID	<b>USEP8804</b>	2006-2008	HYUNDAI TIBURON	2.7L V6 2656cc	
	2004	HONDA CIVIC	1.7L L4 1700cc		2007-2009	HYUNDAI ELANTRA	2.0L L4 1975cc	
	2004	HONDA CR-V	2.4L L4 2354cc 144 CID		2007-2009	KIA AMANTI	3.8L V6 3778cc 231 CID	
	2004	MITSUBISHI ECLIPSE	2.4L L4 2351cc		2007-2009	KIA OPTIMA	2.4L L4 2359cc	
	2005	CHRYSLER SEBRING	2.4L L4 2351cc		2007-2009	KIA OPTIMA	2.7L V6 2656cc	
2005	HONDA ACCORD	2.4L L4 2354cc 144 CID	2007-2009		KIA RONDO	2.7L V6 2656cc		
2005	HONDA CIVIC	1.7L L4 1668cc	2007-2009		KIA SPECTRA	2.0L L4 1975cc		
<b>USEP8458</b>	1999-2004	NISSAN FRONTIER	3.3L V6 3275cc		2007-2009	KIA SPECTRA5	2.0L L4 1975cc	
	2000-2004	NISSAN XTERRA	2.4L L4 2389cc		2009	KIA BORREGO	3.8L V6 3778cc 231 CID	
	2000-2004	NISSAN XTERRA	3.3L V6 3275cc		<b>USEP8818</b>	2005-2006	KIA SORENTO	3.5L V6 3497cc
	2002	NISSAN X-TRAIL	2.5L L4 2488cc 152 CID			2006-2010	MAZDA 5	2.3L L4 2260cc
2007-2008	NISSAN X-TRAIL	2.5L L4 2488cc 152 CID	2006-2011			HYUNDAI AZERA	3.8L V6 3778cc 231 CID	
<b>USEP8465</b>	2005-2006	MITSUBISHI LANCER	2.0L L4 1997cc 122 CID			2007-2009	KIA SORENTO	3.8L V6 3778cc 231 CID
	2005-2006	MITSUBISHI LANCER	2.0L L4 1999cc 122 CID			2007-2011	HYUNDAI AZERA	3.3L V6 3342cc
<b>USEP8480</b>	2000-2005	MERCEDES-BENZ CL500	5.0L V8 4973cc			2007-2011	MITSUBISHI OUTLANDER	3.0L V6 2998cc 182 CID
	2001	MERCEDES-BENZ S600	5.8L V12 5786cc	2007-2012		HYUNDAI VERACRUZ	3.8L V6 3778cc 231 CID	
	2001-2002	MERCEDES-BENZ CL55 AMG	5.5L V8 5439cc 335 CID	2008-2009		KIA SORENTO	3.3L V6 3342cc	
	2001-2002	MERCEDES-BENZ CL600	5.8L V12 5786cc 353 CID	2009-2012		HYUNDAI GENESIS	3.8L V6 3778cc 231 CID	
	2001-2002	MERCEDES-BENZ S55 AMG	5.5L V8 5439cc 335 CID	2010-2011		KIA SOUL	1.6L L4 1591cc	
	2001-2002	MERCEDES-BENZ S430	4.3L V8 4266cc	2010-2011		KIA SOUL	2.0L L4 1975cc	
	2001-2002	MERCEDES-BENZ S500	5.0L V8 4966cc	2010-2012		MAZDA CX-7	2.5L L4 2488cc 152 CID	
	2002	MERCEDES-BENZ S600	5.8L V12 5786cc 353 CID	2011-2015		HYUNDAI SONATA	2.4L L4 2359cc	
	2003	MERCEDES-BENZ SL500	5.0L V8 4973cc	2012-2013		KIA SOUL	2.0L L4 1999cc 122 CID	
	2003-2006	MERCEDES-BENZ S430	5.0L V8 4966cc	2012-2015		KIA OPTIMA	2.4L L4 2359cc	
	2003-2006	MERCEDES-BENZ S500	3.7L V6 3724cc	2012-2015	MAZDA 5	2.5L L4 2489cc 152 CID		
	2004-2005	MERCEDES-BENZ SL500	4.3L V8 4266cc	2013	HYUNDAI ELANTRA COUPE	1.8L L4 1797cc		
	2006	MERCEDES-BENZ CL500	5.0L V8 4966cc	2013	HYUNDAI ELANTRA GT	1.8L L4 1797cc		
	2006	MERCEDES-BENZ S350	5.5L V8 5461cc	<b>USEP8821</b>	2007-2009	HYUNDAI SANTA FE		
	2006	MERCEDES-BENZ S430			<b>USEP8866</b>	2007-2009	LEXUS RX350	3.5L V6 3456cc
2006	MERCEDES-BENZ S500		2008-2010	TOYOTA HIGHLANDER		3.5L V6 3456cc		
2007-2009	MERCEDES-BENZ SL550		<b>USEP8914</b>	2004	FORD RANGER	2.3L L4 140 CID		
<b>USEP8488</b>	2002-2005	BMW 745I			2004	FORD RANGER	3.0L V6 2986cc 182 CID	
	2002-2005	BMW 745LI			2004	FORD RANGER	4.0L V6 245 CID	
	2006	BMW 750I			2004-2006	MAZDA B2300	2.3L L4 140 CID	
	2006	BMW 750LI			2006	FORD RANGER	2.3L L4 140 CID	
	2007-2008	BMW 750I	4.8L V8 4837cc	2006	FORD RANGER	3.0L V6 2986cc 182 CID		
2007-2008	BMW 750LI	4.8L V8 4837cc	2006	FORD RANGER	4.0L V6 245 CID			
<b>USEP8499</b>	2001-2004	NISSAN FRONTIER	3.3L V6 3275cc	<b>USEP9086</b>	2009-2016	TOYOTA RAV4	2.5L L4 2494cc 152 CID	
<b>USEP8501</b>	2003-2005	LEXUS GX470	4.7L V8 4663cc 285 CID		2015-2016	LEXUS NX300H	2.5L L4 2494cc 152 CID	
	2003-2005	TOYOTA 4RUNNER	4.7L V8 4663cc 285 CID	<b>USEP12004</b>	1993-2004	VOLKSWAGEN SEDAN	1.6L H4 1584cc 97 CID	
	2003-2009	TOYOTA 4RUNNER	4.0L V6 3956cc 241 CID		<b>USEP12007</b>	1999	CHEVROLET TIGRA	1.6L L4 1598cc 98 CID
<b>USEP8503</b>	2003-2006	MITSUBISHI OUTLANDER		<b>USEP12011</b>	1999-2000	CHEVROLET CAVALIER	2.2L L4 2190cc 134 CID	
<b>USEP8505</b>	2003-2004	TOYOTA SEQUOIA	4.7L V8 4663cc 285 CID	<b>USEP12016</b>	2001-2002	CHEVROLET S10	2.2L L4 2190cc 134 CID	
<b>USEP8508</b>	2003-2004	HONDA CIVIC	1.3L L4 1339cc	<b>USEP12019</b>	2001-2004	PONTIAC GRAND AM	3.4L V6 3350cc 204 CID	
<b>USEP8513</b>	2003-2004	ACURA MDX	3.5L V6 3471cc		2006-2007	KIA RIO5	1.6L L4 1599cc	
	2004-2006	LEXUS RX330	3.3L V6 3300cc 202 CID		2006-2009	HYUNDAI ACCENT	1.6L L4 1599cc	
2004-2006	TOYOTA SIENNA	3.3L V6 3300cc 202 CID	2006-2009		KIA RIO	1.6L L4 1599cc		
2004-2008	ACURA TL	3.2L V6 3210cc	2007-2010		NISSAN TIIDA	1.8L L4 1798cc		
2004-2008	ACURA TSX	2.4L L4 2354cc 144 CID	<b>USEP12020</b>		2004-2009	PONTIAC MATIZ	1.0L L4 995cc 61 CID	
2005-2007	HONDA ACCORD	3.0L V6 2997cc	<b>USEP12021</b>		1999-2002	DAEWOO LEGANZA	2.2L L4 2198cc 134 CID	
2005-2007	TOYOTA HIGHLANDER	3.3L V6 3300cc 202 CID	<b>USEP12024</b>		1999-2000	VOLKSWAGEN EUROVAN	2.8L V6 2771cc	
2005-2009	SUBARU LEGACY	2.5L H4 2458cc	1999-2005		VOLKSWAGEN BEETLE	2.0L L4 1984cc 121 CID		
2005-2009	SUBARU OUTBACK	2.5L H4 2458cc	2000-2003		VOLKSWAGEN POINTER	2.0L L4 1985cc 121 CID		
2005-2009	SUBARU OUTBACK	3.0L H6 3000cc	2000-2004		AUDI A3	1.8L L4 1781cc		
2006-2011	HONDA CIVIC	1.8L L4 1799cc	2000-2005		VOLKSWAGEN JETTA	1.8L L4 1781cc		
2006-2011	HONDA CIVIC	2.0L L4 1998cc 122 CID	2000-2009		VOLKSWAGEN DERBY	1.8L L4 1781cc		
2006-2014	HONDA RIDGELINE	3.5L V6 3471cc	2000-2009		VOLKSWAGEN JETTA	2.0L L4 1984cc 121 CID		
2007-2009	HONDA CR-V	2.4L L4 2354cc 144 CID	2001-2002		SEAT CORDOBA	1.6L L4 1595cc 97 CID		
2008-2009	SUBARU LEGACY	3.0L H6 3000cc	2001-2005	SEAT TOLEDO	1.8L L4 1781cc			
<b>USEP8516</b>	2004	TOYOTA HIGHLANDER	3.3L V6 3300cc	2001-2006	SEAT LEON	1.8L L4 1781cc		
	2004-2006	LEXUS RX330	3.3L V6 3300cc 202 CID	2002	SEAT ALHAMBRA	2.8L V6 2771cc		
	2005-2007	TOYOTA HIGHLANDER	3.3L V6 3300cc 202 CID	2002-2003	VOLKSWAGEN DERBY	2.0L L4 1984cc 121 CID		
<b>USEP8537</b>	1998-2000	NISSAN FRONTIER	2.4L L4 2389cc	2002-2003	VOLKSWAGEN GOLF	2.0L L4 1984cc 121 CID		
<b>USEP8548</b>	2002-2004	MITSUBISHI LANCER	2.0L L4 2000cc	2002-2005	SEAT ALHAMBRA	1.8L L4 1781cc		
	2004	MITSUBISHI LANCER	2.0L L4 1999cc 122 CID	2002-2006	VOLKSWAGEN SHARAN	1.8L L4 1781cc		
2004	MITSUBISHI LANCER	2.4L L4 2400cc	2003	VOLKSWAGEN VAN	1.8L L4 1781cc			
2007	MITSUBISHI LANCER	2.0L L4 1999cc 122 CID	2003-2008	SEAT CORDOBA	2.0L L4 1984cc 121 CID			
<b>USEP8571</b>	2004-2007	TOYOTA HIGHLANDER	2.4L L4 2362cc	2003-2008	SEAT IBIZA	2.0L L4 1984cc 121 CID		
<b>USEP8643</b>	1993	VOLVO 850		2004-2005	AUDI A3	2.0L L4 1984cc 121 CID		
	1994-1997	VOLVO 850	2.3L L5 2319cc	2004-2005	VOLKSWAGEN BEETLE	1.8L L4 1781cc		
	1997	VOLVO 850	2.4L L5 2435cc	2004-2008	SEAT CORDOBA	1.6L L4 1597cc 98 CID		
<b>USEP8727</b>	2007-2008	TOYOTA CAMRY	2.4L L4 2357cc 144 CID	2005	VOLKSWAGEN JETTA	2.5L L5 2480cc 151 CID		
	2007-2008	TOYOTA SOLARA	2.4L L4 2362cc	2005	VOLKSWAGEN LUPO	1.6L L4 1599cc 98 CID		
	2007-2009	TOYOTA CAMRY	2.4L L4 2362cc	2005-2009	VOLKSWAGEN VAN	1.8L L4 1781cc		
	2009	TOYOTA CAMRY	2.4L L4 2362cc 144 CID	2006	SEAT ALTEA	2.0L L4 1984cc 121 CID		
	2010-2011	TOYOTA CAMRY	2.5L L4 2494cc 152 CID	2006	SEAT TOLEDO	2.0L L4 1984cc 121 CID		
<b>USEP8734</b>	1999-2002	KIA SPORTAGE	2.0L L4 1998cc 122 CID	2006-2008	SEAT LEON	2.0L L4 1984cc 121 CID		
<b>USEP8778</b>	1985-1988	SAAB 900		2007	VOLKSWAGEN CROSSFOX	1.6L L4 1599cc 98 CID		
<b>USEP8798</b>	2008	TOYOTA RAV4	2.4L L4 2362cc	2007	VOLKSWAGEN GOLF	2.0L L4 1984cc 121 CID		
	2008	TOYOTA RAV4	2.4L L4 2400cc 146 CID	2007	VOLKSWAGEN LUPO	1.6L L4 1599cc 98 CID		
<b>USEP8801</b>	2009-2010	PONTIAC VIBE	2.4L L4 2362cc	2007-2009	VOLKSWAGEN SPORTVAN	1.6L L4 1599cc 98 CID		
	2009-2013	TOYOTA MATRIX	2.4L L4 2362cc	2009	VOLKSWAGEN BEETLE	2.0L L4 1984cc 121 CID		
<b>USEP8804</b>	2001	HYUNDAI ELANTRA	2.0L L4 1975cc	2009	VOLKSWAGEN BEETLE	2.5L L5 2480cc 151 CID		
	2003	HYUNDAI ELANTRA	2.0L L4 1975cc	2009-2011	VOLKSWAGEN GOL	1.6L L4 1598cc 98 CID		
	2004	HYUNDAI TIBURON	2.0L L4 1975cc	2011	VOLKSWAGEN JETTA	2.0L L4 1984cc 121 CID		
	2004	HYUNDAI TIBURON	2.7L V6 2656cc	<b>USEP12026</b>	1998-2002	CHEVROLET CHEVY	1.6L L4 1598cc 98 CID	
	2004	HYUNDAI TIBURON	2.7L V6 2656cc		2000-2003	CHEVROLET ASTRA	1.8L L4 1796cc 110 CID	



# FUEL PUMP KITS BUYERS GUIDE



USMW	Years	Application	Engine	USMW	Years	Application	Engine	
<b>USEP12026</b>	2001	CHEVROLET CHEVY	1.4L L4 1389cc 85 CID					
	2001-2002	CHEVROLET ASTRA	2.2L L4 2198cc 134 CID					
	2001-2003	RENAULT MEGANE	2.0L L4 1998cc 122 CID					
	2001-2004	RENAULT SCENIC	2.0L L4 1998cc 122 CID					
	2004-2005	CHEVROLET MERIVA	1.8L L4 1796cc 110 CID					
	2004-2006	CHEVROLET ASTRA	2.0L L4 1999cc 122 CID					
	2004-2007	CHEVROLET TORNADO	1.8L L4 1796cc 110 CID					
	2004-2010	CHEVROLET CHEVY	1.6L L4 1598cc 98 CID					
	2006-2008	CHEVROLET CORSA	1.8L L4 1796cc 110 CID					
	2006-2009	DODGE ATTITUDE	1.6L L4 1599cc 98 CID					
	2009-2010	CHEVROLET TORNADO	1.8L L4 1796cc 110 CID					
	<b>USEP12027</b>	1999-2003	CHEVROLET CHEVY PICKUP	1.6L L4 1598cc 98 CID				
2000-2003		PEUGEOT 206	1.4L L4 1360cc 83 CID					
2000-2004		PEUGEOT 406	2.0L L4 1998cc 122 CID					
2000-2005		NISSAN URVAN	2.4L L4 2389cc					
2001-2008		PEUGEOT 206	1.6L L4 1587cc 97 CID					
2002		PEUGEOT 406	3.0L V6 2950cc 180 CID					
2002-2006		PEUGEOT 607	2.9L V6 2946cc 180 CID					
2002-2009		RENAULT CLIO	1.6L L4 1598cc 98 CID					
2002-2010		NISSAN PLATINA	1.6L L4 1598cc 98 CID					
2003-2005		PEUGEOT 307	2.0L L4 1997cc 122 CID					
2004		RENAULT CLIO	2.0L L4 1998cc 122 CID					
2004-2008		PEUGEOT PARTNER	1.6L L4 1587cc 97 CID					
2006-2008		PEUGEOT 206	1.4L L4 1360cc 83 CID					
2007		PEUGEOT GRAND RAID	1.6L L4 1587cc 97 CID					
2007-2008		FIAT PANDA	1.2L L4 1242cc 76 CID					
2007-2008		FIAT PUNTO	1.4L L4 1368cc 83 CID					
2007-2009		RENAULT KANGOO	1.6L L4 1598cc 98 CID					
2008		FIAT IDEA	1.8L L4 1796cc 110 CID					
<b>USEP12046</b>		2004	CHEVROLET EXPRESS 3500	6.0L V8 5967cc 364 CID				
		2004-2005	GMC SAVANA 3500	6.0L V8 5967cc 364 CID				
	2005	CHEVROLET EXPRESS 3500	4.8L V8 294 CID					
	2005-2006	GMC SAVANA 3500	4.8L V8 294 CID					
	2006-2008	CHEVROLET EXPRESS 3500	6.0L V8 5967cc 364 CID					
	2007-2008	CHEVROLET SILVERADO 1500	4.8L V8 294 CID					
	2007-2008	CHEVROLET SILVERADO 1500	5.3L V8 5328cc 325 CID					
	2007-2008	CHEVROLET SILVERADO 1500	6.0L V8 5967cc 364 CID					
	2007-2008	GMC SAVANA 3500	6.0L V8 5967cc 364 CID					
	2007-2008	GMC SIERRA 1500	4.8L V8 294 CID					
	2007-2008	GMC SIERRA 1500	5.3L V8 5328cc 325 CID					
	2007-2008	GMC SIERRA 1500	6.0L V8 5967cc 364 CID					
<b>USEP12067</b>	1999-2007	VOLKSWAGEN POINTER TRUCK	1.8L L4 1781cc					
	2000-2006	VOLKSWAGEN POINTER	1.8L L4 1781cc					
	2004	FIAT PALIO	1.6L L4 1596cc 97 CID					
	2005-2008	FIAT PALIO	1.8L L4 1796cc 110 CID					
	2007	VOLKSWAGEN POINTER						
	2007-2008	FIAT STRADA	1.8L L4 1796cc 110 CID					
2008-2009	VOLKSWAGEN POINTER	1.8L L4 1781cc						
<b>USEP12083</b>	2007-2009	TOYOTA YARIS	1.5L L4 1497cc					
<b>USEP12143</b>	2006-2008	CHEVROLET MERIVA	1.8L L4 1796cc 110 CID					
	2007-2008	CHEVROLET ASTRA	1.8L L4 1796cc 110 CID					
	2007-2008	CHEVROLET ASTRA	2.0L L4 1999cc 122 CID					
<b>USEP12144</b>	2002	ALFA ROMEO 147	2.0L L4 1970cc 120 CID					
	2002	ALFA ROMEO 156	2.0L L4 1970cc 120 CID					
	2004	ALFA ROMEO 156	2.0L L4 1970cc 120 CID					
	2004-2005	ALFA ROMEO 147	2.0L L4 1970cc 120 CID					
<b>USEP12147</b>	2007-2008	AUDI A4	1.8L L4 1781cc					
	2010-2011	AUDI A4	2.0L L4 1984cc 121 CID					
	2011	AUDI A4	1.8L L4 1781cc 109 CID					
	2011	AUDI A4 QUATTRO	2.0L L4 1984cc 121 CID					
<b>USEP12223</b>	2000-2001	MERCEDES-BENZ A160	1.6L L4 1598cc 98 CID					
	2003	MERCEDES-BENZ A160	1.6L L4 1598cc 98 CID					
<b>USEP12224</b>	2001	PEUGEOT 406	3.0L V6 2950cc 180 CID					
	2005	PEUGEOT 406	2.0L L4 1998cc 122 CID					
	2006-2009	PEUGEOT 307	2.0L L4 1997cc 122 CID					





# FUEL PUMP KITS CROSS REFERENCE



FUEL PUMP KITS

Alfa Romeo	Chrysler (cont'd.)	Chrysler (cont'd.)	Chrysler (cont'd.)
60518556	USEP8149	5012 952AB	USEP7154 MB678398 USEP8023
60521992	USEP8149	5012 952AC	USEP7154 MB698857 USEP8229
60543481	USEP8149	5012 952AD	USEP7154 MB698858 USEP8119
60546091	USEP8149	5012 953AB	USEP7154 MB831262 USEP8229
60572050	USEP8149	5012 953AC	USEP7154 MB831263 USEP8229
<b>AUSTIN</b>		5012 961AC	USEP7154 MB831264 USEP8229
19419450016	USEP8023	5019 600AA	USEP7020 MB831560 USEP8229
19419450022	USEP8023	5080 885AA	USEP7153 MB831561 USEP8229
<b>BMW</b>		5093 135AA	USEP7230 MB831742 USEP8023
16 14 1 178 751	USEP7334	5093 788AA	USEP7154 MB845502 USEP8023
16 14 1 179 232	USEP7334	5093 788AB	USEP7154 MB912304 USEP8229
16 14 1 179 415	USEP7334	5102 594AA	USEP8289 MB923663 USEP8229
16 14 1 179 425	USEP7334	5114 302AA	USEP7154 MB959847 USEP8229
16 14 1 179 427	USEP7334	5114 547AB	USEP7206 MD062978 USEP8000
16 14 1 179 710	USEP8132	5114 547AD	USEP7206 MR134804 USEP8229
16 14 1 180 233	USEP3240	5114 547AE	USEP7206 MR134868 USEP8229
16 14 1 180 504	USEP8233	5114 547AF	USEP7206 MR134901 USEP8271
16 14 1 181 075	USEP3240	5127 562AC	USEP7221 MR135420 USEP8271
16 14 1 181 354	USEP8139	5139 031AE	USEP7221 MR162453 USEP8271
16 14 1 182 355	USEP8287	5140 829AB	USEP7207 MR241080 USEP8229
16 14 1 182 786	USEP8233	5140 829AC	USEP7207 MR431087 USEP8229
16 14 1 182 842	USEP8233	5143 579AB	USEP7206 MR431088 USEP8456
16 14 1 182 985	USEP8233	5143 579AC	USEP7206 MR508282 USEP8455
16 14 1 183 009	USEP8278	5143 579AD	USEP7206 MR508283 USEP8456
16 14 1 183 139	USEP8233	5143 579AE	USEP7206 MR508284 USEP8455
16 14 1 183 687	USEP8233	5143 579AF	USEP7206 MR508285 USEP8456
16 14 1 183 947	USEP8287	5143 579AH	USEP7206 MR990817 USEP8455
16 14 1 183 947	USEP8385	5143 579AI	USEP7206 MR990818 USEP8456
16 14 6 752 499	USEP8233	5143 579AJ	USEP7206
16 14 6 756 323	USEP8233	5161 335AB	USEP7207
16 14 6 758 736	USEP8233	5161 377AA	USEP7207
16 14 6 766 942	USEP8233	5161 377AB	USEP7207
16 14 6 768 653	USEP8132	5161 377AC	USEP7207
16 14 7 161 387	USEP8139	5161 377AD	USEP7207
<b>Chrysler</b>		5183 202AA	USEP8450
1760A049	USEP8229	5183 202AB	USEP8450
1760 A049	USEP8456	5200 4636	USEP7018
3300 1020	USEP7010	5200 4641	USEP7018
4075 445	USEP7000	5201 8387	USEP8229
4203 652	USEP7052	5217 794	USEP7000
4279 951	USEP7031	5217 796	USEP7000
4419 617	USEP7000	5217 852	USEP7012
4419 618	USEP7012	5217 856	USEP7012
4419 623	USEP7031	5217 863	USEP7018
4443 157	USEP7012	5217 866	USEP7018
4495 002	USEP7040	5217 891	USEP7018
4495 088	USEP7000	6800 3339AB	USEP8450
4495 163	USEP7040	6801 1583AA	USEP7207
4637 192	USEP7006A	6802 2583AA	USEP7207
4723 286	USEP8151	6802 4002AA	USEP7207
4742 670	USEP7040	6802 5169AA	USEP7206
4742 671	USEP7040	7700 722393	USEP7334
4746 404	USEP8151	8350 2752	USEP7001
4762 964	USEP8229	8350 2778	USEP7001
4797 880	USEP7000	8350 2779	USEP7001
4797 882	USEP7000	8350 2994	USEP7001
4797 885	USEP7012	8350 2995	USEP7001
4797 887	USEP7012	8350 4619	USEP7020
4798 941	USEP8335	8350 7019	USEP7018
4856 873	USEP8151	8350 7019AB	USEP7018
4874 172	USEP7154	MB400420	USEP8023
4874 173	USEP7154	MB400670	USEP3222
4874 173AB	USEP7154	MB400671	USEP3222
4897 170AA	USEP7153	MB504841	USEP3222
5003 860AB	USEP8335	MB527115	USEP3222
5003 861AA	USEP8335	MB527444	USEP3222
5003 869AA	USEP8335	MB554100	USEP8023
5012 209AB	USEP7153	MB597728	USEP8023
5012 380AA	USEP7154	MB598094	USEP3222
5012 380AB	USEP7154	MB598408	USEP3222
5012 380AD	USEP7154	MB598409	USEP3222
5012 951AB	USEP7154	MB598410	USEP3222
5012 951AC	USEP7154	MB678038	USEP8229
			<b>Daewoo</b>
			96255734 USEP12021
			<b>Daihatsu</b>
			23100-87733-000 USEP8023
			23210-87601-000 USEP8000
			23210-87711-000 USEP8023
			23210-87712-000 USEP8023
			23220-87701-000 USEP8023
			<b>Ford</b>
			1F00-13-350 USEP2068
			1F1Z 9H307-EC USEP2497
			1L2Z 9H307-KD USEP2339
			1L2Z 9H307-KE USEP2339
			1L2Z 9H307-LB USEP2339
			1L2Z 9H307-LC USEP2339
			1L2Z 9H307-LD USEP2339
			1L2Z 9H307-MB USEP2333
			1M5Z 9H307-AA USEP2448
			1M5Z 9H307-CA USEP2448
			1W1Z 9H307-BC USEP2375
			1W1Z 9H307-BD USEP2375
			1W1Z 9H307-BG USEP2375
			2C2Z 9H307-AA USEP2068
			2C2Z 9H307-AB USEP2068
			2C2Z 9H307-CB USEP2068
			2C2Z 9H307-DA USEP2068
			2C2Z 9H307-FA USEP2068
			2C5Z 9H307-CB USEP2068
			2C6Z 9H307-AA USEP2068
			2C6Z 9H307-AB USEP2068
			2F1Z 9H307-BA USEP2497
			2F1Z 9H307-FB USEP2314
			2L2Z 9H307-HC USEP2333
			2M5Z 9H307-AD USEP2386
			3C2Z 9H307-AA USEP2068
			3C2Z 9H307-AB USEP2068
			3C2Z 9H307-BA USEP2068
			3C2Z 9H307-BC USEP2068
			3C2Z 9H307-BD USEP2068
			3C2Z 9H307-CA USEP2068
			3C2Z 9H307-CB USEP2068
			3C2Z 9H307-CB USEP2377
			3C2Z 9H307-DA USEP2068
			3C2Z 9H307-DB USEP2068
			3C2Z 9H307-DB USEP2377





# FUEL PUMP KITS CROSS REFERENCE



FUEL PUMP KITS

Ford (cont'd.)		Ford (cont'd.)		Ford (cont'd.)	
F7AZ 9350-AA	USEP2374	F68Z 9A407-AA	USEP2044	XL5Z 9H307-EA	USEP2226
F7AZ 9350-AB	USEP2375	F69Z 9H307-AA	USEP2001	XL5Z 9H307-EG	USEP2226
F7DZ 9H307-AB	USEP2303	F69Z 9H307-AB	USEP2001	XL5Z 9H307-FA	USEP2226
F7DZ 9H307-DB	USEP2303	F70Z 9A407-AB	USEP2187	XL5Z 9H307-FG	USEP2226
F7DZ 9H307-LB	USEP2284	F70Z 9350-AA	USEP2187	XS2Z 9H307-AA	USEP2372
F7DZ 9350-AA	USEP2303	F75Z 9H307-KC	USEP2158	XS2Z 9H307-CA	USEP2372
F7PZ 9A407-CB	USEP2284	F75Z 9H307-KE	USEP2158	XW1Z 9H307-AB	USEP2374
F7PZ 9H307-BA	USEP2377	F75Z 9H307-LC	USEP2158	XW1Z 9H307-AG	USEP2374
F7PZ 9H307-BA	USEP2379	F75Z 9H307-LE	USEP2158	YC2Z 9H307-AA	USEP2377
F7PZ 9H307-BE	USEP2377	F75Z 9H307-MC	USEP2158	YC2Z 9H307-BA	USEP2377
F7PZ 9H307-BE	USEP2379	F75Z 9H307-ME	USEP2158	YC2Z 9H307-BB	USEP2377
F7PZ 9350-AB	USEP2303	F78Z 9H307-BB	USEP2044	YC2Z 9H307-CA	USEP2377
F7RZ 9H307-GA	USEP2373	F81Z 9C407-AA	USEP2236	YF1Z 9H307-AA	USEP2284
F7RZ 9H307-GB	USEP2373	F81Z 9C407-AC	USEP2236	YF1Z 9H307-AC	USEP2284
F7RZ 9H307-HA	USEP2373	F85Z 9H307-AA	USEP2379	YF1Z 9H307-BA	USEP2284
F7RZ 9H307-HB	USEP2373	F85Z 9H307-AB	USEP2379	YF1Z 9H307-BD	USEP2284
F7UZ 9A407-FA	USEP2379	F85Z 9H307-BA	USEP2379	YL5Z 9H307-DC	USEP2226
F7UZ 9H307-AC	USEP2379	F85Z 9H307-BB	USEP2379	YL5Z 9H307-DF	USEP2226
F7UZ 9H307-AD	USEP2068	F85Z 9H307-CA	USEP2379	YL5Z 9H307-EC	USEP2068
F7UZ 9H307-AD	USEP2379	F85Z 9H307-CB	USEP2379	YL5Z 9H307-EF	USEP2068
F7UZ 9H307-BC	USEP2380	F87Z 9H307-AA	USEP2068	YL5Z 9H307-FC	USEP2068
F7UZ 9H307-BD	USEP2380	F87Z 9H307-AB	USEP2068	YL5Z 9H307-FF	USEP2068
F7UZ 9H307-CC	USEP2380	F87Z 9H307-BA	USEP2068	YS4Z 9H307-EA	USEP2448
F7UZ 9H307-CD	USEP2380	F87Z 9H307-BB	USEP2068	YW4Z 9H307-BB	USEP2314
F7UZ 9H307-DB	USEP2158	F87Z 9H307-CA	USEP2068		
F7UZ 9H307-DC	USEP2158	F87Z 9H307-CB	USEP2068		
F7UZ 9H307-EB	USEP2068	F201-13-350F	USEP8023	<b>General Motors</b>	
F7UZ 9H307-EB	USEP2379	F201-13-350H	USEP8023	893 906 091	USEP8307
F7UZ 9H307-EC	USEP2068	XC2Z 9H307-BA	USEP8023	6010682	USEP8200
F7UZ 9H307-EC	USEP2379	XC2Z 9H307-BB	USEP2376	6019733	USEP8200
F7UZ 9H307-FB	USEP2379	XF1Z 9H307-AA	USEP2376	6443570	USEP3290
F7UZ 9H307-FC	USEP2068	XF1Z 9H307-AB	USEP2284	6472009	USEP3901
F7UZ 9H307-FC	USEP2379	XF1Z 9H307-DA	USEP2284	6472011	USEP3901
F8DZ 9H307-HB	USEP2284	XF1Z 9H307-DB	USEP2284	6472153	USEP3073
F8DZ 9H307-HC	USEP2284	XF2Z 9H307-BA	USEP2284	6472311	USEP3902
F8RZ 9H307-AB	USEP2373	XF2Z 9H307-BB	USEP2284	6472358	USEP3902
F8RZ 9H307-AC	USEP2373	XF5Z 9H307-AD	USEP2319	6472370	USEP3902
F8RZ 9H307-AE	USEP2372	XF5Z 9H307-AE	USEP2319	6472421	USEP3902
F8RZ 9H307-BB	USEP2372	XL1Z 9H307-AB	USEP2226	6472526	USEP3902
F8RZ 9H307-BC	USEP2373	XL1Z 9H307-AC	USEP2226	6472763	USEP3902
F8RZ 9H307-BD	USEP2373	XL1Z 9H307-BB	USEP2226	6472949	USEP3076
F8RZ 9H307-BE	USEP2372	XL1Z 9H307-BC	USEP2226	15018546	USEP3540
F8RZ 9350-AA	USEP2372	XL1Z 9H307-CB	USEP2226	15161174	USEP3526
F8XZ 9H307-DA	USEP2067	XL1Z 9H307-CC	USEP2226	15240786	USEP8200
F8XZ 9H307-DB	USEP2067	XL1Z 9H307-DA	USEP2254	15754298	USEP3540
F8XZ 9H307-EA	USEP2067	XL1Z 9H307-DC	USEP2254	15821962	USEP3526
F8XZ 9H307-EB	USEP2067	XL1Z 9H307-FB	USEP2254	19133466	USEP3526
F8XZ 9H307-EC	USEP2067	XL1Z 9H307-FC	USEP2254	19133483	USEP8200
F8XZ 9H307-FA	USEP2067	XL2Z 9H307-AA	USEP2337	19133486	USEP3526
F8XZ 9H307-FB	USEP2067	XL2Z 9H307-AJ	USEP2337	19133487	USEP3526
F32Z 9A407-A	USEP2068	XL2Z 9H307-AJ	USEP2377	19133489	USEP3526
F32Z 9A407-CC	USEP2068	XL2Z 9H307-AK	USEP2377	19133588	USEP8200
F42Z 9350-A	USEP2068	XL2Z 9H307-AL	USEP2379	19148812	USEP3526
F43Z 9A407-A	USEP2068	XL2Z 9H307-AL	USEP2333	19150401	USEP3526
F43Z 9A407-AA	USEP2068	XL2Z 9H307-AL	USEP2377	19150402	USEP3526
F52Z 9350-AA	USEP2068	XL2Z 9H307-AL	USEP2379	19152169	USEP3526
F52Z 9350-AB	USEP2068	XL2Z 9H307-DA	USEP2377	19153724	USEP3313
F57Z 9H307-B	USEP2059	XL3Z 9H307-AA	USEP2377	19167485	USEP8200
F57Z 9H307-BA	USEP2059	XL3Z 9H307-AB	USEP2377	19179523	USEP3907
F57Z 9H307-C	USEP2059	XL3Z 9H307-AB	USEP8229	19179524	USEP3908
F57Z 9H307-CA	USEP2059	XL3Z 9H307-BA	USEP2377	19179525	USEP3907
F57Z 9H307-D	USEP2379	XL3Z 9H307-BA	USEP2377	19179566	USEP8200
F57Z 9H307-DA	USEP2379	XL3Z 9H307-BB	USEP2377	19179979	USEP3307
F57Z 9H307-E	USEP2002	XL3Z 9H307-BC	USEP2377	19180102	USEP8200
F57Z 9H307-EA	USEP2002	XL3Z 9H307-CB	USEP8229	19206564	USEP8200
F57Z 9H307-F	USEP2001	XL3Z 9H307-CB	USEP2377	19207848	USEP8200
F57Z 9H307-FA	USEP2001	XL3Z 9H307-DA	USEP2377	21015072	USEP3545
F58Z 9A407-DA	USEP2068	XL3Z 9H307-DB	USEP2377	21015152	USEP3545
F67Z 9H307-AA	USEP2059	XL3Z 9H307-EA	USEP2377	25028422	USEP3307
F67Z 9H307-AC	USEP2059	XL3Z 9H307-EB	USEP2377	25028581	USEP3313
F67Z 9H307-BA	USEP2059	XL3Z 9H307-FA	USEP2377	25028725	USEP3904
F67Z 9H307-BB	USEP2059	XL3Z 9H307-FB	USEP2377	25028733	USEP3307
F67Z 9H307-CA	USEP2379	XL5Z 9H307-DA	USEP2226	25028733	USEP3307
F67Z 9H307-CB	USEP2379	XL5Z 9H307-DG	USEP2226	25028921	USEP3313
				25115097	USEP3902
				25115110	USEP3903
				25115224	USEP3158





# FUEL PUMP KITS CROSS REFERENCE



General Motors (cont'd.)		General Motors (cont'd.)		Honda (cont'd.)	
25115462	USEP3902	91171795	USEP8076	17040-SR2-A50	USEP8229
25115463	USEP3212	91174465	USEP8229	17040-SR2-A51	USEP8229
25115466	USEP3240	91177339	USEP8229	17040-SR3-A31	USEP8335
25115689	USEP3240	93181359	USEP3964	17040-SS0-A30	USEP8023
25115764	USEP3212	94384528	USEP8229	17040-SS0-V30	USEP8023
25115951	USEP3212	94464557	USEP3222	17040-SS8-A02	USEP8229
25115981	USEP3212	94845093	USEP8023	17040-ST7-A31	USEP8271
25116053	USEP3210	94847261	USEP8023	17040-ST7-A32	USEP8335
25116144	USEP3222	94850321	USEP8119	17040-ST7-A33	USEP8335
25116156	USEP3240	94854619	USEP8213	17040-ST7-L00	USEP8229
25116161	USEP3240	94856915	USEP8213	17040-ST7-L01	USEP8229
25116162	USEP3240	96055518	USEP8023	17040-ST7-L30	USEP8229
25116163	USEP3210	96068882	USEP8076	17040-ST7-L31	USEP8229
25116164	USEP3211	96068883	USEP8076	17040-SV1-A30	USEP8229
25116167	USEP3240			17040-SV1-A31	USEP8229
25116208	USEP3212	<b>Honda</b>		17040-SV1-A32	USEP8229
25116209	USEP3212	8-97069-336-1	USEP8235	17040-SV1-L00	USEP8229
25116280	USEP3901	8-97118-512-0	USEP8229	17040-SV1-L02	USEP8229
25116285	USEP3212	8-97118-858-0	USEP8229	17040-SV4-A30	USEP8229
25116286	USEP3212	1770A-SR0-A000	USEP8229	17040-SW5-A30	USEP8229
25116296	USEP3240	06167-PE7-741	USEP8000	17040-SW5-A31	USEP8229
25116525	USEP3265	06167-PE7-751	USEP8000	17040-SW5-A32	USEP8229
25116526	USEP3265	16700-PC1-003	USEP8310	17040-SX0-A30	USEP8335
25116527	USEP3212	16700-PC1-013	USEP8310	17040-SX0-A31	USEP8335
25116562	USEP3212	16700-PC6-003	USEP8158	17040-SX0-A32	USEP8335
25116588	USEP3268	16700-PD2-003	USEP8316	17040-SY8-A01	USEP8229
25116881	USEP3271	16700-PD6-662	USEP8000	17040-SZ3-A31	USEP8271
25117021	USEP3305	16700-PE7-335	USEP8000	17040-SZ3-A32	USEP8271
25117081	USEP3290	16700-PE7-734	USEP8000	17040-SZ3-A50	USEP8335
25117264	USEP3270	16700-PJ5-621	USEP8000	17045-SOX-A02	USEP8335
25117339	USEP3285	16700-PJ5-623	USEP8000	17045-SOX-A32	USEP8335
25117340	USEP3309	17040-S01-A30	USEP8229	17045-S3V-A00	USEP8335
25117380	USEP3222	17040-S01-A31	USEP8229	17045-S3V-A50	USEP8513
25117453	USEP3210	17040-S01-A40	USEP8229	17045-S5A-A30	USEP8456
25117454	USEP3210	17040-S2A-930	USEP8335	17045-S5A-A31	USEP8456
25117502	USEP3210	17040-S02-L00	USEP8229	17045-S9A-A30	USEP8335
25160330	USEP3907	17040-S02-L01	USEP8229	17045-S9A-A31	USEP8335
25160334	USEP3908	17040-S3M-A00	USEP2158	17045-SCA-A30	USEP8335
25160338	USEP3907	17040-S04-G30	USEP8229	17045-SDA-A00	USEP8513
25161821	USEP3290	17040-S04-G31	USEP8229	17045-SDA-A30	USEP8513
25163463	USEP3210	17040-S04-G40	USEP8229	17045-SDB-A00	USEP8513
25163464	USEP3270	17040-S04-G41	USEP8229	17045-SDB-A30	USEP8513
25163468	USEP3265	17040-S04-L00	USEP8229	17045-SEC-A00	USEP8513
25163472	USEP3212	17040-S04-L01	USEP8229	17045-SEC-A01	USEP8513
25163473	USEP3270	17040-S5A-930	USEP8229	17045-SEP-A01	USEP8513
25164292	USEP3367	17040-S5B-L00	USEP8508	17045-SWA-A00	USEP8513
25164429	USEP3210	17040-S9A-000	USEP8335	17708-SD4-033	USEP8023
25166252	USEP3268	17040-S10-A00	USEP8229	17708-SE0-013	USEP8371
25166717	USEP3901	17040-S10-C01	USEP8229	17708-SE0-020	USEP8371
25167089	USEP3268	17040-S10-C20	USEP8335	17708-SE0-935	USEP8023
25168719	USEP3567	17040-S30-A30	USEP8335	17708-SE0-936	USEP8023
25168719	USEP3901	17040-S30-A31	USEP8335	17708-SE0-S30	USEP8023
25170093	USEP3367	17040-S30-A50	USEP8335	17708-SF1-A06	USEP8371
25176174	USEP8213	17040-S30-L00	USEP8335	17708-SF1-A31	USEP8023
25177690	USEP8023	17040-S30-L01	USEP8335	17708-SF1-S07	USEP8371
25312959	USEP3933	17040-S84-A02	USEP8229	17708-SF1-S30	USEP8023
25320418	USEP3526	17040-S3800	USEP8032	17708-SG0-932	USEP8023
25326856	USEP3526	17040-S3800	USEP8376	17708-SG0-A30	USEP8023
25348610	USEP8200	17040-S3801	USEP8229	17708-SG0-S31	USEP8023
25350791	USEP3526	17040-SCA-000	USEP8456	17708-SH2-A31	USEP8023
25363855	USEP8200	17040-SD4-000	USEP8023	17708-SH3-A30	USEP8023
30013078	USEP8229	17040-SDC-E00	USEP8456	17708-SH3-A31	USEP8023
30018726	USEP8229	17040-SDD-E00	USEP8513	17708-SH3-A34	USEP8023
30018727	USEP8229	17040-SH5-A30	USEP8023	17708-SH3-A36	USEP8023
30019572	USEP8229	17040-SK7-A70	USEP8119	17708-SH3-A42	USEP8023
30024592	USEP8229	17040-SL0-A30	USEP8119	17708-SH3-S02	USEP8023
30024593	USEP8229	17040-SL0-A31	USEP8119	17708-SH5-A30	USEP8023
30026422	USEP8229	17040-SL0-L30	USEP8119	17708-SH5-A31	USEP8023
30026423	USEP8229	17040-SL5-A30	USEP8023	17708-SH5-S00	USEP8023
88965378	USEP8200	17040-SP0-A30	USEP8023	17708-SK7-A36	USEP8119
88972523	USEP8213	17040-SP0-A50	USEP8271	17708-SL0-A32	USEP8119
89060639	USEP3526	17040-SR1-A31	USEP8229	17708-SL5-A31	USEP8023
89060641	USEP3526	17040-SR2-A31	USEP8335	17708-SM4-A32	USEP8023
90442402	USEP3964	17040-SR2-A32	USEP8229		
		17040-SR2-A33	USEP8229	<b>Hyundai</b>	
				31110-1G500	USEP12019



# FUEL PUMP KITS CROSS REFERENCE



FUEL PUMP KITS

Hyundai (cont'd.)	Isuzu (cont'd.)	Mazda (cont'd.)			
31110-2C531	USEP8335	89711-885-81	USEP8229	FE3N-13-350C	USEP8023
31110-2C631	USEP8335	<b>Jaguar</b>		FE5B-13-35Z	USEP8023
31110-2D500	USEP8335	CBC5656	USEP8002	FE5B-13-35ZA	USEP8023
31110-2D501	USEP8335	CBC5657	USEP8308	FEH2-13-350	USEP8023
31110-2D531	USEP8335	EBC4676	USEP8002	G601-13-35ZC	USEP8023
31110-2E300	USEP8335	EBC10558	USEP8249	G602-13-350A	USEP8023
31110-2H000	USEP8804	EBC10559	USEP8249	G607-13-350	USEP8023
31110-3K600	USEP8335	EBC11365	USEP8249	G607-13-ZE0	USEP8023
31110-3K700	USEP8335	EBC11366	USEP8249	G608-13-350	USEP8023
31110-25510	USEP8335	EBC11367	USEP8249	G608-13-350A	USEP8023
31110-25700	USEP8335	EBC11368	USEP8249	G608-13-350B	USEP8023
31110-26350	USEP8335	JLM12204	USEP8285	G616-13-350	USEP8023
31110-26355	USEP8335	NMD6013AA	USEP8249	G622-13-35Z	USEP8023
31110-26750	USEP8335	NMD6013BA	USEP8249	JE15-13-35ZC	USEP8023
31110-26755	USEP8335	NMD6013CA	USEP8249	JE17-13-350A	USEP8023
31110-28100	USEP8229	<b>Kia</b>		JE22-13-35Z	USEP8023
31110-33610	USEP8229	0K01B-13-350	USEP2068	JE45-13-35ZA	USEP8023
31110-38200	USEP8335	0K01D-13-35Z	USEP8229	JE45-13-35ZB	USEP8023
31110-38250	USEP8229	0K01D-13-35ZA	USEP8229	JE45-13-35ZB	USEP8229
31110-38260	USEP8335	0K24C-13-35ZA	USEP8229	JE47-13-35Z	USEP8023
31110-39000	USEP8335	0K24T-13-35Z	USEP8229	JE47-13-35ZA	USEP8023
31111-1G500	USEP8335	0K24T-13-35ZA	USEP8229	JE47-13-35ZA	USEP8229
31111-1G500	USEP8804	0K29T-13-35Z	USEP8229	JE48-13-35ZC	USEP8229
31111-2D000	USEP8804	0K29T-13-35ZA	USEP8229	JF01-13-350C	USEP8023
31111-3K000	USEP8804	31110-1G500	USEP12019	KJ01-13-35ZA	USEP3285
31111-09000	USEP8335	31110-2E300	USEP8335	KJ01-13-350	USEP3285
31111-22050	USEP8229	31110-2F600	USEP8804	KJ14-13-35Z	USEP3285
31111-23300	USEP8335	31110-2G100	USEP8804	KL11-13-350G	USEP8229
31111-25000	USEP8335	31110-2G150	USEP8804	KL12-13-350G	USEP2068
31111-25700	USEP8335	31110-3E300	USEP8335	KL12-13-350G	USEP8229
31111-25750	USEP8335	31110-3F500	USEP8335	KL12-13-350H	USEP2068
31111-28150	USEP8229	31110-3F510	USEP8335	KL22-13-350	USEP8229
31111-28300	USEP8229	31110-38000	USEP8335	KL47-13-35ZB	USEP8229
31111-33000	USEP8229	31110-38200	USEP8335	KL47-13-350	USEP8229
31111-37150	USEP8229	31110-38250	USEP8229	KL47-13-350	USEP8229
31111-37200	USEP8229	31110-38260	USEP8335	KL47-13-350	USEP8229
31111-37250	USEP8229	31111-1G500	USEP8804	KL47-13-350	USEP8229
31111-38000	USEP8335	31111-2F500	USEP8335	KL47-13-350	USEP8229
31111-38050	USEP8229	31111-2J500	USEP8335	KL47-13-350	USEP8229
31123-25000	USEP8229	31111-3K000	USEP8804	KL47-13-350	USEP8229
3111023010	USEP8211	31111-09000	USEP8335	KL47-13-350	USEP8229
3111023300	USEP8211	31111-38000	USEP8335	KL47-13-350	USEP8229
3111123001	USEP8211	31111-38050	USEP8229	KL47-13-350	USEP8229
3111123100	USEP8211	<b>Mazda</b>		KL47-13-350	USEP8229
<b>Isuzu</b>		1F21-13-350B	USEP2226	KL47-13-350	USEP8229
5-86202-235-0	USEP8229	AJ51-13-350	USEP8335	KL47-13-350	USEP8229
8-94113-205-1	USEP8312	AM16-13-350B	USEP8237	KL47-13-350	USEP8229
8-94146-774-0	USEP8235	AM16-13-350C	USEP8237	KL47-13-350	USEP8229
8-94384-528-0	USEP8229	AM16-13-ZE0	USEP8237	KL47-13-350	USEP8229
8-94384-528-1	USEP8229	AM17-13-350B	USEP8237	KL47-13-350	USEP8229
8-94411-322-0	USEP8235	AM17-13-350C	USEP8237	KL47-13-350	USEP8229
8-94464-557-2	USEP3222	AM17-13-ZE0	USEP8237	KL47-13-350	USEP8229
8-94471-314-0	USEP8235	B3C7-13-350	USEP8229	KL47-13-350	USEP8229
8-94471-315-0	USEP8235	B3E7-13-35ZB	USEP8229	KL47-13-350	USEP8229
8-94471-617-1	USEP8235	B3E7-13-350A	USEP8229	KL47-13-350	USEP8229
8-94473-950-1	USEP8235	B6BF-13-35Z	USEP8229	KL47-13-350	USEP8229
8-94479-418-1	USEP8229	B6BG-13-35Z	USEP8229	KL47-13-350	USEP8229
8-94479-418-2	USEP8229	B6DA-13-350	USEP8229	KL47-13-350	USEP8229
8-97013-922-1	USEP8321	B61P-13-350B	USEP8229	KL47-13-350	USEP8229
8-97016-142-1	USEP8235	B61P-13-ZE0	USEP8229	KL47-13-350	USEP8229
8-97019-185-0	USEP8235	B630-13-350B	USEP8023	KL47-13-350	USEP8229
8-97019-185-1	USEP8235	B630-13-350C	USEP8023	KL47-13-350	USEP8229
8-97019-186-1	USEP8235	BP02-13-35ZD	USEP8023	KL47-13-350	USEP8229
8-97019-187-0	USEP8235	BP4W-13-35ZA	USEP2111	KL47-13-350	USEP8229
8-97019-188-1	USEP8235	BP4W-13-35ZG	USEP2111	KL47-13-350	USEP8229
8-97041-876-3	USEP8229	BP4W-13-350A	USEP2111	KL47-13-350	USEP8229
8-97065-370-1	USEP8235	BP47-13-35ZC	USEP8023	KL47-13-350	USEP8229
8-97065-370-2	USEP8235	BP51-13-350A	USEP8023	KL47-13-350	USEP8229
8-97069-336-1	USEP8235	BPE8-13-35Z	USEP8229	KL47-13-350	USEP8229
8-97069-337-2	USEP8321	BPE8-13-350	USEP8229	KL47-13-350	USEP8229
8-97118-512-0	USEP8229	E5F7-13-350B	USEP8023	KL47-13-350	USEP8229
8-97118-858-0	USEP8229	E5F7-13-350C	USEP8023	KL47-13-350	USEP8229
8-97118-858-1	USEP8229	FE3N-13-350B	USEP8023	KL47-13-350	USEP8229
8-97163-248-1	USEP8335			KL47-13-350	USEP8229



# FUEL PUMP KITS CROSS REFERENCE



Mercedes-Benz	Nissan (cont'd.)	Nissan (cont'd.)	Nissan (cont'd.)		
000 470 59 94	USEP8289	17040-8B000	USEP8229 17042-64M60	USEP8098	
000 470 63 94	USEP8286	17040-8B005	USEP8229	17042-70F00	USEP8235
000 470 78 94	USEP8286	17040-17C01	USEP8118	17042-72A60	USEP8118
000 470 95 94	USEP8289	17040-17C21	USEP8118	17042-73Y00	USEP8272
001 470 12 94	USEP8480	17040-59G00	USEP8229	17042-73Y25	USEP8272
002 091 88 01	USEP8177	17040-59G05	USEP8229	17042-85A00	USEP8118
002 091 97 01	USEP8314	17040-59G10	USEP8376	17042-85E00	USEP8190
003 091 53 01	USEP8289	17040-59G15	USEP8376	17042-85L00	USEP8235
		17040-59G20	USEP8376	17042-88E00	USEP8190
<b>Mitsubishi</b>		17040-59G24	USEP8376	17042-96E00	USEP8235
1760A029	USEP8503	17040-64M60	USEP8098	17042-96E10	USEP8235
1760A031	USEP8465	17040-65A65	USEP8098	17042-AC700	USEP8335
1760A049	USEP8456	17040-65M60	USEP8097	17042-AG901	USEP8450
1760A093	USEP8503	17040-69A10	USEP8097	17042-D4560	USEP8048
1760A094	USEP8503	17040-69A60	USEP8097	17042-Q5601	USEP8272
5142 218AC	USEP7206	17040-72A60	USEP8118	17042-S3800	USEP8032
5142 218AE	USEP7206	17040-84A00	USEP8097	17042-VD71A	USEP8229
6802 4546AA	USEP7206	17040-84A00	USEP8098	17042-VD71A	USEP8454
6802 4546AB	USEP7206	17040-84A60	USEP8097	17042-VE400	USEP8229
3111023300	USEP8211	17040-85A00	USEP8118	17050-01G04	USEP8376
3111123100	USEP8211	17042-0B025	USEP2067	17050-01G08	USEP8376
MB400420	USEP8023	17042-0B026	USEP2067	17050-02P00	USEP8375
MB400671	USEP3222	17042-0M000	USEP8229	17050-11G04	USEP8376
MB554100	USEP8023	17042-0W000	USEP8229	17050-11G14	USEP8376
MB597728	USEP8023	17042-0W005	USEP8229	17050-31G04	USEP8376
MB598094	USEP3222	17042-0Z000	USEP8229	17050-31G13	USEP8376
MB598408	USEP3222	17042-1E300	USEP8247	17050-S3800	USEP8032
MB598409	USEP3222	17042-1E400BC	USEP8247	17051-06F02	USEP8375
MB598410	USEP3222	17042-01G02	USEP8376	17051-06F12	USEP8375
MB698857	USEP8229	17042-01G03	USEP8376		
MB698858	USEP8119	17042-01G12	USEP8032	<b>Peugeot</b>	
MB831262	USEP8229	17042-01G13	USEP8032	1450.7	USEP8149
MB831263	USEP8229	17042-1W210	USEP8229	1450.9	USEP8149
MB831264	USEP8229	17042-1W700	USEP8229	1450.54	USEP8150
MB831560	USEP8229	17042-2B500	USEP8229	1450.59	USEP8260
MB831561	USEP8229	17042-2B500	USEP8229	1450.89	USEP8149
MB831742	USEP8023	17042-02P00	USEP8375	1527.76	USEP8260
MB845502	USEP8023	17042-02Y70	USEP8098	5939725	USEP8149
MB893666	USEP8023	17042-2Y900	USEP8335	5939728	USEP8149
MB893666	USEP8229	17042-3B000	USEP8032		
MB912304	USEP8229	17042-4B000	USEP8229	<b>Porsche</b>	
MB923663	USEP8229	17042-4S400	USEP8458	6006663	USEP8149
MB959847	USEP8229	17042-4W000	USEP8432	6010401	USEP8149
MD062978	USEP8000	17042-4W00A	USEP8432	6010682	USEP8149
MR124999	USEP8229	17042-5M800	USEP2068		
MR134804	USEP8229	17042-5M802	USEP8335	<b>Rock Auto</b>	
MR134868	USEP8229	17042-5S700	USEP8499	USEP8804	USEP8804
MR134901	USEP8271	17042-5Y700	USEP8335	<b>Saab</b>	
MR135420	USEP8271	17042-6P100	USEP8392	30 58 7077	USEP8077
MR162453	USEP8271	17042-7B025	USEP2068	53 28 679	USEP8077
MR344715	USEP8271	17042-7J100	USEP8229	53 28 695	USEP8077
MR431087	USEP8229	17042-7J160	USEP8454	53 28 885	USEP8077
MR431088	USEP8456	17042-7J161	USEP8454	75 26 163	USEP8778
MR508115	USEP8229	17042-11G00	USEP8376	75 36 923	USEP8060
MR508282	USEP8455	17042-11G01	USEP8376	88 22 017	USEP8077
MR508283	USEP8456	17042-11G11	USEP8376	88 22 694	USEP8077
MR508284	USEP8455	17042-30P00	USEP8111	89 81 664	USEP8077
MR508285	USEP8456	17042-30P05	USEP8111	93 61 015	USEP8061
MR990817	USEP8455	17042-30R00	USEP8235	93 93 935	USEP8096
MR990818	USEP8456	17042-30R10	USEP8235		
		17042-30R11	USEP8235	<b>Subaru</b>	
<b>Nissan</b>		17042-31U00	USEP8229	42021 AA020	USEP8235
17011-D3310	USEP8312	17042-31U05	USEP8229	42021 AA080	USEP8235
17011-F5102	USEP8312	17042-31U08	USEP8229	42021 AA330	USEP8229
17020-10W00	USEP8318	17042-33E60	USEP8075	42021 AA350	USEP8229
17040-02Y60	USEP8098	17042-40F00	USEP8235	42021 AC001	USEP8235
17040-02Y70	USEP8098	17042-40P00	USEP8114	42021 AC012	USEP8229
17040-3B000	USEP8229	17042-40P05	USEP8114	42021 AC013	USEP8229
17040-3B010	USEP8229	17042-40R00	USEP8235	42021 AC024	USEP8235
17040-3B015	USEP8229	17042-41G01	USEP8116	42021 AC070	USEP8235
17040-3B800	USEP8229	17042-41G03	USEP8116	42021 AC120	USEP8235
17040-3B805	USEP8229	17042-55L00	USEP8218	42021 AC121	USEP8235
17040-3S500	USEP8537	17042-60U00	USEP8219	42021 AC160	USEP8235
17040-3S505	USEP8229	17042-62E00	USEP8235	42021 AC170	USEP8229
17040-3S510	USEP8537	17042-62J00	USEP8235	42021 AC200	USEP8229
17040-5S105	USEP8229			42021 AE02A	USEP8229





# FUEL PUMP KITS CROSS REFERENCE



FUEL PUMP KITS

Subaru (cont'd.)		Suzuki (cont'd.)		VOLKSWAGEN (cont'd.)	
42021 AE07A	USEP8335	15110-65G00	USEP8335	191 906 091 C	USEP8428
42021 AE08A	USEP8450	<b>Toyota</b>		191 906 091 H	USEP8428
42021 FA000	USEP8235	23220-0A020	USEP8404	191 906 091 J	USEP8428
42021 FA001	USEP8235	23220-0C010	USEP8213	251 906 091	USEP8308
42021 FA040	USEP8229	23220-03020	USEP8213	321 906 091	USEP8309
42021 FA080	USEP8235	23220-03030	USEP8213	357 906 092 C	USEP8200
42021 FA081	USEP8235	23220-03040	USEP8213	431 906 091 D	USEP8307
42021 FA090	USEP8229	23220-16083	USEP8023	441 906 091 E	USEP8236
42021 FA150	USEP8229	23220-16084	USEP8023	443 906 087 BB	USEP8390
42021 FA200	USEP8229	23220-16190	USEP8023	443 906 087 BD	USEP8390
42021 FA250	USEP8229	23220-16270	USEP8023	443 906 091	USEP8348
42021 FC021	USEP8229	23220-19015	USEP8023	443 906 091 A	USEP8348
42021 FE010	USEP8450	23220-20020	USEP8213	447 906 091 C	USEP8348
42021 FE020	USEP8335	23220-21131	USEP12083	447 906 091 E	USEP8348
42021 FE080	USEP8450	23220-21132	USEP12083	447 906 091 G	USEP8348
42021 FE100	USEP8450	23220-21210	USEP12083	867 906 091	USEP8202
42021 FE120	USEP8335	23220-42070	USEP8119	893 906 091 B	USEP8146
42021 FE140	USEP8450	23220-43070	USEP8023	893 906 091 E	USEP8307
42021 GA140	USEP8016S	23220-50130	USEP8501	895 906 091 A	USEP8348
42021 GA242	USEP8059	23220-70170	USEP8023	895 906 091 D	USEP8222
42021 GA290	USEP8312	23220-74020	USEP8213	4443 065	USEP7052
42021 PA000	USEP8235	23220-74021	USEP8213	<b>Volvo</b>	
42021 SA080	USEP8335	23220-79015	USEP8119	271119-0	USEP2487
42022 AE02A	USEP8229	23221-0A020	USEP8418	1317671-0	USEP8381
42022 AE07A	USEP8335	23221-0A030	USEP8404	1336517-0	USEP8123
42022 AE07B	USEP8335	23221-0A040	USEP8213	1336677-0	USEP8381
42022 AE011	USEP8450	23221-0A050	USEP8513	1336679-0	USEP8002
42022 FE000	USEP8450	23221-0D010	USEP8213	1336679-0	USEP8381
42022 FE001	USEP8450	23221-0F010	USEP8505	1389436-0	USEP8381
42022 FE010	USEP8335	23221-03010	USEP8213	1389449-0	USEP8002
42022 FE011	USEP8229	23221-03030	USEP8213	1389449-0	USEP8381
42022 FE031	USEP8450	23221-03040	USEP8419	1389721-0	USEP8002
42022 SA030	USEP8335	23221-07010	USEP8404	3501928-0	USEP2487
74202 1101	USEP8095	23221-11050	USEP8213	3507436-0	USEP8002
74202 1110	USEP8312	23221-15030	USEP8213	3507436-0	USEP8381
74202 1270	USEP8016S	23221-15040	USEP8213	3507499-0	USEP8002
74202 1390	USEP8229	23221-16390	USEP8119	3507736-0	USEP8002
<b>Suzuki</b>		23221-16490	USEP8271	3517714-0	USEP8002
15100-50G00	USEP8229	23221-20030	USEP8404	3517845-0	USEP8002
15100-50G10	USEP8229	23221-21020	USEP8419	3517845-0	USEP8186
15100-58B00	USEP8229	23221-21030	USEP8213	3517845-0	USEP8381
15100-58B01	USEP8229	23221-28020	USEP8404	9142044-0	USEP8002
15100-58B10	USEP8229	23221-28030	USEP8419	9142044-0	USEP8381
15100-60G00	USEP8229	23221-28280	USEP8419	9142045-0	USEP8002
15100-60G20	USEP8229	23221-42130	USEP8119	9142045-0	USEP8381
15100-60G21	USEP8229	23221-46010	USEP8213	9438756-0	USEP8002
15100-61A01	USEP8023	23221-46060	USEP8240	9445444-0	USEP8250
15100-61A1V	USEP8023	23221-46110	USEP8255	EBC11580	USEP8002
15100-61A02	USEP8023	23221-46120	USEP8382		
15100-61AA1	USEP8023	23221-50010	USEP8119		
15100-65D02	USEP8229	23221-50020	USEP8119		
15100-65D12	USEP8229	23221-50060	USEP8240		
15100-65D22	USEP8229	23221-50090	USEP8451		
15100-65D31	USEP8229	23221-50100	USEP8501		
15100-65D32	USEP8229	23221-62010	USEP8240		
15100-65D70	USEP8229	23221-62060	USEP8516		
15100-77E00	USEP8229	23221-70360	USEP8382		
15100-80C1V	USEP2111	23221-74010	USEP8119		
15100-80C02	USEP2111	23221-74090	USEP8404		
15101-60B02	USEP8076	23221-74110	USEP8240		
15101-60B03	USEP8076	23221-75020	USEP8571		
15101-60B10	USEP8076	23249-43080	USEP8023		
15101-61B02	USEP8076	25060-0B025	USEP2067		
15101-61B03	USEP8076	77020-0E012	USEP8513		
15110-50G00	USEP8229	77020-02181	USEP8404		
15110-50GT0	USEP8229	77020-08031	USEP8513		
15110-54G00	USEP8229	<b>VOLKSWAGEN</b>			
15110-54G10	USEP8229	1H0 919 651 P	USEP12024		
15110-60B00	USEP8076	8A0 906 091 A	USEP8222		
15110-60BT0	USEP8076	8A0 906 091 G	USEP8222		
15110-60GT0	USEP8229	8A0 906 091 G	USEP8256		
15110-61B00	USEP8023	8G0 906 091 A	USEP8307		
15110-61BT0	USEP8023	171 906 091 A	USEP8305		
15110-62BT0	USEP8076	191 906 090	USEP8030		



USEP2000



USEP2000A



USEP2001



USEP2002



USEP2008



USEP2014



USEP2015



USEP2019



USEP2024



USEP2025



USEP2031



USEP2035



USEP2036



USEP2042



USEP2044

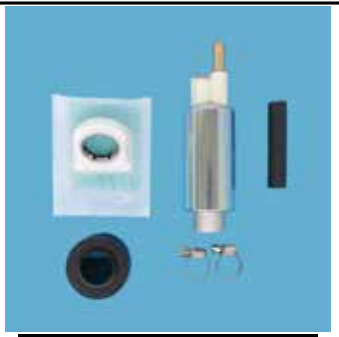

USEP2052



USEP2054



USEP2059



USEP2061

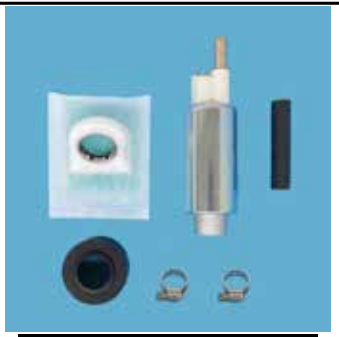

USEP2065

<p>USEP2068</p>	<p>USEP2073</p>	<p>USEP2111</p>	<p>USEP2155</p>
<p>USEP2157</p>	<p>USEP2158</p>	<p>USEP2182</p>	<p>USEP2226</p>
<p>USEP2229</p>	<p>USEP2236</p>	<p>USEP2254</p>	<p>USEP2258</p>
<p>USEP2284</p>	<p>USEP2291</p>	<p>USEP2293</p>	<p>USEP2303</p>
<p>USEP2305</p>	<p>USEP2306</p>	<p>USEP2314</p>	<p>USEP2315</p>





USEP2319



USEP2324



USEP2333

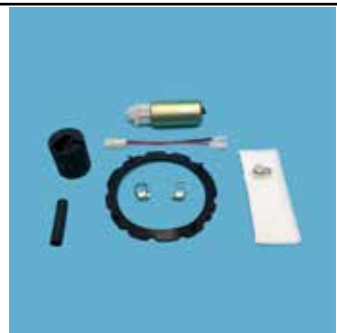

USEP2337



USEP2339



USEP2340



USEP2364

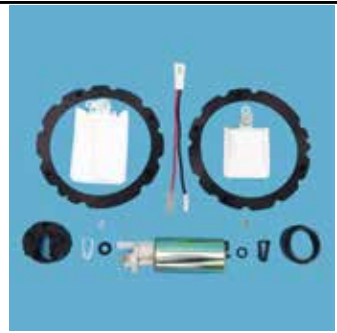

USEP2366



USEP2372



USEP2373

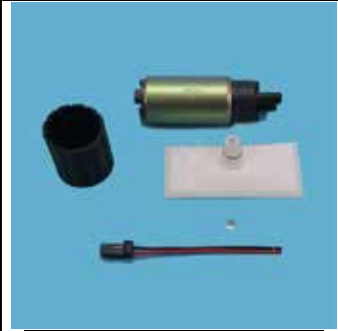

USEP2374



USEP2375



USEP2376



USEP2377



USEP2378



USEP2379



USEP2380



USEP2386



USEP2390



USEP2446



USEP2447



USEP2448



USEP2471



USEP2484



USEP2485



USEP2486



USEP2487



USEP2490



USEP2497



USEP2515



USEP2518



USEP2576



USEP3044



USEP3073



USEP3076



USEP3127



USEP3158



USEP3210



USEP3211



USEP3212



USEP3222



USEP3240



USEP3240R



USEP3265



USEP3268



USEP3270



USEP3271



USEP3285



USEP3290



USEP3290A



USEP3305



USEP3307



USEP3309



USEP3313



USEP3367



USEP3372



USEP3500



USEP3501



USEP3507



USEP3507R



USEP3526	USEP3540	USEP3567	USEP3707
USEP3745	USEP3784	USEP3901	USEP3902
USEP3903	USEP3904	USEP3906	USEP3907
USEP3908	USEP3910	USEP3919	USEP3933
USEP3956	USEP3961	USEP3964	USEP3983



USEP7000



USEP7001



USEP7006



USEP7006A



USEP7010



USEP7012

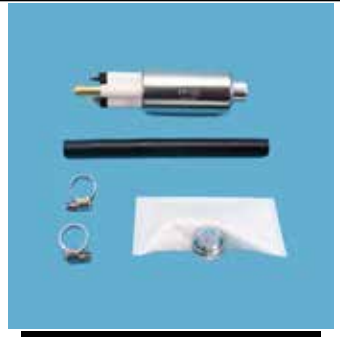

USEP7018



USEP7020



USEP7031



USEP7040



USEP7041



USEP7047



USEP7048



USEP7049



USEP7050



USEP7052



USEP7054



USEP7062



USEP7063



USEP7064

<p>USEP7065</p>	<p>USEP7076</p>	<p>USEP7093</p>	<p>USEP7094</p>
<p>USEP7097</p>	<p>USEP7100</p>	<p>USEP7113</p>	<p>USEP7114</p>
<p>USEP7116</p>	<p>USEP7117</p>	<p>USEP7153</p>	<p>USEP7154</p>
<p>USEP7182</p>	<p>USEP7206</p>	<p>USEP7207</p>	<p>USEP7221</p>
<p>USEP7230</p>	<p>USEP7333</p>	<p>USEP7334</p>	<p>USEP7359</p>





USEP8000



USEP8002



USEP8004



USEP8012SP



USEP8016S



USEP8016SP



USEP8023



USEP8030



USEP8032



USEP8048



USEP8051



USEP8055



USEP8059



USEP8060



USEP8061



USEP8075

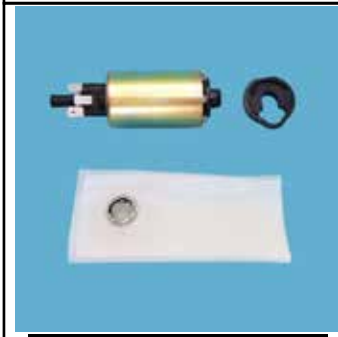

USEP8076



USEP8077



USEP8094



USEP8095

USEP8096	USEP8097	USEP8098	USEP8099
USEP8111	USEP8113	USEP8114	USEP8116
USEP8118	USEP8119	USEP8122	USEP8123
USEP8124	USEP8132	USEP8139	USEP8144
USEP8146	USEP8147	USEP8149	USEP8150



USEP8151



USEP8158



USEP8169



USEP8171



USEP8175



USEP8177



USEP8185



USEP8186



USEP8188



USEP8190



USEP8192



USEP8198

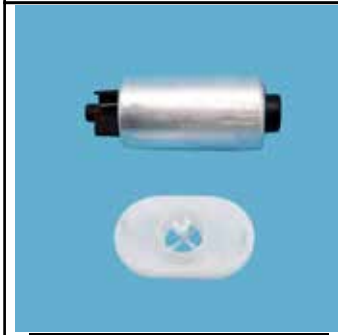

USEP8200



USEP8202



USEP8211



USEP8213



USEP8217



USEP8218



USEP8219



USEP8222



<b>USEP8224</b>	<b>USEP8229</b>	<b>USEP8233</b>	<b>USEP8235</b>
<b>USEP8236</b>	<b>USEP8237</b>	<b>USEP8240</b>	<b>USEP8244</b>
<b>USEP8247</b>	<b>USEP8249</b>	<b>USEP8250</b>	<b>USEP8254</b>
<b>USEP8255</b>	<b>USEP8256</b>	<b>USEP8258</b>	<b>USEP8260</b>
<b>USEP8271</b>	<b>USEP8272</b>	<b>USEP8278</b>	<b>USEP8285</b>



USEP8286



USEP8287



USEP8289



USEP8302



USEP8303



USEP8305



USEP8307



USEP8308

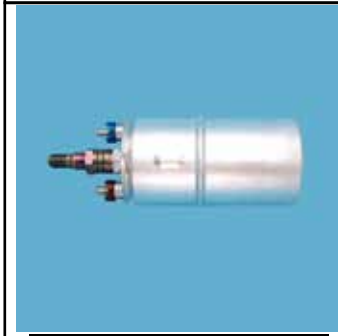

USEP8309



USEP8310



USEP8312



USEP8314



USEP8316



USEP8318



USEP8321



USEP8335



USEP8343



USEP8348



USEP8371



USEP8375

USEP8376	USEP8381	USEP8382	USEP8385
USEP8390	USEP8392	USEP8404	USEP8418
USEP8419	USEP8428	USEP8432	USEP8450
USEP8451	USEP8454	USEP8455	USEP8456
USEP8458	USEP8465	USEP8480	USEP8488





USEP8499



USEP8501



USEP8503



USEP8505



USEP8508



USEP8513



USEP8516



USEP8537



USEP8548



USEP8571



USEP8643

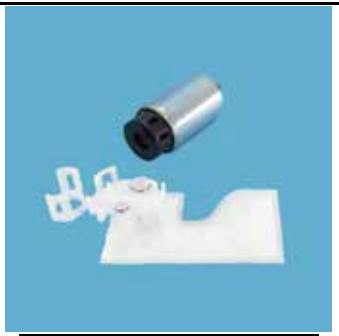

USEP8727



USEP8734



USEP8778



USEP8798



USEP8801

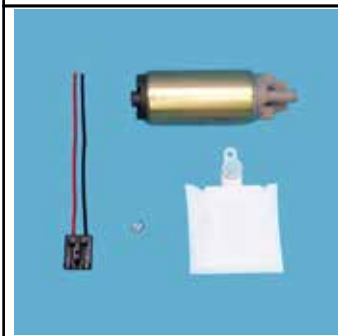

USEP8804



USEP8818



USEP8821



USEP8866

<p>USEP8914</p>	<p>USEP9086</p>	<p>USEP12004</p>	<p>USEP12007</p>
<p>USEP12011</p>	<p>USEP12016</p>	<p>USEP12019</p>	<p>USEP12020</p>
<p>USEP12021</p>	<p>USEP12024</p>	<p>USEP12026</p>	<p>USEP12027</p>
<p>USEP12046</p>	<p>USEP12067</p>	<p>USEP12083</p>	<p>USEP12143</p>
<p>USEP12144</p>	<p>USEP12147</p>	<p>USEP12223</p>	<p>USEP12224</p>



# MECHANICAL FUEL PUMPS

***Trusted by professionals around the world***



**USMW Professional Series offers a wide range of mechanical fuel pumps for import and domestic applications.**



Designed, tested and inspected in the USA

- **High precision castings**
- **Reinforced diaphragms**
- **All gaskets and Hardware included for proper installation**





# MECHANICAL FUEL PUMP APPLICATION GUIDE



MECHANICAL FUEL PUMPS

Engine	Years	Application Description	USMW	Engine	Years	Application Description	USMW
<b>AMERICAN MOTORS</b>				<b>AMERICAN MOTORS (cont'd.)</b>			
<b>AMBASSADOR</b>				<b>JAVELIN (cont'd.)</b>			
3.3L L6 199 CID	1966		USMP17535	4.7L V8 4753cc 290 CID	1969		USMP17587
3.3L L6 3261cc 199 CID	1966		USMP17535	5.0L V8 4982cc 304 CID	1971-1974		USMP16263
3.8L L6 232 CID	1965		USMP17535	5.0L V8 4983cc 304 CID	1971-1974		USMP16263
3.8L L6 232 CID	1967-1969		USMP17535	5.6L V8 5585cc 343 CID	1969		USMP17587
3.8L L6 3802cc 232 CID	1965-1969		USMP17535	5.9L V8 360 CID	1971-1974		USMP16263
4.2L L6 4228cc 258 CID	1971		USMP16843	6.4L V8 6391cc 390 CID	1969		USMP17587
4.2L L6 4229cc 258 CID	1971		USMP16843	6.6L V8 6572cc 401 CID	1971-1974		USMP16263
4.7L V8 4753cc 290 CID	1969		USMP17587	<b>MARLIN</b>			
5.0L V8 304 CID	1971-1974		USMP16263	3.8L L6 3802cc 232 CID	1965-1967		USMP17535
5.0L V8 4982cc 304 CID	1971-1974		USMP16263	<b>MATADOR</b>			
5.0L V8 4983cc 304 CID	1971-1974		USMP16263	3.8L L6 232 CID	1971		USMP16843
5.6L V8 343 CID	1969		USMP17587	3.8L L6 232 CID	1974		USMP16843
5.6L V8 5585cc 343 CID	1969		USMP17587	3.8L L6 3802cc 232 CID	1971		USMP16843
5.9L V8 360 CID	1971-1974		USMP16263	3.8L L6 3802cc 232 CID	1974		USMP16843
6.4L V8 390 CID	1969		USMP17587	4.2L L6 258 CID	1971		USMP16843
6.4L V8 6391cc 390 CID	1969		USMP17587	4.2L L6 258 CID	1974-1978		USMP16843
6.6L V8 6572cc 401 CID	1971-1974		USMP16263	4.2L L6 4228cc 258 CID	1971		USMP16843
<b>AMERICAN</b>				4.2L L6 4228cc 258 CID	1974		USMP16843
3.3L L6 3261cc 199 CID	1967		USMP17535	4.2L L6 4229cc 258 CID	1971		USMP16843
3.8L L6 3802cc 232 CID	1965		USMP17535	4.2L L6 4229cc 258 CID	1974		USMP16843
3.8L L6 3802cc 232 CID	1967		USMP17535	5.0L V8 304 CID	1971-1975		USMP16263
<b>AMX</b>				5.0L V8 304 CID	1976-1977		USMP16840
4.2L L6 258 CID	1978-1980		USMP16843	5.0L V8 4982cc 304 CID	1971-1974		USMP16263
4.7L V8 4753cc 290 CID	1969		USMP17587	5.0L V8 4983cc 304 CID	1971-1974		USMP16263
5.0L V8 304 CID	1978-1979		USMP16840	5.9L V8 360 CID	1971-1975		USMP16263
5.6L V8 343 CID	1969		USMP17587	5.9L V8 360 CID	1976-1978		USMP16840
5.6L V8 5585cc 343 CID	1969		USMP17587	6.6L V8 6572cc 401 CID	1971-1974		USMP16263
5.9L V8 360 CID	1970		USMP16263	<b>PACER</b>			
6.4L V8 390 CID	1969		USMP17587	3.8L L6 232 CID	1975-1978		USMP16843
6.4L V8 390 CID	1970		USMP16263	4.2L L6 258 CID	1975-1980		USMP16843
6.4L V8 6391cc 390 CID	1969		USMP17587	5.0L V8 304 CID	1978-1979		USMP16840
6.4L V8 6391cc 390 CID	1970		USMP16263	<b>RAMBLER</b>			
<b>CLASSIC</b>				3.3L L6 3261cc 199 CID	1969		USMP17535
3.2L L6 3206cc 196 CID	1964		USMP17535	3.8L L6 3802cc 232 CID	1969		USMP17535
3.3L L6 3261cc 199 CID	1965		USMP17535	4.7L V8 4753cc 290 CID	1969		USMP17587
3.8L L6 3802cc 232 CID	1964-1965		USMP17535	6.4L V8 6391cc 390 CID	1969		USMP17587
<b>CONCORD</b>				<b>REBEL</b>			
2.0L L4 121 CID	1978-1979		USMP17495	3.8L L6 232 CID	1967		USMP17535
2.5L L4 151 CID	1980-1982		USMP17502	3.8L L6 232 CID	1969		USMP17535
3.8L L6 232 CID	1978-1979		USMP16843	3.8L L6 3802cc 232 CID	1967-1968		USMP17535
4.2L L6 258 CID	1978-1983		USMP16843	5.6L V8 343 CID	1969		USMP17587
5.0L V8 304 CID	1978-1979		USMP16840	<b>SPIRIT</b>			
<b>EAGLE</b>				2.0L L4 121 CID	1979		USMP17495
2.5L L4 150 CID	1984		USMP50418	2.5L L4 151 CID	1980-1982		USMP17502
2.5L L4 151 CID	1981-1982		USMP17502	3.8L L6 232 CID	1979		USMP16843
4.2L L6 258 CID	1980-1987		USMP16843	4.2L L6 258 CID	1979-1983		USMP16843
<b>GREMLIN</b>				5.0L V8 304 CID	1979		USMP16840
2.0L L4 121 CID	1977-1978		USMP17495	<b>BUICK</b>			
3.8L L6 232 CID	1975-1978		USMP16843	<b>APOLLO</b>			
3.8L L6 3802cc 232 CID	1971		USMP16843		1973-1974		USPR936
3.8L L6 3802cc 232 CID	1974		USMP16843	<b>CENTURION</b>			
4.2L L6 258 CID	1975-1978		USMP16843	7.5L V8 455 CID	1971-1972		USMP17461
4.2L L6 4228cc 258 CID	1971		USMP16843	7.5L V8 7456cc 455 CID	1971-1972		USMP17461
4.2L L6 4228cc 258 CID	1973-1974		USMP16843	<b>CENTURY</b>			
4.2L L6 4229cc 258 CID	1971		USMP16843	2.8L V6 173 CID	1977-1981		USPR936
4.2L L6 4229cc 258 CID	1973-1974		USMP16843	3.2L V6 196 CID	1978-1979		USMP50838
5.0L V8 304 CID	1972-1975		USMP16263	3.8L V6 231 CID	1979		USMP17378
5.0L V8 304 CID	1976		USMP16840	3.8L V6 3800cc 231 CID	1978-1981		USMP17378
5.0L V8 4982cc 304 CID	1972-1974		USMP16263	4.3L V8 265 CID	1980-1981		USMP17533
5.0L V8 4983cc 304 CID	1972-1974		USMP16263	4.4L V8 267 CID	1981		USMP11713
<b>HORNET</b>				4.9L V8 301 CID	1979-1980		USMP17533
3.8L L6 232 CID	1975-1977		USMP16843	5.0L V8 305 CID	1977-1980	2 line pump	USMP16560
3.8L L6 3802cc 232 CID	1971		USMP16843	5.0L V8 305 CID	1981		USMP11713
3.8L L6 3802cc 232 CID	1974		USMP16843	5.7L V8 350 CID	1977-1979	2 line pump	USMP16560
4.2L L6 258 CID	1975-1977		USMP16843	6.0L V8 5967cc 364 CID	1958		USMP11383
4.2L L6 4228cc 258 CID	1971		USMP16843	<b>ELECTRA</b>			
4.2L L6 4228cc 258 CID	1974		USMP16843		1980-1984		USPR936
4.2L L6 4229cc 258 CID	1971		USMP16843	4.1L V6 252 CID	1981-1983		USMP17378
4.2L L6 4229cc 258 CID	1974		USMP16843	5.0L V8 307 CID	1981-1983		USMP15273
5.0L V8 304 CID	1971-1975		USMP16263	5.0L V8 307 CID	1985-1989		USMP15273
5.0L V8 304 CID	1976-1977		USMP16840	6.6L V8 6572cc 401 CID	1959-1965		USMP11383
5.0L V8 4982cc 304 CID	1971-1974		USMP16263	7.0L V8 430 CID	1967-1969		USMP17461
5.0L V8 4983cc 304 CID	1971-1974		USMP16263	7.0L V8 6966cc 425 CID	1964-1965		USMP11383
5.9L V8 360 CID	1971-1974		USMP16263	7.0L V8 7047cc 430 CID	1967-1969		USMP17461
<b>JAVELIN</b>				7.5L V8 455 CID	1970-1974		USMP17461
3.8L L6 3802cc 232 CID	1968-1969		USMP17535	7.5L V8 455 CID	1975-1976		USMP17574
3.8L L6 3802cc 232 CID	1971		USMP16843	7.5L V8 7456cc 455 CID	1970-1974		USMP17461
3.8L L6 3802cc 232 CID	1974		USMP16843				
4.2L L6 4228cc 258 CID	1971-1974		USMP16843				
4.2L L6 4229cc 258 CID	1971-1974		USMP16843				

Engine	Years	Application Description	USMW	Engine	Years	Application Description	USMW
<b>BUICK (cont'd.)</b>				<b>BUICK (cont'd.)</b>			
<b>ESTATE WAGON</b>				<b>WILDCAT (cont'd.)</b>			
	1980-1983		USPR936	7.0L V8 425 CID	1965		USMP11383
6.6L V8 403 CID	1977		USMP15273	7.0L V8 430 CID	1967-1969		USMP17461
7.5L V8 455 CID	1970-1974		USMP17461	7.0L V8 6966cc 425 CID	1964-1965		USMP11383
7.5L V8 455 CID	1975-1976		USMP17574	7.0L V8 7047cc 430 CID	1967-1969		USMP17461
7.5L V8 7456cc 455 CID	1970-1974		USMP17461	7.5L V8 455 CID	1970		USMP17461
<b>GRAN SPORT</b>				7.5L V8 7456cc 455 CID	1970		USMP17461
6.6L V8 6555cc 400 CID	1967		USMP17461	<b>CADILLAC</b>			
6.6L V8 6572cc 401 CID	1965		USMP11383	<b>CALAIS</b>			
<b>INVICTA</b>				7.0L V8 7031cc 429 CID	1965		USMP17573
6.6L V8 6572cc 401 CID	1959-1963		USMP11383	7.7L V8 472 CID	1968		USMP17492
<b>LESABRE</b>				7.7L V8 472 CID	1969-1974		USMP17470
	1978		USPR936	7.7L V8 7735cc 472 CID	1968		USMP17492
	1980-1984		USPR936	7.7L V8 7735cc 472 CID	1969-1974		USMP17470
3.8L V6 3800cc 231 CID	1981-1983		USMP17378	8.2L V8 500 CID	1975-1976		USMP17470
3.8L V6 3800cc 231 CID	1985		USMP17378	<b>DEVILLE</b>			
4.1L V6 252 CID	1981-1983		USMP17378		1979-1984		USPR936
4.4L V8 267 CID	1982		USMP11713	4.1L V6 252 CID	1980		USMP17378
5.0L V8 305 CID	1978	2 line pump	USMP16560	4.1L V6 252 CID	1982		USMP17378
5.0L V8 307 CID	1981-1983		USMP15273	6.0L V8 368 CID	1980		USMP17551
5.0L V8 307 CID	1985-1990		USMP15273	6.0L V8 5972cc 365 CID	1957-1958		USMP17482
5.6L V8 340 CID	1967		USMP11280	6.4L V8 6392cc 390 CID	1959-1962		USMP17482
5.6L V8 5573cc 340 CID	1967		USMP11280	6.4L V8 6392cc 390 CID	1963		USMP17538
6.0L V8 5967cc 364 CID	1959-1961		USMP11383	7.0L V8 425 CID	1977-1979		USMP17551
6.6L V8 6572cc 401 CID	1962-1964		USMP11383	7.0L V8 7031cc 429 CID	1964		USMP17538
7.0L V8 6966cc 425 CID	1964		USMP11383	7.0L V8 7031cc 429 CID	1965		USMP17573
<b>LIMITED</b>				7.7L V8 472 CID	1968		USMP17492
6.0L V8 5967cc 364 CID	1958		USMP11383	7.7L V8 472 CID	1969-1974		USMP17470
<b>REGAL</b>				7.7L V8 7735cc 472 CID	1968		USMP17492
	1977-1987		USPR936	7.7L V8 7735cc 472 CID	1969-1974		USMP17470
3.2L V6 196 CID	1978-1979		USMP17378	8.2L V8 500 CID	1975-1976		USMP17470
3.8L V6 231 CID	1979		USMP17378	<b>ELDORADO</b>			
3.8L V6 3800cc 231 CID	1978-1985		USMP17378		1979-1984		USPR936
3.8L V6 3800cc 231 CID	1987		USMP17596	6.0L V8 5972cc 365 CID	1957-1958		USMP17482
4.1L V6 252 CID	1982-1984		USMP17378	6.4L V8 390 CID	1959-1960		USMP17482
4.3L V8 265 CID	1980-1981		USMP17533	6.4L V8 390 CID	1963		USMP17538
4.4L V8 267 CID	1981-1982		USMP11713	6.4L V8 6392cc 390 CID	1959-1962		USMP17482
4.9L V8 301 CID	1979-1980		USMP17533	6.4L V8 6392cc 390 CID	1963		USMP17538
5.0L V8 305 CID	1977-1980	2 line pump	USMP16560	7.0L V8 425 CID	1977-1978		USMP17470
5.0L V8 305 CID	1985		USMP11713	7.0L V8 429 CID	1964		USMP17538
5.0L V8 305 CID	1987		USMP15273	7.0L V8 7031cc 429 CID	1964		USMP17538
5.0L V8 307 CID	1987		USMP15273	7.0L V8 7031cc 429 CID	1965		USMP17573
5.7L V8 350 CID	1977	2 line pump	USMP16560	7.7L V8 472 CID	1968		USMP17492
<b>RIVIERA</b>				7.7L V8 472 CID	1969		USMP17470
	1980-1984		USPR936	7.7L V8 7735cc 472 CID	1968		USMP17492
5.0L V8 307 CID	1980		USMP15270	7.7L V8 7735cc 472 CID	1969		USMP17470
5.0L V8 307 CID	1981-1982		USMP15273	8.2L V8 500 CID	1970-1976		USMP17470
5.0L V8 307 CID	1985		USMP15273	8.2L V8 8193cc 500 CID	1970-1974		USMP17470
5.7L V8 350 CID	1979-1980		USMP15273	8.2L V8 8195cc 500 CID	1972-1974		USMP17470
6.6L V8 6572cc 401 CID	1963		USMP11383	<b>FLEETWOOD</b>			
6.6L V8 6572cc 401 CID	1965		USMP11383		1979-1984		USPR936
7.0L V8 425 CID	1965		USMP11383	4.1L V6 252 CID	1980		USMP17378
7.0L V8 430 CID	1968		USMP17461	4.1L V6 252 CID	1982		USMP17378
7.0L V8 6966cc 425 CID	1963-1965		USMP11383	6.0L V8 368 CID	1980		USMP17551
7.0L V8 7047cc 430 CID	1967-1968		USMP17461	7.0L V8 425 CID	1977-1979		USMP17551
7.5L V8 455 CID	1971-1974		USMP17461	7.7L V8 472 CID	1968		USMP17492
7.5L V8 455 CID	1975-1976		USMP17574	7.7L V8 472 CID	1969-1974		USMP17470
7.5L V8 7456cc 455 CID	1971-1974		USMP17461	7.7L V8 7735cc 472 CID	1968		USMP17492
<b>ROADMASTER</b>				7.7L V8 7735cc 472 CID	1969-1974		USMP17470
6.0L V8 5967cc 364 CID	1957-1958		USMP11383	8.2L V8 500 CID	1975-1976		USMP17470
<b>SKYLARK</b>				<b>SERIES 62</b>			
	1977-1979		USPR936	6.0L V8 5972cc 365 CID	1957-1958		USMP17482
2.5L L4 2474cc 151 CID	1980-1981		USMP17502	6.4L V8 6392cc 390 CID	1959-1962		USMP17482
2.8L V6 173 CID	1980-1981		USMP75733	6.4L V8 6392cc 390 CID	1963		USMP17538
2.8L V6 173 CID	1983-1984		USMP50838	7.0L V8 7031cc 429 CID	1964		USMP17538
4.9L V8 4917cc 300 CID	1967		USMP11280	<b>SERIES 75 FLEETWOOD</b>			
5.0L V8 305 CID	1977-1979	2 line pump	USMP16560	6.0L V8 5972cc 365 CID	1957-1958		USMP17482
5.6L V8 5573cc 340 CID	1967		USMP11280	6.4L V8 6392cc 390 CID	1959-1962		USMP17482
5.7L V8 350 CID	1977-1979	2 line pump	USMP16560	6.4L V8 6392cc 390 CID	1963		USMP17538
5.7L V8 350 CID	1977-1979	3 line unit	USMP16565	7.0L V8 7031cc 429 CID	1964		USMP17538
6.6L V8 6572cc 401 CID	1965		USMP11383	<b>SEVILLE</b>			
<b>SPECIAL</b>					1978-1984		USPR936
3.2L V6 3245cc 198 CID	1962-1963		USMP17489	<b>CHECKER</b>			
3.5L V8 3528cc 215 CID	1961-1963		USMP17489	<b>AEROBUS</b>			
4.9L V8 4917cc 300 CID	1967		USMP11280	5.7L V8 350 CID	1969-1974	2 line pump	USMP16560
<b>SUPER</b>				<b>DELUXE</b>			
6.0L V8 5967cc 364 CID	1957-1958		USMP11383	5.3L V8 5358cc 327 CID	1969		USMP07800
<b>WILDCAT</b>				5.7L V8 350 CID	1969-1970	2 line pump	USMP16560
6.6L V8 6572cc 401 CID	1963-1965		USMP11383				

Engine	Years	Application Description	USMW	Engine	Years	Application Description	USMW
<b>CHECKER (cont'd.)</b>				<b>CHEVROLET (cont'd.)</b>			
<b>MARATHON</b>				<b>BISCAYNE (cont'd.)</b>			
3.7L L6 226 CID	1963-1964		USMP17576	6.5L V8 6489cc 396 CID	1969		USMP11325
3.7L L6 3704cc 226 CID	1961-1964		USMP17576	6.6L V8 400 CID	1970	2 line pump	USMP16560
4.1L L6 250 CID	1975-1979		USMP16845	6.6L V8 6588cc 402 CID	1970	2 line pump	USMP16560
4.4L V8 267 CID	1980	2 line pump	USMP16560	6.7L V8 6704cc 409 CID	1962		USMP07800
4.4L V8 267 CID	1981-1982		USMP11713	7.0L V8 427 CID	1968-1969		USMP11325
5.0L V8 305 CID	1980	2 line pump	USMP16560	7.0L V8 6998cc 427 CID	1967-1969		USMP11325
5.0L V8 305 CID	1981		USMP11713	7.4L V8 454 CID	1970		USMP11325
5.3L V8 5358cc 327 CID	1965-1969		USMP07800	7.4L V8 7439cc 454 CID	1970		USMP11325
5.7L V8 350 CID	1969-1973	2 line pump	USMP16560	7.4L V8 7441cc 454 CID	1970		USMP11325
5.7L V8 350 CID	1975-1980	2 line pump	USMP16560				
5.7L V8 350 CID	1981-1982		USMP11713	<b>BLAZER</b>			
<b>SUPERBA</b>					1969-1971		USPR936
3.7L L6 226 CID	1960		USMP17576		1973-1974		USPR936
3.7L L6 3704cc 226 CID	1960-1963		USMP17576	5.7L V8 350 CID	1969-1971	2 line pump	USMP16560
<b>TAXICAB</b>				5.7L V8 350 CID	1973	3 line unit	USMP16565
5.7L V8 350 CID	1969-1974	2 line pump	USMP16560	5.7L V8 350 CID	1974	2 line pump	USMP16560
<b>CHEVROLET</b>				7.4L V8 7439cc 454 CID	1973	3 line unit	USMP16565
<b>3100</b>				<b>BROOKWOOD</b>			
	1956-1957		USPR936		1958-1961		USPR936
3.8L L6 3852cc 235 CID	1956-1957		USMP05295		1969-1970		USPR936
4.3L V8 4343cc 265 CID	1956-1957		USMP06170	5.3L V8 5358cc 327 CID	1969	2 line pump	USMP16560
<b>AK</b>				5.7L V8 350 CID	1969-1970	2 line pump	USMP16560
3.5L L6 3548cc 216 CID	1941		USMP01878	6.5L V8 6489cc 396 CID	1969		USMP11325
<b>AL</b>				6.6L V8 400 CID	1970	2 line pump	USMP16560
3.5L L6 3548cc 216 CID	1941		USMP01878	6.6L V8 6588cc 402 CID	1970	2 line pump	USMP16560
<b>AN</b>				7.0L V8 6998cc 427 CID	1969		USMP11325
3.5L L6 3548cc 216 CID	1941		USMP01878	7.4L V8 7439cc 454 CID	1970		USMP11325
<b>ASTRO</b>				<b>C10</b>			
4.3L V6 262 CID	1985		USMP17578		1975-1986		USPR936
<b>B60</b>				4.3L V6 262 CID	1986		USMP82505
5.7L V8 350 CID	1983	3 line unit	USMP16565	5.0L V8 305 CID	1977-1979	2 line pump	USMP16560
5.7L V8 350 CID	1983-1984	2 line pump	USMP16560	5.0L V8 305 CID	1979-1986	3 line unit	USMP16565
5.7L V8 350 CID	1985-1990	3 line unit	USMP16565	5.7L V8 350 CID	1975-1979	2 line pump	USMP16560
6.0L V8 366 CID	1980-1985		USMP11760	5.7L V8 350 CID	1979	3 line unit	USMP16565
7.0L V8 427 CID	1980-1985		USMP11760	5.7L V8 350 CID	1982-1986	3 line unit	USMP16565
<b>BEL AIR</b>				6.6L V8 400 CID	1976-1977	3 line unit	USMP16565
	1955-1957		USPR936	<b>C10 PICKUP</b>			
	1959-1975		USPR936		1963-1974		USPR936
3.5L L6 3548cc 216 CID	1950-1951		USMP01878	3.8L L6 3769cc 230 CID	1963-1965		USMP08825
3.5L L6 3548cc 216 CID	1952		USMP05295	4.1L L6 4097cc 250 CID	1967		USMP11258
3.8L L6 3852cc 235 CID	1950-1951		USMP01878	4.1L L6 4098cc 250 CID	1967		USMP11258
3.8L L6 3852cc 235 CID	1952-1957		USMP05295	4.8L L6 4801cc 292 CID	1963		USMP08825
3.8L L6 3852cc 235 CID	1958-1962		USMP07498	4.8L L6 4801cc 292 CID	1965		USMP11258
4.3L V8 265 CID	1955-1957		USMP06170	5.0L V8 307 CID	1972-1973	2 line pump	USMP16560
4.3L V8 4343cc 265 CID	1955-1957		USMP06170	5.7L V8 350 CID	1969-1974	2 line pump	USMP16560
4.6L V8 283 CID	1957		USMP06170	5.7L V8 350 CID	1973	3 line unit	USMP16565
4.6L V8 4638cc 283 CID	1957		USMP06170	6.5L V8 396 CID	1968-1969		USMP11325
4.6L V8 4638cc 283 CID	1959-1965		USMP11780	6.5L V8 6489cc 396 CID	1968-1969		USMP11325
5.3L V8 5358cc 327 CID	1962-1965		USMP07800	6.6L V8 6588cc 402 CID	1970-1972		USMP11325
5.3L V8 5358cc 327 CID	1969	2 line pump	USMP16560	7.4L V8 454 CID	1974		USMP16570
5.4L V8 327 CID	1969	2 line pump	USMP16560	7.4L V8 7439cc 454 CID	1974		USMP16570
5.7L V8 350 CID	1969-1974	2 line pump	USMP16560	7.4L V8 7441cc 454 CID	1974		USMP16570
5.7L V8 350 CID	1973-1975	3 line unit	USMP16565	<b>C10 SUBURBAN</b>			
5.7L V8 5704cc 348 CID	1959		USMP07800		1967-1971		USPR936
6.5L V8 396 CID	1969		USMP11325		1973-1986		USPR936
6.5L V8 6489cc 396 CID	1969		USMP11325	4.1L L6 250 CID	1978-1980		USMP16845
6.6L V8 400 CID	1970-1975	2 line pump	USMP16560	4.1L L6 4097cc 250 CID	1967		USMP11258
6.6L V8 400 CID	1973-1975	3 line unit	USMP16565	4.6L V8 4638cc 283 CID	1967		USMP11283
6.6L V8 6588cc 402 CID	1970-1972	2 line pump	USMP16560	4.8L L6 4801cc 292 CID	1967		USMP11258
6.7L V8 6704cc 409 CID	1962		USMP07800	5.0L V8 305 CID	1977-1979	2 line pump	USMP16560
7.0L V8 427 CID	1968-1969		USMP11325	5.0L V8 305 CID	1981-1986	3 line unit	USMP16565
7.0L V8 6998cc 427 CID	1967-1969		USMP11325	5.0L V8 307 CID	1968		USMP11283
7.4L V8 454 CID	1970		USMP11325	5.0L V8 5031cc 307 CID	1968		USMP11283
7.4L V8 7439cc 454 CID	1970		USMP11325	5.3L V8 5358cc 327 CID	1967		USMP11283
7.4L V8 7439cc 454 CID	1974	3 line unit	USMP16565	5.7L V8 350 CID	1969-1971	2 line pump	USMP16560
7.4L V8 7441cc 454 CID	1970		USMP11325	5.7L V8 350 CID	1973-1979	2 line pump	USMP16560
7.4L V8 7441cc 454 CID	1974	3 line unit	USMP16565	5.7L V8 350 CID	1981-1986	3 line unit	USMP16565
<b>BISCAYNE</b>				6.2L V8 379 CID	1982-1986		USMP50703
	1959-1970		USPR936	6.5L V8 396 CID	1968-1969		USMP11325
4.6L V8 283 CID	1960		USMP11780	6.5L V8 6489cc 396 CID	1968-1969		USMP11325
4.6L V8 4638cc 283 CID	1959-1965		USMP11780	6.6L V8 6588cc 402 CID	1970-1971		USMP11325
5.3L V8 5358cc 327 CID	1962-1965		USMP07800	<b>C20</b>			
5.3L V8 5358cc 327 CID	1969	2 line pump	USMP16560		1975-1986		USPR936
5.4L V8 327 CID	1969	2 line pump	USMP16560	4.3L V6 262 CID	1986		USMP82505
5.7L V8 348 CID	1960		USMP07800	5.0L V8 305 CID	1977-1979		USMP16560
5.7L V8 350 CID	1969-1970	2 line pump	USMP16560	5.0L V8 305 CID	1979-1986	3 line unit	USMP16565
5.7L V8 5704cc 348 CID	1959-1961		USMP07800	5.7L V8 350 CID	1975-1979		USMP16560
6.5L V8 396 CID	1969		USMP11325	5.7L V8 350 CID	1979	3 line unit	USMP16565
				5.7L V8 350 CID	1982-1986	3 line unit	USMP16565
				6.6L V8 400 CID	1976-1977	3 line unit	USMP16565
				<b>C20 PICKUP</b>			
					1963-1974		USPR936





# MECHANICAL FUEL PUMP APPLICATION GUIDE



Engine	Years	Application Description	USMW	Engine	Years	Application Description	USMW
<b>CHEVROLET (cont'd.)</b>				<b>CHEVROLET (cont'd.)</b>			
<b>C20 PICKUP (cont'd.)</b>				<b>C30 PICKUP (cont'd.)</b>			
3.8L L6 3769cc 230 CID	1963-1965		USMP08825	5.7L V8 350 CID	1972	3 Line Pump	USMP15538
4.1L L6 250 CID	1968-1969		USMP11258	5.7L V8 350 CID	1973	3 line unit	USMP16565
4.1L L6 250 CID	1971-1974		USMP11258	5.7L V8 350 CID	1974	2 line pump	USMP16560
4.1L L6 4097cc 250 CID	1967-1974		USMP11258	6.5L V8 396 CID	1968-1969		USMP11325
4.1L L6 4098cc 250 CID	1967		USMP11258	6.5L V8 6489cc 396 CID	1968-1969		USMP11325
4.1L L6 4098cc 250 CID	1972-1974		USMP11258	6.6L V8 6588cc 402 CID	1970-1972		USMP11325
4.6L V8 4638cc 283 CID	1963-1965		USMP11780	7.4L V8 454 CID	1974		USMP16570
4.6L V8 4638cc 283 CID	1967		USMP11283	7.4L V8 7439cc 454 CID	1974		USMP16570
4.8L L6 292 CID	1968-1974		USMP11258	7.4L V8 7441cc 454 CID	1974		USMP16570
4.8L L6 4786cc 292 CID	1973-1974		USMP11258	<b>C40</b>			
4.8L L6 4801cc 292 CID	1963		USMP08825		1960-1962		USPR936
4.8L L6 4801cc 292 CID	1965		USMP11258	<b>C50</b>			
4.8L L6 4801cc 292 CID	1967-1974		USMP11258	5.7L V8 350 CID	1980-1984		USMP16560
5.0L V8 307 CID	1968		USMP11283	5.7L V8 350 CID	1983	3 line unit	USMP16565
5.0L V8 5031cc 307 CID	1968		USMP11283	5.7L V8 350 CID	1985-1990	3 line unit	USMP16565
5.3L V8 5358cc 327 CID	1968		USMP11713	<b>C60</b>			
5.7L V8 350 CID	1972	3 Line Pump	USMP15538	5.7L V8 350 CID	1980-1984		USMP16560
5.7L V8 350 CID	1973	3 line unit	USMP16565	5.7L V8 350 CID	1983	3 line unit	USMP16565
5.7L V8 350 CID	1974	2 line pump	USMP16560	5.7L V8 350 CID	1985-1990	3 line unit	USMP16565
6.5L V8 396 CID	1968-1969		USMP11325	6.0L V8 366 CID	1980-1985		USMP11760
6.5L V8 6489cc 396 CID	1968-1969		USMP11325	<b>C70</b>			
6.6L V8 6588cc 402 CID	1970-1972		USMP11325	6.0L V8 366 CID	1980-1985		USMP11760
7.4L V8 454 CID	1974		USMP16570	7.0L V8 427 CID	1980-1985		USMP11760
7.4L V8 7439cc 454 CID	1974		USMP16570	7.4L V8 454 CID	1980		USMP11760
7.4L V8 7441cc 454 CID	1974		USMP16570	<b>CAMARO</b>			
<b>C20 SUBURBAN</b>							
	1968-1986		USPR936		1967		USPR936
4.1L L6 250 CID	1968-1969		USMP11258		1969-1987		USPR936
4.1L L6 250 CID	1971-1974		USMP11258	2.8L V6 173 CID	1982-1984		USMP52693
4.1L L6 4097cc 250 CID	1967-1974		USMP11258	3.8L V6 229 CID	1980-1981		USMP17503
4.1L L6 4098cc 250 CID	1972-1974		USMP11258	3.8L V6 3800cc 231 CID	1980-1981		USMP17503
4.6L V8 4638cc 283 CID	1967		USMP11283	4.1L L6 250 CID	1978-1979		USMP16845
4.8L L6 292 CID	1969-1975		USMP11258	4.4L V8 267 CID	1980	2 line pump	USMP16560
4.8L L6 292 CID	1976-1982		USMP16845	4.9L V8 4949cc 302 CID	1969	2 line pump	USMP16560
4.8L L6 4786cc 292 CID	1973-1974		USMP11258	5.0L V8 305 CID	1976-1980	2 line pump	USMP16560
4.8L L6 4801cc 292 CID	1967-1974		USMP11258	5.0L V8 305 CID	1982-1987	3 line unit	USMP16565
5.0L V8 305 CID	1977-1979		USMP16560	5.7L V8 350 CID	1969-1974	2 line pump	USMP16560
5.0L V8 305 CID	1978	2 line pump	USMP16560	5.7L V8 350 CID	1976		USMP15253
5.0L V8 305 CID	1981-1984	3 line unit	USMP16565	5.7L V8 350 CID	1977	3 line unit	USMP16565
5.0L V8 5031cc 307 CID	1968		USMP11283	6.5L V8 6489cc 396 CID	1969		USMP11325
5.0L V8 5031cc 307 CID	1971		USMP16560	6.6L V8 6588cc 402 CID	1970		USMP11713
5.3L V8 5358cc 327 CID	1967		USMP11283	6.6L V8 6588cc 402 CID	1971-1972		USMP11325
5.3L V8 5358cc 327 CID	1968		USMP11713	<b>CAPRICE</b>			
5.7L V8 350 CID	1969-1974		USMP16560		1966-1970		USPR936
5.7L V8 350 CID	1978	3 line unit	USMP16565		1973-1988		USPR936
5.7L V8 350 CID	1981-1984	3 line unit	USMP16565	3.8L V6 229 CID	1980-1984		USMP17503
6.2L V8 379 CID	1982-1984		USMP50703	3.8L V6 3800cc 231 CID	1980-1984		USMP17503
6.5L V8 396 CID	1969		USMP11325	4.1L L6 250 CID	1978-1979		USMP16845
6.5L V8 6489cc 396 CID	1968-1969		USMP11325	5.0L V8 305 CID	1977-1979	2 line pump	USMP16560
6.6L V8 6588cc 402 CID	1970-1972		USMP11325	5.0L V8 305 CID	1980-1981	3 line unit	USMP16565
7.4L V8 454 CID	1978		USMP16570	5.0L V8 305 CID	1983-1986	3 line unit	USMP16565
7.4L V8 454 CID	1981-1984		USMP16570	5.0L V8 305 CID	1989-1990		USMP15273
<b>C30</b>				5.0L V8 307 CID	1986	3 line unit	USMP16565
	1975-1986		USPR936	5.0L V8 307 CID	1989-1990		USMP15273
5.0L V8 305 CID	1978-1979		USMP16560	5.7L V8 350 CID	1969-1970	2 line pump	USMP16560
5.0L V8 305 CID	1979	3 line unit	USMP16565	5.7L V8 350 CID	1973-1974	2 line pump	USMP16560
5.7L V8 350 CID	1975-1979		USMP16560	5.7L V8 350 CID	1973-1976	3 line unit	USMP16565
5.7L V8 350 CID	1979	3 line unit	USMP16565	5.7L V8 350 CID	1977-1980	2 line pump	USMP16560
5.7L V8 350 CID	1981-1986	3 line unit	USMP16565	6.5L V8 396 CID	1969		USMP11325
6.6L V8 400 CID	1976-1977	3 line unit	USMP16565	6.5L V8 6489cc 396 CID	1969		USMP11325
<b>C30 PANEL</b>				6.6L V8 400 CID	1973-1976	3 line unit	USMP16565
	1962-1966		USPR936	6.6L V8 400 CID	1974-1975	2 line pump	USMP16560
<b>C30 PICKUP</b>				7.0L V8 427 CID	1968-1969		USMP11325
	1962-1966		USPR936	7.0L V8 6998cc 427 CID	1967-1969		USMP11325
3.8L L6 3769cc 230 CID	1964-1965		USMP08825	7.4L V8 454 CID	1970		USMP11325
4.1L L6 250 CID	1968-1969		USMP11258	7.4L V8 7439cc 454 CID	1970		USMP11325
4.1L L6 250 CID	1971-1974		USMP11258	7.4L V8 7439cc 454 CID	1973	3 line unit	USMP16565
4.1L L6 4097cc 250 CID	1967-1974		USMP11258	7.4L V8 7441cc 454 CID	1970		USMP11325
4.1L L6 4098cc 250 CID	1967		USMP11258	<b>CELEBRITY</b>			
4.1L L6 4098cc 250 CID	1972-1974		USMP11258		1983-1986		USMP50838
4.6L V8 4638cc 283 CID	1963-1965		USMP11780	<b>CHEVELLE</b>			
4.6L V8 4638cc 283 CID	1967		USMP11283		1964-1973		USPR936
4.8L L6 292 CID	1968-1974		USMP11258	4.1L L6 250 CID	1970		USMP11258
4.8L L6 4786cc 292 CID	1973-1974		USMP11258	4.1L L6 4097cc 250 CID	1970		USMP11258
4.8L L6 4801cc 292 CID	1963		USMP08825	4.1L L6 4098cc 250 CID	1970		USMP11258
4.8L L6 4801cc 292 CID	1965		USMP11258	5.7L V8 350 CID	1969		USMP16560
4.8L L6 4801cc 292 CID	1967-1974		USMP11258	5.7L V8 350 CID	1970-1972	3 Line Pump	USMP15538
5.0L V8 307 CID	1968		USMP11283	5.7L V8 350 CID	1973		USMP16560
5.0L V8 5031cc 307 CID	1968		USMP11283	5.7L V8 350 CID	1973	3 line unit	USMP16565
5.0L V8 5031cc 307 CID	1972	3 Line Pump	USMP15538	6.5L V8 396 CID	1969		USMP11325
5.3L V8 5358cc 327 CID	1967		USMP11283	6.5L V8 6489cc 396 CID	1969		USMP11325
5.3L V8 5358cc 327 CID	1968		USMP11713				



# MECHANICAL FUEL PUMP APPLICATION GUIDE



Engine	Years	Application Description	USMW
<b>CHEVROLET (cont'd.)</b>			
<b>CHEVELLE (cont'd.)</b>			
6.6L V8 400 CID	1973	3 line unit	USMP16565
6.6L V8 6588cc 402 CID	1972	3 Line Pump	USMP15538
7.4L V8 454 CID	1970		USMP11325
7.4L V8 7439cc 454 CID	1970		USMP11325
7.4L V8 7439cc 454 CID	1973	3 line unit	USMP16565
7.4L V8 7441cc 454 CID	1970		USMP11325
<b>CHEVETTE</b>			
	1976-1978		USPR936
<b>CHEVY II</b>			
	1962-1968		USPR936
4.6L V8 283 CID	1964-1965		USMP11780
4.6L V8 4638cc 283 CID	1964-1965		USMP11780
5.3L V8 5358cc 327 CID	1965		USMP07800
6.5L V8 396 CID	1968		USMP11325
6.5L V8 6489cc 396 CID	1968		USMP11325
<b>CITATION</b>			
2.5L L4 2474cc 151 CID	1980-1981		USMP17502
2.8L V6 173 CID	1980-1981		USMP75733
2.8L V6 173 CID	1983		USMP50838
<b>CITATION II</b>			
2.8L V6 173 CID	1984-1985		USMP50838
<b>CORVAIR</b>			
2.3L H6 2294cc 140 CID	1960		USMP09970
2.4L H6 145 CID	1961-1963		USMP09970
2.4L H6 2377cc 145 CID	1961-1963		USMP09970
2.7L H6 164 CID	1964-1967		USMP09970
2.7L H6 2684cc 164 CID	1964-1969		USMP09970
<b>CORVAIR TRUCK</b>			
2.4L H6 2377cc 145 CID	1961-1963		USMP09970
2.7L H6 2684cc 164 CID	1964		USMP09970
<b>CORVETTE</b>			
	1955-1956		USPR936
	1959-1961		USPR936
	1963-1976		USPR936
4.3L V8 4343cc 265 CID	1956		USMP06170
4.6L V8 4638cc 283 CID	1957		USMP06170
5.0L V8 305 CID	1980		USMP17388
5.3L V8 5358cc 327 CID	1963-1966		USMP07800
5.3L V8 5358cc 327 CID	1968		USMP17507
5.7L V8 350 CID	1969		USMP17507
5.7L V8 350 CID	1973-1981		USMP17388
7.0L V8 427 CID	1968-1969		USMP17506
7.0L V8 6998cc 427 CID	1966-1969		USMP17506
7.4L V8 454 CID	1973-1974		USMP17526
7.4L V8 7439cc 454 CID	1973-1974		USMP17526
7.4L V8 7441cc 454 CID	1973-1974		USMP17526
<b>EL CAMINO</b>			
	1964-1978		USPR936
	1980-1987		USPR936
3.2L L6 3180cc 194 CID	1964		USMP08825
3.3L V6 200 CID	1978		USMP17631
3.8L V6 229 CID	1980-1984		USMP17503
3.8L V6 3800cc 231 CID	1978		USMP17378
3.8L V6 3800cc 231 CID	1980-1984		USMP17503
4.4L V8 267 CID	1979-1980	2 line pump	USMP16560
4.6L V8 4638cc 283 CID	1960		USMP11780
4.6L V8 4638cc 283 CID	1964		USMP11780
5.0L V8 305 CID	1976-1980	2 line pump	USMP16560
5.0L V8 305 CID	1985-1987		USMP11713
5.3L V8 5358cc 327 CID	1965		USMP07800
5.7L V8 350 CID	1969-1974	2 line pump	USMP16560
5.7L V8 350 CID	1970-1972	3 Line Pump	USMP15538
5.7L V8 350 CID	1973-1976	3 line unit	USMP16565
5.7L V8 350 CID	1977-1978	2 line pump	USMP16560
6.5L V8 396 CID	1968-1969		USMP11325
6.5L V8 6489cc 396 CID	1967-1969		USMP11325
6.6L V8 400 CID	1974-1976	3 line unit	USMP16565
6.6L V8 6588cc 402 CID	1971	2 line pump	USMP16560
7.4L V8 454 CID	1970		USMP11325
7.4L V8 7439cc 454 CID	1970		USMP11325
7.4L V8 7441cc 454 CID	1970		USMP11325
<b>FLEETLINE</b>			
3.5L L6 3548cc 216 CID	1942		USMP01878
3.5L L6 3548cc 216 CID	1946-1951		USMP01878
3.5L L6 3548cc 216 CID	1952		USMP05295
3.8L L6 3852cc 235 CID	1950-1951		USMP01878
3.8L L6 3852cc 235 CID	1952		USMP05295
<b>FLEETMASTER</b>			
3.5L L6 3548cc 216 CID	1942		USMP01878

Engine	Years	Application Description	USMW
<b>CHEVROLET (cont'd.)</b>			
<b>FLEETMASTER (cont'd.)</b>			
3.5L L6 3548cc 216 CID	1946-1948		USMP01878
<b>G10</b>			
	1975-1980		USPR936
	1982-1984		USPR936
	1986		USPR936
4.1L L6 250 CID	1979-1980		USMP16845
4.1L L6 250 CID	1982-1983		USMP16845
4.3L V6 262 CID	1986		USMP82505
5.0L V8 305 CID	1977-1978		USMP16560
5.0L V8 305 CID	1979-1980		USMP17638
5.0L V8 305 CID	1982-1984		USMP50470
5.0L V8 305 CID	1986		USMP50470
5.7L V8 350 CID	1975-1976	3 Line Pump	USMP15538
5.7L V8 350 CID	1975-1978		USMP16560
5.7L V8 350 CID	1979-1980		USMP17638
5.7L V8 350 CID	1982-1984		USMP50470
5.7L V8 350 CID	1986		USMP50470
<b>G10 VAN</b>			
	1964-1965		USPR936
	1968-1974		USPR936
5.0L V8 307 CID	1972-1973		USMP16560
5.7L V8 350 CID	1970-1974		USMP16560
5.7L V8 350 CID	1973-1974	3 Line Pump	USMP15538
<b>G20</b>			
	1975-1980		USPR936
	1982-1984		USPR936
	1986		USPR936
4.1L L6 250 CID	1975		USMP11258
4.1L L6 250 CID	1976		USMP16845
4.1L L6 250 CID	1979-1980		USMP16845
4.1L L6 250 CID	1982-1983		USMP16845
4.3L V6 262 CID	1986		USMP82505
4.8L L6 292 CID	1975		USMP11258
4.8L L6 292 CID	1976		USMP16845
4.8L L6 292 CID	1979-1980		USMP16845
5.0L V8 305 CID	1977-1978		USMP16560
5.0L V8 305 CID	1979-1980		USMP17638
5.0L V8 305 CID	1982-1984		USMP50470
5.0L V8 305 CID	1986		USMP50470
5.7L V8 350 CID	1975-1976	3 Line Pump	USMP15538
5.7L V8 350 CID	1975-1978		USMP16560
5.7L V8 350 CID	1979-1980		USMP17638
5.7L V8 350 CID	1982-1984		USMP50470
5.7L V8 350 CID	1986		USMP50470
6.2L V8 379 CID	1983-1984		USMP50703
6.2L V8 379 CID	1986-1989		USMP50703
6.6L V8 400 CID	1975-1976	3 Line Pump	USMP15538
6.6L V8 400 CID	1979-1980		USMP17638
<b>G20 VAN</b>			
	1967-1974		USPR936
5.0L V8 5031cc 307 CID	1971		USMP16560
5.0L V8 5031cc 307 CID	1973	3 Line Pump	USMP15538
5.7L V8 350 CID	1970-1972		USMP16560
5.7L V8 350 CID	1973-1974	3 Line Pump	USMP15538
<b>G30</b>			
	1975-1984		USPR936
	1986-1988		USPR936
4.1L L6 250 CID	1976		USMP16845
4.1L L6 250 CID	1979		USMP16845
4.1L L6 250 CID	1981-1983		USMP16845
4.3L V6 262 CID	1986		USMP82505
4.8L L6 292 CID	1975		USMP11258
4.8L L6 292 CID	1976		USMP16845
4.8L L6 292 CID	1979		USMP16845
5.0L V8 305 CID	1978		USMP16560
5.0L V8 305 CID	1979		USMP17638
5.0L V8 305 CID	1982		USMP50470
5.7L V8 350 CID	1975-1976	3 Line Pump	USMP15538
5.7L V8 350 CID	1975-1978		USMP16560
5.7L V8 350 CID	1979-1980		USMP17638
5.7L V8 350 CID	1981-1984		USMP50470
5.7L V8 350 CID	1986-1988		USMP50470
6.2L V8 379 CID	1983-1984		USMP50703
6.2L V8 379 CID	1986-1989		USMP50703
6.6L V8 400 CID	1975-1976	3 Line Pump	USMP15538
6.6L V8 400 CID	1979-1980		USMP17638
<b>G30 VAN</b>			
	1970-1974		USPR936
5.7L V8 350 CID	1970-1974		USMP16560
5.7L V8 350 CID	1973-1974	3 Line Pump	USMP15538
5.7L V8 350 CID	1974		USMP15538



# MECHANICAL FUEL PUMP APPLICATION GUIDE



Engine	Years	Application Description	USMW	Engine	Years	Application Description	USMW
<b>CHEVROLET (cont'd.)</b>				<b>CHEVROLET (cont'd.)</b>			
<b>GC</b>				<b>K10 PICKUP (cont'd.)</b>			
3.5L L6 3548cc 216 CID	1937		USMP01878	6.6L V8 6588cc 402 CID	1970		USMP11325
<b>GD</b>				7.4L V8 454 CID	1974		USMP16570
3.5L L6 3548cc 216 CID	1937		USMP01878	7.4L V8 7439cc 454 CID	1974		USMP16570
<b>GE</b>				7.4L V8 7441cc 454 CID	1974		USMP16570
3.5L L6 3548cc 216 CID	1937		USMP01878	<b>K10 SUBURBAN</b>			
<b>HC</b>				4.1L L6 250 CID	1978-1980		USMP16845
3.5L L6 3548cc 216 CID	1938		USMP01878	4.1L L6 4097cc 250 CID	1967		USMP11258
<b>HD</b>				4.6L V8 4638cc 283 CID	1967		USMP11283
3.5L L6 3548cc 216 CID	1938		USMP01878	4.8L L6 4801cc 292 CID	1967		USMP11258
<b>HE</b>				5.0L V8 305 CID	1981-1982		USMP50098
3.5L L6 3548cc 216 CID	1938		USMP01878	5.0L V8 307 CID	1968		USMP11283
<b>IMPALA</b>				5.0L V8 307 CID	1970		USMP11283
3.8L V6 229 CID	1981-1984		USMP17503	5.0L V8 5031cc 307 CID	1968		USMP11283
3.8L V6 3800cc 231 CID	1981-1984		USMP17503	5.0L V8 5031cc 307 CID	1970		USMP11283
4.1L L6 250 CID	1965		USMP16845	5.3L V8 5358cc 327 CID	1967		USMP11283
4.1L L6 250 CID	1978-1979		USMP16845	5.7L V8 350 CID	1970	2 line pump	USMP16560
4.1L L6 4097cc 250 CID	1965		USMP16845	5.7L V8 350 CID	1973-1977	3 line unit	USMP16565
4.1L L6 4098cc 250 CID	1965		USMP16845	5.7L V8 350 CID	1975-1976	3 Line Pump	USMP15538
4.6L V8 283 CID	1964		USMP11780	5.7L V8 350 CID	1981-1986		USMP50098
4.6L V8 4638cc 283 CID	1959-1965		USMP11780	6.2L V8 379 CID	1982-1986		USMP50703
5.0L V8 305 CID	1977-1979	2 line pump	USMP16560	6.5L V8 396 CID	1968-1969		USMP11325
5.0L V8 305 CID	1980-1981	3 line unit	USMP16565	6.5L V8 6489cc 396 CID	1968-1969		USMP11325
5.0L V8 305 CID	1983-1985	3 line unit	USMP16565	6.6L V8 400 CID	1975-1977	3 line unit	USMP16565
5.3L V8 5358cc 327 CID	1962-1965		USMP07800	6.6L V8 6588cc 402 CID	1970-1971		USMP11325
5.7L V8 350 CID	1971	3 Line Pump	USMP15538	<b>K20</b>			
5.7L V8 350 CID	1973-1976	3 line unit	USMP16565	4.1L L6 250 CID	1975		USMP11258
5.7L V8 350 CID	1977-1979	2 line pump	USMP16560	4.1L L6 250 CID	1976		USMP16845
5.7L V8 350 CID	1981	3 line unit	USMP16565	4.1L L6 250 CID	1978-1980		USMP16845
5.7L V8 5704cc 348 CID	1959-1961		USMP07800	4.8L L6 292 CID	1975		USMP11258
6.5L V8 396 CID	1969		USMP11325	4.8L L6 292 CID	1976-1985		USMP16845
6.5L V8 6489cc 396 CID	1969		USMP11325	5.7L V8 350 CID	1975-1976	3 Line Pump	USMP15538
6.6L V8 400 CID	1971-1972	3 Line Pump	USMP15538	5.7L V8 350 CID	1975-1977	3 line unit	USMP16565
6.6L V8 400 CID	1973-1976	3 line unit	USMP16565	5.7L V8 350 CID	1981-1983		USMP50098
6.6L V8 6588cc 402 CID	1971-1972	3 Line Pump	USMP15538	5.7L V8 350 CID	1984-1985	3 line unit	USMP16565
6.7L V8 6704cc 409 CID	1962		USMP07800	5.7L V8 350 CID	1986		USMP50098
7.0L V8 427 CID	1967-1969		USMP11325	6.2L V8 379 CID	1982-1983		USMP50703
7.0L V8 6998cc 427 CID	1967-1969		USMP11325	6.2L V8 379 CID	1986		USMP50703
7.4L V8 454 CID	1970		USMP11325	6.6L V8 400 CID	1975-1977	3 line unit	USMP16565
7.4L V8 7439cc 454 CID	1970		USMP11325	<b>K20 PICKUP</b>			
7.4L V8 7441cc 454 CID	1970		USMP11325	3.8L L6 3769cc 230 CID	1964-1965		USMP08825
<b>JA MASTER DELUXE</b>				4.1L L6 250 CID	1968-1969		USMP11258
3.5L L6 3548cc 216 CID	1939		USMP01878	4.1L L6 250 CID	1971-1974		USMP11258
<b>JC</b>				4.1L L6 4097cc 250 CID	1967-1974		USMP11258
3.5L L6 3548cc 216 CID	1939		USMP01878	4.1L L6 4098cc 250 CID	1967		USMP11258
<b>JD</b>				4.1L L6 4098cc 250 CID	1972-1974		USMP11258
3.5L L6 3548cc 216 CID	1939		USMP01878	4.6L V8 4638cc 283 CID	1963-1965		USMP11780
<b>K5 BLAZER</b>				4.6L V8 4638cc 283 CID	1967		USMP11283
5.0L V8 305 CID	1977-1979		USMP16560	4.8L L6 292 CID	1969-1974		USMP11258
5.0L V8 305 CID	1979-1984	3 line unit	USMP16565	4.8L L6 4786cc 292 CID	1972-1974		USMP11258
5.7L V8 350 CID	1975-1976	3 Line Pump	USMP15538	4.8L L6 4801cc 292 CID	1965		USMP11258
5.7L V8 350 CID	1975-1977	3 line unit	USMP16565	4.8L L6 4801cc 292 CID	1967		USMP11258
5.7L V8 350 CID	1975-1979		USMP16560	4.8L L6 4801cc 292 CID	1969-1974		USMP11258
5.7L V8 350 CID	1979-1984	3 line unit	USMP16565	5.0L V8 307 CID	1968		USMP11283
6.6L V8 400 CID	1975-1977	3 line unit	USMP16565	5.0L V8 307 CID	1970		USMP11283
<b>K10</b>				5.0L V8 307 CID	1972	2 line pump	USMP16560
4.1L L6 250 CID	1978-1983		USMP16845	5.0L V8 5031cc 307 CID	1968		USMP11283
4.3L V6 262 CID	1986		USMP82505	5.0L V8 5031cc 307 CID	1970		USMP11283
4.8L L6 292 CID	1979-1980		USMP16845	5.0L V8 5031cc 307 CID	1972	2 line pump	USMP16560
5.0L V8 305 CID	1986		USMP50098	5.3L V8 5358cc 327 CID	1967		USMP11283
5.7L V8 350 CID	1975-1976	3 Line Pump	USMP15538	5.3L V8 5358cc 327 CID	1968		USMP11713
5.7L V8 350 CID	1975-1977	3 line unit	USMP16565	5.7L V8 350 CID	1970	2 line pump	USMP16560
5.7L V8 350 CID	1984-1985	3 line unit	USMP16565	5.7L V8 350 CID	1972-1974	2 line pump	USMP16560
5.7L V8 350 CID	1986		USMP50098	6.5L V8 396 CID	1968-1969		USMP11325
6.2L V8 379 CID	1982-1983		USMP50703	6.5L V8 6489cc 396 CID	1968-1969		USMP11325
6.2L V8 379 CID	1986		USMP50703	6.6L V8 6588cc 402 CID	1970		USMP11325
6.6L V8 400 CID	1975-1977	3 line unit	USMP16565	7.4L V8 454 CID	1973-1974		USMP16570
<b>K10 PICKUP</b>				7.4L V8 7439cc 454 CID	1973-1974		USMP16570
3.8L L6 3769cc 230 CID	1964-1965		USMP08825	7.4L V8 7441cc 454 CID	1973-1974		USMP16570
4.1L L6 4097cc 250 CID	1967		USMP11258	<b>K20 SUBURBAN</b>			
4.1L L6 4098cc 250 CID	1967		USMP11258	4.1L L6 250 CID	1968-1969		USMP11258
4.8L L6 4801cc 292 CID	1965		USMP11258	4.1L L6 250 CID	1971		USMP11258
5.0L V8 307 CID	1972	2 line pump	USMP16560	4.1L L6 250 CID	1973-1974		USMP11258
5.0L V8 5031cc 307 CID	1972	2 line pump	USMP16560	4.1L L6 4097cc 250 CID	1967-1971		USMP11258
5.3L V8 5358cc 327 CID	1967		USMP11283	4.1L L6 4097cc 250 CID	1973-1974		USMP11258
5.7L V8 350 CID	1970	2 line pump	USMP16560	4.1L L6 4098cc 250 CID	1973-1974		USMP11258
5.7L V8 350 CID	1972-1974	2 line pump	USMP16560	4.6L V8 4638cc 283 CID	1967		USMP11283
6.5L V8 396 CID	1968-1969		USMP11325	4.8L L6 292 CID	1968-1971		USMP11258
6.5L V8 6489cc 396 CID	1968-1969		USMP11325	4.8L L6 292 CID	1973-1975		USMP11258
				4.8L L6 292 CID	1976-1982		USMP16845
				4.8L L6 4786cc 292 CID	1973-1974		USMP11258
				4.8L L6 4801cc 292 CID	1967-1971		USMP11258
				4.8L L6 4801cc 292 CID	1973-1974		USMP11258
				5.0L V8 307 CID	1968-1970		USMP11283





# MECHANICAL FUEL PUMP APPLICATION GUIDE



Engine	Years	Application Description	USMW	Engine	Years	Application Description	USMW
<b>CHEVROLET (cont'd.)</b>				<b>CHEVROLET (cont'd.)</b>			
<b>K20 SUBURBAN (cont'd.)</b>				<b>MONTE CARLO (cont'd.)</b>			
5.0L V8 307 CID	1971	2 line pump	USMP16560	3.8L V6 3800cc 231 CID	1980-1984		USMP17503
5.0L V8 5031cc 307 CID	1968-1970		USMP11283	4.4L V8 267 CID	1982	3 line unit	USMP16565
5.0L V8 5031cc 307 CID	1971	2 line pump	USMP16560	5.0L V8 305 CID	1977-1978	2 line pump	USMP16560
5.3L V8 5358cc 327 CID	1967		USMP11283	5.0L V8 305 CID	1979-1984	3 line unit	USMP16565
5.3L V8 5358cc 327 CID	1968		USMP11713	5.0L V8 305 CID	1987-1988		USMP15253
5.7L V8 350 CID	1969-1971	2 line pump	USMP16560	5.7L V8 350 CID	1972-1976	3 line unit	USMP16565
5.7L V8 350 CID	1973-1977	3 line unit	USMP16565	5.7L V8 350 CID	1977	2 line pump	USMP16560
5.7L V8 350 CID	1975-1976	3 Line Pump	USMP15538	6.6L V8 400 CID	1973-1976	3 line unit	USMP16565
5.7L V8 350 CID	1981-1986		USMP50098	7.4L V8 454 CID	1970		USMP11325
6.2L V8 379 CID	1982-1986		USMP50703	7.4L V8 7439cc 454 CID	1970		USMP11325
6.5L V8 6489cc 396 CID	1968-1969		USMP11325	7.4L V8 7441cc 454 CID	1970		USMP11325
6.6L V8 400 CID	1975-1977	3 line unit	USMP16565	<b>MONZA</b>			
<b>K30</b>				2.5L L4 2474cc 151 CID	1978-1980		USMP17547
4.8L L6 292 CID	1977-1985		USMP16845	5.0L V8 305 CID	1976	2 line pump	USMP16560
5.7L V8 350 CID	1977	3 line unit	USMP16565	<b>NOVA</b>			
5.7L V8 350 CID	1981-1983		USMP50098	1.6L L4 1588cc 98 CID	1985-1988		USMP75670
5.7L V8 350 CID	1984-1985	3 line unit	USMP16565	4.1L L6 250 CID	1978-1979		USMP16845
5.7L V8 350 CID	1986		USMP50098	5.7L V8 350 CID	1971	2 line pump	USMP16560
6.2L V8 379 CID	1982-1983		USMP50703	5.7L V8 350 CID	1972-1979	3 line unit	USMP16565
6.2L V8 379 CID	1986		USMP50703	6.5L V8 396 CID	1969-1970		USMP11325
6.6L V8 400 CID	1977	3 line unit	USMP16565	6.5L V8 6489cc 396 CID	1969		USMP11325
7.4L V8 454 CID	1981-1983		USMP50478	6.6L V8 6588cc 402 CID	1970		USMP11325
7.4L V8 454 CID	1986		USMP50478	<b>P10</b>			
<b>K30 PICKUP</b>				4.8L L6 292 CID	1976-1980		USMP16845
4.8L L6 292 CID	1973		USMP11258	5.0L V8 305 CID	1979	2 line pump	USMP16560
4.8L L6 4786cc 292 CID	1973		USMP11258	5.7L V8 350 CID	1975	3 line unit	USMP16565
4.8L L6 4801cc 292 CID	1973		USMP11258	5.7L V8 350 CID	1977-1978	3 line unit	USMP16565
5.7L V8 350 CID	1973	2 line pump	USMP16560	<b>P10 VAN</b>			
6.5L V8 396 CID	1968-1969		USMP11325		1967		USMP11258
6.5L V8 6489cc 396 CID	1968-1969		USMP11325	4.1L L6 250 CID	1972		USMP11258
6.6L V8 6588cc 402 CID	1970-1971		USMP11325	5.7L V8 350 CID	1973	2 line pump	USMP16560
<b>KC</b>				<b>P20</b>			
3.5L L6 3548cc 216 CID	1940		USMP01878	4.8L L6 292 CID	1975		USMP11258
<b>KD</b>				4.8L L6 292 CID	1976-1989		USMP16845
3.5L L6 3548cc 216 CID	1940		USMP01878	5.7L V8 350 CID	1975-1987	3 line unit	USMP16565
<b>KF</b>				6.2L V8 379 CID	1988-1989		USMP50703
3.5L L6 3548cc 216 CID	1940		USMP01878	<b>P20 VAN</b>			
<b>KINGSWOOD</b>				4.1L L6 250 CID	1971-1974		USMP11258
5.0L V8 5031cc 307 CID	1969		USMP16560	4.1L L6 4097cc 250 CID	1970		USMP11258
5.7L V8 350 CID	1969-1970		USMP16560	4.1L L6 4098cc 250 CID	1973-1974		USMP11258
5.7L V8 350 CID	1971	3 Line Pump	USMP15538	4.8L L6 292 CID	1968-1973		USMP11258
5.7L V8 350 CID	1972		USMP16560	4.8L L6 4786cc 292 CID	1973		USMP11258
6.6L V8 400 CID	1971-1972	3 Line Pump	USMP15538	5.0L V8 307 CID	1968-1969		USMP11283
6.6L V8 6588cc 402 CID	1971-1972	3 Line Pump	USMP15538	5.0L V8 307 CID	1973	2 line pump	USMP16560
<b>LAGUNA</b>				5.7L V8 350 CID	1970-1973	2 line pump	USMP16560
5.7L V8 350 CID	1973-1976	3 line unit	USMP16565	5.7L V8 350 CID	1974	3 line unit	USMP16565
5.7L V8 350 CID	1974-1975	2 line pump	USMP16560	<b>P30</b>			
6.6L V8 400 CID	1974-1976	3 line unit	USMP16565	4.1L L6 250 CID	1976		USMP16845
<b>LUV</b>				4.1L L6 250 CID	1979		USMP16845
1.8L L4 111 CID	1982		USMP17577	4.8L L6 292 CID	1975		USMP11258
<b>MALIBU</b>				4.8L L6 292 CID	1976-1989		USMP16845
3.3L V6 200 CID	1978		USMP17631	5.7L V8 350 CID	1975-1988	3 line unit	USMP16565
3.3L V6 200 CID	1979		USMP17503	<b>P30 VAN</b>			
3.8L V6 229 CID	1980-1983		USMP17503	4.1L L6 250 CID	1971-1974		USMP11258
3.8L V6 3800cc 231 CID	1978		USMP17378	4.1L L6 4097cc 250 CID	1970		USMP11258
3.8L V6 3800cc 231 CID	1980-1983		USMP17503	4.1L L6 4098cc 250 CID	1973-1974		USMP11258
4.1L L6 4097cc 250 CID	1979		USMP16845	4.8L L6 292 CID	1968-1973		USMP11258
4.1L L6 4097cc 250 CID	1981		USMP16845	4.8L L6 4786cc 292 CID	1973		USMP11258
4.4L V8 267 CID	1979	3 line unit	USMP16565	5.0L V8 307 CID	1968-1969		USMP11283
4.4L V8 267 CID	1982	3 line unit	USMP16565	5.0L V8 307 CID	1973	2 line pump	USMP16560
5.0L V8 305 CID	1976-1978	2 line pump	USMP16560	5.7L V8 350 CID	1970-1973	2 line pump	USMP16560
5.0L V8 305 CID	1979-1983	3 line unit	USMP16565	5.7L V8 350 CID	1974	3 line unit	USMP16565
5.7L V8 350 CID	1973-1976	3 line unit	USMP16565	<b>R10</b>			
5.7L V8 350 CID	1975-1978	2 line pump	USMP16560	6.2L V8 379 CID	1987		USMP50703
5.7L V8 350 CID	1979	3 line unit	USMP16565	<b>R20</b>			
5.7L V8 350 CID	1981	3 line unit	USMP16565	6.2L V8 379 CID	1987-1988		USMP50703
6.5L V8 6489cc 396 CID	1967		USMP11325	<b>R30</b>			
6.6L V8 400 CID	1973-1976	3 line unit	USMP16565	5.7L V8 350 CID	1987-1988	3 line unit	USMP16565
<b>MASTER</b>				<b>R1500 SUBURBAN</b>			
3.5L L6 3548cc 216 CID	1937-1938		USMP01878	6.2L V8 379 CID	1989		USMP50703
<b>MASTER 85</b>				<b>R2500</b>			
3.5L L6 3548cc 216 CID	1939-1940		USMP01878	6.2L V8 379 CID	1989		USMP50703
<b>MONTE CARLO</b>				<b>R2500 SUBURBAN</b>			
3.3L V6 200 CID	1978		USMP17631	6.2L V8 379 CID	1989		USMP50703
3.3L V6 200 CID	1979		USMP17503	<b>R3500</b>			
3.8L V6 229 CID	1980-1984		USMP17503	6.2L V8 379 CID	1989		USMP50703
3.8L V6 231 CID	1987		USMP17596				
3.8L V6 3800cc 231 CID	1978		USMP17378				

MECHANICAL FUEL PUMPS



# MECHANICAL FUEL PUMP APPLICATION GUIDE



Engine	Years	Application Description	USMW	Engine	Years	Application Description	USMW
<b>CHEVROLET (cont'd.)</b>				<b>CHRYSLER (cont'd.)</b>			
<b>R3500 (cont'd.)</b>				<b>NEWPORT (cont'd.)</b>			
7.4L V8 454 CID	1989		USMP17466	6.6L V8 400 CID	1975		USMP17338
<b>S10</b>				6.6L V8 6556cc 400 CID	1972		USMP17597
2.8L V6 173 CID	1982-1983	RWD	USMP17518	6.6L V8 6556cc 400 CID	1973		USMP17338
2.8L V6 173 CID	1983	4WD	USMP52693	7.2L V8 7211cc 440 CID	1967-1968		USMP09180
2.8L V6 173 CID	1984-1985		USMP51010	7.2L V8 7211cc 440 CID	1969		USMP11473
<b>S10 BLAZER</b>				7.2L V8 7211cc 440 CID	1972		USMP17597
2.8L V6 173 CID	1983	RWD	USMP17518	7.2L V8 7211cc 440 CID	1973		USMP17338
2.8L V6 173 CID	1983	4WD	USMP52693	<b>NEW YORKER</b>			
2.8L V6 173 CID	1984-1985		USMP51010	2.2L L4 135 CID	1983		USMP17494
<b>SPECIAL DELUXE</b>				2.6L L4 2555cc 156 CID	1983-1985		USMP17521
3.5L L6 3548cc 216 CID	1940-1942		USMP01878	5.9L V8 360 CID	1977-1978		USMP17484
<b>SPECTRUM</b>				5.9L V8 360 CID	1979-1980		USMP51298
1.5L L4 1471cc 92 CID	1985-1988		USMP17607	6.6L V8 400 CID	1975		USMP17338
<b>V10</b>				6.7L V8 6769cc 413 CID	1959-1965		USMP09180
6.2L V8 379 CID	1987		USMP50703	7.2L V8 7211cc 440 CID	1966-1968		USMP09180
<b>V10 SUBURBAN</b>				7.2L V8 7211cc 440 CID	1969		USMP11473
6.2L V8 379 CID	1987-1988		USMP50703	7.2L V8 7211cc 440 CID	1972		USMP17597
<b>V20</b>				7.2L V8 7211cc 440 CID	1973-1974		USMP17338
6.2L V8 379 CID	1987		USMP50703	<b>ROYAL</b>			
<b>V20 SUBURBAN</b>				4.0L L6 3958cc 242 CID	1940-1941		USMP17477
6.2L V8 379 CID	1987-1988		USMP50703	4.1L L6 4114cc 251 CID	1942		USMP17477
<b>V30</b>				4.1L L6 4114cc 251 CID	1950		USMP17477
5.7L V8 350 CID	1987-1988		USMP50098	<b>SARATOGA</b>			
6.2L V8 379 CID	1987-1988		USMP50703	6.3L V8 6274cc 383 CID	1959		USMP09180
7.4L V8 454 CID	1987-1988		USMP50478	6.3L V8 6286cc 383 CID	1959-1960		USMP09180
<b>V1500 SUBURBAN</b>				<b>TOWN &amp; COUNTRY</b>			
6.2L V8 379 CID	1989		USMP50703	4.1L L6 4114cc 251 CID	1946-1948		USMP17477
<b>V2500 SUBURBAN</b>				5.9L V8 360 CID	1978-1979		USMP51285
6.2L V8 379 CID	1989		USMP50703	6.3L V8 383 CID	1969-1971		USMP11473
<b>V3500</b>				6.3L V8 6286cc 383 CID	1966-1968		USMP09180
6.2L V8 379 CID	1989		USMP50703	6.3L V8 6286cc 383 CID	1969-1971		USMP11473
7.4L V8 454 CID	1989		USMP50478	6.6L V8 400 CID	1972		USMP17597
<b>VA</b>				6.6L V8 400 CID	1975		USMP17338
3.5L L6 3548cc 216 CID	1939		USMP01878	6.6L V8 6556cc 400 CID	1972		USMP17597
<b>CHRYSLER</b>				6.6L V8 6556cc 400 CID	1973-1974		USMP17338
<b>300</b>				7.2L V8 7211cc 440 CID	1967-1968		USMP09180
6.3L V8 383 CID	1962-1966		USMP09180	7.2L V8 7211cc 440 CID	1969-1971		USMP11473
6.3L V8 6286cc 383 CID	1962-1966		USMP09180	7.2L V8 7211cc 440 CID	1972		USMP17597
6.7L V8 6769cc 413 CID	1960-1965		USMP09180	<b>VOLARE</b>			
7.2L V8 7211cc 440 CID	1967-1968		USMP09180	2.2L L4 135 CID	1986-1988	MEX	USMP51440
7.2L V8 7211cc 440 CID	1970-1971		USMP12113	<b>WINDSOR</b>			
<b>CORDOBA</b>				4.0L L6 3958cc 242 CID	1940-1941		USMP17477
5.9L V8 360 CID	1975-1976		USMP51285	4.1L L6 4114cc 251 CID	1942		USMP17477
5.9L V8 360 CID	1977-1980		USMP51298	4.1L L6 4114cc 251 CID	1950-1951		USMP17477
<b>E CLASS</b>				4.3L L6 4343cc 265 CID	1952		USMP17477
2.2L L4 135 CID	1983		USMP17494	6.3L V8 6286cc 383 CID	1959-1961		USMP09180
2.6L L4 2555cc 156 CID	1983-1984		USMP17521	<b>DESOTO</b>			
<b>IMPERIAL</b>				<b>ADVENTURER</b>			
6.7L V8 6769cc 413 CID	1959-1965		USMP09180	5.9L V8 5917cc 361 CID	1958		USMP09180
7.2L V8 7211cc 440 CID	1966-1968		USMP09180	6.3L V8 6286cc 383 CID	1959-1960		USMP09180
7.2L V8 7211cc 440 CID	1969		USMP11473	<b>FIREDOOME</b>			
7.2L V8 7211cc 440 CID	1972		USMP17597	4.5L V8 4524cc 276 CID	1952		USMP17477
<b>LEBARON</b>				5.9L V8 5917cc 361 CID	1958		USMP09180
2.2L L4 135 CID	1982		USMP17494	6.3L V8 6286cc 383 CID	1959		USMP09180
2.2L L4 135 CID	1985-1987	MEX	USMP17494	<b>FIREFLITE</b>			
2.6L L4 2555cc 156 CID	1982		USMP17521	5.6L V8 5589cc 341 CID	1957		USMP52684
2.6L L4 2555cc 156 CID	1985		USMP17521	5.9L V8 5917cc 361 CID	1958		USMP09180
3.7L L6 3687cc 225 CID	1978-1980		USMP51440	5.9L V8 5917cc 361 CID	1960		USMP09180
3.7L L6 3687cc 225 CID	1981		USMP17635	6.3L V8 6286cc 383 CID	1959		USMP09180
5.9L V8 360 CID	1978-1982		USMP51285	<b>FIRESWEEP</b>			
<b>NEWPORT</b>				5.9L V8 5917cc 361 CID	1959		USMP09180
3.7L L6 3687cc 225 CID	1979		USMP51443	<b>DODGE</b>			
3.7L L6 3687cc 225 CID	1981		USMP51443	<b>330</b>			
5.9L V8 360 CID	1972		USMP17165	6.3L V8 6286cc 383 CID	1964		USMP09180
5.9L V8 360 CID	1974-1975		USMP51285	<b>400</b>			
5.9L V8 360 CID	1976-1978		USMP17484	2.2L L4 135 CID	1982-1983		USMP17494
5.9L V8 360 CID	1979-1980		USMP51298	2.6L L4 2555cc 156 CID	1982-1983		USMP17521
5.9L V8 5917cc 361 CID	1961-1964		USMP09180	<b>440</b>			
6.3L V8 383 CID	1967-1968		USMP09180	6.3L V8 6286cc 383 CID	1964		USMP09180
6.3L V8 383 CID	1969		USMP11473	<b>600</b>			
6.3L V8 6286cc 383 CID	1965-1968		USMP09180	2.2L L4 135 CID	1983-1984		USMP17494
6.3L V8 6286cc 383 CID	1969		USMP11473	2.6L L4 2555cc 156 CID	1983-1985		USMP17521
6.6L V8 400 CID	1972		USMP17597	<b>880</b>			
				5.9L V8 361 CID	1963		USMP09180



# MECHANICAL FUEL PUMP APPLICATION GUIDE



MECHANICAL FUEL PUMPS

Engine	Years	Application Description	USMW	Engine	Years	Application Description	USMW
<b>DODGE (cont'd.)</b>				<b>DODGE (cont'd.)</b>			
<b>880 (cont'd.)</b>				<b>CHARGER (cont'd.)</b>			
5.9L V8 5917cc 361 CID	1963-1964		USMP09180	5.6L V8 5572cc 340 CID	1973		USMP51285
6.3L V8 6286cc 383 CID	1963-1964		USMP09180	5.9L V8 360 CID	1971		USMP12113
<b>A100</b>				5.9L V8 360 CID	1974-1977		USMP51285
	1969		USMP17165	5.9L V8 360 CID	1978		USMP51298
2.8L L6 2786cc 170 CID	1964-1965		USMP51443	5.9L V8 5917cc 361 CID	1966		USMP09180
<b>ARIES</b>				6.3L V8 383 CID	1969		USMP11473
2.2L L4 135 CID	1981-1985		USMP17494	6.3L V8 6286cc 383 CID	1966-1968		USMP09180
2.6L L4 2555cc 156 CID	1981-1985		USMP17521	6.3L V8 6286cc 383 CID	1969		USMP11473
<b>ASPEN</b>				6.3L V8 6286cc 383 CID	1970-1971		USMP12113
5.9L V8 360 CID	1976-1980		USMP51285	6.6L V8 6556cc 400 CID	1973-1974		USMP17338
<b>B100</b>				7.0L V8 6981cc 426 CID	1966		USMP09180
3.7L L6 3687cc 225 CID	1978		USMP51443	7.0L V8 6981cc 426 CID	1969		USMP11085
3.7L L6 3687cc 225 CID	1979-1980		USMP51440	7.2L V8 7211cc 440 CID	1967		USMP09180
5.2L V8 5211cc 318 CID	1975-1977		USMP17165	7.2L V8 7211cc 440 CID	1968-1969		USMP11085
5.2L V8 5211cc 318 CID	1978-1980		USMP51285	7.2L V8 7211cc 440 CID	1970-1971		USMP12113
5.9L V8 360 CID	1976-1977		USMP17165	7.2L V8 7211cc 440 CID	1973-1974		USMP17338
5.9L V8 360 CID	1978		USMP51285	<b>COLT</b>			
<b>B150</b>				1.4L L4 1410cc	1979-1981		USMP17491
3.7L L6 3687cc 225 CID	1981-1987		USMP51440	1.5L L4 1468cc 90 CID	1985-1986		USMP17642
5.2L V8 5211cc 318 CID	1981-1987		USMP51285	1.5L L4 1468cc 90 CID	1987-1988		USMP75768
<b>B200</b>				1.6L L4 1597cc 98 CID	1978-1980		USMP17604
3.7L L6 3687cc 225 CID	1975-1978		USMP51443	1.6L L4 1597cc 98 CID	1981-1984		USMP17627
3.7L L6 3687cc 225 CID	1980		USMP51440	2.0L L4 1995cc 122 CID	1984		USMP17642
5.2L V8 5211cc 318 CID	1975-1977		USMP17165	2.0L L4 1997cc 122 CID	1985-1987		USMP17642
5.2L V8 5211cc 318 CID	1978-1980		USMP51285	<b>CORONET</b>			
5.9L V8 360 CID	1975-1977		USMP17165	3.8L L6 3770cc 230 CID	1949-1954		USMP17477
5.9L V8 360 CID	1978-1980		USMP51285	4.5L V8 4473cc 273 CID	1968		USMP17165
6.6L V8 400 CID	1976-1978		USMP17338	5.2L V8 5211cc 318 CID	1974		USMP17338
7.2L V8 7211cc 440 CID	1975-1978		USMP17338	5.6L V8 340 CID	1972		USMP17165
<b>B250</b>				5.6L V8 340 CID	1973		USMP51285
3.7L L6 3687cc 225 CID	1981-1987		USMP51440	5.6L V8 5572cc 340 CID	1970		USMP12113
5.2L V8 5211cc 318 CID	1981-1987		USMP51285	5.6L V8 5572cc 340 CID	1972		USMP17165
5.9L V8 360 CID	1981		USMP51285	5.6L V8 5572cc 340 CID	1973		USMP51285
5.9L V8 360 CID	1984-1988		USMP51285	5.9L V8 360 CID	1973-1976		USMP51285
<b>B300</b>				6.3L V8 383 CID	1969		USMP11473
3.7L L6 3687cc 225 CID	1975-1978		USMP51443	6.3L V8 383 CID	1971		USMP11473
3.7L L6 3687cc 225 CID	1979		USMP51440	6.3L V8 6286cc 383 CID	1959		USMP09180
5.2L V8 5211cc 318 CID	1975-1977		USMP17165	6.3L V8 6286cc 383 CID	1968		USMP11473
5.2L V8 5211cc 318 CID	1978-1980		USMP51285	6.3L V8 6286cc 383 CID	1969		USMP12113
5.9L V8 360 CID	1975-1977		USMP17165	6.3L V8 6286cc 383 CID	1970		USMP11473
5.9L V8 360 CID	1978-1980		USMP51285	6.6L V8 400 CID	1972		USMP17597
6.6L V8 400 CID	1976-1978		USMP17338	6.6L V8 6556cc 400 CID	1972		USMP17597
7.2L V8 7211cc 440 CID	1975-1978		USMP17338	6.6L V8 6556cc 400 CID	1974		USMP17338
<b>B350</b>				7.0L V8 6981cc 426 CID	1969		USMP11085
5.2L V8 5211cc 318 CID	1981-1987		USMP51285	7.2L V8 7211cc 440 CID	1968-1969		USMP11085
5.9L V8 360 CID	1981-1988		USMP51285	7.2L V8 7211cc 440 CID	1970-1971		USMP12113
<b>CARAVAN</b>				7.2L V8 7211cc 440 CID	1972		USMP17597
2.2L L4 135 CID	1984-1987		USMP17494	7.2L V8 7211cc 440 CID	1974-1975		USMP17338
2.6L L4 2555cc 156 CID	1984-1987		USMP17521	<b>CUSTOM</b>			
<b>CB300</b>				3.8L L6 3770cc 230 CID	1946-1948		USMP17477
3.7L L6 3687cc 225 CID	1975		USMP51443	<b>D100</b>			
3.7L L6 3687cc 225 CID	1977		USMP51443	3.7L L6 3687cc 225 CID	1978-1979		USMP51443
5.2L V8 5211cc 318 CID	1975-1977		USMP17165	3.7L L6 3687cc 225 CID	1987		USMP51443
5.2L V8 5211cc 318 CID	1978-1980		USMP51285	5.2L V8 5211cc 318 CID	1975		USMP17165
5.9L V8 360 CID	1974-1977		USMP17165	5.2L V8 5211cc 318 CID	1976		USMP51285
5.9L V8 360 CID	1978-1980		USMP51285	5.2L V8 5211cc 318 CID	1977		USMP17165
7.2L V8 7211cc 440 CID	1977-1979		USMP17338	5.2L V8 5211cc 318 CID	1978-1979		USMP51285
<b>CHALLENGER</b>				5.2L V8 5211cc 318 CID	1986-1987		USMP51285
1.6L L4 1597cc 98 CID	1978-1979		USMP17604	5.9L V8 360 CID	1975		USMP17165
2.6L L4 2555cc 156 CID	1981-1983		USMP75733	5.9L V8 360 CID	1976		USMP51285
3.2L L6 198 CID	1970		USMP51443	5.9L V8 360 CID	1977		USMP17165
3.2L L6 3254cc 198 CID	1970		USMP51443	5.9L V8 360 CID	1978-1979		USMP51285
5.2L V8 5211cc 318 CID	1970		USMP12113	5.9L V8 360 CID	1986-1987		USMP51285
5.6L V8 340 CID	1972		USMP17165	5.9L V8 360 CID	1988		USMP51298
5.6L V8 340 CID	1973		USMP51285	7.2L V8 7211cc 440 CID	1975-1978		USMP17338
5.6L V8 5572cc 340 CID	1970		USMP12113	<b>D100 PICKUP</b>			
5.6L V8 5572cc 340 CID	1972		USMP17165	3.8L L6 3770cc 230 CID	1958		USMP17513
5.6L V8 5572cc 340 CID	1973		USMP51285	5.9L V8 360 CID	1971-1974		USMP17165
5.9L V8 360 CID	1974		USMP51285	6.3L V8 383 CID	1968		USMP09180
6.3L V8 383 CID	1970-1971		USMP12113	6.3L V8 383 CID	1969-1971		USMP11473
6.3L V8 6286cc 383 CID	1970-1971		USMP12113	6.3L V8 6286cc 383 CID	1968		USMP09180
7.2L V8 7211cc 440 CID	1970-1971		USMP12113	6.3L V8 6286cc 383 CID	1969-1971		USMP11473
<b>CHARGER</b>				6.6L V8 400 CID	1972		USMP17597
1.6L L4 1595cc 97 CID	1983-1986		USMP17636	6.6L V8 6556cc 400 CID	1972		USMP17597
2.2L L4 135 CID	1983-1987		USMP17494	6.6L V8 6556cc 400 CID	1973-1974		USMP17338
5.6L V8 340 CID	1973		USMP51285	7.2L V8 7211cc 440 CID	1973-1974		USMP17338
5.6L V8 5572cc 340 CID	1970		USMP12113	<b>D150</b>			
				3.7L L6 3687cc 225 CID	1979-1987		USMP51443
				5.2L V8 5211cc 318 CID	1977		USMP17165
				5.2L V8 5211cc 318 CID	1978-1987		USMP51285





# MECHANICAL FUEL PUMP APPLICATION GUIDE



Engine	Years	Application Description	USMW	Engine	Years	Application Description	USMW
<b>DODGE (cont'd.)</b>				<b>DODGE (cont'd.)</b>			
<b>D150 (cont'd.)</b>				<b>DART (cont'd.)</b>			
5.9L V8 360 CID	1977		USMP17165	5.9L V8 360 CID	1976		USMP51285
5.9L V8 360 CID	1978-1987		USMP51285	5.9L V8 360 CID	1977	MEX	USMP51285
5.9L V8 360 CID	1988		USMP51298	5.9L V8 360 CID	1981	MEX	USMP51285
7.2L V8 7211cc 440 CID	1978		USMP17338	5.9L V8 361 CID	1960-1961		USMP09180
<b>D200</b>				5.9L V8 5917cc 361 CID	1960-1962		USMP09180
3.7L L6 3687cc 225 CID	1975-1980		USMP51443	6.3L V8 383 CID	1967-1968		USMP09180
5.2L V8 5211cc 318 CID	1975		USMP17165	6.3L V8 383 CID	1969		USMP11473
5.2L V8 5211cc 318 CID	1976		USMP51285	6.3L V8 6286cc 383 CID	1961		USMP09180
5.2L V8 5211cc 318 CID	1977		USMP17165	6.3L V8 6286cc 383 CID	1967-1968		USMP09180
5.2L V8 5211cc 318 CID	1978-1980		USMP51285	6.3L V8 6286cc 383 CID	1969		USMP11473
5.9L V8 360 CID	1975		USMP17165	<b>DELUXE</b>			
5.9L V8 360 CID	1976		USMP51285	3.8L L6 3770cc 230 CID	1940		USMP17477
5.9L V8 360 CID	1977		USMP17165	3.8L L6 3770cc 230 CID	1946-1948		USMP17477
5.9L V8 360 CID	1978-1980		USMP51285	<b>DIPLOMAT</b>			
7.2L V8 7211cc 440 CID	1975-1978		USMP17338	3.7L L6 3687cc 225 CID	1978-1980		USMP51440
<b>D200 PICKUP</b>				3.7L L6 3687cc 225 CID	1981		USMP17635
3.8L L6 3770cc 230 CID	1957-1959		USMP17513	5.2L V8 5211cc 318 CID	1983		USMP51298
5.2L V8 5211cc 318 CID	1973-1974		USMP17338	5.2L V8 5211cc 318 CID	1985		USMP51298
5.9L V8 360 CID	1971-1974		USMP17165	5.9L V8 360 CID	1978-1979		USMP51285
6.3L V8 383 CID	1968		USMP09180	<b>MAGNUM</b>			
6.3L V8 383 CID	1969-1971		USMP11473	2.2L L4 135 CID	1983-1988	MEX	USMP17494
6.3L V8 6286cc 383 CID	1968		USMP09180	5.9L V8 360 CID	1978-1979		USMP51298
6.3L V8 6286cc 383 CID	1969-1971		USMP11473	<b>MATADOR</b>			
6.6L V8 400 CID	1972		USMP17597	5.9L V8 5917cc 361 CID	1960		USMP09180
6.6L V8 6556cc 400 CID	1972		USMP17597	6.3L V8 6286cc 383 CID	1960		USMP09180
6.6L V8 6556cc 400 CID	1973-1974		USMP17338	<b>MEADOWBROOK</b>			
7.2L V8 7211cc 440 CID	1973-1974		USMP17338	3.8L L6 3770cc 230 CID	1949-1954		USMP17477
<b>D250</b>				<b>MINI RAM</b>			
3.7L L6 3687cc 225 CID	1981-1987		USMP51443	2.2L L4 135 CID	1984-1987		USMP17494
5.2L V8 5211cc 318 CID	1981-1987		USMP51285	2.6L L4 2555cc 156 CID	1984-1987		USMP17521
5.9L L6 359 CID	1991-1993		USMP82650	<b>MIRADA</b>			
5.9L V8 360 CID	1981-1982		USMP51285	3.7L L6 3687cc 225 CID	1980		USMP51440
5.9L V8 360 CID	1984-1987		USMP51285	3.7L L6 3687cc 225 CID	1981		USMP17635
5.9L V8 360 CID	1988		USMP51298	5.9L V8 360 CID	1980		USMP51298
<b>D300</b>				<b>MONACO</b>			
3.7L L6 3687cc 225 CID	1975-1979		USMP51443	3.7L L6 3687cc 225 CID	1978		USMP51443
5.2L V8 5211cc 318 CID	1975		USMP17165	5.2L V8 5211cc 318 CID	1970		USMP11473
5.2L V8 5211cc 318 CID	1976		USMP51285	5.2L V8 5211cc 318 CID	1973-1974		USMP17338
5.2L V8 5211cc 318 CID	1977		USMP17165	5.9L V8 360 CID	1971-1972		USMP17165
5.2L V8 5211cc 318 CID	1978-1980		USMP51285	5.9L V8 360 CID	1973-1975		USMP51285
5.9L V8 360 CID	1975		USMP17165	5.9L V8 360 CID	1976		USMP17484
5.9L V8 360 CID	1976		USMP51285	5.9L V8 360 CID	1977-1978		USMP51298
5.9L V8 360 CID	1977		USMP17165	6.3L V8 383 CID	1965-1968		USMP09180
5.9L V8 360 CID	1978-1980		USMP51285	6.3L V8 383 CID	1969-1971		USMP11473
7.2L V8 7211cc 440 CID	1975-1978		USMP17338	6.3L V8 6286cc 383 CID	1965-1968		USMP09180
<b>D300 PICKUP</b>				6.3L V8 6286cc 383 CID	1969-1971		USMP11473
3.8L L6 3770cc 230 CID	1957-1959		USMP17513	6.6L V8 400 CID	1972		USMP17597
5.2L V8 5211cc 318 CID	1973-1974		USMP17338	6.6L V8 6556cc 400 CID	1972		USMP17597
5.9L V8 360 CID	1972-1974		USMP17165	6.6L V8 6556cc 400 CID	1973-1974		USMP17338
6.3L V8 383 CID	1968		USMP09180	6.7L V8 6769cc 413 CID	1965		USMP09180
6.3L V8 383 CID	1969-1971		USMP11473	7.0L V8 6981cc 426 CID	1965		USMP09180
6.3L V8 6286cc 383 CID	1968		USMP09180	7.2L V8 7211cc 440 CID	1966-1968		USMP09180
6.3L V8 6286cc 383 CID	1969-1971		USMP11473	7.2L V8 7211cc 440 CID	1969-1971		USMP11473
6.6L V8 400 CID	1972		USMP17597	7.2L V8 7211cc 440 CID	1972		USMP17597
6.6L V8 6556cc 400 CID	1972		USMP17597	7.2L V8 7211cc 440 CID	1973-1975		USMP17338
6.6L V8 6556cc 400 CID	1973-1974		USMP17338	<b>OMNI</b>			
7.2L V8 7211cc 440 CID	1973-1974		USMP17338	1.6L L4 1595cc 97 CID	1983-1986		USMP17636
<b>D350</b>				2.2L L4 135 CID	1981-1987		USMP17494
3.7L L6 3687cc 225 CID	1981-1987		USMP51443	<b>PHOENIX</b>			
5.2L V8 5211cc 318 CID	1981-1983		USMP51285	5.9L V8 5917cc 361 CID	1960		USMP09180
5.9L L6 359 CID	1991-1993		USMP82650	6.3L V8 6286cc 383 CID	1960		USMP09180
5.9L V8 360 CID	1981-1987		USMP51285	<b>PIONEER</b>			
5.9L V8 360 CID	1988		USMP51298	5.9L V8 5917cc 361 CID	1961		USMP09180
<b>DAKOTA</b>				<b>POLARA</b>			
2.2L L4 135 CID	1988		USMP17494	5.2L V8 5211cc 318 CID	1973		USMP17338
3.9L V6 3906cc 239 CID	1987		USMP51298	5.9L V8 360 CID	1971-1972		USMP17165
<b>DART</b>				5.9L V8 360 CID	1973		USMP51285
2.2L L4 135 CID	1983-1989	MEX	USMP17494	5.9L V8 5917cc 361 CID	1960-1962		USMP09180
2.8L L6 170 CID	1965-1969		USMP51443	6.3L V8 383 CID	1963		USMP09180
2.8L L6 2786cc 170 CID	1965-1971		USMP51443	6.3L V8 383 CID	1968		USMP09180
3.2L L6 198 CID	1972-1974		USMP51443	6.3L V8 383 CID	1969-1971		USMP11473
3.2L L6 3254cc 198 CID	1972-1974		USMP51443	6.3L V8 6286cc 383 CID	1960-1968		USMP09180
3.7L L6 3687cc 225 CID	1977-1981	MEX	USMP51440	6.3L V8 6286cc 383 CID	1969-1971		USMP11473
4.5L V8 273 CID	1964-1969		USMP17165	6.6L V8 400 CID	1972		USMP17597
4.5L V8 4473cc 273 CID	1964-1969		USMP17165	6.6L V8 6556cc 400 CID	1972		USMP17597
5.6L V8 340 CID	1968-1972		USMP17165	6.6L V8 6556cc 400 CID	1973		USMP17338
5.6L V8 340 CID	1973		USMP51285	6.7L V8 6769cc 413 CID	1965		USMP09180
5.6L V8 5572cc 340 CID	1968-1972		USMP17165	7.0L V8 6981cc 426 CID	1965		USMP09180
5.6L V8 5572cc 340 CID	1973		USMP51285				
5.9L V8 360 CID	1974		USMP51285				



# MECHANICAL FUEL PUMP APPLICATION GUIDE



MECHANICAL FUEL PUMPS

Engine	Years	Application Description	USMW
<b>DODGE (cont'd.)</b>			
<b>POLARA (cont'd.)</b>			
7.2L V8 721cc 440 CID	1966-1968		USMP09180
7.2L V8 721cc 440 CID	1969-1971		USMP11473
7.2L V8 721cc 440 CID	1972		USMP17597
7.2L V8 721cc 440 CID	1973		USMP17338
<b>RAIDER</b>			
2.6L L4 2555cc 156 CID	1987-1989		USMP75733
<b>RAM 50</b>			
2.0L L4 1995cc 122 CID	1984-1986		USMP17642
2.0L L4 1995cc 122 CID	1987-1989		USMP75768
2.0L L4 1997cc 122 CID	1983		USMP17642
2.6L L4 2555cc 156 CID	1983-1989		USMP75733
<b>RAM 2500</b>			
5.9L L6 359 CID	1994-1998		USMP82760
<b>RAM 3500</b>			
5.9L L6 359 CID	1994-1998		USMP82760
<b>RAMCHARGER</b>			
3.7L L6 3687cc 225 CID	1978-1980		USMP51443
5.2L V8 5211cc 318 CID	1974		USMP17338
5.2L V8 5211cc 318 CID	1975		USMP17165
5.2L V8 5211cc 318 CID	1976		USMP51285
5.2L V8 5211cc 318 CID	1977		USMP17165
5.2L V8 5211cc 318 CID	1978-1987		USMP51285
5.9L V8 360 CID	1974-1975		USMP17165
5.9L V8 360 CID	1976		USMP51285
5.9L V8 360 CID	1977		USMP17165
5.9L V8 360 CID	1978-1987		USMP51285
5.9L V8 360 CID	1988		USMP51298
6.6L V8 400 CID	1978		USMP17338
7.2L V8 7211cc 440 CID	1974-1978		USMP17338
<b>RAMPAGE</b>			
2.2L L4 135 CID	1982-1984		USMP17494
<b>ROYAL</b>			
5.9L V8 5917cc 361 CID	1959		USMP09180
6.3L V8 6286cc 383 CID	1959		USMP09180
<b>ROYAL MONACO</b>			
5.9L V8 360 CID	1975		USMP51285
5.9L V8 360 CID	1976-1977		USMP17484
7.2L V8 7211cc 440 CID	1975		USMP17338
<b>SENECA</b>			
5.9L V8 5917cc 361 CID	1961		USMP09180
<b>SPECIAL</b>			
	1940		USMP17477
<b>ST. REGIS</b>			
5.9L V8 360 CID	1979-1980		USMP51298
<b>W100</b>			
3.7L L6 3687cc 225 CID	1987		USMP51443
5.2L V8 5211cc 318 CID	1975		USMP17165
5.2L V8 5211cc 318 CID	1976		USMP51285
5.2L V8 5211cc 318 CID	1977		USMP17165
5.9L V8 360 CID	1975		USMP17165
5.9L V8 360 CID	1976		USMP51285
5.9L V8 360 CID	1977		USMP17165
5.9L V8 360 CID	1986-1987		USMP51285
5.9L V8 360 CID	1988		USMP51298
7.2L V8 7211cc 440 CID	1975-1977		USMP17338
<b>W150</b>			
3.7L L6 3687cc 225 CID	1979-1987		USMP51443
5.2L V8 5211cc 318 CID	1977		USMP17165
5.9L V8 360 CID	1977		USMP17165
5.9L V8 360 CID	1978-1981		USMP51285
5.9L V8 360 CID	1984-1987		USMP51285
5.9L V8 360 CID	1988		USMP51298
7.2L V8 7211cc 440 CID	1978		USMP17338
<b>W200</b>			
3.7L L6 3687cc 225 CID	1975-1980		USMP51443
5.2L V8 5211cc 318 CID	1975		USMP17165
5.2L V8 5211cc 318 CID	1976		USMP51285
5.2L V8 5211cc 318 CID	1977		USMP17165
5.2L V8 5211cc 318 CID	1978-1980		USMP51285
5.9L V8 360 CID	1975		USMP17165
5.9L V8 360 CID	1976		USMP51285
5.9L V8 360 CID	1977		USMP17165
5.9L V8 360 CID	1978-1980		USMP51285
7.2L V8 7211cc 440 CID	1975-1978		USMP17338
<b>W250</b>			
3.7L L6 3687cc 225 CID	1986-1987		USMP51443

Engine	Years	Application Description	USMW
<b>DODGE (cont'd.)</b>			
<b>W250 (cont'd.)</b>			
5.2L V8 5211cc 318 CID	1981-1987		USMP51285
5.9L L6 359 CID	1991-1993		USMP82650
5.9L V8 360 CID	1981-1982		USMP51285
5.9L V8 360 CID	1984-1987		USMP51285
5.9L V8 360 CID	1988-1989		USMP51298
<b>W300</b>			
3.7L L6 3687cc 225 CID	1975-1978		USMP51443
5.2L V8 5211cc 318 CID	1975		USMP17165
5.2L V8 5211cc 318 CID	1976		USMP51285
5.2L V8 5211cc 318 CID	1977		USMP17165
5.2L V8 5211cc 318 CID	1978		USMP51285
5.2L V8 5211cc 318 CID	1980		USMP51285
5.9L V8 360 CID	1975		USMP17165
5.9L V8 360 CID	1976		USMP51285
5.9L V8 360 CID	1977		USMP17165
5.9L V8 360 CID	1978-1980		USMP51285
7.2L V8 7211cc 440 CID	1975-1978		USMP17338
<b>W350</b>			
5.2L V8 5211cc 318 CID	1982-1983		USMP51285
5.9L L6 359 CID	1989-1993		USMP82650
5.9L V8 360 CID	1981-1987		USMP51285
5.9L V8 360 CID	1988		USMP51298
<b>WAYFARER</b>			
3.8L L6 3770cc 230 CID	1949-1952		USMP17477
<b>WC</b>			
3.6L L6 3570cc 218 CID	1942-1947		USMP50113
<b>WD15</b>			
3.6L L6 3570cc 218 CID	1942-1949		USMP50113
3.9L L6 3878cc 237 CID	1948-1949		USMP50113
<b>EDSEL</b>			
<b>CORSAIR</b>			
5.4L V8 5441cc 332 CID	1959		USMP08820
<b>PACER</b>			
5.9L V8 5917cc 361 CID	1958		USMP17469
<b>RANGER</b>			
5.9L V8 5917cc 361 CID	1958		USMP17469
<b>FORD</b>			
<b>1/2 TON PICKUP</b>			
	1941		USMP17493
2.2L V8 2229cc 136 CID	1940		USMP17493
<b>1 TON PICKUP</b>			
	1941		USMP17493
2.2L V8 2229cc 136 CID	1940		USMP17493
<b>3/4 TON PICKUP</b>			
	1941		USMP17493
2.2L V8 2229cc 136 CID	1940		USMP17493
<b>AEROSTAR</b>			
2.8L V6 171 CID	1986		USMP50828
<b>B600</b>			
6.1L V8 370 CID	1980-1981		USMP50360
6.1L V8 370 CID	1983-1989		USMP50360
7.0L V8 429 CID	1988-1989		USMP50360
<b>B700</b>			
6.1L V8 370 CID	1980-1981		USMP50360
6.1L V8 370 CID	1983-1989		USMP50360
7.0L V8 429 CID	1988-1989		USMP50360
<b>B-100</b>			
5.0L V8 302 CID	1973-1974	MEX	USMP17405
5.0L V8 302 CID	1979-1980	MEX	USMP17405
<b>B-150</b>			
5.0L V8 302 CID	1982-1985	MEX	USMP50795
<b>B-200</b>			
5.0L V8 302 CID	1985-1991	MEX	USMP50795
<b>BRONCO</b>			
4.9L L6 4917cc 300 CID	1980-1986		USMP50825
5.0L V8 302 CID	1970-1974		USMP16470
5.0L V8 302 CID	1975-1977		USMP17405
5.0L V8 302 CID	1980-1984		USMP50795
5.8L V8 5753cc 351 CID	1978-1979		USMP17445
5.8L V8 5753cc 351 CID	1980-1987		USMP50795
6.6L V8 400 CID	1978-1979		USMP17445



# MECHANICAL FUEL PUMP APPLICATION GUIDE



Engine	Years	Application Description	USMW	Engine	Years	Application Description	USMW
<b>FORD (cont'd.)</b>				<b>FORD (cont'd.)</b>			
<b>BRONCO II</b>				<b>E-200 ECONOLINE</b>			
2.8L V6 171 CID	1984-1985		USMP50828	2.8L L6 170 CID	1969-1970		USMP17464
<b>C600</b>				3.9L L6 240 CID	1969-1974		USMP17464
6.1L V8 370 CID	1980-1986		USMP50360	4.9L L6 4917cc 300 CID	1972-1974		USMP17464
<b>C700</b>				5.0L V8 302 CID	1970-1974		USMP16470
6.1L V8 370 CID	1980-1986		USMP50360	<b>E-250 ECONOLINE</b>			
7.0L V8 429 CID	1980-1986		USMP50360	4.9L L6 4917cc 300 CID	1975-1979		USMP17018
<b>C800</b>				4.9L L6 4917cc 300 CID	1980-1984		USMP50825
6.1L V8 370 CID	1980-1986		USMP50360	5.0L V8 302 CID	1979		USMP17405
7.0L V8 429 CID	1980-1986		USMP50360	5.0L V8 302 CID	1980-1984		USMP50795
<b>CORTINA</b>				5.8L V8 5753cc 351 CID	1975-1979		USMP17405
1.6L L4 1599cc 98 CID	1970		USMP17486	5.8L V8 5753cc 351 CID	1980-1984		USMP50795
<b>COUNTRY SQUIRE</b>				6.6L V8 400 CID	1980		USMP50463
6.4L V8 390 CID	1968		USMP17558	7.5L V8 460 CID	1979		USMP50090
6.4L V8 6391cc 390 CID	1967-1968		USMP17558	7.5L V8 460 CID	1980		USMP80503
7.0L V8 427 CID	1968		USMP17558	<b>E-250 ECONOLINE CLUB WAGON</b>			
7.0L V8 428 CID	1968		USMP17558	5.0L V8 302 CID	1979		USMP17405
7.0L V8 6997cc 427 CID	1967-1968		USMP17558	5.8L V8 5753cc 351 CID	1975-1979		USMP17405
7.0L V8 7014cc 428 CID	1967-1968		USMP17558	7.5L V8 460 CID	1986-1987		USMP17499
<b>COURIER SEDAN DELIVERY</b>				<b>E-300 ECONOLINE</b>			
3.6L L6 3655cc 223 CID	1954		USMP17544	2.8L L6 170 CID	1969		USMP17464
<b>CRESTLINE</b>				3.9L L6 240 CID	1969-1974		USMP17464
3.5L L6 3524cc 215 CID	1952-1953		USMP17544	4.9L L6 4917cc 300 CID	1972-1974		USMP17464
3.6L L6 3655cc 223 CID	1954		USMP17544	5.0L V8 302 CID	1970-1974		USMP16470
<b>CUSTOM</b>				<b>E-350 ECONOLINE</b>			
3.5L L6 3524cc 215 CID	1952		USMP17544	4.9L L6 4917cc 300 CID	1975-1979		USMP17018
3.6L L6 3655cc 223 CID	1957		USMP08883	4.9L L6 4917cc 300 CID	1980-1984		USMP50825
3.9L L6 3933cc 240 CID	1957		USMP17464	5.0L V8 302 CID	1979		USMP17405
3.9L V8 3924cc 239 CID	1949-1950		USMP02065	5.0L V8 302 CID	1980-1982		USMP50795
5.0L V8 302 CID	1970		USMP16470	5.8L V8 5753cc 351 CID	1975-1979		USMP17405
5.8L V8 5769cc 352 CID	1964		USMP08820	5.8L V8 5753cc 351 CID	1980-1984		USMP50795
5.8L V8 5769cc 352 CID	1966		USMP17558	6.6L V8 400 CID	1980-1982		USMP50463
6.4L V8 6391cc 390 CID	1964		USMP08820	6.9L V8 420 CID	1983-1984		USMP50695
6.4L V8 6391cc 390 CID	1966-1968		USMP17558	7.3L V8 445 CID	1988-1994		USMP50695
6.4L V8 6391cc 390 CID	1970		USMP17460	7.3L V8 445 CID	1995-1998		USMP52668
7.0L V8 6997cc 427 CID	1966-1968		USMP17558	7.5L V8 460 CID	1979		USMP50090
7.0L V8 7014cc 428 CID	1966-1968		USMP17558	7.5L V8 460 CID	1980-1984		USMP80503
7.0L V8 7014cc 428 CID	1970		USMP17195	7.5L V8 460 CID	1986-1987		USMP17499
7.0L V8 7030cc 429 CID	1970		USMP17195	<b>E-350 ECONOLINE CLUB WAGON</b>			
<b>CUSTOM 300</b>				5.0L V8 302 CID	1979		USMP17405
3.6L L6 3655cc 223 CID	1958		USMP08883	5.8L V8 5753cc 351 CID	1977-1979		USMP17405
<b>CUSTOM 500</b>				7.5L V8 460 CID	1986-1987		USMP17499
5.0L V8 302 CID	1970-1972		USMP16470	<b>ELITE</b>			
5.8L V8 5753cc 351 CID	1975-1976		USMP17205	5.8L V8 5753cc 351 CID	1975-1976		USMP17405
6.6L V8 400 CID	1975-1976		USMP17205	<b>ESCORT</b>			
<b>CUSTOMLINE</b>				1.6L L4 1598cc 98 CID	1981-1985		USMP17639
3.5L L6 3524cc 215 CID	1953		USMP17544	1.9L L4 116 CID	1985-1986		USMP17639
3.6L L6 3655cc 223 CID	1954		USMP17544	<b>EXP</b>			
3.6L L6 3655cc 223 CID	1955-1956		USMP08883	1.6L L4 1598cc 98 CID	1982-1985		USMP17639
<b>DELUXE</b>				1.9L L4 116 CID	1986		USMP17639
3.9L V8 3924cc 239 CID	1947-1948		USMP17493	<b>F1</b>			
3.9L V8 3924cc 239 CID	1950		USMP02065	3.5L L6 3524cc 215 CID	1952		USMP17544
<b>E-100 ECONOLINE</b>				3.9L V8 3924cc 239 CID	1948-1950		USMP02065
4.9L L6 4917cc 300 CID	1978-1979		USMP17018	<b>F2</b>			
4.9L L6 4917cc 300 CID	1980-1983		USMP50825	3.5L L6 3524cc 215 CID	1952		USMP17544
5.0L V8 302 CID	1970		USMP16470	3.9L V8 3924cc 239 CID	1948-1950		USMP02065
5.0L V8 302 CID	1972-1973		USMP16470	<b>F3</b>			
5.0L V8 302 CID	1979		USMP17405	3.5L L6 3524cc 215 CID	1952		USMP17544
5.0L V8 302 CID	1980-1983		USMP50795	3.9L V8 3924cc 239 CID	1948-1950		USMP02065
5.8L V8 5753cc 351 CID	1975-1979		USMP17405	<b>F59</b>			
5.8L V8 5753cc 351 CID	1980-1983		USMP50795	7.3L V8 445 CID	1994-1996		USMP52668
6.6L V8 400 CID	1980		USMP50463	<b>F600</b>			
<b>E-100 ECONOLINE CLUB WAGON</b>				6.1L V8 370 CID	1980-1989		USMP50360
5.0L V8 302 CID	1979		USMP17405	7.0L V8 429 CID	1980-1989		USMP50360
5.8L V8 5753cc 351 CID	1975-1979		USMP17405	<b>F700</b>			
<b>E-150 ECONOLINE</b>				6.1L V8 370 CID	1980-1989		USMP50360
4.9L L6 4917cc 300 CID	1978-1979		USMP17018	7.0L V8 429 CID	1980-1989		USMP50360
4.9L L6 4917cc 300 CID	1980-1984		USMP50825	<b>F800</b>			
5.0L V8 302 CID	1979		USMP17405	6.1L V8 370 CID	1980-1989		USMP50360
5.0L V8 302 CID	1980-1984		USMP50795	7.0L V8 429 CID	1980-1989		USMP50360
5.8L V8 5753cc 351 CID	1975-1979		USMP17405	<b>F100</b>			
5.8L V8 5753cc 351 CID	1980-1984		USMP50795	3.5L L6 3524cc 215 CID	1953		USMP17544
<b>E-150 ECONOLINE CLUB WAGON</b>				3.6L L6 3655cc 223 CID	1954		USMP17544
5.0L V8 302 CID	1979		USMP17405	3.8L V6 232 CID	1982-1983		USMP17537
5.8L V8 5753cc 351 CID	1975-1979		USMP17405	3.9L L6 240 CID	1965-1966		USMP10013
				3.9L L6 3933cc 240 CID	1965-1966		USMP10013





# MECHANICAL FUEL PUMP APPLICATION GUIDE



MECHANICAL FUEL PUMPS

Engine	Years	Application Description	USMW	Engine	Years	Application Description	USMW
<b>FORD (cont'd.)</b>				<b>FORD (cont'd.)</b>			
<b>F-100 (cont'd.)</b>				<b>F-350</b>			
3.9L V8 3917cc 239 CID	1955		USMP08883	3.5L L6 3524cc 215 CID	1953		USMP17544
4.2L V8 255 CID	1981-1982		USMP50795	3.6L L6 3655cc 223 CID	1954		USMP17544
4.4L V8 4458cc 272 CID	1956-1957		USMP08820	3.6L L6 3655cc 223 CID	1955-1957		USMP08883
4.9L L6 4917cc 300 CID	1965		USMP10013	3.6L L6 3655cc 223 CID	1961-1964		USMP08883
4.9L L6 4917cc 300 CID	1978-1979		USMP17018	3.9L L6 240 CID	1968-1972		USMP10013
4.9L L6 4917cc 300 CID	1980-1983		USMP50825	3.9L L6 3933cc 240 CID	1965-1972		USMP10013
5.0L V8 302 CID	1973		USMP16470	4.4L V8 4458cc 272 CID	1956-1957		USMP08820
5.0L V8 302 CID	1975-1979		USMP17405	4.8L V8 4786cc 292 CID	1961-1964		USMP08820
5.0L V8 302 CID	1980-1983		USMP50795	4.9L L6 4917cc 300 CID	1965-1973		USMP10013
5.8L V8 5753cc 351 CID	1977-1978		USMP17205	4.9L L6 4917cc 300 CID	1975-1976		USMP10013
5.8L V8 5753cc 351 CID	1978-1979	Windsor	USMP17405	4.9L L6 4917cc 300 CID	1978		USMP17018
5.8L V8 5753cc 351 CID	1979		USMP17505	4.9L L6 4917cc 300 CID	1982-1984		USMP50825
5.8L V8 5769cc 352 CID	1965-1967		USMP08820	5.0L V8 302 CID	1965-1973		USMP16470
5.9L V8 360 CID	1968-1969		USMP08820	5.0L V8 302 CID	1976		USMP17405
5.9L V8 360 CID	1970-1972		USMP10020	5.0L V8 302 CID	1978		USMP17405
5.9L V8 360 CID	1973		USMP17460	5.0L V8 302 CID	1983-1984		USMP50795
6.4L V8 390 CID	1968-1969		USMP08820	5.0L V8 302 CID	1988-1990		USMP50795
6.4L V8 390 CID	1970-1972		USMP10020	5.8L V8 5753cc 351 CID	1978		USMP17205
6.4L V8 390 CID	1973		USMP17460	5.8L V8 5753cc 351 CID	1979		USMP17505
6.4L V8 6391cc 390 CID	1968-1969		USMP08820	5.8L V8 5753cc 351 CID	1983-1984		USMP50795
6.4L V8 6391cc 390 CID	1970-1972		USMP10020	5.8L V8 5753cc 351 CID	1988-1990		USMP50795
6.4L V8 6391cc 390 CID	1973		USMP17460	5.8L V8 5769cc 352 CID	1965-1967		USMP08820
6.4L V8 6392cc 390 CID	1968-1969		USMP08820	5.9L V8 360 CID	1968-1969		USMP08820
6.4L V8 6392cc 390 CID	1970-1972		USMP10020	5.9L V8 360 CID	1970-1973		USMP10020
6.4L V8 6392cc 390 CID	1973		USMP17460	5.9L V8 360 CID	1975-1976		USMP16690
6.6L V8 400 CID	1977-1978		USMP17205	5.9L V8 5917cc 361 CID	1965		USMP08820
6.6L V8 400 CID	1979		USMP17505	6.4L V8 390 CID	1968-1969		USMP08820
7.5L V8 460 CID	1973		USMP16545	6.4L V8 390 CID	1970-1973		USMP10020
7.5L V8 7539cc 460 CID	1973		USMP16545	6.4L V8 390 CID	1975-1976		USMP16690
<b>F-150</b>				<b>FAIRLANE</b>			
3.8L V6 3797cc 232 CID	1986-1990		USMP17537	2.8L L6 2786cc 170 CID	1963		USMP10013
4.9L L6 4917cc 300 CID	1980		USMP50825	3.3L L6 200 CID	1966		USMP17464
4.9L L6 4917cc 300 CID	1982-1984		USMP50825	3.3L L6 3277cc 200 CID	1966		USMP17464
4.9L L6 4917cc 300 CID	1986		USMP50825	3.6L L6 3655cc 223 CID	1955-1958		USMP08883
5.0L V8 302 CID	1975-1979		USMP17405	4.3L V8 260 CID	1964		USMP10023
5.0L V8 302 CID	1980		USMP50795	4.3L V8 4261cc 260 CID	1964		USMP10023
5.0L V8 302 CID	1982-1984		USMP50795	5.0L V8 302 CID	1969-1970		USMP16470
5.0L V8 302 CID	1986-1990		USMP50795	6.4L V8 390 CID	1963-1964		USMP08820
5.8L V8 5753cc 351 CID	1977		USMP17205	6.4L V8 390 CID	1966		USMP08820
5.8L V8 5753cc 351 CID	1978		USMP17405	6.4L V8 390 CID	1969		USMP17460
5.8L V8 5753cc 351 CID	1979	Windsor Engine Version	USMP17405	6.4L V8 6391cc 390 CID	1963-1964		USMP08820
5.8L V8 5753cc 351 CID	1979	Modified Engine Version, RWD	USMP17505	6.4L V8 6391cc 390 CID	1966		USMP08820
5.8L V8 5753cc 351 CID	1980		USMP50463	6.4L V8 6391cc 390 CID	1969		USMP17460
5.8L V8 5753cc 351 CID	1982-1984		USMP50795	7.0L V8 427 CID	1965-1966		USMP17558
5.8L V8 5753cc 351 CID	1986-1987		USMP50795	7.0L V8 427 CID	1969		USMP17558
6.6L V8 400 CID	1977		USMP17205	7.0L V8 428 CID	1968-1969		USMP17558
6.6L V8 400 CID	1979		USMP17505	7.0L V8 429 CID	1970		USMP17195
7.5L V8 460 CID	1977		USMP50090	7.0L V8 6997cc 427 CID	1965-1967		USMP17558
<b>F-200</b>				<b>FAIRMONT</b>			
5.0L V8 302 CID	1986-1989	MEX	USMP50795	3.3L L6 200 CID	1978-1983		USMP50825
<b>F-250</b>				<b>FALCON</b>			
3.5L L6 3524cc 215 CID	1953		USMP17544	2.4L L6 144 CID	1963-1964		USMP10013
3.6L L6 3655cc 223 CID	1954		USMP17544	2.4L L6 2360cc 144 CID	1963-1964		USMP10013
3.6L L6 3655cc 223 CID	1955-1957		USMP08883	4.3L V8 260 CID	1963-1964		USMP10023
3.6L L6 3655cc 223 CID	1961-1964		USMP08883	4.3L V8 4261cc 260 CID	1963-1964		USMP10023
3.9L L6 240 CID	1968-1972		USMP10013	4.7L V8 289 CID	1965		USMP10023
3.9L L6 3933cc 240 CID	1965-1972		USMP10013	4.7L V8 289 CID	1968		USMP16470
4.4L V8 4458cc 272 CID	1956-1957		USMP08820	4.7L V8 4727cc 289 CID	1965		USMP10023
4.8L V8 4786cc 292 CID	1961-1964		USMP08820	4.7L V8 4727cc 289 CID	1968		USMP16470
4.9L L6 4917cc 300 CID	1965-1972		USMP10013				
4.9L L6 4917cc 300 CID	1982-1984		USMP50825				
5.0L V8 302 CID	1972		USMP10013				
5.0L V8 302 CID	1973		USMP16470				
5.0L V8 302 CID	1982-1984		USMP50795				
5.8L V8 5753cc 351 CID	1979		USMP17505				
5.8L V8 5753cc 351 CID	1983-1984		USMP50795				
5.8L V8 5769cc 352 CID	1965-1967		USMP08820				
5.9L V8 360 CID	1968-1969		USMP08820				
5.9L V8 360 CID	1970-1972		USMP10020				
6.4L V8 390 CID	1968-1969		USMP08820				
6.4L V8 390 CID	1970-1972		USMP10020				
6.4L V8 6391cc 390 CID	1968-1969		USMP08820				
6.4L V8 6391cc 390 CID	1970-1972		USMP10020				
6.4L V8 6392cc 390 CID	1968-1969		USMP08820				
6.4L V8 6392cc 390 CID	1970-1972		USMP10020				
6.6L V8 400 CID	1979		USMP17505				
6.6L V8 400 CID	1982		USMP50463				
6.9L V8 420 CID	1983-1984		USMP50695				
7.3L V8 445 CID	1988-1993		USMP50695				
7.3L V8 445 CID	1995-1996		USMP52668				
7.5L V8 460 CID	1983-1984		USMP80503				
7.5L V8 460 CID	1986-1987		USMP17499				



# MECHANICAL FUEL PUMP APPLICATION GUIDE



Engine	Years	Application Description	USMW	Engine	Years	Application Description	USMW
<b>FORD (cont'd.)</b>				<b>FORD (cont'd.)</b>			
<b>FALCON (cont'd.)</b>				<b>MUSTANG (cont'd.)</b>			
5.0L V8 302 CID	1968-1970		USMP16470	5.0L V8 302 CID	1971-1973		USMP16470
<b>FESTIVA</b>				5.0L V8 302 CID	1973		USMP17205
1.3L L4 1295cc	1988-1989		USMP17525	5.0L V8 302 CID	1980-1981		USMP17405
<b>FIESTA</b>				5.0L V8 302 CID	1982		USMP17565
1.6L L4 1597cc 98 CID	1978-1980		USMP17605	5.0L V8 302 CID	1982-1985		usmp50633
<b>F SUPER DUTY</b>				5.0L V8 302 CID	1984		USMP17519
7.3L V8 445 CID	1995-1997		USMP52668	5.8L V8 5753cc 351 CID	1973		USMP17205
<b>GALAXIE</b>				6.4L V8 390 CID	1969		USMP17460
5.8L V8 5769cc 352 CID	1963		USMP08820	6.4L V8 6391cc 390 CID	1968-1969		USMP17460
6.4L V8 6391cc 390 CID	1963		USMP08820	7.0L V8 428 CID	1969		USMP17558
<b>GALAXIE 500</b>				7.0L V8 429 CID	1971		USMP17195
5.0L V8 302 CID	1970-1972		USMP16470	7.0L V8 6997cc 427 CID	1968		USMP17558
5.8L V8 5769cc 352 CID	1964		USMP08820	7.0L V8 7014cc 428 CID	1968-1969		USMP17558
6.4L V8 390 CID	1964		USMP08820	7.0L V8 7030cc 429 CID	1971		USMP17195
6.4L V8 390 CID	1966-1967		USMP17558	<b>P-100</b>			
6.4L V8 6391cc 390 CID	1964		USMP08820	2.8L L6 2786cc 170 CID	1966-1967		USMP17467
7.0L V8 427 CID	1966-1967		USMP17558	2.8L L6 2786cc 170 CID	1970		USMP10013
<b>GRANADA</b>				3.6L L6 3655cc 223 CID	1957		USMP08883
3.3L L6 200 CID	1981-1982		USMP50825	3.9L L6 3933cc 240 CID	1968		USMP10013
3.8L V6 232 CID	1982		USMP17537	3.9L L6 3933cc 240 CID	1970		USMP10013
4.1L L6 250 CID	1978-1980		USMP50825	4.9L L6 4917cc 300 CID	1970-1976	MEX	USMP10013
4.2L V8 255 CID	1980		USMP16875	5.0L V8 302 CID	1989-1991		USMP17405
4.2L V8 255 CID	1981		USMP17519	<b>PINTO</b>			
5.0L V8 302 CID	1975		USMP17405	2.8L V6 171 CID	1978-1979		USMP17531
5.0L V8 302 CID	1976-1980		USMP16875	<b>RANCHERO</b>			
5.8L V8 5753cc 351 CID	1975-1976		USMP17405	3.3L L6 3277cc 200 CID	1967		USMP17464
5.8L V8 5753cc 351 CID	1977		USMP16875	3.6L L6 3655cc 223 CID	1957-1958		USMP08883
<b>GRAN TORINO</b>				3.6L L6 3655cc 223 CID	1959		USMP17586
5.0L V8 302 CID	1972-1974		USMP16470	4.8L V8 4786cc 292 CID	1959		USMP08820
<b>L800</b>				5.0L V8 302 CID	1968-1974		USMP16470
6.1L V8 370 CID	1980-1985		USMP50360	5.0L V8 302 CID	1977-1979		USMP17405
7.0L V8 429 CID	1980-1985		USMP50360	5.8L V8 5753cc 351 CID	1975-1979		USMP17405
<b>LN600</b>				5.8L V8 5769cc 352 CID	1959		USMP08820
6.1L V8 370 CID	1980-1983		USMP50360	6.4L V8 390 CID	1968-1969		USMP08820
<b>LN700</b>				6.4L V8 6391cc 390 CID	1967-1969		USMP08820
6.1L V8 370 CID	1980-1985		USMP50360	6.6L V8 400 CID	1972-1976		USMP17205
7.0L V8 429 CID	1980-1985		USMP50360	6.6L V8 6555cc 400 CID	1972-1974		USMP17205
<b>LN800</b>				6.6L V8 6556cc 400 CID	1972-1974		USMP17205
6.1L V8 370 CID	1980-1985		USMP50360	7.0L V8 428 CID	1969		USMP17558
7.0L V8 429 CID	1980-1985		USMP50360	7.0L V8 429 CID	1970-1973		USMP17195
<b>LTD</b>				7.0L V8 7014cc 428 CID	1969		USMP17558
3.3L L6 200 CID	1983		USMP50825	7.0L V8 7030cc 429 CID	1970-1973		USMP17195
3.8L V6 232 CID	1983-1984		USMP17537	7.5L V8 460 CID	1974		USMP17195
4.2L V8 255 CID	1982		USMP16875	7.5L V8 7539cc 460 CID	1974		USMP17195
5.0L V8 302 CID	1982		USMP16875	<b>RANCH WAGON</b>			
5.8L V8 5753cc 351 CID	1975-1976		USMP17205	6.4L V8 390 CID	1968		USMP17558
5.8L V8 5753cc 351 CID	1982-1986		USMP17554	6.4L V8 6391cc 390 CID	1967-1968		USMP17558
5.8L V8 5769cc 352 CID	1966		USMP17558	7.0L V8 428 CID	1968		USMP17558
6.4L V8 390 CID	1968		USMP17558	7.0L V8 6997cc 427 CID	1967-1968		USMP17558
6.4L V8 6391cc 390 CID	1966-1968		USMP17558	7.0L V8 7014cc 428 CID	1967-1968		USMP17558
6.4L V8 6392cc 390 CID	1967		USMP17558	<b>RANGER</b>			
6.6L V8 400 CID	1975-1976		USMP17205	2.0L L4 1989cc 122 CID	1983		USMP17530
7.0L V8 427 CID	1968		USMP17558	2.0L L4 1989cc 122 CID	1984-1988		USMP17508
7.0L V8 428 CID	1968		USMP17558	2.3L L4 140 CID	1983		USMP17530
7.0L V8 6997cc 427 CID	1966-1968		USMP17558	2.3L L4 140 CID	1984		USMP17508
7.0L V8 7014cc 428 CID	1966-1968		USMP17558	2.8L V6 171 CID	1983-1985		USMP50828
7.5L V8 460 CID	1975-1976		USMP17205	<b>SEDAN DELIVERY</b>			
<b>LTD II</b>					1941		USMP17493
5.0L V8 302 CID	1979		USMP17405	2.2L V8 2229cc 136 CID	1940		USMP17493
5.8L V8 5753cc 351 CID	1979		USMP17405	3.6L V8 3622cc 221 CID	1942		USMP17493
<b>MAINLINE</b>				3.9L V8 3924cc 239 CID	1942		USMP17493
3.5L L6 3524cc 215 CID	1952-1953		USMP17544	<b>SUPER DELUXE</b>			
3.6L L6 3655cc 223 CID	1954		USMP17544	3.9L V8 3924cc 239 CID	1947-1948		USMP17493
3.6L L6 3655cc 223 CID	1955-1956		USMP08883	<b>THUNDERBIRD</b>			
<b>MAVERICK</b>				3.3L L6 200 CID	1980-1982		USMP50825
5.0L V8 302 CID	1970-1974		USMP16470	3.8L V6 232 CID	1982-1984		USMP17537
5.0L V8 302 CID	1975		USMP17405	4.2L V8 255 CID	1980		USMP17519
5.0L V8 302 CID	1976-1977		USMP16875	4.2L V8 255 CID	1981		USMP16875
<b>MUSTANG</b>				4.2L V8 255 CID	1982		USMP17519
3.3L L6 200 CID	1979-1982		USMP50825	4.8L V8 4786cc 292 CID	1955-1957		USMP82685
4.1L L6 4097cc 250 CID	1973		USMP17205	5.0L V8 302 CID	1980-1981		USMP17519
4.2L V8 255 CID	1980-1982		USMP17519				
4.7L V8 4727cc 289 CID	1964		USMP10023				
4.7L V8 4727cc 289 CID	1968		USMP16470				
5.0L V8 302 CID	1968-1969		USMP16470				



# MECHANICAL FUEL PUMP APPLICATION GUIDE



MECHANICAL FUEL PUMPS

Engine	Years	Application Description	USMW
<b>FORD (cont'd.)</b>			
<b>THUNDERBIRD (cont'd.)</b>			
5.1L V8 5114cc 312 CID	1956-1957		USMP82685
5.8L V8 5769cc 352 CID	1959-1960		USMP08820
6.4L V8 390 CID	1968		USMP17460
6.4L V8 6391cc 390 CID	1961		USMP17476
6.4L V8 6391cc 390 CID	1962-1964		USMP08820
6.4L V8 6391cc 390 CID	1965-1966		USMP10020
6.4L V8 6391cc 390 CID	1967-1968		USMP17460
6.6L V8 400 CID	1972		USMP17205
6.6L V8 6555cc 400 CID	1972		USMP17205
6.6L V8 6556cc 400 CID	1972		USMP17205
7.0L V8 429 CID	1968-1973		USMP17195
7.0L V8 6997cc 427 CID	1966		USMP10020
7.0L V8 6997cc 427 CID	1967		USMP17460
7.0L V8 7014cc 428 CID	1966		USMP10020
7.0L V8 7014cc 428 CID	1967		USMP17460
7.0L V8 7014cc 428 CID	1969		USMP17195
7.0L V8 7030cc 429 CID	1968-1973		USMP17195
7.0L V8 7048cc 430 CID	1960		USMP08820
7.5L V8 460 CID	1972-1974		USMP17195
7.5L V8 7539cc 460 CID	1972-1974		USMP17195
<b>TORINO</b>			
5.0L V8 302 CID	1968-1971		USMP16470
5.8L V8 5753cc 351 CID	1975		USMP17405
6.4L V8 390 CID	1969		USMP17460
6.4L V8 6391cc 390 CID	1969		USMP17460
6.6L V8 400 CID	1975		USMP17205
7.0L V8 427 CID	1968		USMP17558
7.0L V8 428 CID	1968-1969		USMP17558
7.0L V8 429 CID	1970-1971		USMP17195
7.0L V8 6997cc 427 CID	1968		USMP17558
7.0L V8 7014cc 428 CID	1968-1969		USMP17558
7.0L V8 7014cc 428 CID	1970		USMP17195
7.0L V8 7030cc 429 CID	1970-1971		USMP17195
<b>FRAZER</b>			
<b>MANHATTAN</b>			
3.7L L6 3704cc 226 CID	1950-1951		USMP17576
<b>GEO</b>			
<b>SPECTRUM</b>			
1.5L L4 1471cc 92 CID	1989		USMP17607
<b>GMC</b>			
<b>B6000</b>			
5.7L V8 350 CID	1983	3 line unit	USMP16565
6.0L V8 366 CID	1980-1982		USMP11760
6.0L V8 366 CID	1984-1985		USMP11760
7.0L V8 427 CID	1980-1985		USMP11760
<b>C15</b>			
5.7L V8 350 CID	1975-1978	3 line unit	USMP16565
6.6L V8 400 CID	1976	3 line unit	USMP16565
<b>C15/C1500 PICKUP</b>			
5.7L V8 350 CID	1972	3 Line Pump	USMP15538
5.7L V8 350 CID	1973-1974	3 line unit	USMP16565
6.5L V8 396 CID	1968-1969		USMP11325
6.5L V8 6489cc 396 CID	1968-1969		USMP11325
6.6L V8 6588cc 402 CID	1970-1972		USMP11325
<b>C15/C1500 SUBURBAN</b>			
5.7L V8 350 CID	1972	3 Line Pump	USMP15538
5.7L V8 350 CID	1973-1974	3 line unit	USMP16565
6.5L V8 396 CID	1968-1969		USMP11325
6.5L V8 6489cc 396 CID	1968-1969		USMP11325
6.6L V8 6588cc 402 CID	1970-1972		USMP11325
<b>C15 SUBURBAN</b>			
5.7L V8 350 CID	1975-1978	3 line unit	USMP16565
<b>C25</b>			
5.7L V8 350 CID	1975-1978	3 line unit	USMP16565
6.6L V8 400 CID	1976	3 line unit	USMP16565
<b>C25/C2500 PICKUP</b>			
5.7L V8 350 CID	1972	3 Line Pump	USMP15538
5.7L V8 350 CID	1973-1974	3 line unit	USMP16565
6.5L V8 396 CID	1968-1969		USMP11325
6.5L V8 6489cc 396 CID	1968-1969		USMP11325
6.6L V8 6588cc 402 CID	1970-1972		USMP11325
<b>C25/C2500 SUBURBAN</b>			
5.7L V8 350 CID	1974	3 line unit	USMP16565
6.5L V8 396 CID	1968-1969		USMP11325
6.5L V8 6489cc 396 CID	1968-1969		USMP11325
6.6L V8 6588cc 402 CID	1970-1972		USMP11325

Engine	Years	Application Description	USMW
<b>GMC (cont'd.)</b>			
<b>C25 SUBURBAN</b>			
5.7L V8 350 CID	1975-1978	3 line unit	USMP16565
<b>C35</b>			
	1975-1978		USPR936
<b>C35/C3500 PICKUP</b>			
	1967-1974		USPR936
5.7L V8 350 CID	1972	3 Line Pump	USMP15538
6.5L V8 396 CID	1968-1969		USMP11325
6.5L V8 6489cc 396 CID	1968-1969		USMP11325
6.6L V8 6588cc 402 CID	1970-1972		USMP11325
<b>C1500</b>			
4.1L L6 250 CID	1979-1984		USMP16845
4.3L V6 262 CID	1986		USMP82505
4.8L L6 292 CID	1979-1980		USMP16845
5.0L V8 305 CID	1979-1982	3 line unit	USMP16565
5.0L V8 305 CID	1984	3 line unit	USMP16565
5.0L V8 305 CID	1986	3 line unit	USMP16565
5.7L V8 350 CID	1980		USMP50098
5.7L V8 350 CID	1981-1982	3 line unit	USMP16565
5.7L V8 350 CID	1984	3 line unit	USMP16565
5.7L V8 350 CID	1986	3 line unit	USMP16565
5.7L V8 350 CID	1988-1990	3 line unit	USMP16565
6.2L V8 379 CID	1982		USMP50703
6.2L V8 379 CID	1984		USMP50703
6.2L V8 379 CID	1986		USMP50703
6.6L V8 400 CID	1980		USMP50098
7.4L V8 454 CID	1980		USMP16570
<b>C1500 SUBURBAN</b>			
4.1L L6 250 CID	1979-1980		USMP16845
5.0L V8 305 CID	1981-1986	3 line unit	USMP16565
5.7L V8 350 CID	1981-1986	3 line unit	USMP16565
6.2L V8 379 CID	1982-1986		USMP50703
<b>C2500</b>			
	1979-1986		USPR936
4.1L L6 250 CID	1979-1983		USMP16845
4.3L V6 262 CID	1986		USMP82505
4.8L L6 292 CID	1979-1985		USMP16845
5.0L V8 305 CID	1980-1982	3 line unit	USMP16565
5.0L V8 305 CID	1984	3 line unit	USMP16565
5.7L V8 350 CID	1980		USMP50098
5.7L V8 350 CID	1981-1982	3 line unit	USMP16565
5.7L V8 350 CID	1984	3 line unit	USMP16565
5.7L V8 350 CID	1988	3 line unit	USMP16565
6.2L V8 379 CID	1982		USMP50703
6.2L V8 379 CID	1984		USMP50703
7.4L V8 454 CID	1980-1982		USMP16570
7.4L V8 454 CID	1984		USMP16570
<b>C2500 SUBURBAN</b>			
	1979-1986		USPR936
4.8L L6 292 CID	1979-1982		USMP16845
4.8L L6 292 CID	1984		USMP16845
5.0L V8 305 CID	1982-1984	3 line unit	USMP16565
5.7L V8 350 CID	1980		USMP50098
5.7L V8 350 CID	1981-1984	3 line unit	USMP16565
6.2L V8 379 CID	1982-1984		USMP50703
7.4L V8 454 CID	1980-1984		USMP16570
<b>C3500</b>			
	1979-1986		USPR936
4.1L L6 250 CID	1980		USMP16845
4.8L L6 292 CID	1979-1985		USMP16845
5.7L V8 350 CID	1981-1982	3 line unit	USMP16565
5.7L V8 350 CID	1984	3 line unit	USMP16565
6.2L V8 379 CID	1982		USMP50703
6.2L V8 379 CID	1984		USMP50703
7.4L V8 454 CID	1981-1982		USMP16570
7.4L V8 454 CID	1984		USMP16570
<b>C6000</b>			
6.0L V8 366 CID	1980-1985		USMP11760
<b>C7000</b>			
6.0L V8 366 CID	1980-1985		USMP11760
7.0L V8 427 CID	1980-1985		USMP11760
7.4L V8 454 CID	1980		USMP11760
<b>CABALLERO</b>			
	1978		USPR936
	1980-1987		USPR936
3.3L V6 200 CID	1978		USMP17631
3.8L V6 229 CID	1980-1984		USMP17503
3.8L V6 3800cc 231 CID	1978		USMP17378
3.8L V6 3800cc 231 CID	1980-1984		USMP17503
5.0L V8 305 CID	1978	2 line pump	USMP16560





# MECHANICAL FUEL PUMP APPLICATION GUIDE



Engine	Years	Application Description	USMW	Engine	Years	Application Description	USMW
<b>GMC (cont'd.)</b>				<b>GMC (cont'd.)</b>			
<b>CABALLERO (cont'd.)</b>				<b>JIMMY</b>			
5.0L V8 305 CID	1985-1987		USMP11713		1970-1972		USPR936
5.7L V8 350 CID	1978	2 line pump	USMP16560		1974		USPR936
<b>G15</b>					1978-1986		USPR936
	1975-1978		USPR936	4.1L L6 250 CID	1970		USMP11258
5.7L V8 350 CID	1975-1976	3 Line Pump	USMP15538	4.1L L6 4097cc 250 CID	1970		USMP11258
<b>G15/G1500 VAN</b>				5.0L V8 305 CID	1979-1982	3 line unit	USMP16565
	1967-1974		USPR936	5.0L V8 305 CID	1983-1986		USMP50098
5.7L V8 350 CID	1973-1974	3 Line Pump	USMP15538	5.0L V8 307 CID	1970-1971		USMP11283
<b>G25</b>				5.0L V8 5031cc 307 CID	1970-1971		USMP11283
	1975-1978		USPR936	5.7L V8 350 CID	1970-1972	2 line pump	USMP16560
5.7L V8 350 CID	1975-1976	3 Line Pump	USMP15538	5.7L V8 350 CID	1973	3 line unit	USMP16565
<b>G25/G2500 VAN</b>				5.7L V8 350 CID	1974	2 line pump	USMP16560
	1967-1974		USPR936	5.7L V8 350 CID	1975-1977	3 line unit	USMP16565
5.0L V8 307 CID	1973	3 Line Pump	USMP15538	5.7L V8 350 CID	1979-1982	3 line unit	USMP16565
5.7L V8 350 CID	1973-1974	3 Line Pump	USMP15538	5.7L V8 350 CID	1983-1986		USMP50098
<b>G35</b>				6.2L V8 379 CID	1983-1989		USMP50703
	1975-1978		USPR936	6.6L V8 400 CID	1975-1977	3 line unit	USMP16565
5.7L V8 350 CID	1975-1976	3 Line Pump	USMP15538	<b>K15</b>			
6.6L V8 400 CID	1975-1976	3 Line Pump	USMP15538		1975-1978		USPR936
<b>G35/G3500 VAN</b>				5.7L V8 350 CID	1975-1976	3 Line Pump	USMP15538
	1971-1974		USPR936	5.7L V8 350 CID	1975-1977	3 line unit	USMP16565
5.7L V8 350 CID	1973-1974	3 Line Pump	USMP15538	6.6L V8 400 CID	1975-1977	3 line unit	USMP16565
<b>G1000 SERIES</b>				<b>K15/K1500 PICKUP</b>			
	1964-1966		USPR936		1967-1974		USPR936
<b>G1500</b>				6.5L V8 396 CID	1968-1969		USMP11325
	1979-1980		USPR936	6.5L V8 6489cc 396 CID	1968-1969		USMP11325
	1982-1984		USPR936	6.6L V8 6588cc 402 CID	1970		USMP11325
	1986		USPR936	<b>K15/K1500 SUBURBAN</b>			
4.1L L6 250 CID	1979-1980		USMP16845		1967-1974		USPR936
4.1L L6 250 CID	1982-1983		USMP16845	5.7L V8 350 CID	1973-1974	3 line unit	USMP16565
4.3L V6 262 CID	1986		USMP82505	6.5L V8 396 CID	1968		USMP11325
5.0L V8 305 CID	1979-1980		USMP17638	6.5L V8 6489cc 396 CID	1968-1969		USMP11325
5.0L V8 305 CID	1982-1984		USMP50470	6.6L V8 6588cc 402 CID	1970-1971		USMP11325
5.0L V8 305 CID	1986		USMP50470	<b>K15 SUBURBAN</b>			
5.7L V8 350 CID	1979-1980		USMP17638		1975-1978		USPR936
5.7L V8 350 CID	1982-1984		USMP50470	5.7L V8 350 CID	1975-1976	3 Line Pump	USMP15538
5.7L V8 350 CID	1986		USMP50470	5.7L V8 350 CID	1975-1977	3 line unit	USMP16565
6.2L V8 379 CID	1983-1984		USMP50703	6.6L V8 400 CID	1975-1977	3 line unit	USMP16565
6.2L V8 379 CID	1986-1989		USMP50703	<b>K25</b>			
6.6L V8 400 CID	1979		USMP17638		1975-1978		USPR936
<b>G2500</b>				5.7L V8 350 CID	1975	3 Line Pump	USMP15538
	1979-1980		USPR936	5.7L V8 350 CID	1975-1977	3 line unit	USMP16565
	1982-1984		USPR936	6.6L V8 400 CID	1975-1977	3 line unit	USMP16565
	1986		USPR936	<b>K25/K2500 PICKUP</b>			
4.1L L6 250 CID	1979-1980		USMP16845		1967-1974		USPR936
4.1L L6 250 CID	1982-1983		USMP16845	6.5L V8 396 CID	1968-1969		USMP11325
4.3L V6 262 CID	1986		USMP82505	6.5L V8 6489cc 396 CID	1968-1969		USMP11325
5.0L V8 305 CID	1980		USMP17638	6.6L V8 6588cc 402 CID	1970		USMP11325
5.0L V8 305 CID	1982-1984		USMP50470	<b>K25/K2500 SUBURBAN</b>			
5.0L V8 305 CID	1986		USMP50470		1968-1974		USPR936
5.7L V8 350 CID	1979-1980		USMP17638	5.7L V8 350 CID	1973-1974	3 line unit	USMP16565
5.7L V8 350 CID	1982-1984		USMP50470	6.5L V8 396 CID	1968		USMP11325
5.7L V8 350 CID	1986		USMP50470	6.5L V8 6489cc 396 CID	1968-1969		USMP11325
6.2L V8 379 CID	1983-1984		USMP50703	6.6L V8 6588cc 402 CID	1970		USMP11325
6.2L V8 379 CID	1986-1989		USMP50703	<b>K25 SUBURBAN</b>			
6.6L V8 400 CID	1979-1980		USMP17638		1975-1978		USPR936
<b>G3500</b>				5.7L V8 350 CID	1975-1976	3 Line Pump	USMP15538
	1979-1984		USPR936	5.7L V8 350 CID	1975-1977	3 line unit	USMP16565
	1986-1988		USPR936	6.6L V8 400 CID	1975-1977	3 line unit	USMP16565
4.1L L6 250 CID	1979		USMP16845	<b>K35</b>			
4.1L L6 250 CID	1982-1983		USMP16845		1977-1978		USPR936
4.3L V6 262 CID	1986		USMP82505	<b>K35/K3500 PICKUP</b>			
5.0L V8 305 CID	1981		USMP50470		1968-1974		USPR936
5.7L V8 350 CID	1979-1980		USMP17638	6.5L V8 396 CID	1968-1969		USMP11325
5.7L V8 350 CID	1981-1984		USMP50470	6.5L V8 6489cc 396 CID	1968-1969		USMP11325
5.7L V8 350 CID	1986-1988		USMP50470	6.6L V8 6588cc 402 CID	1970-1971		USMP11325
6.2L V8 379 CID	1983-1984		USMP50703	<b>K1500</b>			
6.2L V8 379 CID	1986-1989		USMP50703		1979-1984		USPR936
6.6L V8 400 CID	1979-1980		USMP17638		1986		USPR936
<b>I1000</b>				4.1L L6 250 CID	1981-1983		USMP16845
	1966		USPR936	4.3L V6 262 CID	1986		USMP82505
<b>I1500</b>				5.0L V8 305 CID	1981-1984		USMP50098
	1966		USPR936	5.0L V8 305 CID	1986		USMP50098
<b>I2500</b>				5.7L V8 350 CID	1981-1984		USMP50098
	1966		USPR936	5.7L V8 350 CID	1986		USMP50098
<b>I3500</b>				6.2L V8 379 CID	1982-1984		USMP50703
	1966		USPR936	6.2L V8 379 CID	1986		USMP50703



# MECHANICAL FUEL PUMP APPLICATION GUIDE



Engine	Years	Application Description	USMW	Engine	Years	Application Description	USMW
<b>GMC (cont'd.)</b>				<b>GMC (cont'd.)</b>			
<b>K1500 SUBURBAN</b>				<b>R2500 SUBURBAN</b>			
5.0L V8 305 CID	1979-1986		USPR936	6.2L V8 379 CID	1987-1989		USMP50703
5.7L V8 350 CID	1982		USMP50098	<b>R3500</b>			
5.7L V8 350 CID	1981-1986		USMP50098				
6.2L V8 379 CID	1982-1986		USMP50703				
<b>K2500</b>							
4.8L L6 292 CID	1979-1984		USPR936				
5.7L V8 350 CID	1986		USPR936				
5.7L V8 350 CID	1981-1984		USMP16845				
5.7L V8 350 CID	1981-1984		USMP50098				
6.2L V8 379 CID	1986		USMP50098				
6.2L V8 379 CID	1982-1984		USMP50703				
6.2L V8 379 CID	1986		USMP50703				
<b>K2500 SUBURBAN</b>							
4.8L L6 292 CID	1979-1986		USPR936				
4.8L L6 292 CID	1981-1982		USMP16845				
4.8L L6 292 CID	1984		USMP16845				
5.7L V8 350 CID	1981-1986		USMP50098				
6.2L V8 379 CID	1982-1986		USMP50703				
<b>K3500</b>							
4.8L L6 292 CID	1979-1986		USPR936				
5.7L V8 350 CID	1981-1985		USMP16845				
5.7L V8 350 CID	1981-1986		USMP50098				
6.2L V8 379 CID	1982-1986		USMP50703				
7.4L V8 454 CID	1981-1986		USMP50478				
<b>P15</b>							
	1975		USPR936				
<b>P15/P1500 VAN</b>							
	1967-1974		USPR936				
<b>P25</b>							
	1975		USPR936				
	1977-1978		USPR936				
<b>P25/P2500 VAN</b>							
	1967-1974		USPR936				
<b>P35</b>							
	1975-1978		USPR936				
<b>P35/P3500 VAN</b>							
	1967-1974		USPR936				
<b>P1500</b>							
4.8L L6 292 CID	1979		USPR936				
7.4L V8 454 CID	1979-1980		USMP16845				
7.4L V8 454 CID	1979		USMP16570				
<b>P2500</b>							
4.8L L6 292 CID	1989		USMP16845				
6.2L V8 379 CID	1988-1989		USMP50703				
<b>P3500</b>							
	1985		USPR936				
<b>PB15 SERIES</b>							
	1966		USPR936				
<b>PB25 SERIES</b>							
	1966		USPR936				
<b>PB1000 SERIES</b>							
2.5L L4 2507cc 153 CID	1963-1965		USPR936				
3.8L L6 3769cc 230 CID	1963-1965		USMP08825				
3.8L L6 3769cc 230 CID	1963-1965		USMP08825				
<b>PB1500 SERIES</b>							
2.5L L4 2507cc 153 CID	1965		USMP08825				
3.8L L6 3769cc 230 CID	1963-1965		USMP08825				
5.0L V6 305 CID	1965		USMP17539				
<b>PB2500 SERIES</b>							
2.5L L4 2507cc 153 CID	1963		USPR936				
3.8L L6 3769cc 230 CID	1965		USMP08825				
5.0L V6 305 CID	1963-1965		USMP08825				
5.0L V6 305 CID	1965		USMP17539				
<b>PB3500 VAN</b>							
	1966		USPR936				
<b>R1500</b>							
6.2L V8 379 CID	1987		USMP50703				
<b>R1500 SUBURBAN</b>							
6.2L V8 379 CID	1987-1989		USMP50703				
<b>R2500</b>							
6.2L V8 379 CID	1987-1989		USMP50703				
				<b>HONDA</b>			
				<b>CIVIC</b>			
				1.3L L4 1342cc 82 CID 1984-1987			
				1.5L L4 1487cc 1984-1987			
				1.5L L4 1491cc 91 CID 1987			
				1.5L L4 1493cc 1986			
				<b>HYUNDAI</b>			
				<b>EXCEL</b>			
				1.5L L4 1468cc 90 CID 1986-1989			
				<b>INTERNATIONAL</b>			
				<b>100</b>			
				5.0L V8 304 CID 1974			
				5.0L V8 4982cc 304 CID 1974			
				5.0L V8 4983cc 304 CID 1974			
				5.6L V8 345 CID 1974			
				5.6L V8 5654cc 345 CID 1974			
				6.4L V8 392 CID 1974			
				6.4L V8 6424cc 392 CID 1974			
				6.4L V8 6425cc 392 CID 1974			
				<b>150</b>			
				5.0L V8 304 CID 1975			
				5.6L V8 345 CID 1975			
				6.4L V8 392 CID 1975			
				<b>200</b>			
				5.0L V8 304 CID 1974-1975			
				5.0L V8 4982cc 304 CID 1974			
				5.0L V8 4983cc 304 CID 1974			
				5.6L V8 345 CID 1974-1975			
				5.6L V8 5654cc 345 CID 1974			
				6.4L V8 392 CID 1974-1975			
				6.4L V8 6424cc 392 CID 1974			
				6.4L V8 6425cc 392 CID 1974			

MECHANICAL FUEL PUMPS



# MECHANICAL FUEL PUMP APPLICATION GUIDE



Engine	Years	Application Description	USMW
<b>INTERNATIONAL (cont'd.)</b>			
<b>908B</b>			
5.0L V8 4982cc 304 CID	1967		USMP17398
<b>908C</b>			
5.0L V8 304 CID	1969		USMP17398
5.0L V8 4982cc 304 CID	1968-1969		USMP17398
5.0L V8 4983cc 304 CID	1969		USMP17398
<b>1000D</b>			
4.3L L6 4335cc 264 CID	1969-1970	with inline filter	USMP06935
<b>1010</b>			
5.0L V8 304 CID	1972-1973		USMP17398
5.0L V8 4982cc 304 CID	1972-1973		USMP17398
5.0L V8 4983cc 304 CID	1972-1973		USMP17398
5.6L V8 5654cc 345 CID	1972-1973		USMP17398
5.7L V8 345 CID	1972-1973		USMP17398
6.4L V8 392 CID	1972-1973		USMP17398
6.4L V8 6424cc 392 CID	1972-1973		USMP17398
6.4L V8 6425cc 392 CID	1972-1973		USMP17398
<b>1110</b>			
5.0L V8 304 CID	1972-1973		USMP17398
5.0L V8 4982cc 304 CID	1971-1973		USMP17398
5.0L V8 4983cc 304 CID	1972-1973		USMP17398
5.6L V8 5654cc 345 CID	1971-1973		USMP17398
5.7L V8 345 CID	1971-1973		USMP17398
6.4L V8 392 CID	1972-1973		USMP17398
6.4L V8 6424cc 392 CID	1971-1973		USMP17398
6.4L V8 6425cc 392 CID	1972-1973		USMP17398
<b>1210</b>			
5.0L V8 304 CID	1972-1973		USMP17398
5.0L V8 4982cc 304 CID	1972-1973		USMP17398
5.0L V8 4983cc 304 CID	1972-1973		USMP17398
5.6L V8 5654cc 345 CID	1972-1973		USMP17398
5.7L V8 345 CID	1972-1973		USMP17398
6.4L V8 392 CID	1972-1973		USMP17398
6.4L V8 6424cc 392 CID	1972-1973		USMP17398
6.4L V8 6425cc 392 CID	1972-1973		USMP17398
<b>1310</b>			
5.0L V8 304 CID	1971-1973		USMP17398
5.0L V8 4982cc 304 CID	1971-1973		USMP17398
5.0L V8 4983cc 304 CID	1972-1973		USMP17398
5.6L V8 5654cc 345 CID	1971-1973		USMP17398
6.4L V8 392 CID	1972-1973		USMP17398
6.4L V8 6424cc 392 CID	1971-1973		USMP17398
6.4L V8 6425cc 392 CID	1972-1973		USMP17398
<b>AM120</b>			
3.6L L6 220 CID	1959-1960		USMP17465
3.6L L6 3608cc 220 CID	1961		USMP17465
<b>L110</b>			
3.6L L6 3608cc 220 CID	1950-1951		USMP17465
<b>L120</b>			
3.6L L6 3608cc 220 CID	1950-1951		USMP17465
<b>L150</b>			
3.6L L6 3608cc 220 CID	1950-1951		USMP17465
<b>M800</b>			
5.0L V8 4983cc 304 CID	1969-1970	with inline filter	USMP06935
<b>M1100</b>			
4.3L L6 4335cc 264 CID	1969-1970	with inline filter	USMP06935
<b>MHC1310</b>			
5.0L V8 304 CID	1974		USMP17398
5.0L V8 4982cc 304 CID	1974		USMP17398
5.0L V8 4983cc 304 CID	1974		USMP17398
<b>MS1210</b>			
5.0L V8 304 CID	1972-1974		USMP17398
5.0L V8 4982cc 304 CID	1972-1974		USMP17398
5.0L V8 4983cc 304 CID	1972-1974		USMP17398
5.6L V8 5654cc 345 CID	1972-1974		USMP17398
6.4L V8 6424cc 392 CID	1972-1974		USMP17398
<b>RM120</b>			
3.6L L6 220 CID	1953-1955		USMP17465
<b>SCOUT</b>			
2.5L L4 152 CID	1970		USMP17510
2.5L L4 2491cc 152 CID	1970		USMP17510
3.2L L4 196 CID	1968		USMP17510
3.2L L4 3203cc 196 CID	1968		USMP17510
3.2L L4 3212cc 196 CID	1968		USMP17510
5.0L V8 4982cc 304 CID	1969-1970	with inline filter	USMP06935

Engine	Years	Application Description	USMW
<b>INTERNATIONAL (cont'd.)</b>			
<b>SCOUT II</b>			
5.0L V8 304 CID	1971-1979		USMP17398
5.0L V8 4982cc 304 CID	1971-1974		USMP17398
5.0L V8 4983cc 304 CID	1971-1974		USMP17398
5.6L V8 345 CID	1971		USMP17398
5.6L V8 345 CID	1975-1980		USMP17398
5.6L V8 5654cc 345 CID	1971-1974		USMP17398
6.4L V8 392 CID	1975		USMP17398
<b>SM120</b>			
3.6L L6 220 CID	1956-1957		USMP17465
<b>TRAVELALL</b>			
5.0L V8 304 CID	1975		USMP17398
5.6L V8 345 CID	1975		USMP17398
6.4L V8 392 CID	1975		USMP17398
<b>ISUZU</b>			
<b>AMIGO</b>			
2.3L L4 2254cc	1989-1993		USMP75770
<b>I-MARK</b>			
1.5L L4 1471cc	1985-1989		USMP17607
1.8L L4 1817cc	1982-1984		USMP17577
1.8L L4 1817cc	1985		USMP17607
<b>PICKUP</b>			
2.3L L4 2254cc	1993-1994		USMP75770
<b>TROOPER</b>			
1.9L L4 1949cc	1984-1985		USMP17577
2.3L L4 2254cc	1986-1987		USMP75770
<b>JEEP</b>			
<b>CHEROKEE</b>			
2.8L V6 173 CID	1984-1986		USMP51013
4.2L L6 258 CID	1974-1983		USMP16843
4.2L L6 4228cc 258 CID	1974		USMP16843
4.2L L6 4229cc 258 CID	1974		USMP16843
5.9L V8 360 CID	1974-1975		USMP16263
5.9L V8 360 CID	1976-1983		USMP16840
6.6L V8 6572cc 401 CID	1974		USMP16263
6.6L V8 6572cc 401 CID	1976-1978		USMP16840
<b>CJ5</b>			
2.2L L4 134 CID	1970-1971		USMP05488
2.2L L4 2197cc 134 CID	1970-1971		USMP05488
2.5L L4 151 CID	1980-1983		USMP17502
3.8L L6 232 CID	1967	MEX	USMP16843
3.8L L6 232 CID	1970-1971	MEX	USMP16843
3.8L L6 3802cc 232 CID	1972-1974		USMP16843
4.2L L6 258 CID	1967	MEX	USMP16843
4.2L L6 258 CID	1970-1971	MEX	USMP16843
4.2L L6 258 CID	1974		USMP16843
4.2L L6 258 CID	1979-1983		USMP16843
4.2L L6 4228cc 258 CID	1974		USMP16843
4.2L L6 4229cc 258 CID	1974		USMP16843
4.6L L6 4622cc 282 CID	1973-1974	MEX	USMP17535
4.6L L6 4622cc 282 CID	1979	MEX	USMP17535
5.0L V8 304 CID	1979-1981		USMP16840
<b>CJ6</b>			
2.2L L4 134 CID	1970-1971		USMP05488
2.2L L4 2197cc 134 CID	1970-1971		USMP05488
3.8L L6 232 CID	1975		USMP16843
3.8L L6 3802cc 232 CID	1972-1974		USMP16843
4.2L L6 258 CID	1972-1975		USMP16843
4.2L L6 4228cc 258 CID	1972-1974		USMP16843
4.2L L6 4229cc 258 CID	1972-1974		USMP16843
<b>CJ7</b>			
2.5L L4 151 CID	1980-1982		USMP17502
3.8L L6 232 CID	1976-1978		USMP16843
4.2L L6 258 CID	1976-1983		USMP16843
4.6L L6 4622cc 282 CID	1980-1982		USMP17535
5.0L V8 304 CID	1976-1981		USMP16840
<b>COMANCHE</b>			
2.8L V6 173 CID	1986		USMP51013
<b>COMMANDO</b>			
2.2L L4 2197cc 134 CID	1971		USMP05488
3.8L L6 232 CID	1972-1973		USMP16843
3.8L L6 3802cc 232 CID	1972-1973		USMP16843
4.2L L6 258 CID	1972-1973		USMP16843
4.2L L6 4228cc 258 CID	1972-1973		USMP16843
4.2L L6 4229cc 258 CID	1972-1973		USMP16843
<b>DJ5</b>			
2.2L L4 134 CID	1970-1971		USMP05488





# MECHANICAL FUEL PUMP APPLICATION GUIDE



MECHANICAL FUEL PUMPS

Engine	Years	Application Description	USMW	Engine	Years	Application Description	USMW
<b>JEEP (cont'd.)</b>				<b>LINCOLN</b>			
<b>DJ5 (cont'd.)</b>				<b>CONTINENTAL</b>			
2.2L L4 2197cc 134 CID	1967		USMP05488	3.8L V6 232 CID	1982		USMP17537
2.2L L4 2197cc 134 CID	1970-1971		USMP05488	5.0L V8 302 CID	1982		USMP17519
3.7L V6 3687cc 225 CID	1967		USMP11280	6.6L V8 400 CID	1977-1979		USMP17205
3.7L V6 3687cc 225 CID	1970		USMP11280	7.5L V8 460 CID	1968-1974		USMP17195
3.8L L6 232 CID	1972-1973		USMP16843	7.5L V8 460 CID	1977-1978		USMP17195
3.8L L6 3802cc 232 CID	1972-1973		USMP16843	7.5L V8 7539cc 460 CID	1968-1974		USMP17195
4.2L L6 258 CID	1973-1974		USMP16843	<b>MARK III</b>			
4.2L L6 4228cc 258 CID	1973-1974		USMP16843	7.5L V8 460 CID	1968-1971		USMP17195
4.2L L6 4229cc 258 CID	1973-1974		USMP16843	7.5L V8 7539cc 460 CID	1968-1971		USMP17195
<b>DJ6</b>				<b>MARK IV</b>			
3.7L V6 3687cc 225 CID	1968		USMP11280	7.5L V8 460 CID	1972-1974		USMP17195
<b>GRAND WAGONEER</b>				7.5L V8 7539cc 460 CID	1972-1974		USMP17195
4.2L L6 258 CID	1984-1986		USMP16843	<b>MARK V</b>			
5.9L V8 360 CID	1984-1991		USMP16840	6.6L V8 400 CID	1977-1979		USMP17205
<b>J10</b>				7.5L V8 460 CID	1977-1978		USMP17195
4.2L L6 258 CID	1974-1980		USMP16843	<b>VERSAILLES</b>			
4.2L L6 258 CID	1981-1987		USMP50418	5.0L V8 302 CID	1977-1980		USMP16875
4.2L L6 4228cc 258 CID	1974		USMP16843	5.8L V8 5753cc 351 CID	1977		USMP16875
4.2L L6 4229cc 258 CID	1974		USMP16843	<b>MAZDA</b>			
5.9L V8 360 CID	1974-1975		USMP16263	<b>626</b>			
5.9L V8 360 CID	1976-1988		USMP16840	2.0L L4 1970cc	1983		USMP17640
6.6L V8 6572cc 401 CID	1974-1975		USMP16263	2.0L L4 1998cc 122 CID	1984-1985		USMP17640
6.6L V8 6572cc 401 CID	1976-1978		USMP16840	<b>B2000</b>			
<b>J20</b>				2.0L L4 1998cc 122 CID	1986-1987		USMP75490
4.2L L6 258 CID	1974		USMP16843	<b>B2200</b>			
4.2L L6 258 CID	1976		USMP16843	2.2L L4 2184cc	1987-1993		USMP75490
4.2L L6 4228cc 258 CID	1974		USMP16843	<b>GLC</b>			
4.2L L6 4229cc 258 CID	1974		USMP16843	1.5L L4 1490cc	1985		USMP17606
5.9L V8 360 CID	1974-1975		USMP16263	<b>MERCURY</b>			
5.9L V8 360 CID	1976-1988		USMP16840	<b>BOBCAT</b>			
6.6L V8 6572cc 401 CID	1974		USMP16263	2.8L V6 171 CID	1978-1979		USMP17531
6.6L V8 6572cc 401 CID	1976-1978		USMP16840	<b>CAPRI</b>			
<b>J-100</b>				2.3L L4 140 CID	1976-1977		USMP16870
3.8L L6 230 CID	1967		USMP17535	2.8L V6 171 CID	1979		USMP17531
3.8L L6 232 CID	1968-1969		USMP17535	3.3L L6 200 CID	1979-1982		USMP50825
3.8L L6 3802cc 232 CID	1967-1969		USMP17535	3.8L V6 232 CID	1983		USMP17537
4.2L L6 4228cc 258 CID	1971-1973		USMP16843	4.2L V8 255 CID	1980-1982		USMP17519
5.7L V8 350 CID	1969		USMP17595	5.0L V8 302 CID	1979		USMP17519
5.9L V8 360 CID	1971-1973		USMP16263	5.0L V8 302 CID	1982-1985		usmp50633
<b>JEEPSTER</b>				5.0L V8 302 CID	1982-1985		USMP17565
2.2L L4 134 CID	1970-1971		USMP05488	<b>COLONY PARK</b>			
2.2L L4 2197cc 134 CID	1970-1971		USMP05488	6.4L V8 390 CID	1970		USMP17460
<b>SCRAMBLER</b>				6.4L V8 6391cc 390 CID	1965-1966		USMP08820
2.5L L4 150 CID	1984-1985		USMP16843	6.4L V8 6391cc 390 CID	1970		USMP17460
2.5L L4 151 CID	1982		USMP17502	6.6L V8 400 CID	1971-1974		USMP17205
4.2L L6 258 CID	1981-1985		USMP16843	6.6L V8 6555cc 400 CID	1971-1974		USMP17205
<b>WAGONEER</b>				6.6L V8 6556cc 400 CID	1971-1974		USMP17205
2.8L V6 173 CID	1984-1986		USMP51013	7.0L V8 429 CID	1969-1973		USMP17195
3.8L L6 230 CID	1967		USMP17535	7.0L V8 7014cc 428 CID	1967		USMP17558
4.2L L6 258 CID	1972-1973		USMP16843	7.0L V8 7014cc 428 CID	1969-1970		USMP17195
4.2L L6 258 CID	1980-1983		USMP16843	7.0L V8 7030cc 429 CID	1969-1973		USMP17195
4.2L L6 4228cc 258 CID	1972-1973		USMP16843	7.5L V8 460 CID	1972-1974		USMP17195
4.2L L6 4229cc 258 CID	1972-1973		USMP16843	7.5L V8 7539cc 460 CID	1972-1974		USMP17195
4.6L L6 4622cc 282 CID	1976-1986		USMP17535	<b>COMET</b>			
5.7L V8 350 CID	1971		USMP17595	2.4L L6 144 CID	1961		USMP17504
5.9L V8 360 CID	1972-1975		USMP16263	2.4L L6 2360cc 144 CID	1961		USMP17504
5.9L V8 360 CID	1976-1983		USMP16840	2.8L L6 170 CID	1972		USMP17464
6.6L V8 6572cc 401 CID	1974-1975		USMP16263	2.8L L6 2786cc 170 CID	1961		USMP17504
6.6L V8 6572cc 401 CID	1976-1978		USMP16840	2.8L L6 2786cc 170 CID	1972		USMP17464
<b>WILLYS</b>				3.3L L6 200 CID	1976-1977		USMP50825
2.2L L4 2197cc 134 CID	1947-1949		USMP05488	4.1L L6 250 CID	1976-1977		USMP50825
<b>KAISER</b>				5.0L V8 302 CID	1968-1969		USMP16470
<b>CAROLINA</b>				5.0L V8 302 CID	1971-1974		USMP16470
3.7L L6 3704cc 226 CID	1953		USMP17576	5.0L V8 302 CID	1975		USMP17405
<b>CUSTOM</b>				5.0L V8 302 CID	1976-1977		USMP16875
3.7L L6 3704cc 226 CID	1947-1948		USMP17576	6.4L V8 390 CID	1968-1969		USMP17460
<b>DELUXE</b>				6.4L V8 6391cc 390 CID	1966		USMP08820
3.7L L6 226 CID	1950		USMP17576	6.4L V8 6391cc 390 CID	1968-1969		USMP17460
3.7L L6 3704cc 226 CID	1949-1953		USMP17576	7.0L V8 6997cc 427 CID	1967		USMP17558
<b>DRAGON</b>				<b>COUGAR</b>			
3.7L L6 3704cc 226 CID	1953		USMP17576	3.3L L6 200 CID	1980-1982		USMP50825
<b>MANHATTAN</b>				3.8L V6 232 CID	1982-1983		USMP17537
3.7L L6 3704cc 226 CID	1952-1953		USMP17576	4.2L V8 255 CID	1980		USMP17519
<b>SPECIAL</b>				4.2L V8 255 CID	1981		USMP16875
3.7L L6 3704cc 226 CID	1947-1951		USMP17576	4.2L V8 255 CID	1982		USMP17519
				4.7L V8 289 CID	1968		USMP16470

Engine	Years	Application Description	USMW	Engine	Years	Application Description	USMW
<b>MERCURY (cont'd.)</b>				<b>MERCURY (cont'd.)</b>			
<b>COUGAR (cont'd.)</b>				<b>MONTCLAIR (cont'd.)</b>			
4.7L V8 4727cc 289 CID	1968		USMP16470	5.1L V8 5114cc 312 CID	1956-1957		USMP17469
5.0L V8 302 CID	1968		USMP16470	6.0L V8 6032cc 368 CID	1957		USMP17469
5.0L V8 302 CID	1979		USMP17405	6.4L V8 6391cc 390 CID	1964-1966		USMP08820
5.0L V8 302 CID	1980-1981		USMP17519	6.7L V8 6720cc 410 CID	1966		USMP08820
5.8L V8 5753cc 351 CID	1979		USMP17405	7.0L V8 6997cc 427 CID	1965		USMP17558
6.4L V8 390 CID	1968-1969		USMP17460	7.0L V8 6997cc 427 CID	1966		USMP08820
6.4L V8 6391cc 390 CID	1967-1969		USMP17460	7.0L V8 7014cc 428 CID	1966		USMP08820
6.6L V8 400 CID	1973		USMP17205	7.0L V8 7014cc 428 CID	1967		USMP17558
6.6L V8 6555cc 400 CID	1973		USMP17205	<b>MONTEGO</b>			
6.6L V8 6556cc 400 CID	1973		USMP17205	4.1L L6 4097cc 250 CID	1971		USMP17205
7.0L V8 427 CID	1968		USMP17558	5.0L V8 302 CID	1968-1971		USMP16470
7.0L V8 428 CID	1968-1969		USMP17558	6.4L V8 390 CID	1968-1969		USMP17460
7.0L V8 429 CID	1971		USMP17195	6.4L V8 6391cc 390 CID	1968-1969		USMP17460
7.0L V8 6997cc 427 CID	1968		USMP17558	7.0L V8 427 CID	1968		USMP17558
7.0L V8 7014cc 428 CID	1968-1969		USMP17558	7.0L V8 428 CID	1969		USMP17195
7.0L V8 7030cc 429 CID	1971		USMP17195	7.0L V8 429 CID	1970-1971		USMP17195
<b>CUSTOM</b>				7.0L V8 6997cc 427 CID	1968		USMP17558
4.8L V8 4786cc 292 CID	1955		USMP17469	7.0L V8 6997cc 427 CID	1969		USMP17195
5.1L V8 5114cc 312 CID	1956		USMP17469	7.0L V8 7014cc 428 CID	1969		USMP17195
<b>CYCLONE</b>				7.0L V8 7030cc 429 CID	1970-1971		USMP17195
4.7L V8 4727cc 289 CID	1965		USMP10023	<b>MONTEREY</b>			
5.0L V8 302 CID	1968-1969		USMP16470	4.8L V8 4786cc 292 CID	1955		USMP17469
6.4L V8 390 CID	1968-1969		USMP17460	5.1L V8 5114cc 312 CID	1956-1957		USMP17469
6.4L V8 6391cc 390 CID	1968-1969		USMP17460	6.0L V8 6032cc 368 CID	1957		USMP17469
7.0L V8 429 CID	1970-1971		USMP17195	6.4L V8 390 CID	1963		USMP08820
7.0L V8 7030cc 429 CID	1970-1971		USMP17195	6.4L V8 390 CID	1970		USMP17460
<b>GRAND MARQUIS</b>				6.4L V8 6391cc 390 CID	1963-1965		USMP08820
4.2L V8 255 CID	1982		USMP16875	6.4L V8 6391cc 390 CID	1970		USMP17460
5.0L V8 302 CID	1979		USMP16875	6.6L V8 400 CID	1971-1974		USMP17205
5.0L V8 302 CID	1982		USMP16875	6.6L V8 6555cc 400 CID	1971-1974		USMP17205
5.8L V8 5753cc 351 CID	1979		USMP16875	6.6L V8 6556cc 400 CID	1971-1974		USMP17205
5.8L V8 5753cc 351 CID	1986		USMP17554	7.0L V8 428 CID	1968-1970		USMP17195
6.6L V8 400 CID	1975-1977		USMP17205	7.0L V8 429 CID	1969-1973		USMP17195
7.5L V8 460 CID	1977		USMP17195	7.0L V8 6997cc 427 CID	1965		USMP17558
<b>LN7</b>				7.0L V8 7014cc 428 CID	1967		USMP17558
1.6L L4 1598cc 98 CID	1982-1983		USMP17639	7.0L V8 7014cc 428 CID	1968-1970		USMP17195
<b>LYNX</b>				7.0L V8 7030cc 429 CID	1969-1973		USMP17195
1.6L L4 1598cc 98 CID	1981-1985		USMP17639	7.5L V8 460 CID	1972-1974		USMP17195
1.9L L4 116 CID	1985-1986		USMP17639	7.5L V8 7539cc 460 CID	1972-1974		USMP17195
<b>MARAUDER</b>				<b>PARK LANE</b>			
6.4L V8 390 CID	1970		USMP17460	6.4L V8 6391cc 390 CID	1964-1965		USMP08820
6.4L V8 6391cc 390 CID	1963-1964		USMP08820	7.0L V8 428 CID	1968		USMP17558
6.4L V8 6391cc 390 CID	1970		USMP17460	7.0L V8 6997cc 427 CID	1965		USMP17558
7.0L V8 429 CID	1969-1970		USMP17195	7.0L V8 7014cc 428 CID	1967-1968		USMP17558
7.0L V8 7014cc 428 CID	1969-1970		USMP17195	<b>ZEPHYR</b>			
7.0L V8 7030cc 429 CID	1969-1970		USMP17195	3.3L L6 200 CID	1978-1983		USMP50825
<b>MARQUIS</b>				4.2L V8 255 CID	1980-1982		USMP17519
3.3L L6 200 CID	1983		USMP50825	5.0L V8 302 CID	1978		USMP16875
3.8L V6 232 CID	1983-1984		USMP17537	5.0L V8 302 CID	1979		USMP17519
4.2L V8 255 CID	1982		USMP16875	<b>MITSUBISHI</b>			
5.0L V8 302 CID	1979		USMP16875	<b>CORDIA</b>			
5.0L V8 302 CID	1982		USMP16875	2.0L L4 1997cc 122 CID	1984-1986		USMP17642
5.8L V8 5753cc 351 CID	1979		USMP16875	2.0L L4 1997cc 122 CID	1987-1988		USMP75768
6.4L V8 390 CID	1970		USMP17460	<b>MIRAGE</b>			
6.4L V8 6391cc 390 CID	1970		USMP17460	1.5L L4 1468cc 90 CID	1985-1986		USMP17642
6.6L V8 400 CID	1971-1977		USMP17205	1.5L L4 1468cc 90 CID	1987-1988		USMP75768
6.6L V8 6555cc 400 CID	1971-1974		USMP17205	<b>PRECIS</b>			
6.6L V8 6556cc 400 CID	1971-1974		USMP17205	1.5L L4 1468cc 90 CID	1987-1989		USMP75768
7.0L V8 428 CID	1968		USMP17558	<b>TREDIA</b>			
7.0L V8 429 CID	1970-1973		USMP17195	2.0L L4 1997cc 122 CID	1984-1986		USMP17642
7.0L V8 7014cc 428 CID	1967-1968		USMP17558	2.0L L4 1997cc 122 CID	1987-1988		USMP75768
7.0L V8 7014cc 428 CID	1970		USMP17195	<b>NISSAN</b>			
7.0L V8 7030cc 429 CID	1970-1973		USMP17195	<b>240Z</b>			
7.5L V8 460 CID	1972-1974		USMP17195	2.4L L6 2393cc 146 CID	1970-1973		USMP17462
7.5L V8 460 CID	1977		USMP17195	<b>260Z</b>			
7.5L V8 7539cc 460 CID	1972-1974		USMP17195		1974		USMP17462
<b>MEDALIST</b>				<b>310</b>			
5.1L V8 5114cc 312 CID	1956		USMP17469	1.5L L4 1488cc	1982		USMP17628
5.1L V8 5114cc 312 CID	1958		USMP17469	<b>610</b>			
<b>MONARCH</b>				1.8L L4 1770cc 108 CID	1973		USMP17496
3.3L L6 200 CID	1976-1977		USMP50825	2.0L L4 1952cc	1975		USMP17496
4.1L L6 250 CID	1976-1980		USMP50825	2.0L L4 1952cc 119 CID	1974		USMP17496
4.2L V8 255 CID	1980		USMP16875	<b>620</b>			
5.0L V8 302 CID	1975		USMP17405	2.0L L4 1952cc	1975		USMP17496
5.0L V8 302 CID	1976-1980		USMP16875	2.0L L4 1952cc	1978-1979		USMP17641
5.8L V8 5753cc 351 CID	1975-1976		USMP17405				
5.8L V8 5753cc 351 CID	1977		USMP16875				
<b>MONTCLAIR</b>							
4.8L V8 4786cc 292 CID	1955		USMP17469				

Engine	Years	Application Description	USMW	Engine	Years	Application Description	USMW
<b>NISSAN (cont'd.)</b>				<b>OLDSMOBILE (cont'd.)</b>			
<b>620 PICKUP</b>				<b>CUTLASS SALON</b>			
1.6L L4 1595cc 97 CID	1972-1973		USMP17496		1978-1980		USPR936
1.8L L4 1770cc 108 CID	1974		USMP17496	<b>CUTLASS SUPREME</b>			
<b>710</b>					1978-1986		USPR936
1.8L L4 1770cc 108 CID	1974		USMP17496	5.0L V8 307 CID	1988		USMP15273
2.0L L4 1952cc	1975-1977		USMP17496	<b>DELTA 88</b>			
<b>B210</b>					1977-1984		USPR936
1.4L L4 1393cc 85 CID	1977		USMP17593	3.8L V6 3800cc 231 CID	1978-1980		USMP17378
<b>F10</b>				4.3L V8 260 CID	1978-1980		USMP15270
1.4L L4 1393cc 85 CID	1976		USMP17593	4.9L V8 301 CID	1979		USMP17533
<b>PULSAR</b>				5.0L V8 307 CID	1980		USMP15270
1.6L L4 1597cc 97 CID	1983		USMP17509	5.0L V8 307 CID	1984-1985		USMP15273
<b>SENTRA</b>				5.7L V8 350 CID	1976	3 line unit	USMP15273
1.5L L4 1488cc	1983		USMP17628	5.7L V8 350 CID	1977		USMP16565
1.6L L4 1597cc 97 CID	1983-1985		USMP17509	5.7L V8 350 CID	1978-1980		USMP15273
1.6L L4 1597cc 97 CID	1988		USMP17509	6.6L V8 403 CID	1978-1979		USMP15273
<b>STANZA</b>				7.5L V8 455 CID	1976		USMP15273
2.0L L4 1974cc	1982-1983		USMP17629	<b>F85</b>			
<b>OLDSMOBILE</b>					1966-1968		USPR936
<b>98</b>					1970-1971		USPR936
	1978-1984		USPR936	3.5L V8 215 CID	1962		USMP17489
5.0L V8 307 CID	1980		USMP15270	3.5L V8 3528cc 215 CID	1961-1962		USMP17489
5.0L V8 307 CID	1984		USMP15273	5.4L V8 5409cc 330 CID	1967		USMP40523
5.7L V8 350 CID	1977		USMP15270	5.7L V8 350 CID	1968		USMP40523
5.7L V8 350 CID	1978-1980		USMP15273	<b>OMEGA</b>			
6.5L V8 6458cc 394 CID	1962		USMP17489		1973-1974		USPR936
6.6L V8 400 CID	1975		USMP15305		1977-1979		USPR936
6.6L V8 403 CID	1977-1979		USMP15273	2.5L L4 2474cc 151 CID	1980-1981		USMP17502
7.5L V8 455 CID	1975-1976		USMP15273	2.8L V6 173 CID	1980-1981		USMP75733
<b>442</b>				2.8L V6 173 CID	1983-1984		USMP50838
6.6L V8 400 CID	1968		USMP17616	5.7L V8 350 CID	1973-1974		USMP15273
6.6L V8 400 CID	1969		USMP40523	5.7L V8 350 CID	1977-1979	3 line unit	USMP16565
6.6L V8 6555cc 400 CID	1968		USMP17616	<b>STARFIRE</b>			
6.6L V8 6555cc 400 CID	1969		USMP40523	2.5L L4 2474cc 151 CID	1978-1980		USMP17547
<b>CUSTOM CRUISER</b>				6.5L V8 6458cc 394 CID	1962		USMP17489
	1977-1984		USPR936	<b>SUPER 88</b>			
5.7L V8 350 CID	1977	2 line pump	USMP16560	6.5L V8 6458cc 394 CID	1962		USMP17489
5.7L V8 350 CID	1977	3 line unit	USMP16565	<b>TORONADO</b>			
5.7L V8 350 CID	1978-1979		USMP15273		1979-1984		USPR936
6.6L V8 403 CID	1978-1979		USMP15273	5.0L V8 307 CID	1980		USMP15270
7.5L V8 455 CID	1976		USMP15273	5.0L V8 307 CID	1982		USMP15273
<b>CUTLASS</b>				5.0L V8 307 CID	1984-1985		USMP15273
	1971		USPR936	5.7L V8 350 CID	1979-1980		USMP15273
	1978-1981		USPR936	<b>VISTA CRUISER</b>			
3.1L V6 189 CID	1987		USMP17596	5.4L V8 330 CID	1965		USMP17489
3.5L V8 3528cc 215 CID	1962		USMP17489	5.4L V8 330 CID	1967		USMP40523
3.8L V6 3800cc 231 CID	1978		USMP17378	5.4L V8 5409cc 330 CID	1965		USMP17489
3.8L V6 3800cc 231 CID	1980-1981		USMP17378	5.4L V8 5409cc 330 CID	1967		USMP40523
4.1L L6 250 CID	1975-1976		USMP16845	5.7L V8 350 CID	1968		USMP40523
4.3L V8 260 CID	1975		USMP15270	5.7L V8 350 CID	1975		USMP15270
4.3L V8 260 CID	1976		USMP15273	6.6L V8 400 CID	1968		USMP17616
4.3L V8 260 CID	1977-1978		USMP15270	6.6L V8 6555cc 400 CID	1968		USMP17616
4.3L V8 260 CID	1980-1981		USMP15270	7.5L V8 455 CID	1975		USMP15273
5.0L V8 305 CID	1978	2 line pump	USMP16560	<b>PLYMOUTH</b>			
5.0L V8 305 CID	1980	2 line pump	USMP16560	<b>ARROW</b>			
5.0L V8 305 CID	1985		USMP15273	1.6L L4 1597cc 98 CID	1978-1980		USMP17604
5.0L V8 305 CID	1987		USMP15273	2.6L L4 2555cc 156 CID	1979		USMP17604
5.4L V8 5409cc 330 CID	1967		USMP40523	<b>BARRACUDA</b>			
5.7L V8 350 CID	1968		USMP40523	3.2L L6 3254cc 198 CID	1970		USMP51443
5.7L V8 350 CID	1975-1977		USMP15270	4.5L V8 4473cc 273 CID	1964		USMP17165
5.7L V8 350 CID	1978	2 line pump	USMP16560	4.5L V8 4473cc 273 CID	1967		USMP17165
5.7L V8 350 CID	1980		USMP15273	5.6L V8 340 CID	1968-1969		USMP17165
6.6L V8 400 CID	1968		USMP17616	5.6L V8 340 CID	1972		USMP17165
6.6L V8 403 CID	1977		USMP15273	5.6L V8 340 CID	1973		USMP51285
6.6L V8 6555cc 400 CID	1967-1968		USMP17616	5.6L V8 5572cc 340 CID	1968-1969		USMP17165
7.5L V8 455 CID	1975-1976		USMP15273	5.6L V8 5572cc 340 CID	1972		USMP17165
<b>CUTLASS CALAIS</b>				5.6L V8 5572cc 340 CID	1973		USMP51285
	1978-1984		USPR936	5.9L V8 360 CID	1974		USMP51285
<b>CUTLASS CIERA</b>				6.3L V8 383 CID	1968		USMP09180
2.8L V6 173 CID	1986		USMP50838	6.3L V8 383 CID	1969		USMP11473
<b>CUTLASS CRUISER</b>				6.3L V8 383 CID	1970		USMP12113
	1980-1983		USPR936	6.3L V8 6286cc 383 CID	1968		USMP09180
4.3L V8 260 CID	1980-1981		USMP15270	6.3L V8 6286cc 383 CID	1969		USMP11473
5.0L V8 305 CID	1980	2 line pump	USMP16560	6.3L V8 6286cc 383 CID	1970		USMP12113
5.0L V8 305 CID	1982-1983		USMP15273	<b>BELVEDERE</b>			
5.0L V8 307 CID	1981-1983		USMP15273	3.8L L6 3770cc 230 CID	1954		USMP17477
5.7L V8 350 CID	1980		USMP15273	4.5L V8 273 CID	1968		USMP17165
				4.5L V8 4473cc 273 CID	1965-1968		USMP17165
				4.9L V8 299 CID	1957		USMP52684





# MECHANICAL FUEL PUMP APPLICATION GUIDE



Engine	Years	Application Description	USMW	Engine	Years	Application Description	USMW
<b>PLYMOUTH (cont'd.)</b>				<b>PLYMOUTH (cont'd.)</b>			
<b>BELVEDERE (cont'd.)</b>				<b>HORIZON</b>			
4.9L V8 4933cc 301 CID	1957		USMP52684	1.6L L4 1595cc 97 CID	1983-1986		USMP17636
5.2L V8 317 CID	1958-1959		USMP52684	2.2L L4 135 CID	1981-1987		USMP17494
5.9L V8 5917cc 361 CID	1959-1966		USMP09180	<b>PB100</b>			
6.3L V8 383 CID	1968		USMP09180	3.7L L6 3687cc 225 CID	1978		USMP51443
6.3L V8 383 CID	1969-1970		USMP11473	3.7L L6 3687cc 225 CID	1979-1980		USMP51440
6.3L V8 6286cc 383 CID	1960-1968		USMP09180	5.2L V8 5211cc 318 CID	1976-1977		USMP17165
6.3L V8 6286cc 383 CID	1969-1970		USMP11473	5.2L V8 5211cc 318 CID	1978-1980		USMP51285
7.0L V8 6981cc 426 CID	1964-1966		USMP09180	5.9L V8 360 CID	1976-1977		USMP17165
7.2L V8 7211cc 440 CID	1967		USMP09180	5.9L V8 360 CID	1978		USMP51285
<b>CAMBRIDGE</b>				<b>PB150</b>			
3.6L L6 3570cc 218 CID	1951-1953		USMP17477	3.7L L6 3687cc 225 CID	1981-1983		USMP51440
<b>CARAVELLE</b>				5.2L V8 5211cc 318 CID	1981		USMP51285
2.6L L4 2555cc 156 CID	1985		USMP17521	5.2L V8 5211cc 318 CID	1983		USMP51285
<b>CHAMP</b>				<b>PB200</b>			
1.4L L4 1410cc	1979-1981		USMP17491	3.7L L6 3687cc 225 CID	1976-1978		USMP51443
1.6L L4 1597cc 98 CID	1979-1980		USMP17604	3.7L L6 3687cc 225 CID	1980		USMP51440
1.6L L4 1597cc 98 CID	1981-1982		USMP17627	5.2L V8 5211cc 318 CID	1976-1977		USMP17165
<b>COLT</b>				5.2L V8 5211cc 318 CID	1978-1980		USMP51285
1.5L L4 1468cc 90 CID	1985-1986		USMP17642	5.9L V8 360 CID	1976-1977		USMP17165
1.5L L4 1468cc 90 CID	1987-1988		USMP75768	5.9L V8 360 CID	1978-1980		USMP51285
1.6L L4 1597cc 98 CID	1983-1984		USMP17627	6.6L V8 400 CID	1976-1978		USMP17338
2.0L L4 1997cc 122 CID	1984-1987		USMP17642	7.2L V8 7211cc 440 CID	1976-1978		USMP17338
<b>CONCORD</b>				<b>PB250</b>			
3.6L L6 218 CID	1951-1952		USMP17477	3.7L L6 3687cc 225 CID	1981-1983		USMP51440
3.6L L6 3570cc 218 CID	1951-1952		USMP17477	5.2L V8 5211cc 318 CID	1981-1983		USMP51285
<b>CRANBROOK</b>				5.9L V8 360 CID	1981		USMP51285
3.6L L6 3570cc 218 CID	1951-1953		USMP17477	<b>PB300</b>			
<b>CUDA</b>				5.2L V8 5211cc 318 CID	1976-1977		USMP17165
5.6L V8 5572cc 340 CID	1970		USMP12113	5.2L V8 5211cc 318 CID	1978-1980		USMP51285
6.3L V8 383 CID	1970-1971		USMP12113	5.9L V8 360 CID	1976-1977		USMP17165
6.3L V8 6286cc 383 CID	1970-1971		USMP12113	5.9L V8 360 CID	1978-1980		USMP51285
7.0L V8 6981cc 426 CID	1970-1971		USMP12113	6.6L V8 400 CID	1976-1978		USMP17338
7.2L V8 7211cc 440 CID	1970-1971		USMP12113	7.2L V8 7211cc 440 CID	1976-1978		USMP17338
<b>DELUXE</b>				<b>PB350</b>			
3.6L L6 3570cc 218 CID	1949-1950		USMP17477	5.2L V8 5211cc 318 CID	1981-1983		USMP51285
<b>DUSTER</b>				5.9L V8 360 CID	1981-1983		USMP51285
3.2L L6 198 CID	1970		USMP51443	<b>PLAZA</b>			
3.2L L6 3254cc 198 CID	1970		USMP51443	3.6L L6 3570cc 218 CID	1954		USMP17477
5.6L V8 340 CID	1970-1972		USMP17165	4.5L V8 273 CID	1957		USMP52684
5.6L V8 340 CID	1973		USMP51285	4.5L V8 4540cc 277 CID	1957		USMP52684
5.6L V8 5572cc 340 CID	1970-1972		USMP17165	5.2L V8 317 CID	1958		USMP52684
5.6L V8 5572cc 340 CID	1973		USMP51285	<b>RELIANT</b>			
5.9L V8 360 CID	1974-1976		USMP51285	2.2L L4 135 CID	1981-1985		USMP17494
<b>FURY</b>				2.6L L4 2555cc 156 CID	1981-1985		USMP17521
3.7L L6 3687cc 225 CID	1978		USMP51443	<b>ROAD RUNNER</b>			
5.7L V8 5737cc 350 CID	1958		USMP09180	4.5L V8 273 CID	1968		USMP17165
5.9L V8 360 CID	1972		USMP17165	4.5L V8 4473cc 273 CID	1968		USMP17165
5.9L V8 360 CID	1973-1976		USMP51285	5.6L V8 340 CID	1972		USMP17165
5.9L V8 360 CID	1977-1978		USMP51298	5.6L V8 340 CID	1973		USMP51285
5.9L V8 361 CID	1964		USMP09180	5.6L V8 5572cc 340 CID	1972		USMP17165
5.9L V8 5917cc 361 CID	1959-1964		USMP09180	5.6L V8 5572cc 340 CID	1973		USMP51285
6.3L V8 383 CID	1964-1968		USMP09180	5.9L V8 360 CID	1974-1975		USMP51285
6.3L V8 383 CID	1969		USMP11473	6.3L V8 383 CID	1968		USMP09180
6.3L V8 6286cc 383 CID	1960-1968		USMP09180	6.3L V8 383 CID	1969		USMP11473
6.3L V8 6286cc 383 CID	1969		USMP11473	6.3L V8 383 CID	1970-1971		USMP12113
6.6L V8 400 CID	1972		USMP17597	6.3L V8 6286cc 383 CID	1968		USMP09180
6.6L V8 6556cc 400 CID	1972		USMP17597	6.3L V8 6286cc 383 CID	1969		USMP11473
7.0L V8 426 CID	1964-1965		USMP09180	6.3L V8 6286cc 383 CID	1970-1971		USMP12113
7.0L V8 6981cc 426 CID	1964-1965		USMP09180	6.6L V8 6556cc 400 CID	1972		USMP17597
7.2L V8 7211cc 440 CID	1966-1968		USMP09180	7.2L V8 7211cc 440 CID	1969		USMP11473
7.2L V8 7211cc 440 CID	1969		USMP11473	7.2L V8 7211cc 440 CID	1970-1971		USMP12113
7.2L V8 7211cc 440 CID	1972		USMP17597	7.2L V8 7211cc 440 CID	1972		USMP17597
7.2L V8 7211cc 440 CID	1975		USMP17338	<b>SAPPORO</b>			
<b>GRAN FURY</b>				1.6L L4 1597cc 98 CID	1978-1979		USMP17604
3.7L L6 3687cc 225 CID	1981		USMP51440	2.6L L4 2555cc 156 CID	1981-1983		USMP75733
5.2L V8 5211cc 318 CID	1985		USMP51298	<b>SATELLITE</b>			
5.9L V8 360 CID	1972		USMP17165	4.5L V8 273 CID	1968		USMP17165
5.9L V8 360 CID	1973-1975		USMP51285	4.5L V8 4473cc 273 CID	1965-1968		USMP17165
5.9L V8 360 CID	1976-1977		USMP17484	5.2L V8 5211cc 318 CID	1974		USMP17338
5.9L V8 360 CID	1980		USMP51298	5.6L V8 340 CID	1972		USMP17165
6.6L V8 400 CID	1972		USMP17597	5.6L V8 5572cc 340 CID	1972		USMP17165
6.6L V8 6556cc 400 CID	1972		USMP17597	5.9L V8 360 CID	1974		USMP51285
7.2L V8 7211cc 440 CID	1972		USMP17597	5.9L V8 5917cc 361 CID	1965-1966		USMP09180
7.2L V8 7211cc 440 CID	1975		USMP17338	6.3L V8 383 CID	1968		USMP09180
<b>GTX</b>				6.3L V8 383 CID	1969-1971		USMP11473
7.2L V8 7211cc 440 CID	1967		USMP09180	6.3L V8 6286cc 383 CID	1965		USMP09180
7.2L V8 7211cc 440 CID	1969		USMP11473	6.3L V8 6286cc 383 CID	1968		USMP09180
				6.3L V8 6286cc 383 CID	1969-1971		USMP11473

Engine	Years	Application Description	USMW	Engine	Years	Application Description	USMW
<b>PLYMOUTH (cont'd.)</b>				<b>PONTIAC (cont'd.)</b>			
<b>SATELLITE (cont'd.)</b>				<b>CATALINA (cont'd.)</b>			
6.6L V8 400 CID	1972		USMP17597	6.6L V8 400 CID	1968		USMP11723
6.6L V8 6556cc 400 CID	1972		USMP17597	6.6L V8 400 CID	1976		USMP17533
6.6L V8 6556cc 400 CID	1974		USMP17338	6.6L V8 6555cc 400 CID	1967		USMP17536
7.0L V8 6981cc 426 CID	1965		USMP09180	6.6L V8 6555cc 400 CID	1968		USMP11723
7.2L V8 7211cc 440 CID	1974		USMP17338	7.0L V8 428 CID	1968		USMP11723
<b>SAVOY</b>				<b>CHIEFTAIN</b>			
3.8L L6 3770cc 230 CID	1954		USMP17477	6.1L V8 6064cc 370 CID	1958		USMP11415
4.9L V8 299 CID	1957		USMP52684	<b>EXECUTIVE</b>			
4.9L V8 4933cc 301 CID	1957		USMP52684	6.6L V8 6555cc 400 CID	1967		USMP17536
5.2L V8 317 CID	1958-1959		USMP52684	6.6L V8 6555cc 400 CID	1968		USMP11723
5.9L V8 361 CID	1960-1961		USMP09180	7.0L V8 7014cc 428 CID	1967		USMP17536
5.9L V8 5917cc 361 CID	1959-1964		USMP09180	7.0L V8 7014cc 428 CID	1968		USMP11723
6.3L V8 383 CID	1960-1961		USMP09180	7.5L V8 455 CID	1976		USMP15305
6.3L V8 6286cc 383 CID	1960-1964		USMP09180	<b>FIREBIRD</b>			
7.0L V8 6981cc 426 CID	1964		USMP09180		1970-1971		USPR936
<b>SCAMP</b>					1974		USPR936
2.2L L4 135 CID	1983		USMP17494		1977-1981		USPR936
<b>SPECIAL DELUXE</b>					1982-1984		USMP52693
3.6L L6 218 CID	1949-1950		USMP17477	2.8L V6 173 CID	1982-1987	3 line unit	USMP16565
<b>SUPERBIRD</b>					5.0L V8 305 CID		USMP17536
7.0L V8 6981cc 426 CID	1970		USMP12113	5.3L V8 5343cc 326 CID	1967		USMP11723
7.2L V8 7211cc 440 CID	1970		USMP12113	5.7L V8 350 CID	1968		USMP16565
<b>TC3</b>					5.7L V8 350 CID	3 line unit	USMP11723
2.2L L4 135 CID	1981-1982		USMP17494	5.7L V8 5733cc 350 CID	1968		USMP17536
<b>TURISMO</b>					6.6L V8 400 CID		USMP11723
1.6L L4 1595cc 97 CID	1983-1986		USMP17636	6.6L V8 400 CID	1968		USMP17536
2.2L L4 135 CID	1983-1987		USMP17494	6.6L V8 6555cc 400 CID	1967		USMP11723
<b>VALIANT</b>					6.6L V8 6555cc 400 CID	1968	USMP17536
2.8L L6 2786cc 170 CID	1970		USMP51443	<b>GRAND AM</b>			
4.5L V8 273 CID	1967-1969		USMP17165		1978-1980		USPR936
4.5L V8 4473cc 273 CID	1965-1969		USMP17165	4.9L V8 301 CID	1978-1980		USMP17533
5.9L V8 360 CID	1976		USMP51285	5.0L V8 305 CID	1978-1980	2 line pump	USMP16560
<b>VOLARE</b>					5.7L V8 350 CID		USMP17563
3.7L L6 3687cc 225 CID	1978-1980		USMP51440	5.7L V8 5733cc 350 CID	1973		USMP17563
5.9L V8 360 CID	1976-1980		USMP51285	6.6L V8 400 CID	1973		USMP16013
<b>VOYAGER</b>					6.6L V8 6555cc 400 CID	1973	USMP16013
2.2L L4 135 CID	1984-1987		USMP17494	7.5L V8 455 CID	1973		USMP16013
2.6L L4 2555cc 156 CID	1984-1987		USMP17521	7.5L V8 7456cc 455 CID	1973		USMP16013
<b>PONTIAC</b>				<b>GRAND LEMANS</b>			
<b>6000</b>					1977-1982		USPR936
2.8L V6 173 CID	1983-1986		USMP50838	3.8L V6 229 CID	1980-1981		USMP17503
<b>BONNEVILLE</b>					3.8L V6 231 CID		USMP17378
	1980-1986		USPR936	3.8L V6 3800cc 231 CID	1979		USMP17378
3.8L V6 3800cc 231 CID	1981-1985		USMP17378	3.8L V6 3800cc 231 CID	1980-1981		USMP17503
4.1L V6 252 CID	1982		USMP17378	4.3L V8 265 CID	1980-1981		USMP17533
4.3L V8 265 CID	1981		USMP17533	4.9L V8 301 CID	1979-1980		USMP17533
5.0L V8 305 CID	1983-1985		USMP11713	5.0L V8 305 CID	1977-1980	2 line pump	USMP16560
5.0L V8 307 CID	1981		USMP15273	5.7L V8 350 CID	1978	2 line pump	USMP16560
6.1L V8 6064cc 370 CID	1958		USMP11415	6.6L V8 400 CID	1975		USMP15305
6.4L V8 389 CID	1959-1962		USMP11415	7.5L V8 455 CID	1975		USMP15305
6.4L V8 6376cc 389 CID	1959-1965		USMP11415	<b>GRAND PRIX</b>			
6.6L V8 400 CID	1968		USMP11723		1978-1987		USPR936
6.6L V8 400 CID	1973		USMP16013	3.8L V6 231 CID	1979		USMP17378
6.6L V8 400 CID	1976		USMP17533	3.8L V6 3800cc 231 CID	1978-1985		USMP17378
6.6L V8 6555cc 400 CID	1967		USMP17536	3.8L V6 3800cc 231 CID	1987		USMP17596
6.6L V8 6555cc 400 CID	1968		USMP11723	4.1L V6 252 CID	1982		USMP17378
6.6L V8 6555cc 400 CID	1973		USMP16013	4.3L V8 265 CID	1980-1981		USMP17533
6.6L V8 6555cc 400 CID	1967		USMP17536	4.9L V8 301 CID	1978-1980		USMP17533
6.6L V8 6555cc 400 CID	1968		USMP11723	5.0L V8 305 CID	1978-1980	2 line pump	USMP16560
6.6L V8 6555cc 400 CID	1973		USMP16013	5.0L V8 305 CID	1983-1985		USMP11713
7.0L V8 428 CID	1968		USMP11723	5.0L V8 305 CID	1987		USMP15253
7.0L V8 7014cc 428 CID	1967		USMP17536	6.4L V8 6376cc 389 CID	1962		USMP11415
7.0L V8 7014cc 428 CID	1968		USMP11723	6.6L V8 400 CID	1968		USMP11723
7.5L V8 455 CID	1971		USMP17588	6.6L V8 400 CID	1969		USMP12213
7.5L V8 455 CID	1973		USMP16013	6.6L V8 400 CID	1970-1972		USMP15305
7.5L V8 455 CID	1976		USMP15305	6.6L V8 400 CID	1973-1974		USMP16013
7.5L V8 7456cc 455 CID	1971		USMP17588	6.6L V8 400 CID	1975		USMP15305
7.5L V8 7456cc 455 CID	1973		USMP16013	6.6L V8 6555cc 400 CID	1967		USMP17536
7.5L V8 7457cc 455 CID	1973		USMP16013	6.6L V8 6555cc 400 CID	1968		USMP11723
<b>CATALINA</b>					6.6L V8 6555cc 400 CID	1969	USMP12213
	1980-1981		USPR936	6.6L V8 6555cc 400 CID	1970-1972		USMP15305
3.8L V6 229 CID	1980		USMP17378	6.6L V8 6555cc 400 CID	1973-1974		USMP16013
3.8L V6 3800cc 231 CID	1980-1981		USMP17378	7.0L V8 428 CID	1968		USMP11723
4.3L V8 265 CID	1980-1981		USMP17533	7.0L V8 428 CID	1969		USMP12213
4.9L V8 301 CID	1980		USMP17533	7.0L V8 7014cc 428 CID	1967		USMP17536
5.0L V8 305 CID	1981		USMP15273	7.0L V8 7014cc 428 CID	1968		USMP11723
5.0L V8 307 CID	1981		USMP15273	7.0L V8 7014cc 428 CID	1969		USMP12213
5.7L V8 350 CID	1980		USMP15273	7.5L V8 455 CID	1970-1972		USMP15305
6.4L V8 6376cc 389 CID	1959-1965		USMP11415	7.5L V8 455 CID	1973-1974		USMP16013
6.6L V8 400 CID	1967		USMP17536	7.5L V8 455 CID	1975		USMP15305

Engine	Years	Application Description	USMW	Engine	Years	Application Description	USMW
<b>PONTIAC (cont'd.)</b>				<b>PONTIAC (cont'd.)</b>			
<b>GRAND PRIX (cont'd.)</b>				<b>VENTURA</b>			
7.5L V8 7456cc 455 CID	1970-1972		USMP15305		1971-1974		USPR936
7.5L V8 7456cc 455 CID	1973-1974		USMP16013		1977		USPR936
7.5L V8 7457cc 455 CID	1973		USMP16013	5.7L V8 350 CID	1972-1973	3 line unit	USMP17563
<b>GRAND SAFARI</b>				5.7L V8 350 CID	1977		USMP16565
6.6L V8 400 CID	1973-1974		USMP16013	5.7L V8 5733cc 350 CID	1972-1973		USMP17563
6.6L V8 400 CID	1975		USMP15305	6.4L V8 6376cc 389 CID	1960-1961		USMP11415
6.6L V8 400 CID	1976		USMP17533	<b>STUDEBAKER</b>			
6.6L V8 6555cc 400 CID	1973-1974		USMP16013	<b>2R5</b>			
7.5L V8 455 CID	1973-1974		USMP16013	2.8L L6 2780cc 170 CID	1949-1953		USMP17580
7.5L V8 455 CID	1975-1976		USMP15305	<b>2R10</b>			
7.5L V8 7456cc 455 CID	1973-1974		USMP16013	2.8L L6 2780cc 170 CID	1949-1953		USMP17580
7.5L V8 7457cc 455 CID	1973-1974		USMP16013	<b>3E1</b>			
<b>GRANDVILLE</b>				3.0L L6 3042cc 186 CID	1958		USMP17580
6.6L V8 400 CID	1973		USMP16013	<b>3E5</b>			
6.6L V8 6555cc 400 CID	1973		USMP16013	3.0L L6 3042cc 186 CID	1958		USMP17580
7.5L V8 455 CID	1971		USMP17588	<b>3E6</b>			
7.5L V8 455 CID	1972-1974		USMP16013	4.0L L6 4025cc 246 CID	1958		USMP17512
7.5L V8 7456cc 455 CID	1971		USMP17588	<b>3E11</b>			
7.5L V8 7456cc 455 CID	1972-1974		USMP16013	4.0L L6 4025cc 246 CID	1958		USMP17512
7.5L V8 7457cc 455 CID	1972-1974		USMP16013	<b>3R5</b>			
<b>GTO</b>				2.8L L6 2780cc 170 CID	1954		USMP17580
6.6L V8 400 CID	1967		USMP17498	<b>3R10</b>			
6.6L V8 400 CID	1968		USMP11723	2.8L L6 2780cc 170 CID	1954		USMP17580
6.6L V8 400 CID	1969		USMP12213	<b>4E1</b>			
6.6L V8 400 CID	1970		USMP15305	2.8L L6 2780cc 170 CID	1959		USMP17512
6.6L V8 6555cc 400 CID	1967		USMP17498	<b>4E3</b>			
6.6L V8 6555cc 400 CID	1968		USMP11723	4.0L L6 4025cc 246 CID	1959		USMP17512
6.6L V8 6555cc 400 CID	1969		USMP12213	<b>4E7</b>			
6.6L V8 6555cc 400 CID	1970		USMP15305	4.7L V8 4737cc 289 CID	1959		USMP17512
6.6L V8 6555cc 400 CID	1967		USMP17498	<b>4E11</b>			
6.6L V8 6555cc 400 CID	1968		USMP11723	4.0L L6 4025cc 246 CID	1959		USMP17512
6.6L V8 6555cc 400 CID	1969		USMP12213	<b>4E12</b>			
6.6L V8 6555cc 400 CID	1970		USMP15305	4.7L V8 4737cc 289 CID	1959		USMP17512
<b>LEMANS</b>				<b>6E7</b>			
	1968		USPR936	4.7L V8 4737cc 289 CID	1961		USMP17512
	1970-1974		USPR936	<b>6E12</b>			
	1977-1980		USPR936	4.7L V8 4737cc 289 CID	1961		USMP17512
	1989		USPR936	<b>7E7</b>			
3.8L V6 229 CID	1980		USMP17503	4.7L V8 4737cc 289 CID	1962		USMP17512
3.8L V6 231 CID	1979		USMP17378	<b>7E12</b>			
3.8L V6 3800cc 231 CID	1978-1979		USMP17378	4.7L V8 4737cc 289 CID	1962		USMP17512
3.8L V6 3800cc 231 CID	1980		USMP17503	<b>8E7</b>			
4.9L V8 301 CID	1979		USMP17533	4.7L V8 4737cc 289 CID	1963-1964		USMP17512
5.0L V8 305 CID	1978-1979	2 line pump	USMP16560	<b>8E12</b>			
5.3L V8 5343cc 326 CID	1967		USMP17498	4.7L V8 4737cc 289 CID	1963-1964		USMP17512
5.7L V8 350 CID	1968		USMP11723	<b>CHAMPION</b>			
5.7L V8 350 CID	1973-1974		USMP17563		1947-1949		USMP17580
5.7L V8 350 CID	1978-1979	2 line pump	USMP16560	2.8L L6 2780cc 170 CID	1941-1942		USMP17580
5.7L V8 5733cc 350 CID	1968		USMP11723	2.8L L6 2780cc 170 CID	1950-1954		USMP17580
5.7L V8 5733cc 350 CID	1973-1974		USMP17563	<b>COMMANDER</b>			
6.6L V8 400 CID	1973-1974		USMP16013	3.2L L6 3180cc 194 CID	1966		USMP08825
6.6L V8 6555cc 400 CID	1973-1974		USMP16013	3.7L V8 3671cc 224 CID	1955		USMP17512
7.5L V8 455 CID	1973-1974		USMP16013	4.2L V8 4245cc 259 CID	1955-1957		USMP17512
7.5L V8 7456cc 455 CID	1973-1974		USMP16013	4.2L V8 4245cc 259 CID	1964		USMP17512
7.5L V8 7457cc 455 CID	1973		USMP16013	<b>CRUISER</b>			
<b>PARISIENNE</b>				3.2L L6 3180cc 194 CID	1966		USMP08825
	1983-1986		USPR936	<b>DAYTONA</b>			
3.8L V6 3800cc 231 CID	1984		USMP17378	3.2L L6 3180cc 194 CID	1966		USMP08825
5.0L V8 305 CID	1983-1985		USMP11713	<b>E5</b>			
<b>PHOENIX</b>				3.0L L6 3042cc 186 CID	1955		USMP17580
	1977-1979		USPR936	<b>E7</b>			
2.5L L4 2474cc 151 CID	1980-1981		USMP17502	3.7L V8 3671cc 224 CID	1955		USMP17512
2.8L V6 173 CID	1980-1981		USMP75733	<b>E10</b>			
2.8L V6 173 CID	1983-1984		USMP50838	3.0L L6 3042cc 186 CID	1955		USMP17580
5.0L V8 305 CID	1977	2 line pump	USMP16560	<b>E12</b>			
5.7L V8 350 CID	1977	2 line pump	USMP16560	3.7L V8 3671cc 224 CID	1955		USMP17512
5.7L V8 350 CID	1977-1979	3 line unit	USMP16565	<b>HAWK</b>			
<b>SAFARI</b>				4.7L V8 4737cc 289 CID	1962		USMP17512
5.0L V8 307 CID	1987-1989		USMP15273				
<b>STAR CHIEF</b>							
6.1L V8 370 CID	1958		USMP11415				
6.1L V8 6064cc 370 CID	1958		USMP11415				
6.4L V8 6376cc 389 CID	1959-1965		USMP11415				
<b>SUNBIRD</b>							
2.5L L4 2474cc 151 CID	1978-1980		USMP17547				
<b>SUPER CHIEF</b>							
6.1L V8 6064cc 370 CID	1958		USMP11415				
<b>TEMPEST</b>							
5.3L V8 5343cc 326 CID	1967		USMP17498				
5.7L V8 5733cc 350 CID	1968		USMP11723				
5.7L V8 5733cc 350 CID	1969		USMP12170				



Engine	Years	Application Description	USMW	Engine	Years	Application Description	USMW
<b>STUDEBAKER (cont'd.)</b>				<b>VOLKSWAGEN (cont'd.)</b>			
<b>LARK</b>				<b>SAFARI</b>			
4.2L V8 4245cc 259 CID	1959-1960		USMP17512	1.6L H4 1584cc 97 CID	1974-1980	MEX; alternator only, crimped pump	USMP50440
4.2L V8 4245cc 259 CID	1962		USMP17512	<b>SEDAN</b>			
<b>M5</b>				<b>SQUAREBACK</b>			
2.8L L6 2780cc 170 CID	1946		USMP17512	1.6L H4 1584cc 97 CID	1980-1992	MEX; alternator only, crimped pump	USMP50440
2.8L L6 2780cc 170 CID	1947-1948		USMP17580	<b>SUPER BEETLE</b>			
<b>PRESIDENT</b>				<b>THING</b>			
4.2L V8 4245cc 259 CID	1955		USMP17512	1.6L H4 1584cc 97 CID	1973	alternator only, crimped pump	USMP50440
4.7L V8 4737cc 289 CID	1956-1957		USMP17512	1.6L H4 1584cc 97 CID	1973-1974	bolt style pump, with generator only	USMP50438
<b>SKY HAWK</b>				<b>TRANSPORTER</b>			
4.7L V8 4737cc 289 CID	1956		USMP17512	1.2L H4 1192cc 73 CID	1960-1965		USMP50438
<b>SUZUKI</b>				1.5L H4 1493cc 91 CID	1963-1967		USMP50438
<b>SAMURAI</b>				1.6L H4 1584cc 97 CID	1968-1970		USMP50438
1.3L L4 1325cc 81 CID	1987-1989		USMP75798	1.6L H4 1584cc 97 CID	1971	bolt style pump, with generator only	USMP50438
<b>TOYOTA</b>				<b>WILLYS</b>			
<b>CELICA</b>				<b>BERMUDA</b>			
1.9L L4 1858cc 113 CID	1971		USMP17552	3.7L L6 3704cc 226 CID	1955		USMP17576
2.0L L4 1968cc 120 CID	1973-1974		USMP17552	<b>CUSTOM</b>			
2.2L L4 2189cc	1980		USMP17527	3.7L L6 3704cc 226 CID	1955		USMP17576
2.4L L4 2366cc	1981-1983		USMP51040				
<b>COROLLA</b>							
1.6L L4 1587cc	1983		USMP17501				
1.6L L4 1587cc	1989		USMP17472				
1.8L L4 1770cc	1980-1982		USMP51048				
<b>CORONA</b>							
1.9L L4 1858cc	1971		USMP17552				
1.9L L4 1858cc 113 CID	1971		USMP17552				
2.0L L4 1968cc	1972		USMP17552				
2.0L L4 1968cc 120 CID	1972-1973		USMP17552				
2.2L L4 2189cc	1980		USMP17527				
2.4L L4 2366cc	1981-1982		USMP51040				
<b>LAND CRUISER</b>							
3.9L L6 3878cc	1967-1968		USMP17550				
3.9L L6 3878cc	1973-1974		USMP17550				
4.2L L6 4227cc	1981-1987		USMP75665				
4.2L L6 4228cc 258 CID	1981-1984		USMP75665				
4.2L L6 4228cc 258 CID	1986		USMP75665				
<b>PICKUP</b>							
2.2L L4 2189cc	1980		USMP17527				
2.4L L4 2366cc	1981-1990		USMP51040				
2.4L L4 2446cc	1984-1985		USMP51040				
2.4L L4 2466cc	1986-1987		USMP51040				
<b>TERCEL</b>							
1.5L L4 1452cc	1980-1982		USMP17622				
1.5L L4 1452cc	1983-1986		USMP17488				
1.5L L4 1456cc	1989-1990		USMP17491				
<b>VOLKSWAGEN</b>							
<b>BEETLE</b>							
1.2L H4 1192cc 73 CID	1961-1966		USMP50438				
1.3L H4 1285cc 78 CID	1966		USMP50438				
1.5L H4 1493cc 91 CID	1967-1969		USMP50438				
1.6L H4 1584cc 97 CID	1970		USMP50438				
1.6L H4 1584cc 97 CID	1971-1973	bolt style pump, with Generator only	USMP50438				
1.6L H4 1584cc 97 CID	1971-1979	alternator only, crimped pump	USMP50440				
<b>BRASILIA</b>							
1.6L H4 1584cc 97 CID	1974-1982	MEX; alternator only, crimped pump	USMP50440				
<b>COMBI</b>							
1.5L H4 1493cc 91 CID	1972-1973	MEX; alternator only, crimped pump	USMP50440				
1.6L H4 1584cc 97 CID	1974-1988	MEX; alternator only, crimped pump	USMP50440				
<b>FASTBACK</b>							
1.6L H4 1584cc 97 CID	1966-1967	bolt style pump, with generator only	USMP50438				
<b>HORMIGA</b>							
1.6L H4 1584cc 97 CID	1977-1978	MEX; alternator only, crimped pump	USMP50440				
<b>KARMANN GHIA</b>							
1.2L H4 1192cc 73 CID	1961-1965		USMP50438				
1.3L H4 1285cc 78 CID	1966		USMP50438				
1.5L H4 1493cc 91 CID	1967-1969		USMP50438				
1.6L H4 1584cc 97 CID	1970		USMP50438				
1.6L H4 1584cc 97 CID	1971-1973	bolt type pump, with generator only	USMP50438				
1.6L H4 1584cc 97 CID	1971-1973	alternator only, crimped pump	USMP50440				
<b>PANEL</b>							
1.6L H4 1584cc 97 CID	1975-1988	MEX; alternator only, crimped pump	USMP50440				

USMW	Years	Application	Engine	USMW	Years	Application	Engine
<b>usmp05633</b>	1982-1985	FORD MUSTANG	5.0L V8 302 CID	<b>USMP08820</b>	1963	FORD GALAXIE	5.8L V8 5769cc 352 CID
	1982-1985	MERCURY CAPRI	5.0L V8 302 CID		1963	FORD GALAXIE	6.4L V8 6391cc 390 CID
<b>USMP01878</b>	1937	CHEVROLET GC	3.5L L6 3548cc 216 CID	1963	MERCURY MONTEREY	6.4L V8 390 CID	
	1937	CHEVROLET GD	3.5L L6 3548cc 216 CID	1963-1964	FORD FAIRLANE	6.4L V8 390 CID	
1937	CHEVROLET GE	3.5L L6 3548cc 216 CID	1963-1964	FORD FAIRLANE	6.4L V8 6391cc 390 CID		
1937-1938	CHEVROLET MASTER	3.5L L6 3548cc 216 CID	1963-1964	MERCURY MARAUDER	6.4L V8 6391cc 390 CID		
1938	CHEVROLET HC	3.5L L6 3548cc 216 CID	1963-1965	MERCURY MONTEREY	6.4L V8 6391cc 390 CID		
1938	CHEVROLET HD	3.5L L6 3548cc 216 CID	1964	FORD CUSTOM	5.8L V8 5769cc 352 CID		
1938	CHEVROLET HE	3.5L L6 3548cc 216 CID	1964	FORD CUSTOM	6.4L V8 6391cc 390 CID		
1939	CHEVROLET JA MASTER DELUXE	3.5L L6 3548cc 216 CID	1964	FORD GALAXIE 500	5.8L V8 5769cc 352 CID		
1939	CHEVROLET JC	3.5L L6 3548cc 216 CID	1964	FORD GALAXIE 500	6.4L V8 390 CID		
1939	CHEVROLET JD	3.5L L6 3548cc 216 CID	1964	FORD GALAXIE 500	6.4L V8 6391cc 390 CID		
1939	CHEVROLET VA	3.5L L6 3548cc 216 CID	1964-1965	MERCURY PARK LANE	6.4L V8 6391cc 390 CID		
1939-1940	CHEVROLET MASTER 85	3.5L L6 3548cc 216 CID	1964-1966	MERCURY MONTCLAIR	6.4L V8 6391cc 390 CID		
1940	CHEVROLET KC	3.5L L6 3548cc 216 CID	1965	FORD F-350	5.9L V8 5917cc 361 CID		
1940	CHEVROLET KD	3.5L L6 3548cc 216 CID	1965-1966	MERCURY COLONY PARK	6.4L V8 6391cc 390 CID		
1940	CHEVROLET KF	3.5L L6 3548cc 216 CID	1965-1967	FORD F-100	5.8L V8 5769cc 352 CID		
1940-1942	CHEVROLET SPECIAL DELUXE	3.5L L6 3548cc 216 CID	1965-1967	FORD F-250	5.8L V8 5769cc 352 CID		
1941	CHEVROLET AK	3.5L L6 3548cc 216 CID	1965-1967	FORD F-350	5.8L V8 5769cc 352 CID		
1941	CHEVROLET AL	3.5L L6 3548cc 216 CID	1966	FORD FAIRLANE	6.4L V8 390 CID		
1941	CHEVROLET AN	3.5L L6 3548cc 216 CID	1966	FORD FAIRLANE	6.4L V8 6391cc 390 CID		
1942	CHEVROLET FLEETLINE	3.5L L6 3548cc 216 CID	1966	MERCURY COMET	6.4L V8 6391cc 390 CID		
1942	CHEVROLET FLEETMASTER	3.5L L6 3548cc 216 CID	1966	MERCURY MONTCLAIR	6.7L V8 6720cc 410 CID		
1946-1948	CHEVROLET FLEETMASTER	3.5L L6 3548cc 216 CID	1966	MERCURY MONTCLAIR	7.0L V8 6997cc 427 CID		
1946-1951	CHEVROLET FLEETLINE	3.5L L6 3548cc 216 CID	1966	MERCURY MONTCLAIR	7.0L V8 7014cc 428 CID		
1950-1951	CHEVROLET BEL AIR	3.5L L6 3548cc 216 CID	1967-1969	FORD RANCHERO	6.4L V8 6391cc 390 CID		
1950-1951	CHEVROLET BEL AIR	3.8L L6 3852cc 235 CID	1968-1969	FORD F-100	5.9L V8 360 CID		
1950-1951	CHEVROLET FLEETLINE	3.8L L6 3852cc 235 CID	1968-1969	FORD F-100	6.4L V8 390 CID		
<b>USMP02065</b>	1948-1950	FORD F1	3.9L V8 3924cc 239 CID	1968-1969	FORD F-100	6.4L V8 6391cc 390 CID	
	1948-1950	FORD F2	3.9L V8 3924cc 239 CID	1968-1969	FORD F-100	6.4L V8 6392cc 390 CID	
1948-1950	FORD F3	3.9L V8 3924cc 239 CID	1968-1969	FORD F-250	5.9L V8 360 CID		
1949-1950	FORD CUSTOM	3.9L V8 3924cc 239 CID	1968-1969	FORD F-250	6.4L V8 390 CID		
1950	FORD DELUXE	3.9L V8 3924cc 239 CID	1968-1969	FORD F-250	6.4L V8 6391cc 390 CID		
<b>USMP05295</b>	1952	CHEVROLET BEL AIR	3.5L L6 3548cc 216 CID	1968-1969	FORD F-250	6.4L V8 6392cc 390 CID	
	1952	CHEVROLET FLEETLINE	3.5L L6 3548cc 216 CID	1968-1969	FORD F-350	5.9L V8 360 CID	
1952	CHEVROLET FLEETLINE	3.8L L6 3852cc 235 CID	1968-1969	FORD F-350	6.4L V8 390 CID		
1952-1957	CHEVROLET BEL AIR	3.8L L6 3852cc 235 CID	1968-1969	FORD F-350	6.4L V8 6391cc 390 CID		
1956-1957	CHEVROLET 3100	3.8L L6 3852cc 235 CID	1968-1969	FORD F-350	6.4L V8 6392cc 390 CID		
<b>USMP05488</b>	1947-1949	JEEP WILLYS	2.2L L4 2197cc 134 CID	1968-1969	FORD RANCHERO	6.4L V8 390 CID	
	1967	JEEP DJ5	2.2L L4 2197cc 134 CID	<b>USMP08825</b>	1963	CHEVROLET C10 PICKUP	4.8L L6 4801cc 292 CID
1970-1971	JEEP CJ5	2.2L L4 134 CID	1963		CHEVROLET C20 PICKUP	4.8L L6 4801cc 292 CID	
1970-1971	JEEP CJ5	2.2L L4 2197cc 134 CID	1963	CHEVROLET C30 PICKUP	4.8L L6 4801cc 292 CID		
1970-1971	JEEP CJ6	2.2L L4 134 CID	1963-1965	CHEVROLET C10 PICKUP	3.8L L6 3769cc 230 CID		
1970-1971	JEEP CJ6	2.2L L4 2197cc 134 CID	1963-1965	CHEVROLET C20 PICKUP	3.8L L6 3769cc 230 CID		
1970-1971	JEEP DJ5	2.2L L4 134 CID	1963-1965	GMC PB1000 SERIES	2.5L L4 2507cc 153 CID		
1970-1971	JEEP DJ5	2.2L L4 2197cc 134 CID	1963-1965	GMC PB1000 SERIES	3.8L L6 3769cc 230 CID		
1970-1971	JEEP JEEPSTER	2.2L L4 134 CID	1963-1965	GMC PB1500 SERIES	3.8L L6 3769cc 230 CID		
1970-1971	JEEP JEEPSTER	2.2L L4 2197cc 134 CID	1963-1965	GMC PB2500 SERIES	3.8L L6 3769cc 230 CID		
1971	JEEP COMMANDO	2.2L L4 2197cc 134 CID	1964	CHEVROLET EL CAMINO	3.2L L6 3180cc 194 CID		
<b>USMP06170</b>	1955-1957	CHEVROLET BEL AIR	4.3L V8 265 CID	1964-1965	CHEVROLET C30 PICKUP	3.8L L6 3769cc 230 CID	
	1955-1957	CHEVROLET BEL AIR	4.3L V8 4343cc 265 CID	1964-1965	CHEVROLET K10 PICKUP	3.8L L6 3769cc 230 CID	
1956	CHEVROLET CORVETTE	4.3L V8 4343cc 265 CID	1964-1965	CHEVROLET K20 PICKUP	3.8L L6 3769cc 230 CID		
1956-1957	CHEVROLET 3100	4.3L V8 4343cc 265 CID	1965	GMC PB1500 SERIES	2.5L L4 2507cc 153 CID		
1957	CHEVROLET BEL AIR	4.6L V8 283 CID	1965	GMC PB2500 SERIES	2.5L L4 2507cc 153 CID		
1957	CHEVROLET BEL AIR	4.6L V8 4638cc 283 CID	1966	STUDEBAKER COMMANDER	3.2L L6 3180cc 194 CID		
1957	CHEVROLET CORVETTE	4.6L V8 4638cc 283 CID	1966	STUDEBAKER CRUISER	3.2L L6 3180cc 194 CID		
<b>USMP06935</b>	1969-1970	INTERNATIONAL 1000D	4.3L L6 4335cc 264 CID	1966	STUDEBAKER DAYTONA	3.2L L6 3180cc 194 CID	
	1969-1970	INTERNATIONAL M800	5.0L V8 4983cc 304 CID	<b>USMP08883</b>	1955	FORD F-100	3.9L V8 3917cc 239 CID
1969-1970	INTERNATIONAL M1100	4.3L L6 4335cc 264 CID	1955-1956		FORD CUSTOMLINE	3.6L L6 3655cc 223 CID	
1969-1970	INTERNATIONAL SCOUT	5.0L V8 4982cc 304 CID	1955-1956	FORD MAINLINE	3.6L L6 3655cc 223 CID		
<b>USMP07498</b>	1958-1962	CHEVROLET BEL AIR	3.8L L6 3852cc 235 CID	1955-1957	FORD F-250	3.6L L6 3655cc 223 CID	
	<b>USMP07800</b>	1959	CHEVROLET BEL AIR	5.7L V8 5704cc 348 CID	1955-1957	FORD F-350	3.6L L6 3655cc 223 CID
1959-1961		CHEVROLET BISCAYNE	5.7L V8 5704cc 348 CID	1955-1957	FORD P-350	3.6L L6 3655cc 223 CID	
1959-1961	CHEVROLET IMPALA	5.7L V8 5704cc 348 CID	1955-1958	FORD FAIRLANE	3.6L L6 3655cc 223 CID		
1960	CHEVROLET BISCAYNE	5.7L V8 348 CID	1957	FORD CUSTOM	3.6L L6 3655cc 223 CID		
1962	CHEVROLET BEL AIR	6.7L V8 6704cc 409 CID	1957	FORD P-100	3.6L L6 3655cc 223 CID		
1962	CHEVROLET BISCAYNE	6.7L V8 6704cc 409 CID	1957-1958	FORD RANCHERO	3.6L L6 3655cc 223 CID		
1962	CHEVROLET IMPALA	6.7L V8 6704cc 409 CID	1958	FORD CUSTOM 300	3.6L L6 3655cc 223 CID		
1962-1965	CHEVROLET BEL AIR	5.3L V8 5358cc 327 CID	1961-1964	FORD F-250	3.6L L6 3655cc 223 CID		
1962-1965	CHEVROLET BISCAYNE	5.3L V8 5358cc 327 CID	1961-1964	FORD F-350	3.6L L6 3655cc 223 CID		
1962-1965	CHEVROLET IMPALA	5.3L V8 5358cc 327 CID	1964	FORD P-350	3.6L L6 3655cc 223 CID		
1963-1966	CHEVROLET CORVETTE	5.3L V8 5358cc 327 CID	<b>USMP09180</b>	1958	DESOTO ADVENTURER	5.9L V8 5917cc 361 CID	
1965	CHEVROLET CHEVY II	5.3L V8 5358cc 327 CID		1958	DESOTO FIREDOME	5.9L V8 5917cc 361 CID	
1965	CHEVROLET EL CAMINO	5.3L V8 5358cc 327 CID	1958	DESOTO FIREFLITE	5.9L V8 5917cc 361 CID		
1965-1969	CHEVROLET MARATHON	5.3L V8 5358cc 327 CID	1958	PLYMOUTH FURY	5.7L V8 5737cc 350 CID		
1969	CHEVROLET DELUXE	5.3L V8 5358cc 327 CID	1959	CHRYSLER SARATOGA	6.3L V8 6274cc 383 CID		
<b>USMP08820</b>	1956-1957	FORD F-100	4.4L V8 4458cc 272 CID	1959	DESOTO FIREDOME	6.3L V8 6286cc 383 CID	
	1956-1957	FORD F-250	4.4L V8 4458cc 272 CID	1959	DESOTO FIREFLITE	6.3L V8 6286cc 383 CID	
1956-1957	FORD F-350	4.4L V8 4458cc 272 CID	1959	DESOTO FIRESWEEP	5.9L V8 5917cc 361 CID		
1957	FORD P-350	4.4L V8 4458cc 272 CID	1959	DODGE CORONET	6.3L V8 6286cc 383 CID		
1959	EDSEL CORSAIR	5.4L V8 5441cc 332 CID	1959	DODGE ROYAL	5.9L V8 5917cc 361 CID		
1959	FORD RANCHERO	4.8L V8 4786cc 292 CID	1959	DODGE ROYAL	6.3L V8 6286cc 383 CID		
1959	FORD RANCHERO	5.8L V8 5769cc 352 CID	1959-1960	CHRYSLER SARATOGA	6.3L V8 6286cc 383 CID		
1959-1960	FORD THUNDERBIRD	5.8L V8 5769cc 352 CID	1959-1960	DESOTO ADVENTURER	6.3L V8 6286cc 383 CID		
1960	FORD THUNDERBIRD	7.0L V8 7048cc 430 CID	1959-1961	CHRYSLER WINDSOR	6.3L V8 6286cc 383 CID		
1961-1964	FORD F-250	4.8L V8 4786cc 292 CID	1959-1964	PLYMOUTH FURY	5.9L V8 5917cc 361 CID		
1961-1964	FORD F-350	4.8L V8 4786cc 292 CID	1959-1964	PLYMOUTH SAVOY	5.9L V8 5917cc 361 CID		
1962-1964	FORD THUNDERBIRD	6.4L V8 6391cc 390 CID	1959-1965	CHRYSLER IMPERIAL	6.7L V8 6769cc 413 CID		

USMW	Years	Application	Engine	USMW	Years	Application	Engine		
<b>USMP09180</b>	1959-1965	CHRYSLER NEW YORKER	6.7L V8 6769cc 413 CID	<b>USMP10013</b>	1964	FORD P-350	2.8L L6 2786cc 170 CID		
	1959-1966	PLYMOUTH BELVEDERE	5.9L V8 5917cc 361 CID		1965	FORD F-100	4.9L L6 4917cc 300 CID		
	1960	DESOTO FIREFLITE	5.9L V8 5917cc 361 CID		1965	FORD P-350	3.9L L6 3933cc 240 CID		
	1960	DODGE MATADOR	5.9L V8 5917cc 361 CID		1965	FORD P-350	4.9L L6 4917cc 300 CID		
	1960	DODGE MATADOR	6.3L V8 6286cc 383 CID		1965-1966	FORD F-100	3.9L L6 240 CID		
	1960	DODGE PHOENIX	5.9L V8 5917cc 361 CID		1965-1966	FORD F-100	3.9L L6 3933cc 240 CID		
	1960	DODGE PHOENIX	6.3L V8 6286cc 383 CID		1965-1972	FORD F-250	3.9L L6 3933cc 240 CID		
	1960-1961	DODGE DART	5.9L V8 361 CID		1965-1972	FORD F-250	4.9L L6 4917cc 300 CID		
	1960-1961	PLYMOUTH SAVOY	5.9L V8 361 CID		1965-1972	FORD F-350	3.9L L6 3933cc 240 CID		
	1960-1961	PLYMOUTH SAVOY	6.3L V8 383 CID		1965-1973	FORD F-350	4.9L L6 4917cc 300 CID		
	1960-1962	DODGE DART	5.9L V8 5917cc 361 CID		1968	FORD P-100	3.9L L6 3933cc 240 CID		
	1960-1962	DODGE POLARA	5.9L V8 5917cc 361 CID		1968-1972	FORD F-250	3.9L L6 240 CID		
	1960-1964	PLYMOUTH SAVOY	6.3L V8 6286cc 383 CID		1968-1972	FORD F-350	3.9L L6 240 CID		
	1960-1965	CHRYSLER 300	6.7L V8 6769cc 413 CID		1970	FORD P-100	2.8L L6 2786cc 170 CID		
	1960-1968	DODGE POLARA	6.3L V8 6286cc 383 CID		1970	FORD P-100	3.9L L6 3933cc 240 CID		
	1960-1968	PLYMOUTH BELVEDERE	6.3L V8 6286cc 383 CID		1970-1972	FORD P-350	3.9L L6 240 CID		
	1960-1968	PLYMOUTH FURY	6.3L V8 6286cc 383 CID		1970-1972	FORD P-350	3.9L L6 3933cc 240 CID		
	1961	DODGE DART	6.3L V8 6286cc 383 CID		1970-1976	FORD P-350	4.9L L6 4917cc 300 CID		
	1961	DODGE PIONEER	5.9L V8 5917cc 361 CID		1972	FORD F-250	5.0L V8 302 CID		
	1961	DODGE SENECA	5.9L V8 5917cc 361 CID		1975-1976	FORD F-350	4.9L L6 4917cc 300 CID		
	1961-1964	CHRYSLER NEWPORT	5.9L V8 5917cc 361 CID		<b>USMP10020</b>	1965-1966	FORD THUNDERBIRD	6.4L V8 6391cc 390 CID	
	1962-1966	CHRYSLER 300	6.3L V8 383 CID			1966	FORD THUNDERBIRD	7.0L V8 6997cc 427 CID	
	1962-1966	CHRYSLER 300	6.3L V8 6286cc 383 CID			1966	FORD THUNDERBIRD	7.0L V8 7014cc 428 CID	
	1963	DODGE 880	5.9L V8 361 CID			1970-1972	FORD F-100	5.9L V8 360 CID	
	1963	DODGE POLARA	6.3L V8 383 CID			1970-1972	FORD F-100	6.4L V8 390 CID	
	1963-1964	DODGE 880	5.9L V8 5917cc 361 CID			1970-1972	FORD F-100	6.4L V8 6391cc 390 CID	
	1963-1964	DODGE 880	6.3L V8 6286cc 383 CID			1970-1972	FORD F-100	6.4L V8 6392cc 390 CID	
	1964	DODGE 330	6.3L V8 6286cc 383 CID			1970-1972	FORD F-250	5.9L V8 360 CID	
	1964	DODGE 440	6.3L V8 6286cc 383 CID			1970-1972	FORD F-250	6.4L V8 390 CID	
	1964	PLYMOUTH FURY	5.9L V8 361 CID			1970-1972	FORD F-250	6.4L V8 6391cc 390 CID	
	1964	PLYMOUTH SAVOY	7.0L V8 6981cc 426 CID		1970-1972	FORD F-250	6.4L V8 6392cc 390 CID		
	1964-1965	PLYMOUTH FURY	7.0L V8 426 CID		1970-1973	FORD F-350	5.9L V8 360 CID		
	1964-1965	PLYMOUTH FURY	7.0L V8 6981cc 426 CID		1970-1973	FORD F-350	6.4L V8 390 CID		
	1964-1966	PLYMOUTH BELVEDERE	7.0L V8 6981cc 426 CID		1970-1973	FORD F-350	6.4L V8 6391cc 390 CID		
	1964-1968	PLYMOUTH FURY	6.3L V8 383 CID		1970-1973	FORD F-350	6.4L V8 6392cc 390 CID		
	1965	DODGE MONACO	6.7L V8 6769cc 413 CID		<b>USMP10023</b>	1963-1964	FORD FALCON	4.3L V8 260 CID	
	1965	DODGE MONACO	7.0L V8 6981cc 426 CID			1963-1964	FORD FALCON	4.3L V8 4261cc 260 CID	
	1965	DODGE POLARA	6.7L V8 6769cc 413 CID			1964	FORD FAIRLANE	4.3L V8 260 CID	
	1965	DODGE POLARA	7.0L V8 6981cc 426 CID			1964	FORD FAIRLANE	4.3L V8 4261cc 260 CID	
	1965	PLYMOUTH SATELLITE	6.3L V8 6286cc 383 CID			1964	FORD MUSTANG	4.7L V8 4727cc 289 CID	
	1965	PLYMOUTH SATELLITE	7.0L V8 6981cc 426 CID			1965	FORD FALCON	4.7L V8 289 CID	
	1965-1966	PLYMOUTH SATELLITE	5.9L V8 5917cc 361 CID			1965	FORD FALCON	4.7L V8 4727cc 289 CID	
	1965-1968	CHRYSLER NEWPORT	6.3L V8 6286cc 383 CID			1965	MERCURY CYCLONE	4.7L V8 4727cc 289 CID	
	1965-1968	DODGE MONACO	6.3L V8 383 CID			<b>USMP11085</b>	1968-1969	DODGE CHARGER	7.2L V8 7211cc 440 CID
	1965-1968	DODGE MONACO	6.3L V8 6286cc 383 CID				1968-1969	DODGE CORONET	7.2L V8 7211cc 440 CID
	1966	DODGE CHARGER	5.9L V8 5917cc 361 CID		1969		DODGE CHARGER	7.0L V8 6981cc 426 CID	
	1966	DODGE CHARGER	7.0L V8 6981cc 426 CID		1969		DODGE CORONET	7.0L V8 6981cc 426 CID	
	1966-1968	CHRYSLER IMPERIAL	7.2L V8 7211cc 440 CID		<b>USMP11258</b>		1965	CHEVROLET C10 PICKUP	4.8L L6 4801cc 292 CID
	1966-1968	CHRYSLER NEW YORKER	7.2L V8 7211cc 440 CID				1965	CHEVROLET C20 PICKUP	4.8L L6 4801cc 292 CID
	1966-1968	CHRYSLER TOWN & COUNTRY	6.3L V8 6286cc 383 CID				1965	CHEVROLET C30 PICKUP	4.8L L6 4801cc 292 CID
1966-1968	DODGE CHARGER	6.3L V8 6286cc 383 CID	1965	CHEVROLET K10 PICKUP			4.8L L6 4801cc 292 CID		
1966-1968	DODGE MONACO	7.2L V8 7211cc 440 CID	1965	CHEVROLET K20 PICKUP			4.8L L6 4801cc 292 CID		
1966-1968	DODGE POLARA	7.2L V8 7211cc 440 CID	1967	CHEVROLET C10 PICKUP			4.1L L6 4097cc 250 CID		
1966-1968	PLYMOUTH FURY	7.2L V8 7211cc 440 CID	1967	CHEVROLET C10 SUBURBAN		4.1L L6 4097cc 250 CID			
1967	DODGE CHARGER	7.2L V8 7211cc 440 CID	1967	CHEVROLET C10 SUBURBAN		4.8L L6 4801cc 292 CID			
1967	PLYMOUTH BELVEDERE	7.2L V8 7211cc 440 CID	1967	CHEVROLET C20 PICKUP		4.1L L6 4098cc 250 CID			
1967	PLYMOUTH GTX	7.2L V8 7211cc 440 CID	1967	CHEVROLET C30 PICKUP		4.1L L6 4098cc 250 CID			
1967-1968	CHRYSLER 300	7.2L V8 7211cc 440 CID	1967	CHEVROLET K10 PICKUP	4.1L L6 4097cc 250 CID				
1967-1968	CHRYSLER NEWPORT	6.3L V8 383 CID	1967	CHEVROLET K10 PICKUP	4.1L L6 4098cc 250 CID				
1967-1968	CHRYSLER NEWPORT	7.2L V8 7211cc 440 CID	1967	CHEVROLET K10 SUBURBAN	4.1L L6 4097cc 250 CID				
1967-1968	CHRYSLER TOWN & COUNTRY	7.2L V8 7211cc 440 CID	1967	CHEVROLET K10 SUBURBAN	4.8L L6 4801cc 292 CID				
1967-1968	DODGE DART	6.3L V8 383 CID	1967	CHEVROLET K20 PICKUP	4.1L L6 4098cc 250 CID				
1967-1968	DODGE DART	6.3L V8 6286cc 383 CID	1967	CHEVROLET K20 PICKUP	4.8L L6 4801cc 292 CID				
1968	DODGE CORONET	6.3L V8 6286cc 383 CID	1967	CHEVROLET P10 VAN					
1968	DODGE D100 PICKUP	6.3L V8 383 CID	1967-1971	CHEVROLET K20 SUBURBAN	4.1L L6 4097cc 250 CID				
1968	DODGE D100 PICKUP	6.3L V8 6286cc 383 CID	1967-1971	CHEVROLET K20 SUBURBAN	4.8L L6 4801cc 292 CID				
1968	DODGE D200 PICKUP	6.3L V8 383 CID	1967-1974	CHEVROLET C20 PICKUP	4.1L L6 4097cc 250 CID				
1968	DODGE D200 PICKUP	6.3L V8 6286cc 383 CID	1967-1974	CHEVROLET C20 PICKUP	4.8L L6 4801cc 292 CID				
1968	DODGE D300 PICKUP	6.3L V8 383 CID	1967-1974	CHEVROLET C20 SUBURBAN	4.1L L6 4097cc 250 CID				
1968	DODGE D300 PICKUP	6.3L V8 6286cc 383 CID	1967-1974	CHEVROLET C20 SUBURBAN	4.8L L6 4801cc 292 CID				
1968	DODGE POLARA	6.3L V8 383 CID	1967-1974	CHEVROLET C30 PICKUP	4.1L L6 4097cc 250 CID				
1968	PLYMOUTH BARRACUDA	6.3L V8 383 CID	1967-1974	CHEVROLET C30 PICKUP	4.8L L6 4801cc 292 CID				
1968	PLYMOUTH BARRACUDA	6.3L V8 6286cc 383 CID	1967-1974	CHEVROLET K20 PICKUP	4.1L L6 4097cc 250 CID				
1968	PLYMOUTH BELVEDERE	6.3L V8 383 CID	1968-1969	CHEVROLET C20 PICKUP	4.1L L6 250 CID				
1968	PLYMOUTH ROAD RUNNER	6.3L V8 383 CID	1968-1969	CHEVROLET C20 SUBURBAN	4.1L L6 250 CID				
1968	PLYMOUTH ROAD RUNNER	6.3L V8 6286cc 383 CID	1968-1969	CHEVROLET C30 PICKUP	4.1L L6 250 CID				
1968	PLYMOUTH SATELLITE	6.3L V8 383 CID	1968-1969	CHEVROLET K20 PICKUP	4.1L L6 250 CID				
1968	PLYMOUTH SATELLITE	6.3L V8 6286cc 383 CID	1968-1969	CHEVROLET K20 SUBURBAN	4.1L L6 250 CID				
<b>USMP09970</b>	1960	CHEVROLET CORVAIR	2.3L H6 2294cc 140 CID	1968-1971	CHEVROLET K20 SUBURBAN	4.8L L6 292 CID			
	1961-1963	CHEVROLET CORVAIR	2.4L H6 145 CID	1968-1973	CHEVROLET P20 VAN	4.8L L6 292 CID			
	1961-1963	CHEVROLET CORVAIR	2.4L H6 2377cc 145 CID	1968-1973	CHEVROLET P30 VAN	4.8L L6 292 CID			
	1961-1963	CHEVROLET CORVAIR TRUCK	2.4L H6 2377cc 145 CID	1968-1974	CHEVROLET C20 PICKUP	4.8L L6 292 CID			
	1964	CHEVROLET CORVAIR TRUCK	2.7L H6 2684cc 164 CID	1968-1974	CHEVROLET C20 SUBURBAN	4.8L L6 292 CID			
	1964-1967	CHEVROLET CORVAIR	2.7L H6 164 CID	1968-1974	CHEVROLET C30 PICKUP	4.8L L6 292 CID			
	1964-1969	CHEVROLET CORVAIR	2.7L H6 2684cc 164 CID	1969-1974	CHEVROLET K20 PICKUP	4.8L L6 292 CID			
	<b>USMP10013</b>	1963	FORD FAIRLANE	2.8L L6 2786cc 170 CID	1969-1974	CHEVROLET K20 PICKUP	4.8L L6 4801cc 292 CID		
		1963-1964	FORD FALCON	2.4L L6 144 CID	1969-1975	CHEVROLET C20 SUBURBAN	4.8L L6 292 CID		
		1963-1964	FORD FALCON	2.4L L6 2360cc 144 CID	1970	CHEVROLET CHEVELLE	4.1L L6 250 CID		
1963-1964		FORD FALCON	2.4L L6 2360cc 144 CID						



USMW	Years	Application	Engine	USMW	Years	Application	Engine	
<b>USMP11258</b>	1970	CHEVROLET CHEVELLE	4.1L L6 4097cc 250 CID	<b>USMP11325</b>	1967-1969	CHEVROLET BISCAYNE	7.0L V8 6998cc 427 CID	
	1970	CHEVROLET CHEVELLE	4.1L L6 4098cc 250 CID		1967-1969	CHEVROLET CAPRICE	7.0L V8 6998cc 427 CID	
	1970	CHEVROLET P20 VAN	4.1L L6 4097cc 250 CID		1967-1969	CHEVROLET EL CAMINO	6.5L V8 6489cc 396 CID	
	1970	CHEVROLET P30 VAN	4.1L L6 4097cc 250 CID		1967-1969	CHEVROLET IMPALA	7.0L V8 427 CID	
	1970	GMC JIMMY	4.1L L6 250 CID		1967-1969	CHEVROLET IMPALA	7.0L V8 6998cc 427 CID	
	1970	GMC JIMMY	4.1L L6 4097cc 250 CID		1968	CHEVROLET CHEVY II	6.5L V8 396 CID	
	1971	CHEVROLET K20 SUBURBAN	4.1L L6 250 CID		1968	CHEVROLET CHEVY II	6.5L V8 6489cc 396 CID	
	1971-1974	CHEVROLET C20 PICKUP	4.1L L6 250 CID		1968	GMC K15/K1500 SUBURBAN	6.5L V8 396 CID	
	1971-1974	CHEVROLET C20 SUBURBAN	4.1L L6 250 CID		1968	GMC K25/K2500 SUBURBAN	6.5L V8 396 CID	
	1971-1974	CHEVROLET C30 PICKUP	4.1L L6 250 CID		1968-1969	CHEVROLET BEL AIR	7.0L V8 427 CID	
	1971-1974	CHEVROLET K20 PICKUP	4.1L L6 250 CID		1968-1969	CHEVROLET BISCAYNE	7.0L V8 427 CID	
	1971-1974	CHEVROLET P20 VAN	4.1L L6 250 CID		1968-1969	CHEVROLET C10 PICKUP	6.5L V8 396 CID	
	1971-1974	CHEVROLET P30 VAN	4.1L L6 250 CID		1968-1969	CHEVROLET C10 PICKUP	6.5L V8 6489cc 396 CID	
	1972	CHEVROLET P10 VAN	4.1L L6 250 CID		1968-1969	CHEVROLET C10 SUBURBAN	6.5L V8 396 CID	
	1972-1974	CHEVROLET C20 PICKUP	4.1L L6 4098cc 250 CID		1968-1969	CHEVROLET C10 SUBURBAN	6.5L V8 6489cc 396 CID	
	1972-1974	CHEVROLET C20 SUBURBAN	4.1L L6 4098cc 250 CID		1968-1969	CHEVROLET C20 PICKUP	6.5L V8 396 CID	
	1972-1974	CHEVROLET C30 PICKUP	4.1L L6 4098cc 250 CID		1968-1969	CHEVROLET C20 PICKUP	6.5L V8 6489cc 396 CID	
	1972-1974	CHEVROLET K20 PICKUP	4.1L L6 4098cc 250 CID		1968-1969	CHEVROLET C20 SUBURBAN	6.5L V8 6489cc 396 CID	
	1972-1974	CHEVROLET K20 PICKUP	4.8L L6 4786cc 292 CID		1968-1969	CHEVROLET C30 PICKUP	6.5L V8 396 CID	
	1973	CHEVROLET K30 PICKUP	4.8L L6 292 CID		1968-1969	CHEVROLET C30 PICKUP	6.5L V8 6489cc 396 CID	
	1973	CHEVROLET K30 PICKUP	4.8L L6 4786cc 292 CID		1968-1969	CHEVROLET CAPRICE	7.0L V8 427 CID	
	1973	CHEVROLET K30 PICKUP	4.8L L6 4801cc 292 CID		1968-1969	CHEVROLET EL CAMINO	6.5L V8 396 CID	
	1973	CHEVROLET P20 VAN	4.8L L6 4786cc 292 CID		1968-1969	CHEVROLET K10 PICKUP	6.5L V8 396 CID	
	1973	CHEVROLET P30 VAN	4.8L L6 4786cc 292 CID		1968-1969	CHEVROLET K10 PICKUP	6.5L V8 6489cc 396 CID	
	1973-1974	CHEVROLET C20 PICKUP	4.8L L6 4786cc 292 CID		1968-1969	CHEVROLET K10 SUBURBAN	6.5L V8 396 CID	
	1973-1974	CHEVROLET C20 SUBURBAN	4.8L L6 4786cc 292 CID		1968-1969	CHEVROLET K10 SUBURBAN	6.5L V8 6489cc 396 CID	
	1973-1974	CHEVROLET C30 PICKUP	4.8L L6 4786cc 292 CID		1968-1969	CHEVROLET K20 PICKUP	6.5L V8 396 CID	
	1973-1974	CHEVROLET K20 SUBURBAN	4.1L L6 250 CID		1968-1969	CHEVROLET K20 PICKUP	6.5L V8 6489cc 396 CID	
	1973-1974	CHEVROLET K20 SUBURBAN	4.1L L6 4097cc 250 CID		1968-1969	CHEVROLET K20 SUBURBAN	6.5L V8 6489cc 396 CID	
	1973-1974	CHEVROLET K20 SUBURBAN	4.1L L6 4098cc 250 CID		1968-1969	CHEVROLET K30 PICKUP	6.5L V8 396 CID	
	1973-1974	CHEVROLET K20 SUBURBAN	4.8L L6 4786cc 292 CID		1968-1969	CHEVROLET K30 PICKUP	6.5L V8 6489cc 396 CID	
	1973-1974	CHEVROLET K20 SUBURBAN	4.8L L6 4801cc 292 CID		1968-1969	GMC C15/C1500 PICKUP	6.5L V8 396 CID	
	1973-1974	CHEVROLET P20 VAN	4.1L L6 4098cc 250 CID		1968-1969	GMC C15/C1500 PICKUP	6.5L V8 6489cc 396 CID	
	1973-1974	CHEVROLET P30 VAN	4.1L L6 4098cc 250 CID		1968-1969	GMC C15/C1500 SUBURBAN	6.5L V8 396 CID	
	1973-1975	CHEVROLET K20 SUBURBAN	4.8L L6 292 CID		1968-1969	GMC C15/C1500 SUBURBAN	6.5L V8 6489cc 396 CID	
	1975	CHEVROLET G20	4.1L L6 250 CID		1968-1969	GMC C25/C2500 PICKUP	6.5L V8 396 CID	
	1975	CHEVROLET G20	4.8L L6 292 CID		1968-1969	GMC C25/C2500 PICKUP	6.5L V8 6489cc 396 CID	
	1975	CHEVROLET G30	4.8L L6 292 CID		1968-1969	GMC C25/C2500 SUBURBAN	6.5L V8 396 CID	
	1975	CHEVROLET K20	4.1L L6 250 CID		1968-1969	GMC C25/C2500 SUBURBAN	6.5L V8 6489cc 396 CID	
	1975	CHEVROLET K20	4.8L L6 292 CID		1968-1969	GMC C35/C3500 PICKUP	6.5L V8 396 CID	
	1975	CHEVROLET P20	4.8L L6 292 CID		1968-1969	GMC C35/C3500 PICKUP	6.5L V8 6489cc 396 CID	
	1975	CHEVROLET P30	4.8L L6 292 CID		1968-1969	GMC K15/K1500 PICKUP	6.5L V8 396 CID	
	<b>USMP11280</b>	1967	BUICK LESABRE		5.6L V8 340 CID	1968-1969	GMC K15/K1500 PICKUP	6.5L V8 6489cc 396 CID
		1967	BUICK LESABRE		5.6L V8 5573cc 340 CID	1968-1969	GMC K15/K1500 SUBURBAN	6.5L V8 6489cc 396 CID
		1967	BUICK SKYLARK		4.9L V8 4917cc 300 CID	1968-1969	GMC K25/K2500 PICKUP	6.5L V8 396 CID
		1967	BUICK SKYLARK		5.6L V8 5573cc 340 CID	1968-1969	GMC K25/K2500 PICKUP	6.5L V8 6489cc 396 CID
		1967	BUICK SPECIAL		4.9L V8 4917cc 300 CID	1968-1969	GMC K25/K2500 SUBURBAN	6.5L V8 396 CID
1967		JEEP DJ5	3.7L V6 3687cc 225 CID	1968-1969	GMC K35/K3500 PICKUP	6.5L V8 396 CID		
1968		JEEP DJ6	3.7L V6 3687cc 225 CID	1968-1969	GMC K35/K3500 PICKUP	6.5L V8 6489cc 396 CID		
1970		JEEP DJ5	3.7L V6 3687cc 225 CID	1969	CHEVROLET BEL AIR	6.5L V8 396 CID		
<b>USMP11283</b>		1967	CHEVROLET C10 SUBURBAN	4.6L V8 4638cc 283 CID	1969	CHEVROLET BEL AIR	6.5L V8 6489cc 396 CID	
		1967	CHEVROLET C10 SUBURBAN	5.3L V8 5358cc 327 CID	1969	CHEVROLET BISCAYNE	6.5L V8 396 CID	
		1967	CHEVROLET C20 PICKUP	4.6L V8 4638cc 283 CID	1969	CHEVROLET BISCAYNE	6.5L V8 6489cc 396 CID	
		1967	CHEVROLET C20 PICKUP	5.3L V8 5358cc 327 CID	1969	CHEVROLET BROOKWOOD	6.5L V8 6489cc 396 CID	
		1967	CHEVROLET C20 SUBURBAN	4.6L V8 4638cc 283 CID	1969	CHEVROLET BROOKWOOD	7.0L V8 6998cc 427 CID	
	1967	CHEVROLET C20 SUBURBAN	5.3L V8 5358cc 327 CID	1969	CHEVROLET C20 SUBURBAN	6.5L V8 396 CID		
	1967	CHEVROLET C30 PICKUP	4.6L V8 4638cc 283 CID	1969	CHEVROLET CAMARO	6.5L V8 6489cc 396 CID		
	1967	CHEVROLET C30 PICKUP	5.3L V8 5358cc 327 CID	1969	CHEVROLET CAPRICE	6.5L V8 396 CID		
	1967	CHEVROLET K10 PICKUP	5.3L V8 5358cc 327 CID	1969	CHEVROLET CAPRICE	6.5L V8 6489cc 396 CID		
	1967	CHEVROLET K10 SUBURBAN	4.6L V8 4638cc 283 CID	1969	CHEVROLET CHEVELLE	6.5L V8 396 CID		
	1967	CHEVROLET K10 SUBURBAN	5.3L V8 5358cc 327 CID	1969	CHEVROLET CHEVELLE	6.5L V8 6489cc 396 CID		
	1967	CHEVROLET K20 PICKUP	4.6L V8 4638cc 283 CID	1969	CHEVROLET IMPALA	6.5L V8 396 CID		
	1967	CHEVROLET K20 PICKUP	5.3L V8 5358cc 327 CID	1969	CHEVROLET IMPALA	6.5L V8 6489cc 396 CID		
	1967	CHEVROLET K20 SUBURBAN	4.6L V8 4638cc 283 CID	1969	CHEVROLET NOVA	6.5L V8 6489cc 396 CID		
	1967	CHEVROLET K20 SUBURBAN	5.3L V8 5358cc 327 CID	1969-1970	CHEVROLET NOVA	6.5L V8 396 CID		
	1968	CHEVROLET C10 SUBURBAN	5.0L V8 307 CID	1970	CHEVROLET BEL AIR	7.4L V8 454 CID		
	1968	CHEVROLET C10 SUBURBAN	5.0L V8 5031cc 307 CID	1970	CHEVROLET BEL AIR	7.4L V8 7439cc 454 CID		
	1968	CHEVROLET C20 PICKUP	5.0L V8 307 CID	1970	CHEVROLET BEL AIR	7.4L V8 7441cc 454 CID		
	1968	CHEVROLET C20 PICKUP	5.0L V8 5031cc 307 CID	1970	CHEVROLET BISCAYNE	7.4L V8 454 CID		
	1968	CHEVROLET C20 SUBURBAN	5.0L V8 5031cc 307 CID	1970	CHEVROLET BISCAYNE	7.4L V8 7439cc 454 CID		
	1968	CHEVROLET C30 PICKUP	5.0L V8 307 CID	1970	CHEVROLET BISCAYNE	7.4L V8 7441cc 454 CID		
	1968	CHEVROLET C30 PICKUP	5.0L V8 5031cc 307 CID	1970	CHEVROLET BROOKWOOD	7.4L V8 7439cc 454 CID		
	1968	CHEVROLET K10 SUBURBAN	5.0L V8 307 CID	1970	CHEVROLET CAPRICE	7.4L V8 454 CID		
	1968	CHEVROLET K10 SUBURBAN	5.0L V8 5031cc 307 CID	1970	CHEVROLET CAPRICE	7.4L V8 7439cc 454 CID		
	1968	CHEVROLET K20 PICKUP	5.0L V8 307 CID	1970	CHEVROLET CAPRICE	7.4L V8 7441cc 454 CID		
	1968	CHEVROLET K20 PICKUP	5.0L V8 5031cc 307 CID	1970	CHEVROLET CHEVELLE	7.4L V8 454 CID		
	1968-1969	CHEVROLET P20 VAN	5.0L V8 307 CID	1970	CHEVROLET CHEVELLE	7.4L V8 7439cc 454 CID		
	1968-1969	CHEVROLET P30 VAN	5.0L V8 307 CID	1970	CHEVROLET CHEVELLE	7.4L V8 7441cc 454 CID		
	1968-1970	CHEVROLET K20 SUBURBAN	5.0L V8 307 CID	1970	CHEVROLET EL CAMINO	7.4L V8 454 CID		
	1968-1970	CHEVROLET K20 SUBURBAN	5.0L V8 5031cc 307 CID	1970	CHEVROLET EL CAMINO	7.4L V8 7439cc 454 CID		
	1970	CHEVROLET K10 SUBURBAN	5.0L V8 307 CID	1970	CHEVROLET EL CAMINO	7.4L V8 7441cc 454 CID		
	1970	CHEVROLET K10 SUBURBAN	5.0L V8 5031cc 307 CID	1970	CHEVROLET IMPALA	7.4L V8 454 CID		
	1970	CHEVROLET K20 PICKUP	5.0L V8 307 CID	1970	CHEVROLET IMPALA	7.4L V8 7439cc 454 CID		
1970	CHEVROLET K20 PICKUP	5.0L V8 5031cc 307 CID	1970	CHEVROLET IMPALA	7.4L V8 7441cc 454 CID			
1970-1971	GMC JIMMY	5.0L V8 307 CID	1970	CHEVROLET K10 PICKUP	6.6L V8 6588cc 402 CID			
1970-1971	GMC JIMMY	5.0L V8 5031cc 307 CID	1970	CHEVROLET K20 PICKUP	6.6L V8 6588cc 402 CID			
<b>USMP11325</b>	1967	CHEVROLET MALIBU	6.5L V8 6489cc 396 CID	1970	CHEVROLET MONTE CARLO	7.4L V8 454 CID		
	1967-1969	CHEVROLET BEL AIR	7.0L V8 6998cc 427 CID	1970	CHEVROLET MONTE CARLO	7.4L V8 7439cc 454 CID		

USMW	Years	Application	Engine	USMW	Years	Application	Engine	
<b>USMP11325</b>	1970	CHEVROLET MONTE CARLO	7.4L V8 7441cc 454 CID	<b>USMP11473</b>	1969-1971	PLYMOUTH SATELLITE	6.3L V8 6286cc 383 CID	
	1970	CHEVROLET NOVA	6.6L V8 6588cc 402 CID		1970	DODGE MONACO	5.2L V8 5211cc 318 CID	
	1970	GMC K15/K1500 PICKUP	6.6L V8 6588cc 402 CID		1971	DODGE CORONET	6.3L V8 383 CID	
	1970	GMC K25/K2500 PICKUP	6.6L V8 6588cc 402 CID	1971	DODGE CORONET	6.3L V8 383 CID		
	1970	GMC K25/K2500 SUBURBAN	6.6L V8 6588cc 402 CID	<b>USMP11713</b>	1968	CHEVROLET C20 PICKUP	5.3L V8 5358cc 327 CID	
	1970-1971	CHEVROLET C10 SUBURBAN	6.6L V8 6588cc 402 CID		1968	CHEVROLET C20 SUBURBAN	5.3L V8 5358cc 327 CID	
	1970-1971	CHEVROLET K10 SUBURBAN	6.6L V8 6588cc 402 CID		1968	CHEVROLET C30 PICKUP	5.3L V8 5358cc 327 CID	
	1970-1971	CHEVROLET K30 PICKUP	6.6L V8 6588cc 402 CID		1968	CHEVROLET K20 PICKUP	5.3L V8 5358cc 327 CID	
	1970-1971	GMC K15/K1500 SUBURBAN	6.6L V8 6588cc 402 CID		1968	CHEVROLET K20 SUBURBAN	5.3L V8 5358cc 327 CID	
	1970-1971	GMC K35/K3500 PICKUP	6.6L V8 6588cc 402 CID		1970	CHEVROLET CAMARO	6.6L V8 6588cc 402 CID	
	1970-1972	CHEVROLET C10 PICKUP	6.6L V8 6588cc 402 CID		1981	BUICK CENTURY	4.4L V8 267 CID	
	1970-1972	CHEVROLET C20 PICKUP	6.6L V8 6588cc 402 CID		1981	BUICK CENTURY	5.0L V8 305 CID	
	1970-1972	CHEVROLET C20 SUBURBAN	6.6L V8 6588cc 402 CID		1981	CHECKER MARATHON	5.0L V8 305 CID	
	1970-1972	CHEVROLET C30 PICKUP	6.6L V8 6588cc 402 CID		1981-1982	BUICK REGAL	4.4L V8 267 CID	
	1970-1972	GMC C15/C1500 PICKUP	6.6L V8 6588cc 402 CID		1981-1982	CHECKER MARATHON	4.4L V8 267 CID	
	1970-1972	GMC C15/C1500 SUBURBAN	6.6L V8 6588cc 402 CID	1981-1982	CHECKER MARATHON	5.7L V8 350 CID		
	1970-1972	GMC C25/C2500 PICKUP	6.6L V8 6588cc 402 CID	1982	BUICK LESABRE	4.4L V8 267 CID		
	1970-1972	GMC C25/C2500 SUBURBAN	6.6L V8 6588cc 402 CID	1983-1985	PONTIAC BONNEVILLE	5.0L V8 305 CID		
	1970-1972	GMC C35/C3500 PICKUP	6.6L V8 6588cc 402 CID	1983-1985	PONTIAC GRAND PRIX	5.0L V8 305 CID		
	1971-1972	CHEVROLET CAMARO	6.6L V8 6588cc 402 CID	1983-1985	PONTIAC PARISIENNE	5.0L V8 305 CID		
	<b>USMP11383</b>	1957-1958	BUICK ROADMASTER	6.0L V8 5967cc 364 CID	1985	BUICK REGAL	5.0L V8 305 CID	
		1957-1958	BUICK SUPER	6.0L V8 5967cc 364 CID	1985-1987	CHEVROLET EL CAMINO	5.0L V8 305 CID	
		1958	BUICK CENTURY	6.0L V8 5967cc 364 CID	1985-1987	GMC CABALLERO	5.0L V8 305 CID	
1958		BUICK LIMITED	6.0L V8 5967cc 364 CID	<b>USMP11723</b>	1968	PONTIAC BONNEVILLE	6.6L V8 400 CID	
1959-1961		BUICK LESABRE	6.0L V8 5967cc 364 CID		1968	PONTIAC BONNEVILLE	6.6L V8 6555cc 400 CID	
1959-1963		BUICK INVICTA	6.6L V8 6572cc 401 CID		1968	PONTIAC BONNEVILLE	7.0L V8 428 CID	
1959-1965		BUICK ELECTRA	6.6L V8 6572cc 401 CID		1968	PONTIAC BONNEVILLE	7.0L V8 7014cc 428 CID	
1962-1964		BUICK LESABRE	6.6L V8 6572cc 401 CID		1968	PONTIAC CATALINA	6.6L V8 400 CID	
1963		BUICK RIVIERA	6.6L V8 6572cc 401 CID		1968	PONTIAC CATALINA	6.6L V8 6555cc 400 CID	
1963-1965		BUICK RIVIERA	7.0L V8 6966cc 425 CID		1968	PONTIAC CATALINA	7.0L V8 428 CID	
1963-1965		BUICK WILDCAT	6.6L V8 6572cc 401 CID		1968	PONTIAC CATALINA	7.0L V8 7014cc 428 CID	
1964		BUICK LESABRE	7.0L V8 6966cc 425 CID		1968	PONTIAC EXECUTIVE	6.6L V8 6555cc 400 CID	
1964-1965		BUICK ELECTRA	7.0L V8 6966cc 425 CID		1968	PONTIAC EXECUTIVE	7.0L V8 7014cc 428 CID	
1964-1965		BUICK WILDCAT	7.0L V8 6966cc 425 CID		1968	PONTIAC FIREBIRD	5.7L V8 350 CID	
1965		BUICK GRAN SPORT	6.6L V8 6572cc 401 CID	1968	PONTIAC FIREBIRD	5.7L V8 5733cc 350 CID		
1965		BUICK RIVIERA	6.6L V8 6572cc 401 CID	1968	PONTIAC FIREBIRD	6.6L V8 400 CID		
1965		BUICK RIVIERA	7.0L V8 425 CID	1968	PONTIAC FIREBIRD	6.6L V8 6555cc 400 CID		
1965	BUICK SKYLARK	6.6L V8 6572cc 401 CID	1968	PONTIAC GRAND PRIX	6.6L V8 400 CID			
1965	BUICK WILDCAT	7.0L V8 425 CID	1968	PONTIAC GRAND PRIX	6.6L V8 6555cc 400 CID			
<b>USMP11415</b>	1958	PONTIAC BONNEVILLE	6.1L V8 6064cc 370 CID	1968	PONTIAC GRAND PRIX	7.0L V8 428 CID		
	1958	PONTIAC CHIEFTAIN	6.1L V8 6064cc 370 CID	1968	PONTIAC GRAND PRIX	7.0L V8 7014cc 428 CID		
	1958	PONTIAC STAR CHIEF	6.1L V8 370 CID	1968	PONTIAC GTO	6.6L V8 400 CID		
	1958	PONTIAC STAR CHIEF	6.1L V8 6064cc 370 CID	1968	PONTIAC GTO	6.6L V8 6555cc 400 CID		
	1958	PONTIAC SUPER CHIEF	6.1L V8 6064cc 370 CID	1968	PONTIAC LEMANS	5.7L V8 350 CID		
	1959-1962	PONTIAC BONNEVILLE	6.4L V8 389 CID	1968	PONTIAC LEMANS	5.7L V8 5733cc 350 CID		
	1959-1965	PONTIAC BONNEVILLE	6.4L V8 6376cc 389 CID	1968	PONTIAC TEMPEST	5.7L V8 5733cc 350 CID		
	1959-1965	PONTIAC CATALINA	6.4L V8 6376cc 389 CID	<b>USMP11760</b>	1980	CHEVROLET C70	7.4L V8 454 CID	
	1959-1965	PONTIAC STAR CHIEF	6.4L V8 6376cc 389 CID		1980	GMC C7000	7.4L V8 454 CID	
	1960-1961	PONTIAC VENTURA	6.4L V8 6376cc 389 CID		1980-1982	GMC B6000	6.0L V8 366 CID	
	1962	PONTIAC GRAND PRIX	6.4L V8 6376cc 389 CID		1980-1985	CHEVROLET B60	6.0L V8 366 CID	
	<b>USMP11473</b>	1969	CHRYSLER IMPERIAL		7.2L V8 7211cc 440 CID	1980-1985	CHEVROLET B60	7.0L V8 427 CID
		1969	CHRYSLER NEWPORT		6.3L V8 383 CID	1980-1985	CHEVROLET C60	6.0L V8 366 CID
1969		CHRYSLER NEWPORT	6.3L V8 6286cc 383 CID	1980-1985	CHEVROLET C70	6.0L V8 366 CID		
1969		CHRYSLER NEWPORT	7.2L V8 7211cc 440 CID	1980-1985	CHEVROLET C70	7.0L V8 427 CID		
1969		CHRYSLER NEW YORKER	7.2L V8 7211cc 440 CID	1980-1985	GMC B6000	7.0L V8 427 CID		
1969		DODGE CHARGER	6.3L V8 383 CID	1980-1985	GMC C6000	6.0L V8 366 CID		
1969		DODGE CHARGER	6.3L V8 6286cc 383 CID	1980-1985	GMC C7000	6.0L V8 366 CID		
1969		DODGE CORONET	6.3L V8 383 CID	1980-1985	GMC C7000	7.0L V8 427 CID		
1969		DODGE CORONET	6.3L V8 6286cc 383 CID	1984-1985	GMC B6000	6.0L V8 366 CID		
1969		DODGE DART	6.3L V8 383 CID	<b>USMP11780</b>	1959-1965	CHEVROLET BEL AIR	4.6L V8 4638cc 283 CID	
1969		DODGE DART	6.3L V8 6286cc 383 CID		1959-1965	CHEVROLET BISCAYNE	4.6L V8 4638cc 283 CID	
1969	PLYMOUTH BARRACUDA	6.3L V8 383 CID	1959-1965		CHEVROLET IMPALA	4.6L V8 4638cc 283 CID		
1969	PLYMOUTH BARRACUDA	6.3L V8 6286cc 383 CID	1960		CHEVROLET BISCAYNE	4.6L V8 283 CID		
1969	PLYMOUTH FURY	6.3L V8 383 CID	1960		CHEVROLET EL CAMINO	4.6L V8 4638cc 283 CID		
1969	PLYMOUTH FURY	6.3L V8 6286cc 383 CID	1963-1965		CHEVROLET C20 PICKUP	4.6L V8 4638cc 283 CID		
1969	PLYMOUTH FURY	7.2L V8 7211cc 440 CID	1963-1965	CHEVROLET C30 PICKUP	4.6L V8 4638cc 283 CID			
1969	PLYMOUTH GTX	7.2L V8 7211cc 440 CID	1963-1965	CHEVROLET K20 PICKUP	4.6L V8 4638cc 283 CID			
1969	PLYMOUTH ROAD RUNNER	6.3L V8 383 CID	1964	CHEVROLET EL CAMINO	4.6L V8 4638cc 283 CID			
1969	PLYMOUTH ROAD RUNNER	6.3L V8 6286cc 383 CID	1964	CHEVROLET IMPALA	4.6L V8 283 CID			
1969	PLYMOUTH ROAD RUNNER	7.2L V8 7211cc 440 CID	1964-1965	CHEVROLET CHEVY II	4.6L V8 283 CID			
1969-1970	PLYMOUTH BELVEDERE	6.3L V8 383 CID	1964-1965	CHEVROLET CHEVY II	4.6L V8 4638cc 283 CID			
1969-1970	PLYMOUTH BELVEDERE	6.3L V8 6286cc 383 CID	<b>USMP12113</b>	1970	DODGE CHALLENGER	5.2L V8 5211cc 318 CID		
1969-1971	CHRYSLER TOWN & COUNTRY	6.3L V8 383 CID		1970	DODGE CHALLENGER	5.6L V8 5572cc 340 CID		
1969-1971	CHRYSLER TOWN & COUNTRY	6.3L V8 6286cc 383 CID		1970	DODGE CHARGER	5.6L V8 5572cc 340 CID		
1969-1971	CHRYSLER TOWN & COUNTRY	7.2L V8 7211cc 440 CID		1970	DODGE CORONET	5.6L V8 5572cc 340 CID		
1969-1971	DODGE D100 PICKUP	6.3L V8 383 CID		1970	DODGE CORONET	6.3L V8 6286cc 383 CID		
1969-1971	DODGE D100 PICKUP	6.3L V8 6286cc 383 CID		1970	PLYMOUTH BARRACUDA	6.3L V8 383 CID		
1969-1971	DODGE D200 PICKUP	6.3L V8 383 CID		1970	PLYMOUTH BARRACUDA	6.3L V8 6286cc 383 CID		
1969-1971	DODGE D200 PICKUP	6.3L V8 6286cc 383 CID		1970	PLYMOUTH CUDA	5.6L V8 5572cc 340 CID		
1969-1971	DODGE D300 PICKUP	6.3L V8 383 CID		1970	PLYMOUTH SUPERBIRD	7.0L V8 6981cc 426 CID		
1969-1971	DODGE D300 PICKUP	6.3L V8 6286cc 383 CID		1970	PLYMOUTH SUPERBIRD	7.2L V8 7211cc 440 CID		
1969-1971	DODGE MONACO	6.3L V8 383 CID		1970-1971	CHRYSLER 300	7.2L V8 7211cc 440 CID		
1969-1971	DODGE MONACO	6.3L V8 6286cc 383 CID		1970-1971	DODGE CHALLENGER	6.3L V8 383 CID		
1969-1971	DODGE MONACO	7.2L V8 7211cc 440 CID		1970-1971	DODGE CHALLENGER	6.3L V8 6286cc 383 CID		
1969-1971	DODGE POLARA	6.3L V8 383 CID		1970-1971	DODGE CHALLENGER	7.2L V8 7211cc 440 CID		
1969-1971	DODGE POLARA	6.3L V8 6286cc 383 CID	1970-1971	DODGE CHARGER	6.3L V8 6286cc 383 CID			
1969-1971	DODGE POLARA	7.2L V8 7211cc 440 CID	1970-1971	DODGE CHARGER	7.2L V8 7211cc 440 CID			
1969-1971	PLYMOUTH SATELLITE	6.3L V8 383 CID	1970-1971	DODGE CORONET	7.2L V8 7211cc 440 CID			

MECHANICAL FUEL PUMPS



USMW	Years	Application	Engine	USMW	Years	Application	Engine		
<b>USMP12113</b>	1970-1971	PLYMOUTH CUDA	6.3L V8 383 CID	<b>USMP15305</b>	1976	PONTIAC CATALINA	7.5L V8 455 CID		
	1970-1971	PLYMOUTH CUDA	6.3L V8 6286cc 383 CID		<b>USMP15538</b>	1970-1972	CHEVROLET CHEVELLE	5.7L V8 350 CID	
	1970-1971	PLYMOUTH CUDA	7.0L V8 6981cc 426 CID			1970-1972	CHEVROLET EL CAMINO	5.7L V8 350 CID	
	1970-1971	PLYMOUTH CUDA	7.2L V8 7211cc 440 CID			1971	CHEVROLET IMPALA	5.7L V8 350 CID	
	1970-1971	PLYMOUTH ROAD RUNNER	6.3L V8 383 CID			1971	CHEVROLET KINGSWOOD	5.7L V8 350 CID	
	1970-1971	PLYMOUTH ROAD RUNNER	6.3L V8 6286cc 383 CID			1971-1972	CHEVROLET IMPALA	6.6L V8 400 CID	
	1970-1971	PLYMOUTH ROAD RUNNER	7.2L V8 7211cc 440 CID			1971-1972	CHEVROLET IMPALA	6.6L V8 6588cc 402 CID	
	1971	DODGE CHARGER	5.9L V8 360 CID			1971-1972	CHEVROLET KINGSWOOD	6.6L V8 400 CID	
	<b>USMP12170</b>	1969	PONTIAC TEMPEST			5.7L V8 5733cc 350 CID	1971-1972	CHEVROLET KINGSWOOD	6.6L V8 6588cc 402 CID
		<b>USMP12213</b>	1969			PONTIAC GRAND PRIX	6.6L V8 400 CID	1971-1974	GMC SPRINT
1969			PONTIAC GRAND PRIX	6.6L V8 6555cc 400 CID		1972	CHEVROLET C20 PICKUP	5.7L V8 350 CID	
1969	PONTIAC GRAND PRIX	7.0L V8 428 CID	1972	CHEVROLET C30 PICKUP	5.0L V8 5031cc 307 CID				
1969	PONTIAC GRAND PRIX	7.0L V8 7014cc 428 CID	1972	CHEVROLET C30 PICKUP	5.7L V8 350 CID				
1969	PONTIAC GTO	6.6L V8 400 CID	1972	CHEVROLET CHEVELLE	6.6L V8 6588cc 402 CID				
1969	PONTIAC GTO	6.6L V8 6555cc 400 CID	1972	GMC C15/C1500 PICKUP	5.7L V8 350 CID				
<b>USMP15253</b>	1976	CHEVROLET CAMARO	5.7L V8 350 CID	1972	GMC C15/C1500 SUBURBAN	5.7L V8 350 CID			
	1987	PONTIAC GRAND PRIX	5.0L V8 305 CID	1972	GMC C25/C2500 PICKUP	5.7L V8 350 CID			
	1987-1988	CHEVROLET MONTE CARLO	5.0L V8 305 CID	1972	GMC C35/C3500 PICKUP	5.7L V8 350 CID			
<b>USMP15270</b>	1975	OLDSMOBILE CUTLASS	4.3L V8 260 CID	1973	CHEVROLET G20 VAN	5.0L V8 5031cc 307 CID			
	1975	OLDSMOBILE VISTA CRUISER	5.7L V8 350 CID	1973	GMC G25/G2500 VAN	5.0L V8 307 CID			
	1975-1977	OLDSMOBILE CUTLASS	5.7L V8 350 CID	1973-1974	CHEVROLET G10 VAN	5.7L V8 350 CID			
	1977	OLDSMOBILE 98	5.7L V8 350 CID	1973-1974	CHEVROLET G20 VAN	5.7L V8 350 CID			
	1977-1978	OLDSMOBILE CUTLASS	4.3L V8 260 CID	1973-1974	CHEVROLET G30 VAN	5.7L V8 350 CID			
	1978-1980	OLDSMOBILE DELTA 88	4.3L V8 260 CID	1973-1974	GMC G15/G1500 VAN	5.7L V8 350 CID			
	1980	BUICK RIVIERA	5.0L V8 307 CID	1973-1974	GMC G25/G2500 VAN	5.7L V8 350 CID			
	1980	OLDSMOBILE 98	5.0L V8 307 CID	1973-1974	GMC G35/G3500 VAN	5.7L V8 350 CID			
	1980	OLDSMOBILE DELTA 88	5.0L V8 307 CID	1975	GMC K25	5.7L V8 350 CID			
	1980	OLDSMOBILE TORONADO	5.0L V8 307 CID	1975-1976	CHEVROLET G10	5.7L V8 350 CID			
1980-1981	OLDSMOBILE CUTLASS	4.3L V8 260 CID	1975-1976	CHEVROLET G20	5.7L V8 350 CID				
1980-1981	OLDSMOBILE CUTLASS CRUISER	4.3L V8 260 CID	1975-1976	CHEVROLET G20	6.6L V8 400 CID				
<b>USMP15273</b>	1973-1974	OLDSMOBILE OMEGA	5.7L V8 350 CID	1975-1976	CHEVROLET G30	5.7L V8 350 CID			
	1975	OLDSMOBILE VISTA CRUISER	7.5L V8 455 CID	1975-1976	CHEVROLET G30	6.6L V8 400 CID			
	1975-1976	OLDSMOBILE 98	7.5L V8 455 CID	1975-1976	CHEVROLET K5 BLAZER	5.7L V8 350 CID			
	1975-1976	OLDSMOBILE CUTLASS	7.5L V8 455 CID	1975-1976	CHEVROLET K10	5.7L V8 350 CID			
	1976	OLDSMOBILE CUSTOM CRUISER	7.5L V8 455 CID	1975-1976	CHEVROLET K10 SUBURBAN	5.7L V8 350 CID			
	1976	OLDSMOBILE CUTLASS	4.3L V8 260 CID	1975-1976	CHEVROLET K20	5.7L V8 350 CID			
	1976	OLDSMOBILE DELTA 88	5.7L V8 350 CID	1975-1976	CHEVROLET K20 SUBURBAN	5.7L V8 350 CID			
	1976	OLDSMOBILE DELTA 88	7.5L V8 455 CID	1975-1976	GMC G15	5.7L V8 350 CID			
	1977	BUICK ESTATE WAGON	6.6L V8 403 CID	1975-1976	GMC G25	5.7L V8 350 CID			
	1977	OLDSMOBILE CUTLASS	6.6L V8 403 CID	1975-1976	GMC G35	5.7L V8 350 CID			
1977-1979	OLDSMOBILE 98	6.6L V8 403 CID	1975-1976	GMC G35	6.6L V8 400 CID				
1978-1979	OLDSMOBILE CUSTOM CRUISER	5.7L V8 350 CID	1975-1976	GMC K15	5.7L V8 350 CID				
1978-1979	OLDSMOBILE CUSTOM CRUISER	6.6L V8 403 CID	1975-1976	GMC K15 SUBURBAN	5.7L V8 350 CID				
1978-1979	OLDSMOBILE DELTA 88	6.6L V8 403 CID	1975-1976	GMC K25 SUBURBAN	5.7L V8 350 CID				
1978-1980	OLDSMOBILE 98	5.7L V8 350 CID	1976	GMC SPRINT	5.7L V8 350 CID				
1978-1980	OLDSMOBILE DELTA 88	5.7L V8 350 CID	<b>USMP16013</b>	1972-1974	PONTIAC GRANDVILLE	7.5L V8 455 CID			
1979-1980	BUICK RIVIERA	5.7L V8 350 CID		1972-1974	PONTIAC GRANDVILLE	7.5L V8 7456cc 455 CID			
1979-1980	OLDSMOBILE TORONADO	5.7L V8 350 CID		1972-1974	PONTIAC GRANDVILLE	7.5L V8 7457cc 455 CID			
1980	OLDSMOBILE CUTLASS	5.7L V8 350 CID		1973	PONTIAC BONNEVILLE	6.6L V8 400 CID			
1980	OLDSMOBILE CUTLASS CRUISER	5.7L V8 350 CID		1973	PONTIAC BONNEVILLE	6.6L V8 6555cc 400 CID			
1980	PONTIAC CATALINA	5.7L V8 350 CID		1973	PONTIAC BONNEVILLE	7.5L V8 455 CID			
1981	PONTIAC BONNEVILLE	5.0L V8 307 CID		1973	PONTIAC BONNEVILLE	7.5L V8 7456cc 455 CID			
1981	PONTIAC CATALINA	5.0L V8 305 CID		1973	PONTIAC BONNEVILLE	7.5L V8 7457cc 455 CID			
1981	PONTIAC CATALINA	5.0L V8 307 CID		1973	PONTIAC GRAND AM	6.6L V8 400 CID			
1981-1982	BUICK RIVIERA	5.0L V8 307 CID		1973	PONTIAC GRAND AM	6.6L V8 6555cc 400 CID			
1981-1983	BUICK ELECTRA	5.0L V8 307 CID	1973	PONTIAC GRAND AM	7.5L V8 455 CID				
1981-1983	BUICK LESABRE	5.0L V8 307 CID	1973	PONTIAC GRAND AM	7.5L V8 7456cc 455 CID				
1981-1983	OLDSMOBILE CUTLASS CRUISER	5.0L V8 307 CID	1973	PONTIAC GRAND PRIX	7.5L V8 7457cc 455 CID				
1982	OLDSMOBILE TORONADO	5.0L V8 307 CID	1973	PONTIAC GRANDVILLE	6.6L V8 400 CID				
1982-1983	OLDSMOBILE CUTLASS CRUISER	5.0L V8 305 CID	1973	PONTIAC GRANDVILLE	6.6L V8 6555cc 400 CID				
1984	OLDSMOBILE 98	5.0L V8 307 CID	1973	PONTIAC LEMANS	7.5L V8 7457cc 455 CID				
1984-1985	OLDSMOBILE DELTA 88	5.0L V8 307 CID	1973-1974	PONTIAC GRAND PRIX	6.6L V8 400 CID				
1984-1985	OLDSMOBILE TORONADO	5.0L V8 307 CID	1973-1974	PONTIAC GRAND PRIX	6.6L V8 6555cc 400 CID				
1985	BUICK RIVIERA	5.0L V8 307 CID	1973-1974	PONTIAC GRAND PRIX	7.5L V8 455 CID				
1985	OLDSMOBILE CUTLASS	5.0L V8 305 CID	1973-1974	PONTIAC GRAND PRIX	7.5L V8 7456cc 455 CID				
1985-1989	BUICK ELECTRA	5.0L V8 307 CID	1973-1974	PONTIAC GRAND SAFARI	6.6L V8 400 CID				
1985-1990	BUICK LESABRE	5.0L V8 307 CID	1973-1974	PONTIAC GRAND SAFARI	6.6L V8 6555cc 400 CID				
1987	BUICK REGAL	5.0L V8 305 CID	1973-1974	PONTIAC GRAND SAFARI	7.5L V8 455 CID				
1987	BUICK REGAL	5.0L V8 307 CID	1973-1974	PONTIAC GRAND SAFARI	7.5L V8 7456cc 455 CID				
1987	OLDSMOBILE CUTLASS	5.0L V8 305 CID	1973-1974	PONTIAC GRAND SAFARI	7.5L V8 7457cc 455 CID				
1987-1989	PONTIAC SAFARI	5.0L V8 307 CID	1973-1974	PONTIAC LEMANS	6.6L V8 400 CID				
1988	OLDSMOBILE CUTLASS SUPREME	5.0L V8 307 CID	1973-1974	PONTIAC LEMANS	6.6L V8 6555cc 400 CID				
1989-1990	CHEVROLET CAPRICE	5.0L V8 305 CID	1973-1974	PONTIAC LEMANS	7.5L V8 455 CID				
1989-1990	CHEVROLET CAPRICE	5.0L V8 307 CID	1973-1974	PONTIAC LEMANS	7.5L V8 7456cc 455 CID				
<b>USMP15305</b>	1970	PONTIAC GTO	6.6L V8 400 CID	<b>USMP16263</b>	1970	AMERICAN MOTORS AMX	5.9L V8 360 CID		
	1970	PONTIAC GTO	6.6L V8 6555cc 400 CID		1970	AMERICAN MOTORS AMX	6.4L V8 390 CID		
	1970-1972	PONTIAC GRAND PRIX	6.6L V8 400 CID		1970	AMERICAN MOTORS AMX	6.4L V8 6391cc 390 CID		
	1970-1972	PONTIAC GRAND PRIX	6.6L V8 6555cc 400 CID		1971-1973	JEEP J-100	5.9L V8 360 CID		
	1970-1972	PONTIAC GRAND PRIX	7.5L V8 455 CID		1971-1974	AMERICAN MOTORS AMBASSADOR	5.0L V8 304 CID		
	1970-1972	PONTIAC GRAND PRIX	7.5L V8 7456cc 455 CID		1971-1974	AMERICAN MOTORS AMBASSADOR	5.0L V8 4982cc 304 CID		
	1975	OLDSMOBILE 98	6.6L V8 400 CID		1971-1974	AMERICAN MOTORS AMBASSADOR	5.0L V8 4983cc 304 CID		
	1975	PONTIAC GRAND LEMANS	6.6L V8 400 CID		1971-1974	AMERICAN MOTORS AMBASSADOR	5.9L V8 360 CID		
	1975	PONTIAC GRAND LEMANS	7.5L V8 455 CID		1971-1974	AMERICAN MOTORS AMBASSADOR	6.6L V8 6572cc 401 CID		
	1975	PONTIAC GRAND PRIX	6.6L V8 400 CID		1971-1974	AMERICAN MOTORS HORNET	5.0L V8 4982cc 304 CID		
1975	PONTIAC GRAND PRIX	7.5L V8 455 CID	1971-1974	AMERICAN MOTORS HORNET	5.0L V8 4983cc 304 CID				
1975	PONTIAC GRAND SAFARI	6.6L V8 400 CID	1971-1974	AMERICAN MOTORS HORNET	5.9L V8 360 CID				
1975-1976	PONTIAC GRAND SAFARI	7.5L V8 455 CID	1971-1974	AMERICAN MOTORS JAVELIN	5.0L V8 4982cc 304 CID				
1976	PONTIAC BONNEVILLE	7.5L V8 455 CID	1971-1974	AMERICAN MOTORS JAVELIN	5.0L V8 4983cc 304 CID				





# MECHANICAL FUEL PUMP BUYERS GUIDE



USMW	Years	Application	Engine	USMW	Years	Application	Engine
<b>USMP16263</b>	1971-1974	<b>AMERICAN MOTORS</b> JAVELIN	5.9L V8 360 CID	<b>USMP16560</b>	1970-1973	<b>CHEVROLET</b> P30 VAN	5.7L V8 350 CID
	1971-1974	<b>AMERICAN MOTORS</b> JAVELIN	6.6L V8 6572cc 401 CID		1970-1974	<b>CHEVROLET</b> G10 VAN	5.7L V8 350 CID
	1971-1974	<b>AMERICAN MOTORS</b> MATADOR	5.0L V8 4982cc 304 CID		1970-1974	<b>CHEVROLET</b> G30 VAN	5.7L V8 350 CID
	1971-1974	<b>AMERICAN MOTORS</b> MATADOR	5.0L V8 4983cc 304 CID		1970-1975	<b>CHEVROLET</b> BEL AIR	6.6L V8 400 CID
	1971-1974	<b>AMERICAN MOTORS</b> MATADOR	6.6L V8 6572cc 401 CID		1971	<b>CHEVROLET</b> C20 SUBURBAN	5.0L V8 5031cc 307 CID
	1971-1975	<b>AMERICAN MOTORS</b> HORNET	5.0L V8 304 CID		1971	<b>CHEVROLET</b> EL CAMINO	6.6L V8 6588cc 402 CID
	1971-1975	<b>AMERICAN MOTORS</b> MATADOR	5.0L V8 304 CID		1971	<b>CHEVROLET</b> G20 VAN	5.0L V8 5031cc 307 CID
	1971-1975	<b>AMERICAN MOTORS</b> MATADOR	5.9L V8 360 CID		1971	<b>CHEVROLET</b> K20 SUBURBAN	5.0L V8 307 CID
	1972-1974	<b>AMERICAN MOTORS</b> GREMLIN	5.0L V8 4982cc 304 CID		1971	<b>CHEVROLET</b> K20 SUBURBAN	5.0L V8 5031cc 307 CID
	1972-1974	<b>AMERICAN MOTORS</b> GREMLIN	5.0L V8 4983cc 304 CID		1971	<b>CHEVROLET</b> NOVA	5.7L V8 350 CID
	1972-1975	<b>AMERICAN MOTORS</b> GREMLIN	5.0L V8 304 CID		1972	<b>CHEVROLET</b> K10 PICKUP	5.0L V8 307 CID
	1972-1975	<b>JEEP</b> WAGONEER	5.9L V8 360 CID		1972	<b>CHEVROLET</b> K20 SUBURBAN	5.0L V8 5031cc 307 CID
	1974	<b>JEEP</b> CHEROKEE	6.6L V8 6572cc 401 CID		1972	<b>CHEVROLET</b> K20 PICKUP	5.0L V8 307 CID
	1974	<b>JEEP</b> J20	6.6L V8 6572cc 401 CID		1972	<b>CHEVROLET</b> K20 PICKUP	5.0L V8 5031cc 307 CID
	1974-1975	<b>JEEP</b> CHEROKEE	5.9L V8 360 CID		1972	<b>CHEVROLET</b> KINGSWOOD	5.7L V8 350 CID
	1974-1975	<b>JEEP</b> J10	5.9L V8 360 CID		1972-1973	<b>CHEVROLET</b> C10 PICKUP	5.0L V8 307 CID
	1974-1975	<b>JEEP</b> J10	6.6L V8 6572cc 401 CID		1972-1973	<b>CHEVROLET</b> G10 VAN	5.0L V8 307 CID
	1974-1975	<b>JEEP</b> J20	5.9L V8 360 CID		1972-1974	<b>CHEVROLET</b> K10 PICKUP	5.7L V8 350 CID
	1974-1975	<b>JEEP</b> WAGONEER	6.6L V8 6572cc 401 CID		1972-1974	<b>CHEVROLET</b> K20 PICKUP	5.7L V8 350 CID
	<b>USMP16470</b>	1965-1973	<b>FORD</b> F-350		5.0L V8 302 CID	1973	<b>CHEVROLET</b> CHEVELLE
1968		<b>FORD</b> FALCON	4.7L V8 289 CID	1973	<b>CHEVROLET</b> K30 PICKUP	5.7L V8 350 CID	
1968		<b>FORD</b> FALCON	4.7L V8 4727cc 289 CID	1973	<b>CHEVROLET</b> P10 VAN	5.7L V8 350 CID	
1968		<b>FORD</b> MUSTANG	4.7L V8 4727cc 289 CID	1973	<b>CHEVROLET</b> P20 VAN	5.0L V8 307 CID	
1968		<b>MERCURY</b> COUGAR	4.7L V8 289 CID	1973	<b>CHEVROLET</b> P30 VAN	5.0L V8 307 CID	
1968		<b>MERCURY</b> COUGAR	4.7L V8 4727cc 289 CID	1973-1974	<b>CHEVROLET</b> CAPRICE	5.7L V8 350 CID	
1968		<b>MERCURY</b> COUGAR	5.0L V8 302 CID	1973-1979	<b>CHEVROLET</b> C10 SUBURBAN	5.7L V8 350 CID	
1968-1969		<b>FORD</b> MUSTANG	5.0L V8 302 CID	1974	<b>CHEVROLET</b> BLAZER	5.7L V8 350 CID	
1968-1969		<b>MERCURY</b> COMET	5.0L V8 302 CID	1974	<b>CHEVROLET</b> C20 PICKUP	5.7L V8 350 CID	
1968-1969		<b>MERCURY</b> CYCLONE	5.0L V8 302 CID	1974	<b>CHEVROLET</b> C30 PICKUP	5.7L V8 350 CID	
1968-1970		<b>FORD</b> FALCON	5.0L V8 302 CID	1974	<b>GMC</b> JIMMY	5.7L V8 350 CID	
1968-1971		<b>FORD</b> TORINO	5.0L V8 302 CID	1974-1975	<b>CHEVROLET</b> CAPRICE	6.6L V8 400 CID	
1968-1971		<b>MERCURY</b> MONTEGO	5.0L V8 302 CID	1974-1975	<b>CHEVROLET</b> LAGUNA	5.7L V8 350 CID	
1968-1974		<b>FORD</b> RANCHERO	5.0L V8 302 CID	1975-1978	<b>CHEVROLET</b> G10	5.7L V8 350 CID	
1969-1970		<b>FORD</b> FAIRLANE	5.0L V8 302 CID	1975-1978	<b>CHEVROLET</b> G20	5.7L V8 350 CID	
1970		<b>FORD</b> CUSTOM	5.0L V8 302 CID	1975-1978	<b>CHEVROLET</b> G30	5.7L V8 350 CID	
1970		<b>FORD</b> E-100 ECONOLINE	5.0L V8 302 CID	1975-1978	<b>CHEVROLET</b> MALIBU	5.7L V8 350 CID	
1970-1972		<b>FORD</b> CUSTOM 500	5.0L V8 302 CID	1975-1979	<b>CHEVROLET</b> C10	5.7L V8 350 CID	
1970-1972		<b>FORD</b> GALAXIE 500	5.0L V8 302 CID	1975-1979	<b>CHEVROLET</b> C20	5.7L V8 350 CID	
1970-1974		<b>FORD</b> BRONCO	5.0L V8 302 CID	1975-1979	<b>CHEVROLET</b> C30	5.7L V8 350 CID	
1970-1974		<b>FORD</b> E-200 ECONOLINE	5.0L V8 302 CID	1975-1979	<b>CHEVROLET</b> K5 BLAZER	5.7L V8 350 CID	
1970-1974		<b>FORD</b> E-300 ECONOLINE	5.0L V8 302 CID	1975-1980	<b>CHEVROLET</b> MARATHON	5.7L V8 350 CID	
1970-1974		<b>FORD</b> MAVERICK	5.0L V8 302 CID	1976	<b>CHEVROLET</b> MONZA	5.0L V8 305 CID	
1971-1973		<b>FORD</b> MUSTANG	5.0L V8 302 CID	1976-1978	<b>CHEVROLET</b> MALIBU	5.0L V8 305 CID	
1971-1974		<b>MERCURY</b> COMET	5.0L V8 302 CID	1976-1980	<b>CHEVROLET</b> CAMARO	5.0L V8 305 CID	
1972-1973		<b>FORD</b> E-100 ECONOLINE	5.0L V8 302 CID	1976-1980	<b>CHEVROLET</b> EL CAMINO	5.0L V8 305 CID	
1972-1974		<b>FORD</b> GRAN TORINO	5.0L V8 302 CID	1977	<b>BUICK</b> REGAL	5.7L V8 350 CID	
1973		<b>FORD</b> F-100	5.0L V8 302 CID	1977	<b>CHEVROLET</b> MONTE CARLO	5.7L V8 350 CID	
1973		<b>FORD</b> F-250	5.0L V8 302 CID	1977	<b>GMC</b> SPRINT	5.0L V8 305 CID	
<b>USMP16545</b>		1973	<b>FORD</b> F-100	7.5L V8 460 CID	1977	<b>GMC</b> SPRINT	5.7L V8 350 CID
		1973	<b>FORD</b> F-100	7.5L V8 7539cc 460 CID	1977	<b>OLDSMOBILE</b> CUSTOM CRUISER	5.7L V8 350 CID
		1973	<b>FORD</b> F-350	7.5L V8 460 CID	1977	<b>PONTIAC</b> PHOENIX	5.0L V8 305 CID
		1973	<b>FORD</b> F-350	7.5L V8 7539cc 460 CID	1977	<b>PONTIAC</b> PHOENIX	5.7L V8 350 CID
		1975-1976	<b>FORD</b> F-350	7.5L V8 460 CID	1977-1978	<b>CHEVROLET</b> EL CAMINO	5.7L V8 350 CID
<b>USMP16560</b>		1969	<b>CHEVROLET</b> BEL AIR	5.3L V8 5358cc 327 CID	1977-1978	<b>CHEVROLET</b> G10	5.0L V8 305 CID
	1969	<b>CHEVROLET</b> BEL AIR	5.4L V8 327 CID	1977-1978	<b>CHEVROLET</b> G20	5.0L V8 305 CID	
	1969	<b>CHEVROLET</b> BISCAYNE	5.3L V8 5358cc 327 CID	1977-1978	<b>CHEVROLET</b> MONTE CARLO	5.0L V8 305 CID	
	1969	<b>CHEVROLET</b> BISCAYNE	5.4L V8 327 CID	1977-1979	<b>BUICK</b> CENTURY	5.7L V8 350 CID	
	1969	<b>CHEVROLET</b> BROOKWOOD	5.3L V8 5358cc 327 CID	1977-1979	<b>BUICK</b> SKYLARK	5.0L V8 305 CID	
	1969	<b>CHEVROLET</b> CAMARO	4.9L V8 4949cc 302 CID	1977-1979	<b>BUICK</b> SKYLARK	5.7L V8 350 CID	
	1969	<b>CHEVROLET</b> CHEVELLE	5.7L V8 350 CID	1977-1979	<b>CHEVROLET</b> C10	5.0L V8 305 CID	
	1969	<b>CHEVROLET</b> KINGSWOOD	5.0L V8 5031cc 307 CID	1977-1979	<b>CHEVROLET</b> C10 SUBURBAN	5.0L V8 305 CID	
	1969-1970	<b>CHEVROLET</b> DELUXE	5.7L V8 350 CID	1977-1979	<b>CHEVROLET</b> C20	5.0L V8 305 CID	
	1969-1970	<b>CHEVROLET</b> BISCAYNE	5.7L V8 350 CID	1977-1979	<b>CHEVROLET</b> C20 SUBURBAN	5.0L V8 305 CID	
	1969-1970	<b>CHEVROLET</b> BROOKWOOD	5.7L V8 350 CID	1977-1979	<b>CHEVROLET</b> CAPRICE	5.0L V8 305 CID	
	1969-1970	<b>CHEVROLET</b> CAPRICE	5.7L V8 350 CID	1977-1979	<b>CHEVROLET</b> IMPALA	5.0L V8 305 CID	
	1969-1970	<b>CHEVROLET</b> KINGSWOOD	5.7L V8 350 CID	1977-1979	<b>CHEVROLET</b> IMPALA	5.7L V8 350 CID	
	1969-1971	<b>CHEVROLET</b> BLAZER	5.7L V8 350 CID	1977-1979	<b>CHEVROLET</b> K5 BLAZER	5.0L V8 305 CID	
	1969-1971	<b>CHEVROLET</b> C10 SUBURBAN	5.7L V8 350 CID	1977-1980	<b>BUICK</b> CENTURY	5.0L V8 305 CID	
	1969-1971	<b>CHEVROLET</b> K20 SUBURBAN	5.7L V8 350 CID	1977-1980	<b>BUICK</b> REGAL	5.0L V8 305 CID	
	1969-1973	<b>CHEVROLET</b> MARATHON	5.7L V8 350 CID	1977-1980	<b>CHEVROLET</b> CAPRICE	5.7L V8 350 CID	
	1969-1974	<b>CHEVROLET</b> AEROBUS	5.7L V8 350 CID	1977-1980	<b>PONTIAC</b> GRAND LEMANS	5.0L V8 305 CID	
	1969-1974	<b>CHEVROLET</b> TAXICAB	5.7L V8 350 CID	1978	<b>BUICK</b> LESABRE	5.0L V8 305 CID	
	1969-1974	<b>CHEVROLET</b> BEL AIR	5.7L V8 350 CID	1978	<b>CHEVROLET</b> G30	5.0L V8 305 CID	
	1969-1974	<b>CHEVROLET</b> C10 PICKUP	5.7L V8 350 CID	1978	<b>GMC</b> CABALLERO	5.0L V8 305 CID	
	1969-1974	<b>CHEVROLET</b> C20 SUBURBAN	5.7L V8 350 CID	1978	<b>GMC</b> CABALLERO	5.7L V8 350 CID	
	1969-1974	<b>CHEVROLET</b> CAMARO	5.7L V8 350 CID	1978	<b>OLDSMOBILE</b> CUTLASS	5.0L V8 305 CID	
	1969-1974	<b>CHEVROLET</b> EL CAMINO	5.7L V8 350 CID	1978	<b>OLDSMOBILE</b> CUTLASS	5.7L V8 350 CID	
	1970	<b>CHEVROLET</b> BISCAYNE	6.6L V8 400 CID	1978	<b>PONTIAC</b> GRAND LEMANS	5.7L V8 350 CID	
	1970	<b>CHEVROLET</b> BISCAYNE	6.6L V8 6588cc 402 CID	1978-1979	<b>CHEVROLET</b> C30	5.0L V8 305 CID	
	1970	<b>CHEVROLET</b> BROOKWOOD	6.6L V8 400 CID	1978-1979	<b>PONTIAC</b> LEMANS	5.0L V8 305 CID	
	1970	<b>CHEVROLET</b> BROOKWOOD	6.6L V8 6588cc 402 CID	1978-1979	<b>PONTIAC</b> LEMANS	5.7L V8 350 CID	
	1970	<b>CHEVROLET</b> K10 PICKUP	5.7L V8 350 CID	1978-1980	<b>PONTIAC</b> GRAND AM	5.0L V8 305 CID	
	1970	<b>CHEVROLET</b> K10 SUBURBAN	5.7L V8 350 CID	1978-1980	<b>PONTIAC</b> GRAND PRIX	5.0L V8 305 CID	
	1970	<b>CHEVROLET</b> K20 PICKUP	5.7L V8 350 CID	1979	<b>CHEVROLET</b> P10	5.0L V8 305 CID	
	1970-1972	<b>CHEVROLET</b> BEL AIR	6.6L V8 6588cc 402 CID	1979-1980	<b>CHEVROLET</b> EL CAMINO	4.4L V8 267 CID	
	1970-1972	<b>CHEVROLET</b> G20 VAN	5.7L V8 350 CID	1980	<b>CHEVROLET</b> EL CAMINO	4.4L V8 267 CID	
	1970-1972	<b>GMC</b> JIMMY	5.7L V8 350 CID	1980	<b>CHEVROLET</b> MARATHON	5.0L V8 305 CID	
	1970-1973	<b>CHEVROLET</b> P20 VAN	5.7L V8 350 CID	1980	<b>CHEVROLET</b> CAMARO	4.4L V8 267 CID	

MECHANICAL FUEL PUMPS

USMW	Years	Application	Engine	USMW	Years	Application	Engine
<b>USMP16560</b>	1980	OLDSMOBILE CUTLASS	5.0L V8 305 CID	<b>USMP16565</b>	1979	CHEVROLET C30	5.0L V8 305 CID
	1980	OLDSMOBILE CUTLASS CRUISER	5.0L V8 305 CID		1979	CHEVROLET C30	5.7L V8 350 CID
	1980-1984	CHEVROLET C50	5.7L V8 350 CID		1979	CHEVROLET MALIBU	4.4L V8 267 CID
	1980-1984	CHEVROLET C60	5.7L V8 350 CID		1979	CHEVROLET MALIBU	5.7L V8 350 CID
	1983-1984	CHEVROLET B60	5.7L V8 350 CID		1979	PONTIAC FIREBIRD	5.7L V8 350 CID
<b>USMP16565</b>	1972-1976	CHEVROLET MONTE CARLO	5.7L V8 350 CID	1979-1982	GMC C1500	5.0L V8 305 CID	
	1972-1979	CHEVROLET NOVA	5.7L V8 350 CID	1979-1982	GMC JIMMY	5.0L V8 305 CID	
	1973	CHEVROLET BLAZER	5.7L V8 350 CID	1979-1982	GMC JIMMY	5.7L V8 350 CID	
	1973	CHEVROLET BLAZER	7.4L V8 7439cc 454 CID	1979-1983	CHEVROLET MALIBU	5.0L V8 305 CID	
	1973	CHEVROLET C10 PICKUP	5.7L V8 350 CID	1979-1984	CHEVROLET K5 BLAZER	5.0L V8 305 CID	
	1973	CHEVROLET C20 PICKUP	5.7L V8 350 CID	1979-1984	CHEVROLET K5 BLAZER	5.7L V8 350 CID	
	1973	CHEVROLET C30 PICKUP	5.7L V8 350 CID	1979-1984	CHEVROLET MONTE CARLO	5.0L V8 305 CID	
	1973	CHEVROLET CAPRICE	7.4L V8 7439cc 454 CID	1979-1986	CHEVROLET C10	5.0L V8 305 CID	
	1973	CHEVROLET CHEVELLE	5.7L V8 350 CID	1979-1986	CHEVROLET C20	5.0L V8 305 CID	
	1973	CHEVROLET CHEVELLE	6.6L V8 400 CID	1980-1981	CHEVROLET CAPRICE	5.0L V8 305 CID	
	1973	CHEVROLET CHEVELLE	7.4L V8 7439cc 454 CID	1980-1981	CHEVROLET IMPALA	5.0L V8 305 CID	
	1973	GMC JIMMY	5.7L V8 350 CID	1980-1982	GMC C2500	5.0L V8 305 CID	
	1973-1974	GMC C15/C1500 PICKUP	5.7L V8 350 CID	1981	CHEVROLET IMPALA	5.7L V8 350 CID	
	1973-1974	GMC C15/C1500 SUBURBAN	5.7L V8 350 CID	1981	CHEVROLET MALIBU	5.7L V8 350 CID	
	1973-1974	GMC C25/C2500 PICKUP	5.7L V8 350 CID	1981-1982	GMC C1500	5.7L V8 350 CID	
	1973-1974	GMC K15/K1500 SUBURBAN	5.7L V8 350 CID	1981-1982	GMC C2500	5.7L V8 350 CID	
	1973-1974	GMC K25/K2500 SUBURBAN	5.7L V8 350 CID	1981-1982	GMC C3500	5.7L V8 350 CID	
	1973-1975	CHEVROLET BEL AIR	5.7L V8 350 CID	1981-1984	CHEVROLET C20 SUBURBAN	5.0L V8 305 CID	
	1973-1975	CHEVROLET BEL AIR	6.6L V8 400 CID	1981-1984	CHEVROLET C20 SUBURBAN	5.7L V8 350 CID	
	1973-1976	CHEVROLET CAPRICE	5.7L V8 350 CID	1981-1984	GMC C2500 SUBURBAN	5.7L V8 350 CID	
	1973-1976	CHEVROLET CAPRICE	6.6L V8 400 CID	1981-1986	CHEVROLET C10 SUBURBAN	5.0L V8 305 CID	
	1973-1976	CHEVROLET EL CAMINO	5.7L V8 350 CID	1981-1986	CHEVROLET C10 SUBURBAN	5.7L V8 350 CID	
	1973-1976	CHEVROLET IMPALA	5.7L V8 350 CID	1981-1986	CHEVROLET C30	5.7L V8 350 CID	
	1973-1976	CHEVROLET IMPALA	6.6L V8 400 CID	1981-1986	GMC C1500 SUBURBAN	5.0L V8 305 CID	
	1973-1976	CHEVROLET LAGUNA	5.7L V8 350 CID	1981-1986	GMC C1500 SUBURBAN	5.7L V8 350 CID	
	1973-1976	CHEVROLET MALIBU	5.7L V8 350 CID	1982	CHEVROLET MALIBU	4.4L V8 267 CID	
	1973-1976	CHEVROLET MALIBU	6.6L V8 400 CID	1982	CHEVROLET MONTE CARLO	4.4L V8 267 CID	
	1973-1976	CHEVROLET MONTE CARLO	6.6L V8 400 CID	1982-1984	GMC C2500 SUBURBAN	5.0L V8 305 CID	
	1973-1976	GMC SPRINT	5.7L V8 350 CID	1982-1986	CHEVROLET C10	5.7L V8 350 CID	
	1973-1977	CHEVROLET K10 SUBURBAN	5.7L V8 350 CID	1982-1986	CHEVROLET C20	5.7L V8 350 CID	
	1973-1977	CHEVROLET K20 SUBURBAN	5.7L V8 350 CID	1982-1987	CHEVROLET CAMARO	5.0L V8 305 CID	
	1974	CHEVROLET BEL AIR	7.4L V8 7439cc 454 CID	1982-1987	PONTIAC FIREBIRD	5.0L V8 305 CID	
	1974	CHEVROLET BEL AIR	7.4L V8 7441cc 454 CID	1983	CHEVROLET B60	5.7L V8 350 CID	
	1974	CHEVROLET P20 VAN	5.7L V8 350 CID	1983	CHEVROLET C50	5.7L V8 350 CID	
	1974	CHEVROLET P30 VAN	5.7L V8 350 CID	1983	CHEVROLET C60	5.7L V8 350 CID	
	1974	GMC C25/C2500 SUBURBAN	5.7L V8 350 CID	1983	GMC B6000	5.7L V8 350 CID	
	1974-1976	CHEVROLET EL CAMINO	6.6L V8 400 CID	1983-1985	CHEVROLET IMPALA	5.0L V8 305 CID	
	1974-1976	CHEVROLET LAGUNA	6.6L V8 400 CID	1983-1986	CHEVROLET CAPRICE	5.0L V8 305 CID	
	1974-1976	GMC SPRINT	6.6L V8 400 CID	1984	GMC C1500	5.0L V8 305 CID	
	1975	CHEVROLET P10	5.7L V8 350 CID	1984	GMC C1500	5.7L V8 350 CID	
	1975	GMC SPRINT	7.4L V8 454 CID	1984	GMC C2500	5.0L V8 305 CID	
	1975-1977	CHEVROLET K5 BLAZER	5.7L V8 350 CID	1984	GMC C2500	5.7L V8 350 CID	
	1975-1977	CHEVROLET K5 BLAZER	6.6L V8 400 CID	1984	GMC C3500	5.7L V8 350 CID	
	1975-1977	CHEVROLET K10	5.7L V8 350 CID	1984-1985	CHEVROLET K10	5.7L V8 350 CID	
	1975-1977	CHEVROLET K10	6.6L V8 400 CID	1984-1985	CHEVROLET K20	5.7L V8 350 CID	
	1975-1977	CHEVROLET K10 SUBURBAN	6.6L V8 400 CID	1984-1985	CHEVROLET K30	5.7L V8 350 CID	
	1975-1977	CHEVROLET K20	5.7L V8 350 CID	1985-1990	CHEVROLET B60	5.7L V8 350 CID	
	1975-1977	CHEVROLET K20	6.6L V8 400 CID	1985-1990	CHEVROLET C50	5.7L V8 350 CID	
	1975-1977	CHEVROLET K20 SUBURBAN	6.6L V8 400 CID	1985-1990	CHEVROLET C60	5.7L V8 350 CID	
	1975-1977	GMC JIMMY	5.7L V8 350 CID	1986	CHEVROLET CAPRICE	5.0L V8 307 CID	
	1975-1977	GMC JIMMY	6.6L V8 400 CID	1986	GMC C1500	5.0L V8 305 CID	
	1975-1977	GMC K15	5.7L V8 350 CID	1986	GMC C1500	5.7L V8 350 CID	
	1975-1977	GMC K15	6.6L V8 400 CID	1987-1988	CHEVROLET R30	5.7L V8 350 CID	
	1975-1977	GMC K15 SUBURBAN	5.7L V8 350 CID	1988	GMC C2500	5.7L V8 350 CID	
	1975-1977	GMC K15 SUBURBAN	6.6L V8 400 CID	1988-1990	GMC C1500	5.7L V8 350 CID	
	1975-1977	GMC K25	5.7L V8 350 CID	<b>USMP16570</b>	1973-1974	CHEVROLET K20 PICKUP	7.4L V8 454 CID
	1975-1977	GMC K25	6.6L V8 400 CID	1973-1974	CHEVROLET K20 PICKUP	7.4L V8 7439cc 454 CID	
	1975-1977	GMC K25 SUBURBAN	5.7L V8 350 CID	1973-1974	CHEVROLET K20 PICKUP	7.4L V8 7441cc 454 CID	
	1975-1977	GMC K25 SUBURBAN	6.6L V8 400 CID	1974	CHEVROLET C10 PICKUP	7.4L V8 454 CID	
	1975-1978	GMC C15	5.7L V8 350 CID	1974	CHEVROLET C10 PICKUP	7.4L V8 7439cc 454 CID	
	1975-1978	GMC C15 SUBURBAN	5.7L V8 350 CID	1974	CHEVROLET C10 PICKUP	7.4L V8 7441cc 454 CID	
	1975-1978	GMC C25	5.7L V8 350 CID	1974	CHEVROLET C20 PICKUP	7.4L V8 454 CID	
	1975-1978	GMC C25 SUBURBAN	5.7L V8 350 CID	1974	CHEVROLET C20 PICKUP	7.4L V8 7439cc 454 CID	
	1975-1987	CHEVROLET P20	5.7L V8 350 CID	1974	CHEVROLET C20 PICKUP	7.4L V8 7441cc 454 CID	
	1975-1988	CHEVROLET P30	5.7L V8 350 CID	1974	CHEVROLET C30 PICKUP	7.4L V8 454 CID	
	1976	GMC C15	6.6L V8 400 CID	1974	CHEVROLET C30 PICKUP	7.4L V8 7439cc 454 CID	
	1976	GMC C25	6.6L V8 400 CID	1974	CHEVROLET C30 PICKUP	7.4L V8 7441cc 454 CID	
	1976-1977	CHEVROLET C10	6.6L V8 400 CID	1974	CHEVROLET K10 PICKUP	7.4L V8 454 CID	
	1976-1977	CHEVROLET C20	6.6L V8 400 CID	1974	CHEVROLET K10 PICKUP	7.4L V8 7439cc 454 CID	
	1976-1977	CHEVROLET C30	6.6L V8 400 CID	1974	CHEVROLET K10 PICKUP	7.4L V8 7441cc 454 CID	
	1977	CHEVROLET CAMARO	5.7L V8 350 CID	1978	CHEVROLET C20 SUBURBAN	7.4L V8 454 CID	
	1977	CHEVROLET K30	5.7L V8 350 CID	1979	GMC P1500	7.4L V8 454 CID	
	1977	CHEVROLET K30	6.6L V8 400 CID	1980	GMC C1500	7.4L V8 454 CID	
	1977	OLDSMOBILE CUSTOM CRUISER	5.7L V8 350 CID	1980-1982	GMC C2500	7.4L V8 454 CID	
	1977	OLDSMOBILE DELTA 88	5.7L V8 350 CID	1980-1984	GMC C2500 SUBURBAN	7.4L V8 454 CID	
	1977	PONTIAC VENTURA	5.7L V8 350 CID	1981-1982	GMC C3500	7.4L V8 454 CID	
	1977-1978	CHEVROLET P10	5.7L V8 350 CID	1981-1984	CHEVROLET C20 SUBURBAN	7.4L V8 454 CID	
	1977-1979	BUICK SKYLARK	5.7L V8 350 CID	1984	GMC C2500	7.4L V8 454 CID	
	1977-1979	OLDSMOBILE OMEGA	5.7L V8 350 CID	1984	GMC C3500	7.4L V8 454 CID	
	1977-1979	PONTIAC PHOENIX	5.7L V8 350 CID	<b>USMP16690</b>	1975-1976	FORD F-350	5.9L V8 360 CID
	1978	CHEVROLET C20 SUBURBAN	5.7L V8 350 CID	1975-1976	FORD F-350	6.4L V8 390 CID	
	1979	CHEVROLET C10	5.7L V8 350 CID	<b>USMP16840</b>	1976	AMERICAN MOTORS GREMLIN	5.0L V8 304 CID
	1979	CHEVROLET C20	5.7L V8 350 CID	1976-1977	AMERICAN MOTORS HORNET	5.0L V8 304 CID	

USMW	Years	Application	Engine	USMW	Years	Application	Engine		
<b>USMP16840</b>	1976-1977	<b>AMERICAN MOTORS</b> MATADOR	5.0L V8 304 CID	<b>USMP16843</b>	1976-1978	<b>JEEP</b> CJ7	3.8L L6 232 CID		
	1976-1978	<b>AMERICAN MOTORS</b> MATADOR	5.9L V8 360 CID		1976-1983	<b>JEEP</b> CJ7	4.2L L6 258 CID		
	1976-1978	<b>JEEP</b> CHEROKEE	6.6L V8 6572cc 401 CID		1978-1979	<b>AMERICAN MOTORS</b> CONCORD	3.8L L6 232 CID		
	1976-1978	<b>JEEP</b> J10	6.6L V8 6572cc 401 CID		1978-1980	<b>AMERICAN MOTORS</b> AMX	4.2L L6 258 CID		
	1976-1978	<b>JEEP</b> J20	6.6L V8 6572cc 401 CID		1978-1983	<b>AMERICAN MOTORS</b> CONCORD	4.2L L6 258 CID		
	1976-1978	<b>JEEP</b> WAGONEER	6.6L V8 6572cc 401 CID		1979	<b>AMERICAN MOTORS</b> SPIRIT	3.8L L6 232 CID		
	1976-1981	<b>JEEP</b> CJ7	5.0L V8 304 CID		1979-1983	<b>AMERICAN MOTORS</b> SPIRIT	4.2L L6 258 CID		
	1976-1983	<b>JEEP</b> CHEROKEE	5.9L V8 360 CID		1979-1983	<b>JEEP</b> CJ5	4.2L L6 258 CID		
	1976-1983	<b>JEEP</b> WAGONEER	5.9L V8 360 CID		1980-1983	<b>JEEP</b> WAGONEER	4.2L L6 258 CID		
	1976-1988	<b>JEEP</b> J10	5.9L V8 360 CID		1980-1987	<b>AMERICAN MOTORS</b> EAGLE	4.2L L6 258 CID		
	1976-1988	<b>JEEP</b> J20	5.9L V8 360 CID		1981-1985	<b>JEEP</b> SCRAMBLER	4.2L L6 258 CID		
	1978-1979	<b>AMERICAN MOTORS</b> AMX	5.0L V8 304 CID		1984-1985	<b>JEEP</b> SCRAMBLER	2.5L L4 150 CID		
	1978-1979	<b>AMERICAN MOTORS</b> CONCORD	5.0L V8 304 CID		1984-1986	<b>JEEP</b> GRAND WAGONEER	4.2L L6 258 CID		
	1978-1979	<b>AMERICAN MOTORS</b> PACER	5.0L V8 304 CID		<b>USMP16845</b>	1965	<b>CHEVROLET</b> IMPALA	4.1L L6 250 CID	
	1979	<b>AMERICAN MOTORS</b> SPIRIT	5.0L V8 304 CID			1965	<b>CHEVROLET</b> IMPALA	4.1L L6 4097cc 250 CID	
	1979-1981	<b>JEEP</b> CJ5	5.0L V8 304 CID			1965	<b>CHEVROLET</b> IMPALA	4.1L L6 4098cc 250 CID	
	1984-1991	<b>JEEP</b> GRAND WAGONEER	5.9L V8 360 CID			1975-1976	<b>GMC</b> SPRINT	4.1L L6 250 CID	
	<b>USMP16843</b>	1967	<b>JEEP</b> CJ5			3.8L L6 232 CID	1975-1976	<b>OLDSMOBILE</b> CUTLASS	4.1L L6 250 CID
		1967	<b>JEEP</b> CJ5			4.2L L6 258 CID	1975-1979	<b>CHECKER</b> MARATHON	4.1L L6 250 CID
		1970-1971	<b>JEEP</b> CJ5			3.8L L6 232 CID	1976	<b>CHEVROLET</b> G20	4.1L L6 250 CID
		1970-1971	<b>JEEP</b> CJ5			4.2L L6 258 CID	1976	<b>CHEVROLET</b> G20	4.8L L6 292 CID
		1971	<b>AMERICAN MOTORS</b> AMBASSADOR			4.2L L6 4228cc 258 CID	1976	<b>CHEVROLET</b> G30	4.1L L6 250 CID
		1971	<b>AMERICAN MOTORS</b> AMBASSADOR			4.2L L6 4229cc 258 CID	1976	<b>CHEVROLET</b> G30	4.8L L6 292 CID
		1971	<b>AMERICAN MOTORS</b> GREMLIN			3.8L L6 3802cc 232 CID	1976	<b>CHEVROLET</b> G30	4.1L L6 250 CID
1971		<b>AMERICAN MOTORS</b> GREMLIN	4.2L L6 4228cc 258 CID	1976		<b>CHEVROLET</b> P30	4.1L L6 250 CID		
1971		<b>AMERICAN MOTORS</b> GREMLIN	4.2L L6 4229cc 258 CID	1976-1980		<b>CHEVROLET</b> P10	4.8L L6 292 CID		
1971		<b>AMERICAN MOTORS</b> HORNET	3.8L L6 3802cc 232 CID	1976-1982		<b>CHEVROLET</b> C20 SUBURBAN	4.8L L6 292 CID		
1971		<b>AMERICAN MOTORS</b> HORNET	4.2L L6 4228cc 258 CID	1976-1982		<b>CHEVROLET</b> K20 SUBURBAN	4.8L L6 292 CID		
1971		<b>AMERICAN MOTORS</b> HORNET	4.2L L6 4229cc 258 CID	1976-1985		<b>CHEVROLET</b> K20	4.8L L6 292 CID		
1971		<b>AMERICAN MOTORS</b> JAVELIN	3.8L L6 3802cc 232 CID	1976-1989		<b>CHEVROLET</b> P20	4.8L L6 292 CID		
1971		<b>AMERICAN MOTORS</b> MATADOR	3.8L L6 232 CID	1976-1989		<b>CHEVROLET</b> P30	4.8L L6 292 CID		
1971		<b>AMERICAN MOTORS</b> MATADOR	3.8L L6 3802cc 232 CID	1977-1985		<b>CHEVROLET</b> K30	4.8L L6 292 CID		
1971		<b>AMERICAN MOTORS</b> MATADOR	4.2L L6 258 CID	1978-1979		<b>CHEVROLET</b> CAMARO	4.1L L6 250 CID		
1971		<b>AMERICAN MOTORS</b> MATADOR	4.2L L6 4228cc 258 CID	1978-1979		<b>CHEVROLET</b> CAPRICE	4.1L L6 250 CID		
1971		<b>AMERICAN MOTORS</b> MATADOR	4.2L L6 4229cc 258 CID	1978-1979		<b>CHEVROLET</b> IMPALA	4.1L L6 250 CID		
1971-1973		<b>JEEP</b> J-100	4.2L L6 4228cc 258 CID	1978-1979		<b>CHEVROLET</b> NOVA	4.1L L6 250 CID		
1971-1974		<b>AMERICAN MOTORS</b> JAVELIN	4.2L L6 4228cc 258 CID	1978-1980		<b>CHEVROLET</b> C10 SUBURBAN	4.1L L6 250 CID		
1971-1974		<b>AMERICAN MOTORS</b> JAVELIN	4.2L L6 4229cc 258 CID	1978-1980	<b>CHEVROLET</b> K10 SUBURBAN	4.1L L6 250 CID			
1972-1973		<b>JEEP</b> COMMANDO	3.8L L6 232 CID	1978-1980	<b>CHEVROLET</b> K20	4.1L L6 250 CID			
1972-1973		<b>JEEP</b> COMMANDO	3.8L L6 3802cc 232 CID	1978-1983	<b>CHEVROLET</b> K10	4.1L L6 250 CID			
1972-1973		<b>JEEP</b> COMMANDO	4.2L L6 258 CID	1979	<b>CHEVROLET</b> G30	4.1L L6 250 CID			
1972-1973	<b>JEEP</b> COMMANDO	4.2L L6 4228cc 258 CID	1979	<b>CHEVROLET</b> G30	4.8L L6 292 CID				
1972-1973	<b>JEEP</b> COMMANDO	4.2L L6 4229cc 258 CID	1979	<b>CHEVROLET</b> MALIBU	4.1L L6 4097cc 250 CID				
1972-1973	<b>JEEP</b> DJ5	3.8L L6 232 CID	1979	<b>CHEVROLET</b> P30	4.1L L6 250 CID				
1972-1973	<b>JEEP</b> DJ5	3.8L L6 3802cc 232 CID	1979	<b>GMC</b> G3500	4.1L L6 250 CID				
1972-1973	<b>JEEP</b> WAGONEER	4.2L L6 258 CID	1979-1980	<b>CHEVROLET</b> G10	4.1L L6 250 CID				
1972-1973	<b>JEEP</b> WAGONEER	4.2L L6 4228cc 258 CID	1979-1980	<b>CHEVROLET</b> G20	4.1L L6 250 CID				
1972-1973	<b>JEEP</b> WAGONEER	4.2L L6 4229cc 258 CID	1979-1980	<b>CHEVROLET</b> G20	4.8L L6 292 CID				
1972-1974	<b>JEEP</b> CJ5	3.8L L6 3802cc 232 CID	1979-1980	<b>CHEVROLET</b> K10	4.8L L6 292 CID				
1972-1974	<b>JEEP</b> CJ6	3.8L L6 3802cc 232 CID	1979-1980	<b>GMC</b> C1500	4.8L L6 292 CID				
1972-1974	<b>JEEP</b> CJ6	4.2L L6 4228cc 258 CID	1979-1980	<b>GMC</b> C1500 SUBURBAN	4.1L L6 250 CID				
1972-1974	<b>JEEP</b> CJ6	4.2L L6 4229cc 258 CID	1979-1980	<b>GMC</b> G1500	4.1L L6 250 CID				
1972-1975	<b>JEEP</b> CJ6	4.2L L6 258 CID	1979-1980	<b>GMC</b> G2500	4.1L L6 250 CID				
1973-1974	<b>AMERICAN MOTORS</b> GREMLIN	4.2L L6 4228cc 258 CID	1979-1980	<b>GMC</b> P1500	4.8L L6 292 CID				
1973-1974	<b>AMERICAN MOTORS</b> GREMLIN	4.2L L6 4229cc 258 CID	1979-1982	<b>GMC</b> C2500 SUBURBAN	4.8L L6 292 CID				
1973-1974	<b>JEEP</b> DJ5	4.2L L6 258 CID	1979-1983	<b>GMC</b> C2500	4.1L L6 250 CID				
1973-1974	<b>JEEP</b> DJ5	4.2L L6 4228cc 258 CID	1979-1984	<b>GMC</b> C1500	4.1L L6 250 CID				
1973-1974	<b>JEEP</b> DJ5	4.2L L6 4229cc 258 CID	1979-1985	<b>GMC</b> C2500	4.8L L6 292 CID				
1974	<b>AMERICAN MOTORS</b> GREMLIN	3.8L L6 3802cc 232 CID	1979-1985	<b>GMC</b> C3500	4.8L L6 292 CID				
1974	<b>AMERICAN MOTORS</b> HORNET	3.8L L6 3802cc 232 CID	1980	<b>GMC</b> C3500	4.1L L6 250 CID				
1974	<b>AMERICAN MOTORS</b> HORNET	4.2L L6 4228cc 258 CID	1981	<b>CHEVROLET</b> MALIBU	4.1L L6 4097cc 250 CID				
1974	<b>AMERICAN MOTORS</b> HORNET	4.2L L6 4229cc 258 CID	1981-1982	<b>GMC</b> K2500 SUBURBAN	4.8L L6 292 CID				
1974	<b>AMERICAN MOTORS</b> JAVELIN	3.8L L6 3802cc 232 CID	1981-1983	<b>CHEVROLET</b> G30	4.1L L6 250 CID				
1974	<b>AMERICAN MOTORS</b> MATADOR	3.8L L6 232 CID	1981-1983	<b>GMC</b> K1500	4.1L L6 250 CID				
1974	<b>AMERICAN MOTORS</b> MATADOR	3.8L L6 3802cc 232 CID	1981-1984	<b>GMC</b> K2500	4.8L L6 292 CID				
1974	<b>AMERICAN MOTORS</b> MATADOR	4.2L L6 4228cc 258 CID	1981-1985	<b>GMC</b> K3500	4.8L L6 292 CID				
1974	<b>AMERICAN MOTORS</b> MATADOR	4.2L L6 4229cc 258 CID	1982-1983	<b>CHEVROLET</b> G10	4.1L L6 250 CID				
1974	<b>JEEP</b> CHEROKEE	4.2L L6 4228cc 258 CID	1982-1983	<b>CHEVROLET</b> G20	4.1L L6 250 CID				
1974	<b>JEEP</b> CHEROKEE	4.2L L6 4229cc 258 CID	1982-1983	<b>GMC</b> G1500	4.1L L6 250 CID				
1974	<b>JEEP</b> CJ5	4.2L L6 258 CID	1982-1983	<b>GMC</b> G2500	4.1L L6 250 CID				
1974	<b>JEEP</b> CJ5	4.2L L6 4228cc 258 CID	1982-1983	<b>GMC</b> G3500	4.1L L6 250 CID				
1974	<b>JEEP</b> CJ5	4.2L L6 4229cc 258 CID	1984	<b>GMC</b> C2500 SUBURBAN	4.8L L6 292 CID				
1974	<b>JEEP</b> J10	4.2L L6 4228cc 258 CID	1984	<b>GMC</b> K2500 SUBURBAN	4.8L L6 292 CID				
1974	<b>JEEP</b> J10	4.2L L6 4229cc 258 CID	1989	<b>GMC</b> P2500	4.8L L6 292 CID				
1974	<b>JEEP</b> J20	4.2L L6 258 CID	<b>USMP16870</b>	1976-1977	<b>MERCURY</b> CAPRI	2.3L L4 140 CID			
1974	<b>JEEP</b> J20	4.2L L6 4228cc 258 CID		<b>USMP16875</b>	1976-1977	<b>FORD</b> MAVERICK	5.0L V8 302 CID		
1974-1978	<b>AMERICAN MOTORS</b> MATADOR	4.2L L6 4229cc 258 CID			1976-1977	<b>MERCURY</b> COMET	5.0L V8 302 CID		
1974-1980	<b>JEEP</b> J10	4.2L L6 258 CID			1976-1980	<b>FORD</b> GRANADA	5.0L V8 302 CID		
1974-1983	<b>JEEP</b> CHEROKEE	4.2L L6 258 CID			1976-1980	<b>MERCURY</b> MONARCH	5.0L V8 302 CID		
1975	<b>JEEP</b> CJ6	3.8L L6 232 CID			1977	<b>FORD</b> GRANADA	5.8L V8 5753cc 351 CID		
1975-1977	<b>AMERICAN MOTORS</b> HORNET	3.8L L6 232 CID			1977	<b>LINCOLN</b> VERSAILLES	5.8L V8 5753cc 351 CID		
1975-1977	<b>AMERICAN MOTORS</b> HORNET	4.2L L6 258 CID			1977	<b>MERCURY</b> MONARCH	5.8L V8 5753cc 351 CID		
1975-1978	<b>AMERICAN MOTORS</b> GREMLIN	3.8L L6 232 CID			1977-1980	<b>LINCOLN</b> VERSAILLES	5.0L V8 302 CID		
1975-1978	<b>AMERICAN MOTORS</b> GREMLIN	4.2L L6 258 CID			1978	<b>FORD</b> FAIRMONT	5.0L V8 302 CID		
1975-1978	<b>AMERICAN MOTORS</b> PACER	3.8L L6 232 CID			1978	<b>MERCURY</b> ZEPHYR	5.0L V8 302 CID		
1975-1980	<b>AMERICAN MOTORS</b> PACER	4.2L L6 258 CID			1979	<b>MERCURY</b> GRAND MARQUIS	5.0L V8 302 CID		
1976	<b>JEEP</b> J20	4.2L L6 258 CID			1979	<b>MERCURY</b> GRAND MARQUIS	5.8L V8 5753cc 351 CID		
					1979	<b>MERCURY</b> MARQUIS	5.0L V8 302 CID		



USMW	Years	Application	Engine	USMW	Years	Application	Engine	
<b>USMP16875</b>	1979	MERCURY MARQUIS	5.8L V8 5753cc 351 CID	<b>USMP17165</b>	1977	DODGE D200	5.9L V8 360 CID	
	1980	FORD GRANADA	4.2L V8 255 CID		1977	DODGE D300	5.2L V8 5211cc 318 CID	
	1980	MERCURY MONARCH	4.2L V8 255 CID		1977	DODGE D300	5.9L V8 360 CID	
	1981	FORD THUNDERBIRD	4.2L V8 255 CID		1977	DODGE RAMCHARGER	5.2L V8 5211cc 318 CID	
	1981	MERCURY COUGAR	4.2L V8 255 CID		1977	DODGE RAMCHARGER	5.9L V8 360 CID	
	1982	FORD LTD	4.2L V8 255 CID		1977	DODGE W100	5.2L V8 5211cc 318 CID	
	1982	FORD LTD	5.0L V8 302 CID		1977	DODGE W100	5.9L V8 360 CID	
	1982	MERCURY GRAND MARQUIS	4.2L V8 255 CID		1977	DODGE W150	5.2L V8 5211cc 318 CID	
	1982	MERCURY GRAND MARQUIS	5.0L V8 302 CID		1977	DODGE W150	5.9L V8 360 CID	
	1982	MERCURY MARQUIS	4.2L V8 255 CID		1977	DODGE W200	5.2L V8 5211cc 318 CID	
	1982	MERCURY MARQUIS	5.0L V8 302 CID		1977	DODGE W200	5.9L V8 360 CID	
	<b>USMP17018</b>	1975-1979	FORD E-250 ECONOLINE		4.9L L6 4917cc 300 CID	<b>USMP17195</b>	1968-1970	MERCURY MONTEREY
1975-1979		FORD E-350 ECONOLINE	4.9L L6 4917cc 300 CID	1968-1970	MERCURY MONTEREY		7.0L V8 7014cc 428 CID	
1978		FORD F-350	4.9L L6 4917cc 300 CID	1968-1971	LINCOLN MARK III		7.5L V8 460 CID	
1978-1979		FORD E-100 ECONOLINE	4.9L L6 4917cc 300 CID	1968-1971	LINCOLN MARK III		7.5L V8 7539cc 460 CID	
1978-1979		FORD E-150 ECONOLINE	4.9L L6 4917cc 300 CID	1968-1973	FORD THUNDERBIRD		7.0L V8 429 CID	
1978-1979		FORD F-100	4.9L L6 4917cc 300 CID	1968-1973	FORD THUNDERBIRD		7.0L V8 7030cc 429 CID	
<b>USMP17165</b>		1964	PLYMOUTH BARRACUDA	4.5L V8 4473cc 273 CID	1968-1974		LINCOLN CONTINENTAL	7.5L V8 460 CID
		1964-1969	DODGE DART	4.5L V8 273 CID	1968-1974		LINCOLN CONTINENTAL	7.5L V8 7539cc 460 CID
		1964-1969	DODGE DART	4.5L V8 4473cc 273 CID	1969		FORD THUNDERBIRD	7.0L V8 7014cc 428 CID
		1965-1968	PLYMOUTH BELVEDERE	4.5L V8 4473cc 273 CID	1969		MERCURY MONTEGO	7.0L V8 428 CID
		1965-1968	PLYMOUTH SATELLITE	4.5L V8 4473cc 273 CID	1969		MERCURY MONTEGO	7.0L V8 7014cc 428 CID
		1965-1969	PLYMOUTH VALIANT	4.5L V8 4473cc 273 CID	1969		MERCURY MONTEGO	7.0L V8 7014cc 428 CID
	1967	PLYMOUTH BARRACUDA	4.5L V8 4473cc 273 CID	1969-1970	MERCURY COLONY PARK	7.0L V8 429 CID		
	1967-1969	PLYMOUTH VALIANT	4.5L V8 273 CID	1969-1970	MERCURY MARAUDER	7.0L V8 7014cc 428 CID		
	1968	DODGE CORONET	4.5L V8 4473cc 273 CID	1969-1970	MERCURY MARAUDER	7.0L V8 7014cc 428 CID		
	1968	PLYMOUTH BELVEDERE	4.5L V8 273 CID	1969-1970	MERCURY MARAUDER	7.0L V8 7030cc 429 CID		
	1968	PLYMOUTH ROAD RUNNER	4.5L V8 273 CID	1969-1973	MERCURY COLONY PARK	7.0L V8 429 CID		
	1968	PLYMOUTH ROAD RUNNER	4.5L V8 4473cc 273 CID	1969-1973	MERCURY COLONY PARK	7.0L V8 7030cc 429 CID		
1968	PLYMOUTH SATELLITE	4.5L V8 273 CID	1969-1973	MERCURY COLONY PARK	7.0L V8 429 CID			
1968-1969	PLYMOUTH BARRACUDA	5.6L V8 340 CID	1969-1973	MERCURY MONTEREY	7.0L V8 7030cc 429 CID			
1968-1969	PLYMOUTH BARRACUDA	5.6L V8 5572cc 340 CID	1969-1973	MERCURY MONTEREY	7.0L V8 429 CID			
1968-1972	DODGE DART	5.6L V8 340 CID	1970	FORD CUSTOM	7.0L V8 7014cc 428 CID			
1968-1972	DODGE DART	5.6L V8 5572cc 340 CID	1970	FORD CUSTOM	7.0L V8 7030cc 429 CID			
1969	DODGE A100		1970	FORD FAIRLANE	7.0L V8 429 CID			
1970-1972	PLYMOUTH DUSTER	5.6L V8 340 CID	1970	FORD FAIRLANE	7.0L V8 7014cc 428 CID			
1970-1972	PLYMOUTH DUSTER	5.6L V8 5572cc 340 CID	1970	FORD FAIRLANE	7.0L V8 7030cc 429 CID			
1971-1972	DODGE MONACO	5.9L V8 360 CID	1970	FORD FAIRLANE	7.0L V8 7014cc 428 CID			
1971-1972	DODGE POLARA	5.9L V8 360 CID	1970	FORD TORINO	7.0L V8 7014cc 428 CID			
1971-1974	DODGE D100 PICKUP	5.9L V8 360 CID	1970	MERCURY MARQUIS	7.0L V8 7014cc 428 CID			
1971-1974	DODGE D200 PICKUP	5.9L V8 360 CID	1970-1971	FORD TORINO	7.0L V8 429 CID			
1972	CHRYSLER NEWPORT	5.9L V8 360 CID	1970-1971	FORD TORINO	7.0L V8 7030cc 429 CID			
1972	DODGE CHALLENGER	5.6L V8 340 CID	1970-1971	MERCURY CYCLONE	7.0L V8 429 CID			
1972	DODGE CHALLENGER	5.6L V8 5572cc 340 CID	1970-1971	MERCURY CYCLONE	7.0L V8 7030cc 429 CID			
1972	DODGE CORONET	5.6L V8 340 CID	1970-1971	MERCURY MONTEGO	7.0L V8 429 CID			
1972	DODGE CORONET	5.6L V8 5572cc 340 CID	1970-1971	MERCURY MONTEGO	7.0L V8 7030cc 429 CID			
1972	PLYMOUTH BARRACUDA	5.6L V8 340 CID	1970-1973	FORD RANCHERO	7.0L V8 429 CID			
1972	PLYMOUTH BARRACUDA	5.6L V8 5572cc 340 CID	1970-1973	FORD RANCHERO	7.0L V8 7030cc 429 CID			
1972	PLYMOUTH FURY	5.9L V8 360 CID	1970-1973	MERCURY MARQUIS	7.0L V8 429 CID			
1972	PLYMOUTH GRAN FURY	5.9L V8 360 CID	1970-1973	MERCURY MARQUIS	7.0L V8 7030cc 429 CID			
1972	PLYMOUTH ROAD RUNNER	5.6L V8 340 CID	1971	FORD MUSTANG	7.0L V8 429 CID			
1972	PLYMOUTH ROAD RUNNER	5.6L V8 5572cc 340 CID	1971	FORD MUSTANG	7.0L V8 7030cc 429 CID			
1972	PLYMOUTH SATELLITE	5.6L V8 340 CID	1971	MERCURY COUGAR	7.0L V8 429 CID			
1972	PLYMOUTH SATELLITE	5.6L V8 5572cc 340 CID	1971	MERCURY COUGAR	7.0L V8 7030cc 429 CID			
1972-1974	DODGE D300 PICKUP	5.9L V8 360 CID	1972-1974	FORD THUNDERBIRD	7.5L V8 460 CID			
1974-1975	DODGE RAMCHARGER	5.9L V8 360 CID	1972-1974	FORD THUNDERBIRD	7.5L V8 7539cc 460 CID			
1974-1977	DODGE CB300	5.9L V8 360 CID	1972-1974	LINCOLN MARK IV	7.5L V8 460 CID			
1975	DODGE D100	5.2L V8 5211cc 318 CID	1972-1974	LINCOLN MARK IV	7.5L V8 7539cc 460 CID			
1975	DODGE D100	5.9L V8 360 CID	1972-1974	MERCURY COLONY PARK	7.5L V8 460 CID			
1975	DODGE D200	5.2L V8 5211cc 318 CID	1972-1974	MERCURY COLONY PARK	7.5L V8 7539cc 460 CID			
1975	DODGE D200	5.9L V8 360 CID	1972-1974	MERCURY MARQUIS	7.5L V8 460 CID			
1975	DODGE D300	5.2L V8 5211cc 318 CID	1972-1974	MERCURY MARQUIS	7.5L V8 7539cc 460 CID			
1975	DODGE D300	5.9L V8 360 CID	1972-1974	MERCURY MONTEREY	7.5L V8 460 CID			
1975	DODGE RAMCHARGER	5.2L V8 5211cc 318 CID	1972-1974	MERCURY MONTEREY	7.5L V8 7539cc 460 CID			
1975	DODGE W100	5.2L V8 5211cc 318 CID	1974	FORD RANCHERO	7.5L V8 460 CID			
1975	DODGE W100	5.9L V8 360 CID	1974	FORD RANCHERO	7.5L V8 7539cc 460 CID			
1975	DODGE W200	5.2L V8 5211cc 318 CID	1977	MERCURY GRAND MARQUIS	7.5L V8 460 CID			
1975	DODGE W200	5.9L V8 360 CID	1977	MERCURY MARQUIS	7.5L V8 460 CID			
1975	DODGE W300	5.2L V8 5211cc 318 CID	1977-1978	LINCOLN CONTINENTAL	7.5L V8 460 CID			
1975	DODGE W300	5.9L V8 360 CID	1977-1978	LINCOLN MARK V	7.5L V8 460 CID			
1975-1977	DODGE B100	5.2L V8 5211cc 318 CID	<b>USMP17205</b>	1971	MERCURY MONTEGO	4.1L L6 4097cc 250 CID		
1975-1977	DODGE B200	5.2L V8 5211cc 318 CID		1971-1974	MERCURY COLONY PARK	6.6L V8 400 CID		
1975-1977	DODGE B200	5.9L V8 360 CID		1971-1974	MERCURY COLONY PARK	6.6L V8 6555cc 400 CID		
1975-1977	DODGE B300	5.2L V8 5211cc 318 CID		1971-1974	MERCURY COLONY PARK	6.6L V8 6556cc 400 CID		
1975-1977	DODGE B300	5.9L V8 360 CID		1971-1974	MERCURY MARQUIS	6.6L V8 6555cc 400 CID		
1975-1977	DODGE CB300	5.2L V8 5211cc 318 CID		1971-1974	MERCURY MARQUIS	6.6L V8 6556cc 400 CID		
1976-1977	DODGE B100	5.9L V8 360 CID		1971-1974	MERCURY MONTEREY	6.6L V8 400 CID		
1976-1977	PLYMOUTH PB100	5.2L V8 5211cc 318 CID		1971-1974	MERCURY MONTEREY	6.6L V8 6555cc 400 CID		
1976-1977	PLYMOUTH PB100	5.9L V8 360 CID		1971-1974	MERCURY MONTEREY	6.6L V8 6556cc 400 CID		
1976-1977	PLYMOUTH PB200	5.2L V8 5211cc 318 CID		1971-1977	MERCURY MARQUIS	6.6L V8 400 CID		
1976-1977	PLYMOUTH PB200	5.9L V8 360 CID		1972	FORD THUNDERBIRD	6.6L V8 400 CID		
1976-1977	PLYMOUTH PB300	5.2L V8 5211cc 318 CID		1972	FORD THUNDERBIRD	6.6L V8 6555cc 400 CID		
1976-1977	PLYMOUTH PB300	5.9L V8 360 CID	1972	FORD THUNDERBIRD	6.6L V8 6556cc 400 CID			
1977	DODGE D100	5.2L V8 5211cc 318 CID	1972-1974	FORD RANCHERO	6.6L V8 4097cc 250 CID			
1977	DODGE D100	5.9L V8 360 CID	1972-1974	FORD RANCHERO	6.6L V8 6556cc 400 CID			
1977	DODGE D150	5.2L V8 5211cc 318 CID	1972-1976	FORD RANCHERO	6.6L V8 400 CID			
1977	DODGE D150	5.9L V8 360 CID	1973	FORD MUSTANG	4.1L L6 4097cc 250 CID			
1977	DODGE D200	5.2L V8 5211cc 318 CID	1973	FORD MUSTANG	5.0L V8 302 CID			

USMW	Years	Application	Engine	USMW	Years	Application	Engine		
<b>USMP17205</b>	1973	FORD MUSTANG	5.8L V8 5753cc 351 CID	<b>USMP17378</b>	1979	PONTIAC GRAND PRIX	3.8L V6 231 CID		
	1973	MERCURY COUGAR	6.6L V8 400 CID		1979	PONTIAC LEMANS	3.8L V6 231 CID		
	1973	MERCURY COUGAR	6.6L V8 6555cc 400 CID		1980	CADILLAC DEVILLE	4.1L V6 252 CID		
	1973	MERCURY COUGAR	6.6L V8 6556cc 400 CID		1980	CADILLAC FLEETWOOD	4.1L V6 252 CID		
	1975	FORD TORINO	6.6L V8 400 CID		1980	PONTIAC CATALINA	3.8L V6 229 CID		
	1975-1976	FORD CUSTOM 500	5.8L V8 5753cc 351 CID		1980-1981	OLDSMOBILE CUTLASS	3.8L V6 3800cc 231 CID		
	1975-1976	FORD CUSTOM 500	6.6L V8 400 CID		1980-1981	PONTIAC CATALINA	3.8L V6 3800cc 231 CID		
	1975-1976	FORD LTD	5.8L V8 5753cc 351 CID		1981-1983	BUICK ELECTRA	4.1L V6 252 CID		
	1975-1976	FORD LTD	6.6L V8 400 CID		1981-1983	BUICK LESABRE	3.8L V6 3800cc 231 CID		
	1975-1976	FORD LTD	7.5L V8 460 CID		1981-1983	BUICK LESABRE	4.1L V6 252 CID		
	1975-1977	MERCURY GRAND MARQUIS	6.6L V8 400 CID		1981-1985	PONTIAC BONNEVILLE	3.8L V6 3800cc 231 CID		
	1977	FORD F-150	5.8L V8 5753cc 351 CID		1982	CADILLAC DEVILLE	4.1L V6 252 CID		
	1977	FORD F-150	6.6L V8 400 CID		1982	CADILLAC FLEETWOOD	4.1L V6 252 CID		
	1977-1978	FORD F-100	5.8L V8 5753cc 351 CID		1982	PONTIAC BONNEVILLE	4.1L V6 252 CID		
	1977-1978	FORD F-100	6.6L V8 400 CID		1982	PONTIAC GRAND PRIX	4.1L V6 252 CID		
	1977-1979	LINCOLN CONTINENTAL	6.6L V8 400 CID		1982-1984	BUICK REGAL	4.1L V6 252 CID		
	1977-1979	LINCOLN MARK V	6.6L V8 400 CID		1984	PONTIAC PARISIENNE	3.8L V6 3800cc 231 CID		
	1978	FORD F-350	5.8L V8 5753cc 351 CID		1985	BUICK LESABRE	3.8L V6 3800cc 231 CID		
	1978	FORD F-350	6.6L V8 400 CID		<b>USMP17388</b>	1973-1981	CHEVROLET CORVETTE	5.7L V8 350 CID	
	<b>USMP17338</b>	1973	CHRYSLER NEWPORT			6.6L V8 6556cc 400 CID	1980	CHEVROLET CORVETTE	5.0L V8 305 CID
		1973	CHRYSLER NEWPORT		7.2L V8 7211cc 440 CID	<b>USMP17398</b>	1967	INTERNATIONAL 908B	5.0L V8 4982cc 304 CID
		1973	DODGE POLARA		5.2L V8 5211cc 318 CID		1968-1969	INTERNATIONAL 908C	5.0L V8 4982cc 304 CID
		1973	DODGE POLARA		6.6L V8 6556cc 400 CID		1969	INTERNATIONAL 908C	5.0L V8 304 CID
1973		DODGE POLARA	7.2L V8 7211cc 440 CID	1969	INTERNATIONAL 908C		5.0L V8 4983cc 304 CID		
1973-1974		CHRYSLER NEW YORKER	7.2L V8 7211cc 440 CID	1971	INTERNATIONAL SCOUT II		5.6L V8 345 CID		
1973-1974		CHRYSLER TOWN & COUNTRY	6.6L V8 6556cc 400 CID	1971-1973	INTERNATIONAL 1110		5.0L V8 4982cc 304 CID		
1973-1974		CHRYSLER TOWN & COUNTRY	7.2L V8 7211cc 440 CID	1971-1973	INTERNATIONAL 1110		5.6L V8 5654cc 345 CID		
1973-1974		DODGE CHARGER	6.6L V8 6556cc 400 CID	1971-1973	INTERNATIONAL 1110		5.7L V8 345 CID		
1973-1974		DODGE CHARGER	7.2L V8 7211cc 440 CID	1971-1973	INTERNATIONAL 1110		6.4L V8 6424cc 392 CID		
1973-1974		DODGE D100 PICKUP	6.6L V8 6556cc 400 CID	1971-1973	INTERNATIONAL 1310		5.0L V8 304 CID		
1973-1974		DODGE D100 PICKUP	7.2L V8 7211cc 440 CID	1971-1973	INTERNATIONAL 1310		5.0L V8 4982cc 304 CID		
1973-1974		DODGE D200 PICKUP	5.2L V8 5211cc 318 CID	1971-1973	INTERNATIONAL 1310		5.6L V8 5654cc 345 CID		
1973-1974		DODGE D200 PICKUP	6.6L V8 6556cc 400 CID	1971-1973	INTERNATIONAL 1310		6.4L V8 6424cc 392 CID		
1973-1974		DODGE D200 PICKUP	7.2L V8 7211cc 440 CID	1971-1974	INTERNATIONAL SCOUT II		5.0L V8 4982cc 304 CID		
1973-1974		DODGE D300 PICKUP	5.2L V8 5211cc 318 CID	1971-1974	INTERNATIONAL SCOUT II		5.0L V8 4983cc 304 CID		
1973-1974		DODGE D300 PICKUP	6.6L V8 6556cc 400 CID	1971-1974	INTERNATIONAL SCOUT II		5.6L V8 5654cc 345 CID		
1973-1974		DODGE D300 PICKUP	7.2L V8 7211cc 440 CID	1971-1979	INTERNATIONAL SCOUT II		5.0L V8 304 CID		
1973-1974		DODGE MONACO	5.2L V8 5211cc 318 CID	1972-1973	INTERNATIONAL 1010		5.0L V8 304 CID		
1973-1974		DODGE MONACO	6.6L V8 6556cc 400 CID	1972-1973	INTERNATIONAL 1010		5.0L V8 4982cc 304 CID		
1973-1974		DODGE MONACO	7.2L V8 7211cc 440 CID	1972-1973	INTERNATIONAL 1010		5.0L V8 4983cc 304 CID		
1974		DODGE CORONET	5.2L V8 5211cc 318 CID	1972-1973	INTERNATIONAL 1010		5.6L V8 5654cc 345 CID		
1974		DODGE CORONET	6.6L V8 6556cc 400 CID	1972-1973	INTERNATIONAL 1010		5.7L V8 345 CID		
1974		DODGE RAMCHARGER	5.2L V8 5211cc 318 CID	1972-1973	INTERNATIONAL 1010		6.4L V8 392 CID		
1974		PLYMOUTH SATELLITE	5.2L V8 5211cc 318 CID	1972-1973	INTERNATIONAL 1010		6.4L V8 6424cc 392 CID		
1974		PLYMOUTH SATELLITE	6.6L V8 6556cc 400 CID	1972-1973	INTERNATIONAL 1010		6.4L V8 6425cc 392 CID		
1974		PLYMOUTH SATELLITE	7.2L V8 7211cc 440 CID	1972-1973	INTERNATIONAL 1110		5.0L V8 304 CID		
1974-1975		DODGE CORONET	7.2L V8 7211cc 440 CID	1972-1973	INTERNATIONAL 1110		5.0L V8 4983cc 304 CID		
1974-1978		DODGE RAMCHARGER	7.2L V8 7211cc 440 CID	1972-1973	INTERNATIONAL 1110		6.4L V8 392 CID		
1975		CHRYSLER NEWPORT	6.6L V8 400 CID	1972-1973	INTERNATIONAL 1110		6.4L V8 6425cc 392 CID		
1975		CHRYSLER NEW YORKER	6.6L V8 400 CID	1972-1973	INTERNATIONAL 1210		5.0L V8 304 CID		
1975		CHRYSLER TOWN & COUNTRY	6.6L V8 400 CID	1972-1973	INTERNATIONAL 1210		5.0L V8 4982cc 304 CID		
1975		DODGE ROYAL MONACO	7.2L V8 7211cc 440 CID	1972-1973	INTERNATIONAL 1210		5.0L V8 4983cc 304 CID		
1975		PLYMOUTH FURY	7.2L V8 7211cc 440 CID	1972-1973	INTERNATIONAL 1210		5.6L V8 5654cc 345 CID		
1975		PLYMOUTH GRAN FURY	7.2L V8 7211cc 440 CID	1972-1973	INTERNATIONAL 1210		5.7L V8 345 CID		
1975-1977		DODGE W100	7.2L V8 7211cc 440 CID	1972-1973	INTERNATIONAL 1210		6.4L V8 392 CID		
1975-1978		DODGE B200	7.2L V8 7211cc 440 CID	1972-1973	INTERNATIONAL 1210		6.4L V8 6424cc 392 CID		
1975-1978		DODGE B300	7.2L V8 7211cc 440 CID	1972-1973	INTERNATIONAL 1210		6.4L V8 6425cc 392 CID		
1975-1978		DODGE D100	7.2L V8 7211cc 440 CID	1972-1973	INTERNATIONAL 1310		5.0L V8 4983cc 304 CID		
1975-1978		DODGE D200	7.2L V8 7211cc 440 CID	1972-1973	INTERNATIONAL 1310		6.4L V8 392 CID		
1975-1978		DODGE D300	7.2L V8 7211cc 440 CID	1972-1973	INTERNATIONAL 1310		6.4L V8 6425cc 392 CID		
1975-1978		DODGE W200	7.2L V8 7211cc 440 CID	1972-1974	INTERNATIONAL MS1210		5.0L V8 304 CID		
1975-1978		DODGE W300	7.2L V8 7211cc 440 CID	1972-1974	INTERNATIONAL MS1210		5.0L V8 4982cc 304 CID		
1976-1978		DODGE B200	6.6L V8 400 CID	1972-1974	INTERNATIONAL MS1210		5.0L V8 4983cc 304 CID		
1976-1978		DODGE B300	6.6L V8 400 CID	1972-1974	INTERNATIONAL MS1210		5.6L V8 5654cc 345 CID		
1976-1978		PLYMOUTH PB200	6.6L V8 400 CID	1972-1974	INTERNATIONAL MS1210		6.4L V8 6424cc 392 CID		
1976-1978		PLYMOUTH PB200	7.2L V8 7211cc 440 CID	1974	INTERNATIONAL 100		5.0L V8 304 CID		
1976-1978	PLYMOUTH PB300	6.6L V8 400 CID	1974	INTERNATIONAL 100	5.0L V8 4982cc 304 CID				
1976-1978	PLYMOUTH PB300	7.2L V8 7211cc 440 CID	1974	INTERNATIONAL 100	5.0L V8 4983cc 304 CID				
1977-1979	DODGE CB300	7.2L V8 7211cc 440 CID	1974	INTERNATIONAL 100	5.6L V8 345 CID				
1978	DODGE D150	7.2L V8 7211cc 440 CID	1974	INTERNATIONAL 100	5.6L V8 5654cc 345 CID				
1978	DODGE RAMCHARGER	6.6L V8 400 CID	1974	INTERNATIONAL 100	6.4L V8 392 CID				
1978	DODGE W150	7.2L V8 7211cc 440 CID	1974	INTERNATIONAL 100	6.4L V8 6424cc 392 CID				
<b>USMP17378</b>	1978	CHEVROLET EL CAMINO	3.8L V6 3800cc 231 CID	1974	INTERNATIONAL 100	6.4L V8 6425cc 392 CID			
	1978	CHEVROLET MALIBU	3.8L V6 3800cc 231 CID	1974	INTERNATIONAL 200	5.0L V8 4982cc 304 CID			
	1978	CHEVROLET MONTE CARLO	3.8L V6 3800cc 231 CID	1974	INTERNATIONAL 200	5.0L V8 4983cc 304 CID			
	1978	GMC CABALLERO	3.8L V6 3800cc 231 CID	1974	INTERNATIONAL 200	5.6L V8 5654cc 345 CID			
	1978	OLDSMOBILE CUTLASS	3.8L V6 3800cc 231 CID	1974	INTERNATIONAL 200	6.4L V8 6424cc 392 CID			
	1978-1979	BUICK CENTURY	3.2L V6 196 CID	1974	INTERNATIONAL 200	6.4L V8 6425cc 392 CID			
	1978-1979	BUICK REGAL	3.2L V6 196 CID	1974	INTERNATIONAL MHC1310	5.0L V8 304 CID			
	1978-1979	PONTIAC LEMANS	3.8L V6 3800cc 231 CID	1974	INTERNATIONAL MHC1310	5.0L V8 4982cc 304 CID			
	1978-1980	OLDSMOBILE DELTA 88	3.8L V6 3800cc 231 CID	1974	INTERNATIONAL MHC1310	5.0L V8 4983cc 304 CID			
	1978-1981	BUICK CENTURY	3.8L V6 3800cc 231 CID	1974-1975	INTERNATIONAL 200	5.0L V8 304 CID			
	1978-1985	BUICK REGAL	3.8L V6 3800cc 231 CID	1974-1975	INTERNATIONAL 200	5.6L V8 345 CID			
	1978-1985	PONTIAC GRAND PRIX	3.8L V6 3800cc 231 CID	1974-1975	INTERNATIONAL 200	6.4L V8 392 CID			
	1979	BUICK CENTURY	3.8L V6 231 CID	1975	INTERNATIONAL 150	5.0L V8 304 CID			
	1979	BUICK REGAL	3.8L V6 231 CID	1975	INTERNATIONAL 150	5.6L V8 345 CID			
	1979	PONTIAC GRAND LEMANS	3.8L V6 231 CID	1975	INTERNATIONAL 150	6.4L V8 392 CID			
	1979	PONTIAC GRAND LEMANS	3.8L V6 3800cc 231 CID	1975	INTERNATIONAL SCOUT II	6.4L V8 392 CID			

USMW	Years	Application	Engine	USMW	Years	Application	Engine		
<b>USMP17398</b>	1975	INTERNATIONAL TRAVELALL	5.0L V8 304 CID	<b>USMP17461</b>	1967-1969	BUICK WILDCAT	7.0L V8 430 CID		
	1975	INTERNATIONAL TRAVELALL	5.6L V8 345 CID		1967-1969	BUICK WILDCAT	7.0L V8 7047cc 430 CID		
	1975	INTERNATIONAL TRAVELALL	6.4L V8 392 CID		1968	BUICK RIVIERA	7.0L V8 430 CID		
	1975-1980	INTERNATIONAL SCOUT II	5.6L V8 345 CID		1970	BUICK WILDCAT	7.5L V8 455 CID		
<b>USMP17405</b>	1973-1974	FORD B-100	5.0L V8 302 CID		1970	BUICK WILDCAT	7.5L V8 7456cc 455 CID		
	1975	FORD GRANADA	5.0L V8 302 CID		1970-1974	BUICK ELECTRA	7.5L V8 455 CID		
	1975	FORD MAVERICK	5.0L V8 302 CID		1970-1974	BUICK ELECTRA	7.5L V8 7456cc 455 CID		
	1975	FORD TORINO	5.8L V8 5753cc 351 CID		1970-1974	BUICK ESTATE WAGON	7.5L V8 455 CID		
	1975	MERCURY COMET	5.0L V8 302 CID		1970-1974	BUICK ESTATE WAGON	7.5L V8 7456cc 455 CID		
	1975	MERCURY MONARCH	5.0L V8 302 CID		1971-1972	BUICK CENTURION	7.5L V8 455 CID		
	1975-1976	FORD ELITE	5.8L V8 5753cc 351 CID	1971-1972	BUICK CENTURION	7.5L V8 7456cc 455 CID			
	1975-1976	FORD GRANADA	5.8L V8 5753cc 351 CID	1971-1974	BUICK RIVIERA	7.5L V8 455 CID			
	1975-1976	MERCURY MONARCH	5.8L V8 5753cc 351 CID	1971-1974	BUICK RIVIERA	7.5L V8 7456cc 455 CID			
	1975-1977	FORD BRONCO	5.0L V8 302 CID	<b>USMP17462</b>	1970-1973	NISSAN 240Z	2.4L L6 2393cc 146 CID		
	1975-1979	FORD E-100 ECONOLINE	5.8L V8 5753cc 351 CID		1974	NISSAN 260Z			
	1975-1979	FORD E-100 ECONOLINE CLUB WAGON	5.8L V8 5753cc 351 CID	<b>USMP17464</b>	1966	FORD FAIRLANE	3.3L L6 200 CID		
	1975-1979	FORD E-150 ECONOLINE	5.8L V8 5753cc 351 CID		1966	FORD FAIRLANE	3.3L L6 3277cc 200 CID		
	1975-1979	FORD E-150 ECONOLINE CLUB WAGON	5.8L V8 5753cc 351 CID		1967	FORD RANCHERO	3.3L L6 3277cc 200 CID		
	1975-1979	FORD E-250 ECONOLINE	5.8L V8 5753cc 351 CID		1969	FORD E-300 ECONOLINE	2.8L L6 170 CID		
	1975-1979	FORD E-250 ECONOLINE CLUB WAGON	5.8L V8 5753cc 351 CID		1969-1970	FORD E-200 ECONOLINE	2.8L L6 170 CID		
	1975-1979	FORD E-250 ECONOLINE CLUB WAGON	5.8L V8 5753cc 351 CID		1969-1974	FORD E-200 ECONOLINE	3.9L L6 240 CID		
	1975-1979	FORD E-350 ECONOLINE	5.8L V8 5753cc 351 CID		1969-1974	FORD E-300 ECONOLINE	3.9L L6 240 CID		
	1975-1979	FORD F-100	5.0L V8 302 CID		1970	FORD CUSTOM	3.9L L6 3933cc 240 CID		
	1975-1979	FORD F-150	5.0L V8 302 CID		1972	MERCURY COMET	2.8L L6 170 CID		
	1975-1979	FORD RANCHERO	5.8L V8 5753cc 351 CID		1972	MERCURY COMET	2.8L L6 2786cc 170 CID		
	1976	FORD F-350	5.0L V8 302 CID	<b>USMP17465</b>	1972-1974	FORD E-200 ECONOLINE	4.9L L6 4917cc 300 CID		
	1977-1979	FORD E-350 ECONOLINE CLUB WAGON	5.8L V8 5753cc 351 CID		1972-1974	FORD E-300 ECONOLINE	4.9L L6 4917cc 300 CID		
	1977-1979	FORD RANCHERO	5.0L V8 302 CID		1950-1951	INTERNATIONAL L110	3.6L L6 3608cc 220 CID		
	1978	FORD F-350	5.0L V8 302 CID		1950-1951	INTERNATIONAL L120	3.6L L6 3608cc 220 CID		
	1978-1979	FORD F-100	5.8L V8 5753cc 351 CID		1950-1951	INTERNATIONAL L150	3.6L L6 3608cc 220 CID		
	1978-1979	FORD F-150	5.8L V8 5753cc 351 CID		1953-1955	INTERNATIONAL RM120	3.6L L6 220 CID		
	1979	FORD E-100 ECONOLINE	5.0L V8 302 CID		1956-1957	INTERNATIONAL SM120	3.6L L6 220 CID		
	1979	FORD E-100 ECONOLINE CLUB WAGON	5.0L V8 302 CID		1959-1960	INTERNATIONAL AM120	3.6L L6 220 CID		
	1979	FORD E-150 ECONOLINE	5.0L V8 302 CID		1961	INTERNATIONAL AM120	3.6L L6 3608cc 220 CID		
	1979	FORD E-150 ECONOLINE CLUB WAGON	5.0L V8 302 CID		<b>USMP17466</b>	1989	CHEVROLET R3500	7.4L V8 454 CID	
	1979	FORD E-250 ECONOLINE	5.0L V8 302 CID	1989		GMC R3500	7.4L V8 454 CID		
	1979	FORD E-250 ECONOLINE CLUB WAGON	5.0L V8 302 CID	<b>USMP17467</b>	1966-1967	FORD P-100	2.8L L6 2786cc 170 CID		
	1979	FORD E-350 ECONOLINE	5.0L V8 302 CID		<b>USMP17469</b>	1955	MERCURY CUSTOM	4.8L V8 4786cc 292 CID	
	1979	FORD E-350 ECONOLINE CLUB WAGON	5.0L V8 302 CID	1955		MERCURY MONTCLAIR	4.8L V8 4786cc 292 CID		
	1979	FORD LTD II	5.0L V8 302 CID	1955		MERCURY MONTEREY	4.8L V8 4786cc 292 CID		
	1979	FORD LTD II	5.8L V8 5753cc 351 CID	1956		MERCURY CUSTOM	5.1L V8 5114cc 312 CID		
	1979	MERCURY COUGAR	5.0L V8 302 CID	1956		MERCURY MEDALIST	5.1L V8 5114cc 312 CID		
	1979	MERCURY COUGAR	5.8L V8 5753cc 351 CID	1956-1957		MERCURY MONTCLAIR	5.1L V8 5114cc 312 CID		
	1979-1980	FORD B-100	5.0L V8 302 CID	1956-1957		MERCURY MONTEREY	5.1L V8 5114cc 312 CID		
	1980-1981	FORD MUSTANG	5.0L V8 302 CID	1957		MERCURY MONTCLAIR	6.0L V8 6032cc 368 CID		
	1989-1991	FORD P-350	5.0L V8 302 CID	1957		MERCURY MONTEREY	6.0L V8 6032cc 368 CID		
	<b>USMP17445</b>	1978-1979	FORD BRONCO	5.8L V8 5753cc 351 CID		1958	EDSEL PACER	5.9L V8 5917cc 361 CID	
		1978-1979	FORD BRONCO	6.6L V8 400 CID		1958	EDSEL RANGER	5.9L V8 5917cc 361 CID	
		<b>USMP17460</b>	1967	FORD THUNDERBIRD		7.0L V8 6997cc 427 CID	1958	MERCURY MEDALIST	5.1L V8 5114cc 312 CID
1967			FORD THUNDERBIRD	7.0L V8 7014cc 428 CID		<b>USMP17470</b>	1969	CADILLAC ELDORADO	7.7L V8 472 CID
1967-1968			FORD THUNDERBIRD	6.4L V8 6391cc 390 CID			1969	CADILLAC ELDORADO	7.7L V8 7735cc 472 CID
1967-1969			MERCURY COUGAR	6.4L V8 6391cc 390 CID			1969-1974	CADILLAC CALAIS	7.7L V8 472 CID
1968			FORD THUNDERBIRD	6.4L V8 390 CID	1969-1974		CADILLAC CALAIS	7.7L V8 7735cc 472 CID	
1968-1969			FORD MUSTANG	6.4L V8 6391cc 390 CID	1969-1974		CADILLAC DEVILLE	7.7L V8 472 CID	
1968-1969			MERCURY COMET	6.4L V8 390 CID	1969-1974		CADILLAC DEVILLE	7.7L V8 7735cc 472 CID	
1968-1969			MERCURY COMET	6.4L V8 6391cc 390 CID	1969-1974		CADILLAC FLEETWOOD	7.7L V8 472 CID	
1968-1969	MERCURY COUGAR		6.4L V8 390 CID	1969-1974	CADILLAC FLEETWOOD		7.7L V8 7735cc 472 CID		
1968-1969	MERCURY CYCLONE		6.4L V8 390 CID	1970-1974	CADILLAC ELDORADO		8.2L V8 8193cc 500 CID		
1968-1969	MERCURY CYCLONE		6.4L V8 6391cc 390 CID	1970-1976	CADILLAC ELDORADO		8.2L V8 500 CID		
1968-1969	MERCURY MONTEGO		6.4L V8 390 CID	1972-1974	CADILLAC ELDORADO	8.2L V8 8195cc 500 CID			
1968-1969	MERCURY MONTEGO		6.4L V8 6391cc 390 CID	1975-1976	CADILLAC CALAIS	8.2L V8 500 CID			
1969	FORD FAIRLANE		6.4L V8 390 CID	1975-1976	CADILLAC DEVILLE	8.2L V8 500 CID			
1969	FORD FAIRLANE		6.4L V8 6391cc 390 CID	1975-1976	CADILLAC FLEETWOOD	8.2L V8 500 CID			
1969	FORD MUSTANG	6.4L V8 390 CID	1977-1978	CADILLAC ELDORADO	7.0L V8 425 CID				
1969	FORD TORINO	6.4L V8 390 CID	<b>USMP17472</b>	1989	TOYOTA COROLLA	1.6L L4 1587cc			
1969	FORD TORINO	6.4L V8 6391cc 390 CID		<b>USMP17476</b>	1961	FORD THUNDERBIRD	6.4L V8 6391cc 390 CID		
1970	FORD CUSTOM	6.4L V8 6391cc 390 CID	<b>USMP17477</b>		1940	DODGE DELUXE			
1970	MERCURY COLONY PARK	6.4L V8 390 CID		1940	DODGE SPECIAL				
1970	MERCURY COLONY PARK	6.4L V8 6391cc 390 CID		1940-1941	CHRYSLER ROYAL	4.0L L6 3958cc 242 CID			
1970	MERCURY MARAUDER	6.4L V8 390 CID		1940-1941	CHRYSLER WINDSOR	4.0L L6 3958cc 242 CID			
1970	MERCURY MARAUDER	6.4L V8 6391cc 390 CID		1942	CHRYSLER ROYAL	4.1L L6 4114cc 251 CID			
1970	MERCURY MARQUIS	6.4L V8 390 CID		1942	CHRYSLER WINDSOR	4.1L L6 4114cc 251 CID			
1970	MERCURY MARQUIS	6.4L V8 6391cc 390 CID		1946-1948	CHRYSLER TOWN & COUNTRY	4.1L L6 4114cc 251 CID			
1970	MERCURY MONTEREY	6.4L V8 390 CID		1946-1948	DODGE CUSTOM	3.8L L6 3770cc 230 CID			
1970	MERCURY MONTEREY	6.4L V8 6391cc 390 CID		1946-1948	DODGE DELUXE	3.8L L6 3770cc 230 CID			
1973	FORD F-100	5.9L V8 360 CID		1949-1950	PLYMOUTH DELUXE	3.6L L6 3570cc 218 CID			
1973	FORD F-100	6.4L V8 390 CID		1949-1950	PLYMOUTH SPECIAL DELUXE	3.6L L6 218 CID			
1973	FORD F-100	6.4L V8 6391cc 390 CID		1949-1952	DODGE WAYFARER	3.8L L6 3770cc 230 CID			
1973	FORD F-100	6.4L V8 6392cc 390 CID		1949-1954	DODGE CORONET	3.8L L6 3770cc 230 CID			
<b>USMP17461</b>	1967	BUICK GRAN SPORT		6.6L V8 6555cc 400 CID	1949-1954	DODGE MEADOWBROOK	3.8L L6 3770cc 230 CID		
	1967-1968	BUICK RIVIERA		7.0L V8 7047cc 430 CID	1950	CHRYSLER ROYAL	4.1L L6 4114cc 251 CID		
	1967-1969	BUICK ELECTRA	7.0L V8 430 CID	1950-1951	CHRYSLER WINDSOR	4.1L L6 4114cc 251 CID			
	1967-1969	BUICK ELECTRA	7.0L V8 7047cc 430 CID	1951-1952	PLYMOUTH CONCORD	3.6L L6 218 CID			
				1951-1952	PLYMOUTH CONCORD	3.6L L6 3570cc 218 CID			
				1951-1953	PLYMOUTH CAMBRIDGE	3.6L L6 3570cc 218 CID			
				1951-1953	PLYMOUTH CRANBROOK	3.6L L6 3570cc 218 CID			
				1952	CHRYSLER WINDSOR	4.3L L6 4343cc 265 CID			
				1952	DESOTO FIREDOME	4.5L V8 4524cc 276 CID			





# MECHANICAL FUEL PUMP BUYERS GUIDE



USMW	Years	Application	Engine	USMW	Years	Application	Engine	
USMP17477	1954	PLYMOUTH BELVEDERE	3.8L L6 3770cc 230 CID	USMP17499	1986-1987	FORD E-250 ECONOLINE CLUB WAGON	7.5L V8 460 CID	
	1954	PLYMOUTH PLAZA	3.6L L6 3570cc 218 CID		1986-1987	FORD E-350 ECONOLINE	7.5L V8 460 CID	
	1954	PLYMOUTH SAVOY	3.8L L6 3770cc 230 CID		1986-1987	FORD E-350 ECONOLINE CLUB WAGON	7.5L V8 460 CID	
USMP17482	1957-1958	CADILLAC DEVILLE	6.0L V8 5972cc 365 CID	1986-1987	FORD F-250	7.5L V8 460 CID		
	1957-1958	CADILLAC ELDORADO	6.0L V8 5972cc 365 CID	1986-1987	FORD F-350	7.5L V8 460 CID		
	1957-1958	CADILLAC SERIES 62	6.0L V8 5972cc 365 CID	USMP17501	1983	TOYOTA COROLLA	1.6L L4 1587cc	
	1957-1958	CADILLAC SERIES 75 FLEETWOOD	6.0L V8 5972cc 365 CID		USMP17502	1980-1981	BUICK SKYLARK	2.5L L4 2474cc 151 CID
	1959-1960	CADILLAC ELDORADO	6.4L V8 390 CID	1980-1981		CHEVROLET CITATION	2.5L L4 2474cc 151 CID	
	1959-1962	CADILLAC DEVILLE	6.4L V8 6392cc 390 CID	1980-1981		OLDSMOBILE OMEGA	2.5L L4 2474cc 151 CID	
	1959-1962	CADILLAC ELDORADO	6.4L V8 6392cc 390 CID	1980-1981		PONTIAC PHOENIX	2.5L L4 2474cc 151 CID	
	1959-1962	CADILLAC SERIES 62	6.4L V8 6392cc 390 CID	1980-1982		AMERICAN MOTORS CONCORD	2.5L L4 151 CID	
1959-1962	CADILLAC SERIES 75 FLEETWOOD	6.4L V8 6392cc 390 CID	1980-1982	AMERICAN MOTORS SPIRIT		2.5L L4 151 CID		
USMP17484	1976	DODGE MONACO	5.9L V8 360 CID	1980-1982		JEEP CJ7	2.5L L4 151 CID	
	1976-1977	DODGE ROYAL MONACO	5.9L V8 360 CID	1980-1983		JEEP CJ5	2.5L L4 151 CID	
	1976-1977	PLYMOUTH GRAN FURY	5.9L V8 360 CID	1981-1982	AMERICAN MOTORS EAGLE	2.5L L4 151 CID		
	1976-1978	CHRYSLER NEWPORT	5.9L V8 360 CID	1982	JEEP SCRAMBLER	2.5L L4 151 CID		
	1977-1978	CHRYSLER NEW YORKER	5.9L V8 360 CID	USMP17503	1979	CHEVROLET MALIBU	3.3L V6 200 CID	
USMP17486	1970	FORD CORTINA	1.6L L4 1599cc 98 CID		1979	CHEVROLET MONTE CARLO	3.3L V6 200 CID	
	1983-1986	TOYOTA TERCEL	1.5L L4 1452cc		1980	PONTIAC LEMANS	3.8L V6 229 CID	
USMP17488	1961-1962	OLDSMOBILE F85	3.5L V8 3528cc 215 CID		1980	PONTIAC LEMANS	3.8L V6 3800cc 231 CID	
		BUICK SPECIAL	3.5L V8 3528cc 215 CID		1980-1981	CHEVROLET CAMARO	3.8L V6 229 CID	
USMP17489	1962	OLDSMOBILE 98	6.5L V8 6458cc 394 CID		1980-1981	CHEVROLET CAMARO	3.8L V6 3800cc 231 CID	
	1962	OLDSMOBILE CUTLASS	3.5L V8 3528cc 215 CID		1980-1981	PONTIAC GRAND LEMANS	3.8L V6 229 CID	
	1962	OLDSMOBILE F85	3.5L V8 215 CID		1980-1981	PONTIAC GRAND LEMANS	3.8L V6 3800cc 231 CID	
	1962	OLDSMOBILE STARFIRE	6.5L V8 6458cc 394 CID		1980-1983	CHEVROLET MALIBU	3.8L V6 229 CID	
	1962	OLDSMOBILE SUPER 88	6.5L V8 6458cc 394 CID		1980-1983	CHEVROLET MALIBU	3.8L V6 3800cc 231 CID	
	1962-1963	BUICK SPECIAL	3.2L V6 3245cc 198 CID	1980-1984	CHEVROLET CAPRICE	3.8L V6 229 CID		
	1965	OLDSMOBILE VISTA CRUISER	5.4L V8 330 CID	1980-1984	CHEVROLET CAPRICE	3.8L V6 3800cc 231 CID		
	1965	OLDSMOBILE VISTA CRUISER	5.4L V8 5409cc 330 CID	1980-1984	CHEVROLET EL CAMINO	3.8L V6 229 CID		
	USMP17491	1979-1981	DODGE COLT	1.4L L4 1410cc	1980-1984	CHEVROLET EL CAMINO	3.8L V6 3800cc 231 CID	
		1979-1981	PLYMOUTH CHAMP	1.4L L4 1410cc	1980-1984	CHEVROLET MONTE CARLO	3.8L V6 229 CID	
1989-1990		TOYOTA TERCEL	1.5L L4 1456cc	1980-1984	CHEVROLET MONTE CARLO	3.8L V6 229 CID		
USMP17492	1968	CADILLAC CALAIS	7.7L V8 472 CID	1980-1984	GMC CABALLERO	3.8L V6 229 CID		
	1968	CADILLAC CALAIS	7.7L V8 7735cc 472 CID	1980-1984	GMC CABALLERO	3.8L V6 3800cc 231 CID		
	1968	CADILLAC DEVILLE	7.7L V8 472 CID	1981-1984	CHEVROLET IMPALA	3.8L V6 229 CID		
	1968	CADILLAC DEVILLE	7.7L V8 7735cc 472 CID	1981-1984	CHEVROLET IMPALA	3.8L V6 3800cc 231 CID		
	1968	CADILLAC ELDORADO	7.7L V8 472 CID	USMP17504	1961	MERCURY COMET	2.4L L6 144 CID	
	1968	CADILLAC ELDORADO	7.7L V8 7735cc 472 CID		1961	MERCURY COMET	2.4L L6 2360cc 144 CID	
	1968	CADILLAC FLEETWOOD	7.7L V8 472 CID	1961	MERCURY COMET	2.8L L6 2786cc 170 CID		
	1968	CADILLAC FLEETWOOD	7.7L V8 7735cc 472 CID	USMP17505	1979	FORD F-100	5.8L V8 5753cc 351 CID	
USMP17493	1940	FORD 1/2 TON PICKUP	2.2L V8 2229cc 136 CID		1979	FORD F-100	6.6L V8 400 CID	
	1940	FORD 1 TON PICKUP	2.2L V8 2229cc 136 CID		1979	FORD F-150	5.8L V8 5753cc 351 CID	
	1940	FORD 3/4 TON PICKUP	2.2L V8 2229cc 136 CID		1979	FORD F-150	6.6L V8 400 CID	
	1940	FORD SEDAN DELIVERY	2.2L V8 2229cc 136 CID		1979	FORD F-250	5.8L V8 5753cc 351 CID	
	1941	FORD 1/2 TON PICKUP			1979	FORD F-250	6.6L V8 400 CID	
	1941	FORD 1 TON PICKUP			1979	FORD F-250	5.8L V8 5753cc 351 CID	
	1941	FORD 3/4 TON PICKUP		1979	FORD F-350	6.6L V8 400 CID		
1941	FORD SEDAN DELIVERY		USMP17506	1966-1969	CHEVROLET CORVETTE	7.0L V8 6998cc 427 CID		
1942	FORD SEDAN DELIVERY	3.6L V8 3622cc 221 CID		1968-1969	CHEVROLET CORVETTE	7.0L V8 427 CID		
1942	FORD SEDAN DELIVERY	3.9L V8 3924cc 239 CID	USMP17507	1968	CHEVROLET CORVETTE	5.3L V8 5358cc 327 CID		
1947-1948	FORD DELUXE	3.9L V8 3924cc 239 CID		1969	CHEVROLET CORVETTE	5.7L V8 350 CID		
1947-1948	FORD SUPER DELUXE	3.9L V8 3924cc 239 CID		USMP17508	1984	FORD RANGER	2.3L L4 140 CID	
USMP17494	1981-1982	PLYMOUTH TC3	2.2L L4 135 CID		1984-1988	FORD RANGER	2.0L L4 1989cc 122 CID	
	1981-1985	DODGE ARIES	2.2L L4 135 CID	USMP17509	1983	NISSAN PULSAR	1.6L L4 1597cc 97 CID	
	1981-1985	PLYMOUTH RELIANT	2.2L L4 135 CID		1983-1985	NISSAN SENTRA	1.6L L4 1597cc 97 CID	
	1981-1987	DODGE OMNI	2.2L L4 135 CID		1988	NISSAN SENTRA	1.6L L4 1597cc 97 CID	
	1981-1987	PLYMOUTH HORIZON	2.2L L4 135 CID	USMP17510	1968	INTERNATIONAL SCOUT	3.2L L4 196 CID	
	1982	CHRYSLER LEBARON	2.2L L4 135 CID		1968	INTERNATIONAL SCOUT	3.2L L4 3203cc 196 CID	
	1982-1983	DODGE 400	2.2L L4 135 CID		1968	INTERNATIONAL SCOUT	3.2L L4 3212cc 196 CID	
	1982-1984	DODGE RAMPAGE	2.2L L4 135 CID		1970	INTERNATIONAL SCOUT	2.5L L4 152 CID	
	1983	CHRYSLER E CLASS	2.2L L4 135 CID		1970	INTERNATIONAL SCOUT	2.5L L4 2491cc 152 CID	
	1983	CHRYSLER NEW YORKER	2.2L L4 135 CID		USMP17512	1946	STUDEBAKER M5	2.8L L6 2780cc 170 CID
	1983	PLYMOUTH SCAMP	2.2L L4 135 CID			1955	STUDEBAKER COMMANDER	3.7L V8 3671cc 224 CID
	1983-1984	DODGE 600	2.2L L4 135 CID	1955		STUDEBAKER E7	3.7L V8 3671cc 224 CID	
	1983-1987	DODGE CHARGER	2.2L L4 135 CID	1955		STUDEBAKER E12	3.7L V8 3671cc 224 CID	
	1983-1987	PLYMOUTH TURISMO	2.2L L4 135 CID	1955		STUDEBAKER PRESIDENT	4.2L V8 4245cc 259 CID	
	1983-1988	DODGE MAGNUM	2.2L L4 135 CID	1955-1957		STUDEBAKER COMMANDER	4.2L V8 4245cc 259 CID	
	1983-1989	DODGE DART	2.2L L4 135 CID	1956		STUDEBAKER SKY HAWK	4.7L V8 4737cc 289 CID	
	1984-1987	DODGE CARAVAN	2.2L L4 135 CID	1956-1957		STUDEBAKER PRESIDENT	4.7L V8 4737cc 289 CID	
	1984-1987	DODGE MINI RAM	2.2L L4 135 CID	1958		STUDEBAKER 3E6	4.0L L6 4025cc 246 CID	
	1984-1987	PLYMOUTH VOYAGER	2.2L L4 135 CID	1958		STUDEBAKER 3E11	4.0L L6 4025cc 246 CID	
	1985-1987	CHRYSLER LEBARON	2.2L L4 135 CID	1959		STUDEBAKER 4E1	2.8L L6 2780cc 170 CID	
1988	DODGE DAKOTA	2.2L L4 135 CID	1959	STUDEBAKER 4E3		4.0L L6 4025cc 246 CID		
USMP17495	1977-1978	AMERICAN MOTORS GREMLIN	2.0L L4 121 CID	1959		STUDEBAKER 4E7	4.7L V8 4737cc 289 CID	
	1978-1979	AMERICAN MOTORS CONCORD	2.0L L4 121 CID	1959		STUDEBAKER 4E11	4.0L L6 4025cc 246 CID	
	1979	AMERICAN MOTORS SPIRIT	2.0L L4 121 CID	1959		STUDEBAKER 4E12	4.7L V8 4737cc 289 CID	
USMP17496	1972-1973	NISSAN 620 PICKUP	1.6L L4 1595cc 97 CID	1959-1960	STUDEBAKER LARK	4.2L V8 4245cc 259 CID		
	1973	NISSAN 610	1.8L L4 1770cc 108 CID	1961	STUDEBAKER 6E7	4.7L V8 4737cc 289 CID		
	1974	NISSAN 610	2.0L L4 1952cc 119 CID	1961	STUDEBAKER 6E12	4.7L V8 4737cc 289 CID		
	1974	NISSAN 620 PICKUP	1.8L L4 1770cc 108 CID	1962	STUDEBAKER 7E7	4.7L V8 4737cc 289 CID		
	1974	NISSAN 710	1.8L L4 1770cc 108 CID	1962	STUDEBAKER 7E12	4.7L V8 4737cc 289 CID		
	1975	NISSAN 610	2.0L L4 1952cc	1962	STUDEBAKER HAWK	4.7L V8 4737cc 289 CID		
	1975	NISSAN 620	2.0L L4 1952cc	1962	STUDEBAKER LARK	4.2L V8 4245cc 259 CID		
	1975-1977	NISSAN 710	2.0L L4 1952cc	1963-1964	STUDEBAKER 8E7	4.7L V8 4737cc 289 CID		
	USMP17498	1967	PONTIAC GTO	6.6L V8 400 CID	1963-1964	STUDEBAKER 8E12	4.7L V8 4737cc 289 CID	
		1967	PONTIAC GTO	6.6L V8 6555cc 400 CID	1964	STUDEBAKER COMMANDER	4.2L V8 4245cc 259 CID	
1967		PONTIAC LEMANS	5.3L V8 5343cc 326 CID	USMP17513	1957-1959	DODGE D200 PICKUP	3.8L L6 3770cc 230 CID	
1967		PONTIAC TEMPEST	5.3L V8 5343cc 326 CID					

MECHANICAL FUEL PUMPS

USMW	Years	Application	Engine	USMW	Years	Application	Engine	
<b>USMP17513</b>	1957-1959	<b>DODGE D300 PICKUP</b>	3.8L L6 3770cc 230 CID	<b>USMP17535</b>	1979	<b>JEEP CJ5</b>	4.6L L6 4622cc 282 CID	
	1958	<b>DODGE D100 PICKUP</b>	3.8L L6 3770cc 230 CID		1980-1982	<b>JEEP CJ7</b>	4.6L L6 4622cc 282 CID	
<b>USMP17518</b>	1982-1983	<b>CHEVROLET S10</b>	2.8L V6 173 CID	<b>USMP17536</b>	1967	<b>PONTIAC BONNEVILLE</b>	6.6L V8 6555cc 400 CID	
	1982-1983	<b>GMC S15</b>	2.8L V6 173 CID		1967	<b>PONTIAC BONNEVILLE</b>	7.0L V8 7014cc 428 CID	
	1983	<b>CHEVROLET S10 BLAZER</b>	2.8L V6 173 CID		1967	<b>PONTIAC CATALINA</b>	6.6L V8 400 CID	
	1983	<b>GMC S15 JIMMY</b>	2.8L V6 173 CID		1967	<b>PONTIAC CATALINA</b>	6.6L V8 6555cc 400 CID	
<b>USMP17519</b>	1979	<b>FORD FAIRMONT</b>	5.0L V8 302 CID		1967	<b>PONTIAC CATALINA</b>	7.0L V8 7014cc 428 CID	
	1979	<b>MERCURY CAPRI</b>	5.0L V8 302 CID		1967	<b>PONTIAC EXECUTIVE</b>	6.6L V8 6555cc 400 CID	
	1979	<b>MERCURY ZEPHYR</b>	5.0L V8 302 CID		1967	<b>PONTIAC EXECUTIVE</b>	7.0L V8 7014cc 428 CID	
	1980	<b>FORD THUNDERBIRD</b>	4.2L V8 255 CID		1967	<b>PONTIAC FIREBIRD</b>	5.3L V8 5343cc 326 CID	
	1980	<b>MERCURY COUGAR</b>	4.2L V8 255 CID		1967	<b>PONTIAC FIREBIRD</b>	6.6L V8 400 CID	
	1980-1981	<b>FORD THUNDERBIRD</b>	5.0L V8 302 CID		1967	<b>PONTIAC FIREBIRD</b>	6.6L V8 6555cc 400 CID	
	1980-1981	<b>MERCURY COUGAR</b>	5.0L V8 302 CID		1967	<b>PONTIAC GRAND PRIX</b>	6.6L V8 6555cc 400 CID	
	1980-1982	<b>FORD FAIRMONT</b>	4.2L V8 255 CID		1967	<b>PONTIAC GRAND PRIX</b>	7.0L V8 7014cc 428 CID	
	1980-1982	<b>FORD MUSTANG</b>	4.2L V8 255 CID		<b>USMP17537</b>	1982	<b>FORD GRANADA</b>	3.8L V6 232 CID
	1980-1982	<b>MERCURY CAPRI</b>	4.2L V8 255 CID			1982	<b>LINCOLN CONTINENTAL</b>	3.8L V6 232 CID
	1980-1982	<b>MERCURY ZEPHYR</b>	4.2L V8 255 CID			1982-1983	<b>FORD F-100</b>	3.8L V6 232 CID
	1981	<b>FORD GRANADA</b>	4.2L V8 255 CID			1982-1983	<b>MERCURY COUGAR</b>	3.8L V6 232 CID
	1981-1983	<b>FORD FAIRMONT</b>	5.0L V8 302 CID			1982-1984	<b>FORD THUNDERBIRD</b>	3.8L V6 232 CID
	1982	<b>FORD THUNDERBIRD</b>	4.2L V8 255 CID			1983	<b>MERCURY CAPRI</b>	3.8L V6 232 CID
	1982	<b>LINCOLN CONTINENTAL</b>	5.0L V8 302 CID			1983-1984	<b>FORD LTD</b>	3.8L V6 232 CID
	1982	<b>MERCURY COUGAR</b>	4.2L V8 255 CID			1983-1984	<b>MERCURY MARQUIS</b>	3.8L V6 232 CID
	1984	<b>FORD MUSTANG</b>	5.0L V8 302 CID			1986-1990	<b>FORD F-150</b>	3.8L V6 3797cc 232 CID
	<b>USMP17521</b>	1981-1985	<b>DODGE ARIES</b>	2.6L L4 2555cc 156 CID		<b>USMP17538</b>	1963	<b>CADILLAC DEVILLE</b>
		1981-1985	<b>PLYMOUTH RELIANT</b>	2.6L L4 2555cc 156 CID	1963		<b>CADILLAC ELDORADO</b>	6.4L V8 390 CID
		1982	<b>CHRYSLER LEBARON</b>	2.6L L4 2555cc 156 CID	1963		<b>CADILLAC ELDORADO</b>	6.4L V8 6392cc 390 CID
1982-1983		<b>DODGE 400</b>	2.6L L4 2555cc 156 CID	1963	<b>CADILLAC SERIES 62</b>	6.4L V8 6392cc 390 CID		
1983-1984		<b>CHRYSLER E CLASS</b>	2.6L L4 2555cc 156 CID	1963	<b>CADILLAC SERIES 75 FLEETWOOD</b>	6.4L V8 6392cc 390 CID		
1983-1985		<b>CHRYSLER NEW YORKER</b>	2.6L L4 2555cc 156 CID	1964	<b>CADILLAC DEVILLE</b>	7.0L V8 7031cc 429 CID		
1983-1985		<b>DODGE 600</b>	2.6L L4 2555cc 156 CID	1964	<b>CADILLAC ELDORADO</b>	7.0L V8 429 CID		
1984-1987		<b>DODGE CARAVAN</b>	2.6L L4 2555cc 156 CID	1964	<b>CADILLAC ELDORADO</b>	7.0L V8 7031cc 429 CID		
1984-1987		<b>DODGE MINI RAM</b>	2.6L L4 2555cc 156 CID	1964	<b>CADILLAC SERIES 62</b>	7.0L V8 7031cc 429 CID		
1984-1987		<b>PLYMOUTH VOYAGER</b>	2.6L L4 2555cc 156 CID	1964	<b>CADILLAC SERIES 75 FLEETWOOD</b>	7.0L V8 7031cc 429 CID		
1985		<b>CHRYSLER LEBARON</b>	2.6L L4 2555cc 156 CID	<b>USMP17539</b>	1965	<b>GMC PB1500 SERIES</b>	5.0L V6 305 CID	
1985		<b>PLYMOUTH CARAVELLE</b>	2.6L L4 2555cc 156 CID		1965	<b>GMC PB2500 SERIES</b>	5.0L V6 305 CID	
<b>USMP17525</b>		1988-1989	<b>FORD FESTIVA</b>	1.3L L4 1295cc	<b>USMP17544</b>	1952	<b>FORD CUSTOM</b>	3.5L L6 3524cc 215 CID
<b>USMP17526</b>		1973-1974	<b>CHEVROLET CORVETTE</b>	7.4L V8 454 CID		1952	<b>FORD F1</b>	3.5L L6 3524cc 215 CID
		1973-1974	<b>CHEVROLET CORVETTE</b>	7.4L V8 7439cc 454 CID		1952	<b>FORD F2</b>	3.5L L6 3524cc 215 CID
	1973-1974	<b>CHEVROLET CORVETTE</b>	7.4L V8 7441cc 454 CID	1952		<b>FORD F3</b>	3.5L L6 3524cc 215 CID	
	1980	<b>TOYOTA CELICA</b>	2.2L L4 2189cc	1952-1953		<b>FORD CRESTLINE</b>	3.5L L6 3524cc 215 CID	
1980	<b>TOYOTA CORONA</b>	2.2L L4 2189cc	1952-1953	<b>FORD MAINLINE</b>		3.5L L6 3524cc 215 CID		
1980	<b>TOYOTA PICKUP</b>	2.2L L4 2189cc	1953	<b>FORD CUSTOMLINE</b>		3.5L L6 3524cc 215 CID		
<b>USMP17530</b>	1983	<b>FORD RANGER</b>	2.0L L4 1989cc 122 CID	1953		<b>FORD F-100</b>	3.5L L6 3524cc 215 CID	
	1983	<b>FORD RANGER</b>	2.3L L4 140 CID	1953		<b>FORD F-250</b>	3.5L L6 3524cc 215 CID	
<b>USMP17531</b>	1978-1979	<b>FORD PINTO</b>	2.8L V6 171 CID	1953		<b>FORD F-350</b>	3.5L L6 3524cc 215 CID	
	1978-1979	<b>MERCURY BOBCAT</b>	2.8L V6 171 CID	1954	<b>FORD COURIER SEDAN DELIVERY</b>	3.6L L6 3655cc 223 CID		
	1979	<b>MERCURY CAPRI</b>	2.8L V6 171 CID	1954	<b>FORD CRESTLINE</b>	3.6L L6 3655cc 223 CID		
<b>USMP17533</b>	1976	<b>PONTIAC BONNEVILLE</b>	6.6L V8 400 CID	1954	<b>FORD CUSTOMLINE</b>	3.6L L6 3655cc 223 CID		
	1976	<b>PONTIAC CATALINA</b>	6.6L V8 400 CID	1954	<b>FORD F-100</b>	3.6L L6 3655cc 223 CID		
	1976	<b>PONTIAC GRAND SAFARI</b>	6.6L V8 400 CID	1954	<b>FORD F-250</b>	3.6L L6 3655cc 223 CID		
	1978-1980	<b>PONTIAC GRAND AM</b>	4.9L V8 301 CID	1954	<b>FORD F-350</b>	3.6L L6 3655cc 223 CID		
	1978-1980	<b>PONTIAC GRAND PRIX</b>	4.9L V8 301 CID	1954	<b>FORD MAINLINE</b>	3.6L L6 3655cc 223 CID		
	1979	<b>OLDSMOBILE DELTA 88</b>	4.9L V8 301 CID	<b>USMP17547</b>	1978-1980	<b>CHEVROLET MONZA</b>	2.5L L4 2474cc 151 CID	
	1979	<b>PONTIAC LEMANS</b>	4.9L V8 301 CID		1978-1980	<b>OLDSMOBILE STARFIRE</b>	2.5L L4 2474cc 151 CID	
	1979-1980	<b>BUICK CENTURY</b>	4.9L V8 301 CID		1978-1980	<b>PONTIAC SUNBIRD</b>	2.5L L4 2474cc 151 CID	
	1979-1980	<b>BUICK REGAL</b>	4.9L V8 301 CID		<b>USMP17550</b>	1967-1968	<b>TOYOTA LAND CRUISER</b>	3.9L L6 3878cc
	1979-1980	<b>PONTIAC GRAND LEMANS</b>	4.9L V8 301 CID			1973-1974	<b>TOYOTA LAND CRUISER</b>	3.9L L6 3878cc
	1980	<b>PONTIAC CATALINA</b>	4.9L V8 301 CID		<b>USMP17551</b>	1977-1979	<b>CADILLAC DEVILLE</b>	7.0L V8 425 CID
	1980-1981	<b>BUICK CENTURY</b>	4.3L V8 265 CID			1977-1979	<b>CADILLAC FLEETWOOD</b>	7.0L V8 425 CID
	1980-1981	<b>BUICK REGAL</b>	4.3L V8 265 CID			1980	<b>CADILLAC DEVILLE</b>	6.0L V8 368 CID
	1980-1981	<b>PONTIAC CATALINA</b>	4.3L V8 265 CID		1980	<b>CADILLAC FLEETWOOD</b>	6.0L V8 368 CID	
	1980-1981	<b>PONTIAC GRAND LEMANS</b>	4.3L V8 265 CID		<b>USMP17552</b>	1971	<b>TOYOTA CELICA</b>	1.9L L4 1858cc 113 CID
	1980-1981	<b>PONTIAC GRAND PRIX</b>	4.3L V8 265 CID	1971		<b>TOYOTA CORONA</b>	1.9L L4 1858cc	
	1981	<b>PONTIAC BONNEVILLE</b>	4.3L V8 265 CID	1971		<b>TOYOTA CORONA</b>	1.9L L4 1858cc 113 CID	
	<b>USMP17535</b>	1964	<b>AMERICAN MOTORS CLASSIC</b>	3.2L L6 3206cc 196 CID		1972	<b>TOYOTA CORONA</b>	2.0L L4 1968cc
		1964-1965	<b>AMERICAN MOTORS CLASSIC</b>	3.8L L6 3802cc 232 CID		1972-1973	<b>TOYOTA CORONA</b>	2.0L L4 1968cc 120 CID
		1965	<b>AMERICAN MOTORS AMBASSADOR</b>	3.8L L6 232 CID		1973-1974	<b>TOYOTA CELICA</b>	2.0L L4 1968cc 120 CID
1965		<b>AMERICAN MOTORS AMERICAN</b>	3.8L L6 3802cc 232 CID	<b>USMP17554</b>		1982-1986	<b>FORD LTD</b>	5.8L V8 5753cc 351 CID
1965		<b>AMERICAN MOTORS CLASSIC</b>	3.3L L6 3261cc 199 CID			1986	<b>MERCURY GRAND MARQUIS</b>	5.8L V8 5753cc 351 CID
1965-1967		<b>AMERICAN MOTORS MARLIN</b>	3.8L L6 3802cc 232 CID	<b>USMP17558</b>		1965	<b>MERCURY MONTCLAIR</b>	7.0L V8 6997cc 427 CID
1965-1969		<b>AMERICAN MOTORS AMBASSADOR</b>	3.8L L6 3802cc 232 CID			1965	<b>MERCURY MONTEREY</b>	7.0L V8 6997cc 427 CID
1966		<b>AMERICAN MOTORS AMBASSADOR</b>	3.3L L6 199 CID		1965	<b>MERCURY PARK LANE</b>	7.0L V8 6997cc 427 CID	
1966		<b>AMERICAN MOTORS AMBASSADOR</b>	3.3L L6 3261cc 199 CID		1965-1966	<b>FORD FAIRLANE</b>	7.0L V8 427 CID	
1967		<b>AMERICAN MOTORS AMERICAN</b>	3.3L L6 3261cc 199 CID		1965-1967	<b>FORD FAIRLANE</b>	7.0L V8 6997cc 427 CID	
1967		<b>AMERICAN MOTORS AMERICAN</b>	3.8L L6 3802cc 232 CID		1966	<b>FORD CUSTOM</b>	5.8L V8 5769cc 352 CID	
1967		<b>AMERICAN MOTORS REBEL</b>	3.8L L6 232 CID		1966	<b>FORD LTD</b>	5.8L V8 5769cc 352 CID	
1967		<b>JEEP J-100</b>	3.8L L6 230 CID		1966-1967	<b>FORD GALAXIE 500</b>	6.4L V8 390 CID	
1967		<b>JEEP WAGONEER</b>	3.8L L6 230 CID		1966-1967	<b>FORD GALAXIE 500</b>	7.0L V8 427 CID	
1967-1968		<b>AMERICAN MOTORS REBEL</b>	3.8L L6 3802cc 232 CID		1966-1968	<b>FORD CUSTOM</b>	6.4L V8 6391cc 390 CID	
1967-1969		<b>AMERICAN MOTORS AMBASSADOR</b>	3.8L L6 232 CID	1966-1968	<b>FORD CUSTOM</b>	7.0L V8 6997cc 427 CID		
1967-1969		<b>JEEP J-100</b>	3.8L L6 3802cc 232 CID	1966-1968	<b>FORD CUSTOM</b>	7.0L V8 7014cc 428 CID		
1968-1969		<b>AMERICAN MOTORS JAVELIN</b>	3.8L L6 3802cc 232 CID	1966-1968	<b>FORD LTD</b>	6.4L V8 6391cc 390 CID		
1968-1969		<b>JEEP J-100</b>	3.8L L6 232 CID	1966-1968	<b>FORD LTD</b>	7.0L V8 6997cc 427 CID		
1969		<b>AMERICAN MOTORS RAMBLER</b>	3.3L L6 3261cc 199 CID	1966-1968	<b>FORD LTD</b>	7.0L V8 7014cc 428 CID		
1969	<b>AMERICAN MOTORS RAMBLER</b>	3.8L L6 3802cc 232 CID	1967	<b>FORD LTD</b>	6.4L V8 6392cc 390 CID			
1969	<b>AMERICAN MOTORS REBEL</b>	3.8L L6 232 CID	1967	<b>MERCURY COLONY PARK</b>	7.0L V8 7014cc 428 CID			
1973-1974	<b>JEEP CJ5</b>	4.6L L6 4622cc 282 CID	1967	<b>MERCURY COMET</b>	7.0L V8 6997cc 427 CID			
1976-1986	<b>JEEP WAGONEER</b>	4.6L L6 4622cc 282 CID	1967	<b>MERCURY MONTCLAIR</b>	7.0L V8 7014cc 428 CID			



# MECHANICAL FUEL PUMP BUYERS GUIDE



MECHANICAL FUEL PUMPS

USMW	Years	Application	Engine	USMW	Years	Application	Engine	
<b>USMP17558</b>	1967	MERCURY MONTEREY	7.0L V8 7014cc 428 CID	<b>USMP17587</b>	1969	AMERICAN MOTORS AMBASSADOR	6.4L V8 6391cc 390 CID	
	1967-1968	FORD COUNTRY SQUIRE	6.4L V8 6391cc 390 CID		1969	AMERICAN MOTORS AMX	4.7L V8 4753cc 290 CID	
	1967-1968	FORD COUNTRY SQUIRE	7.0L V8 6997cc 427 CID		1969	AMERICAN MOTORS AMX	5.6L V8 343 CID	
	1967-1968	FORD COUNTRY SQUIRE	7.0L V8 7014cc 428 CID		1969	AMERICAN MOTORS AMX	5.6L V8 5585cc 343 CID	
	1967-1968	FORD RANCH WAGON	6.4L V8 6391cc 390 CID		1969	AMERICAN MOTORS AMX	6.4L V8 390 CID	
	1967-1968	FORD RANCH WAGON	7.0L V8 6997cc 427 CID		1969	AMERICAN MOTORS AMX	6.4L V8 6391cc 390 CID	
	1967-1968	FORD RANCH WAGON	7.0L V8 7014cc 428 CID		1969	AMERICAN MOTORS JAVELIN	4.7L V8 4753cc 290 CID	
	1967-1968	MERCURY MARQUIS	7.0L V8 7014cc 428 CID		1969	AMERICAN MOTORS JAVELIN	5.6L V8 5585cc 343 CID	
	1967-1968	MERCURY PARK LANE	7.0L V8 7014cc 428 CID		1969	AMERICAN MOTORS JAVELIN	6.4L V8 6391cc 390 CID	
	1968	FORD COUNTRY SQUIRE	6.4L V8 390 CID		1969	AMERICAN MOTORS RAMBLER	4.7L V8 4753cc 290 CID	
	1968	FORD COUNTRY SQUIRE	7.0L V8 427 CID		1969	AMERICAN MOTORS RAMBLER	6.4L V8 6391cc 390 CID	
	1968	FORD COUNTRY SQUIRE	7.0L V8 428 CID		1969	AMERICAN MOTORS REBEL	5.6L V8 343 CID	
	1968	FORD LTD	6.4L V8 390 CID		<b>USMP17588</b>	1971	PONTIAC BONNEVILLE	7.5L V8 455 CID
	1968	FORD LTD	7.0L V8 427 CID			1971	PONTIAC BONNEVILLE	7.5L V8 7456cc 455 CID
	1968	FORD LTD	7.0L V8 428 CID			1971	PONTIAC GRANDVILLE	7.5L V8 455 CID
	1968	FORD LTD	7.0L V8 6997cc 427 CID			1971	PONTIAC GRANDVILLE	7.5L V8 7456cc 455 CID
	1968	FORD MUSTANG	7.0L V8 6997cc 427 CID		<b>USMP17593</b>	1976	NISSAN F10	1.4L L4 1393cc 85 CID
	1968	FORD RANCH WAGON	6.4L V8 390 CID			1977	NISSAN B210	1.4L L4 1393cc 85 CID
	1968	FORD RANCH WAGON	7.0L V8 428 CID		<b>USMP17595</b>	1969	JEEP J-100	5.7L V8 350 CID
	1968	FORD TORINO	7.0L V8 427 CID			1971	JEEP WAGONEER	5.7L V8 350 CID
	1968	FORD TORINO	7.0L V8 6997cc 427 CID		<b>USMP17596</b>	1987	BUICK REGAL	3.8L V6 3800cc 231 CID
	1968	MERCURY COUGAR	7.0L V8 427 CID			1987	CHEVROLET MONTE CARLO	3.8L V6 231 CID
	1968	MERCURY COUGAR	7.0L V8 6997cc 427 CID		1987	OLDSMOBILE CUTLASS	3.1L V6 189 CID	
	1968	MERCURY MARQUIS	7.0L V8 428 CID		1987	PONTIAC GRAND PRIX	3.8L V6 3800cc 231 CID	
	1968	MERCURY MONTEGO	7.0L V8 427 CID		<b>USMP17597</b>	1972	CHRYSLER IMPERIAL	7.2L V8 7211cc 440 CID
	1968	MERCURY MONTEGO	7.0L V8 6997cc 427 CID			1972	CHRYSLER NEWPORT	6.6L V8 400 CID
	1968	MERCURY PARK LANE	7.0L V8 428 CID			1972	CHRYSLER NEWPORT	6.6L V8 6556cc 400 CID
	1968-1969	FORD FAIRLANE	7.0L V8 428 CID			1972	CHRYSLER NEWPORT	7.2L V8 7211cc 440 CID
	1968-1969	FORD FAIRLANE	7.0L V8 7014cc 428 CID			1972	CHRYSLER NEW YORKER	7.2L V8 7211cc 440 CID
	1968-1969	FORD MUSTANG	7.0L V8 7014cc 428 CID			1972	CHRYSLER TOWN & COUNTRY	6.6L V8 400 CID
	1968-1969	FORD TORINO	7.0L V8 428 CID			1972	CHRYSLER TOWN & COUNTRY	6.6L V8 6556cc 400 CID
	1968-1969	FORD TORINO	7.0L V8 7014cc 428 CID			1972	CHRYSLER TOWN & COUNTRY	7.2L V8 7211cc 440 CID
	1968-1969	MERCURY COUGAR	7.0L V8 428 CID			1972	DODGE CORONET	6.6L V8 400 CID
	1968-1969	MERCURY COUGAR	7.0L V8 7014cc 428 CID			1972	DODGE CORONET	6.6L V8 6556cc 400 CID
	1969	FORD FAIRLANE	7.0L V8 427 CID			1972	DODGE CORONET	7.2L V8 7211cc 440 CID
	1969	FORD FAIRLANE	7.0L V8 6997cc 427 CID			1972	DODGE D100 PICKUP	6.6L V8 400 CID
	1969	FORD MUSTANG	7.0L V8 428 CID			1972	DODGE D100 PICKUP	6.6L V8 6556cc 400 CID
	1969	FORD RANCHERO	7.0L V8 428 CID			1972	DODGE D200 PICKUP	6.6L V8 400 CID
	1969	FORD RANCHERO	7.0L V8 7014cc 428 CID			1972	DODGE D200 PICKUP	6.6L V8 6556cc 400 CID
	<b>USMP17563</b>	1972-1973	PONTIAC VENTURA			5.7L V8 350 CID	1972	DODGE D300 PICKUP
1972-1973		PONTIAC VENTURA	5.7L V8 5733cc 350 CID	1972		DODGE D300 PICKUP	6.6L V8 6556cc 400 CID	
1973		PONTIAC GRAND AM	5.7L V8 350 CID	1972		DODGE MONACO	6.6L V8 400 CID	
1973		PONTIAC GRAND AM	5.7L V8 5733cc 350 CID	1972		DODGE MONACO	6.6L V8 6556cc 400 CID	
1973-1974		PONTIAC LEMANS	5.7L V8 350 CID	1972		DODGE MONACO	7.2L V8 7211cc 440 CID	
1973-1974		PONTIAC LEMANS	5.7L V8 5733cc 350 CID	1972	DODGE POLARA	6.6L V8 400 CID		
<b>USMP17565</b>		1982	FORD MUSTANG	5.0L V8 302 CID	1972	DODGE POLARA	6.6L V8 6556cc 400 CID	
	1982-1985	MERCURY CAPRI	5.0L V8 302 CID	1972	DODGE POLARA	7.2L V8 7211cc 440 CID		
<b>USMP17573</b>	1965	CADILLAC CALAIS	7.0L V8 7031cc 429 CID	1972	PLYMOUTH FURY	6.6L V8 400 CID		
	1965	CADILLAC DEVILLE	7.0L V8 7031cc 429 CID	1972	PLYMOUTH FURY	6.6L V8 6556cc 400 CID		
	1965	CADILLAC ELDORADO	7.0L V8 7031cc 429 CID	1972	PLYMOUTH FURY	7.2L V8 7211cc 440 CID		
<b>USMP17574</b>	1975-1976	BUICK ELECTRA	7.5L V8 455 CID	1972	PLYMOUTH GRAN FURY	6.6L V8 400 CID		
	1975-1976	BUICK ESTATE WAGON	7.5L V8 455 CID	1972	PLYMOUTH GRAN FURY	6.6L V8 6556cc 400 CID		
	1975-1976	BUICK RIVIERA	7.5L V8 455 CID	1972	PLYMOUTH GRAN FURY	7.2L V8 7211cc 440 CID		
<b>USMP17576</b>	1947-1948	KAISER CUSTOM	3.7L L6 3704cc 226 CID	1972	PLYMOUTH GRAN FURY	7.2L V8 7211cc 440 CID		
	1947-1951	KAISER SPECIAL	3.7L L6 3704cc 226 CID	1972	PLYMOUTH ROAD RUNNER	6.6L V8 6556cc 400 CID		
	1949-1953	KAISER DELUXE	3.7L L6 3704cc 226 CID	1972	PLYMOUTH ROAD RUNNER	7.2L V8 7211cc 440 CID		
	1950	KAISER DELUXE	3.7L L6 226 CID	1972	PLYMOUTH SATELLITE	6.6L V8 400 CID		
	1950-1951	FRAZER MANHATTAN	3.7L L6 3704cc 226 CID	1972	PLYMOUTH SATELLITE	6.6L V8 6556cc 400 CID		
	1952-1953	KAISER MANHATTAN	3.7L L6 3704cc 226 CID	<b>USMP17604</b>	1978-1979	DODGE CHALLENGER	1.6L L4 1597cc 98 CID	
	1953	KAISER CAROLINA	3.7L L6 3704cc 226 CID		1978-1979	PLYMOUTH SAPPORO	1.6L L4 1597cc 98 CID	
	1953	KAISER DRAGON	3.7L L6 3704cc 226 CID	1978-1980	DODGE COLT	1.6L L4 1597cc 98 CID		
	1955	WILLYS BERMUDA	3.7L L6 3704cc 226 CID	1978-1980	PLYMOUTH ARROW	1.6L L4 1597cc 98 CID		
	1955	WILLYS CUSTOM	3.7L L6 3704cc 226 CID	1979	PLYMOUTH ARROW	2.6L L4 2555cc 156 CID		
	1960	CHECKER SUPERBA	3.7L L6 226 CID	1979-1980	PLYMOUTH CHAMP	1.6L L4 1597cc 98 CID		
	1960-1963	CHECKER SUPERBA	3.7L L6 3704cc 226 CID	<b>USMP17605</b>	1978-1980	FORD FIESTA	1.6L L4 1597cc 98 CID	
	1961-1964	CHECKER MARATHON	3.7L L6 3704cc 226 CID		<b>USMP17606</b>	1985	MAZDA GLC	1.5L L4 1490cc
	1963-1964	CHECKER MARATHON	3.7L L6 226 CID	<b>USMP17607</b>		1985	ISUZU I-MARK	1.8L L4 1817cc
	<b>USMP17577</b>	1982	CHEVROLET LUV		1.8L L4 111 CID	1985-1988	CHEVROLET SPECTRUM	1.5L L4 1471cc 92 CID
		1982-1984	ISUZU I-MARK	1.8L L4 1817cc	1985-1989	ISUZU I-MARK	1.5L L4 1471cc	
		1984-1985	ISUZU TROOPER	1.9L L4 1949cc	1989	GEO SPECTRUM	1.5L L4 1471cc 92 CID	
		<b>USMP17578</b>	1985	CHEVROLET ASTRO	4.3L V6 262 CID	<b>USMP17616</b>	1967-1968	OLDSMOBILE CUTLASS
	1985		GMC SAFARI	4.3L V6 262 CID	1968		OLDSMOBILE 442	6.6L V8 400 CID
	<b>USMP17580</b>	1941-1942	STUDEBAKER CHAMPION	2.8L L6 2780cc 170 CID	1968		OLDSMOBILE 442	6.6L V8 6556cc 400 CID
1947-1948		STUDEBAKER M5	2.8L L6 2780cc 170 CID	1968	OLDSMOBILE CUTLASS		6.6L V8 400 CID	
1947-1949	STUDEBAKER CHAMPION		1968	OLDSMOBILE VISTA CRUISER	6.6L V8 400 CID			
1949-1953	STUDEBAKER 2R5	2.8L L6 2780cc 170 CID	1968	OLDSMOBILE VISTA CRUISER	6.6L V8 6556cc 400 CID			
1949-1953	STUDEBAKER 2R10	2.8L L6 2780cc 170 CID	<b>USMP17622</b>	1980-1982	TOYOTA TERCEL	1.5L L4 1452cc		
1950-1954	STUDEBAKER CHAMPION	2.8L L6 2780cc 170 CID		<b>USMP17627</b>	1981-1982	PLYMOUTH CHAMP	1.6L L4 1597cc 98 CID	
1954	STUDEBAKER 3R5	2.8L L6 2780cc 170 CID	1981-1984		DODGE COLT	1.6L L4 1597cc 98 CID		
1954	STUDEBAKER 3R10	2.8L L6 2780cc 170 CID	1983-1984		PLYMOUTH COLT	1.6L L4 1597cc 98 CID		
1955	STUDEBAKER E5	3.0L L6 3042cc 186 CID	<b>USMP17628</b>	1982	NISSAN 310	1.5L L4 1488cc		
1955	STUDEBAKER E10	3.0L L6 3042cc 186 CID		1983	NISSAN SENTRA	1.5L L4 1488cc		
1958	STUDEBAKER 3E1	3.0L L6 3042cc 186 CID	<b>USMP17629</b>	1982-1983	NISSAN STANZA	2.0L L4 1974cc		
1958	STUDEBAKER 3E5	3.0L L6 3042cc 186 CID		<b>USMP17631</b>	1978	CHEVROLET EL CAMINO	3.3L V6 200 CID	
1959	FORD RANCHERO	3.6L L6 3655cc 223 CID	1978		CHEVROLET MALIBU	3.3L V6 200 CID		
<b>USMP17586</b>	1969	AMERICAN MOTORS AMBASSADOR	4.7L V8 4753cc 290 CID		1978	CHEVROLET MONTE CARLO	3.3L V6 200 CID	
	1969	AMERICAN MOTORS AMBASSADOR	5.6L V8 343 CID	1978	GMC CABALLERO	3.3L V6 200 CID		
	1969	AMERICAN MOTORS AMBASSADOR	5.6L V8 5585cc 343 CID	<b>USMP17635</b>	1981	CHRYSLER LEBARON	3.7L L6 3687cc 225 CID	
	1969	AMERICAN MOTORS AMBASSADOR	6.4L V8 390 CID		1981	DODGE DIPLOMAT	3.7L L6 3687cc 225 CID	



USMW	Years	Application	Engine	USMW	Years	Application	Engine
<b>USMP17635</b>	1981	<b>DODGE MIRADA</b>	3.7L L6 3687cc 225 CID	<b>USMP50360</b>	1980-1985	<b>FORD L800</b>	7.0L V8 429 CID
<b>USMP17636</b>	1983-1986	<b>DODGE CHARGER</b>	1.6L L4 1595cc 97 CID		1980-1985	<b>FORD LN700</b>	6.1L V8 370 CID
	1983-1986	<b>DODGE OMNI</b>	1.6L L4 1595cc 97 CID		1980-1985	<b>FORD LN700</b>	7.0L V8 429 CID
	1983-1986	<b>PLYMOUTH HORIZON</b>	1.6L L4 1595cc 97 CID		1980-1985	<b>FORD LN800</b>	6.1L V8 370 CID
	1983-1986	<b>PLYMOUTH TURISMO</b>	1.6L L4 1595cc 97 CID		1980-1985	<b>FORD LN800</b>	7.0L V8 429 CID
<b>USMP17638</b>	1979	<b>CHEVROLET G30</b>	5.0L V8 305 CID		1980-1986	<b>FORD C600</b>	6.1L V8 370 CID
	1979	<b>GMC G1500</b>	6.6L V8 400 CID		1980-1986	<b>FORD C700</b>	6.1L V8 370 CID
	1979-1980	<b>CHEVROLET G10</b>	5.0L V8 305 CID		1980-1986	<b>FORD C700</b>	7.0L V8 429 CID
	1979-1980	<b>CHEVROLET G10</b>	5.7L V8 350 CID		1980-1986	<b>FORD C800</b>	6.1L V8 370 CID
	1979-1980	<b>CHEVROLET G20</b>	5.0L V8 305 CID		1980-1986	<b>FORD C800</b>	7.0L V8 429 CID
	1979-1980	<b>CHEVROLET G20</b>	5.7L V8 350 CID		1980-1989	<b>FORD F600</b>	6.1L V8 370 CID
	1979-1980	<b>CHEVROLET G20</b>	6.6L V8 400 CID		1980-1989	<b>FORD F600</b>	7.0L V8 429 CID
	1979-1980	<b>CHEVROLET G30</b>	5.7L V8 350 CID		1980-1989	<b>FORD F700</b>	6.1L V8 370 CID
	1979-1980	<b>CHEVROLET G30</b>	6.6L V8 400 CID		1980-1989	<b>FORD F700</b>	7.0L V8 429 CID
	1979-1980	<b>GMC G1500</b>	5.0L V8 305 CID		1980-1989	<b>FORD F800</b>	6.1L V8 370 CID
	1979-1980	<b>GMC G1500</b>	5.7L V8 350 CID		1980-1989	<b>FORD F800</b>	7.0L V8 429 CID
	1979-1980	<b>GMC G2500</b>	5.7L V8 350 CID		1983-1989	<b>FORD B600</b>	6.1L V8 370 CID
	1979-1980	<b>GMC G2500</b>	6.6L V8 400 CID		1983-1989	<b>FORD B700</b>	6.1L V8 370 CID
	1979-1980	<b>GMC G3500</b>	5.7L V8 350 CID		1988-1989	<b>FORD B600</b>	7.0L V8 429 CID
	1979-1980	<b>GMC G3500</b>	6.6L V8 400 CID		1988-1989	<b>FORD B700</b>	7.0L V8 429 CID
	1980	<b>GMC G2500</b>	5.0L V8 305 CID	<b>USMP50418</b>	1981-1987	<b>JEEP J10</b>	4.2L L6 258 CID
<b>USMP17639</b>	1981-1985	<b>FORD ESCORT</b>	1.6L L4 1598cc 98 CID		1984	<b>AMERICAN MOTORS EAGLE</b>	2.5L L4 150 CID
	1981-1985	<b>MERCURY LYNX</b>	1.6L L4 1598cc 98 CID	<b>USMP50438</b>	1960-1965	<b>VOLKSWAGEN TRANSPORTER</b>	1.2L H4 1192cc 73 CID
	1982-1983	<b>MERCURY LN7</b>	1.6L L4 1598cc 98 CID		1961-1965	<b>VOLKSWAGEN KARMANN GHIA</b>	1.2L H4 1192cc 73 CID
	1982-1985	<b>FORD EXP</b>	1.6L L4 1598cc 98 CID		1961-1966	<b>VOLKSWAGEN BEETLE</b>	1.2L H4 1192cc 73 CID
	1985-1986	<b>FORD ESCORT</b>	1.9L L4 116 CID		1963-1967	<b>VOLKSWAGEN TRANSPORTER</b>	1.5L H4 1493cc 91 CID
	1985-1986	<b>MERCURY LYNX</b>	1.9L L4 116 CID		1966	<b>VOLKSWAGEN BEETLE</b>	1.3L H4 1285cc 78 CID
	1986	<b>FORD EXP</b>	1.9L L4 116 CID		1966	<b>VOLKSWAGEN KARMANN GHIA</b>	1.3L H4 1285cc 78 CID
<b>USMP17640</b>	1983	<b>MAZDA 626</b>	2.0L L4 1970cc		1966-1967	<b>VOLKSWAGEN FASTBACK</b>	1.6L H4 1584cc 97 CID
	1984-1985	<b>MAZDA 626</b>	2.0L L4 1998cc 122 CID		1966-1967	<b>VOLKSWAGEN SQUAREBACK</b>	1.6L H4 1584cc 97 CID
<b>USMP17641</b>	1978-1979	<b>NISSAN 620</b>	2.0L L4 1952cc		1967-1969	<b>VOLKSWAGEN BEETLE</b>	1.5L H4 1493cc 91 CID
<b>USMP17642</b>	1983	<b>DODGE RAM 50</b>	2.0L L4 1997cc 122 CID		1967-1969	<b>VOLKSWAGEN KARMANN GHIA</b>	1.5L H4 1493cc 91 CID
	1984	<b>DODGE COLT</b>	2.0L L4 1995cc 122 CID		1968-1971	<b>VOLKSWAGEN TRANSPORTER</b>	1.6L H4 1584cc 97 CID
	1984-1986	<b>DODGE RAM 50</b>	2.0L L4 1995cc 122 CID		1970-1973	<b>VOLKSWAGEN BEETLE</b>	1.6L H4 1584cc 97 CID
	1984-1986	<b>MITSUBISHI CORDIA</b>	2.0L L4 1997cc 122 CID		1970-1973	<b>VOLKSWAGEN KARMANN GHIA</b>	1.6L H4 1584cc 97 CID
	1984-1986	<b>MITSUBISHI TREDIA</b>	2.0L L4 1997cc 122 CID		1971-1973	<b>VOLKSWAGEN SUPER BEETLE</b>	1.6L H4 1584cc 97 CID
	1984-1987	<b>PLYMOUTH COLT</b>	2.0L L4 1997cc 122 CID		1973-1974	<b>VOLKSWAGEN THING</b>	1.6L H4 1584cc 97 CID
	1985-1986	<b>DODGE COLT</b>	1.5L L4 1468cc 90 CID	<b>USMP50440</b>	1971-1973	<b>VOLKSWAGEN KARMANN GHIA</b>	1.6L H4 1584cc 97 CID
	1985-1986	<b>MITSUBISHI MIRAGE</b>	1.5L L4 1468cc 90 CID		1971-1973	<b>VOLKSWAGEN SUPER BEETLE</b>	1.6L H4 1584cc 97 CID
	1985-1986	<b>PLYMOUTH COLT</b>	1.5L L4 1468cc 90 CID		1971-1979	<b>VOLKSWAGEN BEETLE</b>	1.6L H4 1584cc 97 CID
	1985-1987	<b>DODGE COLT</b>	2.0L L4 1997cc 122 CID		1972-1973	<b>VOLKSWAGEN COMBI</b>	1.5L H4 1493cc 91 CID
<b>USMP40523</b>	1967	<b>OLDSMOBILE CUTLASS</b>	5.4L V8 5409cc 330 CID		1973	<b>VOLKSWAGEN THING</b>	1.6L H4 1584cc 97 CID
	1967	<b>OLDSMOBILE F85</b>	5.4L V8 5409cc 330 CID		1974-1980	<b>VOLKSWAGEN SAFARI</b>	1.6L H4 1584cc 97 CID
	1967	<b>OLDSMOBILE VISTA CRUISER</b>	5.4L V8 330 CID		1974-1982	<b>VOLKSWAGEN BRASILIA</b>	1.6L H4 1584cc 97 CID
	1967	<b>OLDSMOBILE VISTA CRUISER</b>	5.4L V8 5409cc 330 CID		1974-1988	<b>VOLKSWAGEN COMBI</b>	1.6L H4 1584cc 97 CID
	1968	<b>OLDSMOBILE CUTLASS</b>	5.7L V8 350 CID		1975-1988	<b>VOLKSWAGEN PANEL</b>	1.6L H4 1584cc 97 CID
	1968	<b>OLDSMOBILE F85</b>	5.7L V8 350 CID		1977-1978	<b>VOLKSWAGEN HORMIGA</b>	1.6L H4 1584cc 97 CID
	1968	<b>OLDSMOBILE VISTA CRUISER</b>	5.7L V8 350 CID		1980-1992	<b>VOLKSWAGEN SEDAN</b>	1.6L H4 1584cc 97 CID
	1969	<b>OLDSMOBILE 442</b>	6.6L V8 400 CID	<b>USMP50463</b>	1980	<b>FORD E-100 ECONOLINE</b>	6.6L V8 400 CID
	1969	<b>OLDSMOBILE 442</b>	6.6L V8 6555cc 400 CID		1980	<b>FORD E-250 ECONOLINE</b>	6.6L V8 400 CID
<b>USMP50090</b>	1977	<b>FORD F-150</b>	7.5L V8 460 CID		1980	<b>FORD F-150</b>	5.8L V8 5753cc 351 CID
	1978	<b>FORD F-350</b>	7.5L V8 460 CID		1980-1982	<b>FORD E-350 ECONOLINE</b>	6.6L V8 400 CID
	1979	<b>FORD E-250 ECONOLINE</b>	7.5L V8 460 CID		1982	<b>FORD F-250</b>	6.6L V8 400 CID
	1979	<b>FORD E-350 ECONOLINE</b>	7.5L V8 460 CID		1982	<b>FORD F-350</b>	6.6L V8 400 CID
<b>USMP50098</b>	1980	<b>GMC C1500</b>	5.7L V8 350 CID	<b>USMP50470</b>	1981	<b>GMC G3500</b>	5.0L V8 305 CID
	1980	<b>GMC C1500</b>	6.6L V8 400 CID		1981-1984	<b>CHEVROLET G30</b>	5.7L V8 350 CID
	1980	<b>GMC C2500</b>	5.7L V8 350 CID		1981-1984	<b>GMC G3500</b>	5.7L V8 350 CID
	1980	<b>GMC C2500 SUBURBAN</b>	5.7L V8 350 CID		1982	<b>CHEVROLET G30</b>	5.0L V8 305 CID
	1981-1982	<b>CHEVROLET K10 SUBURBAN</b>	5.0L V8 305 CID		1982-1984	<b>CHEVROLET G10</b>	5.0L V8 305 CID
	1981-1983	<b>CHEVROLET K20</b>	5.7L V8 350 CID		1982-1984	<b>CHEVROLET G10</b>	5.7L V8 350 CID
	1981-1983	<b>CHEVROLET K30</b>	5.7L V8 350 CID		1982-1984	<b>CHEVROLET G20</b>	5.0L V8 305 CID
	1981-1984	<b>GMC K1500</b>	5.0L V8 305 CID		1982-1984	<b>CHEVROLET G20</b>	5.7L V8 350 CID
	1981-1984	<b>GMC K1500</b>	5.7L V8 350 CID		1982-1984	<b>GMC G1500</b>	5.0L V8 305 CID
	1981-1984	<b>GMC K2500</b>	5.7L V8 350 CID		1982-1984	<b>GMC G1500</b>	5.7L V8 350 CID
	1981-1986	<b>CHEVROLET K10 SUBURBAN</b>	5.7L V8 350 CID		1982-1984	<b>GMC G2500</b>	5.0L V8 305 CID
	1981-1986	<b>CHEVROLET K20 SUBURBAN</b>	5.7L V8 350 CID		1982-1984	<b>GMC G2500</b>	5.7L V8 350 CID
	1981-1986	<b>GMC K1500 SUBURBAN</b>	5.7L V8 350 CID		1986	<b>CHEVROLET G10</b>	5.0L V8 305 CID
	1981-1986	<b>GMC K2500 SUBURBAN</b>	5.7L V8 350 CID		1986	<b>CHEVROLET G10</b>	5.7L V8 350 CID
	1981-1986	<b>GMC K3500</b>	5.7L V8 350 CID		1986	<b>CHEVROLET G20</b>	5.0L V8 305 CID
	1982	<b>GMC K1500 SUBURBAN</b>	5.0L V8 305 CID		1986	<b>CHEVROLET G20</b>	5.7L V8 350 CID
	1983-1986	<b>GMC JIMMY</b>	5.0L V8 305 CID		1986	<b>GMC G1500</b>	5.0L V8 305 CID
	1983-1986	<b>GMC JIMMY</b>	5.7L V8 350 CID		1986	<b>GMC G1500</b>	5.7L V8 350 CID
	1986	<b>CHEVROLET K10</b>	5.0L V8 305 CID		1986	<b>GMC G2500</b>	5.0L V8 305 CID
	1986	<b>CHEVROLET K10</b>	5.7L V8 350 CID		1986	<b>GMC G2500</b>	5.7L V8 350 CID
	1986	<b>CHEVROLET K20</b>	5.7L V8 350 CID		1986-1988	<b>CHEVROLET G30</b>	5.7L V8 350 CID
	1986	<b>CHEVROLET K30</b>	5.7L V8 350 CID		1986-1988	<b>GMC G3500</b>	5.7L V8 350 CID
	1986	<b>GMC K1500</b>	5.0L V8 305 CID	<b>USMP50478</b>	1981-1983	<b>CHEVROLET K30</b>	7.4L V8 454 CID
	1986	<b>GMC K1500</b>	5.7L V8 350 CID		1981-1986	<b>GMC K3500</b>	7.4L V8 454 CID
	1986	<b>GMC K2500</b>	5.7L V8 350 CID		1986	<b>CHEVROLET K30</b>	7.4L V8 454 CID
	1987-1988	<b>CHEVROLET V30</b>	5.7L V8 350 CID		1987-1988	<b>CHEVROLET V30</b>	7.4L V8 454 CID
	1987-1988	<b>GMC V3500</b>	5.7L V8 350 CID		1987-1989	<b>GMC V3500</b>	7.4L V8 454 CID
<b>USMP50113</b>	1942-1947	<b>DODGE WC</b>	3.6L L6 3570cc 218 CID		1989	<b>CHEVROLET V3500</b>	7.4L V8 454 CID
	1942-1949	<b>DODGE WD15</b>	3.6L L6 3570cc 218 CID	<b>USMP50695</b>	1983-1984	<b>FORD E-350 ECONOLINE</b>	6.9L V8 420 CID
	1948-1949	<b>DODGE WD15</b>	3.9L L6 3878cc 237 CID		1983-1984	<b>FORD F-250</b>	6.9L V8 420 CID
<b>USMP50360</b>	1980-1981	<b>FORD B600</b>	6.1L V8 370 CID		1983-1984	<b>FORD F-350</b>	6.9L V8 420 CID
	1980-1981	<b>FORD B700</b>	6.1L V8 370 CID		1988-1993	<b>FORD F-250</b>	7.3L V8 445 CID
	1980-1983	<b>FORD LN600</b>	6.1L V8 370 CID		1988-1993	<b>FORD F-350</b>	7.3L V8 445 CID
	1980-1985	<b>FORD L800</b>	6.1L V8 370 CID		1988-1994	<b>FORD E-350 ECONOLINE</b>	7.3L V8 445 CID



# MECHANICAL FUEL PUMP BUYERS GUIDE



USMW	Years	Application	Engine	USMW	Years	Application	Engine	
<b>USMP50703</b>	1982	<b>GMC C1500</b>	6.2L V8 379 CID	<b>USMP50825</b>	1976-1977	<b>MERCURY COMET</b>	4.1L L6 250 CID	
	1982	<b>GMC C2500</b>	6.2L V8 379 CID		1976-1977	<b>MERCURY MONARCH</b>	3.3L L6 200 CID	
	1982	<b>GMC C3500</b>	6.2L V8 379 CID		1976-1980	<b>MERCURY MONARCH</b>	4.1L L6 250 CID	
	1982-1983	<b>CHEVROLET K10</b>	6.2L V8 379 CID		1978-1980	<b>FORD GRANADA</b>	4.1L L6 250 CID	
	1982-1983	<b>CHEVROLET K20</b>	6.2L V8 379 CID		1978-1983	<b>FORD FAIRMONT</b>	3.3L L6 200 CID	
	1982-1983	<b>CHEVROLET K30</b>	6.2L V8 379 CID		1978-1983	<b>MERCURY ZEPHYR</b>	3.3L L6 200 CID	
	1982-1984	<b>CHEVROLET C20 SUBURBAN</b>	6.2L V8 379 CID		1979-1982	<b>FORD MUSTANG</b>	3.3L L6 200 CID	
	1982-1984	<b>GMC C2500 SUBURBAN</b>	6.2L V8 379 CID		1979-1982	<b>MERCURY CAPRI</b>	3.3L L6 200 CID	
	1982-1984	<b>GMC K1500</b>	6.2L V8 379 CID		1980	<b>FORD F-150</b>	4.9L L6 4917cc 300 CID	
	1982-1984	<b>GMC K2500</b>	6.2L V8 379 CID		1980-1982	<b>FORD THUNDERBIRD</b>	3.3L L6 200 CID	
	1982-1986	<b>CHEVROLET C10 SUBURBAN</b>	6.2L V8 379 CID		1980-1982	<b>MERCURY COUGAR</b>	3.3L L6 200 CID	
	1982-1986	<b>CHEVROLET K10 SUBURBAN</b>	6.2L V8 379 CID		1980-1983	<b>FORD E-100 ECONOLINE</b>	4.9L L6 4917cc 300 CID	
	1982-1986	<b>CHEVROLET K20 SUBURBAN</b>	6.2L V8 379 CID		1980-1983	<b>FORD F-100</b>	4.9L L6 4917cc 300 CID	
	1982-1986	<b>GMC C1500 SUBURBAN</b>	6.2L V8 379 CID		1980-1984	<b>FORD E-150 ECONOLINE</b>	4.9L L6 4917cc 300 CID	
	1982-1986	<b>GMC K1500 SUBURBAN</b>	6.2L V8 379 CID		1980-1984	<b>FORD E-250 ECONOLINE</b>	4.9L L6 4917cc 300 CID	
	1982-1986	<b>GMC K2500 SUBURBAN</b>	6.2L V8 379 CID		1980-1984	<b>FORD E-350 ECONOLINE</b>	4.9L L6 4917cc 300 CID	
	1982-1986	<b>GMC K3500</b>	6.2L V8 379 CID		1980-1986	<b>FORD BRONCO</b>	4.9L L6 4917cc 300 CID	
	1983-1984	<b>CHEVROLET G20</b>	6.2L V8 379 CID		1981-1982	<b>FORD GRANADA</b>	3.3L L6 200 CID	
	1983-1984	<b>CHEVROLET G30</b>	6.2L V8 379 CID		1982-1984	<b>FORD F-150</b>	4.9L L6 4917cc 300 CID	
	1983-1984	<b>GMC G2500</b>	6.2L V8 379 CID		1982-1984	<b>FORD F-250</b>	4.9L L6 4917cc 300 CID	
	1983-1984	<b>GMC G3500</b>	6.2L V8 379 CID		1982-1984	<b>FORD F-350</b>	4.9L L6 4917cc 300 CID	
	1983-1989	<b>GMC JIMMY</b>	6.2L V8 379 CID		1983	<b>FORD LTD</b>	3.3L L6 200 CID	
	1984	<b>GMC C1500</b>	6.2L V8 379 CID		1983	<b>MERCURY MARQUIS</b>	3.3L L6 200 CID	
	1984	<b>GMC C2500</b>	6.2L V8 379 CID		1986	<b>FORD F-150</b>	4.9L L6 4917cc 300 CID	
	1984	<b>GMC C3500</b>	6.2L V8 379 CID		<b>USMP50828</b>	1983-1985	<b>FORD RANGER</b>	2.8L V6 171 CID
	1986	<b>CHEVROLET K10</b>	6.2L V8 379 CID			1984-1985	<b>FORD BRONCO II</b>	2.8L V6 171 CID
	1986	<b>CHEVROLET K20</b>	6.2L V8 379 CID		1986	<b>FORD AEROSTAR</b>	2.8L V6 171 CID	
	1986	<b>CHEVROLET K30</b>	6.2L V8 379 CID		<b>USMP50838</b>	1983	<b>CHEVROLET CITATION</b>	2.8L V6 173 CID
	1986	<b>GMC C1500</b>	6.2L V8 379 CID			1983-1984	<b>BUICK SKYLARK</b>	2.8L V6 173 CID
	1986	<b>GMC K1500</b>	6.2L V8 379 CID			1983-1984	<b>OLDSMOBILE OMEGA</b>	2.8L V6 173 CID
	1986	<b>GMC K2500</b>	6.2L V8 379 CID			1983-1984	<b>PONTIAC PHOENIX</b>	2.8L V6 173 CID
	1986-1989	<b>CHEVROLET G20</b>	6.2L V8 379 CID			1983-1986	<b>CHEVROLET CELEBRITY</b>	2.8L V6 173 CID
	1986-1989	<b>CHEVROLET G30</b>	6.2L V8 379 CID			1983-1986	<b>PONTIAC 6000</b>	2.8L V6 173 CID
	1986-1989	<b>GMC G2500</b>	6.2L V8 379 CID			1984-1985	<b>CHEVROLET CITATION II</b>	2.8L V6 173 CID
	1986-1989	<b>GMC G3500</b>	6.2L V8 379 CID			1986	<b>BUICK CENTURY</b>	2.8L V6 173 CID
	1987	<b>CHEVROLET R10</b>	6.2L V8 379 CID			1986	<b>OLDSMOBILE CUTLASS CIERA</b>	2.8L V6 173 CID
	1987	<b>CHEVROLET V10</b>	6.2L V8 379 CID			<b>USMP51010</b>	1984-1985	<b>CHEVROLET S10</b>
	1987	<b>CHEVROLET V20</b>	6.2L V8 379 CID		1984-1985		<b>CHEVROLET S10 BLAZER</b>	2.8L V6 173 CID
	1987	<b>GMC R1500</b>	6.2L V8 379 CID		1984-1985		<b>GMC S15</b>	2.8L V6 173 CID
	1987	<b>GMC V1500</b>	6.2L V8 379 CID		1984-1985	<b>GMC S15 JIMMY</b>	2.8L V6 173 CID	
	1987	<b>GMC V2500</b>	6.2L V8 379 CID		<b>USMP51013</b>	1984-1986	<b>JEEP CHEROKEE</b>	2.8L V6 173 CID
	1987-1988	<b>CHEVROLET R20</b>	6.2L V8 379 CID			1984-1986	<b>JEEP WAGONEER</b>	2.8L V6 173 CID
	1987-1988	<b>CHEVROLET V10 SUBURBAN</b>	6.2L V8 379 CID		1986	<b>JEEP COMANCHE</b>	2.8L V6 173 CID	
	1987-1988	<b>CHEVROLET V20 SUBURBAN</b>	6.2L V8 379 CID		<b>USMP51040</b>	1981-1982	<b>TOYOTA CORONA</b>	2.4L L4 2366cc
	1987-1988	<b>CHEVROLET V30</b>	6.2L V8 379 CID			1981-1983	<b>TOYOTA CELICA</b>	2.4L L4 2366cc
	1987-1989	<b>GMC R1500 SUBURBAN</b>	6.2L V8 379 CID			1981-1990	<b>TOYOTA PICKUP</b>	2.4L L4 2366cc
	1987-1989	<b>GMC R2500</b>	6.2L V8 379 CID			1984-1985	<b>TOYOTA PICKUP</b>	2.4L L4 2446cc
	1987-1989	<b>GMC R2500 SUBURBAN</b>	6.2L V8 379 CID		1986-1987	<b>TOYOTA PICKUP</b>	2.4L L4 2466cc	
	1987-1989	<b>GMC V1500 SUBURBAN</b>	6.2L V8 379 CID		<b>USMP51048</b>	1980-1982	<b>TOYOTA COROLLA</b>	1.8L L4 1770cc
	1987-1989	<b>GMC V2500 SUBURBAN</b>	6.2L V8 379 CID			<b>USMP51285</b>	1973	<b>DODGE CHALLENGER</b>
	1987-1989	<b>GMC V3500</b>	6.2L V8 379 CID		1973		<b>DODGE CHALLENGER</b>	5.6L V8 5572cc 340 CID
	1988-1989	<b>CHEVROLET P20</b>	6.2L V8 379 CID		1973	<b>DODGE CHARGER</b>	5.6L V8 340 CID	
	1988-1989	<b>GMC P2500</b>	6.2L V8 379 CID		1973	<b>DODGE CHARGER</b>	5.6L V8 5572cc 340 CID	
	1989	<b>CHEVROLET R1500 SUBURBAN</b>	6.2L V8 379 CID		1973	<b>DODGE CORONET</b>	5.6L V8 340 CID	
	1989	<b>CHEVROLET R2500</b>	6.2L V8 379 CID		1973	<b>DODGE CORONET</b>	5.6L V8 5572cc 340 CID	
	1989	<b>CHEVROLET R2500 SUBURBAN</b>	6.2L V8 379 CID		1973	<b>DODGE DART</b>	5.6L V8 340 CID	
	1989	<b>CHEVROLET R3500</b>	6.2L V8 379 CID		1973	<b>DODGE DART</b>	5.6L V8 5572cc 340 CID	
1989	<b>CHEVROLET V1500 SUBURBAN</b>	6.2L V8 379 CID	1973	<b>DODGE POLARA</b>	5.9L V8 360 CID			
1989	<b>CHEVROLET V2500 SUBURBAN</b>	6.2L V8 379 CID	1973	<b>PLYMOUTH BARRACUDA</b>	5.6L V8 340 CID			
1989	<b>CHEVROLET V3500</b>	6.2L V8 379 CID	1973	<b>PLYMOUTH BARRACUDA</b>	5.6L V8 5572cc 340 CID			
1989	<b>GMC R3500</b>	6.2L V8 379 CID	1973	<b>PLYMOUTH DUSTER</b>	5.6L V8 340 CID			
<b>USMP50795</b>	1980	<b>FORD F-150</b>	5.0L V8 302 CID	1973	<b>PLYMOUTH DUSTER</b>	5.6L V8 5572cc 340 CID		
	1980-1982	<b>FORD E-350 ECONOLINE</b>	5.0L V8 302 CID	1973	<b>PLYMOUTH ROAD RUNNER</b>	5.6L V8 340 CID		
	1980-1983	<b>FORD E-100 ECONOLINE</b>	5.0L V8 302 CID	1973	<b>PLYMOUTH ROAD RUNNER</b>	5.6L V8 5572cc 340 CID		
	1980-1983	<b>FORD E-100 ECONOLINE</b>	5.8L V8 5753cc 351 CID	1973-1975	<b>DODGE MONACO</b>	5.9L V8 360 CID		
	1980-1983	<b>FORD F-100</b>	5.0L V8 302 CID	1973-1975	<b>PLYMOUTH GRAN FURY</b>	5.9L V8 360 CID		
	1980-1984	<b>FORD BRONCO</b>	5.0L V8 302 CID	1973-1976	<b>DODGE CORONET</b>	5.9L V8 360 CID		
	1980-1984	<b>FORD E-150 ECONOLINE</b>	5.0L V8 302 CID	1973-1976	<b>PLYMOUTH FURY</b>	5.9L V8 360 CID		
	1980-1984	<b>FORD E-150 ECONOLINE</b>	5.8L V8 5753cc 351 CID	1974	<b>DODGE CHALLENGER</b>	5.9L V8 360 CID		
	1980-1984	<b>FORD E-250 ECONOLINE</b>	5.0L V8 302 CID	1974	<b>DODGE DART</b>	5.9L V8 360 CID		
	1980-1984	<b>FORD E-250 ECONOLINE</b>	5.8L V8 5753cc 351 CID	1974	<b>PLYMOUTH BARRACUDA</b>	5.9L V8 360 CID		
	1980-1984	<b>FORD E-350 ECONOLINE</b>	5.8L V8 5753cc 351 CID	1974	<b>PLYMOUTH BARRACUDA</b>	5.9L V8 360 CID		
	1980-1987	<b>FORD BRONCO</b>	5.8L V8 5753cc 351 CID	1974	<b>PLYMOUTH SATELLITE</b>	5.9L V8 360 CID		
	1981-1982	<b>FORD F-100</b>	4.2L V8 255 CID	1974-1975	<b>CHRYSLER NEWPORT</b>	5.9L V8 360 CID		
	1982-1984	<b>FORD F-150</b>	5.0L V8 302 CID	1974-1975	<b>PLYMOUTH ROAD RUNNER</b>	5.9L V8 360 CID		
	1982-1984	<b>FORD F-150</b>	5.8L V8 5753cc 351 CID	1974-1976	<b>PLYMOUTH DUSTER</b>	5.9L V8 360 CID		
	1982-1984	<b>FORD F-250</b>	5.0L V8 302 CID	1974-1977	<b>DODGE CHARGER</b>	5.9L V8 360 CID		
	1982-1985	<b>FORD B-150</b>	5.0L V8 302 CID	1975	<b>DODGE ROYAL MONACO</b>	5.9L V8 360 CID		
	1983-1984	<b>FORD F-250</b>	5.8L V8 5753cc 351 CID	1975-1976	<b>CHRYSLER CORDOBA</b>	5.9L V8 360 CID		
	1983-1984	<b>FORD F-350</b>	5.0L V8 302 CID	1976	<b>DODGE D100</b>	5.2L V8 5211cc 318 CID		
	1983-1984	<b>FORD F-350</b>	5.8L V8 5753cc 351 CID	1976	<b>DODGE D100</b>	5.9L V8 360 CID		
	1985-1991	<b>FORD B-200</b>	5.0L V8 302 CID	1976	<b>DODGE D200</b>	5.2L V8 5211cc 318 CID		
	1986-1987	<b>FORD F-150</b>	5.8L V8 5753cc 351 CID	1976	<b>DODGE D200</b>	5.9L V8 360 CID		
	1986-1989	<b>FORD F-200</b>	5.0L V8 302 CID	1976	<b>DODGE D300</b>	5.2L V8 5211cc 318 CID		
	1986-1990	<b>FORD F-150</b>	5.0L V8 302 CID	1976	<b>DODGE D300</b>	5.9L V8 360 CID		
	1988-1990	<b>FORD F-350</b>	5.0L V8 302 CID	1976	<b>DODGE RAMCHARGER</b>	5.2L V8 5211cc 318 CID		
	1988-1990	<b>FORD F-350</b>	5.8L V8 5753cc 351 CID	1976	<b>DODGE RAMCHARGER</b>	5.9L V8 360 CID		
	<b>USMP50825</b>	1976-1977	<b>MERCURY COMET</b>	3.3L L6 200 CID	1976	<b>DODGE W100</b>	5.2L V8 5211cc 318 CID	
					1976	<b>DODGE W100</b>	5.9L V8 360 CID	

MECHANICAL FUEL PUMPS



# MECHANICAL FUEL PUMP BUYERS GUIDE



USMW	Years	Application	Engine	USMW	Years	Application	Engine	
<b>USMP51285</b>	1976	<b>DODGE</b> W200	5.2L V8 5211cc 318 CID	<b>USMP51298</b>	1988	<b>DODGE</b> W150	5.9L V8 360 CID	
	1976	<b>DODGE</b> W200	5.9L V8 360 CID		1988	<b>DODGE</b> W350	5.9L V8 360 CID	
	1976	<b>DODGE</b> W300	5.2L V8 5211cc 318 CID		1988-1989	<b>DODGE</b> W250	5.9L V8 360 CID	
	1976	<b>DODGE</b> W300	5.9L V8 360 CID		<b>USMP51440</b>	1977-1981	<b>DODGE</b> DART	3.7L L6 3687cc 225 CID
	1976	<b>PLYMOUTH</b> VALIANT	5.9L V8 360 CID			1978-1980	<b>CHRYSLER</b> LEBARON	3.7L L6 3687cc 225 CID
	1976-1977	<b>DODGE</b> DART	5.9L V8 360 CID		1978-1980	<b>DODGE</b> DIPLOMAT	3.7L L6 3687cc 225 CID	
	1976-1980	<b>DODGE</b> ASPEN	5.9L V8 360 CID		1978-1980	<b>PLYMOUTH</b> VOLARE	3.7L L6 3687cc 225 CID	
	1976-1980	<b>PLYMOUTH</b> VOLARE	5.9L V8 360 CID		1979	<b>DODGE</b> B300	3.7L L6 3687cc 225 CID	
	1978	<b>DODGE</b> B100	5.9L V8 360 CID		1979-1980	<b>DODGE</b> B100	3.7L L6 3687cc 225 CID	
	1978	<b>DODGE</b> W300	5.2L V8 5211cc 318 CID		1979-1980	<b>PLYMOUTH</b> PB100	3.7L L6 3687cc 225 CID	
	1978	<b>PLYMOUTH</b> PB100	5.9L V8 360 CID		1980	<b>DODGE</b> B200	3.7L L6 3687cc 225 CID	
	1978-1979	<b>CHRYSLER</b> TOWN & COUNTRY	5.9L V8 360 CID		1980	<b>DODGE</b> MIRADA	3.7L L6 3687cc 225 CID	
	1978-1979	<b>DODGE</b> D100	5.2L V8 5211cc 318 CID		1980	<b>PLYMOUTH</b> PB200	3.7L L6 3687cc 225 CID	
	1978-1979	<b>DODGE</b> D100	5.9L V8 360 CID		1981	<b>PLYMOUTH</b> GRAN FURY	3.7L L6 3687cc 225 CID	
	1978-1979	<b>DODGE</b> DIPLOMAT	5.9L V8 360 CID		1981-1983	<b>PLYMOUTH</b> PB150	3.7L L6 3687cc 225 CID	
	1978-1980	<b>DODGE</b> B100	5.2L V8 5211cc 318 CID		1981-1983	<b>PLYMOUTH</b> PB250	3.7L L6 3687cc 225 CID	
	1978-1980	<b>DODGE</b> B200	5.2L V8 5211cc 318 CID		1981-1987	<b>DODGE</b> B150	3.7L L6 3687cc 225 CID	
	1978-1980	<b>DODGE</b> B200	5.9L V8 360 CID		1981-1987	<b>DODGE</b> B250	3.7L L6 3687cc 225 CID	
	1978-1980	<b>DODGE</b> B300	5.2L V8 5211cc 318 CID		1986-1988	<b>CHRYSLER</b> VOLARE	2.2L L4 135 CID	
	1978-1980	<b>DODGE</b> B300	5.9L V8 360 CID		<b>USMP51443</b>	1964-1965	<b>DODGE</b> A100	2.8L L6 2786cc 170 CID
	1978-1980	<b>DODGE</b> CB300	5.2L V8 5211cc 318 CID			1965-1969	<b>DODGE</b> DART	2.8L L6 170 CID
	1978-1980	<b>DODGE</b> CB300	5.9L V8 360 CID		1965-1971	<b>DODGE</b> DART	2.8L L6 2786cc 170 CID	
	1978-1980	<b>DODGE</b> D200	5.2L V8 5211cc 318 CID		1970	<b>DODGE</b> CHALLENGER	3.2L L6 198 CID	
	1978-1980	<b>DODGE</b> D200	5.9L V8 360 CID		1970	<b>DODGE</b> CHALLENGER	3.2L L6 3254cc 198 CID	
	1978-1980	<b>DODGE</b> D300	5.2L V8 5211cc 318 CID		1970	<b>PLYMOUTH</b> BARRACUDA	3.2L L6 3254cc 198 CID	
	1978-1980	<b>DODGE</b> D300	5.9L V8 360 CID		1970	<b>PLYMOUTH</b> DUSTER	3.2L L6 198 CID	
	1978-1980	<b>DODGE</b> D300	5.2L V8 5211cc 318 CID		1970	<b>PLYMOUTH</b> DUSTER	3.2L L6 3254cc 198 CID	
	1978-1980	<b>DODGE</b> W200	5.9L V8 360 CID		1970	<b>PLYMOUTH</b> VALIANT	2.8L L6 2786cc 170 CID	
	1978-1980	<b>DODGE</b> W300	5.9L V8 360 CID		1972-1974	<b>DODGE</b> DART	3.2L L6 198 CID	
	1978-1980	<b>PLYMOUTH</b> PB100	5.2L V8 5211cc 318 CID		1972-1974	<b>DODGE</b> DART	3.2L L6 3254cc 198 CID	
	1978-1980	<b>PLYMOUTH</b> PB200	5.2L V8 5211cc 318 CID		1975	<b>DODGE</b> CB300	3.7L L6 3687cc 225 CID	
	1978-1980	<b>PLYMOUTH</b> PB200	5.9L V8 360 CID		1975-1978	<b>DODGE</b> B200	3.7L L6 3687cc 225 CID	
	1978-1980	<b>PLYMOUTH</b> PB300	5.2L V8 5211cc 318 CID		1975-1978	<b>DODGE</b> B300	3.7L L6 3687cc 225 CID	
	1978-1980	<b>PLYMOUTH</b> PB300	5.9L V8 360 CID		1975-1978	<b>DODGE</b> W300	3.7L L6 3687cc 225 CID	
	1978-1981	<b>DODGE</b> W150	5.9L V8 360 CID		1975-1979	<b>DODGE</b> D300	3.7L L6 3687cc 225 CID	
	1978-1982	<b>CHRYSLER</b> LEBARON	5.9L V8 360 CID		1975-1980	<b>DODGE</b> D200	3.7L L6 3687cc 225 CID	
	1978-1987	<b>DODGE</b> D150	5.2L V8 5211cc 318 CID		1975-1980	<b>DODGE</b> W200	3.7L L6 3687cc 225 CID	
	1978-1987	<b>DODGE</b> D150	5.9L V8 360 CID		1976-1978	<b>PLYMOUTH</b> PB200	3.7L L6 3687cc 225 CID	
	1978-1987	<b>DODGE</b> RAMCHARGER	5.2L V8 5211cc 318 CID		1977	<b>DODGE</b> CB300	3.7L L6 3687cc 225 CID	
	1978-1987	<b>DODGE</b> RAMCHARGER	5.9L V8 360 CID		1978	<b>DODGE</b> B100	3.7L L6 3687cc 225 CID	
	1980	<b>DODGE</b> W300	5.2L V8 5211cc 318 CID		1978	<b>DODGE</b> MONACO	3.7L L6 3687cc 225 CID	
	1981	<b>DODGE</b> B250	5.9L V8 360 CID		1978	<b>PLYMOUTH</b> FURY	3.7L L6 3687cc 225 CID	
	1981	<b>DODGE</b> DART	5.9L V8 360 CID		1978	<b>PLYMOUTH</b> PB100	3.7L L6 3687cc 225 CID	
	1981	<b>PLYMOUTH</b> PB150	5.2L V8 5211cc 318 CID		1978-1979	<b>DODGE</b> D100	3.7L L6 3687cc 225 CID	
	1981	<b>PLYMOUTH</b> PB250	5.9L V8 360 CID		1978-1980	<b>DODGE</b> RAMCHARGER	3.7L L6 3687cc 225 CID	
	1981-1982	<b>DODGE</b> D250	5.9L V8 360 CID		1979	<b>CHRYSLER</b> NEWPORT	3.7L L6 3687cc 225 CID	
	1981-1982	<b>DODGE</b> W250	5.9L V8 360 CID		1979-1987	<b>DODGE</b> D150	3.7L L6 3687cc 225 CID	
	1981-1983	<b>DODGE</b> D350	5.2L V8 5211cc 318 CID		1979-1987	<b>DODGE</b> W150	3.7L L6 3687cc 225 CID	
	1981-1983	<b>PLYMOUTH</b> PB250	5.2L V8 5211cc 318 CID		1981	<b>CHRYSLER</b> NEWPORT	3.7L L6 3687cc 225 CID	
	1981-1983	<b>PLYMOUTH</b> PB350	5.2L V8 5211cc 318 CID		1981-1987	<b>DODGE</b> D250	3.7L L6 3687cc 225 CID	
1981-1983	<b>PLYMOUTH</b> PB350	5.9L V8 360 CID	1981-1987	<b>DODGE</b> D350	3.7L L6 3687cc 225 CID			
1981-1987	<b>DODGE</b> B150	5.2L V8 5211cc 318 CID	1986-1987	<b>DODGE</b> W250	3.7L L6 3687cc 225 CID			
1981-1987	<b>DODGE</b> B250	5.2L V8 5211cc 318 CID	1987	<b>DODGE</b> D100	3.7L L6 3687cc 225 CID			
1981-1987	<b>DODGE</b> B350	5.2L V8 5211cc 318 CID	1987	<b>DODGE</b> W100	3.7L L6 3687cc 225 CID			
1981-1987	<b>DODGE</b> D250	5.2L V8 5211cc 318 CID	<b>USMP52668</b>	1994-1996	<b>FORD</b> F59	7.3L V8 445 CID		
1981-1987	<b>DODGE</b> D350	5.9L V8 360 CID		1995-1996	<b>FORD</b> F-250	7.3L V8 445 CID		
1981-1987	<b>DODGE</b> W250	5.2L V8 5211cc 318 CID	1995-1997	<b>FORD</b> F-350	7.3L V8 445 CID			
1981-1987	<b>DODGE</b> W350	5.9L V8 360 CID	1995-1997	<b>FORD</b> F SUPER DUTY	7.3L V8 445 CID			
1981-1988	<b>DODGE</b> B350	5.9L V8 360 CID	1995-1998	<b>FORD</b> E-350 ECONOLINE	7.3L V8 445 CID			
1982-1983	<b>DODGE</b> W350	5.2L V8 5211cc 318 CID	<b>USMP52684</b>	1957	<b>DESOTO</b> FIREFLITE	5.6L V8 5589cc 341 CID		
1983	<b>PLYMOUTH</b> PB150	5.2L V8 5211cc 318 CID		1957	<b>PLYMOUTH</b> BELVEDERE	4.9L V8 299 CID		
1984-1987	<b>DODGE</b> D250	5.9L V8 360 CID		1957	<b>PLYMOUTH</b> BELVEDERE	4.9L V8 4933cc 301 CID		
1984-1987	<b>DODGE</b> W150	5.9L V8 360 CID		1957	<b>PLYMOUTH</b> PLAZA	4.5L V8 273 CID		
1984-1987	<b>DODGE</b> W250	5.9L V8 360 CID		1957	<b>PLYMOUTH</b> PLAZA	4.5L V8 4540cc 277 CID		
1984-1988	<b>DODGE</b> B250	5.9L V8 360 CID		1957	<b>PLYMOUTH</b> SAVOY	4.9L V8 299 CID		
1986-1987	<b>DODGE</b> D100	5.2L V8 5211cc 318 CID		1957	<b>PLYMOUTH</b> SAVOY	4.9L V8 4933cc 301 CID		
1986-1987	<b>DODGE</b> D100	5.9L V8 360 CID		1958	<b>PLYMOUTH</b> PLAZA	5.2L V8 317 CID		
1986-1987	<b>DODGE</b> W100	5.9L V8 360 CID		1958-1959	<b>PLYMOUTH</b> BELVEDERE	5.2L V8 317 CID		
1977-1978	<b>DODGE</b> MONACO	5.9L V8 360 CID		1958-1959	<b>PLYMOUTH</b> SAVOY	5.2L V8 317 CID		
<b>USMP51298</b>	1977-1978	<b>PLYMOUTH</b> FURY	5.9L V8 360 CID	<b>USMP52693</b>	1982-1984	<b>CHEVROLET</b> CAMARO	2.8L V6 173 CID	
	1977-1980	<b>CHRYSLER</b> CORDOBA	5.9L V8 360 CID		1982-1984	<b>PONTIAC</b> FIREBIRD	2.8L V6 173 CID	
	1978	<b>DODGE</b> CHARGER	5.9L V8 360 CID		1983	<b>CHEVROLET</b> S10	2.8L V6 173 CID	
	1978-1979	<b>DODGE</b> MAGNUM	5.9L V8 360 CID		1983	<b>CHEVROLET</b> S10 BLAZER	2.8L V6 173 CID	
	1979-1980	<b>CHRYSLER</b> NEWPORT	5.9L V8 360 CID		1983	<b>GMC</b> S15	2.8L V6 173 CID	
	1979-1980	<b>CHRYSLER</b> NEW YORKER	5.9L V8 360 CID		1983	<b>GMC</b> S15 JIMMY	2.8L V6 173 CID	
	1979-1980	<b>DODGE</b> ST. REGIS	5.9L V8 360 CID		<b>USMP75490</b>	1986-1987	<b>MAZDA</b> B2000	2.0L L4 1998cc 122 CID
	1980	<b>DODGE</b> MIRADA	5.9L V8 360 CID			1987-1993	<b>MAZDA</b> B2200	2.2L L4 2184cc
	1980	<b>PLYMOUTH</b> GRAN FURY	5.9L V8 360 CID		<b>USMP75535</b>	1984-1987	<b>HONDA</b> CIVIC	1.3L L4 1342cc 82 CID
	1983	<b>DODGE</b> DIPLOMAT	5.2L V8 5211cc 318 CID			1984-1987	<b>HONDA</b> CIVIC	1.5L L4 1487cc
	1985	<b>DODGE</b> DIPLOMAT	5.2L V8 5211cc 318 CID	1986		<b>HONDA</b> CIVIC	1.5L L4 1493cc	
	1985	<b>PLYMOUTH</b> GRAN FURY	5.2L V8 5211cc 318 CID	1987	<b>HONDA</b> CIVIC	1.5L L4 1491cc 91 CID		
	1987	<b>DODGE</b> DAKOTA	3.9L V6 3906cc 239 CID	<b>USMP75665</b>	1981-1984	<b>TOYOTA</b> LAND CRUISER	4.2L L6 4228cc 258 CID	
	1988	<b>DODGE</b> D100	5.9L V8 360 CID		1981-1987	<b>TOYOTA</b> LAND CRUISER	4.2L L6 4227cc	
	1988	<b>DODGE</b> D150	5.9L V8 360 CID		1986	<b>TOYOTA</b> LAND CRUISER	4.2L L6 4228cc 258 CID	
	1988	<b>DODGE</b> D250	5.9L V8 360 CID	<b>USMP75670</b>	1985-1988	<b>CHEVROLET</b> NOVA	1.6L L4 1588cc 98 CID	
	1988	<b>DODGE</b> D350	5.9L V8 360 CID		<b>USMP75733</b>	1980-1981	<b>BUICK</b> SKYLARK	2.8L V6 173 CID
	1988	<b>DODGE</b> RAMCHARGER	5.9L V8 360 CID	1980-1981		<b>CHEVROLET</b> CITATION	2.8L V6 173 CID	
	1988	<b>DODGE</b> W100	5.9L V8 360 CID	1980-1981	<b>OLDSMOBILE</b> OMEGA	2.8L V6 173 CID		





# MECHANICAL FUEL PUMP BUYERS GUIDE



USMW	Years	Application	Engine	USMW	Years	Application	Engine
<b>USMP75733</b>	1980-1981	PONTIAC PHOENIX	2.8L V6 173 CID	<b>USPR936</b>	1969-1970	CHEVROLET BROOKWOOD	
	1981-1983	DODGE CHALLENGER	2.6L L4 2555cc 156 CID		1969-1971	CHEVROLET BLAZER	
	1981-1983	PLYMOUTH SAPPORO	2.6L L4 2555cc 156 CID		1969-1987	CHEVROLET CAMARO	
	1983-1989	DODGE RAM 50	2.6L L4 2555cc 156 CID		1970-1971	OLDSMOBILE F85	
	1987-1989	DODGE RAIDER	2.6L L4 2555cc 156 CID		1970-1971	PONTIAC FIREBIRD	
<b>USMP75768</b>	1986-1989	HYUNDAI EXCEL	1.5L L4 1468cc 90 CID	1970-1972	GMC JIMMY		
	1987-1988	DODGE COLT	1.5L L4 1468cc 90 CID	1970-1974	CHEVROLET G30 VAN		
	1987-1988	MITSUBISHI CORDIA	2.0L L4 1997cc 122 CID	1970-1974	PONTIAC LEMANS		
	1987-1988	MITSUBISHI MIRAGE	1.5L L4 1468cc 90 CID	1971	OLDSMOBILE CUTLASS		
	1987-1988	MITSUBISHI TREDIA	2.0L L4 1997cc 122 CID	1971-1974	GMC G35/G3500 VAN		
	1987-1988	PLYMOUTH COLT	1.5L L4 1468cc 90 CID	1971-1974	PONTIAC VENTURA		
	1987-1989	DODGE RAM 50	2.0L L4 1995cc 122 CID	1971-1977	GMC SPRINT		
	1987-1989	MITSUBISHI PRECIS	1.5L L4 1468cc 90 CID	1973-1974	BUICK APOLLO		
<b>USMP75770</b>	1986-1987	ISUZU TROOPER	2.3L L4 2254cc	1973-1974	CHEVROLET BLAZER		
	1989-1993	ISUZU AMIGO	2.3L L4 2254cc	1973-1974	OLDSMOBILE OMEGA		
	1993-1994	ISUZU PICKUP	2.3L L4 2254cc	1973-1986	CHEVROLET C10 SUBURBAN		
<b>USMP75798</b>	1987-1989	SUZUKI SAMURAI	1.3L L4 1325cc 81 CID	1973-1988	CHEVROLET CAPRICE		
<b>USMP80503</b>	1980	FORD E-250 ECONOLINE	7.5L V8 460 CID	1974	GMC JIMMY		
	1980-1984	FORD E-350 ECONOLINE	7.5L V8 460 CID	1974	PONTIAC FIREBIRD		
	1983-1984	FORD F-250	7.5L V8 460 CID	1975	GMC P15		
	1983-1984	FORD F-350	7.5L V8 460 CID	1975	GMC P25		
<b>USMP82505</b>	1986	CHEVROLET C10	4.3L V6 262 CID	1975-1978	GMC C35		
	1986	CHEVROLET C20	4.3L V6 262 CID	1975-1978	GMC G15		
	1986	CHEVROLET G10	4.3L V6 262 CID	1975-1978	GMC G25		
	1986	CHEVROLET G20	4.3L V6 262 CID	1975-1978	GMC G35		
	1986	CHEVROLET G30	4.3L V6 262 CID	1975-1978	GMC K15		
	1986	CHEVROLET K10	4.3L V6 262 CID	1975-1978	GMC K15 SUBURBAN		
	1986	GMC C1500	4.3L V6 262 CID	1975-1978	GMC K25		
	1986	GMC C2500	4.3L V6 262 CID	1975-1978	GMC K25 SUBURBAN		
	1986	GMC G1500	4.3L V6 262 CID	1975-1978	GMC P35		
	1986	GMC G2500	4.3L V6 262 CID	1975-1980	CHEVROLET G10		
	1986	GMC G3500	4.3L V6 262 CID	1975-1980	CHEVROLET G20		
	1986	GMC K1500	4.3L V6 262 CID	1975-1984	CHEVROLET G30		
	<b>USMP82650</b>	1989-1993	DODGE W350	5.9L L6 359 CID	1975-1986	CHEVROLET C10	
1991-1993		DODGE D250	5.9L L6 359 CID	1975-1986	CHEVROLET C20		
1991-1993		DODGE D350	5.9L L6 359 CID	1975-1986	CHEVROLET C30		
1991-1993		DODGE W250	5.9L L6 359 CID	1976-1978	CHEVROLET CHEVETTE		
<b>USMP82685</b>	1955-1957	FORD THUNDERBIRD	4.8L V8 4786cc 292 CID	1977	PONTIAC VENTURA		
	1956-1957	FORD THUNDERBIRD	5.1L V8 5114cc 312 CID	1977-1978	GMC K35		
<b>USMP82760</b>	1994-1998	DODGE RAM 2500	5.9L L6 359 CID	1977-1978	GMC P25		
	1994-1998	DODGE RAM 3500	5.9L L6 359 CID	1977-1979	BUICK SKYLARK		
<b>USPR936</b>	1955-1956	CHEVROLET CORVETTE		1977-1979	OLDSMOBILE OMEGA		
	1955-1957	CHEVROLET BEL AIR		1977-1979	PONTIAC PHOENIX		
	1956-1957	CHEVROLET 3100		1977-1980	PONTIAC LEMANS		
	1958-1961	CHEVROLET BROOKWOOD		1977-1981	BUICK CENTURY		
	1959-1961	CHEVROLET CORVETTE		1977-1981	PONTIAC FIREBIRD		
	1959-1970	CHEVROLET BISCAYNE		1977-1982	PONTIAC GRAND LEMANS		
	1959-1975	CHEVROLET BEL AIR		1977-1984	OLDSMOBILE CUSTOM CRUISER		
	1960-1962	CHEVROLET C40		1977-1984	OLDSMOBILE DELTA 88		
	1962-1966	CHEVROLET C30 PANEL		1977-1987	BUICK REGAL		
	1962-1968	CHEVROLET CHEVY II		1978	BUICK LESABRE		
	1963	GMC PB2500 SERIES		1978	GMC CABALLERO		
	1963-1965	GMC PB1000 SERIES		1978-1980	OLDSMOBILE CUTLASS SALON		
	1963-1966	GMC SUBURBAN		1978-1980	PONTIAC GRAND AM		
	1963-1974	CHEVROLET C10 PICKUP		1978-1981	OLDSMOBILE CUTLASS		
	1963-1974	CHEVROLET C20 PICKUP		1978-1984	CADILLAC SEVILLE		
	1963-1974	CHEVROLET C30 PICKUP		1978-1984	OLDSMOBILE 98		
	1963-1976	CHEVROLET CORVETTE		1978-1984	OLDSMOBILE CUTLASS CALAIS		
	1964-1965	CHEVROLET G10 VAN		1978-1986	GMC JIMMY		
	1964-1966	GMC G1000 SERIES		1978-1986	OLDSMOBILE CUTLASS SUPREME		
	1964-1973	CHEVROLET CHEVELLE		1978-1987	PONTIAC GRAND PRIX		
	1964-1978	CHEVROLET EL CAMINO		1979	GMC P1500		
	1966	GMC I1000		1979-1980	GMC G1500		
	1966	GMC I1500		1979-1980	GMC G2500		
	1966	GMC I2500		1979-1984	CADILLAC DEVILLE		
	1966	GMC I3500		1979-1984	CADILLAC ELDORADO		
	1966	GMC PB15 SERIES		1979-1984	CADILLAC FLEETWOOD		
	1966	GMC PB25 SERIES		1979-1984	GMC G3500		
	1966	GMC PB3500 VAN		1979-1984	GMC K1500		
	1966-1968	OLDSMOBILE F85		1979-1984	GMC K2500		
	1966-1970	CHEVROLET CAPRICE		1979-1984	OLDSMOBILE TORONADO		
	1967	CHEVROLET CAMARO		1979-1986	GMC C2500		
	1967-1971	CHEVROLET C10 SUBURBAN		1979-1986	GMC C2500 SUBURBAN		
	1967-1974	CHEVROLET G20 VAN		1979-1986	GMC C3500		
	1967-1974	GMC C35/C3500 PICKUP		1979-1986	GMC K1500 SUBURBAN		
	1967-1974	GMC G15/G1500 VAN		1979-1986	GMC K2500 SUBURBAN		
	1967-1974	GMC G25/G2500 VAN		1979-1986	GMC K3500		
	1967-1974	GMC K15/K1500 PICKUP		1980-1981	PONTIAC CATALINA		
	1967-1974	GMC K15/K1500 SUBURBAN		1980-1983	BUICK ESTATE WAGON		
	1967-1974	GMC K25/K2500 PICKUP		1980-1983	OLDSMOBILE CUTLASS CRUISER		
	1967-1974	GMC P15/P1500 VAN		1980-1984	BUICK ELECTRA		
	1967-1974	GMC P25/P2500 VAN		1980-1984	BUICK LESABRE		
	1967-1974	GMC P35/P3500 VAN		1980-1984	BUICK RIVIERA		
	1968	PONTIAC LEMANS		1980-1986	PONTIAC BONNEVILLE		
	1968-1974	CHEVROLET G10 VAN		1980-1987	CHEVROLET EL CAMINO		
	1968-1974	GMC K25/K2500 SUBURBAN		1980-1987	GMC CABALLERO		
	1968-1974	GMC K35/K3500 PICKUP		1982-1984	CHEVROLET G10		
	1968-1986	CHEVROLET C20 SUBURBAN		1982-1984	CHEVROLET G20		

MECHANICAL FUEL PUMPS



# MECHANICAL FUEL PUMP BUYERS GUIDE



USMW	Years	Application	Engine	USMW	Years	Application	Engine
<b>USPR936</b>	1982-1984	<b>GMC G1500</b>					
	1982-1984	<b>GMC G2500</b>					
	1983-1986	<b>PONTIAC PARISIENNE</b>					
	1985	<b>GMC P3500</b>					
	1986	<b>CHEVROLET G10</b>					
	1986	<b>CHEVROLET G20</b>					
	1986	<b>GMC G1500</b>					
	1986	<b>GMC G2500</b>					
	1986	<b>GMC K1500</b>					
	1986	<b>GMC K2500</b>					
	1986-1988	<b>CHEVROLET G30</b>					
	1986-1988	<b>GMC G3500</b>					
	1987-1989	<b>GMC V3500</b>					
	1988-1989	<b>GMC R3500</b>					
	1989	<b>PONTIAC LEMANS</b>					



# MECHANICAL FUEL PUMP CROSS REFERENCE



Airtex	Airtex (cont'd.)	Carter (cont'd.)	
267	USMP09180	40482 USMP17506 M2468 USMP06170	
361	USMP17460	40503 USMP11283 M2774 USMP06935	
571	USMP17493	40515 USMP11280 M2999 USMP07498	
572	USMP05488	40590 USMP17536 M3120 USMP07800	
578	USMP02065	40607 USMP11723 M3146 USMP17504	
588	USMP17477	40610 USMP17498 M3528 USMP08820	
901	USMP11085	40679 USMP12213 M3530 USMP08825	
1080	USMP17462	40680 USMP12170 M3542 USMP17586	
1096	USMP17496	40709 USMP17507 M3553 USMP08883	
1109	USMP50440	40725 USMP11713 M3643 USMP17489	
1112	USMP17593	40727 USMP11325 M3672 USMP09180	
1124	USMP17531	40777 USMP15253 M3955 USMP17539	
1320	USMP17527	40877 USMP11760 M3988 USMP09970	
1328	USMP17641	40927 USMP17461 M4005 USMP10013	
1330	USMP51040	40930 USMP17563 M4008 USMP10020	
1346	USMP17501	40931 USMP16013 M4009 USMP10023	
1357	USMP75670	40963 USMP16570 M4195 USMP17495	
1368	USMP17509	40966 USMP17470 M4434 USMP11085	
1369	USMP75535	40987 USMP16560 M4503 USMP11258	
1376	USMP75490	41169 USMP16845 M4507 USMP17492	
1384	USMP75733	41198 USMP17574 M4511 USMP17461	
1387	USMP75798	41201 USMP17533 M4512 USMP11280	
1388	USMP17525	41204 USMP17551 M4513 USMP11283	
1395	USMP75768	41209 USMP17378 M4530 USMP11325	
1400	USMP75770	41216 USMP16565 M4552 USMP17506	
1406	USMP17472	41217 USMP15538 M4553 USMP11383	
1407	USMP82650	41240 USMP17388 M4566 USMP11415	
1410	USMP17491	41372 USMP17547 M4589 USMP11473	
1414	USMP75665	41375 USMP17502 M4684 USMP17536	
1486	USMP17642	41378 USMP50098 M4685 USMP11713	
4008	USMP10020	41382 USMP15305 M4689 USMP11723	
4149	USMP05295	41386 USMP17503 M4690 USMP17498	
4206	USMP17469	41566 USMP15270 M4704 USMP11760	
4208	USMP08883	41567 USMP15273 M4712 USMP11780	
4227	USMP17512	41592 USMP50470 M4845 USMP12113	
4406	USMP82685	41615 USMP50478 M4868 USMP12170	
4459	USMP17465	41618 USMP50703 M4885 USMP12213	
4460	USMP06170	42071 USMP17518 M6101 USMP15253	
4512	USMP11415	42182 USMP51013 M6108 USMP15270	
4589	USMP11473	42186 USMP51010 M6109 USMP15273	
4657	USMP07800	42325 USMP17578 M6120 USMP17507	
4754	USMP17539	42440 USMP17466 M6122 USMP15305	
4845	USMP12113	42640 USMP82505 M6191 USMP17597	
4886	USMP09970	60002 USMP17505 M6215 USMP15538	
4896	USMP17504	60007 USMP17205 M6399 USMP17464	
6191	USMP17597	60036 USMP50090 M6404 USMP17563	
6399	USMP17464	60045 USMP50113 M6405 USMP16013	
6491	USMP17586	60081 USMP80503 M6505 USMP16263	
6505	USMP16263	60092 USMP10013 M6588 USMP16470	
6523	USMP08820	60144 USMP50360 M6618 USMP16545	
6588	USMP16470	60167 USMP50418 M6622 USMP17470	
6618	USMP16545	60185 USMP50463 M6624 USMP16560	
6676	USMP16690	60235 USMP17530 M6626 USMP16565	
6736	USMP16840	60237 USMP17519 M6628 USMP16570	
6737	USMP16843	60278 USMP50695 M6676 USMP16690	
6747	USMP16870	60318 USMP50795 M6736 USMP16840	
6750	USMP16875	60328 USMP17508 M6737 USMP16843	
6790	USMP08825	60330 USMP50825 M6738 USMP16845	
6807	USMP17018	60331 USMP50828 M6744 USMP17574	
6838	USMP10023	60443 USMP17499 M6748 USMP16870	
6865	USMP17495	60514 USMP51285 M6750 USMP16875	
6866	USMP17165	60519 USMP51298 M6803 USMP17533	
6878	USMP17195	60576 USMP51440 M6804 USMP17551	
6935	USMP17338	60577 USMP51443 M6807 USMP17018	
6959	USMP17398	61067 USMP52668 M6866 USMP17165	
6962	USMP17405	73104 USMP82760 M6878 USMP17195	
6978	USMP17445		M6882 USMP17205
40001	USMP17489	<b>Carter</b>	M6935 USMP17338
40217	USMP07498	M825 USMP17493	M6951 USMP17378
40254	USMP11780	M826 USMP02065	M6954 USMP17547
40334	USMP06935	M835 USMP17465	M6955 USMP17388
40371	USMP11383	M847 USMP17477	M6959 USMP17398
40443	USMP17492	M2118 USMP05295	M6962 USMP17405
40446	USMP11258	M2195 USMP05488	M6978 USMP17445
		M2211 USMP17512	

MECHANICAL FUEL PUMPS

























# MECHANICAL FUEL PUMP CROSS REFERENCE



Carter (cont'd.)		Spectra Premium (cont'd.)		Spectra Premium (cont'd.)	
M6984	USMP17460	SP1014MP	USMP15273	SP1109MP	USMP11085
M60002	USMP17505	SP1015MP	USMP10020	SP1113MP	USMP17597
M60036	USMP50090	SP1016MP	USMP17205	SP1116MP	USMP80503
M60039	USMP50098	SP1017MP	USMP17405	SP1117MP	USMP17503
M60045	USMP50113	SP1019MP	USMP51298	SP1119MP	USMP17547
M60081	USMP80503	SP1020MP	USMP16840	SP1120MP	USMP17530
M60086	USMP17503	SP1021MP	USMP11258	SP1122MP	USMP51440
M60107	USMP17462	SP1022MP	USMP50418	SP1123MP	USMP17491
M60140	USMP17531	SP1023MP	USMP16845	SP1124MP	USMP17508
M60142	USMP17502	SP1024MP	USMP75490	SP1134MP	USMP17551
M60144	USMP50360	SP1025MP	USMP50703	SP1135MP	USMP17519
M60167	USMP50418	SP1026MP	USMP15253	SP1138MP	USMP17578
M60176	USMP50440	SP1027MP	USMP11325	SP1139MP	USMP75535
M60185	USMP50463	SP1028MP	USMP17378	SP1140MP	USMP15538
M60188	USMP50470	SP1029MP	USMP11283	SP1141MP	USMP82505
M60191	USMP50478	SP1030MP	USMP51013	SP1142MP	USMP12113
M60205	USMP17530	SP1031MP	USMP17460	SP1147MP	USMP17642
M60235	USMP17519	SP1032MP	USMP50090	SP1148MP	USMP17492
M60265	USMP17593	SP1033MP	USMP15270	SP1151MP	USMP17498
M60278	USMP50695	SP1034MP	USMP17464	SP1152MP	USMP11415
M60281	USMP50703	SP1035MP	USMP51010	SP1155MP	USMP50440
M60284	USMP17518	SP1038MP	USMP50463	SP1156MP	USMP17518
M60318	USMP50795	SP1039MP	USMP17018	SP1159MP	USMP08883
M60328	USMP17508	SP1040MP	USMP50470	SP1161MP	USMP12213
M60330	USMP50825	SP1041MP	USMP75670	SP1163MP	USMP16013
M60331	USMP50828	SP1042MP	USMP50828	SP1164MP	USMP17533
M60404	USMP51010	SP1043MP	USMP11473	SP1165MP	USMP17502
M60405	USMP51013	SP1044MP	USMP75770	SP1168MP	USMP17563
M60414	USMP17501	SP1045MP	USMP10023	SP1169MP	USMP12170
M60416	USMP51040	SP1046MP	USMP15305	SP1173MP	USMP17496
M60420	USMP17527	SP1047MP	USMP17472	SP1174MP	USMP17641
M60443	USMP17499	SP1050MP	USMP16875	SP1175MP	USMP17574
M60477	USMP17578	SP1051MP	USMP51443	SP1177MP	USMP17536
M60480	USMP17466	SP1052MP	USMP08820	SP1179MP	USMP11723
M60514	USMP51285	SP1053MP	USMP82650	SP1191MP	USMP17593
M60519	USMP51298	SP1054MP	USMP82760	SP1200MP	USMP09970
M60576	USMP51440	SP1056MP	USMP11760	SP1202MP	USMP17499
M60577	USMP51443	SP1057MP	USMP17445	SP1203MP	USMP17462
M61067	USMP52668	SP1058MP	USMP10013	SP1204MP	USMP17525
M70041	USMP17509	SP1059MP	USMP16690	SP1205MP	USMP16545
M70111	USMP17496	SP1060MP	USMP17388	SP1207MP	USMP17504
M70196	USMP75490	SP1061MP	USMP05295	SP1208MP	USMP17495
M70214	USMP75535	SP1062MP	USMP07800	SP1210MP	USMP17586
M70225	USMP17641	SP1064MP	USMP09180	SP1212MP	USMP17507
M70266	USMP75665	SP1066MP	USMP17470	SP1214MP	USMP75665
M70268	USMP75670	SP1067MP	USMP08825	SP1215MP	USMP17512
M70284	USMP17642	SP1068MP	USMP11780	SP1224MP	USMP17493
M70293	USMP75733	SP1070MP	USMP17398	SP1225MP	USMP02065
M70307	USMP75768	SP1072MP	USMP05488	SP1276MP	USMP17506
M70308	USMP75770	SP1073MP	USMP17338	SP1280MP	USMP17477
M70312	USMP17472	SP1074MP	USMP17195	SP1286MP	USMP17531
M70314	USMP17491	SP1075MP	USMP11383	SP1343MP	USMP17539
M70319	USMP75798	SP1076MP	USMP50360		
M70320	USMP17525	SP1077MP	USMP16263		
M73002	USMP82505	SP1078MP	USMP17461		
M73060	USMP82650	SP1079MP	USMP06170		
M73063	USMP82685	SP1080MP	USMP07498		
M73066	USMP17469	SP1081MP	USMP17469		
M73104	USMP82760	SP1082MP	USMP11280		
		SP1083MP	USMP17489		
<b>Spectra Premium</b>		SP1084MP	USMP17465		
SP1000MP	USMP16560	SP1087MP	USMP82685		
SP1001MP	USMP16565	SP1088MP	USMP16870		
SP1002MP	USMP16470	SP1089MP	USMP06935		
SP1003MP	USMP51040	SP1090MP	USMP17505		
SP1004MP	USMP51285	SP1091MP	USMP50113		
SP1005MP	USMP50795	SP1093MP	USMP75733		
SP1006MP	USMP16843	SP1094MP	USMP75768		
SP1007MP	USMP50098	SP1095MP	USMP17527		
SP1008MP	USMP16570	SP1097MP	USMP17501		
SP1009MP	USMP11713	SP1098MP	USMP17509		
SP1010MP	USMP50695	SP1100MP	USMP75798		
SP1011MP	USMP17165	SP1104MP	USMP17466		
SP1012MP	USMP50825	SP1108MP	USMP50478		
SP1013MP	USMP52668				

			
<b>USMP05295</b>	<b>USMP06170</b>	<b>USMP06935</b>	<b>USMP07800</b>
			
<b>USMP08820</b>	<b>USMP10020</b>	<b>USMP10023</b>	<b>USMP11085</b>
			
<b>USMP11258</b>	<b>USMP11280</b>	<b>USMP11325</b>	<b>USMP11383</b>
			
<b>USMP11473</b>	<b>USMP11713</b>	<b>USMP11723</b>	<b>USMP11760</b>
			
<b>USMP11780</b>	<b>USMP12170</b>	<b>USMP15270</b>	<b>USMP15273</b>

MECHANICAL FUEL PUMPS

			
<b>USMP15305</b>	<b>USMP16013</b>	<b>USMP16470</b>	<b>USMP16545</b>
			
<b>USMP16560</b>	<b>USMP16565</b>	<b>USMP16570</b>	<b>USMP16690</b>
			
<b>USMP16840</b>	<b>USMP16843</b>	<b>USMP16845</b>	<b>USMP16875</b>
			
<b>USMP17018</b>	<b>USMP17165</b>	<b>USMP17205</b>	<b>USMP17378</b>
			
<b>USMP17388</b>	<b>USMP17398</b>	<b>USMP17405</b>	<b>USMP17460</b>





USMP17462



USMP17464



USMP17466



USMP17470



USMP17472



USMP17489



USMP17491



USMP17492



USMP17495



USMP17496



USMP17498



USMP17503



USMP17508



USMP17519



USMP17525



USMP17530



USMP17547



USMP17563



USMP17574



USMP17586



USMP17593



USMP50090



USMP50098



USMP50360



USMP50418



USMP50440



USMP50463



USMP50695



USMP50703



USMP50795



USMP51013



USMP51040



USMP51285



USMP51443



USMP52668



USMP75670



USMP75733



USMP75768



USMP75770



USMP75798







# FUEL PUMP STRAINERS

***Trusted by professionals around the world***

USMW Professional Series offers a wide range of replacement fuel pump strainers for our complete line of fuel pump modules and kits

- **High Quality Multi-density material**
- **All materials compatible with modern fuel blends**
- **Precision molded pump interfaces**

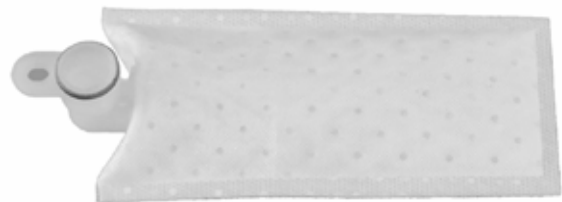
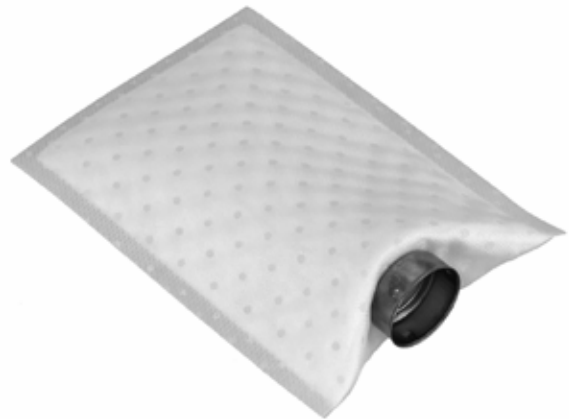

Quality made strainers help protect your fuel pump from contamination, this helps ensure longer lasting fuel pump performance.



Designed, tested and inspected in the USA



USMW	Years	Application	Engine	USMW	Years	Application	Engine
12-1-5	1982	BUICK CENTURY		12-3-5	1985	PONTIAC J2000 SUNBIRD	
	1982	BUICK SKYHAWK			1985-1987	OLDSMOBILE CALAIS	
	1982	PONTIAC J2000			1985-1988	CADILLAC CIMARRON	
	1982-1984	OLDSMOBILE OMEGA			1985-1988	OLDSMOBILE FIRENZA	
	1982-1984	PONTIAC 6000			1985-1989	BUICK SKYHAWK	
	1982-1994	ALFA ROMEO SPIDER			1985-1989	CADILLAC DEVILLE	
	1983	CHEVROLET CELEBRITY			1985-1991	BUICK SKYLARK	
	1983-1984	BUICK SKYLARK			1985-1991	CHEVROLET CAVALIER	
	1984	CHEVROLET CITATION II			1985-1991	PONTIAC 6000	
	1984-1988	PONTIAC FIERO			1985-1991	PONTIAC GRAND AM	
	1985	CHEVROLET MONTE CARLO			1985-1992	OLDSMOBILE CUTLASS CIERA	
	1985-1996	CHEVROLET CORVETTE			1986	CHEVROLET P20	
	1986-1987	VOLVO 740			1986-1987	BUICK RIVIERA	
	1987	CHEVROLET G10			1986-1987	BUICK SOMERSET	
	1987	CHEVROLET G20			1986-1987	CADILLAC ELDORADO	
	1987	CHEVROLET G30			1986-1987	CADILLAC SEVILLE	
	1987	CHEVROLET R10			1986-1987	OLDSMOBILE TORONADO	
	1987	CHEVROLET R20 SUBURBAN			1986-1988	BUICK ELECTRA	
	1987	CHEVROLET V10			1986-1988	OLDSMOBILE 98	
	1987	CHEVROLET V20 SUBURBAN			1986-1989	CADILLAC FLEETWOOD	
	1987	GMC G1500			1986-1989	CHEVROLET P30	
	1987	GMC G2500			1986-1989	GMC P3500	
	1987	GMC G3500			1986-1990	BUICK CENTURY	
	1987	GMC JIMMY			1986-1990	OLDSMOBILE DELTA 88	
	1987	GMC V1500			1986-1991	BUICK LESABRE	
	1987	GMC V2500			1986-1991	PONTIAC SUNBIRD	
	1987	GMC V2500 SUBURBAN			1987	CHEVROLET R20 SUBURBAN	
	1987-1988	CHEVROLET R10 SUBURBAN			1987	CHEVROLET V20	
	1987-1988	CHEVROLET V10 SUBURBAN			1987	GMC R2500	
	1987-1989	CHEVROLET P20			1987-1988	CHEVROLET R30	
	1987-1989	GMC R2500			1987-1988	CHEVROLET V30	
	1987-1990	VOLVO 780			1987-1989	CHEVROLET BERETTA	
	1987-1991	GMC R1500 SUBURBAN			1987-1989	CHEVROLET BLAZER	
	1987-1991	GMC V1500 SUBURBAN			1987-1989	CHEVROLET CELEBRITY	
	1988	CHEVROLET R20			1987-1989	CHEVROLET CORSICA	
	1988-1989	GMC P2500			1987-1989	GMC R3500	
	1988-1991	CHEVROLET C1500			1987-1989	GMC V3500	
	1988-1991	CHEVROLET C2500			1987-1990	GMC R2500 SUBURBAN	
	1988-1991	CHEVROLET C3500			1987-1990	PONTIAC BONNEVILLE	
	1988-1991	CHEVROLET K1500			1987-1992	CADILLAC ALLANTE	
	1988-1991	CHEVROLET K2500			1988	CHEVROLET V20 SUBURBAN	
	1988-1991	CHEVROLET K3500			1988-1989	CADILLAC COMMERCIAL CHASSIS	
	1988-1991	GMC C1500			1988-1989	GMC JIMMY	
	1988-1991	GMC C2500			1988-1990	GMC V2500 SUBURBAN	
	1988-1991	GMC C3500			1988-1990	OLDSMOBILE CUTLASS CRUISER	
	1988-1991	GMC K1500			1988-1991	OLDSMOBILE CUTLASS CALAIS	
	1988-1991	GMC K2500			1989	CHEVROLET R3500	
	1988-1991	GMC K3500			1989	GMC R2500	
	1988-1993	PONTIAC LEMANS			1989-1990	CHEVROLET R2500 SUBURBAN	
	1989	CHEVROLET R2500			1989-1990	CHEVROLET V2500 SUBURBAN	
	1989-1991	CHEVROLET R1500 SUBURBAN			1989-1990	CHEVROLET V3500	
	1989-1991	CHEVROLET V1500 SUBURBAN			1990	BUICK ELECTRA	
	1990	GMC P3500			1990	GMC C7000	
	1990-1991	CHEVROLET BLAZER			1990-1991	CHEVROLET C5500 KODIAK	
	1990-1991	CHEVROLET R3500			1990-1991	GMC C5000 TOPKICK	
	1990-1991	GMC JIMMY			1990-1996	CHEVROLET C60 KODIAK	
	1990-1991	GMC R3500			1990-1996	CHEVROLET C70 KODIAK	
	1990-1992	CADILLAC FLEETWOOD			1990-1996	GMC C6000 TOPKICK	
	1990-1993	CADILLAC DEVILLE			1990-1996	GMC C7000 TOPKICK	
	1990-1995	CHEVROLET P30			1991	CHEVROLET S10 BLAZER	
	1991	CHEVROLET R2500 SUBURBAN			1991	GMC S15 JIMMY	
	1991	CHEVROLET V2500 SUBURBAN			1991	OLDSMOBILE BRAVADA	
	1991	CHEVROLET V3500			1991-1992	CHEVROLET CAPRICE	
	1991	GMC R2500 SUBURBAN			1991-1992	CHEVROLET COMMERCIAL CHASSIS	
	1991	GMC V2500 SUBURBAN			1992	CHEVROLET K1500 SUBURBAN	
	1991	OLDSMOBILE DELTA 88			1992	OLDSMOBILE CUSTOM CRUISER	
	1991-1995	CHEVROLET C3500HD			1992-1994	CHEVROLET BLAZER	
	1991-1995	GMC C3500HD			1992-1996	CHEVROLET P60	
	1992-1994	VOLVO 960			1992-1996	CHEVROLET P6000	
	1992-1995	GMC P3500			1992-1996	GMC P6000	
	1993	CADILLAC 60 SPECIAL			1992-1996	GMC P6500	
	1993-1996	PONTIAC GRAND PRIX			1992-1997	CHEVROLET C1500 SUBURBAN	
	1993-1997	OLDSMOBILE CUTLASS SUPREME			1992-1997	GMC C1500 SUBURBAN	
	1994-1995	VOLVO 940			1992-1997	GMC K1500 SUBURBAN	
	1994-1996	BUICK REGAL			1992-1997	GMC YUKON	
	1994-1996	CHEVROLET LUMINA			1993-1998	CHEVROLET B7	
	1995-1996	CHEVROLET MONTE CARLO			1993-1998	GMC B7	
1996	CHEVROLET LUMINA APV		1994-1996	BUICK COMMERCIAL CHASSIS			
1996	OLDSMOBILE SILHOUETTE		1994-1996	BUICK ROADMASTER			
1996	PONTIAC TRANS SPORT		1994-1997	CHEVROLET K1500 SUBURBAN			
1998	VOLVO V90		1995	CHEVROLET CAMARO			
12-3-5	1982	BUICK SKYLARK		1995	PONTIAC FIREBIRD		
	1984	CHEVROLET CORVETTE		1995-1997	CHEVROLET TAHOE		
	1984	FORD MUSTANG		1996	CHEVROLET K2500		
	1985	BUICK SOMERSET REGAL		1996-1997	GMC C2500 SUBURBAN		
	1985	CADILLAC COMMERCIAL CHASSIS		1996-1997	GMC K2500		
	1985	CHEVROLET CITATION II		1997	CHEVROLET C2500 SUBURBAN		
	1985	GMC SAFARI					

USMW	Years	Application	Engine	USMW	Years	Application	Engine	
12-3-5	1997	CHEVROLET C3500		12-22-5	1993-1996	GMC K2500 SUBURBAN		
	1997	CHEVROLET K2500 SUBURBAN			1993-1997	CHEVROLET C2500		
	1997	CHEVROLET K3500			1994-1996	CHEVROLET IMPALA		
	1997	GMC C2500			1995	CHEVROLET BLAZER		
	1997	GMC C3500			1996	CHEVROLET EXPRESS 2500		
	1997	GMC K2500 SUBURBAN			1996-1997	CHEVROLET P30		
	1997	GMC K3500			1996-1997	GMC P3500		
	1997-1998	CHEVROLET C6500 KODIAK			1997	CHEVROLET K2500		
	1997-1998	CHEVROLET C7500 KODIAK			12-30-5	1979	CADILLAC ELDORADO	
	1997-1998	GMC C6500 TOPKICK				1980-1981	VOLVO 265	
	1997-1998	GMC C7500 TOPKICK				1980-1982	VOLVO 264	
12-10-5	1983-1984	FORD MUSTANG		1982		CHEVROLET CELEBRITY		
	1988-1991	BUICK REATTA		1982		CHEVROLET CORVETTE		
	1988-1992	CADILLAC SEVILLE		1982		PONTIAC PHOENIX		
	1988-1992	OLDSMOBILE TORONADO		1982-1983		CHEVROLET CITATION		
	1988-1993	BUICK RIVIERA		1982-1984		OLDSMOBILE CUTLASS CIERA		
	1988-1993	CADILLAC ELDORADO		1982-1985		BUICK CENTURY		
	1991	BMW 318IS		1982-1987		PONTIAC FIREBIRD		
12-20-5	1975-1976	TOYOTA COROLLA		1983		PONTIAC J2000		
	1975-1979	TOYOTA CELICA		1983-1984	BUICK SKYHAWK			
	1975-1979	TOYOTA CORONA		1983-1984	CADILLAC CIMARRON			
	1986-1989	HONDA ACCORD		1983-1984	CHEVROLET CAVALIER			
	1988-1992	OLDSMOBILE CUTLASS SUPREME		1983-1984	CHEVROLET CHEVETTE			
	1988-1992	PONTIAC GRAND PRIX		1983-1984	OLDSMOBILE FIRENZA			
	1988-1993	BUICK REGAL		1984	FORD THUNDERBIRD			
	1990-1991	CHEVROLET BERETTA		1984	MERCURY COUGAR			
	1990-1991	CHEVROLET CORSICA		1984	PONTIAC J2000 SUNBIRD			
	1990-1993	CHEVROLET LUMINA		1984-1986	CHEVROLET CELEBRITY			
	1990-1994	OLDSMOBILE SILHOUETTE		1984-1987	BUICK REGAL			
	1990-1995	CHEVROLET LUMINA APV		1984-1987	CHEVROLET CAMARO			
	1990-1995	PONTIAC TRANS SPORT		1985	BUICK ELECTRA			
	1991	BUICK CENTURY		1985	OLDSMOBILE 98			
1991	OLDSMOBILE CUSTOM CRUISER		1985-1987	CHEVROLET EL CAMINO				
12-22-5	1981-1984	CADILLAC DEVILLE		1985-1987	GMC CABALLERO			
	1981-1985	CADILLAC ELDORADO		1985-1988	FORD RANGER			
	1981-1985	CADILLAC FLEETWOOD		1985-1989	FORD F-150			
	1981-1985	CADILLAC SEVILLE		1986	CHEVROLET MONTE CARLO			
	1984-1985	BUICK RIVIERA		1986-1987	PONTIAC GRAND PRIX			
	1984-1986	FORD LTD		1986-1988	FORD BRONCO II			
	1984-1986	MERCURY MARQUIS		1986-1989	FORD E-150 ECONOLINE			
	1985	CHEVROLET IMPALA		1986-1989	FORD E-150 ECONOLINE CLUB WAGON			
	1985-1986	PONTIAC PARISIENNE		1986-1989	FORD F-250			
	1985-1990	CHEVROLET CAPRICE		1986-1991	FORD E-250 ECONOLINE			
	1986	PONTIAC BONNEVILLE		1986-1991	FORD E-250 ECONOLINE CLUB WAGON			
	1987-1995	CHEVROLET LLV		1986-1991	FORD E-350 ECONOLINE			
	1987-1996	CHEVROLET ASTRO		1986-1991	FORD E-350 ECONOLINE CLUB WAGON			
	1988-1995	CHEVROLET G10		1987-1988	MAZDA B2600			
	1988-1995	CHEVROLET G20		1987-1989	FORD F-350			
	1988-1995	GMC G1500		1987-1990	MAZDA B2200			
	1988-1995	GMC G2500		1988	CHEVROLET MONTE CARLO			
	1988-1996	CHEVROLET G30		1988-1990	VOLVO 740			
	1988-1996	GMC G3500		1988-1990	VOLVO 760			
	1988-1996	GMC SAFARI		1990-1991	GMC V3500			
	1990-1991	FORD E-150 ECONOLINE		1992	CHEVROLET BERETTA			
	1990-1991	FORD E-150 ECONOLINE CLUB WAGON		1992	CHEVROLET CORSICA			
	1990-1992	CADILLAC BROUGHAM		1992	MAZDA B2200			
	1990-1994	CHEVROLET CAMARO		1992-1993	BUICK CENTURY			
	1990-1994	PONTIAC FIREBIRD		1993	CADILLAC ALLANTE			
	1991	GMC P3500		1993-1994	CADILLAC SEVILLE			
	1991	GMC SYCLONE		1994	CADILLAC DEVILLE			
	1991-1993	BUICK COMMERCIAL CHASSIS		1994	CADILLAC ELDORADO			
	1991-1993	BUICK ROADMASTER		12-38-5	1993-1994	OLDSMOBILE CUTLASS CRUISER		
	1991-1995	CHEVROLET S10			1993-1995	BUICK PARK AVENUE		
	1991-1995	GMC SONOMA			1993-1996	OLDSMOBILE 98		
	1992-1993	GMC TYPHOON			1993-1996	OLDSMOBILE CUTLASS CIERA		
	1992-1994	CHEVROLET S10 BLAZER			1993-1999	BUICK LESABRE		
	1992-1994	OLDSMOBILE BRAVADA			1993-1999	OLDSMOBILE 88		
	1992-1995	GMC JIMMY			1994-1996	BUICK CENTURY		
	1992-1996	CADILLAC COMMERCIAL CHASSIS			1996	OLDSMOBILE LSS		
	1992-1996	CHEVROLET C3500			1997-1998	OLDSMOBILE REGENCY		
	1992-1996	CHEVROLET K3500			1998-1999	OLDSMOBILE LSS		
	1992-1996	GMC C3500			12-40-5	1991-1992	BUICK PARK AVENUE	
	1992-1996	GMC K3500		1992		BUICK LESABRE		
	1992-1997	CHEVROLET C1500		1992		OLDSMOBILE 88		
	1992-1997	CHEVROLET K1500		12-100-5	1975-1980	BUICK SKYHAWK		
	1992-1997	GMC C1500			1975-1980	CHEVROLET MONZA		
1992-1997	GMC K1500		1975-1980		OLDSMOBILE STARFIRE			
1993	CHEVROLET K1500 SUBURBAN		1976-1980		PONTIAC SUNBIRD			
1993-1994	CHEVROLET COMMERCIAL CHASSIS		1983-1985		VOLVO 760			
1993-1995	CHEVROLET K2500		1984		VOLVO 242			
1993-1995	GMC C2500 SUBURBAN		1984		VOLVO 245			
1993-1995	GMC K2500		1984-1985		VOLVO 244			
1993-1996	CADILLAC FLEETWOOD		1985		VOLVO 740			
1993-1996	CHEVROLET C2500 SUBURBAN		1985		VOLVO 745			
1993-1996	CHEVROLET CAPRICE		1986		SAAB 9000			
1993-1996	CHEVROLET K2500 SUBURBAN		1990-1993	VOLVO 240				
1993-1996	GMC C2500							











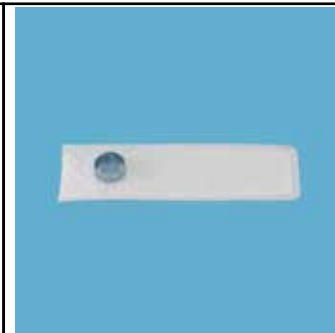





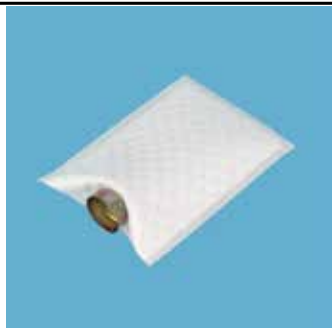







USMW	Years	Application	Engine	USMW	Years	Application	Engine
12-100-5	1991-1992	<b>VOLVO</b> 740		12-139-5	1985-1989	<b>TOYOTA</b> MR2	
	1991-1993	<b>VOLVO</b> 940			1985-1994	<b>TOYOTA</b> 4RUNNER	
12-103-5	1985-1987	<b>TOYOTA</b> CAMRY			1986-1992	<b>TOYOTA</b> SUPRA	
	1985-1989	<b>TOYOTA</b> VAN			1988-1990	<b>TOYOTA</b> LAND CRUISER	
	1985-1991	<b>TOYOTA</b> COROLLA			1991-1993	<b>TOYOTA</b> MR2	
	1988	<b>CHEVROLET</b> NOVA			1991-1994	<b>TOYOTA</b> PREVIA	
	1989-1992	<b>GEO</b> PRIZM			1991-1994	<b>TOYOTA</b> TERCEL	
12-104-5	1983-1987	<b>RENAULT</b> ALLIANCE			1992	<b>TOYOTA</b> COROLLA	
	1984-1986	<b>RENAULT</b> ENCORE			1992-1993	<b>TOYOTA</b> CAMRY	
	1986-1990	<b>JEEP</b> WAGONEER			1992-1995	<b>TOYOTA</b> PASEO	
	1986-1992	<b>JEEP</b> COMANCHE			1993-1998	<b>TOYOTA</b> T100	
	1986-1993	<b>JEEP</b> CHEROKEE			1995-1998	<b>TOYOTA</b> AVALON	
	1987-1993	<b>JEEP</b> WRANGLER			1996-1998	<b>TOYOTA</b> RAV4	
	1988-1990	<b>EAGLE</b> PREMIER			1997	<b>TOYOTA</b> COROLLA	
	1990	<b>DODGE</b> MONACO			1997-2001	<b>TOYOTA</b> CAMRY	
12-111-5	1985-1997	<b>FORD</b> MUSTANG			1997-2002	<b>TOYOTA</b> 4RUNNER	
	1986-1987	<b>FORD</b> AEROSTAR			1998	<b>TOYOTA</b> SIENNA	
	1986-1990	<b>FORD</b> ESCORT			1998-2007	<b>TOYOTA</b> LAND CRUISER	
	1987	<b>MERCURY</b> LYNX			2000	<b>TOYOTA</b> SIENNA	
	1987-1991	<b>FORD</b> LTD CROWN VICTORIA		12-140-5	1991-1997	<b>FORD</b> ESCORT	
	1989-1991	<b>FORD</b> TAURUS			1991-1997	<b>MERCURY</b> TRACER	
	1989-1992	<b>HYUNDAI</b> SONATA		12-141-5	1985-1987	<b>LINCOLN</b> CONTINENTAL	
	1989-1997	<b>FORD</b> RANGER			1985-1988	<b>FORD</b> THUNDERBIRD	
	1990-1992	<b>LINCOLN</b> TOWN CAR			1985-1988	<b>MERCURY</b> COUGAR	
	1990-1992	<b>MERCURY</b> GRAND MARQUIS			1985-1992	<b>LINCOLN</b> MARK VII	
	1991-1994	<b>MAZDA</b> NAVAJO			1991-1994	<b>MERCURY</b> TOPAZ	
	1991-1996	<b>FORD</b> EXPLORER			1994	<b>FORD</b> TEMPO	
	1992	<b>FORD</b> CROWN VICTORIA			1994-1997	<b>MAZDA</b> MIATA	
	1993-1998	<b>MERCURY</b> VILLAGER		12-146-5	1990-1993	<b>MAZDA</b> MIATA	
	1993-1998	<b>NISSAN</b> QUEST			1991-1995	<b>ACURA</b> LEGEND	3.2L V6 3206cc
	1994-1995	<b>JEEP</b> WRANGLER			1997-2001	<b>HONDA</b> PRELUDE	
	1994-1997	<b>MAZDA</b> B2300			1999-2005	<b>MAZDA</b> MIATA	
	1994-1997	<b>MAZDA</b> B4000		12-147-5	1990-1992	<b>NISSAN</b> D21	
	1996-1997	<b>ISUZU</b> OASIS			1995	<b>NISSAN</b> PICKUP	
12-115-5	1983-1984	<b>PLYMOUTH</b> HORIZON		12-148-5	1998-2007	<b>SUBARU</b> FORESTER	
	1984	<b>CHRYSLER</b> LEBARON			1999	<b>SUBARU</b> LEGACY	
	1984	<b>DODGE</b> 600			1999-2007	<b>SUBARU</b> IMPREZA	
	1984-1990	<b>DODGE</b> DAYTONA		12-150-5	1989-1992	<b>HYUNDAI</b> SONATA	
	1985	<b>DODGE</b> OMNI			1996-1997	<b>ISUZU</b> OASIS	
	1985-1987	<b>DODGE</b> CHARGER		12-152-5	1989-1991	<b>ISUZU</b> TROOPER	
	1985-1988	<b>CHRYSLER</b> TOWN & COUNTRY			1990-1993	<b>GEO</b> STORM	
	1986	<b>CHRYSLER</b> LASER			1990-1994	<b>SUBARU</b> JUSTY	
	1986-1988	<b>DODGE</b> 600			1990-1996	<b>MITSUBISHI</b> MIGHTY MAX	
	1986-1988	<b>PLYMOUTH</b> CARAVELLE			1990-2001	<b>MITSUBISHI</b> MIRAGE	
	1986-1989	<b>DODGE</b> ARIES			1991	<b>EAGLE</b> 2000 GTX	
	1986-1989	<b>DODGE</b> LANCER			1991	<b>SUZUKI</b> SAMURAI	
	1986-1989	<b>PLYMOUTH</b> RELIANT			1991-1992	<b>ISUZU</b> IMPULSE	
	1986-1990	<b>CHRYSLER</b> LEBARON			1991-1993	<b>DODGE</b> RAM 50	
	1986-1990	<b>CHRYSLER</b> NEW YORKER			1991-1993	<b>ISUZU</b> STYLUS	
	1987-1988	<b>DODGE</b> MINI RAM			1991-1996	<b>EAGLE</b> SUMMIT	
	1987-1990	<b>CHRYSLER</b> DAYTONA			1991-1998	<b>MITSUBISHI</b> GALANT	
	1987-1990	<b>DODGE</b> CARAVAN			1992-1994	<b>MITSUBISHI</b> EXPO LRV	
	1987-1990	<b>DODGE</b> SHADOW			1992-1994	<b>PLYMOUTH</b> COLT	
	1987-1990	<b>PLYMOUTH</b> SUNDANCE			1992-1995	<b>DODGE</b> COLT	
	1987-1990	<b>PLYMOUTH</b> VOYAGER			1992-1995	<b>MAZDA</b> MX-3	
	1988-1990	<b>CHRYSLER</b> DYNASTY			1992-1995	<b>MITSUBISHI</b> EXPO	
	1988-1990	<b>DODGE</b> DYNASTY			1992-1997	<b>MITSUBISHI</b> DIAMANTE	
	1988-1990	<b>DODGE</b> GRAND CARAVAN			1992-2000	<b>HYUNDAI</b> ELANTRA	
	1988-1990	<b>DODGE</b> OMNI			1992-2000	<b>LEXUS</b> SC300	
	1988-1990	<b>PLYMOUTH</b> GRAND VOYAGER			1992-2000	<b>MITSUBISHI</b> MONTERO	
	1988-1990	<b>PLYMOUTH</b> HORIZON			1993-1994	<b>ISUZU</b> AMIGO	
	1989-1990	<b>CHRYSLER</b> TC MASERATI			1993-1995	<b>SUZUKI</b> SAMURAI	
	1989-1990	<b>DODGE</b> SPIRIT			1993-1997	<b>LEXUS</b> GS300	
	1989-1990	<b>PLYMOUTH</b> ACCLAIM			1993-1997	<b>MAZDA</b> PROTEGE	
	1990	<b>CHRYSLER</b> IMPERIAL			1993-1997	<b>TOYOTA</b> LAND CRUISER	
	1990	<b>CHRYSLER</b> TOWN & COUNTRY			1993-1998	<b>HYUNDAI</b> SONATA	
12-120-5	1990	<b>EAGLE</b> SUMMIT			1993-1998	<b>TOYOTA</b> SUPRA	
	1990	<b>MAZDA</b> B2200			1993-2000	<b>LEXUS</b> SC400	
	1992-1993	<b>MAZDA</b> B2200			1994-1995	<b>ISUZU</b> TROOPER	
	1992-1993	<b>MAZDA</b> B2600			1994-1997	<b>HONDA</b> PASSPORT	
	1992-1995	<b>LEXUS</b> ES300			1995	<b>ISUZU</b> PICKUP	
12-121-5	1988	<b>HONDA</b> CRX			1995	<b>MAZDA</b> 323	
12-126-5	1989-1991	<b>SUZUKI</b> SIDEKICK	1.6L L4 1590cc 97 CID		1995-1996	<b>SUZUKI</b> ESTEEM	
12-127-5	1987-1988	<b>STERLING</b> 825			1995-1997	<b>GEO</b> METRO	
	1988-1991	<b>HONDA</b> CIVIC			1995-1997	<b>MITSUBISHI</b> ECLIPSE	
	1989-1991	<b>STERLING</b> 827			1995-1998	<b>EAGLE</b> TALON	
12-129-5	1990-1991	<b>ACURA</b> INTEGRA			1995-1998	<b>SUZUKI</b> SIDEKICK	
12-130-5	1990-1993	<b>HONDA</b> ACCORD			1995-1999	<b>HYUNDAI</b> ACCENT	
	1992-1994	<b>ACURA</b> VIGOR			1995-2000	<b>CHRYSLER</b> SEBRING	
12-131-5	1988	<b>MITSUBISHI</b> GALANT			1995-2000	<b>DODGE</b> AVENGER	
	1989-1990	<b>MITSUBISHI</b> SIGMA			1995-2001	<b>SUZUKI</b> SWIFT	
	1990	<b>MITSUBISHI</b> ECLIPSE			1996-1997	<b>ISUZU</b> RODEO	
	1990-1991	<b>EAGLE</b> TALON			1996-1998	<b>SUZUKI</b> X-90	
	1990-1991	<b>PLYMOUTH</b> LASER			1996-1999	<b>ACURA</b> SLX	
12-139-5	1983-1993	<b>TOYOTA</b> CELICA			1997	<b>GEO</b> TRACKER	
	1984	<b>TOYOTA</b> VAN			1997	<b>LEXUS</b> LX450	
	1984-1992	<b>TOYOTA</b> CRESSIDA			1997	<b>MAZDA</b> MILLENIA	
	1984-1995	<b>TOYOTA</b> PICKUP			1997-1998	<b>MITSUBISHI</b> MONTERO SPORT	













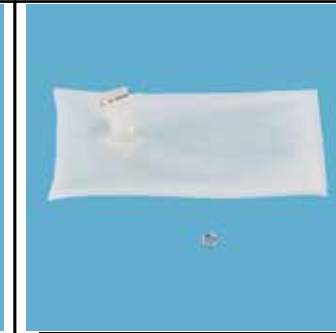



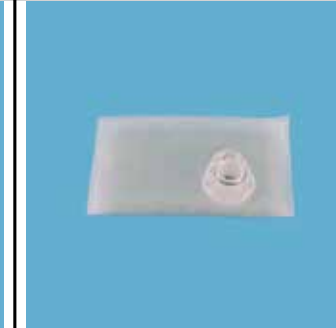

USMW	Years	Application	Engine	USMW	Years	Application	Engine
12-152-5	1997-2000	ISUZU TROOPER		12-197-5	1997-2001	FORD EXPEDITION	
	1997-2001	HYUNDAI TIBURON			1997-2002	FORD E-150 ECONOLINE	
	1998-1999	CHEVROLET TRACKER			1997-2002	FORD E-150 ECONOLINE CLUB WAGON	
	1998-2001	CHEVROLET METRO			1997-2002	FORD E-250 ECONOLINE	
	1999	MITSUBISHI 3000GT			1998	LINCOLN NAVIGATOR	
	1999-2000	LEXUS LS400			1999-2002	MERCURY VILLAGER	
	1999-2001	ISUZU VEHICROSS			1999-2002	NISSAN QUEST	
	2001	SUZUKI GRAND VITARA			2004	FORD F-150 HERITAGE	
	2002-2003	SUZUKI XL-7			2004-2005	FORD E-150 CLUB WAGON	
	2004-2005	FORD E-350 CLUB WAGON			2004-2005	FORD E-350 CLUB WAGON	
12-158-5	1997-1999	ACURA RL		2004-2008	FORD E-150		
	1998-1999	ISUZU OASIS		2004-2008	FORD E-250		
12-160-5	1996	GEO PRIZM		2004-2008	FORD E-350 SUPER DUTY		
	1998	TOYOTA PASEO		2004-2008	FORD E-450 SUPER DUTY		
12-162-5	2001	HYUNDAI XG300		12-199-5	1997-1998	MERCURY MOUNTAINEER	
	2002-2003	HYUNDAI XG350			2001-2002	FORD EXPLORER	
12-164-5	1989-1991	CHEVROLET TRACKER		12-202-5	1981-1982	FIAT X-1/9	
	1989-1991	GMC TRACKER			1981-1983	LINCOLN MARK VI	
	1989-1995	GEO TRACKER			1981-1989	LINCOLN TOWN CAR	
	1991	SUZUKI SIDEKICK			1982	FIAT 124	
	1992-1995	SUZUKI SIDEKICK	1.6L L4 1590cc 97 CID		1982	LINCOLN CONTINENTAL	
12-165-5	1991-1992	ISUZU RODEO		1983	FORD LTD		
	2007-2009	KIA AMANTI	3.8L V6 3778cc 231 CID	1983-1989	MERCURY GRAND MARQUIS		
12-167-5	1989-1994	NISSAN 240SX		1985	LINCOLN MARK VII		
	1992-1994	NISSAN MAXIMA		1987-1991	FORD COUNTRY SQUIRE		
12-168-5	1993-1994	SUBARU IMPREZA		1987-1991	MERCURY COLONY PARK		
	1998	SUBARU LEGACY		12-203-5	1998-2007	SUBARU FORESTER	
	1989-1993	FORD TEMPO			1999	SUBARU LEGACY	
12-170-5	1993-1997	FORD PROBE		1999-2007	SUBARU IMPREZA		
	1993-1997	MAZDA MX-6		12-205-5	1998	MAZDA B3000	3.0L V6 2986cc 182 CID
1993-2002	MAZDA 626		1998-2000		FORD RANGER	3.0L V6 2986cc 182 CID	
2000-2001	NISSAN SENTRA		1998-2000		FORD RANGER	4.0L V6 245 CID	
2002-2003	NISSAN MAXIMA		1998-2000		MAZDA B4000	4.0L V6 4016cc	
1998-2001	FORD RANGER	2.5L L4 153 CID	1998-2001		MAZDA B2500	2.5L L4 2492cc	
12-174-5	1993-1997	HONDA CIVIC DEL SOL		12-206-5	1998-2004	HONDA ACCORD	
	1993-1996	LINCOLN MARK VIII			1999-2003	ACURA TL	
12-175-5	1995-2002	FORD CROWN VICTORIA			2001-2003	ACURA CL	
	1995-2002	LINCOLN TOWN CAR			2006-2007	HONDA ACCORD	
1995-2002	MERCURY GRAND MARQUIS		12-207-5		1999-2000	MAZDA B3000	
1995-2003	JAGUAR VANDEN PLAS			1999-2004	FORD RANGER		
1997-1999	FORD ECONOLINE SUPER DUTY		12-209-5	1997-1999	FORD TAURUS		
1997-2000	FORD E-350 ECONOLINE			1997-1999	MERCURY SABLE		
1997-2000	FORD EXPLORER		1999	FORD F-350 SUPER DUTY			
1997-2002	FORD E-150 ECONOLINE		12-210-5	1991-1993	JEEP WRANGLER		
1997-2002	FORD E-150 ECONOLINE CLUB WAGON			1993-1997	TOYOTA PASEO		
1997-2002	FORD E-250 ECONOLINE			1993-2004	TOYOTA COROLLA		
1997-2002	FORD E-350 ECONOLINE CLUB WAGON			1994-1996	JEEP CHEROKEE		
1997-2002	FORD E-350 ECONOLINE CLUB WAGON			1994-2005	TOYOTA CELICA		
1997-2002	JAGUAR XK8			1995	TOYOTA PICKUP		
1997-2003	FORD F-150			1995-1997	TOYOTA PREVIA		
1998-2003	JAGUAR XJ8			1995-1998	TOYOTA TERCEL		
1998-2003	JAGUAR XJR			1995-2004	TOYOTA TACOMA		
1999	FORD F-250			1996-2005	TOYOTA RAV4		
1999-2003	FORD F53			1998-2000	LEXUS GS400		
2000-2002	FORD E-450 ECONOLINE SUPER DUTY			1998-2002	CHEVROLET PRIZM		
2000-2002	JAGUAR XKR			1998-2005	LEXUS GS300		
2003	FORD E-150			1998-2007	LEXUS LX470		
2003	FORD E-150 CLUB WAGON			1999	TOYOTA AVALON		
2003	FORD E-350 CLUB WAGON			1999-2000	SUZUKI ESTEEM		
2003	FORD E-450 SUPER DUTY			1999-2002	KIA SPORTAGE		
2003	FORD E-550 SUPER DUTY			1999-2003	LEXUS ES300		
12-178-5	1991-1994	INFINITI G20			1999-2004	CHEVROLET TRACKER	
12-180-5	1995-1996	TOYOTA CAMRY			1999-2004	SUZUKI VITARA	
12-187-5	1990-1992	FORD PROBE		1999-2005	SUZUKI GRAND VITARA		
12-191-5	1995-1998	NISSAN 240SX		1999-2008	TOYOTA SOLARA		
12-192-5	1994-1997	HONDA ACCORD		2000-2004	TOYOTA TUNDRA		
	1995-1998	ACURA TL		2000-2005	TOYOTA ECHO		
	1997-1999	ACURA CL		2000-2005	TOYOTA MR2 SPYDER		
	1997-2001	HONDA CR-V		2001-2003	LEXUS RX300		
	1997-2005	ACURA NSX		2001-2003	TOYOTA SIENNA		
12-193-5	1995-1998	NISSAN 200SX		2001-2004	TOYOTA SEQUOIA		
	1995-1999	NISSAN SENTRA		2001-2005	LEXUS GS430		
	1996-2001	NISSAN ALTIMA		2001-2005	LEXUS IS300		
12-194-5	1995-1999	NISSAN MAXIMA		2001-2006	LEXUS LS430		
	1996-1999	INFINITI I30		2001-2006	MITSUBISHI MONTERO		
	1996-2004	NISSAN PATHFINDER		2001-2010	TOYOTA HIGHLANDER		
	1997-2003	INFINITI QX4		2001-2011	TOYOTA AVALON		
	1999-2002	INFINITI G20		2002-2007	SUZUKI AERIO		
12-195-5	1999-2004	NISSAN FRONTIER		2002-2010	LEXUS SC430		
	2000-2004	NISSAN XTERRA		2002-2011	TOYOTA CAMRY		
	1999-2001	HYUNDAI SONATA		2003-2006	PONTIAC VIBE		
2001	KIA OPTIMA		2003-2006	TOYOTA MATRIX			
12-196-5	1995-1997	NISSAN PICKUP		2004-2006	LEXUS ES330		
	1999-2004	NISSAN FRONTIER		2004-2006	SCION XA		
12-197-5	1997-1999	FORD E-350 ECONOLINE		2004-2006	SCION XB		
	1997-1999	FORD E-350 ECONOLINE CLUB WAGON		2005-2010	SCION TC		
	1997-1999	FORD ECONOLINE SUPER DUTY					

USMW	Years	Application	Engine	USMW	Years	Application	Engine	
12-210-5	2006-2008	LEXUS RX400H						
	2007-2010	LEXUS ES350						
12-215-5	2002	MERCURY SABLE						
12-216-5	1995-1997	LINCOLN CONTINENTAL						
	1996-2001	MERCURY SABLE						
	1996-2007	FORD TAURUS						
	1997-1998	LINCOLN MARK VIII						
	1997-2003	FORD WINDSTAR						
	1998-1999	MERCURY TRACER						
	1998-1999	MITSUBISHI ECLIPSE						
	1998-2003	FORD ESCORT						
	1998-2004	FORD MUSTANG						
	1999-2004	MITSUBISHI MONTERO SPORT						
	1999-2010	FORD F-250 SUPER DUTY						
	1999-2010	FORD F-350 SUPER DUTY						
	1999-2010	FORD F-450 SUPER DUTY						
	1999-2010	FORD F-550 SUPER DUTY						
	2000-2002	JAGUAR S-TYPE						
	2000-2002	LINCOLN LS						
	2000-2005	FORD EXCURSION						
	2002	FORD THUNDERBIRD						
	2002-2007	FORD FOCUS						
	2003-2005	MERCURY SABLE						
	2005-2006	MAZDA TRIBUTE						
	2005-2007	FORD FIVE HUNDRED						
	2005-2007	MERCURY MONTEGO						
	2005-2008	FORD ESCAPE						
	2005-2008	MERCURY MARINER						
	2008	MAZDA TRIBUTE						
	12-217-5	1999-2004	HONDA ODYSSEY					
		1999-2004	MITSUBISHI GALANT					
		2000-2001	NISSAN SENTRA					
2000-2005		MITSUBISHI ECLIPSE						
2001-2005		CHRYSLER SEBRING						
2001-2005		DODGE STRATUS						
12-220-5	2005	HONDA ACCORD						
	1997-2001	JEEP CHEROKEE						
	1997-2001	SATURN SW2						
	1997-2002	SATURN SC1						
	1997-2002	SATURN SC2						
	1997-2002	SATURN SL						
	1997-2002	SATURN SL1						
	1997-2002	SATURN SL2						
	1997-2004	JEEP GRAND CHEROKEE						
	1997-2004	JEEP WRANGLER						
	1998-1999	SATURN SW1						
1998-2004	JEEP TJ							
12-221-5	1997-2001	JEEP CHEROKEE						
	1997-2004	JEEP GRAND CHEROKEE						
	1997-2004	JEEP TJ						
	1997-2004	JEEP WRANGLER						
12-226-5	2001-2004	HONDA CIVIC						
	2002-2004	ACURA RSX						
12-233-5	2001-2005	KIA OPTIMA						
	2002-2005	HYUNDAI SONATA						
	2004-2005	HYUNDAI XG350						
12-240-5	2001-2010	HYUNDAI ELANTRA						
	2003-2008	HYUNDAI TIBURON						
	2005-2007	KIA SPORTAGE						
	2005-2008	HYUNDAI TUCSON						
	2006-2010	HYUNDAI SONATA						
	2006-2011	HYUNDAI ACCENT						
	2007-2009	KIA SPECTRA						
	2007-2010	KIA RONDO						
	2008-2011	KIA RIO						
	2008-2011	KIA RIO5						
	2009	KIA BORREGO						
	2009	KIA SPORTAGE						
12-242-5	1997-1999	SATURN SW1						
	1997-2001	SATURN SW2						
	1997-2002	SATURN SC1						
	1997-2002	SATURN SC2						
	1997-2002	SATURN SL						
	1997-2002	SATURN SL1						
	1997-2002	SATURN SL2						

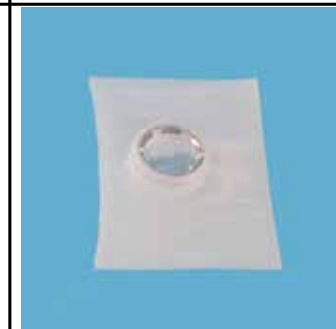







			
12-1-5	12-3-5	12-10-5	12-20-5
			
12-22-5	12-30-5	12-38-5	12-40-5
			
12-100-5	12-103-5	12-104-5	12-111-5
			
12-115-5	12-120-5	12-121-5	12-126-5
			
12-127-5	12-129-5	12-130-5	12-131-5

 12-139-5	 12-140-5	 12-141-5	 12-146-5
 12-147-5	 12-148-5	 12-150-5	 12-152-5
 12-158-5	 12-160-5	 12-162-5	 12-164-5
 12-165-5	 12-167-5	 12-168-5	 12-170-5
 12-173-5	 12-174-5	 12-175-5	 12-178-5

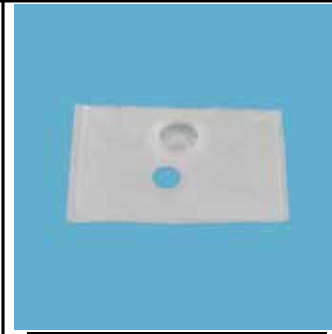
 12-180-5	 12-187-5	 12-191-5	 12-192-5
 12-193-5	 12-194-5	 12-195-5	 12-196-5
 12-197-5	 12-199-5	 12-202-5	 12-203-5
 12-205-5	 12-206-5	 12-207-5	 12-209-5
 12-210-5	 12-215-5	 12-216-5	 12-216-5



 <p>12-217-5</p>	 <p>12-220-5</p>	 <p>12-221-5</p>	 <p>12-226-5</p>
 <p>12-233-5</p>	 <p>12-240-5</p>	 <p>12-242-5</p>	



# UNIVERSAL FUEL PUMPS

***Trusted by professionals around the world***

**US Motor Works offers a complete line of Universal Fuel Pumps to fit all your custom fuel delivery needs.**

**Our Universal Fuel Pumps are compatible with a range of modern fuels, for carbureted and fuel injection applications**

- Multiple mounting configurations
- Low and High pressure
- 100% Tested in the USA

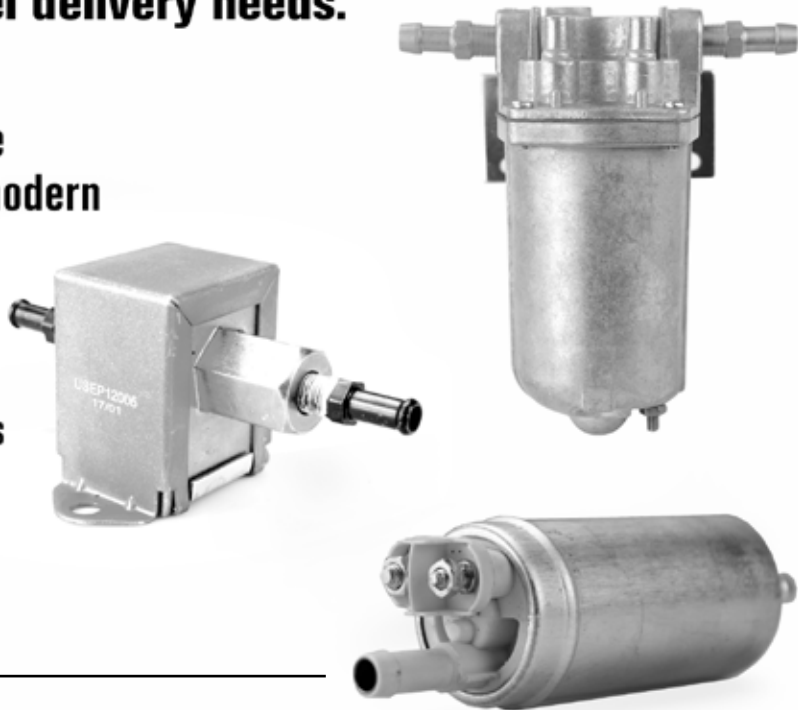

PART NO.	WIDE OPEN LPH	MAX OUTPUT PRESSURE	VOLTAGE	FUEL COMPATIBILITY	PUMP TYPE
USEP8011	110	5-8	6	DIESEL AND GASOLINE	SOLENOID
USEP8012S	110	5-9	12	DIESEL AND GASOLINE	SOLENOID
USEP8016S	110	2.5-4.5	12	DIESEL AND GASOLINE	SOLENOID
USEP8012SP	110	5-9	12	DIESEL AND GASOLINE	SOLENOID
USEP8016SP	110	2.5-4.5	12	DIESEL AND GASOLINE	SOLENOID
USEP12005	90	4-6	12	DIESEL AND GASOLINE	SOLENOID
USEP12043	110	2.5-4.5	12	DIESEL AND GASOLINE	SOLENOID
USEP12045	110	5-9	12	DIESEL AND GASOLINE	SOLENOID
USEP2182	155	90	12	GASOLINE WITH UP TO 15% ETHANOL	ROTARY-VANE
USEP12217	110	6-7	12	GASOLINE WITH UP TO 15% ETHANOL	ROTARY-VANE
USEP8012HPT	120	5-9	12	GASOLINE WITH UP TO 15% ETHANOL	ROTARY-VANE
USEP8016HPT	120	3-5	12	GASOLINE WITH UP TO 15% ETHANOL	ROTARY-VANE
USEP12065	80	3-5	12	DIESEL AND GASOLINE	ROTARY-VANE
USEP84070	150	4-5.75	12	DIESEL AND GASOLINE	ROTARY-VANE
USEP7153	150	15-18	12	DIESEL AND GASOLINE	ROTARY-VANE





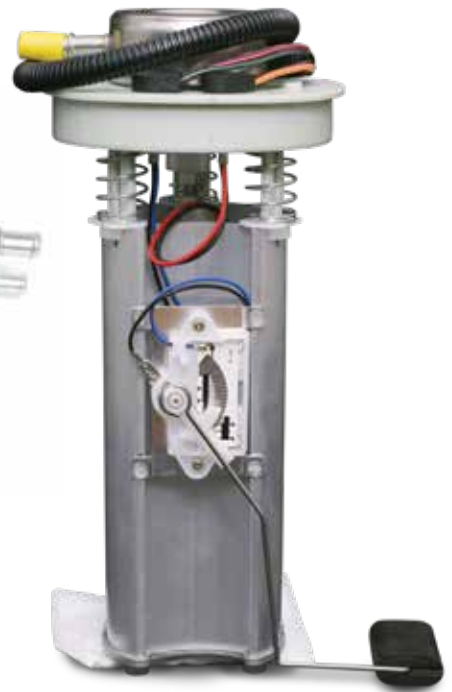

## Product Development

With our 6 simple steps in new product development process, US Motor Works sits in the driver's seat when it comes to quick and precise product development. From product definition to design, production planning and preparations, prototype production and final production run, it's a mere 120 days or less. US Motor Work's OPEX mentality enables us to be on the leading edge of product development.





**US Motor Works, LLC**  
140720 Shuman Drive  
Santa Fe Springs, CA 90703, USA  
Tel: 949-464-3434  
Fax: 949-464-8700  
info@usmotorworks.com  
www.usmotorworks.com

**MARKETING COMMUNICATION PRODUCTS BULLETIN - NEW AUTOMOTIVE COOLING PRODUCTS**

Date of Release: July 26, 2018      Availability: In Stock

 USM1024 12 - 17 Nissan 2.5L OEM # 8261 4224AC	 USM1104 10 - 17 Toyota 3.5L, 4.0L OEM # 14210-0P008	 USM1102A 02 - 10 Mitsubishi Sport Multi-engine OEM # 801 835 13 94
 USM1104 02 - 05 Mitsubishi Multi-engine OEM # 821 905 541 B	 USM273 03 - 15 Mitsubishi 3.0L, 3.5L, 3.6L OEM # 275 269 91 91	 USM801 02 - 17 Suzuki 3.2L OEM # 11 51 7 632 438
 USM708 08 - 11 GM 4.0L OEM # 11 51 7 549 365	 USM118 12 - 17 Nissan 2.5L OEM # 14210-0A2-041	 USM119 15 - 17 Hyundai 2.0L OEM # 19060-080-003
 USM119 14 - 17 General Motors 3.5L OEM # 12687678	 USM134 01 - 10 Volvo 3.0L, 3.2L OEM # 2129202-9	

Please visit [www.usmotorworks.com](http://www.usmotorworks.com) for detailed application or contact customer service for further information.



## E.I.T. Electronic Information Technology

US Motor Works utilizes proprietary Electronic Information Technology as a communication and information platform for new product releases, bulletins, technical updates and general client correspondence. USMW E.I.T. is internet based with 24/7 365 days a year access to keep our clients up to date in the most efficient and expedient format possible.

As part of our E.I.T. Platform we have also added the Pro Tech Center to the [www.usmotorworks.com](http://www.usmotorworks.com) website. The US Motor Works PRO Tech Center is designed to keep you up to date with the latest articles, product releases, tech tips and videos.



## A.E.T.S. Advanced Engineering & Technical Support

US Motor Works has created an engineering and technical environment from the design process to the final production product. Starting with CAD/CAM 3-D projections, computerized testing, a complete manufacturing plan and ending with a reliable distribution network. US Motor Works is able to track and control all related design, quality processes and packaging with specifications and manufacturing excellence in mind.



## Manufacturing

Our State-of-the-art manufacturing utilizes our four principles; Supply Chain (improved flow), Quality Management (robust quality assurance), Production (pull & flow and 5S) and Measurements by KPI's (Key performance indicators). With these manufacturing principles and our continuous improvement ideology under the OPEX umbrella, US Motor Works continues to be the front runner among the industry leaders.



## In-House Marketing & Graphic Design

Our In-house marketing and graphic design department helps to ensure our branding is at the forefront of the automotive industry. Working closely with category managers allows us to create powerful advertisement campaigns, marketing sales tools and educational pieces.

Along with the printed media, our team also works on a digital platform via brand specific websites and social media. Through social media we are able to connect with the end users and get genuine testimony of our products, thus making each brand recognizable and a name they can trust.





American Systems  
**REGISTRAR**

5281 Clyde Park Ave. SW, Suite 1  
Wyoming, MI 49509 USA  
www.asrworldwide.com  
616-942-6273



# CERTIFICATE OF REGISTRATION



American Systems Registrar, LLC, a provider of third-party system registration and accredited by the ANSI-ASQ National Accreditation Board attests that:

## ***US MOTOR WORKS, LLC***

**14722 ANSON AVENUE**

**SANTA FE SPRINGS, CA 90670**

**3901 MEDFORD AVENUE**

**LOS ANGELES, CA 90063**

with a scope of:

***MANUFACTURE OF AUTOMOTIVE COMPONENTS  
FOR OEM AND AFTERMARKET PRODUCTS***

has established a quality management system that is in conformance with the International Quality System Standard

### **ISO 9001:2015**

ASR Certificate Number: ..... 6569  
Date of Certification: ..... September 8, 2019  
Date of Certification Expiration:..... September 7, 2022  
Date of Initial Registration:..... October 18, 2010  
Revision:  
Re-Issue Date:

**President**

## **CERTIFICATE OF REGISTRATION**





Trusted by professionals around the world

US Motor Works, LLC and its employees are committed to providing an extensive line of consistent high quality products and the finest customer service and satisfaction.

95

- US Motor Works Established in Commerce, Ca.

97

- Scaled up Manufacturing of Water Pumps to 30,000/Month

99

- Moved to a 30,000 sq. ft. facility in Cerritos, Ca.
- Purchased Fan Clutch Division

05

- Entered Joint Venture with Chinese Casting Manufacturer

06

- 40% Annual growth
- Expanded Facility to 50,000 sq. ft.

07

- Production reached 1,000,000 Water Pumps per year
- Opened Engineering Facility in China

08

- Development & Distribution of Electric Fuel Pumps

09

- Moved to a 80,000 sq. ft. facility in Santa Fe Springs, Ca.

10

- Became ISO 9001:2008 Certified

11

- Timing Kits w/ Water Pumps added to the product line
- Approved Vendor by APA & Viper HD

12

- Launched HD product lines
- Approved Vendor by ADN Silver
- Expanded the facility to 100,000 sq. ft.

13

- Approved Vendor by Alliance & ADN Gold

14

- Expanded HD offering into Oil Pumps & Mechanical Transfer Pumps

15

- Celebrated 20th Anniversary
- First Automotive aftermarket company certified as ISO 9001:2015
- AASA top 100 Automotive Aftermarket suppliers

16

- Purchased Pacer Performance, est.1965
- Derale Performance, est.1975
- Introduced Max Cooling Kits
- USMW Professional Series undergoes re-branding
- Expanded Facility adding 50,000 sq. ft of Manufacturing & Warehouse

17

- Campaign launch for USMW HD
- Operating out of two facilities in CA (Los Angeles & Santa Fe Springs)
- More than 150,000 SQ FT of Manufacturing and Distribution

18

- Performance Division certified as ISO 9001:2015
- Introduction of mechanical fuel pumps to the line
- Auto Care Association recognizes Max Cooling Kit as an official part type (56846) water pump with fan clutch

19

- Opening of US Motor Works S. de R.L. de C.V. in Santa Caterina N.L. Mexico



US Motor Works, LLC  
14722 Anson Avenue  
Santa Fe Springs, Ca 90670 USA

Tel: (562) 404-0488  
Fax: (562) 404-8770  
email: info@usmotorworks.com



US Motor Works Performance Division  
3901 Medford St.  
Los Angeles, Ca 90063 USA

Tel: (323) 266-3850  
Fax: (323) 263-3948

www.usmotorworks.com

**US MOTOR WORKS, LLC**  
14722 Anson ave.  
Santa Fe Springs, Ca 90670  
Tel: (562) 404-0488  
Fax: (562) 404-8770  
[usmotorworks.com](http://usmotorworks.com)



***Trusted by professionals around the world***

