

CATV AMPLIFIERS

CATV HEAD ENDS

CATV ACCESORIES

DVB-T COFDM TV MODULATORS

ULTRA HIGH DEF TV MODULATORS

0161 818 7649

07563 148128 Preferred calling number

MPEG 2 ENCODERS MPEG 4 ENCODERS MPEG4 versions with 8,16 & 24 inputs +RF and IP out for streaming

F connectors for RG6 , CT100 Etc 2.9 pence each (100 pieces) page 72



F connectors for RG11 , CT167 Etc 25 pence each (100 pieces) page 72



Low cost high quality sat switches



CATV FIBRE OPTIC FIBRE OPTIC LNB'S FIBRE OPTIC IRS SYSTEMS

700MHz Low Pass Filter For UK 700MHz Clearance Page 34B Only £3.49



4 way VHF/UHF High quality splitter £2.29 Page 68



Sales

sue@txsystems.co.uk
suerea@btinternet.com

Technical support

m.rea@btinternet.com

www.txsystems.co.uk www.taylorbros.co.uk

Prices listed in catalogue exlude VAT

**We can help you with system design for Sat (inc Sky Q) and Terrestrial CATV
No Charge for technical support**

Amplifiers UHF/VHF	6-14
Active Channel Filter levelers for adjacent channels	37-40
Analogue TV Modulators	38-42
Attenuators F type and IEC (Belling)	72
Channel Converters	38-42 & 47-52
Channel Filter Levelers & Combiners for CATV	35-36
Digital TV Modulators , RF and IP out	38-57
F Connectors RG6 CT100, RG11 CT167	72
F Connector adapter for quick push on use	72
F Connector Coupler	72
Fibre Optic CATV, Cable and Satellite	15-34
Grounding Blocks	72
LNB Quatro	61
MPEG 2 & 4 Encoders	38-57
Satellite dish 60 cm alloy	61
Satellite Distribution Amplifiers	62-66
Satellite IF processors	59&60
Satellite Switches	63-67
Satellite TV Receiver RF and IP out	38-57
Splitters & Taps	68-70
Stereo Radio Modulators	38-39 & 56
Technical Info	74-75

Prices and specifications are subject to change without notice. Our catalogue is updated on a regular basis.
Please check our website for updates .

Shipping, unless stated otherwise
on most items £4.50.
Next day shipping available for in
stock items by UPS at small extra cost.

Prices listed in catalogue exclude VAT

TX Systems Manchester Ltd
0161 818 7649
www.txsystems.co.uk

Old web site address
www.taylorbros.co.uk

Sales
sue@txsystems.co.uk

Technical Support
m.rea@btinternet.com

Amplifiers UHF,DAB and Band 2 Inputs

- For indoor mounting
- Metal housing with plastic side brackets
- High input selection
- F-Connectors

**Ideal for Separate
Inputs FM,DAB,UHF**



£46.00

**22dB Gain
108dBuV output***

Shipping
£3.90 Prices Ex VAT

Type		TSC2248
Inputs		3
Frequency range	MHz	87 - 108 174 - 230 470 - 862
Gain	dB	22
Output level		
60 dB IMA3	dBuV	108
60 dB IMA2	dBuV	105
Noise figure	dB	65
Operating voltage	V AC	230
Power consumption	VA	45
Connectors		F female
Dimensions	mm	192 x 125 x 50
Weight	kg	0.15

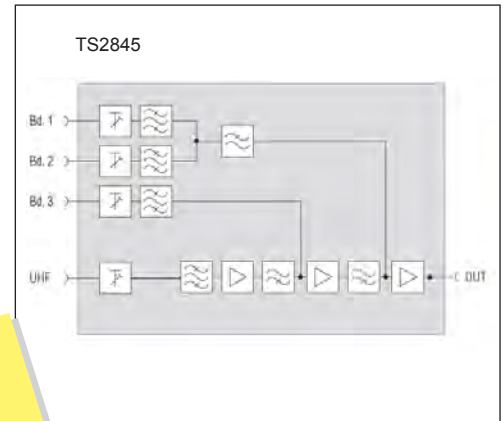

Performance Enhanced for Digital

Discontinued ,see alternatives page 6 and 8

Type	TS2845					TS4560				
Frequency MHz	VHF 1 47-68	FM 87.5-108	VHF 2 174-230	UHF 470-862		VHF 1 47-68	FM 87.5-108	VHF 2 174-230	UHF 470-862	UHF 470-862
Gain dB	21	21	28	28		35	35	35	45	45
Attenuator dB	-20	-20	-20	-20		-20	-20	-20	-20	-20
Output Level 60dB IMA	113dBuV					120dBuV				
Noise dB	≤ 6	≤ 6	≤ 6			≤ 6	≤ 6	≤ 6	≤ 7	≤ 10
Dimensions W xHxD	242x103x60mm					242x103x60mm				
Voltage	230V 6W					230V 9W				
Price	£89.19					£122.94				

Line amplifiers with return path options for distributing cable tv.



TOUGH RELIABLE AMPLIFIERS



Type	Frequency	Gain	Att dB	Reverse Channel	Reverse Channel Gain	Max Output 60dB 1MA 3 DIN 45004B	Noise	Power AC	Price
TSC2054/65	85-862MHz	0-20dB	0-20	5-65MHz	16dB	115dBuV	≤5dB	230V 4.5W	£49.32
TSC3054/65	85-862MHz	10-30dB	0-20	5-65MHz	25dB	115dBuV	≤5dB	230V 4.5W	£49.32



Type	VS 80A				
Frequency MHz	VHF 1 47-68	FM 87-108	VHF 2 174-230	UHF 470-862	UHF 470-862
Gain dB	35	35	35	42	42
Attenuator dB	-18	-18	-18	-18	-18
Output Level EN 50083-5	119dBuV				
Noise dB	≤ 7	≤ 7	≤ 7	≤ 7	≤ 7
Dimensions W xHxD	165x105x45mm				
Voltage	230V 4W				
Test output	-20dB				
Price	£108.28				



Type	TVX 81	TVX 82	TVX 86	TVX 87
Frequency MHz	87-862	87-862	47-862	47-862
Gain dB	18-21	28-31	18-31	28-31
Number of outputs	1	1	1	1
Attenuator dB	-18	-18	-18	-18
Output Level EN 50083-5-3	114dBuV	114dBuV	114dBuV	114dBuV
Output Level 42 ch CENELEC	96dBuV	96dBuV	96dBuV	96dBuV
Output Level 42 ch CENELEC 6dB slope	98.5dBuV	98.5dBuV	98.5dBuV	98.5dBuV
Return path				
Gain dB Active passive via jumper	20dB /-2dB	20dB /-2dB	-2dB	-2dB
Adjustable attenuator dB	-18	-18	-	-
Output Level EN 50083-5-3	112dBuV	112dBuV	-	-
Passive return path MHz	4-65	4-65	4-30	4-30
Active return path MHz	4-65	4-65	-	-
Operating Temperature	-20 deg C + 55 deg C *			
Dimensions W xHxD	163x90x47mm			
Voltage	230V 3.5W			
Price	£36.65	Discontinued	£36.65	£45.70

* MTBF failures worsen running at high temperature. All electronic equipment benefit from operating in moderate temperatures

High Output ,Head End or Line Amplifiers, with active and passive return path options, very flat frequency response.

40-20 dB of gain ,adjustable.

High output capability 127dBuV**

Large channel capacity**

Ideal for distribution from a cable TV feed

20dB Variable gain control, 20dB variable slope control

Broadband ADSL Cable modems can be used on the network via optinal return path.

**DIN 45004B



Return path now function included

Technical data		
Type	TSC4065	TSC4065LP
Frequency range	85...1006 MHz	
Gain	switchable 30/40 dB	
Attenuator adjustable via switches 2,4,6,12dB	0...16 dB	
Equalizer	0...16 dB / Interstage 0 or 6 dB	
Noise figure	≤ 6,5 dB	
Test points	-20 dB	
Output level max IMA3 60 dB	127 dBμV	
Return path freq.	5...65 MHz	
Gain return path	30 dB	
Return path Attenuator	0...16 dB	
Return path Equalizer	0...12 dB	
Operating voltage	180...255 V~	26...70 V~
Power consumption	13,5 W	13,5 W
Dimensions	242 x 105 x 60 mm	

TSC4065 £166.56

TSC4065LP £259.67

Digital multiplexes need four times the power compared to analogue TV, but will work at least 20 dB lower, Consequently this amplifier will provide 9dB extra for a typical system distributing 8 DVB-T multiplexes all at the same level. Allowance has to be made as with old analogue TV channels for different levels that may be received from the antenna.

Design the system for 40dBuV at the outlet, this provides enough for very old TV sets with high tuner noise levels

More modern TV sets will work on at least 10db less than this.

Some local stations use 16QAM or QPSK modulation so again a much lower RF level at the point will work.

Derating for number of channels
DIN45004B

Number of distributed channels, allow additional margin for digital muxes

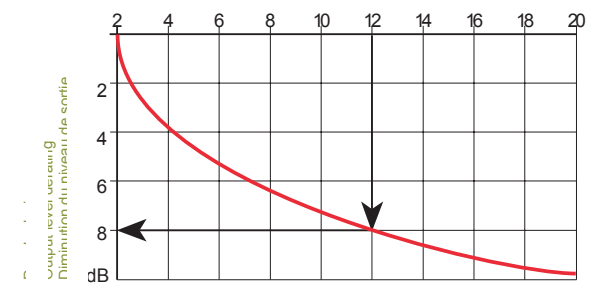

Derating for cascading of amplifiers

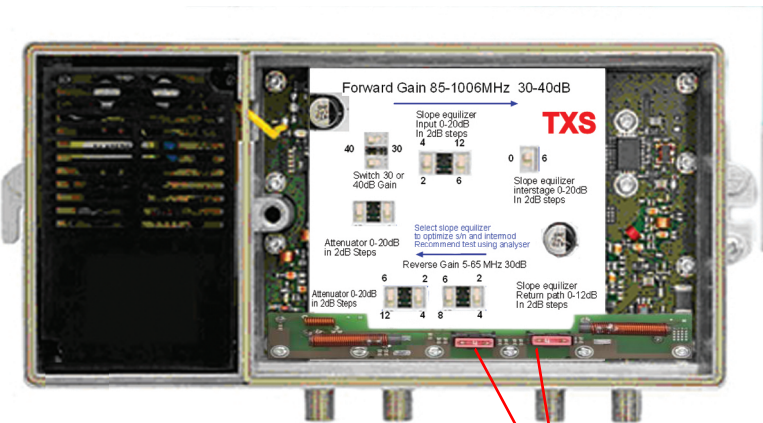
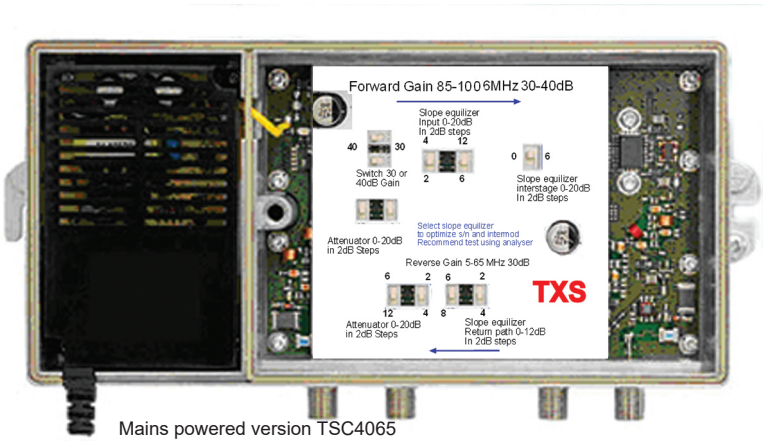
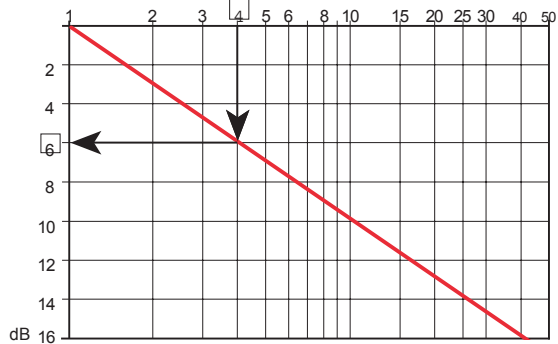

Links to route line power via input or output or through

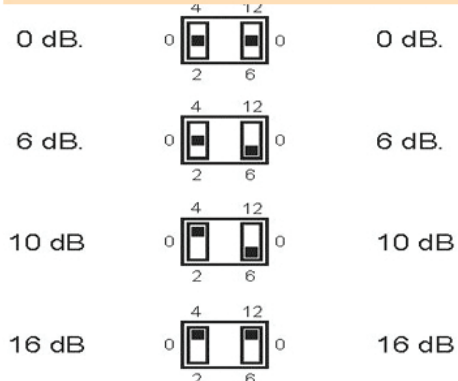
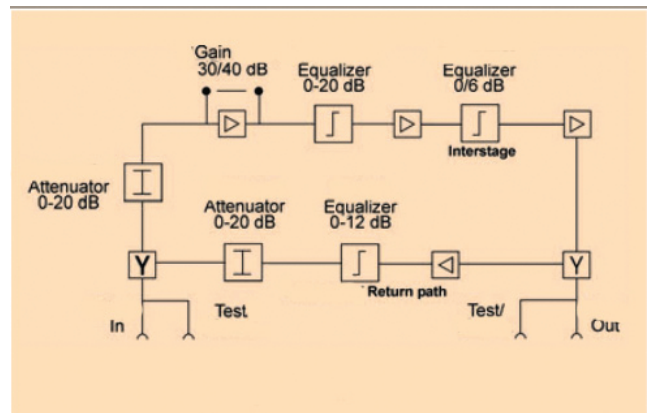

Attenuation and slope control for forward and return path via switch control.

This now makes it simpler to set when calculating coax cable losses

TXS

TSC4065 A High Output CATV amp



TSC4065 A £161.00 Ex Vat

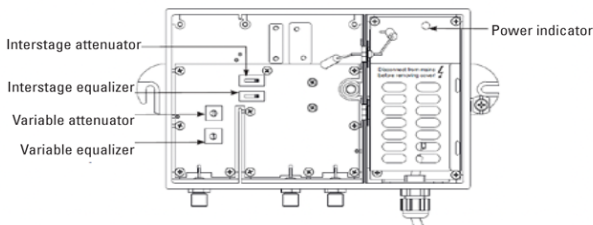

Block diagram



Frequency range	47 ... 862 MHz
Flatness	± 0.5 dB
Gain	41 dB
Gain adjustment	0 ... 18 dB
Slope adjustment, typical	0 ... 18 dB
Interstage attenuator	0/3/6/9 dB
Inverse equalizer	0/3/6/9 dB
Output level IMA3 60 dB	126dBuV
Input and output return loss	$=18$ dB @40 MHz - 1.5 dB/octave
Noise figure	<5 dB uV
Test point	-30 dB
Supply voltage limit values	198...250 VAC, 50/60 Hz
Power consumption	13 W
Operating temperature range	-20...+50 °C

Dimensions

180 x 132 x 76 mm (main body)
213 x 132 x 76 mm (with fixing ears)

Weight (packed) 1.4 kg

High Power Repeater Amplifiers For Networks with Return Path

Return-path modules

Active: VMR 24
Passive: VMR 0

Variable attenuator

Equalizer modules

Fixed equalizer: VM ...
Variable equalizer: VM ... R ...

Return-path filter

for 30 / 55 / 65 MHz
VMF ...

Interstage modules

Variable attenuator: VMD ...
Fixed equalizer: VM ...
Variable equalizer: VM ... R ...

Return-path equalizer

Fixed equalizer: VMR ...
Variable equalizer: VMR ... R ...

Return-path filter

for 30 / 55 / 65 MHz
VMF ...

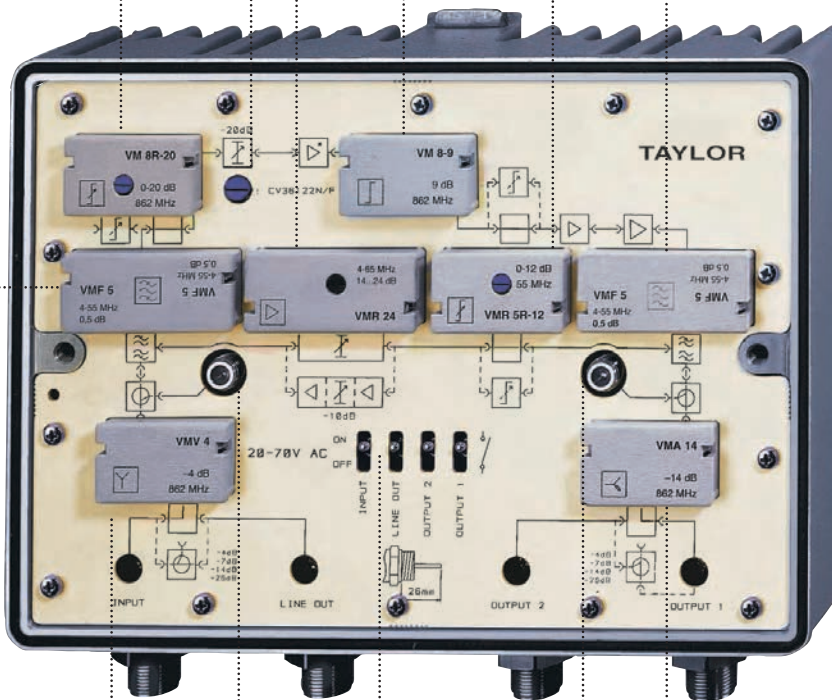

Select F or IEC Connector

F

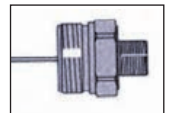

TF1 £7.64

IEC



TIEC 1 £8.11

Modules for line-out port

Splitter: VMV 4
Tap: VMA ...

Input test socket

Remote power

4 switches or plug in fuses to determine the power passing ports

Output modules 1 / 2

Splitter: VMV 4
Tap: VMA ...
Test port: VMM 20

Output test socket

Up to **128dBuV (68dBmV)**
Din4500B

Currently CATV networks are being extended to "Full Service Networks" (FSN), apart from distributing TV and radio programmes, these networks carry interactive services like fast Internet access, cable telephony, and other bi-directional applications. Therefore the return-path is becoming more and more important to transmit subscriber messages back to the headend of the network. Passive return paths have the advantage of being bi-directional and reliable

Return-path of your choice

Depending on the requirements of the cable operator, the upper return-path frequency may be chosen between 30, 55 and 65 MHz. Optional passive or active modules may be inserted. A separate slot is provided for the return-path equalizer.

Customize to suit

With only a few different modules a wide range of configurations can be covered by using the optional modules, without need for a large stock. Each amplifier is supplied with one variable attenuator module and through links apart from the return path filter.

Housings meet highest demands

The new aluminum die-cast housings meet protection class IP66 requirements. This means that the amplifier is dust-proof and water-protected which yields constant electrical features and long product life.

To change the configuration of the amplifier it can be opened by loosening 2 screws and unclasp the lid by 180 degrees where it will lock in position until all changes are done.

The depth from wall to lid was limited to 90 mm to make the amplifier fit into common installation boxes.

Easy installation

The amplifier is held by a mounting bracket. Upon fixing the bracket firmly to its support by means of two screws, the amplifier may be slid on the bracket and arrested with only one screw.

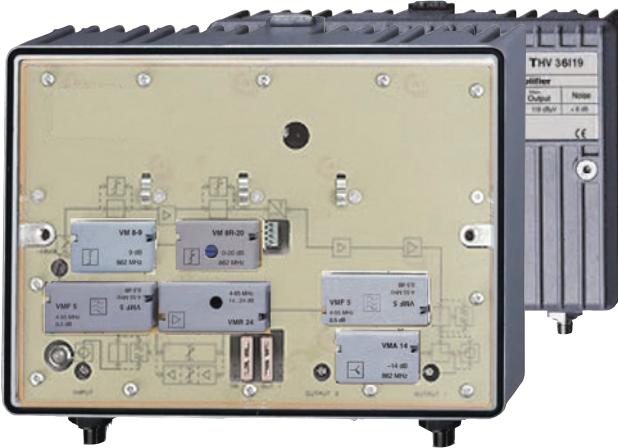

Massive Power

High Power Repeater Amplifiers
Up to **128dBuV (68dBmV)**
DIN4500B
4-862MHz

Type	Frequency	Gain dB	Reverse Channel	Variable Attenuator dB	Noise	Max output **			Power AC	Price
						60dB 1MA 3 DIN4500B	60dB 1MA 2 DIN4500A1	Return Loss		
THV40126	47-73-86 -862MHz *	32/40	4-30-55-65MHz*	20 Forward Path	≤7.0dB	126-128dBuV	118-119dBuV	20dB to 40MHz	180-255V 14W	£312.68
THV40126LP	47-73-86 -862MHz *	32/40	4-30-55-65MHz*	20 Forward Path	≤7.0dB	126-128dBuV	118-119dBuV	20dB to 40MHz	24-70V 14W	£312.68

Frequency Response Flatness ± .75dB Power Through 2.5A Hum Modulation ≥ 65dB

*Depending on which return path filter (VMF) is used

**Output levels quoted are at 862MHz & 600MHz

Connectors F

Specifications subject to change

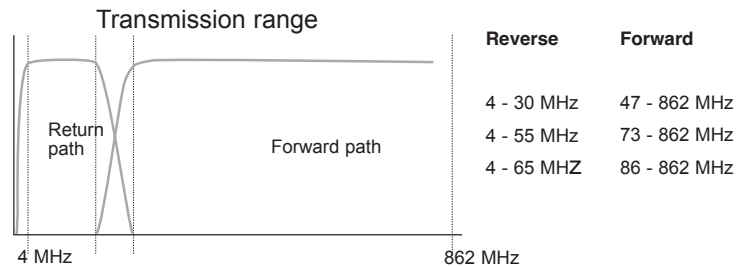
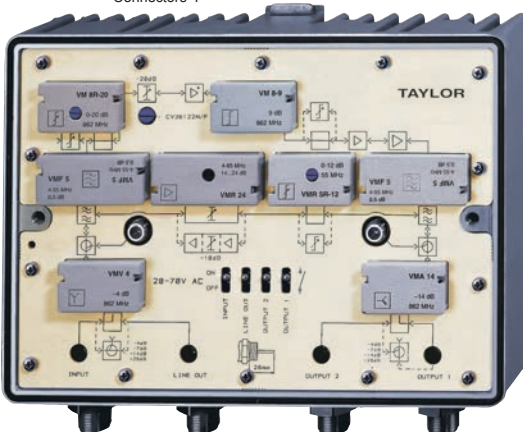

Because of the frequency response flatness and line power through current handling, use these amplifiers for long trunk lines. The gain of the amplifiers can be selected 20-40dB.

Type	Frequency	Gain dB	Reverse Channel	Variable Attenuator dB	Noise	Max output **			Power AC	Price
						60dB 1MA 3 DIN4500B	60dB 1MA 2 DIN4500A1	Return Loss		
TCV40126	47-73-86 -862MHz *	41	4-30-55-65MHz*	20 Forward Path	≤6.5dB	126-128dBuV	118-119dBuV	20dB to 40MHz	180-255V 14W	£368.80
TCV40126LP	47-73-86 -862MHz *	28/36	4-30-55-65MHz*	20 Forward Path	≤6.5dB	126-128dBuV	118-119dBuV	20dB to 40MHz	24-70V 14W	£368.80

Frequency Response Flatness ± .5dB Power Through 2.5A Hum Modulation ≥ 65dB

*Depending on which return path filter (VMF) is used

**Output levels quoted are at 862MHz & 600MHz

Connectors PG11 see connector page for PG11 Adaptors

Plug in modules

Type	Frequency Range	Insertion Loss	Price
Return Path Filter			
VMF3	4-30MHz	.5dB	£14.38
VMF6	4-65MHz	.5dB	£14.38



Type	Frequency Range	Gain	Price
Return Path Filter with Level Adjustment, Passive and Active			
VMR0	4-30MHz	-10/0dB	£10.78
VMR24	4-55MHz	14-24dB	£17.96



Type	Frequency Range	Equalization	Insertion Loss	Price
Variable Equalizers Return Path				
VMR 3R12	4-30MHz	0-10dB	1dB	£11.21
VMR 6R12	4-65MHz	0-10dB	1dB	£11.21



Type	Frequency Range	Equalization	Insertion Loss	Price
Variable Equalizers Forward Path				
VM 4 R-10	47-450MHz	0-10dB	1dB	£10.78
VM 4 R-20	47-450MHz	0-20dB	1dB	£10.78
VM 6 R-10	47-606MHz	0-10dB	1dB	£10.78
VM 6 R-20	47-606MHz	0-20dB	1dB	£10.78
VM 8R-10	47-862MHz	0-10dB	1dB	£10.78
VM 8R-20	47-862MHz	0-20dB	1dB	£10.78
VMD 20	4-862MHz	0-20dB	1dB	£8.44



Type	Port 1	Port 2	Price
Output Splitter Modules 4-862MHz			
VMM20	0.5dB	20dB	£8.87
VMA7	2dB	7dB	£10.46
VMA14	1dB	14dB	£10.46
VMV4	4dB	4dB	£10.46

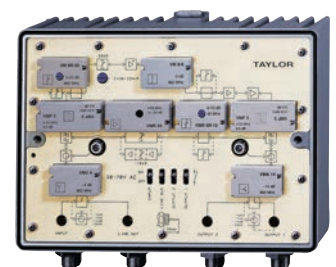
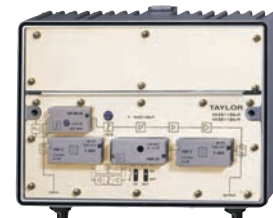
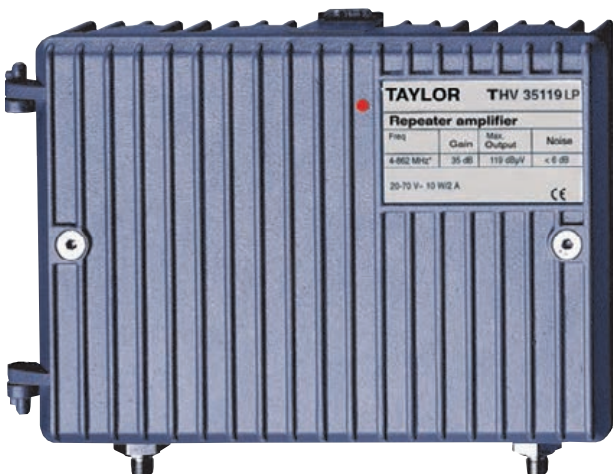

Super Broadband Amplifiers

Discontinued

4-2400MHz INCLUDING RETURN PATH

- For amplification of CATV and SAT-IF signals
- For line and distribution networks up to 2400 MHz
- Configuration on site for forward path as well as return path with plug-in modules
- Return path with frequency edge of 30, 55 or 65 MHz, available as active or passive versions
- Minimal noise figure through equalization and attenuation after pre-amplifier stage
- Test ports for input and output signals
- LED operating indication
- Aluminum die-cast housing with excellent heat dissipation (IP 66)
- PG11 for different connector standards

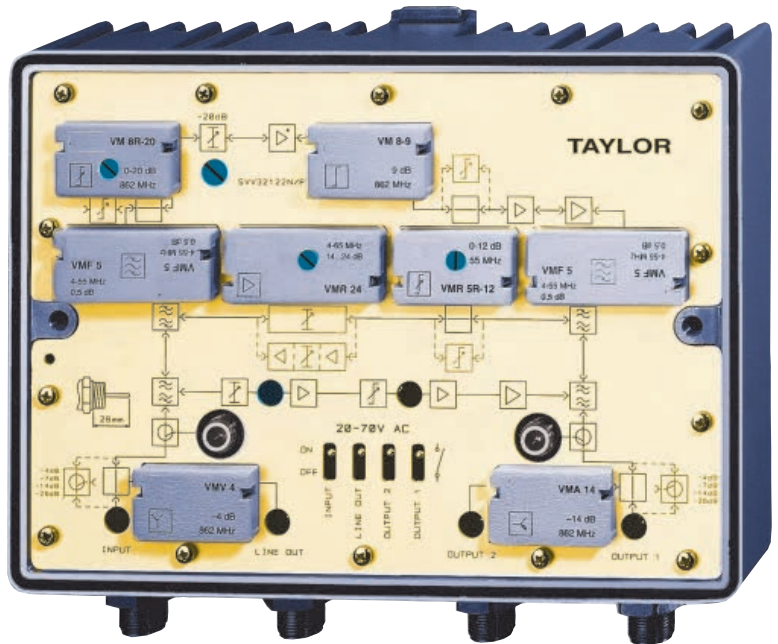

Select F or IEC Connector

F

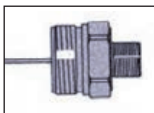

TF1 £7.35

IEC



TIEC 1 £ 10.03

TSVV 36122...

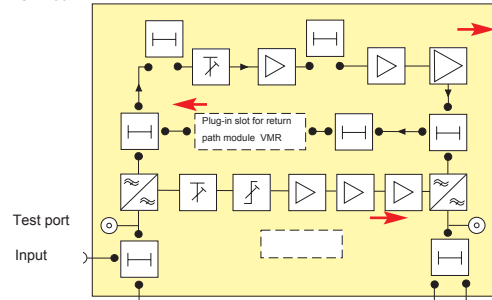

VMR-24

VMR 0

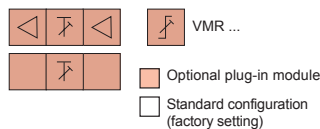

- VM .. Fixed equalizer
- VM ..R .. Variable equalizer
- VMD Variable attenuator
- VM... Fixed Equalizer
- VMA... Tap
- VMV 4 Splitter
- VMF ... Return path filter
- VMM 20 Test port

Type	Frequency	Gain Return Path	Gain 47-860MHz	Gain 950-2400MHz	Reverse Channel	Noise Return path with active module	Noise 47-860MHz	Noise 950-2400MHz	Max output 60dB 1MR3 (DIN 45004B)	Max output 60dB 1MR 2 (DIN 4500A1)	Max output 35dB 1MR 3 /2150MHz	Power AC	Price	5+
TSVV 34122	47-73-862MHz * 950-2400MHz	Choose Module	36dB	37dB	4-30MHz	≤6.5dB	≤7dB	≤9dB	123dBuV	115dBuV	120dBuV	180-255V 16W	£464.06	£433.12
TSVV 34122 LP 4A Through	47-73-862MHz * 950-2400MHz	Choose Module	36dB	40dB	4-65MHz	≤6.5dB	≤7dB	≤9dB	123dBuV	115dBuV	120dBuV	24-70V 16W	£470.50	£439.04

Frequency response 47-862 ± 0.5dB 950-2400MHz ± 1.5dB

* Depending which return path module is used

Amplifier comes with 4x PG11 threads ,please choose F or IEC connector if PG11 connectors are not to be used

Systems for Large Buildings or Large Cities, easily distribute more than 1000 TV Channels ,down a single fibre, then local distribution via a single coax . (Simplex mode)

Basic Unit LX 50 0230 Rack housing for 14 modules

Operating voltage AC 230 V (50/60 Hz)

Full web interface with GUI and SNMP. **£1,443.27**

Basic Unit LX 50 048 Rack housing for 14 modules

Operating voltage DC 48 V DC

Full web interface with GUI and SNMP. **£1,509.70**

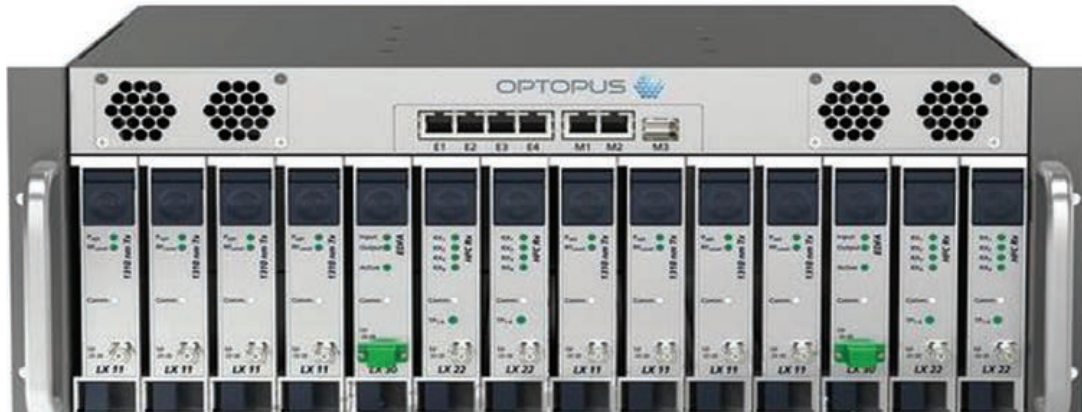

Modules shown fitted into rack ,are not included in price.

Basic Unit LX 52 Rack housing for 2 modules £400.90 (psu required see below)



Modules shown fitted into rack ,are not included in price.

Technical data

Switch/Controller

Protocolls

IPv4, SNMPv1/v2c, DHCP, HTTP

Connections

Module slots

14 pcs.

RJ45

4 pcs. (Ethernet 10/100 Base-T)

SFP socket

1 pcs. (Ethernet 1000 Base-X)

For redundant power supply use two PSU's

LXPS 0230 230V PSU 180...265 V AC £286.36

LXPS power supply , choose voltage type to suite

LXPS 0048 48V PSU 45-75 V DC £400.90



General data

Power input

≤25 W

Dimensions (width x height x depth)

48x178x330 mm (4 HE, 19"-rack)

Environmental parameters

-5...+45 °C (ETSI EN 300 019 -1-3 Class 3.2)

LX 11 S 100 range O-Band Transmitter

Output power, 10 dBm (10 mW)
Wavelengths
1,1330.46 - 1,1325.78 nm ($\pm 0,05$ nm)
Fibre Connections SC/APC
 Optical HFC transmitter for use in LX 50
 Adjustable OMI
 Automatic level control (ALC)
 Electronic predistortion
 Fullband transmitter 10...1006 MHz
 SBS suppression
 O-Band wavelength
 Direct modulated fullband transmitter with
 one O-Band wavelength for use in
 HFC network cluster splitting applications



LX 11 S 1001 Wavelength 1,1330.46 nm ($\pm 0,05$ nm)

£1,706.73

LX 11 S 1002 Wavelength 1,1327.25 nm ($\pm 0,05$ nm)

£1,706.73

LX 11 S 1003 Wavelength 1,1329.22 nm ($\pm 0,05$ nm)

£1,706.73

LX 11 S 1004 Wavelength 1,1325.78 nm ($\pm 0,05$ nm)

£1,706.73

O-Band Transmitter

Technical data

Downstream	
Laser type	Temperature stabilized DFB laser
Optical output power	10 dBm (10 mW)
Frequency range	10...1006 MHz
Optical return loss	>40 dB
Input level broadcast	78 dB μ V (PAL-Level)
Input level Narrowcast	84 dB μ V (QAM-Level, 4 dB back off)
Narrowcast gain/level adjustment	± 2 dB (adjustable)
Inputs AGC	± 5 dB
Decoupling NC BC	≥ 50 dB
Electrical reflection loss	≥ 20 dB (-1 dB /oct., min. 17 dB)
Ripple	$\leq \pm 0,5$ dB
Relative Intensity Noise 1	< -155 dB \sqrt /Hz
CSO	≥ 63 dBc (42 channels CENELEC)
CTB	≥ 65 dBc (42 channels CENELEC)
Input measurement socket	-20 dB (BC-Input level)
Connections	
F-socket	1 pcs.
General data	
Power input	≤ 7 W
Dimensions (width x height x depth)	30x133x320 mm
environmental parameters	-5...+45 °C (ETSI EN 300 019-1-3 Class 3.2)

LX 12 S Range

Output powers 2 x ,3-6 dBm
Wavelength 1310 nm (±10 nm)
Fibre Connections SC/APC

Dual optical HFC transmitter for use in LX 50
 Adjustable OMI
 Automatic level control (ALC)
 Fullband transmitter 10...1006 MHz
 Adjustable Narrowcast-Input

Dual direct modulated fullband transmitter
 with 2x 1310 nm for use in HFC networks



LX 12 S 0300	Optical output power, 3 dBm (2 mW)	£1,174.10
LX 12 S 0600	Optical output power, 6 dBm (4 mW)	£1,757.13

2x 1310 nm transmitter

Technical data

Downstream	
Laser type	Uncooled isolated DFB laser
Wavelength transmitter 1	1310 nm (±10 nm)
Frequency range	10...1006 MHz
Optical return loss	>40 dB
Input level broadcast	78 dBµV (PAL-Level)
Input level Narrowcast	84 dBµV (QAM-Level, 4 dB back off)
Narrowcast gain/level adjustment	±2 dB (adjustable)
Inputs AGC	±5 dB
Decoupling NC BC	≥50 dB
Electrical reflection loss	≥20 dB (-1 dB /oct., min. 17 dB)
Ripple	≤ ±0,75 dB
Relative Intensity Noise 1	< -150 dB√Hz
CSO	≥60 dBc (42 channels CENELEC)
CTB	≥65 dBc (42 channels CENELEC)
Input measurement socket	-20 dB (BC-Input level)
Connections	
F-socket	1 pcs.
General data	
Power input	≤12 W
Dimensions (width x height x depth)	30x133x320 mm
environmental parameters	-5...+45 °C (ETSI EN 300 019-1-3 Class 3.2)

LX 13 S Range CWDM Up Stream Transmitter

Output Powers

2 x 3-5dBm

Wavelength 1511/1531 nm & 1471/1491 nm

Fibre Connections SC/APC

CWDM Up Stream Transmitter
 High Density Dual CWDM-Transmitter
 Two CWDM transmitter in one module
 Highest performance with dual-stage isolator
 Adjustable OMI
 Dual CWDM upstream transmitter with two adjacent CWDM wavelengths for use in return path applications in HFC networks.



LX 13 S 0512	Optical output power, 5 dBm (3,16 mW)
Wavelength 1471/1491 nm	£1,626.55
LX 13 S 0534	Optical output power, 2x 5 dBm (3,16 mW)
Wavelength 1511/1531 nm	£1,626.55
LX 13 S 0556	Optical output power, 2x 5 dBm (3,16 mW)
Wavelength 1551/1571 nm	£1,626.55
LX 13 S 0578	Optical output power, 2x 5 dBm (3,16 mW)
Wavelength 1591/1611 nm	

CWDM Up Stream Transmitter

Technical data

Downstream	
Laser type	Uncooled isolated DFB laser
Wavelength transmitter 1	1511/1531 nm
Frequency range	5...500 MHz
Optical return loss	>40 dB
Input level broadcast	78 dBµV (Low-Level-Input)
Input level Narrowcast	88 dBµV (High-Level-Input)
Narrowcast gain/level adjustment	±2 dB (adjustable)
Inputs AGC	±5 dB
Decoupling NC BC	≥50 dB
Electrical reflection loss	≥20 dB
Ripple	≤ ±0,75 dB
Relative Intensity Noise 1	< -145 dB√Hz
Input measurement socket	-20/-30 dB (Low-Level-/High-Level-Input)
OMI setting range	3...10 %
Dynamic range by 40 dB NPR	≥10 dB
Connections	
F-socket	1 pcs.
General data	
Power input	≤10,5 W
Dimensions (width x height x depth)	30x133x320 mm
Environmental parameters	-5...+45 °C (ETSI EN 300 019-1-3 Class 3.2)

LX 15 S Range
Output Powers
1 x 10 dBm (10 mW)
Wavelength 1555 nm (± 10 nm)
SBS suppression, 16 dBm & 21dBm
Fibre Connections SC/APC

Optical transmitter for use in Chassis LX50

Adjustable OMI

Automatic level control (ALC)

Electronic predistortion

SBS suppression

Dispersion compensation

The LX 15 is part of the Optopus

product portfolio. LX 15 is a direct modulated

fullband transmitter with 1555 nm for use in

RF Overlay and RFoG networks.

LX 15 S 1000

SBS suppression, 16 dBm

£2,755.96
LX 15 S 1001

SBS suppression, 21dBm

£2,755.96
1550 nm BC-transmitter
Technical data

Downstream

Laser type

Temperature stabilized DFB laser

Wavelength transmitter 1

 1555 nm (± 10 nm)

Optical output power

10 dBm (10 mW)

Frequency range

10...1006 MHz

Optical return loss

>40 dB

Input level broadcast

 78 dB μ V (PAL-Level)

Input level Narrowcast

 84 dB μ V (QAM-Level, 4 dB back off)

Narrowcast gain/level adjustment

 ± 2 dB (adjustable)

Inputs AGC

 ± 5 dB

Decoupling NC BC

 ≥ 50 dB

Electrical reflection loss

 ≥ 20 dB (-1 dB /oct., min. 17 dB)

Ripple

 $\leq \pm 0,5$ dB

Relative Intensity Noise 1

 < -155 dB \sqrt Hz

CSO

 ≥ 60 dBc (42 channels CENELEC)

CTB

 ≥ 65 dBc (42 channels CENELEC)

transmission length

25 km

Input measurement socket

-20 dB (BC-Input level)

Connections

F-socket

1 pcs.

General data

Power input

 ≤ 7 W

Dimensions (width x height x depth)

30x133x320 mm

Environmental parameters

-5...+45 °C (ETSI EN 300 019-1-3 Class 3.2)

LX 17 S Range

Output Power
1 x10 dBm (10 mW)
DWDM Transmitter, ITU-channels
Fibre Connections SC/APC

Optical transmitter for use in Chassis LX50
 Adjustable OMI/Auto OMI
 Electronic predistortion
 SBS suppression
 Dispersion compensation
 LX 17 is a DWDM transmitter with an ITU-specific wavelength for use in HFC broadcast/narrowcast applications.



LX 17 S 1030	Wavelength transmitter 1553.33 nm (ITU-Kanal: 30)	£1,969.04
LX 17 S 1031	Wavelength transmitter 1552.52 nm (ITU-Kanal: 31)	£1,969.04
LX 17 S 1032	Wavelength transmitter 1551.72 nm (ITU-Kanal: 32)	£1,969.04
LX 17 S 1033	Wavelength transmitter 1550.92 nm (ITU-Kanal: 33)	£1,969.04
LX 17 S 1034	Wavelength transmitter 1550.12 nm (ITU-Kanal: 34)	£1,969.04
LX 17 S 1035	Wavelength transmitter 1549.32 nm (ITU-Kanal: 35)	£1,969.04
LX 17 S 1036	Wavelength transmitter 1548.32 nm (ITU-Kanal: 36)	£1,969.04
LX 17 S 1037	Wavelength transmitter 1547.72 nm (ITU-Kanal: 37)	£1,969.04
DWDM Transmitter, ITU-channels		£1,969.04

DWDM Transmitter, ITU-channels

Technical data	
Downstream	
Laser type	Temperature stabilized DFB laser
Optical output power	10 dBm (10 mW)
Frequency range	10...1006 MHz
Optical return loss	>40 dB
Input level broadcast	78 dBµV (PAL-Level)
Input level Narrowcast	84 dBµV (QAM-Level, 4 dB back off)
Decoupling NC BC	≥50 dB
Electrical reflection loss	≥20 dB (-1 dB /oct., min. 17 dB)
Relative Intensity Noise 1	< -155 dB√Hz
Input measurement socket	-20/-30 dB (Low-Level-/High-Level-Input)
OMI setting range	4...12 %
Dynamic range by 40 dB NPR	≥10 dB
MER	≥44 dB
BER	≤10 ⁻⁹
Connections	
F-socket	1 pcs.
General data	
Power input	≤7 W
Dimensions (width x height x depth)	30x133x320 mm
Environmental parameters	-5...+45 °C (ETSI EN 300 019-1-3 Class 3.2)

LX 30 Range

Optical amplifier ,1530 -1565 nm, can be used as a repeater and split and amplify. to extend system reach to very large systems

Fibre Connections SC/APC

- Amplification of optical signals in the C-band
- Optical amplifier for use in Chassis LX 50
- Up to four output ports with adjustable output power
- Optical test port for the output signal
- Wide input power range enables application as booster or inline-amplifier
- Low electrical power consumption



LX 30 S 1401	Optical output power, 1 x 14 dBm	£2,703.27
LX 30 S 1402	Optical output power, 2 x 14 dBm	£2,988.49
LX 30 S 1701	Optical output power, 1 x 17 dBm	£2,749.09
LX 30 S 1702	Optical output power, 2 x 17 dBm	£3642.55
LX 30 S 1704	Optical output power, 4 x 17 dBm	£5,383.64
LX 30 S 2101	Optical output power, 1 x 21 dBm	£3,545.18
LX 30 S 2102	Optical output power, 2 x 21 dBm	£4,999.90

Technical data

Amplifier inputs	1 pcs.
Optical input power	-2...+10 dBm
Output level tolerance	polarization, wavelength range and
Output level variation	±0,5 dB
Wave length	1530...1565 nm
Setting range amplifier	5 dB (0,1 dB-steps)
Noise figure	output power and signal wave length 1550
Return loss	≥45 dB (input - output)
Decoupling	≥40 dB (output - input)
Optical test point output	-2.5 dB (in relation to EDFA-output power)
Connections	
SC/APC socket	1 pcs.
General data	
Power input	typ. 5 W, max. 10 W
Dimensions (width x height x depth)	30x133x320 mm
environmental parameters	-5...+45 °C (ETSI EN 300 019-1-3 Class 3).

**Downstream
47-862 MHz**



**High RF
Output**

OK 41A Programming Unit



£51.55

LR 26A

Downstream	
Wavelength	1290nm - 1600nm
Optical return loss	> 40 dB
Fiber	Single Mode
Optical connector	SC/APC
Output impedance	75 ohm
Output return loss	≥ 18 dB (-1,5 dB /
Transmission bandwidth	47 - 862 MHz

Optical input level for controlled electrical output level	-7...+0 dBm
Controlled output level (ALC=on, OMI=5%)	115 dBuV
Distorsion products for (42 ch, CENELEC, flat)	109 dBuV
CTB,CSO	> 60 dB
Output level 42 ch, CENELEC, 9 dB slope. Flat input 0dBm	115 dBuV
Output level 42 ch, CENELEC, 0 dB slope. Flat input 0dBm	111 dBuV
CTB,CSO	> 60 dB
Attenuator adjustable	0-15 dB
Steps	0.5 dB
Equalizer adjustable	0-15 dB
Steps	0.5 dB
Sensitivity	< 5.5 pA/√Hz
RF test point at output	- 20 dB RF test

Handset functions using OK41/41A

Attenuation	0-15 dB
Equalizer	0-15 dB
AGC control	on / manual
AGC offset	- 3...+3 dB

Monitoring

Optical input level	
Attenuator settings	
Equalizer settings	
AGC status	

General

Operating voltage	180-265 V AC
Power consumption	< 15 W
Connectors	PG11
Protection class	IP 24
Operating temperature	-20°C...+55°C
EMC	EN 50083-2
Dimensions	232x145x86m
Price	£197.02

Select F or IEC Connector

F

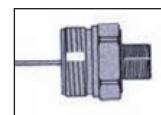

TF1 £7.35

IEC



TIEC 1 £10.03

Fiber Optic Micro Transmitters Receivers

**Downstream
47-1006MHz**

Discontinued ,see page 24A
for updated version

**Incredible
Value**



**Downstream
85-1006 MHz
Upstream
5-65MHz**



*Lower cost option on page 24a
only £95.00*

	LR91	LR92
Downstream		
Wavelength	1260-1630nm	
Opt. Return Loss	>40dB	
Fiber	Single Mode	
Optical Connector	SC/APC	
Output Impedance	75 Ohms	
Frequency Range	47-1006MHz	85-1006MHz
Output Level with input at -8dBm	90dBuV	
Optical Input Level	1dBm to -8dBm	
Typical noise input	4pA/√ Hz	
Signal to noise at -5dBm	≥ 50dB	
Max RF out ,CSO ≥ 60d ,CTB ≥ 60dB , -4dB slope	98-100dBuV	
Variable Attenuator	0-20dB	
RF Connector	F-type	
Optical Input low indication	Red LED	
Optical Input within correct level indication	Green LED	
Optical input high indication	Yellow LED	
Upstream		
Laser	-	*FP 1310nm
Optical power	-	3dBm
Optical Connector	-	SC/APC
RF input level	-	75-95dBuV 80dBuV nominal
RF bandwidth	-	5-65MHz
Gain adjustment	-	0-20dB
Test point up and down stream	-	-20dB
General		
Power	220-240V AC	
Power Consumption	6W	6W
Operating Temperature	-10 +50C	
Dimension WxHxD	163x90x50 mm	
Price	£123.10	£156.30

Very cost effective for CATV distribution, fibre cables are much cheaper than coax.

Fibre Optic Micro Receivers & Transmitter 1100-1600 nm

Transmitter 40-1000MHz
Complete with PSU

Using Fiber Optics for TV distribution ,is cost effective. Fibre cables can be located near high voltage mains cables. See page 34 for very **low cost splicer**



SC/APC



1mW	TXF 1	£95.00
3mW	TXF 3	£95.00
5mW	TXF 5	£95.00

Prices ex VAT

5mW = 54dBuV

Loss at 1600nm on 1km fibre cable is typically 0.21dB

Loss on 100m CT167 coax at 860MHz is -12dB

Receivers. F connector output for direct connection to RF distribution amplifier

Connection Types			
RF out connector		75Ω F-"Female" connector	
Optical Connector In		SC/APC	
Optical Info			
Input Optical Power		0~-18dBm	0dBm = 47dBmV -18dBm = 29dBmV
Optical Return Loss		>45dB	
Optical Receiver Wavelength		1100~1600 nm	
Optical Fiber Type		Single Mode	
RF Parameter			
Frequency Range		40-1000MHZ	
Flatness		±0.5dB	
Output Level	70 dBuV	0dbm optical input power	
Output Impedance	75Ω		
C/N	52 dbc	0dbm optical input power	
Other Parameter			
Power Input Voltage		0 VDC	
Power Consumption		N/A MA	
Dimensions		49*16*12 mm	
Net weight		0.01Kg	

RX3FL £1.95
Great for DVB-T



SC/APC In.
F connector out



AFP F connector Male-Male Adaptor Price £0.64

LNB Full band fiber and RF output

TCG15 FDF G1-O Price £99.95

Quad band LNB with fiber optic output.



DC power via
F connector

FC/PC fiber connector

Converts 4 bands H/V High/Low
Into a single mode fiber 950MHz-5.45GHz 7dBm* at
1310nm.

This provides typically 20dB^{+/-2dB} of reach.
The typical noise figure at 25^{deg} C is 0.5dB.
Gain flatness 0.95-5.45GHz 5dB

LO stability ± 1MHz

Ageing 10 years ± 4MHz

Optical output is via a **FC/PC connector**.

In band intermodulation products. dBc -23dB

The power requirement 12V <450mA.

Power supply included DC routed with via F con-
nector fitted to PSU.

**LNB fiber optic output
with C120 flange option.**

TCG15 FDF G1-O C120

3dB higher output than
standard LNB, doubles
the number of ways the
fibre cable can be split
compared to
,TCG15 FDF G1-O.

Price £90.15



TCG15 HB G1-O Price £85.98

**Quad band LNB with wholeband RF output
option.**



Converts 4 bands H/V High/Low
Into a single coaxial output
.95-5.45GHz 50Ω

This enables large fiber sat systems as it can feed several fiber
transmitters. Normally with a direct fiber output from the LNB
there is a limit to how many ways the fibre cable can be split.
Using a whole,band LNB many fiber transmitters can be added,
to enable very much larger systems to be constructed.

Use **very low loss feeder** from the LNB to the fiber transmitters if
the cable run is long to the head end.

The power requirement is 12VDC power typically 450ma
via a N connector 50Ω.

Fits standard dishes with 40mm clamp.

**C120 Feed horn
TADF 120**

Price £33.48



Prices Exlude VAT

Four way splitter .95-5.45GHz.

TD4-8-5G



4 way active splitter
.95-5.45GHz
Connectors N Type 50 ohm
Price £39.0

Power supply **TD4-8-5G**
PSU 12V 1A £7.95



Lead to connect PSU jack to
F connector.
FWSL £1.45



TCX 78 7/8" 50 ohm feeder

May be required if a longer coax lead is needed to connect from whole band LNB.

Excessive coax cable losses at the top of the band can be reduced if a lower loss feeder is used from the LNB to the laser transmitter. See transmitter section for connectors and similar cables that have low loss at 5GHz.

Frequency Attenuation Attenuation
MHz dB/100 ft dB/100 m

Frequency MHz	Attenuation dB/100 ft	Attenuation dB/100 m
1000	1.25	4.12
2300	2.02	6.63
5000	3.23	10.6

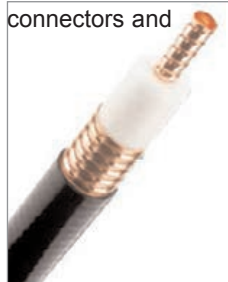

The above type of feeder may be a solution for whole-band LNB downloads if the download is not very short. **RG214** a cable similar to CT167 in size (10.8mm OD) Has a loss of 23dB at 900MHz and 72dB at 5000MHz 100m.



7/8" feeder
1/2" feeder

30m of 7/8 feeder equals typically a 6dB slope 960-5000MHz and approx. 2.0dB across one band
30m of 1/2" feeder equals typically a 3-4dB slope across one band.
If there is a 3dB slope across one of the four band between .95 to 5.65Ghz the system will only feed 50% of the fiber nodes that it otherwise could if there were no or little slope.
So fitting a very good quality download from the LNB is very important. Because of the OD of a 7/8 feeder 50mm and its bending radius a jumper cable will be needed at both ends to reduce the cable size to a manageable size to connect into the LNB and the fiber transmitter or splitter. RG214 is suitable for this.

Fiber receivers four switched sat+terrestrial

TYG1QUAD TA

Price £79.05

Optical input is via a **FC/PC connector** .

Connect directly to sat receivers .

Powered via DC voltage from sat receiver or with a separate PSU, see below, comes with fixing bracket



Converts optical input to 4 switched outputs
H/Highband H/Lowband 1.1GHz-2.10GHz.
V/Highband V/Lowband 0.95GHz-2.10GHz.

The minimum input level is -13dBm and the maximum input 0dBm. Nominal output 70dBuV, this can vary depending on noise floor and variable input levels on different multiplexes.

Fiber receivers quad band output.

TYG1QUAT A

Price £69.07

Connects to sat multi switches.

Powered via DC voltage from switch or with a separate PSU, see below, comes with fixing bracket.



Optical Input is via a **FC/PC connector** .
Used for switch systems

Converts optical input to 4 outputs bands consisting of.
H/Highband H/Lowband 1.1GHz-2.10GHz.

V/Highband V/Lowband 0.95GHz-2.10GHz.
Also one terrestrial output.

The minimum input level is -13dBm and the maximum input 0dBm. Allowance has to be made in the different levels of each carrier transmitted within each band and frequency response errors in the sat dish which will limit the length of fiber used and /or how many splitters are in the network.

If the system reach for example is normally 20dB with the input levels all similar, then if the difference in input carrier levels are poor and vary by 10dB then the system reach is reduced by 10dB. This would also apply in a non fiber network.

There is some allowance for this, approx 3dB for a single fiber output driving 32 points.

It is more critical to ensure the front end levels are correct on a fiber network as adding additional in-line fiber optic amplifiers in the chain is a more expensive option than ensuring the levels are correct at the input.

Power supply £10.95

Sky Q adaptor

Compatible with most traditional multiswitches. [Supplied with a 20 volt power supply.](#)

TYGQ 100A2 Price £59.03

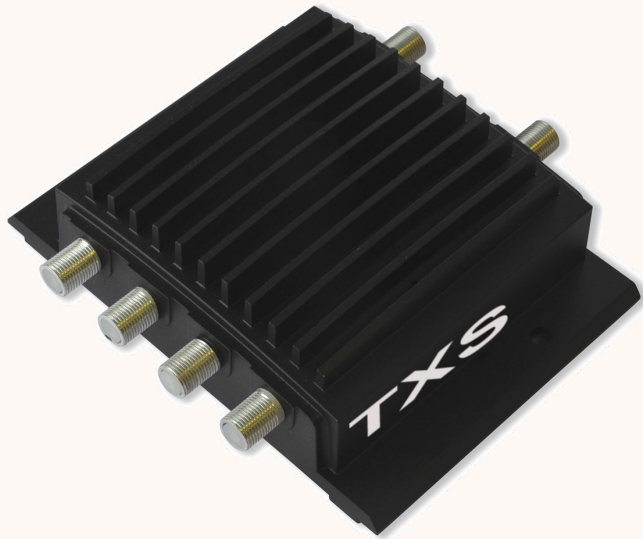

Sky Q Sat receivers enables recordings to be made on up to 6 programs at once as well as providing UHD TV reception.

To do this frequencies up to 5.4GHz are used on the inputs to the Sky Q receiver to avoid too many input coax cables.

Also a facility is provided to input terrestrial broadcasts.

A typical home can then have several TV sets fed from a single Sky Q receiver with Sky satellite TV and Terrestrial TV and radio via Wi Fi radiated in the home from the Sky box.

	Min	Max
Input 1 RF frequency range (MHz)	88	1950
Input 2 RF frequency range (MHz)	950	1950
Input 3 RF frequency range (MHz)	1100	2150
Input 4 RF frequency range (MHz)	1100	2150
Impedance		75Ω
Nominal input level	75dBμV	

RF Specification		
Parameter	Min	Max
Nominal impedance		75Ω
Return loss		10dB
Gain variation across band		6dB
Nominal output level		80dBμV

Control signals			
Vertical select voltage	11.5V	14.0V	13V nominal
Horizontal select voltage	16V	19V	18V nominal
Low / High band	0/22KHz tone		

DC specification	
Input voltage	20V
Current consumption	430mA max
Max supply current (inputs total)	500mA
Max supply current (inputs per port)	250mA

Connectors	
Input	F x 4
Output	F x 2
Power supply	2.1mm Jack

Environmental Specification	
Operating Temperature	-20°C to +50°C
Storage temperature	-40°C to +70°C

Optical cabling	
Fibre type	Single mode
Standard	GI - approved G657a

Dimensions	
Size (W x H x D)	127mm x 118mm x 38mm
Weight	302g

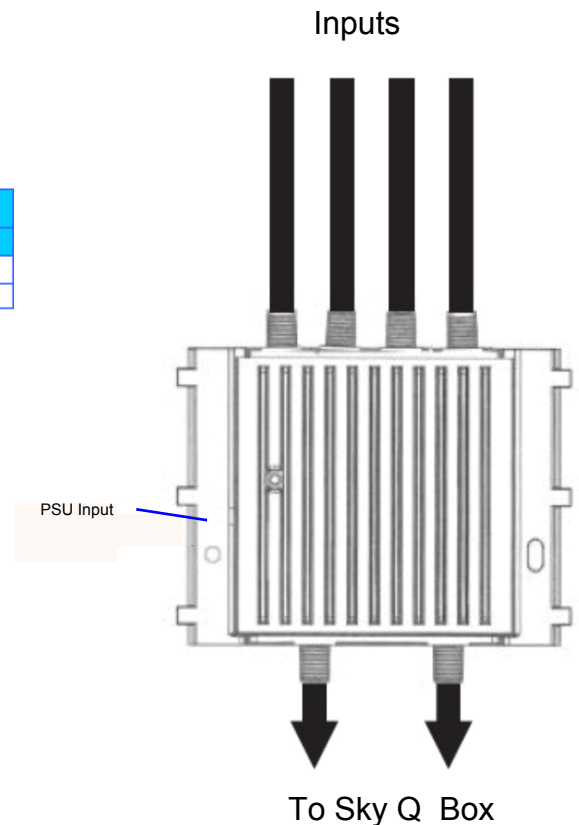

Sat distribution systems can be configured for Sky Q and standard Sky HD /Freesat
Contact tech support on mgrea@bellsouth.net.

Fibre Integrated Reception System

- Converts 4 IF polarities to a single optical output
- Outputs Fibre signal for distribution through 1 x 64 nodes
- Colour coded inputs for polarity matching
- Distributes DTT, FM and DAB
- PSU included

£874.00 Ex VAT



The **Fibre** TQB-F4 has been designed to combine 4 satellite polarities, DTT, FM and DAB onto a single optical output for distribution through a Passive Optical Network of 64 node points. The unit is used to combine all 4 polarities from 1 satellite, or a mixture of 4 polarities from any 4 satellites.

Technical Specifications

Optical specification

Parameter	Min	Typ	Max	Units
Laser 1 wavelength		1550		nm
Laser 2 wavelength		1530		nm
Total optical output power	7	8		dBm Combined 1530nm and 1550nm

Satellite band RF specification

Input RF frequency		950	2150	MHz	SAT1, SAT2, SAT3 and SAT4 inputs
Input impedance			75	Ohm	
Number of inputs			4		
Input return loss			10	dB	
Total input power				97	dBμV
Maximum input power per transponder				82	dBμV For 32 transponders
Output RF frequency		950-2150 (Band 1, Band 3) & 2550-3750 (Band 2, Band 4)		MHz	Stacked frequency bands

Terrestrial band RF specification

RF frequency band		174	862	MHz
Input impedance			75	Ohm
Input return loss			10	dB
Maximum input power		-5dBμV compared with sat band 1 (black triangle)		
Noise figure			10	

DC specifications

Power supply voltage	12	20	21	V
Current consumption		≤ 500		mA For 20V power supply (not including LNB)
LNB voltage		Available on each input		All inputs short circuit protected

Connectors

Output	Fibre optic FC/PC
Satellite inputs	F
DC connector	2.1mm socket

Environmental specification

Operating Temperature	-30 to 60°C
Storage Temperature	-10 to 50°C

Dimensions

Size	140 x 145 x 33 mm
Weight	300g

Optical Cabeling

Fibre Type	Single mode
Standard	GI - Approved G657a

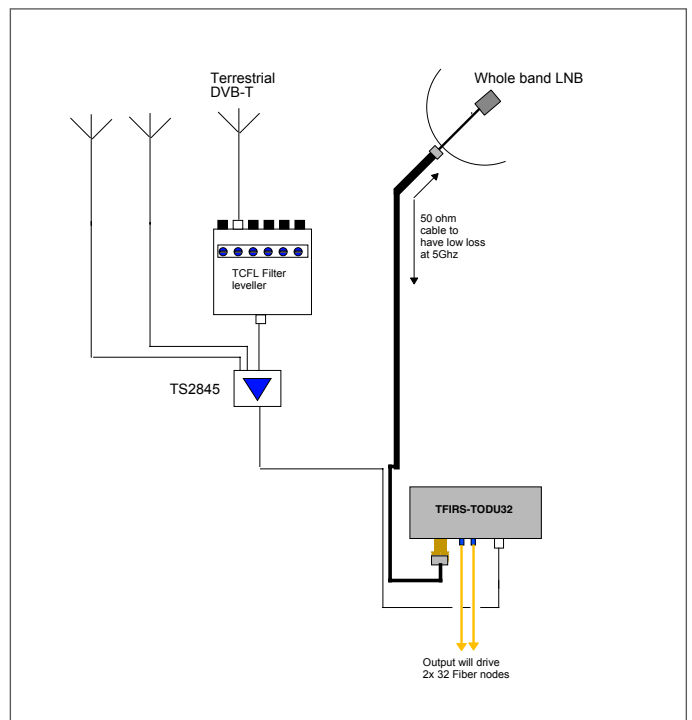
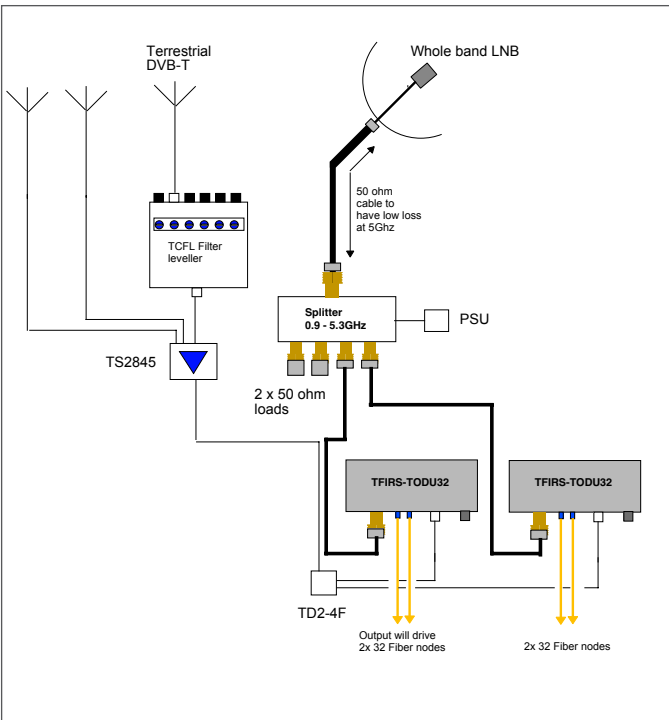
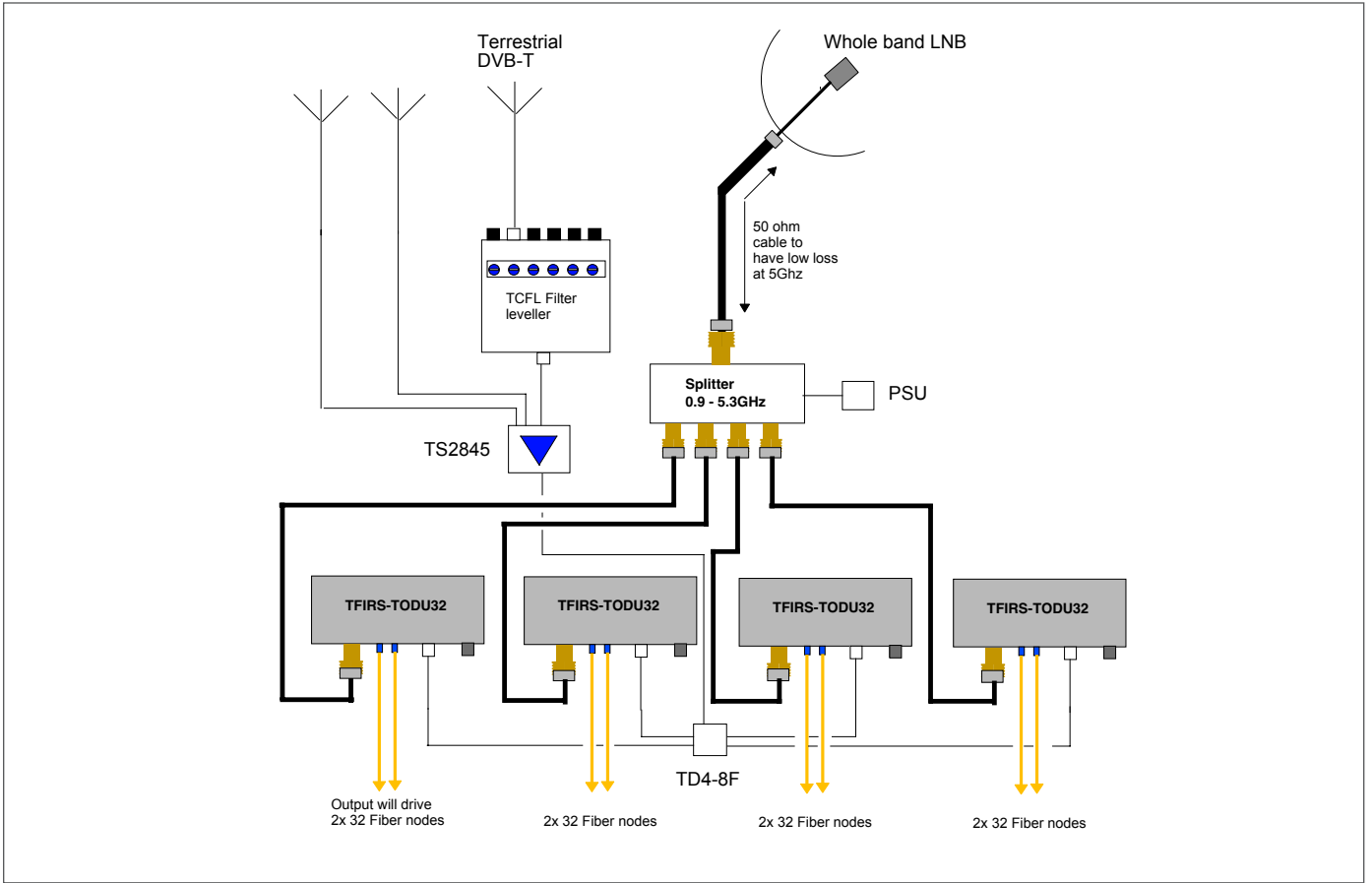

System examples

Fiber splitter options
 2 way
 3 way
 4 way
 8 way
 16 way
 32 way

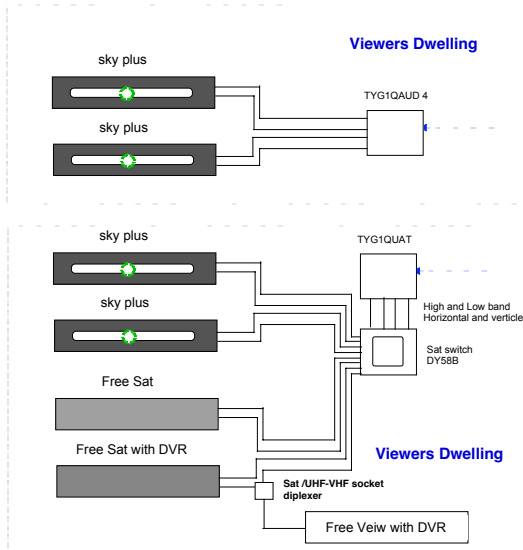

Fiber optic networks are extremely reliable. Like most networks the weak points can be joints and connectors. Fiber connectors are particularly prone to this as any dust or dirt adds attenuation so it makes sense in system design to use as few connections as possible in the chain. Fiber cables can be joined with connectors and adapters, but the most reliable connection is a fusion splice. Fusion splicers however are relatively expensive and it may not be commercial to buy one for a single project. In addition usually training is required to use one. In the UK there are many contractors who specialize in just providing a splicing service and this cost sometimes can be more than set of due to the savings in equipment due to the lower system losses and the maintenance costs associated with reduced reliability. Splicing costs can be as low as £3.00 a splice if the number of splices that can be done compare favorable with the minimum day rates.

Fiber systems also have a huge advantage and that is almost all the equipment for distribution except the fiber receivers can be located in one location and the whole network can be passive due to the very low losses, typically <math><0.4\text{dB km}</math> on single mode fiber. Another huge advantage especially when an installation is being installed on an existing building is the very small size of the cable into the viewers home.

One single fiber cable with a O/D of <math><6\text{mm}</math> is all that is needed avoiding ugly clumps of multiple RG6 cables surface mounted on the outside walls of viewers homes. The viewer can have as many points as they require on satellite and terrestrial DVB-T plus FM radio and DAB with a single fiber cable into the viewers dwelling. The whole network is simpler to install, cheaper to install and easier to maintain.

Continued

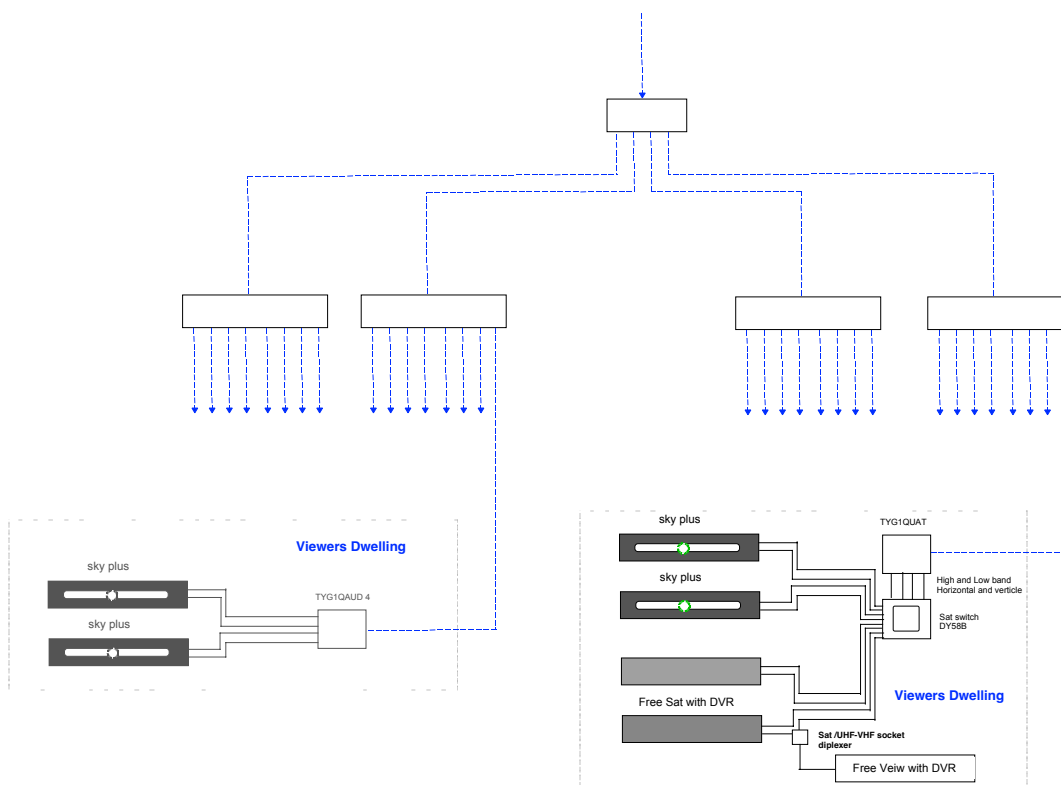

System examples, 384 Twin sat, Terrestrial outputs.

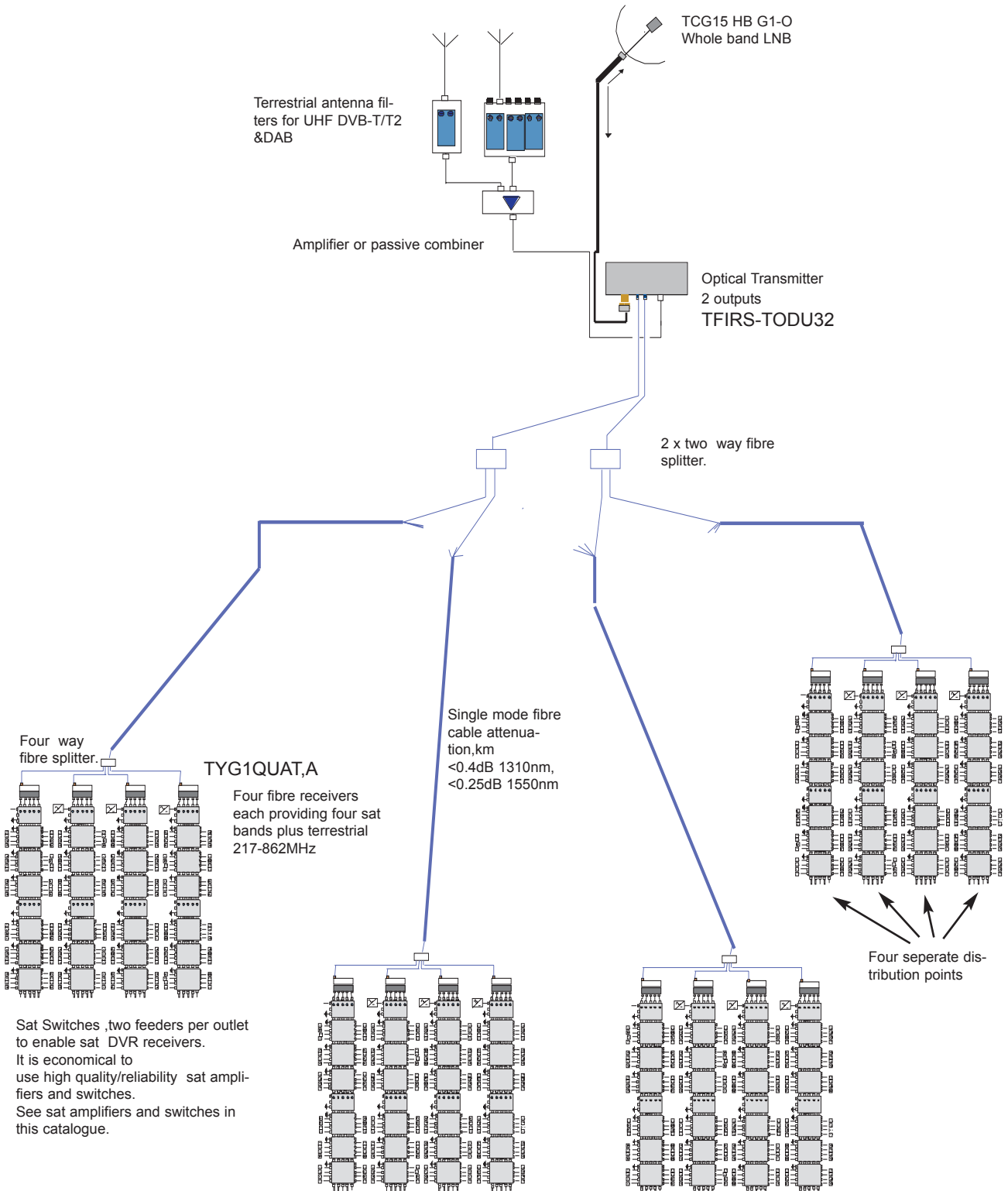

Splitters for fusion splicing. FC/PC and SC/APC connectors

Fusion spliced splitters are more robust and have a lower optical loss compared to mechanical connectors. Losses of <0.02dB can be achieved on a fusion connection.

Mechanical connections have losses which are typically 0.3dB a connection, so this has to be allowed for in network design. These losses do not seem much, but when you compare a connection loss of 0.3dB it is equal to the attenuation of approx 1KM of fiber cable a consideration of these losses has to be made..

Fusion splicing is recommended where the integrity and reliability of the network is extremely important.

Mechanical connectors are a good alternative for non critical applications such as CATV networks.

An alternative to purchasing a fusion splicer is to employ an experienced subcontractor. Costs as low as £3.00 a splice are possible if there are about 100 splices on a project that can be done on one visit.

Design must, as much as possible, limit the amount of cascaded mechanical connections, as MTBF figures increase exponentially the more mechanical connectors are cascaded.

Most new installations can be designed with just a few connections cascaded, typically four to five so reliability is built in the design of the network..

FC/PC connectors are more robust mechanically.

SC/APC connectors have an angled fiber connection and provide slightly better mating between surfaces and consequently lower losses than FC/PC connectors.

FC/PC connectors are better in outdoor and harsh environments used with suitable sealing tapes. So allowances have to be made for the optical loss of the different types of connection used if several are used in a chain.

FC/PC type connector



SC/APC type connector



- SC/APC type Attenuator
- SC/APC FIBATT-1dB 1dB
- SC/APC FIBATT-2dB 2dB
- SC/APC FIBATT-5dB 5dB
- SC/APC FIBATT-10dB 10dB
- SC/APC FIBATT-15dB 15dB
- SC/APC FIBATT-20dB 20dB
- £6.55

- FC/PC type Attenuator
- FC/PC FIBATT-5dB 5dB
- FC/PC FIBATT-10dB 10dB
- FC/PC FIBATT-15dB 15dB
- FC/PC FIBATT-20dB 20dB
- £6.55



SC/APC type coupler, for joining two pre terminated fiber cables together.



SC/APC CPL £3.40

FC/PC type coupler .

FC/PC CPLB Barrel type coupler £0.75



FC/PC Terminator TILFBT £2.86



Patch with SC/APC type on one end and a FC/PC type on the other end .See list of leads with fiber connectors



Pigtails with single mode fiber available with SC/APC or FC/PC connector to fusion splice to an incoming fiber



Fiber Optical Splitters

Splitters with SC/APC and FC/PC connectors 1310-1550nm Polarization stability 0.1dB

Typical variation in insertion /side loss 0.1dB Operating temperature -30 to +70 deg

Type	Description	Side loss	Through loss	Connector	Price
TD2-3.2FBR	Two way equal splitter	3.2dB	3.2dB	None	£12.92
TA2-3.8-2.9FBR	Two way unequal splitter(tap)	3.8dB	2.9dB	None	£21.00
TA2-4.3-2.5FBR	Two way unequal splitter(tap)	4.3dB	2.5dB	None	£21.00
TA2-5.6-1.8FBR	Two way unequal splitter(tap)	5.6dB	1.8dB	None	£21.00
TA2-6.4-1.45FBR	Two way unequal splitter(tap)	6.4dB	1.45dB	None	£21.00
TA2-7.4-1.15FBR	Two way unequal splitter(tap)	7.4dB	1.15dB	None	£21.00
TA2-8.7-0.9FBR	Two way unequal splitter(tap)	8.7dB	0.9dB	None	£21.00
TA2-10.6-0.6FBR	Two way unequal splitter(tap)	10.05dB	0.6dB	None	£21.00
TA2-13.7-0.35FBR	Two way unequal splitter(tap)	13.7dB	0.35dB	None	£21.00
TA2-21-0.15FBR	Two way unequal splitter(tap)	21dB	0.15dB	None	£21.00
TD2-3.2FBR SC/APC	Two way equal splitter	3.2dB	3.2dB	SC/APC	£13.80
TA2-3.8-2.9FBR SC/APC	Two way unequal splitter(tap)	3.8dB	2.9dB	SC/APC	£21.00
TA2-4.3-2.5FBR SC/APC	Two way unequal splitter(tap)	4.3dB	2.5dB	SC/APC	£21.00
TA2-5.6-1.8FBR SC/APC	Two way unequal splitter(tap)	5.6dB	1.8dB	SC/APC	£21.00
TA2-6.4-1.45FBR SC/APC	Two way unequal splitter(tap)	6.4dB	1.45dB	SC/APC	£21.00
TA2-7.4-1.15FBR SC/APC	Two way unequal splitter(tap)	7.4dB	1.15dB	SC/APC	£21.00
TA2-8.7-0.9FBR SC/APC	Two way unequal splitter(tap)	8.7dB	0.9dB	SC/APC	£21.00
TA2-10.6-0.6FBR SC/APC	Two way unequal splitter(tap)	10.05dB	0.6dB	SC/APC	£21.00
TA2-13.7-0.35FBR SC/APC	Two way unequal splitter(tap)	13.7dB	0.35dB	SC/APC	£21.00
TA2-21-0.15FBR SC/APC	Two way unequal splitter(tap)	21dB	0.15dB	SC/APC	£21.00
TD2-3.2FBR FC/PC	Two way equal splitter	3.2dB	3.2dB	FC/PC	£14.92
TA2-3.8-2.9FBR FC/PC	Two way unequal splitter(tap)	3.8dB	2.9dB	FC/PC	£21.00
TA2-4.3-2.5FBR FC/PC	Two way unequal splitter(tap)	4.3dB	2.5dB	FC/PC	£21.00
TA2-5.6-1.8FBR FC/PC	Two way unequal splitter(tap)	5.6dB	1.8dB	FC/PC	£21.00
TA2-6.4-1.45FBR FC/PC	Two way unequal splitter(tap)	6.4dB	1.45dB	FC/PC	£21.00
TA2-7.4-1.15FBR FC/PC	Two way unequal splitter(tap)	7.4dB	1.15dB	FC/PC	£21.00
TA2-8.7-0.9FBR FC/PC	Two way unequal splitter(tap)	8.7dB	0.9dB	FC/PC	£21.00
TA2-10.6-0.6FBR FC/PC	Two way unequal splitter(tap)	10.05dB	0.6dB	FC/PC	£21.00
TA2-13.7-0.35FBR FC/PC	Two way unequal splitter(tap)	13.7dB	0.35dB	FC/PC	£21.00
TA2-21-0.15FBR FC/PC	Two way unequal splitter(tap)	21dB	0.15dB	FC/PC	£21.00
TD3-5.7FBR	Three way splitter	3x5.7dB		None	£15.15
TD4-6.6FBR	Four way splitter	4x 6.6dB		None	£19.70
TD8-10.7FBR	Eight way splitter	8x 10.7dB		None	£41.00
TD16-13.7FBR	Sixteen way splitter	16x 13.7dB		None	£88.00
TD32-16.7FBR	Thirty two way splitter	32x 16.7dB		None	£182.00
TD3-5.7FBR SC/APC	Three way splitter	3x5.7dB		SC/APC	£15.65
TD4-6.6FBR SC/APC	Four way splitter	4x 6.6dB		SC/APC	£20.50
TD8-10.7FBR SC/APC	Eight way splitter	8x 10.7dB		SC/APC	£42.00
TD16-13.7FBR SC/APC	Sixteen way splitter	16x 13.7dB		SC/APC	£90.00
TD32-16.7FBR SC/APC	Thirty two way splitter	32x 16.7dB		SC/APC	£187.00
TD3-5.7FBR FC/PC	Three way splitter	3x5.7dB		FC/PC	£25.26
TD4-6.6FBR FC/PC	Four way splitter	4x 6.6dB		FC/PC	£35.71
TD8-10.7FBR FC/PC	Eight way splitter	8x 10.7dB		FC/PC	£78.70

Fiber pre terminated leads

Pre terminated Single Mode leads/reels	Connector	Price
TLP-FC/PC1M	1 meter lead	FC/PC £3.10
TLP-FC/PC3M	3 meter lead	FC/PC £3.40
TLP-FC/PC5M	5 meter lead	FC/PC £4.30
TLP-FC/PC10M	10 meter lead	FC/PC £6.10
TLP-FC/PC15M	15 meter lead	FC/PC £10.46
TLP-FC/PC20M	20 meter lead	FC/PC £13.25
TLP-FC/PC30M	30 meter lead	FC/PC £17.85
TLP-FC/PC40M	40meter lead	FC/PC £22.45
TLP-FC/PC50M	50meter lead	FC/PC £29.99
TLP-FC/PC75M	75meter lead	FC/PC £43.65
TLP-FC/PC100M	100 meter reel	FC/PC £59.11
TLP-FC/PC150M	150 meter reel	FC/PC £90.02
TLP-FC/PC200M	200 meter reel	FC/PC £116.95
TLP-FC/PC500M	500 meter reel	FC/PC £286.24
TLP-FC/PC-PIG	2.5m FC/PC pigtail	FC/PC £4.50
TLP-SC/APC0.5M	0.5 meter lead	SC/APC £3.28
TLP-SC/APC2M	2 meter lead	SC/APC £3.60
TLP-SC/APC5M	5 meter lead	SC/APC £4.60
TLP-SC/APC-PIG	2.5m SC/APC pigtail	SC/APC £3.90
50 +		
TLP-SC/APC-FC/PC0.5M	0.5 meter lead	SC/APC to FC/PC £9.63 £3.28
TLP-SC/APC-FC/PC2M	2 meter lead	SC/APC to FC/PC £10.35 £3.60
TLP-SC/APC-FC/PC5M	5 meter lead	SC/APC to FC/PC £10.93 £4.60
TLP-SC/APC-SC/PC0.5M	0.5 meter lead	SC/APC to SC/PC £3.98
TLP-SC/APC-SC/PC2M	2 meter lead	SC/APC to SC/PC £10.35 £4.60
TLP-SC/APC-SC/PC5M	5 meter lead	SC/APC to SC/PC £10.39 £5.50

Armoured single fiber cable.
Single mode PVC sheath.

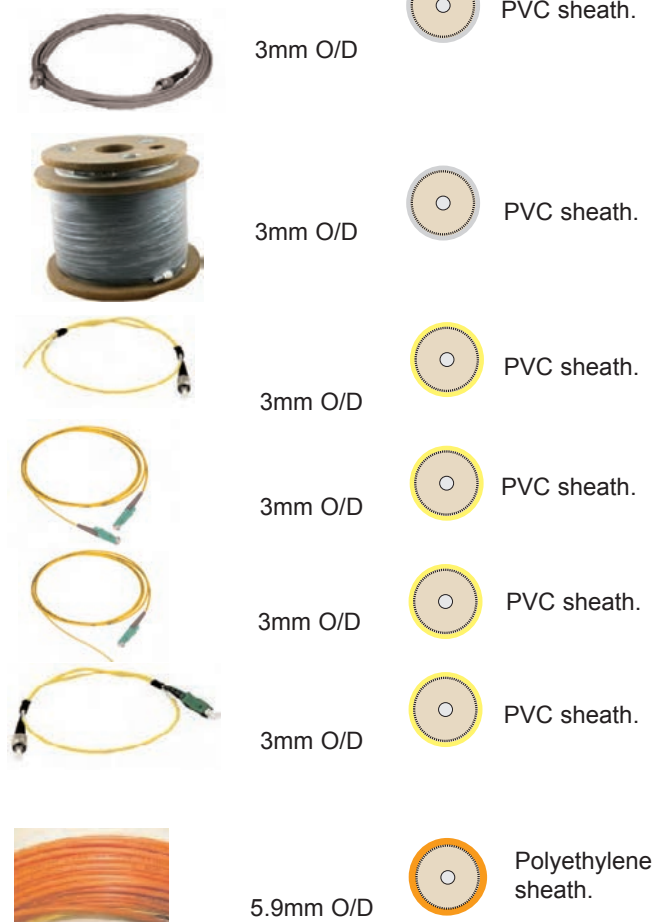

Unterminated Single Mode leads

TLP-UT 200M	200 meter reel	unterminated	£110.86
TLP-UT500M	500 meter reel	unterminated	£280.87

Fiber Cables single mode

Universal . Indoor Outdoor

Attenuation 1310nm 0.32dBkm average, max 0.4dBkm ,1550nm 0.21dBkm average,max 0.3dBkm
FRNC/LSNH Material Orange

Number of Fibers	Weight kg km	Pulling Tension N	Outside Diameter mm	Minimum Bend Radius mm	Part Number	*Reel size m	Price
2	19	800	4.67	54	TSMF802	500m	£187.78 2100 £1,124.93
4	24	860	5.08	59	TSMF804	500m	£267.84 2100 £1,346.59
6	28	1200	5.59	59	TSMF806	500m	£320.62 2100 £1,692.60
8	33	1200	5.97	60	TSMF808	500m	£403.00 2100 £1,878.46
12	40	1330	6.48	76	TSMF812	500m	£447.25 2100 £1,878.46

For Outdoor including underground ducting

Attenuation 1310nm 0.32dBkm average, max 0.4dBkm ,1550nm 0.21dBkm average,max 0.03dBkm
SheathMaterial PE Black

Number of Fibers	Weight kg km	Pulling Tension N	Outside Diameter mm	Minimum Bend Radius mm	Part Number	*Reel size m	Price
4	149.00	3500	5.80	58	TSMFPE804	500m	£161.46 2100 £616.50
6	151.70	3500	5.80	58	TSMFPE806	500m	£185.33 2100 £707.64
8	151.70	3500	8.70	58	TSMFPE808	500m	£228.21 2100 £871.36
12	151.70	3500	8.70	58	TSMFPE812	500m	£256.69 2100 £980.08
24	207.00	3500	8.70	87	TSMFPE824	500m	£530.85 2100 £2,026.89
36	406.00	3500	12.20	183	TSMFPE836	500m	£810.90 2100 £3,096.16
48	420.00	3500	12.20	183	TSMFPE848	500m	£942.10 2100 £3,597.10

Prices and specifications are subject to change. please ask for a quotation with a fixed price period.

Single mode fiber cable PVC sheath.

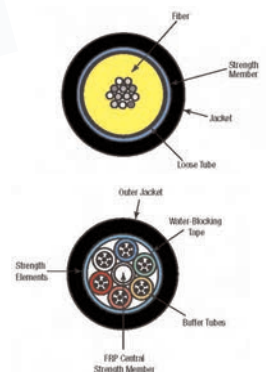
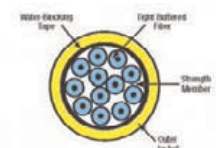

Fibre Light Source TLS - 106

Visible Light Fault Locator,
Ideal for testing fibre networks &
termina**Price £66.39**



TFS1 - Fibre Stripper, for use with
3.0mm fibre, designed to remove outer
jacket and both buffer coverings.
Price £19.28

TCC1 CleanCore, the CleanCore cas-
sette is supplied with a removable car-
tridge containing the cleaning fabric. The
cartridge supports 400 cleaning cycles.
Price £.....

TSP1 Solvent Pen, powerful univer-
sal cleaning solvent in a convenient
pen, compact, portable and most impor-
tantly effective cleaning solvent for fibre
connections. **Price £4.55**

TFSC1 Fiberscope allows the
installer to check fibre terminations,ideal
for use in the field. **Price £81.11**

**TSOPM 1 Optiscan Satellite IF &
Optical Power Meter**, for use with fiber
optic LNB and accurate alignment and
network testing.
In dBuV & dBm.

Specification

Full band 950 to 2150 MHz scan or down to
160MHz at full zoom.

Measuring Range:

RF Input level range 40 dBuV to 90 dBuV
Optical range +10 to -25 dBm

Accuracy:

Typically +/-1 dB.

MER:

(SNR) Pass 8dB or more. Marginal 6-7 dB fail
less than 5 dB

BER:

Pass must be greater than 1E-3 on Pre Viterbi.

Input: RF 75 ohm BNC. BNC to F adaptor
supplied .

Optical type FC/PC.

DiSEqC:

Version 1.2 compatible. Full control of
motorised dishes , any DiSEqC command can be gener-
ated.

On screen battery indicator:

Battery life 5 hours when powering typical
LNB.

Charge time:

12 hours,

Accessories supplied:

Mains charger, car charger lead and BNC to F



TFC1 - Fibre Cleaver, Professional
cleaving tool for use with 3.0mm fibre
and Field termination kit. **Price £418.93**

TKS1 Kevlar Scissors, specifically
designed for cutting the Kevlar strands
within the 3mm fiber cable .**Price £14.73**

TCC2 Cleaning Cube, the cleaning
cube is the perfect cleaning solution for
terminated fibre connections, use dry or
solvent wet, on the bench or in
the field. **Price £12.68**

TFR1 Fibre Rods, 6 flexible rods
(varying flex), 2 x FC/PC adaptor + wire
pulling sock. Aids the installer with pre &
un-terminated fibre cablerouting.

Compatible with Super Rod products.
Price £31.50

**TFS1 Fibre swabs 2.5mm Fibre
Swabs**,the 2.5mm foam swabs are the
most versatile and cost effective way to
clean your female fibre end ports.

Price £3.97



Discontinued

Price £494.83

TFOFS 1 Fiber optic fusion splice

Fiber cleaved length:16mm

Specifications

Average splicing loss.	0.01dB MM/0.02dB SM
Return loss	>60dB
Typical splicing time	8 seconds.
Typical heating time	26seconds.

Work mode

Program/Splicing/Heating: Automation or manual optionally

General Specifications

Power :100-240V 50Hz/60Hz 12 V 25W

(optional)Inner Li-ion battery charger and AC adaptor

Battery Life Support 80 splice and heater operating on one charge.

Weight 1.93kg

Dimensions(L x W x H) 149x120x127mm

Price £825.00



TXPB 700

Low Pass Filter for 700MHz Clearance >50dB rejection.

Shortly the UK will have cleared all the spectrum from 700MHz to 860MHz currently used for TV broadcast. This will be used in the future for 4G & 5G mobile phones. Because of the risk of interference to wideband amplifiers, masthead or distribution, and in extreme cases on the TV tuner, if the interference is excessive it will simply wipe out or pixalate digital TV reception. Fitting a filter on all installations that are capable of receiving signals above 700MHz is absolutely essential as the interference that may result will be difficult to diagnose due to the intermittent transmissions from mobile phones and cell towers.



DC Through for masthead preamps

Specification TXPB 700 Low pass filter

Features	Bandwidth	Specifications
	5-640MHz	0.5 dB(typ)/1.0dB (max)
	640-690MHz	1.0dB(typ)/2.5dB (max)
Insertion loss	690-694MHz	2.5 dB(typ)/3.5dB (max)
Return loss	5-40MHz	20dB(typ)/18(min)
	40-694MHz	16dB(typ)/14(min)
Rejection band loss	714-718MHz	35dB(typ)/30dB (min)
	718-725MHz	45dB(typ)/40dB (min)
	725-1000MHz	55dB(typ)/50dB (min)
DC Power Pass	30V/1A	
Impedance	75 ohm	
F Connector Type	Male to Female (3/8inch-32UNEF)	
Dimensions	20.5×58mm	
Weight	33g	



Price each only £3.39

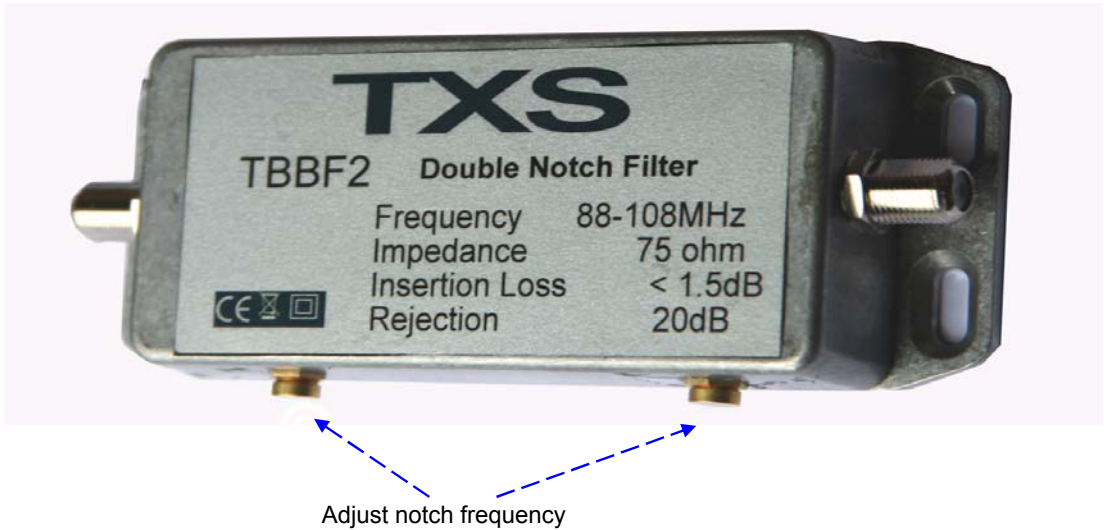

Rejection of notch typically > 40dB if both notches are tuned to same frequency

Double Notch Filters						
Type	Frequency MHz	Bandwidth at 20dB	Bandwidth at 10dB	Typical Notch per trap	Price	Price Pre Tuned
TBBF2	87-108	.06MHz	.02MHz	≥20dB	£60.00	£65.00
TBBF3	174-230	1.4MHz	.06MHz	≥20dB	£60.00	£65.00
TBBF4	470-650	3.5MHz	1.5MHz	≥20dB	£60.00	£65.00
TBBF5	630-860	4.5MHz	1.8MHz	≥20dB	£60.00	£65.00

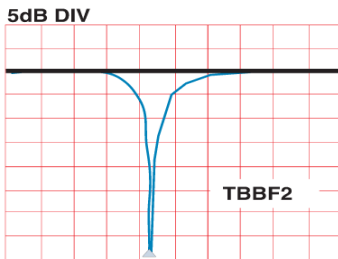

START 80MHz STOP 100MHz

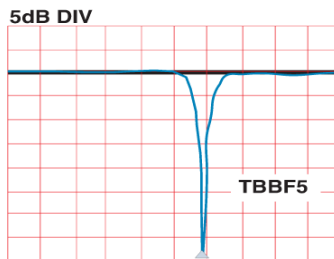

START 580MHz STOP 860MHz

specifications are subject to change

TCFL4 with all attenuators set to minimum

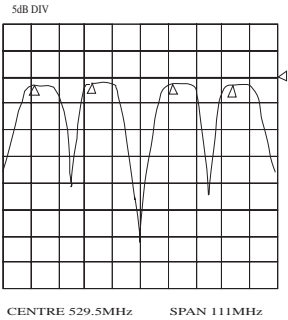

TCFL4 with one attenuator -10dB

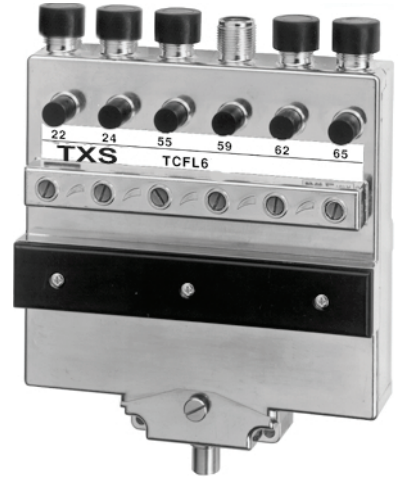
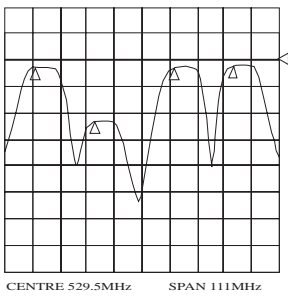

Type	Number of Channels	Inputs 75Ω	Outputs 75Ω	Price
TCFL4	4	See Input Options	1	£89.00
TCFL5	5	See Input Options	1	£99.00
TCFL6	6	See Input Options	1	£109.00

Input Options

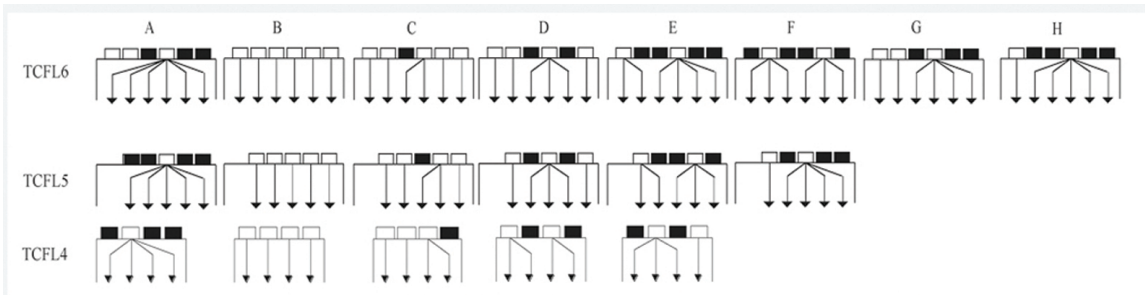

If adjacent channels need to be combined they have to be clustered in one filter cavity if they are not the same level and adjustment is needed, processors such as the TSMP ,range TSMP-TV-TVDTQ have to be used as shown in the following pages.

These use SAW filters to provide the very sharp filtering that may be needed if one of the two multiplexes that are adjacent channel needs levels adjusting.

2 CH=16 MHz
1 CH=8MHz
Adjustment range is less with 1 CH spacing

2 Ch

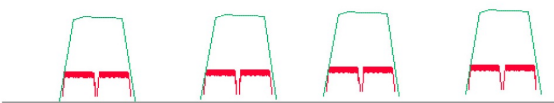

FJ-CP

F to Male Belling Lee type adaptor see connectors



Typical insertion loss -3.5dB with 16MHz or greater spacing between channels

When ordering ,please specify input option and channels required

To avoid errors confirmation by email is required.

Using passive or active filter leveler's ?

Below indicates one of a common problem with digital TV broadcasts and the configuration and levelling of multiplexes .

The two pairs of multiplexes can be passed through a passive filter leveller , so 6 pairs of multiplexes would use a 6 ch filter leveller such as a TCFL6, 6 cavity filter .

However you can see in this example two local TV stations adjacent ch to the main multiplexes ,one is -12dB and the other is -28dB, in this example they are local TV stations.

If the local stations are needed for distribution they may need levelling, a passive filter cannot adjust the adjacent individual multiplexes as in this example.

If the modulation type is QPSK for a local TV station instead of 64 or 256QAM a slightly lower signal level could be tolerated.

However in the Manchester example the radiation patterns of the broadcast antennas are different so coverage can severely com-promised if the difference in levels cannot be accommodated in a CATV system. In this instant both local signal levels get worse at +/- 35 deg as the radiation pattern can be very narrow ,such as in the example of Ch M

The solution is to use a active filters for head ends if the level is too low to distribute, this processes the multiplexes ,converts them down to IF and passes them through a very sharp SAW filter and converts them back up again to the desired frequency . This then provides individual level control on each multiplex.

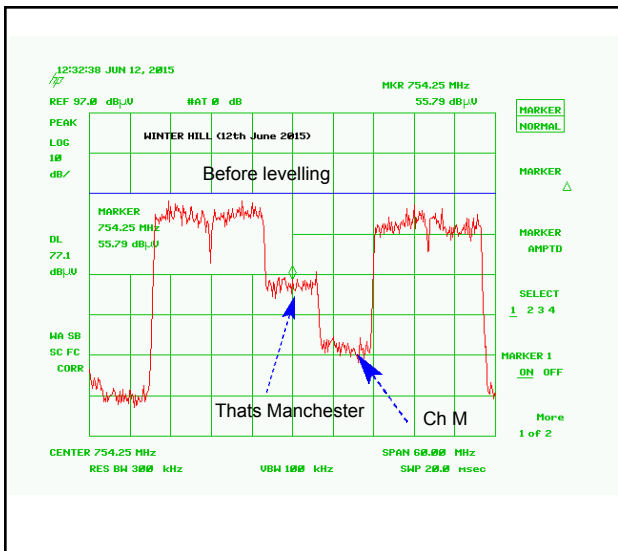

This may not be needed on small systems as using a larger amplifier could accommodate the different levels without overloading ,but on medium to large systems or fibre networks ,levelling is very important .

Below is the equipment that can be used to level the DVB-T/T2 multiplexes that are adjacent channel

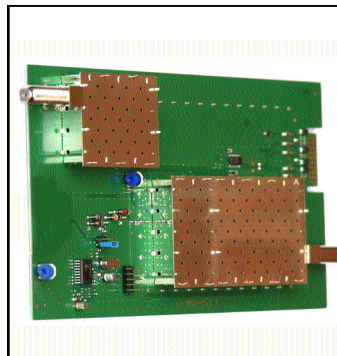

Twin processor convertor .

See pages 37/38

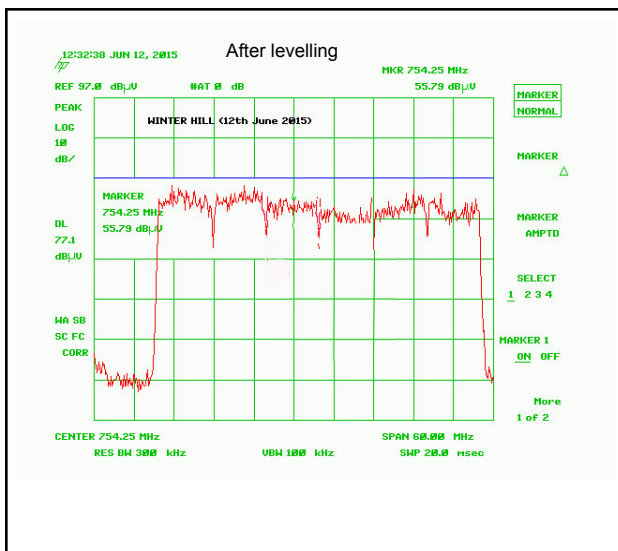

Twin processor convertor .

See page 39/41



TSMP range of analogue digital modulators receivers and re-modulators

DVB-T Digital modulators, HDMI in
 UHF-VHF analogue modulators with stereo options.
 Digital sat receivers for free to air
 Digital sat receivers with conditional access modules
 FM radio tuner remodulator modules
 Agile channel convert VHF/UHF DVB-T/T2 Freeview
 COFDM receiver to PAL Video
 Sat ,re mux to DVB-T

Specifications subject to change



19" RACK 4U

Brackets also supplied for wall mounting

TSMP-MMTQ

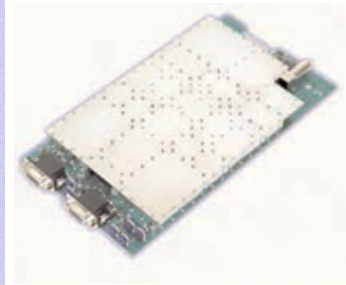

Twin analogue modulator

Remote programming & monitoring via internet ipm option



Digital Freesat or Digital Freeview
 Converted to Freeview in one compact unit
 Amazing Value and Technology



Twin Freeview to PAL AV out receiver



Modulator Multistandard PAL/SECAM/NTSC Agile 47-860MHz

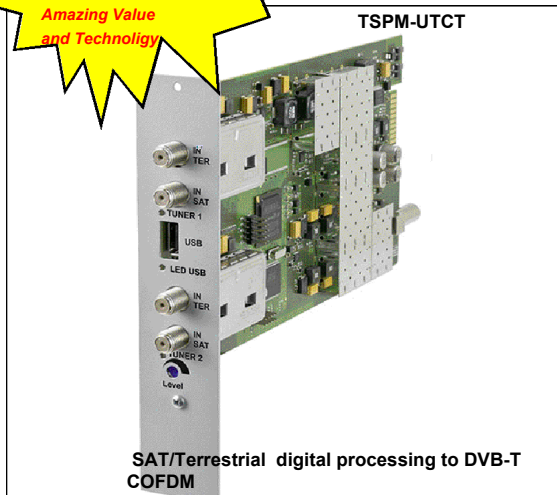

TSMP-UTCT

SAT/Terrestrial digital processing to DVB-T COFDM

TSMP-200 for two single modules



TSMP-H4TCT



DVB-T modulator MPEG4 encoding 4x HDMI inputs

TSMP-H4TCT Specification

Video Encoding	MPEG-4 AVC / H.264
Input	HDMI
Encoding	1920x1080_60P ; 1920x1080_50P ; 1920x1080_60i ; 1920x1080_50i Full HD 1280x720_60P ; 1280x720_50P – HD ready
Audio Encoding	MPEG1 Layer II / AAC/LC
Sampling Rate / Sample rate	48 KHz
Output	DVB-C or DVB-T
Bandwidth	7, 8 MHz
Modulation	16 QPSK, 16 QAM, 64 QAM
MER	≥ 38 dB
Frequency	112–862 MHz
RF output level	80 dBμV
Power consumption	15 W
Operation temp.	0...45 °C

TCLP2.9 12VDC3A
 Switch mode psu
 For TSMP 200 £16.35



DTL 2
 Link lead between twin sat receiver and analogue modulators

£14.75



DTL 1
 Link lead between receiver and analogue modulator



£4.90

Please note ,some older or non HD TV sets may need MPEG2 encoding .

For MPEG 2 Encoding see page 40, 44, 47-49

Type	Description	Price
TSMP-2000ipm	4U 19" Rack base unit (177mm deep) and programmer. With remote monitoring and programming via the internet. PSU 180-265 AC > Includes combiner for ten modules, 20dB test socket. 180-265VAC , max power consumption 115W ,50/60Hz. Power available for LNB's 18VDC 500mA per LNB total 1A .	£487.00
TSMP-200T	Base unit and programme for two twin modules. Requires 12V PSU ,2.5A max	£210.00
TSMP-H4TCT	DVB-T Modulator , 4 HDMI Inputs, modules can be fitted into a TSMP2000 4U rack ,that s 24 , TV programs into digital TV format.Max six modules in TSMP 2000ip	£1,418.48
TSMP-UTCT	Converts 2 sat DVBS/S2 or 2 terrestrial digital DVB-T/2 multiplexes into, 2 DVB-T multiplexes ,Functions include editing LCN,NIT,and TSP, Via LAN connection using a PC.	£491.74
TSMP-UTCT-CI	As above (TSMP-UTCT) but with 2 x CAM slots.	£590.01
TSMP-MMQ	TV Modulator module Video in 1V pk -1dB 75%. Audio 500mV rms 10K%, adjustable -6dB . Frequency agile, adjacent channel performance, 47-860MHz. Multistandard B/G,D/K,I,M and N. Diff gain typ 5%, Diff phase typ 5 deg. Variable attenuator 10dB. Output level when fitted into base unit 100dBuV. AV in via 15 pin D socket	£113.74
TSMP-MMTQ	Twin TV Modulator module. Video in 1V pk -1dB 75%. Audio 500mV rms 10K%, adjustable -6dB. Frequency agile, adjacent channel performance, 47-860MHz. Multistandard B/G, D/K, I, M and N. Diff gain typ 5%, Diff phase typ 5 deg. Variable attenuator 10dB . Output level when fitted into base unit 100dBuV. AV in via 15 pin D socket	£180.41
TSMP-MSTQ	Twin TV Stereo Modulator module for B/G Video in 1V pk -1dB 75%. Audio 500mV rms 10K%, adjustable -6dB . Frequency agile, adjacent channel performance, 47-860MHz, PAL B/G, Diff gain typ 5%, Diff phase typ 5 deg. Variable attenuator 10dB . Output level when fitted into base unit 100dBuV. AV in via 15 pin d socket	£248.18
TSMP-MSTQ	Twin TV Stereo Modulator module for B/G Video in 1V pk -1dB 75%. Audio 500mV rms 10K%, adjustable -6dB . Frequency agile, adjacent channel performance, 47-860MHz, PAL B/G, Diff gain typ 5%, Diff phase typ 5 deg. Variable attenuator 10dB . Output level when fitted into base unit 100dBuV. AV in via 15 pin d socket	£248.18
TSMP-PSTI	QPSK Twin Digital Sat Receiver for free to air broadcasts.Sky and Free sat . AV output. . Requires modulator .LNB control 14-18V ,22kHz ,DISEqC. With CAM module .Two tuners ,select any programs from any multiplex.	£367.64
TSMP-S2T Discontinued see above TSMP-UTCT TSMP-UTCT-CI	QPSK Digital Sat receiver demodulator LNB control 14-18V ,22kHz ,DISEqC. With demodulation and remodulation to DVB-T COFDM. Output 90dB uV adjustable. Intergrated CAM slot. Up to 10 TV programs,selected from a sat multipexes depending on the compression and bandwidth of each TV program and can be processed and modulated on to 8MHz COFDM UHF or VHF channels. Check out FTA programs available on each sat multi[plex. Power consumption 12W . Max six modules in TSMP 2000ip.	£591.82
TSMP-TV-TVDTQ	Twin frequency agile UHF/VHF channel convertor with AGC. Freq range input and output 47-862MHz. Input 65-85dBuV, F connector. TV standards B/G, D/K I, M, N COFDM digital. Very low phase noise synthesizers,improves MER.	£380.86
TSMP-PT	Freeview DVB-T COFDM receiver 147-230mHz/470-862mHz .COFDM 2k,8k Video out 1vpk-pk,audio-6 to +6dB. Output connector 15 pin D socket	£225.11
TSMP-PTT	Twin Freeview DVB-T COFDM receiver 147-230mHz/470-862mHz .COFDM 2k,8k Video out 1vpk-pk,audio-6 to+6dB. Output connector via two 15 pin D sockets.One tuner ,select any two programs from one multiplex.	£251.61
TSMP-T2C-AVT	Twin Freeview DVB/T2 COFDM receiver 147-230mHz/470-862mHz .COFDM 2k,8k Video out 1vpk- pk,audio-6 to+6dB. Output connector both channels via one 15 pin D socket.Use this on new installations!	£428.59
TSMP-PTTI	Twin Freeview DVB-T COFDM receiver 147-230mHz/470-862mHz .COFDM 2k,8k Video out 1vpk-pk,audio-6 to+6dB. Output connectors two 15 pin D sockets. Two tuners ,select any two programs from any multiplex.	£309.84

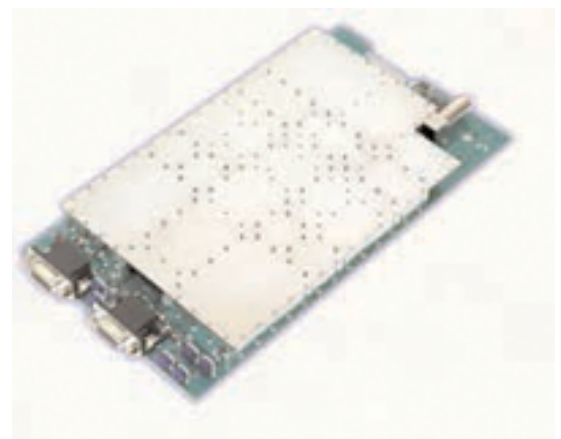
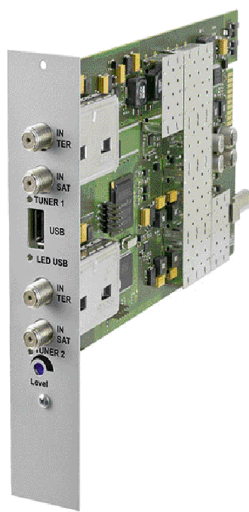

- TSMP DBP 2m D plug to AV Phono lead £7.65
 - TSMP DB 2m D plug to BNC Video Phono audio lead £7.65 for 5m leads add £1.90
 - TSMP DS 2m D plug to scart lead £7.65
 - TSMP DBPS 2m D plug to AV stereo Phono lead £8.90
- [See bottom of page 37 for D to D leads](#)

Compact Head End. OH50 range Rack or wall mounted

- *Rack mounted head end that can be customized and .monitored and controlled via the internet.
- *Composite Video Audio modulated to PAL B/G D/K I,L
- *DVB-S free to air MPEG 2&4 to PAL B/G D/K I,L M,N with CI interface
- *DVB-S /S2 free to air MPEG 2&4 to PAL B/G D/K I,L M,N with CI interface
- *DVB-T/C free to air MPEG 2&4 to PAL B/G D/K I,L M,N with CI interface
- *DVB-S /S2 free to air MPEG 2&4 to COFDM with CI interface
- *DVB-T/C free to air MPEG 2&4 to COFDM with CI interface
- *DVB-S /S2 free to air MPEG 2&4 to COFDM with CI interface
- *DVB-S /S2 free to air MPEG 2&4 to QAM with CI interface
- *Composite Video Audio and SDI ,modulated to QAM and COFDM

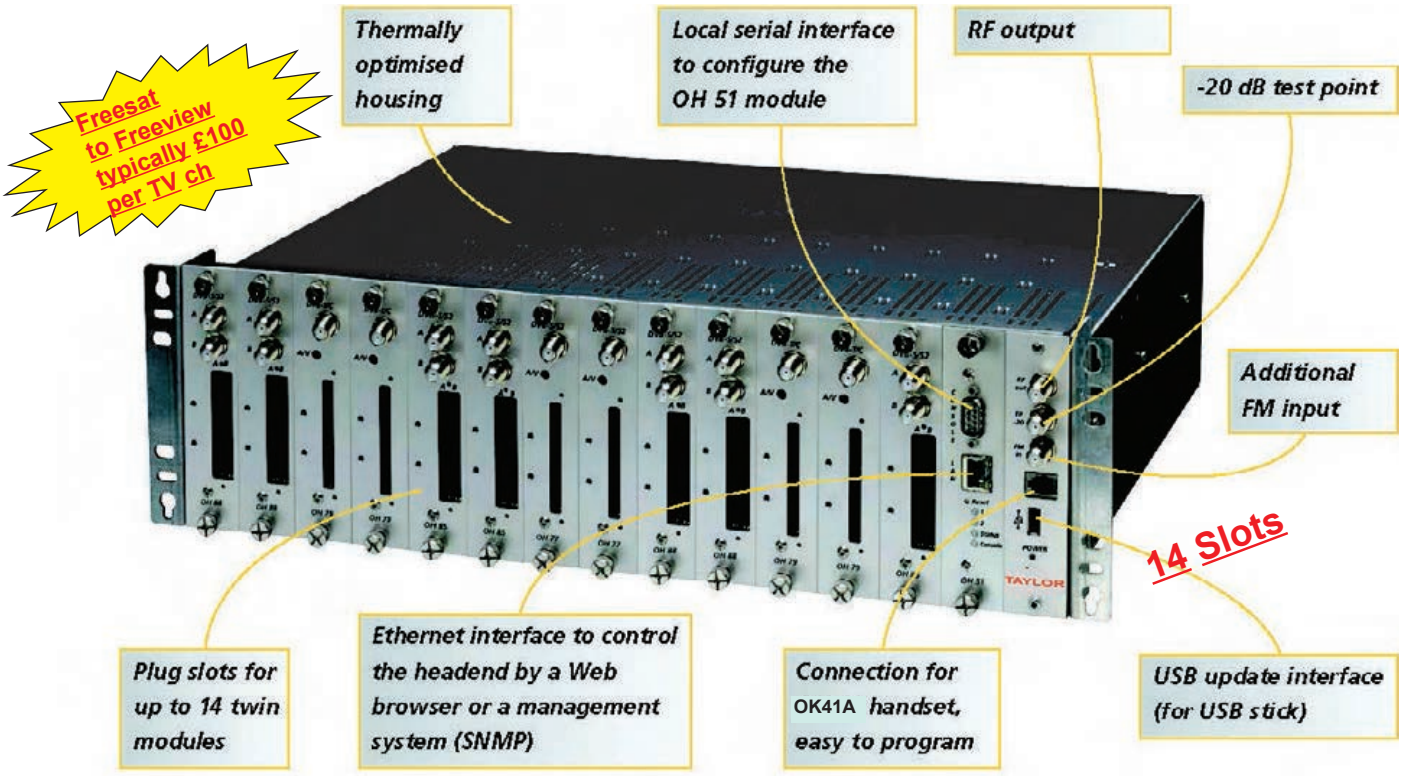

Freesat to Freeview typically £100 per TV ch

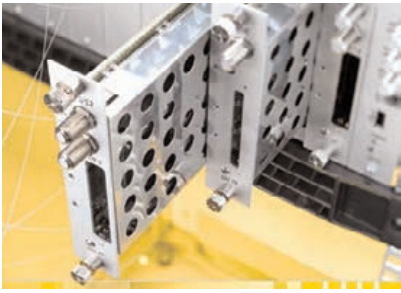

OH50 Base unit



OH41 Programmer £51.55

OH51 Remote Monitoring module

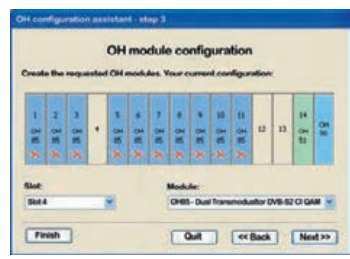



Wall or rack mounting brackets

- * Headend basic unit for analog and digital TV signals
- * Slots for up to 14 modules (28 channels max.)
- * 19" rack mounting or wall mounting
- * Integrated FM amplifier
- * Easy programming with OH 41 handset
- * Update and pre-programming via USB stick
- * Remote monitoring module OH 51 is available
- * High output power

OH 50	Base Unit (3U)
Amplifier Frequency range	
TV	47–862 MHz
FM	87.5–108 MHz
Output level	110 dB _V
Output attenuator	15 dB / 1 dB steps
Input level (FM)	70–100 dB _V
FM attenuator	31 dB / 1dB steps
Test output	- 20 dB
Power supply	
Input voltage	180...265 V AC (47-63 Hz)
Max. power consumption	< 195 W
Efficiency	≥ 85 %
LNB power	12.5 V 1.2 A
Dimensions	443 x 132 (3 HU) x 351 mm
Connectors	
FM input/RF output	2 x F-connector
Test output	1 x F-connector
Control	RJ 11
Software update	USB
Master slave operation	RJ 12
Operating temperature range	- 20 °C to + 40 °C

- * Reception of a DVB-T/C signal and processing to an analog-TV-channel per module
- * Demultiplexing and decoding of MPEG-2 and MPEG-4 signals
- * Built-in CI interface
- * NICAM audio processing
- * Input frequency range 110–858 MHz
- * Output frequency range 45–862 MHz
- * Vestigial sideband modulator



OH79D	DVB-T/C to Analogue UHF/VHF
with CI (MPEG-4)	
Input frequency range	110–858 MHz
Input frequency steps	250 kHz
Input level range	47–90 dB _V
Channel bandwidth	7/8 MHz
COFDM spectral	2k and 8k FFT
COFDM modulation scheme	QPSK, 16QAM, 64QAM
COFDM guard interval	1/32, 1/16, 1/8, 1/4
COFDM FEC inner code Conv.,	K=7, G=1/2, 2/3, 3/4, 4/5, 5/6, 7/8
QAM modulation scheme	16-, 32-, 64-, 128-, 256 QAM
QAM symbol rate	1–7 MBaud
Output frequency range	45–862 MHz
Frequency steps	250 kHz
Stability of output frequency	± 30 kHz
Output channel bandwidth	7/8 MHz
Output level (1dB steps)	95–105 dB _V
Spurious inside TV channel	> 55 dB
Spurious outside a TV channel	> 55 dB
TV standards	B/G, D/K, I, L, M, N
Video standard	PAL, SECAM, NTSC
Video format	4:3, 16:9, 4:3-Zoom
Video decoder	MPEG-2 (ML@MP)H.264 (MPEG-4)
Audio decoder	MPEG-2 (L1/L2), AAC
Audio format	Mono, Stereo, Dual, NICAM
S/N video (CCIR-rec. 567-1)	> 58 dB
S/N audio (color test pattern)	> 50 dB
Stability of output level	± 1 dB
Connectors RF input/output	F-connector
Current consumption	ca. 0.80 A
Power consumption	< 10 W
LNB power*	12 V / 0.5 A max.
Operating temperature range	- 20 °C to + 40 °C

- * Reception of a DVB-S signal and processing to an analog-TV-channel
- * Demultiplexing and decoding of MPEG-2 signals
- * Built-in CI interface
- * Input frequency range 950–2150 MHz
- * Output frequency range 45–862 MHz
- * Frequency agile vsb modulator



OH 76	DVB-S to Analogue UHF/VHF
With CI	
Input frequency range	950–2150 MHz
Input frequency steps	1 MHz
Input level range	47–70 dB _V
Modulation scheme	QPSK
Frequency steps	1 MHz
Symbol rate	1–45 MS/s
FEC outer code	RS (204,16)
FEC inner code	Conv. (1/2, 2/3, 3/4, 5/6, 7/8)
Output frequency range	45–862 MHz
Frequency steps	250 kHz
Stability of output frequency	± 30 kHz
Output channel bandwidth	7/8 MHz
Output level (1dB steps)	95–105 dB _V
TV standards	B/G, D/K, I, L, M, N
Video standard	PAL, SECAM, NTSC
Video format	4:3, 16:9, 4:3-Zoom
Video decoder	MPEG-2 (ML @ MP)
Audio decoder	MPEG-2 (L1/L2)
Audio format	Mono, Stereo, Dual
S/N video (CCIR-rec. 567-1)	≥ 58 dB
S/N audio (color test pattern)	> 50 dB
Stability of output level	± 1 dB
Spurious inside TV channel	> 55 dB
Spurious outside TV channel	> 55 dB
Connectors RF input/output	F-connector
Current consumption	ca. 0.80 A
Power consumption	< 10 W
LNB power*	12 V / 0.5 A max.
Operating temperature range	- 20 °C to + 40 °C

* with 22 kHz/DiSEqC modulator to control multiswitches

- * Reception of a DVB-S/S2 signal and processing to an analog-TV-channel
- * Demultiplexing and decoding of MPEG-2 and MPEG-4 signals
- * Built-in CI interface
- * NICAM audio processing
- * Input frequency range 950–2150 MHz
- * Output frequency range 45–862 MHz
- * Vestigial sideband modulator



OH77	DVB-S/S2 to Analogue UHF/VHF
with CI (MPEG-4)	
Input frequency range	950–2150 MHz
Input frequency steps	1 MHz
Input level range	47–70 dB _V
AFC	± 10 MHz
Modulation scheme	QPSK, 8PSK
Symbol rate	10–30 MS/s
FEC inner code LDPC	(1/2, 3/5, 2/3, 3/4, 4/5, 5/6, 8/9, 9/10)
Spectral inversion X	C-Band/KU-Band
Output frequency range	45–862 MHz
Frequency steps	250 kHz
Stability of output frequency	± 30 kHz
Output channel bandwidth	7/8 MHz
Output level (1dB steps)	95–105 dB _V
Spurious inside TV channel	> 55 dB
Spurious outside a TV channel	> 55 dB
TV standards	B/G, D/K, I, L, M, N
Video standard	PAL, SECAM, NTSC
Video format	4:3, 16:9, 4:3-Zoom
Video decoder	MPEG-2 (ML@MP)H.264 (MPEG-4)
Audio decoder	MPEG-2 (L1/L2), AAC
Audio format	Mono, Stereo, Dual, NICAM
S/N video (CCIR-rec. 567-1)	> 58 dB
S/N audio (color test pattern)	> 50 dB
Stability of output level	± 1 dB
Connectors RF input/output	F-connector
Current consumption	ca. 0.80 A
Power consumption	< 10 W
LNB power*	12 V / 0.5 A max.
Operating temperature range	- 20 °C to + 40 °C

* with 22 kHz/DiSEqC modulator to control multiswitches

- * Modulation of 2 AV or SDI signals to 2 QAM or COFDM TV channels
- * Video resolution adjustable from 1.5-9Mb/s
- * Connectors for audio/video with BNC/3.5mm jack
- * Connectors for SDI with BNC/3.5mm /jack
- * SDI audio input embedded or 2 x 3.5mm Jack



OH66	Twin AV/SDI, MPEG 2 to QAM, COFDM.
Composite video Input level 1 V _{ss} (± 0.4V),	
Frequency range 20 Hz ... 5 MHz	
MPEG 2 Video processing ,ISO/IEC 13818-2, MP@ML (4:2:2)	
Bit rate ,CBR & VBR 1.5 – 9 Mb/s in 1.5Mb/s steps;	
Picture size 720 pixel horizontal, 576 pixel vertical	
Teletext extraction from analogue video signal	
Picture format support for 4:3 and 16:9	
automatic detection by WSS	
PID setting automatic;	
Manual overwriting possible	
PSI/SI settings automatic creation of PAT/PMT/SDT	
NIT setting with LCN Optional with CS77	
Input audio	
Input format Analogue (left/right) or digital (SDI with embedded audio)	
Frequency range 40 Hz ... 15 kHz	
Audio processing	
Sampling frequency 32/44,1/48 kHz	
Encoding standard MPEG 1 L1/L2 ISO/IEC 13818-3	
Bit rate up to 192 kbit/s	
Mode stereo, joint stereo, dual, mono	
Output	
QAM or COFDM* modulation can be selected by the control software	
Output frequency range 47–862 MHz	
Spurious outside TV channel ≥ 50 dB	
QAM-Mode	
Modulation scheme 16-, 32-, 64-, 128-, 256-QAM	
Output frequency steps 500 kHz	
Output channel bandwidth 8 MHz	
Output level 88–103 dB _μ V	
MER ≥ 40 dB	
Symbolrate 3.45–6.9 MS/s	
Bit stuffing yes	
PCR correction yes	
COFDM-Mode*	
Modulation scheme COFDM	
Output frequency steps 250 kHz	
Output channel bandwidth 7/8 MHz	
Output level 82–97 dB _μ V	
MER ≥ 37 dB	
Modulation of single carriers QPSK, 16-, 64-QAM	
FEC 1/2, 2/3, 3/4, 5/6, 7/8	
Guard interval 1/4, 1/8, 1/16, 1/32	
FFT Mode 2k, 8k	
General data	
Connectors	
Video- / Audio-input per channel 1 x BNC / 1 x stereo jack socket 3.5 mm	
RF-output F-connector	
Operating temperature range - 20°C to +55°C	

- * Modulation of 2 AV signals to 2 analog TV channels
- * Multi standard operation
- * Stereo capable vestigial sideband modulator, independently adjustable in 250 kHz steps
- * Interface for audio/video with BNC/Phono(RCA)
- * Output frequency range 45–862 MHz



OH38	Twin AV-Analogue Modulator
Video input level	1 V ± 0.4 V
Video input bandwidth	20 Hz–5 MHz
Audio input impedance	600 / 10 k Ohm
Audio input level (for nom. deviativ)	- 4 dBm / 1 kHz
Audio level range -	9 dB...+ 5 dB
Audio input bandwidth	40–15000 Hz
Output impedance	75 Ohm
Output frequency range	45–862 MHz
Frequency steps	250 kHz
Stability of output frequency	± 30 kHz
Output channel bandwidth	7/8 MHz
Output level (1 dB steps)	± 1 dB
TV standards	B/G, D/K, I, L
Audio format	Mono, Stereo, Dual(notNicam)
S/N video (CCIR-rec. 567-1)	> 58 dB
S/N audio (color test pattern)	> 50 dB
Stability of output level	± 1 dB
Spurious inside TV channel	> 55 dB
Spurious outside TV channel	> 55 dB
Power consumption	< 8 W
Operating temperatur range	- 20 °C to + 40 °C

- Reception of two DVB-S/S2 signals and transmodulation into dual COFDM-TVchannels
- 2 built-in CI interfaces
- Input frequency range 950–2150 MHz
- Output frequency range 110–858 MHz



OH88H	Twin DVB-S/S2 to COFDM
with CI	
Input frequency range	950–2150 MHz
Input frequency steps	1 MHz
Input level range	47–70 dB_V
AFC	± 10 MHz
Modulation scheme	QPSK, 8PSK
Symbol rate	2–45 MS/s
FEC inner code	LDPC (1/2, 3/5, 2/3, 3/4, 4/5 5/6, 8/9, 9/10)
Spectral inversion	C-Band/KU-Band
Output frequency range	110–858 MHz
Frequency steps	1 MHz
Stability of output frequency	± 30 kHz
Output channel bandwidth	2 x 8 MHz
Output level	95–105 dB_V
Stability of output level	± 1 dB
Spurious inside TV channel	> 50 dB
Spurious outside TV channel	> 50 dB
SNR	≥ 41 dB
MER	≥ 37 dB
Modulation	QPSK, 16-, 64-QAM
FEC	1/2, 2/3, 3/4, 5/6, 7/8
Guard interval	1/4, 1/8, 1/16, 1/32
FFT Mode	2k, 8k
Bit stuffing	yes
PID filtering	yes
Connectors RF input/output	F-connector
Current consumption	ca. 0.85 A
Power consumption	< 10 W
LNB power* 1	2 V / 0.5 A max.
Operating temperature range	- 20 °C to + 40 °C

* with 22kHz/DiSEqC modulator to control multiswitches

- * Reception of two DVB-T/C signals and transmodulation into dual COFDM-TVchannels (bonded)
- * Input frequency range 110–858 MHz
- * Output frequency range 110–858 MHz



OH892	Twin DVB-T/C to COFDM
with CI	
Input frequency range	110–858 MHz
Input frequency steps	250 kHz
Input level range	47–90 dB_V
Channel bandwidth	7/8 MHz
COFDM spectral	2k and 8k FFT
COFDM modulation scheme	QPSK, 16QAM, 64QAM
COFDM guard interval	1/32, 1/16, 1/8, 1/4
COFDM FEC inner code Conv., K=7, G=1/2, 2/3, 3/4, 4/5, 5/6, 7/8	
QAM modulation scheme	16-, 32-, 64-, 128-, 256 QAM
QAM symbol rate	1–7 MBaud
Output frequency range	110–858 MHz
Frequency steps	1 MHz
Stability of output frequency	± 30 kHz
Output channel bandwidth	2 x 8 MHz
Output level	95–105 dB_V
Stability of output level	± 1 dB
Spurious inside TV channel	> 50 dB
Spurious outside TV channel	> 50 dB
SNR	≥ 41 dB
MER	≥ 37 dB
Modulation	QPSK, 16-, 64-QAM
FEC	1/2, 2/3, 3/4, 5/6, 7/8
Guard interval	1/4, 1/8, 1/16, 1/32
FFT Mode	2k, 8k
Bit stuffing	yes
PID filtering	yes
Connectors RF input/output	F-connector
Current consumption	ca. 0.85 A
Power consumption	< 10 W
LNB power* 1	2 V / 0.5 A max.
Operating temperature range	- 20 °C to + 40 °C

OH51A.
Remote Monitoring module. Two OH50 units can be monitored and config-ured via the internet.



OH45
DVB-T/T2 ch converter
Useful for changing to lower frequencies and consequently lower cable lossess



Freesat in

Hotbird in

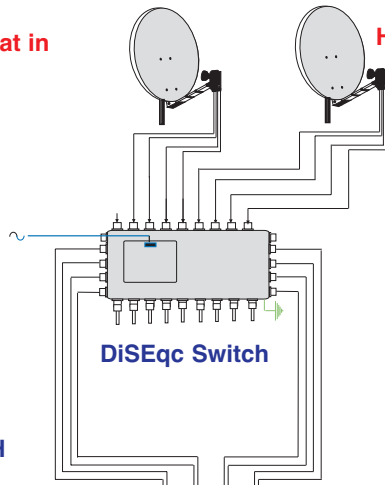

1 x OH 50
4 x OH 88H
Dual units

8 x Freeview DVB-T muxes out using 4 modules ,add more modules for more multiplexes



OH 50	Basic unit for 14 modules; FM amplifier, power supply; USB interface	£499.19
OH 51A	Management module, Web browser, SNMP	£113.40
OH 38	Dual AV modulator, no channel bonding	£262.30
OH 45	Terrestrial DVB-T/T2 channel converter 45-862 MHz,internal SAW filter.7/8 MHz	£251.43
OH 66	Twin AV or SDI input MPEG 2 encoder to QAM or COFDM. 82- 97dBuV , 47-862MHz	£715.90
OH 76	DVB-S to PAL/Secam/NTSC	£222.56
OH 77	DVB-S/DVB-S2/MPEG2/MPEG4 to PAL/Secam/NTSC	£395.75
OH 79D	DVB-S2/MPEG4 to PAL/Secam/NTSC	£467.92
OH 85H	Dual DVB-S/DBV-S2 to QAM transmodulator; HD, 2 CI, bit stuffing,	£479.95
OH 88H	Dual DVB-S/DVB-S2 to COFDM transmodulator, HD, 2 CI, bit stuffing,	£589.80
OH 892	Dual DVB-T/DVB-C to COFDM transmodulator, 2 CI, bit stuffing, PCR,	£647.18

USB Interface Updates:
Received via internet can be transferred to the Headend by USB stick without PC.
Preprogramming:
Can be done in office and transferred
To the Headend for quick installation.



High definition DVB-T
COFDM modulator encoder.
50-860MHZ

MPX-HDMI-DVB-T

Inputs Video Audio, via HDMI



£98.72

VAT 20% £19.74

Free UK Shipping

Full HD
1080

1080p & 1080i encoding

HDMI Encoding Section

Video	Encoding	H.264 MP@L 3.0/3.1/4.0
	Input	Output
	480@59.94/60p	480@60p
	480@59.94/60i	480@30p
	576@50i	576@25p
Resolution	720@50/59.94/60p	720@50/59.94/60p
	1080@50i	1080@25p
	1080@59.94/60i	1080@30p
	1080@59.94/60p	1080@30p
Aspect Ratio	16:9, 4:3	
Bit rate	1.000~18.000 Mbps	
Audio	Encoding	MPEG1 layer 2
	Sample rate	48KHz
	Bit rate	64, 96, 128, 192, 256, 320kbps

Crisp Clear HD pictures
on large screen TV

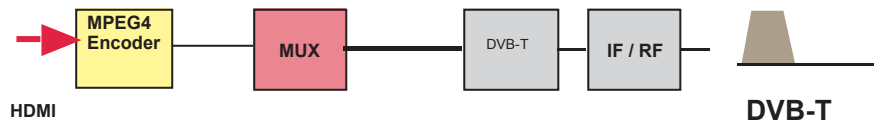

MPEG 4 (H264) Encoder

PSU Included

DVB-T Modulator Section

Standard	DVB-T COFDM
Bandwidth	6M, 7M, 8M
Constellation	QPSK, 16QAM, 64QAM
Code rate	1/2, 2/3, 3/4, 5/6, 7/8
Guard Interval	1/32, 1/16, 1/8, 1/4
Transmission Mode:	2K, 8K
MER	≥31dB
RF frequency	150~950 MHz, 0.1KHz step
RF output level	-47~0 dBm (60~107 dBμV), 1db step

System

RF mix in ATT	10 dB
Management	Local LCD + control buttons
Upgrade	USB

General

Power supply	DC 12V
Dimensions	183*110*50mm
Weight	< 1kg

For MPEG 2 Encoding see page 40-45

HDMI sources sometimes have HDCP, (High bandwidth digital protection) that sometimes restricts use.

Use a HDMI splitter to overcome, using a splitter will usually block the HDCP encryption, see Wikipedia, HDCP

OK with most set top boxes



Control via front panel or PC connected to modulator

Video and Audio MPEG 4 and 2 encoders to IP. DVB-T COFDM version includes both DVB-T and IP out

Composite Audio Video (PAL).

Into MPEG4 or 2 encoder and then modulated into DVB-T

- * RF loop through
- * MPEG2/4 AVC H.262.H264 encoding available
- * LCN Function
- * Modulation QPSK, 16QAM, 64QAM COFDM
- * FFT mode 2K or 8K
- * Channel bandwidth 7-8MHz
- * Output level 97dBuV
- * Level adjustment 15dB
- * Audio Encoding MPEG1 Layer (1*Stereo or 2*mono)
- * MER typ ≥42dB
- * Guard intervals 1/4,1/8,1/16,1/32
- * Code rate 1/2,2/3,3/4,5/6,7/8
- * IP out
- * ASI out
- * LCD + control buttons
- * Remote management Web NMS
- * Mains power 100-240V AC
- * Operation temperature 0-35 Deg C
- * Standard EN300744

Example

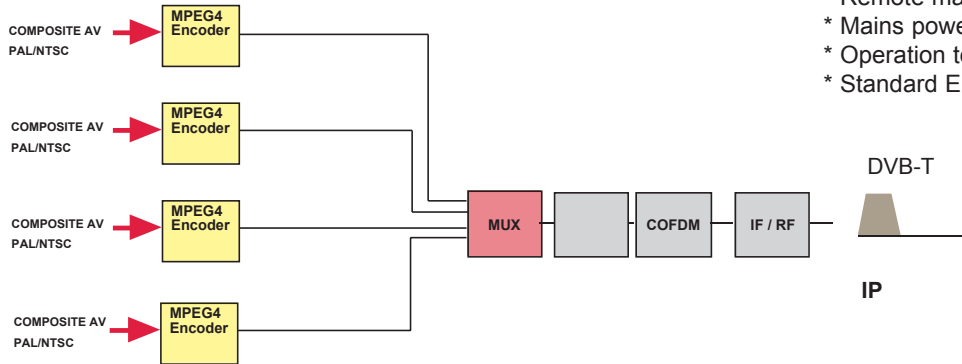

Please note ,some older or non HD TV sets may need MPEG2 encoding.

All DVB-T modulators on this page also have IP out so as well as distributing on a CATV system for TV sets ,the IP out can be connected to a computer network and PC,s or tablets used to receive video and audio. The local area network needs to have the capacity in bandwidth to accommodate the number of TV programmes distributed.

MPX AV4 DVB-T AV R	MPEG 4. Quad Encoder, COFDM modulator,rack mounted	4 x AV input,PAL/NTSC stereo audio	£829.84
MPX AV8 DVB-T AV R	MPEG 4. Eightfold Encoder, COFDM modulator,rack mounted	8 x AV input,PAL/NTSC stereo audio	£1,185.97
MPX AV4 DVB-T AV R 2	MPEG 2. Quad Encoder, COFDM modulator,rack mounted	4x AV input,PAL/NTSC stereo audio	£829.84

MPEG 4 (H264) and MPEG 2 (option) (H262) Encoder Modulators

High definition or Standard definition DVB-T encoder. COFDM modulator. 30-860MHZ



DVB-T COFDM version includes both DVB-T and IP out, systems can be configured to provide all modulated programmes, distributed via coax and via a local area network at the same time.

Embedded Audio Encoding MPEG1 Layer II(1x Stereo or 2 x mono)

Example of MPEG 2 and 4 encoding

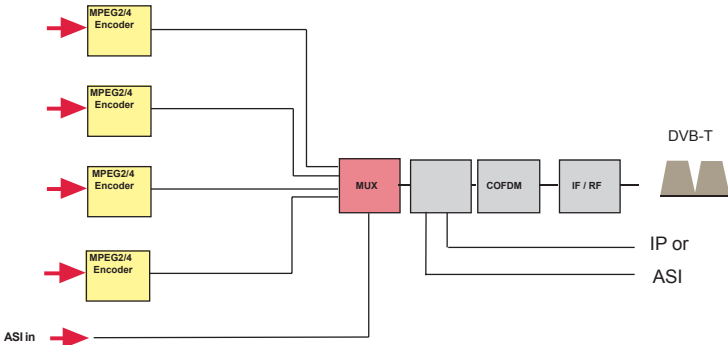

MPEG4 or MPEG2 can be configured, then modulated into DVB-T.

DVB-T2 available on request at an additional cost.

DVB-T2 is not normally needed on CATV systems due to available bandwidth. A modulator above with 4 HD inputs has the capacity to modulate up to 16 mgbits per HD TV program.

Very low latency when using MPEG 2 encoding, mode 1. Example, 1080i@50, Encoding, typical latency utilising maximum available bandwidth (mgbits) 0.17 seconds, 720p@50, 0.086 seconds. This is typical latency using a good quality set top box or TV. MPEG4 encoding can have latency at approximately double of MPEG2. Very useful for time critical applications

Specifications

Encoding section

Video

Encoding [MPEG2 or MPEG4 H.264, see options below](#)

Input HDMI x 4 & x 8 or SDI x 4

Resolution 1920*1080_60i, 1920*1080_50i, 1280*720_60p, 1280*720_50P, 720*480_60i, 720*576_50i

[Option on request 1920*1080_60P, 1920*1080_50P, MPEG4 AVC/H.264 only](#), not recommended uses excessive bandwidth in mux, no noticeable difference compared to 1080i, not normally used for broadcasting or CATV networks

Low delay Normal, mode 1 mode 2

Symbol rate 5.000~9.000Mpsps adjustable

J 83A

Constellation bandwidth 16/32/64/128/256QAM

8M

J 83B

Constellation bandwidth 64QAM/ 256QAM

6M

J 83C

Constellation bandwidth 64QAM/ 256QAM

6M

Modulation options

DVB-T

Standard EN300744

Bandwidth 6M, 7M, 8M

Constellation QPSK, 16QAM, 64QAM,

Code rate 1/2, 2/3, 3/4, 5/6, 7/8.

Guard Interval 1/32, 1/16, 1/8, 1/4

Transmission Mode: 2K, 8K

MER ≥42dB

RF frequency 30 to 960MHz, 1KHz steps

RF Out COFDM DVB-T out

RF output level 77 to 97 dbμV Adjustable

DVB-C

Standard J.83A, J.83B, J.83C

MER ≥42dB

RF frequency 30 to 960MHz, 1KHz steps

RF output level 77 to 97 dbμV Adjustable

MPX-HD/SDI 2DVBT,R HDMI 2/4 MPEG 4/2 Dual Encoder, COFDM modulator, rack mounted	2 x HDMI inputs	£2,151.94
MPX-HD/SDI 4DVBT,R HDMI 2/4 MPEG 4/2 Quad Encoder, COFDM modulator, rack mounted	4 x HDMI inputs	£2,550.59
MPX-HD/SDI 2DVBT,R SDI 2/4 MPEG 4/2 Dual Encoder, COFDM modulator, rack mounted	2 x SDI inputs, embedded audio	£2,835.88
MPX-HD/SDI 4DVBT,R SDI 2/4 MPEG 4/2 Quad Encoder, COFDM modulator, rack mounted	4 x SDI inputs, embedded audio	£3,290.88

All DVB-T COFDM modulators on this page also come with IP out unless otherwise stated.

Suitable for streaming

MPEG 4 (H264) HDMI DVB-T Modulators
Up to 24 HDMI inputs in one, 1 U rack
High definition or Standard definition encoder. DVB-T COFDM modulator. 30-860MHZ
Output Includes IP, into standard local area network.
Costs as less than £130.00 per HD/SD TV programme

Set up and control via web management



MPX-HD/SDI 8DVB-T,R HDMI B	MPEG 4 Eightfold, Encoder ,rack mounted	8 x HDMI inputs	£1,062.50
MPX-HD/SDI 16DVB-T,R HDMI B	MPEG 4. Sixteenfold Encoder,COFDM modulator,rack mounted	16 x HDMI inputs	£1,812.50
MPX-HD/SDI 24DVB-T,R HDMI B	MPEG 4. Twentyfourfold Encoder,COFDM modulator,rack mounted	24 x HDMI inputs	£2,375.00

24 HDMI input version illustrated

Discontinued

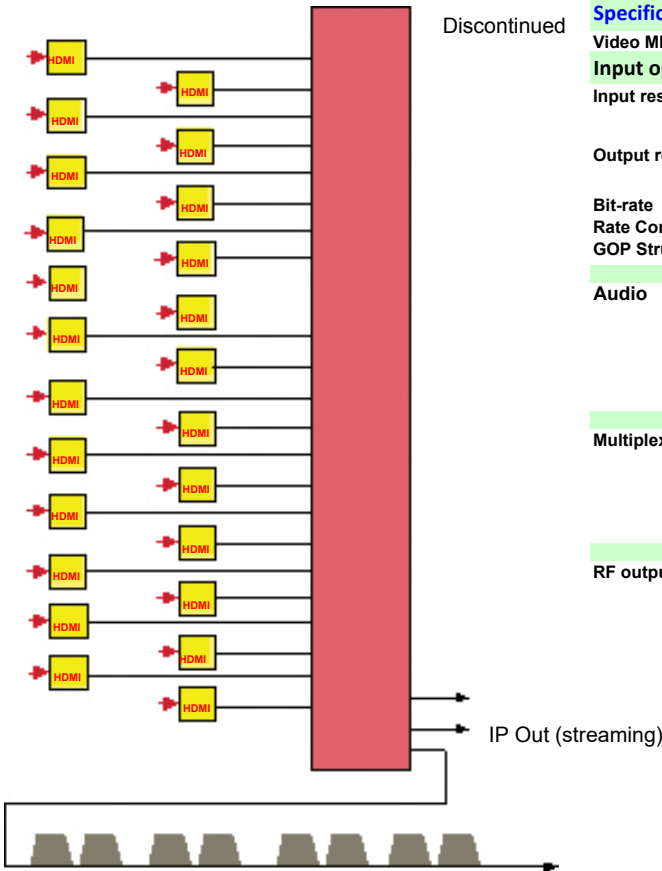

Specifications

Video MPEG4 H264

Input options HDMI 8, 16, 24

Input resolutions	1920×1080_60P, 1920×1080_60i,1920×1080_50P, 1920×1080_50i, 1280×720_60P, 1280×720_50P,720×576_50i,720×480_60i,
Output resolutions	1920×1080_30P, 1920×1080_25P,1280×720_30P, 1280×720_25P, 720×576_25P,720×480_30P,
Bit-rate	1Mbps~13Mbps each channel
Rate Control	CBR/VBR
GOP Structure	IP...P (P Frame adjustment, without B Frame)

Audio	Encoding	MPEG-1 Layer 2
	Sampling rate	48KHz
	Resolution	24-bit
	Audio Gain	0-255 Adjustable
	Bit-rate	64kbps, 128Kbps, 192kbps, 224kbps, 256kbps, 320kbps, 384kbps

Multiplexing	Maximum PID Remapping Function	180 input per channel
	Maximum simulcrypt CA	PID remapping (automatically or manually) Accurate PCR adjusting,Generate PSI/ SI table automatically

RF output Options	DVB-C	QAM Standard	16 non-adjacent carriers output (maximum bandwidth 192MHz) EN300 429/ITU-T J.83A/B
		MER	≥40db
		RF frequency	50~960MHz, 1KHz step
		RF output level	-20~+10dbm (87~117 dbμV), 0.1db step
		Symbol Rate	5.0Msps~7.0Msps, 1ksps stepping
			J.83A J.83B
		Constellation	16/32/64/128/256QAM
		Bandwidth	8M 6M

DVB-T	QPSK, 16QAM, 64QAM	Maximum 8 non-adjacent carriers.
	Standard	EN300744
	FFT mode	2K,4K, 8K
	Bandwidth	6M, 7M, 8M
	Guard Interval	1/4, 1/8, 1/16, 1/32
	FEC	1/2, 2/3, 3/4, 5/6, 7/8
	MER	≥42 dB
	RF frequency	50~960MHz, 1KHz step
	RF output level	-20~ +10 dBm (87~117 dbμV), 0.1db step

Stream output Power	1000M Base-T Ethernet interface AC 110V± 10%, 50/60Hz, AC 220 ± 10%, 50/60Hz
----------------------------	---

For low latency applications use MPEG 2 Encoding, MPEG2 Encoding occupies more bandwidth and consequently needs less compression.

Specification and [prices subject to change without notice.](#)
 Prices plus VAT

HDMI input is sometimes unable to capture from some copy protected HDMI sources, such as blue ray players, if HDCP encryption is embedded in the video /audio stream, doesn't normally apply to set top boxes or normal DVD player. HDCP strippers or HDMI splitters are available from other vendors.

TXS MPX-DVB-T-IP

16 x DVB-T T2, Inputs to IP out



Input 16 x DVB-T 60-890MHz
Bandwidth 6/7/8 MHz
Constellation 16/32/64/128/256 QAM

Output 16 MPTS IP output (for Tuner/ASI passthrough) over UDP and RTP/RTSP protocol through GE1 and GE2 port, Unicast and Multicast

Web based management

Power requirements 100~240VAC, 50/60Hz
Power consumption 20W

Web Management

16 x DVB-T inputs

**Exceptional Quality
Great Price £1,913.60
Ex VAT**

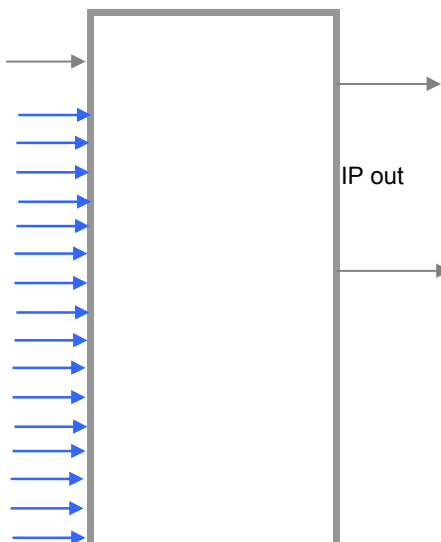

46B

TXS

UHD Digital modulator.

DVB-T or C output

One HDMI input + redundancy. Price Ex VAT



H.265/HEVC and H.264/AVC, multiplexing and modulating functions in one standard 1U case. **£4,754.64**



Logo, Caption, QR code insertion

Video Input	Resolution		Chroma		
	3840×2160_60P, 3840×2160_59.94P, 3840×2160_50P, 3840×2160_30P, 3840×2160_29.96P, 3840×2160_25P, 3840×2160_24P, 1920×1080_60P, 1920×1080_59.94P, 1920×1080_50P, 1920×1080_30P, 1920×1080_25P, 1920×1080_24P,		RGB, YCbCr 4:4:4, YCbCr 4:2:2, YCbCr 4:2:0 (2160P_50/60Hz only)		
Video Encoding	Encoding	H.265/HEVC, H.264/AVC			
	Chroma	4:2:2, 4:2:0			
	Bit-rate	1Mbps~23Mbps			
	Rate Control	CBR			
Audio Encoding	Encoding	MPEG-1 Layer 2, LC-AAC			
	Sampling rate	48KHz			
	Bit-rate	64Kbps~256Kbps each channel			
Multiplexing	2 ASI input multiplexed with local 1 channel of TS				
	PID remapping (automatically or manually)				
	Accurate PCR adjusting				
	Generate PSI/SI table automatically				
Modulator Section	DVB-C	Standard	J.83A, J.83B		
		MER	≥43dB		
		RF frequency	50~960MHz, 1KHz step		
		RF output level	-25.0~ -1 dbm, 0.1db step		
		Symbol rate	5.0 - 7.0 Msps		
			J.83A	J.83B	
		Constellation	16/32/64/128/ 256 QAM	64/ 256 QAM	
		Bandwidth	8M	6M	
		RF out	1*RF DVB-C out		
	DVB-T	Standard	EN300744		
		FFT mode	2K/4K/8K		
		Bandwidth	6M, 7M, 8M		
		Constellation	QPSK, 16QAM, 64QAM		
		Guard Interval	1/4, 1/8, 1/16, 1/32		
		Code rate	1/2, 2/3, 3/4, 5/6, 7/8		
		MER	≥42dB		
		RF frequency	50~960MHz, 1KHz step		
		RF output level	-30 to -3dbm, 79-106dBuV 0.1db step		
RF out		1*RF DVB-T out			
		1*ASI output through 4 BNC interfaces			
Stream output		1 MPTS over UDP/RTP, 1000M/100M Base-T Ethernet interface (unicast/ multicast)			

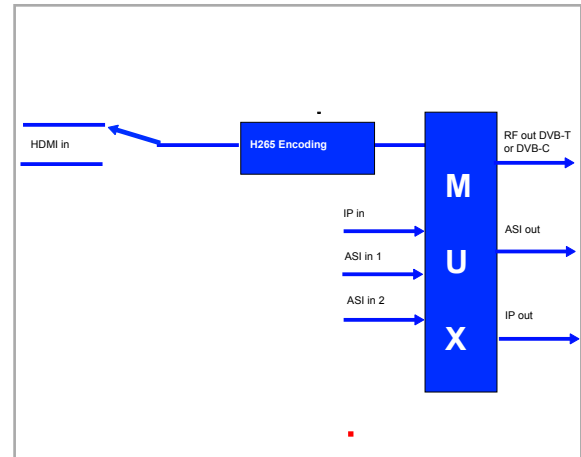

Specification and prices subject to change without notice.

Professional Head End

Standard modules with a comprehensive range of functions



4 x HDMI in
MPEG2&4 encoding
DVB-T out



Rear View

Options configured by software license

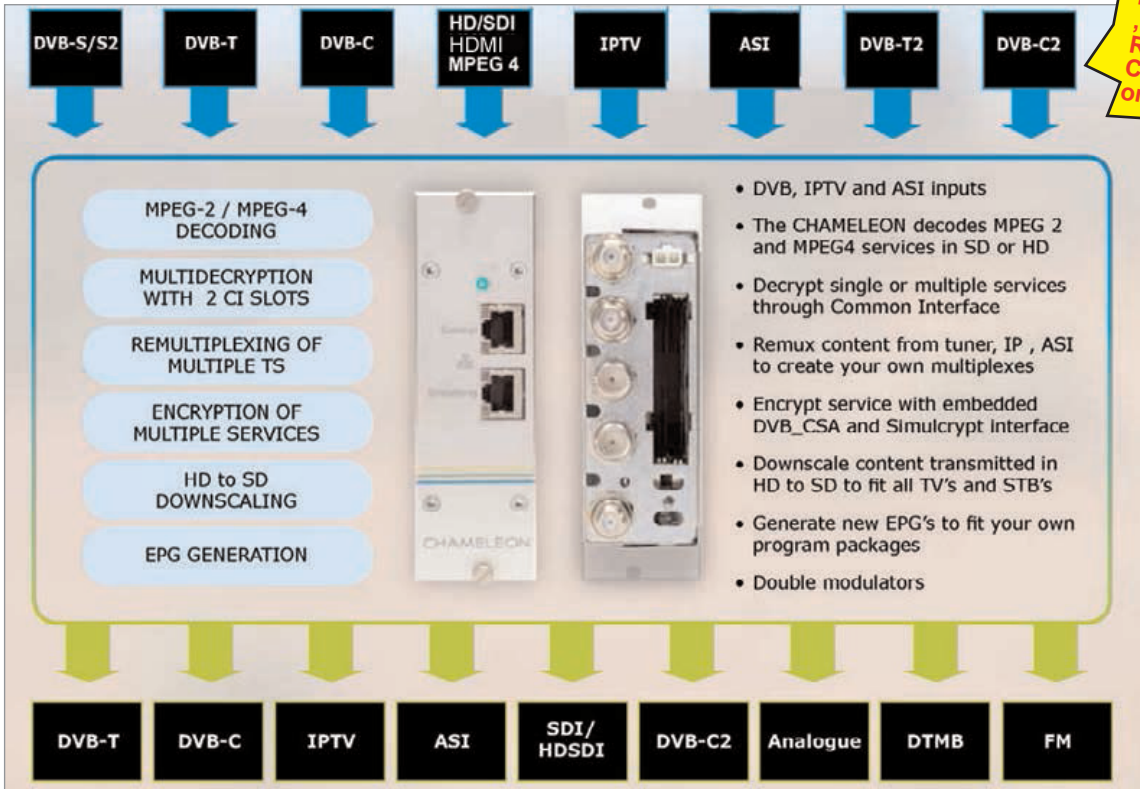

Incredible Value
Two sat DVB-S/S2
Re muxed to 2 x
COFDM Muxes with
only one module



One rack can re mux 20 DVBS/S2 muxes to 20 COFDM DVB-T muxes with only ten modules

Typical Cost for processing one Digital Free Sat TV program to one Digital DVB-T program is £136.00 per TV program. Based on five TV programs per multiplex .



Specifications subject to change

Base Units

Wall mounting accomidates 2 modules



Discontinued,
see alternative options below

For Head Ends accomidates 2 modules

GN20B



£342.49

GN20R With Redundant PSU



£422.67

For Head Ends accomidates 10 modules



£657.39

For IP Systems , accomidates 10 modules



£1,597.90

Not currently available

Part Number

GN 01 W

Basic wall mounting unit for two modules

Technical data

Output Switch/Controller Category Multicast Proccolls

Redundancy control Connections

Module slots 2 pcs.

F-socket 3 pcs.

Power supply 2 pcs.

Voltage AC 100...240 V (50/60 Hz) 18W

Dimensions (width x height x 295x216x105 mm depth)

Gross Weight shipping 1.975 kg

Part Number

GN 20 B GN20 R (Dual redundant power supply supply)

Technical data

Basic unit, 19", 1U Rack unit, for 2 modules Integrated power supply system

Built-in power supply and fan.

The GN 20W can be used individually or in conjunction with an existing installation to include additional modules.

Voltage AC 100...240 V (50/60 Hz) 18W

Dimensions 1U high rack

Gross Weight shipping unit 3.3 kg

Part Number

GN 40 W 0230

Technical data

Basic unit, 19", 4U Rack unit, for 10 modules

Output Switch/Controller Category Multicast Proccolls

Redundancy control Connections

Power supply 1pc

Voltage AC 180... 265 V (47...63 Hz) Power input <245 V

Dimensions 4 U rack unit (width x height x 443x176x270 mm)

Gross Weight shipping unit 6.46 kg

Part Number

GN 50 W 0230

Technical data

Basic unit, 230 V AC, 19", Rack 3U unit for 10 modules

Output Switch/Controller

Streaming-Ports 4 pcs. (1 Gbit/s)

Control-Ports 1 pcs. (100 Mbit/s) Category

Multicast Proccolls

Redundancy control Connections

Module slots 10 pcs.

RJ45 5 pcs.

Power supplys 1 pcs.

Optional redundant power

AC voltage 180... 265 V (47...63 Hz) <245 W

Dimensions (width x height x 443x132x475 mm)

Gross Weight shipping unit 12.44 kg

Modules and Licence options

**Universal module
GN HWUW2**



£842.56

**MPEG 4 Encoder
module 2 x SDI
GN HWENCW**



£1,709.22

**MPEG 2/4 Encoder
4 x HDMI
GNHWENC2H**



£2,136.00

GN HWENCW	Chameleon MPEG 4 HD Encoder module 2xSDI inputs	£1,709.22
GN HWUW2	Chameleon universal tuner, modulator module.	£842.56
GNHWENC2H	Chameleon MPEG 4&2 HD Encoder module 4x HDMI inputs	£2,136.00
RFinput		
GN S2	License for one DVB-S/S2 tuner	£109.57
GN T	License for one DVB-T tuner	£109.57
GN T2	License for one DVB-T2 tuner	£164.35
GN C	License for one DVB-C tuner	£109.57
GN DS2	License for two DVB-S/S2 tuners	£158.87
GN DT	License for two DVB-T tuners	£158.87
GN DT2	License for two DVB-T2 tuners	£268.43
GN DC	License for two DVB-C tuners	£158.87
Type of RF output		
GN CMOD	License for one QAM output	£120.52
GN DCMOD	License for two QAM outputs	£175.30
GN TCMOD	License for three QAM outputs	£262.96
GN QCMOD	License for four QAM outputs	£350.61
GN TMOD	License for one COFDM output	£98.61
GN DTMOD	License for two COFDM outputs	£175.30
GN DMOD	License for one DTMB output	£120.52
GN VMOD	License for one VSB output (Analogue TV) GN	£109.57
DVMOD	License for two VSB outputs (Analogue TV) GN T2MOD	£147.91
	License for one T2 output Not yet available ,	£147.91
GN OCTFM	License for 8 FM Radio outputs	£350.61
BNC Connector		
GN ASI	ASI in/out License on BNC	£98.61
GN SSDI	License for SD SDI decoder on BNC	£169.83
GN HSDI	License for HD SDI decoder on BNC	£246.52
GN DASI	License for two ASI interfaces on BNC	£197.22
GN DSDI	License for two SD, SDI outputs on BNC IP	£339.65
Streaming		
GN STR	License for IP streaming	£219.13
GN STREC	License for IP streaming with FEC for IP in.	£383.48

Not currently available

Technical data

HDMI-Input	
HDMI number of ports	4 pcs. (HDMI)
Input format HDMI	1080i50/60/59.94, 720p50/60/59.94, 576p50, 480p60/59.94, 576i50, 480i60/59.94
Input format Audio	PCM (Pulse code modulation)
Compliance	HDMI 1.4a (no scaling)
HDCP Support	No
Video Encoding	
Encoding capacity	4x HD/SD MPEG-2/MPEG-4
Video system	MPEG-2 HD/SD and MPEG-4 HD/SD (H.264/AVC)
Picture size	1080i50/60/59.94, 720p50/60/59.94, 576p50, 480p60/59.94, 576i50, 480i60/59.94
Profile MPEG-4	Baseline, Main, High
Bit rate	MPEG-2 10-19Mbps, MPEG-4 6-13Mbps @ 1080i50/60/59.94, 720p50/60/59.94; MPEG-2 4-12Mbps, MPEG-4 2-6Mbps @ 576p50, 480p60/59.94; MPEG-2 2-8Mbps, MPEG-4 1-4Mbps @ 576i50, 480i60/59.94
Chroma sample	4:2:0
Aspect ratio	16:9 for HD; 4:3 for SD
Subtitle DVB Support	No
Subtitle OP47 Support	No
Picture size conversion	Downscaling yes, Upscaling no
Frame rate conversion	No
Test pattern	No
Audio Encoding	
Audio-system	ISO 11173-3 (MPEG-1 L2), MPEG-2 AAC (LC)
Number of audio channels	1 per video input @ 4x HD/SD MPEG-2/MPEG-4; 2 per video input @ 2x HD/SD MPEG-2/MPEG-4
Sampling frequency	44.1, 48 kHz
Bit rate	64...288 Kbps (max. MPEG1 L2/AAC)
Audio modes	Stereo
Sampling rate conversion	No
Streaming-In-/Output	
IP-Inputs	0 or 32 pcs. (32 with GNSTR software option)
IP-Outputs	4 or 32 pcs. (32 with GNSTR software option)
IP-Compliance	ISO/IEC 13818
IP-Input bitrate	Max. 425 Mbit/s per IPTS, Max. 850 Mbit/s total
IP-Output bitrate	Max. 425 Mbit/s per IPTS, Max. 850 Mbit/s total
IP-Input protocol	UDP/RTP/RTP+FEC Unicast and Multicast, IGMP v2 and v3
IP-Output protocol	UDP/RTP/RTP+FEC Unicast and Multicast, IGMP v2 and v3
IP-TS-Input format	SPTS CBR/VBR, MPTS CBR



GNHWENC2H
HDMI Encoder

Technical data

IP-TS-Output format	SPTS CBR/VBR, MPTS CBR
IP-FEC inputs	0 or 32 pcs. (with GNSTREC software option)
IP-FEC Outputs	4 or 32 pcs. (with GNSTREC software option)
IP-FEC compliance	SMPTE 2022-1, SMPTE 2022-2
IP-Packet format	MPEG over UDP/IP and RTP/IP
IP-Packet size	188 Byte
IP-PCR restamping	Yes
Processing	
Service remultiplexing	Yes (GNSYMUX functionality is included)
PID filtering and remapping	Yes
PCR correction and de-jitter	Yes
Advanced PSI/SI regeneration	Yes
NIT generation	No
Compliance	ETSI EN 300 468
Processing bitrate	Max. 1200 Mbps total
Number of PIDs	Max. 2000 PIDs total
Connectors	
RJ45	2 pcs. (1x Management, 1x Streaming)
F-socket RF- output	1 pcs. (not in operation, only for mounting in GN40 base unit)
HDMI input	4 pcs. (for type A connector)
GigE/Control/Power supply (Backplane)	CompactPCI Type C (SGMII)
General data	
Power consumption	max. ≤18 W
Operating temperature range	-5°C...+45°C, 23°F...113°F, (ETSI EN 300 019-1-3 Class 3.1)
Max. humidity, non condensing	95 %
Electro Magnetic Compatibility (EMC)	DIN EN 55022:2008-05
Safety compliance	-
HDMI status LED	green, red
Operation Mode	-
Hardware revision	1000
Software version	3.0

Specifications of Chameleon modules

FM Modulation		Analogue modulator	
Number of modulators	Up to 8 FM modulators	Number of modulators	Up to 2 analogue modulators
Audio decoder	MPEG-1 Layer I/II	Standards	PAL B/G, D/K, I, SECAM D/K, B/G, L
Sound	Mono, stereo, joint stereo	Group delay pre-correction	B/G general, D/K GOST20532-75, M FCC, none
Modulation	FM, ref ITU-R BS.450-3	Sound Mono,	NICAM stereo, A2 stereo
FM deviation limiter	Yes	Modulation audio	FM or AM
RDS insertion	Yes, dynamic & static. Ref EN50067	Modulation video	VSB AM, neg. or pos.
Output frequency	87.5-108 MHz, 100 kHz step size	Video bandwidth	4.2, 5.0, 6.0 MHz
Output level per FM ch	Max 92 dB_V	Output frequency	48 – 855 MHz
S/N	> 60 dB (mono), > 55 dB (stereo)	Output level max	Max 111 dB_V (1 channel) , max 108 dB_V (2 channels)
C/N, broadband	Typical 65 dB	Video S/N	(weighted) > 65 dB
Spurious suppression	Typical 60 dBc (FM band 87.5-108 MHz) > 50 dBc (outside FM band)	C/N, broadband	> 70 dB (65 dB typical at adjacent channel)
DTMB Modulation		NICAM standards	NICAM 728 (EN 300 163)
Number of modulators	1 DTMB mux	Spurious suppression	Typical 60 dBc
Code rate	0.6	Channel bonding	All outputs within 40 MHz
Carrier mode	C = 3780 (multi-carrier)	SDI output	
Header length	PN420 / PN945 symbols	Output video	SDI, audio embedded
Interleaving length	M = 240, M = 720	Output audio	Stereo, Mono or Dual Sound
MER	>38 dB	Connector	BNC
Modulation	4QAM, 16QAM, 64QAM	Compliance	SDI-SD SMPTE 259M-C, SMPTE 272M-DEF
Output frequency	40 – 860 MHz	MPEG Decoder – Audio / Video	
Output level Max	101 dB_V	Supported formats video	MPEG2 MP@ML, MPEG2 MP@HL, up to MPEG4 H.264 AVC, H1P, level 4
Spurious suppression	> 60 dBc	Supported formats audio	MPEG 1 layer II, AAC HE Dolby Digital AC-3 (requires specific HW)
Compliance	GB 20600-2006	Aspect Ratio	Letterbox, Pan/Scan, or conversion combined (14:9) programmable, WS
DVB_CSA scrambler / Simulcrypt interface		Teletext Subtitling	Teletext or DVB subtitling
Interface	IP	ASI input / output	
Number of encrypted	PIDs 64 PIDs per output	Number of ports	2 BNC ports, configurable for in/out via UI
Number of SCG	64 SCG per output (64 CWG per output)	Max payload bitrate IN	Typical 200 Mbit/s
Scramble outputs	DVB-C, DVB-T, ASI	Max payload bitrate OUT	Typical 200 Mbit/s
Interface protocol version support	ECMG <=> SCG: V2 and V3 EMMG/PDG <=> MUX: V2 and V3	PCR restamping	Yes
DVB compliance	DVB-SimulCrypt (ETSI TS 103 197)	Packet size	188 byte
		Compliance	EN 50083-9:2002, ASI-C

Rack Enclosures and Accessories		
GN 01 W2	Two-module mounting Box including fans and 2 PS	£141.34
GN 50W 0230	19" 3HU professional subrack with GigE sw. + fan + 1PS 230VAC , prepared for redundancy	£1,698.26
GN 50W 0048	19" 3HU professional subrack with GigE sw. + fan + 1PS 48VDC , prepared for redundancy	£1,807.83
GN 40W 0230	19" 3HU Subrack + 1HU fan + 1PS + DC harness	£657.39
GN 20W	19" 1HU Subrack with PSU. Fans	£327.60
GN20 R	(Dual redundant power supply supply)	£333.00
GN 55W 0230	Redun. 230 VAC PS for GN 50	£322.32
GN 55W 0048	Redun. 48 VDC PS for GN 50	£432.78
DS 35 0035	Patchcord F-quick - F-quick, 35cm	£4.99
DS 35 0050	Patchcord F-quick - F-quick, 50cm	£4.99
GN 11 0025	ASI cable, 25cm	£9.86

GN 55W 0230 Redundant PSU



Tangram High Density Digital TV Head End processing

The Wisi Tangram video platform is a high density digital TV head end, for terrestrial satellite, Ethernet in to Coaxial RF UHF/VHF/ and DVB-IP Gateway out.

This enables systems to be constructed and customised distributing TV and radio programs via coaxial, and Ethernet networks. With DVB and Radio stream editing and processing in a compact 1 U rack unit. Individual TV programs can be removed or time scheduled. Ideal for systems that require programme control, such as schools, hotels or any network requiring individual program control.

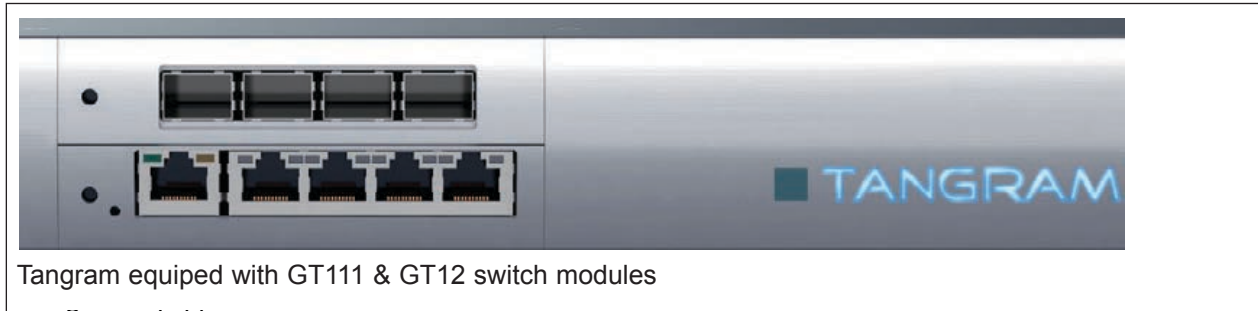

Tangram equipped with GT111 & GT12 switch modules

Tangram has 6 module slots on the rear. For example, this equals a 48 COFDM RF TV multiplex capability, or a mixture of analogue and or digital TV and FM radio, from a single 1U rack unit.



Defining and editing input streams

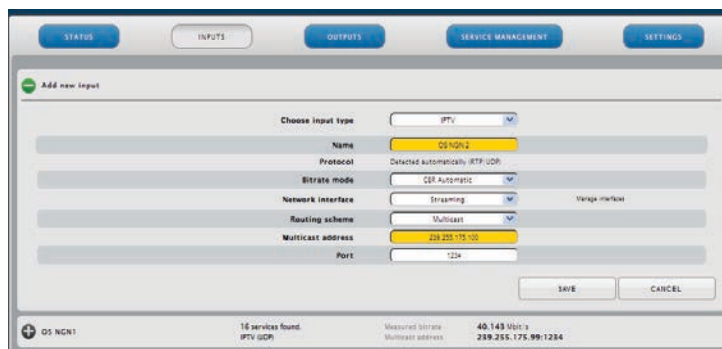

Status information

Digital TV via IP Networks and end to end IPTV solutions such as On Demand TV, Connected TV and OTT (Over The Top) Web TV. The platform is highly customizable and offers advanced DVB stream processing in a small footprint.

The TANGRAM platform can be used in a central or distributed, headend architecture and provides the following processing functions in a central location.

DVB-IP Gateway for DVB-S/S2, -C, -T, -T2, Descrambling.

Remultiplexing, Scrambling, PSI/SI-Processing and Modulation.

In a decentralized architecture with regional Hubs, the modulation is done in the hub site and the aggregated digital TV streams are transported via an IP and or coaxial networks.

Example of modulator settings

The screenshot shows the 'RF Output #1' configuration page. At the top, there are navigation tabs: STATUS, INPUTS, OUTPUTS (selected), SERVICE MANAGEMENT, and SETTINGS. Below the tabs, the page title is 'RF Output #1'. The main content area is for 'QAM 1' under 'DVB-C' with 'Channel 474 (E21) MHz'. The settings are as follows:

Output enabled	ON <input checked="" type="checkbox"/> OFF <input type="checkbox"/>
Name	QAM 1
Frequency table	CCIR
Frequency	E21
	474
Constellation	256QAM
QAM spectrum	Normal
Symbol rate (kBaud)	6000
Carrier level (dBμV)	90

At the bottom right, there are 'SAVE' and 'CANCEL' buttons.

Note: Most settings can be left with the default settings for most applications.

Example of time scheduling.

The screenshot shows the 'SCHEDULER' section of the interface. It includes a 'Schedules' table and an 'Add new task' form. The local time is shown as 2012-11-30 15:50:45 (CET). The 'Add new task' form has the following fields:

Name	Adult channel
Time	12:00
Lua script	

At the bottom right, there are 'SAVE' and 'CANCEL' buttons.

Combine RF outputs with a splitter combiner type TD8-12
See taps and splitters in the catalogue.

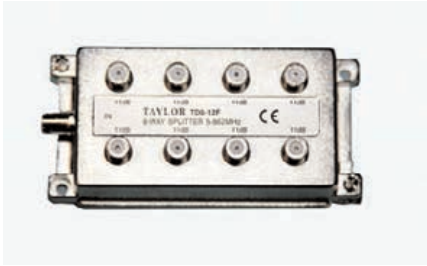

System Overview

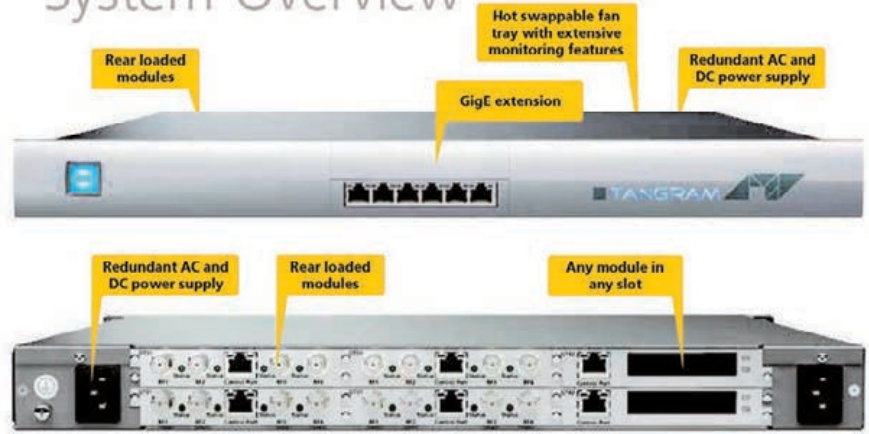

Tangram basic units, 48 V DC OR 230V AC

GT 01 O 0230

19" 1U chassis with backplane, 1 power supply, 230 VAC

£1,354.50

Dimensions (width x height x depth)	295x216x105 mm
Output	
Switch/Controller	
Streaming-Ports	4 pcs. (1 Gbit/s)
Control-Ports	1 pcs. (100 Mbit/s)
Category	Laser type 2+
Multicast	IGMP V2 + V3
Protocols	RTP, UDP, http, ICMP, SNMPv2
Redundancy control	Slots for n+1
Module slots	2 pcs.



GT 01 W 0230

19" 1 U chassis with backplane, 1 power suppl , 230 VAC

£1,879.50

GT 01 W 0048

£1,984.50

19" 1 U chassis with backplane, 1 power supply 48 VDC .

Dimensions (width x height x depth)	295x216x480 mm
8 slots for modules, 2 slots for PSU, 1 slot for fan unit	
Slot 1 to 6: single function modules i. e. GT2x Edge module	
Slot 7: GT11 Ethernet switch and control unit	
Slot 8: GT12 Ethernet port extension,	
Slot 9, 10: Power supply	
Cooling: air flow from right to left (front sight), hot swappable fan unit	
Passive backplane	
All RF plugs on the back	
Single function modules (SFM) are hot swappable from the back without service interruption on the remaining modules.	



Output	
Switch/Controller	
Streaming-Ports	4 pcs. (1 Gbit/s)
Control-Ports	1 pcs. (100 Mbit/s)
Category	Laser type 2+
Multicast	IGMP V2 + V3
Protocols	RTP, UDP, http, ICMP, SNMPv2
Redundancy control	Slots for n+1

Power supplies included in basic units 1 piece

Optional redundant power supply units

GT 55 W 0048 48V DC

£599.75

GT 55 W 0230 230V AC

£519.75



GT 21 W

6 x VSB analogue modulator board

- Gigabit Ethernet MPEG-TS to analogue PAL /SECAM Decoder
- Up to 6 PAL channels on 2 RF outputs
- MPEG-2 & MPEG-4 H.264 decoding (SD & HD)
- Test ports for the output signal
- Outstanding signal parameters by direct digital modulation & adapted output filter
- User friendly configuration via standard web browser
- Low power consumption
- Temperature and Output level monitoring
- UDP/RTP over IP protocol, auto-detected
- Options can be activated via license key

£2,892.75



GT 22C

8 x FM modulator board

- Gigabit Ethernet MPEG-TS to analogue FM Decoder
- Up to 8 FM channels on 1 RF output
- Total of max. 48 FM channels in 1RU
- Outstanding signal parameters by direct digital modulation
- Digital FM modulation & RDS insertion
- User friendly configuration via standard web browser
- Low power consumption
- Test ports for the output signal
- UDP/RTP over IP protocol, auto-detected
- Extraction of RDS data

£1,149.75



GT 24W

8 x COFDM modulator board

4 x multiplexes in 8K ,8 x multiplexes in 2K mode

The GT 24 W module is part of the Tangram product portfolio. The GT 24 W module allows you to add up to 8 channels in COFDM (DVB-T) format per module to your network. Tangram is a very high density and highly flexible solution for all kinds of networks. The Tangram chassis uses a fully redundant concept (n+1, 1+1).

- Gigabit Ethernet MPEG-TS to COFDM
- Up to **8 COFDM** channels on 2 RF outputs
- Total of max. 48 COFDM channels in 1RU
- Outstanding signal parameters by direct digital modulation & adapted output filter
- User friendly configuration via standard web browser
- Low power consumption
- Multi channel processor for up to 2x4 (2k-Mode)
- Test ports for the output signal
- COFDM channels individually switchable on/off
- PCR correction

£1,884.75



GT 23W

8 x QAM modulator board

The GT 23 W module is part of the Tangram product portfolio. This module allows you to add up to 8 services in QAM (DVB-C) format per module to your network. Tangram is a very high density and highly flexible solution for all kinds of networks. The Tangram chassis uses a fully redundant concept (n+1, 1+1).

- Gigabit Ethernet MPEG-TS to QAM Modulator
- Up to 8 QAM channels on 2 RF outputs
- Total of max. 48 QAM channels in 1RU
- Outstanding signal parameters by direct digital modulation & adapted output filter
- User friendly configuration via standard web browser
- Low power consumption
- Multi channel processor for up to 2x4 QAM channels
- Test ports for the output signal
- QAM channels individually switchable on/off
- PCR correction

£1,737.75



GT 31W

4x Universal DVB to IP module with DVB-S/S2/T/T2/C frontend

The GT 31 W module is part of the Tangram product portfolio. This module allows you to add up to 4 DVB- transport streams per module to your network.

Multi transport stream reception for DVB signals

4 x DVB-S / -S2 / -T/T2 / -C input

Gigabit Ethernet output for MPTS and SPTS signals

Redundancy for video streaming output

UDP & RTP over IP protocol, ProMPEG FEC (optional)

Demultiplex MPEG-2/MPEG-4 signals for SPTS transmission

Handling of teletext and EPG data

Configuration via Ethernet interface

Separate Fast Ethernet port for management (optional)

DiSEqC (optional)

£808.50



GT 42W

4 x CI module

The GT 42 module is part of the Tangram product portfolio. The GT 42 W CI module is designed as descrambler to be optionally combined with other Tangram modules. All Common Interfaces can be cascaded to reduce costs by using standard CAMs.

Tangram is a very high density and highly flexible solution for all kinds of networks. The chassis uses a fully redundant concept (n+1, 1+1)

Descrambling + MUX function

Multi channel decryption support (MCD) for payload

loop-through to descramble multiple transport streams

and different scrambling systems with standard CAMs.

Up to 4 CA modules

20 x MPTS or SPTS outputs

Modification of PSI/SI tables

Block PID, PID remapping

User friendly configuration via standard web browser

Low power consumption

£355.95



Module GT 32W 4

x ASI input / output module

£1,354.50

GT12W

SFP extension board

£672.00

GT32W

4 x ASI input / output module

£1,354.50

GTM1

1 year maintenance support

£103.95

GTM3

3 years maintenance support

£204.75

GTMUX

License for multiplexer for GT31, GT32, GT42, GT23, GT24. SI/PSI table generation only from data within this module.

£199.50

GTPSISI

License for sharing SI/PSI data over several modules (for mux and for transmodulation)

£42.00

GTSYMUX

License for multiplexer for GT31, GT32, GT42, GT23, GT24. SI/PSI table generation including sharing data with interconnected multiplexers in this network.

£231.00

GTSCR

SW option for scrambling for GT23 and GT24

£786.45

GTRED

SW option for input redundancy per GT module

£204.75

GTNRED

SW option for n+1 redundancy per chassis

£519.75

GT FEC

IP streaming in FEC per module

£157.50

GT55W0230

Redundant power supply 230 V AC

£519.75

GT99

Support brackets

£57.75

Discontinued see pages 43 to 44C



Wall mounting

The new modular IPTV headend series contains two different base units.
For wall mounting TIPM 6 for six modules and for rack mounting TIPM 11 for eleven modules
They can be combined to provide multiple outputs .

Two receiver modules are available . TIPM-SR for conversion of a DVB-S signal into an IP data stream and TIPM-TR for conversion of a DVB-T signal into an IP data stream.

All connectors at the front, programming of the headends is done with a PC.

Each module converts a complete multiplex into a IP stream.

Input
TIPM-TR DVB-T terrestrial receiver 174-239, 470-862 MHz
TIPM-SR DVB-S satellite receiver 950-2150 MHz
Input frequency steps 1 MHz -166,7 KHz
AFC +/-3 MHz -
2K +/-285 kHz
8K +/-142 kHz
Loop-through loss < 1,5 dB < 1,5 dB
Input level 40-84 dBuV 30-80 dBuV
Return loss 10 dB /
DiSEqC 1.0 /
Demodulation ETS 300421 ETS 300744
Symbol rate 1-40MS/sec -
FEC 1/2, 2/3, 4/5, 5/6, 7/8, auto 1/2, 2/3, 4/5, 5/6, 7/8, auto
Carrier - 2 K, 8 K
Modulation QPSK, 16 QAM, 64 QAM
Connectors F
Output
Connectors RJ 45 Ethernet LAN RJ 45 Ethernet LAN
Encoding standard ETSI TS102034 ETSI TS102034
Type of streaming IPv4 Multicast IPv4 Multicast
General characteristics
Power supply 220-240~V, 50-60Hz 220-240~V, 50-60Hz
Power consumption 11 W 4 W
Dimensions 35 x 130 x 240 mm 35 x 130 x 240 mm
Operating temperature (-5) - 45°C (-5) - 45°C
TIPM 11 mounting frame for 11 modules TIPM 6 mounting frame for 6 modules
Operating voltage 220-240V~, 50-60 Hz
Power consumption 100W max.
Operating temperature -5 °C ... 45°C
Dimensions (WxHxD) 48,3 x 13,3 x 28,8 cm 31,4 x 13,3 x 29,8 cm



Rack mounting

Prices	
TPM-6 Wall mounting frame	£447.61
TPM-11 Rack mounting frame	£483.42
TPM-SR Sat receiver to IP	£1,047.40
TPM-TR Terrestrial receiver to IP	£1,047.40

S790,S791 SATELLITE PROCESSORS

S790 Ten module unit
S791 Individual single or twin modules with capacity for 12 single or twin converters

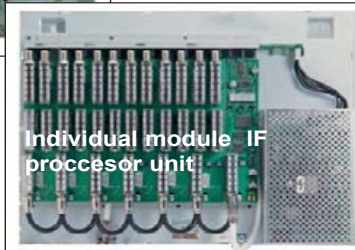
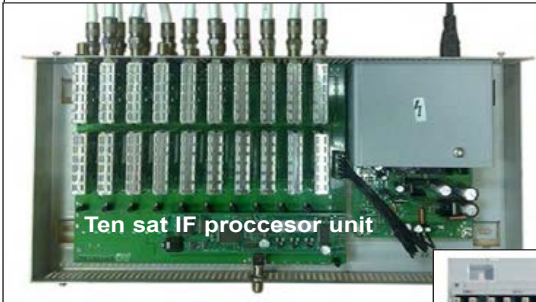
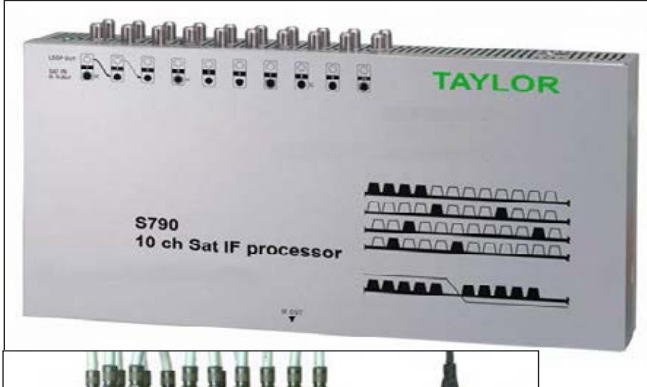

Technical Description

The S790/91 satellite processor converts an individual satellite channel using state of the art phase lock loop oscillators controlled by a microprocessor. To improve the threshold performance of the front end there is a tracking frequency agile bandpass filter in the first stage of each converter.

The individual channel, after amplification, is converted to an intermediate frequency, passed through a SAW filter giving excellent selectivity, before being converted to the output frequency. Each channel has 15dB of AGC, essential to compensate for levels varying due to rain attenuation. The output level of each channel can be adjusted over a range of 10 dB, this will maximize the performance of the head end amplifier as tilt can easily be applied and minor frequency response errors in the head end configuration can be corrected. In addition, the whole system performance is improved if all the channels distributed are processed, as the distribution amplifiers are not having to cope with the full bandwidth of the noise power from the LNB and unwanted channels.

Sky digital channels, can only be distributed **if the multiplex frequencies are not changed due to the Sky digibox software**, so if a single wire system is used for sky there could be some limitations on what programs can be distributed.

The processors are particularly useful on very large five wire switch systems distributing sky, it gives level control on each digital carrier, and also enables other satellite carriers to be fitted into frequencies not being used by sky or into frequencies occupied by sky programmes that are not required by the customer. Also fibre systems to maximize reach will benefit from individual level control of each sat multiplex.

Individual Single, Twin or Ten module
Input Frequency range 950-2150 MHz
Frequency steps 1 MHz
AGC range 55-70 dBuV
Input level AGC range
IF frequency bandwidth 36 MHz
Output frequency range 1015-2150 MHz
Flatness ± 3 dB
Frequency steps 1 MHz
Attenuator adjustment per channel -10 dB
Connectors F
Operating Ambient temperature 0-30 °C
Recommended Ambient temperature 17 °C
Power 190-260V AC 50-60 Hz ≤60W

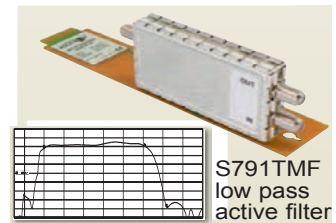
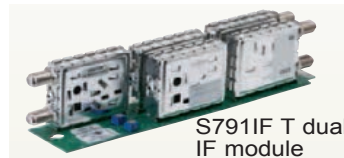
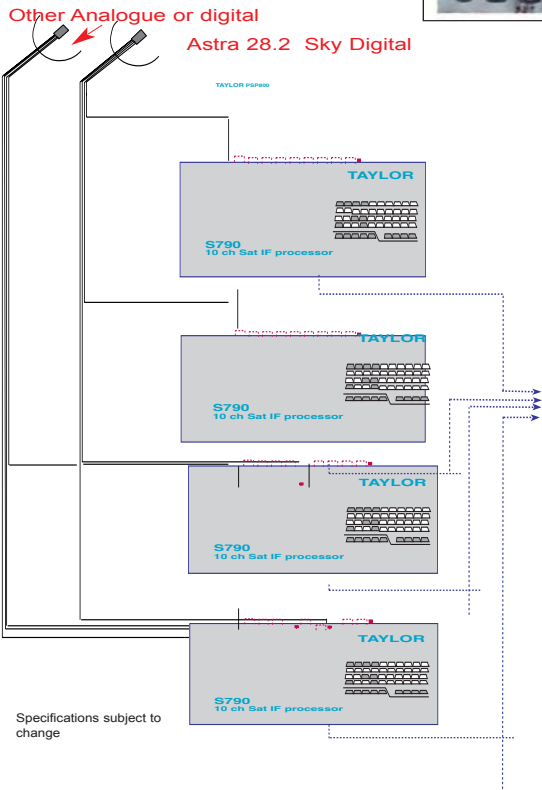

System showing selected Sky digital channels combined with another satellite, using unused or unwanted Sky frequencies.

Some Sky channels must be included due to data essential for the digibox embedded in a multiplex transport stream.

		Price
S790	Ten IF module unit complete with ten module	£784.40
S791	Base unit	£355.72
S791 IF	Single plug in module	£123.03
S791 IF T	Twin plug in module	£168.30
S791 TMF	Low pass active filter to allow pass through of unconverted freq between 1100-1690MHz	£72.70
Copy key	Removable memory card that stores settings	£26.27

No switching
 Sat IF Splitters may be needed

Typical large sat system using a single coax

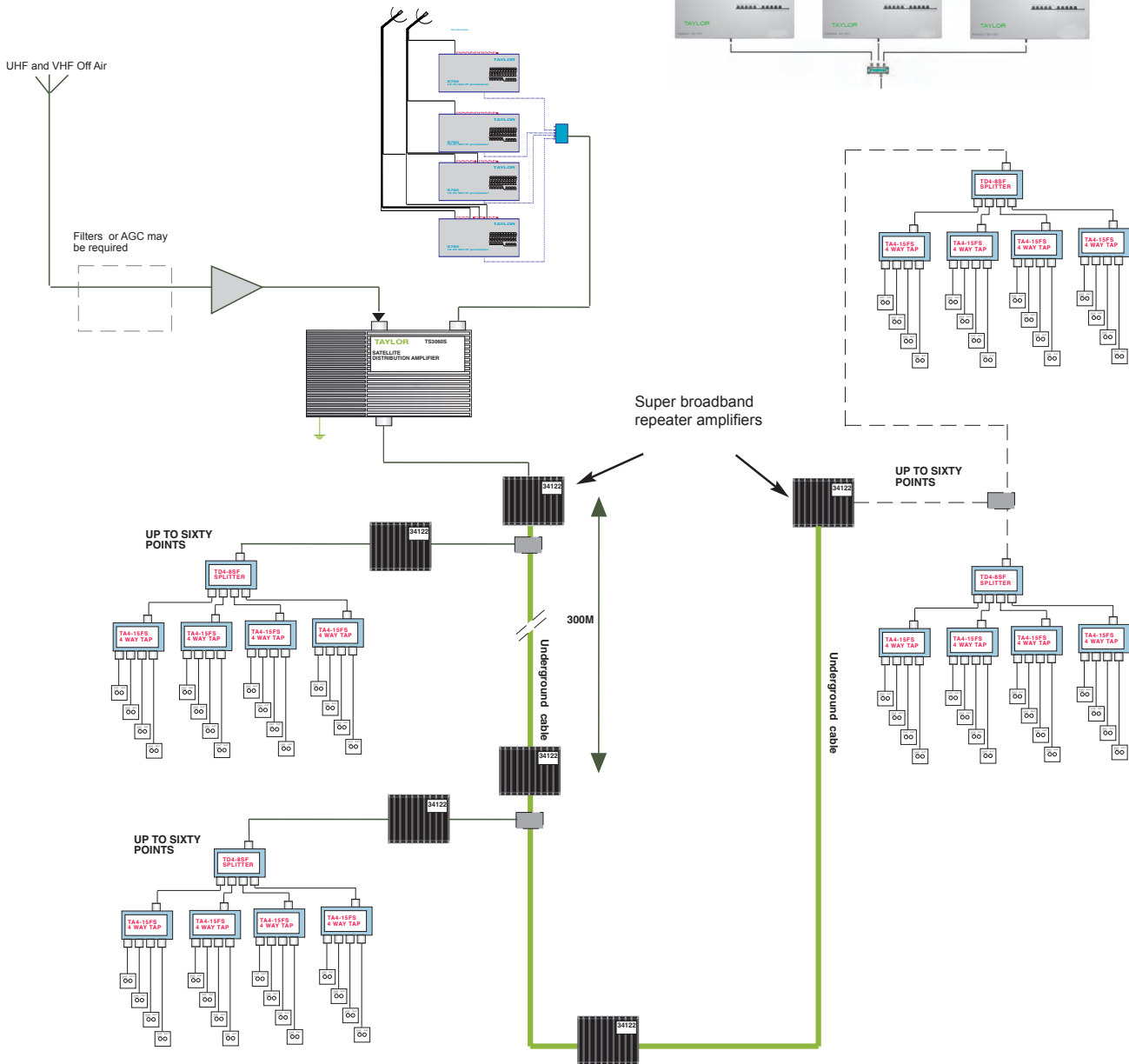

Above is a typical system distributing analogue or digital satellite channels plus terrestrial VHF and UHF.

For large systems this is the only optional way of distributing satellite if the running multiple underground trunk cables is prohibitive.

Systems of over a thousand points can be constructed using coax or tens of thousands of points using a hybrid fibre/coax system. The limitations to the size of system are the same as existing cable networks except greater care has to be taken in calculating frequency response errors at higher frequencies.

The limitations of using a single cable for distribution of satellite is bandwidth, and the software in sky digiboxes being unable to locate transponders, that have been relocated in the IF spectrum. There are various partial solutions to this software problem, see our website, but at the moment no complete solution unless Sky update the receiver software in the future.

As more channels are allocated various options can be used to optimize the available bandwidth.

For example, using satellite demodulators and remodulating, programmes that are broadcast clear in the UHF or VHF band, makes more capacity available in the one to two GHz spectrum for subscription programmes.

Digital broadcast make more efficient use of bandwidth and as broadcasters move over to digital more channels can be distributed in the available bandwidth. If the most efficient current technology is used a single coax system can carry fourteen hundred and seventy channels.

Quatro LNB

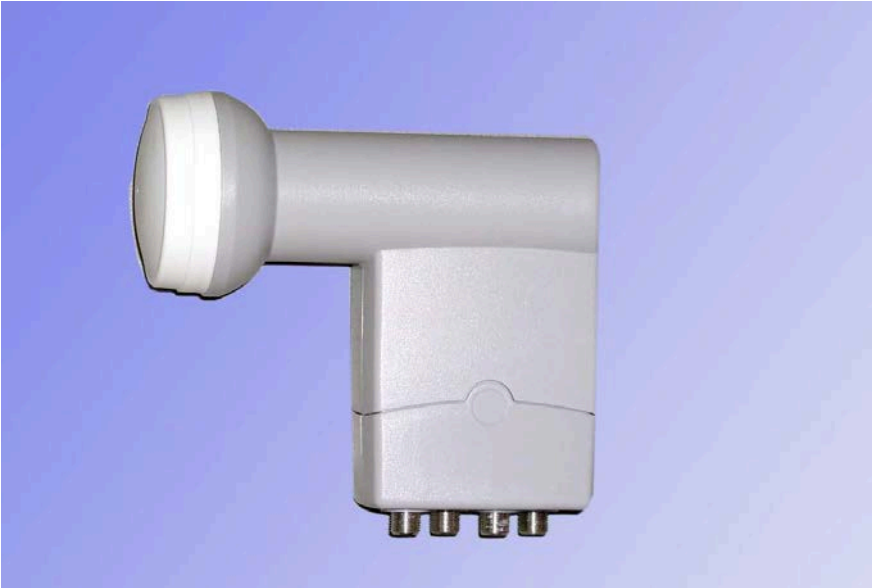

Shipping for one dish and LNB £9.90 Ex Vat

TCG15AD Quatro LNB

Gain.....60dB
 Noise Low band..... .6dB
 Noise High Band.....1.2dB
 Output Frequency.....950-2050MHz
 SwitchingN/A
 Power Consumption..... 250mA

TCG15 AD Quatro £14.90

Circuit of a TCG15 AD

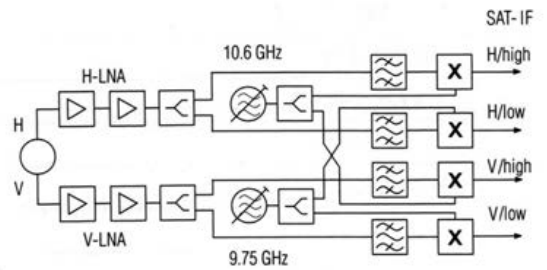

60CM

Dish sizes: **50 cm** **60 cm** **75 cm** **90 cm** **120 cm**



Dish Specification

OA36G 60CM

Gain.....35dB
 Elevation Adjustment.....16-50Deg
 Clamp size for masts.....32-60mm
 Wind load up to 20m
 mounting height.....N280
 Weight.....1.6Kg

Price £39.50

WB 1

£25.98

220mm Wall Bracket

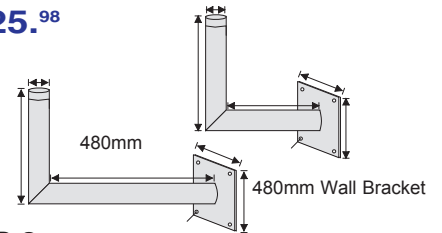

WB 2

£29.76

Astra 2B and 2D have the smallest footprints out of all the Astra transponders beamed towards the UK and Europe. It can be seen from the illustrated footprint that a 60cm dish provides good reception in the whole of the UK and Ireland.

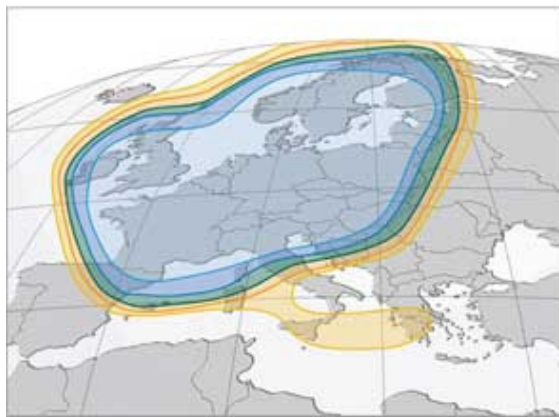

Double LNB Mount

Receive from two satellites with 2 LNB'S and one dish. Eutelsat (13^{deg} East) Astra19.2^{deg}East

OP O8C



£10.70

Specifications subject to change

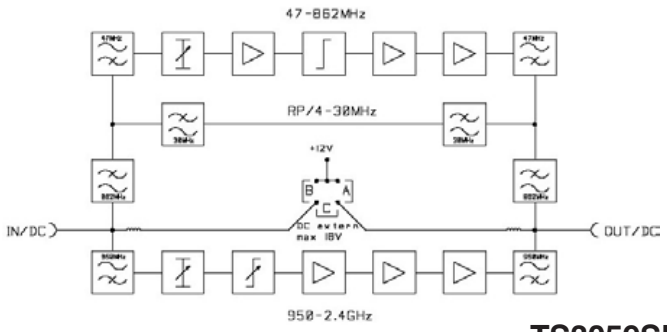
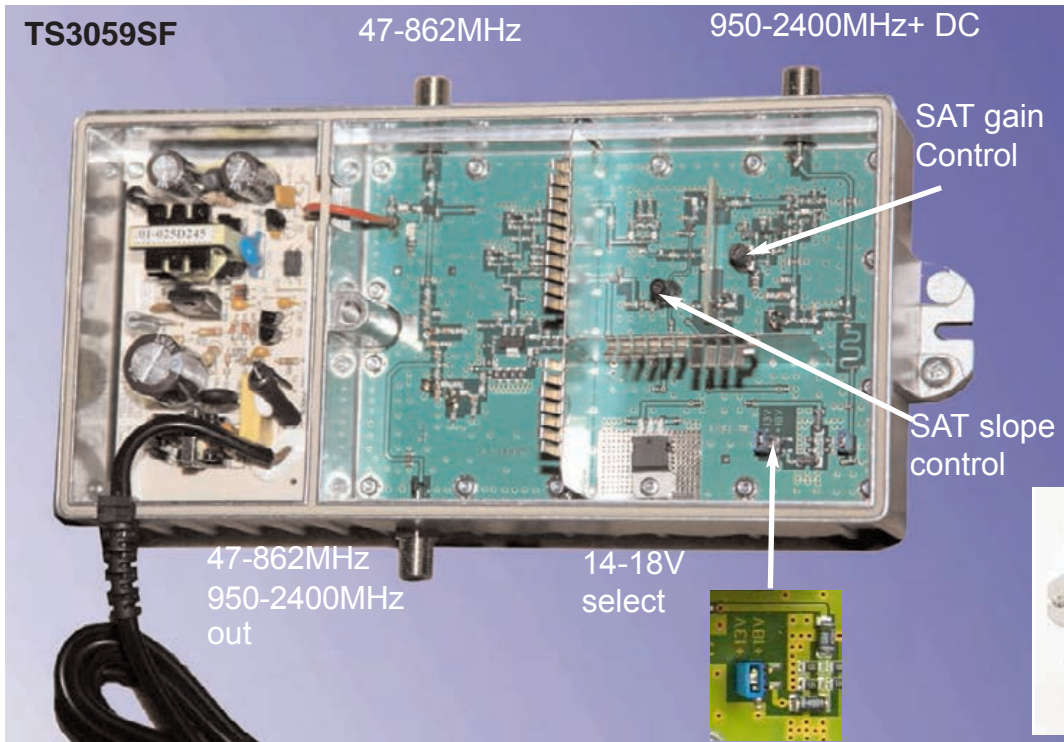

TS3059SF



VS 93B

Type	Frequency MHz	Gain MHz 40-860	Gain MHz 950	Gain MHz 2400	Max output 35dB IMA3	Noise > 950 MHz	LNB power	Voltage	Max through current	Price
VS 93B	87-862/950-2400	13-18dB	27dB	35dB	115dBuV	≤ 7dB	18V 300mA	220/240VAC 14VA		£96.43
TS3059SF	40-860/950-2150	28dB	22dB	28dB	116dBuV	≤ 7dB	12V 400mA	220/240VAC 5VA		£153.23

Specifications subject to change

TDY 40 Satellite Multiswitch Amplifier

Adjustable gain controls and slope equalization
Gain adjustable to 30dB



DV25 Isolated terminator £1.49
DV49A Quick coupler £1.00



TCLP STA £45.89

The TDY40 amplifier is only required to compensate for long cable runs or larger systems. Switches illustrated below and on following page have internal amplification

Technical Info

Frequency range	950-2150 MHz
Gain	10...30 dB
Output level (3.order EN50083-3, 35 dB)	115dBuV
Adjustable attenuation	0...20 dB
Slope	0,4,8,12 dB
Isolation trunk	40 dB typ.
Connectors	F-socket
DC supply voltage	Via F-socket
Operating voltage DC	13...18
Current consumption	200 mA
DC bypass	Yes
Screening factor	Class A, EN 50083-2
Dimensions (width x height x depth)	129 x 86 x 32 mm
Operating temperature range	-20...+50 °C
Weight	0,290 g

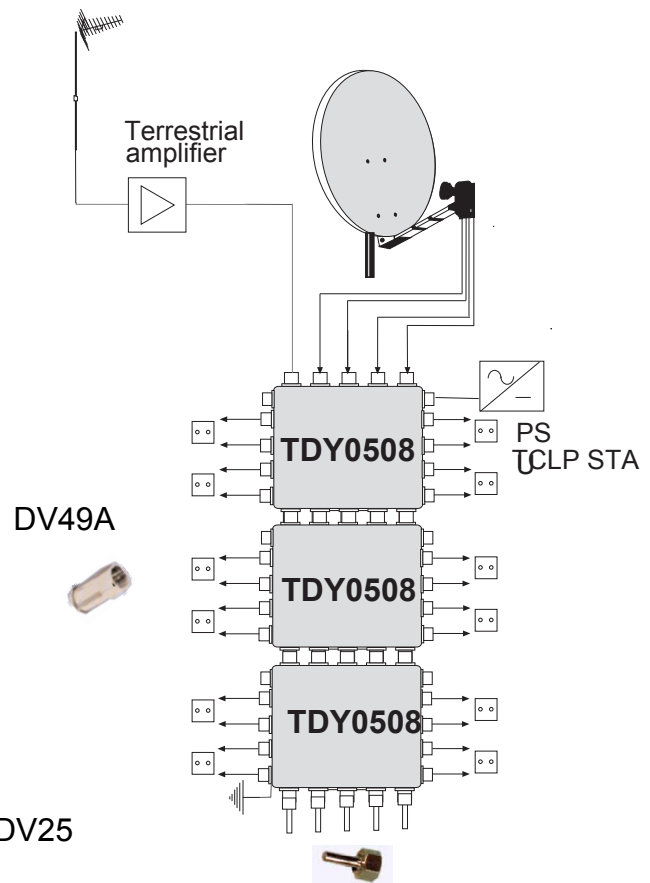

Quad band LNB and terrestrial inputs.
8 outputs for 4 sat receivers, cascadable
for multiple outputs.

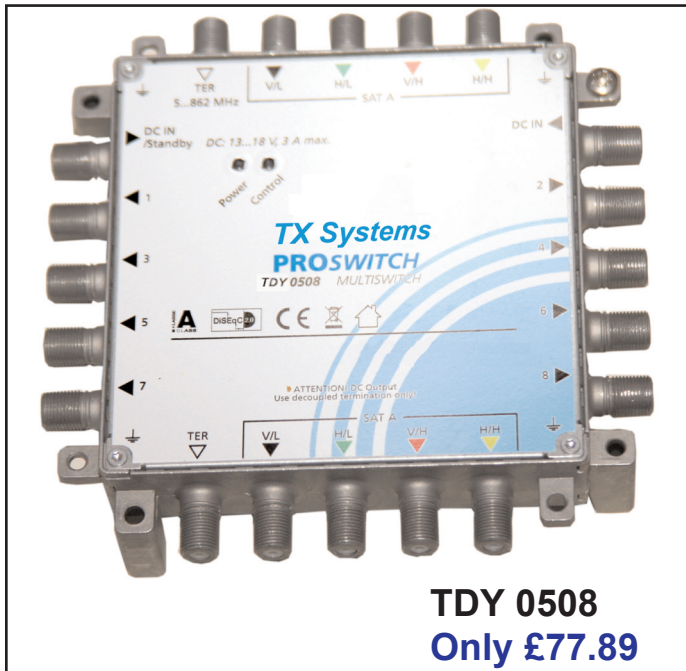

TDY 0508
Only £77.89

Technical data	
Operating voltage	13...18 V DC
Power consumption max.	<0,2 W
Impedance	75 Ω
Frequency Satellite	950...2150 MHz
Control signal	14/18 V, 0/22 kHz, DiSEqC 2.0
Current consumption from receiver	70 mA
Through loss Satellite	1...3 dB
Insertion loss to subscriber ,Satellite	2...2 dB
Trunk Inputs Satellite	8
Trunk Outputs Satellite	8
Isolation , Satellite -Satellite	40 dB typ.
Return loss Satellite	>10 dB
Max. output level subscriber Satellite	101 dBμV
Frequency range Terrestrial	5...862 MHz
Through loss Terrestrial	3,5...4,2 dB
Insertion loss to subscriber ,Terrestrial	24 dB (±2 dB)
Trunk Inputs Terrestrial	1
Trunk Outputs Terrestrial	1
Return loss Terrestrial	>10 dB
Max. output level subscriber Terrestrial	50...110 dBμV (passive)
Connectors	F-socket
DC supply voltage via	F-socket
Colour-coding	VL = black; H=green; VH = red; HH=yellow
Power indicator	LED
Screening factor	Class A, EN 50083-2
Operating temperature range	-20...+50 °C

Note
All satellite and terrestrial signal levels ,may need to be adjusted to operate the sat switch correctly ,please ensure they are within the correct operating range .
Additional attenuators and or levelling may be needed.

More versatile ,high specs, lower cost, same very high quality

Quad band LNB and terrestrial inputs.
16 outputs for 8 sat receivers,cascadable
for multiple outputs.

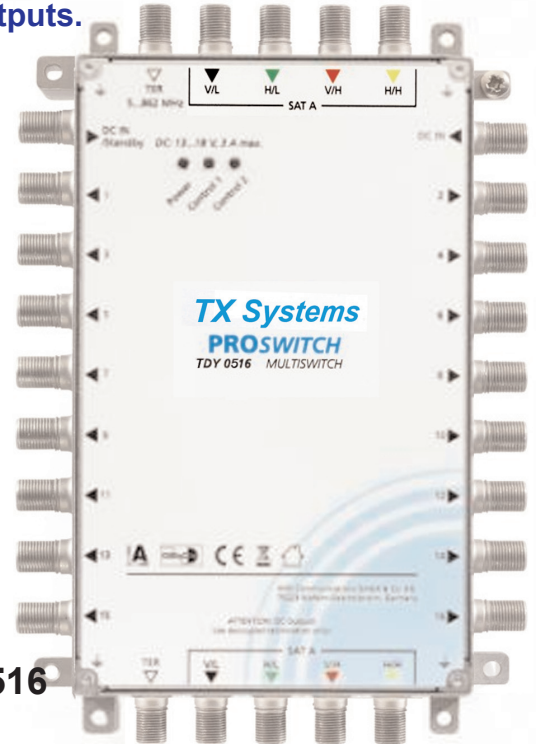

TDY 0516
Only
£124.25

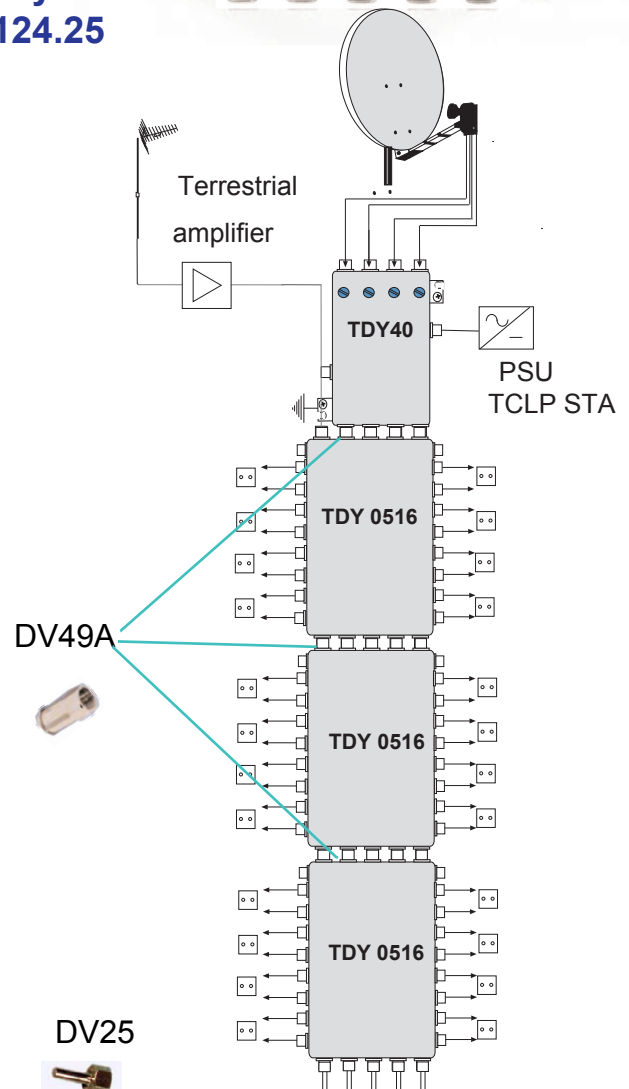

TXS

Incredible Satellite Switches

See page 26B for Sky Q Systems

Except for powering the LNB these active switches use 43ma of power (Normal LNB takes 250 mA) from the set top box to power the amplification. The amplification eliminates the normal tap side loss so less front end amplification is often not needed on many smaller systems.

Systems then can be deployed without the need for providing several power supplies around the network.

£58.74

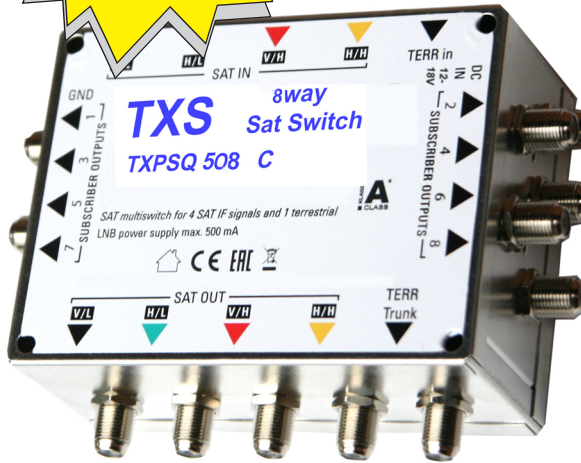

Plastic mounting brackets provided

DV49



Coupler to link switches. £1.00

DV25



75 Ohm DC Isolated load. £1.49



£99.55

Type	TXPSQ 508 C	TXPSQ 512 C	TXPSQ 516 C
Input frequencies, 4 Satellite Bands , 1 Terrestrial		18...862 MHz 950...2400 MHz	
Outputs to subscribers (two outputs needed for most modern STB.s)	8	12	16
Switching method	14 V / 18 V / 0/22 kHz / DiSEqC 1.0		
Through loss	950-2400MHz -1dB..+2dB +/- 1.5dB	-1dB..+3.5dB +/- 2dB	-1dB..+3.5dB +/- 2dB
Tap loss	18-862 MHz -2dB +/- 2dB	-.3dB +/- 3dB	-.3dB +/- 3dB
Isolation Terr./Sat		30 dB typ.	
Isolation H/V		30 dB typ.	
Return loss (input and output) 18..2400 MHz		10 dB typ.	
Input level Sat			
Sat output level		102 dBuV max. (IMD3 35 dB)	
Terr. output level		88 dBuV max. (IMD3 60 dB)	
Current consumption from Set top box		43 mA max.	
Supply current to LNB via power supply		900 mA max.	
Dimensions (W x H x D)	140 x 110 x 63 mm	140 x 150 x 63 mm	140 x 150 x 63 mm
Price	£58.74	£89.60	£99.55

Note . What has a major effect on system design is the number of Digital Sat and Terrestrial channels distributed and the difference in input levels.

Use coaxial cable for the network such as CT100 (RG6) and CT167 for longer main feed runs . CT100 (RG6) has a loss of more than 10dB greater per 100m at 2400MHz than at UHF 860MHz , however terrestrial digital TV channels needs about 30dB less than analogue at the receiver so if you add a design margin of 10dB there is a 20dB advantage using terrestrial digital and the higher frequencies used for satellite are offset even more due to the much lower signal levels needed for sat reception , due to the type of robust modulation employed in DVB-S and DVB-S2 (QPSK 8QPSK). If technical advise is needed in configuring your system design , please do not hesitate to call on our main phone number and ask for **technical support**.

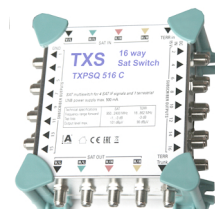

TXS

Amplifier for Satellite Switches

Create large systems using these amplifiers, can be used to drive 100 meters + of CT167 (-23dB attenuation at 2,400MHz)



24 point
Sat/Terr system
2 coax cables
to each TV location

Amplifier Gain
Sat 24dB
Terr 20dB

Longest coax runs
Up to 100m RG6

DV49A
Coupler
£1.00

Shortest coax runs

Typically
-9dB

DV25
75 Ohm DC
Isolated load.
£1.49

TRPK-FS



F Connector 1.5 amp power injector.
5MHz - 2.25 GHz £3.50



PSU to power LNB
and switches if needed
TCLP STA £45.89



Plastic mounting
brackets provided

Most systems will work if the total loss from the dish to the sat receiver is no more than 30dB. So on installations with relatively short coax cable runs ,amplification may not be needed as it is shown in this example

£83.63

Type	TXPSQ 505 AMP	
Input frequencies		
Sat	950-2400	MHz
Terrestrial	18-862	MHz
Inputs	4 SAT, 1 TERR	
Outputs	4 SAT, 1 TERR	
	4 SAT, 1 TERR	

Isolation Terr. / SAT	30 dB typ.	
Isolation H/V	30 dB typ.	
Return loss	10 dB typ	
Input level		
SAT	92 dBµV max.	
Terr.	90 dBµV max.	
Gain 950...2150 MHz	20...24 dB	
Gain 18...862 MHz	20 dB	
Gain adjustment	15 dB	
Slope	TERR / SAT 4 dB	
SAT output level	116 dBµV max. (IMA3 60 dB)	
Terr. output level	110 dBµV max. (IMA3 60 dB)	
Current consumption	420 mA @ 12...18 VDC	
Operation temperature	-20+70 °C	
Operating voltage	12-18 VDC	
LNB supply current	2000 mA	
Dimensions (WxHxD)	140 x 110 x 63 mm	
Price		



TXPOV-F
Voltage Surge
protector £3.10

www.txsystems.co.uk

Specifications subject to update

Prices Ex VAT

TXS Satellite Switches

Simple to install, simple to commission

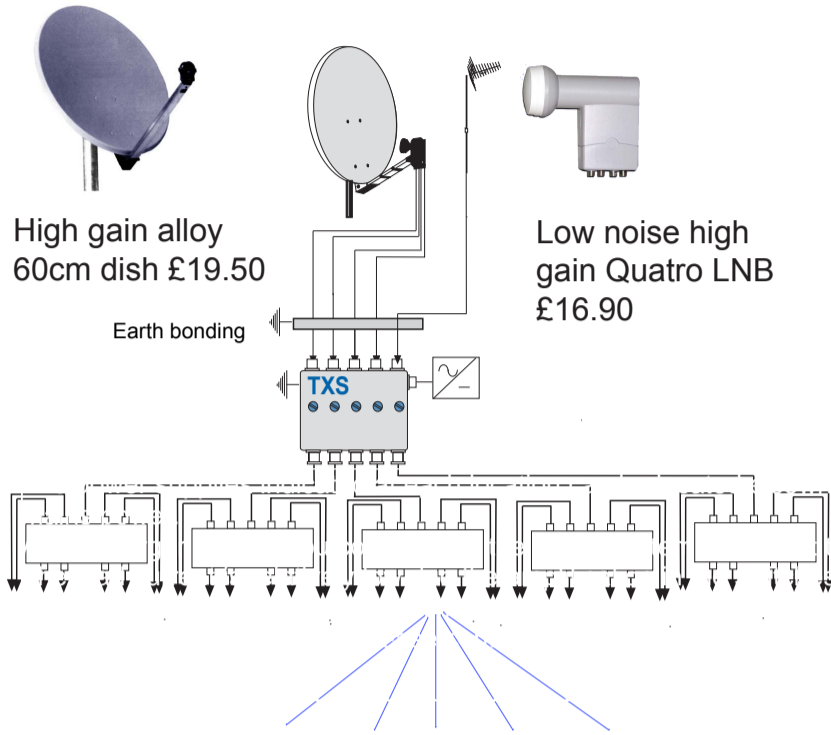

High gain alloy
60cm dish £19.50

Low noise high
gain Quatro LNB
£16.90

Example of a Satellite and Terrestrial
TV distribution system.

192 twin feed outlets

(DAB and FM Radio easily added)

5 x 8 Way wideband splitters
Type TD8-12FS
Insertion loss 12-18dB
£7.90 each

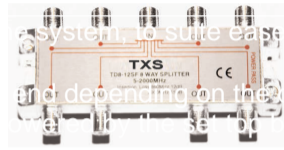

Up to 100m or more with suitable coax

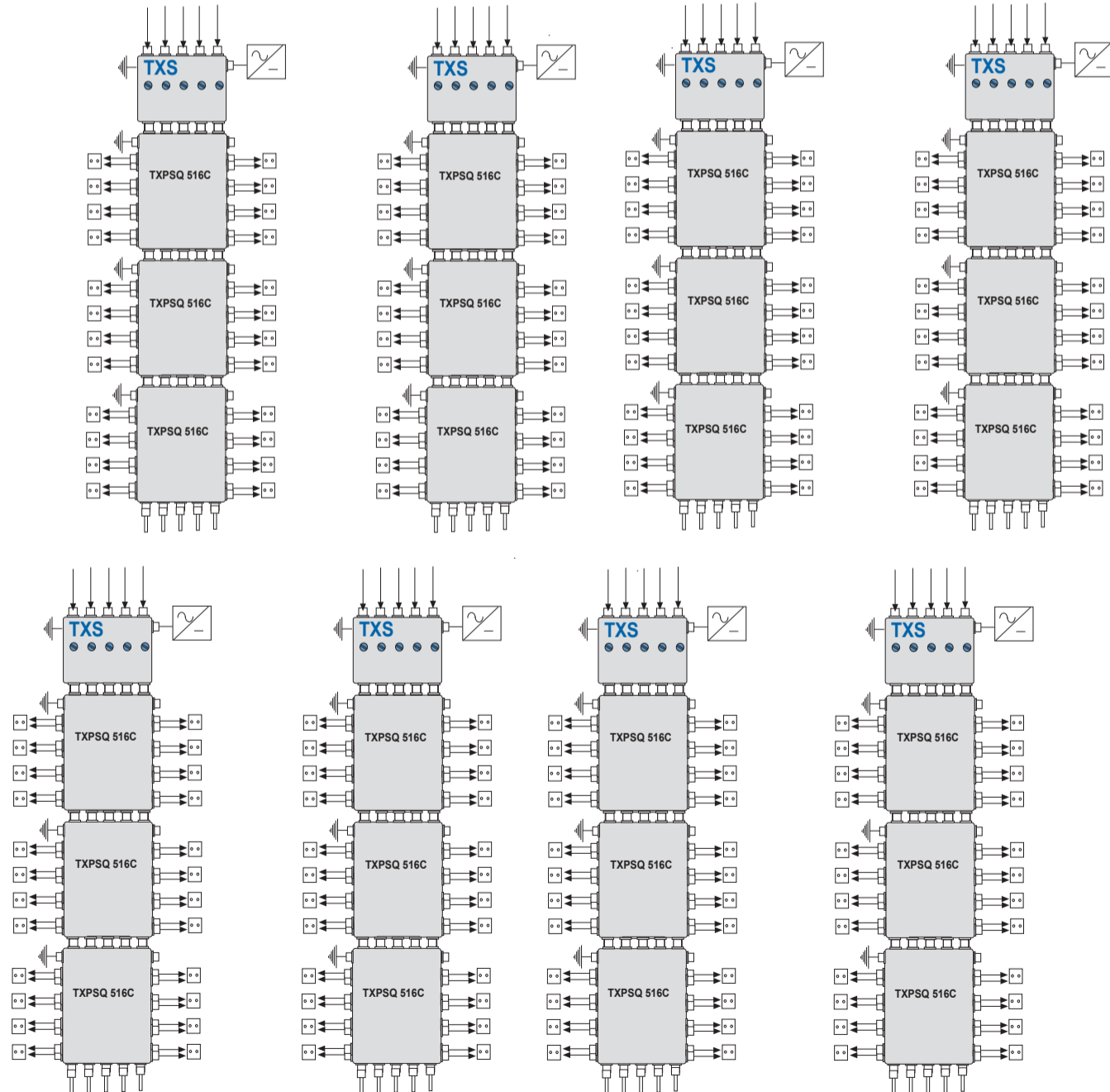

WIDEBAND SPLITTERS 10 - 2400MHz

Type	Way	Insertion loss 400MHz	Insertion loss 700MHz	Insertion loss 2400MHz	Return Loss	Price
TD2-4SF	2	4dB	4dB	5.6dB	>18dB	£2.57
TD3-6SF	3	6dB	6dB	8dB	>18dB	£3.41
TD4-8SF	4	7dB	8dB	10dB	>18dB	£3.91
TD6-10SF	6	9dB	10dB	12.5dB	>18dB	£5.45
TD8-12SF	8	12dB	12dB	14dB	>18dB	£6.23

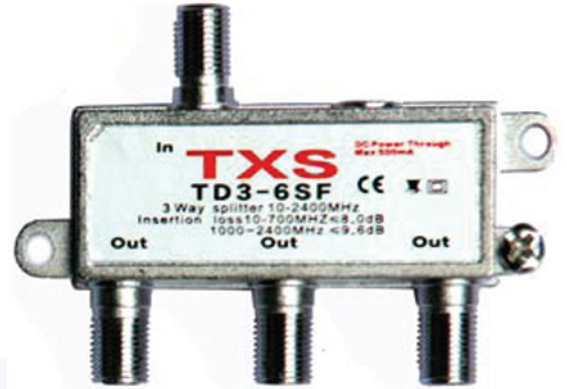

WIDEBAND SPLITTERS UP TO 860MHz

Type	Way	Insertion loss 5MHz	Insertion loss 700MHz	Insertion loss 860MHz	Return Loss	Price
TD2-4F	2	3.2dB	3.7dB	4dB	>18dB	£1.21
TD3-6F	3	5.2dB	5.5dB	6dB	>18dB	£1.76
TD4-8F	4	7dB	7.4dB	7.4dB	>18dB	£2.29
TD6-10F	6	9dB	9dB	9.5dB	>18dB	£3.63
TD8-12F	8	10.5dB	11dB	11.5dB	>18dB	£4.85



FCN F connector
100+ £0.029 each
Shipping 100
pieces £2.49 3 day
No additional shipping cost
when included with
other orders
See page 72



Next day delivery available
Via UPS.
Lower cost shipping (3 days under 2kgs)
via Post Office.

WIDEBAND TAPS 10 - 2400MHz

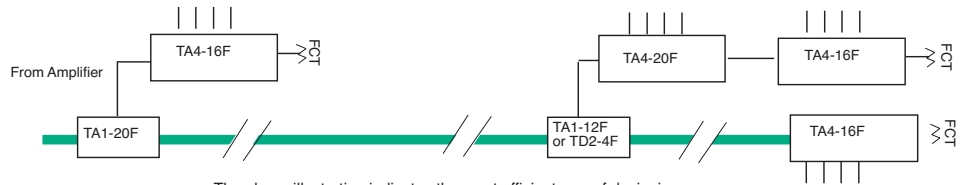

The above illustration indicates the most efficient way of designing distribution systems using multitaps, if a star distribution network is not practical, this method will allow almost any tap value to be configured, minimising reflections and through loss in the distribution line.

Example of five 4 way taps on a long coax line

Type	Taps	Tap Loss dB	Through Loss *	Reverse Isolation dB (Tap Out)	Return Loss dB **	Price
TA1-12FS	1	12	2.7	>19	>14	£2.71
TA1-15FS	1	15	2	>19	>14	£2.71
TA1-20FS	1	20	1.8	>19	>14	£2.71
TA1-25FS	1	25	1.8	>19	>14	£2.71
TA2-12FS	2	12	4.3	>19	>14	£2.84
TA2-15FS	2	15	3.8	>19	>14	£2.84
TA2-20FS	2	20	3.4	>19	>14	£2.84
TA2-25FS	2	25	3.4	>19	>14	£2.84
TA4-12FS	4	12-13	6.5	>19	>14	£5.16
TA4-15FS	4	14-16	5.5	>19	>14	£5.16
TA4-20FS	4	20-22.5	4.5	>19	>14	£5.16
TA4-25FS	4	26-28	3.5	>19	>14	£5.16

* +/- 1dB ** +/-1.5dB
All above require FCT 75 ohm load if through line out not connected

Note Sky Q Use frequencies up to 2.4GHz. These taps work up to 2.4GHz But were manufactured

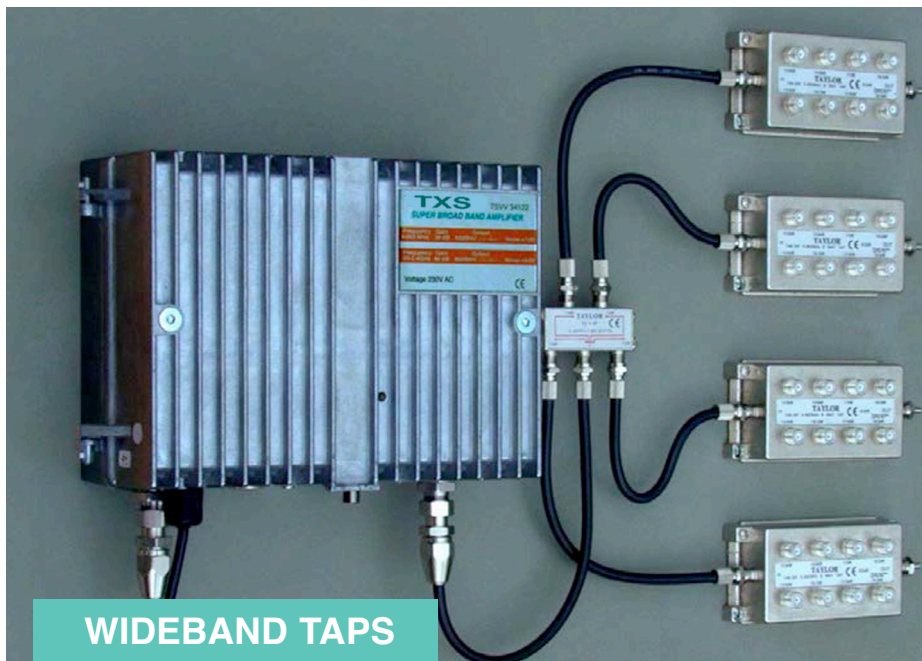
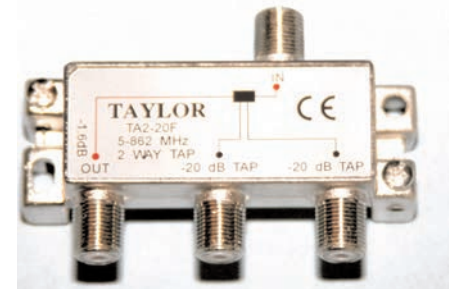

WIDEBAND TAPS 5-860MHz

Type	Taps	Tap Loss dB	Through Loss dB*	Reverse Isolation dB	Return Loss Tap	Price
TA1-12F	1	12	1	>25	>20	£2.42
TA1-16F	1	16	0.8	>25	>20	£2.42
TA1-20F	1	20	0.8	>25	>20	£2.42
TA1-24F	1	24	0.8	>25	>20	£2.42
TA2-12F	2	12	2	>25	>20	£3.30
TA2-16F	2	16	1.8	>25	>20	£3.30
TA2-20F	2	20	1.6	>25	>20	£3.30
TA2-24F	2	24	1.6	>25	>20	£3.30
TA2-27F	2	27	1.3	>25	>20	£3.30
TA2-30F	2	30	1	>25	>20	£3.30
TA4-16F	4	12.8-15.7	4.2	>25	>20	£5.90
TA6-18F	6	12.8-17.7	6.5	>25	>20	£5.90
TA8-20F	8	12.8-19.3	8.5	>25	>20	£9.90

All above require FCT 75 ohm load if through line out not connected

Internet can be routed via a standard TV distribution VHF/UHF system and provides very high bandwidth. Ideal for streaming TV channels and Box sets. Bandwidth usually ten times better than a standard phone line. See return path amplifiers in the front of the catalogue. Over a thousand channels plus internet can be distributed via this very low cost system.



Netgear coax modem

Specifications subject to change

WISI SPLITTERS

5 - 1000MHz

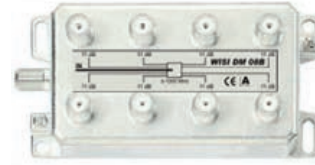
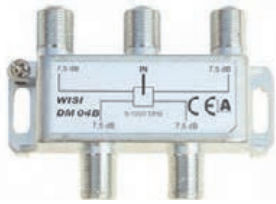

Type	Way	Insertion loss	Return loss	Price
		5-1000 MHz		
DM 02 B	2	3.7dB	>18dB	£3.10
DM 03 B	3	7.5dB	>18dB	£5.00
DM 04 B	4	8.5dB	>18dB	£5.50
DM 06 B	6	10 dB	>18dB	£7.47
DM 08 B	8	12 dB	>18dB	£8.74

WISI SPLITTERS

5 - 2400MHz



Type	Way	Insertion loss	Return loss	Price
		5-860 900-2400MHz		
DM12A	2	4dB	>18dB	£4.79
DM13A	3	7.dB	>18dB	£7.02
DM14A	4	8.5dB	>18dB	£8.36
DM16B	6	11.2dB	>18dB	£19.51

WISI TAPS

5 - 1000MHz



Type	Taps	Tap Loss dB	Through Loss dB	Reverse Isolation dB	Return Loss Tap	Price
DM 21 C	1	8	≤1.8	>25	>20	£2.71
DM 22 C	1	12	≤1	>25	>20	£2.71
DM 24 C	1	16	≤0.8	>28	>20	£2.71
DM 25 C	1	20	≤0.8	>28	>20	£2.71
DM 31 C	2	10	≤3	>25	>20	£3.94
DM 32 C	2	12	≤2	>25	>20	£3.94
DM 34 C	2	16	≤1.2	>28	>20	£3.94
DM 35 C	2	20	≤1	>34	>20	£3.94
DM 36 A 4012	4	12	≤3.5	>28	>20	£9.59
DM 36 A 4016	4	16	≤2	>28	>20	£9.59
DM 36 A 4020	4	20	≤1	>28	>20	£9.59
DM 36 A 4024	4	24	≤0.8	>28	>20	£9.59
DM 37 B 6013	6	13-17.5	≤6	>24	>20	£10.94
DM 38 B 8013	8	13-20	≤8	>32	>20	£14.63

All above require FCT 75 ohm load if through line out not connected

WISI TAPS

5 - 2400MHz



Type	Taps	Tap Loss dB	Through Loss dB	Reverse Isolation dB	Return Loss Tap	Price
DM 51 1010	1	11	≤2.5	>22	>20	£3.11
DM 51 1015	1	15	≤2	>25	>20	£3.11
DM 51 1020	1	20	≤1.8	>28	>20	£3.11
DM 52 2010	2	11	≤4	>20	>20	£3.94
DM 52 2015	2	15	≤3.8	>20	>20	£3.94
DM 52 2020	2	20	≤3.5	>20	>20	£3.94
DM 54 A 4010	4	12.5-14	≤5.5	>21	>20	£4.37
DM 54 A 4015	4	15	≤2.5	>21	>20	£4.37
DM 54 A 4020	4	20	≤2.4	>21	>20	£4.37
DM 54 A 4025	4	25	≤2.4	>25	>20	£4.37

All above require FCT 75 ohm load if through line out not connected



TXAO1 Single coax output 0-860MHz



TXAO2 Screened twin F connector outlet. 2 in 2 out use this socket for Sky or Freesat

Outlet for Sky and or Freesat



TXAO4 Screened twin F connector, twin standard coax socket outlet. 2 in 4 out use this socket for Sky, Freesat, Freeview, DAB and FM radio.

Outlet for Sky Freesat, Freeview DAB and FM Radio

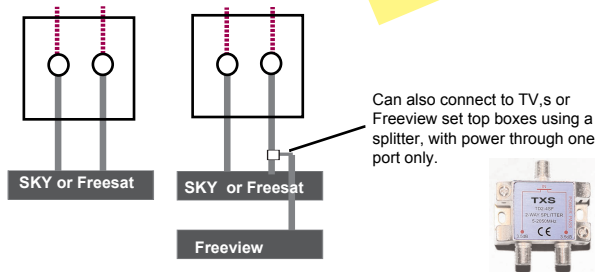

On current installations outlet sockets are not isolated as in the past (BS415) due to voltages from the TV or set top box needing to feed LNB's or Sat switches so a CATV system needs earth bonding.

Earth bonding points are usually located on taps, splitters and amplifiers.

However in the event of coax cables being installed on long runs close to high voltage cables, mains etc from a tap or splitter to the outlet plate use an in line ground block as high voltages can be induced into the coax cable.

See connector page in our catalogue.

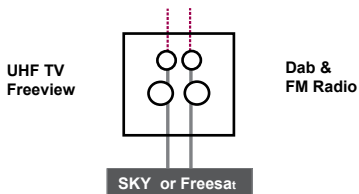

UHF-



FCGB2

Type	Description	Insertion Loss			Frequency Mhz	Inputs	Call for pricing and availability moq 100 pieces		
		VHF	UHF						
TXAO1	Single output	≤1dB	≤1.5dB	≤2dB	0-860	1-1			
TXAO2	Twin output	≤1dB	≤1.5dB	≤2dB	0-2400	2-2			
TXAO4	Quad output	≤1dB	≤1.5dB	≤2dB	DC-22KHz , 88-240 470- 860 950-2400	2-4			

Coaxial connectors

FPSCC

F Connector, push on crimp for RG6 (CT100) (crimp tool needed DZ85)

Price **£0.65**

100+ **£0.32**



AFPSCC

Angle F Connector, push on crimp for RG6 (CT100) (crimp tool needed)

Price **£1.65**

100+ **£1.40**



FPCC

F Connector for ,crimp RG6 (CT100) (crimp tool needed DZ85)

Price **£0.35**

100+ **£0.29**



FPCC11

F Connector for ,crimp RG11 (CT167) (crimp tool needed)

Price **£6.95**

25+ **£5.86**



FCN 11

F compression connector For cable type RG11 CT167

Requires CP1 crimp Tool

Price **£0.25**

100+ **£0.20**



EX6+

High performance compression F connector for CT100. Compression tool required CAT AS EX.

1-10 **£0.30** 11-99 **£0.22**

100+ **£0.20** 1000+**£0.19**

5000+ **£0.18**

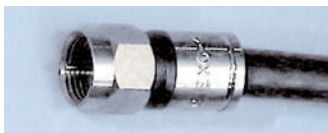

EX60D

High performance outdoor compression F connector with weatherproof boot for CT100. Compression tool required CAT AS EX.

1-10 **£0.30** 11-99 **£0.22**

100+ **£0.15** 1000+**£0.13**



FCN

Screw on F connector for cable 75Ω RG6 etc.

Price each **£0.04**

100+ **£0.029** Each

1000+ **£0.025**



FCQCN

F connector adaptor enables quick plug on

Price each **£0.65**



DV54

Screw on F connector for coax cables 11mm outside diameter. CT167/RG11 etc.

Price **£1.55**

25+ **£1.11**



FJ-CP

Coaxial IEC Male to F-Female adaptor

Price **£0.35**



SFT-CP

Coaxial IEC M14 Male to F-Female adaptor Price **£2.30**



ACF

F connector Female-Male Angle Adaptor

Price **£0.38**



AFP

F connector Male-Male Adaptor

Price **£0.64**



AFPM

F connector Female-Female Adaptor

Price **£0.88**



TRPK-FS

F Connector 1.5 amp line power injector 5MHZ - 2.15 GHz



Price **£3.50**

SAC

Coaxial male to female screw-on angle connector Type IEC M14 75Ω.

Price **£7.07**



SFCP

Coaxial female to female screw-on panel connector Type IEC M14 75Ω.

Price **£4.00**



SCP

Coaxial screw-on plug. Type IEC M14 75Ω. Accepts coax cables up to 9mm outside diameter Price **£7.73**



RAP-SC

Screened coaxial male right angled quality connector. Accepts cables up to 8mm outside diameter

Price **£1.02**



RAP-FSCA

Screened coaxial female right angled quality connector. Accepts cables up to 7.5mm outside diameter. 0-2400MHz. Screening 75dB

Price **£1.02**



SCPP

Screened coaxial screw-on plug. With plastic outer body. Type IEC M14 75Ω Accepts coax cables up to 8mm outside diameter Price **£1.07** **Discontinued**



MFLK35 (35cm) MFLK50 (50cm)

Moulded coaxial lead, screw on IEC connectors

Price

MFLK35 **£2.67** **Discontinued**

MFLK50 **£2.86** **Discontinued**



Specifications subject to change

Accessories

GROUNDING

FCGB2

F Connector grounding block. for two connectors. Price **£1.70**



NB 02

Grounding block for 8 cables. Grounds via cable clamp to braid Price **£5.99**



NB04F

F Connector Grounding block for 4 cables. Price **£2.50**



ATTENUATORS

TILF3 3dB Attenuator

TILF6 6dB

F Connector 75Ω DC 2050 MHz

Price **£2.95**



F connector 75Ω with DC power through ,max 30v DC 1A 5-2050 MHz Price **£4.05**

TILF6 DC 6dB

TILF10 DC 10dB

TILF15 DC 15dB



TR20F-LP

Variable F Attenuator .5-18 dB 40-2150MHz Line Power Through Max 24V 1A Price **£9.90**



LOADS/TERMINATORS

SCP 75

75Ω IEC Terminator DC-2300MHz Price **£4.95**



FCT

75Ω F Terminator DC-2300MHz Price **£0.18**



DV25

75Ω DC Isolated F Terminator .01 -2300MHz Price **£1.49**



Isolators

Isolators

Type	Max Voltage	Isolation	Freq	Price
KTG120K	1000	Centre+screen	4-2300MHz	£61.22
KTG120F	1000	Centre+screen	4-2300MHz	£69.53
DC100K	500	Centre only	4-2300MHz	£4.95
DCF100K	500	Centre only	4-2300MHz	£1.95



DCF100K
F Connector
Voltage Isolator



DC100K
IEC Connector
Voltage Isolator

Centre and screen Isolators are essential for systems where high voltage potentials are created. Line power installations typically have these problems, causing hum modulation. Long coax runs are susceptible to induced high voltages.

Modern head ends with micro-processor circuitry are more vulnerable to damage to voltage surges. The cost of an isolator is small in comparison to the possible saving by protecting valuable equipment from voltage spikes.

Centre conductor Isolators are typically used for blocking line power voltage, LNB power etc.



KTG120F

F Connector
Voltage Isolator



KTG120K

IEC Connector
Voltage Isolator

Fixing Brackets

Type	Price
MK2	£1.58
MK3	£6.33



MK2



MK3

PG11 Connectors for Cable Amplifiers



0-2300MHz 10A IEC,

TIEC 1 £ 10.03

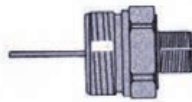

0-2300MHz 3A
F, TF1 £7.35

Cable prep tools

DDT £9.95

Cable stripper
for cables RG59,CT100,CT167



Crimp/compression tools

CP1



Crimp tool for FCN 11
F Connector
Price £29.90

DZ14

Compression tool for
FPCC11 RG11 Connector

£69.72



CAT AS EX

Compression
Tool for EX6
£59.00



DZ 85

Compression tool for
FPSCC FPCC1 RG 58-RG6

Connector £39.72



VT200

Compression tool for EX6/EX6XL
EX7/EX11

£59.72



Technical Information

Derating for number of Analogue TV Channels DIN45004B

dB	Ch
0	2
3	4
6	8
9	16
12	32
15	64

Derating for number of Digital TV Multiplexes ref, to DIN45004B

dB	Ch
6	2
9	4
12	8
15	16
18	32
21	64

Derating for number of cascading amplifiers

dB	Amplifiers
0	0
3	2
6	4
9	8
12	16
15	32

Recommended minimum signal levels at outlet

Analogue TV UHF	60dBuV
Digital TV UHF DVB-T/T2 64QAM & 256QAM (10dB margin at 47dBuV)	47dBuV
Band 2 FM Radio (some modern FM radio tuners will work as low as 20dBuV)	47dBuV

dBuV to dBmV

dBuV	dBmV
0	-60
3	-57
6	-54
9	-51
12	-48
15	-45
18	-42
21	-39
24	-36
27	-33
30	-30
33	-27
36	-24
39	-21
42	-18
45	-15
48	-12
51	-9
54	-6
57	-3
60	0
63	3
66	6
69	9
72	12
75	15
78	18
81	21
84	24
87	27
90	30
93	33
96	36
99	39
102	42
105	45
108	48
111	51
114	54
117	57
120	60
123	63
126	66
129	69

dBm to W

dBm	
-10	10mW
0	1mW
10	10mW
20	100mW
30	1W
40	10W
50	100W
60	1kW
70	10kW

dBuV ,dBmV to uV and mV

dBuV	dBmV	uV	mV
0	-60	1	0.001
20	-40	10	0.010
40	-20	100	0.100
60	0	1,000	1
80	20	10,000	10
100	40	100,000	100
120	60	1,000,000	1,000
140	80	10,000,000	10,000
160	100	100,000,000	100,000
180	120	1,000,000,000	1,000,000

Technical Information UK TV frequencies



Frequency specified is the centre

Vision carrier

Sound carrier



UK DVB-T/T2 Frequencies

Channel	MHz
21	474
22	482
23	490
24	498
25	506
26	514
27	522
28	530
29	538
30	546
31	554
32	562
33	570
34	578
35	586
36	594
37	602
38	610
39	618
40	626
41	634
42	642
43	650
44	658
45	666
46	674
47	682
48	690
49	698
50	706
51	714
52	722
53	730
54	738
55	746
56	754
57	762
58	770
59	778
60	786
61	794
62	802
63	810
64	818
65	826
66	834
67	842
68	850

Not now used for terrestrial broadcast, risk of interference from mobile phones, if low pass filter not fitted on antenna put. see page 34B part number TXB 700

can be used for DVB-T modulators if filter fitted

Analogue UHF TV Frequencies, terrestrial discontinued

Channel	MHz Vision	MHz Sound
21	471.25	477.25
22	479.25	485.25
23	487.25	493.25
24	495.25	501.25
25	503.25	509.25
26	511.25	517.25
27	519.25	525.25
28	527.25	533.25
29	535.25	541.25
30	543.25	549.25
31	551.25	557.25
32	559.25	565.25
33	567.25	573.25
34	575.25	581.25
35	583.25	589.25
36	591.25	597.25
37	599.25	605.25
38	607.25	613.25
39	615.25	621.25
40	623.25	629.25
41	631.25	637.25
42	639.25	645.25
43	647.25	653.25
44	655.25	661.25
45	663.25	669.25
46	671.25	677.25
47	679.25	685.25
48	687.25	693.25
49	695.25	701.25
50	703.25	709.25
51	711.25	717.25
52	719.25	725.25
53	727.25	733.25
54	735.25	741.25
55	743.25	749.25
56	751.25	757.25
57	759.25	765.25
58	767.25	773.25
59	775.25	781.25
60	783.25	789.25
61	791.25	797.25
62	799.25	805.25
63	807.25	813.25
64	815.25	821.25
65	823.25	829.25
66	831.25	837.25
67	839.25	845.25
68	847.25	853.25

