

Service Equipment

Tire Changers | Wheel Balancers | Brake Lathes
Rolling Jacks | Lifts & Work Stations



Changing America's Tires
FOR 70 YEARS!



COATS®



COATS® 1600 DIRECT DRIVE WHEEL BALANCER & 80X RIM CLAMP® TIRE CHANGER



The Coats® X-Series

60X-SERIES SWING ARM TIRE CHANGER

- **Swing arm design** ▪ Air or 110v electric motor
- Built-in water separator (Air) ▪ 6"-24" external clamping range ▪ Metal clamps ▪ Hand actuated bead loosener ▪ Single point sealer ▪ Extended warranty
- **Patented Robo-Arm®** ▪ Metal and plastic duckhead



443-80060

TUFFY NO.	MFG. NO.	DESCRIPTION
443-80060	60X60XE1A1H1	60X-Series Swing Arm Air Tire Changer

70X-SERIES RIM CLAMP TIRE CHANGERS

- **With complete robotics and exclusive Rim Clamp® for run-flat tire changing speed and power** ▪ Robotic arm used to assist in top bead mounting of stiff sidewall, low profile and run-flat tires ▪ Manual bead roller used to assist in holding the tire bead down to lube both the tire and wheel ▪ Robotic arm used to hold tires in the up position to reduce the effort in second bead removal ▪ Handles up to 24" wheels standard ▪ *Also available in electric versions*



COATS 70X-SERIES TIRE CHANGER FEATURES

TUFFY NO.	MFG. NO.	ROBO ARM	MOTOR	BEAD LOOSENER	ACCESSORY KIT INCLUDED
443-71183	70XAF3	Yes	Air	Foot	Premium
443-72183	70XEF3	Yes	Electric	Foot	Premium
443-70183	70XAH3	Yes	Air	Hand	Premium
443-73183	70XE3	Yes	Electric	Hand	Premium

SERVICE EQUIPMENT // TIRE CHANGERS





The Coats® X-Series (cont.)

80X-SERIES SWING ARM TIRE CHANGER

- **Swing arm design** ▪ Air or 110v electric motor ▪ Built-in water separator (air) ▪ 6"-24" external clamping range ▪ **Grip Max® Plus clamps** ▪ Hand-actuated bead loosener ▪ Single point sealer ▪ Extended warranty
- **Patented Robo-Arm®** ▪ Hybrid & high spoke duckhead®
- **RoboRoller®** (right side) ▪ Storage cabinet

90X-SERIES SWING ARM TIRE CHANGER

- **Swing arm design** ▪ Air or 2 Speed 110v electric motor
- Built-in water separator (air) ▪ 6"-28" external clamping range ▪ **Grip Max® Plus clamps** ▪ Hand-actuated bead loosener ▪ Single point sealer ▪ Extended warranty
- **Patented Robo-Arm®** ▪ Hybrid Leverless Duckhead®
- **RoboRoller®** (right side) ▪ Storage cabinet

SERVICE EQUIPMENT // TIRE CHANGERS

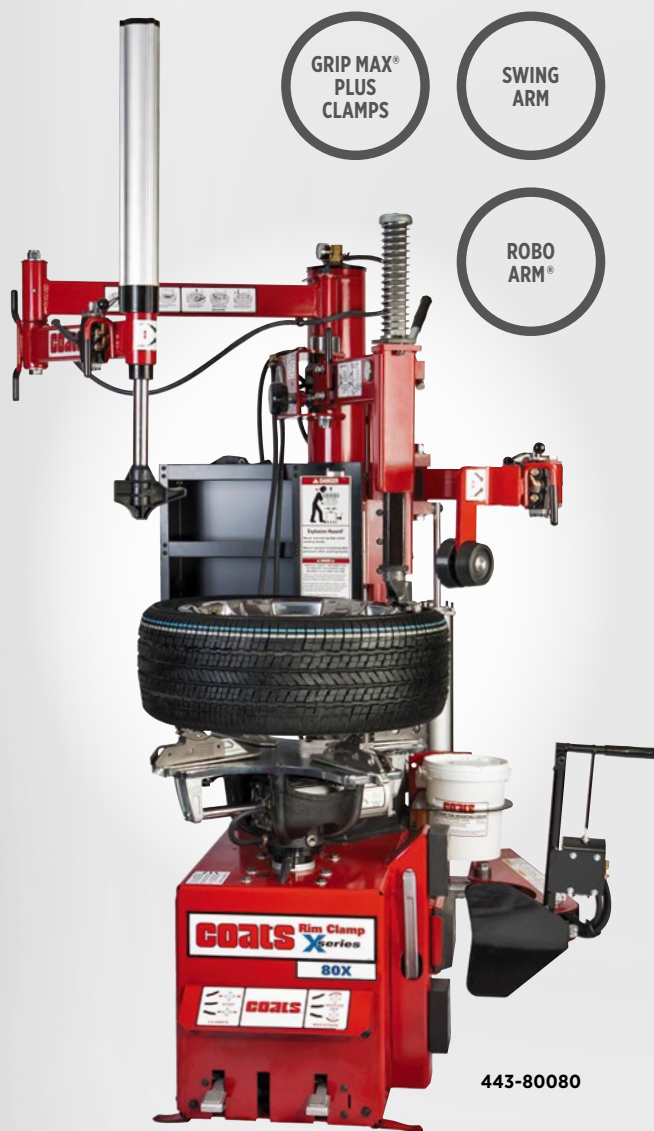

TUFFY NO.	MFG. NO.	DESCRIPTION
443-80080	80XAH3	80X-Series Swing Arm Air Tire Changer
443-80081	80XEH3	80X-Series Swing Arm Electric Tire Changer

TUFFY NO.	MFG. NO.	DESCRIPTION
443-80090	90X AHL	90X-Series Swing Arm Air Tire Changer
443-80091	90X EHL	90X-Series Swing Arm Electric Tire Changer





The Coats® GTS-Series

GTS-50 TILTBACK TIRE CHANGER

- **Tilt-back Design** ▪ Two speed, 110v electric motor
- Hand-actuated bead loosener ▪ Single point sealer
- **Grip Max® Plus clamps** ▪ 6"-24" external clamping range
- Rim protection tower design

GTS-60 TILTBACK TIRE CHANGER

- **Tilt-back Design** ▪ Two speed, 110v electric motor
- Hand-actuated bead loosener ▪ Single point sealer
- **Grip Max® Plus clamps** ▪ 6"-24" external clamping range
- Rim protection tower design
- Powered roller disc
- Built-in air tank reservoir



443-85692



443-85698

TUFFY NO.	MFG. NO.	DESCRIPTION
443-85692	GTS-50	GTS-50 Tiltback Tire Changer

TUFFY NO.	MFG. NO.	DESCRIPTION
443-85698	GTS-60	GTS-60 Tiltback Tire Changer

SERVICE EQUIPMENT // TIRE CHANGERS





The Coats® GTS-Series (cont.)

GTS-70 TILTBACK TIRE CHANGER

- **Tilt-back Design** ▪ Two speed, 110v electric motor
- Hand-actuated bead loosener ▪ Single point sealer
- **Grip Max® Plus clamps** ▪ 6"-24" external clamping range ▪ Rim protection tower design ▪ Powered roller disc ▪ Built-in air tank reservoir ▪ 2nd power bead assist



443-85676

GTS-90 TILTBACK TIRE CHANGER

- **Tilt-back Design** ▪ Two speed, 110v electric motor
- Hand-actuated bead loosener ▪ Single point sealer ▪ **Grip Max® Plus clamps** ▪ 6"-24" external clamping range ▪ Rim protection tower design
- Powered roller disc ▪ Built-in air tank reservoir
- **2nd powered RoboRoller®** ▪ **3rd Robo-Arm®**



443-85690

TUFFY NO.	MFG. NO.	DESCRIPTION
443-85676	GTS-70	GTS-70 Tiltback Tire Changer

TUFFY NO.	MFG. NO.	DESCRIPTION
443-85690	GTS-90	GTS-90 Tiltback Tire Changer

SERVICE EQUIPMENT // TIRE CHANGERS



Coats

→ Passenger Tire Changers

The Coats® RC-Series

RC-45 & RC-55 RIM CLAMP TIRE CHANGERS

▪ BUILT-IN BEAD SEALING JETS:

Quickly seal beads while tabletop inflation provides a faster workflow.

▪ HIGH TORQUE, X-SHAPED

TURNTABLE: Designed for rigid perimeter support of the wheel. Pedal controls make tire mounting and dismounting easier for technicians, especially when working in high volumes.

▪ MANUAL SWING ARM: Easily adjusted so that the Coats Duckhead® Mount/Demount Tool is properly fitted to the tire rim. This will reduce the risk of damage when mounting and demounting the tire.

▪ CONVENIENTLY PLACED FOOT PEDALS: Provide precise control over every step of the changing process. The pedals are ideally placed for fluid technician movements while mounting and demounting tires.

INFLATION GAUGE: Easily and accurately inflate from 0 to 60 PSI. With a pressure limiter and easy-to-read gauge, the built-in tire inflation system ensures technician safety and prevents TPMS related comebacks.

▪ WHEEL PROTECTION:

Available options include bead loosener socks, clamp booties and lift tool protection to prevent metal-to-metal contact that causes scratching or marring.

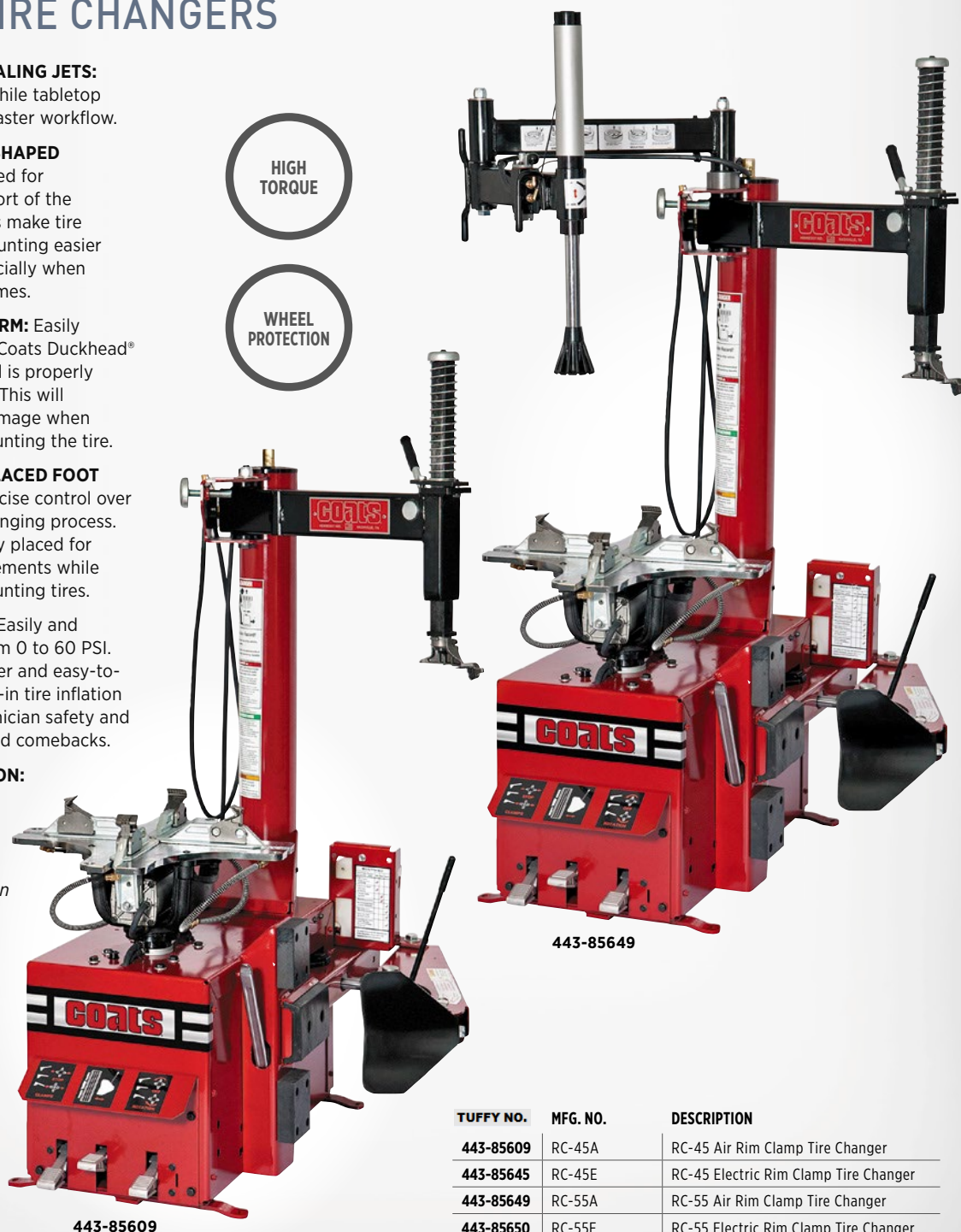
HIGH
TORQUEWHEEL
PROTECTION

443-85649

443-85609

TUFFY NO.	MFG. NO.	DESCRIPTION
443-85609	RC-45A	RC-45 Air Rim Clamp Tire Changer
443-85645	RC-45E	RC-45 Electric Rim Clamp Tire Changer
443-85649	RC-55A	RC-55 Air Rim Clamp Tire Changer
443-85650	RC-55E	RC-55 Electric Rim Clamp Tire Changer





Coats® Tire Changers

4070 DUAL DIRECTION CENTER-POST TIRE CHANGER

The Coats® 4070 is the latest in a long line of fast and durable Center Post Tire Changers from Coats®. Just like its predecessor, the 4070 has all of the operations performed in the same position.

But unlike its predecessor, the new Model 4070 includes:

- **Power Reverse Functionality** ▪ Rebuildable/Serviceable Cylinder ▪ Higher Operating Torque of 900 ft./lb. for more power ▪ Increased rim capacity of 10"-18" ▪ Single bead loosener shoe for easier positioning ▪ Lower anti-rotation pin for ease of use

POWER REVERSE

HIGHER OPERATING TORQUE



442-85680

APX90 PASSENGER TIRE CHANGER

- **LARGE CLAMPING CAPACITY:** Externally clamps wheels up to 30" or as small as 9" to maximize service flexibility
- **HI-TORQUE ELECTRIC TURNABLE:** High start-up torque gives you the power you need for tough applications
- **INTEGRATED WHEEL LIFT:** Lifts heavy assemblies, reducing both wheel damage risk
- **ROBO-ARM®:** Applies pressure to create bead lock and hold top bead in drop center when mounting
- **ROBO-ROLLER®:** Extra leverage for large diameter runflat and low-profile tires
- Available in Air and Electric

ROBO ARM®

ROBO ROLLER®



443-90101

TUFFY NO.	MFG. NO.	DESCRIPTION
442-85680	4070	4070 Dual Direction Center-Post Tire Changer

TUFFY NO.	MFG. NO.	DESCRIPTION
443-90101	APX90E	Electric Tire Changer
443-90102	APX90A	Air Tire Changer

SERVICE EQUIPMENT // TIRE CHANGERS



Coats® Tire Changer Features

TIRE CHANGERS AT A GLANCE

MODEL	STANDARD CLAMPS	SPARE CLAMPS (IN BOX)	STANDARD DUCKHEAD®	SPARE DUCKHEAD®	OPTIONAL CLAMPS
RC-45/RC-55 	8184126	None	8182753 (Steel)	None	None
60X 	8184126	None	8182753 (Steel)	8182960 (Nylon)	85607788 (Grip Max®) 85607986 (28")
70X-3, 80X-3 	85607788	None	85609975 (Hybrid)	8184426 (High Spoke)	85607986 (28")
90X 	85607788	8184126 (Steel) 85607986 (28")	85609095 (Hybrid Leverless)	None	
GTS-50, GTS-60, GTS-70 	85607788	8184926	8182753 (Steel)	83008403 (Nylon Duckhead®)	85607986 (28")
APX90 	85607788	None		85000269 (Nylon 2 PK)	

SERVICE EQUIPMENT // TIRE CHANGERS



CEMB Tire Changers

SM825 SWING ARM PASSENGER & LIGHT TRUCK TIRE CHANGER

- **Air tank in tower** ▪ Dual clamping cylinders ▪ Semi-automatic swing arm ▪ Inflator jets on each clamp
- Inserts protect aluminum wheels
- Adjustable bead breaker



443-91825

SM915ATIPA SWING ARM CAR & LIGHT TRUCK TIRE CHANGER W/ PRESS ARM

- **Air tank in tower** ▪ New and fast clamping range adjustment without dismantling the clamps ▪ Dual clamping cylinders ▪ Semi-automatic swing arm
- Inflator jets on each clamp ▪ Inserts protect aluminum wheels ▪ Low profile press arm ▪ Adjustable bead breaker combo ▪ Tire inflation by pedal



443-91502

SM951HPA TILT BACK PASSENGER & LIGHT TRUCK TIRE CHANGER

- **New and fast clamping range adjustment without dismantling the clamps** ▪ Dual clamping cylinders ▪ Adjustable smart blade bead breaker
- Inflator jets on each clamp
- Inserts protect aluminum wheels ▪ Low profile press arm and help arm combo ▪ Tire inflation by pedal



443-95101

SERVICE EQUIPMENT // TIRE CHANGERS

CEMB TIRE CHANGER SPECIFICATIONS

TUFFY NO.	MFG. NO.	POWER SUPPLY	INSIDE CLAMPING	OUTSIDE CLAMPING	MAX TIRE OUTSIDE	BEAD BREAKER FORCE	MAX RIM WIDTH	GROSS SHIPPING WEIGHT
443-91825	SM825	110 VAC	15" - 26"	13" - 24"	47"	5500 lbs.	15"	630 lbs.
443-91502	SM915ATIPA	110VAC	13" - 28"	10" - 26"	47"	5500 lbs.	15"	630 lbs.
443-95101	SM951HPA	110VAC	13" - 28"	10" - 26"	43"	7000 lbs.	16"	800 lbs.





AM50 LEVERLESS TIRE CHANGER

- Handles all rims 12" - 30" including UHP, runflat, light truck and more
- A revolutionary bead lifter eliminates the need for tire bar, reducing operator risk and torn beads
- Powerful two-speed transmission for precision and speed
- Sleek design with sturdy pneumatic locking swing-arm uses less floor space
- Precision bead breaker disk gently loosens both beads
- Center cone clamping with plastic protector means no metal ever touches the face of the rim

▪ **FEATURES INCLUDE:** (Electric only) **Dynamic bead breaking device** with dual specular bead breaker disc; **Multifunctional control console** contains all the operation controls; Ideal for dynamic bead breaking and for rim and tire match mounting, thanks to the **two dual control discs**; **Motoinverter drive system**; **Wheel lifter** is fitted as standard, for effortlessly placing wheels of any type onto the turntable; Demounting procedure uses the same working movements but absolutely no effort is required from the operator thanks to the **"Leva la leva" (without lever) technology** incorporated in the head (Patent Pending); **Safe and universal wheel clamping**

"LEVA LA LEVA" (WITHOUT LEVER)



TUFFY NO.	MFG. NO.	DESCRIPTION
443-00500	AM50	AM50 Leverless Tire Changer

Corghi Tire Changers

AM26 ARTIGLIO MASTER

- Automatic mount/demount
- Computerized system
- Push-button technology
- RIM DIAMETER: 12" to 26"
- No pry bars or tire tools
- No damage to wheels, tires or operator
- Pneumatic wheel lift

AUTOMATIC MOUNT/DEMOUNT

PNEUMATIC WHEEL LIFT



443-26000

TUFFY NO.	MFG. NO.	DESCRIPTION
443-26000	AM26	AM26 Artiglio Master



Please contact us for more information regarding **TIRE CHANGERS.**

A2024TI-20 SUPER POWER UNIT

- Pneumatic-powered upper disc holds bead into the wheel drop for mounting
- Designed for low-profile, EMT and high-performance tires and wheels
- Loosening upper bead for demounting
- Push down upper bead for lubrication and tire tool insertion
- Lowering upper bead for inspection between bead and demount head
- Lowering upper bead for inserting the bead clamp; this clamp makes it possible to lift the bead over the mount/demount head
- SHIPPING WEIGHT: 815 lbs.

AUTOMATIC MOUNT/DEMOUNT

PNEUMATIC-POWERED UPPER DISC



443-20242

TUFFY NO.	MFG. NO.	DESCRIPTION
443-20242	A2024TI-20	A2024TI-20 Super Power Unit

SERVICE EQUIPMENT // TIRE CHANGERS





Tire Changer Accessories

TIRE CHANGER ACCESSORIES: CENTER-POST

TUFFY NO.	MFG. NO.	ITEM	DESCRIPTION
444-00312	000312	Small Hold Down Cone	1.12" x 5" Secures Wheel to Center-Post Tire Changer During Mount/Demount Operation
444-01701	101701	Deep Hub Adapter	To 5" Diameter - For Models 4040, 4040SA, 4050
444-81891	108276	Hold Down Cone	Cone, Hold Down, for Centre Holes up to 6.6" Diameter
444-02927	102927	Shim Adapter .25"	Used to Adjust Lower Shoe for Wheels with Large Rim Flanges on All Center-Post Changers
444-08311	108311	Center-Post Short Adapter 4"	4040SA and 4050. Short Extension for Center-Post
444-08313	108313	Center-Post Long Adapter 8"	4040SA and 4050. Long Extension for Center-Post
444-00347	000347	Manual Tire Spreader	Tire Spreader, Adjustable For 4040/4050. Must Be Used With #181329 For Rim Clamp® Use
444-81329	181329	Spreader Adapter	Optional Adapter for 000347 Spreader
444-06637	106637	Wheel Bead Loosener	Manual Hand-Operated for Servicing Custom Mag and Decorative Style Wheels. Handles Custom Wheels 13" to 16" Diameter and 4" to 10" Width. Can Be Used With COATS 3040A, 3030 A, 2020A, 2020 And 1010A Tire Changers
444-00768	000768	Combo Tool	Designed Specifically To Mount And Demount Tire Effortlessly And Damage Free On 4050, 4040SA, 3040A, 3030A, 2020A, 2020, 1010A & 1010
444-07156	107156	Combo Tool 34.5" Long	For All Manual Tire Changers. Used When Servicing Custom Wheels And With Any Tire Changer Requiring A Manual
444-06568	106568	Custom Wheel Protector Set	Prevents Marring And Scratching of Custom Mag And Decorative-Style Wheels On Center-Post Tire Changers. Set Consists of Plastic Combo Tool and Polyurethane Bead Loosener Boots
444-07790	107790	Protector Boot Set	Set Of 10 Mount/Demount Plastic Booties For 4050, 4040SA Combo Tool. Prevents Combo Tool from Marring Wheel Finish
444-08397	108397	Bulk Pack Protectors	Mount End Package Of 500 Protective Booties For Mount End Of No. 000768 Combo Tool For 4050, 4040SA And Any Other Center-Post Changer
444-08398	108398	Bulk Pack Protectors	Demount End Package of 500 Protective Booties for Mount End of No. 000768 Combo Tool for 4050, & 4040SA and Any Other Center-post Changer

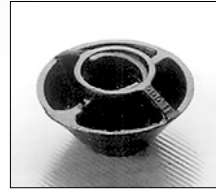

444-00312

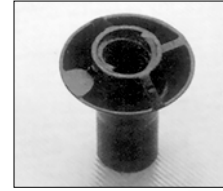

444-01701

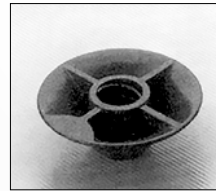

444-81891

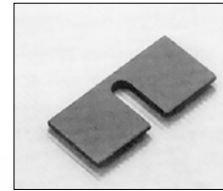

444-02927

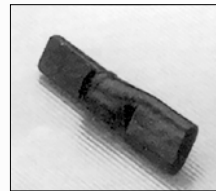

444-08311

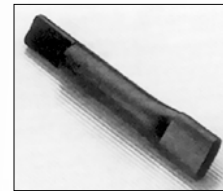

444-08313



444-00347



444-06637



444-07156

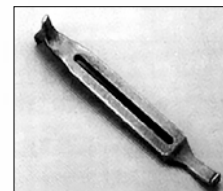

444-00768

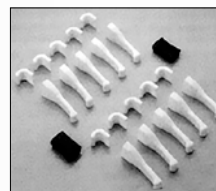

444-06568

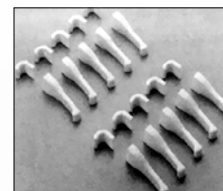

444-07790

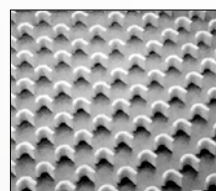

444-08397

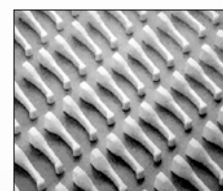

444-08398

SERVICE EQUIPMENT // TIRE CHANGERS



TIRE CHANGER ACCESSORIES & WHEEL PROTECTING ITEMS

TUFFY NO.	MFG. NO.	ITEM	DESCRIPTION
444-01222	TC450310A	Nylon Mount/Demount Head	Nylon Mount/Demount Head for Coats, Corghi & Hunter Tire Changers
444-08043	3008403	Duckhead	Black Plastic Duckhead for 9010/9024/APX-90
444-82963	182963	Plastic Inserts	Plastic Inserts for 182788 Metal Mount/Demount head for 50 & 7065 Series . Quantity of 12.
444-83061	183061	Nylon Mount/Demount Head	Rim clamp [®] tire changers for 5000, 6000 and 7000 series
444-83604	183604	Clamp Sock	Quilted Clamp Sock, RC-TC. 10 Pack
444-83605	85000783	Lift Tool Sock	Lift Tool Sock, RC-TC. 10 Pack
444-83606	183606	Shoe Sock	Bead Loosener Shoe Sock, RC-TC. 2 Pack
444-84432	184432	Duckhead	Raised Spoke Gray Plastic Duckhead. For 5000, 6000 & 7000 Series



TIRE CHANGER ACCESSORIES: RIM CLAMP[®]

TUFFY NO.	MFG. NO.	ITEM	DESCRIPTION
444-18312	183120	Inflation Guard Kit	For 50 Series Rim Clamp[®] Tire Changers
444-35685	435685	Drop Center Tool	Assists in Mounting High Performance Tires by Holding Bead in Drop Center
444-56345	85600345	16" - 28" GRIP MAX Clamp Set	Without teeth, 4 Pk, Fits X Model Rim Clamp Tire Changers (not for use on APX series)
444-56462	5606462	Duckhead Roller	For 50/60/70 Series Rim Clamps
444-80606	85606689	Leverless Power Bead Lifter	Leverless Power Duckhead Bead Lifter for Coats 9024 Tire Changer
444-80758	85000758	6" - 22" GRIP MAX Laminated Clamp Set	INCLUDES: 4 Clamps, 4 Plungers, 1 Extra Set of Grips
444-81257	1845744	Motorcycle Adapter	Coats RC200 Style Motorcycle Clamps for Automotive X Model Rim Clamp[®] Tire Changers
444-81329	181329	Rim Clamp [®] Spreader Adapter	Rim Clamp [®] Tire Changer, Spreader - Used With #000347 or #108028 Tire Spreader (not compatible with 9024E and APX Series)
444-81354	181354	Rim Clamp [®] Bead Lifting Tool	Designed for Ease of Lifting the Head During the Tire Changing Operation
444-82788	1827881	Demount Head	Stainless Steel Duckhead Mount/Demount Head Assembly for 5030 through 7065 series Rim Clamp[®] Tire Changers . (Requires taper end vertical shaft.)
444-83401	184414	Motorcycle Adapter	For RC (Tall Carriers 1.75"), Designed to Mount Wheels with Drive Sprockets etc. Attached. <i>Requires space removal for use on 5035's. (Not for X models, or 9010/9024)</i>
444-83585	183585	ATV Adapter	8 Jaw ATV Adapters. Set of 4. Fits "Tall" Clamp Carriers. (Not Model 9010)
444-84590	184590	4" Ext Clamp	4" Clamps for 9024/9010
444-84926	184926	Extended X-Clamp	3 Positions Enable External Wheel Clamping on 6" Through 22" Diameter Wheels
444-85741	85607471	Leverless Power Bead Lifter	Leverless Power Duckhead Bead Lifter for Coats 70X or APX Series Tire Changer
444-87787	85607787	Set of 4 GRIP MAX Clamps	6-22" Grip Max Plus 3-Position Adjustable Clamps
444-87986	85607986	Set of 4 GRIP MAX Clamps	16"-28" Grip Max Plus 3-Position Adjustable Clamps
444-89408	800059408	GRIP MAX Clamp Set	Laminated Clamp Replacement Kit (8 each)



SERVICE EQUIPMENT // TIRE CHANGERS



➔ Tire Changer Accessories

Tire Changer Accessories (cont.)

TIRE CHANGER LUBE BOTTLES AND SWABS



844-16572

844-16259



437-40006

437-13014

437-0001

TUFFY NO.	MFG. NO.	DESCRIPTION
437-00001	TS-1	11" OAL x 2" Swab Diameter
437-00002	TS-2	15" OAL x 2" Swab Diameter
437-00003	TS-3	18" OAL x 3" Swab Diameter
437-13014	313014	Hunter-Style Tire Lubricating Brush
437-40006	40006	Tire Lubricating Brush
844-16259	106259	Lube Bottle. Rim Clamp. Fits RC-15, RC-20, 5060 and 5070 Series Tire Changers
844-16572	106572	Lube Bottle. Center-Post. Fits 4040, 4040SA and 4050 Tire Changers

COATS REPLACEMENT AIR HOSE

▪ For use with Coats Tire Changers ▪ 60" long x 1/4" diameter ▪ AC-1 Euro-style chuck ▪ All brass connectors ▪ Swivel fitting ▪ Packaged 1 per bag



127-86871

TUFFY NO.	MFG. NO.	DESCRIPTION
127-86871	86871-1	60" x 1/4" Coats Replacement Air Hose

HUNTER REPLACEMENT AIR HOSE

▪ 60" long x 1/4" diameter ▪ European -style air chuck ▪ All brass connectors ▪ Packaged 1 per bag



127-86872

TUFFY NO.	MFG. NO.	DESCRIPTION
127-86872	86872-1	Hunter Replacement Air Hose

LOW PROFILE BEAD LEVER TOOL

▪ Unique angled handle provides more leverage ▪ Curved tip holds tire better



444-05500

TUFFY NO.	MFG. NO.	DESCRIPTION
444-05500	5500	Low Profile Bead Lever Tool



RED PLASTIC HUNTER MOUNT/DEMOUNT HEAD

▪ **Larger channel for difficult wheels** ▪ Specifically designed for low profile tires ▪ **For Hunter TCA34 tire changers** ▪ **APPLICATION CHART BELOW:**

OEM	Part Number	Tire Changer
Hunter	221-675-2	TC250, TC300, TC325, TC350, TC2000, TC3250, TC3500
	221-675-2-B	TC250, TC300, TC325, TC350, TC2000, TC3250, TC3500



444-01224

TUFFY NO.	MFG. NO.	DESCRIPTION
444-01224	TCR343	Red Plastic Hunter Mount/Demount Head

NYLON MOUNT/DEMOUNT HEAD, COATS & HUNTER STYLES



444-01220

444-01221

TUFFY NO.	MFG. NO.	DESCRIPTION
444-01220	VT-1220	Nylon Mount/Demount Head (Coats Style)
444-01221	VT-1221	Nylon Mount/Demount Head (Hunter Style)

MAG/CHROME/ALLOY WHEEL MOUNT/DEMOUNT TOOL

▪ **Eliminates damage to mag, chrome and alloy wheels** ▪ Fits all center-post tire changers ▪ Replaceable polymer inserts get 500 to 700 mount/demounts when used correctly ▪ Eliminates “booties” that slip off “combo” tool ▪ Changes inserts in seconds ▪ *Not for use on steel wheels*

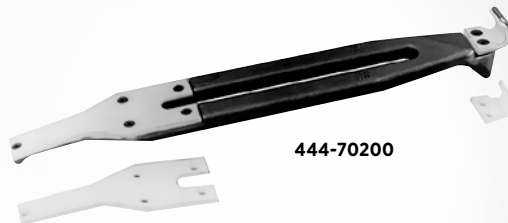

444-70200

TUFFY NO.	MFG. NO.	DESCRIPTION
444-70200	72000	Mount/Demount Tool
444-70201	72010	One Set of Replacement Inserts for 70200 Mount/Demount Tool
444-70202	72020	Mag Tool Replacement Polymer Nose - Only
444-70204	72040	Mag Tool Replacement Polymer Hook - Only
444-70205	72040	Replacement Screw - Demount
444-70206	72020	Replacement Screw - Mount

BEAD SEALER ACCESSORY KIT

▪ **KIT INCLUDES:** Auxiliary Bead Sealer, for Rim Clamp® Tire Changer, Taps off the Tire Changer surge tank



447-85545

TUFFY NO.	MFG. NO.	DESCRIPTION
447-85545	85606545	Bead Sealer Accessory Kit

STORAGE CABINET

▪ **Keep tools, valve stems, TPMS, etc. conveniently at the machine** ▪ Board Storage

The Storage Cabinet in use.

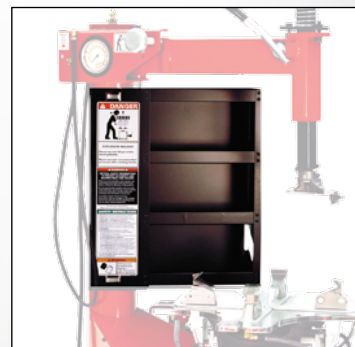

TUFFY NO.	MFG. NO.	DESCRIPTION
444-83621	8113621	Storage Cabinet





Coats® Heavy Duty Tire Changers

LEVERLESS BEAD LIFTER

▪ If you are looking to improve the efficiency of your shop and reduce the chances of rim damage, look no further than the new Coats Leverless Bead Lifter. With the Coats Leverless Bead Lifter, you can upgrade your Coats Rim Clamp tire changer APX, 70X, or 9024 and let the machine do the work (or new units with Leverless option, see page 225). The leverless design eliminates traditional tire tools that can mar the surface due to application difficulty or operator error. This results in a more controlled mount/demount process, flexing the beads just enough for removal and installation.



The Leverless Bead Lifter in use.



444-85689



DEMOUNTING:
With the flip of a switch, the leverless tool hooks the lip of the bead and effortlessly lifts it just above the rim. With a simple rotation of the tabletop, the tire comes off of the rim safely and easily.



MOUNTING:
The leverless tool can also be utilized as an additional helper device when mounting a tire's top bead.

TUFFY NO.	MFG. NO.	DESCRIPTION
444-85689	85606689	Leverless Bead Lifter

HIT 5000 HEAVY DUTY TIRE CHANGER

▪ These heavy duty changers can accommodate tube or tubeless tires with rim diameters from 15" to 38" (5000) and 15" to 44" (9000). Easy-to-use swing-arm houses all hydraulic controls, with a dedicated lever for each powered function. Self-centering hydraulic clamping chuck. Adjustable pressure regulator ensures proper matching of chuck pressure to rim strength. Heavy, tapered roller bearings and a dual direction hydraulic motor provide smooth torque. Roller-type tire spreader standard.



446-05000

TUFFY NO.	MFG. NO.	DESCRIPTION
446-05000	5000	HIT 5000 Heavy Duty Tire Changer

HIT 6000 HEAVY DUTY TIRE CHANGER

▪ The Coats Model 6000 tire changer is designed for servicing tubeless tires. It can change tubeless truck tires in a matter of minutes without the use of adapters, as well as loosen tube-type tire beads. Handles wheel widths of 6" to 15" and diameters of 16.5" to 24.5". Changes all 15-degree single-piece highway rims, including demountable Dayton wheels, reverse disc Budd wheels and standard disc wheels. One control stick for pivoting the tabletop and clamping the rim chuck. Bead loosening, mounting and demounting are activated by dedicated two-way pedals. Optional #183945 nylon head combo tool available for aluminum wheels.

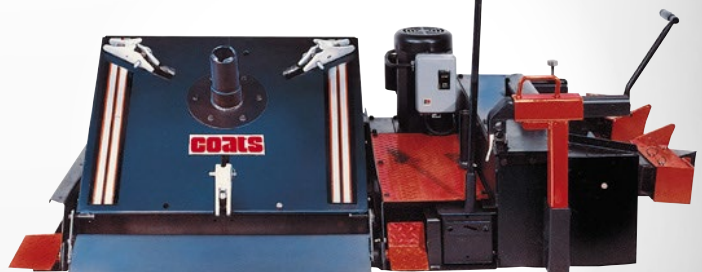

446-06000

TUFFY NO.	MFG. NO.	DESCRIPTION
446-06000	6000	HIT 6000 Heavy Duty Tire Changer





CHD-9551 HEAVY DUTY TIRE CHANGER

- **Our top-of-the-line changer is designed for high-volume shops**
- The CHD-9551 makes it easy to handle the toughest super-single, skidder, agricultural and off-road tires on the market
- **Offers the most automated features and widest range of fittings in the CHD line**
- **Remote control rotating tool head/arm** for the fastest, easiest tool changes in the business
- **Optical wireless remote** gives you freedom to move around the machine without cumbersome cables
- Handles rims from 14" to 46" (up to 56" with clamp extensions) and tires up to 95" in diameter and 51" wide



446-09551

TUFFY NO.	MFG. NO.	DESCRIPTION
446-09551	CHD-9551	CHD-9551 Heavy Duty Tire Changer

CHD-9043 HEAVY DUTY TIRE CHANGER

- **The clear choice for high volume shops that deal with both a variety of applications and large wheel fitments**
- **Solid, single-piece frame** for added capacity and dependability
- **Remote control hydraulically operated tool arm** saves operator effort and speeds tire-changing turnaround time
- Handles rims from 14" to 46" (up to 56" with clamp extensions) and tires up to 90.5" in diameter and 43" wide



446-09043

TUFFY NO.	MFG. NO.	DESCRIPTION
446-09043	CHD-9043	CHD-9043 Heavy Duty Tire Changer

CHD-6330 HEAVY DUTY TIRE CHANGER

- **It's the most compact of the jaw-style clamping machines available today**
- This **easy-to-learn model** is designed for shops with moderate to high volume with a wide range of applications
- **Four-jaw chuck** allows fast and easy clamping of virtually all rim styles, including de-mountable, reverse disc, standard disc and off-road style wheels
- **Floating jaws** match wheel contours for excellent grip and safety
- **Solid, single-piece frame** for added capacity and reliability
- **Portable wired control unit** lets you work from the best angle at all times
- Handles rims from 13" to 27" and tires up to 36" in diameter and 30.5" wide



446-06330

TUFFY NO.	MFG. NO.	DESCRIPTION
446-06330	CHD-6330	CHD-6330 Heavy Duty Tire Changer

Please contact us for more information regarding **COATS® TIRE CHANGERS.**

SERVICE EQUIPMENT // TIRE CHANGERS





Coats® Heavy Duty Tire Changer Features

HEAVY DUTY TIRE CHANGERS AT A GLANCE

FEATURES TO COMPARE	CHD 9551	CHD 9043	CHD 9041	HIT 5000	CHD 6330	HIT 6000	CHD 4730
OPERATION	4 Jaw Chuck	4 Jaw Chuck		3 Jaw Chuck	4 Jaw Chuck	Lay Back, Center Mount	Front Plate or Cone
WHEEL HANDLED	Budd & Dayton, Tube & Tubeless	Budd & Dayton, Tube & Tubeless		Budd & Dayton, Tube & Tubeless	Budd & Dayton, Tube & Tubeless	Budd & Dayton Tubeless	Budd Tubeless
MOUNT DEMOUNT	Hook & Roller on Reversible Mount	Hook & Roller on Reversible Mount		Independent Hook & Roller	Hook & Roller on Reversible Mount	Center Post	Roller on Sliding Mount, Hook Optional
TOOL HEAD OFFSET	Automatic Permanent Mounted	Automatic Permanent Mounted	Foot Release Permanent Mounted	Independent Removable, Mount in Table	Hand Release Permanent Mounted	Independent Removable, Mount in Table	Hand Release Permanent Mounted
TABLE	Moving Table Side Mounted	Moving Table Side Mounted		Moving Table Centered in Frame	Moving Table Side Mounted	Lay Back	Moving Table Side Mounted
WHEEL CLAMPING METHOD	4 Jaw Chuck	4 Jaw Chuck		3 Jaw Chuck	4 Jaw Chuck	Lay Back, Center Mount	Front Plate or Cone
WHEEL LIFT	Clamp Arm Lifting	Clamp Arm Lifting		Clamp Arm Lifting	Clamp Arm Lifting	Tilt Back	Clamp Face Plate Lifting
FRAME STRUCTURE	Full Frame	Full Frame	Open Frame	Center Carriage	Open Frame	Tilt Table	Open Frame
MAX. TIRE DIAMETER	95"	90.5"	90.5"	76"	63"	44"	47"
MAX. TIRE WIDTH	51"	43"	42"	25"+	30.5"	16"	30.5"
RIM DIAMETER RANGE	14-46 (47"-56" with Clamping Extensions)	14-46 (47"-56" with Clamping Extensions)		15"-38"	13-27	16.5"-24.5"	14"-26"
ELECTRIC SPECIFICATIONS	208-230VAC, 3ph, 60Hz, 22Amp	208-230VAC, 3ph, 60Hz, 15Amp		220v / 1ph or 220v / 3ph, 60Hz	208-230VAC, 3ph, 60Hz, 15Amp	220v / 1ph or 220v / 3ph, 60Hz	208-230VAC, 3ph, 50/60Hz, 12Amp
AIR REQUIRED	—	—	—	No	—	Yes	—
MAX. OVERALL DIMENSION	112"(w) x81"(d) x75"(h)	96.5"(w) x85"(d) x73"(h)	88"(w) x79"(d) x59"(h)	96"(w) x108"(d) x66"(h)	69"(w) x68.5"(d) x50"(h)	78"(w) x48"(d)	62"(w) x59"(d) x46"(h)
MAX WHEEL WEIGHT	3300 lbs.	3500 lbs.	3300 lbs.	—	3300 lbs.	—	2800 lbs.
WEIGHT WITH STANDARD ACCESSORIES (SHIPPING)	2282 lbs.	1874 lbs.	1698 lbs.	1400 lbs.	1245 lbs.	1150 lbs.	981 lbs.

SERVICE EQUIPMENT // TIRE CHANGERS





➔ Heavy Duty Tire Changers

Heavy Duty Tire Changer Accessories

TIRE CHANGER ACCESSORIES & WHEEL PROTECTING ITEMS

TUFFY NO.	MFG. NO.	ITEM	DESCRIPTION
447-09249	110849	Combo Tee	Standard Accessory for Models 5000/9000 , Used for Mounting Tubeless and Some Tube-Type Tires. For Units After 1/1/93
447-09342	109342	Tubeless Tire Iron	37" Long; Standard Accessory For Models 5000 and 9000
447-09343	109343	Lock Ring Tool	24" Long; Standard Accessory For Models 5000 and 9000
447-09344	109344	Drop Center Tool	18" Long; Standard Accessory for Models 5000 and 9000
447-09345	109345	Bead Starting Tool	Standard Accessory For Models 5000/9000 Used For Starting Beads Into Drop Centers on Tubeless Wheels
447-09346	109346	Vise Grip	Standard for Models 5000/9000 . For Starting Tire Beads Into Drop Centers on Tubeless Wheels
447-09764	109764	Offset Disc	For Models 5000/9000 . Optional Accessory For Mounting/ Tool Holder Demounting Tires On Dayton Style Wheels, Super Singles And Off-Road Type Tires. For Units Before 1/1/93
447-10842	110842	Ramp	Optional Accessory For Model 5000 . Allows Easy Roll Up Of Large Tires
447-10843	110843	Jaw Extensions	Optional for HIT 5000 & Standard for HIT 9000 . Used for Mounting Large Wheels up to 44". 3 Required
447-10851	110851	Combo Tee	Optional Accessory For 5000/9000 For Tractor Tires & Mounting Large Off-Road/Agricultural Style Tires. For Units After 1/1/93
447-10852	110852	Offset Disc	For Models 5000/9000 . Optional Accessory For Demounting Tool Holder Tires On Dayton Style Wheels, Super Singles and Off-Road Type Tires. For Units After 1/1/93
447-20082	120082	Combo Tee	For Model 6000 Tire Changer to Hold Mount/Demount Tool
447-20334	120334	Bead Lift Tool	57" Long. Standard For Models 5000/6000/9000 . Extra Long Bar For Bead Lifting Tires
447-20564	120564	Combo Tool/Duplex	Optionally Used on 6000 for Mounting/Demounting Duplex Style Tires with Thick Beads
447-83945	183945	Combo Tool	Nylon Head Combo Tool for 6000 Tire Changer
447-83950	183950	Nylon Head	Replacement Nylon Head for 183495 Combo Tool

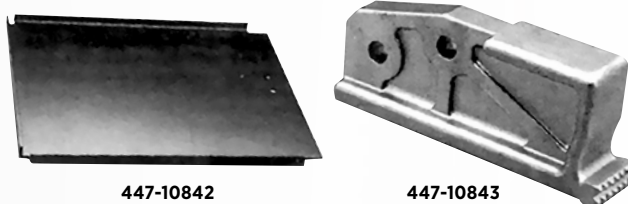
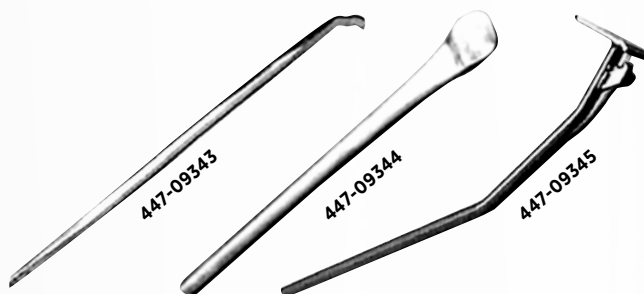

SERVICE EQUIPMENT // TIRE CHANGERS



CEMB Heavy Duty Tire Changers

CM27T HEAVY DUTY TRUCK TIRE CHANGER

- **Mobile cable control unit** ▪ Bi-directional rotation ▪ Self centering universal wheel chuck
- Rim pliers and rim lever standard

SM56T HEAVY DUTY TIRE CHANGER

- **Mobile cable control unit** ▪ Two speed hydraulic pump motor ▪ Bi-directional rotation ▪ Self centering universal wheel chuck
- Rim pliers and rim lever standard

MOBILE
CABLE
CONTROL
UNIT

RIM PLIERS
AND RIM
LEVER



446-00056

MOBILE
CABLE
CONTROL
UNIT

2-SPEED
HYDRAULIC
PUMP
MOTOR

RIM PLIERS
AND RIM
LEVER



446-00027

CEMB HEAVY DUTY TIRE CHANGER SPECIFICATIONS

TUFFY NO.	MFG. NO.	POWER SUPPLY	RIM CLAMPING RANGE	MAX TIRE OUTSIDE	MAX TIRE WIDTH	MAX TIRE WEIGHT	BEAD BREAKER FORCE	SHIPPING WEIGHT
446-00027	CM27T	220 VAC	13" - 27"	63"	30"	3300 lbs.	4100 lbs.	1415 lbs.
446-00056	SM56T	220 VAC	14" - 46"	90.5"	42"	3300 lbs.	6000 lbs.	2000 lbs.

SERVICE EQUIPMENT // TIRE CHANGERS





➔ Coats® Wheel Balancers

Coats® Direct Drive Wheel Balancers

1300 DIRECT DRIVE WHEEL BALANCER

- **Direct drive motor** ▪ Automatic data entry (distance/diameter) ▪ Auto-start hood ▪ New display mounting bracket ▪ Behind the spoke ▪ Static-on-screen

DIRECT DRIVE MOTOR

AUTO START HOOD



481-01300

1400-2D DIRECT DRIVE WHEEL BALANCER

- **Direct drive motor** ▪ Laser-guided Tape-A-Weight operation ▪ Automatic data entry (distance/diameter) ▪ Premium quick nut ▪ Side shadow board with Basic Pro Kit ▪ Auto-start hood ▪ New display mounting bracket ▪ Static-on-screen

DIRECT DRIVE MOTOR

AUTO START HOOD

PREMIUM QUICK NUT



481-01400

TUFFY NO.	MFG. NO.	DESCRIPTION
481-01300	1300	1300 Direct Drive Wheel Balancer

TUFFY NO.	MFG. NO.	DESCRIPTION
481-01400	1400	1400-2D Direct Drive Wheel Balancer

SERVICE EQUIPMENT // WHEEL BALANCERS



Coats® Direct Drive Wheel Balancers (cont.)

1500-3D DIRECT DRIVE WHEEL BALANCER

- **Direct drive motor** ▪ Laser-guided Tape-A-Weight
- Automatic data entry (distance/diameter/width)
- Side shadow board with Basic Pro Kit ▪ Auto-start hood
- New display mounting bracket ▪ Static-on-screen ▪ 12 o'clock inboard laser ▪ Stop, lock & index

DIRECT DRIVE MOTOR

AUTO START HOOD

STOP, LOCK & INDEX



481-01500

TUFFY NO.	MFG. NO.	DESCRIPTION
481-01500	1500	1500-3D Direct Drive Wheel Balancer

1600-3D DIRECT DRIVE WHEEL BALANCER

- **Direct drive motor** ▪ Laser-guided Tape-A-Weight operation
- Automatic data entry (distance/diameter) ▪ Premium quick nut
- Side shadow board with Basic Pro Kit ▪ Auto-start hood
- New display mounting bracket ▪ ProBalance technology™
- 12 o'clock inboard laser ▪ Stop, lock & index ▪ Touchscreen

DIRECT DRIVE MOTOR

AUTO START HOOD

TOUCH SCREEN



481-01600

TUFFY NO.	MFG. NO.	DESCRIPTION
481-01600	1600	1600-3D Direct Drive Wheel Balancer



➔ Coats® Wheel Balancers

Coats® Wheel Balancers

HEAVY DUTY MOBILE HAND SPIN BALANCER

- With a reduced overall size, the Coats 6275 hand spin balancer is a portable, easy to move balancer
- No lift is required, simply roll the balancer into position
- A handle operated mechanical reduction gear makes hand spinning easier
- An intuitive menu featuring self-diagnosis and self-calibration allows for quick and easy balance for almost any type of rim

PORTABLE AND EASY TO MOVE

INTUITIVE MENU



481-06275

TUFFY NO.	MFG. NO.	DESCRIPTION
481-06275	6275	Hand Spin Balancer

ECONOMY BALANCER

- Ideal balancer for cost-conscious shops and service stations performing fewer than 20 balancing jobs per day
- Handles standard OEM tires up to 40" diameter and 100 lbs.
- Digital readouts and data entry
- TEN BALANCING MODES: dynamic, alloy and static-ensure accuracy
- Cycle time is just 10 seconds
- Adapter set not included
- 110V, 1PH



481-00775

TEN BALANCING MODES

TUFFY NO.	MFG. NO.	DESCRIPTION
481-00775	775	Economy Balancer

PORTABLE TIRE/WHEEL BALANCER

- Rugged die-cast aluminum head cone
- Plated steel guide rods with zinc chromate helper springs
- Hardened cast-in place pivot seat
- Recessed circular level bubble



481-00061

RUGGED, HEAVY DUTY DESIGN

TUFFY NO.	MFG. NO.	DESCRIPTION
481-00061	M61	Portable Tire/Wheel Balancer

SERVICE EQUIPMENT // WHEEL BALANCERS



➔ Coats® Wheel Balancers



Coats® Wheel Balancers (cont.)

TRUCK WHEEL BALANCER

▪ **Auto Data Entry for all three parameters with one touch. Just drop the hood and go** ▪ **Auto indexing** automatically moves the wheel to the required weight positions ▪ **Stop and Lock feature** locks the spindle firmly in place for easier, more accurate weight placement ▪ **Powerful 1.5HP direct drive motor** shaves 20 seconds off a typical 22.5" spin ▪ DCS ensures the 6450 is the most accurate heavy duty balancer in car/light truck mode on the market, like two balancers in one ▪ **2 parameter auto data entry system** for clip weight and 3 parameter for Tape-A-Weight™ 500 lbs. ▪ **Met Lab / UL approved** with 52" wheel capacity ▪ **Designed for front line, high-volume balancing** ▪ **Easy-to-read LED readouts** ▪ 2" (51mm) heavy duty arbor on Coats proven direct drive motor ▪ Laser-guided direct Tape-A-Weight placement ▪ *Package units include new 550 air lift, budd plate #8143935, hub centered cone #8109877*



481-45031

TUFFY NO.	MFG. NO.	DESCRIPTION
481-45031	8K645003DKT1P	3D Truck Wheel Balancer Package 220V 1PH
481-45033	8K64503DKT3P	3D Truck Wheel Balancer Package 220V 3PH
481-85645	85006450	2D Truck Wheel Balancer 1P or 3P
481-86401	8K6401KT1P	220V Single Phase Truck Wheel Balancer Package
481-86403	8K6401KT3P	220V 3 Phase Truck Wheel Balancer Package

ADAPTERS, CONES & MISCELLANEOUS HEAVY DUTY WHEEL BALANCER ACCESSORIES



482-08642

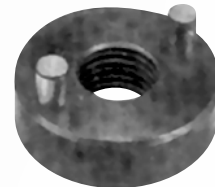

482-09618



482-00501

TUFFY NO.	MFG. NO.	ITEM	DESCRIPTION
482-00501	501	Hydraulic Roll Around Lift	Optional Accessory for 6401. Allows Operator to Lift Large Truck Tires onto the 6401
482-08605	308605	Repl. Shaft	Replacement Shaft for 6401 Balancers
482-08628	308628	Cone	Small 2.44"-3.12" Center Holes
482-08629	308629	Cone	Medium 2.78"-3.46" Center Holes
482-08630	308630	Cone	Large 2.98"-5.06" Center Holes
482-08631	308631	Cone	Truck 4.52"-6.95" Center Holes
482-08639	308639	Spring	Back Cones
482-08642	308642	Large Pressure Drum	Used to Properly Clamp or Decorate Wheels on 6401 Balancer When Using the Preferred Back Cone Balancing Technique. 5.75" Diameter
482-08645	308645	Long Hub Nut Wrench	Standard Accessory for 6401 Balancer . Fits No. 309618 Hub Nut Assembly
482-08646	308646	Short Hub Nut Wrench	Standard Accessory for 6401 Balancer . Fits No. 309618 Hub Nut Assembly
482-09608	309608	Heavy Duty Assembly Caliper	Measures Rim Widths in Inches. For Use with 6401 Balancers
482-09618	109618	Hub Nut Assembly	Replacement Hub Nut for 6401 Balancer Shaft
482-09877	109877	Cone Kit	Hub Centered Wheels, Truck
482-10785	110785	Adapter	Speedy Dayton
482-10786	110786	Adapter Accessories Kit	Speedy: For 22"-24.5" Wheels
482-43622	143622	Spacer Plate	Spaces Wheel out from 6401 Balancer Chassis to Prevent Interference with Chassis when Balancing Some Wide Base and Offset Tires
482-43935	143935	Adapter	Large Budd Wheels
482-86866	85608066	Link	Link for 6401 Balancer for 575 Wheel Lift

SERVICE EQUIPMENT // WHEEL BALANCERS





SOMETIMES THE HOLE ISN'T THE CENTER

Aftermarket and a few OE wheels are designed to that one model can fit many brands of vehicles. To do this, they enlarge the middle hole and center off the bolts. These wheels are called **LUG-CENTRIC** or **BOLT-CENTRIC**.

It is critical for accurate balancing that the wheel centers on the balancer the way it centers of the car.

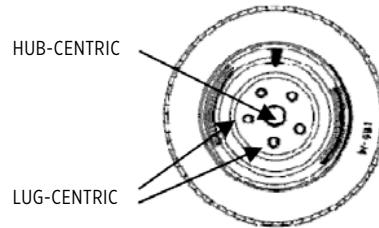
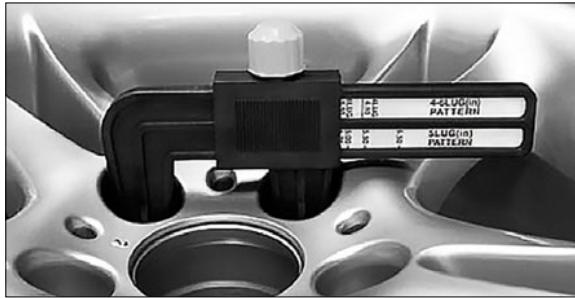

A: Fixed Finger Plates



- Each plate is set to one size and locked
- Offers fast set up on the balancer
- Ideal for very high volume shops with a full set or get just a few plates for fleet applications

B: Stud Plates



- Each plate is set to one size and locked
- Plates are bolted to the wheel and the assembly is mounted on the balancer
- Used when maximum accuracy is needed

C: Adjustable Pin Plates



- Most consistent method for providing accurate mountings for a wide variety of tire and wheel assemblies
- Adjustable design provides fast and easy clamping of tire and wheel assemblies
- Lug clamping and centering of tire and wheel assembly prevents damage to alloy wheels
- Can be used on any 40mm wheel balancer

D: Shadow Board



- Gets adapters up off the floor
- Easy to see and select
- Position where you need it for when you need it

LOW PROFILE HEAVY DUTY SPINNER

- Allows for easy access under today's lower body style cars and trucks
- Completely portable, this heavy duty spinner will handle passenger cars and heavy duty truck tires, including rear wheels and drive duals
- Available in 7.5 HP, 220 Volt, 3 Phase or 5 HP, 220 Volt, Single Phase

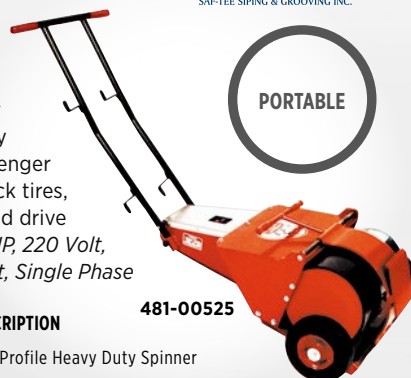

481-00525

TUFFY NO.	MFG. NO.	DESCRIPTION
481-00525	525	Low Profile Heavy Duty Spinner



ELECTRONIC STROBE BALANCER

- Companion to the Model 525 spinner
- Delivers fast precision balancing on-the-vehicle
- No special wheel attachments are required
- The flashing strobe indicator pin-points exact placement of wheel weights
- 110-115 Volt



481-00501

TUFFY NO.	MFG. NO.	DESCRIPTION
481-00501	501A	Electronic Strobe Balancer



CEMB Digital Wheel Balancers

ER72 DIGITAL WHEEL BALANCER

- Professional digital wheel balancer especially designed for tire dealers
- Automatic Distance & Diameter Entry with Width Sonar (3D) ▪ Fully automatic Spotter Laser System for best correction possible ▪ Full-time accuracy with Static unbalance always displayed on screen ▪ LED to light the work space inside the rim ▪ New automatic arm to measure automatically diameters up to 30" ▪ Standard locking with Quick Nut ▪ Electromagnetic brake for easy weight placement ▪ Available 110VAC or 220VAC ▪ Wide working space ▪ Direct selection ounces/grams ▪ Optimization program for compensation of rim and tire unbalance ▪ One Button Split & Hidden Weight Program

ER73 DIGITAL WHEEL BALANCER

- Professional digital wheel balancer especially designed for tire dealers
- Automatic Distance & Diameter Entry with Width Sonar (3D) ▪ Fully automatic Spotter Laser System for best correction possible ▪ Full-time accuracy with Static unbalance always displayed on screen ▪ LED to light the work space inside the rim ▪ New automatic arm to measure automatically diameters up to 30" ▪ Standard locking with Quick Nut ▪ Electromagnetic brake for easy weight placement ▪ *Optional Radial Runout Sonar for wheel diagnostic* ▪ *Optional printer* ▪ Available 110VAC or 220VAC ▪ Wide working space ▪ Direct selection ounces/grams ▪ Optimization program for compensation of rim and tire unbalance ▪ One Button Split & Hidden Weight Program

EZ9 DIGITAL WHEEL BALANCER

- Universal space saving wheel balancer with excellent technical specifications combining a sturdy structure with attractive and modern design ▪ EZ9 balances steel & light alloy wheels of cars, light trucks, motorcycles & scooters (with optional adaptors)
- Automatic Distance & Diameter Entry (2D) ▪ Foot pedal brake for easy weight placement ▪ Splash guard ▪ Standard Quick Nut Mounting ▪ Self-Diagnosis and Self-Calibration ▪ **MENUS FOR QUICK SELECTION OF THE FOLLOWING:** Inches to millimeters, unbalanced thresholds 0.1 or 0.25 ounces (1 or 5g) ▪ Direct selection ounces/grams ▪ Optimization program for compensation of rim and tire unbalance ▪ "Static" program—plus 4 ALU programs for PAX, light alloy or special shaped rims ▪ One Button Split & Hidden Weight Program ▪ Direct weight location program (no repositioning of stick-on weights) ▪ 10-Compartment Weight Tray

WIDE WORKING SPACE



481-00072

ELECTRO-MAGNETIC BRAKE

WIDE WORKING SPACE



481-00073

ELECTRO-MAGNETIC BRAKE

SPACE SAVING DESIGN



481-00019

TUFFY NO.	MFG. NO.	DESCRIPTION
481-00072	ER72	Digital Wheel Balancer

TUFFY NO.	MFG. NO.	DESCRIPTION
481-00073	ER73	Digital Wheel Balancer

TUFFY NO.	MFG. NO.	DESCRIPTION
481-00019	EZ9	Digital Wheel Balancer

SERVICE EQUIPMENT // WHEEL BALANCERS





➔ CEMB Wheel Balancers

C212 MOTORIZED DIGITAL TRUCK WHEEL BALANCER WITH PNEUMATIC LIFT

- C212 balances steel & light alloy wheels of cars, light & heavy commercial trucks and bus thanks to a 40mm shaft and a large assortment of adaptors and cones standard
- Pneumatic stationary brake useful during wheel mounting and counterweight application
- Pedal operated pneumatic lift (soft type) enables excellent centering accuracy of the wheel on the shaft
- Automatic Distance & Diameter Entry (2D)
- Fully Automatic Cycle with Breaking
- 51" wheel guard
- Self-Diagnosis and Self-Calibration
- **MENUS FOR QUICK SELECTION OF THE FOLLOWING:** Inches to millimeters, unbalanced thresholds 0.1 or 0.25 ounces (1 or 5g)
- Direct selection ounces/grams
- Optimization program for compensation of rim and tire unbalance
- "Static" program—plus 4 ALU programs for PAX, light alloy or special shaped rims
- One Button Split & Hidden Weight Program
- Direct weight location program (no repositioning of stick-on weights)

PNEUMATIC STATIONARY BRAKE

FULLY AUTOMATIC CYCLE



C206 MOBILE HAND SPIN TRUCK WHEEL BALANCER

- **Mobile Hand Spin Truck Wheel Balancer for cars and light & commercial trucks**
- C206 balances HD truck and bus tires as well as light truck and car tires
- Portable for mobile service when 12VDC available
- Automatic Distance & Diameter Entry (2D)
- Standard lightweight battery pack for use when power not available
- Self-Diagnosis and Self-Calibration
- **MENUS FOR QUICK SELECTION OF THE FOLLOWING:** Inches to millimeters, unbalanced thresholds 0.1 or 0.25 ounces (1 or 5g)
- Direct selection ounces/grams
- Optimization program for compensation of im and tire unbalance
- "Static" program—plus 4 ALU programs for PAX, light alloy or special shaped rims
- One Button Split & Hidden Weight Program
- Direct weight location program (no repositioning of stick-on weights)

PORTABLE FOR MOBILE SERVICE



481-00206

TUFFY NO.	MFG. NO.	DESCRIPTION
481-00212	C212	Motorized Digital Truck Wheel Balancer with Pneumatic Lift

TUFFY NO.	MFG. NO.	DESCRIPTION
481-00206	C206	Mobile Hand Spin Truck Wheel Balancer

SERVICE EQUIPMENT // WHEEL BALANCERS



➔ Wheel Balancer Accessories

Wheel Balancer Accessories

PREMIUM FIBERGLASS WHEEL WEIGHT HAMMER

- Used to easily install and remove all types of steel and zinc clip-on wheel weights
- Standard with large replaceable hook for prying
- Fiberglass shaft for added durability
- The hook is made from cold rolled steel
- Slip-resistant, ergonomic grip reduces arm strain & fatigue
- The striking face has a non-marring, surface protective medium-hard replaceable tip
- Replacement hooks and caps available
- **MADE IN THE USA**



FIBERGLASS SHAFT

TUFFY NO.	MFG. NO.	DESCRIPTION
486-11000	P110	Premium Fiberglass Wheel Weight Hammer
486-11002	P110-2	Replacement Small Hook for Premium Wheel Weight Hammer
486-11004	P110-4	Replacement Tip for Premium Wheel Weight Hammer
486-11005	4201038	Replacement Large End for P-110 Wheel Weight Hammer

HEAVY DUTY PROFESSIONAL TRUCK WHEEL WEIGHT HAMMER

- Will handle with ease the removal and attachment of HD truck weights
- Fiberglass shaft for a lifetime of use
- New chromalloy hooks designed for large wheels and large weights
- New industry standard
- Longer handle provides added reach on larger wheels
- Comfortable, durable rubber handle
- Larger 1.75" tip for easier application along with heavier total tool weight requires less striking effort
- Use on all truck wheels
- 12" total length
- **NET WEIGHT: 2 lbs.**
- **MADE IN THE USA**



NEW INDUSTRY STANDARD

FIBERGLASS SHAFT

TUFFY NO.	MFG. NO.	DESCRIPTION
486-11011	P110-T	Heavy Duty Truck Wheel Weight Hammer
486-11005	4201038	Replacement Large End for P-110 Wheel Weight Hammer
486-11006	P110-4	Replacement Tip for Premium Wheel Weight Hammer

HEAVY DUTY ADHESIVE WHEEL WEIGHT SCRAPERS

- For use with stick-on wheel weights
- Knobbed handle to prevent hand from slipping while removing wheel weights
- Made of high impact plastic
- Equivalent to ESCO 50146



KNOBBED HANDLE

HIGH IMPACT PLASTIC

TUFFY NO.	MFG. NO.	DESCRIPTION
486-71510	N/A	Red Heavy Duty Adhesive Wheel Weight Scraper
486-71511	N/A	Black Heavy Duty Adhesive Wheel Weight Scraper

SERVICE EQUIPMENT // WHEEL BALANCERS





➔ Wheel Balancer Accessories

Haweke Quick Nuts and Pressure Cups

483-24486



TUFFY NO.	MFG. NO.	DESCRIPTION
483-24486	HW124 408 006	Quick Nut Steel w/ Hood 40-8mm
483-24433	HW140 404 033	Quick Nut HD (metal) 40mm-4mm
483-24343	HW143 404 003	Quick Nut 40mm-4mm
483-24346	HW143 404 006	Quick Nut Pro Grip 40mm-4mm
483-24333	HW143 403 003	Quick Nut 40mm-3mm
483-24336	HW143 403 006	Quick Nut W/Knobs 40mm-3mm
483-21982	HW190 008 002	Pressure Cup - 5"
483-29821	HW190 008 021	Pressure Cup - 8"
483-29827	HW190 008 027	Quick Nut Pressure Ring

Note: Quick Nuts are also available for 28, 36, 38m

Haweke Hub Centering Solutions



482-26547

TUFFY NO.	MFG. NO.	DESCRIPTION
482-26547	HW165 400 007	Duo Expert Collet Kit
482-25411	HW150 400 110	9 Piece Pro Collet Kit
482-26460	HW160 400 060	Ford Precision Collet
482-26462	HW160 400 062	Toyota Precision Collet
482-26463	HW160 400 063	Chrysler Precision Collet 1
482-26464	HW160 400 064	Chrysler Precision Collet 2
482-25491	HW150 400 091	Cone Kit 40mm: Light Truck

Note: All Hub Centering Products also available in 28, 36, 38mm except Duo Expert

Haweke Lug Centering Solutions



482-25949

TUFFY NO.	MFG. NO.	DESCRIPTION
482-25949	HW200 299 409	U.S. Flange Plate Kit 40mm
482-25649	HW210 400 002	Quick Plate Kit: 40mm

Note: Flange Plates and Quick Plates also available in 28, 36, 38mm

Haweke Medium Duty Wheel Balancer Accessories



482-27419

TUFFY NO.	MFG. NO.	DESCRIPTION
482-21374	HW700 400 037	Medium Duty Flange Plate
482-27419	HW700 400 037	Medium Duty Four Arm Star
482-27404	HW700 400 037	Medium Duty Five Arm Star
482-26447	HW160 400 047	Hub Pilot Sleeve 1 - 4.88/4.92"
482-26448	HW160 400 048	Hub Pilot Sleeve 2 - 5.59/6.69"
482-26467	HW160 400 067	Hub Pilot Sleeve 7 - 4.88/6.06"
482-29452	HW190 400 052	Hub Pilot Sleeve 3 - 5.46/5.25"
482-29460	HW190 400 060	Hub Pilot Sleeve 4 - 4.56"
482-29462	HW190 400 062	Hub Pilot Sleeve 5 - 4.6"
482-29471	HW190 400 071	Hub Pilot Sleeve 6 - 4.77"
482-28444	HW280 400 044	Universal Apdaptor 8x6.5

Haweke Storage Solutions

TUFFY NO.	MFG. NO.	DESCRIPTION
482-29895	HW900 008 205	Adapter Storage Stand



482-29895

Haweke Kits



482-25641

TUFFY NO.	MFG. NO.	DESCRIPTION
482-25641	HW280 400 070	ProExpert System IV
482-28415	HW 280 400 139	ProMax MD 40mm
482-28414	HW280 400 142	ProMax MD Standard 40mm

SERVICE EQUIPMENT // WHEEL BALANCERS



➔ Wheel Balancer Accessories



Wheel Balancer Accessories (cont.)

Haweke Pro Centering System



482-28172

TUFFY NO.	MFG. NO.	DESCRIPTION
482-28172	HW280 400 172	Haweke Pro Centering System

Haweke Pro Balancing System



482-28490

TUFFY NO.	MFG. NO.	DESCRIPTION
482-28490	HW280 400 090	Haweke Pro Balancing System

Haweke HD Eco Kit - 40MM

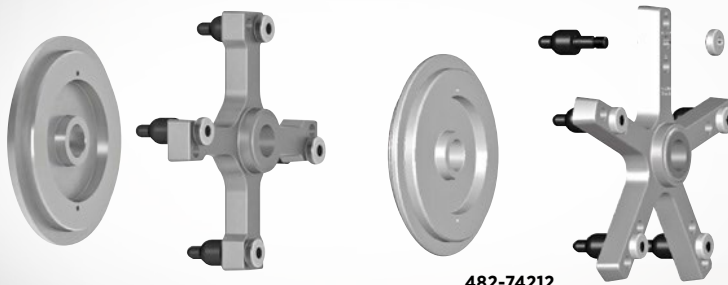

482-74212

TUFFY NO.	MFG. NO.	DESCRIPTION
482-74212	HW700 400 212	Haweke HD Eco Kit - 40mm - Combines HW700 400 205 * HW700 400 206

Haweke Airgo Lift

- The ideal supplement to the wheel balancing machine
- Flexible adjustment of lifting height
- Fast operation of the lift — by one hand only
- Intuitive operation with turning handle
- Ergonomic design
- Wheel weight up to 155 lbs.
- Compressed air connection with North American fitting
- Special holder for centering device
- Low height of 4.33 inches



ONE HAND OPERATION!



481-91618

TUFFY NO.	MFG. NO.	DESCRIPTION
481-91618	HW916 000 018	Haweke Airgo Lift

SERVICE EQUIPMENT // WHEEL BALANCERS





➔ Wheel Balancer Accessories

STEEL PROGRIP QUICKNUT WITH HANDLES AND PRESSURE CUP

▪ **Essential wheel balancer tooling** ▪ Clamping device speeds wheel mounting process on balancers ▪ Heavy duty steel design solution for Road Force balancers



483-40806

HEAVY DUTY STEEL DESIGN

TUFFY NO.	MFG. NO.	DESCRIPTION
483-40806	HW124 408 006	Steel ProGrip QuickNut 40 x 8 with Handles and Pressure Cup

SOFTGRIP QUICKNUTS WITH HANDLES

▪ **Essential wheel balancer tooling** ▪ Upgraded threaded jaws with bigger bearing surface allows higher torque pressure ▪ Softgrip clamping device will not open under load ▪ New alloy metal jaws provides longer life for threaded jaws ▪ Torque ring is ever present - removal not required for use with pressure cup ▪ Heavier duty pressure cup ▪ Lower overall housing height enables use with quick or flange plates on shorter shafts



483-40301

483-40401

483-40801

HEAVIER DUTY PRESSURE CUP

NEW ALLOY METAL JAWS

TUFFY NO.	MFG. NO.	DESCRIPTION
483-40301	HW125 403 001	SoftGrip Quick Nut 40 x 3 with Handles
483-40401	HW125 404 001	SoftGrip Quick Nut 40 x 4 with Handles
483-40801	HW125 408 001	SoftGrip Quick Nut 40 x 8 with Handles

LIGHT TRUCK CONE KIT 40MM

▪ **Covers hub ranges 120mm-174mm** ▪ Kit includes a cone and distance spacer ▪ Works on all balancer makes and models with 40mm shaft



483-40091

TUFFY NO.	MFG. NO.	DESCRIPTION
483-40091	HW150 400 091	Light Truck Cone Kit 40mm

PROCOLLET KIT 40MM

▪ **Two-sided, low taper collets** ▪ Standard cone upgrade ▪ Low taper provides improved centering at wheel hub for more accurate balancing results ▪ Clad wheel Problem Solver



LOW TAPER

483-40110

CLAD WHEEL PROBLEM SOLVER

TUFFY NO.	MFG. NO.	DESCRIPTION
483-40110	HW150 400 110	ProCollet Kit 40mm

SERVICE EQUIPMENT // WHEEL BALANCERS





Wheel Balancer Accessories (cont.)

PROGRIP PRESSURE CUP

- **Pressure Cup for all ProGrip Quicknuts 40mm, 38mm, 36mm, 28mm**
- HW143 403 003, HW143 403 006, HW143 383 003, HW143 383 006, HW143 363 003, HW143 363 006, HW143 283 003, HW143 283 006, HW143 404 003, HW143 404 006, HW143 285 006, HW143 405 006, HW140 403 033, HW140 404 033



483-08002

TUFFY NO.	MFG. NO.	DESCRIPTION
483-08002	HW190 008 002	ProGrip Pressure Cup

RUBBER COVER FOR 5" PRESSURE CUP

- **Provides rubberized protection between wheel rim and pressure cup**



483-08005

TUFFY NO.	MFG. NO.	DESCRIPTION
483-08005	HW190 008 005	Rubber Cover for 5" Pressure Cup

PRESSURE RING FOR ALL PROGRIP QUICKNUTS

- **Pressure Ring must be present on ProGrip QuickNuts when using Quick or Flange Plates**
- Without the pressure ring, the clamping device does not provide enough torque pressure to press rim on cones/collets evenly and consistently eliciting inaccurate balancing results



483-08027

TUFFY NO.	MFG. NO.	DESCRIPTION
483-08027	HW190 008 027	Pressure Ring for all ProGrip QuickNuts

BACKING SPRING

- **Must be present on all balancers with open mid centering devices/hubs (Coats)**
- Without backing spring, wheels can only be front coned – not acceptable for proper balancing



483-40015

TUFFY NO.	MFG. NO.	DESCRIPTION
483-40015	HW190 400 015	Backing Spring





➔ Wheel Balancer Accessories

UNIVERSAL SPACER & UNIVERSAL DONUT

▪ **Spacer provides necessary distance between mid centering device and cone/collet to prevent bottoming out and/or mid centering cup interference** ▪ *Must use spacer with ProCollets 7-9* ▪ *Donut required for use with backing spring on open mid centering device balancers (Coats)*



PROVIDES NECESSARY SPACE

TUFFY NO.	MFG. NO.	DESCRIPTION
483-08047	HW190E008 047	Universal Spacer
483-40045	HW190E008 045	Universal Donut
483-40047	HW190E400 045	Universal Donut - 40mm

TOYOTA PRECISION COLLET

▪ **Precision-designed, application-specific solution for balancing Toyota Truck wheels** ▪ Problem-solving precision collet for Toyota Tundra, Sequoia, Tacoma, 4Runner, FJ as well as Lexus SUV applications and more



PRECISION DESIGNED

APPLICATION SPECIFIC

TUFFY NO.	MFG. NO.	DESCRIPTION
483-40060	HW160 400 062	Toyota Precision Collet

FORD PRECISION COLLET

▪ **Precision-designed, application-specific solution for balancing Ford light truck and SUV applications** ▪ Problem-solving precision collet for Ford F150, Expedition and Lincoln Navigator applications



PRECISION DESIGNED

APPLICATION SPECIFIC

TUFFY NO.	MFG. NO.	DESCRIPTION
483-40062	HW160 400 060	Ford Precision Collet

NORTH AMERICAN FLANGE PLATE KIT 40MM

▪ **Replicates vehicle wheel lug mount on the balancer** ▪ Provides consistent, even pressure when mounting wheel on cones/collets for precision balancing results



PROVIDES CONSISTENT, EVEN PRESSURE

TUFFY NO.	MFG. NO.	DESCRIPTION
483-99409	HW200 299 409	North American Flange Plate Kit 40mm

Please contact us for more information regarding **WHEEL BALANCER ACCESSORIES.**

SERVICE EQUIPMENT // WHEEL BALANCERS





Wheel Balancer Accessories (cont.)

COATS SLIDE NUTS



482-85607

TUFFY NO.	MFG. NO.	ITEM
482-14392	85606472	Hub Nut with Pressure Cup, 40mm. For XR Balancers only
482-56467	8560646701	Hub Nut, Slide, 40mm, Nut Only. For XR Models only
482-59998	85009998	Nut, Slide, 2 Jaw, 40mm, with Drum. For Models 700-1250
482-85607	85607503	COATS Premium Quick Nut, 40mm
483-59996	85009996	Nut, Slide, 2 Jaw, 28mm, with Drum. For Models 700-1250

WHEEL BALANCER SHAFTS



483-13082

TUFFY NO.	MFG. NO.	ITEM	DESCRIPTION
483-13082	8113082	Conversion Shaft Kit	40mm Conversion Shaft Kit (Not for 775,875,1175). Includes Coupler, 7" Length
483-13167	8113167C	Shaft	5" 28mm Coarse Shaft for 700-1055 Series COATS Balancer
483-85401	8500920401	Balancer Shaft	40mm Balancer Shaft for 850,950,1050,1055, 1250 & XR Models
483-85909	85009009	Balancer Shaft	40mm Balancer Shaft for Models 775,875,1175 & 6275 . 4.23mm Pitch

WHEEL BALANCER MISCELLANEOUS ACCESSORIES

TUFFY NO.	MFG. NO.	ITEM	DESCRIPTION
482-09011	8309011	Caliper	Measures Wheel Width in Inches. For use with all COATS Automotive Wheel Balancers
482-10400	81104001	Accessory Pegs	Add four Pegs to your 850 Balancer for storage of Cones or Accessories. Easy installation
482-11021	8111021	Caliper Hanging Bracket	Provides a handy place to hang the no. 309011 Wheel Width Measuring Caliper
482-11087	8111087	Accessory Pocket	Provides a convenient place to store small adapters and extra boxes of Wheel Weights on the COATS Model 950 and 1050 Balancers
482-11088	8111088	Accessory Peg Kit	(1 Rail, 2 Pegs) Cone Storage for COATS 700 Model
482-11480	8111480	Accessory Peg Kit	(2 Rails, 4 Pegs) Cone Storage for COATS 850, 950 & 1250 Balancers
482-11515	8113175	Wheel Weight Tool	Steel Hammer with Molded Rubber Grip. Use one side to remove Weights and Wheel Covers and the other side to add new Weights
482-11934	8111934	Wheel Lift	Pneumatic Wheel Lift for COATS Balancers, 175lbs. Capacity, 33" Tire Diameter
482-44064	8144064	Truck Wheel Weight Tool	Heavy Duty Construction includes a Plier-Type Hook for Weight Removal and Hammer Head for installation. Soft, comfortable Plastic Grip

LIGHT TRUCK CONE KIT

▪ Used for front coning light truck wheels ▪ Cone mounting is quick and easy ▪ Steel backing plate spaces out medium offsets and ensures wheels are held solidly ▪ Good for most light truck wheels including some duallies

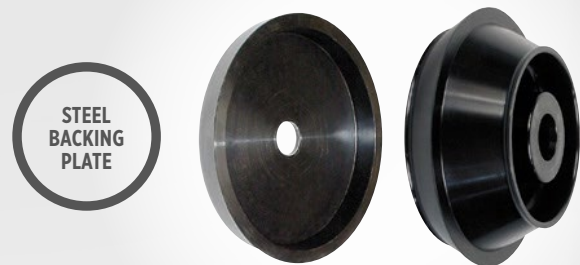

482-83277

TUFFY NO.	MFG. NO.	DESCRIPTION	RANGE
40MM			
482-83277	8113277	Cone Kit	4.8" - 6.8"
482-83280	8113280	Cone Only	4.8" - 6.8"
482-83061	8113061	Backing Plate Only	8"

SERVICE EQUIPMENT // WHEEL BALANCERS





ACCURATE BALANCING

The center isn't what it used to be

Many alloy wheels do not have a simple tapered center any more. There are a number of different taper angles being used. Plus, after the structural part of the center, the wheel may have a narrow cosmetic front.

It is critical for accurate balancing that the cone supports the wheel on the structural taper.

Incorrect contact can allow the wheel to move while on the balancer, giving false readings or chasing weights.

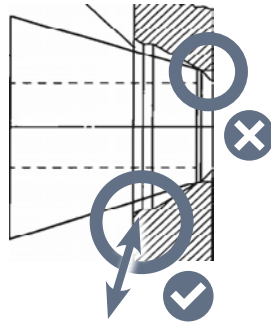

A: Back Cone Spacer

- Allows for the standard "D" cone to be used as a back one on an 850 through XR Series Balancers
- Often needed for applications using the #4 pin plate
- Different Part Number for use on 775 / 875 / 1175



B: Short Cone

- Required to prevent contact with the cosmetic face found on Cadillac Seville, Olds Silhouette, Pontiac Grand Prix & Trans Sport and Chrysler LH Chassis models



C: Ford ULA Cone

- The Ultra Low Angle Cone is specified by Ford to be used on 2003 and newer F150, Expedition & Navigator wheels in conjunction with a pin plate or finger plate



D: Light Truck Back & Tacoma Cones

- These cones are designed to allow for back coning of some light truck wheels
- Can be used on any balancer but are required for light truck back coning on 775/875/1175

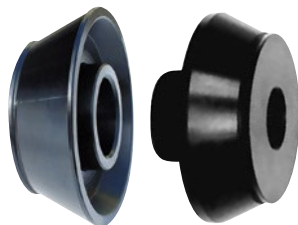

IN BETWEEN CONES (TWEENER)

- Supplemental set for wheels with shallow wheel centers
- Shallow cone angles provide more accurate mounting
- Example vehicles requiring these cones include Ford Edge and Chevy Malibu



482-83795

TUFFY NO.	MFG. NO.	DESCRIPTION	RANGE
40MM			
482-83795	8113795	Cone Set (4)	1.62" - 3.45"
482-83796	8113796	Miniature	1.62" - 2.33"
482-83797	8113797	Small	2.05" - 2.76"
482-83798	8113798	Medium	2.44" - 3.15"
482-83799	8113799	Large	2.8" - 3.45"





Wheel Balancer Accessories (cont.)

PRESSURE DRUMS, RINGS

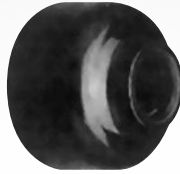

483-10542

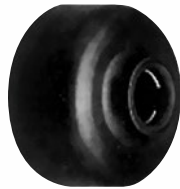

483-10544



483-13308

TUFFY NO.	MFG. NO.	ITEM	DESCRIPTION
483-10542	8110542	Small Pressure Drum	4.625" Diameter, 1.125" I.D.
483-10544	8110544	Large Pressure Drum	5.75" Diameter, 1.125" I.D.
483-12012	8112102	No-Mar Ring	Same as 308105 except with 40mm I.D.
483-12106	8112106	Small Pressure Drum	4.625" Diameter, 40mm I.D.
483-13308	8113308C	XL Pressure Drum	(8.375") O.D. Rubber Lip to help prevent marring the Wheel. 28mm I.D.
483-13309	8113309C	XL Pressure Drum	(8.375") O.D. Rubber Lip to help prevent marring the Wheel. 40mm I.D.
483-82954	8112954	Rubber Lip	For Small Pressure Drum (4.625), Fits 110542 & 112106 Pressure Drums
483-83671	8500036701	XR Pressure Cup	40mm ID Shaft, Fits 85000371 Slide Nut
483-83691	8500036901	Rubber Ring	For XR 40mm Pressure Cup, Fits 85000371 Slide Nut

BALANCER CHUCKS

- **Balancing some light truck wheels on a cone can be challenging.** The greater the offset, the greater the challenge. If the wheel is not sitting straight on the cone, balancers will give false readings
- **The 3-jaw chuck eliminates issues with cone seating providing the MOST ACCURATE balancing**



482-83330

TUFFY NO.	MFG. NO.	DESCRIPTION	RANGE
40MM			
482-83330	8113330C	Standard Balancer Chuck w/Plate	3.13" - 7.13"
482-85856	85000856	Extension Jaws for Standard Chuck	Extended to 9.125"
482-81850	8111850	Front Plate, Optional for Extended Jaws	10"
482-85908	85009088	Heavy Duty Balancer Chuck w/Plate	8" - 12"
482-85909	85009089	Front Plate	12"
2"			
482-85906	85009086	Heavy Duty Balancer Chuck w/Plate	8" - 12"
482-85907	85009087	Front Plate	12"





DEEP OFFSET ADAPTERS

▪ For fleet operators needing the accuracy of a chuck and the speed of a cone ▪ For specific center sizes found on some Ford 19.5" & 16" or GM & Chrysler 16" wheels ▪ Customers must check wheel center sizes closely



482-83042

TUFFY NO.	MFG. NO.	DESCRIPTION	RANGE
40MM			
482-82984	8112984	Fed-Ex Plate with Backing	—
482-82985	8112985	Fed-Ex Plate	8.627" - 8.7"
482-81850	8111850	Backing Plate	10"
482-83042	8113042	Deep Offset Plate Set (3)	—
482-83033	8113033	Ford Double Sided Plate	4.922" & 6.693"
482-83058	8113058	GM/Chrysler Double Sided Plate	4.561" & 4.766"
482-83061	8113061	Backing Plate	8"
482-85945	85009945	Toyota Kit with Fixed Finger Plate and 2 Direct offset Plates	—
482-89950	85009950	Pin - Finger Set of 6 for Toyota Truck	—
2"			
482-82986	8112986	Fed-Ex Plate with Backing	—
482-82987	8112987	Fed-Ex Plate	8.627" - 8.7"
482-89832	8109832	Backing Plate	10"
482-83043	8113043	Deep Offset Plate Set (3)	—
482-83034	8113034	Ford Double Sided Plate	4.922" & 6.693"
482-83059	8113059	GM/Chrysler Double Sided Plate	4.561" & 4.766"
482-83062	8113062	Backing Plate	8"

HEAVY DUTY ADAPTERS



482-81987

TUFFY NO.	MFG. NO.	DESCRIPTION	RANGE
40MM			
482-81853	8111853C	Cone and Backing Plate Kit	8.52" - 8.89"
482-81851	8111851	Cone Only	8.52" - 8.89"
482-81850	8111850	Backing Plate	10"
2"			
482-81987	8109877	Cone and Backing Plate Kit	8.52" - 8.89"
482-81984	8109844	Cone Only	8.52" - 8.89"
482-81983	8109832	Backing Plate	10"

(For Hub Piloted Budd Style Wheels Including 19.5")

DAYTON ADAPTERS FOR HEAVY DUTY BALANCERS

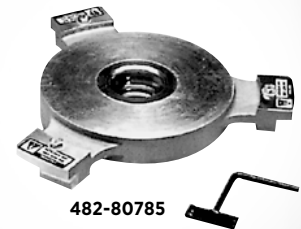

482-80785

TUFFY NO.	MFG. NO.	DESCRIPTION	RANGE
482-80785	8110785	Standard Center Adapter	20" - 22.5"
482-80786	8110786	Extension Kit for Standard Adapter	

BUDD ADAPTER FOR HEAVY DUTY BALANCERS

▪ Standard center adapter stud piloted wheel patterns 8x275mm, 10x335mm



482-84393

TUFFY NO.	MFG. NO.	DESCRIPTION	RANGE
482-84393	8143935	Budd Adapter	22.5" & 24.5"
ACCESSORIES			
482-89772	8109772	Retaining Nuts for Budd Adapter	
482-89625	8309625	Wingnut for Budd Adapter	
482-81609	8301609	Studs for Budd Adapter	
482-81341	8130041	Handle for Budd Adapter	

SERVICE EQUIPMENT // WHEEL BALANCERS





➔ Brake Lathes

Brake Lathes

4000SP SINGLE PASS DISC/DRUM

▪ **Must be ordered with either an "A", "B", "C", "E" or "F" adapter kit** ▪ Designed for speed, it cuts rotors in one pass, with a high-quality finish ▪ Positive rake tool bits allow for precision turning that produces superior machined surfaces every time ▪ Twin cutter dials and depth of cut are clearly marked, and even new operators can quickly turn rotors like seasoned professionals ▪ Precision tool that cuts to one-thousandths of an inch tolerances ▪ Massive "floating spindles" offer superior weight support, and a unique patented system provides a constant oil feed to bearings ▪ Fast change-over from rotors to drum ▪ Motor enclosed in mainframe for maximum service life ▪ *Optional accessories make it easy to customize* ▪ *Can be equipped to machine some flywheels*

CUTS ROTORS IN ONE PASS

PRODUCES SUPERIOR MACHINE SURFACES

DESIGNED FOR SPEED



414-04001

BRAKE LATHE MODELS AT A GLANCE

MFG. NO.	4100B	4000E	4000B	4000SP
TUFFY NO.	414-04100	414-04002	414-04000	414-04001
Volume	High	High	High	Medium
Application	Car - Medium Truck	Car - Medium Truck	Car/ Lt. Truck	Car/ Lt. Truck
Rotors	Yes	Yes	Yes	Yes
Drums	Yes	Yes	Yes	Yes
Flywheel Service Capable	Yes	Yes	Yes	Yes
Spindle Bearings	Bronze Sleeve	Bronze Sleeve	Bronze Sleeve	Bronze Sleeve
Motor	1 HP	1 HP	1 HP	1 HP
Tool Bits (shipped with)	Negative Rake	Both	Negative Rake	Positive Rake
Double Taper Arbor	Yes	Yes	Yes	Yes
Max Rotor Diameter	19"	14.5" 1	14.5" 1	14.5" 1
Max Rotor Face Width	3.75"	3.75"	3.75"	3.75"
Max Rotor Thickness	4"	1.875"2	1.875"	1.875"
Max Arbor Capacity - A: Standard	A. 100 lbs.	A. 200 lbs.	A. 100 lbs.	A. 100 lbs.
Max Arbor Capacity - B: Heavy Duty	B. 200 lbs.	B. N/A lbs.	B. 200 lbs.	B. 200 lbs.
Spindle Speed	60, 80, 115 RPM	100, 150, 200 RPM	100, 200 RPM	100 RPM
Drum Feed Rate	.002" to .020"/REV	Variable	.002" to .020"/REV	.005"/REV
Rotor Feed Rate	.002"/.010"/REV	Variable, .001" to .018"/REV	.002"/.010"/REV	.002"/REV
Drum Depth	Up to 9.875 "	Up to 9.875"	Up to 6.875"	Up to 6.875"
Shipping Weight	480 lbs.	410 lbs.	365 lbs.	385 lbs.

SERVICE EQUIPMENT // BRAKE LATHES





BRAKE LATHE ADAPTER KITS

TUFFY NO.	MFG. NO.	DESCRIPTION
A 417-90001	900001	ADAPTER KIT "A" : Passenger Car - 1" ID
B 417-90002	900002	ADAPTER KIT "B" : Passenger Car & Light Truck to 1/2-Ton - 1" ID
C 417-90003	900003	ADAPTER KIT "C" : Passenger Car & Light Truck to 1-Ton - 1" ID
D 417-90006	900006	ADAPTER KIT "E" : Passenger Car & Light Truck to 1-Ton - 1" ID (Includes Chuck)
E 417-90007	900007	ADAPTER KIT "F" : Extended Passenger Car, SUV & Light Truck to 1-Ton

A 417-90001
Adapter Kit "A"



B 417-90002
Adapter Kit "B"



C 417-90003
Adapter Kit "C"



D 417-90006
Adapter Kit "E"



E 417-90007
Adapter Kit "F"



SERVICE EQUIPMENT // BRAKE LATHES





➔ Brake Lathes

Brake Lathes (cont.)

4100B MEDIUM DUTY COMBINATION DRUM/DISC LATHE

▪ **Must be ordered with either an "A", "B", "C", "E" or "F" adapter kit** ▪ **All of the rugged construction and features of the legendary Model 4000B plus:** extended spindle travel to machine drums up to 8.875" deep; and equipped with Model 7900 twin-cutter featuring independent boring bars to enable machining larger diameter rotors and "spider" hubbed rotors found on some school buses and medium trucks

▪ **Massive spindle**, supported on wide centers by oil fed bronze journal bearings, dampens vibration, contributes to service life ▪ **Variable spindle speed and feed rates** for optimum surface finish on diverse applications ▪ **Translating spindle** for drum machining also provides faster rotor set up by quickly positioning rotor horizontally ▪ **Large diameter, tubular cross-slide** on wide centers ▪ **Double tapered arbor** gives maximum support and quick change to optional arbors if desired ▪ **Fast change-over from rotors to drums**

4000E BRAKE LATHE

▪ **Custom Digital Finishes** ▪ **Shift On The Fly 3 Speed:** The 4000E is the first lathe with an integrated synchronous gearbox and shifter

▪ **Forged Alloy Steel Arbor:** Two tapered mounting surfaces add stability and handle up to 200 lbs.

▪ **Feed Slide Protection:** Keeps travel surfaces free of dirt and chips

▪ **Patented Floating Spindle Design:** Extra large bronze bearings reduce pressure and wear. Larger drive gear adds life

4000B COMBINATION DRUM/DISC LATHE

▪ **Must be ordered with either an "A", "B", "C", "E" or "F" adapter kit** ▪ **Massive spindle**, supported on wide centers by oil fed bronze journal bearings, dampens vibration and contributes to legendary service life

▪ **Variable spindle speed and feed rates** for optimum surface finish on diverse applications

▪ **Translating spindle** for drum machining also provides faster rotor set up by quickly positioning rotor horizontally

▪ **Large diameter, tubular cross-slide**, on wide centers, for maximum vibration dampening and minimal service requirements

▪ **Double tapered arbor** gives maximum support and quick change to optional arbors if desired

▪ **Fast change-over from rotors to drum** ▪ **Motor enclosed in mainframe** for maximum service life

▪ *Optional accessory make it easy to customize* ▪ *Can be equipped to machine some flywheels*



414-04100

TUFFY NO.	MFG. NO.	DESCRIPTION
414-04002	4000E	4000E Brake Lathe



414-04000

TUFFY NO.	MFG. NO.	DESCRIPTION
414-04000	4000B	4000B Combination Drum/Disc Brake Lathe

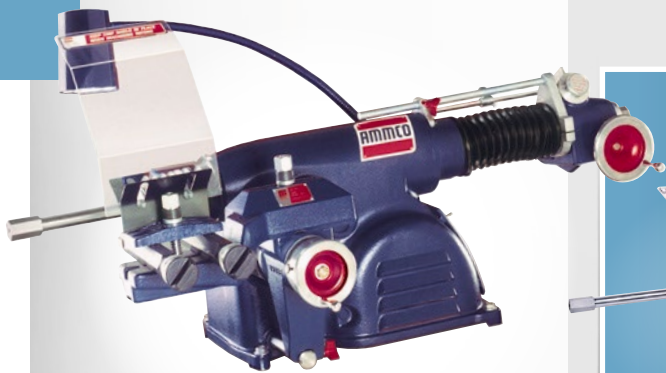

414-04100

TUFFY NO.	MFG. NO.	DESCRIPTION
414-04100	4100B	4100B Medium Duty Combination Drum/Disc Lathe

Please contact us for more information regarding **BRAKE LATHES.**

SERVICE EQUIPMENT // BRAKE LATHES





Brake Lathe Accessories & Adapters

DRUM SILENCER BANDS

▪ **Extra long, premium grade rubber silencer band for automotive and wider truck drums** ▪ Dampens vibrations which occur during the machining operation



416-05280

TUFFY NO.	MFG. NO.	DESCRIPTION	SHIPPING WT.
416-05280	5280	1-3/4" Drum Silencer Band for Automotive Drums	1 lb.
416-05290	5290	2-3/4" Drum Silencer Band for Truck Drums	1 lb.

VENTILATED ROTOR SILENCER BANDS

▪ **Easily wraps around ventilated rotors to dampen machining vibrations** ▪ Made of premium grade rubber with seven lead weights



416-06920

TUFFY NO.	MFG. NO.	DESCRIPTION	SHIPPING WT.
416-06920	6920	Ventilated Rotor Silencer Band, 31" Long	2 Oz.
416-09800	9800	Spring Type Vent Rotor Silencer Band	3 Oz.

SOLID ROTOR SILENCER BANDS

▪ **For thin, solid rotors**
▪ Package of 2



416-06921

TUFFY NO.	MFG. NO.	DESCRIPTION	SHIPPING WT.
416-06921	6921	6.500" Diameter (165.10mm), Pack of 2	2 Oz.
416-06922	6922	9.250" Diameter (234.95mm), Pack of 2	3 Oz.

HEAVY DUTY VENTILATED ROTOR SILENCER BAND

▪ **Easily wraps around ventilated truck rotors to dampen machining vibrations** ▪ Made of premium grade rubber, twice as wide as the No. 6920 ▪ Twenty-four weights for effective dampening



416-06930

TUFFY NO.	MFG. NO.	DESCRIPTION	SHIPPING WT.
416-06930	6930	Heavy- Duty Ventilated Rotor Silencer Band, 50" Long	8 Oz.

MAGNETIC SILENCER

▪ **Firmly attaches to flywheels to dampen vibrations which occur during machining**
▪ Sometimes used to dampen a rotor when machining one side at a time ▪ *Standard with No. 9381 facing & grinding set* ▪ Has hole and lock screw for mounting a No. 3229 diamond nib ▪ *Cannot be used with No's 6900 and 7900 twin-cutters*



416-07670

TUFFY NO.	MFG. NO.	DESCRIPTION	SHIPPING WT.
416-07670	7670	Magnetic Silencer	1 lb., 14 Oz.

DELUXE BENCH LATHE CLIP-ON ROTOR SILENCERS

▪ **Adjust clamping pressure simply by changing spring position on handle** ▪ Essential to silence those hard to dampen, thin, composite, solid rotors (example: GM W-body rear rotors)
▪ Reduced vibration improves surface finish



416-01175

TUFFY NO.	MFG. NO.	DESCRIPTION
416-01180	1180	Deluxe Lathe Clip-On Rotor Silencer For 6900 & 6950
416-01175	1175	Lathe Clip-On Rotor Silencer For 6900 & 6950

416-01180

OPTIONAL TWIN-CUTTER TOOLS

▪ **Optional for lathe Models 4000B and 7500** ▪ Independent boring bars can be positioned to cut rotors up to 4" thick and from 6" to 22" OD on Models 4000, 4100 and 7500 ▪ Boring bars have built-in inch/millimeter micrometers for depth-of-cut settings
▪ Chip shield included ▪ *Standard equipment on Model 4100*

TUFFY NO.	MFG. NO.	DESCRIPTION
416-07900	7900	Twin-Cutter Tool On 4100B
416-06950	6950	Standard Twin For 3860, 4000 And 7500

ENVIRONMENTAL LATHE ENCLOSURE

▪ **An enclosure for most brake lathes, but is specifically designed for AMMCO bench lathe models 1000, 3000, 3850, 4000, 4100 and 7000**
▪ Lathe sold separately ▪ 48" L x 62" H



TUFFY NO.	MFG. NO.	DESCRIPTION
416-02800	2800	Environmental Lathe Enclosure

416-02800





Brake Lathe Accessories & Adapters (cont.)

BRAKE LATHE PARTS

TUFFY NO.	MFG. NO.	ITEM	DESCRIPTION
416-03085	3085	Spindle Boot	Replaces Front/Rear Spindle Boots on 3000/4000 Spindle Boot Lathes . Damaged Boots Should be Replaced to Protect the Spindle and Bearings From Metal Chips and Grinding Dust. Replaces Discontinued Spindle Boot 10401 on Models 4100 and 7700
416-03086	3086	Feed Screw Boot	Used on Lathes 3000, 4000 and 7000
416-03087	3087	Cross Feed Boot	Used on Lathes 3000, 4000, 4100, 7000, 7700
416-03148	3148	Oil Level Stick	Standard on Lathes 3000, 4000, 4100, 7000, 7700
416-04282	4282	Bearing Protector	Mounts Between the Lathe and the Drum or Rotor, on the Arbor, to Keep Chips and Grinding Dust Out of the Hub. Fits any Arbor up to 2.25" (57.15mm)
416-06936	6936	Cross Feed Extension	To Relocate the No. 6900 Twin Cutter on 4000 & 4100 Lathes to Accommodate Rotor Diameters up to 17-15/16" (455.61mm)
416-07996	7996	Shear Gear and C-Clip	Replacement for the "Fail Safe" Gear. Protects Cross Feed Gear Box in the Event of Operator Error during Rotor Machining
416-09590	9590	Spindle Lock Kit	Parts Needed to Easily Add a Spindle Lock to an Older Drum/Disc Lathe that Does Have this Feature
416-23682	23682	Spindle Ring	For Replacing a Rubber Boot on the Front of the Spindle in Order to Mount the Boot to the Spindle
417-02760	2760	Mechanical Rotor Micrometer	Range: 0 to 2.25". English & Metric Display
417-02761	2760-50	Mechanical Metric Rotor Micrometer	Range: 0 to 60.9mm. English & Metric Display
417-02780	2780	Digital Rotor Micrometer	Deep Throat Design Allows Measurement Within Rotor Brake Surfaces. For Checking Rotor Wear, Thickness Variation, and Depth of Scoring. For All Automotive and Truck Applications. Range: 0 to 2.4"
417-02781	9K85452780	Digital Rotor Micrometer	Range 0"-2.4"
417-08500	8500	Brake Drum Micrometer	Measures Drum Diameters On or Off the Lathe. Can be Used to Check Out-of-Roundness. Dial is Graduated by 0.005". Range: 6" to 16.125"
417-08501	8500-50	Metric Brake Drum Micrometer	Graduated By 0.1mm. Range: 154mm to 406mm
417-08539	8539	Micrometer Extension Shaft	Increases 8500 Micrometer Range to 6" to 26"
417-08545	8545	Digital Drum Micrometer	Range 5"-15". Stands up in Drum
417-09582	9582	Checking Gauge	For Brake Drums
417-85391	8539-50	Micrometer Extension Shaft	Increases 8500-50 Micrometer Range From 152.44mm to 660.40mm
417-94127	941270	Three Jaw Chuck	Heavy Duty Three Jaw Chuck for 1-7/8" Arbor



SERVICE EQUIPMENT // BRAKE LATHES





SAFETY SHIELD

▪ Clear plastic shield provides added eye protection ▪ Deflects metal chips downward, while permitting an unobstructed view of the work ▪ Attaches to the No. 6900 twin-cutter with the thumb screw provided ▪ Can be quickly moved out of the way for rotor mounting and demounting



416-09481

TUFFY NO.	MFG. NO.	DESCRIPTION	SHIPPING WT.
416-09481	9481	Safety Shield	2 lbs.
416-11154	11154	Replacement Shield	—

ENCORE/ALLIANCE REAR DRUM ADAPTER

▪ Fits inside the bearing to mount the drum on an 11/16" arbor ▪ Also requires a No. 3127 step-down adapter and a No. 3904 centering cone



416-02170

TUFFY NO.	MFG. NO.	DESCRIPTION	SHIPPING WT.
416-02170	2170	Encore/Alliance Rear Drum Adapter	4.5 oz.

STEP-DOWN ADAPTER

▪ Permits the use of 1" adapters on the 11/16" arbor ▪ 1" x 11/16" ▪ Not standard with the No. 9708 11/16" arbor set



416-03127

TUFFY NO.	MFG. NO.	DESCRIPTION	SHIPPING WT.
416-03127	3127	Step-Down Adapter	4.5 oz.

1" ARBOR & NUT

▪ For drums and rotors up to 100 lbs. ▪ Standard with lathe Models 2002, 3000, 4000, 4100, 7000 and 7700



416-03101

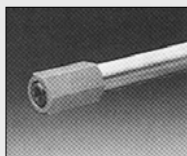

416-03102

TUFFY NO.	MFG. NO.	DESCRIPTION	SHIPPING WT.
416-03101	3101	1" Arbor	6 lbs.
416-03102	3102	1" Arbor Nut	8 oz.

TOOL HOLDER REPLACEMENT KIT FOR 6950 TWIN CUTTER

▪ Increases tool bit reach of early design No. 6900 twin-cutters to allow machining of thin solid rotors ▪ Replaces worn parts in all 6900's ▪ INCLUDES: One No. 10650 LH tool bit holder; one No. 10651 RH tool bit holder; one No. 10701 RH and one No. 10702 LH tool bit assembly; two return Springs; one spring tool



416-08899 416-10650 416-10651

TUFFY NO.	MFG. NO.	DESCRIPTION	SHIPPING WT.
416-08899	8899	Tool Holder Replacement Kit	1 lb., 2.5 Oz.
416-10650	10650	LH Tool Bit Holder	8 Oz.
416-10651	10651	RH Tool Bit Holder	8 Oz.

11/16" ARBOR SET

▪ Used to mount drums and rotors with splined hubs, or with center holes less than 1" in diameter ▪ Used on 2002, 3000, 4000, 4100, 7000, 7700 Lathes ▪ INCLUDES: centering cone, 3 spacers and 11/16"



416-09708

TUFFY NO.	MFG. NO.	DESCRIPTION	SHIPPING WT.
416-09708	9708	11/16" Arbor Set	8 lbs.

11/16" ARBOR NUT

▪ Needed with older No. 9708 11/16" arbor sets to provide a 1-1/4" hex nut to drive the Model 8750 swirl finisher ▪ (LH thread for Models 2002, 3000, 4000)

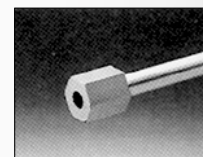

416-25882

TUFFY NO.	MFG. NO.	DESCRIPTION	SHIPPING WT.
416-25882	25882	11/16" Arbor Nut	8 oz.

DOUBLE CHUCK ADAPTER SET

▪ Range 2.125" - 5.750" ▪ Hubless Rotors & Drums through 1 ton vehicles ▪ Double chuck ▪ 4 Backings



TUFFY NO.	MFG. NO.	DESCRIPTION	SHIPPING WT.
416-41412	41412	Double Chuck Adapter Kit	416-41412





➔ Brake Lathe Accessories

Brake Lathe Accessories & Adapters (cont.)

1" CENTERING CONE SET

▪ For mounting some splined hubbed drums and some drums and rotors with unusual hub designs
 ▪ Standard with Models 2002, 3000, 4000, 4100, 7000 and 7700 lathes
 ▪ **CONSISTS OF:** One No. 3902 centering cone; one No. 3903 centering cone



416-03900

TUFFY NO.	MFG. NO.	DESCRIPTION	SHIPPING WT.
416-03900	3900	1" Centering Cone Set	1 lb., 2.5 Oz.

1" SPLINED HUB ADAPTER SET

▪ Used to mount rear drums and some rotors with splined hubs on 1" arbors, such as: Subaru front rotors, Subaru 4 x 4 drums and older VW drums
 ▪ May also be used as spacer



416-05795

TUFFY NO.	MFG. NO.	DESCRIPTION	SHIPPING WT.
416-05795	5795	1" Splined Hub Adapter Set	6 Oz.

HUBLESS ROTOR ADAPTER SET

▪ Easiest, fastest hubless rotor mounting available
 ▪ Used on 1" arbors to mount rigid-center hubless rotors
 ▪ Centering cone easily locates and solidly clamps hubless rotors against the rugged faceplate for fast, accurate mounting with minimal chatter
 ▪ Can also mount Chrysler, Ford and GM composite rotors with the optional No. 8888 clamping plate set for automotive composite rotors and the No. 8889 clamping plate set for light truck composite rotors



416-08800

TUFFY NO.	MFG. NO.	DESCRIPTION	SHIPPING WT.
416-08800	8800	Hubless Rotor Adapter Set	18 lbs.

CLAMPING PLATE SET

▪ Used with No. 8800 hubless rotor adapter set to quickly and easily mount Chrysler, Ford and GM automotive composite rotors
 ▪ Clamping plates apply clamping pressure to the rotor centers

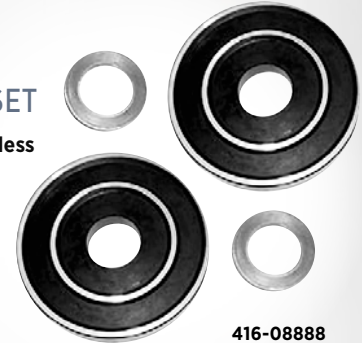

416-08888

TUFFY NO.	MFG. NO.	DESCRIPTION	SHIPPING WT.
416-08888	8888	Clamping Plate Set. INCLUDES: 2 Clamping Plates, 2 Locating Rings	14 lbs.
416-08889	8889	Clamping Plate Set. INCLUDES: 2 Clamping Plates, 1 Locating Ring, For Light Truck	18 lbs.

1" DOUBLE TAPER ADAPTER TRUCK SET

▪ For mounting larger hubbed drums and rotors on 1" arbors
 ▪ Fits bearing face diameters from 2.828" to 3.560" (71.83 to 90.42mm)
 ▪ Some Ford and Chrysler truck drums and many Ford 4 x 4 front rotors require two No. 9195 double taper adapters
 ▪ **INCLUDES:** One No. 9195 1" double taper adapter 2.828" x 3.185" and one No. 9196 1" double taper adapter 3.203" x 3.560"



416-09233

TUFFY NO.	MFG. NO.	DESCRIPTION	SHIPPING WT.
416-09233	9233	1" Double Taper Adapter Truck Set	8 lb., 8 Oz.

SELF-ALIGNING SPACER

▪ Prevents arbor distortion when properly tightening 1" arbor nuts
 ▪ Standard with all Ammco automotive lathes



416-09492

TUFFY NO.	MFG. NO.	DESCRIPTION	SHIPPING WT.
416-09492	9492	Self-Aligning Spacer	11 Oz.

SERVICE EQUIPMENT // BRAKE LATHES





1" ADAPTERS

TUFFY NO.	MFG. NO.	ITEM	DESCRIPTION
416-02160	2160	Ford Probe Adapter	For 1" Arbors. Slips Into The Hub In Place Of The Bearings Of Rear Probe Drums And Rotors
416-03106	3106	1" Centering Cone	3.421" x 3.224" (86.89 x 102.39mm)
416-03107	3107	1" Centering Cone	2.890" x 3.500" (73.41 x 88.90mm)
416-03108	3108	1" Centering Cone	2.328" x 2.968" (59.13 x 75.39mm)
416-03109	3109	1" Hubless Adapter	5.650" (143.52mm) O.D.
416-03110	3110	1" Centering Cone Spring	Presses the Centering Cone into the Center Hole When Mounting a Hubless Drum or Rotor
416-03123	3123	1" Hubless Adapter	5.750" (146.05 mm) O.D.
416-03125	3125	1" Spacer	1/2" (12.70mm) long
416-03178	3178	1" Centering Cone	2.650" x 3.224" (67.31 x 81.89 mm). Fits Many In-Between Center Hole Diameters On Some European Hubless Rotors
416-03902	3902	1" Centering Cone	1.250" x 1.750" (31.75 x 44.45mm)
416-03903	3903	1" Centering Cone	1.187" x 2.250" (30.16 x 57.15mm)
416-03904	3904	1" Centering Cone	1.703" x 2.750" (43.26 x 69.85mm)
416-04790	4790	Step-Down Adapter Set	Permits The Use Of 1-7/8" Adapters On A 1" Arbor. Set Of 3
416-09192	9192	1" Double Taper Adapter	1.711" x 2.073" (43.46 x 52.65mm)
416-09193	9193	1" Double Taper Adapter	2.074" x 2.440" (52.68 x 61.98mm)
416-09194	9194	1" Double Taper Adapter	2.441" x 2.897" (62.00 x 73.58mm)
416-09195	9195	1" Double Taper Adapter	2.828" x 3.185" (71.83 x 80.90mm)
416-09196	9196	1" Double Taper Adapter	3.203" x 3.560" (81.36 x 90.42mm)
416-09232	9232	1" Double Taper Adapter Set	For Mounting Automobile And Light Truck Hubbed Drums And Rotors On 1" Arbors. Fits All Bearing Race Diameters From 1.322" To 2.897" (33.58 to 73.58mm). Standard With Lathe 1000, 2002, 3000, 4000, 4100, 7000 and 7700 . Consists Of: 9192, 9193, 9194, 9921, 9922
416-09263	9263	1" Hubless Adapter	Three Pad, 4.500" (114.30 mm) OD. Used On Outside Of Drums & Rotors For Stable Mounting
416-09265	9625	1" Hubless Adapter	Five Pad, 5.625" (142.88 mm) OD. Used On Outside Of Drums & Rotors For Stable Mounting
416-09489	9489	1" Hubless Adapter	For Mounting Smaller Hubless Drums And Rotors. Permits Boring Bar And Tool Bit Clearance Inside Small Diameter Drums. 3.625" (92.08 mm) O.D. Standard With Models 1000, 2002, 3000, 4000, 4100, 7000 and 7700
416-09490	9490	1" Hubless Adapter	For Mounting Corvette Rear Rotors, Some Eldorado/Tornado Front Rotors And Import Hubless Rotors. 4.500" (114.30 mm) OD. Standard With Models 1000, 2002, 3000, 4000, 4100, 7000 and 7700
416-09921	9921	1" Double Taper Adapter	1.322" x 1.670" (33.58 x 42.42 mm). Needed On Older Lathes. Smaller Size Allows Accurate Mounting Of Current Smaller Rotors
416-09922	9922	1" Double Taper Adapter	1.362" x 1.710" (34.59 x 43.43mm)



416-02160



416-03106



416-03109

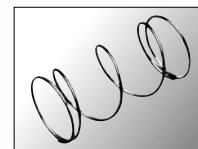

416-03110



416-03123



416-03125



416-03178

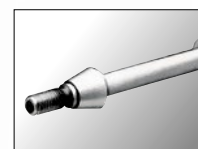

416-03902

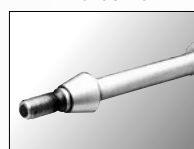

416-03903



416-09192



416-09195



416-09232



416-09263



416-09265



416-09489



416-09490



416-09921



416-09922





➔ Brake Lathe Accessories

Brake Lathe Accessories & Adapters (cont.)

1-7/8" HUBBED AND HUBLESS ADAPTER SET

▪ Used with 1-7/8" Arbors, Nos. 1081 and 3481A



416-04775

TUFFY NO.	MFG. NO.	DESCRIPTION	SHIPPING WT.
416-04775	4775	1-7/8" Hubbed and Hubless Adapter Set	90 lbs.

1-7/8" MEDIUM DUTY ADAPTER SET

▪ Used with Nos. 1081 and 3481 1-7/8" arbors ▪ Standard with No. 4775 hubbed and hubless adapter set



416-08994

TUFFY NO.	MFG. NO.	DESCRIPTION	SHIPPING WT.
416-08994	8994	1-7/8" Medium Duty Adapter Set	90 lbs.

1-7/8" MEDIUM DUTY ADAPTER SET

▪ Used with Nos. 1081 and 3481 1-7/8" arbors ▪ Standard with No. 4775 hubbed and hubless adapter set



416-08995

TUFFY NO.	MFG. NO.	DESCRIPTION	SHIPPING WT.
416-08995	8995	1-7/8" Heavy Duty Adapter Set	51 lbs.

1-7/8" FORD LIGHT TRUCK ADAPTER SET

▪ Needed to mount late model Ford 3/4 and 1-ton, large center, hubless drums ▪ Used with 1-7/8" arbors



416-09399

TUFFY NO.	MFG. NO.	DESCRIPTION	SHIPPING WT.
416-09399	9399	1-7/8" Ford Light Truck Adaptor Set	18 lbs.

1-7/8" LIGHT TRUCK ADAPTER SET

▪ Mounts most light 3/4 and 1-ton truck drums on the standard 1" or 1-7/8" arbors ▪ Standard with Model 4100 lathe



416-09499

TUFFY NO.	MFG. NO.	DESCRIPTION	SHIPPING WT.
416-09499	9499	1-7/8" Light Truck Adapter Set	12 lbs., 10 Oz.

1-7/8" ARBOR SET

▪ Used with all 1-7/8" Adapter Sets to mount a wide range of hubbed and hubless truck drums and rotors up to 200 lbs. ▪ For Model 3860 lathe
▪ INCLUDES: One 1-7/8" arbor nut wrench, one arbor nut, one arbor



416-03491

TUFFY NO.	MFG. NO.	DESCRIPTION	SHIPPING WT.
416-03491	4391	1-7/8" Arbor Set	28 lbs.

1-7/8" ARBOR SET

▪ Used with all 1-7/8" adapter sets to mount a wide range of hubbed and hubless truck drums and rotors up to 200 lbs. ▪ For lathe Models 2002, 3000, 4000, 4100, 7000 and 7700
▪ INCLUDES: One No. 3198 1-7/8" arbor, one No. 3460 1-7/8" arbor nut, one No. 5722 1-7/8" arbor nut wrench



416-03481

TUFFY NO.	MFG. NO.	DESCRIPTION	SHIPPING WT.
416-03481	3481	1-7/8" Arbor Set	38 lbs.

SERVICE EQUIPMENT // BRAKE LATHES





➔ Brake Lathe Accessories

1-7/8" ADAPTERS

TUFFY NO.	MFG. NO.	ITEM	DESCRIPTION
416-03191	3191	1-7/8" Spacer	1" (25.40mm) Long
416-03192	3192	1-7/8" Spacer	2" (50.80mm) Long
416-03193	3193	1-7/8" Spacer	3" (76.20mm) Long
416-03194	3194	1-7/8" Centering Cone	2.000" x 3.375" (50.80 x 85.73mm)
416-03229	3229	Diamond Nib	For the No. 5380 Grinding Wheel Dresser and No. 7670 Magnetic Silencer
416-03460	3460	1-7/8" & 2-1/2" Arbor Nut	For all 1-7/8" Arbors Used On Lathe Models 2002, 3000, 4000, 4100, 7000 and 7700
416-03577	3577	1-7/8" Hubless Adapter	6.250" (158.75mm) O.D.
416-03578	3578	1-7/8" Hubless Adapter	7.813" (198.45mm) O.D.
416-03581	3581	1-7/8" Hubless Adapter	9.625" (244.48mm) O.D.
416-03590	3590	1-7/8" Centering Cone Spring	Presses the Centering Cone into the Center Hole when Mounting Hubless Drum or Rotor
416-04732	4732	1-7/8" Centering Cone	4.656" x 5.250" (118.26 x 133.35mm)
416-04776	4776	1-7/8" Centering Cone	2.750" x 3.344" (69.85 x 84.93mm)
416-04777	4777	1-7/8" Centering Cone	3.281" x 3.891" (83.34 x 98.82mm)
416-04778	4778	1-7/8" Centering Cone	3.828" x 4.421" (97.20 x 112.30mm)
416-04779	4779	1-7/8" Centering Cone	4.359" x 4.968" (110.70 x 126.20mm)
416-04781	4781	1-7/8" Centering Cone	4.891" x 5.500" (123.46 x 139.70mm)
416-04782	4782	1-7/8" Centering Cone	5.438" x 6.031" (138.11 x 153.19mm)
416-04783	4783	1-7/8" Centering Cone	5.969" x 6.563" (151.61 x 188.69mm)
416-04784	4784	1-7/8" Centering Cone	6.500" x 7.438" (165.10 x 188.91mm)
416-04785	4785	1-7/8" Centering Cone	7.031" x 7.641" (178.59 x 194.07mm)
416-04786	4786	1-7/8" Centering Cone	7.578" x 8.172" (192.48 x 202.57mm)
416-05380	5380	Grinding Wheel Dresser	Clamps on the Drum to dress the Grinding Wheel parallel to the Brake Surface. Standard with Model 4850 Brake Drum Grinder . Includes Diamond Nib.
416-05722	5722	1-7/8" & 2-1/2" Arbor Nut Wrench	
416-08756	90875612	Abrasive Pads	Package of 12 Adhesive Backed Abrasive Pads for Model 8750 Swirl Finisher
416-09234	9234	1-7/8" Double Taper Adapter Set	For Use with Nos. 1081 and 3481 1-7/8" Arbors. Standard with Model 4100 Lathe . Consists of: (1) No. 9197 1-7/8" Double Taper Adapter 2.828" x 3.185" and (1) No. 9198 1-7/8" Double Taper Adapter 3.203" x 3.560"



416-03191



416-03192



416-03194



416-03229



416-03460



416-03577



416-03578



416-03581



416-03590



416-04732



416-04776



416-04779



416-05380

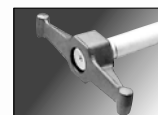

416-05722

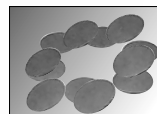

416-08756



416-09234



ADAPTEK® BRAKE LATHE ADAPTERS

▪ Most versatile collection of brake lathe adapters. Self-centering and augmented for stability for better results with less chatter ▪ Reduces adapters needed to handle most car and light truck applications, or specify one of the four application-oriented sets ▪ Engineered for use with most lathes with 1" arbors including Ammco, Accu-Turn, FMC and Performance

TUFFY NO.	MFG. NO.	DESCRIPTION	MIN.	MAX.
416-09310	9310	Auto & Truck Set	1.84"	3.85"
416-09311	9311	Auto Set	1.84"	3.30"
416-09312	9312	Light Truck Set	3.20"	3.85"
416-09313	9313	Truck Set	3.75"	5.23"



416-09310



416-09311



416-09312



416-09313

SERVICE EQUIPMENT // BRAKE LATHES





➔ Brake Lathe Accessories

Brake Lathe Accessories & Adapters (cont.)

TOOL BITS/CARBIDE INSERTS

TUFFY NO.	MFG. NO.	ITEM	DESCRIPTION
418-40410	940410	Carbide Insert Triangular	Positive Rake, for FMC Lathes , 10 pack
418-40415	940415	Carbide Insert Triangular	Positive Rake, for Kwik-Way Lathes , 10 pack
418-40420	940420	Carbide Insert Triangular	Negative Rake, for Hunter Lathes , 10 pack
418-40435	940435	Carbide Insert Triangular	Positive Rake for Accuturn Lathes , 10 pack
418-41435	40435	Carbide Insert, Pos. Rake	For Accuturn Lathes , 10 Pack
418-06610	06610	Carbide Brake Lathe Insert	Round Carbide Bits for All Tool, Ammco, Hunter, Performance Reels Lathes , 10 Pack
418-40608	40608	Tool Bit Assembly	Right-Handed Tool Holder For Round Inserts For Positive Rake
418-40609	40609	Tool Bit Assembly	Left-Handed Tool Holder For Round Inserts For Positive Rake
418-40610	40610	Carbide Insert Round	Positive Rake, 10 Pack. Requires Tool Holder
418-40630	40630	Tool Holder Set	Right- and Left-Handed Tool Holder For Round Inserts
418-04114	4114	Positive Rake Tool Bit	For Drum Turning on Ammco Lathe Models 2002, 3000, 4000, 4100 and 7700 . Brazed Carbide Tip Easily Resharpened by Grinding Top Flat. Shank: 3/8" (9.525 mm) square
418-04725	4725	Positive Rake RH Heavy Duty Tool Bit	Used for Drum Turning on Ammco Lathe 2002, 3000, 4000, 4100 and 7700
418-04728	4728	Positive Rake RH Heavy Duty Tool Bit Set	Package of 3 No. 4725 RH Tool Bits
418-05392	5392	Positive Rake Small Drum Tool Bit Assembly	For Turning Small Diameter Drums On Ammco Lathes . Shank: 5/8" x 3/4" x 5" (15.875 x 19.050 x 127mm) Long For Standard Boring Bars
418-06999	6999	Negative Rake Tool Bit Set	Replacement LH and RH Tool Bit Assemblies for the No. 6900 Twin-Cutter. Includes: One No. 10701 RH Tool Bit and One No. 10702 LH Tool Bit with Carbide Inserts
418-06914	6914-10	10 Carbide Inserts	Negative Rake 10 Pack
418-69142	6914-2	2 Carbide Inserts	Negative Rake 2 Pack
418-69146	6914-6	6 Carbide Inserts	Negative Rake 6 Pack
418-76812	7681-2	2 Carbide Inserts	Positive Rake 2 Pack
418-76816	7681-6	6 Carbide Inserts	Positive Rake 6 Pack
418-07692	7692	Duplex Tool Bit	Used with No. 9381 Facing and Grinding Set. Replacement Carbide Inserts No. 416-07681
418-07999	7999	Positive Rake Tool Bit Set	Permits Up to .100" Maximum Depth-Of-Cut (Total Of Two Sides, One Pass) when Turning Rotors with a No. 6900 Twin Cutter. Includes: One No. 25968 RH Tool Bit and One No. 25969 LH Tool Bit with Carbide Inserts. Replacement Carbide Inserts No. 416-07681
418-09872	9872	Negative Rake Tool Bit Assembly	For Drum Turning. Order Replacement Carbide Insert 418-06914. Standard with Lathe Models 2002, 3000, 4000, 4100, 7700
418-10701	10701	RH Negative Rake Tool Bit Assembly	For The No. 6900 Twin Cutter. Includes: One 418-06914 Six-Cutting-Edge Carbide Insert
418-10702	10702	LH Negative Rake Tool Bit Assembly	For The No. 6900 Twin Cutter. Includes: One 418-06914 Six-Cutting-Edge Carbide Insert
418-40425	40425	Extend Offset Toolholder	Right And Left, 3/8"



418-04114



418-04725

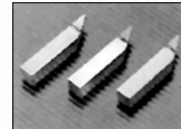

418-04728



418-05392



418-06914



418-06999



418-07692



418-07999



418-09782



418-10701

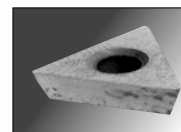

418-40410

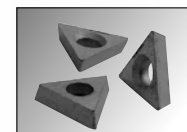

418-40415



418-40425



418-40435

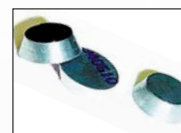

418-40610



418-40630

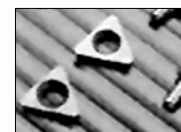

418-69142





Tool Bits/Carbide Inserts

QUICK REFERENCE CHART

ROTOR MACHINING						DRUM MACHINING				
OE STANDARD	OPTIONS					OE STANDARD	OPTIONS			
TUFFY NO. 417-03860										
MFG. NO. 3860										
Twin Cutter	906950					Boring Bar	925750			
Rake	Negative	Positive	Positive	Positive Extended	Positive Round	Rake	Negative	—	—	—
Bit Holder RH	910701	925968	925968	—	940608	Bit Holder	925762	—	—	—
Bit Holder LH	910702	925969	925969	—	940609					
Bits	90691410	9076816	9069186	9069186	940610	Bits	90691410	—	—	—
Package, Bits + Holder	906999	907999	—	940425	940630					
TUFFY NO. 414-04000										
MFG. NO. 4000B										
Twin Cutter	906950					Boring Bar	905843			
Rake	Negative	Positive	Positive	Positive Extended	Positive Round	Rake	Negative	Zero	Positive	Positive
Bit Holder RH	910701	925968	925968	—	940608	Bit Holder	909872	Brazed	Brazed	905392
Bit Holder LH	910702	925969	925969	—	940609					
Bits	90691410	9076816	9069186	9069186	940610	Bits	90691410	904114	904725	9076816
Package, Bits + Holder	906999	907999	—	910425	940630					
TUFFY NO. 414-04001										
MFG. NO. 4000SP										
Twin Cutter	906950					Boring Bar	929240			
Rake	Positive	Negative	Positive	Positive Extended	Positive Round	Rake	Positive	Negative	Positive	—
Bit Holder RH	925968	910701	925968	—	940608	Bit Holder	905390	927118	905390	—
Bit Holder LH	925969	910702	925969	—	940609					
Bits	9076816	90691410	9069186	9069186	940610	Bits	9076816	90691410	9069186	—
Package, Bits + Holder	907999	906999	—	940425	940630					
TUFFY NO. 414-04100										
MFG. NO. 4100B										
Twin Cutter	907900					Boring Bar	905844			
Rake	Negative	Positive	—	—	—	Rake	Negative	Zero	Positive	Positive
Bit Holder RH	925762	—	—	—	—	Bit Holder	909872	Brazed	Brazed	905392
Bit Holder LH	925761	—	—	—	—					
Bits	90691410	9076816	—	—	—	Bits	90691410	904114	904725	9076816
Package, Bits + Holder	—	941201	—	—	—					
TUFFY NO. 414-07500										
MFG. NO. 7500										
Twin Cutter	906950					Boring Bar	N/A			
Rake	Negative	Positive	Positive	Positive Extended	Positive Round	Rake	—	—	—	—
Bit Holder RH	910701	925968	925968	—	940608	Bit Holder	—	—	—	—
Bit Holder LH	910702	925969	925969	—	940609					
Bits	90691410	9076816	9069186	9069186	940610	Bits	—	—	—	—
Package, Bits + Holder	906999	907999	—	940425	940630					

SERVICE EQUIPMENT // BRAKE LATHES



Challenger Lifts

CL10 SERIES 10,000 LB. CAPACITY TWO-POST LIFT

COMPLETE PRODUCTIVITY:
Conventional Power Controls,
Versymmetric® offset 2-stage
front and rear arms

- **Versymmetric® offset front arms provide directSPOT™** to vehicle lift points and safely lifts both symmetrically and asymmetrically within the same service bay maximizing service capabilities and revenue potential
- **Padded overhead shut off system** prevents vehicle damage from being raised too high.
- **Oversized 5" diameter pulley and heavy duty 5/16" cable** reduces stress on equalization system and increases cable life
- **Fully gusseted base plate design** reduces column deflection. 48" elongated carriage design decreases load on bearing
- **Single point mechanical lock release system** with **jacket coated protection** and **no lock cable pulleys, and double clutch release bar** protects cable from stretching while disengaging both column locks simultaneously
- 11' 8" standard height with 2' and 3' extensions available allows lift to be placed in standard service bay with 12' ceiling
- **Rubber door guards** provide added security against vehicle door damage

304-00010



2 Lifts in One™

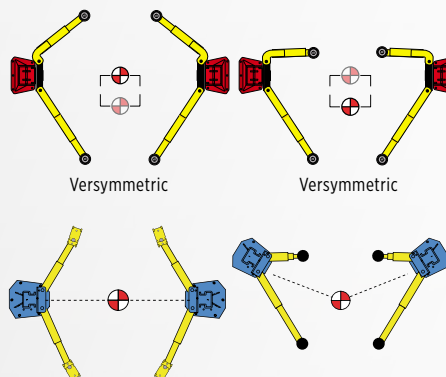

2 Lifts in One

Why should you be forced to decide what type of vehicles you service the most?

- **Asymmetric Lifts** accommodate 70% of top 20 selling vehicles, **Symmetric Lifts** accommodate 30% of the top 20 selling vehicles
- **Versymmetric® Lifts** accommodate 100% of the top 20 selling vehicles, properly lifts cars, trucks, vans and SUVs with one lift

TUFFY NO.	MFG. NO.	DESCRIPTION
304-00010	CL10	CL10 Series: 10,000 lb. Capacity Two-Post Lift

SERVICE EQUIPMENT // LIFTS & ROLLING JACKS





MAXIMUM PRODUCTIVITY (CL10V3)

- **Conventional Power Controls**
- **Versymmetric® Plus** offset 3-stage front + 3-stage rear arms

TUFFY NO.	MFG. NO.	DESCRIPTION
443-02520	CL10V3	Maximum Productivity



CONVENTIONAL POWER CONTROLS

443-02520

MAX PLUS PRODUCTIVITY (CL10V3DPC)

- **Dual Pendant Power Controls**
- **Stack Adapter Kit**
- **Document Caddy**
- **Versymmetric® Plus** offset 3-stage front + 3-stage rear arms

TUFFY NO.	MFG. NO.	DESCRIPTION
304-01103	CL10V3DPC	Max Plus Productivity



DUAL PENDANT POWER CONTROLS

304-01103

SERVICE EQUIPMENT // LIFTS & ROLLING JACKS



➔ Challenger Two-Post Lifts



Challenger Lifts (cont.)



E10: 10,000 LB. CAPACITY TWO-POST LIFT

- Versymmetric 3-stage front arms for asymmetric or symmetric lifting in the same service bay
- Standard height fits in 12" ceiling
- Double Telescoping Screw Pads
- Padded overhead shut off system
- Single-point mechanical lock release system allows technician to disengage both column locks simultaneously
- ALI/ETL certified



304-00110

TUFFY NO.	MFG. NO.	DESCRIPTION
304-00110	E10	E10 Series: 10,000 lb. Capacity Two-Post Lift

E12: 12,000 LB. CAPACITY TWO-POST LIFT

- Heavy-Duty 2-stage telescoping arms provide excellent reach and retraction to accommodate vehicle lifting points
- 13'-10" or 14'-7" adjustable column height accommodates higher profile vehicles and provides maximum headroom to work underneath vehicles
- Heavy-Duty telescoping Screw Pads
- Padded overhead shut off system
- Single-point mechanical lock release system allows technician to disengage both column locks simultaneously
- ALI/ETL certified



304-00120

TUFFY NO.	MFG. NO.	DESCRIPTION
304-00120	E12	E12 Series: 12,000 lb. Capacity Two-Post Lift

CLFP9: 9,000 LB. CAPACITY FLOOR PLATE LIFT

- 10'-7/8" overall column height is ideal for servicing vehicles in a low ceiling height
- Low profile drive-over floor plate for easy vehicle positioning
- 3-stage front + 3-stage rear arms provide excellent reach and retraction to lift a variety of vehicles
- Electric/hydraulic heavy-duty chain lifting operation with cable equalization
- Dual point mechanical pull-lock cable release system



304-00009

TUFFY NO.	MFG. NO.	DESCRIPTION
304-00009	CLFP9	9,000 lb. Capacity Floor Plate Lift

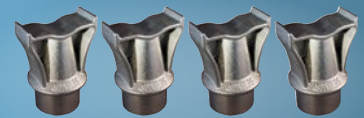

FRAME ENGAGING ADAPTERS ARE REQUIRED WHEN LIFTING TRUCKS OR OTHER FRAME VEHICLES.

TWO-POST LIFTS AT A GLANCE

TUFFY NO.	MFG. NO.	MAX. CAP. (LBS.)	OVERALL WIDTH	BETWEEN COLUMNS	DRIVE-THRU WIDTH	OVERALL HEIGHT	UNDER BAR CLEARANCE	FRONT ARM LENGTH	REAR ARM LENGTH	MAX. LIFT HEIGHT	POWER REG.
304-00110	E10	10,000	10' 11-3/4"	110-1/4"	98-3/8"	11' 11-7/8"	11' 5"	21 3/4" to 39-1/4"	38-1/4" to 55-3/8"	75-3/4"	2HP, Single Phase, 60HZ
304-00120	E12	12,000	11' 7-3/4"	115"	103"	13' 10" or 14' 7"	13' 3-1/2" or 14'-1/2"	35 3/4" to 54-1/4"	35-3/4" to 54-1/4"	78-1/8"	2HP, Single Phase, 60Hz
304-00009	CLFP9	9,000	11' 5-1/2"	109"	98-3/16"	N/A	N/A	24 1/2" to 44-1/2"	24-1/2" to 44-1/2"	79-1/8"	2HP, Single Phase, 60Hz
304-00010	CL10	10,000	11' 6-1/2" to 11' 11"	10" to 114-1/2"	100-1/2" to 105"	11' 11"	11' 2-1/2"	27" to 41"	42" to 59"	74-5/8"	2HP, Single Phase, 208V-230V
304-00103	CL10V3	10,000	11' 6-1/2" to 11' 11"	10" to 114-1/2"	100-1/2" to 105"	11' 11"	14' 2-1/2"	19-13/16" to 42"	37-5/8" to 60"	74-5/8"	2HP, Single Phase, 208V-230V
304-01103	CL10V3-DPC	10,000	11' 6-1/2" to 11' 11"	10" to 114-1/2"	100-1/2" to 105"	11' 11"	11' 2-1/2"	19-13/16" to 42"	37-5/8" to 60"	74-5/8"	2HP, Single Phase, 208V-230V

SERVICE EQUIPMENT // LIFTS & ROLLING JACKS





4015 SERIES: 15,000 LB. CAPACITY GENERAL SERVICE AND ALIGNMENT RACK FOUR POST LIFTS

- **The highest rise in the industry provides more working room underneath vehicles** ▪ Large 9-1/2" heavy-duty pulleys and 1/2" cable diameter reduces wear on cable equalization system
- Compatible with the industry's latest camera imaging alignment systems
- Recessed stainless steel turning radius gauges provide accurate readings
- 14-level locking positions for a variety of alignment and general service tasks
- Durable non-skid surfaces for positive vehicle traction and technician safety
- Fully gusseted base plate and top shroud reduces column deflection and is less sensitive to uneven floors
- 80" rear recessed free floating slip plates offer a wider range of 4 wheel alignment capacities
- *Alignment Rack models include a package of two 7.5K lb. rolling jacks, flush mount stainless steel turning radius gauges and rear slip plates, internal air line system for the dual rolling jacks, multi-position work-steps and automatic wheel stops*



4P14FEX & 4P14XFX: 14,000 LB. CAPACITY FOUR POST LIFT

- **The highest rise in the industry provides more working room underneath vehicles** ▪ Louvered approach ramps for positive vehicle traction
- Solid piece column construction provides rigidity and stability
- Oversized solid machined steel pulleys for prolonged pulley and cable life
- Adjustable runways to accommodate a variety of tread widths
- 14 level locking positions for a variety of general service tasks
- **ALI/ETL certified**
- **OPTIONAL ACCESSORIES:** 7,000 lb. rolling jacks for brake and tire work; Optional bolt on alignment kit converts general service application into alignment rack



TUFFY NO.	MFG. NO.	DESCRIPTION
305-40150	AR4015XFO	Open Front
305-40151	AR4015EFX	Close Front

TUFFY NO.	MFG. NO.	DESCRIPTION
305-41400	4P14EFX	14,000 lb. Capacity Four Post Lift
305-41401	4P14FEX	14,000 lb. Capacity Four Post Lift

FOUR-POST LIFTS AT A GLANCE

TUFFY NO.	MFG. NO.	MAX. CAP. (LBS.)	OVERALL WIDTH	LENGTH OVERALL	INSIDE COLUMNS	HEIGHT OF COLUMNS	HEIGHT OF RUNWAYS	WIDTH OF RUNWAYS	WIDTH BETWEEN RUNWAYS	MAX. LIFT HEIGHT	POWER REG.
305-41400	4P14EFX	14000	10" 10' 3/4"	20" 4-1/2"	116"	90-1/2"	7"	20"	40" - 43"	78"	2HP
305-41401	4P14FEX	14000	10" 10' 3/4"	20" 4-1/2"	116"	90-1/2"	7"	20"	40" - 43"	78"	2HP
305-40001	AR4015EAX	15000	11' 2-1/2"	244-1/2"	120"	7' 6-1/2"	7"	20"	40"	78"	2HP
305-40150	AR4015XFO (Open Front)	15000	11' 10" front - 11' 2-1/2" rear	23'	120"	8' 3-1/2" front - 7' 9-1/2" rear	7"	20"	43"	78"	2HP
305-40151	AR4015EFX (Closed Front)	15000	11' 2-1/2"	22' 8"	120"	7' 6-1/2"	7"	20"	40" - 43"	78"	2HP

SERVICE EQUIPMENT // LIFTS & ROLLING JACKS





Challenger Lifts (cont.)

EV1020: 10,000 LB. CAPACITY IN GROUND LIFT

▪ **Offset 3-stage front and rear safety arms** ▪ 87" drive through capacity ▪ 50% more bearing contact than competitors increases stability ▪ Stainless steel air-lock release cylinder prevents rust

NEW ADDITIONS: Larger 8-1/2" diameter chrome piston ▪ Enhanced raised wiper at top and bottom of bearing provides better grease retention ▪ Minimizes contamination from entering into bearings



307-01021 (Lowered)



87" DRIVE THROUGH CAPACITY

307-01021 (Raised)

TUFFY NO.	MFG. NO.	DESCRIPTION
307-01021	EV1020	10,000 lb. Capacity In Ground Lift

CLHM135 AND CLHM185: HEAVY DUTY MOBILE COLUMN LIFTS

- **Hydraulic operated units provide lifting capacity from 27,000/37,000 (set of 2) to 108,000/148,000 lbs. (set of 8) enabling lifting from small passenger cars to heavy-duty trucks, transit, and municipality vehicles**
- 110-volt built in **multi-stage charging system**
- **Wireless system** for clutter free work area without cables to connect, navigate, roll-over or replace
- **12 radio frequencies** with a channel range from 100-120 for each frequency to prevent radio noise from interrupting service
- **Adjustable wheel carriage**
- **Integrated touch screen control console** provides easy-to-use and precise operating
- **Precise balanced design, heavy-duty tow handle and spring loaded wheels** make moving and aligning individual lift units simple
- Battery operated with **12-volt deep cycle batteries** eliminates the need for power source hook-ups and provide 24 volt operation.
- **Integrated weight gauges** help prevent column overloading and verifies lock engagement



308-00135



INTEGRATED WEIGHT GAUGES

HYDRAULIC OPERATED UNITS

TUFFY NO.	MFG. NO.	DESCRIPTION
308-00135	CLHM135-4	13,500 lbs. Capacity (Per Column) Mobile column Lift - Battery Powered, Wireless, Adjustable Carriage
308-00185	CLHM185-4	18,500 lbs. Capacity (Per Column) Mobile column Lift - Battery Powered, Wireless, Adjustable Carriage





➔ Short-Rise & Mid-Rise Lifts



MR6: 6,000 LB. CAPACITY MID-RISE LIFT

- Portable mid-rise lift with Heavy-Duty tow dolly provides flexibility to service vehicles anywhere, inside or out
- 7 locking positions allow technician to work at an ergonomic height to increase productivity and minimize fatigue
- Electric motor mounted on tow dolly provides convenience and ease of maneuverability
- Single push button power unit with release valve provides convenience when lifting and lowering vehicles
- Slip-on rubber pad adapter kit with height extension accommodates high profile vehicles
- Sliding/rotating arm design accommodates meeting pick-up points on a wider range of vehicles

SRM10: 10,000 LB. CAPACITY SHORT-RISE LIFT

- Standard with 4 two-position adapter blocks for increased vehicle spotting versatility
- Standard storage trays are conveniently placed on each side of the lift to prevent lug nuts and other small parts from being misplaced
- Dual cylinders provide stable 10,000 lb. lifting capabilities to accommodate a wide range of vehicles
- Floor mounted diamond plated approach ramps help to prevent slipping
- 3 locking positions
- ALI/ETL certified

The portable MR6 is easy to move around from one location to another as needed.



PORTABLE AND EASY TO MOVE



303-00010

THREE LOCKING POSITIONS

STANDARD STORAGE TRAYS



307-00006

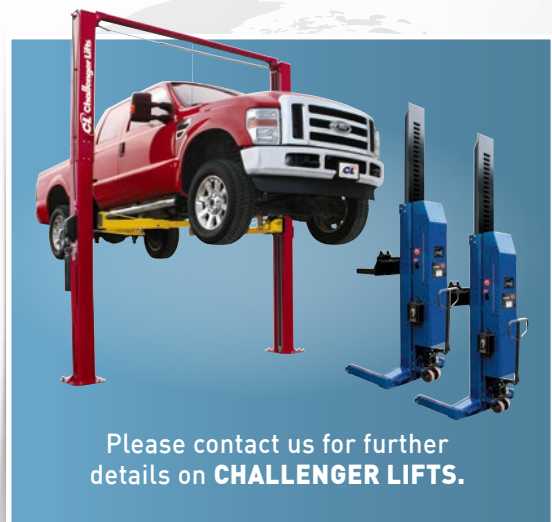

Please contact us for further details on **CHALLENGER LIFTS.**

TUFFY NO.	MFG. NO.	DESCRIPTION
307-00006	MR6	6,000 lb. Capacity Mid-Rise Lift

SERVICE EQUIPMENT // LIFTS & ROLLING JACKS





Rubber Blocks & Lift Pads

RUBBER LIFT PAD (5" ROUND)

▪ **RUBBER PAD DIMENSIONS:** 5" round ▪ Kit of four rubber pads ▪ Replacement pads for Nussbaum lifts

TUFFY NO.	MFG. NO.	DESCRIPTION
309-00003	JOK03M	Rubber Lift Pad - 5" Round



309-00003

RUBBER LIFT PAD (3.25" X 4")

▪ **RUBBER PAD DIMENSIONS:** 3.25" x 4" ▪ Kit of four rubber pads ▪ Replacement pads for Rotary SPO10, SPO12 lifts

TUFFY NO.	MFG. NO.	DESCRIPTION
309-00022	JOK22D	Rubber Lift Pad - 3.25" x 4"



309-00022

RUBBER LIFT PAD (4" X 5")

▪ **RUBBER PAD DIMENSIONS:** 4" x 5" ▪ Kit of four rubber pads ▪ Replacement pads for Ammco, Ben Pearson lifts

TUFFY NO.	MFG. NO.	DESCRIPTION
309-00005	JOK05M	Rubber Lift Pad - 4" x 5"



309-00005

RUBBER LIFT PAD (5.25" ROUND)

▪ **RUBBER PAD DIMENSIONS:** 5.25" round ▪ Kit of four rubber pads ▪ Replacement pads for Challenger CL10, Quality lifts

TUFFY NO.	MFG. NO.	DESCRIPTION
309-00014	JOK140	Rubber Lift Pad - 5.25" Round



309-00014

RUBBER LIFT PAD (5" X 5")

▪ **RUBBER PAD DIMENSIONS:** 5" x 5" ▪ Kit of four rubber pads ▪ Replacement pads for Forward, Worth, American, Gemini, Grand, Tuxedo, Eagle, Whip lifts

TUFFY NO.	MFG. NO.	DESCRIPTION
309-00007	JOK07M	Rubber Lift Pad - 5" x 5"



309-00007

RUBBER BLOCK 1.5"

▪ **RUBBER BLOCK DIMENSIONS:** 6" x 4" ▪ Kit of four 1.5" rubber blocks ▪ Spacer blocks for Rotary Airjacks and all Mid-Rise pad lifts

TUFFY NO.	MFG. NO.	DESCRIPTION
309-00011	JORB-1	Rubber Block 1.5"



309-00011

RUBBER LIFT PAD (4" X 4")

▪ **RUBBER PAD DIMENSIONS:** 4" x 4" ▪ Kit of four rubber pads ▪ Replacement pads for Challenger CL9 and CL10 lifts

TUFFY NO.	MFG. NO.	DESCRIPTION
309-00009	JOK090	Rubber Lift Pad - 4" x 4"



309-00009

RUBBER BLOCK 3"

▪ **RUBBER BLOCK DIMENSIONS:** 6" x 4" ▪ Kit of four 3" rubber blocks ▪ Spacer blocks for Rotary Airjacks and all Mid-Rise pad lifts

TUFFY NO.	MFG. NO.	DESCRIPTION
309-00009	JOK090	Rubber Lift Pad - 4" x 4"



309-00009



Rolling Jacks & Work Stations



ROLLING JACKS

▪ **Optional 6,000 lb. and 7,500 lb. capacity rolling jacks allow easy access to brakes and wheels** ▪ Available for the 4P14 Series lifts ▪ Air/hydraulic operation ▪ Adjustable width ▪ Low vehicle drive-over clearance ▪ Stackable height extensions with built-in storage rack ▪ Factory installed and protected filter lubricator and regular



218-00060

TUFFY NO.	MFG. NO.	DESCRIPTION
218-00060	RJ6	Air/Hydraulic Operation, 40 Series, 4P14 Series and AR40 Series
309-61275	RJ.5	Air/Hydraulic Operation, For 4P14 and 4015 series lifts



ROLLING JACKS

▪ **Heavy duty air/hydraulic rolling jack with telescoping mounting brackets** ▪ Fits many of the popular lifts ▪ Narrow width allows access to tool area of vehicle being serviced ▪ Spring-loaded mounting bracket allows jack to be easily positioned, then automatically locks in place when weight is applied ▪ 6,000 lbs. capacity (specify lift brand) ▪ 9,000 lbs. capacity available

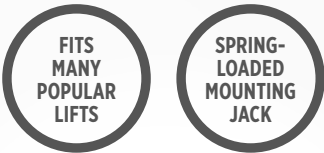

218-08610

TUFFY NO.	MFG. NO.	DESCRIPTION	DRIVE-OVER CLEARANCE	MIN. AIR PRESSURE	MAX. AIR PRESSURE	MIN. LIFT	MAX. LIFT	SHIPPING WEIGHT
218-08610	8610	Rolling Jack - Rotary	3-1/2"	80 PSI	120 PSI	33"	50"	350 lbs.
218-08620	8620	Rolling Jack - JBC/FMC	3-1/2"	80 PSI	120 PSI	33"	50"	350 lbs.
218-08630	8630	Rolling Jack - Hunter	3-1/2"	80 PSI	120 PSI	33"	50"	350 lbs.
218-08640	8640	Rolling Jack - Wheeltronics	3-1/2"	80 PSI	120 PSI	33"	50"	350 lbs.

SERVICE EQUIPMENT // LIFTS & ROLLING JACKS



Rolling Jacks & Work Stations

Rolling Jacks & Work Stations (cont.)

3-TON CAPACITY AIR / HYDRAULIC PUMP OPERATED ROLLING LIFT BRIDGE

Used in quick lube pit applications or in conjunction with above ground lifts. The bridge straddles the lift rails and raises the vehicle's tires off the rails for wheel alignment, brake, tire and suspension work. Push button air/hydraulic pump provides safe, quick lifting up to a height of 20-3/4".

- **The lifting pads** safely support the vehicle on the bridge and the **adjustable lift arms** span up to 60".
- **Universal mounting brackets** adjust to a lift rail opening of 46-1/2".
- **Flat-end and hook-end adapter brackets** are equipped with **spring-loaded roller bearings** for smooth maneuverability of bridge on lift rails. *These brackets are sold separately.*
- **Mechanical stop** prevents accidental lowering of bridge.
- Lowering is accomplished with one hand on the release lever and the other hand releasing the mechanical stop.
- Equipped with **rubber faced saddle** for differential lifting.
- **INCLUDED LIFT ADAPTERS:** (2) 3 1/2" Adapters, (2) 5" Adapters, and (2) Padded Saddles w/ Extension Screws
- **AVAILABLE MOUNTING ADAPTERS:** 79326D: Flat-End Adapter Bracket Kit, 79327D: Hook-End Adapter Bracket Kit

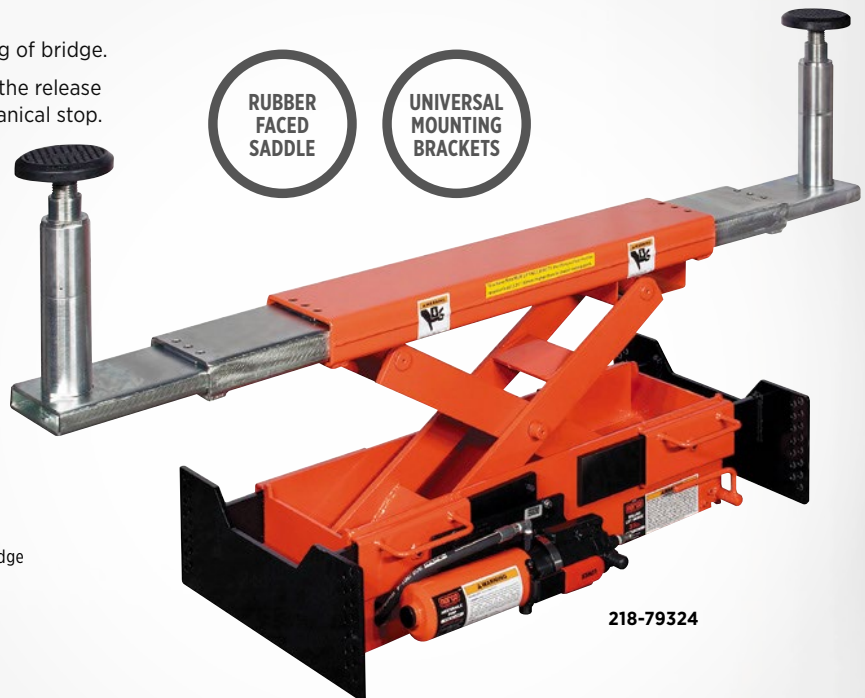

218-79324

TUFFY NO.	MFG. NO.	DESCRIPTION
218-79324	79324G	3-Ton Capacity Air / Hydraulic Pump Operated Rolling Lift Bridge

AIR ELECTRIC WORK STATIONS

- **Air and Electric workstation with filter, lubricator and regulator for four post car and truck lifts** ▪ Increase productivity with air supply and electric outlets on the four post automotive lift column ▪ Convenient power source for extension lights and other tools needed when servicing cars and trucks



309-10310

TUFFY NO.	MFG. NO.	DESCRIPTION
309-10264	B10264	Air/Electric with Filter/Lubricator/Regulator for Two Post Lifts
309-99700	B99700	Tire Tool Manager Work Station with Filter Lubricator/Regulator

3-TON CAPACITY AIR / HYDRAULIC PUMP OPERATED ROLLING LIFT BRIDGE SPECIFICATIONS

TUFFY NO.	MFG. NO.	CAPACITY @ 100 PSI	STROKE	LIFT HEIGHT W/ BASE SADDLE +			EXTENSION SCREW	DIMENSIONS			WEIGHT (LBS.)
				SHORT ADAPTER	TALL ADAPTER	SADDLE		LENGTH	WIDTH	HEIGHT	
218-79324	79324G	3-Ton	8"	3-1/2"	5"	3-3/8"	1-1/4"	35"	19-1/2"	9-1/2"	290 lbs.

SERVICE EQUIPMENT // LIFTS & ROLLING JACKS

