

PRIMERGY RX2530 M5
1U Rack Server
Configurator for all base units

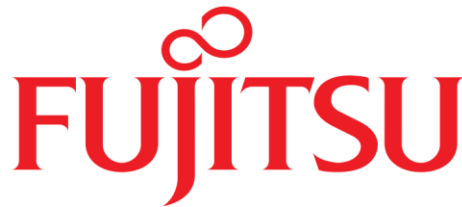

4x 3.5"



4x 2.5" /
8x2,5"



Chapter	Folder	Content
	Cover	List of content, Instructions for usage of this configurator, abbreviations
	Description	System Description for easier understanding
1	Base	describes base unit of RX2530 M4
2		describes rack mount kits and services
3	CPU	Order code and Infos of E5-26xxv5 series processors
4	RAM	DDR4 System memory (RAM) and memory modes
5	GFX	Graphics-, Grid-cards, GPU and Xeon Co processors and other graphics options
6	HD cage	n.a. - not required for PRIMERGY RX2530
7	RAID	SAS / RAID Controller and components
8	ODD	optical disk drives (DVD, DVD-rw, Blu ray)
9	Backup	LTO drives & RDX drive
10	HD SSD	Storage drives - PCIe SSD - SAS/SATA SSD & HDD
11	LAN_FC_IB	LAN Components
12		Fibre Channel Controller
13		Infiniband Controller
14	PSU	Power supply units, power cables, country specific opt.
15	USB devices	Keyboards, Mice, USB devices
16	others	System Management, ATD, RS232 port, TPM module
	LLC	Long life cycle components

Instructions

This document contains basic product and configuration information supporting you in more complicated configurations.

In any case we recommend to use the PC-/SystemArchitect to make sure, that you configure a valid system.

This System configurator is divided into several chapters. They are identical to the current price list and PC-/SystemArchitect.

Please follow this document step by step from the top to the bottom.

Chapter xx - description of chapter

Text fields with grey color offer extra information for related topics (e.g prerequisites, technical back ground, configuration rules, limitations, ...)

S26361-F4610-E2
S26361-F4610-L3
PLAN 2x1Gb Ethern. Controller
i350-T2 chip (based on Intel Powerville) offers 2x1Gb RJ45 connectors
PCIe Gen2 x4 full height card
max. 6x per system

<-- order code E-part (bold) --

<-- order code L-part (bold)

<-- "name" of this part

<--description of this part, in same cases as well description of content

<--requires a free PCIe slot --> means total amount of PCIe slots reduced

<--indicates how often this part can be configured in the related Server

For further information see:

Link to datasheet:

[http:// xxx](http://xxx)

http://ts.fujitsu.com/products/standard_servers/index.html

(internet)

https://partners.ts.fujitsu.com/com/order-supply/configurators/primergy_config/Pages/default.aspx

(extranet)

Fujitsu is providing the content of this document with very high accuracy. In case you identify a mistake, we would kindly encourage you to inform us. We kindly ask for understanding, that errors still may occur and that Fujitsu may change this document without notice

Abbreviations

SAS	Drives, RAID	Serial attached SCSI Device (HDD, SSD, LTO drives); SAS2.0 = 6Gbit/s; SAS3.0 = 12Gbit/s
SATA	Drives, RAID	Serial ATA (HDD, SSD) current SATA speed = 6Gbit/s
HDD	Drives	Hard disk drive (Non volatile storage device), 2.5" (SFF) or 3.5" (LFF)
SSD	Drives	Solid state disk (Non volatile storage device), 2.5" (SFF)
SFF	Drives	small form factor (=2.5")
LFF	Drives	large form factor (=3.5")
CPU	Processor	central processing unit ("processor")
RAID	Drives, RAID	RAID 0 = max speed, RAID 1 = mirroring, RAID 5 = 1 out of x drives is spare
Spaces	OS	Microsoft spaces, optimized in Win2012 R2 offers software RAID and storage tiering
vSAN	OS	
storage tiering	RAID	offers optimized storage allocation (fast area for "hot data"; slower area for "cold data")
hot data	Drives	Data which are currently being processed
cold data	Drives	Data which are currently not processed (only stored)
ODD	Drives	optical disk drive (i.e. DVD-player, DVD-burner, Blu ray player, blu ray burner)
OS	operating system	OS=operating system - required for running, organize and administrating the server
E-Part	"Einbau-Part"	"e.g. S26361-F1234- <u>E</u> 240" ordercode with "E" means it is either integrated into to Server (CPU, Mem, ..) or integrated in the shipping box (Keyboard, Mouse, ..)
L-Part	"Lose Lieferung-Part"	"e.g. S26361-F1234- <u>L</u> 240" ordercode with "L" means, the part will be shipped with extra package, may be as well with extra shipment

PRIMERGY RX2530 M5: Schematics of the System board and fans

V101 / V301 / V401 // D3383-B

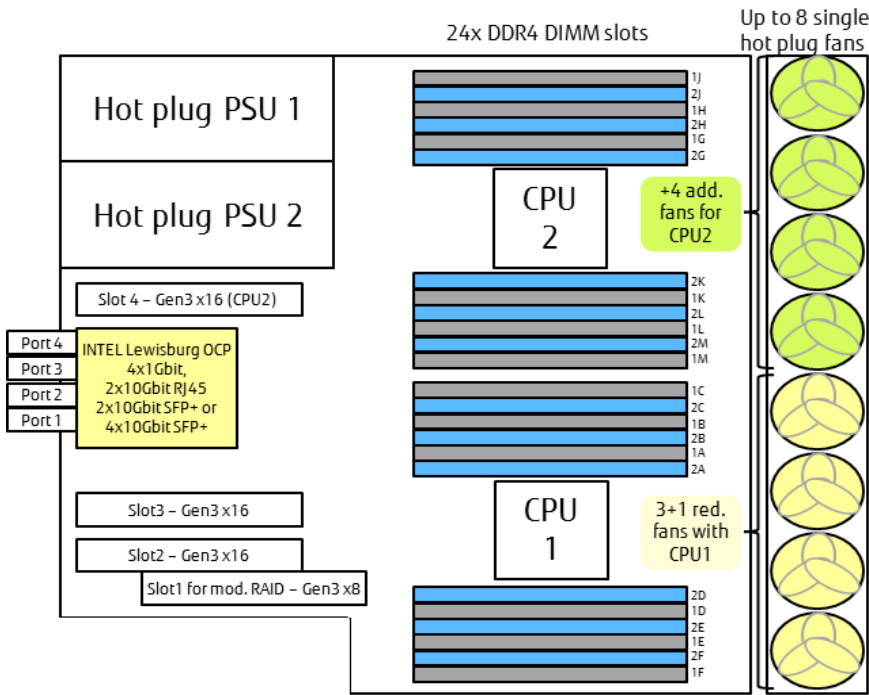

V501 // D3483-B

V601 // D3483-B

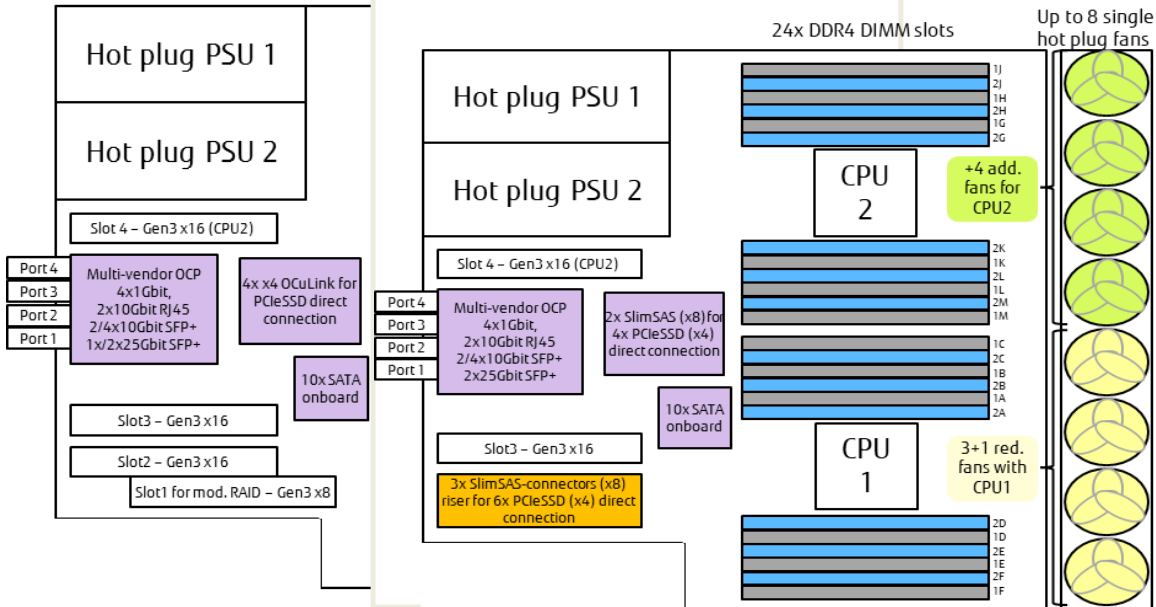

PRIMERGY RX2530 M5 rear view with PSU, PCIe slots and dynamic LoM

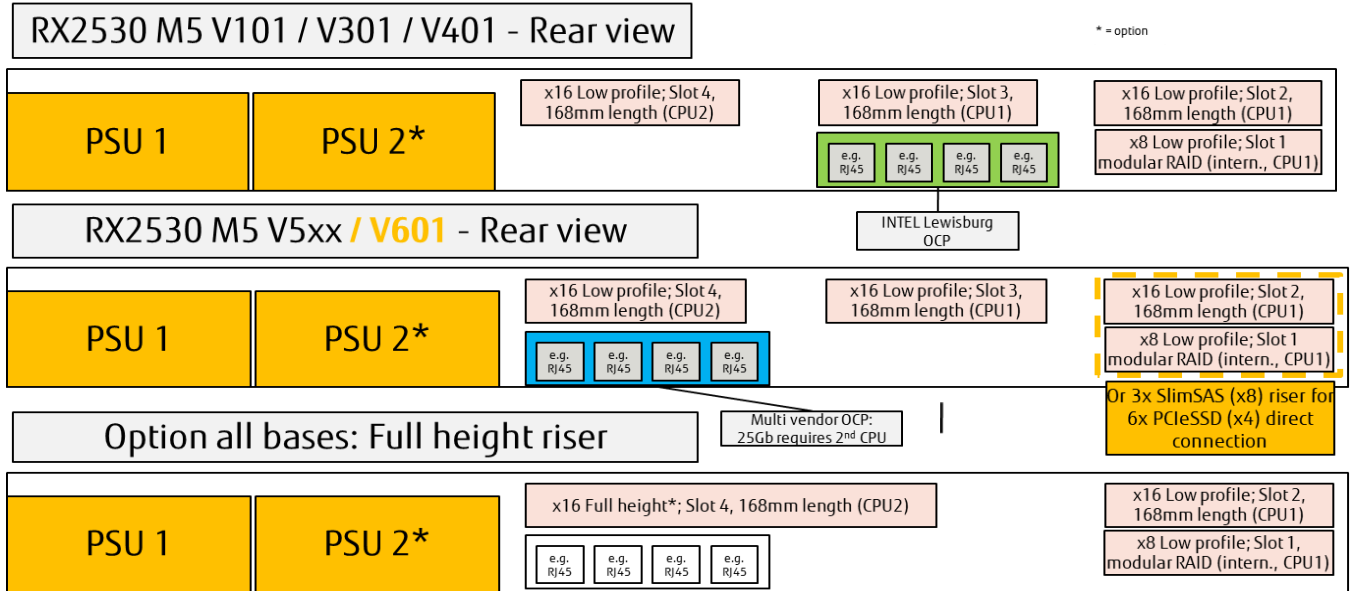

PRIMERGY RX2530 M5 front view with drives and operation panel

RX2530 M5 V101: 4x3.5" - Front view

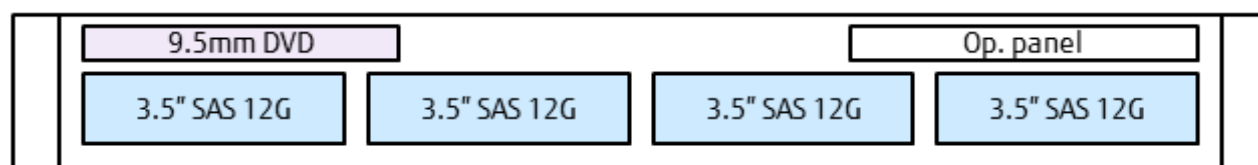

RX2530 M5 V301: 4x2.5" - Front view

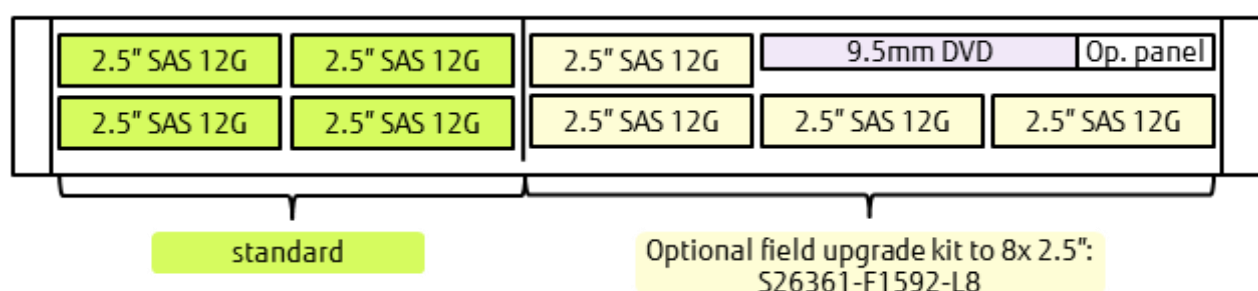

RX2530 M5 V501: 10x2.5" Combo - Front view

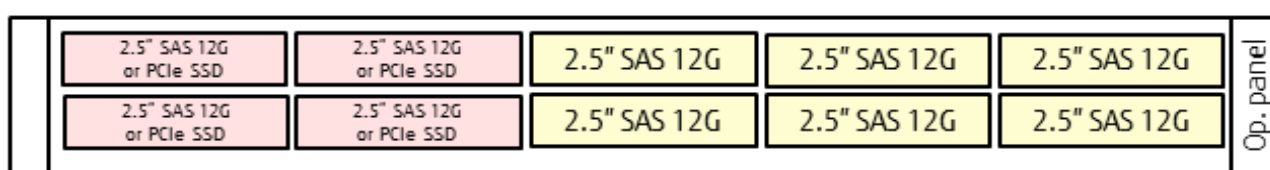

RX2530 M5 V601: 10x SATA / PCIe - Front view

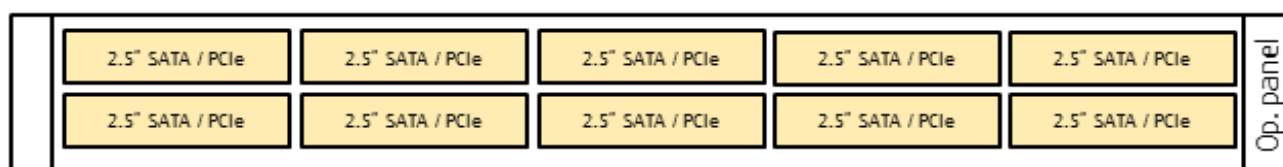

recommended components for RX2530 M5	#
Independant Mode installation	1x
PLAN EM 4x1Gb T interface card	1x
Region kit APAC/EMEA/India	1x
iRMC S5 advanced pack	1x
Modular PSU 450W platinum hot plug	2x

Chapter 1 - base unit

Start

Power supply units & cooling

The PRIMERGY RX2530 M5 offers bays for 1x or 2x direct attached hot plug (opt. redundant) power supply units of 450W, 800W and 1200W with up to 96% efficiency. The PRIMERGY RX2530 M5 comes equipped with ultimate performance processor heat pipes and 3+1 (1CPU) or 7+1 (2 CPU) high performance single hot plug fans (3+1 or 7+1 redundant).

Server Management

iRMC S5 (integrated Remote Management Controller) on-board with dedicated (or shared) 10/100/1000 Service LAN-port and integrated graphics controller. With the integrated onboard indicators and controls you can easily highlight failed components via LEDs. The LEDs can be displayed during service even without mains connection by simply pressing the "indicate CSS" button.

Platform

Fujitsu Systemboard D3383-B "made in Germany" based on Chipset Intel® C624 (Lewisburg) for V101, V301, V401.
 Fujitsu Systemboard D3483-B "made in Germany" based on Chipset Intel® C624 (Lewisburg) for V501, V528, V546, V601.

- > 2 serial QPI links (Quick Path Interconnect)
- > Up to two Intel® Xeon® Processor Scalable Family CPUs (Cascade Lake, DCPMM)
- Slots:** per default, 4 PCIe slots are on Board - please see schematics in "description"
- > 3 PCIe slots low profile, 167mm length @ first CPU:

Slot 1 **PCIe-Gen3 x8 (internal)** - only for modular RAID/SAS controller

Slot 2 **PCIe-Gen3 x16**

Slot 3 **PCIe-Gen3 x16**

- > 1 PCIe slot low profile, 167mm length @ second CPU:

Slot 4 **PCIe-Gen3 x16**

PCIe controller population has to be according to internal or external connectivity requirements. The system offers 1x internal x8 PCIe slot for SAS / RAID controllers and 3x freely configurable PCIe slots x16 for other PCIe controllers. The required riser cards for the above configuration are part of the standard delivery. Slot 4 can also be upgraded to PCIe Gen3 x16 full height, 167mm length (!Slot 3 and it's riser is not available in this case!)

Onboard RAID 0/1 6Gbit/s

available for up to 10x 2.5" SATA drives

System RAM up to DDR4-2666 MHz or 2999MHz

3.072 GB memory with 24x DDR4 LRDIMMs (12 per CPU) or alternatively a mixture of 12 DIMMs and 12x DCPMM modules.

Memory speed depends on CPU and configuration, please see folder "CPU" and "RAM" for further details.

LAN

LAN on Motherboard with 2x1Gbit/s (RJ45) plus the high performance Chip Intel LBG4 with flexible LAN connections - options for 4x1Gbit/s (RJ45), 2x10Gbit/s (RJ45), 2x10Gbit/s (SFP+) and 4x10Gbit/s (SFP+) available.

In addition, 2x25Gbit/s is offered on V501, V528, V546 and V601 base units.

Software

* ServerView Suite Software incl. ServerStart, ServerBooks, Management Software and Updates

Connectivity

<p>Interfaces at rear side</p> <ul style="list-style-type: none"> - 1 service LAN RJ45 (1 Gbit) - 2x RJ45 with integrated LEDs for fixed onboard 1Gb LAN - 1x VGA (15 pins) - 2x USB 3.0 UHCI - 1x serial 16550 interface - Slot for interface cards from INTEL (or other vendors in V501/V528/V546) in OCP FF /w up to 4 LAN ports driven by Lewisburg chip 	<p>Interfaces at front</p> <p>for base units with up to 8 HDD: 2x USB 3.0 and front VGA option for base units with 10HDD: 1x USB2.0 (on "ear"), no front VGA option</p> <p>Interfaces internal</p> <ul style="list-style-type: none"> - 1x USB 3.0, - 2x M.2 - 2x 4* SATA 6G
---	--

Rack version for 19" racks with 1 height unit	
No PSU included in base unit	
Basic unit is without CPU and Memory	
For an orderable basic unit first CPU and one memory = first memory has to be selected	
Basic unit LFF with	
4x 3.5" HDD bays	S26361-K1659-V101
4x 3.5" HDD bays (bulk)	S26361-K1659-V111
No upgrade option LFF available	
No CPU TDP limitation with ATD40 option	
ATD45 max 150W	

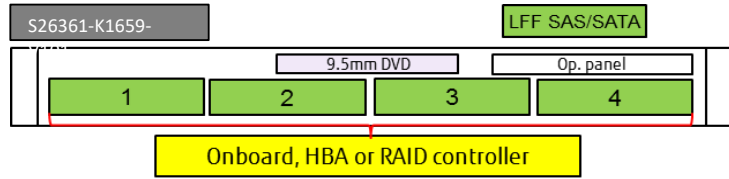

Basic unit SFF with	
4x 2.5" HDD bays	S26361-K1659-V301
4x 2.5" HDD bays (bulk)	S26361-K1659-V311
Optional upgrade kit to 8x 2.5": S26361-F1592-L8	
No CPU TDP limitation with ATD40 option	
ATD45 max 150W	

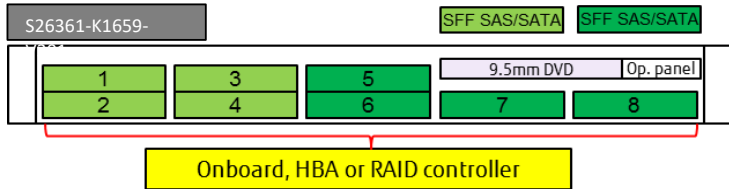

Basic unit SFF with	
8x 2.5" HDD bays	S26361-K1659-V401
8x 2.5" HDD bays (bulk)	S26361-K1659-V411
upgrade kit to 8x 2.5" preconfigured	
No CPU TDP limitation with ATD40 option	
ATD45 max 150W	

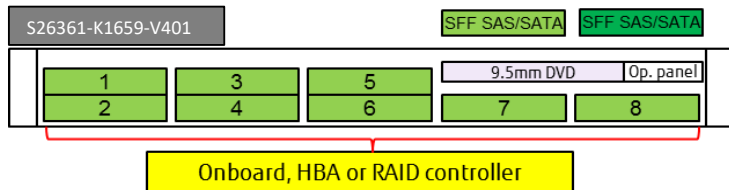

10x 2.5" HDD bays	
S26361-K1659-V501	
Contains MoBo D3483-B with Multi-vendor OCP and 4x x4 SlimSAS for PCIeSSD direct connection	
Up to 10x SAS SFF devices possible	
2 CPUs are mandatory	
No CPU TDP limitation with ATD40 option	
ATD45 max 150W	

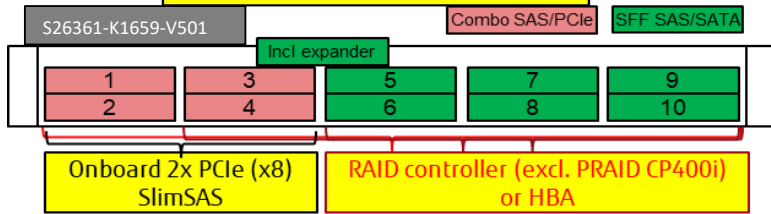

Configuration derivative of V501	
8x 2.5" + 2x PCIe SSD	
S26361-K1659-V528	
Contains MoBo D3483-B with Multi-vendor OCP and needs 1x PRAID EP540i or EP580i for hybrid flash	
Up to 8x SAS SFF devices possible	
No CPU TDP limitation with ATD40 option	
ATD45 max 150W	

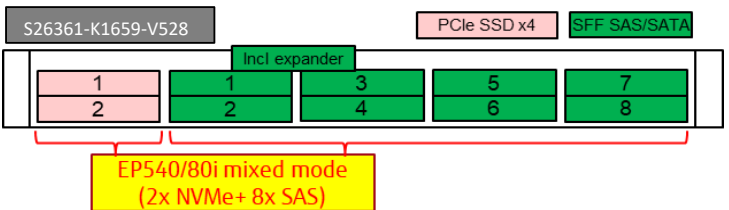

Configuration derivative of V501	
6x 2.5" + 4x PCIe SSD RAID	
S26361-K1659-V546	
Contains MoBo D3483-B with Multi-vendor OCP and needs 2x PRAID EP5x0i for hybrid flash RAID config. Slot1: EP520i, EP540i or HBA possible	
Up to 6x SAS SFF devices possible	
No CPU TDP limitation with ATD40 option	
ATD45 max 150W	

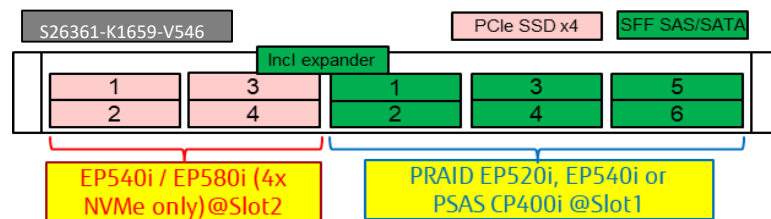

V528 / V546 may also be equipped with up to 10x SAS / SATA

10x 2.5" PCIe SSD AF / SATA	
S26361-K1659-V601	
Contains MoBo D3483-B with Multi-vendor OCP, 4x x4 SlimSAS, 10 ch. onboard SATA and additional 6x x4 SlimSAS riser for PCIeSSD direct connection	
Only two lp PCIe slots available!	
No SAS HBA or RAID controller possible	
2 CPUs are mandatory	
No ATD in this base unit	

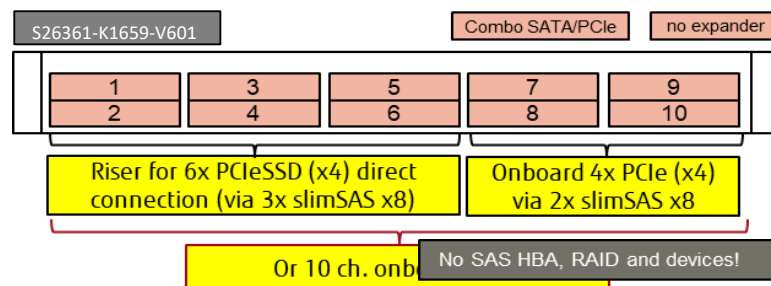

Basic units Liquid Cooled for Performance Storage applications	
10x 2.5" LC performance storage	S26361-K1659-V7xx

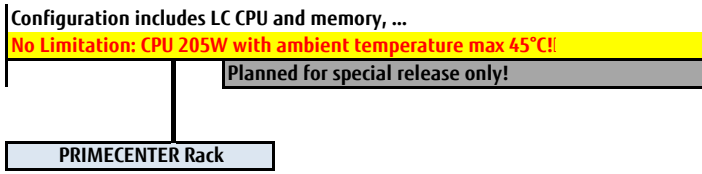

Chapter 2 - Rack architecture

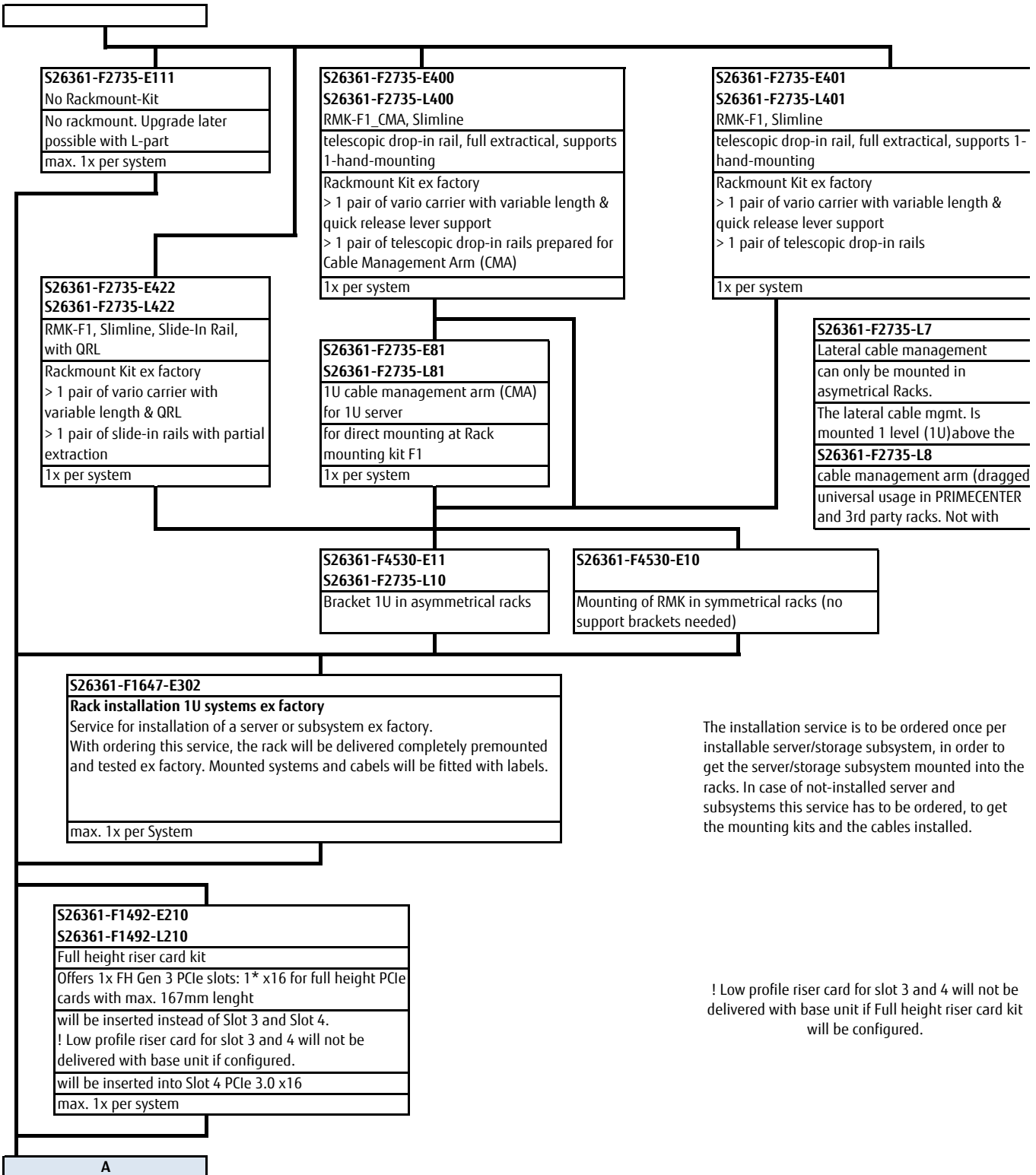

The installation service is to be ordered once per installable server/storage subsystem, in order to get the server/storage subsystem mounted into the racks. In case of not-installed server and subsystems this service has to be ordered, to get the mounting kits and the cables installed.

! Low profile riser card for slot 3 and 4 will not be delivered with base unit if Full height riser card kit will be configured.

Chapter 3 - CPU

B

There are 2 processor sockets available. Please configure 1 or 2 Processors.
 >> All processors have to be the same type.
 >> With **one** processor OCP LOM, iRMC, 3x PCIe card slots (1x internal and 2x lp x16) and 12x DIMM slots are available
 >> With **two** processors all 24x DIMM slots, 4x PCIe card slots (1x internal and 3x lp x16) are available.
 >> To configure 2nd CPU an additional cooler kit is required.
 >> Empty CPU slot have to be filled up with a CPU Dummy!
 * HT = Hyper Threading

Xeon Bronze 3200 - Basic (Shelf 1)		
64-bit Intel Xeon processor supporting DDR4 @ 2133MHz & UPI Bus @ 9.6 GT/s		
Xeon Bronze 3204 6C nHT 1.9 GHz 85W	S26361-F4082-E104	S26361-F4082-L104
Xeon Bronze 3206R 8C nHT 1.9GHz 85W	S26361-F4082-E806	S26361-F4082-L806
Xeon Silver 4200 - Standard (Shelf 2)		
64-bit Intel Xeon processor supporting HT*, DDR4 @ 2400 MHz & UPI Bus 9.6 GT/s		
Xeon Silver 4208 8C 2.1GHz 85W	S26361-F4082-E108	S26361-F4082-L108
Xeon Silver 4210 10C 2.2GHz 85W	S26361-F4082-E110	S26361-F4082-L110
Xeon Silver 4210R 10C 2.4GHz 100W	S26361-F4082-E811	S26361-F4082-L811
Xeon Silver 4214 12C 2.2GHz 85W	S26361-F4082-E114	S26361-F4082-L114
Xeon Silver 4214R 12C 2.4GHz 100W	S26361-F4082-E814	S26361-F4082-L814
Xeon Silver 4216 16C 2.1GHz 100W	S26361-F4082-E116	S26361-F4082-L116
Xeon Silver 4200 - Frequency Optimized (Shelf 2)		
64-bit Intel Xeon processor supporting HT*, DDR4 @ 2400 MHz & UPI Bus @ 9.6 GT/s		
Xeon Silver 4215 8C 2.5GHz 85W	S26361-F4082-E115	S26361-F4082-L115
Xeon Silver 4215R 8C 3.2GHz 130W	S26361-F4082-E815	S26361-F4082-L815
Xeon Gold 5200 - Advanced AEP enabled (Shelf 3)		
64-bit Intel Xeon processor supporting HT*, DDR4 @ 2666 MHz & UPI Bus @ 10.4 GT/s		
Xeon Gold 5215 10C 2.5GHz 85W	S26361-F4082-E215	S26361-F4082-L215
Xeon Gold 5217 8C 3.0GHz 85W	S26361-F4082-E217	S26361-F4082-L217
Xeon Gold 5218 16C 2.3GHz 125W	S26361-F4082-E218	S26361-F4082-L218
Xeon Gold 5218B 16C 2.3GHz 125W	S26361-F4082-E219	S26361-F4082-L219
Xeon Gold 5218R 20C 2.1GHz 125W	S26361-F4082-E818	S26361-F4082-L818
Xeon Gold 5220 18C 2.2GHz 125W	S26361-F4082-E220	S26361-F4082-L220
Xeon Gold 5220R 24C 2.2GHz 150W	S26361-F4082-E820	S26361-F4082-L820
Xeon Gold 5200 - Advanced AEP enabled (Shelf 3)		
64-bit Intel Xeon processor supporting HT*, DDR4 @ 2933 MHz & UPI Bus @ 10.4 GT/s		
Xeon Gold 5222 4C 3.8GHz 105W	S26361-F4082-E222	S26361-F4082-L222
Xeon Gold 5200S - Search Optimized (Shelf 3)		
64-bit Intel Xeon processor supporting HT*, DDR4 @ 2666 MHz & UPI Bus @ 10.4 GT/s		
Xeon Gold 5220S 18C 2.6GHz 125W	S26361-F4082-E221	S26361-F4082-L221
Xeon Gold 6200 - Advanced AEP enabled (Shelf 4)		
64-bit Intel Xeon processor supporting HT*, DDR4 @ 2933 MHz & UPI Bus @ 10.4 GT/s		
Xeon Gold 6226 12C 2.8GHz 125W	S26361-F4082-E326	S26361-F4082-L326
Xeon Gold 6226R 16C 2.9GHz 150W	S26361-F4082-E826	S26361-F4082-L826
Xeon Gold 6230 20C 2.1GHz 125W	S26361-F4082-E330	S26361-F4082-L330
Xeon Gold 6230R 26C 2.1GHz 150W	S26361-F4082-E830	S26361-F4082-L830
Xeon Gold 6234 8C 3.4GHz 130W	S26361-F4082-E334	S26361-F4082-L334
Xeon Gold 6238 22C 2.1GHz 140W	S26361-F4082-E338	S26361-F4082-L338
Xeon Gold 6238R 28C 2.2GHz 165W	S26361-F4082-E838	S26361-F4082-L838
Xeon Gold 6240 18C 2.6GHz 150W	S26361-F4082-E340	S26361-F4082-L340
Xeon Gold 6240R 24C 2.4GHz 165W	S26361-F4082-E840	S26361-F4082-L840
Xeon Gold 6242 16C 2.8GHz 150W	S26361-F4082-E342	S26361-F4082-L342
Xeon Gold 6242R 20C 3.1GHz 205W	S26361-F4082-E842	S26361-F4082-L842
Xeon Gold 6244 8C 3.6GHz 150W	S26361-F4082-E344	S26361-F4082-L344
Xeon Gold 6246 12C 3.3GHz 165W	S26361-F4082-E346	S26361-F4082-L346
Xeon Gold 6246R 16C 3.4GHz 205W	S26361-F4082-E846	S26361-F4082-L846
Xeon Gold 6248 20C 2.5GHz 150W	S26361-F4082-E348	S26361-F4082-L348
Xeon Gold 6248R 24C 3.0GHz 205W	S26361-F4082-E848	S26361-F4082-L848
Xeon Gold 6250 8C 3.9GHz 185W	S26361-F4082-E850	S26361-F4082-L850
Xeon Gold 6252 24C 2.1GHz 150W	S26361-F4082-E352	S26361-F4082-L352
Xeon Gold 6254 18C 3.1GHz 200W	S26361-F4082-E354	S26361-F4082-L354
Xeon Gold 6256 12C 3.6GHz 205W	S26361-F4082-E856	S26361-F4082-L856
Xeon Gold 6258R 28C 2.7GHz 205W	S26361-F4082-E858	S26361-F4082-L858
Xeon Gold 6200V - VM Density Optimized AEP enabled (Shelf 4)		
64-bit Intel Xeon processor supporting HT*, DDR4 @ 2933 MHz & UPI Bus @ 10.4 GT/s		
Xeon Gold 6222V 20C 1.8GHz 115W	S26361-F4082-E322	S26361-F4082-L322
Xeon Gold 6262V 24C 1.9GHz 135W	S26361-F4082-E362	S26361-F4082-L362

B1

* not allowed for Energy Star 3.0

B1

Xeon Platinum 8200 Advanced AEP enabled (Shelf 5)		
64-bit Intel Xeon processor supporting HT*, DDR4 @ 2933 MHz & UPI Bus @ 10.4 GT/s		
Xeon Platinum 8260 24C 2.4GHz 165W	S26361-F4082-E360	S26361-F4082-L360
Xeon Platinum 8268 24C 2.9GHz 205W	S26361-F4082-E368	S26361-F4082-L368
Xeon Platinum 8270 26C 2.7GHz 205W	S26361-F4082-E370	S26361-F4082-L370
Xeon Platinum 8276 28C 2.3GHz 165W	S26361-F4082-E376	S26361-F4082-L376
Xeon Platinum 8280 28C 2.7GHz 205W	S26361-F4082-E380	S26361-F4082-L380
Xeon Gold 5200M - Advanced (Shelf 3; 2.0TB p. Socket)		
64-bit Intel Xeon processor supporting HT*, DDR4 @ 2666 MHz & UPI Bus @ 10.4 GT/s		
Xeon Platinum 5215M 10C 2.5GHz 85W	S26361-F4082-E415	S26361-F4082-L415
Xeon Gold 6200M - Advanced (Shelf 4; 2.0TB p. Socket)		
64-bit Intel Xeon processor supporting HT*, DDR4 @ 2933 MHz & UPI Bus @ 10.4 GT/s		
Xeon Gold 6238M 22C 2.1GHz 140W	S26361-F4082-E438	S26361-F4082-L438
Xeon Gold 6240M 18C 2.6GHz 150W	S26361-F4082-E440	S26361-F4082-L440
Xeon Platinum 8200M - Advanced (2.0 TB p. Socket)		
64-bit Intel Xeon processor supporting HT*, DDR4 @ 2933 MHz & UPI Bus @ 10.4 GT/s		
Xeon Platinum 8260M 24C 2.4GHz 165W	S26361-F4082-E460	S26361-F4082-L460
Xeon Platinum 8276M 28C 2.3GHz 165W	S26361-F4082-E476	S26361-F4082-L476
Xeon Platinum 8280M 28C 2.7GHz 205W	S26361-F4082-E480	S26361-F4082-L480
Xeon Gold 5200L - Advanced (Shelf 3; 4.5TB p. Socket)		
64-bit Intel Xeon processor supporting HT*, DDR4 @ 2666 MHz & UPI Bus @ 10.4 GT/s		
Xeon Platinum 5215L 10C 2.5GHz 85W	S26361-F4082-E515	S26361-F4082-L515
Xeon Gold 6200L - Advanced (Shelf 4; 4.5TB p. Socket)		
64-bit Intel Xeon processor supporting HT*, DDR4 @ 2933 MHz & UPI Bus @ 10.4 GT/s		
Xeon Gold 6238L 22C 2.1GHz 140W	S26361-F4082-E538	S26361-F4082-L538
Xeon Gold 6240L 18C 2.6GHz 150W	S26361-F4082-E540	S26361-F4082-L540
Xeon Platinum 8200L - Advanced (Shelf 5; 4.5TB p. Socket)		
64-bit Intel Xeon processor supporting HT*, DDR4 @ 2933 MHz & UPI Bus @ 10.4 GT/s		
Xeon Platinum 8260L 24C 2.4GHz 165W	S26361-F4082-E560	S26361-F4082-L560
Xeon Platinum 8276L 28C 2.3GHz 165W	S26361-F4082-E576	S26361-F4082-L576
Xeon Platinum 8280L 28C 2.7GHz 205W	S26361-F4082-E580	S26361-F4082-L580
Xeon Silver 4200Y - Speed Select (Shelf 2)		
64-bit Intel Xeon processor supporting HT*, DDR4 @ 2400 MHz & UPI Bus @ 9.6 GT/s		
Xeon Silver 4214Y 8/10/12C 2.2GHz 85W	S26361-F4082-E614	S26361-F4082-L614
Xeon Gold 6200Y - Speed Select (Shelf 4)		
64-bit Intel Xeon processor supporting HT*, DDR4 @ 2933 MHz & UPI Bus @ 10.4 GT/s		
Xeon Gold 6240Y 8/14/18C 2.6GHz 150W	S26361-F4082-E640	S26361-F4082-L640
Xeon Platinum 8200Y - Speed Select (Shelf 5)		
64-bit Intel Xeon processor supporting HT*, DDR4 @ 2933 MHz & UPI Bus @ 10.4 GT/s		
Xeon Platinum 8260Y 16/20/24C 2.4GHz 165W	S26361-F4082-E660	S26361-F4082-L660
Xeon Gold 6200U - Single Socket (Shelf 4)		
64-bit Intel Xeon processor supporting HT*, DDR4 @ 2933 MHz & UPI Bus @ 10.4 GT/s		
Xeon Gold 6208U 16C 2.9GHz 150W	S26361-F4082-E808	
Xeon Gold 6209U 20C 2.1GHz 125W	S26361-F4082-E809	
Xeon Gold 6210U 20C 2.5GHz 150W	S26361-F4082-E810	
Xeon Gold 6212U 24C 2.4GHz 150W	S26361-F4082-E812	
Xeon Gold 6200T - Embedded SKUs		
64-bit Intel Xeon processor supporting HT*, DDR4 @ 2933 MHz & UPI Bus @ 10.4 GT/s		
Xeon Gold 6230T 20C 2.1GHz 125W	S26361-F4082-E930	S26361-F4082-L930
Xeon Gold 6238T 22C 1.9GHz 125W	S26361-F4082-E938	S26361-F4082-L938
Cooler Kit (see comment above; for upgrade please use according kit to the selected CPU)		
Cooling Kit 2nd CPU	S26361-F3849-E100	
Cooling kit up to 130W TDP; no ATD, 4x Single Rotor Fan		S26361-F4051-L830
Cooling kit up to 160W TDP; no ATD, 4x Dual Rotor Fan		S26361-F4051-L831
Cooling kit up to 205W TDP; ATD supported, 4x Dual Rotor Fan		S26361-F4051-L832

C

For configuring a 2nd CPU please order the required cooling kit with this order code

Chapter 4 - DDR4 System memory

C

Each CPU offers 12 Slots for DDR4 Memory Modules organised in 2 Banks and 6 Channels with 2 Memory Controllers (3 Channels each). If you need more than 12 Slots you have to configure the 2nd CPU. Depending on the amount of memory configured you can decide between 3 basic modes of operation (see explanation below).

There are different kinds of DDR4 Memory Modules available: RDIMM x4, RDIMM x8, LRDIMM. Mix of these different kind of memories is not allowed. In addition DCPMM (Data Center Persistent Memory) is available and can be mixed with all kind of memory modules.

Supported memory capacities per CPU:
 768 GB DDR4 RDIMM (12x 64GB 2Rx4)
 1.536 GB DDR4 LRDIMM (12x 128GB 4Rx4/8Rx4) (CPU type with "M" at the end is required)
 960 GB with 6x DDR4 32 GB & 6x DCPMM 128 GB (Standard CPU with type Gold or type Platinum is required; exception is the Xeon Silver 4215 & 4215R SKU)
If DCPMM 128 GB is combined with 64 GB or 128 GB Memory module CPU type with "M" at the end is required!
 1.920 GB with 6x DDR4 64 GB & 6x DCPMM 256 GB (CPU type with "M" at the end is required)
If DCPMM 256 GB is combined with 128 GB Memory module CPU type with "L" at the end is required!
 3.840 GB with 6x DDR4 128 GB & 6x DCPMM 512 GB (CPU type with "L" at the end is required)

Supported memory capacities per System:
 1.536GB using RDIMM
 3.072GB using LRDIMM technology with 128GB per module
 7.680 GB using LRDIMM technology with 128GB per module and 512 GB DCPMM

The memory speed is independent from the configuration (1DPC or 2DPC) but restricted by the CPU SKU (max. 2.933 MT/s). DDR4 memory is operated at 1.2V

S26361-F3694-E10	Independent Mode Installation
Independent Channel Mode allows all channels to be populated in any order. No specific Memory RAS features are defined. 2 different DIMMs are allowed. 6 or 12 identical DIMMs have the best performance per CPU.	
Requires minimum 1 memory Module per CPU	
S26361-F3694-E1	Rank Sparing Mode Installation
BIOS Setup factory preinstalled to this mode. One Rank is spare of other ranks on the same channel. Spare Rank is not shown in System Memory. For effective capacity within a channel, please have a look below. Only one DIMM type is allowed. Not supported with DCPMM modules!	
Requires minimum 2x 1R/2R or 1x 4R/8R modules per CPU	
S26361-F3694-E3	Mirrored Channel Mode Installation
BIOS preconfiguration for Mirror mode. Two or three identical memory modules are always equipped at one memory controller to use the mirrored channel mode. Half of the modules contain active data, the remaining modules contain mirrored data. See details below. Only one DIMM type is allowed. Not supported with DCPMM modules!	
Multiple of 6 identical modules to be configured per CPU	



Resulting memory capacity / Rank Sparing Mode, 1 Channel populated																				
	RDIMM x8				RDIMM x4				LRDIMM											
	8GB	1R	16GB	2R	16GB	1R	32GB	2R	64GB	2R	64GB	4R	128GB	4R						
1DPC	8GB				16GB				32GB				48GB				96GB			
2DPC	8GB				24GB				16GB				48GB				96GB			



Apparently 3DS-DIMMs don't behave like 4Rx4 modules but as 2Rx4; same situation for 8Rx4 organized modules (=> 2Rx4). Result is, that in rank-sparing mode the memory loss is half of one module capacity. This is shown in table above.

DDR4 rg 2933 xRx8			
8GB (1x8GB)	1Rx8 DDR4-2933 R ECC	S26361-F4083-E108	S26361-F4083-L108
16GB (1x16GB)	2Rx8 DDR4-2933 R ECC	S26361-F4083-E116	S26361-F4083-L116

DDR4 rg 2933 xRx4			
16GB (1x16GB)	1Rx4 DDR4-2933 R ECC	S26361-F4083-E316	S26361-F4083-L316
32GB (1x32GB)	2Rx4 DDR4-2933 R ECC	S26361-F4083-E332	S26361-F4083-L332
64GB (1x64GB)	2Rx4 DDR4-2933 R ECC	S26361-F4083-E364	S26361-F4083-L364

DDR4 lr 2933			
64GB (1x64GB)	4Rx4 DDR4-2933 LR ECC	S26361-F4083-E464	S26361-F4083-L464
128GB (1x128GB)	4Rx4 DDR4-2933 LR ECC	S26361-F4083-E428	S26361-F4083-L428

C1

DCPMM configuration section (128 GB Modules)

C1



Only one type of DCPMM is allowed per system!
Only one DCPMM package and one Memory package is allowed per CPU!
Every CPU has to have the same DCPMM & Memory configuration!
Liquid cooling base unit does not support DCPMM

DCPMM 128GB 2666 (Apache Pass)		
128GB (1x128GB) DCPMM-2666	S26361-F4083-E501	S26361-F4083-L501

Available Memory Packages		
192GB (6x32GB) 2Rx4 DDR4-2933 R ECC	S26361-F4083-E333	
384GB (6x64GB) 4Rx4 DDR4-2933 LR ECC	S26361-F4083-E465	

DCPMM 128GB 2666 (Apache Pass)		
256GB (2x128GB) DCPMM-2666	S26361-F4083-E521	
512GB (4x128GB) DCPMM-2666	S26361-F4083-E541	
768GB (6x128GB) DCPMM-2666	S26361-F4083-E561	

Available Memory Packages		
96GB (6x16GB) 1Rx4 DDR4-2933 R ECC	S26361-F4083-E317	
192GB (6x32GB) 2Rx4 DDR4-2933 R ECC	S26361-F4083-E333	
384GB (6x64GB) 4Rx4 DDR4-2933 LR ECC	S26361-F4083-E465	

DCPMM 128GB 2666 (Apache Pass)		
768GB (6x128GB) DCPMM-2666	S26361-F4083-E561	

Available Memory Packages		
768GB (6x128GB) 4Rx4 DDR4-2933 LR ECC	S26361-F4083-E430	

DCPMM 128GB 2666 (Apache Pass)		
256GB (2x128GB) DCPMM-2666	S26361-F4083-E521	

Available Memory Packages		
64GB (4x16GB) 1Rx4 DDR4-2933 R ECC	S26361-F4083-E318	
128GB (4x32GB) 2Rx4 DDR4-2933 R ECC	S26361-F4083-E334	
256GB (4x64GB) 4Rx4 DDR4-2933 LR ECC	S26361-F4083-E466	
128GB (8x16GB) 1Rx4 DDR4-2933 R ECC	S26361-F4083-E319	
256GB (8x32GB) 2Rx4 DDR4-2933 R ECC	S26361-F4083-E335	
512GB (8x64GB) 4Rx4 DDR4-2933 LR ECC	S26361-F4083-E467	

C2

DCPMM configuration section (256 & 512 GB Modules)

C2		
DCPMM 256GB 2666 (Apache Pass)		
256GB (1x256GB) DCPMM-2666		S26361-F4083-L502
512GB (2x256GB) DCPMM-2666	S26361-F4083-E522	
1024GB (4x256GB) DCPMM-2666	S26361-F4083-E542	
1536GB (6x256GB) DCPMM-2666	S26361-F4083-E562	
Available Memory Packages		
96GB (6x16GB) 1Rx4 DDR4-2933 R ECC	S26361-F4083-E317	
192GB (6x32GB) 2Rx4 DDR4-2933 R ECC	S26361-F4083-E333	
384GB (6x64GB) 4Rx4 DDR4-2933 LR ECC	S26361-F4083-E465	
DCPMM 256GB 2666 (Apache Pass)		
1536GB (6x256GB) DCPMM-2666	S26361-F4083-E562	
Available Memory Packages		
768GB (6x128GB) 4Rx4 DDR4-2933 LR ECC	S26361-F4083-E430	
DCPMM 256GB 2666 (Apache Pass)		
512GB (2x256GB) DCPMM-2666	S26361-F4083-E522	
Available Memory Packages		
64GB (4x16GB) 1Rx4 DDR4-2933 R ECC	S26361-F4083-E318	
128GB (4x32GB) 2Rx4 DDR4-2933 R ECC	S26361-F4083-E334	
256GB (4x64GB) 4Rx4 DDR4-2933 LR ECC	S26361-F4083-E466	
128GB (8x16GB) 1Rx4 DDR4-2933 R ECC	S26361-F4083-E319	
256GB (8x32GB) 2Rx4 DDR4-2933 R ECC	S26361-F4083-E335	
512GB (8x64GB) 4Rx4 DDR4-2933 LR ECC	S26361-F4083-E467	
DCPMM 512GB 2666 (Apache Pass)		
512GB (1x512GB) DCPMM-2666		S26361-F4083-L503
2048GB (4x512GB) DCPMM-2666	S26361-F4083-E543	
3072GB (6x512GB) DCPMM-2666	S26361-F4083-E563	
Available Memory Packages		
384GB (6x64GB) 4Rx4 DDR4-2933 LR ECC	S26361-F4083-E465	
DCPMM 512GB 2666 (Apache Pass)		
3072GB (6x512GB) DCPMM-2666	S26361-F4083-E563	
Available Memory Packages		
768GB (6x128GB) 4Rx4 DDR4-2933 LR ECC	S26361-F4083-E430	
D		

Detailed information

Mode	Configuration	RDIMM	RDIMM	Use case, advantage
		x8	LRDIMM x4	
SDDC (chipkill) support	any	no	yes	supports detecting multi-bit errors
Independant channel mode	1 or 2 Modules per Bank	yes	yes	offers max. flexibility, upgradeability, capacity
Mirrored channel mode *)	6 identical Modules / Bank	no	yes	offers maximum security
Rank sparing mode *)	min. 2 Ranks / Channel	no	yes	balances performance and capacity

*) For the delivery ex factory the system will be prepared with dedicated BIOS setting.

Capacity	Configuration	RDIMM	LRDIMM	Notes
Min. Memory per CPU	1 Module / CPU	1x8GB	1x64GB	with one CPU
Max. Memory per CPU	12 Modules / CPU	12x64GB	12x128GB	with one CPU
Max. Memory per System	24 Modules / System	1536GB	3.072GB	if second CPU is configured

The memory sockets on the Systemboards are color coded

Bank I	black sockets	Bank II	blue sockets
---------------	---------------	----------------	--------------

Independant channel mode

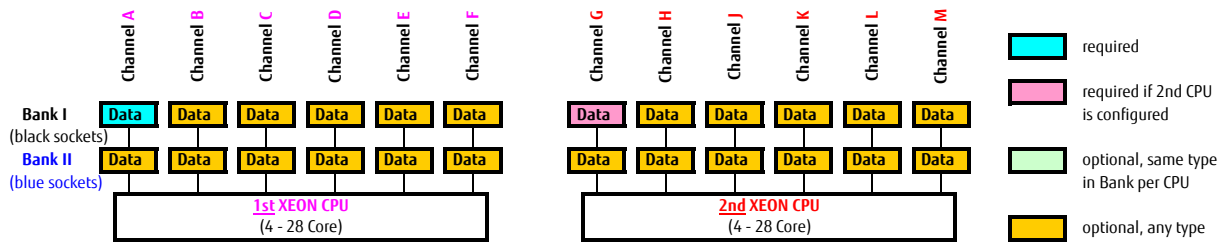

Rank sparing mode --- 1-Rank Memory modules (RDIMM)

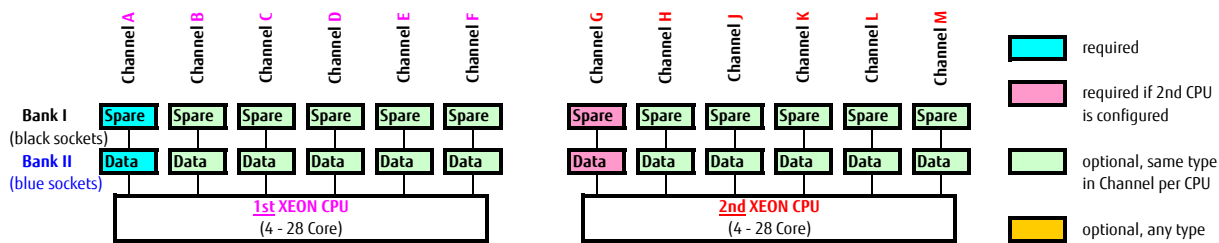

Rank sparing mode --- 2-Rank Memory modules (RDIMM)

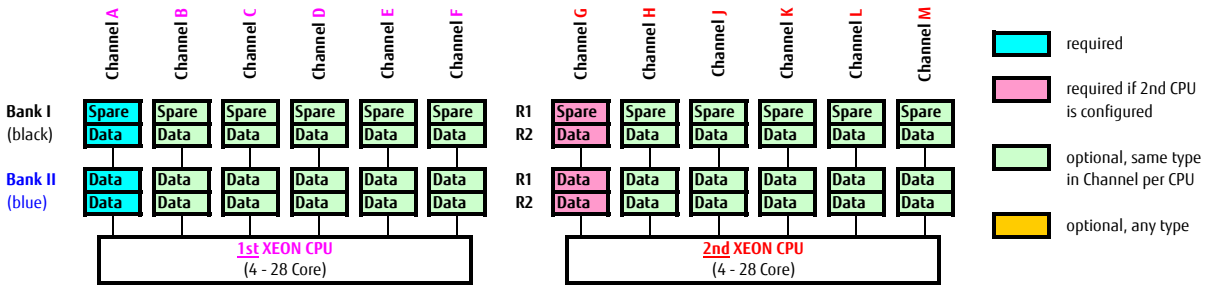

Rank sparing mode --- 4-Rank Memory modules (RDIMM 3DS)

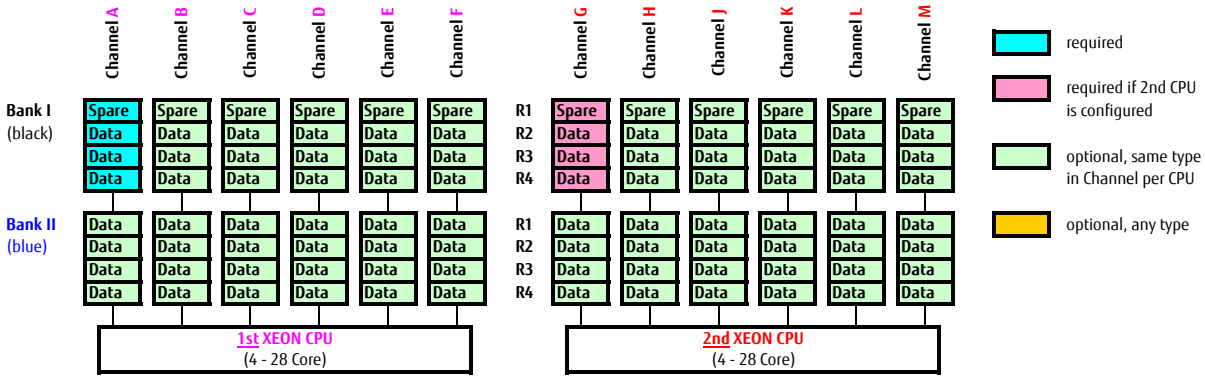

Rank Sparing Mode requires identical modules (same capacity and technology) within the same channel. The available memory for applications will vary depending on configuration. Please refer to the spreadsheet above "Effective Memory capacity with active Rank Sparing Mode". Population rule for Rank sparing mode is to achieve max. available memory, e.g. 4 DIMMs will be spread across two channels, each with 2DPC

Mirror Channel Mode (2 DIMMS per CPU)

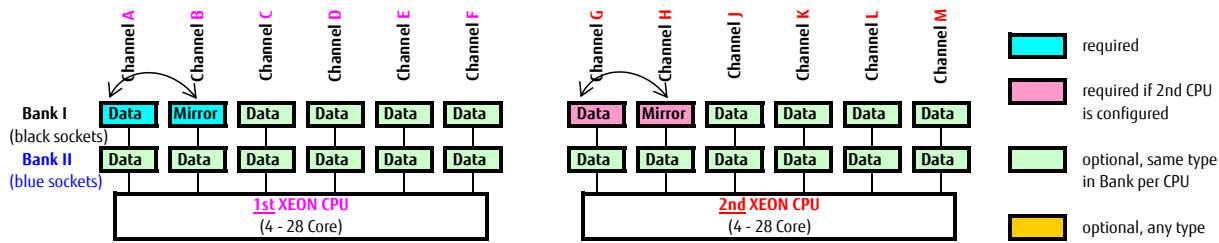

Mirrored Channel Mode (2 DIMMS per CPU) requires identical modules on channel A & B (1st CPU) or channel G & H (2nd CPU) 50% of the capacity is used for the mirror => the available memory for applications is only half of the installed memory. If this mode is used, a multiple of 2 identical modules has to be ordered.

Mirror Channel Mode (3 DIMMS per CPU)

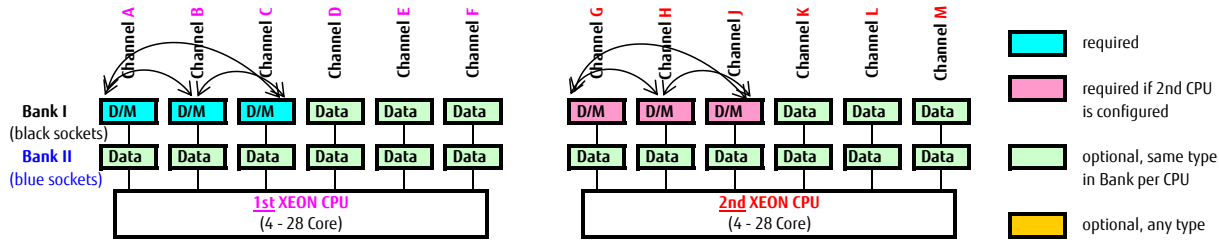

Mirrored Channel Mode (3 DIMMS per CPU) requires identical modules on channel A, B & C (1st CPU) or channel G, H & J (2nd CPU) 50% of the capacity is used for the mirror => the available memory for applications is only half of the installed memory. If this mode is used, a multiple of 3 identical modules has to be ordered.

Mirror Channel Mode (4 DIMMS per CPU)

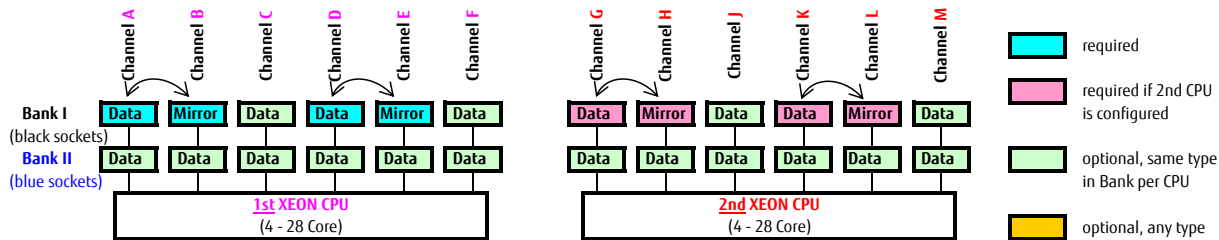

Mirrored Channel Mode (4 DIMMS per CPU) requires identical modules on channel A, B, D & E (1st CPU) or channel G, H, K & L (2nd CPU) 50% of the capacity is used for the mirror => the available memory for applications is only half of the installed memory. If this mode is used, a multiple of 4 identical modules has to be ordered.

Mirror Channel Mode (6 DIMMS per CPU)

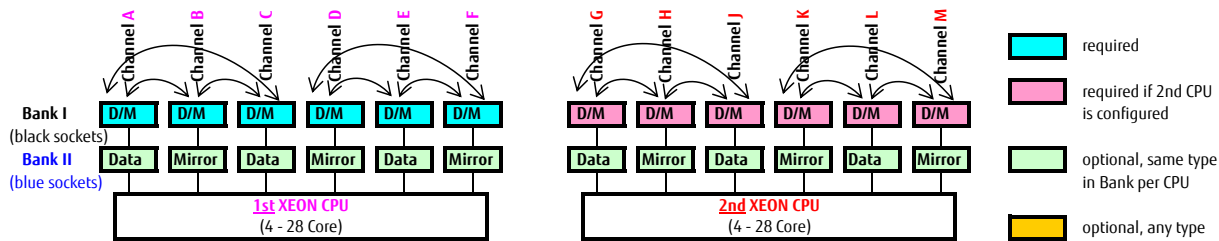

Mirrored Channel Mode requires identical modules on channel A, B, C, D, E, F (1st CPU) or channel G, H, J, K, L and M (2nd CPU) 50% of the capacity is used for the mirror => the available memory for applications is only half of the installed memory. If this mode is used, a multiple of 6 identical modules has to be ordered.

Released configurations with DCPMM modules per CPU

Modes	iMC0						iMC1						Config
	Channel 0		Channel 1		Channel 2		Channel 0		Channel 1		Channel 2		
	Bank II	Bank I	Bank II	Bank I	Bank II	Bank I	Bank II	Bank I	Bank II	Bank I	Bank II	Bank I	
AD + MM	128	16	128	16	128	16	128	16	128	16	128	16	2-2-2
AD + MM	128	32	128	32	128	32	128	32	128	32	128	32	2-2-2
AD	128	64	128	64	128	64	128	64	128	64	128	64	2-2-2
AD	128	128	128	128	128	128	128	128	128	128	128	128	2-2-2
AD + MM	256	16	256	16	256	16	256	16	256	16	256	16	2-2-2
AD + MM	256	32	256	32	256	32	256	32	256	32	256	32	2-2-2
AD + MM	256	64	256	64	256	64	256	64	256	64	256	64	2-2-2
AD	256	128	256	128	256	128	256	128	256	128	256	128	2-2-2
AD + MM	512	64	512	64	512	64	512	64	512	64	512	64	2-2-2
AD + MM	512	128	512	128	512	128	512	128	512	128	512	128	2-2-2
AD + MM	128	16	128	16		16	128	16	128	16		16	2-2-1
AD	128	32	128	32		32	128	32	128	32		32	2-2-1
AD	128	64	128	64		64	128	64	128	64		64	2-2-1
AD + MM	256	16	256	16		16	256	16	256	16		16	2-2-1
AD + MM	256	32	256	32		32	256	32	256	32		32	2-2-1
AD	256	64	256	64		64	256	64	256	64		64	2-2-1
AD + MM	512	64	512	64		64	512	64	512	64		64	2-2-1
AD	128	16		16		16	128	16		16		16	2-1-1
AD	128	32		32		32	128	32		32		32	2-1-1
AD	128	64		64		64	128	64		64		64	2-1-1
AD + MM	256	16		16		16	256	16		16		16	2-1-1
AD	256	32		32		32	256	32		32		32	2-1-1
AD	256	64		64		64	256	64		64		64	2-1-1
AD + MM		16		16		128		16		16		128	1-1-1
AD		32		32		128		32		32		128	1-1-1
AD		64		64		128		64		64		128	1-1-1
AD + MM		16		16		256		16		16		256	1-1-1
AD + MM		32		32		256		32		32		256	1-1-1
AD		64		64		256		64		64		256	1-1-1
AD	16	16	16	16		128	16	16	16	16		128	2-2-1
AD	32	32	32	32		128	32	32	32	32		128	2-2-1
AD	64	64	64	64		128	64	64	64	64		128	2-2-1
AD	16	16	16	16		256	16	16	16	16		256	2-2-1
AD	32	32	32	32		256	32	32	32	32		256	2-2-1
AD	64	64	64	64		256	64	64	64	64		256	2-2-1
AD	128	32		32		32		32		32		32	2/1-1-1
AD	128	64		64		64		64		64		64	2/1-1-1

Chapter 5 - Graphics options

D

S26361-F1420-E131 S26361-F1420-L131 Front VGA connector (15-pin) Front VGA connector (15-pin) including cable and front connector not for 1Dx 2.5" base unit (S26361-K1592-V501); max. 1x per system	S26361-F4066-E401 S26361-F4066-L401 PGRA (P-NVIDIA Quadro P400) NVIDIA Quadro 2GB PCIe 3.0 x16 Connectors: 3x Mini-DP no cable kits included cables must be ordered separately Triplet head + professional 2-D + 3-D supported for Windows OS native driver support for Linux OS Low profile bracket max. 1x per system
Optional Front VGA only possible for onboard graphics	S26361-F4066-E11 S26361-F4066-L11 MiniDP-DP ADAPTER max. 3x per card
S26361-F4066-E12 S26361-F4066-L12 DP-VGA ADAPTER max. 3x per card	S26361-F4066-E13 S26361-F4066-L13 DP-DVI ADAPTER max. 3x per card

NVIDIA TESLA T4 GPU pass through / vGPU

Tesla T4 is not necessary GFX/GPU card external power cable and also not necessary GFX/GPU mounting Kit...

S26391-F3948-L40 GFX/GPU upgrade kit Cable Kit to install one GFX/GPU card ex-work includes different power cables for released cards

S26361-F4025-E400 S26361-F4025-L400
PY NVIDIA Tesla T4
NVIDIA Tesla T4 Card with 2560 graphic cores & 16GB GDDR6 RAM, PCIe Gen3 x16, Low profile, power cables from PSU need to be ordered separately, 800W PSU is recommended
PCIe *16 (Gen3) - single width, low profile bracket, no external power cable, 70W
Limitation: CPU max 150W with ambient temperature max 30°C!
max. 2x per system

For GRID 3.0 or later to use the virtual graphic (GRID) functionality, a SW activation key and support license has to be purchased additionally. Please refer to additional license offerings for Virtual Applications / Virtual PC / Virtual Workstation plus SUMS (Support, Updates & Maintenance [subpartitions](#))
Cards personality is set to graphic card ex factory!

Perpetual Software license

S26361-F4024-S101 S26361-F4024-L101
GRID Virtual Applications (vApps) Perpetual License, 1 CCU
24x per P40 card
32x per M60 card
64x per M10 card

S26361-F4024-S201 S26361-F4024-L201
NVIDIA GRID Virtual PC (vPC) Perpetual License, 1 CCU
24x per P40 card
32x per M60 card
64x per M10 card

S26361-F4024-S301 S26361-F4024-L301
NVIDIA Quadro Virtual Datacenter Work Station (vDWS) Perpetual License, 1 CCU
24x per P40 card
32x per M60 card
64x per M10 card

! SUMS must be ordered in equal numbers with each SW perpetual licenses. Please refer data sheet.

S26361-F4024-S803 S26361-F4024-L803
NVIDIA GRID vApps Prod SUMS 3 year, 1 CCU
same volume with perpetual license

S26361-F4024-S804 S26361-F4024-L804
NVIDIA GRID vApps Prod SUMS 4 year, 1 CCU
same volume with perpetual license

S26361-F4024-S805 S26361-F4024-L805
NVIDIA GRID vApps Prod SUMS 5 year, 1 CCU
same volume with perpetual license

S26361-F4024-S813 S26361-F4024-L813
NVIDIA GRID vPC Prod SUMS 3 year, 1 CCU
same volume with perpetual license

S26361-F4024-S814 S26361-F4024-L814
NVIDIA GRID vPC Prod SUMS 4 year, 1 CCU
same volume with perpetual license

S26361-F4024-S815 S26361-F4024-L815
NVIDIA GRID vPC Prod SUMS 5 year, 1 CCU
same volume with perpetual license

S26361-F4024-S823 S26361-F4024-L823
NVIDIA Quadro vDWS Prod SUMS 3 year, 1 CCU
same volume with perpetual license

S26361-F4024-S824 S26361-F4024-L824
NVIDIA Quadro vDWS Prod SUMS 4 year, 1 CCU
same volume with perpetual license

S26361-F4024-S825 S26361-F4024-L825
NVIDIA Quadro vDWS Prod SUMS 5 year, 1 CCU
same volume with perpetual license

!

NVIDIA SUMS License (6 months) for renewal - Loose Delivery -

S26361-F4024-L956
NVIDIA GRID vApps Prod SUMS 6 months Renew, 1CCU
NVIDIA SUMS License (6 months) for renewal. It needs if you need to continue SUMS.

S26361-F4024-L966
NVIDIA GRID vPC Prod SUMS 6 months Renew, 1 CCU
NVIDIA SUMS License (6 months) for renewal. It needs if you need to continue SUMS.

S26361-F4024-L976
NVIDIA GRID vWS Prod SUMS 6 months Renew, 1 CCU
NVIDIA SUMS License (6 months) for renewal. It needs if you need to continue SUMS.

NVIDIA SUMS License (1 year) for renewal - Loose Delivery -

S26361-F4024-L901
NVIDIA GRID vApps Prod SUMS 1yr Renew, 1CCU
NVIDIA SUMS License (1year) for renewal. It needs if you need to continue SUMS.

S26361-F4024-L911
NVIDIA GRID vPC Prod SUMS 1yr Renew, 1 CCU
NVIDIA SUMS License (1year) for renewal. It needs if you need to continue SUMS.

S26361-F4024-L921
NVIDIA GRID vWS Prod SUMS 1yr Renew, 1 CCU
NVIDIA SUMS License (1year) for renewal. It needs if you need to continue SUMS.

NVIDIA SUMS License (2 years) for renewal - Loose Delivery -

S26361-F4024-L952
NVIDIA GRID vApps Prod SUMS 2yrs Renew, 1CCU
NVIDIA SUMS License (2years) for renewal. It needs if you need to continue SUMS.

S26361-F4024-L962
NVIDIA GRID vPC Prod SUMS 2yrs Renew, 1 CCU
NVIDIA SUMS License (2years) for renewal. It needs if you need to continue SUMS.

S26361-F4024-L972
NVIDIA GRID vWS Prod SUMS 2yrs Renew, 1 CCU
NVIDIA SUMS License (2years) for renewal. It needs if you need to continue SUMS.

NVIDIA SUMS License (3 years) for renewal - Loose Delivery -

S26361-F4024-L953
NVIDIA GRID vApps Prod SUMS 3yrs Renew, 1CCU
NVIDIA SUMS License (3years) for renewal. It needs if you need to continue SUMS.

S26361-F4024-L963
NVIDIA GRID vPC Prod SUMS 3yrs Renew, 1 CCU
NVIDIA SUMS License (3years) for renewal. It needs if you need to continue SUMS.

S26361-F4024-L973
NVIDIA GRID vWS Prod SUMS 3yrs Renew, 1 CCU
NVIDIA SUMS License (3years) for renewal. It needs if you need to continue SUMS.

NVIDIA SUMS License (4 years) for renewal - Loose Delivery -

S26361-F4024-L954
NVIDIA GRID vApps Prod SUMS 4yrs Renew, 1CCU
NVIDIA SUMS License (4years) for renewal. It needs if you need to continue SUMS.

S26361-F4024-L964
NVIDIA GRID vPC Prod SUMS 4yrs Renew, 1 CCU
NVIDIA SUMS License (4years) for renewal. It needs if you need to continue SUMS.

S26361-F4024-L974
NVIDIA GRID vWS Prod SUMS 4yrs Renew, 1 CCU
NVIDIA SUMS License (4years) for renewal. It needs if you need to continue SUMS.

NVIDIA SUMS License (5 years) for renewal - Loose Delivery -

S26361-F4024-L955
NVIDIA GRID vApps Prod SUMS 5yrs Renew, 1CCU
NVIDIA SUMS License (5years) for renewal. It needs if you need to continue SUMS.

S26361-F4024-L965
NVIDIA GRID vPC Prod SUMS 5yrs Renew, 1 CCU
NVIDIA SUMS License (5years) for renewal. It needs if you need to continue SUMS.

S26361-F4024-L975
NVIDIA GRID vWS Prod SUMS 5yrs Renew, 1 CCU
NVIDIA SUMS License (5years) for renewal. It needs if you need to continue SUMS.

Subscription Software license

i This license model is NOT requirement for SUMS (Support license). It is including it.

S26361-F4024-S111 S26361-F4024-L111 GRID Virtual Applications (vApps) Subscription License, 1 year, 1 CCU 24x per P40 card 32x per M60 card 64x per M10 card	S26361-F4024-S113 S26361-F4024-L113 GRID Virtual Applications (vApps) Subscription License, 3 years, 1 CCU 24x per P40 card 32x per M60 card 64x per M10 card	S26361-F4024-S115 S26361-F4024-L115 GRID Virtual Applications (vApps) Subscription License, 5 years, 1 CCU 24x per P40 card 32x per M60 card 64x per M10 card	S26361-F4024-S211 S26361-F4024-L211 NVIDIA GRID Virtual PC (vPC) Subscription License, 1 year, 1 CCU 24x per P40 card 32x per M60 card 64x per M10 card	S26361-F4024-S213 S26361-F4024-L213 NVIDIA GRID Virtual PC (vPC) Subscription License, 3 years, 1 CCU 24x per P40 card 32x per M60 card 64x per M10 card	S26361-F4024-S215 S26361-F4024-L215 NVIDIA GRID Virtual PC (vPC) Subscription License, 5 years, 1 CCU 24x per P40 card 32x per M60 card 64x per M10 card	S26361-F4024-S311 S26361-F4024-L311 NVIDIA Quadro Virtual Datacenter Work Station (vDWS) Subscription License, 1 year, 1 CCU 24x per P40 card 32x per M60 card 64x per M10 card	S26361-F4024-S313 S26361-F4024-L313 NVIDIA Quadro Virtual Datacenter Work Station (vDWS) Subscription License, 3 years, 1 CCU 24x per P40 card 32x per M60 card 64x per M10 card	S26361-F4024-S315 S26361-F4024-L315 NVIDIA Quadro Virtual Datacenter Work Station (vDWS) Subscription License, 5 years, 1 CCU 24x per P40 card 32x per M60 card 64x per M10 card
--	---	---	---	--	--	---	--	--

i

NVIDIA Subscription License (6 months) for renewal - Loose Delivery - S26361-F4024-L906 NVIDIA GRID vApps Subscription License 6 months Renew, 1 CCU NVIDIA Subscription License (6 months) for renewal. It needs if you need to continue Subscription.	S26361-F4024-L916 NVIDIA GRID vPC Subscription License 6 months Renew, 1 CCU NVIDIA Subscription License (6 months) for renewal. It needs if you need to continue Subscription.	S26361-F4024-L926 NVIDIA GRID Quadro vDWS Subscription License 6 months Renew, 1 CCU NVIDIA Subscription License (6 months) for renewal. It needs if you need to continue Subscription.
NVIDIA Subscription License (1 year) for renewal - Loose Delivery - S26361-F4024-L902 NVIDIA GRID vApps Subscription License 1yr Renew, 1 CCU NVIDIA Subscription License (1 year) for renewal. It needs if you need to continue Subscription.	S26361-F4024-L912 NVIDIA GRID vPC Subscription License 1yr Renew, 1 CCU NVIDIA Subscription License (1 year) for renewal. It needs if you need to continue Subscription.	S26361-F4024-L922 NVIDIA GRID Quadro vDWS Subscription License 1yr Renew, 1 CCU NVIDIA Subscription License (1 year) for renewal. It needs if you need to continue Subscription.
NVIDIA Subscription License (2 years) for renewal - Loose Delivery - S26361-F4024-L900 NVIDIA GRID vApps Subscription License 2yrs Renew, 1 CCU NVIDIA Subscription License (2 years) for renewal. It needs if you need to continue Subscription.	S26361-F4024-L910 NVIDIA GRID vPC Subscription License 2yrs Renew, 1 CCU NVIDIA Subscription License (2 years) for renewal. It needs if you need to continue Subscription.	S26361-F4024-L920 NVIDIA GRID Quadro vDWS Subscription License 2yrs Renew, 1 CCU NVIDIA Subscription License (2 years) for renewal. It needs if you need to continue Subscription.
NVIDIA Subscription License (3 years) for renewal - Loose Delivery - S26361-F4024-L903 NVIDIA GRID vApps Subscription License 3yrs Renew, 1 CCU NVIDIA Subscription License (3 years) for renewal. It needs if you need to continue Subscription.	S26361-F4024-L913 NVIDIA GRID vPC Subscription License 3yrs Renew, 1 CCU NVIDIA Subscription License (3 years) for renewal. It needs if you need to continue Subscription.	S26361-F4024-L923 NVIDIA GRID Quadro vDWS Subscription License 3yrs Renew, 1 CCU NVIDIA Subscription License (3 years) for renewal. It needs if you need to continue Subscription.
NVIDIA Subscription License (5 years) for renewal - Loose Delivery - S26361-F4024-L905 NVIDIA GRID vApps Subscription License 5yrs Renew, 1 CCU NVIDIA Subscription License (5 years) for renewal. It needs if you need to continue Subscription.	S26361-F4024-L915 NVIDIA GRID vPC Subscription License 5yrs Renew, 1 CCU NVIDIA Subscription License (5 years) for renewal. It needs if you need to continue Subscription.	S26361-F4024-L925 NVIDIA GRID Quadro vDWS Subscription License 5yrs Renew, 1 CCU NVIDIA Subscription License (5 years) for renewal. It needs if you need to continue Subscription.

Education Software license

Perpetual license

S26361-F4024-S401 S26361-F4024-L401 NVIDIA GRID EDU Perpetual License, 1 CCU 24x per P40 card 32x per M60 card 64x per M10 card

i EDU SUMS must be ordered in equal numbers with each SW perpetual licenses. Please refer data sheet.

Subscription license

S26361-F4024-S411 S26361-F4024-L411 NVIDIA GRID EDU Subscription License, 1 year, 1 CCU 24x per P40 card 32x per M60 card 64x per M10 card	S26361-F4024-S413 S26361-F4024-L413 NVIDIA GRID EDU Subscription License, 3 year, 1 CCU 24x per P40 card 32x per M60 card 64x per M10 card
--	--

S26361-F4024-S833 S26361-F4024-L833 NVIDIA GRID EDU SUMS 3 year, 1 CCU same volume with EDU perpetual license	S26361-F4024-S834 S26361-F4024-L834 NVIDIA GRID EDU SUMS 4 year, 1 CCU same volume with EDU perpetual license	S26361-F4024-S835 S26361-F4024-L835 NVIDIA GRID EDU SUMS 5 year, 1 CCU same volume with EDU perpetual license
---	---	---

i

NVIDIA EDU SUMS License (6 months) for renewal - Loose Delivery - S26361-F4024-L930 NVIDIA GRID EDU SUMS 6 months Renew, 1 CCU NVIDIA EDU SUMS License (6 months) for renewal. It needs if you need to continue EDU SUMS.	NVIDIA EDU SUMS License (1 year) for renewal - Loose Delivery - S26361-F4024-L931 NVIDIA GRID EDU SUMS 1yr Renew, 1 CCU NVIDIA EDU SUMS License (1 year) for renewal. It needs if you need to continue EDU SUMS.	NVIDIA EDU SUMS License (2 years) for renewal - Loose Delivery - S26361-F4024-L932 NVIDIA GRID EDU SUMS 2yrs Renew, 1 CCU NVIDIA EDU SUMS License (2 years) for renewal. It needs if you need to continue EDU SUMS.	NVIDIA EDU SUMS License (3 years) for renewal - Loose Delivery - S26361-F4024-L933 NVIDIA GRID EDU SUMS 3yrs Renew, 1 CCU NVIDIA EDU SUMS License (3 years) for renewal. It needs if you need to continue EDU SUMS.	NVIDIA EDU SUMS License (4 years) for renewal - Loose Delivery - S26361-F4024-L934 NVIDIA GRID EDU SUMS 4yrs Renew, 1 CCU NVIDIA EDU SUMS License (4 years) for renewal. It needs if you need to continue EDU SUMS.	NVIDIA EDU SUMS License (5 years) for renewal - Loose Delivery - S26361-F4024-L935 NVIDIA GRID EDU SUMS 5yrs Renew, 1 CCU NVIDIA EDU SUMS License (5 years) for renewal. It needs if you need to continue EDU SUMS.
---	--	---	---	---	---

i

NVIDIA Subscription License (6 months) for renewal - Loose Delivery - S26361-F4024-L946 NVIDIA GRID EDU Subscription License 6 months Renew, 1 CCU NVIDIA Subscription License (6 months) for renewal. It needs if you need to continue Subscription.	NVIDIA Subscription License (1 year) for renewal - Loose Delivery - S26361-F4024-L941 NVIDIA GRID EDU Subscription License 1yr Renew, 1 CCU NVIDIA Subscription License (1 year) for renewal. It needs if you need to continue Subscription.	NVIDIA Subscription License (2 years) for renewal - Loose Delivery - S26361-F4024-L942 NVIDIA GRID EDU Subscription License 2yrs Renew, 1 CCU NVIDIA Subscription License (2 years) for renewal. It needs if you need to continue Subscription.	NVIDIA Subscription License (3 years) for renewal - Loose Delivery - S26361-F4024-L943 NVIDIA GRID EDU Subscription License 3yrs Renew, 1 CCU NVIDIA Subscription License (3 years) for renewal. It needs if you need to continue Subscription.
---	--	---	---

E

Chapter 7 - SAS / RAID Controller

F			
for combination and max number of controllers please see folder base / chassis			
onboard SATA controller with SW-RAID			
onboard controller for SATA HDD or SSD drives			
4 ports 3, 6Gb/s SATA HDD/SSD	based on Intel chipset	No Cache	SW-RAID 0, 1
		1x	onboard, included
internal HBA and RAID controller, no 2nd Level cache			
internal drive RAID / HBA controllers for SAS, SATA HDD or SSD drives			
PRAID CP400i RAID Contr.	No Cache	RAID 0, 1, 1E, 10, 5, 50	1x S26361-F3842-E1 S26361-F3842-L501
PSAS CP400i HBA SAS Contr.	No Cache	HBA + RAID 0, 1	1x S26361-F3842-E2 S26361-F3842-L502
8 ports 3, 6 & 12Gb/s SAS/SATA HDD/ SSD, supports up to 8 devices without expander requires 1x LP PCIe 3.0 x8 (int.) slot, based on LSI SAS3008			
PSAS CP403i HBA SAS Contr.	No Cache	HBA	1x S26361-F3842-E3 S26361-F3842-L503
8 ports 3, 6 & 12Gb/s SAS/SATA HDD/ SSD, supports up to 8 devices without expander requires 1x LP PCIe 3.0 x8 (int.) slot, based on LSI SAS3008; IT FW stack without RAID functionality; released for VMWare vSAN / vSphere in V301 / V401 / V501			
Attention: not applicable in -V528; PRAID CP400i not applicable in -V501			
Attention: not applicable in -V601			
internal RAID controller with 2nd Level cache 1Gb, 2Gb			
internal drive RAID / SAS, SATA controllers with Cache and opt. TFM module + Flash Backup Unit and opt. Advanced SW Options			
PRAID EP400i RAID Contr.	1Gb Cache	RAID 0, 1, 1E, 10, 5, 50, 6, 60	1x S26361-F5243-E11 S26361-F5243-L11
8 ports 3, 6 & 12Gb/s SAS/SATA HDD/ SSD, supports up to 8 devices without expander requires 1x LP PCIe 3.0 x8 (int.) slot, based on LSI SAS3108			
optional Licence Activation Key, a free of charge test licence is available at PRIMERGY-PM, FastPath is included in Controller FW			
RAID Advanced SW Option CacheCade®Broadcom: SSD-cache-based HDD acceleration		1x	S26361-F5243-E670 S26361-F5243-L670
optional Transportable Flash module (TFM) and Flash Backup Unit (FBU), both components required			
TFM module for 1Gb Cache	NV-RAM & FBU control logic	1x	S26361-F5243-E100 S26361-F5243-L100
FBU Option for PRAID EP4xx for base V1xx: Supercap securing the power supply of the RAID contr. in case of power failure including cable with 55cm length		1x	S26361-F5243-E155 S26361-F5243-L115
FBU Option for PRAID EP4xx for base V3xx, V4xx, V5xx: Supercap securing the power supply of the RAID contr. in case of power failure including cable with 75cm length		1x	S26361-F5243-E175 S26361-F5243-L115
PRAID EP420i RAID Contr.	2Gb Cache	RAID 0, 1, 1E, 10, 5, 50, 6, 60	1x S26361-F5243-E12 S26361-F5243-L12
PRAID EP420i for SafeStore R. Contr.	2Gb Cache	RAID 0, 1, 1E, 10, 5, 50, 6, 60	1x S26361-F5243-E14* S26361-F5243-L14*
8 ports 3, 6 & 12Gb/s SAS/SATA HDD/ SSD, supports up to 8 devices without expander requires 1x LP PCIe 3.0 x8 (int.) slot, based on LSI SAS3108			
optional Licence Activation Key, a free of charge test licence is available at PRIMERGY-PM, FastPath is included in Controller FW			
RAID Advanced SW Option CacheCade®Broadcom: SSD-cache-based HDD acceleration		1x	S26361-F5243-E670 S26361-F5243-L670
optional TFM module and Flash Backup Unit (FBU), both components required			
TFM module for 2Gb Cache	NV-RAM & FBU control logic	1x	S26361-F5243-E200 S26361-F5243-L200
FBU Option for PRAID EP4xx for base V1xx: Supercap securing the power supply of the RAID contr. in case of power failure including cable with 55cm length		1x	S26361-F5243-E155 S26361-F5243-L115
FBU Option for PRAID EP4xx for base V3xx, V4xx, V5xx: Supercap securing the power supply of the RAID contr. in case of power failure including cable with 75cm length.		1x	S26361-F5243-E175 S26361-F5243-L115
Attention: not applicable in -V528			
Attention: not applicable in -V601			
internal NVMe, SAS, SATA RAID controller with 2nd Level cache 2Gb, 4Gb, 8Gb NVMe support for all EP5xxi on special rel			
internal drive RAID / SAS controllers for E91 and SAS, SATA HDD or SSD drives			
PRAID EP520i RAID LP	2Gb Cache	RAID 0, 1, 1E, 10, 5, 50, 6, 60	1x S26361-F4042-E202 S26361-F4042-L502
8 ports 3, 6 & 12Gb/s SAS/SATA HDD/ SSD, supports up to 8 devices without expander or (NVMe support for EP520i on special release for this controller in this system) includes Fastpath and SafeStore Advanced SW-Licence requires 1x LP PCIe 3.0 x8 (int.) slot, based on LSI SAS3516			
PRAID EP540i RAID LP	4Gb Cache	RAID 0, 1, 1E, 10, 5, 50, 6, 60	1x S26361-F4042-E214 S26361-F4042-L514
PRAID EP580i RAID LP	8Gb Cache	RAID 0, 1, 1E, 10, 5, 50, 6, 60	1x S26361-F4042-E208 S26361-F4042-L508
16 ports 3, 6 & 12Gb/s SAS/SATA HDD/ SSD, based on LSI SAS3516, without expander, up to 16 SAS/SATA devices or in mixed configuration up to 8 SAS/SATA devices and with the remaining 8 ports 8Gb/s NVMe PCIe, up to 2 x4 NVMe devices are supported. (the configuration for 4 x 4 NVMe drives require a different order number, please see below) includes FastPath and SafeStore Advanced SW-Licence, CacheCade is no longer supported requires 1x LP PCIe 3.0 x8 (int.) slot, based on LSI SAS3516 (FYI: S26361-F4042-E214 and E224, S26361-F4042-E208 and E228 are identical products. The 2nd Order number was only introduced for explicit ordering and cabling)			
PRAID EP540i RAID NVMe LP	4Gb Cache	RAID 0, 1, 1E, 10, 5, 50, 6, 60	1x S26361-F4042-E224 S26361-F4042-L514
PRAID EP580i RAID NVMe LP	8Gb Cache	RAID 0, 1, 1E, 10, 5, 50, 6, 60	1x S26361-F4042-E228 S26361-F4042-L508
16 ports 3, 6 & 12Gb/s SAS/SATA HDD/ SSD, based on LSI SAS3516, for Chassis Variant -V546 up to 4 x4 NVMe devices are supported. (the configuration for SAS/SATA only or mixed with up to 2 x 4 NVMe drives require a different order number, please see above) includes FastPath and SafeStore Advanced SW-Licence, CacheCade is no longer supported requires 1x LP PCIe 3.0 x8 (int.) slot, based on LSI SAS3516 (FYI: S26361-F4042-E214 and E224, S26361-F4042-E208 and E228 are identical products. The 2nd Order number was only introduced for explicit ordering and cabling)			
optional Flash Backup Unit (FBU), Transportable Flash module (TFM) is already included			
FBU Option für PRAID EP5xx for base V1xx: Supercap securing the power supply of the RAID contr. in case of power failure including cable with 55cm length.		1x	S26361-F4042-E155 S26361-F4042-L110
FBU Option für PRAID EP5xx for base V3xx, V4xx, V5xx: Supercap securing the power supply of the RAID contr. in case of power failure including cable with 83cm length.		1x	S26361-F4042-E183 S26361-F4042-L110
Please be aware that PRAID EP580i series consumes a standard PCI slot instead of the internal slot - other than existing I/O controllers			
Attention: PRAID EP520i RAID Contr. LP not applicable in -V528			
Attention: not applicable in -V601			
base unit -V546: PRAID EP540/80i and PRAID EP540/80i NVMe			
PRAID EP540/80i NVMe for Hardware-RAID for up to 4 NVMe drives, all other base units can use PRAID EP540/80i for SAS,SATA and up to 2 NVMe drives			
maximum number of internal RAID & HBA (See also pictures on folder base / HDD cage):			
FBU cannot be combined with Advanced Thermal design. up to 1x FBU can be integrated per System for PRAID EP540i / 80i and NVMe drives, no FBU is allowed (performance) for PRAID EP540i / 80i and NVMe drives, RHEL 7.5 is not supported			
Expander configurations: Use PRAID EPxxx for optimal performance, PRAID CP400i is not released for expander configurations			
Advanced SW options: simultaneous operation of SafeStore or CacheCade + FastPath or is supported, simultaneous operation of Safestore + CacheCade is not supported			
G			
external SAS controller			
HBA controller for ext. drives SAS, SATA HDD or SSD drives			
PSAS CP400e HBA SAS Contr. LP	No Cache	HBA, no RAID	2x S26361-F3845-E201 S26361-F3845-L501
8 ports 3, 6 & 12Gb/s SAS/SATA HDD/ SSD, 2x SFF8644 (external Mini-SAS HD) requires 1x LP PCIe 3.0 x8 (int.) slot, based on LSI SAS3008			
external SAS, RAID controller with 2nd Level cache 4Gb			
RAID / SAS, SATA controllers for external drives with Cache and opt. Flash Backup Unit			
PRAID EP540e RAID Contr. LP	4Gb Cache	RAID 0, 1, 1E, 10, 5, 50, 6, 60	2x S26361-F4063-E204 S26361-F4063-L504
8 ports 3, 6 & 12Gb/s SAS/SATA HDD/ SSD, 2x SFF8644 (external Mini-SAS HD) includes Fastpath and SafeStore Advanced SW-Licence requires 1x LP PCIe 3.0 x8 (int.) slot, based on LSI SAS3516			
optional Flash Backup Unit (FBU), Transportable Flash module (TFM) is already included			
FBU Option for PRAID EP5xx: Supercap securing the power supply of the RAID controller in case of power failure including cable with 55cm length		1x	S26361-F4042-E155 S26361-F4042-L110
internal controllers for PCIe SSD SFF (2,5" NVMe PCIe) drives, no HW-RAID			
onboard SlimSAS Connector, from CPU to Backplane for 4x internal 2,5" NVMe SSD PCIe SSD SFF (2,5" NVMe PCIe)			
8Gb/s PCIe x8	Intel CPU	No Cache	2x onboard
Attention: not applicable in -I01 / V301 / V401			
H			

Chapter 8 - ODD optical disk drives

The 10x 2,5" base units (S26361-K1659-V501/V528/V546/V601) do NOT support ODD

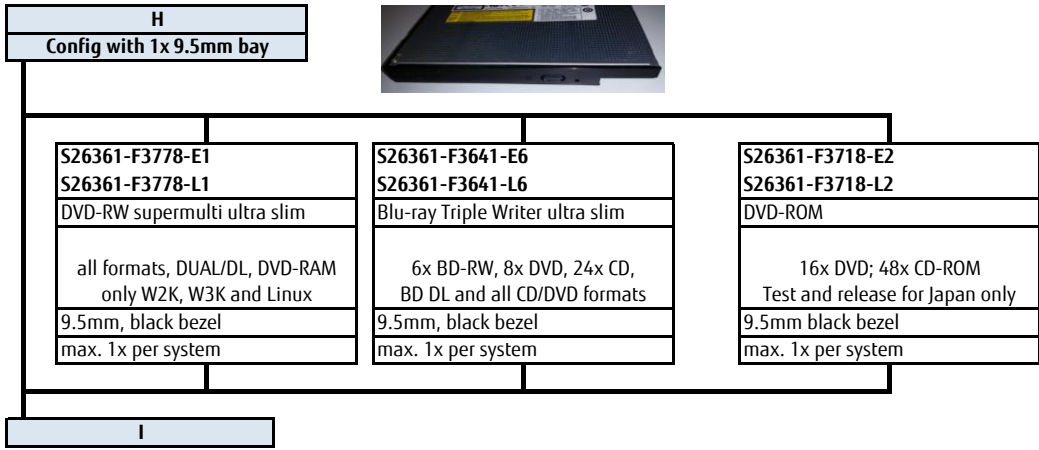

Chapter 10 - storage drives

I

SAS drives and SATA drives can be mixed, but cannot be used in one logical RAID volume.
 SATA drives can be connected to the onboard Controller (max. 8x).
 SAS drives require a dedicated SAS / RAID Controller
 Hard Disk Sector Format Information:
 512n HDD: 512 byte sectors on the drive media.
 512e (e-emulation) HDD: 4K physical sectors on the drive media with 512 byte logical configuration.
 512e HDD Disk Drives: VMware 6.0 or earlier is not supported.
 When using SSDs with VMware ESXi, select the SSDs that meet the endurance requirement described in KB2145210 below.
<https://kb.vmware.com/kb/2145210>
 DWPD: Drive Writes Per Day over 5 years.
 SED (=Self Encrypting Drives) require either a RAID controller with *SafeStore (SED) support or an HBA and in addition a software instance, supporting SED Key Management.
 It is strongly recommended to order SafeStore (SED) RAID controller with SED HDD or SSD devices for SafeStore (SED) functionality.
HDD Classes:
 Business-Critical (BC) -SATA=Nearline SATA Enterprise Drives / 7.2Krpm, SATA 6G.
 Business-Critical (BC) -SAS=Nearline SAS Enterprise Drives / 7.2Krpm, SAS 12G .
 Mission-Critical (MC)=SAS 10K and SAS 15K Enterprise Drives with max. performance and reliability.
Warranty:
 SSD and SATA DOM have a built-in Wear-Out indicator. In this case the warranty for such a component, as an exception to the system warranty, is restricted to the time period until the indicator reaches the exhaust level.

2.5" (SFF) SAS and SATA S

SSD SAS 2.5" Write Intensive (SFF) Enterprise with hot plug/hot replace tray
 based on **Toshiba PM5-M** drives

Capacity	Formfactor	Interface	Endurance	DWPD		order code E-part	order code L-part
400GB	2.5" (SFF)	SAS 12Gb/s	Write Intensive	10		S26361-F5710-E400	S26361-F5710-L400
800GB	2.5" (SFF)	SAS 12Gb/s	Write Intensive	10		S26361-F5710-E800	S26361-F5710-L800
1.6TB	2.5" (SFF)	SAS 12Gb/s	Write Intensive	10		S26361-F5710-E160	S26361-F5710-L160
400GB	2.5" (SFF)	SAS 12Gb/s	Write Intensive	10	SED	S26361-F5711-E400	S26361-F5711-L400
800GB	2.5" (SFF)	SAS 12Gb/s	Write Intensive	10	SED	S26361-F5711-E800	S26361-F5711-L800
1.6TB	2.5" (SFF)	SAS 12Gb/s	Write Intensive	10	SED	S26361-F5711-E160	S26361-F5711-L160

max. 10x - depending on base unit & configuration

SSD SAS 2.5" Mixed Use (SFF) Enterprise with hot plug/hot replace tray
 based on **Western Digital DC S5530** drives

Capacity	Formfactor	Interface	Endurance	DWPD		order code E-part	order code L-part
400GB	2.5" (SFF)	SAS 12Gb/s	Mixed Use	3		S26361-F5713-E400	S26361-F5713-L400
800GB	2.5" (SFF)	SAS 12Gb/s	Mixed Use	3		S26361-F5713-E800	S26361-F5713-L800
1.6TB	2.5" (SFF)	SAS 12Gb/s	Mixed Use	3		S26361-F5713-E160	S26361-F5713-L160
3.2TB	2.5" (SFF)	SAS 12Gb/s	Mixed Use	3		S26361-F5713-E320	S26361-F5713-L320
6.4TB	2.5" (SFF)	SAS 12Gb/s	Mixed Use	3		S26361-F5713-E640	S26361-F5713-L640

max. 10x - depending on base unit & configuration

SSD SAS 2.5" Read Intensive (SFF) Enterprise with hot plug/hot replace tray
 based on **Western Digital DC S5530** drives

Capacity	Formfactor	Interface	Endurance	DWPD		order code E-part	order code L-part
480GB	2.5" (SFF)	SAS 12Gb/s	Read Intensive	1		S26361-F5715-E480	S26361-F5715-L480
960GB	2.5" (SFF)	SAS 12Gb/s	Read Intensive	1		S26361-F5715-E960	S26361-F5715-L960
1.92TB	2.5" (SFF)	SAS 12Gb/s	Read Intensive	1		S26361-F5715-E192	S26361-F5715-L192
3.84TB	2.5" (SFF)	SAS 12Gb/s	Read Intensive	1		S26361-F5715-E384	S26361-F5715-L384
7.68TB	2.5" (SFF)	SAS 12Gb/s	Read Intensive	1		S26361-F5715-E768	S26361-F5715-L768
15.36TB	2.5" (SFF)	SAS 12Gb/s	Read Intensive	1		S26361-F5715-E153	S26361-F5715-L153

max. 10x - depending on base unit & configuration

SSD SATA 2.5" Mixed Use (SFF) Enterprise with hot plug/hot replace tray
 based on **Samsung SM883** drives

Capacity	Formfactor	Interface	Endurance	DWPD		order code E-part	order code L-part
240GB	2.5" (SFF)	SATA 6Gb/s	Mixed Use	3.6		S26361-F5733-E240	S26361-F5733-L240
480GB	2.5" (SFF)	SATA 6Gb/s	Mixed Use	3.6		S26361-F5733-E480	S26361-F5733-L480
960GB	2.5" (SFF)	SATA 6Gb/s	Mixed Use	3.6		S26361-F5733-E960	S26361-F5733-L960
1.92TB	2.5" (SFF)	SATA 6Gb/s	Mixed Use	3.6		S26361-F5733-E192	S26361-F5733-L192
3.84TB	2.5" (SFF)	SATA 6Gb/s	Mixed Use	3.6		S26361-F5588-E384	S26361-F5588-L384

max. 10x - depending on base unit & configuration

SSD SATA 2.5" Read Intensive (SFF) Enterprise with hot plug/hot replace tray
 based on **Micron 5100 PRO or 5200 ECC** *240GB is 5100, others are 5200

Capacity	Formfactor	Interface	Endurance	DWPD		order code E-part	order code L-part
240GB	2.5" (SFF)	SATA 6Gb/s	Read Intensive	1.4		S26361-F5701-E240	S26361-F5701-L240
480GB	2.5" (SFF)	SATA 6Gb/s	Read Intensive	0.9		S26361-F5701-E480	S26361-F5701-L480
960GB	2.5" (SFF)	SATA 6Gb/s	Read Intensive	0.9		S26361-F5701-E960	S26361-F5701-L960
1.92TB	2.5" (SFF)	SATA 6Gb/s	Read Intensive	0.9		S26361-F5701-E192	S26361-F5701-L192
3.84TB	2.5" (SFF)	SATA 6Gb/s	Read Intensive	1.0		S26361-F5701-E384	S26361-F5701-L384
7.68TB	2.5" (SFF)	SATA 6Gb/s	Read Intensive	0.5		S26361-F5701-E768	S26361-F5701-L768

max. 10x - depending on base unit & configuration

J

J

2.5" (SFF) Hard drives

HDD SAS 2.5" 15K (SFF) Enterprise Mission Critical with hot plug/hot replace tray

Capacity	RPM	Interface	Sector	order code E-part	order code L-part
300GB	15 000	SAS 12Gb/s	512n	S26361-F5727-E530	S26361-F5727-L530
600GB	15 000	SAS 12Gb/s	512n	S26361-F5727-E560	S26361-F5727-L560
900GB	15 000	SAS 12Gb/s	512n	S26361-F5531-E590	S26361-F5531-L590

max. 10x - depending on base unit & configuration

HDD SAS 2.5" 10K 512n (SFF) Enterprise Mission Critical with hot plug/hot replace tray

Capacity	RPM	Interface	Sector	order code E-part	order code L-part
300GB	10 000	SAS 12Gb/s	512n	S26361-F5729-E130	S26361-F5729-L130
600GB	10 000	SAS 12Gb/s	512n	S26361-F5729-E160	S26361-F5729-L160
900GB	10 000	SAS 12Gb/s	512n	S26361-F5729-E190	S26361-F5729-L190
1.2TB	10 000	SAS 12Gb/s	512n	S26361-F5729-E112	S26361-F5729-L112
300GB	10 000	SAS 12Gb/s	512n	SED S26361-F5581-E130	S26361-F5581-L130
600GB	10 000	SAS 12Gb/s	512n	SED S26361-F5581-E160	S26361-F5581-L160
1.2TB	10 000	SAS 12Gb/s	512n	SED S26361-F5581-E112	S26361-F5581-L112

max. 10x - depending on base unit & configuration

HDD SAS 2.5" 10K 512e (SFF) Enterprise Mission Critical with hot plug/hot replace tray

Capacity	RPM	Interface	Sector	order code E-part	order code L-part
600GB	10 000	SAS 12Gb/s	512e	S26361-F5730-E160	S26361-F5730-L160
900GB	10 000	SAS 12Gb/s	512e	S26361-F5730-E190	S26361-F5730-L190
1.2TB	10 000	SAS 12Gb/s	512e	S26361-F5730-E112	S26361-F5730-L112
1.8TB	10 000	SAS 12Gb/s	512e	S26361-F5730-E118	S26361-F5730-L118
2.4TB	10 000	SAS 12Gb/s	512e	S26361-F5543-E124	S26361-F5543-L124
1.8TB	10 000	SAS 12Gb/s	512e	SED S26361-F5582-E118	S26361-F5582-L118
2.4TB	10 000	SAS 12Gb/s	512e	SED S26361-F5582-E124	S26361-F5582-L124

max. 10x - depending on base unit & configuration

HDD SAS 2.5" 7.2K 512n (SFF) Enterprise Business Critical with hot plug/hot replace tray

Capacity	RPM	Interface	Sector	order code E-part	order code L-part
1TB	7 200	SAS 12Gb/s	512n	S26361-F5600-E100	S26361-F5600-L100
2TB	7 200	SAS 12Gb/s	512n	S26361-F5600-E200	S26361-F5600-L200

max. 10x - depending on base unit & configuration

HDD SATA 2.5" 7.2K 512n (SFF) Enterprise Business Critical with hot plug/hot replace tray

Capacity	RPM	Interface	Sector	order code E-part	order code L-part
1TB	7 200	SATA 6Gb/s	512n	S26361-F3956-E100	S26361-F3956-L100
2TB	7 200	SATA 6Gb/s	512n	S26361-F3956-E200	S26361-F3956-L200

max. 10x - depending on base unit & configuration

The HDDs not released with PRAID EP5x0i (S26361-F404Z-E202/E214/E208)

HDD SATA 2.5" 7.2K 512e (SFF) Enterprise Business Critical with hot plug/hot replace tray

Capacity	RPM	Interface	Sector	order code E-part	order code L-part
1TB	7 200	SATA 6Gb/s	512e	S26361-F3907-E100	S26361-F3907-L100
2TB	7 200	SATA 6Gb/s	512e	S26361-F3907-E200	S26361-F3907-L200

max. 10x - depending on base unit & configuration

K

K

3.5" (LFF) SAS and SATA SSD

SSD SAS 3.5" Write Intensive (LFF) 2.5" SSD Enterprise with 3.5" hot plug/hot replace tray							
based on Toshiba PM5-M drives							
Capacity	Formfactor	Interface	Endurance	DWPD		order code E-part	order code L-part
400GB	3.5" (LFF)	SAS 12Gb/s	Write Intensive	10		S26361-F5709-E400	S26361-F5709-L400
800GB	3.5" (LFF)	SAS 12Gb/s	Write Intensive	10		S26361-F5709-E800	S26361-F5709-L800
1.6TB	3.5" (LFF)	SAS 12Gb/s	Write Intensive	10		S26361-F5709-E160	S26361-F5709-L160

max. 4x - depending on base unit & configuration

SSD SAS 3.5" Mixed Use (LFF) 2.5" SSD Enterprise with 3.5" hot plug/hot replace tray							
based on Western Digital DC S5530 drives							
Capacity	Formfactor	Interface	Endurance	DWPD		order code E-part	order code L-part
400GB	3.5" (LFF)	SAS 12Gb/s	Mixed Use	3		S26361-F5712-E400	S26361-F5712-L400
800GB	3.5" (LFF)	SAS 12Gb/s	Mixed Use	3		S26361-F5712-E800	S26361-F5712-L800
1.6TB	3.5" (LFF)	SAS 12Gb/s	Mixed Use	3		S26361-F5712-E160	S26361-F5712-L160
3.2TB	3.5" (LFF)	SAS 12Gb/s	Mixed Use	3		S26361-F5712-E320	S26361-F5712-L320

max. 4x - depending on base unit & configuration

SSD SAS 3.5" Read Intensive (LFF) 2.5" SSD Enterprise with 3.5" hot plug/hot replace tray							
based on Western Digital DC S5530 drives							
Capacity	Formfactor	Interface	Endurance	DWPD		order code E-part	order code L-part
480GB	3.5" (LFF)	SAS 12Gb/s	Read Intensive	1		S26361-F5714-E480	S26361-F5714-L480
960GB	3.5" (LFF)	SAS 12Gb/s	Read Intensive	1		S26361-F5714-E960	S26361-F5714-L960
1.92TB	3.5" (LFF)	SAS 12Gb/s	Read Intensive	1		S26361-F5714-E192	S26361-F5714-L192
3.84TB	3.5" (LFF)	SAS 12Gb/s	Read Intensive	1		S26361-F5714-E384	S26361-F5714-L384
7.68TB	3.5" (LFF)	SAS 12Gb/s	Read Intensive	1		S26361-F5714-E768	S26361-F5714-L768

max. 4x - depending on base unit & configuration

SSD SATA 3.5" Mixed Use (LFF) 2.5" SSD Enterprise with 3.5" hot plug/hot replace tray							
based on Samsung SM883 drives							
Capacity	Formfactor	Interface	Endurance	DWPD		order code E-part	order code L-part
240GB	3.5" (LFF)	SATA 6Gb/s	Mixed Use	3.6		S26361-F5732-E240	S26361-F5732-L240
480GB	3.5" (LFF)	SATA 6Gb/s	Mixed Use	3.6		S26361-F5732-E480	S26361-F5732-L480
960GB	3.5" (LFF)	SATA 6Gb/s	Mixed Use	3.6		S26361-F5732-E960	S26361-F5732-L960
1.92TB	3.5" (LFF)	SATA 6Gb/s	Mixed Use	3.6		S26361-F5732-E192	S26361-F5732-L192
3.84TB	3.5" (LFF)	SATA 6Gb/s	Mixed Use	3.6		S26361-F5589-E384	S26361-F5589-L384

max. 4x - depending on base unit & configuration

SSD SATA 3.5" Read Intensive (LFF) 2.5" SSD Enterprise with 3.5" hot plug/hot replace tray							
based on Micron 5100 PRO or 5200 ECO *240GB is 5100, others are 5200							
Capacity	Formfactor	Interface	Endurance	DWPD		order code E-part	order code L-part
240GB	3.5" (LFF)	SATA 6Gb/s	Read Intensive	1.4		S26361-F5700-E240	S26361-F5700-L240
480GB	3.5" (LFF)	SATA 6Gb/s	Read Intensive	0.9		S26361-F5700-E480	S26361-F5700-L480
960GB	3.5" (LFF)	SATA 6Gb/s	Read Intensive	0.9		S26361-F5700-E960	S26361-F5700-L960
1.92TB	3.5" (LFF)	SATA 6Gb/s	Read Intensive	0.9		S26361-F5700-E192	S26361-F5700-L192
3.84TB	3.5" (LFF)	SATA 6Gb/s	Read Intensive	1.0		S26361-F5700-E384	S26361-F5700-L384
7.68TB	3.5" (LFF)	SATA 6Gb/s	Read Intensive	0.5		S26361-F5700-E768	S26361-F5700-L768

max. 4x - depending on base unit & configuration

K

K

3.5" (LFF) Hard drives

HDD SAS 3.5" 15K (LFF) 2.5" HDD Enterprise Mission Critical with 3.5" hot plug/hot replace tray

Capacity	RPM	Interface	Sector	order code E-part	order code L-part
300GB	15 000	SAS 12Gb/s	512n	S26361-F5726-E530	S26361-F5726-L530
600GB	15 000	SAS 12Gb/s	512n	S26361-F5726-E560	S26361-F5726-L560
900GB	15 000	SAS 12Gb/s	512n	S26361-F5532-E590	S26361-F5532-L590

max. 4x - depending on base unit & configuration

HDD SAS 3.5" 10K 512n (LFF) 2.5" HDD Enterprise Mission Critical with 3.5" hot plug/hot replace tray

Capacity	RPM	Interface	Sector	order code E-part	order code L-part
300GB	10 000	SAS 12Gb/s	512n	S26361-F5728-E130	S26361-F5728-L130
600GB	10 000	SAS 12Gb/s	512n	S26361-F5728-E160	S26361-F5728-L160
1.2TB	10 000	SAS 12Gb/s	512n	S26361-F5728-E112	S26361-F5728-L112

max. 4x - depending on base unit & configuration

HDD SAS 3.5" 10K 512e (LFF) 2.5" HDD Enterprise Mission Critical with 3.5" hot plug/hot replace tray

Capacity	RPM	Interface	Sector	order code E-part	order code L-part
1.8TB	10 000	SAS 12Gb/s	512e	S26361-F5731-E118	S26361-F5731-L118
2.4TB	10 000	SAS 12Gb/s	512e	S26361-F5569-E124	S26361-F5569-L124

max. 4x - depending on base unit & configuration

HDD SAS 3.5" 7.2K 512n (LFF) Enterprise Business critical with hot plug/hot replace tray

Capacity	RPM	Interface	Sector	order code E-part	order code L-part
1TB	7 200	SAS 12Gb/s	512n	S26361-F5626-E100	S26361-F5626-L100
2TB	7 200	SAS 12Gb/s	512n	S26361-F5626-E200	S26361-F5626-L200
4TB	7 200	SAS 12Gb/s	512n	S26361-F5626-E400	S26361-F5626-L400

max. 4x - depending on base unit & configuration

HDD SAS 3.5" 7.2K 512e (LFF) Enterprise Business Critical with hot plug/hot replace tray

Capacity	RPM	Interface	Sector	order code E-part	order code L-part	
6TB	7 200	SAS 12Gb/s	512e	S26361-F5635-E600	S26361-F5635-L600	
8TB	7 200	SAS 12Gb/s	512e	S26361-F5635-E800	S26361-F5635-L800	
12TB	7 200	SAS 12Gb/s	512e	S26361-F5571-E120	S26361-F5571-L120	
14TB	7 200	SAS 12Gb/s	512e	S26361-F5571-E140	S26361-F5571-L140	
6TB	7 200	SAS 12Gb/s	512e	SED	S26361-F5584-E600	S26361-F5584-L600
8TB	7 200	SAS 12Gb/s	512e	SED	S26361-F5584-E800	S26361-F5584-L800
12TB	7 200	SAS 12Gb/s	512e	SED	S26361-F5624-E120	S26361-F5624-L120
14TB	7 200	SAS 12Gb/s	512e	SED	S26361-F5624-E140	S26361-F5624-L140

max. 4x - depending on base unit & configuration

HDD SATA 3.5" 7.2K 512n (LFF) Enterprise Business Critical with hot plug/hot replace tray

Capacity	RPM	Interface	Sector	order code E-part	order code L-part
1TB	7 200	SATA 6Gb/s	512n	S26361-F5636-E100	S26361-F5636-L100
2TB	7 200	SATA 6Gb/s	512n	S26361-F5636-E200	S26361-F5636-L200
4TB	7 200	SATA 6Gb/s	512n	S26361-F5636-E400	S26361-F5636-L400

max. 4x - depending on base unit & configuration

HDD SATA 3.5" 7.2K 512e (LFF) Enterprise Business Critical with hot plug/hot replace tray

Capacity	RPM	Interface	Sector	order code E-part	order code L-part
6TB	7 200	SATA 6Gb/s	512e	S26361-F5638-E600	S26361-F5638-L600
8TB	7 200	SATA 6Gb/s	512e	S26361-F5638-E800	S26361-F5638-L800
12TB	7 200	SATA 6Gb/s	512e	S26361-F3904-E120	S26361-F3904-L120
14TB	7 200	SATA 6Gb/s	512e	S26361-F3904-E140	S26361-F3904-L140

max. 4x - depending on base unit & configuration

M.2 SATA SSD

SSD SATA M.2 drive for booting, non hot-plug, for VMware ESXi

Capacity	Formfactor	Interface	Category	order code E-part	order code L-part
240GB	M.2	SATA 6Gb/s	Boot	S26361-F5707-E240	S26361-F5707-L240

M.2 drive is designed for use as a VMware ESXi boot drive.
2x M.2 drive for any Hypervisor by the onboard chipset Software RAID is not supported.
max. 1x per Server; connector located on Motherboard (please see folder "description"). VMware ESXi is only supported.

M.2 drive for VMware ESXi and for other OSs cannot be mixed

SSD SATA M.2 drive for booting, non hot-plug

Capacity	Formfactor	Interface	DWPD	Category	order code E-part	order code L-part
240GB	M.2	SATA 6Gb/s	1.4	Boot	S26361-F5706-E240	S26361-F5706-L240
480GB	M.2	SATA 6Gb/s	1.4	Boot	S26361-F5706-E480	S26361-F5706-L480

M.2 drive is designed for use as a boot drive with the Endurance Spec. above.
2x M.2 drive for any Hypervisor by the onboard chipset Software RAID is not supported.
max. 2x per Server; connector located on Motherboard (please see folder "description"). VMware is not supported.

Dual M.2

Dual microSD, PRAID CP200 and M.2 drive cannot be mixed

PRAID CP200, dual M.2 for booting, non hot-plug

Capacity	Formfactor	Interface	Category	order code E-part	order code L-part
n/a	AIC	PCIe	Boot LP	S26361-F4065-E201	S26361-F4065-L501

PDUAL CP200 is a carrier 2x M.2 SATA modules and offers RAID1 with 2x M.2 modules.
PDUAL CP200 is designed for use as a Hardware-mirrored (RAID1) boot device for Hypervisor, which cannot be supported by M.2 via the onboard chipset Software RAID.
Supported RAID level: RAID1 only, Supported M.2 Modules: SSD SATA M.2 240GB (S26361-F5706-E240/L240 or S26361-F5707-E240/L240 for VMware ESXi) or SSD SATA M.2 480GB (S26361-F5706-E480/L480)
2x M.2 modules (S26361-F5706-E240/L240 or S26361-F5706-E480/L480 or S26361-F5707-E240/L240) need to be ordered separately.
max. 1x per Server, requires 2x SSD SATA M.2 drives.

Dual microSD

Dual microSD and M.2 drive cannot be mixed

Dual microSD Enterprise for booting, non hot-plug, for VMware ESXi

Capacity	Formfactor	Interface	Category	order code E-part	order code L-part
64GB	microSD	USB	Boot	S26361-F4045-E64	S26361-F4045-L64

Dual microSD is designed for use as a VMware ESXi boot drive. Only the standardly equipped microSD are supported.

Dual microSD offers Hardware-mirrored (RAID1) flash boot device for VMware ESXi, which cannot be supported by M.2.
vSAN can be booted in case ESXi host has 512 GB of memory or less. Even in case 512 GB or more, if vSAN is 6.5 or later, it can be booted by resizing the coredump partition on ESXi hosts. For more information, see the VMware knowledge base article at http://kb.vmware.com/kb/2147881 .
max. 1x per Server; connector located on Motherboard (please see folder "description"). VMware ESXi is only supported.

K

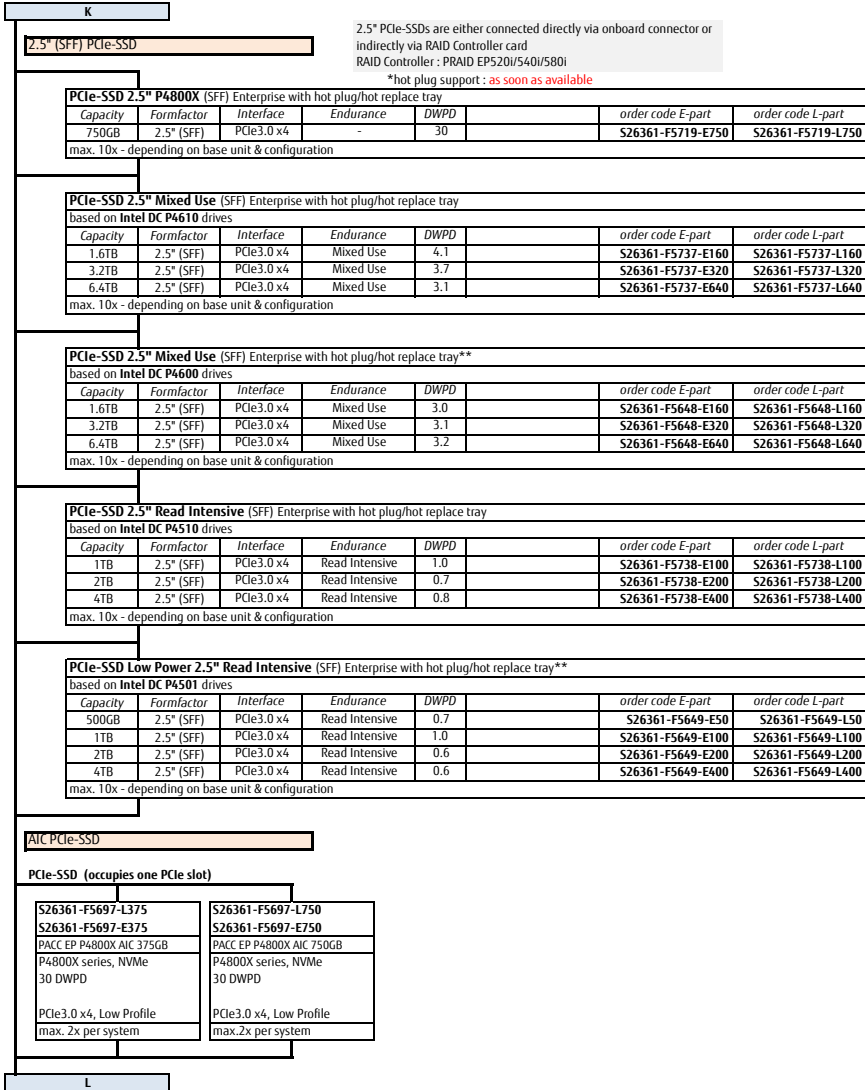

P

Chapter 9 - LAN Components

Default LoM: 2x RJ45 1GbE ports on systemboard

DynamicLoM

Interface card to provide the external connectors for on-board LAN

Select from 1G, 10G, 25G Fujitsu DynamicLoM options.

Mellanox 10G/25G adapters provide RoCE RDMA capabilities, whereas Intel 10G connections provide iWARP RDMA capabilities. Intel 10G/25G adapters XXV710 provide no RDMA capabilities at all.

PLAN EM 4x 1Gb T OCP interface I357-T4	4x RJ45 plug for 1000BASE-T, Intel Ethernet Network Connection OCP I357-T4	S26361-F3953-E401	S26361-F3953-L401
PLAN EM 2x 10Gb T OCP interface X557-T2	2x RJ45 plug for 10GBASE-T, iWARP RDMA, Intel Ethernet Network Connection OCP X557-T2	S26361-F3953-E210	S26361-F3953-L210
PLAN EM 2x 10GB SFP+ OCP interface X527-DA2	2x SFP+ cages for SFP+ optical transceivers or twinax cables, iWARP RDMA, Intel Ethernet Network Connection OCP X527-DA2	S26361-F3953-E211	S26361-F3953-L211
PLAN EM 4x 10GB SFP+ OCP interface X527-DA4	4x SFP+ cages for SFP+ optical transceivers or twinax cables, iWARP RDMA, Intel Ethernet Network Connection OCP X527-DA4	S26361-F3953-E411	S26361-F3953-L411
PLAN EP XXV710-DA2 2x 25G/10G SFP28 OCP V2 Type 1	2x SFP28 cages for SFP+/SFP28 Twinax or DAC cables, no RDMA capabilities at all. Intel XXV710-DA2. Optical transceivers not supported.	S26361-F4055-E302	S26361-F4055-L302
PLAN EP MCX4-LX 2x 25G/10G SFP28 OCP V2 Type 1	2x SFP28 cages for SFP+/SFP28 optical transceivers, Twinax or DAC cables, RoCE RDMA, Mellanox ConnectX4-LX	S26361-F4054-E302	S26361-F4054-L302

Optional, 25Gb SFP28 optical transceiver module, one per cage

SFP28 Optical Transceiver 25G SR MMA2P00-AS LC	1x .. 2x	MMF / SR SFP28 module, Mellanox. Max reach supported 100m	S26361-F4054-E701	S26361-F4054-L701
SFP28 Optical Transceiver 25G SR E25GSFP28SR	1x .. 2x	MMF / SR SFP28 module, Intel. Max reach supported 100m	S26361-F4055-E701	S26361-F4055-L701
"Virtual Connector" for DAC/AOC cables	1x .. 2x	Enablement for System Architect	V:DAC/AOC-CONNECTOR-25	
25G DAC - Cisco	1x .. 2x	DAC are not in Fujitsu's portfolio yet. Thus, purchase from switch vendors.		
25G DAC - Mellanox	1x .. 2x	DAC are not in Fujitsu's portfolio yet. Thus, purchase from switch vendors.		
25G AOC - Cisco	1x .. 2x	AOC are not in Fujitsu's portfolio yet. Thus, purchase from switch vendors.		
25G AOC - Mellanox	1x .. 2x	AOC are not in Fujitsu's portfolio yet. Thus, purchase from switch vendors.		
<i>max. 2x SFP28 or DAC/AOC Cable per adapter</i>				

Optional for products with SFP+ cages: SFP+ optical transceiver modules or twinax cables

SFP+ Optical Transceiver 10G/1G Dual Rate LC	2x .. 4x	LC, MMF / SR SFP+ module, up to 400m, Intel	S26361-F3986-E5	S26361-F3986-L5
SFP+ Optical Transceiver 10G/1G Dual Rate LC	2x .. 4x	LC, SMF / LR SFP+ module, up to 10km, Intel	S26361-F3986-E6	S26361-F3986-L6
SFP+ Optical Transceiver 10G Single Rate SR	2x .. 4x	LC, MMF / SR SFP+ module, up to 400m, Finis	S26361-F3986-E3	S26361-F3986-L3
SFP+ Optical Transceiver 10G Single Rate LR	2x .. 4x	LC, SMF / LR SFP+ module, up to 10km, Finis	S26361-F3986-E4	S26361-F3986-L4
Twinax Anschlussplatz Primergy	2x .. 4x	virtual connector for twinax cables	V:TWX CONNECTOR-PY	
SFP+ active Twinax Cable Fujitsu	2x .. 4x	customized cable length	S26361-F3989-E600	see table at the bottom of this page
SFP+ active Twinax Cable Brocade	2x .. 4x	(best fitting cable length is defined during rack installation at the factory)	S26361-F3873-E500	
SFP+ passive Twinax Cable Cisco - Sold Out	2x .. 4x		S26361-F4571-E500	
<i>max. 1x per cage</i>				

max. 1x per system

Attention: 1x25G / 2x25G and related 25G transceivers not applicable in -101 / V301 / V401

1Gb Ethernet Network Components

1Gb Ethernet network adapter with RJ45 interface (1000BASE-T)

Dual speed support, auto-sense: supports 1Gbps and 100Mbps line rate per-port.

PLAN CP 2x1Gbit Cu Intel I350-T2 LP	3x	2 port, Intel	S26361-F4610-E202	S26361-F4610-L502
PLAN CP 4x1Gbit Cu Intel I350-T4 LP	3x	4 port, Intel	S26361-F4610-E204	S26361-F4610-L504

max. 3 adapters per system

Attention: max. 2 adapters per system in -V601

10Gb Ethernet Network Components

10GBASE-T

10Gb Ethernet network adapters with RJ45 interface (10GBASE-T)

Dual speed support, auto-sense: supports 10Gbps and 1Gbps line rate per-port.

Only Marvell FastLinQ® adapters provide Universal RDMA capabilities, both iWARP and RoCE. Intel adapters don't provide any.

For Converged Network Adapter features such as iSCSI, FCoE please select the PLAN EP X550-T2. Other adapters do not support CNA features. If you wish to get support for FCoE please submit a Release Request with the desired PRIMERGY server system configuration SAR/XLSX file attachment.

PLAN EP QL41112 2x10GBASE-T LP	3x	2 port NIC with Universal RDMA, Marvell FastLinQ® QL41112HLRJ	S26361-F4068-E202	S26361-F4068-L502
PLAN EP QL41134 4x10GBASE-T LP	3x	4 port NIC with Universal RDMA, Marvell FastLinQ® QL41134HLRJ	S26361-F4068-E204	S26361-F4068-L504
PLAN EP X550-T2 2x10GBASE-T LP	3x	2 port NIC, Intel X550-T2	S26361-F3948-E202	S26361-F3948-L502
PLAN EP X710-T4 4x10GBASE-T LP	3x	4 port NIC, Intel X710-T4	S26361-F3948-E204	S26361-F3948-L504

max. 3x adapters per system

Attention: max. 2 adapters per system in -V601

10G SFP+

10Gb Ethernet network adapters with SFP+ cage. Adapter ships with empty cages.

Each cage consumes 1x optical SFP+ transceiver per port, or 1x twinax cable per port, or 1x DAC cable per port. Dual rate 10G/1G support requires 10G/1G Dual Rate SFP+ Optical Transceiver Modules. Only Marvell FastLinQ® adapters provide Universal RDMA capabilities, both iWARP and RoCE. Intel adapters don't provide any.

For Converged Network Adapter features such as iSCSI, iSCSI Offload, FCoE please select the PCNA EP QL41262. Other adapters do not support CNA features. If you wish to get support for FCoE please submit a Release Request with the desired PRIMERGY server system configuration SAR/XLSX file attachment.

Ethernet Network Adapters				
PLAN EP QL41132 2x10Gb SFP+ LP	3x	2 port NIC with Universal RDMA, Marvell FastLinQ® QL41132HLCU	S26361-F4069-E202	S26361-F4069-L502
PLAN EP QL41134 4x10Gb SFP+ LP	1x	4 port NIC with Universal RDMA, Marvell FastLinQ® QL41134HLCU	S26361-F4069-E204	S26361-F4069-L504
PLAN EP X710-DA2 2x10Gb SFP+ LP	3x	2 port NIC, Intel X710-DA2	S26361-F3640-E202	S26361-F3640-L502
PLAN EP X710-DA4 4x10Gb SFP+ LP	1x	4 port NIC, Intel X710-DA4	S26361-F3640-E204	S26361-F3640-L504

Converged Network Adapters				
PCNA EP QL41262 2x10/25Gb SFP+/SFP28 LP	3x	2 port CNA with Universal RDMA, iSCSI Offload, FCoE. Marvell FastLinQ® QL41262HLCU	S26361-F4070-E202	S26361-F4070-L502

Optional, 10Gb SFP+ optical transceiver module, one per cage				
SFP+ Optical Transceiver 10G Single Rate SR	1x .. 4x	LC, MMF / SR SFP+ module, up to 400m, Finis	S26361-F3986-E3	S26361-F3986-L3
SFP+ Optical Transceiver 10G Single Rate LR	1x .. 4x	LC, SMF / LR SFP+ module, up to 10km, Finis	S26361-F3986-E4	S26361-F3986-L4
SFP+ Optical Transceiver 10G/1G Dual Rate SR	1x .. 4x	LC, MMF / SR SFP+ module, up to 400m, Intel	S26361-F3986-E5	S26361-F3986-L5
SFP+ Optical Transceiver 10G/1G Dual Rate LR	1x .. 4x	LC, SMF / LR SFP+ module, up to 10km, Intel	S26361-F3986-E6	S26361-F3986-L6
"Virtual Connector" for Twinax cables	1x .. 4x	Enablement for System Architect	V:TWX CONNECTOR-PY	
SFP+ active Twinax Cable Fujitsu	1x .. 4x	Customized length. Best fitting length	S26361-F3989-E600	see table at the bottom of this page
SFP+ active Twinax Cable Brocade	1x .. 4x	selected at rack factory installation.	S26361-F3873-E500	

max. 4x SFP+, DAC, or Twinax Cable (DynamicLoM, QL41134, X710-DA4) per adapter, or max. 2x SFP+, DAC, or Twinax Cable (Dynamic LoM, QL41132, QL41262, X710-DA2) per adapter

max. 3x adapters per system

Attention: max. 2 adapters per system in -V601

10G/25G Ethernet Network components

10G/25G Ethernet network adapters with 2x SFP28 cages. Adapter ships with empty cages.

Each cage consumes 1x optical SFP+ or SFP28 transceiver per port, or 1x twinax cable per port, or 1x DAC cable per port. Multiple speed support, auto-sense: All adapters support 25Gbps, and 10Gbps. Intel adapters support 1Gbps line rate per-port in addition, with the Intel-branded 10G/1G Dual Rate SFP+ Optical Transceiver Modules. Only Marvell FastLinQ® adapters provide Universal RDMA capabilities, both iWARP and RoCE. Mellanox adapters just provide RoCE RDMA. Intel adapters don't provide any kind of RDMA capabilities.

For Converged Network Adapter features such as iSCSI, iSCSI Offload, FCoE please select the PCNA EP QL41262. Other adapters do not support CNA features.

Ethernet Network Adapters				
PLAN EP QL41212 25Gb 2p SFP28 LP	3x	2 port NIC with Universal RDMA, Marvell FastLinQ® QL41212HLCU	S26361-F4056-E202	S26361-F4056-L502
PLAN EP MCX4-LX 25Gb 2p SFP28 LP	3x	2 port NIC with RoCE RDMA, Mellanox ConnectX4-LX	S26361-F4054-E202	S26361-F4054-L502
PLAN EP XXV710-DA2 2x25Gb LP	3x	2 port NIC, Intel XXV710-DA2	S26361-F4055-E202	S26361-F4055-L502

Converged Network Adapters				
PCNA EP QL41262 2x10/25Gb SFP+/SFP28 LP	3x	2 port CNA with Universal RDMA, iSCSI Offload, FCoE. Marvell FastLinQ® QL41262HLCU	S26361-F4070-E202	S26361-F4070-L502

Optional, 25Gb SFP28 optical transceiver module, one per cage				
SFP28 Optical Transceiver 25G SR MMA2P00-AS LC	1x .. 2x	MMF / SR SFP28 module, Mellanox . Max reach supported 100m	S26361-F4054-E701	S26361-F4054-L701
SFP28 Optical Transceiver 25G SR E25GSFP28SR	1x .. 2x	MMF / SR SFP28 module, Intel . Max reach supported 100m	S26361-F4055-E701	S26361-F4055-L701
"Virtual Connector" for DAC/AOC cables	1x .. 2x	Enablement for System Architect	V:DAC/AOC-CONNECTOR-25	
25G DAC - Cisco	1x .. 2x	DAC are not in Fujitsu's portfolio yet. Thus, purchase from switch vendors.		
25G DAC - Mellanox	1x .. 2x			
25G AOC - Cisco	1x .. 2x	AOC are not in Fujitsu's portfolio yet. Thus, purchase from switch vendors.		
25G AOC - Mellanox	1x .. 2x			

max. 2x SFP28 or DAC/AOC Cable per adapter

Optional Cisco Ethernet Direct Attach Copper Cables (DACs) - not introduced by Fujitsu; available for purchase at Cisco				
Cisco DAC Splitter Cable 100G to 4X25G,	1x	Cisco 100GBase QSFP to 4xSFP25G Passive, 1r	Cisco P/N: QSFP-4SFP25G-CU1M	
Cisco DAC Splitter Cable 100G to 4X25G,	1x	Cisco 100GBase QSFP to 4xSFP25G Passive, 2r	Cisco P/N: QSFP-4SFP25G-CU2M	
Cisco DAC Splitter Cable 100G to 4X25G,	1x	Cisco 100GBase QSFP to 4xSFP25G Passive, 3r	Cisco P/N: QSFP-4SFP25G-CU3M	

One Cisco DAC Splitter cable connects up to 4 25G ports, i.e. 2x PLAN EP QL41212 cards to a single Cisco 100G Switch Port.

Optional 10Gb SFP+ Optical Transceivers with LC Connector, or Active or Passive Twinax Cables SFP+				
SFP+ Optical Transceiver 10G Single Rate SR	2x	LC, MMF / SR SFP+ module, up to 400m	S26361-F3986-E3	S26361-F3986-L3
SFP+ Optical Transceiver 10G Single Rate LR	2x	LC, SMF / LR SFP+ module, up to 10km	S26361-F3986-E4	S26361-F3986-L4
SFP+ Optical Transceiver 10G/1G Dual Rate SR	1x .. 4x	LC, MMF / SR SFP+ module, up to 400m, Intel	S26361-F3986-E5	S26361-F3986-L5
SFP+ Optical Transceiver 10G/1G Dual Rate LR	1x .. 4x	LC, SMF / LR SFP+ module, up to 10km, Intel	S26361-F3986-E6	S26361-F3986-L6
"Virtual Connector" for Twinax cables	2x	Enablement for System Architect	V:TWX CONNECTOR-PY	
Amphenol Active Twinax Cable SFP+ for 10G	2x	Amphenol 10G Active Twinax Cable, 2m	S26361-F3989-E600	S26361-F3989-L102
Amphenol Active Twinax Cable SFP+ for 10G	2x	Amphenol 10G Active Twinax Cable, 5m	Customized Cable Length	S26361-F3989-L105
Amphenol Active Twinax Cable SFP+ for 10G	2x	Amphenol 10G Active Twinax Cable, 10m	Customized Cable Length	S26361-F3989-L110
Brocade Active Twinax Cable SFP+ for 10G,	2x	Brocade 10G Active Twinax Cable, 1m	S26361-F3873-E500	S26361-F3873-L501
Brocade Active Twinax Cable SFP+ for 10G,	2x	Brocade 10G Active Twinax Cable, 3m	Customized Cable Length	S26361-F3873-L503
Brocade Active Twinax Cable SFP+ for 10G,	2x	Brocade 10G Active Twinax Cable, 5m	Customized Cable Length	S26361-F3873-L505
Cisco Passive Twinax Cable SFP+ for 10G, 1m	2x	Cisco 10G Passive Twinax Cable, 1m	Cisco P/N for: S26361-F4571-L101	
Cisco Passive Twinax Cable SFP+ for 10G, 3m	2x	Cisco 10G Passive Twinax Cable, 3m	Cisco P/N for: S26361-F4571-L103	

Cisco Passive Twinax Cable SFP+ for 10G, 5m	2x	Cisco 10G Passive Twinax Cable, 5m	Cisco P/N for: S26361-F4571-L105	
Cisco Active Twinax Cable SFP+ for 10G, 7m	2x	Cisco 10G Active Twinax Cable, 7m	Cisco P/N for: S26361-F4571-L107	
Cisco Active Twinax Cable SFP+ for 10G, 10m	2x	Cisco 10G Active Twinax Cable, 10m	Cisco P/N for: S26361-F4571-L110	
Max. 2x SFP+ or Twinax Cable per controller. Customized Cable Length means: best fitting cable length is defined during rack installation at the factory.				
max. 3x adapters per system				
Attention: max. 2 adapters per system in -V601				

40G Ethernet Network Components

40G Ethernet network adapter with QSFP cage (requires DAC, AOC cables or optical transceiver QSFP modules)				
Supports 40Gbps line rate per-port				
PLAN EP MCX4-EN 40Gb 2p QSFP LP	3x	Dual Port NIC, RoCE RDMA, Mellanox ConnectX4-EN	S26361-F4053-E202	S26361-F4053-L502
Optional, 40Gb QSFP Optical Transceiver module with MPO connector for PLAN EP MCX4-EN 40Gb 2p QSFP				
QSFP 40G SR4L MPO 850nm 30m MC2210411-SR4L	2x	MMF / SR4L QSFP module, Mellanox. Max reach supported 30m	S26361-F4053-E701	S26361-F4053-L701
QSFP 40G SR4 MPO 850nm 150m MC2210411-SR4	2x	MMF / SR4 QSFP module, Mellanox. Max reach supported 150m	S26361-F4053-E702	S26361-F4053-L702
QSFP 40G SR4 MPO 850nm 150m MMA1B00-B150D	2x	MMF / SR4 QSFP module, Mellanox. Max reach supported 150m	S26361-F4053-E703	S26361-F4053-L703
"Virtual Connector" for DAC/AOC cables	2x	Enablement for System Architect	V:DAC/AOC-CONNECTOR-40	
40G DAC - Cisco	2x	DAC are not in Fujitsu's portfolio yet. Thus, test only and purchase from switch vendors.		
40G DAC - Mellanox	2x	DAC are not in Fujitsu's portfolio yet. Thus, test only and purchase from switch vendors.		
40G AOC - Cisco	2x	AOC are not in Fujitsu's portfolio yet. Thus, test only and purchase from switch vendors.		
40G AOC - Mellanox	2x	AOC are not in Fujitsu's portfolio yet. Thus, test only and purchase from switch vendors.		
rmax: 2x QSFP or DAC, AOC per PLAN EP MCX4-EN 40Gb 2p QSFP				
max. 3x adapters per system				
Attention: max. 2 adapters per system in -V601				

100G Ethernet Network Components

100G Ethernet network adapter with 1x QSFP28 cage (requires twinax cables or optical transceiver QSFP28 modules)				
Supports 100Gbps line rate				
PLAN EP QL45611 100Gb 1p QSFP28 LP	3x	Single Port NIC, RoCE RDMA, Marvell FastLinQ® QL45611HLCU	S26361-F4057-E201	S26361-F4057-L501
PLAN EP MCX4-EN 100Gb 1p QSFP28 LP	3x	Single Port NIC, RoCE RDMA, Mellanox ConnectX4-EN	S26361-F4052-E201	S26361-F4052-L501
Optional, 100Gb QSFP28 Optical Transceiver module with MPO connector for PLAN EP QL45611 100Gb 1p QSFP28				
QSFP28 100G SR4 MPO 850nm 100m MMA1B00-C100D	1x	MMF / SR4 QSFP28 module, Mellanox. Max reach supported 100m	S26361-F4052-E701	S26361-F4052-L701
QSFP28 100G PSM4 1310nm 500m MMS1C10-CM	1x	MMF / SR QSFP28 module, Mellanox. Max reach supported 500m	S26361-F4052-E801	S26361-F4052-L801
"Virtual Connector" for DAC/AOC cables	1x	Enablement for System Architect	V:DAC/AOC-CONNECTOR-100	
100G DAC - Cisco	1x	DAC are not in Fujitsu's portfolio yet. Thus, test only and purchase from switch vendors.		
100G DAC - Mellanox	1x	DAC are not in Fujitsu's portfolio yet. Thus, test only and purchase from switch vendors.		
100G AOC - Cisco	1x	AOC are not in Fujitsu's portfolio yet. Thus, test only and purchase from switch vendors.		
100G AOC - Mellanox	1x	AOC are not in Fujitsu's portfolio yet. Thus, test only and purchase from switch vendors.		
Max. 1x QSFP28 or DAC/AOC Cable per PLAN EP QL45611 100Gb 1p QSFP28 or PLAN EP MCX4-EN 100Gb 1p QSFP28				
max. 3x adapters per system				
Attention: max. 2 adapters per system in -V601				

Q
Q

System configurator and order-information guide
PRIMERGY RX2530 M5 Status 2018-07-03

Network cables for later upgrade

Fujitsu active SFP+ Twinax 10Gb cable	
SFP+ active Twinax Cable Fujitsu 2m	S26361-F3989-L102
SFP+ active Twinax Cable Fujitsu 5m	S26361-F3989-L105
SFP+ active Twinax Cable Fujitsu 10m	S26361-F3989-L110
Brocade active SFP+ Twinax 10Gb cable	
SFP+ active Twinax Cable Brocade 1m	S26361-F3873-L501
SFP+ active Twinax Cable Brocade 3m	S26361-F3873-L503
SFP+ active Twinax Cable Brocade 5m	S26361-F3873-L505

R

Chapter 11 - Fibre Channel Adapters

K

32G Fibre Channel adapters with LC interface for 50µm optical cables (OM4 or OM3)

These adapters ship with optical transceiver modules equipped for all ports.

Adapters support 32GFC, 16GFC, and 8GFC infrastructures.

PFC EP LPe32000 1x 32Gb LP	3x	1 port, low profile, Broadcom Emulex®	S26361-F4044-E201	S26361-F4044-L501
PFC EP LPe32002 2x 32Gb LP	3x	2 ports, low profile, Broadcom Emulex®	S26361-F4044-E202	S26361-F4044-L502
PFC EP QLE2740 1x 32Gb LP	3x	1 port, low profile, Marvell Qlogic®	S26361-F4043-E201	S26361-F4043-L501
PFC EP QLE2742 2x 32Gb LP	3x	2 ports, low profile, Marvell Qlogic®	S26361-F4043-E202	S26361-F4043-L502

16G Fibre Channel adapters with LC interface for 50µm optical cables (OM4 or OM3)

These adapters ship with optical transceiver modules equipped for all ports.

Adapters support 16GFC, 8GFC, and 4GFC infrastructures.

PFC EP LPe31000 1x 16Gb LP	3x	1 port, low profile, Broadcom Emulex®	S26361-F5596-E201	S26361-F5596-L501
PFC EP LPe31002 2x 16Gb LP	3x	2 ports, low profile, Broadcom Emulex®	S26361-F5596-E202	S26361-F5596-L502
PFC EP QLE2690 1x 16Gb LP	3x	1 port, low profile, Marvell Qlogic®	S26361-F5580-E201	S26361-F5580-L501
PFC EP QLE2692 2x 16Gb LP	3x	2 ports, low profile, Marvell Qlogic®	S26361-F5580-E202	S26361-F5580-L502

max. 3 adapters per system

Attention: max. 2 adapters per system in -V601

Chapter 13 - Infiniband Adapters

Max. 2x Omni Path Card per System (configuration of different Controllers NOT

Max. 2x IB Controller per System (configuration of different Controllers NOT

S26361-F5717-E102/E202

IB HCA 100Gb 1 / 2channel EDR
100Gbit 1 / 2channel Infiniband Controller EDR technology (8.0GT/s)
1x / 2x Q-SFP+ connector
PCIe Gen3 x16 low profile Card, 170mm
max. 2x per system

S26361-F5724-E102/E202

IB HCA 100Gb 1 / 2channel HDR
100Gbit 1 / 2channel Infiniband Controller HDR technology (8.0GT/s)
1x / 2x Q-SFP+ connector
PCIe Gen3 x16 low profile Card, 170mm
max. 2x per system

S26361-F5562-E10

POP EP 100Gb 1 Channel
100Gbit 1 channel Omni Path HFI Card (8.0GT/s)
1x Q-SFP+ connector
PCIe Gen3 x16 low profile Card, 170mm
max. 2x per system

S26361-F5549-E561/-E563

IB Cu Cable 100Gb
QSFP, 1 or 3m
max. 1/ 2x per Controller

S26361-F5748-E571

IB Cu Y-Cable 100Gb (To HDR SW)
QSFP, 1
max. 1/ 2x per Controller

S26361-F5563-E150/-E200/-E300

Omni Passive Cable 100Gb
QSFP, 1.5m or 2m or 3m
max. 1 per Controller

The following card can not be mixed Infiniband card(S26361-F5717-E102/E202)

S26361-F4054-E302/S26361-F4052-E201/S26361-F4052-E1/S26361-F4053-E2/S26361-F4053-E202

The following card can not be mixed Infiniband card(S26361-F5724-E102/E202)

S26361-F4054-E302/S26361-F4052-E201/S26361-F4052-E1/S26361-F4053-E2/S26361-F4053-E202

The following card can not be mixed with Infiniband card(S26361-F5562-E10)

S26361-F4054-E302/S26361-F4052-E201/S26361-F4052-E1/S26361-F4053-E2/S26361-F4053-E202

Network Components, Controller and cables for later upgrade

100Gbit/s 1ch Infiniband Controller	S26361-F5717-L102
100Gbit/s 2ch Infiniband Controller	S26361-F5717-L202
QSFP, IB 100Gb, 1m	S26361-F5549-L561
QSFP, IB 100Gb, 3m	S26361-F5549-L563

Omni Path**

100Gbit/s 1ch Omni Path HFI Card	S26361-F5562-L10
QSFP, Omni 100Gb, 1.5m	S26361-F5563-L150
QSFP, Omni 100Gb, 2m	S26361-F5563-L200
QSFP, Omni 100Gb, 3m	S26361-F5563-L300

**as soon as available

L

Chapter 14 - Power supply unit, power cable, certifications, region kits

M

Power supply unit

modular redundant Power Supply

2nd PSU for redundancy
occupies hot plug PSU slot, min. 1 / max. 2x per system
input nominal voltage (AC): 100V-240V, max: 90V-264V; input dropout 10ms/100% load, 47Hz-63Hz

450W platinum PSU	94% eff.		S26113-F575-E13	S26113-F575-L13
800W platinum PSU	94% eff.		S26113-F574-E13	S26113-F574-L13
800W titanium PSU	96% eff.	nom. 220-240V, max. 180-264V	S26113-F615-E10	S26113-F615-L10
1200W platinum PSU	94% eff.	100V: 1000W, 90V: 900W	S26113-F616-E10	S26113-F616-L10

DC PSU

800W PSU DC	92% eff.	48V DC, powercord see below	S26113-F624-E10	S26113-F624-L10
1300W PSU HVDC	94% eff.	380V DC as soon as available , powercord: PRIMERGY-PM	S26113-F626-E10	S26113-F626-L10

Dummy module instead PSU

Dummy module for closing the 2nd PSU hole, in case only 1 PSU is equipped, max. 1x per system	S26113-F574-E99	
---	-----------------	--

Power cord option for Rack Server, 1x per PSU

Cable powercord rack, 1.8m, black, IEC 320 C14 -> C13 (10A plug)	T26139-Y1968-E180	T26139-Y1968-L180
Cable powercord rack, 2.5m, black, IEC 320 C14 -> C13 (10A plug)	T26139-Y1968-E250	T26139-Y1968-L250
Cable powercord rack, 4m, black, IEC 320 C14 -> C13 (10A plug)	T26139-Y1968-E100	T26139-Y1968-L10
Cable powercord (USA) 15A, 1.8m, black, NEMA 5-15 connector 498G -> C13 (plug), 15A, , rack or wall	T26139-Y1741-E90	T26139-Y1741-L90
Cable powercord (Taiwan), 1.8m, rack or wall	T26139-Y1757-E10	T26139-Y1757-L10
Cable powercord -48V DC, 3m, black	T26139-Y4024-E10	T26139-Y4024-L10
Cable powercord (D, A, B, F, NL, FIN, N, S, E, P, RUS, TR), 1.8m, grey		T26139-Y1740-L10
Cable powercord (UK, IR), 1.8m, grey		T26139-Y1744-L10
Cable powercord (I), 1.8m, grey		T26139-Y1745-L10
Cable powercord (DK), 1.8m, grey		T26139-Y1746-L10
Cable powercord (ISR), 2.5m, black		T26139-Y1747-L10
no power cord	T26139-Y3850-E10	

Region Kits, **required to order one of them**, 1x per System

	build-in order code	oose delivery order code	
Region Kit APAC/EMEA/India, Contains warranty sheet and safety instructions for APAC, EMEA and	S26361-F1452-E100	-	
Region Kit America, Contains warranty sheet, registration hints and safety instructions for	S26361-F1452-E130	-	
Region Kit Europe, Contains warranty sheet and safety instructions in German, English, French, Spanish, Italian, Polish, Russian and Welsh language, need to be included always into the order from EU and EFTA	S26361-F1452-E140	-	(Sales region for EMEA only)
Region Kit China for CCC systems, Contains warranty sheet and safety instructions for China, need to be included always into the order from China country	S26361-F1452-E101	-	(Sales region for APAC only)
Region Kit China for CCC option not required systems (N/A CCC systems for more than 1300W PSU or, systems printing CCC mark always), Contains warranty sheet and safety instructions for China, need to be included always into the order from China country	S26361-F1452-E102	-	(Sales region for APAC only)

Certifications, Made in Germany Sticker, optional 1x per system

	build-in order code	oose delivery order code
Certification for China, (CCC), Reduced component selection possible, only with no power cord option	S26361-F3301-E120	-
Certification for India, (BIS), Reduced component selection possible, only with no power	S26361-F3301-E123	-

N

0

S26361-F3301-E531

RX2530 M5 E-Star Fam1

Limits configuration in accordance
with Energy Star requirements for systems with 1 CPU
max. 1x per system

S26361-F3301-E532

RX2530 M5 E-Star Fam2

Limits configuration in accordance
with Energy Star requirements for systems with 2 CPU
max. 1x per system

limitations for E-Star Fam1 / 2 certification:

Please make sure to follow the guidelines below in order to meet ENERGY STAR V3.0 Fam1 requirements

1 CPU Variant, **exclusions**, not a single violation is allowed by ENERGY STAR 3.0:

2 CPU Variant, as above, in brackets (xx):

not allowed are:

- CPU Xeon Bronze 3204
- CPU Xeon Gold 5222
- CPUs Xeon Platinum 8268 / 8270 / 8276 (L, M too) / 8280 (L, M too)
- CPUs with Multiplier of core and frequency is less than 16.8
- CPUs with Multiplier of core and frequency is more than 57.6
- less than 6 (12) RAM Modules
- 8 GB RAM Modules
- DCPMM (Apache Pass) Memory Modules
- No 3.5" HHD for 1 CPU Variant only, 3.5" HHD allowed for 2 CPU Variant
- more than 6 (8) x 2.5"/3.5" HDD/SSD/PCIe SSD/M.2 Modules (max 6 / 8 is ok)
- more than 2x (3x) PCIe cards (i.e. Raid, LAN, Fiberchannel, Infiniband card, ...)
- Graphics card
- APA card

CPU restriction according to CPU page

ENERGY STAR-configurations with one CPU will be labeled:
ENERGY STAR-configurations with two CPU will be labeled:
non ENERGY STAR-configurations will be labeled:

PRIMERGY RX2530 M5 E-Star Far
PRIMERGY RX2530 M5 E-Star Far
PRIMERGY RX2530 M5

P



i:

n1
n2

Chapter 14 - ErP Lot 9 restriction

0

*Region kit Europe must be order for shipment to ship in EU and EFTA countries to apply ErP Lot9 restriction

Region Kits, 1x per System	
Region Kit APAC/EMEA/India, Contains warranty sheet and safety instructions for APAC, EMEA and India	S26361-F1452-E100
Region Kit America, Contains warranty sheet, registration hints and safety instructions for America	S26361-F1452-E130

Region Kits, 1x per System	
Region Kit Europe*, Contains warranty sheet and safety instructions in German, English, French, Spanish, Italian, Polish, Russian and Welsh language	S26361-F1452-E140

ErP Lot9 Restriction for 1/2 CPU configuration, 1x per System	
ErP Lot 9 configuration for min 1 DIMM	S26361-F3776-E121

ErP Lot9 Restriction for 1/2 CPU configuration, 1x per System	
ErP Lot 9 configuration with min 4 DIMM	S26361-F3776-E122

ErP Lot9 Restriction for 2 CPU configuration, 1x per System	
ErP Lot 9 configuration for 2 CPUs with min 6 DIMM	S26361-F3776-E123

Restriction for ErP Lot 9 directive,
Not allowed are : (for 1CPU/2CPU variant)

- CPU Xeon Bronze 3204 / 3206R
- CPU Xeon Silver 4215R
- CPU Xeon Gold 5222, 6250, 6256
- 8 GB RAM Modules
- more than 9x 2.5"/3.5" HDD/SSD/PCIe SSD (max 8 is ok)

Restriction for ErP Lot 9 directive,
Not allowed are : (for 1CPU/2PCU variant)

- CPU Xeon Bronze 3204 / 3206R
- less than 4 RAM Modules (min 4 required)

No HDD/SSD qty restricted
No PCIe qty restricted

Restriction for ErP Lot 9 directive,
Not allowed are : (for 2CPUs variant only)

- less than 6 RAM Modules (min 6 required)

No CPU/DIMM type excluded
No HDD/SSD qty restricted
No PCIe qty restricted

P

Chapter 15 - Accessories

Q

<http://www.fujitsu.com/fts/products/computing/peripheral/accessories/index-facts.html>

USB Memory Sticks - Available until August 2020. No successor planned.		
ADATA UC350 USB3.1 Type C OTG Flash Drive 64GB		S26391-F6048-L464

USB Optical Disc Drive		
External Ultra Slim Portable DVD Writer (Hitachi-LG)		S26341-F103-L142

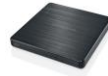

R

Chapter 16 - others

0

S26361-F1790-E243
S26361-F1790-L244
iRMC S4 advanced pack / <i>S5 alternatively</i>
integrated remote Management controller activation key for graphical console redirection and remote media redirection
max. 1x per system

Advanced Thermal design cannot be combined with the Flash backup unit of the RAID controllers

S26361-F1790-E311
embedded Lifecycle Management (eLCM)
Server Online Update OS driver Update Hardware firmware update
Server Offline Update Hardware update via Update Manager Express
PrimeCollect Autonomous creation of Primecollect archives Creation and use of PrimeCollect archives over AIS connect
Custom Image (Jukebox function) Automatic and manual download of CD and DVD Images Automatic and manual start of CD and DVD Images
max. 1x per system

Loose delivery
eLCM Activation Pack (Node Locked License)
BDL:ELCM-PACK
options contains:
- 16GB SD card
- Paper with TAN for Licensekey

S26361-F3776-E440
Cool-safe® Advanced Thermal design 40°C
enables the PRIMERGY Server to cope with temperatures from 5-40° in operating mode due to extended Fan settings
this setting can be activated ex factory only
max. 1x per system

S26361-F3776-E445
Cool-safe® Advanced Thermal design 45°C
enables the PRIMERGY Server to cope with temperatures from 5-45° in operating mode due to extended Fan settings
this setting can be activated ex factory only
max. 1x per system

S26361-F3552-E100
S26361-F3552-L100
TPM 2.0 Module SPI
max. 1x per system

S26361-F3552-E101
TPM 1.2 Module SPI
max. 1x per system

S26361-F3120-E3
S26361-F3120-L3
serial port (RS232)
serial port (RS232) mounted on a low profile PCIe slot
max. 1x per system

You would like to add some customer specific solutions?



With our made4you service we fulfill any individual requirement and wish of our customers perfectly - e.g.

- > special hardware configurations,
- > staging services ex factory,
- > extended lifecycle management,
- > customer specific logos, component,
- > BIOS fixes and many more.

For further information please contact us



Fujitsu Portfolio

Build on industry standards, Fujitsu offers a full portfolio of IT hardware and software products, services, solutions and cloud offering, ranging from clients to datacenter solutions and includes the broad stack of Business Solutions, as well as the full stack of Cloud offering. This allows customers to leverage from alternative sourcing and delivery models to increase their business agility and to improve their IT operation's reliability.

Your Server is ready

Date of change [dd.mm.yyyy]	Folder / order code / description	Name	What has been changed / comment
26.03.2020	PSU	Atsushi Iwata	include Region kit China
24.03.2020	others	Tomokazu Tsuchiya	M4Y removed
10.03.2020	ErP restriction	Atsushi Iwata	updated ErP Lot9 restriction
04.03.2020	ErP restriction	Atsushi Iwata	added ErP Lot9 restriction in new sheet ErP Lot9
18.02.2020	IB	Takaoka Masanori	Change the cable S26361-F5549-E561/E563 -> S26361-F5748-E571
14.02.2020	GFX_FPGA	Takayuki Sasaki	Modify some wrong FTS Order codes in "GFX" tab.
04.02.2020	FC	Seiji Toda	Changed listing order
03.02.2020	CPU	Klaus-Dieter Ruf	Added Cascade Lake-SP Refresh SKUs
28.01.2020	HDD_SSD / Dual M.2	Tatsuya Sudou	added 480GB as supported M.2 Modules
16.01.2020	Base & CPU	Robert Brunnbauer	2 CPUs are mandatory for base units V501 and V601
31.11.2019	CPU and E Star 3 corrected	Robert Brunnbauer	CPU 5222 not allowed
27.11.2019	CPU and E Star 3 / S26361-F3301-E531/32	Robert Brunnbauer	Added Energy Star 3.0 restrictions
08.11.2019	PSU / T26139-Y1748-L10 / removed	Y. Narita	Removed Cable powercord (AUS/NZ), 1.8m, grey
05.11.2019	S26391-F6048-L464	Ulrich Lösch	ADATA UC350 USB3.1 Type C OTG Flash Drive 64GB
04.11.2019	T26139-Y4024-E10 / L10	J.Linne	length of -48V DC PSU cable changed to 3m length
30.10.2019	RAM	Klaus-Dieter Ruf	DCPMM section updated
19.09.2019	CPU	Klaus-Dieter Ruf	Added Xeon Gold 5218B SKU
09.09.2019	CPU	Klaus-Dieter Ruf	T-SKUs added for DTAG project
13.08.2019	RAM	Klaus-Dieter Ruf	DCPMM configuration possibilities update
26.07.2019	HDD_SSD / S26361-F5738-* / updated	Yuichi Sugiyama	removed the description as "as soon as available"
26.07.2019	HDD_SSD / S26361-F5571/F5624/F3904-E140/L140	Yuichi Sugiyama	removed the description as "as soon as available"
17.07.2019	LAN	Ulrich Lösch	S26361-F4053-E703, -L703 Transceiver 40G added
15.07.2019	ODD	Sven Pilz	corrected comment on 10x base unit
05.07.2019	GFX_FPGA	Takayuki Sasaki	Modify GFX canrd - Options in "GFX" tab.
02.07.2019	HDD_SSD / S26361-F5738-* / added	Yuichi Sugiyama	added PCIe-SSD 2.5" Read-Intensive
02.07.2019	HDD_SSD / S26361-F5571/F5624/F3904-E140/L140	Yuichi Sugiyama	added HDD SAS/SATA 3.5" 7.2K 512e 14TB
26.06.2019	Base & CPU	Sven Pilz	Updated some comments on CPU and slot allocation rules
26.06.2019	LAN FC IB	Takaoka Masanori	Add ConnectX6(Infiniband card)
13.06.2019	RAID	Sven Pilz	Updated comment on V546 base unit
07.05.2019	CPU	Klaus-Dieter Ruf	Added missing Xeon Gold 6246 SKU
30.04.2019	RAM	Klaus-Dieter Ruf	DCPMM configuration possibilities update
24.04.2019	HDD_SSD / S26361-F5732/F5733-*	Yuichi Sugiyama	Removed the description as "or SM863a"
24.04.2019	HDD_SSD / S26361-F5737-*	Yuichi Sugiyama	Removed the description as "as soon as available"
18.04.2019	LAN	Ulrich Lösch	Removed: Broadcom/Emulex SFP S26361-F5250-E110, -L110
03.04.2019	RAM	Klaus-Dieter Ruf	Rank sparing mode table updated
19.03.2019	base	Sven Pilz	several improvements and corrections, i.e. DCPMM
19.03.2019	RAID	Sven Pilz	comments corrected, CP403i added
12.03.2019	RAM	Sven Pilz	top section (corrected total capa from 2.048 to 1.920)
11.03.2019	RAM	Klaus-Dieter Ruf	Updated modes within released DCPMM configurations
07.03.2019	RAID	Johannes Linne	added PRAID EP540/80i RAID NVMe LP for -V546
06.03.2019	RAM	Klaus-Dieter Ruf	Added Memory Packages for easy AEP configuration
01.03.2019	HDD_SSD / S26361-F5737-* / added	Yuichi Sugiyama	added
25.02.2019	RAM	Klaus-Dieter Ruf	AEP configuration update including stepwise approach
22.02.2019	LAN	Ulrich Lösch	Cosmetic renamed Cavium/Qlogic to: Marvell FastLinQ®
22.02.2019	FC	Ulrich Lösch	Cosmetic renamed Cavium/Qlogic to: Marvell Qlogic®
22.02.2019	FC	Ulrich Lösch	Cosmetic renamed Broadcom/Emulex to: Broadcom Emulex®
19.02.2019	CPU	M.Pentney-Schmidt	changed TDP on 4214Y
15.02.2019	LAN_FC_IB	Takaoka Masanori	update EDR card parts number
13.02.2019	HDD_SSD / S26361-F3907-* / corrected the	Yuichi Sugiyama	corrected the order codes of PRAID from E204 to E214 in exclusion
12.02.2019	HDD/SSD	Sven Pilz	corrected entry on PCIeSSD connection, section K
12.02.2019	HDD_SSD / S26361-F3907-* / added the exclusion	Yuichi Sugiyama	added the exclusion for HDD SATA 2.5" 7.2K 512e and PRAID
08.02.2019	LAN_FC_IB	Takaoka Masanori	removed FDR card and change EDR card parts number
06.02.2019	GFX	Takayuki Sasaki	Modify Graphic Card - Options in "GFX" tab.
04.02.2019	RAID	Johannes Linne	S26361-F3846-L49
04.02.2019	HDD_SSD	Yuichi Sugiyama	removed the description as "as soon as available" because of
04.02.2019	HDD_SSD	Yuichi Sugiyama	added the description about Supplier / ModelName of SSD
23.01.2019	base	M.Pentney-Schmidt	OCuLink changed to SlimSAS
10.01.2019	HDD_SSD / S26361-F5571/F5624/F3904-E140/L140	Yuichi Sugiyama	removed HDD SAS/SATA 3.5" 7.2K 512e 14TB
08.01.2019	RAM	M.Pentney-Schmidt	LRDIMM 3DS removed; minor update on description
12.12.2018	CPU	M.Pentney-Schmidt	Order codes for cooling kits added
03.12.2018	HDD_SSD / S26361-F5734/F5735-* / removed	Yuichi Sugiyama	removed
28.11.2018	CPU	M.Pentney-Schmidt	Further update of CPU page
27.11.2018	CPU	M.Pentney-Schmidt	Update of CPU page
19.11.2018	HDD_SSD / S26361-F5735-* / add the order codes	Yuichi Sugiyama	add the order codes for PCIe-SSD 2.5" Read Intensive
19.11.2018	HDD_SSD / S26361-F5734-* / add the order codes	Yuichi Sugiyama	add the order codes for PCIe-SSD 2.5" Mixed Use
19.11.2018	HDD_SSD / S26361-F5571/F5624/F3904-E140/L140	Yuichi Sugiyama	add the order codes for HDD SAS/SATA 3.5" 14TB
19.11.2018	HDD_SSD / HDD SAS 3.5" 10K 512e / changed order	Yuichi Sugiyama	changed from F5569-* to F5731-* w/o 2.4TB for WS2019SDDC-AQ
19.11.2018	HDD_SSD / HDD SAS 3.5" 10K 512n / changed order	Yuichi Sugiyama	changed from F5568-* to F5728-* for WS2019SDDC-AQ cert
19.11.2018	HDD_SSD / HDD SAS 3.5" 15K / changed order	Yuichi Sugiyama	changed from F5532-* to F5726-* w/o 900GB for WS2019SDDC-AQ
19.11.2018	HDD_SSD / SSD SATA 3.5" Mixed Use / changed	Yuichi Sugiyama	changed from F5673/F5589-* to F5732-* w/o 3.84TB for
19.11.2018	HDD_SSD / HDD SAS 2.5" 10K 512e / changed order	Yuichi Sugiyama	changed from F5543-* to F5730-* w/o 2.4TB for WS2019SDDC-AQ
19.11.2018	HDD_SSD / HDD SAS 2.5" 10K 512n / changed order	Yuichi Sugiyama	changed from F5550-* to F5729-* for WS2019SDDC-AQ cert
19.11.2018	HDD_SSD / HDD SAS 2.5" 15K / changed order	Yuichi Sugiyama	changed from F5531-* to F5727-* w/o 900GB for WS2019SDDC-AQ
19.11.2018	HDD_SSD / SSD SATA 2.5" Mixed Use / changed	Yuichi Sugiyama	changed from F5675/F5588-* to F5733-* w/o 3.84TB for
31.10.2018	HDD_SSD / S26361-F5635/F5638/F5584-E800/L800	Yuichi Sugiyama	added
31.10.2018	HDD_SSD / exclusions for 8/10TB HDDs and PRAID	Yuichi Sugiyama	removed

17.10.2018	Ethernet Adapters Quad-Port SFP+ Adapters	Ulrich Lösch	Max = 3 --> 1.
26.09.2018	HDD SSD / S26361-F5650-*, PACC EP PM1725b AIC	Yuichi Sugiyama	removed both PM1725b AIC and P4600 AIC
26.09.2018	HDD SSD / PACC EP PM1725b AIC	Yuichi Sugiyama	added PCIe SSD AIC MU 1.6/3.2/6.4TB
26.09.2018	HDD SSD / PCIe-SSD 2.5" Mixed Use	Yuichi Sugiyama	added PCIe SSD 2.5" MU 1.6/3.2/6.4TB
26.09.2018	HDD SSD / PCIe-SSD Low Power 2.5" Read-Int.	Yuichi Sugiyama	added PCIe SSD 2.5" RI 960GB/1.92TB/3.85TB
26.09.2018	HDD SSD / S26361-F5694/F5692-*	Yuichi Sugiyama	removed SSD SATA MU S4600
26.09.2018	HDD SSD / S26361-F5588/F5589-E384/L384	Yuichi Sugiyama	added SSD SATA MU 3.84TB
18.09.2018	GFX	Takayuki Sasaki	Modify Graphic Card - Options in "GFX" tab. - add "DP- DVI/D" adapter
12.09.2018	RAM	M. Pentney-Schmidt	further update of Memory page
31.08.2018	RAM	Klaus-Dieter Ruf	DCPMM update
28.08.2018	S26113-F624-E10 48V DC PSU	J.Linne	change efficiency to 92%
21.08.2018	HD SSD	Yuichi Sugiyama	Upfated
16.08.2018	RAM	Klaus-Dieter Ruf	Further update of Memory page
01.08.2018	RAM	Klaus-Dieter Ruf	Memory page updated (first draft incl. Apache Pass)
01.08.2018	HD SSD	Yuichi Sugiyama	Upfated
11.07.2018	Base units	Sven Pilz	Corrected Draft - Base units
11.07.2018	GFX	Takayuki Sasaki	Update Graphic card information in GFX tab.
04.07.2018	RAID	Johannes Linne	Added PRAID EP540e, special release, changed comments
03.07.2018	LAN_FC_IB	Sven Pilz	Reviewed Draft - LAN_FC_IB
03.07.2018	RAID	Sven Pilz	Reviewed Draft - RAID
26.06.2018	LAN_FC_IB	Sven Pilz	Reviewed Draft - LAN_FC_IB
26.06.2018	RAID	Sven Pilz	Reviewed Draft - RAID
26.06.2018	Base units	Sven Pilz	Reviewed Draft - Description
26.06.2018	Description	Sven Pilz	Reviewed Draft - Description
25.06.2018	Base units	Robert Brunnbauer	Reviewed Draft - Base units
20.06.2018	Fibre Channel Adapters	Ulrich Lösch	Reviewed Draft - Fibre Channel Adapters
20.06.2018	Ethernet Adapters	Ulrich Lösch	Reviewed Draft - Ethernet Adapters
04.05.2018	Draft	Sven Pilz	first draft