











Product Selection Guide

Size and Performance Data F-DH-2

Sound Transmission Class F-DH-2

Features and Options..... F-DH-3

Glazing Performance..... F-DH-4

Grille Types..... F-DH-9

Size Tables F-DH-10

Combination Assemblies..... F-DH-15

Design Data..... F-DH-17

Detailed Product Descriptions..... F-DH-23

Unit Sections

Block Frame F-DH-25

Integral Nailing Fin..... F-DH-26

Document Navigation Tips:

Items listed in the table of contents above are active links that will take you to the corresponding page.
 The Pella logo on each page is a link back to this table of contents.
 Bookmarks are also included in this PDF document and are available as an additional navigation option.

Supporting documents for this product:

Test Reports:

https://media.pella.com/professional/adm/CertificationReports/Test_Reports_IMP.pdf

CSI Specs (readable using Microsoft Word or other text editing application):

https://media.pella.com/professional/adm/Fiberglass-CSI_Specs/08572_DH.rtf

AIA Masterspec (readable using Microsoft Word or other text editing application):

https://media.pella.com/professional/adm/Fiberglass-CSI_Specs/085413_fl.rtf

Detailed Product Description (readable using Microsoft Word or other text editing application):

<https://media.pella.com/professional/adm/Fiberglass/F2-DH.rtf>

Size Tables (requires appropriate CAD software to read and use):

https://media.pella.com/professional/adm/Fiberglass/IMP-DH-Elev_D.dwg

CAD cross sections (requires appropriate CAD software to read and use):

https://media.pella.com/professional/adm/Fiberglass/IMP-DH-Detail_D.dwg

3D & BIM (requires appropriate software to read and use):

https://media.pella.com/professional/adm/RevitFiles/Imp-Revit/Window-Double_Hung-Pella-Impervia.zip

Sketchup (requires appropriate software to read and use):

https://media.pella.com/professional/adm/Fiberglass/PellaSKP_Impervia_Double-Hung.zip

Combination Recommendations:

https://media.pella.com/professional/adm/Fiberglass/F2_Combinations.pdf

Installation Details:

https://media.pella.com/professional/adm/Fiberglass/Pella-Impervia_InstallationDetails.pdf

The information published in this document is believed to be accurate at the time of publication. However, because we are constantly working to improve our products, specifications are subject to change without notice. Consult your local Pella representative for up-to-date product information.

Microsoft and Microsoft Word are registered trademarks of Microsoft Corp.



Impervia® Double-Hung Windows

Size and Performance Data

	Block Frame	Precision Fit	Integral Nailing Fin
Sizes			
Standard Vent–Equal Sash, Cottage and Contemporary Sash	●	●	●
Special Fixed	●	●	●
Special Fixed Companion	●	●	●
Special Sizes Available	●	●	●
Performance ₁			
Meets or Exceeds AAMA/WDMA Ratings	H-LC30–H-LC50 Hallmark Certified	H-LC30–H-LC50 Hallmark Certified	H-LC30–H-LC50 Hallmark Certified
Air Infiltration (cfm/ft ² of frame @ 1.57 psf wind pressure)	0.3	0.3	0.3
Water Resistance	4.5 psf	4.5 psf	4.5 psf
Design Pressure	30–50 psf	30–50 psf	30–50 psf
Other Performance Criteria			
Forced Entry Resistance Level (Minimum Security Grade) ₂	10	10	10
Maximum Operating Force (lb) Initiate Motion/Maintain Motion	20/30 for units with sash ≤ 12 ft ² 30/45 for units with sash > 12 ft ²		
Maximum Locking Force (lb) Lock/Unlock	6/7	6/7	6/7

Sound Transmission Class and Outdoor-Indoor Transmission Class					
Frame Size Tested ₄	Glazing System			STC Rating	OITC Rating
	Overall Glazing Thickness	Exterior Glass Thickness	Interior Glass Thickness		
Double-Hung - Dual pane insulating Glass					
47-1/2" x 59-1/2"	11/16"	2.5mm	2.5mm	26	22
47-1/2" x 59-1/2"	11/16"	3mm	5mm	29	26
47-1/2" x 59-1/2"	11/16"	3mm	6mm Laminated	29	26

(1) See Design Data pages in this section for specific product performance class and grade values.

(2) The higher the level, the greater the product's ability to resist forced entry.

(3) Glazing configurations may result in higher operational forces

(4) ASTM E 1425 defines standard sizes for acoustical testing. Ratings achieved at that size are representative of all sizes of the same configuration.



Impervia® Double-Hung Windows

Features and Options

	Block Frame	Precision Fit	Integral Nailing Fin
Glazing			
Glazing Type			
Dual-pane Insulating Glass	S	S	S
Insulated Glass Options / Low-E Types			
Clear Insulating Glass (no Low-E coating)	S	S	S
Advanced Low-E Insulating Glass	O	O	O
SunDefense™ Low-E Insulating Glass	O	O	O
AdvancedComfort Low-E Insulating Glass	O	O	O
NaturalSun Low-E Insulating Glass	O	O	O
Additional Glass Options			
Annealed Glass	S	S	S
Tempered Glass	O	O	O
Noise reduction glass (3/5mm, 4/6mm combinations)	O	O	O
Noise reduction laminated glass (non-impact)	O	O	O
Tinted glass (Bronze, Gray, Green) Advanced Low-E	O	O	O
Obscure Glass ₁	O	O	O
Gas Fill / High Altitude			
Argon	S	S	S
High Altitude	O	O	O
High Altitude with argon	O	O	O
Exterior			
Powder-Coat White	S	S	S
Powder-Coat Tan, Brown, Black, or Morning Sky Gray	O	O	O
Dual-color (All exterior colors available with White interior)	O	O	–
Hardware			
Match interior finish	S	S	S
Satin Nickel, Bright Brass or Oil-Rubbed Bronze	O	O	O
Sash Locks			
Self-aligning sash lock	S	S	S
Screens			
Full or Half-Size Conventional Black Fiberglass	O	O	O
Full or Half-Size Inview™ screens	O	O	O
Grilles			
Grilles-Between-the-Glass			
3/4" Contoured White, Tan, Brown, Black, or Morning Sky Gray	O	O	O
Patterns			
Traditional	O	O	O
Prairie	O	O	O
Top Row	O	O	O
Special	O	O	O
Tilt-Wash Cleaning			
Both sashes tilt at bottom	S	S	S

S = Standard; O = Optional; (–) = Not available

(1) Contact your local Pella sales representative for current offering.



Impervia® Double-Hung Windows

Glazing Performance - Total Unit

Glazing Thickness	Type of Glazing	NFRC Certified Product #	Glass (mm)		Gap Fill	Performance Values ₁				Shaded Areas Meet ENERGY STAR® Performance Criteria in Zones Shown						
			Ext.	Int.		U-Factor	SHGC	VLT	CR	U. S.				Canada ₂		
										Zone				ER	Zone	
Vent										N	NC	SC	S	CA		
11/16"	Clear IG	PEL-N-126-00757-00001	2.5	2.5	air	0.48	0.58	0.61	43							
	with grilles-between-the-glass	PEL-N-126-00757-00002				0.48	0.52	0.54	43							
11/16"	Clear IG	PEL-N-126-00757-00003	3	3	air	0.48	0.58	0.61	43							
	with grilles-between-the-glass	PEL-N-126-00757-00004				0.48	0.52	0.54	43							
11/16"	Advanced Low-E IG	PEL-N-126-00788-00001	2.5	2.5	argon	0.31	0.28	0.52	57							
	with grilles-between-the-glass	PEL-N-126-00788-00002				0.31	0.25	0.46	57				S			
11/16"	Advanced Low-E IG	PEL-N-126-00788-00003	3	3	argon	0.31	0.28	0.52	57							
	with grilles-between-the-glass	PEL-N-126-00788-00004				0.31	0.25	0.46	57				S			
11/16"	SunDefense™ IG	PEL-N-126-00802-00001	2.5	2.5	argon	0.31	0.21	0.48	57							
	with grilles-between-the-glass	PEL-N-126-00802-00002				0.31	0.19	0.43	57				S			
11/16"	SunDefense™ IG	PEL-N-126-00802-00003	3	3	argon	0.31	0.21	0.48	57							
	with grilles-between-the-glass	PEL-N-126-00802-00004				0.31	0.19	0.43	57				S			
11/16"	AdvancedComfort Low-E IG	PEL-N-126-00814-00001	2.5	2.5	argon	0.27	0.27	0.51	45	N	NC					
	with grilles-between-the-glass	PEL-N-126-00814-00002				0.27	0.25	0.45	45	N	NC	SC	S			
11/16"	AdvancedComfort Low-E IG	PEL-N-126-00814-00003	3	3	argon	0.27	0.27	0.51	45	N	NC					
	with grilles-between-the-glass	PEL-N-126-00814-00004				0.27	0.25	0.45	45	N	NC	SC	S			
11/16"	NaturalSun Low-E IG	PEL-N-126-00776-00001	2.5	2.5	argon	0.32	0.51	0.59	56							
	with grilles-between-the-glass	PEL-N-126-00776-00002				0.32	0.46	0.52	56							
11/16"	NaturalSun Low-E IG	PEL-N-126-00776-00003	3	3	argon	0.32	0.51	0.59	56							
	with grilles-between-the-glass	PEL-N-126-00776-00004				0.32	0.46	0.52	56							
Vent with Foam Insulation																
11/16"	Advanced Low-E IG	PEL-N-126-00862-00001	2.5	2.5	argon	0.29	0.28	0.52	58		NC					
	with grilles-between-the-glass	PEL-N-126-00862-00002				0.29	0.25	0.46	58		NC	SC	S			
11/16"	Advanced Low-E IG	PEL-N-126-00862-00003	3	3	argon	0.29	0.28	0.52	58		NC					
	with grilles-between-the-glass	PEL-N-126-00862-00004				0.29	0.25	0.46	58		NC	SC	S			
11/16"	SunDefense IG	PEL-N-126-00876-00001	2.5	2.5	argon	0.29	0.21	0.48	58		NC	SC	S			
	with grilles-between-the-glass	PEL-N-126-00876-00002				0.29	0.19	0.43	58		NC	SC	S			
11/16"	SunDefense IG	PEL-N-126-00876-00003	3	3	argon	0.29	0.21	0.48	58		NC	SC	S			
	with grilles-between-the-glass	PEL-N-126-00876-00004				0.29	0.19	0.43	58		NC	SC	S			
11/16"	AdvancedComfort Low-E IG	PEL-N-126-00888-00001	2.5	2.5	argon	0.25	0.27	0.51	46	N	NC					
	with grilles-between-the-glass	PEL-N-126-00888-00002				0.25	0.25	0.45	46	N	NC	SC	S			
11/16"	AdvancedComfort Low-E IG	PEL-N-126-00888-00003	3	3	argon	0.25	0.27	0.51	46	N	NC					
	with grilles-between-the-glass	PEL-N-126-00888-00004				0.25	0.25	0.45	46	N	NC	SC	S			
11/16"	NaturalSun Low-E IG	PEL-N-126-00850-00001	2.5	2.5	argon	0.30	0.51	0.59	57	N						
	with grilles-between-the-glass	PEL-N-126-00850-00002				0.30	0.46	0.52	57	N						
11/16"	NaturalSun Low-E IG	PEL-N-126-00850-00003	3	3	argon	0.30	0.51	0.59	57	N						
	with grilles-between-the-glass	PEL-N-126-00850-00004				0.30	0.46	0.52	57	N						

R-Value = 1/U-Factor
 SHGC = Solar Heat Gain Coefficient
 VLT % = Visible Light Transmission
 CR = Condensation Resistance
 ER = Canadian Energy Rating

(1) Glazing performance values are calculated based on NFRC 100, NFRC 200 and NFRC 500. ENERGY STAR® values are updated to 2016 (Version 6) criteria.

(2) The values shown are based on Canada's updated ENERGY STAR® 2020 initiative.

For center-glass values, see the Product Performance section.

See the Product Performance section for more detailed information or visit www.energystar.gov for Energy Star guidelines.

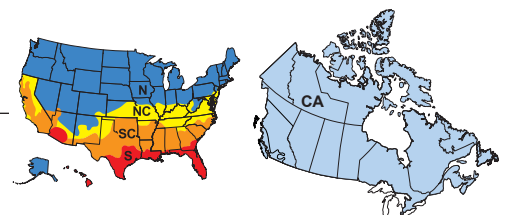



Impervia® Double-Hung Windows

Glazing Performance - Total Unit

Glazing Thickness	Type of Glazing	NFRC Certified Product #	Glass (mm)		Gap Fill	Performance Values ₁				Shaded Areas Meet ENERGY STAR® Performance Criteria in Zones Shown						
			Ext.	Int.		U-Factor	SHGC	VLT	CR	U. S.				Canada ₂		
										Zone				ER	Zone	
Vent with High Altitude Glazing										N	NC	SC	S	CA		
11/16"	(HA) Advanced Low-E IG	PEL-N-126-00781-00001	2.5	2.5	air	0.35	0.28	0.52	54							
	with grilles-between-the-glass	PEL-N-126-00781-00002				0.35	0.25	0.46	54				S			
11/16"	(HA) Advanced Low-E IG	PEL-N-126-00781-00003	3	3	air	0.35	0.28	0.52	54							
	with grilles-between-the-glass	PEL-N-126-00781-00004				0.35	0.25	0.46	54				S			
11/16"	(HA) SunDefense IG	PEL-N-126-00795-00001	2.5	2.5	air	0.34	0.21	0.48	54				S			
	with grilles-between-the-glass	PEL-N-126-00795-00002				0.34	0.19	0.43	54				S			
11/16"	(HA) SunDefense IG	PEL-N-126-00795-00003	3	3	air	0.34	0.21	0.48	54				S			
	with grilles-between-the-glass	PEL-N-126-00795-00004				0.34	0.19	0.43	54				S			
11/16"	(HA) AdvancedComfort Low-E IG	PEL-N-126-00809-00001	2.5	2.5	air	0.30	0.27	0.51	42	NC						
	with grilles-between-the-glass	PEL-N-126-00809-00002				0.30	0.25	0.45	42	NC	SC	S				
11/16"	(HA) AdvancedComfort Low-E IG	PEL-N-126-00809-00003	3	3	air	0.30	0.27	0.51	42	NC						
	with grilles-between-the-glass	PEL-N-126-00809-00004				0.30	0.25	0.45	42	NC	SC	S				
11/16"	(HA) NaturalSun Low-E IG	PEL-N-126-00771-00001	2.5	2.5	air	0.36	0.51	0.59	53							
	with grilles-between-the-glass	PEL-N-126-00771-00002				0.36	0.46	0.52	53							
11/16"	(HA) NaturalSun Low-E IG	PEL-N-126-00771-00003	3	3	air	0.36	0.51	0.59	53							
	with grilles-between-the-glass	PEL-N-126-00771-00004				0.36	0.46	0.52	53							
Vent High Altitude Glazing with Foam Insulation										N	NC	SC	S	CA		
11/16"	(HA) Advanced Low-E IG	PEL-N-126-00855-00001	2.5	2.5	air	0.33	0.28	0.52	54							
	with grilles-between-the-glass	PEL-N-126-00855-00002				0.33	0.25	0.46	54				S			
11/16"	(HA) Advanced Low-E IG	PEL-N-126-00855-00003	3	3	air	0.33	0.28	0.52	54							
	with grilles-between-the-glass	PEL-N-126-00855-00004				0.33	0.25	0.46	54				S			
11/16"	(HA) SunDefense IG	PEL-N-126-00869-00001	2.5	2.5	air	0.32	0.21	0.48	54				S			
	with grilles-between-the-glass	PEL-N-126-00869-00002				0.32	0.19	0.43	54				S			
11/16"	(HA) SunDefense IG	PEL-N-126-00869-00003	3	3	air	0.32	0.21	0.48	54				S			
	with grilles-between-the-glass	PEL-N-126-00869-00004				0.32	0.19	0.43	54				S			
11/16"	(HA) AdvancedComfort Low-E IG	PEL-N-126-00883-00001	2.5	2.5	air	0.28	0.27	0.51	42	NC						
	with grilles-between-the-glass	PEL-N-126-00883-00002				0.28	0.25	0.45	42	NC	SC	S				
11/16"	(HA) AdvancedComfort Low-E IG	PEL-N-126-00883-00003	3	3	air	0.28	0.27	0.51	42	NC						
	with grilles-between-the-glass	PEL-N-126-00883-00004				0.28	0.25	0.45	42	NC	SC	S				
11/16"	(HA) NaturalSun Low-E IG	PEL-N-126-00845-00001	2.5	2.5	air	0.34	0.51	0.59	54							
	with grilles-between-the-glass	PEL-N-126-00845-00002				0.34	0.46	0.52	54							
11/16"	(HA) NaturalSun Low-E IG	PEL-N-126-00845-00003	3	3	air	0.34	0.51	0.59	54							
	with grilles-between-the-glass	PEL-N-126-00845-00004				0.34	0.46	0.52	54							

R-Value = 1/U-Factor
 SHGC = Solar Heat Gain Coefficient
 VLT % = Visible Light Transmission
 CR = Condensation Resistance
 ER = Canadian Energy Rating

(1) Glazing performance values are calculated based on NFRC 100, NFRC 200 and NFRC 500. ENERGY STAR® values are updated to 2016 (Version 6) criteria.

(2) The values shown are based on Canada's updated ENERGY STAR® 2020 initiative.

For center-glass values, see the Product Performance section.

See the Product Performance section for more detailed information or visit www.energystar.gov for Energy Star guidelines.

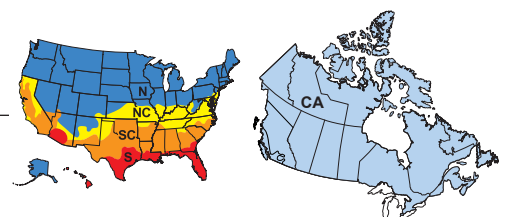



Impervia® Double-Hung Windows

Glazing Performance - Total Unit

Glazing Thickness	Type of Glazing	NFRC Certified Product #	Glass (mm)		Gap Fill	Performance Values ¹				Shaded Areas Meet ENERGY STAR® Performance Criteria in Zones Shown					
			Ext.	Int.		U-Factor	SHGC	VLT	CR	U. S.				Canada ²	
										Zone				ER	Zone
Vent with 3mm / 5mm Glazing										N	NC	SC	S	CA	
11/16"	Clear IG	PEL-N-126-00758-00001	3	5	air	0.49	0.57	0.61	42						
	with grilles-between-the-glass	PEL-N-126-00761-00001				0.49	0.51	0.54	42						
11/16"	Advanced Low-E IG	PEL-N-126-00789-00001	3	5	argon	0.32	0.28	0.52	55						
	with grilles-between-the-glass	PEL-N-126-00792-00001				0.33	0.25	0.46	55				S		
11/16"	SunDefense™ IG	PEL-N-126-00803-00001	3	5	argon	0.32	0.21	0.48	55				S		
	with grilles-between-the-glass	PEL-N-126-00806-00001				0.33	0.19	0.42	55				S		
11/16"	AdvancedComfort Low-E IG	PEL-N-126-00815-00001	3	5	argon	0.28	0.27	0.50	43		NC				
	with grilles-between-the-glass	PEL-N-126-00817-00001				0.29	0.25	0.45	43		NC	SC	S		
11/16"	NaturalSun Low-E IG	PEL-N-126-00777-00001	3	5	argon	0.33	0.51	0.58	55						
	with grilles-between-the-glass	PEL-N-126-00779-00001				0.34	0.46	0.52	54						
Vent 3mm / 5mm Glazing with Foam Insulation											NC				
11/16"	Advanced Low-E IG	PEL-N-126-00863-00001	3	5	argon	0.30	0.28	0.52	56		NC				
	with grilles-between-the-glass	PEL-N-126-00866-00001				0.31	0.25	0.46	56				S		
11/16"	SunDefense IG	PEL-N-126-00877-00001	3	5	argon	0.30	0.21	0.48	56		NC	SC	S		
	with grilles-between-the-glass	PEL-N-126-00880-00001				0.31	0.19	0.42	56				S		
11/16"	AdvancedComfort Low-E IG	PEL-N-126-00889-00001	3	5	argon	0.26	0.27	0.50	43	N	NC				
	with grilles-between-the-glass	PEL-N-126-00891-00001				0.27	0.25	0.45	43	N	NC	SC	S		
11/16"	NaturalSun Low-E IG	PEL-N-126-00851-00001	3	5	argon	0.31	0.51	0.58	55						
	with grilles-between-the-glass	PEL-N-126-00853-00001				0.32	0.46	0.52	55						
Vent 3mm / 5mm High Altitude Glazing															
11/16"	(HA) Advanced Low-E IG	PEL-N-126-00856-00001	3	5	air	0.34	0.28	0.52	52						
	with grilles-between-the-glass	PEL-N-126-00859-00001				0.35	0.25	0.46	52				S		
11/16"	(HA) SunDefense IG	PEL-N-126-00870-00001	3	5	air	0.34	0.21	0.48	52				S		
	with grilles-between-the-glass	PEL-N-126-00873-00001				0.35	0.19	0.42	52				S		
11/16"	(HA) AdvancedComfort Low-E IG	PEL-N-126-00884-00001	3	5	air	0.29	0.27	0.50	40		NC				
	with grilles-between-the-glass	PEL-N-126-00886-00001				0.30	0.25	0.45	40		NC	SC	S		
11/16"	(HA) NaturalSun Low-E IG	PEL-N-126-00846-00001	3	5	air	0.35	0.51	0.58	51						
	with grilles-between-the-glass	PEL-N-126-00848-00001				0.36	0.45	0.52	51						
Vent 3mm / 5mm High Altitude Glazing with Foam Insulation															
11/16"	(HA) Advanced Low-E IG	PEL-N-151-00816-00001	3	5	air	0.32	0.27	0.49	52						
	with grilles-between-the-glass	PEL-N-151-00821-00001				0.33	0.25	0.44	52				S		
11/16"	(HA) SunDefense IG	PEL-N-151-00838-00001	3	5	air	0.32	0.20	0.45	52				S		
	with grilles-between-the-glass	PEL-N-151-00843-00001				0.33	0.19	0.41	52				S		
11/16"	(HA) AdvancedComfort Low-E IG	PEL-N-151-00860-00001	3	5	air	0.28	0.26	0.47	39		NC				
	with grilles-between-the-glass	PEL-N-151-00863-00001				0.28	0.24	0.43	39		NC	SC	S		
11/16"	(HA) NaturalSun Low-E IG	PEL-N-151-00802-00001	3	5	air	0.33	0.48	0.55	51						
	with grilles-between-the-glass	PEL-N-151-00805-00001				0.34	0.44	0.50	51						

R-Value = 1/U-Factor
 SHGC = Solar Heat Gain Coefficient
 VLT % = Visible Light Transmission
 CR = Condensation Resistance
 ER = Canadian Energy Rating

(1) Glazing performance values are calculated based on NFRC 100, NFRC 200 and NFRC 500. ENERGY STAR® values are updated to 2016 (Version 6) criteria.

(2) The values shown are based on Canada's updated ENERGY STAR® 2020 initiative.

For center-glass values, see the Product Performance section.

See the Product Performance section for more detailed information or visit www.energystar.gov for Energy Star guidelines.

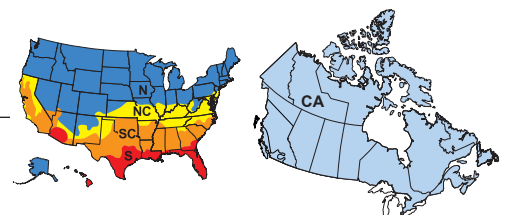



Impervia® Double-Hung Windows

Glazing Performance - Total Unit

Glazing Thickness	Type of Glazing	NFRC Certified Product #	Glass (mm)		Gap Fill	Performance Values ₁				Shaded Areas Meet ENERGY STAR® Performance Criteria in Zones Shown				
			Ext.	Int.		U-Factor	SHGC	VLT	CR	U. S.				Canada ₂
										Zone	ER	Zone	Zone	
Vent with Tinted Glazing										N	NC	SC	S	CA
11/16"	Bronze Advanced Low-E IG	PEL-N-126-00825-00001	5	3	argon	0.32	0.25	0.34	56				S	
	with grilles-between-the-glass	PEL-N-126-00826-00001				0.33	0.22	0.30	56				S	
11/16"	Gray Advanced Low-E IG	PEL-N-126-00827-00001	5	3	argon	0.32	0.23	0.29	56				S	
	with grilles-between-the-glass	PEL-N-126-00828-00001				0.33	0.21	0.26	56				S	
11/16"	Green Advanced Low-E IG	PEL-N-126-00829-00001	5	3	argon	0.32	0.28	0.46	56					
	with grilles-between-the-glass	PEL-N-126-00830-00001				0.33	0.25	0.40	56				S	
Vent Tinted Glazing with Foam Insulation											NC	SC	S	
11/16"	Bronze Advanced Low-E IG	PEL-N-126-00899-00001	5	3	argon	0.30	0.25	0.34	56				S	
	with grilles-between-the-glass	PEL-N-126-00900-00001				0.31	0.22	0.30	56				S	
11/16"	Gray Advanced Low-E IG	PEL-N-126-00901-00001	5	3	argon	0.30	0.23	0.29	56				S	
	with grilles-between-the-glass	PEL-N-126-00902-00001				0.31	0.21	0.26	56				S	
11/16"	Green Advanced Low-E IG	PEL-N-126-00903-00001	5	3	argon	0.30	0.28	0.46	56			NC		
	with grilles-between-the-glass	PEL-N-126-00904-00001				0.31	0.25	0.40	56				S	
Vent Tinted High Altitude Glazing													S	
11/16"	Bronze Advanced Low-E IG	PEL-N-126-00819-00001	5	3	air	0.36	0.25	0.34	52				S	
	with grilles-between-the-glass	PEL-N-126-00820-00001				0.37	0.23	0.30	52				S	
11/16"	Gray Advanced Low-E IG	PEL-N-126-00821-00001	5	3	air	0.36	0.23	0.29	52				S	
	with grilles-between-the-glass	PEL-N-126-00822-00001				0.37	0.21	0.26	52				S	
11/16"	Green Advanced Low-E IG	PEL-N-126-00823-00001	5	3	air	0.36	0.28	0.46	52					
	with grilles-between-the-glass	PEL-N-126-00824-00001				0.37	0.26	0.40	52					
Vent Tinted High Altitude Glazing with Foam Insulation													S	
11/16"	Bronze Advanced Low-E IG	PEL-N-126-00893-00001	5	3	air	0.34	0.25	0.34	53				S	
	with grilles-between-the-glass	PEL-N-126-00894-00001				0.35	0.23	0.30	52				S	
11/16"	Gray Advanced Low-E IG	PEL-N-126-00895-00001	5	3	air	0.34	0.23	0.29	53				S	
	with grilles-between-the-glass	PEL-N-126-00896-00001				0.35	0.21	0.26	52				S	
11/16"	Green Advanced Low-E IG	PEL-N-126-00897-00001	5	3	air	0.34	0.28	0.46	53					
	with grilles-between-the-glass	PEL-N-126-00898-00001				0.35	0.26	0.40	52					

R-Value = 1/U-Factor
 SHGC = Solar Heat Gain Coefficient
 VLT % = Visible Light Transmission
 CR = Condensation Resistance
 ER = Canadian Energy Rating

(1) Glazing performance values are calculated based on NFRC 100, NFRC 200 and NFRC 500. ENERGY STAR® values are updated to 2016 (Version 6) criteria.

(2) The values shown are based on Canada's updated ENERGY STAR® 2020 initiative.

For center-glass values, see the Product Performance section.

See the Product Performance section for more detailed information or visit www.energystar.gov for Energy Star guidelines.

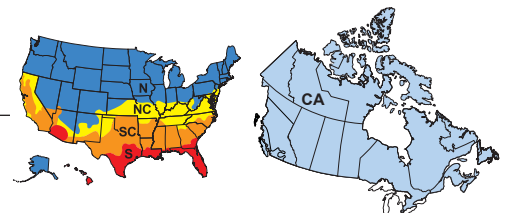



Impervia® Double-Hung Windows

Glazing Performance - Total Unit

Glazing Thickness	Type of Glazing	NFRC Certified Product #	Glass (mm)		Gap Fill	Performance Values ₁				Shaded Areas Meet ENERGY STAR® Performance Criteria in Zones Shown									
			Ext.	Int.		U-Factor	SHGC	VLT	CR	U. S.				Canada ₂					
										Zone				ER	Zone				
										N	NC	SC	S	CA					
Vent with Laminated Glazing																			
11/16"	Advanced Low-E IG	PEL-N-126-00790-00001	3	6	argon	0.34	0.28	0.51	54										
	with grilles-between-the-glass	PEL-N-126-00793-00001				0.35	0.25	0.45	54										
11/16"	SunDefense™ IG	PEL-N-126-00804-00001	3	6	argon	0.33	0.21	0.47	55										
	with grilles-between-the-glass	PEL-N-126-00807-00001				0.35	0.19	0.42	55										
Vent Laminated Glazing with Foam Insulation																			
11/16"	Advanced Low-E IG	PEL-N-126-00864-00001	3	6	argon	0.32	0.28	0.51	55										
	with grilles-between-the-glass	PEL-N-126-00867-00001				0.33	0.25	0.45	55										
11/16"	SunDefense™ IG	PEL-N-126-00878-00001	3	6	argon	0.31	0.21	0.47	55										
	with grilles-between-the-glass	PEL-N-126-00881-00001				0.33	0.19	0.42	55										
Vent Laminated High Altitude Glazing																			
11/16"	Advanced Low-E IG	PEL-N-126-00783-00001	3	6	air	0.39	0.28	0.51	50										
	with grilles-between-the-glass	PEL-N-126-00786-00001				0.40	0.25	0.45	50										
11/16"	SunDefense IG	PEL-N-126-00797-00001	3	6	air	0.38	0.21	0.47	51										
	with grilles-between-the-glass	PEL-N-126-00800-00001				0.40	0.19	0.42	51										
Vent Laminated High Altitude Glazing with Foam Insulation																			
11/16"	Advanced Low-E IG	PEL-N-126-00857-00001	3	6	air	0.37	0.28	0.51	51										
	with grilles-between-the-glass	PEL-N-126-00860-00001				0.38	0.25	0.45	51										
11/16"	SunDefense IG	PEL-N-126-00871-00001	3	6	air	0.36	0.21	0.47	51										
	with grilles-between-the-glass	PEL-N-126-00874-00001				0.38	0.19	0.42	51										

R-Value = 1/U-Factor
 SHGC = Solar Heat Gain Coefficient
 VLT % = Visible Light Transmission
 CR = Condensation Resistance
 ER = Canadian Energy Rating

(1) Glazing performance values are calculated based on NFRC 100, NFRC 200 and NFRC 500. ENERGY STAR® values are updated to 2016 (Version 6) criteria.

(2) The values shown are based on Canada's updated ENERGY STAR® 2020 initiative.

For center-glass values, see the Product Performance section.

See the Product Performance section for more detailed information or visit www.energystar.gov for Energy Star guidelines.

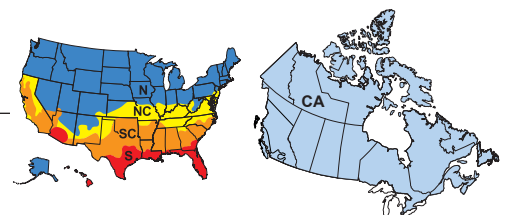



Grille Profiles

Grilles-Between-the-Glass

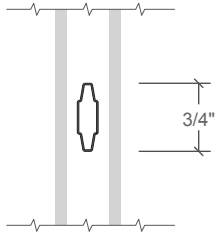

3/4" Contour

Grille Patterns

Prairie Lite Patterns

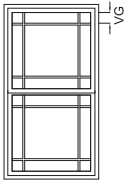

9-Lite Prairie

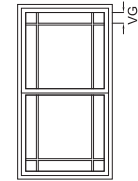
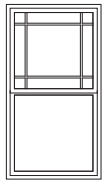

6-Lite Prairie

Prairie

- Standard corner lite dimension for Prairie patterns = 4" visible glass (VG).
- Pattern availability may vary depending on size of unit.

Other Patterns

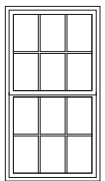

Traditional

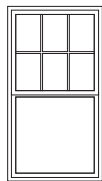

Special

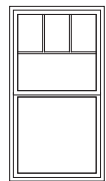

Top Row ⁽¹⁾

- Pattern availability may vary depending on size of unit.

(1) Standard visible glass to center line of separator bar = 14" or half of total visible glass height, whichever is smaller. Multiple rows are available up to 50% glass size.



Impervia® Double-Hung Windows

Size Tables

Fixed Transoms

	(457) (445)	(610) (597)	(711) (699)	(762) (749)	(813) (800)	(914) (902)	(1 016) (1 003)	(1 067) (1 054)	(1 219) (1 207)
Opening	1' 6"	2' 0"	2' 4"	2' 6"	2' 8"	3' 0"	3' 4"	3' 6"	4' 0"
Frame	1' 5 1/2"	1' 11 1/2"	2' 3 1/2"	2' 5 1/2"	2' 7 1/2"	2' 11 1/2"	3' 3 1/2"	3' 5 1/2"	3' 11 1/2"
(356) (343)	1-6/1-2	2-0/1-2	2-4/1-2	2-6/1-2	2-8/1-2	3-0/1-2	3-4/1-2	3-6/1-2	4-0/1-2
(457) (446)	1-6/1-6	2-0/1-6	2-4/1-6	2-6/1-6	2-8/1-6	3-0/1-6	3-4/1-6	3-6/1-6	4-0/1-6
(610) (597)	1-6/2-0	2-0/2-0	2-4/2-0	2-6/2-0	2-8/2-0	3-0/2-0	3-4/2-0	3-6/2-0	4-0/2-0

Vent Units

(762) (749)	1-6/2-6	2-0/2-6	2-4/2-6	2-6/2-6	2-8/2-6	3-0/2-6	3-4/2-6		
(914) (902)	1-6/3-0	2-0/3-0	2-4/3-0	2-6/3-0	2-8/3-0	3-0/3-0	3-4/3-0	3-6/3-0	4-0/3-0
(965) (953)	1-6/3-2	2-0/3-2	2-4/3-2	2-6/3-2	2-8/3-2	3-0/3-2	3-4/3-2	3-6/3-2	4-0/3-2
(1 067) (1 054)	1-6/3-6	2-0/3-6	2-4/3-6	2-6/3-6	2-8/3-6	3-0/3-6	3-4/3-6	3-6/3-6	4-0/3-6
(1 168) (1 156)	1-6/3-10	2-0/3-10	2-4/3-10	2-6/3-10	2-8/3-10	3-0/3-10	3-4/3-10	3-6/3-10	4-0/3-10
(1 219) (1 207)	1-6/4-0	2-0/4-0	2-4/4-0	2-6/4-0	2-8/4-0	3-0/4-0	3-4/4-0	3-6/4-0	4-0/4-0
(1 270) (1 257)	1-6/4-2	2-0/4-2	2-4/4-2	2-6/4-2	2-8/4-2	3-0/4-2	3-4/4-2	3-6/4-2	4-0/4-2
(1 372) (1 359)	1-6/4-6	2-0/4-6	2-4/4-6	2-6/4-6	2-8/4-6	3-0/4-6	3-4/4-6	3-6/4-6	4-0/4-6
(1 473) (1 461)	1-6/4-10	2-0/4-10	2-4/4-10	2-6/4-10	2-8/4-10	3-0/4-10	3-4/4-10	3-6/4-10	4-0/4-10

Egress Notes:

Check all applicable local codes for emergency egress requirements.

E = Window meets minimum clear opening of 24" height, 20" width, and 5.7 ft².

E1 = Window meets minimum clear opening of 24" height, 20" width, and 5.0 ft².

See Design Data pages in this section for clear opening dimensions.

Not to scale.

Special size units are available in 1/8" increments.



Impervia® Double-Hung Windows

Size Tables

Vent Units

	(457) (445)	(610) (597)	(711) (699)	(762) (749)	(813) (800)	(914) (902)	(1 016) (1 003)	(1 067) (1 054)	(1 219) (1 207)
Opening	1' 6"	2' 0"	2' 4"	2' 6"	2' 8"	3' 0"	3' 4"	3' 6"	4' 0"
Frame	1' 5 1/2"	1' 11 1/2"	2' 3 1/2"	2' 5 1/2"	2' 7 1/2"	2' 11 1/2"	3' 3 1/2"	3' 5 1/2"	3' 11 1/2"
(1 524) (1 511) 5' 0"	1-6/5-0	2-0/5-0	2-4/5-0	2-6/5-0	2-8/5-0	3-0/5-0 E ₁	3-4/5-0 E	3-6/5-0 E	4-0/5-0 E
(1 575) (1 562) 5' 2"	1-6/5-2	2-0/5-2	2-4/5-2	2-6/5-2	2-8/5-2 E ₁ (2)	3-0/5-2 E (1)	3-4/5-2 E	3-6/5-2 E	4-0/5-2 E
(1 676) (1 664) 5' 6"	1-6/5-6	2-0/5-6	2-4/5-6	2-6/5-6 E ₁ (2)	2-8/5-6 E ₁	3-0/5-6 E	3-4/5-6 E	3-6/5-6 E	4-0/5-6 E
(1 778) (1 765) 5' 10"	1-6/5-10	2-0/5-10	2-4/5-10 E ₁ (2)	2-6/5-10 E ₁	2-8/5-10 E (1)	3-0/5-10 E	3-4/5-10 E	3-6/5-10 E	4-0/5-10 E
(1 829) (1 816) 6' 0"	1-6/6-0	2-0/6-0	2-4/6-0 E ₁	2-6/6-0 E ₁	2-8/6-0 E	3-0/6-0 E	3-4/6-0 E	3-6/6-0 E	4-0/6-0 E
(1 981) (1 969) 6' 6"	1-6/6-6	2-0/6-6	2-4/6-6 E ₁	2-6/6-6 E	2-8/6-6 E	3-0/6-6 E	3-4/6-6 E	3-6/6-6 E	4-0/6-6 E

Egress Notes:

Check all applicable local codes for emergency egress requirements.

E = Window meets minimum clear opening of 24" height, 20" width, and 5.7 ft².

E₁ = Window meets minimum clear opening of 24" height, 20" width, and 5.0 ft².

(1) Unit meets E₁ with High Performance sill adapter kit installed.

(2) Does not meet egress with High Performance sill adapter kit installed.

See Design Data pages in this section for clear opening dimensions

Not to scale.

Special size units are available in 1/8" increments.

Subtract 1/2" from opening height to calculate vent area for High Performance unit.



Impervia® Double-Hung Windows

Size Tables

Vent Cottage Units

	(457) (445)	(610) (597)	(711) (699)	(762) (749)	(813) (800)	(914) (902)	(1 067) (1 054)	(1 219) (1 207)
Opening	1' 6"	2' 0"	2' 4"	2' 6"	2' 8"	3' 0"	3' 6"	4' 0"
Frame	1' 5 1/2"	1' 11 1/2"	2' 3 1/2"	2' 5 1/2"	2' 7 1/2"	2' 11 1/2"	3' 5 1/2"	3' 11 1/2"
(1 372) (1 359)	1-6/4-6	2-0/4-6	2-4/4-6	2-6/4-6	2-8/4-6	3-0/4-6	3-6/4-6	4-0/4-6
(1 524) (1 511)	1-6/5-0	2-0/5-0	2-4/5-0	2-6/5-0	2-8/5-0	3-0/5-0	3-6/5-0	4-0/5-0
(1 676) (1 664)	1-6/5-6	2-0/5-6	2-4/5-6	2-6/5-6	2-8/5-6	3-0/5-6	3-6/5-6	4-0/5-6
(1 829) (1 816)	1-6/6-0	2-0/6-0	2-4/6-0	2-6/6-0	2-8/6-0	3-0/6-0 E ₁	3-6/6-0 E	4-0/6-0 E
(1 981) (1 969)	1-6/6-6	2-0/6-6	2-4/6-6	2-6/6-6	2-8/6-6 E ₁	3-0/6-6 E	3-6/6-6 E	4-0/6-6 E

Egress Notes:

Check all applicable local codes for emergency egress requirements.

E = Window meets minimum clear opening of 24" height, 20" width, and 5.7 ft².

E₁ = Window meets minimum clear opening of 24" height, 20" width, and 5.0 ft².

See Design Data pages in this section for clear opening dimensions

Cottage units have unequal sash. Sash glass ratio is 40% upper sash to 60% lower sash.

Special size units are available in 1/8" increments.



Impervia® Double-Hung Windows

Size Tables

Vent Contemporary Units

	(457) (445)	(610) (597)	(711) (699)	(762) (749)	(813) (800)	(914) (902)	(1 067) (1 054)	(1 219) (1 207)
Opening	1' 6"	2' 0"	2' 4"	2' 6"	2' 8"	3' 0"	3' 6"	4' 0"
Frame	1' 5 1/2"	1' 11 1/2"	2' 3 1/2"	2' 5 1/2"	2' 7 1/2"	2' 11 1/2"	3' 5 1/2"	3' 11 1/2"
(1 372) (1 359) 4' 6"								
(1 524) (1 511) 5' 0"								
(1 676) (1 664) 5' 6"								
(1 829) (1 816) 6' 0"								
(1 981) (1 969) 6' 6"								

Egress Notes:

Check all applicable local codes for emergency egress requirements.

E = Window meets minimum clear opening of 24" height, 20" width, and 5.7 ft².

E1 = Window meets minimum clear opening of 24" height, 20" width, and 5.0 ft².

See Design Data pages in this section for clear opening dimensions.

Contemporary units have unequal sash. Sash glass ratio is 60% upper sash to 40% lower sash.

Special size units are available in 1/8" increments.



Impervia® Double-Hung Windows

Size Tables

Fixed Transoms

Opening	(356)	(914)	(1 067)	(1 219)	(1 372)	(1 524)	(1 829)
	(343)	(902)	(1 054)	(1 207)	(1 359)	(1 511)	(1 816)
Frame	1' 2"	3' 0"	3' 6"	4' 0"	4' 6"	5' 0"	6' 0"
1' 2"							
1' 6"							
2' 0"							

Fixed Units

Opening	(762)	(914)	(1 067)	(1 219)	(1 372)	(1 524)	(1 676)	(1 829)
	(749)	(902)	(1 054)	(1 207)	(1 359)	(1 511)	(1 664)	(1 816)
Frame	2' 6"	3' 0"	3' 6"	4' 0"	4' 6"	5' 0"	5' 6"	6' 0"
2' 6"								
3' 0"								
3' 6"								
4' 0"								
4' 6"								
5' 0"								
5' 6"								
6' 0"								

Not to scale.

Special size units are available in 1/8" increments.



Impervia® Double-Hung Windows

Special Sizes and Combinations

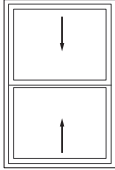
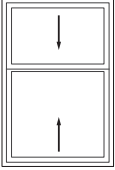
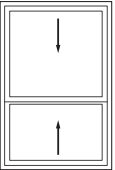
(Equal) Vent Unit	Cottage Vent Unit	Contemporary Vent Unit
 <p>MINIMUM 1' 5-1/2" W x 2' 5-1/2" H (445 x 739)</p> <p>MAXIMUM 3' 11-1/2" W x 6' 5-1/2" H (1 207 x 1 968)</p>	 <p>MINIMUM 1' 5-1/2" W x 4' 5-1/2" H (445 x 1 359)</p> <p>MAXIMUM 3' 11-1/2" W x 6' 5-1/2" H (1 207 x 1 968)</p>	 <p>MINIMUM 1' 5-1/2" W x 4' 5-1/2" H (445 x 1 359)</p> <p>MAXIMUM 3' 11-1/2" W x 6' 5-1/2" H (1 207 x 1 968)</p>

Below are available factory-assembled combination assemblies using joining mullions. See the Pella.com site, Installation Systems section for requirements and limitations related to mulling various combinations plus configurations size range information.

A combination is defined as an assembly formed by two or more separate windows or doors whose frames are mullioned together utilizing a combination mullion or reinforcing mullion.

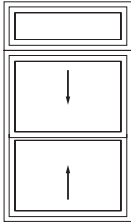
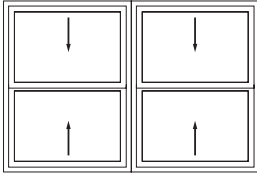
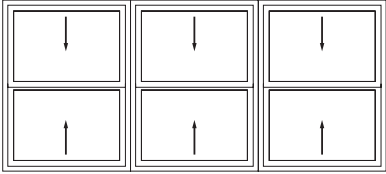
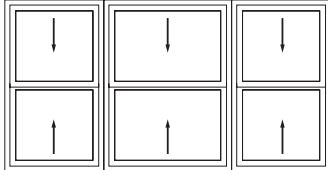
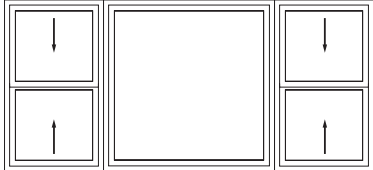
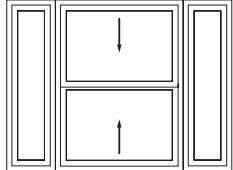
<p>Transom over Double-Hung</p>  <p>MINIMUM 1' 5-1/2" W x 3' 7" H (445 x 1 092)</p> <p>MAXIMUM 3' 11-1/2" W x 8' 5" H (1 219 x 2 565)</p>	<p>2-Wide</p>  <p>MINIMUM 2' 11-1/2" W x 2' 5-1/2" H (914 x 762)</p> <p>MAXIMUM 7' 11" W x 5' 5-1/2" H (2 413 x 1 676)</p>	<p>3-Wide</p>  <p>MINIMUM 4' 4-1/2" W x 2' 5-1/2" H (1 346 x 762)</p> <p>MAXIMUM 8' 10-1/2" W x 5' 5-1/2" H (2 718 x 1 676)</p>
<p>3-Wide with Unequal Center</p>  <p>MINIMUM 4' 1/2" W x 2' 5-1/2" H (1 245 x 762)</p> <p>MAXIMUM 8' 10-1/2" W x 5' 5-1/2" H (2 718 x 1 676)</p>	<p>3-Wide with Center Fixed</p>  <p>MINIMUM 4' 1/2" W x 2' 11-1/2" H (1 245 x 914)</p> <p>MAXIMUM 8' 11-1/2" W x 4' 11-1/2" H (2 743 x 1 524)</p> <p>Center Unit Width ≤ 4' 11-1/2"</p>	<p>3-Wide with Fixed Flankers</p>  <p>MINIMUM 3' 8-1/2" W x 2' 11-1/2" H (1 143 x 914)</p> <p>MAXIMUM 6' 2-1/2" W x 4' 11-1/2" H (1 905 x 1 524)</p>

General Notes:

- To convert areas to square meters (m2), multiply square feet by 0.0929.
- Rough Opening = Frame Dimension + 1/2".
- Keep frame dimensions to the nearest 1/8" increment



Fixed Special Sizes

MINIMUM

1' 1-1/2" W x 2' 5-1/2" H
 (13-1/2" x 29-1/2")
 (343 x 739)

MAXIMUM

5' 11-1/2" W x 5' 11-1/2" H
 (71-1/2" x 71-1/2")
 (1 816 x 1 816)
 Max frame area 33.51 sq ft.

Clear Opening Formulas

	Width	Height ₁
Equal Vent	FW - 4.125"	FH ÷ 2 - 3.75"
Cottage Vent	FW - 4.125"	(FH - ALGH) - 7"
Contemporary Vent	FW - 4.125"	(FH - AUGH) - 7"

Miscellaneous Glass Formulas

	Actual Glass Width (AGW)	Actual Glass Height (Lower Sash) (ALGH)	Actual Glass Height (Upper Sash) (AUGH)	Visible Glass Width (VGW)	Visible Glass Height (Lower Sash) (VLGH)	Visible Glass Height (Upper Sash) (VUGH)
Equal Vent	FW - 5.5"	FH ÷ 2 - 3.25"	FH ÷ 2 - 3.25"	FW - 6.438"	FH ÷ 2 - 4.188"	FH ÷ 2 - 4.188"
Cottage Vent	FW - 5.5"	(FH - 6.5") x 0.6	(FH - 6.5") x 0.4	FW - 6.4375"	(FH - 6.5") x 0.6 - 0.938	(FH - 6.5") x 0.4 - 0.938
Contemporary Vent	FW - 5.5"	(FH - 6.5") x 0.4	(FH - 6.5") x 0.6	FW - 6.4375"	(FH - 6.5") x 0.4 - 0.938	(FH - 6.5") x 0.6 - 0.938
Fixed	FW - 5.125"	FH - 5.125"		FW - 6.0625"	FH - 5.125"	

KEY:

FW = Frame Width
 FH = Frame Height

(1) Subtract one Inch from opening height to calculate vent area for performance upgrade units.



Impervia® Double-Hung Windows

Design Data

Equal Vent									
Unit	Egress	Clear Opening ³ (Inches)		Vent Area Ft ²	Visible Glass Ft ²	Standard Glass Thickness (mm)		Performance Class & Grade ⁴	
		Width	Height			Annealed	Tempered	Standard	Upgrade
1-6/2-6		13-3/8	11	1.0	1.6	3	3	LC30	LC50
1-6/3-0		13-3/8	14	1.3	2.1	2.5	3	LC30	LC50
1-6/3-2		13-3/8	15	1.4	2.2	2.5	3	LC30	LC50
1-6/3-6		13-3/8	17	1.6	2.5	2.5	3	LC30	LC50
1-6/3-10		13-3/8	19	1.8	2.9	2.5	3	LC30	LC50
1-6/4-0		13-3/8	20	1.9	3.0	2.5	3	LC30	LC50
1-6/4-2		13-3/8	21	2.0	3.2	2.5	3	LC30	LC50
1-6/4-6		13-3/8	23	2.1	3.5	2.5	3	LC30	LC50
1-6/4-10		13-3/8	26	2.3	3.8	2.5	3	LC30	LC50
1-6/5-0		13-3/8	26	2.4	3.9	2.5	3	LC30	LC50
1-6/5-2		13-3/8	27	2.5	4.1	2.5	3	LC30	LC50
1-6/5-6		13-3/8	29	2.7	4.4	2.5	3	LC30	LC50
1-6/5-10		13-3/8	31	2.9	4.7	2.5	3	LC30	LC50
1-6/6-0		13-3/8	32	3.0	4.8	2.5	3	LC30	LC50
1-6/6-6		13-3/8	35	3.3	5.3	2.5	3	LC30	–
2-0/2-6		19-3/8	11	1.5	2.5	3	3	LC30	LC50
2-0/3-0		19-3/8	14	1.9	3.2	2.5	3	LC30	LC50
2-0/3-2		19-3/8	15	2.0	3.5	2.5	3	LC30	LC50
2-0/3-6		19-3/8	17	2.3	3.9	2.5	3	LC30	LC50
2-0/3-10		19-3/8	19	2.6	4.4	2.5	3	LC30	LC50
2-0/4-0		19-3/8	20	2.7	4.6	2.5	3	LC30	LC50
2-0/4-2		19-3/8	21	2.8	4.9	2.5	3	LC30	LC50
2-0/4-6		19-3/8	23	3.1	5.3	2.5	3	LC30	LC50
2-0/4-10		19-3/8	25	3.4	5.8	2.5	3	LC30	LC50
2-0/5-0		19-3/8	26	3.5	6.1	2.5	3	LC30	LC50
2-0/5-2		19-3/8	27	3.6	6.3	2.5	3	LC30	LC50
2-0/5-6		19-3/8	29	3.9	6.8	2.5	3	LC30	LC50
2-0/5-10		19-3/8	31	4.2	7.2	2.5	3	LC30	LC50
2-0/6-0		19-3/8	32	4.3	7.5	2.5	3	LC30	LC50
2-0/6-6		19-3/8	35	4.7	8.2	2.5	3	LC30	–
2-4/2-6		23-3/8	11	1.8	3.1	3	3	LC30	LC50
2-4/3-0		23-3/8	14	2.3	4.0	2.5	3	LC30	LC50
2-4/3-2		23-3/8	15	2.4	4.3	2.5	3	LC30	LC50
2-4/3-6		23-3/8	17	2.8	4.8	2.5	3	LC30	LC50
2-4/3-10		23-3/8	19	3.1	5.4	2.5	3	LC30	LC50
2-4/4-0		23-3/8	20	3.2	5.7	2.5	3	LC30	LC50
2-4/4-2		23-3/8	21	3.4	6.0	2.5	3	LC30	LC50
2-4/4-6		23-3/8	23	3.7	6.6	2.5	3	LC30	LC50
2-4/4-10		23-3/8	25	4.1	7.2	2.5	3	LC30	LC50
2-4/5-0		23-3/8	26	4.2	7.5	2.5	3	LC30	LC50
2-4/5-2		23-3/8	27	4.4	7.8	2.5	3	LC30	LC50
2-4/5-6		23-3/8	29	4.7	8.4	2.5	3	LC30	LC50
2-4/5-10	E1 (2)	23-3/8	31	5.0	8.9	2.5	3	LC30	LC50
2-4/6-0	E1	23-3/8	32	5.2	9.2	2.5	3	LC30	LC50
2-4/6-6	E1	23-3/8	35	5.7	10.1	2.5	3	LC30	–

Egress Notes:

Check all applicable local codes for emergency egress requirements.

E = Window meets minimum clear opening of 24" height, 20" width, and 5.7 ft².

E1 = Window meets minimum clear opening of 24" height, 20" width, and 5.0 ft².

(1) Unit meets E1 with High Performance sill adapter kit installed.

(2) Does not meet egress with High Performance sill adapter kit installed.

To convert areas to square meters (m²), multiply square feet (ft²) by 0.0929.

(3) Subtract one inch from opening height to calculate vent area for performance upgrade units.

(4) The upgrade value, where shown, is maximum performance with upgrade kit installed. Both values are based on maximum performance when glazed with the appropriate glass thickness.



Impervia® Double-Hung Windows

Design Data

Equal Vent									
Unit	Egress	Clear Opening ³ (Inches)		Vent Area Ft ²	Visible Glass Ft ²	Standard Glass Thickness (mm)		Performance Class & Grade ⁴	
		Width	Height			Annealed	Tempered	Standard	Upgrade
2-6/2-6		25-3/8	10	1.9	3.4	3	3	LC30	LC50
2-6/3-0		25-3/8	14	2.5	4.3	2.5	3	LC30	LC50
2-6/3-2		25-3/8	15	2.6	4.7	2.5	3	LC30	LC50
2-6/3-6		25-3/8	17	3.0	5.3	2.5	3	LC30	LC50
2-6/3-10		25-3/8	19	3.3	5.9	2.5	3	LC30	LC50
2-6/4-0		25-3/8	20	3.5	6.3	2.5	3	LC30	LC50
2-6/4-2		25-3/8	21	3.7	6.6	2.5	3	LC30	LC50
2-6/4-6		25-3/8	23	4.1	7.2	2.5	3	LC30	LC50
2-6/4-10		25-3/8	25	4.4	7.9	2.5	3	LC30	LC50
2-6/5-0		25-3/8	26	4.6	8.2	2.5	3	LC30	LC50
2-6/5-2		25-3/8	27	4.8	8.5	2.5	3	LC30	LC50
2-6/5-6	E1 (2)	25-3/8	29	5.1	9.1	2.5	3	LC30	LC50
2-6/5-10	E1	25-3/8	31	5.5	9.8	2.5	3	LC30	LC50
2-6/6-0	E1	25-3/8	32	5.6	10.1	2.5	3	LC30	LC50
2-6/6-6	E	25-3/8	35	6.2	11.1	2.5	3	LC30	–
2-8/2-6		27-3/8	11	2.1	3.7	3	3	LC30	LC50
2-8/3-0		27-3/8	14	2.7	4.7	2.5	3	LC30	LC50
2-8/3-2		27-3/8	15	2.9	5.1	2.5	3	LC30	LC50
2-8/3-6		27-3/8	17	3.2	5.8	2.5	3	LC30	LC50
2-8/3-10		27-3/8	19	3.6	6.5	2.5	3	LC30	LC50
2-8/4-0		27-3/8	20	3.8	6.8	2.5	3	LC30	LC50
2-8/4-2		27-3/8	21	4.0	7.2	2.5	3	LC30	LC50
2-8/4-6		27-3/8	23	4.4	7.9	2.5	3	LC30	LC50
2-8/4-10		27-3/8	25	4.8	8.5	2.5	3	LC30	LC50
2-8/5-0		27-3/8	26	4.9	8.9	2.5	3	LC30	LC50
2-8/5-2	E1 (2)	27-3/8	27	5.1	9.2	2.5	3	LC30	LC50
2-8/5-6	E1	27-3/8	29	5.5	9.9	2.5	3	LC30	LC50
2-8/5-10	E (1)	27-3/8	31	5.9	10.6	2.5	3	LC30	LC50
2-8/6-0	E	27-3/8	32	6.1	11.0	2.5	3	LC30	LC50
2-8/6-6	E	27-3/8	35	6.7	12.0	2.5	3	LC30	–
3-0/2-6		31-3/8	11	2.4	4.3	3	3	LC30	LC50
3-0/3-0		31-3/8	14	3.1	5.5	2.5	3	LC30	LC50
3-0/3-2		31-3/8	15	3.3	5.9	2.5	3	LC30	LC50
3-0/3-6		31-3/8	17	3.7	6.7	2.5	3	LC30	LC50
3-0/3-10		31-3/8	19	4.1	7.5	2.5	3	LC30	LC50
3-0/4-0		31-3/8	20	4.4	7.9	2.5	3	LC30	LC50
3-0/4-2		31-3/8	21	4.6	8.3	2.5	3	LC30	LC50
3-0/4-6		31-3/8	23	5.0	9.1	2.5	3	LC30	LC50
3-0/4-10	E1	31-3/8	25	5.4	9.9	2.5	3	LC30	LC50
3-0/5-0	E1	31-3/8	26	5.7	10.3	2.5	3	LC30	LC50
3-0/5-2	E (1)	31-3/8	27	5.9	10.7	2.5	3	LC30	LC50
3-0/5-6	E	31-3/8	29	6.3	11.5	2.5	3	LC30	LC50
3-0/5-10	E	31-3/8	31	6.8	12.3	2.5	3	LC30	LC50
3-0/6-0	E	31-3/8	32	7.0	12.7	2.5	3	LC30	LC50
3-0/6-6	E	31-3/8	35	7.6	14.0	2.5	3	LC30	–

Egress Notes:

Check all applicable local codes for emergency egress requirements.

E = Window meets minimum clear opening of 24" height, 20" width, and 5.7 ft².

E1 = Window meets minimum clear opening of 24" height, 20" width, and 5.0 ft².

(1) Unit meets E1 with High Performance sill adapter kit installed.

(2) Does not meet egress with High Performance sill adapter kit installed.

To convert areas to square meters (m²), multiply square feet (ft²) by 0.0929.

(3) Subtract one Inch from opening height to calculate vent area for performance upgrade units.

(4) The upgrade value, where shown, is maximum performance with upgrade kit installed. Both values are based on maximum performance when glazed with the appropriate glass thickness.



Impervia® Double-Hung Windows

Design Data

Equal Vent									
Unit	Egress	Clear Opening ³ (Inches)		Vent Area Ft ²	Visible Glass Ft ²	Standard Glass Thickness (mm)		Performance Class & Grade ⁴	
		Width	Height			Annealed	Tempered	Standard	Upgrade
3-4/2-6		35-3/8	8	2.7	4.9	3	3	LC30	LC50
3-4/3-0		35-3/8	14	3.4	6.2	2.5	3	LC30	LC50
3-4/3-2		35-3/8	15	3.7	6.7	2.5	3	LC30	LC50
3-4/3-6		35-3/8	17	4.2	7.6	2.5	3	LC30	LC50
3-4/3-10		35-3/8	19	4.7	8.5	2.5	3	LC30	LC50
3-4/4-0		35-3/8	20	4.9	9.0	2.5	3	LC30	LC50
3-4/4-2		35-3/8	21	5.2	9.4	2.5	3	LC30	LC50
3-4/4-6		35-3/8	23	5.7	10.4	2.5	3	LC30	LC50
3-4/4-10	E	35-3/8	25	6.1	11.3	2.5	3	LC30	LC50
3-4/5-0	E	35-3/8	26	6.4	11.7	2.5	3	LC30	LC50
3-4/5-2	E	35-3/8	27	6.6	12.2	2.5	3	LC30	LC50
3-4/5-6	E	35-3/8	29	7.1	13.1	2.5	3	LC30	–
3-4/5-10	E	35-3/8	31	7.6	14.0	2.5	3	LC30	–
3-4/6-0	E	35-3/8	32	7.9	14.5	2.5	3	LC30	–
3-4/6-6	E	35-3/8	35	8.6	15.9	2.5	3	LC30	–
3-6/3-0		37-3/8	14	3.6	6.6	2.5	3	LC30	LC50
3-6/3-2		37-3/8	15	3.9	7.1	2.5	3	LC30	LC50
3-6/3-6		37-3/8	17	4.4	8.1	2.5	3	LC30	LC50
3-6/3-10		37-3/8	19	4.9	9.0	2.5	3	LC30	LC50
3-6/4-0		37-3/8	20	5.2	9.5	2.5	3	LC30	LC50
3-6/4-2		37-3/8	21	5.5	10.0	2.5	3	LC30	LC50
3-6/4-6		37-3/8	23	6.0	11.0	2.5	3	LC30	LC50
3-6/4-10	E	37-3/8	25	6.5	12.0	2.5	3	LC30	LC50
3-6/5-0	E	37-3/8	26	6.7	12.4	2.5	3	LC30	LC50
3-6/5-2	E	37-3/8	27	7.0	12.9	2.5	3	LC30	–
3-6/5-6	E	37-3/8	29	7.5	13.9	2.5	3	LC30	–
3-6/5-10	E	37-3/8	31	8.0	14.9	2.5	3	LC30	–
3-6/6-0	E	37-3/8	32	8.3	15.4	2.5	3	LC30	–
3-6/6-6	E	37-3/8	35	9.1	16.8	2.5	3	LC30	–
4-0/3-0		43-3/8	14	4.2	7.7	2.5	3	LC30	LC50
4-0/3-2		43-3/8	15	4.5	8.3	2.5	3	LC30	LC50
4-0/3-6		43-3/8	17	5.1	9.4	2.5	3	LC30	LC50
4-0/3-10		43-3/8	19	5.7	10.6	2.5	3	LC30	LC50
4-0/4-0		43-3/8	20	6.0	11.2	2.5	3	LC30	LC50
4-0/4-2		43-3/8	21	6.3	11.7	2.5	3	LC30	LC50
4-0/4-6		43-3/8	23	6.9	12.9	2.5	3	LC30	LC50
4-0/4-10	E	43-3/8	25	7.5	14.0	2.5	3	LC30	–
4-0/5-0	E	43-3/8	26	7.8	14.6	2.5	3	LC30	–
4-0/5-2	E	43-3/8	27	8.1	15.1	2.5	3	LC30	–
4-0/5-6	E	43-3/8	29	8.7	16.3	2.5	3	LC30	–
4-0/5-10	E	43-3/8	31	9.3	17.4	2.5	3	LC30	–
4-0/6-0	E	43-3/8	32	9.6	18.0	2.5	3	LC30	–
4-0/6-6	E	43-3/8	35	10.5	19.7	2.5	3	LC30	–

Egress Notes:
 Check all applicable local codes for emergency egress requirements.

E = Window meets minimum clear opening of 24" height, 20" width, and 5.7 ft².

E1 = Window meets minimum clear opening of 24" height, 20" width, and 5.0 ft².

(1) Unit meets E1 with High Performance sill adapter kit installed.

(2) Does not meet egress with High Performance sill adapter kit installed.

To convert areas to square meters (m²), multiply square feet (ft²) by 0.0929.

(3) Subtract one Inch from opening height to calculate vent area for performance upgrade units.

(4) The upgrade value, where shown, is maximum performance with upgrade kit installed. Both values are based on maximum performance when glazed with the appropriate glass thickness.



Impervia® Double-Hung Windows

Design Data

Cottage Sash									
Unit	Egress	Clear Opening ¹ (Inches)		Vent Area Ft ²	Visible Glass Ft ²	Standard Glass Thickness (mm)		Performance Class & Grade ²	
		Width	Height			Annealed	Tempered	Standard	Upgrade
1-6/4-6		13-3/8	18-3/16	1.7	3.5	2.5	3	LC30	LC50
1-6/5-0		13-3/8	20-11/16	1.9	3.9	2.5	3	LC30	LC50
1-6/5-6		13-3/8	23-1/8	2.1	4.4	2.5	3	LC30	LC50
1-6/6-0		13-3/8	25-1/2	2.3	4.8	2.5	3	LC30	LC50
1-6/6-6		13-3/8	27-7/8	2.5	5.3	2.5	3	LC30	–
2-0/4-6		19-3/8	18-3/16	2.4	5.3	2.5	3	LC30	LC50
2-0/5-0		19-3/8	20-11/16	2.7	6.1	2.5	3	LC30	LC50
2-0/5-6		19-3/8	23-1/8	3.1	6.8	2.5	3	LC30	LC50
2-0/6-0		19-3/8	25-1/2	3.4	7.5	2.5	3	LC30	LC50
2-0/6-6		19-3/8	27-7/8	3.7	8.2	2.5	3	LC30	–
2-4/4-6		23-3/8	18-3/16	2.9	6.6	2.5	3	LC30	LC50
2-4/5-0		23-3/8	20-11/16	3.3	7.5	2.5	3	LC30	LC50
2-4/5-6		23-3/8	23-1/8	3.7	8.4	2.5	3	LC30	LC50
2-4/6-0		23-3/8	25-1/2	4.1	9.2	2.5	3	LC30	LC50
2-4/6-6		23-3/8	27-7/8	4.5	10.1	2.5	3	LC30	–
2-6/4-6		25-3/8	18-3/16	3.2	7.2	2.5	3	LC30	LC50
2-6/5-0		25-3/8	20-11/16	3.6	8.2	2.5	3	LC30	LC50
2-6/5-6		25-3/8	23-1/8	4.1	9.1	2.5	3	LC30	LC50
2-6/6-0		25-3/8	25-1/2	4.5	10.1	2.5	3	LC30	LC50
2-6/6-6		25-3/8	27-7/8	4.9	11.1	2.5	3	LC30	–
2-8/4-6		27-3/8	18-3/16	3.4	7.9	2.5	3	LC30	LC50
2-8/5-0		27-3/8	20-11/16	3.9	8.9	2.5	3	LC30	LC50
2-8/5-6		27-3/8	23-1/8	4.3	9.9	2.5	3	LC30	LC50
2-8/6-0		27-3/8	25-1/2	4.8	11.0	2.5	3	LC30	LC50
2-8/6-6	E1	27-3/8	27-7/8	5.3	12.0	2.5	3	LC30	–
3-0/4-6		31-3/8	18-3/16	3.9	9.1	2.5	3	LC30	LC50
3-0/5-0		31-3/8	20-11/16	4.5	10.3	2.5	3	LC30	LC50
3-0/5-6		31-3/8	23-1/8	5.0	11.5	2.5	3	LC30	LC50
3-0/6-0	E1	31-3/8	25-1/2	5.5	12.7	2.5	3	LC30	LC50
3-0/6-6	E	31-3/8	27-7/8	6.0	14.0	2.5	3	LC30	–
3-6/4-6		37-3/8	18-3/16	4.7	11.0	2.5	3	LC30	LC50
3-6/5-0		37-3/8	20-11/16	5.3	12.4	2.5	3	LC30	LC50
3-6/5-6		37-3/8	23-1/8	5.9	13.9	2.5	3	LC30	–
3-6/6-0	E	37-3/8	25-1/2	6.6	15.4	2.5	3	LC30	–
3-6/6-6	E	37-3/8	27-7/8	7.2	16.8	2.5	3	LC30	–
4-0/4-6		43-3/8	18-3/16	5.5	12.9	2.5	3	LC30	–
4-0/5-0		43-3/8	20-11/16	6.2	14.6	2.5	3	LC30	–
4-0/5-6		43-3/8	23-1/8	6.9	16.6	2.5	3	LC30	–
4-0/6-0	E	43-3/8	25-1/2	7.6	18.0	3	3	LC30	–
4-0/6-6	E	43-3/8	27-7/8	8.4	19.7	3	3	LC30	–

Egress Notes:

Check all applicable local codes for emergency egress requirements.

E = Window meets minimum clear opening of 24" height, 20" width, and 5.7 ft².

E1 = Window meets minimum clear opening of 24" height, 20" width, and 5.0 ft².

To convert areas to square meters (m²), multiply square feet (ft²) by 0.0929.

(1) Subtract one inch from opening height to calculate vent area for performance upgrade units.

(2) The upgrade value, where shown, is maximum performance with upgrade kit installed. Both values are based on maximum performance when glazed with the appropriate glass thickness.



Impervia® Double-Hung Windows

Design Data

Contemporary Sash									
Unit	Egress	Clear Opening ₁ (Inches)		Vent Area Ft ²	Visible Glass Ft ²	Standard Glass Thickness (mm)		Performance Class & Grade ₂	
		Width	Height			Annealed	Tempered	Standard	Upgrade
1-6/4-6		13-3/8	18-3/16	1.7	3.5	2.5	3	LC30	LC50
1-6/5-0		13-3/8	20-11/16	1.9	3.9	2.5	3	LC30	LC50
1-6/5-6		13-3/8	23-1/8	2.1	4.4	2.5	3	LC30	LC50
1-6/6-0		13-3/8	25-1/2	2.3	4.8	2.5	3	LC30	LC50
1-6/6-6		13-3/8	27-7/8	2.5	5.3	2.5	3	LC30	–
2-0/4-6		19-3/8	18-3/16	2.4	5.3	2.5	3	LC30	LC50
2-0/5-0		19-3/8	20-11/16	2.7	6.1	2.5	3	LC30	LC50
2-0/5-6		19-3/8	23-1/8	3.1	6.8	2.5	3	LC30	LC50
2-0/6-0		19-3/8	25-1/2	3.4	7.5	2.5	3	LC30	LC50
2-0/6-6		19-3/8	27-7/8	3.7	8.2	2.5	3	LC30	–
2-4/4-6		23-3/8	18-3/16	2.9	6.6	2.5	3	LC30	LC50
2-4/5-0		23-3/8	20-11/16	3.3	7.5	2.5	3	LC30	LC50
2-4/5-6		23-3/8	23-1/8	3.7	8.4	2.5	3	LC30	LC50
2-4/6-0		23-3/8	25-1/2	4.1	9.2	2.5	3	LC30	LC50
2-4/6-6		23-3/8	27-7/8	4.5	10.1	2.5	3	LC30	–
2-6/4-6		25-3/8	18-3/16	3.2	7.2	2.5	3	LC30	LC50
2-6/5-0		25-3/8	20-11/16	3.6	8.2	2.5	3	LC30	LC50
2-6/5-6		25-3/8	23-1/8	4.1	9.1	2.5	3	LC30	LC50
2-6/6-0		25-3/8	25-1/2	4.5	10.1	2.5	3	LC30	LC50
2-6/6-6		25-3/8	27-7/8	4.9	11.1	2.5	3	LC30	–
2-8/4-6		27-3/8	18-3/16	3.4	7.9	2.5	3	LC30	LC50
2-8/5-0		27-3/8	20-11/16	3.9	8.9	2.5	3	LC30	LC50
2-8/5-6		27-3/8	23-1/8	4.3	9.9	2.5	3	LC30	LC50
2-8/6-0		27-3/8	25-1/2	4.8	11.0	2.5	3	LC30	LC50
2-8/6-6	E1	27-3/8	27-7/8	5.3	12.0	2.5	3	LC30	–
3-0/4-6		31-3/8	18-3/16	3.9	9.1	2.5	3	LC30	LC50
3-0/5-0		31-3/8	20-11/16	4.5	10.3	2.5	3	LC30	LC50
3-0/5-6		31-3/8	23-1/8	5.0	11.5	2.5	3	LC30	LC50
3-0/6-0	E1	31-3/8	25-1/2	5.5	12.7	2.5	3	LC30	LC50
3-0/6-6	E	31-3/8	27-7/8	6.0	14.0	2.5	3	LC30	–
3-6/4-6		37-3/8	18-3/16	4.7	11.0	2.5	3	LC30	LC50
3-6/5-0		37-3/8	20-11/16	5.3	12.4	2.5	3	LC30	LC50
3-6/5-6		37-3/8	23-1/8	5.9	13.9	2.5	3	LC30	LC50
3-6/6-0	E	37-3/8	25-1/2	6.6	15.4	2.5	3	LC30	–
3-6/6-6	E	37-3/8	27-7/8	7.2	16.8	2.5	3	LC30	–
4-0/4-6		43-3/8	18-3/16	5.5	12.9	2.5	3	LC30	–
4-0/5-0		43-3/8	20-11/16	6.2	14.6	2.5	3	LC30	–
4-0/5-6		43-3/8	23-1/8	6.9	16.6	2.5	3	LC30	–
4-0/6-0	E	43-3/8	25-1/2	7.6	18	3	3	LC30	–
4-0/6-6	E	43-3/8	27-7/8	8.4	19.7	3	3	LC30	–

Egress Notes:

Check all applicable local codes for emergency egress requirements.

E = Window meets minimum clear opening of 24" height, 20" width, and 5.7 ft².

E1 = Window meets minimum clear opening of 24" height, 20" width, and 5.0 ft².

To convert areas to square meters (m²), multiply square feet (ft²) by 0.0929.

(1) Subtract one inch from opening height to calculate vent area for performance upgrade units.

(2) The upgrade value, where shown, is maximum performance with upgrade kit installed. Both values are based on maximum performance when glazed with the appropriate glass thickness.



Impervia® Double-Hung Windows

Design Data

Fixed Units				
Unit	Visible Glass Ft ²	Standard Glass Thickness (mm)		Performance Class & Grade ¹
		Annealed	Tempered	
3-0/2-6	4.8	2.5	3	CW50
3-0/3-0	6.0	2.5	3	CW50
3-0/3-6	7.2	2.5	3	CW50
3-0/4-0	8.5	2.5	3	CW50
3-0/4-6	9.7	2.5	3	CW45
3-0/5-0	10.9	3	3	CW45
3-0/5-6	12.2	3	3	CW45
3-0/6-0	13.4	3	3	CW40
3-6/2-6	5.8	2.5	3	CW50
3-6/3-0	7.2	2.5	3	CW50
3-6/3-6	8.7	2.5	5	CW45
3-6/4-0	10.2	3	5	CW45
3-6/4-6	11.7	3	5	CW40
3-6/5-0	13.2	3	5	CW40
3-6/5-6	14.6	3	5	CW40
3-6/6-0	16.1	3	5	CW40
4-0/2-6	6.7	2.5	3	CW50
4-0/3-0	8.5	2.5	3	CW50
4-0/3-6	10.2	3	3	CW45
4-0/4-0	11.9	3	3	CW40
4-0/4-6	13.7	3	3	CW40
4-0/5-0	15.4	3	3	CW40
4-0/5-6	17.1	3	3	CW35
4-0/6-0	18.8	5	5	CW35
4-6/2-6	7.7	2.5	3	CW50
4-6/3-0	9.7	2.5	3	CW45
4-6/3-6	11.7	3	5	CW40
4-6/4-0	13.7	3	5	CW40
4-6/4-6	15.6	3	5	CW35
4-6/5-0	17.6	5	5	CW35
4-6/5-6	19.6	5	5	CW35
4-6/6-0	21.6	5	5	CW35
5-0/2-6	8.7	2.5	3	CW45/CW50
5-0/3-0	10.9	3	3	CW45
5-0/3-6	13.2	3	5	CW40
5-0/4-0	15.4	3	5	CW40
5-0/4-6	17.6	5	5	CW35
5-0/5-0	19.8	5	5	CW35
5-0/5-6	22.1	5	5	CW30
5-0/6-0	24.3	5	5	CW30
6-0/2-6	10.7	3	3	CW45/CW50
6-0/3-0	13.4	3	3	CW45
6-0/3-6	16.1	3	5	CW40
6-0/4-0	18.8	5	5	CW35
6-0/4-6	21.6	5	5	CW35
6-0/5-0	24.3	5	5	CW30
6-0/5-6	27.0	5	5	CW30
6-0/6-0	29.7	5	–	CW30

Fixed Units				
Unit	Visible Glass Ft ²	Standard Glass Thickness (mm)		Performance Class & Grade ¹
		Annealed	Tempered	
FLANKERS				
1-2/3-0	1.5	2.5	3	CW50
1-2/3-6	1.8	2.5	3	CW50
1-2/4-0	2.1	–	3	CW50
1-2/4-6	2.5	–	3	CW50
1-2/5-0	2.8	–	3	CW50
TRANSOM UNITS				
1-6/1-2	0.6	3	3	CW50
1-6/1-6	0.9	2.5	3	CW50
1-6/2-0	1.2	2.5	3	CW50
2-0/1-2	0.9	3	3	CW50
2-0/1-6	1.4	2.5	3	CW50
2-0/2-0	1.9	2.5	3	CW50
2-4/1-2	1.1	3	3	CW50
2-4/1-6	1.7	2.5	3	CW50
2-4/2-0	2.3	2.5	3	CW50
2-6/1-2	1.2	3	3	CW50
2-6/1-6	1.9	2.5	3	CW50
2-6/2-0	2.5	2.5	3	CW50
2-8/1-2	1.3	3	3	CW50
2-8/1-6	2.0	2.5	3	CW50
2-8/2-0	2.7	2.5	3	CW50
3-0/1-2	1.5	3	3	CW50
3-0/1-6	2.3	2.5	3	CW50
3-0/2-0	3.2	2.5	3	CW50
3-4/1-2	1.7	3	3	CW50
3-4/1-6	2.7	2.5	3	CW50
3-4/2-0	3.6	2.5	3	CW50
3-6/1-2	1.8	3	3	CW50
3-6/1-6	2.8	2.5	3	CW50
3-6/2-0	3.8	2.5	3	CW50
4-0/1-2	2.1	–	3	CW50
4-0/1-6	3.3	2.5	3	CW50
4-0/2-0	4.4	2.5	3	CW50
4-6/1-2	2.5	–	3	CW50
4-6/1-6	3.8	2.5	3	CW50
4-6/2-0	5.1	2.5	3	CW50
5-0/1-2	2.8	–	3	CW50
5-0/1-6	4.2	2.5	3	CW50
5-0/2-0	5.7	2.5	3	CW50
6-0/1-2	3.4	–	3	CW50
6-0/1-6	5.2	–	3	CW50
6-0/2-0	7.0	–	3	CW50

(1) Maximum performance when glazed with the appropriate glass thickness. Second value, where shown, requires tempered glass.

To convert areas to square meters (m²), multiply square feet by 0.0929.



Detailed Product Description

Frame

- Frame is Duracast® fiberglass composite – five-layer pultruded fiberglass material [with optional foam insulation₁] reinforced with a Pella patented interlocking mat.
- Nominal wall thickness of Duracast fiberglass composite members is .050" to .080" thick.
- [Overall frame depth is 3" for [Block Frame] [Integral Nailing Fin] [Overall frame depth is 3-1/4" for Precision Fit].
- Frame corners are mitered, joined and bonded with corner locks and mechanically fastened with injected polyurethane adhesive.
- Block frame jambs contain factory drilled (counter-bored) installation screw holes.
- Frame has 10° slope sill.

Sash

- Sash is Duracast fiberglass composite–five-layer pultruded fiberglass material [with optional foam insulation₁] reinforced with a Pella patented interlocking mat.
- All sash members have mitered corners bonded with corner locks and sealed with injected polyurethane adhesive.
- Both sashes tilt to interior for cleaning.

Exterior / Interior

- Duracast fiberglass composite surfaces with powder-coat paint finish.
 - Color is [White] [Tan] [Brown] [Black] [Morning Sky Gray].
 - Dual-color option [Tan] [Brown] [Black] [Morning Sky Gray] exterior with White interior₂.

Glazing System

- Quality float glass complying with ASTM C 1036.
- 11/16" insulating glass [[annealed] [tempered]] [obscure₃] [clear] [[Advanced] [SunDefense™] [AdvancedComfort] [NaturalSun] Low-E coated, [with argon]]] [[bronze] [gray] [green] Advanced Low-E [with Argon]] sealed and bonded to sash.
- High altitude glazing [with argon] available.

Weatherstripping

- Fin-type pile on jambs, top rail and stile of upper sash.
- Vinyl-wrapped foam at sill on frame and bottom rail of lower sash.

Hardware

- Galvanized block-and-tackle balances connected to sash with polyester cord and concealed within the frame.
- Upper and lower sash are fully operable for ventilation.
- All fasteners are corrosion-resistant material.
- Two locks are installed on units 37" wide or greater.
- Locks are zinc die-cast, self-aligning cam action factory-installed on the interlocker [powder-coat painted [White] [Tan] [Brown] [Matte Black] [Morning Sky Gray] to match finish] [Satin Nickel] [Bright Brass] [Oil-Rubbed Bronze].

Optional Products

Screens

- Conventional Black Fiberglass
 - [Half-size] [Full-size] with black vinyl coated 18/16 mesh fiberglass screen cloth complying with ASTM D 3656 and SMA 1201.
 - Set in aluminum frame and fitted to outside of window.
 - Supplied complete with all necessary hardware.
 - Screen frame finish is baked enamel, color to match exterior.
- InView™ Screens
 - [Half-size] [Full-size] with black vinyl coated 18/18 mesh fiberglass screen cloth complying with SMA 1201.
 - Set in aluminum frame and fitted to outside of window.
 - Supplied complete with all necessary hardware.
 - Screen frame finish is baked enamel, color to match exterior.

Grilles

- Grilles-Between-the-Glass
 - Insulating glass contains 3/4" contoured aluminum grilles permanently installed between two panes of glass.
 - Grilles are factory prefinished [White] [Tan] [Brown] [Black] [Morning Sky Gray] to match interior and exterior finish.

Hardware

- Optional limited opening device available for field installation on vent units in [White] [Tan] [Brown] [Black] [Morning Sky Gray] foamed PVC to match interior of unit; nominal 3-3/4" opening.
- Optional window opening control device available for field installation. Device allows window to open less than 4" with normal operation, with a release mechanism that allows the sash to open completely. Complies with ASTM F2090-10.
- Optional field applied Duracast sash lift available for vent units in [White] [Tan] [Brown]] [Black] [Morning Sky Gray].

FOAM INSULATION INSERTS ₁

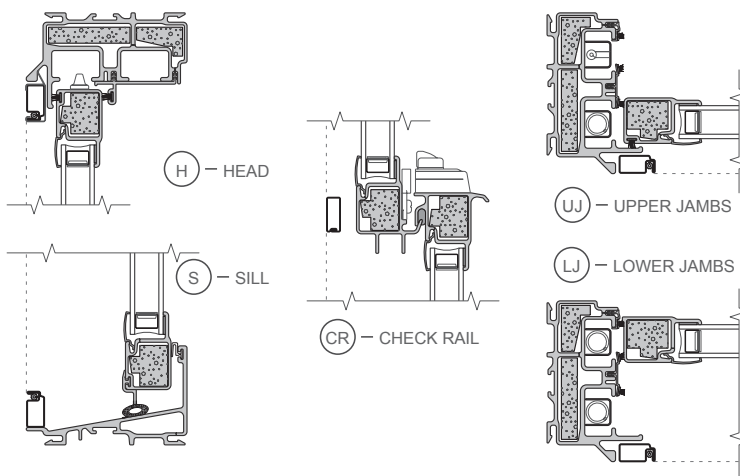

(1) Foam insulation inserts are not available with clear glazing.

(2) Dual-color finish is not available on products with integral nailing fin.

(3) Obscure glazing is not available when AdvancedComfort Low-E coated IG is specified.



Impervia® Double-Hung Windows

Frame Types

STANDARD
BLOCK FRAME

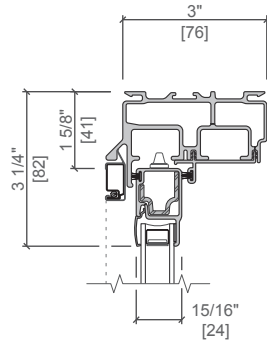

INTEGRAL
NAILING FIN

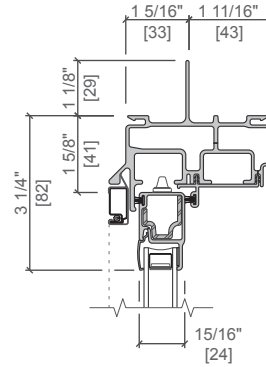

STANDARD
BLOCK FRAME
with STANDARD FIN

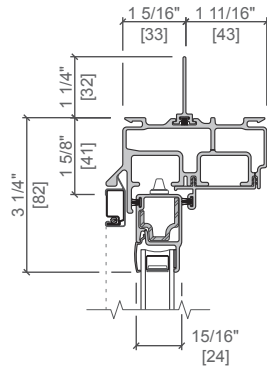

STANDARD
BLOCK FRAME
with OFF SET FIN

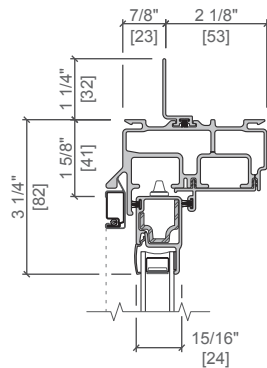

DP 50
UPGRADE

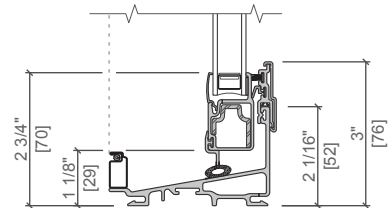

Scale 3" = 1' 0"
All dimensions are approximate.



Impervia® Double-Hung Windows

Unit Sections

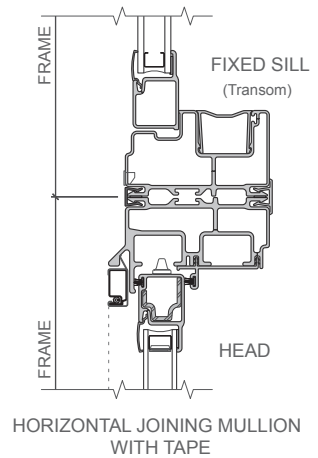
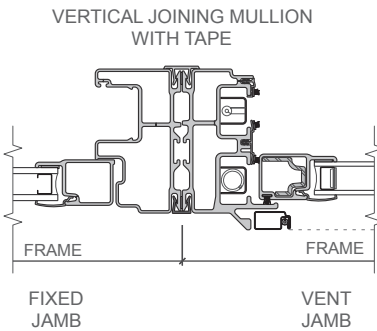
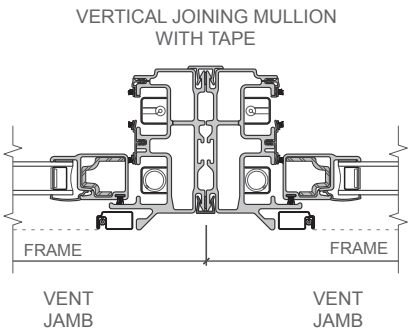
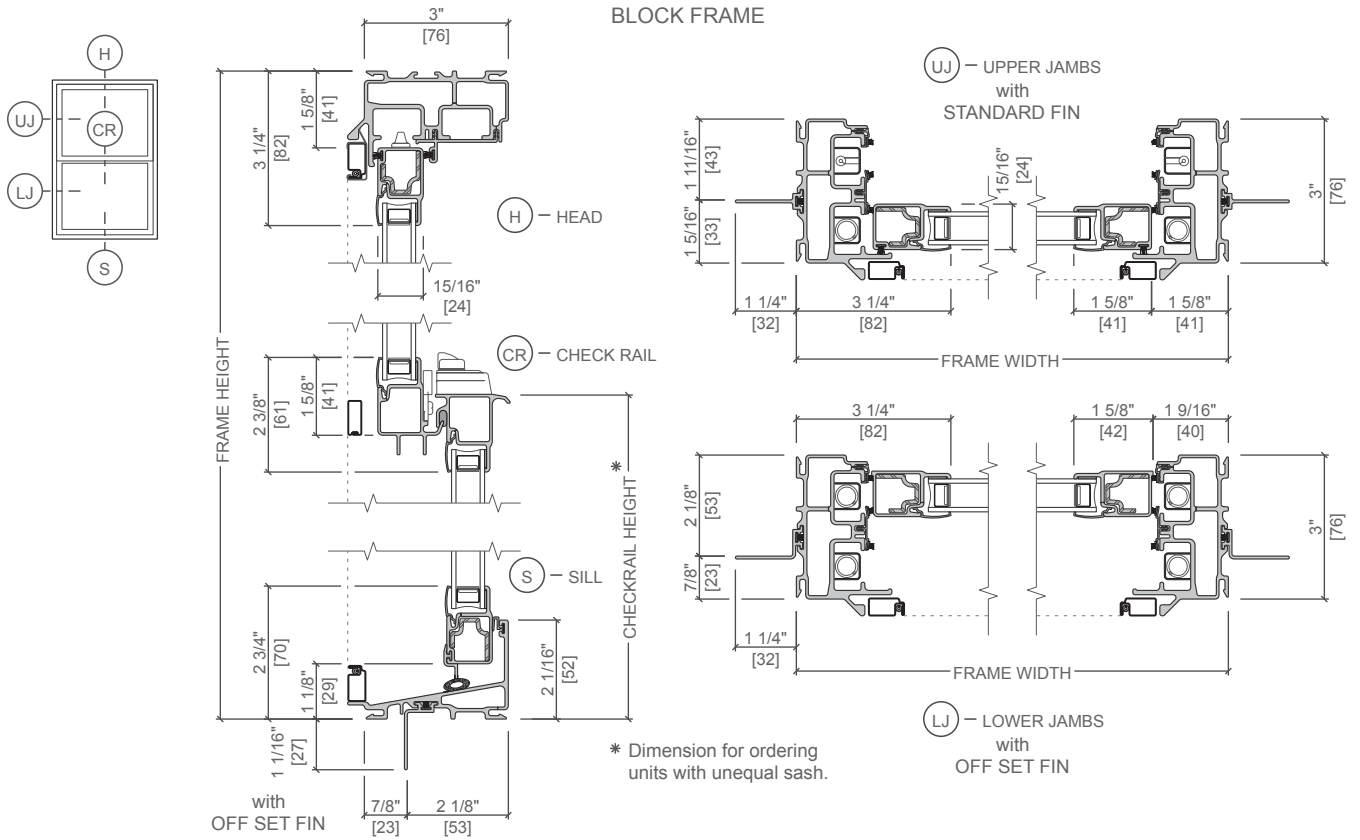

Scale 3" = 1' 0"
 All dimensions are approximate.



Impervia® Double-Hung Windows

Unit Sections

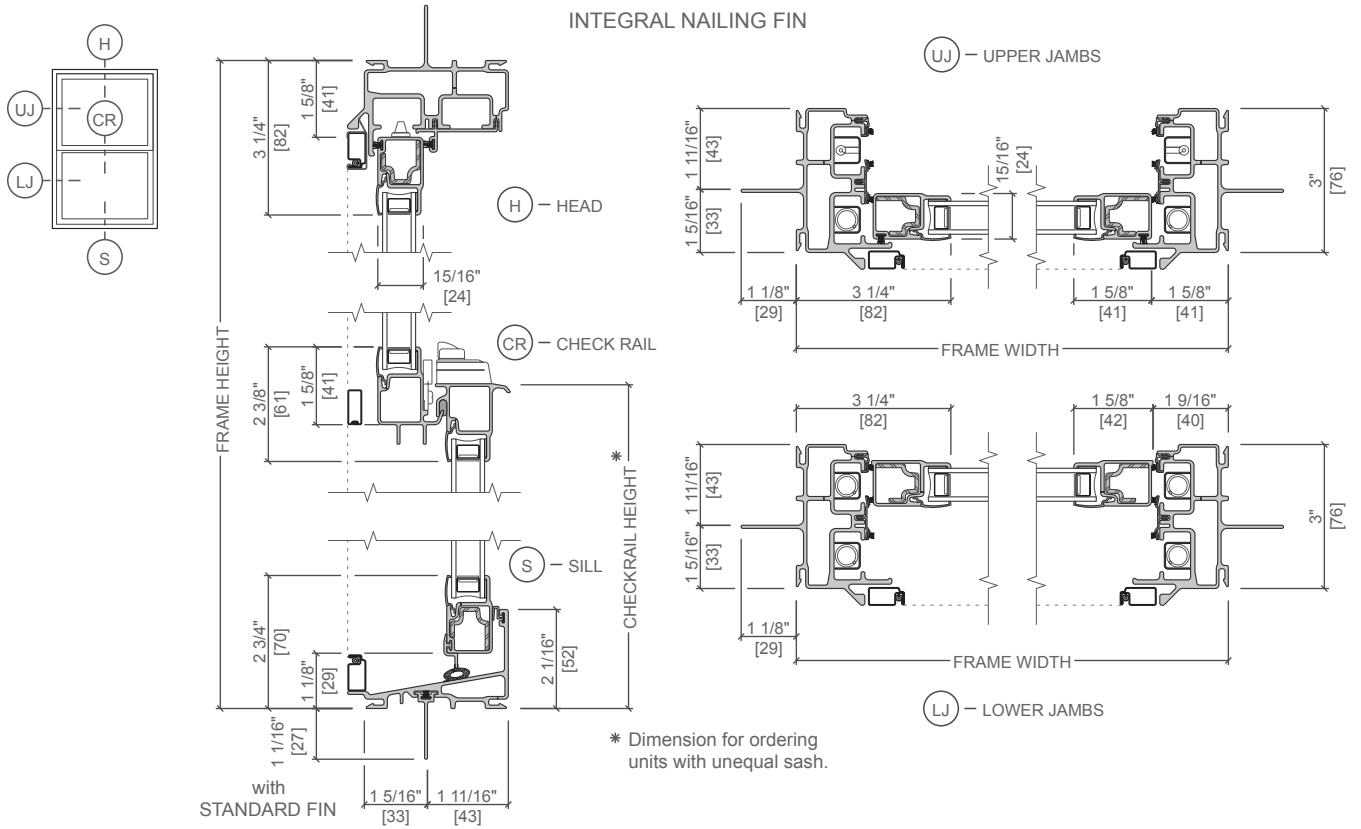

Scale 3" = 1' 0"
All dimensions are approximate.