

# BESSEY® Catalog

Clamping and cutting technology, July 1 2016 / 2017

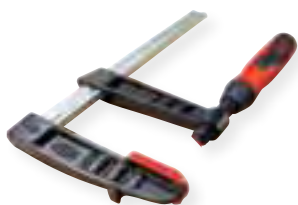

Simply better.





# About BESSEY®

## Innovation with tradition

In 1889 Max Bessey founded BESSEY & Sohn as a bright steel drawing plant. Since then, BESSEY® has continuously expanded the range of products it offers – beginning with the production of manual clamping tools in the mid 1930s. The strength of BESSEY®'s innovation is underlined by numerous patents. In 1979, with the takeover of Diener shears factory, BESSEY® established its cutting technology unit with the already popular Erdi snips.



In 2004 BESSEY & Sohn was spun off into BESSEY Tool GmbH & Co. KG, handling clamping and cutting technology, and BESSEY Präzisionsstahl GmbH, a leading German supplier of high-quality bright and stainless steels. This unique positioning of BESSEY® as a producer of tools and precision steels ensures significant advantages in terms of quality. It allows BESSEY® to procure its rails and spindles

directly from the in-house drawing plant, giving it precise knowledge of the steel quality that is going into particular components which are subjected to particular high stresses. This is because bright steels are produced and tested at BESSEY Precision Steel with consistently high quality and the utmost precision in cutting-edge facilities.

“To stop improving is to stop being good.”  
The motto of company founder Max Bessey remains true today, as it will in the future, and is the guiding principle to everything that the company does.



- 1889** Max Bessey founds drawing plant in Stuttgart.
- 1912** Firm continued by nephew Karl Bessey.
- 1926** Company run by Dr. Mayer who significantly expands product range and adds steel grades.
- 1936** Patent granted for a new malleable cast iron screw clamp, beginning BESSEY clamping tool production.
- 1944** Founding of subsidiary to produce clamping tools.
- 1952** Patent granted for a tempered all-steel clamp.
- 1961** Expansion and start of bright steel production.
- 1966** Dr. Mayer is succeeded by his daughter and son who start dynamic phase of development.
  - Production of bright steel is doubled and complemented by adding stainless steels.
  - New patents and modernized marketing make BESSEY the market leader in global clamping tools.
- 1971** A further increase in bright steel production with the purchase of Aldinger engineering works. Founding of BESSEY FILS from which BESSEY-SER arose in 1988.
- 1979** Purchase of the Diener shears factory.
- 1983** Consolidation of bright steel production.
- 1985** Expansion and purchase of historic spinning mill. After restoration, tool production begins.
- 1989** BESSEY® celebrates its 100 year jubilee.
- 2003** Purchase of sales partner in the strategically important North American market.
 



- 2004** Purchase of the GROSS STABIL TOOL clamping tool brand as part of global growth strategy.
- 2007** Integration of GROSS STABIL TOOL to enhance tool production synergies.
- 2011** Klaus Fuchs becomes Managing Partner and the BESSEY Group is once again owner-managed.
- 2014** BESSEY® celebrates 125 years.



**BESSEY® locations**

**German offices serving Europe and the world**

BESSEY® Tool GmbH & Co. KG Group are located near Stuttgart, Germany. All production, R&D, along with European admin and sales are located here.

The development, manufacture, storage and shipping of clamping and cutting tools takes place a few km north of the main works, in the building of the historic, former Kammgarnspinnerei Bietigheim-Bissingen (spinning mill).

**North American offices serving Canada and the USA.**

With offices in both Canada and the USA, the BESSEY® Group handles the entire North American market in its capacity as a sales and marketing operation.

**BESSEY® means Quality**

Precision and durability are at the core of the BESSEY® brand. Our tools have always been manufactured from the highest-grade materials. Precision steel rails and spindles are manufactured in our own drawing plant in Germany. All components are tested by experienced technicians and development engineers using ultramodern process control techniques.

**BESSEY® means Innovation**

“To stop improving is to stop being good.” The motto of our company founder Max Bessey remains true today and is the guiding principle of everything we do. New products and product improvements continue to be developed on a long-term basis from innovative ideas.

**BESSEY® means Variety**

Thanks to our designers’ many years of experience and continuous communication with customers, BESSEY® has a firm grasp on how to optimize tool ergonomics and efficiency. The result is clamping and cutting tools true to our guiding principle: “BESSEY®. Simply better.” With over 1,600 products, BESSEY® now offers a tremendously wide and deep range of items customised to special requirements.

**BESSEY® means Service**

Reliability, confidence and a sense of responsibility are the backbone of our partnership with the environment and customers. BESSEY® has distinguished itself as a service-oriented company.





# Table of contents

<b>1-2</b>	<b>High-performance all-steel clamps</b>	
1800-S	Medium duty	
2400S	Regular duty	
DT 2400	Regular duty deep throat version	
4800S	Heavy duty	
7200S	Extra heavy duty	
8500HPC	Extra high pressure	
Service parts		

<b>3-5</b>	<b>Shop floor all-steel clamps</b>	
MMS, 660-S, 1200-S	Light to medium duty	
SGL	Medium duty	
SQ	Regular duty	
STB	Heavy duty	
Service parts		
J18	J Series step-over light duty	
2400J	J Series step-over regular duty	
4800J	J Series step-over heavy duty	
SG30VAD	KombiKlamp™	
RSC	OMEGA bend clamps	
CL	Claw clamp	

<b>6</b>	<b>Rapid-Action lever clamps</b>	
LC, 1800L	Lever clamps	
GSH	classiX®	

<b>7</b>	<b>classiX® all-steel bar clamps</b>	
GS	classiX® - Standard pad	
GSL, GSM	classiX® - Heavy duty pad	

<b>8</b>	<b>Clamping angles and miters</b>	
WSM	Angle clamp	
WVS	Multi-angle vise clamp	

<b>9-10</b>	<b>Double force all-steel variable clamps</b>	
SLV, GSV	Variable high-performance set	
Rails and sliding arms		
Service parts		

<b>11-14</b>	<b>Auto-Adjust toggle clamps</b>	
STC-VH	Vertical toggle clamp	
STC-HH, STC-HV, STC-HA	Horizontal toggle clamp	
STC-IHH, STC-IHA	Inline toggle clamps	

<b>15-16</b>	<b>Parallel and case clamps</b>	
KR	K Body® REVO™	
KRV	Vario K Body® REVO™	
KRX	K Body® REVO™ extender kits	
KRK	K Body® REVO™ framing kits	
KRJR	K Body® REVO™ JR	
UK	UniKlamp® case clamp	
Service parts & accessories		

<b>17-18</b>	<b>Malleable cast bar clamps</b>	
TG & TGJ	Light duty series	
TG	Medium duty series	
TGK	Heavy duty series	
CDS	Deep reach with flat rail	
TC	TC series with flat rail	
TG	TG with T-Bar	
BGP	General clamp kit (10 piece)	
BTB30	Small TG kit (30 piece)	
BTB30A	Small TG kit (30 piece with display)	
Service parts		

<b>19</b>	<b>Track / table clamps</b>	
GTR	Wood handle	
GTRH	Lever handle	

<b>20-23</b>	<b>One-handed, light duty &amp; clutch style clamps</b>	
EZS & EZ	One handed clamps	
EZS combo		
KLI	KliKlamp® light duty lever clamp	
PG	PowerGrip one-hand clamp	
DUO	DuoKlamp®, one handed clamp	
DuoKlamp® Combo kit		
LMU	Light duty, zinc die cast, step over	
LM	Light duty, zinc die cast	
GSCC	Clutch style	
GSCC4PK	Clutch style clamshell pack	<b>NEW</b>

<b>24</b>	<b>Clutch style, Rapid Action, and lever clamps</b>	
DHBC	Clutch style with double jaw	
PZ	Rapid Action clamps	
GSH	classiX® lever clamps	
LC, 1800L	Lever clamps	

<b>25</b>	<b>Strap clamps</b>	
VAS	Variable angle	
VAC	Vario corner clips	

<b>26</b>	<b>Edge clamps</b>	
EKT	Edge clamp, one hand	
KF	Edge clamp	
B-EC3	3-way edge clamp, light duty	
KT5	Spindle clamps	

<b>27</b>	<b>Pipe clamps</b>	
PC-2	Pipe clamp, traditional style	
BPC	Pipe clamp, H style	
PC-DR	Deep reach pipe clamp, traditional style	

<b>28</b>	<b>Clamping angles and miters</b>	
WS	Angle clamps	
WS	Corner clamp	

<b>29</b>	<b>Seaming tools</b>	
PS	Extra large solid surface seaming tool	
PS	Solid surface seaming tool	

<b>30</b>	<b>Floor tools</b>	
AV2	Flooring spacer	
PV	Flooring clamps	
SVH	Flooring strap clamps	
Flooring kits		

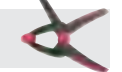
<b>31-32</b>	<b>Spring clamps</b>	
XV	VarioClippix® variable spring clamps	
XV	VarioClippix® variable spring clamp, double jaw	
XCL	Clippix® needle nose plastic spring clamps	
XC	Clippix® premium plastic spring clamps	
XC	Clippix® econo plastic spring clamps	
XC	Plastic spring clamp set	
XCRU	Ratcheting spring clamps, deep reach	
XCR	Ratcheting spring clamp set	
XM	Steel spring clamps	

33-34	C-clamps	
540 series	Ductile alloy	
CDF	Regular duty	
CDFCHV	Regular duty, copper spindle, Hi-Vis	
CDFUS	Regular duty	
100 series	Heavy duty	
HS series	Heavy service, fully closing	
CM	Light duty	
QRCC	Quick release	
DHCC	Double head	

35-36	Hold down products and specialty clamps	
Model L	RiteHite	
Model S	RiteHite	
FC	Jig & fixture clamp	
BSN,HD,BSG	Hold down table clamps	
MCL	Claw machine clamp	

37-40	Welding table clamps	
TWV	Variable throat depth	
TW	Fixed throat depth	
TWM28	With special pressure plate	
TW28GRS	Welding table clamp	
TWVAD	Welding table clamp accessories	
TWA-STC	Welding table clamp adapter	
TWX	Welding table clamp extension	
TW28AV	Welding table clamp tilting adapter	
TW28HO	Welding table clamp attachment	
Service parts, MorPads		

41	Workbench adapter	
TWAW	Accessory for workbenches	

42	Grip pliers	
SG	SuperGrips™ with profiled rail	
SG	SuperGrips™ pipe clamp	
SG-DR	SuperGrips™ deep reach clamp	

43-44	BAS clamps	
BAS-C	Compact clamp with open fixing hole	
BAS-CB	Compact clamp with closed mounting hole	
BASO	Base unit	
BASKN	Wrench with T-bar	
Service parts		

45-47	Vises	
BV-DF	Industrial bench vise	
BV-MPV5	Multi-purpose vise	
BV-HD	Heavy duty workshop vises	
BV-HW45	Light duty workshop vise	
BV-DP40	Drill press vise	
BV-C030	Clamp-on vise	
BV-VB	Vacuum base vise	
BV-NVJ	Multi-purpose vise jaws	
BV-WV65	Wood vise	
Service parts		

48	Other clamps	
S-10	Portable mini-vise	
TK	Table mount clamp	
HS	Wood handscrew clamps	
KF	Panel carrier	
TB	T-bar sash clamps	
TB	T-bar sash clamps accessories	

49-50	Industrial magnets	
WMS-1,3,5	Magnetic squares	
WMS-4	Double magnetic square	
WMS-6	Multi-angle square	
WMS-7	Arrowhead magnetic square	
CMS	"Chunky" magnetic square	
BDMS	"Big Daddy" magnetic square	
MGC	Magnetic ground clamps	
MPU	Mag Pick-Up	
MS	MagStick	
MW	MagWand	
MSP	MagSweep	

51-55	Snips & knives	
D39ASS	Multi-use aviation snip	
D15A	Multi-use aviation snip, compact	
D16	Aviation snips	
D29SS-2	Special hard cutting snips	
D29ASS-2	Offset snips, optimized	
D27AH-BE	Offset, extra hard, high tolerance	
D22A	Long-nose, multi-purpose	
D123-SB	Safety strap cutter	
D47, D48	MultiSnip - Straight	
D48A	MultiSnip - Offset	
D49	Cable cutter	
D50	Combinox	
D51	MultiSnip master	
D-SPS	SuperPower snips - Straight blade	
D-SPC	SuperPower snips - Offset blade	
DBST	Multi-function tool	
DBKAH-2B	Double blade folding tool	
D-BKAH	Folding utility knife - Aluminum handle	
D-BKWH	Folding utility knife - Wood handle	
D-BKPH	Folding utility knife - ABS comfort grip	
DBKPH	Folding utility knife set - ABS comfort grip	

56-57	Industrial fluids & compounds	
LM	Lab-metal®	
HT	Hi-Temp Lab-metal®	
LS	Lab-solvent	
HB	Heat block	
1600	Spatter release	
15-SK	Stick-Kut™ lubricating stick wax	
TC014	Relton dark thread cutting oil	
TC016	Relton light thread cutting oil	
G-RS	Rel-Saw band saw fluid	
OPT	Relton OPTION 1® cutting fluid	
A9	Relton A-9® aluminum cutting fluid	
AF	Relton Air-Flo air tool oil	
RT	Relton Rapid Tap® cutting fluid	

57	Torque multipliers	
JM	Torque multipliers	
JM-R	Anti-Backlash torque multiplier	

58-60	BESSEY® bearing heaters	
PV	Portable, digital temperature control	<b>NEW</b>
PVH, SVH	Fast Action, portable, digital temperature control	<b>NEW</b>
SC, BC, BCS	Induction bearing heaters	
GCS	Cone bearing heaters	<b>NEW</b>
RB	Raising blocks	
HH11B	Pyrometer/Thermometer	
Cross bars for bearing heaters		
MP	Magnetic temperature probe	

61-63	Index
-------	-------

64-66	Resources
Social media	
Connect with BESSEY®	
Customer service	
Fill rate	
Best practices	
Cautions and warnings	
Terms and conditions - distributor	
Warranty policy	
Return procedures	
Calprop statement	
History of James Morton	
Downloads	

# High performance all-steel bar clamps

## High performance all-steel bar clamps

High performance bar clamps from BESSEY® represent the peak of the all-steel bar clamp category. Made in Germany, the high performance series delivers uncompromising quality, patented features, durability and real-world productivity to make it a must-have tool in today's modern workshop.



### 1 Patented rail profile

Offers greater stability, enhanced clamping force and 20% more clamping force per spindle turn, for quicker set-up times (1800-S and 2400S Series).

### 2 BESSEY® MorPad

Designed to reduce friction at the point of contact, increasing and optimizing clamping force. Using BESSEY® product with the MorPad extends tool life and, at full clamping potential.

### 3 Hardened spindle

Heat-treated, high carbon Acme threaded spindle manufactured for high load capacity, durability and spatter resistance.

### 4 Size engineered T-Bar

Ergonomic, high-strength sliding pin T-Bar. BESSEY® Grip comes standard with 1800-S/2400S.

### 5 Drop forged sliding arm

U-shaped sliding arm transfers clamping force evenly across the surface of the forged piece improving power transmission and stability for a longer lasting tool.

Ball-in-socket technology for greatly extended clamp life and, at full pressure... by BESSEY®. Patented.



2400S Video



### A Medium duty all-steel bar clamp (1800-S Series)

BESSEY®'s fast acting all-steel bar clamps are the workhorse of many professional shops. These clamps can be set up an estimated 9X faster than a c-clamp. One can quickly move the sliding arm to the point of application, tighten the handle and be ready to work in seconds! Comes with: Patented rail profile, MorPad, ergonomic BESSEY® grip.

	Clamping Capacity	Throat Depth	Clamping Force	Approx. Weight
<b>1800-S8</b>	8"	4 3/4"	1980 lbs	4.00 lbs
<b>1800-S12</b>	12"	4 3/4"	1980 lbs	4.40 lbs
<b>1800-S18</b>	18"	4 3/4"	1980 lbs	5.30 lbs
<b>1800-S24</b>	24"	4 3/4"	1980 lbs	6.30 lbs



### B Regular duty all-steel bar clamp (2400S Series)

A top-selling tool for BESSEY®, the 2400S Series has the uncompromising quality and features of the 1800-S Series but, it offers greater throat depth, clamping force and a wider range of clamping capacity. Comes with: Patented rail profile, MorPad, ergonomic BESSEY® grip.

	Clamping Capacity	Throat Depth	Clamping Force	Approx. Weight
<b>2400S-8</b>	8"	5 1/2"	2800 lbs	6.45 lbs
<b>2400S-12</b>	12"	5 1/2"	2800 lbs	6.80 lbs
<b>2400S-16</b>	16"	5 1/2"	2800 lbs	7.40 lbs
<b>2400S-20</b>	20"	5 1/2"	2800 lbs	8.10 lbs
<b>2400S-24</b>	24"	5 1/2"	2800 lbs	8.80 lbs
<b>2400S-36</b>	36"	5 1/2"	2800 lbs	11.40 lbs
<b>2400S-48</b>	48"	5 1/2"	2800 lbs	12.30 lbs
<b>2400S-60</b>	60"	5 1/2"	2800 lbs	14.25 lbs

**C Regular duty clamp, deep throat version (DT2400 Series)**

This series has an extended throat depth of 8 In for that extra reach that is sometimes needed. Comes with: Standard rail profile, MorPad, ergonomic BESSEY® grip.

	Clamping Capacity	Throat Depth	Clamping Force	Approx. Weight
DT 2400-12	12"	8"	1770 lbs	7.50 lbs
DT 2400-24	24"	8"	1770 lbs	9.60 lbs



**D Heavy duty all-steel bar clamps (4800S Series)**

With nearly twice the clamp force capacity of the 2400S Series and available clamp lengths up to 60", the 4800S series is a top selling industrial tool at BESSEY®. The spindle has a 19 mm hexagonal head to assist in tightening (torque of 70Nm or less). Comes with: Standard rail profile, MorPad.

	Clamping Capacity	Throat Depth	Clamping Force	Approx. Weight
4800S-12	12"	7"	4880 lbs	12.40 lbs
4800S-18	18"	7"	4880 lbs	14.70 lbs
4800S-24	24"	7"	4880 lbs	16.20 lbs
4800S-36	36"	7"	4880 lbs	20.75 lbs
4800S-48	48"	7"	4880 lbs	23.85 lbs
4800S-60	60"	7"	4880 lbs	26.90 lbs



**E Extra heavy duty all-steel bar clamps (7200 Series)**

'Robust' would hardly begin to describe these highly capable clamps which are designed for extra heavy industrial applications. The spindle has a 36 mm hexagonal head to assist in tightening (torque of 100 Nm or less). Comes with: Standard rail profile, specially designed MorPad.

	Clamping Capacity	Throat Depth	Clamping Force	Approx. Weight
7200S-12	12"	8"	7770 lbs	23.10 lbs
7200S-18	18"	8"	7770 lbs	26.85 lbs
7200S-36	36"	8"	7770 lbs	36.45 lbs



**F Extra high pressure all-steel bar clamp (8500HPC)**

This clamp has a narrower throat depth which enables a much higher clamping force than a comparably sized clamp with a larger throat depth. Comes with: Standard rail profile, MorPad.

	Clamping Capacity	Throat Depth	Clamping Force	Approx. Weight
8500HPC-14	14"	4"	8500 lbs	11.65 lbs



**G BESSEY® service part, MorPads**

- 3100736 12/18/24/4800 Series
- 3101192 Rough face - 12/18/24/4800 Series
- 3101193 V Groove - 12/18/24/4800 Series
- 3100737 7200 Series (Previously 7200P)

**H BESSEY® service part, handle, spindle, MorPad and pin assembly**

- 3100398 1200/1800 Spindle (.700" Dia.)
- 3100399 2400 Spindle (.775" Dia.)
- 3100400 4800/8500 Spindle (.850" Dia.)
- 3100401 7200 Spindle (.925 Dia.)

**I BESSEY® service part, variable angle device VAD**

Fits up to 2400 series

**J BESSEY® service part, wedges for 7200/8500**

- 3000689 For 7200 series
- 3005122 For 8500 series
- 3100579 Nut and lock ring For 7200 series

**K BESSEY® service part, sliding arm assembly**

- |                               | Throat Depth |
|-------------------------------|--------------|
| 3101521 1800S Series          | 4 3/4"       |
| 3101407 2400S Series          | 5 1/2"       |
| 3101331 DT 2400 Series        | 8"           |
| 3101332 4800S Series          | 7"           |
| 3100205 7200S Series          | 8"           |
| 3100753 8500HPC Series        | 4"           |
| 3101519 Wooden handle (1800S) | 4 3/4"       |
| 3101525 Lever handle (1800S)  | 4 3/4"       |
| 3101590 Gripping arm (1800S)  | 4 3/4"       |

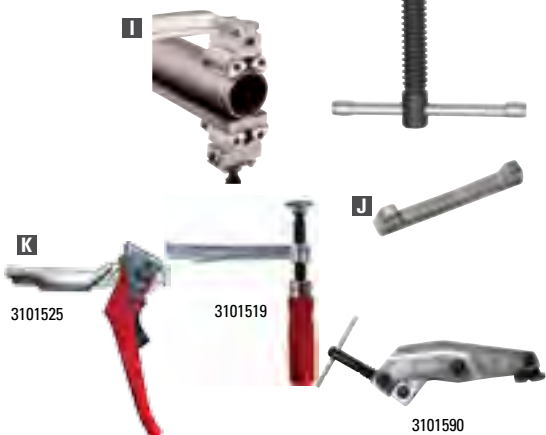

# Shop floor all-steel bar clamps



## Shop floor all-steel bar clamps

Made in Germany, the Shop Floor series of clamps offers a unique value proposition to the professional. Its mid-range pricing offers the highest quality and value but, does not come with all the enhanced features of the High-Performance product offering.

### 1 Patented rail profile

The patented rail profile offers greater stability, enhanced clamping force and 20% more clamping force per spindle turn, for quicker set-up times (for 660 & 1200 Series models).

### 2 Standard pads and heavy duty pads

The standard swivel pads and heavy duty pads are tried-and-true contact surfaces for use with your Shop Floor clamps. Field replaceable (see Page 4).

### 3 Hardened spindle

The heat-treated, high carbon Acme threaded spindle offers high load capacity, durability and spatter resistance.

### 4 Size engineered T-Bar

The high-strength sliding pin T-Bar is sized according to the clamp's capability.

### 5 Drop forged sliding arm

The u-shaped sliding arm transfers clamping force evenly across the surface of the forged piece. This improves power transmission, stability and results in a longer lasting tool (for 660 and 1200 series models).



### A Light duty all-steel bar clamp (MMS Series)

Sometimes the right tool has nothing to do with size. The MMS clamps are easy to use, quick to adjust and offer great value. At 400 lbs of clamping force they offer a high level of performance. Comes with standard rail profile, standard crimped on swivel pads.

	Clamping Capacity	Throat Depth	Clamping Force	Approx. Weight
<b>MMS-4</b>	4"	2 1/4"	400 lbs	0.60 lbs
<b>MMS-8</b>	8"	2 1/4"	400 lbs	0.75 lbs
<b>MMS-12</b>	12"	2 1/4"	400 lbs	0.85 lbs



### B Light to medium duty all-steel bar clamp (660-S and 1200-S Series)

Premium features and value make this series of clamps ever more popular. The 660-S and 1200-S are unique in the BESSEY® Shop Floor series in that they have the upgraded rail profile and force optimized sliding arm like the 2400 & 1800 Series. Comes with: Patented rail profile, replaceable swivel pads.

	Clamping Capacity	Throat Depth	Clamping Force	Approx. Weight
<b>660-S8</b>	8"	4"	726 lbs	2.05 lbs
<b>660-S12</b>	12"	4"	726 lbs	2.35 lbs
<b>660-S18</b>	18"	4"	726 lbs	2.90 lbs
<b>1200-S8</b>	8"	5 1/2"	1320 lbs	3.75 lbs
<b>1200-S12</b>	12"	5 1/2"	1320 lbs	4.20 lbs
<b>1200-S18</b>	18"	4 3/4"	1320 lbs	4.85 lbs
<b>1200-S24</b>	24"	4 3/4"	1320 lbs	5.30 lbs





**C Medium duty all-steel bar clamp (SGL Series)**

Only a few years ago the standard profiled rail and heavy duty pad of this series would have represented the top of the all-steel bar clamp world. Produced in Germany from cold-drawn German steel like the rest of the Shop Floor and High Performance series. Includes standard rail profile, heavy duty pad.

	Clamping Capacity	Throat Depth	Clamping Force	Approx. Weight
<b>SGL-8</b>	8"	4 3/4"	1800 lbs	4.00 lbs
<b>SGL-12</b>	12"	4 3/4"	1800 lbs	4.75 lbs
<b>SGL-18</b>	18"	4 3/4"	1800 lbs	5.85 lbs
<b>SGL-24</b>	24"	4 3/4"	1800 lbs	6.35 lbs



**D Regular duty all-steel bar clamp (SQ Series)**

A top selling product series for BESSEY®. Like the 2400S series it offers a great mixture of size and strength, and like the SGL series it represents what would have been the top of the bar clamp market only a few short years ago. Comes with standard rail profile, heavy duty pad.

	Clamping Capacity	Throat Depth	Clamping Force	Approx. Weight
<b>SQ-4*</b>	6"	4 3/4"	1330 lbs	2.35 lbs
<b>SQ-8</b>	8"	5 1/2"	2660 lbs	6.00 lbs
<b>SQ-12</b>	12"	5 1/2"	2660 lbs	6.70 lbs
<b>SQ-16</b>	16"	5 1/2"	2660 lbs	7.40 lbs
<b>SQ-20</b>	20"	5 1/2"	2660 lbs	8.10 lbs
<b>SQ-24</b>	24"	5 1/2"	2660 lbs	8.75 lbs

\*SQ-4 has a standard pad.



**E Heavy duty all-steel bar clamp (STB Series)**

The STB heavy duty bar clamp offers heavy-duty value. German produced classic profiled rails, hardened spindles (with 19 mm hex head) and sizes up to 36" makes this a real-world solution for heavy duty applications on a tighter budget. Comes with standard rail profile, crimped on swivel pad.

	Clamping Capacity	Throat Depth	Clamping Force	Approx. Weight
<b>STB-12</b>	12"	7"	4880 lbs	12.20 lbs
<b>STB-18</b>	18"	7"	4880 lbs	14.70 lbs
<b>STB-24</b>	24"	7"	4880 lbs	16.00 lbs
<b>STB-36</b>	36"	7"	4880 lbs	20.60 lbs



Ball-in-socket technology for greatly extended clamp life and, at full pressure... by BESSEY®. Patented.



**F BESSEY® clamp service part, replacement for heavy duty pad**

- 3100736** 1200, SGL, SQ, STB, GSL and GSM Series
- 3101192** Rough face - 1200, SGL, SQ, GSL and GSM Series
- 3101193** V Groove - 1200, SGL, SQ, GSL and GSM Series

**G BESSEY® clamp service part, standard pad**

- 3101339** MMS (4 pc) (must be manually crimped on)
- 3101180** GS16K, GS12-8K (4 pc)
- 3101183** RSC-8, 660S, J18, GS16-12K, GS25K, GS20K, SQ-4 (4 pc)
- 3101188** 1200, RSC-12, 18 & 24, SQ, SGL(pre 2008), SG30VAD, GS30K

**H Accessory, BESSEY® Grip handles**

- 3006727** RSC-8, 660S, SQ-4
- 3006786** RSC-12, 18 & 24, 1200, SQ, SGL, SG30VAD

**I BESSEY® clamp service part, screw and pad assembly**

- 3100398** 1200/SGL Screw (.700" Dia.)
- 3100399** SQ, GSL, GSM (.775" Dia. replacement screw)
- 3100400** STB (.850" Dia. replacement screw)

**J BESSEY® clamp service part, spindle**

- 3100119** GS20K, RSC-8
- 3100120** GS16-12K, GS25K, 660S, J18, SQ-4
- 3100121** GS30K, 1200S, RSC-12/18/8, GS60K, SGL

**K Variable angle device**

**VAD** Fits up to SQ series

**L Complete sliding arm assembly**

- |  | Throat Depth |
|--|--------------|
| <b>3101330</b> SQ Series, GSM              | 5 1/2"       |
| <b>3101441</b> 660 Series                  | * 4"         |
| <b>3101447</b> 1200 Series (5 1/2" throat) | * 5 1/2"     |
| <b>3101450</b> 1200 Series (4 3/4" throat) | * 4 3/4"     |
| <b>3100263</b> GS20K, RSC-8                | * 4"         |
| <b>3100264</b> SQ-4, J18, GS25K, GS16-2K*  | * 4 3/4"     |
| <b>3100265</b> GS30K, RSC-12               | * 5 1/2"     |
| <b>3100266</b> GS60K, RSC-18/24            | * 4 3/4"     |
| <b>3100267</b> SGL                         | 4 3/4"       |
| <b>3101338</b> GSL                         | 4 3/4"       |

\*includes standard pad



# Shop floor all-steel clamps



## A J Series Step-Over clamps

The J Series clamps are a total lifesaver in the workshop! Not everything in the shop is flat and this clamp offers a solution to clear obstructions and maintain clamping pressure. Available with a standard swivel pad or MorPad. Ergonomic grip is standard on the 2400J series.

	Clamping Capacity	Throat Depth	Clamping Force	Rail Step-Over Up to	Approx. Weight
<b>Light duty (J18) Standard Pad</b>					
<b>J18-8</b>	10"	4 3/4"	880 lbs	2 1/4"	3.20 lbs
<b>Regular duty (2400J) with MorPad &amp; grip</b>					
<b>2400J-12</b>	12"	5 1/2"	2660 lbs	4"	8.00 lbs
<b>Heavy duty (4800J) with MorPad</b>					
<b>4800J-20</b>	20"	7"	4880 lbs	6"	17.35 lbs



J-series Video

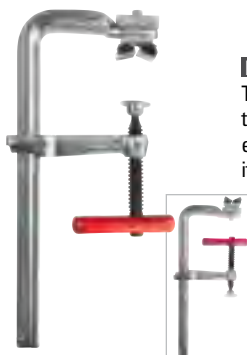

## B Multi-Purpose KombiKlamm™

The KombiKlamm™ has great features that make it very versatile. It is set up to clamp, spread, hold irregular shaped objects and even comes with an ergonomic grip. Made in Germany, the clamp is set at a price point to make it a serious consideration for the active shop.

	Clamping Capacity	Throat Depth	Clamping Force	Approx. Weight
<b>SG30VAD</b>	*12"	4 3/4"	2600 lbs	6.44 lbs

\* 11 inch capacity with VAD in place. Spreading from 9-20".



## C OMEGA bend clamps (RSC Series)

Thanks to the patented OMEGA bend this clamp maintains its positive clamping pressure longer under heavy vibration than a conventional clamp. It is durable, lightweight and easy to use.

	Clamping Capacity	Throat Depth	Clamping Force	Approx. Weight
<b>RSC-8</b>	8"	4"	770 lbs	1.90 lbs
<b>RSC-12</b>	12"	5 1/2"	1100 lbs	4.05 lbs
<b>RSC-18</b>	18"	4 3/4"	1100 lbs	4.90 lbs
<b>RSC-24</b>	24"	4 3/4"	1100 lbs	5.40 lbs



## D Claw clamp (CL)

A welder's versatile clamp or spreader. The spindle mechanism is on the back side of the sliding arm so that it is out of the work area. The V-grooved pressure plate is made of high grade cast iron and swivels up to 30°. Jaw reverses to act as a spreader.

	Clamping Capacity	Throat Depth	Clamping Force	Approx. Weight
<b>CL24</b>	24"	4 3/4"	1775 lbs	7.10 lbs
<b>CLS-Shoe</b>				0.75 lbs

# Rapid-Action lever clamps



## Rapid-Action lever clamps

Quick on, quick off! Secure vibration-resistant clamping with a rapid action ratchet mechanism. Position and reposition clamps quickly and securely.

### 1 Patented rail profile (LC Series)

The patented rail profile offers greater stability, enhanced clamping force and 20% more clamping force for quicker set-up times.

### 2 Secure ratchet mechanism

The ratchet mechanism ensures rapid, vibration-resistant clamping. The hardened cam at the end of the lever ensures a long service life. Trigger protection means fewer pinched fingers.

### 3 Extremely sturdy

Torsion-resistant, fixed bracket and pressure plate are produced and tempered in one piece for maximum tensile strength and sturdiness.

### 4 Forged Sliding Arm

Forged sliding-arm is made from tempered, drop-forged steel for long service life.

### 5 Extremely Sturdy Handle

Ergonomically shaped powder-coated clamping lever and plastic-coated release for comfort and power.

## A All-steel lever bar clamps

Quick on, quick off! Secure vibration-resistant clamping with a rapid action ratchet mechanism. Position and reposition your workpiece quickly and securely. The torsion-resistant, fixed bracket and pressure plate is produced and tempered in one piece for maximum tensile strength and sturdiness.

	Clamping Capacity	Throat Depth	Clamping Force	Approx. Weight
LC4	4"	2 3/8"	400 lbs	1.10 lbs
LC8	8"	4"	660 lbs	2.45 lbs
LC12	12"	5 1/2"	1200 lbs	4.95 lbs
LC20	20"	4 3/4"	1200 lbs	5.80 lbs
LC31	31"	4 3/4"	1200 lbs	6.95 lbs
1800L12	10"	5 1/2"	1800 lbs	7.35 lbs



## B classiX® GSH all-steel lever bar clamps

Quick – up to 5 times faster than regular clamps! Secure, unaffected by vibrations. Strong – high clamping force. Non-slip trigger release. Clamping force up to 1110 lbs.

	Clamping Capacity	Throat Depth	Clamping Force	Approx. Weight
GSH12	4"	2 3/8"	400 lbs	1.10 lbs
GSH20	8"	4"	600 lbs	2.50 lbs
GSH30	12"	5 1/2"	1110 lbs	5.00 lbs
GSH50	20"	4 3/4"	1110 lbs	6.25 lbs



# classiX® all-steel bar clamps



## classiX® all-steel bar clamps

The classiX® line of clamps represents an extension of BESSEY®'s clamping and steel manufacturing skills to overseas production. The goal of this extension is to produce an opening price point offering that also embodies the stringent quality requirements of BESSEY®.

### 1 Choices

The classiX® line is an abbreviated range of the most popular global clamp performance characteristics. A variety of throat depths, pad/swivel styles and clamping capacities provide professionals with a choice that makes sense for real-world applications.

### 2 Quality

Internationally sourced components coordinated by BESSEY® engineering teams to deliver great prices and great quality.

### 3 Standard pads and heavy duty pads

The standard swivel pads and heavy duty pads are tried and true contact surfaces for use with your classiX® clamps. Field replaceable (see page 4).

### 4 Hardened spindle

Heat-treated, high carbon Acme threaded spindle is manufactured to offer high load capacity, durability and spatter resistance.

classiX® Video



### A classiX® - Standard pad

A range of clamp sizes and performance characteristics with a field replaceable contact pad (see page 4).



	Clamping Capacity	Throat Depth	Clamping Force	Approx. Weight
GS12-8K	4"	3 1/8"	550 lbs	1.00 lbs
GS16K	6"	3 1/8"	550 lbs	1.05 lbs
GS20K	8"	4"	880 lbs	1.90 lbs
GS16-12K	6"	4 3/4"	1000 lbs	2.35 lbs
GS25K	10"	4 3/4"	1000 lbs	2.65 lbs
GS30K	12"	5 1/2"	1200 lbs	3.95 lbs
GS60K	24"	4 3/4"	1200 lbs	5.25 lbs

### B classiX® - Heavy duty pad

Designed for heavier applications, the classiX® line with heavy duty pads comes with classic rail profiles and a range of clamp openings that will meet most day to day needs.



	Clamping Capacity	Throat Depth	Clamping Force	Approx. Weight
GSL30	12"	4 3/4"	1880 lbs	5.00 lbs
GSL60	24"	4 3/4"	1880 lbs	6.30 lbs
GSM20	7 1/2"	4 3/4"	2660 lbs	5.20 lbs
GSM25	9"	5 1/2"	2660 lbs	5.75 lbs
GSM30	12"	5 1/2"	2660 lbs	6.35 lbs
GSM40	16"	5 1/2"	2660 lbs	6.70 lbs
GSM50	20"	5 1/2"	2660 lbs	7.40 lbs
GSM60	24"	5 1/2"	2660 lbs	8.10 lbs

# Clamping angles and miters



## Clamping angles and miters

BESSEY® metal angle clamps are specifically designed to hold demanding welding or steel fabrication settings. Tough and versatile, these tools simplify the work process.

### 1 Right angle clamping

The angle clamps have been developed for a wide range of applications but, most especially for aligning materials at 90 degrees for welding.

### 2 Work pieces of different thickness

The copper spindle passes through an articulated bearing that then attaches to a swivel based face. In use, the jaw face will automatically adjust to different thickness work pieces to align them at a 90 degree angle. Aligning work in preparation for further activity has never been so easy.

### 3 Open work area

In addition to the heavy duty construction, the metal angle vises are produced in such a way as to allow passage of t-joints and for easy access to final fastening.

### 4 Stable and solid

The high quality cast-iron construction is produced with wide bases and broad hold down areas to fasten the angle clamp safely.



E-Newsletter sign up



## A Angle clamps (WSM)

Joining two pieces of metal at an exact 90 degree angle has never been easier thanks to the BESSEY® angle clamp. Let the clamp do the work while you do the welding. Even pieces of different thicknesses are no match for this clamp.

	Capacity for both sides	Jaw Height	Max. Passage for Mitres	Approx. Weight
WSM-9	7"	1 3/4"	3 1/2"	8.00 lbs
WSM-12	9 1/2"	2 3/4"	4 3/4"	16.10 lbs
3100953	WSM-9 Spindle Assembly			
3100954	WSM-12 Spindle Assembly			



## B Multi-angle vise clamp (WVS, 3-in-1 angle clamp)

The BESSEY® WVS-4 allows an unusually versatile range of clamping positions. The two individual vises are mounted to a base plate and rotate freely. This allows angle clamping from 5 to 180 degrees and the added flexibility of using the smaller vises independently. Terrific value.

	Clamping Capacity	Jaw Height	Range of Angle	Approx. Weight
WVS-4	4 3/4"	1 3/4"	5° to 180°	22.80 lbs



# New flexibility with large clamping widths

## A myriad of options!

### Modular concept for the widest range of applications

Two available rail models: 1 1/16" x 1/2" profile in three lengths; 1 3/16" x 5/8" profile for high clamping forces and clamping widths up to 118". Rail end fastenings (both sides) can be loosened without tools. Change fitted sliding arms from clamping to spreading or replace with different sliding arms or supplement with others. Sliding arms available with wooden grips, lever handles or T-Bars. This clamping system's flexibility means numerous applications can be handled by the combinations of rails and sliding arms.

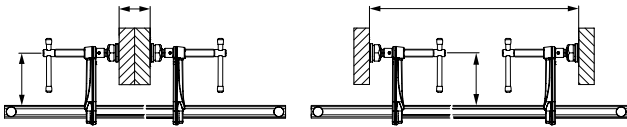

#### A Double force all-steel clamps – Complete Set Options

- Tipping is prevented through central positioning on the workpiece
- Long service life thanks to special heat resistant pressure plate with sintered steel insert, can be tilted by up to 35°
- Clamp can be fed through an opening in the workpiece/component

	Suitable for	Profile Size	Clamping Capacity	Throat Depth	Clamping Force	Approx. Weight
SLV40M	SLV	1 1/16" x 1/2"	16"	4 3/4"	1,450 lbs	6.85 lbs
SLV100M	SLV	1 1/16" x 1/2"	39 1/2"	4 3/4"	1,450 lbs	9.50 lbs
SLV150M	SLV	1 1/16" x 1/2"	60"	4 3/4"	1,450 lbs	11.50 lbs
SLV200M	SLV	1 1/16" x 1/2"	79"	4 3/4"	1,450 lbs	13.00 lbs
GSV300M	GSV	1 3/16" x 5/8"	118"	5 1/2"	2,000 lbs	28.13 lbs



#### B Rails for Sliding Arms

- Cold drawn and galvanised
- End fastenings – on both ends – can be loosened without tools for rapid changeover

	Suitable for	Profile Size	Length	Approx. Weight
3101731	SLV	1 1/16" x 1/2"	47"	6.28 lbs
3101732	SLV	1 1/16" x 1/2"	67"	8.92 lbs
3101733	SLV	1 1/16" x 1/2"	87"	11.57 lbs
3101612	GSV	1 3/16" x 5/8"	130"	23.00 lbs

**1 End fastenings can be loosened without tools**

Both ends can be loosened without tools enabling rapid changeover of the sliding arms for spreading tasks. Replace the sliding arms or add additional sliding arms easily.

**2 Interchangeable sliding arms**

The arms are made from forged tempered steel and offer a high level of security as the linear transfer of forces can withstand large loads. Replace with other sliding arm variants to suit the application or supplement with others.

**3 BESSEY® heavy duty MorPad**

Heavy duty MorPad is designed to reduce friction at the point of contact; which can lower applied clamping force. Longer service life due to the heat-resistant pressure plate with sintered steel insert, which can be tilted up to 35°.



**4 Tempered spindle**

The Acme spindle is sturdy and wear-resistant, considerably increasing its durability.

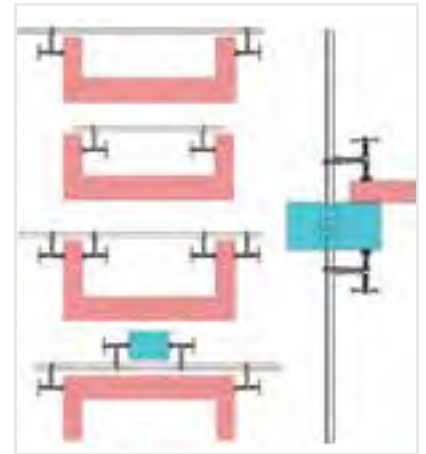
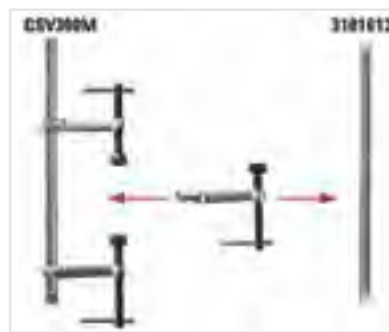
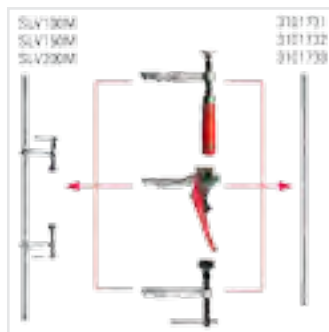

**C Complete sliding arm for SLV sizes**

- Three different grip variants/designs with different throats depths
- Suitable for all SLV size rails

	Description	Throat Depth	Approx. Weight
3101426	Wooden handle	4 3/4"	1.60 lbs
3101337	Lever handle	4 3/4"	2.40 lbs
3101338	T-Bar	4 3/4"	1.80 lbs



**D Complete sliding arm for GSV sizes**

- One arm design with three throat depths
- Suitable for GSV size rails
- T-Bar includes high-performance pressure plate with sintered steel insert

	Throat Depth	Approx. Weight
3101329	4 3/4"	2.50 lbs
3101330	5 1/2"	2.70 lbs
3101331	7 1/2"	3.10 lbs



**BESSEY® clamp service parts**

Available for the clamps listed on these pages.

**E Service part, heavy duty MorPads**

- 3100736 Smooth face (standard) - SLV or GSV Series
- 3101192 Rough face - SLV or GSV Series
- 3101193 V Groove - SLV or GSV Series

Ball-in-socket technology for greatly extended clamp life and, at full pressure... by BESSEY®. Patented.



**F Service part, handle, spindle, MorPad and pin assembly**

- 3100398 SLV Spindle (.700" Dia.)
- 3100399 GSV Spindle (.775" Dia.)



**G Variable angle device**

VAD Fits up SLV and GSV

# Self-adjusting jaw height for rapid clamping



## A range of applied force & height in one clamp: the power to be in position fast

BESSEY® Auto-Adjust Toggle Clamps have changed the way toggle clamps are constructed with variable range clamping force and the ability to auto-adjust to variations in workpiece height while maintaining constant clamping force. Now workpieces of differing heights can be clamped quickly and securely – perfect for small-scale production situations.

BESSEY® Auto-Adjust Toggle Clamps make time-consuming manual adjustments a thing of the past. The clamping force can be optimized to the demands of a particular workpiece simply by turning a set screw on the cantilevered joint, for added flexibility.

### Benefits:

- Increased productivity and more predictable applied clamping force means greater shop safety
- One BESSEY® Auto-Adjust Toggle Clamp replaces a range of competitive clamps for quicker set-ups, smaller tool cribs and consolidated inventories.
- Wide range of clamping force and heights
- Ideal for short production runs, quick set-ups, inventory reduction or tooling simplification
- BESSEY® clamps are made with the finest materials
- Large, ergonomic handles are heat-resistant
- Nickel plate standard coating

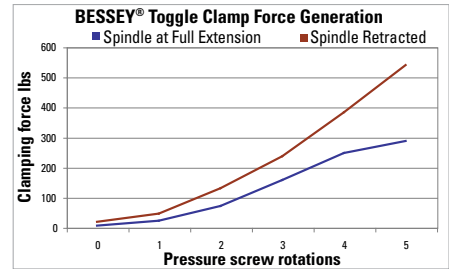

Clamping height: 30mm. Pressure screw set initially to lowest clamp force (0) then 1 full rotation for each measurement point.

## Vertical toggle with open arm and horizontal base plate

	Opening	Nominal Clamping Force Range	Holding Capacity	Approx. Weight	Fastener
STC-VH20	0- <sup>13</sup> / <sub>16</sub> "	25 - 250 lbs.*	450 lbs.	0.44 lbs.	<sup>3</sup> / <sub>16</sub> " or M5
STC-VH50	0-1 <sup>9</sup> / <sub>16</sub> "	25 - 550 lbs.*	700 lbs.	0.94 lbs.	<sup>1</sup> / <sub>4</sub> " or M6

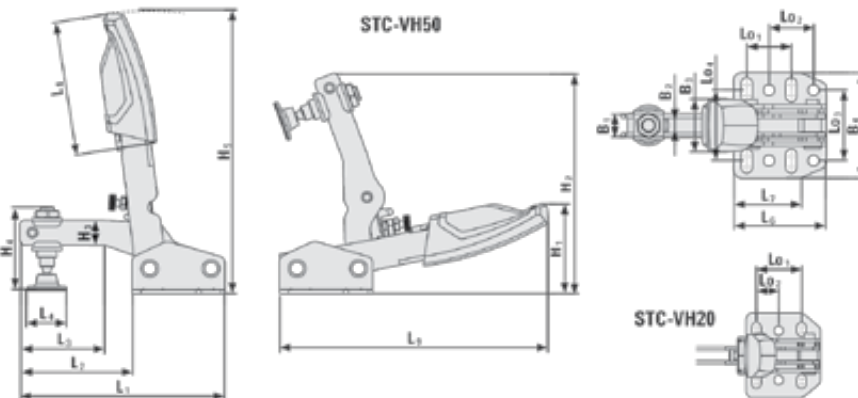

	Total Length	Length of extension arm	Spindle adjustment range	Pressure plate diameter	Length of base	Length of base plate 1	Length of base plate 2	Length of 2-comp handle	Length of handle (open)	Height of handle (closed)	Height of handle (open)	Height of extension arm	Height of spindle, cpl.	Height of base	Width of extension arm (external)	Width of extension arm (internal)	Width of 2-comp. handle	Width of base plate	Length of hole spacing 1	Length of hole spacing 2	Length of hole spacing 3	Width of elongated hole	Diameter of hole
	L1	L2	L3	L4	L5	L6	L7	L8	L9	H1	H2	H3	H4	H5	B1	B2	B3	B4	Lo1	Lo2	Lo3	Lo4	Ø
STC-VH20	3.62"	1.97"	0.79"	0.63"	—	1.69"	1.38"	2.36"	4.84"	1.61"	3.94"	0.39"	1.65"	5.08"	0.39"	0.24"	0.94"	1.89"	1.02"	0.51"	1.10"	1.06-1.26"	0.22"
STC-VH50	4.57"	2.48"	1.57"	0.91"	—	2.09"	1.73"	2.99"	6.06"	2.05"	4.96"	0.55"	1.97"	6.38"	0.52"	0.32"	1.18"	2.36"	1.00"	1.00"	1.57"	1.30-1.89"	0.26"

\* Variable and dependent on spindle settings, pressure screw setting, force applied etc. Some small spindle adjustments may be required to achieve maximum clamping opening. Note: All clamping force values in this catalog are approximate as applied force can vary based on spindle settings, pressure screw settings, force applied etc



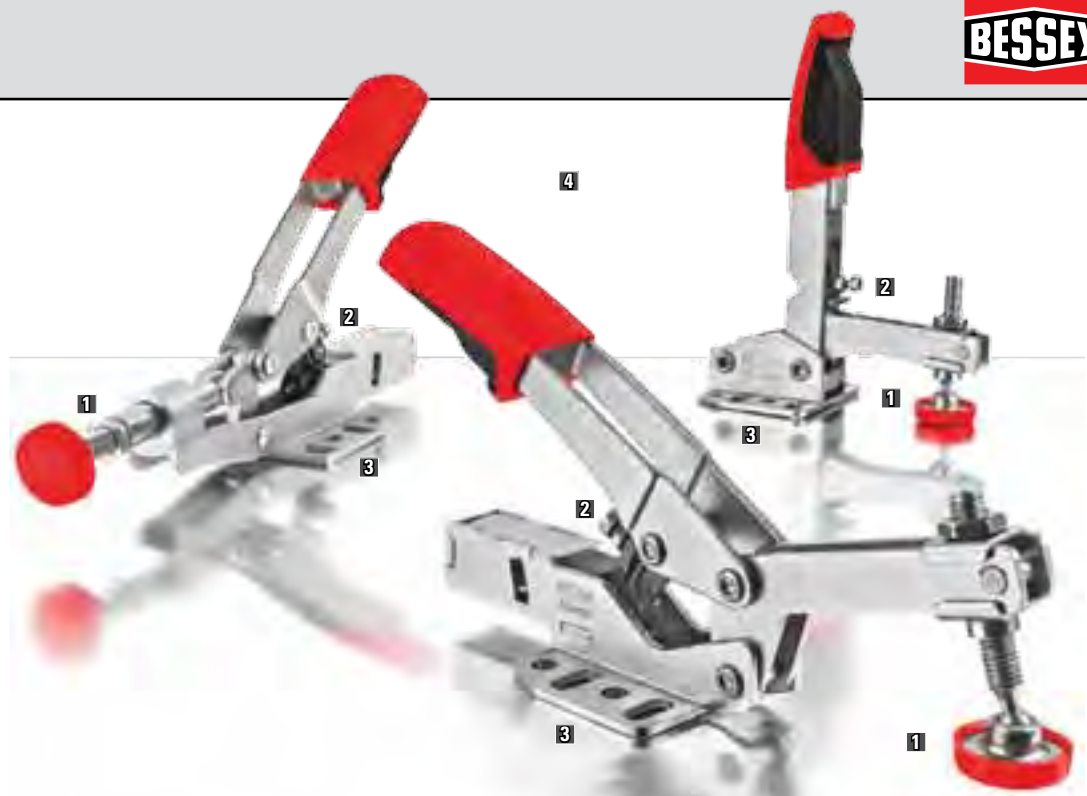

**Optional Bases**



**Service part**

- 3101627 Spindle set, STC-VH
- 3101588 Spindle set, STC-HH70
- 3101589 Spindle set, STC-HH50/1HH25

- 1 Auto-adjustment of the jaw height**  
The BESSEY® Auto-Adjust Toggle Clamp self adjusts to variations in workpiece height while maintaining clamping force.
- 2 Adjustable clamping force**  
The integrated clamping force adjustment screw can vary the applied clamping force in a range.
- 3 Adaptable base plate:**  
Holes are sized and spaced for easy mounting and flexibility in metric and imperial.
- 4 Large ergonomic handle**  
Soft insets for maximum comfort.

Toggle Video



**Horizontal with flanged base**

	Opening	Nominal Clamping Force Range	Holding Capacity	Approx. Weight	Fastener
STC-HH20	0-13/16"	25 - 250 lbs.*	450 lbs.	0.43 lbs.	3/16" or M5
STC-HH50	0-1 9/16"	25 - 550 lbs.*	700 lbs.	0.81 lbs.	1/4" or M6
STC-HH70	0-2 3/8"	25 - 550 lbs.*	700 lbs.	1.00 lbs.	1/4" or M6

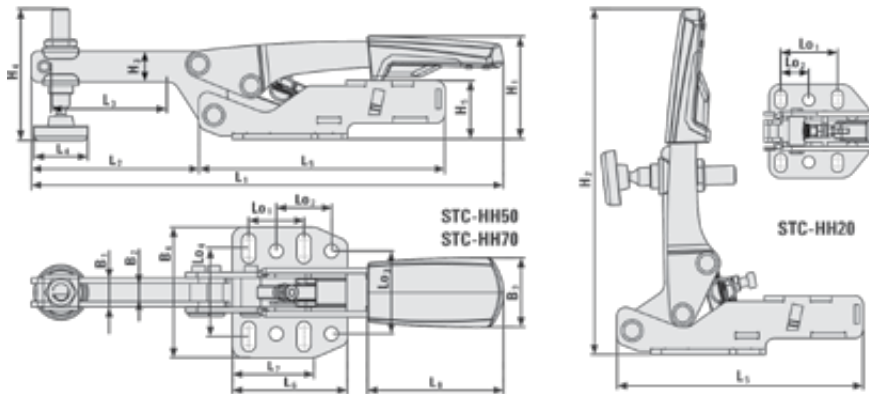

	Total Length	Length of extension arm	Spindle adjustment range	Pressure plate diameter	Length of base	Length of base plate 1	Length of base plate 2	Length of 2-comp handle	Height of handle (closed)	Height of handle (open)	Height of extension arm	Height of spindle, cpl.	Height of base	Width of extension arm (external)	Width of extension arm (internal)	Width of 2-comp. handle	Width of base plate	Length of hole spacing 1	Length of hole spacing 2	Length of hole spacing 3	Width of elongated hole	Diameter of hole
	L1	L2	L3	L4	L5	L6	L7	L8	H1	H2	H3	H4	H5	B1	B2	B3	B4	Lo1	Lo2	Lo3	Lo4	Ø
STC-HH20	6.57"	1.77"	0.79"	0.63"	3.27"	1.77"	1.38"	1.81"	1.73"	5.59"	0.39"	1.65"	0.98"	0.39"	0.24"	0.79"	1.65"	1.02"	0.51"	1.10"	1.02-1.25"	0.22"
STC-HH50	8.54"	3.03"	1.57"	0.91"	4.45"	2.09"	1.50"	2.83"	1.85"	6.22"	0.55"	1.97"	1.06"	0.51"	0.31"	1.26"	2.36"	1.00"	1.00"	1.50"	1.30-1.89"	0.26"
STC-HH70	8.54"	3.03"	1.57"	0.91"	4.45"	2.09"	1.50"	2.83"	2.52"	6.89"	0.55"	2.68"	1.73"	0.51"	0.31"	1.26"	2.36"	1.00"	1.00"	1.50"	1.30-1.89"	0.26"

# Horizontal with vertical base/angled base

## Horizontal toggle clamp with open arm and vertical base plate

STC-HV20      Opening 0-<sup>13</sup>/<sub>16</sub>"      Nominal Clamping Force Range 25 - 250 lbs.\*      Holding Capacity 450 lbs.      Approx. Weight 0.45 lbs.      Fastener <sup>3</sup>/<sub>16</sub>" or M5

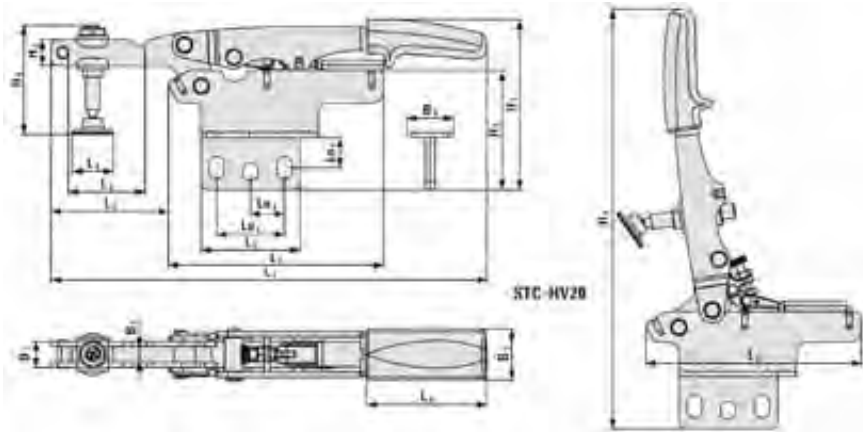

	Total Length	Length of extension arm	Spindle adjustment range	Pressure plate diameter	Length of base	Length of base plate 1	Length of base plate 2	Length of 2-comp handle	Height of handle (closed)	Height of handle (open)	Height of extension arm	Height of spindle, cpl.	Height of base	Width of extension arm (external)	Width of extension arm (internal)	Width of 2-comp. handle	Width of base plate	Length of hole spacing 1	Length of hole spacing 2	Length of hole spacing 3	Width of elongated hole	Diameter of hole
	L1	L2	L3	L4	L5	L6	L7	L8	H1	H2	H3	H4	H5	B1	B2	B3	B4	Lo1	Lo2	Lo3	Lo4	Ø
STC-HV20	6.57"	1.77"	0.79"	0.63"	3.27"	1.50"	-	1.81"	2.56"	6.38"	0.39"	1.65"	1.77"	0.39"	0.24"	0.79"	0.71"	0.39-0.51"	1.02"	0.51"	-	0.22"

## Horizontal toggle with open arm and angled base plate

STC-HA20      Opening 0-<sup>13</sup>/<sub>16</sub>"      Nominal Clamping Force Range 25 - 250 lbs.\*      Holding Capacity 450 lb.      Approx. Weight 0.48 lbs.      Fastener <sup>3</sup>/<sub>16</sub>" or M5

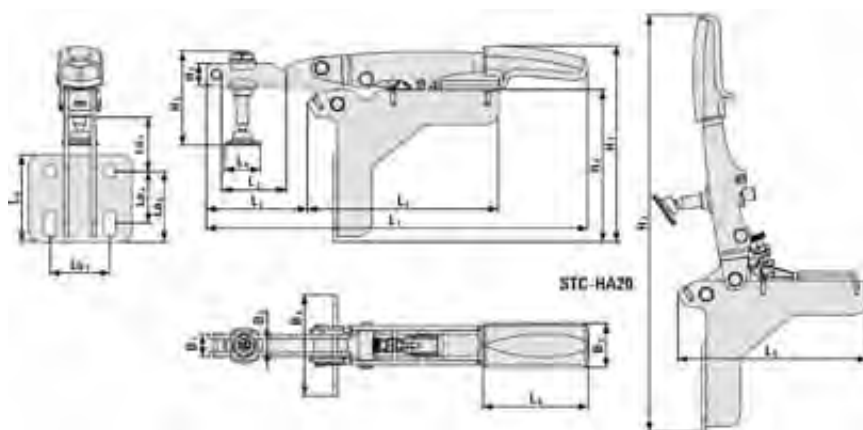

	Total Length	Length of extension arm	Spindle adjustment range	Pressure plate diameter	Length of base	Length of base plate 1	Length of base plate 2	Length of 2-comp handle	Height of handle (closed)	Height of handle (open)	Height of extension arm	Height of spindle, cpl.	Height of base	Width of extension arm (external)	Width of extension arm (internal)	Width of 2-comp. handle	Width of base plate	Length of hole spacing 1	Length of hole spacing 2	Length of hole spacing 3	Width of elongated hole	Diameter of hole
	L1	L2	L3	L4	L5	L6	L7	L8	H1	H2	H3	H4	H5	B1	B2	B3	B4	Lo1	Lo2	Lo3	Lo4	Ø
STC-HA20	6.57"	1.77"	0.79"	0.63"	3.27"	1.50"	-	1.81"	3.35"	7.13"	0.39"	1.65"	2.60"	0.39"	0.24"	0.79"	1.77"	0.39-1.18"	0.79-1.02"	1.02"	-	0.22"

\* Variable and dependent on spindle settings, pressure screw setting, force applied etc. Some small spindle adjustments may be required to achieve maximum clamping opening.

# Inline with flanged base/angled base

## Inline with flanged base

	Opening	Nominal Clamping Force Range	Holding Capacity	Approx. Weight	Fastener
STC-IHH15	0-3/8"	25 - 250 lbs.*	450 lbs.	0.41 lbs.	3/16" or M5
STC-IHH25	0-5/8"	25 - 550 lbs.*	700 lbs.	0.88 lbs.	1/4" or M6

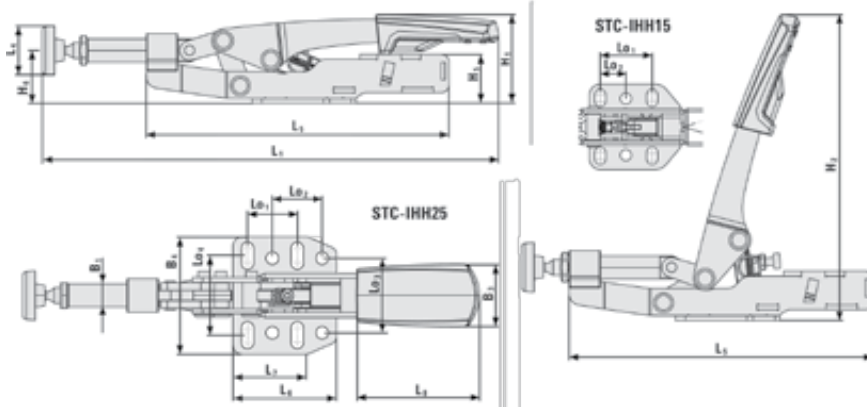

	Total Length	Length of extension arm	Spindle adjustment range	Pressure plate diameter	Length of base	Length of base plate 1	Length of base plate 2	Length of 2-comp handle	Height of handle (closed)	Height of handle (open)	Height of extension arm	Height of spindle, cpl.	Height of base	Height to spindle centre	Width of extension arm (external)	Width of extension arm (internal)	Width of 2-comp. handle	Width of base plate	Length of hole spacing 1	Length of hole spacing 2	Length of hole spacing 3	Width of elongated hole	Diameter of hole
	L1	L2	L3	L4	L5	L6	L7	L8	H1	H2	H3	H4	H5	H6	B1	B2	B3	B4	Lo1	Lo2	Lo3	Lo4	Ø
STC-IHH15	7.13"	-	-	0.63"	4.13"	1.77"	1.38"	1.81"	1.26"	4.21"	-	-	0.51"	0.63"	0.33"	-	0.79"	1.65"	1.02"	0.51"	1.10"	1.02-1.25"	0.22"
STC-IHH25	9.17"	-	-	0.91"	6.06"	2.09"	1.50"	2.87"	1.81"	6.10"	-	-	0.98"	1.06"	0.47"	-	1.26"	2.36"	1.00"	1.00"	1.50"	1.30-1.89"	0.26"

## Inline with angled base plate

	Opening	Nominal Clamping Force Range	Holding Capacity	Approx. Weight	Fastener
STC-IHA15	0-3/8"	25 - 250 lbs.*	450 lbs.	0.48 lbs.	3/16" or M5

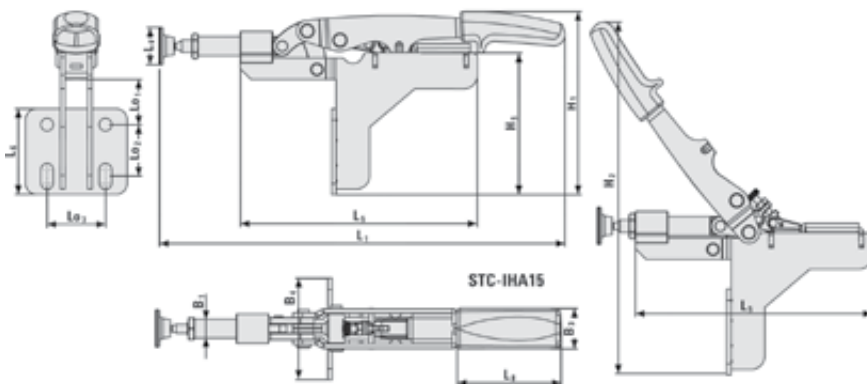

	Total Length	Length of extension arm	Spindle adjustment range	Pressure plate diameter	Length of base	Length of base plate 1	Length of base plate 2	Length of 2-comp handle	Height of handle (closed)	Height of handle (open)	Height of extension arm	Height of spindle, cpl.	Height of base	Height to spindle centre	Width of extension arm (external)	Width of extension arm (internal)	Width of 2-comp. handle	Width of base plate	Length of hole spacing 1	Length of hole spacing 2	Length of hole spacing 3	Diameter of hole
	L1	L2	L3	L4	L5	L6	L7	L8	H1	H2	H3	H4	H5	H6	B1	B2	B3	B4	Lo1	Lo2	Lo3	Ø
STC-IHA15	7.13"	-	-	0.63"	4.13"	1.496"	-	1.81"	3.19"	5.87"	-	-	2.48"	1.37"	0.33"	-	0.79"	1.77"	0.81"	0.79-1.02"	1.125"	0.22"

\* Variable and dependent on spindle settings, pressure screw setting, force applied etc. Some small spindle adjustments may be required to achieve maximum clamping opening.

# Powerful parallel clamping at its best

## Powerful parallel clamping at its best

BESSEY® invented the parallel clamp and continues the innovation to meet the needs of the serious woodworker. For production settings or home shops, there is always a need for a powerful, parallel, BESSEY® product.

### 1 Parallel clamping surface with jaw protection pads

Arguably the most powerful and most parallel clamps in the world. Three large removable (for cleaning or replacement) pressure caps are resistant to glue, paint and solvents.

### 2 Large ergonomic 2K composite handle (REVO™)

High quality 2K composite handle with soft plastic insert for comfort while working and greater tactility resulting in better grip.

### 3 Rail protection pieces

Rail protection pieces work to isolate and elevate the workpiece from the rail. Easily fasten the rail protection pieces to a work surface with TK-6 table clamps.

### 4 Removable end-clip

End-clip ensures clamp sits parallel to work surface. Removable to reverse sliding arm for use as spreader. Clips can also be attached to a work surface with TK-6 table clamps.

### 5 The moveable 'fixed' jaw

Innovation: BESSEY® offers both jaws adjustable to optimize clamping set-up. With the push of a button the 'fixed' jaw can be moved to where you want it.

### 6 Wood handle (UniKlamp®, REVO™ JR)

Ergonomically shaped.



### K Body® REVO™ Extender Kits

	Includes	Weight
KRX2440	2 x KR3.524 (24" K Body® REVO™) 2 x KR3.540 (40" K Body® REVO™) 2 x K Body® Extenders	30 lbs
KRX2450	2 x KR3.524 (24" K Body® REVO™) 2 x KR3.550 (50" K Body® REVO™) 2 x K Body® Extenders	32 lbs



### K Body® REVO™ Framing Kits

	Includes	Weight
KRK2440	2 x KR3.524 (24" K Body® REVO™) 2 x KR3.540 (40" K Body® REVO™) 1 set of KP BLOCKS (4 blocks/set)	29 lbs
KRK2450	2 x KR3.524 (24" K Body® REVO™) 2 x KR3.550 (50" K Body® REVO™) 1 set of KP BLOCKS (4 blocks/set)	31 lbs



### A K Body® REVO™, parallel clamps

Jaws clamp at an accurate 90 degree angle; arguably the most powerful parallel clamp in the world. Nominal clamping force of 1500 lbs with large handles and clamping surface. Replacement parts available.

	Clamping Capacity	Throat Depth	Clamping Force	Approx. Weight
KR3.512	12"	3 3/4"	1500 lbs	4.76 lbs
KR3.518	18"	3 3/4"	1500 lbs	5.40 lbs
KR3.524	24"	3 3/4"	1500 lbs	6.06 lbs
KR3.531	31"	3 3/4"	1500 lbs	6.86 lbs
KR3.540	40"	3 3/4"	1500 lbs	7.61 lbs
KR3.550	50"	3 3/4"	1500 lbs	8.51 lbs
KR3.560	60"	3 3/4"	1500 lbs	9.46 lbs
KR3.582	82"	3 3/4"	1500 lbs	11.66 lbs
KR3.598	98"	3 3/4"	1500 lbs	13.21 lbs

### B Vario K Body® REVO™, variable jaw parallel clamp

Same great clamp as the K Body® REVO™ but with a moveable 'fixed' jaw. Now you can optimize your clamping set-up with a push of a button and the 'fixed' jaw can be moved where you want it.

	Clamping Capacity	Throat Depth	Clamping Force	Approx. Weight
KRV-40	40"	3 3/4"	1500 lbs	8.26 lbs
KRV-60	60"	3 3/4"	1500 lbs	10.16 lbs
KRV-78	78"	3 3/4"	1500 lbs	12.41 lbs
KRV-98	98"	3 3/4"	1500 lbs	13.91 lbs

K Body® REVO™ Video



Vario K Body® REVO™ Video



Size Comparison Chart

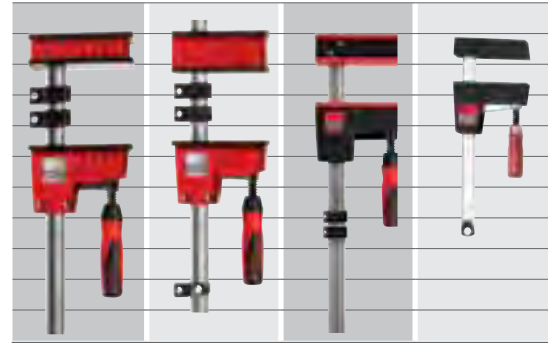

K Body® REVO™ JR Video



UniKlamp® Video



**C** K Body® REVO™ JR parallel clamps

The new K BODY® REVO™ JR is a mid-sized version of what makes the full-sized REVO parallel clamp so great. Parallel jaws, good power and a lighter relative weight, combined with a very competitive price point, makes this clamp a success.

	Clamping Capacity	Throat Depth	Clamping Force	Approx. Weight
KRJR-12	12"	3 1/4"	900 lbs	2.86 lbs
KRJR-18	18"	3 1/4"	900 lbs	3.16 lbs
KRJR-24	24"	3 1/4"	900 lbs	3.40 lbs
KRJR-36	36"	3 1/4"	900 lbs	4.21 lbs
KRJR-50	50"	3 1/4"	900 lbs	4.91 lbs

**D** UniKlamp® case clamp

This light duty universal case clamp is an ideal tool for many jobs around the shop. Lower clamping pressures spread over a wider surface are gentler on delicate work surfaces and, the light weight means less fatigue during glue-ups.

	Clamping Capacity	Throat Depth	Clamping Force	Approx. Weight
UK3.006	6"	3 1/8"	330 lbs	1.36 lbs
UK3.012	12"	3 1/8"	330 lbs	1.59 lbs
UK3.024	24"	3 1/8"	330 lbs	2.04 lbs



**BESSEY® K Body® REVO™ & Vario K Body® REVO™ service parts & accessories**

A range of service parts are available for the clamps listed on these pages.

- E Adjustable Fixed Jaw** (for KR & KRJV)  
KR-V0 Replacement variable jaw, throat depth of 3 3/4"
- F Sliding Jaw** (for KR & KRJV)  
KR-J2K Replacement sliding jaw, throat depth of 3 3/4"
- G Jaw Pads** (for KR & KRJV)  
KR-JP Replacement jaw pads, 2 jaw pads/set
- H End Clip** (for KR & KRJV)  
KR-EC Replacement rail end, 1/set  
3006694 Classic K-Body® end clip, 1/set
- I Rail Protection Pieces** (for KR & KRJV)  
KR-RPP Replacement rail protection pieces, 2/set
- J 2K Handle** (for KR & KRJV)  
3101370 Replacement 2K handle
- K Table Mount Clamp (TK)** (for KR & KRJV)  
TK-6 Accessory, holds KR & KRJV to work surface, 2/set
- L Jaw Adapter** (for KR & KRJV)  
KR-AS Accessory slides onto the jaws of KR & KRJV. The pivoting jaws clamp or spread to irregular angles from -15° to +15°, 2/set
- M Extender** (for KR & KRJV)  
KBX20 Accessory, connects two KR or KRJV clamps
- N KP Blocks (4/set)** (for KR & KRJV)  
KP Accessory, quick set up for raised panel doors, frames, etc.

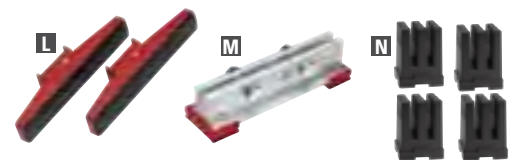

# BESSEY® quality, durability and strength



TG Series Video



## Malleable cast bar clamps

The original BESSEY® malleable cast iron bar clamp is available in two different designs. Either with the tried-and-true wooden handle, or the modern BESSEY® 2K handle. The high quality 2K composite handle with comfort insert allows you to complete tasks more effectively and with less hand fatigue.

### 1 Integrated anti-slip system

Maximum safety is available with the integrated anti-slip system. A set screw that is molded into the sliding arm interlocks with the serration on the rail to prevent the clamp from slipping.

### 2 Reinforced malleable cast iron jaw and sliding arm

Corrugated malleable cast iron fixed jaw and sliding arm generate powerful, rigid clamping. Top jaw is press fitted to the rail.

### 3 High quality profiled rail

The BESSEY® profiled rail from our own German steel plant has been optimized for clamps. The profile acts as a reliable reinforcement against torsional forces, while the serration on six faces additionally prevents the clamp from slipping.

### 4 BESSEY® smooth running spindle

Smooth running spindle with Acme thread allows for more clamping with less effort. Replaceable pressure plates can be easily changed without tools.

### 5 BESSEY® comfort handle

With the TG series you have the choice of the tried-and-true wooden handle or the 2K composite handle with a comfort insert.



### A Light duty (TG & TGJ) with 2K handle or wood handle

Choose your handle, the 2K or wood! The rail's hourglass profile contributes to the TG serie's ability to resist flex. Even the light duty version is a tough tool built with the quality you expect from BESSEY®.



2K Handle	Clamping Capacity	Throat Depth	Clamping Force	Approx. Weight	Wood Handle
TGJ2.506+2K	6"	2 1/2"	600 lbs	1.45 lbs	TGJ2.506
TGJ2.512+2k	12"	2 1/2"	600 lbs	1.80 lbs	TGJ2.512
TGJ2.518+2k	18"	2 1/2"	600 lbs	2.15 lbs	TGJ2.518
TGJ2.524+2k	24"	2 1/2"	600 lbs	2.50 lbs	TGJ2.524
TGJ2.530+2k	30"	2 1/2"	600 lbs	2.90 lbs	TGJ2.530
TGJ2.536+2k	36"	2 1/2"	600 lbs	3.25 lbs	TGJ2.536
TG4.008+2k	8"	4"	880 lbs	2.35 lbs	TG4.008
TG4.012+2k	12"	4"	880 lbs	2.62 lbs	TG4.012
TG4.016+2k	16"	4"	880 lbs	2.90 lbs	TG4.016
TG4.024+2k	24"	4"	880 lbs	3.48 lbs	TG4.024



### B Medium duty (TG) with 2K handle or wood handle

Choose your handle and load up on pressure, durability and versatility. With a total of six serrated edges, the TG & TGJ are capable of withstanding a lot of pressure without slipping.



2K Handle	Clamping Capacity	Throat Depth	Clamping Force	Approx. Weight	Wood Handle
TG4.512+2K	12"	4 1/2"	1000 lbs	3.55 lbs	TG4.512
TG4.518+2k	18"	4 1/2"	1000 lbs	4.30 lbs	TG4.518
TG4.524 +2k	24"	4 1/2"	1000 lbs	4.65 lbs	TG4.524
TG4.530+2k	30"	4 1/2"	1000 lbs	5.40 lbs	TG4.530
TG4.540+2k	40"	4 1/2"	1000 lbs	6.23 lbs	TG4.540
TG5.512+2k	12"	5 1/2"	1320 lbs	4.85 lbs	TG5.512
TG5.518+2k	18"	5 1/2"	1320 lbs	5.80 lbs	TG5.518
TG5.524+2k	24"	5 1/2"	1320 lbs	6.25 lbs	TG5.524
TG7.016+2k	16"	7"	1320 lbs	5.95 lbs	TG7.016
TG7.024+2k	24"	7"	1320 lbs	7.00 lbs	TG7.024
TG7.048+2k	48"	7"	1320 lbs	9.65 lbs	TG7.048

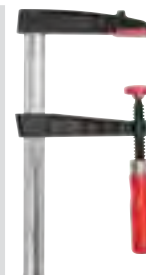

### C Heavy duty (TGK) with 2K handle

More clamp force than most of us will ever need. High-end quality throughout. The 2K composite handle with comfort insert is standard.

	Clamping Capacity	Throat Depth	Clamping Force	Approx. Weight
TGK4.516+2K	16"	4 1/2"	1540 lbs	5.80 lbs
TGK4.524+2K	24"	4 1/2"	1540 lbs	6.75 lbs
TGK4.540+2K	40"	4 1/2"	1540 lbs	9.05 lbs
TGK4.550+2K	50"	4 1/2"	1540 lbs	10.65 lbs
TGK4.579+2K	79"	4 1/2"	1540 lbs	14.65 lbs



### D Deep reach (CDS) with flat rail

Need some extra reach? The CDS offers a throat depth of up to 20" when you need that extra deep reach. The large flat rail is serrated to prevent slipping. Comes with: Flat rail profile, standard pad, and plastic cap.

	Clamping Capacity	Throat Depth	Clamping Force	Approx. Weight
CDS24-10 WP	24"	10"	1550 lbs	11.05 lbs
CDS24-12 WP	24"	12"	1550 lbs	13.90 lbs
CDS24-20 WP	24"	20"	990 lbs	20.15 lbs



### E Malleable cast (TC) with flat rail

Flat rails are an economical alternative - German quality at an appealing price for industrial application. Comes with: Ergonomically shaped wood handle, standard pad, and plastic cap.

	Clamping Capacity	Throat Depth	Clamping Force	Approx. Weight
TC4.008	8"	4"	800 lbs	2.85 lbs
TC4.512	12"	4 1/2"	950 lbs	3.36 lbs
TC5.512	12"	5 1/2"	1200 lbs	4.85 lbs
TC7.016	16"	7"	1200 lbs	5.95 lbs



### F Malleable cast (TG) with T-Bar and profiled rail

Top selling TG Series products with T-Bar handle with rounded ends for simple transfer of force when clamping.

	Clamping Capacity	Throat Depth	Clamping Force	Approx. Weight
TG3.006+TB	6"	3"	700 lbs	1.75 lbs
TG4.008+TB	8"	4"	880 lbs	2.50 lbs
TG4.510+TB	10"	4 1/2"	1000 lbs	3.00 lbs
TG5.512+TB	12"	5 1/2"	1320 lbs	5.00 lbs
TG4.516+TB	16"	4 1/2"	1000 lbs	4.05 lbs
TG4.524+TB	24"	4 1/2"	1000 lbs	4.80 lbs



BESSEY® service parts for the clamps listed on these pages.

#### G Plastic replacement caps

- 3101392 TGJ2.5 (10/set)
- 3101394 TG4.0 (10/set)
- 3101395 TG4.5 (10/set)
- 3101396 TGK, TG5.5, TG7.0 (10/set)



#### H Standard pad

- 3101180 TGJ2.5 (4 pc)
- 3101183 TG4.0, TG4.5 (4 pc)
- 3101188 TG5.5, TG7.0, TGK4.5, CDS (4 pc)



#### I 2K Handle with pad

- 3101179 TGJ (1 pc)
- 3101182 TG4, RSC, 660 (1 pc)
- 3101186 TG4.5 (1 pc)
- 3101187 TG5.5, TG7, TGK, 1200, SGL (1 pc)



### BESSEY® Clamp Sets

#### J Small TG kit BTB30A

30 piece (with display) malleable cast clamps

##### Kit includes:

- 4 x TGJ2.506+2K (6")
- 6 x TGJ2.512+2K (12")
- 4 x TGJ2.518+2K (18")
- 8 x TGJ2.524+2K (24")
- 4 x TGJ2.530+2K (30")
- 4 x TGJ2.536+2K (36")
- 1 x A Frame display

Approx. Weight  
82.00 lbs.



#### K General multi-purpose clamp kit BGP

10 piece

##### Kit includes:

- 2 x TGJ2.506 (6")
- 2 x TG4.008 (8")
- 2 x LM2.004 (4")
- 2 x PC34 (3/4")
- 2 x XM5 (2")

Approx. Weight  
17.00 lbs.



#### L Small TG kit BTB30

30 piece malleable cast clamps

##### Kit includes:

- 4 x TGJ2.506 (6")
- 6 x TGJ2.512 (12")
- 4 x TGJ2.518 (18")
- 8 x TGJ2.524 (24")
- 4 x TGJ2.530 (30")
- 4 x TGJ2.536 (36")

Approx. Weight  
72.00 lbs.



# GTR



## Get in the groove

### Track/table clamp

Our newest innovative clamp designed for holding materials safely and securely on MDF tables that are equipped with matrix holes and T-tracks. Precision and durability are at the core of the BESSEY® brand. Our tools have always been manufactured from the highest-grade materials.

- 1 Special lower arm**  
for 12 x 8 mm grooves.
- 2 Safety by design**  
Track saw guide slots make for secure and fast clamping. High clamping force for increased safety.
- 3 Versatility**  
For use with Festool, Protool, Metabo, Makita, DeWalt track saw guides.
- 4 Wood handle or lever handle with ratchet action**  
Ergonomically shaped wooden handle or ratchet action lever handle for more clamping force, up to 5 times faster than conventional clamps.



### A Track/table clamp (GTR)

High clamping force for safety. Ergonomically shaped wooden handle.

	Clamping Capacity	Throat Depth	Nominal Clamping Force	Approx. Weight
GTR12	4 1/16"	2 5/16"	400 lbs	0.66 lbs
GTR16B6	6 5/16"	2 5/16"	400 lbs	0.71 lbs
GTR30B6	11 13/16"	2 5/16"	400 lbs	0.90 lbs



### B Track/table clamp (GTRH)

Clamping force is variable, with ratchet action lever up to 5 times faster than conventional clamps. Secure – lever / ratchet unaffected by vibrations. Strong – clamping force up to 540 lbs nominal clamping force.

	Clamping Capacity	Throat Depth	Nominal Clamping Force	Approx. Weight
GTR16S6H	6 5/16"	2 5/16"	540 lbs	1.17 lbs



# One-handed clamping or spreading



## Simple is so powerful

### EZ and EZS for one-handed clamping or spreading with all the BESSEY® strength you've come to expect

Another powerhouse from BESSEY®. Built with internal components that reflect German engineering, these clamps transition smoothly from clamping to spreading.

- 1 Powerful technology**  
Single-handed clamping and spreading of workpieces with up to 445 lb clamping force.
- 2 Intelligent release mechanism**  
The upper section can quickly convert from clamping to spreading without tools.
- 3 Handle behind the rail**  
Ergonomic handle positioned behind the rail, enabling a powerful grip.
- 4 Soft pressure caps**  
Soft pressure caps optimize material protection and secure clamping.
- 5 Throat depth to the very edge**  
While all other clamps measure throat depth to the centre of the pad, EZ and EZS extend throat depth right to the outside edge of the pads – power spread across the entire pad.

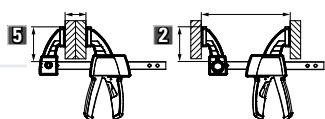

EZS Video



### A One-handed EZS clamps

The EZS One Hand Clamp by BESSEY® offers a revitalized approach to the one hand clamp market. What makes it so new and fresh is that it has been engineered from the start to offer clean design lines, comfortable handles, 445 lbs of clamp force and the ability to transition smoothly from clamping to spreading.

	Clamping Capacity	Throat Depth	Clamping Force	Spreading	Approx. Weight
EZS15-8	6"	3 1/2"	445 lbs	6 1/2" - 14"	1.53 lbs
EZS30-8	12"	3 1/2"	445 lbs	6 1/2" - 20"	1.79 lbs
EZS45-8	18"	3 1/2"	445 lbs	6 1/2" - 25 3/4"	2.00 lbs
EZS60-8	24"	3 1/2"	445 lbs	6 1/2" - 31 3/4"	2.28 lbs
EZS90-8	36"	3 1/2"	445 lbs	6 1/2" - 43 1/2"	2.80 lbs

- B EZ Combo** Includes:  
 2 x EZS15-8  
 2 x EZS30-8  
 2 x EZS45-8  
 11.00 lbs



### C One-handed EZ clamps

A lightweight version of EZS – with 150 lbs of clamping force, the ability to transition smoothly from clamping to spreading, and all the dependability you've come to expect from BESSEY®.

	Clamping Capacity	Throat Depth	Clamping Force	Spreading	Approx. Weight
EZ15-6	6"	2 3/4"	150 lbs	5" - 12"	0.66 lbs
EZ30-6	12"	2 3/4"	150 lbs	5" - 18"	0.83 lbs



# One-handed clamping



## Light as a feather – tough as nails

### The lightweight clamp made of magnesium

Innovative, high-tech, KliKlamp® lever clamp is extremely lightweight, the smallest weighs a tiny 0.70 lbs. Ideal for assembly work or where several clamps are used at once. Pressure builds easily – ratchet mechanism can achieve a huge 260 lbs of clamping force quickly – with just 2 fingers. Quick, easy & gentle!

#### 1 Sturdy magnesium

The surface-coated fixed and sliding arms are made from sturdy magnesium – lightweight and strong.

#### 2 Multi-stage ratchet mechanism

Easy to operate, vibration-resistant, and can be released quickly.

#### 3 Secure hold

The fixed arm with crossed v-grooves holds round, pointed or angular components firmly in place.

#### 4 Ergonomically shaped clamping arm

Made from breakproof fibreglass-reinforced polyamide.



#### A KliKlamp® light duty lever clamp

Light as a feather – tough as nails; it's perfect for your workshop.

	Clamping Capacity	Throat Depth	Clamping Force	Approx. Weight
KLI3.004	4"	3"	260 lbs	0.53 lbs
KLI3.008	8"	3"	260 lbs	0.67 lbs
KLI3.012	12"	3"	260 lbs	0.83 lbs
KLI3.016	16"	3"	260 lbs	0.97 lbs



#### B PowerGrip (PG) heavy duty one-hand clamp

A truly one-handed clamp that is easy to use. To preadjust the jaw use the easy slide button to position the jaw quickly; then squeeze the handle to hold the clamp in place; then simply turn the handle to apply the full pressure. Comes with removable soft pressure caps.

	Clamping Capacity	Throat Depth	Clamping Force	Approx. Weight
PG12	12"	4"	1000 lbs	2.75 lbs
PG24	24"	4"	1000 lbs	3.70 lbs
3101402	PG Pad Set			



#### C DuoKlamp®, large surface one handed clamp

Clamp or spread with the turn of a button, no tools necessary with the intelligent release mechanism. Jaws are designed to resist flex and are capable of withstanding up to 260 lbs of clamping force. Soft pressure caps slide off easily and prevent marring of wood by distributing pressure over a greater area.

	Clamping Capacity	Throat Depth	Clamping Force	Spreading	Approx. Weight
DUO16-8	6"	3 ¼"	260 lbs	2 ¾" - 9 ¼"	1.42 lbs
DUO30-8	12"	3 ¼"	260 lbs	2 ¾" - 14 ¾"	1.53 lbs
DUO45-8	18"	3 ¼"	260 lbs	2 ¾" - 21"	1.87 lbs
DUO65-8	24"	3 ¼"	260 lbs	2 ¾" - 26 ¾"	2.19 lbs

**D DuoKlamp® Includes Combo**  
 2 x DUO16-8  
 2 x DUO30-8  
 2 x DUO45-8



7.60 lbs

# LM Light duty

## Small and very handy

### 1 Step-over clamping U-shape

The rail is made of quality steel drawn in a single piece for durability and strength. The U-shape of the rail enables step-over clamping so you can get to those hard-to-reach places.

### 2 Sliding arm

The sliding arm is made of die-cast zinc. It is light, stable and break-resistant.

### 3 Protective caps

Plastic pressure caps on the top and bottom sections protect the work piece surface.

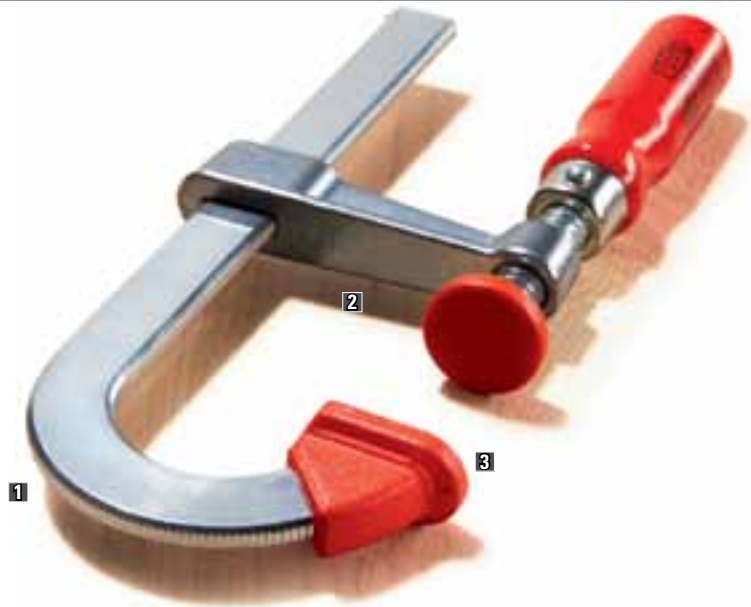

LMU Video



### A Light duty, zinc die cast, step over bar clamp (LMU)

Small, light weight and made of quality durable material. The U shaped bar helps to clamp over small obstructions and apply the clamping force where you need it. Comes with two plastic pressure caps.

	Clamping Capacity	Throat Depth	Clamping Force	Approx. Weight
LMU2.004	4"	2"	330 lbs	0.50 lbs
LMU2.006	6"	2"	330 lbs	0.60 lbs
LMU2.008	8"	2"	330 lbs	0.65 lbs

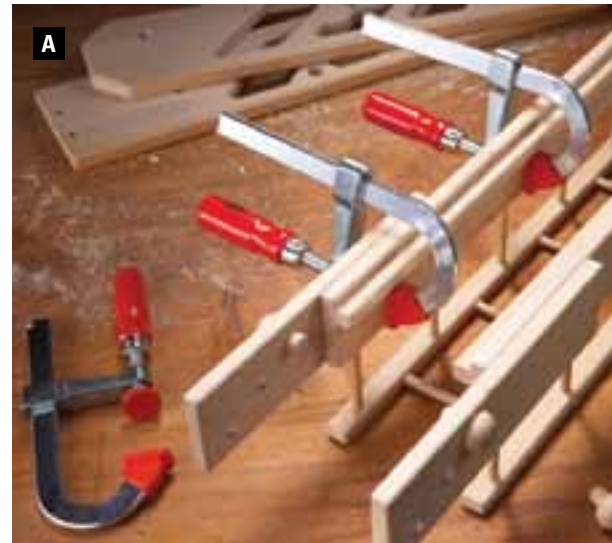

### B Light duty, zinc die cast (LM)

Small, light weight and made of quality durable material. Comes with a plastic cap on pressure pad.

	Clamping Capacity	Throat Depth	Clamping Force	Approx. Weight
LM2.004	4"	2"	330 lbs	0.55 lbs
LM2.006	6"	2"	330 lbs	0.60 lbs
LM2.008	8"	2"	330 lbs	0.70 lbs
LM2.012	12"	2"	330 lbs	0.80 lbs
LM3.006	6"	3"	330 lbs	1.15 lbs
LM3.012	12"	3"	330 lbs	1.40 lbs
LM3.024	24"	3"	330 lbs	2.00 lbs



One handed, light duty & clutch style clamps

# Clutch style bar clamps



BESSEY® Clutch style bar clamps are a popular regular-duty clamp used by cabinet makers, woodworkers, metal workers and homecrafters across North America. These easy-to-use clamps are suitable for "close quarters" clamping.

- 1 Cast iron jaws**  
Durable powder coated cast-iron fixed and sliding jaws.
- 2 Safety by design**  
Nickel plated, drawn and serrated rail.
- 3 Secure**  
2 piece slip-clutch plates keep the jaw sturdy and in place.
- 4 Protective pads**  
Non-marring pads on the top and bottom jaws.
- 5 Ergonomic wood handle or 2K handle**  
Ergonomically shaped, standard wood handle, or 2K comfort handle now available in the most popular GSCC3.5XX models.



A

## A Clutch style (GSCC)

Wood handle is standard with our 2K comfort handle now available in the most popular models.

	2K Handle	Wood Handle	Clamping Capacity	Throat Depth	Load Limit	Approx. Weight
		GSCC2.506	6"	2 1/2"	600 lbs	1.34 lbs
		GSCC2.512	12"	2 1/2"	600 lbs	1.72 lbs
		GSCC2.518	18"	2 1/2"	600 lbs	1.97 lbs
		GSCC2.524	24"	2 1/2"	600 lbs	2.27 lbs
		GSCC2.530	30"	2 1/2"	600 lbs	2.57 lbs
		GSCC2.536	36"	2 1/2"	600 lbs	2.82 lbs
GSCC3.506+2K		GSCC3.506	6"	3 1/2"	1100 lbs	2.34 lbs
GSCC3.512+2K		GSCC3.512	12"	3 1/2"	1100 lbs	2.82 lbs
GSCC3.518+2K		GSCC3.518	18"	3 1/2"	1100 lbs	3.37 lbs
GSCC3.524+2K		GSCC3.524	24"	3 1/2"	1100 lbs	3.73 lbs
GSCC3.536+2K		GSCC3.536	36"	3 1/2"	1100 lbs	4.50 lbs
		GSCC5.012	12"	5"	1200 lbs	4.54 lbs
		GSCC5.018	18"	5"	1200 lbs	5.19 lbs
		GSCC5.024	24"	5"	1200 lbs	5.94 lbs



B



NEW

## B Clutch style (GSCC) set of 4

Our most popular models: 2x GSCC2.506 and 2x GSCC2.512 clutch style bar clamps with wood handle in a convenient clam pack.

	Clamping Force	Approx. Weight
GSCC4PK	600 lbs	6.25 lbs



# Clutch style, rapid action and lever clamps

## C Clutch style (DHBC) with double jaw

The double jaw clamp can do things that other clamps just can't do. Very useful on corner glue ups and where pressure needs to be dispersed for delicate work. Made of powder coated, ductile cast iron jaws and a two piece slip clutch plate for a strong hold.

	Clamping Capacity	Throat Depth	Clamping Force	Approx. Weight
DHBC-12	12"	3 1/2"	400 lbs	2.28 lbs
DHBC-24	24"	3 1/2"	400 lbs	2.88 lbs
DHBC-36	36"	3 1/2"	400 lbs	3.48 lbs

Find Double head (DHCC) C-clamps on page 34



## D Rapid Action clamps

Very quick set-up times and a heavy duty rail for speed and strength. Double spindle mechanism moves the clamping bolt twice as far per handle turn as a normal ACME threaded spindle. The clamping bolt and pressure plate are manufactured from a single piece of German steel with no seams for debris to enter. The clamping bolt is guided firmly in the barrel for "no-twist" clamping (prevents parts from shifting). Anti-slip mechanism meshes the hardened set screw with serrations on the rail.

	Clamping Capacity	Throat Depth	Clamping Force	Approx. Weight
PZ4.012	12"	4"	1320 lbs	3.92 lbs
PZ4.024	24"	4"	1320 lbs	5.04 lbs
PZ4.036	36"	4"	1320 lbs	6.66 lbs
PZ6.012	12"	6"	1620 lbs	5.44 lbs
PZ6.024	24"	6"	1620 lbs	6.92 lbs
PZ6.036	36"	6"	1620 lbs	9.00 lbs



## E Lever clamp classiX® GSH

Quick – up to 5 times faster than regular clamps. Secure – unaffected by vibrations. Strong – high clamping force. Non-slip trigger release.

	Clamping Capacity	Throat Depth	Clamping Force	Approx. Weight
GSH12	4"	2 3/8"	400 lbs	1.10 lbs
GSH20	8"	4"	600 lbs	2.50 lbs
GSH30	12"	5 1/2"	1110 lbs	5.00 lbs
GSH50	20"	4 3/4"	1110 lbs	6.25 lbs



## F Lever clamps

Secure your workpiece with this rapid-action lever clamp. The ratchet mechanism ensures your clamp won't move when vibration is present. Equipped with a large tilting pressure plate for a sturdy grip.

	Clamping Capacity	Throat Depth	Clamping Force	Approx. Weight
LC4	4"	2 3/8"	400 lbs	1.10 lbs
LC8	8"	4"	660 lbs	2.45 lbs
LC12	12"	5 1/2"	1200 lbs	4.95 lbs
LC20	20"	4 3/4"	1200 lbs	5.80 lbs
LC31	31"	4 3/4"	1200 lbs	6.95 lbs
1800L12	10"	5 1/2"	1800 lbs	7.35 lbs



# Strap clamps

## Clamp any shape

### Strap clamps

Some projects defy a simple clamping solution... chair legs, odd angles, really long glue-ups. The strap clamp can surround the project and apply pressure evenly to most corners with the help of the Vario Corner Clips.

#### 1 The strap is drawn in on both sides

Strap draws simultaneously from both sides ensuring pressure is applied equally on all corners without distortion.

#### 2 Integrated coiling mechanisms

Integrated rewind mechanism is operated with a crank handle which eliminates tangling and damage to the strap.

#### 3 Practical Vario corners

Vario clip corners with twin-tilting pressure pads auto-adjust from 60° to 180° for easy assembly of most multi-angle projects.

#### 4 Extremely resistant

The special woven polyester band provides high resistance to tearing, and a clamping range of 23 ft. The steel wire loop opens quickly and simply to adjust or release glue-up.

#### 5 BESSEY® comfort handle

The 2K composite handle with comfort insert comes standard.



Variable Angle Strap Clamp  
Video



#### A Variable angle strap clamp with 2K composite handle (VAS)

High quality strap clamp places even pressure on mitre joints. Applies a positive, even pressure on all joints, perfect for clamping square, round, rectangular or irregular shapes. Comes with 4 pivoting Vario corners.

	Clamping Capacity	Range of Angle	Approx. Weight
VAS-23+2K	Up to 23 feet	60° to 180°	1.27 lbs



#### B Vario corner clips (VAC)

With twin-tilting pressure pads the vario corner clips are a great accessory to the Variable Angle Clamp (VAS-23). The corner clips auto adjust to pressure with a range of angle of 60° to 180°.

	Package Includes	Range of Angle	Approx. Weight
VAC-6	6 corner clips per package	60° to 180°	0.26 lbs

# Edge clamps

## Install edging in a snap

BESSEY® has applied its quality engineering and manufacturing to its edge clamps and made the woodworkers life a little easier. The quality you can expect only from BESSEY®.

### 1 Unique twin spindle

Outer spindle acts on the clamping jaws – inner spindle applies pressure to the front edge. Impact resistant plastic handle for one-handed use.

### 2 Large jaws

Two large non-slip, opposing, gentle jaws for positive grip.

### 3 Swivel pressure plate

The large pressure plate swivels to apply pressure on demand. Removable protective cap.

### 4 Light aluminum housing

Lightweight, corrosion-resistant aluminum housing designed for high static stress load for convenient, one-handed edge clamp EKT.



### A One hand edge clamp (EKT)

The lightweight construction makes the EKT a perfect tool to secure edge banding with just one hand. Try one!

	Clamping Capacity	Throat Depth	Clamping Force	Approx. Weight
EKT-55	2 1/2"	3"	500 lbs	1.85 lbs

### B Edge clamp (KF2-4)

For a quick one hand operation. Non-slip rubber lining for a sure grip. Comes with: Ergonomic wood handle.

	Clamping Capacity	Throat Depth	Approx. Weight
KF2	3/8" - 1 1/8"	3"	1.75 lbs
KF4	3/8" - 3 1/8"	4 1/4"	3.75 lbs
4102100	KF2 pads (2)		
4102056	KF4 pads (2)		

### C Light duty 3-way edge clamp (EC)

The simplest in design, the 3-way edge clamp is lightweight and perfect for those basic edging projects. Adjustable three ways to allow you to align the centre jaw in the right place to apply your pressure.

	Clamping Capacity	Throat Depth	Clamping Force	Approx. Weight
B-EC3	2 1/2"	2 1/2"	300 lbs	0.95 lbs

### D Spindle clamps

Can be used with a bar clamp with rails up to a 1/2" thick. Now you can do your glue-ups and apply the edge banding at the same time. Choice of single or double spindle design. Comes with: Ergonomic wood handle.

	Description	Approx. Weight
KT5-1CP	1 spindle	0.95 lbs
KT5-2	2 spindles	1.30 lbs

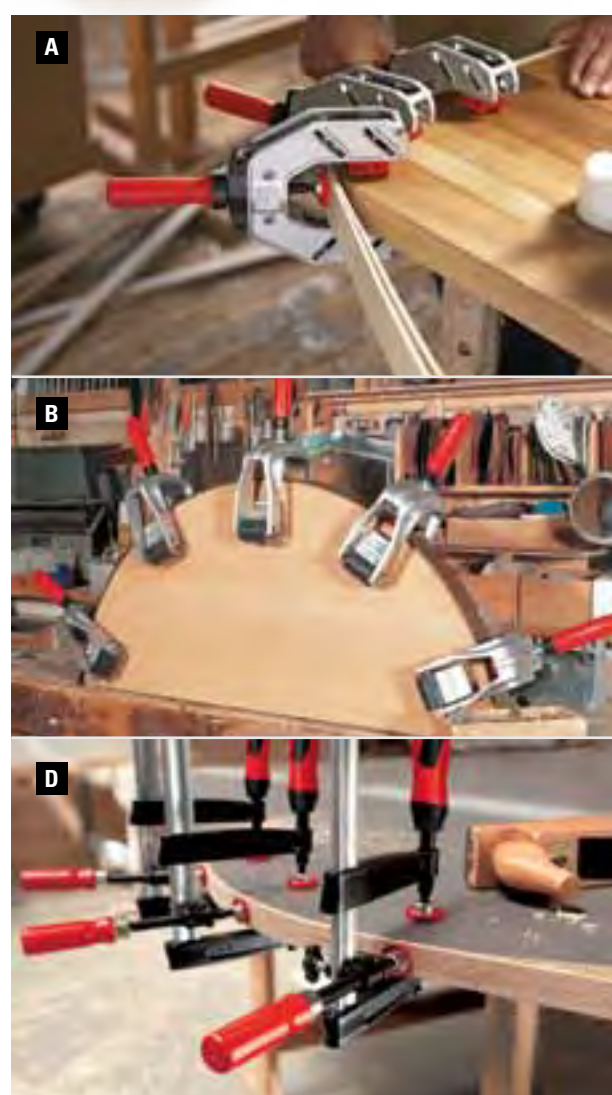

# Pipe clamps

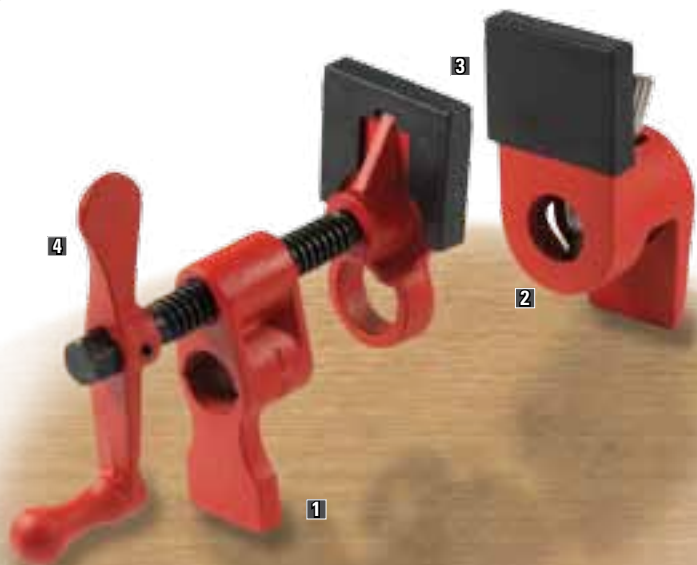

## Clamp any pipe length

### Pipe clamps

Commonly used in woodworking applications for edge gluing of multiple pieces. The versatility of the reach comes from the ability to use a variety of lengths of pipe to suit your needs.

- 1 Foot assembly**  
Foot assembly stabilizes clamp.
- 2 Extra high base**  
Extra high base provides finger-saving clearance from the work surface.
- 3 Cast jaws**  
Cast jaws for durability.
- 4 Smooth spindle with Hex head\***  
Smooth action spindle. Hex head on PC-2 model

\*Hex head spindle is to facilitate clamping, not augment it. Applying too much clamping force may cause the fixture to fail.

HStyle Pipe Clamp Video



### A Pipe clamp, traditional style (PC-2)

Large clamping surface. ACME threaded screw. Hex head on spindle. High base improves clearance from the work surface. An economical alternative to the bar clamp. Virtually limitless clamping capacity determined by the length of pipe used.

	Black Pipe Diameter	Throat Depth	Approx. Weight
PC34-2	3/4"	2 3/4"	2.74 lbs
PC12-2	1/2"	2 1/8"	2.02 lbs



### B Pipe clamp, H style (BPC)

"H" shape foot assembly stabilizes clamp in two dimensions giving dual-axis stability. Extra high base offers clearance between the handle and the work surface. An economical alternative to the bar clamp. Virtually limitless clamping capacity determined by the length of pipe used.

	Black Pipe Diameter	Throat Depth	Approx. Weight
BPC-H34	3/4"	2 1/8"	2.88 lbs
BPC-H12	1/2"	1 1/2"	1.83 lbs



### C Deep reach pipe clamp, traditional style (PC-DR)

The traditional pipe clamp features ACME threaded spindle and multiple clutch plates. Easy to assemble and a staple item for many workshops.

	Black Pipe Diameter	Throat Depth	Approx. Weight
PC34-DR	3/4"	3 1/8"	2.15 lbs



# Clamping angles and miters

## Small and very handy

### Clamping angles and miters

Angle clamps from BESSEY® are specifically designed for clearance of dowels, screws or staples while gluing. These tough and versatile tools are made to simplify the work process and last in a real-world wood shop.

- 1 Sturdy frame**  
Die-cast jaws are plastic coated to protect work.
- 2 Versatility**  
Designed for clearance of dowels, screws or staples while gluing.
- 3 Right angle clamping**  
Holds and aligns material at 90° angle.
- 4 BESSEY® comfort handle**  
Includes either the tried-and-true wooden handle or 2K composite handle with comfort insert.
- 5 Adjustable**  
Adjust automatically to wood thickness.

Angle Clamp Video

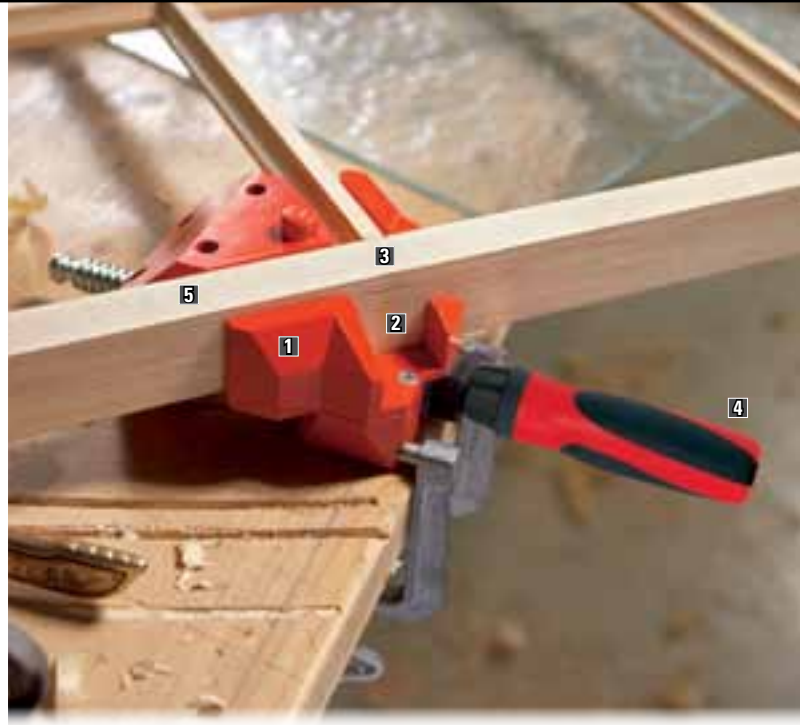

### A Angle clamp (WS)

Ideal for clearance of dowels, screw or staples while gluing. It holds and aligns material at 90° angles and even adjust automatically to wood thickness. Use the TK-6 table mount clamp to hold the clamp in place (included with 2K version).

	Handle Style	Maximum Clamping Capacity	Max. Passage for T-Joints	Approx. Weight
WS-3+2K	2K	Both sides-max 4" thick	1 1/8"	2.40 lbs
WS-6	Wood	Both sides-max 8" thick	2 7/16"	4.80 lbs
TK-6		<b>Table Mount Clamp (TK) Accessory</b> Holds WS to work surface, 2/set (included with 2K version)		



### B Corner clamp (WS)

An economical alternative for fixed 90° angle for miter or butt joints. Use the mounting holes to fix the corner clamp to your work surface. Can be adjusted to various sized work pieces with the 2 spindles. Made for light duty clamping.

	Clamping Capacity	Angle	Approx. Weight
WS-1	Up to 2 3/4" per side	90°	0.50 lbs



# Seaming tools



## BESSEY® : The right tools for the job

### Seaming tools

Get the perfect seam can using the right tools for the job – BESSEY®.

#### 1 Vacuum cups

Twin vacuum cups secure the PS units to any smooth, non-porous material or solid surface such as granite, marble, corian, plastic or glass.

#### 2 Vacuum operating button

Activates and locks the vacuum seal on the work surface, (PS130 only).

#### 3 Steel spindle

Smoothly draws the seams together with just the right pressure.

#### 4 Guide rails

Create a solid, rigid frame for supporting vacuum cups.



#### A Extra large solid surface seaming tool (PS)

Twin vacuum cups for clamping non-porous, solid surface material such as granite, marble, corian, plastic or glass. The 2K composite handle with comfort insert comes standard.



	Clamping Capacity	Cup Diameter	Clamping Force	Approx. Weight
PS130	3 1/8"	8 1/4"	265 lbs	10.15 lbs



#### B Solid surface seaming tool (PS)

Twin vacuum cups for clamping non-porous, solid surface material such as granite, marble, corian, plastic or glass. The levelling toggles ensure smooth surface joint, reduces grinding, sanding and finishing.



	Clamping Capacity	Cup Diameter	Clamping Force	Approx. Weight
PS55	2 1/8"	4 3/4"	48 lbs	3.80 lbs



# Floor tools

## AV2 Spacer

For laying solid wood, and laminate flooring without any wedges. Insert between the wall and the first row of flooring. Use the BESSEY® Floor Spacer for a fast and simple set up.

### 1 Clever dial

Set-up is fast and simple. Insert between the wall and the first row of flooring, the distance to the wall can be set by turning the red dial. To remove, just rotate the dial to release the pressure.

### 2 Wide contact and support surface

Simply put, the pressure points on the wall and the flooring are avoided. There is no danger of the aid slipping or tilting – as can happen with wedges or blocks.

### 3 Exact millimetre scale

Wall surface irregularities of 5 to 20 mm can be compensated for easily. The exact distance required for spacing can be readily seen on the millimetre scale.

### 4 "Robust" in the size of a business card

Manufactured from impact and break resistant, glass fibre reinforced polyamide, the spacer is light and tough and should last for years.



AV2 Video



### A AV2 Spacer (Set of 4)

Simply insert between the wall and the first row of flooring. Adjustable to compensate for wall irregularities and removal is a quick turn of the dial to release pressure.

	Opening Range	Jaw Width	Approx. Weight
AV2	3/16" - 13/16"	3 1/2"	0.42 lbs

### B Flooring Clamps

Insert between the wall and the first row of flooring. Adjustable to compensate for wall irregularities and removal is a quick turn of the handle to release pressure. PVZ65 is a heavy duty flooring spacer ideal for gluing the first 3 rows of flooring.

	Opening Range	Jaw Width	Approx. Weight
PVA	1 3/16"	5"	1.03 lbs
PVZ65	25 1/2"	5"	5.60 lbs



### C Flooring Strap Clamps (SVH)

Perfect for laying parquet, plank and laminate flooring. Strap is 157" long.

	Strap Length	Clamp Plate Width	Clamping Force	Approx. Weight
SVH400	157"	4 3/4"	220 lbs	1.65 lbs
SVH400XL	300"	4 3/4"	220 lbs	1.80 lbs



### D Flooring Kits

	Contains	Approx. Weight
DIY Flooring Kit	4 x PVA, 2 x SVH400, 1 set of 4 x AV2, 1 BESSEY® heavy duty bag	10.00 lbs
PRO Flooring Kit	4 x PVA, 2 x PVZ65, 4 x SVH400, 2 sets of 4 x AV2, 1 BESSEY® heavy duty bag	24.50 lbs



# For flexible, featherlight clamping

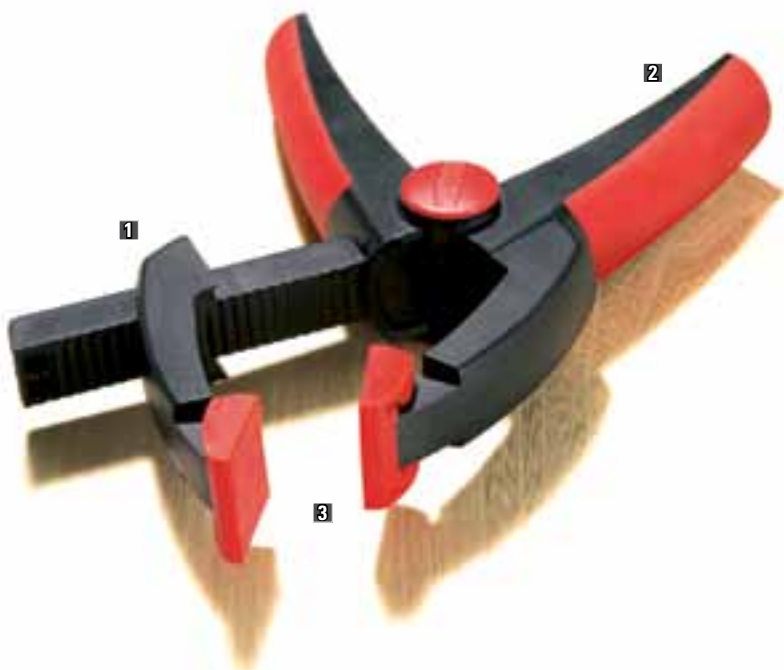

## VarioClippix® spring clamps

The VarioClippix® spring clamps from BESSEY® are not your typical spring clamps...Take a closer look! The unique designs allows you to adjust the sliding jaws for a greater clamping capacity. Try one for yourself!

### 1 Sliding clamping arm

Rapid-action, polyamide, sliding top jaw infinitely adjusts to fit the project... the clamping capacity of a 4" spring clamp with the comfort of a 2" clamp.

### 2 Ergonomic 2-component handle

Soft, anti-slip two component handle for comfort.

### 3 Softpads

Soft-touch pads protect sensitive workpieces and eliminate marring of work.

Clippix® Video



## VarioClippix® (XV) variable spring clamps

A unique design that allows you to adjust one sliding jaw or both, offering a much larger clamping capacity than a regular spring clamp.



	Clamping Capacity	Throat Depth	Approx. Weight
<b>A Variable spring clamp</b>			
XV3-50	2 1/8"	1 1/2"	0.15 lbs
XV5-100	4"	2"	0.28 lbs
<b>B Variable spring clamp, double jaw</b>			
XV5-170	6 1/2"	2"	0.34 lbs

## C Clippix® plastic spring clamps

Choose from a long tapered nose for those hard to reach spaces or a premium spring clamp for those light duty jobs. Both made with an ergonomic 2-component handle, and lightweight polyamide jaws.



	Clamping Capacity	Throat Depth	Approx. Weight
<b>Needle nose plastic spring clamps (XCL)</b>			
XCL2	2"	2"	0.05 lbs
XCL2-Set (2xXCL2)	2"	2"	0.15 lbs
XCL5	3"	4"	0.30 lbs
<b>Premium plastic spring clamps (XC)</b>			
XC1	3/4"	3/4"	0.02 lbs
XC2	1"	1 1/8"	0.05 lbs
XC3	1 3/8"	1 1/2"	0.10 lbs
XC5	2"	1 1/8"	0.25 lbs
XC7	3"	2 3/4"	0.40 lbs

**A Clippix® (XC) plastic spring clamps**

A light duty plastic spring clamp that is perfect for the home or shop.

	Clamping Capacity	Throat Depth	Approx. Weight
<b>Econo spring clamp</b>			
XC1-2	3/4"	3/4"	0.04 lbs
XC2-2	1"	1 1/4"	0.11 lbs
XC5-2	2"	1 1/2"	0.22 lbs
XC7-2	3"	2 3/4"	0.31 lbs

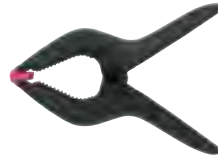

**B Plastic spring clamp set**

<b>XC-14PC</b>	<b>Includes:</b>		2.06 lbs
	2 x 3" clamps		
	2 x 2" clamps		
	4 x 1" clamps		
6 x 3/4" clamps			



**C Clippix® ratcheting spring clamps, deep reach (XCRU)**

Built with a heavy duty resin construction and has a deep reach for those hard to reach places. Features a ratcheting mechanism for quick action and a quick release. Pivoting jaws for a snug fit.

	Clamping Capacity	Throat Depth	Approx. Weight
XCRU3	2"	2"	0.53 lbs
XCRU5	4"	4"	0.74 lbs



**D Clippix® ratcheting spring clamp set (XCR)**

Built with a heavy duty resin construction and a ratcheting mechanism for quick action, quick release. Pivoting jaws for a snug fit.

<b>XCR-4PC</b>	<b>Includes</b>	<b>Approx. Weight</b>
	4 x 2" clamps	



**E Steel spring clamps (XM)**

Made with vinyl tips to prevent marring and vinyl handles for a non-slip grip. Features a heavy duty spring for a tight fit and nickel plating to prevent corrosion.

	Clamping Capacity	Throat Depth	Approx. Weight
XM3	1"	1 1/4"	0.16 lbs
XM5	2"	2 1/4"	0.36 lbs
XM7	3"	3 5/16"	0.80 lbs
XM10	4"	5"	1.15 lbs
<b>Black with pads and tip</b>			
XM3-B	1"	1 1/4"	0.16 lbs
XM5-B	2"	2 1/4"	0.36 lbs
XM7-B	3"	3 5/16"	0.80 lbs
<b>No pads, no tips</b>			
XM3-NPT	1"	1 1/4"	0.13 lbs
XM5-NPT	2"	2 1/4"	0.32 lbs
XM7-NPT	3"	3 5/16"	0.70 lbs



# C-clamps



## C-clamps

C-clamps are used for many trades and if you're going to use a C-clamp why not use the best! BESSEY® has a wide array of C-clamps to choose from, ranging from light duty to heavy service.

### 1 International offering

A globally sourced platform of products

### 2 Choices

Tremendous range of pressures, capacities and applications

### 3 Clamping force

Clamping force offerings from 400 to 40 000 lbs

CDF C-clamp Video



A

### A 540 series ductile alloy C-clamps

Made of high tensile ductile alloy casting which provides excellent strength in a cast clamp. The black oxide spindle resists corrosion.



	Clamping Capacity	Throat Depth	Clamping Force	Approx. Weight
540-2 1/2"	0-2 1/2"	1 3/4"	1100 lbs	1.20 lbs
540-3	0-3"	1 7/8"	1800 lbs	1.60 lbs
540-4	0-4"	2 1/16"	2150 lbs	2.23 lbs
540-5	0-5"	2 1/2"	2250 lbs	2.69 lbs
540-6	0-6"	2 3/4"	2450 lbs	3.20 lbs
540-8	0-8"	3 1/4"	2750 lbs	4.74 lbs
540-10	0-10"	3 5/8"	2850 lbs	7.56 lbs
540-12	0-12"	3 5/8"	2850 lbs	8.18 lbs
540-14	0-14"	3 3/4"	2850 lbs	8.93 lbs



B

### B Regular duty (CDF & CDFCHV) deep throat C-clamps

Two types to choose from. Either in a black frame with a black oxide spindle that resist corrosion, or with a HiVis frame with a copper spindle.



Black Frame	Clamping Capacity	Throat Depth	Clamping Force	Approx. Weight	HiVis
CDF402	0-2"	2 1/8"	3,500 lbs	1.40 lbs	CDF402CHV
CDF403	0-3"	2 3/8"	3,500 lbs	1.90 lbs	CDF403CHV
CDF404	0-4"	3 1/4"	6,200 lbs	3.50 lbs	CDF404CHV
CDF406	0-6"	4 1/8"	6,900 lbs	5.40 lbs	CDF406CHV
CDF408	0-8"	5"	6,900 lbs	7.90 lbs	CDF408CHV
CDF410	0-10"	6"	8,000 lbs	11.60 lbs	CDF410CHV
CDF412	0-12"	6 1/4"	9,300 lbs	14.10 lbs	CDF412CHV



C

### C Regular duty (CDFUS) deep throat C-clamps



Black frame with black oxide spindle that resist corrosion.



Made in USA	Clamping Capacity	Throat Depth	Clamping Force	Approx. Weight
CDF402US	0-2"	2 1/8"	3,500 lbs	1.40 lbs
CDF403US	0-3"	2 3/8"	3,500 lbs	1.90 lbs
CDF404US	0-4"	3 1/4"	6,200 lbs	3.50 lbs
CDF406US	0-6"	4 1/2"	6,900 lbs	5.40 lbs
CDF408US	0-8"	5"	6,900 lbs	7.90 lbs
CDF410US	0-10"	6"	8,000 lbs	11.60 lbs
CDF412US	0-12"	6 1/4"	9,300 lbs	14.10 lbs

### D Heavy duty (100 Series) C-clamps

Designed specifically for heavy duty applications. Square head on the T-handle.

	Clamping Capacity	Throat Depth	Clamping Force	Approx. Weight
B-102	0-2"	1 1/2"	7,500 lbs	1.50 lbs
B-103	0-3"	2"	8,750 lbs	2.65 lbs
B-104	0-3 1/2"	2 1/4"	10,000 lbs	4.15 lbs
B-106	2-5 1/2"	2 1/2"	11,250 lbs	6.00 lbs
B-108	4-7 1/2"	2 3/8"	12,500 lbs	7.80 lbs
B-110	6-9 1/2"	2 3/4"	13,750 lbs	8.70 lbs
B-112	8-11 1/2"	2 7/8"	15,000 lbs	12.10 lbs



### E Heavy service (HS Series) (Fully closing)

The toughest of the C-clamps with a clamping pressure of up to 40,000 lbs. Square head on the spindle.

	Clamping Capacity	Throat Depth	Clamping Force	Approx. Weight
B-HS0	0-3/4"	1 1/16"	2,800 lbs	0.33 lbs
B-HS1	0-1 3/8"	1 3/32"	5,600 lbs	1.00 lbs
B-HS1.5	0-1 3/4"	1 7/16"	8,750 lbs	1.80 lbs
B-HS2	0-2 3/8"	1 7/8"	12,500 lbs	4.50 lbs
B-HS3	0-3 5/16"	2 5/16"	16,250 lbs	7.10 lbs
B-HS4	0-4 1/2"	2 3/4"	20,000 lbs	11.00 lbs
B-HS5	0-5 1/4"	3 1/16"	23,800 lbs	14.90 lbs
B-HS6	0-6 3/8"	3 3/8"	27,500 lbs	19.30 lbs
B-HS8	0-8 1/4"	3 5/8"	31,250 lbs	27.50 lbs
B-HS10	0-10 1/4"	3 15/16"	35,000 lbs	40.10 lbs
B-HS12	0-12 3/8"	4 1/4"	40,000 lbs	47.80 lbs



### F Light duty drop forged C-clamps

A general purpose C-clamps that has a range of openings and clamping force. A galvanized finish for models CM10-CM30, and a black powder coated finish for models CM40-CM80.

	Clamping Capacity	Throat Depth	Clamping Force	Approx. Weight
CM34DR	0-2 3/4"	4 1/2"	900 lbs	1.50 lbs
CM10	0-1"	1"	750 lbs	0.25 lbs
CM15	0-1 1/2"	1 1/2"	750 lbs	0.30 lbs
CM20	0-1 7/8"	1 1/2"	750 lbs	0.40 lbs
CM22	0-2 1/2"	1 3/8"	900 lbs	0.45 lbs
CM30	0-2 7/8"	1 3/4"	1,200 lbs	0.80 lbs
CM40	0-4"	3"	1,300 lbs	1.50 lbs
CM50	0-5"	3"	1,300 lbs	2.25 lbs
CM60	0-6"	3"	1,800 lbs	2.40 lbs
CM80	0-8 1/4"	4"	1,800 lbs	3.30 lbs



### G Quick release (QRCC) C-clamps

A drop forged frame that is powder coated to resist corrosion, ideal for DIY. Use the quick release button for rapid opening and closing. Chrome plated spindle and swivel pad.

	Clamping Capacity	Throat Depth	Clamping Force	Approx. Weight
QRCC3	0-3 1/2"	1 3/4"	1,200 lbs	1.87 lbs
QRCC4	0-4 3/8"	2 1/4"	1,200 lbs	2.37 lbs
QRCC6	0-6 5/8"	3 7/8"	1,200 lbs	4.07 lbs



### H Double head (DHCC) C-clamps

Provides twin top pressure points for light duty clamping applications. The ideal tool for hobbies, crafts and light trades.

	Clamping Capacity	Throat Depth	Clamping Force	Approx. Weight
DHCC-4	0-4"	2 1/4"	1,200 lbs	1.60 lbs
DHCC-6	0-6"	2 7/8"	1,200 lbs	3.00 lbs



# RiteHite



## RiteHite Hold Down Products

A quick and easy set-up, ready for your T-slot table. A value-priced hold down alternative with the great BESSEY® quality you expect.

### 1 Single component design

Self-positioning, single component design for a quick set-up.

### 2 Workpieces of different thicknesses

Wide clamping range. Adjustments up to 5".

### 3 T-slot table ready

For T-slot hold down tables in machine shop applications.

### 4 Sturdy frame

Strong, ductile iron body, strength you can depend on.

### 5 Swivel rocker

Swivel rocker attached to body allows the clamp to self-align on the work piece.



E-Newsletter sign up



### A RiteHite Long Reach (Model L)

Use the BESSEY® RiteHite to hold your workpiece in place with the simple self-positioning, single component design. Its made of strong, ductile iron, for use on a T-slot hold down table in a machine shop. It even has a swivel rocker attached to the body to prevent loss. Use the L series for a longer throw.

	Bolt Size	Max Clamping Height	Nominal Dimensions	Recommended Load Limit	Max Torque	Approx. Weight
375L	3/8"	1 1/4"	3 3/4 x 1 1/8 x 1 1/4	7,000 lbs	43 LB-FT	0.50 lbs
500L	1/2"	2 1/2"	5 3/4 x 1 7/16 x 1 1/2	8,800 lbs	73 LB-FT	1.39 lbs
625L	5/8"	3 1/2"	6 3/4 x 1 3/4 x 1 3/8	14,500 lbs	163 LB-FT	2.33 lbs
750L	3/4"	5"	9 x 2 1/8 x 2 1/4	19,000 lbs	237 LB-FT	4.96 lbs
1000L	1"	5"	11 1/8 x 2 7/8 x 3 3/8	51,000 lbs	850 LB-FT	12.80 lbs



### B RiteHite Standard Reach (Model S)

The S series, slightly smaller than its counterpart but with the strength you can depend on.

	Bolt Size	Max Clamping Height	Nominal Dimensions	Recommended Load Limit	Max Torque	Approx. Weight
376S	3/8"	1"	3 x 1 1/8 x 1 1/4	8,800 lbs	55 LB-FT	0.43 lbs
501S	1/2"	1 3/4"	4 1/4 x 1 7/16 x 1 1/2	13,200 lbs	110 LB-FT	1.04 lbs
626S	5/8"	2 3/4"	5 1/2 x 1 3/4 x 1 5/8	19,000 lbs	213 LB-FT	2.10 lbs
751S	3/4"	3 1/2"	7 x 2 1/8 x 2 1/4	27,600 lbs	345 LB-FT	4.00 lbs
1001S	1"	3"	9 x 2 7/8 x 3 3/8	67,000 lbs	1,116 LB-FT	10.00 lbs



RiteHite charts are for general guidelines only. Specific values may vary depending on but not limited to bolt size and strength, condition, size and pitch of threads, coefficient of friction between parts and other variable factors.



# Specialty All-Steel Clamps

## A Jig & fixture (FC)

A full rotation of 360° for easy work-piece removal. The pressure plate swivels up to 35° and the bushing O/D is 1<sup>13</sup>/<sub>16</sub>", and can fit a table thickness of 1/2" to 1 1/2". Bushing can be set to be freely rotating, fixed or quick release position by adjusting or removing bottom plate.

	Clamping Capacity	Throat Depth	Clamping Force	Approx. Weight
FC24-8 3100459	8"	5 1/2"	2660 lbs	6.45 lbs

Inner/outer bushing set for FC24



## B Hold down table clamp

Vibration proof, ratchet action for rapid clamping. Pressure pad self-adjusts on the workpiece. Drop forged steel clamping arm. Mounting hole accepts 3/8" bolts.

	Max Clamping Height	Throat Depth	Clamping Force	Rail Profile	Fixing Hole	Approx. Weight
BS3N	8"	4.75"	1200 lbs	0.87" x 0.41"	0.51"	3.42 lbs
BS4N	8"	4.75"	1650 lbs	1.10" x 0.43"	0.65"	5.84 lbs
2400 HD-10	9.5"	5.5"	2220 lbs	1.18" x 0.59"	0.65"	7.80 lbs
BS6N	20"	5.5"	2220 lbs	1.18" x 0.59"	0.65"	8.82 lbs

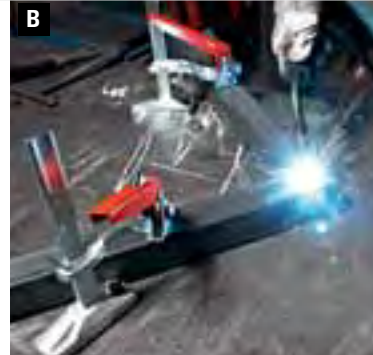
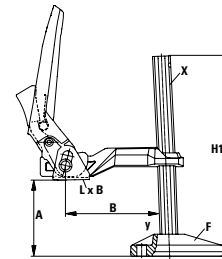

## C Claw machine clamp (MCL)

A cantilever jaw for clamping in tight spaces with the screw positioned outside of work area. Use for drilling and light milling work. Full rotation outside of the work area. Mounting hole accepts 3/8" bolts.

	Max Clamping Height	Throat Depth	Clamping Force	Rail Profile	Fixing Hole	Approx. Weight
MCL8	8"	4.84" - 5.5"	1450 lbs	1.10" x 0.43"	0.65"	6.74 lbs

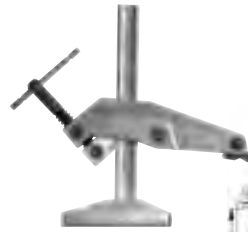

## D Hold down table clamps (BSG)

For fastening to tables and other equipment. Long life due to heat-resistant pressure plate with sintered steel insert, which can be tilted up to 35°. Mounting hole accepts 3/8" bolts.

	Max Clamping Height	Throat Depth	Clamping Force	Rail Profile	Fixing Hole	Approx. Weight
BSG21-14	8.25"	5.5"	2650 lbs	1.18" x 0.59"	0.65"	7.10 lbs

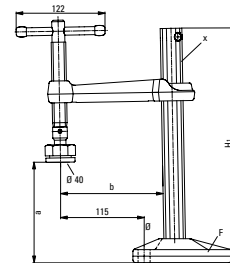

### Table of dimensions

	Opening Max	Throat Depth	Base Height	Pressure Plate Dimensions	Foot Length	Foot Width	Foot Height	Foot Distance to the rail	Rail Profile	Fixing Hole	Clamping Force
	A	B	H1	LxB	F	F	F	F to Y	X	O	
BS3N	200mm/8.00"	120mm/4.75"	260mm/10.24"	42x25mm/1.65 x 0.98"	100mm/3.94"	38mm/1.50"	25mm/0.98"	32mm/1.26"	19.5x9.5mm/0.87x0.41"	10.5mm/0.51"	1200 lbs
BS4N	200mm/8.00"	120mm/4.75"	270mm/10.63"	48x31mm/1.89 x 1.22"	135mm/5.31"	49mm/1.93"	33mm/1.30"	42mm/1.65"	28x11mm/1.10 x 0.43"	16.5mm/0.65"	1650 lbs
2400HD-10	240mm/9.50"	140mm/5.50"	320mm/12.60"	48x31mm/1.89 x 1.22"	135mm/5.31"	49mm/1.93"	33mm/1.30"	42mm/1.65"	30x15mm/1.18 x 0.59"	16.5mm/0.65"	2220 lbs
BS6N	500mm/20.00"	140mm/5.50"	580mm/22.83"	48x31mm/1.89 x 1.22"	135mm/5.31"	49mm/1.93"	33mm/1.30"	42mm/1.65"	30x15mm/1.18 x 0.59"	16.5mm/0.65"	2220 lbs
MCL8	200mm/8.00"	123-140mm/ 4.84-5.50"	265mm/10.43"	25x35mm/0.98 x 1.38"	135mm/5.31"	48mm/1.89"	33mm/1.30"	42mm/1.65"	28x11mm/1.10 x 0.43"	16.5mm/0.65"	1450 lbs
BSG21-14	210mm/8.25"	140mm/5.50"	322mm/12.68"	Ø 40mm/1.57"	135mm/5.31"	48mm/1.89"	33mm/1.30"	42mm/1.65"	30x15mm/1.18 x 0.59"	16.5mm/0.65"	2650 lbs

Note: Clamping force calculated at a height of 2-3" on a solid all-steel welding table platform

# Welding table clamps



### **A** Welding table clamp, variable throat depth (TWV)

Precise, individual clamping with variable height and adjustable throat depth. Tempered profile rail and sliding arm for strong, dependable clamping.

Available with: high quality 2-component plastic handle; T-Bar with rounded ends (each with smooth-running ACME threaded spindle and tool free pressure plate replacement); or lever handle with a ratcheting mechanism for controlled, fast and vibration-proof clamping.

	Handle Style	Hole Diameter	Clamping Capacity	Nominal Throat Depth	Rail Profile	Clamping Force	Approx. Weight
<b>TWV16-20-15-2K</b>	Composite	16 mm	8"	1 3/16" - 6"	7/8" - 3/8"	550 lbs	2.50 lbs
<b>TWV16-20-15K</b>	T-Bar	16 mm	8"	1 3/16" - 6"	7/8" - 3/8"	550 lbs	2.34 lbs
<b>TWV16-20-15H</b>	Lever	16 mm	8"	2 3/8" - 6"	7/8" - 3/8"	550 lbs	2.72 lbs
<b>TWV28-30-17-2K</b>	Composite	28 mm	12"	1 3/16" - 6 3/4"	1 1/8" - 7/16"	1100 lbs	4.89 lbs
<b>TWV28-30-17K</b>	T-Bar	28 mm	12"	1 3/16" - 6 7/8"	1 1/8" - 7/16"	1100 lbs	4.65 lbs
<b>TWV28-30-17H</b>	Lever	28 mm	12"	4 3/16" - 6 7/8"	1 1/8" - 7/16"	1100 lbs	5.47 lbs

Note: Clamping force calculated at a height of 2-3 In on a solid all-steel welding table platform

# Bringing our experience to the table

Clamping elements for welding tables with 28 mm or 16 mm matrix holes. Choose from 3 handle designs for standard elements, plus variable or fixed throat depth versions. Our line-up also includes a clamping element with heat-resistant pressure plate, a gripping arm variant for easy work area access, and attachments for clamping oval, round and square workpieces.

BESSEY® toggle clamps and work table clamps can be used on welding tables thanks to special adapters, extensions and attachments. All elements can integrate into the table without using tools, making them highly adaptable with comfortable, safe and precise operation. Try them for yourself!

**1 Flexible throat depth**

The BESSEY® TWV28 has an infinitely adjustable throat depth and is available in 3 handle variants.

**2 4", 4 3/4", or 5 1/2" throat depth**

The BESSEY® TW elements feature 3 handle variants and 3 throat-depth variants.

**3 Heavy-duty, custom design**

TWM28 with heat-resistant special pressure plate and sintered steel insert, can pivot up to 35°.

TW28GRS gripping arm features a spindle located outside the work area.

**4 Flexible accessories**

TW28VAD and TWVAD vario table clamping attachments are ideal for irregularly shaped workpieces.

They are infinitely adjustable to the workpiece being welded, from 60° internal to 60° external.

**5 Accessories for BESSEY®'s Toggle Clamp**

The TW28A-STC adapter and TWX extension allow BESSEY® toggle clamps with horizontal base plates to quickly and easily be used on welding tables.

**6 Diagonal and horizontal clamping**

Tilting adapter TW28AV used in conjunction with TW28X allows angled or horizontal clamping from -52° to +52°.

**7 Quick conversion of existing table clamps for welding table use**

Convert existing BESSEY® machine table clamps by screwing the TW28HO attachment into the hole on the bottom of the machine table clamp for use on matrix tables.



**B Welding table clamp, fixed throat depth TW**

Precise, individual clamping with variable height and fixed throat depth. Tempered profile and sliding arm for strong, dependable, clamping.

Available with: high quality 2-component plastic handle; T-Bar with rounded ends (each with smooth-running ACME threaded spindle and tool free pressure plate replacement); or lever handle with a ratcheting mechanism for controlled, fast and vibration-proof clamping.

	Handle Style	Hole Diameter	Clamping Capacity	Nominal Throat Depth	Rail Profile	Clamping Force	Approx. Weight
TW16-20-10-2K	Composite	16 mm	8"	4"	7/8" - 3/8"	650 lbs	2.06 lbs
TW16-20-10K	T-Bar	16 mm	8"	4"	7/8" - 3/8"	650 lbs	1.91 lbs
TW16-20-10H	Lever	16 mm	8"	4"	7/8" - 3/8"	650 lbs	2.22 lbs
TW28-30-12-2K	Composite	28 mm	12"	4 3/4"	1 1/8" - 7/16"	1000 lbs	3.70 lbs
TW28-30-14-2K	Composite	28 mm	12"	5 1/2"	1 1/8" - 7/16"	1100 lbs	3.75 lbs
TW28-30-12K	T-Bar	28 mm	12"	4 3/4"	1 1/8" - 7/16"	1000 lbs	3.57 lbs
TW28-30-14K	T-Bar	28 mm	12"	5 1/2"	1 1/8" - 7/16"	1100 lbs	3.64 lbs
TW28-30-12H	Lever	28 mm	12"	4 3/4"	1 1/8" - 7/16"	1000 lbs	4.56 lbs
TW28-30-14H	Lever	28 mm	12"	5 1/2"	1 1/8" - 7/16"	1100 lbs	4.63 lbs

Note: Clamping force calculated at a height of 2-3 In on a solid all-steel welding table platform



# Welding table clamps



### C Welding table clamp with special pressure plate (TWM28)

Tempered profiled rail and drop forged sliding arm for strength where it is most needed. Tempered spindle – particularly sturdy and wear-resistant – for noticeably improved service life. Long life due to heat-resistant pressure plate with sintered steel insert, which can be tilted up to 35°.

	Hole Diameter	Clamping Capacity	Nominal Throat Depth	Rail Profile	Clamping Force	Approx. Weight
<b>TWM28-30-12</b>	28mm	12"	4 3/4"	1 1/8" - 7/16"	1400 lbs	3.92 lbs

Note: Clamping force calculated at a height of 2-3 In on a solid all-steel welding table platform



### D Welding table clamp (TW28GRS)

The spindle is located on the outside for free access to the work area and to protect against welding spatter. Special, sturdy V-grooved pressure plate, ideal even for clamping round or square workpieces. Pivotal and infinitely adjustable in terms of height. Particularly suited to clamping with the tightest of space constraints, in narrow openings as well as for short projections.

	Hole Diameter	Clamping Capacity	Nominal Throat Depth	Rail Profile	Clamping Force	Approx. Weight
<b>TW28GRS30-12</b>	28mm	12"	4 3/4"	1 1/8" - 7/16"	1100 lbs	5.13 lbs

Note: Clamping force calculated at a height of 2-3 In on a solid all-steel welding table platform



TW16VAD / TW28VAD



TWWAD

### E Welding table clamp accessories (TWWAD)

Specifically adapted to round, oval and square workpieces. Angle infinitely adjustable from 60° internal to 60° external. TW16VAD / TW28VAD version – with bolt for rapidly aligning and fixing the workpiece to the welding table. TWWAD version – without bolt for variable movement on the welding table. 2 pieces per bag.

	Hole Diameter	Angle	Jaw Face Width	Approx. Weight
<b>TW16VAD</b>	16 mm	from 60° inner to 60° outer	1 1/16"	0.82 lbs
<b>TW28VAD</b>	28 mm	from 60° inner to 60° outer	1 1/16"	1.24 lbs
<b>TWWAD</b>	–	from 60° inner to 60° outer	1 1/16"	0.62 lbs



### F Welding table toggle clamp adapter (TW-STC)

Accessory for BESSEY® STC toggle clamp with horizontal base plate. With bolt – for use directly on the welding table. Without bolt – for screwing to the extension TWX.

	Hole Diameter	Approx. Weight
<b>TW16A-STC</b>	16 mm	0.39 lbs
<b>TW28A-STC</b>	28 mm	0.62 lbs

### G Welding table clamp extension (TWX)

Accessory for BESSEY® toggle clamp adapter TW28A-STC and TWWAD. Lowering of round workpieces is infinitely adjustable using the adjusting ring in the round plate. Use with TWWAD – requires one 8 x 40 mm flat head screw.

	Hole Diameter	Suitable for	Adjusting Range	Approx. Weight
<b>TW16X</b>	16 mm	TW16A-STC / TW16VAD / TWWAD	5/8" - 7 7/8"	0.93 lbs
<b>TW28X</b>	28 mm	TW28A-STC / TW28VAD / TWWAD	5/8" - 11 13/16"	3.88 lbs



### H Welding table clamp tilting adapter (TW28AV)

Accessory for BESSEY® extension TW28X. Pivoting spindles with stepless adjustment from -52° to +52°. Lockable trapezoidal nut for secure fastening of the workpiece. High quality, 2-component plastic grip with 6 1/8" long spindle.

	Hole Diameter	Max Clamping Height	Suitable for	Approx. Weight
<b>TW28AV</b>	28 mm	6 1/8"	TW28X	2.25 lbs



### I Welding table clamp attachment (TW28H0)

Accessory for BESSEY® work table clamp. It can be used on matrix welding tables by simply screwing it to the work table clamp.

	Hole Diameter	Suitable for	Approx. Weight
<b>TW28H0</b>	28 mm	BAS-C / BAS-CB / BASO / BSN / GRS / BSG	0.31 lbs

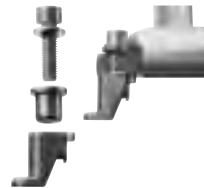

### J BESSEY® clamp service part, MorPads

Long life due to heat-resistant pressure plate with sintered steel insert, which can tilt up to 35°. Three design versions: smooth face (standard version); rough face for secure clamping on dirty surfaces; V-groove face for round, oval and edged workpieces.

- 3100736** Smooth face (standard)
- 3101192** Rough face
- 3101193** V Groove

Ball-in-socket technology for greatly extended clamp life and, at full pressure... by BESSEY®. Patented.



# Workbench adapter

**NEW**

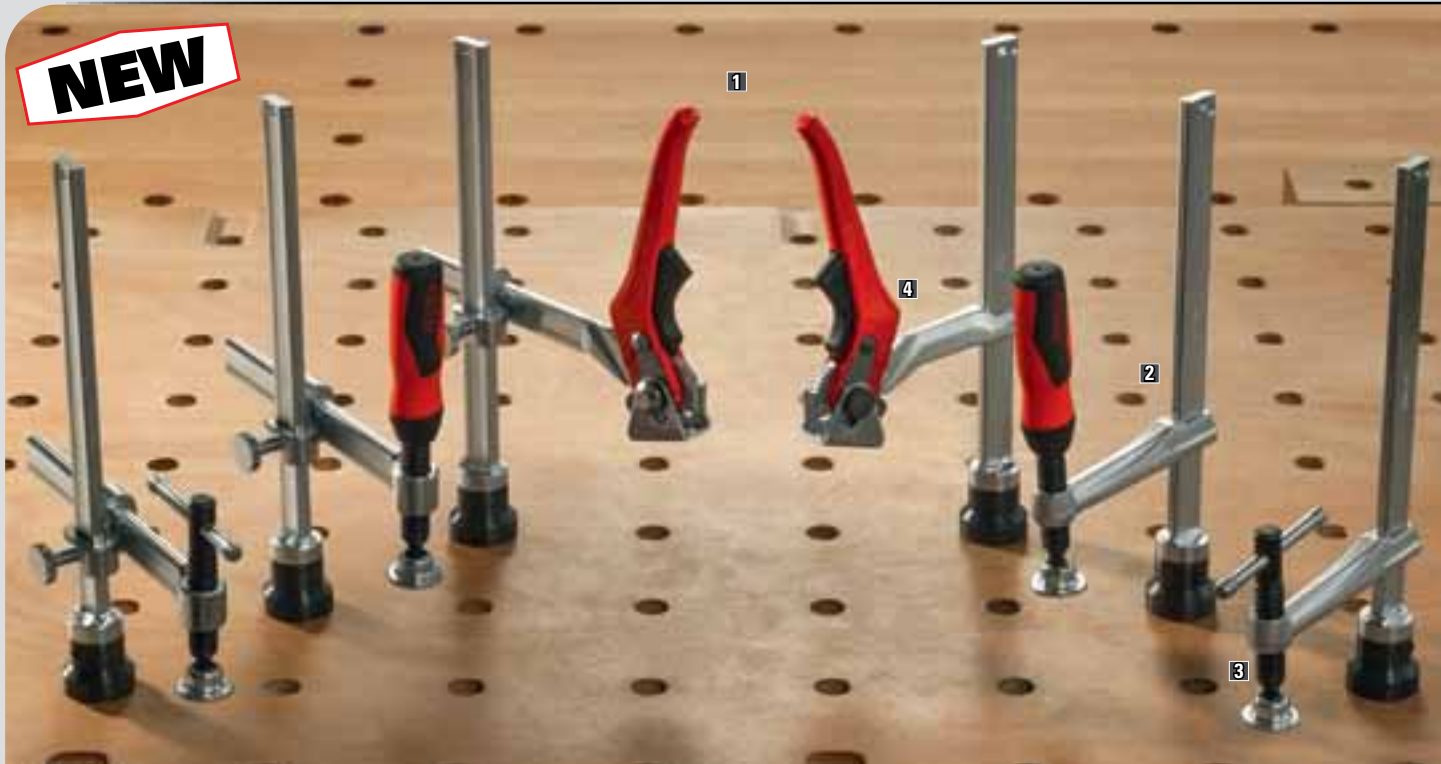

## Accessory for Workbenches with a 3/4" Hole

A clamp specialist, BESSEY® also provides solutions for fixing workpieces to workbenches. Use the BESSEY® TWV and TW clamping elements in conjunction with the TW16AW workbench adapter on any workbench with a 3/4" hole system.

The unique BESSEY® quality steel found in both the optimised profile shape and spindle, ensures a dimensionally stable and torsion-resistant tool. Tried and tested BESSEY® handle variants are also available. Regardless of whether you use clamping elements with a variable (TWV) or a fixed throat depth (TW), a 2-component plastic handle, T-bar or lever handle are included. With the TW16AW, clamping elements can be integrated into your workbench without tools, and placed precisely.

### 1 NEW adapter for workbenches with a 3/4" hole

The TW16AW adapter allows BESSEY® TWV and TW clamping elements with a 16 hole system to also be used on workbenches with a 3/4" hole system.

### 2 Flexible or fixed throat depth

BESSEY® clamping elements with an infinitely adjustable throat depth (TWV) and those with a fixed throat depth (TW) are available in 3 handle variants.

### 3 BESSEY® smooth running spindle

Smooth running surface-coated-spindle with Acme thread (on the 2-component plastic handle and T-bar) allows for more clamping with less effort. Does not jam.

### 4 Ratchet mechanism

The natural force of the lever is used in the lever handle version. The ratchet mechanism ensures rapid, controlled, vibration-free clamping. The wear-resistant cam guarantees a long service life.



### A Workbench adapter, 16 mm (TW16AW19)

Accessories for BESSEY TWV and TW clamping elements with 16 hole system. Suitable for all common workbenches with a 3/4 inch hole system. Can be used without tools. The stud pin can be changed to use other hole systems.

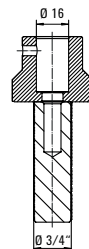

	Hole Diameter	Workbench hole size	Approx. Weight
TW16AW19	16 mm	3/4"	0.82 lbs

## SuperGrips™ grip pliers

Lock it into place with a BESSEY® SuperGrip™ plier. Let the clamp do the holding while you do the work. Adjustable in so many ways, a must have in your shop!

**1 Adjustable top handle**

Adjustable screw/lock nut (on top handle) adjusts clamping force.

**2 Adjustable bottom handle**

Adjustable screw/lock nut (on lower lever) adjusts jaw angle (up to 7°) for clamping tapered parts.

**3 Adjustable sliding arm**

Infinitely adjustable jaw for a quick parallel clamp.

**4 Sturdy rail**

Cold drawn, profiled steel rail.

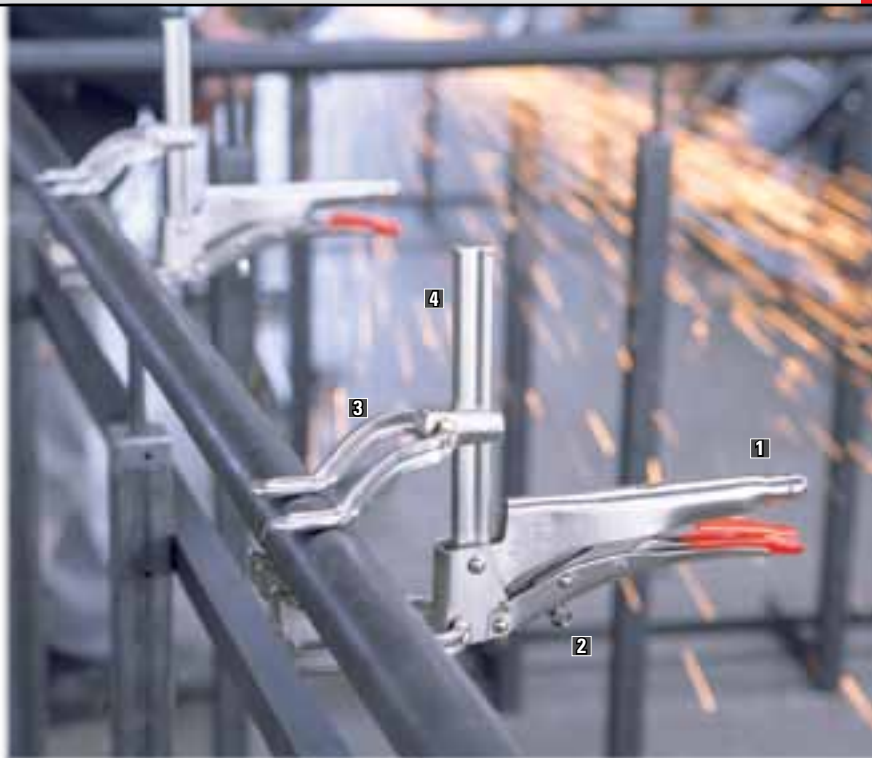

SuperGrips™ Video



**A SuperGrips™ with profiled rail (SG)**

It's a grip plier and clamp all in one tool, just a quick adjustment for a fast and easy set-up.

	Clamping Capacity	Throat Depth	Clamping Force	Approx. Weight
SG4	4"	2 1/2"	440 lbs	2.43 lbs
SG8	8"	2 1/2"	440 lbs	2.60 lbs
3100576 (pair)		Replaceable pads		0.10 lbs

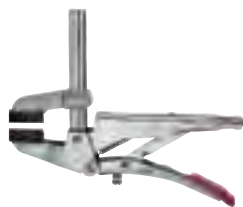

**B SuperGrips™ pipe clamp (SG)**

The innovative shape of the cradle jaw aligns and holds pipe firmly in place.

	Clamping Capacity	Throat Depth	Clamping Force	Approx. Weight
SG24-PC	4 1/2"	2 3/4"	310 lbs	2.60 lbs
3101547 (pair)		Replaceable pads		0.10 lbs



**C SuperGrips™ deep reach clamp**

The deep reach jaws can easily clamp over angle iron, channel iron and other obstacles.

	Clamping Capacity	Throat Depth	Clamping Force	Approx. Weight
SG5-DR	4 1/2"	3"	310 lbs	2.43 lbs



# Machine table clamps

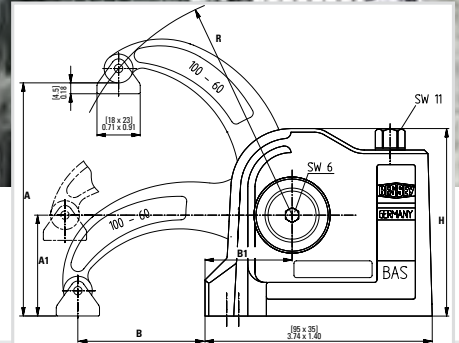
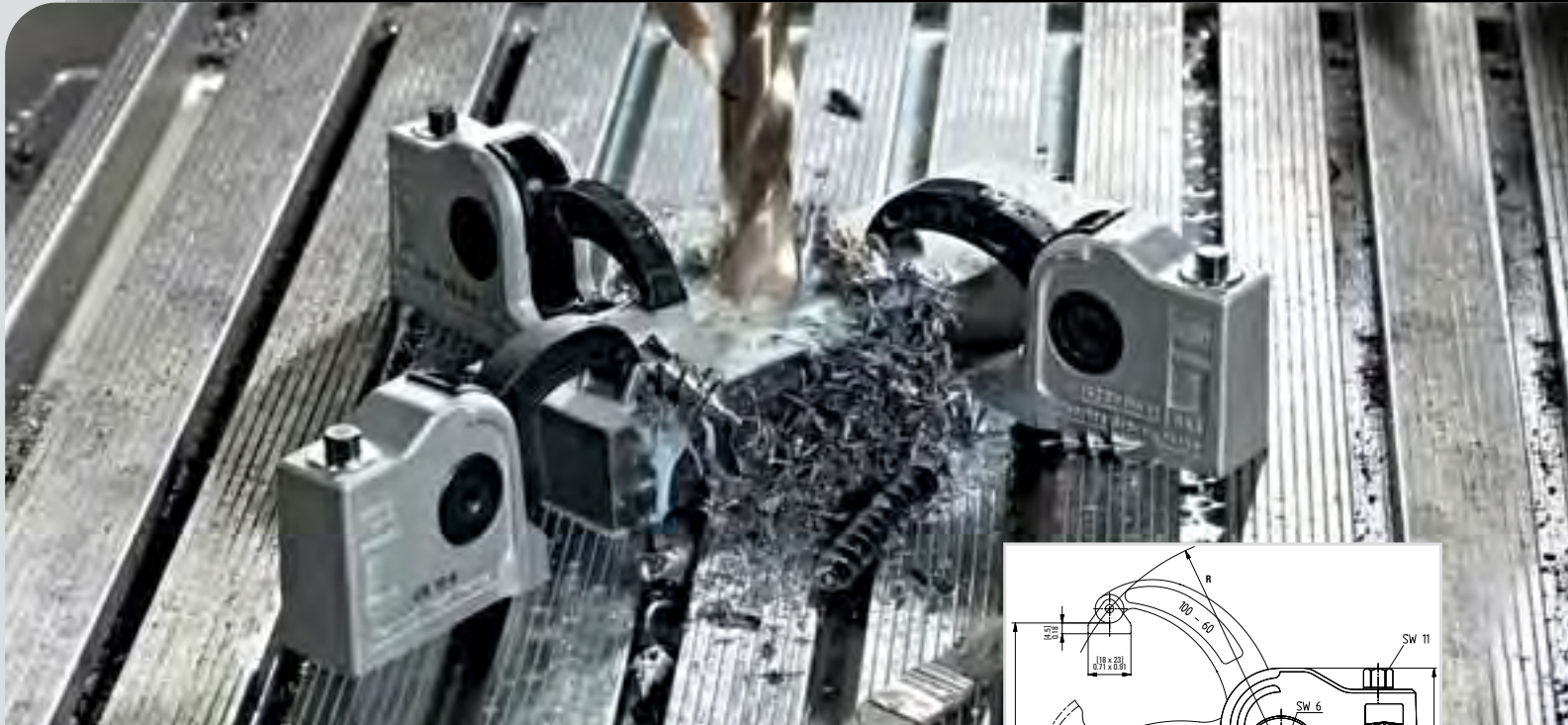

## Rapid, powerful and safe when clamping to equipment and machine tables

BESSEY® manufactures a range of practical work table clamps ideal for assembly, drilling, rubbing, milling, grinding, honing, eroding, testing and much more. Original BESSEY® BAS clamps feature an incredibly compact design and high clamping pressure. The housings and clamping arms are made from tempered stainless steel and are therefore extremely heavy duty – even after many years of use and in the most restricted spaces.



### A BAS-C compact clamp with open fixing hole

Space saving compact design with clamping force up to 3600 lbs. Mounting hole open for M10 / M12 (3/8", 7/16").



	Opening Max.	Throat Depth	Clamping Force	Clamping Arm Length
<b>BAS-C9-4</b> 3101428	88 mm/3.46"	40 mm/1.57"	3600 lbs. Arm for BAS-C9-4	75 mm/2.95"
<b>BAS-C10-6</b> 3101429	97 mm/3.82"	60 mm/2.36"	2700 lbs. Arm for BAS-C10-6	94 mm/3.70"



### B BAS-CB compact clamp with closed mounting hole

Space saving compact design with clamping force up to 3600 lbs. Mounting hole closed for M10 / M12 (3/8", 7/16").



	Opening Max.	Throat Depth	Clamping Force	Clamping Arm Length
<b>BAS-CB9-4</b> 3101428	88 mm/3.46"	40 mm/1.57"	3600 lbs. Arm for BAS-CB9-4	75 mm/2.95"
<b>BAS-CB10-6</b> 3101429	97 mm/3.82"	60 mm/2.36"	2700 lbs. Arm for BAS-CB10-6	94 mm/3.70"





### BAS machine table clamps

An incredibly compact design, both in height and surface, with a heavy duty clamping pressure, puts the BAS clamps above the competition. Try one for yourself!

#### 1 Housing is heat-treated CrMo

BAS clamps are approx. 30% smaller than the competitors while maintaining the same high clamping force. The self-locking worm gear unit exerts up to 3600 lbs of clamping force.

#### 2 Clamping arms with aluminum pressure pads

Smooth and efficient with optimum weight distribution. The short and long clamping arms are equipped with a swivelling aluminum pressure pad. A polyamide seal protects the interior against dirt.

#### 3 Open or closed mounting holes

Clamp and unclamp quickly with open hole models. In closed versions, the screw, nut and clamp form a unit. All BAS clamps are easily fastened and released – thanks to the T bar wrench (BASKN) with an integrated hexagon ball head.

#### 4 Space saving and adjustable

All BAS models feature a compact design in height and in surface. Clamping height can be increased with the BESSEY® BASO base unit, but care must be taken to provide precise workpiece contact surfaces.

Table of dimensions BAS

	Opening Max A	Opening optimal A1	Throat Depth B	Distance B1	Clamping Arm R	Housing Height (H)	Clamping Force Max.
BAS-C9-4	88mm/3.46"	42mm/1.65"	40mm/1.57"	36.5mm/1.44"	75mm/2.95"	78mm/3.07"	3600 lbs.
BAS-C10-6	97mm/3.82"	42mm/1.65"	60mm/2.36"	36.5mm/1.44"	94mm/3.70"	78mm/3.07"	2700 lbs.
BAS-CB9-4	88mm/3.46"	42mm/1.65"	40mm/1.57"	36.5mm/1.44"	75mm/2.95"	78mm/3.07"	3600 lbs.
BAS-CB10-6	97mm/3.82"	42mm/1.65"	60mm/2.36"	36.5mm/1.44"	94mm/3.70"	78mm/3.07"	2700 lbs.
BASO	80mm/3.15"	–	–	–	–	80mm/3.15"	–

### C Base unit BASO

Need more height?  
Use the BASO base unit to add an extra 80 mm. Stackable up to 10 units. Suitable for all BESSEY® BAS clamps. Mounting hole open for M10 / M12 (3/16, 1/8), and includes socket head screw.

	Opening Max.	Fastening Thread
BASO	80 mm/3.15"	M10

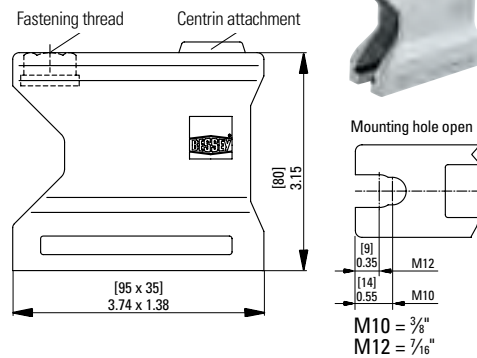

### D BASKN wrench with T-bar

T bar wrench with adjustment tool for M10/M12 (3/16, 1/8) socket head screws. Suitable for all BESSEY® BAS clamps.

	Width across flats, allen key	Width across flats, ball head	T-Bar length
BASKN	SW11	SW8-SW10	230 mm/9.06"

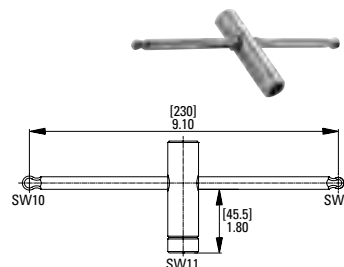

### E Service Part

3101431 BAS Arm Tip, set of 4

# Heavy Duty Vises



- 1 Guaranteed Unbreakable**  
for dependability\* & long service life
- 2 90,000 PSI Drop Forged Alloy Steel Construction**  
for top performance, moveable jaw, stationary jaw & base
- 3 Perfect Parallel Jaw Design** for secure clamping
- 4 Precision Ground & Induction Hardened Jaws & Anvil**  
for dependability & long life, HRC 52-58
- 5 Long Length Alloy Steel Spindle Handle**  
for fast, high force clamping
- 6 Long Length Alloy Steel Swivel Base Locking Handles**  
(2) for fast, easy, high force clamping of swivel base
- 7 360° Rotation Drop Forged Alloy Steel Swivel Base**  
for versatile positioning of parts
- 8 Made in Europe**  
Quality standards; ISO14001, ISO9001, Q1, TÜV SÜED /GS



Vise Video



**A Heavy duty industrial bench vise**

The BESSEY® industrial bench vise series sets new standards for durable work holding. 100% guaranteed unbreakable drop forged moveable jaws, stationary base and swivel base (\*) for the toughest jobs. Adjustable perfect parallel jaw design provides precision clamping. Sliding guides enhance protection against contamination. Large capacity drop forged pipe jaws are welded in place.



	Jaw Width	Jaw Opening	Throat Depth	Pipe Capacity	Length	Width incl. swivel base	Height incl. swivel base	Anvil size	Approx. Weight
<b>BV-DF4SB</b>	4"	4 ¼"	2 ¾"	¼-3"	12"	7"	5 ½"	1 7/16" x 2"	14.00 lbs
<b>BV-DF5SB</b>	5"	6 ½"	3"	¼-3"	15"	8 ¼"	6 ¾"	2" x 2 ¾"	25.20 lbs
<b>BV-DF6SB</b>	6"	7"	4"	¼-5"	19"	10"	8 ¾"	2 ½" x 3 ¾"	50.00 lbs
<b>BV-DF8SB</b>	8"	10 ½"	4 ½"	¼-6"	23 ¾"	10 ¾"	9 ½"	3" x 3 ¾"	67.30 lbs

\* BESSEY® vises with drop forged components are guaranteed against breakage in normal use. This guarantee does not cover abuse, improper use, or handling and storage of the product. Never use cheater bars or pipes to extend the spindle handle. This will void the warranty and can cause injury.

# Vises

## Vises

Similar to clamps, vises are like another pair of hands in the shop. They hold your work securely so that you can saw, grind or drill with both hands. BESSEY® vises have been chosen and offered with an eye for durability and functionality.

### 1 Choices

A range of products from light duty to heavy duty.

### 2 Made for everyday work

Robust design.

### 3 Robust construction

Strong 30,000 psi grey cast iron construction.



Vise Video



### A Multi-purpose vise (rotating pipe and bench vise)

Simply bolt this vise to the top surface of your bench and lock your workpiece in place with the heavy duty jaws. The base swivels 360° with 3 mounting holes and 2 lockdowns. Pipes are no problem with the serrated jaws that rotate 360°. Made with a cast iron body for durability. Built-in anvil.

	Jaw Width	Jaw Opening	Throat Depth	Pipe Capacity	Approx. Weight
<b>BV-MPV5</b>	5"	5"	3"	2"	43 lbs



### B Heavy duty bench vise

Simply bolt this vise to the top surface of your bench and lock your workpiece in place with the heavy duty serrated jaws. The base swivels 360° with 3 mounting holes and 2 lockdowns. Built-in anvil.

	Jaw Width	Jaw Opening	Throat Depth	Approx. Weight
<b>BV-HD40</b>	4"	4"	2"	17 lbs
<b>BV-HD60</b>	6"	6"	3"	44 lbs



### C Light duty bench vise

The base swivels 270° with 4 mounting holes and 1 lockdowns. Made with a cast iron body for durability. Built-in anvil.

	Jaw Width	Jaw Opening	Throat Depth	Pipe Capacity	Approx. Weight
<b>BV-HW45</b>	4 1/2"	4 1/2"	1 3/4"	1"	11 lbs



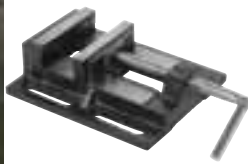

**D Drill press vise**

Malleable cast iron body with a powder coated finish. Machined spindle. A grooved jaw provides a firm secure grip. The holes are elongated for easy fastening onto a drill press or work surface.

	Jaw Width	Jaw Opening	Throat Depth	Approx. Weight
<b>BV-DP40</b>	4"	4 1/2"	1 1/8"	11 lbs



**E Light duty clamp-on vise**

When bench space is at a premium this vise is the perfect answer. Completely portable and ideal for light duty work. This clamp attaches to surfaces up to 1.5" thick. Cast in pipe jaws, serrated jaw faces, and double steel guide bars.

	Jaw Width	Jaw Opening	Throat Depth	Pipe Capacity	Approx. Weight
<b>BV-C030</b>	3"	3"	1 1/2"	3/4"	5 lbs



**F Vacuum base vise (swivelling)**

This portable hobbyist vise attaches securely to any non-porous surface and, by releasing the locking ring can rotate and swivel and, be re-locked. Comes with non-slip rubber pads for vise jaws.

	Jaw Width	Jaw Opening	Approx. Weight
<b>BV-VB</b>	2 3/4"	2 3/4"	4.50 lbs

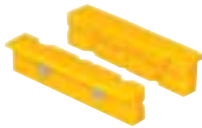

**G Multi-purpose vise jaws**

Designed to fit any 3-6" vise jaw. The magnetic back helps to keep it into place. Works great for holding wood, metal and tubing. Non-marring

	Jaw Width	Approx. Weight
<b>BV-NVJ</b>	5 1/2"	0.50 lbs



**H Light duty wood vise**

This is a versatile vise for home or work. Jaws are pre-drilled for attaching wood facing. For light duty work, made with a cast iron body.

	Jaw Width	Jaw Opening	Throat Depth	Approx. Weight
<b>BV-WV65</b>	6"	6"	2 3/8"	8.50 lbs

**BESSEY® Vise service parts**

A range of service parts for the vises listed on these pages.

**I BV-MPV5 service parts**

1. 9050001 Spindle, casting nut, washer, screw and spring pin
2. 9050002 A set of jaw inserts and 4 screws
3. 9050003 A set of pipe jaw inserts and 5 screws
4. 9050004 Locking screws
5. 9050005 Swivel base

**J BV-HD60 service parts**

1. 9060001 Spindle, spring, washer and spring pin
2. 9060002 A set of jaw inserts and 4 screws
3. 9060003 A set of locking screws
4. 9060004 Two part swivel base
5. 9060005 Casting nut, washer and screw

**K BV-HD40 service parts**

1. 9040001 Spindle, spring, washer and spring pin
2. 9040002 A set of jaw inserts and 4 screws
3. 9040003 A set of locking screws
4. 9040004 Two part swivel base
5. 9040005 Casting nut, washer and screw

**L BV-HW45 service parts**

1. 9045001 Vise jaws with screws

**M BV-DP40 service parts**

1. 9044001 Vise jaws with screws

**N BV-VB service parts**

1. 9000001 Vise jaws and jaw covers with screws
2. 9000002 Rubberized base with washer & cotter pin

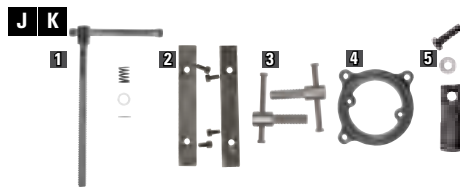
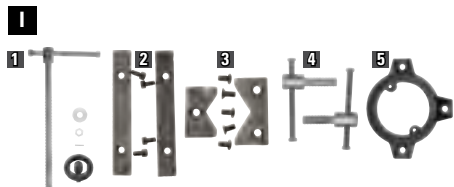

# Other Clamps

## A Portable Mini-Vise Clamp

The BESSEY® Portable Mini Vise Clamp is ideal for holding round, rectangular and odd shaped objects. It has non-marring glue resistant jaws, and can be clamped to work surface with the TK-6 table clamps. TK-6 clamps included with S-10.

	Jaw Width	Clamping Capacity	Approx. Weight
S-10	3 5/8"	4"	1.80 lb
TK-6	Holds vise clamps to flat work surface		



## B Table mount clamp (TK)

Holds your BESSEY® clamps to the edge of a work table to secure your workpiece. Opens to 2 1/4".

### Works with...

TK-6 Fits VAS-23, WS-6, S-10, and K Body® REVO™ (KR & KRV)



## C Wood handscrew clamps (HS)

It's just the clamp you need for gluing; adjustable jaws for a strong grip or delicate for those small projects. The oiled wooden jaws won't damage or slip on your workpiece. The wood handscrew clamp is held together by cold-drawn, carbon-steel spindles and swivel nuts. Large handles for comfort and torque.

	Jaw Length	Clamping Capacity	Throat Depth	Spindle Diameter	Approx. Weight
HS-6	6"	3"	3"	5/16"	1.00 lbs
HS-8	8"	5"	4"	7/16"	1.80 lbs
LHS10	10"	7"	6"	7/16"	2.24 lbs
HS-12	12"	9 1/4"	6"	7/16"	3.85 lbs



## D Panel carrier (KF)

Safely transport panels with the BESSEY® panel carrier. The jaws have a high-friction rubber coating that can withstand up to 150 lbs of carrying weight.

	Opening	Approx. Weight
KFP	1/2" - 2 1/2"	2.2 lbs
4102057	service part	



## E T-bar sash clamps (TB)

	Clamp Face	Clamping Capacity	Clamping Force	Approx. Weight
TB100	2.6" x 1.7"	39"	3150 lbs	18.00 lbs
TB150	2.6" x 1.7"	59"	2600 lbs	23.00 lbs
TB250	2.6" x 1.7"	98"	2100 lbs	33.00 lbs



## F BESSEY® TB clamp service parts (Special order)

3006042	Pressure jaw
3006040	Screw guide
3100920	Clamping jaw
3101405	Screw set

## G BESSEY® accessory bag

Heavy duty construction. Multiple pockets for tool storage. Heavy duty zippers. Waterproof base.

BESSEY® promo bag

## H Zippered pouch

TPM	medium	16" x 9"
TPL	large	21" x 11"



# Industrial Magnets



## Industrial Magnets

Something so simple but so versatile! Use one in your workshop to hold steel parts while you do the welding. Speed up your production time with BESSEY's easy to set up and remove magnetic squares.

- 1 Quality**  
Quality magnets for fast, simple set-ups
- 2 Flexibility**  
Often referred to as "an extra set of hands"
- 3 Variety**  
The wide variety of BESSEY® industrial magnets will offer most metal workers an option that fits their needs
- 4 Speed**  
A simple fast set-up and removal to help increase productivity while you work.

BESSEY® YouTube Channel



Magnet Video



### A Magnetic squares (WMS)

Simple magnets to hold work at set angles.

	Pull	Nominal Dimensions	Pre-set Angles	Approx. Weight
WMS-1	66 lbs	3 3/4" x 4 3/8" x 3/4"	90/45°	1.04 lbs
WMS-3	48.5 lbs	3 3/8" x 3 3/8" x 5/8"	90/45°	0.59 lbs
WMS-5	112 lbs	3 3/4" x 4 3/8" x 3/4"	90/45°	1.29 lbs



### B Double magnetic square (WMS)

The double magnets are joined at a pivot point and can hold at any angle.

	Pull	Nominal Dimensions	Pre-set Angles	Approx. Weight
WMS-4	2 x 48.5 lbs	6 1/8" x 3 3/8" x 5/8"	0 to 180°	1.38 lbs



### C Multi-angle magnetic square (WMS)

This is a quality magnetic multi-angle square for a fast, simple set-up.

	Pull	Nominal Dimensions	Pre-set Angles	Approx. Weight
WMS-6	35 lbs	4" x 2 1/2" x 9/16"	30/45/60/75/90°	0.50 lbs



### D Arrowhead magnetic square (WMS)

This is a quality magnetic multi-angle square for a fast, simple set-up.

	Pull	Nominal Dimensions	Pre-set Angles	Approx. Weight
WMS-7	41 lbs	4 3/4" x 3 1/4" x 9/16"	90/45°	0.69 lbs

## E "Chunky" magnetic square (CMS)

Release your magnet with the convenient T-handle.

	Pull	Nominal Dimensions	Pre-set Angles	Approx. Weight
CMS-1	100 lbs	3 3/4" x 4 3/8" x 1 5/8"	90/45°	2.60 lbs

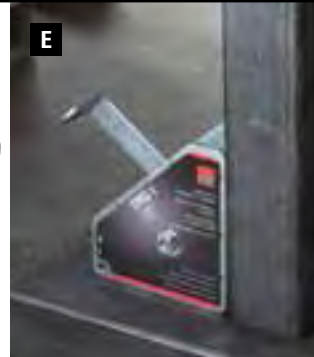

## F "Big Daddy" magnetic square (BDMS)

A quality magnetic square with a convenient T-handle for a quick release.

	Pull	Nominal Dimensions	Pre-set Angles	Approx. Weight
BDMS-1	100 lbs	8" x 8" x 1 5/8"	90/45°	10.00 lbs



## G Magnetic ground clamps (MGC)

Ground clamps only need base surface metal for clamping.

	Pull	Nominal Dimensions	Amps	Approx. Weight
MGC-1	55 lbs	3 1/2" x 2"	250	1.50 lbs
MGC-2	55 lbs	3 1/2" x 2"	800	1.55 lbs



## H Mag Pick-Up (MPU)

Magnetic disc on 35" tubular shaft for picking up small metal parts – also useful during clean-up.

	Description	Approx. Weight
MPU-1	Magnetic disc on 35" tubular shaft	2.10 lbs



## I MagStick (MS)

The MagStick is a 5 1/2" "pen-sized" pocket magnet that extends to 26" to pick-up hard to reach small metal objects.

	Description	Approx. Weight
MS-1	Magnet on 26" telescopic shaft, pocket clip	0.16 lbs



## J MagWand (MW)

Can collect up to 12 lbs of swarf in a pass for a cleaner safer welding and machine shop. It rolls easily over industrial work surfaces and dumps waste by simply pulling and sliding the magnetic insert.

	Description	Approx. Weight
MW-1	15 1/2" length	1.50 lbs



## K MagSweep (MSP)

The MagSweep is a rolling shop-floor magnet on wheels that makes clean up quick and easy.

	Description	Approx. Weight
MSP-24	24" swath	39.00 lbs



# High quality work with less effort

Traditional tin snips



Compound leverage snips

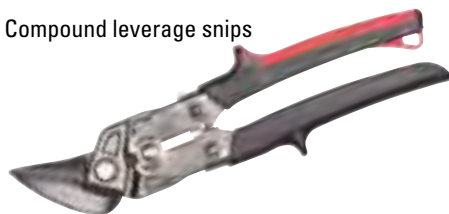

**Ideal snips**



Continuous, straight and curved cuts, right



Continuous, straight and curved cuts, left

**Outline cutting snips**



Short, straight and narrow curved cuts, right



Short, straight and narrow curved cuts, left

**Straight cutting snips**



Straight and curved cuts, large radius in both left and right directions



Short, straight cuts, notch

Left cutting snips



Right cutting snips



**Types**

**Traditional tin snips**

Edges and handle are traditionally forged into one unit. The force required for cutting is determined by the ratio of edge length to the handle length.

**Compound leverage snips**

The cutting heads and handles are made separately and are both hinged. When they're attached to each other, this double hinged (double fulcrumed) assembly greatly increases the leverage, requiring less physical effort.

**Models**

**Ideal snips**

These multi-purpose snips can cut through a metal sheet (straight-cut) as well as cut large and small contours or radii (outline-cut). It doesn't matter whether you're cutting at the edge (edge cut) or at the centre of a sheet. You can naturally use ideal snips for notching-operations.

**Outline cutting snips**

Best suited for fine and narrow radius cuts near the edges of a metal sheet. You can use the delicately shaped edge of these snips to cut extremely narrow shapes or curves without any problem.

**Straight cutting snips**

Ideal for cutting a metal sheet at the centre and/or near the edges. You can use long edges of this tool to cross-cut and notch large metal sheets quickly and precisely with less effort.

**Right cutting or left cutting snips. What's the difference?**

Right cutting snips are designed so that they can cut right radii, a curve from left to right easily. Left cutting snips are the best for radius cuts from right to left.

The common perception is that, right cutting snips are for right-handers, and left cutting snips for left-handers. This is not true. If a right-handed person is cutting a radius from left to right, using right cutting snips (radius from left to right), you have to cut outwards from your wrist. With left cutting snips, (radius is then from right to left) you can cut inwards from your wrist. This is considerably more ergonomic. Try it out once!

**Grades**

The service life of cutting edges depends directly on the grade of steel used and the processing. High-performance snips with case-hardened HSS – edges fulfill the most stringent requirements regarding service life and cutting performance. Cutter heads of the HSS-Tin grade are additionally coated with extremely hard titanium nitride that reduces wear and tear. Other cutting materials, namely special high quality steel, quality steel and standard quality steel, are available depending on the application and the frequency of use.

Grades of blade steel	min. HRC	Durability	Approx. Tensile Strength of Blade PSI	Max. Sheet thickness at tensile strength of:		
				58 000 PSI Mild Carbon Steel	116 000 PSI Hard Carbon Steel	159 000 PSI Very Hard Stainless
<b>HSS</b> D27AH	64	++++	370,000	1.5 mm/16 ga	1.2 mm/18 ga	0.6 mm/25 ga
<b>Special High Grade Steel</b> D29SS; D29ASS; D123S; D39ASS	60	+++	320,000	1.5 mm/16 ga	1.2 mm/18 ga	/
<b>High Grade Steel</b> D22A; D27; D-SPC; D-SPS	58	++	300,000	1.5 mm/16 ga	1.2 mm/18 ga	/
<b>Standard Quality Steel</b>	54	+	266,000	1.2 mm/18 ga	0.8 mm/22 ga	/



## The latest generation of leverage snips

With the new and innovative D39ASS, BESSEY® is bringing an entirely new generation of compound leverage cutting snips to the market for the sheet metalworking industry. These snips enable more capacity, precision and comfort with easier operation as a result of innovative design and unique construction elements.

**NEW**

### 1 Easier to hold

The new D39ASS snips enjoy an optimised handle angle that allows one to comfortably grip the entire unit for maximum application of cutting force.

### 2 Smooth cutting action

The joint area includes a sintered steel insert. This clever addition greatly reduces friction where it counts! Great for extending the tool life and for an exceptionally smooth cutting action.

### 3 Convenient latch

A central latch on the top of the handle allows right and left-handed users to open and close the snips with ease, without a change in grip.

### 4 Cut straight, cut round, cut easier

The compact forged jaws permit high-precision cutting of curves while also being very effective at straight cuts – while the shape of the forged jaw allows work to flow past the user's hand instead of towards for sustained (...and safer) cutting.



## A **NEW** Multi-use aviation snip (D39ASS)

For continuous straight and curved cuts. Extremely compact cutter head with partially countersunk head screw connection for increased manoeuvrability and precision on curved cuts. Joint area screwed connection with stud bolt, sintered disc and maintenance-free spring for extreme robustness. Reduced handle opening for optimised handling and an even cutting length. Central latch for easy operation. Available in right or left cutting versions.

	Overall Length	Blade Length	Cutting Capacity (carbon steel)	Approx. Weight
D39ASS-SB	9"	1 3/16"	18 gauge	1.14 lbs
D39ASSL-SB	9"	1 3/16"	18 gauge	1.14 lbs

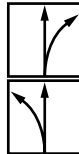

## B Multi-use snip, compact aviation snip (D15A)

Compact design for high performance with minimum effort. Smaller than typical aviation snip – for working in small spaces with all the power you need. For long continuous, straight and curved cuts.

	Overall Length	Blade Length	Cutting Capacity (carbon steel)	Approx. Weight
D15A-BE	7 3/16"	1 3/16"	18 gauge	0.44 lbs
D15AL-BE	7 3/16"	1 3/16"	18 gauge	0.44 lbs
D15S-BE	7 3/16"	1 3/16"	18 gauge	0.44 lbs
D15-SET	1x D15S-BE, 1x D15A-BE, 1x D15AL-BE in a nylon pouch			

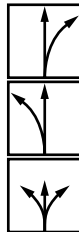

## C Offset snips, optimized (D29ASS-2)

High grade steel cutting blades with compact cutting head for high manoeuvrability. Use 25% less effort with the optimized leverage. Right or left cutting versions available. HRC up to 61.

	Overall Length	Blade Length	Cutting Capacity (carbon steel)	Approx. Weight
D29ASS-2	10 1/4"	1 5/16"	18 gauge	1.16 lbs
D29ASSL-2	10 1/4"	1 5/16"	18 gauge	1.16 lbs

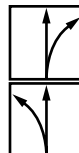



**D Offset extra hard, high tolerance snip (D27AH)**

Made for long continuous, straight and curved cuts. Case-hardened, high-speed steel edges. Right or left cutting versions available. HRC up to 68.

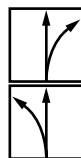

	Overall Length	Blade Length	Cutting Capacity (carbon steel)	Approx. Weight
D27AH-BE	10 1/4"	1 5/16"	18 gauge	1.22 lbs
D27AHL-BE	10 1/4"	1 5/16"	18 gauge	1.22 lbs



**E Special hard cutting snips (D29SS-2)**

High grade steel cutting blades with micro-serrations for slip proof cutting. Right or left cutting versions available. HRC up to 61.



	Overall Length	Blade Length	Cutting Capacity (carbon steel)	Approx. Weight
D29SS-2	10 1/4"	1 9/16"	18 gauge	1.03 lbs
D29SSL-2	10 1/4"	1 9/16"	18 gauge	1.03 lbs



**F Long-nose, multi-purpose snip (D22A)**

High grade steel, extra long cutting blades designed for continuous cuts and large radius cuts. Angled cutter heads keep hands free from work. Available in left cutting version only. HRC up to 59.



	Overall Length	Blade Length	Cutting Capacity (carbon steel)	Approx. Weight
D22A	11"	2 1/2"	18 gauge	1.01 lbs



**G Safety strap cutter (D123)**

Holds banding tightly during cutting to prevent the banding from springing up. Can cut steel straps up to 32 x 1 mm (1 1/4" x 1/32") with one hand. The ergonomic handle and the compound leverage offers comfort and ease of use.

	Overall Length	Blade Length	Approx. Weight
D123S-SB	10 1/4"	1 1/2"	1.21 lbs

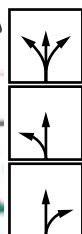

**H Aviation snips (D16)**

High grade steel cutting blades with micro-serrations for slip proof cutting. HRC up to 59.

	Overall Length	Blade Length	Cutting Capacity (carbon steel)	Approx. Weight
D16S	9 1/2"	1 3/4"	18 gauge	1.25 lbs
D16L	9 1/2"	1 9/16"	18 gauge	1.25 lbs
D16	9 1/2"	1 9/16"	18 gauge	1.25 lbs
D16-SET	1 x D16S, 1 x D16L, 1 x D16 in a nylon pouch			

### A MultiSnips

Made for everyday light duty use with a stainless steel blade. The spring opens cutter automatically and it features a thumb operated lock.

	Overall Length	Blade Length	Approx. Weight
<b>Straight Blade (D47, D48)</b>			
<b>D47</b>	5 1/2"	1 1/4"	0.13 lbs
<b>D48</b>	7 3/4"	1 5/8"	0.25 lbs
<b>Offset Blade (D48A)</b>			
<b>D48A</b>	7 1/2"	1 3/8"	0.25 lbs



### B Cable cutter (D49)

Used for cutting multi-core cable with diameters up to 10 mm (3/8"). Stainless steel blade.

	Overall Length	Blade Length	Approx. Weight
<b>D49</b>	6 1/2"	N/A	0.25 lbs



### C Combinox (D50)

The stainless steel blade cuts a wide range of material, and is notched for wire stripping. The spring opens cutter automatically with a thumb operated lock. Ergonomic handle with soft-insert.

	Overall Length	Blade Length	Approx. Weight
<b>D50</b>	7 1/2"	1 3/8"	0.25 lbs



### D MultiSnip master (D51)

The stainless steel cutter edge cuts a wide range of material. The angled cutter head keeps your hands safely free from work. The handle is made of robust fibreglass-reinforced plastic with soft-insert.

	Overall Length	Blade Length	Approx. Weight
<b>D51A</b>	9 1/4"	2"	0.25 lbs



### E SuperPower snips

Compound SuperPower snips need 50% less hand force than ordinary American pattern tin snips. Cuts up to 18 ga. (1 mm) cold rolled steel or 25 ga. (0.6 mm) stainless steel. HRC up to 62.

	Overall Length	Blade Length	Cutting Capacity (Regular metal)	Approx. Weight
<b>Straight blade (DSPS)</b>				
<b>D-SPS8</b>	8 1/2"	1 3/4"	18 gauge	0.75 lbs
<b>D-SPS11</b>	11 1/2"	2 1/4"	18 gauge	1.25 lbs
<b>Offset blade (DSPC)</b>				
<b>D-SPC8</b>	8 1/2"	1 3/4"	18 gauge	0.75 lbs
<b>D-SPC11</b>	11 1/2"	2 1/4"	18 gauge	1.25 lbs





**A Multi-function tool**

1 multi tool with 7 options: Shears, blade, saw, file, Phillips head screwdriver and large and small slotted screwdriver. It can also cut leather, rope, vinyl, thin cable, cord, thin plastic, paper, etc. Includes a belt pouch for handy storage.

	Handle Length	Cutting Edge Length	Total Length	Approx. Weight
<b>DBST</b>	4"	2 1/8"	7"	0.66 lbs



**B Double blade folding tool**

It needs just a short push on the metal release lever to unlock the knife so it can be safely folded. Features a folding stainless steel blade with serrated cut, a quick blade change mechanism, and a comfortable aluminum handle with rubber inlays.

	Handle Length	Cutting Edge Length	Blade Length	Approx. Weight
<b>DBKAH-2B</b>	3 3/4"	3"	1"	0.33 lbs



**C Folding utility knife – Aluminum handle**

Includes folding and locking blade with belt-clip. Uses standard blades that are easy to change with the quick blade exchange mechanism. Spring blade release.

	Overall Length	Blade Length	Approx. Weight
<b>D-BKAH</b>	6 1/4"	2 1/4"	0.29 lbs



**D Folding utility knife – Wood handle**

Includes folding and locking blade with belt-clip. Uses standard blades that are easy to change with the quick blade exchange mechanism. Spring blade release.

	Overall Length	Blade Length	Approx. Weight
<b>D-BKWH</b>	6 1/4"	2 1/4"	0.39 lbs

**E Folding utility knife – ABS comfort grip handle**

Includes folding and locking blade with belt-clip; thumb cushion for maximum contact pressure; replacement blade compartment and 5 extra blades. Uses standard blades. Features quick blade exchange mechanism and spring blade release.

	Overall Length	Blade Length	Approx. Weight
<b>D-BKPH</b>	6 1/4"	2 1/4"	0.32 lbs



**F Folding utility knife set - ABS comfort grip handle**

Includes 4 types of blades: standard, scoring, linoleum, and hook (rug). Convenient case for storage, 2 3/8" H x 6 3/4" W x 4 3/8" D

	Approx. Weight			
<b>DBKPH Set</b>	0.96 lbs			
	Scoring 2 pcs	Hook 5 pcs	Linoleum 2 pcs	Standard 10 pcs

# Industrial fluids and compounds

## Lab-metal

The original ready-to-use metal putty can be drilled, tapped, ground, milled, chisselled, sanded, etc. To build up, apply in thin layers, allow to dry, repeat.

**A Lab-metal** Drying time for 1/8" = 3-4 hours.

	Unit/Container	Approx. Weight/Case
LM-06	6 oz / 170 g	6.00 lbs
LM-12	12 oz / 340 g	13.00 lbs
LM-24	24 oz / 680 g	23.00 lbs
LM-48	48 oz / 1.4 g	42.00 lbs

**B Hi-Temp Lab-metal** Dry for 24 hours then cure at 425° for 1 hour.

	Unit/Container	Approx. Weight/Case
HT-14	14 oz / 397 g	15.00 lbs
HT-24	24 oz / 680 g	23.00 lbs

## C Lab-solvent

Surface-prep for regular and Hi-Temp Lab-metal. Thins Lab-Metal for brushing or spraying and leaves no film.

	Unit/Container	Approx. Weight/Case
LS-16	16 oz / 473 g	16.00 lbs
LS-128	1 gal / 3.8 L	19.00 lbs

## D Heat block

Heat absorbing, insulating paste. Insulates adjacent material against heat transfer during welding, soldering brazing or other heat treatment. Non-toxic and easily applied direct from container.

	Unit/Container	Approx. Weight/Case
HB-PNT	1 pint / .47 L	5.00 lbs

## E Spatter release

The water based version is non-toxic and biodegradable, safe for use outdoors. It is paint friendly with no silicones, non-flammable CO<sub>2</sub> propellant and contains no CFC's or trichloroethylene.

	Unit/Container	Description	Approx. Weight/Case
16300-16	16 oz / 473 ml	Water based	16.00 lbs
1620-16	16 oz / 473 ml	Solvent based	19.00 lbs

## F Stick-Kut™ lubricating stick wax

Used for grinding wheels, sanding belts and saw blades. Eliminates heat build up and belt loading - extends wheel life.

	Unit/Container	Approx. Weight/Case
15-SK	15 oz stick	12.00 lbs

**G Relton thread cutting oil** Reduce friction for a longer tool life with a clean burr-free thread. Forms a tough film for use on a wide variety of materials.

Dark Oil	Unit/Container	Approx. Weight
TC014-01G <sup>1</sup>	4 x 1 US gal/3.785L	36.00 lbs/case
TC014-05G <sup>1</sup>	5 US gal/18.925L	45.00 lbs/each

Light Oil	Unit/Container	Approx. Weight
TC016-01G <sup>1</sup>	4 x 1 US gal/3.785L	36.00 lbs/case
TC016-05G <sup>1</sup>	5 US gal/18.925L	45.00 lbs/each

**H Relton Rel-Saw band saw fluid** Improves blade life and reduces machine wear. Contains rust and corrosion inhibitors.

	Unit/Container	Approx. Weight
01G-RS <sup>1</sup>	4 x 1 US gal/3.785L	38.00 lbs/case
05G-RS <sup>1</sup>	5 US gal/18.925L	45.00 lbs/each

<sup>1</sup>Available as a special order only, Non-stock.



BESSEY® YouTube Channel





**A Relton OPTION 1® cutting fluid**

An environmentally friendly cutting fluid that has no chlorine, no sulfur, a non-toxic formula that's safe to use. Water based; Non-WHMIS.

	Unit/Container	Approx. Weight
OPT114	24 x 4 oz/118 ml	7.40 lbs/case
OPT455	12 x 16 oz/473 ml	14.80 lbs/case
OPT4	4 x 1 US gal/3.785L	36.10 lbs/case
OPT20	5 US gal/18.925L	47.00 lbs/each
OPT205 <sup>1</sup>	55 US gal/205L	500.00 lbs/each



**B Relton A-9® aluminum cutting fluid**

Use for tapping, drilling, boring, milling, sawing, reaming & broaching. Specifically designed for aluminum; also works well on many other metals. Non-WHMIS, environmentally friendly.

	Unit/Container	Approx. Weight
A9114	24 x 4 oz/118 ml	9.00 lbs/case
A9455	12 x 16 oz/473 ml	16.00 lbs/case
A94	4 x 1 US gal/3.785L	33.00 lbs/case
A920	5 US gal/18.925L	42.00 lbs/each
A9205 <sup>1</sup>	55 US gal/205L	450.00 lbs/each



**C Relton Air-Flo air tool oil**

High quality air tool and air line lubricant.

	Unit/Container	Approx. Weight
AF-PNT <sup>1</sup>	12 x 1 pint/473 ml	13.50 lbs/case
AF-01G <sup>1</sup>	4 x 1 US gal/3.785L	36.00 lbs/case



**D Relton Rapid Tap® cutting fluid**

Leaves a fine machined finish even on tough materials such as aluminum, beryllium, brass, bronze, cast iron, copper, inconel, magnesium, molybdenum, stainless steel, and stellite. No 1,1,1 Trichloroethane – ozone friendly, non-toxic, and non-flammable; non-WHMIS.

	Unit/Container	Approx. Weight
RT114	24 x 4 oz/118 ml	11.00 lbs/case
RT455	12 x 16 oz/455 ml	17.00 lbs/case
RT4	4 x 1 US gal/3.785L	42.00 lbs/case
RT20	5 US gal/18.925L	45.00 lbs/each
RT205 <sup>1</sup>	55 US gal/205L	500.00 lbs/each

**E Torque multipliers (JM)**

The geared head offers 4X the power of an ordinary wrench alone, and requires no air or electricity. Use it with a torque wrench when precision is required (always calibrate to be sure). JM units can be stacked for higher power. Up to 12,000 ft. lbs. of torque.

	Input Capacity Foot/Pounds	Output Capacity Foot/Pounds	Input Drive	Output Drive	Ratio	Approx. Weight
JM-750	250	1,000	½"	¾"	4 to 1	5.88 lbs
JM-1000	500	2,000	¾"	1"	4 to 1	11.74 lbs
JM-1200 <sup>1</sup>	209	3,000	¾"	1 ½"	14.3 to 1	28.20 lbs
JM-1500 <sup>1</sup>	923	4,000	1"	1 ½"	4.33 to 1	28.20 lbs
JM-2000 <sup>1</sup>	1739	8,000	1"	1 ½"	4.6 to 1	47.00 lbs
JM-2500 <sup>1</sup>	2000	12,000	1"	2 ½"	6 to 1	73.00 lbs

**F Anti-Backlash torque multiplier**

Limits risk of "spring back" when extender bar is used. Coupled with larger model – makes the entire system anti-backlash.

	Input Capacity Foot/Pounds	Output Capacity Foot/Pounds	Input Drive	Output Drive	Ratio LB:FT	Approx. Weight
JM-1000-R <sup>1</sup>	500	2,000	¾"	1"	4:1	14.50 lbs

<sup>1</sup>Available as a special order only, Non-stock.



# Induction bearing heaters

## **NEW** Portable for workshop and on site!

Induction bearing heaters extend bearing life and cut operating cost by eliminating hammering and pounding to cold-mount bearings. Works on bearings, sprockets, gears, couplings and sleeves. Demagnetizes bearings – easy to use, ready in minutes.

### 1 Digital temperature and time control

All portable models feature a digital time/temperature display and magnetic probe.

### 2 High performance

Fast heating with lower energy use! 120V/15A. 50/60Hz.

### 3 Vertical or Horizontal heating

PVH3813 and SVH5223 can be heated either vertically or horizontally. When in horizontal position, the heating time is 3 to 4 times faster! For example, a 100 lb. unit would heat in under 7 minutes versus more than 25 minutes in the vertical position.



\*Bearings not included

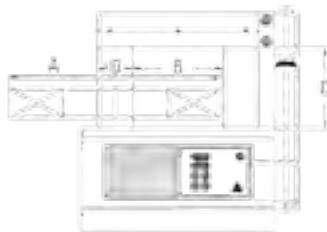

### **NEW**

#### A Portable digital temperature control, certified PV2412

Includes cross bars standard: ¼", ⅜", ⅝", ⅞", 1 ⅛". Approx. weight: 47 lbs.

	Max. weight ± lb bearings	Min. ID Ø	Max. OD Ø A	Max. width B	Max. horizontal heating width C	Cross section poles D	Pole height	Temperature control max reach	Time control max reach
PV2412	44 lbs	⅜"	9 ½"	4 ¾"	—	1 ⅝"	5"	302°F	0-30 min.



\*Bearings not included

### **NEW**

#### B Portable digital temperature control, certified PVH3813

Vertical or horizontal heating. Includes cross bars standard: ¼", ⅜", ⅝", ⅞", 1 ⅛". Approx. weight: 51 lbs.

	Max. weight ± lb bearings	Min. ID Ø	Max. OD Ø A	Max. width B	Max. horizontal heating width C	Cross section poles D	Pole height	Temperature control max reach	Time control max reach
PVH3813	110 lbs	⅝"/Ø3 ⅞"	15"	5 ¼"	5 ¼"	1 ⅝"/Ø3 ¾"	6 ½"	464°F	0-45 min.



\*Bearings not included

### **NEW**

#### C Fast action, portable digital temperature control, certified SVH5223

Features swivel arm for faster change ups. Vertical or horizontal heating. Includes cross bars standard: ⅝", 1 ⅛", 2 ⅜". Approx. weight: 112 lbs.

	Max. weight ± lb bearings	Min. ID Ø	Max. OD Ø A	Max. width B	Max. horizontal heating width C	Cross section poles D	Pole height	Temperature control max reach	Time control max reach
SVH5223	330 lbs	⅝"/Ø4 ¾"	20 ½"	7 ⅞"	9"	2 ⅝"/Ø4 ½"	9"	464°F	0-45 min.



\*Bearings not included

**WARNING:** Do NOT operate an induction heater if you wear a heart pace-maker. The strong magnetic field emitted by the heater may affect operation of such devices.

We welcome your feedback, and are happy to assist you with your questions. Please call us toll free: **1.800.828.1004**

# Induction bearing heaters

**C D**



\*Cross bars not included

Induction bearing heaters extend bearing life and cut operating cost by eliminating hammering and pounding to cold-mount bearings. Works on bearings, sprockets, gears, couplings and sleeves. Demagnetizes bearings – easy to use, ready in minutes.

All Induction Bearing Heaters on this page are single phase 60 hz units. 50 hz versions available as special request.

## **1** Digital temperature and time control

Model SC 110D features a digital time/temperature display and magnetic probe. All other models come with an on/off switch.

## **2** Trusted Performance

Tried and tested design that has stood the test of time. 120V/15A. 50/60Hz.

**A**



**B**



\*Bearings not included

## **A** Digital Temperature Control, induction bearing heater SC 110D (120V or 220V)

Bearing capacity: 4" x 11" O.D. (14"OD with optional raising blocks). Computer chip monitors and stabilizes temperature. Display panel (pre-set times, temperatures) and auto shut off.

	Voltage	Standard Cross Bars	Optional Cross Bars	Approx. Weight
SC 110D	120V (20 amp)	¾, 2	1 ¼	53.50 lbs

## **B** Induction bearing heater SC110V (120V or 220V)

Bearing capacity: 4" x 11" O.D. (14"OD with optional raising blocks).

	Voltage	Standard Cross Bars	Optional Cross Bars	Approx. Weight
SC 110V	120V (17 amp)	¾, 2	1 ¼	49.60 lbs
SC 220V	240V (11 amp)	¾, 2	1 ¼	52.00 lbs

## **C** Induction bearing heater BC (240V, or 480V, or 600V)

Bearing capacity: 7 ½" x 22" O.D. (32"OD with optional raising blocks).

	Voltage	Standard Cross Bars	Optional Cross Bars	Approx. Weight
BC 220V	240V (30 amp)	1 ¼, 3	1, 2	176.00 lbs
BC 440V	480V (20 amp)	1 ¼, 3	¾, 1, 2	176.00 lbs
BC 550V	600V (15 amp)	1 ¼, 3	¾, 1, 2	176.00 lbs

	A	B	C	D	E	F
SC	4 ¾"	3 ⅝"	¾"-2"	¾"	9 ¼"	9"
BC	8"	7"	1 ¼"-3"	1 ¼"	14 ¾"	16"
BCS	12 ¼"	7"	1 ¼"-3"	1 ¼"	18 ¾"	16"

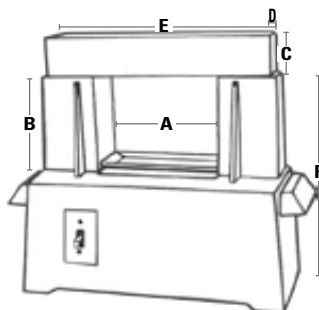

**E**

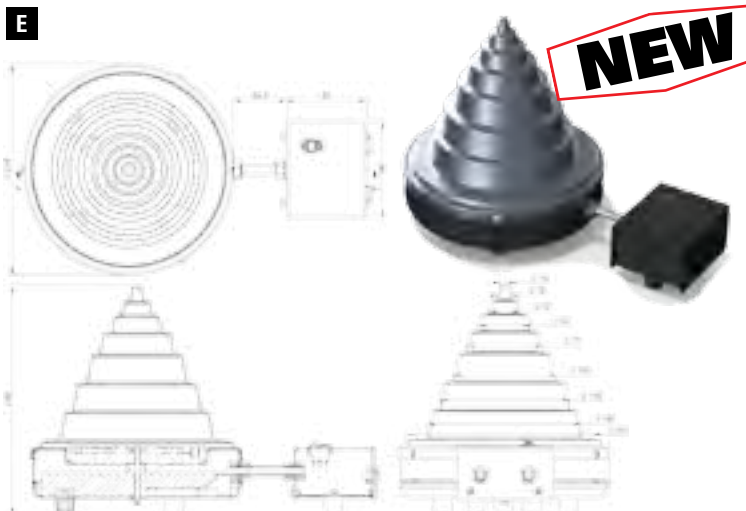

## **D** Model BC Special (240V, or 480V or 600V)

Bearing capacity: 11 ½" x 22" O.D. (32"OD with optional raising blocks).

	Voltage	Standard Cross Bars	Optional Cross Bars	Approx. Weight
BCS 220	240V (30 amp)	1 ¼, 3	1, 2	199.00 lbs
BCS 440	480V (20 amp)	1 ¼, 3	1, 2	199.00 lbs
BCS 550	600V (15 amp)	1 ¼, 3	1, 2	199.00 lbs

## **NEW E** Cone style bearing heaters (non-induction)

\*Comes with control box. NCB version does not have controls.

	Bearing I.D. Range	Voltage	Width	Height	Approx. Weight
GCS-NCB	¾" - 8 ¼"	120V (15 amp)	8 ⅝"	9 ½"	6.00 lbs.
GCS-CB*	¾" - 8 ¼"	120V (15 amp)	8 ⅝"	9 ½"	6.00 lbs.

**WARNING:** Do NOT operate an induction heater if you wear a heart pace-maker. The strong magnetic field emitted by the heater may affect operation of such devices.



# Induction bearing heater accessories

## A Raising blocks for SC, BC, BSC models

Increases the maximum size of bearing that can be heated.

	Fits model	Height	Width	Approx. Weight
SCRB	SC	2 3/8"	2 5/8"	7.50 lbs.
BCRB	BC, BCS	5"	3 5/8"	31.00 lbs.



## B Pyrometer/Thermometer

Multi-purpose measuring device for bearings, gears, etc. Digital readout from -200°C (-328°F) to +1372°C (+1999°F). Probe max rated for 650°C (1200°F).

		Approx. Weight
HH11B	Pyrometer/Thermometer with probe & flex cord	2.00



## C Cross bars for SC, BC, BCS bearing heater models

	Fits model #		Fits model #
SC 3/4	SC	<b>BCS 1<sup>(1)</sup></b>	BC Special
SC 1 1/4 <sup>(1)</sup>	SC	<b>BCS 1 1/4</b>	BC Special
SC 2	SC	<b>BCS 2<sup>(1)</sup></b>	BC Special
BC 3/4 <sup>(1)(2)</sup>	BC	<b>BCS 3</b>	BC Special
BC 1 <sup>(1)</sup>	BC	<b>SC on/off</b>	On/Off switch for SC
BC 1 1/4	BC	<b>BC on/off</b>	On/Off switch for BC
BC 2 <sup>(1)</sup>	BC		
BC 3	BC		



<sup>(1)</sup> Available as a special order only.

<sup>(2)</sup> WARNING: Do NOT use with model BC 220V

## D Cross bars for PV and PVH bearing heater models

	Fits model	Size	Approx. Weight
PV 1/4	PV2412	1/4" x 1/4" x 7 7/8"	0.15 lbs.
PV 3/8	PV2412	3/8" x 3/8" x 7 7/8"	0.31 lbs.
PV 9/16	PV2412	9/16" x 9/16" x 7 7/8"	0.64 lbs.
PV 13/16	PV2412	13/16" x 13/16" x 7 7/8"	1.32 lbs.
PV 1 1/16	PV2412	1 1/16" x 1 1/16" x 7 7/8"	5.22 lbs.
PVH 1/4	PVH3813	1/4" x 1/4" x 9 1/2"	0.20 lbs.
PVH 3/8	PVH3813	3/8" x 3/8" x 9 1/2"	0.40 lbs.
PVH 9/16	PVH3813	9/16" x 9/16" x 9 1/2"	0.77 lbs.
PVH 13/16	PVH3813	13/16" x 13/16" x 9 1/2"	1.61 lbs.
PVH 1 1/16	PVH3813	1 1/16" x 1 1/16" x 9 1/2"	7.21 lbs.



## E Cross bars for SVH bearing heater models

	Fits model	Size	Approx. Weight
SVH 9/16	SVH5223	9/16" x 9/16" x 14"	1.10 lbs.
SVH 1 3/16	SVH5223	1 3/16" x 1 3/16" x 14"	7.28 lbs.
SVH 2 3/8	SVH5223	2 3/8" x 2 3/8" x 14"	22.93 lbs.



## F Magnetic Temperature Probe

Connects to bearing heater and attaches to inner race of bearing. Good up to 350 degrees F (240 degrees C).

	Fits model	Approx. Weight
MP-PV/PVH/SVH	PV/PVH/SVH	0.13 lbs

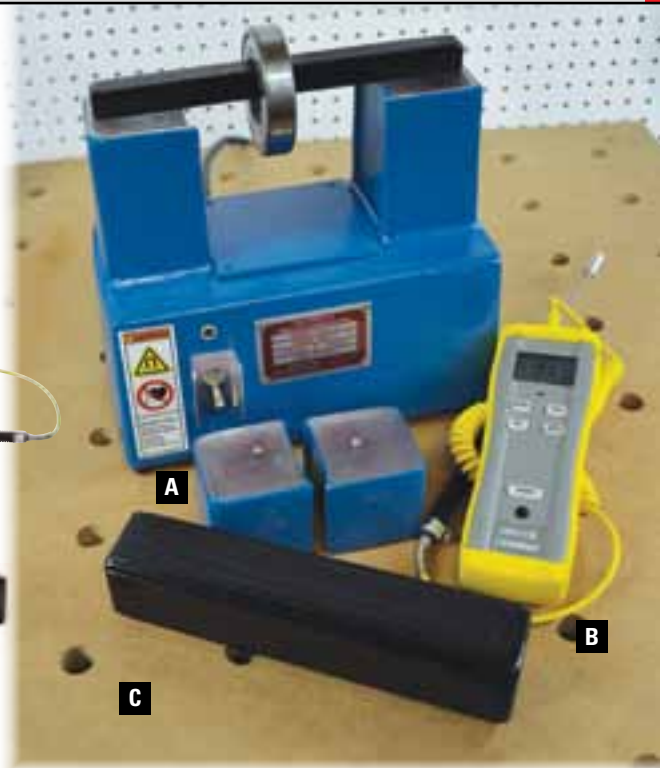







## Social media

### We're interactive.

- 1 Like us on Facebook to receive product announcements, contest alerts and more;
- 2 Follow us on Twitter for the most up-to-the-minute videos and product reviews;
- 3 View our extensive YouTube catalog of product and how-to videos to make your next job faster, safer, simply better.

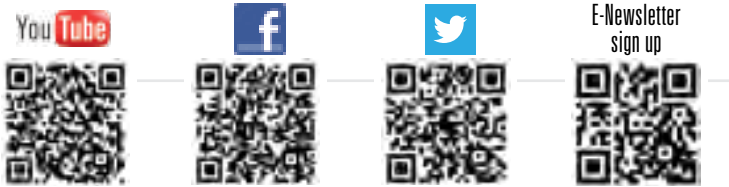

## CONNECT WITH BESSEY

[www.facebook.com/BesseyToolsNorthAmerica](http://www.facebook.com/BesseyToolsNorthAmerica)

[www.twitter.com/BesseyTools](http://www.twitter.com/BesseyTools)

[www.youtube.com/user/BesseyTools](http://www.youtube.com/user/BesseyTools)

[www.besseytools.com](http://www.besseytools.com)

Sign up to receive our E-Newsletter at [info@besseytools.com](mailto:info@besseytools.com)

## Customer service

### We're experienced.

- 1 Our customer service department has over 50 years of combined experience meeting the needs of our customers whether they are distributors or end-users;
- 2 We're here to answer the phone, listen to your concerns, deal with any problems and be helpful in any way possible. We're courteous, knowledgeable and will go the extra step;
- 3 If we can't help, we'll find you someone who can.



## Fill rate

### We're efficient.

- 1 48 hour shipping policy – normal is 24 hours;
- 2 98.7% order fill rate;
- 3 Special Order items available.



## Best practices

### We're here to help.

- 1 Use the right tool for the job – never use a clamp to lift, or use a cheater bar on a handle, or use pliers instead of a proper wrench – these mistakes can lead to accidents and injuries;
- 2 Use tools as recommended by the manufacturer – ie. never use cheaters on handles (this exerts greater force on the tool than it was designed for and is likely to cause breakage and possible injury).
- 3 Remove damaged or broken tools from service – clamps with broken pads, bent handles, corroded pads, snips with notched blades, bent clamps, damaged spindles etc. are unsafe and should be removed from service and either repaired or destroyed.





## 1 BESSEY® General Cautions & Warnings

**PRICING:** Retail prices of our products can change at any time as they are impacted by a wide range of business factors (including transportation, staffing, local/regional taxes and other overhead expenses). Your distributor incurs these expenses in doing business in your community.

**PRODUCT INFORMATION:** BESSEY® Tools North America reserves the right to alter technical and physical specifications at any time. Some product specifications may vary from region to region to meet the requirements of the international marketplace. Errors and omissions excepted, BESSEY® believes that to the best of its knowledge the product illustrations and descriptions provided in the current BESSEY® catalog are accurate. However, such descriptions and illustrations are for the sole purpose of identification, and do not express or imply any warranty or condition that the products are merchantable or fit for a particular purpose or that the products will necessarily conform to the illustrations or descriptions. Our images include application shots which may include accessories and products not included with the product listed. The customer is solely responsible for reliance on, or use of, any information, and for the use or application of any product. BESSEY® expressly disclaims any liability for direct, indirect, consequential or incidental damages in all events. In addition, all claims for damages, losses and causes of action shall be limited to the purchase price paid for the products in question. Note: "Clamping Force" is an estimation (nominal info.)

**CAUTION:** Clamping tools are not suitable for lifting, pulling or transporting. Improper use may lead to personal injuries or material damages. Clamping tools should only be clamped manually and without the use of any auxiliary tools or other devices. Please also see website for further information. Unless otherwise noted, clamping force ratings are generally presented as nominal figures for use in everyday situations and do not represent load limits, nor should they be construed as precise figures.

### **CAUTION:** Cutting Technology

Always wear appropriate protection including goggles and gloves while working. Sheared parts may injure workers and bystanders. Disconnect the power supply while working on electrical devices to avoid the risk of electric shock. Always ensure the cutting direction while using snips, knives and cutters is away from your body. Only use original replacement parts whenever required. Tools should only be used manually without using any auxiliary tools. Improper use may lead to personal injuries, material damages, personal injuries or even death. Please also see website for further information.

## 2 BESSEY® Terms and Conditions - Distributor

**PRICING:** All prices, sizes and product specifications are subject to change without notice. Orders accepted only at price in effect at date of shipment.

**QUOTATIONS:** Quotations expire thirty days from date issued unless otherwise specified in writing.

**FREIGHT TERMS:** All prices are F.O.B. (BESSEY®). Prepaid shipping is based on minimum invoice values and, are subject to change without notice. Please contact BESSEY® Tools North America for this information. All prepaid orders are shipped by ground transportation and using a provider of BESSEY®'s choice. If customers request another carrier, or another method of delivery, they must provide their own billing information in advance. Shipping errors must be reported within 10 days of product receipt.

**TERMS OF PAYMENT:** All orders are subject to BESSEY®'s credit approval and are due and payable thirty days (net) from the shipment date. Past due accounts are subject to interest at 1.5% per month (18% per annum).

**RETURN GOODS:** Products returned for credit will not be accepted. Goods are not returnable unless permission has previously been received in writing from our office. Returned goods are subject to the following conditions:

1. Incoming transportation charges, if not prepaid, will be deducted from credit memorandum.
2. All material returned must be found by BESSEY®, upon arrival, to be in first class saleable condition. If not, the cost of putting it in such condition will be deducted from any credit memorandum.
3. A restocking charge of 20% plus an additional 2% per each month elapsed since date of purchase, of the original invoice cost, will be deducted from any credit memorandum.
4. Products returned must be current products in the BESSEY® product offering.

## 3 BESSEY® Tools North America Warranty Policy

BESSEY® brand clamping products are warranted under a Limited Lifetime program. We warranty that the products will be free from defects in material and workmanship for the life of the tool or we will replace, refund or repair it; provided that this warranty does not cover any damage caused by abuse, misuse, improper handling, negligence, alteration or normal wear and tear. Other tools including but not limited to snips, c-clamps, some specialty clamps, magnets, vises, bearing heaters and pyrometers are guaranteed for 1 year. For all products, BESSEY® Tools North America reserves the right to refuse either a repair or a replacement.

BESSEY® Tools North America makes no other warranties, express or implied, with respect to the tools or their suitability for specific applications. BESSEY® Tools North America neither assumes, nor authorizes any person to assume for it, any other warranty, or obligation express or implied. For a more detailed listing of Terms, Conditions and Warranty please contact BESSEY® Tools North America direct and toll-free at 1.800.828.1004.

BESSEY® Tools North America will, at its sole discretion, define if a product submitted for warranty evaluation is eligible for a warranty return and then, if eligible, offer to repair, refund or replace any defective product. To initiate such a claim, please call and request a return authorization number then, return all parts of the broken tool(s) plus a written warranty evaluation request (with contact information) in a freight prepaid format to BESSEY® Tools North America.

This warranty gives you specific legal rights. Please note: you may also have other rights, which could vary depending upon state, federal and provincial law.

For more information, email [info@besseytools.com](mailto:info@besseytools.com) or call 1-800-828-1004.

#### 4 BESSEY® Return Procedures

**RETURN GOODS** – Purchased direct from a Tool Distributor: Please initiate returns of any sort with the distributor where the tool was purchased.

**RETURN GOODS** – Purchased direct from BESSEY®: Products purchased directly from BESSEY® which are returned for credit (only permitted if incorrectly shipped or if the product is found to be defective upon receipt), warranty or repair will not be accepted unless permission has previously been received in writing from our office. Please contact BESSEY® at [info@besseytools.com](mailto:info@besseytools.com) to initiate a return. You may be asked for invoice numbers, packing slips or proof of delivery; please have this information ready.

Returned goods are subject to the following conditions:

1. Incoming transportation charges, if not prepaid, will be deducted from credit memorandum.
2. All material returned must be found by BESSEY®, upon arrival, to be in first class saleable condition. If not, the cost of putting it in such condition will be deducted from any credit memorandum.
3. A restocking charge of 20% plus an additional 2% per each month elapsed since date of purchase, of the original invoice cost, will be deducted from any credit memorandum.
4. Products returned must be current products in the BESSEY® product offering

#### 5 Calprop Statement (North America)

Proposition 65 (formally titled "The Safe Drinking Water and Toxic Enforcement Act of 1986") is a California law that has been in effect since 1986 to promote clean drinking water and keep toxic substances that cause cancer and birth defects out of consumer products. It is administered by Cal/EPA's California Office of Environmental Health Hazard Assessment (OEHHA). Proposition 65 regulates substances listed by California as causing cancer or birth defects or other reproductive harm in two ways. The first regulatory arm of Proposition 65 prohibits businesses from knowingly discharging listed substances into drinking water sources, or onto land where the substances can pass into drinking water sources. The second regulatory arm of Proposition 65 prohibits businesses from knowingly exposing individuals to listed substances without providing a clear and reasonable warning.

BESSEY® branded products do not, to the best of our knowledge, expose individuals to harmful substances as listed by the Cal Prop 65 Legislation.

#### 6 BESSEY® History of James Morton

In 1985, BESSEY & Sohn appointed James Morton and American Clamping as exclusive distributor in North America. After nearly 20 years of successful business in North America the distributorship was purchased in 2003 by BESSEY® replacing the James Morton Inc. and American Clamping Corporation with a strategic BESSEY® operation.



#### 7 BESSEY® Downloads at [www.besseytools.com](http://www.besseytools.com)

##### Sales Sheets

Produced over the years and continuously updated the BESSEY® sales sheets are a great snapshot of the tool, how it works and its vital statistics. Available as a PDF for easy downloads.



##### Catalog Images

Looking for an image to put into catalogs, articles or reference for working drawings in the field? Contact us at [info@besseytools.com](mailto:info@besseytools.com)



##### BESSEY® Presentations

Catalogs  
Videos



# BESSEY®

Clamping and cutting technology, July 1 2016 / 2017



Simply better.



### Join us on...



[www.facebook.com/BesseyToolsNorthAmerica](http://www.facebook.com/BesseyToolsNorthAmerica)



[twitter.com/BesseyTools](https://twitter.com/BesseyTools)



[www.youtube.com/user/BesseyTools](http://www.youtube.com/user/BesseyTools)



[www.besseytools.com/](http://www.besseytools.com/)



Sign up to receive our e-newsletter at  
[info@besseytools.com](mailto:info@besseytools.com)