

Important information

Intellectual property

Titus group owns the intellectual property rights in its products worldwide whether as trademarks, patents, intellectual, copyright, designs, illustrations, drawings and the 'know how' contained in their design and production. Titus Group respects the equivalent rights in competitors and all other relevant product design rights in others. To our knowledge our products do not infringe any intellectual property rights of competitors or other parties. Titus Group takes infringements of its rights seriously and will rigorously defend these rights to the full extent of the law.

Responsibility

It is the responsibility of the user to ensure the fitness of hardware for the intended purpose. We recommend assessment by appropriate testing in the application and by technical enquiry to our representatives.

Technical information

While every effort has been made in the production of this catalogue to ensure the accuracy of information, our products are continually being revised and users should confirm the up to date specification before ordering.

*Non preferred articles

All Item numbers in the catalogue marked with * are for non preferred non stock items available upon special request. For such products, extended delivery times may apply.

Trademarks

Titus and Titusonic are registered trademarks of Titus International Ltd. Lama is a registered trademark of Lama d.d. Dekani and Huwil is a registered trademark of HUWIL-Werke GmbH, WoodWelding is a registered trademark of WW SA.

Contents

1

2

3

Connectors

	1.1
- System 1	1.7
- System 3	1.9
- System 4	1.11
- System 5	1.15
- System 6	1.31
- System 7	1.40

Soft closing systems

	2.1
- Information	2.3
- Glissando add-on hinge soft closing system	2.11
- Glissando stand-alone soft closing system	2.15
- Glissando for drawers	2.17

Concealed hinges

	3.1
- Information	3.3
- ST-i2 plus	3.19
- ST plus	3.21
- ST	3.25
- Push latch	3.37

Connectors

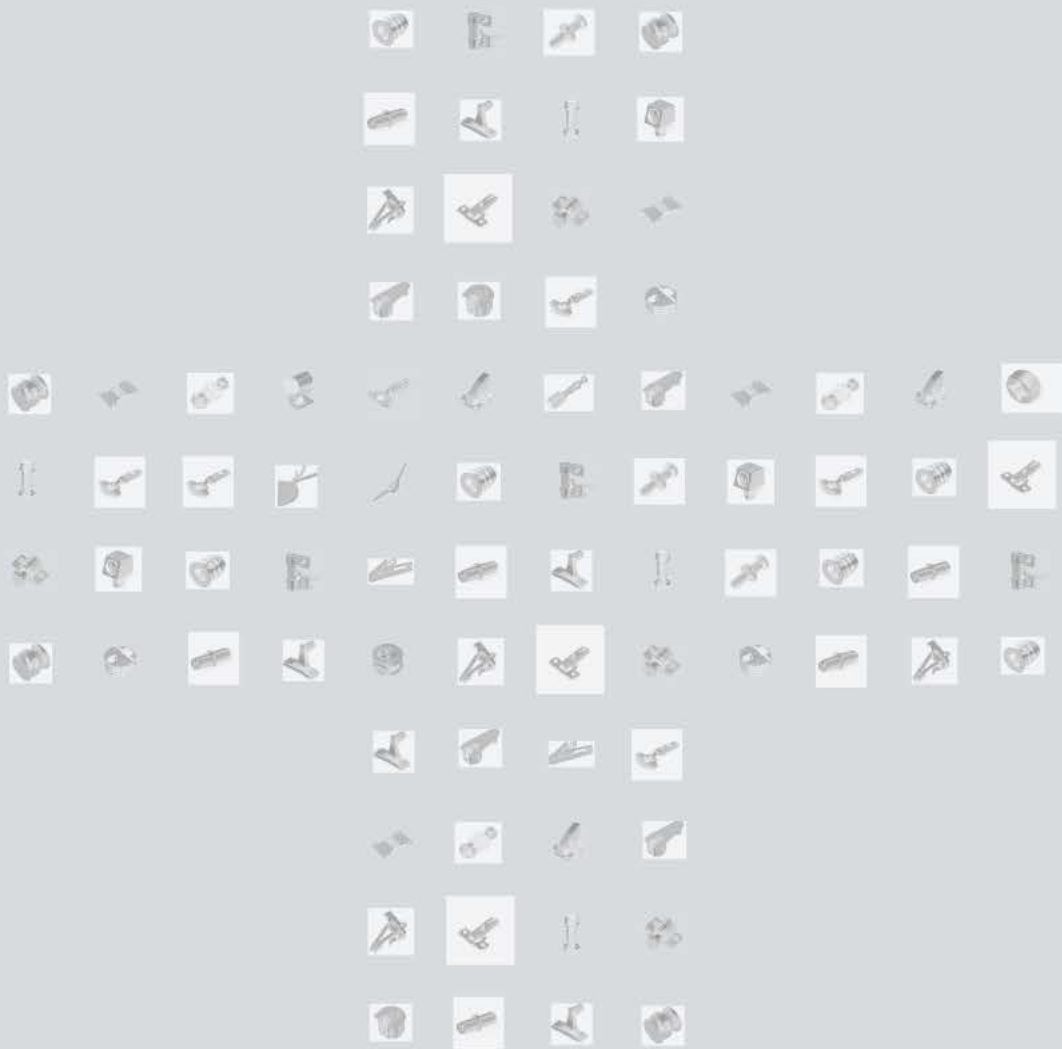

Connectors

Product guide

Page

System 1

Fittings for rigid assembly systems

a highly cost-effective and rigid assembly system for factory, consumer and home assembly

1.7

System 3

Fittings for face and edge boring

two component rigid face and edge drilling fastening

1.9

System 4

Fittings for face-boring only

a range of low-cost one-piece fittings for high volume home assembly applications

1.11

System 5

Cams and dowels

a comprehensive range of cam and dowel connecting fittings for all cabinet applications

1.15

System 6

Quickfit-Expando connectors

face boring expanding connectors for all cabinet applications

1.31

Page

System 7

Heavy duty cams and dowels

high quality fittings for offices
and public furniture

1.40

Why choose Titus?

Titus connectors add value to furniture and to furniture manufacturing

Titus connectors improve the quality of furniture and lower the cost of manufacturing and assembly while ensuring a high degree of customer satisfaction.

The most advanced range of connectors available on the market

Precise and efficient product design.
The broadest possible range of drilling tolerances ensures reliable assembly and consistently strong joints.
Klix locking feature, the engagement of interlocking teeth on cam and dowel, to prevent joint loosening in service or transit.
Expanding function provides degrees of variation in out-of-tolerance drillings ensuring stronger joints and improved quality of furniture.
Twinstart thread for faster and more stable insertion.
Depth stop collar prevents over-insertion.
Firm tightening for greater confidence in use.
Cam locks at 230° assuring smooth tightening action and greater dowel pull-up.

Quickfit for hand dowel insertion.
Quickfit TL2, TL4 with the built-in self adjustment feature is the only available dowel that allows for pre-insertion.
Quickloc one piece fitting for faster assembly with integrated expanding cam and dowel.
Zinc+steel dowel for optimal strength and performance.
Precise dowel manufacturing high precision of zinc and strength of steel assures 100% dimensional accuracy.

Easy and quick consumer friendly self-assembly of furniture

Self-assembly furniture offers consumers good value and instant availability of products.

With the aim of providing consumer with simpler instructions, fewer parts and an easier assembly process, Titus has significantly reduced and simplified the number of fittings traditionally required in furniture production.

Titus connectors provide consumers with easy assembly and furniture producers with increased productivity:

- reduced number of assembly parts
- easy assembly instructions
- security of packed parts during transit

CAF Quick & Easy

Consumer Assembly Friendliness

Easy and quick furniture assembly

CAF formula

CAF=Consumer Assembly Friendliness

Titus CAF formula provides a comparative measure for customer satisfaction. By using it manufacturers are able to evaluate their products internally or against those of their

competitors. While offering consumers easier and faster assembly, there are obvious advantages also for furniture manufacturers – buying, counting, bagging and stocking of fittings can be greatly reduced.

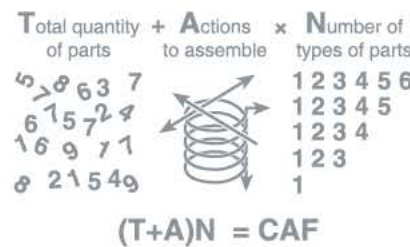

Minimise the numbers in the Titus CAF™ formula to achieve:

- High customer satisfaction
 - Improved productivity
 - Higher profits

How does it work?

Comparative CAF scores to assemble a hand held demonstrator



	T	A	N	CAF
Connecting screw (traditional assembly)	4	38	3	126
Cam & dowel with single start thread	6	21	4	108
Cam & dowel with twin start thread	6	15	4	84
Cam & TL2 dowel (self-assembly)	6	7	4	52
Cam & TL2 dowel (factory pre-Inserted)	2	3	2	10
Quickloc	2	3	1	5
Fully assembled demonstrator	1	0	1	1

System 1

Fittings for rigid assembly systems

System features

Double locking carcass screw

- Zinc diecast for precision
- Titus Double locking carcass screw makes an almost invisible connection
- Collar under the head to pull panels together
- 2nd 'lower' thread pulls against a 'faster' thread to provide maximum connection force and prevents overdriving of fastener
- Almost invisible in position
- Head can be 'fastcapped' or filled

Hi-Lo™ carcass construction screw

The Hi-Lo™ carcass construction screw (CCS) offers a strong, tolerant and cost effective connection with minimal panel preparation.

The combination effect of the elements of a Hi-Lo™ screw means

- A greater differential between drive torque and strip torque in fibrous and particle materials to ensure a reliable and repeatable fixing
- Hi-Lo™ threads provide minimum bursting forces
- 'Hi' thread gives low bursting component force from the sharp 30 degree angle thread
- 'Lo' thread at 60 degree angle uses the vertical force component to press fibrous and particle components of panels onto the 'Hi' thread and are contained by their greater height
- The very small shank on a Hi-Lo™ screw means less material displacement than conventional threads and enables minimum or partial drilling of pilot holes for quicker panel processing

Barrel nut (plastic)

- Used with Titus Hi-Lo™ screws
- Titus barrel nuts provide maximum strip torque for reasonable drive torque
- Capable of multiple reconnection repeatability

Cover caps

- Available in multiple colours
- All recess and head types offered
- High quality engineering polymers used in their construction
- Uniformity of holding with good tolerance
- Wide range of application and use conditions

System 1

Fittings for rigid assembly systems

Hi-Lo™ screw and Barrel nut

- Hi-Lo™ screws have a twin thread for faster insertion
- 'Hi' threads and 'Lo' threads combine to give excellent pull out in chipboard
- Funnel head design means no countersinking
- Steel is case hardened for extra strength

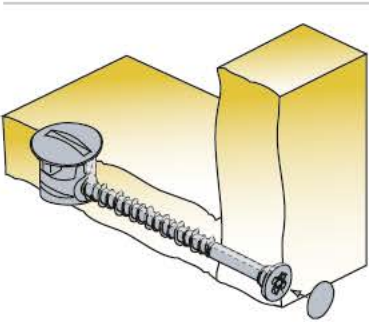

Technical and mounting details

Hi-Lo™ screw

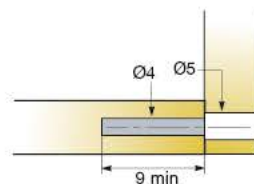
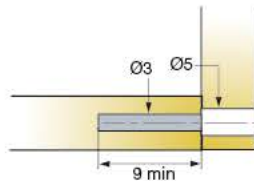

Made of steel

- 10000 Pcs (00062)
- 9000 Pcs (00068)
- 7000 Pcs (00071)
- 4000 Pcs (00077, 00171, 06074)
- 3000 Pcs (00172, 06077, 06080)

Screw diameter	B	L	Drive type	Item number	Black	Phosphate	White
4		24	+	*00062 →		852	
4		28	+	*00068 →		852	
4		33	+	00071 →		852	
4	50	45	+	00077 →		852	
4	50	45	+	*00171 →		852	
4	50	55	+	00172 →		852	
4		38		06074 →		852	
4	45	50	+	*06077 →		852	
5	45	50	+	*06080 →		852	

*American market only

Drive type

hexagonal drive

cross slot

Barrel nut

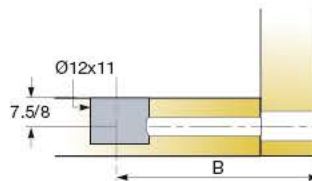

10000 Pcs

Made of plastic

01056 → 835 877

Other colours on request

Screw cap

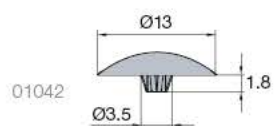
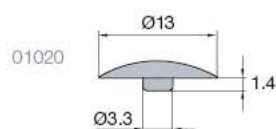

10000 Pcs (01042)
50000 Pcs (01020)

Made of plastic

pozi, philips drive 01020 → 835 877

hexagonal drive 01042 → 835 877

Other colours on request

System 3

Fittings for face and edge boring

System features

Titus System 3 is a two component rigid face and edge drilled fastening with half turn to fasten. System 3 offers almost full concealment and wide tolerances in use.

- Automatic or in-factory placement
- Pre-location pin ensures ease of assembly
- Less than one turn of a screwdriver to fasten
- Shelf edge installation of pin means maximum shelf cut size tolerance
- Can be used on 12mm shelf panels
- No loose parts for maximum convenience in RTA
- Drawer front fixing, cabinet construction

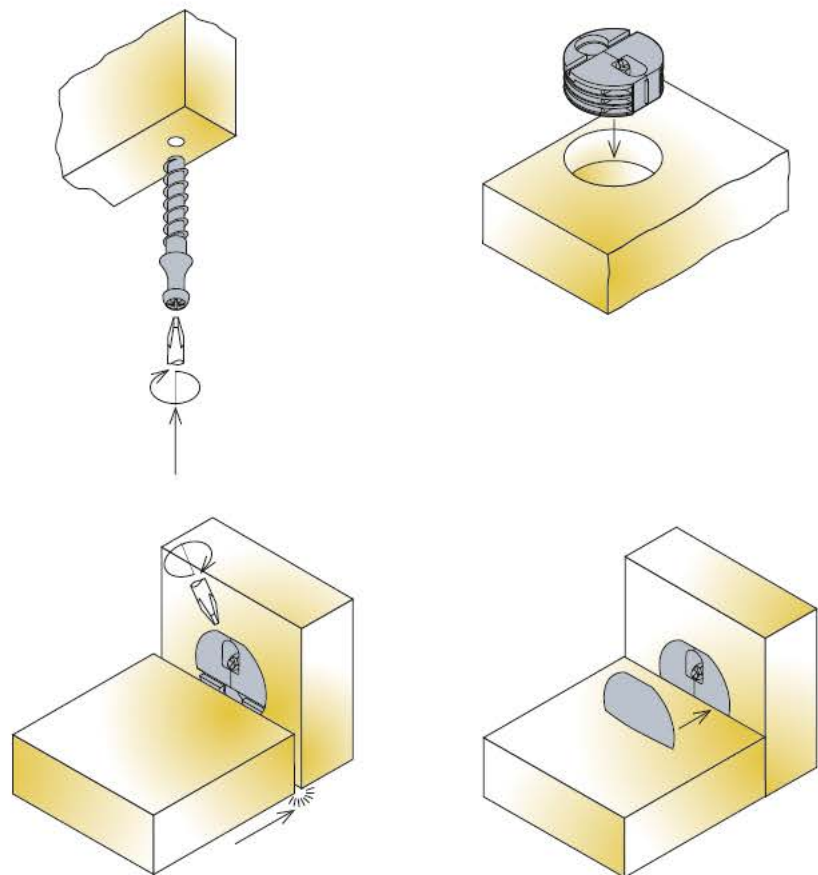









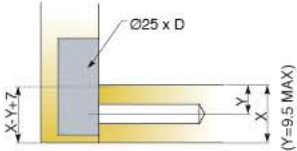

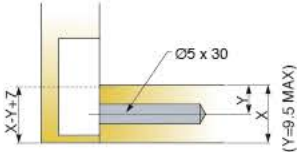
System 3

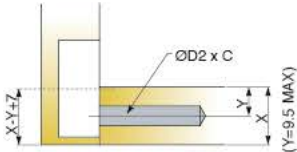
Fittings for face and edge boring

Concealed housing

- One turn locking system reduces assembly time, both in the factory and home
- Pre-assembly feature for consumer convenience
- Choice of dowels to suit drilling
- Hi-Lo screw feature for faster insertion

Technical and mounting details		C	D	D2	Item number	Black	Zinc plated	Yellow passivate	White
		Drilling length for dowel	Drilling depth	Drilling diameter for dowel thread					
Housing assembly 	 Ø25 x D X, Y, Z Y=9.5 MAX X, Y - depends on board thickness		12.5		03118 →	835		877	
			11		03121 →	835			
 2500 Pcs Made of plastic or zinc, plastic		<i>Other colours on request</i>							
Screw dowel Ø5 	 Ø5 x 30 X, Y, Z Y=9.5 MAX X, Y - depends on board thickness				03168 →		883		
		 1000 Pcs Made of steel							
Screw dowel Ø3 	 Ø2 x C X, Y, Z Y=9.5 MAX X, Y - depends on board thickness	30		3.75	03181 →			881	
		 5000 Pcs (03180)  4000 Pcs (03181)  1000 Pcs (03090) Made of steel		9		3	03180 →		881
				25		3	*03090 →		883
Cover cap 					03150 →	835		877	
 15000 Pcs Made of plastic									

System 4 Fittings for face-boring only

System features

Cost effective one piece fittings with face boring benefits

- Flush and block components
- Face-boring only
- Good tolerances
- One piece connectors
- Angledriv versions fastening with maximum driving power and flexibility
- Quickloc™ versions need only one turn to tighten for fast assembly
- Foolproof consumer home insertion

Quickloc™ One-piece connector

The integrated housing and dowel make Quickloc™ the most user-friendly and tolerant product available.

- High degree of drilling tolerance
- Push-in design
- Tool-free insertion
- Integrated expanding housing and dowel provide consistently stronger joints
- 'Klix' locking system

Quickloc™ Assembly

1. Press Quickloc into the face board

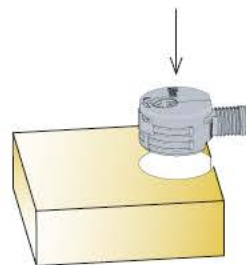

2. Assemble the panels

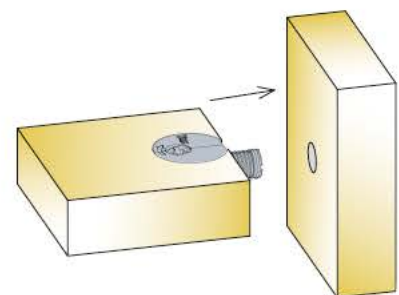

3. Tighten in less than one turn

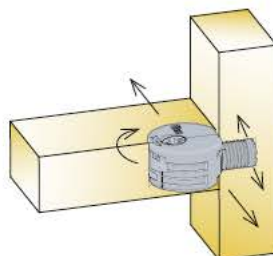

System 4 Quickloc™

One piece expanding connector

- An innovative, one-piece connector, capable of hand insertion
- Is highly tolerant and tightens in less than one turn
- Is a face-bored product
- Offers a high degree of drilling tolerance and is the only connector of its type to provide pull-up of cabinet panels when tightened



Technical and mounting details

Item number	Dark brown	Black	White
06803 →	831	835	877
06806 →	831	835	877
06813 →	831	835	877
06839 →	831	835	877

Quickloc Ø20
flanged

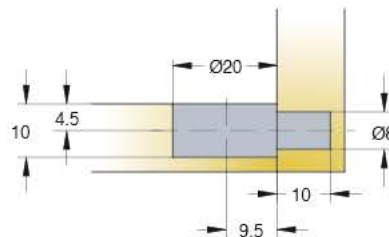
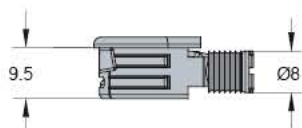

2500 Pcs

Made of zinc, plastic

Quickloc Ø20
flush

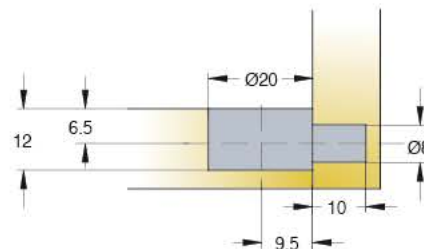
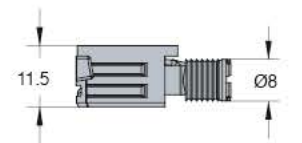

2500 Pcs

Made of zinc, plastic

Quickloc Ø25
flanged

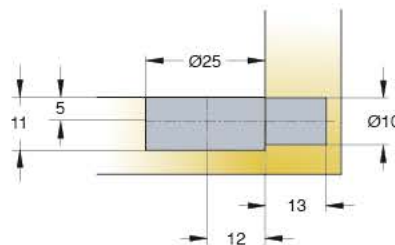
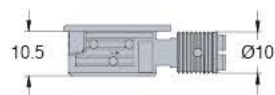

1500 Pcs

Made of zinc, plastic

Quickloc Ø25
flush

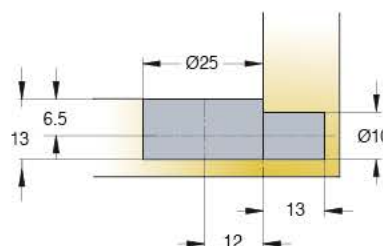
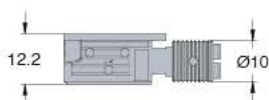







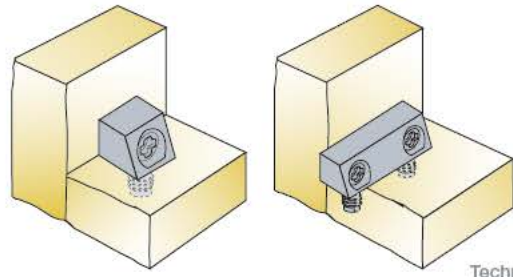

1500 Pcs

Made of zinc, plastic

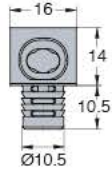
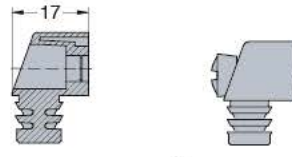
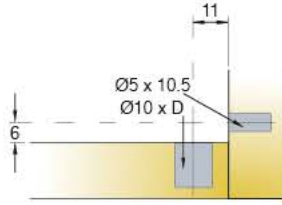
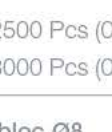
System 4 Fittings for face-boring only

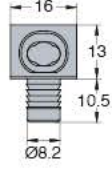
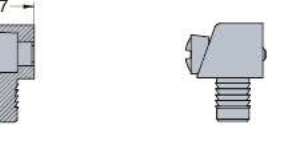
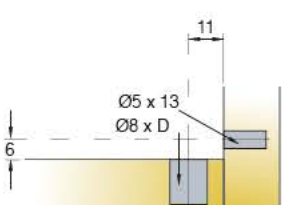
Minibloc™ / Twinbloc™

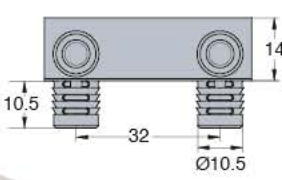
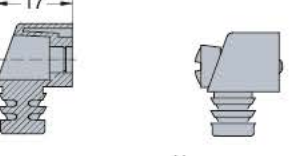
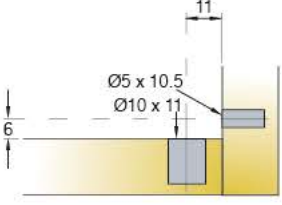
- One-piece connector range
- Face drilling only required
- Easy to use, foolproof home insertion
- Angeldriv screw tolerates good levels of inaccurate drilling increasing consumer confidence

					
Drilling depth	D				
		Dark brown	Black	Silver	White
 <p>Technical and mounting details</p>					
Minibloc Ø10					
					
			2500 Pcs (02107) 3000 Pcs (02120)	Made of zinc, plastic	11 02107 → 831 835 861 877 11 *02120 → 831 835 861 877 <i>* assembly with screw</i> <i>Other colours on request</i>
Minibloc Ø8					
					
			3000 Pcs	Made of zinc, plastic	11 02141 → 835 861 877 11 *02144 → 835 877 <i>* assembly with screw</i> <i>*European market only</i> <i>Other colours on request</i>
Twinbloc Ø10					
					
			1000 Pcs	Made of zinc, plastic	11 02130 → 835 861 877 11 *02139 → 835 877 <i>* assembly with screw</i> <i>Other colours on request</i>

System 5

Cams and dowels

System features

The most advanced cam and dowel range

Titus System 5 is a comprehensive range of cam and dowel connecting fittings with Klix and Quickfit features for all cabinet applications: panel-to-panel, panel-to-hollow profile, back-to-back

Dowels

- **Quickfit TL2, TL4 dowels**
a unique solution for factory pre-insertion, high level of drilling tolerances

- **Quickfit dowels**
quick hand insertion, easy assembly
- **Diecast dowels (zinc)**
precise manufacturing, optimal shape and design
- **Turned dowels (steel)**
'traditional' design, smooth surface, best strength performance
- **Combi dowels (zinc and steel)**
high precision of zinc, strength of steel, 100% dimensional accuracy and optimal performance

Titus Klix™

Titus Klix locking system ensures the engagement of the interlocking teeth on cam and dowel providing:

- vibration-proof joint
- rigid construction that will not loosen in service or transit

Dowel insertion time comparison

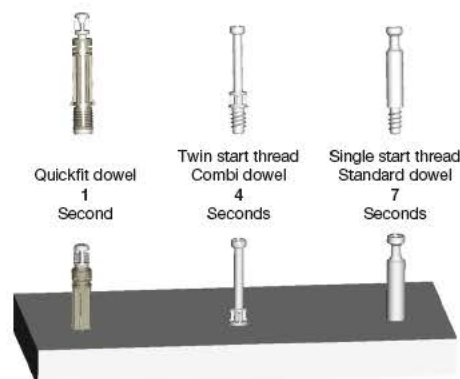

2 o'clock lock Smooth closing

Linear cam profile assures smooth, firm tightening action and greater pull-up. The cam always locks at 2 o'clock lock (230°), enabling greater consumer confidence in use while improving furniture quality.

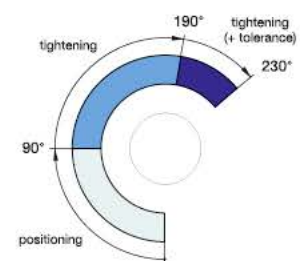

Drilling tolerances

Optimal performance and perfect joint even with inaccurate drillings.

Zinc/Combi dowel

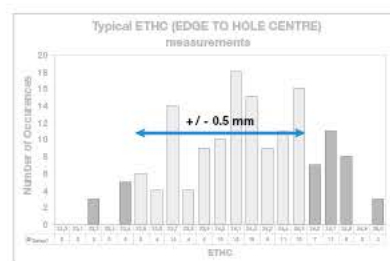
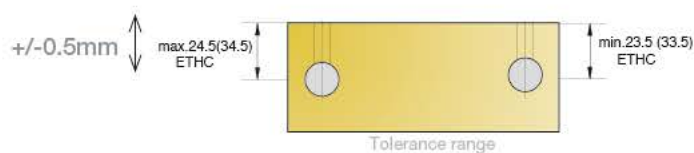

Quickfit TL2 dowel

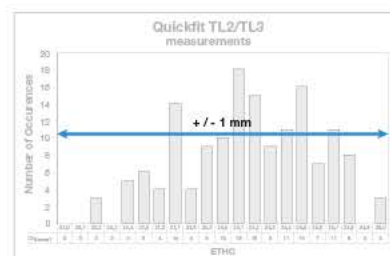
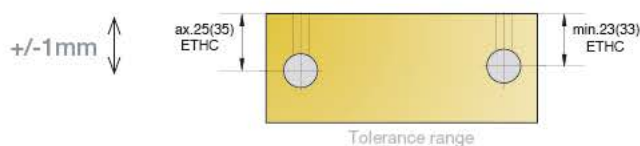

Quickfit TL4 dowel

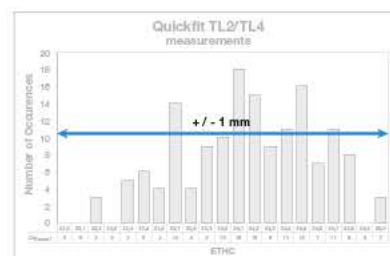
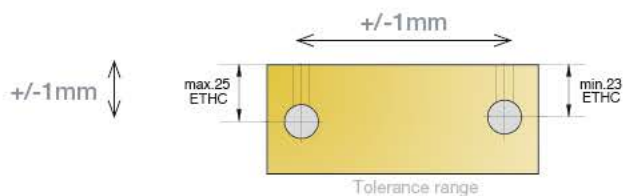

ETHC=Edge To Hole Center

Dowels for factory insertion

Quickfit TL2 and Quickfit TL4 are the only available dowels that allow for factory pre-insertion

- Easier packing
- Less damages in handling
- Perfect for the RTA market

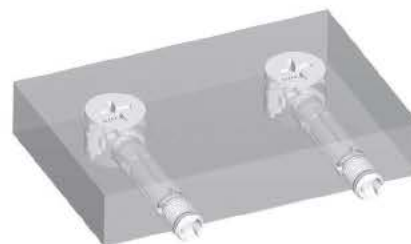

System 5 Cams and dowels

Zinc+steel Combi dowels

Zinc+steel technology for optimal strength and performance

The Combi dowel combines steel and a small amount of zinc to ensure high precision and dimensional accuracy, essential to provide furniture manufacturers with the broadest possible range of drilling tolerances.

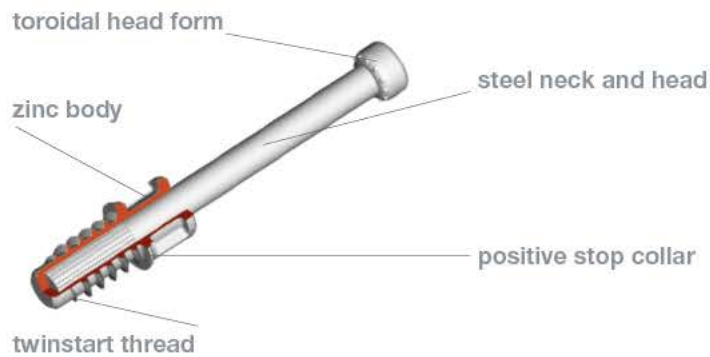

The steel neck and head provide better resistance to torsion and pull-out enabling a high performance joint

Zinc body:
Positive stop collar ensures correct insertion depth
Twinstart for faster and more stable insertion

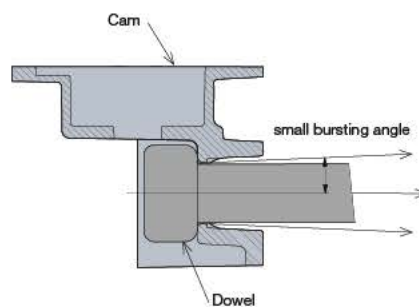

The toroidal dowel head form transfers the forces between cam and dowel more effectively resulting in a small cam bursting force.

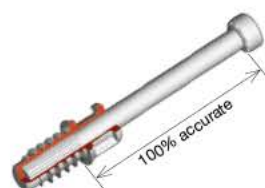

100% dimensional accuracy assured

System 5

Cams and dowels

Quickfit connectors

It is the fastest assembly system on the market. The Quickfit™ dowel may be inserted by hand, using only finger pressure. This eliminates the labour intensive process of screw-in assembly and the potential panel damage.

The Quickfit™ range of dowels has been extended to provide a complete family of fittings available in diameters of 5mm, 8mm and 10mm and lengths of 24mm and 34mm. These dowels are compatible with the range of Titus Ø15mm cams.

Assembly

1. Press the cam into face board

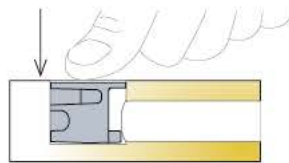

2. Insert the dowel into side panel

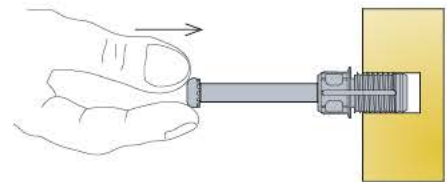

3. Assemble the panels

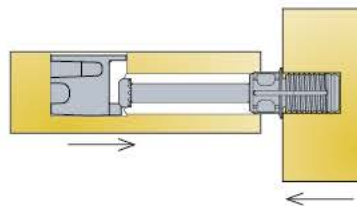

4. Tighten the cam to lock dowel

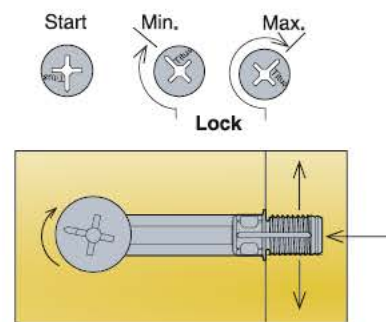

5. Assembled panels

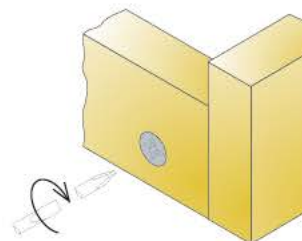

System 5

Cams and dowels

Quickfit TL connectors

Quickfit-TL™ dowel offers furniture manufacturers a fast assembly system providing high drilling tolerances. It has a built-in self-adjustment feature, which enables common drilling inaccuracies to be overcome.

For the self-assembly furniture consumer, Titus Quickfit-TL™ is the most consumer friendly fitting on the market. Apart from the benefit of fully tightened joints and easy locking into the same position, Quickfit-TL™ provides an exceptionally smooth action when tightened, requiring very little effort.

Drilling tolerances

Marginal inconsistencies of drilling and the problems associated with the natural movement of wood panels, no longer present problems.

Quickfit-TL™ provides a tolerance of $+1/-1$ mm on drilling operation while ensuring that the final result is a perfectly precise and aligned joint. No other assembly fittings system can offer such tolerances and still maintain a perfect joint.

Assembly

1. Press the cam into face board



2a. Either push dowel into edge hole or...

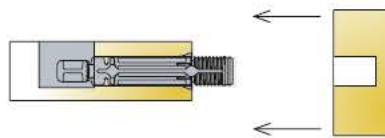

2b. Insert the dowel into side panel

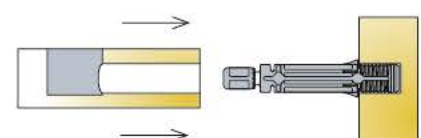

3. Assemble the panels

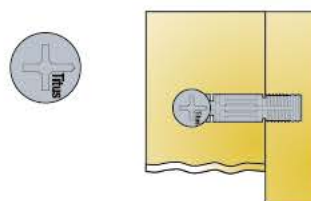

4. Tighten cam to lock dowel

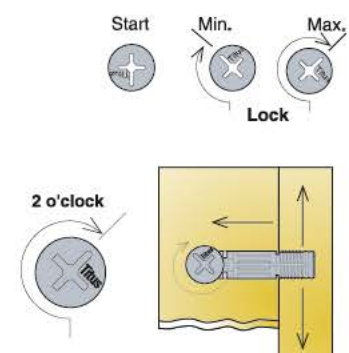

System 5

Cams and dowels

Quickfit-TL dowels

- Available in Ø5mm and Ø8mm for panel-to-panel applications
- Suitable for use with all Ø15mm Cam2000 and Cam3000 products
- 'Klix' locking feature provides a strong, vibration proof joint
- Highly tolerant in edge-inserted, TL3 also in face-inserted applications

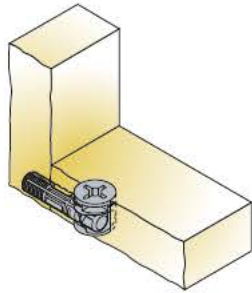

Technical and mounting details

Quickfit-TL2

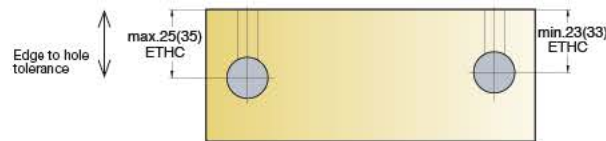
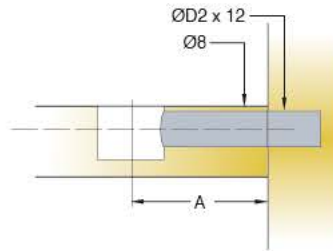

Tolerance range

2000 Pcs
1000 Pcs (05474) Made of zinc, plastic

Quickfit-TL4

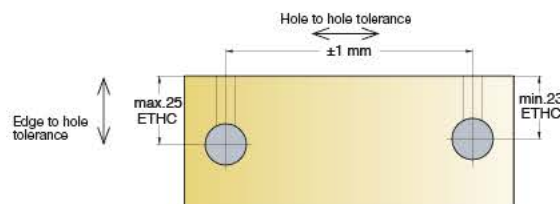
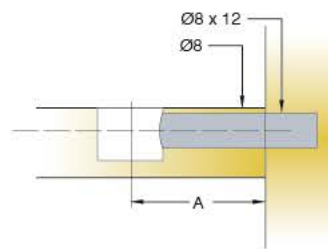

Tolerance range

2000 Pcs
Made of zinc, plastic

A	D2	Item number	Black	Dark grey
Drilling distance	Drilling diameter for dowel thread			
24	5	05453 →	880	
34	5	05503 →	880	
24	8	05441 →	880	
34	8	05474 →	880	
24	8	05388 →	835	

System 5

Cams and dowels

Quickfit-P2F dowels

- The only product to enable standard panel drilling and connection of panel and hollow profile
- Available in Ø8mm for panel-to-hollow profile applications
- Suitable for use with all Ø15mm Cam2000 and Cam3000 products
- 'Klix' locking feature provides a strong, vibration proof joint

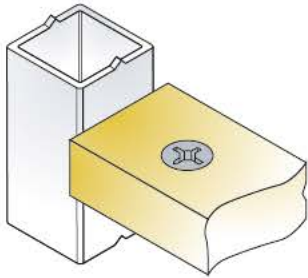

Technical and mounting details

A	Item number	Black
---	-------------	-------

Quickfit - P2F

24	05414 →	835
----	---------	-----

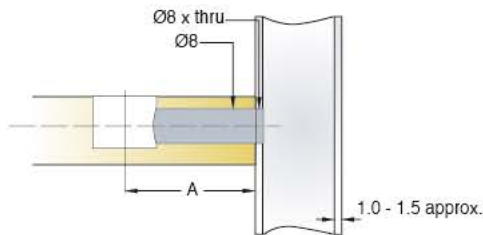
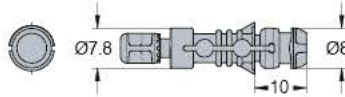

 2000 Pcs

Made of zinc, plastic

System 5

Cams and dowels

Combi dowel

- High quality zinc-steel dowel with greater resistance to torsion and pull-out
- Suitable for use with all Ø12mm and Ø15mm Cam2000 and Cam3000 products
- 'Klix' locking feature provides a strong, vibration proof joint
- Twinstart thread for faster and reliable insertion

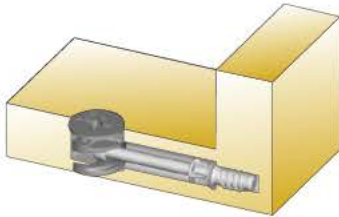

Technical and mounting details

Combi dowel Ø5

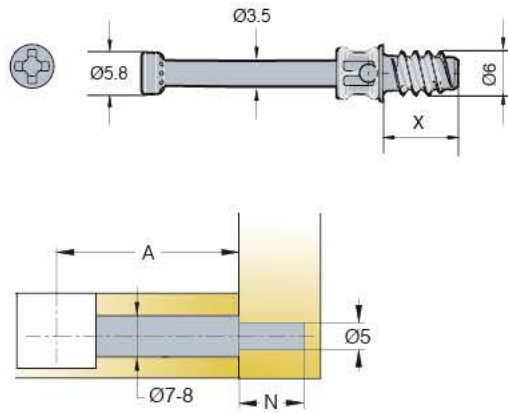

1000 Pcs
*2000 Pcs

Made of steel and zinc

Combi dowel M6

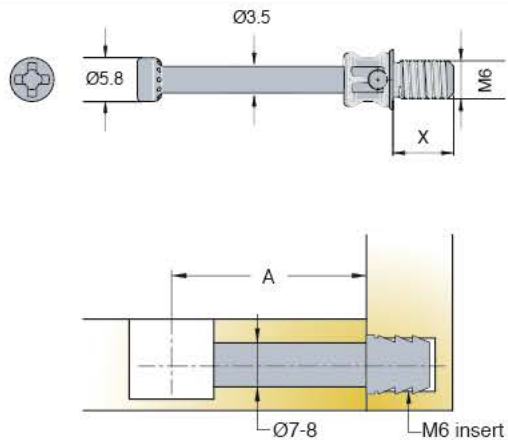

1000 Pcs

Made of steel and zinc



Inserts
Made of zinc

→ see page 1.41



Inserts
Made of plastic

→ see page 1.42

A	N	X	Item number	Zinc
12	11.5	11	09435 →	885
9	8.5	9.5	09588 →	885
24	12	11	09443 →	885
24	9	8.5	09583 →	885
34		8	09592 →	885
34		10.5	09594 →	885

System 5

Cams and dowels

Zinc dowel

Zinc dowel Ø5
Full body

PZ2 head
Blade head

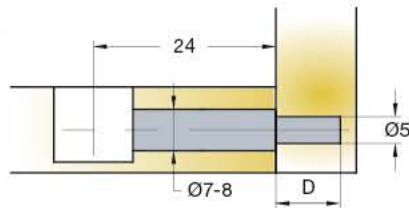
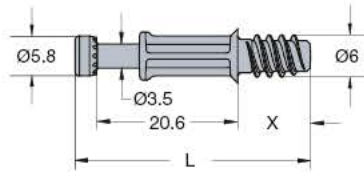

2000 Pcs

Made of zinc

Combi dowel Ø7

Phillips PH2 head

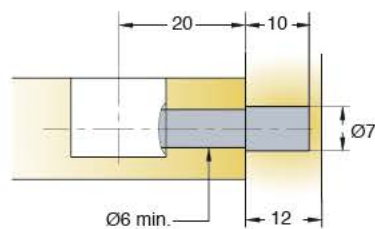
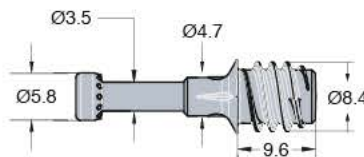

1000 Pcs

Made of steel and zinc

Inserts
Made of plastic

→ see page 1.42

D	X	L		
Drilling depth	Thread length	Total length	Item number	Zinc
12	11.5	35.3	09605 →	885
9	8.5	32.3	09607 →	885

		20	09430 →	885
--	--	----	----------------	-----

System 5

Cams and dowels

Double-ended dowel

- Available in Ø7mm
- Suitable for use with all Ø12mm and Ø15mm Cam2000 and Cam3000 products
- No circlip for increased tolerance
- Available in a variety of lengths to suit most panel-to-panel applications

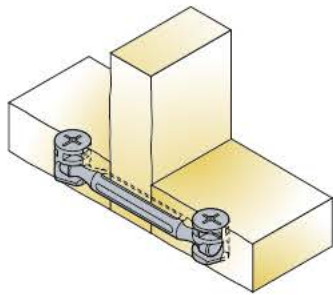

Technical and mounting details

Dowel without circlip

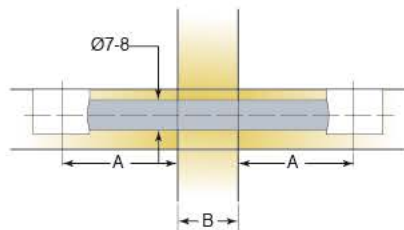
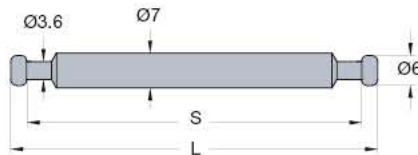

250 Pcs (05753)
500 Pcs
1000 Pcs (05929,05857)

Made of steel

Dowel with circlip

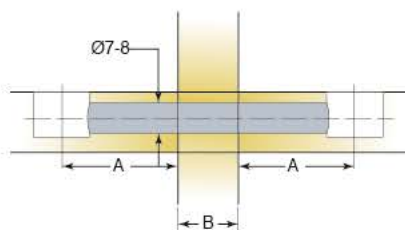
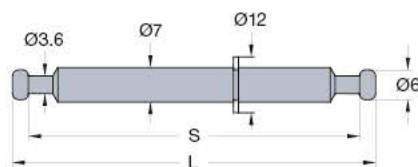

250 Pcs
500 Pcs (05775, 05774)

Made of steel

S	L	A	B	Item number	Zinc plated
		Drilling distance	Panel thickness		
41	47.4	24	0*	05929 →	883
61	67.4	34	0*	05757 →	883
77	83.4	34	16	05858 →	883
79	85.4	34	18	05859 →	883
80	86.4	34	19	05753 →	883
56	62.4	24	15	05592 →	883
57	63.4	24	16	05857 →	883
59	65.4	24	18	05380 →	883
60	66.4	24	19	05778 →	883
*B=0 → no panel required					
77	83.4	34	16	05752 →	883
79	85.4	34	18	05772 →	883
80	86.4	34	19	05751 →	883
57	63.4	24	16	05775 →	883
60	66.4	24	19	05774 →	883

System 5

Cams and dowels

Angled dowels

- Suitable for applications requiring angled joints
- Suitable for use with all Ø12mm and Ø15mm Cam2000 and Cam3000 products
- Adjustable angle from 90° to 180°

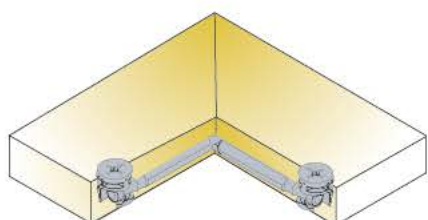

Technical and mounting details

Item number

Zinc plated

Angled dowel

05860 →

883

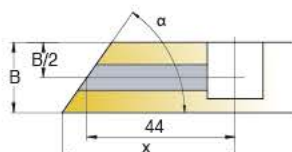
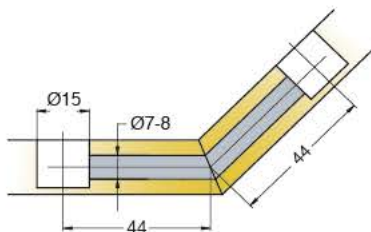

Distance x in mm

α	20°	25°	30°	35°	40°	45°	50°	55°	60°	65°	67,5°	70°	75°	80°	85°
13	61.9	57.9	55.3	53.5	51.7	50.5	49.5	48.6	47.8	47	46.7	46.4	45.7	45.1	44.6
15	64.6	60.1	57	54.7	52.9	51.5	50.3	49.3	48.3	47.5	47.1	46.7	46	45.3	44.7
16	66	61.2	57.9	55.4	53.5	52	50.7	49.6	48.6	47.7	47.3	46.9	46.1	45.4	44.7
B 18	68.8	63.3	59.6	56.9	54.7	53	51.6	50.3	49.2	48.2	47.7	47.3	46.4	45.6	44.8
19	70.1	64.4	60.5	57.6	55.3	53.5	52	50.7	49.5	48.4	47.9	47.5	46.5	45.7	44.8
22	74.2	67.6	63.1	59.7	57.1	55	53.2	51.7	50.4	49.1	48.6	48	46.9	45.9	45
23	75.6	68.7	63.9	60.4	57.7	55.5	53.6	52.1	50.6	49.4	48.8	48.2	47.1	46	45

 250 Pcs

Made of steel

System 5

Cams and dowels

Ø15mm Cam3000

- Its optimised shape provides a more efficient cam profile with smooth tightening action and greater dowel pull-up
- Suitable for use with Combi dowels, forged steel dowels, Quickfit dowels and Quickfit TL2 dowels
- 'Klix' locking feature provides a strong, vibration proof joint
- Cam-retaining pips ensure that a cam is held in panel position prior to assembly

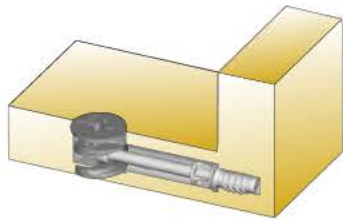

Technical and mounting details

Cam3000 cross drive

PZ2 drive

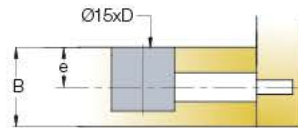
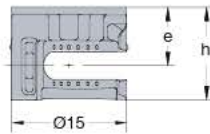

1000 Pcs

Made of zinc

Cam3000 hexagonal drive

combined drive with HEX

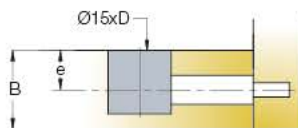
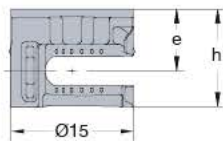

1000 Pcs

Made of zinc

B	D	e	h	Item number	Zinc
Panel thickness	Drilling depth	Drilling for dowel	Cam height		
12/13	10.5	6 min	9.9	09495 →	885
15/16	12.5	7.5-8	11.9	09533 →	885
<i>Black available upon request</i>					
15/16	12.5	7.5-8	11.9	09537 →	885
18/19	14	9-9.5	13.2	09536 →	885
<i>Use standard cover caps with pin=Ø4mm</i>					
<i>Black available upon request</i>					

System 5

Cams and dowels

Ø15mm Cam3000 S

- Innovative design offers optimal performance with maximum cost effectiveness
- Suitable for use with Combi dowels, forged steel dowels and Quickfit dowels
- 'Klix' locking feature provides a strong, vibration proof joint
- Cam-retaining pips ensure that a cam is held in panel position prior to assembly

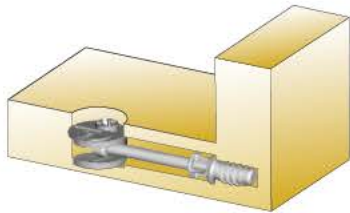

Technical and mounting details

B	D	e	Item number	Zinc	Zinc corrosil
Panel thickness	Drilling depth	Drilling for dowel			

Cam3000 S/15

PZ2 drive

15/16	12.5	7.5-8	09491 →	885	897
-------	------	-------	----------------	-----	-----

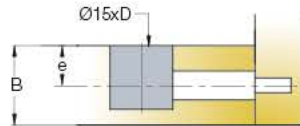
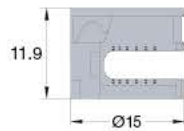

1000 Pcs

Made of zinc

Cam3000 S/12

PZ2 drive

12 min		6 min	*09406 →	885	897
--------	--	-------	-----------------	-----	-----

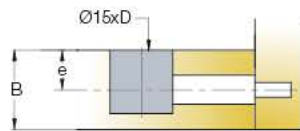
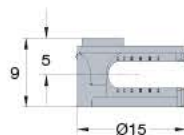

* European market only

2000 Pcs

Made of zinc

Cam3000 S/12

Phillips PH2 drive

12 min	9.5 min	6 min	*09631 →	885	
--------	---------	-------	-----------------	-----	--

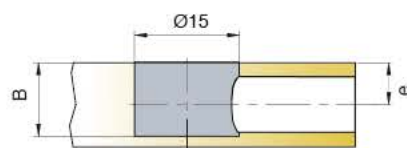
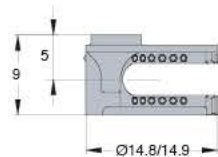

* American market only

1000 Pcs

Made of zinc



Cover caps
Made of plastic





09630

System 5

Cams and dowels

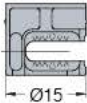
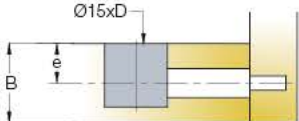
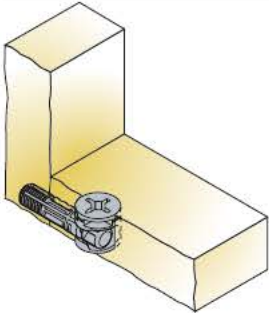
Ø15mm Cam2000

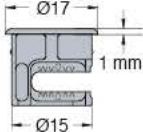
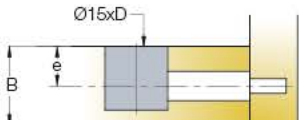
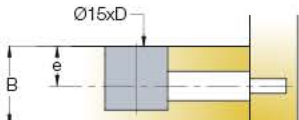
- Available in a variety of head, drive recess and board thickness versions to suit most applications
- Suitable for use with all Titus dowels
- "Klix" locking feature provides a strong, vibration proof joint
- Linear cam profile results in smooth, easy cam rotation and dowel pull-up

Technical and mounting details		B	D	e	Item number	Nickel	Zinc		
		Panel thickness	Drilling depth	Drilling for dowel					
Cam2000 Ø15   		12/13	10min	6-6.5	*05587 →	847	885		
		12/13	10.9	6-6.5	05653 →	847	885		
		15/16	12.7	7.5-8	05644 →	847	885		
		15/16	12.7	7.5-8	05654 →	847	885		
		18/19	14	9-9.5	05656 →	847	885		
		22/23	16	11-11.5	05657 →	847	885		
		25/26	17.9	12.5-13	05676 →	847	885		
		28/29	19.4	14-15.5	05678 →	847	885		
		<i>Other finishes on request</i> *Ultraflat - specially designed for thin panels (does not work with TL dowels)							
		 500 Pcs (05676, 05678) 1000 Pcs	Made of zinc						
Cam2000 Ø15 headed   		12	10min	6	*05586 →	847	885		
		13	10.9min	6.5	05652 →	847	885		
		16	12.9	8	05658 →	847	885		
		19	13	9.5	05659 →	847	885		
		23	14.5	11.5	05675 →	847	885		
		26	16.5	13	05677 →	847	885		
		29	19.4	14.5	05679 →	847	885		
		<i>Other finishes on request</i> *Ultraflat - specially designed for thin panels (does not work with TL dowels)							
		 500 Pcs (05675, 05677, 05679) 1000 Pcs	Made of zinc						

 **Cover caps for Ø15 cams** → see page 1.43
 Made of plastic

System 5

Cams and dowels

Ø12mm Cam2000

- Suitable for all Titus screw-in dowels
- Available in a variety of head, drive recess and board thickness versions to suit most applications
- Particularly suited to drawer front attachment applications
- 'Klix' locking feature provides a strong, vibration proof joint
- Linear cam profile results in smooth, easy cam rotation and dowel pull-up

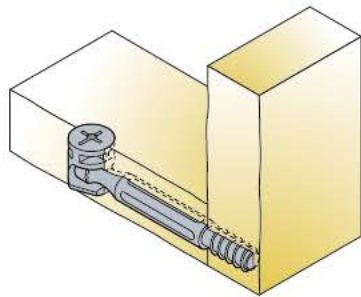

Technical and mounting details

Cam2000
Ø12

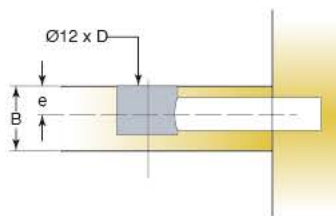
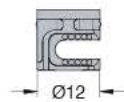

2000 Pcs

Made of zinc

Cam2000
Ø12 headed

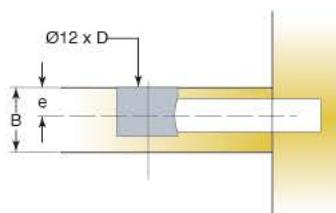
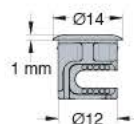

1000 Pcs

2000 Pcs (05576)

Made of zinc

Cover caps for Ø12 cams
Made of plastic

→ see page 1.43

B	D	e	Item number	Black painting plate	Nickel plated	Zinc	Corrosil zinc
Panel thickness	Drilling depth	Drilling for dowel					
12/13	10 min	6-6.5	05575 →	838	847	885	897
15/16	12	7.5-8	05578 →			885	
18/19	13 min	9-9.5	05580 →			885	
<i>Other finishes on request</i>							
12	9.2 min	5.25	05574 →	838	847	885	897
12	10 min	6	05576 →			885	
16	12.5	8	05579 →			885	
<i>Other finishes on request</i>							

System 6

Quickfit-Expando connectors

System features

A face boring connector family for 32mm system drilling with full range of panel and application variants for all cabinet manufacturing applications

- Minimum drilling requirements
- Linear cam design for constant tightening loads when driving
- Angledriv feature on cam for maximum driving comfort
- Interchangeable pins for wood, plastic and steel applications
- Pins with twinstart drive for fast insertion
- Interchangeable Quickfit pin fastenings available
- Toolless fastening capable versions
- Back-to-back fastenings for common vertical panel fixing of shelves

System 6 consists of a range of 20mm and 25mm diameter housings, Quickfit™ and conventional dowels, end dowels and double ended dowels.

Housings are made from high grade plastic or zinc, with zinc cams.

Wedgex-6 connector is a special fastener without cam, simply to snap onto a pre-inserted dowel.

Applications

Titus System 6 is ideal for use in high volume production of case goods, closet and garage storage systems. Because no edge boring is required, it

is an excellent choice for manufacturing environments with limited drilling capacity.

Side-entry Drop-on

Side-entry insertion of shelf panel: from the side or from the top

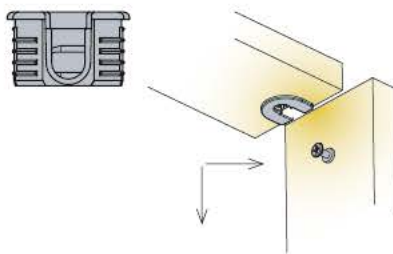

Drop-on insertion of shelf panel: only from the top
Using drop-on connections allows for one-man installation

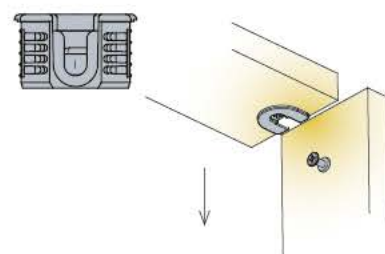

Angledriv feature

The angledriv feature on the cam allows for the angled position of the screwdriver with the locking action creating a tight and secure joint.

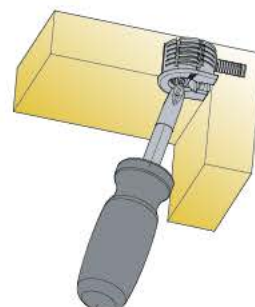

System features

Outrigger/ Non outrigger

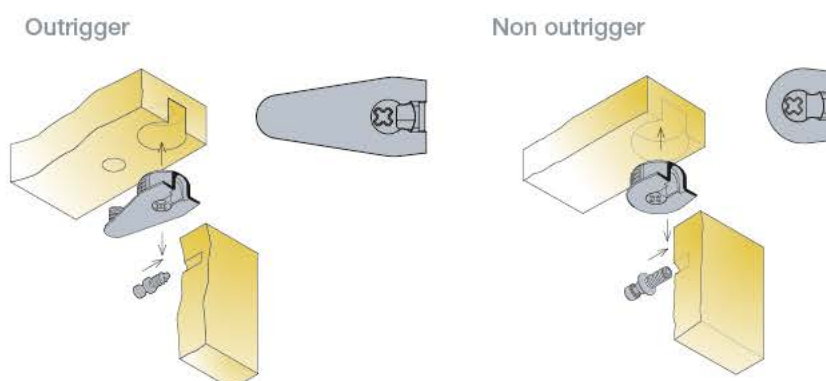

Expando function

Expanding housings and dowels provide a tight joint.



Assembly

1. Press the housing into face board

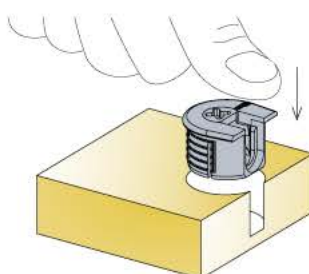

2. Press the dowel into side panel

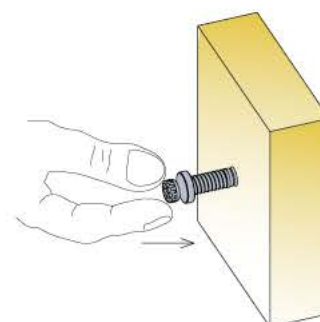

3. Assemble the panels

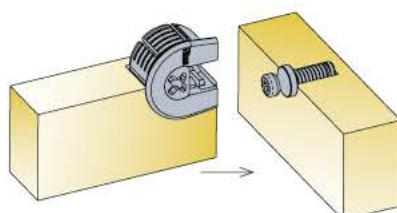

4. Tighten the joint

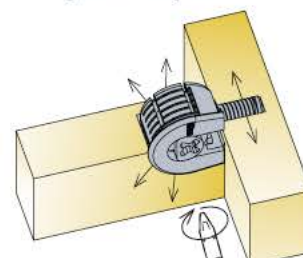

System 6





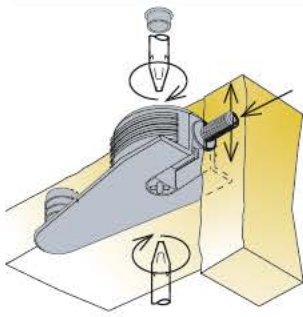

Quickfit-Expando

Expanding dowels

- Available in Ø5mm, Ø8mm and Ø10mm for panel-to-panel, panel-to-hollow profile and back-to-back applications
- Suitable for applications with all Titus Ø20 and/or Ø25mm Expando-6 housings
- 'Klix' locking feature provides a strong, vibration proof connection
- Depth stop collar for accurate insertion

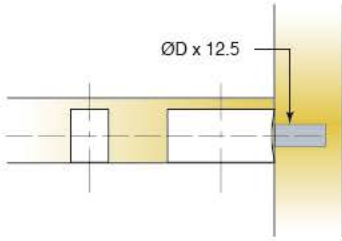

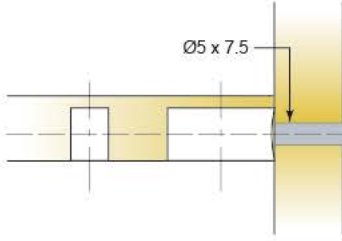







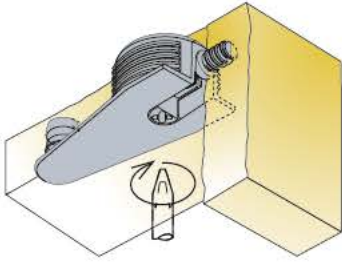

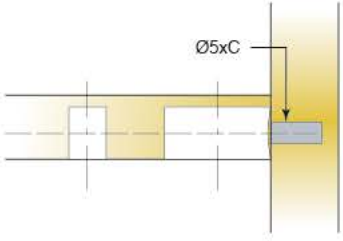



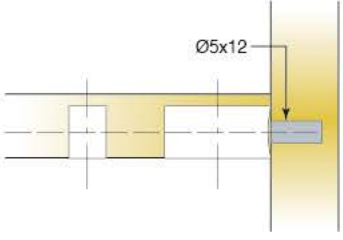

Technical and mounting details

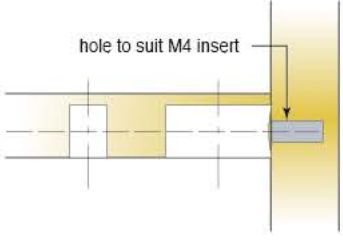
		D		
		Drilling diameter for dowel thread	Item number	Dark grey
				Black
Dowel		5	06408 →	880
		8	06410 →	880
 <p>D= Ø5mm</p>  <p>D= Ø8mm</p>	 <p>ØD x 12.5</p>			
 5000 Pcs	Made of zinc, plastic			
Dowel Ø5 x 7.5 back-to-back applications		 <p>Ø5 x 7.5</p>	06479 →	880
 5000 Pcs	Made of zinc, plastic			

System 6 Quickfit-Expando Dowels

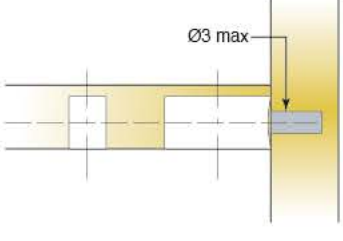
- Available in various Ø3mm and/or Ø5mm thread forms for screw-in, knock-in and/or 'spiked' hole applications
- Suitable for applications with all Titus Ø20mm and/or Ø25mm Expando-6 housings
- 'Klix' locking feature provides a strong, vibration proof connection
- Dowels feature an integral skirt which acts as a positive stop during insertion

Technical and mounting details			C			
			Drilling depth for dowel thread	Item number	Zinc	Zinc plated
						
Dowel Ø5			9	06401 →	885	
  			8	06402 →	885	883
			11.5	06406 →	885	883
				06403 →	885	
						
Dowel M4 x 7				06405 →		883
  						
Dowel Ø3 x 11.5				06495 →		883
  						

 2000 Pcs Made of zinc or steel

 2000 Pcs Made of zinc

 4500 Pcs Made of steel

 12500 Pcs Made of steel

 Inserts
Made of plastic → see page 1.42

System 6

Quickfit-Expando

Double-ended dowels

- For 16mm, 18mm and 19mm board
- Suitable for applications with all Titus Ø20mm and/ or Ø25mm Expando-6 housings
- 'Klix' locking feature provides a strong, vibration proof connection

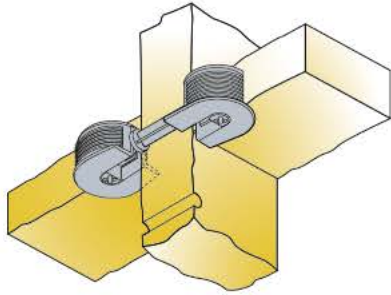

Technical and mounting details

Double-ended dowel

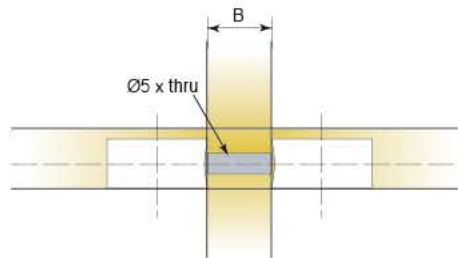

Panel thickness	Item number	Zinc
16	06414 →	885
18	06413 →	885
19	06416 →	885

2500 Pcs

Made of zinc

System 6

Quickfit-Expando

20mm expanding housing
non-outrigger

- Available in 15mm/16mm and 18mm/19mm versions for drop-on and/or side-entry applications
- Available in all-metal or plastic/metal options
- 'Klix' locking feature provides a strong vibration proof connection
- Compatible with all screw-in and Quickfit-6 dowels







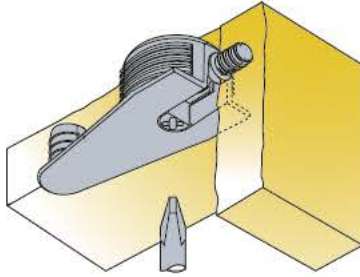

Technical and mounting details		e	B	D	Item number	Dark brown plastic	Nickel plated	Silver plastic	White plastic
Side-entry		8	15/16	12.5	06451 →	847			
		9.5	18/19	14	06453 →	847			
500 Pcs Made of zinc									
Side-entry		8	15/16	12.5	06435 →	831	861	877	
		9.5	18/19	14	06437 →	831	861	877	
2500 Pcs Made of plastic		Other colours on request							
Drop-on		8	15/16	12.5	06447 →	847			
		9.5	18/19	14	06449 →	847			
500 Pcs Made of zinc									
Drop-on		8	15/16	12.5	06431 →	831	861	877	
		9.5	18/19	14	06433 →	831	861	877	
2500 Pcs Made of plastic		Other colours on request							

System 6

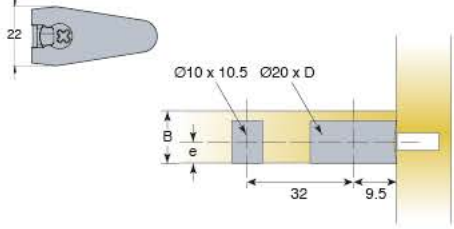
Quickfit-Expando

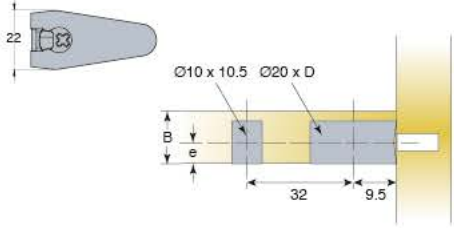
20mm expanding housing outrigger

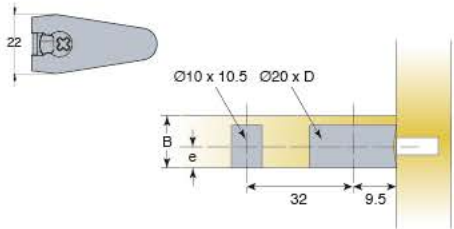
- Available in 15mm/16mm and 18mm/19mm versions for drop-on and/or side-entry applications
- Available in all-metal or plastic/metal options
- 'Klix' locking feature provides a strong vibration proof connection
- Compatible with all screw-in and Quickfit-6 dowels

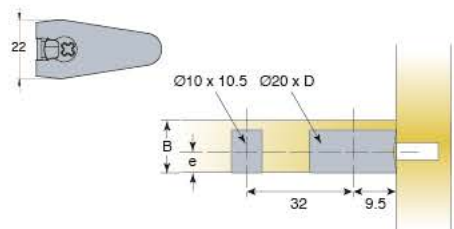
 Technical and mounting details		e	B	D	Item number				
						Dark brown plastic	Black plastic	Nickel plated	White plastic
Side-entry  500 Pcs Made of zinc		8	15/16	12.5	06459 →				847
		9.5	18/19	14	06461 →				847
Side-entry  1250 Pcs Made of plastic		8	15/16	12.5	06443 →				877
		9.5	18/19	14	06445 →	831	835		877
		9.5	18/19	14	*06395 →		835		877
<i>Other colours on request *American market only</i>									
Drop-on  500 Pcs Made of zinc		8	15/16	12.5	06455 →				847
		9.5	18/19	14	06457 →				847
Drop-on  1250 Pcs Made of plastic		8	15/16	12.5	06439 →			835	877
		9.5	18/19	14	06441 →	831	835		877
		9.5	18/19	14	*06397 →		835		877
<i>Other colours on request *American market only</i>									

System 6

Quickfit-Expando

Expanding Wedgefix housing (no inner cam)

- Available in 12mm, 15mm/16mm and/or 18mm/19mm versions for Quickfit-6 and/or Standard Dowel applications
- Available in a variety of plastic colours
- Wedgefix-6 housing allows easy customer hand-assembly or factory automated insertion
- When used with Quickfit-6 dowels this provides a true toolless fastening system

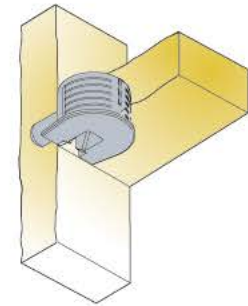

Technical and mounting details

Panel thickness	Drilling depth	Item number	Colours			
			White	Black	Dark brown	Silver
12	10	06470 →	877			861
15/16	12.5	06473 →	877	835	831	861
18/19	14	06465 →	877	835	831	861
22	16	06464 →				861
<i>Other colours on request</i>						
15/16	12.5	06471 →	877	835	831	861
18/19	14	06472 →	877	835	831	861
<i>Other colours on request</i>						

For use with screw-in dowels

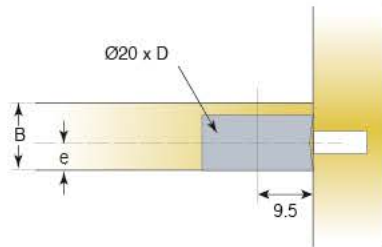
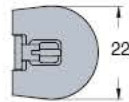

2500 Pcs

Made of plastic

For use with Quickfit dowels

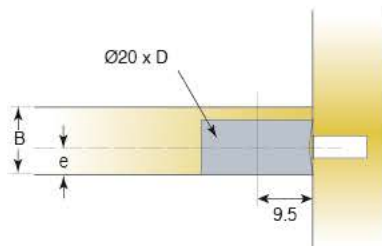
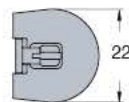







2500 Pcs

Made of plastic

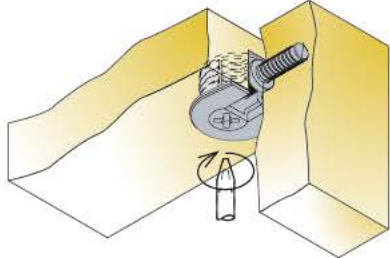
System 6

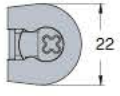
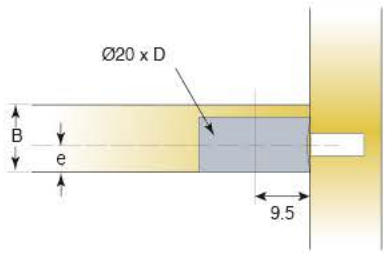
20mm knock-in housing non-outrigger

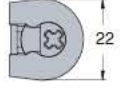
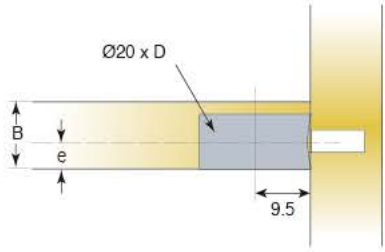
- Available in 15mm/16mm and 18mm/19mm versions for drop-on and/or side-entry applications
- Available in all-metal or plastic/metal options
- 'Klix' locking feature provides a strong vibration proof connection
- Compatible with all screw-in and Quickfit-6 dowels

Technical and mounting details		B	D	Item number	Silver plastic	White plastic
		Panel thickness	Drilling depth			
Side-entry   		15/16	12.5	06381 →	861	877
		18/19	14	06385 →	861	877
 2500 Pcs Made of plastic		Product available on American and Asian market only Other colours on request				
Drop-on   		15/16	12.5	06383 →	861	877
		18/19	14	06387 →	861	877
 2500 Pcs Made of plastic		Product available on American and Asian market only Other colours on request				

 Cover cap 06463
Made of plastic

System 7





High strength connectors Contract fix™ system

- High performance fastener
- Thread design gives repeatability
- Multi-drive recess
- Higher than average pull up

 <p>Technical and mounting details</p>	 <p>Item number Zinc plated Zinc</p>
<p>M6 Dowel 7x34</p>   <p>1000 Pcs Made of steel</p>	<p>05971 → 883</p>
<p>Housing cylinder 15x12</p>   <p>1000 Pcs Made of zinc</p>	<p>05960 → 885</p>
<p>Grub screw</p>   <p>2500 Pcs Made of zinc</p>	<p>05917 → 885</p>
<p>  Inserts Made of zinc → see page 1.41 </p>	

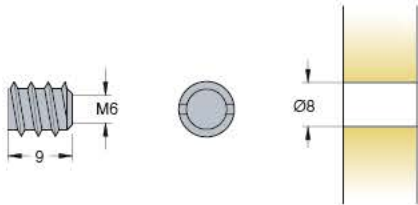
Accessories for connectors

Inserts

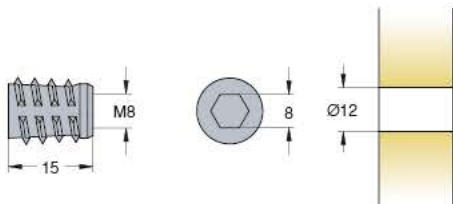
		Technical and mounting details	Item number	Raw
Ø8 x 9			408.3166. →	600
 500 Pcs	Made of zinc			
Ø9 x 13			408.3391 →	600
 1000 Pcs	Made of zinc			
Ø9.5 x 18			408.3423. →	600
 1000 Pcs	Made of zinc			
Ø12 x 15			408.3424. →	600
 1000 Pcs	Made of zinc			

- Available in both zinc and plastic for use in various applications
- Suitable for use with various threaded dowels
- Suitable for use with various panel thicknesses
- Knock-in and screw-in versions available

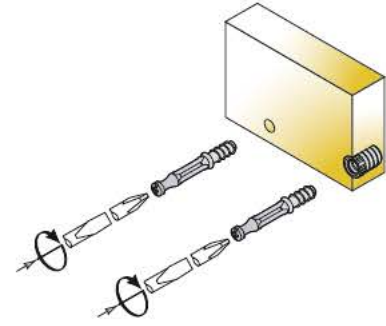

Technical and mounting details		C	Drilling length for insert	Item number	Natural white	Natural
Ø10 x 13/M6 nut   	 20000 Pcs (275.4035.)  30000 Pcs (275.4058.)	Made of plastic	13	275.4035. →	200	
			11	275.4058. →	200	
Ø8 x 10/M4 nut  	 50000 Pcs	Made of plastic		276.4036. →	200	
Euro thread  	 10000 Pcs	Made of plastic		twinstart thread 02182 →	846	

Accessories for connectors

Cover caps

- Available in a variety of colours
- Suitable for use with both pozi and hex cam drive features
- Suitable for use with various diameter cams
- Both domed and flat versions available

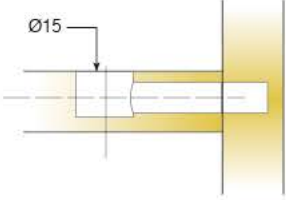
				X					
		Technical and mounting details		Item number	Dark brown	Black	Light brown	Light grey	
	Cover cap Ø17			3.3	*01029 →	834	835	867	882
				2.5	277.4355. →	370	390	330	380
 1000 Pcs	Made of plastic	<i>*American market only Other colours on request</i> <i>Suitable for cams with Pozi 2 recess</i>							
Cover cap Ø17			277.4225. → 370 390 330 380						
			<i>Other colours on request</i> <i>Suitable for cams with Hex recess</i>						
 1000 Pcs	Made of plastic								
Cover cap Ø29.5			275.4034. → 370 390 330 380						
			<i>Other colours on request</i>						
 500 Pcs	Made of plastic								

Glissando

Soft closing systems

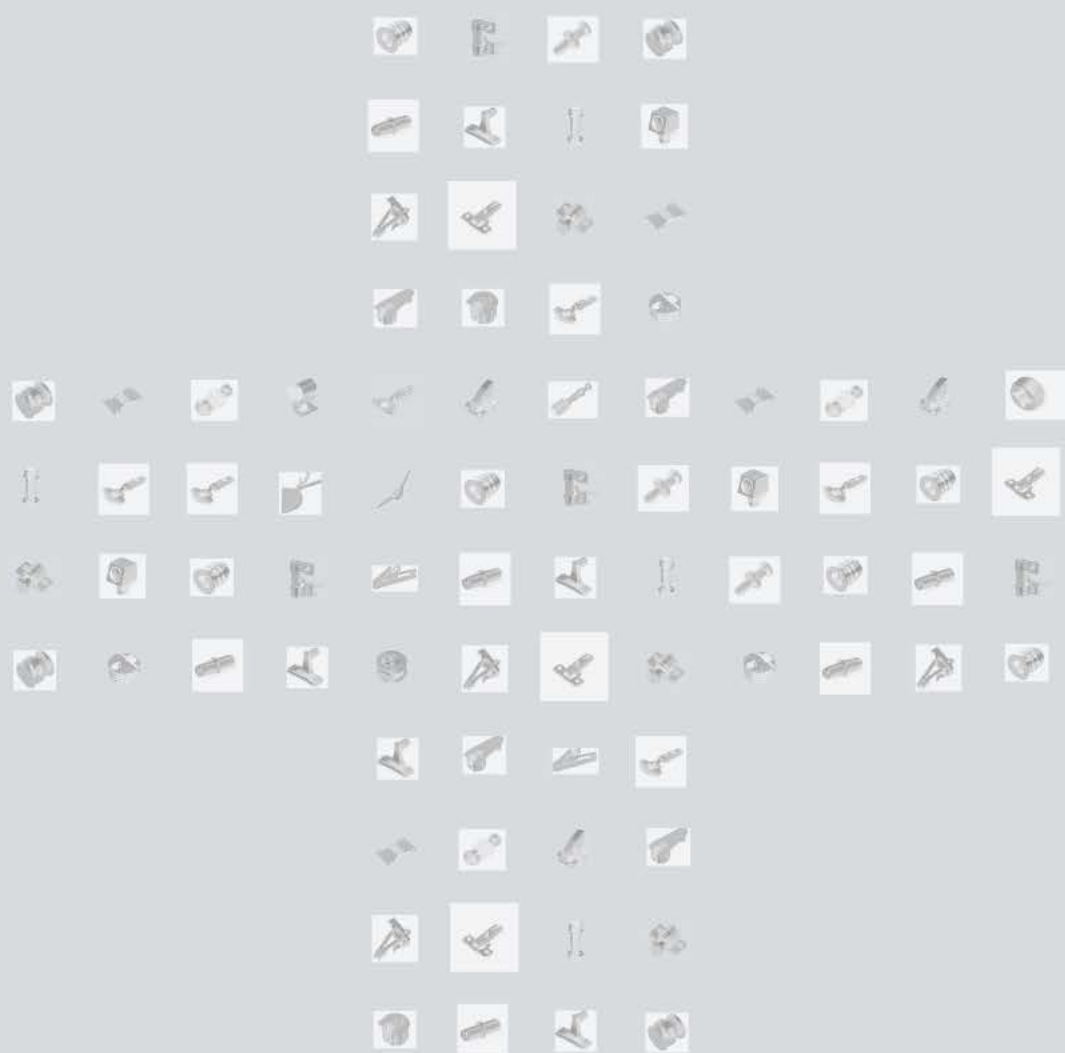

Glissando for concealed hinges

Add-on hinge soft closing solution

2.11

Glissando TL
Glissando BS
Glissando TL 170

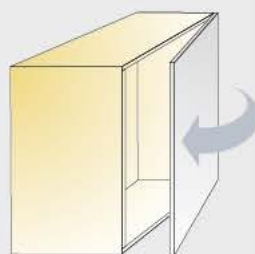

- effortless silent and safe door closing
- fits the hinge's standard drilling patterns
- easy retrofit installation
- adjustable to different door sizes and weights
- perfect door motion
- doesn't occupy additional space inside the cabinet

Stand-alone door soft closing solution

2.15

Glissando CR

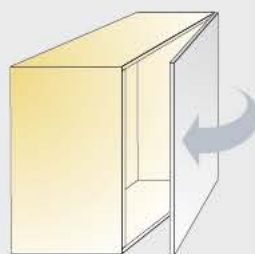

- effortless silent and safe door closing
- easy retrofit installation
- adjustable to different door sizes and weights
- perfect door motion

Glissando for drawers

Stand-alone drawer soft closing solution

2.17

Titusoft for wooden drawers
Titusoft for metal drawers

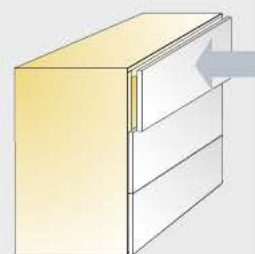

- self closing and soft closing in single mechanism
- safe drawer closing
- easy retrofit installation

Glissando

for concealed hinges

Information

How to choose the right Glissando?

Titus Glissando soft closing system is available for the whole range of hinge applications. The user can choose

between add-on hinge or stand-alone solutions.

Concealed hinges	Add-on hinge soft closing solutions			Stand-alone door soft closing solution
	Glissando TL	Glissando BS	Glissando TL 170	Glissando CR
ST plus 110	X	X		X
ST plus 125		X		X
ST 110	X	X		X
ST 110/15°	X	X		
ST 110/24°	X	X		
ST 110/30°	X	X		
ST 110/45°	X	X		
ST 110/90°	X	X		
ST 170			X	X
Basic 110	X	X		X
Basic 110/30°	X	X		
Basic 110/45°	X	X		
Basic 110/90°	X	X		
Basic 170			X	X
Miniprimat 95				X

Glissando TL 'one for all'

- One item fits multiple applications
- Same item can be used on all crankings and angled hinges
- Adjustable damping enables perfect functioning on every door
- Designed to fit the concealed hinge cup
- Toolless mounting
- Suitable for different types of cabinets for kitchens, living rooms, bathrooms and other furniture

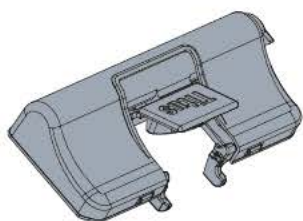

ST plus 110 0mm ST 110 0mm			Basic 110 0mm
ST plus 110 9mm ST 110 9mm			Basic 110 9mm
ST 110 15mm			Basic 110 15mm
ST 110/15° 9mm			Basic 110/30° 9mm
ST 110/24° 9mm			Basic 110/45° 9mm
ST 110/30° 9mm			Basic 110/45° 18mm
ST 110/45° 9mm			Basic 110/90° 0mm
ST 110/45° 18mm			Basic 110/90° 18mm
ST 110/90° 18mm			

Glissando for concealed hinges Information



Titus Glissando soft closing devices can not be used with free-swinging door hinges.

→ see page 3.18 for details

How many Glissandos per door?

Add-on hinge soft closing solution

Glissando BS
Glissando TL
Glissando TL170

Mount Glissando on the bottom hinge in case of 2 hinges on the door or on the middle hinge in case of 3 hinges on the door.

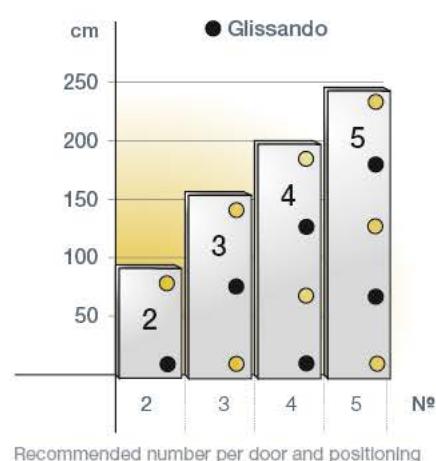

Stand-alone soft closing solution

Glissando CR

Mount a CR on the hinged side of the cabinet on the top or bottom.



How to mount Glissando?

Tool-less mounting

Glissando TL
Glissando TL 170

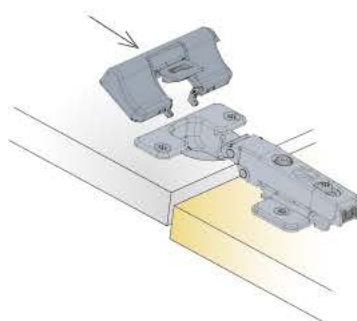

Simple toolless assembly:
Insert Glissando into the holes on the hinge and press down with hand.

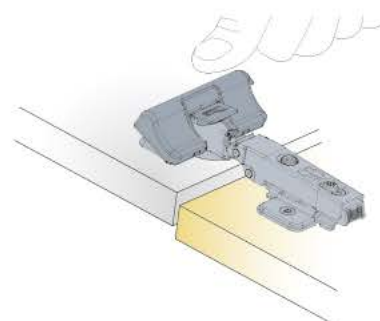

The tool-less 'snap on' version for reduced assembly time and flexibility of application. Glissando TL can be mounted at any time after furniture assembly so can be offered as a retro fit option by the installer.

Screw-on on the hinge cup

Glissando BS

Glissando BS system is mounted on the hinge cup by using cup fixing screws. The fixing screws must be at least 15mm long.

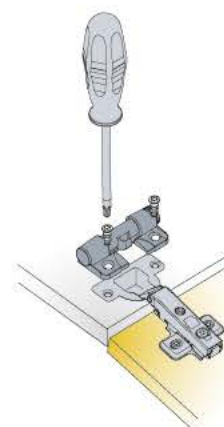

Screw-on into the cabinet corner

Glissando CR

Glissando CR is mounted into the cabinet corner by using chipboard screws 20mm long.

Glissando dampers' discreet design enhances the look of the door and occupies minimal space in the cabinet interior.

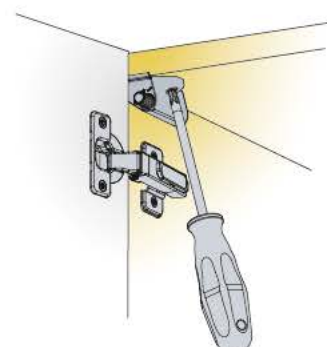

Glissando for concealed hinges Information

Adjustment of the damping

Add-on hinge soft closing solution

Glissando TL
Glissando BS
Glissando TL 170

Glissando features quarter turn adjustment to provide optimal closing speed for any door dimensions and weight.

The damping function can be adjusted to fit different door weights which enables

- perfect door functioning
- use of the same type of Glissando for various doors

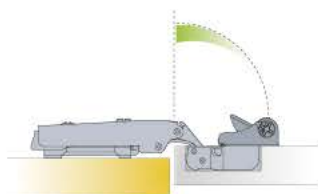

Adjustable damping zone

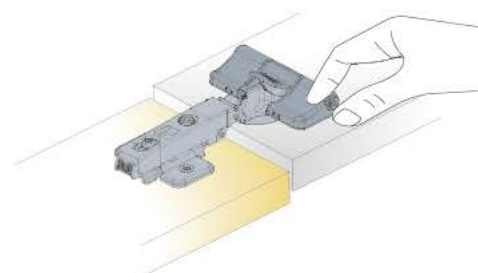

Turn towards '+' to increase and '-' to decrease the damping

Stand-alone soft closing solution

Glissando CR

Turn towards "+" to increase or towards "-" to decrease the damping.

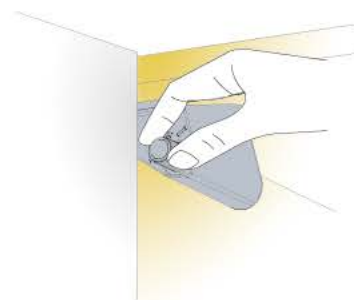

Titus hydraulic damper

Efficient modular design

- Low number of assembly parts enables quick development of customised solutions
- Engineered for efficient and high precision manufacturing
- Wide range of applications



Wide operating scope

- High coefficient γ of Titus damper assures efficient damping at any closing speed
- Damping force can be easily adapted to customer needs

$$\gamma = \frac{F_H}{F_L}$$

F_H – damping force at slam speed (12mm/s)
 F_L – damping force at slow speed (1mm/s)

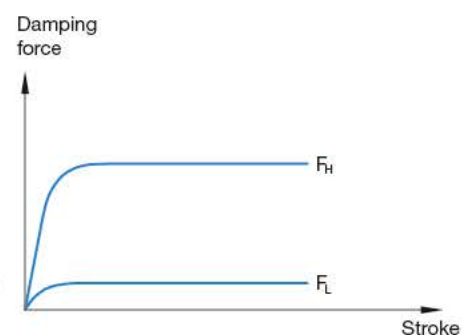

Reliable damping and closing at any speed

Higher coefficient γ means reliable damping at high speed and ensures that the system will reach its final position even at very slow speed



Damping force consistency

- Full control over all phases of manufacturing process
- Quality assured

Standard deviation measured on the sample of 1000 pcs.

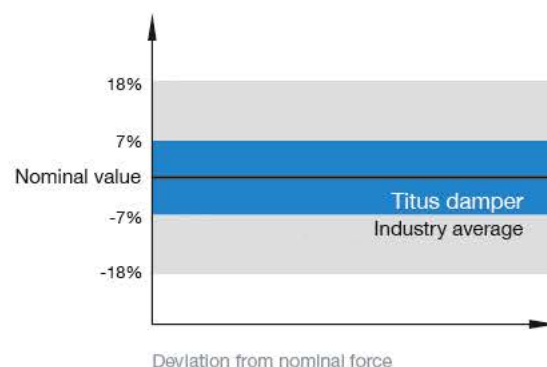

Glissando

Add-on hinge soft closing solution

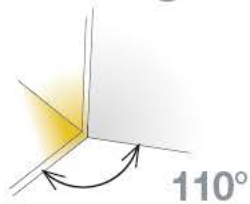

For 110° hinges

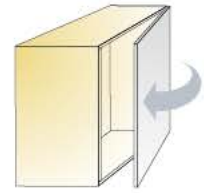

Technical details

Glissando TL snap-on
 • ST plus 110
 • ST 110
 • Basic 110

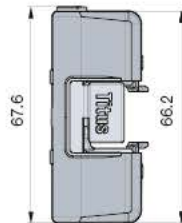
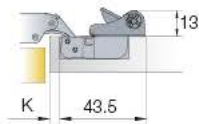

For the following cup types	Hinge opening angle	Damping force	Interaxis 45mm	Interaxis 48mm
			Item number	Item number
	110°	45N	 Ø 35	 Ø 35
	110°	35N	951.0X94.050	951.0P59.050
	110°	60N	951.0P63.050	
	110°	35N	* 951.0253.050	

* 951.0253.050 requires application on every hinge → see page 2.12

100 Pcs

Made of steel and plastic

Legend of hinge cup symbols

- Screw-on ready
- Machine insertion ready
- Pre-mounted euro screws
- Pre-mounted chipboard screws
- Easy-fix system

- Same item can be used on all crankings and angled hinges
- Designed to fit the concealed hinge cup and requires no extra space inside the cabinet
- Adjustable damping
- Screw-on or toolless mounting

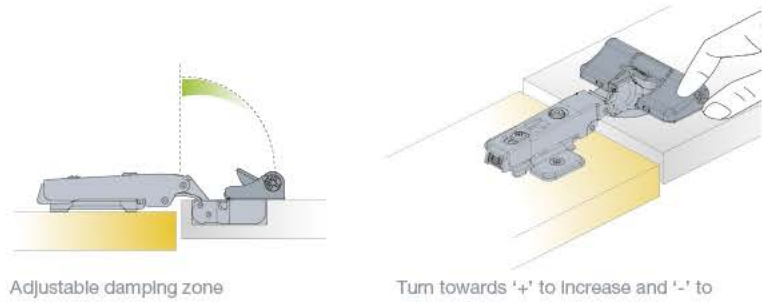

Adjustable damping zone

Turn towards '+' to increase and '-' to decrease the damping

Mounting details

Toolless assembly

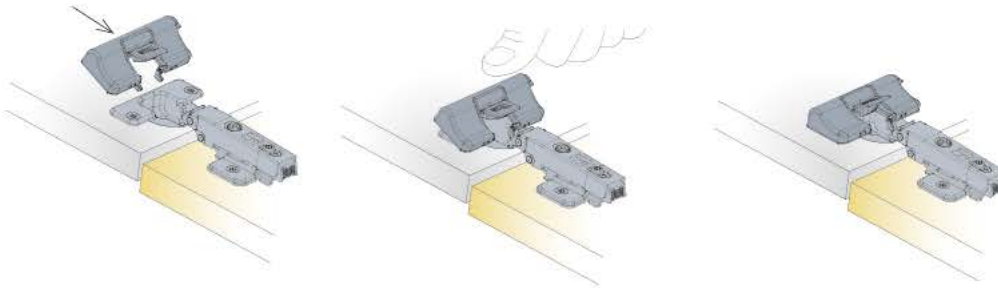

Insert Glissando TL into the holes on the hinge

Press down



No additional drilling is required

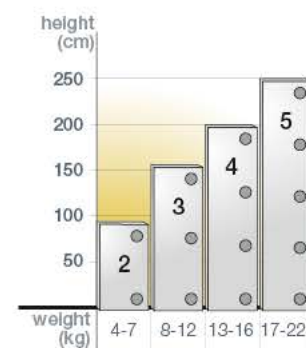

*951.0253.050

Recommended number per door and positioning

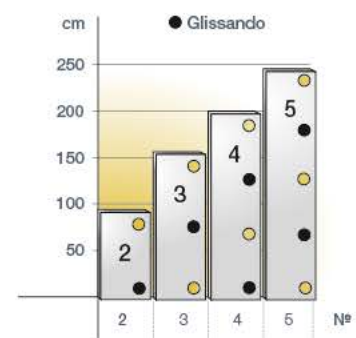

Recommended number per door and positioning

Glissando TL 170

Add-on hinge soft closing solution

For ST 170 and Basic 170 hinges



Glissando TL170

Technical details

Fixing

Item number

snap-on

951.0F15.650

Box content
100 pcs soft closing mechanisms
100 pcs striking plates



Soft closing mechanism



Striking plate

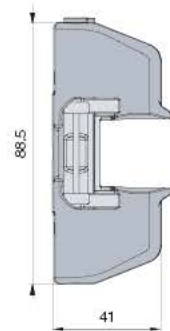
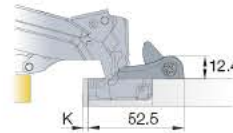

Made of steel and plastic

- Gentle and reliable soft closing on doors with wider opening angle
- Fits perfectly 45/9.5mm, 48/6mm and 52/5.5mm hinge cups
- Furniture consumers' preferred 'confident close'
- Tool free mounting

Damping adjustment

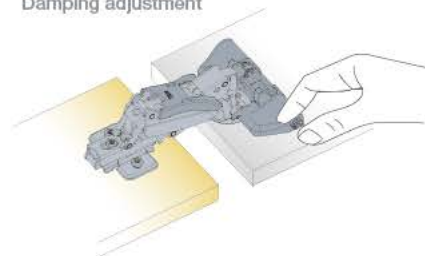

Turn towards '+' to increase and towards '-' to decrease the damping

Mounting details

Toolless mounting

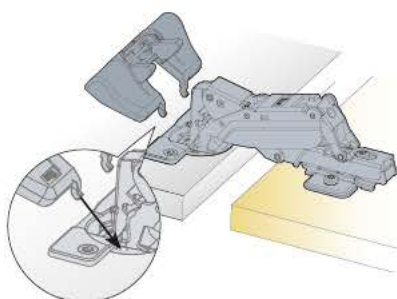

Insert Glissando TL170 into the holes on the hinge cup

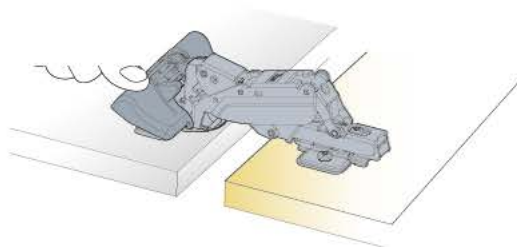

Press down

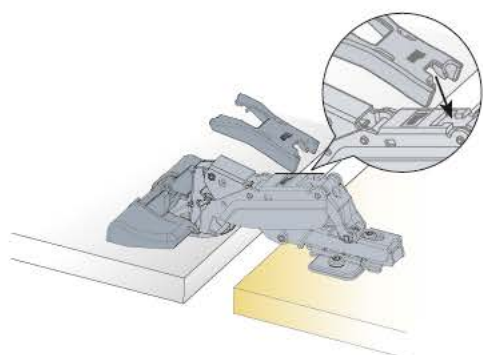

Place the striking plate into the hole on the hinge arm

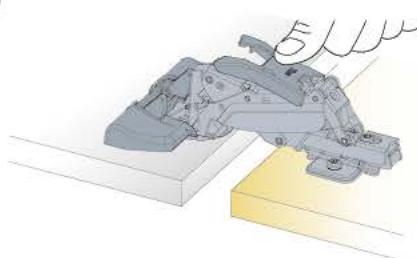

Press down

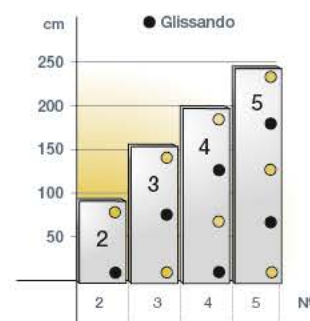

Recommended number per door and positioning

Glissando CR

Stand-alone door soft closing system

For full overlay and half overlay concealed hinges

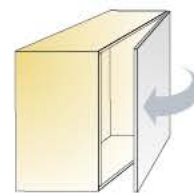

Technical details

Glissando CR for full overlay hinges



Nominal 11
(Adjustment: Nominal + 5mm)

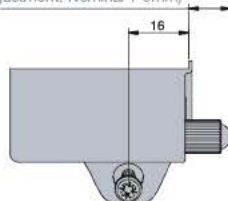

100 Pcs

Made of plastic

Hinge opening angle	Cranking	Item number	White	Grey	Beige
110°	0 mm	972.0X19. →	350	380	360

*Fixing screw included in a set

Glissando CR for half overlay hinges



Nominal 10
(Adjustment: Nominal + 5mm)

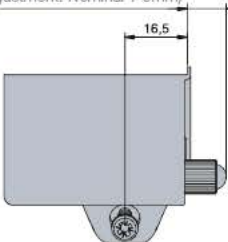

100 Pcs

Made of plastic

110°	9mm	972.0X34. →	380
------	-----	-------------	-----

*Fixing screw included in a set

- Intuitive 'place and fix' installation in the corner of the cabinet
- Tool-less damping adjustment
- One item for a wide range of doors
- Reliable performance

Damping adjustment

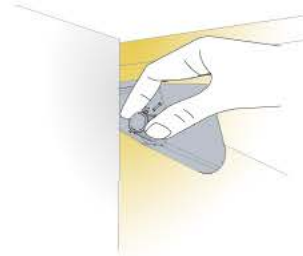

Turn towards '+' to increase and towards '-' to decrease the damping

Mounting details

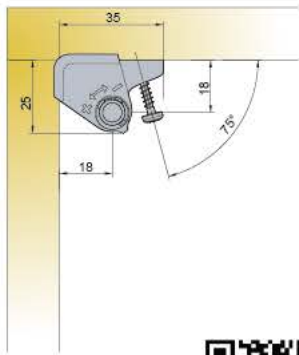

Further explanations --> go to http://www.youtube.com/watch?v=8-uWs_z2d0s

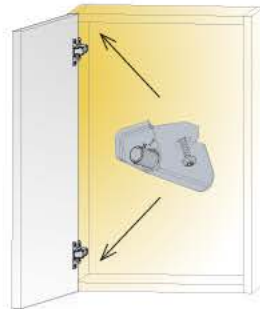

Mount Gilssando CR on the hinged side of the cabinet.

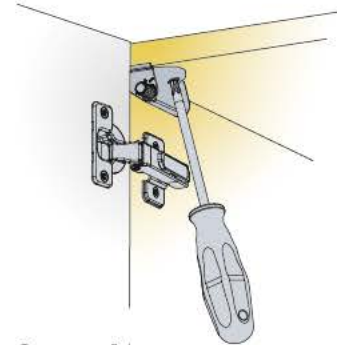

One screw fixing

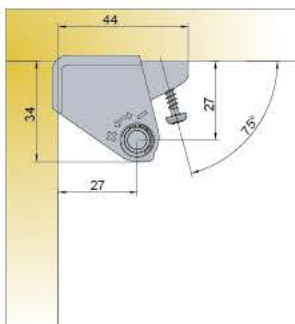

Further explanations --> go to http://www.youtube.com/watch?v=8-uWs_z2d0s

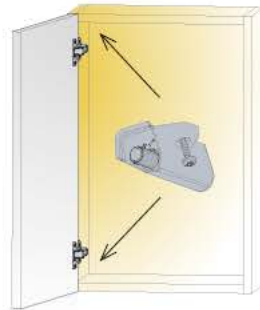

Mount Gilssando CR on the hinged side of the cabinet.

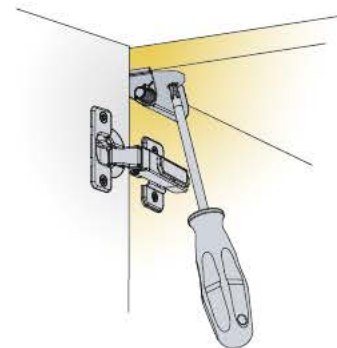

One screw fixing



The functioning of Gilssando CR depends of the hinge's closing force. A trial mounting is always recommended.

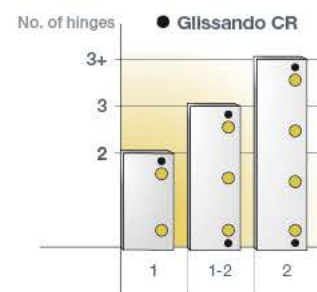

Recommended number per door and positioning

Titusoft WD

Soft closing system for wooden drawer

For wooden drawer with roller runners

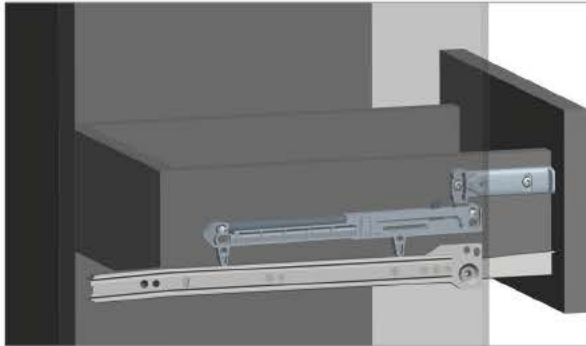
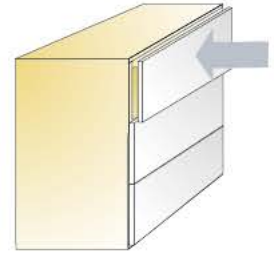

Technical details

Titusoft WD

Titusoft mechanism

Item number

Grey

White

Zinc plated blue

973.0X35 →

380

Activator

973.4451 →

380 350



Titusoft mechanism

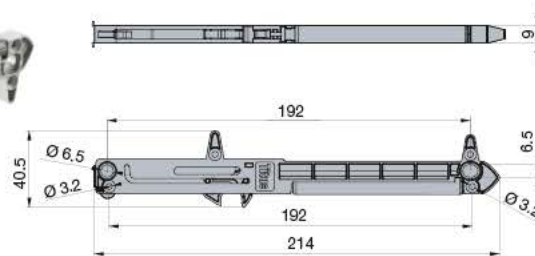

Activator

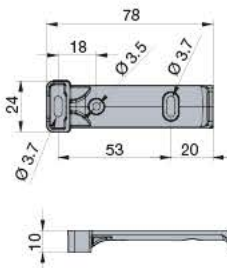

250 Pcs

Made of plastic

Bag of 1
973.0X35.380.K2 120 Bags

- 1 Titusoft mechanism
- 1 activator
- 2 screws Ø3.5mm x 20mm
- 2 screws Ø3.5mm x 12mm
- 1 Mounting instruction sheet

Bag of 2
973.0X35.380.K1 80 Bags

- 2 Titusoft housings
- 2 activators
- 4 screws Ø3.5mm x 20mm
- 4 screws Ø3.5mm x 12mm
- 1 Mounting instruction sheet

L Bracket
Accessory for Titusoft

973.1679 →

040

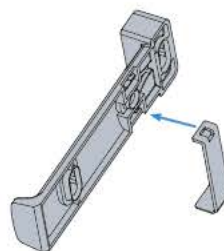

L Bracket is simply pressed into the hole on the back side of the activator.

- Works with most roller runner drawer slides
- Easy, intuitive mounting
- Smooth soft closing action independent of drawer hardware
- Optimal closing speed
- Non handed design

Capacity chart

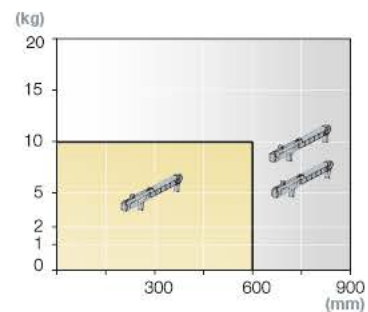

Mount 1 or 2 Titusoft mechanisms depending on drawer weight and width

Mounting details

1.

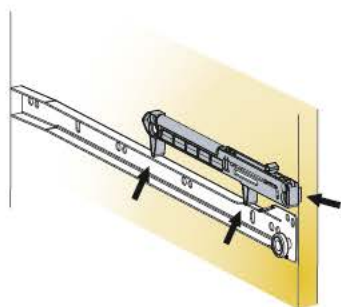

Position the Titusoft mechanism on the top of the drawer slide

2.

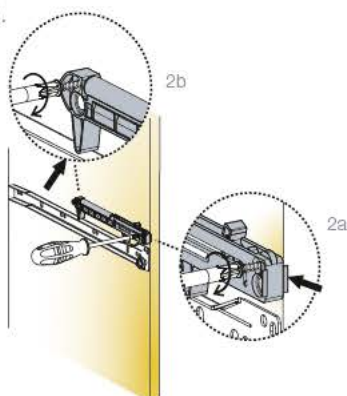

Fix with 2 screws L=20mm

3.

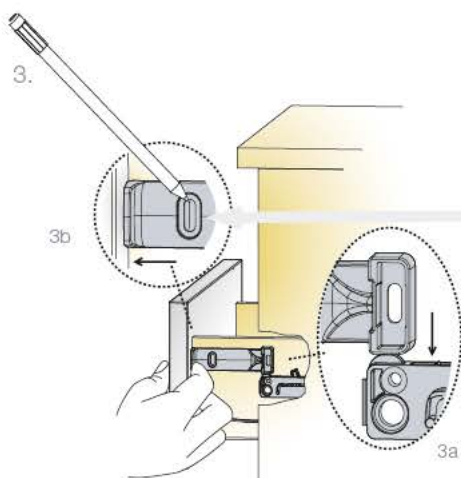

1. Rest the activator against the drawer front
2. Align the vertical position of the activator with the top of the Titusoft mechanism and mark the screw locations

4.

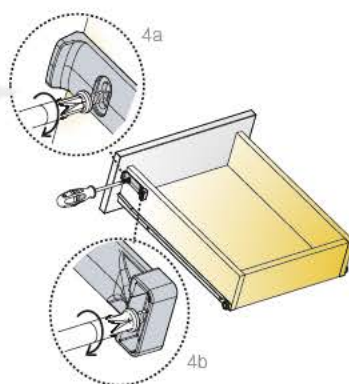

Fix with 2 screws L=12mm



Further explanations → go to <http://www.youtube.com/watch?v=U3aS2r6KC6K>

A trial mounting is always recommended. Please contact Titus Group or your local distributor for further technical assistance.

Titusoft MD

Soft closing system for metal box

For metal boxes

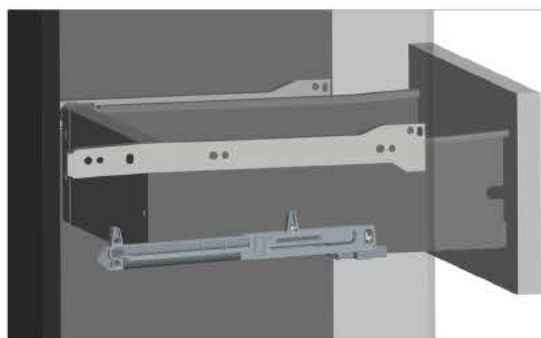
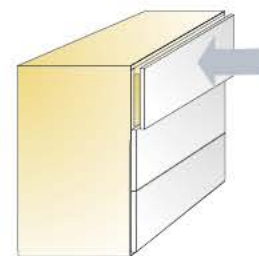

Titusoft MD



Titusoft mechanism



Activator



Mounting jig

 250 Pcs

Made of plastic

Technical details

Retrofit mounting

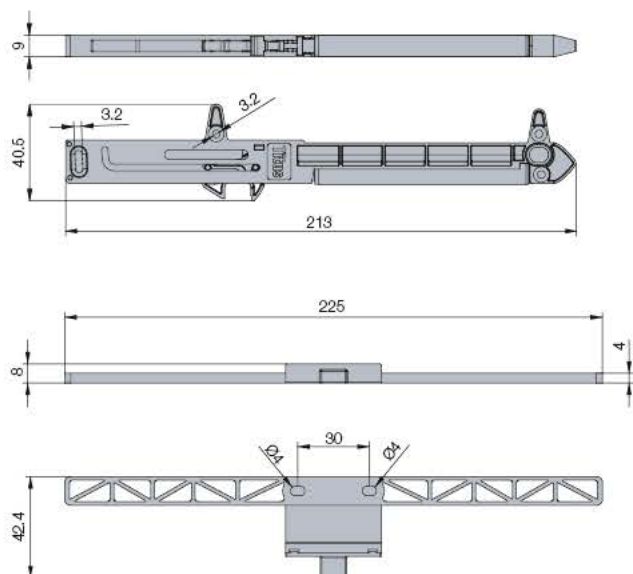

Factory mounting (system holes)

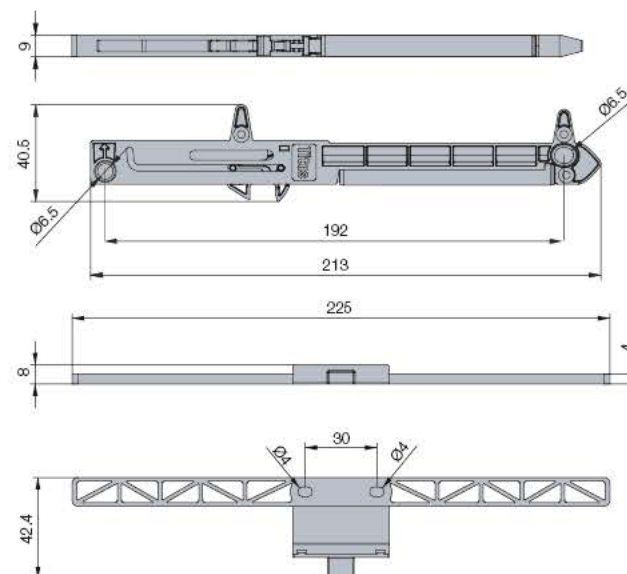

Item number

Grey

White

Light blue

Titusoft mechanism for factory mounting

973.0X95 → 380

Titusoft mechanism for retrofit mounting

973.0X39 → 380

Activator

973.4125 → 350

Mounting jig

973.4126 → 309

Bag of 1
973.0X39.380.K2  90 Bags

- 1 Titusoft mechanism
- 1 activator
- 1 mounting jig
- 4 screws
- 1 mounting instruction sheet

Bag of 2
973.0X39.380.K1  60 Bags

- 2 Titusoft mechanisms
- 2 activators
- 1 mounting jig
- 8 screws
- 1 mounting instruction sheet

- One-for-all' soft closing for single skin metal boxes
- Allows for easy factory mounting or retrofit application
- Intuitive positioning
- Preserve the life-time of the drawer

Capacity chart

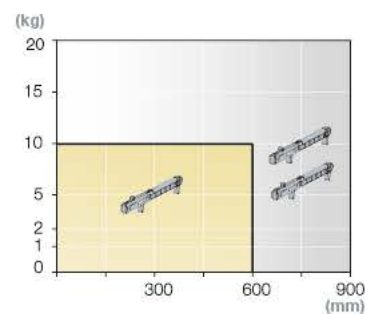

Mount 1 or 2 Titusoft mechanisms depending on drawer weight and width

Mounting details

Retrofit mounting

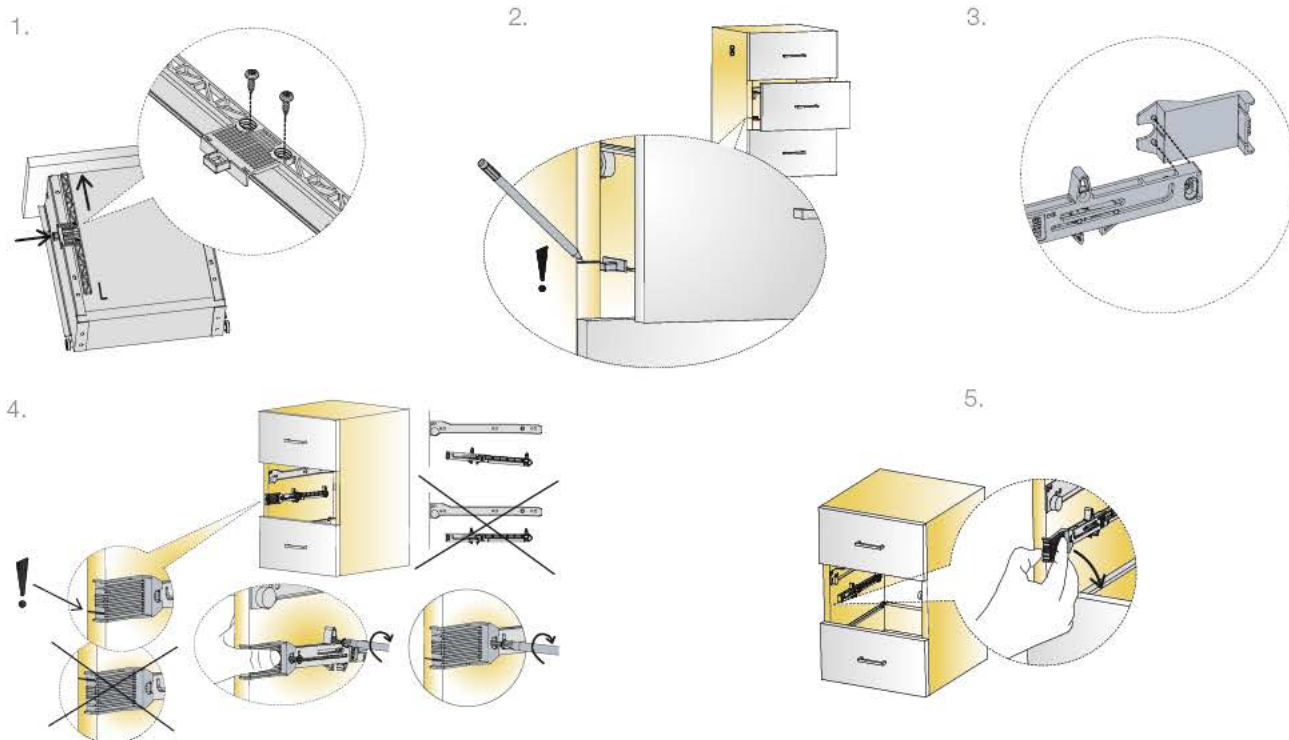

Factory mounting

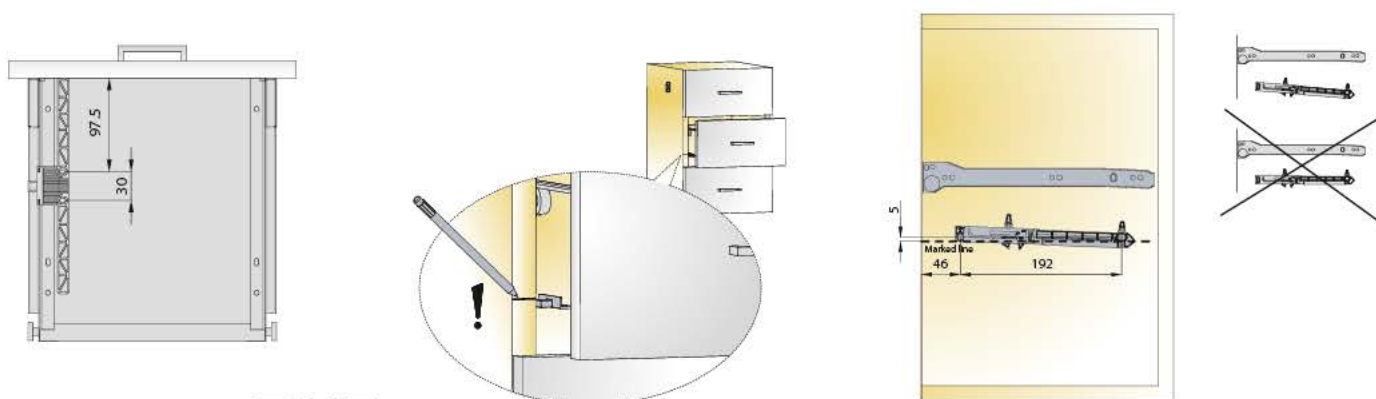

Further explanations → go to <http://www.youtube.com/watch?v=Qplq8uKGbng>

A trial mounting is always recommended. Please contact Titus Group or your local distributor for further technical assistance.

Concealed hinges

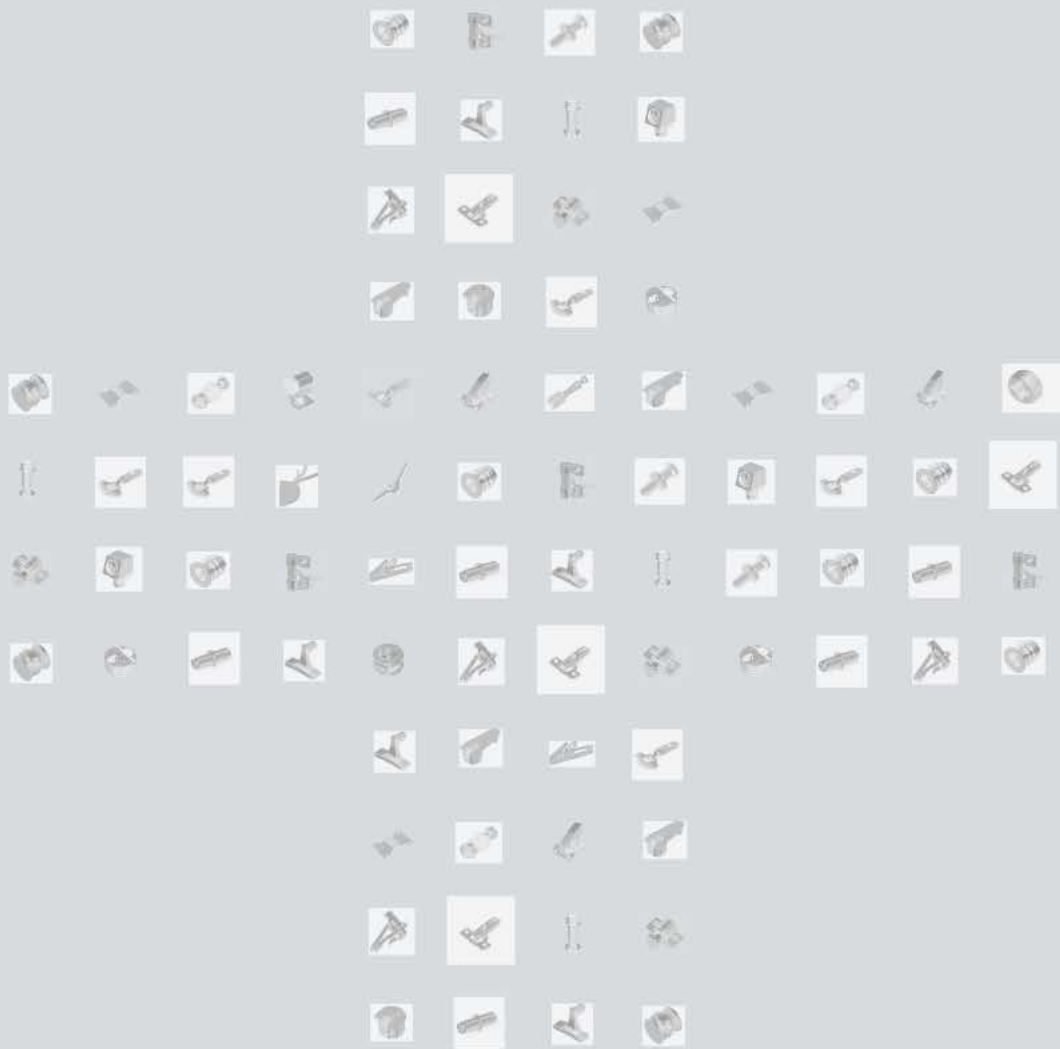

Concealed hinges

Product guide

ST-i2 plus series

cam-adjustable door depth, ST assembly, Ø 35mm cup drilling

	Cranking	Opening angle	Cup type	Page
ST-i2 plus 110, 2 nd Generation	0mm	110°	for wooden door	3.19
	9mm	110°	for wooden door	3.19

ST plus series

ST assembly, Ø 35mm cup drilling

	Cranking	Opening angle	Cup type	Page
ST plus 110	0mm	110°	for wooden door	3.21
	9mm	110°	for wooden door	3.21
ST plus 110 Touch opening	0mm	110°	for wooden door	3.23
	9mm	110°	for wooden door	3.23

ST series

ST assembly, Ø 35mm cup drilling

	Angle and cranking	Opening angle	Cup type	Page
ST 110	0mm	110°	for wooden door	3.25
	9mm	110°	for wooden door	3.25
	15mm	110°	for wooden door	3.25
ST 110/45°	45°, 18mm	110°	for wooden door	3.27
ST 110/90°	90°, 18mm	110°	for wooden door	3.29
ST 170	0mm	165°	for wooden door	3.31
	0mm	135°-165°	for wooden door	3.31
	9mm	165°	for wooden door	3.31
ST for pie-cut corner cabinet			for wooden door	3.33
ST mounting plates				3.35

Accessories

	Page
Push latch	3.37

Concealed hinges

Information

How to achieve the desired door overlay?

By choosing the hinge of appropriate cranking

Concealed hinges with specific hinge arms are available for different door overlays. The most common overlays are:

■ Cabinet side
■ Door

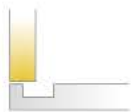

- 1. Full overlay.** Use a hinge with 0mm cranking.

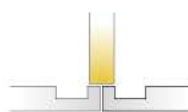

- 2. Half overlay for double doors.** Use a hinge with 9mm cranking.



- 3. Inset door.** Use a hinge with 15mm, 16mm or 18mm cranking.

By choosing the mounting plates of appropriate thickness

To achieve the desired overlay (x) while using a determined drilling distance (K), a mounting plate of appropriate

thickness (D) must be chosen from the enclosed table.

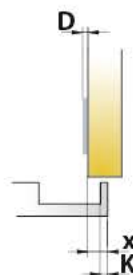

X	4	5	6	7	8	9
3	3	2	0			
K	4	2	1	0		
5		3	2	1	0	D

Door clearance and gap

The door clearance ($F > F_{min}$) and gap (Z) represent the minimal necessary space needed for the correct opening and closing of the door. The minimal required values depend on the cup drilling distance (K), door thickness (V)

and the type of hinge. The minimum clearance scale can be found in the catalogue. When using on double doors with one party-wall the door clearance must be twice as large ($F > 2F_{min}$).

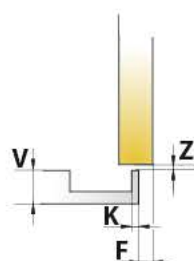

V	16	17	18	19	20	22		
3	0.3	0.5	0.7	1.0	1.3	1.7	3.5	
K	4	0.3	0.7	0.3	0.5	0.7	3.0	3.1
5	1.0	1.7	3.5	3.0	3.1	3.0	F_{min}	

Gap Z=0



Drilling patterns for hinge cups shown on the page 3.8 or on specific product pages for non-standard drillings.

How to mount the hinge on the door?

The choice of hinge cup type depends on the material of which the door is made and the chosen assembly method. The hinge can be assembled on a wooden door by fixing it with

chipboard or euro screws or inserted by machine.



Easy-Fix Time saving system

After inserting the hinge correctly and fully, the cup is fixed by rotating the two screws clockwise (by 90°) with a PZ2 screwdriver.

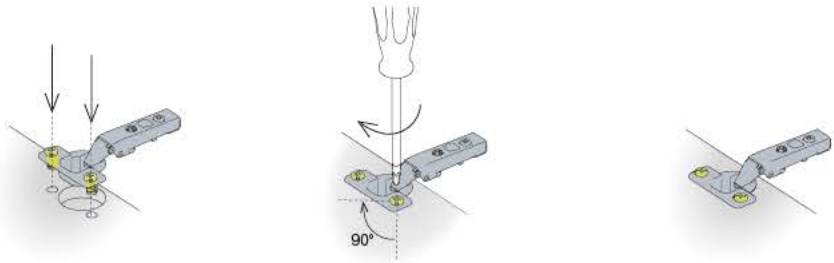

Screw fixing hinge cup

The hinge is fixed on the door with two prescribed screws.

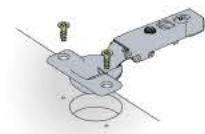

Machine insertion ready hinge cup

Special dowels for machine insertion are pre-mounted. Two versions are available for 10mm or 8mm holes.

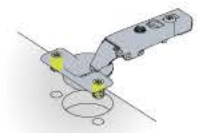

Concealed hinges

Information



Drilling patterns for hinge cups shown **on the next page** or on specific product pages for non-standard drillings.

How to mount the hinge on the door?



Hinge cup with pre-mounted euro screws

The hinge is fixed on the door with two pre-mounted euro screws for 5mm holes. Where not specified otherwise, euro screws are 13mm long.

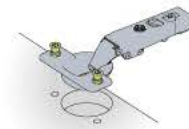

Hinge cup with pre-mounted chipboard screws

The hinge is fixed on the door with two pre-mounted chipboard screws.

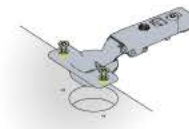

Glass door hinge cup

The hinge is fixed into one single hole on the glass door. Glass thickness must be between 4mm and 6mm.

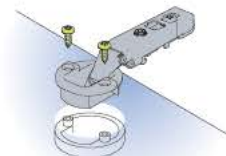

Aluminium frame screw-on hinge cup

The hinge is fixed onto a specific drilling on the aluminium frame with two screws.

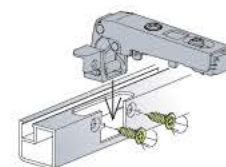

Drilling patterns for hinge cup

Interaxis is the distance between two holes for fixing screws on the hinge cup.

Other drilling patterns can be found on specific product pages.

Interaxis 45mm, 48mm and 52mm

- ST-i2 plus series
- ST-i2 series
- ST-i plus series
- ST-i series
- ST plus series
- ST series
- Basic-i2 series
- Basic-i series
- Basic series









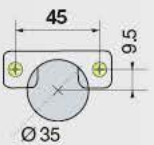
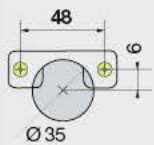
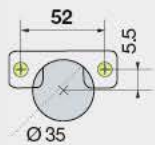
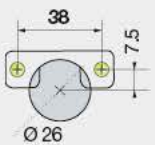

Interaxis 38mm

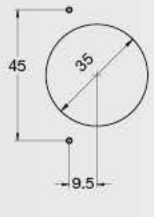
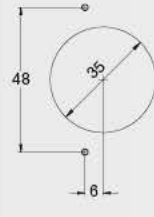
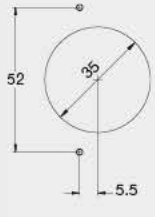
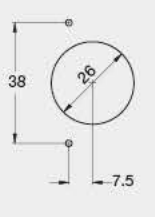
- Miniprimat series

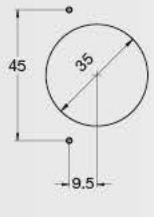
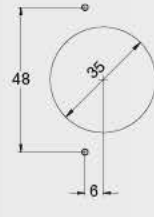
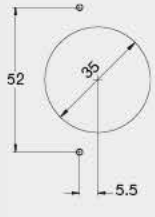
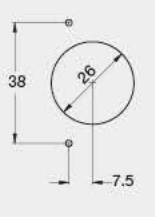
Interaxis 42/11mm*

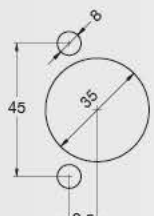
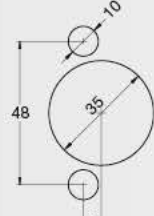
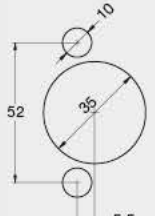
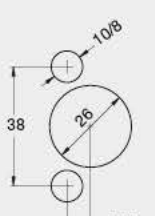
Interaxis 42mm is optionally available with some versions, on special request.

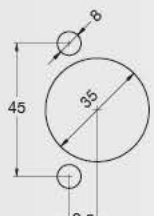
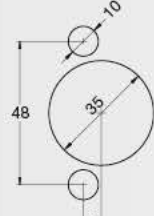
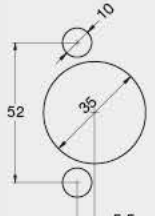
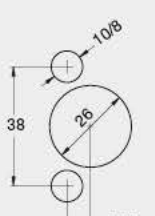
* Available upon special request
→ see page 0.3

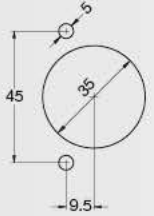
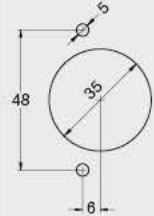
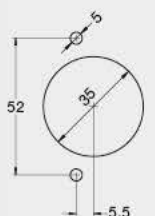
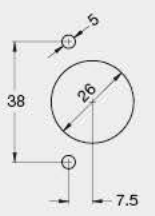
	Interaxis 45mm	Interaxis 48mm	Interaxis 52mm	Interaxis 38mm
Type of hinge cup	Drilling pattern 	Drilling pattern 	Drilling pattern 	Drilling pattern 
 Screw-on ready				
 Premounted chipboard screws				
 Machine insertion ready				
 Easy-fix system				
 Premounted Euro screws				

Concealed hinges

Information



Check the mounting plate drilling distance!

When fixing the mounting plate please check the drilling distance from side border. It may differ depending on mounting situation and mounting plate type. Some mounting plates can be used for both 28 or 37mm drilling distance simply by rotating.

How to fix the mounting plate on the cabinet side?

The mounting plates can be fixed on cabinet side with various methods. Euro screws are most suitable for standard 32mm drillings. Mounting plates with pre-mounted chipboard

screws, spreading dowels or 10mm dowels for machine insertion, are also available.

Euro screws ready mounting plate

The mounting plate is fixed with two standard 6.3mm euro screws.



Mounting plate with pre-mounted euro screws

Euro screws for 5mm holes are pre-mounted on the mounting plate. Different screw lengths available.

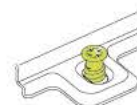

Machine insertion ready mounting plate

Dowels for machine insertion in 10mm holes are pre-mounted on the mounting plate.

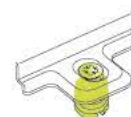

Mounting plate with pre-mounted expanding dowels

Expanding dowels for 5mm holes are pre-mounted on the mounting plate. Two lengths available: 7.5mm and 10.5mm.

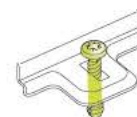

Chipboard screws ready mounting plate

The mounting plate is fixed with two prescribed chipboard screws or equivalent.



Mounting plate with pre-mounted chipboard screws

The mounting plate is fixed with two pre-mounted chipboard screws.



How to assemble the hinge and the mounting plate?

ST time saving system

- ST-i2 plus series
- ST-i2 series
- ST-i series
- ST plus series
- ST series

The door is assembled on the cabinet side simply by fixing the two hooks under the hinge arm on the outer part of the mounting plate and pressing gently on the rear part of the hinge arm.

For disassembly press the button on the rear of the hinge arm.

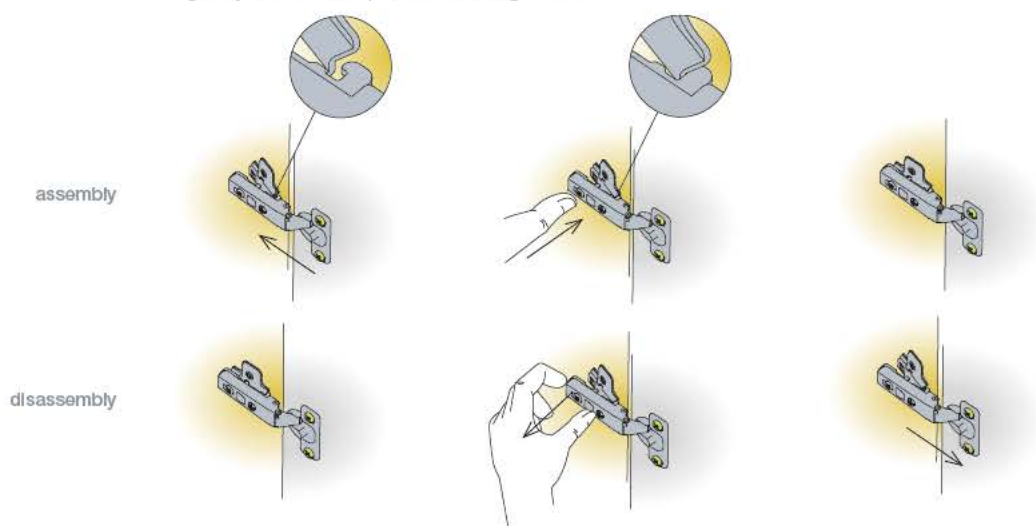

Slide-on system

- Basic-i2 series
- Basic-i series
- Basic series

The hinge is assembled by sliding the hinge arm over the mounting plate. The lower part of the horizontal set-up screw must fit correctly into the groove on the mounting plate. After

adjusting the door depth, the mounting procedure is finished by tightening the fixing screw.

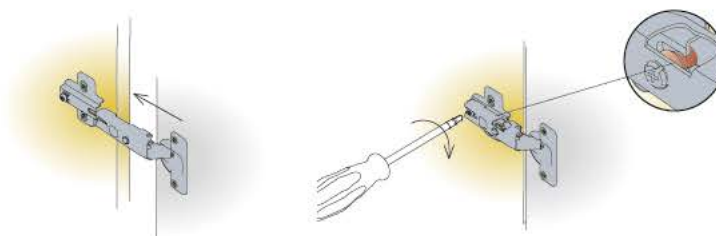

Key-hole system

- Miniprimat series
- Special hinges

The hinge is assembled on the mounting plate by inserting the fixing screw on the appropriate hole on the hinge arm. After adjusting the door

depth, the mounting procedure is finished by tightening the fixing screw.

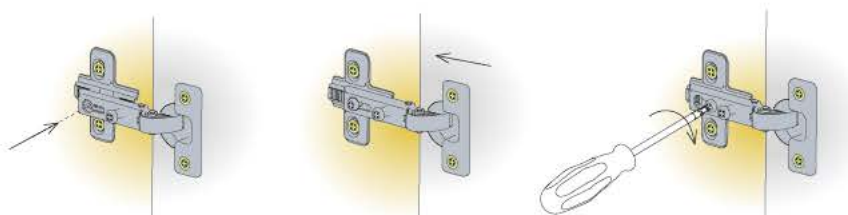

Concealed hinges

Information

 For the furniture user's safety please use the appropriate number of hinges so that the door height or weight does not exceed that shown below.

How many hinges per door?

Check the enclosed specifications for the number of required hinges per door by considering both door height and weight. In case of doubt please contact Titus or your local distributor.

Concealed hinges with Ø 35mm hinge cup diameter

- ST plus series
- ST series
- Basic series
- Special hinges

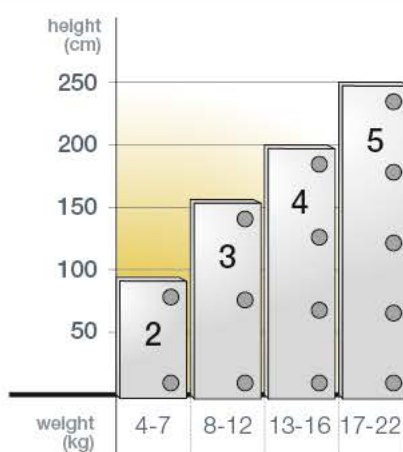

- ST-i2 plus series
- ST-i2 series
- Basic-i2 series
- ST-i plus series
- ST-i series
- Basic-i series

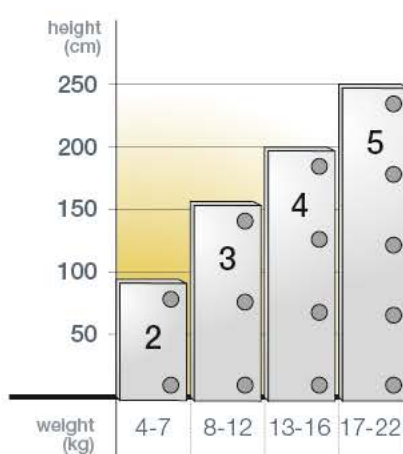

Hinges with integrated damping can be combined with non-damped hinges from standard hinge range. A trial mounting is always recommended. Please contact Titus for further technical assistance.

Concealed hinges with Ø 26mm hinge cup diameter

- Miniprimat series

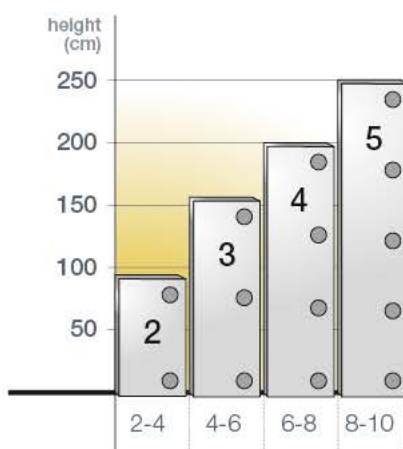



Adjustment range can be found on the product pages.

Side adjustment

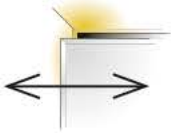

The side adjustment is indispensable to align the door with the side of the cabinet thus allowing perfect lifetime opening and closing of the door.

By rotating the appropriate screw

- ST-i2 plus series
- ST-i2 series
- ST-i plus series
- ST-i series
- ST plus series
- ST series
- Basic-i2 series
- Basic-i series
- Basic series

The side adjustment is made by rotating the appropriate screw on the hinge arm.

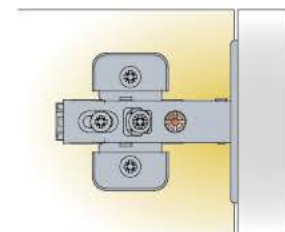
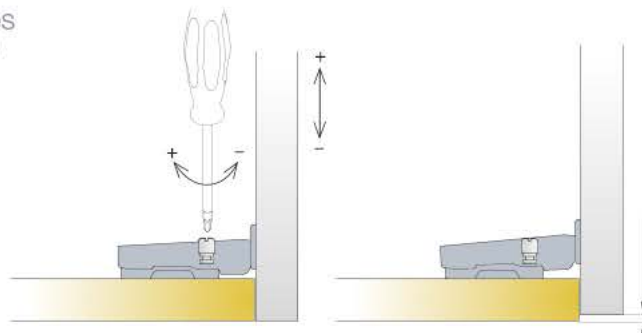

Adjustment range

By temporarily releasing the fixing screw

- Miniprimat series
- Wide angle hinge

For the side adjustment:

1. Release the fixing screw
2. Make the necessary adjustment by rotating the appropriate screw
3. Tighten the fixing screw

Without releasing the fixing screw no side adjustment is possible.

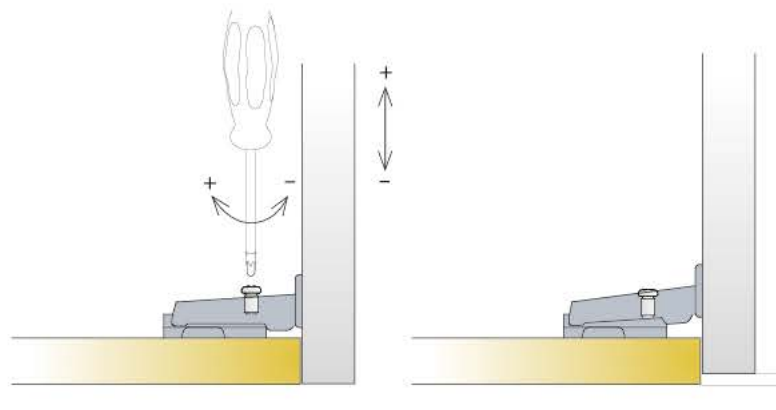

Adjustment range

Concealed hinges

Information

Height adjustment

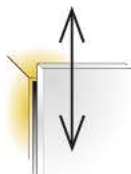

Height adjustment is necessary to achieve perfect vertical door position that emphasises the accuracy of manufacture.

By rotating the cam adjuster

- ST-i2 plus, ST-i2, ST-i plus, ST-i, ST plus and ST series with cam adjustable mounting plate

The height adjustment is made by rotating the cam adjuster on the mounting plate.

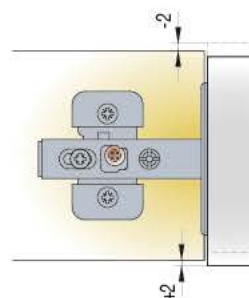
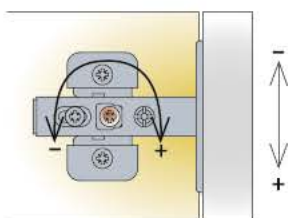

Manual adjustment by releasing the adjustment screw

- ST-i2 plus, ST-i2, ST-i plus, ST-i, ST plus and ST series with horizontal mounting plate

For height adjustment the adjustment screw has to be temporarily released during manual adjustment.

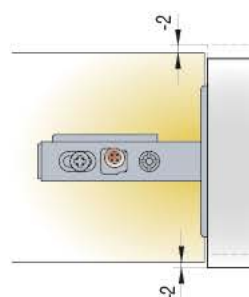
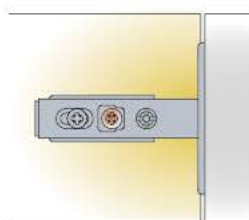

By releasing the fixing screws of mounting plate

- ST-i2 plus, ST-i2, ST-i plus, ST-i, ST plus and ST series without cam-adjustable cruciform mounting plates
- Basic series
- Miniprimat series
- Wide angle hinge

For height adjustment the two mounting plate fixing screws have to be temporarily released while making the manual adjustment.

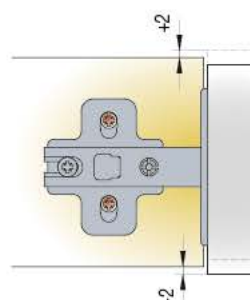
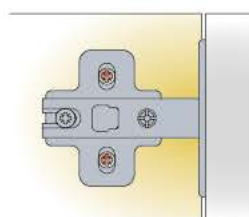

 Adjustment range can be found on the product pages.

Depth adjustment



The system enables easy adjustment of the door depth to assure that the door fits well on the side of the cabinet.

By rotating the cam adjuster

- ST-i2 plus series
- ST-i plus series
- ST plus series

The adjustment is made by rotating the cam adjuster on the hinge arm.

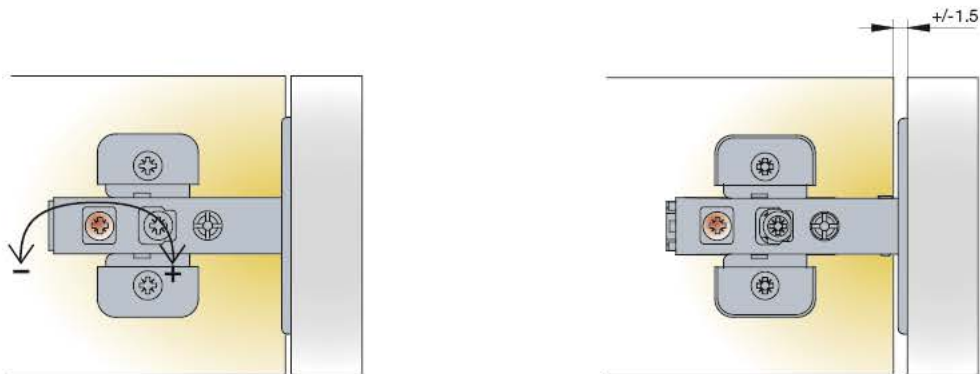

By releasing the fixing or adjustment screw

- ST-i2 plus series
- ST-i series
- ST series
- Basic-i series
- Basic series
- Miniprimat

The depth adjustment is made by temporarily releasing the adjustment screw (ST series) or fixing screw (Basic series). After the adjustment is made the screw has to be re-tightened.

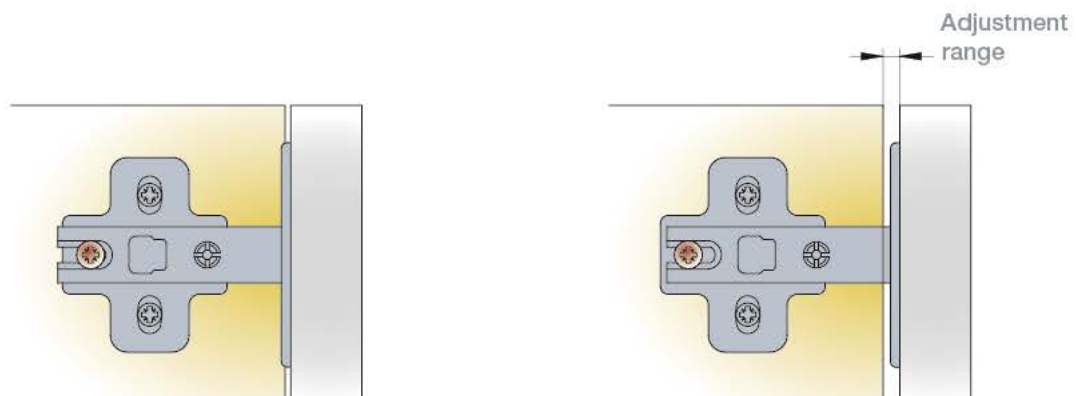

Concealed hinges

Information

Titus recommends!

Most of Titus hinges can be combined with soft closing devices giving silent closing motion.

→see pages 2.11-2.16 for details



Soft closing devices can not be used with free-swinging door hinges.

Door closing systems

There are three types of door closing systems:

self - closing ←
free - swinging -----

Concealed hinges with limited self-closing angle

- ST-i2 plus series
- ST-i2 series
- ST-i plus series
- ST-i series
- ST plus series
- ST series
- Basic-i2 series
- Basic-i series
- Basic series

The self-closing angle is the point from which the door will close by itself, without user assistance. The mechanism starts closing the door from a 14° to 25° angle, depending on the concealed hinge type. From that point to the maximum opening angle the door remains in an open position.

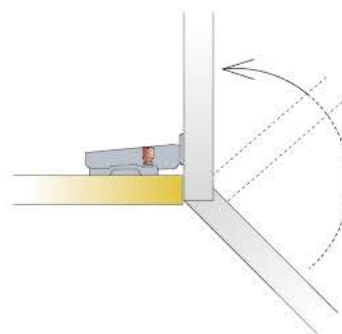

Two-positions self-closing concealed hinges

- Miniprimat series

The door can only be in two positions: closed or fully opened. The closing mechanism does not allow intermediate open door positions unless the door is held.

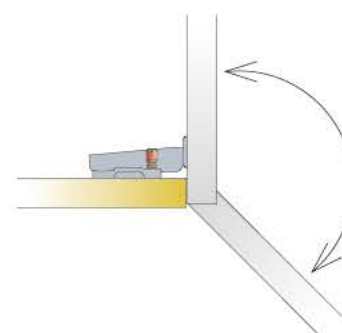

Free-swinging door hinges *

- all series

Optionally most of Lama concealed hinges can be supplied without self-closing mechanism. These hinges are not presented in this catalogue but may be ordered upon request. Please contact Lama or your distributor for item order numbers and technical assistance.

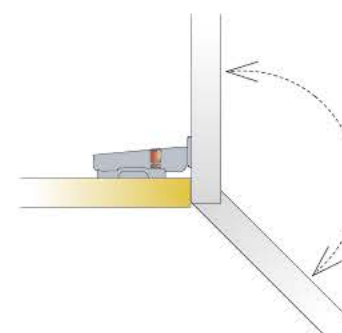

* Available upon special request

→ see page 0.3

Titus damping solutions

Hinges with integrated damping

Key design choices

Damping in the hinge cup

Damper is positioned transversal on the hinge cup

- Allows for an easy and quick introduction of various hinge versions: ST 'snap-on' and Basic 'slide-on' with different hinge arm crankings and angles
- Standard hinge cup drilling depths: requires no changes in drillings for hinge cup
- Standard mounting plates



Adjustable damping force

Flexibility to 'tune' performance for all applications

- Optimal damping on various door weights and sizes
- Intuitive and quick adjustment
- Easily accessible adjustment button

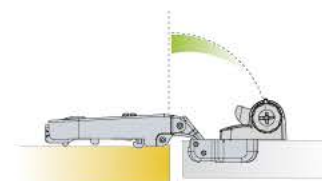

Adjustable damping zone and force

Titus hydraulic damper

Titus hydraulic damper, designed and produced in-house

- Reliable and consistent life-long damping
- Minimum damper rebound
- Dampers' consistency over high volume production runs assured



Titus damping solutions

Hinges with integrated damping

Adjustment of the damping

ST-i plus series
ST-i series
Basic-i series

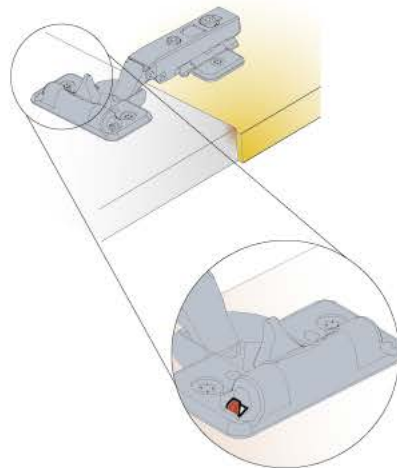

The damping reduction switch in a pre-set position.

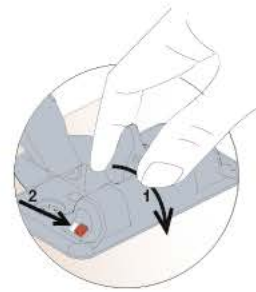

To decrease the damping
1. Lift the damping activator.
2. Slide the damping reduction switch to opposite position.

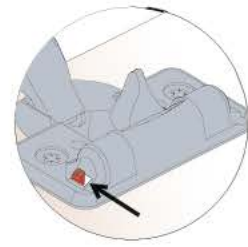

To increase the damping, slide the damping reduction switch back to the factory pre-set position.

To decrease or to increase the damping, change the position of the damping reduction switch. Hinges are factory pre-set to the maximum damping value.

Damping force change

The damping reduction switch adjusts the damping. Example shows the damping change in case of two hinges on door.



ST-i2 plus series
ST-i2 series
Basic-i 2 series

The damping action can be adjusted to fit different door weights which enables perfect door functioning.

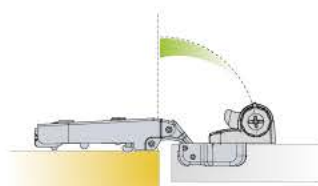

Adjustable damping zone

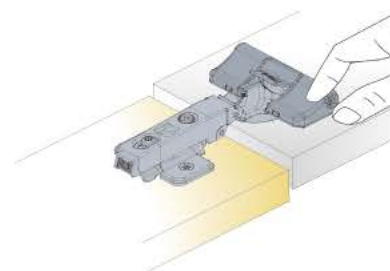

Turn towards '+' to increase and '-' to decrease the damping

How to mount ST-i2 / Basic-i2 hinges?

- ST-i2 plus series
- ST-i2 series
- Basic-i2 series

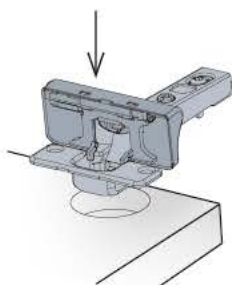

Insert Basic-i 2 / ST-i 2 hinge into the hinge cup hole.

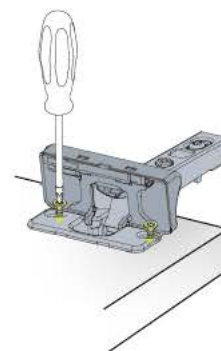

Fix the hinge cup.

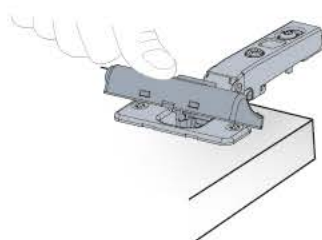

Snap the soft closing mechanism to the hinge cup.

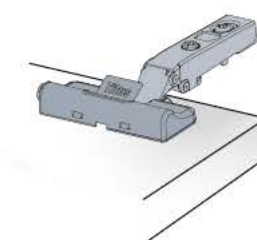

ST-i2 plus 110

2nd Generation

For wooden doors

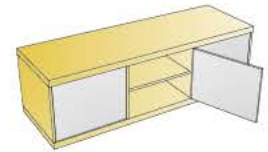
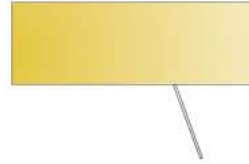
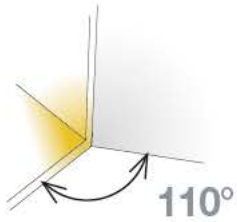

- Opening angle 110°
- Drilling diameter for hinge cup 35mm
- Drilling depth min. 11mm
- Hinge on plate mounting system ST



Technical details

Cup type	Interaxis 45mm	Interaxis 48mm	Interaxis 52mm
Item number			

Cranking 0mm

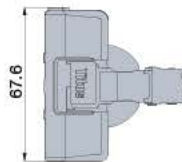
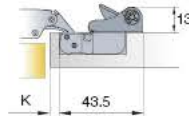

	954.0695.050		
	954.0212.050	954.0213.050	954.0214.050

Drilling patterns for hinge cups → see page 3.8

100 Pcs

Made of steel and plastic

Cranking 9mm

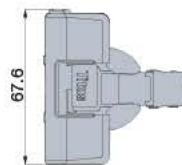
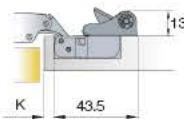

	954.0696.050	954.0808.050	
--	--------------	--------------	--

Drilling patterns for hinge cups → see page 3.8

100 Pcs

Made of steel and plastic

Mounting plates



Steel mounting plates
→ see page 3.35



Zinc diecast mounting plates
→ see page 3.35



Steel mounting plates with cam adjustable height
→ see page 3.35

Hinge cup screws

If not pre-mounted

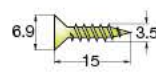

820.6308.050

10000 Pcs



Cover caps for hinge arm

248.1646.050

4000 Pcs

Legend of hinge cup symbols



Screw-on ready
← screws



Easy-fix system



Damping adjustment

Turn towards '+' to increase and towards '-' to decrease the damping

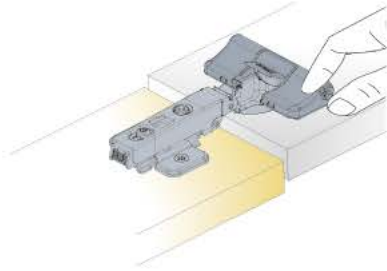

For further explanation → see page 3.17

Door adjustment

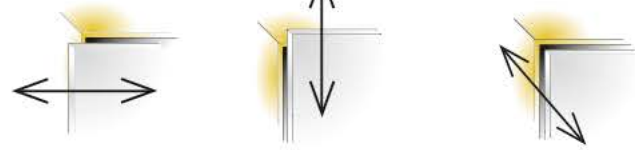

Side adjustment
+3/-1mm

Height adjustment
+2/-2mm

Depth adjustment
+1.5/-1.5mm

For further explanation → see pages 3.12 - 3.14

Mounting details

Mounting plate drilling distance

Mounting plate thickness table

For further explanation → see page 3.5

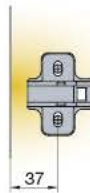
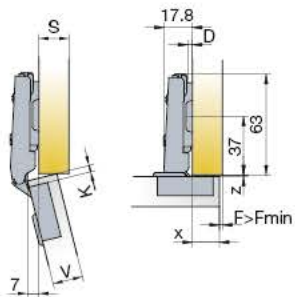

x	13	14	15	16	17	18
3	3	2	1	0		
K 4		3	2	1	0	
5			3	2	1	0 D

Drawings show application on D=0mm thick mounting plate

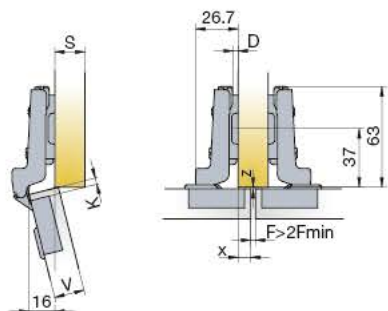

x	4	5	6	7	8	9
3	3	2	1	0		
K 4		3	2	1	0	
5			3	2	1	0 D

Drawings show application on D=0mm thick mounting plate

Recommended number per door and positioning

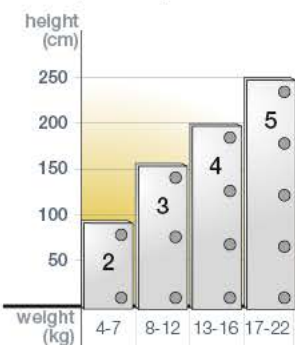

For further explanation → see page 3.11

Door clearance

For further explanation → see page 3.5



V	16	17	18	19	20	21	22
3	0.3	0.5	0.7	1.0	1.3	1.7	2.5
K 4	0.3	0.5	0.7	0.9	1.2	1.6	2.1
5	0.3	0.5	0.7	0.9	1.2	1.5	2.0 F _{MIN}

Gap Z_{MIN}=0

ST plus 110

For wooden doors

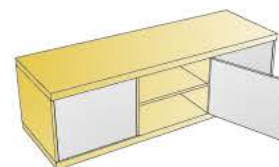
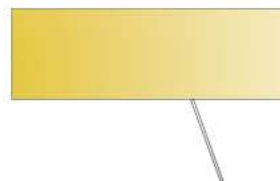
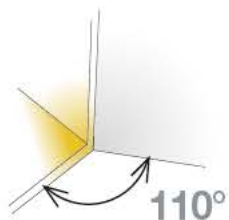

	Interaxis 45mm	Interaxis 48mm	Interaxis 52mm
Cup type	Item number	Item number	Item number

Cranking

0mm



	248.0T10.050	248.0T70.050	
	248.0T13.050	248.0T71.050	248.0T94.050
	248.0T69.050	248.0T72.050	248.0T95.050

Drilling patterns for hinge cups → see page 3.8

200 Pcs

Made of steel

Cranking

9mm



	248.0V69.050	248.0V71.050	
	248.0V70.050	248.0V72.050	248.0274.050
	248.0V56.050		248.0275.050

Drilling patterns for hinge cups → see page 3.8

200 Pcs

Made of steel

Mounting plates



Steel mounting plates
→ see page 3.35



Zinc diecast mounting plates
→ see page 3.35



Steel mounting plates with cam adjustable height
→ see page 3.35

Hinge cup screws
if not pre-mounted

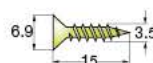

820.6308.050

10000 Pcs



Legend of hinge cup symbols



Screw-on ready
← screws



Machine insertion ready



Easy-fix system



- Opening angle 110°
- Drilling diameter for hinge cup 35mm
- Drilling depth 11.5mm
- Hinge on plate mounting system ST

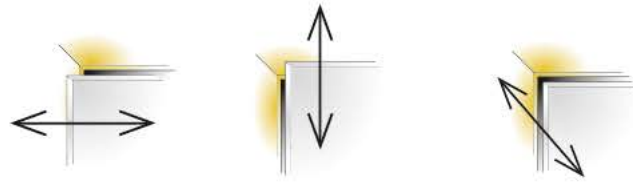

Side adjustment
+3/-1mm

Height adjustment
+2/-2mm

Depth adjustment
+1.5/-1.5mm

- Quick, comfortable and precise depth adjustment

For further explanation → see pages 3.12 - 3.14

Mounting details

Mounting plate drilling distance

Mounting plate thickness table
For further explanation → see page 3.5

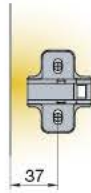
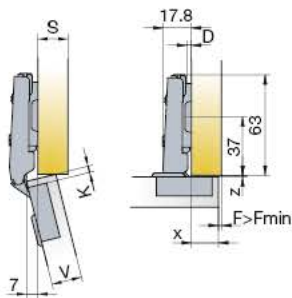

x	13	14	15	16	17	18
	3	2	1	0		
K	4	3	2	1	0	
	5		3	2	1	0 D

Drawings show application on D=0mm thick mounting plate

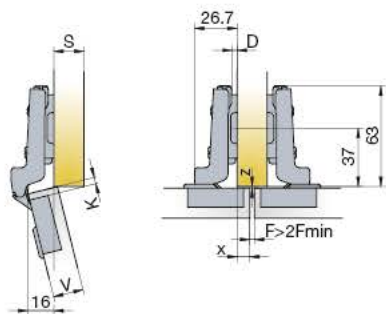

x	4	5	6	7	8	9
	3	2	1	0		
K	4	3	2	1	0	
	5		3	2	1	0 D

Drawings show application on D=0mm thick mounting plate

Soft closing systems

Accessories

Door clearance
For further explanation → see page 3.5

V	16	17	18	19	20	21	22	
	3	0.3	0.5	0.7	1.0	1.3	1.7	2.5
K	4	0.3	0.5	0.7	0.9	1.2	1.6	2.1
	5	0.3	0.5	0.7	0.9	1.2	1.5	2.0 FMIN

Gap Z_{MIN}=0

ST plus 110

Touch opening

For wooden doors without handles

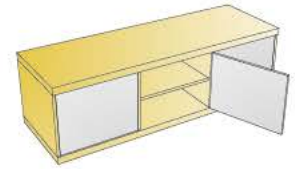
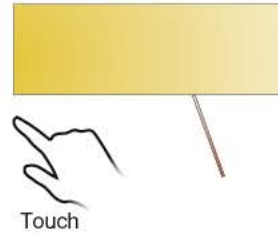
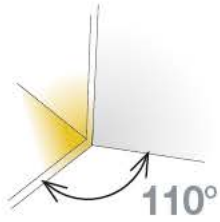

Cup type	Interaxis 45mm	Interaxis 48mm	Interaxis 52mm
	Item number	Item number	Item number

Cranking
0mm



200 Pcs

Made of steel



915.0Z85.050 915.0Z96.050

Drilling patterns for hinge cups → see page 3.8

Cranking
9mm



200 Pcs

Made of steel



915.0007.050

Drilling patterns for hinge cups → see page 3.8

Catches



Catch



Catch with base plate



Knock-in pad



Self adhesive pad

100 Pcs

Made of plastic

Catch	915.7102.380
Catch with base plate	915.7110.380
Knock-in pad	915.7109.050
Self adhesive pad	915.7105.050

Mounting plates



Steel mounting plates
→ see page 3.35



Zinc diecast mounting plates
→ see page 3.35



Steel mounting plates with cam adjustable height
→ see page 3.35

Hinge cup screws
if not pre-mounted

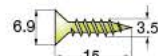

820.6308.050

10000 Pcs

Legend of hinge cup symbols



Screw-on ready
← screws



- Opening angle 110°
- Drilling diameter for hinge cup 35mm
- Drilling depth 11.5mm
- Hinge on plate mounting system ST

- Hinge integrated self-opening mechanism
- Effortless opening with just a light touch

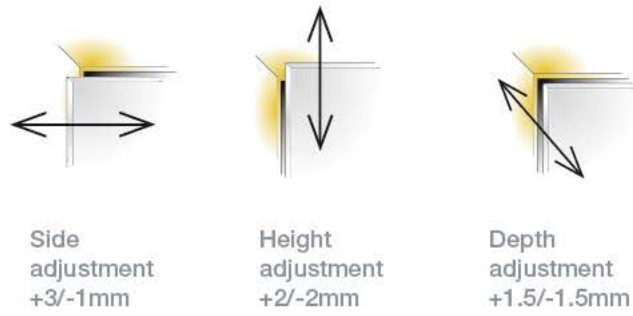

For further explanation → see pages 3.12 - 3.14

Mounting details

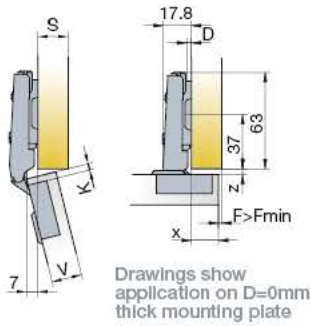

Mounting plate drilling distance

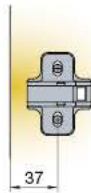

Mounting plate thickness table

For further explanation → see page 3.5

x	13	14	15	16	17	18
3	3	2	1	0		
K	4	3	2	1	0	
5		3	2	1	0	D

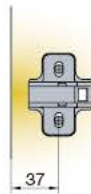
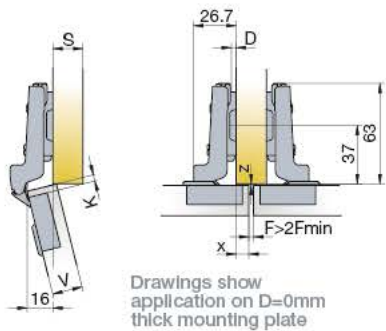

x	4	5	6	7	8	9
3	3	2	1	0		
K	4	3	2	1	0	
5		3	2	1	0	D

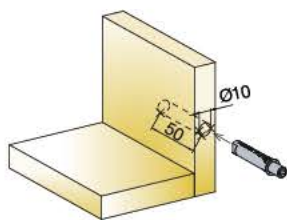

Catch

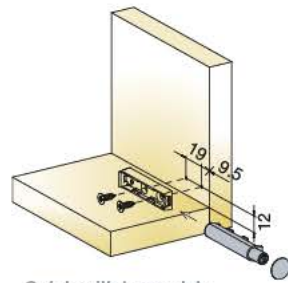

Catch with base plate

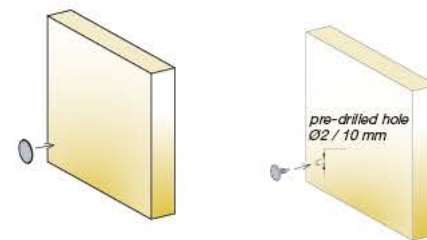

Fixing of pad depends on the catch position

Accessories



Door clearance

For further explanation → see page 3.5



V	16	17	18	19	20	21	22	
3	0.3	0.5	0.7	1.0	1.3	1.7	2.5	
K	4	0.3	0.5	0.7	0.9	1.2	1.6	2.1
5	0.3	0.5	0.7	0.9	1.2	1.5	2.0	F _{MIN}

Gap Z_{MIN}=0

ST 110

For wooden doors

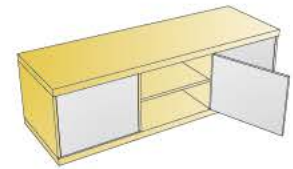
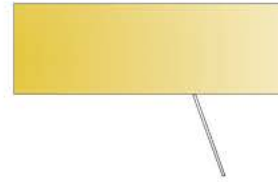
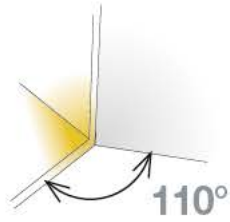

Cup type	Interaxis 45mm	Interaxis 48mm	Interaxis 52mm
	Item number	Item number	Item number

Cranking
0mm



200 Pcs

Made of steel

	248.0535.050	248.0532.050	
	248.0171.050	248.0172.050	248.0184.050

Drilling patterns for hinge cups → see page 3.8

Cranking
9mm

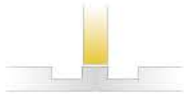

200 Pcs

Made of steel

			248.0401.050
			248.0549.050

Drilling patterns for hinge cups → see page 3.8

Cranking
15mm



200 Pcs

Made of steel

	248.0537.050		
	248.0280.050	248.0328.050	248.0402.050
	248.0487.050	248.0547.050	248.0551.050

Drilling patterns for hinge cups → see page 3.8

Mounting plates



Steel mounting plates
→ see page 3.35



Zinc diecast mounting plates
→ see page 3.35



Steel mounting plates with cam adjustable height
→ see page 3.35

Hinge cup screws if not pre-mounted

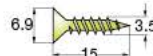

820.6308.050



10000 Pcs

Legend of hinge cup symbols



Screw-on ready
← screws



Machine insertion ready



Easy-fix system

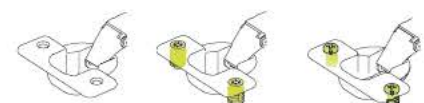

- Opening angle 110°
- Drilling diameter for hinge cup 35mm
- Drilling depth 11.5mm
- Hinge on plate mounting system ST

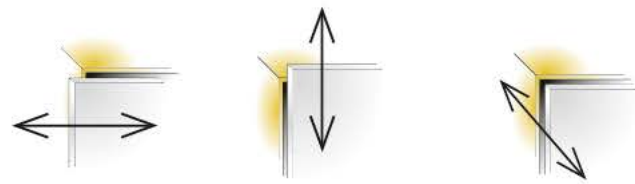

Side adjustment
+3/-1mm

Height adjustment
+2/-2mm

Depth adjustment
+5/-1.5mm

- Quick and practical assembly on the hinge and mounting plate by pressing gently on the rear part of the hinge arm
- One button disassembly

For further explanation → see pages 3.12 - 3.14

Mounting details

Mounting plate drilling distance

Mounting plate thickness table

For further explanation → see page 3.5

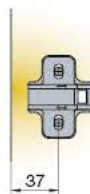
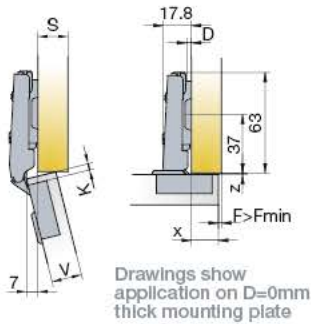

x	13	14	15	16	17	18
3	3	2	1	0		
K	4	3	2	1	0	
5			3	2	1	0 D

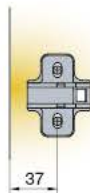
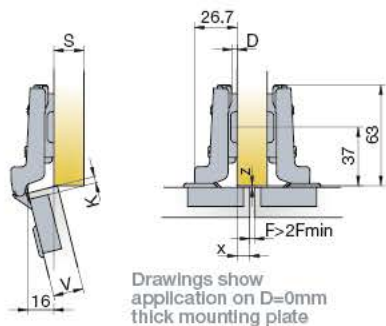

x	4	5	6	7	8	9
3	3	2	1	0		
K	4	3	2	1	0	
5			3	2	1	0 D

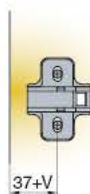
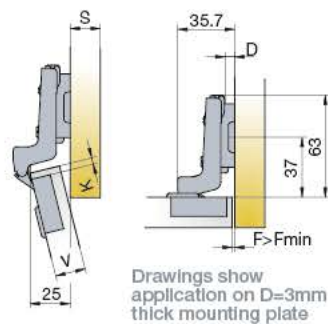

V	16	17	18	19	20	21
3	2	2	2	3	3	3
K	4	3	3			
5	3					

Soft closing systems

Accessories

Door clearance

For further explanation → see page 3.5

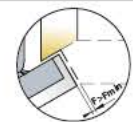

V	16	17	18	19	20	21	22
3	0.3	0.5	0.7	1.0	1.3	1.7	2.5
K	4	0.3	0.5	0.7	0.9	1.2	1.6 2.1
5	0.3	0.5	0.7	0.9	1.2	1.5	2.0 F _{MIN}



Gap Z_{MIN}=0

ST 110/45°

45° angled application for wooden doors

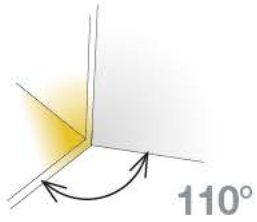

	Interaxis 45mm	Interaxis 48mm	Interaxis 52mm
Cup type	Item number	Item number	Item number
	248.0285.050		
	248.0N20.050		248.0291.050
	248.0P21.050	248.0P64.050	248.0Z78.050

Cranking
18mm



Drilling patterns for hinge cups → see page 3.8.

100 Pcs

Cup made of steel, arm made of zinc

Mounting plates

Steel mounting plates
→ see page 3.35

Zinc diecast mounting plates
→ see page 3.35

Steel mounting plates with cam adjustable height
→ see page 3.35

Hinge cup screws If not pre-mounted

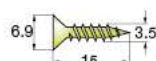

820.6308.050

10000 Pcs

Legend of hinge cup symbols



Screw-on ready
← screws



Machine insertion ready



Easy-fix system



- Opening angle
- Drilling diameter for hinge cup
- Drilling depth
- Hinge on plate mounting system

110°
35mm
11.5mm
ST

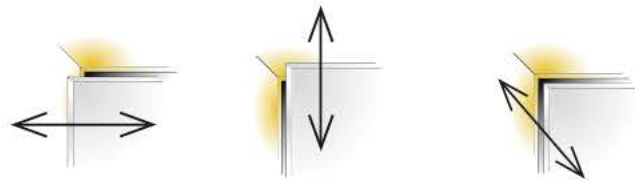

Side
adjustment
+3/-1mm

Height
adjustment
+2/-2mm

Depth
adjustment
+5/-1.5mm

For further explanation → see pages 3.12 - 3.14

Mounting
details

Mounting plate
drilling distance

Mounting plate thickness table
For further explanation → see page 3.5

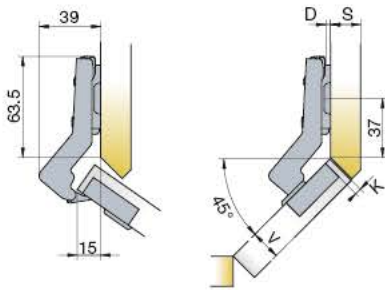

Drawings show
application on D=0mm
thick mounting plate

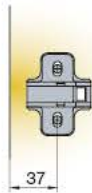

K	3	4	5
D	0	1	2

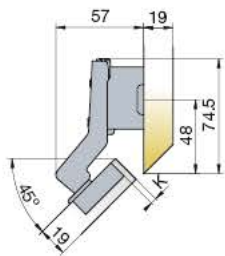

Drawings show
application on D=18mm
thick mounting plate

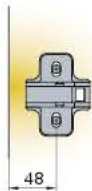

Soft closing systems

Accessories

Door clearance
For further explanation → see page 3.5



V	16	17	18	19	20	21	22	
3	0.3	0.5	0.7	1.0	1.3	1.7	2.5	
K	4	0.3	0.5	0.7	0.9	1.2	1.6	2.1
5	0.3	0.5	0.7	0.9	1.2	1.5	2.0	F _{MIN}

Gap Z_{MIN}=0

ST 110/90°

For wooden door cabinets with blind panels

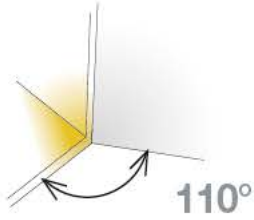
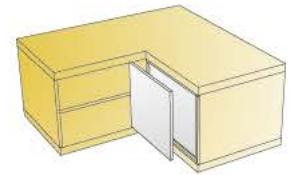

	Interaxis 45mm	Interaxis 48mm	Interaxis 52mm
Cup type	Item number	Item number	Item number
	248.0745.050	248.0742.050	
	248.0N24.050	248.0N25.050	248.0N26.050
	248.0L61.050	248.0N62.050	248.0Z81.050

Cranking
18mm



Drilling patterns for hinge cups → see page 3.8

100 Pcs

Cup made of steel, arm made of zinc

Mounting plates



Steel mounting plates
→ see page 3.35



Zinc diecast mounting plates
→ see page 3.35



Steel mounting plates with
cam adjustable height
→ see page 3.35

Hinge cup screws If not pre-mounted

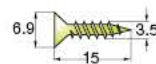

820.6308.050

10000 Pcs

Legend of hinge cup symbols



Screw-on
ready
← screws



Machine
insertion
ready



Easy-fix
system



- Opening angle
- Drilling diameter for hinge cup
- Drilling depth
- Hinge on plate mounting system

110°
35mm
11.5mm
ST

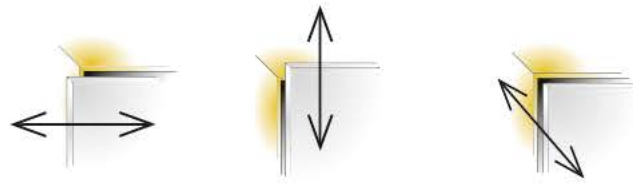

Side
adjustment
+3/-1mm

Height
adjustment
+2/-2mm

Depth
adjustment
+5/-1.5mm

For further explanation → see pages 3.12 - 3.14

Mounting
details

Mounting plate
drilling distance

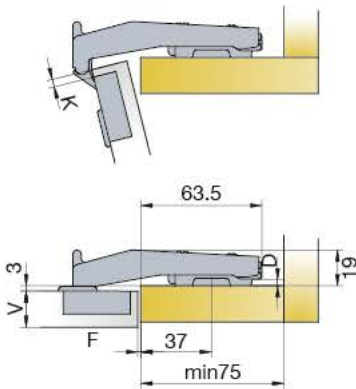

Drawings show
application on D=0mm
thick mounting plate

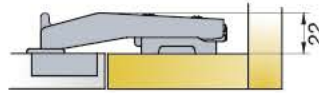

Drawings show
application on D=3mm
thick mounting plate

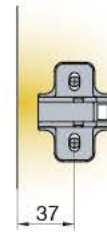

Soft closing systems



Glissando TL
→ see page 2.11

Accessories



Cover caps for hinge arm
248.1646.050
4000 Pcs



Push latch
→ see page 3.37

Door clearance

For further explanation → see page 3.5

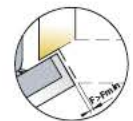

V	16	17	18	19	20	21	22	
3	0.3	0.5	0.7	1.0	1.3	1.7	2.5	
K	4	0.3	0.5	0.7	0.9	1.2	1.6	2.1
5	0.3	0.5	0.7	0.9	1.2	1.5	2.0	F _{MIN}

ST 170

For wooden doors

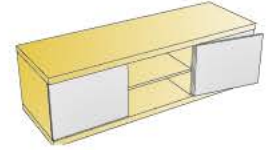
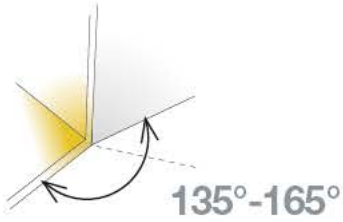

	Interaxis 45mm	Interaxis 48mm	Interaxis 52mm
Cup type	Item number	Item number	Item number

Cranking

0mm



50 Pcs

Made of steel and zinc

	248.0R14.050	248.0R17.050	
	248.0M73.050	248.0R13.050	248.0M74.050
	248.0S17.050	248.0S18.050	248.0S19.050

Drilling patterns for hinge cups → see page 3.8

Cranking
0mm

With adjustable opening angle



50 Pcs

Made of steel and zinc

	248.0R18.050	*248.0V65.050	
		*248.0S69.050	

Drilling patterns for hinge cups → see page 3.8

* Available upon special request → see page 0.3



Adjustable opening angle

Cranking
9mm



50 Pcs

Made of steel and zinc

	248.0162.050	248.0163.050	
--	--------------	--------------	--

Drilling patterns for hinge cups → see page 3.8

Mounting plates



Steel mounting plates
→ see page 3.35



Zinc diecast mounting plates
→ see page 3.35



Steel mounting plates with cam adjustable height
→ see page 3.35

Hinge cup screws if not pre-mounted

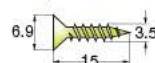

820.6308.050

10000 Pcs



Legend of hinge cup symbols



Screw-on ready
← screws



Machine insertion ready



Easy-fix system



- Opening angle 135°-165°
- Drilling diameter for hinge cup 35mm
- Drilling depth 12mm
- Hinge on plate mounting system ST

- Enables better accessibility into cabinet interior due to the wider opening angle
- Opening angle can be easily adjusted by rotating the appropriate screw on the hinge arm

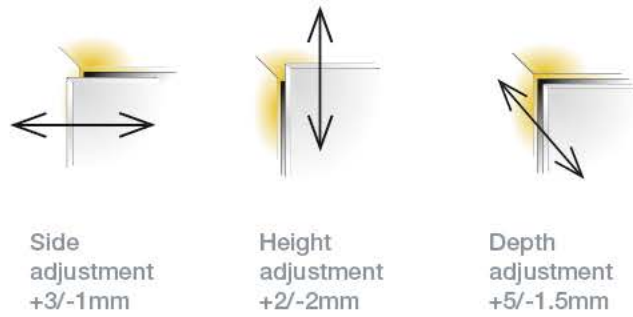

For further explanation → see pages 3.12 - 3.14

Mounting details

Mounting plate drilling distance

Mounting plate thickness table

For further explanation → see page 3.5

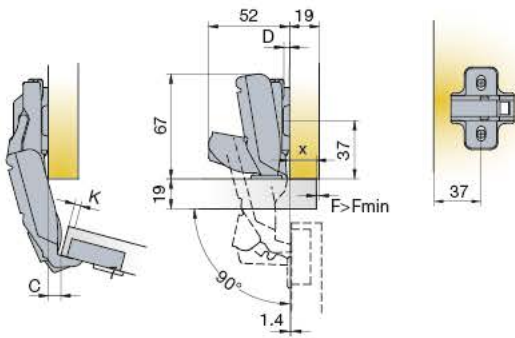

Drawings show application on D=0mm mounting plate

In 90° position the door is only 1.4mm distant from side panel

X	10	11	12	13	14	15	16	17	18	19	20
3	6	5	4	3	2	1	0				
K	4	6	5	4	3	2	1	0			
5			6	5	4	3	2	1	0		
6				6	5	4	3	2	1	0	
7					6	5	4	3	2	1	0

C value with D=0 mounting plates

K	3	4	5	6	7
C	-9.0	-8.1	-7.1	-6.1	-5.2

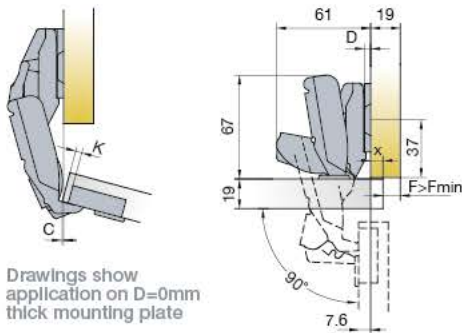

Drawings show application on D=0mm thick mounting plate

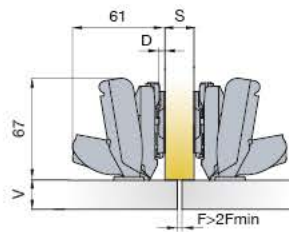

Drawings show application on D=0mm thick mounting plate

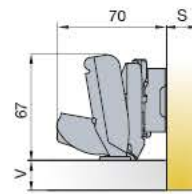

Drawings show application on D=9mm thick mounting plate

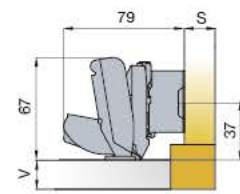

Drawings show application on D=18mm thick mounting plate.

Soft closing systems

Glissando 170 → see page 2.13

Glissando CR → see page 2.15

Door clearance For further explanation → see page 3.5

V	16	17	18	19	20	21	22	23	24
3	0.0	0.0	0.0	0.0	0.0	0.0	0.0	0.0	0.0
K	4	0.0	0.0	0.0	0.0	0.0	0.0	0.0	0.0
5	0.0	0.0	0.0	0.0	0.0	0.0	0.0	0.0	0.0
6	0.0	0.0	0.0	0.0	0.0	0.0	0.0	0.0	2.6
7	0.0	0.0	0.0	0.0	0.0	0.0	0.0	0.0	5.1

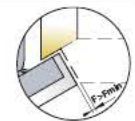

Gap Z_{MIN}=0.5

ST for pie-cut corner cabinet

For wooden doors

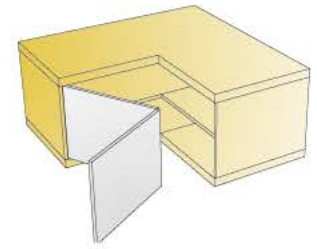

	Interaxis 45mm	Interaxis 48mm	Interaxis 52mm
Cup type	Item number	Item number	Item number
	248.0U21.050	248.0U16.050	
	248.0U22.050	248.0V15.050	248.0Z20.050
	248.0V29.050	248.0Z79.050	248.0Z80.050

Corner cabinet

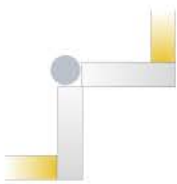

Drilling patterns for hinge cups → see page 3.8

100 Pcs

Cup made of steel, arm made of zinc

Mounting plates



Steel mounting plates
→ see page 3.35



Zinc diecast mounting plates
→ see page 3.35



Steel mounting plates with cam adjustable height
→ see page 3.35

Hinge cup screws If not pre-mounted

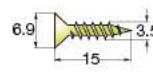

820.6308.050



10000 Pcs

Legend of hinge cup symbols



Screw-on ready
← screws



Machine Insertion ready



Easy-fix system



- Opening angle 110°
- Drilling diameter for hinge cup 35mm
- Drilling depth 11.5mm
- Hinge on plate mounting system ST

- Standard drilling for hinge and mounting plate
- Hinge integrated adjustment

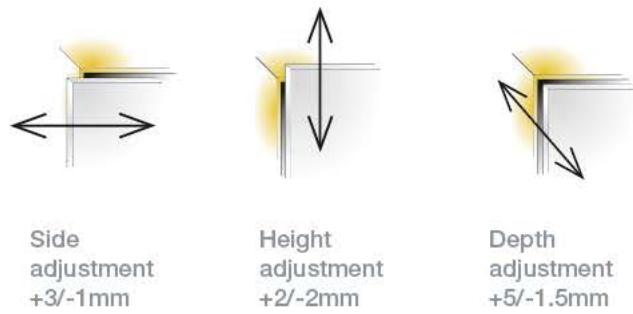

For further explanation → see pages 3.12 - 3.14

Mounting details

Drilling details

Adjustments

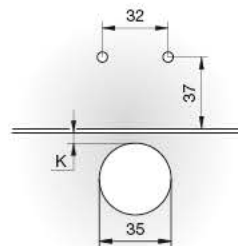
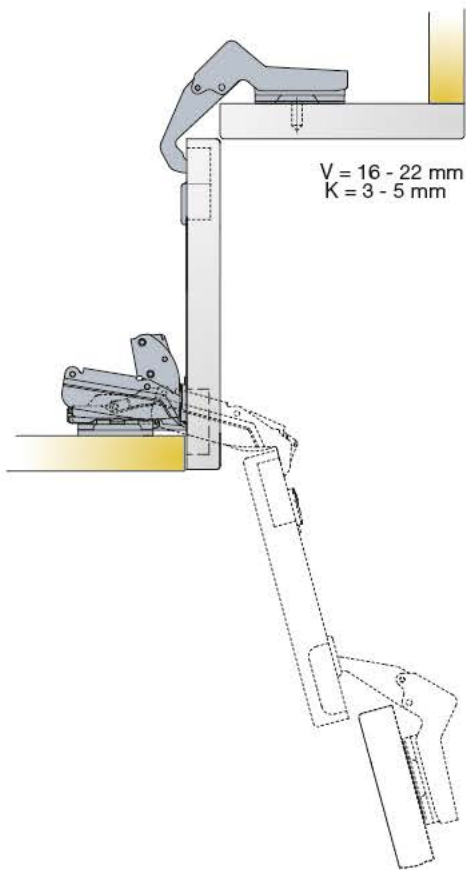

Any ST mounting plate of thickness D=0 can be used

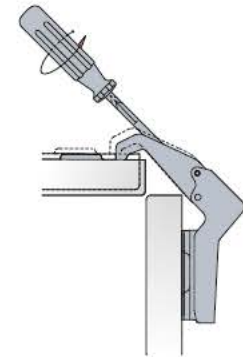

The diagonal adjustment is made by rotating the appropriate screw as shown on the drawing

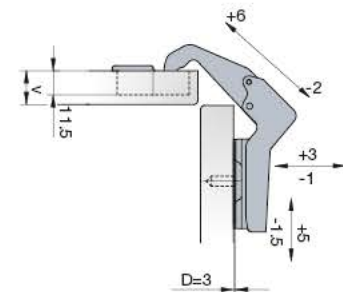

Accessories

-  Cover caps for hinge arm
- 248.1646.050
-  4000 Pcs

ST

Mounting plates

For ST free, ST plus and ST concealed hinges

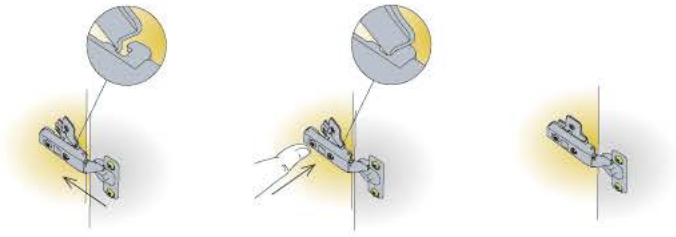

Steel mounting plates with cam adjustable height



200 Pcs

Made of steel

Drilling pattern

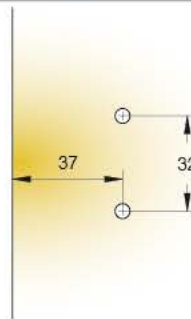

Dimensions

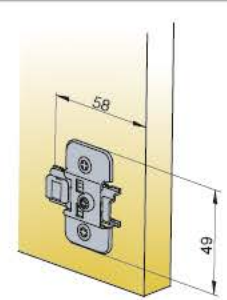

Steel mounting plates



200 Pcs

Made of steel

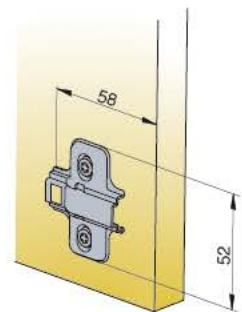
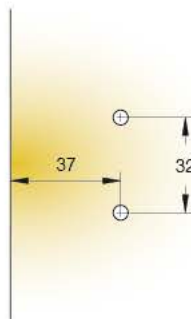

Zinc diecast mounting plates



200 Pcs

Made of zinc

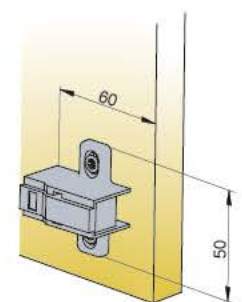
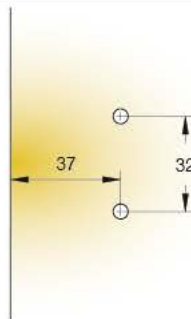

Fixing screws for mounting plates
If not pre-mounted

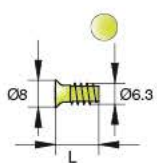

Euro screws
821.6304.050 L=11
821.6323.050 L=13
821.6332.050 L=15

5000 Pcs

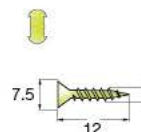

Chipboard screws
820.6328.050

10000 Pcs

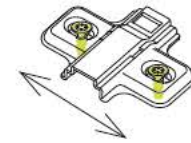
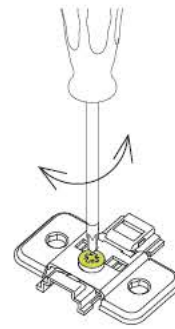
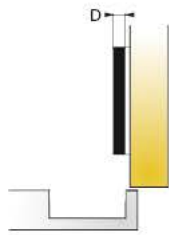

Mounting plate thickness

Cam adjustable mounting plate +/- 2mm

Height adjustment +/- 2mm

Mounting plate type								
Mounting plate thickness (D)								
Item number								
0mm	244.0R22.050			244.0P71.050	244.0S92.050	*244.0P68.050	*244.0P77.050	244.0S43.050
2mm	244.0R23.050			244.0P72.050	244.0S95.050	*244.0P69.050	*244.0P78.050	244.0S44.050
3mm	244.0R24.050			244.0P73.050	244.0S96.050	*244.0P70.050	*244.0P79.050	244.0S45.050
* Available upon special request → see page 0.3								
0mm	244.1136.050	*244.1233.050	244.0Z26.050	244.0134.050	244.0118.050	*244.0136.050	*244.0166.050	244.0P26.050
1mm	244.1137.050	*244.1228.050		244.0561.050		*244.0565.050	*244.0567.050	
2mm	244.1138.050	*244.1229.050	244.0Z63.050	244.0562.050	244.0120.050	*244.0566.050	*244.0568.050	244.0V19.050
3mm	244.1139.050	*244.1234.050		244.0135.050	244.0119.050	*244.0137.050	*244.0167.050	244.0P27.050
6mm	244.1645.050				244.0Z51.050			
* Available upon special request → see page 0.3			* Mounting plates with pre-mounted 7.5mm expanding dowels available upon special request → see page 0.3					
9mm	244.3651.650			244.0M33.650	244.0P29.650			
18mm	244.3016.650			244.0085.650	244.0095.650			
* Available upon special request → see page 0.3								

Legend of mounting plate type symbols

Screw on ready for euro screws ← screws	Screw-on ready for chipboard screws	Pre-mounted 11 mm euro screws	Pre-mounted 13mm euro screws	Pre-mounted 15mm euro screws	Pre-mounted chipboard screws	Machine Insertion ready	Pre-mounted 10.5mm expanding dowels

Push latch

For wooden doors and drawers

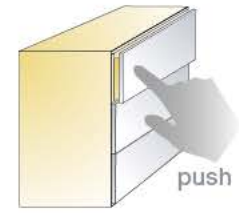
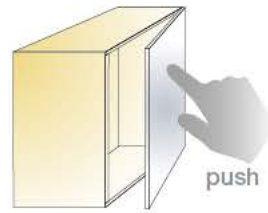

Push Latch



Push latch



Cross mounting plate



Linear mounting plate

Item number

Bronze

Push latch	915.0X59 →	381
Cross m. plate	915.4183 →	381
Linear m. plate	915.4175 →	381

915.0X59.381.K1



915.0X59.381.K2



200 Pcs

Made of steel and plastic

Fixing screws for mounting plates

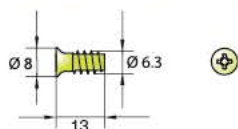

Euro screws
821.6323.050

10000 Pcs



Chipboard screws

- Works with standard concealed hinges and drawers
- Effortless opening with just a light touch
- Depth adjustment ensures reliable closing and consistent performance in cases of inaccurate drilling
- 'Safety click' feature for easy detachment of the mechanism from the mounting plate

Drilling pattern

Dimensions

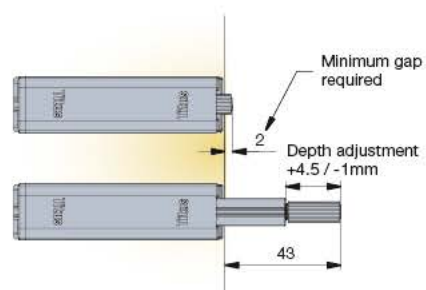
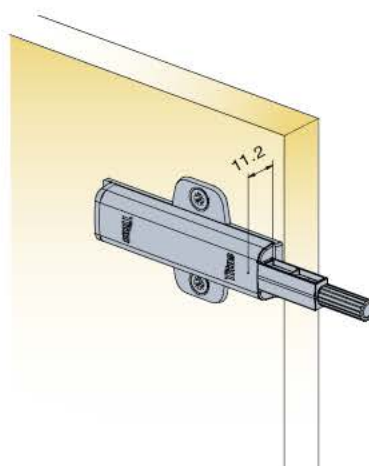
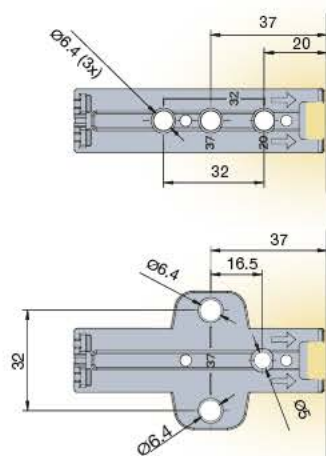

Positioning

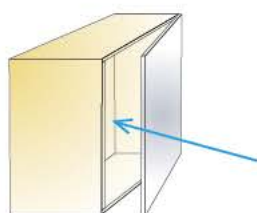

Close to the 'touch opening point' on the side opposite to hinges

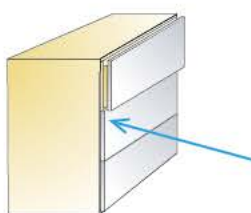

On the cabinet side; gap between drawer and cabinet side = min 12mm

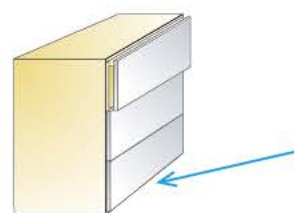

On the drawer bottom; in the middle of drawer

Push latch works with standard hinges.

Push latch works on drawer; the gap between the drawer and the cabinet side = min. 12 mm

Global player

Worldwide design, manufacturing and distribution capabilities

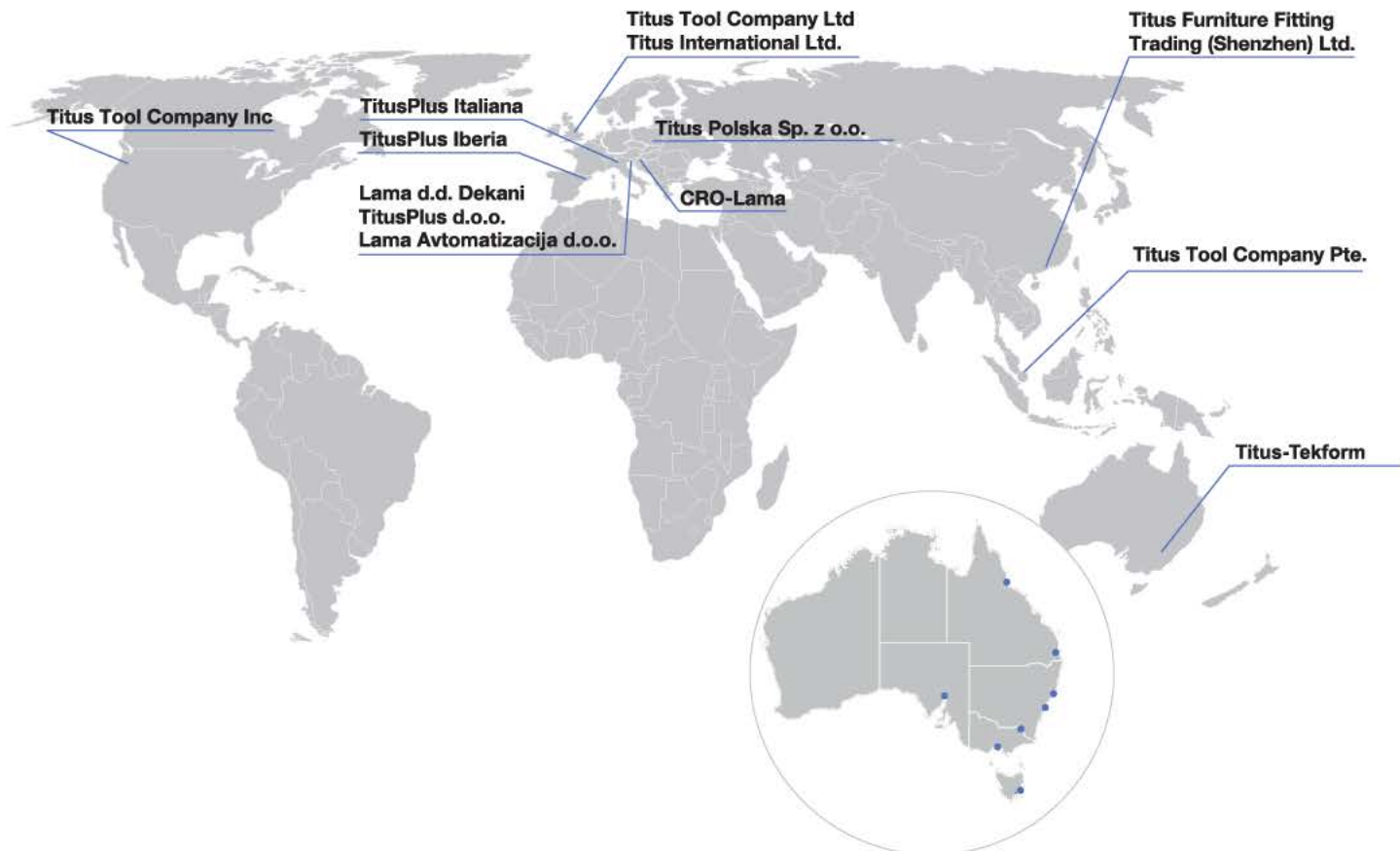

Australia

New South Wales

Titus Tekform Pty Ltd
Unit 1&2, 41-43 Whyalla Place
Prestons, NSW, 2170
Australia
T: +61 2 9826 0007
Fax: +61 2 9826 0074
ABN: 67 168 439 647

Titus Tekform Pty Ltd
Unit 3, 100 Munibung Road
Cardiff, NSW, 2285
Australia
T: +61 2 4954 4011
Fax: +61 2 4954 4233

Queensland

Titus Tekform Pty Ltd
20 Civil Road
Garbutt, QLD, 4814
Australia
T: +61 7 4779 1366
Fax: +61 7 4779 1316
PO Box 7922
Garbutt, QLD, 4815

Titus Tekform Pty Ltd

1/32 Northlink Place
Virginia, QLD, 4014
Australia
T: +61 7 3200 2101
Fax: +61 7 3200 2114
PO Box 266
Northgate, QLD, 4013

South Australia

Titus Tekform Pty Ltd
4/280-288 Grand Junction Road
Athol Park, S.A., 5012
Australia
T: +61 8 8447 3700
Fax: +61 8 8447 3183

Tasmania

Titus Tekform Pty Ltd
88 Hopkins Street
Moonah, TAS, 7009
T: +61 3 6273 1199
Fax: +61 3 6273 0050
Australia
PO Box 658
Moonah, TAS, 7009

Victoria

Titus Tekform Pty Ltd
2/20 Mint Street
Wodonga, VIC, 3690
Australia
T: +61 2 6056 3188
Fax: +61 2 6056 3190

Titus Tekform Pty Ltd
8/59 Jersey Road
Bayswater, VIC, 3153
Australia
T: +61 3 9737 5566
Fax: +61 3 9729 8780
PO Box 357
Bayswater, VIC, 3153

Headquarters

Titus International Ltd
Brook House
54a Cowely Mill Road
Uxbridge, Middlesex
UB8 2QE
United Kingdom
+44 1895 203 730
+44 1895 252 793 Fax

www.titustekform.com.au

Index

Item number	Page	Item number	Page	Item number	Page	Item number	Page
00062	1.8	05656	1.28	2756.4036	1.42	248.0742.050	3.29
00068	1.8	05657	1.28	02182	1.42	248.ON25.050	3.29
00071	1.8	05676	1.28	951.0X94.050	2.11	248.ON62.050	3.29
00077	1.8	05678	1.28	951.0XP59.050	2.11	248.ON26.050	3.29
00171	1.8	05586	1.28	951.0P63.050	2.11	248.OZ81.050	3.29
00172	1.8	05652	1.28	951.0253.050	2.11	248.OR14.050	3.31
06074	1.8	05658	1.28	951.0F15.650	2.13	248.OM73.050	3.31
06077	1.8	05658	1.28	972.0X19.350	2.15	248.OS17.050	3.31
06080	1.8	05675	1.28	972.0X19.380	2.15	248.OR17.050	3.31
01056	1.8	05677	1.28	972.0X19.360	2.15	248.OR13.050	3.31
01020	1.8	05679	1.28	972.0X34.380	2.15	248.OS18.050	3.31
01042	1.8	05575	1.29	973.0X35.380	2.17	248.OM74.050	3.31
03118	1.10	05578	1.29	973.4451.380	2.17	248.OS19.050	3.31
03121	1.10	05580	1.29	973.4451.350	2.17	248.OR18.050	3.31
03168	1.10	05574	1.29	973.1679.040	2.17	248.OV65.050	3.31
03181	1.10	05576	1.29	973.0X95.380	2.19	248.OS69.050	3.31
03180	1.10	05579	1.29	973.0X39.380	2.19	248.0162.050	3.31
03090	1.10	06408	1.33	973.4125.350	2.19	248.0163.050	3.31
03150	1.10	06410	1.33	973.4126.309	2.19	248.OU21.050	3.33
06803	1.12	06479	1.33	954.0695.050	3.19	248.OU22.050	3.33
06806	1.12	06401	1.34	954.0212.050	3.19	248.OV29.050	3.33
06813	1.12	06402	1.34	954.0213.050	3.19	248.OU16.050	3.33
06839	1.12	06406	1.34	954.0214.050	3.19	248.OV15.050	3.33
02107	1.13	06403	1.34	954.0696.050	3.19	248.OZ79.050	3.33
02120	1.13	06405	1.34	954.0808.050	3.19	248.OZ20.050	3.33
02141	1.13	06495	1.34	248.0T10.050	3.21	248.OZ80.050	3.33
02144	1.13	06414	1.35	248.0T13.050	3.21	244.OR22.050	3.36
02130	1.13	06413	1.35	248.0T69.050	3.21	244.OR23.050	3.36
02139	1.13	06416	1.35	248.0T70.050	3.21	244.OR24.050	3.36
05453	1.20	06451	1.36	248.0T71.050	3.21	244.OP71.050	3.36
05503	1.20	06453	1.36	248.0T72.050	3.21	244.OP72.050	3.36
05441	1.20	06435	1.36	248.0T94.050	3.21	244.OP73.050	3.36
05474	1.20	06437	1.36	248.0T95.050	3.21	244.OS92.050	3.36
05388	1.20	06447	1.36	248.OV69.050	3.21	244.OS95.050	3.36
05414	1.21	06449	1.36	248.OV70.050	3.21	244.OS96.050	3.36
09435	1.22	06431	1.36	248.OV56.050	3.21	244.OP68.050	3.36
09588	1.22	06433	1.36	248.OV71.050	3.21	244.OP69.050	3.36
09443	1.22	06459	1.37	248.OV72.050	3.21	244.OP70.050	3.36
09583	1.22	06461	1.37	248.0274.050	3.21	244.OP77.050	3.36
09592	1.22	06443	1.37	248.0275.050	3.21	244.OP78.050	3.36
09594	1.22	06445	1.37	915.0Z85.050	3.23	244.OP79.050	3.36
09605	1.23	06395	1.37	915.0Z96.050	3.23	244.OS43.050	3.36
09607	1.23	06455	1.37	915.0007.050	3.23	244.OS44.050	3.36
09430	1.23	06457	1.37	915.7102.380	3.23	244.OS45.050	3.36
05929	1.24	06439	1.37	915.7110.380	3.23	244.1136.050	3.36
05757	1.24	06441	1.37	915.7109.050	3.23	244.1137.050	3.36
05858	1.24	06397	1.37	915.7105.050	3.23	244.1138.050	3.36
05859	1.24	06470	1.38	248.0535.050	3.25	244.1139.050	3.36
05753	1.24	06473	1.38	248.0171.050	3.25	244.1645.050	3.36
05592	1.24	06465	1.38	248.0532.050	3.25	244.1233.050	3.36
05857	1.24	06464	1.38	248.0172.050	3.25	244.1228.050	3.36
05380	1.24	06471	1.38	248.0184.050	3.25	244.1229.050	3.36
05778	1.24	06472	1.38	248.0401.050	3.25	244.1234.050	3.36
05752	1.24	06381	1.39	248.0549.050	3.25	244.OZ26.050	3.36
05772	1.24	06385	1.39	248.0537.050	3.25	244.OZ63.050	3.36
05751	1.24	06383	1.39	248.0280.050	3.25	244.0134.050	3.36
05775	1.24	06387	1.39	248.0487.050	3.25	244.0561.050	3.36
05774	1.24	05971	1.40	248.0328.050	3.25	244.0562.050	3.36
05860	1.25	05960	1.40	248.0547.050	3.25	244.0135.050	3.36
09495	1.26	05917	1.40	248.0402.050	3.25	244.0118.050	3.36
09533	1.26	01029	1.43	248.0551.050	3.25	244.0120.050	3.36
09537	1.26	277.4355	1.43	248.0285.050	3.27	244.0119.050	3.36
09536	1.26	277.4225	1.43	248.ON20.050	3.27	244.OZ51.050	3.36
09491	1.27	275.4034	1.43	248.OP21.050	3.27	244.0136.050	3.36
09406	1.27	408.3166	1.41	248.OP64.050	3.27	244.0565.050	3.36
09631	1.27	408.3391	1.41	248.0291.050	3.27	244.0566.050	3.36
05587	1.28	408.3423	1.41	248.OZ78.050	3.27	244.0137.050	3.36
05653	1.28	408.3424	1.41	248.0745.050	3.29	244.0166.050	3.36
05644	1.28	275.4035	1.42	248.ON24.050	3.29	244.0567.050	3.36
05654	1.28	275.4058	1.42	248.0L61.050	3.29	244.0568.050	3.36

Index

Item number	Page	Item number	Page	Item number	Page	Item number	Page
244.0167.050	3.36						
244.0P26.050	3.36						
244.0V19.050	3.36						
244.0P27.050	3.36						
244.3651.650	3.36						
244.3016.650	3.36						
244.0M33.650	3.36						
244.0085.650	3.36						
244.0P29.650	3.36						
244.0095.650	3.36						
915.0X59.381	3.37						
915.4183.381	3.37						
915.4175.381	3.37						