



Cembre

13 V 022 E



Certified Quality Management System



GENERAL CATALOGUE

QUALITY POLICY AND OBJECTIVES



This catalogue illustrates the range of our standard products. For each product family we indicate the principal features, and sometimes the most frequent applications and the necessary guidelines for a correct application. Our sales personnel are at your disposal to supply more detailed information and our design and development engineers are available to study new solutions to particular applications.

RoHS
compliant
2002/95/EC

All Cembre products comply with Directive 2002/95/CE of the European Parliament and Council dated 27 January 2003 (and subsequent amendment).

On 14th December 1990 **Cembre SpA Quality Management System** was certified by **Lloyd's Register of Quality Assurance (LRQA)** according to **ISO 9002-1987 EN 29002 - 1987 BS 5750: Part 2: 1987** for the manufacture of insulated and uninsulated copper crimping connectors.

Then on 22nd December 1992 **Cembre SpA** was certified **ISO 9001** for the design and manufacture of cable accessories, electrical connectors and associated tools.

The activities of the main premises in Brescia, the Italian regional offices and the subsidiary companies in Great Britain, France, Spain, Germany and USA are governed by a single Quality System, assessed by **Lloyd's Register of Quality Assurance** conforming to the **ISO 9001:2008** norm, for the design, manufacture and sales of electrical connectors and associated tools, cable accessories, marking systems, tooling and products for railway applications. In house repair, refurbishment and calibration of tooling. This guarantees a homogeneous and high quality level of the products and services that Cembre offers to its customers.

Cembre S.p.A. has recently recognised the need to align its **Environmental Management System** with the spirit and content of **UNI EN ISO 14001: 2004** as fundamental to future development.

To this end the company undertook a wide-ranging review of all functions including development and design stages, material selection, usage and manufacturing processes.

The resulting definition of operational procedures in line with these aims and provisions has enabled **Cembre S.p.A.** to achieve **Environmental Certification**, further highlighting the company's sensitive and careful approach to environmental protection.

Cembre S.p.A. has recently enhanced its business processes with the certification by **Lloyd's Register of Quality Assurance**, of its **Management System for the Health and Safety of Workers**,

in accordance with the standard **OHSAS18001:2007 (Occupational Health and Safety Management System)**.

The project, launched in early 2011, was strategically designed to facilitate the active participation of all employees at every level in the application of systems management, in order to optimise compliance of risk management capability with regard to laws and regulations concerning the health and safety of workers. All employees have received exhaustive training and are involved, by exercising their individual responsibility and competence, as key players in the identification of residual risk situations and the proposal of corrective solutions.

For Cembre then, this certification is not only the proper recognition of the quality of work performed, but also an incentive to maintain a determined competitive advantage in increasingly difficult and aggressive international markets.

Cembre S.p.A. factory in Brescia (ITALY) covers an area of approximately 128.000 sqm

Cembre Ltd.
factory in Curdworth (Birmingham)



Production
Units



CONNECTORS FOR CONTROL, POWER AND DISTRIBUTION

Halogen free insulated terminals type VP, RP, BP, GP	4-5
Insulated chain terminals type CRP, CBP, CGP	6-7
PVC insulated crimp terminals type RF, BF, GF	8-9
Reinforced PA 6.6 insulated terminals type RKY, BKY, GKY	10-11
Female disconnect terminals type RF-F, BF-F, GF-F	12
Male disconnect terminals type RF-M, BF-M, GF-M	12
Partially insulated male/female connectors type RF-FM, BF-FM	12
Insulated bullet and socket connectors type RF-B, BF-B	12
Butt and parallel connectors type PL-M, PL-P	13
Butt connectors type NL-M	13
PE HD insulated, heat shrinkable type WL-M	13
Close end connectors type NL-P	13
Reinforced disconnect terminals type RKF, BKF, GKF	14
Female connectors, open barrel type RN-FA, BN-FA	14
Male connectors, open barrel type RN-MA, BN-MA	15
Male tabs, for board mounting type MP, MPD	15
Connector sleeves type CFA, CMA	15
Insulated end sleeves type PKD, PKE, PKC	16
"Twin" insulated end sleeves type PKT	17
Uninsulated end sleeves type KE	17
Uninsulated terminals type S	18-19
Uninsulated terminals type RN, BN, GN	20-21
Crimping connectors according to DIN 46234 type Q	22-23
Copper tube crimping lugs type A-M	24-25
Ring tongue terminals with contained palm for L.V. circuit breakers type A-M	26
Copper tube crimping lugs type A-L angled 90°	27
Heavy duty copper tube terminals type 2A-M	28
Through connectors type L-M	29
Parallel connectors type L-P	29
PA6.6 insulated copper tube lugs type ANE-M	30
PA6.6 insulated fork terminals type ANE-U	31
Flexible braids type FL	31
PA6.6 insulated pin terminals type ANE-P	32
Uninsulated pin connectors type A-P	32
PA6.6 insulated copper tube lugs type ANE-M, for extra flexible copper conductor	33
Copper tube crimping lugs type A-M, for extra flexible copper conductor	34
Copper tube lugs 4ESI fixing	35
Copper tube crimping lugs according to DIN 46235 type DR	36-37
Crimping through connectors according to DIN 46267 T.1 type DSV	37

CONNECTORS FOR DERIVATIONS AND EARTHING

Sleeve connectors type C	38-39
Mechanical fixing lugs	40
Cable clamps	41

HIGH VOLTAGE COPPER TERMINALS

High voltage copper terminals type CA-M, 2A-M	42
High voltage terminals type CA-2M, 2A-2M, 2A-2M/55°	43
High voltage stalk connectors type MT-C	44
High voltage copper through connectors type MT-TD, MT-GC	45

CONNECTORS FOR ALUMINIUM CONDUCTORS

Aluminium terminals type AA-M	46
Through connectors type MTMA-GC, MTMA/1	47
Reducer through connectors type MTMA-GC	47
Bimetallic connectors, copper palm fixing type CAA-M	48
Bimetallic connectors, copper pin type MTA-C	48

TERMINAL BLOCKS

ZETA più single pole terminal blocks	50-53
ZETA block power distribution blocks	54-55
ZETA mini one way terminal blocks	56

CABLE GLANDS AND ACCESSORIES

MAXI block cable glands, Polyamide, IP68	58-60
spiral block cable glands, Polyamide, IP68	61
MAXI block ATEX cable glands, Polyamide, IP65	62
Compression cable glands, Polyamide PA6, IP54	63-64
Compression cable glands & hole plugs, Polystyrene, IP54	65
MAXI brass cable glands, Nickel plated brass, IP68	66-69
MAXI brass ATEX cable glands, Nickel plated brass, IP65	70
EMC cable glands & locknuts, Nickel plated brass, IP68	70
Compression cable glands, Nickel plated & plain brass, IP54	71
MAXI inox cable glands, Stainless Steel, IP68	72-73
Locknuts with & without collar, Polyamide	74-75
Locknuts, Nickel plated & plain brass	76
EMC locknuts, Nickel plated brass	77
MAXI inox locknuts, Stainless Steel	77
Internal plugs & multi-entry seals for cable glands	78-79
Thread enlargers, reducers and converters, Nickel plated brass	80-81
Accessories	82
O-rings, sealing rings and compression washers	83-85
Entry plugs, Polyamide PA6, Polystyrene, IP54	86-87
Entry bushes, Polyamide PA6	88
Entry plugs & bushes, Nickel plated & plain brass, IP54	89
RUTASEAL grommets, EPDM, IP67	90

CABLE & CONDUIT ACCESSORIES

SICUR clips retaining clips for cable & conduit, ABS	92
Conduit fittings	92

MECHANICAL TOOLS

Mechanical tools	94-113
Pneumatic press and bench tools	115-118

HYDRAULIC TOOLS

Hydraulic crimping tools	120-131
Hydraulic cable cutters	132-140
Special tools	141-142
Accessories	142
Crimping force gauges & pressure test devices	143-144

CORDLESS HYDRAULIC TOOLS

CORDLESS HYDRAULIC TOOLS	146-164
HYDRAULIC PUMPS	166-170
HYDRAULIC UNITS	171-172

MARKETline PRODUCTS

Cable ties and accessories	174-178
Heat-shrinkable tubing type TERMOBLOCK	179
Heat-shrinkable tubing type TERMOSTRIP	180-181
Heat-shrinkable tubing type TERMOCOIL	182-183
Insulated covers ES series	184
Cast resin joints	185-186
Mechanical tools MARKETline range	187-188

DIE SELECTOR CHART

DIE SELECTOR CHART	190-198
--------------------	---------

APPENDIX

Reference/Code cross-chart	200-209
Comparison of AWG, MCM and Metric conductor cross sections	210
IEC 60228 : 2004 - 11 Conductor Tables	211-213
System of denomination of harmonised cables according to CENELEC HD 361	214
UL & VDE approvals	215
IP ratings, flammability tests, torque settings	216-218

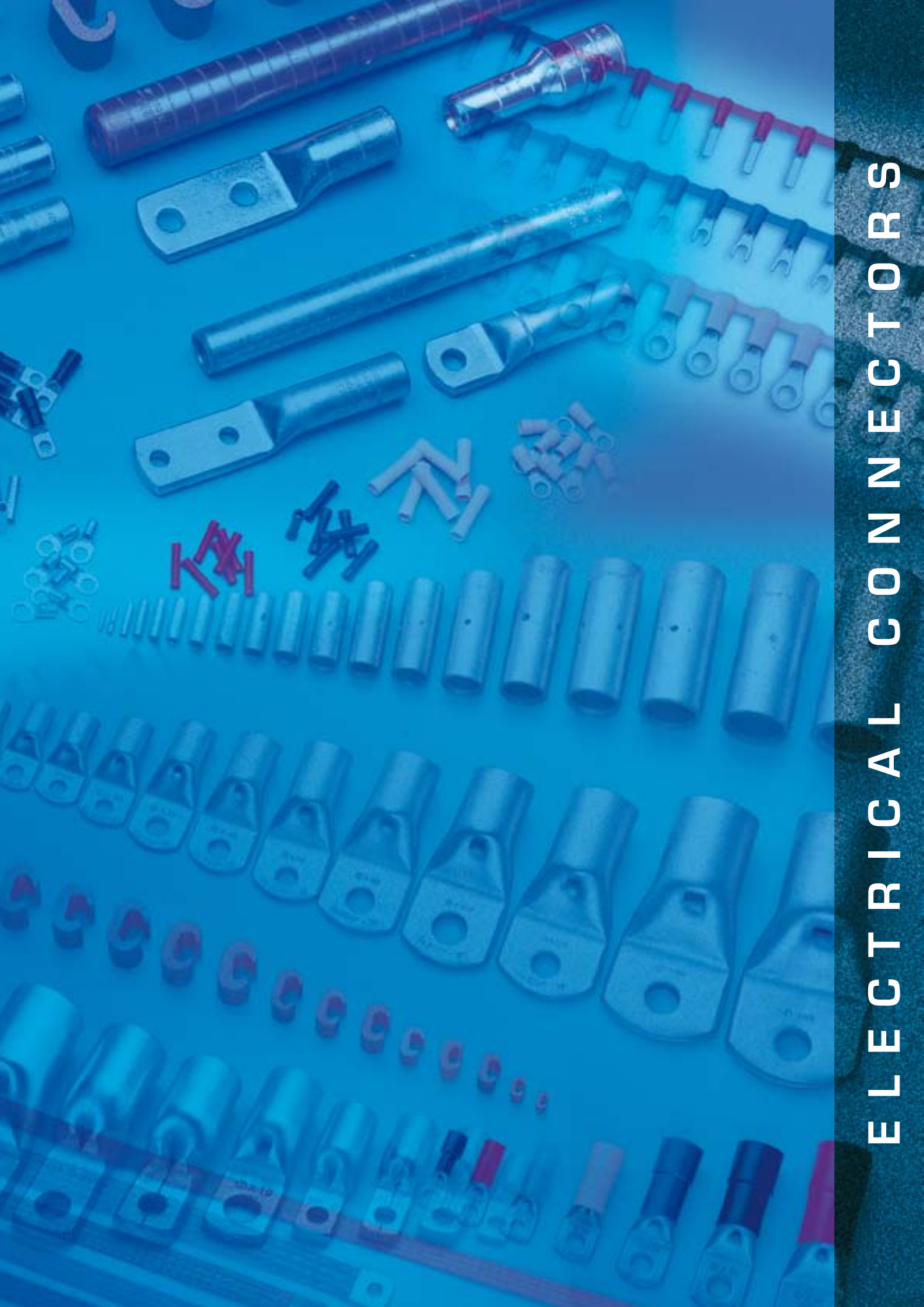

ELECTRICAL CONNECTORS

HALOGEN FREE INSULATED TERMINALS



File no. E125401

VP RP
BP GP



P range funnel entry

OPERATING
TEMPERATURE
UP TO 115°C

HALOGEN FREE

The "P" range of terminals has been designed, to meet the increasing demands for improved safety and reliability of electrical connectors. The polycarbonate insula-





tion, is a halogen free, self extinguishing thermoplastic material class VO (UL 94). The unique funnel shaped entry of the insulation sleeve, guarantees total

insertion of the conductor strands into the terminal barrel, creating a secure and reliable, electrical and mechanical connection.

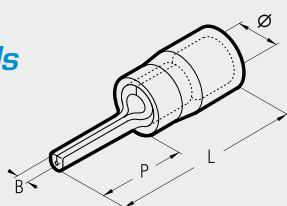
The operating temperature range is - 20 to + 115°C (Surge + 130°C). Recommended crimping tools are shown on pages 94 to 115, 148, 187.





pin terminals

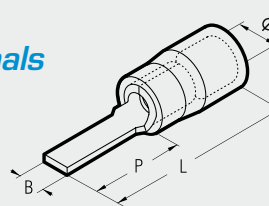

Conductor Size sqmm (AWG)	Ref.	Dimensions mm				Quantity Box/Bag
		Ø	B	P	L	
 0,2÷0,5 (24÷20)	VP-P 10	3,0	1,0	9,8	20,2	4.000/100
 0,25÷1,5 (22÷16)	RP-P 8	4,0	1,6	7,8	17,9	3.500/100
	RP-P 10	4,0	1,6	9,8	19,9	3.500/100
	RP-P 12	4,0	1,6	12,0	22,1	3.000/100
 1,5÷2,5 (16÷14)	BP-P 8	4,9	1,7	7,8	17,9	3.000/100
	BP-P 10	4,9	1,8	9,8	19,9	3.000/100
	BP-P 12	4,9	1,8	11,8	21,9	3.000/100
 4÷6 (12÷10)	GP-P 10	6,6	2,2	10,4	24,5	1.500/100
	GP-P 12	6,6	2,2	12,6	26,7	1.500/100
	GP-P 14	6,6	2,2	14,6	28,7	1.500/100



blade terminals

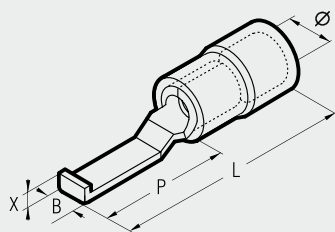

Conductor Size sqmm (AWG)	Ref.	Dimensions mm				Quantity Box/Bag
		Ø	B	P	L	
 0,2÷0,5 (24÷20)	VP-PP 12/19	3,0	1,9	12,4	22,4	4.000/100
 0,25÷1,5 (22÷16)	RP-PP 12	4,0	3,0	12,8	22,9	3.500/100
	RP-PP 12/1	4,0	3,0	11,3	21,4	3.500/100
	RP-PP 12/19	4,0	1,9	13,2	23,3	3.500/100
	RP-PP 12/23	4,0	2,3	13,2	23,3	3.500/100
	RP-PP 14	4,0	3,0	14,8	24,9	3.000/100
	RP-PP 16/23	4,0	2,3	17,2	27,3	2.500/100
 1,5÷2,5 (16÷14)	BP-PP 12	4,9	3,5	12,8	22,9	2.500/100
	BP-PP 12/25	4,9	2,5	13,3	23,4	2.500/100
	BP-PP 12/29	4,9	2,9	13,3	23,4	2.500/100
	BP-PP 16/25	4,9	2,5	17,2	27,3	2.500/100
 4÷6 (12÷10)	GP-PP 12	6,6	4,0	13,3	27,4	1.000/100
	GP-PP 17	6,6	2,9	19,1	33,2	1.000/100

hooked blade terminals



Conductor Size sqmm (AWG)	Ref.	Dimensions mm					Quantity Box/Bag
		Ø	B	P	L	X	
 0,25÷1,5 (22÷16)	RP-PPL 30	4,0	3,0	17,5	28,3	1,7	3.000/100
	RP-PPL 46	4,0	4,6	17,5	28,3	1,7	3.000/100
 1,5÷2,5 (16÷14)	BP-PPL 30	4,9	3,0	17,5	28,3	1,7	2.500/100
	BP-PPL 46	4,9	4,6	17,5	28,3	1,7	2.500/100
 4÷6 (12÷10)	GP-PPL 46	6,6	4,6	17,5	32,6	1,9	1.000/100

HALOGEN FREE INSULATED TERMINALS



File no. E125401

P range funnel entry

VP RP
BP GP

ring terminals

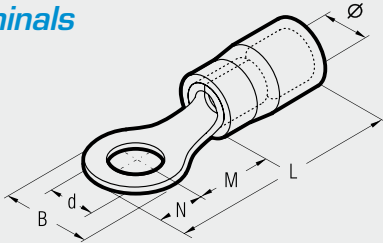

fork/spade terminals

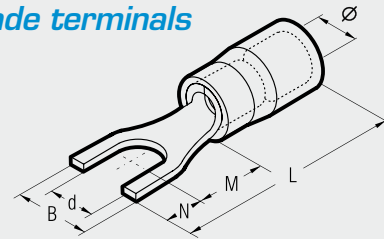

Cond. Size sqmm (AWG)	Ø Stud mm	Ref.	Dimensions mm						Quantity Box/Bag
			Ø	B	M	N	L	d	
0,2÷0,5 (24÷20)		2 *VP-M 2	3,0	5,6	4,5	2,8	17,5	2,2	4.000/100
		3 VP-M 3	3,0	5,6	4,5	2,8	17,5	3,2	4.000/100
		3,5 VP-M 3.5	3,0	5,6	4,5	2,8	17,5	3,7	4.000/100
		4 VP-M 4	3,0	7,0	6,5	3,5	20,2	4,3	4.000/100
		5 VP-M 5	3,0	7,8	7,1	3,9	21,2	5,3	4.000/100
0,25÷1,5 (22÷16)		6 *VP-M 6	3,0	9,4	8,1	4,7	23,0	6,4	4.000/100
		2 *RP-M 2	4,0	5,6	4,5	2,8	17,4	2,2	3.000/100
		3 RP-M 3	4,0	5,6	4,5	2,8	17,4	3,2	3.000/100
		3,5 RP-M 3.5	4,0	5,6	4,5	2,8	17,4	3,7	3.000/100
		3,5 RP-M 3.5/1	4,0	6,2	7,1	3,1	20,2	3,7	3.000/100
		4 RP-M 4	4,0	7,0	6,5	3,5	20,1	4,3	3.000/100
		4 RP-M 4/3	4,0	7,8	7,1	3,9	21,1	4,3	3.000/100
		5 RP-M 5	4,0	7,8	7,1	3,9	21,1	5,3	3.000/100
		6 RP-M 6	4,0	9,4	8,1	4,7	22,9	6,4	3.000/100
		6 RP-M 6/1	4,0	12,0	10,3	6,0	26,4	6,4	2.000/100
1,5÷2,5 (16÷14)		7 RP-M 7	4,0	9,4	8,1	4,7	22,9	7,2	2.500/100
		8 RP-M 8	4,0	12,0	10,3	6,0	26,4	8,4	2.500/100
		10 RP-M 10	4,0	15,5	13,0	7,7	30,9	10,5	2.000/100
		12 RP-M 12	4,0	18,0	15,5	9,0	34,6	13,0	2.000/100
		2 *BP-M 2	4,9	5,6	5,0	2,8	17,9	2,2	2.500/100
		3 BP-M 3	4,9	5,6	5,0	2,8	17,9	3,2	2.500/100
		3,5 BP-M 3.5	4,9	5,6	5,0	2,8	17,9	3,7	3.000/100
		3,5 BP-M 3.5/1	4,9	6,2	6,5	3,1	19,7	3,7	2.500/100
		4 BP-M 4	4,9	8,0	6,5	4,0	20,6	4,3	2.500/100
		5 BP-M 5	4,9	8,0	7,5	4,0	21,6	5,3	2.500/100
4÷6 (12÷10)		6 BP-M 6	4,9	9,4	8,6	4,7	23,4	6,4	2.500/100
		6 BP-M 6/1	4,9	12,0	10,3	6,0	26,4	6,4	2.500/100
		6 *BP-M 6/2	4,9	8,4	5,4	4,2	19,7	6,4	2.500/100
		7 BP-M 7	4,9	10,0	7,8	5,0	22,9	7,2	2.500/100
		8 BP-M 8	4,9	12,0	10,3	6,0	26,4	8,4	1.500/100
		10 BP-M 10	4,9	15,5	13,0	7,7	30,9	10,5	1.500/100
		12 BP-M 12	4,9	18,0	15,5	9,0	34,6	13,0	1.500/100
		3 GP-M 3	6,6	8,0	8,1	4,0	26,2	3,2	1.500/100
		3,5 GP-M 3.5	6,6	8,0	8,1	4,0	26,2	3,7	1.500/100
		4 GP-M 4	6,6	9,0	8,1	4,5	26,7	4,3	1.000/100
5 GP-M 5	6,6	9,0	8,1	4,5	26,7	5,3	1.000/100		
6 GP-M 6	6,6	11,0	11,1	5,5	30,7	6,4	1.000/100		
6 GP-M 6/1	6,6	11,0	8,1	5,5	27,7	6,4	1.000/100		
7 GP-M 7	6,6	11,0	11,1	5,5	30,7	7,2	1.000/100		
8 GP-M 8	6,6	13,6	12,1	6,8	33,0	8,4	1.000/100		
8 *GP-M 8/1	6,6	11,0	8,1	5,5	27,7	8,4	1.000/100		
10 GP-M 10	6,6	13,6	12,1	6,8	33,0	10,5	1.000/100		
10 GP-M 10/1	6,6	15,5	13,8	7,7	35,7	10,5	1.000/100		
12 GP-M 12	6,6	19,0	15,1	9,5	38,7	13,0	500/100		
14 GP-M 14	6,6	21,0	16,1	10,5	40,7	15,0	500/100		
16 GP-M 16	6,6	24,0	17,1	12,0	43,2	17,0	500/100		

Cond. Size sqmm (AWG)	Ø Stud mm	Ref.	Dimensions mm						Quantity Box/Bag
			Ø	B	M	N	L	d	
0,2÷0,5 (24÷20)		3 VP-U 3	3,0	5,5	5,5	4,0	18,7	3,2	4.000/100
		3,5 VP-U 3.5	3,0	6,0	6,5	3,8	19,5	3,7	4.000/100
		4 VP-U 4	3,0	6,5	7,5	3,7	20,4	4,3	4.000/100
		3 RP-U 3	4,0	5,5	5,5	4,0	19,6	3,2	3.500/100
		3,5 RP-U 3.5	4,0	6,0	6,5	3,8	20,4	3,7	3.000/100
0,25÷1,5 (22÷16)		3,5 RP-U 3.5/2	4,0	6,4	6,5	3,8	20,4	3,7	3.500/100
		4 RP-U 4	4,0	6,5	7,5	3,7	21,3	4,3	3.000/100
		4 RP-U 4/1	4,0	8,5	7,5	3,7	21,3	4,3	3.500/100
		4 RP-U 4/2	4,0	7,5	7,5	3,7	21,3	4,3	3.500/100
		5 RP-U 5	4,0	8,5	7,5	3,7	21,3	5,3	3.000/100
		5 *RP-U 5/1	4,0	9,4	7,5	3,7	21,3	5,3	3.000/100
		6 RP-U 6	4,0	9,4	8,1	4,7	22,9	6,4	2.500/100
		6 RP-U 6/1	4,0	12,0	9,2	7,1	26,4	6,4	2.500/100
		8 RP-U 8	4,0	14,0	10,0	6,3	26,4	8,4	2.500/100
		10 RP-U 10	4,0	17,5	13,0	7,7	30,9	10,5	1.500/100
1,5÷2,5 (16÷14)		12 RP-U 12	4,0	20,0	15,5	9,0	34,6	13,0	1.500/100
		3 BP-U 3	4,9	5,5	5,5	4,0	19,6	3,2	2.500/100
		3,5 BP-U 3.5	4,9	6,4	6,5	3,8	20,4	3,7	2.500/100
		3,5 *BP-U 3.5/1	4,9	7,2	6,5	3,8	20,4	3,7	2.500/100
		4 BP-U 4	4,9	6,5	7,5	3,7	21,3	4,3	2.500/100
		4 BP-U 4/1	4,9	8,5	7,5	3,7	21,3	4,3	3.000/100
		4 BP-U 4/2	4,9	7,5	7,5	3,7	21,3	4,3	2.000/100
		5 BP-U 5	4,9	8,5	7,5	3,7	21,3	5,3	2.500/100
		6 BP-U 6	4,9	9,4	8,1	4,7	22,9	6,4	2.500/100
		6 BP-U 6/1	4,9	12,0	9,2	7,1	26,4	6,4	2.500/100
4÷6 (12÷10)		8 BP-U 8	4,9	14,0	10,0	6,3	26,4	8,4	1.500/100
		10 BP-U 10	4,9	17,5	13,0	7,7	30,9	10,5	2.000/100
		12 BP-U 12	4,9	20,0	15,5	9,0	34,6	13,0	1.500/100
		3,5 GPU 3.5	6,6	7,5	8,5	3,9	26,5	3,7	1.500/100
		4 GPU 4	6,6	7,5	8,0	4,4	26,5	4,3	1.000/100
		5 GPU 5	6,6	9,5	8,0	4,4	26,5	5,3	1.000/100
		6 GPU 6	6,6	10,0	11,0	5,5	30,6	6,4	1.000/100
		8 GPU 8	6,6	13,5	12,0	8,0	34,1	8,4	1.000/100
		10 GPU 10	6,6	15,5	13,0	8,0	35,1	10,5	1.000/100
		10 GPU 10/1	6,6	17,5	13,8	7,7	35,7	10,5	1.000/100
12 GPU 12	6,6	21,0	15,1	9,5	38,7	13,0	500/100		
14 GPU 14	6,6	23,0	16,1	10,5	40,7	15,0	500/100		
16 GPU 16	6,6	26,0	17,1	11,5	42,7	17,0	500/100		

*Made to order

INSULATED CHAIN TERMINALS

CP range with easy entry



CRP
CBP
CGP

HALOGEN FREE
OPERATING TEMPERATURE UP TO 115°C



The "CP" range of terminals has been designed to meet the increasing demands for improved safety and reliability of electrical connectors.

Developed for use with production equipment, to give a quick and reliable crimped joint, the polycarbonate insulation is a halogen free, self extinguishing thermoplastic material class

VO (UL 94). The unique funnel shaped entry of the insulation sleeve guarantees total insertion of the conductor strands into the terminal barrel, creating a se-

cure and reliable, electrical and mechanical connection. The operating temperature range is - 20 to + 115°C (Surge + 130°C).

pin terminals

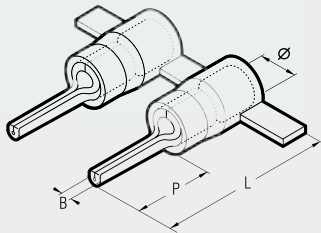

blade terminals

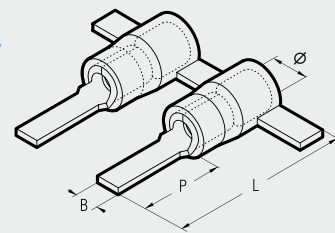

Conductor Size sqmm (AWG)	Ref.	Dimensions mm				Quantity
		Ø	B	P	L	
0,25÷1,5 (22÷16)	CRP-P 8	4,0	1,6	8,0	17,9	2.000
	CRP-P 10	4,0	1,6	10,0	19,9	2.000
	CRP-P 12	4,0	1,6	12,0	22,1	2.000
1,5÷2,5 (16÷14)	CBP-P 8	4,9	1,8	8,0	17,9	1.750
	CBP-P 10	4,9	1,8	10,0	19,9	1.750
	CBP-P 12	4,9	1,8	12,0	21,9	1.750
4÷6 (12÷10)	CGP-P 10	6,6	2,2	10,0	24,5	1.250
	CGP-P 12	6,6	2,2	12,0	26,7	1.250
	CGP-P 14	6,6	2,2	14,0	28,7	1.250

Conductor Size sqmm (AWG)	Ref.	Dimensions mm				Quantity
		Ø	B	P	L	
0,25÷1,5 (22÷16)	CRP-PP 12	4,0	3,0	12,8	22,9	2.000
	*CRP-PP 12/1	4,0	3,0	11,3	21,4	2.000
	*CRP-PP 12/23	4,0	2,3	13,2	23,3	2.000
	CRP-PP 14	4,0	3,0	14,8	24,9	2.000
1,5÷2,5 (16÷14)	CBP-PP 12	4,9	3,5	12,8	22,9	1.750
	*CBP-PP 12/25	4,9	2,5	13,3	23,4	1.750
4÷6 (12÷10)	CGP-PP 12	6,6	4,0	13,3	27,4	1.250
	*CGP-PP 17	6,6	2,9	19,1	33,2	1.250

male disconnect terminals

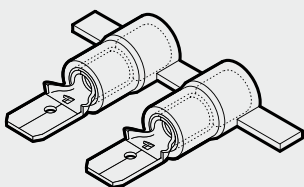

Conductor Size sqmm (AWG)	Ref.	Tab mm	Quantity
0,25÷1,5 (22÷16)	CRP-M 608	6,35 x 0,8	2.000
1,5÷2,5 (16÷14)	CBP-M 608	6,35 x 0,8	1.750
4÷6 (12÷10)	CGP-M 608	6,35 x 0,8	1.250

female disconnect terminals

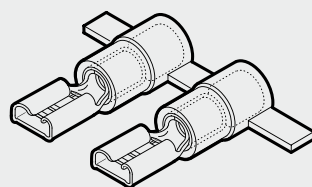

Conductor Size sqmm (AWG)	Ref.	Tab mm	Quantity
0,25÷1,5 (22÷16)	CRP-F 305	2,8 x 0,5	2.000
	CRP-F 308	2,8 x 0,8	2.000
	CRP-F 405	4,8 x 0,5	2.000
	CRP-F 408	4,8 x 0,8	2.000
	CRP-F 608	6,35 x 0,8	2.000
	1,5÷2,5 (16÷14)	CBP-F 405	4,8 x 0,5
CBP-F 408		4,8 x 0,8	1.750
CBP-F 608		6,35 x 0,8	1.750
4÷6 (12÷10)	CGP-F 608	6,35 x 0,8	1.250

female disconnect terminals fully insulated

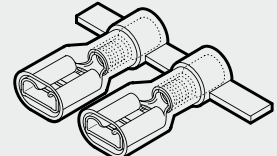

Conductor Size sqmm (AWG)	Ref.	Tab mm	Quantity
0,25÷1,5 (22÷16)	CRP-F 405P	4,8 x 0,5	2.000
	CRP-F 408P	4,8 x 0,8	2.000
	CRP-F 608P	6,35 x 0,8	1.500
1,5÷2,5 (16÷14)	CBP-F 408P	4,8 x 0,8	1.500
	CBP-F 608P	6,35 x 0,8	1.500
4÷6 (12÷10)	CGP-F 608P	6,35 x 0,8	1.250

*Made to order

INSULATED CHAIN TERMINALS



fork/spade terminals

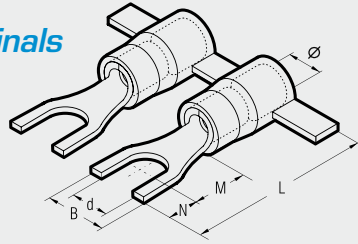

CP range with easy entry

CRP
CBP
CGP

Cond. Size sqmm (AWG)	Ø Stud mm	Ref.	Dimensions mm					Quantity	
			Ø	B	M	N	L		d
0,25÷1,5 (22÷16)	3	CRP-U 3	4,0	5,5	5,5	4,0	19,6	3,2	2.000
	3,5	CRP-U 3.5	4,0	6,0	6,5	3,8	20,4	3,7	2.000
	3,5	*CRP-U 3.5/2	4,0	6,4	6,5	3,8	20,4	3,7	2.000
	4	CRP-U 4	4,0	6,5	7,5	3,7	21,3	4,3	2.000
	4	*CRP-U 4/1	4,0	8,5	7,5	3,7	21,3	4,3	2.000
	4	*CRP-U 4/2	4,0	7,5	7,5	3,7	21,3	4,3	2.000
	5	CRP-U 5	4,0	8,5	7,5	3,7	21,3	5,3	2.000
	6	CRP-U 6	4,0	9,4	8,1	4,7	22,9	6,4	2.000
1,5÷2,5 (16÷14)	6	*CRP-U 6/1	4,0	12,0	9,2	7,1	26,4	6,4	2.000
	8	*CRP-U 8	4,0	14,0	10,0	6,3	26,4	8,4	2.000
	3	CBP-U 3	4,9	5,5	5,5	4,0	19,6	3,2	1.750
	3,5	CBP-U 3.5	4,9	6,4	6,5	3,8	20,4	3,7	1.750
	4	CBP-U 4	4,9	6,5	7,5	3,7	21,3	4,3	1.750
	4	*CBP-U 4/1	4,9	8,5	7,5	3,7	21,3	4,3	1.750
	4	*CBP-U 4/2	4,9	7,5	7,5	3,7	21,3	4,3	1.750
	5	CBP-U 5	4,9	8,5	7,5	3,7	21,3	5,3	1.750
4÷6 (12÷10)	6	CBP-U 6	4,9	9,4	8,1	4,7	22,9	6,4	1.750
	3,5	*CGP-U 3.5	6,6	7,5	8,5	3,9	26,5	3,7	1.250
	4	*CGP-U 4	6,6	7,5	8,0	4,4	26,5	4,3	1.250
	5	CGP-U 5	6,6	9,5	8,0	4,4	26,5	5,3	1.250
6	CGP-U 6	6,6	10,0	11,0	5,5	30,6	6,4	1.250	

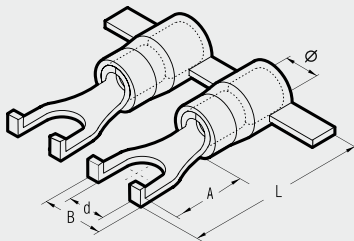

Cond. Size sqmm (AWG)	Ø Stud mm	Ref.	Dimensions mm				Quantity	
			Ø	B	A	L		d
1,5÷2,5 (16÷14)	4	CBP-U 4/3L	4,9	6,5	9,5	14,5	4,3	1.750

hooked blade terminals

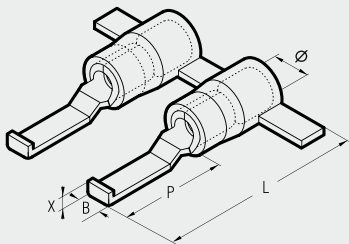

Cond. Size sqmm (AWG)	Ref.	Dimensions mm					Quantity
		Ø	B	P	L	X	
0,25÷1,5 (22÷16)	CRP-PPL30	4,0	3,0	17,5	28,8	1,7	2.000
1,5÷2,5 (16÷14)	CBP-PPL30	4,9	3,0	17,5	28,8	1,7	1.750

*Made to order

ring terminals

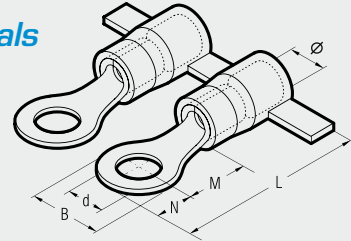

Cond. Size sqmm (AWG)	Ø Stud mm	Ref.	Dimensions mm					Quantity	
			Ø	B	M	N	L		d
0,25÷1,5 (22÷16)	3	CRP-M 3	4,0	5,6	4,5	2,8	17,4	3,2	2.000
	3,5	CRP-M 3.5	4,0	5,6	4,5	2,8	17,4	3,7	2.000
	3,5	*CRP-M 3.5/1	4,0	6,2	7,1	3,1	20,2	3,7	2.000
	4	CRP-M 4	4,0	7,0	6,5	3,5	20,1	4,3	2.000
	4	*CRP-M 4/3	4,0	7,8	7,1	3,9	21,1	4,3	2.000
	5	CRP-M 5	4,0	7,8	7,1	3,9	21,1	5,3	2.000
	6	CRP-M 6	4,0	9,4	8,1	4,7	22,9	6,4	2.000
	6	*CRP-M 6/1	4,0	12,0	10,3	6,0	26,4	6,4	2.000
1,5÷2,5 (16÷14)	7	CRP-M 7	4,0	9,4	8,1	4,7	22,9	7,2	2.000
	8	CRP-M 8	4,0	12,0	10,3	6,0	26,4	8,4	2.000
	3	CBP-M 3	4,9	5,6	5,0	2,8	17,9	3,2	1.750
	3,5	CBP-M 3.5	4,9	5,6	5,0	2,8	17,9	3,7	1.750
	3,5	*CBP-M 3.5/1	4,9	6,2	6,5	3,1	19,6	3,7	1.750
	4	CBP-M 4	4,9	8,0	6,5	4,0	20,6	4,3	1.750
	5	CBP-M 5	4,9	8,0	7,5	4,0	21,6	5,3	1.750
	6	CBP-M 6	4,9	9,4	8,6	4,7	23,4	6,4	1.750
4÷6 (12÷10)	6	*CBP-M 6/1	4,9	12,0	10,3	6,0	26,4	6,4	1.750
	7	CBP-M 7	4,9	10,0	7,8	5,0	22,9	7,2	1.750
	8	CBP-M 8	4,9	12,0	10,3	6,0	26,4	8,4	1.750
	3	CGP-M 3	6,6	8,0	8,1	4,0	26,2	3,2	1.250
	3,5	CGP-M 3.5	6,6	8,0	8,1	4,0	26,2	3,7	1.250
	4	CGP-M 4	6,6	9,0	8,1	4,5	26,7	4,3	1.250
	5	CGP-M 5	6,6	9,0	8,1	4,5	26,7	5,3	1.250
	6	CGP-M 6	6,6	11,0	11,1	5,5	30,7	6,4	1.250
6	*CGP-M 6/1	6,6	11,0	8,1	5,5	27,7	6,4	1.250	
7	CGP-M 7	6,6	11,0	11,1	5,5	30,7	7,2	1.000	
8	CGP-M 8	6,6	13,6	12,1	6,8	33,0	8,4	1.250	
8	*CGP-M 8/1	6,6	11,0	8,1	5,5	27,7	8,4	1.250	



Interchangeable application heads are available for crimping these terminals with the bench press ELB-3 (see page 118).



PVC INSULATED CRIMP TERMINALS

F range funnel entry



File no. E125401

RF BF
GF



VALSTAR V3-F

Comprising:

- An assortment of crimp terminals for conductor sizes 0,25 ÷ 6 sqmm
- Tool HP3

The unique funnel shaped PVC sleeve guarantees total insertion of the conductor strands into the terminal barrel, creating a secure and reliable, electrical and mechanical connection. The internal surface of the

barrel is rifled to improve contact with conductor strands when crimped and to increase tensile strength. The "F" range of terminals offers a wide selection of rings, forks, pins and blades, designed to meet the ever

changing end user requirements.

The operating temperature range is - 20 to + 80°C (Surge + 90°C).

Recommended crimping tools are shown on pages 94 to 115, 148, 187.

pin terminals

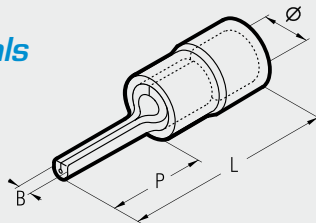

blade terminals

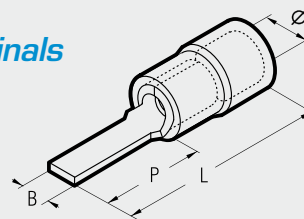

Conductor Size sqmm (AWG)	Ref.	Dimensions mm				Quantity Box/Bag
		Ø	B	P	L	
0,25÷1,5 (22÷16)	RF-P 8	3,9	1,6	8,0	17,9	3.500/100
	RF-P 10	3,9	1,6	10,0	19,9	3.500/100
	RF-P 12	3,9	1,6	12,0	22,1	3.000/100
1,5÷2,5 (16÷14)	BF-P 8	4,9	1,7	8,0	17,9	3.000/100
	BF-P 10	4,9	1,8	10,0	19,9	3.000/100
	BF-P 12	4,9	1,8	12,0	21,9	3.000/100
4÷6 (12÷10)	GF-P 10	6,7	2,2	10,0	24,6	1.500/100
	GF-P 12	6,7	2,2	12,0	26,8	1.500/100
	GF-P 14	6,7	2,2	14,0	28,8	1.500/100

Conductor Size sqmm (AWG)	Ref.	Dimensions mm				Quantity Box/Bag
		Ø	B	P	L	
0,25÷1,5 (22÷16)	RF-PP 12	3,9	3,0	12,8	22,9	3.500/100
	RF-PP 12/1	3,9	3,0	11,3	21,4	3.500/100
	RF-PP 12/19	3,9	1,9	13,2	23,3	3.500/100
	RF-PP 12/23	3,9	2,3	13,2	23,3	3.000/100
	RF-PP 14	3,9	3,0	14,8	24,9	3.000/100
	RF-PP 16/23	3,9	2,3	17,2	27,3	2.500/100
1,5÷2,5 (16÷14)	BF-PP 12	4,9	3,5	12,8	22,9	2.500/100
	BF-PP 12/25	4,9	2,5	13,3	23,4	2.500/100
	BF-PP 12/29	4,9	2,9	13,3	23,4	2.500/100
	BF-PP 16/25	4,9	2,5	17,2	27,3	2.500/100
4÷6 (12÷10)	GF-PP 12	6,7	4,0	13,3	27,5	1.000/100
	GF-PP 17	6,7	2,9	19,2	33,4	1.000/100

hooked blade terminals

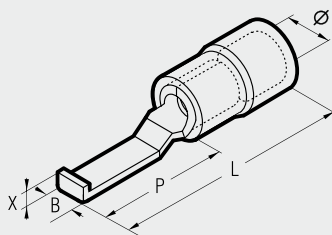

Conductor Size sqmm (AWG)	Ref.	Dimensions mm					Quantity Box/Bag
		Ø	B	P	L	X	
0,25÷1,5 (22÷16)	RF-PPL 30	3,9	3,0	17,5	28,4	1,7	3.000/100
	RF-PPL 46	3,9	4,6	17,5	28,4	1,7	2.500/100
1,5÷2,5 (16÷14)	BF-PPL 30	4,9	3,0	17,5	28,4	1,7	2.500/100
	BF-PPL 46	4,9	4,6	17,5	28,4	1,7	2.500/100
4÷6 (12÷10)	GF-PPL 46	6,7	4,6	17,5	32,7	1,9	1.000/100

PVC INSULATED CRIMP TERMINALS

F range funnel entry

RF BF
GF



File no. E125401

ring terminals

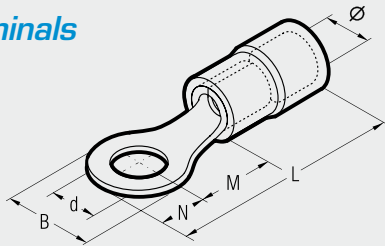

fork/spade terminals

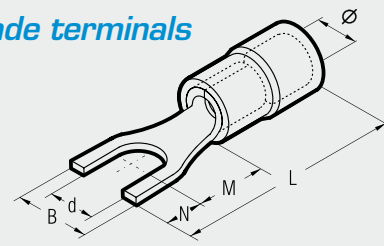

Cond. Size sqmm (AWG)	Ø Stud mm	Ref.	Dimensions mm						Quantity Box/Bag
			Ø	B	M	N	L	d	
2	*	RF-M 2	3,9	5,6	4,5	2,8	17,4	2,2	3.000/100
3		RF-M 3	3,9	5,6	4,5	2,8	17,4	3,2	3.000/100
3,5		RF-M 3,5	3,9	5,6	4,5	2,8	17,4	3,7	3.000/100
3,5		RF-M 3,5/1	3,9	6,2	7,1	3,1	20,3	3,7	3.000/100
4		RF-M 4	3,9	7,0	6,5	3,5	20,1	4,3	3.000/100
4		RF-M 4/3	3,9	7,8	7,1	3,9	21,1	4,3	3.000/100
5		RF-M 5	3,9	7,8	7,1	3,9	21,1	5,3	3.000/100
6		RF-M 6	3,9	9,4	8,1	4,7	22,9	6,4	3.000/100
6		RF-M 6/1	3,9	12,0	10,3	6,0	26,4	6,4	2.000/100
7		RF-M 7	3,9	9,4	8,1	4,7	22,9	7,2	2.500/100
8		RF-M 8	3,9	12,0	10,3	6,0	26,4	8,4	2.000/100
0,25÷1,5 (22÷16)		10 RF-M 10	3,9	15,5	13,0	7,7	30,9	10,5	1.500/100
		12 RF-M 12	3,9	18,0	15,5	9,0	34,6	13,0	1.500/100
2	*	BF-M 2	4,9	5,6	5,0	2,8	17,9	2,2	3.000/100
3		BF-M 3	4,9	5,6	5,0	2,8	17,9	3,2	2.500/100
3,5		BF-M 3,5	4,9	5,6	5,0	2,8	17,9	3,7	2.500/100
3,5		BF-M 3,5/1	4,9	6,2	6,5	3,1	19,7	3,7	2.500/100
4		BF-M 4	4,9	8,0	6,5	4,0	20,6	4,3	2.500/100
5		BF-M 5	4,9	8,0	7,5	4,0	21,6	5,3	2.500/100
6		BF-M 6	4,9	9,4	8,6	4,7	23,4	6,4	2.500/100
6		BF-M 6/1	4,9	12,0	10,3	6,0	26,4	6,4	2.000/100
6	*	BF-M 6/2	4,9	8,4	5,4	4,2	19,7	6,4	2.500/100
7		BF-M 7	4,9	10,0	7,8	5,0	22,9	7,2	2.000/100
8		BF-M 8	4,9	12,0	10,3	6,0	26,4	8,4	1.500/100
1,5÷2,5 (16÷14)		10 BF-M 10	4,9	15,5	13,0	7,7	30,9	10,5	1.500/100
		12 BF-M 12	4,9	18,0	15,5	9,0	34,6	13,0	1.000/100
3		GF-M 3	6,7	8,0	8,1	4,0	26,3	3,2	1.500/100
3,5		GF-M 3,5	6,7	8,0	8,1	4,0	26,3	3,7	1.500/100
4		GF-M 4	6,7	9,0	8,1	4,5	26,8	4,3	1.000/100
5		GF-M 5	6,7	9,0	8,1	4,5	26,8	5,3	1.000/100
6		GF-M 6	6,7	11,0	11,1	5,5	30,8	6,4	1.000/100
6		GF-M 6/1	6,7	11,0	8,1	5,5	27,8	6,4	1.000/100
7		GF-M 7	6,7	11,0	11,1	5,5	30,8	7,2	1.000/100
8		GF-M 8	6,7	13,6	12,1	6,8	33,1	8,4	1.000/100
8	*	GF-M 8/1	6,7	11,0	8,1	5,5	27,8	8,4	1.000/100
10		GF-M 10	6,7	13,6	12,1	6,8	33,1	10,5	1.000/100
10		GF-M 10/1	6,7	15,5	13,8	7,7	35,8	10,5	1.000/100
12		GF-M 12	6,7	19,0	15,1	9,5	38,8	13,0	500/100
4÷6 (12÷10)		14 GF-M 14	6,7	21,0	16,1	10,5	40,8	15,0	500/100
		16 GF-M 16	6,7	24,0	17,1	12,0	43,3	17,0	500/100

Cond. Size sqmm (AWG)	Ø Stud mm	Ref.	Dimensions mm						Quantity Box/Bag
			Ø	B	M	N	L	d	
3		RF-U 3	3,9	5,5	5,5	4,0	19,6	3,2	3.500/100
3,5		RF-U 3,5	3,9	6,0	6,5	3,8	20,4	3,7	3.500/100
3,5		RF-U 3,5/1	3,9	7,2	6,5	3,8	20,4	3,7	4.000/100
3,5		RF-U 3,5/2	3,9	6,4	6,5	3,8	20,4	3,7	3.500/100
4		RF-U 4	3,9	6,5	7,5	3,7	21,3	4,3	3.000/100
4		RF-U 4/1	3,9	8,5	7,5	3,7	21,3	4,3	3.000/100
4		RF-U 4/2	3,9	7,5	7,5	3,7	21,3	4,3	3.000/100
5		RF-U 5	3,9	8,5	7,5	3,7	21,3	5,3	3.000/100
5	*	RF-U 5/1	3,9	9,4	7,5	3,7	21,3	5,3	3.000/100
6		RF-U 6	3,9	9,4	8,1	4,7	22,9	6,4	2.500/100
6		RF-U 6/1	3,9	12,0	9,2	7,1	26,4	6,4	2.500/100
8		RF-U 8	3,9	14,0	10,0	6,3	26,4	8,4	2.000/100
0,25÷1,5 (22÷16)		10 RF-U 10	3,9	17,5	13,0	7,7	30,9	10,5	1.500/100
		12 RF-U 12	3,9	20,0	15,5	9,0	34,6	13,0	1.500/100
3		BF-U 3	4,9	5,5	5,5	4,0	19,6	3,2	2.500/100
3,5		BF-U 3,5	4,9	6,4	6,5	3,8	20,4	3,7	2.500/100
3,5	*	BF-U 3,5/1	4,9	7,2	6,5	3,8	20,4	3,7	3.000/100
4		BF-U 4	4,9	6,5	7,5	3,7	21,3	4,3	2.500/100
4		BF-U 4/1	4,9	8,5	7,5	3,7	21,3	4,3	2.000/100
4		BF-U 4/2	4,9	7,5	7,5	3,7	21,3	4,3	2.000/100
5		BF-U 5	4,9	8,5	7,5	3,7	21,3	5,3	2.500/100
5		BF-U 5/2	4,9	12,0	11,3	5,0	26,3	5,3	1.500/100
6		BF-U 6	4,9	9,4	8,1	4,7	22,9	6,4	2.500/100
6		BF-U 6/1	4,9	12,0	9,2	7,1	26,4	6,4	2.500/100
8		BF-U 8	4,9	14,0	10,0	6,3	26,4	8,4	1.500/100
1,5÷2,5 (16÷14)		10 BF-U 10	4,9	17,5	13,0	7,7	30,9	10,5	1.000/100
		12 BF-U 12	4,9	20,0	15,5	9,0	34,6	13,0	1.500/100
3,5		GF-U 3,5	6,7	7,5	8,5	3,9	26,6	3,7	1.500/100
4		GF-U 4	6,7	7,5	8,0	4,4	26,6	4,3	1.000/100
5		GF-U 5	6,7	9,5	8,0	4,4	26,6	5,3	1.000/100
6		GF-U 6	6,7	10,0	11,0	5,5	30,7	6,4	1.000/100
8		GF-U 8	6,7	13,5	12,0	8,0	34,2	8,4	1.000/100
10		GF-U 10	6,7	15,5	13,0	8,0	35,2	10,5	1.000/100
10		GF-U 10/1	6,7	17,5	13,8	7,7	35,8	10,5	1.000/100
12		GF-U 12	6,7	21,0	15,1	9,5	38,8	13,0	500/100
14		GF-U 14	6,7	23,0	16,1	10,5	40,8	15,0	500/100
4÷6 (12÷10)		16 GF-U 16	6,7	26,0	17,1	11,5	42,8	17,0	500/100

*Made to order

REINFORCED PA 6.6 INSULATED TERMINALS

RKY
BKY
GKY

KY range



'KY' type terminals are designed to offer improved mechanical and electrical integrity under heavy-duty application.

This is achieved via a Copper sleeve located between the Copper barrel and Polya-

imide insulation of the terminal. Then, during crimping, the insulation of the conductor is integrated into the crimp due to the Copper sleeve being deformed around it to maintain the level of 'grip' required in ap-

plications subject to continuous mechanical vibrations (e.g: mobile plant, vehicles, moving components).

The operating temperature range is - 20 to + 105°C (Surge + 110°C).



Recommended crimping tools are shown on pages 94 to 115, 148, 187.

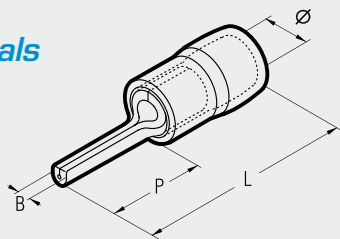

pin terminals

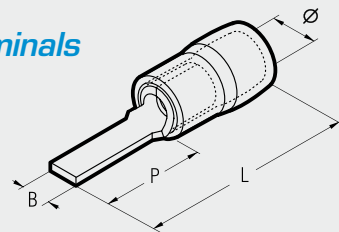

blade terminals



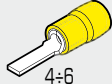

Conductor Size sqmm (AWG)	Ref.	Dimensions mm				Quantity Box/Bag
		Ø	B	P	L	
 0,25÷1,5 (22÷16)	RKY-P 8	4,5	1,9	9,0	19,8	3.500/100
	RKY-P 10	4,5	1,9	10,0	20,8	3.500/100
	RKY-P 12	4,5	1,9	12,0	22,8	3.000/100
 1,5÷2,5 (16÷14)	BKY-P 8	5,2	1,9	9,0	19,8	3.000/100
	BKY-P 10	5,2	1,9	10,0	20,8	3.000/100
	BKY-P 12	5,2	1,9	12,0	22,8	3.000/100
 4÷6 (12÷10)	GKY-P 14	7,0	2,8	14,0	27,0	1.500/100

Conductor Size sqmm (AWG)	Ref.	Dimensions mm				Quantity Box/Bag
		Ø	B	P	L	
 0,25÷1,5 (22÷16)	RKY-PP 12	4,5	3,0	13,0	23,8	3.500/100
	RKY-PP 12/19	4,5	2,0	18,0	28,8	3.000/100
	RKY-PP 16/23	4,5	2,2	18,0	28,8	2.500/100
 1,5÷2,5 (16÷14)	BKY-PP 12	5,2	3,0	13,0	23,8	2.500/100
	BKY-PP 12/25	5,2	2,4	13,0	23,8	2.500/100
	BKY-PP 16/23	5,2	2,2	18,0	28,8	2.500/100
 4÷6 (12÷10)	GKY-PP 12	7,0	4,0	14,0	27,0	1.000/100
	GKY-PP 17	7,0	2,0	18,0	31,0	1.000/100

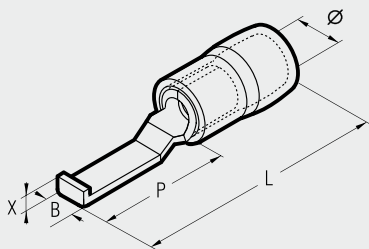
hooked blade terminals



Conductor Size sqmm (AWG)	Ref.	Dimensions mm					Quantity Box/Bag
		Ø	B	P	L	X	
 0,25÷1,5 (22÷16)	RKY-PPL 30	4,5	3,0	16,8	28,2	2,1	3.000/100
	RKY-PPL 46	4,5	4,6	16,8	28,2	2,1	3.000/100
 1,5÷2,5 (16÷14)	BKY-PPL 30	5,2	3,0	16,8	28,2	2,1	2.500/100
	BKY-PPL 46	5,2	4,6	16,8	28,2	2,1	2.500/100
 4÷6 (12÷10)	GKY-PPL 46	7,0	4,6	17,2	30,2	2,4	1.000/100

REINFORCED PA 6.6 INSULATED TERMINALS



KY range

RKY
BKY
GKY

ring terminals

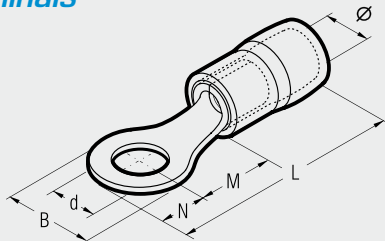

fork/spade terminals

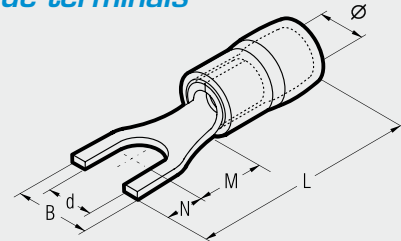

Cond. Size sqmm (AWG)	Ø Stud mm	Ref.	Dimensions mm						Quantity Box/Bag
			Ø	B	M	N	L	d	
0,25÷1,5 (22÷16)		3 RKY-M 3	4,5	5,5	5,0	2,5	18,5	3,2	3.000/100
		3,5 RKY-M 3.5	4,5	5,5	5,0	2,5	18,5	3,7	3.000/100
		3,5 RKY-M 3.5/1	4,5	6,6	6,3	3,1	20,4	3,7	3.000/100
		4 RKY-M 4	4,5	6,6	6,3	3,1	20,4	4,3	3.000/100
		5 RKY-M 5	4,5	8,0	7,0	3,8	21,8	5,3	3.000/100
		6 RKY-M 6/1	4,5	11,6	11,0	5,8	27,8	6,4	2.000/100
		8 RKY-M 8	4,5	11,6	11,0	5,8	27,8	8,4	2.500/100
		10 RKY-M 10	4,5	13,6	13,9	6,6	31,5	10,5	1.500/100
1,5÷2,5 (16÷14)		12 RKY-M 12	4,5	19,6	16,0	9,4	36,4	13,0	1.500/100
		3 BKY-M 3	5,2	6,6	4,8	3,0	18,8	3,2	2.500/100
		3,5 BKY-M 3.5	5,2	6,6	4,8	3,0	18,8	3,7	2.500/100
		3,5 BKY-M 3.5/1	5,2	6,6	6,3	3,1	20,4	3,7	2.500/100
		4 BKY-M 4	5,2	8,5	7,8	4,0	22,8	4,3	2.500/100
		5 BKY-M 5	5,2	8,5	7,8	4,0	22,8	5,3	2.500/100
		6 BKY-M 6/1	5,2	12,0	11,0	5,8	27,8	6,4	2.000/100
		8 BKY-M 8	5,2	12,0	11,0	5,8	27,8	8,4	1.500/100
4÷6 (12÷10)		10 BKY-M 10	5,2	13,6	13,9	6,6	31,5	10,5	1.500/100
		12 BKY-M 12	5,2	19,2	16,0	9,4	36,4	13,0	1.000/100
		3,5 GKY-M 3.5	7,0	7,2	6,1	3,6	22,7	3,7	1.500/100
		4 GKY-M 4	7,0	9,5	9,1	4,5	26,6	4,3	1.000/100
		5 GKY-M 5	7,0	9,5	9,1	4,5	26,6	5,3	1.000/100
		6 GKY-M 6	7,0	12,0	10,5	6,0	29,5	6,4	1.000/100
		8 GKY-M 8	7,0	15,0	13,5	7,5	34,0	8,4	1.000/100
		10 GKY-M 10	7,0	15,0	13,5	7,5	34,0	10,5	1.000/100
4÷6 (12÷10)		12 GKY-M 12	7,0	19,2	16,0	9,6	38,6	13,0	1.000/100
		14 GKY-M 14	7,0	32,0	25,2	16,0	54,2	15,0	500/100
		16 GKY-M 16	7,0	32,0	25,2	16,0	54,2	17,0	500/100

Cond. Size sqmm (AWG)	Ø Stud mm	Ref.	Dimensions mm						Quantity Box/Bag
			Ø	B	M	N	L	d	
0,25÷1,5 (22÷16)		3 RKY-U 3	4,5	5,7	6,5	4,5	22,0	3,2	3.000/100
		3,5 RKY-U 3.5	4,5	5,7	6,5	4,5	22,0	3,7	3.000/100
		4 RKY-U 4	4,5	6,4	6,5	4,5	22,0	4,3	3.000/100
		5 RKY-U 5	4,5	8,1	6,5	4,5	22,0	5,3	3.000/100
		6 RKY-U 6	4,5	9,5	6,5	4,5	22,0	6,4	3.000/100
		6 RKY-U 6/1	4,5	12,0	11,0	6,0	28,0	6,4	3.000/100
1,5÷2,5 (16÷14)		3 BKY-U 3	5,2	5,7	6,5	4,5	22,0	3,2	2.500/100
		3,5 BKY-U 3.5	5,2	6,0	6,5	4,5	22,0	3,7	2.500/100
		4 BKY-U 4	5,2	6,4	6,5	4,5	22,0	4,3	2.500/100
		5 BKY-U 5	5,2	7,9	6,5	4,5	22,0	5,3	2.500/100
		6 BKY-U 6	5,2	9,3	6,5	4,5	22,0	6,4	2.500/100
		6 BKY-U 6/1	5,2	12,0	11,0	6,0	28,0	6,4	2.000/100
4÷6 (12÷10)		3,5 GKY-U 3.5	7,0	7,2	7,5	3,9	24,4	3,7	1.500/100
		4 GKY-U 4	7,0	7,2	7,5	3,9	24,4	4,3	1.000/100
		5 GKY-U 5	7,0	9,0	7,0	5,5	25,5	5,3	1.000/100
		6 GKY-U 6	7,0	12,0	12,0	6,5	31,5	6,4	1.000/100
4÷6 (12÷10)		8 GKY-U 8	7,0	14,0	10,5	7,0	30,5	8,4	1.000/100

RF-F BF-F GF-F



Manufactured from brass strip
- Electrolytically tin plated
- The operating temperature range is -20 to +115°C (Surge +130°C).
- Recommended crimping tools are shown on pages 94 to 115, 148, 187.









FEMALE DISCONNECT TERMINALS











File no. E212000



Polycarbonate insulated terminals - partially reinforced with copper sleeve

Cond. Size sqmm (AWG)	Ref.	Tab Size	Quantity Box/Bag
0,25÷1,5 (22÷16)	 RF-F 305	2,8 x 0,5	3.500/100
	 RF-F 308	2,8 x 0,8	3.500/100
	 RF-F 405	4,8 x 0,5	3.000/100
	 RF-F 408	4,8 x 0,8	3.000/100
1,5÷2,5 (16÷14)	 BF-F 608	6,35 x 0,8	2.000/100
	 BFF 405	4,8 x 0,5	3.000/100
	 BFF 408	4,8 x 0,8	3.000/100
4÷6 (12÷10)	 GF-F 608	6,35 x 0,8	1.000/100

Polycarbonate fully insulated terminals - partially reinforced with copper sleeve

Cond. Size sqmm (AWG)	Ref.	Tab Size	Quantity Box/Bag
0,25÷1,5 (22÷16)	 RF-F 305P	2,8 x 0,5	2.500/100
	 RF-F 308P	2,8 x 0,8	2.500/100
	 RF-F 405P	4,8 x 0,5	2.000/100
	 RF-F 408P	4,8 x 0,8	2.000/100
1,5÷2,5 (16÷14)	 RF-F 608P	6,35 x 0,8	1.500/100
	 BFF 405P	4,8 x 0,5	2.000/100
	 BFF 408P	4,8 x 0,8	2.000/100
4÷6 (12÷10)	 GF-F 608P	6,35 x 0,8	1.000/100

RF-M BF-M GF-M



Manufactured from brass strip
- Electrolytically tin plated
- The operating temperature range is -20 to +115°C (Surge +130°C).
- Recommended crimping tools are shown on pages 94 to 115, 148, 187.



MALE DISCONNECT TERMINALS





File no. E212000



Polycarbonate insulated terminals - partially reinforced with copper sleeve

Cond. Size sqmm (AWG)	Ref.	Tab Size	Quantity Box/Bag
0,25÷1,5 (22÷16)	 RF-M 608	6,35 x 0,8	3.000/100
1,5÷2,5 (16÷14)	 BF-M 608	6,35 x 0,8	2.500/100
4÷6 (12÷10)	 GF-M 608	6,35 x 0,8	1.000/100

Polycarbonate fully insulated terminals - partially reinforced with copper sleeve

Cond. Size sqmm (AWG)	Ref.	Tab Size	Quantity Box/Bag
0,25÷1,5 (22÷16)	 RF-M 608P	6,35 x 0,8	1.000/100
1,5÷2,5 (16÷14)	 BF-M 608P	6,35 x 0,8	1.000/100

RF-FM BF-FM RF-B BF-B





Manufactured from brass strip
- Electrolytically tin plated
- The operating temperature range is -20 to +115°C (Surge +130°C).
- Recommended crimping tools are shown on pages 94 to 115, 148, 187.

MALE/FEMALE CONNECTORS



File no. E212000





Polycarbonate insulated terminals - partially reinforced with copper sleeve

Cond. Size sqmm (AWG)	Ref.	Tab Size	Quantity Box/Bag
0,25÷1,5 (22÷16)	 RF-FM 608	6,35 x 0,8	1.500/100
1,5÷2,5 (16÷14)	 BF-FM 608	6,35 x 0,8	1.500/100

BULLET AND SOCKET CONNECTORS



Polycarbonate insulated terminals - partially reinforced with copper sleeve

Cond. Size sqmm (AWG)	Ref.	Øi mm	Quantity Box/Bag
0,25÷1,5 (22÷16)	 RF-BM 4	4	2.500/100
	 RF-BF 4	4	1.000/100
1,5÷2,5 (16÷14)	 BF-BM 5	5	2.000/100
	 BF-BF 5	5	800/100

BUTT AND PARALLEL CONNECTORS



File no. E125401

butt connectors

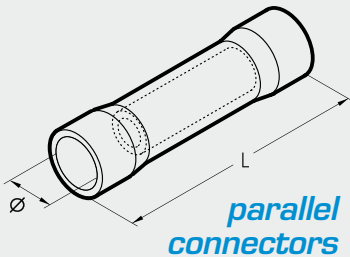

parallel connectors

PVC insulated

Cond. Size sqmm (AWG)	Ref.	Ø mm	L mm	Quantity Box/Bag
0,25÷0,5 (24÷20)	PL 01-M	3,0	25	3.000/100
0,25÷1,5 (22÷16)	PL 03-M	4,0	25	2.000/100
1,5÷2,5 (16÷14)	PL 06-M	5,0	25	1.500/100
4÷6 (12÷10)	PL 1-M	6,5	32	500/100
0,25÷1,5 (22÷16)	PL 03-P	4,0	20	3.000/100
1,5÷2,5 (16÷14)	PL 06-P	5,0	16	2.000/100



PL

- Manufactured from copper tube
- Electrolytically tin plated
 - The operating temperature range is - 20 to + 80°C (Surge + 90°C).
 - Recommended crimping tools are shown on pages 94 to 115, 148, 187.

BUTT CONNECTORS



Polyamide PA6.6 insulated

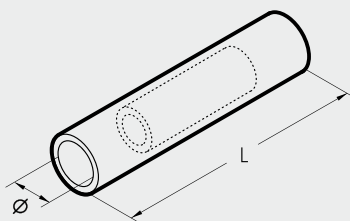

Cond. Size sqmm (AWG)	Ref.	Øi mm	L mm	Quantity Box/Bag
0,25÷1,5 (22÷16)	NL 03-M	4,0	25,0	2.000/100
1,5÷2,5 (16÷14)	NL 06-M	5,4	25,5	1.500/100
4÷6 (12÷10)	NL 1-M	5,4	32,0	1.000/100
10 (8÷7)	NL 2-M	6,8	43,0	500/100
16 (6÷5)	NL 3-M	7,9	44,0	500/100



NL-M

- Manufactured from copper tube
- Electrolytically tin plated
 - The operating temperature range is - 20 to + 115°C (Surge + 130°C).
 - Recommended crimping tools are shown on pages 94 to 115, 148, 187.



PE HD insulated, heat shrinkable

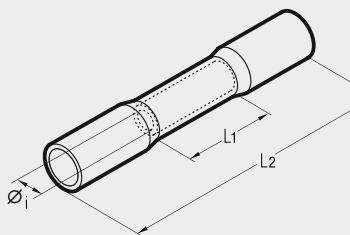

Cond. Size sqmm (AWG)	Ref.	Ø i mm	L1 mm	L2 mm	Quantity Box/Bag
0,5÷1 (20÷17)	WL 03-M	1,7	15,0	36,0	1.500/100
1,5÷2,5 (16÷14)	WL 06-M	2,3	15,0	36,0	1.000/100
4÷6 (12÷10)	WL 1-M	3,4	15,0	41,0	500/100

Max operating voltage: 600 V
Shrink temperature: 150 °C
Temperature range: -40 °C to + 105 °C



WL-M

- Manufactured from copper tube
- Electrolytically tin plated
 - Heat shrink sleeve with sealant
 - Recommended crimping tools are shown on pages 96, 107.



CLOSE END CONNECTORS

Polyamide PA6.6 insulated

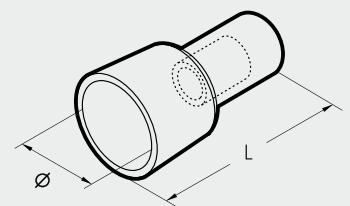

Cond. Size sqmm (AWG)	Ref.	Ø mm	L mm	Quantity Box/Bag
0,25÷1,5 (22÷16)	NL 03-P	9,8	21,0	1.000/100
1,5÷2,5 (16÷14)	NL 06-P	7,9	19,9	1.000/100
1,5÷2,5 (16÷14)	NL 06-PB	6,5	13,6	1.500/100
4÷6 (12÷10)	NL 1-P	10,5	21,5	800/100
4÷6 (12÷10)	NL 1-PG	9,0	17,8	1.000/100



NL-P

- Manufactured from copper tube
- Electrolytically tin plated
 - The operating temperature range is - 20 to + 115°C (Surge + 130°C).
 - Recommended crimping tools are shown on pages 94 to 115, 148, 187.

RKF-F BKF-F GK-F



- Manufactured from brass strip
- Electrolytically tin plated
- fully reinforced with copper sleeve, funnel entry
- The operating temperature range is -20°C to $+105^{\circ}\text{C}$ (Surge $+110^{\circ}\text{C}$)
- Recommended crimping tools are shown on pages 94 to 115, 148, 187.

REINFORCED DISCONNECT TERMINALS

for copper cables



female connectors, fully reinforced with copper sleeve

PA6.6 insulated terminals

Cond. Size sqmm (AWG)	Ref.	Tab Size	Quantity Box/Bag
0,25÷1,5 (22÷16)	RKF-F 305	2,8 x 0,5	3.500/100
	RKF-F 308	2,8 x 0,8	3.500/100
	RKF-F 405	4,8 x 0,5	3.000/100
1,5÷2,5 (16÷14)	RKF-F 408	4,8 x 0,8	3.000/100
	RKF-F 608	6,35 x 0,8	2.500/100
4-6 (12÷10)	BKF-F 405	4,8 x 0,5	3.000/100
	BKF-F 408	4,8 x 0,8	3.000/100
	BKF-F 608	6,35 x 0,8	2.000/100
	GK-F 608	6,35 x 0,8	1.500/100

PA6.6 fully insulated terminals

Cond. Size sqmm (AWG)	Ref.	Tab Size	Quantity Box/Bag
0,25÷1,5 (22÷16)	RKF-F 405P	4,8 x 0,5	2.500/100
	RKF-F 408P	4,8 x 0,8	2.000/100
1,5÷2,5 (16÷14)	RKF-F 608P	6,35 x 0,8	1.000/100
	BKF-F 405P	4,8 x 0,5	2.000/100
4-6 (12÷10)	BKF-F 408P	4,8 x 0,8	2.000/100
	BKF-F 608P	6,35 x 0,8	1.000/100
	GK-F 608P	6,35 x 0,8	1.000/100

RKF BKF GKF



- Manufactured from brass strip
- Electrolytically tin plated
- fully reinforced with copper sleeve, funnel entry
- The operating temperature range is -20°C to $+105^{\circ}\text{C}$ (Surge $+110^{\circ}\text{C}$)
- Recommended crimping tools are shown on pages 94 to 115, 148, 187.

male connectors, fully reinforced with copper sleeve - PA6.6 insulated terminals

Cond. Size sqmm (AWG)	Ref.	Tab Size	Quantity Box/Bag
0,25÷1,5 (22÷16)	RKF-M 608	6,35 x 0,8	3.000/100
1,5÷2,5 (16÷14)	BKF-M 608	6,35 x 0,8	2.500/100
4-6 (12÷10)	GKF-M 608	6,35 x 0,8	1.000/100

male/female connectors, fully reinforced with copper sleeve - PA6.6 insulated terminals

Cond. Size sqmm (AWG)	Ref.	Tab Size	Quantity Box/Bag
0,25÷1,5 (22÷16)	RKF-FM 608	6,35 x 0,8	1.500/100
1,5÷2,5 (16÷14)	BKF-FM 608	6,35 x 0,8	1.500/100

bullet and socket connectors fully reinforced with copper sleeve PA6.6 insulated terminals

Cond. Size sqmm (AWG)	Ref.	Ø mm	Quantity Box/Bag
0,25÷1,5 (22÷16)	RKF-BM 4	4	2.500/100
	RKF-BF 4	4	1.000/100
1,5÷2,5 (16÷14)	BKF-BM 4	4	2.000/100
	BKF-BF 4	4	800/100

RN-FA BN-FA



- Manufactured from brass strip
- The operating temperature range is -40 to $+125^{\circ}\text{C}$.
- Recommended crimping tools are shown on pages 100 to 107, 187.

FEMALE CONNECTORS

open barrel

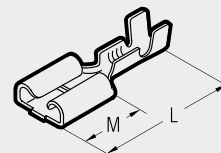

Conductor Size sqmm (AWG)	Ref.	Tab mm	M mm	L mm	Quantity Box/Bag
0,5÷1 (20÷17)	RN-FA 305	2,8 x 0,5	6,3	15,0	6.000/100
	RN-FA 405	4,8 x 0,5	6,3	15,0	5.000/100
	RN-FA 608	6,3 x 0,8	7,7	19,0	3.000/100
1÷2,5 (17÷14)	BN-FA 608	6,3 x 0,8	7,7	19,0	3.000/100
	* BN-FAB 608	6,3 x 0,8	7,7	15,5	1.000/100
	** BN-FAR 608	6,3 x 0,8	7,7	19,0	3.000/100

*flag type **with retainer



MALE CONNECTORS

open barrel

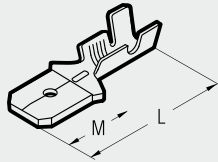

Conductor Size sqmm (AWG)	Ref.	Tab mm	M mm	L mm	Quantity Box/Bag
0,5÷1 (20÷17)	RN-MA 305	2,8 x 0,5	5,8	13,0	6.000/100
	RN-MA 405	4,8 x 0,5	6,3	17,3	5.000/100
	RN-MA 608	6,3 x 0,8	7,9	19,7	4.000/100
1÷2,5 (17÷14)	BN-MA 608	6,3 x 0,8	7,9	20,0	4.000/100

RN-MA BN-MA



- Manufactured from brass strip
- The operating temperature range is - 40 to + 125°C.
- Recommended crimping tool is shown on page 100 to 107, 187.



MALE TABS

for board mounting

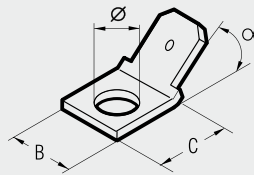

Ref.	Tab mm	Ø Stud mm	B mm	C mm	α	Quantity Box/Bag
MP 608	6,3 x 0,8	4	8	8,5	0°	5.000/100
MP 608/45	6,3 x 0,8	4	8	8,5	45°	6.000/100
MP 608/90	6,3 x 0,8	4	8	8,5	90°	5.000/100
* MP 608D	6,3 x 0,8	5	8	14	0°	5.000/100

*double tab

MP MPD



- Manufactured from brass strip
- The operating temperature range is - 40 to + 125°C.

CONNECTOR SLEEVES

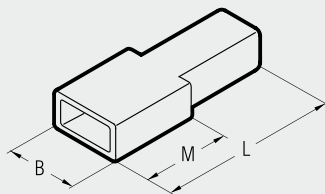

Ref.	Connector	B mm	M mm	L mm	Material	Quantity Box/Bag
CFA 300	Female 2,8	5,5	7	18	Polyethylene	3.000/100
*CFA 400	Female 4,8	7,5	9	20	Polyethylene	2.000/100
*CFA 600	Female 6,3	9,0	11	24	Polyethylene	1.500/100
**CFA2 600	Female 6,3	9,0	9	22	Polyethylene	1.500/100
CFAR 600	Female 6,3 frontal insertion with retainer	9,0	12	25	Polyamide 6.6	1.000/100
CFAB 600	Female 6,3 flag	10,0	-	18	Polyamide 6.6	1.000/100
*CMA 600	Male 6,3	12,0	11	22	Polyethylene	1.000/100

CFA CMA



- * For a single cable.
Colours available:
Transparent: no suffix
Red: add suffix R
Black: add suffix N

- ** For twin cables.
Colours available:
Transparent: no suffix
Red: add suffix R
Black: add suffix N
Green: add suffix V
Blue: add suffix B
Yellow: add suffix G

PKD
PKE
PKC
CPKD



HALOGEN FREE



POLYPROPYLENE INSULATED END SLEEVES

for flexible copper cables

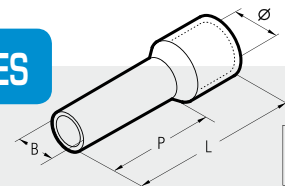

The PKD.. range of end sleeves is manufactured from tin plated electrolytic copper.

Designed and developed to reinforce fine wire strands when terminating a cable into a connector block.

The PKD series of insulated end sleeves comply with specification DIN 46 228/4.

The operating temperature range is - 20 to + 105°C (Surge + 110°C). Recommended crimping tools are shown on pages 94 to 118, 121, 148, 150, 152, 187.

VALSTAR ND#2/PKD

Comprising:

- a selection of end sleeves PKD conductor size 1÷6 sqmm
- tool ND#2

VALSTAR ND#2/PKE

Comprising:

- a selection of end sleeves PKE conductor size 1÷6 sqmm
- tool ND#2

VALSTAR ND#2/PKC

Comprising:

- a selection of end sleeves PKC conductor size 1÷6 sqmm
- tool ND#2

Conductor Size sqmm	Ref.	Dimensions mm				Insulation Colour	Quantity Box/Bag
		Ø	B	P	L		
0,3÷0,5	PKD 506	2,6	1,4	6,0	12,0	○ white	10.000/500
	PKD 508	2,6	1,4	8,0	14,0		10.000/500
	PKD 510	2,6	1,4	10,0	16,0		10.000/500
0,75	PKD 7506	2,8	1,6	6,0	12,4	○ grey	10.000/500
	PKD 7508	2,8	1,6	8,0	14,0		10.000/500
	PKD 7510	2,8	1,6	10,0	16,4		10.000/500
1	PKD 7512	2,8	1,6	12,0	18,4	● red	10.000/500
	PKD 106	3,0	1,8	6,0	12,4		10.000/500
	PKD 108	3,0	1,8	8,0	14,0		10.000/500
1,5	PKD 110	3,0	1,8	10,0	16,4	● black	10.000/500
	PKD 112	3,0	1,8	12,0	18,4		10.000/500
	PKD 1508	3,5	2,1	8,0	14,0		10.000/500
2,5	PKD 1510	3,5	2,1	10,0	16,4	● blue	7.500/500
	PKD 1512	3,5	2,1	12,0	18,4		7.500/500
	PKD 1518	3,5	2,1	18,0	24,4		5.000/500
4	PKD 2508	4,2	2,6	8,0	15,0	● yellow	7.500/500
	PKD 2512	4,2	2,6	12,0	19,0		5.000/500
	PKD 2518	4,2	2,6	18,0	25,0		5.000/500
6	PKD 410	4,8	3,3	10,0	17,0	○ grey	5.000/200
	PKD 412	4,8	3,3	12,0	19,0		4.000/200
	PKD 418	4,8	3,3	18,0	25,0		3.000/200
10	PKD 612	6,3	4,0	12,0	20,0	● yellow	2.500/100
	PKD 618	6,3	4,0	18,0	26,0		2.000/100
	PKD 1012	7,6	5,0	12,0	21,5		1.500/100
16	PKD 1018	7,6	5,0	18,0	27,5	● red	1.500/100
	PKD 1612	8,8	6,2	12,0	22,5		1.000/100
	PKD 1618	8,8	6,2	18,0	28,5		1.000/100
25	PKD 25016	11,2	7,9	16,0	29,0	● blue	500/50
	PKD 25022	11,2	7,9	22,0	35,0		500/50
	PKD 35016	12,7	8,8	16,0	30,0		500/50
35	PKD 35025	12,7	8,8	25,0	39,0	● red	400/50
	PKD 50020	15,0	11,0	20,0	36,0		300/50
	PKD 50025	15,0	11,0	25,0	41,0		300/50

Conductor Size sqmm	Ref.	Dimensions mm				Insulation Colour	Quantity Box/Bag
		Ø	B	P	L		
0,1÷0,3	PKE 308	1,9	1,1	8,0	12,4	● yellow	25.000/500
0,3÷0,5	*PKE 508	2,6	1,3	8,0	14,0	○ white	10.000/500
0,75	PKE 7508	2,8	1,6	8,0	14,0	● blue	10.000/500
1	*PKE 108	3,0	1,8	8,0	14,0	● red	10.000/500
	*PKE 1508	3,5	2,1	8,0	14,0		10.000/500
	*PKE 1510	3,5	2,1	10,0	16,4		7.500/500
1,5	*PKE 1518	3,5	2,1	18,0	24,4	● black	5.000/500
	PKE 2508	4,2	2,6	8,0	15,0		7.500/500
	PKE 2512	4,2	2,6	12,0	19,0		5.000/500
2,5	PKE 2518	4,2	2,6	18,0	25,0	○ grey	5.000/500
	PKE 410	4,8	3,3	10,0	17,0		5.000/200
	PKE 412	4,8	3,3	12,0	19,0		4.000/200
4	PKE 418	4,8	3,3	18,0	25,0	● orange	3.000/200
	PKE 612	5,8	3,9	12,0	20,0		2.500/100
	PKE 618	5,8	3,9	18,0	26,0		2.000/100
10	PKE 1012	7,4	4,9	12,0	21,5	● green	1.500/100
	PKE 1018	7,4	4,9	18,0	27,5		1.500/100
	PKE 1612	8,8	6,2	12,0	22,7		1.000/100
16	PKE 1618	8,8	6,2	18,0	28,6	○ white	1.000/100
	PKE 25016	10,0	7,9	16,0	29,0		500/50
	PKE 25022	10,0	7,9	22,0	35,0		500/50

Conductor Size sqmm	Ref.	Dimensions mm				Insulation Colour	Quantity Box/Bag
		Ø	B	P	L		
0,1÷0,3	PKC 306	1,9	1,1	6,0	10,4	● light blue	25.000/500
	PKC 308	1,9	1,1	8,0	12,4		25.000/500
0,3÷0,5	PKC 508	2,6	1,3	8,0	14,0	● orange	10.000/500
	PKC 510	2,6	1,3	10,0	16,0		10.000/500
0,75	PKC 7508	2,8	1,6	8,0	14,0	○ white	10.000/500
	PKC 7512	2,8	1,6	12,0	18,4		10.000/500
1	PKC 108	3,0	1,8	8,0	14,0	● yellow	10.000/500
	PKC 112	3,0	1,8	12,0	18,4		10.000/500
	PKC 1508	3,5	2,1	8,0	14,0		10.000/500
1,5	PKC 1510	3,5	2,1	10,0	16,4	● red	7.500/500
	PKC 1518	3,5	2,1	18,0	24,4		5.000/500
	*PKC 2508	4,2	2,6	8,0	15,0		7.500/500
2,5	*PKC 2512	4,2	2,6	12,0	19,0	● blue	5.000/500
	*PKC 2518	4,2	2,6	18,0	25,0		5.000/500
	*PKC 410	4,8	3,3	10,0	17,0		5.000/200
4	*PKC 412	4,8	3,3	12,0	19,0	○ grey	4.000/200
	*PKC 418	4,8	3,3	18,0	25,0		3.000/200
	PKC 612	5,8	3,9	12,0	20,0		2.500/100
6	PKC 618	5,8	3,9	18,0	26,0	● black	2.000/100
	PKC 1012	7,4	4,9	12,0	21,5		1.500/100
	PKC 1018	7,4	4,9	18,0	27,5		1.500/100
16	PKC 1612	8,8	6,2	12,0	22,7	○ ivory	1.000/100
	PKC 1618	8,8	6,2	18,0	28,6		1.000/100
	PKC 25016	10,0	7,9	16,0	29,0		500/50
25	PKC 25022	10,0	7,9	22,0	35,0	● green	500/50
	PKC 35016	12,0	8,9	16,0	30,0		500/50
	PKC 35025	12,0	8,9	25,0	39,0		400/50
50	PKC 50020	13,8	11,0	20,0	36,0	● beige	300/50
	PKC 50030	13,8	11,0	30,0	46,0		250/50
70	PKC 70022	16,0	14,3	22,0	38,0	● olive	100/25
95	PKC 95025	18,0	15,7	25,0	44,0	● yellow	100/25
120	PKC 120027	21,0	17,5	27,0	48,0	● red	100/25
						● blue	100/25

Insulated chain end sleeves

Developed for use with production equipment to give a quick and reliable crimped joint. Conforms to DIN standard 46 228/4.

Conductor Size sqmm	Ref.	Dimensions mm				Insulation Colour	Quantity Reel
		Ø	B	P	L		
0,3÷0,5	CPKD 508	2,6	1,3	8,0	14,0	○ white	5.000
0,75	CPKD 7508	2,8	1,5	8,0	14,0	○ grey	5.000
1	CPKD 108	3,0	1,7	8,0	14,0	● red	5.000
1,5	CPKD 1508	3,5	2,0	8,0	14,0	● black	5.000
2,5	CPKD 2508	4,2	2,5	8,0	14,0	● blue	3.000



*To DIN standard 46 228/4

"TWIN" POLYPROPYLENE INSULATED END SLEEVES



for fine stranded cables

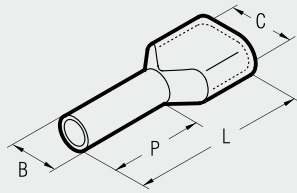

HALOGEN FREE

Conductor Size sqmm	Ref.	Dimensions mm				Insulation Colour	ND#1, ND#2, ND#3 and HINKE 50 Compression Aperture	Quantity Box/Bag
		C	B	P	L			
2 x 0,5	PKT 508	4,9x2,5	1,8	8,0	16,0	○ white	1	5.000/500
	PKT 510	4,9x2,5	1,8	10,0	18,0			5.000/500
2 x 0,75	PKT 7508	5,2x2,6	2,1	8,0	15,0	○ grey	1,5	2.500/100
	PKT 7512	5,2x2,6	2,1	12,0	19,0			2.500/100
2 x 1	PKT 108	5,8x3,2	2,6	8,0	16,0	● red	2,5	2.500/100
	PKT 112	5,8x3,2	2,6	12,0	20,0			2.500/100
2 x 1,5	PKT 1508	6,5x3,6	2,6	8,0	16,0	● black	2,5	2.500/100
	PKT 1512	6,5x3,6	2,6	12,0	20,0			2.500/100
2 x 2,5	PKT 2510	7,5x4,3	3,2	9,0	19,6	● blue	4	2.500/100
	PKT 2512	7,5x4,3	3,2	12,0	21,0			2.500/100
2 x 4	PKT 412	9,0x5,2	4,2	12,0	23,0	○ grey	6	1.500/100
2 x 6	PKT 614	10,0x7,2	5,3	14,0	26,0	● yellow	10	1.000/100
2 x 10	PKT 1014	13,0x7,2	7,0	14,0	26,0	● red	16	500/50
2 x 16	PKT 1614	18,0x9,5	8,8	14,0	30,0	● blue	35	300/50

PKT



Type PKT range of end sleeves is manufactured from tin plated electrolytic copper.

Designed to accommodate two cables terminating in the same sleeve.

The operating temperature range is - 20 to + 105°C (Surge + 110°C).

Recommended crimping tools are shown on pages 94 to 118, 121, 148, 150, 152, 187.

UNINSULATED END SLEEVES



for flexible copper cables

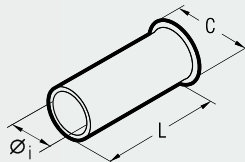

Conductor Size sqmm	Ref.	Dimensions mm			Quantity Box/Bag
		Øi	L	C	
0,5	*KE 506 ST	1,0	6	2,1	50.000/500
	KE 508 ST	1,0	8	2,1	50.000/500
0,75	*KE 7506 ST	1,2	6	2,3	50.000/500
	KE 7508 ST	1,2	8	2,3	50.000/500
1	*KE 106 ST	1,4	6	2,5	25.000/500
	*KE 110 ST	1,4	10	2,5	25.000/500
1,5	*KE 1508 ST	1,8	7	2,8	25.000/500
	*KE 1510 ST	1,8	10	2,8	25.000/500
2,5	*KE 2508 ST	2,3	7	3,4	25.000/500
	*KE 2510 ST	2,3	10	3,4	20.000/500
4	*KE 410 ST	2,8	9	4,0	12.500/500
	*KE 412 ST	2,8	12	4,0	12.500/500
6	*KE 610 ST	3,5	10	4,7	10.000/500
	*KE 612 ST	3,5	12	4,7	7.500/500
10	*KE 616 ST	3,5	15	4,7	5.000/500
	*KE 1016 ST	4,5	15	5,8	4.000/250
16	*KE 1616 ST	5,8	15	7,5	3.000/250
	KE 25012 ST	7,3	12	9,5	2.500/100
25	*KE 25018 ST	7,3	18	9,5	1.500/100
	KE 35012 ST	8,3	12	11,0	1.500/100
35	*KE 35018 ST	8,3	18	11,0	1.000/100

*To DIN standard 46 228/1

KE



KE series end sleeves are manufactured from tin plated electrolytic copper.

Designed and developed for use with flexible cables.

Recommended crimping tools are shown on pages 94 to 118, 121, 148, 150, 152, 187.

S

UNINSULATED TERMINALS

S range - brazed seam



S range terminals are manufactured from electrolytic copper strip and tin plated. The seam is brazed to pro-

vide uniform mechanical strength. The terminal barrel is rifled to enhance electrical con-

tact and to improve mechanical strength.

Recommended crimping tools are shown on pages 94 to 115, 148.

pin terminals

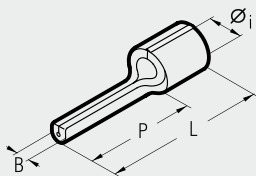

blade terminals

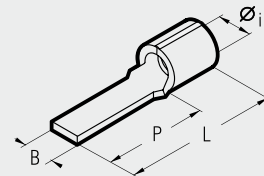

Conductor Size sqmm (AWG)	Ref.	Dimensions mm				Quantity Box/Bag
		Øi	B	P	L	
0,25÷1,25 (22÷16)	S 1.5-P 8	1,8	1,6	8,0	12,0	8.000/100
	S 1.5-P 10	1,8	1,6	10,0	14,0	8.000/100
	S 1.5-P 12	1,8	1,6	12,0	16,2	8.000/100
1,5÷2,5 (16÷14)	S 2.5-P 8	2,4	1,7	8,0	12,0	7.000/100
	S 2.5-P 10	2,4	1,8	10,0	14,0	7.000/100
	S 2.5-P 12	2,4	1,8	12,0	16,0	7.000/100
4÷6 (12÷10)	S 6-P 10	3,6	2,2	10,0	16,8	4.000/100
	S 6-P 12	3,6	2,2	12,0	19,4	4.000/100
	S 6-P 14	3,6	2,2	14,0	21,0	3.500/100

Conductor Size sqmm (AWG)	Ref.	Dimensions mm				Quantity Box/Bag
		Øi	B	P	L	
0,25÷1,25 (22÷16)	S 1.5-PP 12	1,8	3,0	12,8	17,0	8.000/100
	*S 1.5-PP 12/1	1,8	3,0	11,3	15,5	8.000/100
	S 1.5-PP 12/19	1,8	1,9	13,2	17,4	8.000/100
	S 1.5-PP 14	1,8	3,0	14,8	19,0	8.000/100
1,5÷2,5 (16÷14)	S 2.5-PP 12	2,4	3,5	12,8	17,0	7.000/100
	S 2.5-PP 12/25	2,4	2,5	13,3	17,5	7.000/100
	S 2.5-PP 16/25	2,4	2,5	17,2	21,4	7.000/100
4÷6 (12÷10)	S 6-PP 12	3,6	4,0	13,3	19,7	4.000/100
	S 6-PP 17	3,6	2,9	19,1	25,5	4.000/100

*Made to order



UNINSULATED TERMINALS

S range - brazed seam

S

ring terminals

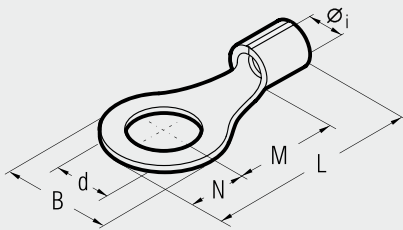

fork/spade terminals

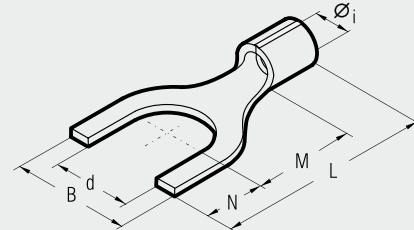

Cond. Size sqmm (AWG)	Ø Stud mm	Ref.	Dimensions mm						Quantity Box/Bag
			Øi	B	M	N	L	d	
0,25÷1,25 (22÷16)	2	*S 1.5-M 2	1,8	5,6	4,5	2,8	11,5	2,2	7.000/100
	3	S 1.5-M 3	1,8	5,6	4,5	2,8	11,5	3,2	7.000/100
	3,5	S 1.5-M 3,5	1,8	5,6	4,5	2,8	11,5	3,7	7.000/100
	3,5	*S 1.5-M 3,5/1	1,8	6,2	7,1	3,1	14,4	3,7	7.000/100
	4	S 1.5-M 4	1,8	7,0	6,5	3,5	14,2	4,3	7.000/100
	4	*S 1.5-M 4/3	1,8	7,8	7,1	3,9	15,2	4,3	7.000/100
	5	S 1.5-M 5	1,8	7,8	7,1	3,9	15,2	5,3	7.000/100
	6	S 1.5-M 6	1,8	9,4	8,1	4,7	17,0	6,4	6.000/100
	6	S 1.5-M 6/1	1,8	12,0	10,3	6,0	20,5	6,4	5.000/100
	7	S 1.5-M 7	1,8	9,4	8,1	4,7	17,0	7,2	6.000/100
	8	S 1.5-M 8	1,8	12,0	10,3	6,0	20,5	8,4	4.000/100
	10	S 1.5-M 10	1,8	15,5	13,0	7,7	25,0	10,5	3.000/100
12	S 1.5-M 12	1,8	18,0	15,5	9,0	28,7	13,0	2.000/100	
1,5÷2,5 (16÷14)	3	S 2.5-M 3	2,4	5,6	5,0	2,8	12,0	3,2	6.000/100
	3,5	S 2.5-M 3,5	2,4	5,6	5,0	2,8	12,0	3,7	6.000/100
	3,5	*S 2.5-M 3,5/1	2,4	6,2	6,5	3,1	13,8	3,7	5.000/100
	4	S 2.5-M 4	2,4	8,0	6,5	4,0	14,7	4,3	5.000/100
	5	S 2.5-M 5	2,4	8,0	7,5	4,0	15,7	5,3	5.000/100
	6	S 2.5-M 6	2,4	9,4	8,6	4,7	17,5	6,4	5.000/100
	6	S 2.5-M 6/1	2,4	12,0	10,3	6,0	20,5	6,4	5.000/100
	7	S 2.5-M 7	2,4	10,0	7,8	5,0	17,0	7,2	5.000/100
	8	S 2.5-M 8	2,4	12,0	10,3	6,0	20,5	8,4	4.000/100
	10	S 2.5-M 10	2,4	15,5	13,0	7,7	25,0	10,5	2.500/100
	12	S 2.5-M 12	2,4	18,0	15,5	9,0	28,7	13,0	2.000/100
	4÷6 (12÷10)	3	S 6-M 3	3,6	8,0	8,1	4,0	18,5	3,2
3,5		S 6-M 3,5	3,6	8,0	8,1	4,0	18,5	3,7	3.000/100
4		S 6-M 4	3,6	9,0	8,1	4,5	19,0	4,3	3.000/100
5		S 6-M 5	3,6	9,0	8,1	4,5	19,0	5,3	2.500/100
6		S 6-M 6	3,6	11,0	11,1	5,5	23,0	6,4	2.500/100
6		*S 6-M 6/1	3,6	11,0	8,1	5,5	20,0	6,4	2.500/100
7		S 6-M 7	3,6	11,0	11,1	5,5	23,0	7,2	2.500/100
8		S 6-M 8	3,6	13,6	12,1	6,8	25,3	8,4	2.000/100
8		*S 6-M 8/1	3,6	11,0	8,1	5,5	20,0	8,4	2.500/100
10		S 6-M 10	3,6	13,6	12,1	6,8	25,3	10,5	2.000/100
10		S 6-M 10/1	3,6	15,5	13,8	7,7	28,0	10,5	2.000/100
12		S 6-M 12	3,6	19,0	15,1	9,5	31,0	13,0	1.000/100
14	S 6-M 14	3,6	21,0	16,1	10,5	33,0	15,0	1.000/100	
16	S 6-M 16	3,6	24,0	17,1	12,0	35,5	17,0	1.000/100	
10 (8)	4	S 10-M 4	4,8	11,5	9,0	5,8	23,8	4,3	2.000/100
	5	S 10-M 5	4,8	11,5	9,0	5,8	23,8	5,3	2.000/100
	6	S 10-M 6	4,8	11,5	9,0	5,8	23,8	6,4	2.000/100
	7	S 10-M 7	4,8	11,5	9,0	5,8	23,8	7,2	1.500/100

Cond. Size sqmm (AWG)	Ø Stud mm	Ref.	Dimensions mm						Quantity Box/Bag
			Øi	B	M	N	L	d	
0,25÷1,25 (22÷16)	3	S 1.5-U 3	1,8	5,5	5,5	4,0	13,7	3,2	7.000/100
	3,5	S 1.5-U 3,5	1,8	6,0	6,5	3,8	14,5	3,7	7.000/100
	3,5	*S 1.5-U 3,5/2	1,8	6,4	6,5	3,8	14,5	3,7	7.000/100
	4	S 1.5-U 4	1,8	6,5	7,5	3,7	15,4	4,3	7.000/100
	4	*S 1.5-U 4/1	1,8	8,5	7,5	3,7	15,4	4,3	7.000/100
	4	S 1.5-U 4/2	1,8	7,5	7,5	3,7	15,4	4,3	7.000/100
	5	S 1.5-U 5	1,8	8,5	7,5	3,7	15,4	5,3	7.000/100
	5	*S 1.5-U 5/1	1,8	9,4	7,5	3,7	15,4	5,3	7.000/100
	6	S 1.5-U 6	1,8	9,4	8,1	4,7	17,0	6,4	6.000/100
	6	*S 1.5-U 6/1	1,8	12,0	9,2	7,1	20,5	6,4	6.000/100
	8	S 1.5-U 8	1,8	14,0	10,0	6,3	20,5	8,4	3.000/100
	10	S 1.5-U 10	1,8	17,5	13,0	7,7	25,0	10,5	2.500/100
12	S 1.5-U 12	1,8	20,0	15,5	9,0	28,7	13,0	2.000/100	
1,5÷2,5 (16÷14)	3	S 2.5-U 3	2,4	5,5	5,5	4,0	13,7	3,2	6.000/100
	3,5	S 2.5-U 3,5	2,4	6,4	6,5	3,8	14,5	3,7	6.000/100
	3,5	*S 2.5-U 3,5/12,4	2,4	7,2	6,5	3,8	14,5	3,7	6.000/100
	4	S 2.5-U 4	2,4	6,5	7,5	3,7	15,4	4,3	5.000/100
	4	*S 2.5-U 4/1	2,4	8,5	7,5	3,7	15,4	4,3	6.000/100
	4	*S 2.5-U 4/2	2,4	7,5	7,5	3,7	15,4	4,3	6.000/100
	5	S 2.5-U 5	2,4	8,5	7,5	3,7	15,4	5,3	6.000/100
	6	S 2.5-U 6	2,4	9,4	8,1	4,7	17,0	6,4	5.000/100
	6	*S 2.5-U 6/1	2,4	12,0	9,2	7,1	20,5	6,4	4.000/100
	8	S 2.5-U 8	2,4	14,0	10,0	6,3	20,5	8,4	2.500/100
	10	S 2.5-U 10	2,4	17,5	13,0	7,7	25,0	10,5	2.000/100
	12	S 2.5-U 12	2,4	20,0	15,5	9,0	28,7	13,0	2.000/100
4÷6 (12÷10)	3,5	S 6-U 3,5	3,6	7,5	8,5	3,9	18,8	3,7	3.000/100
	4	S 6-U 4	3,6	7,5	8,0	4,4	18,8	4,3	3.000/100
	5	S 6-U 5	3,6	9,5	8,0	4,4	18,8	5,3	2.500/100
	6	S 6-U 6	3,6	10,0	11,0	5,5	22,9	6,4	2.500/100
	8	S 6-U 8	3,6	13,5	12,0	8,0	26,4	8,4	2.000/100
	10	S 6-U 10	3,6	15,5	13,0	8,0	27,4	10,5	2.000/100
	10	*S 6-U 10/1	3,6	17,5	13,8	7,7	28,0	10,5	2.000/100
	12	S 6-U 12	3,6	21,0	15,1	9,5	31,0	13,0	1.000/100
	14	*S 6-U 14	3,6	23,0	16,1	10,5	33,0	15,0	1.000/100
	16	*S 6-U 16	3,6	26,0	17,1	11,5	35,0	17,0	1.000/100

*Made to order

UNINSULATED TERMINALS

RN, BN, GN range - unbrazed



RN
BN
GN



RN, BN, GN range terminals are manufactured from electrolytic copper strip and

tin plated. The seam is unbrazed. The terminal barrel is rifled

to enhance electrical contact and to improve mechanical strength.

Recommended crimping tools are shown on pages 94 to 115, 148.

pin terminals

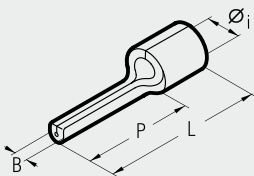

blade terminals

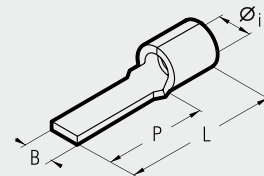

Conductor Size sqmm (AWG)	Ref.	Dimensions mm				Quantity Box/Bag
		Øi	B	P	L	
0,25÷1,5 (22÷16)	RN-P 8	1,8	1,6	8,0	12,0	8.000/100
	RN-P 10	1,8	1,6	10,0	14,0	8.000/100
	RN-P 12	1,8	1,6	12,0	16,2	8.000/100
1,5÷2,5 (16÷14)	BN-P 8	2,4	1,7	8,0	12,0	7.000/100
	BN-P 10	2,4	1,8	10,0	14,0	7.000/100
	BN-P 12	2,4	1,8	12,0	16,0	7.000/100
4÷6 (12÷10)	GN-P 10	3,6	2,2	10,0	16,8	4.000/100
	GN-P 12	3,6	2,2	12,0	19,0	4.000/100
	GN-P 14	3,6	2,2	14,0	21,0	3.500/100

Conductor Size sqmm (AWG)	Ref.	Dimensions mm				Quantity Box/Bag
		Øi	B	P	L	
0,25÷1,5 (22÷16)	RN-PP 12	1,8	3,0	12,8	17,0	8.000/100
	RN-PP 12/1	1,8	3,0	11,3	15,5	8.000/100
	RN-PP 12/19	1,8	1,9	13,2	17,4	8.000/100
	RN-PP 14	1,8	3,0	14,8	19,0	8.000/100
	RN-PP 16/23	1,8	2,3	17,2	21,4	8.000/100
1,5÷2,5 (16÷14)	BN-PP 12	2,4	3,5	12,8	17,0	7.000/100
	BN-PP 12/25	2,4	2,5	13,3	17,5	7.000/100
	BN-PP 16/25	2,4	2,5	17,2	21,4	7.000/100
4÷6 (12÷10)	GN-PP 12	3,6	4,0	13,3	19,7	4.000/100
	GN-PP 17	3,6	2,9	19,1	25,5	4.000/100



UNINSULATED TERMINALS

RN, BN, GN range - unbrazed

RN
BN
GN

ring terminals

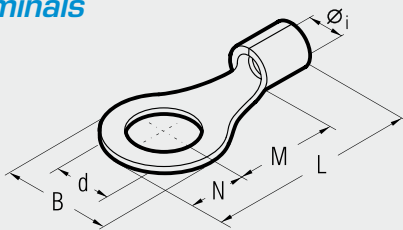

Cond. Size sqmm (AWG)	Ø Stud mm	Ref.	Dimensions mm						Quantity Box/Bag
			Øi	B	M	N	L	d	
0,25÷1,5 (22÷16)	2	*RN-M 2	1,8	5,6	4,5	2,8	11,5	2,2	7.000/100
	3	RN-M 3	1,8	5,6	4,5	2,8	11,5	3,2	7.000/100
	3,5	RN-M 3.5	1,8	5,6	4,5	2,8	11,5	3,7	7.000/100
	3,5	RN-M 3.5/1	1,8	6,2	7,1	3,1	14,4	3,7	7.000/100
	4	RN-M 4	1,8	7,0	6,5	3,5	14,2	4,3	7.000/100
	4	RN-M 4/3	1,8	7,8	7,1	3,9	15,2	4,3	7.000/100
	5	RN-M 5	1,8	7,8	7,1	3,9	15,2	5,3	7.000/100
	6	RN-M 6	1,8	9,4	8,1	4,7	17,0	6,4	6.000/100
	6	RN-M 6/1	1,8	12,0	10,3	6,0	20,5	6,4	4.000/100
	7	RN-M 7	1,8	9,4	8,1	4,7	17,0	7,2	6.000/100
	8	RN-M 8	1,8	12,0	10,3	6,0	20,5	8,4	4.000/100
	10	RN-M 10	1,8	15,5	13,0	7,7	25,0	10,5	3.000/100
12	RN-M 12	1,8	18,0	15,5	9,0	28,7	13,0	2.000/100	
1,5÷2,5 (16÷14)	2	*BN-M 2	2,4	5,6	5,0	2,8	12,0	2,2	6.000/100
	3	BN-M 3	2,4	5,6	5,0	2,8	12,0	3,2	6.000/100
	3,5	BN-M 3.5	2,4	5,6	5,0	2,8	12,0	3,7	6.000/100
	3,5	BN-M 3.5/1	2,4	6,2	6,5	3,1	13,8	3,7	6.000/100
	4	BN-M 4	2,4	8,0	6,5	4,0	14,7	4,3	5.000/100
	5	BN-M 5	2,4	8,0	7,5	4,0	15,7	5,3	5.000/100
	6	BN-M 6	2,4	9,4	8,6	4,7	17,5	6,4	5.000/100
	6	BN-M 6/1	2,4	12,0	10,3	6,0	20,5	6,4	5.000/100
	7	BN-M 7	2,4	10,0	7,8	5,0	17,0	7,2	5.000/100
	8	BN-M 8	2,4	12,0	10,3	6,0	20,5	8,4	4.000/100
	10	BN-M 10	2,4	15,5	13,0	7,7	25,0	10,5	2.500/100
	12	BN-M 12	2,4	18,0	15,5	9,0	28,7	13,0	2.000/100
4÷6 (12÷10)	3	GN-M 3	3,6	8,0	8,1	4,0	18,5	3,2	3.000/100
	3,5	GN-M 3.5	3,6	8,0	8,1	4,0	18,5	3,7	3.000/100
	4	GN-M 4	3,6	9,0	8,1	4,5	19,0	4,3	3.000/100
	5	GN-M 5	3,6	9,0	8,1	4,5	19,0	5,3	2.500/100
	6	GN-M 6	3,6	11,0	11,1	5,5	23,0	6,4	2.500/100
	6	GN-M 6/1	3,6	11,0	8,1	5,5	20,0	6,4	2.500/100
	7	GN-M 7	3,6	11,0	11,1	5,5	23,0	7,2	2.500/100
	8	GN-M 8	3,6	13,6	12,1	6,8	25,3	8,4	2.000/100
	8	*GN-M 8/1	3,6	11,0	8,1	5,5	20,0	8,4	2.500/100
	10	GN-M 10	3,6	13,6	12,1	6,8	25,3	10,5	2.000/100
	10	GN-M 10/1	3,6	15,5	13,8	7,7	28,0	10,5	2.000/100
	12	GN-M 12	3,6	19,0	15,1	9,5	31,0	13,0	1.000/100
	14	GN-M 14	3,6	21,0	16,1	10,5	33,0	15,0	1.000/100
	16	GN-M 16	3,6	24,0	17,1	12,0	35,5	17,0	1.000/100

fork/spade terminals

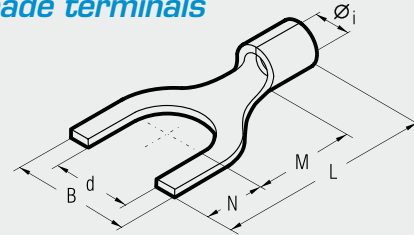

Cond. Size sqmm (AWG)	Ø Stud mm	Ref.	Dimensions mm						Quantity Box/Bag
			Øi	B	M	N	L	d	
0,25÷1,5 (22÷16)	3	RN-U 3	1,8	5,5	5,5	4,0	13,7	3,2	7.000/100
	3,5	RN-U 3.5	1,8	6,0	6,5	3,8	14,5	3,7	7.000/100
	3,5	RN-U 3.5/2	1,8	6,4	6,5	3,8	14,5	3,7	7.000/100
	4	RN-U 4	1,8	6,5	7,5	3,7	15,4	4,3	7.000/100
	4	RN-U 4/1	1,8	8,5	7,5	3,7	15,4	4,3	7.000/100
	4	RN-U 4/2	1,8	7,5	7,5	3,7	15,4	4,3	7.000/100
	5	RN-U 5	1,8	8,5	7,5	3,7	15,4	5,3	5.000/100
	5	*RN-U 5/1	1,8	9,4	7,5	3,7	15,4	5,3	5.000/100
	6	RN-U 6	1,8	9,4	8,1	4,7	17,0	6,4	6.000/100
	6	RN-U 6/1	1,8	12,0	9,2	7,1	20,5	6,4	3.000/100
	8	RN-U 8	1,8	14,0	10,0	6,3	20,5	8,4	5.000/100
	10	RN-U 10	1,8	17,5	13,0	7,7	25,0	10,5	3.000/100
12	RN-U 12	1,8	20,0	15,5	9,0	28,7	13,0	2.000/100	
1,5÷2,5 (16÷14)	3	BN-U 3	2,4	5,5	5,5	4,0	13,7	3,2	6.000/100
	3,5	BN-U 3.5	2,4	6,4	6,5	3,8	14,5	3,7	6.000/100
	3,5	*BN-U 3.5/1	2,4	7,2	6,5	3,8	14,5	3,7	6.000/100
	4	BN-U 4	2,4	6,5	7,5	3,7	15,4	4,3	6.000/100
	4	BN-U 4/1	2,4	8,5	7,5	3,7	15,4	4,3	6.000/100
	4	BN-U 4/2	2,4	7,5	7,5	3,7	15,4	4,3	6.000/100
	5	BN-U 5	2,4	8,5	7,5	3,7	15,4	5,3	5.000/100
	6	BN-U 6	2,4	9,4	8,1	4,7	17,0	6,4	5.000/100
	6	BN-U 6/1	2,4	12,0	9,2	7,1	20,5	6,4	4.000/100
	8	BN-U 8	2,4	14,0	10,0	6,3	20,5	8,4	4.000/100
	10	BN-U 10	2,4	17,5	13,0	7,7	25,0	10,5	3.500/100
	12	BN-U 12	2,4	20,0	15,5	9,0	28,7	13,0	2.000/100
4÷6 (12÷10)	3,5	GN-U 3.5	3,6	7,5	8,5	3,9	18,8	3,7	3.000/100
	4	GN-U 4	3,6	7,5	8,0	4,4	18,8	4,3	3.000/100
	5	GN-U 5	3,6	9,5	8,0	4,4	18,8	5,3	2.500/100
	6	GN-U 6	3,6	10,0	11,0	5,5	22,9	6,4	2.500/100
	8	GN-U 8	3,6	13,5	12,0	8,0	26,4	8,4	2.000/100
	10	GN-U 10	3,6	15,5	13,0	8,0	27,4	10,5	2.000/100
	10	GN-U 10/1	3,6	17,5	13,8	7,7	28,0	10,5	2.000/100
	12	GN-U 12	3,6	21,0	15,1	9,5	31,0	13,0	1.000/100
	14	GN-U 14	3,6	23,0	16,1	10,5	33,0	15,0	1.000/100
	16	GN-U 16	3,6	26,0	17,1	11,5	35,0	17,0	1.000/100

*Made to order

CRIMPING CONNECTORS ACCORDING TO DIN 46234

for copper cables

Q

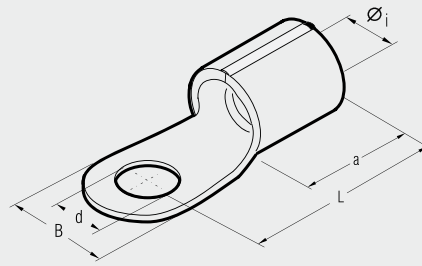

Q type connectors are manufactured from electrolytic copper strip, annealed and surface protected by tin plating; dimensions are compliant with DIN 46234; the sleeve is brazed with a silver-copper alloy.

Details of the conductor csa and stud diameter are engraved on the palm.

Details of the appropriate crimping tools and dies are shown on page 198.

Consult us for special requirements.

Conductor Size sqmm	Ø Stud mm	Ref.	Dimensions mm					Quantity Box/Bag	Mechanical Tools	Hydraulic Tools	
			Øi	d	L	B	a				
6÷10	5	Q 10-5	4,5	5,3	16,0	10,0	8,0	1.500/100	HN 5	B 95-500	HT 81J RHU 81
	6	Q 10-6	4,5	6,5	17,0	11,0	8,0	1.000/100			
	8	Q 10-8	4,5	8,4	20,0	14,0	8,0	1.000/100			
	10	Q 10-10	4,5	10,5	21,0	18,0	8,0	1.000/100			
	12	Q 10-12	4,5	13,0	22,0	22,0	8,0	500/100			
10÷16	5	Q 16-5	5,8	5,3	20,0	11,0	10,0	1.000/100			
	6	Q 16-6	5,8	6,5	20,0	11,0	10,0	1.000/100			
	8	Q 16-8	5,8	8,4	22,0	14,0	10,0	500/100			
	10	Q 16-10	5,8	10,5	24,0	18,0	10,0	500/100			
	12	Q 16-12	5,8	13,0	26,0	22,0	10,0	500/100			
16÷25	5	Q 25-5	7,5	5,3	25,0	12,0	11,0	500/100			
	6	Q 25-6	7,5	6,5	25,0	12,0	11,0	500/100			
	8	Q 25-8	7,5	8,4	25,0	16,0	11,0	500/100			
	10	Q 25-10	7,5	10,5	26,0	18,0	11,0	500/100			
	12	Q 25-12	7,5	13,0	31,0	22,0	11,0	500/100			
25÷35	16	Q 25-16	7,5	17,0	35,0	28,0	11,0	200/100			
	6	Q 35-6	9,0	6,5	26,0	15,0	12,0	400/100			
	8	Q 35-8	9,0	8,4	26,0	16,0	12,0	400/100			
	10	Q 35-10	9,0	10,5	27,0	18,0	12,0	300/100			
	12	Q 35-12	9,0	13,0	31,0	22,0	12,0	250/50			
35÷50	16	Q 35-16	9,0	17,0	36,0	28,0	12,0	200/50			
	6	Q 50-6	11,0	6,5	34,0	18,0	16,0	200/50			
	8	Q 50-8	11,0	8,4	34,0	18,0	16,0	200/50			
	10	Q 50-10	11,0	10,5	34,0	18,0	16,0	200/50			
	12	Q 50-12	11,0	13,0	36,0	22,0	16,0	200/50			
50÷70	16	Q 50-16	11,0	17,0	40,0	28,0	16,0	200/50			
	6	Q 70-6	13,0	6,5	38,0	22,0	18,0	100/50			
	8	Q 70-8	13,0	8,4	38,0	22,0	18,0	100/50			
	10	Q 70-10	13,0	10,5	38,0	22,0	18,0	100/50			
	12	Q 70-12	13,0	13,0	38,0	22,0	18,0	100/50			
70÷95	16	Q 70-16	13,0	17,0	42,0	28,0	18,0	100/50			
	8	Q 95-8	15,0	8,4	42,0	24,0	20,0	100/25			
	10	Q 95-10	15,0	10,5	42,0	24,0	20,0	100/25			
	12	Q 95-12	15,0	13,0	44,0	24,0	20,0	100/25			
	16	Q 95-16	15,0	17,0	70,0	28,0	20,0	100/25			

HT 120 and tools and heads with 130 kN crimping force

ECW+3D

CRIMPING CONNECTORS ACCORDING TO DIN 46234

for copper cables



Conductor Size sqmm	Ø Stud mm	Ref.	Dimensions mm					Quantity Box/Bag	Hydraulic Tools	
			Øi	d	L	B	a		HT 120 and tools and heads with 130 kN crimping force	ECW-H3D
95÷120	8	Q 120-8	16,5	8,4	44,0	24,0	22,0	100/25		
	10	Q 120-10	16,5	10,5	44,0	24,0	22,0	100/25		
	12	Q 120-12	16,5	13,0	44,0	24,0	22,0	100/25		
	16	Q 120-16	16,5	17,0	48,0	28,0	22,0	50/25		
120÷150	10	Q 150-10	19,0	10,5	50,0	30,0	24,0	50/25		
	12	Q 150-12	19,0	13,0	50,0	30,0	24,0	50/25		
	16	Q 150-16	19,0	17,0	50,0	30,0	24,0	50/25		
150÷185	10	Q 185-10	21,0	10,5	50,0	36,0	28,0	40/20		
	12	Q 185-12	21,0	13,0	50,0	36,0	28,0	40/20		
	16	Q 185-16	21,0	17,0	50,0	36,0	28,0	30/15		
185÷240	10	Q 240-10	23,5	10,5	56,0	38,0	32,0	15/15		
	12	Q 240-12	23,5	13,0	56,0	38,0	32,0	15/15		
	16	Q 240-16	23,5	17,0	56,0	38,0	32,0	15/15		

Consult us for further information.

Consult us for special requirements.

A-M



COPPER TUBE CRIMPING LUGS

for copper conductors

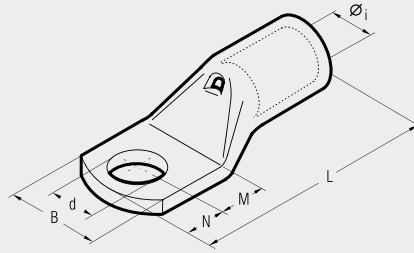

File no. E125401

A-M series lugs are manufactured from electrolytic copper tube.

The dimensions of the tube are designed to obtain the most efficient electrical conductivity and mechanical strength to resist vibration and pull out.

Cembre lugs are annealed to guarantee optimum ductility which is an absolute necessity for connectors which will have to withstand the severe deformation arising when compressed and any bending of the palm during installation.

In applications subject to vibration, lugs still have to provide a reliable connection and annealing plays a vital role in avoiding cracking or breaks between the barrel and palm.

The presence of an inspection hole facilitates full insertion of the conductor, whilst the barrel length has been designed to allow easy and accurate positioning of the dies during the crimping operation.

Lugs are electrolytically tinned to avoid oxidation. A-M series lugs form an important part of Cembre crimping systems for power carrying conductors, details of the appropriate crimping tools and dies are shown opposite and in detail on pages 190 to 191.

Our technicians are always available to provide any technical advice which may be required.

The enclosed table is only indicative of the range and many variations in stud fixing and palm lengths are also available.

Cond. Size sqmm	Ø Stud mm	Ref.	Dimensions mm						Quantity Box/Bag	Mechanical Tools	Hydraulic Tools
			Øi	B	M	N	L	d			
0,25÷1,5	3	A 03-M 3	1,8	6,0	4,5	3,5	16,0	3,2	5.000/100	HN1	B-150
	3,5	A 03-M 3.5	1,8	6,5	4,5	3,5	16,0	3,7	5.000/100		
	4	A 03-M 4	1,8	6,5	5,0	4,0	17,0	4,3	5.000/100		
	5	A 03-M 5	1,8	7,5	5,5	4,5	18,0	5,3	5.000/100		
	6	A 03-M 6	1,8	9,0	6,0	5,0	19,0	6,4	5.000/100		
1,5÷2,5	3	A 06-M 3	2,4	6,0	4,5	3,5	17,0	3,2	4.000/100		
	3,5	A 06-M 3.5	2,4	6,5	4,5	3,5	17,0	3,7	4.000/100		
	4	A 06-M 4	2,4	7,5	5,0	4,0	18,0	4,3	4.000/100		
	5	A 06-M 5	2,4	8,5	5,5	4,5	19,0	5,3	4.000/100		
	6	A 06-M 6	2,4	9,0	6,0	5,0	20,0	6,4	4.000/100		
4÷6	8	A 06-M 8	2,4	12,0	9,0	8,0	26,0	8,4	2.500/100		
	3	A 1-M 3	3,6	7,5	4,5	3,5	20,5	3,2	2.000/100		
	3,5	A 1-M 3.5	3,6	7,5	4,5	3,5	20,5	3,7	2.000/100		
	4	A 1-M 4	3,6	8,0	5,0	4,0	21,5	4,3	2.000/100		
	5	A 1-M 5	3,6	9,0	6,5	6,0	25,0	5,3	2.000/100		
10	6	A 1-M 6	3,6	11,0	7,0	6,0	25,5	6,4	2.000/100		
	8	A 1-M 8	3,6	14,0	9,0	8,0	29,5	8,4	1.500/100		
	10	A 1-M 10	3,6	16,5	11,0	10,0	33,5	10,5	1.000/100		
	4	A 2-M 4	4,6	10,0	5,0	4,0	22,5	4,3	1.500/100		
	5	A 2-M 5	4,6	10,0	6,5	6,0	26,0	5,3	1.500/100		
16	6	A 2-M 6	4,6	11,0	7,0	6,0	26,5	6,4	1.500/100		
	8	A 2-M 8	4,6	15,0	9,0	8,0	30,5	8,4	1.000/100		
	10	A 2-M 10	4,6	18,0	11,0	10,0	34,5	10,5	1.000/100		
	12	A 2-M 12	4,6	19,0	14,0	12,0	39,5	13,2	500/100		
	4	A 3-M 4	5,8	11,5	5,0	4,0	25,5	4,3	1.000/100		
25	5	A 3-M 5	5,8	11,5	6,5	6,0	29,0	5,3	1.000/100		
	6	A 3-M 6	5,8	11,5	7,0	6,0	29,5	6,4	1.000/100		
	8	A 3-M 8	5,8	15,0	9,0	8,0	33,5	8,4	500/100		
	10	A 3-M 10	5,8	18,0	11,0	10,0	37,5	10,5	500/100		
	12	A 3-M 12	5,8	20,0	14,0	12,0	42,5	13,2	500/100		
35	4	A 5-M 4	7,0	14,0	5,0	4,0	28,0	4,3	1.000/100		
	5	A 5-M 5	7,0	14,0	6,5	6,0	31,5	5,3	500/100		
	6	A 5-M 6	7,0	14,0	7,0	6,0	32,0	6,4	500/100		
	8	A 5-M 8	7,0	15,0	9,0	8,0	36,0	8,4	500/100		
	10	A 5-M 10	7,0	18,0	11,0	10,0	40,0	10,5	500/100		
50	12	A 5-M 12	7,0	21,0	14,0	12,0	45,0	13,2	500/100		
	5	A 7-M 5	8,9	17,0	6,5	6,0	34,0	5,3	500/100		
	6	A 7-M 6	8,9	17,0	7,0	6,0	34,5	6,4	500/100		
	8	A 7-M 8	8,9	17,0	9,0	8,0	38,5	8,4	400/100		
	10	A 7-M 10	8,9	19,0	11,0	10,0	42,5	10,5	400/100		
70	12	A 7-M 12	8,9	21,0	14,0	12,0	47,5	13,2	300/50		
	6	A 10-M 6	10,0	19,0	8,0	7,0	40,5	6,4	200/50		
	8	A 10-M 8	10,0	19,0	9,0	8,0	42,5	8,4	200/50		
	10	A 10-M 10	10,0	20,0	11,0	10,0	46,5	10,5	200/50		
	12	A 10-M 12	10,0	21,0	14,0	12,0	51,5	13,2	200/50		
70	14	A 10-M 14	10,0	25,0	16,0	14,0	55,5	15,0	200/50		
	16	A 10-M 16	10,0	26,0	18,0	16,0	59,5	17,0	200/50		
	6	A 14-M 6	11,3	21,0	8,0	7,0	44,0	6,4	200/50		
	8	A 14-M 8	11,3	21,0	9,0	8,0	46,0	8,4	200/50		
	10	A 14-M 10	11,3	21,0	11,0	10,0	50,0	10,5	200/50		
70	12	A 14-M 12	11,3	22,0	14,0	12,0	55,0	13,2	150/50		
	14	A 14-M 14	11,3	25,0	16,0	14,0	59,0	15,0	100/50		
16	A 14-M 16	11,3	26,0	18,0	16,0	63,0	17,0	100/50			

COPPER TUBE CRIMPING LUGS

for copper conductors

A-M



File no. E125401

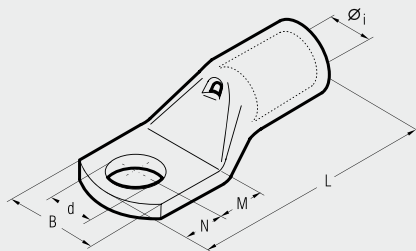

Cond. Size sqmm	Ø Stud mm	Ref.	Dimensions mm						Quantity Box/Bag	Mechanical Tools	Hydraulic Tools
			Øi	B	M	N	L	d			
95	95	6 A 19-M 6	13,5	25,0	8,0	7,0	50,5	6,4	100/25	TN 120 SE** B 35-45D B 35-50D HT 45E	HT 51 RH 50 B 51 B 55 HT 81-U RHU 81 HT 120 and tools and heads with 130 kN crimping force ECW-H3D RHU 520
		8 A 19-M 8	13,5	25,0	9,0	8,0	52,5	8,4	100/25		
		10 A 19-M 10	13,5	25,0	11,0	10,0	56,5	10,5	100/25		
		12 A 19-M 12	13,5	25,0	14,0	12,0	61,5	13,2	100/25		
		14 A 19-M 14	13,5	25,0	16,0	14,0	65,5	15,0	100/25		
		16 A 19-M 16	13,5	27,0	18,0	16,0	69,5	17,0	100/25		
120	95	20 A 19-M 20	13,5	29,5	22,0	20,0	77,5	21,0	50/25		
		8 A 24-M 8	15,2	28,5	9,0	8,0	54,0	8,4	100/25		
		10 A 24-M 10	15,2	28,5	11,0	10,0	58,0	10,5	100/25		
		12 A 24-M 12	15,2	28,5	14,0	12,0	63,0	13,2	100/25		
		14 A 24-M 14	15,2	28,5	16,0	14,0	67,0	15,0	50/25		
150	120	16 A 24-M 16	15,2	28,5	18,0	16,0	71,0	17,0	50/25		
		20 A 24-M 20	15,2	30,0	22,0	20,0	79,0	21,0	50/25		
		8 A 30-M 8	16,7	31,5	13,0	11,0	69,0	8,4	50/25		
		10 A 30-M 10	16,7	31,5	13,0	11,0	69,0	10,5	50/25		
		12 A 30-M 12	16,7	31,5	16,0	14,0	75,0	13,2	50/25		
185	150	14 A 30-M 14	16,7	31,5	18,0	16,0	79,0	15,0	50/25		
		16 A 30-M 16	16,7	31,5	19,0	17,0	81,0	17,0	50/25		
		20 A 30-M 20	16,7	31,5	22,0	20,0	87,0	21,0	50/25		
		8 A 37-M 8	19,2	35,5	13,0	11,0	76,0	8,4	50/25		
		10 A 37-M 10	19,2	35,5	13,0	11,0	76,0	10,5	40/20		
240	185	12 A 37-M 12	19,2	35,5	16,0	14,0	82,0	13,2	40/20		
		14 A 37-M 14	19,2	35,5	18,0	16,0	86,0	15,0	30/15		
		16 A 37-M 16	19,2	35,5	19,0	17,0	88,0	17,0	30/15		
		20 A 37-M 20	19,2	35,5	22,0	20,0	94,0	21,0	30/15		
		8 A 48-M 8	21,1	39,0	13,0	11,0	77,5	8,4	30/15		
300	240	10 A 48-M 10	21,1	39,0	13,0	11,0	77,5	10,5	30/15		
		12 A 48-M 12	21,1	39,0	14,0	12,0	79,5	13,2	30/15		
		14 A 48-M 14	21,1	39,0	18,0	16,0	92,0	15,0	30/15		
		16 A 48-M 16	21,1	39,0	19,0	17,0	94,0	17,0	30/15		
		20 A 48-M 20	21,1	39,0	22,0	20,0	100,0	21,0	30/15		
400	300	10 A 60-M 10	23,7	44,0	20,0	11,0	96,0	10,5	20/10		
		12 A 60-M 12	23,7	44,0	20,0	14,0	99,0	13,2	20/10		
		14 A 60-M 14	23,7	44,0	22,0	16,0	103,0	15,0	20/10		
		16 A 60-M 16	23,7	44,0	22,0	19,0	106,0	17,0	20/10		
		20 A 60-M 20	23,7	44,0	24,0	23,0	112,0	21,0	20/10		
500	400	12 A 80-M 12	27,0	51,0	22,0	19,0	113,0	13,2	15/1		
		14 A 80-M 14	27,0	51,0	22,0	19,0	113,0	15,0	20/1		
		16 A 80-M 16	27,0	51,0	22,0	19,0	113,0	17,0	20/1		
630	500	20 A 80-M 20	27,0	51,0	24,0	23,0	119,0	21,0	20/1		
		16 A 100-M 16	30,3	56,5	22,0	19,0	117,0	17,0	15/1		
		20 A 100-M 20	30,3	56,5	24,0	23,0	123,0	21,0	15/1		
800	630	16 A 120-M 16	33,4	61,6	22,0	19,0	128,0	17,0	12/1		
		20 A 120-M 20	33,4	61,6	24,0	23,0	134,0	21,0	10/1		
1000	800	16 A 160-M 16	38,0	72,0	24,0	19,0	141,0	17,0	6/1		
		20 A 160-M 20	38,0	72,0	24,0	23,0	145,0	21,0	6/3		
1000	800	16 A 200-M 16	44,0	80,0	24,0	19,0	158,0	17,0	6/1		
		20 A 200-M 20	44,0	80,0	24,0	23,0	162,0	21,0	6/1		

*Actual conductor section may require a larger lug eg for 120mm² size use A30... lug.

**See page 109

A-M



RING TONGUE TERMINALS WITH CONTAINED PALM

for L.V. circuit breakers
for copper conductors



File no. E125401

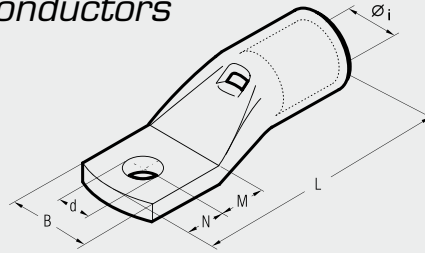

This range of terminals features contained palm width and has been specifically developed for application on L.V. circuit breakers with reduced space terminal blocks. The contained palm width allows an immediate and easier installation. Cembre terminals are manufactured from electrolytic copper tube.

The specifically designed section of the barrel and the choice of principal dimensions are optimising the best combination of mechanical strength and electrical conductivity. These terminals are annealed to guarantee optimum ductility and are electrolytically tin-plated to avoid oxidation. The barrel is provided with an internal taper to ease the introduction of the conductor; furthermore, its length grants a comfortable and correct positioning between dies, during crimping operations. Each palm is marked with the Cembre logo and part number.

Cond. Size Flexible sqmm	Ø Stud mm	Ref.	Dimensions mm						Quantity Box/Bag	Mechanical Tools	Hydraulic Tools						
			Øi	B	M	N	L	d									
10	5	A 2-M 5/9	4,6	9,0	6,5	6,0	26,0	5,3	1000/100	HN5 HN-A25	B 150						
16	5	A 3-M 5/9	5,8	9,0	6,5	6,0	29,0	5,3	1000/100								
25	5	A 5-M 5/9	7,0	9,0	6,5	6,0	31,5	5,3	500/100	TN 70 SE							
35	6	A 7 B-M 6/11.5	8,9	11,5	8,0	7,0	36,5	6,4	400/100								
50	6	A 10 B-M 6/11.5	10,0	11,5	8,0	7,0	40,5	6,4	200/50	TN 120 SE							
70	6	A 14 B-M 6/11.5	11,3	11,5	8,0	7,0	44,0	6,4	200/50								
95	8	A 19 B-M 8/15.5	13,5	15,5	9,0	8,0	52,5	8,4	100/25								
120	8	A 24 B-M 8/19	15,2	19,0	14,0	9,0	60,0	8,4	100/25								
	10	A 24 B-M 10/19	15,2	19,0	14,0	9,0	60,0	10,5	100/25								
150	8	A 30 B-M 8/19	16,7	19,0	18,0	9,0	70,0	8,4	50/25								
	10	A 30 B-M 10/19	16,7	19,0	18,0	9,0	70,0	10,5	50/25								
185	10	A 37 B-M 10/24.5	19,2	24,5	18,0	9,0	77,0	10,5	50/25								
	10	A 48-M 10/31	21,1	31,0	13,0	9,0	80,0	10,5	30/15								
240	12	A 48-M 12/31	21,1	31,0	16,0	12,0	86,0	13,2	30/15								
	16	A 48-M 16/31	21,1	31,0	19,0	17,0	94,0	17,0	30/15								
300	10	A 60 B-M 10/31	23,7	31,0	16,0	12,0	95,0	10,5	20/10								
	12	A 60 B-M 12/31	23,7	31,0	16,0	12,0	95,0	13,2	20/10								

Details of the appropriate crimping tools and dies are shown on pages 190 to 191.



COPPER TUBE CRIMPING LUGS ANGLED 90°



File no. E125401

for copper conductors

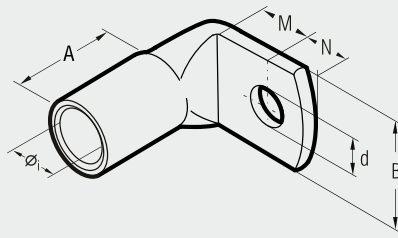

A-L



Cond. Size sqmm	Ø Stud mm	Ref.	Dimensions mm						Quantity Box/Bag	Mechanical Tools	Hydraulic Tools
			Øi	B	M	N	A	d			
6	6	A 1-L 6	3,6	11,0	7,0	6,0	9,5	6,4	2.000/100	HN1	B 150
	5	A 2-L 5	4,6	10,0	6,5	6,0	10,5	5,3	1.500/100		
10	6	A 2-L 6	4,6	11,0	7,0	6,0	10,5	6,4	1.500/100	HN5	B 150
	8	A 2-L 8	4,6	15,0	9,0	8,0	10,5	8,4	500/100		
16	5	A 3-L 5	5,8	11,5	6,5	6,0	12,0	5,3	1.000/100	HN425	B 150
	6	A 3-L 6	5,8	11,5	7,0	6,0	12,0	6,4	1.000/100		
	8	A 3-L 8	5,8	15,0	9,0	8,0	12,0	8,4	1.000/100		
	10	A 3-L 10	5,8	18,0	11,0	10,0	12,0	10,5	500/100		
25	6	A 5-L 6	7,0	14,0	7,0	6,0	13,0	6,4	500/100	TN 70 SE	B 150
	8	A 5-L 8	7,0	15,0	9,0	8,0	13,0	8,4	500/100		
	10	A 5-L 10	7,0	18,0	11,0	10,0	13,0	10,5	500/100		
35	25	A 7-L 6	8,9	17,0	7,0	6,0	15,5	6,4	500/100	TN 120 SE**	B 35-45D B 35-50D HT 45-E
	8	A 7-L 8	8,9	17,0	9,0	8,0	15,5	8,4	300/100		
	10	A 7-L 10	8,9	19,0	11,0	10,0	15,5	10,5	400/100		
	12	A 7-L 12	8,9	21,0	14,0	12,0	15,5	13,2	300/100		
50	6	A 10-L 6	10,0	19,0	8,0	7,0	18,5	6,4	300/100	TN 120 SE**	B 35-45D B 35-50D HT 45-E
	8	A 10-L 8	10,0	19,0	9,0	8,0	18,5	8,4	300/100		
	10	A 10-L 10	10,0	20,0	11,0	10,0	18,5	10,5	200/50		
	12	A 10-L 12	10,0	21,0	14,0	12,0	18,5	13,2	200/50		
70	8	A 14-L 8	11,3	21,0	9,0	8,0	20,0	8,4	200/50	TN 120 SE**	B 35-45D B 35-50D HT 45-E
	10	A 14-L 10	11,3	21,0	11,0	10,0	20,0	10,5	200/50		
	12	A 14-L 12	11,3	22,0	14,0	12,0	20,0	13,2	150/50		
	16	A 14-L 16	11,3	26,0	18,0	16,0	20,0	17,0	150/50		
95	8	A 19-L 8	13,5	25,0	9,0	8,0	24,5	8,4	100/25	TN 120 SE**	B 35-45D B 35-50D HT 45-E
	10	A 19-L 10	13,5	25,0	11,0	10,0	24,5	10,5	100/25		
	12	A 19-L 12	13,5	25,0	14,0	12,0	24,5	13,2	100/25		
120	10	A 24-L 10	15,2	28,5	11,0	10,0	25,5	10,5	50/25	TN 120 SE**	B 35-45D B 35-50D HT 45-E
	12	A 24-L 12	15,2	28,5	14,1	12,0	25,5	13,2	50/25		
150	10	A 30-L 10	16,7	31,5	13,0	11,0	28,5	10,5	50/25	TN 120 SE**	B 35-45D B 35-50D HT 45-E
	12	A 30-L 12	16,7	31,5	16,0	14,0	28,5	13,2	50/25		
185	10	A 37-L 10	19,2	31,5	13,0	11,0	31,5	10,5	50/25	TN 120 SE**	B 35-45D B 35-50D HT 45-E
	12	A 37-L 12	19,2	31,5	16,0	14,0	31,5	13,2	50/25		
240	185	A 48-L 12	21,1	39,0	16,0	14,0	33,0	13,2	30/15	TN 120 SE**	B 35-45D B 35-50D HT 45-E
	240	A 48-L 12	21,1	39,0	16,0	14,0	33,0	13,2	30/15		
300	240	A 60-L 12	23,7	39,0	20,0	14,0	42,0	13,2	20/10	TN 120 SE**	B 35-45D B 35-50D HT 45-E
	300	A 60-L 12	23,7	39,0	20,0	14,0	42,0	13,2	20/10		

*Actual conductor section may require a larger lug eg for 120mm² size use A30-... lug.

**See page 109

A-L series lugs angled 90° are manufactured from electrolytic copper tube. The dimensions of the tube are designed to obtain the most efficient electrical conductivity and mechanical strength to resist vibration and pull out.

Cembre lugs are annealed to guarantee optimum ductility which is an absolute necessity for connectors which will have to withstand the severe deformation arising when compressed and any bending of the palm during installation.

In applications subject to vibration, terminals still have to perform a reliable connection, annealing plays a vital role in avoiding cracking or breaks between the barrel and palm.

The presence of an inspection hole facilitates full insertion of the conductor, whilst the barrel length has been designed to allow easy and accurate positioning of the dies during the crimping operation.

Lugs are electrolytically tinned to avoid oxidation. Details of the appropriate crimping tools and dies are shown on pages 190 to 191.

HEAVY DUTY COPPER TUBE TERMINALS

2A-M

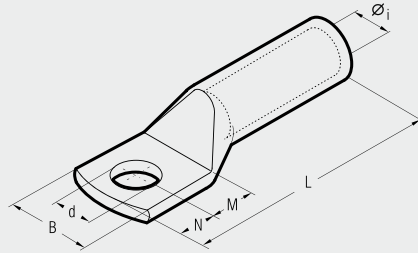

2A-M series terminals are made from high purity copper tube, and are annealed.

They feature a double length barrel for enhanced electrical and mechanical performance in heavy duty applications.

The absence of an inspection hole prevents the entry of water or moisture into the crimped joint making these terminals suitable for outdoor applications.

The terminals are electrolytically tin plated to prevent atmospheric corrosion.

Details of the appropriate crimping tools and dies are shown on pages 190 to 191.

2A-2M series terminals with double stud hole palm are also available, please consult us.



Conductor Size sqmm	Ø Stud mm	Ref.	Dimensions mm						Quantity Box/Bag	Mechanical Tools	Hydraulic Tools	
			Øi	B	M	N	L	d				
16	8	2 A 3-M 8	5,8	15,0	9,0	8,0	43,5	8,4	600/100	HN6	B 150	
	10	2 A 3-M 10	5,8	18,0	11,0	10,0	47,5	10,5	500/100			
25	8	2 A 5-M 8	7,0	15,0	9,0	8,0	51,0	8,4	400/100	HN425		
	10	2 A 5-M 10	7,0	18,0	11,0	10,0	55,0	10,5	300/50			
35	12	2 A 5-M 12	7,0	21,0	14,0	12,0	60,0	13,2	300/50	TN 70 SE		
	8	2 A 7-M 8	8,9	17,0	9,0	8,0	53,0	8,4	250/50			
50	10	2 A 7-M 10	8,9	19,0	11,0	10,0	57,0	10,5	250/50	TN 120 SE*		
	12	2 A 7-M 12	8,9	21,0	14,0	12,0	62,0	13,2	200/50			
63	10	2 A 10-M 10	10,0	20,0	11,0	10,0	63,0	10,5	200/50	B 35-45D		
	12	2 A 10-M 12	10,0	21,0	14,0	12,0	68,0	13,2	150/50			
70	14	2 A 10-M 14	10,0	25,0	16,0	14,0	72,0	15,0	150/50	B 35-50D		
	16	2 A 10-M 16	10,0	26,0	18,0	16,0	76,0	17,0	150/50			
95	10	2 A 14-M 10	11,3	21,0	11,0	10,0	70,0	10,5	100/50	HT 45-E		
	12	2 A 14-M 12	11,3	22,0	14,0	12,0	75,0	13,2	100/50			
120	14	2 A 14-M 14	11,3	25,0	16,0	14,0	79,0	15,0	100/50	HT 51 RH 50 B 51 B 55		
	16	2 A 14-M 16	11,3	26,0	18,0	16,0	83,0	17,0	100/50			
125	10	2 A 19-M 10	13,5	25,0	11,0	10,0	76,5	10,5	75/25	HT 81-J RHU 81		
	12	2 A 19-M 12	13,5	25,0	14,0	12,0	81,5	13,2	75/25			
150	14	2 A 19-M 14	13,5	25,0	16,0	14,0	85,5	15,0	75/25	HT 120 and tools and heads with 130 kN crimping force ECW-H30 RHU 520		
	16	2 A 19-M 16	13,5	27,0	18,0	16,0	90,5	17,0	75/25			
185	20	2 A 19-M 20	13,5	29,5	22,0	20,0	97,5	21,0	75/25			
	10	2 A 24-M 10	15,2	28,5	11,0	10,0	82,0	10,5	50/25			
240	12	2 A 24-M 12	15,2	28,5	14,0	12,0	87,0	13,2	50/25			
	14	2 A 24-M 14	15,2	28,5	16,0	14,0	91,0	15,0	50/25			
300	16	2 A 24-M 16	15,2	28,5	18,0	16,0	95,0	17,0	50/25			
	20	2 A 24-M 20	15,2	30,0	22,0	20,0	103,0	21,0	50/25			
350	10	2 A 30-M 10	16,7	31,5	13,0	11,0	92,0	10,5	50/25			
	12	2 A 30-M 12	16,7	31,5	16,0	14,0	98,0	13,2	30/15			
400	14	2 A 30-M 14	16,7	31,5	18,0	16,0	102,0	15,0	30/15			
	16	2 A 30-M 16	16,7	31,5	19,0	17,0	104,0	17,0	30/15			
450	20	2 A 30-M 20	16,7	31,5	22,0	20,0	110,0	21,0	30/15			
	12	2 A 37-M 12	19,2	35,5	16,0	14,0	108,0	13,2	30/15			
500	14	2 A 37-M 14	19,2	35,5	18,0	16,0	112,0	15,0	30/15			
	16	2 A 37-M 16	19,2	35,5	19,0	17,0	114,0	17,0	30/15			
550	20	2 A 37-M 20	19,2	35,5	22,0	20,0	120,0	21,0	30/15			
	12	2 A 48-M 12	21,1	39,0	16,0	14,0	109,0	13,2	20/5			
600	14	2 A 48-M 14	21,1	39,0	18,0	16,0	113,0	15,0	20/5			
	16	2 A 48-M 16	21,1	39,0	19,0	17,0	115,0	17,0	20/5			
650	20	2 A 48-M 20	21,1	39,0	22,0	20,0	121,0	21,0	25/5			
	12	2 A 60-M 12	23,7	44,0	20,0	14,0	129,5	13,2	20/5			
700	14	2 A 60-M 14	23,7	44,0	22,0	16,0	133,5	15,0	20/5			
	16	2 A 60-M 16	23,7	44,0	22,0	19,0	136,5	17,0	20/5			
750	20	2 A 60-M 20	23,7	44,0	24,0	23,0	142,5	21,0	20/5			
	12	2 A 80-M 12	27,0	51,0	22,0	19,0	140,0	13,2	15/5			
800	14	2 A 80-M 14	27,0	51,0	22,0	19,0	140,0	15,0	10/5			
	16	2 A 80-M 16	27,0	51,0	22,0	19,0	140,0	17,0	10/5			
850	20	2 A 80-M 20	27,0	51,0	24,0	23,0	146,0	21,0	15/5			
	16	2 A 100-M 16	30,3	56,5	22,0	19,0	147,0	17,0	10/1			
900	20	2 A 100-M 20	30,3	56,5	24,0	23,0	153,0	21,0	10/1			
	16	2 A 120-M 16	33,4	61,5	22,0	19,0	159,0	17,0	20/1			
950	20	2 A 120-M 20	33,4	61,5	24,0	23,0	165,0	21,0	20/1			
	800	20	2 A 160-M 20	38,0	72,0	24,0	23,0	187,0	21,0	12/1		
1000	20	2 A 200-M 20	44,0	80,0	24,0	23,0	202,0	21,0	6/1			

**See page 109

THROUGH CONNECTORS



File no. E125401

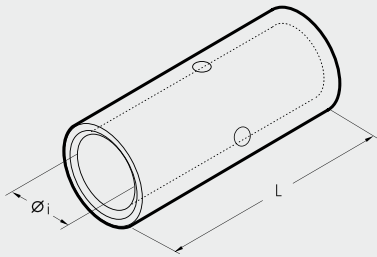

Conductor Size sqmm		Ref.	Dimensions mm		Quantity Box/Bag	Mechanical Tools	Hydraulic Tools
low stranded	Flexible		Øi	L			
0,25÷1,5	0,25÷1,5	L 03-M	1,8	15	6.000/100	HN 1	B 15D
1,5÷2,5	1,5÷2,5	L 06-M	2,4	15	4.000/100		
4÷6	4÷6	L 1-M	3,6	22	2.000/100	HN 5	B 35-45D B 35-50D
10	10	L 2-M	4,6	25	1.000/100		
16	16	L 3-M	5,8	27	1.000/100	HN A25	HT 45-E
25	25	L 5-M	7,0	29	500/100		
35	25÷35	L 7-M	8,9	33	400/100	TN 70 SE	HT 51 RH 50 B 51 B 55
50	35÷50	L 10-M	10,0	37	200/50		
70	50÷70	L 14-M	11,3	39	200/50	TN 120 SE*	HT 81-U RHU 81
95	70÷95	L 19-M	13,5	43	100/25		
120	95÷120	L 24-M	15,2	47	100/25	ECWH3D	RHU 520
150	120÷150	L 30-M	16,7	58	50/25		
185	150÷185	L 37-M	19,2	64	50/25	HT 120 and tools and heads with 130 kN crimping force	
240	185÷240	L 48-M	21,1	75	30/15		
300	240÷300	L 60-M	23,7	90	20/10		
400	300÷400	L 80-M	27,0	94	20/5		
500	400÷500	L 100-M	30,3	98	12/1		
630	500÷630	L 120-M	33,4	105	12/1		
800	600	L 160-M	38,0	112	9/1		
1000	800	L 200-M	44,0	120	6/1		

**See page 109

L-M



L-M range of connectors are designed for jointing low voltage conductors.

Made of electrolytic copper tube having the same dimension as A-M series lugs: L-M connectors are annealed and electrolytically tin plated.

They feature an internal taper at both ends to ease the introduction of the conductor and a central stop to ensure correct positioning.

Details of the appropriate crimping tools and dies are shown on pages 190 to 191.

PARALLEL CONNECTORS

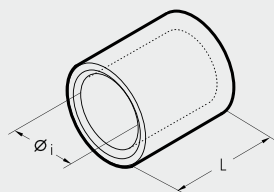

Total Conductor Size sqmm		Ref.	Dimensions mm		Quantity Box/Bag	Mechanical Tools	Hydraulic Tools
low stranded	Flexible		Øi	L			
0,25÷1,5	0,25÷1,5	L 03-P	1,8	6,0	10.000/100	HN 1	B 15D
1,5÷2,5	1,5÷2,5	L 06-P	2,4	6,0	5.000/100		
4÷6	4÷6	L 1-P	3,6	9,0	3.000/100	HN 5	B 35-45D B 35-50D
10	10	L 2-P	4,6	10,5	3.000/100		
16	16	L 3-P	5,8	11,5	2.000/100	HN A25	HT 45-E
25	25	L 5-P	7,0	13,0	1.500/100		
35	25÷35	L 7-P	8,9	14,0	500/100	TN 70 SE	HT 51 RH 50 B 51 B 55
50	35÷50	L 10-P	10,0	16,0	500/100		
70	50÷70	L 14-P	11,3	18,0	500/100	TN 120 SE*	HT 81-U RHU 81
95	70÷95	L 19-P	13,5	19,0	300/50		
120	95÷120	L 24-P	15,2	22,0	200/50	ECWH3D	RHU 520
150	120÷150	L 30-P	16,7	26,5	100/50		
185	150÷185	L 37-P	19,2	26,5	100/50	HT 120 and tools and heads with 130 kN crimping force	
240	185÷240	L 48-P	21,1	34,0	60/15		
300	240÷300	L 60-P	23,7	43,0	50/25		

**See page 109

L-P



Made of electrolytic copper tube, having the same dimensions as A-M series lugs, L-P connectors are annealed and electrolytically tin plated.

They feature an internal taper to ease the introduction of the conductor.

Details of the appropriate crimping tools and dies are shown on pages 190 to 191.

POLYAMIDE PA6.6 INSULATED COPPER TUBE LUGS

ANE-M

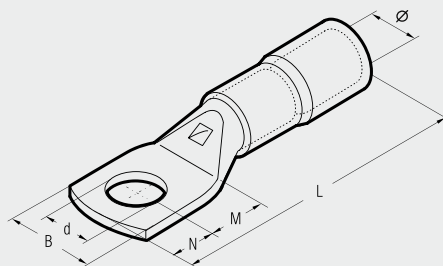

ANE-M series lugs are manufactured from electrolytic copper tube annealed and tin plated.

The interior of the PA6.6 insulated sleeve is funnel shaped so as to ensure complete and easy introduction of the conductor strands.

It also eliminates the need to insulate the terminal using either tape or heat shrinkable tubing.

Furthermore the PA6.6 sleeve avoids the possibility of conductor breakage at the barrel entrance.

The items tabulated all feature black insulated sleeves however other colours are available, please consult us.

The operating temperature range is - 20 to + 115°C (Surge + 130°C).

In order to achieve the best electrical and mechanical performance it is suggested that they are crimped using dies and tools specifically developed for this purpose by Cembre.

Details of the appropriate crimping tools and dies are shown on pages 192 to 193.

Cond. Size Flexible sqmm	Ø Stud mm	Ref.	Dimensions mm						Quantity Box/Bag	Mechanical Tools	Hydraulic Tools
			Ø	B	M	N	L	d			
10	4	ANE 2-M 4	8,0	10,0	5,0	4,0	34,1	4,3	500/100	HMN3	B 15D
	5	ANE 2-M 5	8,0	10,0	6,5	6,0	37,6	5,3	500/100		
	6	ANE 2-M 6	8,0	11,0	7,0	6,0	38,1	6,4	500/100		
	8	ANE 2-M 8	8,0	15,0	9,0	8,0	42,1	8,4	500/100		
	10	ANE 2-M 10	8,0	18,0	11,0	10,0	46,1	10,5	500/100		
	12	ANE 2-M 12	8,0	19,0	14,0	12,0	51,1	13,2	500/100		
16	4	ANE 3-M 4	9,2	11,5	5,0	4,0	38,6	4,3	500/100	HMN4	B 15D
	5	ANE 3-M 5	9,2	11,5	6,5	6,0	42,1	5,3	500/100		
	6	ANE 3-M 6	9,2	11,5	7,0	6,0	42,6	6,4	500/100		
	8	ANE 3-M 8	9,2	15,0	9,0	8,0	46,6	8,4	500/100		
	10	ANE 3-M 10	9,2	18,0	11,0	10,0	50,6	10,5	400/100		
	12	ANE 3-M 12	9,2	20,0	14,0	12,0	55,6	13,2	300/100		
25	4	ANE 5-M 4	11,1	14,0	5,0	4,0	41,0	4,3	300/100	TMN 70	B 35-50D
	5	ANE 5-M 5	11,1	14,0	6,5	6,0	44,5	5,3	300/100		
	6	ANE 5-M 6	11,1	14,0	7,0	6,0	45,0	6,4	300/100		
	8	ANE 5-M 8	11,1	15,0	9,0	8,0	49,0	8,4	300/100		
	10	ANE 5-M 10	11,1	18,0	11,0	10,0	53,0	10,5	300/100		
	12	ANE 5-M 12	11,1	21,0	14,0	12,0	58,0	13,2	250/50		
35	6	ANE 7-M 6	13,6	17,0	7,0	6,0	50,0	6,4	200/50	TMN 120	B 51
	8	ANE 7-M 8	13,6	17,0	9,0	8,0	54,0	8,4	200/50		
	10	ANE 7-M 10	13,6	19,0	11,0	10,0	58,0	10,5	200/50		
	12	ANE 7-M 12	13,6	21,0	14,0	12,0	63,0	13,2	200/50		
50	6	ANE 10-M 6	13,8	19,0	8,0	7,0	55,0	6,4	200/50	TMN 120	B 55
	8	ANE 10-M 8	13,8	19,0	9,0	8,0	57,0	8,4	200/50		
	10	ANE 10-M 10	13,8	20,0	11,0	10,0	61,0	10,5	150/50		
	12	ANE 10-M 12	13,8	21,0	14,0	12,0	66,0	13,2	150/50		
70	6	ANE 14-M 6	15,8	21,0	8,0	7,0	61,0	6,4	100/25	TMN 120	B 51
	8	ANE 14-M 8	15,8	21,0	9,0	8,0	63,0	8,0	100/25		
	10	ANE 14-M 10	15,8	21,0	11,0	10,0	67,0	10,5	100/25		
	12	ANE 14-M 12	15,8	22,0	14,0	12,0	72,0	13,2	100/25		
	14	ANE 14-M 14	15,8	25,0	16,0	14,0	76,0	15,0	100/25		
	8	ANE 19-M 8	18,0	25,0	9,0	8,0	73,0	8,4	50/25		
95	10	ANE 19-M 10	18,0	25,0	11,0	10,0	77,0	10,5	50/25	TMN 120	B 51
	12	ANE 19-M 12	18,0	25,0	14,0	12,0	82,0	13,2	50/25		
	14	ANE 19-M 14	18,0	25,0	16,0	14,0	86,0	15,0	50/25		
	16	ANE 19-M 16	18,0	27,0	18,0	16,0	80,0	17,0	50/25		
120	10	ANE 24-M 10	20,0	28,5	11,0	10,0	77,7	10,5	50/25	TMN 120	B 51
	12	ANE 24-M 12	20,0	28,5	14,0	12,0	86,5	13,2	50/25		
	14	ANE 24-M 14	20,0	28,5	16,0	14,0	88,5	15,0	50/25		
	16	ANE 24-M 16	20,0	28,5	18,0	16,0	90,5	17,0	50/25		
150	12	ANE 30-M 12	23,0	31,5	16,0	14,0	101,0	13,2	30/15	TMN 120	B 51
	14	ANE 30-M 14	23,0	31,5	18,0	16,0	105,0	15,0	30/15		
	16	ANE 30-M 16	23,0	31,5	19,0	17,0	107,0	17,0	30/15		
	20	ANE 30-M 20	23,0	31,5	22,0	20,0	113,0	21,0	30/15		



HT 120 and tools and heads with 130 kN crimping force
ECW-H3D

POLYAMIDE PA6.6 INSULATED FORK TERMINALS

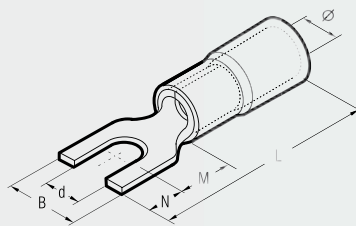

ANE-U



Conductor Size Flexible sqmm	Ø Stud mm	Ref.	Dimensions mm						Quantity Box/Bag	Mechanical Tools			Hydraulic Tools						
			Ø	B	M	N	L	d		HNN 3	HNN 4	TNN70	TNN 120	B 15D	B 35-50D	HT 51 RH 50	B 51 B 55	HT 120 and tools and heads with 130 kN crimping force	ECW-H3D
10	4	ANE 2-U 4	8,0	9,8	7,5	7,0	35,1	4,3	500/100										
	5	ANE 2-U 5	8,0	11,5	7,5	7,0	35,1	5,3	500/100										
16	4	ANE 3-U 4	9,2	10,0	10,0	8,0	41,1	4,3	500/100										
	5	ANE 3-U 5	9,2	11,5	10,0	8,0	41,1	5,3	500/100										

The operating temperature range is - 20 to + 115°C (Surge + 130°C).

In order to achieve the best electrical and mechanical performance it is suggested that they are crimped using dies and tools specifically developed for this purpose by Cembre.

Details of the appropriate crimping tools and dies are shown on pages 192 to 193.

ANE-U series terminals are made from electrolytic copper, rolled, tin plated and brazed.

The interior of the PA6.6 insulated sleeve is funnel shaped so as to ensure complete and easy introduction of the conductor strands.

FLEXIBLE BRAIDS

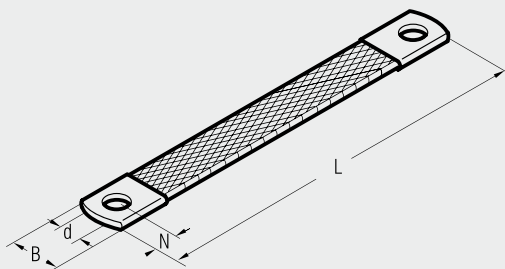

FL

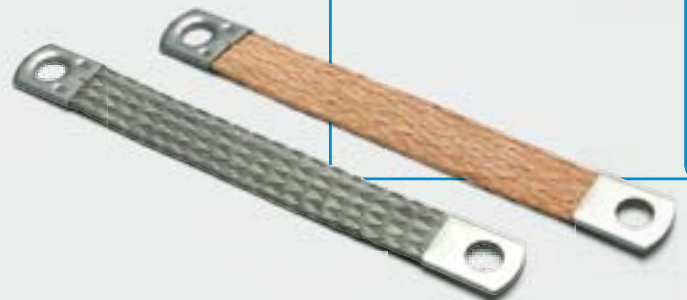

Size sqmm	Ø Stud mm	Ref.	Dimensions mm				Quantity
			B	N	L	d	
10	8	FL 10-150	17	10	150	8,5	50
	8	FL 10-200	17	10	200	8,5	50
	8	FL 10-250	17	10	250	8,5	50
	8	FL 16-150	17	10	150	8,5	50
	8	FL 16-200	17	10	200	8,5	50
16	8	FL 16-250	17	10	250	8,5	50
	8	FL 16-320	17	10	320	8,5	50
	8	FL 16-350	17	10	350	8,5	50
	8	FL 16-420	17	10	420	8,5	25
	8	FL 16-570	17	10	570	8,5	25
	8	FL 16-660	17	10	660	8,5	25
	8	FL 25-150	21	10	150	8,5	50
25	8	FL 25-200	21	10	200	8,5	50
	8	FL 25-250	21	10	250	8,5	50
	8	FL 25-300	21	10	300	8,5	50

Flexible braids are manufactured from electrolytic copper wire.

Braids of different conductor sizes or lengths are available on request.

Standard finish - bright copper.

Flexible braids can be supplied tin plated, in this case add the suffix "ST" to reference.

E.g.:

- FL 10-150 (Bright copper)
- FL 10-150-ST (Tin plated)

ANE-P



POLYAMIDE PA6.6 INSULATED PIN TERMINALS

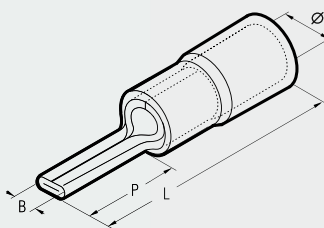

ANE-P series terminals are made from electrolytic copper, rolled, tin plated and brazed. The interior of the PA6.6 insulated sleeve is funnel shaped so as to ensure complete and easy introduction of the conductor strands.

The operating temperature range is - 20 to + 115°C (Surge + 130°C).

In order to achieve the best electrical and mechanical performance it is suggested that they are crimped using dies and tools specifically developed for this purpose by Cembre.

Conductor Size Flexible sqmm	Ref.	Dimensions mm				Quantity Box/Bag	Mechanical Tools			Hydraulic Tools				
		Ø	B	P	L		HNN 3	HNN 4	TNW 70	TNW 120	B 15D	B 35-50D	B 51 RH 50 B 51 B 55	HT 120 and tools and heads with 130 kN crimping force
10	ANE 2-P 12	8,0	4,3	14,5	35,1	500/100								
16	ANE 3-P 14	9,2	5,5	18,0	41,1	500/100								
25	ANE 5-P 16	11,1	7,0	20,3	45,0	300/100								
35	ANE 7-P 20	13,6	8,0	24,5	55,0	200/50								

Details of the appropriate crimping tools and dies are shown on pages 192 to 193.

A-P



UNINSULATED PIN CONNECTORS

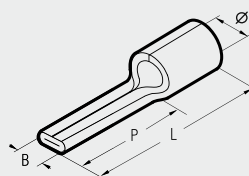

A-P series pin connectors are designed to terminate conductors into contact blocks.

They are manufactured from copper strip, rolled, brazed and tin plated.

Details of the appropriate crimping tools and dies are shown on pages 190 to 191.

Cond. Size sqmm	Ref.	Dimensions mm				Quantity Box/Bag	Mechanical Tools			Hydraulic Tools							
		Ø1	B	P	L		HN 1	HN 5	HN-A25	TN 70 SE	TN 120 SE	B 15D	B 35-45D	HT 45E HT 45	HT 51 RH 50 B 51 B 55	HT 120 and tools and heads with 130 kN crimping force	ECW-H3D
10	A 2-P 12	4,8	4,3	14,5	23,5	1.000/100											
16	A 3-P 14	5,9	5,5	18,0	28,0	1.500/100											
25	A 5-P 16	7,0	7,0	20,3	32,0	1.000/100											
35	A 7-P 20	8,9	8,0	24,5	39,0	500/100											
50	A 10-P 25	10,0	9,5	26,0	45,0	250/50											
70	A 14-P 30	11,5	11,0	31,0	55,0	200/50											

POLYAMIDE PA6.6 INSULATED COPPER TUBE LUGS



for extra flexible copper conductors

ANE-M

for fine stranded
SPECIAL
flexible conductors

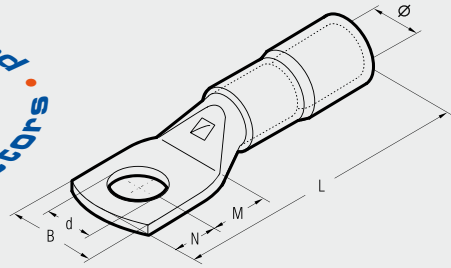

Conductor Size Extra Flexible sqmm	Ø Stud mm	Ref.	Dimensions mm						Quantity Box/Bag	Mechanical Tools	Hydraulic Tools				
			Ø	B	M	N	L	d							
35	6	ANE 9-M 6/15	13,6	15,0	8,0	7,0	54,0	6,4	200/50	TMM 70	B 35-500				
	8	ANE 9-M 8	13,6	17,0	9,0	8,0	56,0	8,4	200/50						
	10	ANE 9-M 10	13,6	18,5	11,0	10,0	60,0	10,5	150/50						
	12	ANE 9-M 12	13,6	21,0	14,0	12,0	65,0	13,2	150/50						
50	6	ANE 12-M 6/15	15,7	15,0	8,0	7,0	59,5	6,4	100/25			TMM 120	B 55 B 51		
	8	ANE 12-M 8	15,7	19,8	9,0	8,0	61,5	8,4	100/25						
	10	ANE 12-M 10	15,7	19,8	11,0	10,0	65,5	10,5	100/25						
	10	ANE 12-M 10/19	15,7	19,0	11,0	10,0	65,5	10,5	100/25						
70	12	ANE 12-M 12	15,7	22,0	14,0	12,0	70,5	13,2	100/25					HT 51 RH 50	B 51
	6	ANE 17-M 6	17,9	23,0	8,0	7,0	63,8	6,4	100/25						
	8	ANE 17-M 8	17,9	23,0	9,0	8,0	65,8	8,4	100/25						
	10	ANE 17-M 10	17,9	23,0	11,0	10,0	69,8	10,5	50/25						
	10	ANE 17-M 10/19	17,9	19,0	11,0	10,0	69,8	10,5	100/25						
	12	ANE 17-M 12	17,9	23,0	14,0	12,0	74,8	13,2	50/25						
95	14	ANE 17-M 14	17,9	25,0	15,5	12,0	76,3	15,0	50/25	HT 120 and tools and heads with 130 kN crimping force ECW-H3D					
	16	ANE 17-M 16	17,9	27,0	16,5	13,5	78,8	17,0	50/25						
	8	ANE 20-M 8	20,0	27,0	9,0	8,0	70,6	8,4	50/25						
	10	ANE 20-M 10	20,0	27,0	11,0	10,0	74,6	10,5	50/25						
120	12	ANE 20-M 12	20,0	27,0	14,0	12,0	79,6	13,2	50/25						
	14	ANE 20-M 14	20,0	27,0	15,5	12,0	81,1	15,0	50/25						
	16	ANE 20-M 16	20,0	27,0	16,5	13,5	83,6	17,0	50/25						
	10	ANE 29-M 10	22,4	30,0	11,0	10,0	81,5	10,5	50/25						
150	12	ANE 29-M 12	22,4	30,0	14,0	12,0	86,5	13,2	50/25						
	14	ANE 29-M 14	22,4	30,0	15,5	12,0	88,5	15,0	50/25						
	16	ANE 29-M 16	22,4	30,0	16,5	13,5	90,5	17,0	50/25						
	20	ANE 29-M 20	22,4	30,0	22,0	20,0	102,5	21,0	50/25						
150	12	ANE 35-M 12	25,0	34,2	16,0	14,0	95,0	13,2	30/15						
	14	ANE 35-M 14	25,0	34,2	18,0	16,0	99,0	15,0	30/15						
	16	ANE 35-M 16	25,0	34,2	19,0	17,0	101,0	17,0	30/15						
	20	ANE 35-M 20	25,0	34,2	22,0	20,0	107,0	21,0	30/15						

These lugs are particularly recommended for use with extra flexible conductors on for instance, welding machines.

ANE-M series lugs are manufactured from electrolytic copper tube annealed and tin plated.

The interior of the PA6.6 insulated sleeve is funnel shaped so as to ensure complete and easy introduction of the conductor strands.

It also eliminates the need to insulate the terminal using either tape or heat shrinkable tubing.

Furthermore the PA6.6 sleeve avoids the possibility of conductor breakage at the barrel entrance.

The items tabulated all feature black insulated sleeves, however other colours are available, please consult us.

The operating temperature range is - 20 to + 115°C (Surge + 130°C).

In order to achieve the best electrical and mechanical performance it is suggested that they are crimped using dies and tools specifically developed for this purpose by Cembre.

Details of the appropriate crimping tools and dies are shown on pages 192 to 193.

A-M



COPPER TUBE CRIMPING LUGS

for extra flexible copper conductors

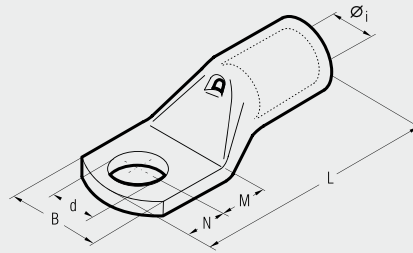

for fine stranded
SPECIAL
flexible conductors

These lugs are particularly recommended for use with extra flexible conductors on for instance, welding machines.

A-M series lugs are designed to suit panel applications.

The dimensions of the tube are designed to obtain the most efficient electrical conductivity and mechanical strength to resist vibration and pull out.

Cembre lugs are annealed to guarantee optimum ductility and electrolytically tin plated to avoid oxidation.

The presence of an inspection hole facilitates full insertion of the conductor.

Details of the appropriate crimping tools and dies are shown on pages 190 to 191.

Conductor Size Extra Flexible sqmm	Ø Stud mm	Ref.	Dimensions mm						Quantity Box/Bag	Mechanical Tools	Hydraulic Tools
			Øi	B	M	N	L	d			
35	6	A 9-M 6/15	9,3	15,0	8,0	7,0	38,5	6,4	400/100	TN 70 SE	
	8	A 9-M 8	9,3	17,0	9,0	8,0	40,5	8,4	400/100		
	10	A 9-M 10	9,3	18,5	11,0	10,0	44,5	10,5	400/100		
	12	A 9-M 12	9,3	21,0	14,0	12,0	49,5	13,2	300/50		
50	6	A 12-M 6/15	11,0	15,0	8,0	7,0	40,5	6,4	200/50		
	8	A 12-M 8	11,0	19,3	9,0	8,0	42,5	8,4	200/50		
	10	A 12-M 10	11,0	19,3	11,0	10,0	46,5	10,5	200/50		
	10	A 12-M 10/19	11,0	19,0	11,0	10,0	46,5	10,5	200/50		
70	12	A 12-M 12	11,0	22,0	14,0	12,0	51,5	13,2	200/50		
	6	A 17-M 6	13,0	23,0	8,0	7,0	45,0	6,4	200/50		
	8	A 17-M 8	13,0	23,0	9,0	8,0	47,0	8,4	150/50		
	10	A 17-M 10	13,0	23,0	11,0	10,0	51,0	10,5	150/50		
95	10	A 17-M 10/19	13,0	19,0	11,0	10,0	51,0	10,5	200/50		
	12	A 17-M 12	13,0	23,0	14,0	12,0	56,0	13,2	150/50		
	14	A 17-M 14	13,0	25,0	15,5	12,0	57,5	15,0	150/25		
	16	A 17-M 16	13,0	27,0	16,5	13,5	60,0	17,0	150/25		
120	8	A 20-M 8	15,0	27,0	9,0	8,0	50,0	8,4	100/25		
	10	A 20-M 10	15,0	27,0	11,0	10,0	54,0	10,5	100/25		
	12	A 20-M 12	15,0	27,0	14,0	12,0	59,0	13,2	100/25		
	14	A 20-M 14	15,0	27,0	15,5	12,0	60,5	15,0	100/25		
150	16	A 20-M 16	15,0	27,0	16,5	13,5	63,0	17,0	100/25		
	8	A 29-M 8	16,5	30,0	9,0	8,0	53,5	8,4	100/25		
	10	A 29-M 10	16,5	30,0	11,0	10,0	57,5	10,5	100/25		
	12	A 29-M 12	16,5	30,0	14,0	12,0	62,5	13,2	100/25		
185	14	A 29-M 14	16,5	30,0	15,5	12,0	64,0	15,0	100/25		
	16	A 29-M 16	16,5	30,0	16,5	13,5	66,5	17,0	100/25		
	20	A 29-M 20	16,5	30,0	22,0	20,0	78,5	21,0	75/25		
	10	A 35-M 10	19,2	34,2	13,0	11,0	65,5	10,5	50/25		
240	12	A 35-M 12	19,2	34,2	16,0	14,0	71,5	13,2	50/25		
	14	A 35-M 14	19,2	34,2	18,0	16,0	75,5	15,0	50/25		
	16	A 35-M 16	19,2	34,2	19,0	17,0	77,5	17,0	50/25		
	20	A 35-M 20	19,2	34,2	22,0	20,0	83,5	21,0	50/25		
300	10	A 40-M 10	21,0	37,5	13,0	11,0	73,0	10,5	30/15		
	12	A 40-M 12	21,0	37,5	16,0	14,0	79,0	13,2	30/15		
	14	A 40-M 14	21,0	37,5	18,0	16,0	83,0	15,0	30/15		
	16	A 40-M 16	21,0	37,5	19,0	17,0	85,0	17,0	30/15		
360	20	A 40-M 20	21,0	37,5	22,0	20,0	91,0	21,0	30/15		

TN 120 SE
B 35-45D
B 35-50D
HT 45E
HT 51 RH 50 B 51 B 55
HT 81-U RHU 81
HT 120 and tools and heads with 130 kN crimping force
ECW-H3D
RHU 520

COPPER TUBE LUGS 4-ESI FIXING



A-4ESI

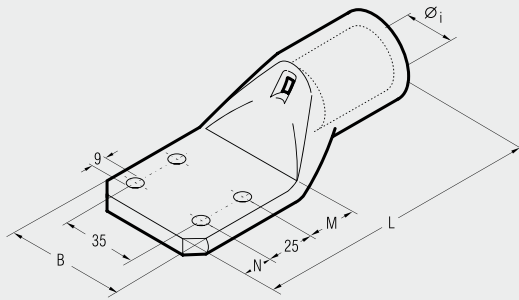

Conductor Size sqmm	Ref.	Dimensions mm					Quantity Box/Bag	Hydraulic Tools				
		Øi	B	M	N	L						
185	A 37-4ESI	19,2	61	20	15	124	20/10	HT 51 RH 50 B 51 B 55	HT 81-U RHU 81	HT 120 and tools and heads with 130 kN crimping force	ECW-H3D	RHU 520
240	A 48-4ESI	21,1	61	20	15	128	20/10					
300	A 60-4ESI	23,7	61	20	15	133	20/10					
400	A 80-4ESI	27,0	61	20	15	134	15/5					
500	A 100-4ESI	30,3	61	20	15	139	10/5					
630	A 120-4ESI	33,4	61	20	15	144	10/5					
800	A 160-4ESI	38,0	61	20	15	158	8/4					

A-4ESI series lugs are made from high purity electrolytic copper tube, annealed and tin plated. The four hole stud fixing in accordance with E.A. specifications ensures compatibility with most transformer fixing arrangements. Details of the appropriate crimping tools and dies are shown on pages 190 to 191.



COPPER TUBE CRIMPING LUGS ACCORDING TO DIN 46235

for copper conductors



DR

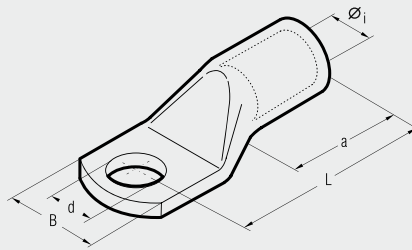

DR series lugs are manufactured from electrolytic copper tube and designed to obtain high electrical conductivity combined with the mechanical strength required to resist vibration and pull out.

Cembre lugs are annealed and tin plated for improved surface protection.

The annealing process optimizes the structural features of the material allowing easier crimping and greater resistance to mechanical stresses.

Dimensions are according to DIN 46235.

The barrel entrance of the lug is chamfered to allow easy conductor insertion, while its length facilitates precise positioning in the crimping die.

Each lug is marked with:

- Cembre logo and part code.
- conductor type and csa (mm²).
- Stud Ø (mm).
- crimping die code (Kennzahl)

Details of the appropriate crimping tools and dies are shown on page 198.

Consult us for special requirements

Conductor Size sqmm	Ø Stud mm	Ref.	Code	Dimensions mm					Quantity Box/Bag	Mechanical Tools	Hydraulic Tools						
				Øi	d	L	B	a									
6	5	DR6-5	5	3,7	5,3	24,0	8,5	10,0	800/100	HND25	B 15D						
	6	DR6-6	5	3,7	6,4	24,0	9,0	10,0	800/100								
	8	DR6-8*	5	3,7	8,4	26,0	13,0	10,0	800/100								
10	5	DR10-5	6	4,4	5,3	27,5	10,0	10,0	800/100	HND25	B 15D						
	6	DR10-6	6	4,4	6,4	27,0	10,0	10,0	800/100								
	8	DR10-8*	6	4,4	8,4	28,0	13,0	10,0	800/100								
16	10	DR10-10*	6	4,4	10,5	28,5	15,0	10,0	800/100	HND25	B 15D						
	5	DR16-5*	8	5,5	5,3	36,0	13,0	20,0	400/100								
	6	DR16-6	8	5,5	6,4	36,0	13,0	20,0	400/100								
25	8	DR16-8	8	5,5	8,4	37,0	13,0	20,0	400/100	HND25	B 15D						
	10	DR16-10	8	5,5	10,5	40,0	16,5	20,0	400/100								
	12	DR16-12*	8	5,5	13,0	41,0	19,0	20,0	400/100								
35	6	DR25-6	10	7,0	6,4	39,0	14,6	20,0	400/100	TND 6-70	B 15D						
	8	DR25-8	10	7,0	8,4	39,5	16,0	20,0	400/100								
	10	DR25-10	10	7,0	10,5	40,0	16,0	20,0	200/100								
50	12	DR25-12	10	7,0	13,0	40,5	18,0	20,0	200/100	TND 6-70	B 15D						
	6	DR35-6*	12	8,2	6,4	42,5	17,5	20,0	200/100			TND 10-120	B 35-45D B 35-50D HT 45-E				
	8	DR35-8	12	8,2	8,4	42,0	17,0	20,0	200/100								
10	DR35-10	12	8,2	10,5	43,0	19,0	20,0	200/100									
70	12	DR35-12	12	8,2	13,0	43,0	21,0	20,0	200/100	TND 10-120	B 35-45D B 35-50D HT 45-E						
	16	DR35-16*	12	8,2	17,0	44,0	28,0	20,0	200/100								
	6	DR50-6*	14	10,0	6,4	52,0	20,0	28,0	100/25								
95	8	DR50-8	14	10,0	8,4	52,0	20,0	28,0	100/25	TND 10-120	B 35-45D B 35-50D HT 45-E						
	10	DR50-10	14	10,0	10,5	53,0	22,0	28,0	100/25								
	12	DR50-12	14	10,0	13,0	53,0	24,0	28,0	100/25								
120	16	DR50-16	14	10,0	17,0	57,0	28,0	28,0	100/25	TND 10-120	B 35-45D B 35-50D HT 45-E						
	8	DR70-8	16	11,5	8,4	56,0	24,0	28,0	50/25								
	10	DR70-10	16	11,5	10,5	56,0	24,0	28,0	50/25								
150	12	DR70-12	16	11,5	13,0	56,0	24,0	28,0	50/25	TND 10-120	B 35-45D B 35-50D HT 45-E						
	16	DR70-16	16	11,5	17,0	60,0	30,0	28,0	50/25								
	20	DR70-20*	16	11,5	21,0	84,5	30,0	28,0	50/25								
185	8	DR95-8*	18	13,5	8,4	65,0	28,0	35,0	50/25	TND 10-120	B 35-45D B 35-50D HT 45-E						
	10	DR95-10	18	13,5	10,5	66,0	28,0	35,0	50/25								
	12	DR95-12	18	13,5	13,0	66,0	28,0	35,0	50/25								
240	16	DR95-16	18	13,5	17,0	65,5	32,0	35,0	50/25	TND 10-120	B 35-45D B 35-50D HT 45-E						
	20	DR95-20*	18	13,5	21,0	71,0	33,0	35,0	50/25								
	8	DR120-8*	20	15,5	8,4	70,0	31,0	35,0	50/25								
300	10	DR120-10	20	15,5	10,5	70,0	31,0	35,0	50/25	TND 10-120	B 35-45D B 35-50D HT 45-E						
	12	DR120-12	20	15,5	13,0	70,5	31,0	35,0	50/25								
	16	DR120-16	20	15,5	17,0	70,0	31,5	35,0	50/25								
400	20	DR120-20	20	15,5	21,0	72,0	36,0	35,0	50/25	TND 10-120	B 35-45D B 35-50D HT 45-E						
	10	DR150-10	22	17,0	10,5	79,0	34,0	35,0	50/25								
	12	DR150-12	22	17,0	13,0	78,5	34,0	35,0	50/25								
500	16	DR150-16	22	17,0	17,0	78,0	34,0	35,0	50/25	TND 10-120	B 35-45D B 35-50D HT 45-E						
	20	DR150-20	22	17,0	21,0	78,0	38,0	35,0	50/25								
	10	DR185-10	25	19,0	10,5	83,0	37,0	40,0	25/25								
600	12	DR185-12	25	19,0	13,0	82,5	37,0	40,0	25/25	TND 10-120	B 35-45D B 35-50D HT 45-E						
	16	DR185-16	25	19,0	17,0	82,0	37,0	40,0	25/25								
	20	DR185-20	25	19,0	21,0	83,0	40,0	40,0	25/25								
800	10	DR240-10*	28	21,5	10,5	92,0	42,0	40,0	20/10	TND 10-120	B 35-45D B 35-50D HT 45-E						
	12	DR240-12	28	21,5	13,0	92,0	42,5	40,0	20/10								
	16	DR240-16	28	21,5	17,0	92,0	42,5	40,0	20/10								
1000	20	DR240-20	28	21,5	21,0	92,0	45,0	40,0	20/10	TND 10-120	B 35-45D B 35-50D HT 45-E						

* Non-standard; dimensions of the tube according to DIN 46.235

HT 51 RH 50 B 51
HT 81-U RHU 81
HT 120 and tools and heads with 130 kN crimping force
ECW43D
RHU 520

COPPER TUBE CRIMPING LUGS ACCORDING TO DIN 46235



for copper conductors

DR

Conductor Size sqmm	Ø Stud mm	Ref.	Code	Dimensions mm					Quantity Box/Bag	Hydraulic Tools	
				Øi	d	L	B	a			
300	12	DR300-12*	32	24,5	13,0	104,0	47,0	50,0	10/5	HT 120 and tools and heads with 130 kN crimping force	ECW-H3D RHU 520
	16	DR300-16	32	24,5	17,0	100,0	48,0	50,0	10/5		
	20	DR300-20	32	24,5	21,0	100,0	47,0	50,0	10/5		
400	12	DR400-12*	38	27,5	13,0	117,0	55,0	70,0	5/5		
	16	DR400-16	38	27,5	17,0	117,0	55,0	70,0	5/5		
	20	DR400-20	38	27,5	21,0	117,0	55,0	70,0	5/5		
500	12	DR500-12*	42	31,0	13,0	130,0	60,0	70,0	5/5		
	16	DR500-16*	42	31,0	17,0	130,0	60,0	70,0	5/5		
	20	DR500-20	42	31,0	21,0	130,0	60,0	70,0	5/5		
625	20	DR625-20	44	34,5	21,0	135,0	63,0	80,0	5/5		

* Non-standard; dimensions of the tube according to DIN 46.235

Consult us for special requirements

CRIMPING THROUGH CONNECTORS ACCORDING TO DIN 46267 T.1



for copper cables

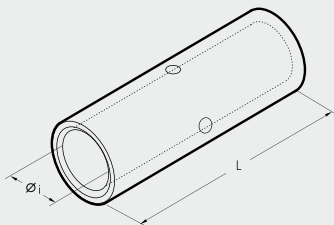

DSV



Conductor Size sqmm	Ref.	Code	Dimensions mm		Quantity Box/Bag	Mechanical Tools		Hydraulic Tools		
			Øi	L						
6	DSV 6	5	3,7	30	1.200/100	HND25 TND 6-70 TND 10-120	B 15D	B 35-45D B 35-50D HT 45-E HT 51 RH 50 B51 HT 81-J RHU 81	HT 120 and tools and heads with 130 kN crimping force	ECW-H3D RHU 520
10	DSV 10	6	4,4	30	1.200/100					
16	DSV 16	8	5,5	50	400/100					
25	DSV 25	10	7,0	50	200/100					
35	DSV 35	12	8,2	50	200/100					
50	DSV 50	14	10,0	56	200/50					
70	DSV 70	16	11,5	56	100/50					
95	DSV 95	18	13,5	70	100/50					
120	DSV 120	20	15,5	70	50/25					
150	DSV 150	22	17,0	80	50/25					
185	DSV 185	25	19,0	85	25/25					
240	DSV 240	28	21,5	90	15/15					
300	DSV 300	32	24,5	100	10/5					
400	DSV 400	38	27,5	150	10/5					
500	DSV 500	42	31,0	160	5/5					
625	DSV 625	44	34,5	160	5/5					

DSV series through connectors are manufactured from electrolytic copper tube, annealed and surface protected by tin plating. Internal and external dimensions match those of DR series lugs.

Chamfered ends and a central stop provide easy and correct insertion of the conductor.

Details of the appropriate crimping tools and dies are shown on page 198.

Consult us for special requirements

SLEEVE CONNECTORS

tin plated version



C

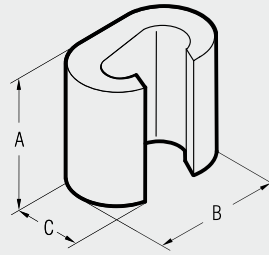

"C" connectors are manufactured from high purity copper profiles and are suitable for a variety of uses either to create an earthing network or tapping off from overhead distribution lines. Each connector is marked as follows:

- Cembre trade mark
- Reference number
- Conductor size-Run
- Conductor size-Tap
- Number of crimps
- Die reference.

Details of the appropriate crimping tools and dies are shown on page 194.

Conductor Size sqmm		Ref.	Dimensions mm			Quantity Box/Bag	Mechanical Tools	Hydraulic Tools	
Run	Tap		A	B	C				
6÷2,5	6÷1,5	C 6-C 6 ST	9,0	9,8	6,4	1,000/100	HP4-C10	B 35-45D B 35-50D HT 45-E RH 50 B 51 B 55 RHU 81 HT 51 HT 81-U HT 120 and tools and heads with 130 kN crimping force ECW-H3D	
10	10÷1,5	C 10-C 10 ST	12,0	12,6	8,4	500/100			
16	16÷1,5	C 16-C 16 ST	17,0	19,4	12,0	500/100			
25÷16	10÷1,5	C 25-C 10 ST	17,0	19,8	13,0	400/50			
25	25÷16	C 25-C 25 ST	17,0	21,4	13,0	300/50			
40÷35	16÷1,5	C 35-C 16 ST	21,0	24,6	15,4	200/25			
40÷35	40÷25	C 35-C 35 ST	21,0	26,6	15,6	200/25			
50	25÷10								
50	25÷4	C 50-C 25 ST	25,0	32,9	21,0	200/25			
50	50÷35	C 50-C 50 ST	26,0	33,0	21,0	100/25			
70÷63	25÷1,5	C 70-C 25 N ST	21,0	26,4	17,5	100/25			
70÷50	40÷4	C 70-C 35 ST	28,0	33,0	21,0	100/25			
70÷50	70÷35	C 70-C 70 ST	28,0	34,0	21,0	100/25			
100÷95	40÷4	C 95-C 35 ST	29,0	40,6	26,0	50/25			
100÷95	70÷40	C 95-C 70 ST	29,0	41,0	26,0	50/25			
100÷95	100÷63	C 95-C 95 ST	29,0	41,0	26,0	50/25			
125÷110	125÷25	C 120-C 120 ST	30,0	45,0	28,0	50/25			
160÷150	125÷25	C 150-C 120 ST	31,0	45,0	28,0	50/25			
150	150÷63	C 150-C 150 ST	30,0	45,0	28,0	50/25			
185	100÷16	C 185-C 95 ST	31,0	45,0	28,0	50/25			
185÷120	185÷120	C 185-C 185 ST	22,6	68,0	34,0	30/15			
240÷150	120÷95	C 240-C 120 ST	22,6	68,0	34,0	30/15			

Example of tap connection

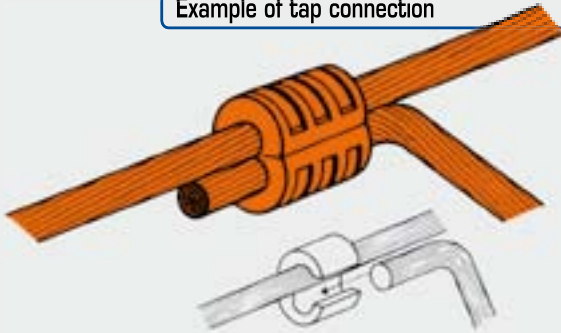

Example of joint connection

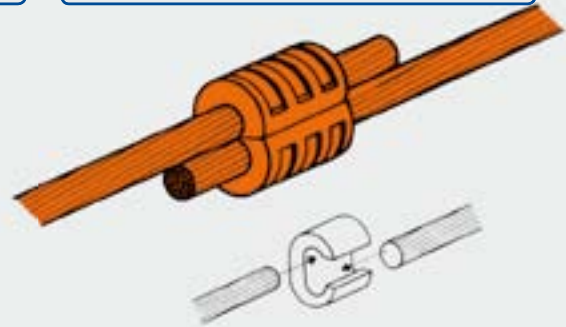

Example of joining two running conductors

Conductor Size sqmm	Ref.
25-25	C 35-C 16 ST
35-35	C 35-C 35 ST
50-50	C 70-C 70 ST
63-63	C 95-C 70 ST
70-70	
95-95	C 150-C 120 ST
120-120	
125-125	C 150-C 150
120-120	C 185-C 95 ST
125-125	

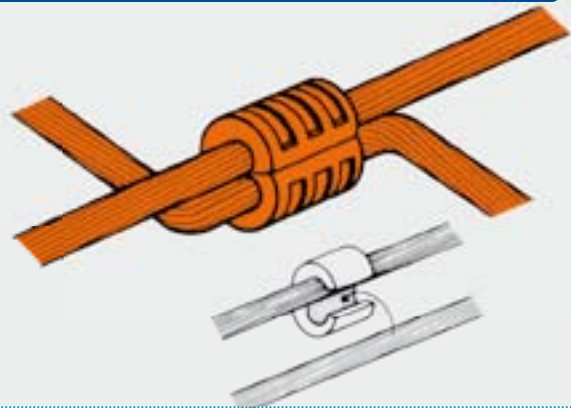



SLEEVE CONNECTORS

bright surface version

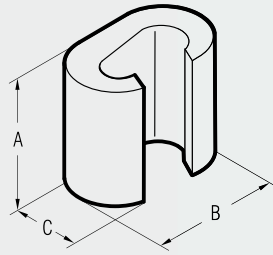

Conductor Size sqmm		Ref.	Dimensions mm			Quantity Box/Bag	Mechanical Tools	Hydraulic Tools			
Run	Tap		A	B	C			B 35-45D	B 35-50D	HT 45-E	RH 50 B 51 B 55
6÷2,5	6÷1,5	C 6-C 6	9,0	9,8	6,4	1.000/100	HP4-C10				
10	10÷1,5	C 10-C 10	12,0	12,6	8,4	500/100					
16	16÷1,5	C 16-C 16	17,0	19,4	12,0	500/100					
25÷16	10÷1,5	C 25-C 10	17,0	19,8	13,0	400/50					
25	25÷16	C 25-C 25	17,0	21,4	13,0	300/50					
40÷35	16÷1,5	C 35-C 16	21,0	24,6	15,4	200/25					
40÷35	40÷25	C 35-C 35	21,0	26,6	15,6	200/25					
50	25÷10										
50	25÷4	C 50-C 25	25,0	32,9	21,0	200/25					
50	50÷35	C 50-C 50	26,0	33,0	21,0	100/25					
70÷63	25÷1,5	C 70-C 25 N	21,0	26,4	17,5	100/25					
70÷50	40÷4	C 70-C 35	28,0	33,0	21,0	100/25					
70÷50	70÷35	C 70-C 70	28,0	34,0	21,0	100/25					
100÷95	40÷4	C 95-C 35	29,0	40,6	26,0	50/25					
100÷95	70÷40	C 95-C 70	29,0	41,0	26,0	50/25					
100÷95	100÷63	C 95-C 95	29,0	41,0	26,0	50/25					
125÷110	125÷25	C 120-C 120	30,0	45,0	28,0	50/25					
160÷150	125÷25	C 150-C 120	31,0	45,0	28,0	50/25					
150	150÷63	C 150-C 150	30,0	45,0	28,0	50/25					
185	100÷16	C 185-C 95	31,0	45,0	28,0	50/25					
185÷120	185÷120	C 185-C 185	22,6	68,0	34,0	30/15					
240÷150	120÷95	C 240-C 120	22,6	68,0	34,0	30/15					

Featuring same characteristics as tin plated version, (see opposite page).

MECHANICAL FIXING LUGS

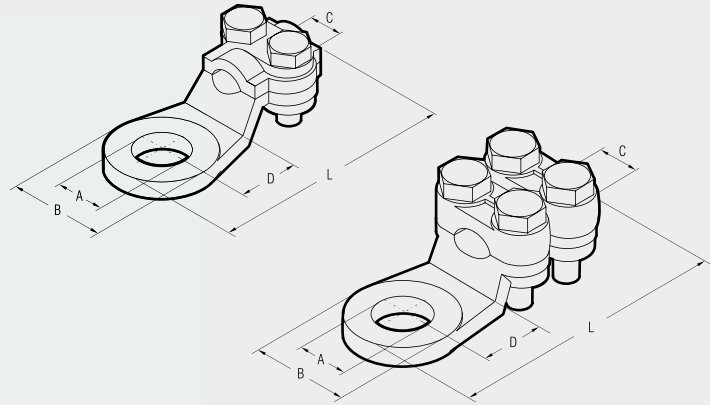

Material:
Brass OT 58 UNI 5705
nickel-plated.
Zinc plated steel bolts.

2 bolt fixing lugs

Conductor Size sqmm	Ref.	A bolt	Dimensions mm				Quantity
			B	C	D	L	
16	2155	M8	18,0	4,5	12,5	40	100
16	2171	M10	18,0	4,5	12,5	40	100
25	2156	M8	19,5	6,0	13,0	43	100
25	2172	M10	19,5	6,0	13,0	43	100
35	2157	M12	23,0	7,0	15,0	49	50
35	2173	M14	23,0	7,0	15,0	49	50
50	2174	M14	25,0	8,0	17,0	56	50

4 bolt fixing lugs

Conductor Size sqmm	Ref.	A bolt	Dimensions mm				Quantity
			B	C	D	L	
50	2158	M12	23,5	8	16,0	57	50
75	2160	M12	28,0	10	20,0	65	25
75	2176	M16	28,0	10	20,0	65	25
100	2161	M12	31,0	13	17,0	66	25
125	2162	M15	33,0	14	18,0	71	25
150	2163	M14	34,0	16	19,5	75	25
175	2164	M15	36,0	16	21,0	78	25

CABLE CLAMPS

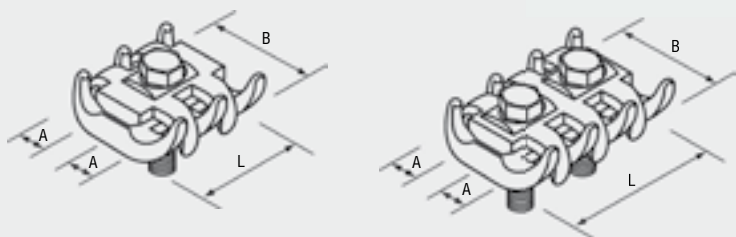

Single bolt fixing

Conductor Size sqmm	Ref.	Ø A for cable mm	Dimensions mm		Quantity
			B	L	
6÷16	2323	3÷ 5	24	20	50
16÷50	2326	5÷ 8	30	25	50
35÷70	2329	7÷12	40	30	25

Material:
Brass OT 58 UNI 5705.
Zinc plated steel bolts.
Zinc plated steel nut.

2 bolt fixing

Conductor Size sqmm	Ref.	Ø A for cable mm	Dimensions mm		Quantity
			B	L	
6÷16	2333	3÷ 5	27	32	50
16÷50	2336	5÷ 8	32	40	50
35÷70	2339	7÷12	40	44	25
50÷95	2342	8÷14	48	48	10
70÷150	2344	12÷16	51	53	10
150÷300	2346	18÷22	70	70	5

HIGH VOLTAGE COPPER TERMINALS

CA-M 2A-M

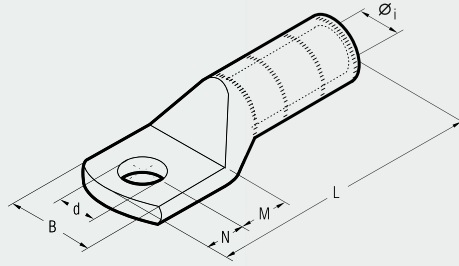

Series CA-M and 2A-M terminals are designed for high voltage applications up to 33 kV.

They are manufactured from high purity copper tube, annealed and tin plated.

The extended barrel enhances both electrical and mechanical performance. The absence of an inspection hole prevents moisture entry into the crimped joint and makes these terminals suitable for outdoor applications.

Details of the appropriate crimping tools and dies are shown on page 194.

Conductor Size sqmm	Ø Stud mm	Ref.	Dimensions mm						Quantity Box/Bag	Hydraulic Tools				
			Øi	B	M	N	L	d						
25 R	8	CA 25-M 8	6,8	14,0	9	8	65,0	8,4	300/50	B35-500	B 51	RH 50	B 51	B 55
	10	CA 25-M 10	6,8	18,0	13	11	72,0	10,5	200/50					
	12	CA 25-M 12	6,8	21,0	16	14	78,0	13,2	200/50					
30 RC/S ÷ 40 S	12	CA 40 S-M 12	8,2	21,0	16	14	79,0	13,2	150/50	HT 81-U	RHU 81	HT 120 and tools and heads with 130 kN crimping force	ECWH30	RHU 520
	16	CA 40 S-M 16	8,2	26,0	19	17	85,0	17,0	100/50					
50 RC	12	CA 50 R-M 12	8,7	20,5	16	14	79,0	13,2	150/50	HT 51	RH 50	B 51	B 55	RHU 81
	16	CA 50 S-M 16	9,5	21,0	16	14	79,0	13,2	150/50					
50 S	12	CA 50 S-M 12	9,5	21,0	16	14	79,0	13,2	150/50	HT 51	RH 50	B 51	B 55	RHU 81
	16	CA 50 S-M 16	9,5	26,0	19	17	85,0	17,0	100/50					
63 S ÷ 70 S	12	CA 70 S-M 12	11,0	28,0	16	14	81,2	13,2	50/25	HT 51	RH 50	B 51	B 55	RHU 81
	16	CA 70 S-M 16	11,0	30,0	19	17	87,2	17,0	50/25					
80 S ÷ 95 RC	12	CA 95 R-M 12	12,0	28,0	16	14	91,0	13,2	50/25	HT 51	RH 50	B 51	B 55	RHU 81
	14	CA 95 S-M 14	12,0	28,0	18	16	95,0	15,0	50/25					
95 S ÷ 100 S	12	CA 95 S-M 12	13,5	28,0	16	14	91,0	13,2	50/25	HT 51	RH 50	B 51	B 55	RHU 81
	14	CA 95 S-M 14	13,5	29,0	18	16	94,5	15,0	50/25					
120 RC/S ÷ 150 RC	12	CA 150 R-M 12	15,0	31,0	16	14	97,0	13,2	30/15	HT 51	RH 50	B 51	B 55	RHU 81
	14	CA 150 R-M 14	15,0	31,0	18	16	101,0	15,0	30/15					
150 S ÷ 160 RC	12	CA 150 S-M 12	16,5	32,0	16	14	97,0	13,2	30/15	HT 51	RH 50	B 51	B 55	RHU 81
	14	CA 150 S-M 14	16,5	32,0	18	16	101,0	15,0	30/15					
160 S ÷ 200 RC	14	CA 200 R-M 14	17,0	32,5	18	16	101,0	15,0	30/15	HT 51	RH 50	B 51	B 55	RHU 81
	14	CA 200 R-M 14	17,0	32,5	18	16	101,0	15,0	30/15					
200 S ÷ 240 RC	14	CA 240 R-M 14	19,2	43,0	18	16	107,0	15,0	15/5	HT 51	RH 50	B 51	B 55	RHU 81
	14	CA 240 R-M 14	19,2	43,0	18	16	107,0	15,0	15/5					
240 S ÷ 315 RC	14	CA 315 R-M 14	21,5	43,0	18	16	105,0	15,0	15/5	HT 51	RH 50	B 51	B 55	RHU 81
	14	CA 315 S-M 14	23,7	44,0	18	16	105,0	15,0	15/5					
315 S	14	CA 315 S-M 14	23,7	44,0	18	16	105,0	15,0	15/5	HT 51	RH 50	B 51	B 55	RHU 81
	14	2 A 80-M 14	27,0	51,0	22	19	140,0	15,0	15/5					
400 R	16	2 A 80-M 16	27,0	51,0	22	19	140,0	17,0	15/5	HT 51	RH 50	B 51	B 55	RHU 81
	20	2 A 80-M 20	27,0	51,0	24	23	146,0	21,0	15/5					
500 R	16	2 A 100-M 16	30,3	56,5	22	19	147,0	17,0	10/5	HT 51	RH 50	B 51	B 55	RHU 81
	20	2 A 100-M 20	30,3	56,5	24	23	153,0	21,0	10/5					
600 R ÷ 630 R	16	2 A 120-M 16	33,4	61,5	22	19	159,0	17,0	20/5	HT 51	RH 50	B 51	B 55	RHU 81
	20	2 A 120-M 20	33,4	61,5	24	23	165,0	21,0	20/5					

R = Round conductors RC = Round Compact conductors S = Sector shaped conductors

HIGH VOLTAGE TERMINALS

two hole fixing

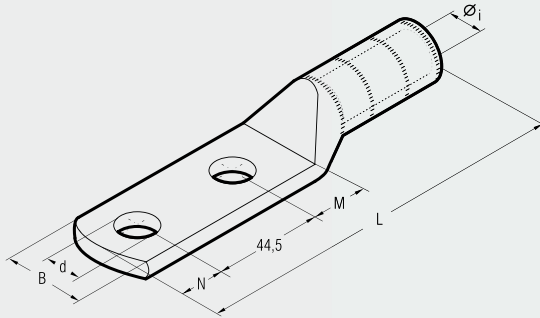

CA-2M 2A-2M



Conductor Size sqmm	Ø Stud mm	Ref.	Dimensions mm						Quantity Box/Bag	Hydraulic Tools		
			Øi	B	M	N	L	d				
25 R	8	CA 25-2 M 8	6,8	14,0	10	11	113,5	8,4	200/50	B35-500 HT 51 RH 50 B 51 B 55 HT 81-J RHU 81 HT 120 and tools and heads with 130 kN crimping force ECM-H3D RHU 520		
	12	CA 25-2 M 12	6,8	21,0	16	14	122,5	13,2	150/50			
30 RC/S ÷ 40 S	12	CA 40 S-2 M 12	8,2	21,5	16	14	123,5	13,2	100/50			
50 RC	12	CA 50 R-2 M 12	8,7	20,5	16	14	123,5	13,2	100/50			
50 S	12	CA 50 S-2 M 12	9,5	21,0	16	14	123,5	13,2	100/50			
63 S ÷ 70 S	12	CA 70 S-2 M 12	11,0	27,0	16	14	127,7	13,2	50/25			
80 S ÷ 95 RC	14	CA 95 R-2 M 14	12,0	28,0	18	16	139,5	15,0	30/15			
95 S ÷ 100 S	14	CA 95 S-2 M 14	13,5	29,0	18	16	139,5	15,0	30/15			
120 RC/S ÷ 150 RC	14	CA 150 R-2 M 14	15,0	31,0	18	16	145,5	15,0	30/15			
150 S ÷ 160 RC	14	CA 150 S-2 M 14	16,5	32,0	18	16	145,5	15,0	30/15			
160 S ÷ 200 RC	14	CA 200 R-2 M 14	17,0	32,5	18	16	145,0	15,0	30/15			
200 S ÷ 240 RC	14	CA 240 R-2 M 14	19,2	43,0	18	16	151,5	15,0	15/5			
240 S ÷ 315 RC	14	CA 315 R-2 M 14	21,5	43,0	18	16	149,5	15,0	20/5			
315 S	14	CA 315 S-2 M 14	23,7	44,0	18	16	149,5	15,0	20/5			
400 R	12	2 A 80-2 M 12	27,0	51,0	20	14	177,5	13,2	15/5			
	14	2 A 80-2 M 14	27,0	51,0	22	16	181,5	15,0	15/5			
	16	2 A 80-2 M 16	27,0	51,0	22	19	184,5	17,0	15/5			
500 R	14	2 A 100-2 M 14	30,3	56,5	22	16	182,5	15,0	10/5			
	16	2 A 100-2 M 16	30,3	56,5	22	19	185,5	17,0	10/5			
600 R ÷ 630 R	14	2 A 120-2 M 14	33,4	61,5	22	16	200,5	15,0	15/5			
	16	2 A 120-2 M 16	33,4	61,5	22	19	202,5	17,0	15/5			

R = Round conductors RC = Round Compact conductors S = Sector shaped conductors

CA-2M and 2A-2M Copper Tube Terminal Lugs are designed for high voltage applications up to 33kV. Manufactured from high purity copper tube, annealed and tin-plated. The extended barrel enhances electrical and mechanical performance.

The absence of an inspection hole prevents moisture entry into the crimped joint.

Featuring an extended palm with two fixing holes at 44.5 mm centres.

Details of the appropriate crimping tools and dies are shown on page 194.

HIGH VOLTAGE TERMINALS

two hole fixing

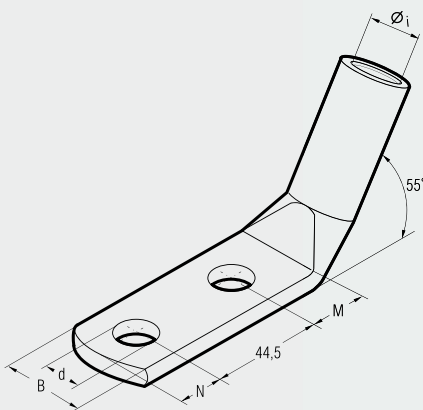

2A-2M/55°



Conductor Size sqmm	Ø Stud mm	Ref.	Dimensions mm						Quantity Box/Bag	Hydraulic Tools		
			Øi	B	M	N	d					
400 R	14	2 A 80 - 2 M 14/55°	27,0	51,0	22	16	15	10/5	HT 120 and tools and heads with 130 kN crimping force ECM-H3D RHU 520			
600 R ÷ 630 R	14	2 A 120 - 2 M 14/55°	33,4	61,5	22	16	15	15/3				

R = Round conductors

The 2A-2M/55° Copper Tube Terminal Lugs have the same characteristics as the CA-2M and 2A-2M ranges, with the additional feature of the palm bent at 55°.

Details of the appropriate crimping tools and dies are shown on page 194.

HIGH VOLTAGE STALK CONNECTORS

MT-C

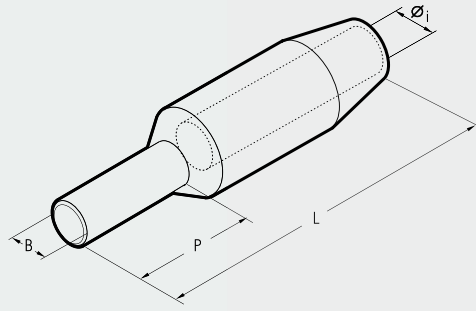

MT-C series connectors are designed for high voltage applications up to 33 kV. They are manufactured from high purity copper, annealed and tin plated. The extended barrel enhances both electrical and mechanical performance. The stalk or pin makes these connectors ideal for terminating conductors into contact blocks. Details of the appropriate crimping tools and dies are shown on page 194.

Conductor Size sqmm	Ref.	Dimensions mm				Quantity Box/Bag	Hydraulic Tools										
		Øi	B	P	L												
25 R	MT 25-C 8	6,8	8	35	80	90/3	B35-50D	HT 51	RH 50	B 51	B 55	RHU 81	HT 81-U	RHU 81	HT 120 and tools and heads with 130 kN crimping force	ECW-H3D	RHU 52D
30 RC/S ÷ 40 S	MT 40 S-C 8	8,2	8	35	80	90/3											
	MT 40 S-C 10	8,2	10	35	80	90/3											
	MT 40 S-C 14-80	8,2	14	80	123	30/3											
50 RC	MT 50 R-C 8	8,8	8	35	80	90/3											
	MT 50 R-C 10	8,8	10	35	80	90/3											
	MT 50 S-C 8	9,5	8	35	80	90/3											
50 S	MT 50 S-C 10	9,5	10	35	80	90/3											
	MT 50 S-C 14-80	9,5	14	80	123	30/3											
	63 S ÷ 70 S	MT 70 S-C 10	11,2	10	35	90											
80 S ÷ 95 RC	MT 95 R-C 10	12,0	10	45	110	60/3											
	MT 95 R-C 12	12,0	12	45	110	60/3											
	MT 95 S-C 10	13,5	10	45	110	60/3											
95 S ÷ 100 S	MT 95 S-C 12	13,5	12	45	110	60/3											
	MT 95 S-C 14-80	13,5	14	80	145	60/3											
	120 RC/S ÷ 150 RC	MT 150 R-C 12	15,0	12	45	110											
150 S ÷ 160 RC	MT 150 R-C 16	15,0	16	45	110	30/3											
	MT 150 S-C 12	16,5	12	45	110	60/3											
	MT 150 S-C 14-80	16,5	14	80	145	45/3											
160 S ÷ 200 RC	MT 150 S-C 16	16,5	16	45	110	60/3											
	MT 200 R-C 10	17,0	10	45	110	30/3											
	MT 200 R-C 16	17,0	16	45	110	30/3											
200 S ÷ 240 RC	MT 240 R-C 12	19,5	12	50	115	30/3											
	MT 240 R-C 16	19,5	16	50	115	30/3											
240 S ÷ 315 RC	MT 315 R-C 16	21,5	16	50	115	30/3											
	MT 315 S-C 16	24,0	16	60	130	30/3											

R = Round conductors RC = Round Compact conductors S = Sector shaped conductors

HIGH VOLTAGE COPPER THROUGH CONNECTORS

MT-TD MT-GC

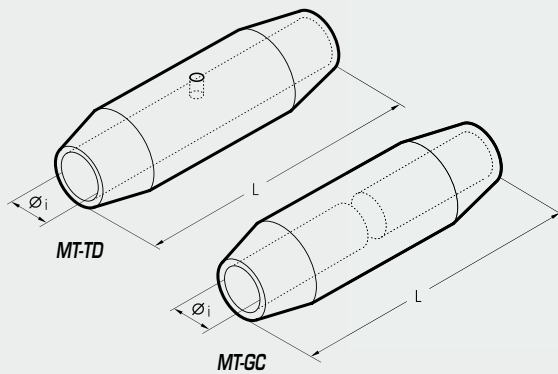

Conductor Size sqmm	Ref.	Ref.	Dimensions mm		Quantity Box/Bag	Hydraulic Tools				
			øi	L		B35-50D	B35-50D	B51	B55	
25 R	MT 25-TD	MT 25-GC	6,8	60	90/3	HT 51 RH 50	RHU 81	HT 120 and tools and heads with 130 kN crimping force	ECW-H3D	RHU 520
30 RC/S ÷ 40 S	MT 40 S-TD	MT 40 S-GC	8,2	60	90/3					
50 RC	MT 50 R-TD	MT 50 R-GC	8,7	60	90/3					
50 S	MT 50 S-TD	MT 50 S-GC	9,5	60	90/3					
63 S ÷ 70 S	MT 70 S-TD	MT 70 S-GC	11,0	70	30/3					
80 S ÷ 95 RC	MT 95 R-TD	MT 95 R-GC	12,0	80	30/3					
95 S ÷ 100 S	MT 95 S-TD	MT 95 S-GC	13,5	80	30/3					
120 RC/S ÷ 150 RC	MT 150 R-TD	MT 150 R-GC	15,0	80	30/3					
150 S ÷ 160 RC	MT 150 S-TD	MT 150 S-GC	16,5	80	30/3					
160 S ÷ 200 RC	MT 200 R-TD	MT 200 R-GC	17,0	100	30/3					
200 S ÷ 240 RC	MT 240 R-TD	MT 240 R-GC	19,2	100	30/3					
240 S ÷ 315 RC	MT 315 R-TD	MT 315 R-GC	21,5	100	30/3					
315 S	MT 315 S-TD	MT 315 S-GC	23,7	100	30/3					
400 R	MT 400-TD		27,0	120	15/3					
500 R	MT 500-TD		30,3	118	15/3					
600 R ÷ 630 R	MT 630-TD		33,4	130	9/3					

R = Round conductors RC = Round Compact conductors S = Sector shaped conductors

MT-TD and MT-GC series connectors are designed to join conductors in high voltage applications up to 33 kV.

They are manufactured from high purity copper, annealed and tin plated.

MT-GC series feature a solid stop which forms a barrier between the two conductors being joined, this prevents the migration of oils or greases, which may be present, in one cable contaminating the other cable.

MT-TD connectors are unblocked and are suitable for joining cables of the same type.

Details of the appropriate crimping tools and dies are shown on page 194.

ALUMINIUM TERMINALS

AA-M

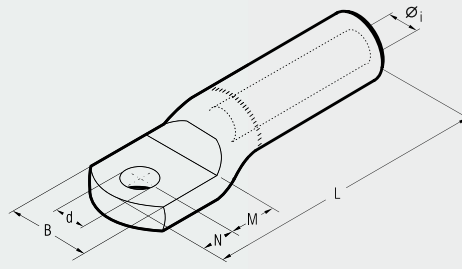

AA-M series terminals are made from aluminium of a purity equal to or greater than 99,5%.

They are designed to accept a variety of conductor forms especially low stranded compacted conductors.

Non circular conductors may require pre-rounding prior to introduction to the terminal.

Barrels are capped and filled with grease so as to avoid oxidation of the aluminium.

Details of the appropriate crimping tools and dies are shown on page 195.

Conductor Size sqmm	Ø Stud mm	Ref.	Dimensions mm						Quantity Box/Bag	Hydraulic Tools	
			Øi	B	M	N	L	d			
16	8	AA 16-M 8	5,5	21	13	11	77,0	8,4	60/3	HT 131-JUC RHU 131-C B 131-JUC	
25	8	AA 25-M 8	6,5	21	13	11	77,0	8,4	60/3		
35	8	AA 35-M 8	8,0	23	13	11	77,5	8,4	60/3		
	10	AA 35-M 10	8,0	23	13	11	77,5	10,5	60/3		
50	12	AA 50-M 12	9,0	26	16	14	91	13,2	60/3		
	14	AA 50-M 14	9,0	26	18	16	95	15,0	60/3		
70	12	AA 70-M 12	11,0	27	16	14	91	13,2	45/3		
	14	AA 70-M 14	11,0	27	18	16	95	15,0	45/3		
95	12	AA 95-M 12	12,5	27	16	14	91	13,2	45/3		
	14	AA 95-M 14	12,5	27	18	16	95	15,0	45/3		
120	12	AA 120-M 12	13,7	35	16	14	115	13,2	30/3		
	14	AA 120-M 14	13,7	35	18	16	119	15,0	30/3		
150	12	AA 150-M 12	15,5	34	16	14	115	13,2	30/3		
	14	AA 150-M 14	15,5	34	18	16	119	15,0	30/3		
185	12	AA 185-M 12	17,0	42	20	14	122	13,2	18/3		
	14	AA 185-M 14	17,0	42	22	16	126	15,0	18/3		
240	12	AA 240-M 12	19,5	44	20	14	122	13,2	15/3		
	14	AA 240-M 14	19,5	44	22	16	126	15,0	15/3		
300	12	AA 300-34 M 12	22,5	47	22	14	130	13,2	15/3	HT120 HT131-C RHC 131	ECW-H3D
	14	AA 300-34 M 14	22,5	47	22	16	132	15,0	15/3		
	16	AA 300-34 M 16	22,5	47	22	17	133	17,0	15/3		
400	16	AA 400-M 16	23,3	49	19	17	172	17,0	12/3	RHU 230-630	
500	16	AA 500-40 M 16	29,1	57	22	19	177	17,0	12/3		
630	16	AA 630-M 16	32,5	70	22	19	177	17,0	9/3		



THROUGH CONNECTORS

for aluminium conductors

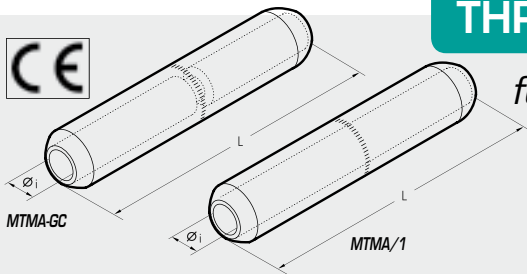

MTMA-GC MTMA/1



Conductor Size sqmm	Ref.	Ref.	Dimensions mm		Quantity Box/Bag	Hydraulic Tools	
			Øi	L			
10	MTMA 10-GC		4,3	90,5	60/3	HT 131-UC RHU 131-C B 131-UC	
16	MTMA 16-GC	MTMA 16/1	5,5	90,5	60/3		
25	MTMA 25-GC	MTMA 25/1	6,5	90,5	60/3		
35	MTMA 35-GC	MTMA 35/1	8,0	90,5	60/3		
	MTMA 35-20-GC		8,0	106,5	30/3		
50	MTMA 50-GC	MTMA 50/1	9,0	106,5	30/3		
70	MTMA 70-GC	MTMA 70/1	11,0	106,5	30/3		
95	MTMA 95-GC		12,5	110,0	30/3		
		MTMA 95/1	12,5	106,5	30/3		
120	MTMA 120-GC	MTMA 120/1	13,7	133,0	30/3		
150	MTMA 150-GC		15,5	135,0	30/3		
		MTMA 150/1	15,5	133,5	30/3		
185	MTMA 185-GC	MTMA 185/1	17,0	143,5	15/3		
240	MTMA 240-GC	MTMA 240/1	19,5	143,5	15/3		
300	MTMAD 300-GC		22,5	144,5	15/3		HT120 HT131-C RHC 131
		MTMAD 300/1	22,5	135,0	15/3		
	MTMA 300-GC		23,3	218,0	15/3		RHU 230-630
		MTMA 400/1	26,0	218,0	15/3		
400	MTMA 500-GC		29,1	218,5	15/3		
500		MTMA 500-40/1	29,1	218,0	12/3		
630		MTMA 630/1	32,5	218,5	12/3		

MTMA-GC series through connectors are made from aluminium of a purity equal to or greater than 99,5%. They feature a solid stop which creates a barrier between the two sides of conductors to be joined. Barrels are capped and filled with grease so as to avoid oxidation of the connector. MTMA/1 series through connectors are unblocked and are suitable for joining cables of the same type. Details of the appropriate crimping tools and dies are shown on pages 196-197.

REDUCER THROUGH CONNECTORS

for aluminium or copper conductors

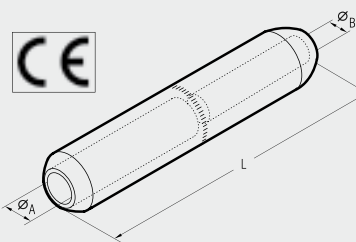

MTMA-GC



Conductor Size sqmm	Side A Al	Side B Al/Cu	Ref.	Dimensions mm			Quantity Box/Bag	Hydraulic Tools	
				ØA	ØB	L			
16	10	10	MTMA 16-10-GC	5,5	4,3	90,5	60/3	HT 131-UC RHU 131-C B 131-UC	
		16	MTMA 16-16-GC	5,5	5,5	90,5	60/3		
25	16	25	MTMA 25-16-GC	6,5	5,5	90,5	60/3		
		25	MTMA 25-25-GC	6,5	6,5	90,5	60/3		
50	25	35	MTMA 50-35-GC	9,0	6,5	106,5	30/3		
		35	MTMA 50-35-GC	9,0	8,0	106,5	30/3		
70	35	50	MTMA 70-50-GC	11,0	8,0	106,5	30/3		
		50	MTMA 70-50-GC	11,0	9,0	106,5	30/3		
95	50	70	MTMA 95-70-GC	12,5	9,0	109,4	30/3		
		70	MTMA 95-70-GC	12,5	11,0	106,5	30/3		
120	70	95	MTMA 120-95-GC	13,7	11,0	133,0	30/3		
		95	MTMA 120-95-GC	13,7	12,5	133,0	30/3		
150	70	95	MTMA 150-70-GC	15,5	11,0	133,0	30/3		
		95	MTMA 150-95-GC	15,5	12,5	134,4	30/3		
185	120	120	MTMA 150-120-GC	15,5	13,7	133,0	30/3		
		120	MTMA 185-120-GC	17,0	13,7	143,5	15/3		
240	150	150	MTMA 185-150-GC	17,0	15,5	143,5	15/3		
		150	MTMA 240-150-GC	19,5	15,5	143,5	15/3		
300	185	185	MTMA 240-185-GC	19,5	17,0	143,5	15/3		
		95	MTMAD 300-95-GC	22,5	12,5	144,5	15/3	HT120 HT131-C RHC 131	
	150	MTMAD 300-150-GC	22,5	15,5	144,5	15/3	ECW-H3D		
	185	MTMAD 300-185-GC	22,5	17,0	144,5	15/3		RHU 230-630	
	240	MTMAD 300-240-GC	22,5	19,5	144,5	15/3			
400	240	240	MTMA 400-240-GC	26,0	19,5	218,0	15/3		
		300	MTMA 400-300-GC	26,0	23,3	218,0	15/3		
500	300	300	MTMA 500-300-GC	29,1	23,3	218,5	12/3		
		400	MTMA 500-400-GC	29,1	26,0	218,5	12/3		

MTMA-GC series reducer through connectors are manufactured to the same specification as MTMA-GC series through connectors. Details of the appropriate crimping tools and dies are shown on pages 196-197.

CAA-M



BIMETALLIC CONNECTORS

copper palm fixing aluminium barrels

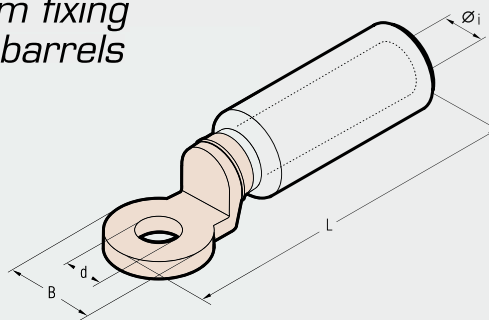

The barrels of series CAA-M connectors are made from aluminium of a purity equal to or greater than 99,5%. The barrel is friction welded to the palm thus achieving the best possible transition between the copper palm and aluminium barrel. Barrels are capped and filled with grease so as to avoid oxidation of the aluminium. Details of the appropriate crimping tools and dies are shown on pages 195, 197.

Conductor Size sqmm	Ø Stud mm	Ref.	Dimensions mm				Quantity Box/Bag	Hydraulic Tools	
			Øi	B	L	d			
10	12	CAA 10-M 12	4,3	24	87,0	13,0	90/3	HT 131-UC RHU 131-C B 131-UC	
16	12	CAA 16-M 12	5,5	24	87,0	13,0	90/3		
25	12	CAA 25-M 12	6,5	24	87,0	13,0	90/3		
35	12	CAA 35-M 12	8,0	24	87,0	13,0	90/3		
	12	CAA 35-20-M 12	8,0	24	87,0	13,0	60/3		
50	12	CAA 50-M 12	9,0	24	87,0	13,0	60/3		
70	12	CAA 70-M 12	11,0	24	87,0	13,0	60/3		
95	12	CAA 95-M 12	12,5	24	87,0	13,0	60/3		
120	12	CAA 120-M 12	13,7	31	111,0	13,0	30/3		
150	12	CAA 150-M 12	15,5	31	111,0	13,0	30/3		
185	12	CAA 185-M 12	17,0	35	116,0	13,0	24/3		
240	12	CAA 240-M 12	19,5	35	116,0	13,0	18/3		
300	12	CAA 300-34 M 12	22,5	35	120,0	13,0	15/3	HT120 HT131C RHC131	
	16	CAA 300-34 M 16	22,5	35	120,0	17,0	15/3		
	16	CAA 300-M 16	23,3	35	152,5	16,5	12/3	ECW-HSD RHU 230-630	
400	16	CAA 400-M 16	26,0	35	152,5	16,5	12/3		
500	16	CAA 500-M 16 TNBD	29,1	35	152,5	16,5	12/3		
630	8	CAA 630-4 M 8	32,5	60	192,0	4 x 9,0*	9/3		

* n° 4 holes with 30 mm as distance between axes

MTA-C



BIMETALLIC CONNECTORS

copper pin aluminium barrels

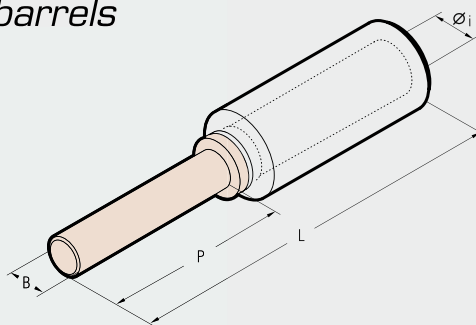

The barrels of series MTA-C connectors are made from aluminium of a purity equal to or greater than 99,5%. The barrel is friction welded to the pin thus achieving the best possible transition between the copper pin and aluminium barrel. Barrels are capped and filled with grease so as to avoid oxidation of the aluminium. Details of the appropriate crimping tools and dies are shown on pages 195, 197.

Conductor Size sqmm	Ref.	Dimensions mm				Quantity Box/Bag	Hydraulic Tools	
		Øi	B	P	L			
16	MTA 16-C	5,5	8	30	82	90/3	HT 131-UC RHU 131-C B 131-UC	
25	MTA 25-C	6,5	8	30	82	90/3		
35	MTA 35-C	8,0	8	30	82	90/3		
50	MTA 50-C	9,0	12	45	97	60/3		
70	MTA 70-C	11,0	12	45	97	60/3		
95	MTA 95-C	12,5	12	45	97	60/3		
120	MTA 120-C	13,7	14	55	125	30/3		
150	MTA 150-C	15,5	14	55	125	30/3		
185	MTA 185-C	17,0	14	55	125	24/3		
240	MTA 240-C	19,5	14	55	125	24/3		

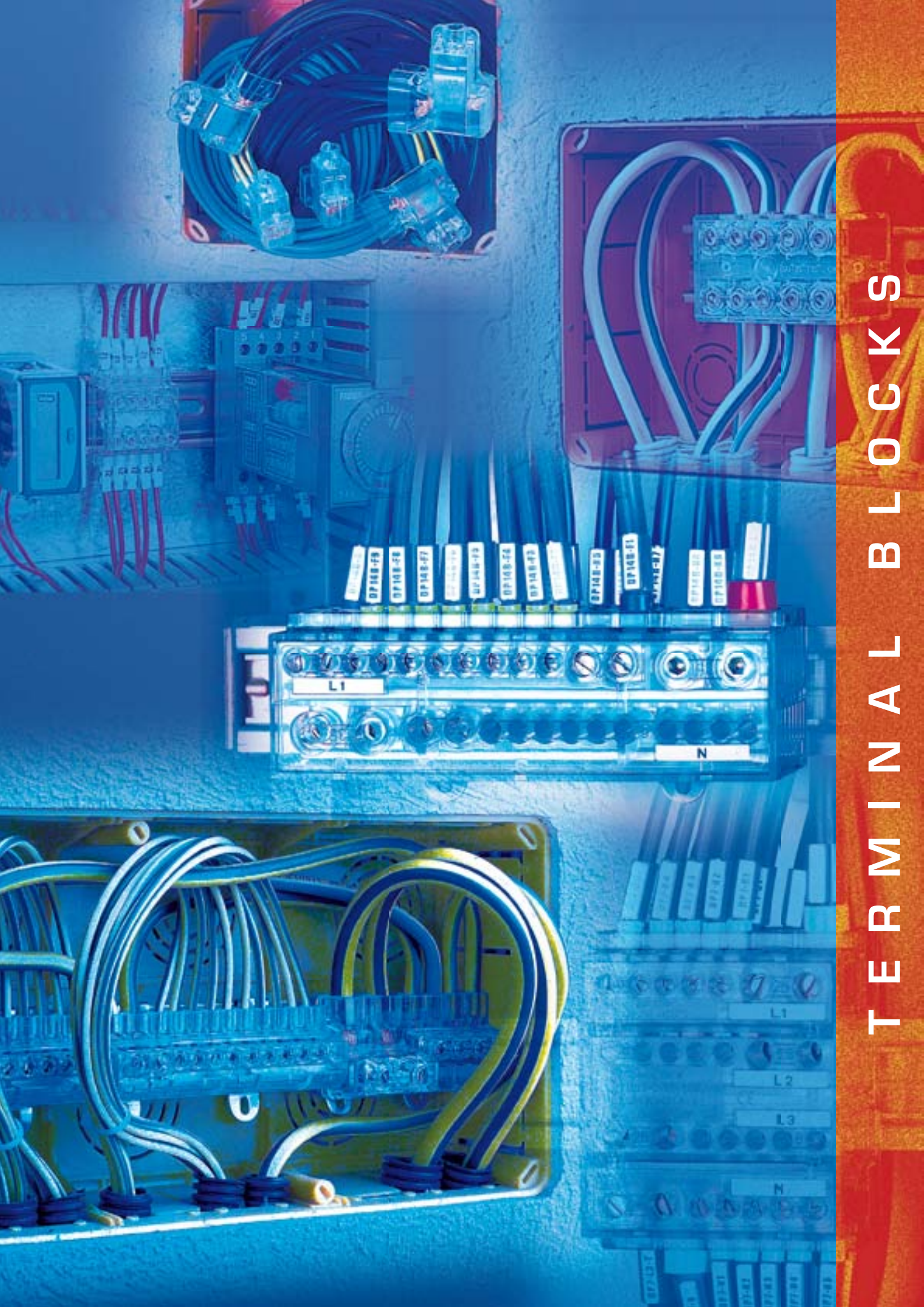

TERMINAL BLOCKS

Z6

SINGLE POLE TERMINAL BLOCKS

indirect clamping
nominal section 6 sqmm



The "Z...D" version has been designed for mounting on DIN rails



3, 5, 6 and 10 way, single pole terminal blocks for conductor section 1 to 6 sqmm. Self contained and robust, they are quick and easy to install for both industrial and domestic use. The indirect clamping of the "ZETA più" terminal blocks guarantees a low and stable contact resistance. Indirect clamping eliminates damage to the conductor strands. The easy-entry receptacles also grant a fast and reliable insertion of the cable.

Ref.	No. of Ways	Connecting Capacity sqmm	Nominal Voltage V	Maximum Operating Temperature °C	Insulation Specification	Self Extinguishing Specification	Dimensions mm	Weight g	Quantity
Z6-3	3	(3 way) 1÷6	450	85	IP 20	V-0 (UL 94)	23x23xh27,5	15	30
Z6-3D							23x40xh36,5	18,5	10
Z6-5	5	(5 way) 1÷6	450	85	IP 20	V-0 (UL 94)	35x23xh27,5	23	20
Z6-5D							35x40xh36,5	26,5	10
Z6-6	6	(6 way) 1÷6	450	85	IP 20	V-0 (UL 94)	23x43xh28,5	26	15
Z6-6D							23x53xh33	31	10
Z6-10	10	(10 way) 1÷6	450	85	IP 20	V-0 (UL 94)	35x43xh28,5	41	10
Z6-10D							35x53xh33	46	15

D= Version with clamp for DIN rail

- Technical features:**
- Self-extinguishing Polycarbonate body
 - Tempered steel clamps
 - Electrolytically tin plated copper connection plate

Z16

SINGLE POLE TERMINAL BLOCKS

indirect clamping
nominal section 16 sqmm



3, 4, 5, 8 and 12 way, single pole terminal blocks. Ideal for use as an equipotential bonding connector for both industrial and domestic use.

Ref.	No. of Ways	Connecting Capacity sqmm	Nominal Voltage V	Maximum Operating Temperature °C	Insulation Specification	Self Extinguishing Specification	Dimensions mm	Weight g	Quantity
Z16-3	3	16	450	85	IP 20	V-0 (UL 94)	38x31,3xh38	52	20
Z16-3D							38x50xh44	55,5	15
Z16-4	4	16	450	85	IP 20	V-0 (UL 94)	27x54xh37	50	15
Z16-4D							27x58xh43	54	10
Z16-5N	5	16	450	85	IP 20	V-0 (UL 94)	61x31,5xh38	64,5	10
Z16-5ND							61x50xh44	68	4
Z16-8	8	(2 way) 16 + (6 way) 6	450	85	IP 20	V-0 (UL 94)	35,5x50xh36,5	50	15
Z16-8D							35,5x57xh42	56	10
Z16-12	12	(2 way) 16 + (10 way) 6	450	85	IP 20	V-0 (UL 94)	104,5x32,5xh36,5	115	8
Z16-12D							104,5x50xh42	125	5

D= Version with clamp for DIN rail



SINGLE POLE TERMINAL BLOCKS

indirect clamping
nominal section 35 sqmm

Z35



Z35-3



Z35-4



Z35-6

Ref.	No. of Ways	Connecting Capacity sqmm	Nominal Voltage V	Maximum Operating Temperature °C	Insulation Specification	Self Extinguishing Specification	Dimensions mm	Weight g	Quantity
Z35-3	3	35	450	85	IP 20	V-0 (UL 94)	53x48,5xh42	110	10
Z35-3D							53x50xh48	114	5
Z35-4	4	35	450	85	IP 20	V-0 (UL 94)	37x85xh42	129	5
Z35-4D							37x85xh48	133	5
Z35-6	6	(2 way) 35 +	450	85	IP 20	V-0 (UL 94)	83x41xh43	130	8
Z35-6D	(2+4)	(4 way) 16					83x49xh52	140	5

D= Version with clamp for DIN rail

3, 4 and 6 way, single pole terminal blocks. Ideal for use as an equipotential bonding connector for both industrial and domestic use.



SINGLE POLE TERMINAL BLOCKS

indirect clamping
for earthing applications 

Z35 Z50



Z50-10D



Z35T-11
Z35T-11D



Z35-26D













Ref.	No. of Ways	Connecting Capacity sqmm	Maximum Operating Temperature °C	Self Extinguishing Specification	Dimensions mm	Weight g	Quantity
Z35T-11	11	(1 way) 35 +	85	V-0 (UL 94)	58x43xh42	70	10
Z35T-11D	(1+10)	(10 way) 6			58x53xh47	75	
Z35-26D	26	(2 way) 35 +	85	V-0 (UL 94)	151x52xh48	379	4
	(2+24)	(24 way) 10					
Z50-10D	10	(2 way) 50 +	85	V-0 (UL 94)	77,5x55xh49	320	6
	(2+8)	(8 way) 25					

D= Version with clamp for DIN rail

10, 11 and 26 way, single pole terminal blocks. Ideal for use as an equipotential bonding connector for both industrial and domestic use.

CONNECTING CAPACITY OF TERMINAL BLOCKS

TERMINAL BLOCKS TYPE "ZETA più"









TYPE		NOMINAL SECTION	No. OF WAYS X NOMINAL SECTION	CONNECTING CAPACITY OF EACH WAY* No. of Conductors x Section	MARKINGS
Z6-3	Z6-3D	6 ²	3 x 6 ²	1 x 6 ² R/F	   
Z6-5	Z6-5D	6 ²	5 x 6 ²	1 x 4 ² R/F	
Z6-6	Z6-6D	6 ²	6 x 6 ²	1÷2 x 2,5 ² R/F	
Z6-10	Z6-10D	6 ²	10 x 6 ²	1÷2 x 1,5 ² R/F 1÷4 x 1 ² R/F	
Z16-3	Z16-3D	16 ²	3 x 16 ²	1 x 16 ² R/F 1 x 10 ² R/F 1÷2 x 6 ² R/F 1÷3 x 4 ² R/F 1÷4 x 2,5 ² R/F 1÷8 x 1,5 ² R/F	   
Z16-4	Z16-4D	16 ²	4 x 16 ²	1 x 16 ² F 1 x 10 ² F 1÷2 x 6 ² F 1÷3 x 4 ² F 1÷4 x 2,5 ² F 1÷8 x 1,5 ² F	
Z16-5N	Z16-5ND	16 ²	5 x 16 ²	1 x 16 ² R/F 1 x 10 ² R/F 1÷2 x 6 ² R/F 1÷3 x 4 ² R/F 1÷4 x 2,5 ² R/F 1÷8 x 1,5 ² R/F	 
Z16-8	Z16-8D	16 ² /6 ²	2 x 16 ²	1 x 16 ² R/F 1 x 10 ² R/F 1÷2 x 6 ² R/F 1÷3 x 4 ² R/F 1÷4 x 2,5 ² R/F 1÷8 x 1,5 ² R/F	
Z16-12	Z16-12D	16 ² /6 ²	2 x 16 ²	1 x 16 ² F 1 x 10 ² F 1÷2 x 6 ² F 1÷3 x 4 ² F 1÷4 x 2,5 ² F	 
			10 x 6 ²	1 x 6 ² F 1 x 4 ² F 1÷2 x 2,5 ² F 1÷2 x 1,5 ² F 1÷4 x 1 ² F	

*Various cable sizes may be connected to the terminal block provided that the sum of cable sections is less than the nominal section.

R = Rigid cable F = Flexible cable

CONNECTING CAPACITY OF TERMINAL BLOCKS

TERMINAL BLOCKS TYPE "ZETA più"

TYPE	NOMINAL SECTION	No. OF WAYS X NOMINAL SECTION	CONNECTING CAPACITY OF EACH WAY* No. of Conductors x Section	MARKINGS
Z35-3 Z35-3D	35 ²	3 x 35 ²	1 x 35 ² R/F 1 x 25 ² R/F 1÷2 x 16 ² R/F 1÷3 x 10 ² R/F 1÷5 x 6 ² R/F	CE 
Z35-4 Z35-4D	35 ²	4 x 35 ²	1 x 35 ² F 1 x 25 ² F 1÷2 x 16 ² F 1÷3 x 10 ² F 1÷6 x 6 ² F	CE 
Z35-6 Z35-6D	35 ² /16 ²	2 x 35 ²	1 x 35 ² R/F 1 x 25 ² R/F 1÷2 x 16 ² R/F 1÷3 x 10 ² R/F 1÷6 x 6 ² F	CE   
		4 x 16 ²	1 x 16 ² R/F 1 x 10 ² R/F 1÷2 x 6 ² R/F 1÷3 x 4 ² R/F 1÷5 x 2,5 ² F	
Z35T-11 Z35T-11D	35 ² /6 ²	1 x 35 ²	1 x 35 ² R/F 1 x 25 ² R/F 1 x 16 ² R/F 1 x 10 ² R/F	CE 
		10 x 6 ²	1 x 6 ² R/F 1 x 4 ² R/F 1÷2 x 2,5 ² R/F 1÷2 x 1,5 ² R/F 1÷4 x 1 ² R/F	
Z35-26D	35 ² /10 ²	2 x 35 ²	1 x 35 ² R/F 1 x 25 ² R/F 1÷2 x 16 ² R/F 1÷3 x 10 ² R/F 1÷6 x 6 ² R/F	CE   
		24 x 10 ²	1 x 10 ² R/F 1 x 6 ² R/F 1÷2 x 4 ² R/F 1÷4 x 2,5 ² R/F	
Z50-10D	50 ² /25 ²	2 x 50 ²	1 x 50 ² R/F 1 x 35 ² R/F 1÷2 x 25 ² R/F 1÷4 x 16 ² R/F	CE ** 
		8 x 25 ²	1 x 25 ² R/F 1÷2 x 16 ² R/F 1÷3 x 10 ² R/F 1÷6 x 6 ² R/F 1÷9 x 4 ² R/F	

*Various cable sizes may be connected to the terminal block provided that the sum of cable sections is less than the nominal section.

R = Rigid cable F = Flexible cable

MARKINGS:



Istituto italiano del Marchio di Qualità type approval



Lloyd's Register of Shipping type approval



Registro Italiano Navale type approval



** EN 60947-7-1: 2002

CONFORM TO:

Directives 2006/95/CE

EN 60998-1: 2004 and
EN 60998-2-1: 2004 Norms

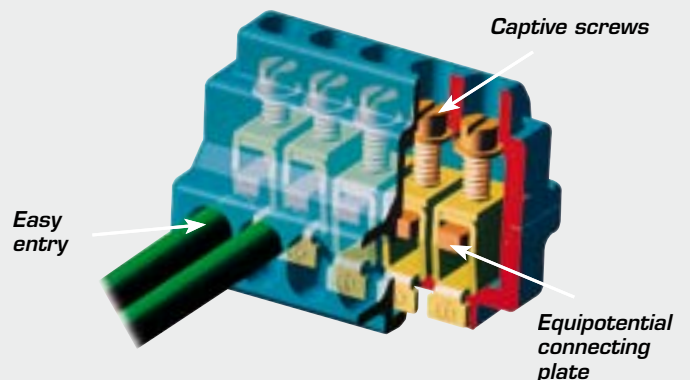

Z-DP

POWER DISTRIBUTION BLOCK

indirect clamping

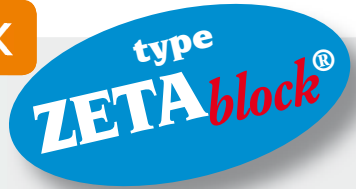

FOUR POLE
100 A

TWO POLE
125 A



Z 25-DP7-100



Z 35-DP14B-125



Z 35-DP14-125



Z 50-DP12-160

FOUR POLE
125 A

FOUR POLE
160 A

100, 125 and 160A, 2-4 pole distribution blocks with 7, 14 and 12 ways per pole respectively.

Accepting a wide cable CSA range (1 - 50 sqmm) and of compact size, ZETA blocks are ideal for control cabinets and distribution panels.

The lateral arrangement of terminals on upper and lower faces (Z35-DP14B one face only), simplifies connection and promotes tidy, homogeneous cable routing to assist subsequent wiring operations.

Easy entry apertures provide quick, effective cable insertion while the indirect clamping feature eliminates damage to cable strands and assures a low, stable contact resistance.

Ref.	No. of poles	No. of Ways per pole	Nominal CSA for each pole sqmm	Maximum operating voltage Ui	Impulse voltage Uimp	Maximum operating current In	Allowable short duration fault current Icw	Maximum allowed peak fault current Ipk	Self Extinguishing Specification	Dimensions mm	Weight g	Qty
Z 25-DP7-100	4	7 (2+5)	(2 way) 25 + (5 way) 6	800 V	8 kV	100 A	3 kA	18 kA	V-0 (UL 94)	70x84xh45	290	2
Z 35-DP14-125	4	14 (2+2+10)	(2 way) 35 + (2 way) 16 + (10 way) 6	800 V	8 kV	125 A	4,2 kA	18 kA	V-0 (UL 94)	137x83xh46	700	1
Z 35-DP14B-125	2	14 (2+2+10)	(2 way) 35 + (2 way) 16 + (10 way) 6	800 V	8 kV	125 A	4,2 kA	18 kA	V-0 (UL 94)	137x44xh46	360	2
Z 50-DP12-160	4	12 (2+4+6)	(2 way) 50 + (4 way) 25 + (6 way) 16	800 V	8 kV	160 A	6 kA	18 kA	V-0 (UL 94)	150x84xh48	780	1

Technical features:

- Self extinguishing antishock Polycarbonate body
- Tempered steel captive clamping screws and plates
- Electrolytically tin plated copper connection plate

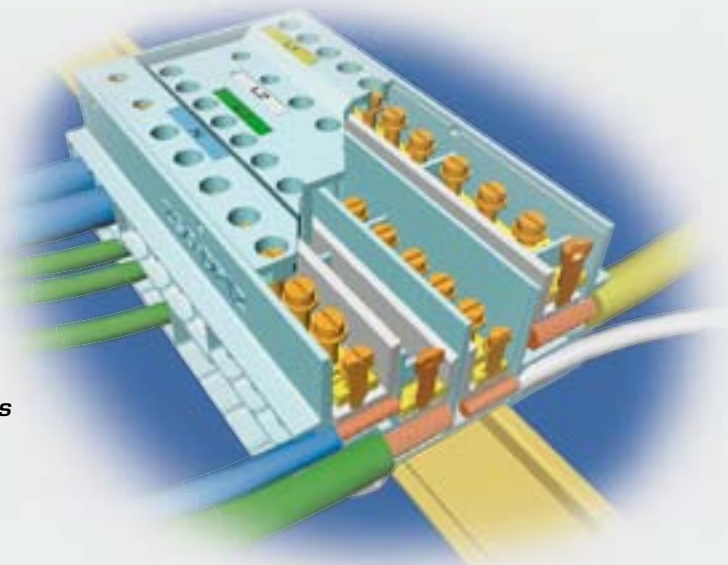

type
ZETAblock®

POWER DISTRIBUTION BLOCK







indirect clamping

Z-DP



CONNECTING CAPACITY OF POWER DISTRIBUTION BLOCK

POWER DISTRIBUTION BLOCK TYPE "ZETAblock"

TYPE	NOMINAL SECTION	No. OF WAYS x NOMINAL SECTION	CONNECTING CAPACITY OF EACH WAY No. of Conductors x Section	MARKINGS
Z25-DP7-100	25 ² /6 ²	2 x 25 ²	1 x 25 ² F 1 x 16 ² F 1÷2 x 10 ² F	  25-6 apmm
		5 x 6 ²	1 x 6 ² F 1 x 4 ² F 1÷2 x 2,5 ² F 1÷2 x 1,5 ² F 1÷4 x 1 ² F	
Z35-DP14-125 Z35-DP14B-125	35 ² /16 ² /6 ²	2 x 35 ²	1 x 35 ² F 1 x 25 ² F 1÷2 x 16 ² F 1÷3 x 10 ² F	  25-16-6 apmm
		2 x 16 ²	1 x 16 ² F 1 x 10 ² F 1÷2 x 6 ² F 1÷3 x 4 ² F 1÷4 x 2,5 ² F	
		10 x 6 ²	1 x 6 ² F 1 x 4 ² F 1÷2 x 2,5 ² F 1÷2 x 1,5 ² F 1÷4 x 1 ² F	
Z50-DP12-160	50 ² /25 ² /16 ²	2 x 50 ²	1 x 50 ² F 1 x 35 ² F 1÷2 x 25 ² F	  50-25-16 apmm
		4 x 25 ²	1 x 25 ² F 1 x 16 ² F 1÷2 x 10 ² F	
		6 x 16 ²	1 x 16 ² F 1 x 10 ² F 1÷2 x 6 ² F	

F = Flexible cable

MARKINGS:



Istituto italiano del Marchio
di Qualità type approval

CONFORM TO:

Directives 2006/95/CE

EN 60947-7-1: 2002 Norms

ONE WAY TERMINAL BLOCKS



Z-1

indirect clamping



Ref.	Connecting Capacity sqmm	Nominal Voltage V	Maximum Operating Temperature °C	Insulation Specification	Self Extinguishing Specification	Dimensions mm	Weight g	Quantity Box/Bag
Z2.5-1	2,5	450	85	IP 20	V-0 (UL 94)	7,6x20xh23,5	3	500/25
Z6-1	6					11,5x28xh29	6	250/25
Z10-1	10					15,6x32xh32,5	11	100/10
Z16-1	16					18x34xh38	15	100/10
Z25-1	25					20,8x42,5xh43,5	29	50/10
Z35-1	35					25x45xh51,5	37	40/10

One way, single pole terminal blocks for conductors sections from 0.5 to 35 sqmm. Self contained and robust, they are ideal for the fast and safe installation for industrial and domestic applications.

The indirect clamping of the "ZETAmini" terminal blocks guarantees a low and stable contact resistance.

The easy-entry receptacle also grants a fast and reliable insertion of the cable.

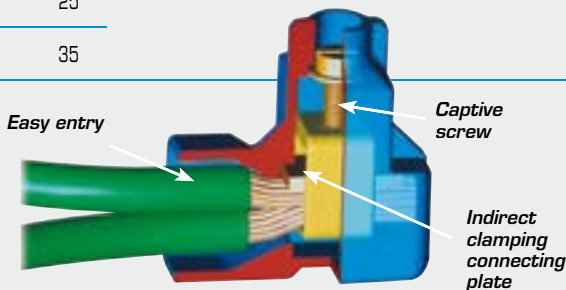

Technical features:

- Self-extinguishing Polycarbonate body
- Electrolytically zinc plated, tempered steel clamp and screw

- Electrolytically tin plated steel connection plate

CONNECTING CAPACITY OF TERMINAL BLOCKS

TYPE	NOMINAL SECTION	CONNECTING CAPACITY *		MARKINGS
		No. of Conductors x Section		
Z2.5-1	2,5 ²	2 x 2,5 ² R/F 2÷3 x 1,5 ² R/F 2÷5 x 1,0 ² R/F	2÷6 x 0,75 ² R/F 2÷10 x 0,5 ² R/F 2÷18 x Ø0,4÷0,6 mm communication type wire	CE, Lloyd's Register, Registro Italiano Navale, IEC, UL, T 85°C P 20
Z6-1	6 ²	2 x 6 ² R/F 2÷3 x 4 ² R/F 2÷4 x 2,5 ² R/F 2÷6 x 1,5 ² R/F 2÷6 x 1 ² R/F	2÷10 x 0,75 ² R/F 2÷12 x 0,5 ² R/F (1 x 6 ²) + (4 x 1,5 ²) (1 x 6 ²) + (2 x 2,5 ²)	CE, Lloyd's Register, Registro Italiano Navale, IEC, UL, T 85°C P 20
Z10-1	10 ²	2 x 10 ² R/F 2÷3 x 6 ² R/F 2÷5 x 4 ² R/F 2÷8 x 2,5 ² R/F (1 x 6 ²) + (1 x 4 ²) + (2 x 2,5 ²) + (3 x 1,5 ²)	2÷12 x 1,5 ² R/F 2÷20 x 1 ² R/F 2÷25 x 0,75 ² R/F	CE, Lloyd's Register, Registro Italiano Navale, IEC, UL, T 85°C P 20
Z16-1	16 ²	2 x 16 ² R/F 2÷3 x 10 ² R/F 2÷5 x 6 ² R/F	2÷8 x 4 ² R/F 2÷12 x 2,5 ² R/F 2÷18 x 1,5 ² R/F	CE, Lloyd's Register, Registro Italiano Navale, IEC, UL, T 85°C P 20
Z25-1	25 ²	2 x 25 ² R/F 2÷3 x 16 ² R/F 2÷4 x 10 ² R/F	2÷8 x 6 ² R/F 2÷11 x 4 ² R/F 4÷16 x 2,5 ² R/F	CE, Lloyd's Register, Registro Italiano Navale, IEC, UL, T 85°C P 20
Z35-1	35 ²	2 x 35 ² R/F 2÷3 x 25 ² R/F 2÷4 x 16 ² R/F 2÷7 x 10 ² R/F	2÷11 x 6 ² R/F 4÷17 x 4 ² R/F 5÷28 x 2,5 ² R/F	CE, Lloyd's Register, Registro Italiano Navale, IEC, UL, T 85°C P 20

*Various cable sizes may be connected to the terminal block provided that the sum of cable sections is less than twice the nominal section.

R = Rigid cable F = Flexible cable

MARKINGS:

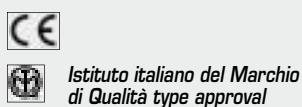

CONFORM TO:

Directives 2006/95/CE
EN 60998-1: 2004 and
EN 60998-2-1: 2004 Norms



CABLE GLANDS AND ACCESSORIES

MAXIblock® CABLE GLANDS

Polyamide PA6.6

1900



Material: POLYAMIDE PA6.6
self-extinguishing class V2 (UL 94)
Temperature range:
-20°C to +90°C (continuous)
Sealing ring: NEOPRENE® 50 sh A
Protection: IP 68
Colour: RAL 7035 light grey,
RAL 9005 black, RAL 7001 dark
grey

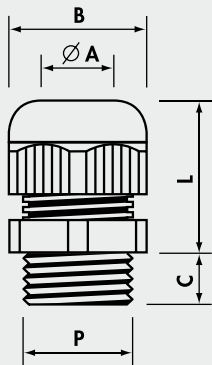

MAXIblock® standard

Metric thread M 1.5 pitch CEI EN 60423 CEI EN 50262

Ref. Light Grey	P	Fixing Hole Ø (mm)	Ø A min-max (mm)	B Spanner (mm)	C (mm)	L min-max (mm)	Quantity
1900.M12	M12X1,5	12,5	3,5- 7	15	8	18-22	100
1900.M16	M16X1,5	16,5	5 -10	19	8	22-27	100
1900.M20	M20X1,5	20,5	7 -13	25	9	24-30	100
1900.M25	M25X1,5	25,5	10 -17	30	10	28-39	50
1900.M32	M32X1,5	32,5	13 -21	36	10	33-44	25
1900.M40	M40X1,5	40,5	19 -28	46	10	36-45	15
1900.M50	M50X1,5	50,5	27 -35	55	12	43-52	10
1900.M63	M63X1,5	63,5	34 -45	66	12	45-55	5

Add to Ref: N for Black, G for Dark Grey

MAXIblock® reduced cable entry

Metric thread M 1.5 pitch CEI EN 60423 CEI EN 50262

Ref. Light Grey	P	Fixing Hole Ø (mm)	Ø A min-max (mm)	B Spanner (mm)	C (mm)	L min-max (mm)	Quantity
1910.M12	M12X1,5	12,5	2- 5	15	8	18-22	100
1910.M16	M16X1,5	16,5	3- 7	19	8	22-27	100
1910.M20	M20X1,5	20,5	5-10	25	9	24-30	100
1910.M25	M25X1,5	25,5	7-13	30	10	28-39	50
1910.M32	M32X1,5	32,5	8-14	36	10	33-44	25
1910.M40	M40X1,5	40,5	15-23	46	10	36-45	15
1910.M50	M50X1,5	50,5	21-29	55	12	43-52	10
1910.M63	M63X1,5	63,5	27-39	66	12	45-55	5

Add to Ref: N for Black, G for Dark Grey

MAXIblock® extended thread

Metric thread M 1.5 pitch CEI EN 60423 CEI EN 50262

Ref. Light Grey	P	Fixing Hole Ø (mm)	Ø A min-max (mm)	B Spanner (mm)	C (mm)	L min-max (mm)	Quantity
1901.M12	M12X1,5	12,5	3,5- 7	15	15	18-22	100
1901.M16	M16X1,5	16,5	5 -10	19	15	22-27	100
1901.M20	M20X1,5	20,5	7 -13	25	15	24-30	50
1901.M25	M25X1,5	25,5	10 -17	30	15	30-41	50
1901.M32	M32X1,5	32,5	13 -21	36	15	33-44	25
1901.M40	M40X1,5	40,5	19 -28	46	18	36-45	15
1901.M50	M50X1,5	50,5	27 -35	55	18	43-52	10
1901.M63	M63X1,5	63,5	34 -45	66	18	45-55	5

Add to Ref: N for Black, G for Dark Grey

MAXIblock® CABLE GLANDS

Polyamide PA6.6

1900

MAXIblock® standard

Pg thread DIN 40 430

Ref. Light Grey	P	Fixing Hole Ø (mm)	Ø A min-max (mm)	B Spanner (mm)	C (mm)	L min-max (mm)	Quantity
1900.07	Pg 7	12,5	3,5- 7	15	8	18-22	100
1900.09	Pg 9	15,5	5 - 8	19	8	22-26	100
1900.11	Pg11	19	5 -10	22	8	23-28	100
1900.13	Pg13,5	20,5	7 -12	24	9	24-29	100
1900.16	Pg16	22,5	10 -14	27	10	26-31	50
1900.21	Pg21	29	13 -18	33	12	30-35	50
1900.29	Pg29	37	18 -25	42	12	33-39	25
1900.36	Pg36	47	20 -32	53	14	42-49	10
1900.42	Pg42	54	28 -38	60	14	42-50	5
1900.48	Pg48	60	37 -45	66	15	45-55	5

Add to Ref: N for Black, G for Dark Grey

MAXIblock® reduced cable entry

Pg thread DIN 40 430

Ref. Light Grey	P	Fixing Hole Ø (mm)	Ø A min-max (mm)	B Spanner (mm)	C (mm)	L min-max (mm)	Quantity
1910.07	Pg 7	12,5	2 - 5	15	8	18-22	100
1910.09	Pg 9	15,5	2 - 6	19	8	22-26	100
1910.11	Pg11	19	4 - 7	22	8	23-28	100
1910.13	Pg13,5	20,5	5 -10	24	9	24-29	100
1910.16	Pg16	22,5	6 -12	27	10	26-31	50
1910.21	Pg21	29	9 -15	33	12	30-35	50
1910.29	Pg29	37	12 -20	42	12	33-39	25
1910.36	Pg36	47	18 -26	53	14	42-49	10
1910.42	Pg42	54	25 -31	60	14	42-50	5
1910.48	Pg48	60	27 -39	66	15	45-55	5

Add to Ref: N for Black

MAXIblock® extended thread

Pg thread DIN 40 430

Ref. Light Grey	P	Fixing Hole Ø (mm)	Ø A min-max (mm)	B Spanner (mm)	C (mm)	L min-max (mm)	Quantity
1901.07	Pg 7	12,5	3,5- 7	15	15	18-22	100
1901.09	Pg 9	15,5	5 - 8	19	15	22-26	100
1901.11	Pg11	19	5 -10	22	15	23-28	100
1901.13	Pg13,5	20,5	7 -12	24	15	24-29	100
1901.16	Pg16	22,5	10 -14	27	15	26-31	50
1901.21	Pg21	29	13 -18	33	15	30-35	50
1901.29	Pg29	37	18 -25	42	15	33-39	25
1901.36	Pg36	47	20 -32	53	18	42-49	10
1901.42	Pg42	54	28 -38	60	18	42-50	5
1901.48	Pg48	60	37 -45	66	18	45-55	5

Add to Ref: N for Black



Material: POLYAMIDE PA6.6
self-extinguishing class V2 (UL 94)
Temperature range:
-20°C to +90°C (continuous)
Sealing ring: NEOPRENE® 50 sh A
Protection: IP 68
Colour: RAL 7035 light grey,
RAL 9005 black, RAL 7001 dark
grey

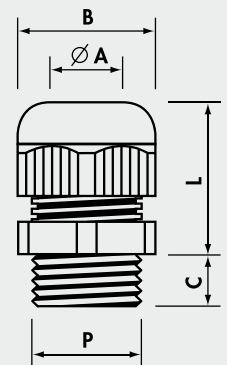

MAXIblock® CABLE GLANDS

Polyamide PA6.6

MAXIblock® standard factory fitted with locknuts with collar

Metric thread M 1.5 pitch CEI EN 60423 CEI EN 50262

1900/X



Material: POLYAMIDE PA6.6
self-extinguishing class V2 (UL 94)
Temperature range:
-20°C to +90°C (continuous)
Sealing ring: NEOPRENE® 50 sh A
Protection: IP 68
Colour: RAL 7035 light grey,



File no. E220310



Ref.	P	Fixing Hole Ø (mm)	Ø A min-max (mm)	B Spanner (mm)	C (mm)	L min-max (mm)	Quantity Box/Bag
1900.M12/X	M12X1,5	12,5	3,5- 7	15	8	18-22	100/10
1900.M16/X	M16X1,5	16,5	5 -10	19	8	22-27	100/10
1900.M20/X	M20X1,5	20,5	7 -13	25	9	24-30	50/10
1900.M25/X	M25X1,5	25,5	10 -17	30	10	28-39	30/10
1900.M32/X	M32X1,5	32,5	13 -21	36	10	33-44	20/10
1900.M40/X	M40X1,5	40,5	19 -28	46	10	36-45	15/5
1900.M50/X	M50X1,5	50,5	27 -35	55	12	43-52	10/5
1900.M63/X	M63X1,5	63,5	34 -45	66	12	45-55	5/5

Pg thread DIN 40 430

Ref.	P	Fixing Hole (mm)	Ø A min-max (mm)	B Spanner (mm)	C (mm)	L min-max (mm)	Quantity Box/Bag
1900.07/X	Pg 7	12,5	3,5- 7	15	8	18-22	100/10
1900.09/X	Pg 9	15,5	5 - 8	19	8	22-26	100/10
1900.11/X	Pg11	19	5 -10	22	8	23-28	100/10
1900.13/X	Pg13,5	20,5	7 -12	24	9	24-29	50/10
1900.16/X	Pg16	22,5	10 -14	27	10	26-31	30/10
1900.21/X	Pg21	29	13 -18	33	12	30-35	20/10
1900.29/X	Pg29	37	18 -25	42	12	33-39	20/10
1900.36/X	Pg36	47	20 -32	53	14	42-49	10/5
1900.42/X	Pg42	54	28 -38	60	14	42-50	5/5
1900.48/X	Pg48	60	37 -45	66	15	45-55	5/5

MAXIblock® standard

BSP thread ISO 228/1

Ref.	P Light	Fixing Hole Ø (mm)	Ø A min-max (mm)	B Spanner (mm)	C (mm)	L min-max (mm)	Quantity
1900.14	G1/4"	13,5	3- 6,5	15	8	18-22	100
1900.38	G3/8"	17	4- 8	19	8	22-26	100
1900.12	G1/2"	21,5	7-12	24	10	24-29	100
1900.34	G3/4"	27	13-18	33	12	30-35	50

Add to Ref: N for Black

MAXIblock® specials

Pg thread DIN 40 430

Ref.	P Light	Fixing Hole Ø (mm)	Ø A min-max (mm)	B Spanner (mm)	C (mm)	L min-max (mm)	Quantity
○*1920.09	Pg 9	15,5	5- 8	19	8	22-26	100
○*1921.09	Pg 9	15,5	5- 8	19	15	22-26	100
△ 1902.13N	Pg13,5	20,5	7-12	24	10	24-29	100
○ 1920.36	Pg36	47	20-32	53	14	42-49	25
○ 1921.36	Pg36	47	20-32	53	18	42-49	25

* Add to Ref: N for Black △ Add to Ref: N for Black ○ PVC blind sealing ring

1900



Material: POLYAMIDE PA6.6
self-extinguishing class V2 (UL 94)
Temperature range:
-20°C to +90°C (continuous)
Sealing ring: NEOPRENE® 50 sh A
Protection: IP 68
Colour: RAL 7035 light grey,
RAL 9005 black

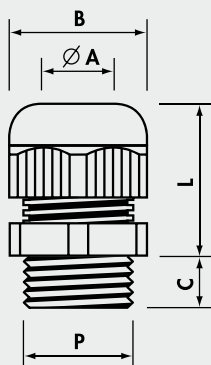

spiralblock® CABLE GLANDS

Polyamide PA6.6



spiralblock® standard

Metric thread M 1.5 pitch CEI EN 60423 CEI EN 50262

Ref. Light Grey	P	Fixing Hole Ø (mm)	Ø A min-max (mm)	B Spanner (mm)	C (mm)	L (mm)	Quantity
1500.M12	M12X1,5	12,5	3,5- 7	15	8	57	100
1500.M16	M16X1,5	16,5	5 -10	19	8	79	50
1500.M20	M20X1,5	20,5	7 -13	25	9	90	25
1500.M25	M25X1,5	25,5	10 -17	30	10	120	20
1500.M32	M32X1,5	32,5	13 -21	36	10	140	10

Add to Ref: N for Black

spiralblock® standard

Pg thread DIN 40 430

Ref. Light Grey	P	Fixing Hole Ø (mm)	Ø A min-max (mm)	B Spanner (mm)	C (mm)	L (mm)	Quantity
1500.07	Pg 7	12,5	3,5- 7	15	8	57	100
1500.09	Pg 9	15,5	5 - 8	19	8	68	100
1500.11	Pg11	19	5 -10	22	8	80	50
1500.13	Pg13.5	20,5	7 -12	24	10	90	50
1500.16	Pg16	22,5	10 -14	27	10	100	25
1500.21	Pg21	29	13 -18	33	12	112	20

Add to Ref: N for Black

spiralblock® standard

BSP thread ISO 228/1

Ref. Light Grey	P	Fixing Hole Ø (mm)	Ø A min-max (mm)	B Spanner (mm)	C (mm)	L (mm)	Quantity
1500.14	G1/4"	13,5	3- 6,5	15	8	57	100
1500.38	G3/8"	17	4- 8	19	9	68	100
1500.12	G1/2"	21,5	7-12	24	10	90	50
1500.34	G3/4"	27	13-18	33	12	112	20

Add to Ref: N for Black

1500



Material: POLYAMIDE PA6.6
self-extinguishing class V2 (UL 94)
Temperature range:
-20°C to +90°C (continuous)
Sealing ring: NEOPRENE® 50 sh A
Protection: IP 68
Colour: RAL 7035 light grey,
RAL 9005 black

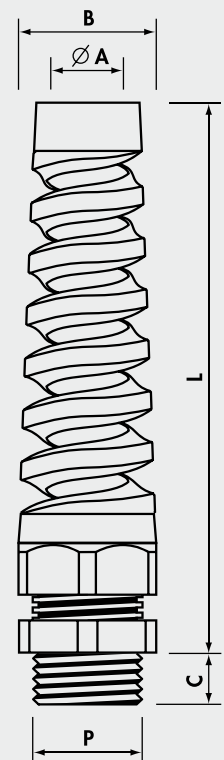

4900



Material: POLYAMIDE PA6.6
 self-extinguishing class V2 (UL 94)
 Safety level: Ex e IIC/Ex tb IIIC
 according to
 EN 60079-0 : 2009
 EN 60079-7 : 2007
 EN 60079-31 : 2009
 Areas of utilisation: 1 & 2, 21 & 22
 Temperature range:
 -20°C to +75°C (continuous)
 Sealing ring: NEOPRENE®
 Protection: IP 65
 Colour: RAL 7035 light grey

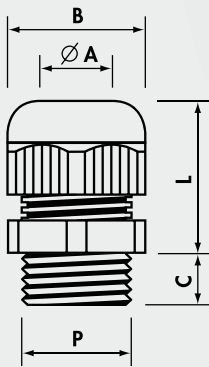

MAXIblock® ATEX CABLE GLANDS

Polyamide PA6.6



II 2 GD

Certificate No IMQ ATEX 028X

Metric thread M 1.5 pitch CEI EN 60423 CEI EN 50262

Ref. Light Grey	P	Fixing Hole Ø (mm)	Ø A min-max (mm)	B Spanner (mm)	C (mm)	L min-max (mm)	Quantity
4900.M12	M12X1,5	12,5	3,5- 6,5	15	8	18-22	100
4900.M16	M16X1,5	16,5	6,5-10	19	8	22-27	100
4900.M20	M20X1,5	20,5	9 -13	25	9	24-30	100
4900.M25	M25X1,5	25,5	11 -17	30	10	28-39	50
4900.M32	M32X1,5	32,5	16 -21	36	10	33-44	25
4900.M40	M40X1,5	40,5	21 -28	46	10	36-45	15
4900.M50	M50X1,5	50,5	27 -35	55	12	43-52	10
4900.M63	M63X1,5	63,5	35 -42	66	12	45-55	5

extended thread

Ref. Light Grey	P	Fixing Hole Ø (mm)	Ø A min-max (mm)	B Spanner (mm)	C (mm)	L min-max (mm)	Quantity
4901.M12	M12X1,5	12,5	3,5- 6,5	15	15	18-22	100
4901.M16	M16X1,5	16,5	6,5-10	19	15	22-27	100
4901.M20	M20X1,5	20,5	9 -13	25	15	24-30	50
4901.M25	M25X1,5	25,5	11 -17	30	15	30-41	50
4901.M32	M32X1,5	32,5	16 -21	36	15	33-44	25
4901.M40	M40X1,5	40,5	21 -28	46	18	36-45	15
4901.M50	M50X1,5	50,5	27 -35	55	18	43-52	10
4901.M63	M63X1,5	63,5	35 -42	66	18	45-55	5

Pg thread DIN 40 430

Ref. Light Grey	P	Fixing Hole Ø (mm)	Ø A min-max (mm)	B Spanner (mm)	C (mm)	L min-max (mm)	Quantity
4900.07	Pg 7	12,5	3,5- 6,5	15	8	18-22	100
4900.09	Pg 9	15,5	6,5- 8	19	8	22-26	100
4900.11	Pg11	19	8 -10	22	8	23-28	100
4900.13	Pg13,5	20,5	9 -12	24	9	24-29	100
4900.16	Pg16	22,5	10 -14	27	10	26-31	50
4900.21	Pg21	29	14 -18	33	12	30-35	50
4900.29	Pg29	37	18 -22	42	12	33-39	25
4900.36	Pg36	47	22 -32	53	14	42-49	10
4900.42	Pg42	54	28 -38	60	14	42-50	5
4900.48	Pg48	60	38 -45	66	15	45-55	5

extended thread

Ref. Light Grey	P	Fixing Hole Ø (mm)	Ø A min-max (mm)	B Spanner (mm)	C (mm)	L min-max (mm)	Quantity
4901.07	Pg 7	12,5	3,5- 6,5	15	15	18-22	100
4901.09	Pg 9	15,5	6,5- 8	19	15	22-26	100
4901.11	Pg11	19	8 -10	22	15	23-28	100
4901.13	Pg13,5	20,5	9 -12	24	15	24-29	100
4901.16	Pg16	22,5	10 -14	27	15	26-31	50
4901.21	Pg21	29	14 -18	33	15	30-35	50
4901.29	Pg29	37	18 -22	42	15	33-39	25
4901.36	Pg36	47	22 -32	53	18	42-49	10
4901.42	Pg42	54	28 -38	60	18	42-50	5
4901.48	Pg48	60	38 -45	66	18	45-55	5

COMPRESSION CABLE GLANDS

Polyamide PA6

1700
1400



Pg thread DIN 40 430 - Dimensions DIN 46 320

Ref. Light Grey	P	Fixing Hole \varnothing (mm)	\varnothing A min-max (mm)	B1 Spanner (mm)	B2 Spanner (mm)	C (mm)	L min-max (mm)	Quantity Box/Bag
1709	Pg 7	12,5	5,5- 7	15	16	8	16-20	300/100
* 1700	Pg 9	15,5	6,5- 8,5	17	20	8	19-22	200/100
* 1701	Pg11	19	8 -10	19	22	8	21-25	100/100
* 1702	Pg13,5	20,5	8 -11	21	24	9	22-26	100/100
1703	Pg16	22,5	11 -14	23	27	10	24-33	50/50
1704	Pg21	29	14,5-18	30	33	11	25-32	50/25
1705	Pg29	37	19 -26	40	42	11	27-32	20/10
1706	Pg36	47	30 -34	50	53	14	33-42	10/10
1707	Pg42	54	30 -38	55	60	13	37-48	10/5
1708	Pg48	60	38 -44	60	65	14,5	37-48	5/5

*Add to Ref: N for Black

Material: POLYAMIDE PA6 self-extinguishing class VO (UL 94)
Temperature range: -20°C to +90°C (continuous)
Sealing ring: PVC 50 sh A
Protection: IP 54
Colour: RAL 7035 light grey, RAL 9005 black

BSP thread ISO 228/1

Ref. Light Grey	P	Fixing Hole \varnothing (mm)	\varnothing A min-max (mm)	B1 Spanner (mm)	B2 Spanner (mm)	C (mm)	L min-max (mm)	Quantity Box/Bag
1400	G1/4"	13,5	5,5- 7	15	16	8	16-20	300/100
* 1401	G3/8"	17	6,5- 8,5	17	20	8	19-22	200/100
* 1401B	G3/8"	17	8 -10	19	22	8	18-24	100/100
* 1401C	G3/8"	17	10 -12	22	24	9	22-26	100/100
* 1402	G1/2"	21,5	8 -11	21	24	9	22-26	100/100
1403	G5/8"	23,5	11 -14	23	27	10	24-33	50/50
1404	G3/4"	27	14,5-18	30	33	11	25-32	50/25
1405	G1"	34	17 -22	34	38	11,5	27-35	20/10
1407	G1"1/2	48	30 -34	50	53	14	33-42	10/10
1408	G2"	60	38 -44	60	65	14,5	37-48	5/5

*Add to Ref: N for Black

Metric thread M 1.5 pitch CEI EN 60423

Ref. Light Grey	P	Fixing Hole \varnothing (mm)	\varnothing A min-max (mm)	B1 Spanner (mm)	B2 Spanner (mm)	C (mm)	L min-max (mm)	Quantity
1730M20	M20X1,5	20,5	8-11	21	24	9	22-26	100

Add to Ref: N for Black

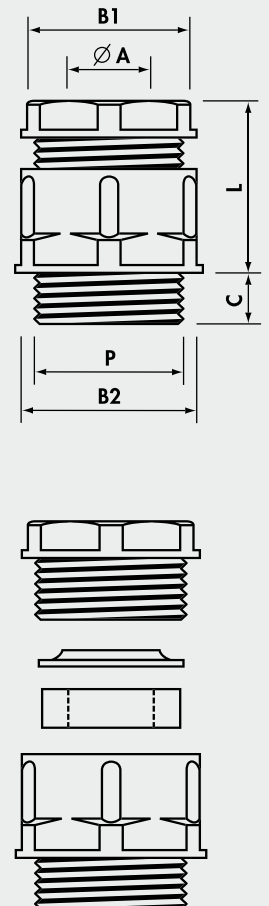

1700T



Material: POLYAMIDE PA6
 self-extinguishing class VO (UL 94)
 Temperature range:
 -20°C to +90°C (continuous)
 Protection: IP 54
 Colour: RAL 7035 light grey,
 RAL 9005 black

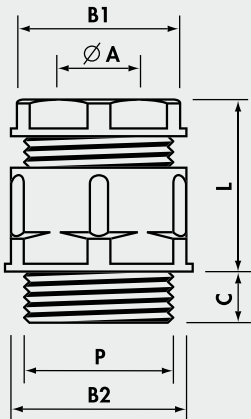

COMPRESSION CABLE GLANDS

Polyamide PA6

Compression cable glands

special Internal blanking disc: PVC 50 sh

Pg thread DIN 40 430 - Dimensions DIN 46 320

Ref. Light Grey	P	Fixing Hole Ø (mm)	Ø A min-max (mm)	B1 Spanner (mm)	B2 Spanner (mm)	C (mm)	L min-max (mm)	Quantity Box/Bag
* 1700T	Pg 9	15,5	6,5- 8,5	17	20	8	19-22	200/100
* 1701T	Pg11	19	8 -10	19	22	8	21-25	100/100
* 1702T	Pg13,5	20,5	8 -11	21	24	9	22-26	100/100

*Add to Ref: N for Black

Compression cable gland - reduced cable entry

Sealing ring: CHLOROPRENE, concentric, multi-sector

Pg thread DIN 40 430 - Dimensions DIN 46 320

Ref Light Grey	P	Fixing Hole Ø (mm)	Ø A min-max (mm)	B1 Spanner (mm)	B2 Spanner (mm)	C (mm)	L min-max (mm)	Quantity
1702CONC	Pg13,5	20,5	5,5-13	21	24	9	22-26	100

Add to Ref: N for Black

POLYSTYRENE CABLE GLANDS

Polystyrene PS

1700P



Cable Glands

Sealing ring: PVC 50 sh A - Protection: IP 54

Pg thread DIN 40 430 - Dimensions DIN 46 320

Ref. Light Grey	P	Fixing Hole ∅ (mm)	∅ A min-max (mm)	B1 Spanner (mm)	B2 Spanner (mm)	C (mm)	L min-max (mm)	Quantity Box/Bag
1700P	Pg9	15,5	7 - 8,5	17	20	8	19-22	200/100
* 1701P	Pg11	19	8 -10	19	22	8	21-25	100/100
* 1702P	Pg13,5	20,5	8 -11	21	24	9	22-26	100/100
1703P	Pg16	22,5	11 -14	24	27	10	24-33	50/50
1704P	Pg21	29	14,5-18	30	33	11	25-32	50/25

*Add to Ref: N for Black

Material: POLYSTYRENE PS
 Temperature range:
 -20°C to +60°C (continuous)
 Colour: RAL 7035 light grey,
 RAL 9005 black

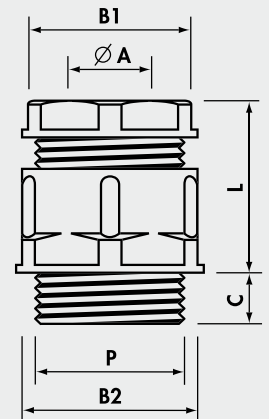

MAXIbrass® CABLE GLANDS

Nickel Plated Brass



2900



Material:
NICKEL PLATED BRASS
(CuZn 40 Pb 3)
Sealing-ring: NEOPRENE®
Cable grip insert:
POLYAMIDE PA6.6
O-Ring: NITRILE 70 sh A
(factory fitted)
Protection: IP 68
Temperature range:
-25°C to +100°C (continuous)

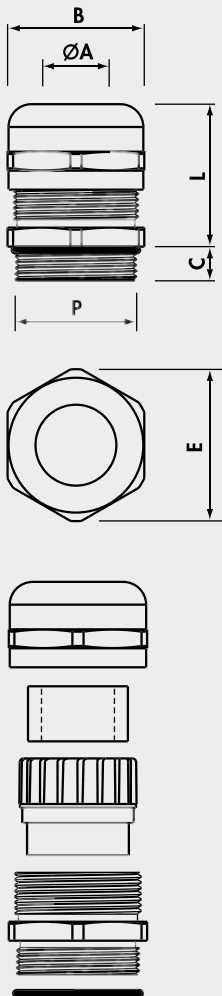

MAXIbrass® standard

Metric thread M 1.5 pitch CEI EN 60423 CEI EN 50262

Ref. Nickel Plated Brass	P	Fixing Hole Ø (mm)	Ø A min-max (mm)	B Spanner (mm)	E (mm)	C (mm)	L min-max (mm)	Quantity
2900.M12N	M12X1,5	12,5	3 - 7	16	18	6,5	16-20	100
2900.M16N	M16X1,5	16,5	4,5-10	20	23	7,0	20-25	100
2900.M20N	M20X1,5	20,5	7 -13	24	27	8,0	20-27	50
2900.M25N	M25X1,5	25,5	10 -17	29	32	8,0	24-30	50
2900.M32N	M32X1,5	32,5	11 -21	36	40	9,0	27-34	25
2900.M40N	M40X1,5	40,5	19 -28	45	50	9,0	34-42	10
2900.M50N	M50X1,5	50,5	26 -35	54	60	10,0	35-43	8
2900.M63N	M63X1,5	63,5	34 -45	67	74	15,0	40-52	5

MAXIbrass® reduced cable entry

Metric thread M 1.5 pitch CEI EN 60423 CEI EN 50262

Ref. Nickel Plated Brass	P	Fixing Hole Ø (mm)	Ø A min-max (mm)	B Spanner (mm)	E (mm)	C (mm)	L min-max (mm)	Quantity
2910.M12N	M12X1,5	12,5	1 - 5	16	18	6,5	16-20	100
2910.M16N	M16X1,5	16,5	2,5- 7	20	23	7,0	20-25	100
2910.M20N	M20X1,5	20,5	5 -10	24	27	8,0	20-27	50
2910.M25N	M25X1,5	25,5	6 -13	29	32	8,0	24-30	50
2910.M32N	M32X1,5	32,5	7 -14	36	40	9,0	27-34	25
2910.M40N	M40X1,5	40,5	13 -23	45	50	9,0	34-42	10
2910.M50N	M50X1,5	50,5	20 -29	54	60	10,0	35-43	8
2910.M63N	M63X1,5	63,5	27 -39	67	74	15,0	40-52	5

MAXIbrass® CABLE GLANDS

Nickel Plated Brass

2900



MAXIbrass® extended thread

Metric thread M 1.5 pitch CEI EN 60423 CEI EN 50262

Ref. Nickel Plated Brass	P	Fixing Hole Ø (mm)	Ø A min-max (mm)	B Spanner (mm)	E (mm)	C (mm)	L min-max (mm)	Quantity
2901.M12N	M12X1,5	12,5	3 - 7	16	18	12	16-20	100
2901.M16N	M16X1,5	16,5	4,5-10	20	23	12	20-25	100
2901.M20N	M20X1,5	20,5	7 -13	24	27	12	20-27	50
2901.M25N	M25X1,5	25,5	10 -17	29	32	12	24-30	50
2901.M32N	M32X1,5	32,5	11 -21	36	40	15	27-34	25
2901.M40N	M40X1,5	40,5	19 -28	45	50	15	34-42	10
2901.M50N	M50X1,5	50,5	26 -35	54	60	15	35-43	8

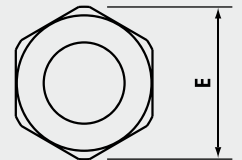
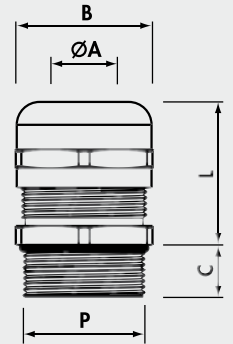

MAXIbrass® extended thread and reduced cable entry

Metric thread M 1.5 pitch CEI EN 60423 CEI EN 50262

Ref. Nickel Plated Brass	P	Fixing Hole Ø (mm)	Ø A min-max (mm)	B Spanner (mm)	E (mm)	C (mm)	L min-max (mm)	Quantity
2911.M12N	M12X1,5	12,5	1 - 5	16	18	12	16-20	100
2911.M16N	M16X1,5	16,5	2,5- 7	20	23	12	20-25	100
2911.M20N	M20X1,5	20,5	5 -10	24	27	12	20-27	50
2911.M25N	M25X1,5	25,5	6 -13	29	32	12	24-30	50
2911.M32N	M32X1,5	32,5	7 -14	36	40	15	27-34	25
2911.M40N	M40X1,5	40,5	13 -23	45	50	15	34-42	10
2911.M50N	M50X1,5	50,5	20 -29	54	60	15	35-43	8

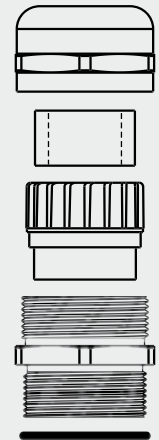

MAXIbrass® CABLE GLANDS

Nickel Plated Brass



2900



Material:
NICKEL PLATED BRASS
(CuZn 40 Pb 3)
Sealing-ring: NEOPRENE®
Cable grip insert:
POLYAMIDE PA6.6
O-Ring: NITRILE 70 sh A
(factory fitted)
Protection: IP 68
Temperature range:
-25°C to +100°C (continuous)

MAXIbrass® standard

Pg thread DIN 40 430

Ref. Nickel Plated Brass	P	Fixing Hole \varnothing (mm)	\varnothing A min-max (mm)	B Spanner (mm)	E (mm)	C (mm)	L min-max (mm)	Quantity
2900.07N	Pg 7	12,5	3 - 7	16	18	5,0	16-20	100
2900.09N	Pg 9	15,5	4 - 8	17	19	6,0	17-23	100
2900.11N	Pg11	19,0	4,5-10	20	23	6,0	20-25	100
2900.13N	Pg13,5	20,5	5 -12	22	25	6,5	20-26	50
2900.16N	Pg16	22,5	7 -13	24	27	6,5	20-27	50
2900.21N	Pg21	29,0	10 -17	30	33	7,0	24-30	50
2900.29N	Pg29	37,0	17 -25	40	45	8,0	30-37	25
2900.36N	Pg36	47,0	20 -32	50	55	8,0	38-48	10
2900.42N	Pg42	54,0	28 -38	57	63	10,0	39-48	5
2900.48N	Pg48	60,0	34 -45	67	74	15,0	40-52	5

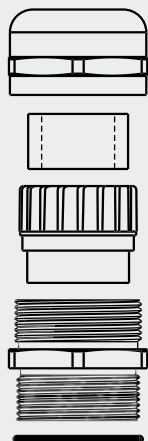
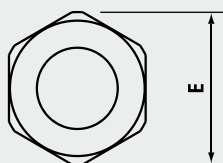
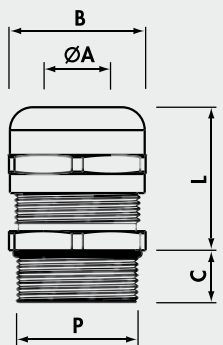

MAXIbrass® reduced cable entry

Pg thread DIN 40 430

Ref. Nickel Plated Brass	P	Fixing Hole \varnothing (mm)	\varnothing A min-max (mm)	B Spanner (mm)	E (mm)	C (mm)	L min-max (mm)	Quantity
2910.07N	Pg 7	12,5	1 - 5	16	18	5,0	16-20	100
2910.09N	Pg 9	15,5	2 - 6	17	19	6,0	17-23	100
2910.11N	Pg11	19,0	2,5- 7	20	23	6,0	20-25	100
2910.13N	Pg13,5	20,5	4 -10	22	25	6,5	20-26	50
2910.16N	Pg16	22,5	5 -10	24	27	6,5	20-27	50
2910.21N	Pg21	29,0	6 -13	30	33	7,0	24-30	50
2910.29N	Pg29	37,0	11 -20	40	45	8,0	30-37	25
2910.36N	Pg36	47,0	18 -26	50	55	8,0	38-48	10
2910.42N	Pg42	54,0	24 -31	57	63	10,0	39-48	5
2910.48N	Pg48	60,0	27 -39	67	74	15,0	40-52	5

MAXIbrass® CABLE GLANDS

Nickel Plated Brass

2900

MAXIbrass® extended thread

Pg thread DIN 40 430

Ref. Nickel Plated Brass	P	Fixing Hole \varnothing (mm)	\varnothing A min-max (mm)	B Spanner (mm)	E (mm)	C (mm)	L min-max (mm)	Quantity
2901.07N	Pg 7	12,5	3 - 7	16	18	12	16-20	100
2901.09N	Pg 9	15,5	4 - 8	17	19	12	17-23	100
2901.11N	Pg11	19,0	4,5-10	20	23	12	20-25	100
2901.13N	Pg13.5	20,5	5 -12	22	25	12	20-26	50
2901.16N	Pg16	22,5	7 -13	24	27	12	20-27	50
2901.21N	Pg21	29,0	10 -17	30	33	12	24-30	50
2901.29N	Pg29	37,0	17 -25	40	45	15	30-37	25
2901.36N	Pg36	47,0	20 -32	50	55	15	38-48	10
2901.42N	Pg42	54,0	28 -38	57	63	15	39-48	5

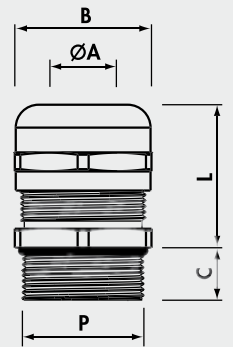

MAXIbrass® extended thread and reduced cable entry

Pg thread DIN 40 430

Ref. Nickel Plated Brass	P	Fixing Hole \varnothing (mm)	\varnothing A min-max (mm)	B Spanner (mm)	E (mm)	C (mm)	L min-max (mm)	Quantity
2911.07N	Pg 7	12,5	1 - 5	16	18	12	16-20	100
2911.09N	Pg 9	15,5	2 - 6	17	19	12	17-23	100
2911.11N	Pg11	19,0	2,5- 7	20	23	12	20-25	100
2911.13N	Pg13.5	20,5	4 -10	22	25	12	20-26	50
2911.16N	Pg16	22,5	5 -10	24	27	12	20-27	50
2911.21N	Pg21	29,0	6 -13	30	33	12	24-30	50
2911.29N	Pg29	37,0	11 -20	40	45	15	30-37	25
2911.36N	Pg36	47,0	18 -26	50	55	15	38-48	10
2911.42N	Pg42	54,0	24 -31	57	63	15	39-48	5

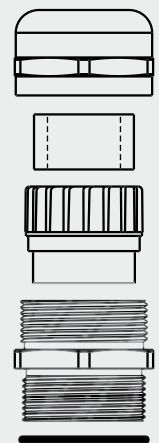
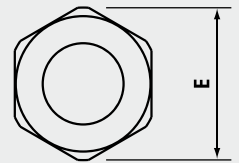

MAXIbrass® ATEX CABLE GLANDS

5900



Material: NICKEL PLATED BRASS
 Sealing-ring: NEOPRENE®
 Cable grip insert: POLYAMIDE PA6.6
 O-Ring: NITRILE 70 sh A (factory fitted)
 Safety level: Ex e IIC/Ex tb IIIC
 according to
 EN 60079-0 : 2009
 EN 60079-7 : 2007
 EN 60079-31 : 2009
 Areas of utilisation: 1 & 2, 21 & 22

Nickel Plated Brass



II 2 GD

Certificate No IMQ ATEX 028X

Temperature range: -25°C to +75°C (continuous)
 Protection: IP 65

Metric thread M 1.5 pitch CEI EN 60423 CEI EN 50262

Ref. Nickel Plated Brass	P	Fixing Hole Ø (mm)	Ø A min-max (mm)	B Spanner (mm)	E (mm)	C (mm)	L min-max (mm)	Quantity
5900.M12N	M12X1,5	12,5	3 - 6,5	16	18	6,5	16-20	100
5900.M16N	M16X1,5	16,5	6,5-10	20	23	7,0	20-25	100
5900.M20N	M20X1,5	20,5	10 -13	24	27	8,0	20-27	50
5900.M25N	M25X1,5	25,5	11 -17	29	32	8,0	24-30	50
5900.M32N	M32X1,5	32,5	14 -21	36	40	9,0	27-34	25
5900.M40N	M40X1,5	40,5	21 -27	45	50	9,0	34-42	10
5900.M50N	M50X1,5	50,5	26 -35	54	60	10,0	35-43	8
5900.M63N	M63X1,5	63,5	35 -42	67	74	15,0	40-52	5

extended thread

Ref. Nickel Plated Brass	P	Fixing Hole Ø (mm)	Ø A min-max (mm)	B Spanner (mm)	E (mm)	C (mm)	L min-max (mm)	Quantity
5901.M12N	M12X1,5	12,5	3 - 6,5	16	18	12	16-20	100
5901.M16N	M16X1,5	16,5	6,5-10	20	23	12	20-25	100
5901.M20N	M20X1,5	20,5	10 -13	24	27	12	20-27	50
5901.M25N	M25X1,5	25,5	11 -17	29	32	12	24-30	50
5901.M32N	M32X1,5	32,5	14 -21	36	40	15	27-34	25
5901.M40N	M40X1,5	40,5	21 -27	45	50	15	34-42	10
5901.M50N	M50X1,5	50,5	26 -35	54	60	15	35-43	8

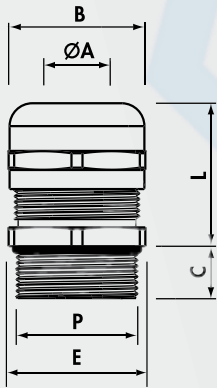

EMC CABLE GLANDS

20M3



Material: NICKEL PLATED BRASS
 (CuZn 40 Pb 3)
 Sealing-ring: Chloroprene (CR)
 Cable grip insert: PA 6
 O-Ring: (NBR) (factory fitted)

Nickel Plated Brass

Protection: IP 68, 5 bar
 Temperature range:
 -30°C to +120°C (continuous)



Metric thread M 1.5 pitch CEI EN 60423 CEI EN 50262

Ref. Nickel Plated Brass	P	Fixing Hole Ø (mm)	Ø A min-max (mm)	B Spanner (mm)	C (mm)	L (mm)	Quantity Box/Bag
20M3M1261N	M12X1,5	12,5	3 - 6,5	14	5	22	300/100
20M3M1661N	M16X1,5	16,5	5,5-10	17	5,5	24,5	200/100
20M3M2061N	M20X1,5	20,5	8 -13	22	6	27	100/50
20M3M2561N	M25X1,5	25,5	11 -18	30	7	31	50/25
20M3M3261N	M32X1,5	32,5	15 -21	34	8	33	30/10
20M3M4061N	M40X1,5	40,5	19 -27	44	8	40	20/10
20M3M5061N	M50X1,5	50,5	26 -35	55	9	48	10/5
20M3M6361N	M63X1,5	63,5	39 -48	66	10	50	5/5

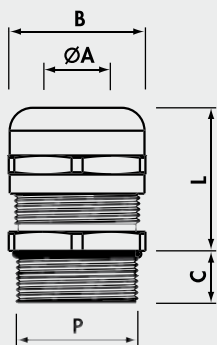

EMC Cable glands and locknuts are designed to work together in electrical or electronic applications where a metallic cable shielding must be equipotential with a metallic enclosure, in accordance with the EMC directive.

Offering IP68 ingress protection at 5 bar pressure, EMC Cable glands will maintain shielding from electromagnetic disturbance in underground applications.

EMC locknuts have serrated teeth to maintain electrical contact through paint or surface coatings, a feature which also enhances vibration resistance.

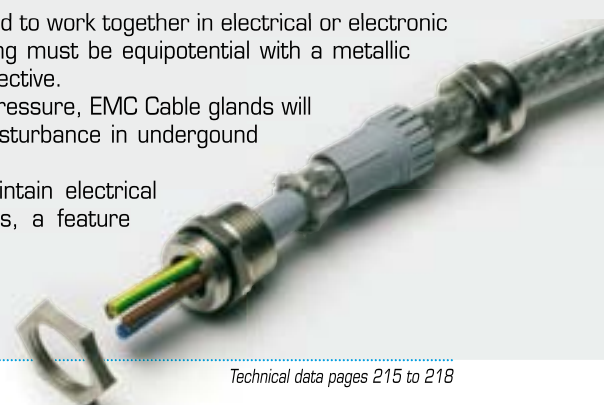



COMPRESSION CABLE GLANDS

Brass

2003
2002
2001

Metric thread M 1.5 pitch CEI EN 60423 CEI EN 50262

Ref. Nickel Plated Brass	P	Fixing Hole \varnothing (mm)	\varnothing A min-max (mm)	B1 Spanner Head (mm)	B2 Spanner Body (mm)	C (mm)	L min-max (mm)	Quantity Box/Bag
2003M1221N	M12X1,5	12,5	4-6	13	14	5	13-16	500/100
2003M1621N	M16X1,5	16,5	8-10	15	17	5	14-17	200/100
2003M2021N	M20X1,5	20,5	10-12	20	22	6	16-19	150/50
2003M2521N	M25X1,5	25,5	17-19	28	30	7	19-23	50/50
2003M3221N	M32X1,5	32,5	26-28	37	39	8	21-25	100/50
2003M4021N	M40X1,5	40,5	33-35	47	50	8	24-30	20/20
2003M5021N	M50X1,5	50,5	39-41	54	57	9	28-34	10/5
2003M6321N	M63X1,5	63,5	43-45	60	66/68	10	30-36	10/5



Material: Metric & Pg threads
NICKEL PLATED BRASS
(CuZn 40 Pb 3)
BSP thread - PLAIN BRASS
Protection: IP 54
Sealing ring:
Metric thread - RUBBER 55sh A
Pg thread - RUBBER 55 sh A
BSP thread - PVC 50 sh A

Pg thread DIN 40 430 - Dimensions DIN 46 320

Ref. Nickel Plated Brass	P	Fixing Hole \varnothing (mm)	\varnothing A min-max (mm)	B1 Spanner Head (mm)	B2 Spanner Body (mm)	C (mm)	L min-max (mm)	Quantity Box/Bag
200200721N	Pg 7	12,5	5-7	13	14	5	13-16	400/100
200200921N	Pg 9	15,5	8-10	15	17	6	14-17	300/100
200201121N	Pg11	19	8-10	18	20	6	14-18	200/50
200201321N	Pg13,5	20,5	10-12	20	22	6,5	16-19	100/50
200201621N	Pg16	22,5	12-14	22	24	6,5	17-20	50/50
200202121N	Pg21	29	17-19	28	30	7	19-23	50/50
200202921N	Pg29	37	26-28	37	40	8	21-25	15/15
200203621N	Pg36	47	33-35	47	50	9	24-30	10/10
200204221N	Pg42	54	39-41	54	57	10	28-34	10/10
200204821N	Pg48	60	43-45	60	64	10	30-36	10/10

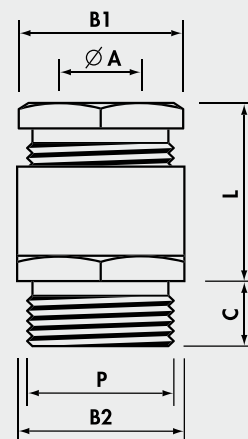

BSP thread ISO 228/1

Ref. Brass	P	Fixing Hole \varnothing (mm)	\varnothing A min-max (mm)	B1 Spanner Head (mm)	B2 Spanner Body (mm)	C (mm)	L min-max (mm)	Quantity Box/Bag
200101441	G1/4"	13,5	5,5-7	13	15	6,5	14-17	400/100
207101441	G1/4"	13,5	5,5-7	13	\varnothing 15	6,5	14-17	400/100
200103841	G3/8"	17	6,5-8,5	17	19	7,5	15-19	200/100
200101241	G1/2"	21,5	8-11	21	23	8	17-23	100/100
200105841	G5/8"	23,5	11-14	23	25	8,5	20-24	100/50
200103441	G3/4"	27	14,5-17,5	27	29	9	20-26	50/50
200110041	G1"	34	18-22	34	36	10	23-28	25/25
200111841	G1*1/8	38	21-26	38	40	10,5	23-28	25/25
200111441	G1*1/4	42	28-32	42	45	11,5	25-31	20/20
200111241	G1*1/2	48	32-36	48	50	11,5	28-35	20/20
200120041	G2"	60	38-42	60	64	13,5	31-37	10/10
• 200121221*	G2*1/2	76	44-57	80	80	20	32-37	5/5
• 200130021	G3"	89	67-69	95	95	20	42-52	5/5

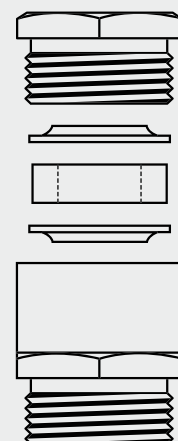

Add to Ref: N for NICKEL PLATED BRASS

• Sealing ring: CLOROPRENE

* Concentric sealing ring

MAXInox CABLE GLANDS



7900
7900A



Stainless Steel 303 (X8 CrNiS 18-9)

Stainless Steel 316L (X2 CrNiMo 17-12-2)

Material:
STAINLESS STEEL 303/316L
Sealing-ring: NEOPRENE®
Cable grip insert:
POLIAMMIDE PA6.6
O-Ring: NITRILE 70 sh A
(factory fitted)
Protection: IP 68
Temperature range:
-25°C to +100°C (continuous)

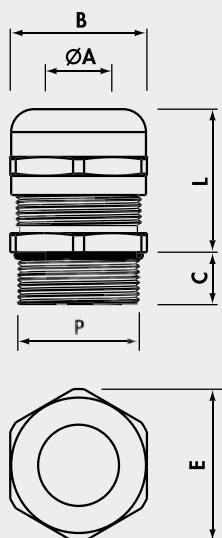

MAXInox Stainless Steel AISI 303

Metric thread M 1.5 pitch CEI EN 60423 CEI EN 50262

Stainless Steel AISI 303	P	Fixing Hole (mm)	Ø A min-max (mm)	B Spanner (mm)	E (mm)	C (mm)	L min-max (mm)	Quantity Box/Bag
7900.M12	M12X1,5	12,5	3 - 7	16	18	6,5	16-20	90/30
7900.M16	M16X1,5	16,5	4,5-10	20	23	7,0	20-25	120/30
7900.M20	M20X1,5	20,5	7 -13	24	27	8,0	20-27	75/25
7900.M25	M25X1,5	25,5	10 -17	29	32	8,0	24-30	40/20
7900.M32	M32X1,5	32,5	11 -21	36	40	9,0	27-34	15
7900.M40	M40X1,5	40,5	19 -28	45	50	9,0	34-42	15
7900.M50	M50X1,5	50,5	26 -35	54	60	10,0	35-43	10
7900.M63	M63X1,5	63,5	34 -45	67	74	15,0	40-52	5

MAXInox Stainless Steel AISI 316L

Metric thread M 1.5 pitch CEI EN 60423 CEI EN 50262

Stainless Steel AISI 316L	P	Fixing Hole (mm)	Ø A min-max (mm)	B Spanner (mm)	E (mm)	C (mm)	L min-max (mm)	Quantity Box/Bag
7900A.M12	M12X1,5	12,5	3 - 7	16	18	6,5	16-20	60/20
7900A.M16	M16X1,5	16,5	4,5-10	20	23	7,0	20-25	80/20
7900A.M20	M20X1,5	20,5	7 -13	24	27	8,0	20-27	60/20
7900A.M25	M25X1,5	25,5	10 -17	29	32	8,0	24-30	30/15
7900A.M32	M32X1,5	32,5	11 -21	36	40	9,0	27-34	12
7900A.M40	M40X1,5	40,5	19 -28	45	50	9,0	34-42	10
7900A.M50	M50X1,5	50,5	26 -35	54	60	10,0	35-43	7
7900A.M63	M63X1,5	63,5	34 -45	67	74	15,0	40-52	5



MAXIinox CABLE GLANDS

Stainless Steel 303 (X8 CrNiS 18-9)

Stainless Steel 316L (X2 CrNiMo 17-12-2)

7900 7900A



MAXIinox Stainless Steel AISI 303

Pg thread DIN 40 430

Stainless Steel AISI 303	P	Fixing Hole (mm)	Ø A min-max (mm)	B Spanner (mm)	E (mm)	C (mm)	L min-max (mm)	Quantity Box/Bag
7900.07	Pg 7	12,5	3 - 7	16	18	5,0	16-20	90/30
7900.09	Pg 9	15,5	4 - 8	17	19	6,0	17-23	90/30
7900.11	Pg11	19,0	4,5-10	20	23	6,0	20-25	60/30
7900.13	Pg13,5	20,5	5 -12	22	25	6,5	20-26	90/30
7900.16	Pg16	22,5	7 -13	24	27	6,5	20-27	60/30
7900.21	Pg21	29,0	10 -17	30	33	7,0	24-30	40/20
7900.29	Pg29	37,0	17 -25	40	45	8,0	30-37	30/15
7900.36	Pg36	47,0	20 -32	50	55	8,0	38-48	10
7900.42	Pg42	54,0	28 -38	57	63	10,0	36-46	5
7900.48	Pg48	60,0	34 -45	67	74	15,0	40-52	5

Material: STAINLESS STEEL 303/316L
 Sealing-ring: NEOPRENE®
 Cable grip insert: POLIAMMIDE PA6.6
 O-Ring: NITRILE 70 sh A (factory fitted)
 Protection: IP 68
 Temperature range: -25°C to +100°C (continuous)

MAXIinox Stainless Steel AISI 316L

Pg thread DIN 40 430

Stainless Steel AISI 316L	P	Fixing Hole (mm)	Ø A min-max (mm)	B Spanner (mm)	E (mm)	C (mm)	L min-max (mm)	Quantity Box/Bag
7900A.07	Pg 7	12,5	3 - 7	16	18	5,0	16-20	60/20
7900A.09	Pg 9	15,5	4 - 8	17	19	6,0	17-23	60/20
7900A.11	Pg11	19,0	4,5-10	20	23	6,0	20-25	100/20
7900A.13	Pg13,5	20,5	5 -12	22	25	6,5	20-26	100/20
7900A.16	Pg16	22,5	7 -13	24	27	6,5	20-27	40/20
7900A.21	Pg21	29,0	10 -17	30	33	7,0	24-30	60/15
7900A.29	Pg29	37,0	17 -25	40	45	8,0	30-37	20/10
7900A.36	Pg36	47,0	20 -32	50	55	8,0	38-48	7
7900A.42	Pg42	54,0	28 -38	57	63	10,0	36-46	5
7900A.48	Pg48	60,0	34 -45	67	74	15,0	40-52	5

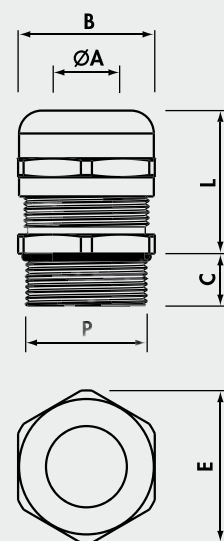

LOCKNUTS WITH COLLAR

Polyamide PA6 or PA6.6

1143
1142
1141



Metric thread M 1.5 pitch CEI EN 60423

Material: POLYAMIDE PA6 or 6.6
self-extinguishing class V2 (UL 94)
Temperature range:
-20°C to +90°C (continuous)
Colour: RAL 7035 light grey,
RAL 9005 black,
RAL 7001 dark grey

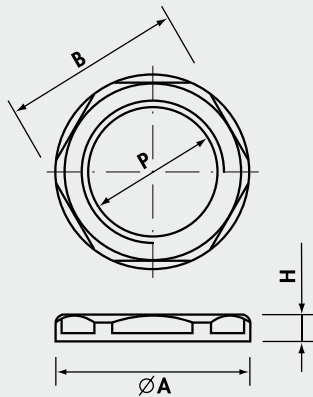

Ref. Light Grey	P	Ø A (mm)	B Spanner (mm)	H (mm)	Quantity Box/Bag
1143M12	M12X1,5	18,5	17	5	1.000/100
1143M16	M16X1,5	24	22	5	600/100
1143M20	M20X1,5	29	27	6	400/100
1143M25	M25X1,5	35,5	32	6	300/100
1143M32	M32X1,5	45	41	7	150/50
1143M40	M40X1,5	55	50	7	30
1143M50	M50X1,5	65	60	8	30
1143M63	M63X1,5	82	75	8	15

Add to Ref: N for Black, G for Dark Grey

Pg thread DIN 40 430 - Dimensions DIN 46 320

Ref. Light Grey	P	Ø A (mm)	B Spanner (mm)	H (mm)	Quantity Box/Bag
1142007	Pg 7	21	19	5	100
1142009	Pg 9	24	22	5	700/100
1142011	Pg11	26	24	5	500/100
1142013	Pg13,5	29	27	6	400/100
1142016	Pg16	33	30	6	300/100
1142021	Pg21	39	36	7	200/50
1142029	Pg29	50	46	7	50
1142036	Pg36	66	60	8	30
1142042	Pg42	73	65	8	25
1142048	Pg48	78	70	8	20

Add to Ref: N for Black, G for Dark Grey

BSP thread ISO 228/1

Ref. Light Grey	P	Ø A (mm)	B Spanner (mm)	H (mm)	Quantity Box/Bag
1141012	G1/2"	29	27	6	400/100
1141112	G1"1/2	66	60	8	30
1141200	G2"	78	70	8	20

Add to Ref: N for Black

LOCKNUTS WITHOUT COLLAR

Polyamide PA6 or PA6.6

1112
1710
1410



Metric thread M 1.5 pitch CEI EN 60423

Ref. Light Grey	P	B Spanner (mm)	H (mm)	Quantity Box/Bag
1112	M12X1,5	17	5	1.000/100
1116	M16X1,5	22	5	700/100
1120	M20X1,5	27	6	400/100
1125	M25X1,5	32	6	100
1132	M32X1,5	41	7	150/50
1140	M40X1,5	50	7	30
1150	M50X1,5	60	8	30
1163	M63X1,5	75	8	15

Add to Ref: N for Black

Pg thread DIN 40 430 - Dimensions DIN 46 320

Ref. Light Grey	P	B Spanner (mm)	H (mm)	Quantity Box/Bag
* 1719E17	Pg 7	17	5	1.000/100
1719	Pg 7	19	5	100
1710	Pg 9	22	5	700/100
1711	Pg11	24	5	500/100
1712	Pg13,5	27	6	400/100
1713	Pg16	30	6	300/100
△*1714E34	Pg21	34	7	200/100
1714	Pg21	36	7	200/100
1715	Pg29	46	7,5	100/50

Add to Ref: N for Black

△ Light Grey only

* Not DIN 46 320

BSP thread ISO 228/1

Ref. Light Grey	P	B Spanner (mm)	H (mm)	Quantity Box/Bag
1410	G1/4"	19	5	800/100
1411	G3/8"	23	6	600/100
1412	G1/2"	27	6	400/100
1413	G5/8"	30	6	100
1414	G3/4"	34	7	200/100
1415	G1"	40	7	50

Add to Ref: N for Black

Material:
POLYAMIDE PA6 or 6.6
self-extinguishing class V2 (UL 94)
Temperature range:
-20°C to +90°C (continuous)
Colour: RAL 7035 light grey,
RAL 9005 black

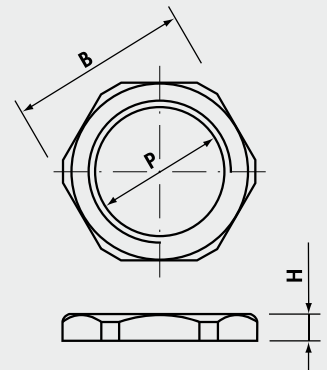

LOCKNUTS

Brass

2033
2032
2031



Metric thread M 1.5 pitch CEI EN 60423

Ref. Nickel Plated Brass	P	B Spanner (mm)	H (mm)	Quantity Box/Bag
2033M12N	M12X1,5	16	2,8	2.000/100
2033M16N	M16X1,5	19	2,8	1.000/100
2033M20N	M20X1,5	24	3	600/100
2033M25N	M25X1,5	30	4,0	500/100
2033M32N	M32X1,5	36	4	250/25
2033M40N	M40X1,5	45	5,0	150/10
2033M50N	M50X1,5	60	5	100/10
2033M63N	M63X1,5	70	5,5	50/5

Pg thread DIN 40 430 - Dimensions DIN 46 320

Ref. Nickel Plated Brass	P	B Spanner (mm)	H (mm)	Quantity Box/Bag
2032007N	Pg 7	16	2,8	1.500/100
2032009N	Pg 9	18	2,8	1.500/100
2032011N	Pg11	21	3	1.000/100
2032013N	Pg13,5	23	3	1.000/100
2032016N	Pg16	26	3	600/100
2032021N	Pg21	32	3,5	500/100
2032029N	Pg29	41	4	300/100
2032036N	Pg36	51	5	100/10
2032042N	Pg42	60	5	50/10
2032048N	Pg48	64	5,5	50/10

BSP thread ISO 228/1

Ref. Plain Brass	P	B Spanner (mm)	H (mm)	Quantity Box/Bag
2031014	G1/4"	16	3	2.400/100
2031038	G3/8"	19	3	2.000/100
2031012	G1/2"	24	3,5	1.000/100
2031058	G5/8"	26	4	500/50
2031034	G3/4"	30	4	500/50
2031100	G1"	37	4	250/25
2031118	G1"1/8	41	4,5	100/25
2031114	G1"1/4	45	4,5	200/20
2031112	G1"1/2	52	5,5	100/20
2031200	G2"	64	7	50/10
2031212	G2"1/2	80	7	20/5
2031300	G3"	95	8	20/5

Add to Ref: N for NICKEL PLATED BRASS

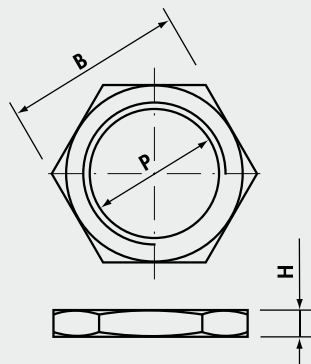
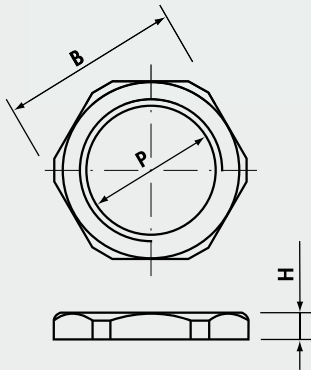

EMC LOCKNUTS

Nickel Plated Brass

20N3



EMC Locknuts

Material: NICKEL PLATED BRASS (CuZn 40 Pb 3)

Metric thread M 1.5 pitch CEI EN 60423

Ref. Nickel Plated Brass	P	B Spanner (mm)	H (mm)	Quantity Box/Bag
20N3M12N	M12X1,5	15	4,1	1000/100
20N3M16N	M16X1,5	19	4,2	1000/100
20N3M20N	M20X1,5	24	4,2	500/100
20N3M25N	M25X1,5	30	4,8	400/100
20N3M32N	M32X1,5	36	5,4	200/100
20N3M40N	M40X1,5	46	6,2	100/50
20N3M50N	M50X1,5	60	7	50/50
20N3M63N	M63X1,5	70	7	50/25

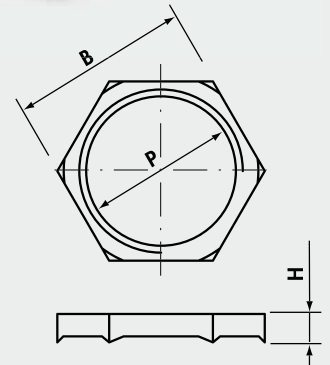

MAXInox LOCKNUTS

Stainless Steel 303 (X8 CrNiS 18-9)

Stainless Steel 316L (X2 CrNiMo 17-12-2)

7032 7033



Metric thread M 1.5 pitch CEI EN 60423

Stainless Steel AISI 303	Stainless Steel AISI 316L	P	B Spanner (mm)	H (mm)	AISI 303 Quantity Box/Bag	AISI 316L Quantity Box/Bag
7033M12	7033AM12	M12X1,5	16	2,8	450/30	300/20
7033M16	7033AM16	M16X1,5	20	2,8	450/30	300/20
7033M20	7033AM20	M20X1,5	24	3,5	250/25	200/20
7033M25	7033AM25	M25X1,5	29	4	160/20	120/15
7033M32	7033AM32	M32X1,5	36	4	105/15	84/12
7033M40	7033AM40	M40X1,5	45	5	60/15	40/10
7033M50	7033AM50	M50X1,5	57	5	40/10	28/7
7033M63	7033AM63	M63X1,5	70	5,5	32/8	20/5

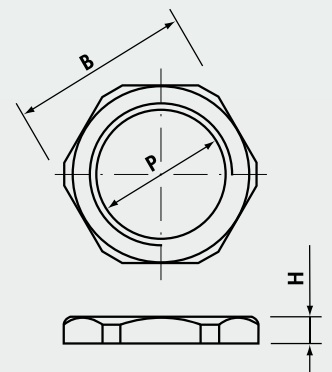

Pg thread DIN 40 430 - Dimensions DIN 46 320

Stainless Steel AISI 303	Stainless Steel AISI 316L	P	B Spanner (mm)	H (mm)	AISI 303 Quantity Box/Bag	AISI 316L Quantity Box/Bag
7032007	7032A007	Pg 7	16	2,8	450/30	300/20
7032009	7032A009	Pg 9	20	2,8	450/30	300/20
7032011	7032A011	Pg11	22	3	300/30	200/20
7032013	7032A013	Pg13,5	22	3	300/30	200/20
7032016	7032A016	Pg16	27	3	240/30	160/20
7032021	7032A021	Pg21	32	3,5	160/20	150/15
7032029	7032A029	Pg29	41	4	60/15	40/10
7032036	7032A036	Pg36	50	5	40/10	28/7
7032042	7032A042	Pg42	60	5	40/10	20/5
7032048	7032A048	Pg48	64	5,5	32/8	20/5

TCP

INTERNAL PLUGS FOR CABLE GLANDS

Polyamide PA6.6



Material: POLYAMIDE PA6.6
 self-extinguishing class V2 (UL 94)
 Temperature range:
 -20°C to +90°C (continuous)
 Colour: RAL 9005 black
 Application:
 Blanking the cable entry of
MAXIblock[®], **MAXIbrass**[®] and
MAXIinox cable glands and
 maintaining IP 68.

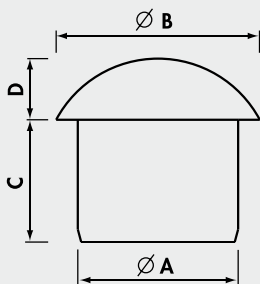

Plugs

Ref.	Suitable for		Ø A (mm)	Ø B (mm)	C (mm)	D (mm)	Quantity Box/Bag
	MAXIblock [®]	MAXIbrass [®] MAXIinox					
TCP5	M12R + Pg7R	M12R	4,5	8,5	10,8	4,5	3.000/100
TCP10	Pg9R	Pg9R	6	12	12	4,5	2.000/100
TCP12	M12 + Pg7	M12 + Pg7	6,8	12	12	4,5	1.000/100
	M16R + Pg11R	M16R + Pg11R					
TCP15	Pg9	Pg9	8	11	11,5	5	1.500/100
TCP18	M16 + Pg11	M16 + Pg11	9,5	12,5	13	5	1.500/100
TCP20	M20R	M20R	10	15	14	6	800/100
	Pg13,5 + Pg13,5R Pg16R	Pg13 + Pg13,5R Pg16R					
TCP25	M20 + Pg16	M20 + Pg16	12,5	17	15	8	400/100
TCP30	M25R + M32R	M25R + M32R	12,5	22,5	18	9	300/100
	Pg21R	Pg21R					
TCP35	M25 + Pg21	M25 + Pg21	16	19,5	18	8	300/100
TCP40	M32	M32	19	22,5	19	9	150/50
TCP45	M40R + Pg29 + Pg36R	M40R + Pg29	22	30	20	10	100/50
TCP50	M40 + M50R + Pg42R	M40 + M50R	27,5	38	25	12	50/25
TCP55	Pg36	Pg36	31,5	36,5	23,5	12	50/25
TCP60	M50	M50	34,5	40	23,5	12	50/25
TCP65	M63R + Pg42 + Pg48R	M63R + Pg42	37,5	48	26,5	12	30/15
TCP70	M63 + Pg48	M63 + Pg48	43	48	26,5	12	30/15

R: reduced cable entry

MULTI-ENTRY SEALS & PLUGS FOR CABLE GLANDS

36 TGM

Material: NEOPRENE® 70 sh A
 Temperature range:
 -40°C to +130°C
 Protection: IP 68
 Colour: black
 Application:
 IP68 sealing of multiple cables entering
MAXIblock®, **MAXIbrass**® or
MAXIinox cable glands.



Multi-entry seals

Ref.	Suitable for		n° entries	Ø Dia entry (mm)	Quantity Box/Bag
	MAXIblock ®	MAXIbrass ® MAXIinox			
36A3M1623	M16 + Pg11	M16 + Pg11	2	3	1.500/100
36A3M1624	M16 + Pg11	M16 + Pg11	2	4	1.000/100
36A3M16322	M16 + Pg11	M16 + Pg11	3	2,2	1.500/100
36A3M2025	M20 + Pg13,5	M20 + Pg13,5 + Pg16	2	5	500/100
36A3M2034	M20 + Pg13,5	M20 + Pg13,5 + Pg16	3	4	500/100
36A3M20356	M20 + Pg13,5	M20 + Pg13,5 + Pg16	3	5,6	500/100
36A3M2526	M25	M25 + Pg21	2	6	300/50
36A3M2536	M25	M25 + Pg21	3	6	300/50
36A3M2537	M25	M25 + Pg21	3	7	300/50
36A3M2545	M25	M25 + Pg21	4	5	300/50
36A3M2546	M25	M25 + Pg21	4	6	300/50
36A3M2554	M25	M25 + Pg21	5	4	300/50
36A3M3228	M32	M32	2	8	150/50
36A3M3239	M32	M32	3	9	150/50
36A3M32465	M32	M32	4	6,5	150/50
36A3M3248	M32	M32	4	8	150/50
36A3M4078	M40	M40	7	8	100/100
36A3M40106	M40	M40	10	6	100/100
36A3M5088	M50	M50	8	8	50/50
36C201629	Pg16	-	2	3+9	400/50

2 ENTRIES

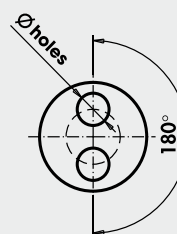

3 ENTRIES

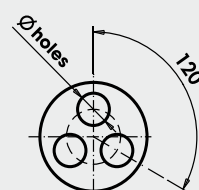

4 ENTRIES

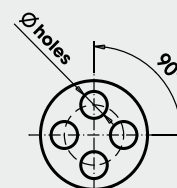

5 ENTRIES

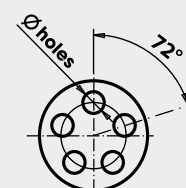

Material: POLYAMIDE PA6.6
 Temperature range:
 -20°C to +90°C (continuous)
 Colour: RAL 7035 light grey

Application:
 Plugging unused entries
 in multi-entry seals and
 maintaining IP68.

Multi-entry seal plugs

Ref.	Suitable for Seal	Ø A	L	Quantity Box/Bag
		(mm)	(mm)	
TGM38	36A3M1623	3	10	5.000/100
TGM48	36A3M1624 + 36A3M2034 + 36A3M2554	4	8	5.000/100
TGM58	36A3M2025	5	8	5.000/100
TGM513	36A3M2545	5	13	2.500/50
TGM613	36A3M2526 + 36A3M2536 + 36A3M40106	6	13	2.000/50
TGM713	36A3M2537	7	13	2.000/50
TGM817	36A3M3248 + 36A3M5088 + 36A3M4078	8	17	100

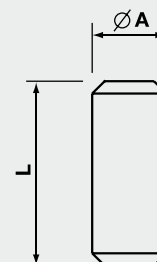

ENTRY THREAD ADAPTERS

Nickel Plated Brass

Entry thread enlargers

Metric thread M 1.5 pitch CEI EN 60423

Ref.	P EXT	P INT	Ø A (mm)	C (mm)	H (mm)	Quantity Box/Bag
20931216N	M12X1,5	M16X1,5	18	5	15,5	500/100
20931620N	M16X1,5	M20X1,5	22	5	17,5	300/100
20932025N	M20X1,5	M25X1,5	27	6	20	150/50
20932532N	M25X1,5	M32X1,5	34	7	22,5	100/50
20932540N	M25X1,5	M40X1,5	42	7	23,5	50/50
20933240N	M32X1,5	M40X1,5	42	8	24,5	50/50
20933250N	M32X1,5	M50X1,5	52	8	27,5	25/25
20934050N	M40X1,5	M50X1,5	52	8	27,5	25/25
20935063N	M50X1,5	M63X1,5	66	9	31	20/10

Entry thread reducers

Metric thread M 1.5 pitch CEI EN 60423

Ref.	P EXT	P INT	Ø A (mm)	C (mm)	H (mm)	Quantity Box/Bag
20431612N	M16X1,5	M12X1,5	18	5	7,5	1.000/100
20432012N	M20X1,5	M12X1,5	22	6	9	600/100
20432016N	M20X1,5	M16X1,5	22	6	9	500/100
20432512N	M25X1,5	M12X1,5	27	7	10	300/50
20432516N	M25X1,5	M16X1,5	27	7	10	300/50
20432520N	M25X1,5	M20X1,5	27	7	10	300/100
20433220N	M32X1,5	M20X1,5	34	8	11	100/25
20433225N	M32X1,5	M25X1,5	34	8	11	200/50
20434025N	M40X1,5	M25X1,5	43	8	11,5	100/25
20434032N	M40X1,5	M32X1,5	43	8	11,5	100/25
20435032N	M50X1,5	M32X1,5	53	9	12,5	50/10
20435040N	M50X1,5	M40X1,5	53	9	12,5	50/25
20436340N	M63X1,5	M40X1,5	66	10	14	30/10
20436350N	M63X1,5	M50X1,5	66	10	14	30/10

Entry thread converters - Metric to Pg

Ref.	P EXT	P INT	Fig.	Ø A (mm)	C (mm)	H (mm)	Quantity Box/Bag
20A42011N	M20X1,5	Pg11	1	22	6,5	17,5	300/100
20A42016N	M20X1,5	Pg16	1	24	6,5	20	200/50
20A42513N	M25X1,5	Pg13,5	2	27	7	10	300/50
20A42516N	M25X1,5	Pg16	2	27	7	10	300/50
20A43216N	M32X1,5	Pg16	2	36	8	11,5	100/25
20A43221N	M32X1,5	Pg21	2	36	8	11,5	100/25

Entry thread converters - Pg to Metric

Ref.	P EXT	P INT	Fig.	Ø A (mm)	C (mm)	H (mm)	Quantity Box/Bag
20A40916N	Pg 9	M16X1,5	1	20	6	15	400/100
20A41120N	Pg11	M20X1,5	1	22	6	16	300/100
20A41320N	Pg13,5	M20X1,5	1	24	6,5	16,5	200/50
20A41620N	Pg16	M20X1,5	2	24	6,5	9,5	50/50
20A42120N	Pg21	M20X1,5	2	30	7	10	100/100
20A42125N	Pg21	M25X1,5	2	30	7	10	100/100
20A42925N	Pg29	M25X1,5	2	39	8	11,5	50/50

2093
2043
20A4



Material: NICKEL PLATED BRASS
(CuZn 40 Pb 3)

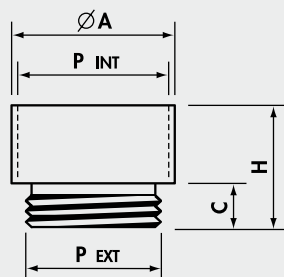

Fig. 1

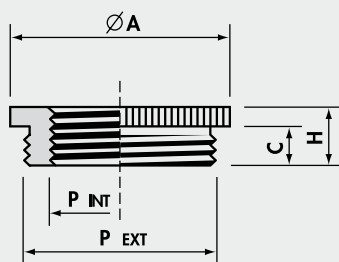

Fig. 2

ENTRY THREAD ADAPTERS

Nickel Plated Brass

1800
2042



Entry thread enlargers

Pg thread DIN 40 430 - Dimensions DIN 46 320-K

Ref.	P EXT	P INT	Ø A (mm)	C (mm)	H (mm)	Quantity Box/Bag
180709	Pg 7	Pg 9	17	5	15	600/100
180911	Pg 9	Pg11	20	6	16,5	500/100
180913	Pg 9	Pg13,5	22	6	17,5	300/100
181113	Pg11	Pg13,5	22	6	17,5	300/100
181116	Pg11	Pg16	24	6	18,5	100/50
181316	Pg13,5	Pg16	24	6,5	19	200/50
181321	Pg13,5	Pg21	30	6,5	21	150/50
181621	Pg16	Pg21	30	6,5	21	100/25
182129	Pg21	Pg29	39	7	23	75/25
182936	Pg29	Pg36	50	8	27,5	30/10
183642	Pg36	Pg42	57	9	31	20/10
184248	Pg42	Pg48	64	10	33	20/10

Material: NICKEL PLATED BRASS
(CuZn 40 Pb 3)

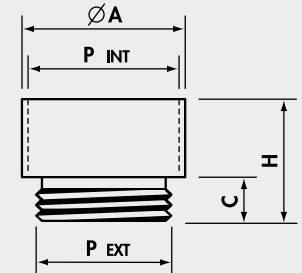

Entry thread reducers

Pg thread DIN 40 430 - Dimensions DIN 46 320-H

Ref.	P EXT	P INT	Ø A (mm)	C (mm)	H (mm)	Quantity Box/Bag
20420907N	Pg 9	Pg 7	17	6	8,5	800/100
20421107N	Pg11	Pg 7	20	6	8,5	600/100
20421109N	Pg11	Pg 9	20	6	8,5	600/100
20421307N	Pg13,5	Pg 7	22	6,5	9	600/100
20421309N	Pg13,5	Pg 9	22	6,5	9	600/100
20421311N	Pg13,5	Pg11	22	6,5	9	600/100
20421607N	Pg16	Pg 7	24	6,5	9,5	300/50
20421609N	Pg16	Pg 9	24	6,5	9,5	400/100
20421611N	Pg16	Pg11	24	6,5	9,5	400/100
20421613N	Pg16	Pg13,5	24	6,5	9,5	400/100
20422111N	Pg21	Pg11	30	7	10	200/50
20422113N	Pg21	Pg13,5	30	7	10	200/50
20422116N	Pg21	Pg16	30	7	10	200/50
20422916N	Pg29	Pg16	39	8	11,5	100/25
20422921N	Pg29	Pg21	39	8	11,5	100/25
20423621N	Pg36	Pg21	50	9	12,5	50/25
20423629N	Pg36	Pg29	50	9	12,5	50/25
20424229N	Pg42	Pg29	57	10	14	50/25
20424236N	Pg42	Pg36	57	10	14	50/25
20424836N	Pg48	Pg36	64	10	14	50/25
20424842N	Pg48	Pg42	64	10	14	50/25

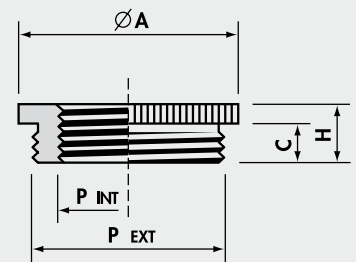

6010

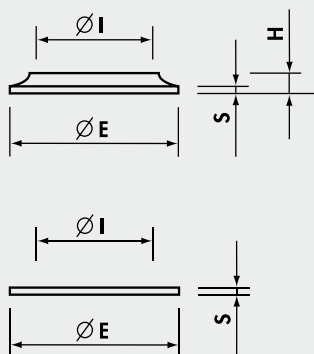

Compression washers

Material: Zinc plated STEEL UNI 5961/84

Ref.	Fits thread	Ø E (mm)	Ø I (mm)	H (mm)	S (mm)	Quantity Box/Bag
6010.14	G1/4"	11	8	1,1	0,5	15.000/1.000
6010.38	G3/8"	14,5	10	1,8	0,5	5.000/1.000
6010.12	Pg13,5 + G1/2"	18	14	1,5	0,5	4.000/1.000
6010.58	Pg16 + G5/8"	20	15,5	2	0,5	3.000/1.000
6010.34	G3/4"	24	18,5	2	0,5	2.500/500
6010.01	G1"	30	24,5	2	0,5	1.500/500
6010.114	G1"1/4	38	33,5	2	0,5	1.000/500
6010.11	Pg11	17	12	1,9	0,5	5.000/1.000
6010.21	Pg21	26,5	20	2,3	0,5	2.000/500
6010.29	Pg29 + G1"1/8	35	26,5	2	0,5	1.000/500
6010.36	Pg36 + G1"1/2	45	38	-	0,8	750/250
6010.42	Pg42	51	42,5	2,3	0,5	500/250
6010.48	Pg48 + G2"	56	47,5	3	0,5	400/100

SEALING RINGS

1880 1890



Concentric sealing rings Material: BUTADIENE-NITRILE NBR with concentric perforations

Ref.	Suitable only for Cable Glands IP54 (1700... 2002...)	Ø E (mm)	Ø 3 (mm)	Ø 2 (mm)	Ø 1 (mm)	Ø I (mm)	H (mm)	Quantity Box/Bag
1880	Pg9	13,3	-	10	7,5	5	5,5	1.500/100
1881	Pg11	16,5	-	12,5	10	7,5	6	1.000/100
1882	Pg13,5	18,3	-	12,5	10	7,5	6	800/100
1883	Pg16	20,4	15	12,5	10	7,5	7	600/100
1884	Pg21	25,9	19	16	13	10	8	300/100
*1885	Pg29	34,7	27	24	21	18	9,5	150/50
1886	Pg36	44,7	33	30	27	24	12	100/50
*1887	Pg42	51,7	39	36	33	30	14	50/25
*1888	Pg48	56,9	45	42	39	36	14	50/25

*material: RUBBER NR

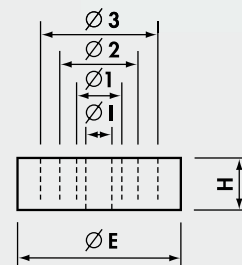

O-rings

Material: Butadiene-Nitrile 70 sh

Ref.	Fits thread	Ø E (mm)	Ø I (mm)	H (mm)	Quantity Box/Bag
1889	M12	12,81	9,25	1,78	1.000
1890	Pg7 + G1/4"	14,38	10,82	1,78	5.000/1.000
1890A	M16 + Pg9 + G3/8"	15,98	12,42	1,78	5.000/1.000
1891	Pg11	19,16	15,60	1,78	5.000/1.000
1891A	M20	20,73	17,17	1,78	5.000/1.000
1892	Pg13,5 + G1/2"	22,33	18,77	1,78	5.000/1.000
1892A	Pg16 + G5/8"	23,91	20,35	1,78	5.000/1.000
1892B	M25	25,51	21,95	1,78	5.000/1.000
1893	Pg21	28,68	25,12	1,78	3.000/500
1893A	M32	30,00	26,00	2,00	500
1925,3	G3/4"	30,31	25,07	2,62	1.000/500
1894	G1"	35,06	29,82	2,62	1.000/500
1895	M40 + Pg29 + G1"1/8	39,84	34,60	2,62	1.000/500
1896	G1"1/4	43,01	37,77	2,62	500
1897	Pg36 + G1"1/2	49,36	44,12	2,62	800/100
1898	Pg42 + G1"3/4	55,71	50,47	2,62	800/100
1899	Pg48 + G2"	62,06	56,82	2,62	100
1899A	G2"1/2	76,50	69,44	3,53	100/1
1899B	G3"	92,60	81,92	5,34	100/1

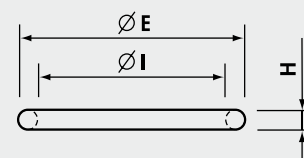

SPARES SEALING RINGS

PVC 50 sh A

341
342
343
344



Material: PVC 50 sh A

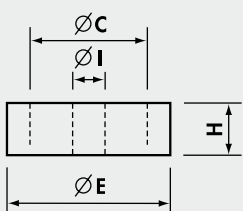
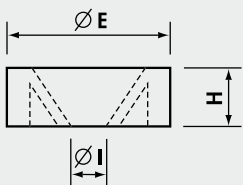
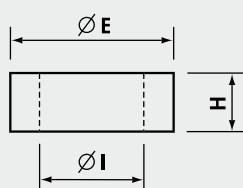

Cylindrical sealing rings

Ref.	Fits thread	C (mm)	Ø E (mm)	Ø I (mm)	H (mm)	Quantity Box/Bag
3411014	G1/4"	-	10,9	6,7	6	1.500/100
3411038	G3/8"	-	14,5	8,5	6	1.000/100
3411012	Pg13,5 + G1/2"	-	18	11	7,5	500/100
3412016	Pg16 + G5/8"	-	20	14	7,5	300/100
3422016	Pg16 + G5/8"	-	20	10	7,5	300/100
3411034	G3/4"	-	23,5	17,5	8	300/100
3411100	G1"	-	29	22	10	200/100
3412011	Pg11	-	16,5	10	7	1.000/100
3412021	Pg21	-	26	18	8,5	300/100
3422021	Pg21	-	26	13	8,5	250/50
3412029	Pg29 + G1*1/8	-	35	26	10	200/100

Membrane sealing rings

Ref.	Fits thread	C (mm)	Ø E (mm)	Ø I (mm)	H (mm)	Quantity Box/Bag
3431038	G3/8"	-	15	6	6	1.000/100
3431100	G1"	-	29	15	9,5	200/100

Double sealing rings

Ref.	Fits thread	C (mm)	Ø E (mm)	Ø I (mm)	H (mm)	Quantity Box/Bag
3441012	G1/2" + Pg13,5	13	18,5	8	6,5	500/100
3441034	G3/4"	17	23	12,5	8,5	300/100

SPARES SEALING RINGS

357 FD



Material: BUTADIENE-NITRILE NBR 70 sh A

Temperature range: -20°C to +70°C

Colour: grey

Ref.	Fits thread	Ø E (mm)	Ø I (mm)	H (mm)	Quantity Box/Bag
3572007	Pg7	16,5	11,5	1	4.000/100
3572011	Pg11	23	17,5	1	2.500/100
35720131	Pg13,5 + M20X1,5 + G1/2"	27,5	20,5	1,4	1.000/100
3572013	Pg13,5	30	20,5	2,2	1.000/100
3572016	Pg16	29	23	2	1.000/100
3572021	Pg21	33,5	27	3	500/100
3573M16	M16X1,5	20,5	16,3	1	3.000/100
3573M20	M20X1,5 + Pg13,5 + G1/2"	25,5	20,5	1	4.000/100
3573M25	M25X1,5	30,5	25,5	1	2.000/100
3573M32	M32X1,5	40,5	32,5	1	1.500/100

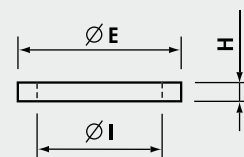

Material: NEOPRENE® 80 sh A

Temperature range: -25°C to +100°C

Colour: black

Ref.	Fits thread	Ø E (mm)	Ø I (mm)	H (mm)	Quantity Box/Bag
FD M12	M12	16	10	1,2	2.500/50
FD 7	Pg7 + G1/4"	17	11,3	1,2	3.000/50
FD 9	Pg9 + M16 + G3/8"	20	13,9	1,2	2.000/50
FD 11	Pg11	23	17,1	1,2	2.000/50
FD M20	M20	24	18	1,2	2.000/50
FD 13,5	Pg13,5 + G1/2"	25	19	1,2	2.500/50
FD 16	Pg16 + G5/8"	27	21	1,2	1.500/50
FD M25	M25	31	23	1,2	1.000/20
FD 21	Pg21 + G3/4"	34,5	27	1,5	1.000/25
FD M32	M32 + G1"	40	30	1,5	600/20
FD 29	Pg29 + G1"1/8"	45	35,2	1,5	500/25
FD M40	M40 + G1"1/4"	48	38	1,5	500/20
FD 36	Pg36 + G1"1/2"	56	45,2	1,5	250/25
FD M50	M50	55	47,5	1,0	10
FD 42	Pg42 + G1"3/4"	62	52	1,0	10
FD 48	Pg48 + G2"	68	58	1,0	10
FD M63	M63	68	60,5	1,0	500/5

ENTRY PLUGS

Polyamide PA6

1053
1052



Material: POLYAMIDE PA6
reinforced with fibreglass
self-extinguishing class VO (UL 94)
Temperature range:
-20°C to +90°C (continuous)
Protection: IP 54
Colour: RAL 7035 light grey,
RAL 9005 black

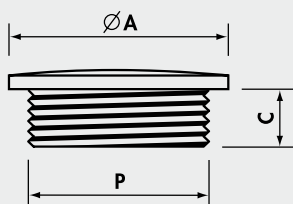

Metric thread M 1.5 pitch CEI EN 60423

Ref. Light Grey	P	Ø A (mm)	C (mm)	Quantity
1053M12	M12X1,5	15	6	1.000/100
1053M16	M16X1,5	20	6	100
1053M20	M20X1,5	25	7	100
1053M25	M25X1,5	30	7	100
1053M32	M32X1,5	37	9	50
1053M40	M40X1,5	47	9	30
1053M50	M50X1,5	58	10	20
1053M63	M63X1,5	72	12	10

Add to Ref: N for Black

Pg thread DIN 40 430 - Dimensions DIN 46 320

Ref. Light Grey	P	Ø A (mm)	C (mm)	Quantity Box/Bag
1052007	Pg 7	15	6	1.000/100
1052009	Pg 9	19	6	500/100
1052011	Pg11	22	7	100
1052013	Pg13,5	25	7	100
1052016	Pg16	27	7	100
1052021	Pg21	33	9	50
1052029	Pg29	44	9	100/50
1052036	Pg36	55	10	20
1052042	Pg42	62	10	10
1052048	Pg48	69	12	10

Add to Ref: N for Black

ENTRY PLUGS

Polystyrene PS

1253
1840



Protection: IP 54

Metric thread M 1.5 pitch CEI EN 60423

Ref. Light Grey	P	Ø A (mm)	C (mm)	Quantity
1253M12	M12X1,5	15	6	100
1253M16	M16X1,5	20	6	100
1253M20	M20X1,5	25	7	100
1253M25	M25X1,5	30	7	100
1253M32	M32X1,5	37	9	50
1253M40	M40X1,5	47	9	30
1253M50	M50X1,5	58	10	20
1253M63	M63X1,5	72	12	10

Add to Ref: N for Black

Material: POLYSTYRENE PS
Temperature range:
-20°C to +60°C (continuous)
Colour: RAL 7035 light grey,
RAL 9005 black

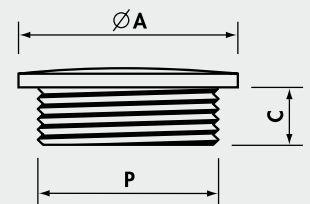

Pg thread DIN 40 430 - Dimensions DIN 46 320

Ref. Light Grey	P	Ø A (mm)	C (mm)	Quantity Box/Bag
1840	Pg 7	15	6	100
1841	Pg 9	19	6	500/100
1842	Pg11	22	7	100
1843	Pg13,5	25	7	100
1844	Pg16	27	7	100
1845	Pg21	33	9	50
1846	Pg29	44	9	100/50
1847	Pg36	55	10	20
1848	Pg42	62	10	10
1849	Pg48	69	12	10

Add to Ref: N for Black

1700

ENTRY BUSHES

Polyamide PA6



Material: POLYAMIDE PA6
 self-extinguishing class VO (UL 94)
 Temperature range:
 -20°C to +90°C (continuous)
 Colour: RAL 7035 light grey,
 RAL 9005 black

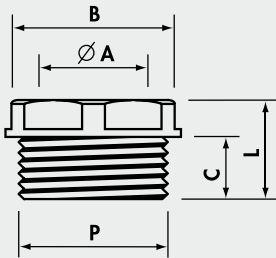

Entry bushes

Pg thread DIN 40 430 - Dimensions DIN 46 320

Ref. Light Grey	P	ØA (mm)	B Spanner (mm)	C (mm)	L (mm)	Quantity Box/Bag
* 1700.2	Pg 9	10	16	9	14	600/100
* 1701.2	Pg11	11,5	19	10	15	300/100
* 1702.2	Pg13,5	13,5	21	11	16,5	300/100
1703.2	Pg16	16	23	12,5	18,5	200/100
1704.2	Pg21	22	30	12	17,5	100/50
1705.2	Pg29	27	40	15	22	50/50

BSP thread ISO 228/1

* 1830	G1/4"	8,5	15	8,5	13,5	800/100
* 1831	G3/8"	11,5	17	9	14	300/100
* 1832	G1/2"	13	21	11	16,5	300/100

Metric thread M 1.5 pitch CEI EN 60423

△1835G	M16X1,5	11,5	17	9	14	100/100
* 1836	M20X1,5	13,5	21	11	16,5	300/100

* Add to Ref: N for Black

△ Dark Grey only

Blind entry bushes

Pg thread DIN 40 430 - Dimensions DIN 46 320

Ref. Light Grey	P	ØA (mm)	B Spanner (mm)	C (mm)	L (mm)	Quantity Box/Bag
* 1702.5	Pg13,5	-	21	11	17	300/100
1703.5	Pg16	-	23	12,5	18,5	200/100

BSP thread ISO 228/1

* 1861	G3/8"	-	17	9	14	600/100
* 1862	G1/2"	-	21	11	16,5	200/100

Metric thread M 1.5 pitch CEI EN 60423

* 1866	M20X1,5	-	21	11	17	100
--------	---------	---	----	----	----	-----

*Add to Ref: N for Black

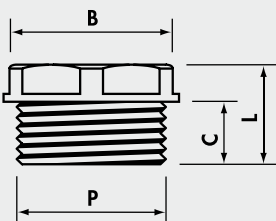

ENTRY PLUGS AND BUSHES

Brass

2053
2052
2021

Entry plugs

Metric thread M 1.5 pitch CEI EN 60423

Ref. Nickel Plated Brass	P	Ø A (mm)	C (mm)	Quantity Box/Bag
2053M12N	M12X1,5	14	5	1,500/100
2053M16N	M16X1,5	18	5	1,000/100
2053M20N	M20X1,5	22	6,5	500/100
2053M25N	M25X1,5	28	7	200/100
2053M32N	M32X1,5	35	8	150/25
2053M40N	M40X1,5	44	8,5	100/25
2053M50N	M50X1,5	54	9	50/25
2053M63N	M63X1,5	67	10	25/25

Pg thread DIN 40 430 - Dimensions DIN 46 320

Ref. Nickel Plated Brass	P	Ø A (mm)	C (mm)	Quantity Box/Bag
2052007N	Pg 7	14	5	1,500/100
2052009N	Pg 9	17	6	1,000/100
2052011N	Pg11	20	6	500/100
2052013N	Pg13,5	22	6,5	500/100
2052016N	Pg16	24	6,5	500/100
2052021N	Pg21	30	7	200/50
2052029N	Pg29	39	8	100/25
2052036N	Pg36	50	9	50/25
2052042N	Pg42	57	10	25/25
2052048N	Pg48	64	10	25/25



Material: Entry plugs - NICKEL PLATED BRASS (CuZn 40 Pb 3)
Entry bushes - PLAIN BRASS
Protection: Entry plugs - IP 54

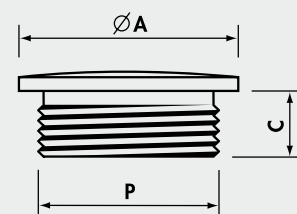

Entry bushes

BSP thread ISO 228/1

Ref. Brass	P	Ø A (mm)	B Spanner (mm)	C (mm)	L (mm)	Quantity Box/Bag
2021014	G1/4"	10	13	6	8,5	1,000/100
2021038	G3/8"	12	17	7,5	10,5	800/100
2021012	G1/2"	16	21	9,5	13	400/100
2021058	G5/8"	18	23	10	13,5	250/50
2021034	G3/4"	21	27	10	14	200/50
2021100	G1"	26,5	34	11	15,5	100/50
2021118	G1"1/8	31	38	12	16,5	100/25
2021114	G1"1/4	35	42	13	18	50/25
2021112	G1"1/2	41,5	48	13	18,5	50/25
2021200	G2"	51,5	60	13,5	19,5	25/25

Add to Ref: N for NICKEL PLATED BRASS

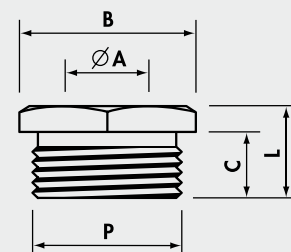

RUTASEAL GROMMETS

RS



Material: EPDM
 halogen-free and chemical resistant
 Temperature range: -40°C to +110°C
 Protection: IP 67
 Colour: RAL 7001 light grey
 Application:
 IP67 sealing of cables and conduits
 in Metric and Pg threaded entries
 through material thickness 0,5-4 mm

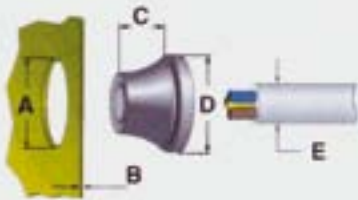

Fits Metric thread

Ref.	Fits Threaded Entry	Dimensions					Quantity Box/Bag
		A (mm)	B (mm)	C (mm)	D (mm)	E (mm)	
RS0407.M12	M12	12,5	0,5 - 2	5,6	20,0	4 - 7	2,000/50
RS0509.M16	M16	16,5	1 - 4	11,0	21,0	5 - 9	2,000/50
RS0813.M20	M20/Pg13,5	20,5	1 - 4	13,4	25,5	8 - 13	3,000/50
RS1117.M25	M25	25,5	1 - 4	15,3	30,5	11 - 17	2,000/50
RS1520.M32	M32	32,5	1 - 4	18,6	38,5	15 - 20	1,000/25
RS1928.M40	M40	40,5	1 - 4	21,7	48,5	19 - 28	600/25
RS2735.M50	M50	50,5	1 - 4	25,0	60,5	27 - 35	250/10

Fits Pg thread

Ref.	Fits Threaded Entry	Dimensions					Quantity Box/Bag
		A (mm)	B (mm)	C (mm)	D (mm)	E (mm)	
RS0305.07	Pg 7	12,5	0,5 - 2	5,4	20,0	3 - 5	2,000/50
RS0507.09	Pg 9	16,0	1 - 4	10,3	21,0	5 - 7	2,000/50
RS0710.11	Pg11	19,0	1 - 4	12,7	24,0	7 - 10	3,000/50
RS1014.16	Pg16	23,0	1 - 4	14,7	28,0	10 - 14	2,000/50
RS1420.21	Pg21	29,0	1 - 4	17,6	35,0	14 - 20	1,000/25
RS2026.29	Pg29	38,0	1 - 4	20,0	46,0	20 - 26	600/25
RS2635.36	Pg36	48,0	1 - 4	23,9	58,0	26 - 35	250/10



CABLE & CONDUIT ACCESSORIES

SICURclips

modular retaining clips - ABS

3600

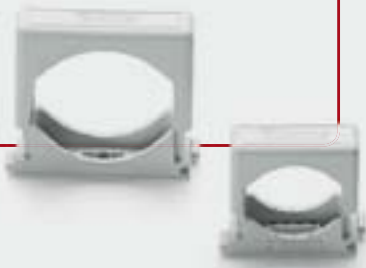

Material: ABS self-extinguishing class VO (UL94) UV stabilised
 Glow wire resistance: 750° C (CEI EN 60695-2-1)
 Temperature range: -20°C to +80°C (continuous)
 Colour: RAL 7035 light grey

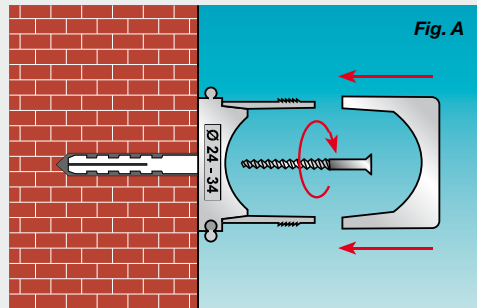

SICURclips for cable, tubing & flexible conduit

Ref.	Ø A min-max (mm)	H (mm)	S (mm)	Quantity
3601	13-21	8,5	16	100
3602	24-34	8,5	16	50
3603	38-50	8,5	16	25

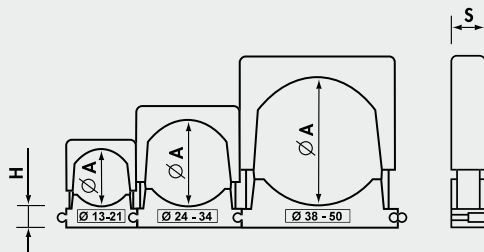

1740



Material: POLYAMIDE PA6 self-extinguishing class VO (UL 94)
 Temperature range: -20°C to +90°C (continuous)

CONDUIT FITTINGS

Polyamide PA6

Colour: RAL 7035 grey
 For all conduits with metal protection: rigid, flexible, spiral, corrugated, etc.
 High level of resistance: the action of sun, moisture or salinity does not affect the products, which are also impervious to fumes, acids, solvents and oils.
 Suits outside diameters 13 - 40 mm.

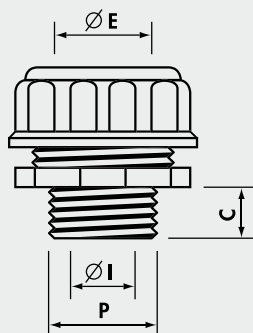

Pg thread DIN 40 430

Ref. Light Grey	P	Fixing Hole Ø (mm)	Ø E min-max (mm)	Ø I (mm)	C (mm)	Quantity Box/Bag
1740	Pg 9	15,5	13-15	9	9	100
* 1741	Pg11	19	14-16,5	13	10	100
1742	Pg13,5	20,5	16-19	15	10	50
1743	Pg16	22,5	20-22	17	11	50
1744	Pg21	29	23-25,5	21	11	50/25
1745	Pg21	29	25-28,5	21	11	25
1746	Pg29	37	30-33	30	13	20/10
1747	Pg36	47	37-42	36	15	10

For nominal conduit diameters 16-20-25-32-40 mm

*Add to Ref: N for Black (RAL 9005)





MECHANICAL AND PNEUMATIC TOOLS

HP 1



Manual tool, compact and easy to use, equipped with:

- treated steel crimp jaws with high mechanical properties.
- factory-set ratchet for crimping control (automatic handle opening upon completion of crimping operation).
- Emergency release lever which, if necessary, opens the crimp jaws before their complete closure.
- Ergonomically designed non-slip moulded plastic grips.

Technical features:



Crimpstar® HP 1

Crimp style:



Crimping range:	PVC, PC and PA6.6 insulated terminals and connectors for conductor sizes 0,2 to 2,5 sqmm
Dimensions:	
Length (closed handles)	234,5 mm
Width (closed handles)	73,0 mm
Height	18,3 mm
Weight:	512 g
Package dimensions:	240 x 81 x 25 mm



HP 3



Manual tool, compact and easy to use, equipped with:

- treated steel crimp jaws with high mechanical properties.
- factory-set ratchet for crimping control (automatic handle opening upon completion of crimping operation).
- Emergency release lever which, if necessary, opens the crimp jaws before their complete closure.
- Ergonomically designed non-slip moulded plastic grips.

Technical features:

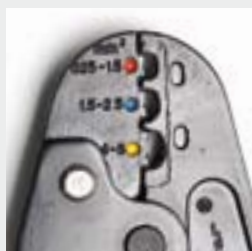

Crimpstar® HP 3

Crimp style:



Crimping range:	PVC, PC and PA6.6 insulated terminals and connectors for conductor sizes 0,25 to 6 sqmm
Dimensions:	
Length (closed handles)	234,5 mm
Width (closed handles)	73,0 mm
Height	18,3 mm
Weight:	498 g
Package dimensions:	240 x 81 x 25 mm



MECHANICAL TOOLS *Crimpstar*[®] RANGE

HNN 3



Manual tool, compact and easy to use, equipped with:

- treated steel crimp jaws with high mechanical properties.
- factory-set ratchet for crimping control (automatic handle opening upon completion of crimping operation).
- Emergency release lever which, if necessary, opens the crimp jaws before their complete closure.
- Ergonomically designed non-slip moulded plastic grips.

Technical features:



Crimpstar[®] HNN 3

Crimp style:



Crimping range:

PA6.6 insulated terminals and connectors for conductor sizes 1,5 to 10 sqmm

Dimensions:

Length (closed handles)

234,5 mm

Width (closed handles)

73,0 mm

Height

18,3 mm

Weight:

491 g

Package dimensions:

240 x 81 x 25 mm



HNN 4



Manual tool, compact and easy to use, equipped with:

- treated steel crimp jaws with high mechanical properties.
- factory-set ratchet for crimping control (automatic handle opening upon completion of crimping operation).
- Emergency release lever which, if necessary, opens the crimp jaws before their complete closure.
- Ergonomically designed non-slip moulded plastic grips.

Technical features:



Crimpstar[®] HNN 4

Crimp style:



Crimping range:

PA6.6 insulated terminals and connectors for conductor sizes 10 and 16 sqmm

Dimensions:

Length (closed handles)

234,5 mm

Width (closed handles)

73,0 mm

Height

18,3 mm

Weight:

492 g

Package dimensions:

240 x 81 x 25 mm



HPH 1



Manual tool, compact and easy to use, equipped with:

- treated steel crimp jaws with high mechanical properties.
- factory-set ratchet for crimping control (automatic handle opening upon completion of crimping operation).
- Emergency release lever which, if necessary, opens the crimp jaws before their complete closure.
- Ergonomically designed non-slip moulded plastic grips.

Technical features:



Crimpstar[®] HPH 1

Crimp style:



Through connectors
PE HD insulated, heat shrinkable.
for conductor sizes 0,5 to 6 sqmm

Crimping range:

Dimensions:

Length (closed handles)

234,5 mm

Width (closed handles)

73,0 mm

Height

18,3 mm

Weight:

512 g

Package dimensions:

240 x 81 x 25 mm



HNKE 4



Manual tool, compact and easy to use, equipped with:

- treated steel crimp jaws with high mechanical properties.
- factory-set ratchet for crimping control (automatic handle opening upon completion of crimping operation).
- Emergency release lever which, if necessary, opens the crimp jaws before their complete closure.
- Ergonomically designed non-slip moulded plastic grips.

Technical features:



Crimpstar[®] HNKE 4

Crimp style:



End sleeves
for conductor sizes 0,5 to 4 sqmm

Crimping range:

Dimensions:

Length (closed handles)

236 mm

Width (closed handles)

73,0 mm

Height

18,3 mm

Weight:

516 g

Package dimensions:

240 x 81 x 25 mm



MECHANICAL TOOLS *Crimpstar*[®] RANGE

HNKE 16



Manual tool, compact and easy to use, equipped with:

- treated steel crimp jaws with high mechanical properties.
- factory-set ratchet for crimping control (automatic handle opening upon completion of crimping operation).
- Emergency release lever which, if necessary, opens the crimp jaws before their complete closure.
- Ergonomically designed non-slip moulded plastic grips.

Technical features:

Crimpstar[®] HNKE 16

Crimp style:



Crimping range:

End sleeves
for conductor sizes 4 to 16 mm²

Dimensions:

Length (closed handles)

236 mm

Width (closed handles)

73,0 mm

Height

18,3 mm

Weight:

491 g

Package dimensions:

240 x 81 x 25 mm



HNKE 50



Manual tool, compact and easy to use, equipped with:

- treated steel crimp jaws with high mechanical properties.
- factory-set ratchet for crimping control (automatic handle opening upon completion of crimping operation).
- Emergency release lever which, if necessary, opens the crimp jaws before their complete closure.
- Ergonomically designed non-slip moulded plastic grips.

Technical features:

Crimpstar[®] HNKE 50

Crimp style:



Crimping range:

End sleeves
for conductor sizes 25 - 35 - 50 mm²

Dimensions:

Length (closed handles)

234,5 mm

Width (closed handles)

73,0 mm

Height

18,3 mm

Weight:

590 g

Package dimensions:

240 x 81 x 25 mm



HN 1



Manual tool, compact and easy to use, equipped with:

- treated steel crimp jaws with high mechanical properties.
- factory-set ratchet for crimping control (automatic handle opening upon completion of crimping operation).
- Emergency release lever which, if necessary, opens the crimp jaws before their complete closure.
- Ergonomically designed non-slip moulded plastic grips.

Technical features:



Crimpstar[®] HN 1

Crimp style:



Uninsulated terminals and connectors for conductor sizes 0,25 to 10 sqmm

Crimping range:

Dimensions:

Length (closed handles)

234,5 mm

Width (closed handles)

73,0 mm

Height

18,3 mm

Weight:

480 g

Package dimensions:

240 x 81 x 25 mm



HN 5



Manual tool, compact and easy to use, equipped with:

- treated steel crimp jaws with high mechanical properties.
- factory-set ratchet for crimping control (automatic handle opening upon completion of crimping operation).
- Emergency release lever which, if necessary, opens the crimp jaws before their complete closure.
- Ergonomically designed non-slip moulded plastic grips.

Technical features:



Crimpstar[®] HN 5

Crimp style:



Uninsulated terminals and connectors for conductor sizes 10 and 16 sqmm

Crimping range:

Dimensions:

Length (closed handles)

234,5 mm

Width (closed handles)

73,0 mm

Height

18,3 mm

Weight:

489 g

Package dimensions:

240 x 81 x 25 mm



HN-A25



Manual tool, compact and easy to use, equipped with:

- treated steel crimp jaws with high mechanical properties.
- factory-set ratchet for crimping control (automatic handle opening upon completion of crimping operation).
- Emergency release lever which, if necessary, opens the crimp jaws before their complete closure.
- Ergonomically designed non-slip moulded plastic grips.

Technical features:



Crimpstar[®] HN-A25

Crimping range:	Uninsulated terminals and connectors A-M, L-M and L-P series for conductor sizes 10 to 25 mm ²
Dimensions:	
Length (closed handles)	229 mm
Width (closed handles)	78,6 mm
Height	18,3 mm
Weight:	500 g
Package dimensions:	240 x 81 x 25 mm

Crimp style:



HN-D25



Manual tool, compact and easy to use, equipped with:

- treated steel crimp jaws with high mechanical properties.
- factory-set ratchet for crimping control (automatic handle opening upon completion of crimping operation).
- Emergency release lever which, if necessary, opens the crimp jaws before their complete closure.
- Ergonomically designed non-slip moulded plastic grips.

Technical features:



Crimpstar[®] HN-D25

Crimping range:	Cu tube lugs DR (DIN 46235) and through connectors DSV (DIN 46267) for conductor sizes 10 to 25 sqmm
Dimensions:	
Length (closed handles)	229 mm
Width (closed handles)	78,6 mm
Height	18,3 mm
Weight:	500 g
Package dimensions:	240 x 81 x 25 mm

Crimp style:



MECHANICAL TOOLS *Crimpstar*[®] RANGE

HF 1



Manual tool, compact and easy to use, equipped with:

- treated steel crimp jaws with high mechanical properties.
- factory-set ratchet for crimping control (automatic handle opening upon completion of crimping operation).
- Emergency release lever which, if necessary, opens the crimp jaws before their complete closure.
- Ergonomically designed non-slip moulded plastic grips.

Technical features:



Crimpstar[®] HF 1

Crimping range:	Crimp style: 
Dimensions:	Open barrel brass terminals for conductors sizes 0,5 to 4 sqmm (not BN-FAB/FAR type)
Length (closed handles)	234,5 mm
Width (closed handles)	73,0 mm
Height	18,3 mm
Weight:	509 g
Package dimensions:	240 x 81 x 25 mm



HF 2



Manual tool, compact and easy to use, equipped with:

- treated steel crimp jaws with high mechanical properties.
- factory-set ratchet for crimping control (automatic handle opening upon completion of crimping operation).
- Emergency release lever which, if necessary, opens the crimp jaws before their complete closure.
- Ergonomically designed non-slip moulded plastic grips.

Technical features:



Crimpstar[®] HF 2

Crimping range:	Crimp style: 
Dimensions:	Open barrel brass terminals for conductors sizes 0,08 to 1,3 sqmm (28 to 16 AWG)
Length (closed handles)	234,5 mm
Width (closed handles)	73,0 mm
Height	18,3 mm
Weight:	497 g
Package dimensions:	240 x 81 x 25 mm



MECHANICAL TOOLS *Crimpstar*[®] RANGE

HX 1



Manual tool, compact and easy to use, equipped with:

- treated steel crimp jaws with high mechanical properties.
- factory-set ratchet for crimping control (automatic handle opening upon completion of crimping operation).
- Emergency release lever which, if necessary, opens the crimp jaws before their complete closure.
- Ergonomically designed non-slip moulded plastic grips.

Technical features:

Crimpstar[®] HX 1

Crimp style:



Crimping range:

Coaxial connectors type
RG58, RG59, RG62 and RG 71

Dimensions:

Length (closed handles) 234,5 mm

Width (closed handles) 73,0 mm

Height 18,3 mm

Weight: 481 g

Package dimensions: 240 x 81 x 25 mm



Specific positioner
for Cembre CS4
connectors

HN-CS4



Technical features:

Crimpstar[®] HN-CS4

Crimp style:



Crimping range:

Cembre CS4 connectors
for conductors sizes 2,5 - 4 - 6 sqmm

Dimensions:

Length (closed handles) 231 mm

Width (closed handles) 78,6 mm

Height 46 mm

Weight: 650 g

Package dimensions: 230 x 85 x 50 mm



Manual tool, compact and easy to use, equipped with:

- treated steel crimp jaws with high mechanical properties.
- factory-set ratchet for crimping control (automatic handle opening upon completion of crimping operation).
- Emergency release lever which, if necessary, opens the crimp jaws before their complete closure.
- Ergonomically designed non-slip moulded plastic grips.

MECHANICAL TOOLS *nd*[®] RANGE

ND#1



A brand new generation of tools, with a unique mechanism to reduce operator effort. Small and compact, with ergonomically designed handles for ease of operation.

High quality materials combined with advanced design and manufacturing technology, produce a reliable tool with a guaranteed consistent, crimping operation.

Technical features:

ND#1	Crimp style:	
Crimping range:	Insulated and uninsulated end sleeves for conductors sizes 0,3 to 1,5 sqmm	
Dimensions:		
Length (closed handles)	190 mm	
Width (closed handles)	72 mm	
Height	21 mm	
Weight:	470 g	

ND#2



Technical features:

ND#2	Crimp style:	
Crimping range:	Insulated and uninsulated end sleeves for conductors sizes 1 to 6 sqmm	
Dimensions:		
Length (closed handles)	190 mm	
Width (closed handles)	72 mm	
Height	21 mm	
Weight:	470 g	

ND#3



Technical features:

ND#3	Crimp style:	
Crimping range:	Insulated and uninsulated end sleeves for conductors sizes 6 to 16 sqmm	
Dimensions:		
Length (closed handles)	190 mm	
Width (closed handles)	72 mm	
Height	21 mm	
Weight:	470 g	

ND#4



Technical features:

ND#4	Crimp style:	
Crimping range:	Insulated and uninsulated end sleeves for conductors sizes 0,5 to 4 sqmm	
Dimensions:		
Length (closed handles)	190 mm	
Width (closed handles)	72 mm	
Height	21 mm	
Weight:	470 g	

Package dimensions: 195 x 76 x 20 mm



MECHANICAL TOOLS ZKE RANGE

Crimp style:



ZKE 6-F

Tool for crimping end sleeves
0,5 to 6 sqmm
front insertion

Crimp style:



ZKE 610

Single aperture, ratchet controlled tool
for crimping end sleeves,
0,08 to 10 sqmm
side insertion

Crimp style:



ZKE 2

For end sleeves
0,5 to 16 sqmm

MECHANICAL TOOLS HP4 RANGE

HP4-R

Professional manual mechanical tool with ratchet mechanism that prevents the handles from opening again before reaching the ratchet.

Equipped with a positioning device to reduce the operator's effort and facilitate proper crimping of the conductor. According to the different thicknesses of the conductor insulation, the crimping on the insulation can be carried out by adjusting the jaws through three different settings:

1) strong, 2) medium, 3) light.

The tool is particularly easy to use thanks to its shape and handle coating.

At the end of the crimping the outer surface of the conductor is automatically stamped with the following crimping code:

one point for red conductor sizes from 0.25 to 1.5 mm²



Construction features:

- Special treated and externally protected steel body, ratchet and handles.
- Handle coating in soft red PVC plastic.

Technical features:



HP4-R

Crimping range:	PVC, PC and PA6.6 insulated terminals and connectors for conductor sizes 0,25 to 1,5 sqmm
Dimensions:	
Length (closed handles)	265 mm
Width (closed handles)	80 mm
Weight:	500 g
Package dimensions:	330 x 110 x 50 mm

Crimp style:



HP4-B

Professional manual mechanical tool with ratchet mechanism that prevents the handles from opening again before reaching the ratchet.

Equipped with a positioning device to reduce the operator's effort and facilitate proper crimping of the conductor. According to the different thicknesses of the conductor insulation, the crimping on the insulation can be carried out by adjusting the jaws through three different settings:

1) strong, 2) medium, 3) light.

The tool is particularly easy to use thanks to its shape and handle coating.

At the end of the crimping the outer surface of the conductor is automatically stamped with the following crimping code:

two points for blue conductor sizes from 1.5 to 2.5 mm²



Construction features:

- Special treated and externally protected steel body, ratchet and handles.
- Handle coating in soft blue PVC plastic.

Technical features:



HP4-B

Crimping range:	PVC, PC and PA6.6 insulated terminals and connectors for conductor sizes 1,5 to 2,5 sqmm
Dimensions:	
Length (closed handles)	265 mm
Width (closed handles)	80 mm
Weight:	500 g
Package dimensions:	330 x 110 x 50 mm

Crimp style:



MECHANICAL TOOLS HP4 RANGE

HP4-G



Construction features:

- Special treated and externally protected steel body, ratchet and handles.
- Handle coating in soft yellow PVC plastic.



Technical features:

HP4-G

Crimp style:



Crimping range:

PVC, PC and PA6.6 insulated terminals and connectors for conductor sizes 4 to 6 sqmm

Dimensions:

Length (closed handles)

320 mm

Width (closed handles)

105 mm

Weight:

810 g

Package dimensions:

330 x 110 x 50 mm



Professional manual mechanical tool with ratchet mechanism that prevents the handles from opening again before reaching the ratchet.

Equipped with a positioning device to reduce the operator's effort and facilitate proper crimping of the conductor. According to the different thicknesses of the conductor insulation, the crimping on the insulation can be carried out by adjusting the jaws through three different settings:

1) strong, 2) medium, 3) light.

The tool is particularly easy to use thanks to its shape and handle coating.

At the end of the crimping the outer surface of the conductor is automatically stamped with the following crimping code:

three points for yellow conductor from 4 to 6 sqmm

HP4-C10



Technical features:

HP4-C10

Crimp style:



Crimping range:

For sleeve connectors type C6-C6 and C10-C10

Dimensions:

Length (closed handles)

325 mm

Width (closed handles)

105 mm

Weight:

730 g

Package dimensions:

330 x 110 x 50 mm



Professional manual mechanical tool with ratchet mechanism that prevents the handles from opening again before reaching the ratchet.

The tool is particularly easy to use thanks to its shape and handle coating.

Construction features:

- Specially treated and externally protected steel body, ratchet and handles.

- Handle coating in soft yellow PVC.

MECHANICAL TOOL HWE1

WITH INTERCHANGEABLE DIES

New

HWE1

A robust and reliable tool designed to optimise the installers time and effort. A single tool body with a range of interchangeable dies allows a quick and simple transfer from one cable/connector combination to another, across a range of applications.

Technical features

- Length: 240 mm
- Weight: 590 g
- Automatic opening of handles following completion of the crimping operation
- Dull Nickel finish
- Anti-slip handle grips



Rapid insertion/extraction of dies without using other tools



Also available:

HWE1 KIT

- comprising:
- HWE1 Manual mechanical tool
 - WF16 die
 - IT6 die
 - all contained in a sturdy plastic case with extra compartments for interchangeable dies



INTERCHANGEABLE DIES TO ORDER SEPARATELY

INSULATED AND UNINSULATED END SLEEVES

WF16

Size 0,5 ÷ 16 mm²

INSULATED CONNECTORS RED, BLUE AND YELLOW

IT6

Size 0,5 ÷ 6 mm²

PHOTOVOLTAIC CONNECTORS (MULTI-CONTACT)

MC3

Size 4 ÷ 6 mm²

MC4

Size 4 ÷ 6 mm²



INSULATED AND UNINSULATED END SLEEVES

WF6

Size 0,5 ÷ 6 mm²

WF35

Size 16 ÷ 35 mm²

UNINSULATED CABLE LUGS

NIT10

Size 0,5 ÷ 10 mm²

OPEN BARREL BRASS CONNECTORS

OB2.5P

Size 0,5 and 2,5 mm²

SUB-D 075

Size 0,05 and 0,75 mm²

SUB-D 050

Size 0,08 and 0,5 mm²

COAXIAL CONNECTORS

C59

RG58, RG59, RG62

See page 111 for HB 11 cable stripper

New

DIES FOR PHOTOVOLTAIC CONNECTORS



MC3
Multi-Contact

MC4
Multi-Contact

Tyco
Solarlok

See page 111 for **HB 11** cable stripper

IDT



Technical features

- Length: 234 mm
- Weight: 460 g
- Automatic opening of handles following completion of the crimping operation
- Colour: black

To assist correct die selection, the type of connector is illustrated on each die.

Each die also carries an illustration of the steps in each crimping process, to assist in achieving the best result.

A robust and reliable tool designed to optimise the installers time and effort.

A single tool body with a range of interchangeable dies allows a quick and simple transfer from one cable/connector combination to another, across a wide range of applications.

Modular dies may be inserted/extracted without using any tools and are connected in pairs for speed and convenience.

INTERCHANGEABLE DIES TO ORDER SEPARATELY

INSULATED TERMINALS RED, BLUE, YELLOW AND GREEN

4300-3129	4300-3128
Size 0,5 ÷ 2,5 mm ² (Red - Blue)	Size 4 ÷ 6 mm ² (Yellow) Size 0,1 ÷ 0,4 mm ² (Green)

CONNECTORS WITH HEAT SHRINKABLE INSULATION

4300-3258	4300-3262
Size 0,5 ÷ 2,5 mm ² (Red - Blue)	Size 4 ÷ 6 mm ² (Yellow) Size 0,32 ÷ 0,75 mm ² (Green)

UNINSULATED CONNECTORS

4300-3137	4300-3241
Size 0,75 ÷ 2,5 mm ²	Size 4 ÷ 10 mm ²

CONTACTS FOR MULTI POLAR CONNECTORS (eg. ILME, HTS, CONTACT)

4300-3147	4300-3148
Size 0,14 ÷ 4 mm ²	Size 6 ÷ 10 mm ²

INSULATED AND UNINSULATED END SLEEVES

4300-3127	4300-3153	4300-3154
Size 0,25 ÷ 10 mm ²	Size 16 ÷ 25 mm ²	Size 35 ÷ 50 mm ²

OPEN BARREL CONNECTORS

4300-3146
Size 0,5 ÷ 6 mm ²

BNC/TNC CONNECTORS FOR COAXIAL CABLES

4300-3136	4300-3140
RG 58, 59, 62, 71	RG 174, 179

TV - SATELLITE RECEIVER CONNECTORS

4300-3138
RG 6, 59

PHONE CONNECTORS

4300-3144	4300-3132
RJ 45 (LARGE)	RJ 11 (SMALL)

PHOTOVOLTAIC CONNECTORS (MULTI-CONTACT)

4300-3540	4300-3539	4300-3541
MC3	MC4	Tyco Solarlok
Size 2,5 - 4/6 mm ²	Size 2,5/4/6 mm ²	Size 2,5/4/6 mm ²



IDT tool pack

Modular die pack



VALSTAR R3 IDT

To order separately - sturdy plastic case designed to store an IDT tool and up to 10 modular dies.

Modular die storage housings are easily combined for convenient transportation



MECHANICAL TOOLS TN RANGE

TN 70SE

Professional manual mechanical tool suitable for crimping A-M Cu lugs and non-insulated L-M and L-P connectors.
Heat treated steel crimp jaws.
Easily adjustable die positioning by knurled screw and reference vernier scale.
Handles made from anti-slip plastic with hilt.



Technical features:



TN 70SE

Crimp style:



Crimping range:

*Uninsulated terminals and connectors for conductor sizes 6 R/F to 70 R/F mm²

Dimensions:

Length (closed handles)

450 mm

Width (closed handles)

127 mm

Weight:

2 kg

*R= Rigid cable F= Flexible cable

TNN 70

Professional manual mechanical tool suitable for the crimping of wire terminals and PA 6.6 insulated connectors.
Heat treated steel crimp jaws.
Easily adjustable die positioning by knurled screw and reference vernier scale.
Handles made from anti-slip plastic with hilt.



Technical features:



TNN 70

Crimp style:



Crimping range:

*Polyamide PA6.6 insulated terminals and connectors for conductor sizes 10 F to 70 F mm²

Dimensions:

Length (closed handles)

450 mm

Width (closed handles)

127 mm

Weight:

2 kg

*F= Flexible cable

MECHANICAL TOOLS TN RANGE

TN 120SE



Professional manual mechanical tool suitable for crimping A-M Cu lugs and non-insulated L-M and L-P connectors. Heat treated steel crimp jaws. Easily adjustable die positioning by knurled screw and reference vernier scale. Handles made from anti-slip plastic with hilt.

Technical features:

TN 120SE

Crimp style:



Crimping range:

*Uninsulated terminals and connectors for conductor sizes 10 R/F to 120 R/150 F mm²

Dimensions:

Length (closed handles)

700 mm

Width (closed handles)

170 mm

Weight:

3 kg

*R= Rigid cable F= Flexible cable

TNN 120



Professional manual mechanical tool suitable for the crimping of wire terminals and PA 6.6 insulated connectors. Heat treated steel crimp jaws. Easily adjustable die positioning by knurled screw and reference vernier scale. Handles made from anti-slip plastic with hilt.

Technical features:

TNN 120

Crimp style:



Crimping range:

*Polyamide PA6.6 insulated terminals and connectors for conductor sizes 10 F to 120 F mm²

Dimensions:

Length (closed handles)

700 mm

Width (closed handles)

170 mm

Weight:

3 kg

*F= Flexible cable

MECHANICAL TOOLS TND RANGE

TND 6-70

Mechanical tools equipped with rotating dies with hexagonal imprint compliant with **DIN 480863** suitable to crimp copper lugs according to **DIN 46235** and through connectors according to **DIN 46267 T.1** (refer to page 36-37), Particularly sturdy and easy to handle.



Technical features:



TND 6-70

Crimp style:



Crimping range:

Uninsulated terminals and connectors according to **DIN 46235** and **DIN 46267 T.1** for conductor sizes 6 to 70 mm²

Dimensions:

Length (closed handles)

515 mm

Width (closed handles)

132 mm

Weight:

2 kg

TND 10-120

Mechanical tools equipped with rotating dies with hexagonal imprint compliant with **DIN 480863** suitable to crimp copper lugs according to **DIN 46235** and through connectors according to **DIN 46267 T.1** (refer to page 36-37), Particularly sturdy and easy to handle.



Technical features:



TND 10-120

Crimp style:



Crimping range:

Uninsulated terminals and connectors according to **DIN 46235** and **DIN 46267 T.1** for conductor sizes 10 to 120 mm²

Dimensions:

Length (closed handles)

665 mm

Width (closed handles)

162 mm

Weight:

3,7 kg

CABLE CUTTERS

KT



KT 1
Hand operated tool
for cutting cables
up to a maximum Ø 15 mm



KT 2
Hand operated tool
for cutting cables
up to a maximum Ø 25 mm



KT 5
Hand operated tool
for cutting cables
up to max section 25 sqmm



KT 3
For cutting cables Ø max 32 mm
Weight: 0,59 kg
Length: 255 mm



KT 4
For cutting cables Ø max 52 mm
Weight: 0,89 kg
Length: 310 mm



5116660250
For cutting cables 6 to 250 sqmm
Weight: 1,5 kg
Length: 600 mm

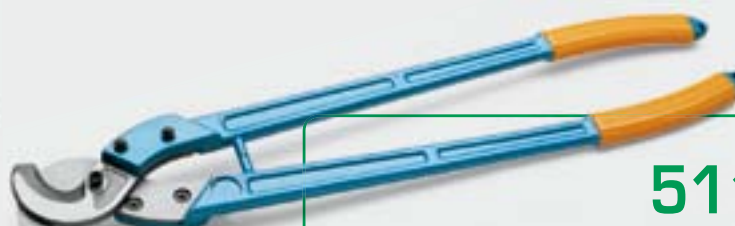

5116660500
For cutting cables 6 to 500 sqmm
Weight: 3 kg
Length: 800 mm

511

WIRE STRIPPERS

HB 6



Wire strippers,
including stripping die for PVC
insulated cables 0,02 to 10 sqmm

Interchangeable stripping
dies available upon request:



4320-0864, flat blade
suitable for:
PVC from 0,02 to 10 sqmm



4320-0866, rounded blades
suitable for:
PVC from 4 to 16 sqmm



4320-0865, 'V' blades
suitable for:
PTFE from 0,1 to 4 sqmm



HB 11



For photovoltaics insulated cables
2,5 to 6 sqmm
stripping length 8,5 mm

SCISSORS

SC 1



Electricians scissors
with high carbon steel
blades and satin
finished Nylon handles.

SC 3X



Multi-purpose scissors
with high hardness blades (56
HRC) and anti slide serrations.
The moulded plastic handles com-
bine a rigid structure with a softer
material for finger comfort.

CABLE STRIPPING TOOLS

HB 13UE

Universal cable stripping tool for external sleeves of Low/Medium Voltage cables Ø 12,7 to 63,5 mm and primary insulator in XLPE max Ø 38,1 mm



New



HB 12N

For vulcanised extruded semiconductor

HB12N cable stripping tool removes the semiconductor layer by being manually rotated around the cable while lateral advancement is achieved automatically. Safe and convenient, it can be used on conductors Ø 18 to 60 mm.

- Sturdy frame in anodised Aluminium alloy and Steel.
- Special Steel blade with precise cutting depth regulation.
- Stripping operation can start at any point along the conductor.
- Bearing mounted rollers provide smooth cutting action.



New

- With "REVERSE" function, which allows the removal of semiconductor up to 7 mm thick from the sheath of the cable.
- Double speed for each direction.



The **HB 12N** kit includes:

- HB 12N cable stripping tool
- sturdy plastic case

HB 2

Cable stripping tool for circular cables Ø 4,5 to 28,5 mm



HB 10

Insulated knife has an interchangeable straight blade and plastic blade protector that folds into the handle. Ergonomic handle made of anti shock plastic material



HB 9

Insulated knife, with curved blade and protective cover. Suitable for insulation and screen removal, equipped with blade guide to avoid damage to strands. Handle is made of a bi-component plastic material.



HAND TOOL FOR CUTTING AND SEALING FLEXIBLE CONDUIT

KTS 1632



Cuts and seals flexibles plastic conduit in a single operation. Lightweight and easy to operate. Suitable for flexible conduits from Ø16 to Ø32 mm.

Length: 230 mm
Width: 58 mm
Thickness: 32 mm.
Weight: 0,32 kg.



PC 1

Plastic pipe cutting tool
 Cutting capacity: Ø 6 to Ø 42 mm.

Body:
 die-cast aluminium alloy
Blade material:
 hardened Carbon Steel

FRAME-TYPE HOLE PUNCHING TOOL FOR CABLE TRUNKING

MT-FC48N

Table denotes the punch/die set reference, for each hole size.
 Suitable for punching holes in mild steel, fibreglass or plastic material, up to 2 mm thick.

Hole dimensions					Maximum thickness of mild steel (mm)	Code
Nominal	Ø (inch)	Pg	ISO	Inch		
15,5	.610	Pg9	-	-	2	RD 15.5 SS-FC
16,2	.638	-	ISO-16	-		RD 16.2 SS-FC
17,5	.689	-	-	-		RD 17.5 SS-FC
18,8	.740	Pg11	-	-		RD 18.8 SS-FC
19,1	.752	-	-	-		RD 19.1 SS
20,5	.807	Pg 13,5	ISO-20	-		RD 20.5 SS
22,6	.890	Pg16	-	-		RD 22.6 SS
23,8	.937	-	-	5/8"		RD 23.8 SS
25,4	1.000	-	ISO-25	-		RD 25.4 SS
27,0	1.063	-	-	3/4"		RD 27.0 SS
28,5	1.122	Pg21	-	-		RD 28.5 SS
30,5	1.201	-	-	7/8"		RD 30.5 SS
31,8	1.252	-	-	-		RD 31.8 SS
32,5	1.279	-	ISO-32	-		RD 32.5 SS
34,6	1.362	-	-	-		RD 34.6 SS
37,2	1.464	Pg29	-	-		RD 37.2 SS
38,1	1.500	-	-	-		RD 38.1 SS
40,5	1.594	-	ISO-40	-		RD 40.5 SS-FC
41,3	1.626	-	-	-		RD 41.3 SS-FC
42,5	1.673	-	-	1"1/4"		RD 42.5 SS-FC
43,2	1.701	-	-	-	RD 43.2 SS-FC	
44,5	1.752	-	-	-	RD 44.5 SS-FC	
47,2	1.858	Pg36	-	-	RD 47.2 SS-FC	



VAL P30
 Supplied in a robust plastic case.

Lightweight and easy to operate, designed for punching holes up to 47,2 mm diameter in the side wall of trunking without the need for pre drilling.

Max centre of hole to edge of trunking: 53,5 mm

Length : 251,5 mm
Width: 224 mm
Thickness: 66 mm
Weight: 3,28 kg



BENCH PRESS TOOLS



BENCH PRESS TOOLS



PNB-1

INTERCHANGEABLE DIES (to be ordered separately)

Die Set	Guard*	Connector Type	Nominal Conductor Size sqmm
PV-1	PU-1	Insulated connectors	green 0,2÷0,5
PR-1			red 0,25÷1,5
PB-1			blue 1,5÷2,5
PG-1			yellow 4÷6
KE 0.75-1	PK-1	End Sleeves	0,3 - 0,5 - 0,75
KE 2.5-1			1 - 1,5 - 2,5
KE 10-1			4 - 6 - 10
MTT 16-50	ME-1		16
MTT 25-50			25
N1-1	PU-1	A 03-M.. S 1.5-..	0,25 - 1,5
		A 06-M.. S 2.5-..	1,5 - 2,5
		A 1-M.. S 6-..	4 - 6
ME 1-50	PU-1		A1-M.. 4 - 6
ME 2-50			A2-M.. S10-M.. 10
ME 3-50	ME-1	Uninsulated copper lugs	A3-M.. 16
ME 5-50			A5-M.. 25
ME 7-50			A7-M.. 35
ME 9-50			A9-M.. 50
ME 10-50			A10-M.. 50
ME 12-50			A12-M.. 50
MN 2RF-50			MN RF-1
MN 3RF-50	ANE3-M.. 16		
MN 5RF-50	ANE5-M.. 25		
MN 7RF-50	ANE7-M.. 35		
			ANE9-M.. 35

* Supplied as standard with the machine

Pneumo-hydraulic, production bench press, controlled by a foot operated pedal, provides a consistent and reliable crimped connection. Extensive range of interchangeable dies available for crimping a wide variety of connectors.

Technical details:

- Nominal operating pressure: 6 bar
- Dimensions LxDxH: 180x320x700 mm
- Weight: 23 kg (without dies)

NOTE: for applications not listed, please contact Cembre.

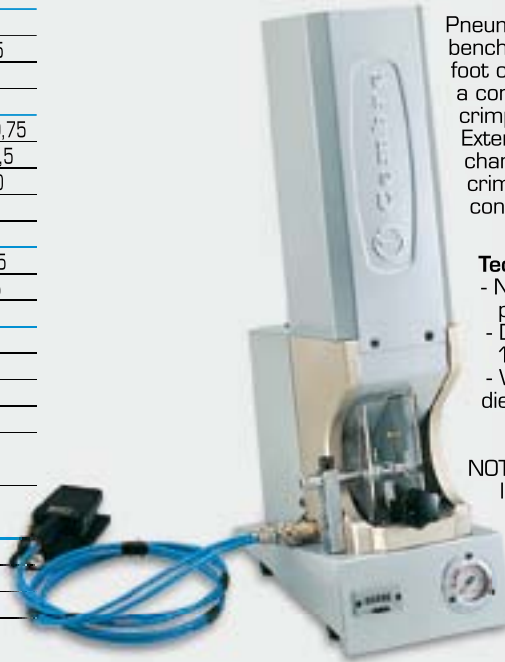

PNB-3

Tool	Connector Type	Conductor Size sqmm
PNB-3P*	Insulated connectors red, blue and yellow	0,25÷6
PNB-3PD	Insulated terminals and butt connectors - frontal insertion	0,25÷6
PNB-3N1	Uninsulated terminals	0,25÷10
PNB-3N5	Uninsulated terminals	10÷16
PNB-3NN3	Polyamide insulated terminals	1,5÷10
PNB-3NN4	Polyamide insulated terminals	10÷16
PNB-3F/M	Bullet connectors	0,5÷2,5

* Will also crimp Polycarbonate fully-insulated terminals if fitted with PNB3F/M positioner; available as an optional accessory.



Technical details:

- Normal operating pressure: 6±7 bar
- Dimensions LxDxH: 130x370x195 mm
- Weight: 10,3 kg

Pneumatic bench press operated by foot pedal for crimping terminals and connectors 0,25 to 16 sqmm.



PNB-4KE

Tool	Connector Type	Conductor Size sqmm
PNB-4KE	End Sleeves type PK. and type KE	0,3÷10

Technical details:

- Nominal operating pressure: 6 bar
- Dimensions LxDxH: 120x160x300mm
- Weight: 6 kg



Pneumatic bench press, controlled by a foot operated pedal. Supplied with a multi-aperture die suitable for crimping insulated and uninsulated end sleeves from 0,3 to 10 sqmm. Compact and efficient. Easy to operate, producing a secure and reliable crimped connection.

ELECTRICAL CRIMPING TOOL

ECT-KE2.5N

Portable

New



Portable electrical crimping tool for end sleeves 0,14 to 2,5 sqmm with 13 mm crimp length. Crimping occurs automatically when the end sleeve activates an internal pressure switch.

Technical details:

- Supply voltage: 220/230V 50Hz
- Maximum operating temperature: 40 °C
- Crimp length: 13 mm

Tool	Connector Type	Conductor Size sqmm
ECT-KE2.5N	End Sleeves type PK.. and type KE	0.14÷2.5



PNEUMATIC CRIMPING TOOLS

Hand held - PNB series

PNB-6KE PNB-7KE



Technical details:

PNB-6KE

Crimping range	0,25 ÷ 2,5 sqmm / 24 ÷ 14 AWG
Weight	400 g
Dimensions	Ø 44 x 200 mm
Spiral hose length	2 m

PNB-7KE

Crimping Range	4 ÷ 10 sqmm / 12 ÷ 8 AWG
Weight	400 g
Dimensions	Ø 44 x 200 mm
Spiral hose length	2 m

New

PNB-6KE and PNB-7KE hand tools facilitate the rapid crimping of insulated end sleeves while avoiding the operator discomfort associated with ordinary manual tools. Lightweight and easy to use, these tools are ideal for panel building applications and component assembly.

Both tools are designed to be maintenance-free and need no routine calibration. A 4-6 bar air supply is required for connection via the quick coupler fitted to the hose supplied with the tool.



PNEUMATIC CRIMPING TOOLS

Bench mounted tools with foot pedal - PNB series

PNB-6KE-T
PNB-7KE-T

New



PNB-6KE-T

Technical details:

Crimping range	0,25 ÷ 2,5 sqmm / 24 ÷ 14 AWG
Weight	1000 g
Dimensions	Ø 140 x 200 x 70 mm
Inclusive of spiral hose, foot pedal and bench mount with storage	

PNB-7KE-T

Crimping Range	4 ÷ 10 sqmm / 12 ÷ 8 AWG
Weight	1000 g
Dimensions	Ø 140 x 200 x 70 mm
Inclusive of spiral hose, foot pedal and bench mount with storage	



PNB-6KE-T and **PNB-7KE-T** have bench mounts with storage and are foot pedal operated to allow operators to have both hands free when assembling cable harnesses.

Both tools are designed to be maintenance-free and need no routine calibration. A 4-6 bar air supply is required for connection via the quick coupler fitted to the hose supplied with the tool.

BENCH PRESS

ELB-3

for polycarbonate insulated chain connectors



Electro-pneumatic, production bench press, controlled by a foot operated pedal. Producing a consistent and reliable crimped connection. Interchangeable application heads available to suit the complete range of polycarbonate insulated connectors.

Technical details:

- Air supply: 6 bar (90 psi)
- Dimensions LxDxH: 180x250x620mm
- Weight: 41 kg (without applicator heads)
- Motor:
 - Power 0,55 kW / 0,75 HP
 - Supply Voltage 220 V / 50 Hz
 - Speed 2.800 turns/minute

INTERCHANGEABLE APPLICATOR HEADS, SIDE ENTRY WITH PNEUMATIC FEED (ORDER AS REQUIRED)

Type.	Connectors	Conductor Size sqmm
RA-3	Polycarbonate insulated chain terminals	red
BA-3		blue
GA-3		yellow
KE 1A-3	Insulated chain end sleeves	0,5÷1
KE 2.5A-3		1÷2,5

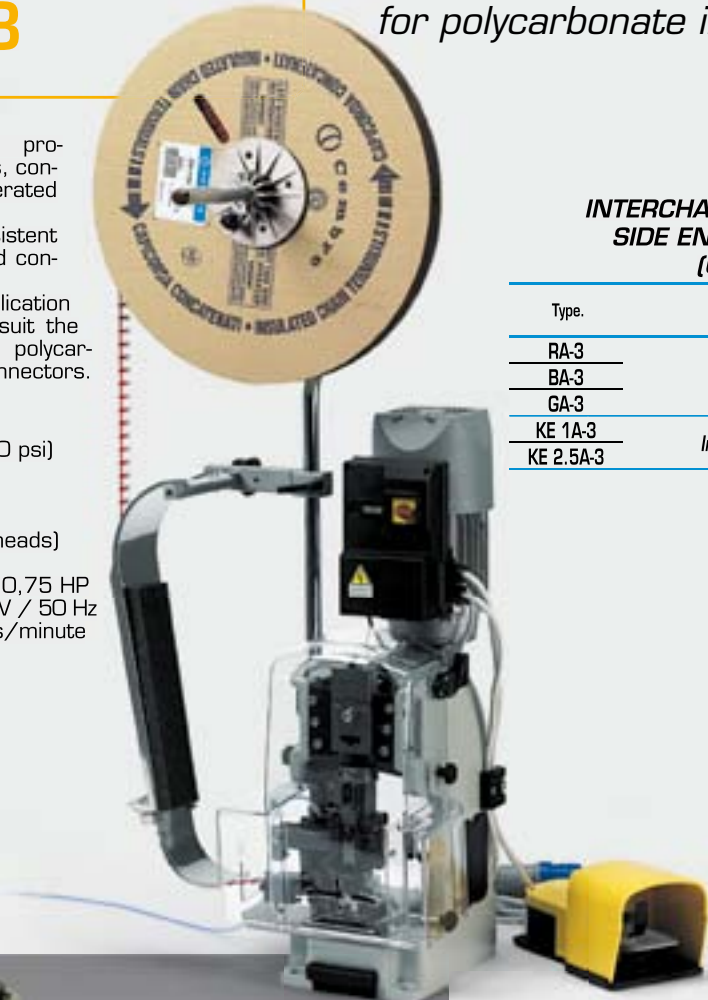

HALOGEN FREE

OPERATING TEMPERATURE UP TO 115°C

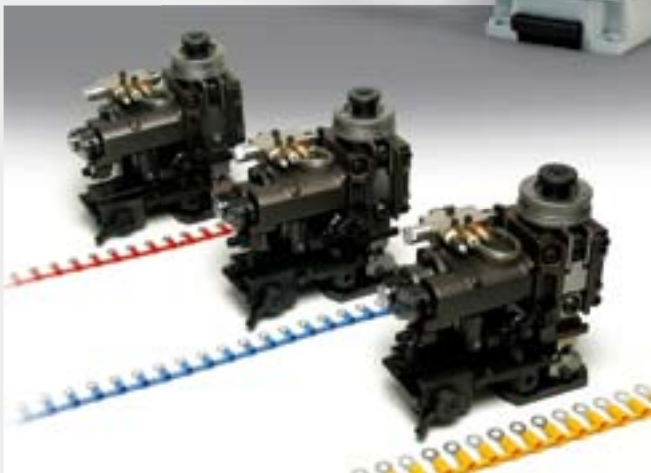

See pages 6-7 and 16 for types and features of the insulated chain connectors and end sleeves.



HYDRAULIC CRIMPING TOOLS AND CUTTERS

HYDRAULIC CRIMPING TOOL

HT 45-E

general features

Crimping force kN	Dimensions mm		Weight kg
	length	width	
50	346	130	2,0

MAIN APPLICATIONS - max section mm²

L.V. lugs and splices	"C" sleeve connectors	H.V. lugs and splices
150	35	70

STORAGE

Type	Dimensions mm	Weight kg	Supplied with the tool	Purchase separately
VAL P1*	445x290xh95	1,2	✳	—

*Suitable for storage of the tool and 20 sets of dies.

Lightweight and compact, this tool is ideal for the compression of connectors on overhead lines and other general applications.

Having the benefit of spring loaded handles, the dies can be advanced using only one hand; therefore leaving the other hand free to position the connector.

For ease of operation and comfort of the operator, the tool head can be fully rotated through 180 degrees.

The built-in safety valve will by-pass the oil supply when the maximum pressure is reached, and a pressure releasing system can easily be operated at any stage of the compression.



The operator can advance the dies using only one hand, leaving the other hand free to position the connector.

Openable head, ideal for derivations from running conductors

180° rotatable head, to work in the most comfortable position

Safety valve bypassing the oil supply when the maximum pressure is reached

Pressure releasing system, that can be operated at any stage.

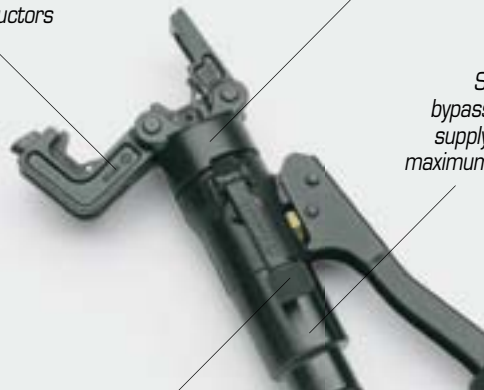

HYDRAULIC CRIMPING TOOL

general features

Crimping force kN	Dimensions mm		Weight kg
	length	width	
50	380	130	2,7

MAIN APPLICATIONS - max section mm²

L.V. lugs and splices	Insulated terminals	End sleeves	"C" sleeve Connectors
240	120	120	70

STORAGE

Type	Dimensions mm	Weight kg	Supplied with the tool	Purchase separately
VAL P1*	445x290x95	1,2	✳	—

* Suitable for storage of the tool and 20 sets of dies.

HT 51-KV version also available for Power Supply Companies



New design two speed hydraulic tool, lightweight and compact, this tool is ideal for working in confined spaces. Having the benefit of spring loaded handles, the dies can be advanced using only one hand; therefore leaving the other hand free to position the connector.

For ease of operation and comfort of the operator, the tool head can be fully rotated through 180 degrees. The built-in safety valve will by-pass the oil supply when the maximum pressure is reached, and a pressure release system can easily be operated at any stage of the compression.

HYDRAULIC PRESSHEAD

general features



Crimping force kN	Max operating pressure bar	Dimensions mm		Weight kg
		length	width	
50	700	196	75	1,6

MAIN APPLICATIONS - max section mm²

L.V. lugs and splices	Insulated terminals	End sleeves	"C" sleeve Connectors
240	120	120	70

STORAGE

Type	Dimensions mm	Weight kg	Supplied with the tool	Purchase separately
VAL P1*	445x290x95	1,2	✳	—
Canvas bag 007	350x105	0,13	—	✳

* Suitable for storage of the tool and 20 sets of dies.



Hydraulic presshead complete with quick automatic coupler for connection to a hydraulic pump with a working pressure of 700 bar max, (see page 166-170) RH 50 is suitable for installing the same range of connectors as HT 51.

HYDRAULIC PRESSHEAD

general features



Crimping force kN	Max operating pressure bar	Dimensions mm		Weight kg
		length	width	
50	700	210	70	1,6

MAIN APPLICATIONS - max section mm²

L.V. lugs and splices	Insulated terminals	End sleeves
240	120	120

STORAGE

Type	Dimensions mm	Weight kg	Supplied with the tool	Purchase separately
VAL P1*	445x290x95	1,2	✳	—
Canvas bag 007	350x105	0,13	—	✳

* Suitable for storage of the tool and 20 sets of dies.



Particularly suitable for high volume bench crimping.

Hydraulic press-head complete with quick automatic coupler for connection to hydraulic pump with working pressure of 700 bar max, (see page 166-170). RHM50 is suitable for installing the same range of connectors as RH50.

These tools are supplied without dies. For die selection, please refer to chart on pages 190 to 198

HT 81-U

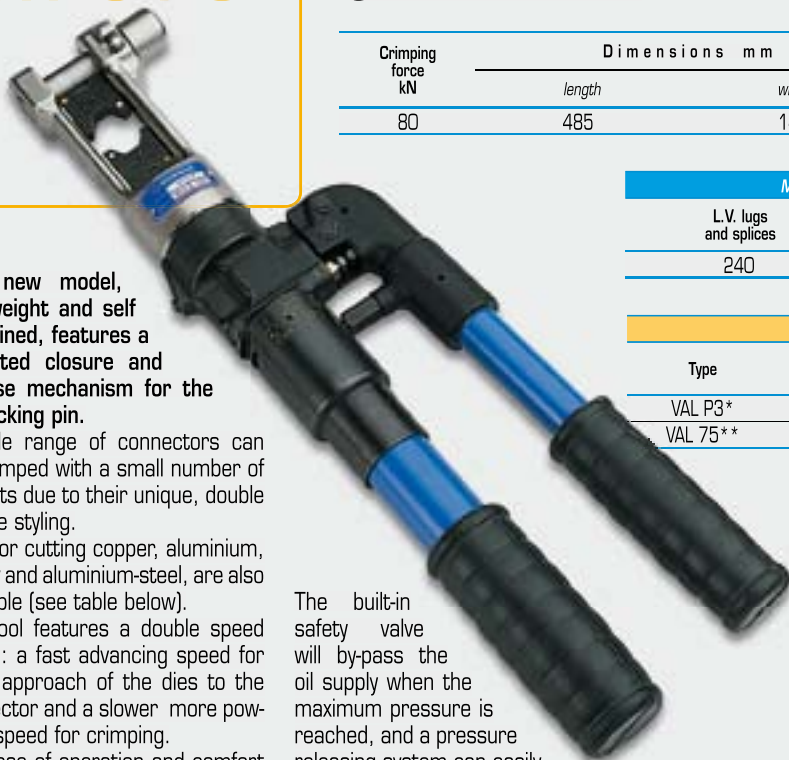

This new model, lightweight and self contained, features a patented closure and release mechanism for the die locking pin.

A wide range of connectors can be crimped with a small number of die sets due to their unique, double groove styling.

Dies for cutting copper, aluminium, aldrej and aluminium-steel, are also available (see table below).

The tool features a double speed action: a fast advancing speed for rapid approach of the dies to the connector and a slower more powerful speed for crimping.

For ease of operation and comfort of the operator the tool head can be fully rotated through 180 degrees.

The built-in safety valve will by-pass the oil supply when the maximum pressure is reached, and a pressure releasing system can easily be operated at any stage of the compression.

HYDRAULIC CRIMPING TOOL

general features

Crimping force kN	Dimensions mm		Weight Kg
	length	width	
80	485	141	3,4

MAIN APPLICATIONS - max section mm²

L.V. lugs and splices	"C" sleeve connectors	H.V. lugs and splices
240	100	200

STORAGE

Type	Dimensions mm	Weight kg	Supplied with the tool	Purchase separately
VAL P3*	620x380xh135	2,5	✳	—
VAL 75**	270x80xh30	0,15	—	✳

* Suitable for storage of the tool and three VAL 75.

** Suitable for storing five sets of dies.



RHU 81



Hydraulic presshead complete with quick automatic coupler for connection to a hydraulic pump with a working pressure of 700 bar max, (see page 166-170).

This new model, lightweight and self contained, features a patented closure and release mechanism for the die locking pin.

The head is easy to use and is ideally suited for crimping in confined spaces.

RHU81 is suitable for installing the same range of connectors as HT 81-U.

HYDRAULIC PRESSHEAD

general features

Crimping force kN	Max operating pressure bar	Dimensions mm		Weight kg
		length	width	
80	700	235	91	1,9



MAIN APPLICATIONS - max section mm²

L.V. lugs and splices	"C" sleeve connectors	H.V. lugs and splices
240	100	200

STORAGE

Type	Dimensions mm	Weight kg	Supplied with the tool	Purchase separately
Canvas bag 007	350x105	0,13	—	✳

HT 81-U and RHU 81 ACCESSORIES FOR CUTTING CONDUCTORS

Die Type	Cutting Capacity	Conductor Type
	Ø 16 mm	Cu, Alu, Aldrej and Alu-Steel
MB2-80U	This die is suitable to cut steel conductors (R ≤ 160 daN/mm ²) having the most common strandings, i.e.: 19 x 1,2 = Ø est. 6,0 mm 7 x 3,0 = Ø est. 9,0 mm 19 x 2,1 = Ø est. 10,5 mm 19 x 2,3 = Ø est. 11,5 mm	
MB3-80U	Suitable to cut aluminium strands of 150 mm ² aluminium-steel conductors, without damage to the steel core	



HYDRAULIC CRIMPING TOOL

general features

HT 120

Crimping force kN	Dimensions mm		Weight kg
	length	width	
120	488	138	5,7

MAIN APPLICATIONS - max section mm²

L.V. lugs and splices	Insulated terminals	"C" sleeve connectors	H.V. lugs and splices
400	240	185	400

STORAGE

Type	Dimensions mm	Weight kg	Supplied with the tool	Purchase separately
VAL P3*	620x380x135	2,5	✳	—

*Suitable for storage of the tool and 14 sets of dies.



The built-in safety valve will by-pass the oil supply when the maximum pressure is reached, and a pressure release system can easily be operated at any stage of the compression.



This light-weight and self contained tool will accept the semi-circular slotted dies, common to most 130 kN tools.

It is particularly suitable for installing crimp type electrical connectors for overhead line applications. The tool features a double speed action: a fast advancing speed for rapid approach of the dies to the connector and a slower more powerful speed for crimping. For ease of operation and comfort of the operator the tool head can be fully rotated through 180 degrees.

HT 120-KV
version also available for
Power Supply Companies



Die release system, protected from accidental operation

HT 120 features a double speed action: a fast advancing speed for rapid approach of the dies to the connector and a slower more powerful speed for crimping.



Pressure release trigger, which can be operated at any stage of the compression.

HYDRAULIC CRIMPING TOOL

HT 131-C

This new model, self contained, robust and sturdy, will accept all semi-circular slotted dies, common to most 130 kN tools. The tool features a double speed action: a fast advancing speed for rapid approach of the dies to the connector and a slower more powerful speed for crimping. For ease of operation and comfort of the operator the tool head can be fully rotated through 180 degrees.

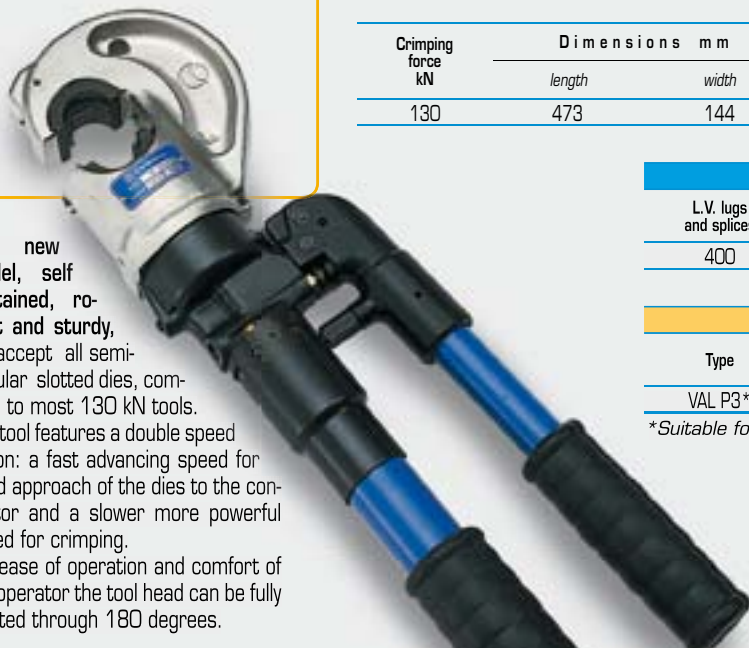

general features

Crimping force kN	Dimensions mm		Jaw Opening mm	Weight kg
	length	width		
130	473	144	25	5,5

MAIN APPLICATIONS - max section mm²

L.V. lugs and splices	Insulated terminals	"C" sleeve connectors	H.V. lugs and splices
400	240	185	400

STORAGE

Type	Dimensions mm	Weight kg	Supplied with the tool	Purchase separately
VAL P3*	620x380xh135	2,5	✳	—

*Suitable for storage of the tool and 14 sets of dies

The built-in safety valve will by-pass the oil supply when the maximum pressure is reached, and the pressure release system can easily be operated at any stage of compression.



HYDRAULIC PRESSHEADS

RHC 131

Hydraulic presshead complete with quick automatic coupler for connection to a hydraulic pump with a working pressure of 700 bar max, (see page 166-170) This new design with improved mechanical features,



general features

Crimping force kN	Max operating pressure bar	Dimensions mm		Jaw Opening mm	Weight kg
		length	width		
130	700	232	124	25	3,8



is suitable for installing the same range of connectors as HT 131-C.

MAIN APPLICATIONS - max section mm²

L.V. lugs and splices	Insulated terminals	"C" sleeve connectors	H.V. lugs and splices
400	240	185	400

STORAGE

Type	Dimensions mm	Weight kg	Supplied with the tool	Purchase separately
VAL P26*	445x290xh115	1,2	—	✳

*Suitable for storage of the head and 14 sets of dies



RHM 132

Hydraulic press-head complete with quick automatic coupler for connection to a hydraulic pump with a working pressure of 700 bar max, (see page 166-170).



general features

Crimping force kN	Max operating pressure bar	Dimensions mm		Weight kg
		length	width	
130	700	216	80	3,1

Particularly suitable for high volume bench crimping.

MAIN APPLICATIONS - max section mm²

L.V. lugs	Insulated terminals	H.V. lugs
400	240	400

STORAGE

Type	Dimensions mm	Weight kg	Supplied with the tool	Purchase separately
VAL P26*	445x290xh115	1,2	—	✳

*Suitable for storage of the head and 14 sets of dies



These tools are supplied without dies. For die selection, please refer to chart on pages 190 to 198

HYDRAULIC CRIMPING TOOL

general features

Crimping force kN	Dimensions mm		Jaw Opening mm	Weight kg
	length	width		
130	538	144	42	7,0

MAIN APPLICATIONS - max section mm²

L.V. lugs and splices	Insulated terminals	"C" sleeve connectors	H.V. lugs and splices
400	240	185	400

STORAGE

Type	Dimensions mm	Weight kg	Supplied with the tool	Purchase separately
VAL P3*	620x380xh135	2,5	✳	—

*Suitable for storage of the tool and 12 sets of dies

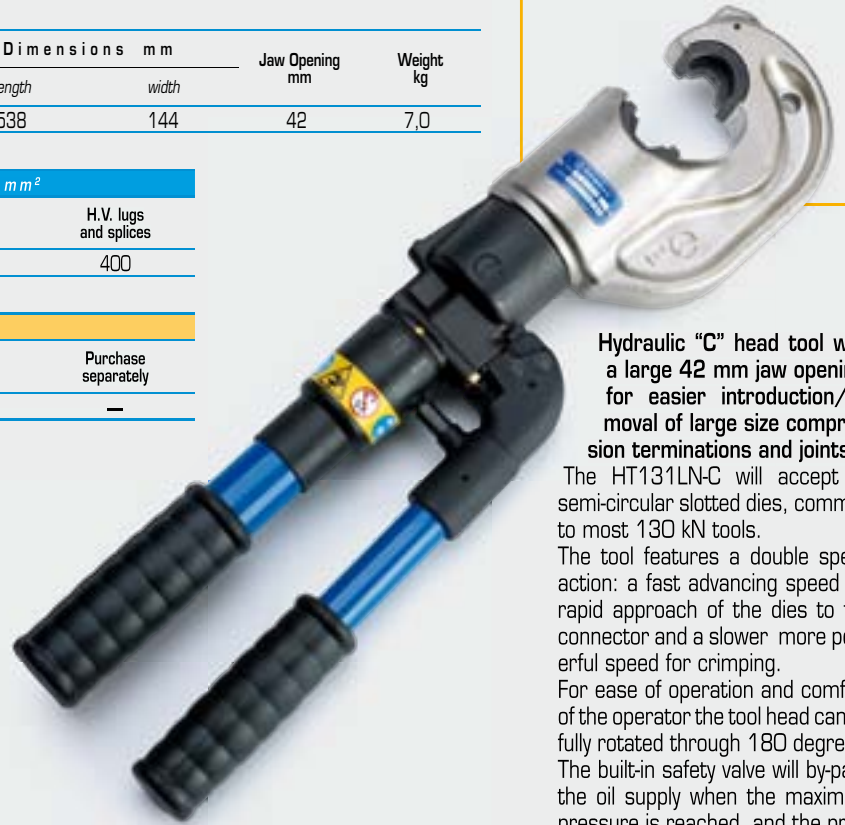

HT 131LN-C

Hydraulic "C" head tool with a large 42 mm jaw opening, for easier introduction/removal of large size compression terminations and joints.

The HT131LN-C will accept all semi-circular slotted dies, common to most 130 kN tools.

The tool features a double speed action: a fast advancing speed for rapid approach of the dies to the connector and a slower more powerful speed for crimping.

For ease of operation and comfort of the operator the tool head can be fully rotated through 180 degrees. The built-in safety valve will by-pass the oil supply when the maximum pressure is reached, and the pressure release system can easily be operated at any stage of compression.

HYDRAULIC PRESSHEAD

general features



Crimping force kN	Max operating pressure bar	Dimensions mm		Jaw Opening mm	Weight kg
		length	width		
130	700	298	122	42	5,4

MAIN APPLICATIONS - max section mm²

L.V. lugs and splices	Insulated terminals	"C" sleeve connectors	H.V. lugs and splices
400	240	185	400

STORAGE

Type	Dimensions mm	Weight kg	Supplied with the tool	Purchase separately
VAL P26*	445x290xh115	1,2	—	✳

*Suitable for storage of the head and 14 sets of dies



RHC 131LN

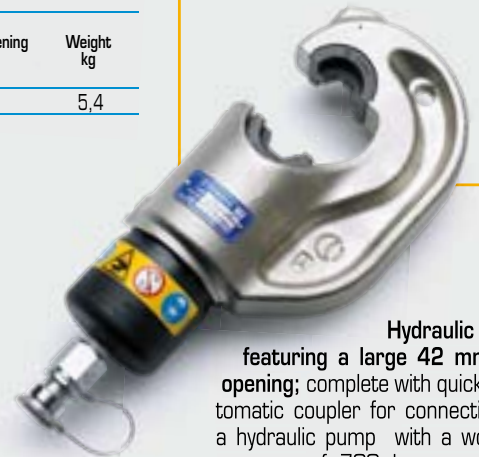

Hydraulic head featuring a large 42 mm jaw opening; complete with quick automatic coupler for connection to a hydraulic pump with a working pressure of 700 bar max, (see page 166-170). Is suitable for installing the same range of connectors as HT 131LN-C.

These tools are supplied without dies. For die selection, please refer to chart on pages 190 to 198

HT 131-UC

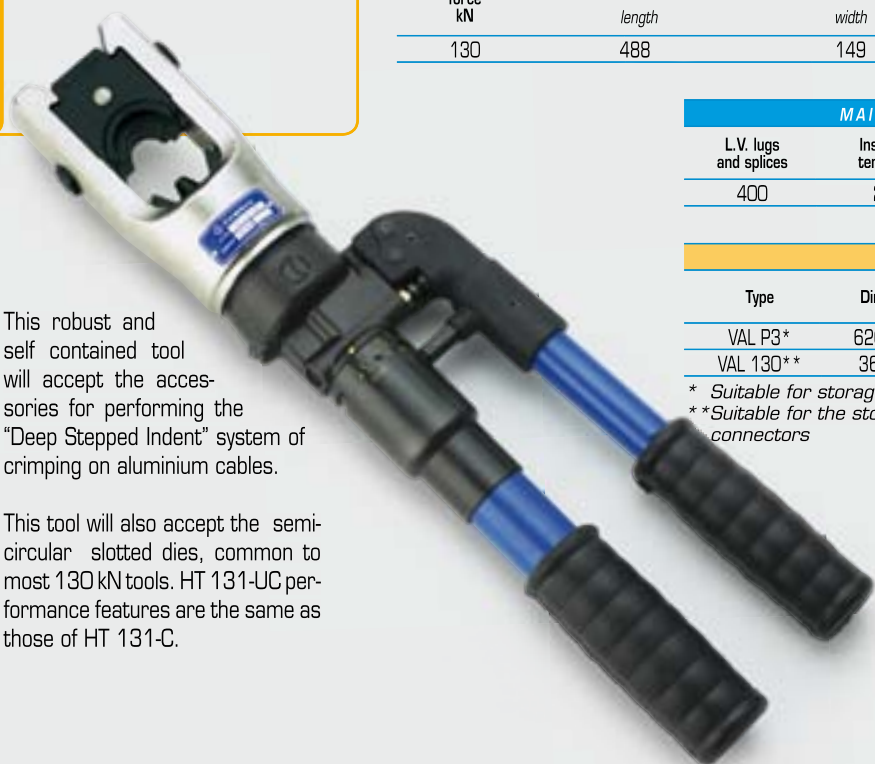

This robust and self contained tool will accept the accessories for performing the "Deep Stepped Indent" system of crimping on aluminium cables.

This tool will also accept the semi-circular slotted dies, common to most 130 kN tools. HT 131-UC performance features are the same as those of HT 131-C.

HYDRAULIC CRIMPING TOOL

general features

Crimping force kN	Dimensions mm		Weight kg
	length	width	
130	488	149	5,4

MAIN APPLICATIONS - max section mm²

L.V. lugs and splices	Insulated terminals	"C" sleeve connectors	H.V. lugs and splices	Alu lugs and splices
400	240	185	400	300

STORAGE

Type	Dimensions mm	Weight kg	Supplied with the tool	Purchase separately
VAL P3*	620x380xh135	2,5	✳	—
VAL 130**	360x280xh48	3,0	—	✳

* Suitable for storage of the tool and 14 sets of semi-circular slotted dies
 ** Suitable for the storage of accessories for crimping aluminium connectors



RHU 131-C



Hydraulic presshead complete with quick automatic coupler for connection to a hydraulic pump with a working pressure of 700 bar max, (see page 166-170).

RHU 131-C is suitable for installing the same range of connectors as HT 131-UC.

HYDRAULIC PRESSHEAD

general features



Crimping force kN	Max operating pressure bar	Dimensions mm		Weight kg
		length	width	
130	700	245	89	3,7

MAIN APPLICATIONS - max section mm²

L.V. lugs and splices	Insulated terminals	"C" sleeve connectors	H.V. lugs and splices	Alu lugs and splices
400	240	185	400	300

STORAGE

Type	Dimensions mm	Weight kg	Supplied with the tool	Purchase separately
VAL P26*	445x290xh115	1,2	—	✳
VAL 130**	360x280xh48	3,0	—	✳
VAL 130-U***	450x305xh80	5,0	—	✳

* Suitable for storage of the head and 14 sets of dies
 ** Suitable for the storage of accessories for crimping aluminium connectors
 *** Suitable for storage of the head, semi-circular slotted dies and dies for crimping aluminium connectors



VAL 130



VAL 130-U



VAL P26

These tools are supplied without dies. For die selection, please refer to chart on pages 190 to 198

HYDRAULIC PRESSHEAD



general features

Crimping force kN	Max operating pressure bar	Dimensions mm		Weight kg
		length	width	
230	700	290	120	5,5

MAIN APPLICATIONS - max section mm²

L.V. lugs and splices	Insulated terminals	"C" sleeve connectors	H.V. lugs and splices
630	300	240	630

STORAGE

Type	Dimensions mm	Weight kg	Supplied with the tool	Purchase separately
VAL ECW-H3D*	345x305xh90	4,2	—	*

* Suitable for storage of the head and 10 sets of dies

ECW-H3D ACCESSORIES FOR CUTTING CONDUCTORS

Die Type	Cutting Capacity	Conductor Type
WT2-3D	Ø 20 mm	Cu, Alu, Aldrey and Alu-Steel
	Ø 20 mm	Extra flexible steel with ≥ 200 strands
This die is suitable to cut steel conductors (R ≤ 160 daN/mm ²) having the most common strandings, i.e.: 19 x 1,2 = Ø est. 6,0 mm 7 x 3,0 = Ø est. 9,0 mm 19 x 2,1 = Ø est. 10,5 mm 19 x 2,3 = Ø est. 11,5 mm		



Hydraulic presshead complete with quick automatic coupler for connection to a hydraulic pump with a working pressure of 700 bar max, (see page 166-170).

Adaptor type **AU230-130D** is available as an optional extra enabling the head to utilise the semi-circular slotted dies which are common to most 130 kN tools. Also available is a series of dies for the compression of DIN electrical connectors, and a die for cutting copper, aluminium, aldreyl, aluminium-steel and steel conductors.



HYDRAULIC PRESSHEAD



general features

Crimping force kN	Max operating pressure bar	Dimensions mm		Weight kg
		length	width	
230	700	320	110	6,4

MAIN APPLICATIONS - max section mm²

Alu lugs and splices	Cu lugs and splices
500	630

STORAGE

Type	Dimensions mm	Weight kg	Supplied with the tool	Purchase separately
VAL 231*	470x273xh96	7,2	*	—

* Suitable for storage of the head and dies for aluminium compression



RHU 231

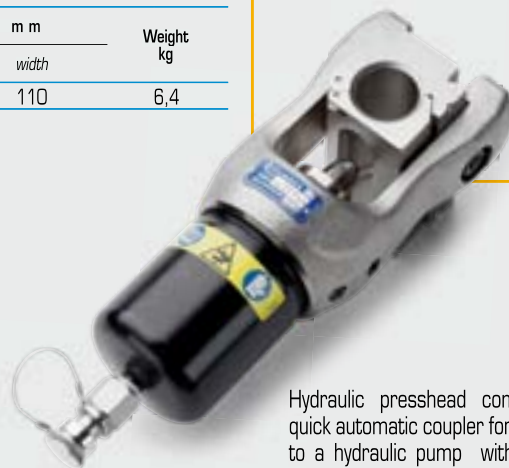

Hydraulic presshead complete with quick automatic coupler for connection to a hydraulic pump with a working pressure of 700 bar max, (see page 166-170).

For crimping up to 500 sqmm aluminium.

Dies are available also for crimping copper connectors.

RHU 230-630



Hydraulic presshead complete with quick automatic coupler for connection to a hydraulic pump with a working pressure of 700 bar max, (see page 166-170).

It allows for crimping up to 630 sqmm aluminium (according to HN 68 S90).

Adapters **AU 230-130-C/N**, and **AU 230-PS/E**, are available as an optional extra enabling the head to utilise the semicircular slotted dies which are common to most 130 kN tools.

HYDRAULIC PRESSHEAD

general features



Crimping force kN	Max operating pressure bar	Dimensions mm		Weight kg
		length	width	
230	700	365	193	9,0

MAIN APPLICATIONS - max section mm²

CU lugs and splices	Alu lugs and splices	"C" sleeve connectors	H.V. lugs and splices
400	630	185	400

STORAGE

Type	Dimensions mm	Weight kg	Supplied with the tool	Purchase separately
VAL 230-630*	405x230xh145	3,5	✳	—
VAL MAT 230-630*	290x260xh70	3,1	—	✳

* Suitable for storage of the head

** Suitable for storage of the accessories



VAL MAT 230-630



VAL 230-630

RHU 450



Hydraulic presshead complete with quick automatic coupler for connection to a hydraulic pump with a working pressure of 700 bar max, (see page 166-170). Adaptor type **AU 450-130 D** is available as an optional extra enabling the head to utilise the semi-circular slotted dies which are common to most 130 kN tools.

HYDRAULIC PRESSHEAD

general features



Crimping force kN	Max operating pressure bar	Dimensions mm		Weight kg
		length	width	
450	700	260	120	10,3

MAIN APPLICATIONS - Hexagonal crimp according to DIN 48083 max section mm²

Cu	Al	Al/St
1000	1000	680/85

These tools are supplied without dies. For die selection, please refer to chart on pages 190 to 198

HYDRAULIC PRESSHEAD

general features



Crimping force kN	Max operating pressure bar	Dimensions mm		Weight kg
		length	width	
520	700	306	200	18,0

MAIN APPLICATIONS - max section mm²

Lugs and splices	H.V. overhead lines
1200	630

STORAGE

Type	Dimensions mm	Weight kg	Supplied with the tool	Purchase separately
VAL 520*	384x231xh145	3,2	—	✳
VAL MAT 520**	500x310xh68	5,1	—	✳

* Suitable for storage of the head

** Suitable for storage of 10 sets of dies



VAL MAT 520



VAL 520

RHU 520



Hydraulic presshead complete with quick automatic coupler for connection to a hydraulic pump with a working pressure of 700 bar max, (see page 166-170).

Adaptor type **AU520-130C** is available as an optional extra enabling the head to utilise the semi-circular slotted dies which are common to most 130 kN tools.

RHU 600

HYDRAULIC PRESSHEAD

general features



Crimping force kN	Max operating pressure bar	Dimensions with support mm		Weight with support kg
		length	width	
600	700	447	241	22.4

MAIN APPLICATIONS

- "U" Alcoa series die and "L" Burndy series die, etc.
- Aluminium and Copper max size 2156 MCM

STORAGE

Type	Dimensions mm	Weight kg	Supplied with the tool	Purchase separately
VAL 600*	480x235xh260	8,6	✳	—

* Suitable for storage of the head



VAL 600

Hydraulic presshead complete with quick automatic coupler for connection to a hydraulic pump with a working pressure of 700 bar max, (see page 166-170).

HYDRAULIC PRESSHEAD



general features

RHU 1000

Crimping force kN	Max operating pressure bar	Dimensions mm		Weight kg
		length	width	
1.100	700	414	278	50,6

STORAGE

Type	Dimensions mm	Weight kg	Supplied with the tool	Purchase separately
VAL 1000*	334x244xh435	12	✳	—

*Suitable for storage of the head



VAL 1000

New

Operable from single or double acting hydraulic power source



Lifting eye; screwed into the base of the cylinder, allows easy transportation of the head in aerial operation.

RHU 1000 is a 1.100 kN hydraulic presshead for full tension, transmission and substation connections, complete with quick automatic coupler for connection to hydraulic pumps with a working pressure of 700 bar max, (see pages 166-170).

The standard version must be operated by a single acting pump; possibility to convert from single to double acting by substitution of the breather valve with a female quick coupling. RHU1000 will accept all semi-circular slotted dies common to most

100 ton heads as the Alcoa ones. The die cap is removable for an easy connector positioning; the upper part of the cap automatically rotates during the die changing process to present the correct positioning of the die. Lifting eye included.

Insertion of the upper die:



After substitution of the dies, insert the die cap into the head.



Pull the pin.



The upper part of the cap automatically rotates...



...to the correct position.

INDUSTRIAL APPLICATION
HT-TC051



Hand operated hydraulic tool specifically designed to cut copper, aluminium and telecommunications cables having a max overall diameter of 50 mm. The tool features a double speed action: a fast advancing speed for rapid approach of the blades to the cable and a slower more powerful speed for cutting. The blades are manufactured from high strength special steel, heat treated to ensure a long service life. The head can be easily opened to allow the cutting of running cables.

The head can rotate through 90 degrees, to enable the operator to work in the most comfortable position. HT-TC051 features an automatic safety valve to bypass oil

when reaching maximum pressure; a pressure release device can also be operated at any stage of operation.



HYDRAULIC CUTTING TOOL

general features

Max cutting Ø mm	Dimensions mm		Weight kg
	length	width	
50	497	129	4,38

STORAGE

Type	Dimensions mm	Weight kg	Supplied with the tool	Purchase separately
Canvas Bag 010	545x160	0,15	✳	—

INDUSTRIAL APPLICATION
TC 050

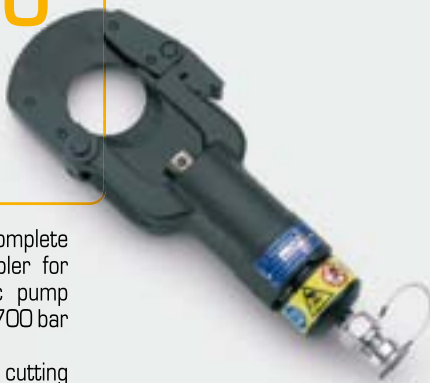

Hydraulic cutting head complete with quick automatic coupler for connection to a hydraulic pump with a working pressure of 700 bar max, (see page 166-170) TC050 features the same cutting capability as HT-TC051.

HYDRAULIC CUTTING HEAD

general features



Max cutting Ø mm	Max operating pressure bar	Dimensions mm		Weight kg
		length	width	
50	700	325	112	3,2

STORAGE

Type	Dimensions mm	Weight kg	Supplied with the tool	Purchase separately
Canvas bag 011	360x137	0,13	✳	—



INDUSTRIAL APPLICATION
HT-TC065

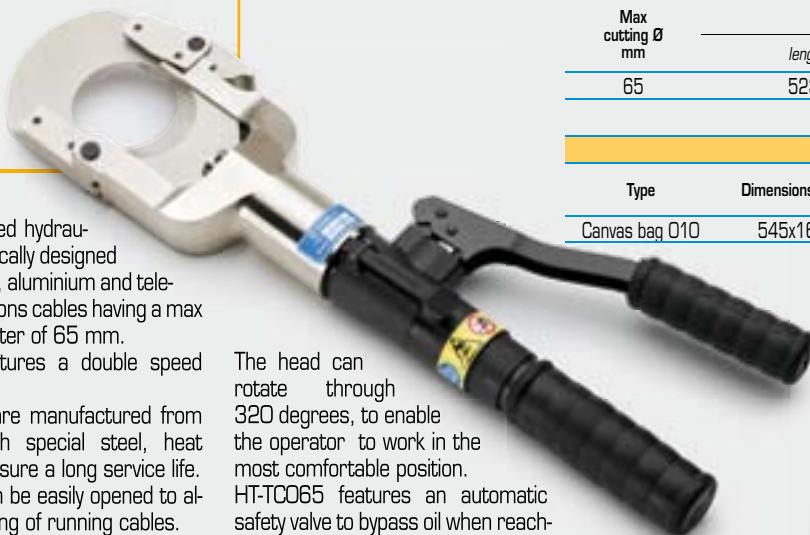

Hand operated hydraulic tool specifically designed to cut copper, aluminium and telecommunications cables having a max overall diameter of 65 mm. The tool features a double speed action. The blades are manufactured from high strength special steel, heat treated to ensure a long service life. The head can be easily opened to allow the cutting of running cables.

The head can rotate through 320 degrees, to enable the operator to work in the most comfortable position. HT-TC065 features an automatic safety valve to bypass oil when reach-

ing maximum pressure; a pressure release device can also be operated at any stage of operation.



HYDRAULIC CUTTING TOOL

general features

Max cutting Ø mm	Dimensions mm		Weight kg
	length	width	
65	523	129	5

STORAGE

Type	Dimensions mm	Weight kg	Supplied with the tool	Purchase separately
Canvas bag 010	545x160	0,15	✳	—

HYDRAULIC CUTTING TOOL

general features

Max cutting Ø mm	Dimensions mm		Weight kg
	length	width	
85	652,5	175	6,6

STORAGE

Type	Dimensions mm	Weight kg	Supplied with the tool	Purchase separately
VAL P7	727x202xh115	1,3	✳	—

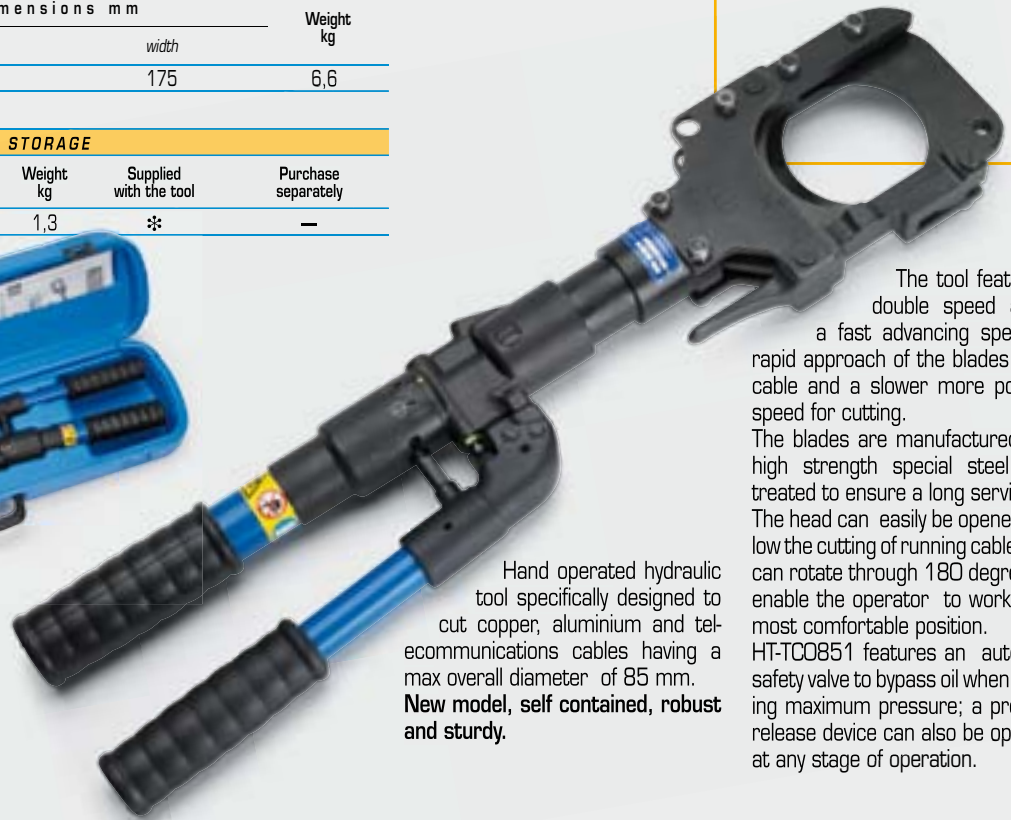

Hand operated hydraulic tool specifically designed to cut copper, aluminium and telecommunications cables having a max overall diameter of 85 mm. **New model, self contained, robust and sturdy.**

INDUSTRIAL APPLICATION HT-TC0851

The tool features a double speed action: a fast advancing speed for rapid approach of the blades to the cable and a slower more powerful speed for cutting. The blades are manufactured from high strength special steel, heat treated to ensure a long service life. The head can easily be opened to allow the cutting of running cables, and can rotate through 180 degrees, to enable the operator to work in the most comfortable position. HT-TC0851 features an automatic safety valve to bypass oil when reaching maximum pressure; a pressure release device can also be operated at any stage of operation.

HYDRAULIC CUTTING HEAD

general features

Max cutting Ø mm	Max operating pressure bar	Dimensions mm		Weight Kg
		length	width	
85	700	409	135	4,9

STORAGE

Type	Dimensions mm	Weight kg	Supplied with the tool	Purchase separately
VAL TC 085	465x155xh65	2,4	✳	—



INDUSTRIAL APPLICATION TC 085

Hydraulic cutting head complete with quick automatic coupler for connection to a hydraulic pump with a working pressure of 700 bar max, (see page 166-170)

TC085 features the same cutting capability as HT-TC0851.



INDUSTRIAL APPLICATION
TC 096

HYDRAULIC CUTTING HEAD



general features

Max cutting Ø mm	Max operating pressure bar	Dimensions mm		Weight kg
		length	width	
95	700	397	249	7,9

STORAGE

Type	Dimensions mm	Weight kg	Supplied with the tool	Purchase separately
VAL 096	450x265xh145	6,8	✳	—

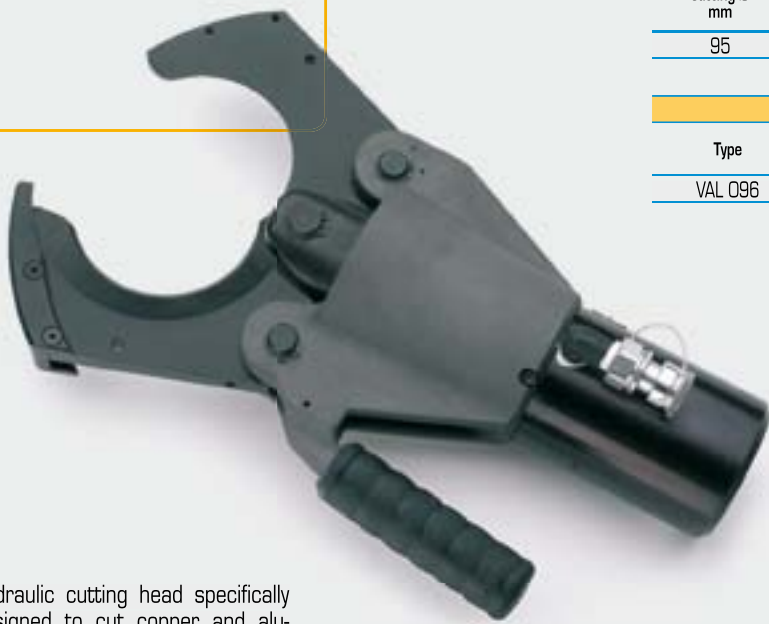

Hydraulic cutting head specifically designed to cut copper and aluminium cables having a max overall diameter of 95 mm.

The head is complete with a quick automatic coupler for connection to a hydraulic pump with a working pressure of 700 bar max, (see page 166-170).



Handle designed for ease of operation



HYDRAULIC CUTTING HEAD

general features

INDUSTRIAL APPLICATION
TC 120

Max cutting Ø mm	Max operating pressure bar	Dimensions mm		Weight kg
		length	width	
120	700	536	175	9,5

STORAGE

Type	Dimensions mm	Weight kg	Supplied with the tool	Purchase separately
VAL TC 120	590x209xh84	4,9	✳	—



Hydraulic cutting head specifically designed to cut copper, aluminium and telecommunications cables having a max overall diameter of 120 mm.

The head can easily be opened to cut running cables, and the handle allows the most comfortable positioning of the head onto the cable to be cut.

The head is complete with a quick automatic coupler for connection to a hydraulic pump with a working pressure of 700 bar max, (see page 166-170).

TC 120 cutting capacity - a few examples:

Cable type	TC 120 cutting capacity - a few examples:
	3x150 mm ² steel armoured Ø80 mm
	1000 mm ² Cu - EPR rubber insulated; Ø85 mm
	1000 mm ² Cu - EPR rubber insulated + lead sheath; Ø92 mm
	1000 mm ² Cu - EPR rubber insulated + lead sheath + PE sheath; Ø100 mm
	240 mm ² EPR rubber insulated



Handle designed for ease of operation



Opening head, to allow cutting of running cables

OVERHEAD LINE APPLICATION
HT-TC026



Hand operated hydraulic tool specifically designed to cut copper, aluminium, aluminium-steel cables and steel ropes, aluminium and steel rods having a max overall diameter of 25 mm.

The tool features a double speed action: a fast advancing speed for rapid approach of the blades to the cable and a slower more powerful speed for cutting.

The blades are manufactured from high strength special steel, heat treated to ensure a long service life.

The head can rotate through 180 degrees, to enable the operator to work in the most comfortable position, and can easily be opened to allow the cutting of running cables. HT-TC026 features an automatic safety valve to bypass oil when reaching maximum pressure; a pressure release device can also be operated at any stage of operation.

HYDRAULIC CUTTING TOOL

general features

Max cutting Ø mm	Dimensions mm		Weight kg
	length	width	
25	382	129	3,2

STORAGE

Type	Dimensions mm	Weight kg	Supplied with the tool	Purchase separately
Canvas bag 001	430x155	0,15	✳	—



CUTTING CAPACITY

MATERIAL	TENSILE STRENGTH (daN/mm²)	MAX CUTTING DIAMETER (mm)		
		B35-TC025 (1)	HT-TC026 TC 025	HT-TC026Y B-TC026 (2)
ROPE & CONDUCTORS	COPPER	≤ 41	25	25
	ALUMINIUM	≤ 20	25	25
	ALMELEC	≤ 34	25	25
	STEEL	≤ 180	INDICATIVE EXAMPLES: (2) 7 x 3,0 : Ø est. = 9,0 mm (1) (2) 19 x 2,1 : Ø est. = 10,5 mm (1) (2) 19 x 2,2 : Ø est. = 11,0 mm (2) 19 x 2,3 : Ø est. = 11,5 mm	
	MULTI STRANDS STEEL (STRANDS Qty ≥ 200)	≤ 180	-	18
	ACSR	≤ 180	25	25
RODS	STEEL	≤ 60	10	13
		≤ 42	-	16
	COPPER	≤ 30	-	20
		≤ 25	16	23
	ALUMINIUM	≤ 16	25	25

OVERHEAD LINE APPLICATION
TC 025



Hydraulic cutting head complete with quick automatic coupler for connection to a hydraulic pump with a working pressure of 700 bar max, (see page 166-170)

TC025 has the same cutting capability as HT-TC026.

HYDRAULIC CUTTING HEAD

general features

Max cutting Ø mm	Max operating pressure bar	Dimensions mm		Weight kg
		length	width	
25	700	213	82	2,0

STORAGE

Type	Dimensions mm	Weight kg	Supplied with the tool	Purchase separately
Canvas bag 007	350x105	0,13	✳	—



HYDRAULIC CUTTING TOOL

general features

OVERHEAD LINE APPLICATION HT-TC026Y

Max cutting Ø mm	Dimensions mm		Weight kg
	length	width	
25	394,5	129	3,35

STORAGE

Type	Dimensions mm	Weight kg	Supplied with the tool	Purchase separately
Canvas Bag 001	430x155	0,15	✳	—

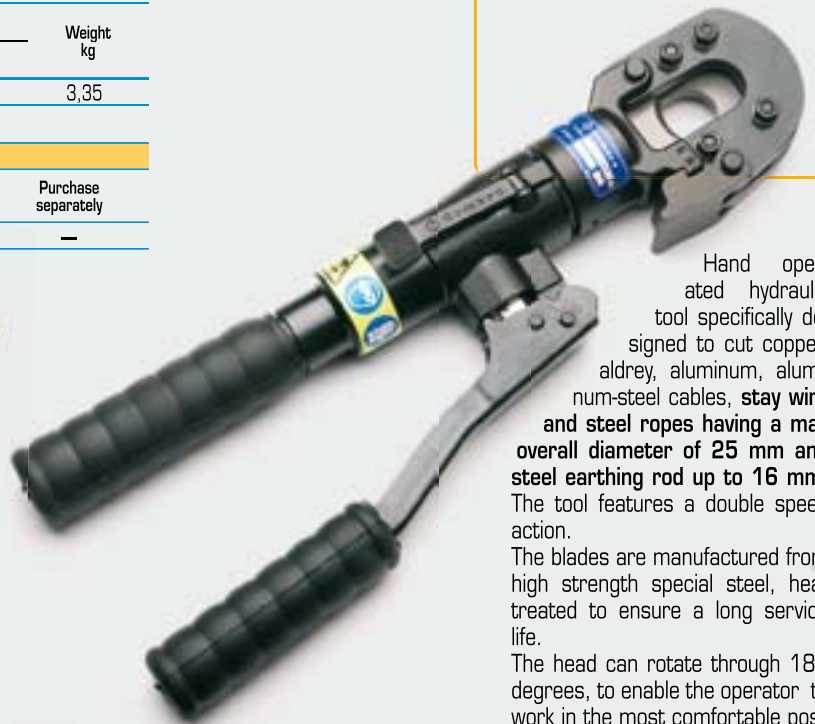

Hand operated hydraulic tool specifically designed to cut copper, aldre, aluminum, aluminum-steel cables, **stay wire and steel ropes having a max overall diameter of 25 mm and steel earthing rod up to 16 mm.** The tool features a double speed action. The blades are manufactured from high strength special steel, heat treated to ensure a long service life. The head can rotate through 180 degrees, to enable the operator to work in the most comfortable position, and can easily be opened to allow the cutting of running cables. HT-TC026Y features an automatic safety valve to bypass oil when reaching maximum pressure; a pressure release device can also be operated at any stage of operation.

Ideal for earthing rod and stay wire

HT-TC026Y cutting capacity - a few examples:

Ø		EARTHING RODS AND STAY WIRES
mm	in.	
12,7	1/2"	STEEL EARTHING ROD, COPPER PLATED; Tensile strength = 79 daN/mm ²
14,2	/	STEEL EARTHING ROD, COPPER PLATED; Tensile strength = 69 daN/mm ²
15,6	/	STEEL EARTHING ROD; Tensile strength = 69 daN/mm ²
15,9	5/8"	STEEL EARTHING ROD, COPPER PLATED (CON ED - ILLINOIS); Tensile strength = 57 daN/mm ²
15,9	5/8"	STEEL EARTHING ROD, COPPER PLATED (CON ED - STATEN ISLAND); Tensile strength = 78 daN/mm ²
19	3/4"	STEEL EARTHING ROD, COPPER PLATED; Tensile strength = 74 daN/mm ²
9,15 (3,05x7)	/	STAY WIRE
10,8 (3,6x7)	/	STAY WIRE (PORTLAND GENERAL ELECTRIC)
11,1 (3,7x7)	/	STAY WIRE (PORTLAND GENERAL ELECTRIC)
12,3 (4,1x7)	/	STAY WIRE (PORTLAND GENERAL ELECTRIC)
12,6 (4,2x7)	/	STAY WIRE (PORTLAND GENERAL ELECTRIC)

OVERHEAD LINE APPLICATION
HT-TC041



Hand operated hydraulic tool specifically designed to cut copper, aluminium, aluminium-steel cables and steel ropes, aluminium and steel rods having a max overall diameter of 40 mm.

New model, even more self contained, robust and sturdy.

The blades are manufactured from high strength special steel, heat treated to ensure a long service life. The head can rotate through 180 degrees, to enable the operator to work in the most comfortable position, and can easily be opened to allow cutting of running cables.

HT-TC041 features an automatic safety valve to bypass oil when reaching maximum pressure; a pressure release device can also be operated at any stage of operation.



HYDRAULIC CUTTING TOOL

general features

Max cutting Ø mm	Dimensions mm		Weight kg
	length	width	
40	550	144	5,8

STORAGE				
Type	Dimensions mm	Weight kg	Supplied with the tool	Purchase separately
VAL P7	727x202x115	1,3	✳	—

CUTTING CAPACITY		
MATERIAL	TENSILE STRENGTH (daN/mm ²)	MAX CUTTING DIAMETER (mm)
		HT-TC 041 TC 04 B-TC04
COPPER	≤ 41	40
ALUMINIUM	≤ 20	40
ALMELEC	≤ 34	40
ROPE & CONDUCTORS	STEEL	≤ 180 <i>INDICATIVE EXAMPLES: 7 x 3,0 : Ø est. = 9,0 mm 19 x 2,1 : Ø est. = 10,5 mm 19 x 2,3 : Ø est. = 11,5 mm</i>
	MULTI STRANDS STEEL (STRANDS Qty ≥ 200)	≤ 180 18
	ACSR	≤ 180 40 <i>INDICATIVE EXAMPLES: 26 x 2,50 + 7 x 1,95 : Ø est. = 15,85 26 x 3,06 + 7 x 2,38 : Ø est. = 19,38 26 x 3,60 + 7 x 2,80 : Ø est. = 22,80 54 x 3,50 + 19 x 2,10 : Ø est. = 31,50 54 x 4,36 + 19 x 2,62 : Ø est. = 39,20</i>
RODS	STEEL	≤ 60 18 ≤ 42 20
	COPPER	≤ 30 30 ≤ 25 32
	ALUMINIUM	≤ 16 40

HYDRAULIC CUTTING HEAD

general features



OVERHEAD LINE APPLICATION
TC 04



Hydraulic cutting head complete with quick automatic coupler for connection to a hydraulic pump with a working pressure of 700 bar max, (see page 166-170)
TC04 has the same cutting capability as HT-TC041.

Max cutting Ø mm	Max operating pressure bar	Dimensions mm		Weight kg
		length	width	
40	700	311	100	4,0

STORAGE				
Type	Dimensions mm	Weight kg	Supplied with the tool	Purchase separately
VAL 04	350x125x68	2,0	✳	—



HYDRAULIC CUTTING TOOL

general features

Max cutting Ø mm	Dimensions mm		Weight kg
	length	width	
50	503	129	4,7

STORAGE

Type	Dimensions mm	Weight kg	Supplied with the tool	Purchase separately
Canvas Bag 010	545x160	0,15	✳	—



OVERHEAD LINE APPLICATION HT-TC051Y

Hand operated hydraulic tool specifically designed to cut copper, aluminum, aluminum-steel cables (ACSR) having a max overall diameter of 50 mm.

The HT-TC051Y is provided with a two stage hydraulic system, which advances the blades quickly to the cable. This proven system saves operator time and effort.

The HT-TC051Y is provided with an automatic safety valve to bypass oil when reaching max pressure. This means safety to the operator and protection to the blades.

The blades are manufactured from high strength special steel, heat treated to ensure a long service life. The shape of the blades provides a "clean" cut.

The head can be opened to allow cutting of running cables and ropes. The head rotates 90 degrees allowing the operator to perform the cut in the most comfortable position.

The tool is supplied complete with canvas bag 010 for protection and storage when not in use.

Not suitable for cutting stay wire, steel rope or earthing rod.

HYDRAULIC CUTTING HEAD

general features



Max cutting Ø mm	Max operating pressure bar	Dimensions mm		Weight kg
		length	width	
50	700	331	112	3,3

STORAGE

Type	Dimensions mm	Weight kg	Supplied with the tool	Purchase separately
Canvas bag 011	360x137	0,13	✳	—



OVERHEAD LINE APPLICATION TC 050Y

Hydraulic cutting head complete with quick automatic coupler for connection to a hydraulic pump with a working pressure of 700 bar max, (see page 166-170).

TC 050Y features the same cutting capability as HT-TC051Y.

Not suitable for cutting stay wire, steel rope or earthing rod.

OVERHEAD LINE APPLICATION
HT-TC055



Hand operated hydraulic tool specifically designed to cut copper, aldreyl, aluminium, aluminium-steel cables and steel ropes, aluminium and steel rods having a max overall diameter of 55 mm.

The HT-TC055 is provided with a two stage hydraulic system, which advances the blades quickly to the cable. This proven system saves operator time and effort.

The head can be opened to allow cutting of running cables and ropes. The head rotates 330 degrees allowing the operator to perform the cut in the most comfortable position. The tool is supplied complete with plastic case VAL P7 for protection and storage when not in use.

The blades are manufactured from high strength special steel, heat treated to ensure a long service life. The shape of the blades provides a "clean" cut.

The HT-TC055 is provided with an automatic safety valve to bypass oil when reaching max pressure. This means safety to the operator and protection to the blades.

The blades are manufactured from high strength special steel, heat treated to ensure a long service life. The shape of the blades provides a "clean" cut.



The head can be opened to allow cutting of running cables and ropes. The head rotates 330 degrees allowing the operator to perform the cut in the most comfortable position. The tool is supplied complete with plastic case VAL P7 for protection and storage when not in use.

HYDRAULIC CUTTING TOOL

general features

Max cutting Ø mm	Dimensions mm		Weight kg
	length	width	
55	595	144	8,3

STORAGE				
Type	Dimensions mm	Weight kg	Supplied with the tool	Purchase separately
VAL P7	727x202xh115	1,3	✳	—

CUTTING CAPACITY		
MATERIAL	TENSILE STRENGTH (daN/mm ²)	MAX CUTTING DIAMETER (mm)
		HT-TC055 B-TC055
COPPER	≤ 41	55
ALUMINIUM	≤ 20	55
ALMELEC	≤ 34	55
ROPE & CONDUCTORS	STEEL	≤ 180
	MULTI STRANDS STEEL (STRANDS Q.TY ≥ 200)	≤ 180
	ACSR	≤ 180
GUY WIRE (GW15-9/16-188)	Extra high strenght grade	7 x 4,77 : Ø est. = 14,30 mm
RODS	STEEL	≤ 60
		≤ 42
	COPPER	≤ 30
		≤ 25
	ALUMINIUM	≤ 16

HYDRAULIC CUTTING HEAD

general features



OVERHEAD LINE APPLICATION
TC 055



Hydraulic cutting head complete with quick automatic coupler for connection to a hydraulic pump with a working pressure of 700 bar max, (see page 166-170)

TC055 has the same cutting capability as HT-TC055.

Max cutting Ø mm	Max operating pressure bar	Dimensions mm		Weight kg
		length	width	
55	700	357	134	6,6

STORAGE				
Type	Dimensions mm	Weight kg	Supplied with the tool	Purchase separately
VAL TC055	384x231x145	3,7	✳	—



SPECIAL TOOLS



Type	Max piercing Ø mm	Max centre of hole to edge of trunking (mm)	Max operating pressure bar	Dimensions mm		Weight kg
				length	width	
RH-FC 48N	47,2	53,5	700	259,5	147,5	3,7

Storage type	Dimensions mm	Weight kg
VAL P30*	315x300x95	0,93

*Supplied with the head

Hole Dimensions				Maximum thickness of mild steel (mm)	Code
Nominal	Pg	ISO	Inch		
Ø (mm)	Ø (inch)				
15,5	.610	Pg9	-	2	RD 15.5 SS-FC
16,2	.638	-	ISO-16		RD 16.2 SS-FC
17,5	.689	-	-		RD 17.5 SS-FC
18,8	.740	Pg11	-		RD 18.8 SS-FC
19,1	.752	-	-		RD 19.1 SS
20,5	.807	Pg 13,5	ISO-20		RD 20.5 SS
22,6	.890	Pg16	-		RD 22.6 SS
23,8	.937	-	5/8"		RD 23.8 SS
25,4	1.000	-	ISO-25		RD 25.4 SS
27,0	1.063	-	3/4"		RD 27.0 SS
28,5	1.122	Pg21	-		RD 28.5 SS
30,5	1.201	-	7/8"		RD 30.5 SS
31,8	1.252	-	-		RD 31.8 SS
32,5	1.279	-	ISO-32		RD 32.5 SS
34,6	1.362	-	-		RD 34.6 SS
37,2	1.464	Pg29	-		RD 37.2 SS
38,1	1.500	-	-		RD 38.1 SS
40,5	1.594	-	ISO-40		RD 40.5 SS-FC
41,3	1.626	-	-		RD 41.3 SS-FC
42,5	1.673	-	1 1/4"		RD 42.5 SS-FC
43,2	1.701	-	-		RD 43.2 SS-FC
44,5	1.752	-	-		RD 44.5 SS-FC
47,2	1.858	Pg36	-		RD 47.2 SS-FC

general features

Frame-type hole punching head RH-FC48N



New

Table denotes the punch/die set reference, for each hole size. Suitable for punching holes in mild steel, fibreglass or plastic material, up to 2 mm thick.

Hydraulic head complete with automatic quick coupler, designed for punching holes from 15,5 up to 47,2 mm diameter in the side wall of trunking without the need for pre drilling. For operation, the head must be joined to a hydraulic pump developing a pressure of 700 bar (see page 166-170).

VAL P30

Supplied in a robust plastic case.

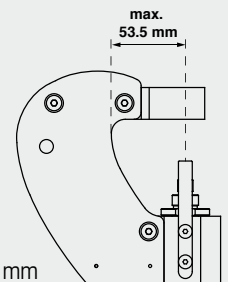

Max centre of hole to edge of trunking: 53,5 mm



Type	Max piercing Ø mm	Max hole distance from bar edge (mm)	Max operating pressure bar	Dimensions mm		Weight kg
				length	width	
RHT 160	19	30	700	240	153	6,5
RHT 160-60N	19	60	700	240	181	9,2

Storage type	Dimensions mm	Weight kg
VAL 160*	283x180x100	2,3

*Supplied with the head

Available accessories (to be ordered separately):

Piercing Ø mm	6,5	8,5	10,5	13	15	17	19
Set die - indenter	RT 6,5	RT 8,5	RT 10,5	RT 13	RT 15	RT 17	RT 19



general features

Piercing heads RHT



Hydraulic head complete with automatic quick coupler, for piercing holes of various diameters in copper, aluminium and steel bars with max. thickness of 10 mm.

This compact and handy tool is widely used for transformer room connections, control switch boards and power plants.

For operation the head must be joined to a hydraulic pump developing a pressure of 700 bar (see page 166-170).

	MAX. THICKNESS						
Hole diameter (mm)	6,5	8,5	10,5	13	15	17	19
Max thickness strep in copper	10	10	10	10	10	10	10
Max thickness strep in steel	10	10	10	9	8	7	6
Punch die/set	RT 6,5	RT 8,5	RT 10,5	RT 13	RT 15	RT 17	RT 19

SPECIAL TOOLS

Puller-type hole punching head RH-FL75



New

Hydraulic head, for hole punching stainless steel, soft steel, fibreglass and plastic sheet materials up to 3,5 mm thickness. Compact and lightweight, easy to handle in

confined spaces due to a rotating 90deg quick automatic coupler for connection to a hydraulic pump with a working pressure of 700 bar max

(see page 166-170). Supplied with Pullers TD-11, TD-19 and spiral bit Ø 11,5 mm. For the punch-die selection chart see page 164.

Max punching Ø mm	Max operating pressure bar	Dimensions mm		Weight kg
		length	width	
120	700	163	106	1,9

Storage type	Dimensions mm	Weight kg
VAL P29*	448x288x105	1,4

*Supplied with the head



Nut splitting heads RHTD



Hydraulic nut splitting head complete with automatic quick coupler. For operating the head must be joined to a hydraulic pump developing a pressure of 700 bar (see page 166-170).

general features

DIMENSIONS mm:

	RHTD 3241	RHTD 1724	RHTD 3241T
A	66	40,5	77
B	36	25	41
C	208	150,5	222
D	75,5	54	75,5
E	16	7,5	21,5

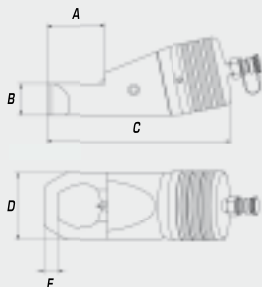

RHTD 1724

Suitable for splitting nuts mm	Max operating pressure bar	Weight kg
16 (M10) ÷ 27 (M18)	700	1,76

RHTD 3241

Suitable for splitting nuts mm	Max operating pressure bar	Weight kg
27 (M18) ÷ 41 (M27)	700	4,6

RHTD 3241T

Suitable for splitting square and hexagonal nuts or fastening bushes mm	Max operating pressure bar	Weight kg
27 (M18) ÷ 41 (M27)	700	4,9

Storage type	Dimensions mm	Weight kg
VAL P4*	315x300x95	0,93

*Supplied with the head



ACCESSORIES

Flexible hoses

High pressure flexible hoses for joining hydraulic heads to pumps. In addition to the standard versions listed below alternative hose lengths are available, please consult us:



TF 300-Q 38 FM

3 m length flexible hose fitted with an automatic female quick coupler and a male quick coupler.

TF 600-Q 38 FM

6 m length flexible hose fitted with an automatic female quick coupler and a 3/8" NPT male threaded bush.

TF 300-Q 38 F

3 m length flexible hose equipped with automatic female quick coupler at one end and male threading at the other end.

Quick couplers



Q 38-M



Q 38-F



Q 38-MS

STANDARD VERSIONS

Q 38-M

Male automatic coupler for hydraulic heads.

Q 38-F

Female automatic coupler for hydraulic pumps and flexible hoses.

Q 38-MS

Male automatic coupler for flexible hoses.

INSULATED VERSIONS



I 38-M



I 38-F



I 38-MS

I 38-M

Male automatic coupler for insulated hydraulic heads.

I 38-F

Female automatic coupler for insulated hydraulic pumps and flexible hoses.

I 38-MS

Male automatic coupler for insulated flexible hoses.

CRIMPING FORCE GAUGES FOR HYDRAULIC TOOLS

MPC 2

Crimping force gauge MPC 2

The MPC2 device, complete with test die set, to measure the maximum force developed by Cembre tools:

HT 131-C, HT 131LN-C,
HT 120, HT 120-KV, RHC 131,
RHC 131-KV, RHC 131LN,
B 131-C, B 131-C-KV, B 131LN-C,
B 131LN-C-KV, B 135-C,
B 135-C-KV, B 135LN-C,
B 135LN-C-KV.



MPC 4

Crimping force gauge MPC 4

The MPC4 device, complete with test die set, to measure the maximum force developed by Cembre tools:

ECW-H3D, RHU240-3D-850,
RHU 300-3D



MPC 7

Crimping force gauge MPC 7

The MPC7 device, complete with test die set, to measure the maximum force developed by Cembre tools:

HT45, HT 51, HT 51-KV, HT 51L,
HT 51L-KV, RH 50, HT 61, RH
61, B15D (use adaptor available
separately),
B 35-45D, B 35-50D, B 46, B 51,
B 51-KV, B 51L, B 51L-KV, B 54D,
B 55, B 55-KV, B 62.



PRESSURE TEST DEVICE FOR HYDRAULIC PUMPS AND TOOLS

MPC 1



Pressure checking device MPC 1

The MPC1 device, complete with test adapter set, is used to measure the maximum oil pressure on all Cembre tools.

FORCE/PRESSURE TEST APPLICATION CHART

For Hydraulic Pumps and Tools	For Hydraulic Tools		
MPC 1	MPC 2	MPC 4	MPC 7
PD 7000 CPP-Q CPE-1 B70M-P24 HT 45 HT 51, HT 51-KV, HT 51L, HT 51L-KV HT 61 HT 81-U HT 131-C HT 131LNC HT 131-UC HT-TC026 HT-TC051 HT-TC055 HT-TC065 HT-TC041 HT-TC0851	HT 131-C HT 131LNC HT 120, HT 120-KV RHC 131, RHC 131-KV RHC 131LN B 131-C, B131-C-KV B 131LN-C, B 131LN-C-KV B 135-C, B 135-C-KV B 135LN-C, B 135LN-C-KV	ECW-H3D RHU 240-3D-850 RHU 300-3D	HT 45 HT 51, HT 51-KV, HT 51L, HT 51L-KV HT 61 B15D (use adaptor available separately) B35-45D B35-50D B 46 B 51, B51-KV, B51L, B51L-KV B 54D B 55, B55-KV B 62 RH 50 RH 61



CORDLESS HYDRAULIC TOOLS

14.4 V CORDLESS TOOL FEATURES

- Cordless tooling can be operated with one hand.
- Balanced tool for greater control.
- Head rotates for ease of operation in confined spaces.
- Battery condition displayed after every crimping operation and battery insertion to show the residual battery power.
- The tools are fitted with a maximum pressure valve to indicate a correct crimping operation or the full extent of the blade travel.
- Extremely quiet in operation with very little vibration.
- Durable moulded body offering high resistance to wear and damage in all operating conditions.

- The plastic or steel carrying case can accommodate the tool and all the accessories.
- The B51, B135-C, B135LNC, B135-UC, B131-C, B131LNC and B131-UC will accept die sets common to the Cembre 50 and 130 kN tooling range.
- **Common features:**



double speed action:
a rapid approach speed
and a slower more powerful
speed for crimping or cutting.



**14.4V
3.0Ah
Li-Ion**

new more powerful Li-Ion battery
14.4V - 3.0Ah; reduced memory
effect, better environmental
compatibility, lighter.



SUPPLIED WITH

- 1 **CB 1430L** 14.4 V 3.0 Ah Li-Ion high power battery (2 pcs.).
- 2 **CFC 230N** Battery charger.
(INPUT 230 V/50-60 Hz; OUTPUT 7.2-18 V DC)
- 3 Shoulder strap.

- Plastic/Metal carrying case suitable for storage of the tool, accessories and dies (depending on tool type).



OPTIONAL ACCESSORIES

- 4 **BPS 230.14** mains power supply.
Main features: INPUT 230V~ 50-60Hz; OUTPUT 14,4V~ thermal and short circuit protection.
Current supply: up to 5A extended use; 23A for 50 s; 30A for 8 s.
- 5 **ESC 600** cable for connection to a 12V DC external power supply/vehicle battery length 6 m (suitable only for tools with 12V DC socket).
- 6 **CFC 12-24ICN** car battery charger.
(INPUT 12-24 V DC; OUTPUT 7.2-18 V DC)



B 51 Acoustic Noise

(Directive 2006/42/EC, annexe 1, point 1.7.4.2 letter u)

- The weighted continuous acoustic pressure level equivalent A at the workplace L_{pA} is equal to **75 dB (A)**
- The maximum value of the weighted acoustic displacement pressure C at the workplace L_{pCpeak} is less than **< 130 dB (C)**
- The acoustic power level emitted by the machine L_{WA} is equal to **85.3 dB (A)**

Risks due to vibration

(Directive 2006/42/EC, annexe 1, point 2.2.1.1)

Tests performed in accordance with specifications UNI ENV 25349 and UNI EN 28662 pt. 1, in operating conditions more severe than normal, certify that the weighed root mean square, in frequency of the acceleration the upper limbs are exposed to, for each biodynamic reference axis, does not exceed **2.5 m/sec²**.

B 131-C Acoustic Noise

(Directive 2006/42/EC, annexe 1, point 1.7.4.2 letter u)

- The weighted continuous acoustic pressure level equivalent A at the workplace L_{pA} is equal to **72.4 dB (A)**
- The maximum value of the weighted acoustic displacement pressure C at the workplace L_{pCpeak} is less than **< 130 dB (C)**
- The acoustic power level emitted by the machine L_{WA} is equal to **83.1 dB (A)**

9.6 V CORDLESS TOOL FEATURES

- Cordless tooling can be operated with one hand.
- Balanced tool for greater control.
- Head rotates for ease of operation in confined spaces.
- Battery condition displayed after every crimping operation and battery insertion to show the residual battery power.
- The tools are fitted with a maximum pressure valve to indicate a correct crimping operation or the full extent of the ram travel.
- Extremely quiet in operation with very little vibration.
- Durable moulded body offering high resistance to wear and damage in all operating conditions.
- The plastic carrying case can accommodate the tool and all the accessories.



*only for B54D-D6

SUPPLIED WITH

- 1 **CB 9620H** 9.6 V 2.0 Ah Ni-MH high power battery (2 pcs.) or **CB 9630H** 9.6 V 3.0 Ah Ni-MH high power battery, only for B54D-D6 (2 pcs.).
 - 2 **CFC 230N** Battery charger. (INPUT 230 V/50-60 Hz; OUTPUT 7.2-18 V DC)
 - 3 **Adaptor CBA 96-144.**
- **VAL P22** Plastic carrying case suitable for storing the tool and accessories.



OPTIONAL ACCESSORIES

- 4 **CFC 12-241CN** car battery charger. (INPUT 12-24 V DC; OUTPUT 7.2-18 V DC)
- 5 **Adaptor CBA 96-144.**
- 6 **BPS 230.96**, mains power supply. **Main features:** INPUT 230V $\overline{\sim}$ 50-60Hz; OUTPUT 9.6V $\overline{\sim}$ thermal and short circuit protection. **Current supply:** up to 8A extended use; 25A for 50 s; 30A for 8 s



B 15D Acoustic Noise

(Directive 2006/42/EC, annexe 1, point 1.7.4.2 letter u)

- The weighted continuous acoustic pressure level equivalent A at the workplace L_{pA} is equal to **66.8 dB (A)**
- The maximum value of the weighted acoustic displacement pressure C at the workplace L_{pCpeak} is less than **< 130 dB (C)**
- The acoustic power level emitted by the machine L_{WA} is equal to **75 dB (A)**

Risks due to vibration

(Directive 2006/42/EC, annexe 1, point 2.2.1.1)

Tests performed in accordance with specifications UNI ENV 25349 and UNI EN 28662 pt. 1, in operating conditions more severe than normal, certify that the weighed root mean square, in frequency of the acceleration the upper limbs are exposed to, for each biodynamic reference axis, does not exceed **2.5 m/sec²**.

9.6 V CORDLESS HYDRAULIC CRIMPING TOOL

B 15D

general features



Crimping force kN	Dimensions mm			Battery Ni-MH	Weight kg (with battery)
	length	height	width		
15	320	117	66	9.6 V 2.0 Ah	1,68

**9.6V
2.0Ah
Ni-MH**

New

Can be operated with one hand. Balanced for greater control. Head rotates 340° for ease of operation in confined spaces. Fitted with a maximum pressure valve. Extremely quiet, minimal vibration. Durable moulded body offering high resistance to wear and damage in all operating conditions. Ni-MH battery; powerful, better environmental compatibility. Complete with a display which, after every operation and battery insertion, indicates the residual battery power. Supplied in a robust plastic case to accommodate the tool and all the accessories.

Two batteries and charger included. Many different interchangeable crimping dies available.

Many different interchangeable crimping dies available

CRIMPING DIES AVAILABLE				
Conductor size mm ² (AWG)		Connector type	DIE SET	
0,25 ÷ 16	22 ÷ 6	A... ; L...-M ; L...-P ; S... ; RN... ; BN... ; GN...	MA03/3-15	☺
1,5 ÷ 10	16 ÷ 8	A... ; L...-M ; L...-P	ME03/2-15	☞
10 ÷ 16	8 ÷ 6	A... ; 2A... ; L...-M ; L...-P	ME2/3-15	
4 ÷ 10	12 ÷ 8	T... (NF C 20130 style) ; L...-T	MS4/10-15	
10 ÷ 16	8 ÷ 6	T... (NF C 20130 style) ; L...-T	MS10/16-15	
10 ÷ 16	8 ÷ 6	HR... ; HSV...	MH10/16-15	☞
6 ÷ 16	10 ÷ 6	DR... (DIN 46235 style) ; DSV... (DIN 46267 T1 style)	MK5/8-15	
10 ÷ 16	8 ÷ 6	ANE... ; AN... ; IN... ; EN...	NN4-15	☺
0,25 ÷ 6	22 ÷ 10	R... ; B... ; G... ; PL... ; NL...	RBG-15	☞
0,25 ÷ 6	22 ÷ 10	R... ; B... ; G... (not suffix P, RF/BF-BF)	RBV-15 with positioner	
0,3 ÷ 4	22 ÷ 12	PKE ; PKC ; PKD ; PKT ; KE	KE4-15	☞
4 ÷ 16	12 ÷ 6	PKE ; PKC ; PKD ; PKT ; KE	KE16-15	
16 ÷ 35	6 ÷ 2	PKE ; PKC ; PKD ; PKT ; KE	KE35-15	

MAIN APPLICATIONS - max section mm²

Copper lugs and splices	Insulated terminals	End sleeves
0,25 - 16	0,25 - 16	0,3 - 35

STORAGE

Type	Dimensions mm	Weight kg	Supplied with the tool	Purchase separately
VAL P22	465x315x116	1,5	✳	—

The tool is supplied as:

- Basic tool with battery and wrist strap
- Spare battery
- Battery charger
- Battery adapter

- Plastic carrying case suitable for storing the tool and accessories

Head rotates 340° for ease of operation

Durable moulded body offering high resistance to wear and damage in all operating conditions

Sculptured body for optimum comfort



Battery condition display



Interchangeable die sets



Ergonomically designed operating switch



Automatic slot-in battery

9.6 V CORDLESS HYDRAULIC CRIMPING TOOL



general features

B 35-45D

**9.6V
2.0Ah
Ni-MH**

Crimping force kN	Dimensions mm			Battery Ni-MH	Weight kg (with battery)
	length	height	width		
35	342	108	66	9.6 V 2.0 Ah	2,1

MAIN APPLICATIONS - max section mm²

L.V. lugs and splices	"C" sleeve Connectors	H.V. lugs and splices
150	35	70

STORAGE

Type	Dimensions mm	Weight kg	Supplied with the tool	Purchase separately
VAL P22	465x315x116	1,5	✳	—

The tool is supplied as:

- Basic tool with battery and wrist strap
- Spare battery
- Battery charger
- Battery adapter
- Plastic carrying case suitable for storing the tool and accessories



Can be operated with one hand.

Balanced for greater control. Head rotates 180° for ease of operation in confined spaces.

Fitted with a maximum pressure valve.

Extremely quiet, minimal vibration. Durable moulded body offering high resistance to wear and damage in all operating conditions.

Ni-MH battery; powerful, better environmental compatibility.

Complete with a display which, after every operation and battery insertion, indicates the residual battery power.

Supplied in a robust plastic case to accommodate the tool and all the accessories.

Two batteries and charger included. B35-45D accepts many of the dies common to 45 kN Cembre crimping tools. B35-45D specific dies available for crimping 120 mm² and 150 mm².

Application field as shown in the table above. For further details please refer to tables of page 190-198.

Wide-opening head, ideal for derivations from running conductors



Motor ventilation



Head rotates 180° for ease of operation



Pressure release button



Sculptured body for optimum comfort

These tools are supplied without dies. For die selection, please refer to chart on pages 190 to 198

9.6 V CORDLESS HYDRAULIC CRIMPING TOOL

B 35-50D

general features



Crimping force kN	Dimensions mm			Battery Ni-MH	Weight kg (with battery)
	length	height	width		
35	372	108	66	9.6 V 2.0 Ah	2,4

**9.6V
2.0Ah
Ni-MH**

New

MAIN APPLICATIONS - max section mm²

L.V. lugs and splices	Insulated terminals	End sleeves	"C" sleeve Connectors
150	50	95	35

STORAGE

Type	Dimensions mm	Weight kg	Supplied with the tool	Purchase separately
VAL P22	465x315x116	1,5	✳	—

Can be operated with one hand.
Balanced for greater control.
Head rotates 180° for ease of operation in confined spaces.
Fitted with a maximum pressure valve.
Extremely quiet, minimal vibration.
Durable moulded body offering high resistance to wear and damage in all operating conditions.
Ni-MH battery; powerful, better environmental compatibility.
Complete with a display which, after every operation and battery insertion, indicates the residual battery power.
Supplied in a robust plastic case to accommodate the tool and all the accessories.
Two batteries and charger included.
B35-50D accepts many of the dies common to 50 kN Cembre crimping tools.

B35-50D specific dies available for crimping 120 mm² and 150 mm². Application field as shown in the table above. For further details please refer to tables of page 190-198.

The tool is supplied as:

- Basic tool with battery and wrist strap
- Spare battery
- Battery charger
- Battery adapter
- Plastic carrying case suitable for storing the tool and accessories



Head rotates by 180° for ease of operation

Sculptured body for optimum comfort

Durable moulded body offering high resistance to wear and damage in all operating conditions



Wide-opening head, ideal for derivations from running conductors



Switch ergonomically designed



Battery condition display



Automatic slot-in battery

These tools are supplied without dies. For die selection, please refer to chart on pages 190 to 198

9.6 V CORDLESS HYDRAULIC CRIMPING TOOL



general features

B 54D-D6

**9.6V
3.0Ah
NI-MH**

Crimping force kN	Dimensions mm			Battery Ni-MH	Weight kg (with battery)
	length	height	width		
54	450	119	66	9.6 V 3.0 Ah	2,9

MAIN APPLICATIONS - max section AWG

Copper lugs and splices	Aluminum lugs and splices	Aluminum H taps
300 MCM	4/0	4/0 - 4/0

STORAGE

Type	Dimensions mm	Weight kg	Supplied with the tool	Purchase separately
VAL P25	497x370x137	2,3	*	—
VAL MAT-W	175x96x45	0,93	—	*

The tool is supplied as:

- Basic tool with battery and wrist strap
- Spare battery
- Battery charger
- Battery adapter
- Plastic carrying case suitable for storing the tool and accessories



VAL P25

Available as optional accessories:
VAL MAT-W metal case for storing 12 Index die sets, fits into VAL-P25.

VAL MAT-W

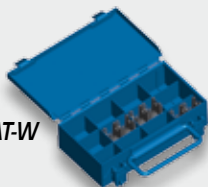

The professional tool ideal for OH lines and residential service applications.



Extremely quiet, minimal vibration. Durable moulded body offering high resistance to wear and damage in all operating conditions. Ni-MH battery; powerful, better environmental compatibility. Supplied in a robust plastic case for storing the tool and all accessories. Two batteries and charger included. Standard interchangeable crimping jaw: CDD6 with "D3" groove to accept all "W" style crimping dies + "BG" fixed groove. Complete with a display which, after every operation and battery insertion, indicates the residual battery power.

Can be operated with one hand. Balanced for greater control. Jaws rotate 180° for ease of operation in confined spaces. Fitted with a maximum pressure valve.

INTERCHANGEABLE CRIMPING JAWS

CAT. No	GROOVES	CRIMPING DIE COMPATIBILITY
CDD6	"D3" TO ACCEPT ALL "W" STYLE CRIMPING DIES + "BG" FIXED GROOVE	FCI Burndy Green lee IlSCO
CDD6-8	"D3" TO ACCEPT ALL "W" STYLE CRIMPING DIES + "O" FIXED GROOVE	Huskie Panduit
CMB1	Cutting jaws for: one-time disposable lock hasps; 4AWG Alumoweld; ACSR 4/0	
CMB2	Cutting jaws for: # 8 Copperweld; 4/0 Cu.; 336 MCM Aluminium; 477 MCM ACSR (Str. 26/7)	
CMB3	Cutting jaws for: 1/4" Guy Wire ; 5/16" Guy Wire	



CDD6 jaws

With "D3" groove to accept all "W" style crimping dies + "BG" fixed groove.



CDD6-8 jaws

With "D3" groove to accept all "W" style crimping dies + "O" fixed groove.



CMB1 jaws

Cutting jaws for: one-time disposable lock hasps, 4AWG Alumoweld; ACSR 4/0



CMB2 jaws

Cutting jaws for:
- # 8 Copperweld
- 4/0 Cu.
- 336 MCM Aluminium
- 477 MCM ACSR (Str. 26/7)



CMB3 jaws

Cutting jaws for:
- 1/4" Guy Wire
- 5/16" Guy Wire



Canvas Bag 013

Sturdy canvas bag, suitable for storing the cutting jaws

New

New



Jaws rotate 180°



Detail of the quick jaw change device.

14.4 V CORDLESS HYDRAULIC CRIMPING TOOL

B 51

general features



Crimping force kN	Dimensions mm			Battery	Weight kg (with battery)
	length	height	width		
50	297	302	94	14,4 V 3.0 Ah	3,7



**14.4V
3.0Ah
Li-Ion**



MAIN APPLICATIONS - max section mm²

L.V. lugs and splices	Insulated terminals	End sleeves	"C" sleeve Connectors
240	120	120	70

STORAGE

Type	Dimensions mm	Weight kg	Supplied with the tool	Purchase separately
VAL P5	543x412x130	2,3	✳	—

The tool is supplied as:

- Basic tool with battery, wrist strap and shoulder strap
- Spare battery
- Battery charger
- Plastic carrying case suitable for storing the tool and 21 die sets



14.4 V cordless hydraulic crimping tool, lightweight and balanced for single hand operation.

The tool features a double speed action: a fast advancing speed for rapid approach of the dies to the connector and a slower more powerful speed for crimping.

The crimping head can rotate through 180° for ease of operation.

The B 51 will accept die sets common to the Cembre 50 kN tooling range.

Fitted with a maximum hydraulic pressure valve.

Complete with a display which, after every operation and battery insertion, indicates the residual battery power.

Extremely quiet in operation, with very little vibration. Ergonomically designed with a sculptured body for operator comfort.



B 51-KV
version also available for
Power Supply Companies

Lightweight and balanced



Motor ventilation



Battery condition display



Switch protected against accidental operation



Automatic slot-in battery



These tools are supplied without dies. For die selection, please refer to chart on pages 190 to 198

14.4 V CORDLESS HYDRAULIC CRIMPING TOOL



general features

B 55



**14.4V
3.0Ah
Li-Ion**

Crimping force kN	Dimensions mm			Battery	Weight kg (with battery)
	length	height	width		
55	358	302	94	14.4 V 3.0 Ah	4,7

MAIN APPLICATIONS - max section mm²

Copper lugs and splices	Insulated terminals	End sleeves	"C" sleeve Connectors
240	120	120	70

STORAGE

Type	Dimensions mm	Weight kg	Supplied with the tool	Purchase separately
VAL P9	543x412x130	2,2	*	—

The tool is supplied as:

- Basic tool with battery, wrist strap and shoulder strap
- Spare battery
- Battery charger
- Plastic carrying case suitable for storing the tool and accessories



14.4 V cordless hydraulic crimping tool, lightweight and balanced for single hand operation. The tool features a double speed action: a fast advancing speed for rapid approach of the dies to the connector and a slower more powerful speed for crimping. The crimping head can rotate through 180° for ease of operation.

The B 55, with adapter AU55-50, will accept all Cembre 50 kN dies; with adapter AU55-W it will accept "W" dies.

Fitted with a maximum hydraulic pressure valve.

Complete with a display which, after every operation and battery insertion, indicates the residual battery power.

Extremely quiet in operation, with very little vibration.

Ergonomically designed with a sculptured body for operator comfort.

With adapter AU55-50 for accepting Cembre dies.

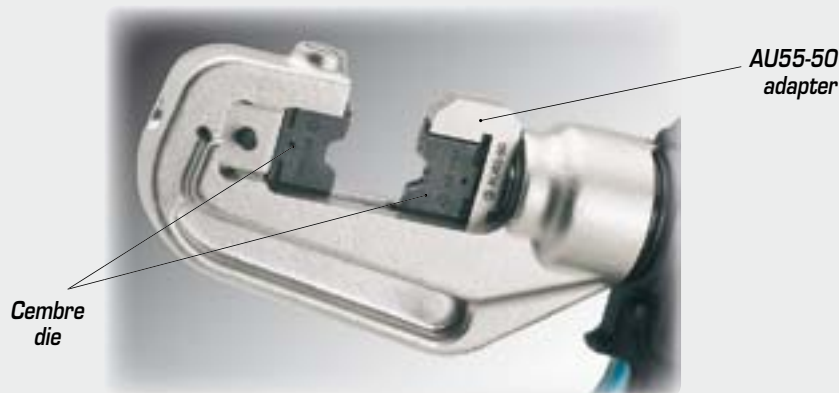

Cembre die

AU55-50 adapter

With adapter AU55-W for accepting "W" dies.

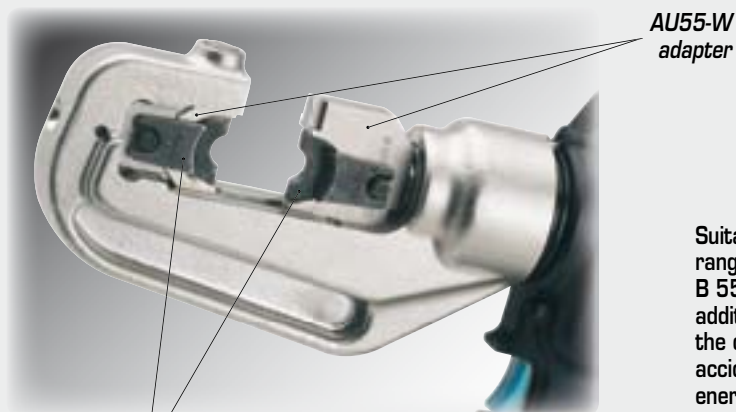

"W" die

AU55-W adapter

Suitable for installing the same range of connectors of B 55, B 55-KV tool is provided with additional coatings to protect the operator and tool against accidental brush contact with energised conductors.

Particularly suitable for Power Supply Companies.



B 55-KV

These tools are supplied without dies. For die selection, please refer to chart on pages 190 to 198

14.4 V CORDLESS HYDRAULIC CRIMPING TOOL

B 135-C

general features



Crimping force kN	Dimensions mm			Jaw Opening mm	Battery	Weight kg (with battery)
	length	height	width			
130	361	302	94	25	14,4 V 3.0 Ah	6,35



**14.4V
3.0Ah
Li-Ion**



14.4 V cordless hydraulic crimping tool, lightweight and balanced for single hand operation.

The tool features a double speed action: a fast advancing speed for rapid approach of the dies to the connector and a slower more powerful speed for crimping.

The crimping head can rotate through 180° for ease of operation.

The B135-C will accept all semi-circular slotted dies, common to most 12 tons tools (U dies).

Fitted with a maximum hydraulic pressure valve.



Complete with a display which, after every operation and battery insertion, indicates the residual battery power. Extremely quiet in operation, with very little vibration. Ergonomically designed with a sculptured body for operator comfort.

MAIN APPLICATIONS - max section mm²

L.V. lugs and splices	Insulated terminals	"C" sleeve Connectors	H.V. lugs and splices
400	240	185	400

STORAGE

Type	Dimensions mm	Weight kg	Supplied with the tool	Purchase separately
VAL P9-C	543x412x130	2,2	*	—

The tool is supplied as:

- Basic tool with battery, wrist strap and shoulder strap
- Spare battery
- Battery charger
- Plastic carrying case suitable for storing the tool and 8 sets of semi-circular slotted dies



B 135-C-V
version also available for
Power Supply Companies



B 135LN-C

general features



Crimping force kN	Dimensions mm			Jaw Opening mm	Battery	Weight kg (with battery)
	length	height	width			
130	424	302	94	42	14,4 V 3.0 Ah	7,85



**14.4V
3.0Ah
Li-Ion**



Also available in the B135LN-C version, featuring a large 42 mm jaw opening, for an easier introduction/removal of large size compression terminations and joints.



The tool is supplied with:

- Basic tool with battery, wrist strap and shoulder strap
- Spare battery
- Battery charger
- Plastic carrying case suitable for storing the tool and 8 sets of semi-circular slotted dies

MAIN APPLICATIONS - max section mm²

L.V. lugs and splices	Insulated terminals	"C" sleeve Connectors	H.V. lugs and splices
400	240	185	400

STORAGE

Type	Dimensions mm	Weight kg	Supplied with the tool	Purchase separately
VAL P9-C	543x412x130	2,2	*	—



These tools are supplied without dies. For die selection, please refer to chart on pages 190 to 198

14.4 V CORDLESS HYDRAULIC CRIMPING TOOL



general features

B 135-UC



**14.4V
3.0Ah
Li-Ion**

Crimping force kN	Dimensions mm			Battery	Weight kg (with battery)
	length	height	width		
130	376	302	94	14,4 V 3.0 Ah	6,2

MAIN APPLICATIONS - max section mm²

L.V. lugs and splices	Insulated terminals	"C" sleeve Connectors	H.V. lugs and splices	Alu lugs and splices
400	240	185	400	300

STORAGE

Type	Dimensions mm	Weight kg	Supplied with the tool	Purchase separately
VAL P9-C	543x412x130	2,2	*	—

The tool is supplied as:

- Basic tool with battery, wrist strap and shoulder strap
- Spare battery
- Battery charger
- Plastic carrying case suitable for storing the tool and 8 sets of semi-circular slotted dies



14.4 V cordless hydraulic crimping tool, lightweight and balanced for single hand operation.

This tool will accept the accessories for performing the "Deep Stepped Indent" system of crimping on aluminium cables.

The B135-UC will accept all semi-circular slotted dies, common to most 12 tons tools (U dies).

The tool features a double speed action: a fast advancing speed for rapid approach of the dies to the connector and a slower more powerful speed for crimping.

The crimping head can rotate through 180° for ease of operation.

Fitted with a maximum hydraulic pressure valve. Complete with a display which, after every operation and battery insertion, indicates the residual battery power. Extremely quiet in operation, with very little vibration. Ergonomically designed with a sculptured body for operator comfort.

Battery condition display



Motor ventilation



Automatic slot-in battery



Switch protected against accidental operation

These tools are supplied without dies. For die selection, please refer to chart on pages 190 to 198

14.4 V CORDLESS HYDRAULIC CRIMPING TOOL

B 131-C

general features



Crimping force kN	Dimensions mm			Jaw Opening mm	Battery	Weight kg (with battery)
	length	height	width			
130	420	250	100	25	14,4 V 3.0 Ah	7,1



**14.4V
3.0Ah
Li-Ion**

**NEW
Li-Ion
BATTERY**



- 14.4 V cordless hydraulic crimping tool, lightweight and balanced for single hand operation. This tool will accept all semi-circular slotted dies, common to most 130 kN tools.
- The tool features a double speed action: a fast advancing speed for rapid approach of the dies to the connector and a slower more powerful speed for crimping.
- For ease of operation and comfort of the operator the tool head can be fully rotated through 180 degrees.
- The tool is powered by 14.4 V dc Li-Ion battery.
- A balanced tool for optimum control.
- Quiet in operation with very little vibration.
- Lightweight construction enables the operator to hold the tool in one hand and to position the con-

- nector with the other hand.
- The operating buttons, crimp/release, are mechanically interlocked, to prevent accidental operation of the tool.
- A microprocessor controls the tool operation and automatically cuts out the motor, on completion of the crimping operation, saving energy and extending battery life.
- The residual battery capacity

MAIN APPLICATIONS - max section mm²

L.V. lugs and splices	Insulated terminals	"C" sleeve Connectors	H.V. lugs and splices
400	240	185	400

STORAGE

Type	Dimensions mm	Weight kg	Supplied with the tool	Purchase separately
VAL P19	542x412x197	3,2	✳	—

Available as optional accessories:
- ESC600 cable for connection to a 12V dc external power supply/vehicle battery length 6 m.

The tool is supplied as:

- Basic tool complete with battery and shoulder strap
- Spare battery
- Battery charger
- Plastic carrying case suitable for storing the tool and 14 sets of semi-circular slotted dies

is automatically displayed after every operation and battery insertion.

- Fitted with an integral socket, for connection to a 12 V dc external power supply/vehicle battery.
- The tool is provided with a maximum pressure valve.

B 131-C-KV
version also available for
Power Supply Companies



B 131LN-C

general features



Crimping force kN	Dimensions mm			Jaw Opening mm	Battery	Weight kg (with battery)
	length	height	width			
130	480	250	100	42	14,4 V 3.0 Ah	8,6



**14.4V
3.0Ah
Li-Ion**

**NEW
Li-Ion
BATTERY**



MAIN APPLICATIONS - max section mm²

L.V. lugs and splices	Insulated terminals	"C" sleeve Connectors	H.V. lugs and splices
400	240	185	400

STORAGE

Type	Dimensions mm	Weight kg	Supplied with the tool	Purchase separately
VAL P19	542x412x197	3,2	✳	—

Also available in the B131LN-C version, featuring a large 42 mm jaw opening, for an easier introduction/removal of large size compression terminations and joints.



14.4 V CORDLESS HYDRAULIC CRIMPING TOOL



general features

B 131-UC



**14.4V
3.0Ah
Li-Ion**

Crimping force kN	Dimensions mm			Battery	Weight kg (with battery)
	length	height	width		
130	435	250	100	14,4 V 3.0 Ah	7,1

MAIN APPLICATIONS - max section mm²

L.V. lugs and splices	Insulated terminals	"C" sleeve Connectors	H.V. lugs and splices	Alu lugs and splices
400	240	185	400	300

STORAGE

Type	Dimensions mm	Weight kg	Supplied with the tool	Purchase separately
VAL P19	542x412x197	3,2	✳	—

The tool is supplied as:

- Basic tool complete with battery and shoulder strap
- Spare battery
- Battery charger
- Plastic carrying case suitable for storing the tool and 14 sets of semi-circular slotted dies



Available as optional accessories:

- ESC600 cable for connection to a 12V dc external power supply/vehicle battery length 6 m.

- 14.4 V cordless hydraulic crimping tool, lightweight and balanced for single hand operation. This tool will accept the accessories for performing the "Deep Stepped Indent" system of crimping on aluminium cables.
- This tool will also accept the semi-circular slotted dies, common to most 130 kN tools.
- The tool features a double speed action: a fast advancing speed for rapid approach of the dies to the connector and a slower more powerful speed for crimping.
- For ease of operation and comfort of the operator the tool head can be fully rotated through 180 degrees.
- The tool is powered by 14.4 V dc Li-Ion battery.
- A balanced tool for optimum control.
- Quiet in operation with very little vibration.
- Lightweight construction enables the operator to hold the tool in one hand and to position the connector with the other hand.
- The operating buttons, crimp/release, are mechanically interlocked, to prevent accidental operation of the tool.
- A microprocessor controls the tool operation and automatically cuts out the motor, on completion of the crimping operation, saving energy and extending battery life.
- The residual battery capacity is automatically displayed after every operation and battery insertion.
- Fitted with an integral socket, for connection to a 12 V dc external power supply/vehicle battery.
- The tool is provided with a maximum pressure valve.



High power battery



Battery condition display

Motor ventilation

Operating and pressure release buttons mechanically interlocked



Socket for 12-14.4 V dc external power supply

Easy to operate with only one hand



Cable type ESC600



These tools are supplied without dies. For die selection, please refer to chart on pages 190 to 198

OVERHEAD LINE APPLICATION
B35-TC025



New

Can be operated with one hand. Balanced for greater control. Head rotates 180° for ease of operation in confined spaces. Fitted with a maximum pressure valve. Extremely quiet, minimal vibration. Durable moulded body offering high resistance to wear and damage in all operating conditions. Ni-MH battery; powerful, better environmental compatibility. Complete with a display which, after every operation and battery insertion, indicates the residual battery power. Supplied in a robust plastic case to accommodate the tool and all the accessories. Two batteries and charger included.

The tool is supplied as:

- Basic tool with battery and wrist strap
- Spare battery
- Battery charger • Battery adapter
- Plastic carrying case suitable for storing the tool and accessories



9.6 V CORDLESS HYDRAULIC CUTTING TOOL

general features



**9.6V
2.0Ah
Ni-MH**

Max cutting Ø mm	Dimensions mm			Battery	Weight kg (with battery)
	length	height	width		
25	377	114	66	9,6 V 2.0 Ah	3,0

STORAGE				
Type	Dimensions mm	Weight kg	Supplied with the tool	Purchase separately
VAL P22	465x315x116	1,5	✳	—

CUTTING CAPACITY			
MATERIAL	TENSILE STRENGTH (daN/mm ²)	MAX CUTTING DIAMETER (mm)	
		B35-TC025	
ROPE & CONDUCTORS	COPPER	≤ 41	25
	ALUMINIUM	≤ 20	25
	ALMELEC	≤ 34	25
	STEEL	≤ 180	INDICATIVE EXAMPLES: 19 x 2,1 : Ø est. = 10,5 mm 19 x 2,2 : Ø est. = 11,0 mm
	MULTI STRANDS STEEL (STRANDS Qty ≥ 200)	≤ 180	-
RODS	ACSR	≤ 180	25
			INDICATIVE EXAMPLES: 26 x 2,50 + 7 x 1,95 : Ø est. = 15,85 26 x 3,06 + 7 x 2,38 : Ø est. = 19,38 26 x 3,60 + 7 x 2,80 : Ø est. = 22,80
	STEEL	≤ 60	10
		≤ 42	-
	COPPER	≤ 30	-
	≤ 25	16	
ALUMINIUM	≤ 16	25	

14.4 V CORDLESS HYDRAULIC CUTTING TOOL

general features



**14.4V
3.0Ah
Li-Ion**

OVERHEAD LINE APPLICATION
B-TC026



**NEW
Li-Ion
BATTERY**

14.4 V cordless hydraulic cutting tool, lightweight and balanced for single hand operation. The tool features a double speed action: a fast advancing speed for rapid approach of the blades to the cable and a slower more powerful speed for cutting. Specifically designed to cut copper, aldrej, aluminium, aluminium-steel cables and steel ropes, aluminium and steel rods having a max overall diameter of 25 mm.

The blades are manufactured from high strength special steel, heat treated to ensure a long service life. The crimping head can rotate through 180° for ease of operation. Fitted with a maximum hydraulic

STORAGE				
Type	Dimensions mm	Weight kg	Supplied with the tool	Purchase separately
VAL P9	543x412x130	2,2	✳	—

The tool is supplied as:

- Basic tool with battery, wrist strap and shoulder strap
- Spare battery
- Battery charger
- Plastic carrying case suitable for storing the tool and accessories



pressure valve. Complete with a display which, after every operation and battery insertion, indicates the residual battery power. Extremely quiet in operation, with very little vibration. Ergonomically designed with

a sculptured body for operator comfort. For cutting capacity data see page 136.

14.4 V CORDLESS HYDRAULIC CUTTING TOOL



general features



14.4V
3.0Ah
Li-Ion

Max cutting Ø mm	Dimensions mm			Battery	Weight kg (with battery)
	length	height	width		
40	438	298	94	14,4 V 3.0 Ah	6,7

STORAGE

Type	Dimensions mm	Weight kg	Supplied with the tool	Purchase separately
VAL B-TC095	565x410x132	6,7	✳	—

The tool is supplied as:

- Basic tool with battery and shoulder strap
- Spare battery
- Battery charger
- Metal carrying case suitable for storing the tool and accessories



14.4 V cordless hydraulic cutting tool specifically designed cut copper, aldrej, aluminium, aluminium-steel cables and steel ropes, aluminium and steel rods having a max overall diameter of 40 mm.

The blades are manufactured from high strength special steel, heat treated to ensure a long service life.

The tool features a double speed action: a fast advancing speed for rapid approach of the blades to the cable and a slower more powerful speed for cutting.

The head can rotate through 180 degrees, to enable the operator to work in the most comfortable

position, and can easily be opened to allow cutting of running cables.

Fitted with a maximum hydraulic pressure valve. Complete with a display which, after every operation and battery insertion, indicates the residual battery power.

Extremely quiet in operation, with very little vibration. Ergonomically designed with a sculptured body for operator comfort.



NEW
Li-Ion
BATTERY

For cutting capacity data see page 138.

OVERHEAD LINE APPLICATION B-TC0405

New

14.4 V CORDLESS HYDRAULIC CUTTING TOOL



general features



14.4V
3.0Ah
Li-Ion

Max cutting Ø mm	Dimensions mm			Battery	Weight kg (with battery)
	length	height	width		
40	492	250	100	14,4 V 3.0 Ah	7,3

STORAGE

Type	Dimensions mm	Weight kg	Supplied with the tool	Purchase separately
VAL BT004	566x410x130	6,7	✳	—

The tool is supplied as:

- Basic tool with battery and shoulder strap
- Spare battery
- Battery charger
- Metal carrying case suitable for storing the tool and accessories



14.4 V cordless hydraulic cutting tool specifically designed cut copper, aldrej, aluminium, aluminium-steel cables and steel ropes, aluminium and steel rods having a max overall diameter of 40 mm.

Lightweight and balanced for single hand operation.

The tool features a double speed action: a fast advancing speed for rapid approach of the blades to the cable and a slower more powerful speed for cutting.

For ease of operation and comfort of the operator the tool head can be rotated through 180 degrees.

The tool is powered by 14.4 V dc Li-Ion battery.

A balanced tool for optimum control.

Quiet in operation with very little vibration.

Lightweight construction enables the operator to hold the tool in one hand and to position the cable with the other hand.

The operating buttons, cut/release, are mechanically interlocked, to prevent accidental operation of the tool.

A microprocessor controls the tool operation and automatically cuts out the motor, on completion

OVERHEAD LINE APPLICATION B-TC04



NEW
Li-Ion
BATTERY

of the cutting operation, saving energy and extending battery life.

- The residual battery capacity is automatically displayed after every operation and battery insertion.

- Fitted with an integral socket, for connection to a 12 V dc external power supply/vehicle battery.

- The tool is provided with a maximum pressure valve.

For cutting capacity data see page 138.

OVERHEAD LINE APPLICATION
B-TC051Y



14.4 V cordless hydraulic cutting tool, lightweight and balanced for single hand operation. Specifically designed to cut copper, aluminum, aluminum-steel cables (ACSR) having a max overall diameter of 50 mm. The tool features a double speed action: a fast advancing speed for rapid approach of the blades to the cable and a slower more powerful speed for cutting. The blades are manufactured from high strength special steel, heat treated to ensure a long service life. The head can be easily opened to allow the cutting of running cables. The head can rotate through 90

degrees, to enable the operator to work in the most comfortable position. Fitted with a maximum hydraulic pressure valve. Complete with a display which, after every operation and battery insertion, indicates the residual battery power.

14.4 V CORDLESS HYDRAULIC CUTTING TOOL

general features

Max cutting Ø mm	Dimensions mm			Battery	Weight kg (with battery)
	length	height	width		
50	414	302	94	14,4 V 3.0 Ah	5,1



**14.4V
3.0Ah
Li-Ion**

STORAGE

Type	Dimensions mm	Weight kg	Supplied with the tool	Purchase separately
VAL P9	543x412x130	2,2	✳	—

The tool is supplied as:

- Basic tool with battery, wrist strap and shoulder strap
- Spare battery
- Battery charger
- Plastic carrying case suitable for storing the tool and accessories



Extremely quiet in operation, with very little vibration. Ergonomically designed with a sculptured body for operator comfort.

Not suitable for cutting stay wire, steel rope or earthing rod.

OVERHEAD LINE APPLICATION
B-TC055



14.4 V cordless hydraulic cutting tool, lightweight and balanced for single hand operation. Specifically designed to cut copper, aldrej, aluminium, aluminium-steel cables and steel ropes, aluminium and steel rods having a max overall diameter of 55 mm. The tool features a double speed action: a fast advancing speed for rapid approach of the blades to the cable and a slower more powerful speed for cutting. The blades are manufactured from high strength special steel, heat treated to ensure a long service life.

The head can be easily opened to allow the cutting of running cables. The head can rotate through 320 degrees, to enable the operator to work in the most comfortable position.

14.4 V CORDLESS HYDRAULIC CUTTING TOOL

general features

Max cutting Ø mm	Dimensions mm			Battery	Weight kg (with battery)
	length	height	width		
55	483	298	94	14,4 V 3.0 Ah	9,1



**14.4V
3.0Ah
Li-Ion**

STORAGE

Type	Dimensions mm	Weight kg	Supplied with the tool	Purchase separately
VAL B-TC095	565x410x132	6,7	✳	—

The tool is supplied as:

- Basic tool with battery and shoulder strap
- Spare battery • Battery charger

- Plastic carrying case suitable for storing the tool and accessories



Fitted with a maximum hydraulic pressure valve. Complete with a display which, after every operation and battery insertion, indicates the residual battery power.

Extremely quiet in operation, with very little vibration. Ergonomically designed with a sculptured body for operator comfort.

For cutting capacity data see page 140.

14.4 V CORDLESS HYDRAULIC CUTTING TOOL



general features

INDUSTRIAL APPLICATION
B-TC051



**14.4V
3.0Ah
Li-Ion**

Max cutting Ø mm	Dimensions mm			Battery	Weight kg (with battery)
	length	height	width		
50	414	302	94	14,4 V 3.0 Ah	5,1

STORAGE

Type	Dimensions mm	Weight kg	Supplied with the tool	Purchase separately
VAL P9	543x412x130	2,2	✳	—

The tool is supplied as:

- Basic tool with battery, wrist strap and shoulder strap
- Spare battery
- Battery charger
- Plastic carrying case suitable for storing the tool and accessories



14.4 V cordless hydraulic cutting tool, lightweight and balanced for single hand operation. Specifically designed to cut copper, aluminium and telecommunication cables having a max overall diameter of 50 mm.

The tool features a double speed action: a fast advancing speed for rapid approach of the blades to the cable and a slower more powerful speed for cutting.

The blades are manufactured from high strength special steel, heat treated to ensure a long service life. The head can be easily opened to allow the cutting of running cables. The head can rotate through 90 degrees, to enable the operator to work in the most comfortable position. Fitted with a maximum hydraulic pressure valve.

Complete with a battery condition display which, after every operation and battery insertion, indicates the residual battery power.

Extremely quiet in operation, with very little vibration.



Ergonomically designed with a sculptured body for operator comfort.

14.4 V CORDLESS HYDRAULIC CUTTING TOOL



general features

INDUSTRIAL APPLICATION
B-TC065



**14.4V
3.0Ah
Li-Ion**

Max cutting Ø mm	Dimensions mm			Battery	Weight kg (with battery)
	length	height	width		
65	445	305	94	14.4 V 3.0 Ah	6,1

STORAGE

Type	Dimensions mm	Weight kg	Supplied with the tool	Purchase separately
VAL P9	543x412x130	2,2	✳	—

The tool is supplied as:

- Basic tool with battery, wrist strap and shoulder strap
- Spare battery
- Battery charger
- Plastic carrying case suitable for storing the tool and accessories



14.4 V cordless hydraulic cutting tool, lightweight and balanced for single hand operation. Specifically designed to cut copper, aluminium and telecommunication cables having a max overall diameter of 65 mm.

The tool features a double speed action: a fast advancing speed for rapid approach of the blades to the cable and a slower more powerful speed for cutting.

The blades are manufactured from high strength special steel, heat treated to ensure a long service life.

The head can be easily opened to allow the cutting of running cables. The head can rotate through 335 degrees, to enable the operator to work in the most comfortable position. Fitted with a maximum hydraulic pressure valve.

Complete with a display which, after every operation and battery insertion, indicates the residual battery power.

Extremely quiet in operation, with very little vibration. Ergonomically designed with a sculptured body for operator comfort.



INDUSTRIAL APPLICATION
B-TC065-SC

14.4 V CORDLESS HYDRAULIC CUTTING TOOL

general features



Max cutting Ø mm	Dimensions mm			Battery	Weight kg (with battery)
	length	height	width		
65	511	313	105	14.4 V 3.0 Ah	7,2



14.4V
3.0Ah
Li-Ion

New



14.4 V cordless hydraulic cutting tool specifically designed to cut copper, aluminium and telecommunication cables having a max overall diameter of 65 mm.

The tool features a double speed action: a fast advancing speed for rapid approach of the blades to the cable and a slower more powerful speed for cutting.

The blades are manufactured from high strength special steel, heat treated to ensure a long service life. The open head and the "scissor"

movement of the blades facilitate the cutting of running cables. The head can rotate by 180 de-

STORAGE

Type	Dimensions in.	Weight kg	Supplied with the tool	Purchase separately
VAL B-TC095	565x410x132	6,7	✳	—

The tool is supplied as:

- Basic tool with battery and shoulder strap
- Spare battery
- Battery charger
- Metal carrying case suitable for storing the tool and accessories



grees, to enable the operator to work in the most comfortable position. Fitted with a maximum hydraulic pressure valve. Complete with a display which, after every operation, indicates the residual battery power. Extremely quiet in operation, with very little vibration.

Ergonomically designed with a sculptured body for operator comfort.

NEW
Li-Ion
BATTERY

INDUSTRIAL APPLICATION
B-TC095

14.4 V CORDLESS HYDRAULIC CUTTING TOOL

general features



Max cutting Ø mm	Dimensions mm			Battery	Weight kg (with battery)
	length	height	width		
95	527	305	94	14.4 V 3.0 Ah	7,06



14.4V
3.0Ah
Li-Ion



14.4 V cordless hydraulic cutting tool specifically designed to cut copper, aluminium and telecommunication cables having a max overall diameter of 95 mm.

The tool features a double speed action: a fast advancing speed for rapid approach of the blades to the cable and a slower more powerful speed for cutting.

The blades are manufactured from high strength special steel, heat treated to ensure a long service life. The head can be easily opened to allow the cutting of running cables. The head can rotate through 335

STORAGE

Type	Dimensions mm	Weight kg	Supplied with the tool	Purchase separately
VAL B-TC095	565x410x132	6,7	✳	—

The tool is supplied as:

- Basic tool with battery and shoulder strap
- Spare battery
- Battery charger
- Metal carrying case suitable for storing the tool and accessories



degrees, to enable the operator to work in the most comfortable position. Fitted with a maximum hydraulic pressure valve.

Complete with a display which, after every operation and battery insertion, indicates the residual battery power.

Extremely quiet in operation, with very little vibration. Ergonomically designed with a sculptured body for operator comfort.

NEW
Li-Ion
BATTERY

14.4 V CORDLESS HYDRAULIC FRAME-TYPE HOLE PUNCHING TOOL



general features



**14.4V
3.0Ah
Li-Ion**

Max hole punch Ø mm	Dimensions mm			Battery	Weight kg (with battery)
	length	height	width		
47,2	354	302	94	14,4 V 3.0 Ah	5,6

STORAGE

Type	Dimensions mm	Weight kg	Supplied with the tool	Purchase separately
VAL P9	543x412x130	2,2	✳	—

The tool is supplied as:

- Basic tool with battery, wrist strap and shoulder strap
- Spare battery
- Battery charger
- Plastic carrying case suitable for storing the tool and accessories



Table denotes the punch/die set reference, for each hole size. Suitable for punching holes in mild steel, fibreglass or plastic material, up to 2 mm thick.

14.4 V cordless hydraulic tool for punching holes from 15,5 up to 47,2 mm diameter in the side wall of trunking without the need for pre drilling. Lightweight and balanced for single-hand operation.

The tool features a double speed action: a fast advancing speed for rapid approach of the dies to the material and a slower, more powerful speed for punching.



**NEW
Li-Ion
BATTERY**

The punching head can rotate through 180° for ease of operation.

Complete with a display which, after every operation and battery insertion, indicates the residual battery power.

Extremely quiet in operation, with very little vibration.

Ergonomically designed with a sculptured body for operator comfort. Also available in the hand operated mechanical version MT-FC48N.

For the punch/die set reference see table.

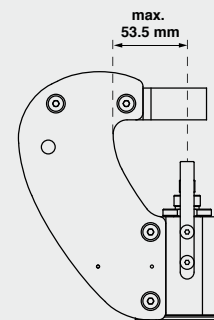

Max centre of hole to edge of trunking: 53,5 mm

Hole Dimensions				Maximum thickness of mild steel (mm)	Code
Nominal	Ø (mm)	Ø (inch)	Pg		
15,5	.610	Pg9	-	-	RD 15.5 SS-FC
16,2	.638	-	ISO-16	-	RD 16.2 SS-FC
17,5	.689	-	-	-	RD 17.5 SS-FC
18,8	.740	Pg11	-	-	RD 18.8 SS-FC
19,1	.752	-	-	-	RD 19.1 SS
20,5	.807	Pg 13,5	ISO-20	-	RD 20.5 SS
22,6	.890	Pg16	-	-	RD 22.6 SS
23,8	.937	-	-	5/8"	RD 23.8 SS
25,4	1.000	-	ISO-25	-	RD 25.4 SS
27,0	1.063	-	-	3/4"	RD 27.0 SS
28,5	1.122	Pg21	-	-	RD 28.5 SS
30,5	1.201	-	-	7/8"	RD 30.5 SS
31,8	1.252	-	-	-	RD 31.8 SS
32,5	1.279	-	ISO-32	-	RD 32.5 SS
34,6	1.362	-	-	-	RD 34.6 SS
37,2	1.464	Pg29	-	-	RD 37.2 SS
38,1	1.500	-	-	-	RD 38.1 SS
40,5	1.594	-	ISO-40	-	RD 40.5 SS-FC
41,3	1.626	-	-	-	RD 41.3 SS-FC
42,5	1.673	-	-	1"1/4"	RD 42.5 SS-FC
43,2	1.701	-	-	-	RD 43.2 SS-FC
44,5	1.752	-	-	-	RD 44.5 SS-FC
47,2	1.858	Pg36	-	-	RD 47.2 SS-FC

14.4 V CORDLESS HYDRAULIC PULLER-TYPE HOLE PUNCHING TOOL

B-FL75

New

general features



Max punching Ø mm	Dimensions mm			Battery	Weight kg (with battery)
	length	height	width		
120	366	303	94	14,4 V 3.0 Ah	4,4



**14.4V
3.0Ah
Li-Ion**



**NEW
Li-Ion
BATTERY**

Cordless hydraulic tool, for hole punching stainless steel, soft steel, fibreglass and plastic sheet materials up to 3,5 mm thickness. Lightweight and quiet this tool is vibration free and allows a complete

punching operation requiring one hand only. The tool features an automatic double speed action so to optimise the energy available: a fast advancing speed for rapid approach of the punch followed automatically by a slower speed for more powerful

STORAGE				
Type	Dimensions mm	Weight kg	Supplied with the tool	Purchase separately
VAL P27	620x360x138	2,4	*	—

The tool is supplied as:

- Basic tool with battery,
- wrist strap and shoulder strap
- Spare battery
- Battery charger
- Puller TD-11
- Puller TD-19
- Spiral bit Ø 11,5 mm

- Plastic carrying case suitable for storing the tool and accessories



punching. The balanced punching head pivots 180deg through a full 360deg rotation for ease of use in confined spaces. Complete with a display which, after every operation and battery insertion, indicates the residual battery power. Ergonomically designed with a sculptured body for operator comfort.

PUNCHING ACCESSORIES AVAILABLE

ROUND PUNCH										
Hole diameter				Material max thickness		Pilot hole Ø (mm)	Code			
Nominal Ø (mm)	Ø (inch)	Pg	ISO	Stainless steel	Mild steel		KIT (Punch+die)		Punch	Die
15,5	.610	Pg9	-	2,5 mm (0,1 in.) Rm= 700 N/mm ²	3,5 mm (0,14 in.) Rm= 510 N/mm ²	11,5	RD 15.5SS	P-RD15.5SS	M-RD15.5SS	TD-11
16,2	.638	-	ISO-16				RD 16.2SS	P-RD16.2SS	M-RD16.2SS	
17,5	.689	-	-				RD 17.5SS	P-RD17.5SS	M-RD17.5SS	
18,8	.740	Pg11	-				RD 18.8SS	P-RD18.8SS	M-RD18.8SS	
19,1	.752	-	-				RD 19.1SS	P-RD19.1SS	M-RD19.1SS	
20,5	.807	Pg 13,5	ISO-20				RD 20.5SS	P-RD20.5SS	M-RD20.5SS	
22,6	.890	Pg16	-				RD 22.6SS	P-RD22.6SS	M-RD22.6SS	
23,8	.937	-	5/8"				RD 23.8SS	P-RD23.8SS	M-RD23.8SS	
25,4	1.000	-	ISO-25				RD 25.4SS	P-RD25.4SS	M-RD25.4SS	
27,0	1.063	-	3/4"				RD 27.0SS	P-RD27.0SS	M-RD27.0SS	
28,5	1.122	Pg21	-			RD 28.5SS	P-RD28.5SS	M-RD28.5SS		
30,5	1.201	-	7/8"			RD 30.5SS	P-RD30.5SS	M-RD30.5SS		
28,5	1.122	Pg 21	-			RD 28.5SS-19	P-RD28.5SS-19	M-RD28.5SS-19		
30,5	1.201	-	7/8"			RD 30.5SS-19	P-RD30.5SS-19	M-RD30.5SS-19		
31,8	1.252	-	-			RD 31.8SS	P-RD31.8SS	M-RD31.8SS		
32,5	1.279	-	ISO-32			RD 32.5SS	P-RD32.5SS	M-RD32.5SS		
34,6	1.362	-	-			RD 34.6SS	P-RD34.6SS	M-RD34.6SS		
37,2	1.464	Pg29	-			RD 37.2SS	P-RD37.2SS	M-RD37.2SS		
38,1	1.500	-	-			RD 38.1SS	P-RD38.1SS	M-RD38.1SS		
40,5	1.594	-	ISO-40			RD 40.5SS	P-RD40.5SS	M-RD40.5SS		
41,3	1.626	-	-	RD 41.3SS	P-RD41.3SS	M-RD41.3SS				
42,5	1.673	-	1 1/4"	RD 42.5SS	P-RD42.5SS	M-RD42.5SS				
43,2	1.701	-	-	RD 43.2SS	P-RD43.2SS	M-RD43.2SS				
44,5	1.752	-	-	RD 44.5SS	P-RD44.5SS	M-RD44.5SS				
47,2	1.858	Pg36	-	RD 47.2SS	P-RD47.2SS	M-RD47.2SS				
50,5	1.988	-	ISO-50	RD 50.5SS	P-RD50.5SS	M-RD50.5SS				
54,2	2.134	Pg42	-	RD 54.2SS	P-RD54.2SS	M-RD54.2SS				
60,0	2.362	Pg48	-	RD 60.0SS	P-RD60.0SS	M-RD60.0SS				
64,0	2.520	-	ISO-63	RD 64.0SS	P-RD64.0SS	M-RD64.0SS				
65,0	2.559	-	-	RD 65.0SS	P-RD65.0SS	M-RD65.0SS				
76,0	2.992	-	2 1/2"	RD 76.0SS	P-RD76.0SS	M-RD76.0SS				
80,5	3.169	-	-	RD 80.5SS	P-RD80.5SS	M-RD80.5SS				
120,0	4.724	-	-	RD 120SS	P-RD120SS	M-RD120SS				

* Puller included in the kit

SQUARE PUNCH									
Hole size		Material max thickness (mm)		Pilot hole Ø (mm)	Code				
Nominal (mm)	(inch)	Stainless steel	Mild steel		KIT (Punch+die + Puller)				
21,0 x 21,0	.827 x .827	2,0	2,0	12,0	RD 21X21				
46,0 x 46,0	1.811 x 1.811				RD 46X46				
68,0 x 68,0	2.677 x 2.677	1,5	1,5	22,5	RD 68X68				
92,0 x 92,0	3.622 x 3.622				RD 92X92				
138,0 x 138,0	5.433 x 5.433	1,0	1,5	28,5	RD 138X138				

RECTANGULAR PUNCH									
Hole size		Material max thickness (mm)		Pilot hole Ø (mm)	Code				
Nominal (mm)	(inch)	Stainless steel	Mild steel		KIT (Punch+die + Puller)				
18,0 x 46,0	.709 x 1.811	2,0	2,0	16,5	RD 18X46				
22,0 x 46,0	.866 x 1.811				RD 22X46				
36,0 x 46,0	1.417 x 1.811				RD 36X46				
46,0 x 54,0	1.811 x 2.126	1,5	1,5	22,5	RD 46X54				
46,0 x 72,0	1.811 x 2.835				RD 46X72				
46,0 x 107,0	1.811 x 4.212				RD 46X107				

Stainless steel = Rm= 700 N/mm² - Mild steel = Rm= 500 N/mm²

USE OF NON ORIGINAL CEMBRE PUNCHING ACCESSORIES			
Code	Punch & Die		Pilot hole Ø mm
KIT TRD-9,4C (*)	KLAUKE, GREENLEE 3/8" - 24 UNF		Ø 9.7
KIT TRD-M11C (*)	IMB, BM, COSMEC (M11x1.5)		Ø 11.5
TD-M16C	IMB, BM, COSMEC (M16x1.5)		Ø 16.5 or KIT RD17.5SS

(*) The washer supplied with the KIT must be threaded onto the draw stud and positioned between the head and the die to allow the die to rest correctly.

Universal joint allows punching head to pivot 180deg over a full 360deg rotation.





HYDRAULIC PUMPS AND UNITS

HYDRAULIC PUMPS

PO 7000

Foot operated double speed pump, developing a maximum pressure of 700 bar. The pump is supplied with 3 m long high pressure flexible hose complete with female self-lock quick coupler. Pressure can be withdrawn at any time during operation by depressing the release lever. A solid shaped stand gives the pump stability during operation.



Operating pressure bar	Dimensions mm			Weight kg
	length	width	height	
700	680	200	163	9,8

Storage type	Dimensions mm	Weight kg
VAL P21*	820x430x290	6,74

*Supplied with the pump



CPE-1 CPE-1-110

Electrically driven hydraulic pump, powered by a 230V / 50-60Hz single-phase electric motor. The remote hand controller allows advancement and pressure release on completion of the crimping operation. The mechanically actuated emergency button located on the pump body allows the pressure release at any time in case of power shortage.



Also available **CPE-1-110** version for 110-115V / 50-60Hz. Both models are IP 55 rated.



Operating pressure bar	Dimensions mm			Weight kg
	length	width	height	
700	372	223	482	21

The pump is supplied with:

- high pressure flexible hose with male and female automatic quick coupler
- remote hand controller
- external supply connection cable

Available as optional accessories:

- Remote foot controller **RCP-B70**.
- Transportation trolley **CS-CPE-1**
- Control handle integrated with 3 m length flex hoses **ERCH-WH**



RCP-B70



CS-CPE-1



HYDRAULIC PUMPS

CPE-O-P12N



Operating pressure bar	Dimensions mm			Weight kg
	length	width	height	
700	343	162	353	19,5*

*without accessories

CPE-O-P12N is supplied with:

- 3 m flexible hose complete with male + female 3/8" NPT self-lock quick couplers
- Remote control cable
- External 12V dc supply cable
- Back-up 12V dc battery
- Battery charger 240 V ac supply cable
- Canvas holdall for carrying accessories

Available as optional accessories:

- Remote pedal control
- External battery charger



Portable electro-hydraulic pump, operating at 12 V, and developing a pressure of 700 bar.

This pump can either be operated by battery for independent use, or by an external 12V dc supply. Complete with internal battery charger.



Operating pressure bar	Dimensions mm			Weight kg
	length	width	height	
700	320	150	200	6,8



CPP-O

The CPP-O air hydraulic power unit intensifies an air supply of 6÷8 bar (87-115 psi) to a power crimping or cutting force of up to 700 bar (10.000 psi) depending upon the input pressure.

The control pedal allows for advancing and pressure release at any stage of the operation.

The unit is provided with a 2 m high pressure flexible hose, including a 3/8" NPT female self-lock quick coupler.

PORTABLE ELECTRO-HYDRAULIC PUMPS B70M-P24 RANGE

BATTERY OPERATED

Easily accessible oil top-up inlet



Remote electrical hand or foot controller connection (not KV version)



Remote pneumatic hand controller connection (KV version only)



**24V
3.3Ah
Ni-MH**



Powerful 24V Ni-MH rechargeable battery



Battery residual power level display



Manual pressure release button



24V dc external power supply socket with protective cap



High pressure hose connects to automatic self-lock quick coupling with protective cap

Variously supplied with different versions:



HYDRAULIC PUMPS

B70M-P24



Operating pressure bar	Dimensions mm			Weight kg
	length	width	height	
700	390	163	323	9,2*

*without accessories



B70M-P24

- 1 Portable electro-hydraulic pump, 24V dc battery for independent use, developing 700 bar pressure; equipped with an integral socket for connection to an external 24 V dc supply
- 2 **BH2433** Battery 24V dc 3.3Ah
- 3 **DC24** External battery charger
- 4 Shoulder strap
- 5 Canvas holdall for carrying accessories
- 6 3 m flexible hose complete with male + female 3/8" NPT self-lock quick couplers
- 7 **ERCH** Remote control



Operating pressure bar	Dimensions mm			Weight kg
	length	width	height	
700	390	163	323	9,2*

*without accessories



B70M-P24-CH

B70M-P24-CH

- 1 Portable electro-hydraulic pump, 24V dc battery for independent use, developing 700 bar pressure; equipped with an integral socket for connection to an external 24 V dc supply
- 2 **BH2433** Battery 24V dc 3.3Ah
- 3 **DC24** External battery charger
- 4 Shoulder strap
- 5 Canvas holdall for carrying accessories
- 6 **ERCH-WH** Remote hand controller integrated with 3 m length flexible hose complete with male + female 3/8" NPT self-lock quick couplers



Operating pressure bar	Dimensions mm			Weight kg
	length	width	height	
700	390	163	323	9,2*

*without accessories



B70M-P24-KV

B70M-P24-KV

- 1 Portable electro-hydraulic pump, 24V dc battery for independent use. Equipped with high dielectric insulated oil and automatic "insulated" lock quick coupler to allow connection only with insulated hoses.
- 2 **BH2433** Battery 24V dc 3.3Ah.
- 3 **DC24** External battery charger.
- 4 Shoulder strap
- 5 Canvas holdall for carrying accessories.
- 6 **PRCH** Remote pneumatic hand controller

Insulated heads suitable for use with this pump are generally supplied complete with high pressure insulated hoses; if necessary the hose can be purchased separately.

ACCESSORIES FOR B70M-P24

ESC 300CEE
CONNECTING CABLE WITH 24V dc CEE TYPE PLUG
(for power from an external source, length 3 meters)



ESC 600
CONNECTING CABLE WITH CROCODILE CLIPS
(for power from an external source, length 6 meters)



BPS 230.24
network power supply
INPUT 230V ac 50-60Hz; OUTPUT 24V dc
thermal and short circuit protection.
Current supply: up to 4A extended use;
18A for 50 s; 25A for 8 s.



EPS 115-230.24
network power supply
SUPPLY IN: 110/240V
ac autorange
50-60Hz; 700W
SUPPLY OUT: 24V dc; 30A max



TRS-B70
CANVAS RUCKSACK
(for carrying the pump)



ERCH-WH
CONTROL HANDLE
FOR FLEX HOSES



Operating
push-button

Pressure release button

SH-B70
HOOK
(for hanging the pump
from a ladder)



VAL-P18
Durable case for pump
and accessories.



RCP-B70
PORTABLE REMOTE
FOOT CONTROL



HYDRAULIC UNITS

(pump PO 7000 + head RHC 131)

Crimping force kN	Dimensions pump mm	Dimensions head mm	Weight kg
130	680x200xh163	232x124	13,6

MAIN APPLICATIONS - max section mm²

L.V. lugs and splices	Insulated terminals	"C" sleeve connectors	H.V. lugs and splices
400	240	185	400

Storage type	Dimensions mm	Weight kg
VAL P21*	820x430xh290	6,74

*Supplied with the unit, suitable for storage of 24 semi-circular slotted dies



CP 1131

Hydraulic units are obtained by combining the double stage hydraulic foot pump with the various hydraulic press heads featured on previous

pages. The use of the double speed pump considerably reduces operating time.

(pump PO 7000 + head RHU 131-C)

Crimping force kN	Dimensions pump mm	Dimensions head mm	Weight kg
130	680x200xh163	245x89	13,5

MAIN APPLICATIONS - max section mm²

L.V. lugs and splices	Insulated terminals	"C" sleeve connectors	H.V. lugs and splices	Alu lugs and splices
400	240	185	400	300

Storage type	Dimensions mm	Weight kg
VAL P21*	820x430xh290	6,74

*Supplied with the unit, suitable for storage of 24 semi-circular slotted dies and accessories for crimping aluminium connectors



CPU 1131-C

(pump PO 7000 + head ECW-H3D)

Crimping force kN	Dimensions pump mm	Dimensions head mm	Weight kg
230	680x200xh163	290x120	15,3

MAIN APPLICATIONS - max section mm²

L.V. lugs and splices	Insulated terminals	"C" sleeve connectors	H.V. lugs and splices
630	300	240	630

Storage type	Dimensions mm	Weight kg
VAL P21*	820x430xh290	6,74

*Supplied with the unit, suitable for storage of 24 semi-circular slotted dies and adaptors and dies specific for head ECW-H3D



CPU 1230-3D

HYDRAULIC CUTTING UNITS

CP 1096



(pump **PO 7000** + head **TC 096**)

Max cutting Ø mm	Dimensions pump mm	Dimensions head mm	Weight kg
95	680x200x163	397x249	17,7

Storage type	Dimensions mm	Weight kg
VAL CP 096*	785x430x175	14,0

*Supplied with the unit

Units CP-W-KV



GS approval
n. ET 12026



Hydraulic units provide protection against short circuit when cutting accidentally live L.V. / M.V. cables with nominal voltage up to 60 kV.

Unit Type	Max cutting Ø mm	Dimensions pump	Dimensions head	Weight kg
CP 1086-W-1000-KV	85	680x200x163	405x143	16,6
CP 1096-W-1000-KV	95	680x200x163	407x245	19,0
CP 1120-W-1000-KV	120	680x200x163	556x185	20,2

Storage case type	Dimensions mm	Weight kg
VAL CPO96-W*	785x430x175	12,6

*Supplied with the unit



Available as optional accessories:

- EK100 earth cable for the pump (1 m length)
- EK500P earth cable for the head (5 m length) with earth rod and canvas bag





In this section of the catalogue you can find selected products at competitive price which complement our traditional range



MARKETLINE PRODUCTS

CABLE TIES

G series, PA6.6 Polyamide

G



Material: PA6.6 Polyamide
 Self-extinguishing V2 (UL 94)
 Humidity absorption:
 2,5% (at 50% relative humidity)
 Operating temperature:
 From -40°C to +85°C (continuous)
 From -40°C to +120°C (short periods)
 Resistant to:
 oils, greases, oil products, chlorinated solvents.
 Colour: Natural or Black (Ral 2005)

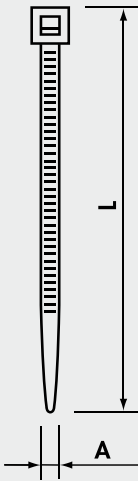

Black ties have higher UV resistance due to increased carbon black loading

Natural ties offer rapid installation due to the low friction coefficient of the material

Cable Ties in PA6.6

Type	L (mm)	A (mm)	Max. Bundle Ø (mm)	Min. Loop Tensile Strength (kg)	Quantity					
G80X2.4	80	2,4	15	8	100					
G80X2.4N					1000					
G80X2.4/M			16		100					
G80X2.4N/M					1000					
G90X2.4	90	2,4	16		8	100				
G90X2.4N						1000				
G100X2.5			22			30	100			
G100X2.5N							1000			
G100X2.5/M	33	30	8	1000						
G100X2.5N/M				1000						
G120X2.5	120	2,5		30		8	100			
G120X2.5N							1000			
G140X2.5				33	40		1000			
G140X2.5N							1000			
G140X2.5/M	53	40		8	1000					
G140X2.5N/M					1000					
G160X2.5	160	2,5	40		8		100			
G160X2.5N							1000			
G160X2.5/M			53			53	1000			
G160X2.5N/M							1000			
G200X2.5	200	2,5	53			8	100			
G200X2.5N							1000			
G200X2.5/M			65	14			14	1000		
G200X2.5N/M								1000		
G250X2.8	250	2,8	65	14	100					
G250X2.8N					1000					
G300X2.8			76		30			18	1000	
G300X2.8N									1000	
G120X3.6	120	3,6	30		18	100				
G120X3.6N						1000				
G140X3.6			33			35	18		1000	
G140X3.6N									1000	
G140X3.6/M	44	53	18	1000						
G140X3.6N/M				1000						
G150X3.6	150	3,6		35		18		100		
G150X3.6N								1000		
G180X3.6				53	53			18	1000	
G180X3.6N									1000	
G200X3.6	200	3,6		53	18		1000			
G200X3.6N							1000			
G200X3.6/M			65	18			18		1000	
G200X3.6N/M									1000	
G250X3.6	250	3,6	65	18		100				
G250X3.6N						1000				
G300X3.6			76			30		18	1000	
G300X3.6N									1000	
G300X3.6/M	102	24	22		1000					
G300X3.6N/M					1000					
G370X3.6	370	3,6			102	22	100			
G370X3.6N							1000			
G120X4.8				120	4,8		24		22	100
G120X4.8N										1000
G160X4.8	160	4,8		38	22		100			
G160X4.8N							1000			
G190X4.8	190	4,8	46	22			1000			
G190X4.8N							1000			
G190X4.8/M			50			60	22	1000		
G190X4.8N/M								1000		
G200X4.8	200	4,8	50			22		100		
G200X4.8N								1000		
G200X4.8/M			60		60			22	1000	
G200X4.8N/M									1000	
G250X4.8	250	4,8	60	22	1000					
G250X4.8N					1000					
G250X4.8/M			70		70		22		1000	
G250X4.8N/M									1000	
G280X4.8	280	4,8	70		22	1000				
G280X4.8N						1000				
G300X4.8			76			102		22	1000	
G300X4.8N									1000	
G370X4.8	370	4,8	102	22		1000				
G370X4.8N						1000				
G390X4.8			105			105	22		1000	
G390X4.8N									1000	
G430X4.8	430	4,8	110		22	1000				
G430X4.8N						1000				

Minimum order: 1.000 pcs

Minimum order: 100 pcs



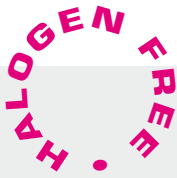

CABLE TIES

G series, PA6.6 Polyamide

G

Cable Ties in PA6.6

Type	L (mm)	A (mm)	Max. Bundle Ø (mm)	Min. Loop Tensile Strength (kg)	Quantity								
G450X4.8	450	4,8	116	22	100								
G450X4.8N													
G530X4.8													
G530X4.8N	530	7,6	140	80									
G150X7.6													
G150X7.6N													
G200X7.6	200	9,0	33			115							
G200X7.6N													
G250X7.6													
G250X7.6N	250	12,6	50				100						
G300X7.6													
G300X7.6N													
G370X7.6	370	15,2	65					80					
G370X7.6N													
G430X7.6													
G430X7.6N	430	18,8	76						100				
G530X7.6													
G530X7.6N													
G430X9.0	430	21,4	102							100			
G430X9.0N													
G530X9.0													
G530X9.0N	530	24,0	125								100		
G710X9.0													
G710X9.0N													
G780X9.0	780	26,6	140									100	
G780X9.0N													
G830X9.0													
G830X9.0N	830	29,2	190										100
G920X9.0													
G920X9.0N													
G1020X9.0	1020	31,8	228		100								
G1020X9.0N													
G1220X9.0													
G1220X9.0N	1220	34,4	239	100									
G230X12.6													
G230X12.6N													
G380X12.6	380	37,0	263			100							
G380X12.6N													
G480X12.6													
G480X12.6N	480	39,6	295				100						
G580X12.6													
G580X12.6N													
G730X12.6	730	42,2	365					100					
G730X12.6N													
G880X12.6													
G880X12.6N	880	44,8	50						100				
G1030X12.6													
G1030X12.6N													

Minimum order: 100 pcs



Angled tongue to facilitate easy introduction into the buckle

Rounded corners for increased safety



Note: In Type, N = Black



CABLE TIES

G series, PA6.6 Polyamide, VO (UL94)

G VO

Cable Ties in PA6.6 - VO (UL94)

Type	L (mm)	A (mm)	Max. Bundle Ø (mm)	Min. Loop Tensile Strength (kg)	Quantity	Minimum Order Qty
G90X2.4 VO	90	2,4	16	8	100	1000
G100X2.5/M VO	100		22			
G140X2.5/M VO	140		33			
G200X2.5/M VO	200	53	18	1000		
G150X3.6 VO	150	35		100		
G200X4.8/M VO	200	50		1000		
G370X4.8 VO	370	4,8	102	22	100	100
G430X4.8 VO	430		110			
G710X9.0 VO	710		190		80	

Same features as G series except: self-extinguishing VO (UL 94)

Recommended tools are shown on page 188

GR

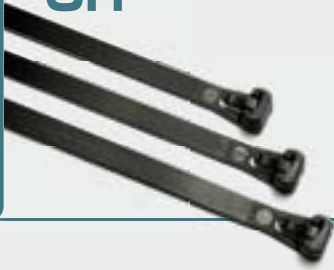

Same features as G series.
Easy installation without tools.
Released by pressure on the tongue.
Suitable for temporary locking.

CABLE TIES

GR series, PA6.6 Polyamide

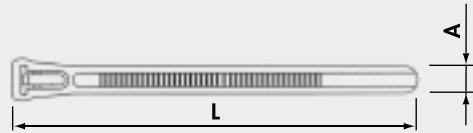

HALOGEN FREE

Releasable cable ties in PA6.6

Type	L (mm)	A (mm)	Max. Bundle Ø (mm)	Min. Loop Tensile Strength (kg)	Quantity
GR100X7.6N	100	7,6	20	22,2	100
GR120X7.6N	120		30		
GR150X7.6N	150		35		
GR200X7.6N	200		50		
GR250X7.6N	250		66		
GR300X7.6N	300		80		
GR370X7.6N	370		102		

GFH



Same features as G series.
Quick and easy identification of bundled conductors.
Write on panel with Felt tip pen.

GFH series, PA6.6 Polyamide



HALOGEN FREE

Markable cable ties in PA6.6

Type	L (mm)	A (mm)	Max. Bundle Ø (mm)	Min. Loop Tensile Strength (kg)	Quantity
GFH100X2.5	100	2,5	18	8,1	100
GFHT112X2.5	112				

1600



Material: PA12 Polyamide
Self-extinguishing HB (UL94)
Halogen free
Operating temperature:
From -45°C to + 85°C (continuous)
From -45°C to + 120°C (short periods)
Resistant to:
UV, salt atmosphere, oils, greases, oil products
Colour: Black

1600 series, PA12 Polyamide

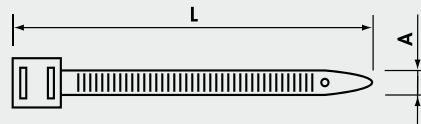

HALOGEN FREE

Cable Ties in PA12 Polyamide

Type	Head Type	L (mm)	A (mm)	Min. Bundle Ø (mm)	Max. Bundle Ø (mm)	Min. Loop Tensile Strength (kg)	Quantity
1618.90	single	180	9	15	40	40	100
1626.90	double	260	9	30	60	55	100
1636.90	double	360	9	30	93	55	100
1651.90	double	510	9	70	140	55	100
1676.90	double	760	9	70	220	55	100

Recommended tools are shown on page 188

CABLE TIES

in Stainless Steel AISI 304

GX

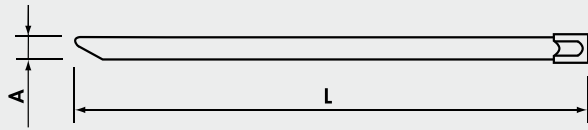

Cable Ties in Stainless Steel

Type	L (mm)	A (mm)	Max. Bundle Ø (mm)	Min. Loop Tensile Strength (kg)	Quantity
GX200X4.5	200	4,5	50	46	100
GX300X4.5	300		76		
GX370X4.5	370		102		
GX520X4.5	520	7,9	156	114	
GX370X7.9	370		102		
GX680X7.9	680		207		
GX1020X7.9	1020		312		

Material: Stainless Steel AISI 304
 Unique ball locking mechanism that allows simple and rapid installation and secure locking.
 Operating temperature: From -80°C to +500°C
 High tensile strength.
 Non-flammability.
 High resistance to acetic acid, alkalies, sulphuric acid, corrosion, etc.
 In general very resistant to most hostile environments.

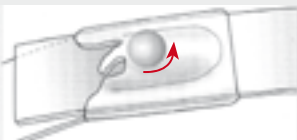

Insert the tongue into the buckle. The internal locking ball rolls freely as the tie is tightened.

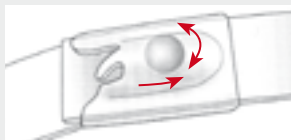

Once the correct tension is reached, use the specific tool to trim the tongue. The ball then wedges into the buckle locking it tightly against both the top and bottom of the tie.

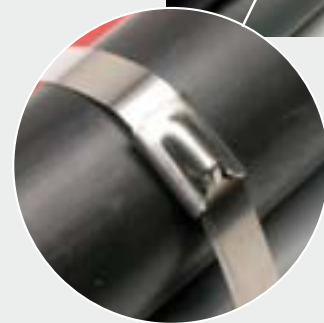

AB
CC
SS



ACCESSORIES

PA6.6 Polyamide

Material: PA6.6 Polyamide
Self-extinguishing V2 (UL 94)
Humidity absorption:
2,5% (at 50% relative humidity)
Operating temperature:
From -40°C to +85°C (continuous)
From -40°C to +120°C (short periods)

Resistant to:
oils, bases, greases, oil products,
chlorinated solvents.
Colour: Natural

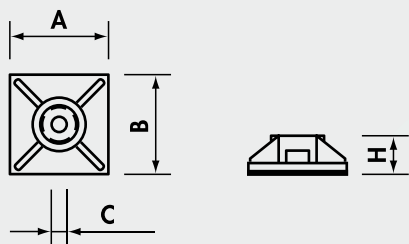

Self adhesive cable tie bases in PA6.6

Type	Max Tie (mm)	A (mm)	B (mm)	C (mm)	H (mm)	Fixing screw hole Ø (mm)	Quantity
AB 13	2,8	13,0	13,0	3,2	3,2	-	100
AB 19	3,6	19,0	19,0	4,0	4,4	3,1	100
AB 28	4,8	28,0	28,0	5,3	5,7	5,5	100

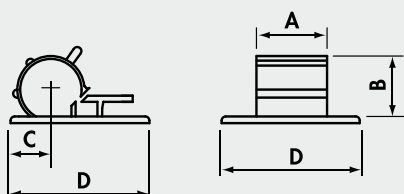

Self adhesive cable clips in PA6.6

Type	Cable Ø (mm)	A (mm)	B (mm)	C (mm)	D (mm)	Quantity
CC 8.9	8-9	9,0	12,0	8,0	21,5	100
CC 9.12	9-12	12,0	15,0	8,2	21,5	100

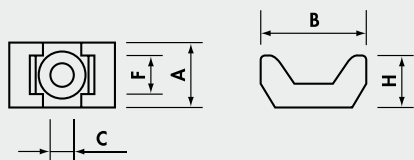

Cable tie saddle clamps in PA6.6

Type	Max Tie (mm)	A (mm)	B (mm)	C (mm)	F (mm)	H (mm)	Quantity
SS 4.8-3.7	4,8	9,5	15	3,7	5,0	7,2	100
SS 4.8-4.5	4,8	9,5	15	4,5	5,0	7,2	100
SS 9.4.5	9	16,0	22	4,5	9,2	9,7	100
SS 9.5	9	16,0	22	5,0	9,2	9,7	100
SS 9.6.4	9	16,0	22	6,4	9,2	9,7	100

GH8



ACCESSORIES

PA6.6 Polyamide

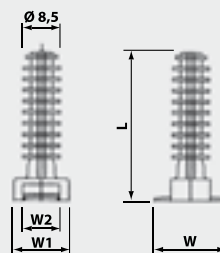

Stud fixing for cable ties in PA6.6

Type	W (mm)	W1 (mm)	W2 (mm)	L (mm)	Fixing hole Ø (mm)	Quantity
GH8	20	15	10	40,5	8	100

Same features as G series.
Push into Ø 8 mm hole.
Cable tie inserted through slot in head.

TERMOBLOCK HEAT-SHRINKABLE TUBING

*flame-retardant Polyolefin
shrinkage ratio 2÷1*

TBS

General characteristics:

- **Operating temperature:** -55°C + 125°C
- **Minimum shrinkage temperature:** 70°C
- **Temperature for complete shrinkage:** 110°C
- **RoHS compliant**
- **Colours:** Black, Red, Blue, Yellow/Green.
- **Packaging:** Roll in Dispenser Box

Technical Specifications:		
Property	Test Method	Performance
Traction resistance (MPa):	GB/T1040	≥10.4
Elongation at failure (%):	GB/T1040	≥200
Traction resistance after heat aging (MPa):	UL 224 158°Cx168hr	≥100
Heat resistance:	UL 224 (250°Cx4hr)	No failure
Low temperature flexibility:	UL 224 -30°Cx4hr	No failure
Dielectric strength (kv/mm):	GB/T1408	≥15
Insulation resistance:	600V UL 224	No perforation at 2500V
Volume resistance (Ω.cm):	GB/T1410	10 ¹⁴
Corrosive action:	UL 224 158°Cx168hr	Not corrosive
Copper compatibility:	UL 224 158°Cx168hr	Not corrosive
Flammability:	UL 224	VW-1

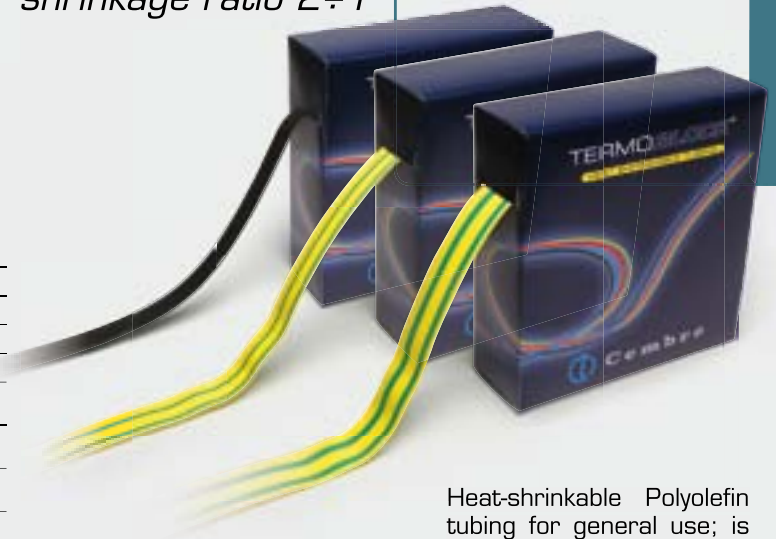

Heat-shrinkable Polyolefin tubing for general use; is environmentally neutral, flexible, not inflammable and offers fast heat shrinkage and stable performance.

Main uses include insulation and protection of electrical conductors, connectors and terminations; protection of metal tubes from corrosion; protection of antennae and various identification applications.

Ref.	Colour		Internal Ø before shrinking	Internal Ø after shrinking	Reel Length
TBS16x20BK	BLACK	●	1,6 mm	0,8 mm	20 m
TBS24x20BK	BLACK	●	2,4 mm	1,2 mm	20 m
TBS32x10BK	BLACK	●	3,2 mm	1,6 mm	10 m
TBS48x10BK	BLACK	●	4,8 mm	2,4 mm	10 m
TBS64x10BK	BLACK	●	6,4 mm	3,2 mm	10 m
TBS95x10BK	BLACK	●	9,5 mm	4,8 mm	10 m
TBS127x10BK	BLACK	●	12,7 mm	6,4 mm	10 m
TBS190x5BK	BLACK	●	19 mm	9,5 mm	5 m
TBS254x5BK	BLACK	●	25,4 mm	12,7 mm	5 m
TBS16x20RE	RED	●	1,6 mm	0,8 mm	20 m
TBS24x20RE	RED	●	2,4 mm	1,2 mm	20 m
TBS32x10RE	RED	●	3,2 mm	1,6 mm	10 m
TBS48x10RE	RED	●	4,8 mm	2,4 mm	10 m
TBS64x10RE	RED	●	6,4 mm	3,2 mm	10 m
TBS95x10RE	RED	●	9,5 mm	4,8 mm	10 m
TBS127x10RE	RED	●	12,7 mm	6,4 mm	10 m
TBS190x5RE	RED	●	19,0 mm	9,5 mm	5 m
TBS254x5RE	RED	●	25,4 mm	12,7 mm	5 m
TBS16x20BU	BLUE	●	1,6 mm	0,8 mm	20 m
TBS24x20BU	BLUE	●	2,4 mm	1,2 mm	20 m
TBS32x10BU	BLUE	●	3,2 mm	1,6 mm	10 m
TBS48x10BU	BLUE	●	4,8 mm	2,4 mm	10 m
TBS64x10BU	BLUE	●	6,4 mm	3,2 mm	10 m
TBS95x10BU	BLUE	●	9,5 mm	4,8 mm	10 m
TBS127x10BU	BLUE	●	12,7 mm	6,4 mm	10 m
TBS190x5BU	BLUE	●	19,0 mm	9,5 mm	5 m
TBS254x5BU	BLUE	●	25,4 mm	12,7 mm	5 m
TBS16x20Y/G	YELLOW/GREEN	●	1,6 mm	0,8 mm	20 m
TBS24x20Y/G	YELLOW/GREEN	●	2,4 mm	1,2 mm	20 m
TBS32x10Y/G	YELLOW/GREEN	●	3,2 mm	1,6 mm	10 m
TBS48x10Y/G	YELLOW/GREEN	●	4,8 mm	2,4 mm	10 m
TBS64x10Y/G	YELLOW/GREEN	●	6,4 mm	3,2 mm	10 m
TBS95x10Y/G	YELLOW/GREEN	●	9,5 mm	4,8 mm	10 m
TBS127x10Y/G	YELLOW/GREEN	●	12,7 mm	6,4 mm	10 m
TBS190x5Y/G	YELLOW/GREEN	●	19 mm	9,5 mm	5 m
TBS254x5Y/G	YELLOW/GREEN	●	25,4 mm	12,7 mm	5 m



TSS

TERMOSTRIP HEAT-SHRINKABLE TUBING

*flame-retardant Polyolefin
shrinkage ratio 2÷1*

Heat-shrinkable Polyolefin tubing strip for general use; is environmentally neutral, flexible, not inflammable and offers fast heat shrinkage and stable performance.

Main uses include insulation and protection of electrical conductors, connectors and terminations; protection of metal tubes from corrosion; protection of antennae and various identification applications.

For general characteristics and technical specifications see page 179.

- **Colours:** Black, Red, White, Blue, Transparent, Yellow, Green, Grey, Brown, Yellow/Green.
- **Packaging:** Strips in Box

Ref.	Colour		Internal Ø before shrinking	Internal Ø after shrinking	Strip Length	Quantity Strips per box
TSS24BK	BLACK	●	2.4 mm	1.2 mm	1,22 m	30
TSS32BK	BLACK	●	3.2 mm	1.6 mm	1,22 m	30
TSS48BK	BLACK	●	4.8 mm	2.4 mm	1,22 m	30
TSS64BK	BLACK	●	6.4 mm	3.2 mm	1,22 m	30
TSS95BK	BLACK	●	9.5 mm	4.8 mm	1,22 m	20
TSS127BK	BLACK	●	12.7 mm	6.4 mm	1,22 m	15
TSS190BK	BLACK	●	19 mm	9.5 mm	1,22 m	10
TSS254BK	BLACK	●	25.4 mm	12.7 mm	1,22 m	6
TSS380BK	BLACK	●	38 mm	19 mm	1,22 m	4
TSS510BK	BLACK	●	51 mm	25.4 mm	1,22 m	2
TSS24RE	RED	●	2.4 mm	1.2 mm	1,22 m	30
TSS32RE	RED	●	3.2 mm	1.6 mm	1,22 m	30
TSS48RE	RED	●	4.8 mm	2.4 mm	1,22 m	30
TSS64RE	RED	●	6.4 mm	3.2 mm	1,22 m	30
TSS95RE	RED	●	9.5 mm	4.8 mm	1,22 m	20
TSS127RE	RED	●	12.7 mm	6.4 mm	1,22 m	15
TSS190RE	RED	●	19 mm	9.5 mm	1,22 m	10
TSS254RE	RED	●	25.4 mm	12.7 mm	1,22 m	6
TSS380RE	RED	●	38 mm	19 mm	1,22 m	4
TSS510RE	RED	●	51 mm	25.4 mm	1,22 m	2
TSS24WH	WHITE	○	2.4 mm	1.2 mm	1,22 m	30
TSS32WH	WHITE	○	3.2 mm	1.6 mm	1,22 m	30
TSS48WH	WHITE	○	4.8 mm	2.4 mm	1,22 m	30
TSS64WH	WHITE	○	6.4 mm	3.2 mm	1,22 m	30
TSS95WH	WHITE	○	9.5 mm	4.8 mm	1,22 m	20
TSS127WH	WHITE	○	12.7 mm	6.4 mm	1,22 m	15
TSS190WH	WHITE	○	19 mm	9.5 mm	1,22 m	10
TSS254WH	WHITE	○	25.4 mm	12.7 mm	1,22 m	6
TSS380WH	WHITE	○	38 mm	19 mm	1,22 m	4
TSS510WH	WHITE	○	51 mm	25.4 mm	1,22 m	2
TSS24BU	BLUE	●	2.4 mm	1.2 mm	1,22 m	30
TSS32BU	BLUE	●	3.2 mm	1.6 mm	1,22 m	30
TSS48BU	BLUE	●	4.8 mm	2.4 mm	1,22 m	30
TSS64BU	BLUE	●	6.4 mm	3.2 mm	1,22 m	30
TSS95BU	BLUE	●	9.5 mm	4.8 mm	1,22 m	20
TSS127BU	BLUE	●	12.7 mm	6.4 mm	1,22 m	15
TSS190BU	BLUE	●	19 mm	9.5 mm	1,22 m	10
TSS254BU	BLUE	●	25.4 mm	12.7 mm	1,22 m	6
TSS380BU	BLUE	●	38 mm	19 mm	1,22 m	4
TSS510BU	BLUE	●	51 mm	25.4 mm	1,22 m	2
TSS24TR	TRANSPARENT	○	2.4 mm	1.2 mm	1,22 m	30
TSS32TR	TRANSPARENT	○	3.2 mm	1.6 mm	1,22 m	30
TSS48TR	TRANSPARENT	○	4.8 mm	2.4 mm	1,22 m	30
TSS64TR	TRANSPARENT	○	6.4 mm	3.2 mm	1,22 m	30
TSS95TR	TRANSPARENT	○	9.5 mm	4.8 mm	1,22 m	20
TSS127TR	TRANSPARENT	○	12.7 mm	6.4 mm	1,22 m	15
TSS190TR	TRANSPARENT	○	19 mm	9.5 mm	1,22 m	10
TSS254TR	TRANSPARENT	○	25.4 mm	12.7 mm	1,22 m	6
TSS380TR	TRANSPARENT	○	38 mm	19 mm	1,22 m	4
TSS510TR	TRANSPARENT	○	51 mm	25.4 mm	1,22 m	2

TERMOSTRIP HEAT-SHRINKABLE TUBING

*flame-retardant Polyolefin
shrinkage ratio 2÷1*

TSS

Ref.	Colour		Internal Ø before shrinking	Internal Ø after shrinking	Strip Length	Quantity Strips per box
TSS24YE	YELLOW	●	2.4 mm	1.2 mm	1,22 m	30
TSS32YE	YELLOW	●	3.2 mm	1.6 mm	1,22 m	30
TSS48YE	YELLOW	●	4.8 mm	2.4 mm	1,22 m	30
TSS64YE	YELLOW	●	6.4 mm	3.2 mm	1,22 m	30
TSS95YE	YELLOW	●	9.5 mm	4.8 mm	1,22 m	20
TSS127YE	YELLOW	●	12.7 mm	6.4 mm	1,22 m	15
TSS190YE	YELLOW	●	19 mm	9.5 mm	1,22 m	10
TSS254YE	YELLOW	●	25.4 mm	12.7 mm	1,22 m	6
TSS380YE	YELLOW	●	38 mm	19 mm	1,22 m	4
TSS510YE	YELLOW	●	51 mm	25.4 mm	1,22 m	2
<hr/>						
TSS24GN	GREEN	●	2.4 mm	1.2 mm	1,22 m	30
TSS32GN	GREEN	●	3.2 mm	1.6 mm	1,22 m	30
TSS48GN	GREEN	●	4.8 mm	2.4 mm	1,22 m	30
TSS64GN	GREEN	●	6.4 mm	3.2 mm	1,22 m	30
TSS95GN	GREEN	●	9.5 mm	4.8 mm	1,22 m	20
TSS127GN	GREEN	●	12.7 mm	6.4 mm	1,22 m	15
TSS190GN	GREEN	●	19 mm	9.5 mm	1,22 m	10
TSS254GN	GREEN	●	25.4 mm	12.7 mm	1,22 m	6
TSS380GN	GREEN	●	38 mm	19 mm	1,22 m	4
TSS510GN	GREEN	●	51 mm	25.4 mm	1,22 m	2
<hr/>						
TSS24GY	GREY	●	2.4 mm	1.2 mm	1,22 m	30
TSS32GY	GREY	●	3.2 mm	1.6 mm	1,22 m	30
TSS48GY	GREY	●	4.8 mm	2.4 mm	1,22 m	30
TSS64GY	GREY	●	6.4 mm	3.2 mm	1,22 m	30
TSS95GY	GREY	●	9.5 mm	4.8 mm	1,22 m	20
TSS127GY	GREY	●	12.7 mm	6.4 mm	1,22 m	15
TSS190GY	GREY	●	19 mm	9.5 mm	1,22 m	10
TSS254GY	GREY	●	25.4 mm	12.7 mm	1,22 m	6
TSS380GY	GREY	●	38 mm	19 mm	1,22 m	4
TSS510GY	GREY	●	51 mm	25.4 mm	1,22 m	2
<hr/>						
TSS24BR	BROWN	●	2.4 mm	1.2 mm	1,22 m	30
TSS32BR	BROWN	●	3.2 mm	1.6 mm	1,22 m	30
TSS48BR	BROWN	●	4.8 mm	2.4 mm	1,22 m	30
TSS64BR	BROWN	●	6.4 mm	3.2 mm	1,22 m	30
TSS95BR	BROWN	●	9.5 mm	4.8 mm	1,22 m	20
TSS127BR	BROWN	●	12.7 mm	6.4 mm	1,22 m	15
TSS190BR	BROWN	●	19 mm	9.5 mm	1,22 m	10
TSS254BR	BROWN	●	25.4 mm	12.7 mm	1,22 m	6
TSS380BR	BROWN	●	38 mm	19 mm	1,22 m	4
TSS510BR	BROWN	●	51 mm	25.4 mm	1,22 m	2
<hr/>						
TSS32Y/G	YELLOW/GREEN	●	3.2 mm	1.6 mm	1,22 m	30
TSS48Y/G	YELLOW/GREEN	●	4.8 mm	2.4 mm	1,22 m	30
TSS64Y/G	YELLOW/GREEN	●	6.4 mm	3.2 mm	1,22 m	30
TSS95Y/G	YELLOW/GREEN	●	9.5 mm	4.8 mm	1,22 m	20
TSS127Y/G	YELLOW/GREEN	●	12.7 mm	6.4 mm	1,22 m	15
TSS190Y/G	YELLOW/GREEN	●	19 mm	9.5 mm	1,22 m	10
TSS254Y/G	YELLOW/GREEN	●	25.4 mm	12.7 mm	1,22 m	6
TSS380Y/G	YELLOW/GREEN	●	38 mm	19 mm	1,22 m	4

TERMOCOIL HEAT-SHRINKABLE TUBING

TCS

flame-retardant Polyolefin
shrinkage ratio 2÷1



Heat-shrinkable Polyolefin tubing coil for general use; is environmentally neutral, flexible, not inflammable and offers fast heat shrinkage and stable performance.

Main uses include insulation and protection of electrical conductors, connectors and terminations; protection of metal tubes from corrosion; protection of antennae and various identification applications.

For general characteristics and technical specifications see page 179.

- **Colours:** Black, Red, White, Blue, Transparent, Yellow, Green, Yellow/Green.
- **Packaging:** Coil on Reel

Ref.	Colour		Internal Ø before shrinking	Internal Ø after shrinking	Coil Length
TCS12X200BK	BLACK	●	1,2 mm	0,6 mm	200 m
TCS16X200BK	BLACK	●	1,6 mm	0,8 mm	200 m
TCS24X200BK	BLACK	●	2,4 mm	1,2 mm	200 m
TCS32X200BK	BLACK	●	3,2 mm	1,6 mm	200 m
TCS48X100BK	BLACK	●	4,8 mm	2,4 mm	100 m
TCS64X100BK	BLACK	●	6,4 mm	3,2 mm	100 m
TCS95X100BK	BLACK	●	9,5 mm	4,8 mm	100 m
TCS127X100BK	BLACK	●	12,7 mm	6,4 mm	100 m
TCS160X100BK	BLACK	●	16 mm	8,0 mm	100 m
TCS190X100BK	BLACK	●	19 mm	9,5 mm	100 m
TCS254X50BK	BLACK	●	25,4 mm	12,7 mm	50 m
TCS320X50BK	BLACK	●	32 mm	16,0 mm	50 m
TCS381X50BK	BLACK	●	38,1 mm	19,0 mm	50 m
TCS508X25BK	BLACK	●	50,8 mm	25,4 mm	25 m
TCS762X25BK	BLACK	●	76,2 mm	38,1 mm	25 m
TCS1016X25BK	BLACK	●	101,6 mm	50,8 mm	25 m
TCS1260X25BK	BLACK	●	126 mm	63,0 mm	25 m
TCS1500X25BK	BLACK	●	150 mm	75,0 mm	25 m
TCS16X200RE	RED	●	1,6 mm	0,8 mm	200 m
TCS24X200RE	RED	●	2,4 mm	1,2 mm	200 m
TCS32X200RE	RED	●	3,2 mm	1,6 mm	200 m
TCS48X100RE	RED	●	4,8 mm	2,4 mm	100 m
TCS64X100RE	RED	●	6,4 mm	3,2 mm	100 m
TCS95X100RE	RED	●	9,5 mm	4,8 mm	100 m
TCS127X100RE	RED	●	12,7 mm	6,4 mm	100 m
TCS190X100RE	RED	●	19 mm	9,5 mm	100 m
TCS254X50RE	RED	●	25,4 mm	12,7 mm	50 m
TCS16X200WH	WHITE	○	1,6 mm	0,8 mm	200 m
TCS24X200WH	WHITE	○	2,4 mm	1,2 mm	200 m
TCS32X200WH	WHITE	○	3,2 mm	1,6 mm	200 m
TCS48X100WH	WHITE	○	4,8 mm	2,4 mm	100 m
TCS64X100WH	WHITE	○	6,4 mm	3,2 mm	100 m
TCS95X100WH	WHITE	○	9,5 mm	4,8 mm	100 m
TCS127X100WH	WHITE	○	12,7 mm	6,4 mm	100 m
TCS190X100WH	WHITE	○	19 mm	9,5 mm	100 m
TCS254X50WH	WHITE	○	25,4 mm	12,7 mm	50 m
TCS16X200BU	BLUE	●	1,6 mm	0,8 mm	200 m
TCS24X200BU	BLUE	●	2,4 mm	1,2 mm	200 m
TCS32X200BU	BLUE	●	3,2 mm	1,6 mm	200 m
TCS48X100BU	BLUE	●	4,8 mm	2,4 mm	100 m
TCS64X100BU	BLUE	●	6,4 mm	3,2 mm	100 m
TCS95X100BU	BLUE	●	9,5 mm	4,8 mm	100 m
TCS127X100BU	BLUE	●	12,7 mm	6,4 mm	100 m
TCS190X100BU	BLUE	●	19 mm	9,5 mm	100 m
TCS254X50BU	BLUE	●	25,4 mm	12,7 mm	50 m

TERMOCOIL HEAT-SHRINKABLE TUBING

*flame-retardant Polyolefin
shrinkage ratio 2÷1*

TCS

Ref.	Colour		Internal Ø before shrinking	Internal Ø after shrinking	Coil Length
TCS16X200YE	YELLOW	●	1,6 mm	0,8 mm	200 m
TCS24X200YE	YELLOW	●	2,4 mm	1,2 mm	200 m
TCS32X200YE	YELLOW	●	3,2 mm	1,6 mm	200 m
TCS48X100YE	YELLOW	●	4,8 mm	2,4 mm	100 m
TCS64X100YE	YELLOW	●	6,4 mm	3,2 mm	100 m
TCS95X100YE	YELLOW	●	9,5 mm	4,8 mm	100 m
TCS127X100YE	YELLOW	●	12,7 mm	6,4 mm	100 m
TCS190X100YE	YELLOW	●	19 mm	9,5 mm	100 m
TCS254X50YE	YELLOW	●	25,4 mm	12,7 mm	50 m
TCS16X200GN	GREEN	●	1,6 mm	0,8 mm	200 m
TCS24X200GN	GREEN	●	2,4 mm	1,2 mm	200 m
TCS32X200GN	GREEN	●	3,2 mm	1,6 mm	200 m
TCS48X100GN	GREEN	●	4,8 mm	2,4 mm	100 m
TCS64X100GN	GREEN	●	6,4 mm	3,2 mm	100 m
TCS95X100GN	GREEN	●	9,5 mm	4,8 mm	100 m
TCS127X100GN	GREEN	●	12,7 mm	6,4 mm	100 m
TCS190X100GN	GREEN	●	19 mm	9,5 mm	100 m
TCS254X50GN	GREEN	●	25,4 mm	12,7 mm	50 m
TCS32X200Y/G	YELLOW / GREEN	●	3,2 mm	1,6 mm	200 m
TCS48X100Y/G	YELLOW / GREEN	●	4,8 mm	2,4 mm	100 m
TCS64X100Y/G	YELLOW / GREEN	●	6,4 mm	3,2 mm	100 m
TCS95X100Y/G	YELLOW / GREEN	●	9,5 mm	4,8 mm	100 m
TCS127X100Y/G	YELLOW / GREEN	●	12,7 mm	6,4 mm	100 m
TCS190X100Y/G	YELLOW / GREEN	●	19 mm	9,5 mm	100 m
TCS254X50Y/G	YELLOW / GREEN	●	25,4 mm	12,7 mm	50 m
TCS381X50Y/G	YELLOW / GREEN	●	38,1 mm	19,0 mm	50 m
TCS508X25Y/G	YELLOW / GREEN	●	50,8 mm	25,4 mm	25 m

ES

INSULATED COVERS ES SERIES

For uninsulated connectors

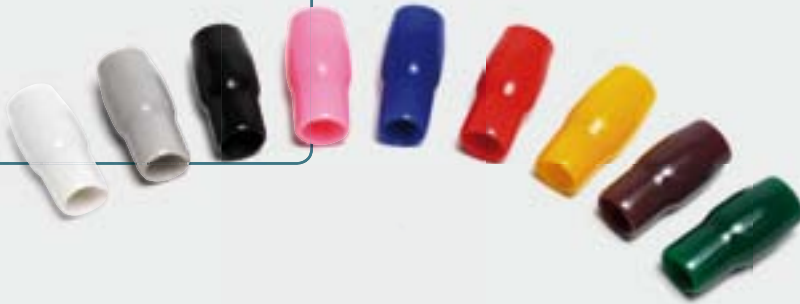

Insulated covers in PVC for general use with Cembre A-M copper tube lugs characterised by environmental tolerance, flexibility, not inflammability & stable performance. Widely used for the insulation and protection of connections and electrical terminations.

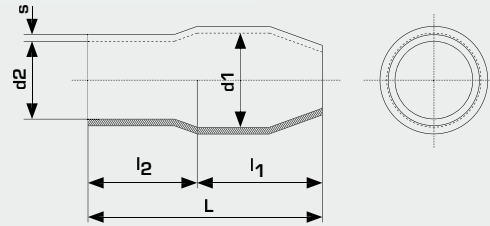

General features:

- **Material:** PVC
- **Self extinguishing (UL94):** VO
- **Working temperature:** 85 °C
- **Colours:** red, yellow, blue, green, black, grey, white, brown, pink.

Ref.	Connectors A-M*	d1 Ø	d2 Ø	l ₁ ±1	l ₂ ±1	L ± 2	s ± 0.2	Quantity	Minimum Order Qty
ES03..	A03	3.3	3.1	7.0	8.0	15.0	0.6	100	3.000
ES06..	A06	4.5	3.7	8.0	8.0	16.0	0.7	100	
ES1..	A1	5.7	4.1	9.0	9.0	18.0	0.8	100	
ES2..	A2	7.2	6.2	11.0	10.0	21.0	1.0	100	1.000
ES3..	A3	10.0	8.0	15.0	13.0	28.0	1.1	100	
ES5..	A5	12.0	9.5	15.0	14.0	29.0	1.2	100	
ES10..	A7, A9, A10	14.0	11.8	17.0	17.0	34.0	1.4	100	500
ES14..	A12, A14	17.0	13.9	22.0	20.0	42.0	1.5	100	
ES19..	A17, A19	19.0	16.0	25.0	21.0	46.0	1.5	50	
ES24..	A20, A24	22.0	18.0	31.0	24.0	55.0	1.7	50	200
ES30..	A29, A30	24.0	20.0	32.0	28.0	60.0	1.8	50	
ES37..	A35, A37	26.0	22.0	34.0	31.0	65.0	1.8	50	
ES40..	A40, A48**	32.2	24.0	38.0	31.0	69.0	2.0	50	100
ES48..	A48**	36.5	27.2	42.0	33.0	75.0	2.0	50	
ES80..	A60, A80	36.7	30.0	42.0	33.0	75.0	2.0	25	

Dimensions are in mm

Add the suffix corresponding to the selected colour to the reference:

-BU blue, **-GY** grey, **-BR** brown, **-BK** black, **-WH** white, **-RE** red, **-GN** green, **-YE** yellow, **-PK** pink

* See A-M type copper tube lugs on pages 24-25, 32

** Depending on the diameter of the insulated cable

CAST RESIN JOINTS

cast resin, low voltage through joints

N

SHELLS

Manufactured from transparent synthetic material which allows a visual check of the connections before and after casting.

The halves of the shell are joined by snap closures which avoid further fixing or sealing.

Shells are left on after casting to provide additional protection against mechanical abrasion, chemical agents and severe weather conditions.



STRAIGHT JOINTS

Type	Dimensions mm				Cable Diameter mm	Indicative Cable Section ⁽²⁾ mm ²
	L	H	D1 ⁽¹⁾	D2 ⁽¹⁾		
N11	200	50	8	26	8 - 25	4C x 1,5 ÷ 10
N12	260	67	16	32	16 - 31	4C x 10 ÷ 25
N13	360	75	21	38	21 - 36	4C x 35 ÷ 50
N14	400	100	26	41	26 - 39	4C x 50 ÷ 70
N15	530	130	35	56	35 - 54	4C x 95 ÷ 150
N16	700	150	47	74	45 - 72	4C x 185 ÷ 300

⁽¹⁾ Internal dimension of the shell

⁽²⁾ Indicative cable sections are approximate and concern only harmonised, PVC or Rubber insulated cables at a working voltage of 0,6/1 kV

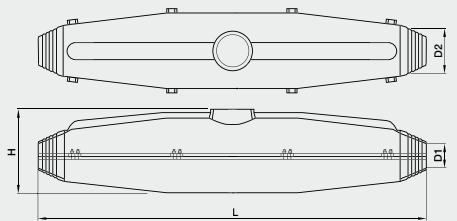

BRANCH JOINTS

Type	Dimensions mm					Cable Diameter mm	Indicative Cable Section ⁽²⁾ mm ²	
	L	H	B	D1 ⁽¹⁾	D2 ⁽¹⁾		Run	Tap
NY00	150	47	70	11	20	11 - 20	4C x 1,5 ÷ 2,5	4C x 1,5
NY0	175	60	94	6	22	6 - 21	4C x 4 ÷ 10	4C x 4
NY1	225	75	110	9	26	9 - 24	4C x 6 ÷ 25	4C x 16

⁽¹⁾ Internal dimension of the shell

⁽²⁾ Indicative cable sections are approximate and concern only harmonised, PVC or Rubber insulated cables at a working voltage of 0,6/1 kV

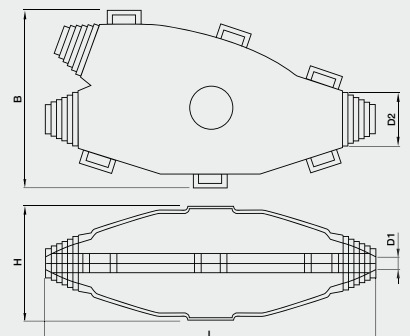

CAST RESIN JOINTS

cast resin, low voltage through joints

CAST RESIN TECHNOLOGY

PUR-cast resin technology was introduced to seal and protect power, signal and telephone cable joints.

This new generation of two component cast resin has been developed for the most demanding environments and circumstances.

Cembre cast resin joints meet the requirements of EN50393 and DIN VDE 57291-2 (VDE0291).

Quick setting properties in humid or even cold conditions make it a fast and reliable solution.

No external measuring or mixing is required as this takes place within an Aluminium foil pouch, avoiding spillage and errors during installation.

Unmixed resin components have a 48 month shelf-life even in the most difficult storage conditions.

Shells are made of durable PET resulting in good hydrophobic properties and excellent impact resistance, while good adhesion to PVC and metals assures a watertight seal.

Technical characteristic	Test result	Requirement of DIN VDE 0291
Pot life @		
5°C	35 min	
23°C	20 min	product conforms ± 30%
35°C	15 min	
Reactant open cup flash point	> 200 °C	> 55
Tensile strength	≥ 8.0 Mpa	≥ 5.0
Hot aging	- 5 Shore A	- 7
Adhesive	> 1500 CP. S	-
Elongation at break	≥ 100%	≥ 50%
Gel time for 300 ml @	23 °C	
Pouch >1000 ml	26 min	product conforms ± 10%
Pouch <1000 ml	17 min	product conforms ± 10%
Max. reaction temp.	60 °C / 333 K	product conforms ± 10%
Total vol. variability when hardening	6 %	max. 6.5 %
Cast resin component open cup flash point	> 200 °C	> 100
Density	1.07 g / cm ³	-
Impact strength	> 10 kJ / m ²	> 10 kJ / m ²
Hardness	75 Shore A	min. 20 Shore D
Expansion coefficient in temp. range 20-50°C	5.9 x 10 ⁻⁴ K ⁻¹	product conforms ± 15%
Thermal conductivity	0.2W x m ⁻¹ x K ⁻¹	product conforms ± 20%
Flammability	Class II c	acc. to DIN VDE 0304, part 3
Water absorption 42 days@50°C	360 mg	max. 400 mg
Electrolytic corrosion	A1	-
Voltage test @		no breakdown @ test voltage
23°C	> 20 kV	> 20 kV
80°C	> 10 kV	> 20 kV
Dielectric dissipation factor @		
23°C and 50 Hz	0.08	max. 0.1
23°C and 1k Hz	0.05	-
Relative permittivity		
@ 23°C and 50 Hz	5	< 6
@ 23°C and 1k Hz	5.1	-
Tracking resistance	KA 3c	min KA 3c
After 28 days of immersion in 90°C water		
Tensile strength	8.2N/mm ²	≥ 65% of initial value
Elongation at break	60%	≥ 65% of initial value
Hardness	47 Shore	≥ 80% of initial value



MLL 1

For crimping insulated terminals, 0,25 to 6 sqmm



MLL 90

Single aperture, ratchet controlled tool for crimping female connectors, open barrel, flag type 1 to 2,5 sqmm side insertion



MLS 1

For crimping end sleeves 0,25 to 6 sqmm



MLS 2

For crimping end sleeves 6 to 16 sqmm



ZP2

For crimping insulated and uninsulated connectors, 0,25 to 6 sqmm

MECHANICAL TOOLS MARKET *line* RANGE

HB 5

Wire stripper,
for PVC insulated cables
0,25 to 6 sqmm



HB 7

A versatile tool for cutting,
crimping, and stripping.
Range: 0,2 to 6 sqmm



HB 8

Wire stripper,
for PVC
insulated cables
0,2 to 6 sqmm



CABLE TIE TOOLS

53130

Type 5313022048
For plastic cable ties
from 2,2 to 4,8 mm
Automatic cutting
Weight : 0,2 kg
Length: 165 mm



55270

Type 5527030079
For stainless steel cable ties
width up to 7,9 mm
With cutting device
Weight: 0,56 kg
Length: 180 mm



55230

Type 5523036090
For plastic cable ties
from 4,8 to 9 mm
Manual cutting
Weight : 0,3 kg
Length: 195 mm



TAPE RULES

FLS

FLS3 3 metres long
FLS5 5 metres long
Robust metal case with comfortable ergonomic
shape and protective mouldings for professional use.
Nylon coated tape for long-life corrosion and
abrasion resistance.
End hook magnet for increased user convenience.
Self-locking on extension, double release button for
controlled retraction.

FLS3 Weight : 166 g – Tape width : 16 mm

FLS5 Weight : 252 g – Tape width : 19 mm

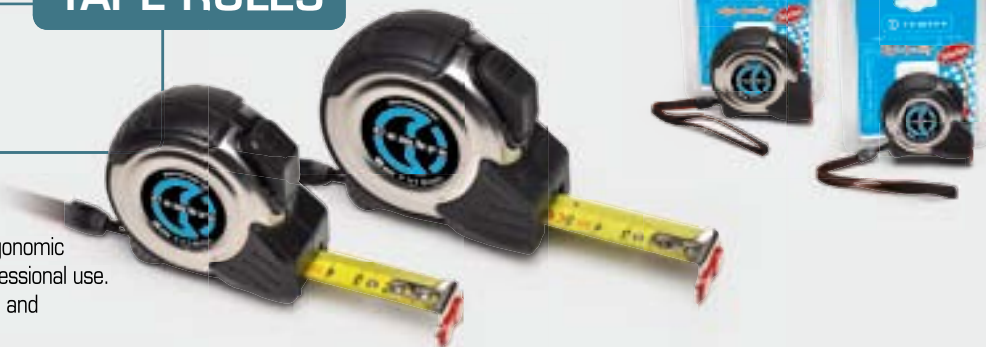





DIE SELECTOR CHART

COPPER CONDUCTORS

EXTRA FLEXIBLE COPPER CONDUCTORS

APPLICATION	CONDUCTOR		CONNECTOR		HYDRAULIC TOOLS													HYDRAULIC TOOLS																		
					B 15D			B 35-45D			B 35-50D			HT 45-E			HT 51 B 51			RH 50 B 55			HT 81-U RHU 81			HT 120 and tools and heads with 130 kN crimping force			ECW-H3D			RHU 520				
					TERMINAL	SPLICE	DIE SET	NEST	INDENTOR	DIE SET	NEST	INDENTOR	DIE SET	NEST	INDENTOR	DIE SET	NEST	INDENTOR	DIE SET	NEST	INDENTOR	DIE SET	NEST	INDENTOR	DIE SET	NEST	INDENTOR	DIE SET	NEST	INDENTOR	DIE SET	NEST	INDENTOR	DIE SET	NEST	INDENTOR
	Conductor Size sqmm																																			
	Low str.	Flex																																		
	0,25 ÷ 2,5		A 03-M. A 06-M.		L 03M / L 03P L 06M / L 06P	ME03/2-15 MA03/3-15																														
	4 ÷ 6		A 1-M. A 1-L.		L 1-M L 1-P	ME03/2-15 MA03/3-15	MA 1	PA 1	ME 1	MA 1-50	PA 1-50	ME 1-50	MA 1	PA 1	ME 1																					
	10		A 2-M. A 2-L. A 2-P12		L 2-M L 2-P	ME03/2-15 MA03/3-15	MA 2.3		ME 2	MA 2.3-50		ME 2-50	MA 2.3		ME 2																					
	16		A 3-M. A 3-L. A 3-P14	2A 3-M.	L 3-M L 3-P	ME2/3-15 MA03/3-15		PA 5	ME 3		PA 5-50	ME 3-50		PA 5	ME 3																					
	25		A 5-M. A 5-L. A 5-P16	2A 5-M.	L 5-M L 5-P		MA 5		ME 5	MA 5-50		ME 5-50	MA 5		ME 5																					
	35	25* 35	A 7-M. A 7-L. A 7-P20	2A 7-M.	L 7-M L 7-P		MA 7		ME 7	MA 7-50		ME 7-50	MA 7		ME 7																					
	50	35* 50	A 10-M. A 10-L. A 10-P25	2A 10-M.	L 10-M L 10-P		MA 10		ME 10	MA 10-50	PA 10-50	ME 10-50	MA 10		ME 10																					
	70	50* 70	A 14-M. A 14-L. A 14-P30	2A 14-M.	L 14-M L 14-P				ME 14	MA 14-50		ME 14-50			ME 14																					
	95	70* 95	A 19-M. A 19-L.	2A 19-M.	L 19-M L 19-P				ME 19	MA 19-50	PA 19-50	ME 19-50			ME 19																					
	120	95* 120	A 24-M. A 24-L.	2A 24-M.	L 24-M L 24-P				ME 24	MA 24-50	PA 24-50	ME 24-50			ME 24																					
	150	120* 150	A 30-M. A 30-L.	2A 30-M.	L 30-M L 30-P				ME 30L			ME 30L-50			ME 30																					
	185	150* 185	A 37-M. A 37-L. A 37-4ESI	2A 37-M.	L 37-M L 37-P																															
	240	185* 240	A 48-M. A 48-L. A 48-4ESI	2A 48-M.	L 48-M L 48-P																															
	300	240 300	A 60-M. A 60-L. A 60-4ESI	2A 60-M.	L 60-M L 60-P																															
	400	300 400	A 80-M. A 80-4ESI	2A 80-M.	L 80-M																															
	500	400 500	A 100-M. A 100-4ESI	2A 100-M.	L 100-M																															
	630	500 630	A 120-M. A 120-4ESI	2A 120-M.	L 120-M																															
	800	630	A 160-M. A 160-4ESI	2A 160-M.	L 160-M																															
1000	800	A 200-M.	2A 200-M.	L 200-M																																
	35		A 9-M.				MA 9	PA 10	ME 9	MA 9-50	PA 10-50	ME 9-50	MA 9	PA 10	ME 9																					
	50		A 12-M.						ME 12	MA 12-50		ME 12-50			ME 12																					
	70		A 17-M.						ME 17	MA 17-50	PA 19-50	ME 17-50			ME 17																					
	95		A 20-M.						ME 20	MA 20-50		ME 20-50			ME 20																					
	120		A 29-M.						ME 29			ME 29-50			ME 29																					
	150		A 35-M.																																	
	185		A 40-M.																																	

Hexagonal crimp (use one size up with fine stranded conductors, E.G.: 95³ fine stranded use A19-.. + ME 19 or A 20-.. + ME 20)













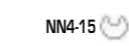

































































Indent crimp

* Contact Cembre for appropriate die set

N.B.: Number inside symbol indicates the number of crimps on A-M barrel





DIE SELECTOR CHART

DIE SELECTOR CHART

APPLICATION	CONDUCTOR	CONNECTOR					HYDRAULIC TOOLS										
							B 15D	B 35-45D	B 35-50D	HT 45-E	HT 51 B 51	RH 50 B 55	HT 81-U RHU 81	HT 120 and tools and heads with 130 kN crimping force			ECW-H3D
	Conductor Size Flex sqmm	TERMINAL					DIE SET		DIE SET		DIE SET		NEST	INDENTOR	DIE SET	NEST	INDENTOR
 ANE..M..  ANE..P..  ANE..U..	10	ANE 2-M..	ANE 2-P12	ANE 2-U..					MN 2 RF-50 		MN 2 RF-50 		MN 2-C 	PN 7-C PN 14-C PN 24-C PN 37-C	MN 2 R-F-C 	Adaptor AU 230-130 D with die set MN..C and indentor PN..C or with die set MN..R-F-C and die set MN..F-C	
	16	ANE 3-M..	ANE 3-P14	ANE 3-U..				MN 3 RF-50 		MN 3 RF-50 		MN 3-C 	MN 3 R-F-C 				
	25	ANE 5-M..	ANE 5-P16					MN 5 RF-50 		MN 5 RF-50 		MN 5-C 	MN 5 R-F-C 				
	35	ANE 7-M..	ANE 7-P20					MN 7 RF-50 		MN 7 RF-50 		MN 7-C 	MN 7 R-F-C 				
	50	ANE 10-M..						MN 10 RF-50 		MN 10 RF-50 		MN 10-C 	MN 10 R-F-C 				
	70	ANE 14-M..								MN 14 RF-50 		MN 14-C 	MN 14 R-F-C 				
	95	ANE 19-M..								MN 19 RF-50 		MN 19-C 	MN 19 R-F-C 				
	120	ANE 24-M..								MN 24 RF-50 		MN 24-C 	MN 24 R-F-C 				
	150	ANE 30-M..										MN 30-C 	MN 30 R-F-C 				
 ANE..M..	35	ANE 9-M..							MN 7 RF-50 		MN 7 RF-50 		MN 9-C 	PN 14-C PN 24-C PN 37-C	MN 7 R-F-C 	Adaptor AU 230-130 D with die set MN..C and indentor PN..C or with die set MN..R-F-C and die set MN..F-C	
	50	ANE 12-M..							MN 12 F-50 		MN 12 F-50 		MN 12-C 		MN 12 F-C 		
	70	ANE 17-M..									MN 17 F-50 		MN 17-C 		MN 17 F-C 		
	95	ANE 20-M..									MN 20 F-50 		MN 20-C 		MN 20 F-C 		
	120	ANE 29-M..										MN 29 F-50 			MN 29-C 		MN 29 F-C 
	150	ANE 35-M..										MN 35-C 			MN 35 F-C 		
 PK ...  KE ...	0,3 ÷ 4	PKD 506 ÷ PKD 418	PKE 508 ÷ PKE 418	PKC 508 ÷ PKC 418	KE 506 ÷ KE 412				KE 4-15 								
	4 ÷ 16	PKD 410 ÷ PKD 1618	PKE 410 ÷ PKE 1618	PKC 410 ÷ PKC 1618	KE 410 ÷ KE 1616				KE 16-15 								
	16	PKD 16..	PKE 16..	PKC 16..	KE 16..				KE 35-15 		MTT 16-50 		MTT 16-50 				
	25	PKD 25..	PKE 25..	PKC 25..	KE 25..					MTT 25-50 		MTT 25-50 					
	35	PKD 35..		PKC 35..	KE 35..					MTT 35-50 		MTT 35-50 					
	50	PKD 50..		PKC 50..							MTT 50-50 		MTT 50-50 				
	70			PKC 70..							MTT 70-50 		MTT 70-50 				
	95			PKC 95..							MTT 95-50 		MTT 95-50 				
	120			PKC 120..								MTT 120-50 					
 PKT ...	2 x 0,5	PKT 508 PKT 510							DIE SET 								
	2 x 0,75	PKT 7508 PKT 7512															
	2 x 1	PKT 108 PKT 112															
	2 x 1,5	PKT 1508 PKT 1512															
	2 x 2,5	PKT 2510 PKT 2512															
	2 x 4	PKT 412															
	2 x 6	PKT 614															
	2 x 10	PKT 1014										MTT 16-50 		MTT 16-50 			
	2 x 16	PKT 1614										MTT 35-50 		MTT 35-50 			

 Incident crimp  Radial crimp  Trapezium crimp

DIE SELECTOR CHART

APPLICATION	CONDUCTOR		CONNECTOR				HYDRAULIC TOOLS									
							B 35-45D	B 35-50D	HT 45-E	HT 51 B 51	RH 50 B 55	HT 81-U RHU 81	HT 120 and tools and heads with 130 kN crimping force	ECW-H3D	RHU 52D	
 c..c..ST  c..c..	Section Conductor mm ²		CONNECTOR	CONNECTOR			DIE SET	DIE SET	DIE SET	DIE SET	DIE SET	DIE SET	DIE SET	DIE SET	DIE SET	
	Run	Tap														
	6 ÷ 2,5	6 ÷ 1,5	C 6 - C 6 ST	C 6 - C 6			MC 6	MC 6-50	MC 6	MC 6-50	MC 6.25-U					
	10	10 ÷ 1,5	C 10 - C 10 ST	C 10 - C 10			MC 10	MC 10-50	MC 10	MC 10-50	MC 10-U		MC 10-C			
	16	16 ÷ 1,5	C 16 - C 16 ST	C 16 - C 16												
	25 ÷ 16	10 ÷ 1,5	C 25 - C 10 ST	C 25 - C 10			MC 25	MC 25-50	MC 25	MC 25-50	MC 6.25-U MC 25-U		MC 25-C		Adaptor AU 230-130 D with die set MC..C	
	25	25 ÷ 16	C 25 - C 25 ST	C 25 - C 25												
	40 ÷ 35	16 ÷ 1,5	C 35 - C 16 ST	C 35 - C 16												
	40 ÷ 35	40 ÷ 25					MC 35	MC 35-50	MC 35							
	50	25 ÷ 10	C 35 - C 35 ST	C 35 - C 35												
	70 ÷ 63	25 ÷ 1,5	C 70 - C 25N ST	C 70 - C 25N												
	50	25 ÷ 4	C 50 - C 25 ST	C 50 - C 25												
	*50	50 ÷ 35	C 50 - C 50 ST	C 50 - C 50												
	*70 ÷ 50	40 ÷ 4	C 70 - C 35 ST	C 70 - C 35						*MC 70-50	MC 70-80-U		MC 70-C	MC 70-3D	Adaptor AU 520-130 C with die set MC..C	
	*70 ÷ 50	70 ÷ 35	C 70 - C 70 ST	C 70 - C 70												
	100 ÷ 95	40 ÷ 4	C 95 - C 35 ST	C 95 - C 35												
	100 ÷ 95	70 ÷ 40	C 95 - C 70 ST	C 95 - C 70							MC 95-80-U		MC 95-C	MC 95-3D		
	100 ÷ 95	100 ÷ 63	C 95 - C 95 ST	C 95 - C 95												
	125 ÷ 110	125 ÷ 25	C 120 - C 120 ST	C 120 - C 120												
	160 ÷ 150	125 ÷ 25	C 150 - C 120 ST	C 150 - C 120												
150	150 ÷ 63	C 150 - C 150 ST	C 150 - C 150													
185	100 ÷ 16	C 185 - C 95 ST	C 185 - C 95													
185 ÷ 120	185 ÷ 120	C 185 - C 185 ST	C 185 - C 185													
240 ÷ 150	120 ÷ 95	C 240 - C 120 ST	C 240 - C 120											MC 240-3D		
 MT..TD MT..GC  CA..M.. CA..2M..  MT..C..	Conductor Size sqmm		TERMINALS		TERMINALS			DIE SET		DIE SET	DIE SET	DIE SET	DIE SET	DIE SET	DIE SET	
	25 R		MT 25 - TD	MT 25 - GC	CA 25 - M..	CA 25 - 2M..	MT 25 - C..		MMT 25-50		MMT 25-50	MMT 25-U	MMT 25-C			
	35 RC/S ÷ 40 S		MT 40 S - TD	MT 40 S - GC	CA 40 S - M..	CA 40 S - 2M..	MT 40 S - C..									
	50 RC		MT 50 R - TD	MT 50 R - GC	CA 50 R - M..	CA 50 R - 2M..	MT 50 R - C..		MMT 50-50		MMT 50-50	MMT 50-U	MMT 50-C			
	50 S		MT 50 S - TD	MT 50 S - GC	CA 50 S - M..	CA 50 S - 2M..	MT 50 S - C..									
	63 S ÷ 70 S		MT 70 S - TD	MT 70 S - GC	CA 70 S - M..	CA 70 S - 2M..	MT 70 S - C..									
	80 S ÷ 95 RC		MT 95 R - TD	MT 95 R - GC	CA 95 R - M..	CA 95 R - 2M..	MT 95 R - C..				MMT 95-50	MMT 95-U	MMT 95-C		Adaptor AU 230-130 D with die set MMT..C	Adaptor AU 520-130 C with die set MMT..C
	95 S ÷ 100 S		MT 95 S - TD	MT 95 S - GC	CA 95 S - M..	CA 95 S - 2M..	MT 95 S - C..									
	120 RC/S ÷ 150 RC		MT 150 R - TD	MT 150 R - GC	CA 150 R - M..	CA 150 R - 2M..	MT 150 R - C..									
	150 S ÷ 160 RC		MT 150 S - TD	MT 150 S - GC	CA 150 S - M..	CA 150 S - 2M..	MT 150 S - C..				MMT 200-50	MMT 200-U	MMT 200-C			
	160 S ÷ 200 RC		MT 200 R - TD	MT 200 R - GC	CA 200 R - M..	CA 200 R - 2M..	MT 200 R - C..									
	200 S ÷ 240 RC		MT 240 R - TD	MT 240 R - GC	CA 240 R - M..	CA 240 R - 2M..	MT 240 R - C..									
	240 S ÷ 315 RC		MT 315 R - TD	MT 315 R - GC	CA 315 R - M..	CA 315 R - 2M..	MT 315 R - C..							MMT 315-C		
	315 S		MT 315 S - TD	MT 315 S - GC	CA 315 S - M..	CA 315 S - 2M..	MT 315 S - C..									
	400 R		MT 400 - TD		2A 80 - M..	2A 80 - 2M..								ME 80-C	ME 80-3D	ME 80-520
500 R		MT 500 - TD		2A 100 - M..	2A 100 - 2M..									ME 100-3D	ME 100-520	
600 R ÷ 630 R		MT 630 - TD		2A 120 - M..	2A 120 - 2M..									ME 120-3D	ME 120-520	

 Hexagonal crimp

 Oval crimp

 Circular crimp





* When using die set type MC70-50, the conductors marked with a star must be annealed.

DIE SELECTOR CHART FOR DEEP STEPPED INDENTING WITH CONTAINING DIES

APPLICATIONS	CONDUCTOR	CONNECTORS			HYDRAULIC TOOLS							
					HT 131-UC	RHU 131-C	B 131-UC					
 	Conductor Size sqmm	LUGS			DIE HOLDER	DIE	INDENTOR					
	10	CAA 10 - M..			AU 130-150	MV 35 	MUA 35 	PS 130-35/E				
	16	CAA 16 - M..	MTA 16 - C			AU 130-150	MV 95 	MUA 95 	PS 130-95/E			
	25	CAA 25 - M..	MTA 25 - C				AU 130-150	MV 150 	MUA 150 	PS 130-150/E		
	35	CAA 35 - M..	MTA 35 - C					AU 130-150	MV 240 	MUA 240 	PS 130-240/E	
	50	CAA 50 - M..	MTA 50 - C						AU 130-240	MUA 300-34 		
	70	CAA 70 - M..	MTA 70 - C..							AU 130-240		
	95	CAA 95 - M..	MTA 95 - C..		AU 130-240							
	120	CAA 120 - M..	MTA 120 - C..			AU 130-240						
	150	CAA 150 - M..	MTA 150 - C..				AU 130-240					
	185	CAA 185 - M..	MTA 185 - C..		AU 130-240							
	240	CAA 240 - M..	MTA 240 - C..			AU 130-240						
300	CAA 300 - 34 - M..			AU 130-240								
	Conductor Size sqmm	LUGS			DIE HOLDER		DIE	INDENTOR				
	16	AA 16 - M..				AU 130-150	MUA 35 	PS 130-35/E				
	25	AA 25 - M..			AU 130-150		MUA 95 	PS 130-95/E				
	35	AA 35 - M..					AU 130-150	MUA 150 	PS 130-150/E			
	50	AA 50 - M..						AU 130-150	MUA 240 	PS 130-240/E		
	70	AA 70 - M..							AU 130-240		MUA 300-34 	
	95	AA 95 - M..				AU 130-240						
	120	AA 120 - M..			AU 130-240							
	150	AA 150 - M..				AU 130-240						
	185	AA 185 - M..			AU 130-240							
240	AA 240 - M..			AU 130-240								
300	AA 300 - 34 - M..				AU 130-240							

 Indent crimp

DIE SELECTOR CHART FOR DEEP STEPPED INDENTING WITH CONTAINING DIES

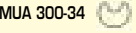
Conductor Size sqmm	SPLICES		Conductor Size sqmm		SPLICES	HYDRAULIC TOOLS HT 131-UC RHU 131-C B 131-UC			
			Al	Al/Cu		DIE HOLDER	DIE	INDENTOR	
10	MTMA 10-GC					AU 130-150	MVM 35 	MUA 35 	PS 130-35/E
16	MTMA 16-GC	MTMA 16/1	16	10	MTMA 16-10 GC				
25	MTMA 25-GC	MTMA 25/1	25	10	MTMA 25-10 GC				
			25	16	MTMA 25-16 GC				
35	MTMA 35-GC	MTMA 35/1							
50	MTMA 50-GC	MTMA 50/1	50	25	MTMA 50-25 GC				
			50	35	MTMA 50-35 GC				
70	MTMA 70-GC	MTMA 70/1	70	35	MTMA 70-35 GC				
			70	50	MTMA 70-50 GC				
95	MTMA 95-GC	MTMA 95/1	95	50	MTMA 95-50 GC				
			95	70	MTMA 95-70 GC				
120	MTMA 120-GC	MTMA 120/1	120	70	MTMA 120-70 GC				
			120	95	MTMA 120-95 GC				
150	MTMA 150-GC	MTMA 150/1	150	70	MTMA 150-70 GC				
			150	95	MTMA 150-95 GC				
185	MTMA 185-GC	MTMA 185/1	185	120	MTMA 185-120 GC				
			185	150	MTMA 185-150 GC				
240	MTMA 240-GC	MTMA 240/1	240	150	MTMA 240-150 GC				
			240	185	MTMA 240-185 GC				
300	MTMAD 300-GC	MTMAD 300/1	300	185	MTMAD 300-185 GC				
			300	240	MTMAD 300-240 GC				
					AU 130-240	MVM 240 	MUA 240 	PS 130-240/E	
						MUA 300-34 			

MTMA...GC

PRE-ROUNDERS SELECTION

DIES DESCRIPTION

DIES SEQUENCE

ALUMINIUM CONDUCTOR SIZE sqmm

PRE-ROUNDER

DIE-SUPPORT

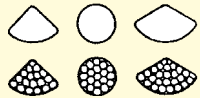

AC 130-P

1) AU 130-.. DIE-HOLDER

Used to house dies and pre-rounders.

2) UP 130-.. PRE-ROUNDERS

Used to round aluminium sectoral conductors in order to introduce them into circular connectors.

Each pre-rounder is made of two parts: the upper part is housed in die-holder AU 130-.. and the lower part is locked onto AC 130-P.. die support.

3) AC 130-P.. DIE SUPPORT

Houses lower part of pre-rounder UP 130-..

4) MUA... DIES

Containing dies.

5) PS 130-../E INDENTORS

Such indentors are specifically engineered for deep indentation of aluminium conductors of any stranding configuration.

CONDUCTOR ROUNDING

CRIMPING

1



1

2



























4

3



5

DIE SELECTOR CHART



APPLICATIONS	CONDUCTOR	CONNECTORS		HYDRAULIC TOOLS									
				HT 120 and tools and heads with 130 kN crimping force	HT 131-UC B 135-UC		RHU 131-C B 131-UC		ECW-H3D	RHU 230-630			
					HEXAGONAL CRIMP	INDENT CRIMP			HEXAGONAL CRIMP	INDENT CRIMP			
	Conductor Size sqmm	LUGS		DIE SET	DIE HOLDER	DIE	INDENTOR	DIE SET	ADAPTOR	DIE	INDENTOR		
CAA..M. 	300	CAA 300-34 - M..		MK34L-C 	AU 130-240	MUA 300-34 	PS 130-240/E	MK34-3D 					
	300	CAA 300 - M16						MK38-3D 	AU 230-630	MV 230-400 MC5E 	PS 230-400 5E		
	400	CAA 400 - M16											
	500	CAA 500 - M16 TNBD											
	630	CAA 630 - 4M8							MK46-3D 		MV 230-630 MC6E 	PS 230-630 6E	
AA..M. 	300	AA 300 - 34 - M..		MK34L-C 	AU 130-240	MUA 300-34 	PS 130-240/E	MK34-3D 					
	300	AA 300 - M16						MK38-3D 	AU 230-630	MUA 230-630-400 	PS 230-400 5E		
	400	AA 400 - M16											
	500	AA 500 - 40 - M16											
	630	AA 630 - M16							MK46-3D 		MUA 230-630-630 	PS 230-630 6E	
MTMA.. 	300	MTMAD 300/1	300	95	MTMAD 300-95-GC	MK34L-C 	AU 130-240	MUA 300-34 	PS 130-240/E	MK34-3D 			
				150	MTMAD 300-150-GC								
		MTMAD 300-GC		185	MTMAD 300-185-GC								
				240	MTMAD 300-240-GC								
	300	MTMA 300-GC								MK38-3D 	AU 230-630	MVM 230-400 MJ5E 	PS 230-400 5E
	400	MTMA 400/1	400	240	MTMA 400-240-GC								
				300	MTMA 400-300-GC								
	500	MTMA 500-40/1											
	500	MTMA 500-GC	500	300	MTMA 500-300-GC					MK46-3D 	AU 230-630	MVM 230-630 MJ6E 	PS 230-630 6E
		400		MTMA 500-400-GC									
630	MTMA 630/1												



 Indent crimp

 Hexagonal crimp

DIE SELECTOR CHART

HYDRAULIC TOOLS

APPLICATIONS	CONDUCTOR	CONNECTORS		HYDRAULIC TOOLS								ECW-H3D			
				B 15D	B 35-45D	B 35-50D	HT 45-E	HT 51 RHM 50	RH 50 B 51	HT 81-U	RHU 81 ^o	HT 120 and tools and heads with 130 kN crimping force	DIE	INDENTOR	
		LUGS	SPLICES	DIE SET	DIE SET	DIE SET	DIE SET	DIE SET	DIE SET	DIE SET	DIE	INDENTOR	DIE	INDENTOR	
	6÷10	Q10..				MQ10-50 (1)		MQ10-50 (1)	MQ10-50 (1)	MQ10-50 (1)	MQM10-C (1)	MGS16-C	Adaptor AU 230-130 D with die set MQ...		
	10÷16	Q16..				MQ16-50 (1)		MQ16-50 (1)	MQ16-50 (1)	MQ16-50 (1)	MQM16-C (1)				
	16÷25	Q25..				MQ25-50 (1)		MQ25-50 (1)	MQ25-50 (1)	MQ25-50 (1)	MQM25-C (1)				
	25÷35	Q35..				MQ35-50 (2)		MQ35-50 (2)	MQ35-50 (2)	MQ35-50 (2)	MQM35-C (1)			MGS35-C	
	35÷50	Q50..				MQ50-50 (2)		MQ50-50 (2)	MQ50-50 (2)	MQ50-50 (2)	MQM50-C (1)				
	50÷70	Q70..				MQ70-50 (2)		MQ70-50 (2)	MQ70-50 (2)	MQ70-50 (2)	MQM70-C (1)			MGS70-C	
	70÷95	Q95..									MQM95-C (1)				
	95÷120	Q120..									MQM120-C (1)			MGS150-C	
	120÷150	Q150..									MQM150-C (1)				
	150÷185	Q185..									MQM185-C (1)			MGS240-C	
185÷240	Q240..									MQM240-C (1)					
 	6	DR6..	DSV6	MK5/8-15 (1)	MK5 (1)	MK5-50 (1)	MK5 (1)	MK5-50 (1)	MK5-50 (1)	MK5-50 (1)	MK5-50 (1)	MK5-C (1)	Adaptor AU 230-130 D with die set MK..C		
	10	DR10..	DSV10		MK6 (1)	MK6-50 (1)	MK6 (1)	MK6-50 (1)	MK6-50 (1)	MK6-50 (1)	MK6-50 (1)	MK6-50 (1)		MK6-C (1)	
	16	DR16..	DSV16		MK8 (2)	MK8-50 (2)	MK8 (2)	MK8-50 (2)	MK8-50 (2)	MK8-50 (2)	MK8-50 (2)	MK8-50 (2)		MK8-C (1)	
	25	DR25..	DSV25		MK10 (2)	MK10-50 (2)	MK10 (2)	MK10-50 (2)	MK10-50 (2)	MK10-50 (2)	MK10-50 (2)	MK10-50 (2)		MK10-C (1)	
	35	DR35..	DSV35		MK12 (2)	MK12-50 (2)	MK12 (2)	MK12-50 (2)	MK12-50 (2)	MK12-50 (2)	MK12-50 (2)	MK12-50 (2)		MK12-C (1)	
	50	DR50..	DSV50		MK14 (3)	MK14-50 (3)	MK14 (3)	MK14-50 (3)	MK14-50 (3)	MK14-50 (3)	MK14-50 (3)	MK14-50 (3)		MK14-C (2)	MK14-3D (2)
	70	DR70..	DSV70		MK16 (3)	MK16-50 (3)	MK16 (3)	MK16-50 (3)	MK16-50 (3)	MK16-50 (3)	MK16-50 (3)	MK16-50 (3)		MK16-C (2)	MK16-3D (2)
	95	DR95..	DSV95		MK18 (4)	MK18-50 (4)	MK18 (4)	MK18-50 (4)	MK18-50 (4)	MK18-50 (4)	MK18-50 (4)	MK18-50 (4)		MK18-C (2)	MK18-3D (2)
	120	DR120..	DSV120		MK20 (4)	MK20-50 (4)	MK20 (4)	MK20-50 (4)	MK20-50 (4)	MK20-50 (4)	MK20-50 (4)	MK20-50 (4)		MK20-C (2)	MK20-3D (2)
	150	DR150..	DSV150		MK22L (4)	MK22L-50 (4)	MK22L (4)	MK22L-50 (4)	MK22L-50 (4)	MK22L-50 (4)	MK22L-50 (4)	MK22L-50 (4)		MK22-C (2)	MK22-3D (2)
	185	DR185..	DSV185						MK25-50 (5)	MK25-50 (5)	MK25-50 (5)	MK25-50 (5)		MK25-C (2)	MK25-3D (2)
	240	DR240..	DSV240						MK28-50 (5)	MK28-50 (5)	MK28-50 (5)	MK28-50 (5)		MK28-C (4)	MK28-3D (2)
	300	DR300..	DSV300											MK32-C (4)	MK32-3D (2)
	400	DR400..	DSV400												MK38-3D (3)
	500	DR500..	DSV500												MK42-3D (3)
625	DR625..	DSV625										MK44-3D (3)			

 Hexagonal crimp Indent crimp**NB:** for through connectors this is the number of crimps per conductor^o Tools type HT 81-U and RHU 81 use the same dies of HT 51 but are equipped with spring type 6522051.



APPENDIX

REFERENCE/CODE CROSS-REFERENCE CHART

Ref.	Code	Ref.	Code	Ref.	Code	Ref.	Code	Ref.	Code
1052007	3005900	1142042N	3005051	1500.12	3002120	1715	3005540	1892	3016440
1052007N	3005901	1142048	3005055	1500.12N	3002121	1715N	3005541	1892A	3016450
1052009	3005903	1142048G	3005057	1500.13	3002025	1719	3005510	1892B	3016451
1052009N	3005904	1142048N	3005056	1500.13N	3002026	1719E17	3005581	1893	3016460
1052011	3005906	1143M12	3005215	1500.14	3002110	1719E17N	3005580	1893A	3016461
1052011N	3005907	1143M12G	3005217	1500.14N	3002111	1719N	3005511	1894	3016480
1052013	3005909	1143M12N	3005216	1500.16	3002030	1730M20	3003225	1895	3016490
1052013N	3005910	1143M16	3005220	1500.16N	3002031	1730M20N	3003226	1896	3016500
1052016	3005912	1143M16G	3005222	1500.21	3002035	1740	3027015	1897	3016510
1052016N	3005913	1143M16N	3005221	1500.21N	3002036	1741	3027020	1898	3016520
1052021	3005915	1143M20	3005225	1500.34	3002130	1741N	3027021	1899	3016530
1052021N	3005916	1143M20G	3005227	1500.34N	3002131	1742	3027025	1899A	3016535
1052029	3005918	1143M20N	3005226	1500.38	3002115	1743	3027030	1899B	3016540
1052029N	3005919	1143M25	3005230	1500.38N	3002116	1744	3027035	1900.07	3001010
1052036	3005921	1143M25G	3005232	1500.M12	3002205	1745	3027037	1900.07G	3001012
1052036N	3005922	1143M25N	3005231	1500.M12N	3002206	1746	3027040	1900.07N	3001011
1052042	3005924	1143M32	3005235	1500.M16	3002210	1747	3027045	1900.07/X	3001077
1052042N	3005925	1143M32G	3005237	1500.M16N	3002211	180709	3017610	1900.09	3001015
1052048	3005927	1143M32N	3005236	1500.M20	3002215	180911	3017620	1900.09G	3001017
1052048N	3005928	1143M40	3005240	1500.M20N	3002216	180913	3017625	1900.09N	3001016
1053M12	3005958	1143M40G	3005242	1500.M25	3002220	181113	3017630	1900.09/X	3001080
1053M12N	3005959	1143M40N	3005241	1500.M25N	3002221	181116	3017640	1900.11	3001020
1053M16	3005961	1143M50	3005245	1500.M32	3002225	181316	3017650	1900.11G	3001022
1053M16N	3005962	1143M50G	3005247	1500.M32N	3002226	181321	3017655	1900.11N	3001021
1053M20	3005964	1143M50N	3005246	1618.90	3041350	181621	3017660	1900.11/X	3001083
1053M20N	3005965	1143M63	3005250	1626.90	3041360	182129	3017670	1900.12	3001120
1053M25	3005967	1143M63G	3005252	1636.90	3041370	182936	3017680	1900.12N	3001121
1053M25N	3005968	1143M63N	3005251	1651.90	3041380	1830	3004110	1900.13	3001025
1053M32	3005970	1150	3005745	1676.90	3041390	1830N	3004111	1900.13G	3001027
1053M32N	3005971	1150N	3005746	1700	3003015	1831	3004115	1900.13N	3001026
1053M40	3005973	1163	3005750	1700.2	3004015	1831N	3004116	1900.13/X	3001086
1053M40N	3005974	1163N	3005751	1700.2N	3004016	1832	3004120	1900.14	3001110
1053M50	3005976	1253M12	3006750	1700N	3003016	1832N	3004121	1900.14N	3001111
1053M50N	3005977	1253M12N	3006751	1700P	3006015	1835G	3004222	1900.16	3001030
1053M63	3005979	1253M16	3006755	1700T	3003515	1836	3004225	1900.16G	3001032
1053M63N	3005980	1253M16N	3006756	1700TN	3003516	183642	3017690	1900.16N	3001031
1112	3005715	1253M20	3006760	1701	3003020	1836N	3004226	1900.16/X	3001089
1112N	3005716	1253M20N	3006761	1701.2	3004020	1840	3006610	1900.21	3001035
1116	3005720	1253M25	3006765	1701.2N	3004021	1840N	3006611	1900.21G	3001037
1116N	3005721	1253M25N	3006766	1701N	3003021	1841	3006615	1900.21N	3001036
1120	3005725	1253M32	3006770	1701P	3006020	1841N	3006616	1900.21/X	3001092
1120N	3005726	1253M32N	3006771	1701PN	3006021	1842	3006620	1900.29	3001040
1125	3005730	1253M40	3006775	1701T	3003517	184248	3017700	1900.29G	3001042
1125N	3005731	1253M40N	3006776	1701TN	3003518	1842N	3006621	1900.29N	3001041
1132	3005735	1253M50	3006780	1702	3003025	1843	3006625	1900.29/X	3001095
1132N	3005736	1253M50N	3006781	1702.2	3004025	1843N	3006626	1900.34	3001130
1140	3005740	1253M63	3006785	1702.2N	3004026	1844	3006630	1900.34N	3001131
1140N	3005741	1253M63N	3006786	1702.5	3004425	1844N	3006631	1900.36	3001045
1141012	3005120	1400	3003110	1702.5N	3004426	1845	3006635	1900.36G	3001047
1141012N	3005121	1401	3003114	1702CONC	3003523	1845N	3006636	1900.36N	3001046
1141112	3005155	1401B	3003116	1702CONCN	3003524	1846	3006640	1900.36/X	3001098
1141112N	3005156	1401BN	3003117	1702N	3003026	1846N	3006641	1900.38	3001115
1141200	3005170	1401C	3003118	1702P	3006025	1847	3006645	1900.38N	3001116
1141200N	3005171	1401CN	3003119	1702PN	3006026	1847N	3006646	1900.42	3001050
1142007	3005010	1401N	3003115	1702T	3003519	1848	3006650	1900.42G	3001052
1142007G	3005012	1402	3003120	1702TN	3003520	1848N	3006651	1900.42N	3001051
1142007N	3005011	1402N	3003121	1703	3003030	1849	3006655	1900.42/X	3001101
1142009	3005015	1403	3003125	1703.2	3004030	1849N	3006656	1900.48	3001055
1142009G	3005017	1404	3003130	1703.5	3004430	1861	3004515	1900.48G	3001057
1142009N	3005016	1405	3003135	1703P	3006030	1861N	3004516	1900.48N	3001056
1142011	3005020	1407	3003155	1704	3003035	1862	3004520	1900.48/X	3001104
1142011G	3005022	1408	3003170	1704.2	3004035	1862N	3004521	1900.M12	3001215
1142011N	3005021	1410	3005610	1704P	3006035	1866	3004615	1900.M12G	3001217
1142013	3005025	1410N	3005611	1705	3003040	1866N	3004616	1900.M12N	3001216
1142013G	3005027	1411	3005615	1705.2	3004040	1880	3016215	1900.M12/X	3001310
1142013N	3005026	1411N	3005616	1706	3003045	1881	3016220	1900.M16	3001220
1142016	3005030	1412	3005620	1707	3003050	1882	3016225	1900.M16G	3001222
1142016G	3005032	1412N	3005621	1708	3003055	1883	3016230	1900.M16N	3001221
1142016N	3005031	1413	3005625	1709	3003010	1884	3016235	1900.M16/X	3001313
1142021	3005035	1413N	3005626	1710	3005515	1884A	3016236	1900.M20	3001225
1142021G	3005037	1414	3005630	1710N	3005516	1885	3016240	1900.M20G	3001227
1142021N	3005036	1414N	3005631	1711	3005520	1886	3016245	1900.M20N	3001226
1142029	3005040	1415	3005635	1711N	3005521	1887	3016250	1900.M20/X	3001316
1142029G	3005042	1415N	3005636	1712	3005525	1888	3016255	1900.M25	3001230
1142029N	3005041	1500.07	3002010	1712N	3005526	1888/5	3016256	1900.M25G	3001232
1142036	3005045	1500.07N	3002011	1713	3005530	1889	3016405	1900.M25N	3001231
1142036G	3005047	1500.09	3002015	1713N	3005531	1890	3016410	1900.M25/X	3001319
1142036N	3005046	1500.09N	3002016	1714	3005535	1890A	3016420	1900.M32	3001235
1142042	3005050	1500.11	3002020	1714E34	3005572	1891	3016430	1900.M32G	3001237
1142042G	3005052	1500.11N	3002021	1714N	3005536	1891A	3016431	1900.M32N	3001236

REFERENCE/CODE CROSS-REFERENCE CHART

Ref.	Code	Ref.	Code	Ref.	Code	Ref.	Code	Ref.	Code
1900.M32/X	3001322	1910.M12N	3001706	2021058N	3014126	20433220N	3017961	2323	3052010
1900.M40	3001240	1910.M16	3001710	2021100	3014135	20433225N	3017963	2326	3052020
1900.M40G	3001242	1910.M16G	3001712	2021100N	3014136	20434025N	3017965	2329	3052030
1900.M40N	3001241	1910.M16N	3001711	2021112	3014155	20434032N	3017967	2333	3052110
1900.M40/X	3001325	1910.M20	3001715	2021112N	3014156	20435032N	3017969	2336	3052120
1900.M50	3001245	1910.M20G	3001717	2021114	3014145	20435040N	3017971	2339	3052130
1900.M50G	3001247	1910.M20N	3001716	2021114N	3014146	20436340N	3017973	2342	3052140
1900.M50N	3001246	1910.M25	3001720	2021118	3014140	20436350N	3017975	2344	3052150
1900.M50/X	3001328	1910.M25G	3001722	2021118N	3014141	2052007N	3011810	2346	3052160
1900.M63	3001250	1910.M25N	3001721	2021200	3014170	2052009N	3011815	2900.07N	3012010
1900.M63G	3001252	1910.M32	3001725	2021200N	3014171	2052011N	3011820	2900.09N	3012015
1900.M63N	3001251	1910.M32G	3001727	2031012	3015620	2052013N	3011825	2900.11N	3012020
1900.M63/X	3001331	1910.M32N	3001726	2031012N	3015621	2052016N	3011830	2900.13N	3012025
1901.07	3001503	1910.M40	3001730	2031014	3015610	2052021N	3011835	2900.16N	3012030
1901.07N	3001504	1910.M40G	3001732	2031014N	3015611	2052029N	3011840	2900.21N	3012035
1901.09	3001515	1910.M40N	3001731	2031034	3015630	2052036N	3011845	2900.29N	3012040
1901.09N	3001516	1910.M50	3001735	2031034N	3015631	2052042N	3011850	2900.36N	3012045
1901.11	3001520	1910.M50G	3001737	2031038	3015615	2052048N	3011855	2900.42N	3012050
1901.11N	3001521	1910.M50N	3001736	2031038N	3015616	2053M12N	3011910	2900.48N	3012055
1901.13	3001535	1910.M63	3001740	2031058	3015625	2053M16N	3011915	2900.M12N	3012215
1901.13N	3001536	1910.M63G	3001742	2031058N	3015626	2053M20N	3011920	2900.M16N	3012220
1901.16	3001550	1910.M63N	3001741	2031100	3015635	2053M25N	3011925	2900.M20N	3012225
1901.16N	3001551	1920.09	3001517	2031100N	3015636	2053M32N	3011930	2900.M25N	3012230
1901.21	3001568	1920.09N	3001518	2031112	3015655	2053M40N	3011935	2900.M32N	3012235
1901.21N	3001569	1920.36	3001584	2031112N	3015656	2053M50N	3011940	2900.M40N	3012240
1901.29	3001575	1921.09	3001513	2031114	3015645	2053M63N	3011945	2900.M50N	3012245
1901.29N	3001576	1921.09N	3001514	2031114N	3015646	207101441	3013607	2900.M63N	3012250
1901.36	3001582	1921.36	3001586	2031118	3015640	207101441N	3013608	2901.07N	3012590
1901.36N	3001583	1925.3	3016470	2031118N	3015641	20931216N	3017705	2901.09N	3012593
1901.42	3001590	200101241	3013120	2031200	3015670	20931620N	3017707	2901.11N	3012596
1901.42N	3001591	200101241N	3013121	2031200N	3015671	20932025N	3017709	2901.13N	3012599
1901.48	3001596	200101441	3013110	2031212	3015685	20932532N	3017711	2901.16N	3012602
1901.48N	3001597	200101441N	3013111	2031212N	3015686	20932540N	3017713	2901.21N	3012605
1901.M12	3001650	200103441	3013130	2031300	3015695	20933240N	3017715	2901.29N	3012608
1901.M12G	3001652	200103441N	3013131	2031300N	3015696	20933250N	3017717	2901.36N	3012611
1901.M12N	3001651	200103841	3013115	2032007N	3015511	20934050N	3017719	2901.42N	3012614
1901.M16	3001655	200103841N	3013116	2032009N	3015516	20935063N	3017721	2901.M12N	3012650
1901.M16G	3001657	200105841	3013125	2032011N	3015521	20A40916N	3018650	2901.M16N	3012652
1901.M16N	3001656	200105841N	3013126	2032013N	3015526	20A41120N	3018655	2901.M20N	3012654
1901.M20	3001660	200110041	3013135	2032016N	3015531	20A41320N	3018657	2901.M25N	3012656
1901.M20G	3001662	200110041N	3013136	2032021N	3015536	20A41620N	3018659	2901.M32N	3012658
1901.M20N	3001661	200111241	3013155	2032029N	3015541	20A42011N	3018610	2901.M40N	3012660
1901.M25	3001665	200111241N	3013156	2032036N	3015546	20A42016N	3018612	2901.M50N	3012662
1901.M25G	3001667	200111441	3013145	2032042N	3015551	20A42120N	3018661	2910.07N	3012501
1901.M25N	3001666	200111441N	3013146	2032048N	3015556	20A42125N	3018665	2910.09N	3012511
1901.M32	3001670	200111841	3013140	2033M12N	3015751	20A42513N	3018615	2910.11N	3012521
1901.M32G	3001672	200111841N	3013141	2033M16N	3015756	20A42516N	3018617	2910.13N	3012531
1901.M32N	3001671	200120041	3013170	2033M20N	3015761	20A42925N	3018667	2910.16N	3012541
1901.M40	3001675	200120041N	3013171	2033M25N	3015766	20A43216N	3018620	2910.21N	3012551
1901.M40G	3001677	200121221	3013185	2033M32N	3015771	20A43221N	3018621	2910.29N	3012555
1901.M40N	3001676	200121221N	3013186	2033M40N	3015776	20M3M1261N	3011410	2910.36N	3012560
1901.M50	3001680	200130021	3013195	2033M50N	3015781	20M3M1661N	3011412	2910.42N	3012565
1901.M50G	3001682	200130021N	3013196	2033M63N	3015786	20M3M2061N	3011414	2910.48N	3012570
1901.M50N	3001681	200200721N	3013011	20420907N	3017810	20M3M2561N	3011416	2910.M12N	3012710
1901.M63	3001685	200200921N	3013016	20421107N	3017820	20M3M3261N	3011418	2910.M16N	3012712
1901.M63G	3001687	200201121N	3013021	20421109N	3017822	20M3M4061N	3011420	2910.M20N	3012714
1901.M63N	3001686	200201321N	3013026	204211307N	3017830	20M3M5061N	3011422	2910.M25N	3012716
1902.13N	3001538	200201621N	3013031	20421309N	3017832	20M3M6361N	3011424	2910.M32N	3012718
1910.07	3001501	200202121N	3013036	20421311N	3017835	20N3M12N	3015810	2910.M40N	3012720
1910.07N	3001502	200202921N	3013041	20421607N	3017840	20N3M16N	3015812	2910.M50N	3012722
1910.09	3001509	200203621N	3013046	20421609N	3017842	20N3M20N	3015814	2910.M63N	3012724
1910.09N	3001510	200204221N	3013051	20421611N	3017845	20N3M25N	3015816	2911.07N	3012110
1910.11	3001526	200204821N	3013056	20421613N	3017847	20N3M32N	3015818	2911.09N	3012113
1910.11N	3001527	2003M1221N	3013215	20422111N	3017850	20N3M40N	3015820	2911.11N	3012116
1910.13	3001539	2003M1621N	3013220	20422113N	3017855	20N3M50N	3015822	2911.13N	3012119
1910.13N	3001540	2003M2021N	3013225	20422116N	3017858	20N3M63N	3015824	2911.16N	3012122
1910.16	3001552	2003M2521N	3013230	20422916N	3017860	2155	3051010	2911.21N	3012125
1910.16N	3001553	2003M3221N	3013235	20422921N	3017865	2156	3051015	2911.29N	3012128
1910.21	3001565	2003M4021N	3013240	20423621N	3017870	2157	3051020	2911.36N	3012131
1910.21N	3001566	2003M5021N	3013245	20423629N	3017875	2158	3051125	2911.42N	3012134
1910.29	3001578	2003M6321N	3013250	20424229N	3017880	2160	3051130	2911.M12N	3012750
1910.29N	3001579	2021012	3014120	20424236N	3017885	2161	3051135	2911.M16N	3012752
1910.36	3001588	2021012N	3014121	20424836N	3017890	2162	3051140	2911.M20N	3012754
1910.36N	3001589	2021014	3014110	20424842N	3017895	2163	3051145	2911.M25N	3012756
1910.42	3001592	2021014N	3014111	20431612N	3017949	2164	3051150	2911.M32N	3012758
1910.42N	3001593	2021034	3014130	20432012N	3017951	2171	3051310	2911.M40N	3012760
1910.48	3001598	2021034N	3014131	20432016N	3017953	2172	3051315	2911.M50N	3012762
1910.48N	3001599	2021038	3014115	20432512N	3017955	2173	3051320	2A10-M10	2502070
1910.M12	3001705	2021038N	3014116	20432516N	3017957	2174	3051325	2A10-M12	2502150
1910.M12G	3001707	2021058	3014125	20432520N	3017959	2176	3051430	2A10-M14	2502190

REFERENCE/CODE CROSS-REFERENCE CHART

Ref.	Code	Ref.	Code	Ref.	Code	Ref.	Code	Ref.	Code
2A10-M16	2502230	3573M16	3017520	4901.M20	3002956	7900.21	3010025	A10-M8	2220110
2A100-2M14	2509760	3573M20	3017530	4901.M25	3002959	7900.29	3010030	A10-P25	2221990
2A100-2M16	2509780	3573M25	3017540	4901.M32	3002962	7900.36	3010035	A100-M16	2370030
2A100-M16	2509630	3573M32	3017550	4901.M40	3002965	7900.42	3010040	A100-M20	2370110
2A100-M20	2509670	3601	3026020	4901.M50	3002968	7900.48	3010045	A10B-M6/11.5	2220078
2A120-2M14	2509930	3602	3026030	4901.M63	3002971	7900A.07	3010060	A12-M10	2230270
2A120-2M14/55°	2509952	3603	3026040	5116660250	3061210	7900A.09	3010062	A12-M10/19	2230280
2A120-2M16	2509970	36A3M1623	3016910	5116660500	3061215	7900A.11	3010064	A12-M12	2230310
2A120-M16	2509870	36A3M1624	3016912	5313022048	3061605	7900A.13	3010066	A12-M6/15	2230210
2A120-M20	2509890	36A3M16322	3016913	5523036090	3061610	7900A.16	3010068	A12-M8	2230230
2A14-M10	2503030	36A3M2025	3016920	5527030079	3061615	7900A.21	3010070	A120-M16	2372070
2A14-M12	2503110	36A3M2034	3016922	5900.M12N	3012810	7900A.29	3010072	A120-M20	2372150
2A14-M14	2503150	36A3M20356	3016923	5900.M16N	3012812	7900A.36	3010074	A14-M10	2240230
2A14-M16	2503190	36A3M2526	3016930	5900.M20N	3012814	7900A.42	3010076	A14-M12	2240270
2A160-M20	2509980	36A3M2536	3016932	5900.M25N	3012816	7900A.48	3010078	A14-M14	2240310
2A19-M10	2504030	36A3M2537	3016934	5900.M32N	3012818	7900.M12	3010110	A14-M16	2240350
2A19-M12	2504110	36A3M2545	3016936	5900.M40N	3012820	7900.M16	3010113	A14-M6	2240110
2A19-M14	2504190	36A3M2546	3016937	5900.M50N	3012822	7900.M20	3010116	A14-M8	2240150
2A19-M16	2504270	36A3M2554	3016938	5900.M63N	3012824	7900.M25	3010119	A14-P30	2241730
2A19-M20	2504350	36A3M3228	3016944	5901.M12N	3012850	7900.M32	3010122	A14B-M6/11.5	2240118
2A200-M20	2509989	36A3M3239	3016946	5901.M16N	3012852	7900.M40	3010125	A160-M16	2374150
2A24-M10	2505030	36A3M32465	3016945	5901.M20N	3012854	7900.M50	3010128	A160-M20	2374170
2A24-M12	2505150	36A3M3248	3016943	5901.M25N	3012856	7900.M63	3010131	A17-M10	2250270
2A24-M14	2505230	36A3M4078	3016952	5901.M32N	3012858	7900A.M12	3010150	A17-M10/19	2250280
2A24-M16	2505310	36A3M40106	3016954	5901.M40N	3012860	7900A.M16	3010152	A17-M12	2250310
2A24-M20	2505390	36A3M5088	3016968	5901.M50N	3012862	7900A.M20	3010154	A17-M14	2250350
2A3-M10	2500070	36C201629	3016982	6010.01	3016090	7900A.M25	3010156	A17-M16	2250860
2A3-M8	2500030	4300-3127	2590942	6010.11	3016030	7900A.M32	3010158	A17-M6	2250210
2A30-M10	2506020	4300-3128	2590930	6010.12	3016040	7900A.M40	3010160	A17-M8	2250230
2A30-M12	2506030	4300-3129	2590931	6010.14	3016010	7900A.M50	3010162	A19-M10	2260190
2A30-M14	2506110	4300-3132	2590957	6010.21	3016080	7900A.M63	3010164	A19-M12	2260230
2A30-M16	2506190	4300-3136	2590950	6010.29	3016100	A1-L6	2103200	A19-M14	2260270
2A30-M20	2506270	4300-3137	2590934	6010.34	3016060	A2-L5	2170820	A19-M16	2260310
2A37-M12	2507070	4300-3138	2590954	6010.36	3016110	A2-L6	2170830	A19-M20	2260390
2A37-M14	2507110	4300-3140	2590951	6010.38	3016020	A2-L8	2170850	A19-M6	2260110
2A37-M16	2507190	4300-3144	2590958	6010.42	3016120	A3-L5	2180620	A19-M8	2260150
2A37-M20	2507270	4300-3146	2590947	6010.48	3016130	A3-L6	2180630	A19B-M8/15.5	2260163
2A48-M12	2508030	4300-3147	2590938	6010.58	3016050	A3-L8	2180640	A1-M10	2103270
2A48-M14	2508070	4300-3148	2590939	6010.114	3016070	A3-L10	2180659	A1-M3	2103030
2A48-M16	2508110	4300-3153	2590943	7032007	3010604	A5-L6	2190670	A1-M3.5	2103070
2A48-M20	2508190	4300-3154	2590944	7032009	3010606	A5-L8	2190710	A1-M4	2103110
2A5-M10	2500570	4300-3241	2590935	7032011	3010608	A5-L10	2190750	A1-M5	2103150
2A5-M12	2500650	4300-3258	2590932	7032013	3010610	A7-L6	2200710	A1-M6	2103190
2A5-M8	2500530	4300-3262	2590933	7032016	3010614	A7-L8	2200750	A1-M8	2103230
2A60-M12	2508480	4300-3539	2590959	7032021	3010616	A7-L10	2200790	A20-M10	2270270
2A60-M14	2508500	4300-3540	2590960	7032029	3010618	A7-L12	2200830	A20-M12	2270310
2A60-M16	2508530	4300-3541	2590961	7032036	3010620	A10-L6	2220605	A20-M14	2270350
2A60-M20	2508610	4320-0864	2591274	7032042	3010622	A10-L8	2220610	A20-M16	2270390
2A7-M10	2501110	4320-0865	2591272	7032048	3010624	A10-L10	2220650	A20-M8	2270230
2A7-M12	2501150	4320-0866	2591273	7032A007	3010628	A10-L12	2220690	A200-M16	2376090
2A7-M8	2501030	4900.07	3002710	7032A009	3010630	A14-L8	2241245	A200-M20	2376100
2A80-2M12	2509310	4900.09	3002713	7032A011	3010632	A14-L10	2241250	A24-M10	2280150
2A80-2M14	2509350	4900.11	3002716	7032A013	3010634	A14-L12	2241290	A24-M12	2280190
2A80-2M14/55°	2509346	4900.13	3002719	7032A016	3010636	A19-L8	2260560	A24-M14	2280230
2A80-2M16	2509390	4900.16	3002722	7032A021	3010638	A19-L10	2260570	A24-M16	2280270
2A80-M12	2509030	4900.21	3002725	7032A029	3010640	A19-L12	2260610	A24-M20	2280310
2A80-M14	2509070	4900.29	3002728	7032A036	3010642	A24-L10	2281010	A24-M8	2280110
2A80-M16	2509150	4900.36	3002731	7032A042	3010644	A24-L12	2281050	A24B-M10/19	2280155
2A80-M20	2509230	4900.42	3002734	7032A048	3010646	A30-L10	2300870	A24B-M8/19	2280115
3411012	3016645	4900.48	3002737	7033M12	3010652	A30-L12	2300910	A29-M10	2290270
3411014	3016615	4900.M12	3002750	7033M16	3010654	A37-L10	2320510	A29-M12	2290310
3411034	3016665	4900.M16	3002753	7033M20	3010656	A37-L12	2320550	A29-M14	2290350
3411038	3016625	4900.M20	3002756	7033M25	3010658	A48-L12	2341295	A29-M16	2290390
3411100	3016695	4900.M25	3002759	7033M32	3010660	A60-L12	2351010	A29-M20	2290430
3412011	3016635	4900.M32	3002762	7033M40	3010662	A03-M3	2100030	A29-M8	2290230
3412016	3016657	4900.M40	3002765	7033M50	3010664	A03-M3.5	2100070	A2-M10	2170270
3412021	3016685	4900.M50	3002768	7033M63	3010666	A03-M4	2100110	A2-M12	2170310
3412029	3016705	4900.M63	3002771	7033AM12	3010670	A03-M5	2100150	A2-M4	2170070
3422016	3016658	4901.07	3002910	7033AM16	3010672	A03-M6	2100190	A2-M5	2170150
3422021	3016686	4901.09	3002913	7033AM20	3010674	A06-M3	2101030	A2-M5/9	2170155
3431038	3016825	4901.11	3002916	7033AM25	3010676	A06-M3.5	2101070	A2-M6	2170190
3431100	3016895	4901.13	3002919	7033AM32	3010678	A06-M4	2101110	A2-M8	2170230
3441012	3017045	4901.16	3002922	7033AM40	3010680	A06-M5	2101150	A2-P12	2170650
3441034	3017065	4901.21	3002925	7033AM50	3010682	A06-M6	2101190	A30-M10	2300110
3572007	3017410	4901.29	3002928	7033AM63	3010684	A06-M8	2101230	A30-M12	2300150
3572011	3017430	4901.36	3002931	7900.07	3010000	A10-M10	2220150	A30-M14	2300230
3572013	3017445	4901.42	3002934	7900.09	3010005	A10-M12	2220190	A30-M16	2300270
35720131	3017446	4901.48	3002937	7900.11	3010010	A10-M14	2220230	A30-M20	2300350
3572016	3017455	4901.M12	3002950	7900.13	3010015	A10-M16	2220270	A30-M8	2300070
3572021	3017480	4901.M16	3002953	7900.16	3010020	A10-M6	2220070	A30B-M10/19	2300120

REFERENCE/CODE CROSS-REFERENCE CHART

Ref.	Code	Ref.	Code	Ref.	Code	Ref.	Code	Ref.	Code
A30B-M8/19	2300080	AA185-M12	2742510	ANE30-M14	2458350	BF-M6/1	2052270	BN-P8	2153150
A35-M10	2310265	AA185-M14	2742550	ANE30-M16	2458370	BF-M6/2	2052280	BN-PP12	2153270
A35-M12	2310270	AA240-M12	2743030	ANE30-M20	2458390	BF-M608	2053650	BN-PP12/25	2153310
A35-M14	2310310	AA240-M14	2743070	ANE35-M12	2460010	BF-M608P	2053655	BN-PP16/25	2153350
A35-M16	2310350	AA300-M16	2743150	ANE35-M14	2460030	BF-M7	2052310	BN-U10	2152910
A35-M20	2310390	AA300-34-M12	2743205	ANE35-M16	2460050	BF-M8	2052350	BN-U12	2152950
A37-M10	2320110	AA300-34-M14	2743210	ANE35-M20	2460070	BF-P10	2053250	BN-U3	2152630
A37-M12	2320150	AA300-34-M16	2743215	ANE5-M10	2418540	BF-P12	2053290	BN-U3.5	2152670
A37-M14	2320190	AA400-M16	2743310	ANE5-M12	2418550	BF-P8	2053210	BN-U3.5/1	2152680
A37-M16	2320230	AA50-M12	2740110	ANE5-M4	2418500	BF-PP12	2053330	BN-U4	2152710
A37-M20	2320270	AA50-M14	2740150	ANE5-M5	2418510	BF-PP12/25	2053370	BN-U4/1	2152730
A37-M8	2320070	AA500-40-M16	2743330	ANE5-M6	2418520	BF-PP12/29	2053380	BN-U4/2	2152732
A37B-M10/24.5	2320120	AA630-M16	2743370	ANE5-M8	2418530	BF-PP16/25	2053410	BN-U5	2152750
A3-M10	2180270	AA70-M12	2740510	ANE5-P16	2418560	BF-PPL30	2053460	BN-U6	2152790
A3-M12	2180310	AA70-M14	2740550	ANE7-M6	2422300	BF-PPL46	2053465	BN-U6/1	2152830
A3-M4	2180030	AA95-M12	2741030	ANE7-M8	2422310	BF-U10	2052910	BN-U8	2152870
A3-M5	2180110	AA95-M14	2741070	ANE7-M10	2422320	BF-U12	2052950	BP-M10	2046345
A3-M5/9	2180120	AB13	3041530	ANE7-M12	2422330	BF-U3	2052630	BP-M12	2046350
A3-M6	2180150	AB19	3041532	ANE7-P20	2422360	BF-U3.5	2052670	BP-M2	2046305
A3-M8	2180190	AB28	3041534	ANE9-M10	2430170	BF-U3.5/1	2052671	BP-M3	2046310
A3-P14	2180830	AC130-P	2615531	ANE9-M12	2430180	BF-U4	2052710	BP-M3.5	2046315
A40-M10	2330230	ANE10-M6	2439350	ANE9-M6/15	2430150	BF-U4/1	2052720	BP-M3.5/1	2046316
A40-M12	2330270	ANE10-M8	2439360	ANE9-M8	2430160	BF-U4/2	2052730	BP-M4	2046320
A40-M14	2330310	ANE10-M10	2439370	AU130-150	2615560	BF-U5	2052750	BP-M5	2046325
A40-M16	2330350	ANE10-M12	2439380	AU130-240	2615590	BF-U5/2	2052765	BP-M6	2046330
A40-M20	2330390	ANE12-M10	2442220	AU230-130D	2636960	BF-U6	2052790	BP-M6/1	2046331
A48-M10	2340110	ANE12-M10/19	2442225	AU230-630	2680300	BF-U6/1	2052830	BP-M6/2	2046332
A48-M10/31	2340120	ANE12-M12	2442230	AU520-130C	2648230	BF-U8	2052870	BP-M7	2046335
A48-M12	2340150	ANE12-M6/15	2442200	AU55-50	2672515	BH2433	2596105	BP-M8	2046340
A48-M12/31	2340158	ANE12-M8	2442210	AU55-W	2672511	BKF-BF4	2053632	BP-P10	2046415
A48-M14	2340190	ANE14-M6	2446410	B-FC48N	2598870	BKF-BM4	2053662	BP-P12	2046420
A48-M16	2340230	ANE14-M8	2446420	B-FL75	2598861	BKF-F405	2053562	BP-P8	2046410
A48-M16/31	2340238	ANE14-M10	2446430	B-TC026	2598760	BKF-F405P	2053567	BP-PP12	2046440
A48-M20	2340310	ANE14-M12	2446440	B-TC04	2599410	BKF-F408	2053572	BP-PP12/25	2046445
A48-M8	2340070	ANE14-M14	2446450	B-TC0405	2598780	BKF-F408P	2053577	BP-PP12/29	2046450
A5-M10	2190190	ANE17-M10	2447260	B-TC051	2598820	BKF-F608	2053612	BP-PP16/25	2046455
A5-M12	2190230	ANE17-M10/19	2447265	B-TC051Y	2598823	BKF-F608P	2053622	BP-PPL30	2046470
A5-M4	2190030	ANE17-M12	2447270	B-TC055	2598830	BKF-FM608	2053692	BP-PPL46	2046475
A5-M5	2190070	ANE17-M14	2447280	B-TC065	2598835	BKF-M608	2053652	BP-U10	2046565
A5-M5/9	2190075	ANE17-M16	2447290	B-TC065-SC	2598840	BKY-M3	2145842	BP-U12	2046570
A5-M6	2190110	ANE17-M6	2447240	B-TC095	2598845	BKY-M3.5	2145845	BP-U3	2046510
A5-M8	2190150	ANE17-M8	2447250	B15D	2598833	BKY-M3.5/1	2145847	BP-U3.5	2046515
A5-P16	2191510	ANE19-M8	2449510	B131-C	2599010	BKY-M4	2145853	BP-U3.5/1	2046516
A60-M10	2350030	ANE19-M10	2449520	B131-C-KV	2599015	BKY-M5	2145856	BP-U4	2046530
A60-M12	2350070	ANE19-M12	2449530	B131-JC	2599110	BKY-M6/1	2145862	BP-U4/1	2046531
A60-M14	2350150	ANE19-M14	2449540	B131LN-C	2599036	BKY-M8	2145871	BP-U4/2	2046540
A60-M16	2350190	ANE19-M16	2449550	B135-C	2599250	BKY-M10	2145874	BP-U5	2046545
A60-M20	2350230	ANE2-M10	2408840	B135-C-KV	2599256	BKY-M12	2145878	BP-U6	2046555
A60B-M10/31	2350033	ANE2-M12	2408845	B135LN-C	2599262	BKY-P8	2145930	BP-U6/1	2046556
A60B-M12/31	2350072	ANE2-M4	2408820	B135-UC	2599270	BKY-P10	2145932	BP-U8	2046560
A7-M10	2200190	ANE2-M5	2408825	B35-45D	2599894	BKY-P12	2145934	BPS230.14	2598500
A7-M12	2200230	ANE2-M6	2408830	B35-50D	2599904	BKY-PP12	2145940	BPS230.24	2598603
A7-M5	2200070	ANE2-M8	2408835	B35-TC025	2599510	BKY-PP12/25	2145942	BPS230.96	2598497
A7-M6	2200110	ANE2-P12	2408850	B51	2598525	BKY-PP16/23	2145944	C10-C10	2490070
A7-M8	2200150	ANE2-U4	2408860	B51-KV	2598527	BKY-PPL30	2145950	C120-C120	2490630
A7-P20	2201750	ANE2-U5	2408865	B54D-D6	2599923	BKY-PPL46	2145952	C150-C120	2490670
A7B-M6/11.5	2200120	ANE20-M10	2451320	B55	2598990	BKY-U3	2145900	C150-C150	2490690
A80-M12	2360030	ANE20-M12	2451330	B55-KV	2598984	BKY-U3.5	2145903	C16-C16	2490110
A80-M14	2360070	ANE20-M14	2451340	B70M-P24	2596120	BKY-U4	2145906	C185-C185	2490745
A80-M16	2360110	ANE20-M16	2451350	B70M-P24-CH	2596136	BKY-U5	2145909	C185-C95	2490710
A80-M20	2360150	ANE20-M8	2451310	B70M-P24-KV	2596127	BKY-U6	2145912	C240-C120	2490760
A9-M10	2210270	ANE24-M10	2453530	BA-3	2598424	BKY-U6/1	2145914	C25-C10	2490150
A9-M12	2210310	ANE24-M12	2453550	BF-BF5	2053630	BN-FA608	3031640	C25-C25	2490190
A9-M6/15	2210210	ANE24-M14	2453570	BF-BM5	2053660	BN-FAB608	3031660	C35-C16	2490230
A9-M8	2210230	ANE24-M16	2453590	BF-F405	2053560	BN-FAR608	3031680	C35-C35	2490270
A100-4ESI	2370990	ANE29-M10	2456010	BF-F405P	2053565	BN-M10	2152390	C50-C25	2490350
A120-4ESI	2372850	ANE29-M12	2456030	BF-F408	2053570	BN-M12	2152430	C50-C50	2490390
A160-4ESI	2374350	ANE29-M14	2456050	BF-F408P	2053575	BN-M2	2152010	C59	8420035
A37-4ESI	2321510	ANE29-M16	2456070	BF-F608	2053610	BN-M3	2152030	C6-C6	2490030
A48-4ESI	2340950	ANE29-M20	2456090	BF-F608P	2053620	BN-M3.5	2152070	C70-C25N	2490310
A60-4ESI	2350850	ANE3-M10	2415840	BF-FM608	2053690	BN-M3.5/1	2152110	C70-C35	2490430
A80-4ESI	2360850	ANE3-M12	2415850	BF-M10	2052390	BN-M4	2152150	C70-C70	2490470
AA16-M8	2740020	ANE3-M4	2415800	BF-M12	2052430	BN-M5	2152190	C95-C35	2490510
AA25-M8	2740050	ANE3-M5	2415810	BF-M2	2052010	BN-M6	2152230	C95-C70	2490550
AA35-M8	2740070	ANE3-M6	2415820	BF-M3	2052030	BN-M6/1	2152270	C95-C95	2490590
AA35-M10	2740075	ANE3-M8	2415830	BF-M3.5	2052070	BN-M7	2152310	C10-C10ST	2492070
AA120-M12	2741510	ANE3-P14	2415860	BF-M3.5/1	2052110	BN-M8	2152350	C120-C120ST	2492630
AA120-M14	2741550	ANE3-U4	2415870	BF-M4	2052150	BN-MA608	3031740	C150-C120ST	2492670
AA150-M12	2742030	ANE3-U5	2415875	BF-M5	2052190	BN-P10	2153190	C150-C150ST	2492690
AA150-M14	2742070	ANE30-M12	2458320	BF-M6	2052230	BN-P12	2153230	C16-C16ST	2492110

REFERENCE/CODE CROSS-REFERENCE CHART

Ref.	Code	Ref.	Code	Ref.	Code	Ref.	Code	Ref.	Code
C185-C185ST	2492745	CBP-F405	2076535	CPU1230-3D	2630200	DR120-8	2388450	ES37-GY	2470441
C185-C95ST	2492710	CBP-F408	2076540	CRP-F305	2076225	DR120-10	2388460	ES40-GY	2470442
C240-C120ST	2492760	CBP-F408P	2076543	CRP-F308	2076230	DR120-12	2388470	ES48-GY	2470443
C25-C10ST	2492150	CBP-F608	2076545	CRP-F405	2076235	DR120-16	2388490	ES80-GY	2470444
C25-C25ST	2492190	CBP-F608P	2076550	CRP-F405P	2076237	DR120-20	2388500	ES03-BR	2470450
C35-C16ST	2492230	CBP-M3	2076310	CRP-F408	2076240	DR150-10	2388530	ES06-BR	2470451
C35-C35ST	2492270	CBP-M3.5	2076315	CRP-F408P	2076242	DR150-12	2388540	ES1-BR	2470452
C50-C25ST	2492350	CBP-M3.5/1	2076320	CRP-F608	2076245	DR150-16	2388560	ES2-BR	2470453
C50-C50ST	2492390	CBP-M4	2076325	CRP-F608P	2076250	DR150-20	2388570	ES3-BR	2470454
C6-C6ST	2492030	CBP-M5	2076335	CRP-M3	2076010	DR185-10	2388600	ES5-BR	2470455
C70-C25NST	2492310	CBP-M6	2076340	CRP-M3.5	2076015	DR185-12	2388610	ES10-BR	2470456
C70-C35ST	2492430	CBP-M6/1	2076345	CRP-M3.5/1	2076020	DR185-16	2388620	ES14-BR	2470457
C70-C70ST	2492470	CBP-M608	2076560	CRP-M4	2076025	DR185-20	2388630	ES19-BR	2470458
C95-C35ST	2492510	CBP-M7	2076350	CRP-M4/3	2076030	DR240-10	2388710	ES24-BR	2470459
C95-C70ST	2492550	CBP-M8	2076355	CRP-M5	2076035	DR240-12	2388720	ES30-BR	2470460
C95-C95ST	2492590	CBP-P10	2076455	CRP-M6	2076040	DR240-16	2388730	ES37-BR	2470461
CA150R-2M14	2533010	CBP-P12	2076460	CRP-M6/1	2076045	DR240-20	2388740	ES40-BR	2470462
CA150R-M12	2532810	CBP-P8	2076450	CRP-M608	2076260	DR300-10	2388780	ES48-BR	2470463
CA150R-M14	2532850	CBP-PP12	2076480	CRP-M7	2076050	DR300-12	2388790	ES80-BR	2470464
CA150S-2M14	2533330	CBP-PP12/25	2076490	CRP-M8	2076055	DR300-16	2388810	ES03-BK	2470470
CA150S-M12	2533210	CBP-PPL30	2076498	CRP-P10	2076155	DR300-20	2388820	ES06-BK	2470471
CA150S-M14	2533250	CBP-U3	2076380	CRP-P12	2076160	DR400-12	2388870	ES1-BK	2470472
CA200R-2M14	2533570	CBP-U3.5	2076385	CRP-P8	2076150	DR400-16	2388890	ES2-BK	2470473
CA200R-M14	2533530	CBP-U4	2076395	CRP-PP12	2076180	DR400-20	2388900	ES3-BK	2470474
CA240R-2M14	2533850	CBP-U4/1	2076400	CRP-PP12/1	2076185	DR500-12	2388950	ES5-BK	2470475
CA240R-M14	2533770	CBP-U4/2	2076405	CRP-PP12/23	2076190	DR500-16	2388970	ES10-BK	2470476
CA25-2M12	2530210	CBP-U4/3L	2076408	CRP-PP14	2076195	DR500-20	2388980	ES14-BK	2470477
CA25-2M8	2530130	CBP-U5	2076410	CRP-PPL30	2076205	DR625-12	2389030	ES19-BK	2470478
CA25-M10	2530050	CBP-U6	2076415	CRP-U3	2076080	DR625-16	2389050	ES24-BK	2470479
CA25-M12	2530090	CC8.9	3041630	CRP-U3.5	2076085	DR625-20	2389060	ES30-BK	2470480
CA25-M8	2530010	CC9.12	3041632	CRP-U3.5/2	2076090	DSV6	2489010	ES37-BK	2470481
CA315R-2M14	2534430	CDD6	2599940	CRP-U4	2076095	DSV10	2489015	ES40-BK	2470482
CA315R-M14	2534330	CDD6-8	2599941	CRP-U4/1	2076100	DSV16	2489020	ES48-BK	2470483
CA315S-2M14	2534610	CFA2600	3031942	CRP-U4/2	2076105	DSV25	2489025	ES80-BK	2470484
CA315S-M14	2534530	CFA300	3031900	CRP-U5	2076110	DSV35	2489030	ES03-WH	2470490
CA40S-2M12	2530510	CFA400	3031914	CRP-U6	2076115	DSV50	2489035	ES06-WH	2470491
CA40S-M12	2530450	CFA600	3031928	CRP-U6/1	2076120	DSV70	2489040	ES1-WH	2470492
CA40S-M16	2530490	CFAB600	3031970	CRP-U8	2076125	DSV95	2489045	ES2-WH	2470493
CA50R-2M12	2530870	CFAR600	3031956	CS-CPE-1	2592748	DSV120	2489050	ES3-WH	2470494
CA50R-M12	2530790	CFC12-24ICN	2598492	DC24	2596100	DSV150	2489055	ES5-WH	2470495
CA50S-2M12	2531190	CFC230N	2598490	DR6-5	2387910	DSV185	2489060	ES10-WH	2470496
CA50S-M12	2531110	CGP-F608	2076845	DR6-6	2387920	DSV240	2489065	ES14-WH	2470497
CA50S-M16	2531150	CGP-F608P	2076850	DR6-8	2387930	DSV300	2489070	ES19-WH	2470498
CA70-M12	2531870	CGP-M3	2076610	DR10-5	2388000	DSV400	2489075	ES24-WH	2470499
CA70S-2M12	2531510	CGP-M3.5	2076615	DR10-6	2388005	DSV500	2489080	ES30-WH	2470500
CA70S-M12	2531430	CGP-M4	2076625	DR10-8	2388010	DSV625	2489085	ES37-WH	2470501
CA70S-M16	2531470	CGP-M5	2076635	DR10-10	2388015	ECT-KE2.5N	2598330	ES40-WH	2470502
CA95R-2M14	2532230	CGP-M6	2076640	DR16-5	2388025	ECW-H3D	2630073	ES48-WH	2470503
CA95R-M12	2532150	CGP-M6/1	2076645	DR16-6	2388030	EK100	2597990	ES80-WH	2470504
CA95R-M14	2532190	CGP-M608	2076860	DR16-8	2388040	EK500P	2597992	ES03-RE	2470510
CA95S-2M14	2532610	CGP-M7	2076650	DR16-10	2388050	ELB-3	2598422	ES06-RE	2470511
CA95S-M12	2532450	CGP-M8	2076660	DR16-12	2388060	EPS115-230.24	2596091	ES1-RE	2470512
CA95S-M14	2532490	CGP-M8/1	2076665	DR25-6	2388110	ERCH	2596112	ES2-RE	2470513
CA95S-M16	2532500	CGP-P10	2076755	DR25-8	2388120	ERCH-WH	2596114	ES3-RE	2470514
CAA10-M12	2760005	CGP-P12	2076760	DR25-10	2388130	ES03-BU	2470410	ES5-RE	2470515
CAA120-M12	2760310	CGP-P14	2076765	DR25-12	2388140	ES06-BU	2470411	ES10-RE	2470516
CAA150-M12	2760350	CGP-PP12	2076780	DR25-16	2388160	ES1-BU	2470412	ES14-RE	2470517
CAA16-M12	2760012	CGP-PP17	2076790	DR35-6	2388210	ES2-BU	2470413	ES19-RE	2470518
CAA185-M12	2760430	CGP-U3.5	2076685	DR35-8	2388220	ES3-BU	2470414	ES24-RE	2470519
CAA240-M12	2760590	CGP-U4	2076695	DR35-10	2388230	ES5-BU	2470415	ES30-RE	2470520
CAA25-M12	2760030	CGP-U5	2076710	DR35-12	2388240	ES10-BU	2470416	ES37-RE	2470521
CAA300-M16	2760710	CGP-U6	2076715	DR35-16	2388246	ES14-BU	2470417	ES40-RE	2470522
CAA300-34-M12	2760680	CMA600	3031984	DR50-6	2388250	ES19-BU	2470418	ES48-RE	2470523
CAA300-34-M16	2760715	CMB1	2599943	DR50-8	2388255	ES24-BU	2470419	ES80-RE	2470524
CAA35-M12	2760070	CMB2	2599945	DR50-10	2388260	ES30-BU	2470420	ES03-GN	2470530
CAA35ADN	2762260	CP1086-W-1000-KV	2597905	DR50-12	2388270	ES37-BU	2470421	ES06-GN	2470531
CAA400-M16	2760750	CP1096	2597700	DR50-14	2388280	ES40-BU	2470422	ES1-GN	2470532
CAA50-M12	2760110	CP1096-W-1000-KV	2597695	DR50-16	2388290	ES48-BU	2470423	ES2-GN	2470533
CAA500-M16-TNBD	2760852	CP1120-W-1000-KV	2597958	DR70-8	2388320	ES80-BU	2470424	ES3-GN	2470534
CAA630-4M8	2760950	CP1131	2610120	DR70-10	2388330	ES03-GY	2470430	ES5-GN	2470535
CAA70-M12	2760150	CPE-1	2592751	DR70-12	2388340	ES06-GY	2470431	ES10-GN	2470536
CAA95-M12	2760190	CPE-1-110	2592752	DR70-14	2388350	ES1-GY	2470432	ES14-GN	2470537
Canvas Bag 001	2593300	CPE-O-P12N	2592735	DR70-16	2388360	ES2-GY	2470433	ES19-GN	2470538
Canvas Bag 007	2593295	CPKD108	2808582	DR70-20	2388380	ES3-GY	2470434	ES24-GN	2470539
Canvas Bag 010	2593298	CPKD1508	2808587	DR95-8	2388390	ES5-GY	2470435	ES30-GN	2470540
Canvas Bag 011	2593299	CPKD2508	2808592	DR95-10	2388395	ES10-GY	2470436	ES37-GN	2470541
Canvas Bag 013	2593294	CPKD508	2808573	DR95-12	2388400	ES14-GY	2470437	ES40-GN	2470542
CB1430L	2598494	CPKD7508	2808578	DR95-14	2388410	ES19-GY	2470438	ES48-GN	2470543
CB9620H	2598503	CPP-0	2592671	DR95-16	2388420	ES24-GY	2470439	ES80-GN	2470544
CBA96-144	2598508	CPU1131-C	2610150	DR95-20	2388430	ES30-GY	2470440	ES03-YE	2470550

REFERENCE/CODE CROSS-REFERENCE CHART

Ref.	Code	Ref.	Code	Ref.	Code	Ref.	Code	Ref.	Code
ES06-YE	2470551	FLS5	3026815	G390X4.8	3041825	GF-U12	2054890	GP-PPL46	2046755
ES1-YE	2470552	G80X2.4	3041700	G390X4.8N	3041826	GF-U14	2054930	GP-U10	2046865
ES2-YE	2470553	G80X2.4N	3041701	G430X4.8	3041830	GF-U16	2054970	GP-U10/1	2046866
ES3-YE	2470554	G80X2.4/M	3041702	G430X4.8 VO	3041834	GF-U3.5	2054610	GP-U12	2046870
ES5-YE	2470555	G80X2.4N/M	3041703	G430X4.8N	3041831	GF-U4	2054650	GP-U14	2046875
ES10-YE	2470556	G90X2.4	3041705	G450X4.8	3041835	GF-U5	2054690	GP-U16	2046880
ES14-YE	2470557	G90X2.4N	3041706	G450X4.8N	3041836	GF-U6	2054730	GP-U3.5	2046825
ES19-YE	2470558	G90X2.4 VO	3041709	G530X4.8	3041840	GF-U8	2054770	GP-U4	2046830
ES24-YE	2470559	G100X2.5	3041710	G530X4.8N	3041841	GFHT112X2.5	3042805	GP-U5	2046845
ES30-YE	2470560	G100X2.5N	3041711	G150X7.6	3041845	GFH100X2.5	3042810	GP-U6	2046855
ES37-YE	2470561	G100X2.5/M	3041712	G150X7.6N	3041846	GH8	3041550	GP-U8	2046860
ES40-YE	2470562	G100X2.5/M VO	3041714	G200X7.6	3041850	GK-F608	2145500	GR100X7.6N	3042620
ES48-YE	2470563	G100X2.5N/M	3041713	G200X7.6N	3041851	GK-F608P	2145502	GR120X7.6N	3042625
ES80-YE	2470564	G120X2.5	3041715	G250X7.6	3041855	GK-FM608	2055672	GR150X7.6N	3042630
ES03-PK	2470570	G120X2.5N	3041716	G250X7.6N	3041856	GKY-M3.5	2145982	GR200X7.6N	3042635
ES06-PK	2470571	G140X2.5	3041720	G300X7.6	3041860	GKY-M4	2145985	GR250X7.6N	3042640
ES1-PK	2470572	G140X2.5N	3041721	G300X7.6N	3041861	GKY-M5	2145988	GR300X7.6N	3042645
ES2-PK	2470573	G140X2.5/M	3041722	G370X7.6	3041865	GKY-M6	2145991	GR370X7.6N	3042650
ES3-PK	2470574	G140X2.5/M VO	3041724	G370X7.6N	3041866	GKY-M8	2145994	GX200X4.5	3042245
ES5-PK	2470575	G140X2.5N/M	3041723	G430X7.6	3041870	GKY-M10	2145997	GX300X4.5	3042250
ES10-PK	2470576	G160X2.5	3041725	G430X7.6N	3041871	GKY-M12	2146000	GX370X4.5	3042255
ES14-PK	2470577	G160X2.5N	3041726	G530X7.6	3041875	GKY-M14	2146003	GX370X7.9	3042260
ES19-PK	2470578	G160X2.5/M	3041727	G530X7.6N	3041876	GKY-M16	2146006	GX520X4.5	3042257
ES24-PK	2470579	G160X2.5N/M	3041728	G430X9.0	3041880	GKY-P14	2146040	GX680X7.9	3042265
ES30-PK	2470580	G200X2.5	3041730	G430X9.0N	3041881	GKY-PP12	2146045	GX1020X7.9	3042270
ES37-PK	2470581	G200X2.5N	3041731	G530X9.0	3041885	GKY-PP17	2146047	HB2	2591308
ES40-PK	2470582	G200X2.5/M	3041732	G530X9.0N	3041886	GKY-PPL46	2146055	HB5	2591318
ES48-PK	2470583	G200X2.5/M VO	3041734	G710X9.0	3041890	GKY-U3.5	2146020	HB6	2591285
ES80-PK	2470584	G200X2.5N/M	3041733	G710X9.0N	3041891	GKY-U4	2146023	HB7	2591310
ESC300CEE	2596110	G250X2.8	3041735	G710X9.0 VO	3041894	GKY-U5	2146026	HB8	2591284
ESC600	2599001	G250X2.8N	3041736	G780X9.0	3041895	GKY-U6	2146029	HB9	2591336
F1-15	2599865	G300X2.8	3041740	G780X9.0N	3041896	GKY-U8	2146032	HB10	2591337
FD11	3017354	G300X2.8N	3041741	G830X9.0	3041900	GNY-M10	2154250	HB11	2591343
FD13.5	3017356	G120X3.6	3041745	G830X9.0N	3041901	GN-M10/1	2154290	HB12N	2591345
FD16	3017358	G120X3.6N	3041746	G920X9.0	3041905	GN-M12	2154330	HB13UE	2591347
FD21	3017360	G140X3.6	3041750	G920X9.0N	3041906	GN-M14	2154370	HF1	2590900
FD29	3017362	G140X3.6N	3041751	G1020X9.0	3041910	GN-M16	2154410	HF2	2590905
FD36	3017364	G140X3.6/M	3041753	G1020X9.0N	3041911	GN-M3	2154010	HN1	2590300
FD42	3017366	G140X3.6N/M	3041752	G1220X9.0	3041915	GN-M3.5	2154030	HN5	2590291
FD48	3017368	G150X3.6	3041755	G1220X9.0N	3041916	GN-M4	2154070	HNA25	2590401
FD7	3017350	G150X3.6N	3041756	G230X12.6	3041920	GN-M5	2154110	HNCS4	2590024
FD9	3017352	G150X3.6 VO	3041759	G230X12.6N	3041921	GN-M6	2154150	HND25	2590403
FDM12	3017375	G180X3.6	3041760	G380X12.6	3041925	GN-M6/1	2154160	HNKE4	2590299
FDM20	3017377	G180X3.6N	3041761	G380X12.6N	3041926	GN-M7	2154170	HNKE16	2590329
FDM25	3017379	G200X3.6	3041765	G480X12.6	3041930	GN-M8	2154210	HNKE50	2590342
FDM32	3017381	G200X3.6N	3041766	G480X12.6N	3041931	GN-M8/1	2154220	HNN3	2590296
FDM40	3017383	G200X3.6/M	3041767	G580X12.6	3041935	GN-P10	2155250	HNN4	2590292
FDM50	3017385	G200X3.6N/M	3041768	G580X12.6N	3041936	GN-P12	2155290	HP1	2590500
FDM63	3017387	G250X3.6	3041770	G730X12.6	3041940	GN-P14	2155310	HP1-1	2590502
FL10-150	2510070	G250X3.6N	3041771	G730X12.6N	3041941	GN-PP12	2155330	HP3	2590531
FL10-200	2510150	G300X3.6	3041775	G880X12.6	3041945	GN-PP17	2155370	HP3-1	2590532
FL10-250	2510190	G300X3.6N	3041776	G880X12.6N	3041946	GN-U10	2154850	HP4-B	2590032
FL16-150	2510470	G300X3.6/M	3041777	G1030X12.6	3041950	GN-U10/1	2154890	HP4-C10	2590040
FL16-200	2510550	G300X3.6N/M	3041778	G1030X12.6N	3041951	GN-U12	2154930	HP4-G	2590033
FL16-250	2510590	G370X3.6	3041780	GA-3	2598429	GN-U14	2154970	HP4-R	2590031
FL16-320	2510670	G370X3.6N	3041781	GF-F608	2055630	GN-U16	2155010	HPH-1	2590029
FL16-350	2510690	G120X4.8	3041785	GF-F608P	2055650	GN-U3.5	2154650	HT-TC026	2591406
FL16-420	2510710	G120X4.8N	3041786	GF-M10	2054250	GN-U4	2154690	HT-TC026Y	2591408
FL16-570	2510750	G160X4.8	3041790	GF-M10/1	2054290	GN-U5	2154730	HT-TC041	2591426
FL16-660	2510790	G160X4.8N	3041791	GF-M12	2054330	GN-U6	2154770	HT-TC051	2591472
FL25-150	2510950	G190X4.8	3041795	GF-M14	2054370	GN-U8	2154810	HT-TC051Y	2591475
FL25-200	2511070	G190X4.8N	3041796	GF-M16	2054410	GP-M10	2046645	HT-TC055	2591445
FL25-250	2511110	G190X4.8/M	3041797	GF-M3	2054010	GP-M10/1	2046646	HT-TC065	2591477
FL25-300	2511190	G190X4.8N/M	3041798	GF-M3.5	2054030	GP-M12	2046650	HT-TC081	2591496
FL10-150ST	2518510	G200X4.8	3041800	GF-M4	2054070	GP-M14	2046655	HT120	2610420
FL10-200ST	2518550	G200X4.8N	3041801	GF-M5	2054110	GP-M16	2046660	HT120-KV	2610430
FL10-250ST	2518590	G200X4.8/M	3041802	GF-M6	2054150	GP-M3	2046610	HT131-C	2610416
FL16-150ST	2518870	G200X4.8/M VO	3041804	GF-M6/1	2054160	GP-M3.5	2046615	HT131-UC	2610436
FL16-200ST	2518910	G200X4.8N/M	3041803	GF-M608	2055670	GP-M4	2046620	HT131LN-C	2610419
FL16-250ST	2518950	G250X4.8	3041805	GF-M7	2054170	GP-M5	2046625	HT45-E	2650040
FL16-320ST	2518990	G250X4.8N	3041806	GF-M8	2054210	GP-M6	2046630	HT51	2670610
FL16-350ST	2519030	G250X4.8/M	3041807	GF-M8/1	2054220	GP-M6/1	2046631	HT51-KV	2670611
FL16-420ST	2519070	G250X4.8N/M	3041808	GF-P10	2055310	GP-M7	2046635	HT81-U	2600036
FL16-570ST	2519150	G280X4.8	3041810	GF-P12	2055350	GP-M8	2046640	HWE-1	8420010
FL16-660ST	2519170	G280X4.8N	3041811	GF-P14	2055370	GP-M8/1	2046641	HX1	2590298
FL25-150ST	2519530	G300X4.8	3041815	GF-PP12	2055390	GP-P10	2046715	I38-F	2593863
FL25-200ST	2519570	G300X4.8N	3041816	GF-PP17	2055430	GP-P12	2046720	I38-M	2593858
FL25-250ST	2519610	G370X4.8	3041820	GF-PPL46	2055465	GP-P14	2046725	I38-MS	2593862
FL25-300ST	2519690	G370X4.8 VO	3041824	GF-U10	2054810	GP-PP12	2046740	IDT	2590920
FLS3	3026810	G370X4.8N	3041821	GF-U10/1	2054850	GP-PP17	2046750	IT6	8420016

REFERENCE/CODE CROSS-REFERENCE CHART

Ref.	Code	Ref.	Code	Ref.	Code	Ref.	Code	Ref.	Code
KE0.75-1	2591050	M113.173-U	2603730	MA30-C	2610940	ME17-50	2676090	MK8	2651610
KE10-1	2591049	M118	2651150	MA35-C	2610950	ME17-C	2614217	MK10	2651640
KE1016ST	2803150	M118-50	2675860	MA35-U	2600390	ME19	2652210	MK12	2651670
KE106ST	2802310	M118-C	2611910	MA37-C	2610960	ME19-50	2676100	MK14	2651700
KE110ST	2802390	M118.158-U	2603725	MA37-U	2600410	ME19-C	2614219	MK16	2651730
KE1508ST	2802510	M140	2651170	MA40-C	2610970	ME2	2652030	MK18	2651750
KE1510ST	2802550	M140-50	2675870	MA40-U	2600430	ME2/3-15	2599876	MK20	2651770
KE16-15	2599861	M140-C	2612010	MA48-C	2610980	ME2-50	2676010	MK5-50	2675360
KE1616ST	2803190	M140.190-U	2603800	MA48-U	2600450	ME2-C	2614201	MK6-50	2675370
KE1A-3	2598430	M145-520	2648770	MA5	2650150	ME2.19-U	2604750	MK8-50	2675390
KE2.5-1	2591048	M158	2651200	MA5-50	2675662	ME20	2652230	MK10-50	2675410
KE2.5A-3	2598432	M158-50	2675880	MA5-C	2610830	ME20-50	2676110	MK12-50	2675430
KE25012ST	2803450	M158-C	2612130	MA60-C	2610990	ME200-520	2648558	MK14-50	2675450
KE25018ST	2803460	M160-520	2648771	MA7	2650170	ME20-C	2614221	MK16-50	2675470
KE2508ST	2802670	M173	2651210	MA7-50	2675664	ME24	2652250	MK18-50	2675490
KE2510ST	2802710	M173-50	2675890	MA7-C	2610840	ME24L	2652251	MK20-50	2675510
KE35-15	2599862	M173-C	2612230	MA7.14-U	2600250	ME24-50	2676120	MK22-50	2675530
KE35012ST	2803470	M173L-C	2612240	MA80-3D	2631770	ME24L-50	2676121	MK22L	2651791
KE35018ST	2803480	M190-50	2675900	MA80-520	2645671	ME24-C	2614223	MK22L-50	2675534
KE4-15	2599860	M190-520	2648772	MA9	2650180	ME29	2652260	MK25-50	2675550
KE410ST	2802870	M190-C	2612330	MA9-50	2675665	ME29-50	2676130	MK28-50	2675560
KE412ST	2802910	M208-C	2612420	MA9-C	2610850	ME29-C	2614225	MK28-60	2671460
KE506ST	2802030	M208-U	2603780	MA9.17-U	2600270	ME29-U	2604870	MK6-C	2614250
KE508ST	2802070	M215-50	2675910	MB2-80U	2604350	ME3	2652050	MK8-C	2614260
KE610ST	2802990	M215-520	2648773	MB3-80U	2604400	ME3-50	2676020	MK10-C	2614270
KE612ST	2803030	M215-C	2612490	MCO	2650490	ME3-C	2614203	MK12-C	2614280
KE616ST	2803070	M220-520	2648774	MCO-U	2603510	ME3.14-U	2604770	MK14-C	2614290
KE7506ST	2802110	M232-C	2612590	MCO2-U	2603550	ME30	2652270	MK16-C	2614300
KE7508ST	2802150	M255-520	2648776	MC10	2650530	ME30L	2652271	MK18-C	2614310
KITHWE1	8420012	M295-520	2648780	MC10-50	2675610	ME30-50	2676140	MK20-C	2614320
KITTRD-9.4C	2685015	M340-520	2648784	MC10-C	2611100	ME30L-50	2676141	MK22-C	2614330
KITTRD-M11C	2685016	M440-520	2648840	MC10-U	2600610	ME30-C	2614227	MK25-C	2614340
KT1	2591319	M540-520	2648910	MC185-3D	2632030	ME30-U	2604890	MK28-C	2614350
KT2	2591320	M70	2651090	MC185-C	2611150	ME35-50	2676150	MK32-C	2614360
KT3	2591275	M70-50	2675800	MC2	2650500	ME35-C	2614229	MK34L-C	2614371
KT4	2591277	M70-C	2611590	MC240-3D	2632035	ME35-U	2604910	MLL1	2590802
KT5	2591279	M70.140-U	2603710	MC25	2650550	ME37-50	2676160	MLL90	2590812
KTS1632	2590700	M75	2651100	MC25-50	2675620	ME37-C	2614231	MLS1	2590805
L03-M	2480020	M75-50	2675805	MC25-C	2611110	ME37-U	2604930	MLS2	2590807
L03-P	2485010	M75-C	2611650	MC25-U	2600650	ME40-50	2676165	MMT200-50	2676388
L06-M	2480050	M75.96-U	2603715	MC3	8420018	ME40-C	2614233	MMT200-C	2611190
L06-P	2485040	M96	2651110	MC35	2650570	ME40-U	2604950	MMT200-U	2601170
L10-M	2480330	M96-50	2675850	MC35-50	2675630	ME48-50	2676170	MMT25-50	2676380
L10-P	2485270	M96-C	2611800	MC35-C	2611120	ME48-C	2614235	MMT25-C	2611160
L100-M	2480930	MA03/3-15	2599870	MC35-U	2600690	ME48-U	2604970	MMT25-U	2601050
L120-M	2481010	MA1	2650110	MC4	8420019	ME5	2652070	MMT315-C	2611200
L14-M	2480410	MA1-50	2675658	MC6	2650510	ME5-50	2676030	MMT50-50	2676382
L14-P	2485350	MA10	2650190	MC6-50	2675605	ME5-C	2614205	MMT50-C	2611170
L160-M	2481050	MA10-50	2675666	MC6.25-U	2600630	ME5.7-U	2604790	MMT50-U	2601090
L19-M	2480490	MA10-C	2610860	MC70-3D	2632010	ME60-C	2614237	MMT95-50	2676384
L19-P	2485430	MA10.19-U	2600290	MC70-50	2675640	ME7	2652090	MMT95-C	2611180
L1-M	2480090	MA100-3D	2631790	MC70-80U	2600720	ME7-50	2676040	MMT95-U	2601130
L1-P	2485070	MA100-520	2645690	MC70-C	2611130	ME7-C	2614207	MN10-C	2610560
L200-M	2481090	MA12-50	2675668	MC95-3D	2632020	ME80-3D	2634930	MN10RF-50	2676250
L24-M	2480570	MA12-C	2610870	MC95-80U	2600730	ME80-520	2648550	MN10RF-C	2610768
L24-P	2485510	MA12.20-U	2600310	MC95-C	2611140	ME80-C	2614239	MN12-C	2610570
L2-M	2480130	MA120-3D	2631810	MCCC16-C	2617050	ME9	2652110	MN12F-50	2676260
L2-P	2485100	MA120-520	2645711	MCCC25-C	2617070	ME9-50	2676050	MN12F-C	2610770
L30-M	2480650	MA14-50	2675670	MCCC35-C	2617090	ME9-C	2614209	MN14-C	2610580
L30-P	2485590	MA14-C	2610880	MCCC50-C	2617110	ME9.20-U	2604810	MN14RF-50	2676270
L37-M	2480730	MA160-520	2645731	ME03/2-15	2599875	MFB13-40	2598040	MN14RF-C	2610772
L37-P	2485670	MA17-50	2675672	ME1	2652010	MFB50-63	2598045	MN17-C	2610591
L3-M	2480170	MA17-C	2610890	ME1-50	2676005	MH10/16-15	2599886	MN17F-50	2676280
L3-P	2485130	MA19-50	2675674	ME10	2652130	MK17S-C	2614307	MN17F-C	2610774
L48-M	2480810	MA19-C	2610900	ME10-50	2676060	MK14-3D	2634781	MN19-C	2610600
L48-P	2485680	MA19-U	2600320	ME10-C	2614211	MK16-3D	2634783	MN19RF-50	2676285
L5-M	2480210	MA2-C	2610810	ME10.24-U	2604830	MK18-3D	2634785	MN19RF-C	2610776
L5-P	2485160	MA2.3	2650130	ME100-3D	2634940	MK20-3D	2634786	MN2-C	2610511
L60-M	2480850	MA2.3-50	2675660	ME100-520	2648552	MK22-3D	2634787	MN20-C	2610610
L60-P	2485690	MA20-50	2675675	ME12	2652150	MK25-3D	2634788	MN20F-50	2676290
L7-M	2480250	MA20-C	2610910	ME12-50	2676070	MK28-3D	2634790	MN20F-C	2610778
L7-P	2485190	MA200-520	2645750	ME12-C	2614213	MK32-3D	2634800	MN24-C	2610620
L80-M	2480890	MA24-50	2675676	ME12.17-U	2604850	MK34-3D	2634810	MN24RF-50	2676295
M108-520	2648752	MA24-C	2610920	ME120-3D	2634950	MK38-3D	2634830	MN24RF-C	2610780
M108-C	2611860	MA24-U	2600330	ME120-520	2648554	MK42-3D	2634850	MN29-C	2610625
M108.215-U	2603723	MA29-C	2610930	ME14	2652170	MK44-3D	2634870	MN29F-C	2610782
M110-520	2648754	MA29.80-U	2600360	ME14-50	2676080	MK46-3D	2634880	MN29F-50	2676210
M113	2651130	MA3-C	2610820	ME14-C	2614215	MK5/8-15	2599890	MN2RF-C	2610760
M113-50	2675855	MA3.5-U	2600210	ME160-520	2648556	MK5	2651575	MN3-C	2610520
M113-C	2611870	MA30-80-U	2600380	ME17	2652190	MK6	2651580	MN30-C	2610630

REFERENCE / CODE CROSS-REFERENCE CHART

Ref.	Code	Ref.	Code	Ref.	Code	Ref.	Code	Ref.	Code
MN30RF-C	2610784	MT40S-C8	2543400	MTMA185/1	2720370	PB-1	2591046	PKE2518	2809140
MN35-C	2610635	MT40S-GC	2541610	MTMA240/1	2720400	PC-1	2590705	PKE308	2809030
MN35F-C	2610786	MT40S-TD	2540190	MTMAD300/1	2720460	PG-1	2591047	PKE410	2809152
MN37-C	2610640	MT500-TD	2540870	MTMA400/1	2720475	PKC1012	2809490	PKE412	2809155
MN37RF-C	2610788	MT50R-C10	2543650	MTMA500-40/1	2720509	PKC1018	2809500	PKE418	2809160
MN3RF-50	2676220	MT50R-C8	2543610	MTMA630/1	2720530	PKC108	2809390	PKE508	2809050
MN3RF-C	2610762	MT50R-GC	2541690	MTMAD300-GC	2720440	PKC112	2809400	PKE612	2809170
MN48-C	2610650	MT50R-TD	2540270	MTMAD300-95-GC	2722121	PKC1508	2809410	PKE618	2809180
MN48RF-C	2610790	MT50S-C10	2543850	MTMAD300-150-GC	2722140	PKC1510	2809415	PKE7508	2809070
MN5-C	2610530	MT50S-C14-80	2546110	MTMAD300-185-GC	2722160	PKC1518	2809420	PKT1014	2809870
MN5RF-50	2676230	MT50S-C8	2543810	MTMAD300-240-GC	2722220	PKC1612	2809510	PKT108	2809790
MN5RF-C	2610764	MT50S-GC	2541650	MTT16-50	2677220	PKC1618	2809520	PKT112	2809800
MN60-C	2610660	MT50S-TD	2540230	MTT25-50	2677230	PKC25016	2809530	PKT1508	2809810
MN7-C	2610540	MT630-TD	2540890	MTT35-50	2677240	PKC25022	2809540	PKT1512	2809820
MN7RF-50	2676240	MT70S-C10	2544050	MTT50-50	2677250	PKC2508	2809430	PKT1614	2809880
MN7RF-C	2610766	MT70S-GC	2541730	MTT70-50	2677260	PKC2512	2809435	PKT2510	2809830
MN80-3D	2631450	MT70S-TD	2540350	MTT95-50	2677270	PKC2518	2809440	PKT2512	2809840
MN9-C	2610551	MT95R-C10	2544290	MTT120-50	2677275	PKC306	2809320	PKT412	2809850
MP608	3031810	MT95R-C12	2544330	MUA150	2616050	PKC308	2809330	PKT508	2809760
MP608/45	3031815	MT95R-GC	2541770	MUA230-630-400	2680129	PKC35016	2809550	PKT510	2809765
MP608/90	3031820	MT95R-TD	2540390	MUA230-630-630	2680130	PKC35025	2809560	PKT614	2809860
MP608D	3031830	MT95S-C10	2544530	MUA240	2616070	PKC410	2809452	PKT7508	2809770
MPC1	2595201	MT95S-C12	2544570	MUA300-34	2616090	PKC412	2809455	PKT7512	2809780
MPC2	2595203	MT95S-C14-80	2546230	MUA35	2616010	PKC418	2809460	PL01-M	2049510
MPC4	2595208	MT95S-GC	2541850	MUA95	2616030	PKC50020	2809570	PL03-M	2051850
MPC7	2595221	MT95S-TD	2540470	MV150	2616170	PKC50030	2809580	PL03-P	2051860
MQ10-50	2675010	MTA16-C	2770001	MV230-400 MC5E	2680860	PKC508	2809350	PL06-M	2053850
MQ16-50	2675013	MTA25-C	2770020	MV230-630 MC6E	2680870	PKC510	2809360	PL06-P	2053860
MQ25-50	2675016	MTA35-C	2770030	MV240	2616180	PKC612	2809470	PL1-M	2055870
MQ35-50	2675019	MTA50-C	2770310	MV35	2616150	PKC618	2809480	PN14-C	2610710
MQ50-50	2675021	MTA70-C	2770550	MV95	2616160	PKC70022	2809595	PN24-C	2610720
MQ70-50	2675024	MTA95-C	2770830	MVM150	2616310	PKC7508	2809370	PN37-C	2610730
MQM10-C	2610661	MTA120-C	2771510	MVM230-400 MJ5E	2680910	PKC7512	2809380	PN48-C	2610740
MQM16-C	2610662	MTA150-C	2771710	MVM230-630 MJ6E	2680920	PKC95025	2809600	PN60-C	2610750
MQM25-C	2610663	MTA185-C	2772150	MVM240	2616320	PKC120027	2809605	PN7-C	2610700
MQM35-C	2610664	MTA240-C	2773010	MVM35	2616290	PKD1012	2808915	PN80-3D	2631460
MQM50-C	2610665	MTMA10-GC	2720025	MVM95	2616300	PKD1018	2808917	PNB-1	2591040
MQM70-C	2610666	MTMA120-70-GC	2721410	N1-1	2591059	PKD106	2808870	PNB-3F/M	2591088
MQM95-C	2610667	MTMA120-95-GC	2721450	N11	2581310	PKD108	2808872	PNB-3N1	2591092
MQM120-C	2610668	MTMA120-GC	2720272	N12	2581312	PKD110	2808874	PNB-3N5	2591096
MQM150-C	2610669	MTMA150-120-GC	2721630	N13	2581314	PKD112	2808876	PNB-3NN3	2591094
MQM185-C	2610670	MTMA150-70-GC	2721550	N14	2581316	PKD1508	2808880	PNB-3NN4	2591095
MQM240-C	2610671	MTMA150-95-GC	2721590	N15	2581318	PKD1510	2808882	PNB-3P	2591090
MQS16-C	2610752	MTMA150-GC	2720330	N16	2581320	PKD1512	2808884	PNB-3PD	2591091
MQS35-C	2610753	MTMA16-10-GC	2720560	ND1	2590080	PKD1612	2808886	PNB-3PD	2591091
MQS70-C	2610754	MTMA16-GC	2720035	ND2	2590082	PKD1618	2808890	PNB-4KE	2591251
MQS150-C	2610755	MTMA185-120-GC	2721900	ND3	2590084	PKD1618	2808922	PNB-6KE	2591260
MQS240-C	2610756	MTMA185-150-GC	2721910	ND4	2590086	PKD25016	2808925	PNB-6KE-T	2591262
MS4/10-15	2599880	MTMA185-GC	2720360	NT10	8420017	PKD25022	2808927	PNB-7KE	2591268
MS10/16-15	2599881	MTMA240-GC	2720410	NLO3-M	2469328	PKD2508	2808890	PNB-7KE-T	2591270
MT-FC48N	2685903	MTMA240-150-GC	2722050	NLO3-P	2110870	PKD2512	2808892	PO7000	2595904
MT150R-C12	2545010	MTMA240-185-GC	2722090	NLO6-M	2469330	PKD2518	2808894	PR-1	2591045
MT150R-C16	2545090	MTMA25-10-GC	2720575	NLO6-P	2111950	PKD35016	2808930	PRCH	2596113
MT150R-GC	2541870	MTMA25-16-GC	2720580	NLO6-PB	2111960	PKD35025	2808932	PS130-150/E	2616371
MT150R-TD	2540550	MTMA25-GC	2720090	NL1-M	2469350	PKD410	2808900	PS130-240/E	2616381
MT150S-C12	2545310	MTMA300-GC	2720430	NL1-P	2113970	PKD412	2808902	PS130-35/E	2616351
MT150S-C14-80	2546270	MTMA35-20-GC	2720135	NL1-PG	2113990	PKD418	2808904	PS130-95/E	2616361
MT150S-C16	2545350	MTMA35-GC	2720130	NL2-M	2469390	PKD50020	2808935	PS230-400 5E	2680186
MT150S-GC	2541910	MTMA400-240-GC	2722245	NL3-M	2469430	PKD50025	2808937	PS230-630 6E	2680189
MT150S-TD	2540630	MTMA400-300-GC	2722250	NN4-15	2599867	PKD506	2808850	PV-1	2591044
MT200R-C10	2545540	MTMA50-25-GC	2720650	NY00	2581322	PKD508	2808852	Q10-5	2167010
MT200R-C16	2545550	MTMA50-35-GC	2720660	NY0	2581324	PKD510	2808854	Q10-6	2167015
MT200R-GC	2542030	MTMA50-GC	2720152	NY1	2581326	PKD612	2808910	Q10-8	2167020
MT200R-TD	2540670	MTMA500-GC	2720515	OB2_5P	8420034	PKD618	2808912	Q10-10	2167025
MT240R-C12	2545710	MTMA500-300-GC	2722260	PA1	2650230	PKD7506	2808860	Q10-12	2167030
MT240R-C16	2545750	MTMA500-400-GC	2722270	PA1-50	2675680	PKD7508	2808862	Q16-5	2167080
MT240R-GC	2542110	MTMA70-35-GC	2720940	PA10	2650290	PKD7510	2808864	Q16-6	2167085
MT240R-TD	2540710	MTMA70-50-GC	2720980	PA10-50	2675686	PKD7512	2808866	Q16-8	2167090
MT25-C8	2543030	MTMA70-GC	2720195	PA10-C	2611010	PKE1012	2809190	Q16-10	2167095
MT25-GC	2541570	MTMA95-50-GC	2721030	PA100-3D	2631930	PKE1018	2809200	Q16-12	2167100
MT25-TD	2540150	MTMA95-70-GC	2721070	PA120-3D	2631950	PKE108	2809090	Q25-5	2167150
MT315R-C16	2545950	MTMA95-GC	2720232	PA120-520	2645600	PKE1508	2809110	Q25-6	2167155
MT315R-GC	2542150	MTMA16/1	2720031	PA19-50	2675694	PKE1510	2809115	Q25-8	2167160
MT315R-TD	2540750	MTMA25/1	2720071	PA200-520	2645610	PKE1518	2809120	Q25-10	2167165
MT315S-C16	2545990	MTMA35/1	2720111	PA24-50	2675696	PKE1612	2809210	Q25-12	2167170
MT315S-GC	2542290	MTMA50/1	2720160	PA24-C	2611020	PKE1618	2809220	Q25-16	2167175
MT315S-TD	2540790	MTMA70/1	2720191	PA48-C	2611030	PKE25016	2809230	Q35-6	2167230
MT400-TD	2540830	MTMA95/1	2720250	PA5	2650250	PKE25022	2809240	Q35-8	2167235
MT40S-C10	2543410	MTMA120/1	2720280	PA5-50	2675682	PKE2508	2809130	Q35-10	2167240
MT40S-C14-80	2546070	MTMA150/1	2720320	PA60-C	2611040	PKE2512	2809135	Q35-12	2167245

REFERENCE / CODE CROSS-REFERENCE CHART

Ref.	Code	Ref.	Code	Ref.	Code	Ref.	Code	Ref.	Code
Q35-16	2167250	RD50.5SS	2685610	RHU81	2600045	RP-M3.5	2046015	S1.5-U3	2160630
Q50-6	2167310	RD54.2SS	2685612	RKF-BF4	2051632	RP-M3.5/1	2046016	S1.5-U3.5	2160670
Q50-8	2167315	RD60SS	2685614	RKF-BM4	2051662	RP-M4	2046020	S1.5-U3.5/2	2160682
Q50-10	2167320	RD64SS	2685616	RKF-F305	2051562	RP-M4/3	2046023	S1.5-U4	2160710
Q50-12	2167325	RD65SS	2685618	RKF-F308	2051582	RP-M5	2046025	S1.5-U4/1	2160730
Q50-16	2167330	RD68X68	2685666	RKF-F405	2051602	RP-M6	2046030	S1.5-U4/2	2160750
Q70-6	2167390	RD76SS	2685620	RKF-F405P	2051607	RP-M6/1	2046031	S1.5-U5	2160790
Q70-8	2167395	RD80.5SS	2685622	RKF-F408	2051592	RP-M7	2046035	S1.5-U5/1	2160800
Q70-10	2167400	RD92X92	2685668	RKF-F408P	2051597	RP-M8	2046040	S1.5-U6	2160830
Q70-12	2167405	RF-BF4	2051630	RKF-F608	2051612	RP-P10	2046115	S1.5-U6/1	2160870
Q70-16	2167410	RF-BM4	2051660	RKF-F608P	2051622	RP-P12	2046120	S1.5-U8	2160910
Q95-8	2167470	RF-F305	2051560	RKF-FM608	2051692	RP-P8	2046110	S2.5-M10	2162170
Q95-10	2167475	RF-F305P	2051565	RKF-M608	2051652	RP-PP12	2046140	S2.5-M12	2162210
Q95-12	2167480	RF-F308	2051580	RKY-M3	2145684	RP-PP12/1	2046145	S2.5-M2	2161800
Q95-16	2167485	RF-F308P	2051585	RKY-M3.5	2145685	RP-PP12/19	2046150	S2.5-M3	2161810
Q120-8	2167540	RF-F405	2051600	RKY-M3.5/1	2145687	RP-PP12/23	2046155	S2.5-M3.5	2161850
Q120-10	2167545	RF-F405P	2051605	RKY-M4	2145699	RP-PP14	2046160	S2.5-M3.5/1	2161890
Q120-12	2167550	RF-F408	2051590	RKY-M5	2145699	RP-PP16/23	2046165	S2.5-M4	2161930
Q120-16	2167555	RF-F408P	2051595	RKY-M6/1	2145705	RP-PPL30	2046180	S2.5-M5	2161970
Q150-10	2167610	RF-F608	2051610	RKY-M8	2145711	RP-PPL46	2046185	S2.5-M6	2162010
Q150-12	2167615	RF-F608P	2051620	RKY-M10	2145715	RP-U10	2046265	S2.5-M6/1	2162050
Q150-16	2167620	RF-FM608	2051690	RKY-M12	2145718	RP-U12	2046270	S2.5-M7	2162090
Q185-10	2167680	RF-M10	2050390	RKY-P8	2145782	RP-U3	2046210	S2.5-M8	2162130
Q185-12	2167685	RF-M12	2050430	RKY-P10	2145783	RP-U3.5	2046215	S2.5-P10	2163050
Q185-16	2167690	RF-M2	2050010	RKY-P12	2145784	RP-U3.5/2	2046217	S2.5-P12	2163090
Q240-10	2167750	RF-M3	2050030	RKY-PP12	2145790	RP-U4	2046230	S2.5-P8	2163010
Q240-12	2167755	RF-M3.5	2050070	RKY-PP12/19	2145792	RP-U4/1	2046231	S2.5-PP12	2163170
Q240-16	2167760	RF-M3.5/1	2050110	RKY-PP16/23	2145793	RP-U4/2	2046240	S2.5-PP12/25	2163210
Q38-F	2593861	RF-M4	2050150	RKY-PPL30	2145795	RP-U5	2046245	S2.5-PP16/25	2163250
Q38-M	2593859	RF-M4/3	2050170	RKY-PPL46	2145798	RP-U5/1	2046246	S2.5-U10	2162730
Q38-MS	2593860	RF-M5	2050190	RKY-U3	2145730	RP-U6	2046255	S2.5-U12	2162770
RA-3	2598428	RF-M6	2050230	RKY-U3.5	2145733	RP-U6/1	2046256	S2.5-U3	2162410
RBG-15	2599850	RF-M6/1	2050270	RKY-U4	2145736	RP-U8	2046260	S2.5-U3.5	2162450
RBV-15	2599852	RF-M608	2051650	RKY-U5	2145739	RS0305.07	3008006	S2.5-U3.5/1	2162460
RCP-B70	2596116	RF-M608P	2051655	RKY-U6	2145742	RS0407.M12	3008050	S2.5-U4	2162490
RD120SS	2685624	RF-M7	2050310	RKY-U6/1	2145743	RS0507.09	3008008	S2.5-U4/1	2162510
RD138X138	2685670	RF-M8	2050350	RN-FA305	3031610	RS0509.M16	3008052	S2.5-U4/2	2162530
RD15.5SS	2685560	RF-P10	2051250	RN-FA405	3031615	RS0710.11	3008010	S2.5-U5	2162570
RD15.5SS-FC	2685550	RF-P12	2051290	RN-FA608	3031620	RS0813.M20	3008054	S2.5-U6	2162610
RD16.2SS	2685562	RF-P8	2051210	RN-M10	2150430	RS1014.16	3008012	S2.5-U6/1	2162650
RD16.2SS-FC	2685552	RF-PP12	2051330	RN-M12	2150470	RS1117.M25	3008056	S2.5-U8	2162690
RD17.5SS	2685564	RF-PP12/1	2051340	RN-M2	2150010	RS1420.21	3008014	S6-M10	2163930
RD17.5SS-FC	2685554	RF-PP12/19	2051370	RN-M3	2150030	RS1520.M32	3008058	S6-M10/1	2163850
RD18.8SS	2685566	RF-PP12/23	2051380	RN-M3.5	2150070	RS1928.M40	3008060	S6-M12	2163890
RD18.8SS-FC	2685556	RF-PP14	2051410	RN-M3.5/1	2150110	RS2026.29	3008016	S6-M14	2163930
RD18X46	2685654	RF-PP16/23	2051450	RN-M4	2150150	RS2635.36	3008018	S6-M16	2163970
RD19.1SS	2685568	RF-PPL30	2051460	RN-M4/3	2150170	RS2735.M50	3008062	S6-M3	2163510
RD20.5SS	2685570	RF-PPL46	2051465	RN-M5	2150190	RT10.5	2592470	S6-M3.5	2163550
RD21X21	2685650	RF-U10	2050950	RN-M6	2150230	RT13	2592490	S6-M4	2163590
RD22.6SS	2685572	RF-U12	2050990	RN-M6/1	2150270	RT15	2592510	S6-M5	2163630
RD22X46	2685656	RF-U3	2050630	RN-M7	2150350	RT17	2592530	S6-M6	2163670
RD23.8SS	2685574	RF-U3.5	2050670	RN-M8	2150390	RT19	2592540	S6-M6/1	2163710
RD25.4SS	2685576	RF-U3.5/1	2050680	RN-MA305	3031710	RT6.5	2592430	S6-M7	2163750
RD27SS	2685578	RF-U3.5/2	2050681	RN-MA405	3031715	RT8.5	2592450	S6-M8	2163790
RD28.5SS	2685580	RF-U4	2050710	RN-MA608	3031720	S10-M4	2165130	S6-M8/1	2163800
RD30.5SS	2685582	RF-U4/1	2050730	RN-P10	2151270	S10-M5	2165150	S6-P10	2164710
RD28.5SS-19	2685584	RF-U4/2	2050750	RN-P12	2151310	S10-M6	2165190	S6-P12	2164750
RD30.5SS-19	2685586	RF-U5	2050790	RN-P8	2151230	S10-M7	2165230	S6-P14	2164790
RD31.8SS	2685588	RF-U5/1	2050791	RN-PP12	2151350	S1.5-M10	2160390	S6-PP12	2164830
RD32.5SS	2685590	RF-U6	2050830	RN-PP12/1	2151370	S1.5-M12	2160430	S6-PP17	2164870
RD34.6SS	2685592	RF-U6/1	2050870	RN-PP12/19	2151390	S1.5-M2	2160010	S6-U10	2164370
RD36X46	2685658	RF-U8	2050910	RN-PP14	2151400	S1.5-M3	2160030	S6-U10/1	2164390
RD37.2SS	2685594	RH50	2670050	RN-PP16/23	2151410	S1.5-M3.5	2160070	S6-U12	2164430
RD38.1SS	2685596	RHC131	2619010	RN-U10	2150990	S1.5-M3.5/1	2160110	S6-U14	2164470
RD40.5SS	2685598	RHC131LN	2619021	RN-U12	2151030	S1.5-M4	2160150	S6-U16	2164510
RD40.5SS-FC	2685627	RH-FC48N	2592596	RN-U3	2150670	S1.5-M4/3	2160160	S6-U3.5	2164170
RD41.3SS	2685600	RH-FL75	2592597	RN-U3.5	2150710	S1.5-M5	2160190	S6-U4	2164210
RD41.3SS-FC	2685628	RHM132	2619410	RN-U3.5/2	2150720	S1.5-M6	2160230	S6-U5	2164250
RD42.5SS	2685602	RHM50	2670035	RN-U4	2150750	S1.5-M6/1	2160270	S6-U6	2164290
RD42.5SS-FC	2685629	RHT160	2592422	RN-U4/1	2150760	S1.5-M7	2160310	S6-U8	2164330
RD43.2SS	2685604	RHT160-60N	2592584	RN-U4/2	2150790	S1.5-M8	2160350	SC1	2591261
RD43.2SS-FC	2685630	RHTD1724	2682482	RN-U5	2150830	S1.5-P10	2161190	SC3X	2591264
RD44.5SS	2685606	RHTD3241	2682502	RN-U5/1	2150840	S1.5-P12	2161230	SH-B70	2596080
RD44.5SS-FC	2685632	RHTD3241T	2682517	RN-U6	2150870	S1.5-P8	2161150	SS4.8-3.7	3041670
RD46X107	2685652	RHU131-C	2619210	RN-U6/1	2150910	S1.5-PP12	2161310	SS4.8-4.5	3041672
RD46X46	2685660	RHU230-630	2680075	RN-U8	2150950	S1.5-PP12/1	2161330	SS9-4.5	3041675
RD46X54	2685662	RHU450	2640011	RP-M10	2046045	S1.5-PP12/19	2161350	SS9-5	3041677
RD46X72	2685664	RHU520	2640151	RP-M12	2046050	S1.5-PP14	2161360	SS9-6.4	3041679
RD47.2SS	2685608	RHU600	2640250	RP-M2	2046005	S1.5-U10	2160950	SUB-D050	8420033
RD47.2SS-FC	2685634	RHU1000	2640810	RP-M3	2046010	S1.5-U12	2160990	SUB-D075	8420032

REFERENCE/CODE CROSS-REFERENCE CHART

Ref.	Code	Ref.	Code	Ref.	Code	Ref.	Code	Ref.	Code
TBS16X20RE	2811035	TCS32X200YE	2811356	TSS510BK	2811668	TSS510BR	2811908	Z16-3	2844115
TBS24X20RE	2811037	TCS48X100YE	2811358	TSS24RE	2811680	TSS32Y/G	2811920	Z16-3D	2844116
TBS32X10RE	2811039	TCS64X100YE	2811360	TSS32RE	2811682	TSS48Y/G	2811922	Z16-4	2844130
TBS48X10RE	2811041	TCS95X100YE	2811362	TSS48RE	2811684	TSS64Y/G	2811924	Z16-4D	2844131
TBS64X10RE	2811043	TCS127X100YE	2811364	TSS64RE	2811686	TSS95Y/G	2811926	Z16-5N	2844122
TBS95X10RE	2811045	TCS190X100YE	2811366	TSS95RE	2811688	TSS127Y/G	2811928	Z16-5ND	2844123
TBS127X10RE	2811047	TCS254X50YE	2811368	TSS127RE	2811690	TSS190Y/G	2811930	Z16-8	2844140
TBS190X5RE	2811049	TCS16X200GN	2811390	TSS190RE	2811692	TSS254Y/G	2811932	Z16-8D	2844141
TBS254X5RE	2811051	TCS24X200GN	2811392	TSS254RE	2811694	TSS380Y/G	2811934	Z25-1	2845050
TBS16X20BK	2811110	TCS32X200GN	2811394	TSS380RE	2811696	UP130-120	2616520	Z25-DP7-100	2845180
TBS24X20BK	2811112	TCS48X100GN	2811396	TSS510RE	2811698	UP130-150	2616530	Z2.5-1	2845010
TBS32X10BK	2811114	TCS64X100GN	2811398	TSS24WH	2811710	UP130-185	2616550	Z35-1	2845060
TBS48X10BK	2811116	TCS95X100GN	2811400	TSS32WH	2811712	UP130-240	2616560	Z35-26D	2844216
TBS64X10BK	2811118	TCS127X100GN	2811402	TSS48WH	2811714	UP130-240	2616560	Z35-3D	2844205
TBS95X10BK	2811120	TCS190X100GN	2811404	TSS64WH	2811716	UP130-70	2616490	Z35-3D	2844206
TBS127X10BK	2811122	TCS254X50GN	2811406	TSS95WH	2811718	UP130-95	2616500	Z35-4	2844201
TBS190X5BK	2811124	TCS16X200BU	2811420	TSS127WH	2811720	VAL04	2593310	Z35-4D	2844202
TBS254X5BK	2811126	TCS24X200BU	2811422	TSS190WH	2811722	VAL096	2593669	Z35-6	2844210
TBS16X20Y/G	2811160	TCS32X200BU	2811424	TSS254WH	2811724	VAL1000	2593426	Z35-6D	2844211
TBS24X20Y/G	2811162	TCS48X100BU	2811426	TSS380WH	2811726	VAL130	2610450	Z35-DP14-125	2845210
TBS32X10Y/G	2811164	TCS64X100BU	2811428	TSS510WH	2811728	VAL130-U	2610451	Z35-DP14B-125	2845212
TBS48X10Y/G	2811166	TCS95X100BU	2811430	TSS24BU	2811740	VAL160	2593405	Z35T-11	2844220
TBS64X10Y/G	2811168	TCS127X100BU	2811432	TSS32BU	2811742	VAL231	2593384	Z35T-11D	2844221
TBS95X10Y/G	2811170	TCS190X100BU	2811434	TSS48BU	2811744	VAL520	2593410	Z50-10D	2844230
TBS127X10Y/G	2811172	TCS254X50BU	2811436	TSS64BU	2811746	VAL600	2593425	Z50-DP12-160	2845220
TBS190X5Y/G	2811174	TCS16X200RE	2811450	TSS95BU	2811748	VAL75	2600110	Z6-1	2845020
TBS254X5Y/G	2811176	TCS24X200RE	2811452	TSS127BU	2811750	VALB-TC04	2593705	Z6-10	2844106
TBS16X20BU	2811185	TCS32X200RE	2811454	TSS190BU	2811752	VALB-TC095	2593703	Z6-10D	2844107
TBS24X20BU	2811187	TCS48X100RE	2811456	TSS254BU	2811754	VALCP096	2593671	Z6-3	2844080
TBS32X10BU	2811189	TCS64X100RE	2811458	TSS380BU	2811756	VALCP096-W	2593674	Z6-3D	2844081
TBS48X10BU	2811191	TCS95X100RE	2811460	TSS510BU	2811758	VALECW-H3D	2593421	Z6-5	2844100
TBS64X10BU	2811193	TCS127X100RE	2811462	TSS24TR	2811770	VALMAT520	2593411	Z6-5D	2844101
TBS95X10BU	2811195	TCS190X100RE	2811464	TSS32TR	2811772	VALMATW	2670076	Z6-6	2844108
TBS127X10BU	2811197	TCS254X50RE	2811466	TSS48TR	2811774	VALP1	2590595	Z6-6D	2844109
TBS190X5BU	2811199	TCS16X200WH	2811480	TSS64TR	2811776	VALP3	2590610	ZKE2	2590710
TBS254X5BU	2811201	TCS24X200WH	2811482	TSS95TR	2811778	VALP4	2590612	ZKE610	2590718
TC025	2591895	TCS32X200WH	2811484	TSS127TR	2811780	VALP5	2590614	ZKE6-F	2590716
TC04	2591396	TCS48X100WH	2811486	TSS190TR	2811782	VALP7	2590616	ZP2	2590760
TC050	2597050	TCS64X100WH	2811488	TSS254TR	2811784	VALP9	2590619	ZS-B16	2842185
TC055	2591860	TCS95X100WH	2811490	TSS380TR	2811786	VALP9-C	2590609	ZS-B4	2842115
TC085	2597150	TCS127X100WH	2811492	TSS510TR	2811788	VALP10	2590620	ZS-B6	2842155
TC096	2597360	TCS190X100WH	2811494	TSS24YE	2811800	VALP18	2590628	ZS-T16	2842190
TC120	2597250	TCS254X50WH	2811496	TSS32YE	2811802	VALP19	2590629	ZS-T4	2842120
TCP10	3019220	TCS32X200Y/G	2811515	TSS48YE	2811804	VALP21	2874156	ZS-T6	2842160
TCP12	3019225	TCS48X100Y/G	2811519	TSS64YE	2811806	VALP22	2874157	ZS-U16	2842180
TCP15	3019230	TCS64X100Y/G	2811519	TSS95YE	2811808	VALP25	2590633	ZS-U4	2842110
TCP18	3019235	TCS95X100Y/G	2811521	TSS127YE	2811810	VALP26	2590635	ZS-U6	2842150
TCP20	3019240	TCS127X100Y/G	2811523	TSS190YE	2811812	VALP27	2590638		
TCP25	3019250	TCS190X100Y/G	2811525	TSS254YE	2811814	VALP29	2590641		
TCP30	3019260	TCS254X50Y/G	2811527	TSS380YE	2811816	VALP30	2590642		
TCP35	3019270	TCS381X50Y/G	2811511	TSS510YE	2811818	VALSTAR ND2/PKC	2590565		
TCP40	3019280	TCS508X25Y/G	2811513	TSS24GN	2811831	VALSTAR ND2/PKD	2590567		
TCP45	3019290	TD-M16C	2685010	TSS32GN	2811833	VALSTAR ND2/PKE	2590566		
TCP5	3019210	TF300-Q38F	2592862	TSS48GN	2811835	VALSTAR R3/IDT	2590593		
TCP50	3019300	TF300-Q38FM	2592863	TSS64GN	2811837	VALSTAR V3-F	2590577		
TCP55	3019305	TF600-Q38FM	2592981	TSS95GN	2811839	VALTC055	2593325		
TCP60	3019310	TGM38	3016155	TSS127GN	2811841	VALTC085	2593323		
TCP65	3019315	TGM48	3016157	TSS190GN	2811843	VALTC120	2593322		
TCP70	3019320	TGM513	3016165	TSS254GN	2811845	VP-M2	2048010		
TCS12X200BK	2811312	TGM58	3016159	TSS380GN	2811847	VP-M3	2048030		
TCS16X200BK	2811314	TGM613	3016167	TSS510GN	2811849	VP-M3.5	2048070		
TCS24X200BK	2811316	TGM713	3016169	TSS24GY	2811861	VP-M4	2048150		
TCS32X200BK	2811318	TGM817	3016171	TSS32GY	2811863	VP-M5	2048190		
TCS48X100BK	2811320	TN120S	2590270	TSS48GY	2811865	VP-M6	2048210		
TCS64X100BK	2811322	TN70	2590230	TSS64GY	2811867	VP-P10	2049210		
TCS95X100BK	2811324	TND6-70	2590120	TSS95GY	2811869	VP-PP12/19	2049370		
TCS127X100BK	2811326	TND10-120	2590145	TSS127GY	2811871	VP-U3	2048630		
TCS160X100BK	2811328	TNN120	2590290	TSS190GY	2811873	VP-U3.5	2048670		
TCS190X100BK	2811330	TNN70	2590240	TSS254GY	2811875	VP-U4	2048710		
TCS254X50BK	2811332	TNN71	2590241	TSS380GY	2811877	WF6	8420030		
TCS320X50BK	2811334	TRS-B70	2593280	TSS510GY	2811879	WF16	8420015		
TCS381X50BK	2811336	TSS24BK	2811650	TSS24BR	2811890	WF35	8420031		
TCS508X25BK	2811338	TSS32BK	2811652	TSS32BR	2811892	WLO3-M	2469780		
TCS762X25BK	2811340	TSS48BK	2811654	TSS48BR	2811894	WLO6-M	2469785		
TCS1016X25BK	2811342	TSS64BK	2811656	TSS64BR	2811896	WL1-M	2469790		
TCS1260X25BK	2811344	TSS95BK	2811658	TSS95BR	2811898	WT2-3D	2636970		
TCS1500X25BK	2811346	TSS127BK	2811660	TSS127BR	2811899	Z10-1	2845030		
TCS16X200YE	2811352	TSS190BK	2811662	TSS190BR	2811902	Z16-1	2845040		
TCS24X200YE	2811354	TSS254BK	2811664	TSS254BR	2811904	Z16-12	2844156		
		TSS380BK	2811666	TSS380BR	2811906	Z16-12D	2844157		

COMPARISON OF AWG, MCM AND METRIC CONDUCTOR CROSS SECTIONS

AWG comparison to Metric

AWG	Actual conductor csa mm ²	Comparable metric csa mm ²
27	0,10	
26	0,13	0,14
25	0,16	-
24	0,21	0,2
23	0,26	0,25
22	0,33	0,34
21	0,41	-
20	0,52	0,5
19	0,65	-
18	0,82	0,75
17	1,04	1
16	1,31	-
15	1,65	1,5
14	2,08	-
13	2,63	2,5
12	3,31	-
11	4,15	4
10	5,27	6
9	6,62	-
8	8,35	-
7	10,6	10
6	13,3	-
5	16,8	16
4	21,2	-
3	26,7	25
2	33,6	35
1	42,4	-
1/0	53,4	50
2/0	67,5	70
3/0	85,0	95
4/0	107,2	120

MCM comparison to Metric

MCM	Actual conductor csa mm ²	Comparable metric csa mm ²
250	127	120
300	152	150
350	177	185
400	203	-
500	253	240
600	304	300
700	355	-
800	405	400
900	456	-
1000	507	500
1250	633	625
1500	760	800
1750	887	-
2000	1010	1000

MAXIMUM DIAMETERS OF CIRCULAR COPPER CONDUCTORS: SOLID, NON COMPACTED STRANDED AND FLEXIBLE

Cross sectional area [mm ²]	Conductors in cables for fixed installations		Flexible conductors (Classes 5 and 6) Maximum diameter [mm]
	Solid (Class 1) Maximum diameter [mm]	Stranded (Class 2) Maximum diameter [mm]	
0,5	0,9	1,1	1,1
0,75	1,0	1,2	1,3
1	1,2	1,4	1,5
1,5	1,5	1,7	1,8
2,5	1,9	2,2	2,4
4	2,4	2,7	3,0
6	2,9	3,3	3,9
10	3,7	4,2	5,1
16	4,6	5,3	6,3
25 ^a	5,7	6,6	7,8
35 ^a	6,7	7,9	9,2
50 ^a	7,8	9,1	11,0
70 ^a	9,4	11,0	13,1
95 ^a	11,0	12,9	15,1
120 ^a	12,4	14,5	17,0
150 ^a	13,8	16,2	19,0
185	15,4	18,0	21,0
240	17,6	20,6	24,0
300	19,8	23,1	27,0
400	22,2	26,1	31,0
500	-	29,2	35,0
630	-	33,2	39,0
800	-	37,6	-
1000	-	42,2	-

NOTE: The values given for flexible conductors represent both class 5 and class 6 conductors.

^a Solid copper conductor having cross-sectional areas of 25 mm² and above are for particular types of cable, e.g. mineral insulated, and not for general purposes.

MINIMUM AND MAXIMUM DIAMETERS OF STRANDED COMPACTED CIRCULAR COPPER, ALUMINIUM AND ALUMINIUM ALLOY CONDUCTORS

Cross-sectional area [mm ²]	Stranded compacted circular conductors (Class 2)	
	Minimum diameter [mm]	Maximum diameter [mm]
10	3,6	4,0
16	4,6	5,2
25	5,6	6,5
35	6,6	7,5
50	7,7	8,6
70	9,3	10,2
95	11,0	12,0
120	12,3	13,5
150	13,7	15,0
185	15,3	16,8
240	17,6	19,2
300	19,7	21,6
400	22,3	24,6
500	25,3	27,6
630	28,7	32,5

NOTES: - The dimensional limits of aluminium conductors with cross-sectional areas above 630 mm² are not given as the compaction technology is not generally established.

- The values are given for compacted copper conductors in the size range 1,5 mm² to 6 mm².

MINIMUM AND MAXIMUM DIAMETERS OF CIRCULAR ALUMINIUM CONDUCTORS

Cross-sectional area [mm ²]	Solid conductors (Class 1)	
	Minimum diameter [mm]	Maximum diameter [mm]
10	3,4	3,7
16	4,1	4,6
25	5,2	5,7
35	6,1	6,7
50	7,2	7,8
70	8,7	9,4
95	10,3	11,0
120	11,6	12,4
150	12,9	13,8
185	14,5	15,4
240	16,7	17,6
300	18,8	19,8
400	21,2	22,2
500	24,0	25,1
630	27,3	28,4
800	30,9	32,1
1000	34,8	36,0
1200	37,8	39,0

CLASS 1:

SOLID CONDUCTORS FOR SINGLE-CORE AND MULTI-CORE CABLES

Nominal cross-sectional area [mm ²]	Maximum resistance of conductor at 20 °C		
	Circular, annealed copper conductors		Aluminium and aluminium alloy conductors, circular or shaped ^c [ohm/km]
	Plain [ohm/km]	Metal [ohm/km]	
0,5	36	36,7	-
0,75	24,5	24,8	-
1	18,1	18,2	-
1,5	12,1	12,2	-
2,5	7,41	7,56	-
4	4,61	4,70	-
6	3,08	3,11	-
10	1,83	1,84	3,08 ^a
16	1,15	1,16	1,91 ^a
25	0,727 ^b	-	1,20 ^a
35	0,524 ^b	-	0,868 ^a
50	0,387 ^b	-	0,641
70	0,268 ^b	-	0,443
95	0,193 ^b	-	0,320 ^d
120	0,153 ^b	-	0,253 ^d
150	0,124 ^b	-	0,206 ^d
185	0,101 ^b	-	0,164 ^d
240	0,0775 ^b	-	0,125 ^d
300	0,0620 ^b	-	0,100 ^d
400	0,0465 ^b	-	0,0778
500	-	-	0,0605
630	-	-	0,0469
800	-	-	0,0367
1000	-	-	0,0291
1200	-	-	0,0247

^a Aluminium conductors 10 mm² to 35 mm² circular only

^b Solid copper conductors having nominal cross-sectional area of 25 mm² and above are for particular types of cable, e.g. mineral insulated, and not for general purposes.

^c For solid aluminium alloy conductors, having the same nominal cross-sectional area as an aluminium conductor, the resistance value given in the table should be multiplied by a factor of 1,162 unless otherwise agreed between the manufacturer and the purchaser.

^d For single core cables, four sectoral shaped conductors may be assembled into a single circular conductor. The maximum resistance of the assembled conductor shall be 25% of that of the individual component conductors.

CLASS 2:

STRANDED CONDUCTORS FOR SINGLE-CORE AND MULTI-CORE CABLES

Nominal cross-sectional area [mm ²]	Minimum number of wires in the conductor						Maximum resistance of conductor at 20 °C		
	Circular		Circular compacted		Shaped		Annealed copper conductor		Aluminium or aluminium alloy conductor ^c [ohm/km]
	Cu	Al	Cu	Al	Cu	Al	Plain wires [ohm/km]	Metal-coated wires [ohm/km]	
0,5	7	-	-	-	-	-	36,0	36,7	-
0,75	7	-	-	-	-	-	24,5	24,8	-
1,0	7	-	-	-	-	-	18,1	18,2	-
1,5	7	-	6	-	-	-	12,1	12,2	-
2,5	7	-	6	-	-	-	7,41	7,56	-
4	7	-	6	-	-	-	4,61	4,70	-
6	7	-	6	-	-	-	3,08	3,11	-
10	7	7	6	6	-	-	1,83	1,84	3,08
16	7	7	6	6	-	-	1,15	1,16	1,91
25	7	7	6	6	6	6	0,727	0,734	1,20
35	7	7	6	6	6	6	0,524	0,529	0,868
50	19	19	6	6	6	6	0,387	0,391	0,641
70	19	19	12	12	12	12	0,268	0,270	0,443
95	19	19	15	15	15	15	0,193	0,195	0,320
120	37	37	18	15	18	15	0,153	0,154	0,253
150	37	37	18	15	18	15	0,124	0,126	0,206
185	37	37	30	30	30	30	0,0991	0,100	0,164
240	61	61	34	30	34	30	0,0754	0,0762	0,125
300	61	61	34	30	34	30	0,0601	0,0607	0,100
400	61	61	53	53	53	53	0,0470	0,0475	0,0778
500	61	61	53	53	53	53	0,0366	0,0369	0,0605
630	91	91	53	53	53	53	0,0283	0,0286	0,0469
800	91	91	53	53	-	-	0,0221	0,0224	0,0367
1000	91	91	53	53	-	-	0,0176	0,0177	0,0291
1200			<i>b</i>				0,0151	0,0151	0,0247
1400 ^a			<i>b</i>				0,0129	0,0129	0,0212
1600			<i>b</i>				0,0113	0,0113	0,0186
1800 ^a			<i>b</i>				0,0101	0,0101	0,0165
2000			<i>b</i>				0,0090	0,0090	0,0149
2500			<i>b</i>				0,0072	0,0072	0,0127

^a Non-preferred sizes. Other non-preferred sizes are recognized for some specialized applications but are not within the scope of this standard.

^b The minimum number of wires for these sizes is not specified. These sizes may be constructed from 4, 5 or 6 equal segments (Milliken).

^c For stranded aluminium alloy conductors having the same nominal cross-sectional area as an aluminium conductor the resistance value should be agreed between the manufacturer and the purchaser.

CLASS 5:

FLEXIBLE COPPER CONDUCTORS FOR SINGLE-CORE AND MULTI-CORE CABLES

Nominal cross-sectional [mm ²]	Maximum diameter of wires in conductor [mm]	Maximum resistance of conductor at 20 °C	
		Plain wires [ohm/km]	Metal-coated wires [ohm/km]
0,5	0,21	39,0	40,1
0,75	0,21	26,0	26,7
1,0	0,21	19,5	20,0
1,5	0,26	13,3	13,7
2,5	0,26	7,98	8,21
4	0,31	4,95	5,09
6	0,31	3,30	3,39
10	0,41	1,91	1,95
16	0,41	1,21	1,24
25	0,41	0,780	0,795
35	0,41	0,554	0,565
50	0,41	0,386	0,393
70	0,51	0,272	0,277
95	0,51	0,206	0,210
120	0,51	0,161	0,164
150	0,51	0,129	0,132
185	0,51	0,106	0,108
240	0,51	0,0801	0,0817
300	0,51	0,0641	0,0654
400	0,51	0,0486	0,0495
500	0,61	0,0384	0,0391
630	0,61	0,0287	0,0292

CLASS 6:

FLEXIBLE COPPER CONDUCTORS FOR SINGLE-CORE AND MULTI-CORE CABLES

Nominal cross-sectional [mm ²]	Maximum diameter of wires in conductor [mm]	Maximum resistance of conductor at 20 °C	
		Plain wires [ohm/km]	Metal-coated wires [ohm/km]
0,5	0,16	39,0	40,1
0,75	0,16	26,0	26,7
1,0	0,16	19,5	20,0
1,5	0,16	13,3	13,7
2,5	0,16	7,98	8,21
4	0,16	4,95	5,09
6	0,21	3,30	3,39
10	0,21	1,91	1,95
16	0,21	1,21	1,24
25	0,21	0,780	0,795
35	0,21	0,554	0,565
50	0,31	0,386	0,393
70	0,31	0,272	0,277
95	0,31	0,206	0,210
120	0,31	0,161	0,164
150	0,31	0,129	0,132
185	0,41	0,106	0,108
240	0,41	0,0801	0,0817
300	0,41	0,0641	0,0654

- H Cable conforming to harmonised standards
- A Recognised national type of cable
- N Other type of national cable

- 00 Less than 100 / 100 V
- 01 Above 100 / 100 V and less than 300 / 300 V
- 03 300 / 300 V
- 05 300 / 500 V
- 07 450 / 750 V
- 1 0,6 / 1 kV

- B Ethylenpropylene rubber for working temperature of 60° C
- N Polychloroprene
- N2 Polychloroprene for welding cables
- Q Polyurethane
- R Rubber
- V Common-quality PVC
- V2 PVC for working temperatures of 90° C
- V3 PVC for low temperature cables
- V4 Reticulate PVC
- V5 Oil-resistant PVC
- Z Polyolefine mixture

- C Concentric copper core
- C4 Copper braid screen on multiple cores
- C5 Copper braid screen on single cores
- C7 Screen made of copper straps or ribbons

- Z2 Round steel strand armour
- Z3 Steel strap armour
- Z4 Steel ribbon armour
- Z5 Steel strand braid

- H Flat divisible cable with or without sheath
- H2 Flat indivisible cable
- H3 Flat cable with cores separated by a slot
- H6 Flat cable with three or more cores
- H7 Cable with double-layered insulation
- H8 Extendable cord

- D Flexible core for weldings cables
- E Very flexible core for welding cables
- F Flexible core for moving connections
- H Very flexible core for moving connections
- K Flexible core for fixed laying
- R Rigid round cord
- U Round rigid single strand

REFERENCE TO THE STANDARDS

RATED VOLTAGE

INSULATION AND SHEATH MATERIAL

SCREENS

ARMOURS

CONSTRUCTIVE FORM OF THE CABLE

CONDUCTOR FLEXIBILITY DEGREE

UL AND VDE MARKING OF CABLE GLANDS

MAXIblock® - spiralblock®

Ref. Light Grey	Thread	COMPRESSION RANGE Ø min-max				IMPACT CATEGORY (*)	MARKING
		Nominal [mm]	UL 514B [mm] [inches]		EN 50262 [mm]		
1900.M12	M12x1.5	3.5-7	3.5	0.14	3.5-7	1	USR-CNR / VDE
1900.M16	M16x1.5	5-10	7	0.28	7-10	1	USR-CNR / VDE
1900.M20	M20x1.5	7-13	13	0.51	7-13	3	USL-CNL / VDE
1900.M25	M25x1.5	10-17	17	0.67	10-17	3	USL-CNL / VDE
1900.M32	M32x1.5	13-21	15-21	0.60-0.83	13-21	3	USL-CNL / VDE
1900.M40	M40x1.5	19-28	21-28	0.83-1.10	19-28	3	USL-CNL / VDE
1900.M50	M50x1.5	27-35	27-34	1.06-1.34	27-35	3	USL-CNL / VDE
1900.M63	M63x1.5	34-45	35-45	1.38-1.77	34-45	3	USL-CNL / VDE
1910.M12	M12x1.5	2-5	2-5	0.08-0.20	2-5	1	USR-CNR / VDE
1910.M16	M16x1.5	3-7	4-7	0.16-0.28	4-7	1	USR-CNR / VDE
1910.M20	M20x1.5	5-10	5-10	0.20-0.40	5-10	3	USR-CNR / VDE
1910.M25	M25x1.5	7-13	7-13	0.28-0.51	7-13	3	USR-CNR / VDE
1910.M32	M32x1.5	8-14	8-14	0.31-0.55	8-14	3	USR-CNR / VDE
1910.M40	M40x1.5	15-23	15-23	0.59-0.91	15-23	3	USL-CNL / VDE
1910.M50	M50x1.5	21-29	21-29	0.83-1.14	21-29	3	USL-CNL / VDE
1910.M63	M63x1.5	27-39	28-39	1.1-1.54	27-39	3	USL-CNL / VDE
1901.M12	M12x1.5	3.5-7	3.5	0.14	3.5-7	1	USR-CNR / VDE
1901.M16	M16x1.5	5-10	7	0.28	7-10	1	USR-CNR / VDE
1901.M20	M20x1.5	7-13	13	0.51	7-13	3	USL-CNL / VDE
1901.M25	M25x1.5	10-17	17	0.67	10-17	3	USL-CNL / VDE
1901.M32	M32x1.5	13-21	15-21	0.60-0.83	13-21	3	USL-CNL / VDE
1901.M40	M40x1.5	19-28	21-28	0.83-1.10	19-28	3	USL-CNL / VDE
1901.M50	M50x1.5	27-35	27-34	1.06-1.34	27-35	3	USL-CNL / VDE
1901.M63	M63x1.5	34-45	35-45	1.38-1.77	34-45	3	USL-CNL / VDE
1500.M12	M12x1.5	3.5-7	3.5	0.14	3.5-7	1	USR-CNR / VDE
1500.M16	M16x1.5	5-10	7	0.28	7-10	1	USR-CNR / VDE
1500.M20	M20x1.5	7-13	13	0.51	7-13	3	USL-CNL / VDE
1500.M25	M25x1.5	10-17	17	0.67	10-17	3	USL-CNL / VDE
1500.M32	M32x1.5	13-21	15-21	0.60-0.83	13-21	3	USL-CNL / VDE
1940.M25	M25x1.5	13-18	13-18	0.51-0.71	-	-	USL-CNL
1540.M25	M25x1.5	13-18	13-18	0.51-0.71	-	-	USL-CNL

Add to Ref: N for Black, G for Dark Grey

MAXIblock® - spiralblock®

Ref. Light Grey	Thread	COMPRESSION RANGE Ø min-max			MARKING
		Nominal [mm]	UL 514B [mm] [inches]		
1900.07	Pg 7	3.5-7	4.5-6.5	0.18-0.25	USR-CNR
1900.09	Pg 9	5-8	5.5-8	0.22-0.31	USR-CNR
1900.11	Pg 11	5-10	6.5-9.5	0.26-0.37	USR-CNR
1900.13	Pg 13.5	7-12	8-11.5	0.31-0.45	USL-CNL
1900.16	Pg 16	10-14	10.5-14	0.41-0.55	USL-CNL
1900.21	Pg 21	13-18	13-18	0.51-0.71	USL-CNL
1900.29	Pg 29	18-25	18.5-25	0.73-0.98	USL-CNL
1900.36	Pg 36	20-32	21.5-32	0.85-1.26	USL-CNL
1900.42	Pg 42	28-38	28-38	1.10-1.49	USL-CNL
1900.48	Pg 48	37-45	40-44	1.57-1.73	USL-CNL
1901.09	Pg 9	5-8	5.5-8	0.22-0.31	USR-CNR
1901.11	Pg 11	5-10	6.5-9.5	0.26-0.37	USR-CNR
1901.13	Pg 13.5	7-12	8-11.5	0.31-0.45	USL-CNL
1901.16	Pg 16	10-14	10.5-14	0.41-0.55	USL-CNL
1901.21	Pg 21	13-18	13-18	0.51-0.71	USL-CNL
1901.29	Pg 29	18-25	18.5-25	0.73-0.98	USL-CNL
1901.36	Pg 36	20-32	21.5-32	0.85-1.26	USL-CNL
1500.07	Pg 7	3.5-7	4.5-6.5	0.18-0.25	USR-CNR
1500.09	Pg 9	5-8	5.5-8	0.22-0.31	USR-CNR
1500.11	Pg 11	5-10	6.5-9.5	0.26-0.37	USR-CNR
1500.13	Pg 13.5	7-12	8-11.5	0.31-0.45	USL-CNL
1500.16	Pg 16	10-14	10.5-14	0.41-0.55	USL-CNL
1500.21	Pg 21	13-18	13-18	0.51-0.71	USL-CNL
1900.14	G1/4"	3-6.5	4.5-6.5	0.18-0.25	USR-CNR
1900.38	G3/8"	4-8	5.5-8	0.22-0.31	USR-CNR
1900.12	G1/2"	7-12	8-11.5	0.31-0.45	USL-CNL
1900.34	G3/4"	13-18	13-18	0.51-0.71	USL-CNL
1901.12	G1/2"	7-12	8-11.5	0.31-0.45	USL-CNL
1500.14	G1/4"	3-6.5	4.5-6.5	0.18-0.25	USR-CNR
1500.38	G3/8"	4-8	5.5-8	0.22-0.31	USR-CNR
1500.12	G1/2"	7-12	8-11.5	0.31-0.45	USL-CNL
1500.34	G3/4"	13-18	13-18	0.51-0.71	USL-CNL

Add to Ref: N for Black, G for Dark Grey

MAXIbrass®

Ref. Nickel Plated Brass	Thread	COMPRESSION RANGE Ø min-max				IMPACT CATEGORY (*)	MARKING
		Nominal [mm]	UL 514B [mm] [inches]		EN 50262 [mm]		
2900.M12N	M12x1.5	3-7	3-7	0.12-0.28	3-7	5	USR-CNR / VDE
2900.M16N	M16x1.5	4.5-10	4.5-10	0.18-0.39	4.5-10	6	USL-CNL / VDE
2900.M20N	M20x1.5	7-13	8-13	0.31-0.51	7-13	6	USL-CNL / VDE
2900.M25N	M25x1.5	10-17	10-17	0.39-0.67	10-17	6	USL-CNL / VDE
2900.M32N	M32x1.5	11-21	11-21	0.43-0.83	11-21	6	USL-CNL / VDE
2900.M40N	M40x1.5	19-28	19-28	0.75-1.10	19-28	6	USL-CNL / VDE
2900.M50N	M50x1.5	26-35	27-35	1.06-1.38	26-35	6	USL-CNL / VDE
2900.M63N	M63x1.5	34-45	34-45	1.33-1.77	34-45	6	USL-CNL / VDE
2910.M12N	M12x1.5	1-5	2-5	0.08-0.20	1-5	5	USR-CNR / VDE
2910.M16N	M16x1.5	2.5-7	3.5-7	0.14-0.28	2.5-7	6	USR-CNR / VDE
2910.M20N	M20x1.5	5-10	5-10	0.20-0.39	5-10	6	USR-CNR / VDE
2910.M25N	M25x1.5	6-13	6-13	0.24-0.51	6-13	6	USR-CNR / VDE
2910.M32N	M32x1.5	7-14	7-14	0.28-0.55	7-14	6	USR-CNR / VDE
2910.M40N	M40x1.5	13-23	15-23	0.59-0.90	17-23	6	USL-CNL / VDE
2910.M50N	M50x1.5	20-29	20-29	0.79-1.14	22-29	6	USL-CNL / VDE
2910.M63N	M63x1.5	27-39	28-39	1.10-1.54	31-39	6	USL-CNL / VDE
2901.M12N	M12x1.5	3-7	3-7	0.12-0.28	3-7	5	USR-CNR / VDE
2901.M16N	M16x1.5	4.5-10	4.5-10	0.18-0.39	4.5-10	6	USL-CNL / VDE
2901.M20N	M20x1.5	7-13	8-13	0.31-0.51	7-13	6	USL-CNL / VDE
2901.M25N	M25x1.5	10-17	10-17	0.39-0.67	10-17	6	USL-CNL / VDE
2901.M32N	M32x1.5	11-21	11-21	0.43-0.83	11-21	6	USL-CNL / VDE
2901.M40N	M40x1.5	19-28	19-28	0.75-1.10	19-28	6	USL-CNL / VDE
2901.M50N	M50x1.5	26-35	27-35	1.06-1.38	26-35	6	USL-CNL / VDE
2911.M12N	M12x1.5	1-5	2-5	0.08-0.20	1-5	5	USR-CNR / VDE
2911.M16N	M16x1.5	2.5-7	3.5-7	0.14-0.28	2.5-7	6	USR-CNR / VDE
2911.M20N	M20x1.5	5-10	5-10	0.20-0.39	5-10	6	USR-CNR / VDE
2911.M25N	M25x1.5	6-13	6-13	0.24-0.51	6-13	6	USR-CNR / VDE
2911.M32N	M32x1.5	7-14	7-14	0.28-0.55	7-14	6	USR-CNR / VDE
2911.M40N	M40x1.5	13-23	15-23	0.59-0.90	13-23	6	USL-CNL / VDE
2911.M50N	M50x1.5	20-29	20-29	0.79-1.14	22-29	6	USL-CNL / VDE

VDE: Licence nos 40008472, 40008474, 40008475 and 40008476

USL-CNL: UL LISTING file no E220310; control no 48SB valid in USA & Canada

USR-CNR: UL RECOGNITION file no E220310 valid in USA & Canada (with reduced tightening force)

(*) EN 50262 § 9.4

MAXIbrass®

Ref. Nickel Plated Brass	Thread	COMPRESSION RANGE Ø min-max			MARKING
		Nominal [mm]	UL 514B [mm] [inches]		
2900.07N	Pg 7	3-7	3-7	0.12-0.28	USR-CNR
2900.09N	Pg 9	4-8	4-8	0.16-0.31	USR-CNR
2900.11N	Pg 11	4.5-10	4.5-10	0.18-0.39	USR-CNR
2900.13N	Pg 13.5	5-12	9-12	0.35-0.47	USL-CNL
2900.16N	Pg 16	7-13	10-13	0.39-0.51	USL-CNL
2900.21N	Pg 21	10-17	12-17	0.47-0.67	USL-CNL
2900.29N	Pg 29	17-25	18-25	0.71-0.98	USL-CNL
2900.36N	Pg 36	20-32	22-32	0.86-1.26	USL-CNL
2900.42N	Pg 42	28-38	28-35	1.10-1.38	USL-CNL
2900.48N	Pg 48	34-45	34-45	1.33-1.77	USL-CNL
2910.07N	Pg 7	1-5	1-5	0.04-0.20	USR-CNR
2910.09N	Pg 9	2-6	3-6	0.12-0.24	USR-CNR
2910.11N	Pg 11	2.5-7	3.5-7	0.14-0.28	USR-CNR
2910.13N	Pg13.5	4-10	5.5-10	0.22-0.39	USR-CNR
2910.16N	Pg 16	5-10	6-10	0.24-0.39	USR-CNR
2910.21N	Pg 21	6-13	7-13	0.28-0.51	USR-CNR
2910.29N	Pg 29	11-20	12-20	0.47-0.79	USR-CNR
2910.36N	Pg 36	18-26	19-26	0.75-1.02	USL-CNL
2910.42N	Pg 42	24-31	24-31	0.94-1.22	USL-CNL
2910.48N	Pg 48	27-39	31-39	1.22-1.54	USL-CNL
2901.07N	Pg 7	3-7	3-7	0.12-0.28	USR-CNR
2901.09N	Pg 9	4-8	4-8	0.16-0.31	USR-CNR
2901.11N	Pg 11	4.5-10	4.5-10	0.18-0.39	USR-CNR
2901.13N	Pg13.5	5-12	9-12	0.35-0.47	USL-CNL
2901.16N	Pg 16	7-13	10-13	0.39-0.51	USL-CNL
2901.21N	Pg 21	10-17	12-17	0.47-0.67	USL-CNL
2901.29N	Pg 29	17-25	18-25	0.71-0.98	USL-CNL
2901.36N	Pg 36	20-32	22-32	0.86-1.26	USL-CNL
2901.42N	Pg 42	28-38	28-35	1.10-1.38	USL-CNL
2911.07N	Pg 7	1-5	1-5	0.04-0.20	USR-CNR
2911.09N	Pg 9	2-6	3-6	0.12-0.24	USR-CNR
2911.11N	Pg 11	2.5-7	3.5-7	0.14-0.28	USR-CNR
2911.13N	Pg13.5	4-10	5.5-10	0.22-0.39	USR-CNR
2911.16N	Pg 16	5-10	6-10	0.24-0.39	USR-CNR
2911.21N	Pg 21	6-13	7-13	0.28-0.51	USR-CNR
2911.29N	Pg29	11-20	12-20	0.47-0.79	USR-CNR
2911.36N	Pg36	18-26	19-26	0.75-1.02	USL-CNL
2911.42N	Pg42	24-31	24-31	0.94-1.22	USL-CNL

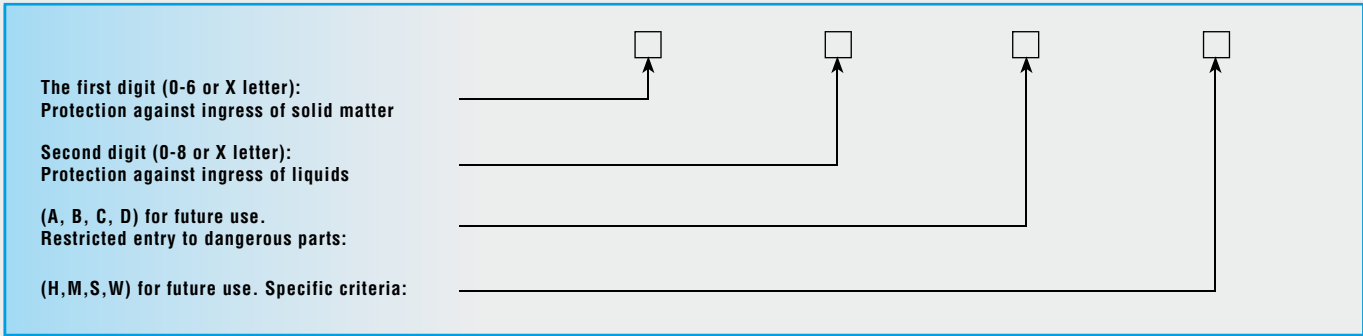

**1st CHARACTERISTIC NUMBER:
PROTECTION AGAINST INGRESS OF SOLID MATTER**

PROTECTION	0	1	2	3	4	5	6
Protection against ingress of solid matter caused by		solid bodies measuring over 50 mm	solid bodies measuring over 12,5 mm	solid bodies measuring over 2,5 mm	solid bodies measuring over 1 mm	powder in harmful quantities	Powder (completely protected)
Test method		Accessibility gauge \varnothing 50 mm	Accessibility gauge \varnothing 12,5 mm	Accessibility gauge \varnothing 2,5 mm	Accessibility gauge \varnothing 1 mm	talcum powder	talcum powder

**2nd CHARACTERISTIC NUMBER:
PROTECTION AGAINST INGRESS OF LIQUIDS**



PROTECTION	0	1	2	3	4	5	6	7	8
Protection against ingress of liquids caused by		Drops of water falling vertically	Vertical drops of water with inclination of casing up to 15°	Rain	Sprays of water	Jets of water	Powerful jets of water	Temporary Immersion	Permanent Immersion
Test method		Agreement between manufacturer and user but more severe than 7	Agreement between manufacturer and user but more severe than 7	Agreement between manufacturer and user but more severe than 7	Agreement between manufacturer and user but more severe than 7	Agreement between manufacturer and user but more severe than 7	Agreement between manufacturer and user but more severe than 7	Agreement between manufacturer and user but more severe than 7	Agreement between manufacturer and user but more severe than 7

**1st ADDITIONAL LETTER
RESTRICTED ENTRY TO DANGEROUS PARTS**

RESTRICTED ENTRY	A	B	C	D
Restricted entry to dangerous parts caused by	back of hand	finger	tool	wire
Test method	accessibility gauge \varnothing 50 mm	articulated test finger	accessibility gauge \varnothing 2,5 mm	accessibility gauge \varnothing 1 mm

**2nd ADDITIONAL LETTER
MEANING OF THE SECOND ADDITIONAL LETTER**

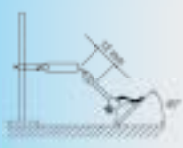
SPECIFIC CRITERIA	H	M	S	W
Specific criteria	High voltage equipment	Tested against negative effects of water penetration, when the moveable parts of the equipment (e.g. wheels of a revolving machine) are moving	Tested against the negative effects of water penetration, when the moveable parts of the equipment (e.g. wheels of a revolving machine) are stationary	Suitable for use in environmental conditions as specified and equipped with additional measures of protection

TYPE OF TEST	TEST EQUIPMENT	COMPLIANCE WITH STANDARDS	OBJECTIVE OF TEST	TEST RESULTS	TEST CONDITIONS		
					heat source	length of test	characteristic features
CHARACTERISTIC FEATURES		IEC 695-2-1 CEI 50-11 DIN VDE 0471-2-1	Check that abnormal heating produced by overcurrent and bad contacts does not compromise the safety of the insulating material. Lighting test. The wire is pressed against the sample using force and penetrates up to 7 mm.	Any sign of flame starting must stop within 30 sec. of removing the glowing wire TEST TEMPERATURE <ul style="list-style-type: none"> • 650° for materials which do not support parts under tension • 750° for materials which support parts under tension of moving sockets and plugs • 850° for materials which support parts under tension of fixed sockets and switches 	Glow-wire 4 mm in diameter	Wire applied for 30 seconds	Flame extinction time
NEEDLE FLAME		IEC 695-2-1 CEI 50-11	Simulates the effect small flames have which may occur due to internal faults of products in order to judge the fire risk.	<ul style="list-style-type: none"> • the sample does not catch fire • the flame and incandescent particles do not spread the fire • combustion lasts less than 30 seconds 	Bunsen burner flame	Flame applied for (Ta) 5, 10, 20, 30, 60, 120 sec. According to particular standards	The degree of severity: flame application time (Ta)
UL (UNDERWRITER LABORATORIES)		UL 94	Measuring of time the sample continues to burn after the direct flame has been removed	<ul style="list-style-type: none"> • V0 if the sample burns for less than 5 sec. before going out. • V1 if it burns for less than 25 sec. • V2 if it burns for less than 25 sec. With incandescent drops • HB if it burns for more than 25 sec. (horizontal sample and burning speed less than 38 mm per minute) Comparable to ASTM D-635 	Bunsen burner flame	Flame applied for 10 seconds twice following	Length of combustion

MAXIblock[®], *spiralblock*[®], **MAXIbrass**[®], **MAXIinox**

to obtain IP68 ingress protection in accordance with EN 50262

Torque ratio values apply to mounting in a threaded entry and to use with a locknut

THREAD CABLE GLAND	CABLE GLAND torque ratio Nm	
	metallic	non-metallic
M12 x 1,5	6	2,7
M16 x 1,5	6	5,0
M20 x 1,5	8	7,0
M25 x 1,5	8	7,5
M32 x 1,5	12	8,0
M40 x 1,5	18	8,0
M50 x 1,5	18	10,0
M63 x 1,5	18	10,0

MAXIblock[®], *spiralblock*[®], **MAXIbrass**[®], **MAXIinox**

to obtain IP68 ingress protection in accordance with DIN VDE for Pg threads

Torque ratio values apply to mounting in a threaded entry and to use with a locknut

THREAD CABLE GLAND	CABLE GLAND torque ratio Nm		
	metallic	non-metallic series	
		1900	1910
Pg 7	6.25	2.5	2.5
Pg 9	6.25	3.75	3.75
Pg 11	6.25	3.75	3.75
Pg 13,5	6.25	3.75	3.75
Pg 16	7.5	5.0	5.0
Pg 21	10.0	7.5	7.5
Pg 29	10.0	7.5	7.5
Pg 36	18.0	7.5	7.5
Pg 42	18.0	7.5	10.0
Pg 48	18.0	7.5	10.0

MAXIblock[®], *spiralblock*[®]

to obtain IP68 with reduced tightening force for GAS threads

Torque ratio values apply to mounting in a threaded entry and to use with a locknut

THREAD CABLE GLAND	CABLE GLAND non-metallic torque ratio Nm
	G1/4"
G3/8"	5
G1/2"	6
G3/4"	10

Also available in the Cembre product range

"Industrial Marking Systems"



GENERAL MARKING

Group Company Cembre

ROLLY

THERMAL TRANSFER SYSTEM FOR REEL MEDIA PRINTING



MARKINGENIUS 2

PC-DRIVEN THERMAL TRANSFER MARKER PRINTING SYSTEM



PLOT SYSTEM

PC-DRIVEN INK PLOTTER MARKER PRINTING SYSTEM

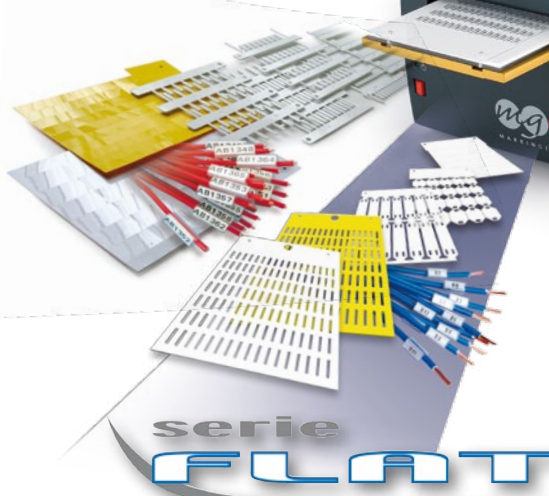

serie FLAT

NEW MARKERS FOR THE IDENTIFICATION OF TERMINAL BLOCKS AND CABLES

SIGN stick-onsys

WARNING, PROHIBITION AND MANDATORY SIGNS



RING cablesys

MANUAL CABLE MARKING SYSTEMS

ASK FOR THE CATALOGUES



Cembre

Crimpstar

ZETAmini

MAXIblock



oelma

nd

ZETApiù

spiralblock

MARKIN Genius

ZETAblock

MAXIbrass



SICUR clips

are registered trademarks of Cembre S.p.A.

The information contained in this catalogue is to aid the commercial selection of products. It is not intended for use as an instruction manual. Information concerning application and the correct operational use is provided by the specific manual delivered with the products.

This catalogue is the property of Cembre. Any reproduction (in full or in part) is forbidden without the prior written permission of Cembre.

Cembre reserve the right to modify the specifications in this catalogue without prior notice.



Cembre S.p.A.
Via Serenissima, 9
25135 Brescia (Italia)
Telefono: +39 030 36921
Telefax: +39 030 3365766
E-mail: info@cembre.com
www.cembre.it



Cembre Ltd.
Dunton Park
Kingsbury Road, Curdworth - Sutton Coldfield
West Midlands B76 9EB (Great Britain)
Tel.: 01675 470440 - Fax: 01675 470220
E-mail: sales@cembre.co.uk
www.cembre.co.uk



Cembre S.a.r.l.
22 Avenue Ferdinand de Lesseps
91420 Morangis (France)
Tél.: 01 60 49 11 90 - Fax: 01 60 49 29 10
B.P. 37 - 91421 Morangis Cédex
E-mail: info@cembre.fr
www.cembre.fr



Cembre España S.L.
Calle Verano 6 y 8
Polígono Industrial "Las Monjas"
28850 Torrejón de Ardoz - Madrid (España)
Teléfono: 91 4852580 - Telefax: 91 4852581
E-mail: info@cembre.es
www.cembre.es



Cembre AS
Fossnes Senter
N-3160 Stokke (Norway)
Phone: 33361765
Telefax: 33361766
E-mail: cembre@cembre.no
www.cembre.no



Cembre GmbH
Heidemannstraße 166
80939 München (Deutschland)
Telefon: 089/3580676
Telefax: 089/3580677
E-mail: info@cembre.de
www.cembre.de



Cembre Inc.
Raritan Center Business Park
181 Fieldcrest Avenue
Edison, New Jersey 08837 (USA)
Tel.: (732) 225-7415 - Fax: (732) 225-7414
E-mail: Sales.US@cembreinc.com
www.cembreinc.com

www.cembre.com