



LASERJET PRO M1212NF

MULTIFUNCTION PRINTER \$199.99

TECH 2000, INC.

Tackle your everyday office tasks with an affordable, full-featured MFP. Easily Print, Copy, Scan and Fax from one compact machine—with Ethernet connectivity and energy-saving features.

- Print:** Up to 19 ppm black (letter); Up to 18 ppm black (A4); First page out black: As fast as 8.5 sec
- Scan:** Up to 1200 x 1200 dpi; Scan Type: Flatbed, ADF
- Copy:** Up to 600 x 400 dpi resolution; Up to 99 copies maximum number of copies
- Fax:** 33.6 kbps; Letter: 3 sec per page
- Paper Handling:** 150-sheet input tray, 100-sheet face-down bin
- Standard Connectivity:** Hi-Speed USB 2.0 port, 10/100Base-T Ethernet network port, RJ-11 Telephone port
- Monthly Volume (Duty Cycle):** Up to 8,000 pages



Get more done—affordably—with a full-featured MFP

- Share a printing network, using built-in Ethernet, and save office space with the compact size.
- Print high-quality documents with bold text and sharp images, using Original HP print cartridges.
- Send and receive faxes from your PC, using the 33.6 kbps fax.
- Print documents at up to 19 ppm letter/18 ppm A4. Start printing fast with Instant-on Technology.

Get up and running quickly and easily

- Install in a flash on your PC or Netbook—without a CD—using HP Smart Install.¹
- Set up and start printing fast with an easy-to-use control panel. Copy a duplex ID onto one page with ID Copy.
- Connect the MFP directly to a PC or Netbook via the included Hi-Speed USB 2.0 port
- Ensure reliable printing with an HP all-in-one print cartridge. Easily replace it with HP SureSupply.²

Reduce your impact and protect your bottom line

- Conserve energy with HP Auto-On/Auto-Off Technology³, Instant-on Technology and Instant-on Copy.
- Reduce your impact—pre-installed cartridges decrease packaging. Recycle easily with HP Planet Partners.⁴
- Get the services, solutions, software and support of HP Total Care.
- Save energy with an ENERGY STAR[®] qualified MFP.

ecoHIGHLIGHTS

HP LASERJET PRO M1212NF MULTIFUNCTION PRINTER

- Save energy—HP Auto-On/Auto-Off Technology turns your printer on when you need it, off when you don't.¹
- Save up to four times the energy with Instant-on Copy.²

ENERGY STAR[®] Qualified Product

¹HP Auto-On and Auto-Off capabilities subject to printer and settings.

²When compared with fluorescent tubes, Instant-on Copy with LED technology drops energy use by 4 times in idle mode and 1.4 times in copy mode.

www.hp.com/ecosolutions

Please recycle your computing hardware and printing supplies. Find out how at our website.



¹HP Smart Install works with Windows only. ²Program features and availability may vary by country. For more information, visit <http://www.hp.com/learn/suresupply>. ³HP Auto-On and Auto-Off capabilities subject to printer and settings. ⁴HP toner cartridge return and recycling is available in 49 countries and territories around the world, covering 88% of the addressable market; see <http://www.hp.com/recycle> for details.





LASERJET PRO M1212NF

MULTIFUNCTION PRINTER

TECH 2000, INC.

TECHNICAL SPECIFICATIONS

| | |
|--|---|
| FUNCTIONS | Print, copy, scan, fax |
| STANDARD PRINTER LANGUAGES | Host-based |
| PRINT RESOLUTION | Black (Best): Up to 600 x 600 dpi (1200 dpi effective); Black (Normal): Up to 600 x 400 dpi |
| PRINT TECHNOLOGY RESOLUTION | FastRes 600; FastRes 1200 |
| PRINT TECHNOLOGY | Laser |
| PRINT SPEED¹ | Black (Letter): Up to 19 ppm; Black (A4): Up to 18 ppm; First Page Out Black²: As fast as 8.5 sec |
| NUMBER OF PRINT CARTRIDGES | 1 (black) |
| PRINTER SMART SOFTWARE FEATURES | Smart Install, Simplified control panel, Auto-On/Auto-Off, Compact design |
| RECOMMENDED MONTHLY PAGE VOLUME | 250 to 2,000 |
| DUTY CYCLE (MONTHLY) | Up to 8,000 pages |
| TWAIN VERSION | Version 1.9 |
| COLOR SCANNING | Yes |
| SCAN TYPE | Flatbed, ADF |
| SCAN RESOLUTION | Enhanced: Up to 19,200 dpi; Hardware: Up to 1200 x 1200 dpi; Optical: Up to 1200 dpi |
| SCAN SPEED | 4 x 6 in (10 x 15 cm) color photo to file: less than 7 sec for single; Black (Normal): Up to 6 ppm; Color (Normal): Up to 3 ppm; ADF: Up to 7.4 ppm (black and white), Up to 3 ppm (color) |
| GRAYSCALE LEVELS/BIT DEPTH | 256/24-bit |
| SCAN FILE FORMAT | JPEG, TIF (compressed and uncompressed), PDF, GIF, BMP |
| SCAN INPUT MODES | Scanning via HP LaserJet scan application or TWAIN—or WIA-compliant application software |
| SCAN SIZE MAXIMUM | ADF: 8.5 x 14 in (216 x 356 mm); Flatbed: 8.5 x 11.7 in (216 x 297 mm) |
| COPY RESOLUTION | Black (Text and Graphics): Up to 600 x 400 dpi; Color (Text and Graphics): Up to 600 x 400 dpi |
| COPY SPEED | Black (Letter): Up to 19 cpm; Black (A4): Up to 18 cpm |
| MAXIMUM NUMBER OF COPIES | Up to 99 copies |
| COPIER RESIZE | 25 to 400% |
| FAX RESOLUTION | Black and White, Best Mode: Up to 300 x 300 dpi; Black and White, Standard Mode: 203 x 98 dpi |
| FAX SPEED | 33.6 kbps; Letter: 3 sec per page |
| FAX FEATURES | Fax Memory (Letter): Up to 500 pages; Auto Fax Reduction Supported: Yes; Auto-Retrieving: Yes; Fax Delayed Sending: Yes; Distinctive Ring Detection Supported: Yes; Fax Forwarding Supported: Yes; Fax Phone TAM Interface Supported: Yes; Fax Polling Supported: Yes; Fax Telephone Mode Supported: Yes; Junk Barrier Supported: Yes; Maximum Speed Dialing Numbers: Up to 100 numbers; PC Interface Supported: Yes; Remote Retrieval Capability Supported: Yes; Telephone Handset Supported: No |
| MODEM | 33.6 kbps |
| STANDARD CONNECTIVITY | Hi-Speed USB 2.0 port, 10/100Base-T Ethernet network port, RJ-11 Telephone port |
| NETWORK CAPABILITIES | Via built-in 10/100Base-T TCP/IP networking; Network Ready: Standard (built-in Ethernet) |
| CONTROL PANEL | 2-line, 16-character display, menu and navigation buttons (Setup/Enter, Left, Right, Cancel), copy control buttons (Number buttons, Lighter/Darker, More copy settings, Start Copy), Fax control buttons (Redial, Start Fax), 3 LED indicator lights (Attention, Ready, Toner low) |
| OUTPUT FILE FORMAT | PDF, TIF, BMP, GIF, JPG |
| DIGITAL SENDING STANDARD FEATURES | Scan to E-mail, scan to application, scan to file |
| DISPLAY | 2-line LCD |
| MAXIMUM/STANDARD MEMORY | 64 MB |
| PROCESSOR TYPE/SPEED | Marvell processor/400 MHz |
| DUPLEX PRINT OPTIONS | Manual (driver support provided) |
| MEDIA TYPE AND CAPACITY | ADF: Up to 35 sheets; Tray 1: Sheets: 150, Envelopes: 10 |
| MEDIA TYPES SUPPORTED | Paper (plain, laser), envelopes, transparencies, labels, cardstock, postcards |

| | |
|--------------------------------------|--|
| MEDIA WEIGHT | ADF: 60 to 90 g/m ² (16 to 24 lb) bond; Tray 1: 16 to 43 lb |
| CUSTOM MEDIA SIZES | 3 x 5 to 8.5 x 14 in (76 x 127 to 216 x 356 mm) |
| AUTO DOCUMENT FEEDER CAPACITY | Standard, 35 sheets |
| PRINT HANDLING | 150-sheet input tray, 100-sheet face-down bin Input Capacity: Up to 150 sheets, Up to 10 envelopes; Output Capacity: Up to 100 sheets, Up to 10 envelopes, Up to 75 sheets transparencies |
| POWER | Power Supply Type: Built-in power supply; Power Requirements: Input voltage 110 to 127 VAC (+/- 10%), 60 Hz (+/- 2 Hz); 220 to 240 VAC (+/- 10%), 50/60 Hz (+/- 2 Hz); Power Consumption: 375 watts active, 0.3 watts off, 2 watts powersave, 4.7 watts standby; Typical Electricity Consumption (TEC) Number: 0.771 kWh/Week; ENERGY STAR [®] qualified models; see http://www.hp.com/go/energystar |
| SOFTWARE INCLUDED | Host-based print drivers, TWAIN, WIA, Scan to application, XPS driver, Mac driver, Send Fax, Toolbox |
| COMPATIBLE OPERATING SYSTEMS | Microsoft [®] Windows [®] 7, Windows Vista [®] , Windows [®] XP, Windows [®] Server 2003; Mac OS X v 10.4, v 10.5, v 10.6; Linux (see: http://www.hp.com/go/linux) |
| MINIMUM SYSTEM REQUIREMENTS | PC: Microsoft [®] Windows [®] 7, Windows Vista [®] , Windows [®] XP, Windows [®] Server 2003, Windows [®] Server 2008: 1 GHz processor, 1 GB RAM, 700 MB free hard disk space, SVGA 800 x 600 with 16-bit color display, Internet Explorer 5.5 or higher, USB or Ethernet port Mac: Mac OS X v 10.4, v 10.5, v 10.6; PowerPC G3, G4, G5, or Intel processors; 1 GB RAM; 200 MB available hard disk space; CD-ROM drive; USB or network port |
| ACOUSTIC² | Acoustic Power Emissions: 6.3 B(A); Acoustic Power Emissions (Ready): Inaudible; Acoustic Pressure Emissions: 50 dB(A) |
| OPERATING ENVIRONMENT | Operating Temperature Range: 10 to 32.5° C; Recommended Operating Temperature: 50 to 91° F (10 to 32.5° C); Maximum Operating Temperature: 50 to 91° F; Storage Temperature Range: 32 to 95° F (0 to 35° C); Non-Operating Humidity Range: 10 to 80% RH; Operating Humidity Range: 10 to 80% RH; Recommended Humidity Operating Range: 10 to 80% RH |
| PRODUCT DIMENSIONS | W X D X H: 17.1 x 10.4 x 12 in (435 x 265 x 306 mm); Maximum: 17.1 x 14.4 x 12 in |
| PRODUCT WEIGHT | 18.3 lb (8.3 kg) |
| WHAT'S IN THE BOX | HP LaserJet Pro M1212nf MFP, power cord(s), phone cord(s), 150-sheet input tray, output tray, introductory HP LaserJet Black print cartridge, Readiris PRO text recognition software, CD(s) with software and documentation, Installation Guide, support flyer, Errata sheet, Discovery Sheet, Ferrite with flyer, Warranty Guide (where applicable) |
| WARRANTY | One-year limited warranty |
| REPLACEMENT CARTRIDGES | HP LaserJet Black Print Cartridge, CE285A ; Declared yield value in accordance with ISO/IEC 19752 |
| HP CARE PACK SERVICES | UG606E, HP 2-year NBD ExchPrinting and Imaging-M SVC UG609E, HP 3-year NBD ExchPrinting and Imaging-M SVC UH610E, HP 4-year NBD ExchPrinting and Imaging-M SVC US284E, HP Basic Installation Service for one consumer printer with wireless capability US285E, HP Premium Installation Service with wireless network setup for up to three PCs and/or printers |
| ACCESSORIES | Hi-Speed USB Cable (6 ft./1.8 m), Q6264A |

ADDITIONAL INFORMATION

| | |
|---------------------------|--|
| BUSINESS UNIT | Transaction Laser Products |
| COUNTRY OF ORIGIN | Product of China; Brazil |
| MATERIAL TYPE CODE | FERT |
| PALLET INFORMATION | Dimensions: 47.24 x 39.37 x 96.73 in Weight: 881.5 lb Layers: 7 |

FOR MORE INFORMATION VISIT OUR WEBSITE AT WWW.HP.COM

HP LASERJET PRO M1212NF MULTIFUNCTION PRINTER Product Number: **CE841A**

¹Exact speed varies depending on the system configuration, software program, and document complexity. ²Acoustic values are subject to change. For current information, see <http://www.hp.com/support>. Configuration tested: LaserJet Pro M1212nf MFP printing simplex on A4 paper



LaserJet Pro M1217nfw

Multifunction Printer **\$249.99**

TECH 2000, INC.

Print from virtually anywhere in your office with a full-featured, wireless MFP.⁶ Plug and print with HP Smart Install². Easily tackle everyday business tasks—copying, scanning and faxing—and share resources from one Ethernet-connected machine.

- Print Speed¹:** Up to 19 ppm (letter) **First Page Out:** As fast as 8.5 sec
Scan Resolution: Up to 1200 x 1200 dpi; **Scan Type:** Flatbed, ADF
Copy Resolution: Up to 600 x 400 dpi resolution; **Max Number of Copies:** Up to 99 copies
Fax Speed⁷: 33.6 kbps, 3 sec per page letter
Paper Handling: 150-sheet input tray, 100-sheet face-down bin
Standard Connectivity: Hi-Speed USB 2.0 port, 10/100Base-T Ethernet network port, RJ-11 Telephone port, Wireless 802.11b/g/n
Monthly Volume (Duty Cycle): Up to 8,000 pages



Get more done—affordably—with a full-featured MFP

- Share a printing network using built-in Ethernet. Work from anywhere in the office using built-in wireless.⁶
- Print high-quality documents with bold text and sharp images, using Original HP print cartridges.
- Send and receive faxes from your PC, using the 33.6 kbps fax.
- Print documents at up to 19 ppm letter. Start printing fast with Instant-on Technology.

Get up and running quickly and easily

- Plug and print in as fast as five minutes—no CD required with HP Smart Install.²
- Set up and start printing fast with an easy-to-use control panel. Copy a duplex ID onto one page with ID Copy.
- Connect the MFP directly to a PC or Netbook via the included Hi-Speed USB 2.0 port.
- Ensure reliable printing with an HP all-in-one print cartridge. Easily replace it with HP SureSupply.³

Reduce your impact and protect your bottom line

- Conserve energy with HP Auto-On/Auto-Off Technology,⁴ Instant-on Technology and Instant-on Copy.
- Reduce your impact—pre-installed cartridges decrease packaging. Recycle easily with HP Planet Partners.⁵
- Get the services, solutions, software and support of HP Total Care.
- Save energy with an ENERGY STAR[®] qualified MFP.

ecoHIGHLIGHTS

HP LaserJet Pro M1217nfw Multifunction Printer

- Save energy—HP Auto-on/Auto-off Technology turns your printer on when you need it, Off when you don't.¹
- Save up to four times the energy with Instant-on Copy.²

ENERGY STAR[®] qualified

¹HP Auto-On and Auto-Off capabilities subject to printer and settings.
²When compared with fluorescent tubes, Instant-on Copy with LED technology drops energy use by 4 times in idle mode and 1.4 times in Copy mode.

www.hp.com/ecosolutions

Please recycle your computing hardware and printing supplies. Find out how at our website.



¹Exact speed varies depending on the system configuration, software program, and document complexity. ²For Microsoft Windows only. Installation time may vary. ³Program features and availability may vary by country. For more information, visit <http://www.hp.com/learn/suresupply>. ⁴HP Auto-On and Auto-Off capabilities subject to printer and settings. ⁵HP toner cartridge return and recycling is available in 49 countries and territories around the world, covering 88% of the addressable market; see <http://www.hp.com/recycle> for details. ⁶Wireless performance is dependent upon physical environment and distance from access point, and may be limited during active VPN connections. ⁷Based on standard ITU-T test image #1 at standard resolution. More complicated pages or higher resolution will take longer and use more memory.





LaserJet Pro M1217nfw

Multifunction Printer

TECH 2000, INC.

TECHNICAL SPECIFICATIONS

| | |
|--|---|
| FUNCTIONS | Print, copy, scan, fax |
| STANDARD PRINTER LANGUAGES | Host-based |
| PRINT RESOLUTION | Black (Best): Up to 600 x 600 dpi (1200 dpi effective); Black (Normal): Up to 600 x 400 dpi |
| PRINT TECHNOLOGY RESOLUTION | FastRes 600, FastRes 1200 |
| PRINT TECHNOLOGY | Laser |
| PRINT SPEED¹ | Black (Letter): Up to 19 ppm First Page Out²: As fast as 8.5 sec |
| NUMBER OF PRINT CARTRIDGES | 1 (black) |
| PRINTER SMART SOFTWARE FEATURES | Smart Install, Simplified control panel, Auto-on/Auto-off, Compact design, Wireless connection |
| DUTY CYCLE (MONTHLY)³ | Up to 8,000 pages |
| RECOMMENDED MONTHLY PAGE VOLUME⁴ | Up to 250 to 2,000 pages |
| COLOR SCANNING | Yes |
| TWAIN VERSION | Version 1.9 |
| SCAN TYPE | Flatbed, ADF |
| SCAN RESOLUTION | Enhanced: Up to 19,200 dpi; Hardware: Up to 1200 x 1200 dpi; Optical: Up to 1200 dpi |
| SCAN SPEED | 4 x 6 in (10 x 15 cm) color photo to file: less than 7 sec for single; Black (Normal): Up to 6 ppm; Color (Normal): Up to 3 ppm; ADF: Up to 7.4 ppm (black and white), Up to 3 ppm (color) |
| GRAYSCALE LEVELS/BIT DEPTH | 256/24-bit |
| SCAN FILE FORMAT | JPEG, TIF (compressed and uncompressed), PDF, GIF, BMP |
| SCAN INPUT MODES | Scanning via HP LaserJet scan application or TWAIN—or WIA-compliant application software |
| SCAN SIZE MAXIMUM | ADF: 8.5 x 14 in (216 x 356 mm); Flatbed: 8.5 x 11.7 in (216 x 297 mm) |
| COPY RESOLUTION | Black (Text and Graphics): Up to 600 x 400 dpi; Color (Text and Graphics): Up to 600 x 400 dpi |
| COPY SPEED | Black (Letter): Up to 19 cpm; Black (A4): Up to 18 cpm |
| MAX NUMBER OF COPIES | Up to 99 copies |
| COPIER RESIZE | 25 to 400% |
| COPIER SETTINGS | Number of copies, Lighter/Darker, Reduce/Enlarge, Copy quality (draft, text, mixed, picture, photo) |
| FAX RESOLUTION | Black and White, Best Mode: Up to 300 x 300 dpi; Black and White, Standard Mode: Up to 203 x 98 dpi |
| FAX SPEED⁵ | 33.6 kbps; Letter: 3 sec per page |
| FAX FEATURES | Fax Memory (Letter): Up to 500 pages; Auto Fax Reduction Supported: Yes; Fax Auto-Redialing: Yes; Fax Delayed Sending: Yes; Distinctive Ring Detection Supported: Yes; Fax Forwarding Supported: Yes; Fax Phone TAM Interface Supported: Yes; Fax Polling Supported: Yes; Fax Telephone Mode Supported: Yes; Junk Barrier Supported: Yes; Maximum Speed Dialing Numbers: Up to 100 numbers; PC Interface Supported: Yes; Remote Retrieval Capability Supported: Yes; Telephone Handset Supported: No |
| MODEM | 33.6 kbps |
| STANDARD CONNECTIVITY | Hi-Speed USB 2.0 port, 10/100Base-T Ethernet network port, RJ-11 Telephone port, Wireless 802.11b/g/n |
| NETWORK CAPABILITIES | Via built-in 10/100Base-T TCP/IP networking; Network Ready: Standard (built-in Ethernet, WiFi 802.11b/g/n) |
| CONTROL PANEL | 2-line, 16-character display, menu and navigation buttons (Setup/Enter, Left, Right, Cancel), copy control buttons (Number buttons, Lighter/Darker, More copy settings, Start Copy), Fax control buttons (Redial, Start Fax), 3 LED indicator lights (Attention, Ready, Toner low) |
| DIGITAL SENDING STANDARD FEATURES | Scan to E-mail, scan to application, scan to file |
| DISPLAY | 2-line LCD |
| MAXIMUM/STANDARD MEMORY | 64 MB |
| PROCESSOR TYPE/SPEED | Marvell processor/400 MHz |

| | |
|---|--|
| DUPLEX PRINT OPTIONS | Manual (driver support provided) |
| MEDIA TYPE AND CAPACITY | ADF: Up to 35 sheets; Tray 1: Sheets: 150, Envelopes: 10 |
| MEDIA TYPES | Paper (plain, laser), envelopes, transparencies, labels, cardstock, postcards |
| MEDIA WEIGHT | ADF: 60 to 90 g/m ² (16 to 24 lb) bond; Tray 1: 16 to 43 lb |
| CUSTOM MEDIA SIZES | 3 x 5 to 8.5 x 14 in (76 x 127 to 216 x 356 mm) |
| AUTO DOCUMENT FEEDER CAPACITY | Standard, 35 sheets |
| PRINT HANDLING | 150-sheet input tray, 100-sheet face-down bin; Input Capacity: Up to 150 sheets, Up to 10 envelopes; Output Capacity: Up to 100 sheets, Up to 10 envelopes, Up to 75 sheets transparencies |
| POWER⁶ | Power Supply Type: Built-in power supply; Power Requirements: Input voltage 110 to 127 VAC (+/- 10%), 60 Hz (+/- 2 Hz); 220 to 240 VAC (+/- 10%), 50/60 Hz (+/- 2 Hz) |
| SOFTWARE INCLUDED | Host-based print drivers, TWAIN, WIA, Scan-To application, XPS driver, Mac driver, Send Fax, Toolbox, Wireless config utility |
| COMPATIBLE OPERATING SYSTEMS⁷ | Microsoft® Windows® 7, Windows Vista®, Windows® XP, Windows® Server 2008, Windows® Server 2003, Mac OS X v 10.4, v 10.5, v 10.6, Linux (see http://www.hp.com) |
| MINIMUM SYSTEM REQUIREMENTS | PC: Microsoft® Windows® 7, Windows Vista®, Windows® XP, Windows® Server 2008, Windows® Server 2003: 1 GHz processor, 1 GB RAM, 700 MB free hard disk space, SVGA 800 x 600 with 16-bit color display, Internet Explorer 5.5 or higher, USB or Ethernet port; Mac: Mac OS X v 10.4, v 10.5, v 10.6, PowerPC G3, G4, G5, or Intel processors, 1 GB RAM, 200 MB available hard disk space, CD-ROM drive, USB or network port |
| ACOUSTIC⁸ | Acoustic Power Emissions: 6.3 B(A); Acoustic Power Emissions (Ready): Inaudible; Acoustic Pressure Emissions: 50 dB(A); Acoustic Pressure Emissions Bystander (Ready): Inaudible |
| OPERATING ENVIRONMENT | Operating Temperature Range: 50 to 91° F (10 to 32.5° C); Recommended Operating Temperature: 50 to 91° F (10 to 32.5° C); Storage Temperature Range: 32 to 95° F (0 to 35° C); Non-Operating Humidity Range: 10 to 80% RH; Operating Humidity Range: 10 to 80% RH; Recommended Humidity Operating Range: 10 to 80% RH |
| PRODUCT DIMENSIONS | W x D x H: 17.1 x 10.4 x 12 in (435 x 265 x 306 mm); Maximum: 17.1 x 14.4 x 12 in |
| PRODUCT WEIGHT | 18.3 lb (8.3 kg) |
| WHAT'S IN THE BOX | HP LaserJet Pro M1217nfw MFP, power cord(s), phone cord(s), 150-sheet input tray, output tray, introductory HP LaserJet Black print cartridge, Readiris PRO text recognition software, CD(s) with software and documentation, Installation Guide, support flyer, Errata sheet, Discovery Sheet, Ferrite with flyer, Warranty Guide, USB cable |
| WARRANTY | One-year limited warranty |
| REPLACEMENT CARTRIDGES | HP LaserJet Black Print Cartridge, CE285A |
| ACCESSORIES | Hi-Speed USB Cable (6 ft./1.8 m), Q6264A |
| HP SERVICES AND SUPPORT OPTIONS | HP 2-year Next Business Day Exch w/Enhanced Phone Support, UQ223A HP 3-year Next Business Day Exch w/Enhanced Phone Support, UQ224A HP 4-year Next Business Day Exch w/Enhanced Phone Support, UQ225A |

FOR MORE INFORMATION VISIT OUR WEBSITE AT [WWW.HP.COM](http://www.hp.com)

HP LaserJet Pro M1217nfw Multifunction Printer Product Number: **CE844A**

ENERGY STAR® qualified models; see <http://www.hp.com/go/energystar>

¹Exact speed varies depending on the system configuration, software program, and document complexity. ²Acoustic values are subject to change. For current information, see <http://www.hp.com/support>. Configuration tested: LaserJet Pro M1217nfw MFP printing simplex on A4 paper. ³Duty cycle is defined as the maximum number of pages per month of imaged output. This value provides a comparison of product robustness in relation to other HP LaserJet or HP Color LaserJet devices, and enables appropriate deployment of printers and MFPs to satisfy the demands of connected individuals or groups. ⁴HP recommends that the number of pages per month of imaged output be within the stated range for optimum device performance, based on factors including supplies replacement intervals and device life over an extended warranty period. ⁵Based on standard ITU-T test image #1 at standard resolution. More complicated pages or higher resolution will take longer and use more memory. ⁶Values subject to change. See <http://www.hp.com/support> for current information. Power numbers are the highest values measured using all standard voltages. Default time from Ready-Mode to Auto-Off: 15 minutes. ⁷For Windows® Server 2008 and Windows® Server 2003, add Print and Scan drivers only. ⁸Measured according to ISO 7779 and declared in accordance with ISO 9296; values are subject to change. For current information, see <http://www.hp.com/support>. Configuration tested: LaserJet Pro M1217nfw MFP printing simplex on A4 paper.

©2011 Hewlett-Packard Development Company, L.P. HP is a registered trademark of the Hewlett-Packard Company. ENERGY STAR and the ENERGY STAR logo are registered U.S. marks. All other trademarks are the property of their respective owners. Microsoft and Windows are registered trademarks of Microsoft Corporation. Adobe and Acrobat are trademarks of Adobe Systems Incorporated. This listing of non HP products does not constitute an endorsement by Hewlett-Packard Company. The information contained herein is subject to change without notice and is provided "as is" without warranty of any kind. HP shall not be liable for technical or editorial errors or omissions contained herein. **January 2011, Rev 1**



LASERJET PRO M1536DNF

MULTIFUNCTION PRINTER \$299.99-\$50.00

TECH 2000, INC.

Tackle daily business tasks with a cost-effective, fast HP LaserJet MFP. Print two-sided documents from anywhere, using HP ePrint.⁵ Streamline your workflow by copying, scanning, faxing and connecting securely via Ethernet networking.

Print Speed⁶: Black: Up to 26 ppm; **First Page Out Black:** As fast as 8.5 sec
Print Resolution: Up to 600 x 600 x 2 dpi; **Technology Resolution:** HP REt, HP FastRes
Scan Resolution: Up to 1200 x 1200 dpi; **Scan Type:** Flatbed, ADF
Copy Resolution (Black Graphics): Up to 1200 x 1200 dpi; **Max Copies:** Up to 99 copies
Fax Resolution (Black): 203 x 196 dpi; **Fax Speed Dialing, Max Numbers:** 120 numbers
Standard Connectivity: 1 Hi-Speed USB 2.0 port, 1 10/100 Ethernet network port
Duty Cycle (Monthly): Up to 8,000 pages
Duplex Print Options: Automatic (standard)



Do more with a fast MFP and two-sided printing

- Stay productive—Print at up to 26 ppm and get a first page out in as fast as 8.5 seconds.⁶
- Share printing resources with an Ethernet-connected MFP.
- Tackle multiple-page documents and two-sided prints with the 35-page automatic document feeder.
- Fax directly to and from a PC, and control fax access with assigned PINs.

Create high-quality documents in multiple sizes

- Print high-quality documents with bold text and sharp images, using Original HP LaserJet print cartridges.
- Achieve improved print quality with HP FastRes 1200.
- Handle multiple media sizes and types with a 10-sheet priority tray and the 250-sheet paper tray. HP LaserJet recommends ColorLok[®] papers for best printing results.

Print from anywhere⁵ and use intuitive features

- With HP ePrint, print from anywhere, anytime, using a mobile phone, notebook PC or other mobile device.⁵
- Simplify printing tasks with an intuitive control panel and LCD. Produce one-sided copies of two-sided IDs.
- Easily find and purchase cartridge replacements with HP SureSupply,³ and install them in a snap.
- Use embedded HP tools for easy MFP configuration, operation and maintenance.

Minimize your environmental impact

- Reduce your impact on the environment, and use up to 50 percent less paper with two-sided printing.
- Conserve energy with Instant-on Technology¹ and Instant-on Copy.⁴
- Get free and easy recycling—cartridges returned through HP Planet Partners are recycled responsibly.²
- Save energy and space with a compact, ENERGY STAR[®] qualified MFP.



ecoHIGHLIGHTS

HP LaserJet Pro M1536dnf Multifunction Printer

- Reduce energy up to 50% with Instant-on Technology.¹
- Save up to four times the energy with Instant-on Copy.²
- Reduce clutter and waste—scan, store and share documents digitally

ENERGY STAR[®] qualified

¹Energy savings based on HP testing using the ENERGY STAR[®] program's Typical Electricity Consumption (TEC) method on HP LaserJet products with Instant-on Technology vs. top competitive models as of March 2009. ²Program availability varies. HP print cartridge return and recycling is currently available in more than 49 countries, territories and regions in Asia, Europe, and North and South America through the HP Planet Partners program. For more information, visit <http://www.hp.com/recycle>. ³Program features and availability may vary by country. For more information, visit <http://www.hp.com/learn/suresupply>. ⁴When compared with fluorescent tubes, Instant-on Copy with LED technology drops energy use by 4 times in idle mode and 1.4 times in Copy mode. ⁵May require an Internet connection to the printer. Feature works with any Internet- and e-mail-capable device and requires a firmware upgrade. For details, <http://www.hp.com/go/ePrintCenter>. ⁶Measured using ISO/IEC 24734, excludes first set of test documents. For more information see <http://www.hp.com/go/printerclaims>. Exact speed varies depending on the system configuration, software application, driver, and document complexity.

www.hp.com/ecosolutions

Please recycle your computing hardware and printing supplies. Find out how at our website.



¹Energy savings based on HP testing using the ENERGY STAR[®] program's Typical Electricity Consumption (TEC) method on HP LaserJet products with Instant-on Technology vs. top competitive models as of March 2009. ²Program availability varies. HP print cartridge return and recycling is currently available in more than 49 countries, territories and regions in Asia, Europe, and North and South America through the HP Planet Partners program. For more information, visit <http://www.hp.com/recycle>. ³Program features and availability may vary by country. For more information, visit <http://www.hp.com/learn/suresupply>. ⁴When compared with fluorescent tubes, Instant-on Copy with LED technology drops energy use by 4 times in idle mode and 1.4 times in Copy mode. ⁵May require an Internet connection to the printer. Feature works with any Internet- and e-mail-capable device and requires a firmware upgrade. For details, <http://www.hp.com/go/ePrintCenter>. ⁶Measured using ISO/IEC 24734, excludes first set of test documents. For more information see <http://www.hp.com/go/printerclaims>. Exact speed varies depending on the system configuration, software application, driver, and document complexity.





LASERJET PRO M1536DNF

MULTIFUNCTION PRINTER

TECH 2000, INC.

TECHNICAL SPECIFICATIONS

| | |
|--|--|
| FUNCTIONS | Print, copy, scan, fax |
| STANDARD PRINTER LANGUAGES | HP PCL 6, HP PCL 5, PostScript |
| PRINT RESOLUTION | Black (Best): Up to 600 x 600 x 2 dpi; Black (Normal): Up to 600 x 600 x 2 dpi |
| PRINT TECHNOLOGY RESOLUTION | HP REt, HP FastRes |
| PRINT SPEED¹ | Black (Letter): Up to 26 ppm; First Page Out: As fast as 8.5 sec |
| NUMBER OF PRINT CARTRIDGES | 1 (black) |
| PRINTER SMART SOFTWARE FEATURES | Duplex printing, ePrinting, HP Universal Print Driver and HP Web Jetadmin supported |
| SCAN TYPE | Flatbed, ADF |
| SCANNER ADVANCED FEATURES | Instant on scanner, 35-page Automatic Document Feeder (ADF), OCR software in box |
| SCAN RESOLUTION | Enhanced: Up to 19,200 dpi; Hardware: Up to 1200 x 1200 dpi Optical: Up to 1200 dpi |
| SCAN SPEED | Black (Normal): Up to 26 ppm; ADF Speed: Up to 15 ppm |
| SCAN SIZE ADF (MAXIMUM) | 8.5 x 14 in (216 x 356 mm) |
| SCAN FILE FORMAT | JPEG, TIF, BMP, GIF, PDF, PNG |
| BIT DEPTH | 24-bit |
| COPY RESOLUTION | Black (Text): Up to 600 x 600 dpi; Black (Graphics): Up to 1200 x 1200 dpi Color (Text and Graphics): Up to 1200 x 1200 dpi |
| COPY SPEED | Black (Best, Letter): Up to 26 cpm; Black (Best, A4): Up to 25 cpm |
| MAXIMUM NUMBER OF COPIES | Up to 99 copies |
| COPY REDUCE/ENLARGE SETTINGS | 25 to 400% |
| COPIER SETTING | Up to 99 multiple copies, Collation, Reduce/Enlarge from 25% to 400%, Contrast (Lighter/Darker), Resolution (Copy quality), ID copy, Copy optimization, Draft mode copy, Manual duplex |
| FAX RESOLUTION | Black Photo Grayscale: 300 x 300 dpi (halftone enabled) Black and White, Standard Mode: 203 x 98 dpi; Black and White, Superfine Mode: 300 x 300 dpi (no halftone) |
| FAX SPEED DIALING, MAX NUMBERS | 120 numbers |
| FAX MODEM | 33.6 kbps |
| FAX MEMORY | Up to 400 pages |
| FAX FEATURES | Auto Fax Reduction Supported: Yes; Auto Redial: Yes Fax Delayed Sending: Yes; Distinctive Ring Detection Supported: Yes; Broadcast Locations: 119 Locations Fax Forwarding: Yes; Fax Phone Tam Interface Supported: Yes; Polling: Yes (Poll To Receive Only); Fax Telephone Mode Supported: Yes; Junk Fax Barrier: Yes Speed Dials, Maximum Number: Up To 120 Numbers (119 Group Dials) PC Interface Supported: Yes; Remote Retrieval: No Telephone Handset Supported: No |
| DUTY CYCLE (MONTHLY)⁴ | Up to 8,000 pages |
| RECOMMENDED MONTHLY PAGE VOLUME | Up to 500 to 2,000 pages |
| STANDARD CONNECTIVITY | 1 Hi-Speed USB 2.0 port, 1 10/100 Ethernet network port |
| NETWORK CAPABILITIES | 10/100 Ethernet; Network Ready: Standard (built-in Ethernet) |
| CONTROL PANEL | 2-line LCD text display, Buttons (Alphanumeric, Navigational), Copy buttons (Start copy, Reduce/Enlarge, Lighter/Darker, Copy menu, Number of copies), Fax buttons (Start fax, Phone book, Fax menu, Redial, Speed Dial), LED indicator lights (Setup, Left, Ok, Right, Back, Cancel) |
| DISPLAY | 2-line LCD (text) display |
| MAXIMUM/STANDARD MEMORY | 128 MB |
| PROCESSOR | Type: Freescale Coldfire V5X processor; Speed: 500 MHz |
| DUPLEX PRINT OPTIONS | Automatic (standard) |
| MEDIA TYPE AND CAPACITY | ADF: 35 sheets; Tray 1: 250 sheets; Tray 2: 10 sheets, 10 transparencies, 10 envelopes |
| MEDIA SIZES SUPPORTED | Tray 1 (priority feed tray): minimum: 3 x 5 in; maximum: 8.5 x 14 in; Tray 2 (main tray): minimum: 3 x 7.4 in; maximum: 8.5 x 14 in |
| STANDARD MEDIA SIZES (DUPLEX, IMPERIAL) | A4, letter and legal |

| | |
|-------------------------------------|--|
| CUSTOM MEDIA SIZES | 3 x 5 to 8.5 x 14 in (76 x 127 to 216 x 356 mm) |
| PRINT HANDLING | Input Capacity: Up to 250 sheets, Up to 10 envelopes Output Capacity: Up to 100 sheets, Up to 10 envelopes, Up to 10 sheets transparencies |
| POWER² | Power Supply Type: Built-in power supply Power Requirements: Input voltage 110 to 127 VAC (+/- 10%), 50/60 Hz (+/- 2 Hz), 5.4 A; 220 to 240 VAC (+/- 10%), 50/60 Hz (+/- 2 Hz), 2.9 A; Power Consumption: 445 watts printing, 325 watts copying, 4.7 watts ready, 0.2 watts off; Typical Electricity Consumption (TEC) Number: 1.386 kWh/Week |
| SOFTWARE INCLUDED | Windows: HP Installer/Uninstaller, HP PCL 6 print driver, HP WIA Scan Driver, HP TWAIN Scan Driver, HP Scan, HP Fax Setup Wizard, HP Send Fax, HP Fax Print Driver, Readiris Software, Mac: HP Installer/Uninstaller, HP PS driver, HP Scan, HP Setup Assistant, HP Fax Print Driver, HP Ink Widget, HP Utility, Readiris Software |
| COMPATIBLE OPERATING SYSTEMS | Full software installs supported on: Microsoft® Windows® 7 32-bit and 64-bit, Windows® Vista 32-bit and 64-bit, Windows® XP 32-bit (SP2 or higher), Driver only installs supported on: Microsoft® Windows® Server 2003 32-bit (SP3 or higher), Windows® Server 2008 32-bit and 64-bit, Mac OS X v 10.5.8, v 10.6, Linpus Linux (9.4, 9.5), Red Hat Enterprise Linux 5.0 (supported with a pre-built package), SUSE linux (10.3, 11.0, 11, 11.1, 11.2), Fedora (9, 9.0, 10, 10.0, 11.0, 11, 12, 12.0), Ubuntu (8.04, 8.04.1, 8.04.2, 8.10, 9.04, 9.10, 10.04), Debian (5.0, 5.0.1, 5.0.2, 5.0.3) (supported by the automatic installer), HP/UX 11 and Solaris 8/9 |
| MINIMUM SYSTEM REQUIREMENTS | PC: Microsoft® Windows® 7, Windows Vista®: 1 GHz 32-bit(x86) or 64-bit(x64) processor, 1 GB RAM (32-bit) or 2 GB RAM (64-bit), 200 MB free hard disk space, CD/DVD-ROM or Internet, USB or Network port, Windows® XP (32-bit) Service Pack 2: Pentium 233 MHz processor, 512 MB RAM (32-bit) or 2 GB RAM (64-bit), 200 MB free hard disk space, CD/DVD-ROM or Internet, USB or Network port; Mac: Mac OS X v10.5.8, v10.6, Power PC G4, G5, or Intel Core Processor, 256 MB RAM, 300 MB free hard disk space, CD/DVD-ROM or Internet, USB or Network port |
| ACOUSTIC³ | Acoustic Power Emissions: 6.5 B(A) Acoustic Power Emissions (Ready): Inaudible Acoustic Pressure Emissions: 51 dB(A) |
| OPERATING ENVIRONMENT | Operating Temperature Range: 59 to 90.5° F (15 to 32.5° C) Recommended Operating Temperature: 62.6 to 77° F (17 to 25° C) Storage Temperature Range: -4 to 104° F (-20 to 40° C); Operating Humidity Range: 10 to 80% RH Recommended Humidity Operating Range: 30 to 70% RH |
| PRODUCT DIMENSIONS | W X D X H: 17.4 x 13.5 x 14.7 in (441 x 343 x 373 mm) |
| PRODUCT WEIGHT | 25.8 lb (11.7 kg) |
| WHAT'S IN THE BOX | HP LaserJet M1536dnf MFP, HP LaserJet Introductory Black Print Cartridge, control panel overlay, ADF input support, CDs containing device software and electronic User's Guide, Getting Started Guide, Support flyer, power cord(s), Telecom cable, USB cable (where applicable), Fax cable, Ferrite assembly |
| WARRANTY | One-year limited warranty |
| REPLACEMENT CARTRIDGES | HP LaserJet Print Cartridge 78A (yield 2100 pages), CE278A |
| ACCESSORIES | HP USB Cable, Q6264A |
| HP SERVICES AND SUPPORT | HP 2-year Next Business Day Exch w/Enhanced Phone Support IPG prtr-H SVC, UQ223A HP 3-year Next Business Day Exch w/Enhanced Phone Support IPG prtr-H SVC, UQ224A HP 4-year Next Business Day Exch w/Enhanced Phone Support IPG prtr-H SVC, UQ225A |

FOR MORE INFORMATION VISIT OUR WEBSITE AT WWW.HP.COM

HP LASERJET PRO M1536DNF MULTIFUNCTION PRINTER Product Number: **CE538A**

¹Measured using ISO/IEC 24734, excludes first set of test documents. For more information see <http://www.hp.com/go/printerclaims>. Exact speed varies depending on the system configuration, software application, driver, and document complexity.

²Power reported is highest values measured for all product models using all standard voltages. Values are based on preliminary data, see http://www.hp.com/go/lim1530_regulatory for current information.

³Values are based on preliminary data, see http://www.hp.com/go/lim1530_regulatory for current information. Configuration tested: U Pro M1536dnf MFP printing simplex and ADF copy simplex on A4 paper.

⁴Duty cycle is defined as the maximum number of pages per month of imaged output. This value provides a comparison of product robustness in relation to other HP LaserJet or HP Color LaserJet devices, and enables appropriate deployment of printers and MFPs to satisfy the demands of connected individuals or groups.



HP LaserJet M2727nf MFP \$599.99-\$100.00



Do more and do it well with this high-powered, fully loaded black-and-white MFP.

Enhanced performance

Don't waste time waiting for your documents. The HP LaserJet M2727nf MFP features professional print and copy speeds of up to 27 ppm (pages per minute). Other MFPs need time to warm up before printing the first page, but with no-wait Instant-on Technology your first page will print two times faster than devices without it.¹ And with a stable light source, copy or scan jobs begin in a matter of seconds—even first thing in the morning.

Your documents always look great with reliable, high-quality printing at true 1200 dpi. We design our toner formulas and papers to work with each other and with the device's high speeds—so you get crisp and consistent print quality without sacrificing performance.

Easily handle even the most demanding jobs with HP PCL and HP postscript level 3 emulation driver support, a powerful 450 MHz processor, and 64 MB RAM (expandable to 320 MB).

All the features you need

Fax documents at up to 33.6 kbps and enjoy digital storage for up to 600 pages. Use private receive to securely store faxes on the device until you are ready to print them. And with Fax/Tel, your MFP will determine if the call is a voice or a fax call.²

Get the job done faster with the paper handling features your business needs. The MFP's maximum input capacity of up to 300 sheets (expandable to up to 550 sheets) helps you maintain your momentum.³ Count on default copy collation and standard two-sided printing and copying to conserve paper. And with the device's multi-tasking capabilities, if one person is printing or copying, you can still receive faxes.

Your workteam can share resources easily, efficiently, and securely with fast, value-featured networking.

HP LaserJet reliability

Experience worry-free operation and continually refresh your MFP with Original HP print cartridges. They comprise 70 percent of the imaging system and communicate with the MFP to automatically optimize print quality, provide alerts when supplies run low, and facilitate convenient supplies reordering.⁴

¹ Studies from Quality Logic show the typical print job is three to five pages. Instant-on Technology uses cutting-edge fuser technology to produce the first page faster when a printer is coming out of PowerSave mode so your print job is done sooner.

² A downstream telephone is required to enable the Fax/Tel feature (not included).

³ The MFP comes standard with one 50-sheet multipurpose input tray and one 250-sheet input tray, and the option for an additional 250-sheet tray.

⁴ HP SureSupply availability varies by region. For more information, visit www.hp.com/learn/suresupply.

HP LaserJet M2727nf MFP

TECH 2000, INC.

- 1 50-sheet automatic document feeder (ADF) supports copying, scanning, and faxing up to legal size
- 2 Flatbed scanner for books or documents up to letter/A4 size
- 3 Control panel with 10-key number pad and 2-line display provides effortless interaction with each of the MFP's functions
- 4 125-sheet output bin
- 5 Front door print cartridge access
- 6 50-sheet multipurpose input tray 1 handles heavy custom paper up to 43 lb (163 g/m²)
- 7 Adjustable 250-sheet input tray 2
- 8 Automatic two-sided printing and copying
- 9 Rear door opens for straight-through paper path
- 10 Hi-Speed USB 2.0 port
- 11 10/100Base-T Ethernet port for easy networking
- 12 Included Kensington Lock
- 13 64 MB memory (expandable to 320 MB) and a powerful 450 MHz processor
- 14 RJ-11 fax port and RJ-11 line-out telephone port



Front view



Rear view

Convenience, reliability, and outstanding support make the HP LaserJet M2727nf MFP the perfect choice for businesses with no time to worry about device management.



Saves valuable time

The HP LaserJet M2727nf MFP is designed to save you time and effort with powerful management tools:

- Included with the product installation CD, HP ToolboxFX lets you interact with your MFP from the comfort of your desk, with configuration, status, and support for every feature.
- HP Easy Printer Care Software is a tool that helps smaller businesses manage up to 15 HP printers or MFPs.⁵
- HP Web Jetadmin is a simple fleet management utility for remotely installing, configuring, monitoring, and managing a wide variety of HP and non-HP printing and imaging devices from anywhere on the network.⁶
- The HP Embedded Web Server provides a universal interface to the device that anyone with a network-connected computer and a standard Web browser can easily access.

⁵ Easy Printer Care Software is free and may be downloaded at www.hp.com/go/easyprintercare, where you can also find a detailed printer compatibility matrix.

⁶ Find more information and download HP Web Jetadmin for free at www.hp.com/go/webjetadmin.

Legendary reliability and support

You don't have to worry about Microsoft® Windows Vista™ compatibility. The HP LaserJet M2727nf MFP is Vista-certified, meaning it will work seamlessly with computers running the new operating system.

Reliable devices lower your overall labor costs by minimizing downtime. PC Magazine (August 2006) recently gave HP the Reader's Choice award in its annual service and reliability survey for the 15th year in a row. No other printer vendor can claim this record.

Award-winning customer service and support backs your MFP with a one-year limited warranty, knowledgeable online support available 24/7 at www.hp.com/support, and phone support provided by trained HP agents. Plus, you can enhance your warranty protection with affordable HP Care Pack Services.

Get the most out of your MFP with HP accessories, supplies, and services.



Q7556A

Increase your input capacity to 550 sheets with the 250-sheet input tray 3.



CB421A, CB422A, CB423A

Upgrade the device's memory to a maximum of 320 MB RAM with 64 MB, 128 MB, or 256 MB memory modules.



C6264A, C6520A

Connect directly with the 2-meter or 3-meter Hi-Speed USB A to B printer cable.



Q7553A/X

HP's all-in-one print cartridges and toner are specifically designed with the MFP to deliver consistent quality and reliable, trouble-free printing.



Choose from a selection of HP papers to create impressive, professional marketing materials.

Paper handling accessories

Optional 250-sheet input tray 3

Q7556A

Supplies

HP LaserJet print cartridge. Average cartridge yield 3,000 standard pages.⁷

Q7553A

High-yield HP LaserJet print cartridge. Average cartridge yield 7,000 standard pages.⁷

Q7553X

Memory

64 MB 144-pin DDR2 DIMM

CB421A

128 MB 144-pin DDR2 DIMM

CB422A

256 MB 144-pin DDR2 DIMM

CB423A

Cables

Hi-Speed USB A to B printer cable (2-meter)

C6264A

Hi-Speed USB A to B printer cable (3-meter)

C6520A

Service and support

HP 3-year Next Business Day Exchange Hardware Service

H5471E

HP 3-year Next Business Day Onsite Hardware Support

H5478E

HP 3-year Return to Depot Hardware Service

H2646E

Paper

North America: www.hp.com/go/paper

USA: 1-800-477-5010

Solutions

www.hp.com/go/gsc

⁸ Declared yield value in accordance with ISO/IEC 19752. For page and photo yields and other cartridge options, see www.hp.com/go/pageyield.

HP LaserJet M2727nf MFP

TECH 2000, INC.

| Technical specifications | HP LaserJet M2727nf MFP (CB532A) |
|---|--|
| Print and copy speed⁹ | Up to 27 ppm letter |
| First page out | Printing: less than 10 seconds from PowerSave mode; Copying: less than 8 seconds from PowerSave mode |
| Resolution, enhancement technologies | Up to 1200 dpi; RET, HP FastRes, HP ProRes 1200 |
| Features | |
| Control panel | 2-line LCD text display, alphanumeric buttons, navigational buttons plus 3 LEDs, fax buttons plus 1 LED, copy buttons plus 2 LEDs, 2 scan buttons |
| Copying | Up to 99 multiple copies, reduce/enlarge from 25 to 400%, two-sided copying, contrast adjustments, resolution copy quality (text, mixed, film photo and picture), draft quality (on/off), multipage (on/off), copy collation, number of copies, tray select, paper size, paper type, restore default |
| Scanning | Color flatbed scanner or ADF; input modes: front control panel scan, copy or fax buttons, scanning via HP LaserJet Scan (Windows), HP Director (Macintosh), or TWAIN-compliant or WIA-compliant software |
| Faxing | Up to 33.6 kbps, auto fax reduction, fax forwarding, fax polling (receive only), broadcasting to up to 119 locations, speed dial (up to 120 numbers), junk barrier, auto redialing, delayed sending, distinctive ring, PC interface supported, fax telephone mode supported, fax memory (up to 600 pages) ¹⁰ |
| Processor | Motorola Coldfire V5e, 450 MHz |
| Memory/storage | 64 MB RAM (fixed), expandable to 320 MB via one open 144-pin DDR2 DIMM slot; 8 MB non-volatile fax storage (600 fax pages) ¹⁰ ; Memory Enhancement technology (MET) |
| Recommended monthly page volume¹¹ | 750 to 3,000 |
| Maximum monthly duty cycle¹² | Printer: up to 15,000 pages; copier: up to 15,000 pages; ADF: up to 2,250 pages |
| Languages and fonts | HP PCL 6, HP PCL 5e, HP postscript level 3 emulation; 45 scalable TrueType, 35 PostScript |
| Paper | |
| Handling | 50-sheet ADF, 50-sheet multipurpose input tray 1, 250-sheet input tray 2, optional 250-sheet input tray 3, 125-sheet output bin, automatic two-sided printing/copying |
| Sizes | Tray 1: letter, legal, envelopes (No. 5 1/2 Baronial through No. 11), index cards, postcards; custom: 76 by 127 mm to 216 by 356 mm (3 by 5 in to 8.5 by 14 in) Tray 2, optional tray 3: letter, legal; custom: 5.8 by 8.3 in to 8.5 by 14 in (148 by 210 mm to 216 by 356 mm) ADF: letter, legal; custom: 5.5 by 5.5 in to 8.5 by 14 in (127 by 127 mm to 216 by 356 mm) Automatic two-sided printing unit: letter, legal |
| Weights | Tray 1, tray 2, optional tray 3: 16 to 43 lb bond (60 to 163 g/m ²); ADF: 16 to 24 lb bond (60 to 90 g/m ²) |
| Types | Paper (bond, color, heavy, letterhead, light, plain, preprinted, prepunched, recycled, rough), envelopes, transparencies, labels, cardstock |
| Connectivity | |
| Interfaces | 10/100Base-T wired Ethernet network port, Hi-Speed USB 2.0 port, RJ-11 fax port, RJ-11 line-out telephone port |
| Client operating systems | Fully supported: Windows® XP® 32, Windows XP x64, Windows Vista 32, Windows Vista 64, Mac OS X v10.3 or higher; Basic functionality supported (Print/scan/Embedded Web Server): Windows 2000, Windows Server 2003; Print driver only: Unix®, Linux |
| Network operating systems | Via on-board 10/100 Ethernet connection, supports TCP/IP based solutions: Windows 2000, Windows XP Home, Windows Professional, Windows XP Professional x64, Windows Server 2003, Windows Vista Ready, Windows Vista-64; Novell NetWare NDPS services via TCP/IP only on 3.2, 4.2, 5.x, 6.x; HP Gateway (TCP/IP raw only) and Novell LPD gateway; Mac OS 10.3 or higher; Bonjour discovery supported; Red Hat Linux 6.x or higher; SuSE Linux 6.x or higher; HP-UX 10.20, 11.x; Solaris 2.5x, 2.6, 7, 8, 9, 10 (SPARC systems only); IBM AIX 3.2.5 or higher; MPE-iX; Citrix MetaFrame; Windows Terminal Services |
| Network protocols | TCP/IP: IPv4, IPv6, LPD, SLP, Bonjour, BOOTP/DHCP/AutoIP, WINS, SNMP v1, HTTP |
| Security | SNMP v1 (community name); control panel, embedded Web server, and HP Toolbox FX (password-protected); Kensington lock included with device |
| Dimensions (W by D by H) | 19.7 by 16 by 18 in (500 by 406 by 457 mm) |
| Weight | 37.8 lb (17.2 kg) |
| What's in the box | M2727nf MFP, power cord(s), print cartridge, Getting Started Guide, support flyer, software/documentation CD, control panel faceplate, Readiris PRO text recognition software, ADF input support, phone cord(s), 250-sheet input tray 2 |
| Warranty | One-year limited warranty |

| | | | |
|---|--|-------------------------------|---|
| Environmental ranges | | Acoustics¹⁴ | |
| Recommended temperature | 59 to 90.5 degrees F (15 to 32.5 degrees C) | Sound power | Active: 6.4 B(A) printing, 6.9 B(A) copying, Ready: inaudible |
| Storage temperature | -4 to 104 degrees F (-20 to 40 degrees C) | Bystander sound pressure | Active: 50.4 dB(A) printing, 55.4 dB(A) copying, Ready: inaudible |
| Operating relative humidity | 10 to 80 percent, non-condensing | Certifications | |
| Storage relative humidity | 0 to 95 percent, non-condensing | Safety | IEC 60950-1: 2001/EN 60950-1: 2001+A11; IEC 60825-1: 1993+A1: 1997+A2: 2001/EN 60825-1: 1994+A1: 2002+A2: 2001 (Class 1 Laser/LED Product); GB4943-1995. |
| Altitude | 0 to 10,000 ft (0 to 3,040 m) | EMC | CISPR 22: 2005/EN 55022: 2006-Class B; EN 61000-3-2: 2000+A2; EN 61000-3-3: 1995+A1; EN 55024: 1998+A1+A2; FCC Title 47 CFR, Part 15 Class B 2/ICES-003, Issue 3; GB9254-1998 |
| Power specifications¹³ | | Telecom | ES 203 021, FCC Part 68, Industry Canada CS03 |
| Required input voltage | 110-volt models: 110 to 127 volts (± 10 percent), 50/60 Hz (±2 Hz), 4.5 amp 220-volt models: 220 to 240 volts (± 10 percent), 50/60 Hz (±2 Hz), 2.6 amp | HP SureSupply enabled | To learn more, please visit www.hp.com/go/suresupply |
| Power consumption | Printing: 425 watts; Copying: 405 watts; Ready: 15 watts; Sleep: 15 watts; Off: 0.1 watts | | |
| Typical Electricity Consumption (TEC): 3.041 kWh/Week | | | |
| ENERGY STAR® qualified models; see www.hp.com/go/energystar | | | |

⁹ Exact speed varies depending on the system configuration, software program, and document complexity. Copy speed measured by a single page on the flatbed glass with number of copies set to 99. ADF copy speed: up to 19 cpm.
¹⁰ Based on ITU-T test image #1 at standard resolution. More complicated pages or higher resolution will take longer and use more memory.

¹¹ HP recommends that the number of printed pages per month be within the stated range for optimum device performance, based on factors including supplies replacement intervals and device life over an extended warranty period.

¹² Duty cycle is defined as the maximum number of pages per month of imaged output. This value provides a comparison of product robustness in relation to other HP LaserJet or HP Color LaserJet devices, and enables appropriate deployment of printers and MFPs to satisfy the demands of connected individuals or groups.

¹³ Values subject to change. See www.hp.com/support for current information. Power numbers are the highest values measured using all standard voltages.

¹⁴ Acoustic values are subject to change. See www.hp.com/support for current information. Configuration tested: simplex printing or copying, A4-size at average print speed of 27 ppm.



© Copyright 2008, 2009 Hewlett-Packard Development Company, L.P.

The information contained herein is subject to change without notice. The only warranties for HP products and services are set forth in the express warranty statements accompanying such products and services. Nothing herein should be construed as constituting an additional warranty. HP shall not be liable for technical or editorial errors or omissions contained herein.

ENERGY STAR and the ENERGY STAR mark are U.S. registered marks. Microsoft, Windows, and Windows XP are U.S. registered trademarks of Microsoft Corporation. Windows Vista is either a registered trademark or trademark of Microsoft Corporation in the United States and/or other countries. Pentium is a registered trademark of Intel Corporation or its subsidiaries in the United States and other countries. Linux is a U.S. registered trademark of Linus Torvalds. Unix is a registered trademark of The Open Group.

Printed in U.S.A.



To learn more, visit www.hp.com

4AA1-4400ENUC, November 2009, Rev. 2.1



HP LaserJet M3035 MFP series

M3035 • M3035xs \$1,599.99 \$2,049.99



Empower workteams with print, copy, scan, fax, and digital sending functionality in one convenient device.

Efficient

Get more done in less time. The MFP delivers print and copy speeds of up to 35 pages per minute (ppm) and a first page out in under 10 seconds with Instant-on Technology. The unique HP toner formula is engineered to deliver consistent, great-looking documents at fast speeds.

Accelerate existing workflows. The MFP comes standard with send to e-mail, send to network folder, network authentication, and LDAP support embedded in the device for easy integration into your existing infrastructure. Add optional HP Digital Sending Software 4.3 for send to ftp sites and fax services.¹ Consider optional HP AutoStore software to improve paper-intensive workflows by connecting the MFP to document management solutions.

Reduce interruptions. The MFP supports up to 1,100 sheets² plus a 20-sheet convenience stapler for easy finishing. A 50-sheet reversing automatic document feeder (ADF) provides effortless copying and scanning of multi-page documents up to legal size.

¹ Fax functionality and 20-sheet convenience stapler come standard on the M3035xs model only and cannot be added to the M3035 model as accessories.

² The extra 500-sheet input tray comes standard on the M3035xs model only and can be added to the M3035 model as an accessory.

³ IPv6 is only supported with Microsoft® Server 2003 and Windows XP® (print only).

⁴ Using genuine HP supplies ensures availability of all HP printing features.

⁵ For more information, visit www.hp.com/learn/suresupply.

Easy

Experience simple, dependable networking. The MFP features IPv6-ready³ best-in-class networking and management tools via the HP Jetdirect Fast Ethernet embedded print server. HP Web Jetadmin offers remote installation, configuration, and proactive management.

Expandable

Add the solutions your business needs. An FIH port, open EIO slot, and host USB port allow you to easily expand the MFP's capabilities. Add HP and third-party solutions such as additional fonts, forms, barcode printing, and market-leading solutions for document capture, job accounting, and security. Get investment protection with access to IPSec TCP/IP security, Gigabit Ethernet, and wireless network compatibility.

Reliable

Expect consistency. Original HP cartridges are carefully designed with HP Smart printing technology⁴ to automatically optimize print quality and consistency throughout cartridge life, provide pages-remaining data and alerts when supplies run low, and facilitate convenient supplies reordering through HP SureSupply.⁵

HP LaserJet M3035 MFP series

TECH 2000, INC.

HP LaserJet M3035xs MFP shown

- 1 50-sheet reversing automatic document feeder (ADF) supports the two-sided copying and scanning of double-sided originals up to legal size
- 2 Legal-size, color, flatbed scanner
- 3 Easy-to-use touch-screen control panel with 13-key number pad provides effortless device interaction
- 4 Front door print cartridge access
- 5 100-sheet multipurpose input tray handles custom paper up to 53 lb (199 g/m²)
- 6 Adjustable 500-sheet input trays 2 and 3 for a 1,100-sheet input capacity
- 7 20-sheet convenience stapler (M3035xs model only)
- 8 250-sheet output bin
- 9 Automatic two-sided printing
- 10 RJ-11 fax port
- 11 HP Jetdirect Fast Ethernet embedded print server (RJ-45 network port)
- 12 Foreign interface harness (FIH) port supports HP and third-party solutions
- 13 Host USB port for additional functionality
- 14 Hi-Speed USB 2.0 port for direct connection
- 15 256 MB total memory and a powerful 400 MHz processor perform complex tasks quickly
- 16 Open EIO slot for additional functionality
- 17 Built-in hard disk for effective digital sending, private printing, and job storage

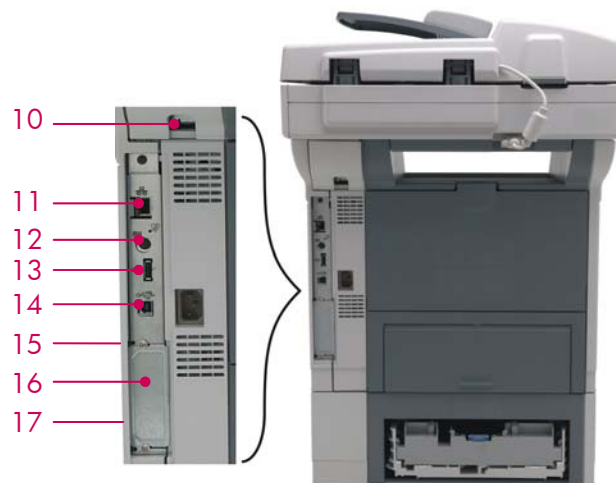

Series at a glance



HP LaserJet M3035 MFP (CC476A)

- HP Jetdirect Fast Ethernet embedded print server
- Hi-Speed USB 2.0 port
- 256 MB total memory and a 400 MHz processor
- Open EIO slot
- Built-in HP high-performance EIO hard disk
- 50-sheet ADF automatically scans two-sided documents up to legal size
- Legal-size, color, flatbed scanner
- 100-sheet multipurpose input tray and a 500-sheet input tray 2 for a 600-sheet input capacity



HP LaserJet M3035xs MFP (CC477A)

- All the features of the base model, plus:
- Analog faxing
 - 20-sheet convenience stapler
 - 500-sheet input tray 3 for a 1,100-sheet input capacity

Simplicity, convenience, and outstanding support make the HP LaserJet M3035 MFP series the perfect choice for small workteams with no time to worry about device management.



Secure printing

For many businesses, information is one of their most valuable assets. The HP LaserJet M3035 MFP series is designed to protect critical information—in both hardcopy and electronic form—and simplify the way you manage your environment with easy tools and checklists.

- Private Printing lets you protect confidential documents by allowing you to hold a job for printing until you release it using a 4-digit Personal Identification Number (PIN) at the MFP's control panel.
- HP Secure Storage Erase makes sure that data you want to eliminate is unrecoverable. Unless otherwise specified, the MFP deletes data from the hard disk when the print job is finished.

- Our renowned family of HP Jetdirect connectivity products support a wide range of industry-standard and trusted security protocols, including 802.1x for Wired Networks, SNMPv3 and HTTPS, and Secure IPP (IPP-S) and IPsec.⁶
- Network authentication (LDAP, SMTP) adds another layer of security by allowing administrators to control device access. By requiring users to log in, administrators can limit usage of all the device features, or of just the copying or sending functions.

Go to www.hp.com/go/secureprinting for more information.

Get the most out of your MFP with HP accessories, supplies, and services.



Q7817A
500-sheet input tray offers an input capacity of up to 1,100 sheets.



J7989G
HP high-performance EIO hard disk provides convenient storage.



J7961G
HP Jetdirect 635n IPv6/IPSec Internal Print Server delivers the latest in network security.



J7951G
Enjoy wireless networking with the HP Jetdirect ew2400 802.11g Wireless External Print Server (USB 2.0).



Choose from a selection of HP Brochure and Flyer papers to create impressive, professional marketing materials.

Put the power of HP Imaging and Printing Services to work to improve productivity and reduce costs. Select predefined services or tailor your own to meet your precise needs.

| | |
|---|---------------|
| HP LaserJet M3035 MFP | CC476A |
| HP LaserJet M3035xs MFP | CC477A |
| Paper handling | |
| 500-sheet input tray | Q7817A |
| Supplies | |
| HP LaserJet Black Print Cartridge with Smart Printing Technology. Average cartridge yield 6,500 standard pages. ⁷ | Q7551A |
| HP LaserJet Black Print Cartridge with Smart Printing Technology. Average cartridge yield 13,000 standard pages. ⁷ | Q7551X |
| Staple cartridge refill (2 cartridges, 1,500 staples each) | Q7432A |
| Memory/storage | |
| 128 MB 100-pin DDR DIMM | Q7718A |
| 256 MB 100-pin DDR DIMM | Q7719A |
| 512 MB 100-pin DDR DIMM | Q7720A |
| HP high-performance EIO hard disk | J7989G |
| Connectivity | |
| HP Jetdirect en1700 USB 2.0 Print Server ⁸ | J7988G |
| HP Jetdirect en3700 USB 2.0 Print Server ⁹ | J7942G |
| HP Jetdirect ew2400 802.11g Wireless External Print Server ⁹ | J7951G |
| HP Jetdirect 175x Fast Ethernet USB External Print Server ⁹ | J6035G |
| HP Jetdirect 630n IPv6 Gigabit Ethernet Print Server | J7997G |
| HP Jetdirect 635n IPv6/IPSec Internal Print Server | J7961G |
| HP Jetdirect 620n Fast Ethernet Print Server | J7934G |
| HP 1284B parallel card | J7972G |
| Hi-speed USB A to B printer cable (2-meter) | Q6264A |
| Digital sending software | |
| HP Digital Sending Software 4.3 | T1936AA |
| HP AutoStore | T1943AA |
| Service and support | |
| 3-year next business day hardware support | UE685E |
| 4-year next business day hardware support | UE686E |
| 5-year next business day hardware support | UE687E |
| 3-year 4 hour response 9x5 hardware support | UE688E |
| 4-year 4 hour response 9x5 hardware support | UE689E |
| 5-year 4 hour response 9x5 hardware support | UE690E |
| 3-year 4 hour response 13x5 hardware support | UE691E |
| 1-year post-warranty 4 hour response 9x5 hardware support | UE694PE |
| 1-year post-warranty 4 hour response 13x5 hardware support | UE695PE |
| 1-year post-warranty next business day hardware support | UE696PE |
| Network install mid-range LaserJet MFP service | U2010E |
| Extended warranty options: www.hp.com/support | |
| Paper | |
| North America: www.hp.com/go/paper | |
| Latin America: contact HP via phone: | |
| USA: 1-800-477-5010, Europe: +800 7644 7644, Asia: 65-6253-8500, Australia/New Zealand: 61-2997-2299LAR, Brasil: sac 0800 70 300 70 | |
| Solutions | |
| www.hp.com/go/gsc | |

⁶ Currently only the HP Jetdirect 635n IPv6/IPSec print server supports Secure IPP (IPP-S) and IPsec capabilities.

⁷ Declared yield value in accordance with ISO/IEC 19752. For page yields and other cartridge options, see www.hp.com/go/pageyield.

⁸ Supports printing only, no software scan, no webscan.

⁹ Supports printing only, no webscan.

HP LaserJet M3035 MFP series

| Technical specifications | HP LaserJet M3035 MFP (CC476A) | HP LaserJet M3035xs MFP (CC477A) |
|---|--|---|
| Print and copy speed | Up to 35 pages per minute (ppm), letter; up to 33 ppm, A4 ¹⁰ | |
| First page out | Less than 10 seconds | |
| Resolution | Up to 1200 dpi, FastRes 1200, ProRes 1200 (1200 by 1200 dpi), RET (Resolution Enhancement technology) | |
| Features | | |
| Copying | Up to 1000 multiple copies, reduce/enlarge from 25 to 400% (from scanner glass), two-sided copying, contrast adjustments, mixed originals, image adjustment, paper selection, content orientation, pages per sheet, booklet format, optimize text/picture, job build, edge to edge | |
| Scanning | Color, legal-sized flatbed scanner or ADF; scan input modes: front-panel scan, copy, fax (M3035xs only), e-mail; file types: PDF, JPG, TIFF, MTIFF | |
| Faxing | Not available | Up to 33.6 kbps, auto fax reduction, fax forwarding, fax polling, broadcasting to up to 100 locations, speed dial (up to 100 lists), junk barrier, remote retrieval capability, auto redialing, Windows® faxing supported |
| Digital sending | Send to e-mail, send to network folder, LDAP and SMTP authentication, LDAP addressing; file formats: PDF, JPG, TIFF, MTIFF | |
| Processor | 400 MHz | |
| Memory/storage | 256 MB DDR RAM (fixed), expandable to 512 MB via one open DDR DIMM slot; Memory Enhancement technology (MET); HP high-performance EIO hard disk | |
| Recommended monthly page volume¹¹ | 2,000 to 6,000 pages | |
| Duty cycle¹² | Up to 75,000 pages per month | |
| Languages and fonts | HP PCL6, HP PCL5, HP postscript level 3 emulation, direct PDF printing (v 1.4); 80 scalable TrueType fonts | |
| Paper | | |
| Handling | 100-sheet multipurpose input tray 1, 500-sheet input tray 2, 50-sheet two-sided reversing automatic document feeder (ADF), 250-sheet output bin, automatic two-sided printing | 100-sheet multipurpose input tray 1, 500-sheet input trays 2 and 3, 50-sheet two-sided reversing automatic document feeder (ADF), 250-sheet output bin, automatic two-sided printing, 20-sheet convenience stapler |
| Sizes | Multipurpose input tray 1: 3 by 5 in (76 by 127 mm) to 8.5 by 14 in (216 by 356 mm); letter, legal, executive, envelopes 500-sheet input trays 2 and 3: 5.8 by 8.3 in (148 by 210 mm) to 8.5 by 14 in (216 by 356 mm); letter, legal, executive automatic two-sided printing unit: letter, legal; flatbed scanner: up to 8.5 by 14 in (216 by 356 mm); ADF: letter, legal, executive, custom | |
| Weights | Multipurpose input tray 1 (straight through paper path for special paper): 16 to 53 lb (60 to 199 g/m ²); 500-sheet input trays 2 and 3: 16 to 32 lb (60 to 120 g/m ²); ADF: 16 to 28 lb (60 to 105 g/m ²) | |
| Types | Paper (plain, printed, letterhead, prepunched, bond, recycled, color, rough), transparencies, labels, envelopes, card stock | |
| Connectivity | | |
| Interfaces | One HP Jetdirect Fast Ethernet embedded print server, one Foreign Interface Harness (FIH) port, one USB type A port for adding accessories, one USB type B port for printing, one open EIO slot | One HP Jetdirect Fast Ethernet embedded print server, one Foreign Interface Harness (FIH) port, one USB type A port for adding accessories, one USB type B port for printing, one open EIO slot, one analog fax port |
| Operating systems | Full software installation: Microsoft® Windows® XP® (32-bit), Windows Server 2003 (32-bit), Windows 2000; printer driver only: Windows XP (64-bit) (Web only); Windows Server 2003 (64-bit) (Web only); Linux (Web only); UNIX model scripts (Web only); Mac OS X v10.2.8, v10.3, v10.4 and later | |
| Network protocols | IPv6: ¹³ DHCPv6, HTTP, HTTPS, Port 9100, LPD, IIP, Secure IIP, MLDv6, ICMPv6 IPv4: FTP, IPP, Secure IPP, Auto-IP, Apple Bonjour Compatible, Telnet, SLP, IGMPv2, BOOTP/DHCP, WINS, SNMPv1/v2c/v3, TFTP, HTTP, HTTPS, Port9100, LPD Other: IPX/SPX, DLC, LLC, AppleTalk, Network NDS, Binary, NCP | |
| Security | Private print, HP Secure Storage Erase, network authentication (LDAP, SMTP), HP Jetdirect - 802.1x for Wired Networks, SNMPv3 and HTTPS, Secure IPP (IPP-S), and IPsec ¹³ | |
| Dimensions (W by D by H) | 20.5 by 20 by 21.7 in (520 by 508 by 550 mm) | 20.5 by 20 by 27.2 in (520 by 508 by 690 mm) |
| Weight | 60.6 lb (27.6 kg) | 73.5 lb (33.4 kg) |
| What's in the box | Both models include: print cartridge, support flyer, power cord, control panel overlays, software/documentation CD, Getting Started Guide, wall poster Also includes: HP LaserJet M3035 MFP | Also includes: HP LaserJet M3035xs MFP (with 20-sheet convenience stapler, analog fax, additional 500-sheet input tray), phone cord |
| Warranty | One-year on-site warranty; 24-hour, 7 days a week phone support | |

| | | |
|--|--|--|
| Environmental ranges | Recommended temperature: 63 to 77 degrees F (17.5 to 25.0 degrees C) Storage temperature: -4 to 104 degrees F (-20 to 40 degrees C) Operating relative humidity: 30 to 70 percent, non-condensing Altitude: 0 to 10,000 ft (0 to 3,100 m) | Acoustics¹⁵ Sound power: Active: 6.5 B(A) printing, 6.8 B(A) copying, Ready: inaudible Bystander sound pressure: Active: 56 dB(A) printing, 54 dB(A) copying, Ready: inaudible |
| Power specifications¹⁴ | Required input voltage: 110-volt models: 110 to 127 volts (± 10 percent), 60 Hz (±2 Hz), 7.5 amp 220-volt models: 220 to 240 volts (± 10 percent), 50 Hz (±2 Hz), 4.5 amp Power consumption: Printing: 610 watts; Copying: 620 watts; Ready: 28.5 watts; Sleep: 24.0 watts; Off: 0.1 watts | Certifications Safety: Canada (cUL-CAN/CSA C22.2 No.60950-1-03), USA (UL-UL 60950-1; FDA-21 CFR Chapter 1 Subchapter J for lasers). Class 1 Laser/LED Product. EMC: CISPR 22:1993 / EN 55022:1994 Class A, EN 61000-3-2:2000, EN 61000-3-3:1995, EN 55024:1998, FCC Title 47 CFR, Part 15 Class A / ICES-003, Issue 4 / GB9254-1998, GB17625.1-2003, EMC Directive 89/336/EEC and the Low Voltage Directive 73/23/EEC, and carries the CE-Marking accordingly |
| Typical Electricity Consumption (TEC): 6.331 kWh/Week ENERGY STAR [®] qualified models; see www.hp.com/go/energystar | | Telecom: TBR-21:1998; EG 201 121:1998, FCC Part 68, Industry Canada CS03, NOM-151-SCTI-1999 (Mexico) HP SureSupply enabled: To learn more, please visit www.hp.com/go/SureSupply |

¹⁰ Exact speed varies depending on the system configuration, software program, and document complexity. Speed specifications have been updated to reflect current industry testing methods.
¹¹ HP recommends that the number of pages per month of imaged output be within the stated range for optimum device performance, based on factors including supplies replacement intervals and device life over an extended warranty period.
¹² Duty cycle is defined as the maximum number of pages per month of imaged output. This value provides a comparison of product robustness in relation to other HP LaserJet or HP Color LaserJet devices, and enables appropriate deployment of printers and MFPs to satisfy the demands of connected individuals or groups.
¹³ IPv6 is only supported with Microsoft Server 2003 and Windows XP (print only).
¹⁴ Power requirements are based on the country/region where the printer is sold. Do not convert operating voltages. This will damage the printer and void the product warranty.
¹⁵ Configuration tested: base model, simplex printing, A4 paper at an average of 33 ppm.



© Copyright 2007, 2009 Hewlett-Packard Development Company, L.P.
 The information contained herein is subject to change without notice. The only warranties for HP products and services are set forth in the express warranty statements accompanying such products and services. Nothing herein should be construed as constituting an additional warranty. HP shall not be liable for technical or editorial errors or omissions contained herein.
 ENERGY STAR and the ENERGY STAR logo are registered U.S. marks. Microsoft, Windows, and Windows XP are U.S. registered trademarks of Microsoft Corp. Linux is a U.S. registered trademark of Linus Torvalds. UNIX is a registered trademark of The Open Group.

To learn more, visit www.hp.com
 4AA1-5419ENUC, August 2009, Rev. 3



HP LaserJet M4345 MFP series

M4345 • M4345x • M4345xs \$2,599.99 \$3,699.99 \$4,799.99



Reach new heights with the M4345 MFP series. This powerful, scalable, and easy-to-use workgroup MFP combines print, copy, digital send, and advanced paper handling into one cost-effective device.

Raises the bar on performance

- **Accomplish more in less time.** Attain printing and copying speeds as fast as 45 ppm and a quick first page out with Instant-on Technology. Get consistently great-looking output with a choice of HP FastRes 1200 for speedy day-to-day printing or HP ProRes 1200 for true 1200 by 1200 dpi for those extra critical jobs where only the best will do.
- **Boost workgroup efforts and easily integrate documents into office workflows.** The MFP comes standard with send-to-e-mail and network folder capability, as well as network authentication, and LDAP support. The HP Digital Sending Software (DSS) 4.3¹ lets you send documents to ftp sites and fax services, including LAN fax, Internet fax, and Windows® 2000/XP fax services.
- **Process documents effortlessly.** The 50-sheet reversing automatic document feeder (ADF) eliminates the need to manually feed originals, even two-sided documents. Conserve paper with automatic two-sided printing and copying.

Radical simplicity—easy to succeed

- **Work without interruption.** Original HP LaserJet print cartridges employ HP Smart printing technology² to keep you up and running. The cartridge sends alerts when supplies are low, and even helps you reorder through HP SureSupply.³ Pages remaining data helps you determine if supplies are adequate to complete your job.
- **Experience easy, reliable, best-in-class networking** with the IPv6-ready⁴ HP Jetdirect Fast Ethernet embedded print server.⁵ HP Web Jetadmin offers remote installation, configuration, and proactive management for all your networked peripherals. HP Embedded Web Server performs remote diagnostics, sends e-mail alerts, provides job tracking/accounting, and easy reordering of supplies.
- **Enjoy remarkably simple interaction.** Take control of your MFP's complete feature set with a new, intuitive user interface that clearly displays all available options. Navigate with ease using Windows emulation icons that visually walk you through procedures and helpful wizards that assist with setup.

- **Delight in the luxury of local storage.** Save time and eliminate frustration with the embedded hard drive.⁵ Use the high-capacity storage to keep local copies of frequently used documents, such as invoices or expense reports. Use "proof and hold" to check one copy before printing the rest—right from the control panel. Need privacy? Print sensitive material with password access protection.

Grows with your business

- **Increase your options.** Take advantage of market-leading HP and third-party solutions via open DIMM and EIO slots and a foreign interface port. Choose from a variety of solutions, including wireless, Gigabit Ethernet, or IPsec compatible networking, additional fonts or memory, business process forms, barcode printing, document capture, job accounting, and enhanced security.
- **Configure output abilities to suit your needs.** Choose a stapler/stacker that can staple up to 30 sheets and stack up to 500 sheets. Or, you may select the 3-bin mailbox for separating print, copy, and fax jobs, assigning mailboxes for users, or stacking up to 700 sheets.
- **Focus on your work rather than tending to your MFP.** With a total input capacity of up to 2,100 sheets, you'll spend less time loading paper. Business mailings are a snap with the optional 75-sheet envelope feeder.

HP's rock-solid reliability

- **Reap the benefits of HP LaserJet world-renowned engineering quality** in a device with more functionality. Depend on the uptime so paramount to your workgroup's success. Get worry-free operation with the original HP cartridge that makes up 70% of the imaging system.

HP printing and imaging systems help you create powerful, professional communications easily. HP multifunction products, supplies, accessories, and services are designed together to work together and are invented to meet your business needs.

¹ Standard features vary by model.

² Trial software included, full version sold separately. Server based application, requires server.

³ Using genuine HP supplies ensures availability of all HP printing features.

⁴ Program availability may vary by country. Internet access required. For more information, visit www.hp.com/learn/suresupply.

⁵ IPv6 is only supported Microsoft Server 2003 and Windows XP (print only).

⁶ Embedded features are standard in all models and reside on the formatter board.

HP LaserJet M4345 MFP series

TECH 2000, INC.

- 1 50-sheet automatic document feeder (ADF) automatically scans two-sided documents in full color
- 2 Color flatbed scanner for scanning, copying, and faxing jobs
- 3 Simple, intuitive touch-screen graphical control panel with numeric keypad provides effortless device interaction
- 4 100-sheet multipurpose tray handles heavy custom paper up to 53 lb (200 g/m²)
- 5 Automatic two-sided printing accessory for fast two-sided printing
- 6 Adjustable 500-sheet input trays 2 and 3
- 7 Optional 500-sheet input trays 4 and 5 for a 2,100-sheet total input capacity
- 8 MFP stand with storage cabinet
- 9 33.6 kbps analog fax accessory (RJ-11 port)
- 10 Hi-Speed USB 2.0 port (type B) for direct connection
- 11 Foreign interface port for HP and third-party solutions
- 12 HP JetDirect Fast Ethernet embedded print server (RJ-45 port)
- 13 Open EIO slot enables HP and third-party solutions
- 14 256 MB total memory and a powerful 480 MHz processor perform complex tasks quickly
- 15 High-performance embedded hard disk for effective digital sending, private printing, and job storage
- 16 Stapler/stacker accessory

HP LaserJet M4345xs MFP with optional 500-sheet input trays 4 and 5 shown



M4345 MFP (CB425A)

- 100-sheet multipurpose tray and 500-sheet input tray 2 for a total 600-sheet capacity
- 500-sheet output bin
- 50-sheet ADF
- HP Jetdirect Fast Ethernet embedded print server
- 256 MB DDR RAM
- One available EIO slot
- One available DIMM slot



M4345x MFP (CB426A)

Base model plus:

- 500-sheet input tray 3 for a total 1,100-sheet capacity
- Automatic two-sided printing accessory (duplexer)
- 33.6 kbps analog fax accessory



M4345xs MFP (CB427A)

Base model plus:

- 500-sheet input tray 3 for a total 1,100-sheet capacity
- Automatic two-sided printing accessory (duplexer)
- 33.6 kbps analog fax accessory
- MFP stand with storage cabinet
- Stapler/stacker accessory (30-sheet stapler and 500-sheet stacker replaces the 500-sheet output bin)

Simplicity, convenience, and outstanding support make the HP LaserJet M4345 MFP series the perfect choice for small workteams with no time to worry about device management.

Work with confidence

The HP LaserJet M4345 MFP series is an extension of the HP LaserJet you already know. Count on it to deliver the HP quality and reliability you've come to expect. Position it close to workgroups for efficiency and convenience.

Safeguard your business with enhanced network security.

Whether your concern is data security, privacy, auditing issues or any combination of these, HP helps you proactively eliminate internal and external threats. HP's security framework lets you manage and maintain a secure environment with tools and checklists. Next generation TCP/IP protocol support via IPv6 and optional IPsec or Gigabit network compatibility assures even greater peace of mind.

Depend on worry-free, high-performance operation. Complex print jobs are not a problem with the 480 MHz processor and 256 MB of memory (expandable to 512 MB). Process print, fax, and digital send-jobs quickly, with a rapid return to the application. With the world-renowned HP imaging system, you can count on sharp black text, fine lines, and clear detail on every job. The new Automatic Printer Wakeup feature ensures the device is warmed up and ready for work when you are.

Trust HP's universal print driver for easy network access.⁶

Businesses have a huge investment in their print resources, and providing and managing end-user access to these resources can be a full-time job for busy IT professionals. The HP Universal Print Driver Series for Windows can alleviate such headaches with a single, intelligent driver that replaces individual drivers for all HP networked printers. For more information and to download the driver for free, go to www.hp.com/go/universalprintdriver.

Easy to use, easy to manage, easy to succeed

HP redefines the term *usability* with its new, radically simple user interface. Easily take advantage of your MFP's complete feature set with an intuitive interface that clearly displays all available applications. Navigation is a snap with familiar Windows emulation icons, automatic navigation that visually walks you through troubleshooting, and installation wizards that assist with set up.

HP Smart printing advantage

HP papers and HP LaserJet print cartridges are designed to work together with HP printing devices, so you can depend on producing consistent, high-quality documents with the clarity needed for halftone images, smooth grayscales, and fine details. HP Smart printing technology is activated every time you put an HP print cartridge into your MFP, allowing you to monitor and order supplies.² And each HP print cartridge continually adjusts toner properties to ensure high-quality output over the life of the cartridge.

Award-winning HP support





HP's award-winning customer service and support backs every MFP with a one-year limited warranty, knowledgeable online support available 24/7 at www.hp.com/support, and easy-to-access phone support provided by HP-trained agents. Plus, you can enhance your warranty protection with the purchase of affordable HP Care Pack Services.

100 million HP LaserJets shipped

No one has supplied more printers to more people than HP. For more than 20 years, HP has introduced innovative laser printing products. And now, HP celebrates shipment of the 100 millionth HP LaserJet printer. HP printers offer proven reliability, award-winning service and support, and the broadest portfolio of printing solutions in the industry. Count on the legendary quality of HP LaserJet printers.



Build an MFP to meet the needs of your business.

| | | | | | |
|---|--|---|---|---|--|
|  |  |  |  |  |  |
| 500-sheet input trays offer an input capacity of up to 2,100 sheets | 700-sheet 3-bin mailbox may be assigned to individuals or device functions | Stapler/stacker staples documents up to 30 sheets and stacks up to 500 sheets | 75-sheet envelope feeder makes business mailing simple and efficient | Automatic two-sided printing accessory for fast, efficient two-sided printing | Stand with storage cabinet makes the MFP more accessible and lets you store paper and supplies |
|  |  |  |  |  |  |
| HP LaserJet MFP Analog Fax Accessory quickly and securely processes documents | HP Jetdirect ew2400 802.11g Wireless Print Server allows easy network access without the wires | HP Jetdirect 635n IPv6/IPsec Print Server with the latest in network security | HP Digital Sending Software 4.3 lets you digitally capture paper-based documentation for easy routing and storage | HP AutoStore software allows you to send scanned documents to document management and collaboration platforms | Add memory for up to 512 MB total |

⁶ The HP Universal Print Driver Series for Windows comes on a CD with the MFP.

HP LaserJet M4345 MFP series

| Technical specifications | HP LaserJet M4345 MFP | HP LaserJet M4345x MFP | HP LaserJet M4345xs MFP |
|---------------------------------|--|---|--|
| Print and copy speed | Up to 45 ppm letter | | |
| First page out | Less than 10 seconds | | |
| Resolution | Printing: up to 1200 by 1200 dpi; copying: up to 600 by 600 dpi; color scanning: up to 600 dpi optical (up to 1200 dpi enhanced) | | |
| Features | Copying: Number of copies: up to 1000; Reduce or enlarge: 25 to 400% from scanner glass or ADF; staple collate, image and contrast adjustment, pages per sheet, booklet format, optimize text/picture, original size, job build, edge to edge, mixed original support Scanning: Color, flatbed, ADF; file types: PDF, JPEG, TIFF, MTIFF Faxing: Optional analog fax accessory; Standard analog fax accessory: speed: up to 33.6 kbps, ⁸ JBIG compression, fax forwarding, fax polling, auto redialing Digital sending: Standard: Send to e-mail, send to network folder, LDAP and SMTP authentication, LDAP addressing; File formats: PDF, JPG, TIFF, MTIFF; Optional HP Digital Sending Software, HP AutoStore Processor: 480 MHz Memory/storage: 256 MB DDR RAM (fixed), expandable to 512 MB via one open DDR DIMM slot; Memory Enhancement technology (MET); embedded hard disk Durability ratings: Recommended monthly page volume ⁹ : 5,000–15,000 pages per month; Duty cycle ¹⁰ : up to 200,000 pages per month Paper: Input: 100-sheet multipurpose tray 1, 500-sheet input tray 2, 50-sheet ADF; Output: 500-sheet output bin; 100-sheet multipurpose tray 1, two 500-sheet input trays (2 and 3), 50-sheet ADF; 500-sheet stacker, 30-sheet stapler Two-sided printing: Manual; optional automatic accessory; Automatic two-sided printing accessory (duplexer) Sizes: 100-sheet multipurpose tray, 3-bin mailbox, and stacker: 3 by 5 in (76 by 127 mm) to 8.5 by 14 in (216 by 356 mm), letter, legal, executive, statement, 8.5 x 13 in; 500-sheet trays: 5.8 by 8.3 in (148 by 210 mm) to 8.5 by 14 in (216 by 356 mm), letter, legal, executive, 8.5 x 13 in; ADF: 5.8 x 8.3 in (148 x 210 mm) to 8.5 x 14 in (216 x 356 mm), letter, legal; Flatbed scanner: up to 8.9 x 11.9 in (227 x 302 mm); Custom sizes not supported on two-sided accessory, envelope feeder, or stapler Weights: 100-sheet multipurpose tray, 3-bin mailbox: 16 to 53 lb (60 to 200 g/m ²); trays 2, 3, 4, 5, automatic two-sided printing accessory, stapler/stacker, ADF: 16 to 32 lb (60 to 120 g/m ²); optional envelope feeder: 20 to 28 lb (75 to 105 g/m ²) Types: Paper (plain, preprinted, letterhead, prepunched, bond, recycled, color, rough), transparencies, labels, envelopes, cardstock | | |
| Connectivity | Interfaces: One HP Jetdirect Fast Ethernet embedded print server; one Hi-Speed USB 2.0 port (type B); one Foreign Interface port; one open EIO slot; One HP Jetdirect Fast Ethernet embedded print server; one Hi-Speed USB 2.0 port (type B); one Foreign Interface port; one open EIO slot; one analog fax port Languages and fonts: HP PCL6, HP PCL5e, HP postscript level 3 emulation, direct PDF printing (v 1.4); 80 scalable TrueType fonts Client operating systems: Windows 2000, XP Home, XP Professional, XP Professional x64, Server 2003, Certified for Windows Vista®; Mac OS X v10.2.8, v10.3, v10.4 or later; PowerPC G3, G4, G5, and Intel Core processor Network operating systems: Via HP Jetdirect print servers: Windows 2000, XP Home, XP Professional, XP Professional x64, Server 2003; Novell 5.1 and higher; Mac OS X v10.2.8, v10.3, v10.4 and higher; Red Hat Linux 7.x and higher; SuSE Linux 8.x and higher; HP-UX 10.20, 11.x, 11.i; Solaris 2.5 and higher (SPARC systems only); IBM AIX 3.2.5 and higher (requires software from NOS vendor); MPE-iX; Citrix MetaFrame Server; Windows Terminal Services Network protocols: IPv6: DHCPv6, HTTP, HTTPS, Port 9100, LPD, IIP, Secure IIP, MLDv6, ICMPv6; IPv4: FTP, IPP, Secure IPP, Auto-IPP, Apple Bonjour Compatible, Telnet, SLP, IGMPv2, BOOTP/DHCP, WINS, SNMPv1/v2c/v3, TFTP, HTTP, HTTPS, Port9100, LPD; other: IPX/SPX, DLC, LLC, AppleTalk, Netware NDS, Binary, NCP | | |
| Security | Standard: Private print, HP Secure Storage Erase, network authentication (LDAP, SMTP); With optional HP Jetdirect print servers: 802.1x for Wired Networks, SNMPv3 and HTTPS, and Secure IPP (IPPS) and IPsec | | |
| Dimensions (w by d by h) | 30 by 22.3 by 21.5 in (762 by 566 by 545 mm) | 30 by 22.3 by 26.3 in (762 by 566 by 667 mm) | 40.4 by 29.3 by 43.7 in (1026 by 744 by 1110 mm) |
| Weight | 117.7 lb (53.5 kg) | 140.5 lb (63.9 kg) | 219 lb (99.4 kg) |
| What's in the box | All models: straight power cord, control panel overlay, print cartridge, software and documentation on CD, in-box documentation: (Getting Started guide, Network Configuration guide, wall poster, support flyer) | | Also includes: phone cord, 500-sheet input tray 3, analog fax accessory, automatic two-sided printing accessory |
| | | Also includes: phone cord, 500-sheet input tray 3, analog fax accessory, automatic two-sided printing accessory | Also includes: phone cord, 500-sheet input tray 3, analog fax accessory, automatic two-sided printing accessory, stapler/stacker, MFP stand with storage cabinet |

Ordering information

| Product | Number |
|---|---------|
| HP LaserJet M4345 MFP | CB425A |
| HP LaserJet M4345x MFP | CB426A |
| HP LaserJet M4345xs MFP | CB427A |
| Connectivity | |
| HP Jetdirect en1700 USB 2.0 Print Server ¹⁴ | J7988G |
| HP Jetdirect en3700 USB 2.0 Print Server ¹⁵ | J7942G |
| HP Jetdirect ew2400 wireless USB 2.0 Print Server ¹⁵ | J7951G |
| HP Jetdirect 175x Fast Ethernet USB external print server ¹⁵ | J6035G |
| HP Jetdirect 630n IPv6 Gigabit Ethernet Print Server | J7997G |
| HP Jetdirect 635n IPv6/Ipsec internal Print Server | J7961G |
| HP high-performance serial ATA EIO hard disk | J7989G |
| HP 1284B parallel card | J7927G |
| Software and accessories | |
| HP LaserJet MFP analog fax accessory | Q3701A |
| HP Digital Sending Software 4 | T1936AA |
| HP AutoStore software | T1943AA |
| Paper handling | |
| 500-sheet input feeder tray | Q5968A |
| Automatic two-sided printing accessory (for HP LaserJet M4345 MFP only) | Q5969A |
| 75-sheet envelope feeder | Q2438B |
| Stapler/stacker | Q5691A |
| 3-bin mailbox | Q5692A |
| Printer stand with storage cabinet | Q5970A |
| Supplies | |
| HP LaserJet black print cartridge with Smart Printing Technology, 18,000 page yield ¹³ | Q5945A |
| Staple cartridge (5,000 staples) for stapler/stacker | CB091A |
| ADF replacement Mylar sheets | Q6496A |
| ADF maintenance kit | Q5997A |
| HP printer maintenance kit (110 V) | Q5998A |
| HP printer maintenance kit (220 V) | Q5999A |
| Memory | |
| 128 MB 100-Pin DDR DIMM | Q7718A |
| 256 MB 100-Pin DDR DIMM | Q7719A |
| Service and support | |
| 3 year, next-day onsite response | H7668E |
| 3 year, 9x5 same-day onsite response | U4845E |
| 3 year, 13x5 same-day onsite response | H7686E |
| 4 year, next-day onsite response | U8025E |
| 4 year, 9x5 same-day onsite response | UA328E |
| 4 year, 13x5 same-day onsite response | UA330E |
| 5 year, next-day onsite response | U8026E |
| 5 year, 9x5 same-day onsite response | UA329E |
| 5 year, 13x5 same-day onsite response | UA331E |
| Network installation | U2010E |
| Solutions | |
| See the Global Solutions Catalog: www.hp.com/go/gsc | |
| HP papers | |
| North America: www.hp.com/go/paper | |
| USA: 1-800-477-5010 | |

| Environmental ranges | |
|---|---|
| Operating temperature | Recommended: 63 to 77° F (17 to 25° C) |
| Storage temperature | 50 to 99° F (13 to 38° C) |
| Relative humidity | Recommended: 30% to 70%, non-condensing |
| Acoustics ¹¹ | |
| Power emissions | Active: 6.9 B(A) printing, 7.2 B(A) copying Standby: Inaudible |
| Pressure emissions | Active: 54 dB(A) printing, 56 dB(A) copying Standby: Inaudible |
| Power requirements ¹² | 110 to 127 VAC (±10%), 50/60 Hz (±2 Hz), recommended circuit capacity 15 amps 220 to 240 VAC (±10%), 50/60 Hz (±2 Hz), recommended circuit capacity 8 amps |
| Power consumption ¹² | Maximum: 725 watts (printing), 830 watts (copying); Ready: 49 watts (M4345: 46 watts) Sleep: 16 watts (M4345: 15 watts) Off: 0.26 watts Typical Electricity Consumption (TEC): 5.963 kWh/Week ENERGY STAR [®] qualified models; see: http://www.hp.com/go/energystar |
| Product certifications | |
| Safety | Canada (cUL-CAN/CSA C22.2 No.60950-00), USA (UL-UL 60950; FDA-21 CFR Chapter 1 Subchapter J for lasers), Class 1 Laser/LED Product |
| Electromagnetic Compatibility | CISPR 22: 1993/EN 55022: 1994 Class B, EN 61000-3-2: 2000, EN 61000-3-3: 1995, EN 55024: 1998, FCC Title 47 CFR, Part 15 Class B/ICES-003, Issue 4/G89254-1998, GB17625.1-2003, EMC Directive 89/336/EEC and the Low Voltage Directive 73/23/EEC, and carries the CE-Marking accordingly |
| Warranty | One-year, next day, on-site limited warranty plus free phone support during warranty |
| HP SureSupply enabled | To learn more, please visit www.hp.com/go/SureSupply |

⁸ Based on standard ITU-T test image #1 at standard resolution. More complicated pages or higher resolution will take longer.
⁹ HP recommends that the number of pages per month of imaged output be within the stated range for optimum device performance, based on factors including supplies replacement intervals and device life over an extended warranty period.
¹⁰ Duty cycle is defined as the maximum number of pages per month of imaged output. This value provides a comparison of product robustness in relation to other HP LaserJet or HP Color LaserJet devices, and enables appropriate deployment of printers and MFPs to satisfy the demands of connected individuals or groups.
¹¹ Configuration tested: base model, simplex printing, A4 paper at an average of 45 ppm.
¹² Power requirements are based on the country/region where the printer is sold. Do not convert operating voltages. This will damage the printer and void the product warranty.
¹³ Average cartridge yield: 18,000 standard pages. Declared yield value in accordance with ISO/IEC 19752.
¹⁴ Supports printing only, no software scan, no webscan.
¹⁵ Supports printing only, no webscan.



ENERGY STAR and the ENERGY STAR logo are registered U.S. marks. Linux is a U.S. registered trademark of Linus Torvalds. Microsoft, Windows, and Windows XP are U.S. registered trademarks of Microsoft Corporation. Windows Vista is a trademark or registered trademark of Microsoft Corporation in the United States and/or other countries. UNIX is a registered trademark of The Open Group.

© Copyright 2006-2007 Hewlett-Packard Development Company, L.P. The information contained herein is subject to change without notice. The only warranties for HP products and services are set forth in the express warranty statements accompanying such products and services. Nothing herein should be construed as constituting an additional warranty. HP shall not be liable for technical or editorial errors or omissions contained herein.

Printed in the U.S.A.

For more information, visit our website at www.hp.com

4AA0-6872ENUC, December 2007, Rev. 6





LASERJET ENTERPRISE M4555 MFP SERIES

TECH 2000, INC.

M4555h • M4555f • M4555fskm

\$2,799.99 \$3,499.99 \$4,499.99

Achieve versatile, powerful MFP performance for a more productive printing environment. Print and copy at high speeds, use image preview to process jobs from the HP Easy Select pivoting color control panel and get robust paper handling up to 2100 sheets.¹ Expand the functionality of imaging and printing devices with market-leading management and extensibility. This ENERGY STAR[®] qualified MFP can help save on energy and paper, and advanced security features can help protect sensitive data.



Productive, dependable performance

- Stay productive with high performance speeds—print and copy at up to 55 ppm.²
- Boost productivity—get up to 2100-sheet paper capacity for large printing jobs from this workhorse MFP.¹
- Preview jobs using the pivoting color control panel and use image preview to make adjustments to scan jobs.
- Save time with easy installation, and get exceptional value from optional high-capacity print cartridges.³

Outstanding energy- and paper-saving features

- Reduce energy use with Instant-on Technology and Instant-on Copy.⁵
- Conserve resources and save paper—use automatic two-sided printing and PIN printing.
- Original HP LaserJet print cartridges with energy-efficient toner enable an energy savings of over 18%.⁴
- Get free, easy cartridge recycling,⁶ plus reduce shipping materials with HP ClearView packaging.



Market-leading manageability and extensibility

- Proactively manage printing environments and get easy setup and configuration with HP management tools.
- Extend the capabilities of workgroup print environments with a rich portfolio of easy-to-integrate solutions.
- Easily update, manage and expand the capabilities of networked printers with HP FutureSmart Firmware.
- Make printing as mobile as you are with HP ePrint.

Advanced security for sensitive information

- Protect sensitive data stored on the HP MFP with the standard encrypted HP High-Performance Secure Hard Disk.
- Process jobs securely through user authentication, IPsec and IPv6.
- Create, print, scan and share sensitive business information securely via encrypted email and PDFs.
- Add optional authentication security solutions through the control panel's hardware integration pocket.⁷



ecoHIGHLIGHTS

HP LaserJet Enterprise M4555 MFP series

ECO INFORMATION

- Reduce energy use with Instant-on Technology and Instant-on Copy.¹
- Reduce paper use by up to 50% using automatic two-sided printing.
- Reduce clutter and waste—scan, store and share documents digitally.

¹Compared with products that use traditional fusing and cold cathode fluorescent lamp (CCFL) copying.



ENERGY STAR[®] Qualified Product

www.hp.com/ecosolutions

Please recycle your computing hardware and printing supplies. HP asset management and recycling services make responsible disposal easy.



¹The 500-sheet feeder, 1 x 500 sheet feeder with cabinet and 3 x 500 sheet feeder with stand may be purchased separately for the HP LaserJet Enterprise M4555 MFP and the HP LaserJet Enterprise M4555h MFP. The 3 x 500 feeder with stand may be purchased separately for the HP LaserJet Enterprise M4555f MFP. ²Measured using ISO/IEC 24734, excludes first set of test documents. For more information see <http://www.hp.com/go/printerclaims>. Exact speed varies depending on the system configuration, software application, driver, and document complexity. ³The HP LaserJet CE390X Black Print Cartridge not included; please purchase separately. ⁴Energy savings based on comparing conventional toner and print system used in HP LaserJet M4345 MFP series with energy-efficient HP toner and print system used in HP LaserJet Enterprise M4555 MFP series. Testing per Energy Star Typical Electricity Consumption test. Actual savings may vary. ⁵Compared with products that use traditional fusing and cold cathode fluorescent lamp (CCFL) copying. ⁶Program availability varies. HP print cartridge return and recycling is currently available in more than 50 countries and territories around the world through the HP Planet Partners program. For more information, or to request return envelopes and bulk collection boxes, visit <http://www.hp.com/recycle>. ⁷Solutions deployed through the hardware integration pocket may require additional purchase.

- 1 Intuitive HP Easy Select pivoting touch screen color control panel
- 2 Walkup USB port
- 3 Hardware Integration Pocket for solution integration
- 4 900-sheet 3-bin stapling mailbox
- 5 Built-in automatic two-sided printing
- 6 Four 500-sheet input trays for a 2,100-sheet total input capacity
- 7 50-sheet ADF scanner processes two-sided documents. Plate-glass scanner handles documents up to legal size
- 8 Top cover release lever allows convenient access to the toner cartridge
- 9 100-sheet multipurpose tray 1 handles heavy custom media
- 10 Hi-Speed USB 2.0 port
- 11 Access port for optional Kensington-style lock
- 12 HP Jetdirect Gigabit Ethernet embedded print server
- 13 1280 MB total memory and an 800 MHz processor quickly handle complex print jobs
- 14 Embedded HP Secure High Performance Hard Disk
- 15 One open EIO slot
- 16 RJ-11 fax port

HP LaserJet Enterprise M4555fskm MFP shown

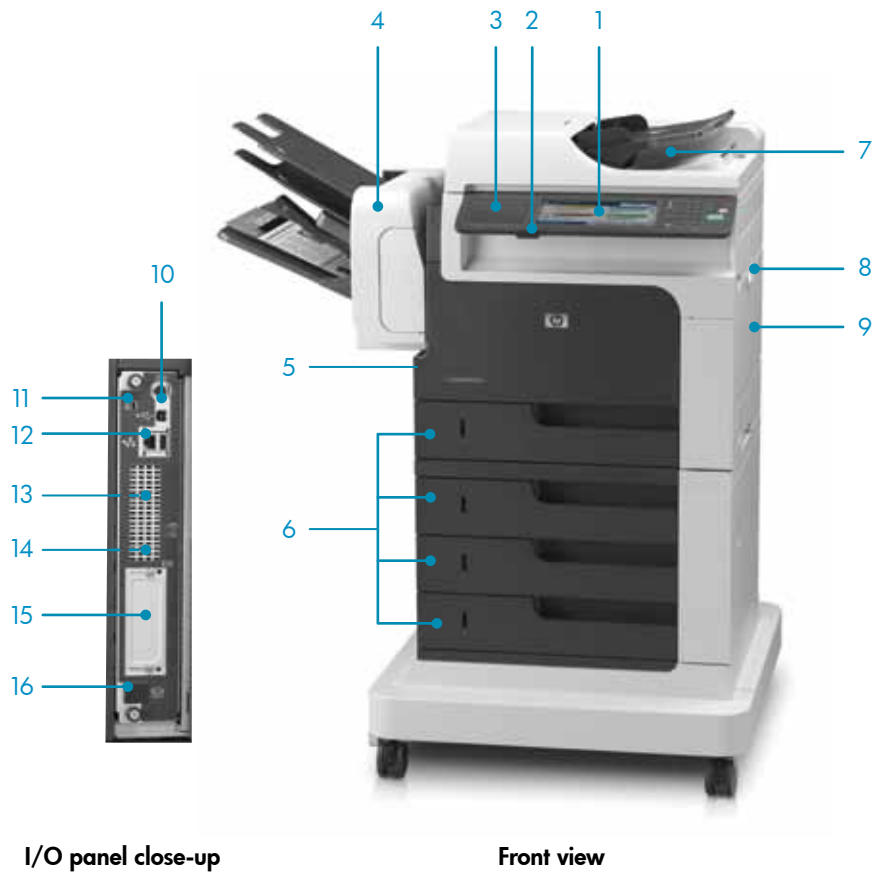

Series at a glance



| | M4555h MFP | M4555f MFP | M4555fskm MFP |
|--|---------------|---------------|---------------|
| Part number | CE738A | CE503A | CE504A |
| 100-sheet multipurpose tray 1 | √ | √ | √ |
| 500-sheet tray 2 | √ | √ | √ |
| 500-sheet Paper Feeder | Optional | | |
| 1 x 500-sheet Paper Feeder with Cabinet | Optional | √ | |
| 3 x 500-sheet Paper Feeder with Stand | Optional | Optional | √ |
| 75-sheet Envelope Feeder | Optional | Optional | Optional |
| 500-sheet Output Bin | √ | √ | |
| 900-sheet 3-bin Stapling Mailbox | Optional | Optional | √ |
| HP Secure High Performance Hard Disk | √ | √ | √ |
| HP LaserJet MFP Analog Fax Accessory 500 | Optional | √ | √ |

Maximize uptime with a productive MFP. Print and copy at up to 55 ppm,² and manage tasks from the HP Easy Select pivoting color control panel. Get paper capacity up to 2,100 sheets,¹ plus great value with optional high-capacity cartridges.³

Invest in an MFP that integrates into IT-managed print environments. Management tools monitor products and settings to control productivity and quality. Do more with the MFP—deploy HP and partner solutions via the hardware integration pocket.⁶

Stay in control of sensitive data and information with impressive security features from this MFP. The HP High-Performance Secure Hard Disk helps keep stored data secure.⁵ Process print jobs securely, and easily create encrypted emails and PDFs.

Conserve resources and meet environmental goals with this ENERGY STAR® qualified MFP. Save paper with automatic two-sided printing. Original HP LaserJet print cartridges with energy-efficient toner enable over 18% energy-savings with every print.⁴

Get the most out of your printer with HP accessories, supplies, and services.

HP Services

Because downtime can have serious business consequences, HP provides high-quality services that extend beyond the standard warranty and help you avoid unbudgeted repair costs. Benefits include reduced printing and infrastructure costs, maximized uptime, expert technical phone support, and predictable, consistent service delivery— even across multiple locations.

Recommended services:

- Same Day Onsite Service: An HP technician or authorized service provider arrives at your site within four hours after the service call is received, if this time falls within the coverage window
- Next Day Onsite Service: Technician delivered onsite service the next business day after the service call is received

These services and additional coverage options can be purchased as:

- HP Care Pack Services: easy-to-buy, easy-to-use support packages
- HP Contractual Services: a comprehensive portfolio for maintaining maximum IT availability

For more information visit: www.hp.com/go/printservices

MFP

HP LaserJet Enterprise M4555h MFP
 HP LaserJet Enterprise M4555f MFP
 HP LaserJet Enterprise M4555fsm MFP

CE738A
 CE503A
 CE504A

HP LaserJet Print Cartridges⁷

HP 90A Black LaserJet Toner Cartridge with Smart Printing (~ 10,000 pages)
 HP 90X Black LaserJet Toner Cartridge with Smart Printing (~ 24,000 pages)

CE390A
 CE390X

Accessories

1 x 500-sheet paper feeder with cabinet
 3 x 500-sheet paper feeder with stand
 3-bin, 900-sheet stapling mailbox
 500-sheet paper tray
 Staple cartridge refill
 75-sheet Envelope feeder
 110V Maintenance Kit
 220V Maintenance Kit
 ADF Printer Maintenance Kit
 HP LaserJet MFP Analog Fax Accessory 500
 HP BarCode Printing USB Solution
 HP BarCodes and More USB Solution
 HP Scalable BarCode Set USB Solution
 HP MICR USB Solution

CE734A
 CE735A
 CE736A
 CE737A
 C8091A
 CB524A
 CE731A
 CE732A
 CE248A
 CC487A
 HG271US
 HG281US
 HG282UT
 HG283US

HP Care Pack Services

HP 3y NBD LaserJet M4555 MFP HW Support
 HP 4y NBD LaserJet M4555 MFP HW Support
 HP 5y NBD LaserJet M4555 MFP HW Support
 HP 1y PW NBD LaserJet M4555 MFP Support
 HP 2y PW NBD LaserJet M4555 MFP Support
 HP Network Install mid-range LaserJet MFP SVC

HN909E
 HP562E
 HP557E
 HP567PE
 HP564PE
 U2010E

Connectivity

HP Jetdirect 635n IPv6/IPsec Print Server
 HP Jetdirect 690n IPv6/IPsec 802.11g Wireless Print Server
 HP Jetdirect ew2500 802.11b/g Wireless Print Server

J7961G
 J8007G
 J8021A

Paper

www.hp.com/go/paper

Software

HP Web Jetadmin: www.hp.com/go/wja
 HP Easy Printer Care: www.hp.com/go/easyprintercare
 HP Universal Print Driver: www.hp.com/go/upd
 HP Install Network Printer Wizard: www.hp.com/go/inpw_sw

¹The 500-sheet feeder, 1 x 500 sheet feeder with cabinet and 3 x 500 sheet feeder with stand may be purchased separately for the HP LaserJet Enterprise M4555 MFP and the HP LaserJet Enterprise M4555h MFP. The 3 x 500 feeder with stand may be purchased separately for the HP LaserJet Enterprise M4555f MFP. ²Measured using ISO/IEC 24734, excludes first set of test documents. For more information see <http://www.hp.com/go/printerclaims>. Exact speed varies depending on the system configuration, software application, driver, and document complexity. ³The HP LaserJet CE390X Black Print Cartridge not included; please purchase separately. ⁴Energy savings based on comparing conventional toner and print system used in HP LaserJet M4345 MFP series with energy-efficient HP toner and print system used in HP LaserJet Enterprise M4555 MFP series. Testing per Energy Star Typical Electricity Consumption test. Actual savings may vary. ⁵The HP High-Performance Secure Hard Disk not included on the HP LaserJet Enterprise CM4555 MFP; only available through upgrade. ⁶Solutions deployed through the hardware integration pocket may require additional purchase. ⁷Declared yield value for black cartridge in accordance with ISO/IEC 19752. Actual yields vary considerably based on images printed and other factors. For more information, visit <http://www.hp.com/go/learnaboutsupplies>

HP LASERJET ENTERPRISE M4555 MFP SERIES

TECH 2000, INC.

| Technical specifications | HP LaserJet Enterprise M4555h MFP (CE738A) | HP LaserJet Enterprise M4555f MFP (CE503A) | HP LaserJet Enterprise M4555fskm MFP (CE504A) |
|---------------------------------------|--|---|--|
| Print Speed¹ | Black: Up to 55 ppm letter | | |
| Copy Speed | Black: Up to 55 cpm letter | | |
| Scan Speed | Letter: Up to 57 ppm (b&w), up to 42 ppm (color) | | |
| First Page Out² | Print: As fast as 9.5 sec; Copy: As fast as 8.5 sec (M4555h & M4555f only) | | |
| Print Resolution | Up to 1200 x 1200 dpi (with HP FastRes 1200) | | |
| Scanning Resolution | Hardware: Up to 600 x 600 dpi; Optical: Up to 600 dpi; 30 bit depth | | |
| Control Panel | 8.07" HP Easy Select color control panel; rotating (adjustable angle) Touchscreen; job control buttons (Start, Stop, Sleep, Reset, Clear, Brightness Up/Down); numeric keypad; LED status lights (Ready, Data, Attention, Sleep); Hardware Integration Pocket; walk-up USB | | |
| Features | | | |
| Scanning | Color flatbed scanner or ADF; Scan input modes: Front panel applications: Copy, Scan to E-mail, Save-to-Network Folder, Scan-to-USB, Save to Device Memory, Open Extensibility Platform (EXP) applications | | |
| Copying | Up to 9,999 copies, reduce or enlarge from 25 to 400% (from scanner glass), scaling from 25 to 200% (from ADF) | | |
| Faxing | NA | Fax speed ³ : Up to 33.6 kbps; Fax resolution: Up to 300 x 300 dpi (400 x 400 dpi for received faxes only); Auto Fax Reduction Supported: Yes; Fax Auto-redialing: Yes; Fax Broadcasting, Max Locations: 100; Fax Forwarding Supported: Yes; Fax Polling Supported: Yes (poll to receive only); Fax Speed Dialing, Max Numbers: Up to 100 numbers (each with 100 destinations); Junk Barrier Supported: Yes; PC Interface Supported: Yes | |
| Processor | Type: Intel LE80578; Speed: 800 MHz | | |
| Memory | 1280MB (not expandable) RAM | | |
| Hard Disk | Standard, HP High-performance Secure Hard Disk (embedded) | | |
| Durability Ratings | Duty cycle ⁴ : Up to 250,000 pages (letter); Recommended monthly page volume ⁵ : 5,000 to 20,000 pages | | |
| Paper | | | |
| Input | 100-sheet multipurpose tray 1, 500-sheet tray 2, 50-sheet automatic document feeder (ADF), automatic two-sided printing | 100-sheet multipurpose tray 1, 500-sheet tray 2, 1 x 500-sheet feeder with cabinet, 50-sheet automatic document feeder (ADF), automatic two-sided printing | 100-sheet multipurpose tray 1, 500-sheet tray 2, 3 x 500-sheet feeder with stand, 50-sheet automatic document feeder (ADF), automatic two-sided printing |
| Output | 500-sheet output bin | | 900-sheet, 3-bin stapling mailbox |
| Two-sided Printing | Automatic | | |
| Media Types | Paper (plain, light, bond, recycled, cardstock), transparency, labels, letterhead, envelope, preprinted, prepunched, colored, rough | | |
| Media Sizes, Standard | Tray 1: 3 x 5 to 8.5 x 14 in; Tray 2: 5.8 x 8.3 to 8.5 x 14 in | Tray 1: 3 x 5 to 8.5 x 14 in; Tray 2-3: 5.8 x 8.3 to 8.5 x 14 in | Tray 1: 3 x 5 to 8.5 x 14 in; Tray 2-5: 5.8 x 8.3 to 8.5 x 14 in |
| Media Weight | Tray 1: 16 to 53 lb bond (plain), 16 to 24 lb (envelopes); Tray 2: 16 to 32 lb bond (plain) | Tray 1: 16 to 53 lb bond (plain), 16 to 24 lb (envelopes); Tray 2-3: 16 to 32 lb bond (plain) | Tray 1: 16 to 53 lb bond (plain), 16 to 24 lb (envelopes); Tray 2-5: 16 to 32 lb bond (plain) |
| Interfaces | 1 Hi-Speed USB 2.0 Host port; 1 Hi-Speed USB 2.0 Device port; 1 Gigabit Ethernet 10/100/1000Base-TX network port; 1 open EIO slot; 1 Foreign Interface port; 1 Hardware Integration Pocket; 3 Internal USB Host ports | | |
| Languages | HP PCL 6, HP PCL 5c (HP PCL 5c driver available from the Web only), HP postscript level 3 emulation, native PDF printing (v 1.4) | | |
| Network Capabilities | Via HP Jetdirect Gigabit 10/100/1000Base-TX Ethernet embedded print server (standard); IPsec (standard), 802.11g wireless (optional) | | |
| Fonts | 105 internal TrueType fonts scalable in HP PCL, 92 internal scalable fonts in HP postscript Level 3 emulation (Euro symbol built-in); 1 internal Unicode Fonts (Andale Mono WorldType); 2 Internal Windows Vista 8 Fonts (Calibri, Cambria); additional font solutions available via third-party flash memory cards; HP LaserJet Fonts and IPDS Emulation available at http://www.hp.com/go/laserjetfonts | | |
| Network Protocols | IPv4/IPv6: Apple Bonjour Compatible (Mac OS v 10.2.4 or higher), SNMPv1/v2c/v3, HTTP, HTTPS, FTP, TFTP, Port 9100, LPD, WS Discovery, IPP, Secure-IPP, IPsec/Firewall; IPv6: DHCPv6, MLDv1, ICMPv6; IPv4: Auto-IP, SLP, Telnet, IGMPv2, BOOTP/DHCP, WINS, IP Direct Mode, WS Print; Other: NetWare NDS, Bindery, NDPS, iPrint | | |
| Security | Management security: SNMPv3, SSL/TLS, 802.1X authentication (EAP-PEAP, EAP-TLS), IPP over TLS, IPsec/Firewall with Certificate, Pre-Shared Key Authentication, and Kerberos Authentication; Support for WJA-10 IPsec Configuration using IPsec Plug-in | | |
| Dimensions (w x d x h) | 31.10 x 20.08 x 22.44 in (790 x 510 x 570 mm) | 32.48 x 27.95 x 43.90 in (825 x 710 x 1115 mm) | 39.96 x 27.95 x 43.90 in (1015 x 710 x 1115 mm) |
| Weight (with print cartridges) | 115.4 lb (52.5 kg) | 166.4 lb (75 kg) | 192.9 lb (87.5 kg) |
| System Requirements, Windows | Microsoft® Windows 7®, Windows Vista®, Windows® XP SP2 or higher, Windows® Server 2003, Windows® Server 2008; operating system compatible hardware system requirements, see http://www.microsoft.com system requirements; 200 MB available hard disk space Mac: Mac OS X v 10.5 or higher; operating system compatible hardware system requirements, see: http://www.apple.com ; 150 MB available hard disk space | | |
| What's in the Box | HP LaserJet Enterprise M4555h MFP (100-sheet multipurpose tray; 500-sheet input tray; HP Jetdirect Gigabit Ethernet embedded print server; Encrypted Hard Disk Drive); HP LaserJet Toner cartridge standard capacity; CD with software and documentation; Documentation (Hardware Install Guide, Support flyer, Wall poster); power cord M4555f: As above plus 1 x 500 paper feeder with cabinet; HP Analog fax accessory 500 (built-in); phone cord M4555fskm: As above plus 3 x 500 paper feeder with stand; 900-sheet, 3-bin stapling mailbox; HP Analog fax accessory 500 (built-in); phone cord | | |
| Warranty | One year next day on-site warranty, one year free phone support, chat, and e-mail | | |

| | | | |
|-------------------------------------|---|--|--|
| Environmental Ranges | | Power Consumption ⁷ | 960 watts (Printing), 1024 watts (Copying), 54 watts (Ready), 21.6 watts (Sleep), 0.15 watts (Off) |
| Temperature range | Operating: 10 to 30° C (50 to 86° F) Recommended: 15 to 27° C (59 to 80.6° F) Storage: 0 to 35° C (32 to 95° F) | Typical Electricity Consumption (TEC) | 7.349 kWh/Week |
| Humidity range | Operating: 10 to 80% RH Recommended: 30 to 70% RH Non-operating: 10 to 90% RH | Safety approvals and requirements | IEC 60950-1: 2005 (International), EN 60950-1: 2006 +A11 (EU), UL/cUL Listed (US/Canada), GS license (Europe), IEC 60825-1: 2007 (International), EN 60825-1: 2007 (Class 1 Laser/LED Device), Low Voltage Directive 2006/95/EC with CE Marking (Europe); other safety approvals as required by individual countries |
| Acoustics | | Electromagnetic emission standard | CISPR 22: 2005+A1/EN 55022: 2006+A1 Class A, EN 61000-3-2: 2006, EN 61000-3-3: 2008, EN 55024: 1998+A1+A2, FCC Title 47 CFR, Part 15 Class A (USA), ICES-003, Issue 4, (Canada), GB9254-2008, EMC Directive 2004/108/EC with CE Marking (Europe), other EMC approvals as required by individual countries |
| Sound power emissions ⁸ | Active, Print: 7.1 B(A), Copy/Scan: 7.2 B(A), Idle/Ready: 4.9 B(A) | | |
| Sound pressure (bystander position) | Active, Print: 57 dB(A), Copy/Scan: 58 dB(A), Idle/Ready: 35 dB(A) | | |
| Power | | | |
| Power Supply required | Input voltage: 110 to 127 VAC (+/- 10%), 60 Hz (+/- 2 Hz), 12 A; 220 to 240 VAC (+/- 10%), 50 Hz (+/- 2 Hz), 6 A | | |

¹Measured using ISO/IEC 24734, excludes first set of test documents. For more information see <http://www.hp.com/go/printerclaims>. Exact speed varies depending on the system configuration, software application, driver, and document complexity. ²Exact speed varies depending on the system configuration, software application, driver and document complexity for first page out. A firmware upgrade may be required to realize stated first copy out time (FCOT). ³Based on standard ITU-T test image #1 at standard resolution. More complicated pages or higher resolution will take longer and use more memory. ⁴Duty cycle is defined as the maximum number of pages per month of imaged output. This value provides a comparison of product robustness in relation to other HP LaserJet or HP Color LaserJet devices, and enables appropriate deployment of printers and MFPs to satisfy the demands of connected individuals or groups. ⁵HP recommends that the number of printed pages per month be within the stated range for optimum device performance, based on factors including supplies replacement intervals and device life over an extended warranty period. ⁶Declared per ISO 9296 and 7779; values are subject to change. Configuration tested: HP LaserJet Enterprise M4555 MFP. ⁷Power requirements are based on the country/region where the printer is sold. Do not convert operating voltages. This will damage the printer and void the product warranty. Values subject to change. Power numbers are the highest average values measured using all standard voltages.



ENERGY STAR® qualified models; see: <http://www.hp.com/go/energystar>

© Copyright 2011 Hewlett-Packard Development Company, L.P.

The information contained herein is subject to change without notice. The only warranties for HP products and services are set forth in the express warranty statements accompanying such products and services. Nothing herein should be construed as constituting an additional warranty. HP shall not be liable for technical or editorial errors or omissions contained herein.

ENERGY STAR and the ENERGY STAR mark are registered U.S. marks. Microsoft, Windows, and Windows XP are registered trademarks of Microsoft Corporation.

Windows Vista is either a registered trademark or trademark of Microsoft Corporation in the United States and/or other countries.

To learn more, visit <http://www.hp.com>

4AA3-3260ENUC, March 2011



HP LaserJet M5035 MFP series

M5035 • M5035x • M5035xs !!! \$4,899.99 \$5,999.99



Watch workgroup productivity soar with the HP LaserJet M5035 MFP series, an easy to use, wide-format MFP you can count on: enjoy print, copy, scan, fax¹, and multiple digital sending functions from one reliable, cost-effective device.

Full 11 by 17 multifunction productivity

- **Enjoy fast, professional printing and copying.** Save time and money with print and copy speeds of up to 35 pages per minute (ppm). Instant-on Technology reduces warm-up time from minutes to seconds, so you see a fast first page.
- **Provide big impact in a small size.** The MFP offers the 11 by 17 printing you want, and its smaller footprint enables placement close to workgroups, where you need it.
- **Integrate documents into workflows.** The MFP comes standard with send-to- e-mail and send-to-network-folder capabilities, including LDAP and address book support. With optional HP Digital Sending Software (DSS) 4.3, you can incorporate paper documents into electronic business processes, and send them quickly and securely to printers, ftp sites, and fax services.² Add optional HP AutoStore software to effortlessly route information to document management applications.
- **Improve efficiency with two-sided printing, copying, and scanning.** The MFP includes a 50-sheet reversing automatic document feeder (ADF) that supports wide-format, two-sided copying and scanning of double-sided originals. An automatic two-sided printing unit conserves paper, reducing office costs.³

Easy to use, easy to succeed

- **Save time with an embedded hard drive.** Enjoy password-printing capabilities, high-capacity storage of frequently used documents, and proof-and-hold features.

- **Count on reliable and simple networking.** The MFP features best-in-class networking through the HP Jetdirect, IPv6-ready, Fast Ethernet embedded print server.⁴ HP Web Jetadmin software offers remote installation, configuration, and proactive management. The HP Embedded Web Server performs remote diagnostics, sends e-mail alerts, and facilitates supplies reordering.
- **Work without interruption.** Interactive HP Smart printing technology in the HP print cartridge and the device optimizes print quality, provides convenient troubleshooting, enables status monitoring, sends alerts when supplies are low, and facilitates convenient on-line supplies reordering.⁵

Flexibility and expandability

- **Support workgroup productivity with flexible paper handling.** Complete jobs more quickly with an input capacity of up to 2,100 sheets. The HP LaserJet M5035xs MFP's automatic 30-sheet stapler/500-sheet stacker increases your output options.⁶
- **Safeguard your business with HP's security framework.** Count on capabilities that better secure the device, protect critical information, and simplify the way you manage and maintain your environment.

HP printing and imaging systems help you create powerful, professional communications easily. HP multifunction products, supplies, accessories, and services are designed to work together and are invented to meet your business needs.

¹Fax functionality comes standard on the HP LaserJet M5035x MFP and HP LaserJet M5035xs MFP only. It is an optional feature that can be added onto the HP LaserJet M5035 MFP (not included, sold separately).

²HP Digital Sending Software 4.3 is optional (not included, sold separately). Software is server based, server required. Trial is included.

³Standard and available features vary according to model. For more information, see "Series at a glance" on page 2.

⁴IPv6 is only supported with Microsoft Server 2003 and Windows XP (print only).

⁵Using genuine HP supplies ensures availability of all HP printing features. For more information, visit www.hp.com/learn/suresupply.

⁶Automatic stapling is available on the HP LaserJet M5035xs MFP only. It is not an upgradeable accessory.

HP LaserJet M5035xs MFP shown

- 1 50-sheet automatic document feeder (ADF) automatically scans two-sided documents in full color
- 2 Color flatbed scanner for scanning, copying, and faxing jobs
- 3 Automatic 30-page stapler/stacker with a 500-sheet output bin⁶
- 4 Automatic two-sided printing unit
- 5 Two 250-sheet input trays
- 6 Integrated 3 by 500-sheet input trays
- 7 Intuitive control panel features a touch-screen graphical display
- 8 250-sheet output bin
- 9 Side door access to the print cartridge
- 10 100-sheet multipurpose tray 1
- 11 Right side access door
- 12 USB accessory connection
- 13 A powerful 460 MHz processor and 256 MB of standard memory (expandable up to 512 MB)
- 14 One open EIO slot
- 15 Hi-Speed USB 2.0 port
- 16 Security lock slot
- 17 Foreign interface harness (FIH) port
- 18 HP Jetdirect Fast Ethernet embedded print server
- 19 V.34 fax modem port



Series at a glance



HP LaserJet M5035 MFP

- 100-sheet multipurpose tray and two 250-sheet input trays for 600-sheet input capacity
- Color flatbed scanner and 50-page ADF
- 250-sheet output bin
- 256 MB RAM
- Embedded hard drive
- HP Jetdirect Fast Ethernet embedded print server
- 15,000 page HP LaserJet Black Print Cartridge with Smart Printing Technology⁷

HP LaserJet M5035x MFP

- Base model, plus:
- 500-sheet input tray 4 with storage cabinet for a 1,100-sheet input capacity
 - Analog fax functionality
 - Automatic two-sided printing unit

HP LaserJet M5035xs MFP

- Base model, plus:
- Integrated 3 by 500-sheet input trays 4, 5, and 6 for a 2,100-sheet input capacity
 - Analog fax functionality
 - Automatic two-sided printing unit
 - Automatic 30-page stapler/stacker with a 500-sheet output bin

⁶ The stapler is available with the HP LaserJet M5035xs MFP only.

⁷ Declared yield value in accordance with ISO/IEC 19752. For more information, visit www.hp.com/go/pageyield.

Simplicity, convenience, and outstanding support make the HP LaserJet M5035 MFP series the perfect choice for small workteams with no time to worry about device management.



Radically simple

HP completely redefines the term usability with its new, radically simple user interface.

- Easily take advantage of your MFP's complete feature set with an intuitive control panel that clearly displays all available applications. Getting around is a snap with familiar Windows emulation icons, automatic navigation that visually walks you through troubleshooting, and setup installation wizards .
- The control panel's unique touch-screen graphical display offers all the features you expect from a standard photocopier as well as faxing, scanning, digital sending capabilities, and printing.
- A built-in Help system explains how to use each screen. To open the Help system, touch the Help button (?) in the upper-right corner of the screen. You can search for specific topics and view explanations of the settings available for an individual job.
- Just like your coffee maker, the Automatic Printer Wakeup feature allows you to set your MFP to be warmed up and ready first thing in the morning.

Extended functionality

A Foreign Interface Harness, open EIO slot, and host USB port allow you to expand the MFP's capabilities with HP and third-party solutions. Get investment protection with optional Gigabit Ethernet, IPsec security, or wireless networking and memory expandability up to 512 MB RAM. HP partnerships enable access to integrated third-party solutions such as additional forms, fonts, barcode printing, and business process solutions for document capture and security.

Legendary HP support

HP's award-winning customer service and support backs every product with a one-year limited on-site warranty; fast, knowledgeable online support available 24/7 at www.hp.com/support, and easy-to-access phone support provided by HP trained agents. Plus, you can enhance your warranty protection with the purchase of affordable HP Care Pack Services.

100 million HP LaserJet printers shipped

No one has supplied more printers to more people than HP. For more than 20 years, HP has introduced innovative laser printing products. Now, HP celebrates shipment of the 100 millionth HP LaserJet printer. HP printers offer proven reliability, award winning service and support, and the broadest portfolio of printing solutions in the industry. Count on the legendary quality of HP LaserJet printers.

Saves valuable time

The HP LaserJet M5035 MFP series is designed to save you time and effort with powerful management tools and convenient, thoughtful features:

- **The HP Embedded Web Server** provides a universal interface to the device that anyone with a network-connected PC and a standard Web browser can easily access. It requires no special software to install or configure. You can check status information, change settings, and facilitates convenient supplies reordering.
- **HP Web Jetadmin** is a simple, Web-based peripheral management utility for remotely installing, configuring, and managing a wide variety of HP and non-HP network peripherals. Through a standard Web browser, you can manage supplies, configure devices, conduct remote diagnostics, set up automatic e-mail alerts, and solve potential problems before they impact user productivity.
- **The HP Universal Print Driver Series for Windows** can alleviate administration headaches with a single, intelligent driver that replaces individual drivers for all HP networked devices. For more information, go to www.hp.com/go/universalprintdriver.
- **Built-in hard drive.** HP's world-class designers have thought through all the details and included a built-in hard drive on both models, which provides a virtual mailbox to keep sensitive documents confidential, proof a document before releasing the remaining copies, and store frequently printed jobs for easy retrieval, such as expense reports or invoices.

Build the wide-format MFP to suit your business



Automatic two-sided printing unit

Save time with the automatic two-sided printing unit



Input trays

Add input capacity with a 500-sheet tray with storage cabinet or integrated 3 by 500-sheet trays



Analog fax accessory

Add fax capabilities for a complete office hard-copy solution



Digital sending

Add digital sending capabilities with DSS 4.3 or AutoStore



Enhanced Input/Output

Add wireless, Gigabit Ethernet, or IPsec compatibility via the open EIO slot



Additional memory

Get up to 512 MB RAM via one open DIMM slot

HP LaserJet M5035 MFP series

| Technical specifications | HP LaserJet M5035 MFP (Q7829A) | HP LaserJet M5035x MFP (Q7830A) | HP LaserJet M5035xs MFP (Q7831A) |
|---|---|--|--|
| Print and copy speed⁸ | Up to 35 ppm, letter | | |
| First page out | Less than 10 seconds | | |
| Print resolution | HP FastRes 1200, HP ProRes 1200 (1200 by 1200 dpi), REt (Resolution Enhancement technology) | | |
| Features | | | |
| Copying | Up to 1,000 multiple copies, two-sided copying (standard on x and xs bundles), reduce/enlarge from 25 to 400% (from scanner glass), contrast (lighter/darker), mixed originals (letter and legal), image adjustment, paper selection, content orientation, pages per sheet, booklet format, optimize text/picture, job build, edge to edge | | |
| Scanning | Color flatbed scanner or ADF; scan input modes: front-panel scan, copy, fax (standard on x and xs bundles), e-mail; file types: PDF, JPG, TIFF, MTIFF | | |
| Faxing | Optional faxing accessory | 300 dpi, 33.6 kbps, auto fax reduction, fax forwarding, fax polling, broadcasting, speed dial, junk barrier, remote retrieval, auto redialing, Windows faxing | |
| Digital sending | Send to e-mail, send to network folder, LDAP and SMTP authentication, LDAP addressing; file formats: PDF, JPG, TIFF, MTIFF Optional features: Digital Sending Software, HP AutoStore | | |
| Processor | 460 MHz | | |
| Memory/storage | 256 MB RAM (fixed), expandable up to 512 MB via a single open 100-pin DDR DIMM slot; Memory Enhancement technology (MET); hard drive | | |
| Durability rating | Recommended monthly page volume: ⁹ 3,000 to 12,500 pages Duty cycle: ¹⁰ up to 200,000 pages per month | | |
| Paper | | | |
| Handling | 100-sheet multipurpose tray 1, 250-sheet input tray 2, 250-sheet input tray 3, 50-sheet two-sided reversing automatic document feeder | 100-sheet multipurpose tray 1, 250-sheet input tray 2, 250-sheet input tray 3, 500-sheet input tray 4 with storage cabinet, 50-sheet two-sided reversing automatic document feeder | 100-sheet multipurpose tray 1, 250-sheet input tray 2, 250-sheet input tray 3, integrated 3 by 500-sheet trays 4, 5, and 6, 50-sheet two-sided reversing automatic document feeder |
| Output | 250-sheet output bin | | 250-sheet output bin, 30-sheet automatic stapler/stacker with 500-sheet output bin |
| Two-sided printing | Optional accessory | Automatic two-sided printing unit | |
| Sizes | 100-sheet multipurpose tray 1: 3 by 5 in to 12.28 by 18.5 in (76 by 127 mm to 312 by 470 mm) 250-sheet tray 2: 5.83 by 8.27 in to 11.7 by 14.33 in (148 by 210 mm to 297 by 364 mm) 250-sheet tray 3, integrated 3 by 500-sheet trays 4, 5, and 6: 5.83 by 8.27 in to 11.7 by 17 in (148 by 210 mm to 297 by 432 mm) Automatic document feeder: 5.43 by 8.27 in by 11 by 17 in (138 by 210 mm to 297 by 432 mm) Flatbed scanner: 8.5 by 11 in to 11.7 by 17 in (215.9 by 279.4 mm to 297 by 432 mm) | | |
| Weights | Input trays and finishing devices: 16 to 32 lb (60 to 120 g/m ²) Automatic document feeder: 16 to 28 lb (60 to 105 g/m ²) | | |
| Types | Paper (plain, printed, letterhead, prepunched, bond, recycled, color, rough), transparencies, labels, envelopes, card stock | | |
| Connectivity | | | |
| Interfaces | One HP Jetdirect Fast Ethernet embedded print server, one Foreign Interface Harness (FIH), one USB type A port, one USB type B port, one open EIO slot, analog fax accessory (M5035x and M5035xs only) | | |
| Languages and fonts | HP PCL6, HP PCL5, HP postscript level 3 emulation, PDF 1.4; 80 Scalable TrueType fonts | | |
| Operating systems | Microsoft® Windows 2000, Windows Server 2003 x86, XP x86, Windows Server 2003 x64, XP x64, Certified for Windows Vista®; Mac OS X v10.3, v10.4 or higher, PowerPC G3, G4, G5, and Intel Core processor | | |
| Network operating systems | Via HP Jetdirect print servers: Windows 2000, XP Home, XP Professional, XP Professional x64, Server 2003; Novell 5.1 and higher; Mac v10.3, v10.4 or higher; Red Hat Linux 7.x and higher; SuSE Linux 8.x and higher; HP-UX 10.20, 11.x, 11.i; Solaris 2.5 and higher (SPARC systems only); IBM AIX 3.2.5 and higher (requires software from NOS vendor); MPE-iX; Citrix MetaFrame Server; Windows Terminal Services | | |
| Network protocols | IPv6: ¹¹ DHCPv6, HTTP, HTTPS, Port 9100, LPD, IPP, Secure IPP, MLDv6, ICMPv6; IPv4: FTP, IPP, Secure IPP, Auto-IP, Apple Bonjour Compatible, Telnet, SLIP, IGMPv2, BOOTP/DHCP, WINS, SNMPv1/v2c/v3, TFTP, HTTP, HTTPS, Port9100, LPD; Other: IPX/SPX, DLC, LLC, Apple | | |
| Security | Private print, HP Secure Storage Erase, HP JetDirect — 802.1X for wired networks, SNMPv3 and HTTPS, and Secure IPP (IPP-S) and IPSec | | |
| Dimensions (W by D by H) | 24 by 22.5 by 23 in (610 by 571 by 584 mm) | 29.1 by 29.2 by 40.1 in (743 by 743 by 997 mm) | 29.1 by 29.1 by 46.5 in (743 by 743 by 1183 mm) |
| Weight | 121 lb (55 kg) | 192 lb (93 kg) | 213 lb (97 kg) |
| What's in the box | HP LaserJet M5035 MFP, power cord, original HP print cartridge, control panel overlay, Getting Started Guide, Wall Poster, software/documentation CD | | Also includes: automatic two-sided printing unit, cabinet with 500-sheet input tray |

| | |
|--|---|
| Recommended temperature | 63 to 77 degrees F (17 to 25 degrees C) |
| Storage temperature | 50 to 99 degrees F (13 to 38 degrees C) |
| Recommended humidity | 30 to 70 percent, non-condensing |
| Sound power¹² | Active: 6.6 dB(A); Active copy or scan: 7.1 dB(A); Ready: inaudible |
| Bystander sound pressure¹² | Active: 51 dB(A); Active copy or scan: 56 dB(A); Ready: inaudible |
| Power specifications | 110-volt models: 115 to 127 V (± 10 percent), 60 Hz (± 2 Hz); 12 amp 220-volt models: 220 to 240 V (± 10 percent), 50 Hz (± 2 Hz); 6 amp Active: 600 watts; Active copy: 1265 watts; Ready: 28 watts; PowerSave: 24 watts; Off: 0.1 watt Typical Electricity Consumption (TEC): 7.314 kWh/Week |
| Power consumption¹³ | ENERGY STAR® qualified models; see: www.hp.com/go/energystar Canada (cULCAN/CSA C22.2 No.60950-1-03), USA (UL/UL 60950-1; FDA-21 CFR Chapter 1 Subchapter J for lasers), Class 1 Laser/LED Product |
| Safety certifications | CISPR 22:1993/EN 55022:1994 Class A, EN 61000-3-2:2000, EN 61000-3-3:1995, EN 55024:1998, FCC Title 47 CFR, Part 15 Class B/ICES-003, Issue 4/GB9254-1998, GB17625.1-2003, EMC Directive 89/336/EEC and the Low Voltage Directive 73/23/EEC, and carries the CE-Marking accordingly |
| EMC certifications | TBR-21:1998; EG 201 121:1998, FCC Part 68, Industry Canada CS03, NOM-151-SCTI-1999 (Mexico) |
| Telecom | |
| Warranty | One year, next business day, on-site warranty with free phone support during warranty |
| HP SureSupply enabled | To learn more, please visit www.hp.com/go/SureSupply |

⁸ Print speed may slow down on large jobs using letter-landscape and ledger sized paper. The degree of speed reduction will depend upon paper weight and fuser mode, and is determined by the maximum allowable fuser temperature. Copy speed specifications are based on long-edge feed (landscape) scanning through the ADF.

⁹ HP recommends that the number of pages per month of imaged output be within the stated range for optimum device performance, based on factors including supplies replacement intervals and device life over an extended warranty period.

¹⁰ Duty cycle is defined as the maximum number of pages per month of imaged output. This value provides a comparison of product robustness in relation to other HP LaserJet or HP Color LaserJet devices, and enables appropriate deployment of printers and MFPs to satisfy the demands of connected individuals or groups.

¹¹ IPv6 is only supported with Microsoft Server 2003 and Windows XP (print only).

¹² Configuration tested: base model, simplex printing, A4 paper at an average of 35 ppm.

¹³ Power requirements are based on the country/region where the printer is sold. Do not convert operating voltages. This will damage the printer and void the product warranty.

¹⁴ Declared yield value in accordance with ISO/IEC 19752. For more information, visit www.hp.com/go/pageyield.



© Copyright 2006-2007 Hewlett-Packard Development Company, L.P.
The information contained herein is subject to change without notice. The only warranties for HP products and services are set forth in the express warranty statements accompanying such products and services. Nothing herein should be construed as constituting an additional warranty. HP shall not be liable for technical or editorial errors or omissions contained herein.

ENERGY STAR and the ENERGY STAR logo are registered U.S. marks. Microsoft, Windows, and Windows XP are U.S. registered trademarks of Microsoft Corporation. Windows Vista is a trademark or registered trademark of Microsoft Corporation in the United States and/or other countries. Linux is a U.S. registered trademark of Linus Torvalds. PostScript is a trademark of Adobe Systems Incorporated.
Printed in U.S.A.

Ordering information

| Product | Number |
|--|---------|
| HP LaserJet M5035 MFP | Q7829A |
| HP LaserJet M5035x MFP | Q7830A |
| HP LaserJet M5035xs MFP | Q7831A |
| Supplies | |
| HP LaserJet Black Print Cartridge with Smart Printing Technology. Average cartridge yield 15,000 standard pages ¹⁴ | Q7570A |
| HP Printer Maintenance Kit 110V | Q7832A |
| ADF Maintenance Kit | Q7842A |
| Stapler cartridge (5,000 staples) | C8091A |
| Connectivity | |
| HP Jetdirect en1700 USB 2.0 Print Server (print only) | J7988G |
| HP Jetdirect 620n Fast Ethernet Print Server | J7934G |
| HP Jetdirect 635n IPv6/IPsec internal print server (EIO) | J7961G |
| HP Jetdirect 630n EIO Print Server | J7997G |
| HP Jetdirect ew2400 wireless USB 2.0 Print Server (print only) | J7951G |
| HP Jetdirect en3700 external Fast Ethernet print server (USB 2.0) (print only) | J7942G |
| HP Jetdirect 175x Fast Ethernet USB external Print Server (print only) | J6035G |
| HP 1284B parallel card | J7972G |
| Accessories | |
| Automatic two-sided printing unit | Q7549A |
| Analog fax accessory | Q3701A |
| 1x500 sheet tray with integrated stand and cabinet | Q7834A |
| 3x500 sheet trays 4, 5 and 6 with integrated stand | Q7835A |
| HP AutoStore | T1943AA |
| HP Digital Sending Software 4.3 | T1936AA |
| Memory and storage | |
| 128 MB 100-Pin DDR DIMM | Q7718A |
| 256 MB 100-Pin DDR DIMM | Q7719A |
| HP EIO Serial ATA High Performance Hard Disk | J7989G |
| Cables | |
| USB, 2-meter A to B cable | Q6264A |
| Service and support | |
| Network installation | U2014E |
| 3 year, next-day onsite response | UE670E |
| 3 year, 9x5 same day onsite response | UE673E |
| 3 year, 13x5 same day onsite response | UE676E |
| See www.hp.com/support for extended warranty options | |
| Solutions | |
| www.hp.com/go/gsc | |
| Paper | |
| www.hp.com/go/paper | |

USA: 1-800-477-5010

For more information, visit our website at
4AA0-6838ENUC, October 2007, Rev. 4.3





HP Color LaserJet M9040/M9050 MFP \$9,999.99 \$12,999.99



Increase the productivity in your workplace with a well-rounded workhorse suited to diverse business environments.

Demanding workgroups of 30 to 50 users benefit from a centralized printing environment featuring up to 11 by 17 inch general office printing, copying, scanning, and optional faxing. Meet your needs with fast, high-volume, cost-effective printing and copying, digital sending, automatic two-sided printing, and advanced finishing options.

Saves time and effort

The HP LaserJet M9040/M9050 MFP includes a host of different features that let you perform office functions more easily. The Easy Select Control Panel provides an intuitive, consistent user experience across the HP lineup.

Use the dual-head color scanner on the automatic document feeder (ADF) to copy and scan double-sided originals. Reduce printing costs, save time, and make paperwork more manageable with automatic two-sided printing and copying.

Get more done with lightning-fast printing and copying speeds of up to 50 pages per minute (ppm) for the HP LaserJet M9050 MFP (up to 40 ppm for the HP LaserJet M9040 MFP).

Increases productivity

Save time and get professional-looking results with a variety of paper-handling and finishing options. The device's adjustable, high-capacity paper trays feature automatic media size detection for accurate printing. Choose one of four available output solutions, including the eight-bin mailbox, stacker, stacker/stapler, or multifunction finisher.

Use the included scan to e-mail and additional digital sending features to transform document workflow processes with fast, easy conversion of paper-based documents into electronic files.

Print and scan wide-format documents such as spreadsheets or architectural drawings with the 11 by 17 inch printing capabilities of this versatile MFP. The color scanner delivers 600 by 600 dots per inch (dpi) for high image quality.

Extend the MFP's capabilities by adding third-party solutions such as integrated capture, job accounting, and security solutions. Or add the optional HP LaserJet MFP Analog Fax Accessory 300 to send and receive documents with ease.

HP LaserJet reliability

Enjoy the reliability that you've come to expect from the HP LaserJet brand, along with the convenience of multiple functions in one device. Consistently produce all your business documents with industry-leading print quality.

HP LaserJet M9040/M9050 MFP

- 1 100-sheet ADF supports copying and scanning of double-sided originals
- 2 One-door access to the easy-to-replace print cartridge
- 3 Choose the 8-bin mailbox, 3,000-sheet stacker, 3,000-sheet stapler/stacker, or multifunction finisher (stapling, stacking, and booklet-making) finishing output solution¹
- 4 Intuitive, graphical touch-screen display with a time-saving help function
- 5 100-sheet multipurpose tray for specialty papers
- 6 Built-in automatic two-sided printing and copying
- 7 500-sheet input trays 2 and 3
- 8 2,000-sheet input tray 4 for a 3,100-sheet total input capacity
- 9 A powerful 533 MHz processor and 384 MB memory, upgradeable to 512 MB
- 10 One available EIO slot
- 11 Host USB port for additional functionality
- 12 Hi-Speed USB 2.0 device port
- 13 Optional HP LaserJet MFP Analog Fax Accessory 300
- 14 Jetlink connection for paper handling device
- 15 HP Jetdirect Gigabit Ethernet Embedded Print Server
- 16 Foreign Interface Harness
- 17 Embedded hard disk

HP LaserJet M9050 MFP shown with optional 3,000-sheet stacker



Front view

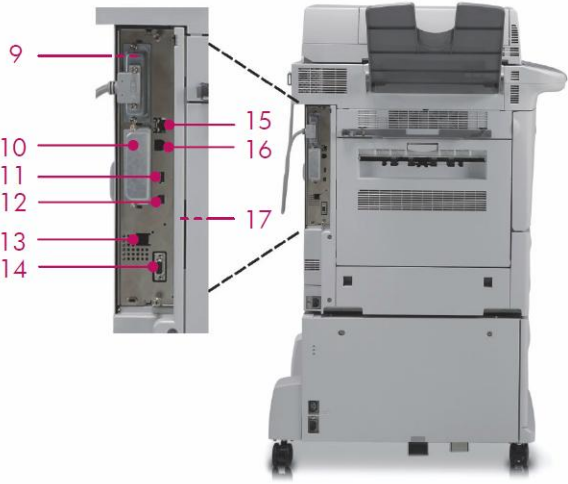

Left side view

Choose the paper output solution that fits your business¹



8-bin Mailbox
Q5693A—Assign each mailbox bin to an individual, workgroup, or department, or use it as a sorter/collator, stacker, and job separator.



3,000-sheet Stacker
C8084A—Stack up to 3,000 sheets of paper with job offset.



3,000-sheet Stacker/Stapler
C8085A—Get 3,000-sheet stacker capabilities as well as multi-position stapling for up to 50 sheets of paper per job.



Multifunction Finisher
C8088B—Stack 1,000 sheets, staple up to 50 sheets per job, fold sheets into booklet sets, and get folding and saddle stitching.

¹ One output solution option must be ordered.

Users can count on reliable, impressive printing while administrators enjoy easy, comprehensive management.



Consistent, high-quality output

Make a great first impression with true 1200 dpi and Resolution Enhancement technology (REt). Original HP toners and papers are designed to work with each other and with the device's high speeds—so you get crisp and consistent print quality without sacrificing performance.

Experience worry-free operation and continually refresh your MFP with Original HP print cartridges with Smart Printing Technology. They communicate with the MFP to automatically optimize print quality and provide alerts when supplies need to be reordered. Just choose your preferred reseller and place your order through HP SureSupply.²

Simple management

Easily manage your MFP with HP Web Jetadmin, HP's comprehensive fleet management tool. Install, configure, monitor, and troubleshoot a variety of printing and imaging devices—and manage consumables—from anywhere on the network. The HP Embedded Web Server allows you to manage printing functions from your computer instead of from the control panel.

Large workgroups can count on reliable, efficient sharing with HP Jetdirect networking. HP Universal Print Driver solutions provide easy, familiar, and consistent setup and operation across a network for HP printing and imaging devices.

Optional HP Digital Sending Software allows you to send digitized information quickly and securely to network folders, printers, and fax services.

Get the most out of your MFP with HP accessories, supplies, and services.

HP Support Services

Minimize the cost of downtime

Because MFP downtime can have serious business consequences, HP provides high-quality services that extend beyond the standard warranty.

No one knows printing and imaging services better than HP

HP is the most recognized name in printing with one of the world's largest services organizations. Our 69,000 service professionals in 170 countries can help you reduce infrastructure costs, avoid unbudgeted repair costs, and fix problems quickly. With expert technical phone support and predictable, consistent service delivery across multiple locations, we'll help keep your business operations running smoothly.

Choose from the following services:

- **Installation Service with Network Configuration:** expert assembly of HP accessories, hardware verification, network configuration, and basic administrator familiarization
- **Same Day Onsite Service:** technician arrives at your site within four hours after service call is received, if this time falls within the coverage window
- **Next Day Onsite Service:** technician-delivered onsite service the next business day after the service call

Any of the above options can be purchased as:

- **HP Care Pack Services:** easy-to-buy, easy-to-use support packages
- **HP Contractual Services:** a comprehensive portfolio for maintaining maximum IT availability

HP also offers:

- **Managed Print Services:** a scalable solution providing everything from imaging and printing devices and toner cartridges, to installation, management, maintenance and support.

For more information visit: www.hp.com/go/printservices.

Original HP print cartridges with Smart Printing Technology³

HP LaserJet Black Print Cartridge **C8543X**

Paper handling (one output solution option must be ordered)

8-Bin Mailbox **Q5693A**

3,000-sheet Stacker **C8084A**

3,000-sheet Stacker/Stapler **C8085A**

Multifunction Finisher (stapling, stacking, and booklet-making) **C8088B**

Accessories

HP LaserJet MFP Analog Fax Accessory 300 Q3701A

HP Digital Sending Software (DSS) 4 T1936AA

Supplies

Staple Cartridge for 3,000-sheet Stacker/Stapler C8091A

Staple Cartridge for Multifunction Finisher C8092A

HP Printer Maintenance Kit (110V) C9152A

HP Printer Maintenance Kit (220V) C9153A

Memory/storage

HP 256 MB 100-pin DDR DIMM Q7719A

HP high-performance embedded hard disk J7989G

Connectivity

HP Jetdirect 635n EIO Print Server J7961G

HP Jetdirect 690n Wireless Print Server J8007G

Service and support

3-year, Next Business Day, Onsite Service H7700E

3-year, 4-hour, 13 by 5, Same Day, Onsite Service U2019E

On-site Installation and Network Configuration U2014E

Maintenance Kit Replacement Service, Fuser U9877E

1-year, Post-warranty, Next Business Day, Onsite Service U2020PE

1-year, Post-warranty, 4-hour, 13 by 5, Same Day, Onsite Service U2052PE

1-year, Post-warranty Phone and Online Assistance UD628PE

Paper

www.hp.com/go/paper

1-800-477-5010

Solutions

www.hp.com/go/gsc

² For more information, visit www.hp.com/learn/suresupply.

³ Declared yield value in accordance with ISO/IEC 19752. Actual yields vary considerably based on images printed and other factors. Please visit www.hp.com/go/learnaboutsupplies.

HP LaserJet M9040/M9050 MFP

| Technical specifications | HP LaserJet M9040 MFP (CC394A) | HP LaserJet M9050 MFP (CC395A) |
|--|--|--|
| Print and copy speed⁴ | Up to 40 ppm | Up to 50 ppm |
| Document delivery speed | First page out: less than 8 seconds from Ready, letter | |
| Resolution | 600 by 600 dpi; HP FastRes 1200 (1200 dpi quality); HP REt technology | |
| Features | | |
| Copying | Up to 999 multiple copies, reduce/enlarge from 25 to 400% (from scanner glass), two-sided copying, contrast adjustments, image adjustment, content orientation, N-up, optimize text/picture, crop, move, hide | |
| Scanning | Color flatbed scanner and ADF, up to 11.7 by 17 in; scan input modes: front-panel scan, copy, fax (optional), e-mail; file types: PDF, JPG, TIFF, MTIFF | |
| Digital sending | Standard: scan to e-mail; optional: send to folder, authentication, send to LAN Fax, send to printer, send to application; file types: PDF, JPG, TIF, MTIF | |
| Faxing | Via optional HP LaserJet MFP Analog Fax Accessory 300: Up to 33.6 kbps, fax forwarding, fax polling, broadcasting (to up to 100 locations), speed dial (up to 100 lists), auto redialing, Windows faxing supported, fax memory depends on the free storage on the hard drive, telephone mode supported | |
| Processor | 533 MHz | |
| Memory | 384 MB, expandable up to 512 MB; Memory Enhancement technology (MEt) | |
| Durability ratings | Recommended monthly volume: 15,000 to 50,000 pages ⁵ ; Duty cycle: up to 300,000 pages per month ⁶ | |
| Paper | | |
| Input | 100-sheet automatic document feeder (ADF), 100-sheet multipurpose tray 1, 500-sheet trays 2 and 3, 2,000-sheet tray 4 | |
| Output | Choose one finishing output solution: 3,000-sheet stacker, 3,000-sheet stacker with stapler, multifunction finisher, or 2,000-sheet 8-bin mailbox | |
| Two-sided printing | Automatic | |
| Sizes | ADF: letter, legal, executive, tabloid; 5.8 by 8.3 in to 11.7 by 17 in; Multipurpose tray 1: letter, legal, executive, tabloid, JPostD; 3.9 by 7.5 in to 12.3 by 18.5 in; Trays 2, 3, and 4: letter, letter-R, legal, executive, tabloid; 5.8 by 8.3 in to 11.7 by 17 in; Duplex: letter, letter-R, legal, executive, tabloid | |
| Weights | Multipurpose tray 1: 16 to 58 lb bond; input trays 2, 3, and 4: 16 to 53 lb bond | |
| Types | Paper (bond, color, letterhead, plain, preprinted, prepunched, recycled, rough), transparencies, labels, cardstock | |
| Connectivity | | |
| Interfaces | Hi-Speed USB 2.0 device port, HP Jetdirect Gigabit Ethernet Embedded Print Server, embedded hard disk, 1 open EIO slot, Jetlink connection for paper handling device, Host USB port for additional functionality, 1 Foreign Interface Harness | |
| Languages and fonts | HP PCL 6, HP PCL 5e, HP postscript level 3 emulation, direct PDF printing (v1.3) with at least 128 MB memory enabled, XHTML-Print v0.95, HP PJI (Printer Job Language), PML (Printer Management Language); 80 internal scalable TrueType fonts; additional font solutions available | |
| Client operating systems | Microsoft® Windows® 2000, XP® Home, XP Professional; Certified for Windows Vista®; OS/2 v3.0 or later; Mac OS 10.2x or later; Linux; AutoCAD | |
| Network operating systems | Microsoft Windows 2000, Server 2003, XP, Windows Vista, 2003 64-bit, XP 64-bit, Vista 64-bit (for Microsoft IPv6 compatible with Windows 2003, XP, and Vista); Novell 5.1 and later; Mac OS X v10.2, v10.3, v10.4 and later; Red Hat Linux 7.x and later; SuSe Linux 8.x and later; HP-UX 10.20, 11.x, 11.i; Solaris 2.5 and later (SPARC systems only); IBM AIX 3.2.5 and later ⁷ ; MPE-iX; Citrix MetaFrame Server; Windows Terminal Services | |
| Network protocols | IPv4/IPv6: Apple Bonjour compatible (Mac OS 10.2.4 and later), SNMPv1/v2c/v3, HTTP, HTTPS, FTP, Port 9100, LPD, IPP, Secure-IPP, WS Discovery, IPSec/Firewall; IPv6: DHCPv6, MLDv1, ICMPv6; IPv4: Auto-IP, SLP, TFTP, Telnet, IGMPv2, BOOTP/DHCP, WINS, IP Direct Mode, WS Print; Other: IPX/SPX, AppleTalk, NetWare NDS, Bindery, NDPS, iPrint | |
| Security | Management security: SNMPv3, SSL/TLS (HTTPS), 802.1X Authentication (EAP-PEAP, EAP-TLS), IPSec/Firewall with Kerberos, Certificate, and PreShared Key Authentication | |
| Dimensions (w by d by h) | With 8-bin mailbox: 43 by 33 by 48 in; With stacker: 46 by 31 by 47 in; With stacker/stapler: 46 by 31 by 47 in; With multifunction finisher: 51 by 31 by 47 in | |
| Weight (includes print cartridge) | 317 lb (without finishing output solution) | |
| What's in the box | MFP, 38,000-page black HP LaserJet print cartridge ⁸ ; in-box documentation (Getting Started Guide), software drivers and documentation on CD-ROM, HP DSS demonstration CD, control panel overlay, power cable, 100-sheet multipurpose tray, two 500-sheet input trays, 2000-sheet input tray, choice of output paper handling device, automatic two-sided printing accessory (installed), HP Jetdirect Gigabit Ethernet Embedded Print Server, automatic document feeder | |
| Warranty | One-year, next day, on-site limited warranty backed by HP Customer Care, service and support; one year technical phone support | |
| Environmental ranges | M9040: Print: 1022 watts; Copy: 1030 watts; Ready: 331 watts; Sleep 1: 244 watts; Sleep 2: 47 watts; Sleep 3: 30 watts; Off: 2.0 watts Typical Electricity Consumption (TEC): M9050 and M9040: 18.9 kWhr/Week | |
| Recommended temperature | 63 to 77 degrees F | |
| Storage temperature | 32 to 95 degrees F | |
| Recommended relative humidity | 30 to 70 percent | |
| Storage relative humidity | 15 to 90 percent | |
| Acoustics⁹ | | |
| Sound power | Print: 7.0 B(A); Copy: 7.3 B(A); Ready: 5.6 B(A) | |
| Bystander sound pressure | Print: 54 dB(A); Copy: 58 dB(A); Ready: 41 dB(A) | |
| Power specifications | | |
| Required input voltage | 110 to 127 V (±10 percent), 50/60 Hz (±2 Hz) 220 to 240 V (±10 percent), 50/60 Hz (±2 Hz) | |
| Power consumption | M9050: Print: 1092 watts; Copy: 1090 watts; Ready: 345 watts; Sleep 1: 255 watts; Sleep 2: 48 watts; Sleep 3: 31 watts; Off: 2.1 watts | |
| | Certifications | USA (UL-UL 60950; FDA-21 CFR Chapter 1 Subchapter J for lasers); Class 1 Laser/LED Product EMC CISPR 22: 2005/EN 55022: 2006 Class A, EN 61000-3-2: 2000, EN 61000-3-3: 1995, EN 55024: 1998, FCC Title 47 CFR, Part 15 Class A/ICES-003, Issue 4/GB9254-1998, GB17625.1-2003, EMC Directive 2004/108/EC and the Low Voltage Directive 2006/95/EC, and carries the CE-Marking accordingly HP SureSupply enabled. To learn more, visit www.hp.com/learn/suresupply |

⁴ All printed pages originate from the default tray of a HP LaserJet 9050/9040 MFP with high-capacity input trays.

⁵ HP recommends that the number of printed pages per month be within the stated range for optimum device performance, based on factors including supplies replacement intervals and device life over an extended warranty period.

⁶ Duty cycle is defined as the maximum number of pages per month of imaged output. This value provides a comparison of product robustness in relation to other HP LaserJet or HP Color LaserJet devices, and enables appropriate deployment of printers and MFPs.

⁷ Requires software from the NOS vendor.

⁸ Declared yield value in accordance with ISO/IEC 19752. Actual yields vary considerably based on images printed and other factors. Please visit www.hp.com/go/learnaboutsupplies.

⁹ Values subject to change. See www.hp.com/support/ljm9050 for current information. Power reported is the highest value measured for printing and copying using all standard voltages.



Linux is a U.S. registered trademark of Linus Torvalds. Microsoft, Windows, and Windows XP are registered trademarks of Microsoft Corporation. Windows Vista is either a registered trademark or trademark of Microsoft Corporation in the United States and/or other countries.

© Copyright 2008, 2010-2011 Hewlett-Packard Development Company, L.P.

The information contained herein is subject to change without notice. The only warranties for HP products and services are set forth in the express warranty statements accompanying such products and services. Nothing herein should be construed as constituting an additional warranty. HP shall not be liable for technical or editorial errors or omissions contained herein.





LASERJET PRO CM1415FNW

COLOR MULTIFUNCTION PRINTER \$449.99

TECH 2000, INC.

Use a color touchscreen to print, copy, scan—in color—and fax. Connect this MFP to a wired or wireless network and give your office high-quality prints with vivid color and sharp black⁴. Save energy and reduce your impact.

Maximum Print Speed: Black: Up to 12 ppm; Color: Up to 8 ppm
Print Resolution: Up to 600 x 600 dpi; **Technology Resolution:** HP ImageREt 3600
Scan Resolution (Optical): Up to 1200 dpi; **Scan Type:** Flatbed, ADF
Copy: Up to 600 x 600 dpi resolution; **Maximum Copies:** Up to 99 copies
Fax: 33.6 kbps; **Fax Speed Dialing, Max Numbers:** 120 numbers
Standard Connectivity: 1 Hi-Speed USB 2.0 port, 1 Host USB, 1 built-in 10/100 wired Ethernet network connectivity with 1 RJ-45 port, 1 Wireless 802.11b/g/n networking
Recommended Monthly Page Volume: Up to 300 to 1,500 pages
Duplex Print Options: Manual (Driver support provided)



Bring easy, touchscreen printing to your office

- Use the 3.5-inch (8.89 cm) color touchscreen to access and print information.
- Print from anywhere, anytime, with a smartphone, notebook PC or other mobile device using HP ePrint¹
- Spend more time on business and less time on setup and maintenance.
- Easily copy both sides of an ID card onto a single-sided document.

Produce professional-quality marketing materials

- Make the most of your printed images, with HP ImageREt 3600.
- Enhance the quality of your copied images, text and graphics with automatic copy optimization.
- Print crisp text and vivid color images—use Original HP LaserJet print cartridges with HP ColorSphere toner.
- Print black text affordably—at the same cost per page as a black-and-white HP LaserJet printer.⁶

Increase productivity—share the MFP on a network

- Print from anywhere in the office with integrated wireless.^{4,5} Share resources, using built-in Ethernet.
- Start and finish printing sooner from low-power or Ready modes, using Instant-on Technology.
- Tackle multiple-page documents, using the 35-page automatic document feeder.
- Print quickly and conveniently with a front-panel USB port.

Minimize your environmental impact

- Reduce energy use with Instant-on Technology and Instant-on Copy.³
- Save space and resources with the compact size of this color laser printer.
- Get free and easy recycling—cartridges returned through HP Planet Partners are recycled responsibly.²



ecoHIGHLIGHTS

HP LaserJet Pro CM1415fnw Color MFP Printer

- Reduce energy use with Instant-on Technology and Instant-on Copy.¹
- Avoid reprints with the consistency of Original HP toners plus HP Professional Color Technologies.
- Print what you need and save paper with HP do-it-yourself marketing solutions.

ENERGY STAR® Qualified Product

¹Compared with products that use traditional fusing and cold cathode fluorescent lamp (CCFL) copying.

www.hp.com/ecosolutions

Please recycle your computing hardware and printing supplies. Find out how at our website.



¹Expected availability late 2010. Require an Internet connection to the printer. Feature works with any Internet and e-mail capable device and requires a firmware upgrade. For details, <http://www.hp.com/go/ePrintcenter>. ²Program availability varies. HP print cartridge return and recycling is currently available in more than 50 countries and territories around the world through the HP Planet Partners program. For more information, or to request return envelopes and bulk collection boxes, visit www.hp.com/recycle. ³Compared with products that use traditional fusing and cold cathode fluorescent lamp (CCFL) copying. ⁴Wireless performance is dependent upon physical environment and distance from access point, and may be limited during active VPN connections. ⁵Built-in wireless is available on the HP LaserJet Pro CM1415fnw Color MFP. ⁶Compared with HP LaserJet Pro P1566/ P1606dn printer (single function) and HP LaserJet Pro M1536dnf MFP. Assuming customer is printing at least 30 percent of total pages in color with content similar to the color ISO/IEC 19798 test suite (www.iso.org/itc1/sc28) and overall average job length of three pages. Yields established using ISO/IEC test standards. Actual yields and costs vary considerably depending on images printed, number of color pages printed, and other factors.





LASERJET PRO CM1415FNW

COLOR MULTIFUNCTION PRINTER

TECH 2000, INC.

TECHNICAL SPECIFICATIONS

| | |
|--|--|
| FUNCTIONS | Print, copy, scan, fax |
| STANDARD PRINTER LANGUAGES | HP PCL 6, HP PCL 5c, HP postscript level 3 emulation (via Universal Print Driver) |
| PRINT RESOLUTION | Black (Best): Up to 600 x 600 dpi; Black (Normal): Up to 600 x 400 dpi; Color (Best): Up to 600 x 400 dpi |
| PRINT TECHNOLOGY RESOLUTION | HP ImageREt 3600 |
| PRINT SPEED¹ | Black (Letter): Up to 12 ppm; Color (normal): Up to 8 ppm; First Page Out Color: As fast as 32 sec |
| NUMBER OF PRINT CARTRIDGES | 4 (1 each black, cyan, magenta, yellow) |
| RECOMMENDED MONTHLY PAGE VOLUME | Up to 300 to 1,500 pages |
| DUTY CYCLE (MONTHLY) | Up to 30,000 pages |
| SCAN TYPE | Flatbed, ADF |
| SCAN RESOLUTION | Optical: Up to 1200 dpi |
| SCAN SPEED | Black (Normal): Up to 12 ppm; Color (Normal): Up to 8 ppm |
| AUTO DOCUMENT FEEDER CAPACITY | Standard, 35 sheets |
| COPY RESOLUTION | Black (Text and Graphics): Up to 600 x 600 dpi Color (Text and Graphics): Up to 600 x 600 dpi |
| COPY SPEED | Black (Best, Letter): Up to 12 cpm; Color (Best, Letter): Up to 8 cpm |
| MAXIMUM NUMBER OF COPIES | Up to 99 copies |
| COPIER SETTING | Up to 99 multiple copies, Collation, Reduce/Enlarge from 25% to 400%, Fit to page, two or four pages to one page, customizable copy presets, Contrast (Lighter/Darker), Resolution (Copy quality), network protocols supported, ID copy, Copy optimization, Draft mode copy, manual duplex |
| FAX RESOLUTION | Black (Best): Up to 203 x 196 dpi Black Photo Grayscale: Up to 300 x 300 dpi |
| FAX SPEED | 33.6 kbps |
| FAX SPEED DIALING, MAX NUMBERS | 120 numbers |
| FAX MEMORY (A4) | Up to 250 pages |
| FAX FEATURES | Fax Auto-redialing: Yes; Auto Fax Reduction Supported: Yes; Distinctive Ring Detection Supported: Yes; Fax Delayed Sending: Yes; Fax Forwarding Supported: Yes; Fax Polling Supported: Yes (receive only); Fax Telephone Mode Supported: Yes; Junk Barrier Supported: Yes; PC Interface Supported: Yes (PC Fax send only); Remote Retrieval Capability Supported: No; Telephone Handset Supported: No |
| STANDARD CONNECTIVITY | 1 Hi-Speed USB 2.0 port, 1 Host USB, 1 built-in 10/100 wired Ethernet network connectivity with 1 RJ-45 port, 1 Wireless 802.11b/g/n networking |
| NETWORK CAPABILITIES | 10/100 Ethernet; 802.11b/g/n wireless Network Ready: Standard (WiFi 802.11b/g/n, Ethernet) |
| CONTROL PANEL | Intuitive touchscreen control panel with color graphic display, Buttons (Home, Cancel, Help, Right/Left Arrows, Back), LED indicator lights (Ready, Error, Wireless) |
| DISPLAY | 3.5" (8.89 cm) touchscreen CGD (color graphics) |
| MAXIMUM/STANDARD MEMORY | 160 MB |
| PROCESSOR | Type: ARM 11 embedded processor Speed: 600 MHz |
| DUPLEX PRINT OPTIONS | Manual (driver support provided) |
| MEDIA TYPE AND CAPACITY | ADF: Sheets: 35, transparencies: 1; Tray 1: Sheets: 150, Envelopes: 10 |
| STANDARD MEDIA SIZES SUPPORTED (IMPERIAL) | Letter, legal, executive, envelopes (No. 10, Monarch), postcard |
| MEDIA WEIGHT SUPPORTED | 60 to 176 g/m ² (up to 200 g/m ² with HP laser cover papers, up to 220 g/m ² with HP laser glossy photo papers) |
| CUSTOM MEDIA SIZES | 3 x 5 to 8.5 x 14 in (76 x 127 to 216 x 356 mm) |

| | |
|-------------------------------------|--|
| PRINT HANDLING | Input Capacity: Up to 150 sheets, Up to 10 envelopes Output Capacity: Up to 125 sheets, Up to 10 envelopes, Up to 50 sheets transparencies |
| POWER¹ | Power Supply Type: Built-in power supply Power Requirements: Input voltage 110 to 127 VAC (+/- 10%), 60 Hz (+/- 2 Hz) Power Consumption: 285 watts active, 9.0 watts sleep, 17.5 watts standby Typical Electricity Consumption (TEC) Number: 1.791 kWh/Week |
| SOFTWARE INCLUDED | Windows: HP Installer/Uninstaller, HP PCL 6 print driver, HP WIA Scan Driver, HP TWAIN Scan Driver, HP Scan, HP Fax Setup Wizard, HP Send Fax, HP Fax Print Driver, ReadIris Software, Mac: HP Installer/Uninstaller, HP PS driver, HP Scan, HP Setup Assistant, HP Fax Print Driver, HP Ink Widget, HP Utility, ReadIris Software |
| COMPATIBLE OPERATING SYSTEMS | Full software installs supported on: Microsoft® Windows®7 32-bit and 64-bit, Windows Vista® 32-bit and 64-bit, Windows® XP 32-bit (SP2 or higher), Driver only installs supported on: Microsoft® Windows® Server 2008 32-bit and 64-bit, Windows® Server 2003 32-bit (SP3 or higher), Mac OS X v 10.5.8, v 10.6, Linpus Linux (9.4, 9.5), Red Hat Enterprise Linux 5.0 (supported with a pre-built package), SUSE Linux (10.3, 11.0, 11.1, 11.2), Fedora (9, 9.0, 10, 10.0, 11.0, 11, 12, 12.0), Ubuntu (8.04, 8.04.1, 8.04.2, 8.10, 9.04, 9.10, 10.04), Debian (5.0, 5.0.1, 5.0.2, 5.0.3) (supported by the automatic installer), HPUX 11 and Solaris 8/9 |
| MINIMUM SYSTEM REQUIREMENTS | PC: Microsoft® Windows® 7, Windows Vista®: 1 GHz 32-bit(x86) or 64-bit(x64) processor, 1 GB RAM (32-bit) or 2 GB RAM (64-bit), 200 MB free hard disk space, CD/DVD-ROM or Internet, USB or Network port, Windows® XP (32-bit) (SP2): Pentium 233 MHz processor, 512 MB RAM (32-bit) or 2 GB RAM (64-bit), 200 MB free hard disk space, CD/DVD-ROM or Internet, USB or Network port; Mac: Mac OS X v 10.5.8, v 10.6, PowerPC G4, G5, or Intel Core Processor, 256 MB RAM, 300 MB free hard disk space, CD/DVD-ROM or Internet, USB or Network port |
| ACOUSTIC² | Acoustic Power Emissions: 6.1 B(A) Acoustic Power Emissions (Ready): Inaudible Acoustic Pressure Emissions: 48 dB(A) |
| OPERATING ENVIRONMENT | Operating Temperature Range: 59 to 90.5° F (15 to 32.5° C) Recommended Operating Temperature: 62.6 to 77° F (17 to 25° C) Storage Temperature Range: -4 to 104° F (-20 to 40° C) Non-Operating Humidity Range: 95% RH or less Operating Humidity Range: 10 to 80% RH Recommended Humidity Operating Range: 20 to 80% RH |
| PRODUCT DIMENSIONS | W X D X H: 17.4 x 18.6 x 16.3 in (443 x 472 x 415 mm) |
| PRODUCT WEIGHT | 50.1 lb (22.7 kg) |
| WHAT'S IN THE BOX | HP LaserJet Pro CM1415fnw color MFP, Preinstalled introductory 750-page black, cyan, magenta, yellow HP Color LaserJet print cartridges with ColorSphere toner, Control panel, ADF input support, CDs containing device software and electronic User's Guide, ReadIris PRO text recognition software, ReadIris registration card, Installation Guide, Support flyer, power cord(s), Phone cord(s), USB cable |
| WARRANTY | One-year limited warranty |
| REPLACEMENT CARTRIDGES | HP Black Print Cartridge (2,000 pages), CE320A HP Cyan Print Cartridge (1,300 pages), CE321A HP Color Yellow Print Cartridge (1,300 pages), CE322A HP Magenta Print Cartridge (1,300 pages), CE323A |
| ACCESSORIES | HP USB Cable 2.0 (a-b) 3 meter, C6520A HP Hi-Speed USB Cable (6 ft./1.8 m), Q6264A HP Network cable 14 feet, C7536A |
| HP SERVICES AND SUPPORT | HP 2-year Next Business Day Exch w/Enhanced Phone Support IPG prtr-H SVC, UQ223A HP 3-year Next Business Day Exch w/Enhanced Phone Support IPG prtr-H SVC, UQ224A HP 4-year Next Business Day Exch w/Enhanced Phone Support IPG prtr-H SVC, UQ225A |

FOR MORE INFORMATION VISIT OUR WEBSITE AT WWW.HP.COM

HP LASERJET PRO CM1415FNW COLOR MULTIFUNCTION PRINTER Product Number: **CE862A**

¹Power requirements are based on the country/region where the Printer is sold. Do not convert operating voltages. This will damage the Printer and void the product warranty.
²Configuration tested: CM1415fnw bundle, simplex Printing, A4 paper at an average of 12 ppm.



HP Color LaserJet CM2320 MFP series

CM2320n • CM2320nf • CM2320fxi !!! \$699.99 \$899.99



Maximize your budget and turn printed pages into customers.



Enhances productivity

Get advanced print, copy, fax,¹ and scan capabilities in a single easy-to-use device, eliminating the expense and space of multiple single-function devices. Receive both black-and-white and color output quickly with print speeds of up to 21 pages per minute (ppm) on letter-size paper.

Typical office print job Time To Completion can be nearly three times faster with the MFP's Instant-on Technology.² Instant-on Copy with LED-based scanning technology delivers your first copy in seconds.

With a total input capacity of up to 550 sheets, you can stay focused on your work.¹ Use the 50-page automatic document feeder (ADF) for unattended copying, scanning, and faxing. Save time with built-in automatic two-sided printing and copying.¹

The HP Color LaserJet CM2320fxi MFP's photo memory card slots make it simple to create impressive marketing materials with high-quality photo accents.¹ Import images directly into business documents, or print them from the control panel.

¹ Standard and optional features vary by model. For more information, see "Series at a glance" on page 2.

² Instant-on Technology uses cutting-edge fuser technology to produce the first page faster when a device is coming out of low power mode. An InfoTrends study shows the typical office print job is three to five pages long: www.infotrends.com/public/Content/Presentations/officeprinteruse.pdf. Time To Completion of a typical office print job tested on HP and select competing products. Actual results may vary.

³ The HP Marketing Resources Software may be downloaded for free through the URL included with the MFP's installation software. For more information, visit www.hp.com/go/ihm.

Unlimited possibilities

Print professional-quality brochures and more at your desk. Free HP marketing tools allow you to create and customize your documents instantly, so each communication speaks directly to your customers' needs.³ With the included Print View feature, you can change print settings and see immediately how those changes affect your document before you print. Determine costs beforehand for better project planning and decision-making with the Print Cost Estimator.

Easily get optimized print quality for each of the many supported media types. With a single click in your print driver, select from a collection of pre-configured Printing Shortcuts—including settings for everyday printing, envelopes, glossy paper, and more.

Simplifies your office

We designed this MFP so that it's not just easy to use—it's also easy to install, share, and maintain. Set-up wizards and installers help you get started. Original HP print cartridges are preinstalled and a handy front-access panel makes replacement effortless.

Ideal for small work teams, the MFP offers networking performance. Manage your MFP with HP Easy Printer Care Software, a simple tool to deploy, monitor, and maintain up to 20 devices.

HP Color LaserJet CM2320 MFP series

TECH 2000, INC.

- 1 50-sheet ADF for hands-free copying, scanning, and faxing
- 2 Intuitive color graphical display with fax, copy, and scan keys, a built-in help function, and photo preview
- 3 150-sheet output bin
- 4 One-door access to the preinstalled, easy-to-replace Original HP print cartridges with HP ColorSphere toner
- 5 50-sheet multipurpose tray for convenient use of specialty papers
- 6 250-sheet input tray 2 with the option to add a 250-sheet input tray 3 for a maximum input capacity of 550 sheets
- 7 Color flatbed scanner with LED illumination
- 8 RJ-11 fax ports
- 9 A powerful 450 MHz processor and 160 MB memory, expandable to 416 MB
- 10 Built-in Ethernet/Fast Ethernet networking
- 11 Hi-Speed USB 2.0 port

HP Color LaserJet CM2320nf MFP shown. CM2320fxi model, with automatic two-sided printing and copying, photo memory card slots and additional 250-sheet input tray, shown in "Series at a glance" table below.

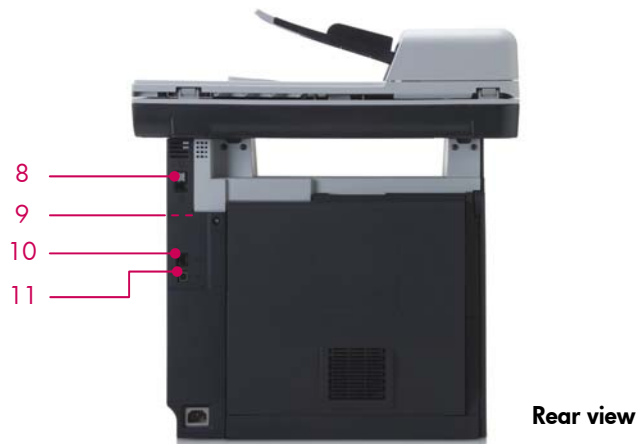

ColorSphere
HP TONERS

Series at a glance



CM2320n



CM2320nf



CM2320fxi

| Part number | CC434A | CC436A | CC435A |
|--|---------------|---------------|-------------|
| 50-sheet ADF, 50-sheet multipurpose tray 1, and 250-sheet input tray 2 | ✓ | ✓ | ✓ |
| 250-sheet input tray 3 | Optional | Optional | ✓ |
| Color printing, scanning, and copying | ✓ | ✓ | ✓ |
| Built-in Ethernet/Fast Ethernet networking | ✓ | ✓ | ✓ |
| Fax (including FaxTel and private receive) | Not available | ✓ | ✓ |
| Color graphical display | Not available | ✓ | ✓ |
| Two-sided printing and copying | Manual | Manual | Automatic |
| Photo memory card slots | Not available | Not available | ✓ |
| Scan to e-mail | PC assisted | Stand alone | Stand alone |

Get copy-shop quality color consistently and effortlessly with an affordable MFP.

Professional-looking output

HP ColorSphere toner combined with Original HP specialty media make it possible to produce amazing copy-shop quality documents in your office. Immediately see the difference with sharper text and graphics and vibrant, attention-grabbing color.

Make no compromises when it comes to color quality. HP ImageREt 3600 print technology is the difference between color that looks good, and color that looks exceptional. This suite of innovative HP color technologies enables you to create professional marketing materials in-house for a fraction of what you'd spend at a copy shop.

Get the best image quality automatically with Photo mode, which optimizes photos based on the media. The Autoselect setting determines whether the original is text, image, or mixed for higher-quality copies.

More affordable than ever

Not only does this HP Color LaserJet MFP have a great purchase price, but you can print black pages for the same cost as printing black pages on a black-and-white HP laser device.⁴ And you can still print in color!

The device can also help reduce operating expenses over time. The four all-in-one individual print cartridges incorporate HP toner and the imaging drum in one supply and are designed to reduce waste and unnecessary replacement expenditures.⁵

Keep color usage under control with password-protected color lockout features. The color copy lockout feature turns off color copies, while photo lockout blocks card slots on the HP Color LaserJet CM2320fxi MFP from being read to save unnecessary photo printing expenses.

Get the most out of your MFP with HP accessories, supplies, and services.



The 250-sheet input tray 3 (CB500A) adds media flexibility while increasing total input capacity to up to 550 sheets.⁶



HP's all-in-one print cartridges and ColorSphere toner are specifically designed with the MFP to deliver consistent quality and reliable, trouble-free printing.



Choose from a selection of HP papers to create impressive, professional documents.

HP Imaging and Printing Services provide convenient and configurable solutions that help you get the most value out of your printing. Choose the level of support that best fits your business needs.

Replacement print cartridges with HP ColorSphere toner⁵

| | |
|---|--------|
| HP Color LaserJet Black Print Cartridge | CC530A |
| HP Color LaserJet Cyan Print Cartridge | CC531A |
| HP Color LaserJet Yellow Print Cartridge | CC532A |
| HP Color LaserJet Magenta Print Cartridge | CC533A |

Paper handling

| | |
|-------------------------------------|--------|
| 250-sheet input tray 3 ⁶ | CB500A |
|-------------------------------------|--------|

Memory

| | |
|--------------------------------|--------|
| 64 MB DDR2 144-pin SDRAM DIMM | CB421A |
| 128 MB DDR2 144-pin SDRAM DIMM | CB422A |
| 256 MB DDR2 144-pin SDRAM DIMM | CB423A |

Service and support⁷

| | |
|--|---------|
| HP 3-year Next Business Day Onsite Hardware Support | UJ574E |
| HP 3-year 4-hour 9 by 5 Onsite Hardware Support | UJ575E |
| HP 3-year 4-hour 13 by 5 Onsite Hardware Support | UJ576E |
| HP 1-year Post-warranty Next Business Day Onsite Hardware Support | UJ577PE |
| HP 1-year Post-warranty 4-hour 9 by 5 Onsite Hardware Support | UJ578PE |
| HP 1-year Post-warranty 4-hour 13 by 5 Onsite Hardware Support | UJ579PE |
| HP 1-year Post-warranty Phone and Online Assistance Hardware Service | HC127PE |
| HP Network Installation for One Personal Printer | H3110E |

Paper

North America: www.hp.com/go/paper
 Europe: www.hp.com/go/learnaboutsupplies
 Asia Pacific: www.hp.com/apac/printingsupplies
 Latin America: contact HP via phone:
 USA: 1-800-477-5010, Europe: +800 7644 7644,
 Asia: 65-6253-8500, Australia/New Zealand: 61-2997-2299LAR
 Brasil: sac 0800 70 300 70

Solutions

www.hp.com/go/gsc

⁴ Compared to HP LaserJet P2030 Printer series. Assuming customer is printing at least 30% of total pages in color with content similar to the color ISO/IEC 19798 test suite (www.iso.org/jtc1/sc28) and overall average job length of three pages. Yields established using ISO/IEC test standards. Actual yields and costs vary considerably depending on images printed, number of color pages printed or copied, and other factors.

⁵ Replacement cartridges: average continuous composite cyan/yellow/magenta yield 2,800 standard pages and average continuous black cartridge yield 3,500 standard pages. Declared yield values for replacement cartridges in accordance with ISO/IEC 19798. Actual yields vary considerably based on images printed and other factors. For more information, visit www.hp.com/go/learnaboutsupplies.

⁶ The 250-sheet input tray 3 is an optional accessory for the CM2320n and CM2320nf models only and is standard on the CM2320fxi model. No additional input trays can be added to the CM2320fxi model.

⁷ Availability may vary by region. For more information, visit www.hp.com/services/printer.

HP Color LaserJet CM2320 MFP series

| Technical specifications | HP Color LaserJet CM2320n MFP (CC434A) | HP Color LaserJet CM2320nf MFP (CC436A) | HP Color LaserJet CM2320fxi MFP (CC435A) |
|--|--|--|---|
| Print and copy speed⁸ | Black-and-white and color: up to 21 ppm, letter | | |
| Document delivery speed | First page out (letter): black-and-white: as fast as 17.8 seconds (Ready), as fast as 17.9 seconds (low power mode); color: as fast as 17.9 seconds (Ready), as fast as 18.3 seconds (low power mode) | | |
| Resolution | Print: 600 by 600 dpi, HP ImageREt 3600 technology; Copy: up to 600 by 600 dpi; Scan: up to 1200 by 1200 dpi optical or up to 19,200 by 19,200 dpi enhanced resolution | | |
| Features | Instant-on copy, duplex copy, up to 99 multiple copies, scan once print many, collation, reduce/enlarge from 25 to 400% (with page-size presets), fit to page, two or four pages to one page, customizable copy presets, contrast (lighter/darker), resolution (copy quality), network protocols supported, optimize copy selection (with presets: autoselect, mixed, printed picture, photograph, text) | | |
| Copying | Instant-on copy, duplex copy, up to 99 multiple copies, scan once print many, collation, reduce/enlarge from 25 to 400% (with page-size presets), fit to page, two or four pages to one page, customizable copy presets, contrast (lighter/darker), resolution (copy quality), network protocols supported, optimize copy selection (with presets: autoselect, mixed, printed picture, photograph, text) | | |
| Scanning | High depth-of-focus CCD scanner with instant-on LED illumination captures high quality images, 3-D objects and double page spreads minimizing visible black lines at the binding | | |
| Faxing | Up to 33.6 kbps, duplex fax receive, Fax Setup Wizard, FaxTel, private fax receive, auto fax reduction, fax forwarding, fax polling (receive only), fax confirmation report, junk fax blocking, fax security, eight cover page templates available, broadcasting (to up to 119 locations), speed dial (up to 8 numbers), 120-entry phone book, auto redialing, send fax from PC, delayed sending, distinctive ring, telephone mode supported, digital storage, up to 250 fax pages | | |
| Photo memory cards supported | | | CompactFlash Type I and II, Memory Stick, Memory Stick PRO, Memory Stick Duo, Secure Digital, Multi Media Card, xD-Picture Card |
| Color Lockout | Turn color copy off/on and password protect | | Turn color copy and photo card slots off/on and password protect |
| Processor | 450 MHz | | |
| Memory | 160 MB, expandable to 416 MB | | |
| Durability ratings | Recommended monthly volume: 1,000 to 2,500 pages; ⁹ Duty cycle: up to 40,000 pages ¹⁰ | | |
| Paper | 50-sheet ADF, 50-sheet multipurpose tray 1, 250-sheet tray 2, optional 250-sheet tray 3 | | |
| Input | 50-sheet ADF, 50-sheet multipurpose tray 1, 250-sheet tray 2, optional 250-sheet tray 3 | | 50-sheet ADF, 50-sheet multipurpose tray 1, 250-sheet tray 2, 250-sheet tray 3 |
| Output | 150-sheet face-down output bin | | |
| Two-sided printing and copying | Manual | | Automatic |
| Sizes | Multipurpose tray 1: letter, legal, executive, 8.5 by 13 in, 3 by 5 in, 4 by 6 in, 5 by 8 in, postcards (Standard #10), envelopes (No 10, Monarch); custom: 3 by 5 in to 8.5 by 14 in Input trays 2 and 3: letter, legal, executive, 8.5 by 13 in, 4 by 6 in, 5 by 8 in, envelopes (No 10, Monarch); custom: 3.94 by 5.83 in to 8.5 by 14 in ADF: letter, legal, executive; Automatic duplexer: letter, legal, 8.5 by 13 in | | |
| Weights | Multipurpose tray 1: 16 to 47 lb (up to 58 lb with HP laser glossy photo papers) Input trays 2 and 3: 16 to 43 lb (up to 47 lb with postcards, up to 58 lb with HP laser glossy photo papers) ADF: 16 to 24 lb; Automatic duplexer: 16 to 43 lb | | |
| Types | Paper (bond, brochure, colored, glossy, letterhead, photo, plain, preprinted, prepunched, recycled, rough), transparencies, labels, envelopes | | |
| Connectivity | Hi-Speed USB 2.0 port, built-in Ethernet/Fast Ethernet networking | | |
| Interfaces | Hi-Speed USB 2.0 port, built-in Ethernet/Fast Ethernet networking | Hi-Speed USB 2.0 port, built-in Ethernet/Fast Ethernet networking, RJ-11 line-out port, RJ-11 fax port | |
| Languages and fonts | Languages: HP PCL 6, HP postscript Level 3 emulation, HP PCL5c emulation; fonts: 80 TrueType internal scalable PCL 6, 80 TrueType internal scalable PostScript | | |
| Client operating systems | Microsoft® Windows® 2000, Windows Server 2003, Certified for Windows Vista®, Windows XP® Home, Windows XP Media Center, Windows XP Professional, Windows XP Professional x64, Windows XP Tablet PC; Mac OS X v10.3 or higher | | |
| Network operating systems | Via built-in networking solution: Windows 2000 (print drivers only), XP, XP 64-Bit, Server 2003/2008, Certified for Windows Vista; Mac OS X v10.3, v10.4, v10.5; Red Hat / SuSE Linux 6.x and later; Novell NetWare 3.2 and later (NDPS-TCP/IP only); Citrix MetaFrame (print only); Windows Terminal Services (print only) ¹¹ | | |
| Network protocols | Via built-in networking solution: TCP/IP, IPv4, IPv6; Print: TCP-IP port 9100 Direct Mode, LPD (raw que support only), Web Services Printing; Photo card: CIFS; Discovery: SLP, Bonjour, Web Services Discovery; IP Config: IPv4 (BootP, DHCP, AutoIP, Manual), IPv6 (Stateless Link-Local and via Router, Statefull via DHCPv6); Management: SNMPv1, HTTP | | |
| Security | Password-protected network embedded Web server, enable/disable Network ports, SNMPv1 community password change | | |
| Dimensions (w by d by h) | 19.6 by 19.4 by 21.7 in | | 19.6 by 19.4 by 25.6 in |
| Weight (includes print cartridge) | 64.8 lb | 65 lb | 76.9 lb |
| What's in the box | MFP; power cord(s); preinstalled introductory 1,200-page black, cyan, magenta, and yellow HP Color LaserJet print cartridges with ColorSphere toner; ¹² in-box documentation (Getting Started Guide, support flyer); CD (User's Guide and device software); control panel faceplate; Readiris PRO OCR software and registration card; ADF input support; HP Marketing Starter Kit (specialty media samples, discounts to partner offerings, document templates) | | |
| Also includes | Fax capability, 2.4-inch color graphics display, phone cord(s) | | Fax capability, 2.4-inch color graphics display, 250-sheet input tray 3, automatic two-sided printing, photo memory card slots, phone cord(s) |
| Warranty | One-year, onsite repair, limited hardware HP warranty; telephone and web support | | |
| Environmental ranges | Typical Electricity Consumption (TEC): 2.535 kWhr/Week ENERGY STAR® qualified models, see www.hp.com/go/energystar | | |
| Recommended temperature | 59 to 80.6 degrees F | | |
| Storage temperature | -4 to 104 degrees F | | |
| Recommended relative humidity | 20 to 70 percent | | |
| Storage relative humidity | 10 to 95 percent | | |
| Altitude | Up to 9,000 ft | | |
| Acoustics¹³ | Safety IEC 60950-1 (International), IEC 60825-1+A1+A2, UL/cUL listed (US/Canada), EN 60825-1+A1+A2 (Class 1 Laser/LED Device) GB4943-2001, | | |
| Sound power | Active, print: CM2320n, CM2320nf: 6.6 B(A); CM2320fxi: 6.8 B(A) Active, copy or scan: CM2320n: 6.7 B(A); CM2320nf: 6.8 B(A); CM2320fxi: 6.9 B(A) Ready: CM2320n, CM2320nf, CM2320fxi: inaudible | | EMC CISPR 22: 2005/EN 55022: 2006 Class B, EN 61000-3-2: 2000+A2, EN 61000-3-3: 1995+A1, EN 55024: 1998+A1+A2, FCC Title 47 CFR, Part 15 Class B (USA), ICES-003, Issue 4, (Canada), GB9254-1998, |
| Bystander sound pressure | Active, print: CM2320n, CM2320nf: 53 dB(A); CM2320fxi: 55 dB(A) Active, copy or scan: CM2320n, CM2320fxi: 54 dB(A); CM2320nf: 55 dB(A) Ready: CM2320n, CM2320nf, CM2320fxi: inaudible | | Telecom ES 203 021, FCC Part 68, Industry Canada CS03, NOM-151-SCTI-1999 (Mexico) |
| Power specifications¹⁴ | Works with HP SureSupply. To learn more, visit www.hp.com/learn/suresupply | | |
| Required input voltage | 100 to 127 V (±10 percent), 60 Hz (±3 Hz); 220 to 240 V (±10 percent), 50 Hz (±3 Hz) | | |
| Power consumption | Active, print: 460 watts, copy: 425 watts; Ready: 27 watts; Sleep: 9.2 watts; Off: 0.5 watts | | |

⁸ Exact speed varies depending on system configuration, software application, driver, and document complexity.
⁹ HP recommends that the number of printed pages per month be within the stated range for optimum device performance, based on factors including supplies replacement intervals and device life over an extended warranty period.
¹⁰ Duty cycle is defined as the maximum number of pages in a month of imaged output. This value provides a comparison of product robustness in relation to other HP LaserJet or HP Color LaserJet devices, and enables appropriate deployment of printers and MFPs.
¹¹ Not all protocol and operating system configurations are supported. For more information, go to www.hp.com/support/net_printing.
¹² The MFP includes introductory print cartridges (average continuous composite cyan/yellow/magenta cartridge yield 1,200 pages and average continuous black cartridge yield 1,200 pages). Refresh your printing system with Original HP replacement print cartridges (average continuous composite cyan/yellow/magenta cartridge yield 2,800 standard pages and average continuous black cartridge yield 3,500 standard pages). Declared yield values for replacement cartridges in accordance with ISO/IEC 19798. Actual yields vary considerably based on images printed and other factors. For more information, visit www.hp.com/go/learnaboutsupplies.
¹³ Configuration tested: simplex printing, A4 paper at an average of 20 ppm.
¹⁴ Power requirements are based on the country/region where the printer is sold. Do not convert operating voltages. This will damage the printer and void the product warranty.



ENERGY STAR and the ENERGY STAR logo are registered U.S. marks. Linux is a U.S. registered trademark of Linus Torvalds. PostScript is a trademark of Adobe Systems Incorporated. Microsoft, Windows, and Windows XP are registered trademarks of Microsoft Corporation. Windows Vista is either a registered trademark or trademark of Microsoft Corporation in the United States and/or other countries.
 © Copyright 2008-2009 Hewlett-Packard Development Company, L.P.

The information contained herein is subject to change without notice. The only warranties for HP products and services are set forth in the express warranty statements accompanying such products and services. Nothing herein should be construed as constituting an additional warranty. HP shall not be liable for technical or editorial errors or omissions contained herein.

To learn more, visit www.hp.com

4AA2-0270ENUC, April 2009, Rev 1.1





HP Color LaserJet CM3530 MFP series

CM3530 • CM3530fs \$2,499.99 \$2,999.99



Accelerate business results with fully-equipped MFP performance in an easy-to-use, space-saving desktop design.

Enjoy enhanced networking and enterprise-class security with the HP Jetdirect embedded print server. Powerful management tools like HP Web Jetadmin, HP Easy Printer Care software, and HP Embedded Web Server save time and money. Remote troubleshooting, print job tracking, and proactive alerts make HP supplies easy to manage and replace.

Increase productivity

Reduce the direct and indirect costs of enterprise imaging and printing with the HP Color LaserJet CM3530 MFP series. This device sits on a desktop, yet has all the features of a high-performance color MFP—with print, copy, scan, digital send, and fax¹ capabilities. Enhance work team productivity with black-and-white and color print speeds up to 31 pages per minute (ppm), letter (30 ppm, A4). Time To Completion of a typical office print job can be up to 40 percent faster with Instant-on Technology.²

Count on reliable, consistent, high-gloss, high-quality printing with HP ImageREt 3600 and improved HP ColorSphere toner. Meet your specific business needs with support for a range of paper sizes and types, including glossy and heavy paper.

Reduce total costs

Save time while providing greater value to users and your business. Easily control who can print in color and how much with HP's Color Access Control technology. Auto Color Sensing detects whether a document is color or mono and adjusts settings accordingly. Cut paper consumption with standard automatic two-sided printing and copying.

Get black prints for the same cost as on a black-and-white HP LaserJet MFP—and you can still print in color!³ Choose the high-capacity black print cartridge for even more value.

Create professional-looking documents in-house and make the desired impression on employees and customers for less than the cost of outsourcing.



¹ Faxing is standard on the HP Color LaserJet CM3530fs MFP, optional for the HP Color LaserJet CM3530 MFP.

² Instant-on Technology uses cutting-edge fuser technology to produce the first page faster when a printer is coming out of low power mode so your print job is done sooner. An InfoTrends study shows the typical office print job is three to five pages long:

www.infotrends.com/public/Content/Presentations/officeprinteruse.pdf. Time To Completion of a typical office print job tested on HP and select competing products. Actual results may vary.

³ Compared to the HP LaserJet M3035MFP series, using HP Q751X print cartridge. Yields established using ISO/IEC test standards. Actual yields and costs vary considerably depending on images, number of color pages printed or copied and other factors (including frequency of TCU replacement).

HP Color LaserJet CM3530 MFP series

- 1 External USB host port for font cards or third-party solutions
- 2 A powerful 515 MHz processor and 512 MB memory, expandable to 1 GB
- 3 Two internal USB host ports for font cards or third-party solutions
- 4 Hi-Speed USB 2.0 port provides simple connections
- 5 Built-in faxing
- 6 HP Jetdirect Gigabit Ethernet embedded print server
- 7 FIH port and open EIO slot for third-party solutions and optional connectivity
- 8 Hardware Integration Pocket for security solutions
- 9 50-sheet ADF and legal/A4 flatbed scanner
- 10 Intuitive Easy Select color touchscreen control panel with a built-in help function
- 11 Convenience stapler
- 12 250-sheet output bin
- 13 One-door access to the four preinstalled print cartridges with ColorSphere toner and the toner collection unit
- 14 Automatic two-sided printing
- 15 250-sheet input tray with the option to add a 500-sheet input tray 3 for a maximum input capacity of 850 sheets
- 16 Single-door paper path access
- 17 100-sheet multipurpose tray for specialty papers

HP Color LaserJet CM3530fs MFP shown

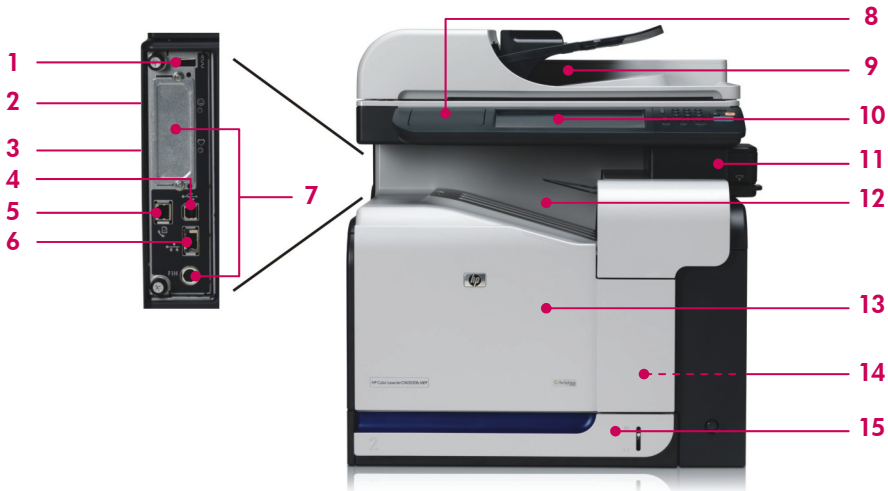

Front view

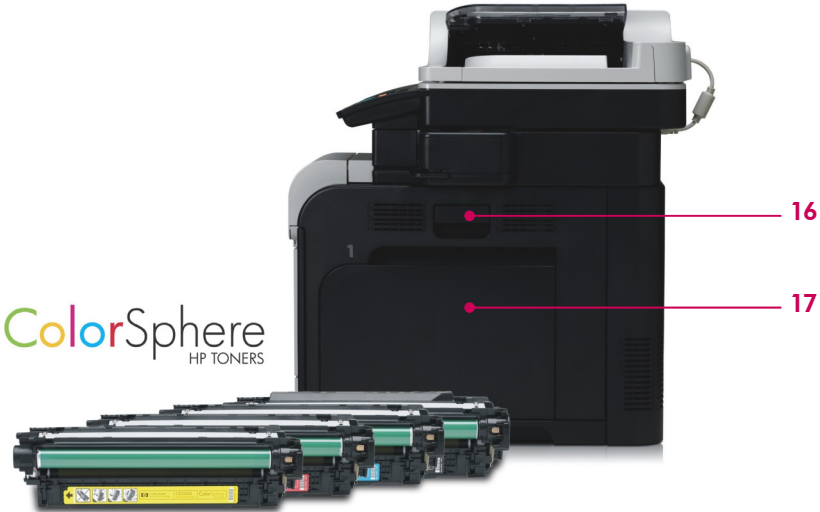

Left side view

Series at a glance



CM3530



CM3530fs

| Part number | CC519A | CC520A |
|---|---------------|----------|
| 100-sheet multipurpose tray 1, 250-sheet tray 2 | ✓ | ✓ |
| 500-sheet tray 3 | Optional | Optional |
| HP Jetdirect Gigabit Ethernet embedded print server | ✓ | ✓ |
| Automatic two-sided printing and copying | ✓ | ✓ |
| Fax capability | Optional | ✓ |
| Convenience stapler | Not available | ✓ |
| Meets ENERGY STAR® guidelines | ✓ | ✓ |
| Meets Blue Angel award criteria | ✓ | |

Reduce risks and increase operational effectiveness.

Accelerate business results

Streamline document-intensive processes and leverage your network for business advantage. By adding the optional 500-sheet paper and heavy media tray, you can easily expand the device's input capacity to 850 sheets. The CM3530fs model includes embedded fax capability and a convenience stapler for even greater efficiency.

Integrate documents into workflows with embedded send to e-mail and send to folder functionality. Optional HP Digital Sending software (HP DSS)⁴ enables documents to be sent to FTP sites, network folders, and fax services.

Extend MFP capabilities as business needs change using the on-board FIH port, open EIO slot, and additional USB ports. Maximize the return on your hardware investment with access to integrated third-party solutions such as document capture, job accounting, and security solutions.

Make recycling convenient and practical. Since 1991, HP's industry-leading Planet Partners recycling program has made it easy to recycle printers, cartridges, and other technology products responsibly. We make the process hassle-free for you by providing postage paid shipping materials in many regions.

Get the most out of your MFP with HP accessories, supplies, and services.

500-sheet Paper and Heavy Media Tray

Print on a range of paper types in sizes from 5.83 by 8.27 in (148 by 210 mm) to 8.5 by 14 in (216 by 356 mm) while increasing total input capacity to up to 850 sheets.

CE522A



HP LaserJet MFP Analog Fax Accessory 500

Support efficient information sharing and improve work team productivity (standard on the CM3530fs model).

CC487A



The HP portfolio of business publishing paper is optimized for HP ColorSphere toner and is available in a variety of sizes, finishes, and weights.



Print cartridges with HP ColorSphere toner⁵

- HP Color LaserJet Black Print Cartridge
- HP Color LaserJet Black Print Cartridge
- HP Color LaserJet Cyan Print Cartridge
- HP Color LaserJet Yellow Print Cartridge
- HP Color LaserJet Magenta Print Cartridge

- CE250A
- CE250X
- CE251A
- CE252A
- CE253A

Supplies

- HP Color LaserJet Toner Collection Unit
- Staple Cartridge Refill
- 110 Volt Fuser Kit
- 220 Volt Fuser Kit

- CE254A
- Q7432A
- CE484A
- CE506A

Accessories

- 500-sheet Paper and Heavy Media Tray
- HP LaserJet MFP Analog Fax Accessory 500
- HP Digital Sending Software 4

- CE522A
- CC487A
- T1936AA

Memory/storage

- 128 MB, 200-pin DDR DIMM
- 256 MB, 200-pin DDR DIMM
- 512 MB, 200-pin DDR DIMM
- HP High-performance Secure Hard Disk
- HP High-performance Secure EIO Hard Disk

- CC409A
- CC410A
- CC411A
- J8018A
- J8019A

Connectivity

- HP Jetdirect 630n IPv6 Gigabit Ethernet Print Server
 - HP Jetdirect 635n IPv6/IPsec Print Server
 - HP Jetdirect en3700 Fast Ethernet Print Server
 - HP Jetdirect en1700 IPv4/IPv6 Print Server
 - HP Jetdirect ew2400 802.11g Wireless Print Server
 - HP 1284B Parallel Card
- (For more information, visit www.hp.com/go/jetdirect)

- J7997G
- J7961G
- J7942G
- J7988G
- J7951G
- J7972G

Paper

- North America: www.hp.com/go/paper
- Europe: www.hp.com/go/learnaboutsupplies
- Asia Pacific: www.hp.com/apac/printingsupplies
- Latin America: contact HP via phone:
- USA: 1-800-477-5010, Europe: +800 7644 7644,
- Asia: 65-6253-8500, Australia/New Zealand: 61-2997-2299LAR,
- Brazil: sac 0800 70 300 70

Solutions

- www.hp.com/go/qsc

HP Support Services

Minimize the cost of downtime. Because downtime can have serious business consequences, HP provides high-quality services to help you avoid unbudgeted repair costs. Rely on expert technical phone support and consistent, predictable delivery of services—even across multiple locations.

- **Installation Service with Network Configuration:** expert assembly of HP accessories, hardware verification, network configuration, and basic administrator familiarization
- **Same Day Onsite Service:** technician arrives at your site within four hours after service call is received, if this time falls within the coverage window
 - HP 3-year 4-hour 9 by 5 Same Day Hardware Support UL358E
 - HP 3-year 4-hour 13 by 5 Same Day Hardware Support UL359E
- **Next Day Onsite Service:** onsite service next business day after service call
 - HP 3-year Next Business Day Hardware Support UK937A/E
 - HP 4-year Next Business Day Hardware Support UL356E
 - HP 5-year Next Business Day Hardware Support UL357E
- **Post-warranty Service:** extend coverage beyond the HP warranty period
 - HP 1-year Post-warranty 4-hour 9 by 5 Hardware Support UL365PE
 - HP 1-year Post-warranty 4-hour 13 by 5 Hardware Support UL366PE
 - HP 1-year Post-warranty Next Business Day HW Support UL364PE

These services and additional coverage options can be purchased as **HP Care Pack Services** or **HP Contractual Services**. HP also offers **HP Managed Print Services:** scalable assessment, procurement, implementation, management, maintenance, support, and workflow services.

For more information visit: www.hp.com/go/printservices.

⁴ HP Digital Sending Software is optional (not included, sold separately). Software is server based; server required.

⁵ Average continuous composite black cartridge yield 5,000 standard pages and average continuous composite cyan/yellow/magenta cartridge yield 7,000 standard pages. CE250X high-capacity black cartridge yield 10,500 standard pages. Standard yield value in accordance with ISO/IEC 19798. Actual yields vary considerably based on images printed and other factors. For more information, visit www.hp.com/go/learnaboutsupplies.

HP Color LaserJet CM3530 MFP series

| Technical specifications | HP Color LaserJet CM3530 MFP (CC519A) | HP Color LaserJet CM3530f MFP (CC520A) |
|--|---|--|
| Print and copy speed⁶ | Black-and-white and color: up to 31 ppm, letter (30 ppm, A4) | |
| Document delivery speed | First page out: as fast as 11 seconds from Ready, as fast as 16.5 seconds from Sleep; Time To Completion for a typical print job: ⁷ as fast as 23.3 seconds, letter | |
| Resolution | HP ImageREt 3600 technology; Print: up to 1200 by 600 dpi; Copy: up to 600 dpi; Scan: up to 600 by 600 dpi (scanner), 600 by 300 dpi (ADF); Fax: up to 300 dpi send, 400 dpi receive | |
| Features | | |
| Copying | Up to 999 multiple copies, reduce/enlarge from 25 to 400 percent, two-sided copying, scalability, image adjustments (darkness, background cleanup, sharpness), N-up, N- or Z-ordering, content orientation, collation, booklet, job build, edge-to-edge, job storage | |
| Scanning | High depth-of-focus CCD color flatbed scanner and ADF with instant-on LED illumination captures high quality images up to 8.5 by 14 in; scan input modes: copy, fax (optional), e-mail, folder; file types: PDF, JPG, TIFF, MTIFF | |
| Faxing | Optional (with the separate purchase of the HP LaserJet MFP Analog Fax Accessory 500) | Up to 33.6 kbps, auto fax reduction, fax forwarding, remote retrieval of faxes with fax polling (receive only), broadcasting (to up to 100 locations), speed dial (up to 100 lists), junk barrier, auto redialing, Windows® faxing supported |
| Digital sending | Standard: embedded scan to e-mail, send to network folder; Optional via HP Digital Sending Software (HP DSS): secondary e-mail, send to folder, send to workflow, send to printer, authentication, digital fax (send to LAN, Windows 2000, Internet); file formats: PDF, JPEG, TIFF, MTIFF | |
| Processor | 515 MHz | |
| Memory | 512 MB, expandable to 1 GB; embedded 80 GB hard disk | |
| Durability ratings | Recommended monthly volume: 2,000 to 6,000 pages; ⁸ Duty cycle: up to 75,000 pages ⁹ | |
| Paper | | |
| Input | 50-sheet ADF, 100-sheet multipurpose tray 1, 250-sheet tray 2, optional 500-sheet tray 3 | |
| Output | 250-sheet output bin | |
| Two-sided printing and copying | Automatic (configurable) | |
| Sizes | Multipurpose tray 1: A4, A5, A6, B5 (JIS), B6 (JIS), double postcard (JIS), 16K; envelopes (No. 9, No. 10, Monarch, C5, C6, DL, B5); letter, legal, executive, statement, 4 by 6 in, 5 by 8 in, 8.5 by 13 in; custom sizes: 98.4 by 148 mm (3.9 by 5.8 in) to 216 by 356 mm (8.5 by 14 in); Tray 2: A4, A5, B5 (JIS), 16K; letter, executive; custom sizes: 148 by 210 mm (5.8 by 8.3 in) to 216 by 297 mm (8.5 by 11.7 in); Optional Tray 3: A4, A5, B5 (JIS), 16K; letter, legal, executive, 8.5 by 13 in; custom sizes: 148 by 210 mm (5.8 by 8.3 in) to 216 by 356 mm (8.5 by 14 in); Automatic two-sided printing unit: A4, A5, B5 (JIS) 16K; letter, legal, executive, 8.5 by 13 in | |
| Weights | Multipurpose tray 1: plain paper: 60 to 216 g/m ² (16 to 58 lb bond); glossy paper: 105 to 220 g/m ² (28 to 58 lb bond); Tray 2: plain paper: 60 to 163 g/m ² (16 to 43 lb bond); glossy paper: 105 to 220 g/m ² (28 to 58 lb bond); Tray 3: plain paper: 60 to 176 g/m ² (16 to 47 lb bond); glossy paper: 105 to 220 g/m ² (28 to 58 lb bond); Automatic two-sided printing unit: plain paper: 60 to 163 g/m ² (16 to 43 lb bond); glossy paper: 105 to 220 g/m ² (28 to 58 lb bond) | |
| Types | Paper (plain, preprinted, letterhead, prepunched, bond, recycled, color, light, intermediate, heavy, extra heavy, rough, glossy, heavy glossy, tough), transparencies, labels, envelopes, card stock | |
| Connectivity | | |
| Interfaces | FIH port, open EIO slot, one external USB host port, one Hi-Speed USB 2.0 device port, two additional internal USB ports, HP Jetdirect Gigabit Ethernet embedded print server, hardware integration pocket on control panel | FIH port, open EIO slot, one external USB host port, one Hi-Speed USB 2.0 device port, two additional internal USB ports, fax port, HP Jetdirect Gigabit Ethernet embedded print server, hardware integration pocket on control panel |
| Languages and fonts | Languages: HP PCL 6, HP PCL 5, HP postscript level 3 emulation, direct PDF printing v1.4; Fonts: 80 HP font set (plus Greek, Hebrew, Cyrillic, Arabic) | |
| Client operating systems | Microsoft® Windows 2000, XP®, Server 2003, Server 2008, Certified for Windows Vista®; x86 and x64; Mac Installer for OS X v10.3, v10.4, v10.5 | |
| Network operating systems | Windows Vista compatible, Vista Premium, XP Home, XP Professional, XP Professional x64, Server 2003 (32/64 bit), Server 2008 (32/64 bit), 2000 (IPv4 and IPsec on IPv4 available on all listed Windows systems; IPv6 and IPsec on IPv6 only supported on Windows Vista and Server 2008); Novell 5.1 or higher; Mac OS X v10.3 or higher; Red Hat Linux 7.x or higher; SuSE Linux 8.x or higher; HP-UX 10.20, 11.x, 11.i; Solaris 2.5 or higher (SPARC systems only); IBM AIX 3.2.5 or higher (requires software from the NOS vendor); MPE-iX; Citrix MetaFrame Server; Windows Terminal Services | |
| Network protocols | IPv4/IPv6: Apple Bonjour compatible (Mac OS v10.2.4 and later), SNMPv1/v2c/v3, HTTP, HTTPS, FTP, Port 9100, LPD, IPP, Secure-IPP, WS Discovery, IPsec/Firewall; IPv6: DHCPv6, MLDv1, ICMPv6; IPv4: Auto-IP, SLP, TFTP, Telnet, IGMPv2, BOOTP/DHCP, WINS, IP Direct Mode, WS Print; Other: IPX/SPX, AppleTalk, NetWare NDS, Bindery, NDPS, iPrint | |
| Security | Management security: SNMPv3, SSL/TLS, 802.1X authentication (EAP: PEAP, EAP-TLS), IPP over TLS, IPsec/firewall with certificate, pre-shared key authentication, Kerberos authentication. Support for WJA 10 IPsec configuration using IPsec plug-in. | |
| Dimensions (w by d by h) | 515 by 519 by 560.5 mm (20.3 by 20.4 by 22.1 in) | 543 by 519 by 560.5 mm (21.4 by 20.4 by 22.1 in) |
| Weight (includes print cartridge) | 47.6 kg (105 lb) | 48.4 kg (106.6 lb) |
| What's in the box | MFP, preinstalled full-capacity 5,000-page ¹⁰ black and 7,000-page ¹⁰ cyan, magenta, and yellow HP Color LaserJet print cartridges with HP ColorSphere toner, toner collection unit, in-box documentation (Getting Started Guide, digital send installation guide, support flyer, wall poster), software drivers and documentation on CD-ROM, power cable, control panel overlay, 100-sheet multipurpose tray, 250-sheet input tray | |
| Also includes | HP LaserJet MFP Analog Fax Accessory 500, phone cord, convenience stapler | |
| Warranty | One-year, next business day, onsite warranty backed by HP Customer Care, service and support; one-year technical phone support | |

| Environmental ranges | Certifications | | |
|--|---|--|--|
| Recommended temperature | Safety | IEC 60950-1 (International), EN 60950-1+A1 1 (EU), IEC 60825-1+A1+A2, UL/cUL Listed (US/Canada), GS License (Europe), EN 60825-1+A1+A2 (Class 1 Laser/LED Device) GB4943-2001, Low Voltage Directive 2006/95/EC with CE Marking (Europe); other safety approvals as required by individual countries | |
| Storage temperature | | 0 to 35 degrees C (32 to 95 degrees F) | |
| Recommended relative humidity | | 20 to 60 percent | |
| Storage relative humidity | | 10 to 90 percent | |
| Altitude | 2,500 m (8,000 ft) | EMC | CISPR 22: 2005/EN 55022: 2006 Class A, EN 61000-3-2: 2000+A2, EN 61000-3-3: 1995+A1, EN 55024:1998+A1+A2, FCC Title 47 CFR, Part 15 Class A (USA), ICES-003, Issue 4, (Canada), GB9254-1998, EMC Directive 2004/108/EC with CE Marking (Europe); other EMC approvals as required by individual countries |
| Acoustics | | | Telecom |
| Sound power | Active, printing: 6.8 B(A), copying: 7.0 B(A); Ready: 4.8 B(A) | | |
| Bystander sound pressure | Active, printing: 53 dB(A), copying: 55 dB(A); Ready: 34 dB(A) | | |
| Power specifications | | | |
| Required input voltage | 115 to 127 V (±10 percent), 50/60 Hz (±2 Hz) 220 to 240 V (±10 percent), 50/60 Hz (±2 Hz) | | |
| Power consumption ¹¹ | Active: 652 w; Active copy/scan: 666 w; Ready: 87.4 w; Sleep 1: 72.2 w; Sleep 2: 18.1 w; Off: 0.84 w | | |
| Typical Electricity Consumption (TEC): 6.070 kWh/Week | | | |
| Energy Star qualified models, see www.hp.com/go/energystar | | | |

Works with HP SureSupply. To learn more, visit www.hp.com/learn/suresupply

⁶ Exact speed varies depending on system configuration, software application, driver, and document complexity.

⁷ An InfoTrends study shows the typical office print job is three to five pages long: www.infotrends.com/public/Content/Presentations/officeprinteruse.pdf. Time To Completion of a typical office print job tested on HP and select competing products. Actual results may vary.

⁸ HP recommends that the number of pages per month of imaged output be within the stated range for optimum device performance, based on factors including supplies replacement intervals and device life over an extended warranty period.

⁹ Duty cycle is defined as the maximum number of pages per month of imaged output. This value provides a comparison of product robustness in relation to other HP LaserJet or HP Color LaserJet devices, and enables appropriate deployment of printers.

¹⁰ Average continuous composite black cartridge yield 5,000 standard pages and average continuous composite cyan/yellow/magenta cartridge yield 7,000 standard pages. CE250X high-capacity black cartridge yield 10,500 standard pages.

¹¹ Declared yield value in accordance with ISO/IEC 19798. Actual yields vary considerably based on images printed and other factors. For more information, visit www.hp.com/go/learnaboutsupplies.

¹¹ Power requirements are based on the country/region where the printer is sold. Do not convert operating voltages. This will damage the printer and void the product warranty.



ENERGY STAR and the ENERGY STAR logo are registered U.S. marks. Linux is a U.S. registered trademark of Linus Torvalds. Microsoft, Windows, and Windows XP are registered trademarks of Microsoft Corporation. Windows Vista is either a registered trademark or trademark of Microsoft Corporation in the United States and/or other countries.

© Copyright 2008 Hewlett-Packard Development Company, L.P.

The information contained herein is subject to change without notice. The only warranties for HP products and services are set forth in the express warranty statements accompanying such products and services. Nothing herein should be construed as constituting an additional warranty. HP shall not be liable for technical or editorial errors or omissions contained herein.

To learn more, visit www.hp.com

XXXX-XXXXENW, September 2008, Rev. 6





COLOR LASERJET ENTERPRISE CM4540 MFP PRINTER SERIES

CM4540 • CM4540f • CM4540fsm

\$3,799.99 \$4,499.99 \$5,549.99

Set your sights on productivity with this high-performance MFP. Print high-impact color documents quickly and easily with an MFP that packs robust paper handling, market-leading management and security features into a desktop footprint. Copy, Scan, and Digital Send functions support multiple workflows, and HP Easy Select touchscreen control panel makes this MFP easy to use. Plus, easily integrate HP and third-party solutions developed on the HP Open Extensibility Platform.



Brilliant results made simple

- Process jobs at the MFP with the award-winning HP Easy Select control panel. Print from the walk-up USB port.⁷
- Achieve sharp contrast and bright color with high-gloss toner. HP ImageREt delivers crisp, consistent detail.
- Pre-installed Original HP LaserJet print cartridges and optional high-capacity black cartridges save time.⁵
- Get the paper capacity you need—600 sheets—in a space-saving size or upgrade to 1100 or 2100 sheets.⁴

Market-leading manageability and extensibility

- Proactively manage printing fleets and control color usage and costs with HP management tools.
- Simple setup wizards for save-to-folder and scan-to-email functions make digital workflows a breeze.
- Extend your MFP capabilities with a rich portfolio of solutions that are easy to integrate.
- Make printing as mobile as you are with the HP ePrint Enterprise solution.¹

Protect your data with advanced security features

- Protect sensitive data stored on your HP MFP with the standard encrypted HP High-Performance Secure Hard Disk.
- Attach security solutions to the control panel's hardware integration pocket for a seamless appearance.
- Process jobs securely without compromising efficiency and speed via user authentication, IPsec and IPv6.
- Create, print, scan and share sensitive business information securely via encrypted e-mail and PDFs.

Minimize your environmental impact

- Get up to 50% energy savings over competitive products, using Instant-on Technology.²
- Save paper and conserve resources—use digital workflows, two-sided printing, PIN print and image preview.⁶
- Get free and easy recycling—print cartridges returned through HP Planet Partners are recycled responsibly.³
- Reduce shipping materials and packaging waste with optional high-capacity black print cartridges.⁵



ecoHIGHLIGHTS

HP Color LaserJet Enterprise CM4540 MFP Printer Series

ECO INFORMATION

- Reduce energy use up to 50% with Instant-on Technology.
- Reduce paper use by up to 50% using automatic two-sided printing.
- Reduce clutter and waste—scan, store and share documents digitally.



ENERGY STAR® Qualified Product

www.hp.com/ecosolutions

Please recycle your computing hardware and printing supplies. HP asset management and recycling services make responsible disposal easy.



¹Requires BlackBerry Enterprise Server deployment, Internet- and e-mail-capable BlackBerry smartphone OS 4.5 or newer with separately purchased wireless Internet service, HP ePrint app, HP ePrint server. Solution works with PCL 5/6, PCL 3, PCL 3 GUI printers (HP and non-HP). ²Energy savings based on HP testing using the ENERGY STAR® program's Typical Electricity Consumption (TEC) method on HP LaserJet products with Instant-on Technology vs. top competitive models as of March 2009. ³Program availability varies. HP print cartridge return and recycling is currently available in more than 49 countries, territories and regions in Asia, Europe, and North and South America through the HP Planet Partners program. For more information, visit: <http://www.hp.com/recycle>. ⁴The 1 x 500-sheet Feeder, 1 x 500-sheet Paper Feeder and cabinet and 3 x 500-sheet Paper Feeder and stand may be purchased separately for the CM4540 model. ⁵HP Color LaserJet CE264X Black print cartridge not included; please purchase separately. ⁶Image preview may require a firmware upgrade. ⁷Compatible with most USB 2.0 certified, NAND Flash Memory Devices. Supported file types: Scan to walk-up USB: PDF; JPEG; TIFF; MTIFF; XPS; PDF/A; Print from walk-up USB: PDF, PS, Print Ready files (.prn, .pcl, .cht).

HP COLOR LASERJET ENTERPRISE CM4540 MFP PRINTER SERIES

TECH 2000, INC.

HP Color LaserJet Enterprise CM4540fskm MFP shown

- 1 Intuitive 8-inch HP Easy Select pivoting touch screen color control panel
- 2 Hardware Integration Pocket for solution integration
- 3 900-sheet 3-bin stapling mailbox
- 4 Front door allows convenient access to four, all-in-one HP print cartridges
- 5 Built-in automatic two-sided printing
- 6 Four 500-sheet input trays for a 2,100-sheet total input capacity
- 7 50-sheet ADF scanner processes two-sided documents at full speed Plate-glass scanner handles documents up to legal size
- 8 100-sheet multipurpose tray 1 handles heavy custom media up to 220 g/m² (58 lb bond)
- 9 Hi-Speed USB 2.0 port
- 10 HP Jetdirect Gigabit Ethernet embedded print server
- 11 RJ-11 fax port
- 12 One open EIO slot
- 13 1280MB (not upgradable) total memory and an 800 MHz processor quickly handle complex print jobs
- 14 HP Secure High Performance embedded hard disk
- 15 Access port for optional Kensington-style lock

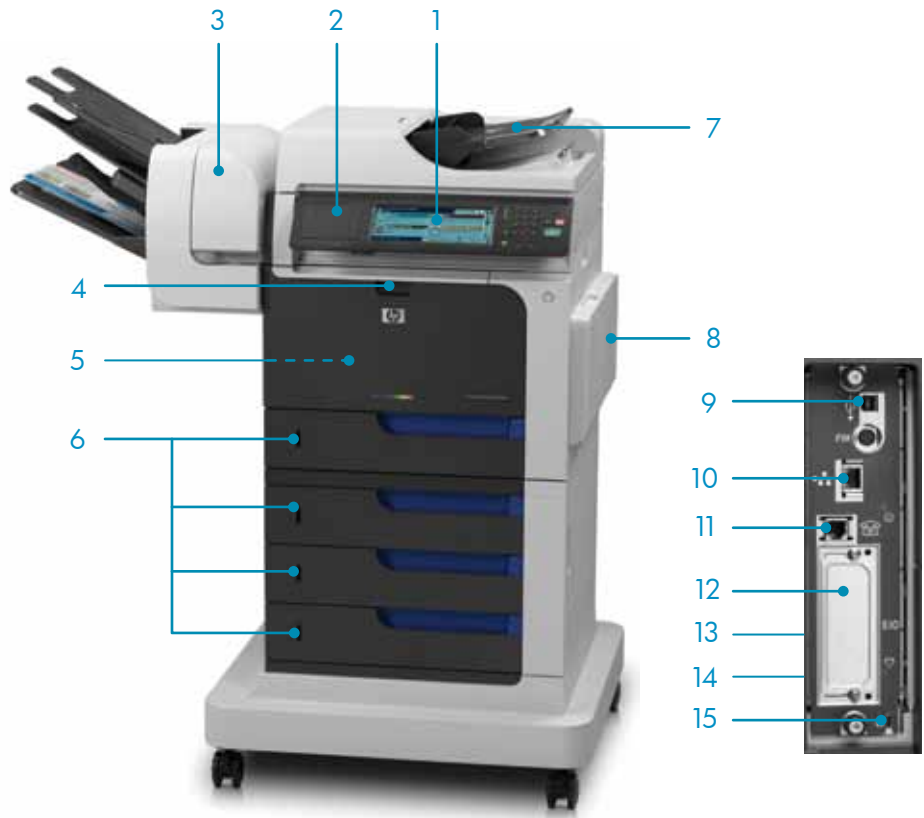

Front view

I/O panel close-up

Series at a glance



| | CM4540 MFP | CM4540f MFP | CM4540fskm MFP |
|--|---------------|---------------|----------------|
| Part number | CC419A | CC420A | CC421A |
| 100-sheet multipurpose tray 1 | ✓ | ✓ | ✓ |
| 500 sheet tray 2 | ✓ | ✓ | ✓ |
| 500-sheet Paper Feeder | Optional | | |
| 500-sheet Paper Feeder and Cabinet | Optional | ✓ | |
| 3 x 500-sheet Paper Feeder and Stand | Optional | | ✓ |
| 500-sheet output bin | ✓ | ✓ | |
| 900-sheet 3-bin stapling mailbox | Optional | Optional | ✓ |
| Automatic two-sided printing | ✓ | ✓ | ✓ |
| HP Secure High Performance embedded hard disk | ✓ | ✓ | ✓ |
| HP LaserJet MFP Analog Fax Accessory 500 | Optional | ✓ | ✓ |
| ENERGY STAR® qualified | ✓ | ✓ | ✓ |

Brilliant results made simple

Take care of jobs at the MFP with the award-winning HP Easy Select control panel for a trouble-free user experience. Preview digital send jobs to add, delete, and reorder pages on the 8-inch pivoting color control panel.² Use the walk-up USB port⁸ to print directly from—and save scans to—flash drives.

Maximize the impact of business documents. HP EasyColor, HP ImageREt, and HP ColorSphere toner deliver high-quality, glossy text, bold graphics, and vivid images with consistent details.

Process documents quickly with speeds up to 42 ppm letter (up to 40 ppm A4) and a first page out as fast as 9.5 seconds from Ready (A4/letter). Instant-on Technology enables output jobs to begin quickly from low-power mode.

Streamline setup. Original HP LaserJet print cartridges are pre-installed to save time and reduce packaging.

Boost productivity with robust paper handling in a compact device. An input capacity of up to 2,100 sheets means large print and copy jobs can be completed without reloading. With the 900-sheet, 3-bin stapling mailbox that sorts, collates, staples, and stacks documents, the MFP facilitates complex document jobs for your busy office.¹

Market-leading manageability and extensibility

Increase business productivity and save money by proactively managing imaging and printing fleets and controlling color usage. Manage networked products remotely with industry-leading HP Web Jetadmin, easily restrict color output to those who need it with HP Color Access Controls, and give users instant access to many HP imaging and printing devices with the HP Universal Print Driver.

Use the intuitive setup wizard to easily configure save-to-folder and scan-to-email parameters. Convert hard copies into digital files for fast and easy distribution and storage. Digital workflows are a breeze when capturing, saving, and sending scanned files is as easy as pushing a button.

Do more with your investment. The HP Open Extensibility Platform simplifies the development and deployment of HP and third-party solutions, allowing you to easily integrate solutions such as job accounting, secure printing, and document management.³

Print from anywhere, anytime directly to your HP MFP, using a smartphone, notebook, or other mobile device with HP ePrint.⁴ For businesses deploying BlackBerry phones, HP ePrint Enterprise enables printing on any networked printing device.⁵

Get the most out of your printer with HP accessories, supplies, and services.

900-sheet 3-bin Stapling Mailbox

Improve workflow management and accommodate multiple users easily with the HP 900-sheet 3-bin Stapling Mailbox. Convenient, automatic job stapling and sorting saves time.



CC424A

HP Services

Because downtime can have serious business consequences, HP provides high-quality services that extend beyond the standard warranty and help you avoid unbudgeted repair costs. Benefits include reduced printing and infrastructure costs, maximized uptime, expert technical phone support, and predictable, consistent service delivery—even across multiple locations.

Recommended services:

- **Same Day Onsite Service:** An HP technician or authorized service provider arrives at your site within four hours after the service call is received, if this time falls within the coverage window
- **Next Day Onsite Service:** Technician delivered onsite service the next business day after the service call is received

These services and additional coverage options can be purchased as:

- **HP Care Pack Services:** easy-to-buy, easy-to-use support packages
- **HP Contractual Services:** a comprehensive portfolio for maintaining maximum IT availability

For more information visit: www.hp.com/go/printservices

MFPs

HP Color LaserJet Enterprise CM4540 MFP

HP Color LaserJet Enterprise CM4540f MFP

HP Color LaserJet Enterprise CM4540fskm MFP

HP Color LaserJet Print Cartridges with HP ColorSphere toner⁶

HP Color LaserJet Black Print Cartridge (8,500 pages)

HP Color LaserJet Black Print Cartridge (17,000 pages)

HP Color LaserJet Cyan Print Cartridge (12,500 pages)

HP Color LaserJet Yellow Cartridge (12,500 pages)

HP Color LaserJet Magenta Cartridge (12,500 pages)

Supplies

Toner Collection Unit (36,000 pages)⁷

110 Volt Fuser Kit

220 Volt Fuser Kit

Automatic Document Feeder Maintenance Kit

Maintenance Kit Transfer Kit

Accessories

HP Color LaserJet 500-sheet Paper Tray

HP 500-sheet paper feeder and cabinet

HP 3 x 500-sheet paper feeder and stand

HP 900-sheet, 3-bin stapling mailbox

HP LaserJet MFP Analog Fax Accessory 500

Connectivity

HP Jetdirect 690n IPv6/IPsec 802.11g Wireless Print Server

HP Jetdirect ew2500 802.11b/g Wireless Print Server

HP Care Pack Services

HP 3y Nbd CLJ CM4540 MFP HW Support

HP 3y Nbd + DMR Clr LsrJt CM4540 MFP Support

HP 4y Nbd CLJ CM4540 MFP HW Support

HP 5y Nbd CLJ CM4540 MFP HW Support

HP 1y PW Nbd CLJ CM4540MFP HW Support

HP 2y PW Nbd CLJ CM4540MFP HW Support

HP Ntwk Install mid-high ClrLaserJet SVC

Paper

www.hp.com/go/paper

Software

HP Web Jetadmin: www.hp.com/go/wja

HP Easy Printer Care: www.hp.com/go/easyprinterware

HP Universal Print Driver: www.hp.com/go/upd

HP Install Network Printer Wizard: www.hp.com/go/inpw_sw

Solutions

HP BarCodes and More USB Solution

HP Scalable BarCode Set USB Solution

HP BarCode Printing USB Solution

HP MICR USB Solution

HP LaserJet Fonts and IPDS Emulation available at www.hp.com/go/laserjetfonts

For more solutions information, please visit www.hp.com/go/gsc.

CC419A

CC420A

CC421A

CE260A

CE264X

CF031A

CF032A

CF033A

CE265A

CE246A

CE247A

CE248A

CE249A

CC425A

CC422A

CC423A

CC424A

CC487A

J8007G

J8021A

UV259E

UV273E

UV264E

UV265E

UV284PE

UV285PE

H2872E

HG281US

HG282UT

HG271US

HG283US

¹Standard and optional features vary by model. ²Image preview may require a firmware upgrade. ³Solutions may not be available at product introduction. ⁴May require an Internet connection to the printer. Feature works with any Internet and email-capable device and may require a firmware upgrade. For more information, visit www.hp.com/go/ePrintCenter. ⁵Requires BlackBerry Enterprise Server deployment, Internet and email-capable BlackBerry smartphone OS 4.5 or newer with separately purchased wireless Internet service, HP ePrint app, HP ePrint server. Solution works with PCL5/6, PCL3, PCL3GUI printers (HP and non-HP). ⁶Average continuous composite cyan/yellow/magenta cartridge yield 11,000 standard pages, average continuous black cartridge yield 8,500 standard pages (CE260A), and average continuous black cartridge high-capacity yield 17,000 standard pages (CE264X). Declared yield value in accordance with ISO/IEC 19798. Actual yields vary considerably based on images printed and other factors. For details see www.hp.com/go/learnaboutsupplies. ⁷Toner Collection Unit capacity approximately 36,000 pages (individual experience may vary considerably based on images printed, media used, environmental conditions and other factors). ⁸Compatible with most USB 2.0 certified, NAND Flash Memory Devices. Supported file types: Scan to walk-up USB: PDF; JPEG; TIFF; MTIFF; XPS; PDF/A; Print from walk-up USB: PDF, PS, Print Ready files (.prn, .pcl, .cht).

HP COLOR LASERJET ENTERPRISE CM4540 MFP PRINTER SERIES

| Technical specifications | HP Color LaserJet Enterprise CM4540 MFP Printer | HP Color LaserJet Enterprise CM4540f MFP Printer | HP Color LaserJet Enterprise CM4540fsk MFP Printer |
|---|---|---|---|
| Print and copy speed³ | Color and black-only: Up to 42 ppm letter (up to 40 ppm A4) | | |
| First page out | Print: As fast as 11.5 seconds from ready; Copy: As fast as 12 seconds from ready | | |
| Print resolution | HP ImageREt 3600 (600 x 600 dpi) | | |
| Scanning resolution | Up to 600 x 600 dpi, 30 bit depth (flatbed), up to 600 x 300 dpi, 30 bit depth (ADF) | | |
| Control panel | Rotating (adjustable angle); 8.07" color graphical display; touchscreen; job control buttons (Start, Stop, Sleep, Reset, Clear, Brightness Up/Down); numeric keypad; LED status lights (Ready, Data, Attention, Sleep); Hardware Integration Pocket; walk-up USB | | |
| Features | Color flatbed scanner or ADF; scan input modes: copy, email, fax, secondary email, folder, workflow | | |
| Scanning | Up to 9,999 copies, reduce or enlarge from 25 to 400% (from scanner glass), scaling from 25 to 200% (from ADF) | | |
| Copying | Fax speed: up to 33.6 kbps; JBIG compression, fax forwarding, fax polling, broadcasting to up to 100 locations, speed dial (up to 100 numbers), auto fax reduction, auto redialing | | |
| Faxing ¹ | 800 MHz | | |
| Processor | 1280MB (not upgradeable) RAM | | |
| Memory | HP High-performance Secure Hard Disk (embedded) | | |
| Hard disk | Recommended monthly page volume: 5,000 to 9,000 pages ⁴ ; Duty cycle: up to 175,000 pages (A4/letter) ² | | |
| Durability ratings | Paper | | |
| Input | 100-sheet multipurpose tray, 500-sheet tray | 100-sheet multipurpose tray, 500-sheet tray, 500-sheet paper feeder and cabinet | 100-sheet multipurpose tray, 500-sheet tray, 3 x 500-sheet paper feeder and stand |
| Output | 500-sheet output bin | | 900-sheet, 3-bin stapling mailbox |
| Two-sided printing | Automatic | | |
| Interfaces | Hi-Speed USB 2.0 port, walkup USB port, Hardware Integration Pocket, RJ-45 port (10/100/1000 Base-TX), EIO slot, RJ-11 fax port (CM4540f and CM4540fsk models only) | | |
| Languages | HP PCL 6, HP PCL 5c (HP PCL 5c driver available from the Web only), HP postscript level 3 emulation, native PDF printing (v 1.4) | | |
| Network capabilities | Via HP Jetdirect 10/100/1000 Base-TX Ethernet embedded print server (standard), IPsec (standard), SNMP3, 802.1x wireless (optional), TC/IP support (optional) | | |
| Fonts | 105 internal TrueType fonts scalable in HP PCL, 92 internal scalable fonts in HP postscript Level 3 emulation (Euro symbol built-in); 1 internal Unicode Fonts (Andale Mono WorldType); 2 Internal Windows Vista 8 Fonts (Calibri, Cambria). Additional Font Solutions available at http://www.hp.com/go/laserjetfonts | | |
| Network protocols | IPv4/IPv6: Apple Bonjour Compatible (Mac OS 10.2.4 or higher), SNMPv1/v2c/v3, HTTP, HTTPS, FTP, TFTP, Port 9100, LPD, WS Discovery, IPP, Secure-IPP, IPsec/Firewall; IPv6: DHCPv6, MLDv1, ICMPv6; IPv4: Auto-IP, SLP, Telnet, IGMPv2, BOOTP/DHCP, WINS, IP Direct Mode, WS Print; Other: NetWare NDS, Bindery, NDPS, iPrint | | |
| Security | Management security: SNMPv3, SSL/TLS, 802.1X authentication (EAP: PEAP, EAP-TLS), IPP over TLS, IPsec/Firewall with Certificate, Pre-Shared Key Authentication, and Kerberos Authentication; Support for WJA-10 IPsec Configuration using IPsec Plug-in | | |
| Dimensions (w x d x h) | 35.6 x 24.5 x 22.6 in (905 x 623 x 575 mm) | 35.8 x 26.3 x 44.1 in (909 x 668 x 1119 mm) | 42.2 x 26.3 x 44.1 in (1072 x 668 x 1119 mm) |
| Weight (with print cartridges) | 120.5 lb (54.8 kg) | 166.5 lb (75.7 kg) | 195 lb (88.6 kg) |
| System requirements, Windows | Microsoft® Windows 7, Windows Vista®, Windows® XP SP2 or higher, Windows® Server 2003, Windows® Server 2008; operating system compatible hardware system requirements, see http://www.microsoft.com system requirements; 220 MB available hard disk space; Mac: Mac OS X v 10.4 or higher; operating system compatible hardware system requirements, see: http://www.apple.com ; 150 MB free hard disk space | | |
| What's in the box | MFP; power cable; 100-sheet multipurpose tray; 500-sheet input tray; 500-sheet output bin, HP Jetdirect Gigabit Ethernet embedded print server; HP LaserJet Black Print Cartridge (8,500 pages) HP Color LaserJet Cyan, Yellow, and Magenta Print Cartridges with HP ColorSphere Toner (11,000 pages); Hardware and Software Installation Guide; CD-ROM with software drivers and documentation CP4540f: As above plus 500-sheet paper feeder and cabinet), Fax (embedded) CM4540fsk: As above plus 3 x 500-sheet feeder with stand, 900-sheet 3-bin stapling mailbox, Fax (embedded) | | |
| Warranty | One-year, next business day, on-site warranty | | |

| | | | |
|---------------------------------------|---|--|--|
| Environmental ranges | | Safety approvals and requirements | IEC 60950-1 (International); EN 60950-1+A11 (EU); IEC 60825-1+A1+A2; UL/cUL Listed (US/Canada); GS license (Europe); EN 60825-1+A1+A2 (Class 1 Laser/LED Device); Low Voltage Directive 2006/95/EC with CE Marking (Europe); other safety approvals as required by individual countries |
| Temperature range | Operating: 10 to 30° C (50 to 86° F) Recommended: 15 to 27° C (59 to 80.6° F) Storage: 0 to 35° C (32 to 95° F) | | |
| Humidity range | Operating: 10 to 80% RH Recommended: 30 to 70% RH Non-operating: 10 to 90% RH | | |
| Acoustic | | Electromagnetic emission standard | CISPR 22: 2005+A1/EN 55022: 2006+A1 Class A, EN 61000-3-2: 2006, EN 61000-3-3: 1995+A1+A2, EN 55024: 1998+A1+A2, FCC Title 47 CFR, Part 15 Class A (USA), ICES-003, Issue 4, (Canada), GB 9254-2008, EMC Directive 2004/108/EC with CE Marking (Europe), other EMC approvals as required by individual countries |
| Sound power emissions ⁶ | Active, Print: 7.2 B(A), Copy/Scan: 7.3 B(A), Idle/Ready: 5.5 Bels | | |
| Sound pressure (bystander position) | Active, Print: 54 dB(A), Copy/Scan: 57 dB(A), Idle/Ready: 37 dB(A) | | |
| Power | | | |
| Power Supply required | Input voltage 110 to 127 VAC (+/- 10%), 60 Hz (+/- 2 Hz), 12 A | | |
| Power Consumption ⁷ | 780 watts (Printing), 850 watts (Copying), 91 watts (Ready), 21.5 watts (Sleep), 0.3 watts (Off) | | |
| Typical Electricity Consumption (TEC) | 8.062 kWh/Week | | |

¹Standard and optional features vary by model. ²Duty cycle is defined as the maximum number of pages per month of imaged output. This value provides a comparison of product robustness in relation to other HP LaserJet or HP Color LaserJet devices, and enables appropriate deployment of printers and MFPs to satisfy the demands of connected individuals or groups. ³Exact speed varies depending on the system configuration, software application, driver, and document complexity. ⁴HP recommends that the number of printed pages per month be within the stated range for optimum device performance, based on factors including supplies replacement intervals and device life over an extended warranty period. ⁵Average continuous composite cyan/yellow/magenta cartridge yield 11,000 standard pages, average continuous black cartridge yield 8,500 standard pages (CE260A), and average continuous black cartridge high-capacity yield 17,000 standard pages (CE264X). Declared yield value in accordance with ISO/IEC 19798. Actual yields vary considerably based on images printed and other factors. For details see www.hp.com/go/learnaboutsupplies. ⁶Declared per ISO 9296 and 7729; values are subject to change. Configuration tested: HP Color LaserJet CP4525dn, printing at 40 ppm on A4 paper. ⁷Values subject to change. Power numbers are the highest values measured using all standard voltages.



© Copyright 2010 Hewlett-Packard Development Company, L.P.

The information contained herein is subject to change without notice. The only warranties for HP products and services are set forth in the express warranty statements accompanying such products and services. Nothing herein should be construed as constituting an additional warranty. HP shall not be liable for technical or editorial errors or omissions contained herein.

ENERGY STAR and the ENERGY STAR mark are registered U.S. marks. Microsoft, Windows, and Windows XP are registered trademarks of Microsoft Corporation. Windows Vista is either a registered trademark or trademark of Microsoft Corporation in the United States and/or other countries.

To learn more, visit www.hp.com
4AA3-1357ENUC November 2010





HP Color LaserJet CM6030/CM6040 MFP series

CM6030 • CM6030f • CM6040f

!!! !!! \$8,999.99



Maximize workgroup productivity with this breakthrough color laser MFP: consolidate multiple functions and get efficient A3 printing.



The HP Color LaserJet CM6030/CM6040 MFP series offers competitive color output quality along with scan, copy, digital send, and fax¹ in an exceptionally reliable and easy-to-manage package. Its low acquisition price, overall cost per page value, and space-saving design make it the best choice for your business environment.

High performance

Do more and do it quickly. Get black-and-white and color speeds of up to 40/41 ppm (letter/A4) for the HP Color LaserJet CM6040f MFP (30/31 ppm for the CM6030 MFP series). Process complex documents quickly with an 835 MHz processor and 512 MB standard memory (expandable up to 768 MB). Efficiently produce general and wide-format documents up to 12 by 18 inches (A3/SRA3).

Easily capture documents electronically and speed up workflow with scan to e-mail, printer, network folder, and fax services.¹ Included installation wizards make configuring send to network and desktop folder fast and simple.

¹ Faxing is standard for the HP Color LaserJet CM6030f MFP and CM6040f MFP, optional for the CM6030 MFP (not included, sold separately).

Easy to use and manage

Enjoy the intuitive, familiar interface of the Easy Select touch-screen control panel. Reduce costs and time associated with installing, configuring, managing, and troubleshooting your fleet and supplies from anywhere on the network with HP Web Jetadmin. Auto Color Sensing and Color Access Control let you efficiently manage black and color toner usage. Built-in cartridge intelligence helps IT monitor toner levels and configure automatic alerts, preventing hassle and waste.

Protect your network infrastructure with optional third-party solutions such as job accounting, integrated document capture, and security options.

Competitive output quality

Produce color and black-and-white documents that make an impact, thanks to key technologies. Get outstanding edge acuity for detailed line work, spreadsheets, and architectural drawings with up to 1200 by 600 dpi, HP ColorSphere toner, and ImageREt 4800. Support for color matching standards and PANTONE® certification means you'll have superior color accuracy every time.

Make an impression with the improved formulation of HP ColorSphere toner—produce consistent, high gloss, high-quality prints at fast speeds.

HP Color LaserJet CM6030/CM6040 MFP series

HP Color LaserJet CM6040f shown

- 1 Four-line Easy Select control panel (including touch-screen graphical display)
- 2 500-sheet face-down output bin with long paper extension
- 3 Front-door access to the four easy-to-install Original HP LaserJet print cartridges with ColorSphere toner
- 4 Built-in automatic two-sided printing
- 5 Four 500-sheet input trays for 2,100-sheet input capacity
- 6 50-sheet automatic document feeder
- 7 100-sheet multipurpose tray 1
- 8 HP high performance embedded hard disk for faster processing speed
- 9 A powerful 835 MHz processor and 512 MB memory
- 10 Access port for Kensington lock
- 11 Foreign interface harness
- 12 Fax connection
- 13 One EIO expansion slot
- 14 Hi-Speed USB 2.0 device port
- 15 HP Jetdirect Gigabit Ethernet embedded print server for easy network sharing



ColorSphere
HP TONERS

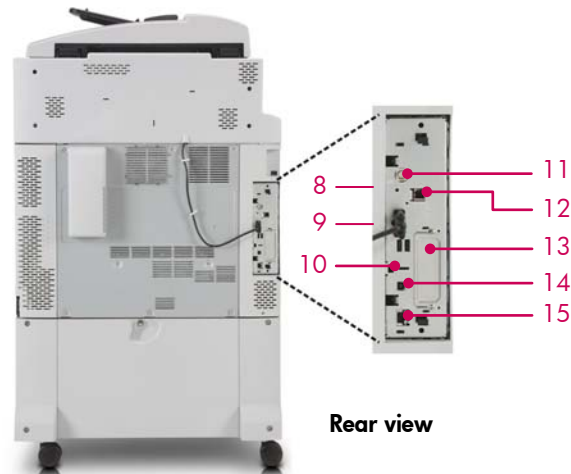

Series at a glance



CM6030 MFP



CM6030f MFP



CM6040f MFP

| Part number | CE664A | CE665A | Q3939A |
|---|-----------------|-----------------|-----------------|
| Print and copy speed | Up to 30/31 ppm | Up to 30/31 ppm | Up to 40/41 ppm |
| Embedded Gigabit networking | ✓ | ✓ | ✓ |
| Automatic two-sided printing | ✓ | ✓ | ✓ |
| 50-sheet ADF, 100-sheet multipurpose tray 1, 500-sheet tray 2 | ✓ | ✓ | ✓ |
| 500-sheet tray and cabinet | ✓ | Not available | Not available |
| Three 500-sheet trays | Not available | ✓ | ✓ |
| Fax capability | Optional | ✓ | ✓ |
| HP 3-bin stapler/stacker | Optional | Optional | Optional |
| HP booklet maker/finisher | Optional | Optional | Optional |

Minimize intervention and easily manage jobs.

Efficient to operate and maintain

The MFP's intuitive design enables you to operate the device with minimal intervention. Cartridges are shipped preinstalled and the device's software installs in just a few simple clicks.

Job Queue Management allows you to view and manipulate the list of print and copy jobs and faxes via the control panel. AutoNav Jam Removal gives you step-by-step automated and written instructions for easy and simple paper removal.

Simplified accessibility means you can replace fusers, transfer kits, and transfer rollers as easily as the toner cartridges and image drums. And replacement parts are easily identifiable with HP signature Blue tabs.

Its compact size lets you position the device closer to users. Choose no finisher for a smaller footprint—or improve productivity with the optional HP stapler/stacker or HP booklet maker/finisher accessory. Produce a greater variety of output with support for media sizes up to 12 by 18 inches (A3/SRA3) and weights up to 220 g/m².

Get the most out of your MFP with HP accessories, supplies, and services.

HP 3-bin stapler/stacker with output accessory bridge

Enjoy hassle-free, unattended printing, including automatic offset, multi-position stapling, and a three-bin mailbox

CC517A



HP booklet maker/finisher with output accessory bridge

Create complex documents with three bins, automatic offset, inline stapling and stacking, and booklet making with saddle-stitching and v-folding

CC516A



HP LaserJet MFP Analog Fax Accessory 300

Quickly and reliably send and receive faxes⁵

Q3701A



Print cartridges with HP ColorSphere toner²

- HP Color LaserJet Black Print Cartridge
- HP Color LaserJet Cyan Print Cartridge
- HP Color LaserJet Yellow Print Cartridge
- HP Color LaserJet Magenta Print Cartridge

- CB390A
- CB381A
- CB382A
- CB383A

Supplies

- HP Color LaserJet Black Image Drum³
- HP Color LaserJet Cyan Image Drum³
- HP Color LaserJet Yellow Image Drum³
- HP Color LaserJet Magenta Image Drum³
- HP Color LaserJet 110 volt fuser kit
- HP Color LaserJet 220 volt fuser kit
- HP Color LaserJet roller kit
- HP Color LaserJet transfer kit
- HP ADF Roller Kit
- Staple cartridge for the stapler/stacker
- Staple cartridge for the booklet maker/finisher

- CB384A
- CB385A
- CB386A
- CB387A
- CB457A
- CB458A
- CB459A
- CB463A
- CE487A
- C8091A
- CC383A

Memory/storage

- HP 128 MB, 167 MHz, 200-pin DDR DIMM
- HP 256 MB, 167 MHz, 200-pin DDR DIMM
- HP High Performance EIO Hard Disk

- Q7557A
- Q7558A
- J7989G

Connectivity

- HP Jetdirect 635n EIO Print Server
- HP Jetdirect 620n EIO Print Server
- HP Jetdirect 630n EIO Print Server
- HP Jetdirect 690n EIO 802.11g Wireless Print Server
- HP Jetdirect en1700 IPv4/IPv6 Print Server
- HP Jetdirect en3700 Fast Ethernet Print Server
- HP Jetdirect ew2400 802.11g Wireless Print Server
- HP EIO 1284B Adapter
- Security Lock Adapter Kit⁴

- J7961G
- J7934G
- J7997G
- J8007G
- J7988G
- J7942G
- J7951G
- J7972G
- Q3931-67925

Paper

- www.hp.com/go/paper
- 1-800-477-5010

Solutions

- www.hp.com/go/gsc

² Average continuous composite black cartridge yield 19,500 standard pages and average continuous composite cyan/yellow/magenta cartridge yield 21,000 standard pages. Declared yield value in accordance with ISO/IEC 19798. Actual yields vary considerably based on images printed and other factors. For more information, visit www.hp.com/go/learnaboutsupplies.

³ Declared yield 35,000 pages based on printing 2 page simplex jobs at 2,500 pages per day on letter / A4 size media, long-edge feed, with documents at 5% coverage. Actual yields vary considerably based on images printed and other factors such as low print volumes, low toner coverage, duplex printing, job complexity, and job length.

⁴ To order the Security Lock Adapter Kit, visit www.hp.com/buy/parts.

⁵ Faxing is standard for the HP Color LaserJet CM6030f MFP and CM6040f MFP, optional for the CM6030 MFP (not included, sold separately).

HP Color LaserJet CM6030/CM6040 MFP series

| Technical specifications | HP Color LaserJet CM6030 MFP (CE664A) | HP Color LaserJet CM6030f MFP (CE665A) | HP Color LaserJet CM6040f MFP (Q3939A) |
|--|---|--|--|
| Print and copy speed | Color and black-and-white: up to 30 ppm, letter (up to 31 ppm, A4) | | Color and black-and-white: up to 40 ppm, letter (up to 41 ppm, A4) |
| First page out | As fast as 16 seconds from Ready mode | | As fast as 12 seconds from Ready mode |
| Resolution | 1200 by 600 dpi (Best mode), 600 by 600 dpi (default); HP ImageREt 4800 technology | | |
| Features | | | |
| Copying | Up to 999 multiple copies, reduce/enlarge from 25 to 400%, two-sided copying, collation, contrast adjustments, image adjustment, content orientation, N-up, background removal, job storage, output bin selection, job build | | |
| Scanning | Color flatbed scanner and ADF: up to 11.7 by 17 in; scan input modes: front-panel scan, copy, fax (optional), e-mail; file types: PDF, JPG, TIFF, MTIFF | | |
| Faxing | Optional (with the separate purchase of the HP LaserJet MFP Analog Fax Accessory 300) | Up to 33.6 kbps, fax forwarding, fax polling (receive only), broadcasting (up to 100 locations), speed dial (up to 100 lists), junk barrier, auto redialing, auto fax reduction, Windows® faxing supported, fax memory | |
| Digital sending | Scan to folder (includes shared address book for fax), scan direct to e-mail server, send to e-mail, analog fax, LDAP e-mail addressing; authentication: Windows negotiated (Kerberos and NTLM), group 1 and group 2 PIN, LDAP, authentication manager; advanced digital sending capabilities via optional Digital Sending Software | | |
| Processor | 835 MHz | | |
| Memory | 512 MB, upgradeable 768 MB | | |
| Recommended monthly volume | 5,000 to 10,000 pages | | 8,000 to 17,000 pages |
| Duty cycle⁶ | Up to 200,000 pages | | |
| Paper | | | |
| Input | 50-sheet ADF, 100-sheet multipurpose tray 1, 500-sheet trays 2 and 3 | 50-sheet ADF, 100-sheet multipurpose tray 1, 500-sheet trays 2, 3, 4, and 5 | |
| Output | 500-sheet output bin; optional finishers: HP 3-bin stapler/stacker or HP booklet maker/finisher | | |
| Two-sided printing | Automatic | | |
| Sizes | ADF: letter, legal, 11 by 17 Multipurpose tray 1: letter, letter-R, legal, executive, statement, 8.5 by 13, 11 by 17, 12 by 18, index cards (4 by 6, 5 by 8), envelopes (#9, #10, Monarch); custom sizes: 4 by 5.5 in to 12.6 by 18 in Input tray 2: letter, letter-R, legal, executive, 8.5 by 13, 11 by 17; custom sizes: 5.8 by 8.2 in to 11.7 by 17 in Input trays 3, 4, and 5: letter, letter-R, legal, executive, 8.5 by 13, 11 by 17, 12 by 18; custom sizes: 5.8 by 8.2 in to 12.6 by 18 in Duplex: letter, letter-R, legal, executive, 8.5 by 13, 11 by 17, 12 by 18 | | |
| Weights | All trays: 16 to 58 lb bond | | |
| Types | Paper (bond, recycled, glossy, mid-weight, heavy, heavy glossy, extra heavy, extra heavy glossy), transparencies, labels, envelopes, cardstock, tough paper, rough paper, user-defined | | |
| Connectivity | | | |
| Interfaces | Hi-Speed USB 2.0 device port, one EIO slot, fax port, FIH port, PCI express | | |
| Languages and fonts | HP PCL 5, HP PCL 6, HP postscript level 2 emulation; (HP postscript level 3 emulation supported); 80 HP font set (plus Greek, Hebrew, Cyrillic, Arabic) | | |
| Client operating systems | Microsoft® Windows 2000, XP®, Server 2003, Vista®; Macintosh OS X v10.2.8 or later | | |
| Network operating systems | Microsoft Windows 2000, Server 2003, XP, Vista, 2003 64-bit, XP 64-bit, Vista 64-bit (IPv6 compatible with Windows 2003, XP, and Vista); Novell 5.1 and later; Mac OS X v10.2, v10.3, v10.4 and later; Red Hat Linux 7.x and later; SuSE Linux 8.x and later; HP-UX 10.20, 11.x, 11.i; Solaris 2.5 and later (SPARC systems only); IBM AIX 3.2.5 and later 1; MPE-iX; Citrix Presentation Server; Windows Terminal Services | | |
| Network protocols | IPv4/IPv6: Apple Bonjour Compatible (Mac OS 10.2.4 and later), SNMPv1/v2c/v3, HTTP, HTTPS, FTP, Port 9100, LPD, IPP, Secure-IPP, WS Discovery, IPsec/Firewall; IPv6: DHCPv6, MLDv1, ICMPv6; IPv4: Auto-IP, SLP, TFTP, Telnet, IGMPv2, BOOTP/DHCP, WINS, IP Direct Mode, WS Print; Other: IPX/SPX, AppleTalk, NetWare NDS, Bindery, NDPS, iPrint | | |
| Security | SNMP v3, SSL/TLS (HTTPS), 802.1x authentication (EAP-PEAP, EAP-TLS) | | |
| Dimensions (w by d by h) | 27.7 by 26.5 by 47.9 in (without finisher) | | |
| Weight (includes print cartridge) | 307.7 lb | 318.8 lb | |
| What's in the box | MFP, preinstalled full-capacity black, cyan, magenta, and yellow HP Color LaserJet toner cartridges with HP ColorSphere toner ⁷ ; preinstalled black, cyan, yellow, and magenta image drums ⁸ ; Getting Started Guide, Wall Poster, Telephone Support Flyer; software drivers and documentation on CD-ROM; control panel overlays, Digital Sending Software Trial Version CD, power cables, HP embedded hard disk | | |
| Also includes | Two 500-sheet input trays | Four 500-sheet input trays, HP LaserJet MFP Analog Fax Accessory 300 | |
| Warranty | One year, next day, on-site limited warranty backed by HP Customer Care, service and support; one year technical phone support | | |

| | | |
|-------------------------------|---|---|
| Environmental ranges | | CM6040f: Active print: 881 watts; Active copy: 920 watts; Ready: 230 watts; Sleep 1: 208 watts; Sleep 2: 24.5 watts; Off: 0.24 watts |
| Recommended temperature | 63 to 77 degrees F | Typical Electricity Consumption (TEC): CM6030/CM6030f: 12.505 kWhr/Week; CM6040f: 15.24 kWhr/Week |
| Storage temperature | 32 to 95 degrees F | ENERGY STAR [®] qualified models, see www.hp.com/go/energystar |
| Recommended relative humidity | 30 to 70 percent | Certifications |
| Storage relative humidity | 35 to 85 percent | Safety |
| Altitude | 0 to 10,000 ft | EMC |
| Acoustics⁹ | | Telecom |
| Sound power | Active print: 6.8 B(A), copy: 7.3 B(A); Ready: 4.3 B(A) | Safety |
| Bystander sound pressure | Active print: 56.8 dB(A), copy: 57.1 dB(A); Ready: 40.3 dB(A) | EMC |
| Power specifications | | Telecom |
| Required input voltage | 110 to 127 V (±10 percent), 60 Hz (±2 Hz), 10.5 amp 220 to 240 V (±10 percent), 50 Hz (±2 Hz), 5.5 amp | Safety |
| Power consumption | CM6030/CM6030f: Active print: 1026 watts; Active copy: 1070 watts; Ready: 214 watts; Sleep 1: 193 watts; Sleep 2: 23 watts; Off: 0.24 watts | EMC |
| | | Telecom |
| | | Works with HP SureSupply. ¹⁰ To learn more, visit www.hp.com/learn/suresupply |

⁶ Duty cycle is defined as the maximum number of pages per month of imaged output. This value provides a comparison of product robustness in relation to other HP LaserJet or HP Color LaserJet devices, and enables appropriate deployment of printers and MFPs.

⁷ Average continuous composite black cartridge yield 19,500 standard pages and average continuous composite cyan/yellow/magenta cartridge yield 21,000 standard pages. Declared yield value in accordance with ISO/IEC 19798. Actual yields vary considerably based on images printed and other factors. For more information, visit www.hp.com/go/learnaboutsupplies.

⁸ Declared yield 35,000 pages based on printing 2 page simplex jobs at 2,500 pages per day on letter / A4 size media, long-edge feed, with documents at 5% coverage. Actual yields vary considerably based on images printed and other factors such as low print volumes, low toner coverage, duplex printing, job complexity, and job length.

⁹ Configurations tested (3 units on 8/15/07) included color and mono printing, simplex and duplex printing, and 110 V and 220 V units at 30 ppm and 40 ppm.

¹⁰ HP SureSupply alerts you when you should replace a print cartridge and helps you purchase locally or via the Internet. Only available with original HP supplies; Internet access required.



ENERGY STAR and the ENERGY STAR logo are registered U.S. marks. Linux is a U.S. registered trademark of Linus Torvalds. Microsoft, Windows, and Windows XP are registered trademarks of Microsoft Corporation. Windows Vista is either a registered trademark or trademark of Microsoft Corporation in the United States and/or other countries. PANTONE® is the property of Pantone, Inc. © Copyright 2008-2010 Hewlett-Packard Development Company, L.P.

The information contained herein is subject to change without notice. The only warranties for HP products and services are set forth in the express warranty statements accompanying such products and services. Nothing herein should be construed as constituting an additional warranty. HP shall not be liable for technical or editorial errors or omissions contained herein.

To learn more, visit www.hp.com

4AA1-8132ENUC, December 2010, Rev. 4

