

THE  
PERMANENT  
VALUE

ADI

INDUSTRIAL DIAMOND APPLICATION

ADVANCED **STONE**  
TOOL TECHNOLOGY

Stone Fab Lab 2019



## INDEX - INDICE

CNC TOOLS FOR DRILLING - UTENSILI PER FORATURA	p. 05
CNC TOOLS FOR MILLING - UTENSILI PER FRESATURA	p. 11
CNC TOOLS FOR DRAIN BOARD EXECUTION - UTENSILI PER PIANI CUCINA	p. 25
CNC TOOLS FOR PRECUTTING - UTENSILI PRE TAGLIO	p. 55
CNC TOOLS FOR MITRE - UTENSILI PER PIANI CUCINA	p. 61
CNC TOOLS FOR ZERO CHIPPING & EUROSEAM - UTENSILI SENZA SBECCATURA	p. 65
CNC PROFILES TOP - FAST - TWIST - MICRON - UTENSILI PROFILATURA	p. 71
CNC PROFILES NANO LINE—UTENSILI LINEA NANO	p. 233
CNC TOOLS WORKING PARAMETERS—PARAMETRI DI LAVORO	p. 235
CNC TOOLS ERASER - UTENSILI RESINOIDI	p. 241
CNC TOOLS FOR MONUMENTAL STONE - UTENSILI PER FUNERARIA	p. 245
CNC DIAMOND BLADES - DISCHI	p. 249
CNC SOLID SINK EXECUTION - UTENSILI SCAVO MASSELLO	p. 257
CNC TOOLS FOR MARBLE - UTENSILI PER MARMO	p. 265
CNC TOOLS FOR ENGRAVING - UTENSILI PER INCISIONE	p. 293
TOOL HOLDERS ADAPTORS AND ACCESSORIES - ADATTATORI E CONI	p. 319
TOOLS FOR EDGE POLISHING MACHINES - UTENSILI LUCIDACOSTE	p. 337
CNC TOOLS FOR UCS - UTENSILI SUPERFICI COMPATTE (ULTRA COMPACT SURFACES)	p. 361

[BACK TO INDEX](#)

# CNC TOOLS FOR DRILLING

# UTENSILI PER FORATURA

[BACK TO INDEX](#)

VACUUM BRAZED CORE DRILLS FOR **MARBLE**  
FORETTI SALDO BRASATI PER **MARMO**

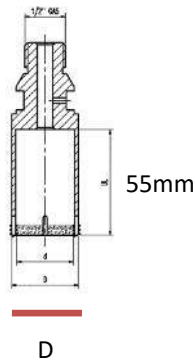

ADI CODE	D [mm]	GRIT SIZE GRANA	RPM	FEED [mm/min]
PG18020	20	D427	2.800-3.500	60-120
PG18035	35	D427	2.300-2.800	60-120
PG18280	80	D602	1.000-1.500	50-100

SINTERED CORE DRILLS FOR **GRANITE** WALL THICKNESS 3 mm  
FORETTI SINTERIZZATI PER **GRANITO** SPESSORE PARETE 3 mm

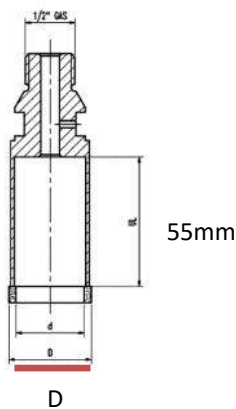

ADI CODE	D [mm]	RPM	FEED [mm/min]
PG091135	35	2.000-2.500	40-80

[BACK TO INDEX](#)

CORE DRILL THIN WALL 1 MM THICKNESS FOR **MARBLE** AND **ENGINEERED STONE**  
FORETTI A PARETE SOTTILE 1 MM SPESSORE PER **MARMO** E **AGGLOMERATI**

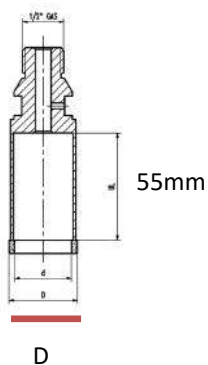

ADI CODE	D [mm]	RPM	FEED [mm/min]
PG081020	20	3.000	30-40
PG081022	22	2.800	30-40
PG081025	25	2.600	30-40
PG081030	30	2.400	40-50
PG081032	32	2.400	40-50
PG081035	35	2.200	50
PG081038	38	2.200	50
PG081040	40	2.200	50

“GRECATO” CORE DRILLS FOR **GRANITE** WALL THICKNESS 2MM  
FORETTI GRECATO PER **GRANITO** SPESSORE PARETE 2MM

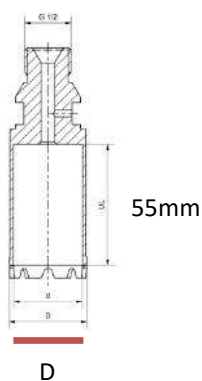

ADI CODE	D [mm]	RPM	FEED [mm/min]
PG091920	20	2.800	40-80
PG091925	25	2.600	40-80
PG091930	30	2.400	40-80
PG091935	35	2.200	40-80



[BACK TO INDEX](#)

“GRECATO” CORE DRILLS FOR **GRANITE** WALL THICKNESS 2MM *Left thread*  
FORETTI GRECATO PER **GRANITO** SPESSORE PARETE 2MM *Filetto Sinistro*

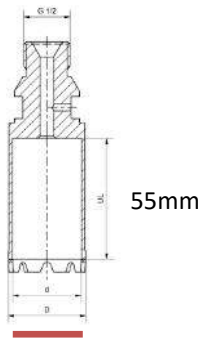

D



ADI CODE	D [mm]	RPM	FEED [mm/min]
PG092120	20	2.600	40-80
PG092125	30	2.400	40-80
PG092130	32	2.400	40-80
PG092135	35	2.200	40-80



[BACK TO INDEX](#)

BLIND DRILL “STONE WORM” 1/2” Gas  
FORETTI “MANGIATUTTO” 1/2” Gas

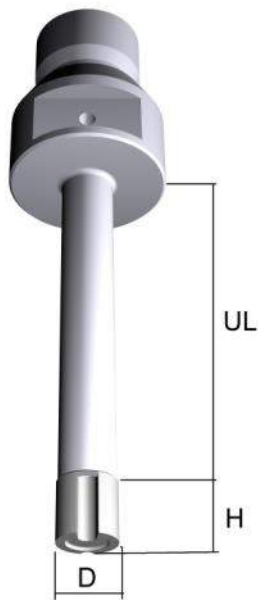

<i>ADI CODE</i>	<i>D</i> [mm]	<i>H</i> [mm]	<i>UL</i> [mm]	<i>RPM</i>	<i>FEED</i> [mm/min]
PG34035	3,5	5	15	7.000-10.000	20-50
PG34004	4	7	20	7.000-10.000	20-50
PG34005	5	7	25	7.000-10.000	20-50
PG34006	6	10	40	7.000-10.000	20-50
PG34007	7	10	40	7.000-10.000	20-50
PG34008	8	10	40	7.000-10.000	20-50
PG34009	9	10	40	7.000-10.000	20-50
PG34010	10	10	40	7.000-10.000	20-50

[BACK TO INDEX](#)

BLIND DRILL “STONE WORM” fitting M 14 (Flex)

FORETTI “MANGIATUTTO” attacco M14 (Flex )

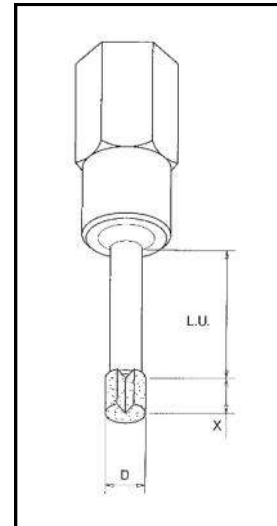

ADI CODE	Diametro Diameter [D]	X	LU
PG36004	Ø 4	7	15
PG36005	Ø 5		20
PG36006	Ø 6		
PG36007	Ø 7		
PG36008	Ø 8	10	40
PG36009	Ø 9		
PG36010	Ø10		

BLIND DRILL “STONE WORM” Shank 10mm

FORETTI “MANGIATUTTO” Stelo 10mm

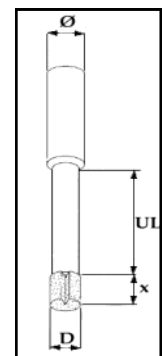

ADI CODE	Diametro Diameter [D]	X	LU	STELO SHANK [Ø]
PG32004	Ø 4	7	25	10
PG32005	Ø 5		30	
PG32006	Ø 6	10	40	
PG32007	Ø 7			
PG32008	Ø 8			
PG32009	Ø 9			
PG32010	Ø10			

# CNC TOOLS FOR MILLING

# UTENSILI PER FRESATURA

Electroplated Finger Bit for **Marble** - 1/2" Gas

Fresa elettrolitica per **Marmo** - 1/2" Gas

[BACK TO INDEX](#)

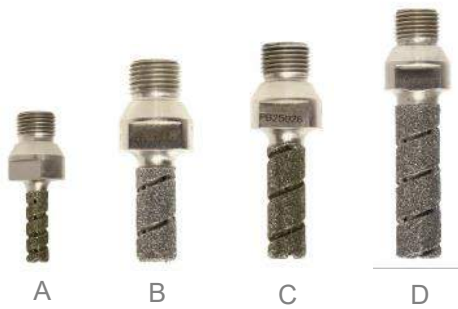

ADI CODE	DIMENSION [DxL]	TYPE	RPM	FEED [mm/min]
PB25261	12x35	A	5.500-6.500	100-300
PB25008	16x35	B	5.500	400-600
PB25026	16x45	C	5.500	400-600
PB25002	20x65	D	5.200	300-450
PB25003	20x110		5.000	200-350

Vacuum Brazed Finger Bit for **Marble** - 1/2" Gas

Fresa Saldo Brasata per **Marmo** - 1/2" Gas

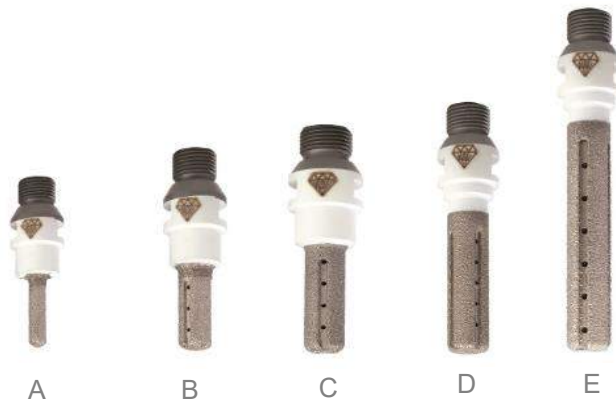

ADI CODE	DIMENSION [DxL]	TYPE	RPM	FEED [mm/min]
PB52092	10x35	A	5.500-6.500	100-300
PB52004	16x35	B	5.500	400-600
PB52005	16x45	C	5.500	400-600
PB52006	20x65	D	5.200	300-450
PB52111	20x110	E	5.000	200-350

[BACK TO INDEX](#)

Electroplated Finger Bit for **Marble** - **1/2" Gas Left Thread**

Fresa elettrolitica per **Marble**—**1/2" Gas filettatura sinistra**



ADI CODE	DIMENSION [DxL]	RPM	FEED [mm/min]
PB25233	16X45	5.500	400-600

Vacuum Brazed Finger Bit for **Marble** - **1/2" Gas Left Thread**

Fresa elettrolitica per **Marble**—**1/2" Gas filettatura sinistra**

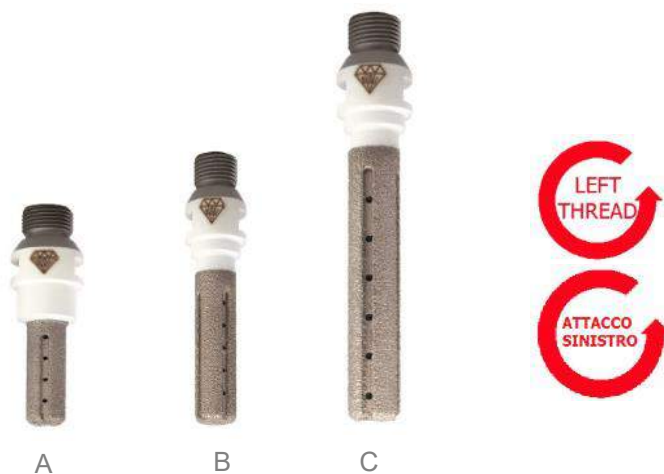

ADI CODE	DIMENSION [DxL]	TYPE	RPM	FEED [mm/min]
PB52145	16x45	A	5.500	400-600
PB52134	20x65	B	5.200	300-450
PB52091	20x110	C	5.000	200-350

[BACK TO INDEX](#)

Electroplated Tools for Cutting **Marble**

Fresa elettrodeposta per **Marmo**

1/2" gas



M12



ADI Code	Description	RPM	FEED [mm/min]
PB25223	Body 1A1W Ø 20x20 LU=100	-	-
PB25153	(1) 1U1W Ø20x20	6.000-7.000	200-300

1/2" gas



M14



ADI Code	Description	RPM	FEED [mm/min]
PB25285	Body 1A1W 25x20 LU=100	-	-
PB25286	(1) 1U1W Ø 25x20	5.000-6.000	200-300

[BACK TO INDEX](#)

Vacuum Brazed Router for **Marble**

Fresa elettrolitica for **Marble**

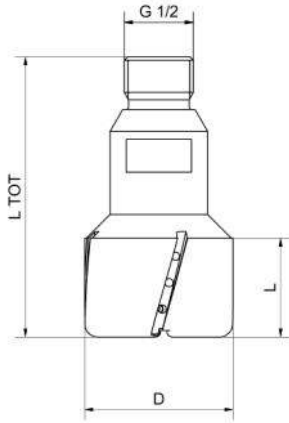

ADI Code	Description	RPM	FEED [mm/min]
PB52043	1A1W Ø 45X30	5.000-6.000	400-800
PB52113	1A1W Ø 32X32	5.000-6,000	500-1.000

*EXTENSION FLANGE - 1/2" GAS*  
*PROLUNGA FLANGIATA - 1/2" GAS*

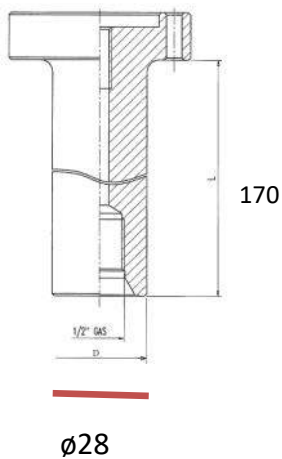

Code	Description
SL02057	FLANGE 1/2"GAS





Segment Finger Bit - 1/2" Gas

[BACK TO INDEX](#)

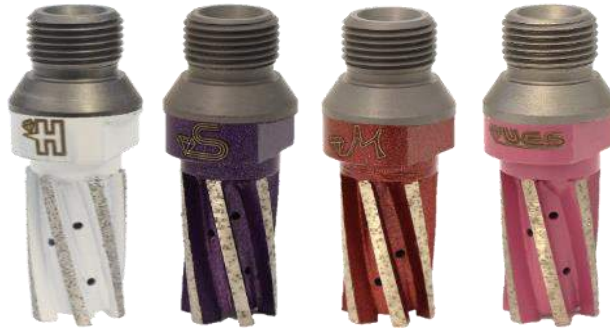
Fresa a settori — 1/2" Gas



ADI CODE	DIMENSION [DxL]	TYPE	NAME	MATERIALS	RPM	FEED [mm/min]
PB22618	22x35			High Performance Engineered Stone	6.000-7.000	400-600
				High Performance Granite	4.500-4.800	200-300

ADI CODE	DIMENSION [DxL]	TYPE	NAME	MATERIALS	RPM	FEED [mm/min]
PB22620	22x35			Engineered Stone	6.000-7.000	400-600
PB22623	24x48			Granite	4.500-4.800	200-300
				Engineered Stone	5.500-6.500	300-400
				Granite	4.300-4.500	200-300

ADI CODE	DIMENSION [DxL]	TYPE	NAME	MATERIALS	RPM	FEED [mm/min]
PB22619	22x35			Universal	4.500	200-400
PB22624	24x48				4.300	200-300

ADI CODE	DIMENSION [DxL]	TYPE	NAME	MATERIALS	RPM	FEED [mm/min]
MT74030	22x35			Technical Materials Ultra Compact Surfaces	4.500-4.800	250-300



Finger Bit Application Chart  
Applicazioni frese

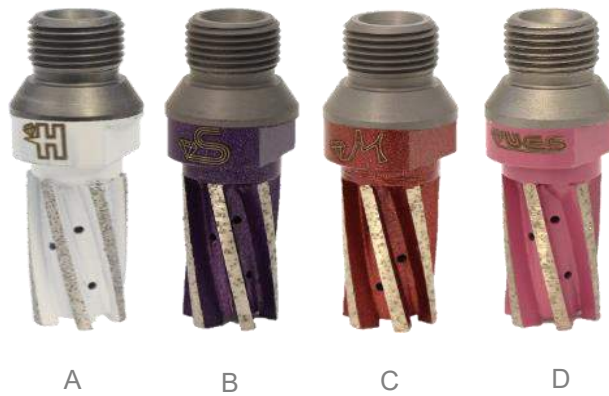

TYPE	NAME	Engineered Stone	Abrasive Material	Soft Granite	Medium Granite	Hard Granite	Compact Surface
		Agglomerato	Materiali abrasivi	Granito morbido	Granito Medio	Granito Duro	Superfici compatte
A	HYDRO	XXXX	XXXX	-	-	-	-
B	THE SOLUTION	XXXX	-	XXXX	XXX	-	-
C	MAGNIFICA	XXX	-	X	XXXX	XXXX	XX
D	UCS	-	-	-	-	-	XXXX

[BACK TO INDEX](#)

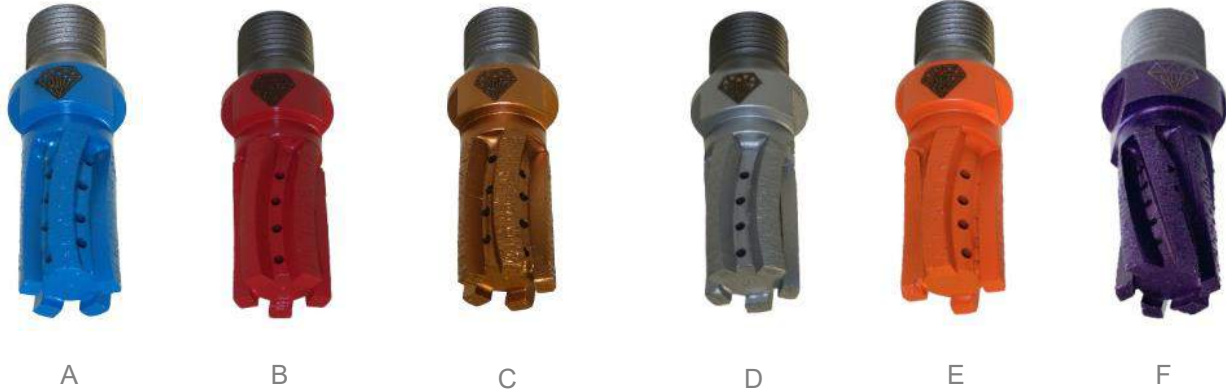

Finger Bit Application Chart

TYPE	NAME	Engineered Stone	Abrasive Material	Soft Granite	Medium Granite	Hard Granite	Gres Ceramic
A	STD TYPE BLUE	XX	XX	XXXX	XXX	X	X
B	STD TYPE RED	XX	X	X	XXX	XXXX	XX
C	STD TYPE BRONZE	XXX	XX	XX	XXXX	XXX	XX
D	STD TYPE SILVER	XXX	XXXX	XXXX	XX	X	X
E	TYPE "UHS"	XXXX	XX	XXXX	XXX	X	X
F	THE SOLUTION	XXXX	XX	XXXX	XXX	XX	XX

[BACK TO INDEX](#)



A B C D E F

Segmented Finger Bit - 1/2" Gas Connection

ADI CODE	DIMENSION [DxL]	TYPE	NAME	MATERIAL	RPM	FEED [mm/min]
PB22003	22x35	A	STD TYPE BLUE	GRANITE	4.500	280-330
				SOFT GRANITE	4.500	300-350
PB22200	24x48	A		GRANITE	4.400	250-300
				SOFT GRANITE	4.500	300-400
PB22070	26x60	A		GRANITE	4.200	240-260
				SOFT GRANITE	4.200	280-300
PB22008	22x35	B	STD TYPE RED	HARD GRANITE	4.800	200-220
PB22214	24x48	B	HARD GRANITE	HARD GRANITE	4.600	200-220
PB22191	22x35	C	STD TYPE BRONZE	GRANITE	4.800	250-300
PB22321	24x48	C	GRANITE	GRANITE	4.800	240-280
PB22130	22x35	D	STD TYPE SILVER	SOFT GRANITE	4.500	300-350
				ABRASIVE STONE	4.500	300-350
PB22155	24x48	D		GRANITE	4.400	280-330
				ABRASIVE STONE	4.400	280-330
PB22402	22x35	E	TYPE "UHS"	GRANITE	5.500-7.000	400-600
PB22407	24x48	E		ENGINEERED STONE	5.500-7.000	300-400
PB22548	20x35	F	THE SOLUTION	GRANITE	5.000-7.000	350-600
				ENGINEERED STONE	5.000-7.000	400-700
				SOFT GRANITE	5.000-7.000	400-600
				HARD GRANITE	5.000-7.000	300-400
				ABRASIVE STONE	5.000-7.000	300-400
PB22561	22x48	F		GRANITE	5.000-7.000	300-500
				ENGINEERED STONE	5.000-7.000	300-500
				SOFT GRANITE	5.000-7.000	300-500
				HARD GRANITE	5.000-7.000	250-350
				ABRASIVE STONE	5.000-7.000	250-400

[BACK TO INDEX](#)

Segmented Finger Bit - 1/2" Gas with diamond on the bottom

Fresa a settori — 1/2"Gas con diamante in testa



ADI CODE	DIMENSION [DxL]	TYPE	NAME	MATERIALS	RPM	FEED [mm/min]
PB22616	22X35		<b>HYDRO</b>	Engineered stone	7000	600/800
PB22635	24X48		<b>HYDRO</b>	Engineered stone		

ADI CODE	DIMENSION [DxL]	TYPE	NAME	MATERIALS	RPM	FEED [mm/min]
PB22625	22x35		<b>SOLUTION</b>	Eng. Stone - Granite	7.000	500-600
PB22634	24x48		<b>SOLUTION</b>	Eng. Stone - Granite		

ADI CODE	DIMENSION [DxL]	TYPE	NAME	MATERIALS	RPM	FEED [mm/min]
PB22626	22x35		<b>MAGNIFICA</b>	Universal	7.000	300-400
PB22633	24x48		<b>MAGNIFICA</b>	Universal		

[BACK TO INDEX](#)



Segmented Finger Bit - **1/2" Gas Left Thread** with diamond on the bottom

Frese a settori - **1/2" Gas filettatura sinistra** con diamante in testa



A

B

ADI CODE	DIMENSION [DxL]	TYPE	NAME	MATERIAL	RPM	FEED [mm/min]
PB22636	22x35		Magnifica	Universal	4.500	200 - 400
PB22637	24x48			Universal	4.300	200 - 300
PB22638	22x35		Solution	Engineered Stone	6.000-7.000	400-600
				Granite	4.500-4.800	200-30
PB22639	24x48			Engineered Stone	5.500-6.500	300-400
		Granite	4.300-4.500	200-300		

[BACK TO INDEX](#)

Incremental cutting router - **1/2"Gas**

Fresa incrementale - **1/2"gas**



ADI CODE	DIMENSION [DxL]	RPM	FEED [mm/min]	Stock Removal [mm]
PB27505	6x15	7.000-10.000	150-250	3 max
PB27394	8x15	7.000-10.000	150-250	3 max
PB27395	10x20	7.000-10.000	150-250	3 max
PB27383	12x20	7.000-10.000	150-250	3 max
PB27362	20x12	7.000 - 7.500	700 - 1.000	3 max
PB27526	20x20	7.000 - 7.500	700 - 1.000	3 max

Incremental Finger Bit - **M12**

Fresa taglio incrementale - **M12**



ADI CODE	DIMENSION [DxL]	RPM	FEED [mm/min]	Stock Removal [mm]
PR06050	20x20	7.000-10.000	150-250	3 max
PR06051	20x20 Slot	7.000-10.000	150-250	3 max

See Adaptor for router on the next page \*\*

Vedere adattatori per la fresa nella prossima pagina \*\*

[BACK TO INDEX](#)

Incremental Finger Bit - **1/2" Gas**  
Fresa Incrementale - **1/2" Gas**



ADI CODE	DIMENSION [DxL]	TYPE	RPM	FEED [mm/min]	Stock Removal [mm]
PB27010	20x12	GRANITE	7.000-7.500	700-1.000	3 max
PB27002	20x12	UNIVERSAL	7.000-7.500	700-1.000	3 max
PB27019	20x12	MARBLE G	7.000-7.500	700-1.000	3 max

Incremental Finger Bit - **Screw Connection**  
Frese incrementali - **attacco M12 / M14 / M18**

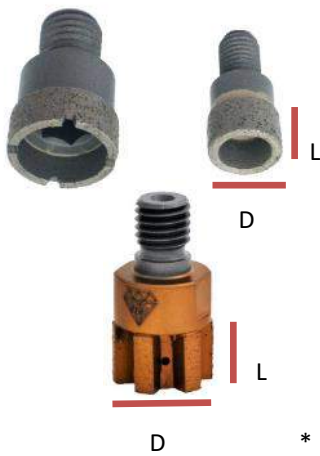

ADI CODE	DIMENSION [DxL]	TYPE	RPM	FEED [mm/min]	Stock Removal [mm]
PR06009	20x12 M12	GRANITE	7.000-7.500	700-1.000	3 max
PR06021	20x12 M12	UNIVERSAL	7.000-7.500	700-1.000	3 max
PR06010	20x12 M12	MARBLE G	7.000-7.500	700-1.000	3 max
PR06019	30x12 M18	GRANITE	6.000-7.000	700-1.000	3 max
PR06024	30x12 M18	UNIVERSAL	6.000-7.000	700-1.000	3 max
PR06028	30x12 M18	MARBLE G	6.000-7.000	700-1.000	3 max
PR06075	25x12 M14	GRANITE UHS	5.000-6.000	700-1.500	2 max
PB22629	25x15 M14	UNIVERSAL	5.000-6.000	200-500	5 max

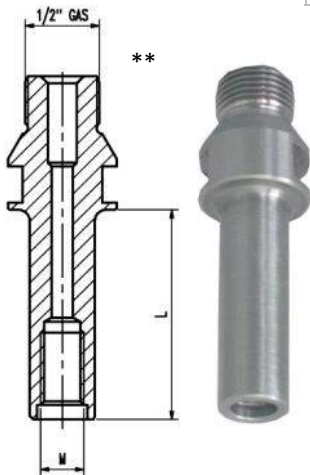

Extension - **1/2" Gas - M12 / M14 / M18**  
Adattatore - **1/2" Gas - M12 / M14 / M18**

Code	Description
SL02219	1/2" Gas—M12 L= 55
SL02376	1/2" Gas—M12 L= 90
SL02349	1/2" Gas—M12 L=120
SL02377	1/2" Gas—M12 L=150
SL02334	1/2" Gas—M12 L=200
* SL02806	1/2" Gas—M14 L= 90
SL02518	1/2" Gas—M18 L= 90
SL02548	1/2" Gas—M18 L= 200

Router for Drain Board - **1/2" Gas**  
Fresa con settore in testa - **1/2" Gas**



ADI CODE	DIMENSION [DxL]	TYPE	RPM	FEED [mm/min]	Stock Removal [mm]
PB22303	20X10 LU=40	B	5.000	300 - 500	8 max

[BACK TO INDEX](#)



Incremental Finger Bit - **1/2" Gas Left Thread - M12 or M18**

Fresa incrementale - **1/2" Gas Left Thread - M12 o M18**



ADI CODE	DIMENSION [DxL]	TYPE	RPM	FEED [mm/min]	Stock Removal [mm]	Price [€] Euro
PB27087	20x12 1/2" GAS	Granite	7.000-7.500	700-1.000	3 max	75
PB27097	20x12 1/2" GAS	Universal	7.000-7.500	700-1.000	3 max	75
PB27088	20x12 1/2" GAS	Marble	7.000-7.500	700-1.000	3 max	75

D



ADI CODE	DIMENSION [DxL]	TYPE	RPM	FEED [mm/min]	Stock Removal [mm]
PR06053	20x12 M12	Granito	7.000-7.500	700-1.000	3 max
PR06054	20x12 M12	Universal	7.000-7.500	700-1.000	3 max
PR06055	20x12 M12	Marble	7.000-7.500	700-1.000	3 max
PR06056	30x12 M18	Granite	6.000-7.000	700-1.000	3 max
PR06057	30x12 M18	Universal	6.000-7.000	700-1.000	3 max
PR06058	30x12 M18	Marble	6.000-7.000	700-1.000	3 max

D

Extension - **1/2" Gas Left Thread - M12 and M18 Left Thread**

Prolunga - **1/2" Gas filettatura sinistra M12 e M18 filettatura sinistra**

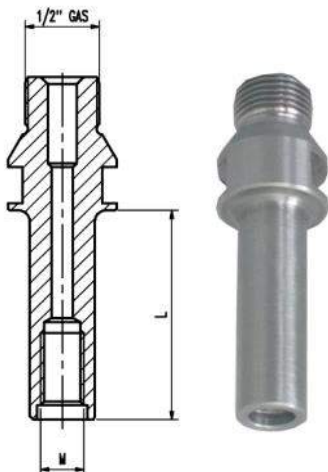

Code	Description
SL02574	1/2" GAS - M12 L= 55
SL02575	1/2" GAS - M12 L= 90
SL02576	1/2" GAS - M12 L=120
SL02577	1/2" GAS - M12 L=150
SL02578	1/2" GAS - M12 L=200
SL02579	1/2" GAS - M18 L= 90
SL02580	1/2" GAS - M18 L= 200



# CNC TOOLS FOR DRAIN BOARD EXECUTION

# UTENSILI PER ESECUZIONE PIANO CUCINA

[BACK TO INDEX](#)

[BACK TO INDEX](#)

Electroplated Tools for Drain Board on **Marble**  
Utensili Elettrodeposti per piani cucina **per Marmo**



Type	ADI CODE	DIMENSION [DxL] [mm]	Fitting	RPM	FEED [mm/min]	Stock Removal [mm]
A	PB29083	Φ87x20 (3+3)	Φ50 mm	5.000-6.000	600-1.200	1-5 Max
B	PB29015	Φ50x10(3 Holes)	1/2" Gas	-	-	
C	SL01050	Φ50x3 (3 Holes)	Φ35 mm	-	-	
D	PB29727	74 PLATE	Φ50 mm	5.000-6.000	600-1.200	1-5 Max



Type	ADI CODE	DIMENSION [DxL] [mm]	Fitting	RPM	FEED [mm/min]	Stock Removal [mm]
E	PB29728	Φ45x20	1/2" Gas	6.500-7.500	600-1.200	1-5 Max
F	PB29400	Φ50x20 (3+3)	Φ14mm	6.000-7.000	600-1.200	1-5 Max
G	PB29579	Φ50x20 (2+2)	Φ10mm	6.000-7.000	600-1.200	1-5 Max
H	PB29618	Φ50x22 2 Holes	Φ10mm	6.000-7.000	600-1.200	1-5 Max
I	SL02358	Φ14x4 (3 Holes)	1/2" Gas	-	-	-
L	SL02613	Φ10x4 (2 Holes)	1/2" Gas	-	-	-

Segmented Wheels for Drain Board for **Marble**

[BACK TO INDEX](#)



Type	ADI CODE	DIMENSION [mm]	Type	Fitting	RPM	FEED [mm/min]	Stock Removal [mm]
A	SL01050	Φ50x3 (3 Holes)	-	Φ35 mm	-	-	
B	PB29015	Φ50x10(3 Holes)	-	1/2" Gas	-	-	
C	PB29006	Φ87x20x5	Granite Std	Φ50 (3+3)	4.500-4.800	400-700	1-5 Max
C	PB29141	Φ87x20x5	Granite Pos.2	Φ50 (3+3)	4.500-4.800	1.000- 1.500	0,2-0,5
D	PB29035	Φ91x30x7	Hard Granite	Φ50 (3+3)	4.500-4.800	400-700	1-5 Max
E	PB29036	Φ91x30x7	Medium Granite	Φ50 (3+3)	4.500-4.800	400-700	1-5 Max
F	SL02358	Φ14x4 (3 Holes)	-	1/2" Gas	-	-	-
G	PB29410	Φ50X25X5	Granite Std	Φ14 (3+3)	5.500-6.000	200-400	1-5 Max
G	PB29396	Φ50X25X5	Marble	Φ14 (3+3)	5.500-6.000	300-600	1-5 Max
H	SL01063	Φ34 (2 Pin)	-	1/2" Gas	-	-	-
I	PB29058	Φ40X20X5	Granite Std	Φ8,5 + 2 holes	5.500-6.000	200-400	2-3 Max
I	PB29138	Φ40X20X5	Marble	Φ8,5 + 2 holes	5.500-6.000	200-400	2-3 Max
I	PB29074	Φ50X25X5	Granite Std	Φ8,5 + 2 holes	5.500-6.000	200-400	2-3 Max
I	PB29155	Φ50X25X5	Marble	Φ8,5 + 2 holes	5.500-6.000	200-400	2-3 Max
L	PB29802	Φ50X23X5 RADIUS 40MM	Limestone	Φ14 (3 holes)	4.000-4500	Max 500	2-3 Max
L	PB29810	Φ50X23X5	Limestone	Φ14 (3) holes	4.000-4.500	Max 500	2-3 Max

*Super Duty wheels for drain Board on **Marble**  
Mole da scasso Grecate per piani cucina **di Marmo***

[BACK TO INDEX](#)



A



B



C



D



E



F

Type	ADI CODE	DIMENSION [DxL] [mm]	Fitting	RPM	FEED [mm/min]	Stock Removal [mm]
A	PB29525	Φ54x25x7	Φ14 (3+3)	5.000	500	1-5 Max
B	PB29532	Φ54x25x7	Φ10 (2+2)	5.000	500	1-5 Max
C	PB29448	Φ91x30x7	Φ50 (3+3)	4.500	800	1-5 Max
D	PB29537	Φ150x25x7	Φ50 (3+3)	4.000	500	1-5 Max
E	PB29015	Φ50x10(3 Holes)	1/2" Gas	-	-	
F	SL01050	Φ50x3 (3 Holes)	Φ35	-	-	



G



H



I



L

Type	ADI CODE	DIMENSION [mm]	Fitting	L [mm]
G	SL01407	Φ77	Flange - 14 (3 Holes)	100
G	SL01408	Φ77	Flange - 14 (3 Holes)	200
G	SL01430	Φ77	Flange - 10 (2 Holes)	100
G	SL01431	Φ77	Flange - 10 (2 Holes)	200
H	SL02487	Φ34	M30 - 14 (3 Holes)	100
H	SL02489	Φ34	M30 - 14 (3 Holes)	200
H	SL02704	Φ34	M30 - 10 (2 Holes)	100
H	SL02705	Φ34	M30 - 10 (2 Holes)	200
I	SL01157	Φ74	Flange - Flange	100
I	SL01159	Φ74	Flange - Flange	200
L	SL01409	Φ74	M30 - Flange	100
L	SL01410	Φ74	M30 - Flange	200

Super Duty wheels for drain Board on **Granite** and **Engineered Stone**

[BACK TO INDEX](#)

Mole da scasso Grecate per piani cucina di **Granito** e **Agglomerato**

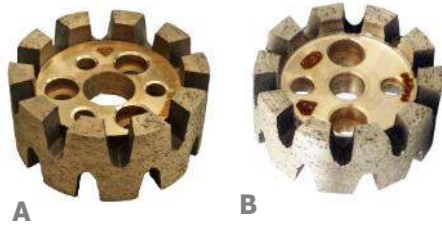

F

G

H

I

L

Pos	ADI CODE	DIMENSION [DxL] [mm]	Type	Fitting	RPM	FEED [mm/min]	Stock Removal [mm]
A	PB29470	Φ54x25x7	UHS	Φ14 (3+3)	5.000	400	1 - 5 Max
B	PB29531	Φ54x25x7	UHS	Φ10 (2+2)	5.000	400	1 - 5 Max
C	PB29443	Φ91x30x7	GRANITE	Φ50 (3+3)	4500	400-800	1 - 5 Max
C	PB29501	Φ91x30x7	UHS	Φ50 (3+3)	4.500	400-600	1 - 5 Max
D	PB29444	Φ91x30x7	GRANITE	Φ50 (4+4)	4500	400-800	1 - 5 Max
D	PB29619	Φ91x30x7	UHS	Φ50 (4+4)	4.500	400-600	1 - 5 Max
E	PB29536	Φ150x25x7	UHS	Φ50 (3+3)	4.000	200-400	1 - 5 Max
F	SL02358	Φ14x4 (3 Holes)	-	1/2" Gas	-	-	-
G	SL02613	Φ10x4 (2 Holes)	-	1/2" Gas	-	-	-
H	PB29015	Φ50x10(3 Holes)	-	1/2" Gas	-	-	-
I	PB29305	Φ50x10(4 Holes)	-	1/2" Gas	-	-	-
L	SL01050	Φ50x3 (3 Holes)	-	Φ35	-	-	-

45° Wheels Drain Board on **Engineered Stone**

Utensili a 45° per piani cucina su **Agglomerato**

[BACK TO INDEX](#)

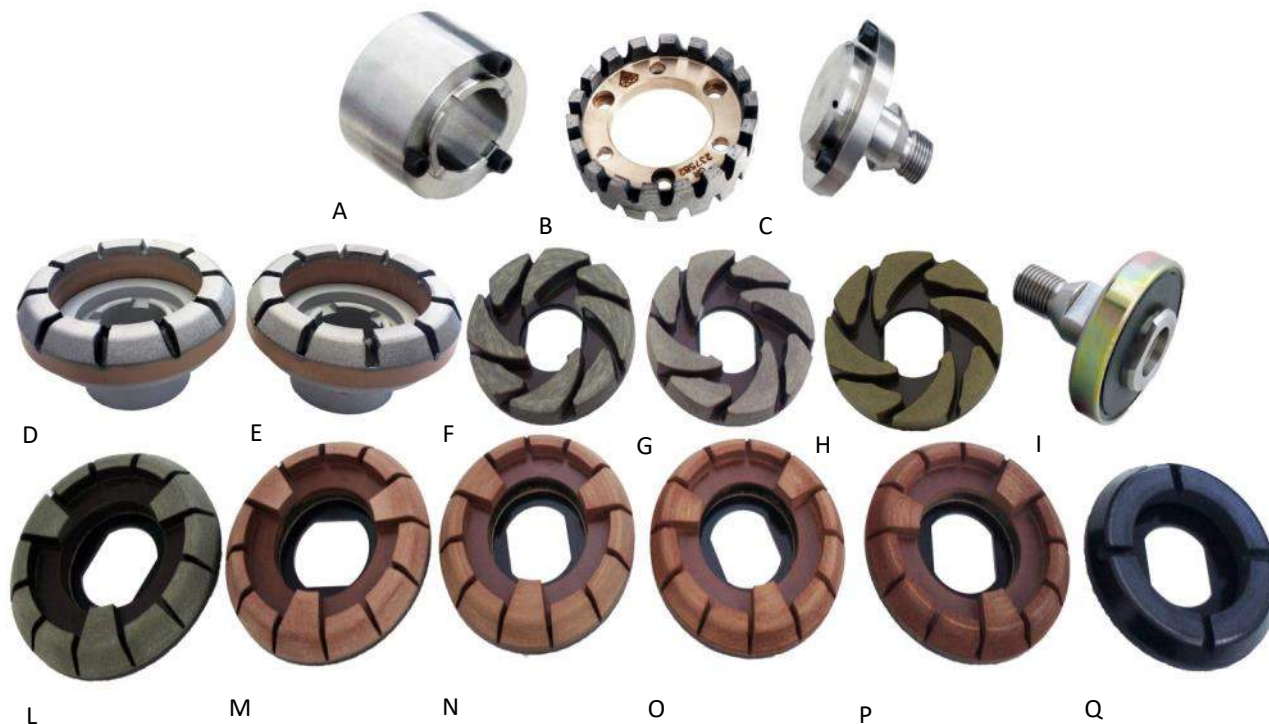

Type	Code	Description [mm]	RPM [mm/min.]	Feeding Speed [mm/min]	Stock Removal [mm]
B	PB29443	Super Duty $\Phi 91 \times 30 \times 7$ B=50	4500	400-800	To Shape
D	PB29504	Metal Bond $\Phi 119$ - 45° F=35 Pos.1	4.500-5.500	900-1.000	0,15
E	PB29505	Metal Bond $\Phi 119$ - 45° F=35 Pos.2	4.000 -4.500	1.000	0,1
F	PB29365	FLAT $\Phi 100$ Magnetic #50R	1.200-1.500	4.000-6.000	0,1
G	PB29371	FLAT $\Phi 100$ Magnetic #100R	1.200-1.500	4.000-6.000	0,1
H	PB29336	FLAT $\Phi 100$ Magnetic #200R	1.200-1.500	4.000-6.000	0,1
L	PB29720	45° $\Phi 107$ Magnetic #200R	1.000-1.200	800-1.200	0,05
M	PB29557	45° $\Phi 107$ Magnetic #500R	1.000-1.200	800-1.200	0,05
N	PB29558	45° $\Phi 107$ Magnetic #1000R	1.000-1.200	800-1.200	0,05
O	PB29559	45° $\Phi 107$ Magnetic #2000R	1.000-1.200	800-1.200	0,05
P	PB29721	45° $\Phi 107$ Magnetic #3000R	1.000-1.200	800-1.200	0,05
Q	PB29722	45° $\Phi 100$ Magnetic #LUX	1.000	3.000	0,1
I	SL02558	Magn Adaptor - Fitting 1/2" Gas Safety Lock - *	-	-	-
A	SL01050	$\Phi 50 \times 3$ (3 Holes)	-	-	-
C	PB29015	$\Phi 50 \times 10$ (3 Holes)	-	-	-

\* needed 9 pieces, - necessari 9 pezzi

60° Wheels Drain Board on **Engineered Stone**

Utensili a 60° per piani cucina su **Agglomerato**

[BACK TO INDEX](#)



Type	Code	Description [mm]	RPM [mm/min.]	Feeding Speed [mm/min]	Stock Removal [mm]
B	PB29443	Stubbing wheel $\Phi 91 \times 30 \times 7$ B=50	4500	400-800	1 - 5 Max
D	PB29449	Metal Bond $\Phi 114$ - 60° B=35 Pos.1	4.500-5.500	900-1.000	0,15
E	PB29450	Metal Bond $\Phi 114$ - 60° B=35 Pos.2	4.000 -4.500	1.000	0,1
F	PB29365	FLAT $\Phi 100$ Magnetic #50R	1.200-1.500	4.000-6.000	0,1
G	PB29371	FLAT $\Phi 100$ Magnetic #100R	1.200-1.500	4.000-6.000	0,1
H	PB29336	FLAT $\Phi 100$ Magnetic #200R	1.200-1.500	4.000-6.000	0,1
L	PB29683	60° $\Phi 107$ Magnetic #200R	1.000-1.200	800-1.200	0,05
M	PB29545	60° $\Phi 107$ Magnetic #500R	1.000-1.200	800-1.200	0,05
N	PB29546	60° $\Phi 107$ Magnetic #1000R	1.000-1.200	800-1.200	0,05
O	PB29547	60° $\Phi 107$ Magnetic #2000R	1.000-1.200	800-1.200	0,05
P	PB29684	60° $\Phi 107$ Magnetic #3000R	1.000-1.200	800-1.200	0,05
Q	PB29725	60° $\Phi 100$ Magnetic #LUX	1.000	3.000	0,1
I	SL02558	Magn Adaptor - Fitting 1/2" Gas Safety Lock *	-	-	-
A	SL01050	$\Phi 50 \times 3$ (3 Holes)	-	-	-
C	PB29015	$\Phi 50 \times 10$ (3 Holes)	-	-	-

\* needed 9 pieces, - necessari 9 pezzi



**45° Wheels for Drain Board on Granite**

[BACK TO INDEX](#)

**Utensili a 45° per piani cucina su Granito**



1

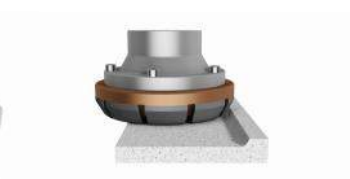

2-3



4-5-6-7-8



9

Seq	Code	Description [mm]	Grit	RPM [mm/min.]	Feeding Speed [mm/min]	Stock Removal [mm]
(1)	SL01050	Φ50x10(3 Holes)	-	-	-	-
1	PB29443	Super Duty Φ91x30x7 B=50	Coarse	4.500-5.500	400-800	To Shape
2	PB29504	Φ119x12x5—45° B=35	Pos.1 Metal	4.000 -4.500	900-1.000	0,15
3	PB29505	Φ119x12x5—45° B=35	Pos.2 Metal	4.000-4.500	1.000	0,1
4	PB39051	Φ123x31,5x5—45° B=35	#325 Resin	1.800	2.000	0,1 (2 Steps)
5	PB39053	Φ123x31,5x5—45° B=35	#600 Resin	1.500	2.500	0,1
6	PB39055	Φ123x31,5x5—45° B=35	#800 Resin	1.300	2.500	0,05
7	PB39057	Φ123x31,5x5—45° B=35	#1500 Resin	1.100	2.000	0,05
8	PB39059	Φ123x31,5x5—45° B=35	#3000 Resin	1.000	2.000	0,05
9	PB29722	Φ100x20x12 Magnetic	LUX	1.000	3.000	0,1
	SL02558	Magnetic Adaptor - Fitting 1/2" Gas Safety Lock		-	-	-

**60° Wheels Drain Board on Granite**  
**Utensili a 60° per piani cucina su Granito**

[BACK TO INDEX](#)

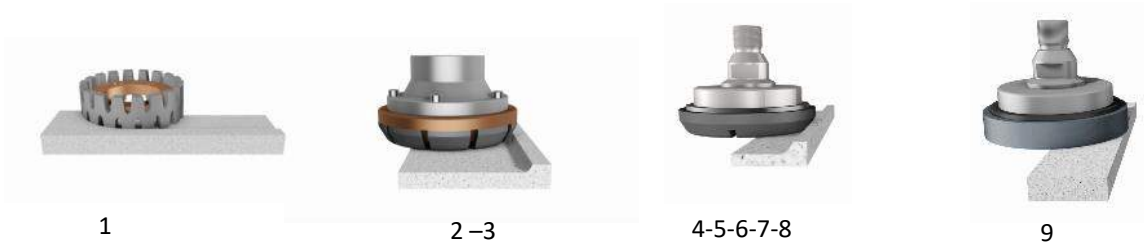

Seq	Code	Description [mm]	Grit	RPM [mm/min.]	Feeding Speed [mm/min]	Stock Removal [mm]
(1)	SL01050	Φ50x10(3 Holes)	-	-	-	-
1	PB29443	Super Duty Φ91x30x7 B=50	Coarse	4.500-5.500	400-800	To Shape
2	PB29449	Φ114x12x5—60° B=35	Pos.1 Metal	4.000 -4.500	900-1.000	0,15
3	PB29450	Φ114x12x5—60° B=35	Pos.2 Metal	4.000-4.500	1.000	0,1
4	PB39021	Φ114x27x5—60° B=35	#325 Resin	1.800	2.000	0,1 (2 Steps)
5	PB39007	Φ114x27x5—60° B=35	#600 Resin	1.500	2.500	0,1
6	PB39026	Φ114x27x5—60° B=35	#800 Resin	1.300	2.500	0,05
7	PB39042	Φ114x27x5—60° B=35	#1500 Resin	1.100	2.000	0,05
8	PB39020	Φ114x27x5—60° B=35	#3000 Resin	1.000	2.000	0,05
9	PB29725	Φ100x20x12 Magnetic	LUX	1.000	3.000	0,1
	SL02558	Magnetic Adaptor - Fitting 1/2" Gas Safety Lock		-	-	-

BACK TO INDEX

*Polishing wheels for flat Drain Board on **Granite***

*Lucidanti piatte per piani cucina su **Granito***



Seq	Code	Description [mm]	Grit	RPM [mm/min.]	Feeding Speed [mm/min]	Stock Removal [mm]
1	PB29202	Φ100X30X5 Magnetic	#120	4.000-6.000	1.500	0,15
2	PB29203	Φ100X30X5 Magnetic	#220	4.000-6.000	1.500	0,15
3	PB29204	Φ100X30X5 Magnetic	#400	4.000-6.000	1.500	0,20
4	PB29205	Φ100X30X5 Magnetic	#800	4.000-6.000	1.200	0,30
5	PB29206	Φ100X30X5 Magnetic	#1500	4.000-6.000	1.000	0,3
6	PB29207	Φ100X30X5 Magnetic	#3000	4.000-6.000	900-1.000	0,4
7	PB29129	Φ100X20X12 Magnetic	LUX	5.000	800-1.000	0,4
A	SL02558	SAFETY LOCK Fitting=1/2" GAS	-	-	-	-
B	SL02569	SAFETY LOCK Fitting=1/2" GAS WITH RUBBER	-	-	-	-

[BACK TO INDEX](#)

*Polishing Wheels for Flat Drain Board on **Engineered Stone** and **Marble***

*Lucidanti piatte per piani cucina su **Agglomerato** e **Marmo***



Seq	Code	Description [mm]	Grit	RPM [mm/min.]	Feeding Speed [mm/min]	Stock Removal [mm]
1	PB29365	Ø100x40x12	50R	4.000-6.000	1.200-1.500	0,1
2	PB29371	Ø100x40x12	100R	4.000-6.000	1.200-1.500	0,1
3	PB29336	Ø100x40x12	200R	4.000-6.000	1.200-1.500	0,1
4	PB29337	Ø100x40x12	500R	4.000-6.000	1.200-1.500	0,1
5	PB29338	Ø100x40x12	1000R	4.000-6.000	1.200-1.500	0,05-0,1
6	PB29339	Ø100x40x12	2000R	4.000-6.000	1.200-1.500	0,05-0,1
7	PB29340	Ø100x40x12	3000R	4.000-6.000	1.200-1.500	0,05-0,1
A	SL02558	SAFETY LOCK Fitting=1/2" GAS	-	-	-	-
B	SL02569	SAFETY LOCK Fitting=1/2" GAS WITH RUBBER	-	-	-	-

[BACK TO INDEX](#)

*Wheels for angle Drain Board for **Granite***  
*Utensili piano cucina inclinato per **Granito***

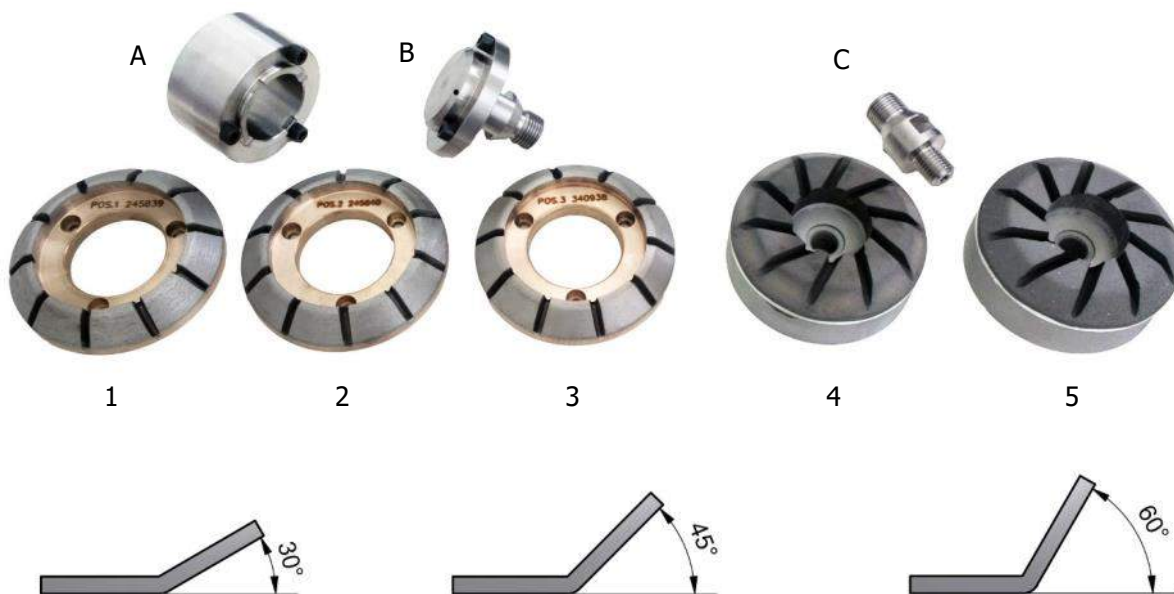

Seq	Code	Description [mm]	RPM [mm/min.]	Feeding Speed [mm/min]	Stock Removal [mm]
1	PB29386	Metal $\Phi 122 \times 12 \times 5$ $-30^\circ$ B= 50	4.500	800-1.000	to shape
2	PB29387	Metal $\Phi 122 \times 12 \times 5$ $-30^\circ$ B= 50	4.500-4.700	1.000-1.200	0,2-0,3 max
3	PB29388	Metal $\Phi 122 \times 12 \times 5$ $-30^\circ$ B= 50	4.500-4.700	1.000-1.200	0,1-0,2 max
4	PB29381	Resin $\Phi 100 \times 30 \times 12$ $-30^\circ$ B=M16	1.500	800-1.000	0,01-0,015
5	PB29382	Resin $\Phi 100 \times 30 \times 12$ $-30^\circ$ B=M16	1.500	800-1.000	0,01-0,015
1	PB29272	Metal $\Phi 107 \times 12 \times 5$ $-45^\circ$ B= 50	4.500	800-1.000	to shape
2	PB29273	Metal $\Phi 107 \times 12 \times 5$ $-45^\circ$ B= 50	4.500-4.700	1.000-1.200	0,2-0,3 max
3	PB29274	Metal $\Phi 107 \times 12 \times 5$ $-45^\circ$ B= 50	4.500-4.700	1.000-1.200	0,1-0,2 max
4	PB29275	Resin $\Phi 100 \times 30 \times 12$ $-45^\circ$ B=M16	1.500	800-1.000	0,01-0,015
5	PB29276	Resin $\Phi 100 \times 30 \times 12$ $-45^\circ$ B=M16	1.500	800-1.000	0,01-0,015
1	PB29269	Metal $\Phi 104 \times 12 \times 5$ $-60^\circ$ B= 50	4.500	800-1.000	to shape
2	PB29270	Metal $\Phi 104 \times 12 \times 5$ $-60^\circ$ B= 50	4.500-4.700	1.000-1.200	0,2-0,3 max
3	PB29271	Metal $\Phi 104 \times 12 \times 5$ $-60^\circ$ B= 50	4.500-4.700	1.000-1.200	0,1-0,2 max
4	PB29256	Resin $\Phi 100 \times 30 \times 12$ $-60^\circ$ B=M16	1.500	800-1.000	0,01-0,015
5	PB29257	Resin $\Phi 100 \times 30 \times 12$ $-60^\circ$ B=M16	1.500	800-1.000	0,01-0,015
A	SL01050	Adaptor $\Phi 50 \times 3$ (3 Holes) A=1/2" Gas	-	-	-
B	PB29015	Adaptor $\Phi 50 \times 10$ (3 Holes) A=1/2" Gas	-	-	-
C	SL02230	ADAPTOR Fitting 1/2" GAS - M16	-	-	-

[BACK TO INDEX](#)

*Wheels for angle Drain Board on **Marble***  
*Utensili piano cucina inclinato per **Marmo***



Seq	Code	Description	RPM	Feeding Speed [mm/min]	Stock Removal [mm]
1	PB59001	Vacuum Brazed $\Phi 87 \times 20$ B=50	5.000-6.000	600-1.200	1-5 Max
2	PB59034	Vacuum Brazed $\Phi 87 \times 20$ B=50	5.000-6.000	500-1.000	0,1
3	PB59035	Vacuum Brazed $\Phi 87 \times 20$ B=50	5.000-6.000	500-1.000	0,05
4	PB29780	Polish $\Phi 95 \times 30$ B=50 Gr.400	3.000-4.000	1.200-1.500	0,1
5	PB29676	Polish $\Phi 95 \times 30$ B=50 Gr.600	3.000-4.000	1.200-1.500	0,1
6	PB29678	Polish $\Phi 95 \times 30$ B=50 Gr.1000	3.000-4.000	1.200-1.500	0,1
7	PB59015	Vacuum Brazed $\Phi 107 \times 12$ $-45^\circ$ B=50 Pos.1	4.500-5.000	300-600	0,15
8	PB59016	Vacuum Brazed $\Phi 107 \times 12$ $-45^\circ$ B=50 Pos.2	4.500-5.000	300-600	0,1
9	PB59017	Electroplated $\Phi 107 \times 12$ $-45^\circ$ B=50 Pos.3	4.500-5.000	300-600	0,05
10	PB59018	Polish $\Phi 107 \times 16$ $-45^\circ$ B=50 Gr.600	1.000-1.200	800-1.200	0,05
11	PB59019	Polish $\Phi 107 \times 16$ $-45^\circ$ B=50 Gr.1000 Marble	1.000-1.200	800-1.200	0,05
7	PB59036	Vacuum Brazed $\Phi 104 \times 12$ $-60^\circ$ B=50 Pos.1	4.500-5.000	300-600	0,15
8	PB59037	Vacuum Brazed $\Phi 104 \times 12$ $-60^\circ$ B=50 Pos.2	4.500-5.000	300-600	0,1
9	PB59038	Electroplated $\Phi 104 \times 12$ $-60^\circ$ B=50 Pos.3	4.500-5.000	300-600	0,05
10	PB59039	Polish $\Phi 107 \times 16$ $-60^\circ$ B=50 Gr.600	1.000-1.200	800-1.200	0,05
11	PB59040	Polish $\Phi 107 \times 16$ $-60^\circ$ B=50 Gr.1000 Marble	1.000-1.200	800-1.200	0,05
A	PB29015	Adaptor $\Phi 50 \times 10$ (3 Holes) A=1/2" Gas	-	-	-
B	SL01050	Adaptor $\Phi 50 \times 3$ (3 Holes) A=1/2" Gas	-	-	-
C	SL02128	ADAPTOR $\Phi 100$ Snail- 1/2" Gas	-	-	-

[BACK TO INDEX](#)

*Drain Board Re-Shaper Vacuum Brazed*  
*Barra Rettificatrice Saldo Brasata*

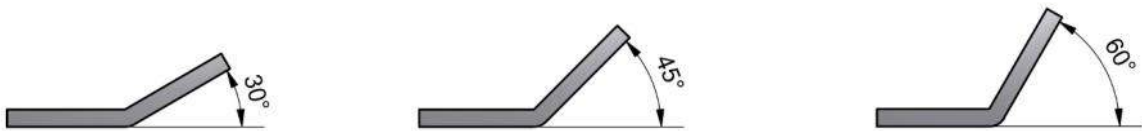

ADI CODE	DIMENSION [DxL]
PB39230	Brazed Re- Shaper 30°
PB39245	Brazed Re- Shaper 45°
PB39260	Brazed Re- Shaper 60°

[BACK TO INDEX](#)

*Router for flat grooving*  
*Frese piatte per gocciolatoio*



<i>Code</i>	<i>Dimensions</i> DxH [mm]	<i>Stock</i> <i>Removal</i> [mm]	RPM [mm/min.]	Feeding Speed [mm/min]
PB27555	Φ 8X12	<i>to shape</i>	6.000-8.000	150-300
PB27280	Φ10X12		6.000-8.000	150-300
PB27556	Φ12X12		6.000-8.000	150-300
PB27486	Φ15X12		5.000-6.000	150-300
PB27557	Φ20X12		5.000-6.000	150-300
PB27612	Φ22x12		5.000-6.000	150-300



[BACK TO INDEX](#)



**Routers for Grooving 1/2" gas**  
**Utensili per Gocciolatoio 1/2" gas**

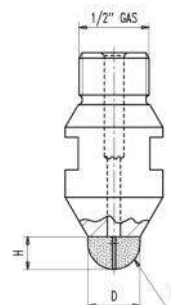
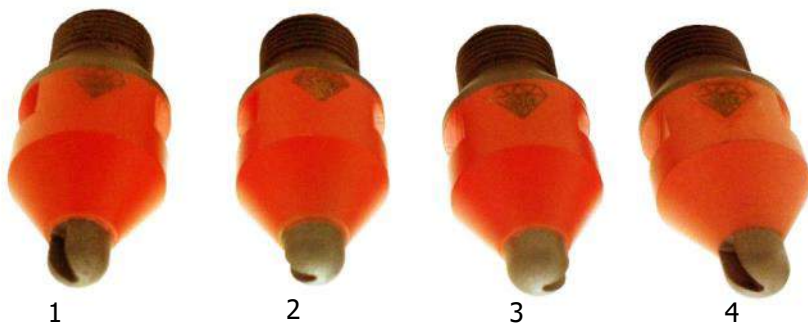

Position	Code	Dimensions [mm]	Stock Removal [mm]	RPM [mm/min.]	Feeding Speed [mm/min]
1	PB27528	Φ12 R=6	to shape	7.000-8.000	150-300
2	PB27529		0,2-0,15		600-800
3	PB27530		0,15-0,1		
4	PB27531		0,1		
1	PB27566	Φ16 R=8	to shape	6.000-7.000	150-300
2	PB27567		0,2-0,15		600-800
3	PB27568		0,15-0,1		
4	PB27569		0,1		

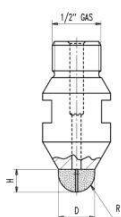

**Polishing Routers for Grooving 1/2" gas**  
**Lucidanti per Gocciolatoio 1/2" gas**

Position	Code	Dimensions [mm]	Stock Removal [mm]	RPM [mm/min.]	Feeding Speed [mm/min]
5	PBK21297	Φ12 R=6	0,05-0,1	3000-4000	600-800
6	PBK21298		0,05-0,1		600-800
7	PBK21299		0,05-0,1		

[BACK TO INDEX](#)

Routers for Grooving 1/2" gas

Utensili per Gocciolatoio 1/2" gas

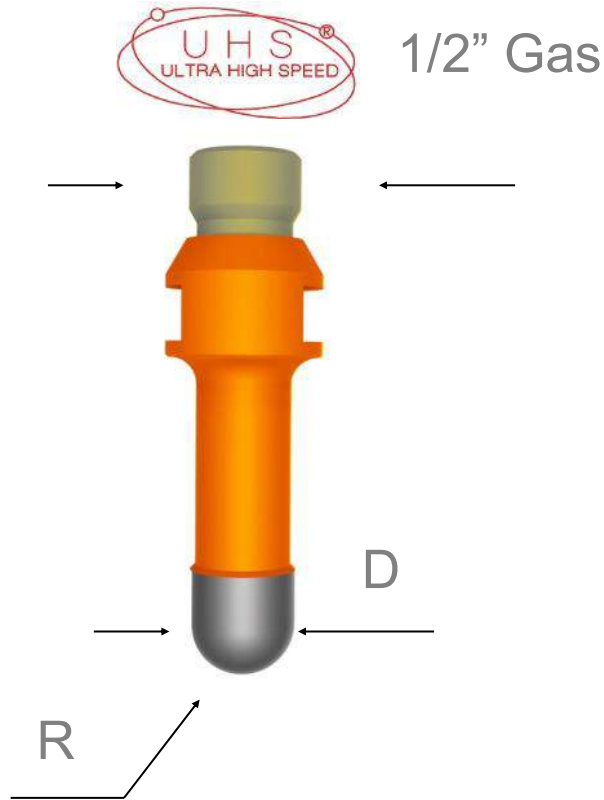

Code	Dimensions [mm]	Pos	Stock Removal [mm]	RPM [mm/min.]	Feeding Speed [mm/min]
PB27613	Φ12x20 R=6	1	To Shape	7.000-8.000	150-300
PB27614	Φ12x20 R=6	2	0,2-0,15	7.000-8.000	150-300
PB27615	Φ12x20 R=6	3	0,15-0,1	7.000-8.000	600-800
PB27616	Φ12x20 R=6	4	0,1	6.000-7.000	600-800
PB27617	Φ16x20 R=8	1	To Shape	6.000-7.000	150-300
PB27618	Φ16x20 R=8	2	0,2-0,15	6.000-7.000	150-300
PB27619	Φ16x20 R=8	3	0,15-0,1	6.000-7.000	600-800
PB27620	Φ16x20 R=8	4	0,1	6.000-7.000	600-800
PB27621	Φ20x20 R=10	1	To Shape	5.500-6.500	150-300
PB27622	Φ20x20 R=10	2	0,2-0,15	5.500-6.500	150-300
PB27623	Φ20x20 R=10	3	0,15-0,1	5.500-6.500	600-800
PB27624	Φ20x20 R=10	4	0,1	5.500-6.500	600-800
PB27625	Φ22x20 R=11	1	To Shape	5.000-6.000	150-300
PB27626	Φ22x20 R=11	2	0,2-0,15	5.000-6.000	150-300
PB27627	Φ22x20 R=11	3	0,15-0,1	5.000-6.000	600-800
PB27628	Φ22x20 R=11	4	0,1	5.000-6.000	600-800

[BACK TO INDEX](#)



1/2" Gas

Vacuum brazed rounded routers for **Marble**  
Fresa rotonda saldo brasata per **Marmo**

<i>Code</i>	<i>Dimensions</i> [mm]	RPM [mm/min.]	Feeding Speed [mm/min]
PB52041	Φ30X30 Radius 15	5.000-6.000	400-800



1/2" Gas

<i>Code</i>	<i>Dimensions</i> [mm]	RPM [mm/min.]	Feeding Speed [mm/min]
PB52106	Φ40X40 Radius 20	5.000-6.000	400-800



1/2" Gas

<i>Code</i>	<i>Dimensions</i> [mm]	RPM [mm/min.]	Feeding Speed [mm/min]
PB52127	Φ50X40 Radius 25	5.000-6.000	400-800

[BACK TO INDEX](#)

Electroplated Semi Spherical Routers for **Marble**

Fresa rotonda saldo brasata per **Marmo**

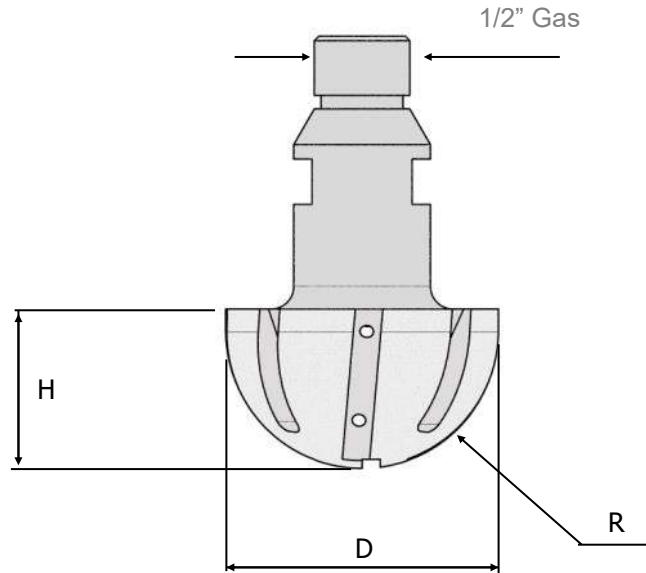

Code	Dimensions [mm]	Position	Stock Removal [mm]	RPM [mm/min.]	Feeding Speed [mm/min]
PB23320	Φ30x20 R=15	1 (D602)	<i>to shape</i>	5.000-6.000	400-800
PB23321		2 (D107)	0,5 - 0,2		1.000-2.000
PB23322	Φ40x25 R=20	1 (D602)	<i>to shape</i>	5.000-6.000	400-800
PB23323		2 (D107)	0,5 - 0,2		1.000-2.000
PB23324	Φ50x30 R=25	1 (D602)	<i>to shape</i>	5.000-6.000	400-800
PB23325		2 (D107)	0,5 - 0,2		1.000-2.000
PB23326	Φ60x35 R=30	1 (D602)	<i>to shape</i>	5.000-6.000	400-800
PB23327		2 (D107)	0,5 - 0,2		1.000-2.000

Segmented Semi Spherical Routers for **Granite**

Fresa rotonda a settori per **Granito**

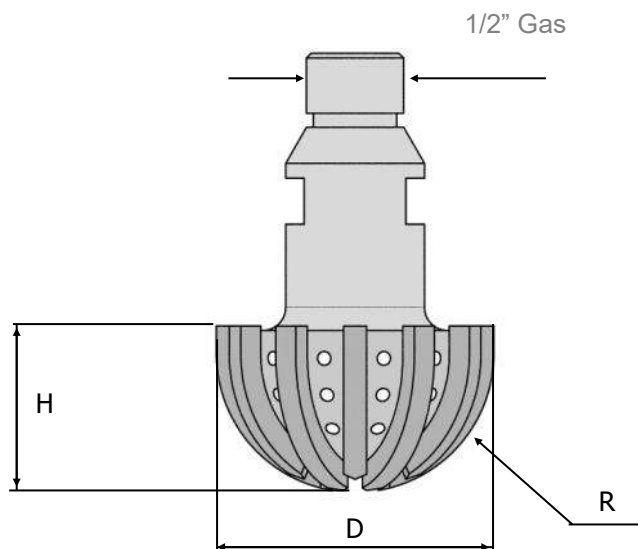

Code	Dimensions [mm]	Position	Stock Removal [mm]	RPM [mm/min.]	Feeding Speed [mm/min]
PB30161	Φ30x20 R=15	1	to shape	5.000-5.500	200-400
PB30162		2	0,3 - 0,2		600-800
PB30163	Φ40x25 R=20	1	to shape	5.000-5.500	200-400
PB30164		2	0,3 - 0,2		600-800
PB30165	Φ50x30 R=25	1	to shape	4.500-5.000	200-400
PB30166		2	0,3 - 0,2		600-800
PB30167	Φ60x35 R=30	1	to shape	4.500-5.000	200-400
PB30168		2	0,3 - 0,2		600-800

\* needed 9 pieces, - necessari 9 pezzi

[BACK TO INDEX](#)



**Wheels for Grooving for 90° angle gear**  
**Utensile da Gocciolatoio per rinvio angolare**

For **GRANITE** - per **GRANITO**

Bore 30 - Foro 30

Code	Dimensions [mm]	Pos	Stock Removal [mm]	RPM [mm/min.]	Feeding Speed [mm/min]
PA27488	Φ140x12x6 Metal	1	Max 3	4.000	1.000
PA27489	Φ140x12 Abrasive	2	0,05 - 0,1	3.000	600
PA27490	Φ140x12 Abrasive	3	0,05 - 0,1	3.000	600



Radius 8 mm  
Raggio 8mm

For **ENGINEERED STONE** - per **AGGLOMERATO**

Bore 30—Foro 30

Code	Dimensions [mm]	Pos	Stock Removal [mm]	RPM [mm/min.]	Feeding Speed [mm/min]
PA27571	Φ140x12x6 Metal	1	Max 3	4.000	1.000
PB38204	Φ140x12 Eraser	2	0,05 - 0,1	3.500	800
PBK22997	Φ140x12 Kristal polishing	3	0,05 - 0,1	2.700	800



Radius 8 mm  
Raggio 8mm

Bore 22,2—Foro 22,2

Code	Dimensions [mm]	Pos	Stock Removal [mm]	RPM [mm/min.]	Feeding Speed [mm/min]
PA27666	Φ140x12x6 Metal	1	Max 3	4.000	1.000
PB38215	Φ140x12 Eraser	2	0,05 - 0,1	3.500	800
PBK22999	Φ140x12 Kristal polishing	3	0,05 - 0,1	2.700	800

[BACK TO INDEX](#)

For **ENGINEERED STONE** - per **AGGLOMERATO** Bore 50 - Foro 50



<i>Code</i>	<i>Dimensions</i> [mm]	Pos	<i>Stock Removal</i> [mm]	RPM [mm/min.]	Feeding Speed [mm/min]
PA27620	Φ150x22x6 -146,7°	1	4.000	Max 3	1.000
PB38211		2	3.500	0,05 - 0,1	800

## Big Surface Polishing wheels Set

[BACK TO INDEX](#)

### Set

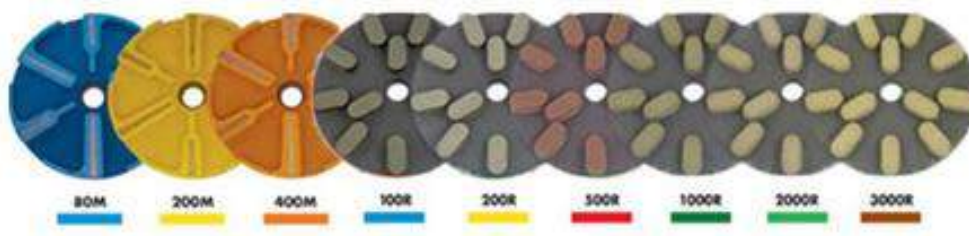

Metal Bond Plateaux D.200 (for Granite Marble Engineered Stone Concrete)

Soluzione metallica per Marmo e Granito

<i>Code</i>	<i>Description</i> [mm]	GRIT	RPM [mm/min.]	Feeding Speed [mm/min]	<i>Stock Removal</i> [mm]	<i>N.er of Repetitions</i>	<i>Step</i> [mm]
PA46001	Φ200	#80M	1.000	7000-10.000	0,1	1 Ext 1 Out	80
PA46002	Φ200	#200M	1.000	7000-10.000	0,1	1 Ext 1 Out	120
PA46003	Φ200	#400M	1.000	7000-10.000	0,1	1 Ext 1 Out	100

Resin Bond Plateaux D.200 (for Granite Marble Engineered Stone Concrete)

Lucidanti per Granito—Marmo e Engineered Stone

<i>Code</i>	<i>Description</i> [mm]	GRIT	RPM [mm/min.]	Feeding Speed [mm/min]	<i>Stock Removal</i> [mm]	<i>N.er of Repetitions</i>	<i>Step</i> [mm]
PA46019	Φ200	#100R	1.000	7000-10.000	0,1	1 Ext 1 Out	90
PA46010	Φ200	#200R	1.000	7000-10.000	0,1	1 Ext 1 Out	150
PA46011	Φ200	#500R	1.000	7000-10.000	0,05	2 Ext 2 Out	145
PA46012	Φ200	#1000R	1.000	7000-10.000	0,05	1 Ext 1 Out	90
PA46013	Φ200	#2000R	1.000	7000-10.000	0,05	1 Ext 1 Out	85
PA46014	Φ200	#3000R	1.000	7000-10.000	0,05	1 Ext 1 Out	70
PA46018	Φ200	#LUX	1.000	7000-10.000	0,05	1 Ext 1 Out	60



[BACK TO INDEX](#)

Resin Bond Plateaux D.200 (for Better **Marble** Results)

Sequenza Lucidante per **Marmo**

Code	Description [mm]	GRIT	RPM [mm/min.]	Feeding Speed [mm/min]	Stock Removal [mm]	N.er of Repetitions	Step [mm]
PA46004	Φ200	#500R	1.000	7000-10.000	0,1	1 Ext 1 Out	90
PA46005	Φ200	#1000R	1.000	7000-10.000	0,1	1 Ext 1 Out	150
PA46006	Φ200	#2000R	1.000	7000-10.000	0,05	2 Ext 2 Out	145
PA46007	Φ200	#4000R	1.000	7000-10.000	0,05	2 Ext 2 Out	145

Resin Bond Plateaux D.200 (for Better **Granite** Results)

Sequenza Lucidante per **Granito**

Code	Description [mm]	GRIT	RPM [mm/min.]	Feeding Speed [mm/min]	Stock Removal [mm]	N.er of Repetitions	Step [mm]
PA46015	Φ200	#500R	1.000	7000-10.000	0,1	1 Ext 1 Out	90
PA46016	Φ200	#1000R	1.000	7000-10.000	0,1	1 Ext 1 Out	150
PA46017	Φ200	#2000R	1.000	7000-10.000	0,05	2 Ext 2 Out	145
PA46018	Φ200	Black Lux	1.000	7000-10.000	0,05	2 Ext 2 Out	145



Code	Description [mm]	GRIT	RPM [mm/min.]	Feeding Speed [mm/min]	Stock Removal [mm]	N.er of Repetitions	Step [mm]
PA46008	STEEL SUPPORT (1 for each pos.)	-	-	-	-	-	-
PE09032	ADAPTOR FLANGE - MAGNETIC	-	-	-	-	-	-

BACK TO INDEX

**FLAT EDGE POLISHING WITH 4th AXIS  
FOR BRETON AND THIBAUT MACHINES**



PF06070 (FOR BRETON)



<i>Code</i>	<i>Description</i> [mm]	GRIT	RPM [mm/min.]	Feeding Speed [mm/min]	<i>Stock Removal</i> [mm]
PF06070	Cutting Blade $\Phi$ 150x5 B=25	GR	2.200	500	Shape
PB29610	Polish $\Phi$ 125x40x5 Magnetic	#100R	1.200	1.000	0,25
PB29611	Polish $\Phi$ 125x40x5 Magnetic	#200R	1.200	1.000	0,15
PB29612	Polish $\Phi$ 125x40x5 Magnetic	#500R	1.200	1.000	0,08
PB29613	Polish $\Phi$ 125x40x5 Magnetic	#1000R	1.200	1.000	0,05
PB29614	Polish $\Phi$ 125x40x5 Magnetic	#2000R	1.200	1.000	0,04
PB29615	Polish $\Phi$ 125x40x5 Magnetic	#3000R	1.200	1.000	0,03

**ADAPTOR : see page 327**

**ADATTATORI : vedi pagina 327**

**REGULAR-IRREGULAR SURFACE POLISHING**

[BACK TO INDEX](#)

**LUCIDATURA REGOLARE E IRREGOLARE DELLE SUPERFICI**

**METAL BOND PAD WITH VELCRO (WET USE)**

**PAD METALLICO CON VELCRO (UMIDO)**



ADI CODE	GRIT
PE51011	K0+ (20/30)
PE51012	K1 (40/60)

GR

ENG

M

SUGGESTED RPM 2.000—3.000

MAX RPM 3.500

**OCTRON F POLISHING PAD WITH VELCRO (WET USE)**

**LUCIDANTI PAD "OCTRON F" CON VELCRO (UMIDO)**

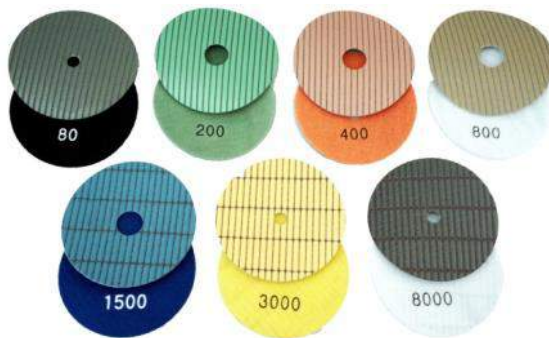

ADI CODE	GRIT
PE51001	80
PE51002	200
PE51003	400
PE51004	800
PE51005	1500
PE51006	3000
PE51007	8000

ENG

M

SUGGESTED RPM 2.500—3.000

MAX RPM 4.000

**DIAFACE POLISHING PAD WITH VELCRO -MORE FLEXIBLE- (WET USE)**

**DIAMETER 100 mm**

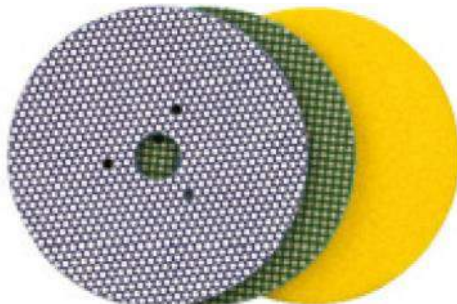

ADI CODE	GRIT
PE50401	60M
PE50402	120M
PE50403	200M
PE50404	400M
PE50405	600M
PE50406	500R
PE50407	1000R
PE50408	8000R

GR

ENG

M

SUGGESTED RPM 2.500—3.000

**REGULAR-IRREGULAR SURFACE POLISHING**

**LUCIDATURA REGOLARE E IRREGOLARE DELLE SUPERFICI**

[BACK TO INDEX](#)

**KIT OCTRON 3 POLISHING PAD WITH VELCRO FOR MARBLE - (WET USE)**



ADI CODE	POS
PE51019	M1-M2-M3

M

SUGGESTED RPM 2.500—3.000

MAX RPM 4.000

**KIT OCTRON 3 POLISHING PAD WITH VELCRO FOR GRANITE - (WET USE)**

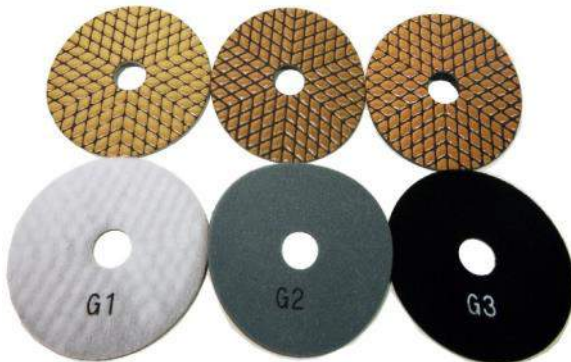

ADI CODE	POS
PE51020	G1-G2-G3

GR

SUGGESTED RPM 2.500—3.000

MAX RPM 4.000

**KIT OCTRON 3 POLISHING PAD WITH VELCRO FOR ENGINEERED STONE - (WET USE)**



ADI CODE	POS
PE51021	E1-E2-E3

ENG

SUGGESTED RPM 2.500—3.000

MAX RPM 4.000

[BACK TO INDEX](#)

**EXTENSION 1/2" GAS - M14**

**ADATTATORI 1/2" GAS - M14**

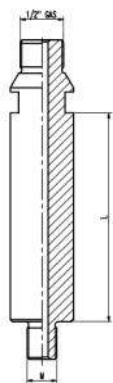

Code	Product details
SL02264	Fitting 1/2" GAS - Fitting M14 (A)
SL02496	Fitting 1/2" GAS - Fitting M14 L= 100 (B)

**ADAPTOR D.100 WITH VELCRO M14 CONNECTION**



ADI CODE	TYPE
PZSUP17	(A) SOFT
PZSUP18	(B) MEDIUM
PZSUP24	(C) HARD
PZSUP26	(D) MORE SOFT(*)

(\*) SPACER VELCRO - VELCRO WITHOUT CONNECTION

[BACK TO INDEX](#)

CNC TOOLS  
FOR  
PRE CUTTING  
  
UTENSILI CNC  
PER  
PRE-TAGLIO

[BACK TO INDEX](#)



[BACK TO INDEX](#)

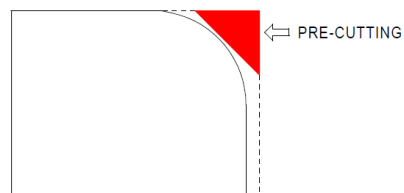

**Pre Cutting Wheel Shape “Y” Slab Thickness 2-3-4 CM 45°**

**Mola pre-taglio Y—spessore lastra 2-3-4– CM 45°**

<i>ADI Code</i>	<i>Description</i>	<i>RPM</i>	<i>FEED</i> [mm/min]
PB01241	Φ125 F=35	4.500-5.500	1.000-2.000

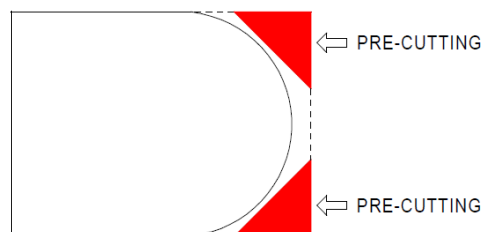

**Pre Cutting Wheel Shape “X” Slab Thickness 2-3-4 CM 45°**

**Mola pre Taglio “X” - spessore lastra 2-3-4 CM 45°**

<i>ADI Code</i>	<i>Description</i>	<i>RPM</i>	<i>FEED</i> [mm/min]
PB01261	Φ100 F=35	4.500-5.500	1.000-2.000

[BACK TO INDEX](#)

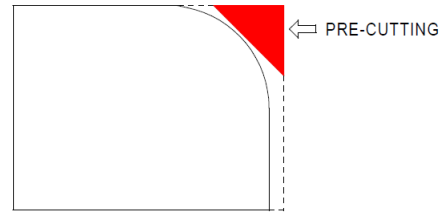

**Pre Cutting Wheel Shape “Y” Slab Thickness 2-3-4 CM 45°**

**Mola Pre taglio “Y” - spessore lastra 2-3-4 CM 45°**

<i>ADI Code</i>	<i>Description</i>	<i>RPM</i>	<i>FEED</i> [mm/min]
PB122640	Φ130 F=35	4.500-5.500	1.000-2.000

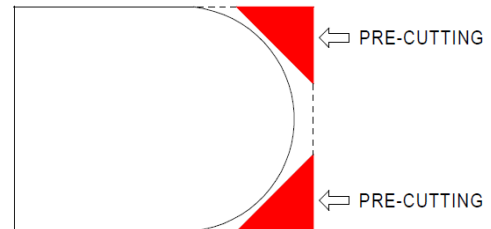

**Pre Cutting Wheel Shape “X” Slab Thickness 2-3-4 CM 45°**

**Mola Pre-taglio “X” spessore lastra 2-3-4 CM 45°**

<i>ADI Code</i>	<i>Description</i>	<i>RPM</i>	<i>FEED</i> [mm/min]
PB122681	Φ120 F=35	4.500-5.500	1.000-2.000

 **Ninja  
Blades**

[BACK TO INDEX](#)

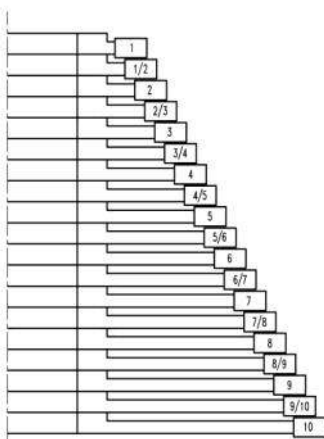

ADI Code	Description	N°	RPM	FEED [mm/min]
PC12070	Φ70 F=35	1	4.500-5.500	1.000-2.000
PC12075	Φ75 F=35	1/2		
PC12080	Φ80 F=35	2		
PC12085	Φ85 F=35	2/3		
PC12090	Φ90 F=35	3		
PC12095	Φ95 F=35	3/4		
PC12100	Φ100 F=35	4		
PC12105	Φ105 F=35	4/5		
PC12110	Φ110 F=35	5		
PC12115	Φ115 F=35	5/6		
PC12120	Φ120 F=35	6	4.500-5.500	1.000-2.000
PC12125	Φ125 F=35	6/7		
PC12130	Φ130 F=35	7		
PC12135	Φ135 F=35	7/8		
PC12140	Φ140 F=35	8		
PC12145	Φ145 F=35	8/9		
PC12150	Φ150 F=35	9		
PC12155	Φ155 F=35	9/10		
PC12160	Φ160 F=35	10		

Spacer for Ninja Blades

Spaziatore per Ninja Blades

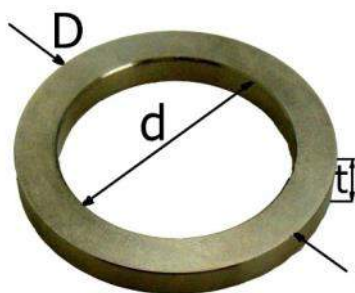

Adi Code	d [mm]	D [mm]	t
SL02446	35	48	5

[BACK TO INDEX](#)

# CNC TOOLS FOR MITRE

# UTENSILI CNC PER MITRE

[BACK TO INDEX](#)

# MITRE

*SAVER SOLUTION FOR 90° COUPLING*  
*SISTEMA INCOLLAGGIO PER 90°*

Pos. 1

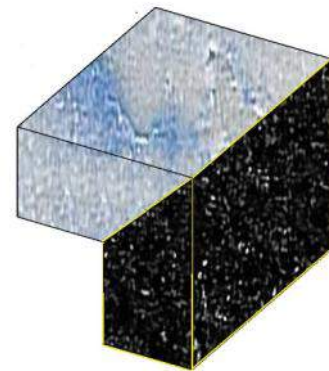

Pos. 2

*Coupling 90° on 2-3-4 cm*

*Incollaggio 90° on 2-3-4 cm*

<i>ADI Code</i>	<i>Description</i>	<i>RPM</i>	<i>FEED</i> [mm/min]
PB122640	ø130	4.500-5.500	800-1.200
PB40327	ø146	3.800-4.500	800-1.200

# MITRE



[BACK TO INDEX](#)

*TOP SOLUTION FOR 90° COUPLING*



Optional  
Pos. 0

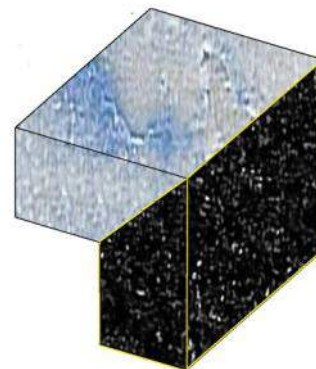

Pos. 1



Pos. 2



Pos. 3

*Coupling 90° on 2-3 cm*

*Incollaggio 90° on 2-3 cm*

ADI Code	Position	Description	RPM	FEED [mm/min]
PB01241	1	ø125	4.500	500-1.000
PB01242	2	ø140	4.500	1.000-1.500
PB01243	3	ø140	4.500	1.000



CNC TOOLS  
ZERO CHIPPING &  
EUROSEAM

UTENSILI CNC  
NO SBECCATURA &  
SOLUZIONE COMPATTA

[BACK TO INDEX](#)

[BACK TO INDEX](#)



**ZERO CHIPPING SEAM SOLUTION Ø50X45mm**

**SEQUENZA SENZA SBECCATURA Ø50X45mm**



**STANDARD BORE 35mm - FORO 35mm**

ADI Code	Pos	Type	Pos	Slab Thickness [Inches or mm]	RPM (Min-Max)	Stock Removal [Inches or mm]	Feeding Speed [Inches/minute or mm/minute]
PB01323	1	Seg	1	1 1/4" - 1 37/64" 30-40	6.000	To Shape	59"-118" 1.500-3.000
PB01324	2	Cr+S	2		6.000	0,008"-0,012" 0,2-0,3	59"-157" 1.500-4.000
PB01325	3	Cr+S	3		4.800-5.300	0,002"-0,004" 0,05-0,1	39"-59" 1.000-1.500

[BACK TO INDEX](#)

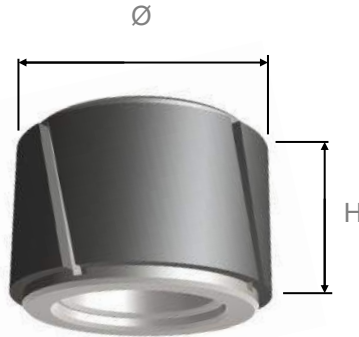

Ø = DIAMETER

H = HIGH

(20-30-40-50)

**WORKING PARAMETERS**  
**PARAMETRI DI LAVORO**

Pos	Slab Thickness [Inches or mm]	RPM (Min-Max)	Stock Removal [Inches or mm]	Feeding Speed [Inches/minute or mm/minute]	Note
1	3/4"-1 1/4" - 1 1/2" 20-30-40	6.000	to shape	59"-118" 1.500-3.000	Segmented 
2	3/4"-1 1/4" - 1 1/2" 20-30-40	6.000	0,012"-0,016" 0,3-0,4	59"-157"	Continuous Rim 
3			0,008"-0,012" 0,2-0,3	1.500-4.000	
5	3/4"-1 1/4" - 1 1/2" 20-30-40	2.800-3.500	0,0011"-0,0019" 0,03-0,05 Pressure	47"-59" 1.200-1.500	Express Polishing 
6					
7					
5	3/4"-1 1/4" - 1 1/2" 20-30-40	2.800-3.300	Dynamic Compensation for Diameter per Foot [Inch] 0,00024"	39"-47" 1.000-1.200	Magic Polishing 
6			Dynamic Compensation for Radius per Meter [mm] 0,008-0,01		

[BACK TO INDEX](#)

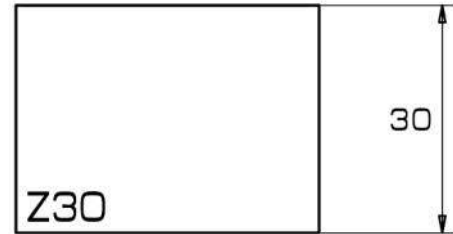
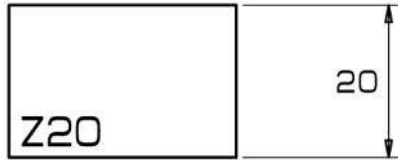

Pos	Type	Code	Ed mm	H mm
1	Seg	PB01013	60	35
2	Cr+S	PB01011	60	25
3	Cr+S	PB01012	60	25
5	Exp	PB02190	60	25
6	Exp	PB02191	60	25
7	Exp	PB02192	60	25
5	Magic	PB69193	58	28
6	Magic	PB69194	58	28

Pos	Type	Code	Ed mm	H mm
1	Seg	PB01013	60	35
2	Cr+S	PB01014	60	35
3	Cr+S	PB01015	60	35
5	Exp	PB02198	60	35
6	Exp	PB02193	60	35
7	Exp	PB02194	60	35
5	Magic	PB69196	58	45
6	Magic	PB69197	58	45

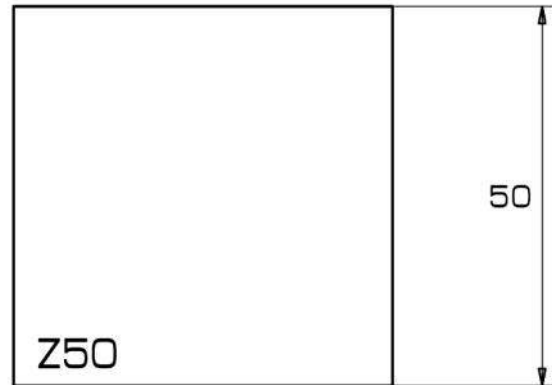

Pos	Type	Code	Ed mm	h mm
1	Seg	PB01016	60	45
2	Cr+S	PB01017	60	45
3	Cr+S	PB01018	60	45
5	Exp	PB02195	60	45
6	Exp	PB02196	60	45
7	Exp	PB02197	60	45
5	Magic	PB69196	58	45
6	Magic	PB69197	58	45

Pos	Type	Code	Ed mm	h mm
1	Seg	PB01353	60	55
2	Cr+S	PB01354	60	55
3	Cr+S	PB01355	60	55
5	Exp	PB02397	60	55
6	Exp	PB02398	60	55
7	Exp	PB02399	60	55
5	Magic	PB691278	58	55
6	Magic	PB691279	58	55

All Wheel are 35mm Bore Connection

[BACK TO INDEX](#)

# CNC PROFILES

## PROFILI CNC

[BACK TO INDEX](#)

# CNC PROFILES LINE

## PROFILI CNC

**TOP** Ø120 bore/foro Ø 35



**FAST** Ø80/90 bore/foro Ø 35



**TWIST** Ø50/60 bore/foro Ø 22



**MICRON** Ø20 fitting 1/2" Gas



**NANO** Ø10 fitting 1/2" Gas





[BACK TO INDEX](#)

**Metal Wheels profile sequence**  
**Sequenza mole metalliche per profilatura**



**TYPE :**

**Segmented type / mole a settori = Seg**

The best solution for profile shaping

La migliore soluzione per creare il profilo

**Continuous rim with slots / Mola fascia continua con intagli = Cr+S**

EDM machines water channels for coolant directly on the diamond surface.

Intagli creati con macchina EDM per il passaggio dell'acqua e la refrigerazione della superficie diamantata

**Metal Finer Position 5 / Posizione metallica grana fine 5 = MPF5**

Optional suggested for very high finishing

Opzionale suggerito per una alta finitura



[BACK TO INDEX](#)

Polishing Wheels profile sequence  
Sequenza mole lucidanti per profilatura



**TYPE :**

Express : EXP

Pos. 5      Express Polishing tools - OPTIONAL

Pos. 6      Express Polishing tools

Pos.7      Express Polishing tools

**MAGIC**

Abrasive polishing tool Pos. 6

Abrasive polishing tool Pos. 7



**KRISTAL**

Abrasive polishing tool Pos. 6

Abrasive polishing tool Pos. 7



[BACK TO INDEX](#)

Our working use suggestion

Suggerimento di utilizzo

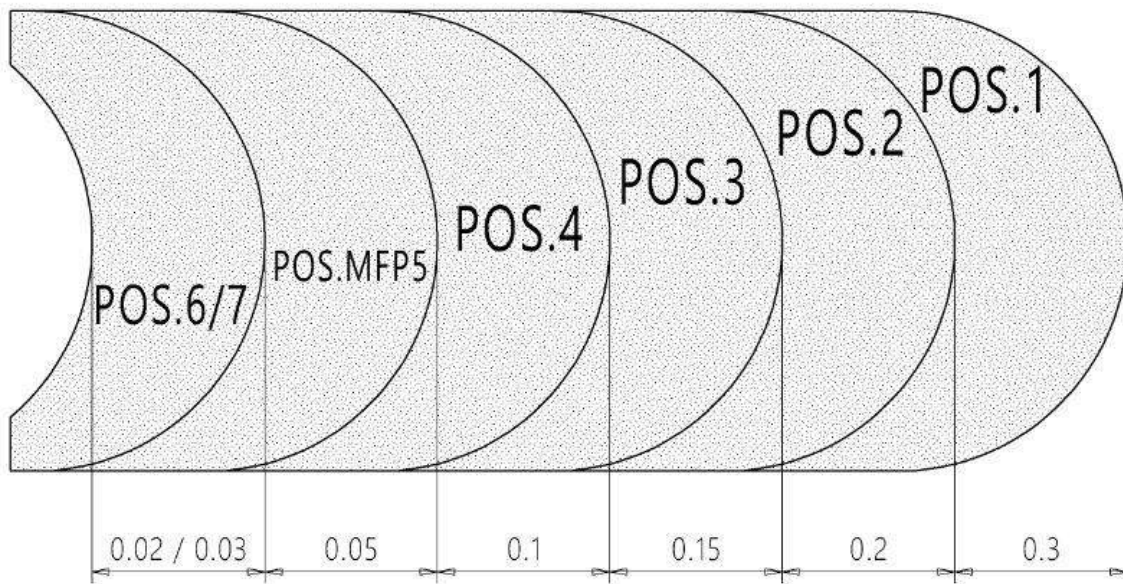

[BACK TO INDEX](#)

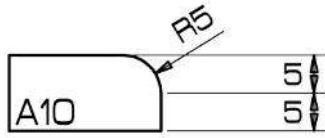

**Ninja Composition**  
A10

Position	TopLine STONE DIVISION				FastLine STONE DIVISION				TwistLine STONE DIVISION				MicronLine STONE DIVISION			
	Code	Type	ID	ED	Code	Type	ID	ED	Code	Type	ID	ED	Code	Type	ID	ED
1					PB124411	Cr+S	70	85								
2					PB124412	Cr+S	70	85								
3					PB124413	Cr+S	70	85								
4					PB124414	Cr+S	70	85								
MFP5					PB01681	MFP5	70	85								
5					PB021699	Exp	60	73								
6					PB021700	Exp	60	73								
7					PB021701	Exp	60	73								
6					PB69458	Magic	65	80								
7					PB69459	Magic	65	80								

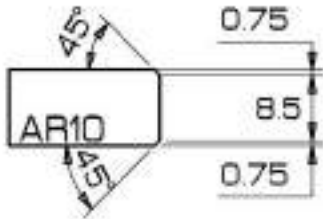

**Ninja Composition**  
AR10

Position	TopLine STONE DIVISION				FastLine STONE DIVISION				TwistLine STONE DIVISION				MicronLine STONE DIVISION				Price [€] Euro		
	Code	Type	ID	ED	Code	Type	ID	ED	Code	Type	ID	ED	Code	Type	ID	ED			
1										PB161363	Cr+S	40	45		PB201001	2 Seg	20	25	150
2										PB161364	Cr+S	40	45		PB201002	2 Seg	20	25	150
3										PB161365	Cr+S	40	45		PB201003	2 Seg	20	25	150
4										PB161266	Cr+S	40	45		PB201004	2 Seg	20	25	150
MFP5										PB11545	MFP5	40	45		PB015014	Mfp5	20	25	158
5										PB02735	Exp	40	45		PB021152	Exp	20	25	125
6										PB02736	Exp	40	45		PB021153	Exp	20	25	125
7										PB02737	Exp	40	45		PB021154	Exp	20	25	125
6										PB68196	Magic	45	50		PB67073	Magic	20	25	
7										PB68197	Magic	45	50		PB67074	Magic	20	25	

[BACK TO INDEX](#)

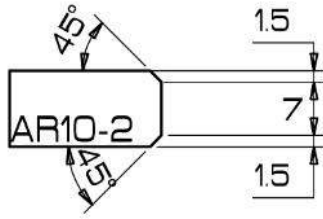

**Ninja Composition**  
AR10-2

Position	TopLine STONE DIVISION					FastLine STONE DIVISION					TwistLine STONE DIVISION				MicronLine STONE DIVISION				
	Code	Type	ID	ED							Code	Type	ID	ED		Code	Type	ID	ED
1	PB122953	Cr+S	115	120							PB161367	Cr+S	40	45		PB201005	2 Seg	20	25
2	PB122954	Cr+S	115	120							PB161368	Cr+S	40	45		PB201006	2 Seg	20	25
3	PB122955	Cr+S	115	120							PB161369	Cr+S	40	45		PB201007	2 Seg	20	25
4	PB122956	Cr+S	115	120							PB161370	Cr+S	40	45		PB201008	2 Seg	20	25
MFP5	PB01641	MFP5	75	80							PB11546	MFP5	40	45		PB015015	Mfp5	20	25
5	PB021554	Exp	60	65							PB02738	Exp	40	45		PB021161	Exp	20	25
6	PB021555	Exp	60	65							PB02739	Exp	40	45		PB021162	Exp	20	25
7	PB021556	Exp	60	65							PB02740	Exp	40	45		PB021163	Exp	20	25
6	PB69461	Magic	55	60							PB68139	Magic	45	50		PB67076	Magic	20	25
7	PB69462	Magic	55	60							PB68140	Magic	45	50		PB67077	Magic	20	25



**Ninja Composition**  
B10

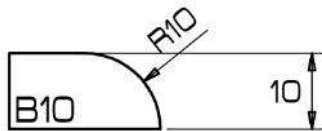

Position	TopLine STONE DIVISION					FastLine STONE DIVISION					TwistLine STONE DIVISION				MicronLine STONE DIVISION				
	Code	Type	ID	ED							Code	Type	ID	ED		Code	Type	ID	ED
1	PB124131	Seg	83	105															
2	PB124132	Cr+S	80	105															
3	PB124133	Cr+S	80	105															
4	PB124134	Cr+S	80	105															
MFP5	PB01630	MFP5	80	105															
5	PB021702	Exp	60	85															
6	PB021527	Exp	60	85															
7	PB021528	Exp	55	85															
6	PB69464	Magic	55	80															
7	PB69465	Magic	55	80															

[BACK TO INDEX](#)

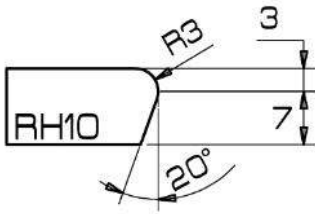

**Ninja Composition**  
RH10

Position	TopLine STONE DIVISION				FastLine STONE DIVISION				TwistLine STONE DIVISION				MicronLine STONE DIVISION			
	Code	Type	ID	ED	Code	Type	ID	ED	Code	Type	ID	ED	Code	Type	ID	ED
1					PB123503	Cr+S	66	80								
2					PB123870	Cr+S	66	80								
3					PB122752	Cr+S	66	80								
4					PB122753	Cr+S	66	80								
MFP5					PB01682	MFP5	66	80								
5					PB021703	Exp	60	74								
6					PB021704	Exp	60	74								
7					PB021705	Exp	60	74								
6					PB69298	Magic	68	80								
7					PB69299	Magic	68	80								



**Ninja Composition**  
SM10



Position	TopLine STONE DIVISION				FastLine STONE DIVISION				TwistLine STONE DIVISION				MicronLine STONE DIVISION			
	Code	Type	ID	ED	Code	Type	ID	ED	Code	Type	ID	ED	Code	Type	ID	ED
1					PB124415	Cr+S	75	80								
2					PB124416	Cr+S	75	80								
3					PB124417	Cr+S	75	80								
4					PB124418	Cr+S	75	80								
MFP5					PB01683	MFP5	75	80								
5					PB021706	Exp	60	65								
6					PB021707	Exp	60	65								
7					PB021708	Exp	60	65								
6					PB691200	Magic	56	60								
7					PB691201	Magic	56	60								

[BACK TO INDEX](#)



**Ninja Composition**  
V10

Position	<b>TopLine</b> STONE DIVISION				<b>FastLine</b> STONE DIVISION				<b>TwistLine</b> STONE DIVISION				<b>MicronLine</b> STONE DIVISION			
	Code	Type	ID	ED												
1	PB124423	Seg	70	83												
2	PB124424	Seg	70	83												
3	PB124425	Seg	70	83												
4	PB124426	Seg	70	83												
MFP5	-	MFP5	-	-												
5	PB021709	Exp	60	73												
6	PB021710	Exp	60	73												
7	PB021711	Exp	60	73												
6	PB691009	Magic	64	80												
7	PB691010	Magic	64	80												



**Ninja Composition**  
Z10

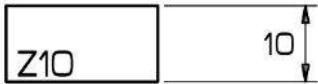

Position	<b>TopLine</b> STONE DIVISION				<b>FastLine</b> STONE DIVISION				<b>TwistLine</b> STONE DIVISION				<b>MicronLine</b> STONE DIVISION			
	Code	Type	ID	ED												
1	PB124076	Seg	80	80												
2	PB124077	Cr+S	80	80												
3	PB124078	Cr+S	80	80												
4	PB124079	Cr+S	80	80												
MFP5	PB01629	MFP5	80	80												
5	PB021931	Exp	60	60												
6	PB021932	Exp	60	60												
7	PB021933	Exp	60	60												
6	PB69403	Magic	78	78												
7	PB69404	Magic	78	78												

[BACK TO INDEX](#)



**Ninja Composition**  
ZS10

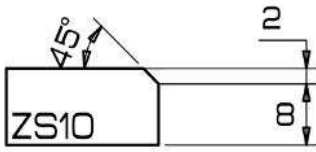

Position	<b>TopLine</b> STONE DIVISION				<b>FastLine</b> STONE DIVISION				<b>TwistLine</b> STONE DIVISION				<b>MicronLine</b> STONE DIVISION			
	Code	Type	ID	ED	Code	Type	ID	ED	Code	Type	ID	ED	Code	Type	ID	ED
1					PB124419	Cr+S	75	80	PB161371	Cr+S	40	45				
2					PB124420	Cr+S	75	80	PB161372	Cr+S	40	45				
3					PB124421	Cr+S	75	80	PB161373	Cr+S	40	45				
4					PB124422	Cr+S	75	80	PB161374	Cr+S	40	45				
MFP5					PB01684	MFP5	75	80	PB11547	MFP5	40	45				
5					PB021712	Exp	60	70	PB02741	Exp	40	45				
6					PB021713	Exp	60	70	PB02742	Exp	40	45				
7					PB021714	Exp	60	70	PB02743	Exp	40	45				
6					PB691203	Magic	54	60	PB68142	Magic	45	51				
7					PB691204	Magic	54	60	PB68143	Magic	45	51				



**Ninja Composition**  
AR11

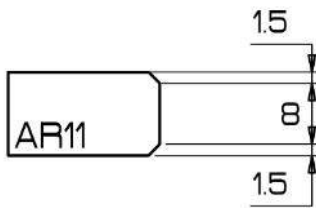

Position	<b>TopLine</b> STONE DIVISION				<b>FastLine</b> STONE DIVISION				<b>TwistLine</b> STONE DIVISION				<b>MicronLine</b> STONE DIVISION			
	Code	Type	ID	ED	Code	Type	ID	ED	Code	Type	ID	ED	Code	Type	ID	ED
1	PB122550	Cr+S	115	120					PB161375	Cr+S	40	45	PB201009	2 Seg	20	25
2	PB122551	Cr+S	115	120					PB161376	Cr+S	40	45	PB201010	2 Seg	20	25
3	PB122552	Cr+S	115	120					PB161377	Cr+S	40	45	PB201011	2 Seg	20	25
4	PB122553	Cr+S	115	120					PB161378	Cr+S	40	45	PB201012	2 Seg	20	25
MFP5	PB01642	MFP5	75	80					PB11548	MFP5	40	45	PB015016	Mfp5	20	25
5	PB021557	Exp	60	65					PB02744	Exp	40	45	PB021164	Exp	20	25
6	PB021558	Exp	60	65					PB02745	Exp	40	45	PB021165	Exp	20	25
7	PB021559	Exp	60	65					PB02746	Exp	40	45	PB021166	Exp	20	25
6	PB69467	Magic	55	60					PB68145	Magic	45	50	PB67079	Magic	20	25
7	PB69468	Magic	55	60					PB68146	Magic	45	50	PB67080	Magic	20	25



[BACK TO INDEX](#)

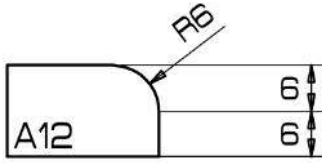

**Ninja Composition**  
A12

Position	<b>TopLine</b> STONE DIVISION					<b>FastLine</b> STONE DIVISION					<b>TwistLine</b> STONE DIVISION					<b>MicronLine</b> STONE DIVISION				
	Code	Type	ID	ED		Code	Type	ID	ED											
1	PB123728	Seg	103	120		PB124427	Cr+S	70	87											
2	PB124289	Seg	103	120		PB124428	Cr+s	70	87											
3	PB124290	Seg	103	120		PB124429	Cr+S	70	87											
4	PB124291	Seg	103	120		PB124430	Cr+S	70	87											
MFP5	-	MFP5	-	-		PB01685	MFP5	70	87											
5	PB021560	Exp	60	77		PB021560	Exp	60	77											
6	PB021561	Exp	60	77		PB021561	Exp	60	77											
7	PB021562	Exp	60	77		PB021562	Exp	60	77											
6	PB69470	Magic	63	80		PB69470	Magic	63	80											
7	PB69471	Magic	63	80		PB69471	Magic	63	80											

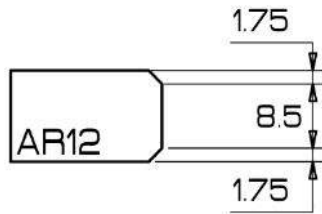

**Ninja Composition**  
AR12

Position	<b>TopLine</b> STONE DIVISION					<b>FastLine</b> STONE DIVISION					<b>TwistLine</b> STONE DIVISION					<b>MicronLine</b> STONE DIVISION				
	Code	Type	ID	ED		Code	Type	ID	ED		Code	Type	ID	ED		Code	Type	ID	ED	
1						PB123543	Cr+S	75	80		PB161379	Cr+S	40	45		PB201013	2 Seg	20	25	
2						PB123544	Cr+S	75	80		PB161380	Cr+S	40	45		PB201014	2 Seg	20	25	
3						PB123545	Cr+S	75	80		PB161381	Cr+S	40	45		PB201015	2 Seg	20	25	
4						PB123546	Cr+S	75	80		PB161382	Cr+S	40	45		PB201016	2 Seg	20	25	
MFP5						PB01638	MFP5	75	80		PB11549	MFP5	40	45		PB015017	Mfp5	20	25	
5						PB02321	Exp	60	67		PB02735	Exp	40	45		PB021152	Exp	20	25	
6						PB02322	Exp	60	67		PB02736	Exp	40	45		PB021153	Exp	20	25	
7						PB02323	Exp	60	67		PB02737	Exp	40	45		PB021154	Exp	20	25	
6						PB69473	Magic	55	60		PB68148	Magic	45	50		PB67082	Magic	20	25	
7						PB69474	Magic	55	60		PB68149	Magic	45	50		PB67083	Magic	20	25	

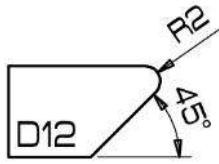

[BACK TO INDEX](#)



**Ninja Composition**  
D12

Position	TopLine STONE DIVISION				FastLine STONE DIVISION				TwistLine STONE DIVISION				MicronLine STONE DIVISION			
	Code	Type	ID	ED	Code	Type	ID	ED	Code	Type	ID	ED	Code	Type	ID	ED
1					PB124592	Cr+S	69	90								
2					PB124593	Cr+S	69	90								
3					PB124594	Cr+S	69	90								
4					PB124595	Cr+S	69	90								
MFP5					PB01832	MFP5	69	90								
5					PB021889	Exp	60	80								
6					PB021890	Exp	60	80								
7					PB021891	Exp	60	80								
6					PB691266	Magic	59	80								
7					PB691267	Magic	59	80								

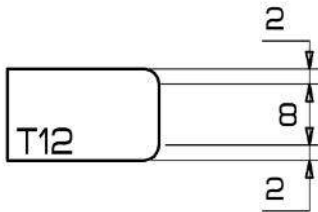

**Ninja Composition**  
T12

Position	TopLine STONE DIVISION				FastLine STONE DIVISION				TwistLine STONE DIVISION				MicronLine STONE DIVISION			
	Code	Type	ID	ED	Code	Type	ID	ED	Code	Type	ID	ED	Code	Type	ID	ED
1													PB201169	2 Seg	20	25
2													PB201170	2 Seg	20	25
3													PB201171	2 Seg	20	25
4													PB201172	2 Seg	20	25
MFP5													PB015018	Mfp5	20	25
5													PB021136	Exp	20	25
6													PB021137	Exp	20	25
7													PB021138	Exp	20	25
6													PB67160	Magic	20	35
7													PB67161	Magic	20	35

[BACK TO INDEX](#)



**Ninja Composition**  
W12

Position	<b>TopLine</b> STONE DIVISION				<b>FastLine</b> STONE DIVISION				<b>TwistLine</b> STONE DIVISION				<b>MicronLine</b> STONE DIVISION			
	Code	Type	ID	ED	Code	Type	ID	ED	Code	Type	ID	ED	Code	Type	ID	ED
1					PB124209	Cr+S	60	100								
2					PB124210	Cr+S	60	100								
3					PB124211	Cr+S	60	100								
4					PB124212	Cr+S	60	100								
MFP5					PB01829	MFP5	60	100								
5					PB021873	Exp	60	100								
6					PB021874	Exp	60	100								
7					PB021875	Exp	60	100								
6					PB691254	Magic	57	97								
7					PB691255	Magic	57	97								

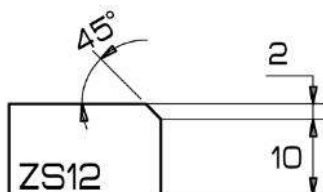

**Ninja Composition**  
ZS12

Position	<b>TopLine</b> STONE DIVISION				<b>FastLine</b> STONE DIVISION				<b>TwistLine</b> STONE DIVISION				<b>MicronLine</b> STONE DIVISION			
	Code	Type	ID	ED	Code	Type	ID	ED	Code	Type	ID	ED	Code	Type	ID	ED
1					PB123611	Cr+S	76	80					PB161383	Cr+S	40	45
2					PB123612	Cr+S	76	80					PB161384	Cr+S	40	45
3					PB123613	Cr+S	76	80					PB161385	Cr+S	40	45
4					PB123614	Cr+S	76	80					PB161386	Cr+S	40	45
MFP5					PB01686	MFP5	76	80					PB11550	MFP5	40	45
5					PB021712	Exp	60	70					PB02741	Exp	40	45
6					PB021713	Exp	60	70					PB02742	Exp	40	45
7					PB021714	Exp	60	70					PB02743	Exp	40	45
6					PB69476	Magic	54	60					PB68151	Magic	45	51
7					PB69477	Magic	54	60					PB68152	Magic	45	51

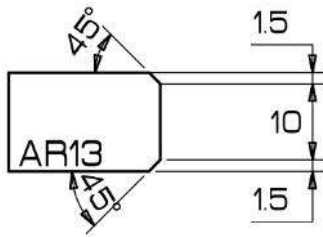

[BACK TO INDEX](#)



**Ninja Composition**  
AR13

Position	<b>TopLine</b> STONE DIVISION				<b>FastLine</b> STONE DIVISION				<b>TwistLine</b> STONE DIVISION					<b>MicronLine</b> STONE DIVISION			
	Code	Type	ID	ED	Code	Type	ID	ED	Code	Type	ID	ED	Price [€]	Code	Type	ID	ED
1					PB124431	Cr+S	75	80	PB161387	Cr+S	40	45	285	PB201017	2 Seg	20	25
2					PB124432	Cr+S	75	80	PB161388	Cr+S	40	45	285	PB201018	2 Seg	20	25
3					PB124433	Cr+S	75	80	PB161389	Cr+S	40	45	285	PB201019	2 Seg	20	25
4					PB124434	Cr+S	75	80	PB161390	Cr+S	40	45	285	PB201020	2 Seg	20	25
MFP5					PB01687	MFP5	75	80	PB11551	MFP5	40	45	299	PB015019	Mfp5	20	25
5					PB021730	Exp	60	70	PB02753	Exp	40	45	155	PB021170	Exp	20	25
6					PB021731	Exp	60	70	PB02754	Exp	40	45	155	PB021171	Exp	20	25
7					PB021732	Exp	60	70	PB02755	Exp	40	45	155	PB021172	Exp	20	25
6					PB69479	Magic	72	80	PB68154	Magic	45	53		PB67085	Magic	20	35
7					PB69480	Magic	72	80	PB68155	Magic	45	53		PB67086	Magic	20	35

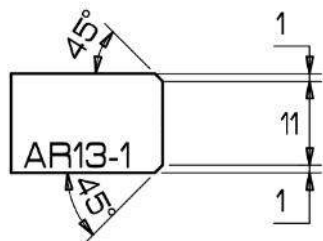

**Ninja Composition**  
AR13-1

Position	<b>TopLine</b> STONE DIVISION				<b>FastLine</b> STONE DIVISION				<b>TwistLine</b> STONE DIVISION					<b>MicronLine</b> STONE DIVISION			
	Code	Type	ID	ED	Code	Type	ID	ED	Code	Type	ID	ED	Price [€]	Code	Type	ID	ED
1					PB124435	Cr+S	75	80	PB161391	Cr+S	40	45	285	PB20918	2 Seg	20	25
2					PB124436	Cr+S	75	80	PB161392	Cr+S	40	45	285	PB20919	2 Seg	20	25
3					PB124437	Cr+S	75	80	PB161393	Cr+S	40	45	285	PB20920	2 Seg	20	25
4					PB124438	Cr+S	75	80	PB161394	Cr+S	40	45	285	PB20921	2 Seg	20	25
MFP5					PB01688	MFP5	75	80	PB11552	MFP5	40	45	299	PB015020	Mfp5	20	25
5					PB021721	Exp	60	70	PB02756	Exp	40	45	155	PB021122	Exp	20	25
6					PB021722	Exp	60	70	PB02757	Exp	40	45	155	PB021123	Exp	20	25
7					PB021723	Exp	60	70	PB02758	Exp	40	45	155	PB021124	Exp	20	25
6					PB69482	Magic	55	80	PB68157	Magic	45	50		PB67088	Magic	20	35
7					PB69483	Magic	55	80	PB68158	Magic	45	50		PB67089	Magic	20	35

[BACK TO INDEX](#)

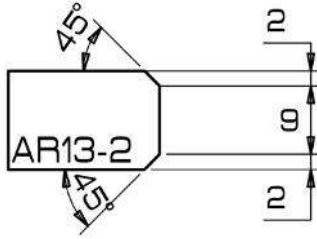

**Ninja Composition**  
AR13-2

Position	<b>TopLine</b> STONE DIVISION				<b>FastLine</b> STONE DIVISION				<b>TwistLine</b> STONE DIVISION				<b>MicronLine</b> STONE DIVISION			
	Code	Type	ID	ED	Code	Type	ID	ED	Code	Type	ID	ED	Code	Type	ID	ED
1					PB123664	Cr+S	75	80					PB161395	Cr+S	40	45
2					PB123665	Cr+S	75	80					PB161396	Cr+S	40	45
3					PB123666	Cr+S	75	80					PB161397	Cr+S	40	45
4					PB123667	Cr+S	75	80					PB161398	Cr+S	40	45
MFP5					PB01689	MFP5	75	80					PB11553	MFP5	40	45
5					PB021724	Exp	60	70					PB02759	Exp	40	45
6					PB021725	Exp	60	70					PB02760	Exp	40	45
7					PB021726	Exp	60	70					PB02761	Exp	40	45
6					PB691206	Magic	55	60					PB68199	Magic	45	51
7					PB691207	Magic	55	60					PB68200	Magic	45	51

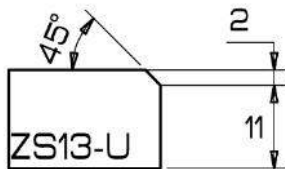

**Ninja Composition**  
ZS13-U

Position	<b>TopLine</b> STONE DIVISION				<b>FastLine</b> STONE DIVISION				<b>TwistLine</b> STONE DIVISION				<b>MicronLine</b> STONE DIVISION							
	Code	Type	ID	ED	Code	Type	ID	ED	Code	Type	ID	ED	Code	Type	ID	ED				
1													PB161399	Cr+S	40	45	PB201161	2 Seg	20	25
2													PB161400	Cr+S	40	45	PB201162	2 Seg	20	25
3													PB161401	Cr+S	40	45	PB201163	2 Seg	20	25
4													PB161402	Cr+S	40	45	PB201164	2 Seg	20	25
MFP5													PB11554	MFP5	40	45	PB015021	Mfp5	20	25
5													PB02741	Exp	40	45	PB021188	Exp	20	25
6													PB02742	Exp	40	45	PB021189	Exp	20	25
7													PB02743	Exp	40	45	PB021190	Exp	20	25
6													PB68160	Magic	45	51	PB67163	Magic	20	35
7													PB68161	Magic	45	51	PB67164	Magic	20	35

[BACK TO INDEX](#)

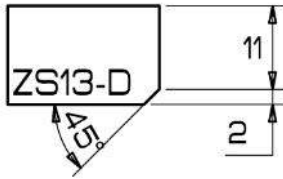

**Ninja Composition**  
ZS13-D

Position	TopLine STONE DIVISION				FastLine STONE DIVISION				TwistLine STONE DIVISION				MicronLine STONE DIVISION				
	Code	Type	ID	ED	Code	Type	ID	ED	Code	Type	ID	ED	Code	Type	ID	ED	
1													PB201165	2 Seg	20	25	
2													PB201166	2 Seg	20	25	
3													PB201167	2 Seg	20	25	
4													PB201168	2 Seg	20	25	
MFP5													PB015022	Mfp5	20	25	
5													PB021191	Exp	20	25	
6													PB021192	Exp	20	25	
7													PB021193	Exp	20	25	
6													PB67166	Magic	20	35	
7													PB67167	Magic	20	35	

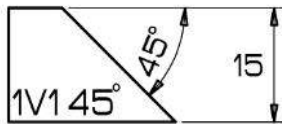

**Ninja Composition**  
1V1 45° S15

Position	TopLine STONE DIVISION				FastLine STONE DIVISION				TwistLine STONE DIVISION				MicronLine STONE DIVISION			
	Code	Type	ID	ED	Code	Type	ID	ED	Code	Type	ID	ED	Code	Type	ID	ED
1					PB123734	Sed	66	100								
2					PB123735	Cr+S	66	100								
3					PB123736	Cr+S	66	100								
4					PB123737	Cr+S	66	100								
MFP5					PB01848	MFP5	66	100								
5					PB021569	Exp	60	108								
6					PB021570	Exp	60	108								
7					PB021571	Exp	60	108								
6					PB69455	Magic	56	120								
7					PB69456	Magic	56	120								

[BACK TO INDEX](#)

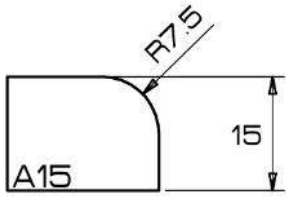

**Ninja Composition**  
A15

Position	TopLine STONE DIVISION				FastLine STONE DIVISION				TwistLine STONE DIVISION				MicronLine STONE DIVISION			
	Code	Type	ID	ED												
1	PB124292	Seg	100	120												
2	PB124293	Cr+S	100	120												
3	PB124294	Cr+S	100	120												
4	PB124295	Cr+S	100	120												
MFP5	PB01644	MFP5	100	120												
5	PB021563	Exp	60	80												
6	PB021564	Exp	60	80												
7	PB021565	Exp	60	80												
6	PB691245	Magic	63	80												
7	PB691246	Magic	63	80												

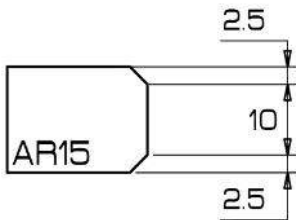

**Ninja Composition**  
AR15

Position	TopLine STONE DIVISION				FastLine STONE DIVISION				TwistLine STONE DIVISION				MicronLine STONE DIVISION			
					Code	Type	ID	ED					Code	Type	ID	ED
1					PB123513	Cr+S	70	80					PB201025	2 Seg	20	25
2					PB123514	Cr+S	70	80					PB201026	2 Seg	20	25
3					PB123515	Cr+S	70	80					PB201027	2 Seg	20	25
4					PB123516	Cr+S	70	80					PB201028	2 Seg	20	25
MFP5					PB01690	MFP5	70	80					PB015023	Mfp5	20	25
5					PB021730	Exp	60	70					PB021173	Exp	20	25
6					PB021731	Exp	60	70					PB021174	Exp	20	25
7					PB021732	Exp	60	70					PB021175	Exp	20	25
6					PB69485	Magic	72	80					PB67091	Magic	20	35
7					PB69486	Magic	72	80					PB67092	Magic	20	35

BACK TO INDEX

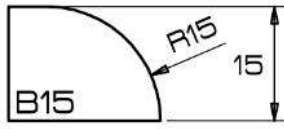

**Ninja Composition**  
B15

Position	<b>TopLine</b> STONE DIVISION				<b>FastLine</b> STONE DIVISION				<b>TwistLine</b> STONE DIVISION				<b>MicronLine</b> STONE DIVISION			
	Code	Type	ID	ED												
1	PB124439	Seg	70	105												
2	PB124440	Seg	70	105												
3	PB124441	Seg	70	105												
4	PB124442	Seg	70	105												
MFP5	-	MFP5	-	-												
5	PB021727	Exp	60	95												
6	PB021728	Exp	60	95												
7	PB021729	Exp	60	95												
6	PB691221	Magic	62	97												
7	PB691222	Magic	62	97												

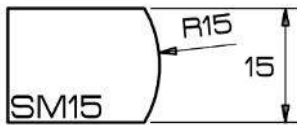

**Ninja Composition**  
SM15

Position	<b>TopLine</b> STONE DIVISION				<b>FastLine</b> STONE DIVISION				<b>TwistLine</b> STONE DIVISION				<b>MicronLine</b> STONE DIVISION			
	Code	Type	ID	ED												
1	PB124443	Cr+S	74	80												
2	PB124444	Cr+S	74	80												
3	PB124445	Cr+S	74	80												
4	PB124446	Cr+S	74	80												
MFP5	PB01691	MFP5	74	80												
5	PB021733	Exp	60	67												
6	PB021734	Exp	60	67												
7	PB021735	Exp	60	67												
6	PB691227	Magic	55	60												
7	PB691228	Magic	55	60												



[BACK TO INDEX](#)

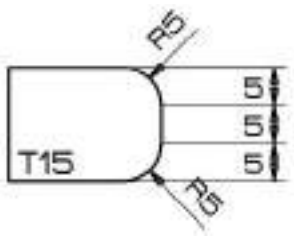

**Ninja Composition**  
T15

Position	TopLine STONE DIVISION					FastLine STONE DIVISION				TwistLine STONE DIVISION					MicronLine STONE DIVISION				
						Code	Type	ID	ED										
1						PB124447	Seg	70	85										
2						PB124448	Seg	70	85										
3						PB124449	Seg	70	85										
4						PB124450	Seg	70	85										
MFP5						-	MFP5	-	-										
5						PB021736	Exp	60	75										
6						PB021737	Exp	60	75										
7						PB021738	Exp	60	75										
6						PB691230	Magic	65	80										
7						PB691231	Magic	65	80										

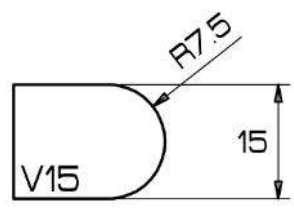

**Ninja Composition**  
V15

Position	TopLine STONE DIVISION					FastLine STONE DIVISION				TwistLine STONE DIVISION					MicronLine STONE DIVISION				
						Code	Type	ID	ED										
1						PB124451	Seg	70	90										
2						PB124452	Seg	70	90										
3						PB124453	Seg	70	90										
4						PB124454	Seg	70	90										
MFP5						-	MFP5	-	-										
5						PB021739	Exp	60	80										
6						PB021740	Exp	60	80										
7						PB021741	Exp	60	80										
6						PB691006	Magic	59	80										
7						PB691007	Magic	59	80										

[BACK TO INDEX](#)



**Ninja Composition**  
Z15

Position	<b>TopLine</b> STONE DIVISION				<b>FastLine</b> STONE DIVISION				<b>TwistLine</b> STONE DIVISION				<b>MicronLine</b> STONE DIVISION			
					Code	Type	ID	ED								
1					PB123483	Seg	80	80								
2					PB123484	Cr+S	80	80								
3					PB123485	Cr+S	80	80								
4					PB123486	Cr+S	80	80								
MFP5					PB01629	MFP5	80	80								
5					PB021931	Exp	60	60								
6					PB021932	Exp	60	60								
7					PB021933	Exp	60	60								
6					PB69403	Magic	78	78								
7					PB69404	Magic	78	78								

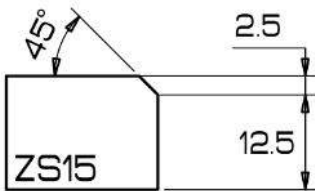



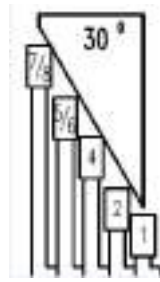
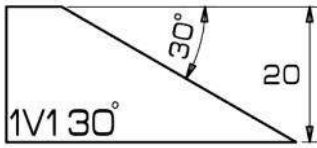

**Ninja Composition**  
ZS15

Position	<b>TopLine</b> STONE DIVISION				<b>FastLine</b> STONE DIVISION				<b>TwistLine</b> STONE DIVISION				<b>MicronLine</b> STONE DIVISION			
					Code	Type	ID	ED								
1					PB124455	Cr+S	70	80								
2					PB124456	Cr+S	70	80								
3					PB124457	Cr+S	70	80								
4					PB124458	Cr+S	70	80								
MFP5					PB01692	MFP5	70	80								
5					PB021712	Exp	60	70								
6					PB021713	Exp	60	70								
7					PB021714	Exp	60	70								
6					PB69488	Magic	54	60								
7					PB69489	Magic	54	60								

[BACK TO INDEX](#)





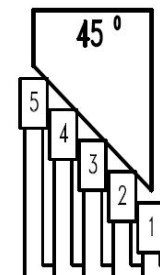
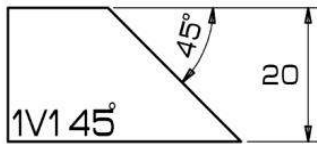

**Ninja Composition**  
1V1 30° S20

Position	 <b>TopLine</b> STONE DIVISION				 <b>FastLine</b> STONE DIVISION				 <b>TwistLine</b> STONE DIVISION				 <b>MicronLine</b> STONE DIVISION			
	Code	Type	ID	ED												
1	PB123805	Seg	70	140												
2	PB123806	Cr+S	54	140												
3	PB123807	Cr+S	54	140												
4	PB123808	Cr+S	54	140												
MFP5	PB01645	MFP5	54	140												
5	PB021566	Exp	60	110												
6	PB021567	Exp	60	110												
7	PB021568	Exp	60	110												
6	PB69901	Magic	56	139												
7	PB69902	Magic	56	139												



**Ninja Composition**  
1V1 45° S20

Position	 <b>TopLine</b> STONE DIVISION				 <b>FastLine</b> STONE DIVISION				 <b>TwistLine</b> STONE DIVISION				 <b>MicronLine</b> STONE DIVISION			
	Code	Type	ID	ED												
1	PB123247	Seg	66	210												
2	PB123248	Cr+S	72	120												
3	PB123249	Cr+S	72	120												
4	PB123250	Cr+S	72	120												
MFP5	PB01646	MFP5	72	120												
5	PB021569	Exp	60	110												
6	PB021570	Exp	60	110												
7	PB021571	Exp	60	110												
6	PB69455	Magic	56	120												
7	PB69456	Magic	56	120												

[BACK TO INDEX](#)



**Ninja Composition**  
A20

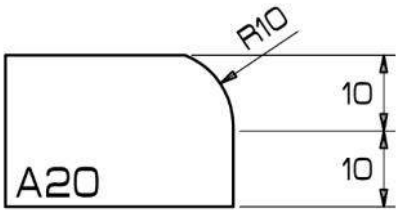

Position	<b>TopLine</b> STONE DIVISION				<b>FastLine</b> STONE DIVISION				<b>TwistLine</b> STONE DIVISION				<b>MicronLine</b> STONE DIVISION			
	Code	Type	ID	ED	Code	Type	ID	ED	Code	Type	ID	ED				
1	PB122682	Seg	98	120	PB123150	Seg	71	93	PB161209	Seg	40	62				
2	PB122683	Cr+S	98	120	PB123151	Cr+S	70	93	PB161210	Cr+S	40	66				
3	PB122684	Cr+S	98	120	PB123152	Cr+S	70	93	PB161211	Cr+S	40	66				
4	PB122685	Cr+S	98	120	PB123153	Cr+S	70	93	PB161212	Cr+S	40	66				
MFP5	PB01501	MFP5	70	93	PB01501	MFP5	70	93	PB11501	MFP5	40	66				
5	PB02001	Exp	60	90	PB02001	Exp	60	90	PB02601	Exp	40	66				
6	PB02002	Exp	60	90	PB02002	Exp	60	90	PB02602	Exp	40	66				
7	PB02003	Exp	60	90	PB02003	Exp	60	90	PB02603	Exp	40	66				
6	PB69001	Magic	67	90	PB69001	Magic	67	90	PB68001	Magic	45	67				
7	PB69002	Magic	67	90	PB69002	Magic	67	90	PB68002	Magic	45	67				



**Ninja Composition**  
SM10

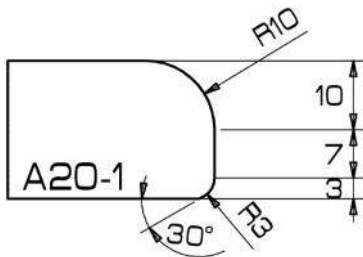

Position	<b>TopLine</b> STONE DIVISION				<b>FastLine</b> STONE DIVISION				<b>TwistLine</b> STONE DIVISION				<b>MicronLine</b> STONE DIVISION			
	Code	Type	ID	ED					Code	Type	ID	ED				
1	PB122682	Seg	98	120					PB161209	Seg	40	62				
2	PB123888	Cr+S	99	120					PB161324	Cr+S	40	64				
3	PB123889	Cr+S	99	120					PB161325	Cr+S	40	64				
4	PB123890	Cr+S	99	120					PB161326	Cr+S	40	64				
MFP5	PB01595	MFP5	99	120					PB11555	MFP5	40	64				
5	PB02446	Exp	60	90					PB02765	Exp	40	64				
6	PB02447	Exp	60	90					PB02766	Exp	40	64				
7	PB02448	Exp	60	90					PB02767	Exp	40	64				
6	PB69331	Magic	58	79					PB68163	Magic	45	66				
7	PB69332	Magic	58	79					PB68164	Magic	45	66				

[BACK TO INDEX](#)



**Ninja Composition**

A20-3

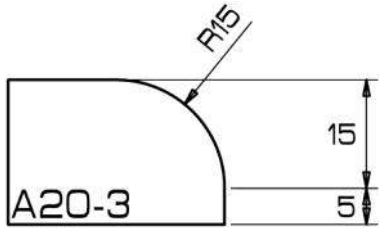

Position	<b>TopLine</b> STONE DIVISION					<b>FastLine</b> STONE DIVISION				<b>TwistLine</b> STONE DIVISION				<b>MicronLine</b> STONE DIVISION				
	Code	Type	ID	ED		Code	Type	ID	ED									
1	PB123307	Seg	88	120		PB124459	Seg	60	92									
2	PB123308	Cr+S	88	120		PB123415	Cr+S	58	90									
3	PB123309	Cr+S	88	120		PB123416	Cr+S	58	90									
4	PB123310	Cr+S	88	120		PB123417	Cr+S	58	90									
MFP5	PB01648	MFP5	58	90		PB01648	MFP5	58	90									
5	PB021715	Exp	60	95		PB021715	Exp	60	95									
6	PB021716	Exp	60	95		PB021716	Exp	60	95									
7	PB021717	Exp	60	95		PB021717	Exp	60	95									
6	PB69904	Magic		93		PB69904	Magic	61	93									
7	PB69905	Magic		93		PB69905	Magic	61	93									

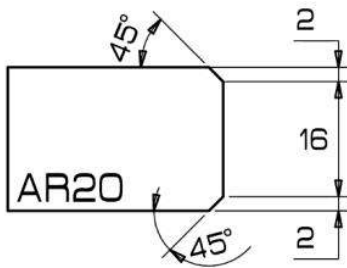

**Ninja Composition**

AR20

Position	<b>TopLine</b> STONE DIVISION					<b>FastLine</b> STONE DIVISION				<b>TwistLine</b> STONE DIVISION				<b>MicronLine</b> STONE DIVISION					
	Code	Type	ID	ED		Code	Type	ID	ED					Code	Type	ID	ED		
1						PB122847	Cr+S	70	78		PB161213	Cr+S	40	50		PB20593	2 Seg	20	25
2						PB122848	Cr+S	70	78		PB161214	Cr+S	40	50		PB20594	2 Seg	20	25
3						PB122849	Cr+S	70	78		PB161215	Cr+S	40	50		PB20595	2 Seg	20	25
4						PB122850	Cr+S	70	78		PB161216	Cr+S	40	50		PB20596	2 Seg	20	25
MFP5						PB01507	MFP5	70	78		PB11503	MFP5	40	50		PB015008	Mfp5	20	25
5						PB02013	Exp	60	68		PB02664	Exp	40	48		PB021004	Exp	20	28
6						PB02014	Exp	60	68		PB02665	Exp	40	48		PB021005	Exp	20	28
7						PB02015	Exp	60	68		PB02666	Exp	40	48		PB021006	Exp	20	38
6						PB69154	Magic	72	80		PB68010	Magic	45	53		PB67001	Magic	20	33
7						PB69155	Magic	72	80		PB68011	Magic	45	53		PB67002	Magic	20	33

[BACK TO INDEX](#)



**Ninja Composition**

AR20-1

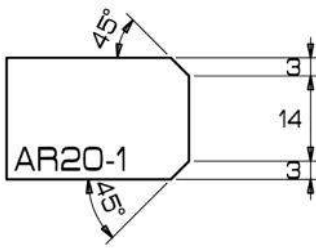

Position	<b>TopLine</b> STONE DIVISION				<b>FastLine</b> STONE DIVISION				<b>TwistLine</b> STONE DIVISION				<b>MicronLine</b> STONE DIVISION							
	Code	Type	ID	ED	Code	Type	ID	ED	Code	Type	ID	ED	Code	Type	ID	ED				
1					PB123532	Cr+S	68	78					PB161403	Cr+S	40	57				
2					PB123533	Cr+S	68	78					PB161404	Cr+S	40	57				
3					PB123534	Cr+S	68	78					PB161405	Cr+S	40	57				
4					PB123535	Cr+S	68	78					PB161406	Cr+S	40	57				
MFP5					PB01694	MFP5	68	78					PB11556	MFP5	40	57				
5					PB021745	Exp	60	70					PB02768	Exp	40	50				
6					PB021746	Exp	60	70					PB02769	Exp	40	50				
7					PB021747	Exp	60	70					PB02770	Exp	40	50				
6					PB69907	Magic	72	80					PB68106	Magic	52	60				
7					PB69908	Magic	72	80					PB68107	Magic	52	60				



**Ninja Composition**

AR20-3

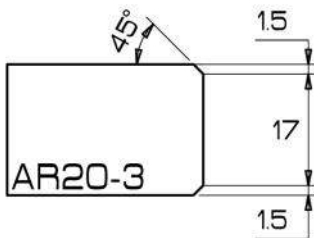

Position	<b>TopLine</b> STONE DIVISION				<b>FastLine</b> STONE DIVISION				<b>TwistLine</b> STONE DIVISION				<b>MicronLine</b> STONE DIVISION							
	Code	Type	ID	ED	Code	Type	ID	ED	Code	Type	ID	ED	Code	type	ID	ED				
1					PB124460	Cr+S	70	78					PB161407	Cr+S	40	50				
2					PB124461	Cr+S	70	78					PB161408	Cr+S	40	50				
3					PB124462	Cr+S	70	78					PB161409	Cr+S	40	50				
4					PB124463	Cr+S	70	78					PB161410	Cr+S	40	50				
MFP5					PB01695	MFP5	70	78					PB11557	MFP5	40	50				
5					PB021748	Exp	60	70					PB02771	Exp	40	48				
6					PB021749	Exp	60	70					PB02772	Exp	40	48				
7					PB021750	Exp	60	70					PB02773	Exp	40	48				
6					PB69910	Magic	72	80					PB68166	Magic	45	53				
7					PB69911	Magic	72	80					PB68167	Magic	45	53				

[BACK TO INDEX](#)

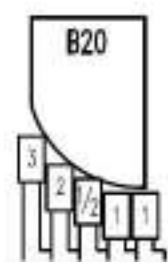
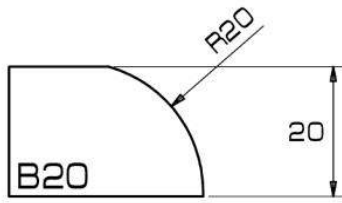

**Ninja Composition**  
B20

Position	<b>TopLine</b> STONE DIVISION					<b>FastLine</b> STONE DIVISION				<b>TwistLine</b> STONE DIVISION				<b>MicronLine</b> STONE DIVISION					
	Code	Type	ID	ED		Code	Type	ID	ED		Code	Type	ID	ED					
1	PB122667	Seg	76	120		PB123903	Seg	56	100		PB161169	Seg	40	84					
2	PB122668	Cr+S	76	120		PB123904	Cr+S	56	100		PB161170	Cr+S	40	84					
3	PB122669	Cr+S	76	120		PB123905	Cr+S	56	100		PB161171	Cr+S	40	84					
4	PB122670	Cr+S	76	120		PB124115	Cr+S	56	100		PB161172	Cr+S	40	84					
MFP5	PB01513	MFP5	56	100		PB01513	MFP5	56	100		PB11531	MFP5	40	84					
5	PB02028	Exp	60	110		PB02028	Exp	60	110		PB02610	Exp	40	85					
6	PB02029	Exp	60	110		PB02029	Exp	60	110		PB02611	Exp	40	85					
7	PB02030	Exp	60	110		PB02030	Exp	60	110		PB02612	Exp	40	85					
6	PB69013	Magic	70	114		PB69013	Magic	70	114		PB68019	Magic	45	89					
7	PB69014	Magic	70	114		PB69014	Magic	70	114		PB68020	Magic	45	89					

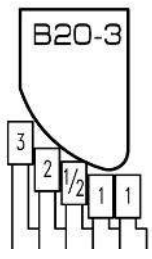
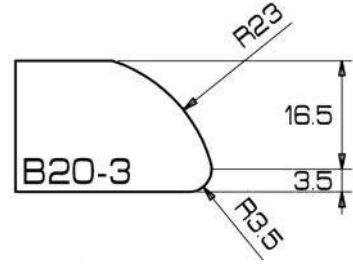

**Ninja Composition**  
B20-3

Position	<b>TopLine</b> STONE DIVISION					<b>FastLine</b> STONE DIVISION				<b>TwistLine</b> STONE DIVISION				<b>MicronLine</b> STONE DIVISION					
	Code	Type	ID	ED															
1	PB123891	Seg	82	120															
2	PB123892	Cr+S	83	120															
3	PB123893	Cr+S	83	120															
4	PB123894	Cr+S	83	120															
MFP5	PB01649	MFP5	83	120															
5	PB02301	Exp	60	100															
6	PB02302	Exp	60	100															
7	PB02303	Exp	60	100															
6	PB69337	Magic	58	97															
7	PB69338	Magic	58	97															

[BACK TO INDEX](#)

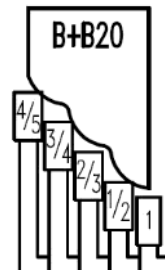
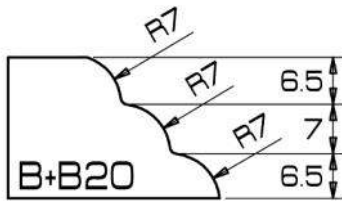

**Ninja Composition**  
B+B20

Position	TopLine STONE DIVISION				FastLine STONE DIVISION				TwistLine STONE DIVISION				MicronLine STONE DIVISION			
	Code	Type	ID	ED												
1	PB123220	Seg	76	120												
2	PB122676	Cr+S	76	120												
3	PB122677	Cr+S	76	120												
4	PB122678	Cr+S	76	120												
MFP5	PB01517	MFP5	76	120												
5	PB02040	Exp	60	110												
6	PB02041	Exp	60	110												
7	PB02042	Exp	60	110												
6	PB69025	Magic	76	120												
7	PB69026	Magic	76	120												

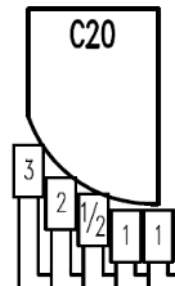
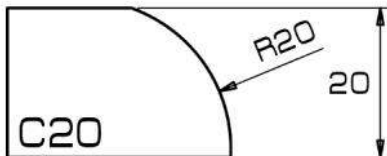



**Ninja Composition**  
C20

Position	TopLine STONE DIVISION				FastLine STONE DIVISION				TwistLine STONE DIVISION				MicronLine STONE DIVISION			
	Code	Type	ID	ED												
1	PB124464	Seg	60	90												
2	PB124465	Cr+S	60	90												
3	PB124466	Cr+S	60	90												
4	PB124467	Cr+S	60	90												
MFP5	PB01696	MFP5	60	90												
5	PB021751	Exp	60	89												
6	PB021752	Exp	60	89												
7	PB021753	Exp	60	89												
6	PB69913	Magic	68	97												
7	PB69914	Magic	68	97												



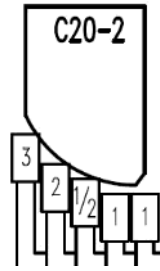
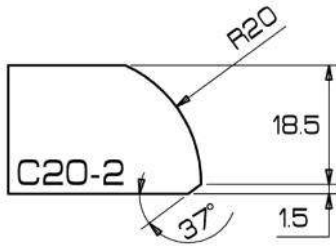

[BACK TO INDEX](#)





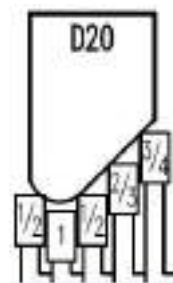
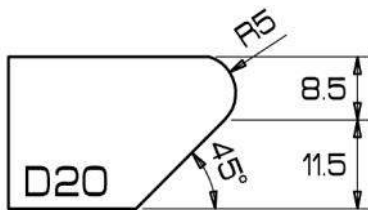

 **Ninja Composition**  
C20-2

 <b>TopLine</b> STONE DIVISION					 <b>FastLine</b> STONE DIVISION				 <b>TwistLine</b> STONE DIVISION				 <b>MicronLine</b> STONE DIVISION			
Position					Code	Type	ID	ED								
1					PB123907	Seg	71	100								
2					PB123908	Cr+S	71	100								
3					PB123909	Cr+S	71	100								
4					PB123910	Cr+S	71	100								
MFP5					PB01612	MFP5	71	100								
5					PB02467	Exp	60	90								
6					PB02468	Exp	60	90								
7					PB02469	Exp	60	90								
6					PB69364	Magic	68	97								
7					PB69365	Magic	68	97								



 **Ninja Composition**  
D20

 <b>TopLine</b> STONE DIVISION					 <b>FastLine</b> STONE DIVISION				 <b>TwistLine</b> STONE DIVISION				 <b>MicronLine</b> STONE DIVISION			
Position	Code	Type	ID	ED												
1	PB122698	Seg	87	120												
2	PB122699	Cr+S	87	120												
3	PB122700	Cr+S	87	120												
4	PB122701	Cr+S	87	120												
MFP5	PB01521	MFP5	87	120												
5	PB02052	Exp	60	91												
6	PB02053	Exp	60	91												
7	PB02054	Exp	60	91												
6	PB69037	Magic	64	97												
7	PB69038	Magic	64	97												

[BACK TO INDEX](#)



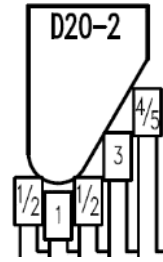
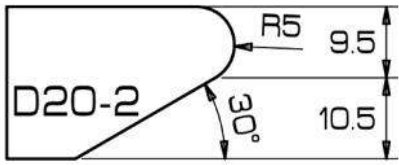

 **Ninja Composition**  
D20-2

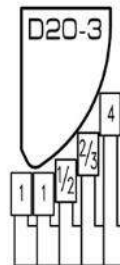
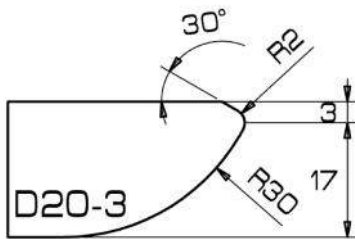

Position	 <b>TopLine</b> STONE DIVISION				 <b>FastLine</b> STONE DIVISION				 <b>TwistLine</b> STONE DIVISION				 <b>MicronLine</b> STONE DIVISION			
	Code	Type	ID	ED												
1	PB124304	Seg	72	210												
2	PB124305	Cr+S	72	120												
3	PB124306	Cr+S	72	120												
4	PB124307	Cr+S	72	120												
MFP5	PB01650	MFP5	72	120												
5	PB021417	Exp	60	108												
6	PB021418	Exp	60	108												
7	PB021419	Exp	60	108												
6	PB69916	Magic	58	106												
7	PB69917	Magic	58	106												

 **Ninja Composition**  
D20-3





Position	 <b>TopLine</b> STONE DIVISION				 <b>FastLine</b> STONE DIVISION				 <b>TwistLine</b> STONE DIVISION				 <b>MicronLine</b> STONE DIVISION			
	Code	Type	ID	ED												
1	PB122978	Seg	68	138												
2	PB122979	Cr+S	68	138												
3	PB122980	Cr+S	68	138												
4	PB122981	Cr+S	68	138												
MFP5	PB01599	MFP5	68	138												
5	PB02455	Exp	60	130												
6	PB02456	Exp	60	130												
7	PB02457	Exp	60	130												
6	PB69343	Magic	58	128												
7	PB69344	Magic	58	128												

[BACK TO INDEX](#)

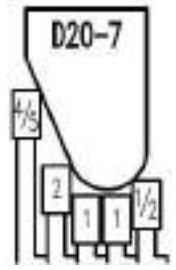
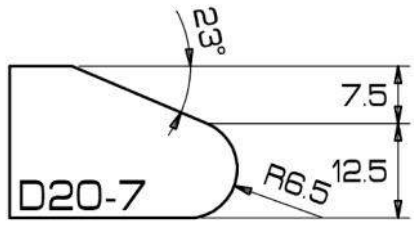



 **Ninja Composition**  
D20-7

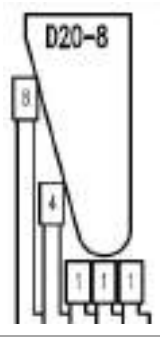
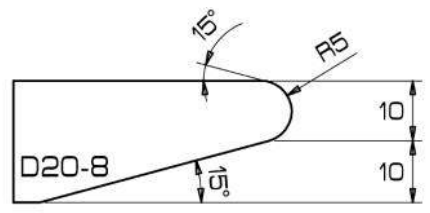

Position	 <b>TopLine</b> STONE DIVISION				 <b>FastLine</b> STONE DIVISION				 <b>TwistLine</b> STONE DIVISION				 <b>MicronLine</b> STONE DIVISION			
	Code	Type	ID	ED												
1	PB124655	Seg	60	136												
2	PB124656	Cr+S	60	136												
3	PB124657	Cr+S	60	136												
4	PB124658	Cr+S	60	136												
MFP5	PB01835	MFP5	60	136												
5	PB021916	Exo	60	136												
6	PB021917	Exp	60	136												
7	PB021918	Exp	60	136												
6	PB691287	Magic	57	133												
7	PB691288	Magic	57	133												

 **Ninja Composition**  
D20-8



Position	 <b>TopLine</b> STONE DIVISION				 <b>FastLine</b> STONE DIVISION				 <b>TwistLine</b> STONE DIVISION				 <b>MicronLine</b> STONE DIVISION			
	Code	Type	ID	ED												
1	PB124668	Seg	60	150												
2	PB124669	Cr+S	60	150												
3	PB124670	Cr+S	60	150												
4	PB124671	Cr+S	60	150												
MFP5	PB01843	MFP5	60	150												
5	PB021434	Exp	60	150												
6	PB021435	Exp	60	150												
7	PB021436	Exp	60	150												
6	PB691308	Magic	57	147												
7	PB691309	Magic	57	147												

[BACK TO INDEX](#)



**Ninja Composition**

D20-11

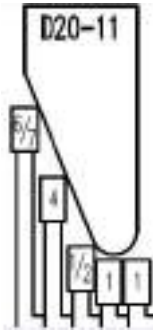
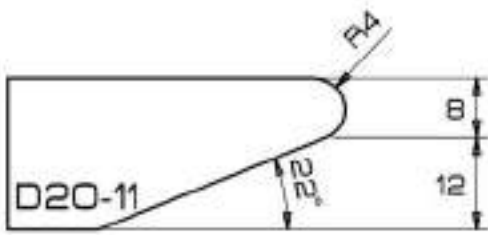

Position	<b>TopLine</b> STONE DIVISION				<b>FastLine</b> STONE DIVISION				<b>TwistLine</b> STONE DIVISION				<b>MicronLine</b> STONE DIVISION			
	Code	Type	ID	ED												
1	PB124308	Seg	60	136												
2	PB124309	Cr+S	60	136												
3	PB124310	Cr+S	60	136												
4	PB124311	Cr+S	60	136												
MFP5	PB01651	MFP5	60	136												
5	PB021420	Exp	60	136												
6	PB021421	Exp	60	136												
7	PB021422	Exp	60	136												
6	PB691142	Magic	57	133												
7	PB691143	Magic	57	133												

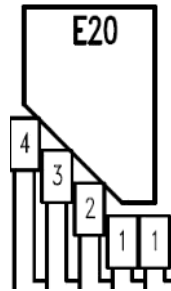
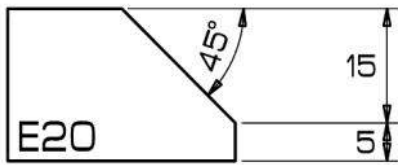

**Ninja Composition**

E20

Position	<b>TopLine</b> STONE DIVISION				<b>FastLine</b> STONE DIVISION				<b>TwistLine</b> STONE DIVISION				<b>MicronLine</b> STONE DIVISION			
	Code	Type	ID	ED					Code	Type	ID	ED				
1	PB124312	Seg	88	120					PB161411	Seg	40	72				
2	PB124313	Cr+S	88	120					PB161412	Cr+S	40	72				
3	PB124314	Cr+S	88	120					PB161413	Cr+S	40	72				
4	PB124315	Cr+S	88	120					PB161414	Cr+S	40	72				
MFP5	PB01652	MFP5	88	120					PB11558	MFP5	40	72				
5	PB021510	Exp	55	100					PB02774	Exp	40	72				
6	PB021511	Exp	55	100					PB02775	Exp	40	72				
7	PB021512	Exp	55	100					PB02776	Exp	40	72				
6	PB69919	Magic	65	97					PB68109	Magic	45	77				
7	PB69920	Magic	65	97					PB68110	Magic	45	77				

[BACK TO INDEX](#)

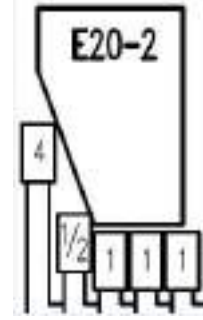
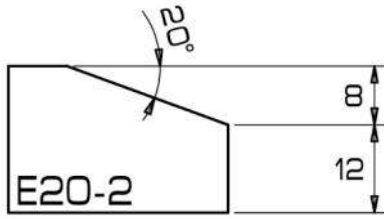

**Ninja Composition**  
E20-2

Position	TopLine STONE DIVISION				FastLine STONE DIVISION				TwistLine STONE DIVISION				MicronLine STONE DIVISION			
	Code	Type	ID	ED												
1	PB123835	Seg	72	120												
2	PB124316	Cr+S	72	120												
3	PB123836	Cr+S	72	120												
4	PB124317	Cr+S	72	120												
MFP5	PB01653	MFP5	72	120												
5	PB021516	Exp	60	108												
6	PB021572	Exp	60	108												
7	PB021573	Exp	60	108												
6	PB69922	Magic	63	111												
7	PB69923	Magic	63	111												

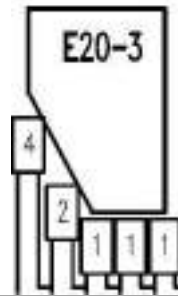
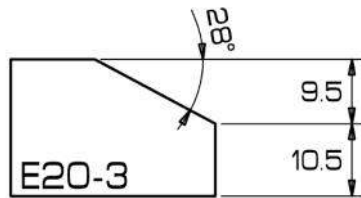

**Ninja Composition**  
E20-3

Position	TopLine STONE DIVISION				FastLine STONE DIVISION				TwistLine STONE DIVISION				MicronLine STONE DIVISION			
	Code	Type	ID	ED												
1	PB124101	Seg	73	110												
2	PB124102	Cr+S	73	110												
3	PB124103	Cr+S	73	110												
4	PB124104	Cr+S	73	110												
MFP5	PB01626	MFP5	73	110												
5	PB021513	Exp	60	100												
6	PB021514	Exp	60	100												
7	PB021515	Exp	60	100												
6	PB69925	Magic	60	97												
7	PB69926	Magic	60	97												

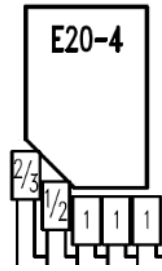
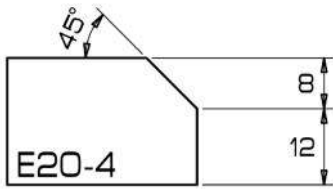

[BACK TO INDEX](#)



**Ninja Composition**  
E20-4

Position	TopLine STONE DIVISION				FastLine STONE DIVISION				TwistLine STONE DIVISION				MicronLine STONE DIVISION			
	Code	Type	ID	ED												
1	PB123146	Seg	100	120												
2	PB123147	Seg	100	120												
3	PB123148	Seg	100	120												
4	PB123149	Seg	100	120												
MFP5	-	MFP5	-	-												
5	PB02391	Exp	60	84												
6	PB02392	Exp	60	84												
7	PB02393	Exp	60	84												
6	PB69943	Magic	60	80												
7	PB69944	Magic	60	80												

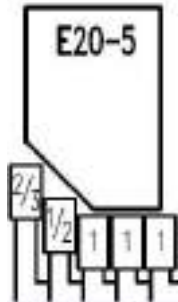
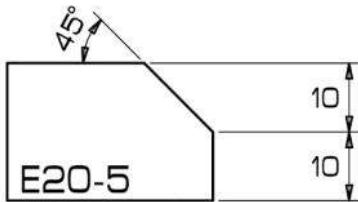

**Ninja Composition**  
E20-5

Position	TopLine STONE DIVISION				FastLine STONE DIVISION				TwistLine STONE DIVISION				MicronLine STONE DIVISION			
	Code	Type	ID	ED												
1					PB123383	Seg	70	94								
2					PB123384	Seg	70	94								
3					PB123385	Seg	70	94								
4					PB123386	Seg	70	94								
MFP5					-	MFP5	-	-								
5					PB021754	Exp	60	84								
6					PB021755	Exp	60	84								
7					PB021756	Exp	60	84								
6					PB69946	Magic	56	80								
7					PB69947	Magic	56	80								

[BACK TO INDEX](#)

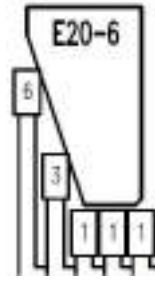
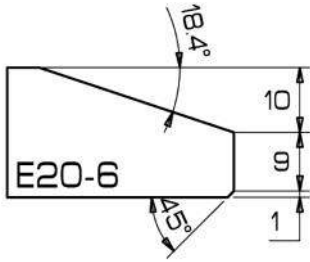

**Ninja Composition**  
E20-6

Position	TopLine STONE DIVISION				FastLine STONE DIVISION				TwistLine STONE DIVISION				MicronLine STONE DIVISION			
	Code	Type	ID	ED												
1	PB123655	Seg	65	145												
2	PB123656	Cr+S	60	140												
3	PB123657	Cr+S	60	140												
4	PB123658	Cr+S	60	140												
MFP5	PB01605	MFP5	60	140												
5	PB02458	Exp	60	140												
6	PB02459	Exp	60	140												
7	PB02460	Exp	60	140												
6	PB69346	Magic	64	144												
7	PB69347	Magic	64	144												

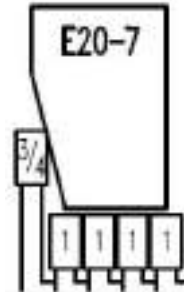
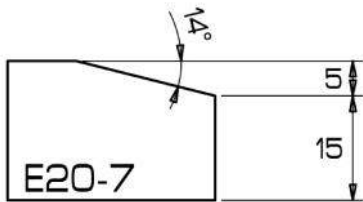

**Ninja Composition**  
E20-7

Position	TopLine STONE DIVISION				FastLine STONE DIVISION				TwistLine STONE DIVISION				MicronLine STONE DIVISION			
	Code	Type	ID	ED												
1	PB124567	Seg	70	120												
2	PB124568	Seg	70	120												
3	PB124569	Seg	70	120												
4	PB124570	Seg	70	120												
MFP5	-	MFP5	-	-												
5	PB021574	Exp	60	124												
6	PB021575	Exp	60	124												
7	PB021576	Exp	60	124												
6	PB69949	Magic	74	120												
7	PB69950	Magic	74	120												

[BACK TO INDEX](#)

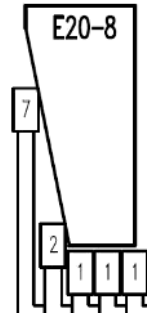
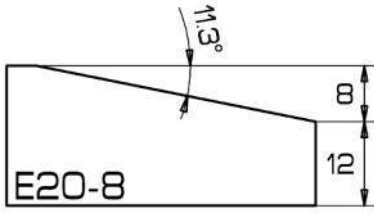

**Ninja Composition**  
E20-8

Position	<b>TopLine</b> STONE DIVISION					<b>FastLine</b> STONE DIVISION					<b>TwistLine</b> STONE DIVISION					<b>MicronLine</b> STONE DIVISION				
	Code	Type	ID	ED																
1	PB123866	Seg	65	150																
2	PB123867	Seg	65	150																
3	PB123868	Seg	65	150																
4	PB123869	Seg	65	150																
MFP5	-	MFP5	-	-																
5	PB021577	Exp	60	145																
6	PB021578	Exp	60	145																
7	PB021579	Exp	60	145																
6	PB69349	Magic	58	122																
7	PB69350	Magic	58	122																

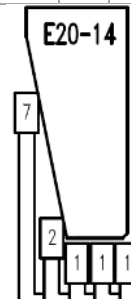
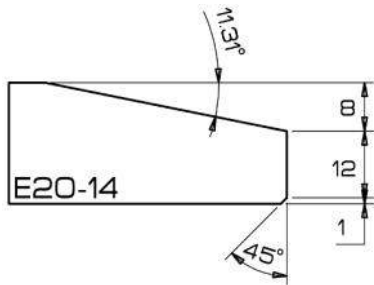

**Ninja Composition**  
E20-14

Position	<b>TopLine</b> STONE DIVISION					<b>FastLine</b> STONE DIVISION					<b>TwistLine</b> STONE DIVISION					<b>MicronLine</b> STONE DIVISION				
	Code	Type	ID	ED																
1	PB124319	Seg	70	155																
2	PB124320	Cr+S	60	145																
3	PB124321	Cr+S	60	145																
4	PB124322	Cr+S	60	145																
MFP5	PB01654	MFP5	60	145																
5	PB021580	Exp	60	145																
6	PB021581	Exp	60	145																
7	PB021582	Exp	60	145																
6	PB691161	Magic	60	150																
7	PB691162	Magic	60	150																



[BACK TO INDEX](#)

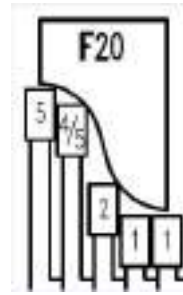
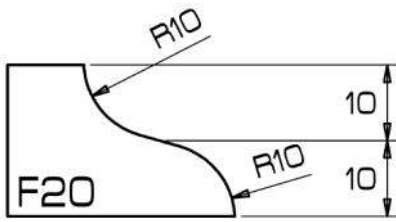

**Ninja Composition**

F20

Position	TopLine STONE DIVISION				FastLine STONE DIVISION				TwistLine STONE DIVISION				MicronLine STONE DIVISION			
	Code	Type	ID	ED					Code	Type	ID	ED				
1	PB122706	Seg	80	120					PB161296	Seg	40	80				
2	PB122707	Cr+S	80	120					PB161297	Cr+S	40	80				
3	PB122708	Cr+S	80	120					PB161298	Cr+S	40	80				
4	PB122709	Cr+S	80	120					PB161299	Cr+S	40	80				
MFP5	PB01523	MFP5	80	120					PB11507	MFP5	40	80				
5	PB02058	Exp	60	101					PB02613	Exp	40	80				
6	PB02059	Exp	60	101					PB02614	Exp	40	80				
7	PB02060	Exp	60	101					PB02615	Exp	40	80				
6	PB69043	Magic	80	122					PB68025	Magic	45	86				
7	PB69044	Magic	80	122					PB68026	Magic	45	86				

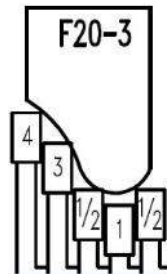
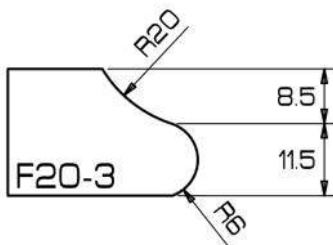

**Ninja Composition**

F20-3

Position	TopLine STONE DIVISION				FastLine STONE DIVISION				TwistLine STONE DIVISION				MicronLine STONE DIVISION			
	Code	Type	ID	ED	Code	Type	ID	ED								
1	PB123366	Seg	88	120	PB123519	Seg	63	95								
2	PB123367	Cr+S	88	120	PB123520	Cr+S	60	92								
3	PB123368	Cr+S	88	120	PB123521	Cr+S	60	92								
4	PB123369	Cr+S	88	120	PB123522	Cr+S	60	92								
MFP5	PB01655	MFP5	60	92	PB01655	MFP5	60	92								
5	PB02349	Exp	60	92	PB02349	Exp	60	92								
6	PB02350	Exp	60	92	PB02350	Exp	60	92								
7	PB02351	Exp	60	92	PB02351	Exp	60	92								
6	PB69928	Magic	65	92	PB69928	Magic	65	97								
7	PB69929	Magic	65	92	PB69929	Magic	65	97								

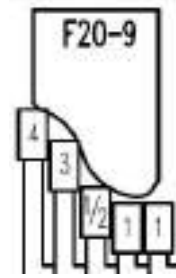
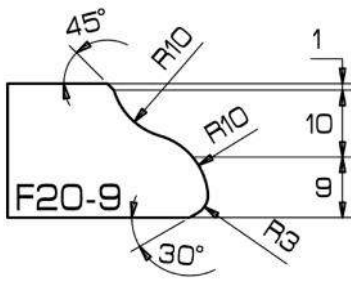

[BACK TO INDEX](#)



**Ninja Composition**  
F20-9

Position	TopLine STONE DIVISION				FastLine STONE DIVISION				TwistLine STONE DIVISION				MicronLine STONE DIVISION				
	Code	Type	ID	ED	Code	Type	ID	ED	Code	Type	ID	ED	Code	Type	ID	ED	
1					PB123766	Seg	67	95									
2					PB123767	Cr+S	60	93									
3					PB123768	Cr+S	60	93									
4					PB123769	Cr+S	60	93									
MFP5					PB01615	MFP5	60	93									
5					PB02473	Exp	60	95									
6					PB02474	Exp	60	95									
7					PB02475	Exp	60	95									
6					PB69280	Magic	64	97									
7					PB69281	Magic	64	97									

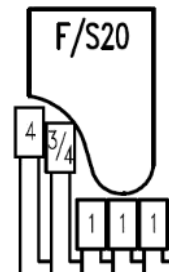
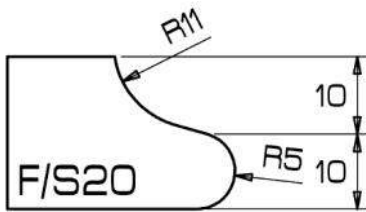

**Ninja Composition**  
F/S20

Position	TopLine STONE DIVISION				FastLine STONE DIVISION				TwistLine STONE DIVISION				MicronLine STONE DIVISION				
	Code	Type	ID	ED	Code	Type	ID	ED	Code	Type	ID	ED	Code	Type	ID	ED	
1	PB123223	Seg	88	120													
2	PB122715	Cr+S	88	120													
3	PB122716	Cr+S	88	120													
4	PB122717	Cr+S	88	120													
MFP5	PB01656	MFP5	88	120													
5	PB02070	Exp	60	92													
6	PB02071	Exp	60	92													
7	PB02072	Exp	60	92													
6	PB69055	Magic	65	97													
7	PB69056	Magic	65	97													

[BACK TO INDEX](#)

 **Ninja Composition**  
F/20-1

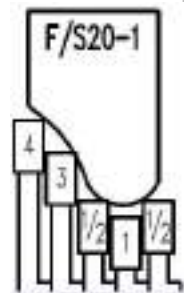
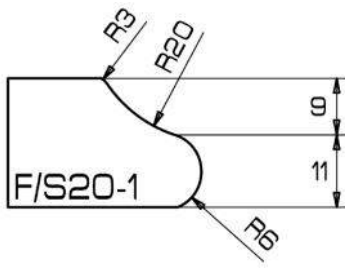

Position	 <b>TopLine</b> STONE DIVISION				 <b>FastLine</b> STONE DIVISION				 <b>TwistLine</b> STONE DIVISION				 <b>MicronLine</b> STONE DIVISION			
	Code	Type	ID	ED	Code	Type	ID	ED	Code	Type	ID	ED	Code	Type	ID	ED
1					PB123518	Seg	63	95					PB161327	Seg	40	75
2					PB123911	Cr+S	60	95					PB161328	Cr+S	40	75
3					PB123912	Cr+S	60	95					PB161329	Cr+S	40	75
4					PB123913	Cr+S	60	95					PB161330	Cr+S	40	75
MFP5					PB01616	MFP5	60	95					PB01579	MFP5	40	75
5					PB02476	Exp	60	95					PB02817	Exp	40	75
6					PB02477	Exp	60	95					PB02818	Exp	40	75
7					PB02478	Exp	60	95					PB02819	Exp	40	75
6					PB69370	Magic	57	97					PB68205	Magic	45	75
7					PB69371	Magic	57	97					PB68206	Magic	45	75

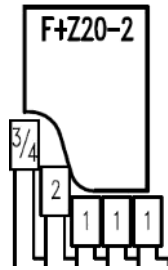
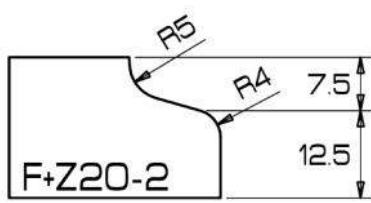

 **Ninja Composition**  
F+Z20-2

Position	 <b>TopLine</b> STONE DIVISION				 <b>FastLine</b> STONE DIVISION				 <b>TwistLine</b> STONE DIVISION				 <b>MicronLine</b> STONE DIVISION			
	Code	Type	ID	ED	Code	Type	ID	ED	Code	Type	ID	ED	Code	Type	ID	ED
1					PB123752	Seg	70	89								
2					PB123753	Seg	70	89								
3					PB123754	Seg	70	89								
4					PB123755	Seg	70	89								
MFP5					-	MFP5	-	-								
5					PB02376	Exp	60	79								
6					PB02377	Exp	60	79								
7					PB02378	Exp	60	79								
6					PB69307	Magic	61	80								
7					PB69308	Magic	61	80								

BACK TO INDEX

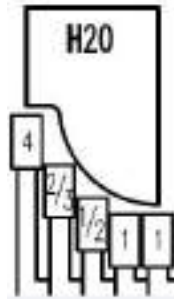
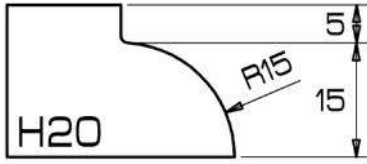

Ninja Composition

H20

Position	TopLine STONE DIVISION				FastLine STONE DIVISION				TwistLine STONE DIVISION				MicronLine STONE DIVISION			
	Code	Type	ID	ED					Code	Type	ID	ED				
1	PB122734	Seg	90	120					PB161300	Seg	40	72				
2	PB122735	Cr+S	90	120					PB161301	Cr+S	40	70				
3	PB122736	Cr+S	90	120					PB161302	Cr+S	40	70				
4	PB122737	Cr+S	90	120					PB161303	Cr+S	40	70				
MFP5	PB01535	MFP5	90	120					PB11509	MFP5	40	70				
5	PB02094	Exp	60	90					PB02622	Exp	40	70				
6	PB02095	Exp	60	90					PB02623	Exp	40	70				
7	PB02096	Exp	60	90					PB02624	Exp	40	70				
6	PB69076	Magic	67	97					PB68031	Magic	45	75				
7	PB69077	Magic	67	97					PB68032	Magic	45	75				

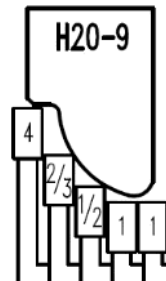
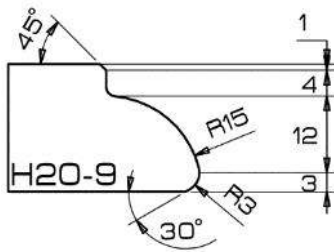



Ninja Composition

H20-9

Position	TopLine STONE DIVISION				FastLine STONE DIVISION				TwistLine STONE DIVISION				MicronLine STONE DIVISION			
	Code	Type	ID	ED												
1	PB122734	Seg	90	120												
2	PB124120	Cr+S	85	120												
3	PB124121	Cr+S	85	120												
4	PB124122	Cr+S	85	120												
MFP5	PB01657	MFP5	85	120												
5	PB021339	Exp	60	95												
6	PB021340	Exp	60	95												
7	PB021341	Exp	60	95												
6	PB691164	Magic	62	97												
7	PB691165	Magic	62	97												

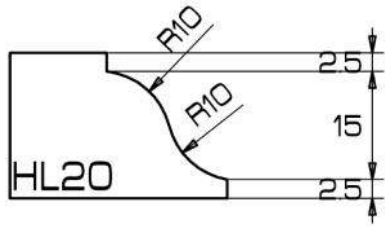
[BACK TO INDEX](#)



 **Ninja Composition**  
HL20

Position	 <b>TopLine</b> STONE DIVISION				 <b>FastLine</b> STONE DIVISION				 <b>TwistLine</b> STONE DIVISION				 <b>MicronLine</b> STONE DIVISION			
	Code	Type	ID	ED												
1					PB124323	Seg	70	104								
2					PB124324	Seg	70	104								
3					PB124325	Seg	70	104								
4					PB124326	Seg	70	104								
MFP5					-	MFP5	-	-								
5					PB021583	Exp	60	94								
6					PB021584	Exp	60	94								
7					PB021585	Exp	60	94								
6					PB69955	Magic	64	97								
7					PB69956	Magic	64	97								

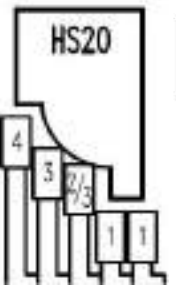
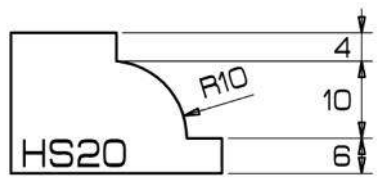

 **Ninja Composition**  
HS20

Position	 <b>TopLine</b> STONE DIVISION				 <b>FastLine</b> STONE DIVISION				 <b>TwistLine</b> STONE DIVISION				 <b>MicronLine</b> STONE DIVISION			
	Code	Type	ID	ED												
1					PB123809	Seg	70	100								
2					PB123810	Seg	70	100								
3					PB123811	Seg	70	100								
4					PB123812	Seg	70	100								
MFP5					-	MFP5	-	-								
5					PB021535	Exp	60	90								
6					PB021536	Exp	60	90								
7					PB021537	Exp	60	90								
6					PB69958	Magic	67	97								
7					PB69959	Magic	67	97								

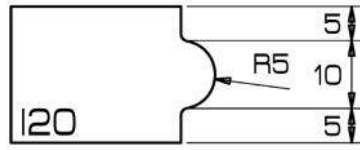

BACK TO INDEX



**Ninja Composition**  
I20

Position	<b>TopLine</b> STONE DIVISION				<b>FastLine</b> STONE DIVISION				<b>TwistLine</b> STONE DIVISION				<b>MicronLine</b> STONE DIVISION			
	Code	Type	ID	ED												
1	PB122755	Seg	110	120												
2	PB122760	Cr+S	110	120												
3	PB122761	Cr+S	110	120												
4	PB122762	Cr+S	110	120												
MFP5	PB01539	MFP5	110	120												
5	PB02106	Exp	60	70												
6	PB02107	Exp	60	70												
7	PB02108	Exp	60	70												
6	PB69088	Magic	70	80												
7	PB69089	Magic	70	80												

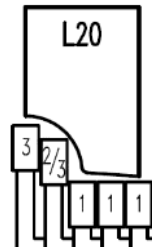
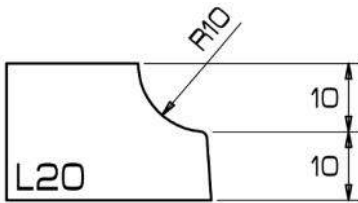

**Ninja Composition**  
L20

Position	<b>TopLine</b> STONE DIVISION				<b>FastLine</b> STONE DIVISION				<b>TwistLine</b> STONE DIVISION				<b>MicronLine</b> STONE DIVISION			
	Code	Type	ID	ED												
1	PB122767	Seg	98	120												
2	PB122768	Cr+S	98	120												
3	PB122769	Cr+S	98	120												
4	PB122770	Cr+S	98	120												
MFP5	PB01541	MFP5	98	120												
5	PB02112	Exp	60	82												
6	PB02113	Exp	60	82												
7	PB02114	Exp	60	82												
6	PB69094	Magic	58	80												
7	PB69095	Magic	58	80												

[BACK TO INDEX](#)

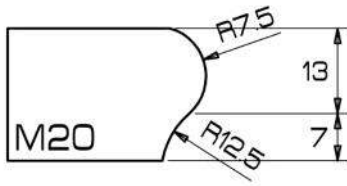

**Ninja Composition**  
M20

Position	TopLine STONE DIVISION				FastLine STONE DIVISION				TwistLine STONE DIVISION				MicronLine STONE DIVISION				
	Code	Type	ID	ED	Code	Type	ID	ED	Code	Type	ID	ED	Code	Type	ID	ED	
1					PB124468	Seg	70	85									
2					PB124469	Seg	70	85									
3					PB124470	Seg	70	85									
4					PB124471	Seg	70	85									
MFP5					-	MFP5	-	-									
5					PB02364	Exp	60	78									
6					PB02365	Exp	60	78									
7					PB02366	Exp	60	78									
6					PB69961	Magic	62	80									
7					PB69962	Magic	62	80									

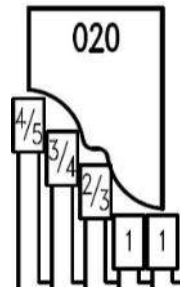
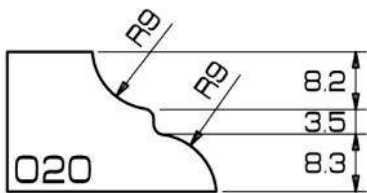

**Ninja Composition**  
O20

Position	TopLine STONE DIVISION				FastLine STONE DIVISION				TwistLine STONE DIVISION				MicronLine STONE DIVISION				
	Code	Type	ID	ED	Code	Type	ID	ED	Code	Type	ID	ED	Code	Type	ID	ED	
1	PB123593	Seg	84	120													
2	PB123163	Cr+S	84	120													
3	PB123164	Cr+S	84	120													
4	PB123165	Cr+S	84	120													
MFP5	PB01637	MFP5	84	120													
5	PB021586	Exp	60	96													
6	PB021540	Exp	60	96													
7	PB021541	Exp	60	96													
6	PB69931	Magic	65	101													
7	PB69932	Magic	65	101													

[BACK TO INDEX](#)

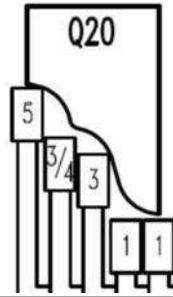
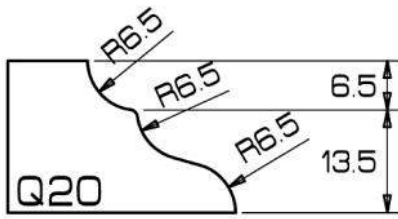

**Ninja Composition**  
Q20

Position	<b>TopLine</b> STONE DIVISION				<b>FastLine</b> STONE DIVISION				<b>TwistLine</b> STONE DIVISION				<b>MicronLine</b> STONE DIVISION			
	Code	Type	ID	ED												
1	PB123567	Seg	70	110												
2	PB123502	Cr+S	81	120												
3	PB123652	Cr+S	81	120												
4	PB123653	Cr+S	81	120												
MFP5	PB01658	MFP5	81	120												
5	PB021587	Exp	60	100												
6	PB021588	Exp	60	100												
7	PB021589	Exp	60	100												
6	PB69934	Magic	66	118												
7	PB69935	Magic	66	118												

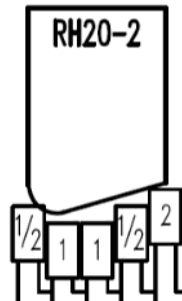
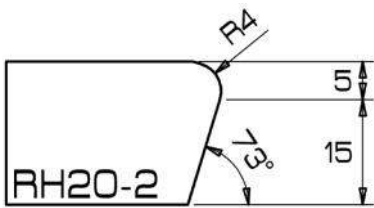

**Ninja Composition**  
RH20-2

Position	<b>TopLine</b> STONE DIVISION				<b>FastLine</b> STONE DIVISION				<b>TwistLine</b> STONE DIVISION				<b>MicronLine</b> STONE DIVISION			
	Code	Type	ID	ED												
1	PB124012	Seg	70	84												
2	PB124013	Seg	70	84												
3	PB124014	Seg	70	84												
4	PB124472	Seg	70	84												
MFP5	-	MFP5	-	-												
5	PB021757	Exp	60	74												
6	PB021758	Exp	60	74												
7	PB021759	Exp	60	74												
6	PB691209	Magic	67	80												
7	PB691210	Magic	67	80												



[BACK TO INDEX](#)

 **Ninja Composition**  
SM20

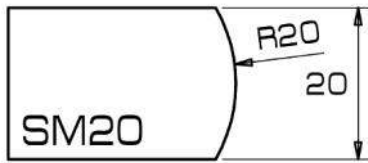

Position	 <b>TopLine</b> STONE DIVISION				 <b>FastLine</b> STONE DIVISION				 <b>TwistLine</b> STONE DIVISION				 <b>MicronLine</b> STONE DIVISION			
	Code	Type	ID	ED	Code	Type	ID	ED	Code	Type	ID	ED	Code	Type	ID	ED
1					PB123391	Cr+S	72	80								
2					PB123392	Cr+S	72	80								
3					PB123393	Cr+S	72	80								
4					PB123394	Cr+S	72	80								
MFP5					PB01550	MFP5	72	80								
5					PB02139	Exp	60	67								
6					PB02140	Exp	60	67								
7					PB02141	Exp	60	67								
6					PB69178	Magic	73	80								
7					PB69179	Magic	73	80								

 **Ninja Composition**  
T20

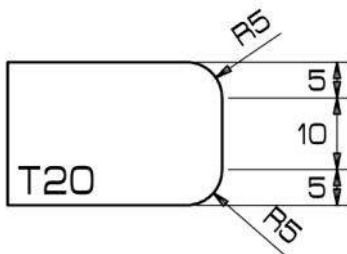

Position	 <b>TopLine</b> STONE DIVISION				 <b>FastLine</b> STONE DIVISION				 <b>TwistLine</b> STONE DIVISION				 <b>MicronLine</b> STONE DIVISION			
	Code	Type	ID	ED	Code	Type	ID	ED	Code	Type	ID	ED	Code	Type	ID	ED
1	PB122795	Seg	103	120	PB123324	Seg	60	77	PB161304	Seg	40	57	PB20413	6 Seg	20	38
2	PB122796	Cr+S	103	120	PB123325	Cr+S	60	77	PB161305	Cr+s	40	57	PB20414	6 Seg	20	38
3	PB122797	Cr+S	103	120	PB123326	Cr+S	60	77	PB161306	Cr+S	40	57	PB20415	6 Seg	20	38
4	PB122798	Cr+S	103	120	PB123327	Cr+S	60	77	PB161307	Cr+S	40	57	PB20416	6 Seg	20	38
MFP5	PB01553	MFP5	60	77	PB01553	MFP5	60	77	PB11524	MFP5	40	57	PB38502	Era	20	20
5	PB02148	Exp	60	80	PB02148	Exp	60	80	PB02628	Exp	40	60	PB021013	Exp	20	37
6	PB02149	Exp	60	80	PB02149	Exp	60	80	PB02629	Exp	40	60	PB021014	Exp	20	37
7	PB02150	Exp	60	80	PB02150	Exp	60	80	PB02630	Exp	40	60	PB021015	Exp	20	37
6	PB69118	Magic	63	80	PB69118	Magic	63	80	PB68037	Magic	45	60	PB67010	Magic	20	35
7	PB69119	Magic	63	80	PB69119	Magic	63	80	PB68038	Magic	45	60	PB67011	Magic	20	35

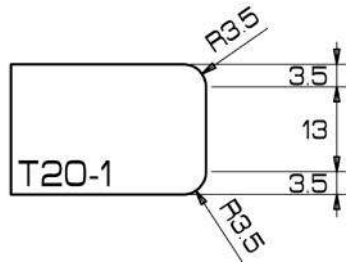

[BACK TO INDEX](#)



**Ninja Composition**  
T20-1

Position	<b>TopLine</b> STONE DIVISION				<b>FastLine</b> STONE DIVISION				<b>TwistLine</b> STONE DIVISION				<b>MicronLine</b> STONE DIVISION			
	Code	Type	ID	ED	Code	Type	ID	ED	Code	Type	ID	ED	Code	Type	ID	ED
1	PB123142	Seg	103	120	PB122966	Seg	60	77	PB16898	Seg	40	57	PB201037	2 Seg	20	30
2	PB123143	Cr+S	103	120	PB122967	Cr+S	60	77	PB16899	Cr+S	40	57	PB201038	2 Seg	20	30
3	PB123144	Cr+S	103	120	PB122968	Cr+S	60	77	PB16900	Cr+S	40	57	PB201039	2 Seg	20	30
4	PB123145	Cr+S	103	120	PB122969	Cr+S	60	77	PB16901	Cr+S	40	57	PB201040	2 Seg	20	30
MFP5	PB01554	MFP5	60	77	PB01554	MFP5	60	77	PB11559	MFP5	40	57	PB015025	Mfp5	20	30
5	PB02151	Exp	60	75	PB02151	Exp	60	75	PB02616	Exp	40	60	PB021056	Exp	20	37
6	PB02152	Exp	60	75	PB02152	Exp	60	75	PB02617	Exp	40	60	PB021057	Exp	20	37
7	PB02153	Exp	60	75	PB02153	Exp	60	75	PB02618	Exp	40	60	PB021058	Exp	20	37
6	PB69187	Magic	63	80	PB69187	Magic	63	80	PB69687	Magic	43	60	PB67019	Magic	20	35
7	PB69188	Magic	63	80	PB69188	Magic	63	80	PB69688	Magic	43	60	PB67020	Magic	20	35

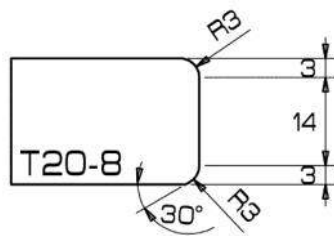

**Ninja Composition**  
T20-8

Position	<b>TopLine</b> STONE DIVISION				<b>FastLine</b> STONE DIVISION				<b>TwistLine</b> STONE DIVISION				<b>MicronLine</b> STONE DIVISION			
	Code	Type	ID	ED	Code	Type	ID	ED	Code	Type	ID	ED	Code	Type	ID	ED
1	PB124058	Seg	103	120	PB123670	Seg	60	77	PB161221	Seg	40	57				
2	PB124059	Cr+S	103	120	PB123671	Cr+S	60	71	PB161222	Cr+S	40	57				
3	PB124060	Cr+S	103	120	PB123672	Cr+S	60	71	PB161223	Cr+S	40	57				
4	PB124061	Cr+S	103	120	PB123673	Cr+S	60	71	PB161224	Cr+S	40	57				
MFP5	PB01582	MFP5	60	71	PB01582	MFP5	60	71	PB11520	MFP5	40	57				
5	PB02244	Exp	60	75	PB02244	Exp	60	75	PB02688	Exp	40	55				
6	PB02245	Exp	60	75	PB02245	Exp	60	75	PB02689	Exp	40	55				
7	PB02246	Exp	60	75	PB02246	Exp	60	75	PB02690	Exp	40	55				
6	PB69238	Magic	63	80	PB69238	Magic	63	80	PB68040	Magic	45	60				
7	PB69239	Magic	63	80	PB69239	Magic	63	80	PB68041	Magic	45	60				

[BACK TO INDEX](#)

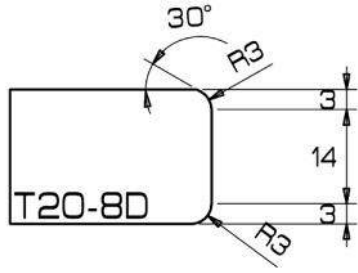

**Ninja Composition**

T20-8D

Position	TopLine STONE DIVISION				FastLine STONE DIVISION				TwistLine STONE DIVISION				MicronLine STONE DIVISION				
	Code	Type	ID	ED	Code	Type	ID	ED	Code	Type	ID	ED	Code	Type	ID	ED	
1													PB201041	2 Seg	20	30	
2													PB201042	2 Seg	20	30	
3													PB201043	2 Seg	20	30	
4													PB201044	2 Seg	20	30	
MFP5													PB015026	Mfp5	20	30	
5													PB021065	Exp	20	37	
6													PB021066	Exp	20	37	
7													PB021067	Exp	20	37	
6													PB67028	Magic	20	35	
7													PB67029	Magic	20	35	

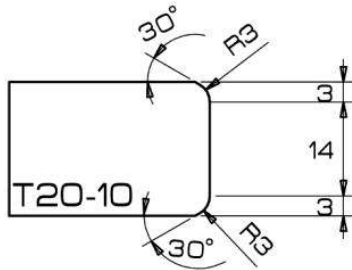

**Ninja Composition**

T20-10

Position	TopLine STONE DIVISION				FastLine STONE DIVISION				TwistLine STONE DIVISION				MicronLine STONE DIVISION			
	Code	Type	ID	ED	Code	Type	ID	ED	Code	Type	ID	ED	Code	Type	ID	ED
1	PB124239	Seg	103	120	PB124177	Seg	60	77	PB161355	Seg	40	57	PB20838	2 Seg	20	30
2	PB124240	Cr+S	103	120	PB124178	Cr+S	60	71	PB161356	Cr+S	40	52	PB20839	2 Seg	20	30
3	PB124241	Cr+S	103	120	PB124179	Cr+S	60	71	PB161357	Cr+S	40	52	PB20840	2 Seg	20	30
4	PB124242	Cr+S	103	120	PB124180	Cr+S	60	71	PB161358	Cr+S	40	52	PB20841	2 Seg	20	30
MFP5	PB01633	MFP5	60	71	PB01633	MFP5	60	71	PB11544	MFP5	40	52	PB015006	Mfp5	20	30
5	PB021349	Exp	60	75	PB021349	Exp	60	75	PB02729	Exp	40	55	PB021149	Exp	20	37
6	PB021350	Exp	60	75	PB021350	Exp	60	75	PB02730	Exp	40	55	PB021150	Exp	20	37
7	PB021351	Exp	60	75	PB021351	Exp	60	75	PB02731	Exp	40	55	PB021151	Exp	20	37
6	PB691154	Magic	63	80	PB691154	Magic	63	80	PB68130	Magic	43	60	PB67064	Magic	20	35
7	PB691155	Magic	63	80	PB691155	Magic	63	80	PB6131	Magic	43	60	PB67065	Magic	20	35

BACK TO INDEX



Ninja Composition

V20

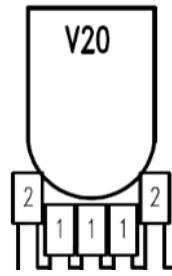
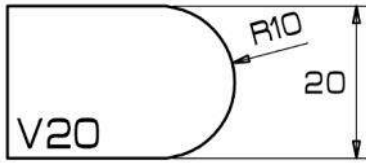

Position	TopLine STONE DIVISION				FastLine STONE DIVISION				TwistLine STONE DIVISION				MicronLine STONE DIVISION			
	Code	Type	ID	ED	Code	Type	ID	ED	Code	Type	ID	ED				
1	PB122815	Seg	94	120	PB123040	Seg	60	86	PB161121	Seg	40	66				
2	PB122816	Cr+S	94	120	PB123041	Cr+S	60	86	PB161122	Cr+S	40	66				
3	PB122817	Cr+S	94	120	PB123042	Cr+S	60	86	PB161123	Cr+S	40	66				
4	PB122818	Cr+S	94	120	PB123043	Cr+S	60	86	PB161124	Cr+S	40	66				
MFP5	PB01561	MFP5	60	86	PB01561	MFP5	60	86	PB11560	MFP5	40	66				
5	PB02172	Exp	60	90	PB02172	Exp	60	90	PB02777	Exp	40	66				
6	PB02173	Exp	60	90	PB02173	Exp	60	90	PB02778	Exp	40	66				
7	PB02174	Exp	60	90	PB02174	Exp	60	90	PB02779	Exp	40	66				
6	PB69136	Magic	71	97	PB69136	Magic	71	97	PB68049	Magic	45	71				
7	PB69137	Magic	71	97	PB69137	Magic	71	97	PB68050	Magic	45	71				

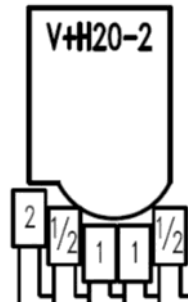
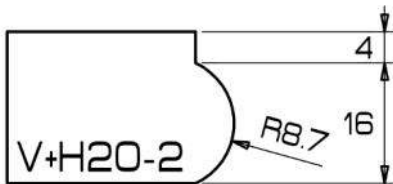

Ninja Composition

V+H20-2

Position	TopLine STONE DIVISION				FastLine STONE DIVISION				TwistLine STONE DIVISION				MicronLine STONE DIVISION			
	Code	Type	ID	ED	Code	Type	ID	ED	Code	Type	ID	ED				
1					PB124473	Seg	70	84								
2					PB124474	Seg	70	84								
3					PB124475	Seg	70	84								
4					PB124476	Seg	70	84								
MFP5					-	MFP5	-	-								
5					PB021760	Exp	60	74								
6					PB021761	Exp	60	74								
7					PB021762	Exp	60	74								
6					PB69964	Magic	66	80								
7					PB69965	Magic	66	80								

[BACK TO INDEX](#)



**Ninja Composition**

Z20

Position	<b>TopLine</b> STONE DIVISION				<b>FastLine</b> STONE DIVISION				<b>TwistLine</b> STONE DIVISION				<b>MicronLine</b> STONE DIVISION				
	Code	Type	ID	ED	Code	Type	ID	ED	Code	Type	ID	ED	Code	Type	ID	ED	
1					PB122875	Seg	80	80		PB161113	Seg	40	40				
2					PB122876	Cr+S	80	80		PB161114	Cr+S	40	40				
3					PB122877	Cr+S	80	80		PB161115	Cr+S	40	40				
4					PB122878	Cr+S	80	80		PB161116	Cr+S	40	40				
MFP5					PB01504	MFP5	80	60		PB11510	MFP5	40	40				
5					PB02403	Exp	80	80		PB02646	Exp	40	40				
6					PB02404	Exp	80	80		PB02647	Exp	40	40				
7					PB02405	Exp	80	80		PB02648	Exp	40	40				
6					PB69403	Magic	78	78		PB68058	Magic	45	45				
7					PB69404	Magic	78	78		PB68059	Magic	45	45				

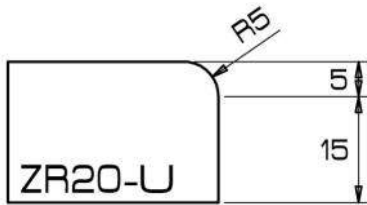

**Ninja Composition**

ZR20

Position	<b>TopLine</b> STONE DIVISION				<b>FastLine</b> STONE DIVISION				<b>TwistLine</b> STONE DIVISION				<b>MicronLine</b> STONE DIVISION					
	Code	Type	ID	ED	Code	Type	ID	ED	Code	Type	ID	ED	Code	Type	ID	ED		
1					PB122887	Cr+S	70	85		PB161133	Seg	40	55		PB201045	2 Seg	20	30
2					PB122888	Cr+S	70	85		PB161134	Cr+S	40	55		PB201046	2 Seg	20	30
3					PB122889	Cr+S	70	85		PG161135	Cr+S	40	55		PB201047	2 Seg	20	30
4					PB122890	Cr+S	70	85		PG161136	Cr+S	40	55		PB201048	2 Seg	20	30
MFP5					PB01567	MFP5	70	85		PB11513	MFP5	40	55		PB015027	Mfp5	20	30
5					PB02199	Exp	60	80		PB02655	Exp	40	60		PB021019	Exp	20	30
6					PB02200	Exp	60	80		PB02656	Exp	40	60		PB021020	Exp	20	30
7					PB02201	Exp	60	80		PB02657	Exp	40	60		PB021021	Exp	20	30
6					PB69199	Magic	65	80		PB68064	Magic	45	60		PB67037	Magic	20	35
7					PB69200	Magic	65	80		PB68065	Magic	45	60		PB67038	Magic	20	35

[BACK TO INDEX](#)

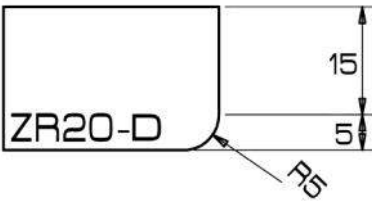

**Ninja Composition**  
ZR20-D

Position	TopLine STONE DIVISION				FastLine STONE DIVISION				TwistLine STONE DIVISION				MicronLine STONE DIVISION			
	Code	Type	ID	ED	Code	Type	ID	ED	Code	Type	ID	ED	Code	Type	ID	ED
1													PB201049	2 Seg	20	30
2													PB201050	2 Seg	20	30
3													PB201051	2 Seg	20	30
4													PB201052	2 Seg	20	30
MFP5													PB015028	Mfp5	20	30
5													PB021022	Exp	20	30
6													PB021023	Exp	20	30
7													PB021024	Exp	20	30
6													PB67041	Magic	20	35
7													PB67042	Magic	20	35

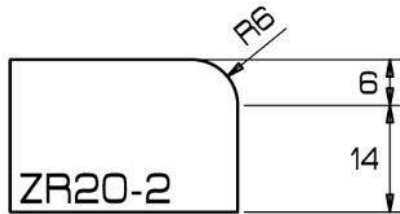

**Ninja Composition**  
ZR20-2

Position	TopLine STONE DIVISION				FastLine STONE DIVISION				TwistLine STONE DIVISION				MicronLine STONE DIVISION			
	Code	Type	ID	ED	Code	Type	ID	ED	Code	Type	ID	ED	Code	Type	ID	ED
1					PB124250	Cr+S	70	85								
2					PB124251	Cr+S	70	85								
3					PB124252	Cr+S	70	85								
4					PB124253	Cr+S	70	85								
MFP5					PB01639	MFP5	70	85								
5					PB021763	Exp	60	75								
6					PB021412	Exp	60	75								
7					PB021413	Exp	60	75								
6					PB69937	Magic	65	80								
7					PB69938	Magic	65	80								

[BACK TO INDEX](#)



**Ninja Composition**  
ZR20-3

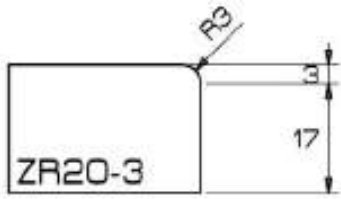

Position	<b>TopLine</b> STONE DIVISION				<b>FastLine</b> STONE DIVISION				<b>TwistLine</b> STONE DIVISION				<b>MicronLine</b> STONE DIVISION					
	Code	Type	ID	ED	Code	Type	ID	ED	Code	Type	ID	ED	Code	type	ID	ED		
1					PB123508	Cr+S	70	85		PB161285	Seg	40	55		PB201053	2 Seg	20	30
2					PB123509	Cr+S	70	85		PB161286	Cr+S	40	55		PB201054	2 Seg	20	30
3					PB123510	Cr+S	70	85		PB161287	Cr+S	40	55		PB201055	2 Seg	20	30
4					PB123511	Cr+S	70	85		PB161288	Cr+S	40	55		PB201056	2 Seg	20	30
MFP5					PB01698	MFP5	70	85		PB11561	MFP5	40	55		PB015029	Mfp5	20	30
5					PB02253	Exp	60	75		PB02703	Exp	40	60		PB021125	Exp	20	30
6					PB02254	Exp	60	75		PB02704	Exp	40	60		PB021126	Exp	20	30
7					PB02255	Exp	60	75		PB02705	Exp	40	60		PB021127	Exp	20	30
6					PB69256	Magic	65	80		PB68756	Magic	45	60		PB67097	Magic	20	35
7					PB69257	Magic	65	80		PB68757	Magic	45	60		PB67098	Magic	20	35



**Ninja Composition**  
ZR20-3D

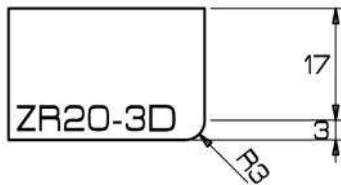

Position	<b>TopLine</b> STONE DIVISION				<b>FastLine</b> STONE DIVISION				<b>TwistLine</b> STONE DIVISION				<b>MicronLine</b> STONE DIVISION				
	Code	Type	ID	ED	Code	Type	ID	ED	Code	Type	ID	ED	Code	Type	ID	ED	
1														PB201057	2 Seg	20	30
2														PB201058	2 Seg	20	30
3														PB201059	2 Seg	20	30
4														PB201060	2 Seg	20	30
MFP5														PB015030	Mfp5	20	30
5														PB021167	Exp	20	30
6														PB021168	Exp	20	30
7														PB021169	Exp	20	30
6														PB67100	Magic	20	35
7														PB67101	Magic	20	35

BACK TO INDEX



**Ninja Composition**  
ZR20-4

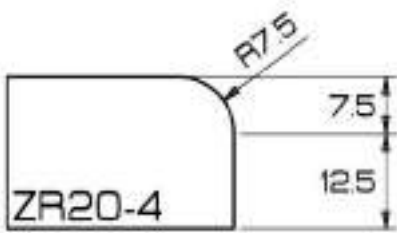

Position	<b>TopLine</b> STONE DIVISION				<b>FastLine</b> STONE DIVISION				<b>TwistLine</b> STONE DIVISION				<b>MicronLine</b> STONE DIVISION			
	Code	Type	ID	ED	Code	Type	ID	ED	Code	Type	ID	ED	Code	Type	ID	ED
1	PB124327	Seg	105	120	PB124477	Cr+S	70	85	PB161415	Seg	40	55				
2	PB124328	Cr+S	105	120	PB124478	Cr+S	70	85	PB161416	Cr+s	40	55				
3	PB124329	Cr+S	105	120	PB124479	Cr+S	70	85	PB161417	Cr+S	40	55				
4	PB124330	Cr+S	105	120	PB124480	Cr+S	70	85	PB161418	Cr+S	40	55				
MFP5	PB01659	MFP5	70	85	PB01659	MFP5	70	85	PB11562	MFP5	40	55				
5	PB021590	Exp	60	75	PB021590	Exp	60	75	PB02780	Exp	40	55				
6	PB021591	Exp	60	75	PB021591	Exp	60	75	PB02781	Exp	40	55				
7	PB021592	Exp	60	75	PB021592	Exp	60	75	PB02782	Exp	40	55				
6	PB69940	Magic	60	80	PB69940	Magic	60	80	PB68115	Magic	50	70				
7	PB69941	Magic	60	80	PB69941	Magic	60	80	PB68116	Magic	50	70				

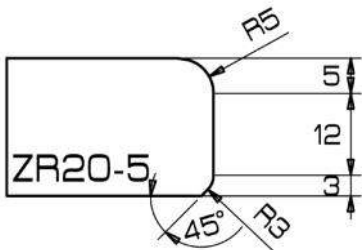

**Ninja Composition**  
ZR20-5

Position	<b>TopLine</b> STONE DIVISION				<b>FastLine</b> STONE DIVISION				<b>TwistLine</b> STONE DIVISION				<b>MicronLine</b> STONE DIVISION			
	Code	Type	ID	ED	Code	Type	ID	ED	Code	Type	ID	ED	Code	Type	ID	ED
1	PB123899	Seg	103	120	PB122903	Cr+S	70	82					PB201061	2 Seg	20	30
2	PB123900	Cr+S	103	120	PB122904	Cr+S	70	82					PB201062	2 Seg	20	30
3	PB123901	Cr+S	103	120	PB122905	Cr+S	70	82					PB201063	2 Seg	20	30
4	PB123902	Cr+S	103	120	PB122906	Cr+S	70	82					PB201064	2 Seg	20	30
MFP5	PB01608	MFP5	60	77	PB01572	MFP5	70	82					PB015031	Mfp5	20	30
5	PB02464	Exp	60	77	PB02214	Exp	60	72					PB021176	Exp	20	33
6	PB02465	Exp	60	77	PB02215	Exp	60	72					PB021177	Exp	20	33
7	PB02466	Exp	60	77	PB02216	Exp	60	72					PB021178	Exp	20	33
6	PB69356	Magic	65	80	PB69214	Magic	68	80					PB67103	Magic	20	35
7	PB69357	Magic	65	80	PB69215	Magic	68	80					PB67104	Magic	20	35



[BACK TO INDEX](#)



**Ninja Composition**  
ZR20-5D

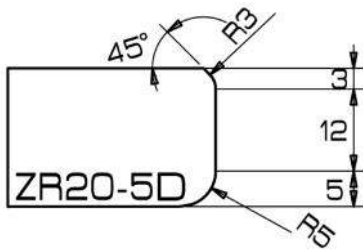

Position	TopLine STONE DIVISION				FastLine STONE DIVISION				TwistLine STONE DIVISION				MicronLine STONE DIVISION				
	Code	Type	ID	ED	Code	Type	ID	ED	Code	Type	ID	ED	Code	Type	ID	ED	
1													PB201065	2 Seg	20	30	
2													PB201066	2 Seg	20	30	
3													PB201067	2 Seg	20	30	
4													PB201068	2 Seg	20	30	
MFP5													PB015032	Mfp5	20	30	
5													PB021119	Exp	20	33	
6													PB021120	Exp	20	33	
7													PB021121	Exp	20	33	
6													PB67106	Magic	20	35	
7													PB67107	Magic	20	35	

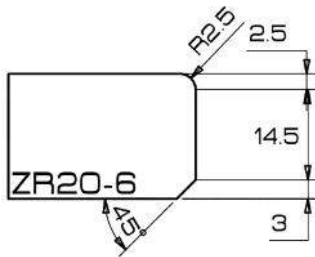

**Ninja Composition**  
ZR20-6

Position	TopLine STONE DIVISION				FastLine STONE DIVISION				TwistLine STONE DIVISION				MicronLine STONE DIVISION			
	Code	Type	ID	ED	Code	Type	ID	ED	Code	Type	ID	ED	Code	Type	ID	ED
1					PB124484	Seg	60	77								
2					PB124485	Seg	60	77								
3					PB124486	Seg	60	77								
4					PB124487	Seg	60	77								
MFP5					PB01801	MFP5	60	77								
5					PB021764	Exp	60	77								
6					PB021765	Exp	60	77								
7					PB021766	Exp	60	77								
6					PB691224	Magic	72	80								
7					PB691225	Magic	72	80								

[BACK TO INDEX](#)



**Ninja Composition**

ZR20-8

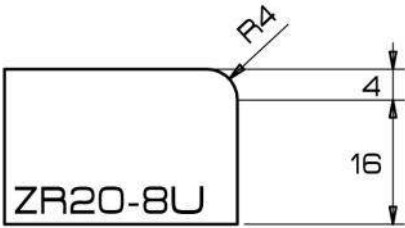

	<b>TopLine</b> STONE DIVISION				<b>FastLine</b> STONE DIVISION				<b>TwistLine</b> STONE DIVISION				<b>MicronLine</b> STONE DIVISION							
Position									Code	Type	ID	ED					Code	Type	ID	ED
1									PB161331	Cr+S	40	55					PB201069	2 Seg	20	30
2									PB161332	Cr+S	40	55					PB201070	2 Seg	20	30
3									PB161333	Cr+S	40	55					PB201071	2 Seg	20	30
4									PB161334	Cr+S	40	55					PB201072	2 Seg	20	30
MFP5									PB11563	MFP5	40	55					PB015033	Mfp5	20	30
5									PB02783	Exp	40	55					PB021179	Exp	20	32
6									PB02784	Exp	40	55					PB021180	Exp	20	32
7									PB02785	Exp	40	55					PB021181	Exp	20	32
6									PB68169	Magic	45	60					PB67109	Magic	20	35
7									PB68170	Magic	45	60					PB67110	Magic	20	35

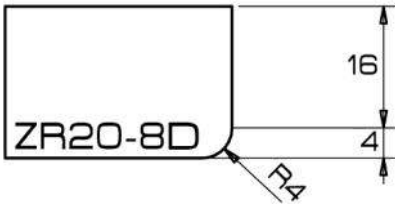

**Ninja Composition**

ZR20-8D

	<b>TopLine</b> STONE DIVISION				<b>FastLine</b> STONE DIVISION				<b>TwistLine</b> STONE DIVISION				<b>MicronLine</b> STONE DIVISION							
Position																	Code	type	ID	ED
1																	PB201073	2 Seg	20	30
2																	PB201074	2 Seg	20	30
3																	PB201075	2 Seg	20	30
4																	PB201076	2 Seg	20	30
MFP5																	PB015034	Mfp5	20	30
5																	PB021182	Exp	20	32
6																	PB021183	Exp	20	32
7																	PB021184	Exp	20	32
6																	PB67112	Magic	20	35
7																	PB67113	Magic	20	35

[BACK TO INDEX](#)



**Ninja Composition**

ZS20

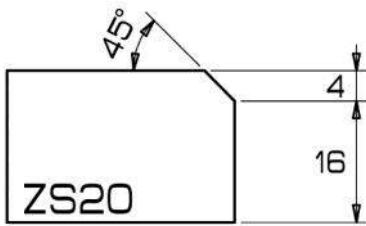

Position	<b>TopLine</b> STONE DIVISION					<b>FastLine</b> STONE DIVISION				<b>TwistLine</b> STONE DIVISION				<b>MicronLine</b> STONE DIVISION				
						Code	Type	ID	ED	Code	Type	ID	ED					
1						PB122903	Cr+S	70	82	PB161233	Seg	40	60					
2						PB122904	Cr+S	70	82	PB161234	Cr+S	40	60					
3						PB122905	Cr+S	70	82	PB161235	Cr+S	40	60					
4						PB122906	Cr+S	70	82	PB161236	Cr+S	40	60					
MFP5						PB01572	MFP5	70	82	PB11516	MFP5	40	60					
5						PB02214	Exp	60	72	PB02673	Exp	40	52					
6						PB02215	Exp	60	72	PB02674	Exp	40	52					
7						PP02216	Exp	60	72	PB02675	Exp	40	52					
6						PB69214	Magic	68	80	PB68070	Magic	45	57					
7						PB29215	Magic	68	80	PB68071	Magic	45	57					



**Ninja Composition**

ZS20-2

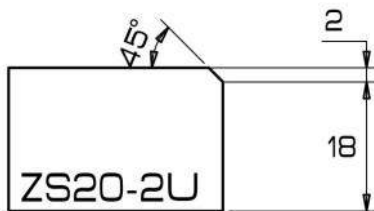

Position	<b>TopLine</b> STONE DIVISION					<b>FastLine</b> STONE DIVISION				<b>TwistLine</b> STONE DIVISION				<b>MicronLine</b> STONE DIVISION			
						Code	Type	ID	ED	Code	Type	ID	ED	Code	type	ID	ED
1						PB123682	Seg	70	78	PB161420	Cr+S	40	55	PB20614	2 Seg	20	26
2						PB123683	Cr+S	70	78	PB161421	Cr+S	40	55	PB20615	2 Seg	20	26
3						PB123684	Cr+S	70	78	PB161422	Cr+S	40	55	PB20616	2 Seg	20	26
4						PB123685	Cr+S	70	78	PB161423	Cr+S	40	55	PB20617	2 Seg	20	26
MFP5						PB01578	MFP5	70	78	PB11564	MFP5	40	55	PB015035	Mfp5	20	26
5						PB02232	Exp	60	70	PB02786	Exp	40	60	PB021043	Exp	20	32
6						PB02233	Exp	60	70	PB02787	Exp	40	60	PB021044	Exp	20	32
7						PB02234	Exp	60	70	PB02788	Exp	40	60	PB021045	Exp	20	32
6						PB69232	Magic	70	80	PB68172	Magic	45	57	PB67115	Magic	20	35
7						PB69233	Magic	70	80	PB68173	Magic	45	57	PB67116	Magic	20	35

[BACK TO INDEX](#)



**Ninja Composition**

ZS20-2D

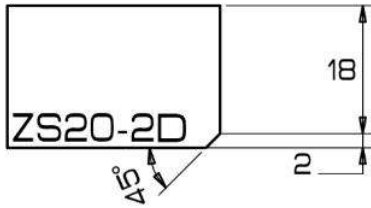

Position	TopLine STONE DIVISION				FastLine STONE DIVISION				TwistLine STONE DIVISION				MicronLine STONE DIVISION				
	Code	Type	ID	ED	Code	Type	ID	ED	Code	Type	ID	ED	Code	Type	ID	ED	
1													PB20626	2 Seg	20	26	
2													PB20627	2 Seg	20	26	
3													PB20628	2 Seg	20	26	
4													PB20629	2 Seg	20	26	
MFP5													PB015062	Mfp5	20	26	
5													PB021046	Exp	20	32	
6													PB021047	Exp	20	32	
7													PB021048	Exp	20	32	
6													PB67118	Magic	20	35	
7													PB67119	Magic	20	35	

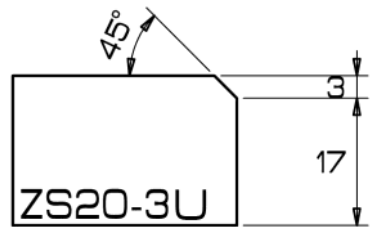

**Ninja Composition**

ZS20-3

Position	TopLine STONE DIVISION				FastLine STONE DIVISION				TwistLine STONE DIVISION				MicronLine STONE DIVISION					
	Code	Type	ID	ED	Code	Type	ID	ED	Code	Type	ID	ED	Code	Type	ID	ED		
1					PB124171	Cr+S	70	78		PB161285	Seg	40	55		PB201077	2 Seg	20	30
2					PB124481	Cr+S	70	78		PB161286	Cr+S	40	55		PB201078	2 Seg	20	30
3					PB124482	Cr+S	70	78		PB161287	Cr+S	40	55		PB201079	2 Seg	20	30
4					PB124483	Cr+S	70	78		PB161288	Cr+S	40	55		PB201080	2 Seg	20	30
MFP5					PB01699	MFP5	70	78		PB11561	MFP5	40	55		PB015063	Mfp5	20	30
5					PB021895	Exp	60	75		PB02703	Exp	40	60		PB021043	Exp	20	32
6					PB021896	Exp	60	75		PB02704	Exp	40	60		PB021044	Exp	20	32
7					PB021897	Exp	60	75		PB02705	Exp	40	60		PB021045	Exp	20	32
6					PB69256	Magic	65	80		PB68756	Magic	45	60		PB67121	Magic	20	35
7					PB69257	Magic	65	80		PB68757	Magic	45	60		PB67122	Magic	20	35

[BACK TO INDEX](#)

 **Ninja Composition**  
ZS20-3D

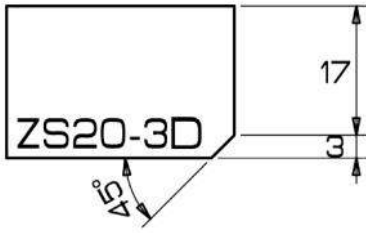

	 <b>TopLine</b> STONE DIVISION				 <b>FastLine</b> STONE DIVISION				 <b>TwistLine</b> STONE DIVISION				 <b>MicronLine</b> STONE DIVISION			
Position													Code	Type	ID	ED
1													PB201081	2 Seg	20	30
2													PB201082	2 Seg	20	30
3													PB201083	2 Seg	20	30
4													PB201084	2 Seg	20	30
MFP5													PB015036	Mfp5	20	30
5													PB021046	Exp	20	32
6													PB021047	Exp	20	32
7													PB021048	Exp	20	32
6													PB67124	Magic	20	35
7													PB67125	Magic	20	35

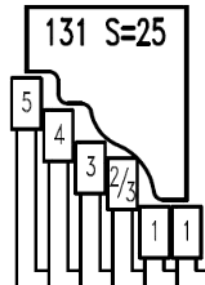
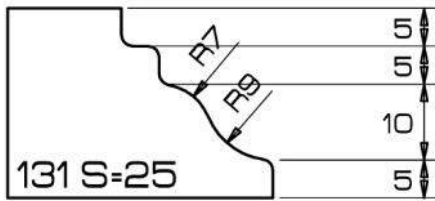

 **Ninja Composition**  
131 S25

	 <b>TopLine</b> STONE DIVISION				 <b>FastLine</b> STONE DIVISION				 <b>TwistLine</b> STONE DIVISION				 <b>MicronLine</b> STONE DIVISION			
Position	Code	Type	ID	ED												
1	PB124162	Seg	100	140												
2	PB124163	Seg	100	140												
3	PB124164	Seg	100	140												
4	PB124165	Seg	100	140												
MFP5	-	MFP5	-	-												
5	PB021593	Exp	60	100												
6	PB021344	Exp	60	100												
7	PB021345	Exp	60	100												
6	PB691167	Magic	57	97												
7	PB691168	Magic	57	97												

[BACK TO INDEX](#)

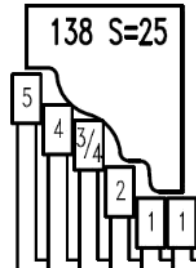
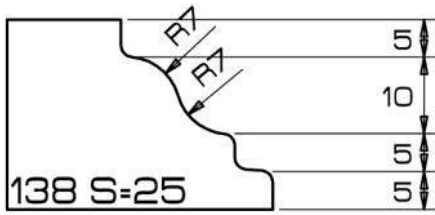

**Ninja Composition**  
138 S25

Position	<b>TopLine</b> STONE DIVISION				<b>FastLine</b> STONE DIVISION				<b>TwistLine</b> STONE DIVISION				<b>MicronLine</b> STONE DIVISION			
	Code	Type	ID	ED												
1	PB124116	Seg	110	140												
2	PB124117	Seg	110	140												
3	PB124118	Seg	110	140												
4	PB124119	Seg	110	140												
MFP5	-	MFP5	-	-												
5	PB021594	Exp	60	100												
6	PB021337	Exp	60	100												
7	PB021338	Exp	60	100												
6	PB691170	Magic	57	97												
7	PB691171	Magic	57	97												

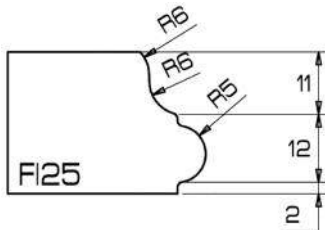

**Ninja Composition**  
F125

Position	<b>TopLine</b> STONE DIVISION				<b>FastLine</b> STONE DIVISION				<b>TwistLine</b> STONE DIVISION				<b>MicronLine</b> STONE DIVISION			
	Code	Type	ID	ED												
1	PB161428	Cr+S	40	68												
2	PB161429	Cr+S	40	68												
3	PB161430	Cr+S	40	68												
4	PB161431	Cr+S	40	68												
MFP5	PB11566	MFP5	40	68												
5	PB02792	Exp	40	68												
6	PB02793	Exp	40	68												
7	PB02794	Exp	40	68												
6	PB68175	Magic	45	73												
7	PB68176	Magic	45	73												

[BACK TO INDEX](#)



**Ninja Composition**  
T28

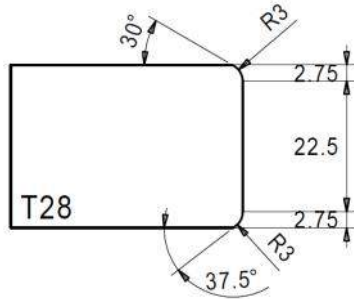

Position	<b>TopLine</b> STONE DIVISION					<b>FastLine</b> STONE DIVISION					<b>TwistLine</b> STONE DIVISION					<b>MicronLine</b> STONE DIVISION				
	Code	Type	ID	ED		Code	Type	ID	ED		Code	Type	ID	ED		Code	Type	ID	ED	
1						PB124700	Seg	60	72							PB201184	Seg	20	30	
2						PB124701	Seg	60	70							PB201185	Seg	20	30	
3						PB124702	Seg	60	70							PB201186	Seg	20	30	
4						PB124703	Seg	60	70							PB201187	Seg	20	30	
MFP5						PB01844	MFP5	60	70							PB015051	MFP5	20	30	
5						PB021937	Exp	60	70							PB021210	Exp	20	30	
6						PB021938	Exp	60	70							PB021211	Exp	20	30	
7						PB021939	Exp	60	70							PB021212	Exp	20	30	
6							Magic										Magic			
7							Magic										Magic			

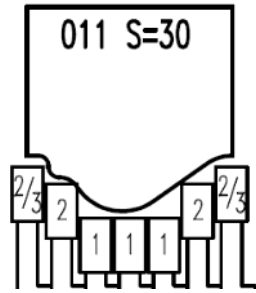
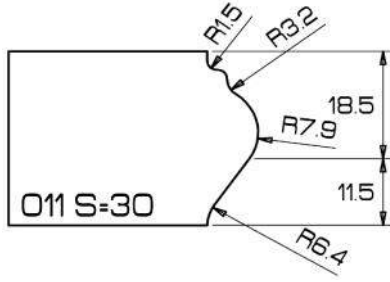

[BACK TO INDEX](#)



**Ninja Composition**

011 S30

Position	<b>TopLine</b> STONE DIVISION				<b>FastLine</b> STONE DIVISION				<b>TwistLine</b> STONE DIVISION				<b>MicronLine</b> STONE DIVISION			
	Code	Type	ID	ED												
1					PB123523	Seg	70	86								
2					PB123524	Seg	70	86								
3					PB123525	Seg	70	86								
4					PB123526	Seg	70	86								
MFP5					-	MFP5	-	-								
5					PB021767	Exp	60	76								
6					PB021768	Exp	60	76								
7					PB021769	Exp	60	76								
6					PB69979	Magic	64	80								
7					PB69980	Magic	64	80								

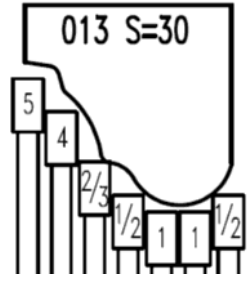
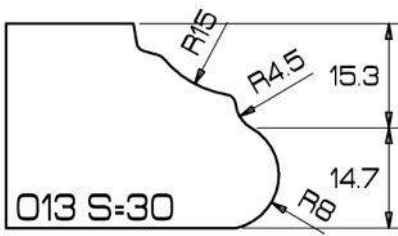

**Ninja Composition**

013 S30

Position	<b>TopLine</b> STONE DIVISION				<b>FastLine</b> STONE DIVISION				<b>TwistLine</b> STONE DIVISION				<b>MicronLine</b> STONE DIVISION			
	Code	Type	ID	ED												
1					PB123587	Seg	64	108								
2					PB123594	Cr+S	60	104								
3					PB123595	Cr+S	60	104								
4					PB123596	Cr+S	60	104								
MFP5					PB01802	MFP5	60	104								
5					PB021770	Exp	60	104								
6					PB021771	Exp	60	104								
7					PB021772	Exp	60	104								
6					PB69976	Magic	73	118								
7					PB69977	Magic	73	118								



[BACK TO INDEX](#)

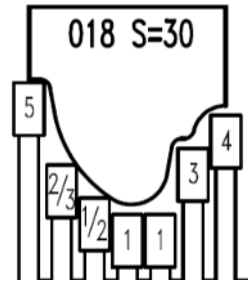
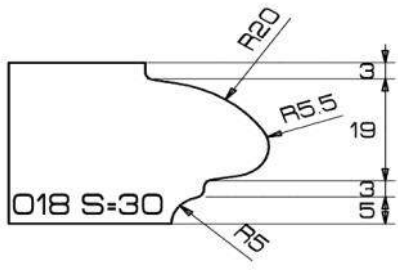

**Ninja Composition**

018 S30

Position	TopLine STONE DIVISION				FastLine STONE DIVISION				TwistLine STONE DIVISION				MicronLine STONE DIVISION			
	Code	Type	ID	ED												
1	PB124586	Seg	70	108												
2	PB124587	Seg	70	108												
3	PB124588	Seg	70	108												
4	PB124589	Seg	70	108												
MFP5	-	MFP5	-	-												
5	PB021876	Exp	60	98												
6	PB021877	Exp	60	98												
7	PB021878	Exp	60	98												
6	PB691263	Magic	59	97												
7	PB691264	Magic	59	97												

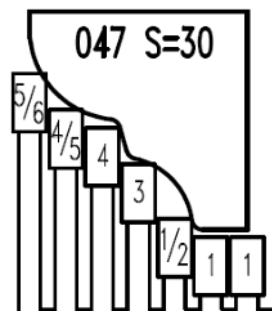
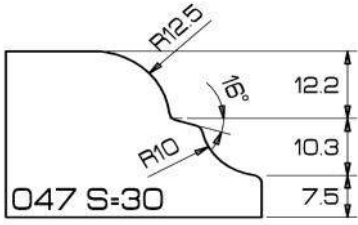

**Ninja Composition**

047 S30

Position	TopLine STONE DIVISION				FastLine STONE DIVISION				TwistLine STONE DIVISION				MicronLine STONE DIVISION			
	Code	Type	ID	ED												
1	PB124070	Seg	70	130												
2	PB124071	Cr+S	60	120												
3	PB124072	Cr+S	60	120												
4	PB124073	Cr+S	60	120												
MFP5	PB01660	MFP5	60	120												
5	PB021595	Exp	60	120												
6	PB021596	Exp	60	120												
7	PB021597	Exp	60	120												
6	PB691115	Magic	60	120												
7	PB691116	Magic	60	120												

BACK TO INDEX



Ninja Composition

183 S30

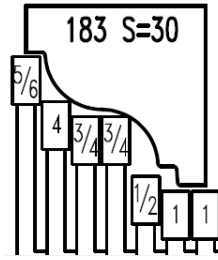
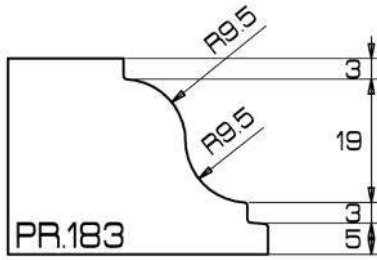

Position	TopLine STONE DIVISION				FastLine STONE DIVISION				TwistLine STONE DIVISION				MicronLine STONE DIVISION			
	Code	type	ID	ED	Code	type	ID	ED	Code	type	ID	ED	Code	type	ID	ED
1					PB124612	Seg	66	110								
2					PB124613	Cr+S	60	104								
3					PB124614	Cr+S	60	104								
4					PB124615	Cr+S	60	104								
MFP5					PB01839	MFP5	60	104								
5					PB021925	Exp	60	104								
6					PB021926	Exp	60	104								
7					PB021927	Exp	60	104								
6					PB691281	Magic	59	103								
7					PB691282	Magic	59	103								

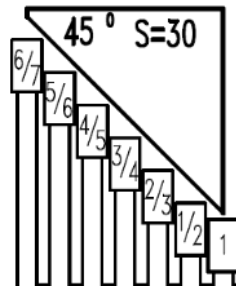
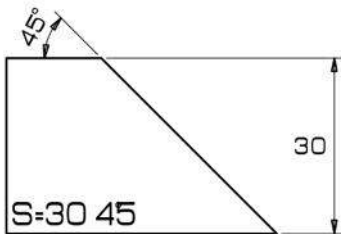

Ninja Composition

1V1 45° S30

Position	TopLine STONE DIVISION				FastLine STONE DIVISION				TwistLine STONE DIVISION				MicronLine STONE DIVISION			
	Code	type	ID	ED	Code	type	ID	ED	Code	type	ID	ED	Code	type	ID	ED
1	PB123251	Seg	62	130												
2	PB123252	Cr+S	72	140												
3	PB123253	Cr+S	72	140												
4	PB123254	Cr+S	72	140												
MFP5	PB01661	MFP5	72	140												
5	PB021598	Exp	60	128												
6	PB021599	Exp	60	128												
7	PB021600	Exp	60	128												
6	PB69455	Magic	56	120												
7	PB69456	Magic	56	120												

[BACK TO INDEX](#)



**Ninja Composition**  
A30

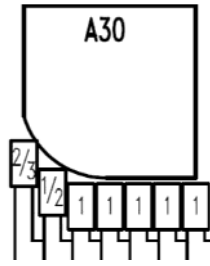
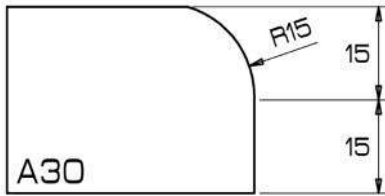

Position	<b>TopLine</b> STONE DIVISION				<b>FastLine</b> STONE DIVISION				Price [€] Euro	<b>TwistLine</b> STONE DIVISION				<b>MicronLine</b> STONE DIVISION			
	Code	Type	ID	ED	Code	Type	ID	ED		Code	Type	ID	ED				
1	PB122564	Seg	88	120	PB122626	Seg	58	90	400	PB161097	Seg	40	72				
2	PB122565	Cr+S	88	120	PB122627	Cr+S	58	90	390	PB161098	Cr+S	40	76				
3	PB122566	Cr+S	88	120	PB122628	Cr+S	58	90	390	PB161099	Cr+S	40	76				
4	PB122641	Cr+S	88	120	PB122839	Cr+S	58	90	390	PB161100	Cr+S	40	76				
MFP5	PB01502	MFP5	58	90	PB01502	MFP5	58	90	410	PB11502	MFP5	40	76				
5	PB02004	Exp	60	95	PB02004	Exp	60	95	163	PB02649	Exp	40	76				
6	PB02005	Exp	60	95	PB02005	Exp	60	95	163	PB02650	Exp	40	76				
7	PB02006	Exp	60	95	PB02006	Exp	60	95	163	PB02651	Exp	40	76				
6	PB69004	Magic	61	93	PB69004	Magic	61	93		PB68004	Magic	45	77				
7	PB69005	Magic	61	93	PB69005	Magic	61	93		PB68005	Magic	45	77				

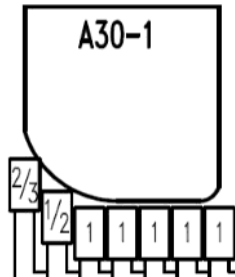
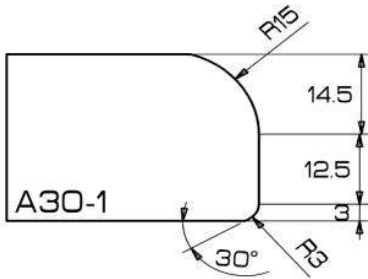

**Ninja Composition**  
A30-1

Position	<b>TopLine</b> STONE DIVISION				<b>FastLine</b> STONE DIVISION				Price [€] Euro	<b>TwistLine</b> STONE DIVISION				<b>MicronLine</b> STONE DIVISION			
	Code	Type	ID	ED	Code	Type	ID	ED		Code	Type	ID	ED				
1	PB122564	Seg	88	120	PB122626	Seg	58	90		PB161097	Seg	40	72				
2	PB123337	Cr+S	88	120	PB123578	Cr+S	58	90		PB161289	Cr+S	40	72				
3	PB123338	Cr+S	88	120	PB123579	Cr+S	58	90		PB161290	Cr+S	40	72				
4	PB123339	Cr+S	88	120	PB123580	Cr+S	85	90		PB161291	Cr+S	40	72				
MFP5	PB01512	MFP5	58	90	PB01512	MFP5	58	90		PB11533	MFP5	40	72				
5	PB02007	Exp	60	97	PB02007	Exp	60	97		PB02709	Exp	40	77				
6	PB02008	Exp	60	97	PB02008	Exp	60	97		PB02710	Exp	40	77				
7	PB02009	Exp	60	97	PB02009	Exp	60	97		PB02711	Exp	40	77				
6	PB69010	Magic	65	97	PB69010	Magic	65	97		PB68085	Magic	45	80				
7	PB69011	Magic	65	97	PB69011	Magic	65	97		PB68086	Magic	45	80				

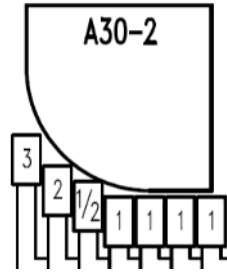
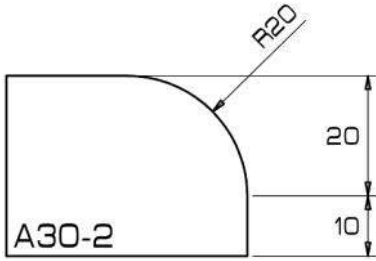

[BACK TO INDEX](#)



**Ninja Composition**  
A30-2

Position	<b>TopLine</b> STONE DIVISION				<b>FastLine</b> STONE DIVISION				<b>TwistLine</b> STONE DIVISION				<b>MicronLine</b> STONE DIVISION			
	Code	type	ID	ED	Code	type	ID	ED								
1	PB123311	Seg	74	120	PB123410	Seg	88	97								
2	PB123312	Cr+S	74	120	PB123411	Cr+S	88	97								
3	PB123313	Cr+S	74	120	PB123412	Cr+S	88	97								
4	PB123314	Cr+S	74	120	PB123413	Cr+S	88	97								
MFP5	PB01662	MFP5	55	97	PB01662	MFP5	88	97								
5	PB021898	Exp	60	110	PB021899	Exp	60	110								
6	PB021899	Exp	60	110	PB021890	Exp	60	110								
7	PB021900	Exp	60	110	PB021900	Exp	60	110								
6	PB691118	Magic	78	120	PB691118	Magic	78	120								
7	PB691119	Magic	78	120	PB691119	Magic	78	120								

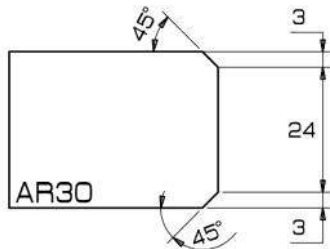

**Ninja Composition**  
AR30

Position	<b>TopLine</b> STONE DIVISION				<b>FastLine</b> STONE DIVISION				<b>TwistLine</b> STONE DIVISION				<b>MicronLine</b> STONE DIVISION			
	Code	Type	ID	ED	Code	Type	ID	ED	Code	Type	ID	ED	Code	Type	ID	ED
1					PB122571	Cr+S	70	80	PB161185	Seg	40	50	PB201085	2 Seg	20	30
2					PB122572	Cr+S	70	80	PB161186	Cr+S	40	50	PB201086	2 Seg	20	30
3					PB122573	Cr+S	70	80	PB161187	Cr+S	40	50	PB201087	2 Seg	20	30
4					PB122642	Cr+S	70	80	PB161188	Cr+S	40	50	PB201088	2 Seg	20	30
MFP5					PB01508	MFP5	70	80	PB11504	MFP5	40	50	PB015009	Mfp5	20	30
5					PB02016	Exp	60	70	PB02667	Exp	40	50	PB021007	Exp	20	30
6					PB02017	Exp	60	70	PB02668	Exp	40	50	PB021008	Exp	20	30
7					PB02018	Exp	60	70	PB02669	Exp	40	50	PB021009	Exp	20	30
6					PB69157	Magic	70	80	PB68013	Magic	45	55	PB67004	Magic	20	35
7					PB69158	Magic	70	80	PB68014	Magic	45	55	PB67005	Magic	20	35

[BACK TO INDEX](#)

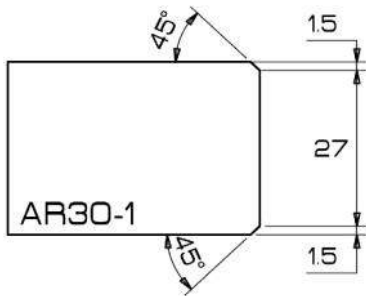

**Ninja Composition**  
AR30-1

Position	<b>TopLine</b> STONE DIVISION				<b>FastLine</b> STONE DIVISION				<b>TwistLine</b> STONE DIVISION				<b>MicronLine</b> STONE DIVISION			
	Code	Type	ID	ED	Code	Type	ID	ED	Code	Type	ID	ED	Price [€] Euro	Code	type	ID
1	PB123303	Cr+S	70	80	PB161432	Cr+S	40	57	375	PB20564	2 Seg	20	25			
2	PB123304	Cr+S	70	80	PB161433	Cr+S	40	57	375	PB20565	2 Seg	20	25			
3	PB123305	Cr+S	70	80	PB161434	Cr+S	40	57	375	PB20566	2 Seg	20	25			
4	PB123306	Cr+S	70	80	PB161435	Cr+S	40	57	375	PB20567	2 Seg	20	25			
MFP5	PB01803	MFP5	70	80	PB11567	MFP5	40	57	394	PB015037	Mfp5	20	25			
5	PB021773	Exp	70	79	PB02795	Exp	40	57	160	PB021081	Exp	20	27			
6	PB021774	Exp	70	79	PB02796	Exp	40	57	160	PB021082	Exp	20	27			
7	PB021775	Exp	70	79	PB02797	Exp	40	57	160	PB021083	Exp	20	27			
6	PB691063	Magic	70	80	PB68107	Magic	50	60		PB67127	Magic	20	33			
7	PB691064	Magic	70	80	PB68108	Magic	50	60		PB67128	Magic	20	33			

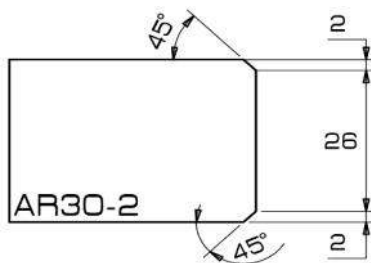

**Ninja Composition**  
AR30-2

Position	<b>TopLine</b> STONE DIVISION				<b>FastLine</b> STONE DIVISION				<b>TwistLine</b> STONE DIVISION				<b>MicronLine</b> STONE DIVISION			
	Code	Type	ID	ED	Code	Type	ID	ED	Code	Type	ID	ED	Code	type	ID	ED
1	PB123496	Cr+S	70	80	PB161217	Seg	40	50		PB20606	2 Seg	20	25			
2	PB123497	Cr+S	70	80	PB161218	Cr+S	40	50		PB20607	2 Seg	20	25			
3	PB123498	Cr+S	70	80	PB161219	Cr+S	40	50		PB20608	2 Seg	20	25			
4	PB123499	Cr+S	70	80	PB161220	Cr+S	40	50		PB20609	2 Seg	20	25			
MFP5	PB01509	MFP5	70	80	PB11505	MFP5	40	50		PB015038	Mfp5	20	25			
5	PB02019	Exp	60	70	PB02682	Exp	40	50		PB021101	Exp	20	27			
6	PB02020	Exp	60	70	PB02683	Exp	40	50		PB021102	Exp	20	27			
7	PB02021	Exp	60	70	PB02684	Exp	40	50		PB021103	Exp	20	27			
6	PB69163	Magic	70	80	PB69664	Magic	45	55		PB67052	Magic	20	35			
7	PB69164	Magic	70	80	PB69665	Magic	45	55		PB67053	Magic	20	35			

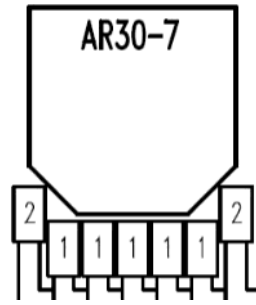
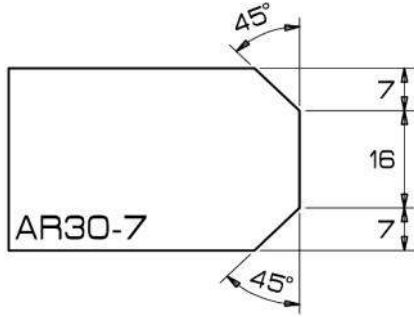

[BACK TO INDEX](#)



**Ninja Composition**  
AR30-7

TopLine STONE DIVISION					FastLine STONE DIVISION					TwistLine STONE DIVISION					MicronLine STONE DIVISION				
Position	Code	Type	ID	ED															
1	PB124331	Seg	106	120															
2	PB124332	Seg	106	120															
3	PB124333	Seg	106	120															
4	PB124334	Seg	106	120															
MFP5	-	MFP5	-	-															
5	PB021601	Exp	60	78															
6	PB021602	Exp	60	78															
7	PB021603	Exp	60	78															
6	PB69431	Magic	62	80															
7	PB69432	Magic	62	80															

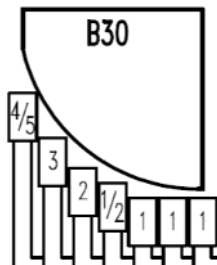
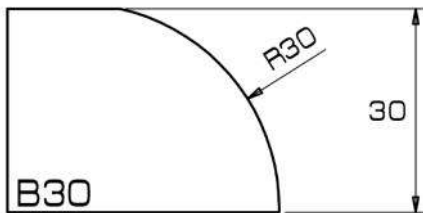

**Ninja Composition**  
B30

TopLine STONE DIVISION					FastLine STONE DIVISION					TwistLine STONE DIVISION					MicronLine STONE DIVISION				
Position	Code	Type	ID	ED						Code	Type	ID	ED						
1	PB122629	Seg	66	130						PB161316	Seg	40	104						
2	PB122630	Cr+S	56	120						PB161317	Cr+S	40	104						
3	PB122631	Cr+S	56	120						PB161318	Cr+S	40	104						
4	PB122645	Cr+S	56	120						PB161319	Cr+S	40	104						
MFP5	PB01514	MFP5	56	120						PB11568	MFP5	40	104						
5	PB02031	Exp	60	125						PB02631	Exp	40	110						
6	PB02032	Exp	60	125						PB02632	Exp	40	110						
7	PB02033	Exp	60	125						PB02633	Exp	40	110						
6	PB69016	Magic	60	124						PB68022	Magic	45	109						
7	PB69017	Magic	60	124						PB68023	Magic	45	109						

[BACK TO INDEX](#)

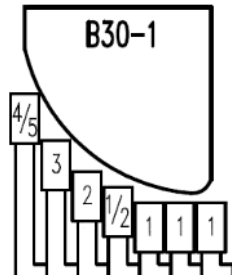
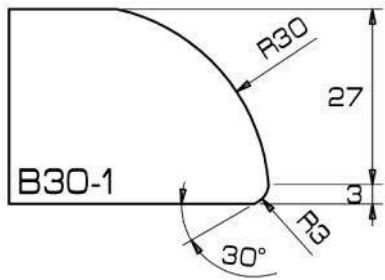

**Ninja Composition**  
B30-1

	<b>TopLine</b> STONE DIVISION				<b>FastLine</b> STONE DIVISION				<b>TwistLine</b> STONE DIVISION				<b>MicronLine</b> STONE DIVISION			
Position	Code	Type	ID	ED												
1	PB122629	Seg	66	130												
2	PB123276	Cr+S	56	120												
3	PB123277	Cr+S	56	120												
4	PB123278	Cr+S	56	120												
MFP5	PB01515	MFP5	56	120												
5	PB02034	Exp	60	125												
6	PB02035	Exp	60	125												
7	PB02036	Exp	60	125												
6	PB69019	Magic	61													
7	PB69020	Magic	61													

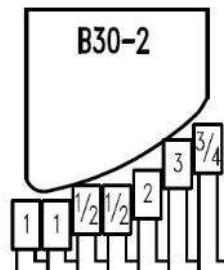
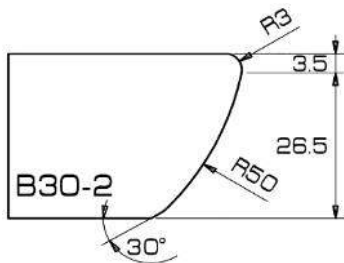

**Ninja Composition**  
B30-2

	<b>TopLine</b> STONE DIVISION				<b>FastLine</b> STONE DIVISION				<b>TwistLine</b> STONE DIVISION				<b>MicronLine</b> STONE DIVISION			
Position					Code	type	ID	ED								
1					PB123635	Seg	70	103								
2					PB123636	Seg	70	103								
3					PB123637	Seg	70	103								
4					PB123638	Seg	70	103								
MFP5					-	MFP5	-	-								
5					PB02336	Exp	60	97								
6					PB02311	Exp	60	97								
7					PB02312	Exp	60	97								
6					PB69361	Magic	60	97								
7					PB69362	Magic	60	97								

[BACK TO INDEX](#)

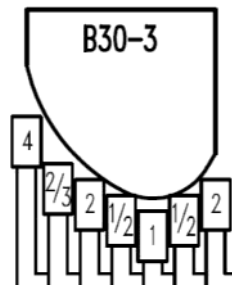
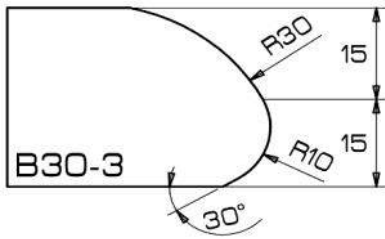

**Ninja Composition**  
B30-3

TopLine STONE DIVISION					FastLine STONE DIVISION					TwistLine STONE DIVISION					MicronLine STONE DIVISION				
Position	Code	Type	ID	ED															
1	PB123659	Seg	65	120															
2	PB123660	Seg	65	120															
3	PB123661	Seg	65	120															
4	PB123662	Seg	65	120															
MFP5	-	MFP5	-	-															
5	PB02337	Exp	60	115															
6	PB02310	Exp	60	115															
7	PB02316	Exp	60	115															
6	PB69274	Magic	67	120															
7	PB69275	Magic	67	120															

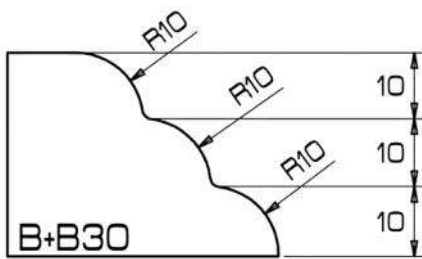

**Ninja Composition**  
B+B30

TopLine STONE DIVISION					FastLine STONE DIVISION					TwistLine STONE DIVISION					MicronLine STONE DIVISION				
Position	Code	Type	ID	ED															
1	PB123221	Seg	70	133															
2	PB122672	Cr+S	57	120															
3	PB122673	Cr+S	57	120															
4	PB122674	Cr+S	57	120															
MFP5	PB01518	MFP5	57	120															
5	PB02043	Exp	60	125															
6	PB02044	Exp	60	125															
7	PB02045	Exp	60	125															
6	PB69028	Magic	62	125															
7	PB69029	Magic	62	125															



[BACK TO INDEX](#)

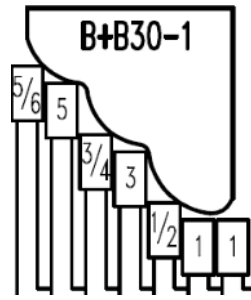
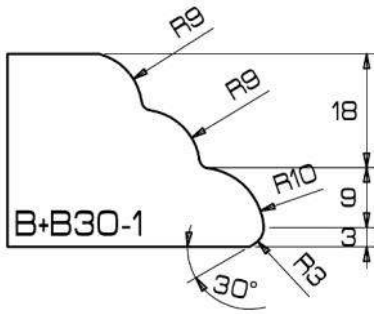

**Ninja Composition**

B+B30-1

Position	TopLine STONE DIVISION				FastLine STONE DIVISION				TwistLine STONE DIVISION				MicronLine STONE DIVISION			
	Code	Type	ID	ED												
1	PB123447	Seg	70	133												
2	PB122409	Cr+S	60	120												
3	PB122410	Cr+S	60	120												
4	PB122411	Cr+S	60	120												
MFP5	PB01519	MFP5	60	120												
5	PB02046	Exp	60	120												
6	PB02047	Exp	60	120												
7	PB02048	Exp	60	120												
6	PB69034	Magic	59	119												
7	PB69035	Magic	59	119												

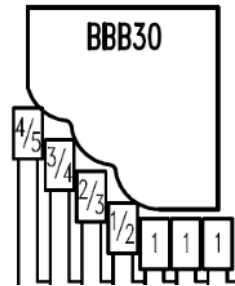
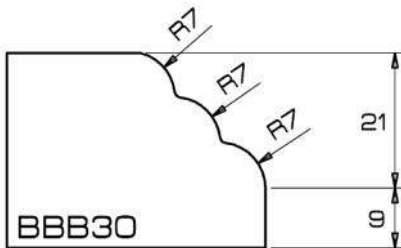

**Ninja Composition**

BBB30

Position	TopLine STONE DIVISION				FastLine STONE DIVISION				TwistLine STONE DIVISION				MicronLine STONE DIVISION			
	Code	type	ID	ED												
1	PB123895	Seg	76	120												
2	PB124191	Cr+S	74	120												
3	PB124192	Cr+S	74	120												
4	PB124193	Cr+S	74	120												
MFP5	PB01663	MFP5	74	120												
5	PB021355	Exp	60	106												
6	PB021356	Exp	60	106												
7	PB021357	Exp	60	106												
6	PB69967	Magic	67	113												
7	PB69968	Magic	67	113												

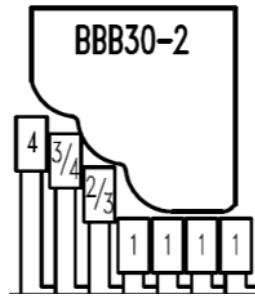
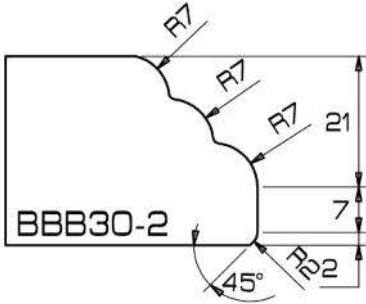

[BACK TO INDEX](#)



**Ninja Composition**

BBB30-2

Position	<b>TopLine</b> STONE DIVISION				<b>FastLine</b> STONE DIVISION				<b>TwistLine</b> STONE DIVISION				<b>MicronLine</b> STONE DIVISION			
	Code	type	ID	ED												
1	PB123895	Seg	76	120												
2	PB123896	Cr+S	74	120												
3	PB123897	Cr+S	74	120												
4	PB123898	Cr+S	74	120												
MFP5	PB01598	MFP5	74	120												
5	PB02452	Exp	60	106												
6	PB02453	Exp	60	106												
7	PB02454	Exp	60	106												
6	PB69340	Magic	69	115												
7	PB69341	Magic	69	115												

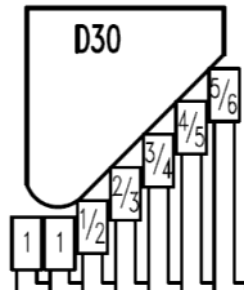
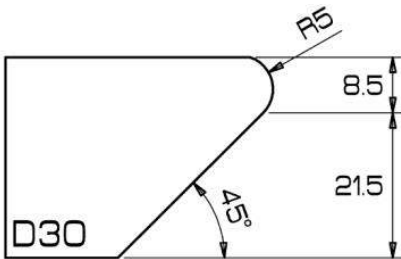

**Ninja Composition**

D30

Position	<b>TopLine</b> STONE DIVISION				<b>FastLine</b> STONE DIVISION				<b>TwistLine</b> STONE DIVISION				<b>MicronLine</b> STONE DIVISION			
	Code	Type	ID	ED												
1	PB122702	Seg	67	120												
2	PB122703	Cr+S	67	120												
3	PB122704	Cr+S	67	120												
4	PB122705	Cr+S	67	120												
MFP5	PB01522	MFP5	67	120												
5	PB02055	Exp	60	111												
6	PB02056	Exp	60	111												
7	PB02057	Exp	60	111												
6	PB69040	Magic	67	120												
7	PB69041	Magic	67	120												

[BACK TO INDEX](#)

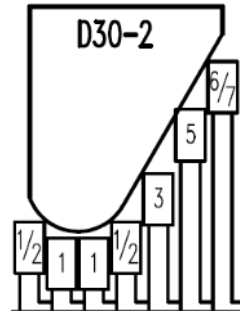
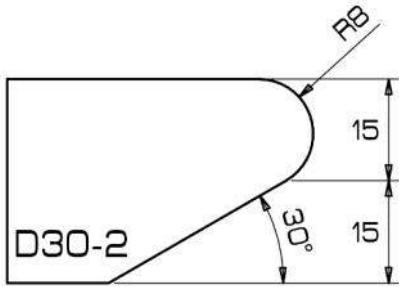

**Ninja Composition**  
D30-2

Position	TopLine STONE DIVISION				FastLine STONE DIVISION				TwistLine STONE DIVISION				MicronLine STONE DIVISION			
	Code	Type	ID	ED												
1	PB122879	Seg	73	140												
2	PB122880	Cr+S	73	140												
3	PB122881	Cr+S	73	140												
4	PB122882	Cr+S	73	140												
MFP5	PB01601	MFP5	73	140												
5	PB02313	Exp	60	130												
6	PB02314	Exp	60	130												
7	PB02315	Exp	60	130												
6	PB69425	Magic	55	122												
7	PB69426	Magic	55	122												

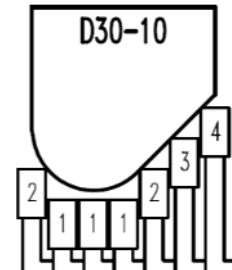
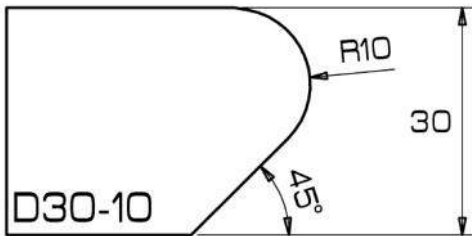

**Ninja Composition**  
D30-10

Position	TopLine STONE DIVISION				FastLine STONE DIVISION				TwistLine STONE DIVISION				MicronLine STONE DIVISION			
	Code	Type	ID	ED												
1	PB124111	Seg	84	120												
2	PB124112	Cr+S	84	120												
3	PB124113	Cr+S	84	120												
4	PB124114	Cr+S	84	120												
MFP5	PB01627	MFP5	84	120												
5	PB021604	Exp	60	96												
6	PB021342	Exp	60	96												
7	PB021343	Exp	60	96												
6	PB691173	Magic	61	97												
7	PB691174	Magic	61	97												

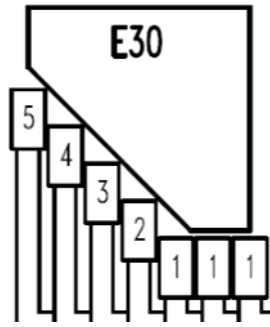
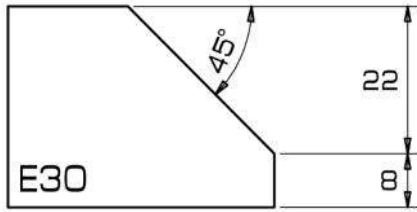

[BACK TO INDEX](#)



**Ninja Composition**  
E30

Position	<b>TopLine</b> STONE DIVISION				<b>FastLine</b> STONE DIVISION				<b>TwistLine</b> STONE DIVISION				<b>MicronLine</b> STONE DIVISION			
	Code	type	ID	ED					Code	type	ID	ED				
1	PB122819	Seg	74	120					PB161436	Seg	40	86				
2	PB122820	Cr+S	74	120					PB161437	Cr+S	40	86				
3	PB122821	Cr+S	74	120					PB161438	Cr+S	40	86				
4	PB122822	Cr+S	74	120					PB161439	Cr+S	40	86				
MFP5	PB01590	MFP5	74	120					PB11569	MFP5	40	86				
5	PB02340	Exp	60	112					PB02798	Exp	40	86				
6	PB02341	Exp	60	112					PB02799	Exp	40	86				
7	PB02342	Exp	60	112					PB02800	Exp	40	86				
6	PB69289	Magic	74	120					PB68193	Magic	45	91				
7	PB69290	Magic	74	120					PB68194	Magic	45	91				

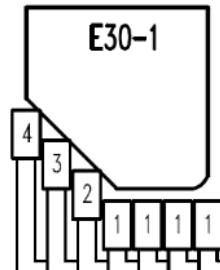
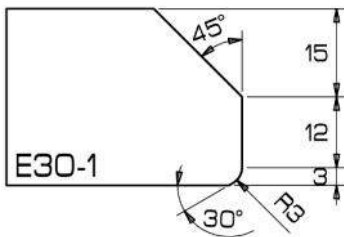

**Ninja Composition**  
E30-1

Position	<b>TopLine</b> STONE DIVISION				<b>FastLine</b> STONE DIVISION				<b>TwistLine</b> STONE DIVISION				<b>MicronLine</b> STONE DIVISION			
	Code	Type	ID	ED					Code	Type	ID	ED				
1					PB123719	Seg	70	102								
2					PB123720	Cr+S	60	92								
3					PB123721	Cr+S	60	92								
4					PB123722	Cr+S	60	92								
MFP5					PB01610	MFP5	60	92								
5					PB02470	Exp	60	94								
6					PB02471	Exp	60	94								
7					PB02472	Exp	60	94								
6					PB69253	Magic	65	97								
7					PB69254	Magic	65	97								

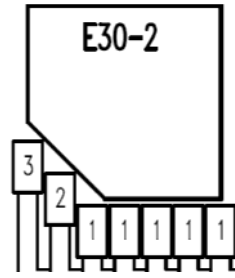
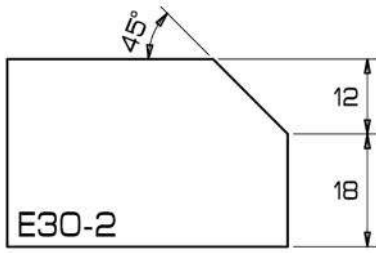



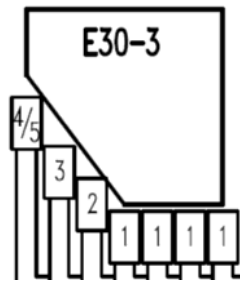
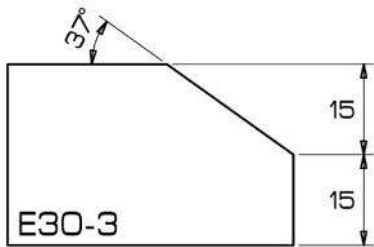

[BACK TO INDEX](#)

 **Ninja Composition**  
E30-2

	 <b>TopLine</b> STONE DIVISION					 <b>FastLine</b> STONE DIVISION					 <b>TwistLine</b> STONE DIVISION					 <b>MicronLine</b> STONE DIVISION				
Position	Code	type	ID	ED																
1	PB123138	Seg	80	108																
2	PB123139	Seg	80	108																
3	PB123140	Seg	80	108																
4	PB123141	Seg	80	108																
MFP5	-	MFP5	-	-																
5	PB02394	Exp	60	90																
6	PB02395	Exp	60	90																
7	PB02396	Exp	60	90																
6	PB69322	Magic	62	90																
7	PB69323	Magic	62	90																



 **Ninja Composition**  
E30-3

	 <b>TopLine</b> STONE DIVISION					 <b>FastLine</b> STONE DIVISION					 <b>TwistLine</b> STONE DIVISION					 <b>MicronLine</b> STONE DIVISION				
Position	Code	Type	ID	ED																
1	PB123178	Seg	80	125																
2	PB123179	Seg	80	125																
3	PB123180	Seg	80	125																
4	PB123181	Seg	80	125																
MFP5	-	MFP5	-	-																
5	PB021605	Exp	60	105																
6	PB021606	Exp	60	105																
7	PB021607	Exp	60	105																
6	PB69416	Magic	75	120																
7	PB69417	Magic	75	120																

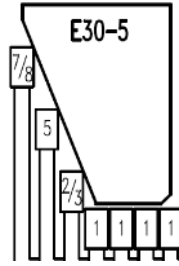
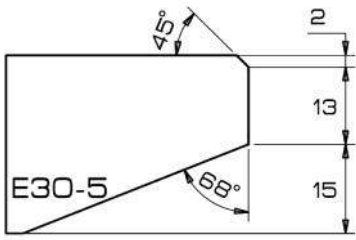



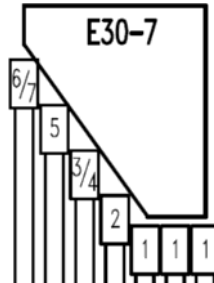
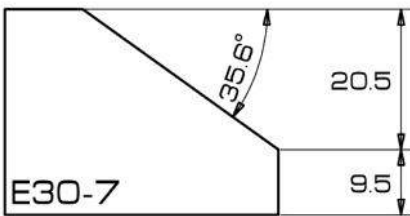

[BACK TO INDEX](#)

 **Ninja Composition**  
E30-5

 <b>TopLine</b> STONE DIVISION					 <b>FastLine</b> STONE DIVISION					 <b>TwistLine</b> STONE DIVISION					 <b>MicronLine</b> STONE DIVISION				
Position	Code	Type	ID	ED															
1	PB123922	Seg	65	145															
2	PB123923	Seg	65	145															
3	PB123924	Seg	65	145															
4	PB123925	Seg	65	145															
MFP5	-	MFP5	-	-															
5	PB021608	Exp	60	140															
6	PB021609	Exp	60	140															
7	PB021610	Exp	60	140															
6	PB691176	Magic	62	142															
7	PB691177	Magic	62	142															



 **Ninja Composition**  
E30-7

 <b>TopLine</b> STONE DIVISION					 <b>FastLine</b> STONE DIVISION					 <b>TwistLine</b> STONE DIVISION					 <b>MicronLine</b> STONE DIVISION				
Position	Code	Type	ID	ED															
1	PB123832	Seg	70	134															
2	PB123833	Seg	70	134															
3	PB123834	Seg	70	134															
4	PB124318	Seg	70	134															
MFP5	-	MFP5	-	-															
5	PB021611	Exp	60	124															
6	PB021612	Exp	60	124															
7	PB021613	Exp	60	124															
6	PB691179	Magic	60	124															
7	PB691180	Magic	60	124															

[BACK TO INDEX](#)

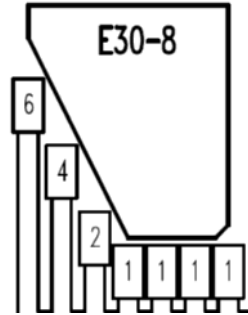
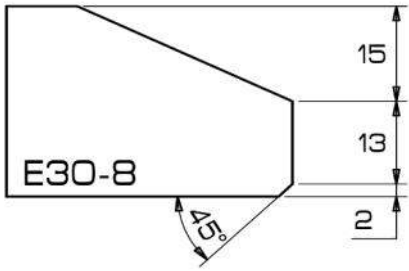

 **Ninja Composition**  
E30-8

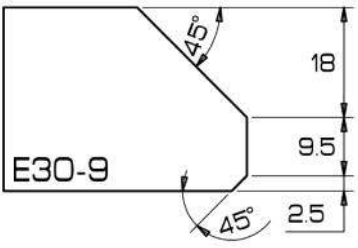

	 <b>TopLine</b> STONE DIVISION				 <b>FastLine</b> STONE DIVISION				 <b>TwistLine</b> STONE DIVISION				 <b>MicronLine</b> STONE DIVISION			
Position	Code	type	ID	ED												
1	PB123461	Seg	66	130												
2	PB123462	Seg	66	130												
3	PB123463	Seg	66	130												
4	PB123464	Seg	66	130												
MFP5	-	MFP5	-	-												
5	PB02461	Exp	60	125												
6	PB02462	Exp	60	125												
7	PB02463	Exp	60	125												
6	PB69349	Magic	58	122												
7	PB69350	Magic	58	122												

 **Ninja Composition**  
E30-9



	 <b>TopLine</b> STONE DIVISION				 <b>FastLine</b> STONE DIVISION				 <b>TwistLine</b> STONE DIVISION				 <b>MicronLine</b> STONE DIVISION			
Position					Code	type	ID	ED								
1					PB123573	Seg	60	99								
2					PB123574	Cr+S	60	99								
3					PB123575	Cr+S	60	99								
4					PB123576	Cr+S	60	99								
MFP5					PB01614	MFP5	60	99								
5					PB02293	Exp	60	100								
6					PB02294	Exp	60	100								
7					PB02295	Exp	60	100								
6					PB69367	Magic	57	97								
7					PB69368	Magic	57	97								

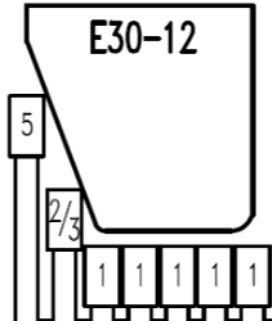
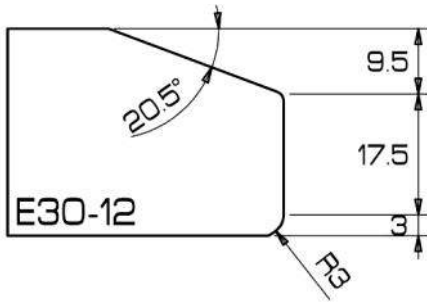

[BACK TO INDEX](#)



**Ninja Composition**  
E30-12

	<b>TopLine</b> STONE DIVISION				<b>FastLine</b> STONE DIVISION				<b>TwistLine</b> STONE DIVISION				<b>MicronLine</b> STONE DIVISION			
Position	Code	Type	ID	ED												
1	PB123762	Seg	70	124												
2	PB123763	Cr+S	60	114												
3	PB123764	Cr+S	60	114												
4	PB123765	Cr+S	60	114												
MFP5	PB01607	MFP5	60	114												
5	PB02385	Exp	60	116												
6	PB02386	Exp	60	116												
7	PB02387	Exp	60	116												
6	PB69352	Magic	64	120												
7	PB69353	Magic	64	120												

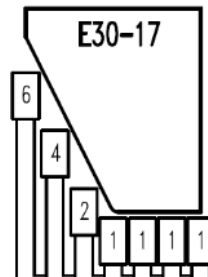
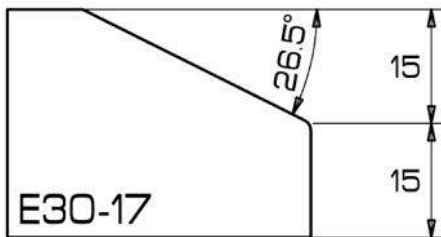

**Ninja Composition**  
E30-17

	<b>TopLine</b> STONE DIVISION				<b>FastLine</b> STONE DIVISION				<b>TwistLine</b> STONE DIVISION				<b>MicronLine</b> STONE DIVISION			
Position	Code	Type	ID	ED												
1	PB124660	Seg	70	135												
2	PB124661	Seg	70	135												
3	PB124662	Seg	70	135												
4	PB124663	Seg	70	135												
MFP5	-	MFP5	-	-												
5	PB021919	Exp	60	125												
6	PB021920	Exp	60	125												
7	PB021921	Exp	60	125												
6	PB691290	Magic	57	125												
7	PB691291	Magic	57	125												





[BACK TO INDEX](#)

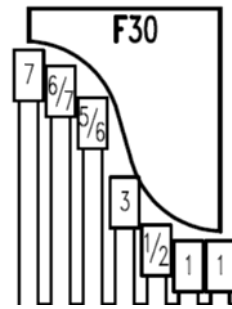
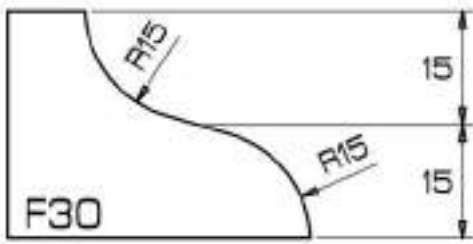

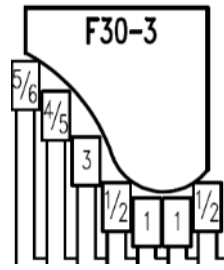
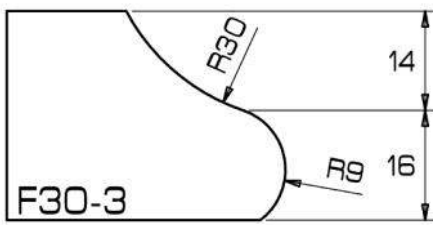

 **Ninja Composition**  
F30



Position	 <b>TopLine</b> STONE DIVISION				 <b>FastLine</b> STONE DIVISION				 <b>TwistLine</b> STONE DIVISION				 <b>MicronLine</b> STONE DIVISION			
	Code	Type	ID	ED					Code	Type	ID	ED				
1	PB122605	Seg	70	130					PB161269	Seg	40	100				
2	PB122606	Cr+S	60	120					PB161270	Cr+S	40	100				
3	PB122607	Cr+S	60	120					PB161271	Cr+S	40	100				
4	PB122647	Cr+S	60	120					PB161272	Cr+S	40	100				
MFP5	PB01524	MFP5	60	120					PB11508	MFP5	40	100				
5	PB02061	Exp	60	120					PB02619	Exp	40	100				
6	PB02062	Exp	60	120					PB02620	Exp	40	100				
7	PB02063	Exp	60	120					PB02621	Exp	40	100				
6	PB69046	Magic	59	120					PB68028	Magic	45	107				
7	PB69047	Magic	59	120					PB68029	Magic	45	107				



 **Ninja Composition**  
F30-3

Position	 <b>TopLine</b> STONE DIVISION				 <b>FastLine</b> STONE DIVISION				 <b>TwistLine</b> STONE DIVISION				 <b>MicronLine</b> STONE DIVISION			
	Code	Type	ID	ED												
1	PB123048	Seg	70	118												
2	PB123017	Cr+S	66	114												
3	PB123018	Cr+S	66	114												
4	PB123019	Cr+S	66	114												
MFP5	PB01525	MFP5	66	114												
5	PB02064	Exp	60	108												
6	PB02065	Exp	60	108												
7	PB02066	Exp	60	108												
6	PB69049	Magic	72	120												
7	PB69050	Magic	72	120												

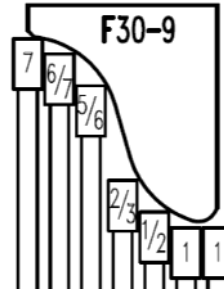
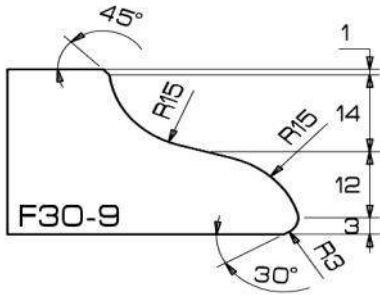

[BACK TO INDEX](#)



**Ninja Composition**  
F30-9

	<b>TopLine</b> STONE DIVISION				<b>FastLine</b> STONE DIVISION				<b>TwistLine</b> STONE DIVISION				<b>MicronLine</b> STONE DIVISION			
Position	Code	type	ID	ED												
1	PB122605	Seg	70	130												
2	PB123340	Cr+S	57	120												
3	PB123341	Cr+S	57	120												
4	PB123342	Cr+S	57	120												
MFP5	PB01526	MFP5	57	120												
5	PB02067	Exp	60	122												
6	PB02068	Exp	60	122												
7	PB02069	Exp	60	122												
6	PB69247	Magic	59	122												
7	PB69248	Magic	59	122												

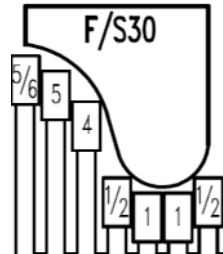
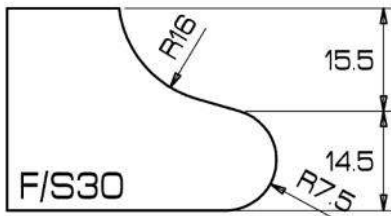

**Ninja Composition**  
F/S30

	<b>TopLine</b> STONE DIVISION				<b>FastLine</b> STONE DIVISION				<b>TwistLine</b> STONE DIVISION				<b>MicronLine</b> STONE DIVISION			
Position	Code	type	ID	ED												
1	PB122718	Seg	73	120												
2	PB122719	Cr+S	73	120												
3	PB122720	Cr+S	73	120												
4	PB122721	Cr+S	73	120												
MFP5	PB01528	MFP5	73	120												
5	PB02073	Exp	60	107												
6	PB02074	Exp	60	107												
7	PB02075	Exp	60	107												
6	PB69058	Magic	65	112												
7	PB69059	Magic	65	112												

[BACK TO INDEX](#)

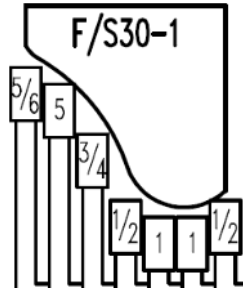
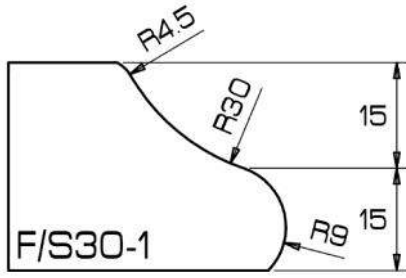

**Ninja Composition**  
F/S30-1

<b>TopLine</b> STONE DIVISION					<b>FastLine</b> STONE DIVISION					<b>TwistLine</b> STONE DIVISION					<b>MicronLine</b> STONE DIVISION				
Position	Code	Type	ID	ED															
1	PB123233	Seg	70	124															
2	PB122994	Cr+S	66	120															
3	PB122995	Cr+S	66	120															
4	PB122996	Cr+S	66	120															
MFP5	PB01529	MFP5	66	120															
5	PB02076	Exp	60	114															
6	PB02077	Exp	60	114															
7	PB02078	Exp	60	114															
6	PB69061	Magic	65	119															
7	PB69062	Magic	65	119															

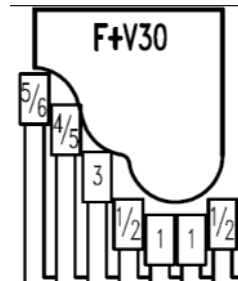
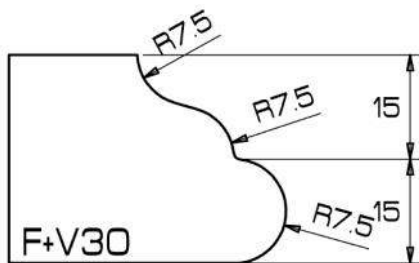

**Ninja Composition**  
F+V30

<b>TopLine</b> STONE DIVISION					<b>FastLine</b> STONE DIVISION					<b>TwistLine</b> STONE DIVISION					<b>MicronLine</b> STONE DIVISION				
Position	Code	Type	ID	ED															
1	PB123224	Seg	77	120															
2	PB122723	Cr+S	77	120															
3	PB122724	Cr+S	77	120															
4	PB122725	Cr+S	77	120															
MFP5	PB01530	MFP5	77	120															
5	PB02079	Exp	60	103															
6	PB02080	Exp	60	103															
7	PB02081	Exp	60	103															
6	PB69064	Magic	73	117															
7	PB69065	Magic	73	117															

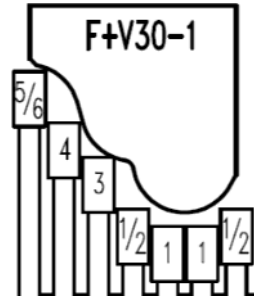
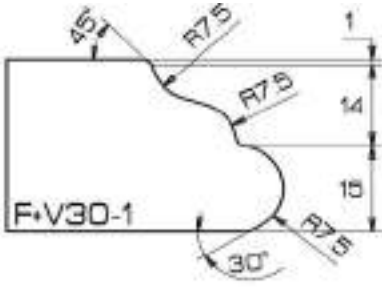

[BACK TO INDEX](#)



**Ninja Composition**  
F+V30-1

	<b>TopLine</b> STONE DIVISION					<b>FastLine</b> STONE DIVISION					<b>TwistLine</b> STONE DIVISION					<b>MicronLine</b> STONE DIVISION				
Position	Code	Type	ID	ED																
1	PB123224	Seg	77	120																
2	PB123783	Cr+S	60	108																
3	PB123784	Cr+S	60	108																
4	PB123785	Cr+S	60	108																
MFP5	PB01592	MFP5	60	108																
5	PB02437	Exp	60	108																
6	PB02438	Exp	60	108																
7	PB02439	Exp	60	108																
6	PB69286	Magic	72	120																
7	PB69287	Magic	72	120																

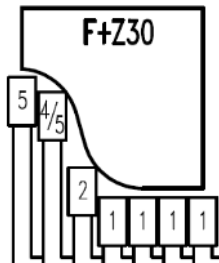
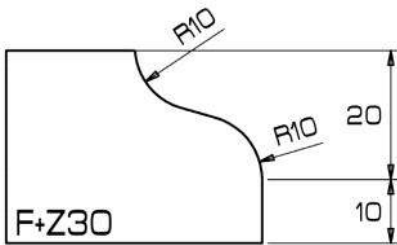

**Ninja Composition**  
F+Z30

	<b>TopLine</b> STONE DIVISION					<b>FastLine</b> STONE DIVISION					<b>TwistLine</b> STONE DIVISION					<b>MicronLine</b> STONE DIVISION				
Position	Code	Type	ID	ED																
1	PB123226	Seg	80	120																
2	PB122609	Cr+S	80	120																
3	PB122610	Cr+S	80	120																
4	PB122643	Cr+S	80	120																
MFP5	PB01532	MFP5	50	90																
5	PB02085	Exp	60	100																
6	PB02086	Exp	60	100																
7	PB02087	Exp	60	100																
6	PB69070	Magic	61	97																
7	PB69071	Magic	61	97																

[BACK TO INDEX](#)

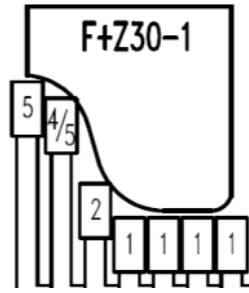
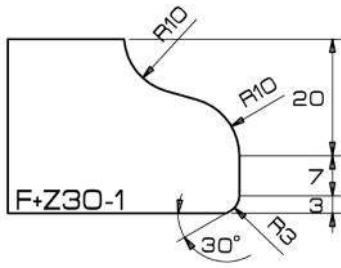

**Ninja Composition**  
F+Z30-1

<b>TopLine</b> STONE DIVISION					<b>FastLine</b> STONE DIVISION					<b>TwistLine</b> STONE DIVISION					<b>MicronLine</b> STONE DIVISION				
Position	Code	Type	ID	ED															
1	PB123226	Seg	80	120															
2	PB124598	Cr+S	80	120															
3	PB124599	Cr+S	80	120															
4	PB124600	Cr+S	80	120															
MFP5	PB01834	MFP5	80	120															
5	PB021324	Exp	60	100															
6	PB021325	Exp	60	100															
7	PB021326	Exp	60	100															
6	PB691275	Magic	57	97															
7	PB691276	Magic	57	97															

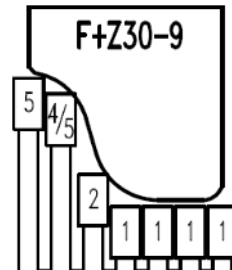
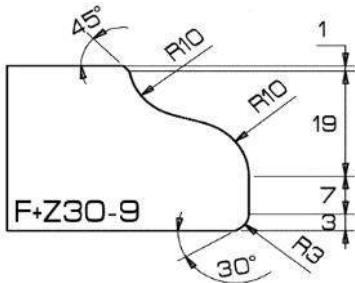





**Ninja Composition**  
F+Z30-9

<b>TopLine</b> STONE DIVISION					<b>FastLine</b> STONE DIVISION					<b>TwistLine</b> STONE DIVISION					<b>MicronLine</b> STONE DIVISION				
Position					Code	type	ID	ED											
1					PB123185	Seg	55	95											
2					PB123343	Cr+S	60	104											
3					PB123344	Cr+S	60	104											
4					PB123345	Cr+S	60	104											
MFP5					PB01533	MFP5	60	104											
5					PB02088	Exp	60	105											
6					PB02089	Exp	60	105											
7					PB02090	Exp	60	105											
6					PB69172	Magic	74	118											
7					PB69173	Magic	74	118											

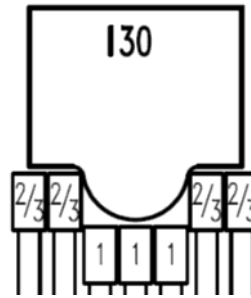
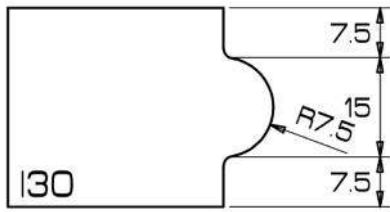
[BACK TO INDEX](#)

 **Ninja Composition**  
I30



Position	 <b>TopLine</b> STONE DIVISION				 <b>FastLine</b> STONE DIVISION				 <b>TwistLine</b> STONE DIVISION				 <b>MicronLine</b> STONE DIVISION			
	Code	type	ID	ED												
1	PB122763	Seg	105	120												
2	PB122764	Cr+S	105	120												
3	PB122765	Cr+S	105	120												
4	PB122766	Cr+S	105	120												
MFP5	PB01540	MFP5	105	120												
5	PB02109	Exp	60	75												
6	PB02110	Exp	60	75												
7	PB02111	Exp	60	75												
6	PB69091	Magic	65	80												
7	PB69092	Magic	65	80												

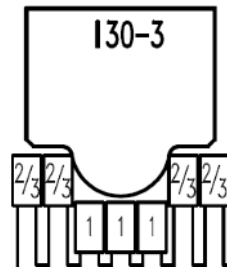
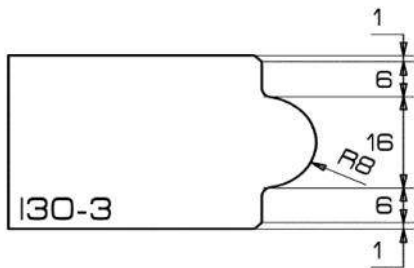

 **Ninja Composition**  
I30-3

Position	 <b>TopLine</b> STONE DIVISION				 <b>FastLine</b> STONE DIVISION				 <b>TwistLine</b> STONE DIVISION				 <b>MicronLine</b> STONE DIVISION			
	Code	Type	ID	ED												
1	PB123698	Seg	70	91												
2	PB123699	Seg	70	91												
3	PB123700	Seg	70	91												
4	PB123701	Seg	70	91												
MFP5	-	MFP5	-	-												
5	PB02333	Exp	60	81												
6	PB02334	Exp	60	81												
7	PB02335	Exp	60	81												
6	PB69277	Magic	59	80												
7	PB69278	Magic	59	80												

[BACK TO INDEX](#)

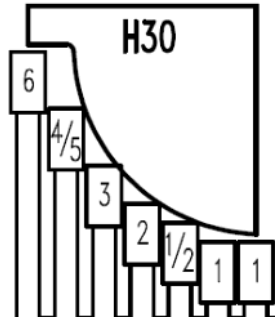
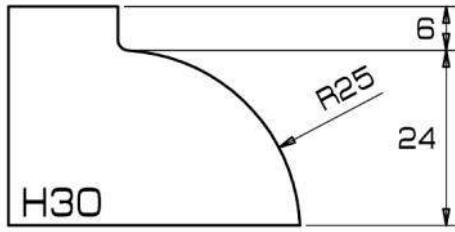

**Ninja Composition**  
H30

Position	<b>TopLine</b> STONE DIVISION				<b>FastLine</b> STONE DIVISION				<b>TwistLine</b> STONE DIVISION				<b>MicronLine</b> STONE DIVISION			
	Code	Type	ID	ED					Code	Type	ID	ED				
1	PB122851	Seg	70	120					PB161200	Seg	40	90				
2	PB122852	Cr+S	70	120					PB161201	Seg	40	90				
3	PB122853	Cr+S	70	120					PB161202	Seg	40	90				
4	PB122854	Cr+S	70	120					PB161203	Seg	40	90				
MFP5	PB01536	MFP5	70	120					-	MFP5	-	-				
5	PB02097	Exp	60	110					PB02625	Exp	40	90				
6	PB02098	Exp	60	110					PB02626	Exp	40	90				
7	PB02099	Exp	60	110					PB02627	Exp	40	90				
6	PB69079	Magic	70	120					PB68034	Magic	45	95				
7	PB69080	Magic	70	120					PB69035	Magic	45	95				

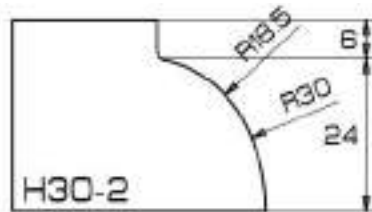

**Ninja Composition**  
H30-2

Position	<b>TopLine</b> STONE DIVISION				<b>FastLine</b> STONE DIVISION				<b>TwistLine</b> STONE DIVISION				<b>MicronLine</b> STONE DIVISION			
	Code	Type	ID	ED												
1	PB124345	Seg	70	110												
2	PB124346	Seg	70	110												
3	PB124347	Seg	70	110												
4	PB124348	Seg	70	110												
MFP5	-	MFP5	-	-												
5	PB021623	Exp	60	100												
6	PB021624	Exp	60	100												
7	PB021625	Exp	60	100												
6	PB69310	Magic	63	97												
7	PB69311	Magic	63	97												

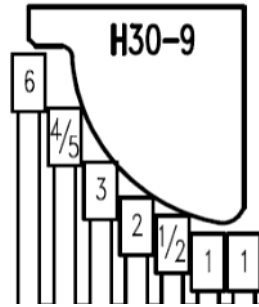
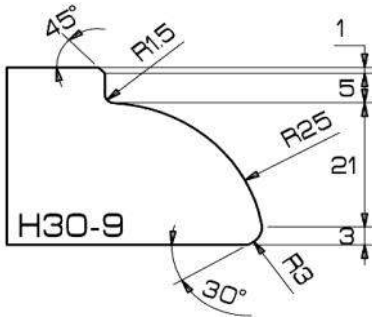

[BACK TO INDEX](#)



**Ninja Composition**  
H30-9

	<b>TopLine</b> STONE DIVISION				<b>FastLine</b> STONE DIVISION				<b>TwistLine</b> STONE DIVISION				<b>MicronLine</b> STONE DIVISION			
Position	Code	Type	ID	ED												
1	PB122851	Seg	70	120												
2	PB123346	Cr+S	60	113												
3	PB123347	Cr+S	60	113												
4	PB123348	Cr+S	60	113												
MFP5	PB01537	MFP5	60	113												
5	PB02100	Exp	60	115												
6	PB02101	Exp	60	115												
7	PB02102	Exp	60	115												
6	PB69082	Magic	62	116												
7	PB69083	Magic	62	116												

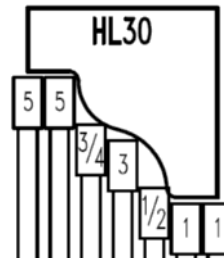
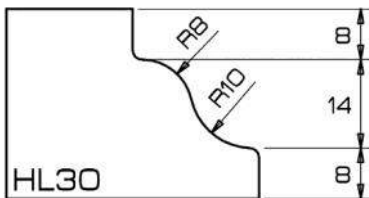

**Ninja Composition**  
HL30

	<b>TopLine</b> STONE DIVISION				<b>FastLine</b> STONE DIVISION				<b>TwistLine</b> STONE DIVISION				<b>MicronLine</b> STONE DIVISION			
Position	Code	Type	ID	ED												
1	PB124335	Seg	80	120												
2	PB124336	Cr+S	80	120												
3	PB124337	Cr+S	80	120												
4	PB124338	Cr+S	80	120												
MFP5	PB01606	MFP5	80	120												
5	PB021614	Exp	60	104												
6	PB021615	Exp	60	104												
7	PB021616	Exp	60	104												
6	PB691182	Magic	57	97												
7	PB691183	Magic	57	97												



[BACK TO INDEX](#)

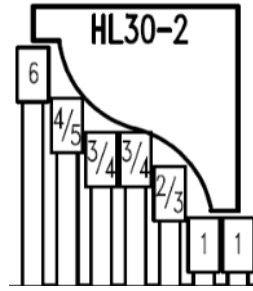
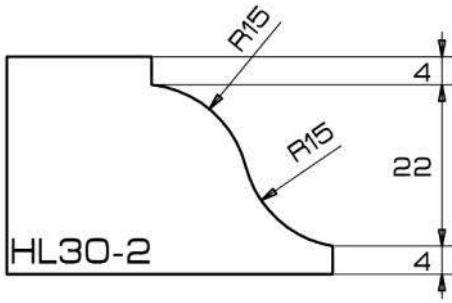

**Ninja Composition**  
HL30-2

Position	TopLine STONE DIVISION				FastLine STONE DIVISION				TwistLine STONE DIVISION				MicronLine STONE DIVISION			
	Code	type	ID	ED												
1	PB124339	Seg	70	120												
2	PB124340	Seg	70	120												
3	PB124341	Seg	70	120												
4	PB124342	Seg	70	120												
MFP5	-	MFP5	-	-												
5	PB021617	Exp	60	110												
6	PB021618	Exp	60	110												
7	PB021619	Exp	60	110												
6	PB691185	Magic	66	116												
7	PB691186	Magic	66	116												

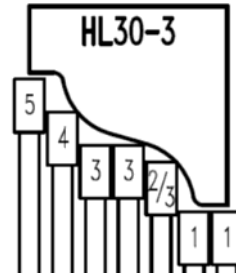
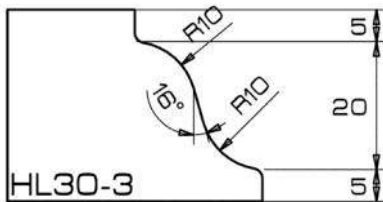

**Ninja Composition**  
HL30-3

Position	TopLine STONE DIVISION				FastLine STONE DIVISION				TwistLine STONE DIVISION				MicronLine STONE DIVISION			
	Code	Type	ID	ED												
1	PB123963	Seg	70	110												
2	PB123694	Seg	70	110												
3	PB124343	Seg	70	110												
4	PB124344	Seg	70	110												
MFP5	-	MFP5	-	-												
5	PB021620	Exp	60	100												
6	PB021621	Exp	60	100												
7	PB021622	Exp	60	100												
6	PB691188	Magic	57	97												
7	PB691189	Magic	57	97												

[BACK TO INDEX](#)

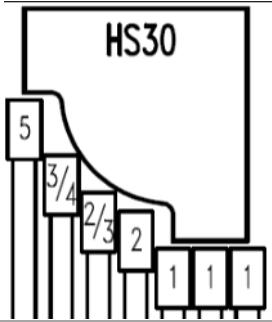
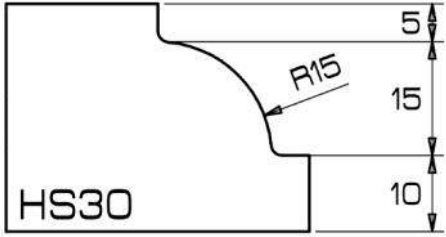

**Ninja Composition**

HS30

 <b>TopLine</b> STONE DIVISION					 <b>FastLine</b> STONE DIVISION					 <b>TwistLine</b> STONE DIVISION					 <b>MicronLine</b> STONE DIVISION				
Position	Code	type	ID	ED															
1	PB123387	Seg	70	110															
2	PB123388	Seg	70	110															
3	PB123389	Seg	70	110															
4	PB123390	Seg	70	110															
MFP5	-	MFP5	-	-															
5	PB02103	Exp	60	100															
6	PB02104	Exp	60	100															
7	PB02105	Exp	60	100															
6	PB69085	Magic	57	97															
7	PB69086	Magic	57	97															

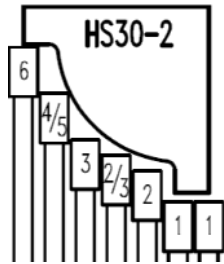
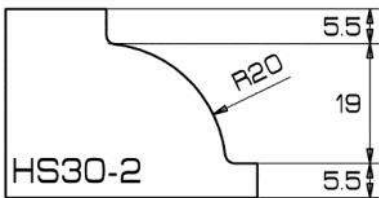

**Ninja Composition**

HS30-2

 <b>TopLine</b> STONE DIVISION					 <b>FastLine</b> STONE DIVISION					 <b>TwistLine</b> STONE DIVISION					 <b>MicronLine</b> STONE DIVISION				
Position	Code	Type	ID	ED															
1	PB124005	Seg	70	118															
2	PB124006	Seg	70	118															
3	PB124007	Seg	70	118															
4	PB124008	Seg	70	118															
MFP5	-	MFP5	-	-															
5	PB021879	Exp	60	108															
6	PB021880	Exp	60	108															
7	PB021881	Exp	60	108															
6	PB69319	Magic	57	97															
7	PB69320	Magic	57	97															

[BACK TO INDEX](#)

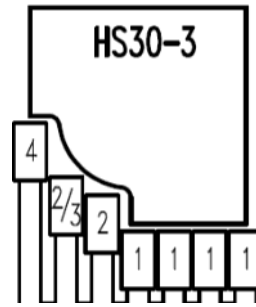
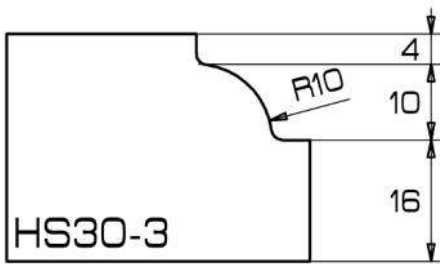

**Ninja Composition**  
HS30-3

Position	TopLine STONE DIVISION				FastLine STONE DIVISION				TwistLine STONE DIVISION				MicronLine STONE DIVISION			
	Code	type	ID	ED	Code	type	ID	ED	Code	type	ID	ED	Code	type	ID	ED
1					PB124601	Seg	70	100								
2					PB124602	Cr+S	58	88								
3					PB124603	Cr+S	58	88								
4					PB124604	Cr+S	58	88								
MFP5					PB01840	MFP5	58	88								
5					PB021429	Exp	60	88								
6					PB021430	Exp	60	88								
7					PB021431	Exp	60	88								
6					PB691284	Magic	67	97								
7					PB691285	Magic	67	97								

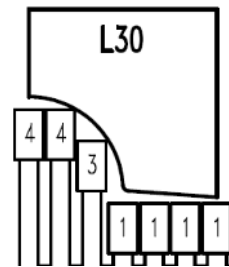
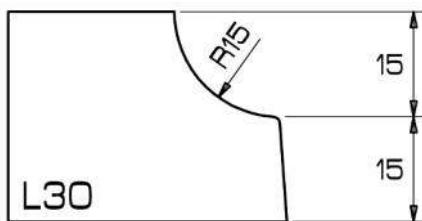

**Ninja Composition**  
L30

Position	TopLine STONE DIVISION				FastLine STONE DIVISION				TwistLine STONE DIVISION				MicronLine STONE DIVISION			
	Code	Type	ID	ED	Code	Type	ID	ED	Code	Type	ID	ED	Code	Type	ID	ED
1	PB122771	Seg	88	120												
2	PB122772	Cr+S	87	120												
3	PB122773	Cr+S	87	120												
4	PB122774	Cr+S	87	120												
MFP5	PB01542	MFP5	87	120												
5	PB02115	Exp	60	93												
6	PB02116	Exp	60	93												
7	PB02117	Exp	60	93												
6	PB79097	Magic	62	97												
7	PB97098	Magic	62	97												

[BACK TO INDEX](#)



**Ninja Composition**  
L30-2

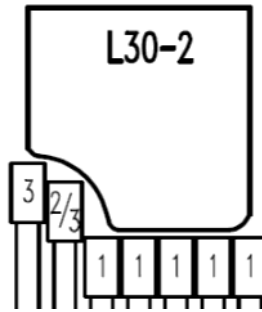
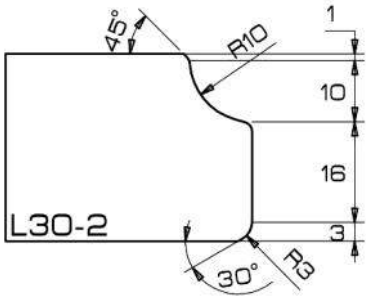

	<b>TopLine</b> STONE DIVISION	<b>FastLine</b> STONE DIVISION	<b>TwistLine</b> STONE DIVISION	<b>MicronLine</b> STONE DIVISION													
Position	Code	Type	ID	ED													
1	PB123974	Seg	100	120													
2	PB123975	Cr+S	94	120													
3	PB123976	Cr+S	94	120													
4	PB123977	Cr+S	94	120													
MFP5	PB01664	MFP5	94	120													
5	PB021626	Exp	60	86													
6	PB021627	Exp	60	86													
7	PB021628	Exp	60	86													
6	PB69382	Magic	71	97													
7	PB69383	Magic	71	97													



**Ninja Composition**  
M30

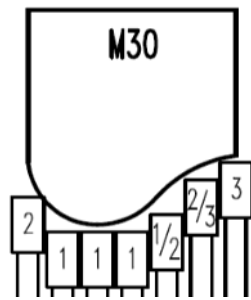
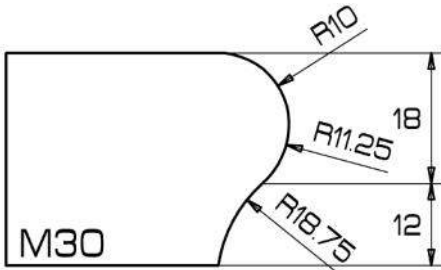

	<b>TopLine</b> STONE DIVISION	<b>FastLine</b> STONE DIVISION	<b>TwistLine</b> STONE DIVISION	<b>MicronLine</b> STONE DIVISION													
Position	Code	Type	ID	ED													
1	PB123217	Seg	94	120													
2	PB122776	Cr+S	94	120													
3	PB122777	Cr+S	94	120													
4	PB122778	Cr+S	94	120													
MFP5	PB01543	MFP5	94	120													
5	PB02118	Exp	60	88													
6	PB02119	Exp	60	88													
7	PB02120	Exp	60	88													
6	PB69100	Magic	71	97													
7	PB69101	Magic	71	97													

[BACK TO INDEX](#)

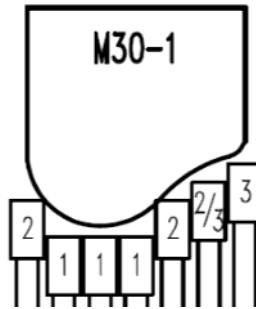
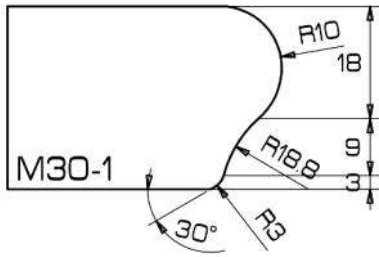

**Ninja Composition**  
M30-1

Position	TopLine STONE DIVISION				FastLine STONE DIVISION				TwistLine STONE DIVISION				MicronLine STONE DIVISION			
	Code	Type	ID	ED	Code	Type	ID	ED	Code	Type	ID	ED	Code	Type	ID	ED
1					PB123818	Seg	60	88								
2					PB123819	Cr+S	60	88								
3					PB123820	Cr+S	60	88								
4					PB123821	Cr+S	60	88								
MFP5					PB01804	MFP5	60	88								
5					PB021776	Exp	60	88								
6					PB021777	Exp	60	88								
7					PB021778	Exp	60	88								
6					PB69301	Magic	74	100								
7					PB69302	Magic	74	100								

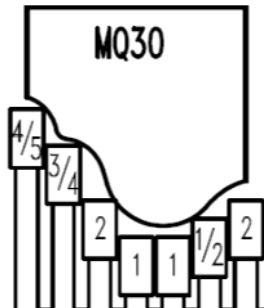
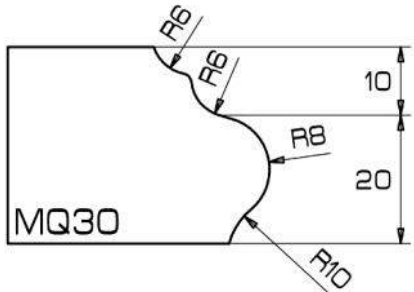

**Ninja Composition**  
MQ30

Position	TopLine STONE DIVISION				FastLine STONE DIVISION				TwistLine STONE DIVISION				MicronLine STONE DIVISION			
	Code	Type	ID	ED	Code	Type	ID	ED	Code	Type	ID	ED	Code	Type	ID	ED
1	PB123218	Seg	84	120												
2	PB122780	Cr+S	84	120												
3	PB122781	Cr+S	84	120												
4	PB122782	Cr+S	84	120												
MFP5	PB01544	MFP5	84	120												
5	PB02121	Exp	60	96												
6	PB02122	Exp	60	96												
7	PB02123	Exp	60	96												
6	PB69103	Magic	61	97												
7	PB69104	Magic	61	97												

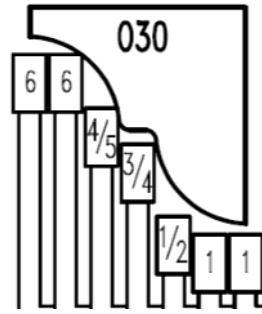
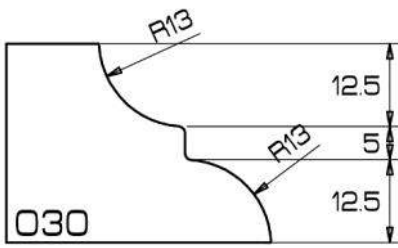

[BACK TO INDEX](#)



**Ninja Composition**

030

Position	TopLine STONE DIVISION				FastLine STONE DIVISION				TwistLine STONE DIVISION				MicronLine STONE DIVISION			
	Code	Type	ID	ED												
1	PB123219	Seg	70	122												
2	PB122784	Cr+S	68	120												
3	PB122785	Cr+S	68	120												
4	PB122786	Cr+S	68	120												
MFP5	PB01545	MFP5	68	120												
5	PB02124	Exp	60	112												
6	PB02125	Exp	60	112												
7	PB02126	Exp	60	112												
6	PB69106	Magic	66	119												
7	PB69107	Magic	66	119												

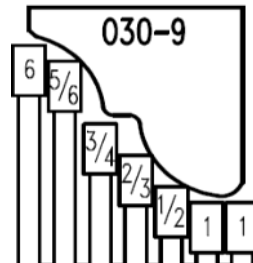
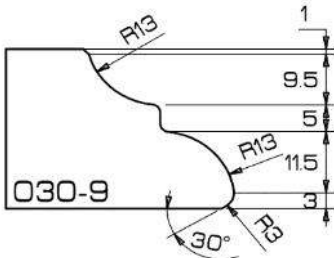

**Ninja Composition**



030-9

Position	TopLine STONE DIVISION				FastLine STONE DIVISION				TwistLine STONE DIVISION				MicronLine STONE DIVISION			
	Code	type	ID	ED												
1	PB123219	Seg	70	122												
2	PB123349	Cr+S	60	115												
3	PB123350	Cr+S	60	115												
4	PB123351	Cr+S	60	115												
MFP5	PB01546	MFP5	60	115												
5	PB02127	Exp	60	118												
6	PB02128	Exp	60	118												
7	PB02129	Exp	60	118												
6	PB69109	Magic	59	114												
7	PB69110	Magic	59	114												

[BACK TO INDEX](#)

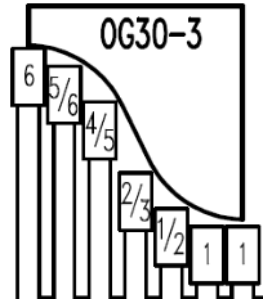
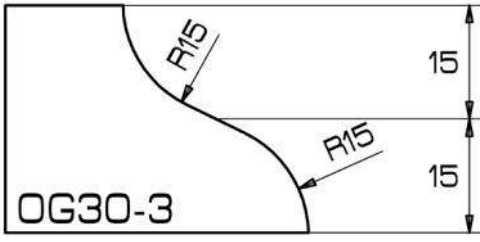
 **Ninja Composition**  
OG30-3



 <b>TopLine</b> STONE DIVISION					 <b>FastLine</b> STONE DIVISION				 <b>TwistLine</b> STONE DIVISION				 <b>MicronLine</b> STONE DIVISION			
Position	Code	Type	ID	ED												
1	PB124349	Seg	71	120												
2	PB124350	Seg	71	120												
3	PB124351	Seg	71	120												
4	PB124352	Seg	71	120												
MFP5	-	MFP5	-	-												
5	PB021629	Exp	60	109												
6	PB021630	Exp	60	109												
7	PB021631	Exp	50	109												
6	PB691036	Magic	62	111												
7	PB691037	Magic	62	111												

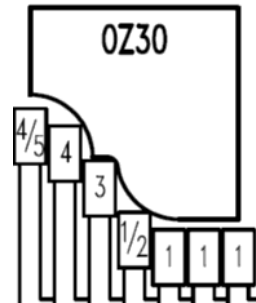
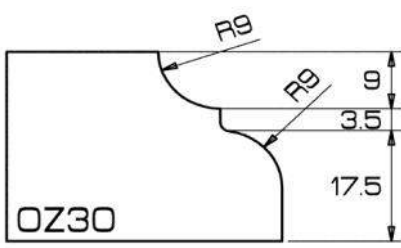

 **Ninja Composition**  
OZ30

 <b>TopLine</b> STONE DIVISION					 <b>FastLine</b> STONE DIVISION				 <b>TwistLine</b> STONE DIVISION				 <b>MicronLine</b> STONE DIVISION			
Position	Code	type	ID	ED	Code	type	ID	ED								
1	PB124046	Seg	84	120	PB122970	Seg	60	96								
2	PB124047	Seg	84	120	PB122971	Seg	60	96								
3	PB124048	Seg	84	120	PB122972	Seg	60	96								
4	PB124049	Seg	84	120	PB122973	Seg	60	96								
MFP5	-	MFP5	-	-	-	MFP5	-	-								
5	PB02136	Exp	60	96	PB02136	Exp	60	96								
6	PB02137	Exp	60	96	PB02137	Exp	60	96								
7	PB02138	Exp	60	96	PB02138	Exp	60	96								
6	PB69175	Magic	61	97	PB69175	Magic	61	97								
7	PB69176	Magic	61	97	PB69176	Magic	61	97								

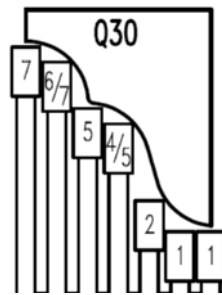
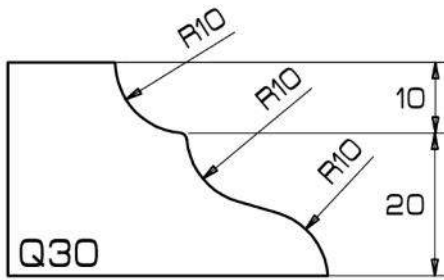

**BACK TO INDEX**



**Ninja Composition**

Q30

<b>TopLine</b> STONE DIVISION					<b>FastLine</b> STONE DIVISION					<b>TwistLine</b> STONE DIVISION					<b>MicronLine</b> STONE DIVISION				
Position	Code	Type	ID	ED															
1	PB123228	Seg	70	130															
2	PB122788	Cr+S	60	120															
3	PB122789	Cr+S	60	120															
4	PB122790	Cr+S	60	120															
MFP5	PB01548	MFP5	60	120															
5	PB02130	Exp	60	121															
6	PB02131	Exp	60	121															
7	PB02132	Exp	60	121															
6	PB69112	Magic	58	120															
7	PB69113	Magic	58	120															

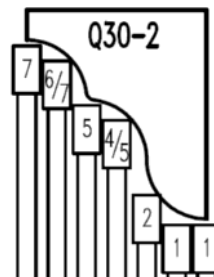
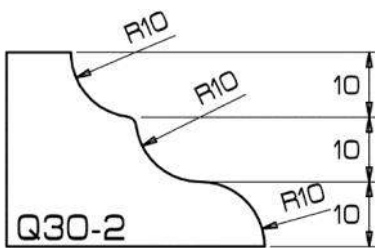

**Ninja Composition**

Q30-2

<b>TopLine</b> STONE DIVISION					<b>FastLine</b> STONE DIVISION					<b>TwistLine</b> STONE DIVISION					<b>MicronLine</b> STONE DIVISION				
Position	Code	type	ID	ED															
1	PB123068	Seg	60	120															
2	PB123069	Cr+S	60	120															
3	PB123070	Cr+S	60	120															
4	PB123071	Cr+S	60	120															
MFP5	PB01665	MFP5	60	120															
5	PB02373	Exp	60	120															
6	PB02374	Exp	60	120															
7	PB02375	Exp	60	120															
6	PB69265	Magic	59	120															
7	PB69266	Magic	59	120															



[BACK TO INDEX](#)

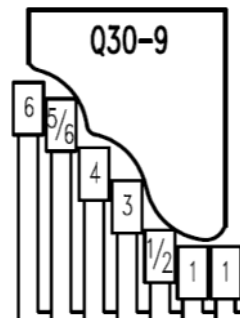
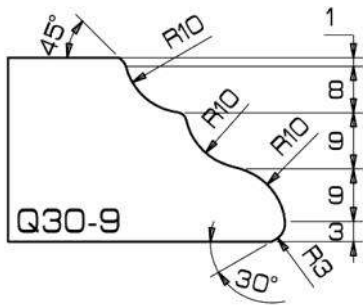

**Ninja Composition**

Q30-9

	<b>TopLine</b> STONE DIVISION					<b>FastLine</b> STONE DIVISION					<b>TwistLine</b> STONE DIVISION					<b>MicronLine</b> STONE DIVISION				
Position	Code	Type	ID	ED																
1	PB123748	Seg	70	122																
2	PB123749	Cr+S	60	116																
3	PB123750	Cr+S	60	116																
4	PB123751	Cr+S	60	116																
MFP5	PB01589	MFP5	60	116																
5	PB02296	Exp	60	118																
6	PB02297	Exp	60	118																
7	PB02298	Exp	60	118																
6	PB69268	Magic	64	120																
7	PB69269	Magic	64	120																

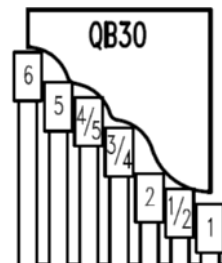
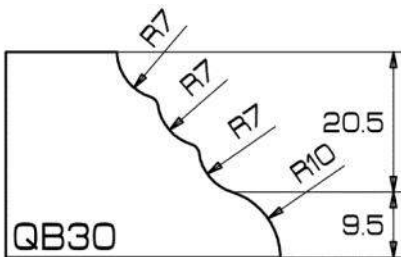

**Ninja Composition**

QB30

	<b>TopLine</b> STONE DIVISION					<b>FastLine</b> STONE DIVISION					<b>TwistLine</b> STONE DIVISION					<b>MicronLine</b> STONE DIVISION				
Position	Code	Type	ID	ED																
1	PB123229	Seg	72	120																
2	PB122792	Cr+S	72	120																
3	PB122793	Cr+S	72	120																
4	PB122794	Cr+S	72	120																
MFP5	PB01549	MFP5	72	120																
5	PB02133	Exp	60	108																
6	PB02134	Exp	60	108																
7	PB02135	Exp	60	108																
6	PB69115	Magic	71	120																
7	PB69116	Magic	71	120																

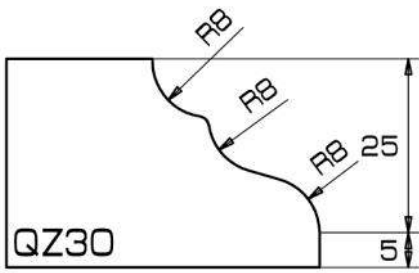

[BACK TO INDEX](#)



**Ninja Composition**

QZ30

	<b>TopLine</b> STONE DIVISION				<b>FastLine</b> STONE DIVISION				<b>TwistLine</b> STONE DIVISION				<b>MicronLine</b> STONE DIVISION			
Position	Code	Type	ID	ED												
1	PB123588	Seg	70	118												
2	PB123589	Seg	70	118												
3	PB123590	Seg	70	118												
4	PB123591	Seg	70	118												
MFP5	-	MFP5	-	-												
5	PB02304	Exp	60	108												
6	PB02305	Exp	60	108												
7	PB02306	Exp	60	108												
6	PB69250	Magic	63	111												
7	PB69251	Magic	63	111												

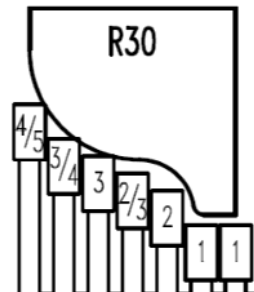
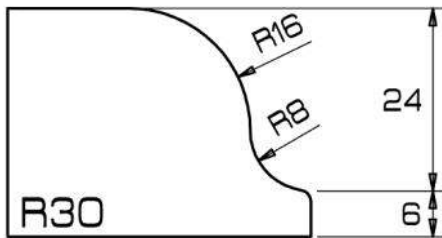

**Ninja Composition**

R30

	<b>TopLine</b> STONE DIVISION				<b>FastLine</b> STONE DIVISION				<b>TwistLine</b> STONE DIVISION				<b>MicronLine</b> STONE DIVISION			
Position	Code	Type	ID	ED												
1	PB124353	Seg	70	121												
2	PB124354	Cr+S	69	120												
3	PB124355	Cr+S	69	120												
4	PB124356	Cr+S	69	120												
MFP5	PB01666	MFP5	69	120												
5	PB021632	Exp	60	111												
6	PB021633	Exp	60	111												
7	PB021634	Exp	60	111												
6	PB691027	Magic	64	115												
7	PB692028	Magic	64	115												

[BACK TO INDEX](#)

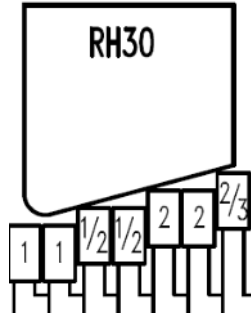
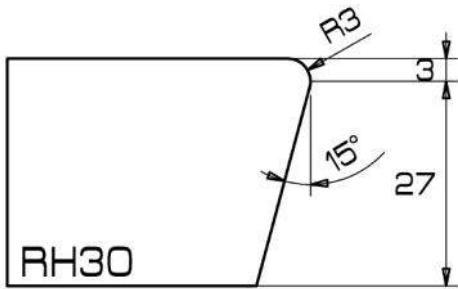

**Ninja Composition**  
RH30

Position	TopLine STONE DIVISION				FastLine STONE DIVISION				TwistLine STONE DIVISION				MicronLine STONE DIVISION			
	Code	type	ID	ED												
1	PB123690	Seg	104	120												
2	PB123691	Cr+S	104	120												
3	PB123692	Cr+S	104	120												
4	PB123693	Cr+S	104	120												
MFP5	PB01577	MFP5	104	120												
5	PB02229	Exp	60	76												
6	PB02230	Exp	60	76												
7	PB02231	Exp	60	76												
6	PB69235	Magic	64	80												
7	PB69236	Magic	64	80												

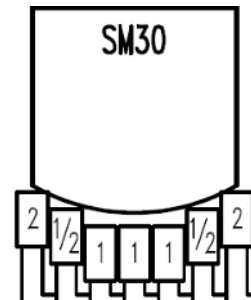
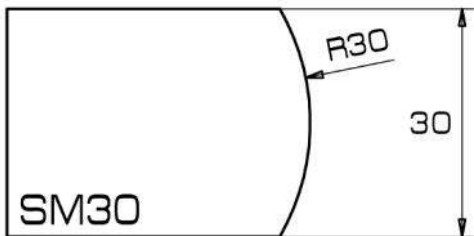

**Ninja Composition**  
SM30

Position	TopLine STONE DIVISION				FastLine STONE DIVISION				TwistLine STONE DIVISION				MicronLine STONE DIVISION			
	Code	Type	ID	ED												
1	PB122859	Cr+S	70	80												
2	PB122860	Cr+S	70	80												
3	PB122861	Cr+S	70	80												
4	PB122862	Cr+S	70	80												
MFP5	PB01551	MFP5	70	80												
5	PB02142	Exp	60	71												
6	PB02143	Exp	60	71												
7	PB02144	Exp	60	71												
6	PB69181	Magic	70	80												
7	PB69182	Magic	70	80												

[BACK TO INDEX](#)



**Ninja Composition**

SM30-1

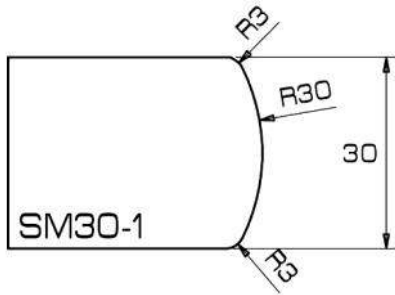

Position	<b>TopLine</b> STONE DIVISION				<b>FastLine</b> STONE DIVISION				<b>TwistLine</b> STONE DIVISION				<b>MicronLine</b> STONE DIVISION			
					Code	type	ID	ED								
1					PB123742	Seg	60	77								
2					PB123743	Cr+S	60	77								
3					PB123744	Cr+S	60	77								
4					PB123745	Cr+S	60	77								
MFP5					PB01622	MFP5	60	77								
5					PB02370	Exp	60	77								
6					PB02371	Exp	60	77								
7					PB02372	Exp	60	77								
6					PB69262	Magic	61	78								
7					PB69263	Magic	61	78								



**Ninja Composition**

SM30-2

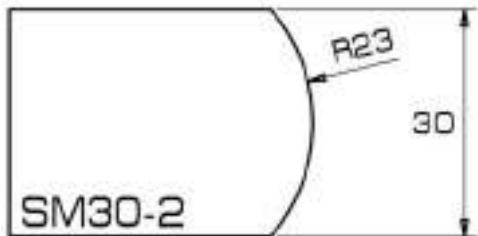

Position	<b>TopLine</b> STONE DIVISION				<b>FastLine</b> STONE DIVISION				<b>TwistLine</b> STONE DIVISION				<b>MicronLine</b> STONE DIVISION			
					Code	type	ID	ED								
1					PB123423	Cr+S	70	80								
2					PB123424	Cr+S	70	80								
3					PB123425	Cr+S	70	80								
4					PB123426	Cr+S	70	80								
MFP5					PB01805	MFP5	70	80								
5					PB02327	Exp	60	77								
6					PB02328	Exp	60	77								
7					PB02329	Exp	60	77								
6					PB69762	Magic	61	78								
7					PB69763	Magic	61	78								

[BACK TO INDEX](#)

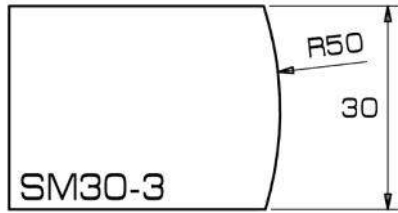

**Ninja Composition**

SM30-3

Position	<b>TopLine</b> STONE DIVISION				<b>FastLine</b> STONE DIVISION				<b>TwistLine</b> STONE DIVISION				<b>MicronLine</b> STONE DIVISION			
	Code	Type	ID	ED	Code	Type	ID	ED	Code	Type	ID	ED	Code	Type	ID	ED
1					PB124488	Cr+S	70	77								
2					PB124489	Cr+S	70	77								
3					PB124490	Cr+S	70	77								
4					PB124491	Cr+S	70	77								
MFP5					PB01806	MFP5	70	77								
5					PB021779	Exp	60	67								
6					PB021780	Exp	60	67								
7					PB021781	Exp	60	67								
6					PB691018	Magic	73	80								
7					PB691019	Magic	73	80								

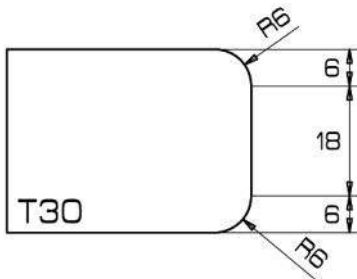

**Ninja Composition**

T30

Position	<b>TopLine</b> STONE DIVISION				<b>FastLine</b> STONE DIVISION				<b>TwistLine</b> STONE DIVISION				<b>MicronLine</b> STONE DIVISION			
	Code	Type	ID	ED	Code	Type	ID	ED	Code	Type	ID	ED	Code	Type	ID	ED
1	PB122614	Seg	103	120	PB122611	Seg	60	77	PB161229	Seg	40	57	PB20417	6 Seg	20	40
2	PB122615	Cr+S	103	120	PB122612	Cr+S	60	77	PB161230	Cr+S	40	57	PB20418	6 Seg	20	40
3	PB122616	Cr+S	103	120	PB122613	Cr+S	60	77	PB161231	Cr+S	40	57	PB20419	6 Seg	20	40
4	PB122648	Cr+S	103	120	PB122637	Cr+S	60	77	PB161232	Cr+S	40	57	PB20420	6 Seg	20	40
MFP5	PB01556	MFP5	60	77	PB01556	MFP5	60	77	PB11525	MFP5	40	57	PB38502	Mfp5	20	20
5	PB02154	Exp	60	80	PB02154	Exp	60	80	PB02661	Exp	40	60	PB021016	Exp	20	37
6	PB02155	Exp	60	80	PB02155	Exp	60	80	PB02662	Exp	40	60	PB021017	Exp	20	37
7	PB02156	Exp	60	80	PB02156	Exp	60	80	PB02663	Exp	40	60	PB021018	Exp	20	37
6	PB69121	Magic	63	80	PB69121	Magic	63	80	PB68043	Magic	45	60	PB67013	Magic	20	40
7	PB69122	Magic	63	80	PB69122	Magic	63	80	PB68044	Magic	45	60	PB67014	Magic	20	40

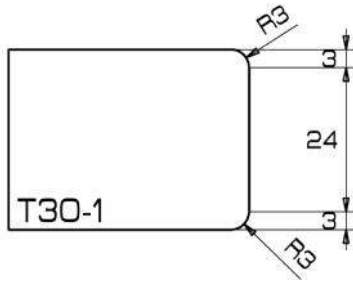

[BACK TO INDEX](#)



**Ninja Composition**  
T30-1

Position	<b>TopLine</b> STONE DIVISION				<b>FastLine</b> STONE DIVISION				<b>TwistLine</b> STONE DIVISION				<b>MicronLine</b> STONE DIVISION				
	Code	Type	ID	ED	Code	Type	ID	ED	Code	Type	ID	ED	Code	type	ID	ED	Price [€] Euro
1	PB122799	Seg	103	120	PB122663	Seg	60	77	PB161105	Seg	40	57	PB201089	2 Seg	20	30	244
2	PB122800	Cr+S	103	120	PB122664	Cr+S	60	77	PB161106	Cr+S	40	57	PB201090	2 Seg	20	30	244
3	PB122801	Cr+S	103	120	PB122665	Cr+S	60	77	PB161107	Cr+S	40	57	PB201091	2 Seg	20	30	191
4	PB122802	Cr+S	103	120	PB122666	Cr+S	60	77	PB161108	Cr+S	40	57	PB201092	2 Seg	20	30	191
MFP5	PB01555	MFP5	60	77	PB01555	MFP5	60	77	PB11571	MFP5	40	57	PB015039	Mfp5	20	30	201
5	PB02157	Exp	60	75	PB02157	Exp	60	75	PB02691	Exp	40	57	PB021059	Exp	20	37	125
6	PB02158	Exp	60	75	PB02158	Exp	60	75	PB02692	Exp	40	57	PB021060	Exp	20	37	125
7	PB02159	Exp	60	75	PB02159	Exp	60	75	PB02693	Exp	40	57	PB021061	Exp	20	37	125
6	PB69124	Magic	63	80	PB69124	Magic	63	80	PB69624	Magic	45	60	PB67022	Magic	20	40	
7	PB69125	Magic	63	80	PB69125	Magic	63	80	PB69625	Magic	45	60	PB67023	Magic	20	40	

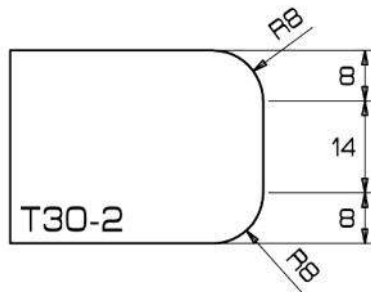

**Ninja Composition**  
T30-2

Position	<b>TopLine</b> STONE DIVISION				<b>FastLine</b> STONE DIVISION				<b>TwistLine</b> STONE DIVISION				<b>MicronLine</b> STONE DIVISION				
	Code	Type	ID	ED	Code	Type	ID	ED	Code	Type	ID	ED	Code	type	ID	ED	Price [€] Euro
1	PB123602	Seg	101	120	PB123191	Seg	60	77									
2	PB123603	Cr+S	101	120	PB123192	Cr+S	58	77									
3	PB123604	Cr+S	101	120	PB123193	Cr+S	58	77									
4	PB123605	Cr+S	101	120	PB123194	Cr+S	58	77									
MFP5	PB01588	MFP5	58	77	PB01807	MFP5	58	77									
5	PB02330	Exp	60	83	PB02330	Exp	60	83									
6	PB02331	Exp	60	83	PB02331	Exp	60	83									
7	PB02332	Exp	60	83	PB02332	Exp	60	83									
6	PB69316	Magic	61	80	PB69316	Magic	61	80									
7	PB69317	Magic	61	80	PB69317	Magic	61	80									

[BACK TO INDEX](#)



**Ninja Composition**  
T30-3

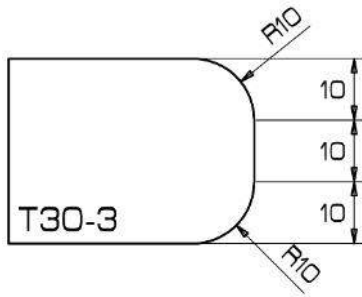

Position	<b>TopLine</b> STONE DIVISION					<b>FastLine</b> STONE DIVISION				<b>TwistLine</b> STONE DIVISION				<b>MicronLine</b> STONE DIVISION			
	Code	Type	ID	ED	Price [€] Euro												
1	PB122807	Seg	94	120	530												
2	PB122808	Cr+S	94	120	577												
3	PB122809	Cr+S	94	120	577												
4	PB122810	Cr+S	94	120	577												
MFP5	PB01557	MFP5	94	120	606												
5	PB02166	Exp	60	90	179												
6	PB02167	Exp	60	90	179												
7	PB02168	Exp	60	90	179												
6	PB69127	Magic	71	97													
7	PB69128	Magic	71	97													



**Ninja Composition**  
T30-4

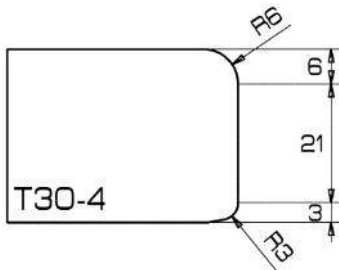

Position	<b>TopLine</b> STONE DIVISION					<b>FastLine</b> STONE DIVISION				<b>TwistLine</b> STONE DIVISION				<b>MicronLine</b> STONE DIVISION			
	Code	Type	ID	ED		Code	Type	ID	ED								
1	PB124203	Seg	103	120		PB123125	Seg	60	77								
2	PB124204	Cr+S	103	120		PB123126	Cr+S	60	77								
3	PB124205	Cr+S	103	120		PB123127	Cr+S	60	77								
4	PB124206	Cr+S	103	120		PB123128	Cr+S	60	77								
MFP5	PB01558	MFP5	60	77		PB01558	MFP5	60	77								
5	PB02160	Exp	60	80		PB02160	Exp	60	80								
6	PB02161	Exp	60	80		PB02161	Exp	60	80								
7	PB02162	Exp	60	80		PB02162	Exp	60	80								
6	PB69190	Magic	63	80		PB69190	Magic	63	80								
7	PB69191	Magic	63	80		PB69191	Magic	63	80								

BACK TO INDEX



Ninja Composition

T30-8

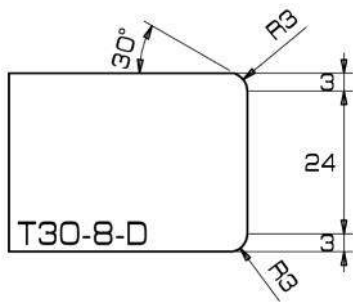

Position	<b>TopLine</b> STONE DIVISION				<b>FastLine</b> STONE DIVISION				<b>TwistLine</b> STONE DIVISION				<b>MicronLine</b> STONE DIVISION			
	Code	Type	ID	ED	Code	Type	ID	ED	Code	Type	ID	ED	Code	type	ID	ED
1	PB124062	Seg	103	120	PB123674	Seg	60	77	PB161225	Seg	40	57	PB201093	2 Seg	20	29
2	PB124063	Cr+S	103	120	PB123675	Cr+S	60	71	PB161226	Cr+S	40	52	PB201094	2 Seg	20	29
3	PB124064	Cr+S	103	120	PB123676	Cr+S	60	71	PB161227	Cr+S	40	52	PB201095	2 Seg	20	29
4	PB124065	Cr+S	103	120	PB123677	Cr+S	60	71	PB161228	Cr+S	40	52	PB201096	2 Seg	20	29
MFP5	PB01583	MFP5	60	71	PB01583	MFP5	60	71	PB11521	MFP5	40	52	PB015041	MFP5	20	29
5	PB02247	Exp	60	75	PB02247	Exp	60	75	PB02670	Exp	40	55	PB021068	Exp	20	35
6	PB02248	Exp	60	75	PB02248	Exp	60	75	PB02671	Exp	40	55	PB021069	Exp	20	35
7	PB02249	Exp	60	75	PB02249	Exp	60	75	PB02672	Exp	40	55	PB021070	Exp	20	35
6	PB69241	Magic	63	80	PB69241	Magic	63	80	PB68046	Magic	45	60	PB67031	Magic	20	35
7	PB69242	Magic	63	80	PB69242	Magic	63	80	PB68047	Magic	45	60	PB67032	Magic	20	35

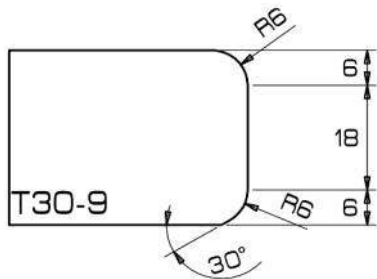

Ninja Composition

T30-9

Position	<b>TopLine</b> STONE DIVISION				<b>FastLine</b> STONE DIVISION				<b>TwistLine</b> STONE DIVISION				<b>MicronLine</b> STONE DIVISION			
	Code	Type	ID	ED	Code	type	ID	ED								
1	PB124357	Seg	103	120	PB124015	Seg	60	77								
2	PB124358	Cr+S	103	120	PB124016	Cr+S	60	77								
3	PB124359	Cr+S	103	120	PB124017	Cr+S	60	77								
4	PB124360	Cr+S	103	120	PB124018	Cr+S	60	77								
MFP5	PB01667	MFP5	60	77	PB01667	MFP5	60	77								
5	PB021501	Exp	60	80	PB021910	Exp	60	75								
6	PB021502	Exp	60	80	PB021911	Exp	60	75								
7	PB021503	Exp	60	80	PB021912	Exp	60	75								
6	PB691096	Magic	60	77	PB691096	Magic	60	77								
7	PB691097	Magic	60	77	PB691097	Magic	60	77								



[BACK TO INDEX](#)



**Ninja Composition**

T30-10

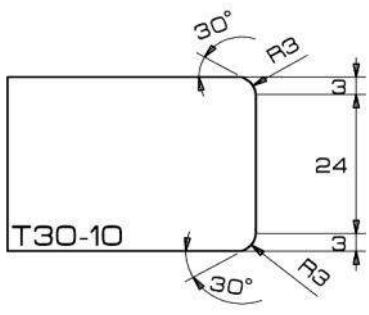

Position	<b>TopLine</b> STONE DIVISION					<b>FastLine</b> STONE DIVISION				<b>TwistLine</b> STONE DIVISION				<b>MicronLine</b> STONE DIVISION					
	Code	Type	ID	ED		Code	Type	ID	ED		Code	Type	ID	ED		Code	Type	ID	ED
1	PB124231	Seg	103	120		PB124166	Seg	60	77		PB161347	Seg	40	57		PB20826	2 Seg	20	29
2	PB124232	Cr+S	103	120		PB124167	Cr+S	60	71		PB161348	Cr+S	40	52		PB20827	2 Seg	20	29
3	PB124233	Cr+S	103	120		PB124168	Cr+S	60	71		PB161349	Cr+S	40	52		PB20828	2 Seg	20	29
4	PB124234	Cr+S	103	120		PB124169	Cr+S	60	71		PB161350	Cr+S	40	52		PB20829	2 Seg	20	29
MFP5	PB01634	MFP5	60	71		PB01634	MFP5	60	71		PB11542	MFP5	40	52		PB015040	Mfp5	20	29
5	PB021346	Exp	60	75		PB021346	Exp	60	75		PB02723	Exp	40	60		PB021145	Exp	20	35
6	PB021347	Exp	60	75		PB021347	Exp	60	75		PB02724	Exp	40	60		PB021143	Exp	20	35
7	PB021348	Exp	60	75		PB021348	Exp	60	75		PB02725	Exp	40	60		PB021144	Exp	20	35
6	PB691148	Magic	63	80		PB691148	Magic	63	80		PB68133	Magic	43	60		PB67067	Magic	20	35
7	PB691149	Magic	63	80		PB691149	Magic	63	80		PB68134	Magic	43	60		PB67068	Magic	20	35

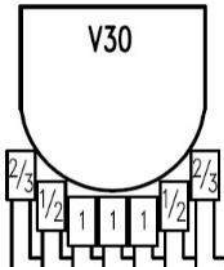
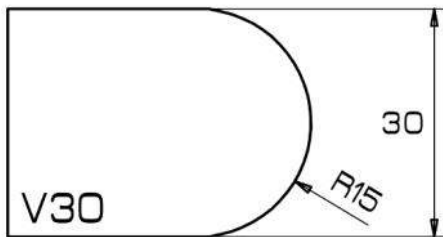

**Ninja Composition**

V30

Position	<b>TopLine</b> STONE DIVISION					<b>FastLine</b> STONE DIVISION				<b>TwistLine</b> STONE DIVISION				<b>MicronLine</b> STONE DIVISION					
	Code	Type	ID	ED		Code	Type	ID	ED		Code	Type	ID	ED		Code	Type	ID	ED
1	PB122602	Seg	84	120		PB122871	Seg	60	96		PB161125	Seg	40	76					
2	PB122603	Cr+S	84	120		PB122872	Cr+S	60	96		PB161126	Cr+S	40	76					
3	PB122604	Cr+S	84	120		PB122873	Cr+S	60	96		PB161127	Cr+S	40	76					
4	PB122638	Cr+S	84	120		PB122874	Cr+S	60	96		PB161128	Cr+S	40	76					
MFP5	PB01562	MFP5	60	96		PB01562	MFP5	60	96		PB11527	MFP5	40	76					
5	PB02175	Exp	60	100		PB02175	Exp	60	100		PB02640	Exp	40	80					
6	PB02176	Exp	60	100		PB02176	Exp	60	100		PB02641	Exp	40	80					
7	PB02177	Exp	60	100		PB02177	Exp	60	100		PB02642	Exp	40	80					
6	PB69139	Magic	61	97		PB69139	Magic	61	97		PB68052	Magic	45	80					
7	PB69140	Magic	61	97		PB69140	Magic	61	97		PB68053	Magic	45	80					

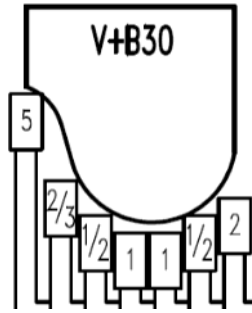
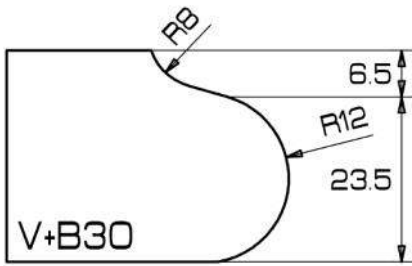

[BACK TO INDEX](#)



**Ninja Composition**

V+B30

Position	TopLine STONE DIVISION				FastLine STONE DIVISION				TwistLine STONE DIVISION				MicronLine STONE DIVISION			
	Code	Type	ID	ED												
1	PB123230	Seg	80	120												
2	PB122832	Cr+S	80	120												
3	PB122833	Cr+S	80	120												
4	PB122834	Cr+S	80	120												
MFP5	PB01565	MFP5	80	120												
5	PB02184	Exp	60	100												
6	PB02185	Exp	60	100												
7	PB02186	Exp	60	100												
6	PB69148	Magic	56	97												
7	PB69149	Magic	56	97												

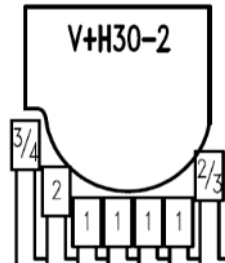
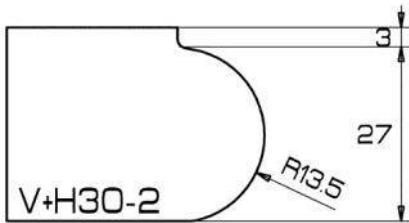

**Ninja Composition**

V+H30-2

Position	TopLine STONE DIVISION				FastLine STONE DIVISION				TwistLine STONE DIVISION				MicronLine STONE DIVISION			
	Code	Type	ID	ED												
1	PB124492	Seg	70	97												
2	PB124493	Seg	70	97												
3	PB124494	Seg	70	97												
4	PB124495	Seg	70	97												
MFP5	-	MFP5	-	-												
5	PB021782	Exp	60	87												
6	PB021783	Exp	60	87												
7	PB021784	Exp	60	87												
6	PB69997	Magic	70	97												
7	PB69998	Magic	70	97												

[BACK TO INDEX](#)



**Ninja Composition**  
VX30

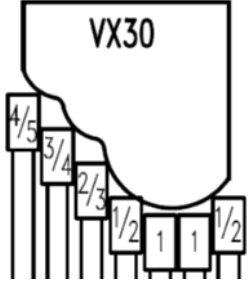
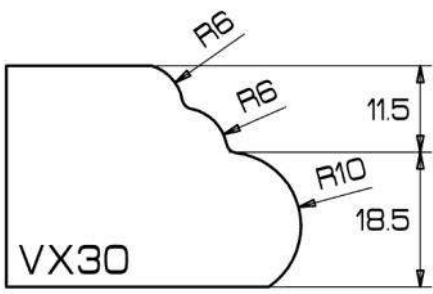

Position	TopLine STONE DIVISION				FastLine STONE DIVISION				TwistLine STONE DIVISION				MicronLine STONE DIVISION			
	Code	Type	ID	ED												
1	PB123232	Seg	73	120												
2	PB122828	Cr+S	73	120												
3	PB122829	Cr+S	73	120												
4	PB122830	Cr+S	73	120												
MFP5	PB01564	MFP5	73	120												
5	PB02181	Exp	60	107												
6	PB02182	Exp	60	107												
7	PB02183	Exp	60	107												
6	PB69145	Magic	73	120												
7	PB69146	Magic	73	120												

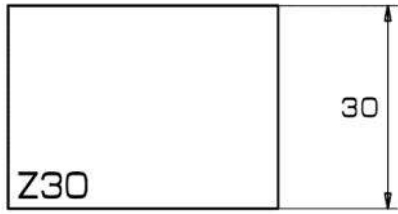

**Ninja Composition**  
Z30

Position	TopLine STONE DIVISION				FastLine STONE DIVISION				TwistLine STONE DIVISION				MicronLine STONE DIVISION			
	Code	Type	ID	ED	Code	Type	ID	ED	Code	Type	ID	ED	Code	Type	ID	ED
1	PB123822	Seg	-	120	PB122575	Seg	80	80	PB16886	Seg	40	40	PB20496	2 Seg	20	20
2	PB123823	Cr+S	-	120	PB122576	Cr+S	80	80	PB16887	Cr+S	40	40	PB20497	2 Seg	20	20
3	PB123824	Cr+S	-	120	PB122577	Cr+S	80	80	PB16888	Cr+S	40	40	PB20498	2 Seg	20	20
4	PB123825	Cr+S	-	120	PB122636	Cr+S	80	80	PB16889	Cr+S	40	40	PB20523	2 Seg	20	20
MFP5	PB01505	MFP5	-	60	PB01505	MFP5	80	60	PB11511	MFP5	40	40	PB015001	Mfp5	20	20
5	PB02388	Exp	-	80	PB02388	Exp	80	80	PB02604	Exp	40	40	PB021001	Exp	20	20
6	PB02389	Exp	-	80	PB02389	Exp	80	80	PB02605	Exp	40	40	PB021002	Exp	20	20
7	PB02390	Exp	-	80	PB02390	Exp	80	80	PB02606	Exp	40	40	PB021003	Exp	20	20
6	PB69973	Magic	-	80	PB69406	Magic	78	78	PB68058	Magic	45	45	PB67049	Magic	20	20
7	PB69974	Magic	-	80	PB69407	Magic	78	78	PB68059	Magic	45	45	PB67050	Magic	20	20

[BACK TO INDEX](#)



**Ninja Composition**

ZR30

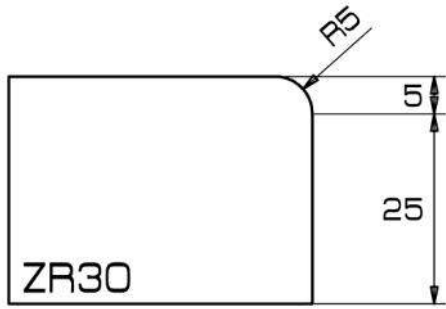

Position	TopLine STONE DIVISION				FastLine STONE DIVISION				TwistLine STONE DIVISION				MicronLine STONE DIVISION			
	Code	Type	ID	ED	Code	Type	ID	ED	Code	Type	ID	ED	Code	Type	ID	ED
1	PB124571	Seg	105	120	PB122623	Cr+S	65	80	PB161101	Cr+S	40	55	PB201097	2 Seg	20	30
2	PB124572	Cr+S	105	120	PB122624	Cr+S	65	80	PB161102	Cr+S	40	55	PB201098	2 Seg	20	30
3	PB124573	Cr+S	105	120	PB122625	Cr+S	65	80	PB161103	Cr+S	40	55	PB201099	2 Seg	20	30
4	PB124574	Cr+S	105	120	PB122646	Cr+S	65	80	PB161104	Cr+S	40	55	PB201100	2 Seg	20	30
MFP5	PB01568	MFP5	65	80	PB01568	MFP5	65	80	PB11514	MFP5	40	55	PB015067	Mfp5	20	30
5	PB02202	Exp	60	80	PB02202	Exp	60	80	PB02658	Exp	40	60	PB021025	Exp	20	30
6	PB02203	Exp	60	80	PB02203	Exp	60	80	PB02659	Exp	40	60	PB021026	Exp	20	30
7	PB02204	Exp	60	80	PB02204	Exp	60	80	PB02660	Exp	40	60	PB021027	Exp	20	30
6	PB69199	Magic	65	80	PB69199	Magic	65	80	PB68064	Magic	45	60	PB67037	Magic	20	35
7	PB69200	Magic	65	80	PB69200	Magic	65	80	PB68065	Magic	45	60	PB67038	Magic	20	35



**Ninja Composition**

ZR30-D

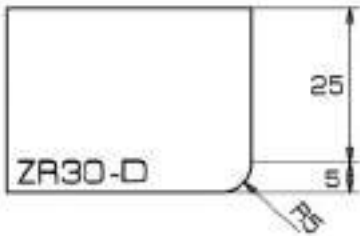

Position	TopLine STONE DIVISION				FastLine STONE DIVISION				TwistLine STONE DIVISION				MicronLine STONE DIVISION			
	Code	Type	ID	ED	Code	Type	ID	ED	Code	Type	ID	ED	Code	Type	ID	ED
1													PB201101	2 Seg	20	30
2													PB201102	2 Seg	20	30
3													PB201103	2 Seg	20	30
4													PB201104	2 Seg	20	30
MFP5													PB015068	Mfp5	20	30
5													PB021028	Exp	20	30
6													PB021029	Exp	20	30
7													PB021030	Exp	20	30
6													PB67040	Magic	20	35
7													PB67041	Magic	20	35

[BACK TO INDEX](#)

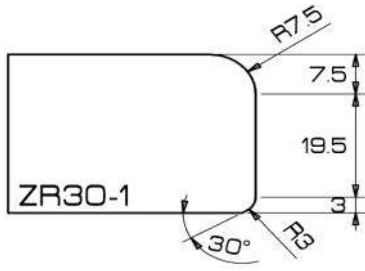

**Ninja Composition**  
ZR30-1

Position	<b>TopLine</b> STONE DIVISION				<b>FastLine</b> STONE DIVISION				<b>TwistLine</b> STONE DIVISION				<b>MicronLine</b> STONE DIVISION			
	Code	type	ID	ED	Code	type	ID	ED	Code	type	ID	ED	Code	type	ID	ED
1					PB123778	Seg	70	86								
2					PB123779	Cr+S	60	80								
3					PB123780	Cr+S	60	80								
4					PB123781	Cr+S	60	80								
MFP5					PB01620	MFP5	60	80								
5					PB02284	Exp	60	82								
6					PB02285	Exp	60	82								
7					PB02286	Exp	60	82								
6					PB69295	Magic	60	80								
7					PB69296	Magic	60	80								

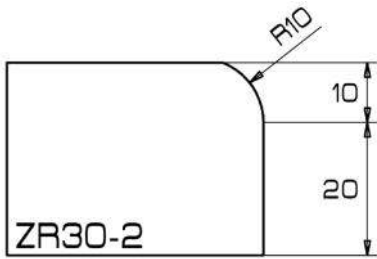

**Ninja Composition**  
ZR30-2

Position	<b>TopLine</b> STONE DIVISION				<b>FastLine</b> STONE DIVISION				<b>TwistLine</b> STONE DIVISION				<b>MicronLine</b> STONE DIVISION			
	Code	Type	ID	ED	Code	Type	ID	ED	Code	Type	ID	ED	Code	Type	ID	ED
1					PB123770	Seg	70	95	PB161281	Seg	40	65				
2					PB122618	Cr+S	70	93	PB161282	Cr+S	40	66				
3					PB122619	Cr+S	70	93	PB161283	Cr+S	40	66				
4					PB122649	Cr+S	70	93	PB161284	Cr+S	40	66				
MFP5					PB01569	MFP5	70	93	PB11572	MFP5	40	66				
5					PB02205	Exp	60	83	PB02706	Exp	40	66				
6					PB02206	Exp	60	83	PB02707	Exp	40	66				
7					PB02207	Exp	60	83	PB02708	Exp	40	66				
6					PB69205	Magic	67	90	PB68082	Magic	45	68				
7					PB69206	Magic	67	90	PB68083	Magic	45	68				

BACK TO INDEX



Ninja Composition

ZR30-3

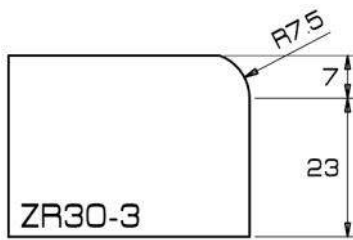

Position	<b>TopLine</b> STONE DIVISION					<b>FastLine</b> STONE DIVISION					<b>TwistLine</b> STONE DIVISION					<b>MicronLine</b> STONE DIVISION				
	Code	Type	ID	ED	Price [€] Euro	Code	Type	ID	ED	Price [€] Euro	Code	Type	ID	ED	Price [€] Euro	Code	Type	ID	ED	Price [€] Euro
1						PB123028	Cr+S	65	80	440	PB161265	Cr+S	40	55	360					
2						PB123029	Cr+S	65	80	440	PB161266	Cr+S	40	55	380					
3						PB123030	Cr+S	65	80	440	PB161267	Cr+S	40	55	380					
4						PB123031	Cr+S	65	80	440	PB161268	Cr+S	40	55	380					
MFP5						PB01570	MFP5	65	80	462	PB11573	MFP5	40	55	399					
5						PB02208	Exp	60	82	163	PB02801	Exp	40	65	155					
6						PB02209	Exp	60	82	163	PB02718	Exp	40	65	155					
7						PB02210	Exp	60	82	163	PB02719	Exp	40	65	155					
6						PB69208	Magic	70	90		PB68202	Magic	45	65						
7						PB69209	Magic	70	90		PB68203	Magic	45	65						



Ninja Composition

ZR30-4

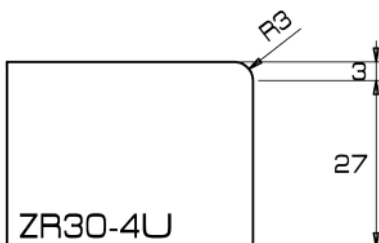

Position	<b>TopLine</b> STONE DIVISION					<b>FastLine</b> STONE DIVISION					<b>TwistLine</b> STONE DIVISION					<b>MicronLine</b> STONE DIVISION				
	Code	type	ID	ED	Price [€] Euro	Code	type	ID	ED	Price [€] Euro						Code	type	ID	ED	Price [€] Euro
1	PB124361	Seg	103	120	515	PB123196	Cr+S	65	80	484						PB201105	2 Seg	20	30	244
2	PB124362	Cr+S	103	120	560	PB123197	Cr+S	65	80	484						PB201106	2 Seg	20	30	244
3	PB124363	Cr+S	103	120	560	PB123198	Cr+S	65	80	484						PB201107	2 Seg	20	30	191
4	PB124364	Cr+S	103	120	560	PB123199	Cr+S	65	80	484						PB201108	2 Seg	20	30	191
MFP5	PB01668	MFP5	65	80	508	PB01668	MFP5	65	80	508						PB015012	Mfp5	20	30	201
5	PB02256	Exp	60	77	163	PB02415	Exp	60	77	190						PB021128	Exp	20	30	125
6	PB02257	Exp	60	77	163	PB02416	Exp	60	77	190						PB021129	Exp	20	30	125
7	PB02258	Exp	60	77	163	PB02417	Exp	60	77	190						PB021130	Exp	20	30	125
6	PB69259	Magic	65	80		PB69259	Magic	65	80							PB67130	Magic	20	35	
7	PB69260	Magic	65	80		PB69260	Magic	65	80							PB67131	Magic	20	35	

[BACK TO INDEX](#)

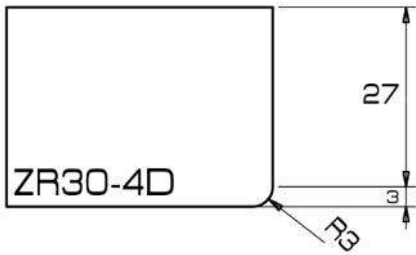

**Ninja Composition**  
ZR30-4D

Position	TopLine STONE DIVISION					FastLine STONE DIVISION					TwistLine STONE DIVISION					MicronLine STONE DIVISION								
	Code	type	ID	ED	Price [€] Euro	Code	type	ID	ED	Price [€] Euro	Code	type	ID	ED	Price [€] Euro	Code	type	ID	ED	Price [€] Euro				
1																PB201109	2 Seg	20	30	244				
2																PB201110	2 Seg	20	30	244				
3																PB201111	2 Seg	20	30	191				
4																PB201112	2 Seg	20	30	191				
MFP5																PB015007	Mfp5	20	30	201				
5																PB021084	Exp	20	30	125				
6																PB021085	Exp	20	30	125				
7																PB021086	Exp	20	30	125				
6																PB67133	Magic	20	35					
7																PB67134	Magic	20	35					

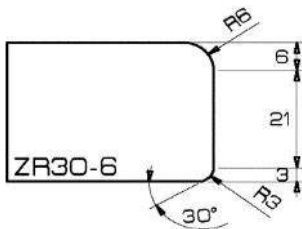

**Ninja Composition**  
ZR30-6

Position	TopLine STONE DIVISION					FastLine STONE DIVISION					TwistLine STONE DIVISION					MicronLine STONE DIVISION				
	Code	type	ID	ED	Price [€] Euro	Code	type	ID	ED	Price [€] Euro	Code	type	ID	ED	Price [€] Euro	Code	type	ID	ED	Price [€] Euro
1	PB123876	Seg	103	120	565	PB124496	Seg	60	77	484	PB161440	Cr+S	40	57	418					
2	PB123877	Cr+S	103	120	615	PB124497	Cr+S	60	77	484	PB161441	Cr+S	40	57	418					
3	PB123879	Cr+S	103	120	615	PB124498	Cr+S	60	77	484	PB161442	Cr+S	40	57	418					
4	PB123880	Cr+S	103	120	615	PB124499	Cr+S	60	77	484	PB161443	Cr+S	40	57	418					
MFP5	PB01609	MFP5	60	77	508	PB01609	MFP5	60	77	508	PB11574	MFP5	40	57	439					
5	PB02443	Exp	60	77	170	PB02443	Exp	60	77	170	PB02802	Exp	40	57	160					
6	PB02444	Exp	60	77	170	PB02444	Exp	60	77	170	PB02803	Exp	40	57	160					
7	PB02445	Exp	60	77	170	PB02445	Exp	60	77	170	PB02804	Exp	40	57	160					
6	PB69358	Magic	63	80		PB69443	Magic	63	80		PB68181	Magic	45	62						
7	PB69359	Magic	63	80		PB69444	Magic	63	80		PB68182	Magic	45	62						

[BACK TO INDEX](#)



**Ninja Composition**  
ZR30-7

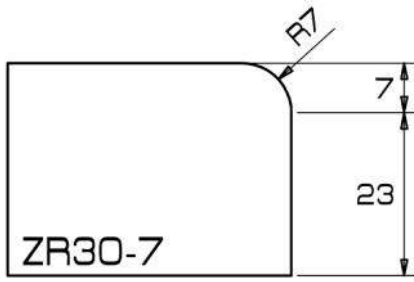

Position	<b>TopLine</b> STONE DIVISION				<b>FastLine</b> STONE DIVISION				<b>TwistLine</b> STONE DIVISION				<b>MicronLine</b> STONE DIVISION			
	Code	type	ID	ED	Price [€]											
1	PB124050	Cr+S	70	93	484											
2	PB124051	Cr+S	70	93	484											
3	PB124052	Cr+S	70	93	484											
4	PB124053	Cr+S	70	93	484											
MFP5	PB01809	MFP5	70	93	508											
5	PB021785	Exp	60	83	165											
6	PB021786	Exp	60	83	165											
7	PB021787	Exp	60	83	165											
6	PB69982	Magic	57	80												
7	PB69983	Magic	57	80												



**Ninja Composition**  
ZR30-10

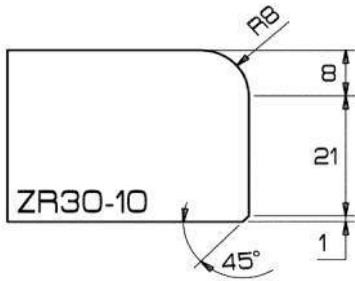

Position	<b>TopLine</b> STONE DIVISION				<b>FastLine</b> STONE DIVISION				<b>TwistLine</b> STONE DIVISION				<b>MicronLine</b> STONE DIVISION			
	Code	Type	ID	ED	Price [€] Euro											
1	PB123914	Seg	59	77	485											
2	PB123915	Cr+S	60	80	485											
3	PB123916	Cr+S	60	80	485											
4	PB123917	Cr+S	60	80	485											
MFP5	PB01621	MFP5	60	80	510											
5	PB02485	Exp	60	82	191											
6	PB02486	Exp	60	82	191											
7	PB02487	Exp	60	82	191											
6	PB69376	Magic	60	80												
7	PB69377	Magic	60	80												



[BACK TO INDEX](#)

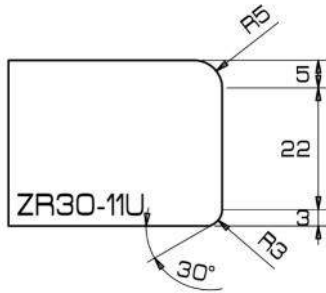

**Ninja Composition**  
ZR30-11

Position	<b>TopLine</b> STONE DIVISION					<b>FastLine</b> STONE DIVISION					<b>TwistLine</b> STONE DIVISION					<b>MicronLine</b> STONE DIVISION				
	Code	type	ID	ED	Price [€] Euro	Code	type	ID	ED	Price [€] Euro	Code	type	ID	ED	Price [€] Euro	Code	type	ID	ED	Price [€] Euro
1						PB124027	Seg	60	77	440	PB161101	Seg	40	55	360	PB201113	2 Seg	20	30	264
2						PB124028	Cr+S	60	77	484	PB161321	Cr+S	40	57	420	PB201114	2 Seg	20	30	264
3						PB124029	Cr+S	60	77	484	PB161322	Cr+S	40	57	420	PB201115	2 Seg	20	30	207
4						PB124030	Cr+S	60	77	484	PB161323	Cr+S	40	57	420	PB201116	2 Seg	20	30	207
MFP5						PB01810	MFP5	60	77	508	PB11575	MFP5	40	57	441	PB015042	Mfp5	20	30	217
5						PB021788	Exp	60	77	191	PB02715	Exp	40	60	160	PB021113	Exp	20	30	125
6						PB021789	Exp	60	77	191	PB02716	Exp	40	60	160	PB021114	Exp	20	30	125
7						PB021790	Exp	60	77	191	PB02717	Exp	40	60	160	PB021115	Exp	20	30	125
6						PB691103	Magic	62	80		PB68184	Magic	45	62		PB67136	Magic	20	35	
7						PB691104	Magic	62	80		PB68185	Magic	45	62		PB67137	Magic	20	35	

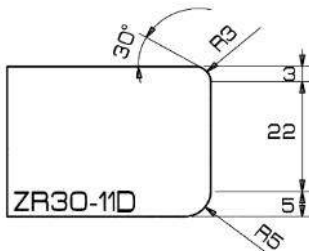

**Ninja Composition**  
ZR30-11D

Position	<b>TopLine</b> STONE DIVISION					<b>FastLine</b> STONE DIVISION					<b>TwistLine</b> STONE DIVISION					<b>MicronLine</b> STONE DIVISION				
	Code	type	ID	ED	Price [€] Euro	Code	type	ID	ED	Price [€] Euro	Code	type	ID	ED	Price [€] Euro	Code	type	ID	ED	Price [€] Euro
1																PB20880	2 Seg	20	30	264
2																PB20881	2 Seg	20	30	264
3																PB20882	2 Seg	20	30	207
4																PB20883	2 Seg	20	30	207
MFP5																PB015043	Mfp5	20	30	217
5																PB021116	Exp	20	30	125
6																PB021117	Exp	20	30	125
7																PB021118	Exp	20	30	125
6																PB67139	Magic	20	35	
7																PB67140	Magic	20	35	

BACK TO INDEX



Ninja Composition

ZR30-12

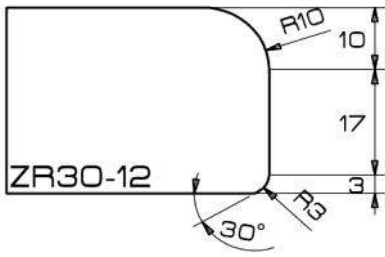

Position	<b>TopLine</b> STONE DIVISION				<b>FastLine</b> STONE DIVISION				<b>TwistLine</b> STONE DIVISION				<b>MicronLine</b> STONE DIVISION			
	Code	type	ID	ED	Code	type	ID	ED								
1	PB124019	Seg	98	120	PB122617	Cr+S	70	93								
2	PB124020	Cr+S	95	120	PB123980	Cr+S	60	85								
3	PB124021	Cr+S	95	120	PB123981	Cr+S	60	85								
4	PB124022	Cr+S	95	120	PB123982	Cr+S	60	85								
MFP5	PB01628	MFP5	60	85	PB01628	MFP5	60	85								
5	PB021332	Exp	60	85	PB021332	Exp	60	85								
6	PB021333	Exp	60	85	PB021333	Exp	60	85								
7	PB021334	Exp	60	85	PB021334	Exp	60	85								
6	PB69385	Magic	72	97	PB69385	Magic	72	97								
7	PB69386	Magic	72	97	PB69386	Magic	72	97								



Ninja Composition

ZS30

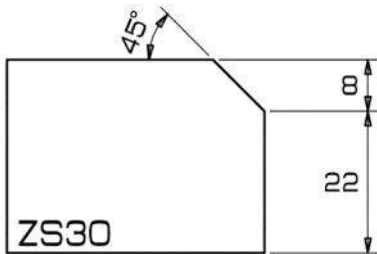

Position	<b>TopLine</b> STONE DIVISION				<b>FastLine</b> STONE DIVISION				<b>TwistLine</b> STONE DIVISION				<b>MicronLine</b> STONE DIVISION			
	Code	Type	ID	ED	Code	Type	ID	ED	Code	Type	ID	ED				
1					PB122620	Cr+S	70	90	PB161241	Seg	40	60				
2					PB122621	Cr+S	70	90	PB161242	Cr+S	40	60				
3					PB122622	Cr+S	70	90	PB161243	Cr+S	40	60				
4					PB122644	Cr+S	70	90	PB161244	Cr+S	40	60				
MFP5					PB01573	MFP5	70	90	PB11518	MFP5	40	60				
5					PB02217	Exp	60	80	PB02676	Exp	40	60				
6					PB02218	Exp	60	80	PB02677	Exp	40	60				
7					PB02219	Exp	60	80	PB02678	Exp	40	60				
6					PB69217	Magic	60	80	PB68073	Magic	45	65				
7					PB69218	Magic	60	80	PB06874	Magic	45	65				

[BACK TO INDEX](#)



**Ninja Composition**

ZS30-1

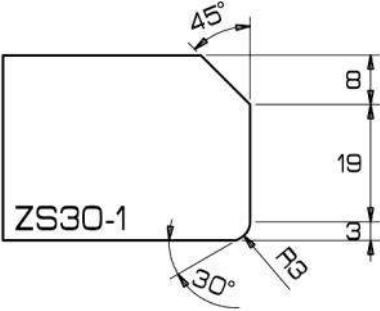

Position	<b>TopLine</b> STONE DIVISION				<b>FastLine</b> STONE DIVISION				<b>TwistLine</b> STONE DIVISION				<b>MicronLine</b> STONE DIVISION			
	Code	Type	ID	ED	Code	Type	ID	ED	Code	Type	ID	ED	Code	Type	ID	ED
1					PB122620	Cr+S	70	90								
2					PB123319	Cr+S	70	90								
3					PB123320	Cr+S	70	90								
4					PB123321	Cr+S	70	90								
MFP5					PB01574	MFP5	70	90								
5					PB02220	Exp	60	80								
6					PB02221	Exp	60	80								
7					PB02222	Exp	60	80								
6					PB69220	Magic	60	80								
7					PB69221	Magic	60	80								



**Ninja Composition**

ZS30-2

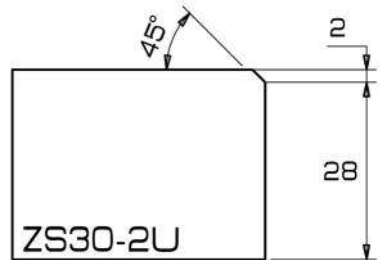

Position	<b>TopLine</b> STONE DIVISION				<b>FastLine</b> STONE DIVISION				<b>TwistLine</b> STONE DIVISION				<b>MicronLine</b> STONE DIVISION			
	Code	Type	ID	ED	Code	Type	ID	ED	Code	Type	ID	ED	Code	Type	ID	ED
1					PB123370	Cr+S	70	80					PB20581	2 Seg	20	26
2					PB123371	Cr+S	70	80					PB20582	2 Seg	20	26
3					PB123372	Cr+S	70	80					PB20583	2 Seg	20	26
4					PB123373	Cr+S	70	80					PB20584	2 Seg	20	26
MFP5					PB01579	MFP5	70	80					PB015044	Mfp5	20	26
5					PB02235	Exp	60	70					PB021043	Exp	20	32
6					PB02236	Exp	60	70					PB021044	Exp	20	32
7					PB02237	Exp	60	70					PB021045	Exp	20	32
6					PB69232	Magic	70	80					PB67058	Magic	20	35
7					PB69233	Magic	70	80					PB67059	Magic	20	35

[BACK TO INDEX](#)

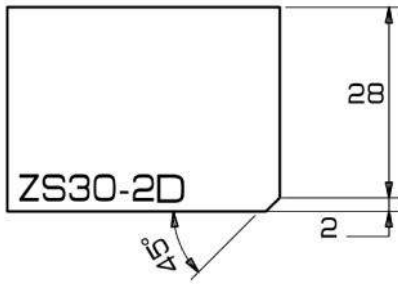

**Ninja Composition**

ZS30-2D

Position	TopLine STONE DIVISION				FastLine STONE DIVISION				TwistLine STONE DIVISION				MicronLine STONE DIVISION				
	Code	type	ID	ED	Code	type	ID	ED	Code	type	ID	ED	Code	type	ID	ED	
1													PB20577	2 Seg	20	26	
2													PB20578	2 Seg	20	26	
3													PB20579	2 Seg	20	26	
4													PB20580	2 Seg	20	26	
MFP5													PB015064	Mfp5	20	26	
5													PB021046	Exp	20	32	
6													PB021047	Exp	20	32	
7													PB021048	Exp	20	32	
6													PB67061	Magic	20	35	
7													PB67062	Magic	20	35	

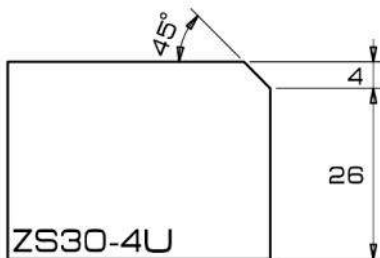

**Ninja Composition**

ZS30-4U

Position	TopLine STONE DIVISION				FastLine STONE DIVISION				TwistLine STONE DIVISION				MicronLine STONE DIVISION				
	Code	type	ID	ED	Code	type	ID	ED	Code	type	ID	ED	Code	type	ID	ED	
1													PB201117	2 Seg	20	30	
2													PB201118	2 Seg	20	30	
3													PB201119	2 Seg	20	30	
4													PB201120	2 Seg	20	30	
MFP5													PB015045	Mfp5	20	30	
5													PB021043	Exp	20	32	
6													PB021044	Exp	20	32	
7													PB021045	Exp	20	32	
6													PB67142	Magic	20	35	
7													PB67143	Magic	20	35	

[BACK TO INDEX](#)

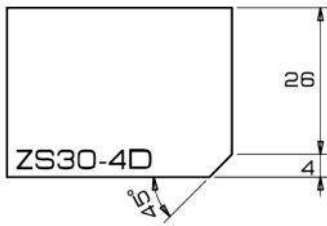

**Ninja Composition**  
ZS30-4D

	<b>TopLine</b> STONE DIVISION					<b>FastLine</b> STONE DIVISION					<b>TwistLine</b> STONE DIVISION					<b>MicronLine</b> STONE DIVISION				
Position																Code	type	ID	ED	
1																PB201121	2 Seg	20	30	
2																PB201122	2 Seg	20	30	
3																PB201123	2 Seg	20	30	
4																PB201124	2 Seg	20	30	
MFP5																PB015005	Mfp5	20	30	
5																PB021046	Exp	20	32	
6																PB021047	Exp	20	32	
7																PB021048	Exp	20	32	
6																PB67145	Magic	20	35	
7																PB67146	Magic	20	35	

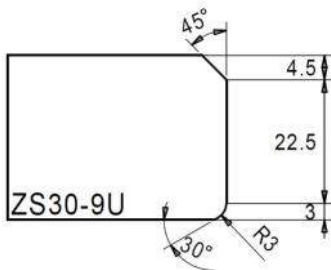

**Ninja Composition**  
ZS30-9

	<b>TopLine</b> STONE DIVISION					<b>FastLine</b> STONE DIVISION					<b>TwistLine</b> STONE DIVISION					<b>MicronLine</b> STONE DIVISION				
Position	Code	Type	ID	ED												Code	type	ID	ED	
1	PB124135	Seg	101	115												PB201190	2 Seg	20	30	
2	PB124136	Cr+S	103	115												PB201191	2 Seg	20	30	
3	PB124137	Cr+S	103	115												PB201192	2 Seg	20	30	
4	PB124138	Cr+S	103	115												PB201193	2 Seg	20	30	
MFP5	PB01833	MFP5	65	77												PB015046	Mfp5	20	30	
5	PB021409	Exp	60	72												PB021213	Exp	20	32	
6	PB021410	Exp	60	72												PB021214	Exp	20	32	
7	PB021411	Exp	60	72												PB021215	Exp	20	32	
6	PB691139	Magic	66	80												PB67159	Magic	20	33	
7	PB691140	Magic	66	80												PB67160	Magic	20	33	

[BACK TO INDEX](#)



**Ninja Composition**

ZS30-9D

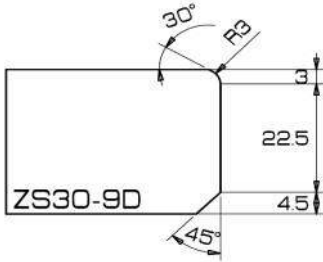

Position	TopLine STONE DIVISION				FastLine STONE DIVISION				TwistLine STONE DIVISION				MicronLine STONE DIVISION				
	Code	type	ID	ED													
1														PB201194	2 Seg	20	30
2														PB201195	2 Seg	20	30
3														PB201196	2 Seg	20	30
4														PB201197	2 Seg	20	30
MFP5														PB015047	Mfp5	20	30
5														PB021216	Exp	20	32
6														PB021217	Exp	20	32
7														PB021218	Exp	20	32
6														PB67162	Magic	20	33
7														PB67163	Magic	20	33

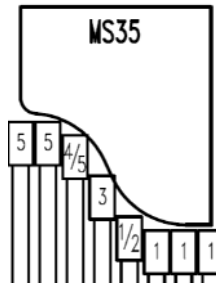
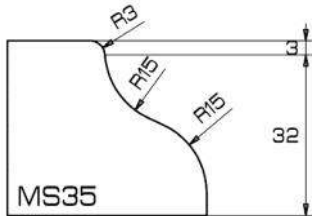

**Ninja Composition**

MS35

Position	TopLine STONE DIVISION				FastLine STONE DIVISION				TwistLine STONE DIVISION				MicronLine STONE DIVISION			
	Code	Type	ID	ED												
1	PB123738	Seg	70	110												
2	PB123739	Cr+S	60	110												
3	PB123740	Cr+S	60	110												
4	PB123741	Cr+S	60	110												
MFP5	PB01669	MFP5	60	110												
5	PB02367	Exp	60	110												
6	PB02368	Exp	60	110												
7	PB02369	Exp	60	110												
6	PB691042	Magic	62	112												
7	PB691043	Magic	62	112												

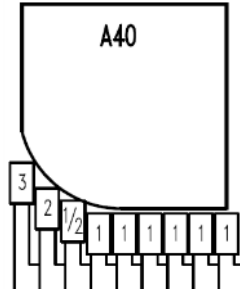
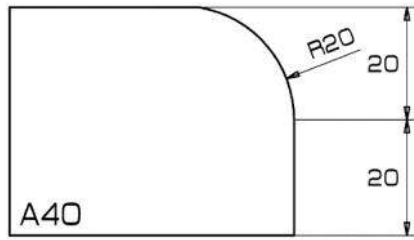

[BACK TO INDEX](#)



**Ninja Composition**  
A40

	<b>TopLine</b> STONE DIVISION				<b>FastLine</b> STONE DIVISION				<b>TwistLine</b> STONE DIVISION				<b>MicronLine</b> STONE DIVISION			
Position	Code	Type	ID	ED	Code	type	ID	ED	Code	type	ID	ED				
1	PB122686	Seg	74	120	PB122843	Seg	55	97	PB161292	Seg	40	86				
2	PB122687	Cr+S	74	120	PB122844	Cr+S	55	97	PB161293	Cr+S	40	86				
3	PB122688	Cr+S	74	120	PB122845	Cr+S	55	97	PB161294	Cr+S	40	86				
4	PB122689	Cr+S	74	120	PB122846	Cr+S	55	97	PB161295	Cr+S	40	86				
MFP5	PB01503	MFP5	55	97	PB01503	MFP5	55	97	PB11506	MFP5	40	86				
5	PB02010	Exp	60	110	PB02010	Exp	60	110	PB02607	Exp	40	86				
6	PB02011	Exp	60	110	PB02011	Exp	60	110	PB02608	Exp	40	86				
7	PB02012	Exp	60	110	PB02012	Exp	60	110	PB02609	Exp	40	86				
6	PB69007	Magic	70	116	PB69007	Magic	70	116	PB68007	Magic	45	96				
7	PB69008	Magic	70	116	PB69008	Magic	70	116	PB68008	Magic	45	96				

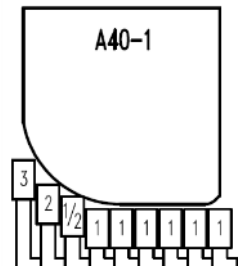
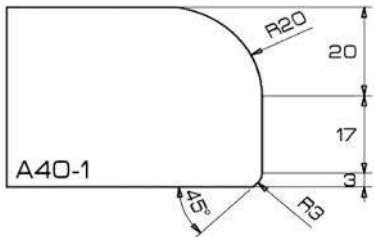

**Ninja Composition**  
A40-1

	<b>TopLine</b> STONE DIVISION				<b>FastLine</b> STONE DIVISION				<b>TwistLine</b> STONE DIVISION				<b>MicronLine</b> STONE DIVISION			
Position	Code	Type	ID	ED												
1	PB122686	Seg	74	120												
2	PB123885	Cr+S	74	120												
3	PB123886	Cr+S	74	120												
4	PB123887	Cr+S	74	120												
MFP5	PB01596	MFP5	74	120												
5	PB02449	Exp	60	105												
6	PB02450	Exp	60	105												
7	PB02451	Exp	60	105												
6	PB69334	Magic	70	120												
7	PB69335	Magic	70	120												

[BACK TO INDEX](#)



**Ninja Composition**

AR40

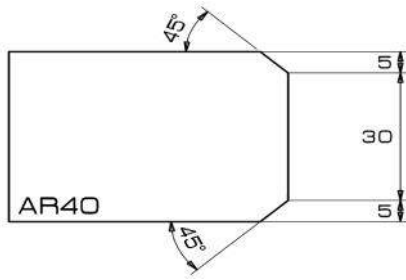

Position	<b>TopLine</b> STONE DIVISION				<b>FastLine</b> STONE DIVISION				<b>TwistLine</b> STONE DIVISION				<b>MicronLine</b> STONE DIVISION			
	Code	type	ID	ED	Code	type	ID	ED	Code	type	ID	ED	Code	type	ID	ED
1					PB122855	Seg	70	85					PB20409	3 Seg	20	32
2					PB122856	Cr+S	70	85					PB20410	3 Seg	20	32
3					PB122857	Cr+S	70	85					PB20411	3 Seg	20	32
4					PB122858	Cr+S	70	85					PB20412	3 Seg	20	32
MFP5					PB01510	MFP5	70	85					PB38501	Era	20	20
5					PB02022	Exp	60	74					PB021010	Exp	20	34
6					PB02023	Exp	60	74					PB021011	Exp	20	34
7					PB02024	Exp	60	74					PB021012	Exp	20	34
6					PB69160	Magic	65	80					PB67007	Magic	20	35
7					PB69161	Magic	65	80					PB67008	Magic	20	35

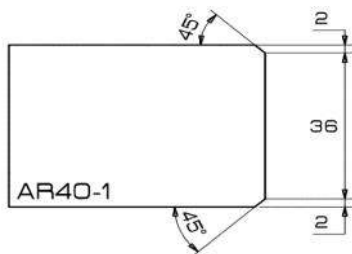

**Ninja Composition**

AR40-1

Position	<b>TopLine</b> STONE DIVISION				<b>FastLine</b> STONE DIVISION				<b>TwistLine</b> STONE DIVISION				<b>MicronLine</b> STONE DIVISION				
	Code	Type	ID	ED	Code	Type	ID	ED	Code	Type	ID	ED	Code	type	ID	ED	Price [€] Euro
1					PB123036	Cr+S	70	79					PB20409	2 Seg	20	26	207
2					PB123037	Cr+S	70	79					PB20410	2 Seg	20	26	207
3					PB123038	Cr+S	70	79					PB20411	2 Seg	20	26	180
4					PB123039	Cr+S	70	79					PB20412	2 Seg	20	26	180
MFP5					PB01511	MFP5	70	79					PB015070	Mfp5	20	26	189
5					PB02025	Exp	60	68					PB021010	Exp	20	28	135
6					PB02026	Exp	60	68					PB021011	Exp	20	28	135
7					PB02027	Exp	60	68					PB021012	Exp	20	28	135
6					PB69166	Magic	71	80					PB67007	Magic	20	34	
7					PB69167	Magic	71	80					PB67008	Magic	20	34	



[BACK TO INDEX](#)

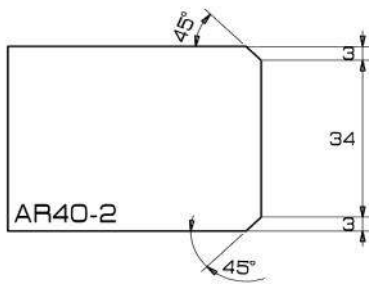

**Ninja Composition**

AR40-2

Position	<b>TopLine</b> STONE DIVISION				<b>FastLine</b> STONE DIVISION				<b>TwistLine</b> STONE DIVISION				<b>MicronLine</b> STONE DIVISION			
	Code	Type	ID	ED												
1	PB122999	Cr+S	70	79												
2	PB123001	Cr+S	70	79												
3	PB123560	Cr+S	70	79												
4	PB123561	Cr+S	70	79												
MFP5	PB01811	MFP5	70	79												
5	PB021791	Exp	60	69												
6	PB021792	Exp	60	69												
7	PB021793	Exp	60	69												
6	PB69440	Magic	69	80												
7	PB69441	Magic	69	80												

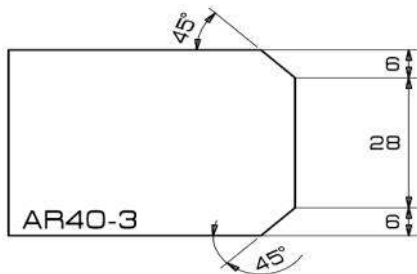

**Ninja Composition**

AR40-3

Position	<b>TopLine</b> STONE DIVISION				<b>FastLine</b> STONE DIVISION				<b>TwistLine</b> STONE DIVISION				<b>MicronLine</b> STONE DIVISION			
	Code	Type	ID	ED												
1	PB124500	Cr+S	70	85												
2	PB124501	Cr+S	70	85												
3	PB124502	Cr+S	70	85												
4	PB124503	Cr+S	70	85												
MFP5	PB01812	MFP5	70	85												
5	PB021794	Exp	60	75												
6	PB021795	Exp	60	75												
7	PB021796	Exp	60	75												
6	PB69437	Magic	63	80												
7	PB69438	Magic	63	80												

[BACK TO INDEX](#)



**Ninja Composition**

AR40-4

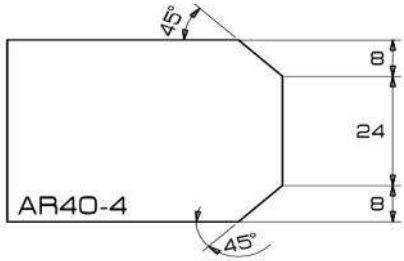

Position	<b>TopLine</b> STONE DIVISION				<b>FastLine</b> STONE DIVISION				<b>TwistLine</b> STONE DIVISION				<b>MicronLine</b> STONE DIVISION			
	Code	Type	ID	ED												
1	PB124504	Cr+S	70	90												
2	PB124505	Cr+S	70	90												
3	PB124506	Cr+S	70	90												
4	PB124507	Cr+S	70	90												
MFP5	PB01813	MFP5	70	90												
5	PB021797	Exp	60	80												
6	PB021798	Exp	60	80												
7	PB021799	Exp	60	80												
6	PB69434	Magic	60	80												
7	PB69435	Magic	60	80												



**Ninja Composition**

AR40-5

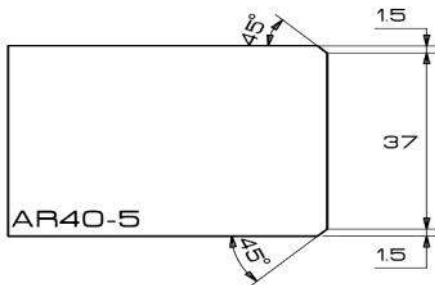

Position	<b>TopLine</b> STONE DIVISION				<b>FastLine</b> STONE DIVISION				<b>TwistLine</b> STONE DIVISION				<b>MicronLine</b> STONE DIVISION			
	Code	type	ID	ED												
1	PB20585	2 Seg	20	26												
2	PB20586	2 Seg	20	26												
3	PB20587	2 Seg	20	26												
4	PB20588	2 Seg	20	26												
MFP5	PB38501	Era	20	20												
5	PB021093	Exp	20	27												
6	PB021094	Exp	20	27												
7	PB021095	Exp	20	27												
6	PB67148	Magic	20	33												
7	PB67149	Magic	20	33												

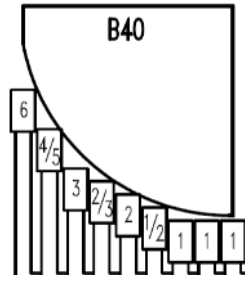
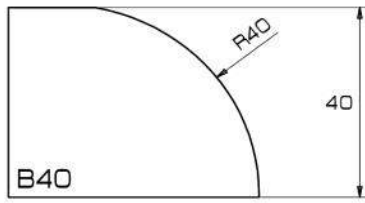

[BACK TO INDEX](#)



**Ninja Composition**

B40

Position	<b>TopLine</b> STONE DIVISION				<b>FastLine</b> STONE DIVISION				<b>TwistLine</b> STONE DIVISION				<b>MicronLine</b> STONE DIVISION			
	Code	Type	ID	ED					Code	Type	ID	ED				
1	PB122690	Seg	66	150					PB161444	Seg	40	124				
2	PB122691	Cr+S	66	150					PB161445	Cr+S	40	124				
3	PB122692	Cr+S	66	150					PB161446	Cr+S	40	124				
4	PB122693	Cr+S	66	150					PB161447	Cr+S	40	124				
MFP5	PB01516	MFP5	66	150					PB11576	MFP5	40	124				
5	PB02037	Exp	60	144					PB02805	Exp	40	124				
6	PB02038	Exp	60	144					PB02806	Exp	40	124				
7	PB02039	Exp	60	144					PB02807	Exp	40	124				
6	PB69022	Magic	66	150					PB68187	Magic	40	129				
7	PB69023	Magic	66	150					PB68188	Magic	40	129				

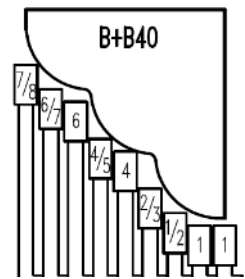
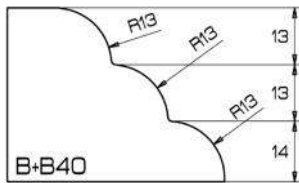

**Ninja Composition**

B+B40

Position	<b>TopLine</b> STONE DIVISION				<b>FastLine</b> STONE DIVISION				<b>TwistLine</b> STONE DIVISION				<b>MicronLine</b> STONE DIVISION			
	Code	Type	ID	ED												
1	PB123222	Seg	70	152												
2	PB122695	Cr+S	68	150												
3	PB122696	Cr+S	68	150												
4	PB122697	Cr+S	68	150												
MFP5	PB01520	MFP5	68	150												
5	PB02049	Exp	60	142												
6	PB02050	Exp	60	142												
7	PB02051	Exp	60	142												
6	PB69031	Magic	68	150												
7	PB69032	Magic	68	150												

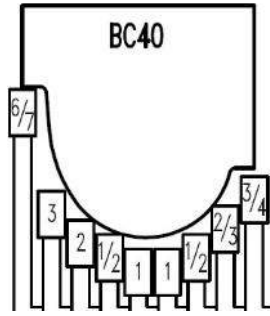
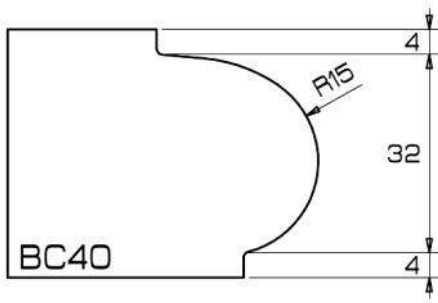

[BACK TO INDEX](#)



**Ninja Composition**  
BC40

Position	TopLine STONE DIVISION				FastLine STONE DIVISION				TwistLine STONE DIVISION				MicronLine STONE DIVISION			
	Code	Type	ID	ED												
1	PB124365	Seg	68	120												
2	PB124366	Seg	68	120												
3	PB124367	Seg	68	120												
4	PB124368	Seg	68	120												
MFP5	-	MFP5	-	-												
5	PB021635	Exp	60	112												
6	PB021636	Exp	60	112												
7	PB021637	Exp	60	112												
6	PB69428	Magic	62	114												
7	PB69429	Magic	62	114												

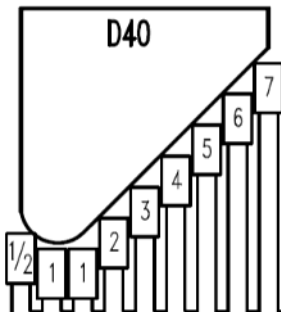
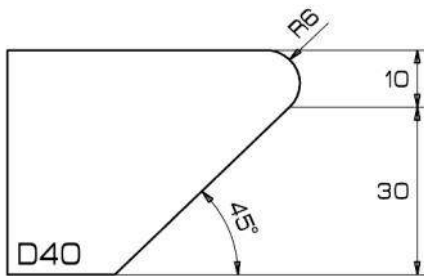

**Ninja Composition**  
D40

Position	TopLine STONE DIVISION				FastLine STONE DIVISION				TwistLine STONE DIVISION				MicronLine STONE DIVISION			
	Code	Type	ID	ED												
1	PB124043	Seg	65	135												
2	PB124044	Seg	65	135												
3	PB124610	Seg	65	135												
4	PB124611	Seg	65	135												
MFP5	-	MFP5	-	-												
5	PB021907	Exp	60	130												
6	PB021908	Exp	60	130												
7	PB021909	Exp	60	130												
6	PB691293	Magic	56	126												
7	PB691294	Magic	56	126												

[BACK TO INDEX](#)

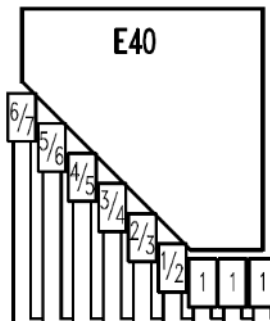
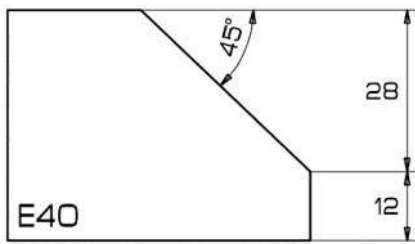

**Ninja Composition**

E40

Position	TopLine STONE DIVISION				FastLine STONE DIVISION				TwistLine STONE DIVISION				MicronLine STONE DIVISION			
	Code	Type	ID	ED												
1	PB123758	Seg	70	130												
2	PB123759	Cr+S	70	130												
3	PB123760	Cr+S	70	130												
4	PB123761	Cr+S	70	130												
MFP5	PB01670	MFP5	70	130												
5	PB02287	Exp	60	120												
6	PB02288	Exp	60	120												
7	PB02289	Exp	60	120												
6	PB69422	Magic	60	120												
7	PB69423	Magic	60	120												

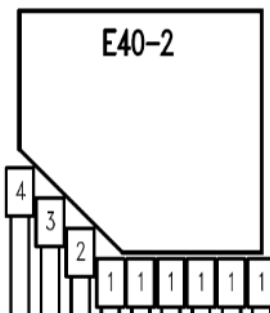
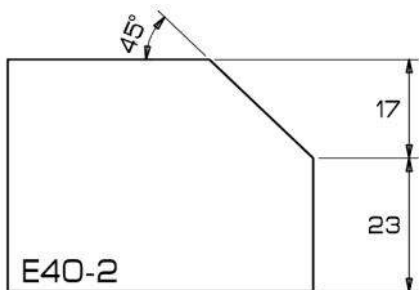

**Ninja Composition**

E40-2

Position	TopLine STONE DIVISION				FastLine STONE DIVISION				TwistLine STONE DIVISION				MicronLine STONE DIVISION			
	Code	type	ID	ED												
1	PB123154	Seg	70	108												
2	PB123155	Seg	70	108												
3	PB123156	Seg	70	108												
4	PB123157	Seg	70	108												
MFP5	-	MFP5	-	-												
5	PB02406	Exp	60	100												
6	PB02407	Exp	60	100												
7	PB02408	Exp	60	100												
6	PB69419	Magic	59	97												
7	PB69420	Magic	59	97												

[BACK TO INDEX](#)

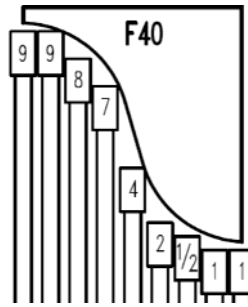
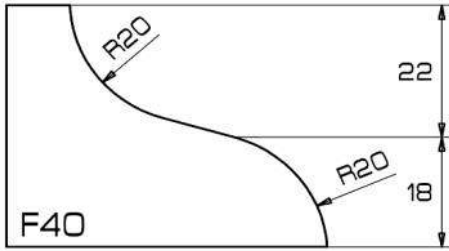

Ninja Composition

F40

Position	TopLine STONE DIVISION				FastLine STONE DIVISION				TwistLine STONE DIVISION				MicronLine STONE DIVISION			
	Code	type	ID	ED												
1	PB122710	Seg	60	140												
2	PB122711	Cr+S	60	140												
3	PB122712	Cr+S	60	140												
4	PB122713	Cr+S	60	140												
MFP5	PB01671	MFP5	60	140												
5	PB021321	Exp	60	141												
6	PB021322	Exp	60	141												
7	PB021323	Exp	60	141												
6	PB69413	Magic	56	138												
7	PB69414	Magic	56	138												

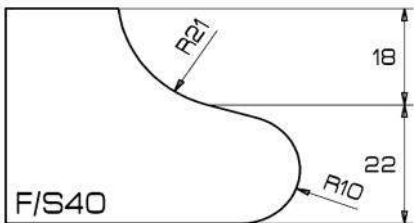

Ninja Composition

F/S40

Position	TopLine STONE DIVISION				FastLine STONE DIVISION				TwistLine STONE DIVISION				MicronLine STONE DIVISION			
	Code	Type	ID	ED												
1	PB123648	Seg	68	130												
2	PB123649	Cr+S	68	130												
3	PB123650	Cr+S	68	130												
4	PB123651	Cr+S	68	130												
MFP5	PB01672	MFP5	68	130												
5	PB021638	Exp	60	122												
6	PB021639	Exp	60	122												
7	PB021640	Exp	60	122												
6	PB69410	Magic	58	120												
7	PB69411	Magic	58	120												

[BACK TO INDEX](#)

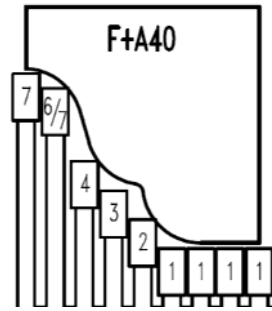
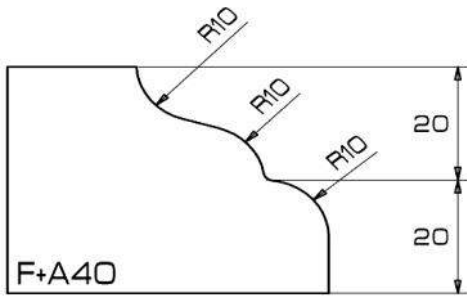

**Ninja Composition**  
F+A40

Position	TopLine STONE DIVISION				FastLine STONE DIVISION				TwistLine STONE DIVISION				MicronLine STONE DIVISION			
	Code	Type	ID	ED												
1	PB124300	Seg	65	125												
2	PB124301	Cr+S	60	120												
3	PB124302	Cr+S	60	120												
4	PB124303	Cr+S	60	120												
MFP5	PB01828	MFP5	60	120												
5	PB021365	Exp	60	120												
6	PB021366	Exp	60	120												
7	PB021367	Exp	60	120												
6	PB691236	Magic	60	120												
7	PB691237	Magic	60	120												

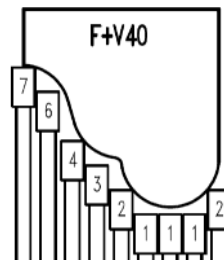
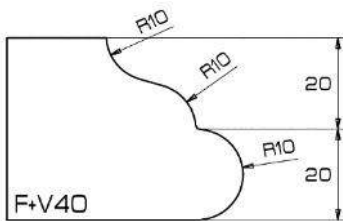

**Ninja Composition**  
F+V40

Position	TopLine STONE DIVISION				FastLine STONE DIVISION				TwistLine STONE DIVISION				MicronLine STONE DIVISION			
	Code	type	ID	ED												
1	PB123225	Seg	70	128												
2	PB122727	Cr+S	62	120												
3	PB122728	Cr+S	62	120												
4	PB122729	Cr+S	62	120												
MFP5	PB01531	MFP5	62	120												
5	PB02082	Exp	60	118												
6	PB02083	Exp	60	118												
7	PB02084	Exp	60	118												
6	PB69067	Magic	61	120												
7	PB69068	Magic	61	120												

[BACK TO INDEX](#)

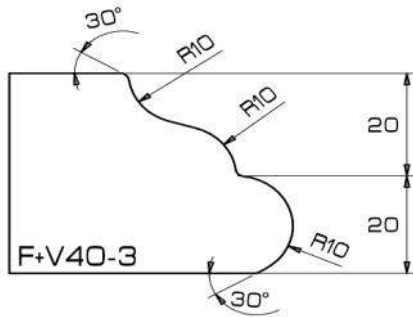

**Ninja Composition**

F+V40-3

Position	TopLine STONE DIVISION				FastLine STONE DIVISION				TwistLine STONE DIVISION				MicronLine STONE DIVISION			
	Code	type	ID	ED												
1	PB123225	Seg	70	128												
2	PB124282	Cr+S	62	130												
3	PB124283	Cr+S	62	130												
4	PB124284	Cr+S	62	130												
MFP5	PB01647	MFP5	62	130												
5	PB021884	Exp	60	128												
6	PB021882	Exp	60	128												
7	PB021883	Exp	60	128												
6	PB691158	Magic	52	120												
7	PB691159	Magic	52	120												

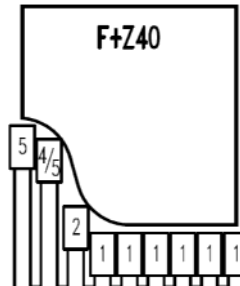
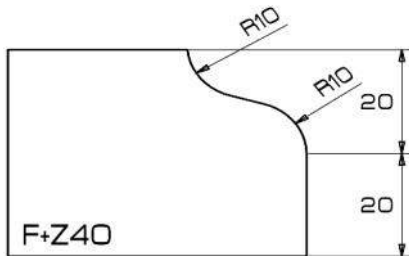

**Ninja Composition**

F+Z40

Position	TopLine STONE DIVISION				FastLine STONE DIVISION				TwistLine STONE DIVISION				MicronLine STONE DIVISION			
	Code	Type	ID	ED	Code	Type	ID	ED								
1	PB123227	Seg	80	120	PB124001	Seg	60	100								
2	PB122731	Cr+S	80	120	PB124002	Cr+S	60	100								
3	PB122732	Cr+S	80	120	PB124003	Cr+S	60	100								
4	PB122733	Cr+S	80	120	PB124004	Cr+S	60	100								
MFP5	PB01534	MFP5	60	100	PB01534	MFP5	60	100								
5	PB02091	Exp	60	100	PB02091	Exp	60	100								
6	PB02092	Exp	60	100	PB02092	Exp	60	100								
7	PB02093	Exp	60	100	PB02093	Exp	60	100								
6	PB69073	Magic	57	97	PB69073	Magic	57	97								
7	PB69074	Magic	57	97	PB69074	Magic	57	97								



[BACK TO INDEX](#)

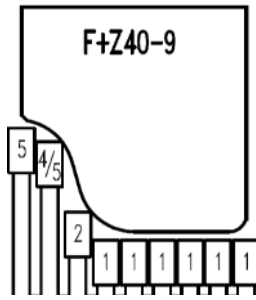
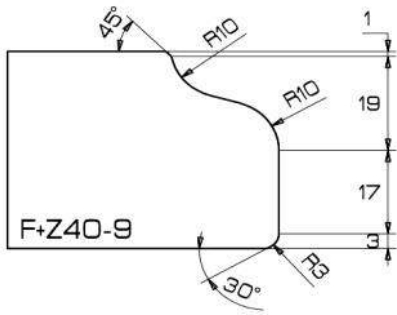

**Ninja Composition**

F+Z40-9

Position	<b>TopLine</b> STONE DIVISION				<b>FastLine</b> STONE DIVISION				<b>TwistLine</b> STONE DIVISION				<b>MicronLine</b> STONE DIVISION			
	Code	Type	ID	ED												
1					PB123227	Seg	80	120								
2					PB123706	Cr+S	60	104								
3					PB123707	Cr+S	60	104								
4					PB123708	Cr+S	60	104								
MFP5					PB01617	MFP5	60	104								
5					PB02290	Exp	60	105								
6					PB02291	Exp	60	105								
7					PB02292	Exp	60	105								
6					PB69325	Magic	74	119								
7					PB69326	Magic	74	119								

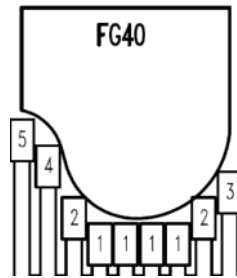
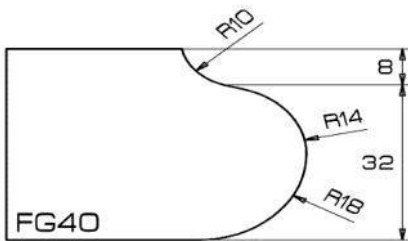

**Ninja Composition**

FG40

Position	<b>TopLine</b> STONE DIVISION				<b>FastLine</b> STONE DIVISION				<b>TwistLine</b> STONE DIVISION				<b>MicronLine</b> STONE DIVISION			
	Code	Type	ID	ED												
1	PB122803	Seg	78	120												
2	PB122804	Cr+S	78	120												
3	PB122805	Cr+S	78	120												
4	PB122806	Cr+S	78	120												
MFP5	PB01591	MFP5	78	120												
5	PB02382	Exp	60	102												
6	PB02383	Exp	60	102												
7	PB02384	Exp	60	102												
6	PB69292	Magic	78	120												
7	PB69293	Magic	78	120												

[BACK TO INDEX](#)

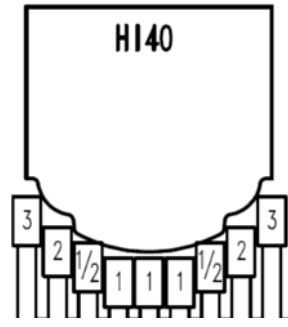
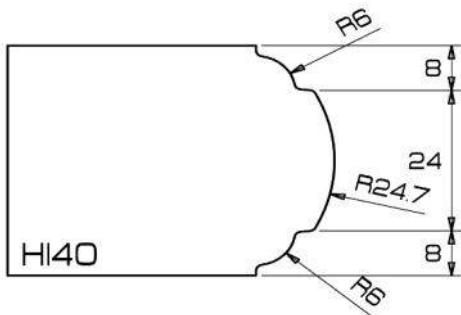

**Ninja Composition**

HI40

Position	<b>TopLine</b> STONE DIVISION				<b>FastLine</b> STONE DIVISION				<b>TwistLine</b> STONE DIVISION				<b>MicronLine</b> STONE DIVISION			
	Code	type	ID	ED												
1					PB124508	Seg	76	100								
2					PB124509	Seg	76	100								
3					PB124510	Seg	76	100								
4					PB124511	Seg	76	100								
MFP5					-	MFP5	-	-								
5					PB021800	Exp	60	84								
6					PB021801	Exp	60	84								
7					PB021802	Exp	60	84								
6					PB691057	Magic	56	80								
7					PB691058	Magic	56	80								

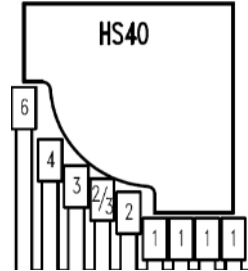
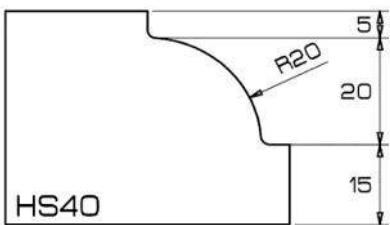

**Ninja Composition**

HS40

Position	<b>TopLine</b> STONE DIVISION				<b>FastLine</b> STONE DIVISION				<b>TwistLine</b> STONE DIVISION				<b>MicronLine</b> STONE DIVISION			
	Code	Type	ID	ED												
1	PB123293	Seg	70	120												
2	PB123294	Seg	70	120												
3	PB123295	Seg	70	120												
4	PB123296	Seg	70	120												
MFP5	-	MFP5	-	-												
5	PB02338	Exp	60	110												
6	PB02317	Exp	60	110												
7	PB02318	Exp	60	110												
6	PB691054	Magic	68	118												
7	PB691055	Magic	68	118												

[BACK TO INDEX](#)

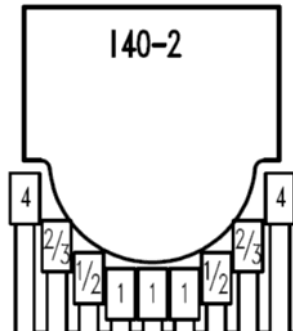
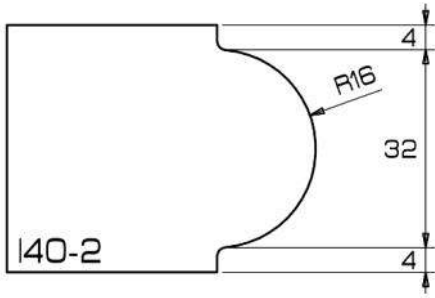

**Ninja Composition**  
I40-2

Position	TopLine STONE DIVISION				FastLine STONE DIVISION				TwistLine STONE DIVISION				MicronLine STONE DIVISION			
	Code	Type	ID	ED	Code	Type	ID	ED	Code	Type	ID	ED	Code	Type	ID	ED
1					PB124512	Seg	70	102								
2					PB124513	Seg	70	102								
3					PB124514	Seg	70	102								
4					PB124515	Seg	70	102								
MFP5					-	MFP5	-	-								
5					PB021803	Exp	60	92								
6					PB021804	Exp	60	92								
7					PB021805	Exp	60	92								
6					PB691051	Magic	65	97								
7					PB691052	Magic	65	97								

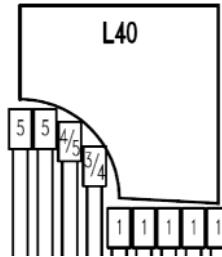
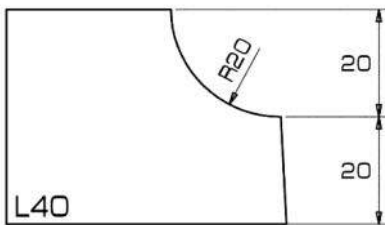

**Ninja Composition**  
L40

Position	TopLine STONE DIVISION				FastLine STONE DIVISION				TwistLine STONE DIVISION				MicronLine STONE DIVISION			
	Code	Type	ID	ED	Code	Type	ID	ED	Code	Type	ID	ED	Code	Type	ID	ED
1	PB124369	Seg	78	120												
2	PB124370	Seg	78	120												
3	PB124371	Seg	78	120												
4	PB124372	Seg	78	120												
MFP5	-	MFP5	-	-												
5	PB021641	Exp	60	102												
6	PB021642	Exp	60	102												
7	PB021643	Exp	60	102												
6	PB691048	Magic	64	106												
7	PB691049	Magic	64	106												

BACK TO INDEX

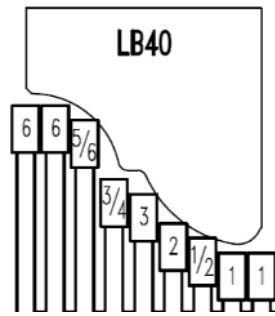
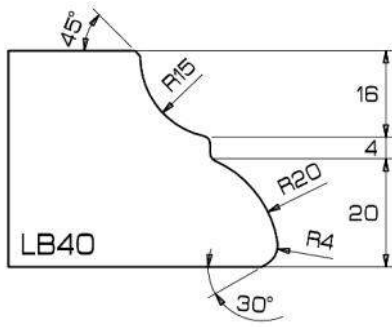

Ninja Composition

LB40

Position	TopLine STONE DIVISION				FastLine STONE DIVISION				TwistLine STONE DIVISION				MicronLine STONE DIVISION			
	Code	Type	ID	ED												
1	PB124556	Seg	70	121												
2	PB124557	Cr+S	60	116												
3	PB124558	Cr+S	60	116												
4	PB124559	Cr+S	60	116												
MFP5	PB01831	MFP5	60	116												
5	PB021888	Exp	60	116												
6	PB021858	Exp	60	116												
7	PB021859	Exp	60	116												
6	PB691260	Magic	64	120												
7	PB691261	Magic	64	120												

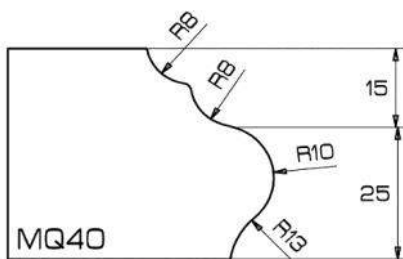

Ninja Composition

MQ40

Position	TopLine STONE DIVISION				FastLine STONE DIVISION				TwistLine STONE DIVISION				MicronLine STONE DIVISION			
	Code	type	ID	ED												
1	PB123235	Seg	74	120												
2	PB124373	Cr+S	74	120												
3	PB124374	Cr+S	74	120												
4	PB124375	Cr+S	74	120												
MFP5	PB01673	MFP5	74	120												
5	PB021644	Exp	60	106												
6	PB021645	Exp	60	106												
7	PB021646	Exp	60	106												
6	PB691045	Magic	72	118												
7	PB691046	Magic	72	118												

[BACK TO INDEX](#)

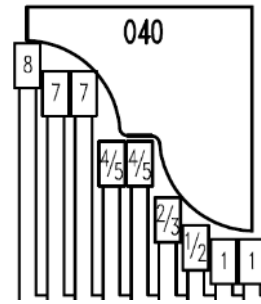
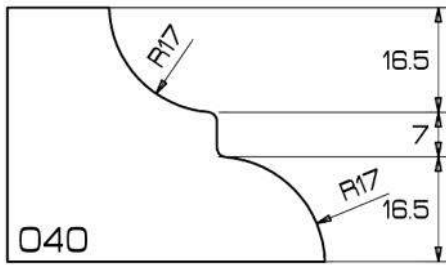

**Ninja Composition**

O40

Position	TopLine STONE DIVISION				FastLine STONE DIVISION				TwistLine STONE DIVISION				MicronLine STONE DIVISION			
	Code	type	ID	ED												
1	PB123474	Seg	67	135												
2	PB123475	Seg	67	135												
3	PB123476	Seg	67	135												
4	PB123477	Seg	67	135												
MFP5	-	MFP5	-	-												
5	PB021647	Exp	60	129												
6	PB021648	Exp	60	129												
7	PB021649	Exp	60	129												
6	PB69379	Magic	64	133												
7	PB69380	Magic	64	133												

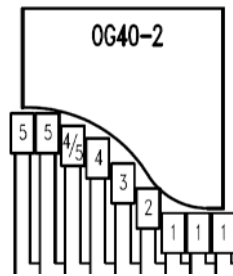
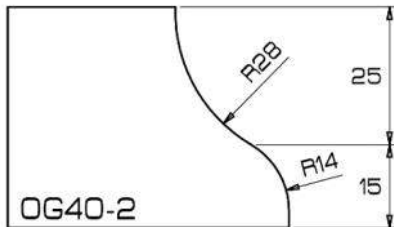

**Ninja Composition**

OG40-2

Position	TopLine STONE DIVISION				FastLine STONE DIVISION				TwistLine STONE DIVISION				MicronLine STONE DIVISION			
	Code	Type	ID	ED	Code	Type	ID	ED	Code	Type	ID	ED				
1					PB123629	Seg	60	100	PB161339	Seg	40	80				
2					PB123630	Seg	60	100	PB161340	Seg	40	80				
3					PB123746	Seg	60	100	PB161341	Seg	40	80				
4					PB123747	Seg	60	100	PB161342	Seg	40	80				
MFP5					-	MFP5	-	-	-	MFP5	-	-				
5					PB021806	Exp	60	100	PB02808	Exp	40	80				
6					PB021807	Exp	60	100	PB02809	Exp	40	80				
7					PB021808	Exp	60	100	PB02810	Exp	40	80				
6					PB691039	Magic	57	97	PB68190	Magic	45	85				
7					PB691040	Magic	57	97	PB68191	Magic	45	85				

BACK TO INDEX



Ninja Composition

OH40

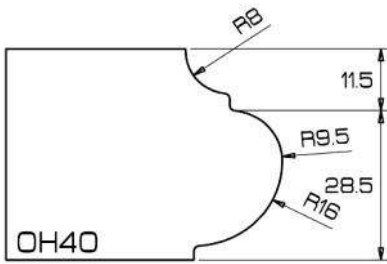

Position	TopLine STONE DIVISION					FastLine STONE DIVISION					TwistLine STONE DIVISION					MicronLine STONE DIVISION				
	Code	Type	ID	ED																
1	PB123255	Seg	85	120																
2	PB123256	Seg	85	120																
3	PB123257	Seg	85	120																
4	PB123258	Seg	85	120																
MFP5	-	MFP5	-	-																
5	PB021650	Exp	60	95																
6	PB021651	Exp	60	95																
7	PB021652	Exp	60	95																
6	PB691033	Magic	62	97																
7	PB691034	Magic	62	97																

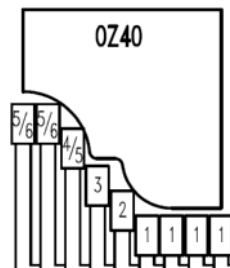
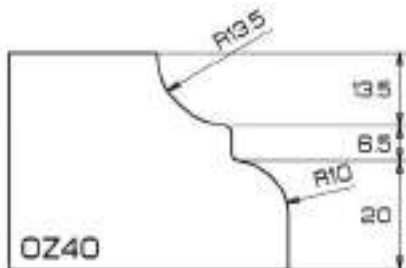

Ninja Composition

OZ40

Position	TopLine STONE DIVISION					FastLine STONE DIVISION					TwistLine STONE DIVISION					MicronLine STONE DIVISION				
	Code	Type	ID	ED																
1	PB124642	Seg	70	117																
2	PB124643	Cr+S	60	107																
3	PB124644	Cr+S	60	107																
4	PB124645	Cr+S	60	107																
MFP5	PB01836	MFP5	60	107																
5	PB021913	Exp	60	95																
6	PB021914	Exp	60	95																
7	PB021915	Exp	60	95																
6	PB691296	Magic	73	120																
7	PB691297	Magic	73	120																

[BACK TO INDEX](#)

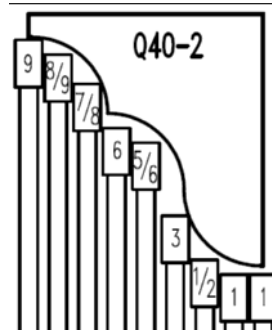
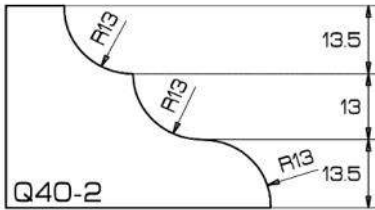

**Ninja Composition**

Q40-2

Position	TopLine STONE DIVISION				FastLine STONE DIVISION				TwistLine STONE DIVISION				MicronLine STONE DIVISION			
	Code	Type	ID	ED												
1	PB123406	Seg	62	140												
2	PB123407	Cr+S	62	140												
3	PB123408	Cr+S	62	140												
4	PB123409	Cr+S	62	140												
MFP5	PB01674	MFP5	62	140												
5	PB021653	Exp	60	138												
6	PB021654	Exp	60	138												
7	PB021655	Exp	60	138												
6	PB691030	Magic	56	134												
7	PB691031	Magic	56	134												

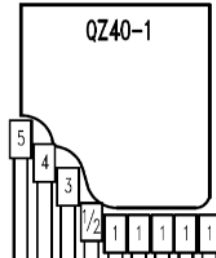
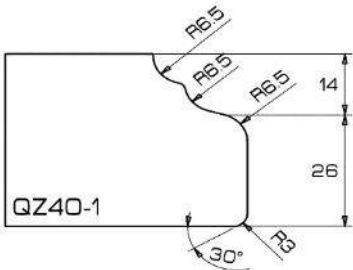

**Ninja Composition**

QZ40-1

Position	TopLine STONE DIVISION				FastLine STONE DIVISION				TwistLine STONE DIVISION				MicronLine STONE DIVISION			
					Code	type	ID	ED								
1					PB123881	Seg	60	109								
2					PB123882	Cr+S	60	99								
3					PB123883	Cr+S	60	99								
4					PB123884	Cr+S	60	99								
MFP5					PB01827	MFP5	60	99								
5					PB021852	Exp	60	97								
6					PB021853	Exp	60	97								
7					PB021854	Exp	60	97								
6					PB69313	Magic	60	97								
7					PB69314	Magic	60	97								

[BACK TO INDEX](#)

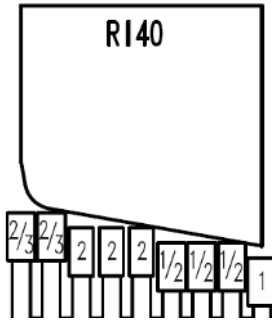
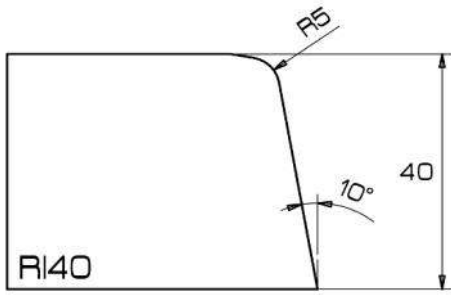

**Ninja Composition**

R140

Position	<b>TopLine</b> STONE DIVISION				<b>FastLine</b> STONE DIVISION				<b>TwistLine</b> STONE DIVISION				<b>MicronLine</b> STONE DIVISION			
	Code	Type	ID	ED	Code	Type	ID	ED	Code	Type	ID	ED	Code	Type	ID	ED
1									PB161191	Cr+S	40	70				
2									PB161448	Cr+S	40	70				
3									PB161449	Cr+S	40	70				
4									PB161450	Cr+S	40	70				
MFP5									PB11578	MFP5	40	70				
5									PB02814	Exp	40	70				
6									PB02815	Exp	40	70				
7									PB02816	Exp	40	70				
6									PB68127	Magic	45	80				
7									PB68128	Magic	45	80				

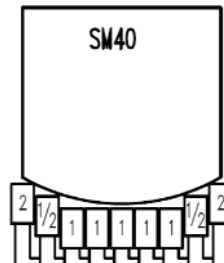
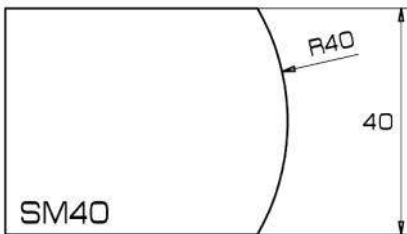

**Ninja Composition**

SM40

Position	<b>TopLine</b> STONE DIVISION				<b>FastLine</b> STONE DIVISION				<b>TwistLine</b> STONE DIVISION				<b>MicronLine</b> STONE DIVISION			
	Code	Type	ID	ED	Code	Type	ID	ED	Code	Type	ID	ED	Code	Type	ID	ED
1					PB122895	Cr+S	68	80								
2					PB122896	Cr+S	68	80								
3					PB122897	Cr+S	68	80								
4					PB122898	Cr+S	68	80								
MFP5					PB01552	MFP5	68	80								
5					PB02145	Exp	60	72								
6					PB02146	Exp	60	72								
7					PB02147	Exp	60	72								
6					PB69184	Magic	68	80								
7					PB69185	Magic	68	80								



[BACK TO INDEX](#)

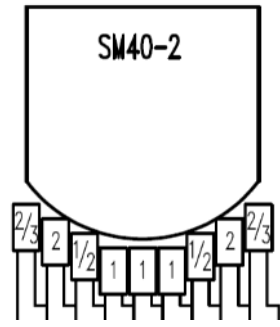
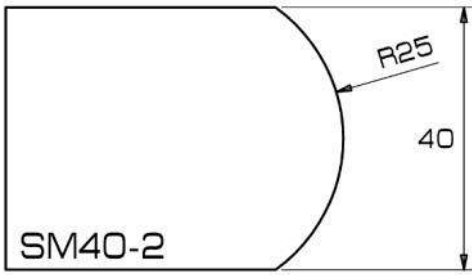

**Ninja Composition**  
SM40-2

Position	TopLine STONE DIVISION				FastLine STONE DIVISION				TwistLine STONE DIVISION				MicronLine STONE DIVISION			
	Code	type	ID	ED	Code	type	ID	ED	Code	type	ID	ED	Code	type	ID	ED
1					PB124516	Seg	70	96								
2					PB124517	Seg	70	96								
3					PB124518	Seg	70	96								
4					PB124519	Seg	70	96								
MFP5					-	MFP5	-	-								
5					PB021809	Exp	60	86								
6					PB021810	Exp	60	86								
7					PB021811	Exp	60	86								
6					PB691021	Magic	71	97								
7					PB691022	Magic	71	97								

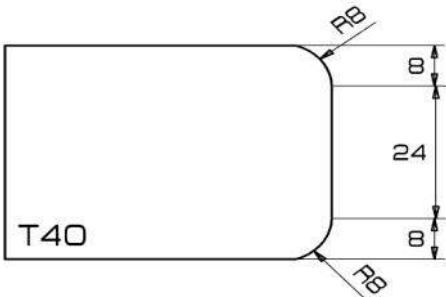

**Ninja Composition**  
T40

Position	TopLine STONE DIVISION				FastLine STONE DIVISION				TwistLine STONE DIVISION				MicronLine STONE DIVISION			
	Code	type	ID	ED	Code	type	ID	ED	Code	type	ID	ED	Code	type	ID	ED
1	PB122811	Seg	103	120									PB20505	6 Seg	20	41
2	PB122812	Cr+S	103	120									PB20506	6 Seg	20	41
3	PB122813	Cr+S	103	120									PB20507	6 Seg	20	41
4	PB122814	Cr+S	103	120									PB20508	6 Seg	20	41
MFP5	PB01560	MFP5	103	120									PB38501	Era	20	20
5	PB02169	Exp	60	86									PB021074	Exp	20	40
6	PB02170	Exp	60	86									PB021075	Exp	20	40
7	PB02171	Exp	60	86									PB021076	Exp	20	40
6	PB69130	Magic	63	80									PB67016	Magic	20	40
7	PB69131	Magic	63	80									PB67017	Magic	20	40

[BACK TO INDEX](#)



**Ninja Composition**

T40-1

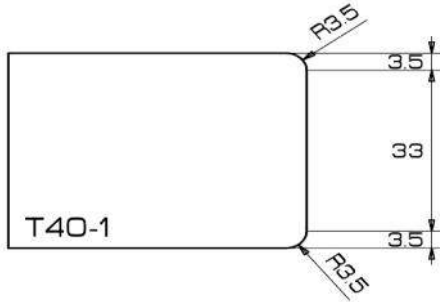

Position	<b>TopLine</b> STONE DIVISION					<b>FastLine</b> STONE DIVISION					<b>TwistLine</b> STONE DIVISION					<b>MicronLine</b> STONE DIVISION				
	Code	Type	ID	ED		Code	Type	ID	ED							Code	type	ID	ED	
1	PB123021	Seg	103	120		PB123032	Seg	60	77							PB201133	2 Seg	20	30	
2	PB123022	Cr+S	103	120		PB123033	Cr+S	60	77							PB201134	2 Seg	20	30	
3	PB123023	Cr+S	103	120		PB123034	Cr+S	60	77							PB201135	2 Seg	20	30	
4	PB123024	Cr+S	103	120		PB123035	Cr+S	60	77							PB201136	2 Seg	20	30	
MFP5	PB01559	MFP5	60	77		PB01559	MFP5	60	77							PB015072	Mfp5	20	30	
5	PB02163	Exp	60	75		PB02163	Exp	60	75							PB021062	Exp	20	37	
6	PB02164	Exp	60	75		PB02164	Exp	60	75							PB021063	Exp	20	37	
7	PB02165	Exp	60	75		PB02165	Exp	60	75							PB021064	Exp	20	37	
6	PB69133	Magic	63	80		PB69133	Magic	63	80							PB67025	Magic	20	40	
7	PB69314	Magic	63	80		PB69134	Magic	63	80							PB67026	Magic	20	40	

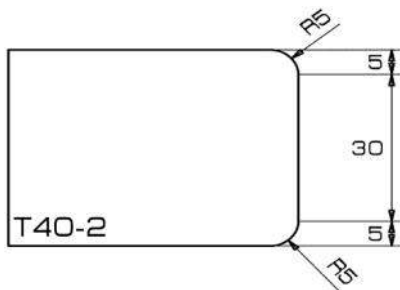

**Ninja Composition**

T40-2

Position	<b>TopLine</b> STONE DIVISION					<b>FastLine</b> STONE DIVISION					<b>TwistLine</b> STONE DIVISION					<b>MicronLine</b> STONE DIVISION																							
						Code	Type	ID	ED							Code	Type	ID	ED																				
1						PB122659	Seg	60	77							PB161308	Seg	40	57																				
2						PB122660	Cr+S	60	77							PB161309	Cr+S	40	57																				
3						PB122661	Cr+S	60	77							PB161310	Cr+S	40	57																				
4						PB122662	Cr+S	60	77							PB161311	Cr+S	40	57																				
MFP5						PB01619	MFP5	60	77							PB11529	MFP5	40	57																				
5						PB02482	Exp	60	80							PB02697	Exp	40	60																				
6						PB02483	Exp	60	80							PB02698	Exp	40	60																				
7						PB02484	Exp	60	80							PB02699	Exp	40	60																				
6						PB69373	Magic	65	80							PB68088	Magic	45	60																				
7						PB69374	Magic	65	80							PB68089	Magic	45	60																				

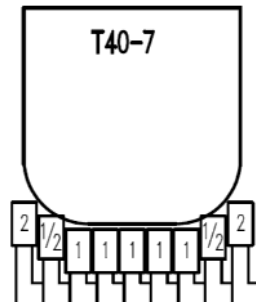
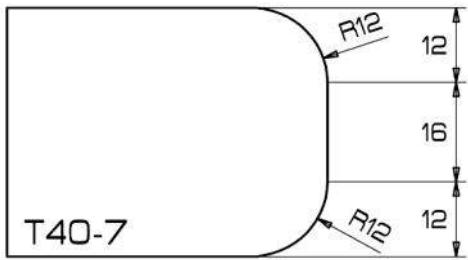

[BACK TO INDEX](#)

 **Ninja Composition**  
T40-7

Position	 <b>TopLine</b> STONE DIVISION				 <b>FastLine</b> STONE DIVISION				 <b>TwistLine</b> STONE DIVISION				 <b>MicronLine</b> STONE DIVISION			
	Code	type	ID	ED	Code	type	ID	ED	Code	type	ID	ED	Code	type	ID	ED
1					PB123826	Seg	60	88								
2					PB123827	Cr+S	60	88								
3					PB123828	Cr+S	60	88								
4					PB123829	Cr+S	60	88								
MFP5					PB01815	MFP5	60	88								
5					PB02418	Exp	60	90								
6					PB02419	Exp	60	90								
7					PB02420	Exp	60	90								
6					PB691015	Magic	69	97								
7					PB691016	Magic	69	97								

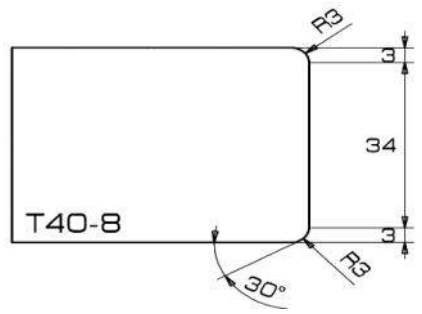

 **Ninja Composition**  
T40-8

Position	 <b>TopLine</b> STONE DIVISION				 <b>FastLine</b> STONE DIVISION				 <b>TwistLine</b> STONE DIVISION				 <b>MicronLine</b> STONE DIVISION			
	Code	Type	ID	ED	Code	type	ID	ED	Code	type	ID	ED	Code	type	ID	ED
1	PB124066	Seg	103	120	PB123678	Seg	60	77	PB161312	Seg	40	57	PB201137	2 Seg	20	29
2	PB124067	Cr+S	103	120	PB123679	Cr+S	60	71	PB161313	Cr+S	40	57	PB201138	2 Seg	20	29
3	PB124068	Cr+S	103	120	PB123680	Cr+S	60	71	PB161314	Cr+S	40	57	PB201139	2 Seg	20	29
4	PB124069	Cr+S	103	120	PB123681	Cr+S	60	71	PB161315	Cr+S	40	57	PB201140	2 Seg	20	29
MFP5	PB01584	MFP5	60	77	PB01584	MFP5	60	71	PB11530	MFP5	40	57	PB015073	Mfp5	20	29
5	PB02250	Exp	60	75	PB02250	Exp	60	75	PB02700	Exp	40	55	PB021071	Exp	20	37
6	PB02251	Exp	60	75	PB02251	Exp	60	75	PB02701	Exp	40	55	PB021072	Exp	20	37
7	PB02252	Exp	60	75	PB02252	Exp	60	75	PB02702	Exp	40	55	PB021073	Exp	20	37
6	PB69244	Magic	63	80	PB69244	Magic	63	80	PB68091	Magic	45	60	PB67034	Magic	20	35
7	PB69245	Magic	63	80	PB69245	Magic	63	80	PB68092	Magic	45	60	PB67035	Magic	20	35

BACK TO INDEX



Ninja Composition

T40-10

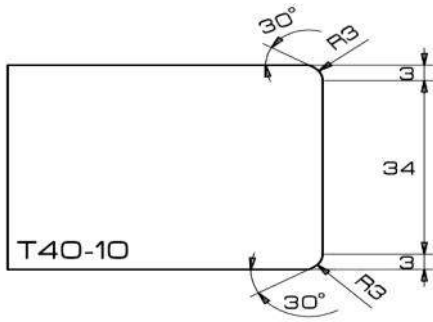

Position	TopLine STONE DIVISION				FastLine STONE DIVISION				TwistLine STONE DIVISION				MicronLine STONE DIVISION			
	Code	type	ID	ED	Code	type	ID	ED	Code	type	ID	ED	Code	type	ID	ED
1	PB124235	Seg	103	120	PB124181	Seg	60	77	PB161351	Seg	40	57	PB20834	2 Seg	20	30
2	PB124236	Cr+S	103	120	PB124182	Cr+S	60	71	PB161352	Cr+S	40	57	PB20835	2 Seg	20	30
3	PB124237	Cr+S	103	120	PB124183	Cr+S	60	71	PB161353	Cr+S	40	57	PB20836	2 Seg	20	30
4	PB124238	Cr+S	103	120	PB124184	Cr+S	60	71	PB161354	Cr+S	40	57	PB20837	2 Seg	20	30
MFP5	PB01635	MFP5	60	71	PB01635	MFP5	60	71	PB11543	MFP5	40	57	PB015074	Mfp5	20	30
5	PB021352	Exp	60	75	PB021352	Exp	60	75	PB02726	Exp	40	55	PB021146	Exp	20	37
6	PB021353	Exp	60	75	PB021353	Exp	60	75	PB02727	Exp	40	55	PB021147	Exp	20	37
7	PB021354	Exp	60	75	PB021354	Exp	60	75	PB02728	Exp	40	55	PB021148	Exp	20	37
6	PB691156	Magic	69	80	PB691156	Magic	69	80	PB68136	Magic	45	60	PB67070	Magic	20	35
7	PB691157	Magic	69	80	PB691157	Magic	69	80	PB68137	Magic	45	60	PB67071	Magic	20	35

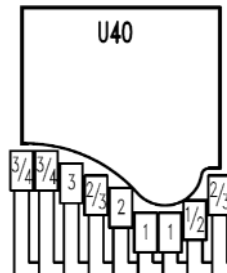
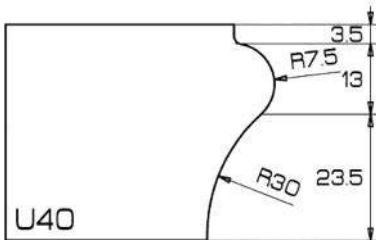

Ninja Composition

U40

Position	TopLine STONE DIVISION				FastLine STONE DIVISION				TwistLine STONE DIVISION				MicronLine STONE DIVISION			
	Code	type	ID	ED												
1	PB124376	Seg	95	120												
2	PB124377	Cr+S	95	120												
3	PB124378	Cr+S	95	120												
4	PB124379	Cr+S	95	120												
MFP5	PB01675	MFP5	95	120												
5	PB021656	Exp	60	85												
6	PB021657	Exp	60	85												
7	PB021658	Exp	60	85												
6	PB691012	Magic	72	97												
7	PB691013	Magic	72	97												

[BACK TO INDEX](#)

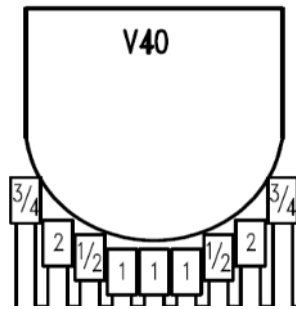
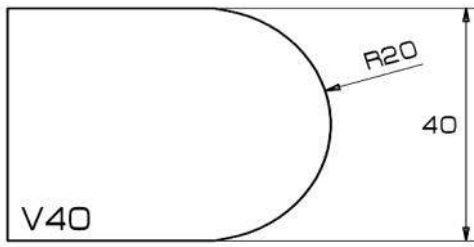

**Ninja Composition**

V40

Position	TopLine STONE DIVISION				FastLine STONE DIVISION				TwistLine STONE DIVISION				MicronLine STONE DIVISION			
	Code	Type	ID	ED	Code	Type	ID	ED	Code	Type	ID	ED				
1	PB122823	Seg	74	120	PB124123	Seg	60	106	PB161129	Seg	40	86				
2	PB122824	Cr+S	74	120	PB124124	Cr+S	60	106	PB161130	Cr+S	40	86				
3	PB122825	Cr+S	74	120	PB124125	Cr+S	60	106	PB161131	Cr+S	40	86				
4	PB122826	Cr+S	74	120	PB124126	Cr+S	60	106	PB161132	Cr+S	40	86				
MFP5	PB01563	MFP5	60	106	PB01563	MFP5	60	106	PB11528	MFP5	40	86				
5	PB02178	Exp	60	107	PB02178	Exp	60	107	PB02643	Exp	40	86				
6	PB02179	Exp	60	107	PB02179	Exp	60	107	PB02644	Exp	40	88				
7	PB02180	Exp	60	107	PB02180	Exp	60	107	PB02645	Exp	40	88				
6	PB69142	Magic	74	120	PB69142	Magic	74	120	PB68055	Magic	45	91				
7	PB69143	Magic	74	120	PB69143	Magic	74	120	PB680056	Magic	45	91				

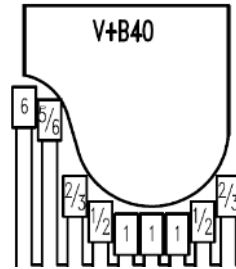
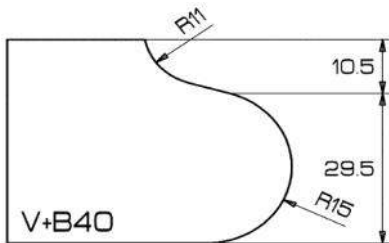

**Ninja Composition**

V+B40

Position	TopLine STONE DIVISION				FastLine STONE DIVISION				TwistLine STONE DIVISION				MicronLine STONE DIVISION			
	Code	Type	ID	ED												
1	PB123231	Seg	70	122												
2	PB122836	Cr+S	68	120												
3	PB122837	Cr+S	68	120												
4	PB122838	Cr+S	68	120												
MFP5	PB01566	MFP5	68	120												
5	PB02187	Exp	60	112												
6	PB02188	Exp	60	112												
7	PB02189	Exp	60	112												
6	PB69151	Magic	66	118												
7	PB69152	Magic	66	118												

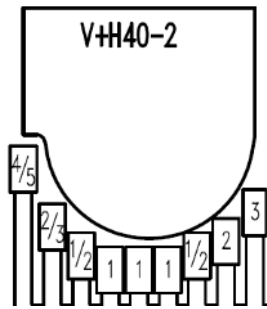
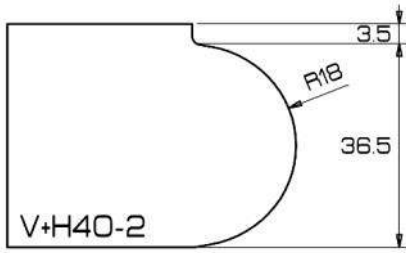

[BACK TO INDEX](#)



**Ninja Composition**  
V+H40-2

Position	TopLine STONE DIVISION				FastLine STONE DIVISION				TwistLine STONE DIVISION				MicronLine STONE DIVISION			
	Code	Type	ID	ED												
1	PB124380	Seg	70	110												
2	PB124381	Seg	70	110												
3	PB124382	Seg	70	110												
4	PB124383	Seg	70	110												
MFP5	-	MFP5	-	-												
5	PB021659	Exp	60	102												
6	PB021660	Exp	60	102												
7	PB021661	Exp	60	102												
6	PB69271	Magic	78	120												
7	PB69272	Magic	78	120												

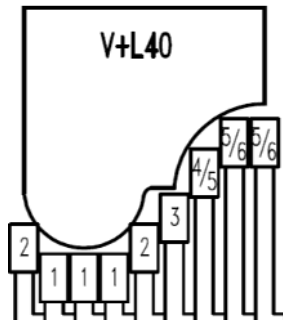
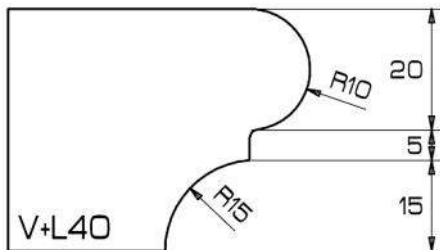

**Ninja Composition**  
V+L40

Position	TopLine STONE DIVISION				FastLine STONE DIVISION				TwistLine STONE DIVISION				MicronLine STONE DIVISION			
	Code	type	ID	ED												
1	PB124194	Seg	70	118												
2	PB124579	Seg	70	118												
3	PB124580	Seg	70	118												
4	PB124581	Seg	70	118												
MFP5	-	MFP5	-	-												
5	PB021867	Exp	60	108												
6	PB021868	Exp	60	108												
7	PB021869	Exp	60	108												
6	PB691299	Magic	72	120												
7	PB691300	Magic	72	120												

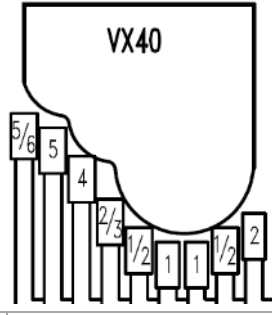
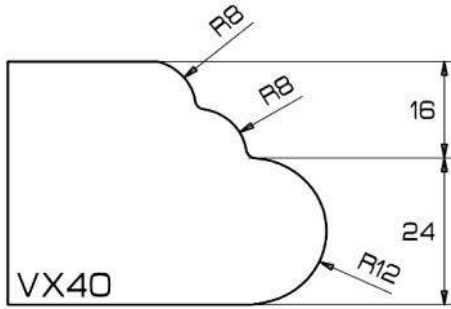

[BACK TO INDEX](#)



**Ninja Composition**  
VX40

Position	TopLine STONE DIVISION				FastLine STONE DIVISION				TwistLine STONE DIVISION				MicronLine STONE DIVISION			
	Code	Type	ID	ED												
1	PB123234	Seg	70	130												
2	PB123487	Cr+S	73	120												
3	PB123488	Cr+S	73	120												
4	PB123489	Cr+S	73	120												
MFP5	PB01676	MFP5	73	120												
5	PB021662	Exp	60	107												
6	PB021663	Exp	60	107												
7	PB021664	Exp	60	107												
6	PB69994	Magic	57	117												
7	PB69995	Magic	57	117												

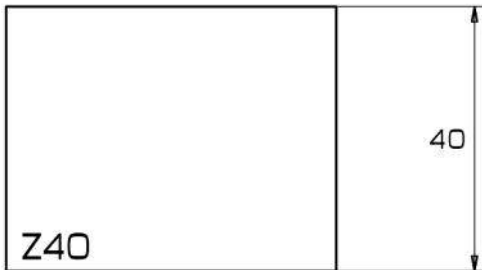

**Ninja Composition**  
Z40

Position	TopLine STONE DIVISION				FastLine STONE DIVISION				TwistLine STONE DIVISION				MicronLine STONE DIVISION			
	Code	Type	ID	ED	Code	type	ID	ED	Code	type	ID	ED	Code	type	ID	ED
1	PB123871	Seg	-	120	PB122598	Seg	80	80	PB161117	Seg	40	40	PB20511	2 Seg	20	20
2	PB123872	Cr+S	-	120	PB122599	Cr+S	80	80	PB161118	Cr+S	40	40	PB20512	2 Seg	20	20
3	PB123873	Cr+S	-	120	PB122600	Cr+S	80	80	PB161119	Cr+S	40	40	PB20513	2 Seg	20	20
4	PB123874	Cr+S	-	120	PB122635	Cr+S	80	80	PB161120	Cr+S	40	40	PB20524	2 Seg	20	20
MFP5	PB01506	MFP5	-	60	PB01506	MFP5	80	60	PB11512	MFP5	40	40	PB015002	Mfp5	20	20
5	PB02440	Exp	-	80	PB02440	Exp	80	80	PB02652	Exp	40	40	PB021001	Exp	20	20
6	PB02441	Exp	-	80	PB02441	Exp	80	80	PB02653	Exp	40	40	PB021002	Exp	20	20
7	PB02442	Exp	-	80	PB02442	Exp	80	80	PB02654	Exp	40	40	PB021003	Exp	20	20
6	PB69973	Magic	-	80	PB69406	Magic	78	78	PB68058	Magic	45	45	PB67049	Magic	20	20
7	PB69974	Magic	-	80	PB69407	Magic	78	78	PB68059	Magic	45	45	PB67050	Magic	20	20

[BACK TO INDEX](#)



**Ninja Composition**

ZR40

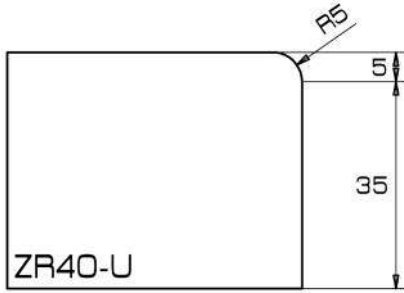

Position	<b>TopLine</b> STONE DIVISION					<b>FastLine</b> STONE DIVISION					<b>TwistLine</b> STONE DIVISION					<b>MicronLine</b> STONE DIVISION				
	Code	type	ID	ED		Code	type	ID	ED		Code	type	ID	ED		Code	type	ID	ED	
1						PB122899	Cr+S	65	80		PB161137	Seg	40	55		PB201125	2 Seg	20	33	
2						PB122900	Cr+S	65	80		PB161138	Cr+S	40	55		PB201126	2 Seg	20	33	
3						PB122901	Cr+S	65	80		PB161139	Cr+S	40	55		PB201127	2 Seg	20	33	
4						PB122902	Cr+S	65	80		PB161140	Cr+S	40	55		PB201128	2 Seg	20	33	
MFP5						PB01571	MFP5	65	80		PB11515	MFP5	40	55		PB015078	MFP5	20	20	
5						PB02211	Exp	60	80		PB02634	Exp	40	55		PB021031	Exp	20	33	
6						PB02212	Exp	60	80		PB02635	Exp	40	55		PB021032	Exp	20	33	
7						PB02213	Exp	60	80		PB02636	Exp	40	55		PB021033	Exp	20	33	
6						PB69211	Magic	65	80		PB68067	Magic	45	60		PB67037	Magic	20	40	
7						PB69212	Magic	65	80		PB68068	Magic	45	60		PB67038	Magic	20	40	



**Ninja Composition**

ZR40-D

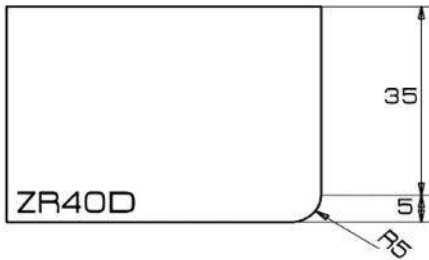

Position	<b>TopLine</b> STONE DIVISION					<b>FastLine</b> STONE DIVISION					<b>TwistLine</b> STONE DIVISION					<b>MicronLine</b> STONE DIVISION				
	Code	type	ID	ED		Code	type	ID	ED		Code	type	ID	ED		Code	type	ID	ED	
1																PB201129	2 Seg	20	33	
2																PB201130	2 Seg	20	33	
3																PB201131	2 Seg	20	33	
4																PB201132	2 Seg	20	33	
MFP5																PB015079	MFP5	20	20	
5																PB021034	Exp	20	33	
6																PB021035	Exp	20	33	
7																PB021036	Exp	20	33	
6																PB67040	Magic	20	40	
7																PB67041	Magic	20	40	



[BACK TO INDEX](#)

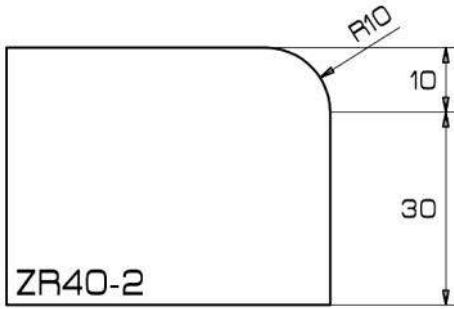

**Ninja Composition**

ZR40-2

Position	TopLine STONE DIVISION				FastLine STONE DIVISION				TwistLine STONE DIVISION				MicronLine STONE DIVISION			
					Code	Type	ID	ED								
1					PB123072	Seg	70	92								
2					PB123073	Cr+S	60	90								
3					PB123074	Cr+S	60	90								
4					PB123075	Cr+S	60	90								
MFP5					PB01816	MFP5	60	90								
5					PB021812	Exp	60	90								
6					PB021813	Exp	60	90								
7					PB021814	Exp	60	90								
6					PB69988	Magic	67	97								
7					PB69989	Magic	67	97								

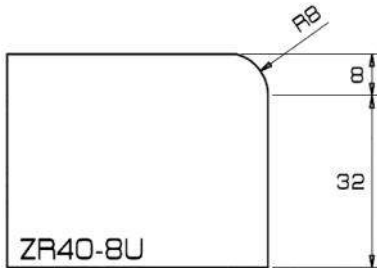

**Ninja Composition**

ZR40-8U

Position	TopLine STONE DIVISION				FastLine STONE DIVISION				TwistLine STONE DIVISION				MicronLine STONE DIVISION			
													Code	type	ID	ED
1													PB20830	6 Seg	20	41
2													PB20831	6 Seg	20	41
3													PB20832	6 Seg	20	41
4													PB20833	6 Seg	20	41
MFP5													PB38502	Era	20	20
5													PB021219	Exp	20	38
6													PB021099	Exp	20	38
7													PB021100	Exp	20	38
6													PB67156	Magic	20	38
7													PB67157	Magic	20	38

BACK TO INDEX



Ninja Composition

ZS40

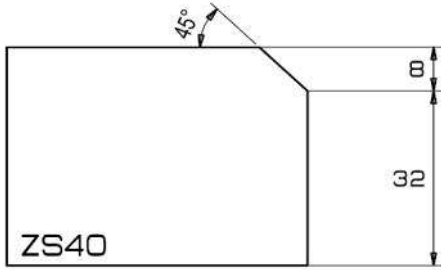

Position	<b>TopLine</b> STONE DIVISION				<b>FastLine</b> STONE DIVISION				<b>TwistLine</b> STONE DIVISION				<b>MicronLine</b> STONE DIVISION							
	Code	Type	ID	ED	Code	Type	ID	ED	Code	Type	ID	ED	Code	Type	ID	ED				
1					PB122911	Cr+S	70	90					PB161245	Seg	40	60				
2					PB122912	Cr+S	70	90					PB161246	Cr+S	40	60				
3					PB122913	Cr+S	70	90					PB161247	Cr+S	40	60				
4					PB122914	Cr+S	70	90					PB161248	Cr+S	40	60				
MFP5					PB01575	MFP5	70	90					PB11519	MFP5	40	60				
5					PB02223	Exp	60	80					PB02679	Exp	40	60				
6					PB02224	Exp	60	80					PB02680	Exp	40	60				
7					PB02225	Exp	60	80					PB02681	Exp	40	60				
6					PB69223	Magic	60	80					PB68079	Magic	45	65				
7					PB69224	Magic	60	80					PB68080	Magic	45	65				

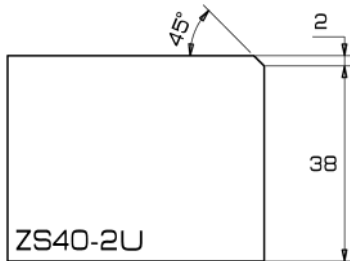

Ninja Composition

ZS40-2

Position	<b>TopLine</b> STONE DIVISION				<b>FastLine</b> STONE DIVISION				<b>TwistLine</b> STONE DIVISION				<b>MicronLine</b> STONE DIVISION							
	Code	type	ID	ED	Code	type	ID	ED	Code	type	ID	ED	Code	type	ID	ED				
1					PB123686	Cr+S	70	79					PB20622	2 Seg	20	26				
2					PB123687	Cr+S	70	79					PB20623	2 Seg	20	26				
3					PB123688	Cr+S	70	79					PB20624	2 Seg	20	26				
4					PB123689	Cr+S	70	79					PB20625	2 Seg	20	26				
MFP5					PB01580	MFP5	70	79					PB015075	Mfp5	20	26				
5					PB02238	Exp	60	70					PB021049	Exp	20	32				
6					PB02239	Exp	60	70					PB021050	Exp	20	32				
7					PB02240	Exp	60	70					PB021051	Exp	20	32				
6					PB69232	Magic	70	80					PB67058	Magic	20	35				
7					PB69233	Magic	70	80					PB67059	Magic	20	35				

[BACK TO INDEX](#)



**Ninja Composition**

ZS40-2D

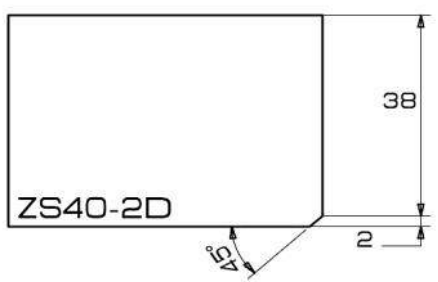

	<b>TopLine</b> STONE DIVISION	<b>FastLine</b> STONE DIVISION	<b>TwistLine</b> STONE DIVISION	<b>MicronLine</b> STONE DIVISION			
Position				Code	type	ID	ED
1				PB20634	2 Seg	20	26
2				PB20635	2 Seg	20	26
3				PB20636	2 Seg	20	26
4				PB20637	2 Seg	20	26
MFP5				PB015076	MFP5	20	26
5				PB021052	Exp	20	32
6				PB021053	Exp	20	32
7				PB021054	Exp	20	32
6				PB67061	Magic	20	35
7				PB67062	Magic	20	35



**Ninja Composition**

ZS40-5

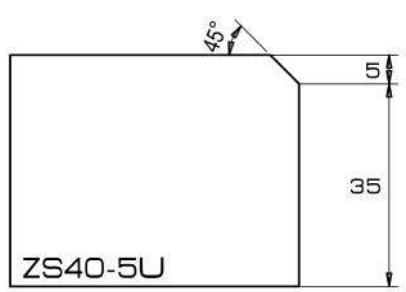

	<b>TopLine</b> STONE DIVISION	<b>FastLine</b> STONE DIVISION	<b>TwistLine</b> STONE DIVISION	<b>MicronLine</b> STONE DIVISION			
Position				Code	type	ID	ED
1				PB20465	3 Seg	20	33
2				PB20466	3 Seg	20	33
3				PB20467	3 Seg	20	33
4				PB20468	3 Seg	20	33
MFP5				PB38501	Era	20	20
5				PB021049	Exp	20	32
6				PB021050	Exp	20	32
7				PB021051	Exp	20	32
6				PB67151	Magic	20	35
7				PB67152	Magic	20	35

[BACK TO INDEX](#)



**Ninja Composition**

ZS40-5D

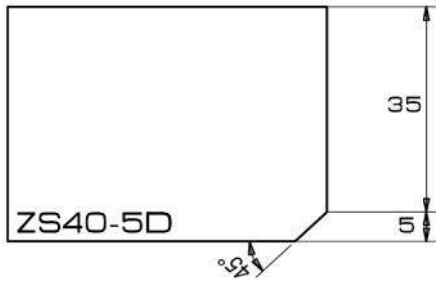

Position	TopLine STONE DIVISION				FastLine STONE DIVISION				TwistLine STONE DIVISION				MicronLine STONE DIVISION			
	Code	type	ID	ED												
1													PB20477	3 Seg	20	33
2													PB20478	3 Seg	20	33
3													PB20479	3 Seg	20	33
4													PB20480	3 Seg	20	33
MFP5													PB38501	Era	20	20
5													PB021052	Exp	20	32
6													PB021053	Exp	20	32
7													PB021054	Exp	20	32
6													PB67154	Magic	20	35
7													PB67155	Magic	20	35

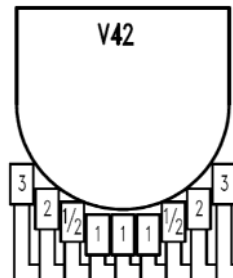
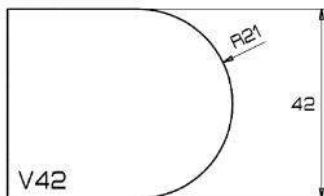

**Ninja Composition**

V42

Position	TopLine STONE DIVISION				FastLine STONE DIVISION				TwistLine STONE DIVISION				MicronLine STONE DIVISION			
	Code	Type	ID	ED												
1	PB124384	Seg	74	120												
2	PB124385	Cr+S	74	120												
3	PB124386	Cr+S	74	120												
4	PB124387	Cr+S	74	120												
MFP5	PB01677	MFP5	74	120												
5	PB021665	Exp	60	106												
6	PB021666	Exp	60	106												
7	PB021667	Exp	60	106												
6	PB691003	Magic	71	117												
7	PB691004	Magic	71	117												

[BACK TO INDEX](#)

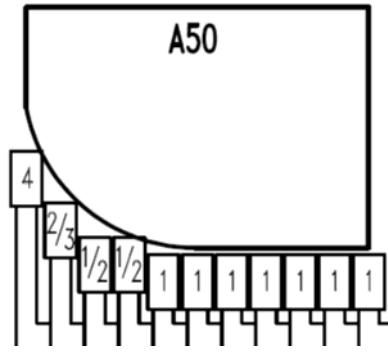
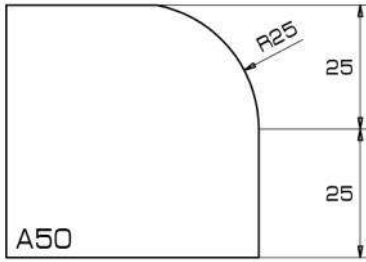

**Ninja Composition**  
A50

	<b>TopLine</b> STONE DIVISION					<b>FastLine</b> STONE DIVISION					<b>TwistLine</b> STONE DIVISION					<b>MicronLine</b> STONE DIVISION				
Position	Code	Type	ID	ED																
1	PB123851	Seg	70	125																
2	PB124388	Cr+S	70	125																
3	PB124389	Cr+S	70	125																
4	PB124390	Cr+S	70	125																
MFP5	-	MFP5	-	-																
5	PB021668	Exp	60	112																
6	PB021669	Exp	60	112																
7	PB021670	Exp	60	112																
6	PB691127	Magic	68	120																
7	PB691128	Magic	68	120																

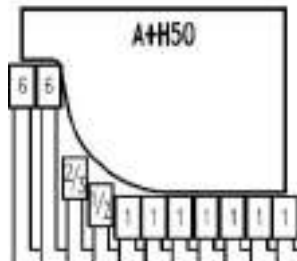
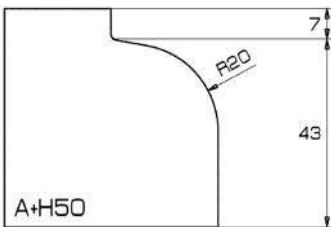

**Ninja Composition**  
A+H50

	<b>TopLine</b> STONE DIVISION					<b>FastLine</b> STONE DIVISION					<b>TwistLine</b> STONE DIVISION					<b>MicronLine</b> STONE DIVISION				
Position	Code	type	ID	ED																
1	PB123837	Seg	70	120																
2	PB123838	Seg	70	120																
3	PB123839	Seg	70	120																
4	PB123840	Seg	70	120																
MFP5	-	MFP5	-	-																
5	PB021671	Exp	60	110																
6	PB02429	Exp	60	110																
7	PB02430	Exp	60	110																
6	PB691124	Magic	66	116																
7	PB691125	Magic	66	116																

[BACK TO INDEX](#)

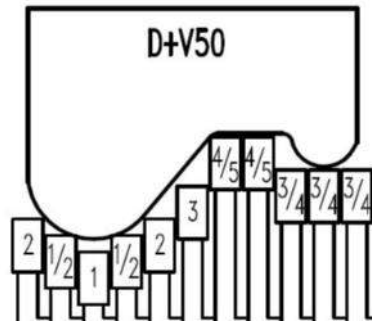
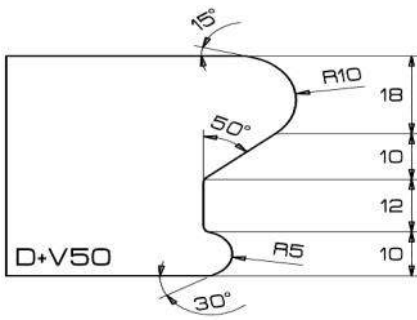

**Ninja Composition**

D+V50

<b>TopLine</b> STONE DIVISION					<b>FastLine</b> STONE DIVISION				<b>TwistLine</b> STONE DIVISION				<b>MicronLine</b> STONE DIVISION			
Position	Code	Type	ID	ED												
1	PB124625	Seg	70	102												
2	PB124626	Cr+S	60	93												
3	PB124627	Cr+S	60	93												
4	PB124628	Cr+S	60	93												
MFP5	PB01841	MFP5	60	93												
5	PB021928	Exp	60	93												
6	PB021929	Exp	60	93												
7	PB021930	Exp	60	93												
6	PB691305	Magic	67	100												
7	PB691306	Magic	67	100												

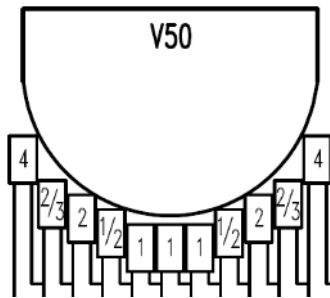
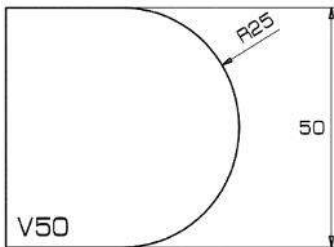



**Ninja Composition**

V50

<b>TopLine</b> STONE DIVISION					<b>FastLine</b> STONE DIVISION				<b>TwistLine</b> STONE DIVISION				<b>MicronLine</b> STONE DIVISION			
Position	Code	Type	ID	ED												
1	PB123215	Seg	64	120												
2	PB123540	Cr+S	64	120												
3	PB123541	Cr+S	64	120												
4	PB123542	Cr+S	64	120												
MFP5	PB01636	MFP5	64	120												
5	PB021318	Exp	60	116												
6	PB021319	Exp	60	116												
7	PB021320	Exp	60	116												
6	PB691081	Magic	64	120												
7	PB691082	Magic	64	120												

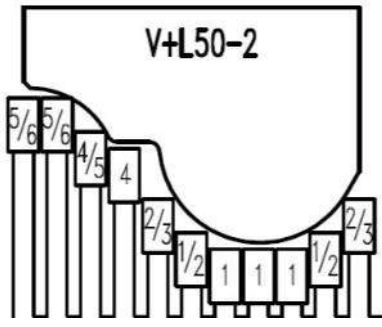
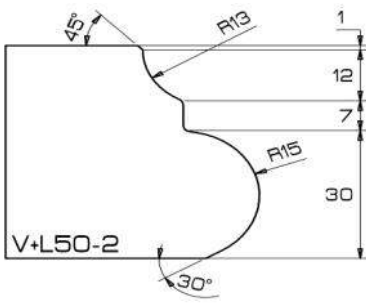
[BACK TO INDEX](#)





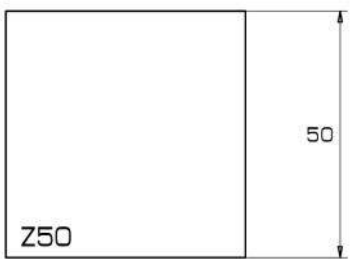

 **Ninja Composition**  
V+L50-2

Position	 <b>TopLine</b> STONE DIVISION				 <b>FastLine</b> STONE DIVISION				 <b>TwistLine</b> STONE DIVISION				 <b>MicronLine</b> STONE DIVISION			
	Code	Type	ID	ED												
1	PB124621	Seg	70	116												
2	PB124622	Cr+S	60	112												
3	PB124623	Cr+S	60	112												
4	PB124624	Cr+S	60	112												
MFP5	PB01837	MFP5	60	112												
5	PB021922	Exp	60	112												
6	PB021923	Exp	60	112												
7	PB021924	Exp	60	112												
6	PB691302	Magic	68	120												
7	PB691303	Magic	68	120												



 **Ninja Composition**  
Z50

Position	 <b>TopLine</b> STONE DIVISION				 <b>FastLine</b> STONE DIVISION				 <b>TwistLine</b> STONE DIVISION				 <b>MicronLine</b> STONE DIVISION			
	Code	Type	ID	ED												
1	PB123958	Seg	-	80												
2	PB123959	Cr+S	-	80												
3	PB123960	Cr+S	-	80												
4	PB123961	Cr+S	-	80												
MFP5	PB01581	MFP5	-	80												
5	PB021815	Exp	-	80												
6	PB021816	Exp	-	80												
7	PB021817	Exp	-	80												
6	PB69328	Magic	-	80												
7	PB69329	Magic	-	80												

[BACK TO INDEX](#)

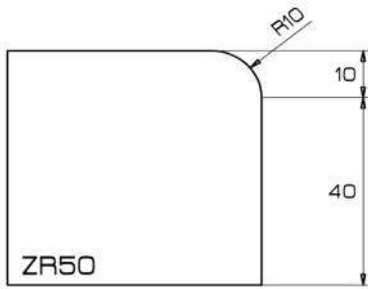

**Ninja Composition**  
ZR50

Position	<b>TopLine</b> STONE DIVISION				<b>FastLine</b> STONE DIVISION				<b>TwistLine</b> STONE DIVISION				<b>MicronLine</b> STONE DIVISION			
					Code	type	ID	ED								
1					PB124520	Seg	70	95								
2					PB124521	Cr+S	60	90								
3					PB124522	Cr+S	60	90								
4					PB124523	Cr+S	60	90								
MFP5					PB01817	MFP5	60	90								
5					PB021818	Exp	60	90								
6					PB021819	Exp	60	90								
7					PB021820	Exp	60	90								
6					PB69991	Magic	57	80								
7					PB69992	Magic	57	80								

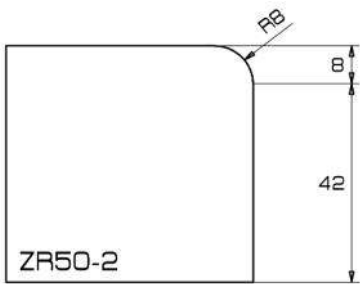

**Ninja Composition**  
ZR50-2

Position	<b>TopLine</b> STONE DIVISION				<b>FastLine</b> STONE DIVISION				<b>TwistLine</b> STONE DIVISION				<b>MicronLine</b> STONE DIVISION			
					Code	type	ID	ED								
1					PB124524	Seg	70	91								
2					PB124525	Cr+S	60	90								
3					PB124526	Cr+S	60	90								
4					PB124527	Cr+S	60	90								
MFP5					PB01818	MFP5	60	90								
5					PB021821	Exp	60	90								
6					PB021822	Exp	60	90								
7					PB021823	Exp	60	90								
6					PB691090	Magic	60	90								
7					PB691091	Magic	60	90								



[BACK TO INDEX](#)

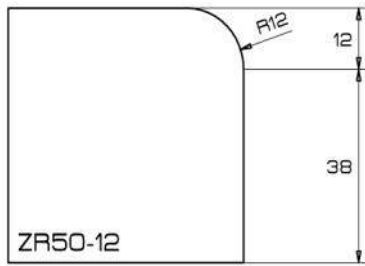

**Ninja Composition**  
ZR50-12

Position	TopLine STONE DIVISION					FastLine STONE DIVISION				TwistLine STONE DIVISION				MicronLine STONE DIVISION				
	Code	Type	ID	ED	Price	Code	Type	ID	ED									
1						PB123853	Seg	65	92									
2						PB123854	Cr+S	60	90									
3						PB123855	Cr+S	60	90									
4						PB123856	Cr+S	60	90									
MFP5						PB01820	MFP5	60	90									
5						PB021824	Exp	60	90									
6						PB021825	Exp	60	90									
7						PB021826	Exp	60	90									
6						PB691218	Magic	66	97									
7						PB691219	Magic	66	97									

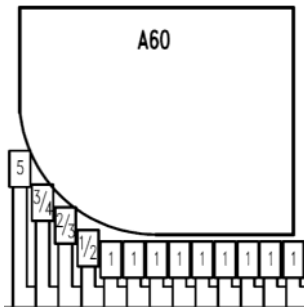
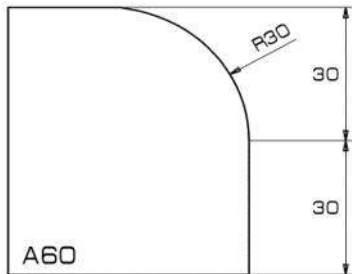

**Ninja Composition**  
A60

Position	TopLine STONE DIVISION					FastLine STONE DIVISION				TwistLine STONE DIVISION				MicronLine STONE DIVISION				
	Code	Type	ID	ED														
1	PB124273	Seg	70	135														
2	PB124274	Seg	70	135														
3	PB124275	Seg	70	135														
4	PB124276	Seg	70	135														
MFP5	-	MFP5	-	-														
5	PB021545	Exp	60	125														
6	PB021546	Exp	60	125														
7	PB021547	Exp	60	125														
6	PB691130	Magic	85	150														
7	PB691131	Magic	85	150														

[BACK TO INDEX](#)



**Ninja Composition**

A60-1

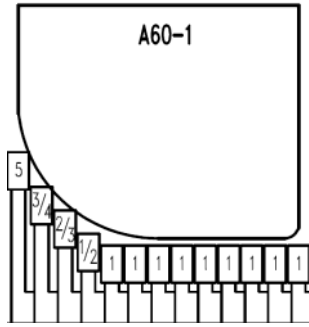
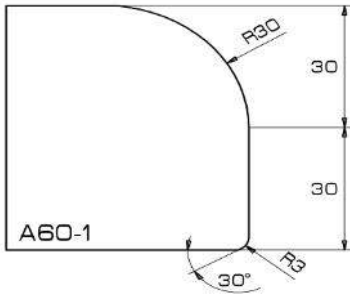

Position	TopLine STONE DIVISION				FastLine STONE DIVISION				TwistLine STONE DIVISION				MicronLine STONE DIVISION			
	Code	Type	ID	ED												
1	PB124273	Seg	70	135												
2	PB124532	Cr+S	60	125												
3	PB124533	Cr+S	60	125												
4	PB124534	Cr+S	60	125												
MFP5	PB01829	MFP5	60	125												
5	PB021843	Exp	60	125												
6	PB021844	Exp	60	125												
7	PB021845	Exp	60	125												
6	PB691239	Magic	60	120												
7	PB691240	Magic	60	120												

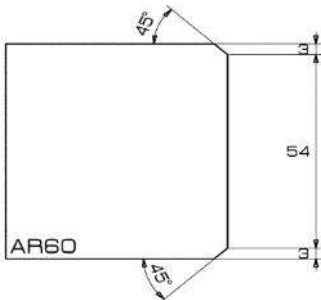

**Ninja Composition**

AR60

Position	TopLine STONE DIVISION				FastLine STONE DIVISION				TwistLine STONE DIVISION				MicronLine STONE DIVISION			
	Code	type	ID	ED												
1	PB124528	Seg	70	80												
2	PB124529	Seg	70	80												
3	PB124530	Seg	70	80												
4	PB124531	Seg	70	80												
MFP5	-	MFP5	-	-												
5	PB021827	Exp	60	70												
6	PB021828	Exp	60	70												
7	PB021829	Exp	60	70												
6	PB691121	Magic	63	80												
7	PB691122	Magic	63	80												

[BACK TO INDEX](#)

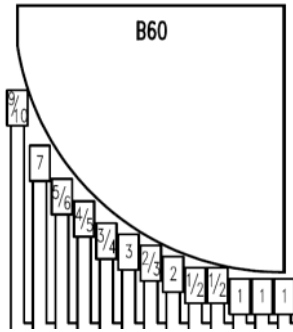
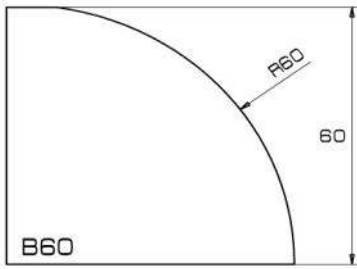

**Ninja Composition**

B60

Position	TopLine STONE DIVISION				FastLine STONE DIVISION				TwistLine STONE DIVISION				MicronLine STONE DIVISION			
	Code	type	ID	ED												
1	PB124391	Seg	70	190												
2	PB124392	Seg	70	190												
3	PB124393	Seg	70	190												
4	PB124394	Seg	70	190												
MFP5	-	MFP5	-	-												
5	PB021672	Exp	60	180												
6	PB021673	Exp	60	180												
7	PB021674	Exp	60	180												
6		Magic														
7		Magic														

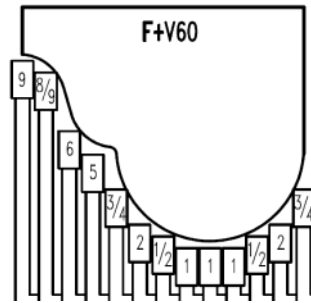
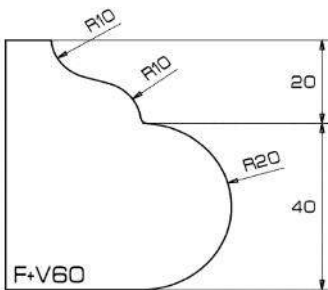

**Ninja Composition**

F+V60

Position	TopLine STONE DIVISION				FastLine STONE DIVISION				TwistLine STONE DIVISION				MicronLine STONE DIVISION			
	Code	Type	ID	ED												
1	PB123200	Seg	70	150												
2	PB123201	Seg	70	150												
3	PB123202	Seg	70	150												
4	PB123203	Seg	70	150												
MFP5	-	MFP5	-	-												
5	PB02343	Exp	60	140												
6	PB02344	Exp	60	140												
7	PB02345	Exp	60	140												
6	PB69305	Magic	66	150												
7	PB69306	Magic	66	150												

[BACK TO INDEX](#)



**Ninja Composition**

F+V60-2

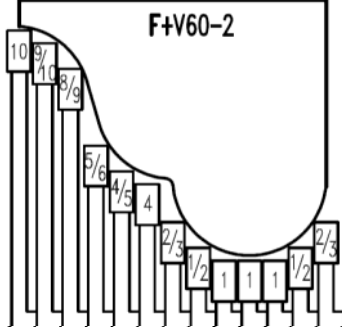
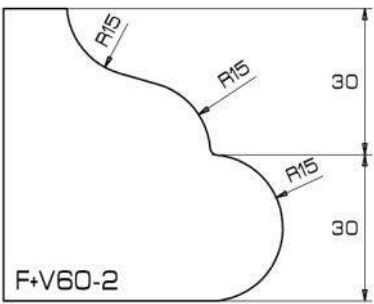

Position	TopLine STONE DIVISION				FastLine STONE DIVISION				TwistLine STONE DIVISION				MicronLine STONE DIVISION			
	Code	Type	ID	ED												
1	PB123478	Seg	70	150												
2	PB123479	Seg	70	150												
3	PB123480	Seg	70	150												
4	PB123481	Seg	70	150												
MFP5	-	MFP5	-	-												
5	PB02352	Exp	60	140												
6	PB02353	Exp	60	140												
7	PB02354	Exp	60	140												
6	PB69408	Magic	59	149												
7	PB69409	Magic	59	149												



**Ninja Composition**

F+V60-9

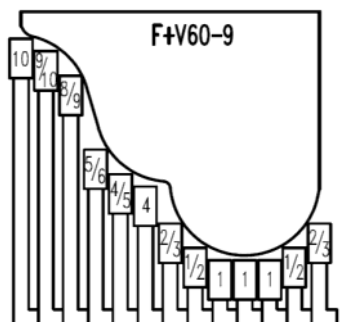
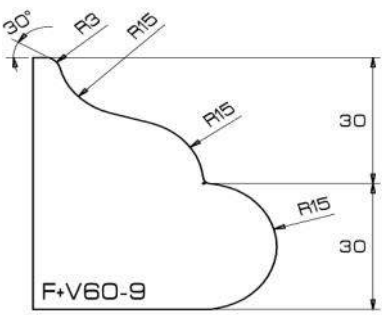

Position	TopLine STONE DIVISION				FastLine STONE DIVISION				TwistLine STONE DIVISION				MicronLine STONE DIVISION			
	Code	Type	ID	ED												
1	PB123478	Seg	70	160												
2	PB124535	Cr+S	60	158												
3	PB124536	Cr+S	60	158												
4	PB124537	Cr+S	60	158												
MFP5	PB01830	MFP5	60	158												
5	PB021846	Exp	60	158												
6	PB021847	Exp	60	158												
7	PB021848	Exp	60	158												
6	PB691242	Magic	62	160												
7	PB691243	Magic	62	160												

[BACK TO INDEX](#)

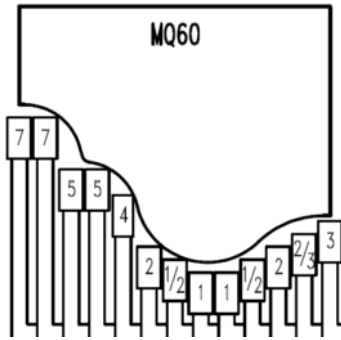
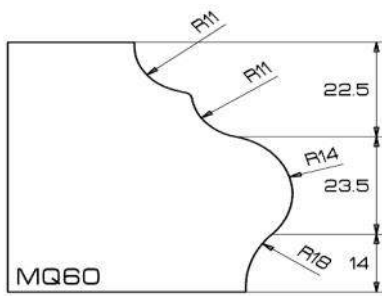

**Ninja Composition**  
MQ60

	<b>TopLine</b> STONE DIVISION				<b>FastLine</b> STONE DIVISION				<b>TwistLine</b> STONE DIVISION				<b>MicronLine</b> STONE DIVISION			
Position	Code	type	ID	ED												
1	PB123668	Seg	70	120												
2	PB123444	Cr+S	60	120												
3	PB123445	Cr+S	60	120												
4	PB123446	Cr+S	60	120												
MFP5	PB01679	MFP5	60	120												
5	PB02324	Exp	60	121												
6	PB02325	Exp	60	121												
7	PB02326	Exp	60	121												
6	PB691066	Magic	59	120												
7	PB691067	Magic	59	120												

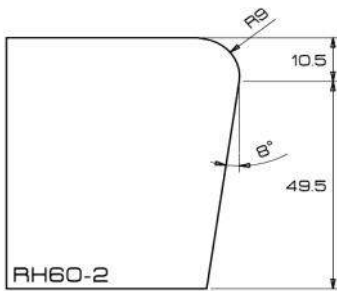

	<b>TopLine</b> STONE DIVISION				<b>FastLine</b> STONE DIVISION				<b>TwistLine</b> STONE DIVISION				<b>MicronLine</b> STONE DIVISION			
Position					Code	type	ID	ED								
1					PB124154	Seg	70	92								
2					PB124155	Seg	70	92								
3					PB124156	Seg	70	92								
4					PB124157	Seg	70	92								
MFP5					-	MFP5	-	-								
5					PB021675	Exp	60	82								
6					PB021676	Exp	60	82								
7					PB021677	Exp	60	82								
6					PB691191	Magic	57	80								
7					PB691192	Magic	57	80								

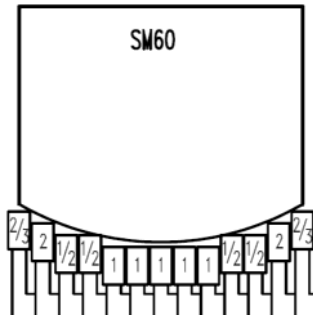
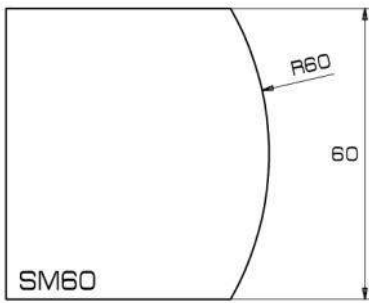

[BACK TO INDEX](#)



Ninja Composition

SM60

Position	<b>TopLine</b> STONE DIVISION				<b>FastLine</b> STONE DIVISION				<b>TwistLine</b> STONE DIVISION				<b>MicronLine</b> STONE DIVISION			
	Code	type	ID	ED												
1					PB123134	Seg	82	100								
2					PB123135	Seg	82	100								
3					PB123136	Seg	82	100								
4					PB123137	Seg	82	100								
MFP5					-	MFP5	-	-								
5					PB021830	Exp	60	78								
6					PB021831	Exp	60	78								
7					PB021832	Exp	60	78								
6					PB691069	Magic	62	80								
7					PB691070	Magic	62	80								

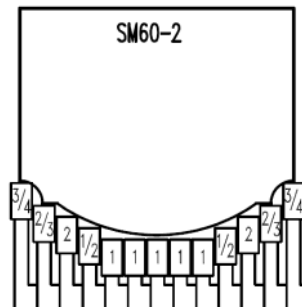
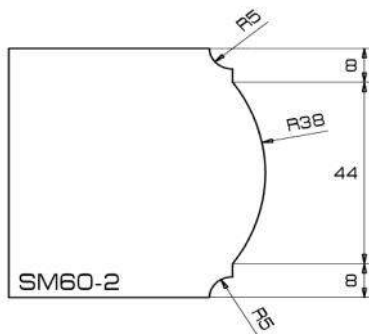

Ninja Composition

SM60-2

Position	<b>TopLine</b> STONE DIVISION				<b>FastLine</b> STONE DIVISION				<b>TwistLine</b> STONE DIVISION				<b>MicronLine</b> STONE DIVISION			
	Code	Type	ID	ED												
1					PB123504	Seg	766	100								
2					PB123505	Seg	76	100								
3					PB123506	Seg	76	100								
4					PB123507	Seg	76	100								
MFP5					-	MFP5	-	-								
5					PB021833	Exp	60	84								
6					PB021834	Exp	60	84								
7					PB021835	Exp	60	84								
6					PB691072	Magic	56	80								
7					PB691073	Magic	56	80								

[BACK TO INDEX](#)



**Ninja Composition**

T60

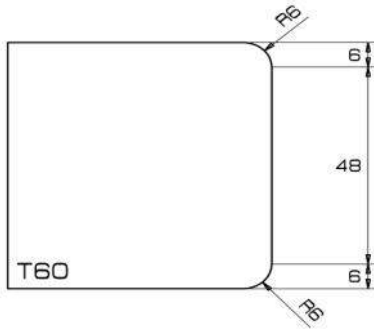

Position	<b>TopLine</b> STONE DIVISION				<b>FastLine</b> STONE DIVISION				<b>TwistLine</b> STONE DIVISION				<b>MicronLine</b> STONE DIVISION			
	Code	Type	ID	ED												
1					PB123025	Seg	60	77								
2					PB123026	Seg	60	77								
3					PB123773	Seg	60	77								
4					PB123027	Seg	60	77								
MFP5					-	MFP5	-	-								
5					PB02358	Exp	60	77								
6					PB02359	Exp	60	77								
7					PB02360	Exp	60	77								
6					PB691075	Magic	63	80								
7					PB691076	Magic	63	80								

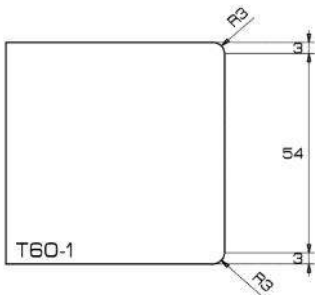

**Ninja Composition**

T60-1

Position	<b>TopLine</b> STONE DIVISION				<b>FastLine</b> STONE DIVISION				<b>TwistLine</b> STONE DIVISION				<b>MicronLine</b> STONE DIVISION			
	Code	type	ID	ED												
1					PB123570	Seg	60	77								
2					PB123571	Seg	60	77								
3					PB123772	Seg	60	77								
4					PB123572	Seg	60	77								
MFP5					-	MFP5	-	-								
5					PB02339	Exp	60	77								
6					PB02319	Exp	60	77								
7					PB02320	Exp	60	77								
6					PB691078	Magic	63	80								
7					PB691079	Magic	63	80								

[BACK TO INDEX](#)

 **Ninja Composition**

V60

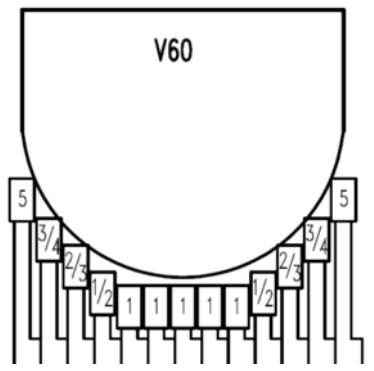
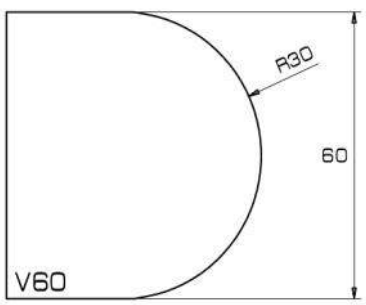

Position	 <b>TopLine</b> STONE DIVISION				 <b>FastLine</b> STONE DIVISION				 <b>TwistLine</b> STONE DIVISION				 <b>MicronLine</b> STONE DIVISION			
	Code	Type	ID	ED												
1	PB123044	Seg	70	136												
2	PB123045	Seg	70	136												
3	PB123046	Seg	70	136												
4	PB123047	Seg	70	136												
MFP5	-	MFP5	-	-												
5	PB02355	Exp	60	130												
6	PB02356	Exp	60	130												
7	PB02357	Exp	60	130												
6	PB691000	Magic	84	150												
7	PB691001	Magic	84	150												

 **Ninja Composition**

V+B60

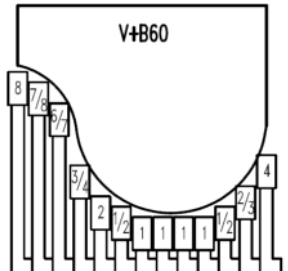
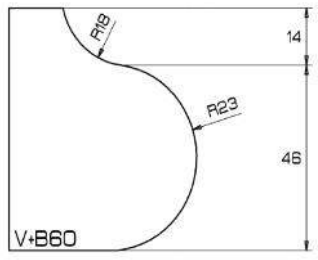

Position	 <b>TopLine</b> STONE DIVISION				 <b>FastLine</b> STONE DIVISION				 <b>TwistLine</b> STONE DIVISION				 <b>MicronLine</b> STONE DIVISION			
	Code	type	ID	ED												
1	PB123757	Seg	70	142												
2	PB123996	Seg	70	142												
3	PB123997	Seg	70	142												
4	PB123998	Seg	70	142												
MFP5	-	MFP5	-	-												
5	PB02361	Exp	60	132												
6	PB02362	Exp	60	132												
7	PB02363	Exp	60	132												
6	PB691194	Magic	127	150												
7	PB691195	Magic	127	150												



[BACK TO INDEX](#)



**Ninja Composition**

V+L60-2

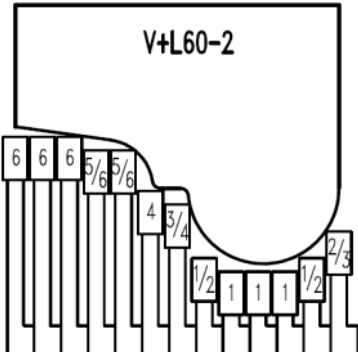
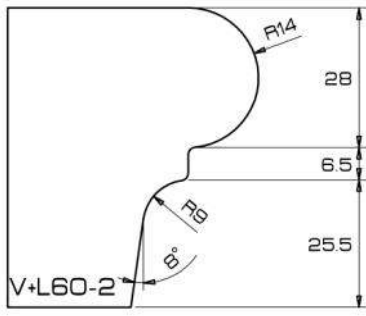

Position	<b>TopLine</b> STONE DIVISION				<b>FastLine</b> STONE DIVISION				<b>TwistLine</b> STONE DIVISION				<b>MicronLine</b> STONE DIVISION			
	Code	Type	ID	ED												
1	PB124158	Seg	70	121												
2	PB124159	Seg	70	121												
3	PB124160	Seg	70	121												
4	PB124161	Seg	70	121												
MFP5	-	MFP5	-	-												
5	PB021678	Exp	60	111												
6	PB021679	Exp	60	111												
7	PB021680	Exp	60	111												
6	PB691197	Magic	69	120												
7	PB691198	Magic	69	120												



**Ninja Composition**

Z60

Position	<b>TopLine</b> STONE DIVISION				<b>FastLine</b> STONE DIVISION				<b>TwistLine</b> STONE DIVISION				<b>MicronLine</b> STONE DIVISION			
	Code	Type	ID	ED												
1	PB123129	Seg	-	80												
2	PB123297	Cr+S	-	80												
3	PB123298	Cr+S	-	80												
4	PB123299	Cr+S	-	80												
MFP5	PB01602	MFP5	-	80												
5	PB021836	Exp	-	80												
6	PB02488	Exp	-	80												
7	PB02489	Exp	-	80												
6	PB69328	Magic	-	80												
7	PB69329	Magic	-	80												

[BACK TO INDEX](#)



**Ninja Composition**

ZR60

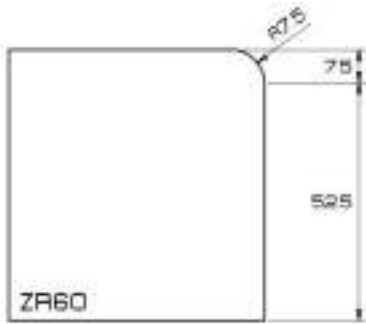

Position	<b>TopLine</b> STONE DIVISION				<b>FastLine</b> STONE DIVISION				<b>TwistLine</b> STONE DIVISION				<b>MicronLine</b> STONE DIVISION			
	Code	type	ID	ED												
1					PB123796	Seg	70	87								
2					PB123797	Seg	70	87								
3					PB123798	Seg	70	87								
4					PB123799	Seg	70	87								
MFP5					-	MFP5	-	-								
5					PB021837	Exp	60	80								
6					PB021838	Exp	60	80								
7					PB021839	Exp	60	80								
6					PB691087	Magic	63	80								
7					PB691088	Magic	63	80								

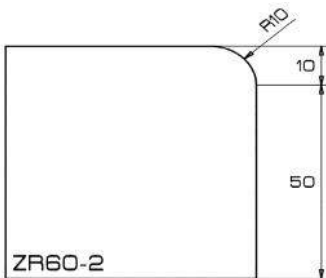

**Ninja Composition**

ZR60-2

Position	<b>TopLine</b> STONE DIVISION				<b>FastLine</b> STONE DIVISION				<b>TwistLine</b> STONE DIVISION				<b>MicronLine</b> STONE DIVISION			
	Code	type	ID	ED												
1					PB123989	Seg	70	92								
2					PB123990	Seg	70	92								
3					PB123991	Seg	70	92								
4					PB123992	Seg	70	92								
MFP5					-	MFP5	-	-								
5					PB021681	Exp	60	77								
6					PB021682	Exp	60	77								
7					PB021683	Exp	60	77								
6					PB691272	Magic	56	80								
7					PB691273	Magic	56	80								



[BACK TO INDEX](#)



**Ninja Composition**

Z70

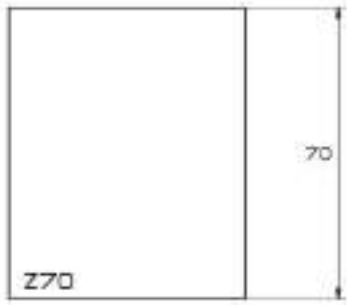

Position	<b>TopLine</b> STONE DIVISION				<b>FastLine</b> STONE DIVISION				<b>TwistLine</b> STONE DIVISION				<b>MicronLine</b> STONE DIVISION			
	Code	Type	ID	ED												
1	PB123928	Seg	-	80												
2	PB123929	Cr+S	-	80												
3	PB123930	Cr+S	-	80												
4	PB123931	Cr+S	-	80												
MFP5	PB01822	MFP5	-	80												
5	PB021507	Exp	-	80												
6	PB021508	Exp	-	80												
7	PB021509	Exp	-	80												
6	PB691093	Magic	-	80												
7	PB691094	Magic	-	80												

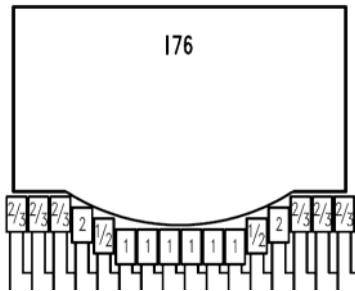
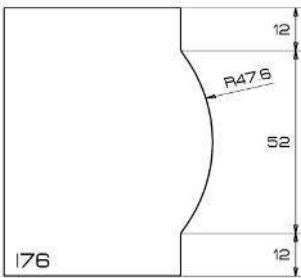

**Ninja Composition**

I76

Position	<b>TopLine</b> STONE DIVISION				<b>FastLine</b> STONE DIVISION				<b>TwistLine</b> STONE DIVISION				<b>MicronLine</b> STONE DIVISION			
	Code	type	ID	ED												
1	PB124543	Seg	70	85												
2	PB124544	Seg	70	85												
3	PB124545	Seg	70	85												
4	PB124546	Seg	70	85												
MFP5	-	MFP5	-	-												
5	PB021870	Exp	60	71												
6	PB021871	Exp	60	71												
7	PB021872	Exp	60	71												
6	PB691257	Magic	64	79												
7	PB691258	Magic	64	79												

[BACK TO INDEX](#)

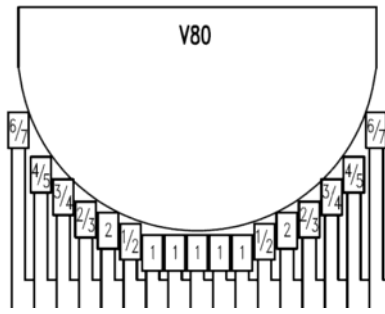
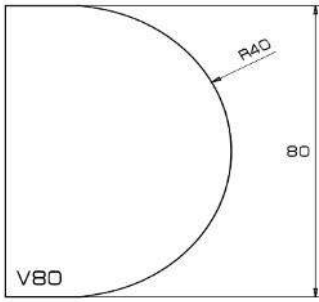

**Ninja Composition**  
V80

Position	TopLine STONE DIVISION				FastLine STONE DIVISION				TwistLine STONE DIVISION				MicronLine STONE DIVISION			
	Code	Type	ID	ED												
1	PB124403	Seg	70	156												
2	PB124404	Seg	70	156												
3	PB124405	Seg	70	156												
4	PB124406	Seg	70	156												
MFP5	-	MFP5	-	-												
5	PB021687	Exp	60	142												
6	PB021688	Exp	60	142												
7	PB021689	Exp	60	142												
6		Magic														
7		Magic														



**Ninja Composition**  
Z80

Position	TopLine STONE DIVISION				FastLine STONE DIVISION				TwistLine STONE DIVISION				MicronLine STONE DIVISION			
	Code	Type	ID	ED												
1	PB123315	Seg	-	80												
2	PB123733	Cr+S	-	80												
3	PB123756	Cr+S	-	80												
4	PB123317	Cr+S	-	80												
MFP5	PB01823	MFP5	-	80												
5	PB021304	Exp	-	80												
6	PB021305	Exp	-	80												
7	PB021306	Exp	-	80												
6		Magic														
7		Magic														

BACK TO INDEX



Ninja Composition

T90-1

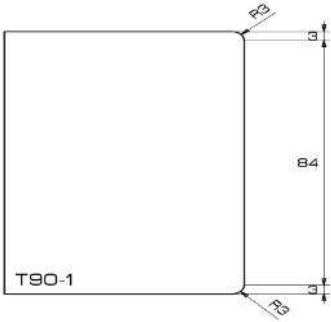

Position	TopLine STONE DIVISION				FastLine STONE DIVISION				TwistLine STONE DIVISION				MicronLine STONE DIVISION			
	Code	type	ID	ED												
1	PB124646	Seg	100	117												
2	PB124647	Cr+S	103	120												
3	PB124648	Cr+S	103	120												
4	PB124649	Cr+S	103	120												
MFP5	PB01838	MFP5	103	120												
5	PB022319	Exp	60	75												
6	PB022320	Exp	60	75												
7	PB022321	Exp	60	75												
6		Magic														
7		Magic														

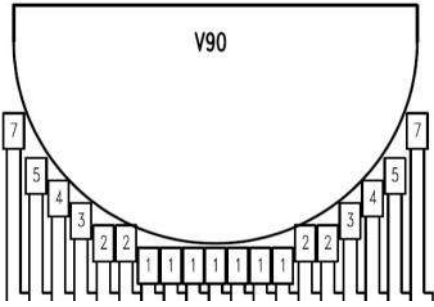
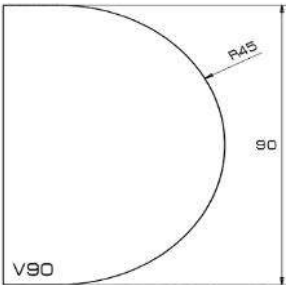

Ninja Composition

V90

Position	TopLine STONE DIVISION				FastLine STONE DIVISION				TwistLine STONE DIVISION				MicronLine STONE DIVISION			
	Code	Type	ID	ED												
1	PB124407	Seg	70	165												
2	PB124408	Seg	70	165												
3	PB124409	Seg	70	165												
4	PB124410	Seg	70	165												
MFP5	-	MFP5	-	-												
5	PB021690	Exp	60	153												
6	PB021691	Exp	60	153												
7	PB021692	Exp	60	153												
6		Magic														
7		Magic														

[BACK TO INDEX](#)



**Ninja Composition**

Z90



	<b>TopLine</b> STONE DIVISION				<b>FastLine</b> STONE DIVISION				<b>TwistLine</b> STONE DIVISION				<b>MicronLine</b> STONE DIVISION			
Position					Code	type	ID	ED								
1					PB124039	Seg	-	80								
2					PB124040	Cr+S	-	80								
3					PB124041	Cr+S	-	80								
4					PB124042	Cr+S	-	80								
MFP5					PB01824	MFP5	-	80								
5					PB021313	Exp	-	80								
6					PB021314	Exp	-	80								
7					PB021315	Exp	-	80								
6						Magic										
7						Magic										



**Ninja Composition**

Z100

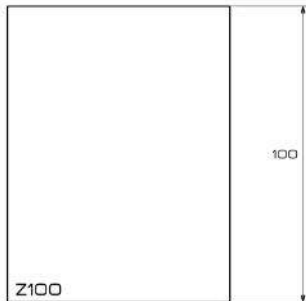

	<b>TopLine</b> STONE DIVISION				<b>FastLine</b> STONE DIVISION				<b>TwistLine</b> STONE DIVISION				<b>MicronLine</b> STONE DIVISION			
Position					Code	Type	ID	ED								
1					PB123352	Seg	-	80								
2					PB123353	Cr+S	-	80								
3					PB123354	Cr+S	-	80								
4					PB123355	Cr+S	-	80								
MFP5					PB01825	MFP5	-	80								
5					PB02409	Exp	-	80								
6					PB02410	Exp	-	80								
7					PB02411	Exp	-	80								
6						Magic										
7						Magic										





[BACK TO INDEX](#)

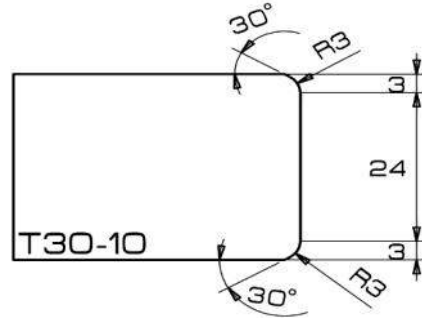
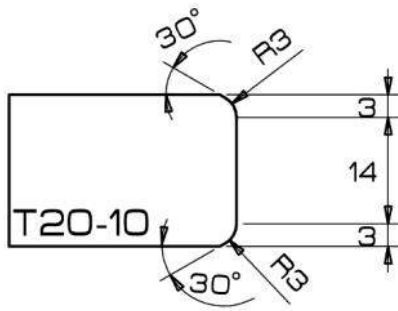

Pos	Type	Code	ID mm	ED mm
1	VB	PB50132	10	18
2	VB	PB50133	10	18
3	VB	PB50134	10	18
6	KRI	PBK21385	10	18
7	KRI	PBK21386	10	18

Pos	Type	Code	ID mm	ED mm
1	VB	PB50135	10	18
2	VB	PB50136	10	18
3	VB	PB50137	10	18
6	KRI	PBK21388	10	18
7	KRI	PBK21389	10	18

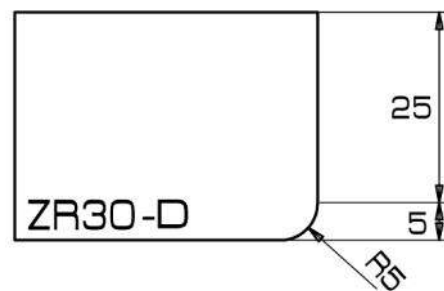
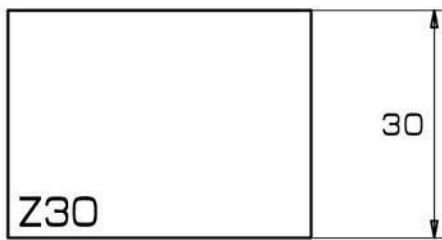

Pos	Type	Code	ED mm	H mm
1	VB	PB52092	10	35
2	VB	PB50117	10	35
3	VB	PB50118	10	35
6	KRI	PBK21398	10	35
7	KRI	PBK21399	10	35

Pos	Type	Code	ID mm	ED mm
1	VB	PB50138	10	35
2	VB	PB50139	10	35
3	VB	PB50140	10	35
6	KRI	PBK21373	10	35
7	KRI	PBK21374	10	35

All Routers are 1/2" Gas Thread Connection

[BACK TO INDEX](#)

# CNC TOOLS WORKING PARAMETERS

# PARAMETRI DI LAVORO

BACK TO INDEX



∅ 120 mm

bore/foro ∅ 35 mm

TOP LINE

Pos	Slab Thickness [Inches or mm]	RPM (Min-Max)	Stock Removal [Inches or mm]	Feeding Speed [Inches/minute or mm/minute]	Note
1	3/4"-1 1/4" - 1 1/2" 20-30-40	4.500-5.500	shape	* Max Speed 150" Max Speed 4.000	Segmented 
2	3/4"-1 1/4" - 1 1/2" 20-30-40	4.500-5.500	0,012"-0,016" 0,3-0,4	* Max Speed 250" Max Speed 6.500	Continuous Rim 
3			0,008"-0,012" 0,2-0,3		
4	3/4"-1 1/4" - 1 1/2" 20-30-40	4.500-4.800	0,002"-0,004" 0,05-0,1	Max Speed 80" Max Speed 2.000	MFP5 
5	3/4"-1 1/4" - 1 1/2" 20-30-40	4.000-4.500	0,0011"-0,0019" 0,03-0,05	Max Speed 70" Max Speed 1.800	Express Polishing 
6	3/4"-1 1/4" - 1 1/2" 20-30-40	2.500-3.000	0,0011"-0,0019" 0,03-0,05 Pressure	Max Speed 50" Max Speed 1.250	Magic Polishing 
7					
5	3/4"-1 1/4" - 1 1/2" 20-30-40	2.500-2.800	Dynamic Compensation for Diameter per Foot [Inch] 0,00024"	Max Speed 50" Max Speed 1.250	
6			Dynamic Compensation for Radius per Meter [mm] 0,008-0,01		

\* Max feeding speed ONLY for shallow profiles - Massima velocità di avanzamento SOLO per profili poco scavati

FAST LINE

Pos	Slab Thickness [Inches or mm]	RPM (Min-Max)	Stock Removal [Inches or mm]	Feeding Speed [Inches/minute or mm/minute]	Note
1	3/4"-1 1/4" - 1 1/2" 20-30-40	5.000-6.000	shape	* Max Speed 150" Max Speed 4.000	Segmented 
2	3/4"-1 1/4" - 1 1/2" 20-30-40	5.000-6.000	0,012"-0,016" 0,3-0,4	* Max Speed 250" Max Speed 6.500	Continuous Rim 
3			0,008"-0,012" 0,2-0,3		
4	3/4"-1 1/4" - 1 1/2" 20-30-40	4.500-4.800	0,002"-0,004" 0,05-0,1	Max Speed 80" Max Speed 2.000	
5	3/4"-1 1/4" - 1 1/2" 20-30-40	4.000-4.500	0,0011"-0,0019" 0,03-0,05	Max Speed 70" Max Speed 1.800	MFP5 
5	3/4"-1 1/4" - 1 1/2" 20-30-40	2.500-3.000	0,0011"-0,0019" 0,03-0,05 Pressure	Max Speed 50" Max Speed 1.250	Express Polishing 
6					
7					
5	3/4"-1 1/4" - 1 1/2" 20-30-40	2.500-2.800	Dynamic Compensation for Diameter per Foot [Inch] 0,00024"	Max Speed 50" Max Speed 1.250	Magic Polishing 
6			Dynamic Compensation for Radius per Meter [mm] 0,008-0,01		

\* Max feeding speed ONLY for shallow profiles - Massima velocità di avanzamento SOLO per profili poco scavati

BACK TO INDEX



∅ 40mm

bore/foro ∅ 22 mm

TWIST LINE

Pos	Slab Thickness [Inches or mm]	RPM (Min-Max)	Stock Removal [Inches or mm]	Feeding Speed [Inches/minute or mm/minute]	Note
1	3/4"-1 1/4" - 1 1/2" 20-30-40	5.500-6.000	shape	* 50" - 120" 1.250 - 3000	Segmented 
2	3/4"-1 1/4" - 1 1/2" 20-30-40	5.500-6.000	0,012"-0,016" 0,3-0,4	* 50" - 160 " 1.250 - .4.000	Continuous Rim 
3			0,008"-0,012" 0,2-0,3		
4	3/4"-1 1/4" - 1 1/2" 20-30-40	4.800-5.300	0,002"-0,004" 0,05-0,1	35 " - 55" 900 - 1.400	MFP5 
5	3/4"-1 1/4" - 1 1/2" 20-30-40	4.000-4.500	0,0011"-0,0019" 0,03-0,05	35" - 45" 900 - 1.150	Express Polishing 
6	3/4"-1 1/4" - 1 1/2" 20-30-40	2.800-3.500	0,0011"-0,0019" 0,03-0,05 Pressure	40" - 60" 1.000 - 1.500	Magic Polishing 
7					
5	3/4"-1 1/4" - 1 1/2" 20-30-40	2.800-3.300	Dynamic Compensation for Diameter per Foot [Inch] 0,00024"	30"-50" 750 - 1.250	
6			Dynamic Compensation for Radius per Meter [mm] 0,008-0,01		

\* Max feeding speed ONLY for shallow profiles - Massima velocità di avanzamento SOLO per profili poco scavati

[BACK TO INDEX](#)



Ø20 mm

fitting 1/2" Gas

MICRON LINE



Pos	Slab Thickness [Inches or mm]	RPM (Min-Max)	Stock Removal [Inches or mm]	Feeding Speed [Inches/minute or mm/minute]	Note
1	3/4"-1 1/4" - 1 1/2" 20-30-40	6.000-7.000	shape	30" - 50" 750 - 1.250	Segmented 
2			0,008"-0,012" 0,2-0,3		
3			0,006"-0,008" 0,15-0,2		
4		5.500-6.000	0,002" 0,05	30" - 40" 750 - 1.000	
5	3/4"-1 1/4" - 1 1/2" 20-30-40	3.800-4.200	0,0011"-0,0019" 0,02-0,05	30" - 40" 750 - 1.000	ERASER (Only Flat Shape) 
5	3/4"-1 1/4" - 1 1/2" 20-30-40	3.800-4.200	0,0011"-0,0019" 0,02-0,05	30" - 40" 750 - 1.000	MFP5 
5	3/4"-1 1/4" - 1 1/2" 20-30-40	3.300-3.800	0,0011"-0,0019" 0,03-0,05 Pressure	30" - 40" 750 - 1.000	Express Polishing 
6					
7					
5	3/4"-1 1/4" - 1 1/2" 20-30-40	2.500-3.500	Dynamic Compensation for Diameter per Foot [Inch] 0,00024"	30" - 40" 750 - 1.000	Magic Polishing 
6			Dynamic Compensation for Radius per Meter [mm] 0,008-0,01		

[BACK TO INDEX](#)

**NanoLine**  $\varnothing 10$  mm  
STONE DIVISION

fitting 1/2" Gas

NANO LINE

Pos	Slab Thickness [Inches or mm]	RPM (Min-Max)	Stock Removal [Inches or mm]	Feeding Speed [Inches/minute or mm/minute]	Note
1	3/4"-1 1/4" 20-30	6.000-7.000	shape	25" - 40" 600 - 1.000	Metal Position 
2			0,008"-0,012" 0,2-0,3		
3			0,006"-0,008" 0,15-0,2		
4			0,002" 0,05		
5	3/4"-1 1/4" 20-30	3.000-4.000	0,0011"-0,0019"	25" - 35" 600 - 900	Kristal Polishing 
6			0,03-0,05		
7			Pressure		



CNC TOOLS  
ERASER

UTENSILI  
RESINOIDI

[BACK TO INDEX](#)

[BACK TO INDEX](#)

RESIN BOND DIAMOND TOOL FOR FLAT EDGE  
MOLA IN RESINA DIAMANTATA

**ERASER**



BORE 35mm FORO 35mm

Code	Dimensions [mm]	Pos	Stock Removal [mm]	RPM [mm/min.]	Feeding Speed [mm/min]	Price [€]
PB38004	80X25	5	0,0011"-0,0019" 0,02—0,05	4.000-4.500	32"	260
PB38001	80X35	5		4.000-4.500		800
PB38005	80X35	5		4.000-4.500		360



1/2" GAS CONNECTION - CONNESSIONE 1/2" GAS

Code	Dimensions [mm]	Pos	Stock Removal [mm]	RPM [mm/min.]	Feeding Speed [mm/min]	Price [€]
PB38501	20X35	5	0,0011"-0,0019" 0,02—0,05	3.800-4.200	32"	127
PB38502	20X45	5		3.800-4.200	800	116

[BACK TO INDEX](#)

# CNC TOOLS FOR MONUMENTAL STONE

# UTENSILI PER TOMBALI

[BACK TO INDEX](#)

[BACK TO INDEX](#)

## MONUMENTAL STONE WHEELS UTENSILI PER TOMBALI



<i>ADI Code</i>	<i>Position</i>	<i>Description</i>	<i># Size Grana</i>
PB40691	1	Ø 78x175mm	Metal
PB13691	2	Ø 78x175mm	Metal
PB31851	3	Ø 78x175mm	# 300
PB31852	4	Ø 78x175mm	# 500
PB31853	5	Ø 78x175mm	# 1000
PB31854	6	Ø 78x175mm	# 2000
PB31855	7	Ø 78x175mm	# 3000
PB31856	8	Ø 78x175mm	Lux
SL01286*	-	FLANGE-35 UL=160	

[BACK TO INDEX](#)

**WORKING PARAMETER**  
**PARAMETRI DI LAVORO**

<i>Posizione</i> - <i>Position</i>	<b>RPM</b>	<b>Avanzamento</b> - <b>Feeding Speed</b> [mm/min]	<b>Avanzamento In Z Per Oscillazione</b> - <b>Feeding on Z Axis with oscillation</b> [mm/min]	<b>Asportazione</b> - <b>Stock Removal</b> [mm]	<i>Passaggi</i> - <i>Steps</i>
<b>1</b>	1500	1500	—	1	<i>2 x 0,5</i>
<b>2</b>	1500 –2000	1500—2000		0,5	<i>2 x 0,25</i>
<b>300</b>		1500—2000	300—400 (*)	0,3	<i>2 x 0,15</i>
<b>500</b>		1500—2000	400—500 (*)	0,2	<i>2 x 0,1</i>
<b>1000</b>		1500—2000	300—400 (*)	0,2	<i>2 x 0,1</i>
<b>2000</b>		1000– 1500	1000—1500	400—500 (*)	0,1
<b>3000</b>	1000—1500		300—400 (*)	0,04	<i>2 x 0,02 + 1 x in appoggio</i>
<b>Lux</b>	1000	1000	200—300 (*)	0,01	<i>1 x 0,01 2 x in appoggio</i>



CNC  
DIAMOND  
BLADES

DISCHI  
DIAMANTATI  
CNC

[BACK TO INDEX](#)

[BACK TO INDEX](#)

Electroplated Blades for **Marble**  
Dischi elettrolitici per **Marmo**

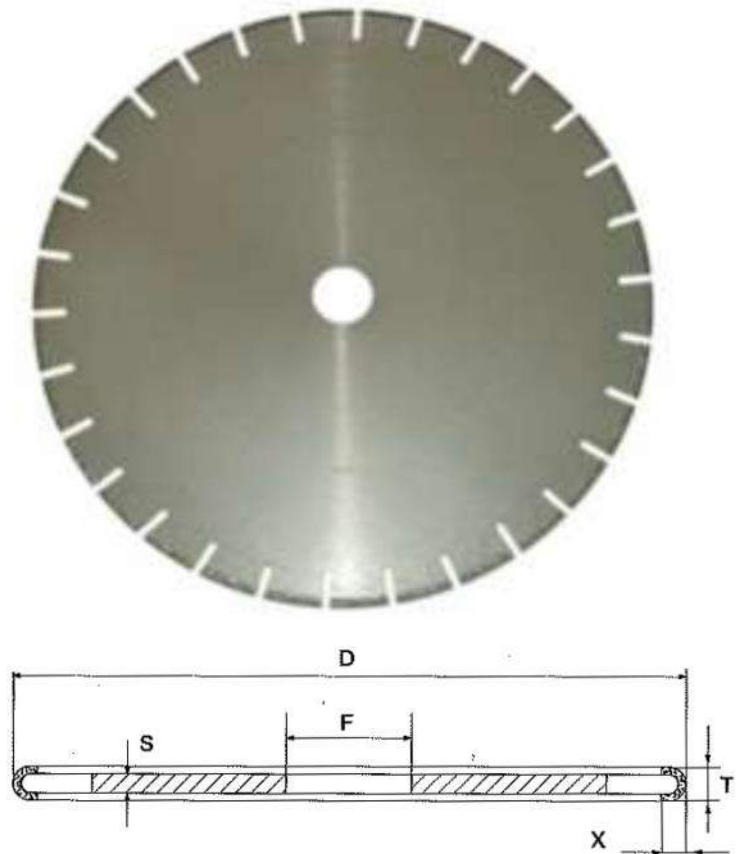

ADI CODE	DIMENSION [D]	Fitting [mm]	Core Thickness (S) [mm]	Diamond Thickness (T) [mm]	Diamond Height (X) [mm]	RPM	FEED [mm/min]
PF05090	240	30	1,8	3,0	3,0	3.500-4.000	300-600
PF05002	290	30	1,8	3,0	3,0	2.900-3.500	300-600
PF05016	340	30	2,2	3,4	3,5	2.500-3.000	300-600
PF05017	390	50/30	2,5	3,7	3,5	2.200-2.700	300-600
PF05143	440	50/30	2,8	4,0	3,5	1.800-2.300	300-600
PF05018	490	50/30	2,8	4,0	3,5	1.500-1.800	300-600
PF05144	540	50/30	3,5	4,5	3,5	1.300-1.500	300-600
PF05145	590	50/30	3,5	4,5	3,5	1.100-1.300	300-600

Segmented Diamond Blades for **Granite and Engineered Stone**

[BACK TO INDEX](#)

Dischi a settori diamantati per **Granito e Agglomerato**

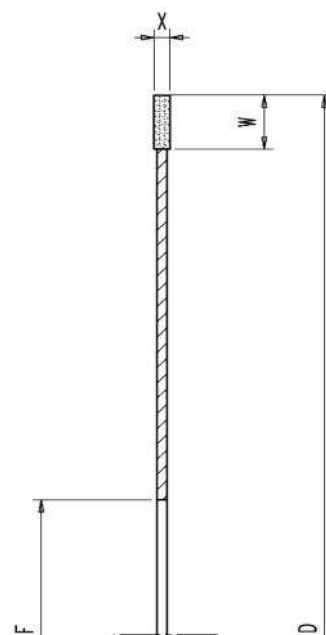

**Granite**

ADI CODE	DIMENSION [D]	Fitting [mm]	Machine	Diamond Thickness (X) [mm]	Diamond Height (W) [mm]	RPM	FEED [mm/min]
PH02119	150	22	Intermac	4	5	3.000-3.500	500-700
PH02155	150	25	Park Industries	4	5	3.000-3.500	500-700
PH02185	200	50	Denver/Thibaut	2,8	10	2.400-2.900	700-1.000
PH01032	210	28	Ravelli Teorema	2,8	10	2.400-2.900	700-1.000
PH02111	210	50	Brembana	2,8	10	2.400-2.900	700-1.000
PH02253	210	22,2	Bavelloni	3	10	2.400-2.900	700-1.000
PH02095	210	50	Breton	2,8	10	2.400-2.900	700-1.000
PH02148	260	50	Breton	2,8	10	2.000-2.300	700-1.000
PH02078	.350	50	Breton	3,2	10	1.500-1.800	800-1.200

**Engineered Stone**

PH02508	210	30	Intermac	2,8	10	2.400-2.900	700-1.000
PH02152	260	50	Breton	2,8	10	2.000-2.300	700-1.000
PH02151	350	50	Breton	3,2	10	1.500-1.800	800-1.200

[BACK TO INDEX](#)

Electroplated Saw Blades to Shape for **Marble**  
Disco da taglio elettrolitico per **Marmo**

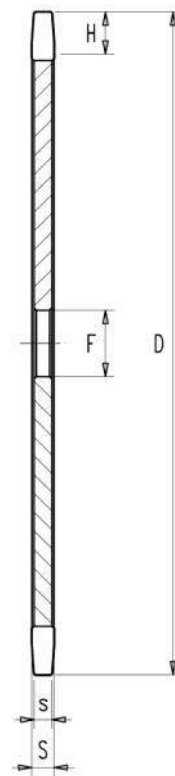

ADI CODE	DIMENSION [D]	Fitting [F] [mm]	Core Thickness (S) [mm]	Head Thickness (s) [mm]	Diamond Height (H) [mm]	Diamond Grit	RPM
PF05516	300	50/30	10	8	19	D427	2.900-3.500
PF05508	350	50/30	10	8	19	D427	2.500-3.000
PF05517	400	50/30	11	8	20	D427	2.200-2.700
PF05524	450	50/30	12	9	20	D427	1.800-2.300
PF05525	500	50/30	14	11	20	D427	1.500-1.800
PF05515	300	50/30	10	8	19	D602	2.900-3.500
PF05520	350	50/30	10	8	19	D602	2.500-3.000
PF05507	400	50/30	11	8	20	D602	2.200-2.700
PF05509	450	50/30	12	9	20	D602	1.800-2.300
PF05510	500	50/30	14	11	20	D602	1.500-1.800

[BACK TO INDEX](#)

Segmented Saw Blades to Shape for **Marble** and **Granite**

Disco da taglio a settori per **Marmo** e **Granito**

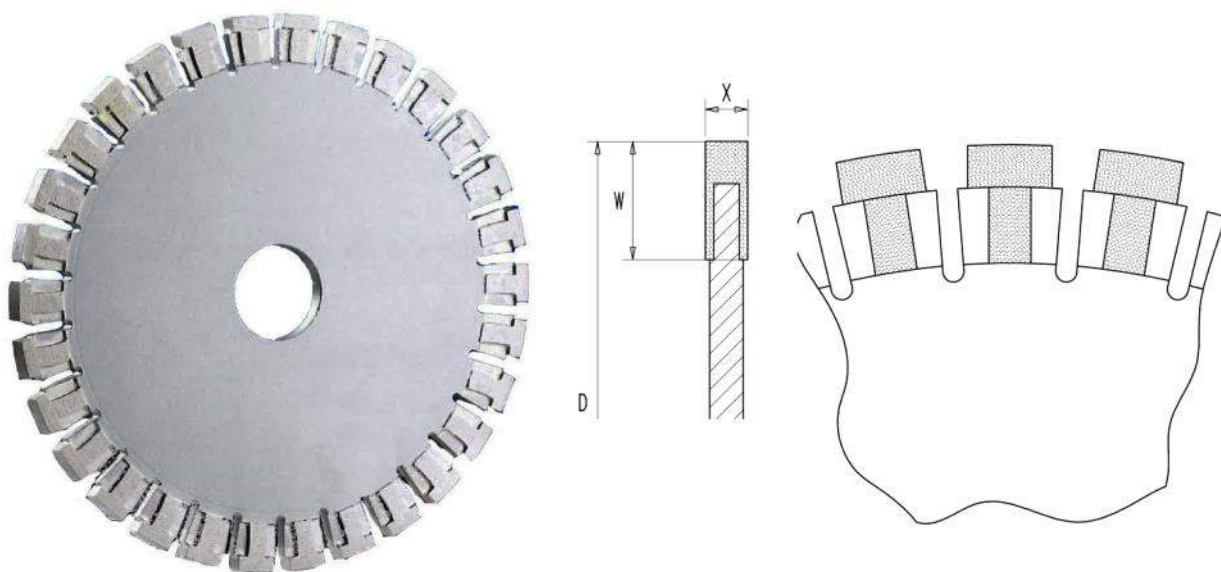

ADI CODE	DIMENSION [D]	Fitting [F] [mm]	Head Thickness (X) [mm]	Diamond Height (W) [mm]	Material	RPM
PC10806	350	50	10	28	Marble	2.500-3.000
PC10804	400	50	10	28	Marble	2.200-2.700
PC10807	500	50	10	28	Marble	1.700-2.100
PC10501	350	50	10	28	Granite	1.400-1.800
PC10502	400	50	10	28	Granite	1.200-1.700
PC10511	500	50	10	28	Granite	1.000-1.300

[BACK TO INDEX](#)

**Diamond Blades General Purpose for **Marble** foro 60/50**

**Dischi diamantati per **Marmo** foro 60/50**



Code	Description
PK02341	1A1R SET Ø 350X3,3X7 Z=25 Narrow Slot Sandwich
PK02340	1A1R SET Ø 400X3,6X7 Z=28 Narrow Slot Sandwich
PK02270	1A1R SET Ø 500X4,4X7 Z=36 Narrow Slot Sandwich

**Diamond Blades Fast Cutting for **Granite** bore 60/50**

**Disco diamantato per taglio veloce su **Granito** foro 60/50**



Code	Description
PH02645	1A1R SET Ø370X3,0X15 Z=42 Narrow Slot Sandwich
PH02637	1A1R SET Ø420X3,4X15 Z=48 Narrow Slot Sandwich
PH02671	1A1R SET Ø470X3,8X15 Z=52 Narrow Slot Sandwich
PH02638	1A1R SET Ø520X3,8X15 Z=60 Narrow Slot Sandwich
PH02672	1A1R SET Ø570X4,5X15 Z=64 Narrow Slot Sandwich
PH02693	1A1R SET Ø620X4,5X15 Z=72 Narrow Slot Sandwich
PH02673	1A1R SET 640X4,5X15 Z=72 Narrow Slot Sandwich

[BACK TO INDEX](#)



CNC  
SOLID SINK EXECUTION  
TOOLS

CNC  
ESECUZIONE SCAVI  
MASSELLI

[BACK TO INDEX](#)

[BACK TO INDEX](#)

**SINTERED CORE DRILLS FOR MARBLE**  
**FORETTO SINTERIZZATO PER MARBLE**

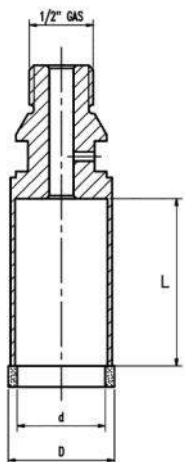

D

ADI CODE	TYPE	D [mm]	d [mm]	L [mm]	Grit size	RPM	FEED [mm/min]
PG18280	VACUUM BRAZED	80	74	200	D602	1.000-1.500	50-100

**SEGMENTED SINTERED CORE DRILLS FOR GRANITE**  
**FORETTO SINTERIZZATO A SETTORI PER GRANITO**

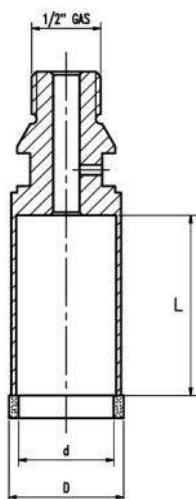

D

ADI CODE	D [mm]	d [mm]	L [mm]	Wall Thickness [mm]	RPM	FEED [mm/min]
PG11078	80	74	200	4	800-1.200	40-60

[BACK TO INDEX](#)

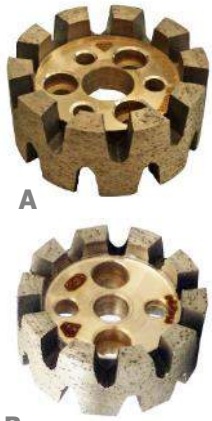

**SUPER DUTY WHEELS FOR SOLID SINK ON MARBLE**  
**MOLA DA SCAVO PER SCAVO MASSELLO MARBLE**

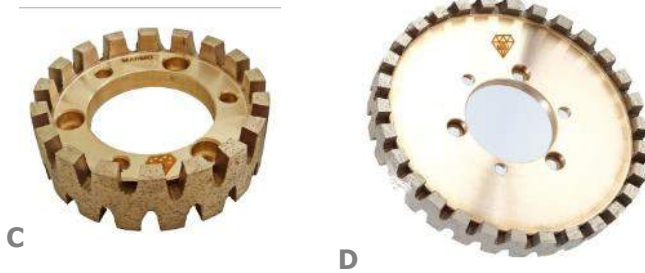

Type	ADI CODE	DIMENSION [DxL] [mm]	Fitting	RPM	FEED [mm/min]	Stock Removal [mm]
A	PB29525	Φ54x25x7	Φ14 (3+3)	5.000	500	1-5 Max
B	PB29532	Φ54x25x7	Φ10 (2+2)	5.000	500	1-5 Max
C	PB29448	Φ91x30x7	Φ50 (3+3)	4.500	800	1-5 Max
D	PB29537	Φ150x25x7	Φ50 (3+3)	4.000	500	1-5 Max
E	PB29015	Φ50x10(3 Holes)	1/2" Gas	-	-	-
F	SL01050	Φ50x3 (3 Holes)	Φ35	-	-	-

**SUPER DUTY WHEELS FOR SOLID SINK ON GRANITE**  
**MOLE DA SCAVO PER SCAVO MASSELLO PER GRANITO**

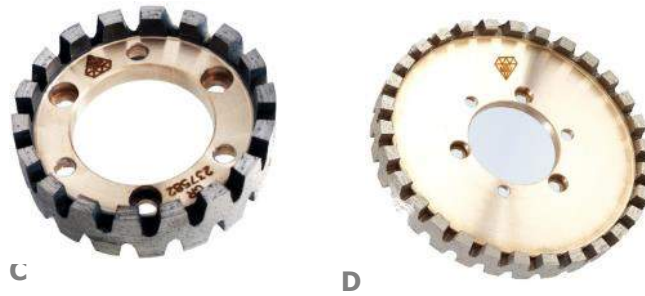
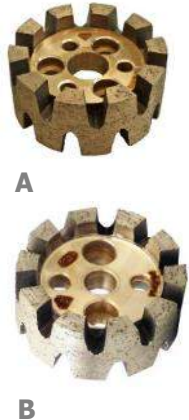

Type	ADI CODE	DIMENSION [DxL] [mm]	Fitting	RPM	FEED [mm/min]	Stock Removal [mm]
A	PB29470	Φ54x25x7	Φ14 (3+3)	5.000	400	1 - 5 Max
B	PB29531	Φ54x25x7	Φ10 (2+2)	5.000	400	1 - 5 Max
C	PB29443	Φ91x30x7	Φ50 (3+3)	4500	400-800	1 - 5 Max
D	PB29536	Φ150x25x7	Φ50 (3+3)	4.000	200-400	1 - 5 Max
E	PB29015	Φ50x10(3 Holes)	1/2" Gas	-	-	-
F	SL01050	Φ50x3 (3 Holes)	Φ35	-	-	-

[BACK TO INDEX](#)

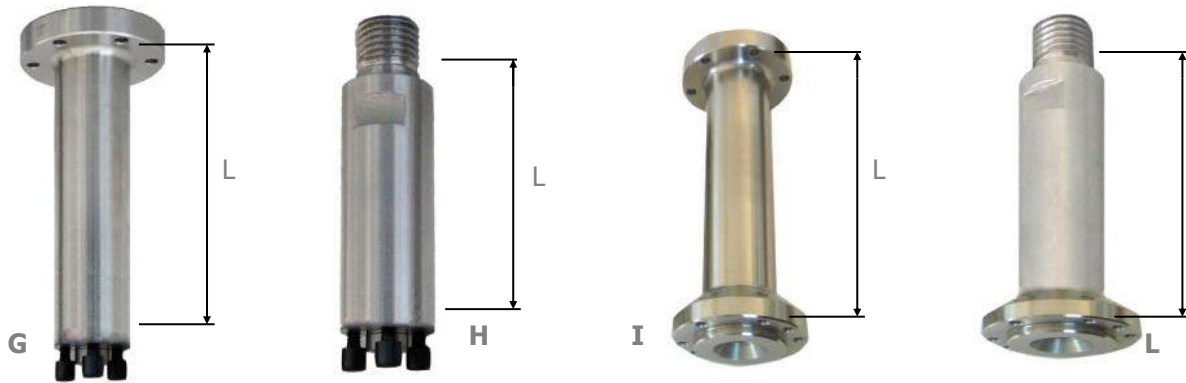

Type	ADI CODE	DIMENSION [mm]	Fitting	L [mm]
G	SL01407	Φ77	Flange - 14 (3 Holes)	100
G	SL01408	Φ77	Flange - 14 (3 Holes)	200
G	SL01430	Φ77	Flange - 10 (2 Holes)	100
G	SL01431	Φ77	Flange - 10 (2 Holes)	200
H	SL02487	Φ34	M30 - 14 (3 Holes)	100
H	SL02489	Φ34	M30 - 14 (3 Holes)	200
H	SL02704	Φ34	M30 - 10 (2 Holes)	100
H	SL02705	Φ34	M30 - 10 (2 Holes)	200
I	SL01157	Φ74	Flange - Flange	100
I	SL01159	Φ74	Flange - Flange	200
L	SL01409	Φ74	M30 - Flange	100
L	SL01410	Φ74	M30 - Flange	200

[BACK TO INDEX](#)



A

VACUUM BRAZED WHEELS FOR SOLID  
SINK EXECUTION ON **MARBLE**

MOLE BRASATE PER ESECUZIONE  
SCAVO MASSELLO PER **MARMO**



B

Type	ADI CODE	DIMENSION [DxL] [mm]	Fitting [mm]	RPM	FEED [mm/min]	Stock Removal [mm]
Coarse (A)	PB60003	85x60 R=25	35	4.000	800	Shape
				5.000	1.500	
Fine (B)	PB60027	85x60 R=25	35	4.000	1.000	0,2-0,5
				5.000	2.000	

SEGMENTED WHEELS FOR SOLID SINK EXECUTION ON **GRANITE**  
MOLA A SETTORI PER SCAVO MASSELLO PER **GRANITO**



A



Type	ADI CODE	DIMENSION [DxL]	Fitting [mm]	RPM	FEED [mm/min]	Stock Removal [mm]
Coarse (A)	PB30085	85x60 R=25	35	4.000	600	1 To 5 Max
				4.500	1.000	
Fine (B)	PB30100	85x60 R=25	35	4.000	1.000	0,2-0,5
				4.500	2.000	

[BACK TO INDEX](#)

**SEGMENTED WHEELS FOR SOLID SINK EXECUTION ON GRANITE**  
**MOLA A SETTORI PER SCAVO MASSELLO GRANITE**

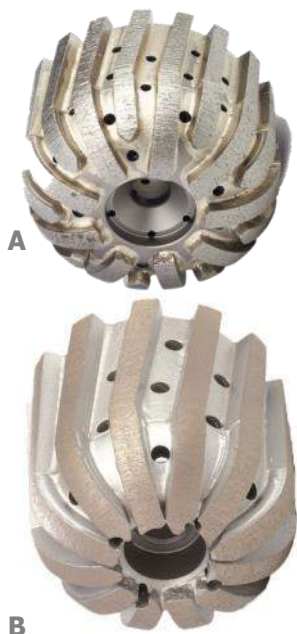

Type	ADI CODE	DIMENSION [DxL]	Fitting [mm]	RPM	FEED [mm/min]	Stock Removal [mm]
Coarse (A)	PB30127	60x60 R=20	35	4.000 4.500	600 1.000	1 To 5 Max
Fine (B)	PB30128	60x60 R=20	35	4.000 4.500	1.000 2.000	0,2 - 0,5

**Extension Fitting 35 mm - Flange**  
**Prolunga attacco 35mm—Flangia**

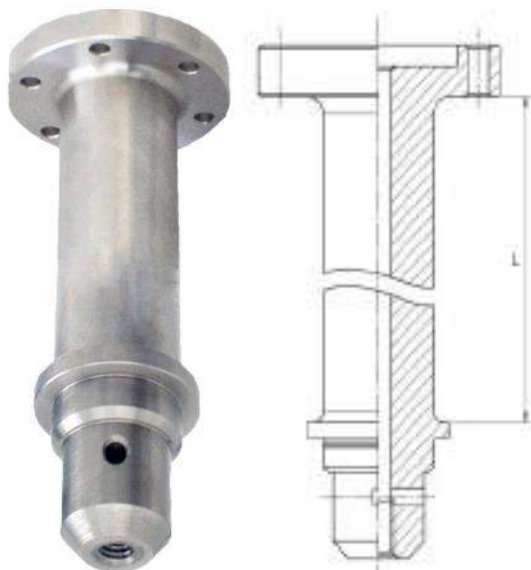

Code	Product details
SL01411	Fitting 35mm L=160 Flange

**Extension Fitting 35 mm - 1/2" GAS**  
**Prolunga Attacco 35mm—1/2" GAS**

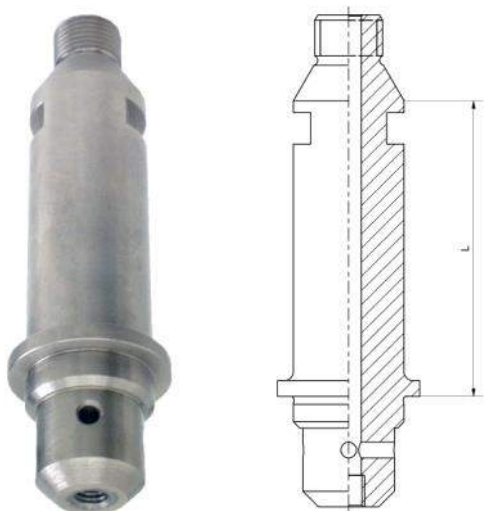

Code	Product details
SL01123	Fitting 35mm L= 90 - Fitting 1/2" Gas

[BACK TO INDEX](#)



# CNC TOOLS FOR MARBLE

# UTENSILI CNC PER MARMO

[BACK TO INDEX](#)



Cnc Profiles Set for **Marble**  
Set Profili CNC per **Marmo**



3 Electroplated tools - bore 35mm  
3 Mole elettrodeposte - foro 35mm



2 Abrasive polishing wheels - bore 35mm  
2 Mole Abrasive lucidanti - foro 35mm

[BACK TO INDEX](#)

Pos. 1 Elettroplated wheel with milled body  
Mola elettrodeposta con corpo fresato



Pos. 2 Continous rim electroplated  
Fascia continua elettrodeposta



Pos. 3 Continous rim electroplated  
Fascia continua elettrodeposta



Pos. 4 Abrasive Polishing  
Lucidante abrasiva



Pos. 5 Abrasive Polishing  
Lucidante abrasiva



**Suggested Working parameter**  
**Parametri di lavoro suggeriti**

<i>Parameters</i>	Pos.1	Pos.2	Pos.3	Pos.4	Pos.5
<b>RPM</b>	5.500-6.000	5.500-6.000	5.500-6.000	1.200-1.500	1.200-1.500
<b>Feed [mm/min]</b>	300-600	600-800	600-800	400-800	400-800
<b>Stock Removal [mm]</b>	To Shape	0,15-0,1	0,1-0,05	0,05-0,1	0,05-0,1

[BACK TO INDEX](#)

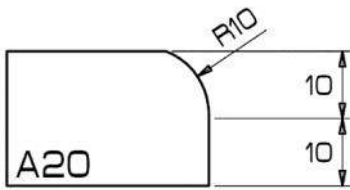

ADI CODE	PROFILE	POSITION
PB131101	A 20	Pos. 1 Electroplated
PB131102	A 20	Pos. 2 Electroplated
PB13501	A 20	Pos. 3 Electroplated
PB13601	A 20	Pos. 4 Abrasive Polishing
PB13901	A 20	Pos. 5 Abrasive Polishing

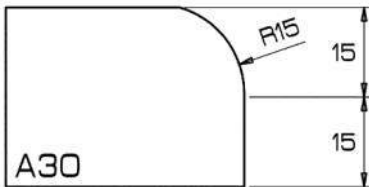

ADI CODE	PROFILE	POSITION
PB131103	A 30	Pos. 1 Electroplated
PB131104	A 30	Pos. 2 Electroplated
PB13502	A 30	Pos. 3 Electroplated
PB13602	A 30	Pos. 4 Abrasive Polishing
PB13902	A 30	Pos. 5 Abrasive Polishing

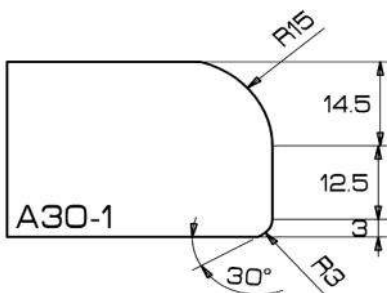

ADI CODE	PROFILE	POSITION
PB131105	A 30-1	Pos. 1 Electroplated
PB131106	A 30-1	Pos. 2 Electroplated
PB13503	A 30-1	Pos. 3 Electroplated
PB13603	A 30-1	Pos. 4 Abrasive Polishing
PB13903	A 30-1	Pos. 5 Abrasive Polishing

[BACK TO INDEX](#)

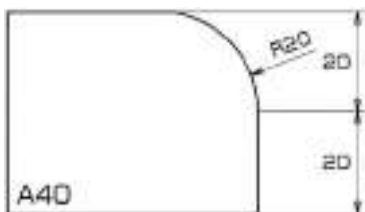

ADI CODE	PROFILE	POSITION
----------	---------	----------

PB131107	A 40	Pos. 1 Electroplated
PB131108	A 40	Pos. 2 Electroplated
PB13504	A 40	Pos. 3 Electroplated
PB13604	A 40	Pos. 4 Abrasive Polishing
PB13904	A 40	Pos. 5 Abrasive Polishing

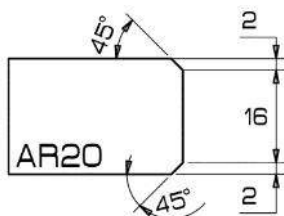

ADI CODE	PROFILE	POSITION
----------	---------	----------

PB131109	AR20	Pos. 1 Electroplated
PB131110	AR20	Pos. 2 Electroplated
PB13505	AR20	Pos. 3 Electroplated
PB13605	AR20	Pos. 4 Abrasive Polishing
PB13905	AR20	Pos. 5 Abrasive Polishing

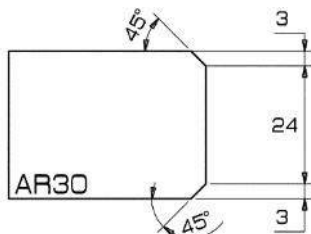

ADI CODE	PROFILE	POSITION
----------	---------	----------

PB131111	AR30	Pos. 1 Electroplated
PB131112	AR30	Pos. 2 Electroplated
PB13506	AR30	Pos. 3 Electroplated
PB13606	AR30	Pos. 4 Abrasive Polishing
PB13906	AR30	Pos. 5 Abrasive Polishing

[BACK TO INDEX](#)

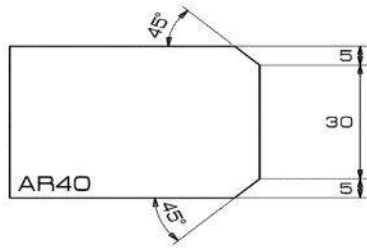

ADI CODE	PROFILE	POSITION
PB131113	AR40	Pos. 1 Electroplated
PB131114	AR40	Pos. 2 Electroplated
PB13507	AR40	Pos. 3 Electroplated
PB13607	AR40	Pos. 4 Abrasive Polishing
PB13907	AR40	Pos. 5 Abrasive Polishing

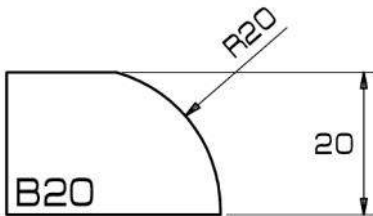

ADI CODE	PROFILE	POSITION
PB131115	B20	Pos. 1 Electroplated
PB131116	B20	Pos. 2 Electroplated
PB13508	B20	Pos. 3 Electroplated
PB13608	B20	Pos. 4 Abrasive Polishing
PB13908	B20	Pos. 5 Abrasive Polishing

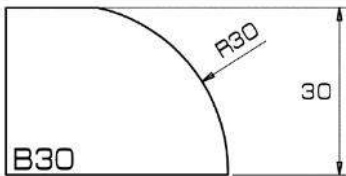

ADI CODE	PROFILE	POSITION
PB131117	B30	Pos. 1 Electroplated
PB131118	B30	Pos. 2 Electroplated
PB13509	B30	Pos. 3 Electroplated
PB13609	B30	Pos. 4 Abrasive Polishing
PB13909	B30	Pos. 5 Abrasive Polishing

[BACK TO INDEX](#)

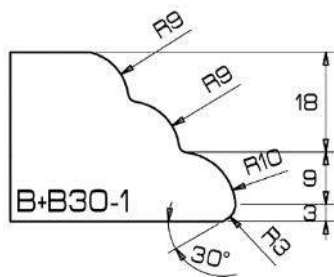

ADI CODE	PROFILE	POSITION
PB131119	B30-1	Pos. 1 Electroplated
PB131120	B30-1	Pos. 2 Electroplated
PB13510	B30-1	Pos. 3 Electroplated
PB13610	B30-1	Pos. 4 Abrasive Polishing
PB13910	B30-1	Pos. 5 Abrasive Polishing

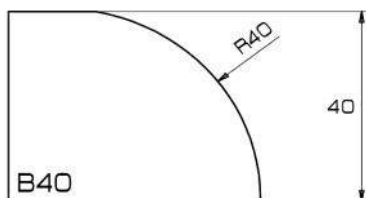

ADI CODE	PROFILE	POSITION
PB131121	B40	Pos. 1 Electroplated
PB131122	B40	Pos. 2 Electroplated
PB13511	B40	Pos. 3 Electroplated
PB13611	B40	Pos. 4 Abrasive Polishing
PB13911	B40	Pos. 5 Abrasive Polishing

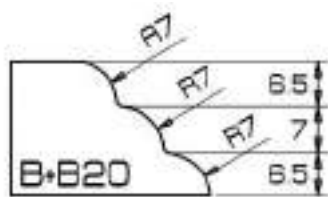

ADI CODE	PROFILE	POSITION
PB131123	B+B20	Pos. 1 Electroplated
PB131124	B+B20	Pos. 2 Electroplated
PB13512	B+B20	Pos. 3 Electroplated
PB13612	B+B20	Pos. 4 Abrasive Polishing
PB13912	B+B20	Pos. 5 Abrasive Polishing

[BACK TO INDEX](#)

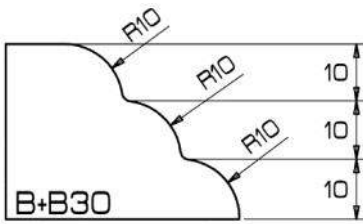

ADI CODE	PROFILE	POSITION
PB131125	B+B30	Pos. 1 Electroplated
PB131126	B+B30	Pos. 2 Electroplated
PB13513	B+B30	Pos. 3 Electroplated
PB13613	B+B30	Pos. 4 Abrasive Polishing
PB13913	B+B30	Pos. 5 Abrasive Polishing

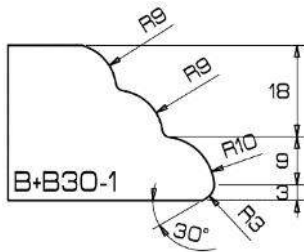

ADI CODE	PROFILE	POSITION
PB131127	B+B30-1	Pos. 1 Electroplated
PB131128	B+B30-1	Pos. 2 Electroplated
PB13514	B+B30-1	Pos. 3 Electroplated
PB13614	B+B30-1	Pos. 4 Abrasive Polishing
PB13914	B+B30-1	Pos. 5 Abrasive Polishing

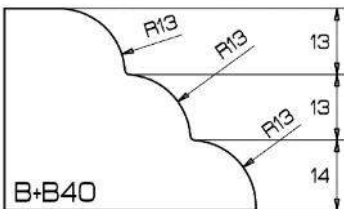

ADI CODE	PROFILE	POSITION
PB131129	B+B40	Pos. 1 Electroplated
PB131130	B+B40	Pos. 2 Electroplated
PB13515	B+B40	Pos. 3 Electroplated
PB13615	B+B40	Pos. 4 Abrasive Polishing
PB13915	B+B40	Pos. 5 Abrasive Polishing



[BACK TO INDEX](#)

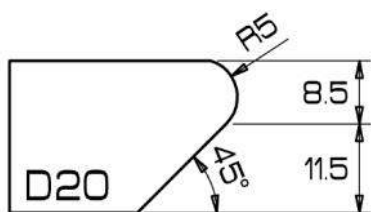

ADI CODE	PROFILE	POSITION
PB131131	D20-45°	Pos. 1 Electroplated
PB131132	D20-45°	Pos. 2 Electroplated
PB13516	D20-45°	Pos. 3 Electroplated
PB13616	D20-45°	Pos. 4 Abrasive Polishing
PB13916	D20-45°	Pos. 5 Abrasive Polishing

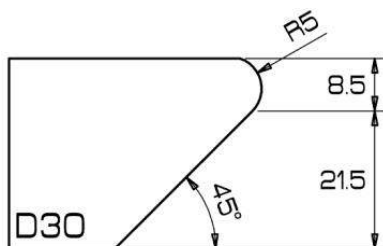

ADI CODE	PROFILE	POSITION
PB131133	D30-45°	Pos. 1 Electroplated
PB131134	D30-45°	Pos. 2 Electroplated
PB13517	D30-45°	Pos. 3 Electroplated
PB13617	D30-45°	Pos. 4 Abrasive Polishing
PB13917	D30-45°	Pos. 5 Abrasive Polishing

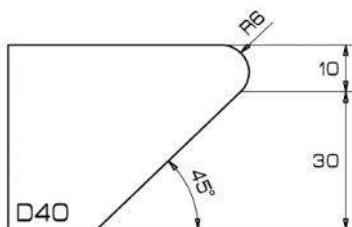

ADI CODE	PROFILE	POSITION
PB131135	D40-45°	Pos. 1 Electroplated
PB131136	D40-45°	Pos. 2 Electroplated
PB13555	D40-45°	Pos. 3 Electroplated
PB13655	D40-45°	Pos. 4 Abrasive Polishing
PB13955	D40-45°	Pos. 5 Abrasive Polishing

[BACK TO INDEX](#)

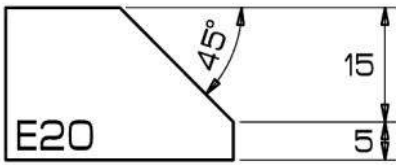

ADI CODE	PROFILE	POSITION
PB131137	E20-45°	Pos. 1 Electroplated
PB131138	E20-45°	Pos. 2 Electroplated
PB13518	E20-45°	Pos. 3 Electroplated
PB13618	E20-45°	Pos. 4 Abrasive Polishing
PB13918	E20-45°	Pos. 5 Abrasive Polishing

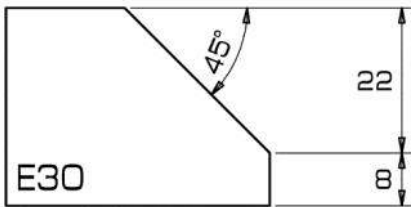

ADI CODE	PROFILE	POSITION
PB131139	E30-45°	Pos. 1 Electroplated
PB131140	E30-45°	Pos. 2 Electroplated
PB13519	E30-45°	Pos. 3 Electroplated
PB13619	E30-45°	Pos. 4 Abrasive Polishing
PB13919	E30-45°	Pos. 5 Abrasive Polishing

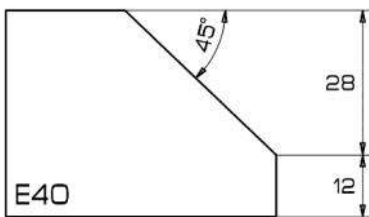

ADI CODE	PROFILE	POSITION
PB131141	E40-45°	Pos. 1 Electroplated
PB131142	E40-45°	Pos. 2 Electroplated
PB13520	E40-45°	Pos. 3 Electroplated
PB13620	E40-45°	Pos. 4 Abrasive Polishing
PB13920	E40-45°	Pos. 5 Abrasive Polishing

[BACK TO INDEX](#)

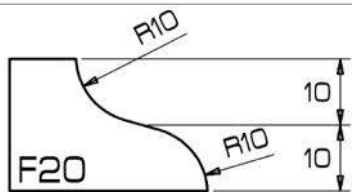

ADI CODE	PROFILE	POSITION
PB131143	F20	Pos. 1 Electroplated
PB131144	F20	Pos. 2 Electroplated
PB13521	F20	Pos. 3 Electroplated
PB13621	F20	Pos. 4 Abrasive Polishing
PB13921	F20	Pos. 5 Abrasive Polishing

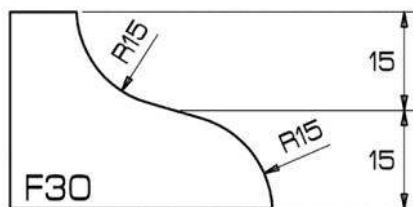

ADI CODE	PROFILE	POSITION
PB131145	F30	Pos. 1 Electroplated
PB131146	F30	Pos. 2 Electroplated
PB13522	F30	Pos. 3 Electroplated
PB13622	F30	Pos. 4 Abrasive Polishing
PB13922	F30	Pos. 5 Abrasive Polishing

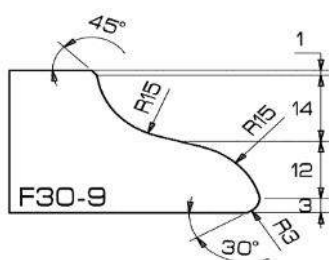

ADI CODE	PROFILE	POSITION
PB131147	F30-9	Pos. 1 Electroplated
PB131148	F30-9	Pos. 2 Electroplated
PB13523	F30-9	Pos. 3 Electroplated
PB13623	F30-9	Pos. 4 Abrasive Polishing
PB13923	F30-9	Pos. 5 Abrasive Polishing

[BACK TO INDEX](#)

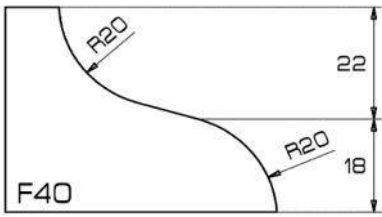

ADI CODE	PROFILE	POSITION
PB131149	F40	Pos. 1 Electroplated
PB131150	F40	Pos. 2 Electroplated
PB13524	F40	Pos. 3 Electroplated
PB13624	F40	Pos. 4 Abrasive Polishing
PB13924	F40	Pos. 5 Abrasive Polishing

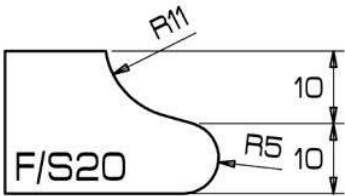

ADI CODE	PROFILE	POSITION
PB131151	F/S20	Pos. 1 Electroplated
PB131152	F/S20	Pos. 2 Electroplated
PB13525	F/S20	Pos. 3 Electroplated
PB13625	F/S20	Pos. 4 Abrasive Polishing
PB13925	F/S20	Pos. 5 Abrasive Polishing

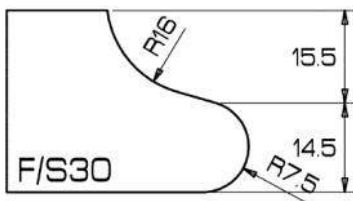

ADI CODE	PROFILE	POSITION
PB131153	F/S30	Pos. 1 Electroplated
PB131154	F/S30	Pos. 2 Electroplated
PB13526	F/S30	Pos. 3 Electroplated
PB13626	F/S30	Pos. 4 Abrasive Polishing
PB13926	F/S30	Pos. 5 Abrasive Polishing

[BACK TO INDEX](#)

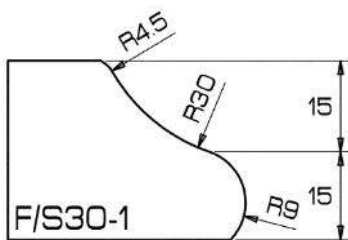

ADI CODE	PROFILE	POSITION
PB131155	F/S-1 30	Pos. 1 Electroplated
PB131156	F/S-1 30	Pos. 2 Electroplated
PB13527	F/S-1 30	Pos. 3 Electroplated
PB13627	F/S-1 30	Pos. 4 Abrasive Polishing
PB13927	F/S-1 30	Pos. 5 Abrasive Polishing

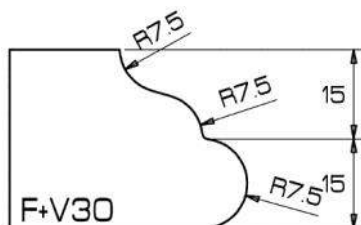

ADI CODE	PROFILE	POSITION
PB131157	F+V30	Pos. 1 Electroplated
PB131158	F+V30	Pos. 2 Electroplated
PB13528	F+V30	Pos. 3 Electroplated
PB13628	F+V30	Pos. 4 Abrasive Polishing
PB13928	F+V30	Pos. 5 Abrasive Polishing

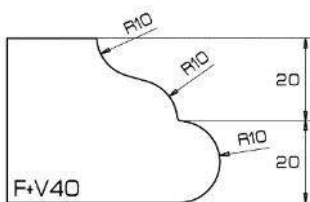

ADI CODE	PROFILE	POSITION
PB131159	F+V40	Pos. 1 Electroplated
PB131160	F+V40	Pos. 2 Electroplated
PB13529	F+V40	Pos. 3 Electroplated
PB13629	F+V40	Pos. 4 Abrasive Polishing
PB13929	F+V40	Pos. 5 Abrasive Polishing

[BACK TO INDEX](#)

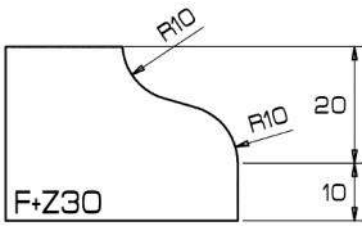

ADI CODE	PROFILE	POSITION
PB131161	F+Z30	Pos. 1 Electroplated
PB131162	F+Z30	Pos. 2 Electroplated
PB13530	F+Z30	Pos. 3 Electroplated
PB13630	F+Z30	Pos. 4 Abrasive Polishing
PB13930	F+Z30	Pos. 5 Abrasive Polishing

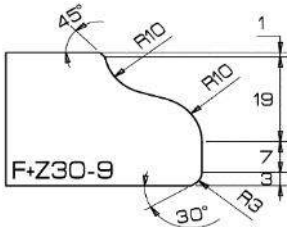

ADI CODE	PROFILE	POSITION
PB131163	F+Z30-9	Pos. 1 Electroplated
PB131164	F+Z30-9	Pos. 2 Electroplated
PB13531	F+Z30-9	Pos. 3 Electroplated
PB13631	F+Z30-9	Pos. 4 Abrasive Polishing
PB13931	F+Z30-9	Pos. 5 Abrasive Polishing

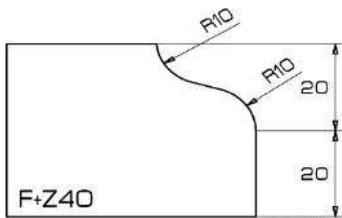

ADI CODE	PROFILE	POSITION
PB131165	F+Z40	Pos. 1 Electroplated
PB131166	F+Z40	Pos. 2 Electroplated
PB13532	F+Z40	Pos. 3 Electroplated
PB13632	F+Z40	Pos. 4 Abrasive Polishing
PB13932	F+Z40	Pos. 5 Abrasive Polishing

[BACK TO INDEX](#)

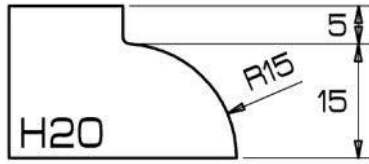

ADI CODE	PROFILE	POSITION
PB131167	H20	Pos. 1 Electroplated
PB131168	H20	Pos. 2 Electroplated
PB13533	H20	Pos. 3 Electroplated
PB13633	H20	Pos. 4 Abrasive Polishing
PB13933	H20	Pos. 5 Abrasive Polishing

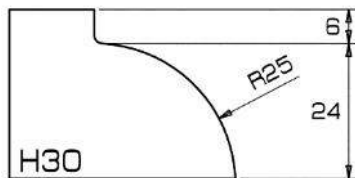

ADI CODE	PROFILE	POSITION
PB131169	H30	Pos. 1 Electroplated
PB131170	H30	Pos. 2 Electroplated
PB13534	H30	Pos. 3 Electroplated
PB13634	H30	Pos. 4 Abrasive Polishing
PB13934	H30	Pos. 5 Abrasive Polishing

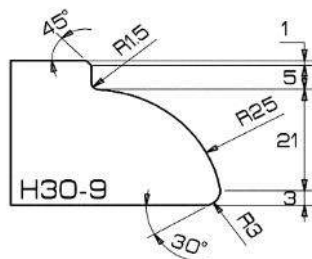

ADI CODE	PROFILE	POSITION
PB131171	H30-9	Pos. 1 Electroplated
PB131172	H30-9	Pos. 2 Electroplated
PB13535	H30-9	Pos. 3 Electroplated
PB13635	H30-9	Pos. 4 Abrasive Polishing
PB13935	H30-9	Pos. 5 Abrasive Polishing

[BACK TO INDEX](#)

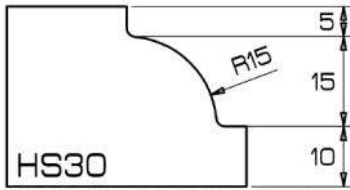

ADI CODE	PROFILE	POSITION
PB131173	HS30	Pos. 1 Electroplated
PB131174	HS30	Pos. 2 Electroplated
PB13536	HS30	Pos. 3 Electroplated
PB13636	HS30	Pos. 4 Abrasive Polishing
PB13936	HS30	Pos. 5 Abrasive Polishing

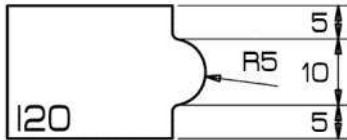

ADI CODE	PROFILE	POSITION
PB131175	I 20	Pos. 1 Electroplated
PB131176	I 20	Pos. 2 Electroplated
PB13537	I 20	Pos. 3 Electroplated
PB13637	I 20	Pos. 4 Abrasive Polishing
PB13937	I 20	Pos. 5 Abrasive Polishing

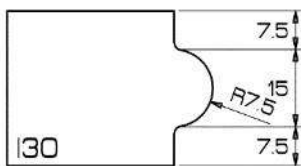

ADI CODE	PROFILE	POSITION
PB131177	I 30	Pos. 1 Electroplated
PB131178	I 30	Pos. 2 Electroplated
PB13538	I 30	Pos. 3 Electroplated
PB13638	I 30	Pos. 4 Abrasive Polishing
PB13938	I 30	Pos. 5 Abrasive Polishing



[BACK TO INDEX](#)

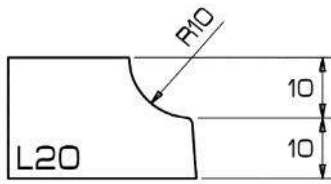

ADI CODE	PROFILE	POSITION
----------	---------	----------

PB131179	L20	Pos. 1 Electroplated
PB131180	L20	Pos. 2 Electroplated
PB13539	L20	Pos. 3 Electroplated
PB13639	L20	Pos. 4 Abrasive Polishing
PB13939	L20	Pos. 5 Abrasive Polishing

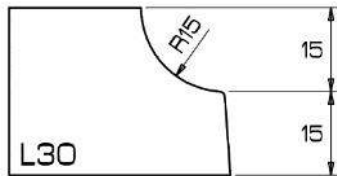

ADI CODE	PROFILE	POSITION
----------	---------	----------

PB131181	L30	Pos. 1 Electroplated
PB131182	L30	Pos. 2 Electroplated
PB13540	L30	Pos. 3 Electroplated
PB13640	L30	Pos. 4 Abrasive Polishing
PB13940	L30	Pos. 5 Abrasive Polishing

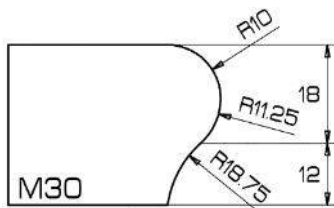

ADI CODE	PROFILE	POSITION
----------	---------	----------

PB131183	M30	Pos. 1 Electroplated
PB131184	M30	Pos. 2 Electroplated
PB13541	M30	Pos. 3 Electroplated
PB13641	M30	Pos. 4 Abrasive Polishing
PB13941	M30	Pos. 5 Abrasive Polishing

[BACK TO INDEX](#)

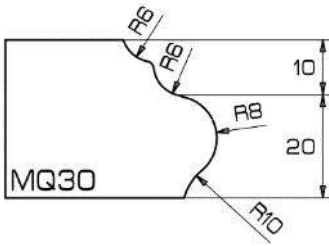

ADI CODE	PROFILE	POSITION
PB131185	MQ30	Pos. 1 Electroplated
PB131186	MQ30	Pos. 2 Electroplated
PB13542	MQ30	Pos. 3 Electroplated
PB13642	MQ30	Pos. 4 Abrasive Polishing
PB13942	MQ30	Pos. 5 Abrasive Polishing

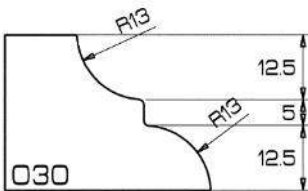

ADI CODE	PROFILE	POSITION
PB131187	O 30	Pos. 1 Electroplated
PB131188	O 30	Pos. 2 Electroplated
PB13543	O 30	Pos. 3 Electroplated
PB13643	O 30	Pos. 4 Abrasive Polishing
PB13943	O 30	Pos. 5 Abrasive Polishing

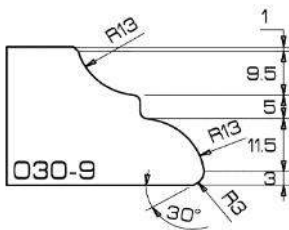

ADI CODE	PROFILE	POSITION
PB131189	O 30 -9	Pos. 1 Electroplated
PB131190	O 30 -9	Pos. 2 Electroplated
PB13544	O 30 -9	Pos. 3 Electroplated
PB13644	O 30 -9	Pos. 4 Abrasive Polishing
PB13944	O 30 -9	Pos. 5 Abrasive Polishing

[BACK TO INDEX](#)

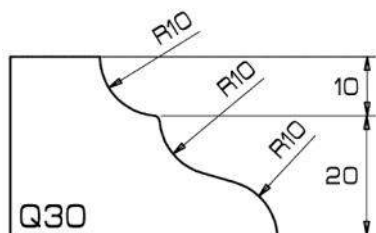

ADI CODE	PROFILE	POSITION
PB131191	Q30	Pos. 1 Electroplated
PB131192	Q30	Pos. 2 Electroplated
PB13545	Q30	Pos. 3 Electroplated
PB13645	Q30	Pos. 4 Abrasive Polishing
PB13945	Q30	Pos. 5 Abrasive Polishing

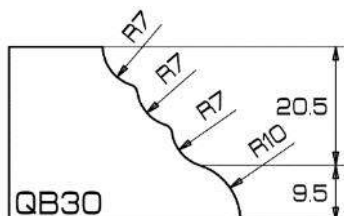

ADI CODE	PROFILE	POSITION
PB131193	QB30	Pos. 1 Electroplated
PB131194	QB30	Pos. 2 Electroplated
PB13546	QB30	Pos. 3 Electroplated
PB13646	QB30	Pos. 4 Abrasive Polishing
PB13946	QB30	Pos. 5 Abrasive Polishing

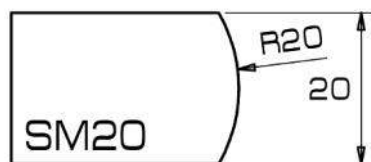

ADI CODE	PROFILE	POSITION
PB131195	SM20	Pos. 1 Electroplated
PB131196	SM20	Pos. 2 Electroplated
PB13547	SM20	Pos. 3 Electroplated
PB13647	SM20	Pos. 4 Abrasive Polishing
PB13947	SM20	Pos. 5 Abrasive Polishing

[BACK TO INDEX](#)

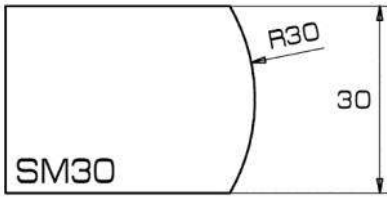

ADI CODE	PROFILE	POSITION
PB131197	SM30	Pos. 1 Electroplated
PB131198	SM30	Pos. 2 Electroplated
PB13548	SM30	Pos. 3 Electroplated
PB13648	SM30	Pos. 4 Abrasive Polishing
PB13948	SM30	Pos. 5 Abrasive Polishing

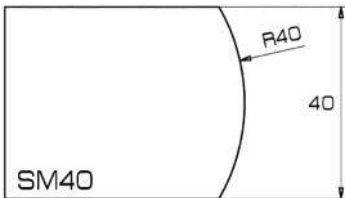

ADI CODE	PROFILE	POSITION
PB131199	SM40	Pos. 1 Electroplated
PB131200	SM40	Pos. 2 Electroplated
PB13549	SM40	Pos. 3 Electroplated
PB13649	SM40	Pos. 4 Abrasive Polishing
PB13949	SM40	Pos. 5 Abrasive Polishing

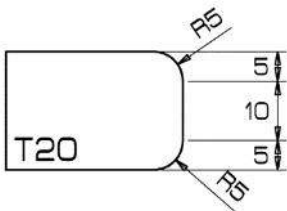

ADI CODE	PROFILE	POSITION
PB131201	T20	Pos. 1 Electroplated
PB131202	T20	Pos. 2 Electroplated
PB13550	T20	Pos. 3 Electroplated
PB13650	T20	Pos. 4 Abrasive Polishing
PB13950	T20	Pos. 5 Abrasive Polishing

[BACK TO INDEX](#)

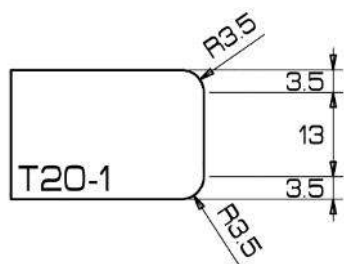

ADI CODE	PROFILE	POSITION
PB131203	T20-1	Pos. 1 Electroplated
PB131204	T20-1	Pos. 2 Electroplated
PB13551	T20-1	Pos. 3 Electroplated
PB13651	T20-1	Pos. 4 Abrasive Polishing
PB13951	T20-1	Pos. 5 Abrasive Polishing

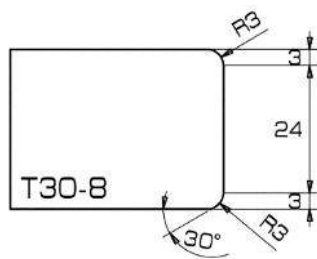

ADI CODE	PROFILE	POSITION
PB131205	T30	Pos. 1 Electroplated
PB131206	T30	Pos. 2 Electroplated
PB13552	T30	Pos. 3 Electroplated
PB13652	T30	Pos. 4 Abrasive Polishing
PB13952	T30	Pos. 5 Abrasive Polishing

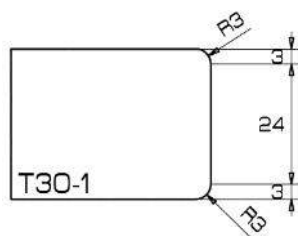

ADI CODE	PROFILE	POSITION
PB131207	T30-1	Pos. 1 Electroplated
PB131208	T30-1	Pos. 2 Electroplated
PB13553	T30-1	Pos. 3 Electroplated
PB13653	T30-1	Pos. 4 Abrasive Polishing
PB13953	T30-1	Pos. 5 Abrasive Polishing

[BACK TO INDEX](#)

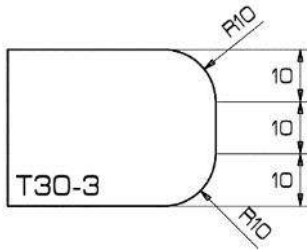

ADI CODE	PROFILE	POSITION
PB131209	T30-3	Pos. 1 Electroplated
PB131210	T30-3	Pos. 2 Electroplated
PB13554	T30-3	Pos. 3 Electroplated
PB13654	T30-3	Pos. 4 Abrasive Polishing
PB13954	T30-3	Pos. 5 Abrasive Polishing

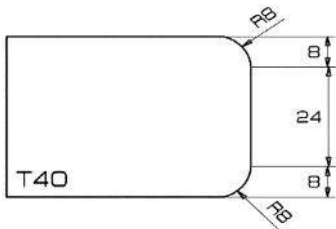

ADI CODE	PROFILE	POSITION
PB131211	T40	Pos. 1 Electroplated
PB131212	T40	Pos. 2 Electroplated
PB13556	T40	Pos. 3 Electroplated
PB13656	T40	Pos. 4 Abrasive Polishing
PB13956	T40	Pos. 5 Abrasive Polishing

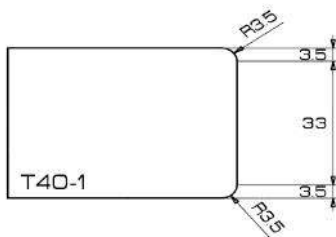

ADI CODE	PROFILE	POSITION
PB131213	T40-1	Pos. 1 Electroplated
PB131214	T40-1	Pos. 2 Electroplated
PB13557	T40-1	Pos. 3 Electroplated
PB13657	T40-1	Pos. 4 Abrasive Polishing
PB13957	T40-1	Pos. 5 Abrasive Polishing

[BACK TO INDEX](#)

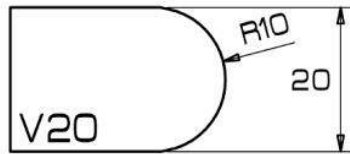

ADI CODE	PROFILE	POSITION
PB131215	V20	Pos. 1 Electroplated
PB131216	V20	Pos. 2 Electroplated
PB13558	V20	Pos. 3 Electroplated
PB13658	V20	Pos. 4 Abrasive Polishing
PB13958	V20	Pos. 5 Abrasive Polishing

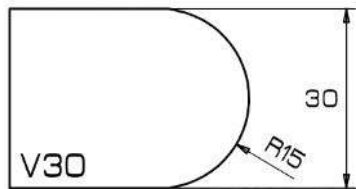

ADI CODE	PROFILE	POSITION
PB131217	V30	Pos. 1 Electroplated
PB131218	V30	Pos. 2 Electroplated
PB13559	V30	Pos. 3 Electroplated
PB13659	V30	Pos. 4 Abrasive Polishing
PB13959	V30	Pos. 5 Abrasive Polishing

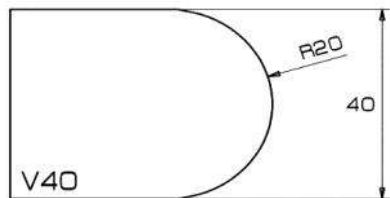

ADI CODE	PROFILE	POSITION
PB131219	V40	Pos. 1 Electroplated
PB131220	V40	Pos. 2 Electroplated
PB13560	V40	Pos. 3 Electroplated
PB13660	V40	Pos. 4 Abrasive Polishing
PB13960	V40	Pos. 5 Abrasive Polishing

[BACK TO INDEX](#)

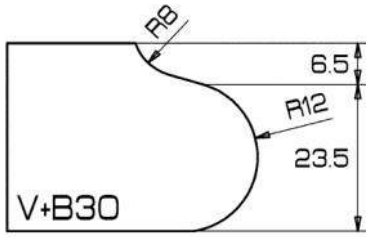

ADI CODE	PROFILE	POSITION
PB131221	V+B30	Pos. 1 Electroplated
PB131222	V+B30	Pos. 2 Electroplated
PB13561	V+B30	Pos. 3 Electroplated
PB13661	V+B30	Pos. 4 Abrasive Polishing
PB13961	V+B30	Pos. 5 Abrasive Polishing

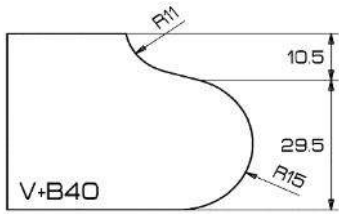

ADI CODE	PROFILE	POSITION
PB131223	V+B40	Pos. 1 Electroplated
PB131224	V+B40	Pos. 2 Electroplated
PB13562	V+B40	Pos. 3 Electroplated
PB13662	V+B40	Pos. 4 Abrasive Polishing
PB13962	V+B40	Pos. 5 Abrasive Polishing

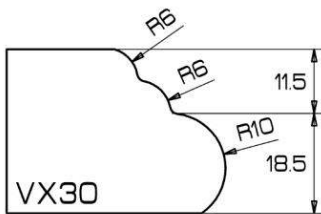

ADI CODE	PROFILE	POSITION
PB131225	VX30	Pos. 1 Electroplated
PB131226	VX30	Pos. 2 Electroplated
PB13563	VX30	Pos. 3 Electroplated
PB13663	VX30	Pos. 4 Abrasive Polishing
PB13963	VX30	Pos. 5 Abrasive Polishing



[BACK TO INDEX](#)



ADI CODE	PROFILE	POSITION
PB131227	1A1 (Z) 20	Pos. 1 Electroplated
PB131228	1A1 (Z) 20	Pos. 2 Electroplated
PB13564	1A1 (Z) 20	Pos. 3 Electroplated
PB13665	1A1 (Z) 20	Pos. 4 Abrasive Polishing
PB13965	1A1 (Z) 20	Pos. 5 Abrasive Polishing

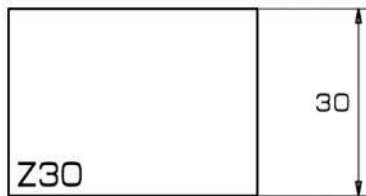

ADI CODE	PROFILE	POSITION
PB131229	1A1 (Z) 30	Pos. 1 Electroplated
PB131230	1A1 (Z) 30	Pos. 2 Electroplated
PB13565	1A1 (Z) 30	Pos. 3 Electroplated
PB13665	1A1 (Z) 30	Pos. 4 Abrasive Polishing
PB13965	1A1 (Z) 30	Pos. 5 Abrasive Polishing



ADI CODE	PROFILE	POSITION
PB131231	1A1 (Z) 40	Pos. 1 Electroplated
PB131232	1A1 (Z) 40	Pos. 2 Electroplated
PB13566	1A1 (Z) 40	Pos. 3 Electroplated
PB13666	1A1 (Z) 40	Pos. 4 Abrasive Polishing
PB13966	1A1 (Z) 40	Pos. 5 Abrasive Polishing

[BACK TO INDEX](#)

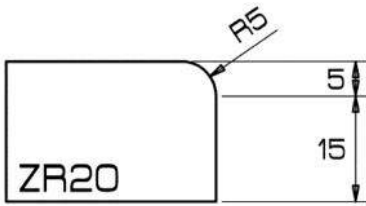

ADI CODE	PROFILE	POSITION
PB131233	ZR20	Pos. 1 Electroplated
PB131234	ZR20	Pos. 2 Electroplated
PB13567	ZR20	Pos. 3 Electroplated
PB13664	ZR20	Pos. 4 Abrasive Polishing
PB13964	ZR20	Pos. 5 Abrasive Polishing

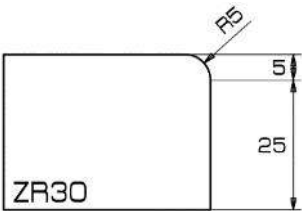

ADI CODE	PROFILE	POSITION
PB131235	ZR30	Pos. 1 Electroplated
PB131236	ZR30	Pos. 2 Electroplated
PB13568	ZR30	Pos. 3 Electroplated
PB13668	ZR30	Pos. 4 Abrasive Polishing
PB13968	ZR30	Pos. 5 Abrasive Polishing

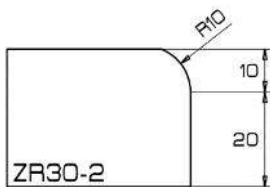

ADI CODE	PROFILE	POSITION
PB131237	ZR30-2	Pos. 1 Electroplated
PB131238	ZR30-2	Pos. 2 Electroplated
PB13569	ZR30-2	Pos. 3 Electroplated
PB13669	ZR30-2	Pos. 4 Abrasive Polishing
PB13969	ZR30-2	Pos. 5 Abrasive Polishing

[BACK TO INDEX](#)

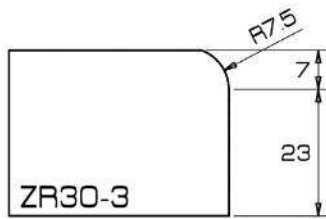

ADI CODE	PROFILE	POSITION
PB131239	ZR30-3	Pos. 1 Electroplated
PB131240	ZR30-3	Pos. 2 Electroplated
PB13570	ZR30-3	Pos. 3 Electroplated
PB13670	ZR30-3	Pos. 4 Abrasive Polishing
PB13970	ZR30-3	Pos. 5 Abrasive Polishing

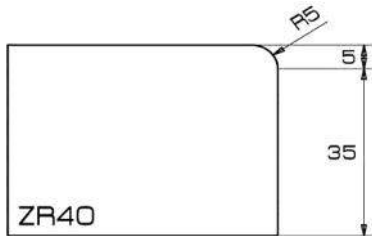

ADI CODE	PROFILE	POSITION
PB131241	ZR40	Pos. 1 Electroplated
PB131242	ZR40	Pos. 2 Electroplated
PB13571	ZR40	Pos. 3 Electroplated
PB13671	ZR40	Pos. 4 Abrasive Polishing
PB13971	ZR40	Pos. 5 Abrasive Polishing

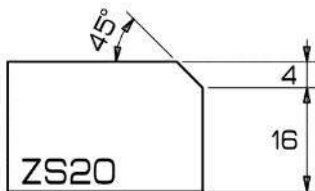

ADI CODE	PROFILE	POSITION
PB131243	ZS20	Pos. 1 Electroplated
PB131244	ZS20	Pos. 2 Electroplated
PB13572	ZS20	Pos. 3 Electroplated
PB13672	ZS20	Pos. 4 Abrasive Polishing
PB13972	ZS20	Pos. 5 Abrasive Polishing

[BACK TO INDEX](#)

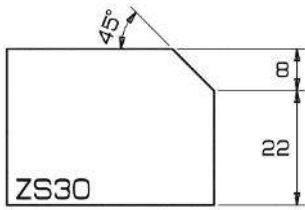

ADI CODE	PROFILE	POSITION
PB131245	ZS30	Pos. 1 Electroplated
PB131246	ZS30	Pos. 2 Electroplated
PB13573	ZS30	Pos. 3 Electroplated
PB13673	ZS30	Pos. 4 Abrasive Polishing
PB13973	ZS30	Pos. 5 Abrasive Polishing

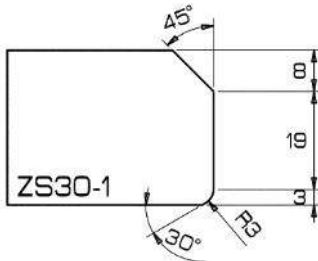

ADI CODE	PROFILE	POSITION
PB131247	ZS30-1	Pos. 1 Electroplated
PB131248	ZS30-1	Pos. 2 Electroplated
PB13574	ZS30-1	Pos. 3 Electroplated
PB13674	ZS30-1	Pos. 4 Abrasive Polishing
PB13974	ZS30-1	Pos. 5 Abrasive Polishing

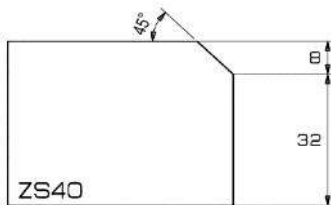

ADI CODE	PROFILE	POSITION
PB131249	ZS40	Pos. 1 Electroplated
PB131250	ZS40	Pos. 2 Electroplated
PB13575	ZS40	Pos. 3 Electroplated
PB13675	ZS40	Pos. 4 Abrasive Polishing
PB13975	ZS40	Pos. 5 Abrasive Polishing

CNC TOOLS  
FOR  
ENGRAVING

UTENSILI CNC  
PER SCOLPITURA

Electroplated Tools for Engraving **Marble**

[BACK TO INDEX](#)

Utensili da scultura elettrodeposti per **Marmo**



Body

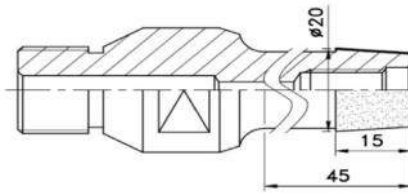

1

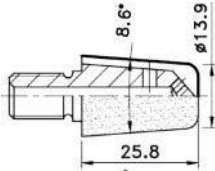

2

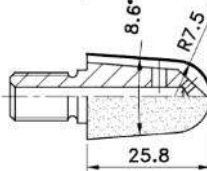

3

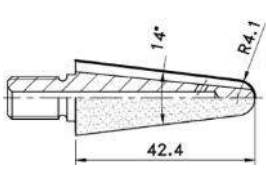

ADI Code	Description	Fitting	RPM	FEED [mm/min]	Stock Removal [mm]
PB23152	Body 20x15 M10 Female	A1/2"Gas	6.000-7.000	150-300	3-4
PB23153	(1) 1V1W EL 17x25	M10	6.000-7.000	150-300	3-4
PB23162	(2) 1T1W EL 17x25 R=7,5	M10	6.000-7.000	150-300	3-4
PB23337	(3) 1E1W EL 17x42 R=4,1	M10	6.000-7.000	150-300	3-4



Adaptor

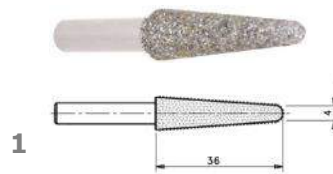

Adattatore

ADI Code	Description	Fitting	RPM	FEED [mm/min]	Stock Removal [mm]
SL02103	Adaptor Bore 6mm	A1/2"Gas	-	-	-
PB23105	(1) 1K1W EL 4x36	Shaft 6mm	7.000-8.000	150-300	3



Body -Corpo



1

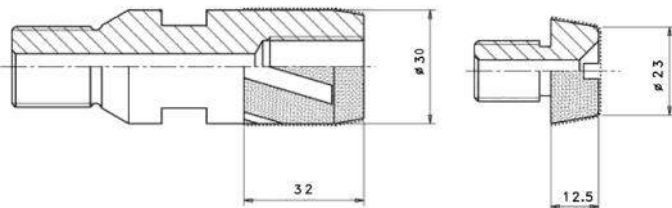

ADI Code	Description	Fitting	RPM	FEED [mm/min]	Stock Removal [mm]
PB23159	Body 30x32 M10	A1/2"Gas	6.000-7.000	150-300	3-4
PB23158	(1) 1V1W EL 23x12,5	M16	6.000-7.000	150-300	3-4

Electroplated Tools for Engraving **Marble**

[BACK TO INDEX](#)

Utensili per scultura elettrodeposti per **Marmo**



ADI Code	Description	Fitting	RPM	FEED [mm/min]	Stock Removal [mm]
PB23214	1U1W EL D. 4x12	Shaft 10	8.000-10.000	150-300	1-2 Max
PB23215	1U1W EL D. 5x12	Shaft 10	8.000-10.000	150-300	1-2 Max
PB23216	1U1W EL D. 6x12	Shaft 10	8.000-10.000	150-300	1-2 Max
PB23217	1U1W EL D. 8x12(*)	Shaft 10	8.000-10.000	150-300	1-2 Max
PB23218	1U1W EL D.10x12(*)	Shaft 10	7.000-8.000	150-300	1-2 Max
PB23219	1U1W EL D.12x12(*)	Shaft 10	7.000-8.000	150-300	1-2 Max
PB23220	1U1W EL D.15x12(*)	Shaft 10	7.000-8.000	150-300	1-2 Max
PB23221	1U1W EL D.18x12(*)	Shaft 10	6.000-7.000	150-300	1-2 Max
PB23222	1U1W EL D.20x12(*)	Shaft 10	6.000-7.000	150-300	1-2 Max
PB23338	1U1W EL D.11x30(*) L=100	Shaft 10	7.000-8.000	150-300	1-2 Max
PB23339	1U1W EL D.11x35(*) L=100	Shaft 10	7.000-8.000	150-300	1-2 Max
PB23340	1K1W EL D.4/9x35 L=110	Shaft 8	8.000-10.000	150-300	1-2 Max
PB23341	1K1W EL D.5/10x35 L=110	Shaft 10	8.000-10.000	150-300	1-2 Max
PB23342	1K1W EL D.5/10x35 for Granite L=110	Shaft 10	8.000-10.000	150-300	1-2 Max

(\*) With internal water—con acqua interna

Electroplated Tools for Writing on **Marble**

Utensili per scrittura elettrodeposti per **Marble**



ADI Code	Description	Fitting	RPM	FEED [mm/min]	Stock Removal [mm]
PB23343	1K1W EL D.10 - 90°	Shaft 10	7.000-8.000	150-300	1-2 Max
PB23344	1K1W EL D.12 - 90° (*)	Shaft 10	7.000-8.000	150-300	1-2 Max

(\*) With internal water—con acqua interna

Electroplated Tools for Engraving **Marble**

Utensili da scoltura elettrodeposti per **Marmo**

[BACK TO INDEX](#)



**Body  
Corpo**

**1**

**2**

ADI Code	Description	RPM	FEED [mm/min]	Fitting
PB25223	Body 1A1W Ø20x20 LU=100	-	-	1/2" Gas
PB25153	(1) 1U1W Ø 20x20	6.000-7.000	200-300	M12
PB25163	(2) 1F1W Ø 20x20	6.000-7.000	200-300	M12



**Body  
Corpo**

**1**

**2**

ADI Code	Description	RPM	FEED [mm/min]	Fitting
PB25285	Body 1A1W Ø 25x20 LU=100	-	-	1/2" Gas
PB25286	(1) 1U1W Ø 25x20	5.000-6.000	200-300	M14
PB25287	(2) 1F1W Ø 25x20	5.000-6.000	200-300	M14



**Body  
Corpo**

**1**

**2**

ADI Code	Description	RPM	FEED [mm/min]	Fitting
PB25291	Steel Body Ø 30x20 LU=100	-	-	1/2" Gas
PB25289	(1) 1U1W Ø 30x20	5.000-5.500	200-300	M14
PB25290	(2) 1F1W Ø 30x20	5.000-5.500	200-300	M14



Electroplated Tools for Engraving **Marble**

[BACK TO INDEX](#)

PB23286

Utensili da scoltitura elettrodeposti per **Marmo**

PB23294



PB23287

5x60

PB23289

4x12x60



PB23042

6x60

PB23290

5x12x60



PB23043

8x60

PB23037

6x12x60



PB23044

10x60

PB23059

8x12x60



PB23045

12x60

PB23113

10x12x60



PB23018

16x60

PB23114

12x12x60



PB23293

3x15x60

PB23019

16,7x25x60



PB23036

4x15x60

PB23032

8x20x60



PB23112

5x15x60

PB23017

10x25x60



PB23016

6x12x60

PB23012

12x30x65



Electroplated Tools for Engraving **Marble**

[BACK TO INDEX](#)

Utensili da scoltitura elettrodeposti per **Marmo**

ADI Code	Description	Fitting [mm]	RPM	FEED [mm/min]	Stock Removal [mm]	1 Pcs Price [€]	5 Pcs Price [€]
PB23286	1R1W EL 4x60	Shaft 6	8.000-10.000	150-300	1-2 max	19,1	16,4
PB23287	1R1W EL 5x60	Shaft 6	8.000-10.000	150-300	1-2 max	19,9	17,1
PB23042	1R1W EL 6x60	Shaft 6	8.000-10.000	150-300	1-2 max	19,9	17,1
PB23043	1R1W EL 8x60	Shaft 6	8.000-10.000	150-300	3 max	22,5	19,3
PB23044	1R1W EL 10x60	Shaft 6	7.000-8.000	150-300	3 max	25,7	22,1
PB23045	1R1W EL 12x60	Shaft 6	7.000-8.000	150-300	3 max	30,1	25,8
PB23018	1R1W EL 16x60	Shaft 6	6.000-7.000	150-300	3 max	38,6	33,1
PB23293	1F1W EL 3x15x60 R=1,5	Shaft 6	8.000-10.000	150-300	1-2 max	19,1	16,4
PB23036	1F1W EL 4x15x60 R=2,0	Shaft 6	8.000-10.000	150-300	1-2 max	19,9	17,1
PB23112	1F1W EL 5x15x60 R=2,5	Shaft 6	8.000-10.000	150-300	1-2 max	19,9	17,1
PB23016	1F1W EL 6x12x60	Shaft 6	8.000-10.000	150-300	1-2 max	22,5	19,3
PB23294	1U1W EL 3x12x60	Shaft 6	8.000-10.000	150-300	1 max	19,9	17,1
PB23289	1U1W EL 4x12x60	Shaft 6	8.000-10.000	150-300	1-2 max	19,9	17,1
PB23290	1U1W EL 5x12x60	Shaft 6	8.000-10.000	150-300	1-2 max	19,9	17,1
PB23037	1U1W EL 6x12x60	Shaft 6	8.000-10.000	150-300	1-2 max	20,7	17,8
PB23059	1U1W EL 8x12x60	Shaft 6	8.000-10.000	150-300	1-2 max	22,5	19,3
PB23113	1U1W EL 10x12x60	Shaft 6	7.000-8.000	150-300	3 max	28,5	24,4
PB23114	1U1W EL 12x12x60	Shaft 6	7.000-8.000	150-300	3 max	29,0	25,2
PB23019	1A1PW EL 16,7x25x60	Shaft 6	6.000-7.000	150-300	3 max	51,8	44,7
PB23032	1U1W EL 8x20x60	Shaft 6	8.000-10.000	150-300	1-2 max	31,0	26,6
PB23017	1U1W EL 10x25x60	Shaft 6	7.000-8.000	150-300	3 max	38,6	33,1
PB23012	1U1W EL 12x30x65	Shaft 6	7.000-8.000	150-300	3 max	51,8	44,7

Electroplated Tools for Engraving **Marble**

[BACK TO INDEX](#)

Utensili da scultura elettrodeposti per **Marmo**

PB23115



PB23103

6,5x30x65



PB23104

9x36x65



PB23038

5x15x60



PB23015

6x12x60



PB23118

9x36x65



PB23025

6x14x60



PB23026

8x17x60



PB23039

10x20x60



PB23100

12x22x60



PB23033



PB23040

8x7x60



PB23116

10x8,5x60



PB23117

12x10,5x60



PB23070

16x14x60



PB23034

10x 5x60



PB23041

16x 8x60



PB23119

20x10x60



Electroplated Tools for Engraving **Marble**

[BACK TO INDEX](#)

Utensili da scoltura elettrodeposti per **Marmo**

ADI Code	Description	Fitting [mm]	RPM	FEED [mm/min]	Stock Removal [mm]
PB23115	1F1W EL 4,5x30x65 R=2,75	Shaft 6	8.000-10.000	150-300	1 mm
PB23103	1F1W EL 6,5x15x65 R=3,75	Shaft 6	8.000-10.000	150-300	1-2 max
PB23104	1F1W EL 9x36x65 R=4,5	Shaft 6	8.000-10.000	150-300	3 max
PB23038	1K1W EL 5x15x60	Shaft 6	8.000-10.000	150-300	1-2 max
PB23015	1K1W EL 6x12x60	Shaft 6	8.000-10.000	150-300	1-2 max
PB23118	1K1W EL 9x36x65	Shaft 6	8.000-10.000	150-300	1-2 max
PB23025	1A1W DIS EL 6x14x60	Shaft 6	8.000-10.000	150-300	1-2 max
PB23026	1A1W DIS EL 8x17x60	Shaft 6	8.000-10.000	150-300	1-2 max
PB23039	1A1W DIS EL 10x20x60	Shaft 6	8.000-10.000	150-300	1-2 max
PB23100	1A1W DIS EL 12x22x60	Shaft 6	7.000-8.000	150-300	3 max
PB23033	1K1W EL 6x5,2x60 -60°	Shaft 6	7.000-8.000	150-300	3 max
PB23040	1K1W EL 8x7x60 -60°	Shaft 6	8.000-10.000	150-300	1-2 max
PB23116	1K1W EL 10x8,5x60 -60°	Shaft 6	7.000-8.000	150-300	3 max
PB23117	1K1W EL 12x10,5x60 -60°	Shaft 6	7.000-8.000	150-300	3 max
PB23070	1K1W EL 16x14x60 -60°	Shaft 6	7.000-8.000	150-300	3 max
PB23034	1K1W EL 10x5x60 -90°	Shaft 6	7.000-8.000	150-300	3 max
PB23041	1K1W EL 16x8x60 -90°	Shaft 6	7.000-8.000	150-300	3 max
PB23119	1K1W EL 20x10x60 -90°	Shaft 6	6.000-7.000	150-300	3 max

Electroplated Tools for Engraving **Marble**

[BACK TO INDEX](#)

Utensili da scoltura elettrodeposti per **Marmo**

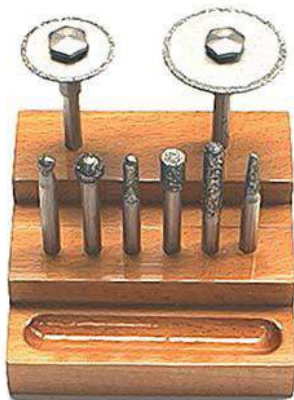

ADI Code	Description	Composition
PB23271	KIT 1	PB23042 - PB23112-PB23103- PB23044-PB23059-PB23038- PF05050(+M2)-PF05075(+M2)



ADI Code	Description	Composition
PB23190	KIT 2	PB23042 - PB23043 - PB23038 - PB23116 - PB23044 - PB23019 - PB23104-PB23112 - PB23103 - PB23026



ADI Code	Description	Composition
PB23284	KIT 3	PB23042 - PB23036 - PB23103 - PB23025-PB23043-PB23037- PB23104-PB23039-PB23044- PB23113-PB23038-PB23116- PB23045-PB23019-PB23118



ADI Code	Description	Composition
PB23285	KIT 4	PB23042 - PB23059 - PB23104 - PB23040 - PB23043 - PB23113 - PB23038 - PB23116-PB23044 - PB23114 - PB23015 - PB23117 - PB23045 - PB23019 - PB23118 - PB23070-PB23018 - PB23032 - PB23025 - PB23034 - PB23036 - PB23017 - PB23026 - PB23041  PB23112 - PB23012 - PB23039 - PB23119 - PB23015 - PB23115 - PB23100 - PB23037-PB23103 - PB23033

Electroplated Tools for Engraving **Granito**

[BACK TO INDEX](#)

Utensili da scultura elettrodeposti per **Granito**

PB23079

3x6



PB23081

4x7



PB23064

5x8



PB23083

6x12



PB23085

3x 7



PB23080

3x12



PB23082

3x12



PB23065

4x7



PB23084

5x12



PB23086

6x11



PB23087

6x60



PB23089

10x60



PB23091

6x12x60



PB23093

8x20x60



PB23095

5x15x60



PB23291

9x36x65



PB23088

6x30x65



PB23090

5x15x60



PB23092

10x8,5x60



PB23094

10x5x60



PB23096

8x17x60



PB23292

16x8x60



Electroplated Tools for Engraving **Granito**

Utensili da scolpitura elettrodeposti per **Granito**

ADI Code	Description	Fitting [mm]	RPM	FEED [mm/min]	Stock Removal [mm]
PB23079	1R1W EL 3x6 R=1,5	Shaft 3	8.000-10.000	150-300	3 max
PB23081	1R1W EL 4x7 R=2,0	Shaft 3	8.000-10.000	150-300	3 max
PB23064	11V2W EL 5x8	Shaft 3	8.000-10.000	150-300	3 max
PB23083	1U1W EL 6x12	Shaft 3	8.000-10.000	150-300	3 max
PB23085	1F1W EL 3x7 R=1,5	Shaft 3	8.000-10.000	150-300	3 max
PB23080	1T1W EL 3x12	Shaft 3	8.000-10.000	150-300	3 max
PB23082	1K1W EL 3x12	Shaft 3	8.000-10.000	150-300	3 max
PB23065	1K1W EL 4x 7	Shaft 3	8.000-10.000	150-300	3 max
PB23084	1K1W EL 5x12	Shaft 3	8.000-10.000	150-300	3 max
PB23086	1T1W EL 6x11	Shaft 3	8.000-10.000	150-300	3 max
PB23087	1R1W EL 6x60 R=3,0	Shaft 6	8.000-10.000	150-300	3 max
PB23089	1R1W EL 10x60 R=5,0	Shaft 6	8.000-10.000	150-300	3 max
PB23091	1U1W EL 6x12x60	Shaft 6	8.000-10.000	150-300	3 max
PB23093	1U1W EL 8x20x60	Shaft 6	8.000-10.000	150-300	3 max
PB23095	1F1W EL 5x15x60 R=2,5	Shaft 6	8.000-10.000	150-300	3 max
PB23291	1K1W EL 9x36x65 R=2,5	Shaft 6	8.000-10.000	150-300	3 max
PB23088	1F1W EL 6x30x65 R=3,0	Shaft 6	8.000-10.000	150-300	3 max
PB23090	1K1W EL 5x15x60	Shaft 6	8.000-10.000	150-300	3 max
PB23092	1K1W EL 10x10,5x60	Shaft 6	8.000-10.000	150-300	3 max
PB23094	1K1W EL 10x5x60	Shaft 6	8.000-10.000	150-300	3 max
PB23096	1A1W DIS EL 8x17x60	Shaft 6	8.000-10.000	150-300	3 max
PB23292	1K1W EL 16x 8x60 -90°	Shaft 6	8.000-10.000	150-300	3 max

Widia Router Bits for Writing on **Marble**

[BACK TO INDEX](#)

Fresa Widia per scrittura su **Marmo**

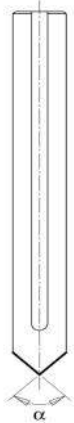

ADI CODE	Dimension [mm]	RPM	FEED [mm/min]	Stock Removal [mm]
PG29505	Widia D.10 - 36° With Water	8.000 10.000	150-250	0-3 Max
PG29504	Widia D.10 - 60° With Water			
PG29499	Widia D.10 - 90° With Water			
PG29512	Widia D.10 - 120° With Water			

PCD Router Bits for Writing **Marble** and **Granite**

Fresa PCD per scrittura su **Marmo** e **Granito**

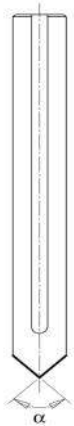

ADI CODE	Dimension [mm]	RPM	FEED [mm/min]	Stock Removal [mm]
PB35009	PCD D.10 - 36° With Water	7.000 8.000	150-250	0-3 Max
PB35002	PCD D.10 - 70° With Water			
PB35001	PCD D.10 - 90° With Water			
PB35004	PCD D.10 - 120° With Water			

Sintered Router Bits for Writing on **Granite**

Fresa sinterizzata per scrittura su **Granito**

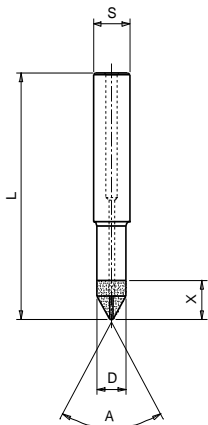

ADI CODE	Dimension [mm]	RPM	FEED [mm/min]	Stock Removal [mm]
PG01808	1A1W D.8-60° DIS. ST.10	7.000	150-250	Max 3
PG01810	1A1W D.10-60° DIS. ST.10	8.000		

Adaptor see page nr. 310

Adattatori vedi pagina nr. 310



Hard Metal Router Bits for Engraving **Marble** and **Granite**

[BACK TO INDEX](#)

Fresa Metallo duro per scrittura su **Marmo** e **Granito**

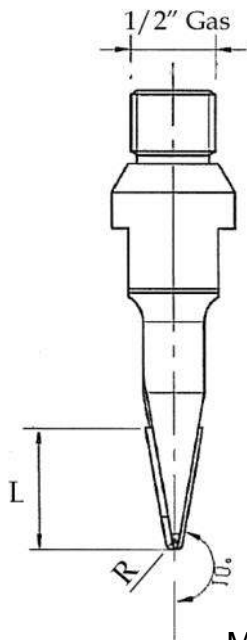

MINIMUM ORDER 2 PCS EACH.

MINIMO D'ORDINE 2 PEZZI PER ARTICOLO

ADI CODE	DESCRIPTION	RPM	FEED [mm/min]	Stock Removal [mm]
PB36001	CONICAL BIT D.3x30 R=1,5 A=1/2" GAS	3.000 4.000	150-300	3 Max
PB36002	CONICAL BIT D.3x30 R=1,5 A=1/2" GAS WITH WATER HOLES			
PB36003	CONICAL BIT D.5x30 R=2,5 A=1/2" GAS			
PB36004	CONICAL BIT D.5x30 R=2,5 A=1/2" GAS WITH WATER HOLES			
PB36005	CONICAL BIT D.8x30 R=4,0 A=1/2" GAS			
PB36006	CONICAL BIT D.8x30 R=4,0 A=1/2" GAS WITH WATER HOLES			
PB36007	CONICAL BIT D.3x50 R=1,5 A=1/2" GAS			
PB36008	CONICAL BIT D.3x50 R=1,5 A=1/2" GAS WITH WATER HOLES			
PB36009	CONICAL BIT D.5x50 R=2,5 A=1/2" GAS			
PB36010	CONICAL BIT D.5x50 R=2,5 A=1/2" GAS WITH WATER HOLES			
PB36011	CONICAL BIT D.8x50 R=4,0 A=1/2" GAS			
PB36012	CONICAL BIT D.8x50 R=4,0 A=1/2" GAS WITH WATER HOLES			

(\* ) *Type standard at Stock*

(\* ) *Tipo standard a magazzino*

[BACK TO INDEX](#)

Hard Metal Router Bits for Engraving **Marble** and **Granite**

Frese Metallo duro per scoltitura **Marmo** e **Granito**

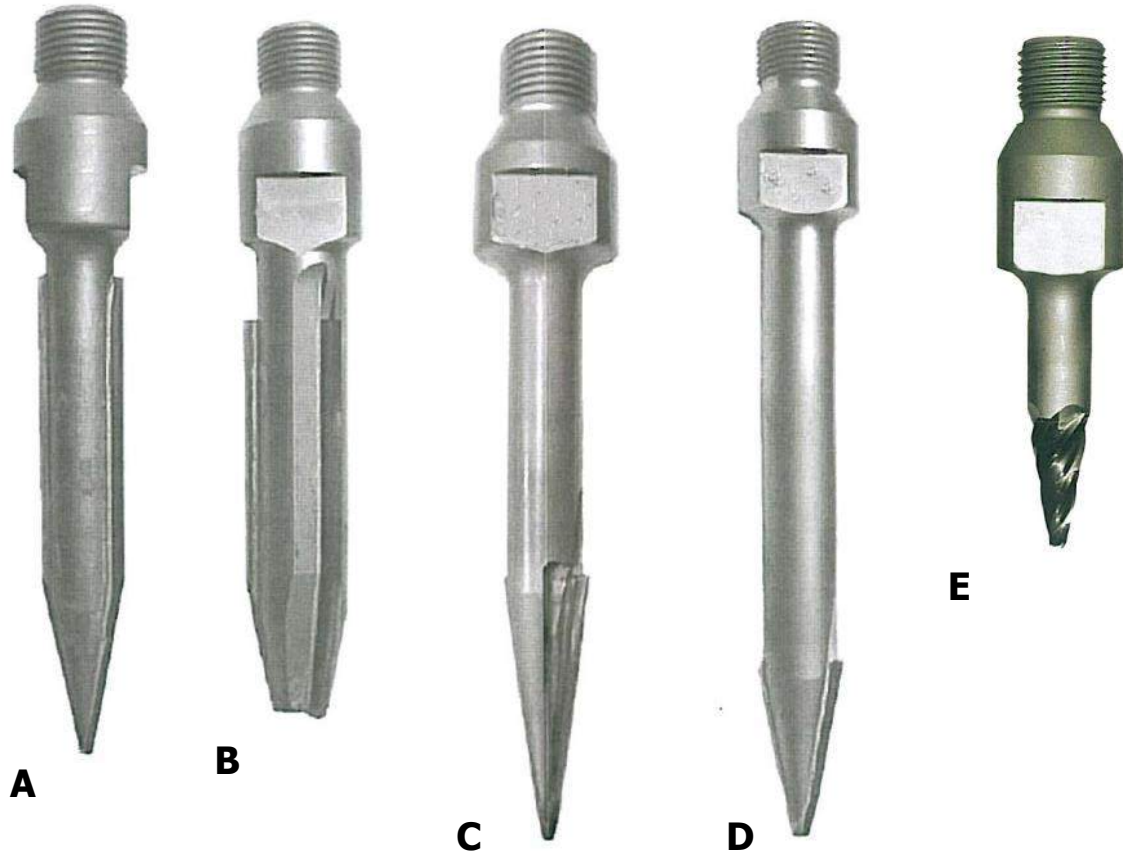

Type	ADI CODE	D [mm]	RPM	FEED [mm/min]	Stock Removal [mm]
A	PB36018	Conical Bit Ø18,9x120 (radius 1,5mm) A=1/2" Gas	3.000 4.000	150-300	3 Max
A	PB36019	Conical Bit Ø18,9x120 (radius 2,5mm) A=1/2" Gas			
B	PB36020	Conical Bit Ø20x100 LT=175 mm A=1/2" Gas			
C	PB36021	Conical Bit Ø3x50 (Radius=1,5mm) LU100 LT=170 A=1/2" Gas			
C	PB36022	Conical Bit Ø5x50 (Radius=2,5mm) LU100 LT=170 A=1/2" Gas			
C	PB36023	Conical Bit Ø8x50 (Radius=4,0mm) LU100 LT=170 A=1/2" Gas			
D	PB36024	Conical Bit Ø3x30 (Radius=1,5mm) LU110 LT=167 A=1/2" Gas			
D	PB36025	Conical Bit Ø5x30 (Radius=2,5mm) LU110 LT=167 A=1/2" Gas			
D	PB36026	Conical Bit Ø8x30 (Radius=4,0mm) LU110 LT=167 A=1/2" Gas			
E	PB36027	FIntegral Bit with Internal Water Ø5 A=1/2" Gas			

Hard Metal Router Bits for Engraving **Marble** and **Granite**

[BACK TO INDEX](#)

Frese metallo duro per scoltitura per **Marmo** and **Granite**



ADI CODE	Dimension [mm]	RPM	FEED [mm/min]	Stock Removal [mm]
PG29506	Flat St.10	3.000 4.000	150-300	3 Max
PG29540	Flat St.10 With Water			



ADI CODE	Dimension [mm]	RPM	FEED [mm/min]	Stock Removal [mm]
PG29507	R=10 St.10	3.000 4.000	150-300	3 Max
PG29541	R= 10 St.10 With Water			
PG29508	R= 5 St.10			
PG29542	R= 5 St.10 With Water			



ADI CODE	Dimension [mm]	RPM	FEED [mm/min]	Stock Removal [mm]
PG29522	R=2,7 St.10	3.000 4.000	150-300	Max 3
PG29537	R=2,7 St.10 With Water			
PG29538	R=4,0 St.10			
PG29539	R=4,0 St.10 With Water			

MINIMUM ORDER 5 PCS EACH.  
ORDINE MINIMO 5 PEZZI PER TIPOLOGIA

[BACK TO INDEX](#)

MINIMUM ORDER 5 PCS EACH.  
ORDINE MINIMO PER 5 PEZZI PER TIPOLOGIA



ADI CODE	Dimension [mm]	RPM	FEED [mm/min]	Stock Removal [mm]
PG29519	Conical 30° Flat 3	3.000 4.000	150-300	3 Max
PG29534	Conical 30° Flat 3 With Water			
PG29520	Conical 30° Flat 2			
PG29524	Conical 30° Flat 2 With Water			
PG29531	Conical 30° Flat 1,5			
PG29525	Conical 30° Flat 1,5 With Water			
PG29521	Conical 30° Flat 1			
PG29526	Conical 30° Flat 1 With Water			
PG29532	Conical 30° Flat 0,5			
PG09535	Conical 30° Flat 0,5 With Water			
PG29533	Conical 30° Flat 0			
PG09536	Conical 30° Flat 0 With Water			

ADI CODE	Dimension [mm]	RPM	FEED [mm/min]	Stock Removal [mm]
PG29523	Rounded R=3 30° St.10	3.000 4.000	150-300	3 Max
PG29543	Rounded R=3 30° St.10 With Water			
PG29544	Rounded R=2 30° St.10			
PG29545	Rounded R=2 30° St.10 With Water			
PG29546	Rounded R=1,5 30° St.10			
PG29547	Rounded R=1,5 30° St.10 With Water			
PG29548	Rounded R=1 30° St.10			
PG29549	Rounded R=1 30° St.10 With Water			
PG29550	Rounded R=0,5 30° St.10			
PG29551	Rounded R=0,5 30° St.10 With Water			

Integral Hard Metal Router Bits for Engraving **Marble**  
Frese integrali per metallo duro per scoltitura **Marmo**

[BACK TO INDEX](#)

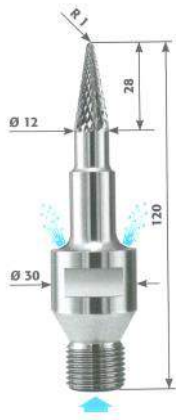

PB36015



PB36032

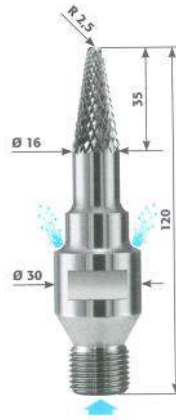

PB36033

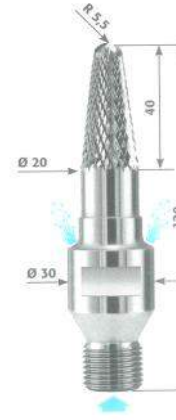

PB36016

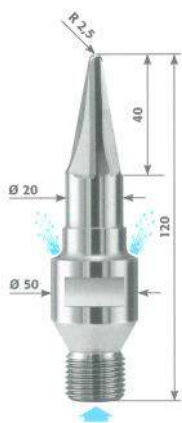

PB36036



PB36014



PB36034



PB36035

Conical Hard Metal Finger Bit

ADI Code	Description	RPM	FEED [mm/min]	Stock Removal [mm]
PB36015	BIT D.12X28 R=1.0 CONICAL A=1/2"GAS	3.500	150 - 300	Max 3
PB36032	BIT D.12X28 R=3.0 CONICAL A=1/2"GAS			
PB36033	BIT D.16X35 R=2.5 CONICAL A=1/2"GAS			
PB36016	BIT D.20X40 R=5.5 CONICAL A=1/2"GAS			
PB36036	BIT D.20X40 R=2.5 CONICAL A=1/2"GAS			
PB36014	BIT D.12X50 R=2.5 CONICAL A=1/2"GAS			
PB36034	BIT D.16X80 R=2.5 CONICAL A=1/2"GAS			
PB36035	BIT D.20X102 R=4.0 CONICAL A=1/2"GAS			

[BACK TO INDEX](#)

**Integral Hard Metal Router Bits for Engraving Marble**  
**Frese integrali per metallo duro per scoltitura Marmo**

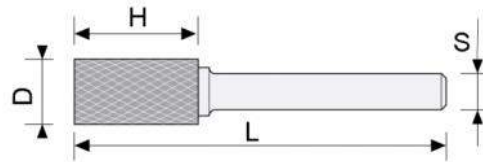

**Cilindrical Shape**



ADI Code	D	H	L	S
PB36535	4	14	50	6
PB36555	6	18	50	6
PB36536	8	18	63	6
PB36514	10	20	65	6
PB36537	12	25	70	6
PB36557	16	25	70	6
PB36538	16	25	70	8
PB36539	20	25	70	6
PB36540	20	25	70	8

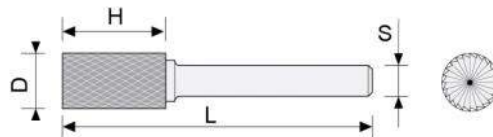

**Cilindrical Shape with End Cut**



ADI Code	D	H	L	S
PB36553	4	14	50	6
PB36509	6	18	50	6
PB36554	8	18	63	6
PB36510	10	20	65	6
PB36556	12	25	70	6
PB36511	16	25	70	6
PB36558	16	25	70	8
PB36559	20	25	70	6
PB36560	20	25	70	8

[BACK TO INDEX](#)

Integral Hard Metal Router Bits for Engraving **Marble**  
Frese integrali per metallo duro per scoltitura **Marmo**

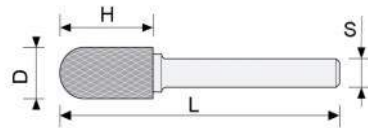

Cilindrica With Radius End Shape



ADI Code	D	H	L	S
PB36573	4	14	50	6
PB36574	6	18	50	6
PB36575	8	20	65	6
PB36515	10	20	65	6
PB36576	12	25	70	6
PB36577	16	25	70	6
PB36578	16	25	70	8
PB36579	20	25	70	6
PB36580	20	25	70	8

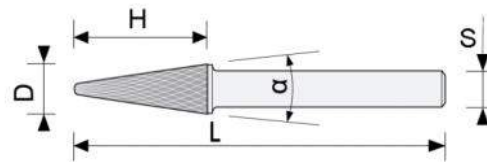

Conical With Radius End Shape



ADI Code	D	H	L	S	α
PB36589	4	14	50	6	14°
PB36502	6	20	50	6	14°
PB36503	8	24	69	6	14°
PB36504	10	28	73	6	14°
PB36590	12	30	75	6	14°
PB36591	16	38	83	6	14°
PB36592	16	38	83	8	14°
PB36593	20	42	87	6	14°
PB36594	20	42	87	8	14°

[BACK TO INDEX](#)

Integral Hard Metal Router Bits for Engraving **Marble**  
Frese integrali per metallo duro per scoltitura **Marmo**

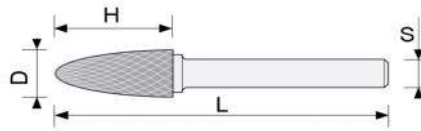

Ogiva With Radius End Shape



ADI Code	D	H	L	S
PB36619	4	14	50	6
PB36620	6	18	50	6
PB36621	8	16	61	6
PB36516	10	20	65	6
PB36622	12	25	70	6
PB36623	16	28	73	6
PB36624	16	28	73	8
PB36625	20	35	80	6
PB36626	20	35	80	8

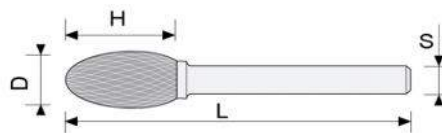

Oval With Radius End Shape



ADI Code	D	H	L	S
PB36636	4	6	50	6
PB36637	6	9	50	6
PB36638	8	14	59	6
PB36520	10	16	61	6
PB36639	12	21	66	6
PB36640	16	25	70	6
PB36641	16	25	70	8
PB36642	20	25	70	6
PB36643	20	25	70	8



[BACK TO INDEX](#)

**Integral Hard Metal Router Bits for Engraving **Marble****  
**Frese integrali per metallo duro per scoltitura **Marmo****

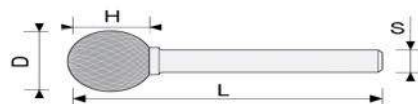

**Spherical Shape**



ADI Code	D	H	L	S
PB36672	4	3.5	50	6
PB36673	6	5	50	6
PB36674	8	7	52	6
PB36521	10	9	54	6
PB36675	12	11	56	6
PB36676	16	15	60	6
PB36677	16	15	60	8
PB36678	20	18	63	6
PB36679	20	18	63	8

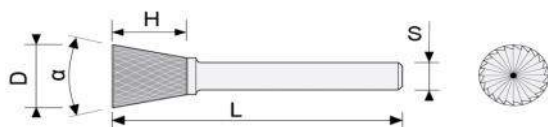

**Inverted Cone Shape With End Cut**



ADI Code	D	H	L	S	$\alpha$
PB36705	4	4	50	6	15°
PB36706	6	6	50	6	15°
PB36707	8	8	53	6	15°
PB36708	10	10	55	6	15°
PB36709	12	12	57	6	15°
PB36710	16	16	61	6	15°
PB36711	20	20	65	6	15°
PB36712	20	20	65	8	15°

[BACK TO INDEX](#)

**Integral Hard Metal Router Bits for Engraving Marble**  
**Frese integrali per metallo duro per scoltitura Marmo**

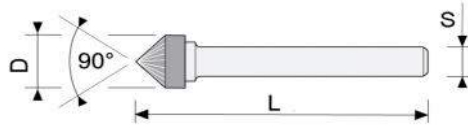

**90° Conical Shape**

ADI Code	D	L	S
PB36735	4	50	6
PB36736	6	50	6
PB36737	8	56	6
PB36519	10	57	6
PB36738	12	60	6
PB36739	16	64	6
PB36740	20	68	6
PB36741	20	68	8

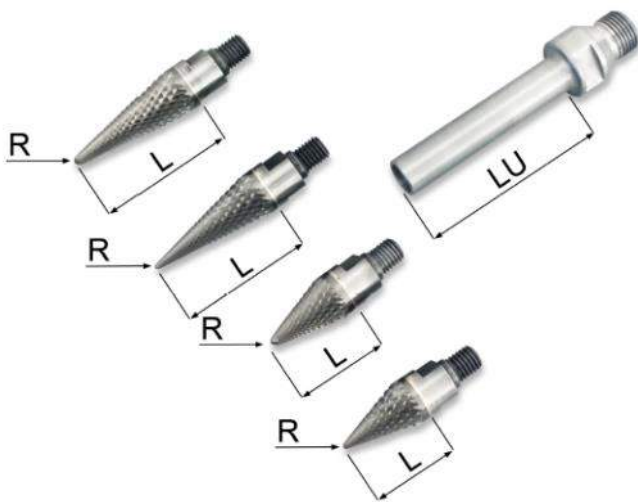

**Conical Hard Metal Finger Bit**

ADI Code	D	Connection	R [mm]	L [mm]
PB36037	20	M12	1.5	30
PB36038			1.5	50
PB36039			2.5	30
PB36040			2.5	50

**Adaptors**

ADI Code	LU	Connection	LU [mm]
SL02219	LU55	A=1/2" Gas	55
SL02376	LU90		90
SL02349	LU120		120
SL02377	LU150		150
SL02334	LU200		200

[BACK TO INDEX](#)

Sintered Router Bits for Engraving **Granite** with Internal Water  
Frese sinterizzate per scolpitura **Granito** con acqua interna

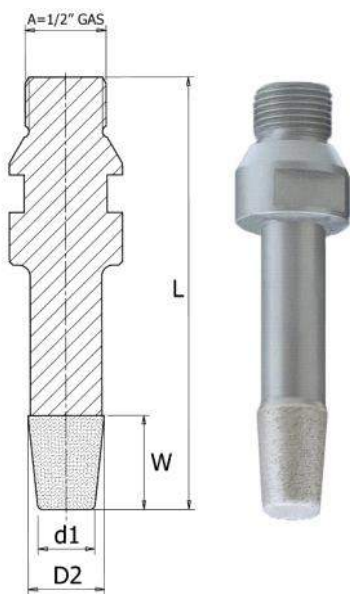

ADI CODE	d1 [mm]	D2 [mm]	W [mm]	L [mm]	RPM	FEED [mm/min]	Stock Removal [mm]
PB27221	6	11	25	115	7000 8000	150-300	3
PB27222	8	13	25	115			
PB27223	14	19	25	115			3-4
PB27224	15	20	25	115			
PB27225	25	30	25	115			

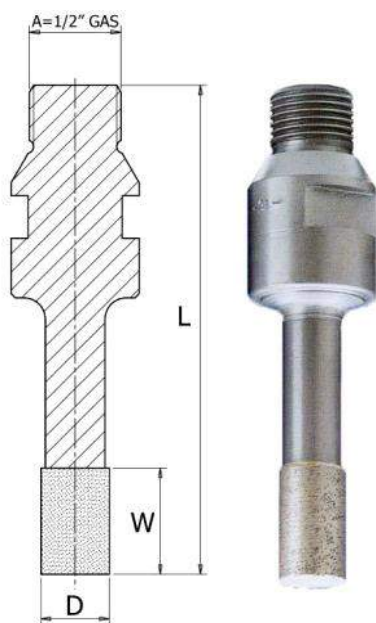

ADI CODE	D [mm]	W [mm]	L [mm]	RPM	FEED [mm/min]	Stock Removal [mm]
PB27226	16	25	115	7000 8000	150-300	3-4

[BACK TO INDEX](#)

Sintered Router Bits for Engraving **Granite**

Frese sinterizzate per **Granito**

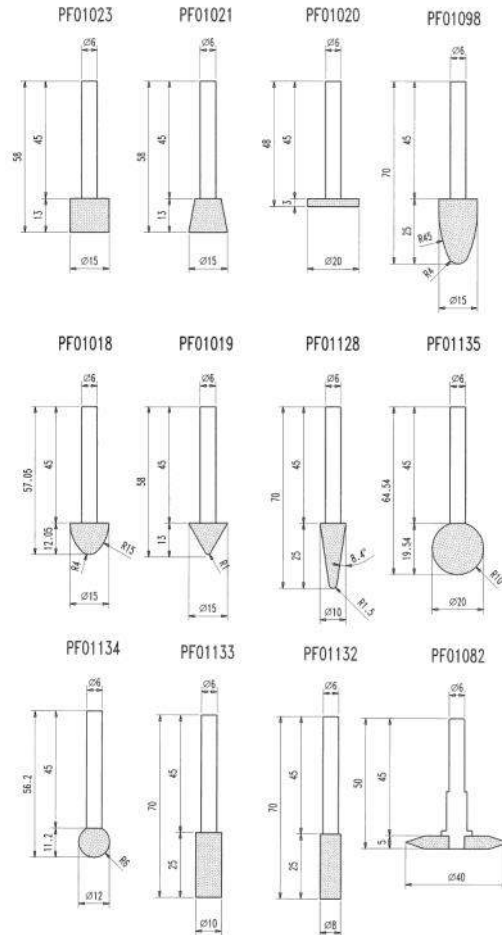

ADI CODE	D [mm]	W [mm]	L [mm]	Shaft [mm]	RPM	FEED [mm/min]	Stock Removal [mm]
PF01018	15	12	57	6	8.000 10.000	150-300	3
PF01019	15	12	58				3
PF01020	20	3	48				1,5-3
PF01021	15	13	58				3
PF01023	15	13	58				3
PF01098	15	25	70				3
PF01128	10	25	70				3
PF01135	20	19,5	64,5				3
PF01134	12	11,2	56				3
PF01133	10	25	70				3
PF01132	8	25	70				3
PF01082	40	5	50				3

[BACK TO INDEX](#)

Pcd Router Bits for Engraving **Granite**

Fresa PCD per scoltitura **Granito**

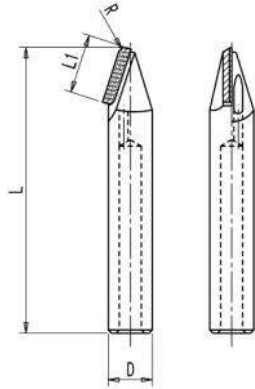

ADI CODE	D [mm]	R [mm]	L [mm]	L1 [mm]	RPM	FEED [mm/min]	Stock Removal [mm]
PB35201	10	1,5	65	13,5	7.000 8.000	180 250	0-3 Max
PB35202	10	2,5	65	12,5			0-3 Max
PB35203	10	3,5	65	15			0-3 Max

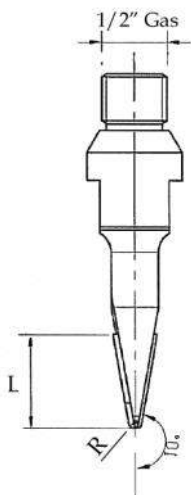

ADI CODE	DESCRIPTION	RPM	FEED [mm/min]	Stock Removal [mm]
PB35110	PCD CONICAL BIT D.3x30 R=1,5 A=1/2" GAS WITH WATER HOLES	7.000 8.000	180 250	0-3 Max
PB35111	PCD CONICAL BIT D.5x30 R=2,5 A=1/2" GAS WITH WATER HOLES			0-3 Max
PB35112	PCD CONICAL BIT D.8x30 R=4,0 A=1/2" GAS WITH WATER HOLES			0-3 Max

[BACK TO INDEX](#)

**Diamond Wheel for Sharpening Bits**  
**Mola per riaffilatura frese**

**For Hard Metal (Widia) Bits**  
**Per Metallo Duro frese (Widia)**



<i>ADI CODE</i>	<i>Dimension [mm]</i>
MA05024	6A2 100X10X2 F= 20

**For PCD bits**  
**Per frese PCD**



<i>ADI CODE</i>	<i>Dimension [mm]</i>
MA051387	6A2 100X10X4 F= 20

TOOL HOLDERS  
ADAPTORS  
AND  
ACCESSORIES  
-  
CONI  
ADATTATORI  
ACCESSORI

[BACK TO INDEX](#)

# ISO CONE PARTS

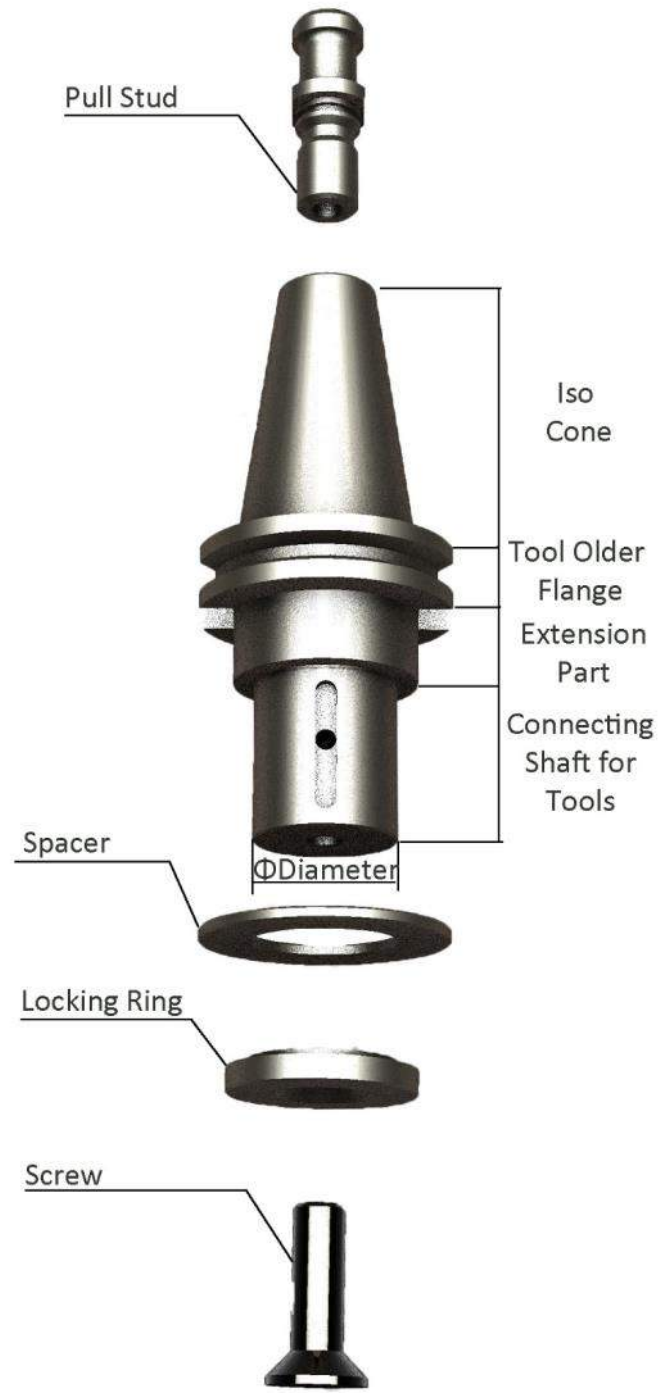



[BACK TO INDEX](#)

**TOOL HOLDERS WITH 1/2" GAS CONNECTION AND SHAFT Ø 35MM**  
**CONI 1/2" GAS E CON PERNO Ø 35MM**



Code	Product details	Machine
SL01037	HSK B80 - 1/2" Gas	Breton
SL01549	HSK B80 - 35x52(*)	Breton



Code	Product details	Machine
SL01554	ISO 40 - 1/2" Gas(-)	Intermac Bavelloni
SL01556	ISO 40 - 35x52(*)	Northwood Bimatech



Code	Product details	Machine
SL01572	ISO 40 - 1/2" Gas(-)	CMS/Brembana
SL01571	ISO 40 - 35x52(*)	



Code	Product details	Machine
SL01544	BT 40 - 1/2" Gas(-)	Denver Thibaut
SL01542	BT 40 - 35x52(*)	Park Industries



(-) Cone without pull stud

(\*) Cone without pull stud , with 2 spacers 60x5 calibrated , 2 spacers 48x5 calibrated , screw M12x30 and locking washer

**PULL STUD**

[BACK TO INDEX](#)

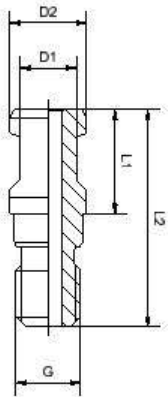

Code	D1	D2	L1	L2	G	Machine
SL01026	14	19	26	54	M16x2	CMS/Brembana Bavelloni Park Industries (II° Gen.) Northwood

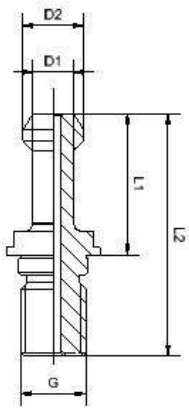

Code	D1	D2	L1	L2	G	Machine
SL01057	10	15	35	60	M16x2	V.E.M. Denver Park Industries (I° Gen.) Thibaut (Old)

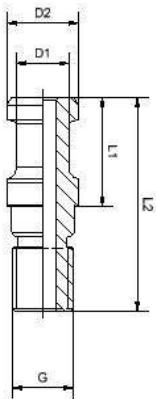

Code	D1	D2	L1	L2	G	Machine
SL01425	14	19	29	57	M16x2	Thibaut (New)

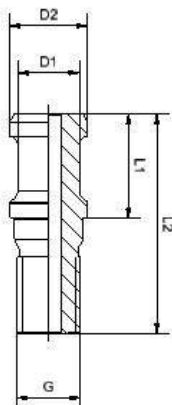

Code	D1	D2	L1	L2	G	Machine
SL01109	15	19	26	54	M16x2	Intermac



[BACK TO INDEX](#)

**EXTENSION M30 - F= 1/2" GAS**  
**PROLUNGHE M30—1/2" GAS**

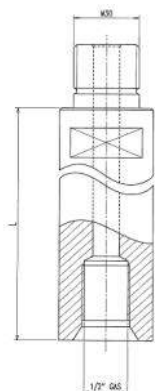

Code	Product details
SL01184	A=M30 L=100mm F=1/2"G
SL01185	A=M30 L=150mm F=1/2"G
SL01186	A=M30 L=200mm F=1/2"G
SL01187	A=M30 L=300mm F=1/2"G



**EXTENSION FLANGE - F= 1/2" GAS**

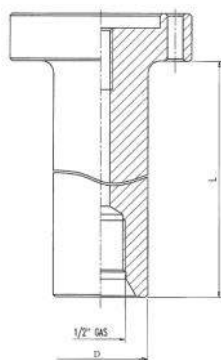

Code	Product details
SL02445	A=FLANGE L=100mm D38 F=1/2"G
SL02408	A=FLANGE L=150mm D38 F=1/2"G
SL02057	A=FLANGE L=170mm <b>D28</b> F=1/2"G
SL02443	A=FLANGE L=200mm D38 F=1/2"G



**EXTENSION FLANGE - FLANGE**

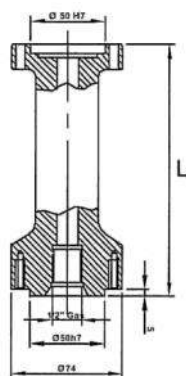

Code	Product details
SL01157	A=FLANGE L=100mm F=FLANGE
SL01158	A=FLANGE L=170mm F=FLANGE
SL01159	A=FLANGE L=200mm F=FLANGE
SL01160	A=FLANGE L=225mm F=FLANGE



**EXTENSION 1/2" GAS**

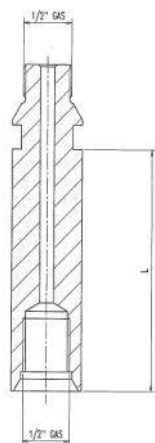

Code	Product details
SL02208	A=1/2"G L=100 F=1/2"G
SL02343	A=1/2"G L=150 F=1/2"G
SL02382	A=1/2"G L=200 F=1/2"G
SL02217	A=1/2"G L=300 F=1/2"G



[BACK TO INDEX](#)

**Extension Flange - 14 (3 Holes) or 10 (2 Holes)**

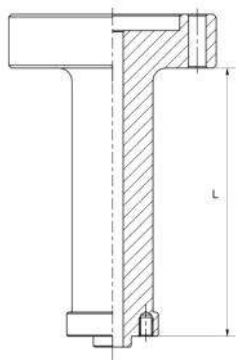

ADI CODE	DIMENSION [D]	Fitting	L [mm]
SL01407	Φ14x4 (3 Holes)	Flange	100
SL01408	Φ14x4 (3 Holes)	Flange	200
SL01430	Φ10x4 (2 Holes)	Flange	100
SL01431	Φ10x4 (2 Holes)	Flange	200



**Extension M30 - 14 (3 Holes) or 10 (2 Holes)**

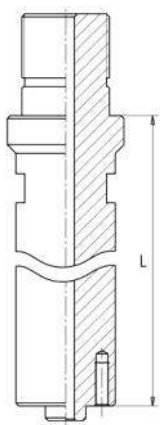

ADI CODE	DIMENSION [D]	Fitting	L [mm]
SL02487	Φ14x4 (3 Holes)	M30	100
SL02489	Φ14x4 (3 Holes)	M30	200
SL02704	Φ10x4 (2 Holes)	M30	100
SL02705	Φ10x4 (2 Holes)	M30	200



**Extension M30 - Flange**

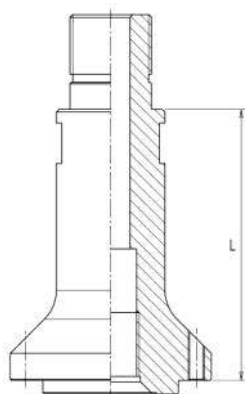

ADI CODE	DIMENSION [D]	Fitting	L [mm]
SL01409	50x5	M30 - Flange	100
SL01410	50x5	M30 - Flange	200



[BACK TO INDEX](#)

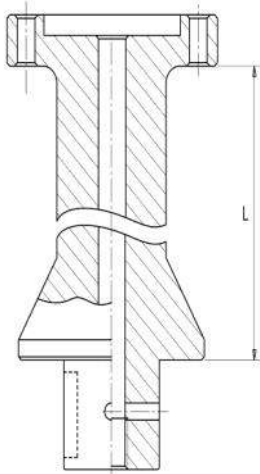

**EXTENSION A=35 - Flange**

Code	Product details
SL01088	A=35 L=70 Flange
SL01095	A=35 L=160 Flange

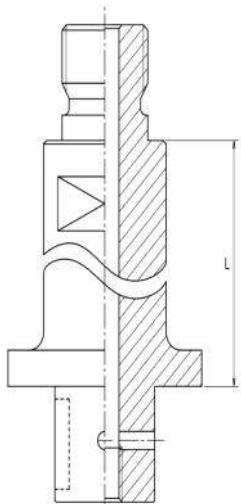

**EXTENSION A=35 - M30**

Code	Product details
SL01077	A=35 L=70 M30
SL01072	A=35 L=140 M30



**EXTENSION A= 35 - A=1/2" Gas**

Code	Product details
SL01123	A= 35 L= 90 - A=1/2" Gas

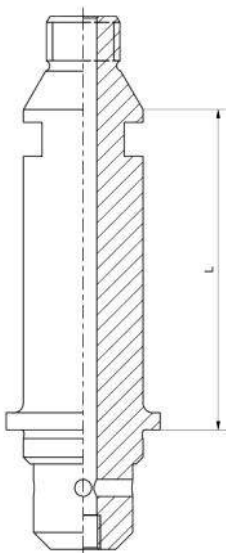

[BACK TO INDEX](#)

**EXTENSION A=1/2" GAS - M12**

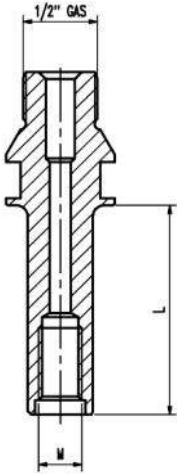

Code	Product details
SL02219	A=1/2" GAS—M12 L= 55
SL02376	A=1/2" GAS—M12 L= 90
SL02349	A=1/2" GAS—M12 L=120
SL02377	A=1/2" GAS—M12 L=150
SL02334	A=1/2" GAS—M12 L=200

**EXTENSION A=1/2" GAS - M18**

Code	Product details
SL02518	A=1/2" GAS—M18 L= 90
SL02548	A=1/2" GAS—M18 L= 200



**EXTENSION A=1/2" GAS - D.34**

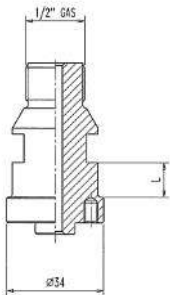

Code	Product details
SL02358	A=1/2" Gas (L=12) - D.14x4+3 Holes
SL02479	A=1/2" Gas (L=60) - D.14x4+3 Holes
SL02399	A=1/2" Gas (L=90) - D.14x4+3 Holes
SL02392	A=1/2" Gas (L=150) - D.14x4+3 Holes
SL02613	A=1/2" Gas (L=12) - D.14x4+2 Holes



**EXTENSION A=1/2" GAS - D.72**

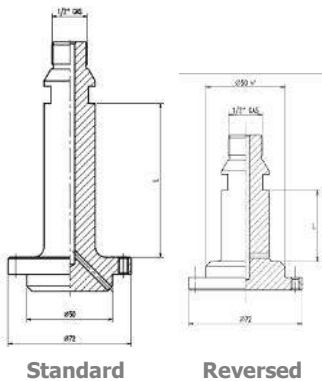

Code	Product details
PB29015	A=1/2" GAS - D.50x10 + 3 Holes
SL02347	A=1/2" GAS D.50x10 (L= 90) + 3 Holes
SL02396	A=1/2" GAS D.50x10 (L=150) + 3 Holes
SL01056	A=1/2" GAS D.50x10 (L=45) + 3 Holes (Reversed)



**EXTENSION F=35 - D.72**

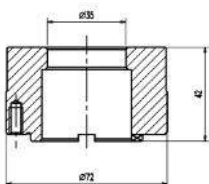

Code	Product details
SL01050	F= 35 - D.50x3 +3 Holes



[BACK TO INDEX](#)

**ADAPTORS FOR FLAT POLISHING**

*Adattatore per Lucidanti superfici piane (OCTO)*



Code	Product details	Machine
SL02595	D.35/20X40	THIBAUT

**ADAPTORS**



Code	Product details	Machine
SL02275	D.35/20X40	BREMBANA
SL02262	D.35/30X32	BREMBANA/RAVELLI
SL02288	D.35/22X32	INTERMAC
SL02261	D.35/25X32	MARMOMECCANICA

**ADAPTORS FOR ISO CONE WITH 1/2" GAS**



Code	Product details
SL01055	A=1/2" GAS D.22x39
SL01033	A=1/2" GAS D.20x39
SL02015	SPACER ADAPTOR FOR BAVELLONI



[BACK TO INDEX](#)

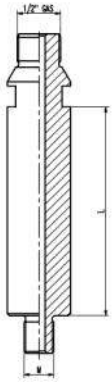

**EXTENSION A=1/2" GAS - M14**

Code	Product details
SL02264	A=1/2" GAS—M14 (A)
SL02496	A=1/2" GAS—M14 L= 100 (B)

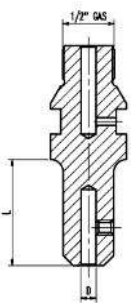

**EXTENSION A=1/2" GAS - Shaft 6mm**

Code	Product details
SL02103	A=1/2" GAS - L=42 Shaft 6mm

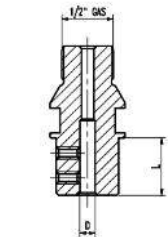

**EXTENSION A=1/2" GAS - Different Shaft Connection**

Code	Product details
SL02005	A=1/2" GAS - Shaft 6mm
SL02002	A=1/2" GAS - Shaft 10mm

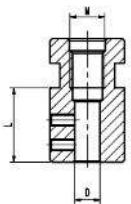

**EXTENSION F=M14 - Shaft 10mm Connection**

Code	Product details
SL02014	ATTACCO F=M14 - F=10

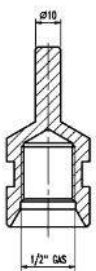

**EXTENSION Shaft 10mm - 1/2" Gas Connection Female**

Code	Product details
SL02008	Shaft 10 - 1/2" Gas Female





[BACK TO INDEX](#)

**Premium Adapter A=1/2GAS**



ADI Code	Description
SL02231	ER 16 Adapter A=1/2"Gas
SL02656	ER 25 Adapter A=1/2"Gas
SL02500	ER 32 Adapter A=1/2"Gas

*Complete of Key and Collets D.6 and D.10*

**Nut Replacement**



ADI Code	Description
SL02333	Nut for ER 16
SL02657	Nut for ER 25
SL02563	Nut for ER 32

**Special Key Replacement**



ADI Code	Description
SL02352	Key for ER 16
SL02658	Key for ER 25
SL02607	Ket for ER 32

**Collet Table**

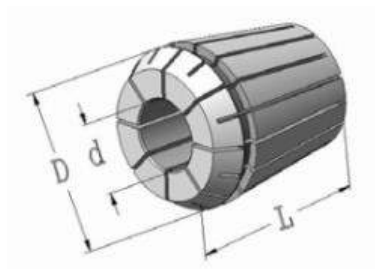

ADI Code	Type	L	D [mm]	d [mm]
PB29695	ER 16	27.5	16	2.50
PB29519	ER 16	27.5	16	3.00
PB29170	ER 16	27.5	16	6.00
PB29696	ER 16	27.5	16	8.00
PB29172	ER 16	27.5	16	10.00
PB29697	ER 20	31.5	20	2.50
PB29698	ER 20	31.5	20	3.00
PB29686	ER 20	31.5	20	6.00
PB29685	ER 20	31.5	20	8.00
PB29679	ER 20	31.5	20	10.00
PB29699	ER 25	34	25	2.50
PB29700	ER 25	34	25	3.00
PB29701	ER 25	34	25	6.00
PB29702	ER 25	34	25	8.00
PB29703	ER 25	34	25	10.00
PB29704	ER 32	40	32	2.50
PB29663	ER 32	40	32	3.00
PB29668	ER 32	40	32	6.00
PB29705	ER 32	40	32	8.00
PB29596	ER 32	40	32	10.00

For finger bit with Diameter 2.35 shaft we suggest to use collet of diameter 2.5mm

[BACK TO INDEX](#)



**Economical Adapter Shaft 12mm to A=1/2GAS Female**

ADI Code	Description
SL02006	Adaptor St.12 - 1/2" Gas

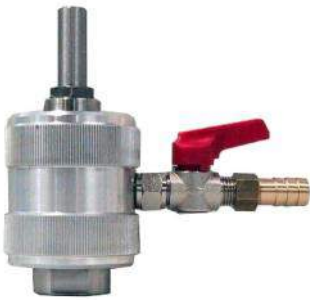

**Professional Adapter Shaft 12mm to A=1/2GAS Female**

ADI Code	Description
SL02009	Adaptor St.13 - 1/2" Gas



**Professional Adapter A=1/2GAS Male to A=1/2GAS Female**

ADI Code	Description
SL02283	Adaptor 1/2" Gas M - 1/2" Gas F

[BACK TO INDEX](#)

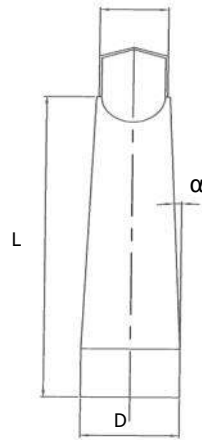

Morse	D	d	L	$\alpha$
1	12,065	9,388	57	1°26'
2	17,78	14,527	70	1°26'
3	23,825	19,771	86	1°26'
4	31,267	26	108	1°26'
5	44,399	37,564	137	1°26'



**Adapter Morse to A=1/2GAS Female Without Flange**

ADI Code	Description
SL01012	Adaptor Morse 1 - 1/2" Gas Without Flange
SL01006	Adaptor Morse 2 - 1/2" Gas Without Flange
SL01001	Adaptor Morse 3 - 1/2" Gas Without Flange



**Adapter Morse to A=1/2GAS Female With Flange**

ADI Code	Description
SL01005	Adaptor Morse 3 - 1/2" Gas With Flange
SL01004	Adaptor Morse 4 - 1/2" Gas With Flange
SL01003	Adaptor Morse 5 - 1/2" Gas With Flange

[BACK TO INDEX](#)

**TOOL HOLDERS FOR WHEELS BORE 35 mm**



Code	Product details	Machine
SL01034	HSK-B80	BRETON CNC
SL01241	HSK-B80	BRETON CNC
SL01041	ISO 40 D.35x39	BREMBANA
SL01250	ISO 40 D.35x47	BREMBANA
SL01058	BT 40 D.35x39	V.E.M. - Park (1° gen.)
SL01248	BT 40 D.35x47	V.E.M. - Park (1° gen.)
SL01306	BT 40 D.35x39	DENVER
SL01307	BT 40 D.35x47	DENVER
SL01357	BT 40 D.35x39	THIBAUT
SL01419	BT 40 D.35x47	THIBAUT
SL01028	ISO 50 D.35x39	OMAG
SL01255	ISO 50 D.35x47	OMAG
SL01256	ISO 40 D.35x39	OMAG
SL01217	ISO 40 D.35x47	OMAG
SL01066	ISO 40 D.35x39	C.M.S.
SL01249	ISO 40 D.35x47	C.M.S.
SL01047	ISO 40 D.35x39	INTERMAC
SL01102	ISO 40 D.35x47	INTERMAC
SL01099	ISO 40 D.35x39	BAVELLONI
SL01257	ISO 40 D.35x47	BAVELLONI
SL01258	ISO 40 D.35x39	NORTHWOOD OLD
SL01259	ISO 40 D.35x47	NORTHWOOD OLD

**BORE 35 mm to Flange Adaptor (for Cone 35x39)**



Code	Product details
SL01417	D.72 Bore 35mm

[BACK TO INDEX](#)

**TOOL HOLDERS FOR WHEELS BORE 22 mm**



<i>Code</i>	<i>Product details</i>	<i>Machine</i>
SL01254	HSK-B80 D.22x39	BRETON CNC
SL01230	ISO 40 D.22x39	BREMBANA
SL01219	BT 40 D.22x39	V.E.M. - Park (1° gen.)
SL01394	BT 40 D.22x20	DENVER
SL01329	BT 40 D.22x39	DENVER
SL01420	BT 40 D.22x39	THIBAUT
SL01239	ISO 50 D.22x39	OMAG
SL01237	ISO 40 D.22x39	OMAG
SL01395	ISO 40 D.22x20	C.M.S.
SL01231	ISO 40 D.22x39	C.M.S.
SL01398	ISO 40 D.22x20	INTERMAC CNC
SL01124	ISO 40 D.22x39	INTERMAC CNC
SL01396	ISO 40 D.22x20	BAVELLONI
SL01129	ISO 40 D.22x39	BAVELLONI
SL01397	ISO 40 D.22x20	NORTHWOOD OLD
SL01235	ISO 40 D.22x39	NORTHWOOD OLD
SL01443	ISO 40 D.22x20	BIMATECH
SL01301	ISO 40 D.22x39	BIMATECH

**TOOL HOLDERS FOR TOOLS WITH 1/2" GAS CONNECTION**



<i>Code</i>	<i>Product details</i>	<i>Machine</i>
SL01049	ISO 40 - 1/2" GAS	BREMBANA
SL01305	BT 40 - 1/2" GAS	DENVER
SL01098	ISO 50 - 1/2" GAS	OMAG
SL01260	ISO 40 - 1/2" GAS	OMAG
SL01070	ISO 40 - 1/2" GAS	C.M.S.

[BACK TO INDEX](#)

**TOOL HOLDERS FOR TOOLS WITH FLANGE CONNECTION**



<i>Code</i>	<i>Product details</i>	<i>Machine</i>
SL01322	HSK-B80-FLANGE	BRETON CNC
SL01023	ISO 40 - FLANGE	BREMBANA
SL01189	BT 40 - FLANGE	V.E.M. - Park (I° gen.)
SL01323	BT 40 - FLANGE	DENVER
SL01392	BT 40 - FLANGE	THIBAUT
SL01308	ISO 40 - FLANGE	OMAG
SL01311	ISO 50 - FLANGE	OMAG
SL01113	ISO 40 - FLANGE	C.M.S.
SL01073	ISO 40 - FLANGE	INTERMAC CNC
SL01209	ISO 40 - FLANGE	BAVELLONI
SL01324	ISO 40 - FLANGE	NORTHWOOD OLD

**TOOL HOLDERS FOR TOOLS WITH M30 CONNECTION**



<i>Code</i>	<i>Product details</i>	<i>Machine</i>
SL01035	HSK-B80-M30	BRETON CNC
SL01325	ISO 40 - M30	BREMBANA
SL01078	BT 40 - M30	V.E.M. - Park (I° gen.)
SL01326	BT 40 - M30	DENVER
SL01422	BT 40 - M30	THIBAUT
SL01327	ISO 40 - M30	OMAG
SL01064	ISO 50 - M30	OMAG
SL01075	ISO 40 - M30	C.M.S.
SL01032	ISO 40 - M30	INTERMAC CNC
SL01060	ISO 40 - M30	BAVELLONI
SL01328	ISO 40 - M30	NORTHWOOD OLD

[BACK TO INDEX](#)

**PULL STUD**

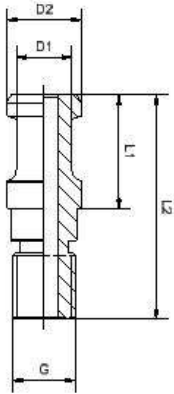

Code	D1	D2	L1	L2	G	Machine
SL01428	14	19	29	57	M16x2	Omag (Iso 40)

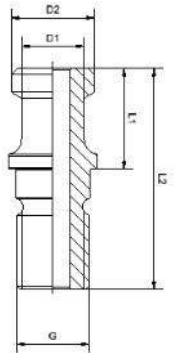

Code	D1	D2	L1	L2	G	Machine
SL01415	21	28	34	74,5	M24	Omag (ISO 50)

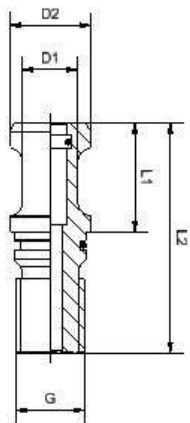

Code	D1	D2	L1	L2	G	Machine
SL01423	15	19	26	54	M16x2	Bimatech



[BACK TO INDEX](#)



# TOOLS FOR EDGE POLISHING MACHINES

-

UTENSILI PER  
MACCHINE  
LUCIDACOSTE

[BACK TO INDEX](#)

## EDGE POLISHING TOOLS VIEW

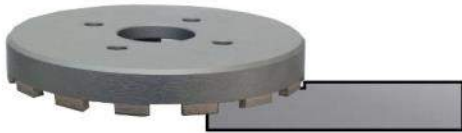

CALIBRATING WHEEL

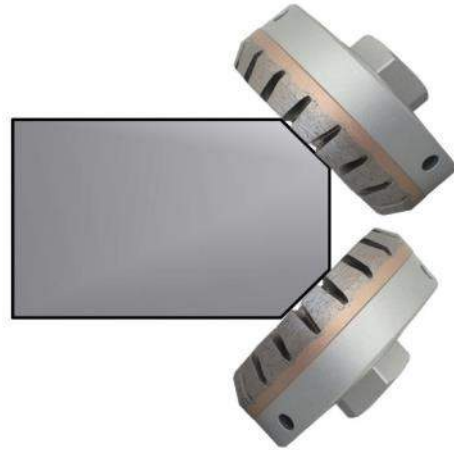

PRECUTTING WHEELS

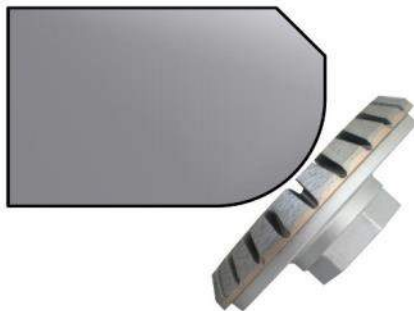

GENERATING WHEEL

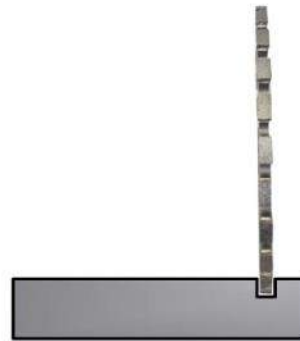

GROOVING WHEEL

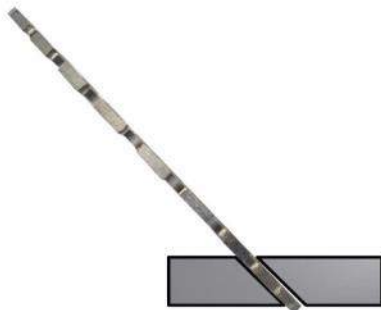

45° CUTTING BLADE



90° CUTTING BLADE

[BACK TO INDEX](#)



A

CALIBRATING



B



PRE CUT



GENERATING WHEEL



GROOVING



CUTTING



CUTTING 45°

Application	Description	Fitting	Code	Model
Calibrating	D.260 (A)	B50 + 4	PA34103	Platinum Edge
	D.175 (B)	B50 + 4	PE05107	Easy Edge
Pre Cut	D.130	B94	PA32116	Platinum Edge
Generating	D.130 SLOT	M30x1,5	PA33381	Platinum Edge
Grooving	D.250 x 6	B30	PC06167	Platinum Edge
	D.250 x 8	B50 + 4	PC06215	Easy Edge
Cutting Blade	D.250	B50 + 4	PH02310	Easy Edge
Cutting Blade 45°	D.250 TSET	B50 + 4	PF01146	Platinum Edge

All original manufacturer and brands are used for identification purposes only

\*trademark property of BRETON Spa

[BACK TO INDEX](#)

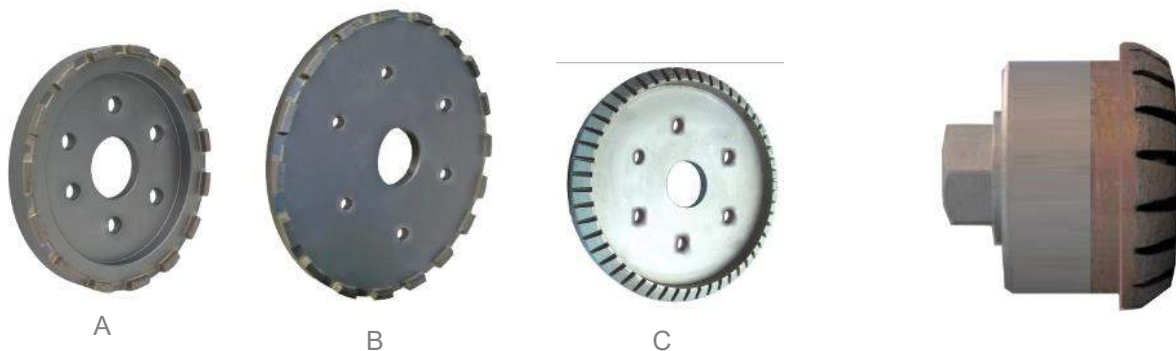

CALIBRATING WHEELS

PRE CUT

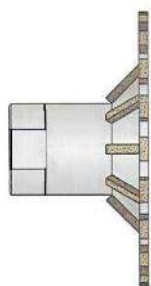

COMBI PRE CUT



GENERATING WHEEL



GROOVING

Application	Description	Fitting	Code	Model
Calibrating	D.200 (A)	B50 + 6	PA34064	
	D.250 (B)	B50 + 6	PA34025	
	D.200 TUR (C)	B50 + 6	PA32082	
Pre Cut Combi Pre Cut	D.130 TUR	M30	PA32055	
	D.150 SEG	M30	PA35009	
Generating	D.130	M30	PA33190	
	D.150	M30	PA33413	
Grooving	D.250x6	B50 + 6	PC06127	
	D.250x8	B50 + 6	PC06203	
	D.300x6	B50 + 6	PC06188	
	D.300x8	B50 + 6	PC06129	

All original manufacturer and brands are used for identification purposes only

\*trademark property of CMIG S.r.l.

[BACK TO INDEX](#)

# CMPI \*



CALIBRATING



A



B

PRE CUT



GENERATING WHEEL



GROOVING

Application	Description	Fitting	Code	Model
Calibrating	D.250	B50 + 8	PA34013	LA 80 - LP 100 - MINI 60
Pre Cut	D.250 Silenced (A)	B50 + 8	PA32042	LA 80
	D.150 (B)	B50 + 4	PA32099	MINI 60
Generating	D.155 SLOT	SNAIL	PA33176	MINI 60
Grooving	D.250 x 8	B50 + 8	PC06011	LA 80 - LP 100 - MINI 60

All original manufacturer and brands are used for identification purposes only

\*trademark property of CMPI Technology S.r.l.

[BACK TO INDEX](#)



CALIBRATING



PRE CUT



A



B

GENERATING WHEELS



BEVELLING



GROOVING

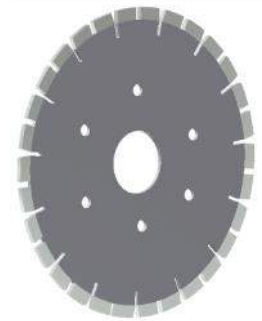

CUTTING

Application	Description	Fitting	Code	Model
Calibrating	D.260	B50 + 4	PA34011	Edilux - Pnc - Omega
	D.190	B50 + 4	PA34095	Musa - Alma - Penta
Pre Cut	D.155	B50 + 4	PA32111	Synthesis - Omega
Generating	D.130 C.R. (A)	M30	PA33186	Pnc - Omega - Synthesis
	D.130 SLOT (B)	M30	PA33334	Pnc - Omega - Synthesis
Bevelling	D.100	M30	PA45018	Edilplus - Penta - Musa
	D.100	B32	PD02027	Pnc - Omega - Synthesis
Grooving	D.200x4	B50 + 6	PC06144	Edilux-Synthesis-Omega-Alma-Musa
	D.200x6	B50 + 6	PC06106	
	D.200x8	B50 + 6	PC06077	
	D.250 x 8	B50 + 4+6	PC06019	Omega 60/100 - Alma - Musa
Cutting Blade	D.300 x 8	B50 + 6	PC06032	Edilux - Synthesis
	D.210x2,8	B50 + 6	PH02071	Synthesis - Edilux
	D.260x2,8	B50 + 6 + 4	PH02072	Synthesis - Edilux - Omega

All original manufacturer and brands are used for identification purposes only

\*trademark property of Comandulli CM S.r.l.

[BACK TO INDEX](#)



\*

**marmo meccanica** SPA

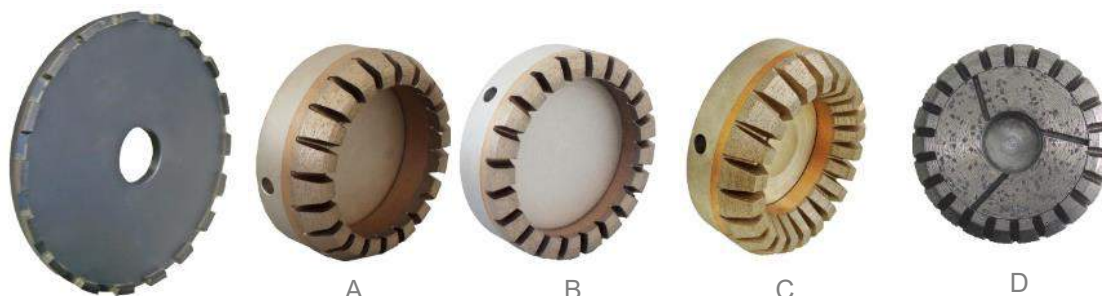

CALIBRATING

PRE CUT WHEELS

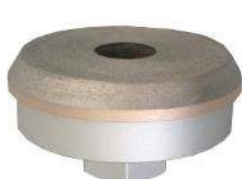

A



B

GENERATING WHEELS



GROOVING

Application	Description	Fitting	Code	Model
Calibrating	D.250	B50	PA34002	LCT - LCV - LCH - LTH
Pre Cut	D.130x18 (A)	M24	PA32001	LCT - LCV
	D.130x15 (B)	M24	PA32007	LCT - LCV
	D.130 BI-TUR (C)	M24	PA32098	LCT - LTH
	D.150 COMBI (D)	M24	PA32010	LTH
Generating	D.130 (A)	M24	PA33153	LCT
	D.150 (B)	M24	PA33018	LTA - LTH
Grooving	D.250 x 8	B50	PC06019	LCT - LCV - LCH - LTH

All original manufacturer and brands are used for identification purposes only

\*trademark property of Marmo Meccanica Spa

[BACK TO INDEX](#)



**MONTRESOR**

\*



CALIBRATING



A



B



C



D



E

PRE CUT WHEELS



A



B

GENERATING WHEELS



GROOVING



CUTTING

Application	Description	Fitting	Code	Model
Calibrating	D.250	B50	PA34041 (DX)	LOLA - LUNA - LARA - UNICA
			PA34086 (SX)	
Pre Cut	D.130 TUR (A)	M30	PA32009	LARA - LUNA
	D.130 SEG (B)	M30	PA32048	LARA - LUNA
	D.130 BI TUR (C)	M30	PA32097	LARA - LUNA
	D.250 TUR (D)	B50	PA32042	LARA
	D.300 TUR (E)	B50	PA32030	LARA
Generating	D.130 (A)	M30	PA33130	LARA
	D.155 (B)	M30	PA33403	LUNA
Grooving	D.250 x 6	B50 4+4	PC06121	LOLA - LUNA - LARA - UNICA
Cutting	D.250	B50 4+4	PH01123	VIVA
	D.260	B50 4+4	PH01122	VIVA

All original manufacturer and brands are used for identification purposes only

\*trademark property of Montresor & C. S.r.l.



[BACK TO INDEX](#)



\*



CALIBRATING



A



B

PRE CUT WHEELS



GENERATING WHEEL



GROOVING

Application	Description	Fitting	Code	Model
Calibrating	D.140 TUR	B30	PA34005	MODULO—SUPER MODULO-COMET
Pre Cut	D.130 SEG (A)	B84	PA32059	COMET
	D.150 SEG (B)	B30	PA32062	MODULO—SUPER MODULO
Generating	D.150	B30	PA33007	MODULO—SUPER MODULO-COMET
Grooving	D.200 x 8 x10	B30	PC06078	MODULO—SUPER MODULO-COMET

All original manufacturer and brands are used for identification purposes only

\*trademark property of O.M.G.M. S.r.l.

[BACK TO INDEX](#)



CALIBRATING



CALIBRATING + GROOVING



PRE CUT



GENERATING WHEEL



GROOVING



CUTTING



ADAPTOR

Application	Description	Fitting	Code	Model
Calibrating	D.130 SET	B95	PA34004	EXPERIENCE TE - FULL TE
Calibrating + Grooving	D.160 SET	B50+6	PA27362	FLYING FLAT - RCM TE
Pre Cut	D.130 TUR	B95	PA32005	RCM TE - EXPERIENCE TE - FULL TE
Generating	D.130	B95	PA33010	RCM TE - EXPERIENCE TE - FULL TE
Grooving	D.160 x 8	B50+6	PC06108	EXPERIENCE TE - FULL TE
Cutting	D.250 x 3	B40	PH02124	EXPERIENCE FULL TE
Adaptor	D.130	95 + 6	SL02249	RCM TE - EXPERIENCE TE - FULL TE

All original manufacturer and brands are used for identification purposes only

\*trademark property of SASSOMECCANICA S.r.l.

[BACK TO INDEX](#)

## EAGLE LINE FLAT EDGE TOOLS



Pos Grit	Description	Fitting	Code	Model
POS.1 [40/50]	D.130x40x4	SNAIL	PE05098	-
POS.1/2 [60/80]	D.130x40x4	SNAIL	PE05077	-
POS.2 [140/170]	D.130x40x4	SNAIL	PE05069	-
POS.1 [40/50]	D.150x40x4	SNAIL	PE05112	-
POS.1/2 [60/80]	D.150x40x4	SNAIL	PE05211	-
POS.2 [140/170]	D.150x40x4	SNAIL	PE05113	-

[BACK TO INDEX](#)

## MULTI MACHINE HALF AND FULL BULLNOSE WHEELS



Application	Description	Fitting	Code	Model
HALF BULLNOSE	D.250 R=15 CC	B50 4+4	PA04003	COMANDULLI - CMPI - MARMOMECCANICA - MONTRESOR
	D.250 R=20 CC		PA04004	
	D.250 R=25 CC		PA04034	
	D.250 R=30 CC		PA04218	
	D.250 R=31,5 CC		PA04072	



Application	Description	Fitting	Code	Model
FULL BULLNOSE	D.250 R=11 CC	B50 4+4	PA11002	COMANDULLI - CMPI - MARMOMECCANICA - MONTRESOR
	D.250 R=16 CC		PA11003	
	D.250 R=21 CC		PA11004	

[BACK TO INDEX](#)

## V GROOVING SYSTEM

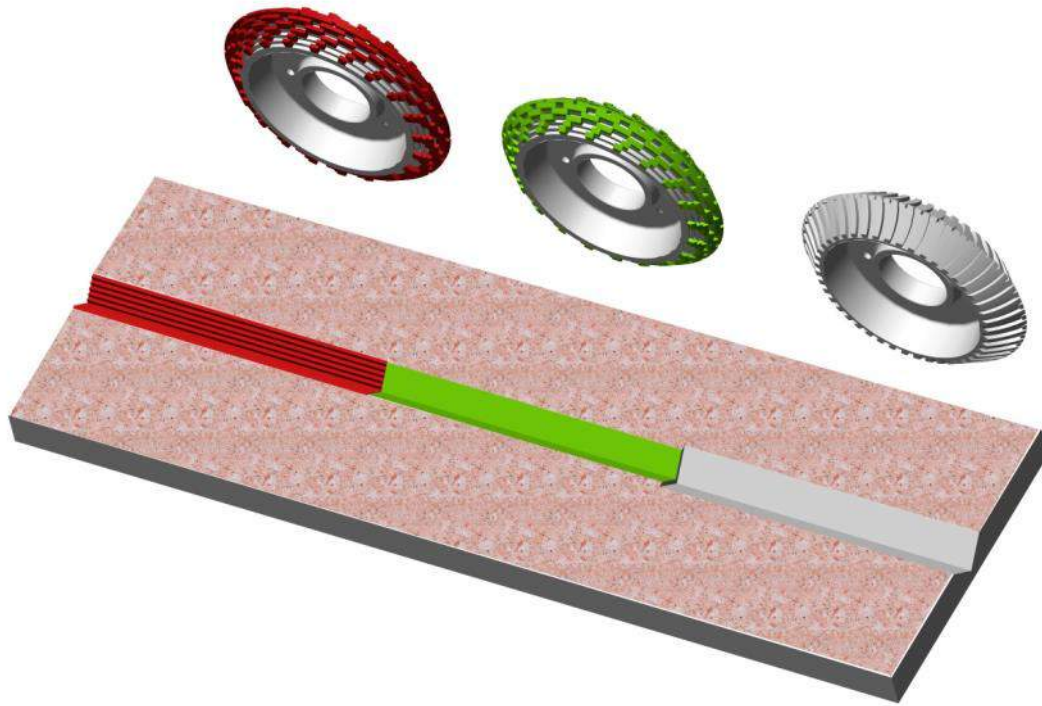

Application	Description	Fitting	Code	Model
V GROOVING	1EE1 LAM D.300 S=20	B90	PA27585	BRETON COLDEN GROOVE CTV 3
	1EE1 SEG D.300 S=20		PA27559	
	1EE1 LAM D.300 S=30		PA27586	
	1EE1 LAM D.300 S=30		PA27553	
	1EE1 SEG D.300 S=30		PA27554	
			PA27547	

[BACK TO INDEX](#)

## SINGLE HEAD EDGE POLISHING TOOLS



A



B



C



D



E

Application	Description	Fitting	Code	Model
FRONTAL	D.120x27,5+15 (A)	B40 + 4	PA33158	COMANDULLI
FRONTAL	D.150x27,5+15 (A)	B40 + 4	PA33448	COMANDULLI
FRONTAL	D.120x27,5+15 (B)	M24	PA33165	COMANDULLI
FRONTAL	D.120x35x4 (C)	M18	PA33175	COMANDULLI
FRONTAL	D.120x35x5 (C)	M18	PA33185	COMANDULLI
FRONTAL	D.100x35x4 (C)	M18	PA33295	DENVER QUASAR
FRONTAL	D.120x49x3 (D)	SNAIL	PA33203	MARMOMECCANICA
FRONTAL	D.130x40x3	M24x2	PE05078	THIBAUT T55

[BACK TO INDEX](#)

## RAPTOR LINE SINGLE HEAD EDGE POLISHING TOOLS



Pos Grit	Description	Fitting	Code	Model
POS.00 [30/40]	D.100x25x6	SMALL SNAIL	PE12083	ALL SNAIL MACHINES
POS.1 [45/50]	D.100x25x6	SMALL SNAIL	PE12084	ALL SNAIL MACHINES
POS.2 [270/325]	D.100x25x5	SMALL SNAIL	PE12085	ALL SNAIL MACHINES
POS.00 [30/40]	D.125x25x6	<b>SMALL</b> SNAIL	PE12106	ALL SNAIL MACHINES
POS.1 [45/50]	D.125x25x6	<b>SMALL</b> SNAIL	PE12105	ALL SNAIL MACHINES
POS.2 [270/325]	D.125x25x5	<b>SMALL</b> SNAIL	PE12107	ALL SNAIL MACHINES
POS.00 [30/40]	D.125x25x6	SNAIL	PE12088	ALL SNAIL MACHINES
POS.1 [45/50]	D.125x25x6	SNAIL	PE12089	ALL SNAIL MACHINES
POS.2 [270/325]	D.125x25x5	SNAIL	PE12111	ALL SNAIL MACHINES

[BACK TO INDEX](#)

Threaded aluminium adaptors  
Adattatore in alluminio avvitato



Description	Fitting	Code
D.100	5/8" USS	PZSUP07
D.100	M18	PZSUP08
D.100	M20	PZSUP09
D.100	M24	PZSUP10
D.100	M30	PZSUP11
D.130	5/8" USS	PZSUP12
D.130	M18	PZSUP13
D.130	M20	PZSUP14
D.130	M24	PZSUP15
D.130	M30	PZSUP16

Snail support with Velcro  
Support a chioccola con Velcro



Description	Fitting	Code
D.100 RIGID	SNAIL	PZSUP27
D.100 + 2 RUBBER	SNAIL	PZSUP28
D.100 + 10 RUBBER	SNAIL	PZSUP29
D.130 RIGID	SNAIL	PZSUP30
D.130 + 2 RUBBER	SNAIL	PZSUP31
D.130 + 10 RUBBER	SNAIL	PZSUP32
D.150 RIGID	SNAIL	PZSUP33
D.150 + 2 RUBBER	SNAIL	PZSUP34
D.150 + 10 RUBBER	SNAIL	PZSUP35



[BACK TO INDEX](#)

# Uno Evolution

Edge Polishing Wheels

Mole per lucidatura costa piana

Ø130



ADI CODE	D [mm]	FITTING	GRIT SIZE	COLOR
PA43291	130	Snail Lock	100/120	Green
PA43292	130		200/230	White
PA43293	130		325/400	Yellow
PA43294	130		400/500	Blue
PA43295	130		800	Orange
PA43296	130		1200	Dark Green
PA43297	130		1800	Red
PA43298	130		3000	Black

[BACK TO INDEX](#)

# Uno Evolution

Edge Polishing Wheels

Mole per lucidatura costa piana

Ø150



ADI CODE	D [mm]	FITTING	GRIT SIZE	COLOR
PA43373	150	Snail Lock	100/120	Green
PA43374	150		200/230	White
PA43375	150		325/400	Yellow
PA43376	150		400/500	Blue
PA43377	150		800	Orange
PA43378	150		1200	Dark Green
PA43379	150		1800	Red
PA43380	150		3000	Black

[BACK TO INDEX](#)

## SHINING Ø130

*Flat Edge Polishing Wheels*  
*Mole per lucidatura costa piana*



*Suggested for natural stone , eginereed stone*

*Suggerito per pietra naturale e agglomerati*

*Optional*

ADI CODE	D [mm]	FITTING	GRIT SIZE
PA43329	125	Snail	46
PA43330	125	Lock	60

ADI CODE	D [mm]	FITTING	GRIT SIZE
PA43321	125	Snail Lock	80
PA43322	125		120
PA43323	125		220
PA43324	125		320
PA43325	125		400
PA43326	125		600
PA43327	125		800

[BACK TO INDEX](#)

**SHINING Ø150**  
*Flat Edge Polishing Wheels*  
*Mole lucidanti per costa piana*



*Optional*

ADI CODE	D [mm]	FITTING	GRIT SIZE
PA43353	150	<i>Snail</i>	46
PA43336	150	<i>Lock</i>	60

ADI CODE	D [mm]	FITTING	GRIT SIZE
PA43337	150	<i>Snail</i> <i>Lock</i>	80
PA43338	150		120
PA43339	150		220
PA43340	150		320
PA43341	150		400
PA43342	150		600
PA43343	150		800

[BACK TO INDEX](#)

## SHINING GALAXY Ø130

*Flat Edge Polishing Wheels*

*Mole lucidanti per costa piana*



With Rubber

ADI CODE	Diameter [mm]	Abrasive Height [mm]	FITTING	GRIT SIZE
PA43440	125	24	Snail Lock	60
PA43441	125	24		80
PA43354	125	24		120
PA43355	125	24		220
PA43356	125	24		320
PA43357	125	11		400
PA43358	125	11		600
PA43359	125	11		800

[BACK TO INDEX](#)

## SPEED LINE

*Flat Edge Polishing Wheels*  
*Lucidanti piane profilo dritto*



ADI Code	Diameter [mm]	FITTING	GRIT SIZE
PA43404	125	Snail Lock	60
PA43405	125		120
PA43406	125		200
PA43407	125		400
PA43408	125		800
PA43409	125		1500
PA43410	125		3000

ADI Code	Diameter [mm]	FITTING	GRIT SIZE
PA43411	150	Snail Lock	60
PA43412	150		120
PA43413	150		200
PA43414	150		400
PA43415	150		800
PA43416	150		1500
PA43417	150		3000

*Bevel Polishing Wheels*  
*Mole lucidanti per smusso*



<i>ADI Code</i>	<i>Diameter [mm]</i>	<i>FITTING</i>	<i>GRIT SIZE</i>
PA43451	130	<i>Snail</i>	400
PA43452	130	<i>Lock</i>	800

Solution for two head machine

Soluzione per macchina con due teste

<i>ADI Code</i>	<i>Diameter [mm]</i>	<i>FITTING</i>	<i>GRIT SIZE</i>
PA43451	130	<i>Snail</i>	400
PA43452	130		800
PA43453	130	<i>Lock</i>	1500

Solution for three head machine

Soluzione per macchina con tre teste

[BACK TO INDEX](#)

## OCTO LINE

*Flat Edge Polishing Wheels*  
*Lucidanti piane per profili dritti*



ADI Code	Diameter [mm]	FITTING	GRIT SIZE
PB29604	125	Snail Lock	100
PB29605	125		200
PB29606	125		500
PB29607	125		1000
PB29608	125		2000
PB29609	125		3000

ADI Code	Diameter [mm]	FITTING	GRIT SIZE
PB29639	150	Snail Lock	100
PB29640	150		200
PB29641	150		500
PB29642	150		1000
PB29643	150		2000
PB29644	150		3000



[BACK TO INDEX](#)



# CNC TOOLS FOR UTENSILI CNC PER

**U**LTRA  
**E**OMPACT  
**S**URFACES

[BACK TO INDEX](#)



Bore 60mm

**Segmented Diamond Blades for ULTRA COMPACT SURFACES**

- ⇒ With Soft Bond for Low Power Machines (Less Than 20HP)
- ⇒ With Reinforced Body for Cutting 45° On UCS Materials and glass

**Disco a settori per materiali ULTRA COMPACT SURFACES**

- ⇒ Legante morbido per macchine con potenza meno di 20HP
- ⇒ Corpo rinforzato per taglio a 45° su materiali UCS e vetro

ADI Code	Description	RPM	FEED [mm/min]
MTD64003	<b>Φ350</b>	1600 / 1800	400-600
MTD64001	<b>Φ400</b>	1400 / 1600	300-500

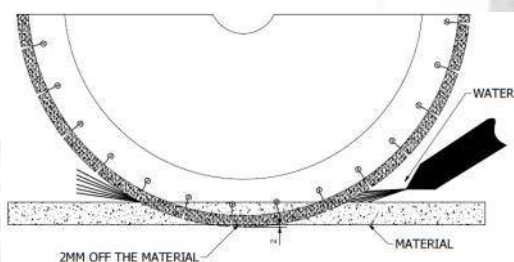

For the 45° we suggest to reduce the Feed speed 50%  
*Per taglio 45° suggeriamo la riduzione dell'avanzamento del 50%*

[BACK TO INDEX](#)

**ULTRA  
COMPACT  
SURFACES**



Bore 60mm

**Segmented Diamond Blades for ULTRA COMPACT SURFACES**

- ⇒ With Soft Bond for Low Power Machines (Less Than 20HP)
- ⇒ With Reinforced Body for Cutting 45° On UCS Materials, and Glass
- ⇒ Snarrows tooting for low pressure and low tension cutting
- ⇒ Very fine cut , no chipped edge

**Disco a settori per materiali ULTRA COMPACT SURFACES**

- ⇒ Settori morbidi per macchine con bassa potenza (meno di 20HP)
- ⇒ Corpo rinforzato per taglio a 45° su materiali UCS e Vetro
- ⇒ Settori ravvicinati per bassa pressione e bassa tensione di taglio
- ⇒ Taglio pulito senza sbecature

ADI Code	Description	RPM	FEED [mm/min]
MTJ64001	Φ350	2.000	500-1.500
MTJ64002	Φ400	1.600	500-1.500
MTJ64003	Φ450	1.400	500-1.500



Bore 60mm

**Segmented Diamond Blades for ULTRA COMPACT SURFACES-SPEED**

- ⇒ With Soft Bond for Hight Power Machines (Hight Than 20HP)
- ⇒ With Reinforced Body for Cutting 45° On UCS Materials and Glass
- ⇒ Silent core and hight advance speed

**Disco a settori per materiali ULTRA COMPACT SURFACES- VELOCE**

- ⇒ Legante morbido per macchine con alta potenza (più di 20HP)
- ⇒ Corpo rinforzato per taglio a 45° su materiali UCS e vetro
- ⇒ Corpo silenziato e alta velocità di avanzamento

ADI Code	Description	RPM	FEED [mm/min]
MTJ64006	Φ350	2.000	1.200-2.000
MTJ64007	Φ400	1.600	1.200-2.000
MTJ64008	Φ450	1.400	1.200-2.000

[BACK TO INDEX](#)

**ULTRA  
COMPACT  
SURFACES**



**Turbo Segmented Diamond Blades**

⇒ **With Standard Bond for High Power Machines (Minimum 20 HP)**

**Disco a settori TURBO**

⇒ **Settori standard per macchine con alta potenza (minimo 20 HP)**

<i>ADI Code</i>	<i>Description</i>	<i>RPM</i>	<i>FEED</i> [mm/min]
MT64031	<b>Φ250 Bore Φ50</b>	2.000-2.200	1.000-1.200
MT64036	<b>Φ300 Bore Φ60</b>	1.600-1.800	1.000-1.200
MT64015	<b>Φ350 Bore Φ60</b>	1.300-1.600	1.000-1.200
MT64016	<b>Φ400 Bore Φ60</b>	1.200-1.500	1.000-1.200
MT64017	<b>Φ500 Bore Φ60</b>	1.000-1.200	1.000-1.200

**Continuous Rim Diamond Blades for Gres Materials (Wet Cutting)**

**Disco a fascia continua specifico per materiali ceramici (taglio umido)**



<i>ADI Code</i>	<i>Description</i>	<i>RPM</i>	<i>FEED</i> [mm/min]
MT60003	<b>Φ250 Bore Φ30</b>	2.400-2.600	600-1.000
MT60001	<b>Φ280 Bore Φ30</b>	2.000-2.200	600-1.000
MT60015	<b>Φ300 Bore Φ60</b>	1.600-1.800	800-1.200
MT60012	<b>Φ350 Bore Φ60</b>	1.300 - 1.600	1.000 - 1.200
MT60005	<b>Φ400 Bore Φ60</b>	1.200 - 1.500	1.000 - 1.200
MT60006	<b>Φ450 Bore Φ60/50</b>	1.100-1.300	800-1.200

[BACK TO INDEX](#)

**ULTRA  
COMPACT  
SURFACES**

1/2" gas



**Blind Drills**  
**Foretti ciechi**

<i>ADI Code</i>	<i>Description</i>	<i>RPM</i>	<i>FEED</i> [mm/min]
MT82006	<b>D.6x10</b>	4.000-6.000	15-30
MT82007	<b>D.7x10</b>	4.000-6.000	15-30
MT82008	<b>D.8x10</b>	4.000-6.000	15-30
MT82010	<b>D.10x10</b>	4.000-6.000	15-30
MT82012	<b>D.12x10</b>	4.000-6.000	15-30





Core Drills (Thin Wall 1mm)

Foretti a settori (Parete sottile 1mm)

<i>ADI Code</i>	<i>Description</i>	<i>Working Length</i>	<i>RPM</i>	<i>FEED [mm/min]</i>
MT81106	<b>D.6</b>	<b>16</b>	4.000-5.000	15-30
MT81108	<b>D.8</b>	<b>16</b>	4.000-5.000	15-30
MT81110	<b>D.10</b>	<b>16</b>	4.000-5.000	15-30
MT81112	<b>D.12</b>	<b>16</b>	4.000-5.000	15-30
MT81115	<b>D.15</b>	<b>16</b>	4.000-5.000	15-30
MT81118	<b>D.18</b>	<b>16</b>	4.000-5.000	15-30
MT81120	<b>D.20</b>	<b>16</b>	4.000-5.000	15-30
MT81122	<b>D.22</b>	<b>16</b>	2.600-3.000	15-30
MT81125	<b>D.25</b>	<b>26</b>	2.400-2.800	15-30
MT81130	<b>D.30</b>	<b>26</b>	2.200-2.600	15-30
MT81132	<b>D.32</b>	<b>26</b>	2.000-2.400	15-30
MT81135	<b>D.35</b>	<b>26</b>	1.800 -2.200	15-30
MT81138	<b>D.38</b>	<b>16</b>	1.600-2.000	15-30
MT81140	<b>D.40</b>	<b>16</b>	1.600-2.000	15-30
MT81168	<b>D.68</b>	<b>35</b>	1.100-1.500	15-30

**ULTRA  
COMPACT  
SURFACES**

Core Drills (Segment Thickness 2mm)

Foretti (spessore corona 2mm)

[BACK TO INDEX](#)



1/2" gas



ADI Code	Description	RPM	FEED [mm/min]
MT81215	<b>D.15</b>	4.000-6.000	15-30
MT81218	<b>D.18</b>	4.000-6.000	15-30
MT81220	<b>D.20</b>	4.000-5.000	15-30
MT81222	<b>D.22</b>	2.600-3.000	15-30
MT81225	<b>D.25</b>	2.400-2.800	15-30
MT81230	<b>D.30</b>	2.200-2.600	15-30
MT81232	<b>D.32</b>	2.000-2.400	15-30
MT81235	<b>D.35</b>	1.800 -2.200	15-30
MT81240	<b>D.40</b>	1.600-2.000	15-30
MT81250	<b>D.50</b>	1.500-2.100	15-30
MT81260	<b>D.60</b>	1.300-1.800	15-30
MT81268	<b>D.68</b>	1.100-1.500	15-30
MT81270	<b>D.70</b>	1.100-1.500	15-30
MT81280	<b>D.80</b>	1.000-1.400	15-30
MT81310	<b>D.100</b>	800-1.200	15-30

ADI Code	Description	RPM	FEED [mm/min]
MT81325	<b>D.25</b>	2.400-2.800	15-30
MT81335	<b>D.30</b>	2.200-2.600	15-30
MT81330	<b>D.35</b>	1.800 -2.200	15-30





[BACK TO INDEX](#)

**ULTRA  
COMPACT  
SURFACES**

Segmented Finger Bit

Fresa settori



1/2" gas



ADI Code	Description	RPM	FEED [mm/min]
MT74022	Ø 20x15 Z5	4.000 - 4.500	150 - 250
MT74028	Ø 22x25 Z6	4.000 - 4.500	150 - 250
MT74030	Ø 22x35 Z6	4.500 - 4.800	250 - 300
MT74031	Ø 22x35 Z6 With Bottom Crown Con settore in testa	3.700 - 4.000	150 - 250

Incremental Cutting Finger Bit Pos.1

Fresa incrementale Pos. 1



1/2" gas

ADI Code	Description	RPM	FEED [mm/min]	Stock Removal [mm]
MT75037	Φ16x15	6.000-7.000	150-250	2 Max
MT75038	Φ20x15	5.000-6.000	150-250	2 Max

Incremental Cutting Finger Bit Pos.1

Fresa Incrementale Pos. 1



1/2" gas

ADI Code	Description	RPM	FEED [mm/min]	Stock Removal [mm]
MT75039	Φ20x15	5.000-6.000	150-250	2 Max
SL02204	1/2" GAS Male M12 Female L=20	-	-	-



M12

**ULTRA  
COMPACT  
SURFACES**

BACK TO INDEX



Segmented Finger Bit **with Left Thread**

Fresa settori **filetto sinistro**



1/2" gas



ADI Code	Description	RPM	FEED [mm/min]
MT74033	Ø 22x35 Z6	4.500 - 4.800	250 - 300
MT74041	Ø 22x35 Z6 With Bottom Crown	3.700 - 4.000	150 - 250

Incremental Cutting Finger Bit **Pos.1 with Left Thread**

Fresa incrementale **Pos. 1 filettatura sinistra**



1/2" gas

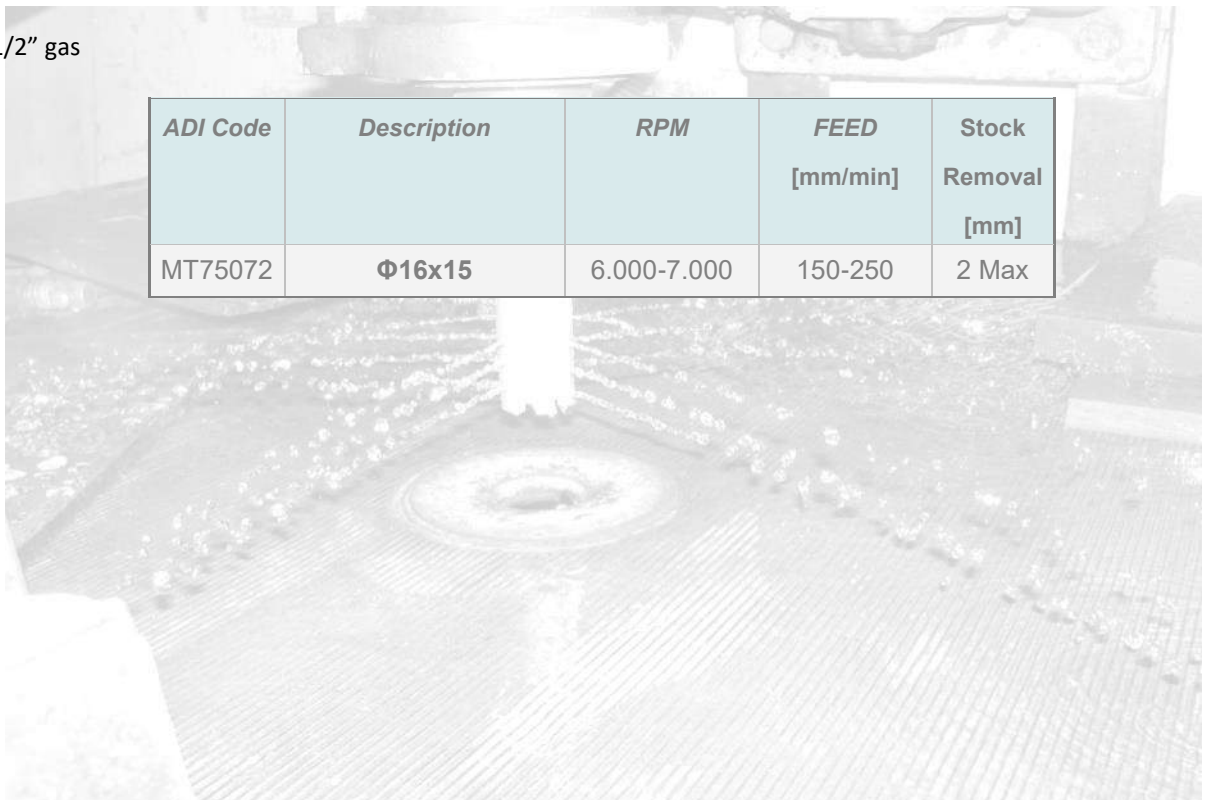

[BACK TO INDEX](#)

**ULTRA  
COMPACT  
SURFACES**



1/2" gas

Filotop Finger Bit **Pos.2**

Fresa per Filotop Pos. 2

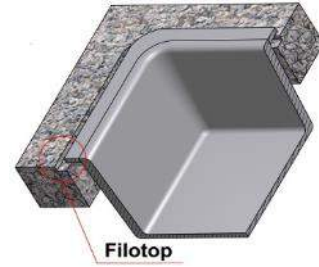

M12

ADI Code	Description	RPM	FEED [mm/min]	Stock Removal [mm]
MT75019	$\Phi 20 \times 15$	5.000-6.000	1.000-1.200	0,5 Max
SL02204	1/2" GAS Male M12 Female L=20	-	-	-

1/2" gas



Filotop Finger Bit **Pos.2**

Fresa per Filotop Pos. 2

ADI Code	Description	RPM	FEED [mm/min]	Stock Removal [mm]
MT75015	$\Phi 6 \times 12$	6.000 - 7.000	1.000-1.200	0,5 Max
MT75016	$\Phi 8 \times 12$	6.000 - 7.000	1.000-1.200	0,5 Max
MT75017	$\Phi 10 \times 12$	6.000 - 7.000	1.000-1.200	0,5 Max
MT75018	$\Phi 12 \times 12$	6.000 - 7.000	1.000-1.200	0,5 Max
MT75021	$\Phi 14 \times 15$	6.000 - 7.000	1.000-1.200	0,5 Max
MT75022	$\Phi 16 \times 15$	5.500 - 6.000	1.000-1.200	0,5 Max
MT75020	$\Phi 20 \times 15$	5.000 - 5.500	1.000-1.200	0,5 Max

**ULTRA  
COMPACT  
SURFACES**

[BACK TO INDEX](#)

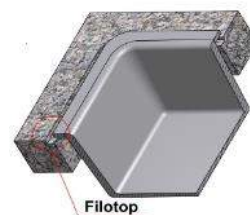

Incremental Cutting Finger Bit **Pos.2 with Left Thread**

Fresa incrementale **Pos. 2 filettatura sinistra**

ADI Code	Description	RPM	FEED [mm/min]	Stock Removal [mm]
MT75065	Φ6x12	6.000 - 7.000	1.000-1.200	0,5 Max
MT75066	Φ8x12	6.000 - 7.000	1.000-1.200	0,5 Max
MT75067	Φ10x12	6.000 - 7.000	1.000-1.200	0,5 Max
MT75068	Φ12x12	6.000 - 7.000	1.000-1.200	0,5 Max



[BACK TO INDEX](#)

**ULTRA  
COMPACT  
SURFACES**

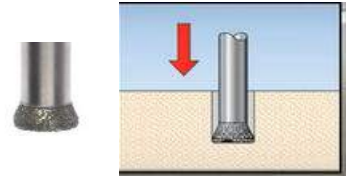

Sintered router bit for Anchor System for ULTRA COMPACT SURFACES  
Fresa sinterizzata per ancoraggio MATERIALI COMPATTI

ADI Code	Description	RPM	FEED [mm/min]
MT83101	D.7 - 45° - KEIL	7.000-10.000	15-30
MT83102	D.10 - 45° - FISCHER	7.000-10.000	15-30



[BACK TO INDEX](#)

Drain Board Wheels  
Mola da scasso



D



C



ADI Code	Description	Type	RPM	FEED [mm/min]	Stock Removal [mm]
MT73037	Φ150x28x7 Bore 50				
MT73030	Φ91x28x7 Bore 50		4.000 - 4.500	400 - 600	1 to 4 Max
MT73032	Φ54x28x7 Bore 14		5.500 - 6.000	400 - 600	1 to 3 Max
PB29015	Φ72 (3 Holes)	C	-	-	-
SL02358	Φ34 (3 Holes)	D	-	-	-



**Router for Grooving**  
**Utensili per gocciolatoio**



1 2 3 4

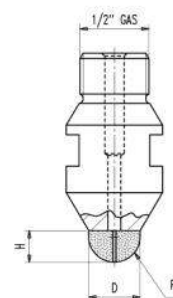

Code	Dimensions [mm]	Position	Stock Removal [mm]	RPM	Feeding Speed [mm/min]
MT75033	Φ12 R=6	1	to shape	6.000-7.000	150-200
MT75034		2	0,2-0,15		300-400
MT75035		3	0,15-0,1		
MT75036		4	0,1		
MT75023	Φ16 R=8	1	to shape	5.000-6.000	150-200
MT75024		2	0,2-0,15		300-400
MT75025		3	0,15-0,1		
MT75026		4	0,1		

**Router for Grooving for 90° angle gear**  
**Utensili per gocciolatoio per rinvio angolare 90°**



Code	Dimensions [mm]	Pos	Stock Removal [mm]	RPM [mm/min.]	Feeding Speed [mm/min]
MT73028	Φ140x12x6 R=8 B=30	1	Max 3	4.000	1.000
PB38204	Φ140x12 R=8 B=30	2	0,05 - 0,1	3.500	800

[BACK TO INDEX](#)

**ULTRA  
COMPACT  
SURFACES**

*PCD router for writing*

*Frese PCD per scrittura*

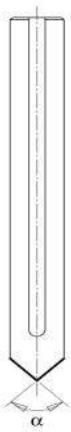

ADI CODE	Dimension [mm]	RPM	FEED [mm/min]	Stock Removal [mm]
PB35009	PCD D.10 - 36° With Water	7.000 8.000	150-250	0-3 Max
PB35002	PCD D.10 - 70° With Water			
PB35001	PCD D.10 - 90° With Water			
PB35004	PCD D.10 - 120° With Water			
PB35032	PCD D.15 - 90° With Water			
PB35030	PCD D.22 - 90° With Water			

**PCD ROUTER FOR FILO TOP**



ADI CODE	Dimension [mm]	RPM	FEED [mm/min]	Stock Removal [mm]
PB35031	PCD D.12 With Water	7.000 8.000	150-250	0-3 Max







[BACK TO INDEX](#)

ED = EXTERNAL DIAMETER

ID = INTERNAL DIAMETER

## Working Parameters for profiling tools

### Parametri di lavoro per mole a profilo

Description	RPM	FEED [mm/min]	Stock Removal [mm]
<b>TOP LINE TOOLS</b>	<b>Ø 120MM</b>		
UCS TOP LINE POS.1	5.000	400	On Shape
UCS TOP LINE POS.2	5.000	800	0,3
UCS TOP LINE POS.3	5.000	800	0,1
UCS TOP LINE POS.4	5.000	800	0,05-0,1
<b>FAST LINE TOOLS</b>	<b>Ø 80/90 mm</b>		
UCS FAST LINE POS.1	5.500	400	On Shape
UCS FAST LINE POS.2	5.500	800	0,3
UCS FAST LINE POS.3	5.500	800	0,1
UHS FAST LINE POS.4	5.500	800	0,05-0,1
<b>POLISHING TOOLS</b>			
<b>LUCIDANTI</b>			
EXPRESS POS.5	2.500-3.000	1.200 - 1.500	0.03 - 0.05
EXPRESS POS.6	2.500-3.000	1.200 - 1.500	0.03 - 0.05
EXPRESS POS.7	2.500-3.000	1.200 - 1.500	0.03 - 0.05

#### Segmented type / mole a settori = Seg

The best solution for profile shaping

La migliore soluzione per creare il profilo

#### Continuous with slots / Mola fascia continua con intagli = C+S

EDM machines water channels for coolant and holes for coolant directly on the diamond surface.

Intagli creati con macchina EDM per il passaggio dell'acqua e con fori d'acqua per la refrigerazione dell'utensile durante la lavorazione

#### Polishing Express = Exp

Polishing Express for a high gloss finishing

Lucidanti Express per una finitura lucida

[BACK TO INDEX](#)

**ULTRA  
COMPACT  
SURFACES**

**TOP & FAST BORE 35 mm**

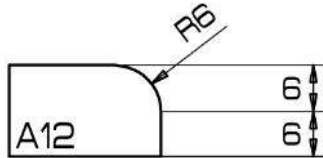

Pos	Type	Code	ED mm	ID mm
1	C+S	MT91040	87	70
2	C+S	MT91041	87	70
3	C+S	MT91042	87	70
4	C+S	MT91124	87	70
5	Exp	PB021560	77	60
6	Exp	PB021561	77	60
7	Exp	PB021562	77	60

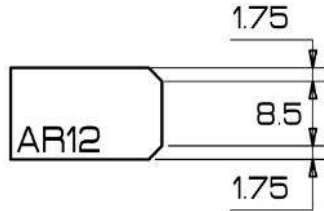

Pos	Type	Code	ED mm	ID mm
1	C+S	MT91023	80	75
2	C+S	MT91024	80	75
3	C+S	MT91025	80	75
4	C+S	MT91026	80	75
5	Exp	PB02321	67	60
6	Exp	PB02322	67	60
7	Exp	PB02323	67	60

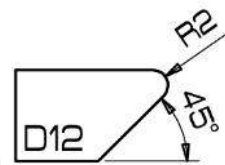

Pos	Type	Code	ED mm	ID mm
1	C+S	MT91073	90	69
2	C+S	MT91074	90	69
3	C+S	MT91075	90	69
4	C+S	MT91076	90	69
5	Exp	PB021889	80	60
6	Exp	PB021890	80	60
7	Exp	PB021891	80	60

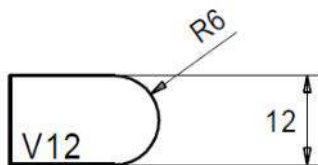

Pos	Type	Code	ED mm	ID mm
1	C+S	MT91222	90	71
2	C+S	MT91223	90	71
3	C+S	MT91224	90	71
4	C+S	MT91225	90	71
5	Exp	PB021991	80	60
6	Exp	PB021992	70	60
7	Exp	PB021993	70	60

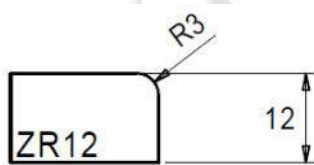

Pos	Type	Code	ED mm	ID mm
1	C+S	MT91230	80	75
2	C+S	MT91231	80	75
3	C+S	MT91232	80	75
4	C+S	MT91233	80	75
5	Exp	PB021994	70	60
6	Exp	PB021995	70	60
7	Exp	PB021996	70	60

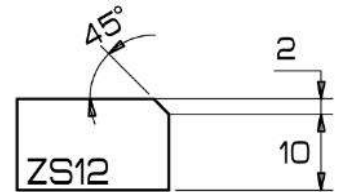

Pos	Type	Code	ED mm	ID mm
1	C+S	MT91043	80	75
2	C+S	MT91044	80	75
3	C+S	MT91045	80	75
4	C+S	MT91125	80	75
5	Exp	PB021712	70	60
6	Exp	PB021713	70	60
7	Exp	PB021714	70	60

[BACK TO INDEX](#)

**ULTRA  
COMPACT  
SURFACES**

**TOP & FAST BORE 35 mm**

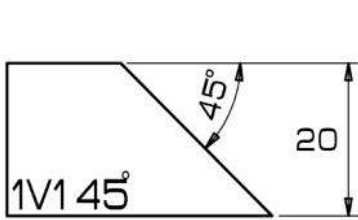

Pos	Type	Code	ED mm	ID mm
1	SEG	MT91027	120	82
2	C+S	MT91028	120	72
3	C+S	MT91029	120	72
4	C+S	MT91068	120	72
5	Exp	PB021569	108	60
6	Exp	PB021570	108	60
7	Exp	PB021571	108	60

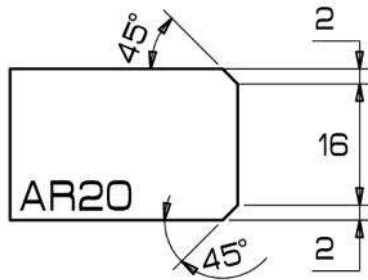

Pos	Type	Code	ED mm	ID mm
1	C+S	MT91005	78	70
2	C+S	MT91006	78	70
3	C+S	MT91007	78	70
4	C+S	MT91114	78	70
5	Exp	PB02013	68	60
6	Exp	PB02014	68	60
7	Exp	PB02015	68	60

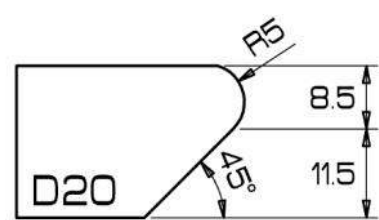

Pos	Type	Code	ED mm	ID mm
1	SEG	MT91011	120	87
2	C+S	MT91012	120	87
3	C+S	MT91013	120	87
4	C+S	MT91126	120	87
5	Exp	PB02052	91	60
6	Exp	PB02053	91	60
7	Exp	PB02054	91	60

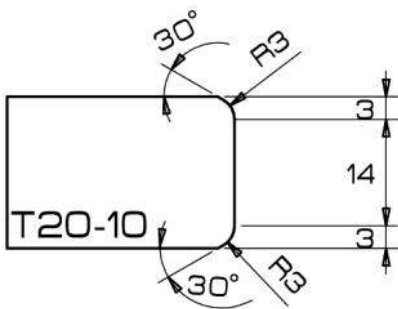

Pos	Type	Code	ED mm	ID mm
1	SEG	MT91016	71	60
2	C+S	MT91017	71	60
3	C+S	MT91018	71	60
4	C+S	MT91143	71	60
5	Exp	PB021349	75	60
6	Exp	PB021350	75	60
7	Exp	PB021351	75	60

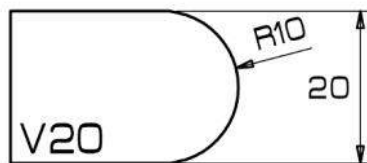

Pos	Type	Code	ED mm	ID mm
1	SEG	MT91115	86	60
2	C+S	MT91116	86	60
3	C+S	MT91117	86	60
4	C+S	MT91118	86	60
5	Exp	PB02172	90	60
6	Exp	PB02173	90	60
7	Exp	PB02174	90	60



Pos	Type	Code	ED mm	ID mm
1	SEG	MT91008	80	80
2	C+S	MT91009	80	80
3	C+S	MT91010	80	80
4	C+S	MT91144	80	80
5	Exp	PB02403	80	80
6	Exp	PB02404	80	80
7	Exp	PB02405	80	80

[BACK TO INDEX](#)

**ULTRA  
COMPACT  
SURFACES**

*TOP & FAST BORE 35 mm*

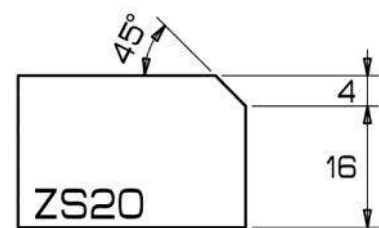
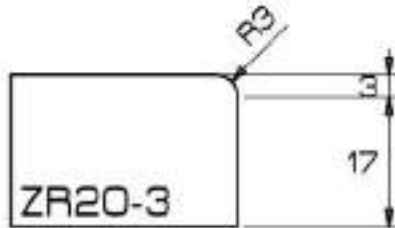
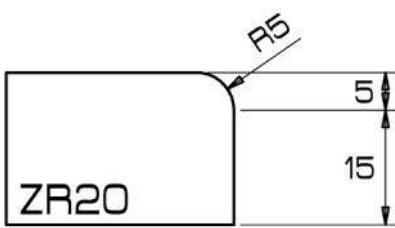

Pos	Type	Code	ED mm	ID mm
1	C+S	MT91046	85	70
2	C+S	MT91047	85	70
3	C+S	MT91048	85	70
4	C+S	MT91145	85	70
5	Exp	PB02199	80	60
6	Exp	PB02200	80	60
7	Exp	PB02201	80	60

Pos	Type	Code	ED mm	ID mm
1	C+S	MT91049	85	70
2	C+S	MT91050	85	70
3	C+S	MT91051	85	70
4	C+S	MT91146	85	70
5	Exp	PB02253	75	60
6	Exp	PB02254	75	60
7	Exp	PB02255	75	60

Pos	Type	Code	ED mm	ID mm
1	C+S	MT91052	82	70
2	C+S	MT91053	82	70
3	C+S	MT91054	82	70
4	C+S	MT91147	82	70
5	Exp	PB02214	72	60
6	Exp	PB02215	72	60
7	Exp	PB02216	72	60

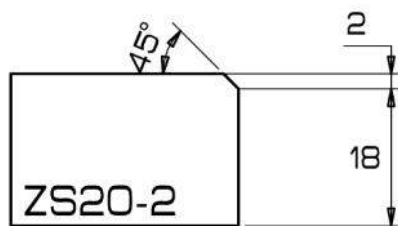

Pos	Type	Code	ED mm	ID mm
1	C+S	MT91019	78	70
2	C+S	MT91020	78	70
3	C+S	MT91021	78	70
4	C+S	MT91022	78	70
5	Exp	PB02232	70	60
6	Exp	PB02233	70	60
7	Exp	PB02234	70	60



[BACK TO INDEX](#)

**ULTRA  
IMPACT  
SURFACES**

**TOP & FAST BORE 35 mm**

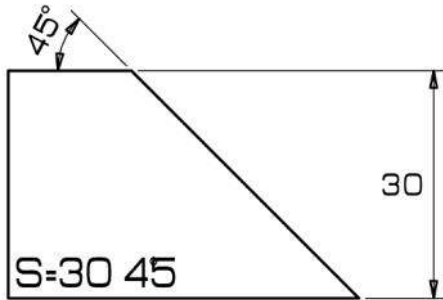

Pos	Type	Code	ED mm	ID mm
1	SEG	MT91086	130	62
2	C+S	MT91128	140	72
3	C+S	MT91129	140	72
4	C+S	MT91130	140	72
5	Exp	PB021598	128	60
6	Exp	PB021599	128	60
7	Exp	PB021600	128	60

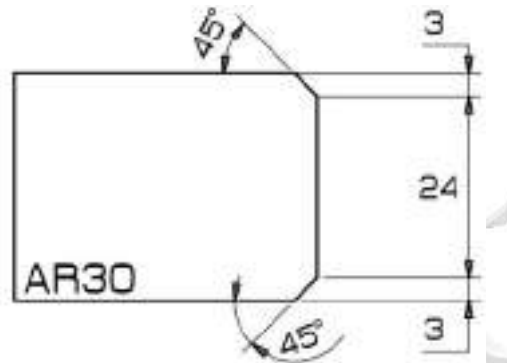

Pos	Type	Code	ED mm	ID mm
1	C+S	MT91034	80	70
2	C+S	MT91035	80	70
3	C+S	MT91036	80	70
4	C+S	MT91174	80	70
5	Exp	PB02016	70	60
6	Exp	PB02017	70	60
7	Exp	PB02018	70	60

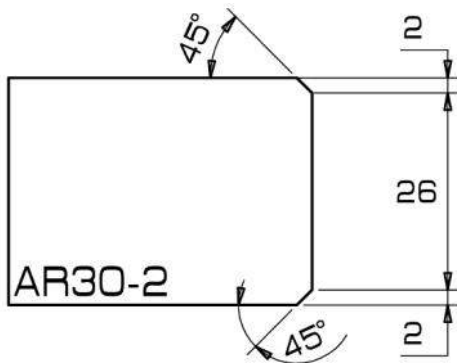

Pos	Type	Code	ED mm	ID mm
1	C+S	MT91131	80	70
2	C+S	MT91132	80	70
3	C+S	MT91133	80	70
4	C+S	MT91134	80	70
5	Exp	PB02019	70	60
6	Exp	PB02020	70	60
7	Exp	PB02021	70	60

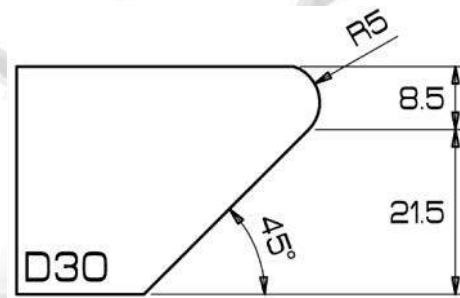

Pos	Type	Code	ED mm	ID mm
1	SEG	MT91135	120	67
2	C+S	MT91136	120	67
3	C+S	MT91137	120	67
4	C+S	MT91138	120	67
5	Exp	PB02055	111	60
6	Exp	PB02056	111	60
7	Exp	PB02057	111	60

[BACK TO INDEX](#)

**ULTRA  
COMPACT  
SURFACES**

TOP & FAST BORE 35 mm

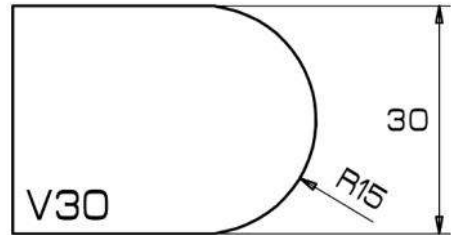
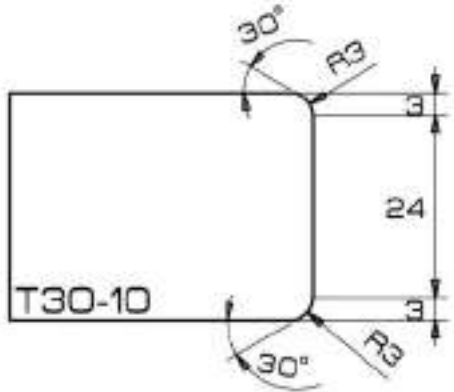

Pos	Type	Code	ED mm	ID mm
1	SEG	MT91139	77	60
2	C+S	MT91140	71	60
3	C+S	MT91141	71	60
4	C+S	MT91142	71	60
5	Exp	PB021346	75	60
6	Exp	PB021347	75	60
7	Exp	PB021348	75	60

Pos	Type	Code	ED mm	ID mm
1	SEG	MT91064	96	60
2	C+S	MT91065	96	60
3	C+S	MT91066	96	60
4	C+S	MT91067	96	60
5	Exp	PB02175	100	60
6	Exp	PB02176	100	60
7	Exp	PB02177	100	60

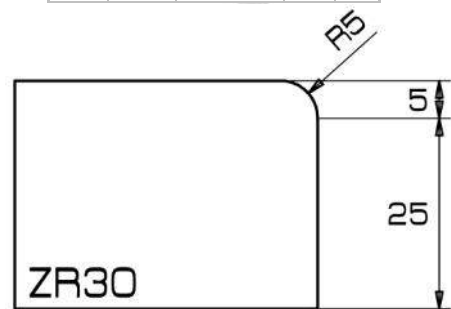
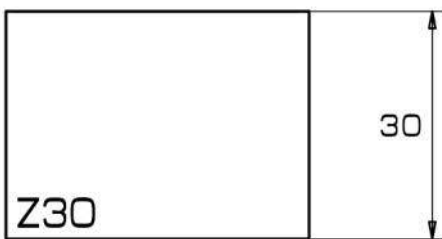

Pos	Type	Code	ED mm	ID mm
1	SEG	MT91059	80	80
2	C+S	MT91060	80	80
3	C+S	MT91061	80	80
4	C+S	MT91062	80	80
5	Exp	PB02388	80	80
6	Exp	PB02389	80	80
7	Exp	PB02390	80	80

Pos	Type	Code	ED mm	ID mm
1	C+S	MT91152	80	65
2	C+S	MT91153	80	65
3	C+S	MT91154	80	65
4	C+S	MT91155	80	65
5	Exp	PB02202	80	60
6	Exp	PB02203	80	60
7	Exp	PB02204	80	60

[BACK TO INDEX](#)

**ULTRA  
COMPACT  
SURFACES**

**TOP & FAST BORE 35 mm**

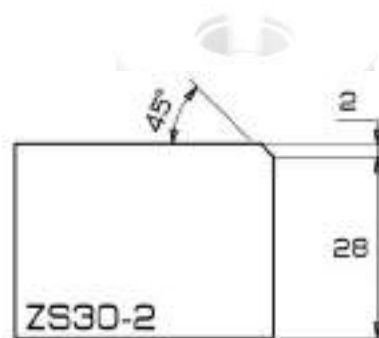
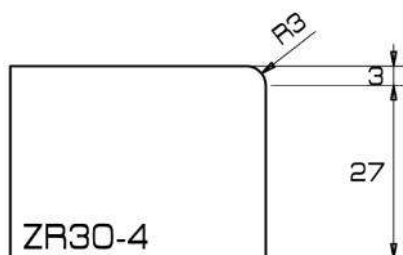

Pos	Type	Code	ED mm	ID mm
1	C+S	MT91156	80	65
2	C+S	MT91157	80	65
3	C+S	MT91158	80	65
4	C+S	MT91159	80	65
5	Exp	PB02256	80	60
6	Exp	PB02257	80	60
7	Exp	PB02258	80	60

Pos	Type	Code	ED mm	ID mm
1	C+S	MT91030	80	70
2	C+S	MT91031	80	70
3	C+S	MT91032	80	70
4	C+S	MT91033	80	70
5	Exp	PB02235	70	60
6	Exp	PB02236	70	60
7	Exp	PB02237	70	60

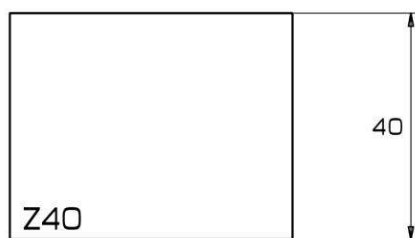

Pos	Type	Code	ED mm	ID mm
1	C+S	MT91096	80	-
2	C+S	MT91097	80	-
3	C+S	MT91098	80	-
4	C+S	MT91099	80	-
5	Exp	PB02440	80	-
6	Exp	PB02441	80	-
7	Exp	PB02442	80	-

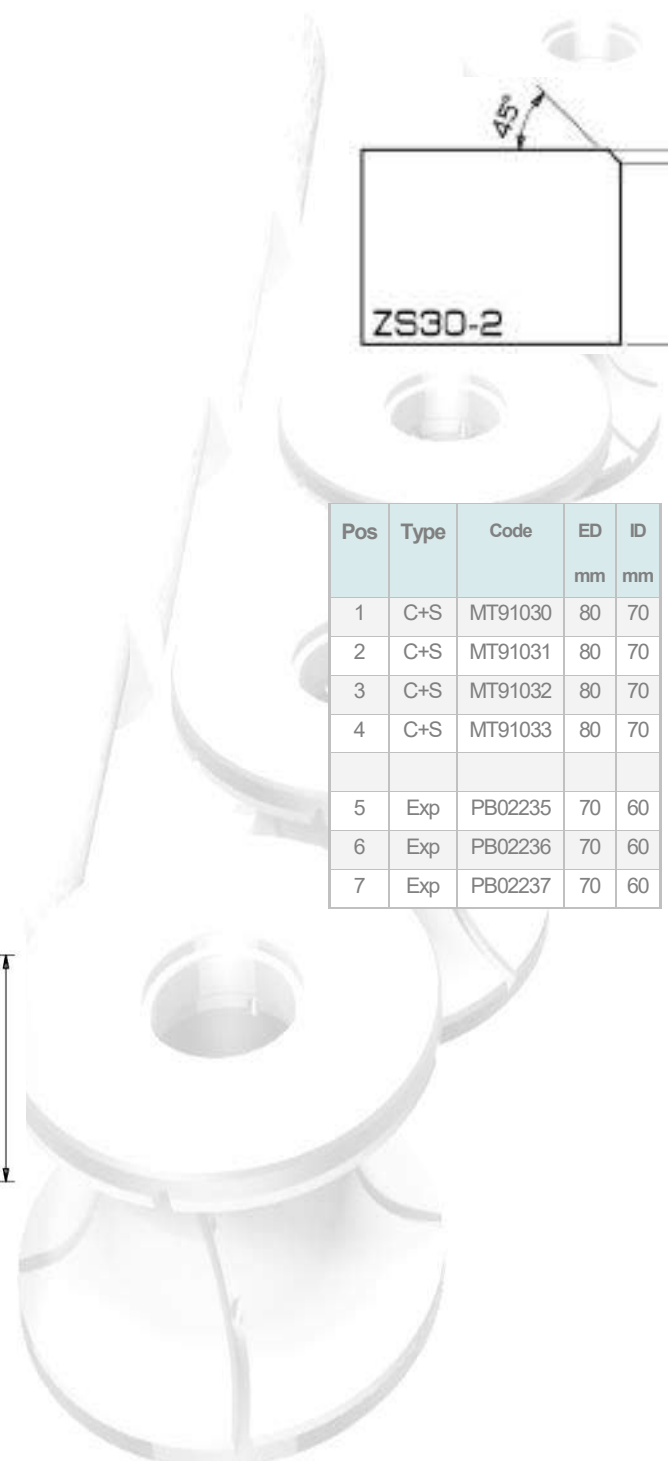

[BACK TO INDEX](#)

**ULTRA  
COMPACT  
SURFACES**

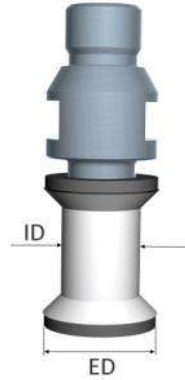

ED = EXTERNAL DIAMETER

ID = INTERNAL DIAMETER

Pos	<i>Slab Thickness</i> [Inches or mm]	RPM (Min-Max)	<i>Stock Removal</i> [Inches or mm]	Feeding Speed [Inches/minute or mm/minute]	<i>Note</i>
1	20-30-40	6.000—6.500	<i>to shape</i> <i>0,3 max</i>	1.500-3.000	<i>Segmented</i>
2	20-30-40	6.000—6.500	0,2-0,3	1.500-4.000	<i>Segmented</i>
3			0,15		
4			0,10		
5	20-30-40	5.500	0,05	1.000	MFP5
5	20-30-40	3.500	0,03-0,05 <i>Pressure</i>	600	<i>Express Polishing</i>
6					
7					



**ULTRA  
COMPACT  
SURFACES**

Ø20 mm

[BACK TO INDEX](#)

fitting 1/2" Gas



Pos	Type	Code	ED mm	ID mm
1	2 SEG	MT90010	25	20
2	2 SEG	MT90011	25	20
3	2 SEG	MT90012	25	20
4	2 SEG	MT90028	25	20
5	Exp	PB021152	25	20
6	Exp	PB021153	25	20
7	Exp	PB021154	25	20

Pos	Type	Code	ED mm	ID mm
1	2 SEG	MT90007	25	20
2	2 SEG	MT90008	25	20
3	2 SEG	MT90009	25	20
4	2 SEG	MT90029	25	20
5	Exp	PB021136	25	20
6	Exp	PB021137	25	20
7	Exp	PB021138	25	20

Pos	Type	Code	ED mm	ID mm
1	2 SEG	MT90013	25	20
2	2 SEG	MT90014	25	20
3	2 SEG	MT90015	25	20
4	2 SEG	MT90046	25	20
5	Exp	PB021188	25	20
6	Exp	PB021189	25	20
7	Exp	PB021190	25	20

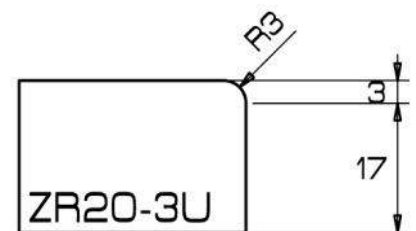
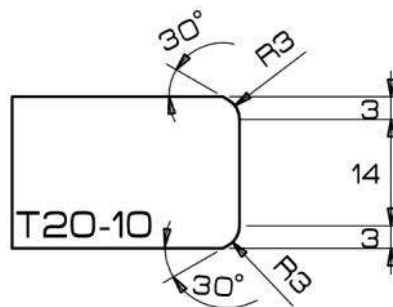
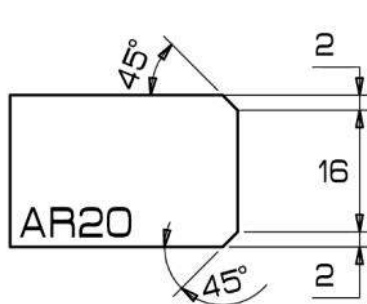

Pos	Type	Code	ED mm	ID mm
1	2 SEG	MT90016	25	20
2	2 SEG	MT90017	25	20
3	2 SEG	MT90018	25	20
4	2 SEG	MT90035	25	20
5	Exp	PB021004	28	20
6	Exp	PB021005	28	20
7	Exp	PB021006	28	20

Pos	Type	Code	ED mm	ID mm
1	2 SEG	MT90019	30	20
2	2 SEG	MT90020	30	20
3	2 SEG	MT90021	30	20
4	2 SEG	MT90048	30	20
5	Exp	PB021149	37	20
6	Exp	PB021150	37	20
7	Exp	PB021151	37	20

Pos	Type	Code	ED mm	ID mm
1	2 SEG	MT90025	30	20
2	2 SEG	MT90026	30	20
3	2 SEG	MT90027	30	20
4	2 SEG	MT90047	30	20
5	Exp	PB021125	30	20
6	Exp	PB021126	30	20
7	Exp	PB021127	30	20

**ULTRA  
COMPACT  
SURFACES**

Ø20 mm

[BACK TO INDEX](#)

fitting 1/2" Gas

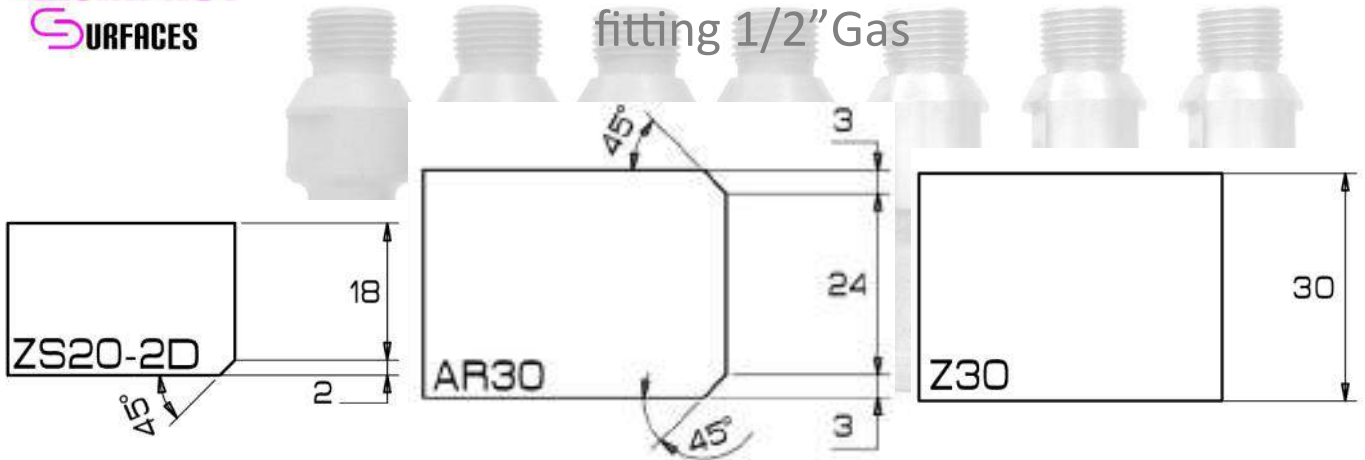

Pos	Type	Code	ED mm	ID mm
1	2 SEG	MT90037	26	20
2	2 SEG	MT90038	26	20
3	2 SEG	MT90039	26	20
4	2 SEG	MT90040	26	20
5	Exp	PB021046	32	20
6	Exp	PB021047	32	20
7	Exp	PB021048	32	20

Pos	Type	Code	ED mm	ID mm
1	2 SEG	MT90053	30	20
2	2 SEG	MT90054	30	20
3	2 SEG	MT90055	30	20
4	2 SEG	MT90056	30	20
5	Exp	PB021007	30	20
6	Exp	PB021008	30	20
7	Exp	PB021009	30	20

Pos	Type	Code	ED mm	ID mm
1	2 SEG	MT90022	20	20
2	2 SEG	MT90023	20	20
3	2 SEG	MT90024	20	20
4	2 SEG	MT90036	20	20
5	Exp	PB021001	20	20
6	Exp	PB021002	20	20
7	Exp	PB021003	20	20

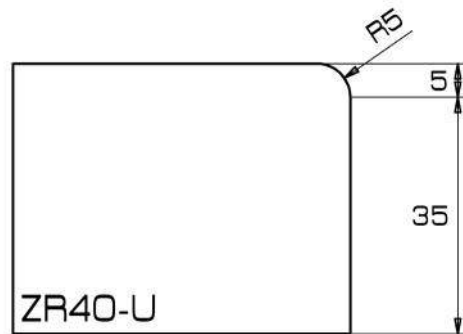
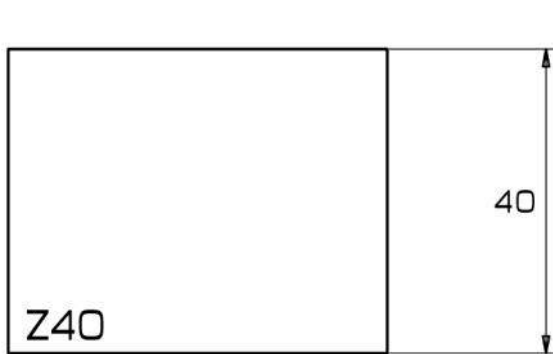

Pos	Type	Code	ED mm	ID mm
1	2 SEG	MT90042	20	20
2	2 SEG	MT90043	20	20
3	2 SEG	MT90044	20	20
4	2 SEG	MT90045	20	20
5	Exp	PB021001	20	20
6	Exp	PB021002	20	20
7	Exp	PB021003	20	20

Pos	Type	Code	ED mm	ID mm
1	2 SEG	MT90095	20	20
2	2 SEG	MT90096	20	20
3	2 SEG	MT90097	20	20
4	2 SEG	MT90098	20	20
5	Exp	PB021031	20	20
6	Exp	PB021032	20	20
7	Exp	PB021033	20	20

[BACK TO INDEX](#)



Ø10 mm

Connection 1/2" Gas

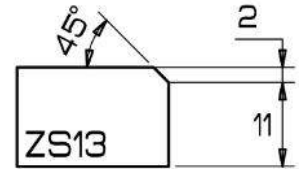
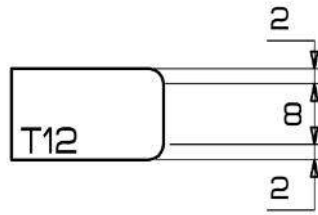
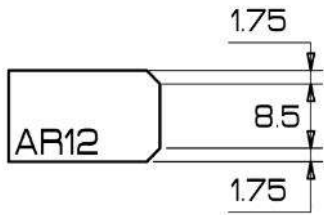

Pos	Type	Code	ED mm	ID mm
1	2 SEG	MT90120	10	10
2	2 SEG	MT90121	10	10
3	2 SEG	MT90122	10	10
4	2 SEG	MT90123	10	10
6	Kristal	PBK21153	10	10
7	Kristal	PBK21154	10	10

Pos	Type	Code	ED mm	ID mm
1	2 SEG	MT90124	10	10
2	2 SEG	MT90125	10	10
3	2 SEG	MT90126	10	10
4	2 SEG	MT90127	10	10
6	Kristal	PBK21137	10	10
7	Kristal	PBK21138	10	10

Pos	Type	Code	ED mm	ID mm
1	2 SEG	MT90128	10	10
2	2 SEG	MT90129	10	10
3	2 SEG	MT90130	10	10
4	2 SEG	MT90131	10	10
6	Kristal	PBK21189	10	10
7	Kristal	PBK21190	10	10

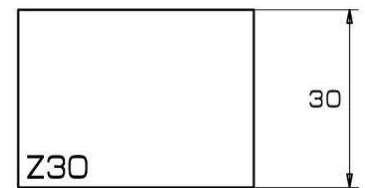
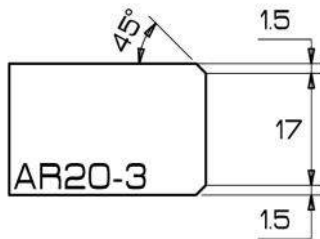

Pos	Type	Code	ED mm	ID mm
1	2 SEG	MT90116	10	10
2	2 SEG	MT90117	10	10
3	2 SEG	MT90118	10	10
4	2 SEG	MT90119	10	10
6	Kristal	PBK21235	10	10
7	Kristal	PBK21236	10	10

Pos	Type	Code	ED mm	ID mm
1	2 SEG	MT90108	10	10
2	2 SEG	MT90109	10	10
3	2 SEG	MT90110	10	10
4	2 SEG	MT90111	10	10
6	Kristal	PBK21379	10	10
7	Kristal	PBK21396	10	10

Pos	Type	Code	ED mm	ID mm
1	2 SEG	MT90112	10	10
2	2 SEG	MT90113	10	10
3	2 SEG	MT90114	10	10
4	2 SEG	MT90115	10	10
6	Kristal	PBK21398	10	10
7	Kristal	PBK21399	10	10

**ULTRA  
COMPACT  
SURFACES**

[BACK TO INDEX](#)



Bore 22mm

Foro 22mm

**Diamond Blade (Dry Cutting) For Portable Machines**

**Disco da taglio (Taglio a secco) Per macchine portatili**

ADI Code	Description	RPM	FEED [mm/min]
MT67010	<b>Φ115</b>	2.200-2.800	Manual
MT67004	<b>Φ125</b>	2.200-2.800	Manual

**Diamond Blade for Gres - Ceramic - Granite - Marble and UCS Materials (Dry Cutting) For Portable Machines**

**Disco da taglio per Gres - Ceramica - Granito - Marmo e UCS (taglio a secco) per macchine portatili**



Bore 22mm

Foro 22mm

ADI Code	Description
MT67013	<b>Φ115x1,5x10 Bore Φ22.2</b>
MT67014	<b>Φ125x1,5x10 Bore Φ22.2</b>
MT67016	<b>Φ180x1,8x10 Bore Φ22.2</b>
MT67017	<b>Φ200x1,8x10 Bore Φ25.4</b>



**Vanity Blade (Dry Cutting) for Portable Machines**

**Platirelli per macchina portatili**



M14

ADI Code	Description	Grit	RPM	FEED [mm/min]
MT67012	<b>D.125x25+25</b>	#50 [Pos.1]	2.200-2.800	Manual
MT67011	<b>D.125x25+25</b>	#80 [Pos.2]	2.200-2.800	Manual

[BACK TO INDEX](#)



Vacuum brazed Core Drills for Gres Ceramic Materials (Dry Cutting)  
Foretto Saldo Brasato per Gres Ceramico (taglio a secco)

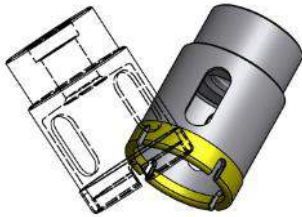

Correct Use in Starting  
Utilization  
Come iniziare la  
lavorazione

ADI CODE	DIAMETER	USEFULL LENGHT	CONNECTION	RECOMMENDED RPM
MT85004	20	31,5 MM	M14 Female	Max 11.000
MT85007	35			
MT85008	40			
MT85009	50			
MT85017	68			

**ULTRA  
COMPACT  
SURFACES**

[BACK TO INDEX](#)



**Cup Wheel (Dry Cutting) for Portable Machines**  
**Mola a tazza (Taglio a secco) per macchine portatili**

<i>ADI Code</i>	<i>Description</i>	<i>RPM</i>	<i>FEED</i> [mm/min]	<i>Price</i> [€] Euro
PE08232	Φ115x30		Manual	93

SUGGESTED RPM 2.000—3.000 - MAX RPM 3.500



**Polishing Pads For Glass and Gres Materials - HYBRID KERAMIK**  
**PAD lucidanti per vetro e GRES—CERAMICA IBRIDA**

<i>ADI CODE</i>	<i>DESCRIPTION</i>	<i>COLOR</i>	<i>POS</i>
MTJ0001	PAD D.100 HYBRID KERAMIK	Violet	0
MTJ0002	PAD D.100 HYBRID KERAMIK	Violet	0+
MTJ0003	PAD D.100 HYBRID KERAMIK	Red	1
MTJ0004	PAD D.100 HYBRID KERAMIK	Yellow	2
MTJ0005	PAD D.100 HYBRID KERAMIK	Blue	3
MTJ0006	PAD D.100 HYBRID KERAMIK	Green	4
MTJ0007	PAD D.100 HYBRID KERAMIK	Orange	5
MTJ0008	PAD D.100 HYBRID KERAMIK	Pink	6

SUGGESTED RPM 2.500—3.000 - MAX RPM 4.000

**Hand Sponge For Glass and Gres Materials**  
**Spugne manuali per vetro e Gres**



<i>ADI CODE</i>	<i>DESCRIPTION</i>	<i>COLOR</i>	<i>POS</i>
PJL0501	Sponge 90x55	Green	1
PJL0502	Sponge 90x55	Black	2
PJL0503	Sponge 90x55	Red	3
PJL0504	Sponge 90x55	Yellow	4
PJL0505	Sponge 90x55	White	5
PJL0506	Sponge 90x55	Blue	6
PJL0507	Sponge 90x55	Orange	LUX

[BACK TO INDEX](#)

***Zinc Based White Grease Highly Raccomended to Lubricate and Avoid Locking in Machinery and Equipment Operating Under the Action of Water***



ADI Code	Description
SMT1001	<i>White Grease Zinc Based 250ml</i>

[BACK TO INDEX](#)

**ULTRA  
COMPACT  
SURFACES**

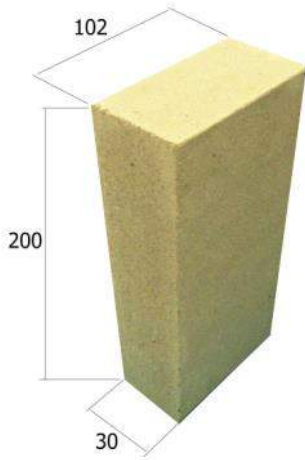

**RE-SHARPENING BRICK FOR DIAMOND BLADES**

<i>ADI Code</i>	<i>Description</i>
3B00080	<b>Pumice Brick 30x102x200</b>

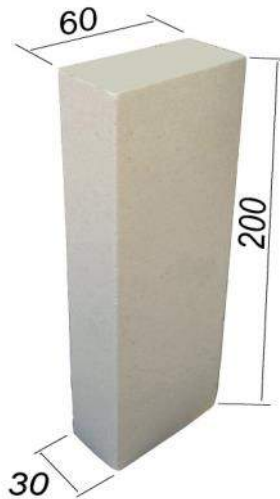

**RE-SHARPENING BRICK FOR DIAMOND WHEELS**

<i>ADI Code</i>	<i>Description</i>
3B00091	<b>Pumice Brick 30x60x200</b>



**ABRASIVE BRICK**

<i>ADI Code</i>	<i>Description</i>
3B00093	<b>Abrasive Brick 50x70x200</b>



[BACK TO INDEX](#)

[BACK TO INDEX](#)

[www.aditools.com](http://www.aditools.com)

**ADI**  
INDUSTRIAL DIAMOND APPLICATION  
a company of  
 **Surfaces Group**  
Absolute finishing

**ADI S.r.l.**  
Via dell'Economia, 12/16 - 36016 Thiene (VI) Italy  
Tel: +39.0445.360244 Fax: +39.0445.366862  
info@aditools.com - [www.aditools.com](http://www.aditools.com)

**ADI USA Inc.**  
1477 Connelly Springs Rd 28645 Lenoir  
North Carolina - USA  
Tel. 1-828-7284711 - Fax 1-828-7289613  
info@aditools-usa.com - [www.aditools-usa.com](http://www.aditools-usa.com)

**ADI Turkey**  
Baksan San. Sit. 31 - 26190 Eskisehir - Turkey  
Tel: + 90.533.3556077  
info@aditools.com - [www.aditurkey.com](http://www.aditurkey.com)